

aerospace  
 climate control  
 electromechanical  
 filtration  
 fluid & gas handling  
 hydraulics  
 pneumatics  
 process control  
 sealing & shielding



# Brass, Composite and Thermoplastic Fittings and Valves

Catalog 3501E USA | October 2008



ENGINEERING YOUR SUCCESS.



OTSEGO, MICHIGAN



ANNEMASSE, FRANCE



ALBION, INDIANA



LAKEVIEW, MICHIGAN



KENT, OHIO

## **WARNING**

FAILURE OR IMPROPER SELECTION OR IMPROPER USE OF THE PRODUCTS AND/OR SYSTEMS DESCRIBED HEREIN OR RELATED ITEMS CAN CAUSE DEATH, PERSONAL INJURY AND PROPERTY DAMAGE.

Before selecting or using any Parker hose or fittings or related accessories, it is important that you read and follow Parker Safety Guide for Selecting and Using Hose, Fittings, and Related Accessories (Parker Publication No. 4400-B.1).

This document and other information from Parker Hannifin Corporation, its subsidiaries and authorized distributors provide product and/or system options for further investigation by users having technical expertise. It is important that you analyze all aspects of your application and review the information concerning the product or system, in the current catalog. Due to the variety of operating conditions and applications for these products or systems, the user, through its own analysis and testing, is solely responsible for making the final selection of the products and systems and assuring that all performance, safety and warning requirements are met.

The products described herein, including without limitation, product features, specifications, designs, availability and pricing, are subject to change by Parker Hannifin Corporation and its subsidiaries at any time without notice.

## **Offer of Sale**

The items described in this document are hereby offered for sale by Parker Hannifin Corporation, its subsidiaries or its authorized distributors. This offer and its acceptance are governed by the provisions stated on the separate page of this document entitled "Offer of Sale".

© Copyright 1997, Parker Hannifin Corporation, All Rights Reserved



**Parker Hannifin Corporation**  
Fluid Connectors Group  
Otsego, Michigan

**Compression Style, Pneumatic**

Compression, Compress-Align®, Poly-Tite, Hi-Duty, Metru-Lok™

**A****Push-to-Connect, Pneumatic**

Prestolok, PrestoWeld , Global Connect

**B****Integrated Fittings**

Right Angle Flow Controls, Metric Right Angle Flow Controls, In-Line Flow Controls, Metric In-Line Flow Controls, Slow Start, Metric Slow Start, Blocking, Metric Blocking, Metric Combination, Metric Pressure Sensor, Metric Pressure Reducing, Metric Silencer

**C****Thermoplastic Fittings and Valves**

TrueSeal™ Thermoplastic Push-In Fittings, Fast &amp; Tite® Thermoplastic Fittings, Par-Barb® Thermoplastic Fittings

**D****Flare Fittings**

45° Flare, Inverted Flare, Access Valves

**E****Adapters**

Pipe, Metric Adapters, ISO Port Adapters, Garden Hose

**F****Barbed Fittings**

Dubl-Barb®, Hose Barbs

**G****Compression Style, Transportation**

NTA®, Transmission Fittings, Air Brake, Air Brake Hose Ends, Vibra-Lok

**H****Push-to-Connect, Transportation**

Prestomatic, PTC, Metric Prestomatic

**I****Cartridges & Manifolds**

SAE Cartridges, Manifolds

**J****Valves**

Ball Valves, Plug Valves, Needle Valves, Truck Valves, Lanyard Valve, Shutoff Cocks, Drain Cocks

**K****Tube Fabricating Equipment**

Cutters, Benders, Flaring Tools, Tool Kits, Swaging Tools, Ratchet Wrenches, Deburring Tools, Sawing Vise

**L****Accessories**

Bins, Bags, Copper Tubing

**M****General Technical****N****Numerical Index**

Numerical Index, Parker Safety Guide, Offer of Sale

**O**

<b>Compression Style Pneumatic..... A1</b>	<b>Barbed Fittings ..... G1</b>
Compression Fittings..... A5	Dubl-Barb® Fittings.....G3
Compress-Align® Fittings..... A13	Hose Barb Fittings.....G9
Parker Metru-Lok™ Fittings..... A20	
Poly-Tite Fittings ..... A30	<b>Compression Style Transportation ..... H1</b>
Hi-Duty Flareless Tube Fittings..... A42	Air Brake-NTA® Fittings..... H4
	Transmission Fittings ..... H11
<b>Push to Connect Pneumatic..... B1</b>	Air Brake-AB Fittings ..... H13
Prestolok Fittings..... B6	Air Brake Hose Ends ..... H18
PrestoWeld Fittings ..... B35	Vibra-Lok Fittings..... H22
Global Connect Fittings ..... B41	
	<b>Push to Connect Transportation ..... I1</b>
<b>Integrated Fittings ..... C1</b>	Prestomatic Air Brake Push-In Fittings.....I4
Right Angle Flow Control Valves..... C4	PTC Composite Push-In Air Brake Fitting .....I14
Metric Right Angle Flow Control Valves..... C8	Metric Prestomatic Air Brake Push-In Fittings .....I18
Slow Start Flow Control Valves..... C14	
Blocking Valves..... C17	<b>Cartridges &amp; Manifolds ..... J1</b>
In-Line Flow Control Valves ..... C21	Prestomatic SAE Encapsulated Cartridges.....J3
Non-Return Valves..... C31	Brass Manifold.....J5
	Presto Manifold.....J6
<b>Thermoplastic Fittings and Valves..... D1</b>	
TrueSeal™ Thermoplastic Push-In Fittings ..... D4	
Fast & Tite® Thermoplastic Fittings..... D22	
Par-Barb® Thermoplastic Fittings..... D28	
<b>Flare Fittings..... E1</b>	
SAE 45° Flared Fittings ..... E4	
Inverted Flared Fittings..... E14	
Access Valves..... E18	
<b>Adapters.....F1</b>	
Pipe Fittings..... F4	
Parker Brass Metric Adapters..... F12	
ISO Port Adapters ..... F17	
Garden Hose Fittings..... F20	



<b>Valves</b> .....	<b>K1</b>	<b>Tube Fabricating Equipment</b> .....	<b>L1</b>
Brass Ball Valves Series 500 .....	K4		
Male/Female Ball Valves Series 501 .....	K8	<b>Accessories</b> .....	<b>M1</b>
Brass Panel Mount Ball Valves Series 502.....	K11		
Female/Female Straight Thread Brass Ball Valve Series 506.....	K14	<b>General Technical</b> .....	<b>N1</b>
Solder End Ball Valves Series 509 .....	K16	Manufacturing Techniques.....	N2
Male/Female Straight Thread Ball Valves Series 510 .....	K18	Tubing Compatibility Chart .....	N3
Brass Ball Valves Series 520.....	K21	Tube Line Fabrication Guide for Leak Free Systems.....	N3
Brass Ball Valves Series 533 3-Way Diversion / Series 540 4-Way .....	K23	Thread Specifications.....	N5
90° Ball Valves Series 590/591.....	K25	Flaring Instructions .....	N6
Brass Hose Barb Ball Valves Series 500HB.....	K27	Thread Designations and Standards for Threads Used in Fluid Connectors.....	N7
Brass Ball Valves Series 600 Six Port Diversion ..	K28	Straight Thread Size Comparison Chart.....	N8
Carbon Steel Ball Valves Series 500CS/502CS ...	K30	S.A.E. Part Index .....	N9
Carbon Steel Ball Valves Series 506CS .....	K34	SAE Standards (Current).....	N9
High Pressure Carbon Steel Ball Valves Series 500HP, 506HP, 507HP.....	K36	U.L. Listed Fittings .....	N10
Stainless Steel Ball Valves Series 501SS .....	K40	Flow Curves.....	N11
Stainless Steel Ball Valves Series 502SS .....	K42	Metric Fitting Nomenclature.....	N14
Rotary Actuator Ball Valves Series ACT.....	K45	Flare and Thread Profiles .....	N15
Parker Metric Ball Valves Series BVGC.....	K50	Pressure Conversions .....	N16
Parker Metric Ball Valves Series BVGL .....	K52	English/Metric Conversions .....	N17
Parker Metric Ball Valves Series BVGPLOCK .....	K54	Fluid Compatibility Guide.....	N18
Parker Metric Ball Valves Series MBVG .....	K57		
Micro Ball Valve Series 708 / 709 .....	K59	<b>Numerical Index</b> .....	<b>O1</b>
Mini Ball Valves Series 200/608/609 .....	K64		
Plug Valves Series PV .....	K66	<b>Parker Safety Guide</b> .....	<b>O8</b>
Needle Valves, Truck Valves, Lanyard Valve .....	K68		
Drain Cocks/Ground Plug Shutoff .....	K74	<b>Offer of Sale</b> .....	<b>O10</b>





# Compression Style Pneumatic



## Compression

- Economical
- UL Listed
- Thermoplastic / Soft Metal Tubing



## Compress-Align®

- Captive Sleeve
- Two piece
- Pre-assembled



## Parker Metru-Lok™

- Captive Sleeve
- Metric Tubing
- NPT, BSPT, BSPP, Metric Threads



## Poly-Tite

- Built-in Tube Support
- Captive Sleeve
- Knurled Nut











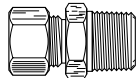
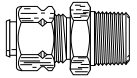
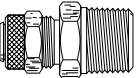
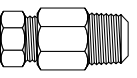
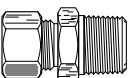
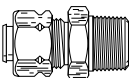
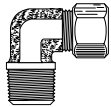
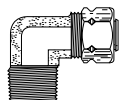
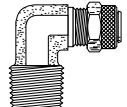

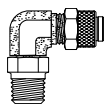
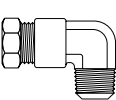
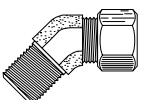
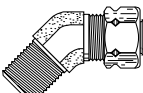
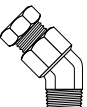
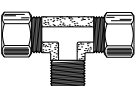
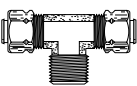
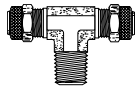
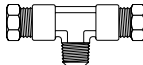
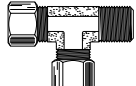
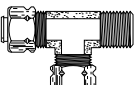
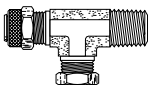
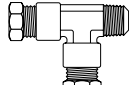

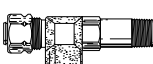
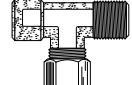
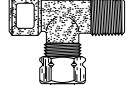
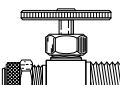



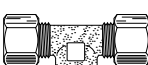

## Hi-Duty

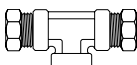
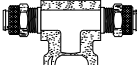
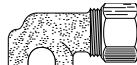
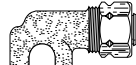
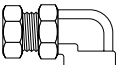
- Two Piece Design
- Easy Assembly
- Higher Pressure Rating

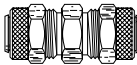
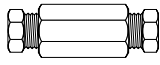

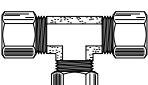
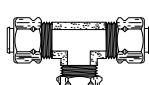
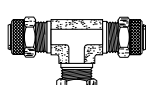
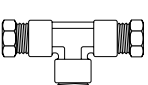
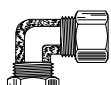
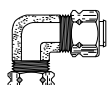







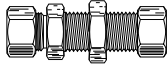
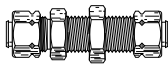
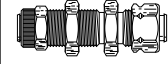
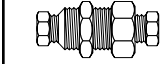

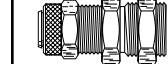

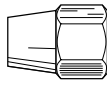

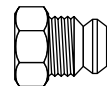

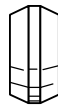

***The World Standard***

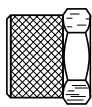
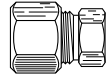
**A**

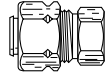
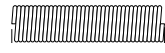
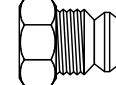
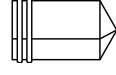
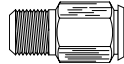
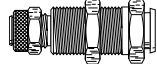
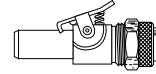
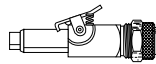

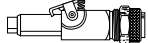







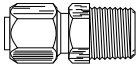
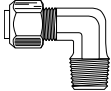
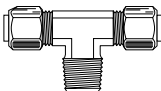
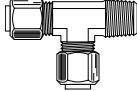
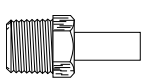
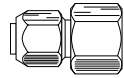
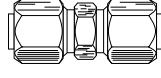
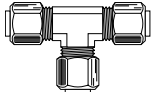

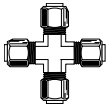
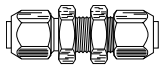
<b>Tube to Male NPTF</b>	<b>68C</b> Male Connector  Page A8	<b>68CA</b> Male Connector  Page A16	<b>68P</b> Male Connector  Page A34	<b>68HD</b> Male Connector  Page A44	<b>682C</b> Tank Fitting  Page A12	<b>682CA</b> Tank Fitting  Page A19	
	<b>169C-269C</b> Male Elbow  Page A10	<b>169CA-269CA</b> Male Elbow  Page A17	<b>169P/269P</b> Male Elbow  Page A39	<b>169LP</b> Long Elbow  Page A39	<b>169PS</b> Male Elbow  Page A39	<b>169HD</b> Male Elbow  Page A44	<b>179C</b> 45° Male Elbow  Page A11
	<b>179CA</b> 45° Male Elbow  Page A19	<b>179HD</b> 45° Male Elbow  Page A45	<b>172C</b> Male Branch Tee  Page A11	<b>172CA</b> Male Branch Tee  Page A18	<b>172P</b> Male Branch Tee  Page A40	<b>172HD</b> Male Branch Tee  Page A45	<b>171C</b> Male Run Tee  Page A10
	<b>171CA</b> Male Run Tee  Page A18	<b>171P</b> Male Run Tee  Page A40	<b>171HD</b> Male Run Tee  Page A45	<b>168C</b> Gauge Tee  Page A9	<b>168CA</b> Gauge Tee  Page A17	<b>176C</b> Adaptor  Page A11	<b>176CA</b> Adaptor  Page A18
	<b>NV311P</b> Needle Valve  Page A41	<b>NV312P</b> Needle Valve  Page A41	<b>Tube to Female NPT</b>	<b>66C</b> Female Connector  Page A8	<b>66CA</b> Female Connector  Page A15	<b>66P</b> Female Connector  Page A33	<b>66HD</b> Female Connector  Page A44
	<b>177C</b> Female Tee  Page A11	<b>177CA</b> Female Tee  Page A18		<b>177HD</b> Female Tee  Page A46	<b>177P</b> Female Tee  Page A40	<b>170C-270C</b> Female Elbow  Page A10	<b>170CA-270CA</b> Female Elbow  Page A18
	<b>170HD</b> Female Elbow  Page A45	<b>Tube to Tube</b>	<b>62C</b> Union  Page A7	<b>62CA</b> Union  Page A14	<b>62P</b> Union  Page A32	<b>62HD</b> Union  Page A43 & 44	<b>62PCA</b> Union  Page A15, A32
<b>164C-264C</b> Union Tee  Page A9	<b>164CA-264CA</b> Union Tee  Page A16		<b>164P</b> Union Tee  Page A38	<b>164HD</b> Union Tee  Page A43	<b>165C-265C</b> Union Elbow  Page A9	<b>165CA-265CA</b> Union Elbow  Page A17	<b>165HD</b> Union Elbow  Page A43



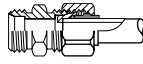

<b>Bulkhead Unions</b>	<b>62CBH</b> Bulkhead Union  Page A7	<b>62CABH</b> Bulkhead Union  Page A14	<b>62PCABH</b> Bulkhead Union  Page A15, A33	<b>62HDBH</b> Bulkhead Union  Page A43	<b>62PBH</b> Bulkhead Union  Page A32	<b>62PTBH</b> Bulkhead Union  Page A33
	<b>Auxiliary Components</b>	<b>61C</b> Nut  Page A6	<b>61CL</b> Long Nut  Page A6	<b>61CA</b> Nut/Sleeve  Page A14	<b>61HD</b> Nut/Sleeve  Page A43	<b>61P</b> Nut/Plastic Sleeve  Page A31
<b>61PN</b> Nut Only  Page A31		<b>60C</b> Sleeve  Page A6	<b>60PT</b> Plastic Sleeve  Page A6	<b>60P</b> Plastic Sleeve  Page A31	<b>60PB</b> Brass Sleeve  Page A31	<b>61PSGN</b> Spring Gaurd Nut  Page A32
<b>639C</b> Seal Plug  Page A12	<b>59CA</b> Plug  Page A14	<b>639CA</b> Seal Plug  Page A19	<b>56PSG</b> Spring Gaurd  Page A31	<b>59HD</b> Plug  Page A46	<b>59P</b> Plug  Page A31	
<b>Couplers</b>	<b>391P &amp; 391PSS</b> Coupler Body  Page A34	<b>392P &amp; 392PSS</b> Bulkhead Body  Page A35	<b>393P &amp; 393PSS</b> Through Insert  Page A35	<b>393PD &amp; 393PDSS</b> Shutoff Insert  Page A35, A36	<b>394P &amp; 394PSS</b> Single Shutoff  Page A36	<b>394PD &amp; 394PDSS</b> Double Shutoff  Page A36, A37
	<b>398P &amp; 398PSS</b> Single Shutoff  Page A37	<b>398PD &amp; 398PDSS</b> Double Shutoff  Page A38	<b>Tube Stub</b>	<b>97P</b> Tube End Reducer  Page A34		

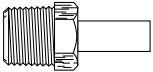
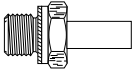
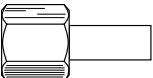
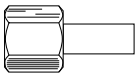
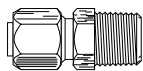
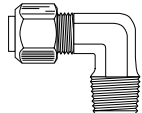
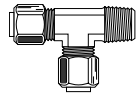
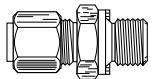
**A**

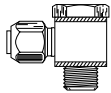
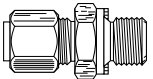
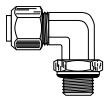
<b>Metric Tube to Male NPTF</b>	<b>FBMB</b> Male Connector  Page A21	<b>CBMB</b> Male Elbow  Page A23	<b>SBMB</b> Male Branch Tee  Page A25	<b>RBMB</b> Male Run Tee  Page A24	<b>T2HFB</b> Tube End Adaptor  Page A26			
	<b>GBMB</b> Female Connector  Page A22	<b>Metric Tube to Metric Tube</b>	<b>HBMB</b> Union  Page A22	<b>JBMB</b> Union Tee  Page A24	<b>EBMB</b> Union Elbow  Page A24	<b>KBMB</b> Union Cross  Page A25		
	<b>WBMB</b> Bulkhead Union  Page A22		<b>WBMPB</b> Bulkhead Union  Page A23	<b>Metric Auxiliary Components</b>	<b>BMB</b> Nut  Page A27	<b>BTMB</b> Nut/Sleeve  Page A28	<b>TMB</b> Sleeve  Page A28	
<b>Metric Bulkhead Unions</b>	<b>FNMB</b> Cap  Page A28	<b>PNMB</b> Plug  Page A28	<b>TRBMB</b> Tube End Reducer  Page A29		<b>T23UB</b> Tube Support  Page A29	<b>Metric Tube Stubs</b>	<b>T23HFB</b> Tube Stub/BSPT  Page A26	<b>T28HFB</b> Tube Stub Metric Straight Thread  Page A26
	<b>T2HGB</b> Female Tube Stub  Page A27	<b>T24HGB</b> Female BSPP  Page A27	<b>Metric Tube to BSPT</b>		<b>F3BMB</b> Male Connector  Page A21		<b>C3BMB</b> Male Elbow  Page A23	<b>R3BMB</b> Male Run Tee  Page A24
<b>Metric Tube to BSPP</b>	<b>F4BMB</b> Male Connector  Page A21	<b>G4BMB</b> Female Connector  Page A22		<b>COR4BMB</b> Single Banjo  Page A25	<b>Metric Tube to Metric Straight Thread</b>	<b>F8BMB</b> Male Connector  Page A21	<b>C8BMB</b> Male Elbow  Page A23	

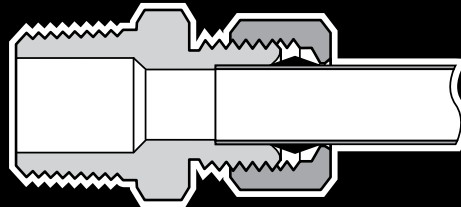

## Compression Fittings

### Advantages

No flaring, soldering or other preparation of tubing necessary to assemble. This economical fitting is readily available in a broad selection of styles. Manufactured from CA 360, CA 345 or CA 377 brass.

### Specifications

Listed with Underwriter's Laboratories for flammable liquid. Compression fittings meet functional requirements of SAE J-512. Refer to list of UL listed fittings on page M10 for specific configurations.

### Applications

Use with annealed copper, aluminum, and Parflex thermoplastic tubing. Not recommended for steel tubing. Manufactured for low and medium pressure tubing connection work where excessive vibration or tube movement is not involved.

### Working Pressure Ranges

Temperature and type of tubing used are important factors. However, the following table is a good guide for proper selection. Temperature 73°F. For thermoplastic tubing, see manufacturers recommendation for pressure range.

PSI	Tube O.D. (Inches)	Tube Wall (Inches)
400	1/8	.030
400	3/16	.030
300	1/4	.030
300	5/16	.032
200	3/8	.032
200	1/2	.032
150	5/8	.035
100	3/4	.035
75	7/8	.035

### Temperature Ranges

From -65° to +250°F with soft metal tubing. For thermoplastic tubing, see manufacturers recommendation for tubing temperature range.

### Vibration

Fair resistance to vibration or tube movement, depending on applications involved. Use long nut for additional resistance to vibration.

### Assembly Instructions

1. Slide nut, then sleeve onto tubing. The thread end of the nut must face out.
2. Insert the tube into the fitting. Be sure the tube is bottomed on the fitting shoulder.
3. Assemble nut to body, and tighten "hand-tight". Then follow the number of wrench turns as indicated in the following table.

### Order

By part number and name.

Fitting Size	Tube Size	Turns required to seal from hand-tight	
		60C with soft metal tubing	60PT with thermoplastic tubing
2	1/8	1-1/4	—
3	3/16	1-1/4	—
4	1/4	1-1/4	2
5	5/16	1-1/4	2
6	3/8	2-1/4	2
8	1/2	2-1/4	2
10	5/8	2-1/4	2
12	3/4	2-1/4	2
14	7/8	2-1/4	—

### Nomenclature

Part numbers are constructed from symbols that identify the style and size of the fitting. The first series of numbers and letters identifies the style and type fitting. The second series of numbers describes the size.

#### Example:

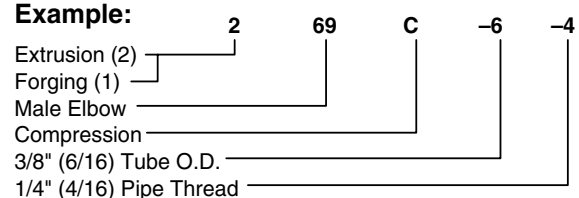

Note: To order compression assemblies with long nuts, add the letter "L" after the letter "C". Example: 62C-4 with short nut, 62CL-4 with long nut

### Sizes

Tube sizes are determined by the numbers of sixteenths of an inch in the tube O.D.

### Special Fittings

Fitting configurations and/or sizes other than those shown in the catalog can be furnished. It is suggested that a print or sketch be submitted with the inquiry. Special UL stamped fittings are available. Please consult price list.

### Pricing

Only items priced in current supplementary price list PL3501 are carried in stock. Price and delivery for non-stock items furnished on request for specified quantity.

**A**

**Sleeve 60C**

Ref. SAE 060115

PART NO.	TUBE SIZE	A	D	L
60C-2	1/8	.187	.130	.19
60C-3	3/16	.266	.192	.22
60C-4	1/4	.344	.255	.25
60C-5	5/16	.406	.318	.25
60C-6	3/8	.469	.382	.25
60C-7	7/16	.531	.444	.31
60C-8	1/2	.594	.507	.38
60C-10	5/8	.719	.632	.38
60C-12	3/4	.875	.758	.44
60C-14	7/8	1.000	.883	.41

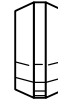
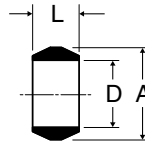

**Delrin Sleeve 60PT**

PART NO.	PLASTIC TUBE WALL	TUBE WALL	A	D	L
60PT-4	1/4	.040	.375	.254	.19
60PT-5	5/16	.062	.438	.317	.19
60PT-6	3/8	.062	.500	.379	.19
60PT-8	1/2	.062	.631	.507	.25
60PT-10	5/8	.062	.747	.632	.22
60PT-12	3/4	.062	.931	.760	.25

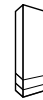
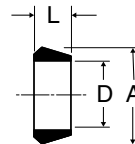

**Nut 61C**

Ref. SAE 060110

PART NO.	TUBE SIZE	STRAIGHT THREAD	C HEX	D	L
61C-2	1/8	5/16-24	3/8	.130	.38
61C-3	3/16	3/8-24	7/16	.192	.41
61C-4	1/4	7/16-24	1/2	.255	.44
61C-5	5/16	1/2-24	9/16	.318	.44
61C-6	3/8	9/16-24	5/8	.382	.47
61C-7	7/16	5/8-24	11/16	.444	.50
61C-8	1/2	11/16-20	13/16	.507	.62
61C-10	5/8	13/16-18	15/16	.632	.62
61C-12	3/4	1-18	1-3/16	.758	.69
61C-14	7/8	1-1/8-18	1-1/4	.890	.62

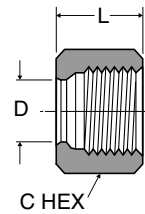

**Long Nut 61CL**

Ref. SAE 060111

PART NO.	TUBE SIZE	STRAIGHT THREAD	C HEX	D	L
61CL-4	1/4	7/16-24	1/2	.255	.75
61CL-5	5/16	1/2-24	9/16	.318	.84
61CL-6	3/8	9/16-24	5/8	.382	.97
61CL-8	1/2	11/16-20	13/16	.507	1.06
61CL-10	5/8	13/16-18	15/16	.632	1.19
61CL-12	3/4	1-18	1-3/16	.758	1.38

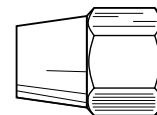
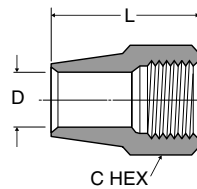





**Union 62C**

Ref. SAE 060101 BA

PART NO.	TUBE SIZE	STRAIGHT THREAD	C HEX	L	M	FLOW DIA. D
62C-2	1/8	5/16-24	5/16	1.05	.64	.094
62C-3	3/16	3/8-24	3/8	1.21	.72	.125
62C-4	1/4	7/16-24	7/16	1.33	.79	.188
62C-5	5/16	1/2-24	1/2	1.39	.85	.250
62C-6	3/8	9/16-24	9/16	1.52	.97	.312
62C-7	7/16	5/8-24	5/8	1.70	1.02	.312
62C-8	1/2	11/16-20	11/16	1.90	1.08	.406
62C-10	5/8	13/16-18	13/16	2.06	1.23	.500
62C-12	3/4	1-18	1	2.37	1.41	.562
62C-14	7/8	1-1/8-18	1-1/8	2.07	1.19	.766

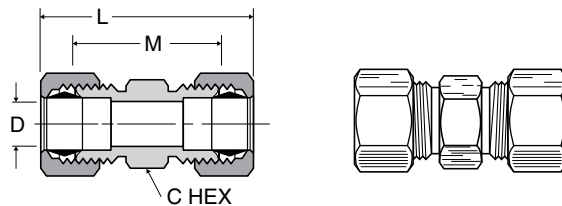

**Union Reducers 62C**

Ref. SAE 060101 BA

PART NO.	1 TUBE SIZE	2 TUBE SIZE	1 STRAIGHT THREAD	2 STRAIGHT THREAD	C HEX	L	M	FLOW DIA. D
62C-4-3	3/16	1/4	3/8-24	7/16-24	7/16	1.29	.78	.125
62C-6-4	1/4	3/8	7/16-24	9/16-24	9/16	1.46	.91	.188
62C-8-6	3/8	1/2	9/16-24	11/16-20	11/16	1.71	1.03	.312
62C-10-6	3/8	5/8	9/16-24	13/16-18	13/16	1.82	1.13	.312

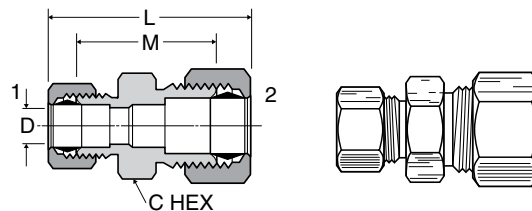

**Bulkhead Union 62CBH**

PART NO.	TUBE SIZE	STRAIGHT THREAD	C HEX	L	M	BULKHEAD HOLE DIA.	FLOW DIA. D
62CBH-4	1/4	7/16-24	9/16	2.29	1.75	7/16	.188
62CBH-6	3/8	9/16-24	11/16	2.42	1.88	9/16	.312

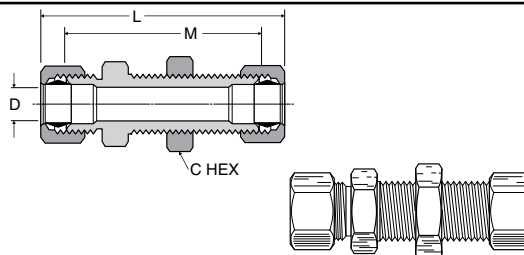

**Brass Insert 63PT**

(For industrial grade plastic tubing)

PART NO.	TUBE O.D.	TUBE WALL	L	O.D.
63PT-2-16	1/8	.016	.46	.080
63PT-2-23	1/8	.023	.45	.073
63PT-2-32	1/8	.032	.31	.061
63PT-3-25	3/16	.025	.45	.135
63PT-3-40	3/16	.040	.52	.095
63PT-4-40	1/4	.040	.50	.163
63PT-4-62	1/4	.062	.33	.110
63PT-5-40	5/16	.040	.50	.232
63PT-5-62	5/16	.062	.53	.187
63PT-6-62	3/8	.062	.56	.250
63PT-8-62	1/2	.062	.72	.370
63PT-10-62	5/8	.062	.72	.483

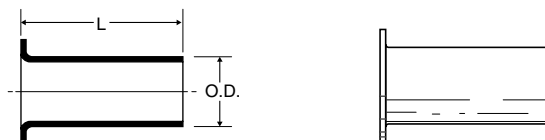

For plastic tubing

Derlin Sleeve 60PT and Brass Insert 63PT converts standard compression fittings for use with industrial grades of thermoplastic tubing.

**A**

**Female Connector 66C**

Ref. SAE 060103 BA

PART NO.	TUBE SIZE	PIPE THREAD	STRAIGHT THREAD	C HEX	L	M	FLOW DIA. D
66C-2-2	1/8	1/8	5/16-24	9/16	.95	.75	.094
66C-3-2	3/16	1/8	3/8-24	9/16	1.02	.78	.125
66C-3-4	3/16	1/4	3/8-24	11/16	1.20	.96	.125
66C-4-2	1/4	1/8	7/16-24	9/16	1.02	.78	.188
66C-4-4	1/4	1/4	7/16-24	11/16	1.24	1.00	.188
66C-5-2	5/16	1/8	1/2-24	9/16	1.07	.81	.250
66C-5-4	5/16	1/4	1/2-24	11/16	1.29	1.03	.250
66C-6-2	3/8	1/8	9/16-24	9/16	1.06	.78	.312
66C-6-4	3/8	1/4	9/16-24	11/16	1.34	1.06	.312
66C-6-6	3/8	3/8	9/16-24	13/16	1.34	1.06	.312
66C-6-8	3/8	1/2	9/16-24	1	1.54	1.27	.312
66C-7-6	7/16	3/8	5/8-24	13/16	1.43	1.09	.312
66C-8-4	1/2	1/4	11/16-20	11/16	1.49	1.09	.406
66C-8-6	1/2	3/8	11/16-20	13/16	1.52	1.12	.406
66C-8-8	1/2	1/2	11/16-20	1	1.71	1.31	.406
66C-10-8	5/8	1/2	13/16-18	1	1.80	1.38	.500

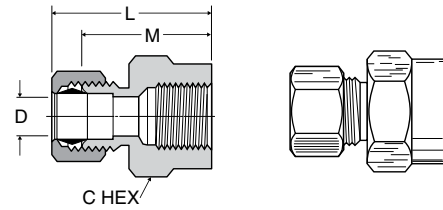

**Male Connector 68C**

Ref. SAE 060102 BA

PART NO.	TUBE SIZE	PIPE THREAD	STRAIGHT THREAD	C HEX	L	M	FLOW DIA. D
68C-2-1	1/8	1/16	5/16-24	11/32	.99	.78	.095
68C-2-2	1/8	1/8	5/16-24	7/16	.97	.77	.094
68C-3-1	3/16	1/16	3/8-24	3/8	1.08	.84	.125
68C-3-2	3/16	1/8	3/8-24	7/16	1.08	.84	.125
68C-3-4	3/16	1/4	3/8-24	9/16	1.27	1.03	.125
68C-4-2	1/4	1/8	7/16-24	7/16	1.10	.86	.188
68C-4-4	1/4	1/4	7/16-24	9/16	1.30	1.06	.188
68C-4-6	1/4	3/8	7/16-24	11/16	1.27	1.03	.188
68C-4-8	1/4	1/2	7/16-24	7/8	1.55	1.31	.188
68C-5-2	5/16	1/8	1/2-24	1/2	1.15	.89	.234
68C-5-4	5/16	1/4	1/2-24	9/16	1.33	1.07	.250
68C-6-2	3/8	1/8	9/16-24	9/16	1.25	.97	.250
68C-6-4	3/8	1/4	9/16-24	9/16	1.42	1.14	.312
68C-6-6	3/8	3/8	9/16-24	11/16	1.44	1.16	.312
68C-6-8	3/8	1/2	9/16-24	7/8	1.53	1.25	.312
68C-7-4	7/16	1/4	5/8-24	5/8	1.50	1.17	.312
68C-8-4	1/2	1/4	11/16-20	11/16	1.60	1.20	.312
68C-8-6	1/2	3/8	11/16-20	11/16	1.60	1.20	.406
68C-8-8	1/2	1/2	11/16-20	7/8	1.71	1.31	.406
68C-10-6	5/8	3/8	13/16-18	13/16	1.73	1.31	.406
68C-10-8	5/8	1/2	13/16-18	7/8	1.90	1.48	.500
68C-10-12	5/8	3/4	13/16-18	1-1/16	1.98	1.56	.500
68C-12-8	3/4	1/2	1-18	1	2.05	1.60	.562
68C-12-12	3/4	3/4	1-18	1-1/16	2.08	1.63	.656
68C-14-12	7/8	3/4	1-1/8-18	1-1/8	1.76	1.41	.750

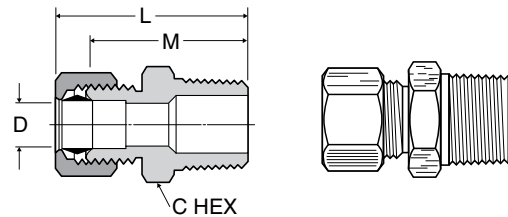



**Union Tee 164C-264C**

Ref. SAE 060401 BA

PART NO.	TUBE SIZE	STRAIGHT THREAD	L	M	FLOW DIA. D
164C-2	1/8	5/16-24	.82	.61	.094
264C-3	3/16	3/8-24	.84	.60	.125
164C-4	1/4	7/16-24	.86	.61	.188
264C-4	1/4	7/16-24	.84	.60	.188
164C-5	5/16	1/2-24	.98	.71	.250
164C-6	3/8	9/16-24	1.03	.74	.312
164C-8	1/2	11/16-20	1.34	.93	.406
164C-10	5/8	13/16-18	1.54	1.08	.500
164C-12	3/4	1.00-18	1.65	1.17	.560

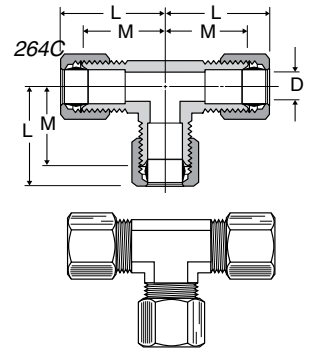
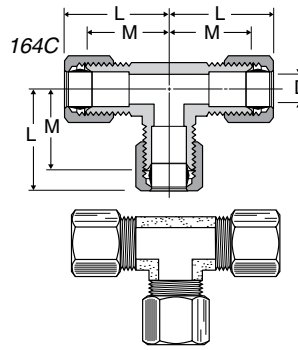

**Union Tee 164C-264C Combination Sizes**

Ref. SAE 060401 BA

PART NO.	1 TUBE SIZE	2 TUBE SIZE	3 TUBE SIZE	L1	L2	L3	M1	M2	M3	FLOW DIA. D
164C-6-4-4	3/8	1/4	1/4	1.03	.96	.96	.75	.72	.72	.188
164C-6-6-4	3/8	3/8	1/4	1.03	.96	.96	.75	.75	.72	.188
164C-8-8-6	1/2	1/2	3/8	1.34	1.16	1.16	.94	.94	.88	.312

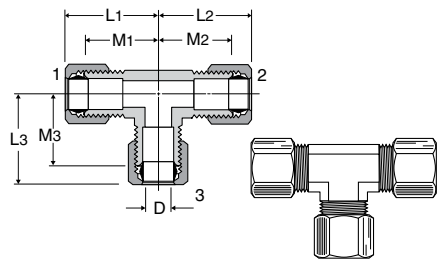

**Union Elbow 165C-265C**

Ref. SAE 060201 BA

PART NO.	TUBE SIZE	STRAIGHT THREAD	L	M	FLOW DIA. D
165C-2	1/8	5/16-24	.82	.61	.094
165C-3	3/16	3/8-24	.87	.61	.125
165C-4	1/4	7/16-24	.88	.61	.188
265C-4	1/4	7/16-24	.84	.60	.188
165C-5	5/16	1/2-24	.95	.71	.250
165C-6	3/8	9/16-24	1.03	.74	.312
165C-7	7/16	5/3-24	1.16	.82	.312
165C-8	1/2	11/16-20	1.34	.93	.406
165C-10	5/8	13/16-18	1.48	1.05	.500
165C-12	3/4	1-18	1.65	1.17	.560

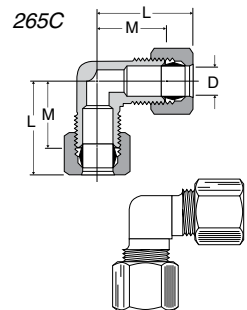
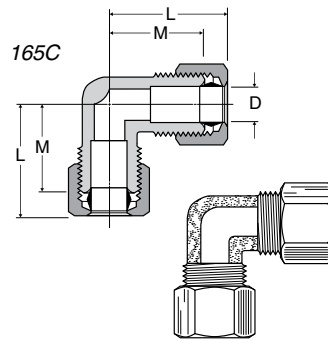

**Compression Gage Tee 168C**

PART NO.	TUBE SIZE	PIPE THREAD	STRAIGHT THREAD	L	M	N	N1	FLOW DIA. D
168C-4-2	1/4	1/8	7/16-24	.96	.72	1.41	.56	.188

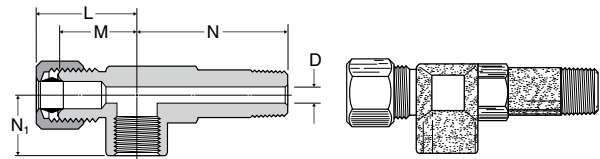

**A**

**Male Elbow 169C-269C**

Ref. SAE 060202 BA

PART NO.	TUBE SIZE	PIPE THREAD	STRAIGHT THREAD	L	M	N	FLOW DIA. D
169C-2-1	1/8	1/16	5/16-24	.81	.60	.67	.095
269C-2-2	1/8	1/8	5/16-24	.80	.60	.67	.094
169C-3-1	3/16	1/16	3/8-24	.85	.61	.67	.126
169C-3-2	3/16	1/8	3/8-24	.84	.61	.69	.125
269C-3-2	3/16	1/8	3/8-24	.84	.60	.67	.125
169C-3-4	3/16	1/4	3/8-24	.86	.64	.93	.125
169C-4-2	1/4	1/8	7/16-24	.86	.61	.74	.188
269C-4-2	1/4	1/8	7/16-24	.84	.60	.73	.188
169C-4-4	1/4	1/4	7/16-24	.86	.62	.94	.188
269C-4-4	1/4	1/4	7/16-24	.84	.60	.79	.188
169C-4-6	1/4	3/8	7/16-24	.93	.68	1.00	.188
169C-5-2	5/16	1/8	1/2-24	.88	.61	.74	.234
269C-5-2	5/16	1/8	1/2-24	.86	.60	.73	.250
169C-5-4	5/16	1/4	1/2-24	.95	.71	.93	.250
269C-5-4	5/16	1/4	1/2-24	.93	.67	.82	.250
169C-5-6	5/16	3/8	1/2-24	1.01	.75	1.00	.250
169C-6-2	3/8	1/8	9/16-24	1.03	.74	.74	.234
269C-6-2	3/8	1/8	9/16-24	.97	.69	.75	.220
169C-6-4	3/8	1/4	9/16-24	1.03	.74	.93	.312
269C-6-4	3/8	1/4	9/16-24	1.01	.73	.92	.312
169C-6-6	3/8	3/8	9/16-24	1.03	.75	1.00	.312
269C-6-6	3/8	3/8	9/16-24	1.12	.84	.97	.312
169C-6-8	3/8	1/2	9/16-24	1.22	.94	1.27	.312
269C-7-6	7/16	3/8	5/8-24	1.16	.82	.98	.312
169C-8-4	1/2	1/4	11/16-20	1.34	.94	1.00	.312
169C-8-6	1/2	3/8	11/16-20	1.34	.93	1.11	.406
169C-8-8	1/2	1/2	11/16-20	1.48	1.00	1.37	.406
169C-10-8	5/8	1/2	13/16-18	1.48	1.06	1.31	.500
169C-12-8	3/4	1/2	1-18	1.64	1.18	1.49	.562
169C-12-12	3/4	3/4	1-18	1.70	1.27	1.58	.562

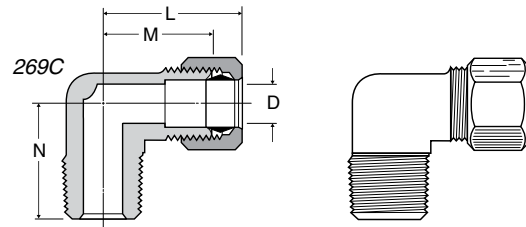
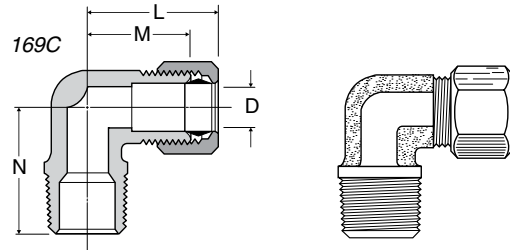

**Female Elbow 170C-270C**

Ref. SAE 060203 BA

PART NO.	TUBE SIZE	PIPE THREAD	STRAIGHT THREAD	L	M	N	FLOW DIA. D
170C-2-2	1/8	1/8	5/16-24	.89	.69	.56	.094
170C-3-2	3/16	1/8	3/8-24	.98	.73	.56	.125
170C-4-2	1/4	1/8	7/16-24	.93	.69	.56	.188
270C-4-2	1/4	1/8	7/16-24	.91	.67	.54	.188
170C-4-4	1/4	1/4	7/16-24	1.02	.78	.70	.188
170C-6-4	3/8	1/4	9/16-24	1.06	.79	.73	.312
170C-6-6	3/8	3/8	9/16-24	1.22	.94	.69	.312
170C-7-4	7/16	1/4	5/8-24	1.27	.93	.73	.312
170C-8-6	1/2	3/8	11/16-20	1.34	1.00	.69	.406
170C-8-8	1/2	1/2	11/16-20	1.56	1.15	.97	.408
170C-12-12	3/4	3/4	1-18	2.06	1.58	1.58	.560

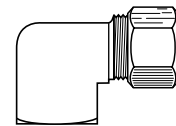
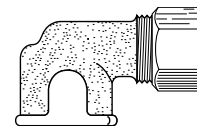
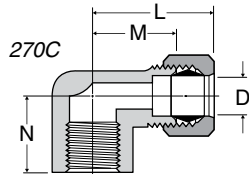
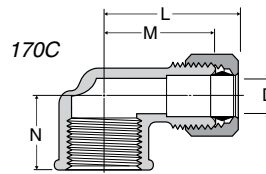

**Male Run Tee 171C**

Ref. SAE 060424 BA

PART NO.	TUBE SIZE	PIPE THREAD	STRAIGHT THREAD	L	M	N	FLOW DIA. D
171C-2-2	1/8	1/8	5/16-24	.82	.61	.71	.094
171C-3-2	3/16	1/8	3/8-24	.86	.61	.71	.125
171C-4-2	1/4	1/8	7/16-24	.90	.64	.75	.188
171C-4-4	1/4	1/4	7/16-24	.93	.69	.92	.188
171C-6-4	3/8	1/4	9/16-24	1.09	.81	1.03	.312

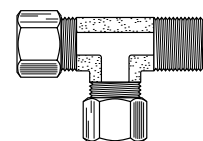
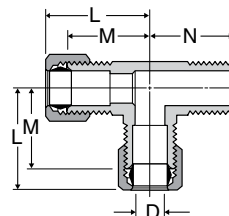



**A**

**Male Branch Tee 172C**

Ref. SAE 060425 BA

PART NO.	TUBE SIZE	PIPE THREAD	STRAIGHT THREAD	L	M	N	FLOW DIA. D
172C-2-2	1/8	1/8	5/16-24	.82	.61	.71	.094
172C-3-2	3/16	1/8	3/8-24	.86	.61	.71	.125
172C-4-2	1/4	1/8	7/16-24	.86	.61	.74	.188
172C-4-4	1/4	1/4	7/16-24	.93	.69	.92	.188
172C-6-2	3/8	1/8	9/16-24	1.03	.75	.75	.234
172C-6-4	3/8	1/4	9/16-24	1.09	.77	1.03	.312
172C-6-6	3/8	3/8	9/16-24	1.09	.81	1.00	.312
172C-8-6	1/2	3/8	11/16-20	1.34	.93	1.10	.406

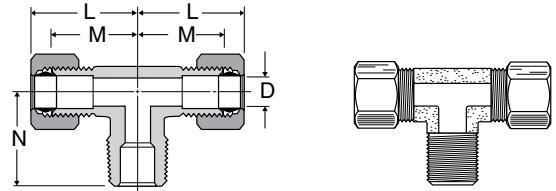

**Adapter Tee 176C**

PART NO.	TUBE SIZE	PIPE THREAD	STRAIGHT THREAD	L	M	N	N1	FLOW DIA. D
176C-4-2	1/4	1/8	7/16-24	.93	.69	.75	.66	.188

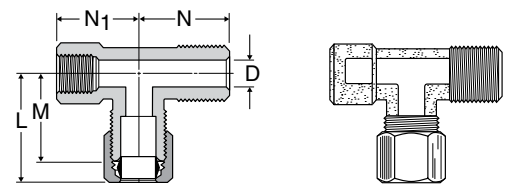

**Female Branch Tee 177C**

PART NO.	TUBE SIZE	PIPE THREAD	STRAIGHT THREAD	L	M	N	FLOW DIA. D
177C-4-2	1/4	1/8	7/16-24	.86	.63	.53	.188

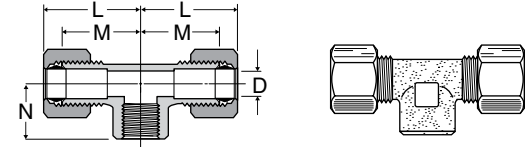

**45° Elbow 179C**

Compression to male pipe

PART NO.	TUBE SIZE	PIPE THREAD	STRAIGHT THREAD	L	M	N	FLOW DIA. D
179C-4-2	1/4	1/8	7/16-24	.90	.66	.56	.188
179C-4-4	1/4	1/4	7/16-24	.80	.56	.84	.188
179C-6-2	3/8	1/8	9/16-24	.90	.63	.65	.234
179C-6-4	3/8	1/4	9/16-24	.90	.63	.84	.312
179C-6-6	3/8	3/8	9/16-24	.97	.75	.95	.312
179C-8-6	1/2	3/8	11/16-24	1.15	.81	.95	.406

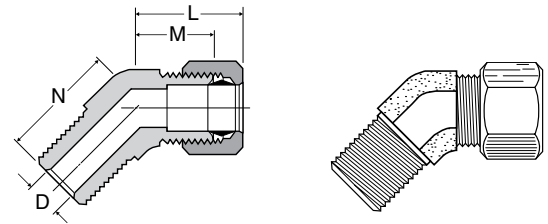

**A**

**Seal Plug 639C**

PART NO.	TUBE SIZE	STRAIGHT THREAD	C HEX	L	M
639C-4	1/4	7/16-24	7/16	.74	.50

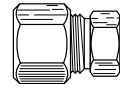
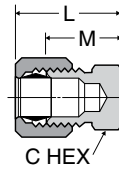

**Straight Through Tank Fitting 682C**

PART NO.	TUBE SIZE	PIPE THREAD	STRAIGHT THREAD	C HEX	L	M	FLOW DIA. D
682C-3-2	3/16	1/8	3/8-24	7/16	1.06	0.84	.195
682C-6-6	3/8	3/8	9/16-24	11/16	1.44	1.16	.387
682C-8-8	1/2	1/2	11/16-20	7/8	1.90	1.31	.516

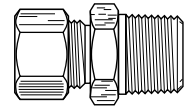
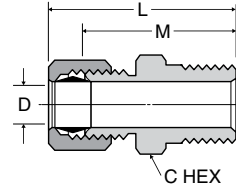

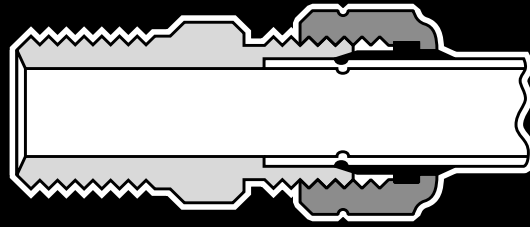

## Compress-Align® Fittings

### Advantages

No flaring, soldering or other preparation of tubing is necessary. Pre-assembled fitting, with captive sleeve. Sleeve is always oriented for correct installation, visible for inspection before and after installation. Heavy-duty fitting aligns to seal even out-of-round tubing. More quickly assembled than either flare or standard tapered sleeve compression fittings. Compress-Align bodies are interchangeable with standard compression fitting bodies. This economical fitting is available in straights, tees and elbows 1/8 in. O.D. through 1 in. O.D. tube size. Manufactured from CA 360, CA 345 or CA 377 brass.

### Specifications

Listed with Underwriter's Laboratories for flammable liquids. Consult list of UL listed fittings on page M10 for specific configurations.

### Applications

Use with annealed copper, brass, aluminum and thermoplastic tubing. Manufactured for low and medium pressure tubing connections.

PSI	Tube O.D. (in.)	Tube Wall (in.)
2800	1/8	.030
1900	3/16	.030
1400	1/4	.030
1200	5/16	.032
1000	3/8	.032
750	1/2	.032
650	5/8	.035
550	3/4	.035
450	7/8	.035
350	1	.035

### Temperature Ranges

From -65° to +250°F.

### Vibration

Fair resistance to minimal vibration or tube movement.

### Assembly Instructions

With nut finger tight on fitting body, insert tubing until it bottoms in the fitting. Complete the seal with one wrench turn on all sizes.

### Order

By part number and name.

### Nomenclature

Part numbers are constructed from symbols that identify the style and size of the fitting. The first series of numbers and letters identifies the style and type fitting. The second series of numbers describes the size.

#### Example:

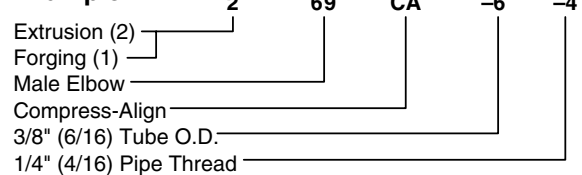

### Sizes

Tube sizes are determined by the number of sixteenths of an inch O.D.

### Special Fittings

Fitting configurations and/or sizes other than those shown in the catalog can be furnished. It is suggested that a print or sketch be submitted with the inquiry.

### Pricing

Only items priced in current supplementary price list PL3501 are carried in stock. Price and delivery for non-stock items furnished on request for specified quantity.

### Remake Instructions

Tighten to original make-up position plus 1/16 turn to reseal sleeve. Approximately 8 remakes are possible using this reassembly method.

**A**

**Plug 59CA**

PART NO.	TUBE SIZE	STRAIGHT THREAD	C HEX	L
59CA-4	1/4	7/16-24	1/2	.40
59CA-6	3/8	9/16-24	5/8	.45
59CA-8	1/2	11/16-20	13/16	.50

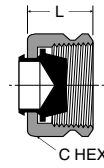

**Nut and Sleeve Assembly 61CA**

PART NO.	TUBE SIZE	STRAIGHT THREAD	C HEX	D	L
61CA-2	1/8	5/16-24	3/8	.130	.36
61CA-3	3/16	3/8-24	7/16	.194	.38
61CA-4	1/4	7/16-24	1/2	.255	.40
61CA-5	5/16	1/2-24	9/16	.318	.42
61CA-6	3/8	9/16-24	5/8	.382	.45
61CA-8	1/2	11/16-20	13/16	.507	.50
61CA-10	5/8	13/16-18	15/16	.632	.53
61CA-12	3/4	1-18	1-3/16	.760	.56
61CA-14	7/8	1-1/8-18	1-3/8	.885	.68
61CA-16	1	1-1/4-18	1-1/2	1.012	.63

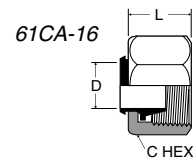
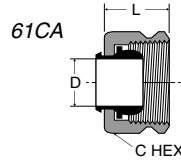

**Union 62CA**

PART NO.	TUBE SIZE	STRAIGHT THREAD	C HEX	L	M	FLOW DIA. D
62CA-2	1/8	5/16-24	5/16	1.12	.64	.094
62CA-3	3/16	3/8-24	3/8	1.19	.72	.125
62CA-4	1/4	7/16-24	7/16	1.26	.79	.188
62CA-5	5/16	1/2-24	1/2	1.32	.85	.250
62CA-6	3/8	9/16-24	9/16	1.42	.97	.312
62CA-8	1/2	11/16-20	11/16	1.53	1.08	.406
62CA-10	5/8	13/16-18	13/16	1.71	1.23	.500
62CA-12	3/4	1-18	1	2.20	1.41	.562
62CA-14	7/8	1-1/8-18	1-1/8	2.08	1.19	.766

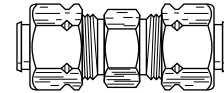
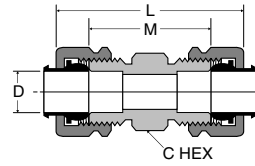

**Union Reducers 62CA**

PART NO.	1 TUBE SIZE	2 TUBE SIZE	1 STRAIGHT THREAD	2 STRAIGHT THREAD	C HEX	L	M	FLOW DIA. D
62CA-4-3	3/16	1/4	3/8-24	7/16-24	7/16	1.25	.78	.125
62CA-6-4	1/4	3/8	7/16-24	9/16-24	9/16	1.37	.91	.188
62CA-8-6	3/8	1/2	9/16-24	11/16-20	11/16	1.48	1.03	.312
62CA-10-6	3/8	5/8	9/16-24	13/16-18	13/16	1.59	1.13	.312

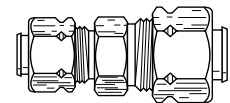
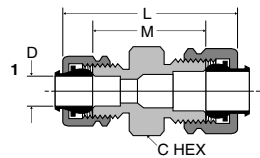

**Bulkhead Union 62CABH**

PART NO.	TUBE SIZE	STRAIGHT THREAD	C HEX	L	M	BULKHEAD HOLE DIA.	FLOW DIA. D
62CABH-4	1/4	7/16-24	9/16	2.22	1.75	7/16	.188
62CABH-6	3/8	9/16-24	11/16	2.32	1.88	9/16	.312

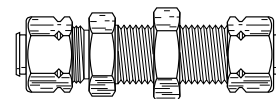
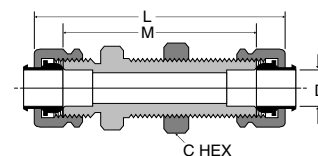





**Union 62PCA**

(Poly-Tite to Compress-Align)

PART NO.	TUBE SIZE	1 STRAIGHT THREAD	2 STRAIGHT THREAD	C HEX	L	M	FLOW DIA. D
62PCA-4	1/4	3/8-24	7/16-24	7/16	1.24	.89	.125
62PCA-5	5/16	7/16-24	1/2-24	1/2	1.26	.92	.144
62PCA-6	3/8	1/2-24	9/16-24	9/16	1.32	.98	.204

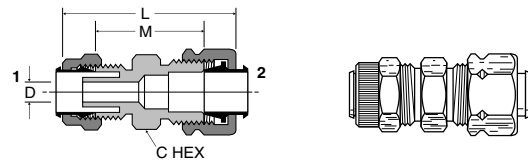

**Bulkhead Union 62PCABH**

(Poly-Tite to Compress-Align)

PART NO.	TUBE SIZE	1 STRAIGHT THREAD	2 STRAIGHT THREAD	C HEX	P MAX	L	M	BULKHEAD HOLE DIA.	FLOW DIA. D
62PCABH-4	1/4	3/8-24	7/16-24	9/16	.38	1.80	1.45	3/8	.125
62PCABH-6	3/8	1/2-24	9/16-24	11/16	.47	1.98	1.64	1/2	.204

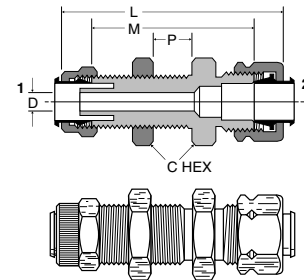

**Brass Insert 63PT**

(For industrial grade plastic tubing)

PART NO.	TUBE SIZE	TUBE WALL	L	O.D.
63PT-2-16	1/8	.016	.46	.080
63PT-2-23	1/8	.023	.45	.073
63PT-2-32	1/8	.032	.31	.061
63PT-3-25	3/16	.025	.45	.135
63PT-3-40	3/16	.040	.52	.095
63PT-4-40	1/4	.040	.50	.163
63PT-4-62	1/4	.062	.33	.110
63PT-5-40	5/16	.040	.50	.232
63PT-5-62	5/16	.062	.53	.187
63PT-6-62	3/8	.062	.56	.250
63PT-8-62	1/2	.062	.72	.370
63PT-10-62	5/8	.062	.72	.483

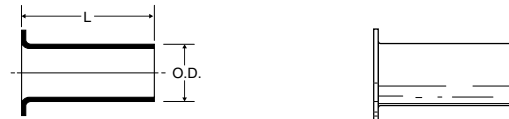

**Female Connector 66CA**

PART NO.	TUBE SIZE	PIPE THREAD	STRAIGHT THREAD	C HEX	L	M	FLOW DIA. D
66CA-2-2	1/8	1/8	5/16-24	9/16	.99	.75	.094
66CA-3-2	3/16	1/8	3/8-24	9/16	1.01	.78	.125
66CA-3-4	3/16	1/4	3/8-24	11/16	1.19	.96	.125
66CA-4-2	1/4	1/8	7/16-24	9/16	1.02	.78	.188
66CA-4-4	1/4	1/4	7/16-24	11/16	1.24	1.00	.188
66CA-5-2	5/16	1/8	1/2-24	9/16	1.05	.81	.250
66CA-5-4	5/16	1/4	1/2-24	11/16	1.27	1.03	.250
66CA-6-2	3/8	1/8	9/16-24	9/16	1.00	.78	.312
66CA-6-4	3/8	1/4	9/16-24	11/16	1.28	1.06	.312
66CA-6-6	3/8	3/8	9/16-24	13/16	1.29	1.06	.312
66CA-6-8	3/8	1/2	9/16-24	1	1.49	1.27	.312
66CA-8-4	1/2	1/4	11/16-20	11/16	1.32	1.09	.406
66CA-8-6	1/2	3/8	11/16-20	13/16	1.35	1.12	.406
66CA-8-8	1/2	1/2	11/16-20	1	1.54	1.31	.406
66CA-10-8	5/8	1/2	13/16-18	1	1.62	1.38	.500

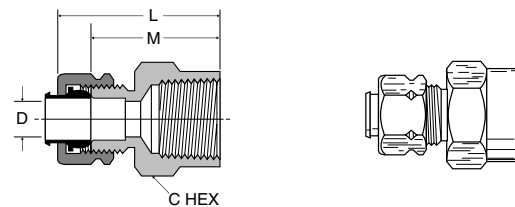

**A**

**Male Connector 68CA**

PART NO.	TUBE SIZE	PIPE THREAD	STRAIGHT THREAD	C HEX	L	M	FLOW DIA. D
68CA-2-1	1/8	1/16	5/16-24	11/32	1.02	.78	.095
68CA-2-2	1/8	1/8	5/16-24	7/16	1.01	.77	.094
68CA-3-1	3/16	1/16	3/8-24	3/8	1.07	.84	.125
68CA-3-2	3/16	1/8	3/8-24	7/16	1.07	.84	.125
68CA-3-4	3/16	1/4	3/8-24	9/16	1.26	1.03	.125
68CA-4-2	1/4	1/8	7/16-24	7/16	1.10	.86	.188
68CA-4-4	1/4	1/4	7/16-24	9/16	1.31	1.06	.188
68CA-4-6	1/4	3/8	7/16-24	11/16	1.28	1.03	.188
68CA-4-8	1/4	1/2	7/16-24	7/8	1.56	1.31	.188
68CA-5-2	5/16	1/8	1/2-24	1/2	1.13	.89	.234
68CA-5-4	5/16	1/4	1/2-24	9/16	1.35	1.07	.250
68CA-6-2	3/8	1/8	9/16-24	9/16	1.19	.97	.250
68CA-6-4	3/8	1/4	9/16-24	9/16	1.36	1.14	.312
68CA-6-6	3/8	3/8	9/16-24	11/16	1.43	1.16	.312
68CA-6-8	3/8	1/2	9/16-24	7/8	1.52	1.25	.312
68CA-8-4	1/2	1/4	11/16-20	11/16	1.45	1.22	.312
68CA-8-6	1/2	3/8	11/16-20	11/16	1.43	1.20	.406
68CA-8-8	1/2	1/2	11/16-20	7/8	1.54	1.31	.406
68CA-10-6	5/8	3/8	13/16-18	13/16	1.55	1.31	.406
68CA-10-8	5/8	1/2	13/16-18	7/8	1.72	1.48	.500
68CA-10-12	5/8	3/4	13/16-18	1-1/16	1.80	1.56	.500
68CA-12-8	3/4	1/2	1-18	1	1.99	1.60	.562
68CA-12-12	3/4	3/4	1-18	1-1/16	2.02	1.63	.656
68CA-14-12	7/8	3/4	1-1/8-18	1-1/8	1.85	1.41	.750
68CA-16-12	1	3/4	1-1/4-18	1-1/4	1.83	1.39	.750
68CA-16-16	1	1	1-1/4-18	1-3/8	2.02	1.58	.875

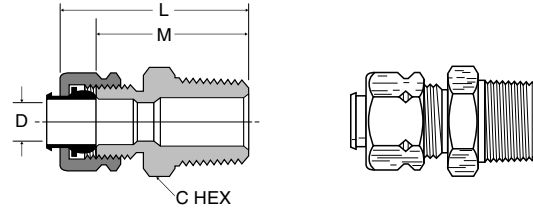

**Union Tee 164CA-264CA**

PART NO.	TUBE SIZE	STRAIGHT THREAD	L	M	FLOW DIA. D
164CA-2	1/8	5/16-24	.84	.61	.093
264CA-3	3/16	3/8-24	.83	.60	.125
164CA-4	1/4	7/16-24	.84	.61	.188
264CA-4	1/4	7/16-24	.84	.60	.188
164CA-5	5/16	1/2-24	.95	.71	.250
164CA-6	3/8	9/16-24	.96	.74	.312
164CA-8	1/2	11/16-20	1.15	.93	.406
164CA-10	5/8	13/16-18	1.32	1.08	.500
164CA-12	3/4	1.00-18	1.56	1.17	.560

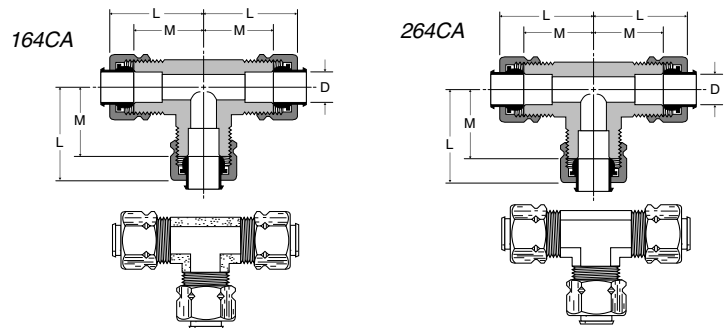

**Union Tee 164CA combination sizes**

PART NO.	1 TUBE SIZE	2 TUBE SIZE	3 TUBE SIZE	L1	L2	L3	M1	M2	M3	FLOW DIA. D
164CA-6-4-4	3/8	1/4	1/4	.97	.96	.96	.75	.72	.72	.188
164CA-6-6-4	3/8	3/8	1/4	.97	.97	.96	.75	.75	.72	.188
164CA-8-8-6	1/2	1/2	3/8	1.17	1.17	1.10	.94	.94	.88	.312

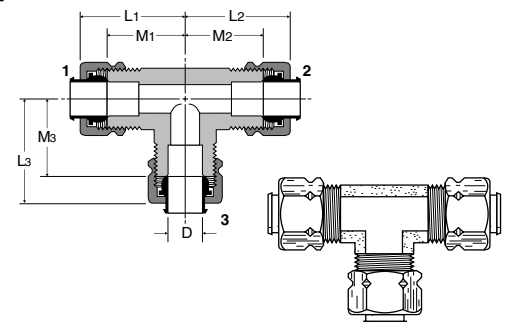



**Union Elbow 165CA-265CA**

PART NO.	TUBE SIZE	STRAIGHT THREAD	L	M	FLOW DIA. D
165CA-2	1/8	5/16-24	.84	.61	.094
165CA-3	3/16	3/8-24	.84	.61	.125
165CA-4	1/4	7/16-24	.84	.61	.188
265CA-4	1/4	7/16-24	.84	.60	.188
165CA-5	5/16	1/2-24	.94	.71	.250
165CA-6	3/8	9/16-24	.96	.74	.312
165CA-8	1/2	1 1/16-20	1.15	.93	.406
165CA-10	5/8	1 3/16-18	1.29	1.05	.500
165CA-12	3/4	1-18	1.56	1.17	.560
165CA-16	1	1-1/4-18	1.63	1.19	.877

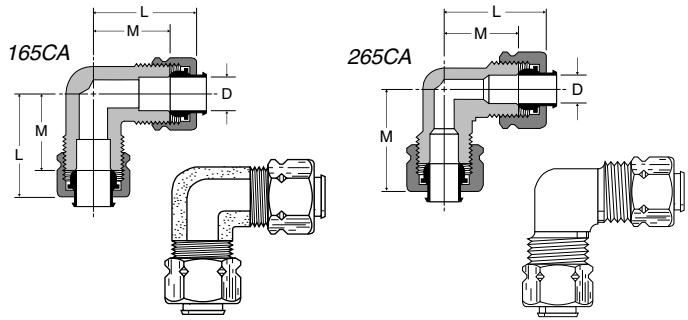

**Gage Tee 168CA**

PART NO.	TUBE SIZE	PIPE THREAD	STRAIGHT THREAD	L	M	N	N1	FLOW DIA. D
168CA-4-2	1/4	1/8	7/16-24	.96	.72	1.41	.56	.188

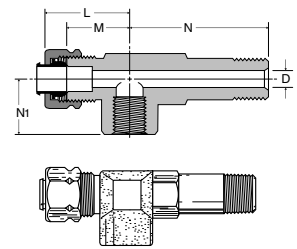

**Male Elbow 169CA-269CA**

PART NO.	TUBE SIZE	PIPE THREAD	STRAIGHT THREAD	L	M	N	FLOW DIA. D
169CA-2-1	1/8	1/16	5/16-24	.84	.60	.67	.095
269CA-2-2	1/8	1/8	5/16-24	.84	.60	.67	.094
169CA-3-1	3/16	1/16	3/8-24	.84	.61	.67	.126
169CA-3-2	3/16	1/8	3/8-24	.84	.61	.69	.125
269CA-3-2	3/16	1/8	3/8-24	.83	.60	.67	.125
169CA-3-4	3/16	1/4	3/8-24	.87	.64	.93	.125
169CA-4-2	1/4	1/8	7/16-24	.84	.61	.74	.188
269CA-4-2	1/4	1/8	7/16-24	.84	.60	.73	.188
169CA-4-4	1/4	1/4	7/16-24	.86	.62	.94	.188
269CA-4-4	1/4	1/4	7/16-24	.84	.60	.79	.188
169CA-4-6	1/4	3/8	7/16-24	.92	.68	1.00	.188
169CA-5-2	5/16	1/8	1/2-24	.84	.61	.74	.234
269CA-5-2	5/16	1/8	1/2-24	.84	.60	.73	.250
169CA-5-4	5/16	1/4	1/2-24	.94	.71	.93	.250
269CA-5-4	5/16	1/4	1/2-24	.91	.67	.82	.250
169CA-5-6	5/16	3/8	1/2-24	.99	.75	1.00	.250
169CA-6-2	3/8	1/8	9/16-24	.96	.74	.74	.234
269CA-6-2	3/8	1/8	9/16-24	.96	.69	.75	.220
169CA-6-4	3/8	1/4	9/16-24	.96	.74	.93	.312
269CA-6-4	3/8	1/4	9/16-24	.95	.73	.92	.312
169CA-6-6	3/8	3/8	9/16-24	.97	.75	1.00	.312
269CA-6-6	3/8	3/8	9/16-24	1.06	.84	.97	.312
169CA-6-8	3/8	1/2	9/16-24	1.16	.94	1.27	.312
169CA-8-4	1/2	1/4	1 1/16-20	1.17	.94	1.00	.312
169CA-8-6	1/2	3/8	1 1/16-20	1.15	.93	1.11	.406
169CA-8-8	1/2	1/2	1 1/16-20	1.23	1.00	1.37	.406
169CA-10-6	5/8	3/8	1 3/16-18	1.30	1.06	1.15	.406
169CA-10-8	5/8	1/2	1 3/16-18	1.30	1.06	1.31	.500
169CA-12-8	3/4	1/2	1-18	1.57	1.18	1.49	.562
169CA-12-12	3/4	3/4	1-18	1.66	1.27	1.58	.562
169CA-16-12	1	3/4	1-1/4-18	1.63	1.19	1.60	.875

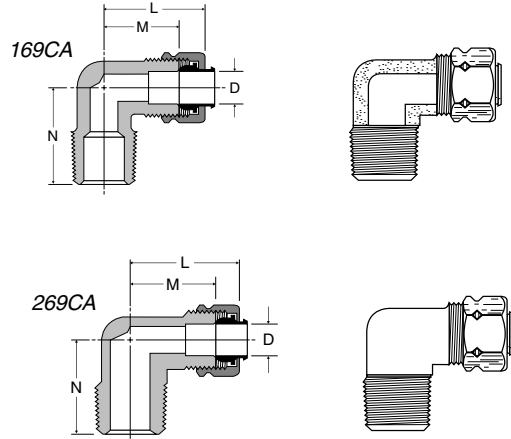

**A**

**Female Elbow 170CA-270CA**

PART NO.	TUBE SIZE	PIPE THREAD	STRAIGHT THREAD	L	M	N	FLOW DIA. D
170CA-2-2	1/8	1/8	5/16-24	.93	.69	.56	.094
170CA-3-2	3/16	1/8	3/8-24	.98	.69	.56	.125
170CA-4-2	1/4	1/8	7/16-24	.98	.69	.56	.188
270CA-4-2	1/4	1/8	7/16-24	.91	.67	.54	.188
170CA-4-4	1/4	1/4	7/16-24	1.02	.78	.70	.188
170CA-6-4	3/8	1/4	9/16-24	1.09	.79	.73	.312
170CA-6-6	3/8	3/8	9/16-24	1.16	.94	.69	.312
170CA-8-6	1/2	3/8	11/16-20	1.23	1.00	.69	.406
170CA-8-8	1/2	1/2	11/16-20	1.38	1.15	.97	.408
170CA-12-12	3/4	3/4	1-18	1.97	1.58	1.58	.560

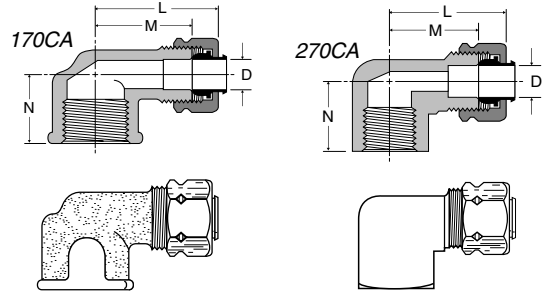

**Male Run Tee 171CA**

PART NO.	TUBE SIZE	PIPE THREAD	STRAIGHT THREAD	L	M	N	FLOW DIA. D
171CA-2-2	1/8	1/8	5/16-24	.84	.61	.71	.094
171CA-3-2	3/16	1/8	3/8-24	.83	.61	.71	.125
171CA-4-2	1/4	1/8	7/16-24	.88	.64	.75	.188
171CA-4-4	1/4	1/4	7/16-24	.93	.69	.92	.188
171CA-6-4	3/8	1/4	9/16-24	1.03	.81	1.03	.312

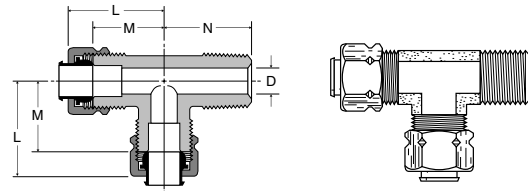

**Male Branch Tee 172CA**

PART NO.	TUBE SIZE	PIPE THREAD	STRAIGHT THREAD	L	M	N	FLOW DIA. D
172CA-2-2	1/8	1/8	5/16-24	.84	.61	.71	.093
172CA-3-2	3/16	1/8	3/8-24	.83	.61	.71	.125
172CA-4-2	1/4	1/8	7/16-24	.84	.61	.74	.188
172CA-4-4	1/4	1/4	7/16-24	.93	.69	.92	.188
172CA-6-2	3/8	1/8	9/16-24	.97	.75	.75	.234
172CA-6-4	3/8	1/4	9/16-24	.99	.77	1.03	.312
172CA-6-6	3/8	3/8	9/16-24	1.03	.81	1.00	.312
172CA-8-6	1/2	3/8	11/16-20	1.15	.93	1.10	.406
172CA-12-12	3/4	3/4	1-18	1.67	1.27	1.50	.562

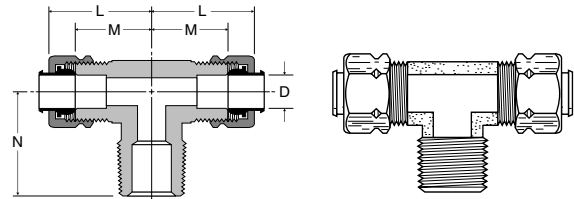

**Adapter Tee 176CA**

PART NO.	TUBE SIZE	PIPE THREAD	STRAIGHT THREAD	L	M	N	N1	FLOW DIA. D
176CA-4-2	1/4	1/8	7/16-24	.92	.69	.75	.66	.188

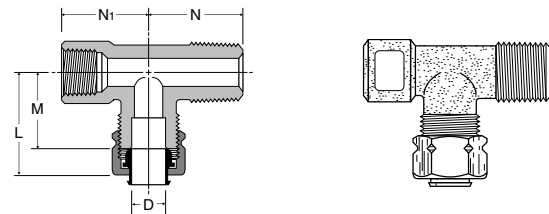

**Female Branch Tee 177CA**

PART NO.	TUBE SIZE	PIPE THREAD	STRAIGHT THREAD	L	M	N	FLOW DIA. D
177CA-4-2	1/4	1/8	7/16-24	.86	.63	.53	.188

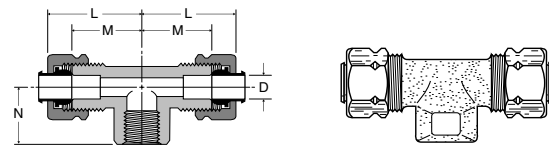



**45° Elbow 179CA**

PART NO.	TUBE SIZE	PIPE THREAD	STRAIGHT THREAD	L	M	N	FLOW DIA. D
179CA-4-2	1/4	1/8	7/16-24	.89	.66	.56	.188
179CA-4-4	1/4	1/4	7/16-24	.80	.56	.84	.188
179CA-6-2	3/8	1/8	9/16-24	.85	.63	.65	.234
179CA-6-4	3/8	1/4	9/16-24	.85	.63	.84	.281
179CA-6-6	3/8	3/8	9/16-24	.97	.75	.95	.312
179CA-8-6	1/2	3/8	11/16-20	1.03	.81	.95	.406

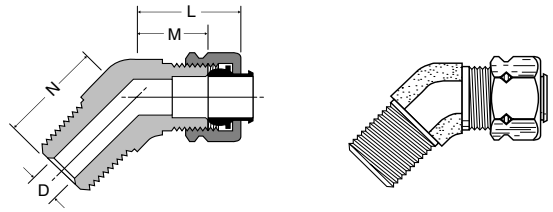

**Seal Plug 639CA**

PART NO.	TUBE SIZE	STRAIGHT THREAD	C HEX	L	M
639CA-4	1/4	7/16-24	7/16	.74	.50

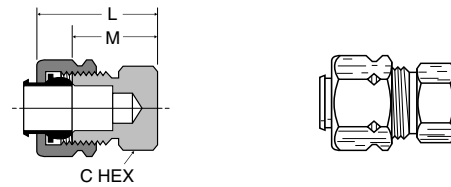

**Straight Through Tank Fitting 682CA**

PART NO.	TUBE SIZE	PIPE THREAD	STRAIGHT THREAD	C HEX	L	M	FLOW DIA. D
682CA-3-2	3/16	1/8	3/8-24	7/16	1.07	.84	.194

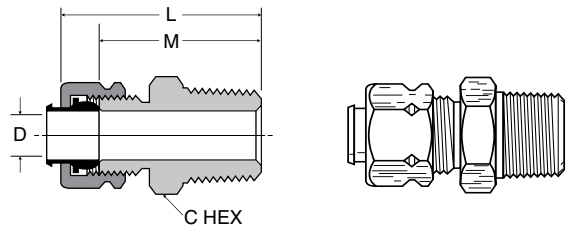

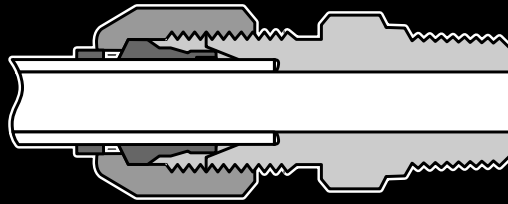

# Parker Metru-Lok™ Fittings

## Advantages

Metru-Lok™ is a one-piece, ready-to-use, bite-type fitting for use with either copper or plastic tubing. The ferrule is held captive in the nut. The fitting is designed to permit tube entry and fitting makeup without removal of the nut and ferrule, avoiding the assembly of the fitting components prior to use.

## Fitting ready to use

- Compact fully assembled fitting, timesaving at makeup.
- Captive snap in ferrule.
- Simplified handling and stock-keeping.
- No presetting of the ferrule necessary.

## Positive sealing and bite

- The wedging action of the nut when tightened causes the ferrule to bite into the outside diameter of the tube wall for a leakproof connection.
- With flexible tubing (polyurethane, PEBA or polyethylene), it is recommended to use a tube insert for a positive holding of the tube.

## Safety

- Visible ferrule (extending to rear of nut) allows quality control checks for correct assembly.

## Excellent vibration resistance

- Vibration is contained by the rear compression of the ferrule extending outside the nut.
- The tube is held at the bottom of the fitting.
- The tube is thus held between the above two points so that vibration running along the tube does not affect the sealing and bite area.

## How to Use: Assembly

- Cut the tube square.
- De-burr (copper tube).
- Insert the tube through the nut and ferrule until it bottoms.
- Finger tighten the nut.
- Wrench tighten the nut one turn, or one and one half turns, according to size.

## Disassembly - remake

- The Metru-Lok™ fitting can be assembled and disassembled at least 15 times. At each remake, hand tighten the nut, then wrench tighten 1/16 of a turn.

## Technical Features

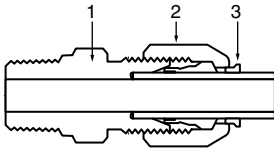

MATERIAL			WORKING TEMP.	WORKING PRESSURE* DEPENDING ON TUBE O.D.							
1	2	3		TUBE O.D. MM	4	6	8	10	12	14	16 to 20
BODY BRASS	NUT BRASS	FERRULE BRASS	FROM -65° TO +250° F	PSI	2600	2600	1800	1500	1300	1000	800

## Fitting Dimensions

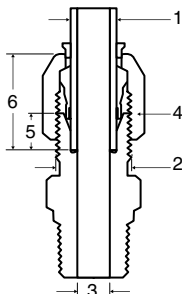

1 TUBE O.D. MM	2 METRIC STRAIGHT THREAD	3 INSIDE DIAMETER MM	4 HEX OF NUT MM	5 TUBE ENTRY BODY MM	6 TUBE ENTRY COMPL. FITTING MM	WRENCH TIGHTENING IN TURNS
4	M8x1	2	10	4	12	1 1/2
6	M10x1	4	12	5	13	1 1/2
8	M12x1	6	14	6	14	1 1/2
10	M14x1	8	17	6	14	1 1/2
12	M16x1	10	19	7	15	1 1/2
14	M18x1	12	22	8	16	1 1/2
16	M22x1.50	14	27	8	16	1
18	M24x1.50	16	30	9	21	1
20	M26x1.50	18	32	9	21	1
22	M28x1.50	20	36	10	22	1



**FBMB Male Connector NPT**

PART NO.	TUBE SIZE	NPT THREAD	C HEX	C1	L
FBMB4-1/16	4	1/16	8	10	26
FBMB4-1/8	4	1/8	11	10	27
FBMB6-1/8	6	1/8	11	12	28
FBMB6-1/4	6	1/4	14	12	32
FBMB8-1/8	8	1/8	12	14	29
FBMB8-1/4	8	1/4	14	14	33
FBMB10-1/4	10	1/4	14	17	33
FBMB10-3/8	10	3/8	19	17	34
FBMB12-3/8	12	3/8	19	19	35
FBMB12-1/2	12	1/2	22	19	40
FBMB14-3/8	14	3/8	19	22	36
FBMB14-1/2	14	1/2	22	22	41
FBMB16-1/2	16	1/2	22	27	40
FBMB18-1/2	18	1/2	24	30	46
FBMB20-3/4	20	3/4	27	32	47
FBMB22-3/4	22	3/4	30	36	49

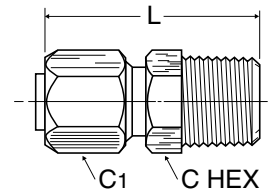

**F3BMB Male Connector BSPT**

PART NO.	TUBE SIZE	BSPT THREAD	C HEX	C1	L
F3BMB4-1/8	4	1/8	10	10	25
F3BMB6-1/8	6	1/8	11	12	27
F3BMB6-1/4	6	1/4	14	12	31
F3BMB8-1/8	8	1/8	12	14	29
F3BMB8-1/4	8	1/4	14	14	32
F3BMB8-3/8	8	3/8	17	17	34
F3BMB10-1/4	10	1/4	14	17	32
F3BMB10-3/8	10	3/8	17	17	33
F3BMB12-3/8	12	3/8	17	19	34
F3BMB12-1/2	12	1/2	22	19	39
F3BMB14-3/8	14	3/8	19	22	35
F3BMB14-1/2	14	1/2	22	22	40
F3BMB16-3/8	16	3/8	22	27	36
F3BMB16-1/2	16	1/2	22	27	39
F3BMB18-1/2	18	1/2	24	30	45
F3BMB20-3/4	20	3/4	27	32	46
F3BMB22-3/4	22	3/4	30	36	48

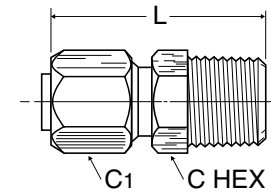

**F4BMB Male Connector BSPP**

PART NO.	TUBE SIZE	BSPP THREAD	C HEX	C1	L
F4BMB4-1/8	4	1/8	14	10	29
F4BMB6-1/8	6	1/8	14	12	30
F4BMB6-1/4	6	1/4	19	12	32
F4BMB8-1/4	8	1/4	19	14	33
F4BMB10-1/4	10	1/4	19	17	33

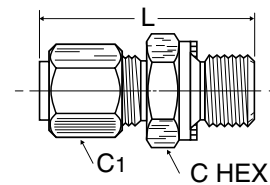

**F8BMB Male Connector Metric Straight Thread**

PART NO.	TUBE SIZE	MM THREAD	C HEX	C1	L
F8BMB4M5	4	M5x0.8	8	10	24
F8BMB12M16	12	M16x1.5	22	19	37
F8BMB12M22	12	M22x1.5	27	19	40
F8BMB14M16	14	M16x1.5	22	22	38
F8BMB14M22	14	M22x1.5	27	22	41
F8BMB16M16	16	M16x1.5	22	27	37
F8BMB16M22	16	M22x1.5	27	27	40

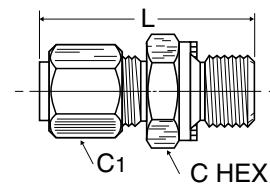

These parts are supplied with a copper seal.



**A**

**HBMB Equal Union**

PART NO.	TUBE SIZE	C HEX	C1	L
HBMB4	4	8	10	31
HBMB6	6	10	12	34
HBMB8	8	12	14	37
HBMB10	10	14	17	37
HBMB12	12	17	19	39
HBMB14	14	19	22	41
HBMB16	16	22	27	41
HBMB18	18	24	30	51
HBMB20	20	27	32	51
HBMB22	22	30	36	54

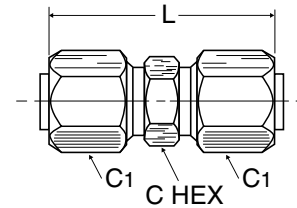

**GBMB Female Connector NPT**

PART NO.	TUBE SIZE	NPT THREAD	C HEX	C1	L
GBMB6-1/8	6	1/8	14	12	29
GBMB6-1/4	6	1/4	19	12	32
GBMB8-1/8	8	1/8	14	14	30
GBMB8-1/4	8	1/4	19	14	33
GBMB10-1/4	10	1/4	19	17	33
GBMB10-3/8	10	3/8	22	17	35
GBMB12-3/8	12	3/8	22	19	36
GBMB12-1/2	12	1/2	27	19	38
GBMB14-3/8	14	3/8	22	22	37
GBMB14-1/2	14	1/2	27	27	39
GBMB16-1/2	16	1/2	27	27	39

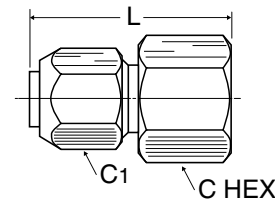

**G4BMB Female Connector BSPP**

PART NO.	TUBE SIZE	BSPP THREAD	C HEX	C1	L
G4BMB4-1/8	4	1/8	14	10	26
G4BMB6-1/8	6	1/8	14	12	27
G4BMB6-1/4	6	1/4	19	12	29
G4BMB8-1/8	8	1/8	14	14	28
G4BMB8-1/4	8	1/4	19	14	30
G4BMB10-1/4	10	1/4	19	17	30
G4BMB10-3/8	10	3/8	22	17	32
G4BMB12-3/8	12	3/8	22	19	33
G4BMB12-1/2	12	1/2	27	19	36
G4BMB14-3/8	14	3/8	22	22	34
G4BMB14-1/2	14	1/2	27	22	37
G4BMB16-1/2	14	1/2	27	27	37
G4BMB18-1/2	18	1/2	27	30	41

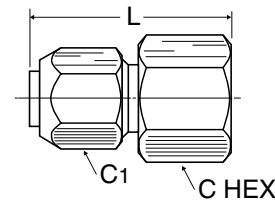

**WBMB Bulkhead Union**

PART NO.	TUBE SIZE	MM THREAD	C HEX	C1	L	L1	L2	BULKHEAD HOLE DIA.
WBMB4	4	M8x1	12	10	47	19	28	8mm
WBMB6	6	M10x1	14	12	49	20	29	10mm
WBMB8	8	M12x1	16	14	52	21	31	12mm
WBMB10	10	M14x1	19	17	53	22	31	14mm
WBMB12	12	M16x1	22	19	56	24	32	16mm
WBMB14	14	M18x1	24	22	60	26	34	18mm
WBMB16	16	M22x1.5	27	27	58	25	33	22mm
WBMB18	18	M24x1.5	30	30	70	31	39	24mm
WBMB20	20	M26x1.5	32	32	70	31	39	26mm
WBMB22	22	M28x1.5	36	36	74	33	41	28mm

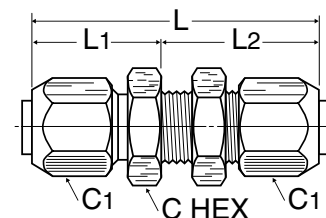



**WBMPB Mixed Bulkhead Union**

PART NO.	TUBE SIZE 1	TUBE SIZE 2	MM THREAD	C1	C HEX	L	W	BULKHEAD HOLE DIA.
WBMPB4	4	4	M8x1	10	12	34	5	8mm
WBMPB6	6	6	M10x1	12	12	37	5	10mm
WBMPB8	8	8	M12x1	14	16	39	5	12mm
WBMPB10	10	10	M14x1	17	19	45	5	14mm
WBMPB12	12	12	M16x1	19	22	49	5	16mm
WBMPB14	14	14	M18x1	22	22	52	7	18mm

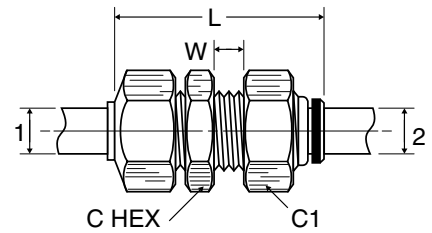

**CBMB 90° Male Elbow NPT**

PART NO.	TUBE SIZE	NPT THREAD	C1	M	N
CBMB4-1/8	4	1/8	10	22	17
CBMB6-1/8	6	1/8	12	24	18
CBMB6-1/4	6	1/4	12	24	22
CBMB8-1/8	8	1/8	14	26	19
CBMB8-1/4	8	1/4	14	26	23
CBMB10-1/4	10	1/4	17	27	24
CBMB10-3/8	10	3/8	17	28	25
CBMB12-3/8	12	3/8	19	32	27
CBMB12-1/2	12	1/2	19	32	31
CBMB14-3/8	14	3/8	22	32	26
CBMB14-1/2	14	1/2	22	33	31
CBMB16-1/2	16	1/2	27	35	34
CBMB18-1/2	18	1/2	30	41	35
CBMB20-3/4	20	3/4	32	45	40
CBMB22-3/4	22	3/4	36	46	40

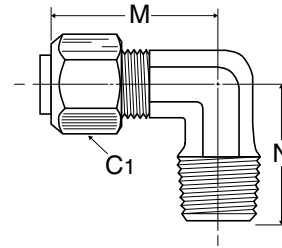

**C3BMB 90° Male Elbow BSPT**

PART NO.	TUBE SIZE	BSPT THREAD	C1	M	N
C3BMB4-1/8	4	1/8	10	22	17
C3BMB6-1/8	6	1/8	12	24	18
C3BMB6-1/4	6	1/4	12	24	22
C3BMB8-1/8	8	1/8	14	26	19
C3BMB8-1/4	8	1/4	14	26	23
C3BMB10-1/4	10	1/4	17	27	24
C3BMB10-3/8	10	3/8	17	28	25
C3BMB12-3/8	12	3/8	19	32	27
C3BMB12-1/2	12	1/2	19	32	31
C3BMB14-3/8	14	3/8	22	32	26
C3BMB14-1/2	14	1/2	22	32	31
C3BMB16-1/2	16	1/2	27	35	34
C3BMB18-1/2	18	1/2	30	41	35
C3BMB22-3/4	22	3/4	36	46	40

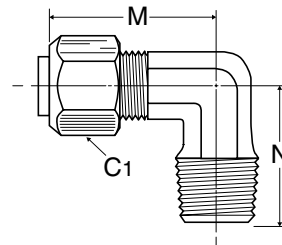

**C8BMB 90° Adjustable Male Elbow Metric Straight Thread**

PART NO.	TUBE SIZE	MM THREAD	C1	C4	M	N
C8BMB12M16	12	M16x1.5	19	22	32	35
C8BMB12M22	12	M22x1.5	19	30	35	39
C8BMB14M16	14	M16x1.5	22	22	32	33
C8BMB14M22	14	M22x1.5	22	30	35	39
C8BMB16M16	16	M16x1.5	24	22	35	36
C8BMB16M22	16	M22x1.5	27	30	36	39

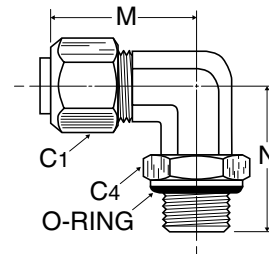

**A**

**EBMB 90° Union Elbow**

PART NO.	TUBE SIZE	C1	L	Y
EBMB4	4	10	22	7
EBMB6	6	12	24	8
EBMB8	8	14	26	10
EBMB10	10	17	27	12
EBMB12	12	19	32	14
EBMB14	14	22	32	16
EBMB16	16	27	35	18
EBMB18	18	30	41	20
EBMB20	20	32	45	24

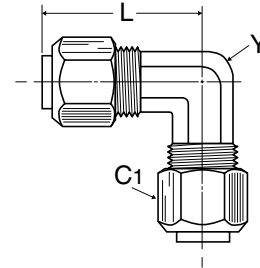

**JBMB Union Tee**

PART NO.	TUBE SIZE	C1	L	M
JBMB4	4	10	47	23.5
JBMB6	6	12	48	24.0
JBMB8	8	14	52	26.0
JBMB10	10	17	54	27.0
JBMB12	12	19	63	31.5
JBMB14	14	22	63	31.5
JBMB16	16	27	69	34.5
JBMB18	18	30	82	41.0
JBMB20	20	32	89	44.5
JBMB22	22	36	91	45.5

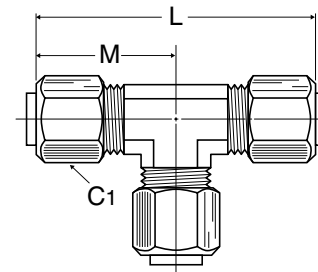

**RBMB Male Run Tee NPT**

PART NO.	TUBE SIZE	NPT THREAD	C1	L	M	N
RBMB6-1/4	6	1/4	12	48	25	23
RBMB8-1/8	8	1/8	14	45	26	19
RBMB8-1/4	8	1/4	14	49	26	23
RBMB10-1/4	10	1/4	17	51	27	24
RBMB10-3/8	10	3/8	17	52	28	24
RBMB12-3/8	12	3/8	19	59	32	27
RBMB12-1/2	12	1/2	19	63	32	31
RBMB14-3/8	14	3/8	22	60	33	28
RBMB14-1/2	14	1/2	22	64	33	31
RBMB16-1/2	16	1/2	22	69	35	34

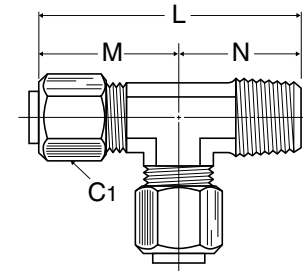

**R3BMB Male Run Tee BSPT**

PART NO.	TUBE SIZE	BSPT THREAD	C1	L	M	N
R3BMB6-1/8	6	1/8	12	42	24	18
R3BMB6-1/4	6	1/4	12	48	25	23
R3BMB8-1/8	8	1/8	14	45	26	19
R3BMB8-1/4	8	1/4	14	49	26	23
R3BMB10-1/4	10	1/4	17	51	27	24
R3BMB10-3/8	10	3/8	17	52	28	24
R3BMB12-3/8	12	3/8	19	59	32	27
R3BMB12-1/2	12	1/2	19	63	32	31
R3BMB14-3/8	14	3/8	22	59	33	28
R3BMB14-1/2	14	1/2	22	63	33	31
R3BMB16-1/2	16	1/2	27	69	35	34

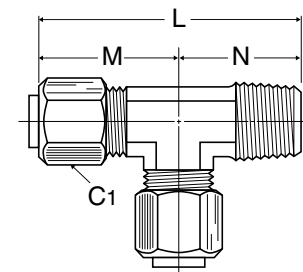



**SBMB Male Branch Tee NPT**

PART NO.	TUBE SIZE	NPT THREAD	C1	L	M	N
SBMB6-1/8	6	1/8	12	48	24.0	18
SBMB6-1/4	6	1/4	12	50	25.0	23
SBMB8-1/8	8	1/8	14	52	26.0	19
SBMB8-1/4	8	1/4	14	52	26.0	23
SBMB10-1/4	10	1/4	17	56	28.0	24
SBMB10-3/8	10	3/8	17	56	28.0	24
SBMB12-3/8	12	3/8	19	63	31.5	25
SBMB12-1/2	12	1/2	19	63	31.5	31
SBMB14-3/8	14	3/8	22	63	31.5	28
SBMB14-1/2	14	1/2	22	65	32.5	31
SBMB16-1/2	16	1/2	27	69	34.5	34

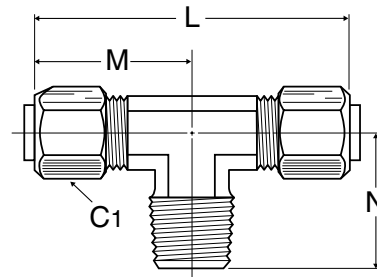

**S3BMB Male Branch Tee BSPT**

PART NO.	TUBE SIZE	BSPT THREAD	C1	L	M	N
S3BMB6-1/8	6	1/8	12	48	24.0	18
S3BMB6-1/4	6	1/4	12	49	24.5	23
S3BMB8-1/8	8	1/8	14	52	26.0	19
S3BMB8-1/4	8	1/4	14	52	26.0	23
S3BMB10-1/4	10	1/4	17	54	27.0	24
S3BMB10-3/8	10	3/8	17	56	28.0	24
S3BMB12-3/8	12	3/8	19	63	31.5	27
S3BMB12-1/2	12	1/2	19	63	31.5	31
S3BMB14-3/8	14	3/8	22	63	31.5	28
S3BMB14-1/2	14	1/2	22	65	32.5	31
S3BMB16-1/2	16	1/2	27	69	34.5	34

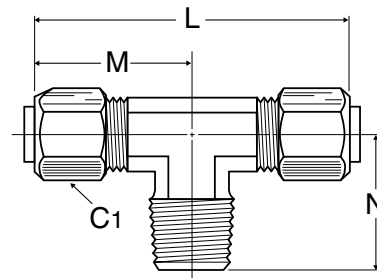

**KBMB Union Cross**

PART NO.	TUBE SIZE	C1	L	M
KBMB6	6	12	48	24.0
KBMB8	8	14	52	26.0
KBMB10	10	17	54	27.0
KBMB12	12	19	63	31.5
KBMB14	14	22	65	32.5

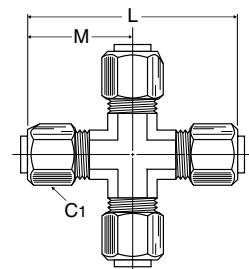

**COR4BMB Single Banjo BSPP**

PART NO.	TUBE SIZE	BSPP THREAD	C1	C5	M	N	N1
COR4BMB4-1/8	4	1/8	10	14	23	15	27
COR4BMB6-1/4	6	1/4	12	19	26	18	29
COR4BMB8-1/4	8	1/4	14	19	27	20	35
COR4BMB14-1/2	14	1/2	22	27	34	27	48
COR4BMB16-1/2	16	1/2	27	27	33	27	48
COR4BMB18-1/2	18	1/2	30	27	38	29	54
COR4BMB20-3/4	20	3/4	32	32	41	33	60
COR4BMB22-3/4	22	3/4	36	32	43	38	70

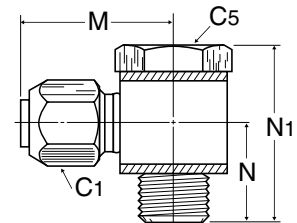

**A**

**T2HFB Tube End Male Adapter NPT**

PART NO.	TUBE SIZE	NPT THREAD	C HEX	L
T2HFB6-1/8	6	1/8	11	31
T2HFB6-1/4	6	1/4	14	36
T2HFB8-1/8	8	1/8	11	32
T2HFB8-1/4	8	1/4	14	36
T2HFB10-1/4	10	1/4	14	37
T2HFB10-3/8	10	3/8	19	38
T2HFB12-3/8	12	3/8	19	38
T2HFB12-1/2	12	1/2	22	43
T2HFB14-3/8	14	3/8	19	39
T2HFB14-1/2	14	1/2	22	44
T2HFB16-1/2	16	1/2	22	46
T2HFB18-1/2	18	1/2	22	50
T2HFB20-3/4	20	3/4	27	51
T2HFB22-3/4	22	3/4	27	54

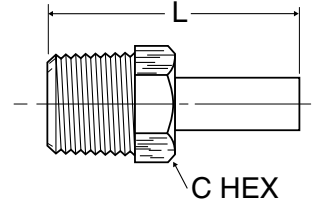

**T23HFB Tube End Male Adapter BSPT**

PART NO.	TUBE SIZE	BSPT THREAD	C HEX	L
T23HFB6-1/8	6	1/8	10	30
T23HFB6-1/4	6	1/4	14	34
T23HFB8-1/8	8	1/8	10	30
T23HFB8-1/4	8	1/4	14	35
T23HFB10-1/4	10	1/4	14	36
T23HFB10-3/8	10	3/8	17	36
T23HFB12-3/8	12	3/8	17	37
T23HFB12-1/2	12	1/2	22	40
T23HFB14-3/8	14	3/8	17	38
T23HFB14-1/2	14	1/2	22	41
T23HFB16-1/2	16	1/2	22	43
T23HFB18-1/2	18	1/2	22	47
T23HFB20-3/4	20	3/4	27	49
T23HFB22-3/4	22	3/4	27	51

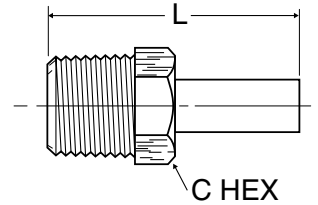

**T28HFB Tube Adapter Metric Straight Thread**

PART NO.	TUBE SIZE	MM THREAD	C HEX	L
T28HFB12M14	12	M14x1.5	19	39
T28HFB12M16	12	M16x1.5	22	40
T28HFB12M18	12	M18x1.5	24	40
T28HFB12M22	12	M22x1.5	27	43
T28HFB14M16	14	M16x1.5	22	41
T28HFB14M22	14	M22x1.5	27	44
T28HFB16M16	16	M16x1.5	22	43
T28HFB16M18	16	M18x1.5	24	43
T28HFB16M22	16	M22x1.5	27	46

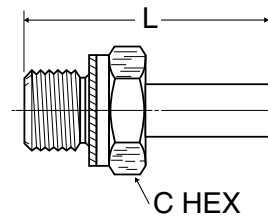

**A**

**T2HGB Tube End Female Adapter NPT**

PART NO.	TUBE SIZE	NPT THREAD	C HEX	L
T2HGB6-1/8	6	1/8	14	32
T2HGB6-1/4	6	1/4	19	35
T2HGB8-1/8	8	1/8	14	33
T2HGB8-1/4	8	1/4	19	36
T2HGB10-1/4	10	1/4	19	37
T2HGB10-1/2	10	1/2	27	41
T2HGB12-3/8	12	3/8	22	39
T2HGB12-1/2	12	1/2	27	41
T2HGB14-3/8	14	3/8	22	40
T2HGB14-1/2	14	1/2	27	42
T2HGB16-1/2	16	1/2	27	44
T2HGB18-1/2	18	1/2	27	48
T2HGB20-3/4	20	3/4	32	49
T2HGB22-3/4	22	3/4	32	51

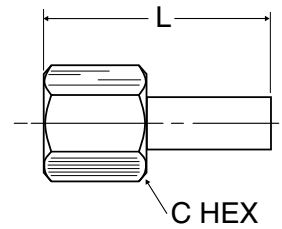

**T24HGB Tube End Female Adapter BSPP**

PART NO.	TUBE SIZE	BSPP THREAD	C HEX	L
T24HGB6-1/8	6	1/8	14	30
T24HGB6-1/4	6	1/4	19	32
T24HGB8-1/8	8	1/8	14	31
T24HGB8-1/4	8	1/4	19	33
T24HGB10-1/4	10	1/4	19	34
T24HGB10-3/8	10	3/8	22	36
T24HGB12-3/8	12	3/8	22	36
T24HGB12-1/2	12	1/2	27	40
T24HGB14-3/8	14	3/8	22	37
T24HGB14-1/2	14	1/2	27	41
T24HGB16-1/2	16	1/2	27	42
T24HGB18-1/2	18	1/2	27	46
T24HGB20-3/4	20	3/4	32	47
T24HGB22-3/4	22	3/4	32	49

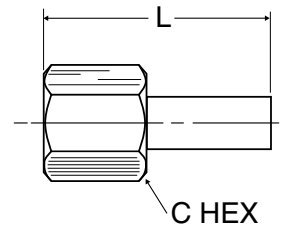

**BMB Nut**

PART NO.	TUBE SIZE	C1	L
BMB4	4	10	11
BMB6	6	12	12
BMB8	8	14	13
BMB10	10	17	13
BMB12	12	19	14
BMB14	14	22	15
BMB16	16	27	15
BMB18	18	30	19
BMB20	20	32	19
BMB22	22	36	20



**A**

**BTMB Nut and Ferrule**

PART NO.	TUBE SIZE	C1	L
BTMB4	4	10	12
BTMB6	6	12	13
BTMB8	8	14	14
BTMB10	10	17	14
BTMB12	12	19	15
BTMB14	14	22	16
BTMB16	16	27	16
BTMB18	18	30	21
BTMB20	20	32	21
BTMB22	22	36	22

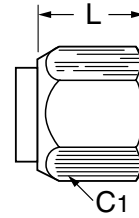

**FNMB Fitting Body Cap**

PART NO.	TUBE SIZE	C1	L
FNMB4	4	10	14
FNMB6	6	12	15
FNMB8	8	14	16
FNMB10	10	17	16
FNMB12	12	19	17
FNMB14	14	22	18
FNMB16	16	27	18
FNMB18	18	30	23
FNMB20	20	32	23
FNMB22	22	36	24

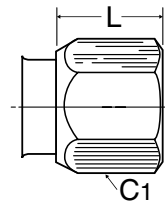

**PNMB Tube Plug**

PART NO.	TUBE SIZE	C HEX	L
PNMB4	4	8	11
PNMB6	6	10	13
PNMB8	8	12	15
PNMB10	10	14	15
PNMB12	12	17	16
PNMB14	14	19	17
PNMB16	16	22	18
PNMB18	18	24	20
PNMB20	20	27	20
PNMB22	22	30	22

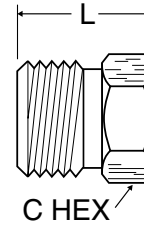

**TMB Ferrule**

PART NO.	TUBE SIZE	L
TMB4A	4	10
TMB6A	6	10
TMB8A	8	10
TMB10A	10	10
TMB12A	12	10
TMB14A	14	10
TMB16A	16	10
TMB18A	18	14
TMB20A	20	14
TMB22A	22	14

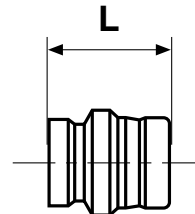

**A**

**TRBMB Tube End Reducer**

PART NO.	TUBE 1	TUBE 2	C1	L
TRBMB6-4	6	4	12	14
TRBMB8-4	8	4	14	15
TRBMB8-6	8	6	14	15
TRBMB10-6	10	6	17	16
TRBMB10-8	10	8	17	16
TRBMB12-8	12	8	19	16
TRBMB12-10	12	10	19	16
TRBMB14-10	14	10	22	18
TRBMB14-12	14	12	22	18
TRBMB16-12	16	12	27	19
TRBMB16-14	16	14	27	19
TRBMB18-14	18	14	30	21
TRBMB20-16	20	16	32	21
TRBMB22-18	22	18	36	21

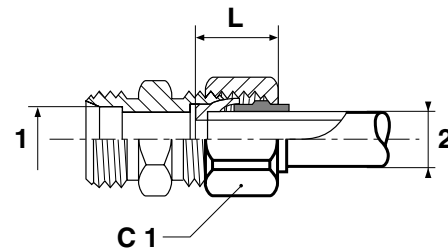

**T23UB Tube Insert**

PART NO.	TUBE I.D.	TUBE O.D.	L
T23UB4	4	6	10
T23UB6	6	8	15
T23UB8	8	10	15
T23UB10	10	12	15
T23UB12	12	14	15

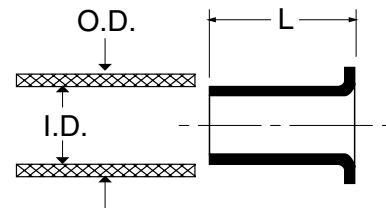



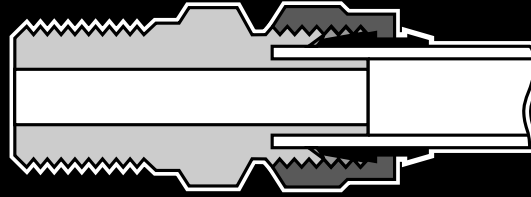

## Poly-Tite Fittings

### Advantages

A compact brass compression fitting designed to speed any installation. Body, nut and sleeve are furnished pre-assembled, ready for installation. An exclusive acetal copolymer sleeve holds plastic tubing where it belongs, even when the system pressure exceeds the tubing burst point. Poly-Tite sleeves have superior resilience to resist creeping and stress caused from compression. The black acetal copolymer sleeve also resists ultra-violet ray attack and has excellent dimensional stability. Poly-Tite nuts will rotate around the sleeve as it tightens to prevent twisting and weakening of the plastic tubing. Poly-Tite fittings can be assembled and disassembled repeatedly.

### Materials

Bodies and Nuts: CA 377, CA 360, CA 345, 316 Stainless Steel  
Plastic Sleeves: Acetal Copolymer.

O-rings: Buna N on chrome plated couplings  
Viton on stainless steel couplings

### Applications

Use with Parker Parflex® or other high-quality thermoplastic tubing for pneumatic instrumentation circuits, lubricant and coolant lines, and applications with other gases and liquids. For use with soft metal tubing and nylon thermoplastic tubing, use brass sleeve and nut assembly 61PB.

### Working Pressure and Temperature Ranges

Up to 150 PSI from 0° to +150°F with thermoplastic tubing. Up to 300 PSI from 0° to +175°F with soft metal tubing.

### Assembly Instructions

#### Polyethylene, polypropylene and vinyl tubing:

1. Cut tubing squarely—maximum of 15° angle allowable.
2. Check that port or mating part is clean and free of debris.
3. Insert tube end until it bottoms in the Poly-Tite fitting and tighten knurl/hex nut finger-tight — plus one wrench turn.

#### Copper, aluminum and nylon tubing:

Brass sleeves are recommended. Insert tube until it bottoms in the Poly-Tite fitting and tighten one wrench turn past finger-tight.

#### Maximum allowable metal tube wall thickness for use with Poly-Tite fittings:

1/8", 3/16" O.D. — no limitation, 1/4" O.D. — .035  
5/16", 3/8", 1/2" O.D. — .049

### Order

By part number and name.

### Nomenclature

Part numbers are constructed from symbols that identify the style and size of the fitting. The first series of numbers and letters identifies the style and type fitting. The second series of numbers describes the size.

**Example:**                    66            P            -4            -2

Female Connector ————┐  
(Tube to female pipe)     └───┬───┐  
Poly-Tite                    └───┬───┐  
1/4" (4/16) Tube O.D.        └───┬───┐  
1/8" (2/16) Pipe Thread     └───┬───┐

### Sizes

Tube sizes are determined by the number of sixteenths of an inch in the tube O.D.

### Special Fittings

Fitting configurations and/or sizes other than those shown in the catalog can be furnished. It is suggested that a print or sketch be submitted with the inquiry.

### Pricing

Only items priced in current supplementary price list PL3501 are carried in stock. Price and delivery for nonstock items furnished on request for specified quantity.

### Tube Support O.D.

Tube Size Inches	* D1 Tube Support O.D.
1/4	.168
5/16	.185
3/8	.248
1/2	.373

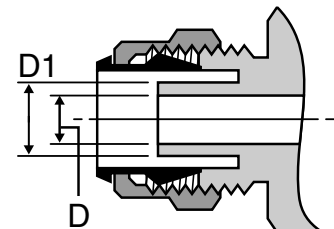

\* Note: No tube support for sizes 1/8" and 3/16"



**Spring Guard 56PSG**

PART NO.	TUBE O.D.	L
56PSG-4	1/4	3.000
56PSG-5	5/16	3.000
56PSG-6	3/8	3.000

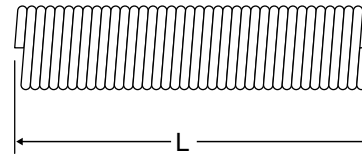

**Plastic Cap 59P**

PART NO.	TUBE SIZE	A	L
59P-4	1/4	.247	.50
59P-5	5/16	.307	.53
59P-6	3/8	.372	.56
59P-8	1/2	.497	.63

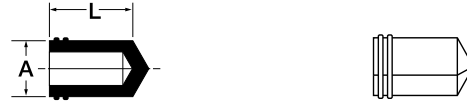

**Acetal Plastic Sleeve 60P**

PART NO.	TUBE SIZE	A	D	L
60P-4	1/4	.334	.261	.338
60P-5	5/16	.405	.321	.340
60P-6	3/8	.465	.381	.367
60P-8	1/2	.628	.514	.399

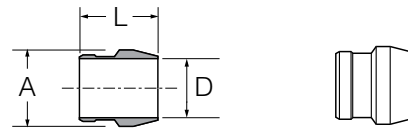

**Sleeve 60PB**

PART NO.	L	O.D.	I.D.
60PB-2	.187	.265	.130
60PB-3	.187	.322	.192
60PB-4	.187	.336	.255
60PB-5	.187	.400	.318
60PB-6	.218	.460	.382
60PB-8	.250	.620	.507

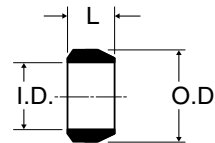

**Nut and Plastic Sleeve Assembly 61P**

PART NO.	TUBE SIZE	STRAIGHT THREAD	C HEX	D	L
61P-2*	1/8	5/16-24	3/8	.130	.34
61P-3*	3/16	3/8-24	7/16	.192	.37
61P-4	1/4	3/8-24	7/16	.261	.38
61P-5	5/16	7/16-24	1/2	.321	.34
61P-6	3/8	1/2-24	9/16	.380	.38
61P-8	1/2	11/16-20	3/4	.514	.44

\* Brass Sleeve

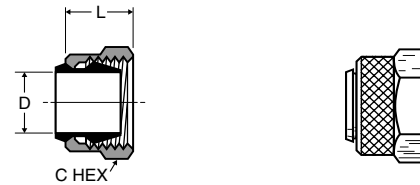

**Nut and Brass Sleeve Assembly 61PB**

PART NO.	TUBE SIZE	STRAIGHT THREAD	C HEX	D	L
61PB-4	1/4	3/8-24	7/16	.255	.38
61PB-5	5/16	7/16-24	1/2	.318	.34
61PB-6	3/8	1/2-24	9/16	.382	.38
61PB-8	1/2	11/16-20	3/4	.507	.44

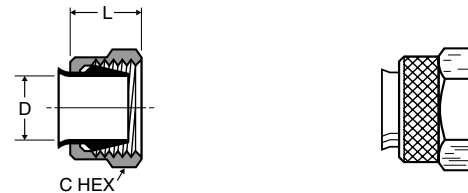

**Nut 61PN**

PART NO.	TUBE SIZE	STRAIGHT THREAD	C HEX	L
61PN-2	1/8	5/16-24	3/8	.34
61PN-3	3/16	3/8-24	7/16	.37
61PN-4	1/4	3/8-24	7/16	.38
61PN-5	5/16	7/16-24	1/2	.34
61PN-6	3/8	1/2-24	9/16	.38
61PN-8	1/2	11/16-20	3/4	.44

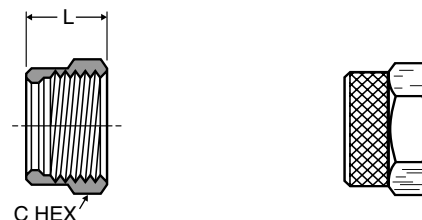

**A**

**Nut only for use with Spring Gaurd 61PSGN**

PART NO.	TUBE O.D.	L	C HEX
61PSGN-4	1/4	.625	.437
61PSGN-5	5/16	.625	.500
61PSGN-6	3/8	.656	.562

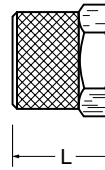

**Union 62P**

PART NO.	TUBE SIZE	STRAIGHT THREAD	C HEX	L	M	FLOW DIA. D
62P-2*	1/8	5/16-24	5/16	1.08	.64	.094
62P-3*	3/16	3/8-24	3/8	1.16	.73	.125
62P-4	1/4	3/8-24	3/8	1.17	.96	.125
62P-5	5/16	7/16-24	7/16	1.16	.96	.144
62P-6	3/8	1/2-24	1/2	1.23	.99	.204
62P-8	1/2	11/16-20	11/16	1.47	1.24	.323

\* Brass Sleeve, No Tube Support

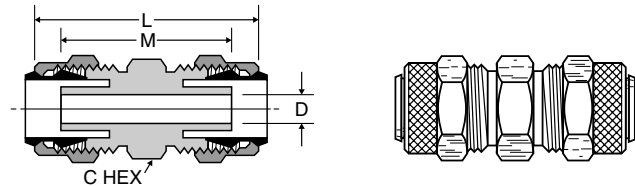

**Union Reducer 62P**

PART NO.	1 TUBE SIZE	2 TUBE SIZE	1 STRAIGHT THREAD	2 STRAIGHT THREAD	C HEX	L	M	FLOW DIA. D
62P-6-4	1/4	3/8	3/8-24	1/2-24	1/2	1.22	.99	.125

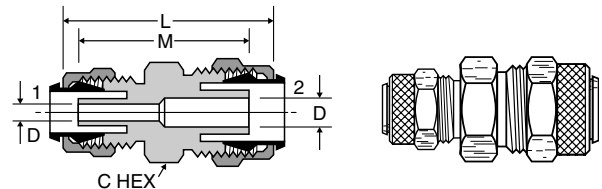

**Bulkhead Union 62PBH**

PART NO.	TUBE SIZE	STRAIGHT THREAD	C HEX	P MAX.	L	M	BULKHEAD HOLE DIA.	FLOW DIA. D
62PBH-4	1/4	3/8-24	9/16	.38	1.75	1.53	3/8	.125
62PBH-5	5/16	7/16-24	5/8	.38	1.71	1.52	7/16	.144
62PBH-6	3/8	1/2-24	11/16	.47	1.89	1.65	1/2	.204
62PBH-8	1/2	11/16-20	7/8	.63	2.28	2.05	11/16	.323

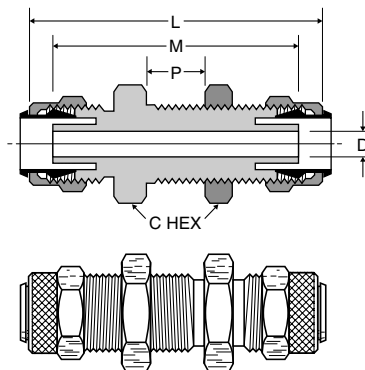

**Union 62PCA**

(Tube to Compress-Align)

PART NO.	TUBE SIZE	1 STRAIGHT THREAD	2 STRAIGHT THREAD	C HEX	L	M	FLOW DIA. D
62PCA-4	1/4	3/8-24	7/16-24	7/16	1.25	.89	.125
62PCA-5	5/16	7/16-24	1/2-24	1/2	1.30	.92	.144
62PCA-6	3/8	1/2-24	9/16-24	9/16	1.37	.98	.204

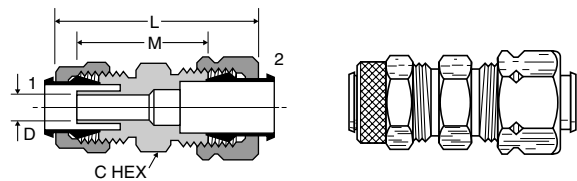



**Bulkhead Union 62PCABH**

(Tube to Compress-Align)

PART NO.	TUBE SIZE	1 STRAIGHT THREAD	2 STRAIGHT THREAD	C HEX	P MAX	L	M	BULKHEAD HOLE DIA.	FLOW DIA. D
62PCABH-4	1/4	3/8-24	7/16-24	9/16	.38	1.81	1.45	3/8	.125
62PCABH-6	3/8	1/2-24	9/16-24	11/16	.47	2.03	1.64	1/2	.204

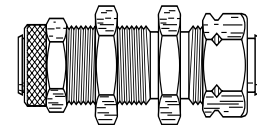
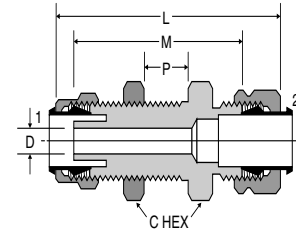

**Bulkhead Union 62PTBH**

(Straight Through)

PART NO.	TUBE SIZE	STRAIGHT THREAD	C HEX	P MAX.	L	M	BULKHEAD HOLE DIA.	FLOW DIA. D
62PTBH-4	1/4	3/8-24	9/16	.31	1.19	.93	3/8	.260
62PTBH-5	5/16	7/16-24	5/8	.31	1.19	.93	7/16	.323
62PTBH-6	3/8	1/2-24	11/16	.34	1.26	.99	1/2	.387

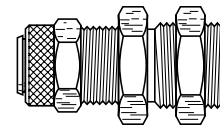
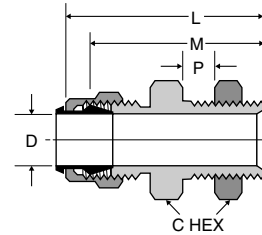

**Brass Insert 63PT**

PART NO.	TUBE SIZE	L	O.D.
63PT-2-16	1/8	.46	.080
63PT-2-32	1/8	.31	.061
63PT-3-25	3/16	.45	.135
63PT-3-40	3/16	.52	.095

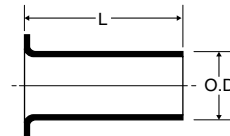

**Female Connector 66P**

PART NO.	TUBE SIZE	PIPE THREAD	STRAIGHT THREAD	C HEX	L	M	FLOW DIA. D
66P-2-2*	1/8	1/8	5/16-24	9/16	.97	.75	.094
66P-3-2*	3/16	1/8	3/8-24	9/16	1.00	.78	.125
66P-3-4*	3/16	1/4	3/8-24	11/16	1.18	.96	.125
66P-4-2	1/4	1/8	3/8-24	1/2	.97	.86	.125
66P-4-4	1/4	1/4	3/8-24	5/8	1.18	1.07	.125
66P-5-2	5/16	1/8	7/16-24	1/2	.97	.86	.144
66P-6-4	3/8	1/4	1/2-24	5/8	1.18	1.07	.204
66P-8-6	1/2	3/8	11/16-20	13/16	1.31	1.20	.323

\*Brass Sleeve, No Tube Support

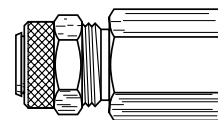
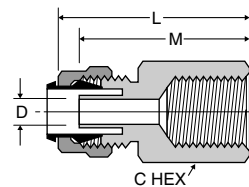

**A**

**Male Connector 68P**

PART NO.	TUBE SIZE	PIPE THREAD	STRAIGHT THREAD	C HEX	L	M	FLOW DIA. D
68P-2-1*	1/8	1/16	5/16-24	11/32	1.00	.78	.094
68P-2-10X32*	1/8	10-32	5/16-24	3/8	.86	.64	.094
68P-2-2*	1/8	1/8	5/16-24	7/16	.99	.77	.094
68P-3-1	3/16	1/16	3/8-24	7/16	1.09	.84	.094
68P-3-2*	3/16	1/8	3/8-24	7/16	1.06	.84	.125
68P-3-4*	3/16	1/4	3/8-24	9/16	1.25	1.03	.125
68P-4-1	1/4	1/16	3/8-24	3/8	1.06	.95	.125
68P-4-10X32	1/4	10-32	3/8-24	3/8	.86	.75	.094
68P-4-2	1/4	1/8	3/8-24	7/16	1.06	.95	.125
68P-4-4	1/4	1/4	3/8-24	9/16	1.25	1.14	.125
68P-4-6	1/4	3/8	3/8-24	11/16	1.28	1.17	.125
68P-5-2	5/16	1/8	7/16-24	7/16	1.05	.95	.144
68P-5-4	5/16	1/4	7/16-24	9/16	1.24	1.14	.144
68P-6-2	3/8	1/8	1/2-24	1/2	1.10	.98	.204
68P-6-4	3/8	1/4	1/2-24	9/16	1.29	1.17	.204
68P-6-6	3/8	3/8	1/2-24	11/16	1.29	1.17	.204
68P-8-4	1/2	1/4	11/16-20	11/16	1.46	1.29	.320
68P-8-6	1/2	3/8	11/16-20	11/16	1.37	1.29	.323

\*Brass Sleeve, No Tube Support

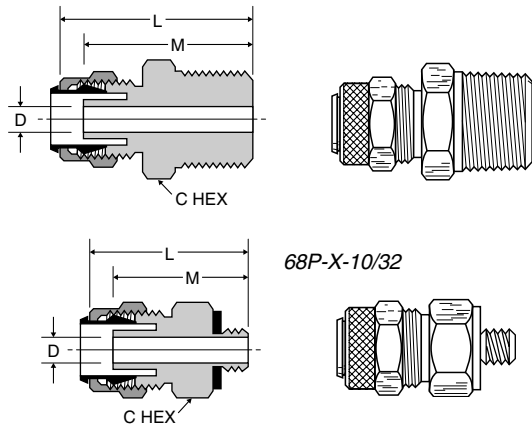

**Tube End Reducer 97P**

PART NO.	TUBE O.D.	L	M	C HEX
97P-4-6	3/8 X 1/4	1.718	1.625	.437
97P-6-8	1/2 X 3/8	1.875	1.781	.562

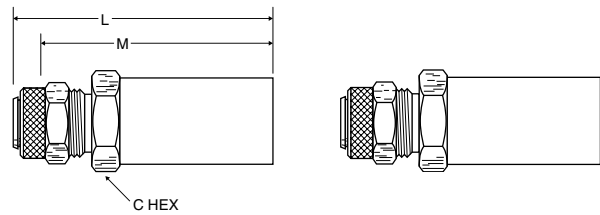

**Pipe Coupler Body 391P**

(Chrome Plated)

PART NO.	D-INSERT DIA.	PIPE THREAD	C HEX	H	L
391P-4-2	1/4	1/8	1/2	.91	1.29
391P-4-4	1/4	1/4	9/16	.73	1.29
391P-6-4	3/8	1/4	5/8	.85	1.41

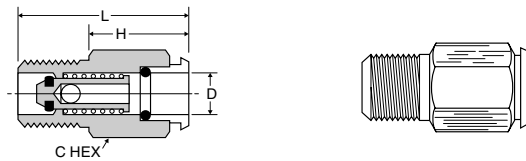

**Pipe Coupler Body 391PSS**

(Stainless Steel)

PART NO.	D INSERT DIA.	PIPE THREAD	L	C HEX	M
391PSS-4-2	1/4	1/8	1.271	.500	.900
391PSS-4-4	1/4	1/4	1.271	.562	.710
391PSS-6-4	3/8	1/4	1.40	.625	.840

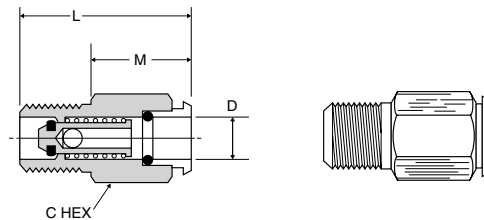



**Bulkhead Coupler Body 392P**

(Chrome Plated)

PART NO.	TUBE SIZE	D-INSERT DIA.	STRAIGHT THREAD	C HEX	P MAX.	H	L	BULKHEAD HOLE DIA.
392P-4-4	1/4	1/4	1/2-24	5/8	.84	.39	2.13	1/2
392P-6-6	3/8	3/8	11/16-24	13/16	.93	.37	2.01	11/16

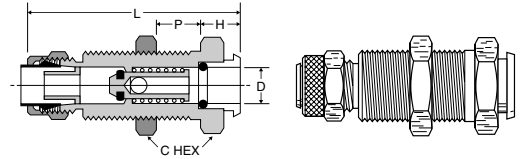

**Bulkhead Coupler Body 392PSS**

(Stainless Steel)

PART NO.	TUBE O.D.	BULKHEAD THREAD	L	C HEX	H	P MAX	BULKHEAD HOLE DIA.
392PSS-4-4	1/4	1/2-24	2.03	.625	.28	.84	1/2
392PSS-6-6	3/8	11/16-24	2.20	.812	.31	.93	11/16

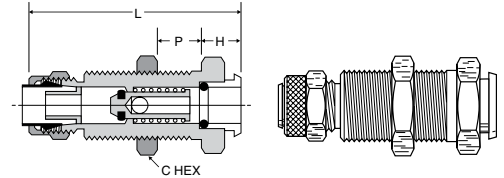

**Through Type Insert 393P**

(Chrome Plated)

PART NO.	TUBE SIZE	D-INSERT DIA.	STRAIGHT THREAD	C SQUARE	H	FLOW DIA.F
393P-4-4	1/4	1/4	3/8-24	7/16	1.12	.125
393P-6-6	3/8	3/8	1/2-24	1/2	1.34	.203

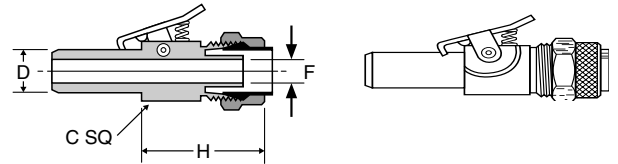

**Through Type Insert 393PSS**

(Stainless Steel)

PART NO.	TUBE O.D.	D-INSERT DIA.	L	C SQUARE	H	FLOW DIA.F
393PSS-4-4	1/4	1/4	1.677	.500	.99	.125
393PSS-6-6	3/8	3/8	2.030	.500	1.27	.203

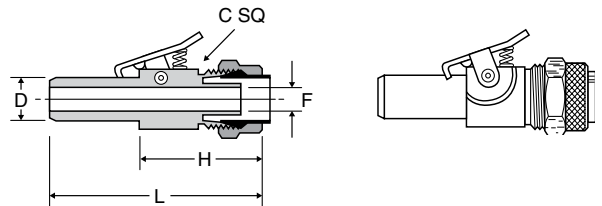

**Shutoff Type Insert 393PD**

(Chrome Plated)

PART NO.	TUBE SIZE	D-INSERT DIA.	STRAIGHT THREAD	C SQUARE	H	FLOW DIA.F
393PD-4-4	1/4	1/4	3/8-24	7/16	1.61	.110
393PD-6-6	3/8	3/8	1/2-24	1/2	1.45	.187

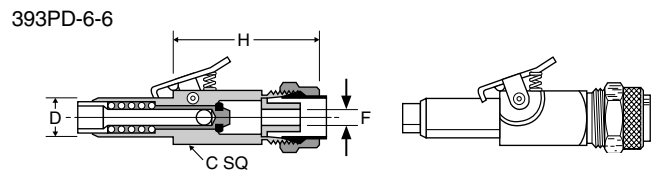
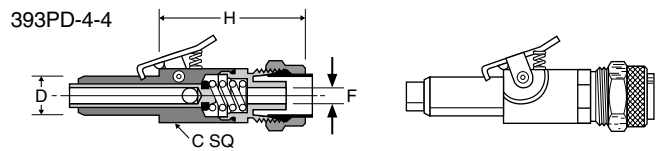

**A**

**Shut-Off Type Insert 393PDSS**

(Stainless Steel)

PART NO.	TUBE O.D.	D-INSERT DIA.	L	C SQUARE	H	FLOW DIA.F
393PDSS-4-4	1/4	1/4	2.46	.500	1.62	.116
393PDSS-6-6	3/8	3/8	2.60	.500	1.67	.157

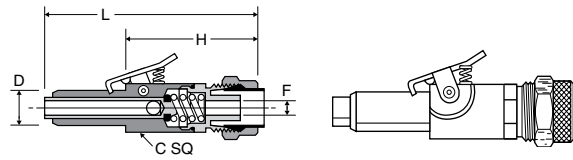

**Single End Shutoff Bulkhead Quick Coupler 394P**

(Chrome Plated)

PART NO.	TUBE SIZE	STRAIGHT THREAD	C HEX	P MAX.	H	L	M	BULKHEAD HOLE DIA.	FLOW DIA.F
394P-4-4	1/4	1/2-24	5/8	.84	.39	3.28	2.13	1/2	.125
394P-6-6	3/8	11/16-24	13/16	.93	.37	3.41	2.01	11/16	.203

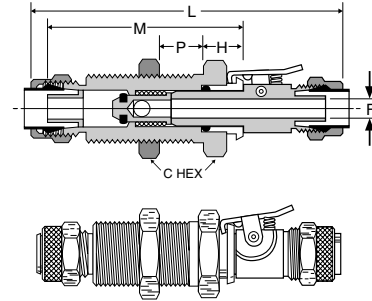

**Coupler Single End Shut-Off Bulkhead 394PSS**

(Stainless Steel)

PART NO.	TUBE O.D.	BULKHEAD THREAD	L	M	C HEX	H	P MAX.	FLOW DIA.F
394PSS-4-4	1/4	1/2-24	3.05	2.06	.625	.31	.84	.125
394PSS-6-6	3/8	11/16-24	3.50	2.23	.812	.34	.93	.203

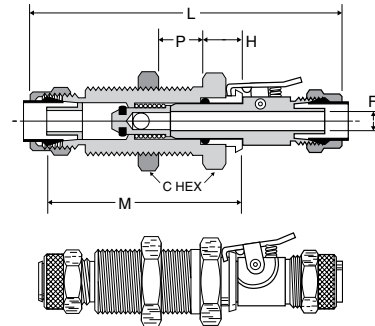

**Double End Shutoff Bulkhead Quick Coupler 394PD**

(Chrome Plated)

PART NO.	TUBE SIZE	STRAIGHT THREAD	C HEX	P MAX.	H	L	M	BULKHEAD HOLE DIA.	FLOW DIA.F
394PD-4-4	1/4	1/2-24	5/8	.84	.39	3.77	2.13	1/2	.125
394PD-6-6	3/8	11/16-24	13/16	.93	.37	3.48	2.01	11/16	.204

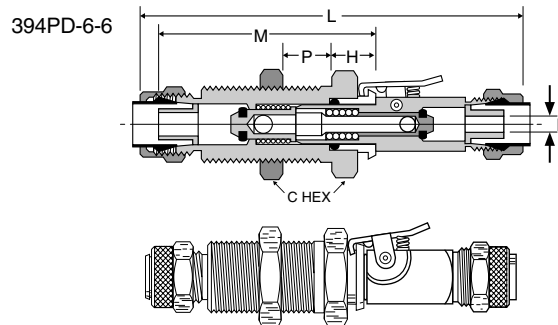
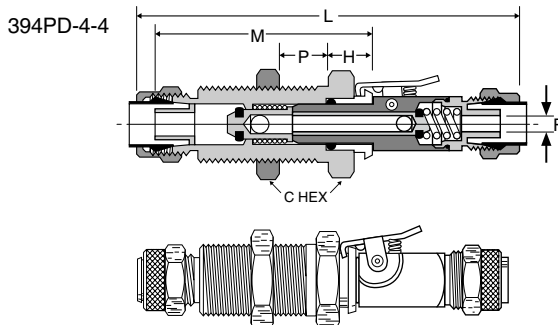



**Double End Shut-Off Bulkhead Quick Coupler 394PDSS**

(Stainless Steel)

PART NO.	TUBE O.D.	BULKHEAD THREAD	L	M	C HEX	H	P MAX	FLOW DIA. F
394PDSS-4-4	1/4	1/2-24	3.69	2.67	.625	.32	.84	.125
394PDSS-6-6	3/8	11/16-24	3.91	2.24	.812	.34	.93	.203

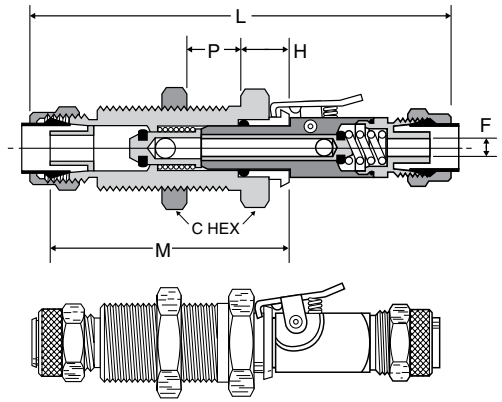

**Single End Shutoff Pipe Connector Quick Coupler 398P**

(Chrome Plated)

PART NO.	TUBE SIZE	PIPE THREAD	STRAIGHT THREAD	C HEX	L	M	FLOW DIA.F
398P-4-2	1/4	1/8	3/8-24	1/2	2.45	1.32	.125
398P-4-4	1/4	1/4	3/8-24	9/16	2.45	1.32	.125
398P-6-4	3/8	1/4	1/2-24	5/8	2.80	1.46	.203

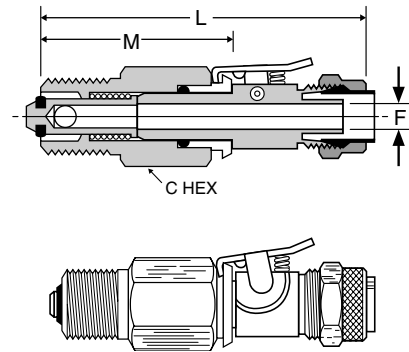

**Single End Shut-Off Connector Quick Coupler 398PSS**

(Stainless Steel)

PART NO.	TUBE O.D.	PIPE THREAD	L	M	C HEX	FLOW DIA. F
398PSS-4-2	1/4	1/8	2.30	1.32	.500	.125
398PSS-4-4	1/4	1/4	2.30	1.32	.562	.125
398PSS-6-4	3/8	1/4	2.70	1.43	.625	.203

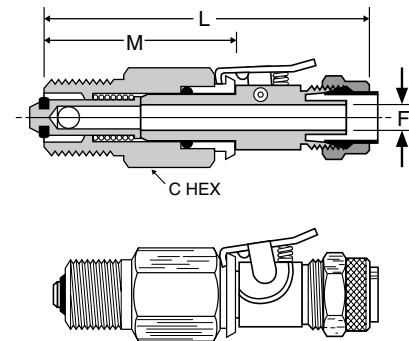



**A**

**Double End Shutoff Pipe Connector Quick Coupler 398PD**

(Chrome Plated)

PART NO.	TUBE SIZE	PIPE THREAD	STRAIGHT THREAD	C HEX	L	M	FLOW DIA.F
398PD-4-2	1/4	1/8	3/8-24	1/2	2.93	1.31	.125
398PD-4-4	1/4	1/4	3/8-24	9/16	2.93	1.32	.125
398PD-6-4	3/8	1/4	1/2-24	5/8	2.88	1.43	.204

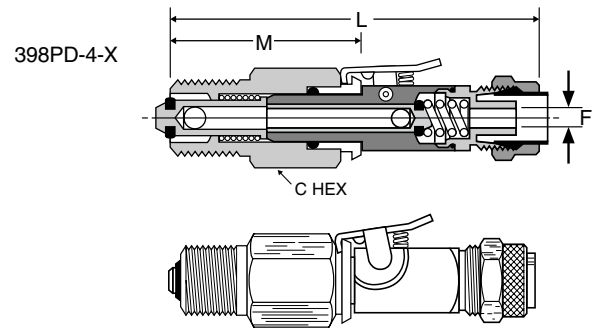
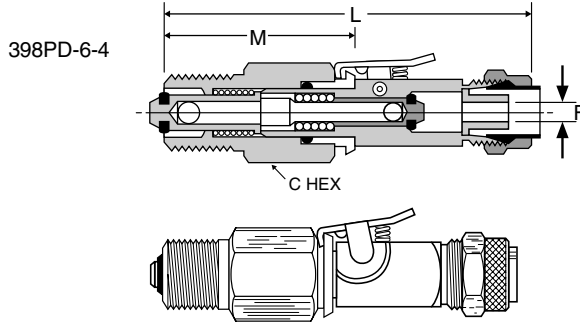

**Double End Shut-Off Pipe Connector Quick Coupler 398PDSS**

(Stainless Steel)

PART NO.	TUBE O.D.	PIPE THREAD	L	M	C HEX	FLOW DIA. D
398PDSS-4-2	1/4	1/8	2.93	1.31	.500	.125
398PDSS-4-4	1/4	1/4	2.93	1.31	.562	.125
398PDSS-6-4	3/8	1/4	3.10	1.43	.625	.125

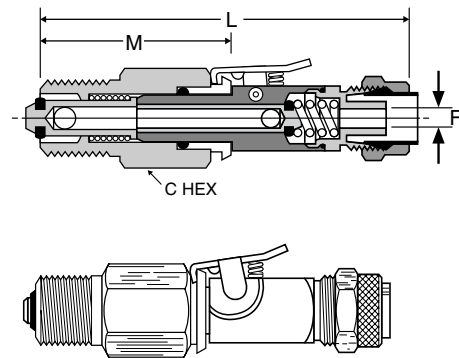

**Union Tee 164P**

PART NO.	TUBE SIZE	STRAIGHT THREAD	L	M	FLOW DIA.D
164P-2*	1/8	5/16-24	.83	.61	.094
264P-3*	3/16	3/8-24	.83	.61	.125
164P-4	1/4	3/8-24	.84	.73	.125
164P-5	5/16	7/16-24	.83	.73	.144
164P-6	3/8	1/2-24	.98	.86	.203
164P-8	1/2	1 1/16-20	1.12	1.04	.323

\*Brass Sleeve, No Tube Support

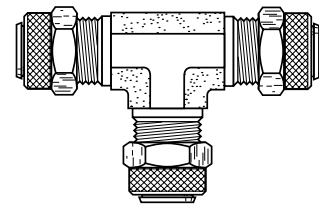
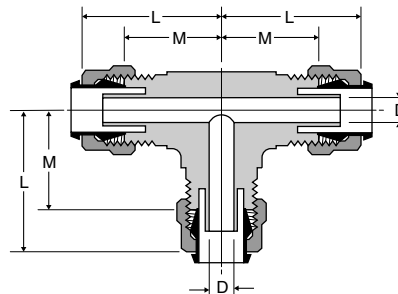



**Union Tee 164P combination size**

PART NO.	1 TUBE SIZE	2 TUBE SIZE	3 TUBE SIZE	L	L1	M	M1	FLOW DIA.D
164P-6-4	3/8	3/8	1/4	.98	.90	.86	.79	.125

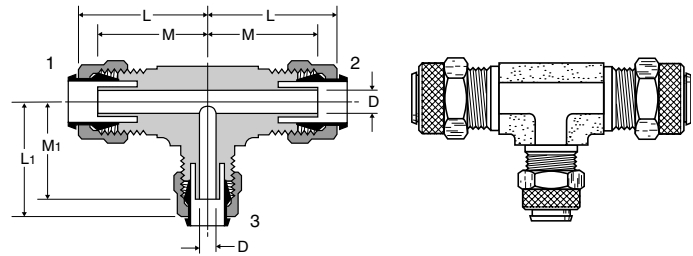

**Male Elbow 169P/269P**

PART NO.	TUBE SIZE	PIPE THREAD	STRAIGHT THREAD	L	M	N	FLOW DIA.D
169P-2-1	1/8	1/16	5/16-24	.88	.63	.69	.094
269P-2-2*	1/8	1/8	5/16-24	.83	.61	.67	.094
169P-3-1	3/16	1/16	3/8-24	.88	.63	.69	.094
169P-3-2*	3/16	1/8	3/8-24	.83	.61	.69	.125
169P-3-4*	3/16	1/4	3/8-24	.85	.63	.94	.125
169P-4-1	1/4	1/16	3/8-24	.92	.58	.67	.130
169P-4-2	1/4	1/8	3/8-24	.84	.73	.75	.121
169P-4-4	1/4	1/4	3/8-24	.90	.79	.92	.125
169P-4-6	1/4	3/8	3/8-24	.93	.84	1.08	.125
169P-5-2	5/16	1/8	7/16-24	.87	.73	.68	.144
169P-6-2	3/8	1/8	1/2-24	.93	.81	.73	.203
169P-6-4	3/8	1/4	1/2-24	.98	.86	1.05	.203
169P-6-6	3/8	3/8	1/2-24	.98	.86	1.08	.203
169P-8-6	1/2	3/8	11/16-20	1.12	1.04	1.13	.323

\*Brass Sleeve, No Tube Support

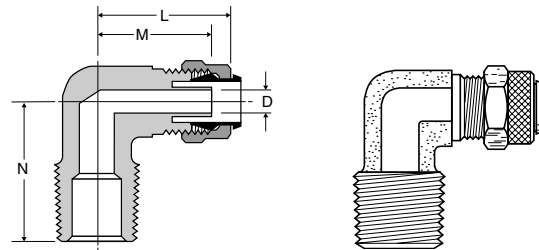

**Long Male Elbow 169LP**

PART NO.	TUBE SIZE	PIPE THREAD	STRAIGHT THREAD	L	M	N	FLOW DIA.D
169LP-4-4	1/4	1/4	3/8-24	.90	.79	1.38	.125

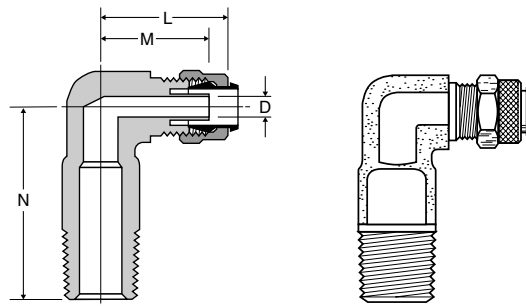

**Male Elbow Swivel 169PS**

PART NO.	TUBE O.D.	PIPE THREAD	A	B	C HEX	D	E
169PS-4-2	1/4	1/8	.812	.594	.375	.862	.437
169PS-4-4	1/4	1/4	.906	.688	.562	1.218	.562
169PS-6-2	3/8	1/8	.875	.625	.437	.904	.437
169PS-6-4	3/8	1/4	.937	.685	.562	1.218	.562
169PS-6-6	3/8	3/8	.859	.602	.562	1.190	.687
169PS-8-6	1/2	3/8	1.031	.782	.500	1.218	.687

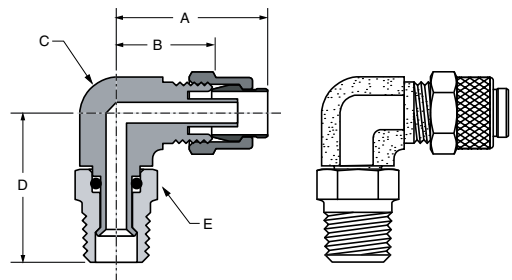

**A**

**Female Elbow 170P**

PART NO.	TUBE SIZE	PIPE THREAD	STRAIGHT THREAD	L	M	N	FLOW DIA.D
170P-2-2*	1/8	1/8	5/16-24	.91	.69	.56	.094
170P-3-2*	3/16	1/8	3/8-24	.91	.69	.56	.125
170P-4-2	1/4	1/8	3/8-24	.90	.79	.56	.125
170P-4-4	1/4	1/4	3/8-24	1.00	.89	.69	.125
170P-6-4	3/8	1/4	1/2-24	1.01	.89	.69	.204
170P-8-6	1/2	3/8	11/16-20	1.19	1.11	1.13	.323

\*Brass Sleeve, No Tube Support

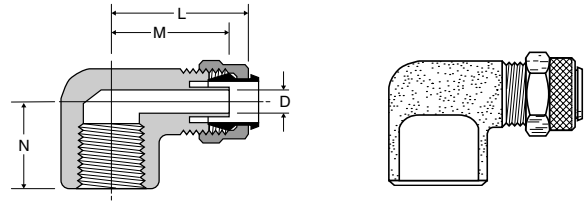

**Male Run Tee 171P**

PART NO.	TUBE SIZE	PIPE THREAD	STRAIGHT THREAD	L	M	N	FLOW DIA.D
171P-2-2*	1/8	1/8	5/16-24	.82	.60	.67	.094
171P-3-2*	3/16	1/8	3/8-24	.82	.60	.67	.125
171P-4-2	1/4	1/8	3/8-24	.84	.73	.72	.125
171P-4-4	1/4	1/4	3/8-24	.92	.81	.92	.125
171P-5-2	5/16	1/8	7/16-24	.83	.73	.72	.144
171P-6-4	3/8	1/4	1/2-24	.98	.86	1.03	.203
171P-8-6	1/2	3/8	11/16-20	1.12	1.04	1.13	.323

\*Brass Sleeve, No Tube Support

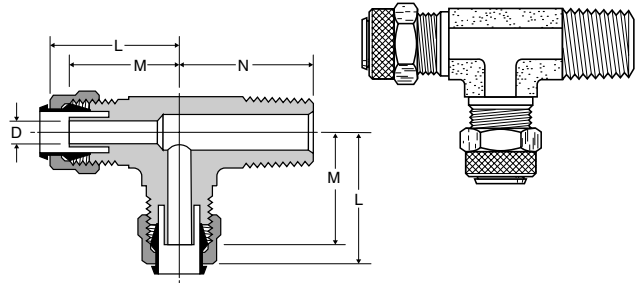

**Male Branch Tee 172P**

PART NO.	TUBE SIZE	PIPE THREAD	STRAIGHT THREAD	L	M	N	FLOW DIA.D
172P-2-2*	1/8	1/8	5/16-24	.82	.60	.67	.094
172P-3-2*	3/16	1/8	3/8-24	.82	.60	.67	.125
172P-4-2	1/4	1/8	3/8-24	.84	.73	.72	.125
172P-4-4	1/4	1/4	3/8-24	.92	.81	.92	.125
172P-5-2	5/16	1/8	7/16-24	.83	.73	.72	.144
172P-6-2	3/8	1/8	1/2-24	.88	.86	.74	.204
172P-6-4	3/8	1/4	1/2-24	.98	.86	1.03	.204
172P-8-6	1/2	3/8	11/16-20	1.12	1.04	1.13	.323

\*Brass Sleeve, No Tube Support

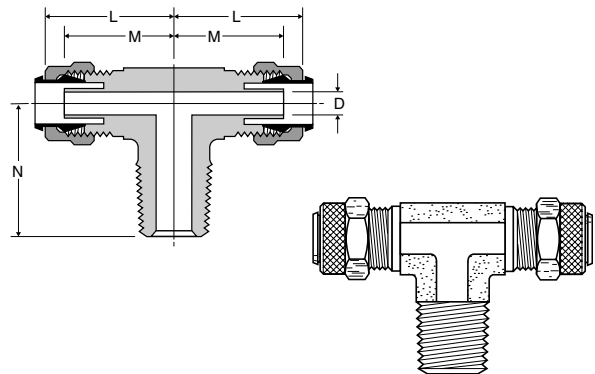

**Female Branch Tee 177P**

PART NO.	TUBE SIZE	PIPE THREAD	STRAIGHT THREAD	L	M	N	FLOW DIA.D
177P-4-2	1/4	1/8	3/8-24	.92	.81	.88	.125
177P-4-4	1/4	1/4	3/8-24	.92	.81	1.03	.125
177P-4-6	1/4	3/8	3/8-24	1.03	.92	1.13	.125

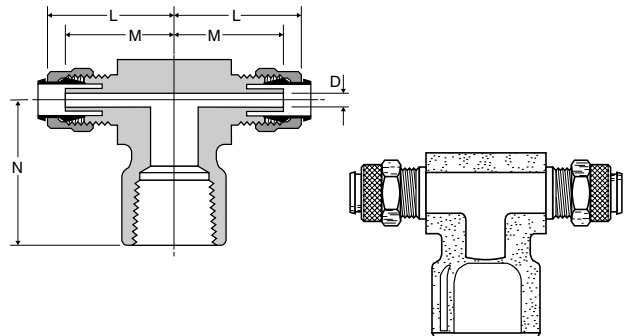



**Needle Valve NV311P**

PART NO.	TUBE SIZE	PIPE THREAD	H	L OPEN	L CLOSED	M	N
NV311P-4-2	1/4	1/8	1.06	1.36	1.16	.64	.63
NV311P-4-4	1/4	1/4	1.06	1.38	1.18	.64	.72
NV311P-6-4	3/8	1/4	1.06	1.38	1.18	.64	.72

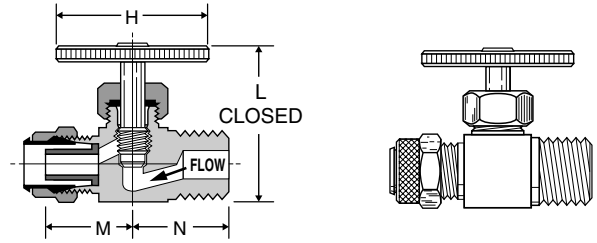

**Angle Needle Valve NV312P**

PART NO.	TUBE SIZE	PIPE THREAD	H	L OPEN	L CLOSED	M	N
NV312P-4-2	1/4	1/8	1.06	1.70	1.50	.63	.68
NV312P-4-4	1/4	1/4	1.06	2.07	1.82	.71	.86
NV312P-6-4	3/8	1/4	1.06	2.00	1.75	.74	.86

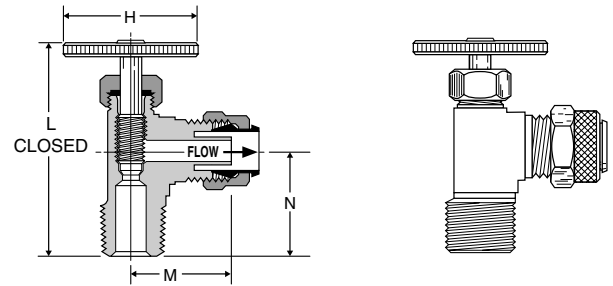

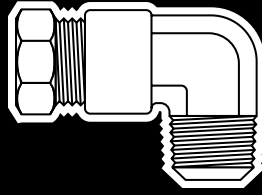

## Hi-Duty Flareless Tube Fittings

### Advantages

No flaring, soldering or other preparation of tubing is necessary. Pre-assembled brass fitting, with sleeve machined onto nut. This two piece flareless compression design is available in a broad selection of configurations from 1/8" through 5/8" OD. tube size.

### Applications

Use with copper, brass, seamless steel and thermoplastic tubing for instrumentation systems, farm and mobile construction equipment, hydraulic and pneumatic controls, process control systems and laboratory equipment.

Steel tubing must be cold drawn and annealed seamless low-carbon steel tubing per SAE J524 with a maximum hardness of Rockwell B 65. Brass insert 63PT is recommended for use with thermoplastic tubing.

### Working Pressure Range

Up to 4,300 psi depending on tubing being used

### Maximum Recommended Working Pressure

Tube O.D.	PSI
1/8	4,300
3/16	2,850
1/4	2,100
5/16	1,800
3/8	1,500
1/2	1,150
5/8	1,000

### Assembly Instructions

1. Cut tube squarely and cleanly removing all burrs.
2. Grasp fitting. Do not remove nut.
3. Insert tube in fitting through nut until tube seats firmly against tube shoulder in body.
4. Grip tube firmly to prevent turning and tighten nut to finger-tight. Continue to tighten nut for one and three-quarter additional turns (one and one-half turns for 1/2" size tube fittings) for a positive, leak proof seal. During tightening a slight "give" will be felt. This "give" indicates the sleeve has been sheared from the nut. It is not necessary to tighten the nut all the way down.

### To Reconnect:

1. Reinsert tubing
2. Tighten nut one-eighth of a turn more than previous make-up.

### Order

By part number and name.

### Nomenclature

Part numbers are constructed from symbols that identify the style and size of the fitting. The first series of numbers and letters identifies the style and type of fitting. The second series of numbers describes the size.

### Example:

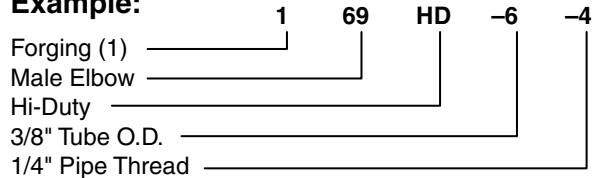

### Special Fittings

Fitting configurations and/or sizes other than those shown in the catalog can be furnished. It is suggested that a print or sketch be submitted with the inquiry.

### Pricing

Only items priced in current supplementary price list PL3501 are carried in stock. Price and delivery for non-stock items furnished on request for specified quantity.



**Bulkhead Union 62HDBH**

PART NO.	TUBE SIZE	MIN. ORIFICE SIZE	A	B	C	D	E
62HDBH-2	1/8	.093	1.781	1.156	.562	.625	7/16-24
62HDBH-4	1/4	.187	1.968	1.156	.687	.625	9/16-24

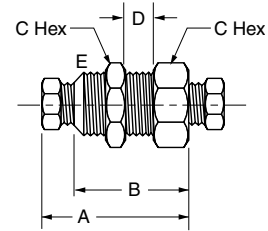

**Nut/Sleeve 61HD**

PART NO.	TUBE SIZE	PIPE THREAD	A	C
61HD-2	1/8	5/16-24	.656	.312
61HD-3	3/16	3/8-24	.687	.375
61HD-4	1/4	7/16-24	.734	.437
61HD-5	5/16	1/2-20	.765	.500
61HD-6	3/8	9/16-20	.843	.562
61HD-8	1/2	1 1/16-16	.921	.688
61HD-10	5/8	7/8-18	1.078	.875

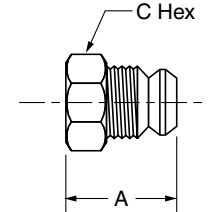

**Union 62HD**

PART NO.	TUBE SIZE	MIN. ORIFICE SIZE	A	B	C
62HD-2	1/8	.093	1.687	1.062	.375
62HD-3	3/16	.125	1.781	1.031	.437
62HD-4	1/4	.187	1.906	1.093	.562
62HD-6	3/8	.312	2.187	1.375	.625
62HD-8	1/2	.437	2.437	1.562	.812
62HD-10	5/8	.500	2.937	1.812	1.062

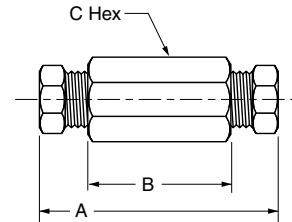

**Union Tee 164HD**

PART NO.	TUBE SIZE	MIN. ORIFICE SIZE	A	B	C HEX
164HD-4	1/4	.187	1.082	.687	.500
164HD-6	3/8	.312	1.357	.970	.562
164HD-8	1/2	.437	1.481	1.060	.750

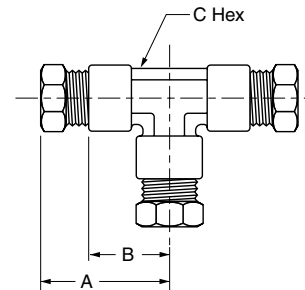

**Union Elbow 165HD**

PART NO.	TUBE SIZE	MIN. ORIFICE SIZE	A	B	C HEX
165HD-4	1/4	.187	1.084	.690	.552
165HD-6	3/8	.312	1.376	.970	.615
165HD-8	1/2	.437	1.546	1.060	.750

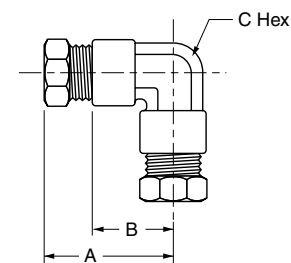

**A**

**Female Connector 66HD**

PART NO.	TUBE SIZE	PIPE THREAD	MIN. ORIFICE SIZE	A	B	C HEX
66HD-2-2	1/8	1/8	.093	1.312	1.000	.500
66HD-4-2	1/4	1/8	.187	1.406	1.000	.562
66HD-4-4	1/4	1/4	.187	1.593	1.187	.687
66HD-6-2	3/8	1/8	.312	1.531	1.125	.625
66HD-6-4	3/8	1/4	.312	1.718	1.312	.625
66HD-6-6	3/8	3/8	.312	1.750	1.343	.812

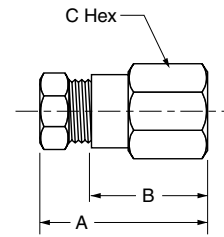

**Reducing Union 62HD**

PART NO.	TUBE SIZE	MIN. ORIFICE SIZE	A	B	C HEX
62HD-6-4	3/8 X 1/4	.187	2.000	1.187	.625
62HD-8-4	1/2 X 1/4	.187	2.125	1.281	.812
62HD-8-6	1/2 X 3/8	.312	2.656	1.406	.812

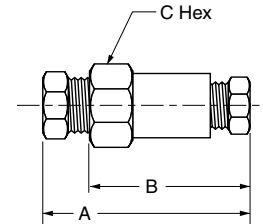

**Male Connector 68HD**

PART NO.	TUBE SIZE	PIPE THREAD	MIN. ORIFICE SIZE	A	B	C HEX
68HD-2-2	1/8	1/8	.093	1.062	.750	.437
68HD-3-2	3/16	1/8	.125	1.140	.765	.437
68HD-4-2	1/4	1/8	.187	1.343	.937	.562
68HD-4-4	1/4	1/4	.187	1.468	1.062	.562
68HD-4-6	1/4	3/8	.187	1.343	.937	.687
68HD-4-8	1/4	1/2	.187	1.531	1.125	.875
68HD-5-2	5/16	1/8	.218	1.406	1.000	.562
68HD-5-4	5/16	1/4	.218	1.500	1.093	.562
68HD-6-2	3/8	1/8	.218	1.531	1.125	.625
68HD-6-4	3/8	1/4	.312	1.656	1.250	.625
68HD-6-6	3/8	3/8	.312	1.531	1.125	.687
68HD-6-8	3/8	1/2	.312	1.531	1.125	.875
68HD-8-4	1/2	1/4	.312	1.813	1.375	.812
68HD-8-6	1/2	3/8	.406	1.750	1.312	.812
68HD-8-8	1/2	1/2	.437	1.812	1.375	.875
68HD-8-12	1/2	3/4	.437	1.625	1.187	1.062
68HD-10-6	5/8	3/8	.406	2.031	1.468	1.062
68HD-10-8	5/8	1/2	.500	2.156	1.593	1.062

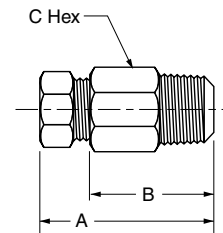

**Male Elbow 169HD**

PART NO.	TUBE SIZE	PIPE THREAD	MIN. ORIFICE SIZE	A	B	C HEX	D
169HD-2-2	1/8	1/8	.093	.975	.656	.438	.720
169HD-3-2	3/16	1/8	.125	1.056	.687	.437	.750
169HD-4-2	1/4	1/8	.187	1.084	.687	.500	.750
169HD-4-4	1/4	1/4	.187	1.144	.750	.500	.937
169HD-5-2	5/16	1/8	.218	1.144	.750	.562	.810
169HD-5-4	5/16	1/4	.250	1.206	.812	.562	1.000
169HD-6-2	3/8	1/8	.218	1.281	.875	.562	.875
169HD-6-4	3/8	1/4	.312	1.281	.875	.562	1.000
169HD-6-6	3/8	3/8	.312	1.376	.970	.615	1.031
169HD-6-8	3/8	1/2	.312	1.526	1.120	.687	1.310
169HD-8-4	1/2	1/4	.312	1.421	1.000	.678	1.062
169HD-8-6	1/2	3/8	.406	1.421	1.000	.678	1.062
169HD-8-8	1/2	1/2	.437	1.481	1.060	.740	1.420
169HD-10-6	5/8	3/8	.406	1.818	1.270	.875	1.340
169HD-10-8	5/8	1/2	.500	1.818	1.270	.875	1.480

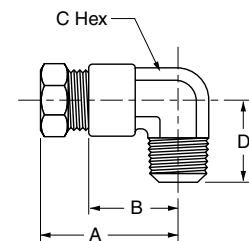



**Female Elbow 170HD**

PART NO.	TUBE SIZE	PIPE THREAD	MIN. ORIFICE SIZE	A	B	C HEX	D
170HD-2-2	1/8	1/8	.093	1.005	.690	.500	.750
170HD-4-2	1/4	1/8	.187	1.084	.687	.500	.750
170HD-4-4	1/4	1/4	.187	1.234	.843	.562	.875
170HD-6-2	3/8	1/8	.312	1.281	.875	.562	.937
170HD-6-4	3/8	1/4	.312	1.376	.970	.615	1.093
170HD-6-6	3/8	3/8	.312	1.526	1.120	.690	1.150
170HD-8-6	1/2	3/8	.437	1.481	1.062	.740	1.281

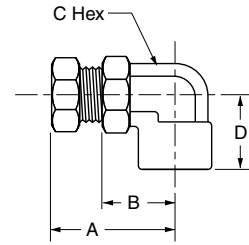

**Male Run Tee 171HD**

PART NO.	TUBE SIZE	PIPE THREAD	MIN. ORIFICE SIZE	A	B	C HEX	D
171HD-4-2	1/4	1/8	.187	1.144	.750	.500	.780
171HD-4-4	1/4	1/4	.187	1.207	.812	.500	.937
171HD-6-4	3/8	1/4	.312	1.376	.970	.562	1.000

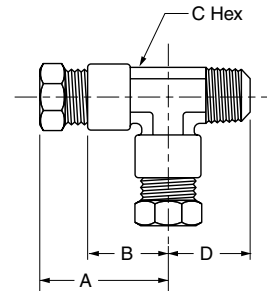

**Male Branch Tee 172HD**

PART NO.	TUBE SIZE	PIPE THREAD	MIN. ORIFICE SIZE	A	B	C HEX	D
172HD-4-2	1/4	1/8	.187	1.082	.687	.500	.780
172HD-4-4	1/4	1/4	.187	1.269	.875	.500	.937
172HD-6-6	3/8	3/8	.312	1.406	1.000	.562	1.125

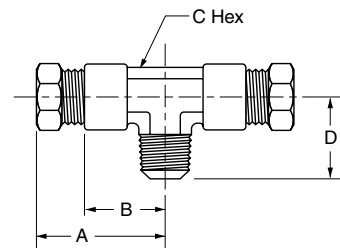

**45° Male Elbow 179HD**

PART NO.	TUBE SIZE	PIPE THREAD	MIN. ORIFICE SIZE	A	B	C HEX	D
179HD-4-2	1/4	1/8	.187	1.093	.687	.562	.750
179HD-6-4	3/8	1/4	.280	1.138	.710	.550	.850

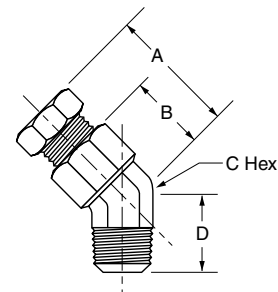





**Female Branch Tee 177HD**

PART NO.	TUBE SIZE	PIPE THREAD	MIN. ORIFICE SIZE	A	B	C HEX	D
177HD-4-2	1/4	1/8	.187	1.082	.687	.500	.750
177HD-4-4	1/4	1/4	.187	1.144	.750	.562	1.093
177HD-6-4	3/8	1/4	.312	1.376	.970	.562	1.093

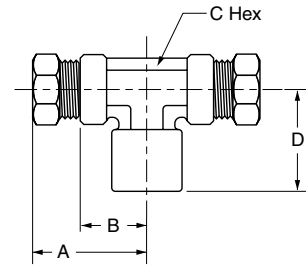

**Plug 59HD**

PART NO.	TUBE SIZE	A	C
59HD-4	1/4	.734	.437

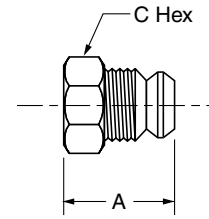



# ***Push to Connect Pneumatic***



## **Prestolok**

- Brass & Composite Bodies
- Inch & Metric Sizes
- Swivels on Shaped Male Threads
- Pre-applied Sealant



## **PrestoWeld**

- Ease of assembly,
- Flame resistant
- Positive Tube Retention
- Prevents Weld Spatter Build-up











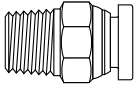
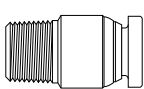
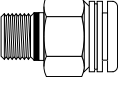
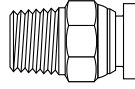
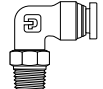
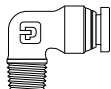
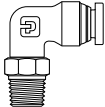

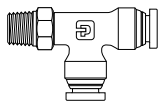

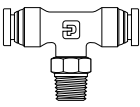
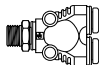
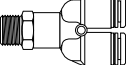



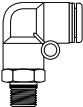
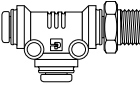
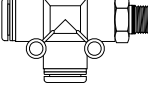

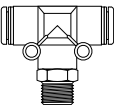
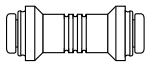
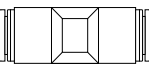

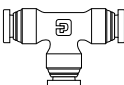
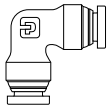
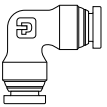
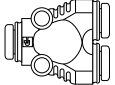
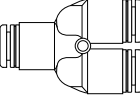
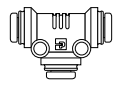
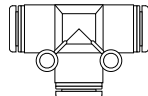
## **Global Connect**

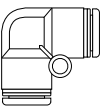
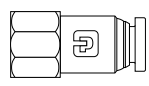
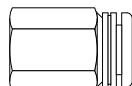
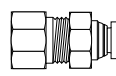
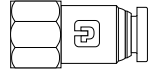
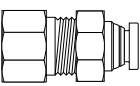

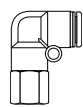

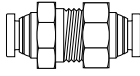
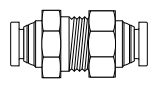
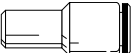
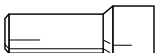

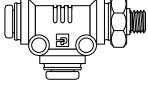
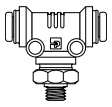
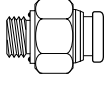
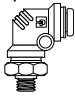
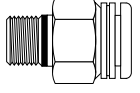
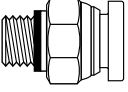
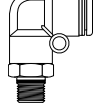
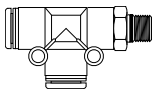
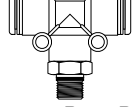
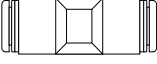

- Economical
- Durable
- Composite Bodies
- Nickel Plated Componentry

***The World Standard***

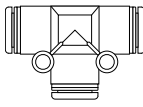
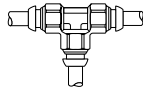
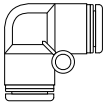

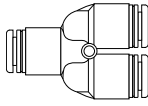
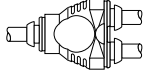
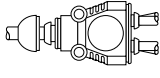
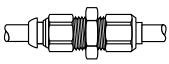
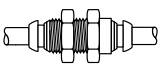

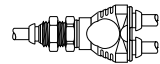
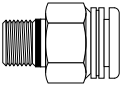
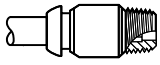
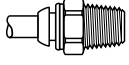
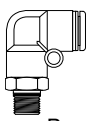
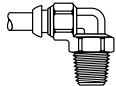
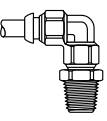

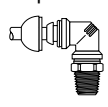
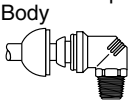
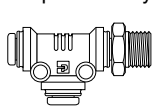
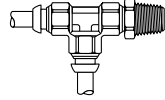
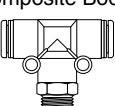
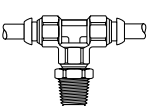
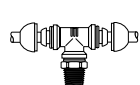
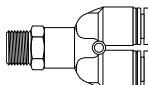
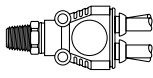
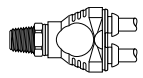
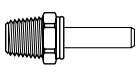







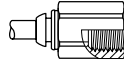
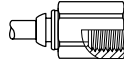
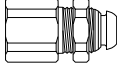



**B**

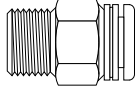
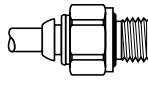
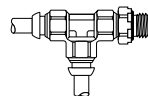
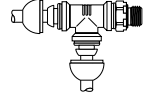
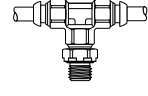
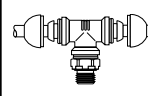
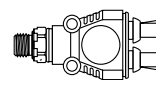
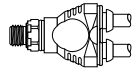
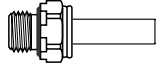

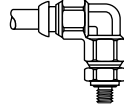
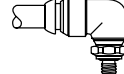
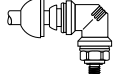
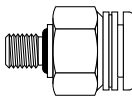
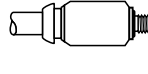
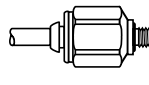
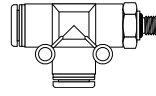
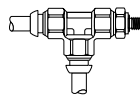
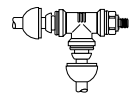
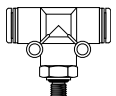
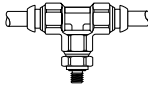
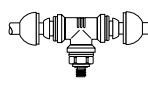
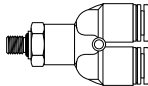
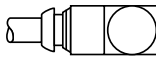

<b>Tube to Male NPTF</b>	<b>W68PLP</b> Male Connector  Page B8	<b>W68PLPR</b> Round Body Male Connector  Page B9	<b>W68GC</b> Male Connector  Page B42	<b>W68PW</b> Male Connector  Page B37	<b>W169PLP</b> Male Elbow Nickel Plated Body  Page B10	<b>W169PLPNS</b> Male Elbow Nickel Plated Body  Page B11	
	<b>W169PW</b> Male Elbow Swivel  Page B37	<b>W171PLP</b> Male Run Tee Nickel Plated Body  Page B12	<b>W171PW</b> Male Run Tee Swivel  Page B38	<b>W172PLP</b> Male Branch Tee Nickel Plated Body  Page B13	<b>W172PW</b> Male Branch Tee Swivel  Page B38	<b>W368PL</b> Union Y Connector Composite Body  Page B14	<b>W368GC</b> Union Y Connector Composite Body  Page B46
	<b>W369PLC</b> Compact Male Elbow Composite Body  Page B11	<b>W369PL</b> Male Elbow Composite Body  Page B10	<b>W369PLX</b> Long Male Elbow Composite Body  Page B11	<b>W369GC</b> Male Elbow Composite Body  Page B43	<b>W371PL</b> Male Run Tee Composite Body  Page B12	<b>W371GC</b> Male Run Tee Composite Body  Page B44	<b>W372PL</b> Male Branch Tee Composite Body  Page B13
	<b>W372GC</b> Male Branch Tee Composite Body  Page B45	<b>Tube to Tube</b>		<b>32PL</b> Union Composite Body  Page B7	<b>32GC</b> Union Composite Body  Page B42	<b>62PLP</b> Union Nickel Plated Body  Page B7	<b>62PW</b> Union Nickel Plated Body  Page B36
<b>164PW</b> Union Tee Nickel Plated Body  Page B37	<b>165PLP</b> Union Elbow Nickel Plated Body  Page B9	<b>165PW</b> Union Elbow Nickel Plated Body  Page B37	<b>362PL</b> Union Y Composite Body  Page B14	<b>362GC</b> Union Y Composite Body  Page B45	<b>364PL</b> Union Tee Composite Body  Page B9	<b>364GC</b> Union Tee Composite Body  Page B43	
<b>365PL</b> Union Elbow Composite Body  Page B9	<b>365GC</b> Union Elbow Composite Body  Page B43	<b>Tube to Female NPTF</b>		<b>66PLP</b> Female Connector  Page B8	<b>66GC</b> Female Connector  Page B42	<b>66PLPBH</b> Female Bulkhead  Page B8	<b>66PW</b> Female Connector  Page B36
<b>66PWBH</b> Female Bulkhead  Page B36	<b>370PL</b> Female Elbow Composite Body  Page B12	<b>370GC</b> Female Elbow Composite Body  Page B44	<b>377PL</b> Female Branch Tee Composite Body  Page B13	<b>Bulkhead Unions</b>		<b>62PLPBH</b> Bulkhead Union  Page B7	<b>62PWBH</b> Bulkhead Union  Page B36
<b>Auxiliary Components</b>	<b>67PPL</b> Tube End Reducer  Page B8	<b>639PL</b> Plug  Page B14	<b>DB</b> Dust/Weld Spatter Boot  Page B36				

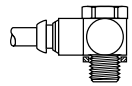
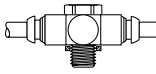
**B**

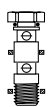
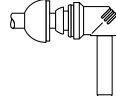
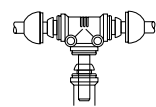
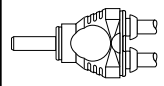
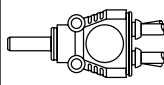
<b>Tube to Male BSPP</b>	<b>PLR2BF4-K</b> Male Run Tee  Page B24	<b>PLSBF4-K</b> Male Branch Tee  Page B26	<b>PLHBF4-B</b> Male Connector  Page B17	<b>PLE2BF4-K</b> Male Elbow Composite Body  Page B21	<b>Tube to Male Straight Thread</b>	<b>68GC</b> Male Connector  Page B42
	<b>68PLP</b> Male Connector  Page B9	<b>369GC</b> Male Elbow Composite Body  Page B43	<b>371GC</b> Male Run Tee Composite Body  Page B44	<b>372GC</b> Male Branch Tee Composite Body  Page B45		<b>Metric Tube to Male NPTF</b>
<b>Metric Tube to Metric Tube</b>	<b>HGC</b> Metric Union Composite Body  Page B47	<b>HPB</b> Metric Union Brass Body  Page B15	<b>HPK</b> Metric Union Composite Body  Page B15	<b>JGC</b> Metric Union Tee Composite Body  Page B48	<b>JPB</b> Metric Union Tee Brass Body  Page B19, 39	
	<b>EGC</b> Union Elbow Composite Body  Page B48	<b>EPB</b> Metric Union Elbow Brass Body  Page B19, 39	<b>EPK</b> Metric Union Elbow Composite Body  Page B19	<b>YJGC</b> Union Y Composite Body  Page B51	<b>YJPK</b> Metric Union Y Composite Body  Page B29	<b>YJ5PK</b> Metric Double Y Composite Body  Page B29
<b>Metric Bulkhead Unions</b>	<b>WBMPB</b> Metric Bulkhead Union  Page B15	<b>WPB</b> Metric Bulkhead Union  Page B15, 38	<b>WE6PB</b> Metric Bulkhead Union Elbow  Page B20	<b>WE6PK</b> Metric Bulkhead Union Elbow  Page B20	<b>WYJ6PK</b> Metric Bulkhead Union Y  Page B29	
	<b>Metric Tube to Male BSPT</b>	<b>F3GC</b> Male Connector  Page B47	<b>F23PB</b> Male Connector  Page B18	<b>F3PB</b> Male Connector  Page B17, 38	<b>C63GC</b> Male Elbow Composite Body  Page B48	<b>C3PB</b> Compact Male Elbow  Page B23
<b>C63PB</b> Male Elbow  Page B20, 39		<b>C63LPK</b> Long Male Elbow Composite Body  Page B24	<b>C63PK</b> Male Elbow Composite Body  Page B21	<b>C63SPK</b> Compact Male Elbow Composite Body  Page B23	<b>R63GC</b> Male Run Tee Composite Body  Page B50	<b>R63PB</b> Male Run Tee  Page B25, 39
<b>S63GC</b> Male Branch Tee Composite Body  Page B50	<b>S63PB</b> Male Branch Tee  Page B27, 40	<b>S63PK</b> Male Branch Tee Composite Body  Page B27	<b>YJ63GC</b> Union Y Connector Composite Body  Page B52	<b>YJ563PK</b> Double Union Y Composite Body  Page B30	<b>YJ63PK</b> Male Union Y Composite Body  Page B30	<b>T23FPK</b> Tube End Male Adaptor  Page B33

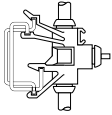
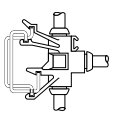
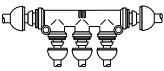
**B**

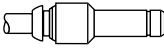
<p><b>Metric Tube to Female BSPT</b></p>  <p>Page B49</p>	<p><b>CF63GC</b> Female Elbow Composite Body</p>  <p>Page B49</p>	<p><b>Metric Tube to Female Metric Straight Thread</b></p>  <p>Page B49</p>	<p><b>CF68GC</b> Female Elbow Composite Body</p>  <p>Page B49</p>	<p><b>Metric Tube to Female BSPP</b></p>  <p>Page B16</p>	<p><b>G4PB</b> Female Connector</p>  <p>Page B16</p>	<p><b>WG4PB</b> Female Bulkhead</p>  <p>Page B16</p>	
<p><b>Metric Tube to Male BSPP</b></p>  <p>Page B49</p>	<p><b>C64GC</b> Male Elbow Composite Body</p>  <p>Page B49</p>	<p><b>C64PB</b> Male Elbow Brass Body</p>  <p>Page B21</p>	<p><b>C64SPB</b> Compact Male Elbow Brass Body</p>  <p>Page B22</p>	<p><b>C64PK</b> Male Elbow Composite Elbow</p>  <p>Page B22</p>	<p><b>C64SPK</b> Compact Male Elbow Composite Body</p>  <p>Page B23</p>	<p><b>F4GC</b> Male Connector</p>  <p>Page B47</p>	
<p><b>F4PB</b> Male Connector</p>  <p>Page B18</p>	<p><b>R64PB</b> Male Run Tee Brass Body</p>  <p>Page B25</p>	<p><b>R64PK</b> Male Run Tee Composite Body</p>  <p>Page B26</p>	<p><b>S64PB</b> Male Branch Tee Brass Body</p>  <p>Page B27</p>	<p><b>S64PK</b> Male Branch Tee Composite Tee</p>  <p>Page B28</p>	<p><b>YJ564PK</b> Union Double Y Composite Body</p>  <p>Page B30</p>	<p><b>YJ64PK</b> Male Y Composite Body</p>  <p>Page B30</p>	
<p><b>T24FPK</b> Tube End Male Adaptor</p>  <p>Page B33</p>	<p><b>Metric Tube to Metric Straight Thread</b></p>  <p>Page B49</p>	<p><b>C68GC</b> Male Elbow Composite Body</p>  <p>Page B23</p>	<p><b>C68SPK</b> Compact Male Elbow Composite Body</p>  <p>Page B22</p>	<p><b>C68PB</b> Male Elbow</p>  <p>Page B22</p>	<p><b>C68SPB</b> Compact Male Elbow</p>  <p>Page B22</p>	<p><b>C68PK</b> Male Elbow Composite Body</p>  <p>Page B23</p>	
<p><b>F8GC</b> Male Connector</p>  <p>Page B47</p>	<p><b>F28PB</b> Male Connector</p>  <p>Page B18</p>	<p><b>F8PB</b> Male Connector</p>  <p>Page B18</p>	<p><b>R68GC</b> Male Run Tee Composite Body</p>  <p>Page B50</p>	<p><b>R68PB</b> Male Run Tee</p>  <p>Page B26</p>	<p><b>R68PK</b> Male Run Tee Composite Body</p>  <p>Page B26</p>	<p><b>S68GC</b> Male Branch Tee Composite Body</p>  <p>Page B51</p>	
<p><b>S68PB</b> Male Branch Tee</p>  <p>Page B28</p>	<p><b>S68PK</b> Male Branch Tee Composite Body</p>  <p>Page B28</p>	<p><b>YJ68GC</b> Union Y Connector Composite Body</p>  <p>Page B52</p>	<p><b>Metric Banjo Fittings</b></p>		<p><b>CORPB</b> Single Body</p>  <p>Page B31</p>	<p><b>CORPBD</b> Double Body</p>  <p>Page B31</p>	<p><b>COR8PB / COR4PB</b> Single Banjo</p>  <p>Page B31</p>
<p><b>COR8PBD / COR4PBD</b> Double Banjo</p>  <p>Page B31</p>	<p><b>SC4U / SC8U</b> Single Banjo Bolt</p>  <p>Page B31</p>	<p><b>SC4UD / SC8UD</b> Stacking Banjo Bolt</p>  <p>Page B32</p>	<p><b>Metric Plug-Ins</b></p>		<p><b>T2ESPK</b> Compact Elbow</p>  <p>Page B24</p>	<p><b>T2JPK</b> Branch Tee</p>  <p>Page B28</p>	<p><b>YJ2PK</b> Y Connector</p>  <p>Page B29</p>
<p><b>YJ52PK</b> Double Y Connector</p>  <p>Page B30</p>							

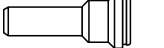
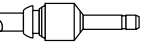
<b>Metric Manifolds</b>	<p><b>HS3PK</b> 2 Tubes</p>  <p style="text-align: center;">Page B33</p>	<p><b>J3PK</b> 3 Tubes</p>  <p style="text-align: center;">Page B34</p>	<p><b>J5PK</b> Multiple Tee</p>  <p style="text-align: center;">Page B32</p>	<p><b>J6PK</b> Multiple Tee</p>  <p style="text-align: center;">Page B32</p>	<p><b>J663PK</b> Multiple Tee</p>  <p style="text-align: center;">Page B32</p>	
	<b>Metric Auxiliary Components</b>	<p><b>TRPB</b> Metric Tube End Reducer</p>  <p style="text-align: center;">Page B16</p>	<p><b>TR2PK</b> Tube End Reducer Composite Body</p>  <p style="text-align: center;">Page B16</p>	<p><b>FNPB</b> Metric Plug</p>  <p style="text-align: center;">Page B33, 40</p>	<p><b>FNPK</b> Composite Metric Plug</p>  <p style="text-align: center;">Page B33</p>	<p><b>TEPB</b> Tube End Expander</p>  <p style="text-align: center;">Page B16</p>

B

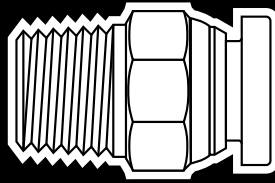

# Prestolok Fittings

## Advantages

Ready-to-use compact one-piece fitting for use with most thermoplastic tubing. This fitting is specially designed for low pressure circuits where fast assembly, disassembly and reassembly is important. No special tools are needed for assembly; just insert the tubing until it bottoms. Prestolok is designed to be used with no tube support. Radial claws on the stainless steel grab ring grip the tubing securely to provide retention. Brass Male pipe threads come standard with a white acrylic sealant pre-applied ("W" prefix) swivels are featured on all male pipe threaded shapes for installation in tight places and for precise positioning. Prestolok should not be used for live swivel applications. The outside diameter of the tubing to be used with the fitting is marked on the release button.

## Materials

Prestolok Nickel Plated Bodies: CA377, CA360, CA345  
 Prestolok Composite Bodies: Glass Filled Nylon  
 O-Ring: Nitrile (other compounds available on request)  
 Release Button: Polyacetal  
 Grab Ring: Stainless Steel

**Note: For brass body Prestolok replace PLP with PLN.**

## Recommended Tubing

Prestolok nickel plated and composite fittings are designed to be used with the following Parker Hannifin Parflex Division tubing.

Tubing Series	Tubing Material
E	Linear Low Density Polyethylene
PP	Polypropylene
N	Plasticized Polyamide (Nylon)
NR	Unplasticized Polyamide (Rigid Nylon)
U	Polyurethane 90 Durometer Shore A
HU	Polyurethane 95 Durometer Shore A

Other materials for Prestolok inch sized nickel plated fittings:  
 Polyurethane 85 Durometer Shore A

**CAUTION:** All current manufacturers of 85A PU tubing do not approve the use of push-to-connect fittings with their product.

Testing has shown acceptable use with certain O.D. – I.D. combinations. Applications and service conditions vary and therefore the use of a tube support may be required for any 85A PU tubing.

The following commercially available O.D. – I.D. 85A tubing sizes require the use of a tube support regardless of application.

5/32" – 3/32"	3/16" – 1/8"	1/4" - .170"	1/4" – 3/16"
5/16" – 1/4"	3/8" – 5/16"	1/2" – 3/8"	

## Working pressure and temperature ranges

Prestolok	Zero to 200°F at up to 300 PSI depending on tubing being used.
Prestolok Composite	Zero to 150°F at up to 150 PSI depending on tubing being used

Vacuum applications are dependent upon temperature and type of tubing used.

## Assembly Instructions

1. Cut thermoplastic tubing squarely, using Parker Tube Cutter PTC-001. Be certain the port or mating part is clean and free of debris.
2. Insert tubing into fitting until it bottoms. A slight twisting motion will ease the insertion. Pull on tubing to verify it is properly retained in the fitting.
3. To disassemble, simply push the release button against the body and remove tubing.
4. It is recommended to trim the tubing after every disassembly to insure a proper seal.

## Order

By part number and name.

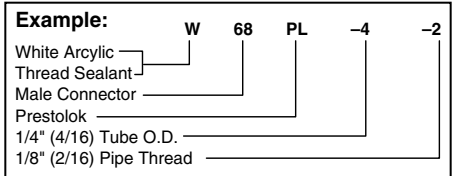

## Nomenclature

Part numbers are constructed from symbols that identify the style and size of the fitting. The

first series of numbers and letters identify the style and type fitting. The second series of numbers describe the size.

## Sizes

Tube sizes are determined by the number of sixteenths of an inch in the tube O.D.

## Metric Fittings

Metric fittings are available in Catalog 3550.  
 Thread types: BSPT and BSPP Sizes: 1/8-1/2.  
 Tube sizes: 4MM-14MM.

## Specials

Fitting configurations and/or sizes other than those shown in the catalog can be furnished. It is suggested that a print or sketch be submitted with the inquiry.

## Pricing

Only items priced in current supplementary price list PL3501 are carried in stock. Price and delivery for non-stock items furnished on request for specified quantity.

**32PL Equal Union (Composite Body)**

PART NO.	TUBE SIZE (IN)	O.D.	L	FLOW DIA. D
32PL-2	1/8	.51	1.32	.09
32PL-5/32	5/32	.51	1.32	.12
32PL-3	3/16	.59	1.37	.16
32PL-4	1/4	.59	1.37	.19
32PL-5	5/16	.67	1.49	.25
32PL-6	3/8	.82	1.76	.31

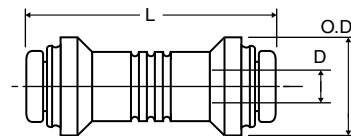

**32PL Unequal Union (Composite Body)**

PART NO.	1 TUBE SIZE (IN)	2 TUBE SIZE (IN)	O.D.	L	FLOW DIA. D
32PL-5/32-2	5/32	1/8	.51	1.32	.09
32PL-4-2	1/4	1/8	.59	1.37	.09
32PL-5-4	5/16	1/4	.67	1.47	.19
32PL-6-4	3/8	1/4	.82	1.75	.19

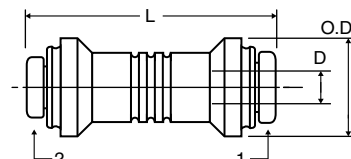

**62PLP Union (Nickel Plated)**

PART NO.	TUBE SIZE	O.D.	L	FLOW DIA. D
62PLP-2	1/8	.375	1.40	.094
62PLP-3	3/16	.437	1.41	.156
62PLP-5/32	5/32	.375	1.41	.125
62PLP-4	1/4	.500	1.43	.188
62PLP-5	5/16	.562	1.65	.250
62PLP-6	3/8	.625	1.66	.312
62PLP-8	1/2	.750	1.82	.375

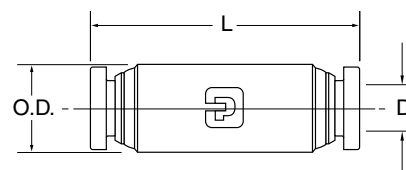

**62PLP Unequal Union (Nickel Plated)**

PART NO.	TUBE 1 SIZE (IN)	TUBE 2 SIZE (IN)	O.D.	L	FLOW DIA. D
62PLP-5/32-2	5/32	1/8	.375	1.41	.094
62PLP-4-2	1/4	1/8	.500	1.43	.094
62PLP-4-5/32	1/4	5/32	.500	1.43	.125
62PLP-4-6	1/4	3/8	.625	1.66	.188
62PLP-6-8	3/8	1/2	.750	1.82	.312

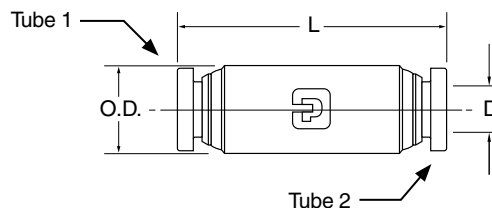

**62PLPBH Bulkhead Union (Nickel Plated)**

PART NO.	TUBE SIZE (IN)	BULKHEAD HOLE DIA. B	C HEX	P MAX.	L	D
62PLPBH-2	1/8	7/16	9/16	.39	1.40	.094
62PLPBH-5/32	5/32	7/16	9/16	.39	1.41	.125
62PLPBH-4	1/4	9/16	11/16	.29	1.43	.188
62PLPBH-5	5/16	5/8	3/4	.60	1.65	.250
62PLPBH-6	3/8	3/4	7/8	.54	1.66	.312
62PLPBH-8	1/2	7/8	1	.66	2.04	.375

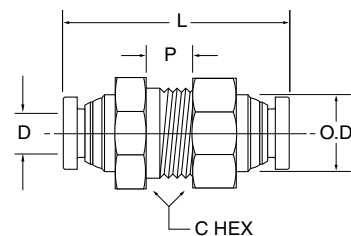

**63PL Double Male Union (Composite Body)**

PART NO.	TUBE SIZE (IN)	L	D
63PL-2	1/8	1.49	.078
63PL-5/32	5/32	1.49	.106
63PL-4	1/4	1.61	.188
63PL-5	5/16	1.61	.236
63PL-6	3/8	2.00	.295
63PL-8	1/2	2.22	.374

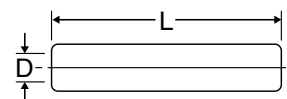



**B**

**66PLP Female Connector (Nickel Plated)**

PART NO.	TUBE SIZE	PIPE THREAD (NPTF)	C HEX	L	FLOW DIA. D
66PLP-2-2	1/8	1/8	9/16	1.17	.094
66PLP-2-2	1/8	1/4	11/16	1.34	.094
66PLP-3-2	3/16	1/8	9/16	1.13	.156
66PLP-5/32-2	5/32	1/8	9/16	1.17	.125
66PLP-5/32-4	5/32	1/4	11/16	1.38	.125
66PLP-4-2	1/4	1/8	9/16	1.17	.188
66PLP-4-4	1/4	1/4	11/16	1.38	.188
66PLP-5-2	5/16	1/8	9/16	1.25	.250
66PLP-5-4	5/16	1/4	11/16	1.45	.250
66PLP-6-4	3/8	1/4	11/16	1.46	.312
66PLP-6-6	3/8	3/8	13/16	1.51	.312

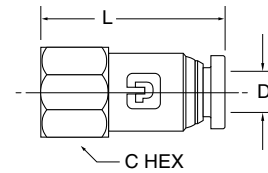

**66PLPBH Female Bulkhead (Nickel Plated)**

PART NO.	TUBE SIZE (IN)	PIPE THREAD (NPTF)	C HEX	P MAX.	L	FLOW DIA. D	BULKHEAD HOLE DIA.
66PLPBH-5/32-4	5/32	1/4	11/16	.19	1.39	.125	1/2
66PLPBH-4-4	1/4	1/4	11/16	.24	1.35	.188	9/16
66PLPBH-6-6	3/8	3/8	1	.22	1.47	.312	7/8
66PLPBH-8-6	1/2	3/8	1 1/4	.35	1.56	.344	1

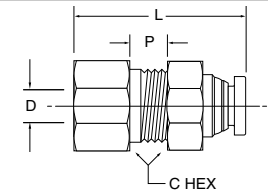

**67PPL Tube End Reducer (Composite Body)**

PART NO.	TUBE 1 SIZE (IN)	TUBE 2 SIZE (IN)	L	FLOW DIA. D
67PPL-2-5/32	1/8	5/32	1.76	.120
67PPL-2-4	1/8	1/4	1.48	.078
67PPL-5/32-4	5/32	1/4	1.32	.125
67PPL-5/32-5	5/32	5/16	1.31	.125
67PPL-5/32-6	5/32	3/8	1.64	.125
67PPL-4-5	1/4	5/16	1.65	.220
67PPL-4-6	1/4	3/8	1.76	.220
67PPL-4-8	1/4	1/2	1.77	.220
67PPL-5-6	5/16	3/8	1.81	.220
67PPL-6-8	3/8	1/2	2.02	.315

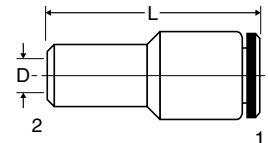

**W68PLP Male Connector (Nickel Plated)**

PART NO.	TUBE SIZE (IN)	PIPE THREAD (NPTF)	C HEX	L	FLOW DIA. D
W68PLP-2-1	1/8	1/16	3/8	.79	.094
W68PLP-2-2	1/8	1/8	7/16	.79	.094
W68PLP-2-4	1/8	1/4	9/16	1.02	.094
W68PLP-3-2	3/16	1/8	7/16	.85	.156
W68PLP-3-4	3/16	1/4	9/16	1.01	.156
W68PLP-5/32-1	5/32	1/16		.88	.940
W68PLP-5/32-2	5/32	1/8	7/16	.80	.125
W68PLP-5/32-4	5/32	1/4	9/16	1.03	.125
W68PLP-4-1	1/4	1/16	1/2	1.07	.141
W68PLP-4-2	1/4	1/8	1/2	.89	.188
W68PLP-4-4	1/4	1/4	9/16	1.00	.188
W68PLP-4-6	1/4	3/8	3/4	1.04	.188
W68PLP-5-2	5/16	1/8	9/16	1.18	.250
W68PLP-5-4	5/16	1/4	9/16	1.04	.250
W68PLP-5-6	5/16	3/8	11/16	1.04	.250
W68PLP-6-2	3/8	1/8	5/8	1.21	.250
W68PLP-6-4	3/8	1/4	5/8	1.08	.312
W68PLP-6-6	3/8	3/8	11/16	1.02	.312
W68PLP-6-8	3/8	1/2	7/8	1.28	.312
W68PLP-8-4	1/2	1/4	13/16	1.44	.344
W68PLP-8-6	1/2	3/8	13/16	1.24	.344
W68PLP-8-8	1/2	1/2	7/8	1.35	.375
68PLP-5/32-4LT*	5/32	1/4-28	7/16	.88	.093

\*SAE-LTThreads

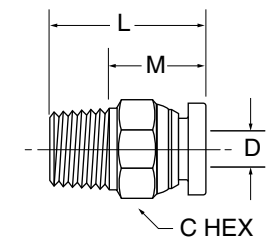

**68PLP-X-10X32 Male Connector (Nickel Plated)**

PART NO.	TUBE SIZE (IN)	PIPE THREAD (NPTF)	C HEX	L	FLOW DIA. D
68PLP-2-0	1/8	10x32	3/8	.92	.094
68PLP-5/32-0	5/32	10x32			
68PLP-4-0	1/4	10x32	1/2	.96	.094

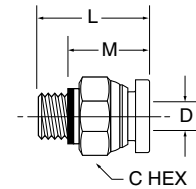

**68PLPR Round Body Male Connector (Nickel Plated)**

PART NO.	TUBE SIZE	THREAD SIZE NPTF	INTERNAL HEX BROACH	BODY DIA. O.D.	L	FLOW DIA.
68PLPR-2-0	1/8	10-32	3/32	3/8"	.89	.094
68PLPR-5/32-0	5/32	10-32	3/32	3/8"	.91	.094
68PLPR-4-0	1/4	10-32	3/32	1/2"	.95	.094
W68PLPR-5/32-1	5/32	1/16	1/8	7/16"	.87	.125
W68PLPR-5/32-2	5/32	1/8	1/8	7/16"	.79	.125
W68PLPR-4-1	1/4	1/16	5/32	1/2"	1.06	.156
W68PLPR-4-2	1/4	1/8	3/16	1/2"	.88	.188
W68PLPR-4-4	1/4	1/4	3/16	5/8"	.99	.188

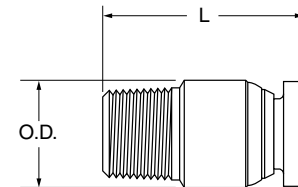

**164PLP Union Tee (Nickel Plated)**

PART NO.	TUBE SIZE (IN)	L	FLOW DIA. D
164PLP-2	1/8	.74	.094
164PLP-3	3/16	.82	.156
164PLP-5/32	5/32	.77	.125
164PLP-4	1/4	.85	.188
164PLP-5	5/16	.97	.250
164PLP-6	3/8	1.01	.250
164PLP-8	1/2	1.15	.375

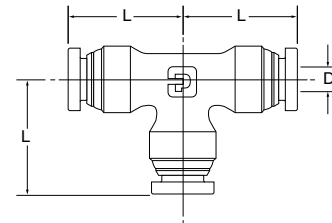

**364PL Union Tee (Composite Body)**

PART NO.	TUBE SIZE (IN)	MOUNTING HOLE DIA.	L	G	FLOW DIA. D
364PL-2	1/8	.13	.71	.52	.094
364PL-5/32	5/32	.13	.71	.52	.125
364PL-3	3/16	.17	.76	.64	.156
364PL-4	1/4	.17	.76	.64	.188
364PL-5	5/16	.17	.84	.71	.250
364PL-6	3/8	.17	1.04	.83	.312
364PL-8	1/2	.17	1.30	.99	.344

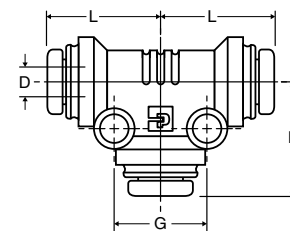

**165PLP Union Elbow (Nickel Plated)**

PART NO.	TUBE SIZE (IN)	L	FLOW DIA. D
165PLP-2	1/8	.74	.094
165PLP-5/32	5/32	.77	.125
165PLP-3	3/16	.82	.156
165PLP-4	1/4	.85	.188
165PLP-5	5/16	.97	.250
165PLP-6	3/8	1.01	.312
165PLP-8	1/2	1.15	.375

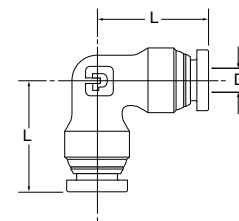

**365PL Union Elbow (Composite Body)**

PART NO.	TUBE SIZE (IN)	MOUNTING HOLE DIA.	L	FLOW DIA. D
365PL-2	1/8	.13	.71	.094
365PL-3	3/16	.17	.76	.156
365PL-5/32	5/32	.13	.71	.125
365PL-4	1/4	.17	.76	.188
365PL-5	5/16	.17	.84	.250
365PL-6	3/8	.17	1.04	.312
365PL-8	1/2	.17	1.03	.344

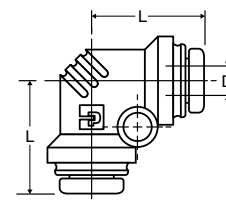

**W169PLP Male Elbow Swivel 90° (Nickel Plated)**

PART NO.	TUBE SIZE (IN)	PIPE THREAD (NPTF)	C			FLOW DIA. D
			HEX	L	N	
W169PLP-2-1	1/8	1/16	3/8	.74	.93	.160
W169PLP-2-2	1/8	1/8	7/16	.74	.92	.094
W169PLP-2-0	1/8	10-32	3/8	.74	.74	.080
W169PLP-2-4	1/8	1/4	9/16	.74	1.10	.094
W169PLP-3-2	3/16	1/8	7/16	.82	.92	.156
W169PLP-5/32-1	5/32	1/16	3/8	.84	.93	.160
W169PLP-5/32-2	5/32	1/8	7/16	.77	.92	.125
W169PLP-5/32-4	5/32	1/4	9/16	.77	1.10	.125
W169PLP-5/32-0	5/32	10-32	3/8	.85	.74	.080
W169PLP-4-1	1/4	1/16	3/8	.84	.93	.160
W169PLP-4-2	1/4	1/8	7/16	.85	.92	.156
W169PLP-4-4	1/4	1/4	9/16	.85	1.10	.156
W169PLP-4-6	1/4	3/8	11/16	.85	1.19	.156
W169PLP-4-0	1/4	10-32	3/8	.85	.74	.080
W169PLP-5-2	5/16	1/8	9/16	.97	1.02	.250
W169PLP-5-4	5/16	1/4	9/16	.97	1.24	.250
W169PLP-6-2	3/8	1/8	9/16	1.01	1.02	.250
W169PLP-6-4	3/8	1/4	9/16	1.01	1.24	.250
W169PLP-6-6	3/8	3/8	11/16	1.01	1.24	.250
W169PLP-6-8	3/8	1/2	7/8	1.01	1.48	.250
W169PLP-8-4	1/2	1/4	9/16	1.15	1.28	.312
W169PLP-8-6	1/2	3/8	11/16	1.15	1.31	.312
W169PLP-8-8	1/2	1/2	7/8	1.15	1.52	.312

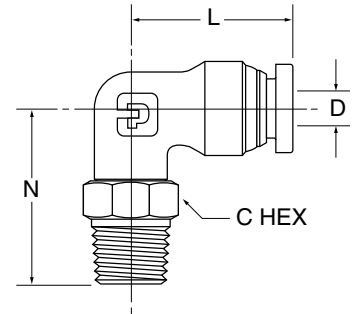

**W369PL Male Elbow Swivel 90° (Composite Body)**

PART NO.	TUBE SIZE (IN)	PIPE THREAD (NPTF)	C HEX	MOUNTING HOLE			FL FLOW DIA. D
				DIA.	L	N	
W369PL-2-1	1/8	1/16	3/8	.13	.71	1.08	.078
W369PL-2-2	1/8	1/8	7/16	.13	.71	1.14	.078
W369PL-2-10X32	1/8	10-32	3/8	.13	.71	.94	.078
W369PL-2-4	1/8	1/4	9/16	.13	.71	1.32	.078
W369PL-3-2	3/16	1/8	7/16	.17	.76	1.20	.147
W369PL-3-4	3/16	1/4	9/16	.17	.76	1.44	.147
W369PL-5/32-2	5/32	1/8	7/16	.13	.74	1.14	.094
W369PL-5/32-4	5/32	1/4	9/16	.13	.74	1.32	.094
W369PL-5/32-10X32	5/32	10-32	3/8	.13	.74	.94	.094
W369PL-4-1	1/4	1/16	7/16	.17	.76	1.20	.094
W369PL-4-2	1/4	1/8	7/16	.17	.76	1.20	.172
W369PL-4-4	1/4	1/4	9/16	.17	.76	1.38	.172
W369PL-4-6	1/4	3/8	11/16	.17	.76	1.42	.172
W369PL-4-10X32	1/4	10-32	7/16	.17	.76	1.05	.094
W369PL-5-2	5/16	1/8	9/16	.17	.84	1.23	.234
W369PL-5-4	5/16	1/4	9/16	.17	.84	1.46	.234
W369PL-6-2	3/8	1/8	9/16	.17	1.04	1.48	.234
W369PL-6-4	3/8	1/4	5/8	.17	1.04	1.66	.234
W369PL-6-6	3/8	3/8	11/16	.17	1.04	1.66	.297
W369PL-6-8	3/8	1/2	7/8	.17	1.04	1.85	.297
W369PL-8-4	1/2	1/4	3/4	.17	1.03	1.80	.314
W369PL-8-6	1/2	3/8	3/4	.17	1.03	1.80	.375
W369PL-8-8	1/2	1/2	7/8	.17	1.03	1.99	.375

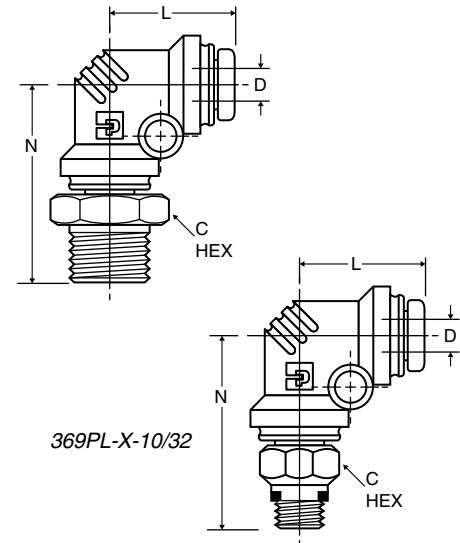

**W369PLC Compact Elbow (Composite Body)**

PART NO.	TUBE SIZE (IN)	PIPE THREAD (NPTF)	C HEX	L	N	FLOW DIA. D
W369PLC-2-2	1/8	1/8	7/16	.81	.71	.08
W369PLC-5/32-2	5/32	1/8	7/16	.83	.71	.08
W369PLC-5/32-4	5/32	1/4	9/16	.83	.89	.08
W369PLC-3-2	3/16	1/8	7/16	.86	.81	.08
W369PLC-4-2	1/4	1/8	7/16	.86	.81	.08
W369PLC-6-4	3/8	1/4	5/8	1.13	1.07	.20
W369PLC-6-6	3/8	3/8	3/4	1.13	1.15	.20

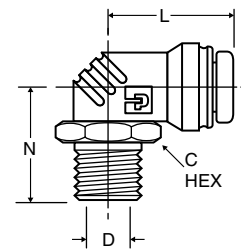

**B**

**W169PLPNS Male Elbow 90° (Nickel Plated)**

PART NO.	TUBE SIZE (IN)	PIPE THREAD (NPTF)	L	N	FLOW DIA. D
W169PLPNS-2-2	1/8	1/8	.74	.67	.094
W169PLPNS5/32-2	5/32	1/8	.77	.67	.125
W169PLPNS5/32-4	5/32	1/4	.77	.87	.125
W169PLPNS-4-2	1/4	1/8	.85	.67	.188
W169PLPNS-4-4	1/4	1/4	.85	.87	.188
W169PLPNS-5-2	5/16	1/8	.97	.75	.234
W169PLPNS-5-4	5/16	1/4	.97	.94	.250
W169PLPNS-6-4	3/8	1/4	1.01	.94	.312
W169PLPNS-6-6	3/8	3/8	1.01	1.01	.312
W169PLPNS-6-8	3/8	1/2	1.01	1.27	.312
W169PLPNS-8-6	1/2	3/8	1.15	1.00	.375
W169PLPNS-8-8	1/2	1/2	1.15	1.27	.375
169PLPNS532-4LT*	5/32	1/4-28	.60	.48	.090

\* SAE-LT Threads

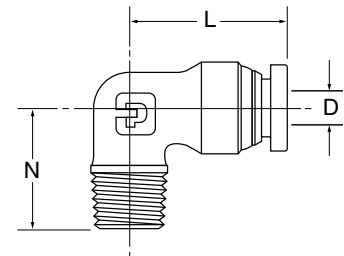

**W369PLX Male Elbow Swivel 90° (Composite Body)**

PART NO.	TUBE SIZE (IN)	PIPE THREAD (NPTF)	C HEX	MOUNTING HOLE DIA.	L	N	FLOW DIA. D
W369PLX-2-2	1/8	1/8	7/16	.13	.70	1.74	.078
W369PLX-2-4	1/8	1/4	9/16	.13	.70	1.74	.078
W369PLX-3-2	3/16	1/8	7/16	.17	.76	1.88	.147
W369PLX-3-4	3/16	1/4	9/16	.17	.76	1.88	.147
W369PLX-3-6	3/16	3/8	11/16	.17	.76	1.88	.147
W369PLX-4-2	1/4	1/8	7/16	.17	.76	1.88	.172
W369PLX-4-4	1/4	1/4	9/16	.17	.76	1.88	.170
W369PLX-4-6	1/4	3/8	11/16	.17	.76	1.88	.172
369PLX-5/32-0	5/32	10-32	3/8	.13	.73	1.54	.094
W369PLX-5/32-2	5/32	1/8	7/16	.13	.73	1.54	.094
W369PLX-5/32-4	5/32	1/4	9/16	.13	.73	1.54	.094
W369PLX-5-2	5/16	1/8	9/16	.17	.84	1.99	.234
W369PLX-5-4	5/16	1/4	9/16	.17	.84	1.99	.234
W369PLX-5-6	5/16	3/8	11/16	.17	.84	1.99	.234
W369PLX-6-4	3/8	1/4	5/8	.17	1.04	2.56	.234
W369PLX-6-6	3/8	3/8	11/16	.17	1.04	2.56	.297
W369PLX-6-8	3/8	1/2	7/8	.17	1.04	2.56	.297
W369PLX-8-4	1/2	1/4	3/4	.17	1.03	2.80	.314
W369PLX-8-6	1/2	3/8	3/4	.17	1.03	2.80	.344
W369PLX-8-8	1/2	1/2	7/8	.17	1.03	2.80	.344

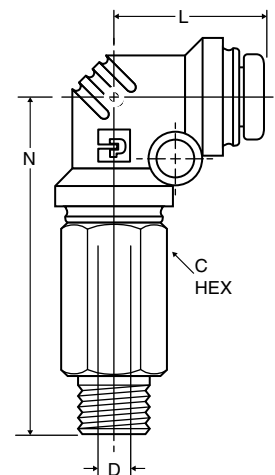

**370PL Female Elbow Swivel (Composite Body)**

PART NO.	TUBE SIZE (IN)	PIPE THREAD (NPTF)	C HEX	MOUNTING HOLE DIA.	L	N	FLOW DIA. D
370PL-2-2	1/8	1/8	9/16	.13	.71	1.01	.078
370PL-5/32-2	5/32	1/8	9/16	.13	.73	1.01	.094
370PL-5/32-4	5/32	1/4	3/4	.13	.73	1.23	.094
370PL-4-10x32	1/4	10x32	7/16	.17	.76	1.02	.159
370PL-4-2	1/4	1/8	9/16	.17	.76	1.07	.174
370PL-4-4	1/4	1/4	3/4	.17	.76	1.29	.174
370PL-5-4	5/16	1/4	3/4	.17	.84	1.37	.234
370PL-6-4	3/8	1/4	3/4	.17	1.04	1.57	.297
370PL-8-6	1/2	3/8	7/8	.17	1.03	1.57	.344

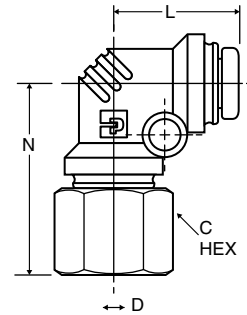

**B**

**W171PLP Male Run Tee Swivel (Nickel Plated)**

PART NO.	TUBE SIZE (IN)	PIPE THREAD (NPTF)	C HEX	L	N	FLOW DIA. D
W171PLP-2-2	1/8	1/8	7/16	.74	.92	.094
W171PLP-5/32-2	5/32	1/8	7/16	.77	.92	.125
W171PLP-4-2	1/4	1/8	7/16	.85	.92	.156
W171PLP-4-4	1/4	1/4	9/16	.85	1.10	.156
W171PLP-4-6	1/4	3/8	11/16	.85	1.24	.156
W171PLP-5-2	5/16	1/8	9/16	.97	1.02	.250
W171PLP-5-4	5/16	1/4	9/16	.97	1.24	.250
W171PLP-6-4	3/8	1/4	9/16	1.01	1.24	.250
W171PLP-6-6	3/8	3/8	11/16	1.01	1.24	.250
W171PLP-8-6	1/2	3/8	11/16	1.15	1.31	.312
W171PLP-8-8	1/2	1/2	7/8	1.15	1.52	.312

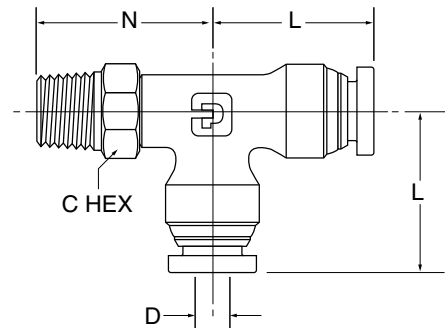

**W371PL Male Run Tee Swivel (Composite Body)**

PART NO.	TUBE SIZE (IN)	PIPE THREAD (NPTF)	C HEX	MOUNTING HOLE DIA.	L	N	G	FL FLOW DIA. D
W371PL-2-1	1/8	1/16	3/8	.13	.71	1.08	.52	.078
W371PL-2-2	1/8	1/8	7/16	.13	.71	1.14	.52	.078
W371PL-2-4	1/8	1/4	9/16	.13	.71	1.32	.52	.078
371PL-2-10x32	1/8	10-32	3/8	.13	.71	.94	.52	.078
W371PL-3-2	3/16	1/8	7/16	.17	.76	1.20	.64	.147
W371PL-3-4	3/16	1/4	9/16	.17	.76	1.43	.64	.147
W371PL-5/32-2	5/32	1/8	7/16	.13	.71	1.14	.52	.094
W371PL-5/32-4	5/32	1/4	9/16	.13	.71	1.32	.52	.094
371PL5/32-10x32	5/32	10-32	3/8	.13	.71	.94	.52	.094
W371PL-4-1	1/4	1/16	7/16	.17	.76	1.20	.64	.094
W371PL-4-2	1/4	1/8	7/16	.17	.76	1.20	.64	.172
W371PL-4-4	1/4	1/4	9/16	.17	.76	1.38	.64	.172
371PL-4-10x32	1/4	10-32	7/16	.13	.76	1.05	.64	.094
W371PL-4-6	1/4	3/8	11/16	.17	.76	1.42	.64	.172
W371PL-5-2	5/16	1/8	9/16	.17	.84	1.28	.71	.234
W371PL-5-4	5/16	1/4	9/16	.17	.84	1.46	.71	.234
W371PL-6-2	3/8	1/8	9/16	.13	1.04	1.48	.83	.234
W371PL-6-4	3/8	1/4	5/8	.17	1.04	1.66	.83	.297
W371PL-6-6	3/8	3/8	11/16	.17	1.04	1.66	.83	.297
W371PL-6-8	3/8	1/2	7/8	.13	1.04	1.85	.83	.297
W371PL-8-4	1/2	1/4	3/4	.17	1.30	2.07	.99	.314
W371PL-8-6	1/2	3/8	3/4	.17	1.30	2.07	.99	.344
W371PL-8-8	1/2	1/2	7/8	.17	1.30	2.26	.99	.344

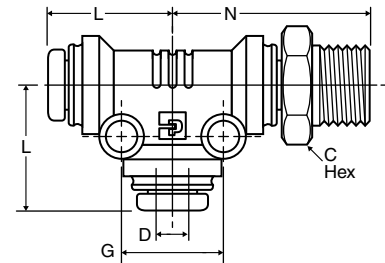

**W172PLP Male Branch Tee Swivel (Nickel Plated)**

PART NO.	TUBE SIZE (IN)	PIPE THREAD (NPTF)	C HEX	L	N	FLOW DIA. D
W172PLP-2-2	1/8	1/8	7/16	.74	.92	.094
W172PLP-3-2	3/16	1/8	7/16	.82	.92	.156
W172PLP-5/32-2	5/32	1/8	7/16	.77	.92	.125
W172PLP-4-2	1/4	1/8	7/16	.85	.92	.156
W172PLP-4-4	1/4	1/4	9/16	.85	1.10	.156
W172PLP-4-6	1/4	3/8	11/16	.85	1.10	.156
W172PLP-5-2	5/16	1/8	9/16	.97	1.02	.250
W172PLP-5-4	5/16	1/4	9/16	.97	1.24	.250
W172PLP-6-4	3/8	1/4	9/16	1.01	1.24	.250
W172PLP-6-6	3/8	3/8	11/16	1.01	1.24	.250
W172PLP-8-4	1/2	1/4	9/16	1.15	1.30	.312
W172PLP-8-6	1/2	3/8	11/16	1.15	1.31	.312
W172PLP-8-8	1/2	1/2	7/8	1.15	1.52	.312

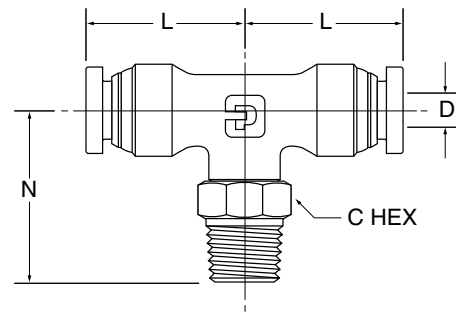

**W372PL Male Branch Tee Swivel (Composite Body)**

PART NO.	TUBE SIZE (IN)	PIPE THREAD (NPTF)	C HEX	MOUNTING HOLE DIA.	L	N	FLOW G	FLOW DIA. D
W372PL-2-1	1/8	1/16	3/8	.13	.71	1.08	.52	.078
W372PL-2-2	1/8	1/8	7/16	.13	.71	1.14	.52	.078
W372PL-2-4	1/8	1/4	9/16	.13	.71	1.32	.52	.078
372PL-2-10X32	1/8	10-32	3/8	.13	.71	.94	.52	.078
W372PL-3-2	3/16	1/8	7/16	.17	.76	1.20	.64	.147
W372PL-3-4	3/16	1/4	9/16	.17	.76	1.40	.64	.147
W372PL-5/32-2	5/32	1/8	7/16	.13	.71	1.14	.52	.094
W372PL-5/32-4	5/32	1/4	9/16	.13	.68	1.32	.52	.094
372PL5/32-10x32	5/32	10-32	3/8	.13	.70	.94	.52	.094
W372PL-4-1	1/4	1/16	7/16	.17	.76	1.20	.64	.094
W372PL-4-2	1/4	1/8	7/16	.17	.76	1.20	.64	.172
W372PL-4-4	1/4	1/4	9/16	.17	.76	1.38	.64	.172
372PL-4-10x32	1/4	10-32	7/16	.17	.76	1.05	.64	.094
W372PL-4-6	1/4	3/8	11/16	.17	.76	1.42	.64	.172
W372PL-5-2	5/16	1/8	9/16	.17	.84	1.23	.71	.234
W372PL-5-4	5/16	1/4	9/16	.17	.84	1.23	.71	.234
W372PL-6-2	3/8	1/8	9/16	.17	1.04	1.48	.83	.234
W372PL-6-4	3/8	1/4	5/8	.17	1.04	1.66	.83	.297
W372PL-6-6	3/8	3/8	11/16	.17	1.04	1.66	.83	.297
W372PL-6-8	3/8	1/2	7/8	.17	1.04	1.85	.83	.297
W372PL-8-4	1/2	1/4	3/4	.17	1.30	2.07	.99	.314
W372PL-8-6	1/2	3/8	3/4	.17	1.30	2.07	.99	.344
W372PL-8-8	1/2	1/2	7/8	.17	1.30	2.26	.99	.344

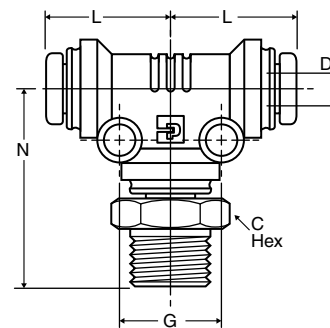

**377PL Female Branch Tee Swivel (Composite Body)**

PART NO.	TUBE SIZE (IN)	PIPE THREAD (NPTF)	C HEX	MOUNTING HOLE DIA.	L	N	F G	FLOW DIA. D
377PL-2-2	1/8	1/8	9/16	.17	.71	1.01	.52	.078
377PL-5/32-2	5/32	1/8	9/16	.13	.71	1.01	.52	.094
377PL-5/32-4	5/32	1/4	3/4	.13	.71	1.23	.52	.094
377PL-4-2	1/4	1/8	9/16	.17	.76	1.07	.64	.176
377PL-4-4	1/4	1/4	3/4	.17	.76	1.29	.64	.176
377PL-5-4	5/16	1/4	3/4	.17	.84	1.37	.71	.234
377PL-6-4	3/8	1/4	3/4	.17	1.04	1.57	.83	.298
377PL-8-6	1/2	3/8	7/8	.17	1.30	1.84	.99	.344

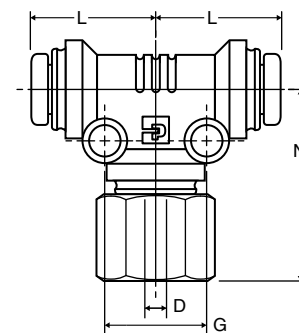

**B**

**362PL Union Y Connector (Composite Body)**

PART NO.	TUBE SIZE (IN)	MOUNTING HOLE DIA.	L	N	N1	G	FLOW DIA. D
362PL-2	1/8	.13	1.37	.92	.41	.57	.130
362PL-5/32	5/32	.13	1.36	.92	.41	.57	.160
362PL-3	3/16	.17	1.49	1.13	.53	.67	.200
362PL-4	1/4	.17	1.49	1.13	.53	.67	.260
362PL-5	5/16	.17	1.46	1.21	.54	.72	.320
362PL-6	3/8	.17	1.88	1.53	.71	.76	.380

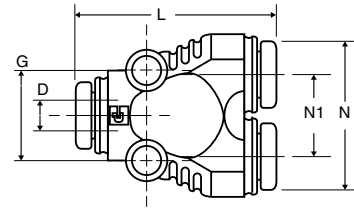

**W368PL Union Y Male Connector (Composite Body)**

PART NO.	TUBE SIZE (IN)	PIPE SIZE	G	MOUNTING HOLE DIA.	L	N	N1	FLOW DIA. D
W368PL-2-2	1/8	1/8	.57	.13	1.81	.92	.41	.080
W368PL-2-4	1/8	1/4	.57	.13	1.98	.92	.41	.080
368PL5/32-10x32	5/32	10-32	.57	.13	1.60	.92	.41	.090
W368PL-5/32-2	5/32	1/8	.57	.13	1.80	.92	.41	.090
W368PL-5/32-4	5/32	1/4	.57	.13	1.98	.92	.41	.090
W368PL-3-2	3/16	1/8	.67	.17	1.92	1.13	.53	.150
W368PL-3-4	3/16	1/4	.67	.17	2.16	1.13	.53	.150
368PL-4-10x32	1/4	10-32	.67	.17	1.78	1.13	.53	.090
W368PL-4-2	1/4	1/8	.67	.17	1.93	1.13	.53	.172
W368PL-4-4	1/4	1/4	.67	.17	2.11	1.13	.53	.170
W368PL-4-6	1/4	3/8	.67	.17	2.15	1.13	.53	.170
W368PL-5-2	5/16	1/8	.72	.17	1.87	1.20	.54	.230
W368PL-5-4	5/16	1/4	.72	.17	2.10	1.20	.54	.230
W368PL-5-6	5/16	3/8	.72	.17	2.10	1.20	.54	.234
W368PL-6-4	3/8	1/4	.76	.17	2.50	1.53	.71	.300
W368PL-6-6	3/8	3/8	.76	.17	2.50	1.53	.71	.300

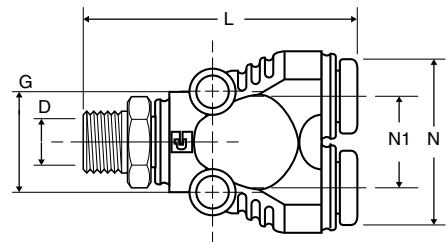

**Plug 639PL (Composite Body)**

PART NO.	TUBE SIZE (IN)	L
639PL-2	1/8	1.30
639PL-5/32	5/32	1.30
639PL-4	1/4	1.34
639PL-5	5/16	1.28
639PL-6	3/8	1.50
639PL-8	1/2	1.59

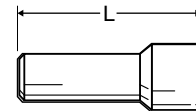

**Protective Cap**

PART NO.	1
C4*	4
C6*	6
C8*	8
C10*	10
C12*	12
C14*	14

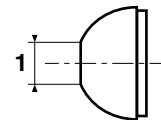

\*Add the following code, corresponding to the chosen color W: white; BU: blue; G: green; R: red; Y: yellow; BL: black. Example: cap red suitable for tube 4mm: C4R. In case of no color specification, we will deliver yellow cap (standard color).

**HPB Equal Union (Nickel Plated)**

PART NO.	TUBE SIZE (MM)	L
HPB4	4	33.0
HPB5	5	34.5
HPB6	6	36.0
HPB8	8	38.0
HPB10	10	48.0
HPB12	12	48.0
HPB14	14	54.0

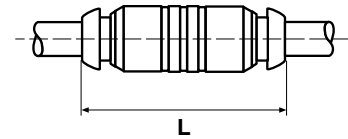

**HPK Equal Union (Composite Body)**

PART NO.	TUBE SIZE (MM)	L
HPK4	4	33.5
HPK6	6	37.0
HPK8	8	39.0
HPK10	10	48.0
HPK12	12	49.0
HPK14	14	54.0

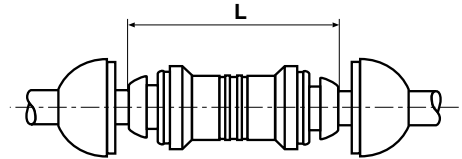

**HPK Unequal Union (Composite Body)**

PART NO.	TUBE 1 SIZE (MM)	TUBE 2 SIZE (MM)	L
HPK6-4	6	4	36.0
HPK8-4	8	4	38.0
HPK8-6	8	6	39.0
HPK10-6	10	6	47.0
HPK10-8	10	8	47.0
HPK12-10	12	10	49.5

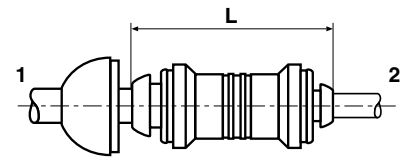

**WPB Bulkhead Union (Nickel Plated)**

PART NO.	TUBE SIZE (MM)	B-MM THREAD	C HEX	L	W	BULKHEAD HOLE DIA.
WPB4	4	M11x0.75	16	33	6	11mm
WPB6	6	M13x1	19	35	6	13mm
WPB8	8	M15x1.25	22	36	6	16mm
WPB10	10	M18x1	22	43	8	18mm
WPB12	12	M23x1.5	27	46	10	23mm
WPB14	14	M24x1.5	30	52	10	24mm

Jam nut is supplied loose in box

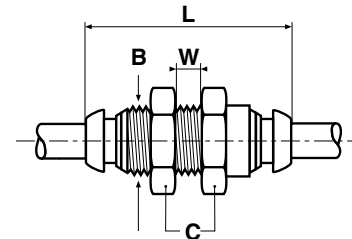

**WBMPB Mixed Bulkhead Union (Nickel Plated)**

PART NO.	TUBE 1 SIZE (MM)	TUBE 2 SIZE (MM)	B-MM THREAD	C1	C2	C4	L	W	BULKHEAD HOLE DIA.
WBMPB4	4	4	M8x1	10	10	12	34	5	8mm
WBMPB6	6	6	M10x1	12	10	12	37	5	10mm
WBMPB8	8	8	M12x1	14	14	16	39	5	12mm
WBMPB10	10	10	M14x1	17	17	19	45	5	14mm
WBMPB12	12	12	M16x1	22	19	22	49	5	16mm
WBMPB14	14	14	M18x1	24	22	22	52	7	18mm

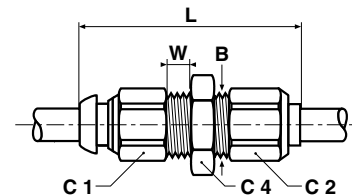

**BPK Double Male Union (Composite Body)**

PART NO.	TUBE SIZE (MM)	L
BPK4	4	38
BPK6	6	41
BPK8	8	41
BPK10	10	51
BPK12	12	54
BPK14	14	55

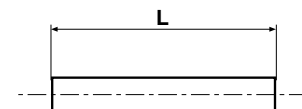



**B**

**G4PB Female Connector BSPP (Nickel Plated)**

PART NO.	TUBE SIZE (MM)	BSPP	C HEX	L
G4PB4-1/8	4	1/8	14	26.0
G4PB6-1/8	6	1/8	14	27.5
G4PB6-1/4	6	1/4	17	33.0
G4PB8-1/8	8	1/8	17	29.0
G4PB8-1/4	8	1/4	17	33.0

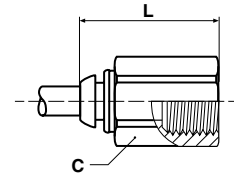

**WG4PB Bulkhead Union Female BSPP (Nickel Plated)**

PART NUMBER	TUBE SIZE (MM)	BSPP	B2	C1 HEX	C2 HEX	J	L	W
WG4PB4-1/8	4	G1/8	M11x0.75	14	14	8	25.0	6
WG4PB6-1/8	6	G1/8	M13x1	17	17	8	25.0	6
WG4PB6-1/4	6	G1/4	M13x1	17	19	12	29.5	6
WG4PB8-1/8	8	G1/8	M15x1.25	19	17	8	25.0	6
WG4PB8-1/4	8	G1/4	M15x1.25	19	19	12	30.0	6
WG4PB10-3/8	10	G3/8	M18x1	22	22	12	34.0	8
WG4PB12-3/8	12	G3/8	M23x1.5	27	24	12	35.0	10
WG4PB12-1/2	12	G1/2	M23x1.5	27	27	14	40.0	10

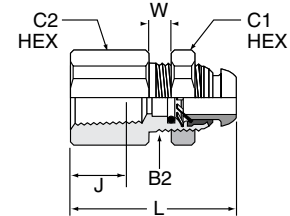

**TRPB Tube End Reducer (Nickel Plated)**

PART NO.	TUBE 1 SIZE (MM)	TUBE 2 SIZE (MM)	L
TRPB6-4	6	4	40.0
TRPB8-4	8	4	39.5
TRPB8-6	8	6	41.5
TRPB10-4	10	4	37.0
TRPB10-6	10	6	43.0
TRPB10-8	10	8	47.5
TRPB12-6	12	6	38.0
TRPB12-8	12	8	44.0
TRPB12-10	12	10	52.0
TRPB14-8	14	8	41.0
TRPB14-10	14	10	51.0
TRPB14-12	14	12	55.0

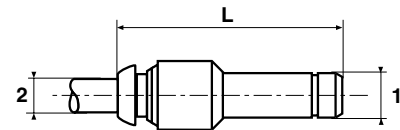

**TR2PK Tube End Reducer (Composite Body)**

PART NO.	TUBE 1 SIZE (MM)	TUBE 2 SIZE (MM)	L
TR2PK6-4	6	4	38
TR2PK8-4	8	4	36
TR2PK8-6	8	6	39
TR2PK10-4	10	4	41
TR2PK10-6	10	6	43
TR2PK10-8	10	8	47
TR2PK12-6	12	6	36
TR2PK12-8	12	8	38
TR2PK12-10	12	10	48
TR2PK14-8	14	8	39
TR2PK14-10	14	10	42
TR2PK14-12	14	12	51

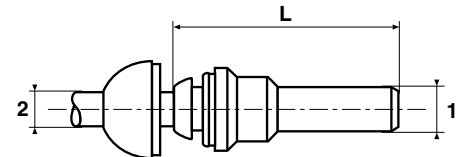

**TEPB Tube End Expander (Nickel Plated)**

PART NO.	TUBE 1 SIZE (MM)	TUBE 2 SIZE (MM)	L
TEPB4-6	4	6	39

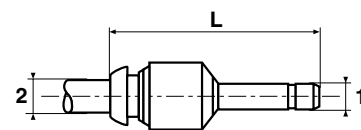

**PLHBF4-B Male Connector BSPP (Nickel Plated)**

PART NO.	TUBE SIZE (IN)	PIPE THREAD BSPP	C HEX	L	FLOW DIA. D
3-1/8PLHBF4-B	3/16	1/8-28	11/16	.96	.156
3-1/4PLHBF4-B	3/16	1/4-19	3/4	.97	.156
4-1/8PLHBF4-B	1/4	1/8-28	11/16	1.13	.188
4-1/4PLHBF4-B	1/4	1/4-19	3/4	1.13	.188
4-3/8PLHBF4-B	1/4	3/8-19	7/8	1.13	.188
6-1/4PLHBF4-B	3/8	1/4-19	3/4	1.26	.256
6-3/8PLHBF4-B	3/8	3/8-19	7/8	1.26	.312
6-1/2PLHBF4-B	3/8	1/2-14	1-1/16	1.26	.312
8-3/8PLHBF4-B	1/2	3/8-19	7/8	1.41	.452
8-1/2PLHBF4-B	1/2	1/2-14	1-1/16	1.37	.452

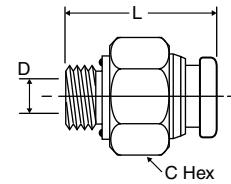

**B**

**FPB Male Connector NPT (Nickel Plated)**

PART NO.	TUBE SIZE (MM)	NPT	C HEX	L	P	INT. HEX
W68PLP-5/32-2	4	1/8-27	7/16"	21.7	9.7	-
W68PLP-5/32-4	4	1/4-18	9/16"	28.1	14.2	-
FPB6-1/8	6	1/8-27	14	26.0	10.1	4
FPB6-1/4	6	1/4-18	14	28.5	14.6	4
FPB10-1/4	10	1/4-18	19	40.0	14.6	8
FPB10-3/8	10	3/8-18	19	34.0	14.6	8
FPB12-3/8	12	3/8-18	22	36.5	14.6	10

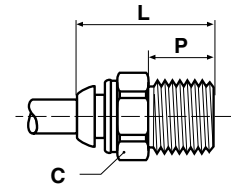

**F3PB Male Connector BSPT (Nickel Plated)**

PART NO.	TUBE SIZE (MM)	BSPT	C HEX	L
F3PB4-1/8	4	1/8	12	20.5
F3PB4-1/4	4	1/4	14	23.0
F3PB5-1/8	5	1/8	11	22.5
F3PB5-1/4	5	1/4	14	24.0
F3PB6-1/8	6	1/8	14	24.0
F3PB6-1/4	6	1/4	14	24.0
F3PB8-1/8	8	1/8	17	28.0
F3PB8-1/4	8	1/4	17	28.5
F3PB8-3/8	8	3/8	17	26.5
F3PB10-1/4	10	1/4	19	35.5
F3PB10-3/8	10	3/8	19	33.0
F3PB10-1/2	10	1/2	22	31.0
F3PB12-1/4	12	1/4	22	36.5
F3PB12-3/8	12	3/8	22	36.0
F3PB12-1/2	12	1/2	22	36.0
F3PB14-3/8	14	3/8	24	39.0
F3PB14-1/2	14	1/2	24	37.0

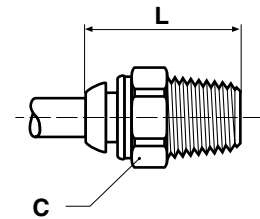

**B**

**F4PB Compact Male Connector BSPP (Nickel Plated)**

PART NO.	TUBE SIZE (MM)	BSPP	C HEX	J	L
F4PB4-1/8	4	1/8	13	4.7	20.0
F4PB4-1/4	4	1/4	16	6.0	20.4
F4PB6-1/8	6	1/8	13	4.7	23.7
F4PB6-1/4	6	1/4	16	6.0	22.6
F4PB8-1/4	8	1/4	16	4.7	25.3
F4PB8-1/8	8	1/8	14	6.0	26.7
F4PB8-3/8	8	3/8	20	6.5	23.5
F4PB10-1/4	10	1/4	17	6.0	32.1
F4PB10-3/8	10	3/8	20	6.5	27.5
F4PB10-1/2	10	1/2	24	7.5	26.8
F4PB12-1/4	12	1/4	20	6.0	32.3
F4PB12-3/8	12	3/8	20	6.5	32.3
F4PB12-1/2	12	1/2	24	7.5	28.3
F4PB14-3/8	14	3/8	22	6.5	35.4
F4PB14-1/2	14	1/2	24	7.5	30.5

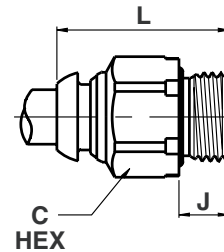

**F23PB Male Connector BSPT (Nickel Plated)**

PART NO.	TUBE SIZE (MM)	BSPT	L
F23PB4-1/8	4	1/8	21
F23PB6-1/8	6	1/8	24
F23PB6-1/4	6	1/4	28
F23PB8-1/8	8	1/8	28
F23PB8-1/4	8	1/4	28

This fitting has been designed for use where space is at a premium. It is assembled using the internal hexagon and an allen key.

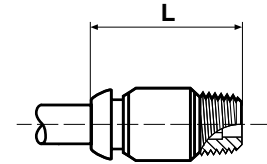

**F28PB Male Connector Metric Straight Thread (Nickel Plated)**

PART NO.	TUBE SIZE (MM)	MM THREAD	L
F28PB4M3	4	M3x0.5	24
F28PB4M5	4	M5x0.8	26
F28PB6M5	6	M5x0.8	26

This fitting has been designed for use where space is at a premium. It is assembled using the internal hexagon and an allen key.

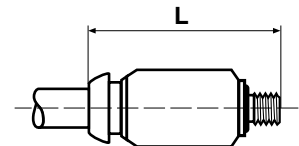

**F8PB Male Connector Metric Straight Thread (Nickel Plated)**

PART NO.	TUBE SIZE (MM)	MM THREAD	C HEX	L
F8PB4M5	4	M5x0.8	12	25.5
F8PB4M10	4	M10x1	14	24.0
F8PB6M5	6	M5x0.8	14	26.0
F8PB6M10	6	M10x1	14	28.0
F8PB6M12	6	M12x1.5	17	30.0
F8PB8M12	8	M12x1.5	17	30.0
F8PB8M16	8	M16x1.5	22	28.0
F8PB8M22	8	M22x1.5	27	30.0

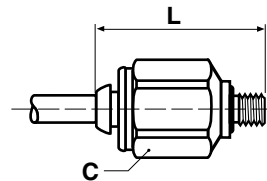

**JPB Union Tee (Nickel Plated)**

PART NO.	TUBE SIZE (MM)	C	L	M
JPB4	4	10	36	18
JPB5	5	12	41	21
JPB6	6	12	40	20
JPB8	8	14	44	22
JPB10	10	17	56	28
JPB12	12	22	60	30
JPB14	14	25	68	34

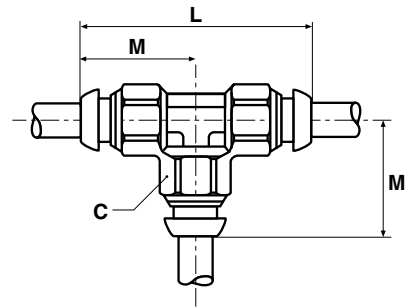

**B**

**JPK Equal Tee (Composite Body)**

PART NO.	TUBE SIZE (MM)	L	M
JPK4	4	36	18.0
JPK6	6	41	20.5
JPK8	8	45	22.5
JPK10	10	57	28.5
JPK12	12	60	30.0
JPK14	14	67	33.5

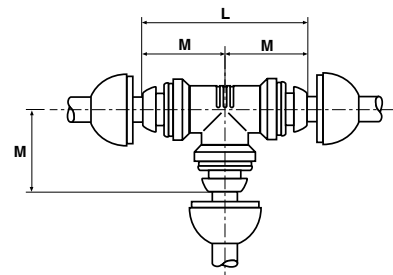

**JPK Unequal Tee (Composite Body)**

PART NO.	TUBE 1 SIZE (MM)	TUBE 2 SIZE (MM)	L	M	O	Q
JPK6-6-4	6	4	41	21.5	15	17.0
JPK8-8-6	8	6	45	22.5	17	19.0
JPK10-10-8	10	8	57	28.5	21	23.5
JPK12-12-10	12	10	60	30.0	23	25.5
JPK4-4-6	4	6	43	20.5	15	17.0
JPK6-6-8	6	8	45	22.5	17	19.0
JPK8-8-10	8	10	57	28.5	21	23.5
JPK10-10-12	10	12	61	30.5	23	25.5

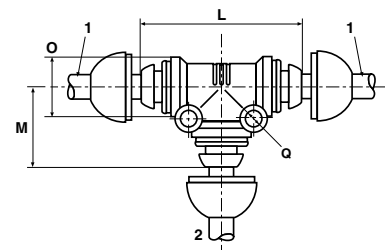

**EPB 90° Union Elbow (Nickel Plated)**

PART NO.	TUBE SIZE (MM)	C HEX	M
EPB4	4	10	18.0
EPB5	5	12	20.5
EPB6	6	12	20.0
EPB8	8	14	22.0
EPB10	10	17	28.0
EPB12	12	22	30.0
EPB14	14	25	34.0

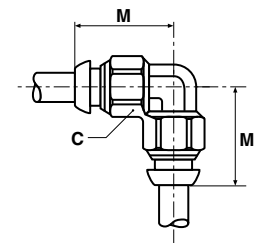

**EPK Equal Elbow (Composite Body)**

PART NO.	TUBE SIZE (MM)	M
EPK4	4	18.0
EPK6	6	20.5
EPK8	8	22.5
EPK10	10	28.5
EPK12	12	30.0
EPK14	14	33.5

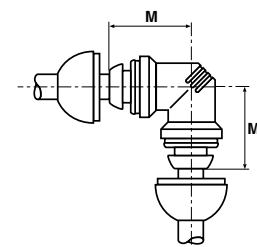

**B**

**WE6PB Adjustable Bulkhead Union Elbow (Nickel Plated)**

PART NO.	TUBE SIZE (MM)	THREAD B (MM)	C HEX	C4 HEX	L	L1	M	W	BULKHEAD HOLE DIA.
WE6PB4	4	M11x0.75	14	16	37	18.0	18.0	6	11mm
WE6PB6	6	M13x1	17	17	39	19.5	20.5	6	13mm
WE6PB8	8	M15x1.25	19	19	43	21.5	22.5	6	15mm
WE6PB10	10	M18x1	22	22	54	22.8	28.5	8	18mm
WE6PB12	12	M23x1.5	27	27	59	30.0	30.0	10	23mm

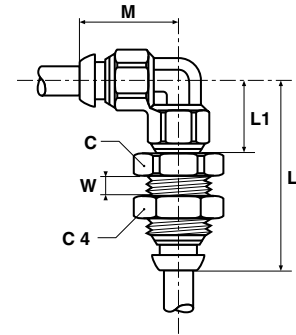

**WE6PK 90° Adjustable Bulkhead Union Elbow (Composite Body)**

PART NO.	TUBE SIZE (MM)	THREAD (MM)	C	C4	M	L	W	BULKHEAD HOLE DIA.
WE6PK4	4	M11x0.75	14	16	18.0	37	6	11mm
WE6PK6	6	M13x1	17	17	20.5	39	6	13mm
WE6PK8	8	M15x1.25	19	19	22.5	43	6	15mm
WE6PK10	10	M18x1	22	22	28.5	54	8	18mm
WE6PK12	12	M23x1.5	27	27	30.0	59	10	23mm

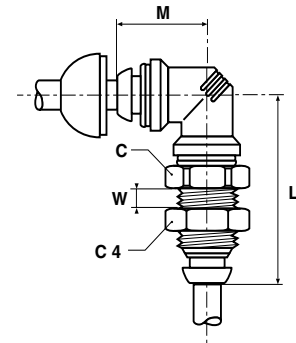

**C6PB Adjustable Male Elbow NPT (Nickel Plated)**

PART NO.	TUBE SIZE (MM)	NPT	C HEX	C4 HEX	M	N
C6PB6-1/4	6	1/4-18	12	14	20	36.0
C6PB6-3/8	6	3/8-18	12	19	20	36.5
C6PB10-1/4	10	1/4-18	17	16	28	41.5
C6PB10-3/8	10	3/8-18	17	19	28	41.5
C6PB12-3/8	12	3/8-18	17	19	30	44.0
C6PB12-1/2	12	1/2-14	22	22	30	47.5

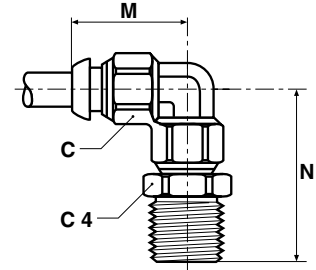

**C63PB Adjustable Male Elbow BSPT (Nickel Plated)**

PART NO.	TUBE SIZE (MM)	BSPT	C HEX	C4 HEX	M	N
C63PB4-1/8	4	1/8	10	10	18	26.5
C63PB4-1/4	4	1/4	10	14	18	30.0
C63PB6-1/8	6	1/8	12	11	20	28.0
C63PB6-1/4	6	1/4	12	14	20	31.0
C63PB8-1/8	8	1/8	14	14	22	30.0
C63PB8-1/4	8	1/4	14	14	22	33.0
C63PB8-3/8	8	3/8	14	17	22	34.5
C63PB10-1/4	10	1/4	17	17	28	40.0
C63PB10-3/8	10	3/8	17	17	28	39.0
C63PB12-1/4	12	1/4	22	19	30	42.0
C63PB12-3/8	12	3/8	22	19	30	41.0
C63PB12-1/2	12	1/2	22	22	30	44.5
C63PB14-3/8	14	3/8	25	22	34	46.0
C63PB14-1/2	14	1/2	25	22	34	48.5

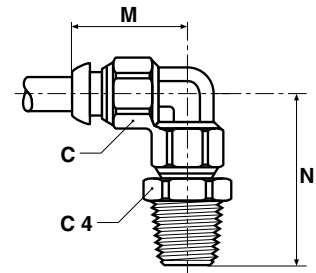

**C63PK Adjustable Male Elbow BSPT (Composite Body)**

PART NO.	TUBE SIZE (MM)	BSPT	C HEX	M	N
C63PK4-1/8	4	1/8	10	18.0	25.5
C63PK4-1/4	4	1/4	14	18.0	29.0
C63PK6-1/8	6	1/8	11	20.5	27.0
C63PK6-1/4	6	1/4	14	20.5	30.5
C63PK8-1/8	8	1/8	14	22.5	29.5
C63PK8-1/4	8	1/4	14	22.5	32.5
C63PK8-3/8	8	3/8	17	28.5	40.0
C63PK10-1/4	10	1/4	17	28.5	40.0
C63PK10-3/8	10	3/8	17	28.5	39.0
C63PK12-1/4	12	1/4	19	30.0	41.5
C63PK12-3/8	12	3/8	19	30.0	41.0
C63PK12-1/2	12	1/2	22	30.0	44.5
C63PK14-3/8	14	3/8	22	33.5	45.5
C63PK14-1/2	14	1/2	22	33.5	48.0

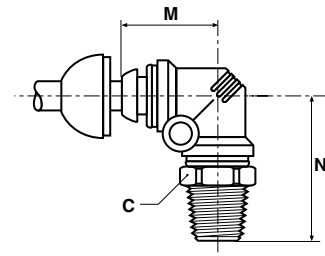

**B**

**PLE2BF4-K Male Elbow Swivel BSPP (Composite Body)**

PART NO.	TUBE SIZE (IN)	PIPE THREAD BSPP	C HEX	MOUNTING HOLE DIA.	L	N	FL FLOW DIA. D
3-1/8PLE2BF4-K	3/16	1/8-28	11/16	.17	.76	1.17	.147
3-1/4PLE2BF4-K	3/16	1/4-19	3/4	.17	.76	1.31	.147
4-1/8PLE2BF4-K	1/4	1/8-28	11/16	.17	.76	1.06	.177
4-1/4PLE2BF4-K	1/4	1/4-19	3/4	.17	.76	1.31	.172
4-3/8PLE2BF4-K	1/4	3/8-19	7/8	.17	.76	1.31	.182
6-1/4PLE2BF4-K	3/8	1/4-19	3/4	.17	1.04	1.57	.297
6-3/8PLE2BF4-K	3/8	3/8-19	7/8	.17	1.04	1.68	.297
6-1/2PLE2BF4-K	3/8	1/2-14	1-1/16	.17	1.04	1.83	.297
8-3/8PLE2BF4-K	1/2	3/8-19	7/8	.17	1.03	1.63	.344
8-1/2PLE2BF4-K	1/2	1/2-14	1-1/16	.17	1.03	1.78	.344

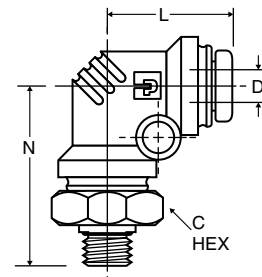

**C64PB Adjustable Male Elbow BSPP (Nickel Plated)**

PART NO.	TUBE SIZE (MM)	BSPP	C HEX	C4 HEX	J	M	N
C64PB4-1/8	4	1/8	10	13	4.7	18	23.8
C64PB4-1/4	4	1/4	10	16	6.0	18	25.6
C64PB6-1/8	6	1/8	12	13	4.7	20	28.8
C64PB6-1/4	6	1/4	12	16	6.0	20	27.1
C64PB8-1/8	8	1/8	14	13	4.7	22	28.8
C64PB8-1/4	8	1/4	14	16	6.0	22	29.1
C64PB8-3/8	8	3/8	14	20	6.5	22	31.3
C64PB10-1/4	10	1/4	17	16	6.0	28	35.1
C64PB10-3/8	10	3/8	17	20	6.5	28	35.3
C64PB12-1/4	12	1/4	22	19	6.0	30	37.1
C64PB12-3/8	12	3/8	22	22	6.5	30	38.2
C64PB12-1/2	12	1/2	22	24	7.5	30	39.3
C64PB14-3/8	14	3/8	25	22	6.5	34	43.6
C64PB14-1/2	14	1/2	25	24	7.5	34	43.2

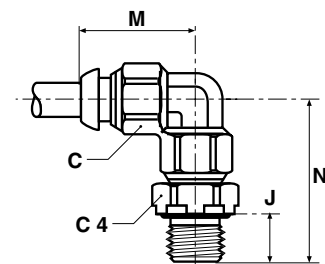

**B**

**C64PK Adjustable Male Elbow BSPP (Composite Body)**

PART NO.	TUBE SIZE (MM)	BSPP THREAD	C HEX	M	N
C64PK4-1/8	4	1/8	14	18.0	25.5
C64PK4-1/4	4	1/4	19	18.0	30.5
C64PK6-1/8	6	1/8	14	20.5	27.0
C64PK6-1/4	6	1/4	19	20.5	32.0
C64PK8-1/8	8	1/8	14	22.5	29.0
C64PK8-1/4	8	1/4	19	22.5	34.0
C64PK8-3/8	8	3/8	22	22.5	35.0
C64PK10-1/4	10	1/4	19	28.5	39.0
C64PK10-3/8	10	3/8	22	28.5	40.0
C64PK12-1/4	12	1/4	19	30.0	40.5
C64PK12-3/8	12	3/8	22	30.0	41.5
C64PK14-3/8	14	3/8	22	33.5	45.0
C64PK14-1/2	14	1/2	27	33.5	49.5

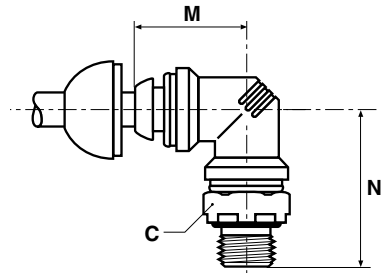

**C64SPB Compact Adjustable Male Elbow BSPP (Nickel Plated)**

PART NUMBER	TUBE SIZE (MM)	BSPP	C HEX	J	M	N
C64SPB4-1/8	4	1/8	13	4.7	17	16.5
C64SPB6-1/8	6	1/8	13	4.7	22	16.5
C64SPB6-1/4	6	1/4	16	6.0	22	19.0
C64SPB8-1/8	8	1/8	13	4.7	25	16.2
C64SPB8-1/4	8	1/4	16	6.0	25	18.5
C64SPB8-3/8	8	3/8	20	6.5	25	20.5
C64SPB10-1/4	10	1/4	16	6.0	30	20.5
C64SPB10-3/8	10	3/8	20	6.5	30	22.5
C64SPB12-1/4	12	1/8	16	6.0	32	21.5
C64SPB12-3/8	12	3/8	20	6.5	32	23.5
C64SPB12-1/2	12	1/2	24	7.5	32	25.5

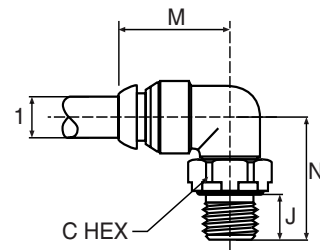

**C68PB Adjustable Male Elbow Metric Straight Thread (Nickel Plated)**

PART NO.	TUBE SIZE (MM)	THREAD (MM)	C HEX	C4 HEX	M	N
C68PB4M3	4	M3x0.5	10	10	18	23.0
C68PB4M5	4	M5x0.8	10	10	18	24.5
C68PB6M5	6	M5x0.8	12	11	20	25.5

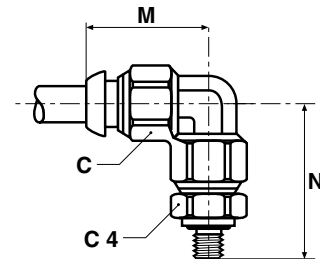

**C68SPB Compact Adjustable Male Elbow Metric Straight Thread (Nickel Plated)**

PART NUMBER	TUBE SIZE (MM)	THREAD (MM)	C HEX	J	M	N
C68SPB4M5	4	M5x0.8	12.5	5	17	18
C68SPB6M5	6	M5x0.8	12.5	5	17	18

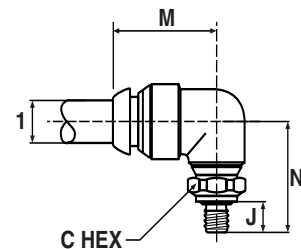

**C64SPK Compact Adjustable Male Elbow BSPP (Composite Body)**

PART NO.	TUBE SIZE (MM)	BSPP THREAD	C HEX	H	M
C64SPK4-1/8	4	1/8	14	16.7	20.5
C64SPK4-1/4	4	1/4	19	17.4	20.5
C64SPK6-1/8	6	1/8	14	17.9	23.0
C64SPK6-1/4	6	1/4	19	19.4	23.0
C64SPK8-1/8	8	1/8	14	18.9	25.0
C64SPK8-1/4	8	1/4	19	20.4	25.0
C64SPK8-3/8	8	3/8	22	21.9	25.0

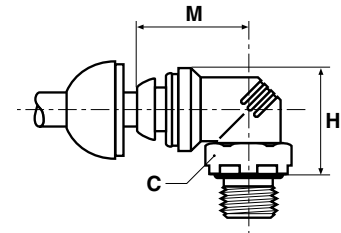

**B**

**C68PK Adjustable Male Elbow Metric Straight Thread (Composite Body)**

PART NO.	TUBE SIZE (MM)	THREAD (MM)	C HEX	M	N
C68PK4M3	4	M3x0.5	10	18.0	22.0
C68PK4M5	4	M5x0.8	10	18.0	23.5
C68PK6M5	6	M5x0.8	11	20.5	25.0
C68PK8M12	8	M12x1.5	17	22.5	35.0
C68PK8M16	8	M16x1.5	22	22.5	35.0
C68PK8M22	8	M22x1.5	27	22.5	39.0
C68PK10M12	10	M12x1.5	17	30.0	40.0

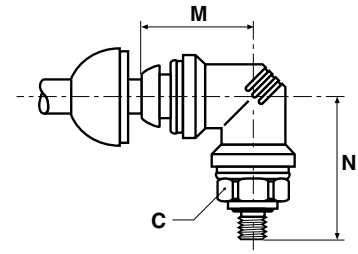

**C68SPK Compact Adjustable Male Elbow Metric Straight Thread (Composite Body)**

PART NO.	TUBE SIZE (MM)	THREAD (MM)	C HEX	H	M
C68SPK4M5	4	M5x0.8	10	15.5	20.5

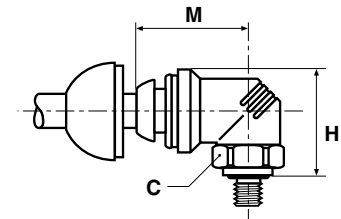

**C3PB Compact Elbow BSPT (Nickel Plated)**

PART NO.	TUBE SIZE (MM)	BSPT	C HEX	M	N
C3PB4-1/8	4	1/8	14	18	21
C3PB6-1/8	6	1/8	14	20	21
C3PB6-1/4	6	1/4	14	20	21
C3PB8-1/8	8	1/8	14	22	23
C3PB8-1/4	8	1/4	14	22	23
C3PB10-1/4	10	1/4	17	28	26
C3PB10-3/8	10	3/8	17	28	26
C3PB12-3/8	12	3/8	17	30	27
C3PB12-1/2	12	1/2	17	30	31
C3PB14-3/8	14	3/8	20	34	30
C3PB14-1/2	14	1/2	20	34	33

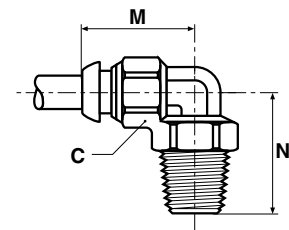

**C63SPK Adjustable Male Elbow BSPT (Composite Body)**

PART NO.	TUBE SIZE (MM)	BSPT	C HEX	H	M
C63SPK4-1/8	4	1/8	10	14.5	20.5
C63SPK4-1/4	4	1/4	14	14.5	20.5
C63SPK6-1/8	6	1/8	11	16.5	23.0
C63SPK6-1/4	6	1/4	14	16.0	23.0
C63SPK8-1/8	8	1/8	14	19.5	25.0
C63SPK8-1/4	8	1/4	14	18.5	25.0
C63SPK8-3/8	8	3/8	17	18.5	25.0
C63SPK10-1/4	10	1/4	17	23.0	31.0
C63SPK10-3/8	10	3/8	17	22.5	31.0
C63SPK10-1/2	10	1/2	22	24.0	31.0

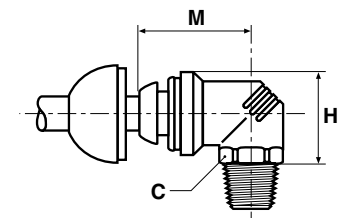



**C63LPB Adjustable Extended Male Elbow BSPT (Nickel Plated)**

PART NO.	TUBE SIZE (MM)	BSPT	C HEX	C4 HEX	M	N
C63LPB4-1/8	4	1/8	10	10	18	42.0
C63LPB4-1/4	4	1/4	10	14	18	46.0
C63LPB6-1/8	6	1/8	12	11	20	45.5
C63LPB6-1/4	6	1/4	12	14	20	49.5
C63LPB8-1/8	8	1/8	14	14	22	50.0
C63LPB8-1/4	8	1/4	14	14	22	52.5

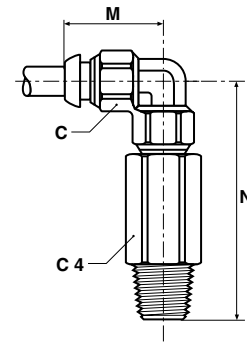

**C63LPK Adjustable Male Elbow BSPT (Composite Body)**

PART NO.	TUBE SIZE (MM)	BSPT	C HEX	M	N
C63LPK4-1/8	4	1/8	10	18.0	41.0
C63LPK4-1/4	4	1/4	14	18.0	45.0
C63LPK6-1/8	6	1/8	11	20.5	45.0
C63LPK6-1/4	6	1/4	14	20.5	49.0
C63LPK8-1/8	8	1/8	14	22.5	49.5
C63LPK8-1/4	8	1/4	14	22.5	52.0

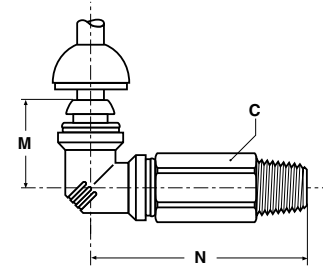

**T2ESPK Compact Plug-in Elbow (Composite Body)**

PART NO.	TUBE 1 SIZE (MM)	TUBE 2 SIZE (MM)	M	H
T2ESPK4	4	4	20.5	31.0
T2ESPK6	6	6	23.0	36.0
T2ESPK4-6	4	6	23.0	33.0
T2ESPK8	8	8	25.0	38.0

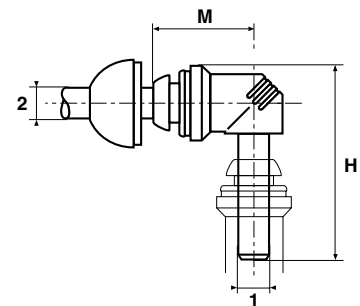

**PLR2BF4-K Male Run Tee Swivel BSPP (Composite Body)**

PART NO.	TUBE SIZE (IN)	PIPE THREAD BSPP	C HEX	MOUNTING HOLE DIA.	L	N	G	FL FLOW DIA. D
3-1/4PLR2BF4-K	3/16	1/4-19	3/4	.17	.76	1.31	.64	.147
4-1/8PLR2BF4-K	1/4	1/8-28	11/16	.17	.76	1.06	.64	.177
4-1/4PLR2BF4-K	1/4	1/4-19	3/4	.17	.76	1.31	.64	.172
6-1/4PLR2BF4-K	3/8	1/4-19	3/4	.17	1.04	1.56	.83	.296
6-3/8PLR2BF4-K	3/8	3/8-19	7/8	.17	1.04	1.68	.83	.296
8-3/8PLR2BF4-K	1/2	3/8-19	7/8	.17	1.30	1.90	.99	.344
8-1/2PLR2BF4-K	1/2	1/2-19	1-1/16	.17	1.30	2.05	.99	.344

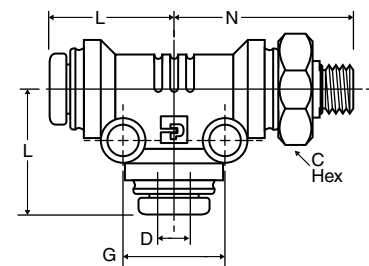

**B**

**R63PB Swivel Male Run Tee BSPT (Nickel Plated)**

PART NO.	TUBE SIZE (MM)	BSPT	C HEX	C4 HEX	L	M	N
R63PB4-1/8	4	1/8	10	10	44.5	18	26.5
R63PB4-1/4	4	1/4	10	14	48.0	18	30.0
R63PB6-1/8	6	1/8	12	11	48.0	20	28.0
R63PB6-1/4	6	1/4	12	14	51.0	20	31.0
R63PB8-1/8	8	1/8	14	14	52.0	22	30.0
R63PB8-1/4	8	1/4	14	14	55.0	22	33.0
R63PB8-3/8	8	3/8	14	17	56.5	22	34.5
R63PB10-1/4	10	1/4	17	17	68.0	28	40.0
R63PB10-3/8	10	3/8	17	17	67.0	28	39.0
R63PB12-1/4	12	1/4	22	19	72.0	30	42.0
R63PB12-3/8	12	3/8	22	19	71.0	30	41.0
R63PB12-1/2	12	1/2	22	22	74.5	30	44.5
R63PB14-3/8	14	3/8	25	22	80.0	34	46.0
R63PB14-1/2	14	1/2	25	22	82.5	34	48.5

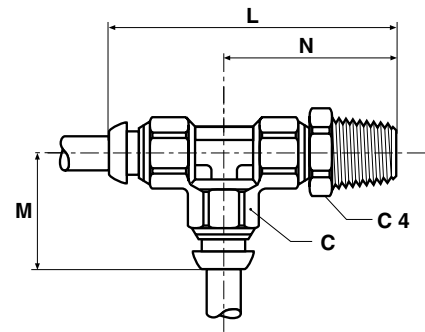

**B**

**R63PK Adjustable Male Run Tee BSPT (Composite Body)**

PART NO.	TUBE SIZE (MM)	BSPT	C HEX	M	N
R63PK4-1/8	4	1/8	10	18.0	25.5
R63PK4-1/4	4	1/4	14	18.0	29.0
R63PK6-1/8	6	1/8	11	20.5	27.0
R63PK6-1/4	6	1/4	14	20.5	30.5
R63PK8-1/8	8	1/8	14	22.5	29.5
R63PK8-1/4	8	1/4	14	22.5	32.5
R63PK8-3/8	8	3/8	17	22.5	34.0
R63PK10-1/4	10	1/4	17	28.5	40.0
R63PK10-3/8	10	3/8	17	28.5	39.0
R63PK12-1/4	12	1/4	19	30.0	41.5
R63PK12-3/8	12	3/8	19	30.0	41.0
R63PK12-1/2	12	1/2	22	30.0	44.5
R63PK14-3/8	14	3/8	22	33.5	45.5
R63PK14-1/2	14	1/2	22	33.5	48.0

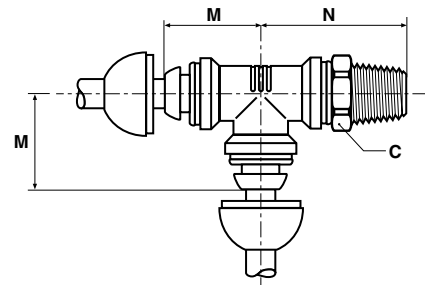

**R64PB Swivel Male Branch Run Tee BSPP (Nickel Plated)**

PART NO.	TUBE SIZE (MM)	BSPP	C HEX	C4 HEX	J	L	M	N
R64PB4-1/8	4	1/8	10	13	4.7	44.5	18	23.8
R64PB4-1/4	4	1/4	10	16	6.0	49.5	18	25.6
R64PB6-1/8	6	1/8	12	13	4.7	50.0	20	28.8
R64PB6-1/4	6	1/4	12	16	6.0	53.0	20	27.1
R64PB8-1/8	8	1/8	14	13	4.7	52.0	22	28.8
R64PB8-1/4	8	1/4	14	16	6.0	57.0	22	29.1
R64PB8-3/8	8	3/8	14	20	6.5	58.0	22	31.3
R64PB10-1/4	10	1/4	17	16	6.0	67.0	28	35.1
R64PB10-3/8	10	3/8	17	20	6.5	68.0	28	35.3
R64PB12-1/4	12	1/4	22	19	6.0	71.0	30	37.1
R64PB12-3/8	12	3/8	22	22	6.5	72.0	30	38.2
R64PB14-3/8	14	3/8	25	22	6.5	80.0	34	43.6
R64PB14-1/2	14	1/2	25	24	7.5	84.5	34	43.2

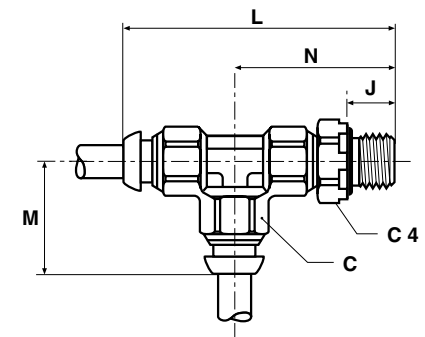

**R64PK Adjustable Male Run Tee BSPP (Composite Body)**

PART NO.	TUBE SIZE (MM)	BSPP	C HEX	M	N
R64PK4-1/8	4	1/8	14	18.0	25.5
R64PK4-1/4	4	1/4	19	18.0	30.5
R64PK6-1/8	6	1/8	14	20.5	27.0
R64PK6-1/4	6	1/4	19	20.5	32.0
R64PK8-1/8	8	1/8	14	22.5	29.0
R64PK8-1/4	8	1/4	19	22.5	34.0
R64PK8-3/8	8	3/8	22	22.5	35.0
R64PK10-1/4	10	1/4	19	28.5	39.0
R64PK10-3/8	10	3/8	22	28.5	40.0
R64PK12-1/4	12	1/4	19	30.0	40.5
R64PK12-3/8	12	3/8	22	30.0	41.5
R64PK14-3/8	14	3/8	22	33.5	45.0
R64PK14-1/2	14	1/2	27	33.5	49.5

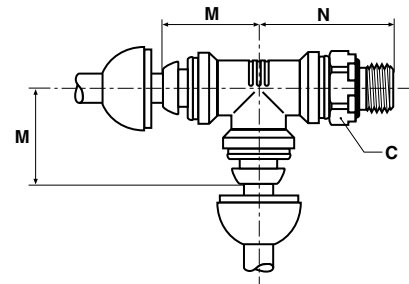

**B**

**R68PB Adjustable Male Run Tee Metric Straight Thread (Nickel Plated)**

PART NO.	TUBE SIZE (MM)	THREAD (MM)	C HEX	C4 HEX	L	M	N
R68PB4M3	4	M3x0.5	10	10	41.0	18	23.0
R68PB4M5	4	M5x0.8	10	10	42.5	18	24.5
R68PB6M5	6	M5x0.8	12	11	45.5	20	25.5

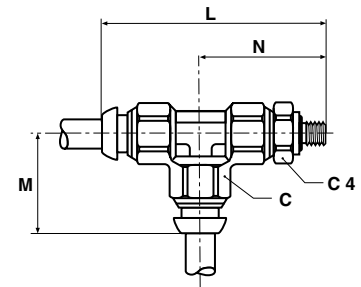

**R68PK Adjustable Male Run Tee Metric Straight Thread (Composite Body)**

PART NO.	TUBE SIZE (MM)	THREAD (MM)	C HEX	M	N
R68PK4M3	4	M3x0.5	10	18.0	22.0
R68PK4M5	4	M5x0.8	10	18.0	23.5
R68PK6M5	6	M5x0.8	11	20.5	25.0
R68PK8M12	8	M12x1.5	17	22.5	35.0
R68PK8M16	8	M16x1.5	22	22.5	35.0
R68PK8M22	8	M22x1.5	27	22.5	39.0

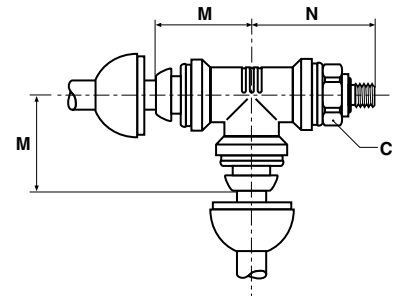

**PLS2BF4-K Male Branch Tee Swivel BSPP (Composite Body)**

PART NO.	TUBE SIZE (IN)	PIPE THREAD BSPP	C HEX	MOUNTING HOLE DIA.	FLOW			
					L	N	G	FLOW DIA. D
3-1/8PLS2BF4-K	3/16	1/8-28	11/16	.17	.76	1.05	.64	.147
3-1/4PLS2BF4-K	3/16	1/4-19	3/4	.17	.76	1.31	.64	.147
4-1/8PLS2BF4-K	1/4	1/8-28	11/16	.17	.76	1.06	.64	.177
4-1/4PLS2BF4-K	1/4	1/4-19	3/4	.17	.76	1.31	.64	.172
6-1/4PLS2BF4-K	3/8	1/4-19	3/4	.17	1.04	1.56	.83	.296
6-3/8PLS2BF4-K	3/8	3/8-19	7/8	.17	1.04	1.68	.83	.296
6-1/2PLS2BF4-K	3/8	1/2-14	1-1/16	.17	1.04	1.83	.83	.297
8-3/8PLS2BF4-K	1/2	3/8-19	7/8	.17	1.30	1.90	.99	.344

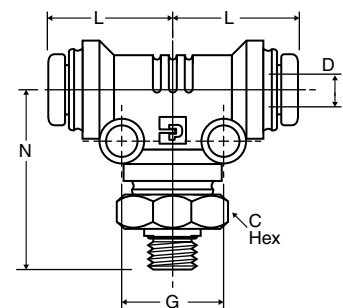

**S63PB Swivel Male Branch Tee BSPT (Nickel Plated)**

PART NO.	TUBE SIZE (MM)	BSPT	C HEX	C4 HEX	L	M	N
S63PB4-1/8	4	1/8	10	10	36	18	26.5
S63PB4-1/4	4	1/4	10	14	36	18	30.0
S63PB6-1/8	6	1/8	12	11	40	20	28.0
S63PB6-1/4	6	1/4	12	14	40	20	31.0
S63PB8-1/8	8	1/8	14	14	44	22	30.0
S63PB8-1/4	8	1/4	14	14	44	22	33.0
S63PB8-3/8	8	3/8	14	17	44	22	34.5
S63PB10-1/4	10	1/4	17	17	56	28	40.0
S63PB10-3/8	10	3/8	17	17	56	28	39.0
S63PB12-1/4	12	1/4	22	19	60	30	42.0
S63PB12-3/8	12	3/8	22	19	60	30	41.0
S63PB12-1/2	12	1/2	22	22	60	30	44.5
S63PB14-3/8	14	3/8	25	22	68	34	46.0
S63PB14-1/2	14	1/2	25	22	68	34	48.5

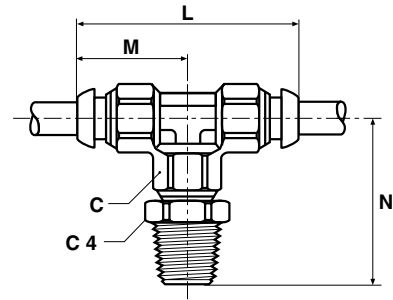

**B**

**S63PK Adjustable Male Branch Tee BSPT (Composite Body)**

PART NO.	TUBE SIZE (MM)	BSPT	C HEX	M	N
S63PK4-1/8	4	1/8	10	18.0	25.5
S63PK4-1/4	4	1/4	14	18.0	29.0
S63PK6-1/8	6	1/8	11	18.0	29.0
S63PK6-1/4	6	1/4	14	20.5	30.5
S63PK8-1/8	8	1/8	14	22.5	29.5
S63PK8-1/4	8	1/4	14	22.5	32.5
S63PK8-3/8	8	3/8	17	22.5	34.0
S63PK10-1/4	10	1/4	17	28.5	40.0
S63PK10-3/8	10	3/8	17	28.5	39.0
S63PK12-1/4	12	1/4	19	30.0	41.5
S63PK12-3/8	12	3/8	19	30.0	41.0
S63PK12-1/2	12	1/2	22	30.0	44.5
S63PK14-3/8	14	3/8	22	33.5	45.5
S63PK14-1/2	14	1/2	22	33.5	48.0

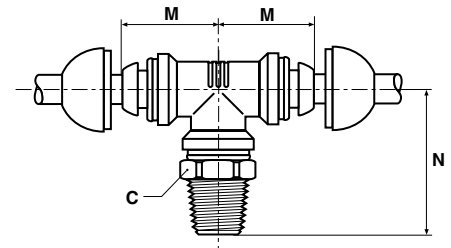

**S64PB Swivel Male Branch Tee BSPP (Nickel Plated)**

PART NO.	TUBE SIZE (MM)	BSPP	C HEX	C4 HEX	L	M	N
S64PB4-1/8	4	1/8	10	13	36	18	23.8
S64PB4-1/4	4	1/4	10	16	36	18	25.6
S64PB6-1/8	6	1/8	12	13	40	20	28.8
S64PB6-1/4	6	1/4	12	16	40	20	27.1
S64PB8-1/8	8	1/8	14	13	44	22	28.8
S64PB8-1/4	8	1/4	14	16	44	22	29.1
S64PB8-3/8	8	3/8	14	20	44	22	31.3
S64PB10-1/4	10	1/4	17	16	56	28	35.1
S64PB10-3/8	10	3/8	17	20	56	28	35.3
S64PB12-1/4	12	1/4	22	19	60	30	37.1
S64PB12-3/8	12	3/8	22	22	60	30	38.2
S64PB14-3/8	14	3/8	25	22	68	34	43.6
S64PB14-1/2	14	1/2	25	24	68	34	43.2

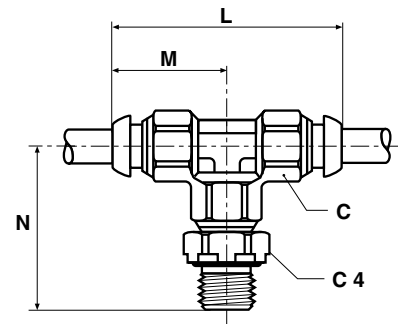

**B**

**S64PK Adjustable Male Branch Tee BSPP (Composite Body)**

PART NO.	TUBE SIZE (MM)	BSPP	C HEX	M	N
S64PK4-1/8	4	1/8	14	18.0	25.5
S64PK4-1/4	4	1/4	19	18.0	30.5
S64PK6-1/8	6	1/8	14	20.5	27.0
S64PK6-1/4	6	1/4	19	20.5	32.0
S64PK8-1/8	8	1/8	14	22.5	29.0
S64PK8-1/4	8	1/4	19	22.5	34.0
S64PK8-3/8	8	3/8	22	22.5	35.0
S64PK10-1/4	10	1/4	19	28.5	39.0
S64PK10-3/8	10	3/8	22	28.5	40.0
S64PK12-1/4	12	1/4	19	30.0	40.5
S64PK12-3/8	12	3/8	22	30.0	41.5
S64PK14-3/8	14	3/8	22	33.5	45.0
S64PK14-1/2	14	1/2	27	33.5	49.5

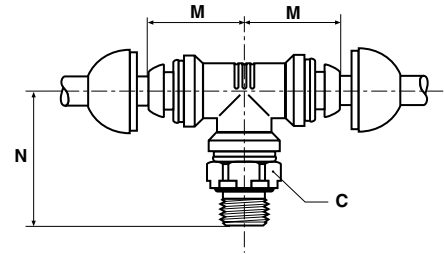

**S68PB Adjustable Male Branch Tee Metric Straight Thread (Nickel Plated)**

PART NO.	TUBE SIZE (MM)	THREAD (MM)	C HEX	C4 HEX	L	M	N
S68PB4M3	4	M3x0.5	10	10	36	18	23.0
S68PB4M5	4	M5x0.8	10	10	36	18	24.5
S68PB6M5	6	M5x0.8	12	11	40	20	25.5

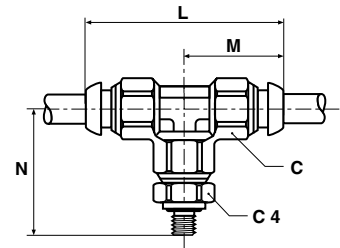

**S68PK Adjustable Male Branch Tee Metric Straight Thread (Composite Body)**

PART NO.	TUBE SIZE (MM)	THREAD (MM)	C HEX	M	N
S68PK4M3	4	M3x0.5	10	18.0	22.0
S68PK4M5	4	M5x0.8	10	18.0	23.5
S68PK6M5	6	M5x0.8	11	20.5	25.0
S68PK8M12	8	M12x1.5	17	22.5	35.0
S68PK8M16	8	M16x1.5	22	22.5	35.0
S68PK8M22	8	M22x1.5	27	22.5	39.0

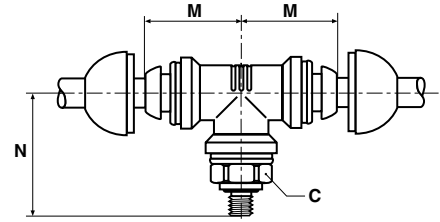

**T2JPK Plug-in Branch Tee (Composite Body)**

PART NUMBER	TUBE 1 SIZE (MM)	TUBE 2 SIZE (MM)	MOUNTING HOLE DIA.	H	M	N
T2JPK4	4	4	3.2	19.5	18.0	33.5
T2JPK6	6	6	4.2	21.0	20.5	36.5
T2JPK8	8	8	4.2	22.0	22.5	39.5

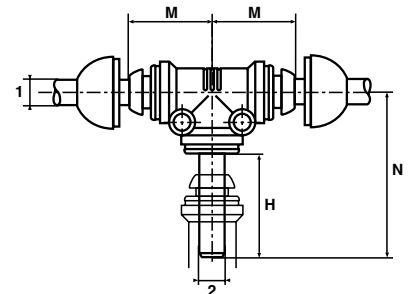

**WYJ6PK Adjustable Male Bulkhead Y Connector (Composite Body)**

PART NO.	TUBE SIZE	MM THREAD	C	C4	L	L1	L2	M
WYJ6PK4	4	M11x0.75	14	16	46	22	11.0	27
WYJ6PK6	6	M13x1	17	17	54	30	13.5	35
WYJ6PK8	8	M15x1.25	19	19	64	30	13.5	35

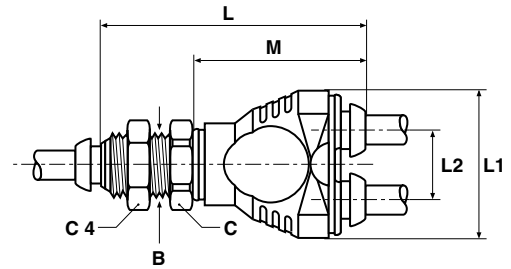

**YJPK Union Y Connector (Composite Body)**

PART NO.	TUBE SIZE (MM)	L	L1	L2
YJPK4*	4	31.0	22	11.0
YJPK6*	6	40.0	30	13.5
YJPK8*	8	40.0	30	13.5

\* Fittings not suitable for use with protective cap.

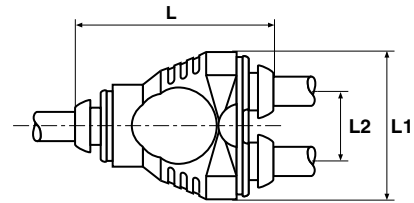

**YJPK Unequal Union Y Connector (Composite Body)**

PART NO.	TUBE 1 SIZE (MM)	TUBE 2 SIZE (MM)	MOUNTING HOLE DIA.	L	L1	L2
YJPK4-4-6	4	6	4.2	40	30	13.5
YJPK6-6-8	6	8	4.2	40	30	13.5
YJPK8-8-10	8	10	4.2	40	31	13.6

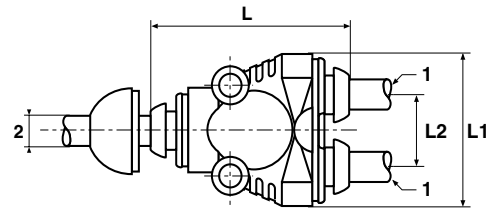

**YJ5PK Union Double Y Connector (Composite Body)**

PART NO.	TUBE 1 SIZE (MM)	TUBE 2 SIZE (MM)	H	L	N	MOUNTING HOLE DIA.
YJ5PK6-4	6	4	22.5	38	9.5	4.2
YJ5PK4	4	4	22.5	35	9.5	3.2

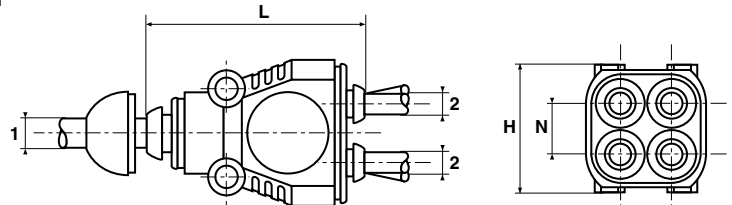

**YJ2PK Plug-In Y Connector (Composite Body)**

PART NO.	TUBE SIZE (MM)	L	L1	L2	L3
YJ2PK4*	4	46.5	22	11.0	27
YJ2PK6*	6	56.0	30	13.5	35
YJ2PK8*	8	57.0	30	13.5	35

\* Fittings not suitable for use with protective cap.

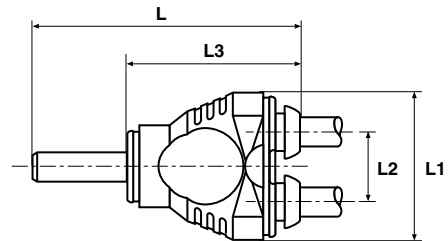

**B**

**YJ52PK Plug-in Double Y Connector (Composite Body)**

PART NUMBER	TUBE 1 SIZE (MM)	TUBE 2 SIZE (MM)	MOUNTING HOLE DIA	L	L1	L2	M
YJ52PK6-4	6	4	3.2	52	22.5	9.5	31

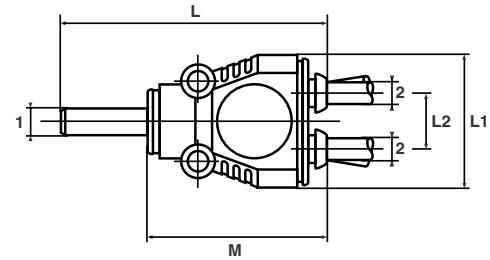

**YJ63PK Adjustable Male Y Connector BSPT (Composite Body)**

PART NO.	TUBE SIZE (MM)	BSPT	C HEX	L	L1	L2
YJ63PK4-1/8*	4	1/8	10	38.5	22	11.0
YJ63PK4-1/4*	4	1/4	14	42.0	22	11.0
YJ63PK6-1/8*	6	1/8	11	51.5	30	13.5
YJ63PK6-1/4*	6	1/4	14	50.0	30	13.5
YJ63PK8-1/8*	8	1/8	14	47.0	30	13.5
YJ63PK8-1/4*	8	1/4	14	50.0	30	13.5

\*Fittings not suitable for use with protective cap.

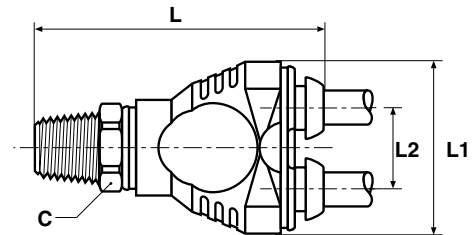

**YJ563PK Union Double Y Connector Adjustable Male BSPT (Composite Body)**

PART NUMBER	TUBE SIZE (MM)	BSPT	MOUNTING HOLE DIA	C HEX	L	L1	L2
YJ563PK4-1/8	4	1/8	3.2	10	42.5	22.5	9.5
YJ563PK4-1/4	4	1/4	3.2	14	46.0	22.5	9.5

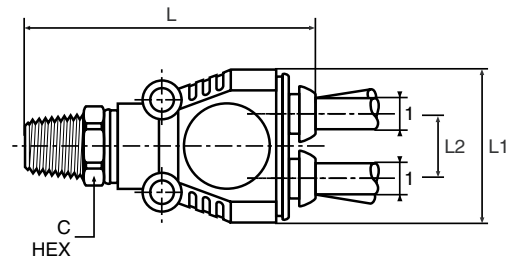

**YJ64PK Adjustable Male Y Connector BSPP (Composite Body)**

PART NO.	TUBE SIZE (MM)	BSPP	C HEX	L	L1	L2
YJ64PK4-1/8*	4	1/8	14	38.5	22	11.0
YJ64PK4-1/4*	4	1/4	19	43.5	22	11.0
YJ64PK6-1/8*	6	1/8	14	46.5	30	13.5
YJ64PK6-1/4*	6	1/4	19	51.5	30	13.5
YJ64PK8-1/8*	8	1/8	14	46.5	30	13.5
YJ64PK8-1/4*	8	1/4	19	51.5	30	13.5

\* Fittings not suitable for use with protective cap.

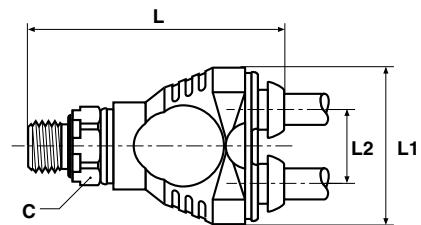

**YJ564PK Union Double Y Connector Adjustable Male BSPP (Composite Body)**

PART NUMBER	TUBE SIZE (MM)	BSPP	MOUNTING HOLE DIA	C HEX	J	L	L1	L2
YJ564PK4-1/8	4	1/8	3.2	14	6	42.5	22.5	9.5
YJ564PK4-1/4	4	1/4	3.2	19	9	47.5	22.5	9.5

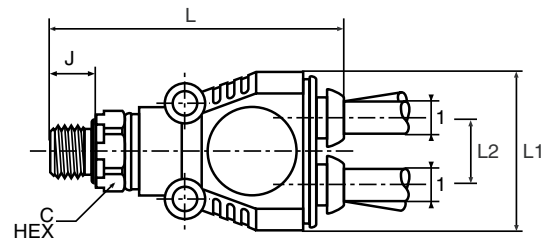

**CORPB Single Banjo Body Only (Nickel Plated)**

PART NO.	TUBE SIZE (MM)	PART NO. SINGLE BOLT	PART NO. STACKING BOLT	M	X	Y
CORPB4-5	4	SC8UM5-4	SC8UDM5-4	19.0	10	10
CORPB4-10	4	SC4U1/8-4	SC4UD1/8-4	22.5	14	14
CORPB6-10	6	SC4U1/8-4	SC4UD1/8-4	23.0	14	14
CORPB6-13	6	SC4U1/4-6	SC4UD1/4-6	24.5	14	17
CORPB8-10	8	SC4U1/8-4	SC4UD1/8-4	24.0	14	14
CORPB8-13	8	SC4U1/4-6	SC4UD1/4-6	25.5	14	17
CORPB10-17	10	SC4U3/8-10	SC4UD3/8-10	32.0	17	22

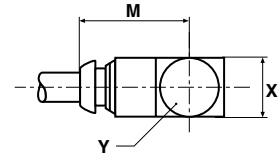

**CORPBD Double Banjo Body Only (Nickel Plated)**

PART NO.	TUBE SIZE (MM)	PART NO. SINGLE BOLT	PART NO. STACKING BOLT	L	M	X	Y
CORPB4D5	4	SC8UM5-4	SC8UDM5-4	38	19.0	10	10
CORPB4D10	4	SC4U1/8-4	SC4UD1/8-4	45	22.5	14	14
CORPB6D10	6	SC4U1/8-4	SC4UD1/8-4	46	23.0	14	14
CORPB6D13	6	SC4U1/4-6	SC4UD1/4-6	49	24.5	14	17
CORPB8D10	8	SC4U1/8-4	SC4UD1/8-4	48	24.0	14	14

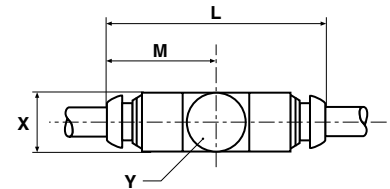

**COR8PB/COR4PB Single Banjo Assembled (Nickel Plated)**

PART NO.	TUBE SIZE (MM)	BSPP	C HEX	D	J	K	L	M	N	O	Y
COR8PB4M5	4	M5x0.8	8	8.2	4.5	1.0	24.0	19.0	13.5	6.0	10
COR4PB4-1/8	4	1/8	14	14.4	6.0	1.5	29.5	22.5	19.5	8.5	14
COR4PB6-1/8	6	1/8	14	14.4	6.0	1.5	30.0	23.0	19.5	8.5	14
COR4PB6-1/4	6	1/4	17	18.4	9.0	2.0	33.0	24.5	21.0	9.0	17
COR4PB8-1/8	8	1/8	14	14.4	6.0	1.5	31.0	34.0	19.5	8.5	14
COR4PB8-1/4	8	1/4	17	18.4	9.0	2.0	34.0	25.5	21.0	9.0	17
COR4PB10-3/8	10	3/8	22	21.6	9.0	2.5	43.0	32.0	25.5	11.0	22

These parts are delivered complete with sealing washer.

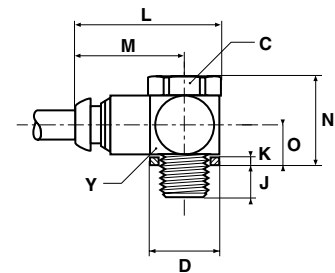

**COR8PBD/COR4PBD Double Banjo Assembled (Nickel Plated)**

PART NO.	TUBE SIZE (MM)	BSPP	C HEX	D	J	K	L	M	N	O	Y
COR8PB4DM5	4	M5x0.8	8	8.2	4.5	1.0	38	19.0	13.5	6.0	10
COR4PB4D1/8	4	1/8	14	14.4	6.0	1.5	45	22.5	19.5	8.5	14
COR4PB6D1/8	6	1/8	14	14.4	6.0	1.5	46	23.0	19.5	8.5	14
COR4PB6D1/4	6	1/4	17	18.4	9.0	2.0	49	24.5	21.0	9.0	17
COR4PB8D1/8	8	1/8	14	14.4	6.0	1.5	48	24.0	19.5	8.5	14

These parts are delivered complete with sealing washer.

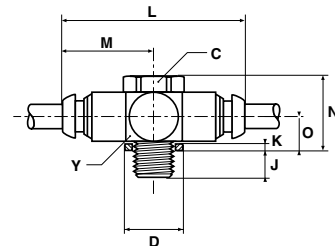

**SC8U/SC4U Single Banjo Bolt with Seals BSPP (Nickel Plated)**

PART NO.	BSPP	C HEX	D	J	K	L
SC8UM5-4	M5x0.8	8	8.2	4.5	1.0	18.5
SC4U1/8-4	1/8	14	14.4	6.0	1.5	25.5
SC4U1/4-6	1/4	17	18.4	9.0	2.0	30.0
SC4U3/8-10	3/8	22	21.6	9.0	2.5	34.5

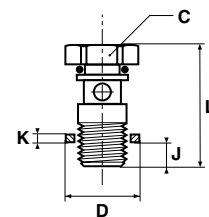



**SC8UD/SC4UD Stacking Banjo Bolt with Seals BSPP (Nickel Plated)**

PART NO.	BSPP	C HEX	D	J	K	L
SC8UDM5-4	M5x0.8	8	8.2	4.5	1.0	29.5
SC4UD1/8-4	1/8	14	14.4	6.0	1.5	41.0
SC4UD1/4-6	1/4	17	18.4	9.0	2.0	46.0

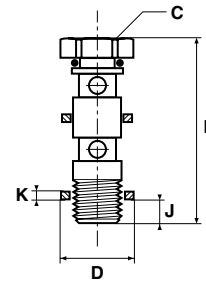

**B**

**J5PK Multiple Tee (Composite Body)**

PART NO.	TUBE 1 SIZE (MM)	TUBE 2 SIZE (MM)	MOUNTING HOLE DIA	H	L	L1	N
J5PK6-4	6	4	4.2	27	78	52	18
J5PK8-4	8	4	4.2	28	80	52	18
J5PK8-6	8	6	4.2	30	80	52	18
J5PK10-6	10	6	4.2	33	90	52	18

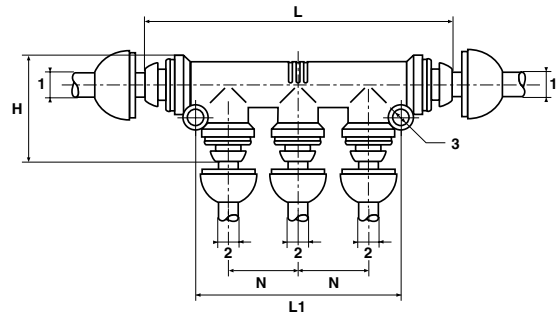

**J6PK Multiple Tee (Composite Body)**

PART NO.	TUBE 1 SIZE (MM)	TUBE 2 SIZE (MM)	MOUNTING HOLE DIA	H	L	L1	N
J6PK6-4	6	4	4.4	27	96	70	18
J6PK8-4	8	4	4.4	28	98	70	18
J6PK8-6	8	6	4.4	30	98	70	18
J6PK10-6	10	6	4.4	33	108	70	18

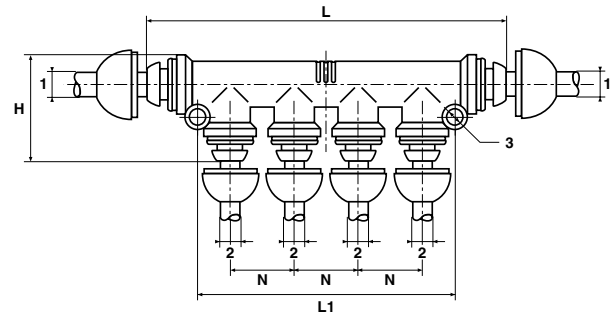

**J663PK Adjustable Male Multiple Tee BSPT (Composite Body)**

PART NUMBER	TUBE 1 SIZE (MM)	TUBE 2 SIZE (MM)	MOUNTING HOLE DIA	BSPT	C HEX	H	L	L1	N
J663PK6-4-1/4	6	4	4.4	1/4	14	27	106.5	70	18

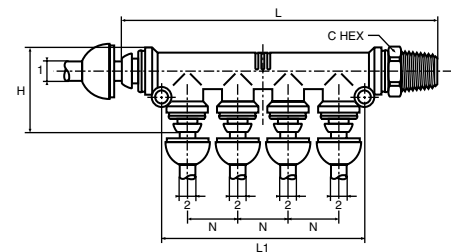

**FNPB Plug (Nickel Plated)**

PART NO.	TUBE SIZE (MM)	L
FNPB4	4	27
FNPB6	6	27
FNPB8	8	30
FNPB10	10	30
FNPB12	12	35
FNPB14	14	36

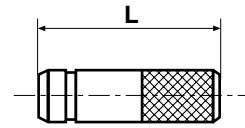

**FNPK Plug (Composite Body)**

PART NO.	TUBE SIZE (MM)	L
FNPK4	4	34.5
FNPK6	6	35.0
FNPK8	8	35.0
FNPK10	10	42.0
FNPK12	12	41.0
FNPK14	14	40.0

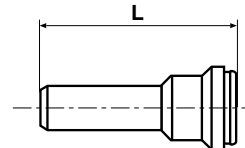

**T23FPK Tube End Male Adaptor BSPT (Composite Body)**

PART NUMBER	TUBE SIZE (MM)	BSPT	C HEX	L	N
T23FPK4-1/8	4	1/8	12	36	19.5
T23FPK4-1/4	4	1/4	14	40	19.5
T23FPK6-1/8	6	1/8	14	40	21.0
T23FPK6-1/4	6	1/4	14	40	21.0
T23FPK8-1/8	8	1/8	17	45	22.0
T23FPK8-1/4	8	1/4	17	46	22.0
T23FPK8-3/8	8	3/8	17	44	22.0

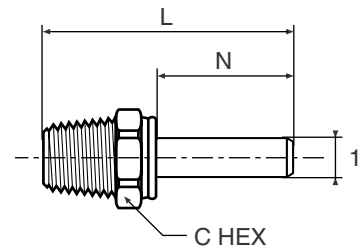

**T24FPK Tube End Male Adaptor BSPP (Composite Body)**

PART NUMBER	TUBE SIZE (MM)	BSPP	C HEX	J	L	N
T24FPK4-1/8	4	1/8	14	6	38	19.0
T24FPK4-1/4	4	1/4	16	9	38	19.5
T24FPK6-1/8	6	1/8	14	6	41	21.0
T24FPK6-1/4	6	1/4	16	9	41	20.5
T24FPK8-1/8	8	1/8	14	6	45	22.0
T24FPK8-1/4	8	1/4	16	9	45	22.0
T24FPK8-3/8	8	3/8	19	9	45	22.0
T24FPK10-1/4	10	1/4	19	9	57	27.0

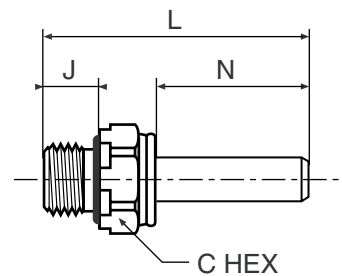

**HS3PK Manifold for 2 Tubes And Pressure Indicator (Composite Body)**

PART NO.	TUBE SIZE (MM)	L 1	M
HS3PK4	4	14	16
HS3PK6	6	15	18
HS3PK8	8	15	29

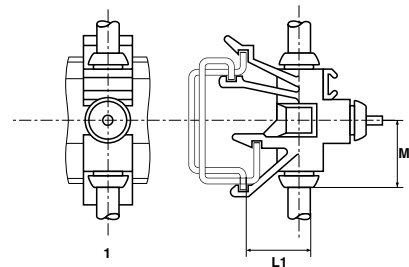

**J3PK Manifold for 3 Tubes (Composite Body)**

PART NO.	TUBE SIZE (MM)	L 1	M
J3PK4	4	14	16
J3PK6	6	15	18
J3PK8	8	15	29

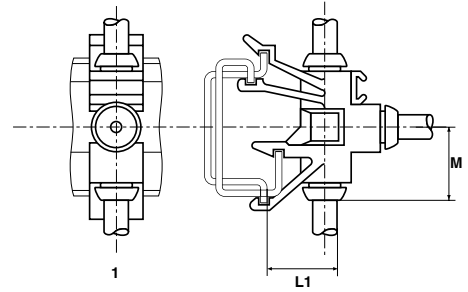

**TS2PK Pressure Indicator (Composite Body)**

PART NO.	TUBE SIZE (MM)	L
TS2PK4	4	36
TS2PK6	6	37
TS2PK8	8	36

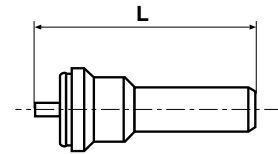

**B**

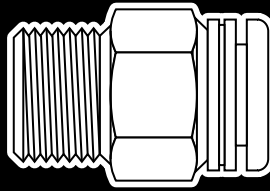

## PrestoWeld Fittings

### Advantages

Parker Prestoweld Push-to-Connect fittings are weld splatter resistant and silicone free to meet the stringent requirements of the robotic welding industry for pneumatic controls. All fittings feature nickel-plated brass bodies and threads. Release buttons are made from a UL94-V0 engineered thermoplastic and color coded black to designate inch size. The fittings are designed for use with special Parker Microweld tubing. Microweld tubing is an ether-based polyurethane for maximum hydrolytic stability and has a UL-94 V2 flame rating. Microweld tubing does not contain silicone or other contaminants that affect paint surfaces. The Prestoweld fitting is based on the design of the Parker Prestolok push-in fitting, with a silicone free lubricated nitrile o-ring and stainless steel grab ring to ensure positive tube retention. The release button collet aids in preventing weld spatter into the fittings.

### Materials

- Body: Nickel Plated Brass
- O-ring: Nitrile silicone free
- Release Ring: PBT UL94-V0
- Black release ring: Inch
- Yellow release ring: Metric
- Grab Ring: Stainless Steel

### Applications

Use with Parker Microweld tubing to meet the stringent requirements of the robotic welding industry for pneumatic controls. Consult the factory with any questions regarding special product applications. All applications should be carefully tested through the range of conditions which may be encountered prior to use.

### Working Pressure and Temperature Range

0° to +200°F at up to 300 PSI depending on tubing being used

### Assembly Instructions

1. Cut tubing squarely, be certain the port of mating part is clean and free of debris
2. Insert tubing into fitting until it bottoms. A slight twisting motion will ease the insertion. Pull on the tubing to verify it is properly retained in the fitting.
3. To disassemble, simply push in the release button against the body and remove the tubing.
4. It is recommended to trim the tubing after every disassembly to insure a proper seal.

### Order

By part number and name.

### Nomenclature

Part numbers are constructed from symbols that identify the style and size of the fitting. The first series of numbers and letters identify the style and type fitting. The second series of numbers describe the size.

Note: 0 indicates 10-32 UNF Thread

**Example:**

	W	169	PW	-4	-2
White PCTFE	_____				
Thread Sealant	_____				
Male Elbow	_____				
PrestoWeld	_____				
¼" (4/16) Tube O.D.	_____				
1/8" (2/16) Pipe Thread	_____				

### Sizes

Tube sizes are determined by the number of sixteenths of an inch in the tube O.D.

### Pricing

Only items priced in current supplementary price list PL3501 are carried in stock. Price and delivery for non-stock items furnished on request for special quantity.

### DB Dust/Weld Spatter Boot

PART NO.	FITTING SIZE
DB-4	1/4", 5/16", 6MM, 8MM
DB-6	3/8", 10MM
DB-8	1/2", 12MM



**DB Dust/Weld Spatter Boot**

PART NO.	TUBE SIZE (IN)	L	D
DB-4	1/4	.50	.53
DB-6	3/8	.50	.76
DB-8	1/2	.50	.88

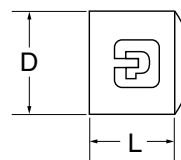

**62PW Union (Nickel Plated)**

PART NO.	TUBE SIZE	O.D.	L	FLOW DIA. D
62PW-4	1/4	.500	1.43	.188
62PW-5	5/16	.562	1.65	.250
62PW-6	3/8	.625	1.66	.312
62PW-8	1/2	.750	1.82	.375

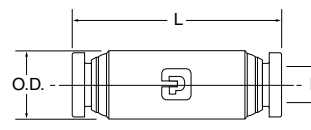

**62PWBH Bulkhead Union (Nickel Plated)**

PART NO.	TUBE SIZE (IN)	BULKHEAD HOLE DIA. B	C HEX	P MAX.	L	D
62PWBH-4	1/4	9/16	11/16	.29	1.43	.188
62PWBH-5	5/16	5/8	3/4	.60	1.65	.250
62PWBH-6	3/8	3/4	7/8	.54	1.66	.312
62PWBH-8	1/2	7/8	1	.66	2.04	.375

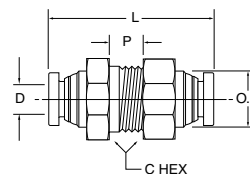

**66PW Female Connector (Nickel Plated)**

PART NO.	TUBE SIZE	PIPE THREAD (NPTF)	C HEX	L	FLOW DIA. D
66PW-4-2	1/4	1/8	9/16	1.17	.188
66PW-4-4	1/4	1/4	11/16	1.38	.188
66PW-5-2	5/16	1/8	9/16	1.25	.250
66PW-5-4	5/16	1/4	11/16	1.45	.250
66PW-6-4	3/8	1/4	11/16	1.46	.312
66PW-6-6	3/8	3/8	13/16	1.51	.312

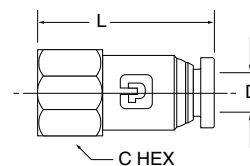

**66PWBH Female Bulkhead (Nickel Plated)**

PART NO.	TUBE SIZE (IN)	THREAD (NPTF)	C HEX	P MAX.	L	FLOW DIA. D	BULKHEAD HOLE DIA.
66PWBH-4-4	1/4	1/4	11/16	.24	1.35	.188	9/16
66PWBH-6-6	3/8	3/8	1	.22	1.47	.312	7/8
66PWBH-8-6	1/2	3/8	1 1/4	.35	1.56	.344	1

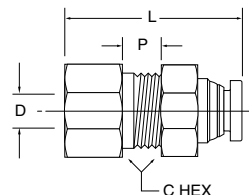

**B**

**W68PW Male Connector (Nickel Plated)**

PART NO.	TUBE SIZE (IN)	PIPE THREAD (NPTF)	C HEX	L	FLOW DIA. D
W68PW-4-2	1/4	1/8	1/2	.89	.188
W68PW-4-4	1/4	1/4	9/16	1.00	.188
W68PW-4-6	1/4	3/8	3/4	1.04	.188
W68PW-5-2	5/16	1/8	9/16	1.18	.250
W68PW-5-4	5/16	1/4	9/16	1.04	.250
W68PW-5-6	5/16	3/8	11/16	1.04	.250
W68PW-6-2	3/8	1/8	5/8	1.21	.250
W68PW-6-4	3/8	1/4	5/8	1.08	.312
W68PW-6-6	3/8	3/8	11/16	1.02	.312
W68PW-6-8	3/8	1/2	7/8	1.28	.312
W68PW-8-4	1/2	1/4	13/16	1.44	.344
W68PW-8-6	1/2	3/8	13/16	1.24	.344
W68PW-8-8	1/2	1/2	7/8	1.35	.375

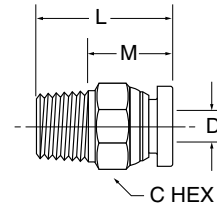

**B**

**164PW Union Tee (Nickel Plated)**

PART NO.	TUBE SIZE (IN)	L	FLOW DIA. D
164PW-4	1/4	.85	.188
164PW-5	5/16	.97	.250
164PW-6	3/8	1.01	.250
164PW-8	1/2	1.15	.375

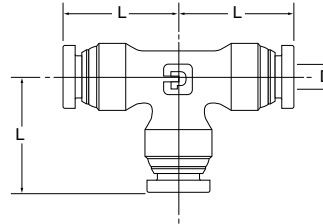

**165PW Union Elbow (Nickel Plated)**

PART NO.	TUBE SIZE (IN)	L	FLOW DIA. D
165PW-4	1/4	.85	.188
165PW-5	5/16	.97	.250
165PW-6	3/8	1.01	.312
165PW-8	1/2	1.15	.375

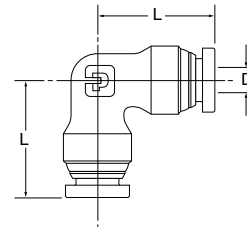

**W169PW Male Elbow Swivel 90° (Nickel Plated)**

PART NO.	TUBE SIZE (IN)	PIPE THREAD (NPTF)	C HEX	L	N	FLOW DIA. D
W169PW-4-2	1/4	1/8	7/16	.85	.92	.156
W169PW-4-4	1/4	1/4	9/16	.85	1.10	.156
W169PW-4-6	1/4	3/8	11/16	.85	1.19	.156
W169PW-5-2	5/16	1/8	9/16	.97	1.02	.250
W169PW-5-4	5/16	1/4	9/16	.97	1.24	.250
W169PW-6-2	3/8	1/8	9/16	1.01	1.02	.250
W169PW-6-4	3/8	1/4	9/16	1.01	1.24	.250
W169PW-6-6	3/8	3/8	11/16	1.01	1.24	.250
W169PW-6-8	3/8	1/2	7/8	1.01	1.48	.250
W169PW-8-4	1/2	1/4	9/16	1.15	1.28	.312
W169PW-8-6	1/2	3/8	11/16	1.15	1.31	.312
W169PW-8-8	1/2	1/2	7/8	1.15	1.52	.312

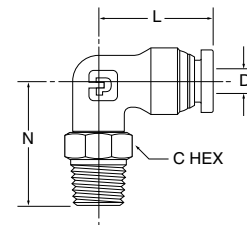

**W171PW Male Run Tee Swivel (Nickel Plated)**

PART NO.	TUBE SIZE (IN)	PIPE THREAD (NPTF)	C HEX	L	N	FLOW DIA. D
W171PW-4-2	1/4	1/8	7/16	.85	.92	.156
W171PW-4-4	1/4	1/4	9/16	.85	1.10	.156
W171PW-4-6	1/4	3/8	11/16	.85	1.24	.156
W171PW-5-2	5/16	1/8	9/16	.97	1.02	.250
W171PW-5-4	5/16	1/4	9/16	.97	1.24	.250
W171PW-6-4	3/8	1/4	9/16	1.01	1.24	.250
W171PW-6-6	3/8	3/8	11/16	1.01	1.24	.250
W171PW-8-6	1/2	3/8	11/16	1.15	1.31	.312
W171PW-8-8	1/2	1/2	7/8	1.15	1.52	.312

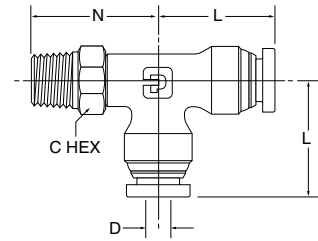

**W172PW Male Branch Tee Swivel (Nickel Plated)**

PART NO.	TUBE SIZE (IN)	PIPE THREAD (NPTF)	C HEX	L	N	FLOW DIA. D
W172PW-4-2	1/4	1/8	7/16	.85	.92	.156
W172PW-4-4	1/4	1/4	9/16	.85	1.10	.156
W172PW-4-6	1/4	3/8	11/16	.85	1.10	.156
W172PW-5-2	5/16	1/8	9/16	.97	1.02	.250
W172PW-5-4	5/16	1/4	9/16	.97	1.24	.250
W172PW-6-4	3/8	1/4	9/16	1.01	1.24	.250
W172PW-6-6	3/8	3/8	11/16	1.01	1.24	.250
W172PW-8-4	1/2	1/4	9/16	1.15	1.30	.312
W172PW-8-6	1/2	3/8	11/16	1.15	1.31	.312
W172PW-8-8	1/2	1/2	7/8	1.15	1.52	.312

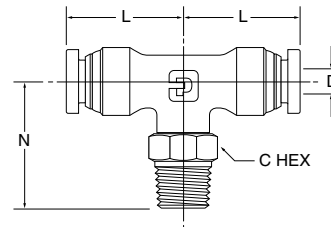

**HPB Equal Union**

PART NO.	TUBE SIZE (MM)	L
HPB6	6	36.0
HPB8	8	38.0
HPB10	10	48.0
HPB12	12	48.0

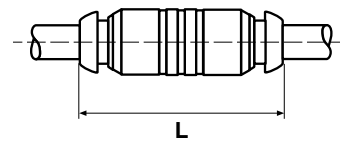

**WPB Bulkhead Union**

PART NO.	TUBE SIZE (MM)	B-MM THREAD	C HEX	L	W	BULKHEAD HOLE DIA.
WPB6	6	M13x1	19	35	6	13mm
WPB8	8	M15x1.25	22	36	6	16mm
WPB10	10	M18x1	22	43	8	18mm
WPB12	12	M23x1.5	27	46	10	23mm

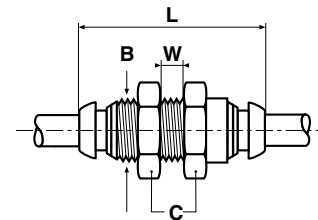

**F3PB Male Connector BSPT**

PART NO.	TUBE SIZE (MM)	BSPT	C HEX	L
F3PB6-1/8	6	1/8	14	24.0
F3PB6-1/4	6	1/4	14	24.0
F3PB8-1/8	8	1/8	17	28.0
F3PB8-1/4	8	1/4	17	28.5
F3PB8-3/8	8	3/8	17	26.5
F3PB10-1/4	10	1/4	19	35.5
F3PB10-3/8	10	3/8	19	33.0
F3PB10-1/2	10	1/2	22	31.0
F3PB12-1/4	12	1/4	22	36.5
F3PB12-3/8	12	3/8	22	36.0
F3PB12-1/2	12	1/2	22	36.0

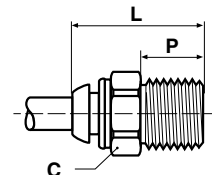

**JPB Equal Tee**

PART NO.	TUBE SIZE (MM)	C	L	M
JPB6	6	12	40	20
JPB8	8	14	44	22
JPB10	10	17	56	28
JPB12	12	22	60	30

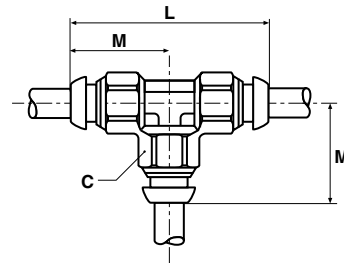

**EPB Equal Elbow**

PART NO.	TUBE SIZE (MM)	C HEX	M
EPB6	6	12	20.0
EPB8	8	14	22.0
EPB10	10	17	28.0
EPB12	12	22	30.0

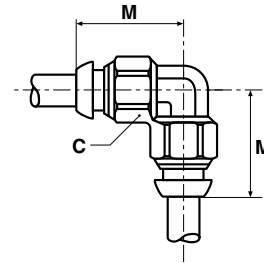

**C63PB Adjustable Male Elbow BSPT**

PART NO.	TUBE SIZE (MM)	BSPT	C HEX	C4 HEX	M	N
C63PB6-1/8	6	1/8	12	11	20	28.0
C63PB6-1/4	6	1/4	12	14	20	31.0
C63PB8-1/8	8	1/8	14	14	22	30.0
C63PB8-1/4	8	1/4	14	14	22	33.0
C63PB8-3/8	8	3/8	14	17	22	34.5
C63PB10-1/4	10	1/4	17	17	28	40.0
C63PB10-3/8	10	3/8	17	17	28	39.0
C63PB12-1/4	12	1/4	22	19	30	42.0
C63PB12-3/8	12	3/8	22	19	30	41.0
C63PB12-1/2	12	1/2	22	22	30	44.5

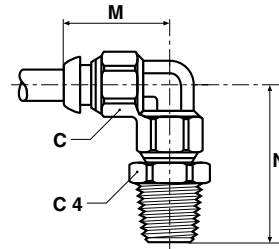

**R63PB Swivel Male Run Tee BSPT**

PART NO.	TUBE SIZE (MM)	BSPT	C HEX	C4 HEX	L	M	N
R63PB6-1/8	6	1/8	12	11	48.0	20	28.0
R63PB6-1/4	6	1/4	12	14	51.0	20	31.0
R63PB8-1/8	8	1/8	14	14	52.0	22	30.0
R63PB8-1/4	8	1/4	14	14	55.0	22	33.0
R63PB8-3/8	8	3/8	14	17	56.5	22	34.5
R63PB10-1/4	10	1/4	17	17	68.0	28	40.0
R63PB10-3/8	10	3/8	17	17	67.0	28	39.0
R63PB12-1/4	12	1/4	22	19	72.0	30	42.0
R63PB12-3/8	12	3/8	22	19	71.0	30	41.0
R63PB12-1/2	12	1/2	22	22	74.5	30	44.5

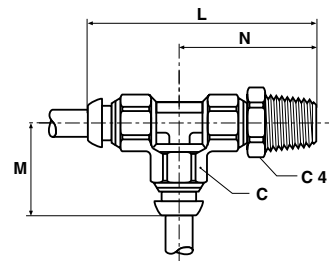



**S63PB Swivel Male Branch Tee BSPT**

PART NO.	TUBE SIZE (MM)	BSPT	C HEX	C4 HEX	L	M	N
S63PB6-1/8	6	1/8	12	11	40	20	28.0
S63PB6-1/4	6	1/4	12	14	40	20	31.0
S63PB8-1/8	8	1/8	14	14	44	22	30.0
S63PB8-1/4	8	1/4	14	14	44	22	33.0
S63PB8-3/8	8	3/8	14	17	44	22	34.5
S63PB10-1/4	10	1/4	17	17	56	28	40.0
S63PB10-3/8	10	3/8	17	17	56	28	39.0
S63PB12-1/4	12	1/4	22	19	60	30	42.0
S63PB12-3/8	12	3/8	22	19	60	30	41.0
S63PB12-1/2	12	1/2	22	22	60	30	44.5

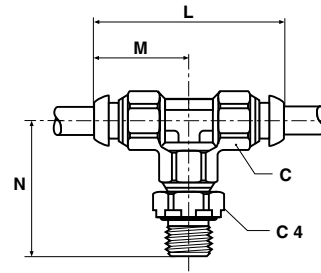

**B**

**FNPB Plug**

PART NO.	TUBE SIZE (MM)
FNPB6	6
FNPB8	8
FNPB10	10
FNPB12	12



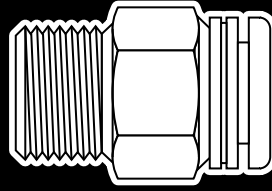

## Global Connect Fittings

### Advantages

Ready-to-use compact one piece fitting for use with most thermoplastic tubing. This fitting was designed to meet the needs of the motion control industry where fast assembly, disassembly and reassembly is important. No special tools needed for tube assembly, just insert the tubing until it bottoms. Global Connect is designed to be used without a tube support to provide full flow through the tubing. The grab ring design of Global Connect grips the tubing securely to provide retention. Global Connect straight fittings have a nickel plated brass body and shaped fittings have a composite body with nickel plated brass componentry. Global Connect external pipe threads come with a pre-applied white PCTFE sealant. Positional external pipe threaded ends are featured on shapes for installation in compact areas and for precise positioning.

*Global Connect fittings should not be used for live swivel applications.*

### Materials

- Global Connect Straights: Brass, nickel plated
- Global Connect Shape Bodies: Polyamide
- Ellipse Button: Acetal Copolymer
- Grab Ring: Ring Stainless Steel
- O-Ring: Nitrile
- Sealant: PCTFE

### Applications

Use with Parker Parflex series "U" and "HU" polyurethane tubing and series "N" nylon tubing. Global Connect was designed as an economical alternative for pneumatic applications that do not require the higher pressure capacity of the Prestolok fittings.

Consult the factory with any questions regarding special product applications. All applications should be carefully tested through the range of conditions which may be encountered prior to use.

### Working Pressure and Temperature Range

32° to + 140°F at up to 150 PSI depending on tubing being used

Vacuum applications are dependent upon temperature and type of tubing used.

### Assembly Instructions

1. Cut thermoplastic tubing squarely, using Parker Tube Cutter PTC-001. Be certain the port or mating part is clean and free of debris.
2. Insert tubing into fitting until it bottoms. A slight twisting motion will ease the insertion. Pull on tubing to verify it is properly retained in the fitting.
3. To disassemble, simply push the elliptical button against the body and remove tubing.

### Order

By part number and name.

### Nomenclature

Part numbers are constructed from symbols that identify the style and size of the fitting. The first series of numbers and letters identify the style and type fitting. The second series of numbers describe the size.

Note: 0 indicates 10-32 UNF Thread

<b>Example:</b>	<b>W</b>	<b>369</b>	<b>GC</b>	<b>-4</b>	<b>-2</b>
White PCTFE	_____	_____	_____	_____	_____
Thread Sealant	_____	_____	_____	_____	_____
Male Elbow	_____	_____	_____	_____	_____
Global Connect	_____	_____	_____	_____	_____
¼" (4/16) Tube O.D.	_____	_____	_____	_____	_____
1/8" (2/16) Pipe Thread	_____	_____	_____	_____	_____

### Sizes

Tube sizes are determined by the number of sixteenths of an inch in the tube O.D.

### Pricing

Only items priced in current supplementary price list PL3501 are carried in stock. Price and delivery for non-stock items furnished on request for specified quantity.

**Union 32GC**

PART NO.	TUBE SIZE	O.D.	L
32GC-2	1/8	.433	1.299
32GC-5/32	5/32	.433	1.300
32GC-3	3/16	.512	1.535
32GC-4	1/4	.560	1.570
32GC-5	5/16	.610	1.614
32GC-6	3/8	.728	1.890
32GC-8	1/2	.866	2.362

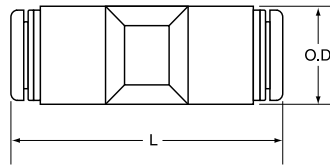

**B**

**66GC Female Connector**

PART NO.	TUBE SIZE	PIPE THREAD	C HEX	L
66GC-3-2	3/16	1/8	1/2	1.12
66GC-4-2	1/4	1/8	1/2	1.11
66GC-4-4	1/4	1/4	5/8	1.31
66GC-5/32-2	5/32	1/8	1/2	1.07
66GC-5/32-4	5/32	1/4	5/8	1.26
66GC-5-2	5/16	1/8	9/16	1.17
66GC-5-4	5/16	1/4	5/8	1.33
66GC-6-4	3/8	1/4	13/16	1.40
66GC-6-6	3/8	3/8	13/16	1.45

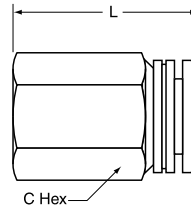

**Male Connector W68GC**

PART NO.	TUBE SIZE	PIPE THREAD	C HEX	L
W68GC-2-1	1/8	1/16	1/2	.950
W68GC-2-2	1/8	1/8	1/2	.900
W68GC-2-4	1/8	1/4	9/16	1.050
W68GC-5/32-1	5/32	1/16	1/2	.940
W68GC-5/32-2	5/32	1/8	1/2	.890
W68GC-5/32-4	5/32	1/4	9/16	1.050
W68GC-3-2	3/16	1/8	1/2	.940
W68GC-3-4	3/16	1/4	9/16	1.090
W68GC-4-1	1/4	1/16	1/2	1.130
W68GC-4-2	1/4	1/8	1/2	.940
W68GC-4-4	1/4	1/4	9/16	1.090
W68GC-4-6	1/4	3/8	11/16	1.090
W68GC-5-2	5/16	1/8	9/16	1.300
W68GC-5-4	5/16	1/4	9/16	1.260
W68GC-5-6	5/16	3/8	11/16	1.250
W68GC-6-2	3/8	1/8	3/4	1.220
W68GC-6-4	3/8	1/4	3/4	1.340
W68GC-6-6	3/8	3/8	3/4	1.340
W68GC-6-8	3/8	1/2	15/16	1.540
W68GC-8-4	1/2	1/4	13/16	1.460
W68GC-8-6	1/2	3/8	13/16	1.450
W68GC-8-8	1/2	1/2	15/16	1.650

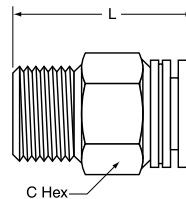

**Male Connector 68GC**

PART NO.	TUBE SIZE	THREAD UNF	C HEX	L
68GC-2-0	1/8	10-32	1/2	.930
68GC-5/32-0	5/32	10-32	1/2	.910
68GC-3-0	3/16	10-32	1/2	.900
68GC-4-0	1/4	10-32	1/2	.900

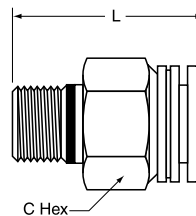

All dimensions are preliminary and could change during final production.

**Union Tee 364GC**

PART NO.	TUBE SIZE	MOUNTING HOLE DIA.	L	M
364GC-2	1/8	•	.689	
364GC-5/32	5/32	•	.689	
364GC-3	3/16	.138	.740	.63
364GC-4	1/4	.150	.740	.72
364GC-5	5/16	.173	.906	.81
364GC-6	3/8	.165	1.122	.92
364GC-8	1/2	.165	1.142	1.04

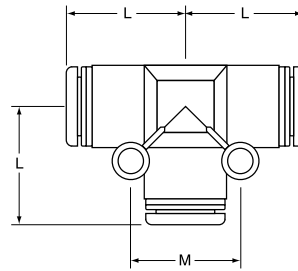

**B**

**Union Elbow 365GC**

PART NO.	TUBE SIZE	MOUNTING HOLE DIA.	L
365GC-2	1/8	•	.65
365GC-5/32	5/32	•	.65
365GC-3	3/16	.130	.76
365GC-4	1/4	.130	.76
365GC-5	5/16	.170	.87
365GC-6	3/8	.157	1.13
365GC-8	1/2	.170	1.24

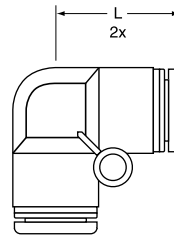

**Male Elbow Swivel 369GC**

PART NO.	TUBE SIZE	THREAD UNF	MOUNTING HOLE DIA.	C HEX	L	N
369GC-2-0	1/8	10-32	*	1/2	.96	.650
369GC-5/32-0	5/32	10-32	*	1/2	.96	.650
369GC-3-0	3/16	10-32	.138	9/16	1.09	.760
369GC-4-0	1/4	10-32	.138	9/16	1.09	.760

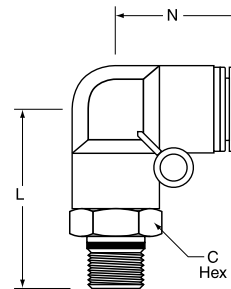

**Male Elbow Swivel W369GC**

PART NO.	TUBE SIZE	PIPE THREAD	MOUNTING HOLE DIA.	C HEX	L	N
W369GC-2-1	1/8	1/16	•	1/2	1.09	.650
W369GC-2-2	1/8	1/8	•	1/2	1.10	.650
W369GC-2-4	1/8	1/4	•	9/16	1.30	.650
W369GC-5/32-1	5/32	1/16	•	1/2	1.09	.650
W369GC-5/32-2	5/32	1/8	•	1/2	1.10	.650
W369GC-5/32-4	5/32	1/4	•	9/16	1.30	.650
W369GC-3-2	3/16	1/8	.138	9/16	1.47	.760
W369GC-3-4	3/16	1/4	.138	9/16	1.43	.760
W369GC-4-2	1/4	1/8	.138	9/16	1.47	.760
W369GC-4-4	1/4	1/4	.138	9/16	1.43	.760
W369GC-4-6	1/4	3/8	.138	13/16	1.44	.760
W369GC-5-2	5/16	1/8	.169	5/8	1.26	.866
W369GC-5-4	5/16	1/4	.169	5/8	1.46	.866
W369GC-5-6	5/16	3/8	.169	13/16	1.50	.866
W369GC-6-2	3/8	1/8	.158	13/16	1.52	1.130
W369GC-6-4	3/8	1/4	.158	13/16	1.72	1.130
W369GC-6-6	3/8	3/8	.158	13/16	1.72	1.130
W369GC-6-8	3/8	1/2	.158	15/16	1.94	1.130
W369GC-8-4	1/2	1/4	.173	15/16	1.88	1.240
W369GC-8-6	1/2	3/8	.173	15/16	1.89	1.240
W369GC-8-8	1/2	1/2	.173	15/16	2.07	1.240

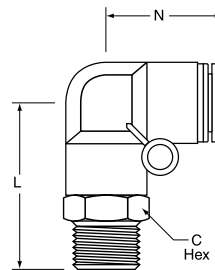

All dimensions are preliminary and could change during final production.

**B**

**Female Elbow Swivel 370GC**

PART NO.	TUBE SIZE	PIPE THREAD	MOUNTING HOLE DIA.	C HEX	L	N
370GC-2-2	1/8	1/8	•	1/2	.98	.650
370GC-2-4	1/8	1/4	•	5/8	1.14	.650
370GC-5/32-2	5/32	1/8	•	1/2	.98	.650
370GC-5/32-4	5/32	1/4	•	5/8	1.14	.650
370GC-3-4	3/16	1/4	.138	9/16	1.23	.760
370GC-4-2	1/4	1/8	.138	9/16	1.08	.760
370GC-4-4	1/4	1/4	.138	5/8	1.23	.760
370GC-4-6	1/4	3/8	.138	13/16	1.27	.760
370GC-5-2	5/16	1/8	.173	5/8	1.14	.866
370GC-5-4	5/16	1/4	.173	5/8	1.30	.866
370GC-6-2	3/8	1/8	.157	13/16	1.36	1.130
370GC-6-4	3/8	1/4	.157	13/16	1.52	1.130
370GC-6-6	3/8	3/8	.157	13/16	1.56	1.130
370GC-6-8	3/8	1/2	.157	15/16	1.70	1.130
370GC-8-6	1/2	3/8	.173	15/16	1.68	1.240
370GC-8-8	1/2	1/2	1.730	15/16	2.27	1.240

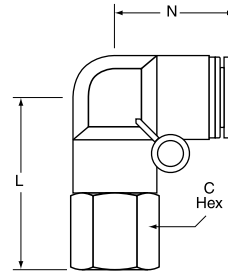

**Male Run Tee Swivel 371GC**

PART NO.	TUBE SIZE	THREAD UNF	MOUNTING HOLE DIA.	C HEX	L	N	G
371GC-5/32-0	5/32	10-32	*	1/2	1.71	.689	
371GC-4-0	1/4	10-32	.138	9/16	1.81	.740	.630

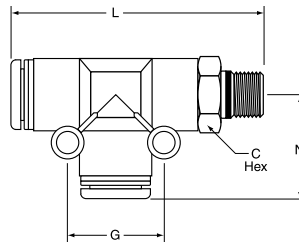

**Male Run Tee Swivel W371GC**

PART NO.	TUBE SIZE	PIPE THREAD	MOUNTING HOLE DIA.	C HEX	L	N	G
W371GC-2-1	1/8	1/16	•	1/2	1.86	.689	
W371GC-2-2	1/8	1/8	•	1/2	1.86	.689	
W371GC-2-4	1/8	1/4	•	9/16	2.06	.689	
W371GC-5/32-1	5/32	1/16	•	1/2	1.85	.689	
W371GC-5/32-2	5/32	1/8	•	1/2	1.85	.689	
W371GC-5/32-4	5/32	1/4	•	9/16	2.05	.689	
W371GC-3-2	3/16	1/8	.138	9/16	1.94	.740	.630
W371GC-3-4	3/16	1/4	.138	9/16	2.15	.740	.630
W371GC-4-2	1/4	1/8	.138	9/16	1.94	.740	.630
W371GC-4-4	1/4	1/4	.138	9/16	2.15	.740	.630
W371GC-4-6	1/4	3/8	.138	13/16	2.19	.740	.630
W371GC-5-2	5/16	1/8	.173	5/8	2.21	.906	.811
W371GC-5-4	5/16	1/4	.173	5/8	2.41	.906	.811
W371GC-5-6	5/16	3/8	.173	13/16	2.46	.906	.811
W371GC-6-2	3/8	1/8	.165	13/16	2.61	1.122	.921
W371GC-6-4	3/8	1/4	.165	13/16	2.80	1.122	.921
W371GC-6-6	3/8	3/8	.165	13/16	2.81	1.122	.921
W371GC-6-8	3/8	1/2	.165	15/16	3.03	1.122	.921
W371GC-8-4	1/2	1/4	.165	15/16	2.89	1.142	1.035
W371GC-8-6	1/2	3/8	.165	15/16	2.90	1.142	1.035
W371GC-8-8	1/2	1/2	.165	15/16	3.12	1.142	1.035

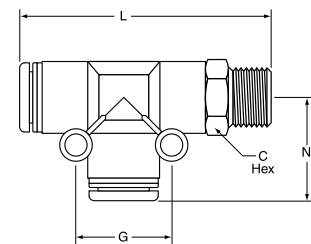

All dimensions are preliminary and could change during final production. \*Note 1/8", 5/32" and 4mm sizes do not have mounting holes.



**Male Branch Tee Swivel 372GC**

PART NO.	TUBE SIZE	PIPE THREAD	MOUNTING HOLE DIA.	C HEX	L	N	G
372GC-2-0	1/8	10-32	•	1/2	.689	1.00	
372GC-5/32-0	5/32	10-32	•	1/2	.689	1.00	
372GC-4-0	1/4	10-32	.138	9/16	.740	1.04	.630

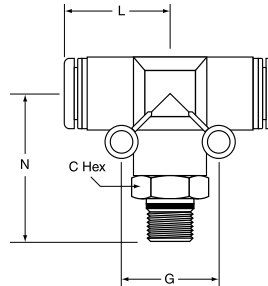

**Male Branch Tee Swivel W372GC**

PART NO.	TUBE SIZE	PIPE THREAD	MOUNTING HOLE DIA.	C HEX	L	N	G
W372GC-2-2	1/8	1/8	•	1/2	.689	1.14	
W372GC-2-4	1/8	1/4	•	9/16	.689	1.34	
W372GC-5/32-2	5/32	1/8	•	1/2	.689	1.14	
W372GC-3-2	3/16	1/8	.138	9/16	.740	1.17	.630
W372GC-3-4	3/16	1/4	.138	9/16	.740	1.38	.630
W372GC-4-2	1/4	1/8	.138	9/16	.740	1.17	.630
W372GC-4-4	1/4	1/4	.138	9/16	.740	1.38	.630
W372GC-4-6	1/4	3/8	.138	13/16	.740	1.42	.630
W372GC-5-2	5/16	1/8	.173	5/8	.906	1.31	.811
W372GC-5-4	5/16	1/4	.173	5/8	.906	1.51	.811
W372GC-5-6	5/16	3/8	.173	13/16	.906	1.56	.811
W372GC-6-2	3/8	1/8	.165	13/16	1.122	1.50	.921
W372GC-6-4	3/8	1/4	.165	13/16	1.122	1.70	.921
W372GC-6-6	3/8	3/8	.165	13/16	1.122	1.71	.921
W372GC-6-8	3/8	1/2	.165	15/16	1.122	1.93	.921
W372GC-8-4	1/2	1/4	.165	15/16	1.142	1.74	1.035
W372GC-8-6	1/2	3/8	.165	15/16	1.142	1.74	1.035
W372GC-8-8	1/2	1/2	.165	15/16	1.142	1.96	1.035

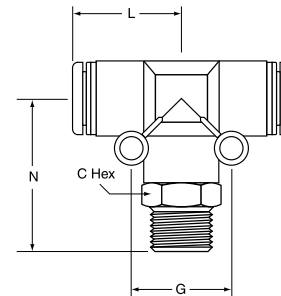

**Union Y Connector 362GC**

PART NO.	TUBE SIZE	MOUNTING HOLE DIA.	L	M	N
362GC-2	1/8	.118	1.358	.421	.846
362GC-5/32	5/32	.118	1.358	.421	.846
362GC-3	3/16	.129	1.417	.531	1.063
362GC-4	1/4	.150	1.450	.561	1.100
362GC-5	5/16	.150	1.693	.591	1.201
362GC-6	3/8	.165	1.969	.728	1.457
362GC-8	1/2	.173	2.256	.807	1.646

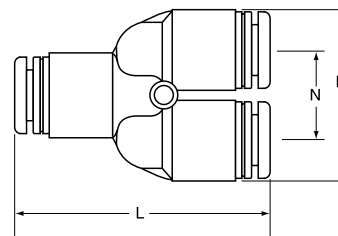

All dimensions are preliminary and could change during final production. \*Note 1/8" and 4mm sizes do not have mounting holes.



**Union Y Male Swivel Connector W368GC**

PART NO.	TUBE SIZE	PIPE THREAD	MOUNTING HOLE DIA.	C HEX	L	G	M
W368GC-2-2	1/8	1/8	.118	1/2	1.84	.433	.854
W368GC-2-4	1/8	1/4	.118	9/16	2.04	.433	.854
W368GC-3-2	3/16	1/8	.134	9/16	1.89	.531	1.063
W368GC-3-4	3/16	1/4	.134	9/16	2.09	.531	1.063
W368GC-5/32-2	5/32	1/8	.118	1/2	1.83	.433	.854
W368GC-5/32-4	5/32	1/4	.118	9/16	2.03	.433	.854
W368GC-4-2	1/4	1/8	.134	9/16	1.89	.531	1.063
W368GC-4-4	1/4	1/4	.134	9/16	2.09	.531	1.063
W368GC-4-6	1/4	3/8	.134	13/16	2.10	.531	1.063
W368GC-5-2	5/16	1/8	.150	5/8	2.07	.590	1.201
W368GC-5-4	5/16	1/4	.150	5/8	2.28	.590	1.201
W368GC-6-2	3/8	1/8	.165	13/16	2.36	.728	1.457
W368GC-6-4	3/8	1/4	.165	13/16	2.57	.728	1.457
W368GC-6-6	3/8	3/8	.165	13/16	2.57	.728	1.457
W368GC-6-8	3/8	1/2	.173	15/16	2.79	.728	1.457
W368GC-8-4	1/2	1/4	.173	15/16	2.91	.807	1.654
W368GC-8-6	1/2	3/8	.173	15/16	2.92	.807	1.654
W368GC-8-8	1/2	1/2	.173	15/16	3.11	.807	1.654

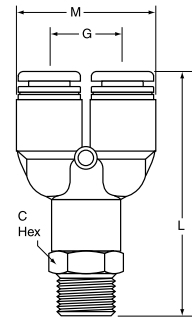

**B**

All dimensions are preliminary and could change during final production. \*Note 1/8", 5/32" and 4mm sizes do not have mounting holes.

**Union HGC (Metric)**

PART NO.	TUBE SIZE MM	O.D.	L
HGC4	4	11.00	33.00
HGC6	6	13.00	39.00
HGC8	8	15.50	41.00
HGC10	10	18.50	48.00
HGC12	12	22.00	60.00

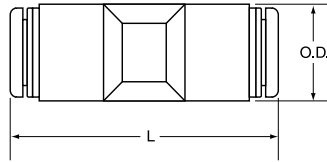

**B**

**Male Connector BSPT F3GC (Metric)**

PART NO.	TUBE SIZE MM	BSPT THREAD	C HEX	L
F3GC4-1/8	4	1/8	12	21.00
F3GC4-1/4	4	1/4	14	18.50
F3GC6-1/8	6	1/8	14	22.00
F3GC6-1/4	6	1/4	14	23.00
F3GC8-1/8	8	1/8	17	26.40
F3GC8-1/4	8	1/4	17	24.00
F3GC8-3/8	8	3/8	17	23.00
F3GC10-1/4	10	1/4	21	31.80
F3GC10-3/8	10	3/8	21	29.20
F3GC10-1/2	10	1/2	22	27.00
F3GC12-1/4	12	1/4	22	34.00
F3GC12-3/8	12	3/8	22	32.00
F3GC12-1/2	12	1/2	22	33.00

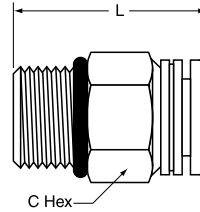

**Male Connector BSPP F4GC (Metric)**

PART NO.	TUBE SIZE MM	BSPP THREAD	C HEX	L
F4GC4-1/8	4	1/8	14	21.00
F4GC4-1/4	4	1/4	17	20.00
F4GC6-1/8	6	1/8	14	25.50
F4GC6-1/4	6	1/4	17	24.00
F4GC8-1/8	8	1/8	14	27.40
F4GC8-1/4	8	1/4	17	26.20
F4GC8-3/8	8	3/8	21	26.20
F4GC10-1/4	10	1/4	17	34.30
F4GC10-3/8	10	3/8	21	31.30
F4GC10-1/2	10	1/2	24	34.30
F4GC12-1/4	12	1/4	19	35.60
F3GC12-3/8	12	3/8	21	31.60
F4GC12-1/2	12	1/2	24	34.60

**Male Connector Metric Thread F8GC**

PART NO.	TUBE SIZE MM	MM THREAD	C HEX	L
F8GC4M5	4	M5	12	23.00
F8GC6M5	6	M5	14	22.50
F8GC6M10	6	M10	14	23.50
F8GC6M12	6	M12	17	25.50
F8GC8M12	8	M12	17	29.70
F8GC8M16	8	M16	21	25.20

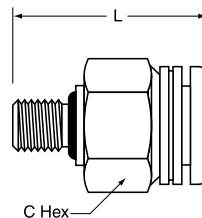

All dimensions are preliminary and could change during final production. \*Note 1/8", 5/32" and 4mm sizes do not have mounting holes.



**Union Tee JGC (Metric)**

PART NO.	TUBE SIZE MM	MOUNTING HOLE DIA.	L	M
JGC4	4	•	17.50	
JGC6	6	18.80	18.80	3.50
JGC8	8	23.00	23.00	4.40
JGC10	10	28.50	28.50	4.20
JGC12	12	29.00	29.00	4.20

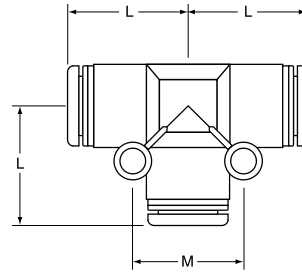

**B**

**Union Elbow EGC (Metric)**

PART NO.	TUBE SIZE MM	MOUNTING HOLE DIA.	L
EGC4	4	*	16.50
EGC6	6	3.50	19.30
EGC8	8	4.30	22.00
EGC10	10	4.00	28.70
EGC12	12	4.40	31.50

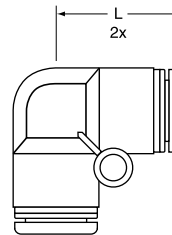

**Male Elbow Swivel BSPT C63GC (Metric)**

PART NO.	TUBE SIZE MM	BSPT THREAD	MOUNTING HOLE DIA.	C HEX	L	N
C63GC4-1/8	4	1/8	•	12	24.90	16.50
C63GC4-1/4	4	1/4	•	14	24.90	16.50
C63GC4-3/8	4	3/8	•	17	27.90	16.50
C63GC6-1/8	6	1/8	3.5	14	27.70	13.00
C63GC6-1/4	6	1/4	3.5	14	29.70	13.00
C63GC6-3/8	6	3/8	3.5	17	31.70	13.00
C63GC8-1/8	8	1/8	4.3	17	29.00	22.00
C63GC8-1/4	8	1/4	4.3	17	31.00	22.00
C63GC8-3/8	8	3/8	4.3	17	33.00	22.00
C63GC8-1/2	8	1/2	4.3	22	35.00	22.00
C63GC10-1/4	10	1/4	4.0	21	36.50	28.70
C63GC10-3/8	10	3/8	4.0	21	37.50	28.70
C63GC10-1/2	10	1/2	4.0	22	40.50	28.70
C63GC12-1/4	12	1/4	4.4	22	40.70	31.50
C63GC12-3/8	12	3/8	4.4	22	41.70	31.50
C63GC12-1/2	12	1/2	4.4	22	43.70	31.50

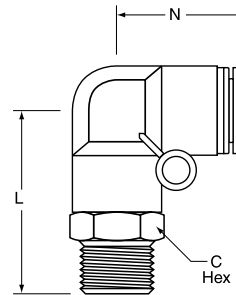

All dimensions are preliminary and could change during final production. \*Note 1/8", 5/32" and 4mm sizes do not have mounting holes.

**Male Elbow Swivel BSPP C64GC (Metric)**

PART NO.	TUBE SIZE MM	BSPP THREAD	MOUNTING HOLE DIA.	C HEX	L	N
C64GC4-1/8	4	1/8	•	12	26.90	16.50
C64GC4-1/4	4	1/4	•	17	30.90	16.50
C64GC4-3/8	4	3/8	•	21	32.90	16.50
C64GC6-1/8	6	1/8	3.5	14	29.30	13.00
C64GC6-1/4	6	1/4	3.5	17	33.30	13.00
C64GC6-3/8	6	3/8	3.5	21	33.30	13.00
C64GC8-1/8	8	1/8	4.3	17	30.00	22.00
C64GC8-1/4	8	1/4	4.3	17	34.00	22.00
C64GC8-3/8	8	3/8	4.3	21	34.00	22.00
C64GC8-1/2	8	1/2	4.3	24	36.00	22.00
C64GC10-1/4	10	1/4	4.0	21	40.50	28.70
C64GC10-3/8	10	3/8	4.0	21	40.50	28.70
C64GC10-1/2	10	1/2	4.0	24	42.50	28.70
C64GC12-1/4	12	1/4	4.4	22	41.70	31.50
C64GC12-3/8	12	3/8	4.4	22	41.70	31.50
C64GC12-1/2	12	1/2	4.4	24	45.70	31.50

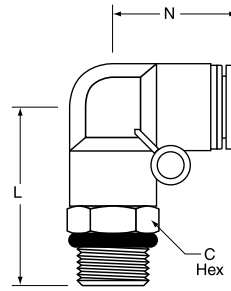

**B**

**Male Elbow Swivel Metric Thread C68GC**

PART NO.	TUBE SIZE MM	METRIC THREAD	MOUNTING HOLE DIA.	C HEX	L	N
C68GC4M5	4	M5X0.8	•	12	26.90	16.50
C68GC4M6	4	M6X1.0	•	12	26.90	16.50
C68GC6M5	6	M5X0.8	3.5	14	29.30	19.30
C68GC6M6	6	M6X1.0	3.5	14	29.30	19.30

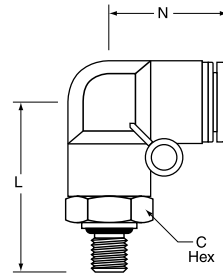

**Female Elbow Swivel BSPT CF63GC (Metric)**

PART NO.	TUBE SIZE MM	BSPT THREAD	MOUNTING HOLE DIA.	C HEX	L	N
CF63GC4-1/8	4	1/8	•	12	24.50	16.50
CF63GC4-1/4	4	1/4	•	17	25.90	16.50
CF63GC4-3/8	4	3/8	•	21	26.40	16.50
CF63GC6-1/8	6	1/8	3.5	14	28.80	19.30
CF63GC6-1/4	6	1/4	3.5	17	28.80	19.30
CF63GC6-3/8	6	3/8	3.5	21	28.80	19.30
CF63GC8-1/8	8	1/8	4.3	17	31.00	22.00
CF63GC8-1/4	8	1/4	4.3	17	31.00	22.00
CF63GC8-3/8	8	3/8	4.3	21	32.00	22.00
CF63GC8-1/2	8	1/2	4.3	22	32.00	22.00
CF63GC10-1/4	10	1/4	4.0	21	36.50	28.70
CF63GC10-3/8	10	3/8	4.0	21	37.50	28.70
CF63GC10-1/2	10	1/2	4.0	24	37.50	28.70
CF63GC12-1/4	12	1/4	4.4	22	40.70	31.50
CF63GC12-3/8	12	3/8	4.4	22	40.70	31.50
CF63GC12-1/2	12	1/2	4.4	24	51.20	31.50

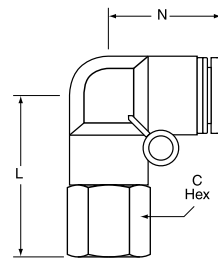

**Female Elbow Swivel Metric Thread CF68GC**

PART NO.	TUBE SIZE MM	METRIC THREAD	MOUNTING HOLE DIA.	C HEX	L	N
CF68GC4M5	4	M5X0.8	•	12	23.00	16.50
CF68GC4M6	4	M6X1.0	•	12	23.00	16.50
CF68GC6M5	6	M5X0.8	3.5	14	25.30	19.30
CF68GC6M6	6	M6X1.0	3.5	14	25.30	19.30

All dimensions are preliminary and could change during final production. \*Note 1/8", 5/32" and 4mm sizes do not have mounting holes.

**Male Run Tee Swivel BSPT R63GC (Metric)**

PART NO.	TUBE SIZE MM	BSPT THREAD	MOUNTING HOLE DIA.	C HEX	L	N	G
R63GC4-1/8	4	1/8	•	12	43.90	17.50	
R63GC4-1/4	4	1/4	•	14	45.90	17.50	
R63GC4-3/8	4	3/8	•	17	47.90	17.50	
R63GC6-1/8	6	1/8	3.5	14	46.30	18.80	16.00
R63GC6-1/4	6	1/4	3.5	14	48.30	18.80	16.00
R63GC6-3/8	6	3/8	3.5	17	50.30	18.80	16.00
R63GC8-1/8	8	1/8	4.4	17	53.20	23.00	20.60
R63GC8-1/4	8	1/4	4.4	17	55.20	23.00	20.60
R63GC8-3/8	8	3/8	4.4	17	57.20	23.00	20.60
R63GC8-1/2	8	1/2	4.4	22	59.20	23.00	20.60
R63GC10-1/4	10	1/4	4.2	21	64.20	28.50	23.40
R63GC10-3/8	10	3/8	4.2	21	65.20	28.50	23.40
R63GC10-1/2	10	1/2	4.2	22	68.20	28.50	23.40
R63GC12-1/4	12	1/4	4.2	22	67.00	29.00	26.30
R63GC12-3/8	12	3/8	4.2	22	68.00	29.00	26.30
R63GC12-1/2	12	1/2	4.2	22	70.00	29.00	26.30

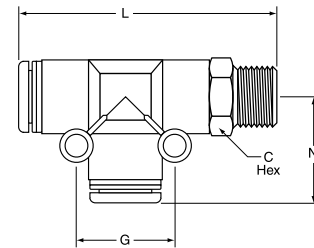

**B**

**Male Run Tee Swivel Metric Thread R68GC**

PART NO.	TUBE SIZE MM	METRIC THREAD	MOUNTING HOLE DIA.	C HEX	L	N	G
R68GC4M5	4	M5X0.8	•	12	46.00	17.50	
R68GC4M6	4	M6X1.0	•	12	46.00	17.50	
R68GC6M5	6	M5X0.8	3.5	14	48.30	18.80	16.00
R68GC6M6	6	M6X1.0	3.5	14	48.30	18.80	16.00

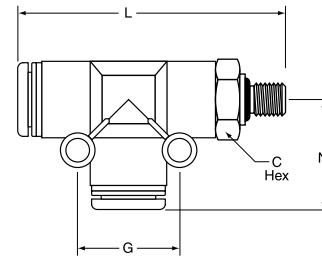

**Male Branch Tee Swivel BSPT S63GC (Metric)**

PART NO.	TUBE SIZE MM	BSPT THREAD	MOUNTING HOLE DIA.	C HEX	L	N	G
S63GC4-1/8	4	1/8	•	12	17.50	26.00	
S63GC4-1/4	4	1/4	•	14	17.50	28.00	
S63GC4-3/8	4	3/8	•	17	17.50	30.00	
S63GC6-1/8	6	1/8	3.5	14	18.80	26.80	16.00
S63GC6-1/4	6	1/4	3.5	14	18.80	28.80	16.00
S63GC6-3/8	6	3/8	3.5	17	18.80	30.80	16.00
S63GC8-1/8	8	1/8	4.4	17	23.00	30.20	20.60
S63GC8-1/4	8	1/4	4.4	17	23.00	32.20	20.60
S63GC8-3/8	8	3/8	4.4	17	23.00	34.20	20.60
S63GC8-1/2	8	1/2	4.4	22	23.00	36.20	20.60
S63GC10-1/4	10	1/4	4.2	21	28.50	36.20	23.40
S63GC10-3/8	10	3/8	4.2	21	28.50	37.20	23.40
S63GC10-1/2	10	1/2	4.2	22	28.50	40.20	23.40
S63GC12-1/4	12	1/4	4.2	22	29.00	38.00	26.30
S63GC12-3/8	12	3/8	4.2	22	29.00	39.00	26.30
S63GC12-1/2	12	1/2	4.2	22	29.00	41.00	26.30

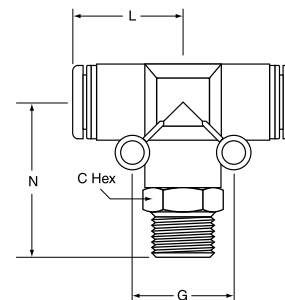

All dimensions are preliminary and could change during final production.



**Male Branch Tee Swivel Metric Thread S68GC**

PART NO.	TUBE SIZE MM	METRIC THREAD	MOUNTING HOLE DIA.	C HEX	L	N	G
S68GC4M5	4	M5X0.8	•	12	17.50	28.00	
S68GC4M6	4	M6X1.0	•	12	17.50	28.00	
S68GC6M5	6	M5X0.8	3.5	14	18.80	28.80	16.00
S68GC6M6	6	M6X1.0	3.5	14	18.80	28.80	16.00

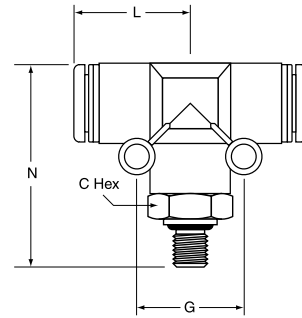

**B**

**Union Y Connector YJGC (Metric)**

PART NO.	TUBE SIZE MM	MOUNTING HOLE DIA.	L	M	N
YJGC4	4	3.00	34.50	21.50	10.70
YJGC6	6	3.40	36.00	27.00	13.50
YJGC8	8	3.80	43.00	30.50	15.00
YJGC10	10	4.20	50.80	37.00	18.50
YJGC12	12	4.40	57.80	41.50	20.50

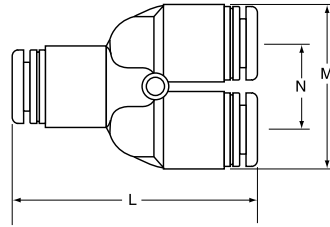

All dimensions are preliminary and could change during final production.

**Union Y Male Swivel Connector BSPT YJ63GC (Metric)**

PART NO.	TUBE SIZE MM	BSPT THREAD	MOUNTING HOLE DIA.	C HEX	L	G	M
YJ63GC4-1/8	4	1/8	3.0	12	43.40	11.0	21.50
YJ63GC4-1/4	4	1/4	3.0	14	45.40	11.0	21.50
YJ63GC4-3/8	4	3/8	3.0	17	47.40	11.0	21.50
YJ63GC6-1/8	6	1/8	3.4	14	44.20	13.5	27.00
YJ63GC6-1/4	6	1/4	3.4	14	46.20	13.5	27.00
YJ63GC6-3/8	6	3/8	3.4	17	48.20	13.5	27.00
YJ63GC8-1/8	8	1/8	3.8	17	50.00	15.0	30.50
YJ63GC8-1/4	8	1/4	3.8	17	52.00	15.0	30.50
YJ63GC8-3/8	8	3/8	3.8	17	54.00	15.0	30.50
YJ63GC8-1/2	8	1/2	3.8	22	56.00	15.0	30.50
YJ63GC10-1/4	10	1/4	4.2	21	58.30	18.5	37.00
YJ63GC10-3/8	10	3/8	4.2	21	59.30	18.5	37.00
YJ63GC10-1/2	10	1/2	4.2	22	62.30	18.5	37.00
YJ63GC12-1/4	12	1/4	4.4	22	66.80	20.5	41.50
YJ63GC12-3/8	12	3/8	4.4	22	67.80	20.5	41.50
YJ63GC12-1/2	12	1/2	4.4	22	69.80	20.5	41.50

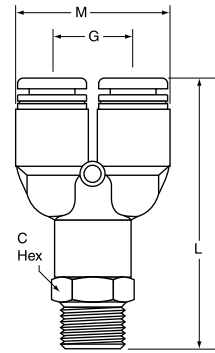

**B**

**Union Y Male Swivel Connector Metric Thread YJ68GC**

PART NO.	TUBE SIZE MM	METRIC THREAD	MOUNTING HOLE DIA.	C HEX	L	G	M
YJ68GC4M5	4	M5X0.8	3.0	12	43.40	11.0	21.50
YJ68GC4M6	4	M6X1.0	3.0	12	43.40	11.0	21.50
YJ68GC6M5	6	M5X0.8	3.4	14	44.20	13.5	27.00
YJ68GC6M6	6	M6X1.0	3.4	14	44.20	13.5	27.00

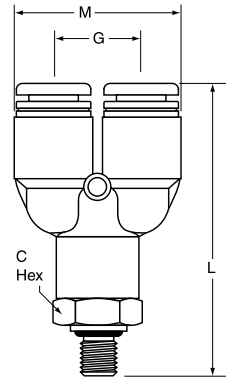

All dimensions are preliminary and could change during final production.



## Flow Controls

- Direct Mounting
- Right Angle & In-line
- Compact & Miniature Styles
- Brass & Composite Bodies
- Inch & Metric Sizes



## Slow Start Fittings

- Mount to FRL or Power Unit
- Permits Gradual Increase in Pressure
- Prevents Shocks to System



## Blocking Valves

- Direct Mounting
- Safe & Immediate Stopping of Piston Rod
- Push-in or Threaded Terminations



## Combination Valves

- Multi Function
- Blocking & Flow Control
- Blocking & Exhaust



## Pressure Sensor Valves

- Direct Mounting
- Pneumatic, Electric or Electronic Sensing
- Detect End of Stroke Travel



## Pressure Reducing Valves













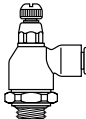
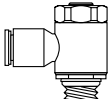
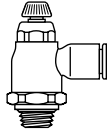
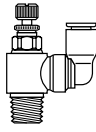
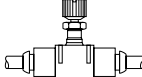
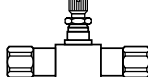
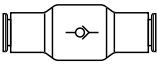
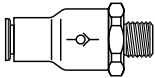

- Energy Savings
- Optimum air Pressure
- Reduce Air Consumption

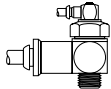

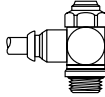
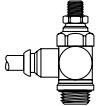
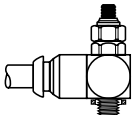
## Non-Return Valves

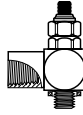
- Compact
- Light Weight
- In-line or Threaded Versions

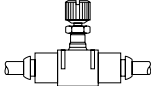
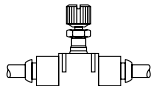
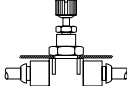
**C**

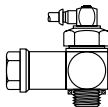
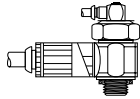
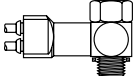
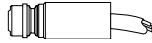
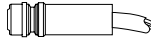
<b>Right Angle Flow Controls</b>	<b>FC701</b> Push-In Connection  Page C5	<b>FC702</b> Threaded Connection  Page C5	<b>FCM701</b> Miniature  Page C6	<b>FCM703</b> Miniature  Page C6	<b>FCS701</b> Swivel Outlet  Page C5	<b>FC705</b> Metal  Page C7
	<b>FCC701</b> Knobless Compact  Page C7	<b>FCC703</b> Compact  Page C7	<b>FCS703</b> Swivel Outlet  Page C6	<b>In-Line Flow Controls</b>	<b>FC800</b> Push-In Connection  Page C22	<b>FC806</b> Threaded Connection  Page C22
<b>Non-Return Valves</b>	<b>NRV800</b> In-Line  Page C32	<b>NRV808</b> Male  Page C32	<b>Slow Start Valves</b>		<b>FC902</b> Threaded Connection  Page C14	
	<b>Blocking Valves</b>	<b>FC601</b> Push-In Connection  Page C18		<b>FC602</b> Threaded Connection  Page C18	<b>Metric Right Angle Flow Controls</b>	<b>PT4/8PB</b> Exhaust Flow  Page C10
<b>PTFL4/8PB</b> Exhaust Flow  Page C12		<b>PTFAL8PB</b> Inlet Flow  Page C12	<b>PTFL4/8</b> Exhaust Flow  Page C12	<b>PTFAL8</b> Inlet Flow  Page C12		<b>PTF4/8E6PB</b> Swivel Outlet  Page C13
<b>Metric In-Line Flow Controls</b>	<b>PTFIPK</b> Metric Push-In  Page C23	<b>PTFMIPK</b> Ultrafine Adjustment  Page C24	<b>PTFIWPK</b> Panel Mountable  Page C24			
	<b>Metric Slow Start Valves</b>	<b>PCV4</b> Power Valve Version  Page C16	<b>Metric Blocking Valves</b>	<b>PWB</b> Metric  Page C20	<b>Metric Combination Valves</b>	<b>PWR-HB / PWR-HE</b> Metric  Page C25
<b>Metric Sensor Valves</b>		<b>PTP4/8PB</b> Pneumatic Output  Page C26		<b>PWS-M</b> Sensor-Electrical  Page C27		<b>PWS-E</b> Sensor-Electrical  Page C27

Metric Reducing Valves	<b>PRB4PB</b> Push-In Connection  Page C29	<b>PRB4</b> Threaded Connection  Page C29	<b>PR1PB</b> In-Line  Page C29	<b>PR14</b> In-Line  Page C29	Metric Silencer & Flow Control	<b>PRS</b> Silencer  Page C30

**C**



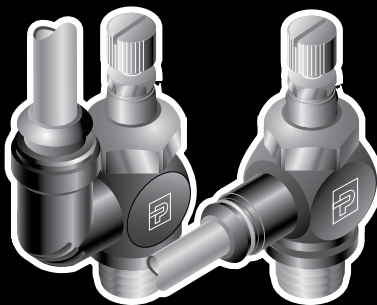

## Right Angle Flow Control Valves

### General Information

Parker offers a wide range of flow controls to meet a large variety of applications. Parker flow controls are designed for mounting directly onto the cylinder ports to provide precise control of piston rod speed. Due to their compactness they are particularly suitable for applications where space is at a premium.

### General Principle

The piston rod moves as a result of the pressure differential on either side of the piston. The speed of the rod is normally determined by the exhaust air flow from the cylinder, although certain applications require control from the inlet. The control of the air flow is via an adjustable flow control valve installed on the exhaust port.

### Operation

The mounting of two flow controls on a cylinder permits speed control of the cylinder rod in both directions. Air passes freely through the flow control valve A, with the check valve in the open position. The exhaust is controlled by the flow control valve B, where the check valve in the closed position forces the air to go through the adjustable needle valve. The function of A and B are reversed when inlet air is applied to port B.

### Advantages

- Direct mounting
- Compact
- Positional
- Optimum flow control
- Swivel outlet for use where access is restricted

### Valve Specifications

Maximum working pressure: 145 PSI  
 Operating Temperature: - 10° to 200° F  
 Body Material: Brass black epoxy coated  
 Bolt Material: Brass

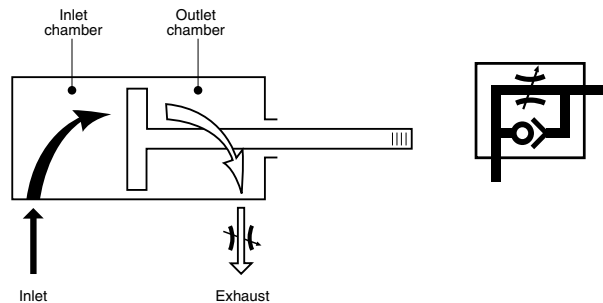

Flow regulation on the exhaust port

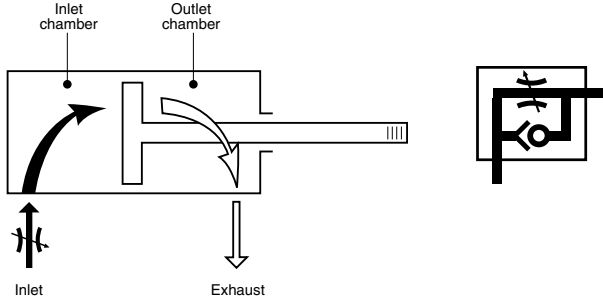

Flow regulation on the inlet port

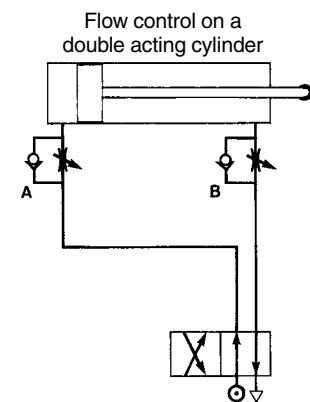
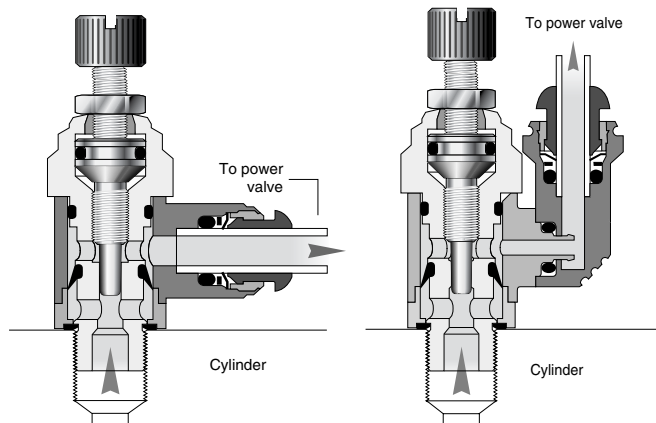

**Push-in Connection Exhaust Flow Control FC701**

PART NO.	TUBE SIZE	THREAD SIZE	HEX 1	HEX 2	L OPEN	L CLOSED	N	M	J
FC701-2-0	1/8	10-32	1/16	5/16	1.363	1.167	1.040	0.870	0.393
FC701-5/32-4	5/32	1/4	5/16	5/8	2.566	2.318	1.377	1.008	0.679
FC701-4-2	1/4	1/8	5/16	5/8	2.181	2.000	1.361	0.992	0.679
FC701-4-4	1/4	1/4	5/16	5/8	2.566	2.318	1.381	1.011	0.679
FC701-4-6	1/4	3/8	5/16	13/16	3.157	2.696	1.582	1.090	0.984
FC701-6-4	3/8	1/4	5/16	5/8	2.566	2.318	1.507	1.138	0.679
FC701-6-6	3/8	3/8	5/16	13/16	3.157	2.696	1.677	1.177	0.984
FC701-6-8	3/8	1/2	9/16	1	3.858	3.287	1.866	1.276	1.181

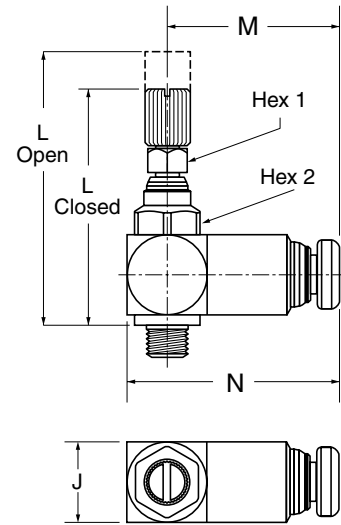

**Threaded Connection Exhaust Flow Control FC702**

PART NO.	MALE PIPE	FEMALE PIPE	HEX 1	HEX 2	L OPEN	L CLOSED	N	M	J
FC702-2	1/8	1/8	5/16	5/8	2.181	2.000	1.117	0.748	0.679
FC702-4	1/4	1/4	5/16	5/8	2.566	2.318	1.274	0.905	0.679
FC702-6	3/8	3/8	5/16	13/16	3.157	2.696	1.535	1.043	0.984
FC702-8	1/2	1/2	9/16	1	3.858	3.287	1.791	1.200	1.181

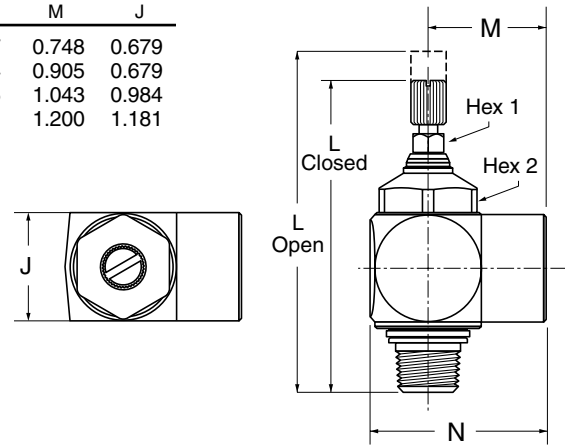

**Swivel Exhaust Flow Control FCS701**

PART NO.	TUBE SIZE	THREAD SIZE	HEX 1	HEX 2	L OPEN	L CLOSED	N	M	J
FCS701-2-2	1/8	1/8	5/16	5/8	2.181	2.000	1.240	0.620	0.679
FCS701-5/32-2	5/32	1/8	5/16	5/8	2.181	2.000	1.239	0.618	0.679
FCS701-5/32-4	5/32	1/4	5/16	5/8	2.566	2.318	1.240	0.620	0.679
FCS701-4-2	1/4	1/8	5/16	5/8	2.181	2.000	1.318	0.657	0.679
FCS701-6-6	3/8	3/8	5/16	13/16	3.157	2.696	1.740	0.834	0.984
FCS701-6-8	3/8	1/2	9/16	1	3.858	3.287	1.619	0.992	1.181

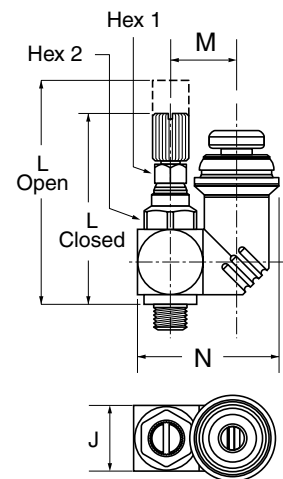

**Miniature Swivel Exhaust Flow Control FCS703**

PART NO.	TUBE SIZE	THREAD SIZE	C HEX (MM)	H CLOSED	H OPEN	L	M	N
FCS703-5/32-0	5/32	10-32	6	.96	1.08	.55	.73	.26
FCS703-5/32-2	5/32	1/8	8	1.08	1.20	.55	.73	.33

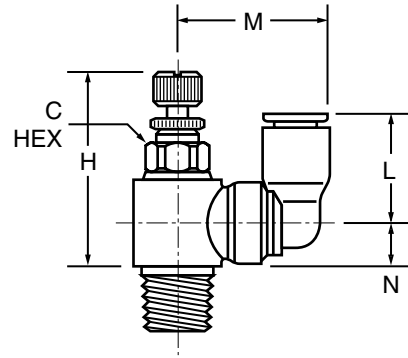

**Miniature Exhaust Flow Control FCM701**

Composite Body

PART NO.	TUBE SIZE	THREAD SIZE	C HEX (MM)	H CLOSED	H OPEN	L	M	FLOW DIA. D
FCM701-5/32-0	5/32	10-32	6	.925	1.023	.846	.669	.080
FCM701-5/32-2	5/32	1/8	7	1.000	1.083	.935	.708	.100
FCM701-4-0	1/4	10-32	6	.925	1.023	.885	.708	.080
FCM701-4-2	1/4	1/8	7	1.000	1.083	.957	.730	.100
FCM701-4-4	1/4	1/4	8	1.083	1.180	1.013	.748	.160

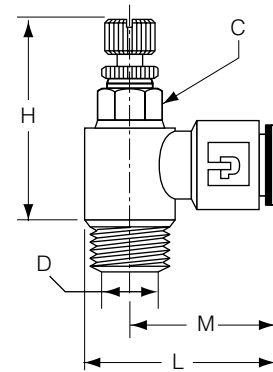

**Knobless Miniature Exhaust Flow Control FCM703**

Composite Body

PART NO.	TUBE SIZE	THREAD SIZE	C HEX (MM)	H CLOSED	H OPEN	L	M	FLOW DIA. D
FCM703-5/32-0	5/32	10-32	6	.650	.787	.846	.669	.080
FCM703-5/32-2	5/32	1/8	6	.708	.860	.935	.708	.100
FCM703-4-0	1/4	10-32	6	.650	.790	.825	.650	.080
FCM703-4-2	1/4	1/8	7	.708	.860	.956	.730	.100
FCM703-4-4	1/4	1/4	8	.826	.964	1.013	.748	.160

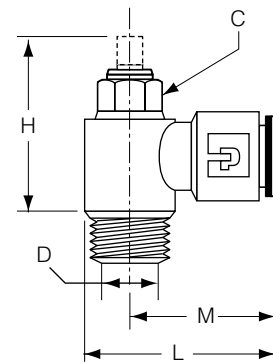

C

**Knobless Compact Exhaust Flow Control FCC701**

PART NO.	TUBE SIZE	THREAD SIZE	C HEX (MM)	H	L
FCC701-2-2	1/8	1/8	13	.79	.75
FCC701-5/32-2	5/32	1/8	13	.79	.75
FCC701-4-2	1/4	1/8	13	.79	.85
FCC701-4-4	1/4	1/4	17	1.04	.89
FCC701-5-2	5/16	1/8	13	.79	1.02
FCC701-5-4	5/16	1/4	17	1.04	1.06
FCC701-6-4	3/8	1/4	17	1.04	1.14
FCC701-6-6	3/8	3/8	20	1.14	1.36

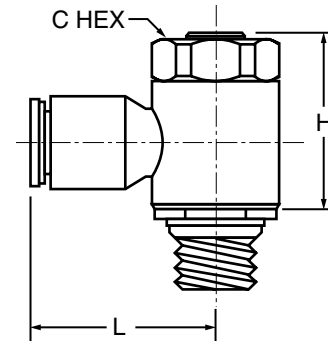

**Compact Exhaust Flow Control FCC703**

PART NO.	TUBE SIZE	THREAD SIZE	B HEX	C HEX	H CLOSED	H OPEN	L	M
FCC703-5/32-2	5/32	1/8	.39	.63	1.44	1.67	.85	.59
FCC703-4-2	1/4	1/8	.39	.63	1.44	1.67	.85	.59
FCC703-6-4	3/8	1/4	.67	.91	1.71	2.03	1.22	.71

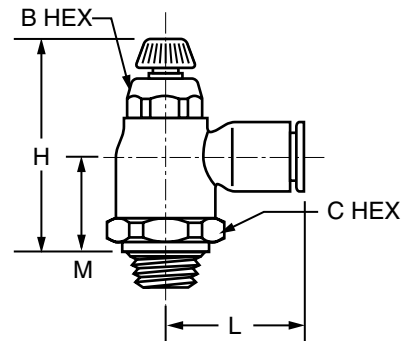

**Push-to-Connect Exhaust Metal Flow Control FC705**

PART NO.	TUBE SIZE	THREAD SIZE	B HEX	C HEX	H CLOSED	H OPEN	L	M
FC705-5/32-2	5/32	1/8	.39	.75	1.79	2.01	.85	.87
FC705-4-2	1/4	1/8	.39	.75	1.79	2.01	.85	.87
FC705-4-4	1/4	1/4	.39	.75	1.79	2.01	.97	.87
FC705-6-4	3/8	1/4	.55	.75	1.91	2.11	1.14	.91
FC705-6-6	3/8	3/8	.67	.99	2.15	2.40	1.40	.91

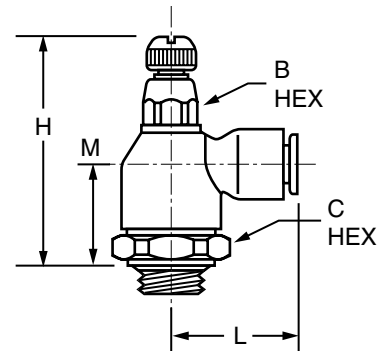

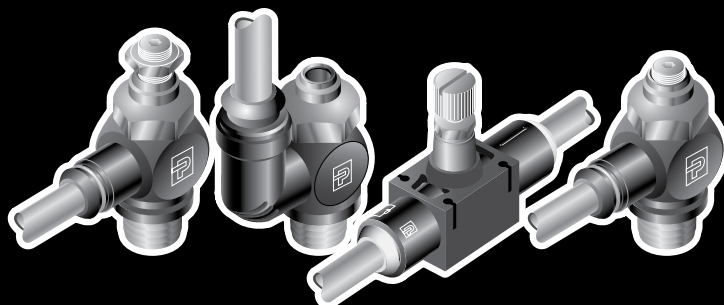

## Metric Right Angle Flow Control Valves

### Prestoflow - Flow regulators

Parker offers a wide range of flow regulators to meet a large variety of applications. Prestoflow can be fitted directly to a cylinder port or mounted in the line. Prestoflow regulators with push-in terminations are suitable for use with a wide range of plastic tubing. Prestoflow regulators with threaded terminations can be adapted for use with copper and steel tubing or hoses.

### General principle

The piston rod moves as a result of the pressure differential on either side of the piston. The speed of the rod is normally determined by the exhaust air flow from the cylinder. The control of this air flow is via an adjustable needle valve installed on the exhaust port.

On single acting cylinders and some miniature (M5) double acting cylinders, the air flow can be controlled from the inlet port.

To permit regular and smooth movement of the piston rod, flow control should be made as near to the cylinder as possible.

### Operation

The mounting of two flow control devices on a cylinder permits speed control of the cylinder rod in both directions.

The sketch opposite shows a cylinder with inlet air at port A. Air passes freely through the flow control valve A, with the check valve in the open position. The exhaust is controlled by the flow control fitting B, where the check valve in the closed position forces the air to go through the adjustable needle valve. The function of A and B are reversed when inlet air is applied to port B.

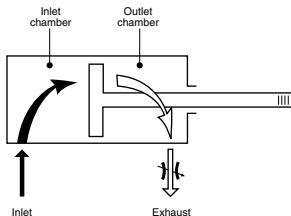

Flow regulation on the exhaust port

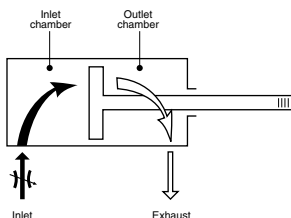

Flow regulation on the inlet port

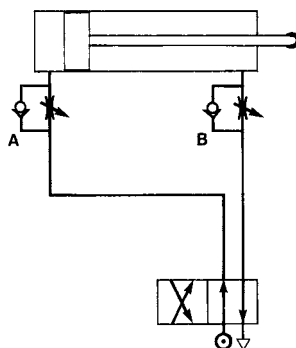

Flow control on a double acting cylinder

### Flow characteristics

Prestoflow pneumatic integrated fittings are designed to permit maximum flow in both directions. This full flow in both directions, together with the very precise setting of the screw, permits a wide range of adjustment between the minimum and maximum speeds. The sketch opposite shows the flow progression according to the adjustment of the screw.

### Flow regulators - assembly torques

To ensure a leak free connection for port mounted regulators the regulator bolt should be tightened in accordance with the table opposite.

ASSEMBLY TORQUE		
THREAD	MIN. NM	MAX. NM
M5	0.2	0.5
1/8	6	9
1/4	10	15
3/8	14	22
1/2	30	42

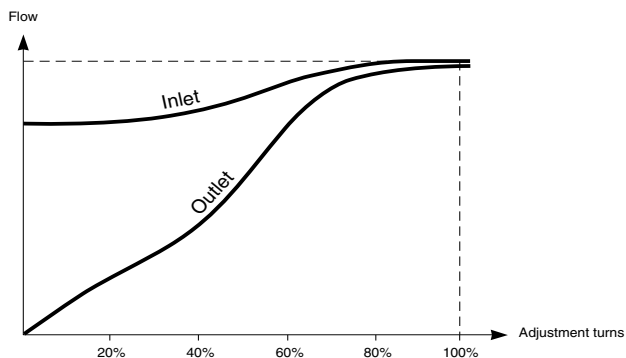

**Prestoflow - Flow regulator - Compact series**

**Principle**

Prestoflow compact flow regulators are designed for mounting directly onto cylinder ports to provide precise control of piston rod speed. Thanks to their compactness they are particularly suitable for applications where space is at a minimum. These unidirectional flow regulators are available for exhaust or inlet flow control.

- A check valve blocks the full flow ports in the exhaust or inlet direction.
- The flow is controlled by a needle valve fitted in the regulator bolt.

**Flow adjustment**

Flow control is adjusted with an Allen key. The large number of turns from fully closed to fully open allows for precise flow control.

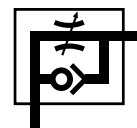

Exhaust flow control

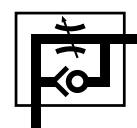

Inlet flow control

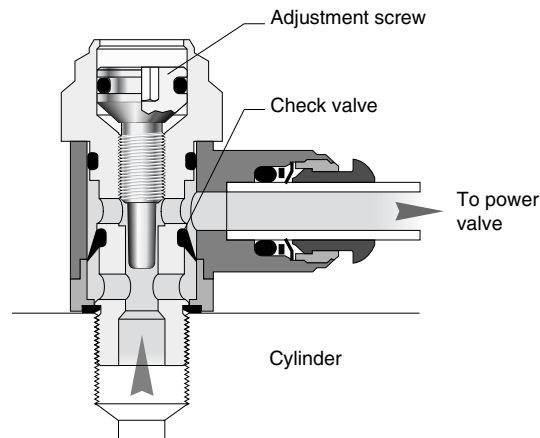
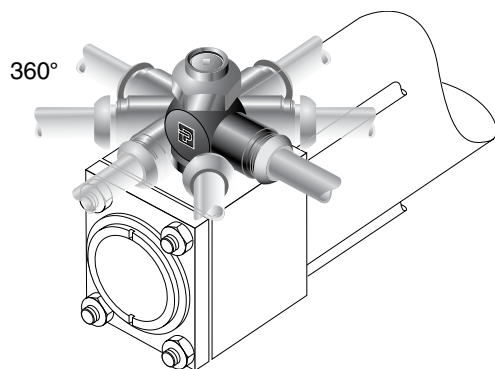

**Technical**

BODY MATERIAL	BOLT MATERIAL	BOLT THREAD	SEALING DEVICE		TERMINATIONS		WORKING TEMPERATURE	WORKING PRESSURE
Brass Black Epoxy Coated	Brass	M5 1/8 BSPP 1/4 BSPP 3/8 BSPP 1/2 BSPP	M5 Thread Nylon Washer	1/8 - 1/2 BSPP Nitrile E.D. Seal	4 mm - 12 mm Push-In Connection	1/8 - 1/2 BSPP +M5 Female Thread DIN 3852 Long	From 0° to +200° F	140 PSI



**PTF4/8PB Flow Regulator with Push-In Connection**

PART NO.	1	B	C5	D	G1	H1	J	M	M1	N	N1	O	Y
PTF8PB4M5*	4	M5x0.8	8	1.65	10.0	1.5	4	19.5	24.5	6.3	22.0	10	10
PTF4PB4-1/8	4	1/8	14	3.00	14.4	2.0	6	22.0	30.1	10.7	34.5	10	14
PTF8PB6M5*	6	M5x0.8	8	1.65	10.0	1.5	4	20.5	26.5	7.3	24.5	12	12
PTF4PB6-1/8	6	1/8	14	3.20	14.4	2.0	6	23.5	31.6	10.7	34.5	12	14
PTF4PB6-1/4	6	1/4	17	5.20	18.4	4.0	7	25.0	34.9	13.8	41.0	12	17
PTF4PB6-3/8	6	3/8	22	5.50	21.6	4.0	7	28.0	40.7	17.3	51.0	12	22
PTF4PB8-1/8	8	1/8	14	3.20	14.4	2.0	6	25.0	33.1	10.7	34.5	14	14
PTF4PB8-1/4	8	1/4	17	5.20	18.4	4.0	7	28.5	38.3	13.8	41.0	14	17
PTF4PB8-3/8	8	3/8	22	6.00	21.6	4.0	7	29.5	42.2	17.3	51.0	14	22
PTF4PB10-1/4	10	1/4	17	5.20	18.4	4.0	7	31.5	41.3	13.8	41.0	17	17
PTF4PB10-3/8	10	3/8	22	6.00	21.6	4.0	7	34.0	46.7	17.3	51.0	17	22
PTF4PB10-1/2	10	1/2	27	8.00	26.5	4.0	9	36.5	52.1	20.1	61.0	17	27
PTF4PB12-3/8	12	3/8	22	6.00	21.6	4.0	7	34.0	46.7	17.3	51.0	20	22
PTF4PB12-1/2	12	1/2	27	8.50	26.5	4.0	9	36.5	52.1	20.1	61.0	20	27

\* These fittings are supplied with Nylon seal.

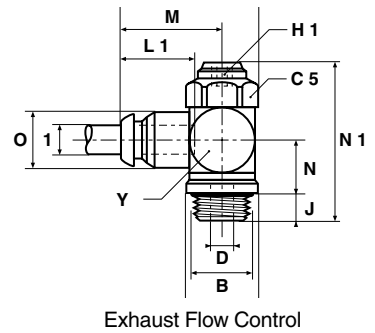

**PTFA4/8PB Flow Regulator with Push-In Connection**

PART NO.	1	B	C5	D	G1	H1	J	M	M1	N	N1	O	Y
PTFA8PB4M5*	4	M5x0.8	8	1.7	10.0	1.5	4	19.5	24.5	6.3	22.0	10	10
PTFA4PB4-1/8	4	1/8	14	3.0	14.4	2.0	6	22.0	30.1	10.7	34.5	10	14
PTFA8PB6M5*	6	M5x0.8	8	1.7	10.0	1.5	4	20.5	26.5	7.3	24.5	12	12
PTFA4PB6-1/8	6	1/8	14	3.2	14.4	2.0	6	23.5	31.6	10.7	34.5	12	14
PTFA4PB6-1/4	6	1/4	17	5.2	18.4	4.0	7	25.0	34.9	13.8	41.0	12	17
PTFA4PB8-1/8	8	1/8	14	3.2	14.4	2.0	6	25.0	33.1	10.7	34.5	14	14
PTFA4PB8-1/4	8	1/4	17	5.2	18.4	4.0	7	28.5	38.3	13.8	41.0	14	17

\* These fittings are supplied with Nylon seal.

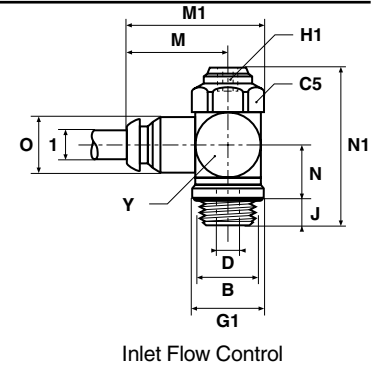

**PTF4 Flow Regulator with Threaded Connection**

PART NO.	A	B	C5	D	G1	H1	J	LU	M	M1	N	N1	O	Y
PTF4-1/8	1/8	1/8	14	3.2	14.4	2	6	8.5	17.5	25.6	10.7	34.5	13.9	14
PTF4-1/4	1/4	1/4	17	5.2	18.4	4	7	12.5	24.5	34.3	10.7	34.5	16.9	17
PTF4-3/8	3/8	3/8	22	6.0	21.6	4	7	12.5	27.5	40.2	13.8	41.0	21.6	22
PTF4-1/2	1/2	1/2	27	8.5	26.5	4	9	14.5	33.5	49.1	17.3	51.0	26.5	27

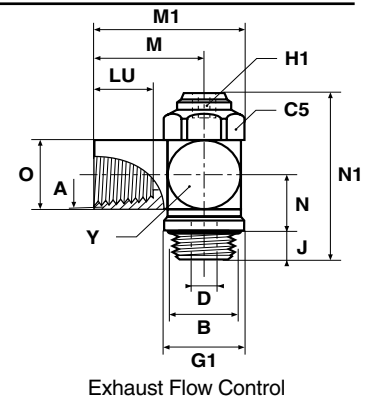

Only items priced in current price list are carried in stock. Dimensions shown may be changed at any time without prior notice.

**Prestoflow - Flow regulator - Locknut series**

**Principle**

Prestoflow compact flow regulators are designed for mounting directly onto cylinder ports to provide precise control of piston rod speed. Thanks to their compactness they are particularly suitable for applications where space is at a premium. These unidirectional flow regulators are available for exhaust or inlet flow control.

- A check valve blocks the full flow ports in the exhaust or inlet direction.
- The flow is controlled by a needle valve fitted in the regulator bolt.
- The adjustment screw can be locked in position to prevent tampering

**Flow adjustment**

Flow control is adjusted with an Allen key. When the desired flow is set the adjusting screw can be locked using the locking nut. The large number of turns from fully closed to fully open allows for precise flow control.

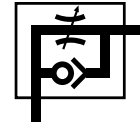

Exhaust flow control

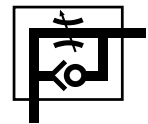

Inlet flow control

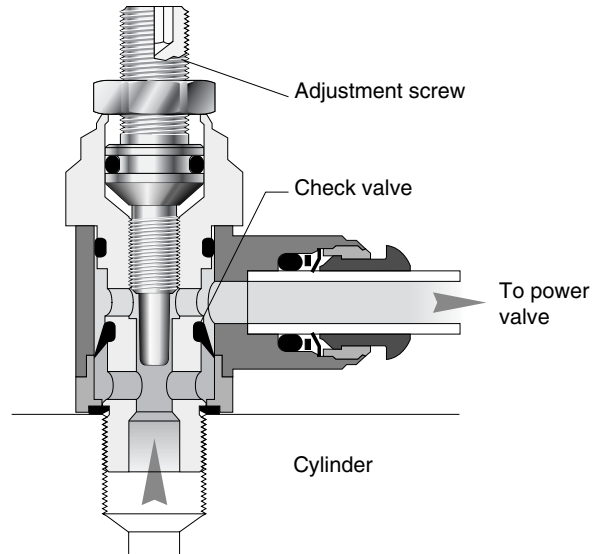
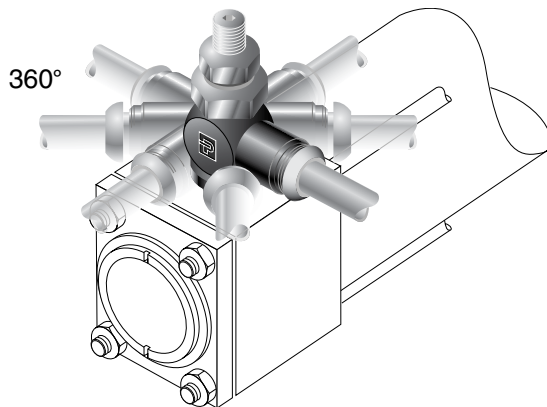

**Technical features**

BODY MATERIAL	BOLT MATERIAL	LOCK NUT	BOLT THREAD	SEALING DEVICE		TERMINATIONS		WORKING TEMPERATURE	WORKING PRESSURE
Brass Black Epoxy Coated	Brass	Brass	M5 1/8 BSPP 1/4 BSPP 3/8 BSPP 1/2 BSPP	M5 Thread Nylon Washer	1/8 - 1/2 BSPP Nitrile E.D. Seal	4 mm - 12 mm Push-In Connection	1/8 - 1/2 BSPP +M5 Female Thread DIN 3852 Long	From 0° to +200° F	140 PSI





**PTFL4/8PB Flow Regulator with Push-In Connection**

PART NO.	1	B	C5	D	G1	H1	H2	J	M	M1	N	N1	O	Y
PTFL8PB4M5*	4	M5x0.8	8	1.65	10.0	1.5	8	4	19.5	24.5	6.3	28.5	10	10
PTFL4PB4-1/8	4	1/8	14	3.00	14.4	2.0	7	6	22.0	30.1	10.7	43.7	10	14
PTFL8PB6M5*	6	M5x0.8	8	1.65	10.0	1.5	8	4	20.5	26.5	7.3	31.0	12	12
PTFL4PB6-1/8	6	1/8	14	3.20	14.4	2.0	7	6	23.5	31.6	10.7	43.7	12	14
PTFL4PB6-1/4	6	1/4	17	5.20	18.4	4.0	11	7	25.0	34.9	13.8	51.8	12	17
PTFL4PB6-3/8	6	3/8	22	5.50	21.6	4.0	11	7	28.0	40.7	17.3	63.7	12	22
PTFL4PB8-1/8	8	1/8	14	3.20	14.4	2.0	7	6	25.0	33.1	10.7	43.7	14	14
PTFL4PB8-1/4	8	1/4	17	5.20	18.4	4.0	11	7	28.5	38.3	13.8	51.8	14	17
PTFL4PB8-3/8	8	3/8	22	6.00	21.6	4.0	11	7	29.5	42.2	17.3	63.7	14	22
PTFL4PB10-1/4	10	1/4	17	5.20	18.4	4.0	11	7	31.5	41.3	13.8	51.8	17	17
PTFL4PB10-3/8	10	3/8	22	6.00	21.6	4.0	11	7	34.0	46.7	17.3	63.7	17	22
PTFL4PB10-1/2	10	1/2	27	8.00	26.5	4.0	14	9	36.5	52.1	20.1	76.1	17	27
PTFL4PB12-3/8	12	3/8	22	6.00	21.6	4.0	11	7	34.0	46.7	17.3	63.7	20	22
PTFL4PB12-1/2	12	1/2	27	8.50	26.5	4.0	14	9	36.5	52.1	20.1	76.1	20	27

\* These fittings are supplied with Nylon seal.

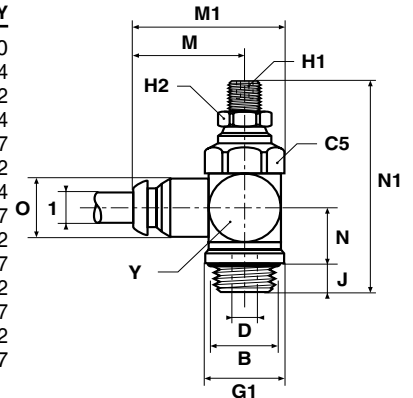

Exhaust Flow Control

**PTFAL8PB Flow Regulator with Push-In Connection**

PART NO.	1	B	C5	D	G1	H1	H2	J	M	M1	N	N1	O	Y
PTFAL8PB4M5	4	M5x0.8	8	1.65	10.0	1.5	8	4	19.5	24.5	6.3	28.5	10	10

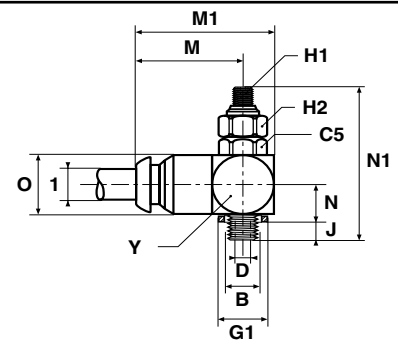

Inlet Flow Control

**PTFL4/8 Flow Regulator with Threaded Connection**

PART NO.	A	B	C5	D	G1	H1	H2	J	LU	M	M1	N	N1	O	Y
PTFL8M5*	M5x0.8	M5x0.8	8	1.65	10.0	1.5	8	4	5.0	11.0	16.0	6.3	28.5	8.0	10
PTFL4-1/8	1/8	1/8	14	3.20	14.4	2.0	7	6	8.5	17.5	25.6	10.7	43.7	13.9	14
PTFL4-1/4	1/4	1/4	17	5.20	18.4	4.0	11	7	12.5	24.5	34.3	10.7	51.8	16.9	17
PTFL4-3/8	3/8	3/8	22	6.00	21.6	4.0	11	7	12.5	27.5	40.2	13.8	63.7	21.6	22
PTFL4-1/2	1/2	1/2	27	8.50	26.5	4.0	14	9	14.5	33.5	49.1	17.3	76.1	26.5	27

\* These fittings are supplied with Nylon seal.

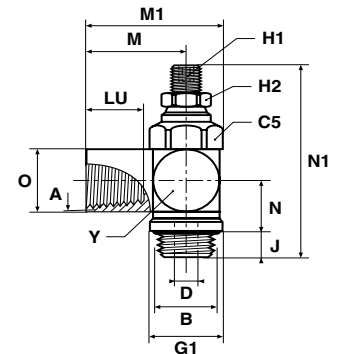

Exhaust Flow Control

**PTFAL8 Flow Regulator with Threaded Connection**

PART NO.	A	B	C5	D	G1	H1	H2	J	LU	M	M1	N	N1	O	Y
PTFAL8M5	M5x0.8	M5x0.8	8	1.65	10.0	1.5	8	4	5	11	16	6.3	28.5	8	10

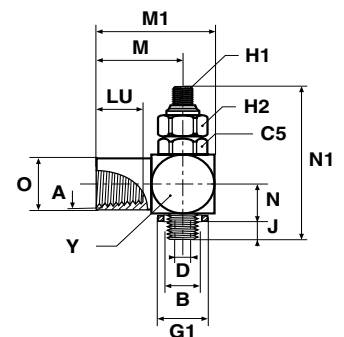

Inlet Flow Control

Only items priced in current price list are carried in stock. Dimensions shown may be changed at any time without prior notice.

**Prestoflow - Flow regulator - Swivel outlet**

**Principle**

Prestoflow unidirection swivel flow regulators are designed for mounting directly onto the cylinder exhaust port and provide precise control of the piston rod speed. The swivel outlet is designed to allow vertical or oblique tube exit where access is restricted.

- A check valve blocks the full flow ports in the exhaust direction.
- The flow is controlled by a needle valve fitted in the regulator bolt.
- The swivel outlet can be positioned in the most suitable direction.

**Flow adjustment**

Flow control is adjusted with an Allen key. The large number of turns from fully closed to fully open allows for precise flow control.



Exhaust flow control

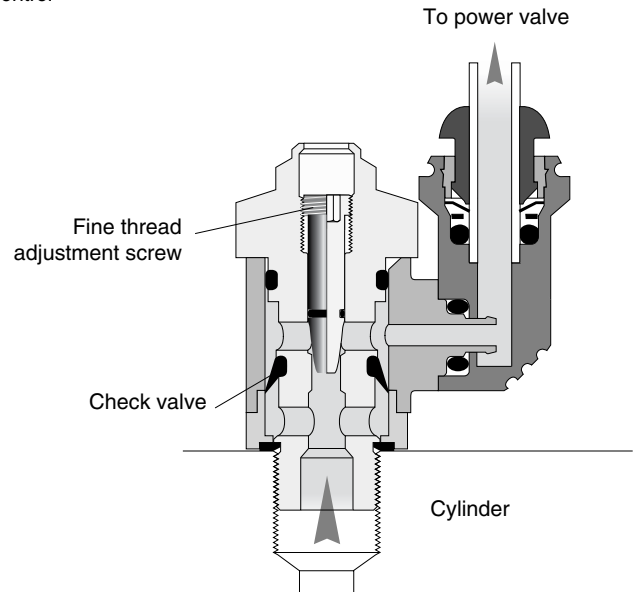
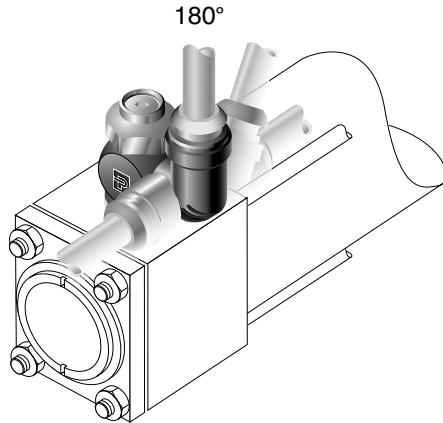

**Technical features**

BODY MATERIAL	SWIVEL ELBOW MATERIAL	BOLT MATERIAL	BOLT THREAD	SEALING DEVICE		TERMINATIONS	ADJUSTMENT SCREW	WORKING TEMP.	WORKING PRESSURE
				M5 Nylon Washer	1/8 - 3/8 BSPP Nitrile E.D. Seal				
Brass Black Epoxy Coated	High Resistance Polyamide	Brass	M5 1/8 BSPP 1/4 BSPP 3/8 BSPP 1/2 BSPP	M5 Nylon Washer	1/8 - 3/8 BSPP Nitrile E.D. Seal	4 mm - 8 mm Push-In	Brass	From 0° to +150° F	140 PSI

**PTF4/8E6PB Flow Regulator with Push-In Connection**

PART NO.	1	B	C5	D	G1	H1	J	M	M2	N	N1	P	Y
PTF8E6PB4M5*	4	M5x0.8	8	1.65	10.0	1.5	4	11.7	18.4	6.2	22.5	20.5	10
PTF4E6PB4-1/8	4	1/8	14	3.00	14.4	2.0	6	14.3	30.0	10.7	34.5	20.5	14
PTF8E6PB6M5*	6	M5x0.8	8	1.65	10.0	1.5	4	12.7	20.4	7.2	24.5	23.0	12
PTF4E6PB6-1/8	6	1/8	14	3.20	14.4	2.0	6	15.3	31.0	10.7	34.5	23.0	14
PTF4E6PB6-1/4	6	1/4	17	5.20	18.4	4.0	7	17.3	35.0	13.8	41.0	23.0	17
PTF4E6PB6-3/8	6	3/8	22	5.50	21.6	4.0	7	19.8	40.0	17.3	51.0	23.0	22
PTF4E6PB8-1/8	8	1/8	14	3.20	14.4	2.0	6	16.8	33.5	10.7	34.5	25.0	14
PTF4E6PB8-1/4	8	1/4	17	5.20	18.4	4.0	7	18.3	37.0	13.8	41.0	25.0	17
PTF4E6PB8-3/8	8	3/8	22	6.00	21.6	4.0	7	20.8	42.0	17.3	51.0	25.0	22

\* These fittings are supplied with Nylon seal.

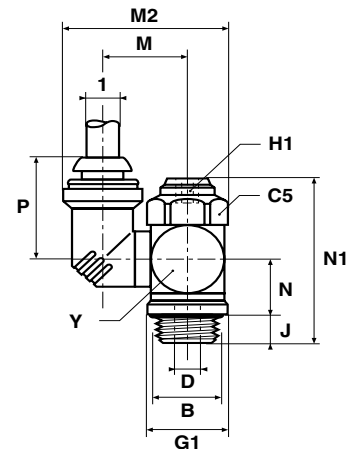

Only items priced in current price list are carried in stock. Dimensions shown may be changed at any time without prior notice.





## Slow Start Flow Control Valves

### Principle

Designed for mounting on either the FRL or power valve, Parker Prestostart slow start function fittings permit the gradual increase in pressure to a section of the pneumatic system. This prevents shocks to the system that may occur when full system pressure is introduced thus reducing wear and potential damage to components.

### Operation

- Mounted on outlet port of FRL to control downstream installation.
- Initial flow through the bolt is controlled by a restrictor and adjustable needle valve.
- When 2/3rd system pressure is achieved the spring is compressed allowing immediate increase to full system pressure.
- When the system is pressurized after an emergency stop all cylinders will return to the position they were in before the system air was vented.

### Pressurization speed

Adjustment of the needle valve to regulate the air flow controls the time taken to pressurize the system.

### Advantages

- Simplified cabling
- Compact installation
- Reduces wear and damage

### Valve Specifications

Maximum Working Pressure: 145 PSI  
 Operating Temperature: +5° - +150° F  
 Body Material: Brass nickel plated  
 Bolt Material: Brass nickel plated

### Soft start operation/Full flow

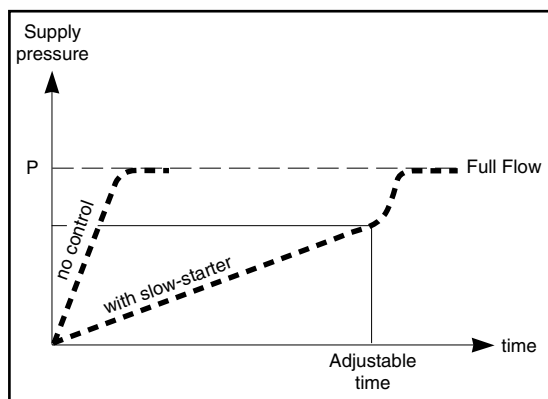
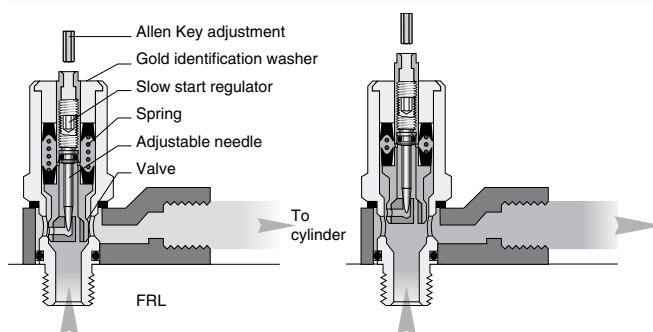

### FC902 Slow Start with Threaded Connection

PART NO.	NPT THREADS	H MAX.	H MIN.	F	A	J	L	K
FC902-4	1/4	2.44	2.17	7/8	3/4	.95	1.22	.55
FC902-6	3/8	2.44	2.17	7/8	3/4	.95	1.22	.55

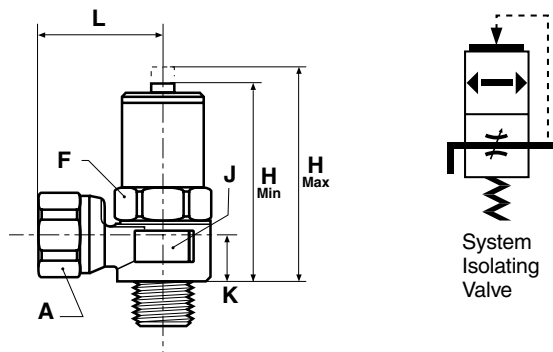

**Prestostart  
Pneumatic slow start fittings**

**Principle**

Designed for mounting on either the FRL or power valve, Parker Prestostart slow start function fittings permit the gradual increase in pressure to a section of the pneumatic system. This prevents shocks to the system that may occur when full system pressure is introduced thus reducing wear and potential damage to components.

**PIV Series**

- Mounted on outlet port of FRL to control downstream installation.
- Initial flow through the bolt is controlled by a restrictor and adjustable needle valve.
- When 2/3 of the system pressure is achieved the spring is compressed allowing immediate increase to full system pressure.
- When the system is pressurized after an emergency stop all cylinders will return to the rest position.

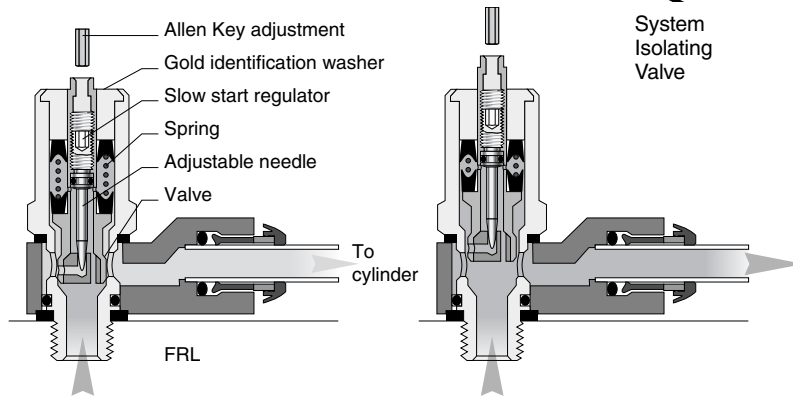

**PCV Series**

- Mounted on the supply port of the power valve or on the common supply of associated power valves.
- Initial flow into the power valve is controlled by the needle valve assembly.
- When 2/3 of the system pressure is achieved the spring is compressed allowing immediate increase to full system pressure.
- When the system is pressurized after an emergency stop all cylinders will return to the rest position.

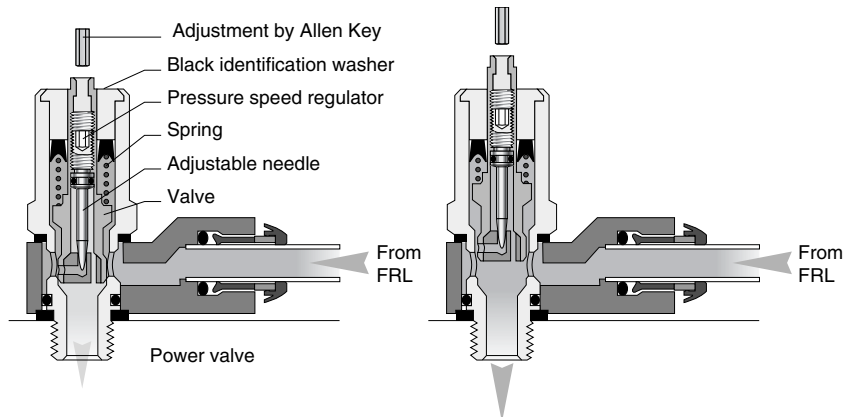

**Pressurization speed**

Adjustment of the needle valve to regulate the air flow controls the time taken to pressurize the system.

**Adjustment**

- Use a spanner to prevent the bolt assembly turning.
- Use an Allen key to adjust the needle valve. Maximum torque 1N/m.

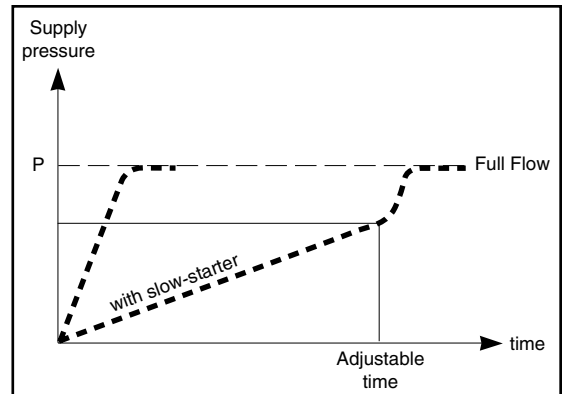
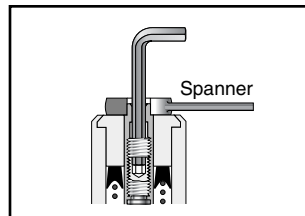

**Technical features**

BODY MATERIAL		BOLT ASSEMBLY MATERIAL	BOLT THREAD	SEALING DEVICE	TERMINATORS		WORKING TEMP.	WORKING PRESSURE
PUSH-IN VERSION	THREAD VERSION				8 to 12 mm Push-In	1/4 to 1/2 BSPP Female Thread		
High Resistance Polyamide	Brass Nickel Plated	Brass Nickel Plated	1/4 BSPP 3/8 BSPP 1/2 BSPP	Nylon Washer	8 to 12 mm Push-In	1/4 to 1/2 BSPP Female Thread	From 0° to +140° F	100 PSI



**PCV4 Slow Start Fitting Power Valve Version with Threaded Connection**

PART NO.	B	C5	G1	H MIN.	H MAX.	J	L	Y	TORQUE MDAN	AIR FLOW NL/MN AT 87 PSI	KV
PCV4-1/4 <sup>†</sup>	1/4	22	19.5	55	62	9	31	24	1.3	2000	1.15
PCV4-3/8	3/8	22	21.0	55	62	10	31	24	1.5	2000	1.15

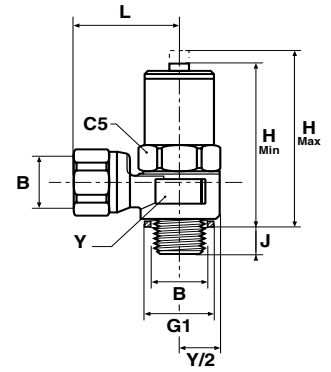

<sup>†</sup>Indicates non-standard part.  
Only items priced in current price list are carried in stock. Dimensions shown may be changed at any time without prior notice.



# Blocking Valves

## Principle

Prestobloc pilot-operated blocking fittings are designed for mounting directly to the cylinder ports. Available with push-in or threaded terminations, these function fittings permit safe and immediate stopping of the piston rod by blocking the cylinder supply and exhaust.

## Operation

- Pilot operated diaphragm maintains full flow when pilot signal is present.
- Spring closes the poppet valve locking air in the cylinder when the pilot signal is removed.
- Prestobloc fittings used in conjunction with Prestoflow flow regulators are mounted on inlet and outlet ports.
- Pilot signal should be independent from the control valve.

## Advantages

- Compact
- Direct mounting
- Safety
- Independent control

## Valve Specifications

Maximum Working Pressure: 145 PSI  
 Operating Temperature: +5°- +150° F  
 Body Material: Zinc alloy epoxy coated  
 Bolt Material: Brass

## With control signal

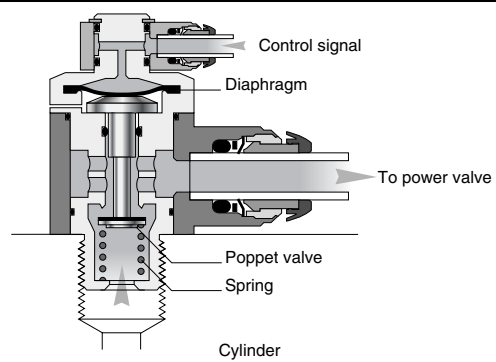

## Without control signal

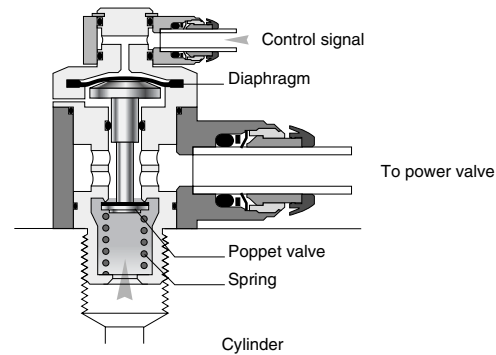

## Blocking principle

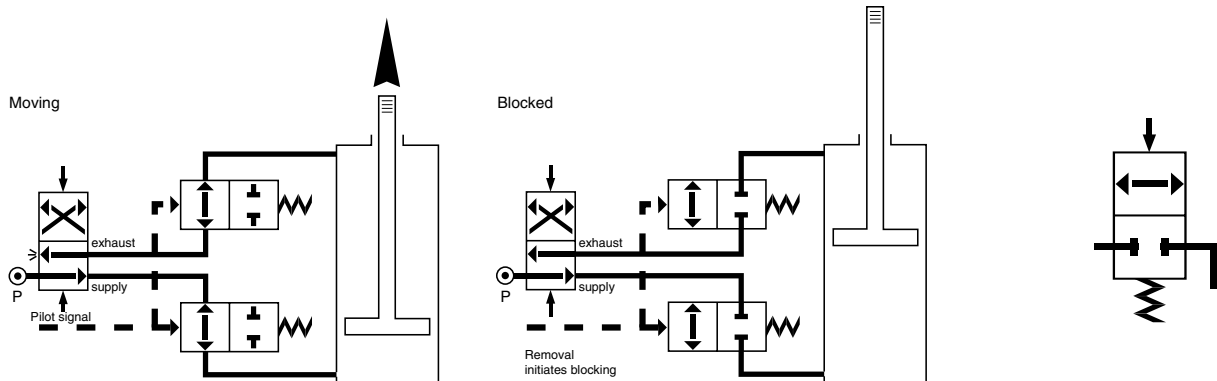

**FC601 Blocker with Push-In Connection**

PART NO.	TUBE 1	TUBE 2	NPT	FLOW	A	B	C	K	H	L
FC601-4-2	1/4	5/32	1/8	14.80	.86	.82	.94	.53	2.32	1.54
FC601-4-4	1/4	5/32	1/4	19.40	.86	.82	.94	.53	2.09	1.54
FC601-6-6	3/8	5/32	3/8	49.90	1.06	1.10	.94	.55	2.09	1.98
FC601-8-8	1/2	5/32	1/2	81.20	1.22	1.22	1.30	.94	2.59	2.59

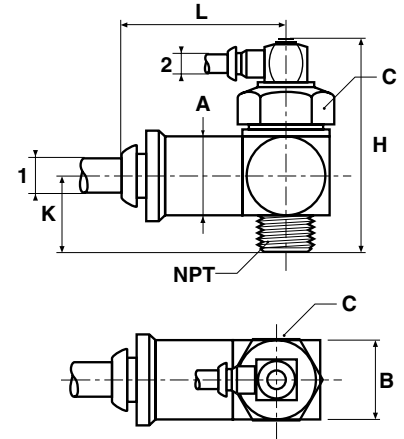

**FC602 Blocker with Threaded Connection**

PART NO.	FEMALE THREAD 1	TUBE 2	FLOW	A	B	C	K	H	L	NPT
FC602-2	1/8	5/32	14.80	.86	.82	.94	.53	2.32	1.71	1/8
FC602-4	1/4	10-32	19.40	.86	.82	.94	.53	2.09	1.71	1/4
FC602-6	3/8	10-32	49.90	1.06	1.10	.94	.55	2.09	2.18	3/8
FC602-8	1/2	10-32	81.20	1.22	1.30	1.30	.94	2.59	2.47	1/2

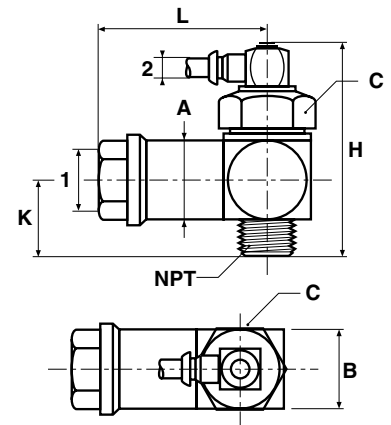

**Operating Characteristics**

BOLT SIZE	PILOT OPERATING PRESSURE (100% FLOW)				PILOT RELEASE PRESSURE				MAX. INPUT FLOW AT 87 PSI
	29 psi	58 psi	87 psi	116 psi	29 psi	58 psi	87 psi	116 psi	
1/8"	45.0	51.0	58.0	65.5	11.5	14.5	17.5	20.5	17.6 cfm
1/4"	45.0	51.0	58.0	65.5	11.5	14.5	17.5	20.5	22.9 cfm
3/8"	35.5	40.0	44.0	49.5	20.5	24.5	58.0	34.0	45.9 cfm
1/2"	44.0	49.5	53.5	58.5	25.5	30.5	35.0	40.5	81.2 cfm

**Prestobloc - Pilot-operated blocking fittings**

**Principle**

Prestobloc pilot-operated blocking fittings are designed for mounting directly to the cylinder ports. Available with push-in or threaded terminations, these function fittings permit safe and immediate stopping of the piston rod by blocking the cylinder supply and exhaust.

**Operation**

- Pilot operated diaphragm maintains full flow when pilot signal is present.
- Spring closes the poppet valve locking air in the cylinder when the pilot signal is removed.
- Prestobloc fittings used in conjunction with Prestoflow flow regulators are mounted on inlet and outlet ports.
- Pilot signal should be independent from the control valve.

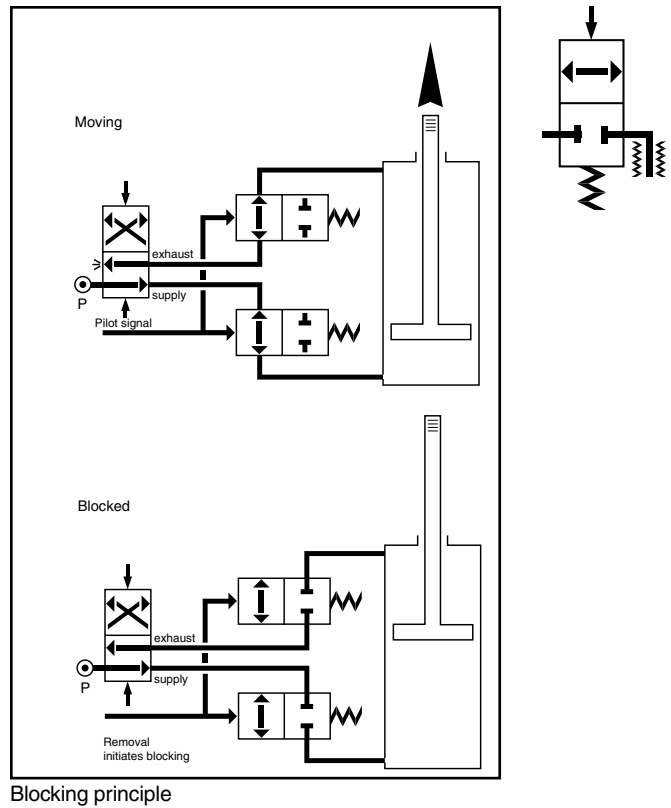
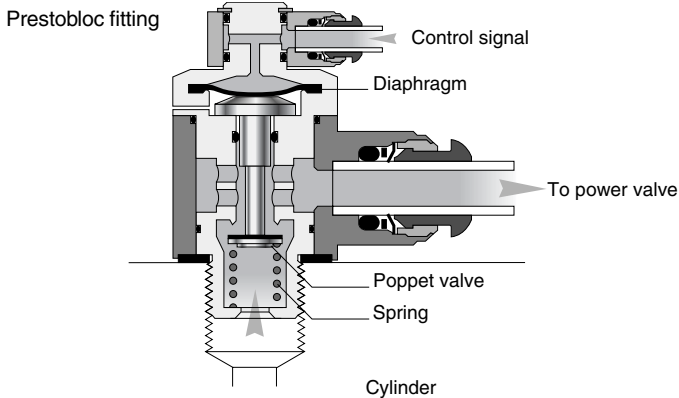

**Technical features**

BODY MATERIAL	BOLT MATERIAL	BOLT THREAD	SEALING DEVICE	TERMINATIONS		PILOT TERMINATION	WORKING TEMPERATURE	WORKING PRESSURE
				6 mm - 12 mm Push-In	1/4 - 1/2 BSPP Female Thread			
Zinc Alloy Epoxy Coated	Brass	1/8 BSPP 1/4 BSPP 3/8 BSPP 1/2 BSPP	Nylon Washer	6 mm - 12 mm Push-In	1/4 - 1/2 BSPP Female Thread	4 mm - 8 mm Push-In	From 0° to +150° F	140 PSI

**Applications**

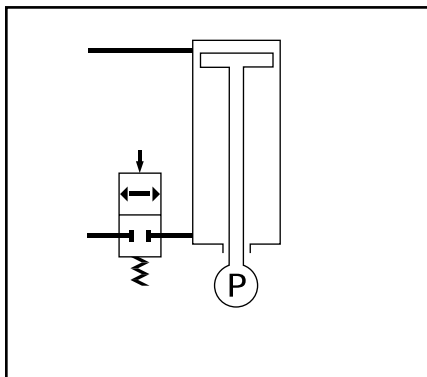

**Safety stop**

Prevents descent under load in the event of power failure

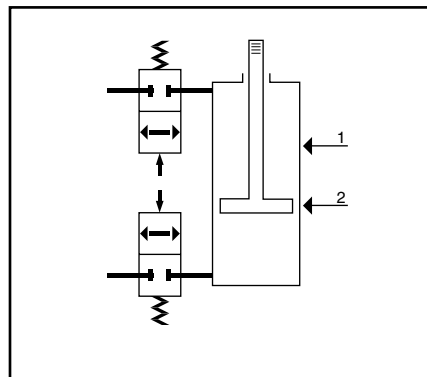

Stops the piston in various positions for conveying and handling applications.

**Safety locks**

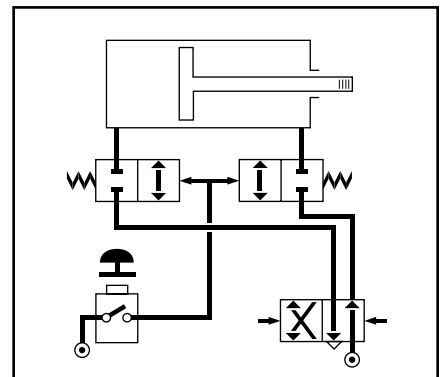

Safety guards for assembly and punch presses. Combination with an emergency switch: restarting the cylinder after resetting the emergency switch.

**Stroke control**



**PWB-A- Blocker with Push-In Connection**

OLD PART NO.	NEW PART NO.	1	B	2	C5	M	N	N1	O	Y
PBV4PB6-1/8	PWB-A1468	6	1/8	4	24	39	20	59	20	22
PBV4PB6-1/4	PWB-A1469	6	1/4	4	24	39	22	61	22	24
PBV4PB8-1/4	PWB-A1489	8	1/4	4	24	39	22	61	22	24
PBV4PB8-3/8	PWB-A1483	8	3/8	4	27	50	25	64	27	24
PBV4PB10-3/8	PWB-A1493	10	3/8	4	27	50	25	64	27	24
PBV4PB12-1/2	PWB-A1412	12	1/2	4	27	66	36	78	31	33

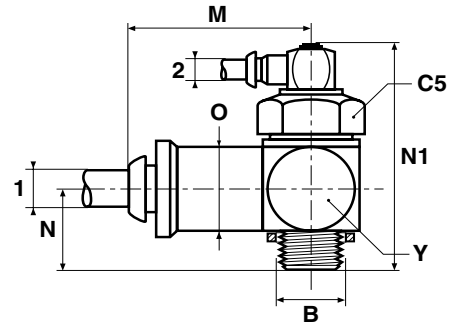

**PWB-A- Blocker with Threaded Connection**

OLD PART NO.	NEW PART NO.	B	B1	2	C5	M1	N	N1	O	Y
PBV4-1/8-1/4	PWB-A1898	1/8	1/4	4	24	44	20	59	20	24
PBV4-1/4	PWB-A1899	1/4	1/4	4	24	44	22	61	22	24
PBV4-3/8	PWB-A1833	3/8	3/8	4	27	56	25	64	27	24
PBV4-1/2	PWB-A1822	1/2	1/2	4	27	63	36	78	31	33

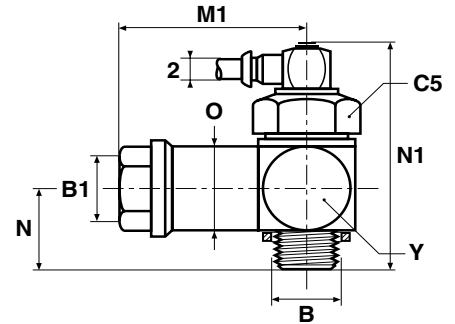

**Operating Characteristics**

Bolt Size	Pilot operating pressure			Pilot release pressure			Max. input flow at 6 Bar
	3 Bar	6 Bar	8 Bar	3 Bar	6 Bar	8 Bar	
1/8 BSPP	1.75	3.35	4.50	.95	2.05	2.75	1450 l/mn ANR
1/4 BSPP	2.35	4.30	5.90	.95	2.05	2.75	2800 l/mn ANR
3/8 BSPP	2.00	4.10	4.80	.90	2.00	3.00	3950 l/mn ANR
1/2 BSPP	1.40	3.35	5.00	.90	2.20	3.50	4750 l/mn ANR

Only items priced in current price list are carried in stock. Dimensions shown may be changed at any time without prior notice.





## In-Line Flow Control Valves

### General Information

It is sometimes impossible to mount a flow control directly on the port of the cylinder, either due to lack of space or because of the need for remote adjustment of the flow control. To resolve this problem in-line flow controls are designed to mount on the piping between the directional valve and the cylinder or can be mounted on the control panel next to other control units.

### Designed to be versatile

Parker In-Line Flow Controls are unidirectional flow control valves. Intake air flows freely through the flow control; exhaust air is metered out through a specially designed adjustment screw. An arrow on the body of the valve indicates the direction of controlled flow. Since it is a tube to tube connection, our in-line flow controls may be installed as a meter in or a meter out device.

Parker in-line flow controls can be easily added to existing circuitry. Simply splice it into the cylinder port line. In-line flow controls may be used individually or, they may be stacked together using two joining clips, supplied standard with each valve. Panel mounting is accomplished by using the through holes in the molded body.

### Adjustment characteristics

Control is achieved through a finely threaded special adjustment screw. The special shaped adjustment screw produces a more linear flow control than ordinary tapered screws. With the use of a locking nut, the in-line flow control may be secured in its final setting. Settings are maintained even under adverse conditions such as vibration. A captive adjustment screw prevents loss or dangerous blow out.

### Full flow in both directions

Intake capacity is always slightly greater than the full open exhaust capacity, enabling maximum variation of speeds between outward and return strokes.

### Advantages

- Assembly in banks
- Panel mounting
- Allows other function fittings to be mounted on a cylinder
- Space saving
- Weight saving
- Flexibility

### Valve Specifications

Maximum Working pressure: 145 PSI  
 Operating Temperature: +5° - +150° F  
 Body material: High resistance polyamide  
 Adjustment screw material: Brass

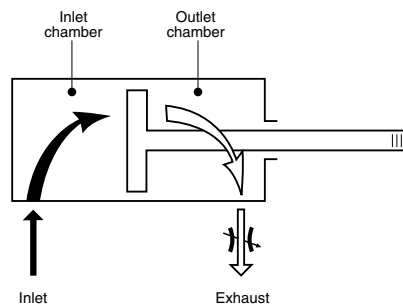
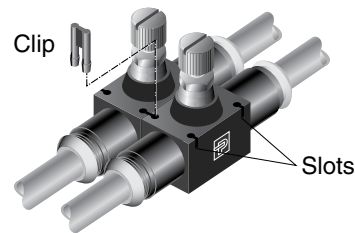
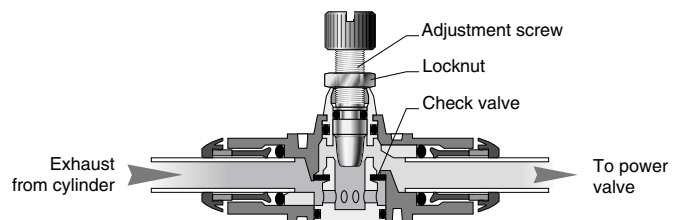

Flow regulation on the exhaust port

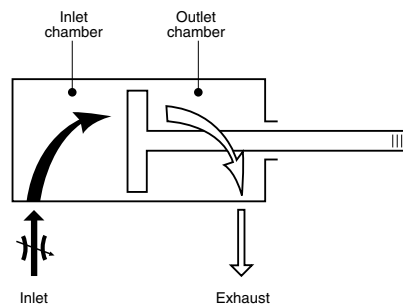

Flow regulation on the inlet port

**Push-in Connection In-line Exhaust Flow Control FC800**

PART NO.	1 ØD	H MIN.	H MAX.	L	L1	K	N1	N2	T	ORIFICE	H2 (MM)
FC800-5/32	5/32	1.15	1.31	1.52	.59	.47	.31	.43	.09	.12	5
FC800-4	1/4	1.54	1.74	2.11	.90	.66	.43	.66	.12	.16	8
FC800-6	3/8	2.03	2.38	2.96	1.29	.94	.62	1.01	.16	.31	14
FC800-8	1/2	2.24	2.63	3.35	1.37	1.09	.78	1.07	.16	.39	14

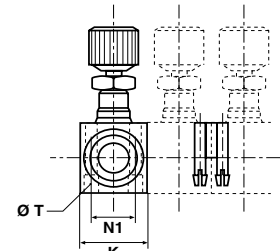
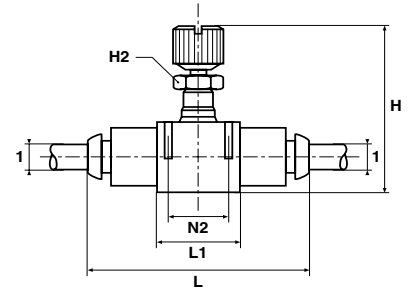

Supplied with 2 clips

**Threaded In-line Exhaust Flow Control FC806**

PART NO.	THREAD SIZE	B HEX (MM)	C HEX (MM)	H CLOSED	H OPEN	L	L1	K	N	N1
FC806-2	1/8	13	8	1.56	1.75	2.70	.91	.67	.67	.43
FC806-4	1/4	16	11	1.73	1.97	3.27	1.02	.73	.79	.49
FC806-6	3/8	22	14	2.05	2.40	3.82	1.30	.94	1.02	.63
FC806-8	1/2	24	14	2.26	2.66	4.76	1.38	1.10	1.08	.79

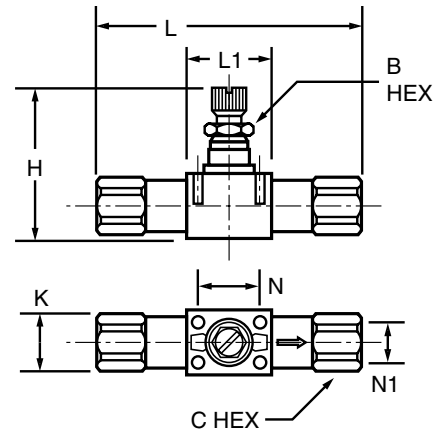

C

**Prestoflow - Flow regulator - In-line series**

**Principle**

Prestoflow unidirection in-line flow regulators are designed to be used directly in the compressed air line when cylinder access is difficult or where another function fitting is already connected to the cylinder port. The fine thread knurled adjuster provides precise control of piston rod speed. When the desired flow has been set the adjusting bolt can be locked in position.

- A check valve blocks the full flow ports in the exhaust direction.
- The flow is controlled by a needle valve fitted in the regulator body.
- These regulators can be :
  - mounted using the 4 fixing holes
  - assembled into banks using the joining clips included.

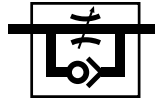

**Flow adjustment**

Flow control is adjusted with a screwdriver or manually with the knurled nut. When the desired flow is set the adjusting screw can be locked using the locking nut. The large number of turns from fully closed to fully open allows for precise flow control.

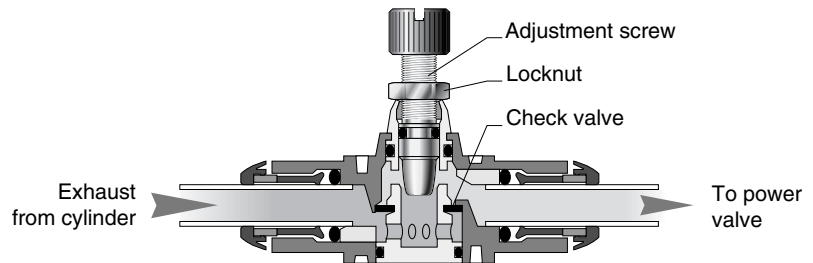
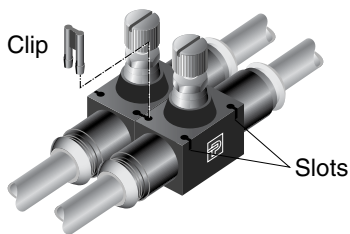

**Technical features**

BODY MATERIAL	CARTRIDGE MATERIAL	ADJUSTMENT AND LOCKING NUT		TERMINATIONS	WORKING TEMPERATURE	WORKING PRESSURE
		Standard Adjustment Brass	Ultrafine Adjustment Duralumin			
High Resistance Polyamide	Brass	Standard Adjustment Brass	Ultrafine Adjustment Duralumin	4 mm - 12 mm Push-In	From 0° to +150° F	140 PSI

**PTFIPK Flow Regulator with Push-In Connection**

PART NO.	1	H		H2	K	L	L1	N1	N2	T
		MIN.	MAX.							
PTFIPK4	4	29.5	33.5	5	12.0	39.0	15	8.0	11.0	2.2
PTFIPK6	6	39.5	44.5	8	17.0	55.0	23	11.0	17.0	3.2
PTFIPK8	8	44.0	50.0	11	18.5	61.5	26	12.5	20.0	3.2
PTFIPK10	10	52.0	61.0	14	24.0	77.0	33	16.0	26.0	4.2
PTFIPK12	12	57.5	67.5	14	28.0	87.0	35	20.0	27.5	4.2

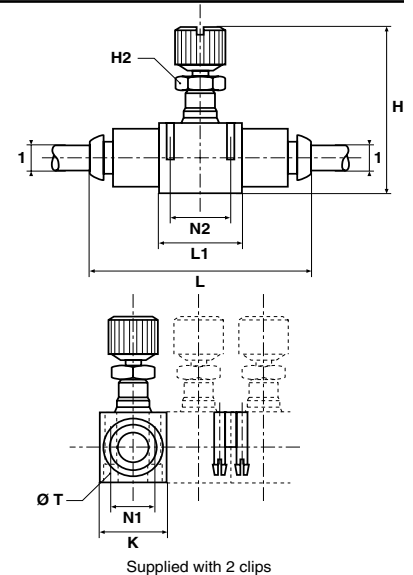

Only items priced in current price list are carried in stock. Dimensions shown may be changed at any time without prior notice.



**PTFMIPK Flow regulator with Push-In Connection Ultrafine Adjustment**

PART NO.	1	H MIN.	H MAX.	K	L	L1	N1	N2	T
PTFMIPK4	4	34	37.0	12	39	15	8	11	2.2
PTFMIPK6	6	42	45.5	17	54	23	11	17	3.2

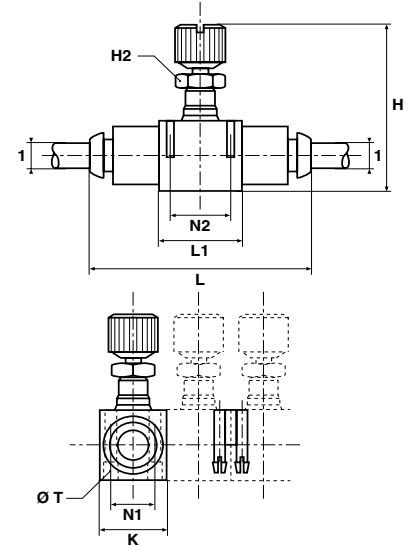

Supplied with 2 clips

**PTFIWPK Flow Regulator with Push-In Connection Panel Mountable**

PART NO.	1	C	H MIN.	H MAX.	H1	H2	H3	L	T	W MAX.
PTFIWPK4*	4	14	21.5	25.5	6.5	-	11.0	39.0	10.5	6
PTFIWPK6*	6	19	27.5	32.5	7.5	-	13.5	54.0	16.5	7
PTFIWPK8	8	24	28.5	34.5	9.0	11	13.5	60.5	18.5	7
PTFIWPK10†	10	30	29.5	38.5	11.5	14	13.5	76.0	24.5	7
PTFIWPK12†	12	32	32.0	42.0	12.5	14	15.5	86.0	27.5	8

\* Ultrafine adjustment

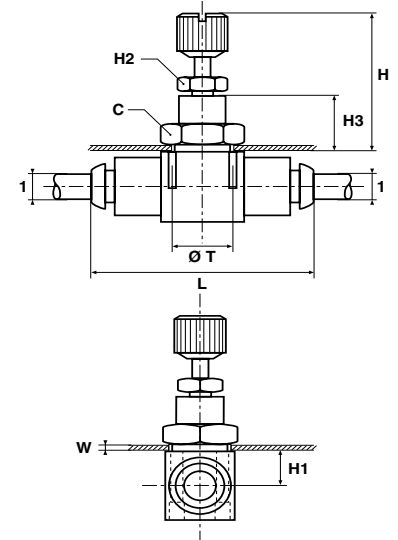

†Indicates non-standard part.

Only items priced in current price list are carried in stock. Dimensions shown may be changed at any time without prior notice.

**Prestotwin - Combined flow - blocking - valves**

**Principle**

Prestotwin are multi-function fittings combining flow control and blocking. This avoids the requirement for two function fittings offering a compact solution with significant space saving. They meet the requirements for a safety fitting and incorporate the facility to accurately control the piston rod speed.

**Operation**

**PBVF4PK Flow regulator + blocker**

- The pilot signal acting on the diaphragm keeps the poppet valve open. When the pilot signal is removed the spring closes the poppet valve.
- Flow control is obtained by the adjustment of the rotating barrel against a ball bearing.
- The flow control locknut ensures the optimum setting is maintained.

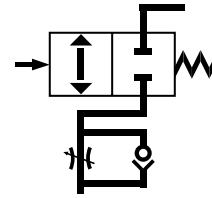

Speed control and blocker

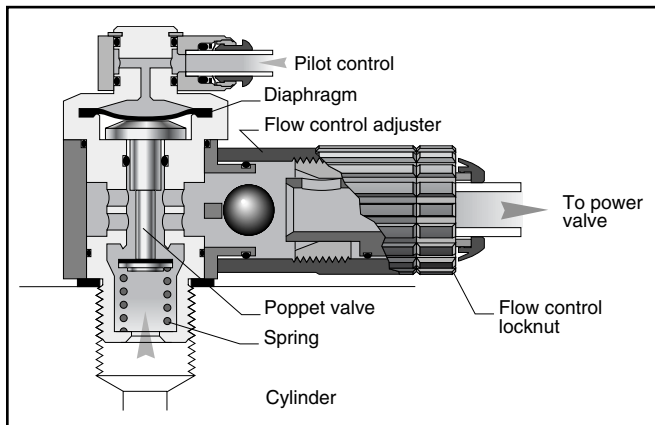

Combined flow control and blocker

**Technical features**

BODY MATERIAL	BOLT MATERIAL	BOLT THREAD	SEALING DEVICE	PILOT TERMINATION	FLOW CONTROL ADJUSTMENT	FLOW CONTROL LOCKING	WORKING TEMP.	WORKING PRESSURE
Zinc Alloy Epoxy Coated	Brass	1/8 BSPP 1/4 BSPP	Nylon Washer	4 mm - 8 mm Push-In	Rotating Barrel	Knurled Locknut	From 0° to +140° F	140 PSI

**PWR-HB- Flow Regulator + Blocker with Push-In Connection**

PART NO.	1	B	2	C5	J	M	N	N1	O	Y
PWR-HB1448	4	1/8	4	24	8	47	21.5	67	22.5	21
PWR-HB1468	6	1/8	4	24	8	47	21.5	67	22.5	21
PWR-HB1469	6	1/4	4	24	10	47	23.5	69	22.5	21
PWR-HB1489	8	1/4	4	24	10	47	23.5	69	22.5	21
PWR-HB1483	8	3/8	4	27	11	60	29.0	73	29.0	28
PWR-HB1493	10	3/8	4	27	11	60	29.0	73	29.0	28

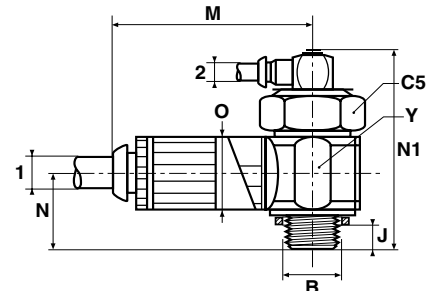

**Prestosensor  
Pressure sensor fittings**

**Principle**

Prestosensor fittings are designed for direct mounting onto the cylinder. These sensors detect end of stroke travel by the variation in internal operating pressure. The sensing can be pneumatic, electric or electronic to suit the application. These fittings remove the need for mechanical position switches.

**Operation**

- Mounting to cylinder port
- Pressure sensors should be mounted in conjunction with flow regulators
- Pressure sensing on diaphragm valve.

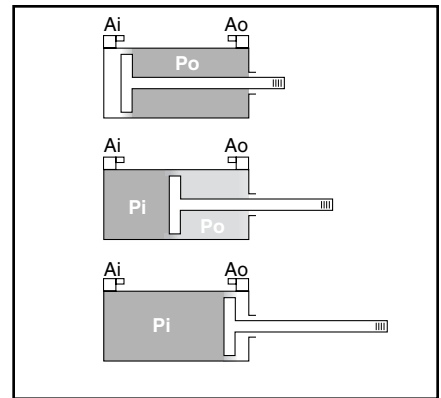
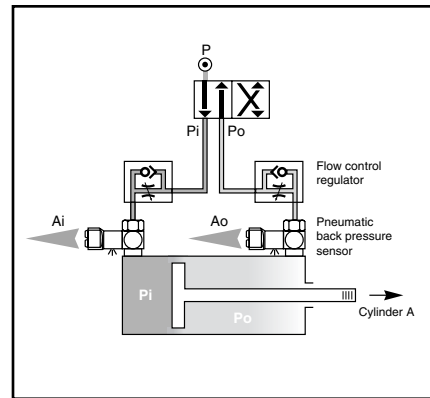
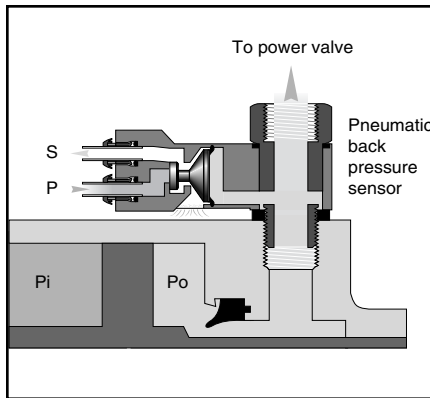
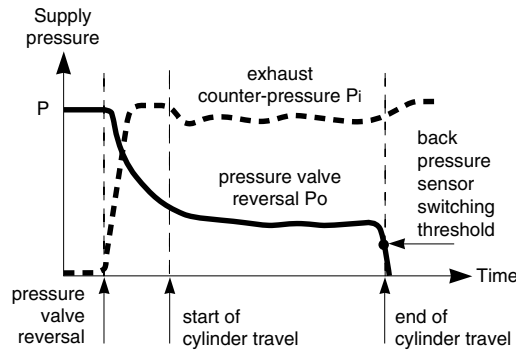
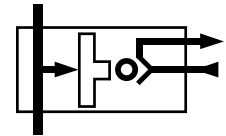

Mounting of pressure sensors

Signals from pressure sensors

**Technical features**

BODY MATERIAL		BOLT MATERIAL	BOLT THREAD	SEALING DEVICE	TERMINATORS			WORKING TEMP.	WORKING PRESSURE
PNEUMATIC OUTPUT VERSION	ELECTRIC AND ELECTRONIC VERSION				PNEUMATIC OUTPUT VERSION	ELECTRIC OUTPUT VERSION	ELECTRONIC OUTPUT VERSION		
Zinc Alloy and Thermoplastic	Thermoplastic	M5 Bichromate steel 1/8 to 1/2 BSPP: Brass	M5 1/8 BSPP 1/4 BSPP 3/8 BSPP 1/2 BSPP	Nylon Washer	4 mm Push-In or M5 Female Thread	3 Core Cable 0.5 mm <sup>2</sup> 2 Meters Long	3 Core Cable 0.1 mm <sup>2</sup> 2 Meters Long	From 0° to +140° F	100 PSI

**PTP4/8PB Pressure Sensor Pneumatic Output with Push-In Connection**

PART NO.	B	C5	G1	H	J	M	Y
PTP4PB4-1/8	1/8	14	6.0	23	14.0	45.0	16.0
PTP4PB4-1/4	1/4	17	7.0	28	17.5	47.0	19.5
PTP4PB4-3/8	3/8	22	8.0	29	21.0	49.5	23.5
PTP4PB4-1/2	1/2	27	10.0	30	25.5	53.5	31.5

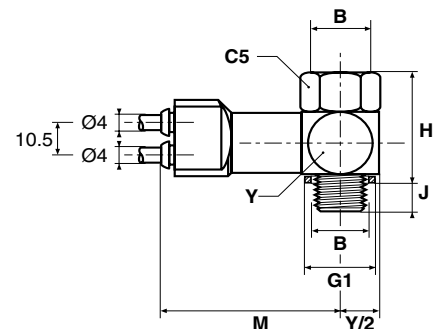

Only items priced in current price list are carried in stock. Dimensions shown may be changed at any time without prior notice.

**PWS-M -Plug-in Sensor-Electrical Output**

PART NO.	WEIGHT GRAMS	OUTPUT FUNCTION	OUTPUT CONNECTION	OUTPUT CHARACTERISTICS
PWS-M1012	0.08	Electrical ~ Ve = 3 A	3 wires 0.5 mm <sup>2</sup> long. 2 m	Contact OF 12 to 230 V ~ /10 VA 12 to 48 VCC/ 5W

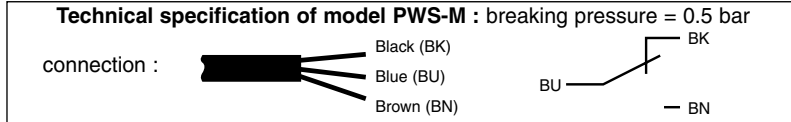
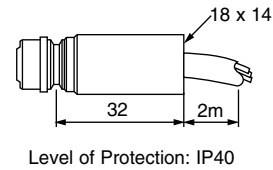

**PWS-B-Banjo Socket (with sensor locking clip)**

B	PART NO.	C5	J	N	N1	Y	WEIGHT GRAMS	TOOL REQUIRED
1/8	PWS-B188	6	8	18	28	16	0.04	Allen key 5 mm
1/4	PWS-B199	8	10	18	28	21	0.05	Allen key 8 mm
3/8	PWS-B133	10	11	22	32	28	0.07	Allen key 10 mm
1/2	PWS-B122	12	12	26	38	33	0.11	Allen key 12 mm

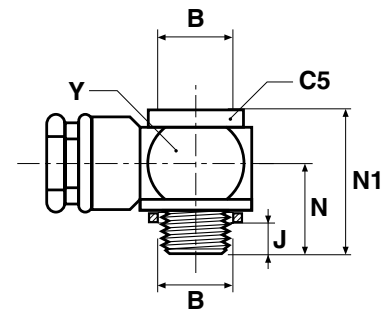

NEW PART NO.	OLD PART NO.
PWS-M1012 + PWS-B155	PTZ8M5
PWS-M1012 + PWS-B188	PTZ4-1/8
PWS-M1012 + PWS-B199	PTZ4-1/4
PWS-M1012 + PWS-B133	PTZ4-3/8
PWS-M1012 + PWS-B122	PTZ4-1/2
PWS-E101 + PWS-B155	PTE8M5
PWS-E101 + PWS-B188	PTE4-1/8
PWS-E101 + PWS-B199	PTE4-1/4
PWS-E101 + PWS-B133	PTE4-3/8
PWS-E101 + PWS-B122	PTE4-1/2
PWS-E111 + PWS-B155	PTE8M5C
PWS-E111 + PWS-B188	PTE4-1/8C
PWS-E111 + PWS-B199	PTE4-1/4C
PWS-E111 + PWS-B133	PTE4-3/8C
PWS-E111 + PWS-B122	PTE4-1/2C

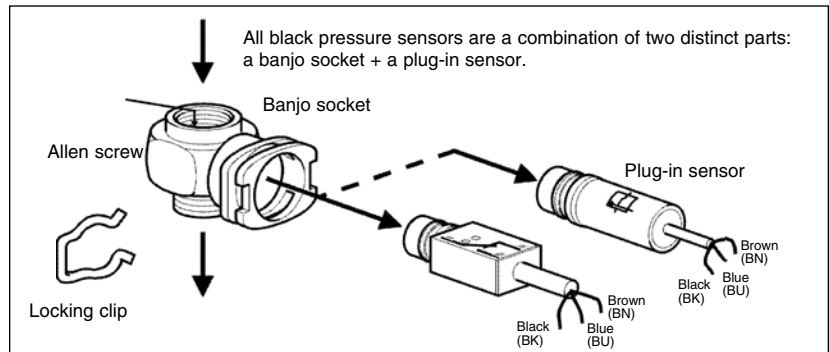

Only items priced in current price list are carried in stock. Dimensions shown may be changed at any time without prior notice.





**Prestoreduce  
Pressure reduction fittings**

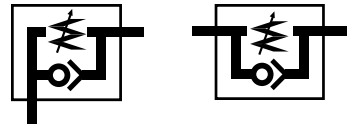

**Principle**

This function fitting is manually preset to provide the cylinder with optimum air pressure. This reduces the air consumption of the cylinder generating energy savings. This fitting is particularly suitable for cylinders used in cutting, pressing or gripping operations.

- System pressure ( $P_i$ ) is reduced by a spring-loaded valve which can be calibrated by the set screw.
- The greater the reduction between inlet and outlet pressure the larger the energy savings.
- The coloured indicator shows the energy savings achieved.
- The purge vent allows rapid exhaust of air in emergencies.
- Adjustment can be made with an Allen key or manual ratchet control.
- An anti-tamper plug can be fitted after the pressure has been set.

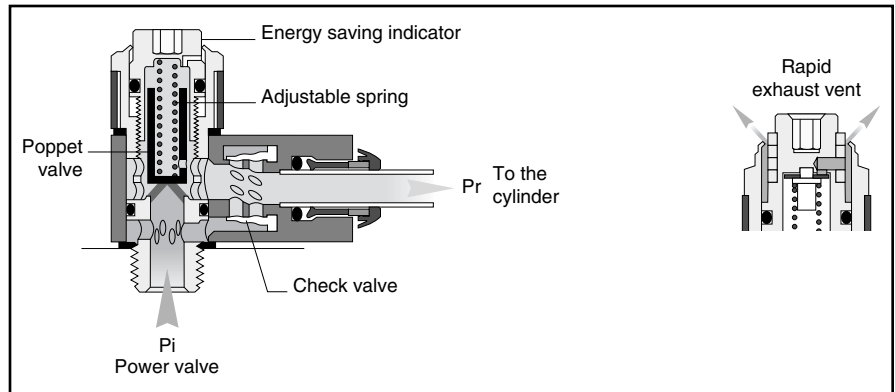

**Technical features**

BODY MATERIAL		BOLT ASSEMBLY MATERIAL	BOLT THREAD	SEALING DEVICE	TERMINATORS		WORKING TEMP.	WORKING PRESSURE
PUSH-IN VERSION	THREAD VERSION							
Zinc Alloy	Brass Nickel Plated	Brass	1/8 BSPP 1/4 BSPP 3/8 BSPP 1/2 BSPP	Nylon Washer	6 to 10 mm Push-In	1/8 to 1/2 BSPP Female Thread	From 0° to +150° F	100 PSI

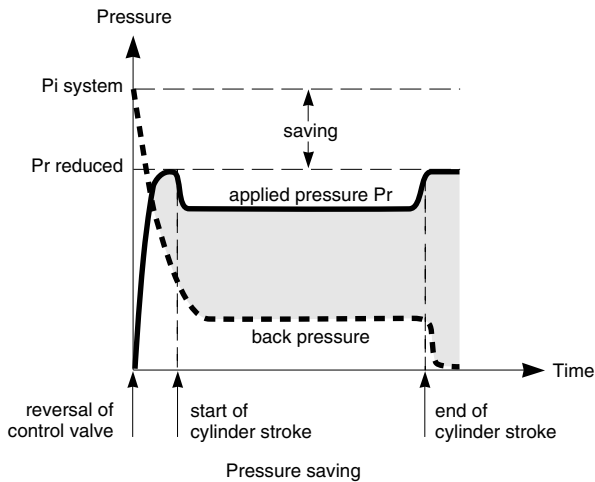

Alignment between the level of saving shown by the indicator and that shown by the marking

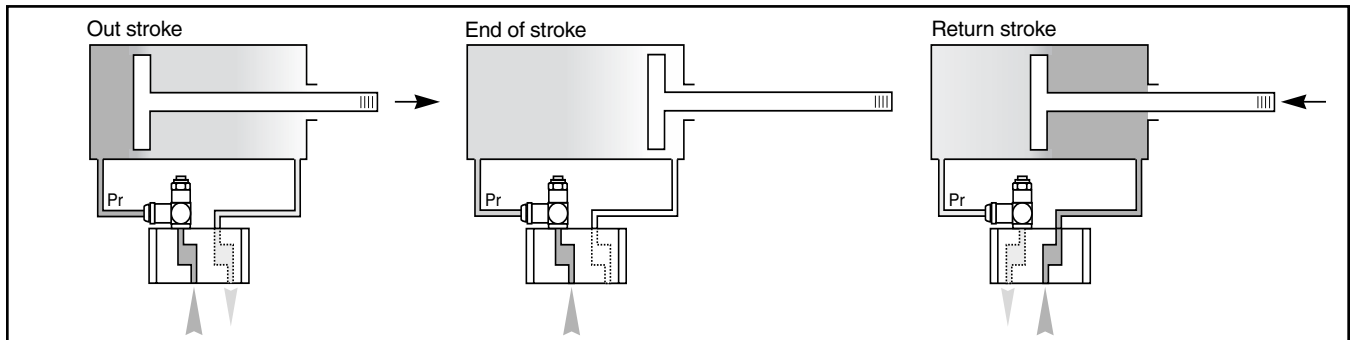
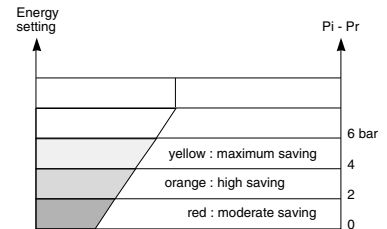
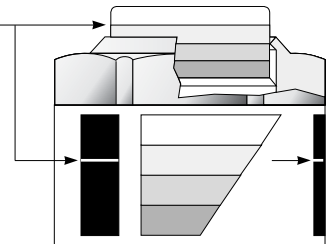

**PRB4PB Pressure Reducer Banjo Version with Push-In Connection**

PART NO.	1	B	C5	G1	G2	G3	H		H1	J	M	Y
							MIN.	MAX.				
PRB4PB6-1/8	6	1/8	19	19.5	22	20	49	57	12	6	43	21
PRB4PB6-1/4	6	1/4	19	19.5	22	20	49	57	12	6	43	21
PRB4PB8-1/4	8	1/4	19	19.5	22	20	49	57	12	6	40	21
PRB4PB10-1/4†	10	1/4	27	26.0	28	26	55	64	15	6	50	28
PRB4PB10-3/8†	10	3/8	27	26.0	28	26	55	64	15	8	50	28

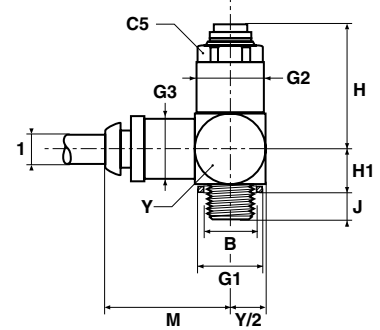

**PRB4 Pressure Reducer Banjo Version with Threaded Connection**

PART NO.	B	C1	C5	G1	G2	G3	H		H1	J	L	Y
							MIN.	MAX.				
PRB4-1/8†	1/8	19	19	19.5	22	20	49	57	12	6	45	21
PRB4-1/4	1/4	19	19	19.5	22	20	49	57	12	6	45	21
PRB4-3/8	3/8	24	27	26.0	28	26	55	64	15	6	56	28
PRB4-1/2†	1/2	30	30	30.0	32	31	75	86	23	8	63	33

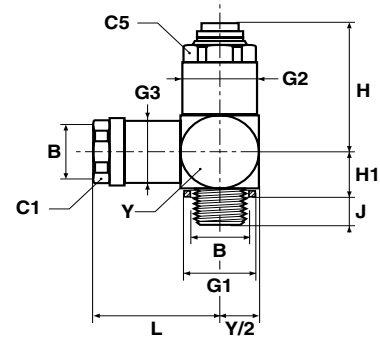

**PRIPB Pressure Reducer In-Line Version with Push-In Connection**

PART NO.	1	G2	G3	H		H1	H2	L	M	T	W
				MIN.	MAX.						
PRIPB6	6	11	21	49	57	14	22	75	32.5	18.5	4
PRIPB8	8	13	21	49	57	14	22	72	32.5	18.5	4
PRIPB10†	10	17	28	61	70	19	27	90	41.5	22.5	5

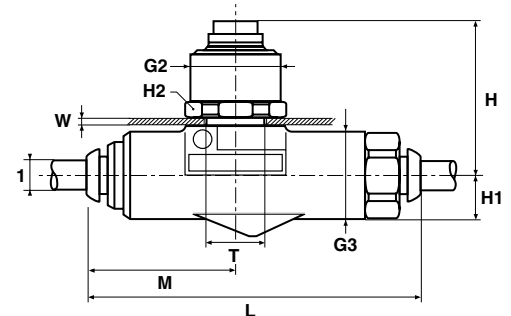

**PRI4 Pressure Reducer In-Line Version with Threaded Connection**

PART NO.	B	C1	C2	G2	G3	H		H1	H2	L	L1	T	W
						MIN.	MAX.						
PRI4-1/8	1/8	17	19	11	21	49	57	14	22	74	35	18.5	4
PRI4-1/4	1/4	17	19	13	21	49	57	14	22	83	44	18.5	4
PRI4-3/8	3/8	22	27	17	28	61	70	19	27	90	44	22.5	5
PRI4-1/2†	1/2	27	30	19	31	75	86	23	32	119	61	27.5	7

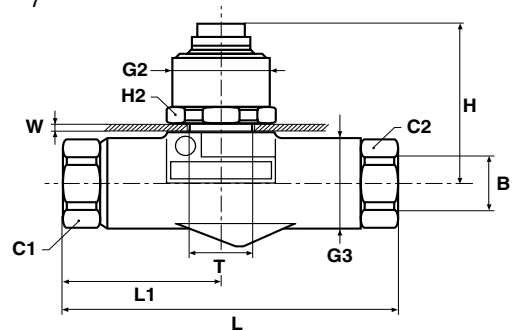

†Indicates non-standard part.

Only items priced in current price list are carried in stock. Dimensions shown may be changed at any time without prior notice.

**Prestosil - Silencer and flow control valve**

**Principle**

Prestosil silencers are designed for mounting into the exhaust valve of single acting cylinders or on the directional control valve.

**Operation**

**Noise reduction**

The escaping air is pre-expanded in the chamber of the silencer. It then flows through a sintered bronze cartridge whose design provides a complete expansion of the exhaust air.

**Flow control**

The adjusting screw of the uni-direction flow control valve allows fine adjustment of the restriction and thus precise control of the piston-rod speed. The setting is secured by a lock nut.

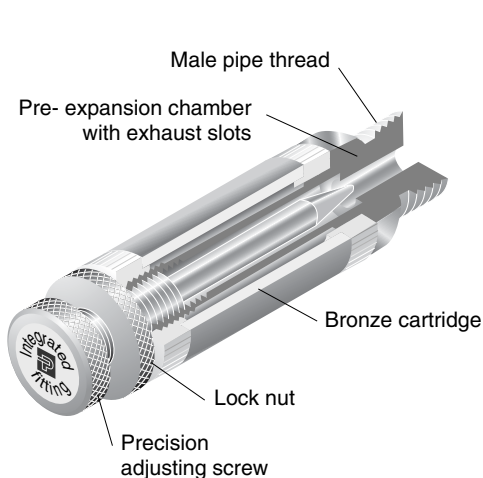

**Technical features**

BODY MATERIAL	BOLT MATERIAL	NEEDLE VALVE MATERIAL	LOCKNUT MATERIAL	SILENCER THREAD	WORKING TEMPERATURE	WORKING PRESSURE
Aluminum	Bronze	Aluminum	Aluminum	1/8 BSPP 1/4 BSPP 3/8 BSPP 1/2 BSPP	From 0° to +200° F	140 PSI

**Noise reduction characteristics**

At an average working pressure of 75 PSI the noise reduction achieved with the appropriate Prestosil model ranges from 22 to 37 dB.

PART NO.	WORKING PRESSURE						
	15 PSI	30 PSI	45 PSI	60 PSI	75 PSI	90 PSI	105 PSI
PRS 4-1/8	6	15	20	21	22	24	24
PRS 4-1/4	11	22	27	29	32	32	32
PRS 4-3/8	19	27	33	35	37	39	40
PRS 4-1/2	19	27	33	35	37	39	40

**PRS Silencer and Flow Control Valve**

PART NO.	B	C	L MIN.	L MAX.	O
PRS4-1/8	1/8	11	43	48	14
PRS4-1/4	1/4	14	60	68	17
PRS4-3/8	3/8	19	80	88	26
PRS4-1/2	1/2	22	83	91	26

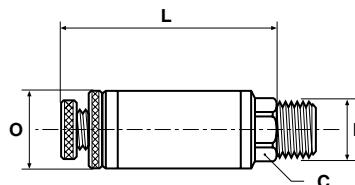

Only items priced in current price list are carried in stock. Dimensions shown may be changed at any time without prior notice.

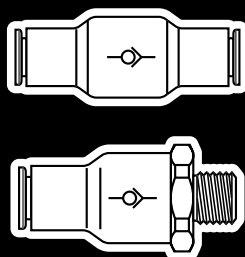

## Non-Return Valves

### General Information

Parker offers two styles of Non-Return valves, In-Line, tube to tube, and a threaded version with NPT male threads. Their extreme compactness and light weight make them suitable as a safety item in compressed air circuits.

The body of the fitting is marked with an arrow to indicate the direction of flow.

### General Principle

Parker Non-Return Valves allow air to pass in one direction while blocking flow in the other direction. A pressure of more than 7 psi will overcome the spring pressure, which is keeping the valve closed, thus allowing the passage of air.

### Valve Specifications

Maximum Working Pressure: 145 PSI

Operating Temperature: +30° to +160° F

Body Material: Nylon / Nickel-Plated Brass Body

**Non-Return Valves**

Parker Non-Return Valves allow air to pass in one direction while blocking flow in the other direction. A pressure of more than 7 psi will overcome the spring pressure, which is keeping the valve closed, thus allowing the passage of air.

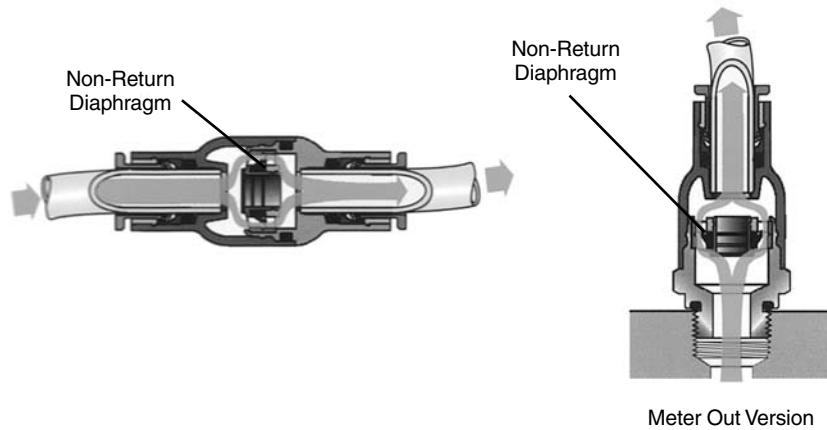

**In-Line Non-Return Valve NRV800**

PART NO.	TUBE SIZE	L	M
NRV800-5/32	5/32	1.52	.63
NRV800-4	1/4	1.61	.63
NRV800-5	5/16	2.03	.75
NRV800-6	3/8	2.50	.91

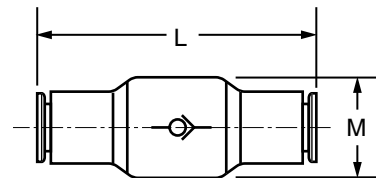

**Male Thread Non-Return Valve NRV808**

PART NO.	TUBE SIZE	THREAD SIZE	C HEX	L
NRV808-5/32-0	5/32	10-32	.35	1.26
NRV808-5/32-2	5/32	1/8	.63	1.12
NRV808-4-2	1/4	1/8	.75	1.42
NRV808-4-4	1/4	1/4	.75	1.42
NRV808-6-4	3/8	1/4	.91	1.65
NRV808-6-6	3/8	3/8	.91	1.65

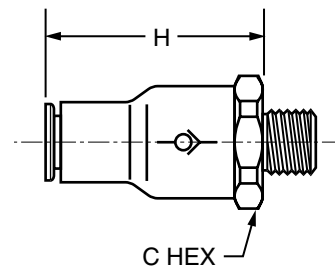



# ***Thermoplastic Fittings and Valves***



## **TrueSeal™**

- FDA Compliant
- NSF-51 Listed
- Acetal Fittings meet NSF-61
- All Plastic Body Designs



## **Polypropylene Ball Valves**

- FDA Compliant
- NSF-51 Listed
- Bi-directional
- Corrosion Resistant

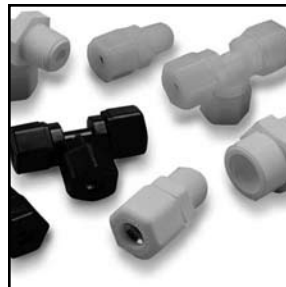

## **Fast & Tite®**

- FDA Compliant
- NSF-51 Listed
- Stainless Steel Grab Ring
- O-ring Seal









































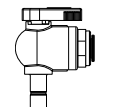



















## **Par-Barb®**

- FDA Compliant
- NSF-51 Listed
- High Strength,  
Chemically Inert

***The World Standard***

**D**

<p><b>TrueSeal™</b></p>	<p><b>MC</b> Male Connector Tube to Pipe</p>  <p>Page D5</p>	<p><b>EU</b> Elbow Union Tube to Tube</p>  <p>Page D5</p>	<p><b>TU</b> Tee Union Tube to Tube</p>  <p>Page D6</p>	<p><b>WY</b> "Y" Union Tube to Tube</p>  <p>Page D6</p>	<p><b>MES</b> Male Elbow Swivel Tube to Pipe</p>  <p>Page D7</p>	<p><b>MRS</b> Male Run Swivel Tube to Pipe</p>  <p>Page D7</p>	
	<p><b>MTS</b> Male Tee Swivel Tube to Pipe</p>  <p>Page D8</p>	<p><b>UC</b> Union Connector Tube to Tube</p>  <p>Page D8</p>	<p><b>CU</b> Cross Union Tube to Tube</p>  <p>Page D9</p>	<p><b>FA</b> Faucet Adapter Tube to Faucet</p>  <p>Page D9</p>	<p><b>FC</b> Female Connector Tube to Pipe</p>  <p>Page D9</p>	<p><b>FF</b> Female Flare Tube to Flare</p>  <p>Page D10</p>	<p><b>TMC</b> Tube Stem Adapter Tube Stem to Pipe</p>  <p>Page D10</p>
	<p><b>BU</b> Bulkhead Union Tube to Tube</p>  <p>Page D11</p>	<p><b>TEU</b> Tube Elbow Union Tube to Tube Stem</p>  <p>Page D11</p>	<p><b>RD</b> Tube Reducer Tube to Tube Stem</p>  <p>Page D12</p>	<p><b>CAP</b> Tube Cap</p>  <p>Page D12</p>	<p><b>FE</b> Female Elbow Tube to Tube</p>  <p>Page D12</p>	<p><b>ME</b> Male Elbow Tube to Pipe</p>  <p>Page D13</p>	<p><b>ST</b> Straight Thread Tube to Male O-Ring Boss</p>  <p>Page D13</p>
	<p><b>TCB</b> Tube to Barb Connector</p>  <p>Page D13</p>	<p><b>TEB</b> Tube Elbow Barb Connector</p>  <p>Page D14</p>	<p><b>TPL</b> Plug</p>  <p>Page D14</p>	<p><b>TSC</b> Cartridge Insert</p>  <p>Page D15</p>	<p><b>VC</b> Check Valve</p>  <p>Page D16</p>	<p><b>VME</b> Valve Male Elbow</p>  <p>Page D17</p>	<p><b>VFE</b> Valve Female Elbow</p>  <p>Page D17</p>
	<p><b>VUC</b> Valve Union Connector</p>  <p>Page D18</p>	<p><b>VEU</b> Valve Elbow Union</p>  <p>Page D18</p>	<p><b>VMC</b> Valve Male Con- nector</p>  <p>Page D18</p>	<p><b>VFC</b> Valve Female Connector</p>  <p>Page D19</p>	<p><b>VTEU</b> Valve Tube Elbow Union</p>  <p>Page D19</p>	<p><b>VTU</b> Water Supply Valve</p>  <p>Page D20</p>	<p><b>TFA</b> Tube Faucet Adapter (Female Thread)</p>  <p>Page D21</p>
	<p><b>TAF</b> Tube Faucet Adapter (Male Thread)</p>  <p>Page D21</p>	<p><b>SC</b> Safety Clip</p>  <p>Page D21</p>	<p><b>TS</b> Tube Support</p>  <p>Page D21</p>	<p><b>PTS</b> Pipe Thread Seal- ant</p>  <p>Page D21</p>	<p><b>AQRT</b> Quick Release Tool</p>  <p>Page D21</p>		

<b>Fast &amp; Tite®</b>	<b>MC</b> Male Connector Tube to Male Pipe  Page D23	<b>UC</b> Union Connector Tube to Tube  Page D23	<b>ME</b> Male Elbow Tube to Male Pipe  Page D24	<b>EU</b> Elbow Union Tube to Tube  Page D24	<b>BU</b> Bulkhead Union Tube to Tube  Page D25	<b>FE</b> Female Elbow Tube to Female Pipe  Page D25
	<b>FC</b> Female Connector Tube to Female Pipe  Page D25	<b>MR</b> Male Run Tee Tube to Tube to Male Pipe  Page D26	<b>TU</b> Tee Union Tube to Tube  Page D26	<b>MT</b> Male branch Tee Tube to Male Pipe  Page D26	<b>GR</b> Grab Ring Stainless or Plastic  Page D27	<b>OR</b> O-Ring  Page D27
<b>NS</b> Nut & Spacer Sets  Page D27						
<b>Par-Barb®</b>	<b>TUB</b> Tee Union  Page D29	<b>EUB</b> Elbow Union  Page D29	<b>MTB</b> Tee Male Branch  Page D30	<b>HPL</b> Hex Head Pipe Plug  Page D30	<b>MEB</b> Male Elbow Con- nector  Page D31	<b>UCB</b> Union Connector  Page D31
	<b>HPN</b> Hex Pipe Nipple  Page D32	<b>MCB</b> Male Connector Adapter  Page D33				

**D**



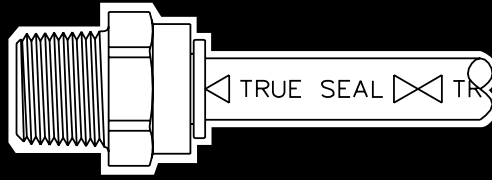

# TrueSeal™ Thermoplastic Push-In Fittings

The patented\* TrueSeal™ push-to-connect thermoplastic fittings are light weight, Field Attachable, and connect to plastic tubing without the use of tools.

D

## Features

- All components in TrueSeal™ fittings are manufactured from FDA compliant materials and are NSF-51 listed for contact with food.
- Gray acetal TrueSeal™ fittings meet NSF-61 requirements for drinking water (potable water) system components.
- All-plastic body designs offer reduced weight, eliminate rust, corrosion, and system contamination in applications where metal components cannot be tolerated.
- Collets are offered in either a patented all-plastic design for use with flexible tubing or with a metal grip edge made from 300 series stainless steel for use on all tubing including copper.
- Extra deep tube seat in fitting body provides support to reduce side-load leakage.
- Elastomer o-ring seal provides positive compression on tubing O.D. in vacuum or pressure applications.
- Removable collet design permits o-ring replacement in the field. Collets are available in colors for easy color coding of systems.
- Tube stem adapters provide a wide range of tube-to-port jump size potential and allow elbows and tees to swivel for positive tube routing alignment. Connections made with metal gripper collets, may require tube stems to be replaced upon reconnection.

## Applications

TrueSeal™ fittings find wide acceptance in water conditioning, filtration, and reverse osmosis industries and on water, soft drink, beer, wine, and condiment dispensing equipment. Industrial applications range from vacuum to low-pressure hydraulic and pneumatic systems on robotics, air logic, packaging/filling equipment, and conveyors. Ink and dye transfer, lubrication and cooling lines on presses, machine tools, ion implanting devices—all rely on TrueSeal™.

## Standard Materials

Material	Fitting Color	O-Ring
Acetal	Gray	EPDM
Polypropylene	White	EPDM
Kynar®	Natural	Viton

Black nitrile o-rings and colored collets in black, white, red, blue, green, yellow and orange are also available. Consult Division. KYNAR® is a registered trademark of Atochem North America, Inc. \*U.S. Patent 5,584,513

Note: Provide adequate fail-safe mechanisms such as leakage detection sensors, automatic shut-off controls or other industry and code appropriate fail-safe devices in the design of your water-handling appliance to protect against personal injury and property damage. Plastic fittings containing an o-ring have a finite life depending on the environment, media and severity of the application. Frequent inspections and replacement of the fitting when anomalies are found is recommended.

## How to Order

A 4 MC 4 - MG - V

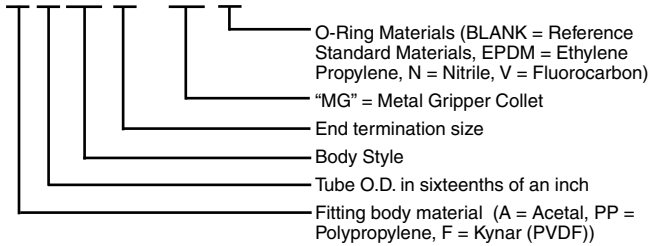

## Working Pressure

TrueSeal™ fittings are rated for the pressures listed below or at 1/4 (one-fourth) of the rated burst pressure of the tubing being used (whichever is less).

Fitting Size	Acetal	Polypropylene	Kynar®
1/4"	300	150	300
5/16"	300		
3/8"	300	150	300
1/2"	250	150	
Temp. Range	-20°F (-29°C) to +180°F (85°C)	0°F (-18°C) to +225°F (110°C)	0°F (-18°C) to +275°F (135°C)

- These pressure ratings are based on tests conducted with Series NR tubing at 73°F.
- Actual working pressures will be lower at elevated temperatures. Consult division.
- Meets pressure integrity tests of NSF-53 and NSF-58

## Tubing

Parker TrueSeal™ fittings with all plastic collets can be used with the following tubing materials: polyethylene, polypropylene, nylon, vinyl, fluoropolymer, and polyurethane (3/8" and 1/2" polyurethane and all sizes of vinyl should use tube supports). TrueSeal™ fittings with metal gripper collets can be used with tubing listed above and soft copper tubing. For stainless steel or glass tubing or all other metal tubing, consult factory.

Tube Sizes	O.D. Tolerance	Insertion Depth
5/32"	±005"	9/16"
1/4"	±005"	11/16"
5/16"	±005"	13/16"
3/8"	±005"	3/4"
1/2"	±005"	7/8"

## Assembly Instructions

1. Cut tubing square and clean. (Use a Parker plastic tube cutter, Part No. PTC.)
2. Mark from end of tube the length of insertion (see table above).
3. Push tube into the fitting until it bottoms out.
4. To remove, depress collet and pull tubing out.
5. Use TrueSealant™ (Part No. PTS) on threads.

# MC - Male Connector

## Tube-to-Pipe

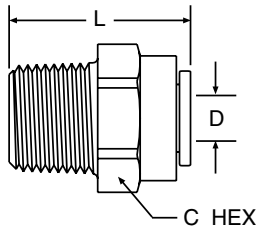

Gray Acetal EPDM Seal	White Polypropylene EPDM Seal	Natural Kynar Fluorocarbon Seal	Nom. Tube O.D.	NPTF Thread Size	C Hex	L Overall Length	D Thru Hole Min.
#	#	#					
A4MC2-MG	PP4MC2	F4MC2	1/4	1/8	11/16	1.28	.175
A4MC4-MG	PP4MC4	F4MC4	1/4	1/4	11/16	1.14	.175
A4MC6-MG	PP4MC6	F4MC6	1/4	3/8	11/16	1.18	.175
A5MC2-MG			5/16	1/8	13/16	1.46	.175
A5MC4-MG			5/16	1/4	13/16	1.41	.188
A5MC6-MG			5/16	3/8	13/16	1.27	.188
A6MC2-MG		F6MC2	3/8	1/8	13/16	1.46	.175
A6MC4-MG	PP6MC4	F6MC4	3/8	1/4	13/16	1.41	.250
A6MC6-MG	PP6MC6	F6MC6	3/8	3/8	13/16	1.27	.250
A6MC8-MG		F6MC8	3/8	1/2	15/16	1.45	.250
A8MC6-MG	PP8MC6		1/2	3/8	15/16	1.65	.360
A8MC8-MG	PP8MC8		1/2	1/2	15/16	1.46	.375

For nonstandard plastic collet, remove -MG suffix.



# EU - Elbow Union

## Tube-to-Tube

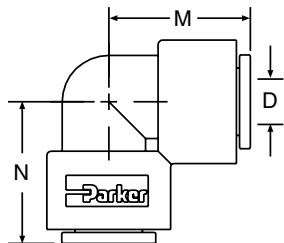

Gray Acetal EPDM Seal	White Polypropylene EPDM Seal	Natural Kynar Fluorocarbon Seal	Nom. Tube O.D.	M	N	D Thru Hole Min.
#	#	#				
A4EU4-MG	PP4EU4	F4EU4	1/4	0.87	0.87	.175
A5EU4-MG			5/16-1/4	1.052	0.90	.175
A5EU5-MG			5/16	1.02	1.02	.188
A6EU4-MG	PP6EU4	F6EU4	3/8-1/4	1.02	0.90	.212
A6EU5-MG			3/8-5/16	1.02	1.02	.175
A6EU6-MG	PP6EU6	F6EU6	3/8	1.02	1.02	.250
A8EU6-MG			1/2-3/8	1.20	1.20	.250
A8EU8-MG	PP8EU8		1/2	1.20	1.20	.375

For nonstandard plastic collet, remove -MG suffix.

All sizes in inches.



# TU - Tee Union

## Tube-to-Tube

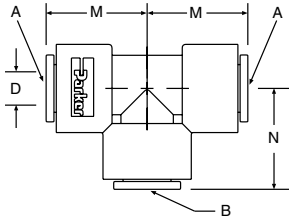

**D**

Gray Acetal EPDM Seal	White Polypropylene EPDM Seal	Natural Kynar Fluorocarbon Seal	Nom. Tube O.D.		M	N	D Thru Hole Min.
			Tube A Run	Tube B Stem			
#	#	#					
A4TU4-MG	PP4TU4	F4TU4	1/4	1/4	0.81	0.85	.175
A5TU5-MG			5/16	5/16	1.02	1.02	.188
A6TU4-MG	PP6TU4	F6TU4	3/8	1/4	1.02	1.03	.175
A6TU6-MG	PP6TU6	F6TU6	3/8	3/8	1.02	1.02	.290
A8TU8-MG	PP8TU8		1/2	1/2	1.20	1.20	.375

For nonstandard plastic collet, remove -MG suffix.

# WY - "Y" Union

## Tube-to-Tube

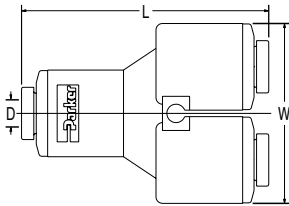

Gray Acetal EPDM Seal	White Polypropylene EPDM Seal	Natural Kynar Fluorocarbon Seal	Nom. Tube O.D.		L	W	D Thru Hole Min.
			Inlet Tube A Run	Outlet Tube B Stem			
#	#	#					
A5WY5-MG			5/16	5/16	2.250	1.75	0.190
A6WY4-MG			3/8	1/4	2.100	1.43	0.190
A6WY5-MG			3/8	5/16	2.200	1.75	0.190
A6WY6-MG			3/8	3/8	2.175	1.75	0.250

All sizes in inches

# MES - Male Elbow Swivel

## Tube-to-Pipe

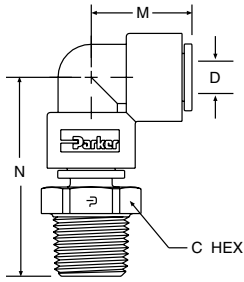

Gray Acetal EPDM Seal	White Polypropylene EPDM Seal	Natural Kynar Fluorocarbon Seal	Nom. Tube O.D.	NPTF Thread Size	C Hex	M	N	D Thru Hole Min.
#	#	#						
A4MES2-MG	PP4MES2	F4MES2	1/4	1/8	9/16	0.87	1.60	.175
A4MES4-MG	PP4MES4	F4MES4	1/4	1/4	11/16	0.87	1.71	.175
A4MES6-MG	PP4MES6	F4MES6	1/4	3/8	13/16	0.90	1.91	.212
A5MES2-MG			5/16	1/8	9/16	1.02	1.78	.188
A5MES4-MG			5/16	1/4	11/16	1.02	1.90	.188
A5MES6-MG			5/16	3/8	13/16	1.02	1.90	.188
A6MES2-MG		F6MES2	3/8	1/8	9/16	1.02	1.65	.175
A6MES4-MG	PP6MES4	F6MES4	3/8	1/4	13/16	1.02	1.90	.250
A6MES6-MG	PP6MES6	F6MES6	3/8	3/8	13/16	1.02	1.90	.250
A8MES4-MG			1/2	1/4	13/16	1.20	2.10	.240
A8MES6-MG	PP8MES6		1/2	3/8	13/16	1.20	2.10	.375
A8MES8-MG	PP8MES8		1/2	1/2	1	1.20	2.32	.375

\*Part consists of elbow union and tube stem adaptor.  
 Note: Assemblies with metal gripper collets are permanent.  
 Assemblies with plastic collets can be taken apart.

# MRS - Male Run Swivel

## Tube-to-Pipe

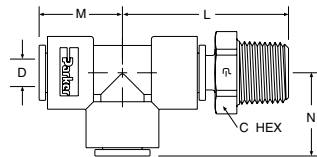

Gray Acetal EPDM Seal	White Polypropylene EPDM Seal	Natural Kynar Fluorocarbon Seal	Nom. Tube O.D.	NPTF Thread Size	C Hex	L	M	N	D Thru Hole Min.
#	#	#							
A4MRS2-MG	PP4MRS2	F4MRS2	1/4	1/8	9/16	1.55	0.81	0.85	.175
A4MRS4-MG	PP4MRS4	F4MRS4	1/4	1/4	11/16	1.67	0.81	0.85	.175
A5MRS2-MG			5/16	1/8	9/16	1.78	1.02	1.02	.188
A5MRS4-MG			5/16	1/4	11/16	1.90	1.02	1.02	.188
A5MRS6-MG			5/16	3/8	13/16	1.90	1.02	1.02	.188
A6MRS4-MG	PP6MRS4	F6MRS4	3/8	1/4	13/16	1.90	1.02	1.02	.250
A6MRS6-MG	PP6MRS6	F6MRS6	3/8	3/8	13/16	1.90	1.02	1.02	.250
A8MRS4-MG			1/2	1/4	13/16	2.10	1.20	1.20	.240
A8MRS6-MG	PP8MRS6		1/2	3/8	13/16	2.10	1.20	1.20	.375
A8MRS8-MG	PP8MRS8		1/2	1/2	1	2.32	1.20	1.20	.375

\*Part consists of tee union and tube stem adaptor.  
 Note: Assemblies with metal gripper collets are permanent.  
 Assemblies with plastic collets can be taken apart.

All sizes in inches



# MTS - Male Tee Swivel

## Tube-to-Pipe

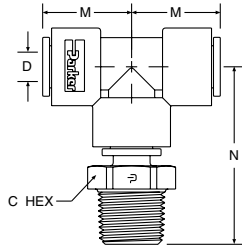

Gray Acetal EPDM Seal	White Polypropylene EPDM Seal	Natural Kynar Fluorocarbon Seal	Nom. Tube O.D.	NPTF Thread Size	C Hex	M	N	D Thru Hole Min.
#	#	#						
A4MTS2-MG	PP4MTS2	F4MTS2	1/4	1/8	9/16	0.81	1.60	.175
A4MTS4-MG	PP4MTS4	F4MTS4	1/4	1/4	11/16	0.81	1.71	.175
A5MTS2-MG			5/16	1/8	9/16	1.02	1.78	.188
A5MTS4-MG			5/16	1/4	11/16	1.02	1.90	.188
A5MTS6-MG			5/16	3/8	13/16	1.02	1.90	.188
A6MTS2-MG		F6MTS2	3/8	1/8	9/16	1.02	1.75	.175
A6MTS4-MG	PP6MTS4	F6MTS4	3/8	1/4	13/16	1.02	1.90	.250
A6MTS6-MG	PP6MTS6	F6MTS6	3/8	3/8	13/16	1.02	1.90	.250
A8MTS4-MG			1/2	1/4	13/16	1.20	2.10	.240
A8MTS6-MG	PP8MTS6		1/2	3/8	13/16	1.20	2.10	.375
A8MTS8-MG	PP8MTS8		1/2	1/2	1	1.20	2.32	.375

\*Part consists of tee union and tube stem adaptor.  
 Note: Assemblies with metal gripper collets are permanent.  
 Assemblies with plastic collets can be taken apart.

# UC - Union Connector

## Tube-to-Tube

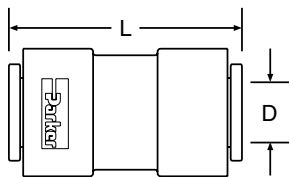

Gray Acetal EPDM Seal	White Polypropylene EPDM Seal	Natural Kynar Fluorocarbon Seal	Nom. Tube O.D.	L Overall Length	D Thru Hole Min.
#	#	#			
A4UC4-MG	PP4UC4	F4UC4	1/4	1.49	.175
A5UC4-MG			5/16-1/4	1.70	.175
A5UC5-MG			5/16	1.70	.188
A6UC4-MG	PP6UC4	F6UC4	3/8-1/4	1.70	.175
A6UC5-MG			3/8-5/16	1.70	.188
A6UC6-MG	PP6UC6	F6UC6	3/8	1.70	.250
A8UC5-MG			1/2-5/16	1.90	.188
A8UC6-MG	PP8UC6		1/2-3/8	1.90	.250
A8UC8-MG	PP8UC8		1/2	1.91	.375

For nonstandard plastic collet, remove -MG suffix.

All sizes in inches



## CU - Cross Union

### Tube-to-Tube

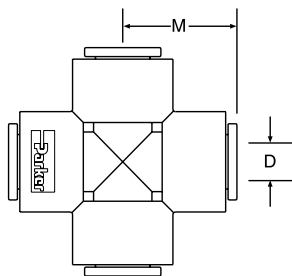

Gray Acetal EPDM Seal	White Polypropylene EPDM Seal	Natural Kynar Fluorocarbon Seal	Nom. Tube O.D.	M	D Thru Hole Min.
#	#	#			
A4CU4-MG			1/4	.91	.175
A6CU6-MG			3/8	1.08	.250

For nonstandard plastic collet, remove -MG suffix.



## FA - Faucet Adapter

### Tube-to-Faucet

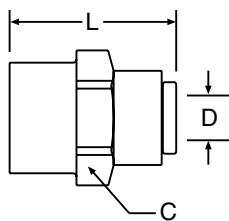

Gray Acetal EPDM Seal	White Polypropylene EPDM Seal	Natural Kynar Fluorocarbon Seal	Nom. Tube O.D.	UNS-2B Thread Size	C Hex	L Overall Length	D Thru Hole Min.
#	#	#					
A4FA7-MG	PP4FA7	F4FA7	1/4	7/16-24	23/32	1.32	.190
A5FA7-MG			5/16	7/16-24	13/16	1.41	.190
A6FA7-MG	PP6FA7	F6FA7	3/8	7/16-24	13/16	1.41	.190

For nonstandard plastic collet, remove -MG suffix.

## FC - Female Connector

### Tube-to-Pipe

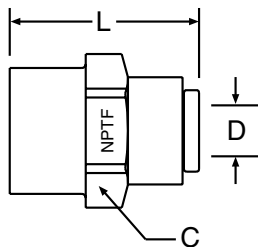

Gray Acetal EPDM Seal	White Polypropylene EPDM Seal	Natural Kynar Fluorocarbon Seal	Nom. Tube O.D.	NPTF Thread Size	C Hex	L Overall Length	D Thru Hole Min.
#	#	#					
A4FC2-MG	PP4FC2	F4FC2	1/4	1/8	11/16	1.20	.175
A4FC4-MG	PP4FC4	F4FC4	1/4	1/4	23/32	1.32	.175
A5FC4-MG			5/16	1/4	13/16	1.41	.188
A5FC6-MG			5/16	3/8	1	1.50	.188
A6FC4-MG	PP6FC4	F6FC4	3/8	1/4	13/16	1.41	.250
A6FC6-MG	PP6FC6	F6FC6	3/8	3/8	1	1.50	.250
A6FC8-MG			3/8	1/2	1-1/8	1.52	.250
A8FC6-MG	PP8FC6		1/2	3/8	1-1/8	1.60	.375
A8FC8-MG	PP8FC8		1/2	1/2	1-1/8	1.75	.375

For nonstandard plastic collet, remove -MG suffix.

All sizes in inches

# FF - 45° Female Flare

## Tube-to-Flare

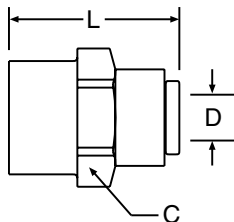

Gray Acetal EPDM Seal	White Polypropylene EPDM Seal	Natural Kynar Fluorocarbon Seal	Nom. Tube O.D.	UNF-2B Thread Size	C Hex	L Overall Length	D Thru Hole Min.
#	#	#					
A4FF4-MG	PP4FF4	F4FF4	1/4	7/16-20	23/32	1.32	.190
A6FF4-MG		F6FF4	3/8	7/16-20	13/16	1.41	.190
A6FF6-MG	PP6FF6	F6FF6	3/8	5/8-18	1	1.50	.250

For nonstandard plastic collet, remove -MG suffix.



# TMC - Tube Stem Adapter

## Tube Stem-to-Pipe

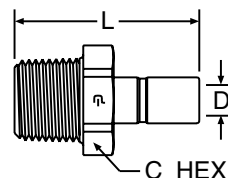

Gray Acetal EPDM Seal	White Polypropylene EPDM Seal	Natural Kynar Fluorocarbon Seal	Nom. Tube O.D.	NPTF Thread Size	C Hex	L Overall Length	D Thru Hole Min.
#	#	#					
A4TMC2	PP4TMC2	F4TMC2	1/4	1/8	9/16	1.44	.175
A4TMC4	PP4TMC4	F4TMC4	1/4	1/4	11/16	1.56	.175
A5TMC2			5/16	1/8	9/16	1.5	.188
A5TMC4			5/16	1/4	11/16	1.67	.188
A5TMC6			5/16	3/8	13/16	1.67	.188
A6TMC4	PP6TMC4	F6TMC4	3/8	1/4	13/16	1.70	.250
A6TMC6	PP6TMC6	F6TMC6	3/8	3/8	13/16	1.70	.250
A8TMC4			1/2	1/4	13/16	1.82	.240
A8TMC6	PP8TMC6		1/2	3/8	13/16	1.82	.375
A8TMC8	PP8TMC8		1/2	1/2	1	2.04	.375

All sizes in inches

# BU - Bulkhead Union

## Tube-to-Tube

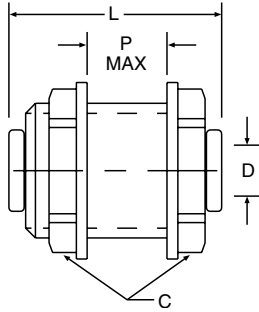

Gray Acetal EPDM Seal	White Polypropylene EPDM Seal	Natural Kynar Fluorocarbon Seal	Nom. Tube O.D.	C1 Hex	C2 Hex	L Overall Length	P Max. Wall Thk.	D Thru Hole Min.	Bulkhead Hole Drill Size
#	#	#							
A4BU4-MG	PP4BU4	F4BU4	1/4	15/16	15/16	1.50	.50	.175	7/8
A5BU5-MG			5/16	1-1/16	1-1/16	1.75	.62	.188	1
A6BU4-MG	PP6BU4		3/8-1/4	1-1/16	1-1/16	1.75	.62	.175	1
A6BU6-MG	PP6BU6	F6BU6	3/8	1-1/16	1-1/16	1.75	.62	.250	1
A8BU8-MG			1/2	1-1/4	1-1/4	2.04	.70	.375	1-1/8

For nonstandard plastic collet, remove -MG suffix.



# TEU - Tube Elbow Union

## Tube-to-Tube Stem

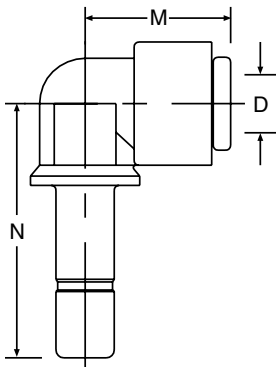

Gray Acetal EPDM Seal	White Polypropylene EPDM Seal	Natural Kynar Fluorocarbon Seal	Nom. Tube O.D.	Tube Stem O.D.	M	N	D Thru Hole Min.
#	#	#					
A4TEU4-MG	PP4TEU4	F4TEU4	1/4	1/4	.84	1.21	.125
A4TEU6-MG		F4TEU6	1/4	3/8	.84	1.35	.125
A5TEU5-MG			5/16	5/16	1.03	1.40	.188
A6TEU4-MG		F6TEU4	3/8	1/4	1.03	1.29	.125
A6TEU6-MG	PP6TEU6	F6TEU6	3/8	3/8	1.03	1.64	.250
A8TEU8-MG	PP8TEU8		1/2	1/2	1.21	1.64	.380

For nonstandard plastic collet, remove -MG suffix.

All sizes in inches





# RD - Tube Reducer

## Tube-to-Tube Stem

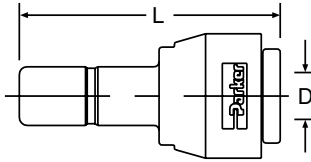

Gray Acetal EPDM Seal	White Polypropylene EPDM Seal	Natural Kynar Fluorocarbon Seal	Nom. Tube O.D.	Tube Stem O.D.	L	D Thru Hole Min.
#	#	#				
A4RD5-MG	PP4RD5		1/4	5/16	1.62	.18
A4RD6-MG	PP4RD6		1/4	3/8	1.62	.18
A5RD6-MG			5/16	3/8	1.78	.25
A5RD8-MG			5/16	1/2	1.90	.25
A6RD8-MG			3/8	1/2	1.90	.25

For nonstandard plastic collet, remove -MG suffix.

# CAP - Tube Cap

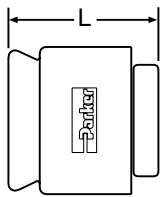

Gray Acetal EPDM Seal	White Polypropylene EPDM Seal	Natural Kynar Fluorocarbon Seal	Nom. Tube O.D.	L Overall Length
#	#	#		
A4CAP-MG	PP4CAP	F4CAP	1/4	0.77
A6CAP-MG	PP6CAP		3/8	0.88

For nonstandard plastic collet, remove -MG suffix.

# FE - Female Elbow

## Tube-to-Tube

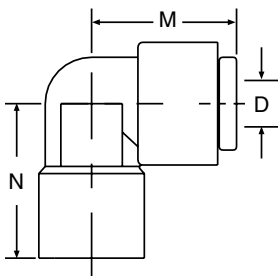

Gray Acetal EPDM Seal	White Polypropylene EPDM Seal	Natural Kynar Fluorocarbon Seal	Nom. Tube O.D.	NPTF Thread Size	M	N	D Thru Hole Min.
#	#	#					
A4FE4-MG			1/4	1/4	0.84	1.00	.18
A6FE4-MG			3/8	1/4	1.03	1.00	.25
A6FE6-MG			3/8	3/8	1.03	1.00	.25

For nonstandard plastic collet, remove -MG suffix.

All sizes in inches



# ME - Male Elbow

## Tube-to-Pipe

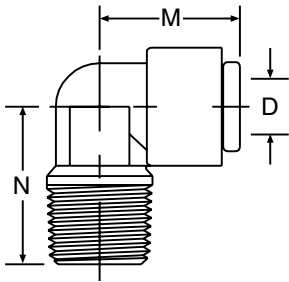

Gray Acetal EPDM Seal	White Polypropylene EPDM Seal	Natural Kynar Fluorocarbon Seal	Nom. Tube O.D.	NPTF Thread Size	M	N	D Thru Hole Min.
#	#	#					
A4ME2-MG	PP4ME2	F4ME2	1/4	1/8	0.84	0.94	.175
A4ME4-MG	PP4ME4	F4ME4	1/4	1/4	0.84	0.94	.175
A4ME6-MG	PP4ME6	F4ME6	1/4	3/8	0.84	1.04	.175
A5ME4-MG			5/16	1/4	1.03	1.08	.175
A5ME6-MG			5/16	3/8	1.03	1.06	.188
A6ME4-MG	PP6ME4	F6ME4	3/8	1/4	1.03	1.08	.250
A6ME6-MG	PP6ME6	F6ME6	3/8	3/8	1.03	1.06	.250

For nonstandard plastic collet, remove -MG suffix.



# ST - Straight Thread

## Tube-to-Male O-Ring Boss

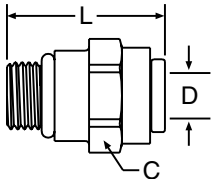

Gray Acetal EPDM Seal	White Polypropylene EPDM Seal	Natural Kynar Fluorocarbon Seal	Nom. Tube O.D.	UNF-2B Thread Size	C Hex	L Overall Length	D Thru Hole Min.
#	#	#					
A6ST9-MG		F6ST9 (+)	3/8	9/16-18	13/16	1.39	.250

For nonstandard plastic collet, remove -MG suffix.

# TCB - Tube-to-Barb Connector

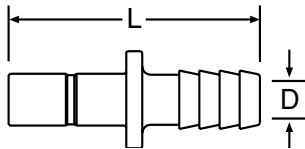

Gray Acetal	White Polypropylene	Natural Kynar	Tube Stem O.D.	Tube I.D.	L Overall Length	D Thru Hole Min.
#	#	#				
A4TCB4	PP4TCB4	F4TCB4	1/4	1/4	1.67	.140
A6TCB4		F6TCB4	3/8	1/4	1.82	.140
A6TCB6	PP6TCB6	F6TCB6	3/8	3/8	1.98	.250
A8TCB6			1/2	3/8	2.10	.250
A8TCB8			1/2	1/2	2.10	.375

All sizes in inches

# TEB - Tube Elbow Barb Connector

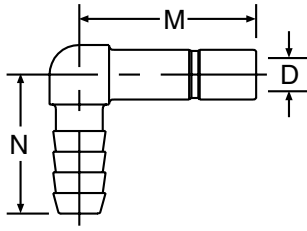

Gray Acetal	White Polypropylene	Natural Kynar	Tube Stem O.D.	Tube I.D.	M	N	D Thru Hole Min.
#	#	#					
A4TEB4	PP4TEB4	F4TEB4	1/4	1/4	0.89	1.00	.140
A6TEB6	PP6TEB6	F6TEB6	3/8	3/8	1.34	1.21	.250
A8TEB8			1/2	1/2	1.30	1.30	.390

**D**

# TPL - Plug

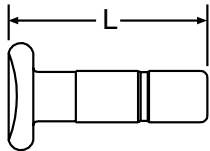

Gray Acetal	White Polypropylene	Natural Kynar	Fitting Size	L Overall Length
#	#	#		
A4TPL	PP4TPL	F4TPL	1/4	0.88
A6TPL	PP6TPL	F6TPL	3/8	1.45
A8TPL	PP8TPL		1/2	1.50

All sizes in inches

# TSC - Cartridge Insert



Part Number with EPDM Seal	Nom. Tube O.D.	A* Diameter ±002	B Diameter ±003	C Diameter ±003	D Diameter Minimum	E Depth ±002	F Depth ±002	G Depth ±002	H* Centerline of Ports Minimum
#									
ATSC4-MG	1/4	.528	.421	.260	.19	.230	.435	.600	.670
ATSC6-MG	3/8	.632	.545	.385	.31	.280	.455	.705	.790
ATSC8-MG	1/2	.774	.668	.510	.41	.315	.510	.810	1.250

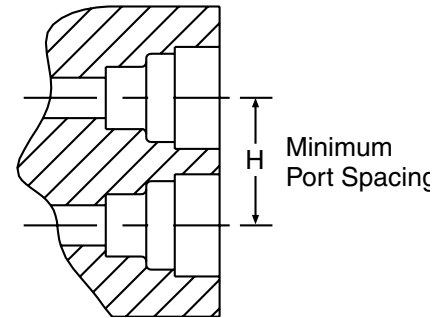
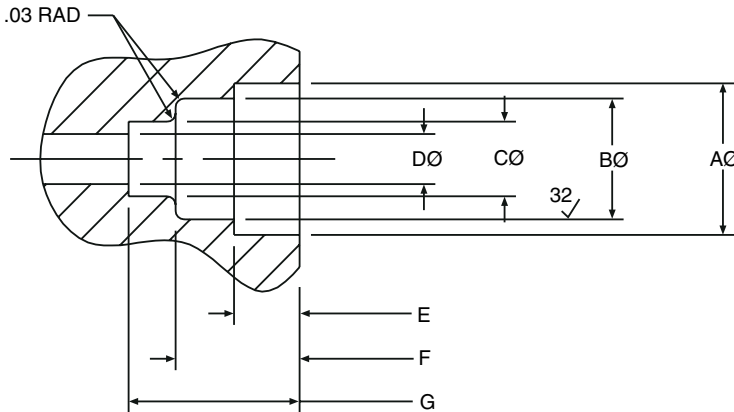

**Parker TrueSeal™ Cartridge Inserts:**

Allow you to machine or mold a tube connection into your equipment or components. By using cartridge inserts, you will reduce your material and assembly costs, reduce potential leak paths, and give your equipment a new, clean profile by eliminating the need for threaded connections. TSC Cartridge Inserts consist of 1 o-ring, 1 cartridge, and 1 collet.

\*Cartridge inserts are rated at 300 psi in ports dimensioned as above and having Noryl as the receiving material. Other materials may have different ratings and require different port dimensions. Consult the Brass Products Division when using polypropylene, unfilled polypropylene, ABS or Nylon.

**Assembly Instructions:**

- Step 1**—Machine or mold the receiving orifice as per the above dimensions.
- Step 2**—Place the cartridge insert squarely onto the prepared port opening making sure that the barbs of the cartridge are going into the hole and the lettering on the face of the cartridge is visible.
- Step 3**—Using a rubber mallet or press, insert the cartridge into the first gland orifice until its face is flush with the top surface of the port.
- Step 4**—Insert the o-ring into the cartridge and seat it evenly into the second gland orifice.
- Step 5**—Insert the collet into the cartridge opening.
- Step 6**—Insert tubing.

NORYL® is a registered trademark of the General Electric Co.

All sizes in inches



# TrueSeal Check Valves

Push-to-Connect check valves that ensures protection against reversal of flow. The valves have an arrow molded into the body to indicate the direction of flow. Valves are designed for connection with either thermoplastic or soft metal tubing and are intended for use with liquids only.

**Materials of Construction**

**Body:** Acetal

**O-ring:** EPDM

**Metal Grip Edge:** 300 Stainless

**Working Pressure**

Up to 150 PSI depending on tubing being used

**Temperature Range**

+34°F (1° C) to +150°F (65°C)

**Cracking Pressure**

1/3 PSI



**VC – Check Valve**

PART NO.	TUBE SIZE	L	O.D.
A4VC4-MG	1/4	2.00	.66
A5VC5-MG	5/16	2.10	.70
A6VC6-MG	3/8	2.15	.80

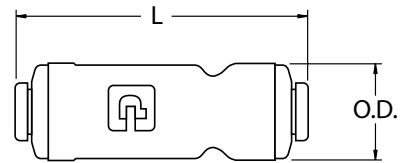

# Polypropylene Ball Valves

For proven leak-free performance, specify **Polypropylene Ball Valves**. Their corrosion-resistant, all-plastic design makes them ideal for water filtration units, coffee and beverage machines and a wide variety of other fluid applications. Polypropylene material meets all FDA and NSF-51 requirements for food contact.

**Features/Benefits:**

- Precision molded, all-plastic design is leak free and corrosion resistant.
- Polypropylene material offers a wider chemical acceptance range, as well as a wide temperature range.
- Bi-directional flow maximizes productivity.
- Full flow design reduces pressure drop across the valve.
- Special o-ring seal ensures a reliable leak-tight connection.
- TrueSeal™ connection reduces potential leaks.

**Specifications:**

- Temperature range: 0°F to 225°F (-18°C to 107°C).
- O-ring seal material: Nitrile.
- NSF-51 listed.
- Pressure rated to 150 PSI with a 600 PSI burst pressure. Actual working pressures will be lower at elevated temperatures

**Advantages:**

- Reduce costs—Built-in TrueSeal™ connection eliminates the need for a secondary fitting.
- Save space—Low-profile design allows for easy assembly and access where space is at a premium.

**Assembly Instructions:**

1. Inspect the mating threads for debris or damage. Remove any old fluoropolymer tape or sealant on previously used threads. If threads are damaged, replace with new adapter before proceeding.
2. Apply 2 to 3 wraps of fluoropolymer tape, Parker TrueSealant™ or an NSF/FDA approved silicon sealant. Do not use Plumbers Putty or Pipe Dope. These chemically react with plastic materials and could cause a failure.
3. Align ball valve to mating thread to ensure cross threading does not occur.
4. Screw ball valve onto mating thread 3 to 5 turns. This should be sufficient to properly seal the threads.
5. Pressurize system and check for leaks.

## VME - Valve Male Elbow

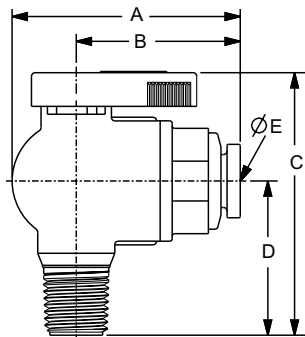

Part Number	Nom. Tube O.D.	NPTF Thread Size	A	B	C	D	ØE Thru Hole Min.
#							
PP4VME2-MG (+)	1/4	1/8	1.74	1.21	2.00	1.10	.19
PP4VME4-MG	1/4	1/4	1.74	1.21	2.18	1.28	.19
PP4VME6-MG	1/4	3/8	1.74	1.21	2.18	1.28	.19
PP4VME8-MG (+)	1/4	1/2	1.74	1.21	2.37	1.47	.19
PP6VME2-MG (+)	3/8	1/8	1.85	1.32	2.00	1.10	.25
PP6VME4-MG	3/8	1/4	1.85	1.32	2.18	1.28	.25
PP6VME6-MG	3/8	3/8	1.85	1.32	2.18	1.28	.25
PP6VME8-MG	3/8	1/2	1.85	1.32	2.37	1.47	.25

## VFE - Valve Female Elbow

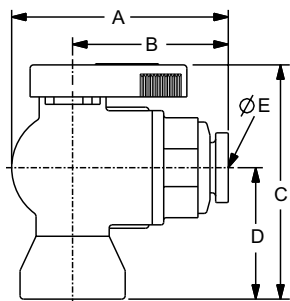

Part Number	Nom. Tube O.D.	NPTF Thread Size	A	B	C	D	ØE Thru Hole Min.
#							
PP4VFE2-MG (+)	1/4	1/8	1.74	1.21	1.82	0.92	.19
PP4VFE4-MG	1/4	1/4	1.74	1.21	2.05	1.15	.19
PP4VFE6-MG	1/4	3/8	1.74	1.21	2.18	1.28	.19
PP6VFE2-MG (+)	3/8	1/8	1.85	1.32	1.82	0.92	.25
PP6VFE4-MG	3/8	1/4	1.85	1.32	2.05	1.15	.25
PP6VFE6-MG	3/8	3/8	1.85	1.32	2.18	1.28	.25

(+) Non Standard.



# VUC - Valve Union Connector

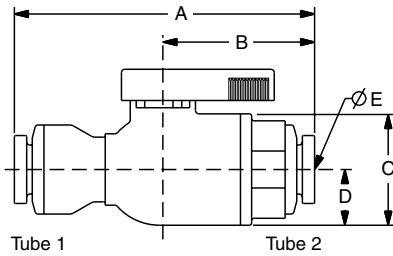

Part Number	1 Tube Size	2 Tube Size	A	B	C	D	ØE Thru Hole Min.
<b>#</b>							
PP4VUC4-MG	1/4	1/4	2.55	1.22	1.0	0.5	.19
PP4VUC6-MG	1/4	3/8	2.55	1.22	1.0	0.5	.19
PP6VUC4-MG	3/8	1/4	2.57	1.30	1.0	0.5	.19
PP6VUC6-MG	3/8	3/8	2.67	1.32	1.4	0.5	.25

**D**

# VEU - Valve Elbow Union

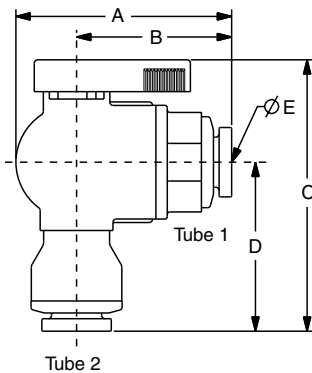

Part Number	1 Tube Size	2 Tube Size	A	B	C	D	ØE Thru Hole Min.
<b>#</b>							
PP4VEU4-MG	1/4	1/4	1.75	1.22	2.33	1.42	.19
PP4VEU6-MG	1/4	3/8	1.75	1.22	2.33	1.42	.11
PP6VEU4-MG	3/8	1/4	1.83	1.30	2.32	1.40	.19
PP6VEU6-MG	3/8	3/8	1.85	1.32	2.34	1.44	.25

# VMC - Valve Male Connector

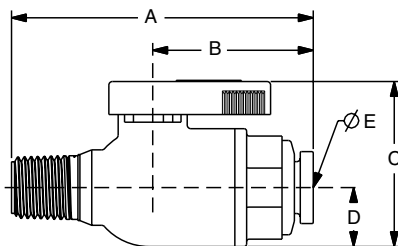

Part Number	Nom. Tube O.D.	NPTF Thread Size	A	B	C	D	ØE Thru Hole Min.
<b>#</b>							
PP4VMC2-MG (+)	1/4	1/8	2.22	1.21	1.4	0.5	.19
PP4VMC4-MG	1/4	1/4	2.40	1.21	1.4	0.5	.19
PP4VMC6-MG	1/4	3/8	2.40	1.21	1.4	0.5	.19
PP4VMC8-MG (+)	1/4	1/2	2.59	1.21	1.4	0.5	.19
PP6VMC2-MG (+)	3/8	1/8	2.33	1.32	1.4	0.5	.25
PP6VMC4-MG	3/8	1/4	2.51	1.32	1.4	0.5	.25
PP6VMC6-MG	3/8	3/8	2.51	1.32	1.4	0.5	.25
PP6VMC8-MG (+)	3/8	1/2	2.70	1.32	1.4	0.5	.25

(+) Non Standard.

## VFC - Valve Female Connector

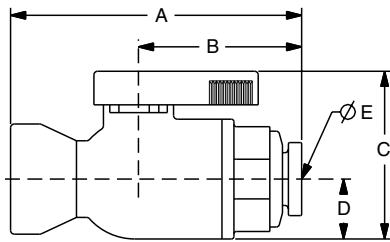

Part Number	Nom. Tube O.D.	NPTF Thread Size	A	B	C	D	ØE Thru Hole Min.
#							
PP4VFC2-MG	1/4	1/8	2.04	1.21	1.4	0.5	.19
PP4VFC4-MG	1/4	1/4	2.27	1.21	1.4	0.5	.19
PP4VFC6-MG	1/4	3/8	2.40	1.21	1.4	0.5	.19
PP6VFC2-MG	3/8	1/8	2.15	1.32	1.4	0.5	.25
PP6VFC4-MG	3/8	1/4	2.38	1.32	1.4	0.5	.25
PP6VFC6-MG	3/8	3/8	2.51	1.32	1.4	0.5	.25



## VTEU - Valve Tube Elbow Union

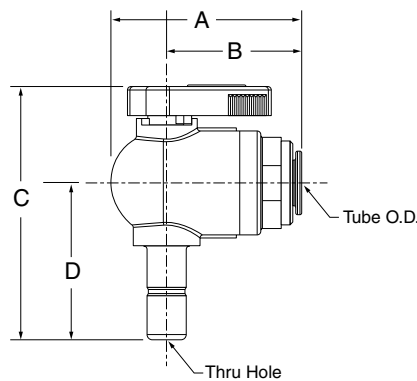

Part Number	Nom. Tube O.D.	Stem	A	B	C	D	ØE Thru Hole Min.
#							
PP4VTEU6-MG	1/4	3/8	1.75	1.22	2.43	1.50	.17
PP6VTEU6-MG	3/8	3/8	1.83	1.30	2.43	1.50	.25

## Cold Water Supply Valve (Patent No. 6,213,149)

Parker's water supply valve is intended for use with Point Of Use water appliances requiring a cold water supply such as POU faucets, instant hot water faucets, reverse osmosis systems and water filtration systems. The Parker TrueSeal™ Cold Water Supply Valve is designed for temporary cold water shut-off to a POU appliance to change filters, tanks or when servicing the appliance — all while maintaining full water flow to the sink or water basin above. When the POU system is removed from service, the Parker TrueSeal™ Cold Water Supply Valve is to be removed also.

TrueSeal™ Cold Water Supply Valves are for cold water service at temperatures above freezing to 125°F ambient. Not for use in hot water service applications.

### Features/Benefits:

- Fast, easy installation.
- No pierced lines or saddle hookups.
- Optimum flow to the faucet - full flow porting.
- No need to pierce the supply line.
- Connects 3/8" OD tubing directly to valve.
- 1/2" NPT connections available.
- Excellent resistance to chlorine and other chemicals.
- Integrated handle for easy on/off operation.
- Visual indicator shows open/closed position.

### Specifications:

- NSF Standard 51 listed.
- Pressure rating: 150 PSI with a 600 PSI burst pressure.
- Design factor: 4:1
- O-ring seal material: EPDM.
- Meets the pressure integrity test of NSF-53 and NSF-58.

### Applications:

- Reverse osmosis systems.
- Under sink filtration systems.
- POU faucets.
- Water supply valves are intended for cold water service at temperatures from above freezing to 125°F ambient.
- NOT for use in hot water service applications.



# VTU - Water Supply Valve

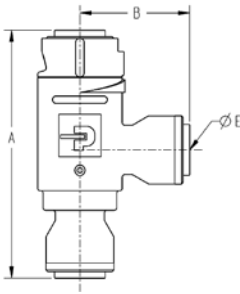

White Polypropylene	Nom. Tube O.D.	A	B	D Thru Hole Min.
#				
PP6VTU6-MG	3/8	2.92	1.3	.30

**D**

## TrueSeal™ Cold Water Supply Valve Assembly Instructions

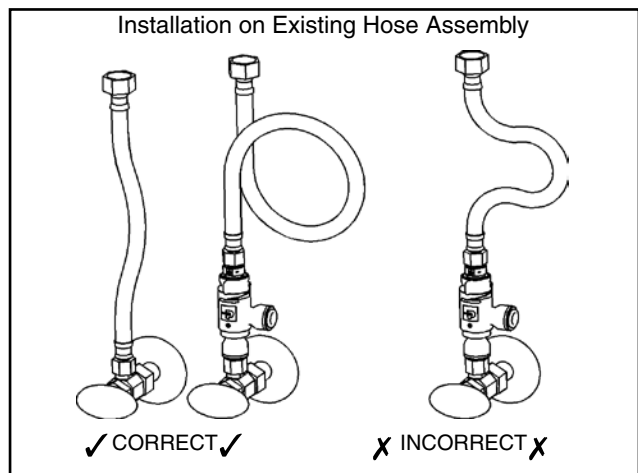
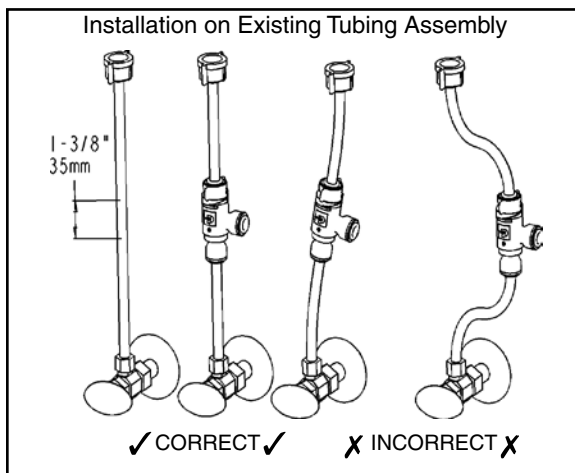

### For Installation with 3/8" Plastic Tubing:

1. Shut off water at the chrome or brass valve.
2. Disconnect existing tube assembly.
3. Cut out a 1-3/8" (35 mm) section near the center of the existing tubing. Cut the tube squarely and remove any burrs.
4. Place an insertion depth mark 3/4" (19 mm) from the end of each cut on the tubing to be reused. Refer to "TrueSeal Assembly Instructions," Steps 2 and 3, for tubing assembly (reverse side).
5. Reconnect tube assembly with new valve.
6. Make sure new valve is closed before opening water valve. Open valve in Step 1 and check for leaks.
7. Insert 3/8" tubing from water appliance into side port.
8. Open new valve by turning pointer to large end of flow indicator.

### For Installation with Flexible Hose:

1. Shut off water at the chrome or brass valve.
2. Disconnect one end of existing hose assembly.
3. Place the appropriate adapters on the chrome or brass valve and the hose end.
4. Tighten adapter on chrome or brass valve finger tight plus 1/2 turn. Do not over tighten.
5. Push tube portion of adapters into top and bottom of valve until bottomed out. Hose should not be kinked. A longer hose assembly might be required if a gently loop cannot be made.
6. Make sure new valve is closed before opening water valve. Pointer will be at the small end of triangle flow indicator. Open valve in Step 1 and check for leaks.
7. Insert 3/8" tubing from water appliance into side port.
8. Open new valve by turning pointer to large end of flow indicator.

## Water Supply Valve Kits

Part No.	Connects to:	Kit Contains
WSV4-Kit	1/4" Compression Valve	AW6TAF7-MG, AW6TFA7-MG, PP6VTU6-MG
WSV6-Kit	3/8" Compression Valve	AW6TAF9-MG, AW6TFA9-MG, PP6VTU6-MG
WSV8-Kit	1/2" NPSM Faucet Stem	AW6TAF8-MG, AW6TFA8-MG, PP6VTU6-MG

## TFA - Tube Faucet Adapter (Female Thread)

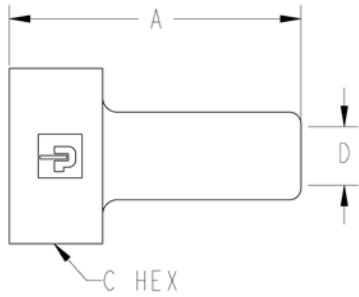

White Acetal	Tube Stem O.D.	Thread Size	A	C Hex	D Min.
#					
AW6TFA7-MG	3/8	7/16-24	1.25	.69	.17
AW6TFA8-MG	3/8	1/2-14 NPSM	1.45	1.06	.22
AW6TFA9-MG	3/8	9/16-24	1.25	.75	.22

## TAF - Tube Faucet Adapter (Male Thread)

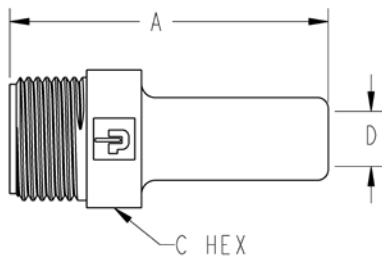

White Acetal	Tube Stem O.D.	Thread Size	A	C Hex	D Min.
#					
AW6TAF7-MG	3/8	7/16-24	1.41	.50	.22
AW6TAF8-MG	3/8	1/2-14 NPSM	1.65	.88	.22
AW6TAF9-MG	3/8	9/16-24	1.45	.63	.22

## SC - Safety Clip (Patent No. 6,065,779)

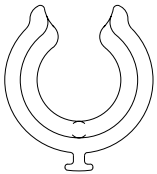

Standard color is black or blue. Other colors available upon request.

Part Number	Part Number	For Nominal Tube O.D.
#	#	
SC-4	SC-4-B	1/4
SC-5	SC-5-B	5/16
SC-6	SC-6-B	3/8
SC-8	SC-8-B	1/2

## TS - Tube Supports

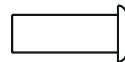

To be used with soft durometer tubing.

Nylon Part Number	Polypropylene Part Number
#	#
N4TS3	P4TS3
N5TS3	P5TS3
N6TS4	P6TS4
N8TS6	P8TS6

## PTS - Pipe Thread Sealant



NSF-51 listed silicone.

## AQRT - Quick Release Tool

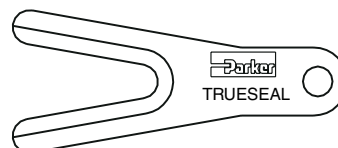

Makes disconnection of tube adapters and tubing a breeze.

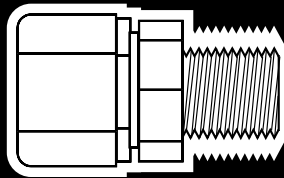

## Fast & Tite® Thermoplastic Fittings

Fast & Tite® fittings are the most complete line of plastic fittings for thermoplastic tubing in the industry.

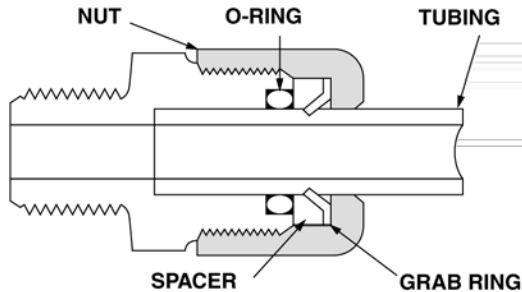

Fast & Tite® thermoplastic tube fittings from Parker will prove to be the answer to your tubing connector needs. Patented Fast & Tite® fittings install in seconds without tools and provide a tight, sure, leak proof seal without clamps or adjustments. A unique 302 stainless steel grab ring for tube retention, coupled with a Nitrile O-Ring for positive seal, assures good tube connection with only hand tight assembly. A plastic grab ring is also available upon special request. Vibration or tube movement will not break the seal and cause leakage. Preassembled in either highly inert polypropylene, or strong, durable nylon, Fast & Tite® fittings are the answer to full flow thermoplastic tubing system requirements.

When necessary, Fast & Tite® fittings can be disassembled by hand for fast system drainage. Fittings are completely Field Attachable. Parts are easily replaced. O-Rings are standard size and universally available. (For applications requiring other than Nitrile O-Rings, consult your Fast & Tite® distributor.)

Use Fast & Tite® fittings with Parker Parflex tubing or other plastic, glass or metal tubing for low pressure or vacuum lines up to the pressure limits shown below. When using clear vinyl tubing or urethane tubing, it is necessary to use a TS tube support. A tube support can be used with any tubing for maximum holding power where tensiling, vibration or pressure spikes may occur.

Fast & Tite® fittings meet FDA and NSF-51 requirements for food contact.

### Working Pressures for Fast & Tite® Fittings

Tube O. D., in.	Air-Oil-Water Pressure in PSI		
	Up to 75°F	76° to 125°F	126° to 175°F
1/4	300	300	300
5/16	300	300	300
3/8	250	250	150
1/2	200	200	150
5/8	150	100	50

Ratings are based on use with copper tubing, and in all cases represent the maximum recommended working pressure of the fitting only. Working pressures (vs. temperatures) of other types of tubing may limit the tube and fitting assembly to pressures lower than shown above. Consult factory for recommendations on applications other than shown above.

### Temperature Range:

Black/White Polypropylene: 0°F (-18°C) to +212°F (+100°C) White Nylon: -40°F (-40°C) to +200°F (+93°C)

### Fast Assembly

#### Step 1.

Cut the tube squarely and remove any burrs.

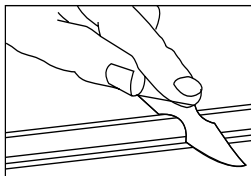

#### Step 2.

Mark from end of tube the length of insertion. If using a tube support, insert fully into tube and then mark from end of tube support length of insertion. (See table below)

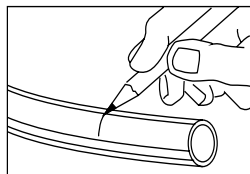

Tube O.D. (in.)	Insertion Length with Tube Support (in.)	Insertion Length without Tube Support (in.)
1/4	5/8	9/16
5/16	5/8	9/16
3/8	13/16	3/4
1/2	7/8	13/16
5/8	1	15/16

#### Step 3.

Loosen nut on fitting until three threads are visible. Fittings for glass tubes must be disassembled and the grab ring removed. If the fitting has been disassembled the components are to be placed in the following order: fitting body, o-ring, spacer, grab ring and nut. Assemble the nut until three threads are showing on the body before inserting tube.

#### Step 4.

Moisten end of the tube with water. Push the tube Straight into fitting until it bottoms on the fitting's shoulder. Tighten nut by hand. Additional tightening should not be necessary, but 1/4 additional turn may be added if desired. Do not overtighten nut as the threads will strip and the fitting will not function properly. A proper assembly will not show the insertion mark extending beyond the nut. If the insertion mark is visible, then steps 1 thru 4 must be repeated.

Note: Provide adequate fail-safe mechanisms such as leakage detection sensors, automatic shut-off controls or other industry and code appropriate fail-safe devices in the design of your water-handling appliance to protect against personal injury and property damage. Plastic fittings containing an o-ring have a finite life depending on the environment, media and severity of the application. Frequent inspections and replacement of the fitting when anomalies are found is recommended.

# MC - Male Connector

Tube to male pipe

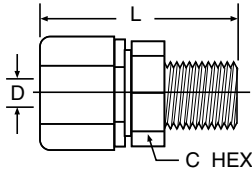

White Polypropylene Part Number	Black Polypropylene Part Number	White Nylon Part Number	Nom. Tube O.D.	NPTF Thread Size	C Hex	L Overall Length	D Thru Hole Min.
#	#	#					
W4MC2	P4MC2	N4MC2	1/4	1/8	11/16	1.38	.170
W4MC4	P4MC4	N4MC4	1/4	1/4	11/16	1.51	.170
W4MC6 (+)	P4MC6 (+)	N4MC6 (+)	1/4	3/8	11/16	.148	.170
W5MC2 (+)	P5MC2	N5MC2	5/16	1/8	11/16	1.38	.170
W5MC4 (+)	P5MC4	N5MC4	5/16	1/4	11/16	1.50	.250
W6MC2 (+)	P6MC2	N6MC2	3/8	1/8	13/16	1.50	.170
W6MC4	P6MC4	N6MC4	3/8	1/4	13/16	1.67	.250
W6MC6	P6MC6	N6MC6	3/8	3/8	13/16	1.67	.250
W6MC8 (+)	P6MC8	N6MC8	3/8	1/2	1	1.78	.250
W6MC12	P6MC12	N6MC12	3/8	3/4	1	1.84	.250
W8MC2 (+)	P8MC2	N8MC2	1/2	1/8	1	1.61	.170
W8MC4 (+)	P8MC4	N8MC4	1/2	1/4	1	1.74	.250
W8MC6	P8MC6	N8MC6	1/2	3/8	1	1.74	.375
W8MC8	P8MC8	N8MC8	1/2	1/2	1	1.87	.375
W8MC12 (+)	P8MC12	N8MC12	1/2	3/4	1	1.89	.375
W10MC2 (+)	P10MC2	N10MC2	5/8	1/8	1-18	1.75	.170
W10MC4 (+)	P10MC4	N10MC4	5/8	1/4	1-18	1.90	.250
W10MC6 (+)	P10MC6	N10MC6	5/8	3/8	1-18	1.90	.375
W10MC8 (+)	P10MC8	N10MC8	5/8	1/2	1-18	2.01	.500
W10MC12 (+)	P10MC12	N10MC12	5/8	3/4	1-18	2.04	.500



# UC - Union Connector

Tube to tube

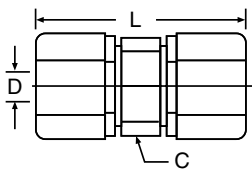

White Polypropylene Part Number	Black Polypropylene Part Number	White Nylon Part Number	Nom. Tube O.D.	C Hex	L Overall Length	D Thru Hole Min.
#	#	#				
W4UC4	P4UC4	N4UC4	1/4	11/16	1.62	.170
W5UC4 (+)	P5UC4	N5UC4	5/16-1/4	11/16	1.62	.170
W5UC5 (+)	P5UC5	N5UC5	5/16	11/16	1.62	.190
W6UC4	P6UC4	N6UC4	3/8-1/4	13/16	1.80	.170
W6UC5 (+)	P6UC5	N6UC5	3/8-5/16	13/16	1.80	.190
W6UC6	P6UC6	N6UC6	3/8	13/16	1.92	.250
W8UC6	P8UC6	N8UC6	1/2-3/8	1	1.95	.250
W8UC8	P8UC8	N8UC8	1/2	1	2.03	.375
W10UC6 (+)	P10UC6	N10UC6	5/8-3/8	1-18	2.19	.250
W10UC8 (+)	P10UC8	N10UC8	5/8-1/2	1-18	2.24	.375
W10UC10 (+)	P10UC10	N10UC10	5/8	1-18	2.40	.500

(+) Non Standard. see page XX for information on non-standard products.

# ME - Male Elbow

Tube to male pipe

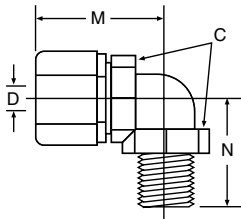

White Polypropylene Part Number	Black Polypropylene Part Number	White Nylon Part Number	Nom. Tube O.D.	NPTF Thread Size	C Hex	M	N	D Thru Hole Min.
#	#	#						
W4ME2	P4ME2	N4ME2	1/4	1/8	3/4	1.06	0.81	.170
W4ME4	P4ME4	N4ME4	1/4	1/4	3/4	1.06	1.02	.170
W4ME6	P4ME6	N4ME6	1/4	3/8	3/4	1.06	1.02	.170
W5ME2 (+)	P5ME2	N5ME2	5/16	1/8	3/4	1.06	0.81	.193
W5ME4 (+)	P5ME4	N5ME4	5/16	1/4	3/4	1.06	1.02	.193
W5ME6 (+)	P5ME6	N5ME6	5/16	3/8	3/4	1.06	1.02	.193
W6ME4	P6ME4	N6ME4	3/8	1/4	7/8	1.28	1.12	.250
W6ME6	P6ME6	N6ME6	3/8	3/8	7/8	1.28	1.12	.250
W6ME8	P6ME8	N6ME8	3/8	1/2	1	1.28	1.34	.250
W6ME12 (+)	P6ME12	N6ME12	3/8	3/4	1-3/16	1.59	1.40	.250
W8ME4 (+)	P8ME4	N8ME4 (+)	1/2	1/4	1-1/16	1.48	1.22	.250
W8ME6	P8ME6	N8ME6	1/2	3/8	1-1/16	1.56	1.21	.375
W8ME8	P8ME8	N8ME8	1/2	1/2	1-1/16	1.56	1.34	.375
W8ME12 (+)	P8ME12 (+)	N8ME12 (+)	1/2	3/4	1-1/8	1.50	1.40	.375
W10ME8 (+)	P10ME8	N10ME8	5/8	1/2	1-3/16	1.72	1.40	.500

**D**

# EU - Elbow Union

Tube to tube

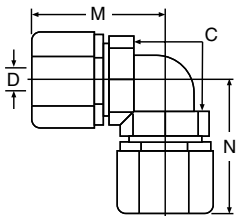

White Polypropylene Part Number	Black Polypropylene Part Number	White Nylon Part Number	Nom. Tube O.D.	C Hex	M	N	D Thru Hole Min.
#	#	#					
W4EU4	P4EU4	N4EU4	1/4	3/4	1.06	1.06	.170
W5EU4 (+)	P5EU4	N5EU4	5/16-1/4	3/4	1.06	1.06	.170
W5EU5 (+)	P5EU5	N5EU5	5/16	3/4	1.06	1.06	.193
W6EU4	P6EU4	N6EU4	3/8-1/4	7/8	1.06	1.28	.170
W6EU5 (+)	P6EU5	N6EU5	3/8-5/16	7/8	1.06	1.28	.170
W6EU6	P6EU6	N6EU6	3/8	7/8	1.28	1.28	.250
W8EU6	P8EU6	N8EU6	1/2-3/8	1-1/16	1.37	1.56	.250
W8EU8	P8EU8	N8EU8	1/2	1-1/16	1.56	1.56	.375
W10EU10 (+)	P10EU10	N10EU10	5/8	1-3/16	1.72	1.72	.500

(+) Non Standard. see page XX for information on non-standard products.

## BU - Bulkhead Union

Tube to tube

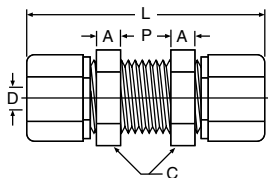

White Polypropylene Part Number	Black Polypropylene Part Number	White Nylon Part Number	Nom. Tube O.D.	A Ref.	C Hex	L Overall Length	P Max.	D Thru Hole Min.	Bulkhead Hole Drill Size
#	#	#							
W4BU4	P4BU4	N4BU4	1/4	1/4	13/16	2-11/64	3/8	.170	21/32
W5BU5 (+)	P5BU5	N5BU5	5/16	1/4	13/16	2-11/64	3/8	.187	21/32
W6BU6	P6BU6	N6BU6	3/8	9/32	15/16	2-39/64	1/2	.250	25/32
W8BU8	P8BU8	N8BU8	1/2	5/16	1-5/32	2-3/4	1/2	.375	31/32



## FE - Female Elbow

Tube to female pipe

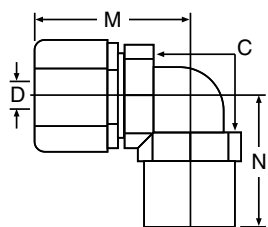

White Polypropylene Part Number	Black Polypropylene Part Number	White Nylon Part Number	Nom. Tube O.D.	NPTF Thread Size	C Hex	M	N	D Thru Hole Min.
#	#	#						
W4FE2	P4FE2	N4FE2	1/4	1/8	11/16	1.10	0.84	.170
W4FE4	P4FE4	N4FE4	1/4	1/4	11/16	1.10	0.94	.170
W5FE2 (+)	P5FE2	N5FE2	5/16	1/8	11/16	1.10	0.84	.193
W6FE4	P6FE4	N6FE4	3/8	1/4	13/16	1.30	1.06	.250
W6FE6	P6FE6	N6FE6	3/8	3/8	13/16	1.30	1.03	.250
W8FE6 (+)	P8FE6	N8FE6	1/2	3/8	1	1.50	1.16	.375
W8FE8	P8FE8	N8FE8	1/2	1/2	1	1.50	1.27	.375
W10FE8 (+)	P10FE8	N10FE8	5/8	1/2	1-1/8	1.70	1.34	.500

## FC - Female Connector

Tube to female pipe

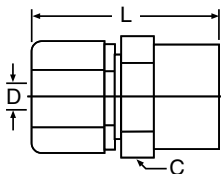

White Polypropylene Part Number	Black Polypropylene Part Number	White Nylon Part Number	Nom. Tube O.D.	NPTF Thread Size	C Hex	L Overall Length	D Thru Hole Min.
#	#	#					
W4FC2	P4FC2	N4FC2	1/4	1/8	11/16	1.30	.170
W4FC4	P4FC4	N4FC4	1/4	1/4	11/16	1.40	.170
W6FC4	P6FC4	N6FC4	3/8	1/4	1	1.57	.250
W6FC6	P6FC6	N6FC6	3/8	3/8	1-1/8	1.57	.250
W6FC8 (+)	P6FC8	N6FC8	3/8	1/2	1-1/8	1.67	.250
W8FC6	P8FC6	N8FC6	1/2	3/8	1	1.66	.375
W8FC8	P8FC8	N8FC8	1/2	1/2	1-1/8	1.78	.375
W10FC8 (+)	P10FC8	N10FC8	5/8	1/2	1-1/8	1.95	.500

(+) Non Standard. see page XX for information on non-standard products.

# MR - Male Run Tee

Tube to male pipe

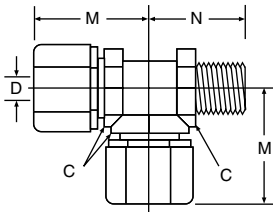

White Polypropylene Part Number	Black Polypropylene Part Number	White Nylon Part Number	Nom. Tube O.D.	NPTF Thread Size	C Hex	M	N	D Thru Hole Min.
#	#	#						
W4MR2	P4MR2	N4MR2	1/4	1/8	11/16	1.09	0.89	.170
W6MR4	P6MR4	N6MR4	3/8	1/4	13/16	1.30	1.17	.250
W8MR6	P8MR6	N8MR6	1/2	3/8	1	1.46	1.28	.375
W10MR8 (+)	P10MR8	N10MR8	5/8	1/2	1-1/8	1.68	1.50	.500

**D**

# TU - Tee Union

Tube to tube

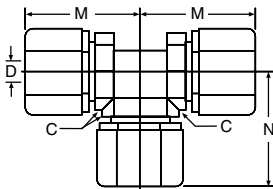

White Polypropylene Part Number	Black Polypropylene Part Number	White Nylon Part Number	Nom. Tube O.D.	C Hex	M	N	D Thru Hole Min.
#	#	#					
W4TU4	P4TU4	N4TU4	1/4	11/16	1.09	1.09	.170
W5TU5 (+)	P5TU5	N5TU5	5/16	11/16	1.09	1.09	.187
W6TU6	P6TU6	N6TU6	3/8	13/16	1.30	1.30	.250
W8TU6 (+)	P8TU6	N8TU6	1/2-3/8	1	1.46	1.39	.250
W8TU8	P8TU8	N8TU8	1/2	1	1.46	1.46	.375
W10TU6 (+)	P10TU6	N10TU6	5/8-3/8	1-1/8	1.68	1.46	.250
W10TU10 (+)	P10TU10	N10TU10	5/8	1-3/16	1.68	1.68	.500

# MT - Male Branch Tee

Tube to male pipe

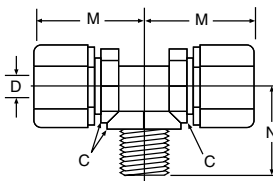

White Polypropylene Part Number	Black Polypropylene Part Number	White Nylon Part Number	Nom. Tube O.D.	NPTF Thread Size	C Hex	M	N	D Thru Hole Min.
#	#	#						
W4MT2	P4MT2	N4MT2	1/4	1/8	11/16	1.09	0.89	.170
W4MT4	P4MT4	N4MT4	1/4	1/4	11/16	1.09	1.06	.170
W5MT2 (+)	P5MT2	N5MT2	5/16	1/8	11/16	1.09	0.89	.170
W5MT4 (+)	P5MT4	N5MT4	5/16	1/4	11/16	1.09	1.06	.187
W6MT4	P6MT4	N6MT4	3/8	1/4	13/16	1.30	1.12	.250
W6MT6	P6MT6	N6MT6	3/8	3/8	13/16	1.30	1.10	.250
W8MT6	P8MT6	N8MT6	1/2	3/8	1	1.46	1.22	.375
W8MT8	P8MT8	N8MT8	1/2	1/2	1	1.46	1.43	.375
W10MT8 (+)	P10MT8	N10MT8	5/8	1/2	1-1/8	1.68	1.41	.500

(+) Non Standard. see page XX for information on non-standard products.

## GR - Grab Ring (Stainless or Plastic)



Stainless Grab Ring Part Number	Plastic Grab Ring Part Number	O-Ring Part Number	For Nom. Tube O.D.
#	#	#	
4GR	4GRP	4OR	1/4
5GR	5GRP	5OR	5/16
6GR	6GRP	6OR	3/8
8GR	8GRP	8OR	1/2
10GR	10GRP	10OR	5/8

## OR - O-Ring

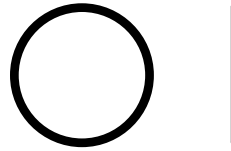

## NS - Nut and Spacer Sets

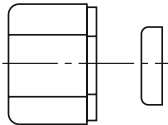

White Polypropylene Part Number	Black Polypropylene Part Number	White Nylon Part Number	For Nom. Tube O.D.
#	#	#	
W4NS	P4NS	N4NS	1/4
W5NS	P5NS	N5NS	5/16
W6NS	P6NS	N6NS	3/8
W8NS	P8NS	N8NS	1/2
W10NS	P10NS	N10NS	5/8

## TS - Tube Support

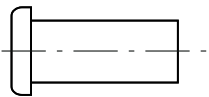

Polypropylene Part Number	Nylon Part Number	For Tube Part Number
#	#	
P4TS3	N4TS3	PV43
P5TS3	N5TS3	PV53
P6TS4	N6TS3	PV64
P8TS6	N8TS6	PV86
P10TS8	N10TS8	PV108



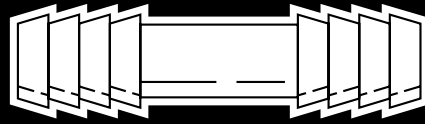

## Par-Barb® Thermoplastic Fittings

Par-Barb® fittings are precision injection molded from high-strength, chemically inert, thermoplastic materials.

The specially engineered four-barb design generates the maximum gripping and sealing power when combined with a hose clamp. The unique barb design requires the tube or hose to expand slightly to accept the fitting, providing a positive seal on the barbs.

Par-Barb® fittings are widely used with Parflex clear vinyl tubing, urethane tubing and a variety of rubber tubing and hose. Par-Barb® fittings meet FDA and NSF-51 specifications for food contact.

Par-Barb® is recommended in medical, pollution control, food and beverage applications. Other uses include irrigation, instrumentation, reverse osmosis and deionized water systems.

### Temperature range:

Black Polyethylene: -65°F (-54°C) to +190°F (+88°C.)

White Nylon: -40°F (-40°C) to +200°F (+93°C.)

### Working pressures:

Par-Barb® fittings are generally used in systems where pressures do not exceed 125 PSI. When used in excess of 125 PSI, Par-Barb® fittings, in all sizes, should be tested by the customer in his particular application. Operating pressures of Par-Barb® fittings are governed by ambient and fluid temperatures, type of fluid conveyed, hose or tubing used, clamping mechanism employed and conditions of mechanical abuse.

### How to order Par-Barb® fittings:

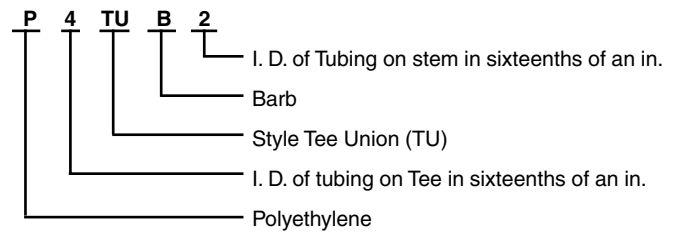

# TUB - Tee Union

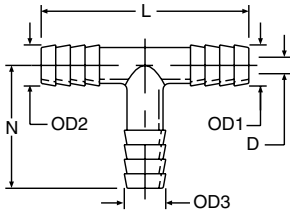

Black High Density Linear Polyethylene Part Number	White Nylon Part Number	Tube or Hose I.D. 1&2	Tube or Hose I.D. 3	O.D. 1&2	O.D. 3	L	N	D Flow Diameter
#	#							
P2TUB2	N2TUB2	1/8	1/8	.141	.141	1.203	0.594	.078
P3TUB3	N3TUB3	3/16	3/16	.245	.245	1.941	1.256	.106
P4TUB3 (+)	N4TUB3	1/4	3/16	.308	.245	2.004	1.256	.106
P4TUB4	N4TUB4	1/4	1/4	.308	.308	2.004	1.256	.153
P5TUB5	N5TUB5	5/16	5/16	.361	.361	2.058	1.256	.215
P6TUB3 (+)	N6TUB3 (+)	3/8	3/16	.425	.245	1.941	1.256	.106
P6TUB4	N6TUB4	3/8	1/4	.425	.308	2.121	1.256	.153
P6TUB6	N6TUB6	3/8	3/8	.425	.425	2.134	1.256	.247
P6TUB8	N6TUB8	3/8	1/2	.425	.550	2.121	1.256	.247
P8TUB4 (+)	N8TUB4 (+)	1/2	1/4	.550	.308	2.246	1.256	.153
P8TUB6	N8TUB6	1/2	3/8	.550	.425	2.248	1.256	.247
P8TUB8	N8TUB8	1/2	1/2	.550	.550	2.248	1.256	.372
P10TUB8	N10TUB8	5/8	1/2	.644	.550	2.340	1.256	.372
P10TUB10	N10TUB10	5/8	5/8	.644	.644	2.340	1.256	.465

\*P2UCB2, P2TUB2, P12HPN6 are not FDA compliant.



# EUB - Elbow Union

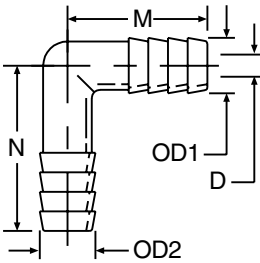

Black High Density Linear Polyethylene Part Number	White Nylon Part Number	Tube or Hose I.D.		O.D. 1	O.D. 2	M	N	D Flow Diameter
		1	2					
#	#							
P4EUB4	N4EUB4	1/4	1/4	.308	.308	1.002	1.256	.153
P6EUB6	N6EUB6	3/8	3/8	.425	.425	1.060	1.256	.247
P8EUB4	N8EUB4	1/2	1/4	.550	.308	1.002	1.256	.153
P8EUB6	N8EUB6	1/2	3/8	.550	.425	1.060	1.256	.247
P8EUB8	N8EUB8	1/2	1/2	.550	.550	1.123	1.256	.372
P10EUB10	N10EUB10	5/8	5/8	.644	.644	1.170	1.256	.465
P12EUB12	N12EUB12	3/4	3/4	.788	.788	1.242	1.256	.606

(+) Non Standard. see page XX for information on non-standard products.

# MTB - Tee Male Branch

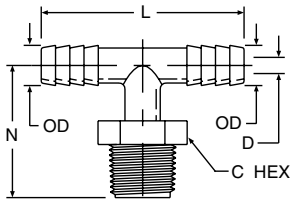

**D**

Black High Density Linear Polyethylene Part Number	White Nylon Part Number	Tube or Hose I.D.	NPTF Pipe Thread Size	O.D.	C Hex	L	N	D Flow Diameter
#	#							
P3MTB2	N3MTB2	3/16	1/8	.245	7/16	1.941	1.187	.106
P3MTB4	N3MTB4	3/16	1/4	.245	9/16	1.941	1.406	.106
P4MTB2	N4MTB2	1/4	1/8	.308	7/16	2.004	1.187	.153
P4MTB4	N4MTB4	1/4	1/4	.308	9/16	2.004	1.406	.153
P4MTB6	N4MTB6	1/4	3/8	.308	11/16	2.004	1.436	.153
P6MTB4	N6MTB4	3/8	1/4	.425	9/16	2.121	1.406	.247
P6MTB6	N6MTB6	3/8	3/8	.425	11/16	2.121	1.436	.247
P6MTB8	N6MTB8	3/8	1/2	.425	7/8	2.121	1.626	.247
P8MTB4	N8MTB4	1/2	1/4	.550	9/16	2.246	1.406	.281
P8MTB6	N8MTB6	1/2	3/8	.550	11/16	2.246	1.436	.372
P8MTB8	N8MTB8	1/2	1/2	.550	7/8	2.246	1.626	.372
P12MTB12	N12MTB12 (+)	3/4	3/4	.788	1-1/8	2.484	1.636	.606

# HPL - Hex Head Pipe Plug

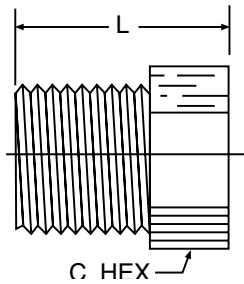

Black High Density Linear Polyethylene Part Number	White Nylon Part Number	NPTF Pipe Thread Size	C Hex	L Overall Length
#	#			
P2HPL	N2HPL	1/8	7/16	0.660
P4HPL	N4HPL	1/4	9/16	0.880
P6HPL	N6HPL	3/8	11/16	0.905
P8HPL	N8HPL	1/2	7/8	1.092
P12HPL	N12HPL	3/4	1-1/8	1.115

(+) Non Standard. see page XX for information on non-standard products.

# MEB - Male Elbow Connector

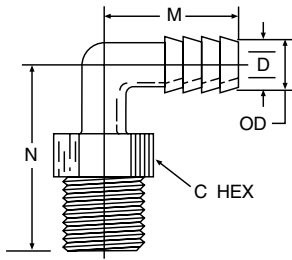

Black High Density Linear Polyethylene Part Number	White Nylon Part Number	Tube or Hose I.D.	NPTF Pipe Thread Size	O.D.	C Hex	M	N	D Flow Diameter
#	#							
P3MEB2	N3MEB2	3/16	1/8	.245	7/16	1.971	1.186	.106
P3MEB4	N3MEB4	3/16	1/4	.245	9/16	1.971	1.406	.106
P4MEB2	N4MEB2	1/4	1/8	.308	7/16	1.002	1.186	.153
P4MEB4	N4MEB4	1/4	1/4	.308	9/16	1.002	1.406	.153
P4MEB6	N4MEB6	1/4	3/8	.308	11/16	1.002	1.436	.153
P4MEB8	N4MEB8	1/4	1/2	.308	7/8	1.002	1.626	.153
P4MEB12	N4MEB12	1/4	3/4	.308	1-1/8	1.002	1.636	.153
P6MEB2	N6MEB2	3/8	1/8	.425	7/16	1.060	1.186	.247
P6MEB4	N6MEB4	3/8	1/4	.425	9/16	1.060	1.406	.247
P6MEB6	N6MEB6	3/8	3/8	.425	11/16	1.060	1.436	.247
P6MEB8	N6MEB8	3/8	1/2	.425	7/8	1.060	1.626	.247
P6MEB12	N6MEB12	3/8	3/4	.425	1-1/8	1.060	1.636	.247
P8MEB4	N8MEB4	1/2	1/4	.550	9/16	1.123	1.406	.372
P8MEB6	N8MEB6	1/2	3/8	.550	11/16	1.123	1.436	.372
P8MEB8	N8MEB8	1/2	1/2	.550	7/8	1.123	1.626	.372
P8MEB12	N8MEB12	1/2	3/4	.550	1-1/8	1.123	1.636	.372
P10MEB6	N10MEB6	5/8	3/8	.644	11/16	1.170	1.436	.465
P10MEB8	N10MEB8	5/8	1/2	.644	7/8	1.170	1.626	.465
P10MEB12	N10MEB12	5/8	3/4	.644	1-1/8	1.170	1.636	.465
P12MEB8	N12MEB8	3/4	1/2	.788	7/8	1.242	1.626	.606



# UCB - Union Connector

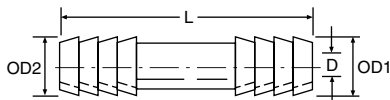



Black High Density Linear Polyethylene Part Number	White Nylon Part Number	Tube or Hose I.D. 1&2	Tube or Hose I.D. 3	O.D. 1&2	O.D. 3	L	D Flow Diameter
#	#						
P2UCB2	N2UCB2	1/8	1/8	.152	.152	.625	.090
P3UCB3	N3UCB3	3/16	3/16	.245	.245	1.750	.106
P4UCB3	N4UCB3	1/4	3/16	.308	.245	1.750	.106
P4UCB4	N4UCB4	1/4	1/4	.308	.308	1.750	.153
P5UCB5	N5UCB5	5/16	5/16	.361	.361	1.750	.215
P6UCB4	N6UCB4	3/8	1/4	.425	.308	1.750	.153
P6UCB6	N6UCB6	3/8	3/8	.425	.425	1.733	.247
P8UCB4	N8UCB4	1/2	1/4	.550	.308	1.750	.153
P8UCB6	N8UCB6	1/2	3/8	.550	.425	1.750	.247
P8UCB8	N8UCB8	1/2	1/2	.550	.550	1.750	.372
P10UCB6	N10UCB6	5/8	3/8	.644	.425	1.750	.247
P10UCB8	N10UCB8	5/8	1/2	.644	.550	1.750	.372
P10UCB10	N10UCB10	5/8	5/8	.644	.644	1.750	.465

\*P2UCB2, P2TUB2, P12HPN6 are not FDA compliant.

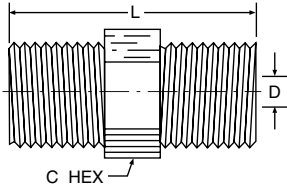
# HPN - Hex Pipe Nipple



**D**

Black High Density Linear Polyethylene Part Number	White Nylon Part Number	Side 1	Side 2	C Hex	L	D1 Diameter	D2 Diameter
#	#						
P2HPN2	N2HPN2	1/8	1/8	7/16	1.062	.187	.187
P4HPN2	N4HPN2	1/4	1/8	9/16	1.281	.286	.187
P4HPN4	N4HPN4	1/4	1/4	9/16	1.469	.285	.285
P6HPN2	N6HPN2	3/8	1/8	11/16	1.332	.406	.187
P6HPN4	N6HPN4	3/8	1/4	11/16	1.488	.406	.285
P6HPN6	N6HPN6	3/8	3/8	11/16	1.500	.406	.406
P8HPN2	N8HPN2	1/2	1/8	7/8	1.485	.618	.187
P8HPN4	N8HPN4	1/2	1/4	7/8	1.687	.618	.285
P8HPN6	N8HPN6	1/2	3/8	7/8	1.687	.618	.406
P8HPN8	N8HPN8	1/2	1/2	7/8	1.875	.618	.618
P12HPN6	N12HPN6	3/4	3/8	1-1/8	1.703	.750	.408
P12HPN8	N12HPN8	3/4	1/2	1-1/8	1.891	.750	.618
P10HPN12	N10HPN12	3/4	3/4	1-1/8	1.932	.750	.750

\*P2UCB2, P2TUB2, P12HPN6 are not FDA compliant.

# MCB - Male Connector Adapter

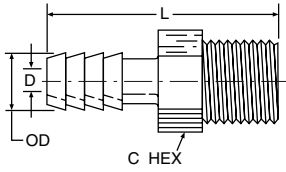

Black High Density Linear Polyethylene Part Number	White Nylon Part Number	Tube or Hose I.D.	NPTF Pipe Thread Size	O.D.	C Hex	L	D Flow Diameter
#	#						
P3MCB2	N3MCB2	3/16	1/8	.245	7/16	1.530	.106
P3MCB4	N3MCB4	3/16	1/4	.245	9/16	1.750	.106
P3MCB8	N3MCB8	3/16	1/2	.245	7/8	1.970	.106
P4MCB2	N4MCB2	1/4	1/8	.308	7/16	1.530	.153
P4MCB4	N4MCB4	1/4	1/4	.308	9/16	1.750	.153
P4MCB6	N4MCB6	1/4	3/8	.308	11/16	1.780	.153
P4MCB8	N4MCB8	1/4	1/2	.308	7/8	1.970	.153
P4MCB12	N4MCB12	1/4	3/4	.308	1-1/8	1.980	.153
P5MCB2	N5MCB2	5/16	1/8	.361	7/16	1.530	.215
P5MCB4	N5MCB4	5/16	1/4	.361	9/16	1.750	.215
P5MCB6	N5MCB6	5/16	3/8	.361	11/16	1.780	.215
P6MCB2	N6MCB2	3/8	1/8	.425	7/16	1.530	.187
P6MCB4	N6MCB4	3/8	1/4	.425	9/16	1.750	.247
P6MCB6	N6MCB6	3/8	3/8	.425	11/16	1.780	.247
P6MCB8	N6MCB8	3/8	1/2	.425	7/8	1.970	.247
P6MCB12	N6MCB12	3/8	3/4	.425	1-1/8	1.980	.247
P8MCB4	N8MCB4	1/2	1/4	.550	9/16	1.750	.372
P8MCB6	N8MCB6	1/2	3/8	.550	11/16	1.780	.372
P8MCB8	N8MCB8	1/2	1/2	.550	7/8	1.970	.372
P8MCB12	N8MCB12	1/2	3/4	.550	1-1/8	1.980	.372
P10MCB6	N10MCB6	5/8	3/8	.644	11/16	1.780	.465
P10MCB8	N10MCB8	5/8	1/2	.644	7/8	1.970	.465
P10MCB12	N10MCB12	5/8	3/4	.644	1-1/8	1.980	.465
P12MCB8	N12MCB8	3/4	1/2	.788	7/8	1.970	.606
P12MCB12	N12MCB12	3/4	3/4	.788	1-1/8	1.980	.606



**Notes**

---

---

---

---

---

---

---

---

---

---

---

---

---

---

---

---

---

---

---

---

---

---

---

---

---

---

---

---

---

---

**D**

# Flare Fittings



## SAE 45° Flare

- Meets SAE Functional Requirements
- Resists Vibration
- Resists Mechanical Pull-out
- UL Listed



## Inverted Flare

- UL Listed
- Economical
- Steel Nut option











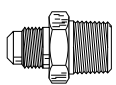
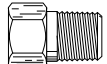
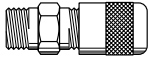
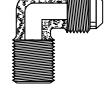
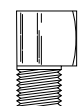
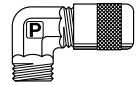
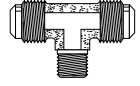

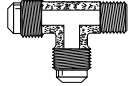
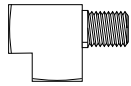
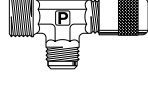
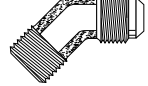
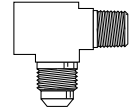
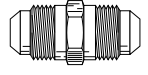

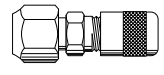
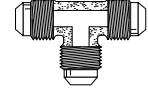
## Access Valves

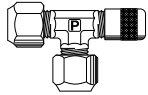
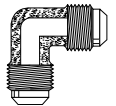

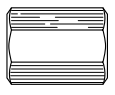
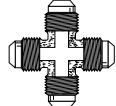
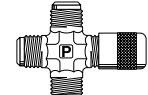
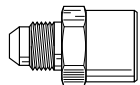

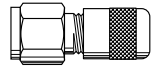
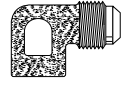
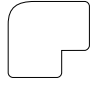

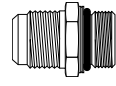
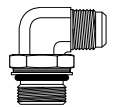
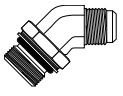
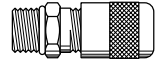
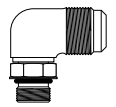
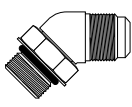
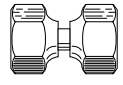
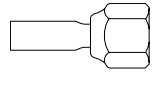
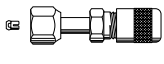
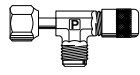
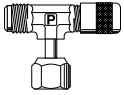



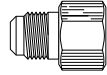

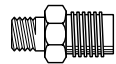
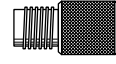
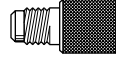

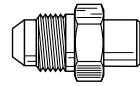
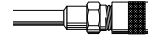
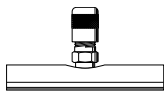
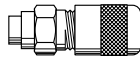
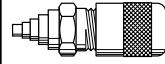
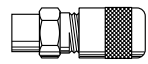



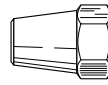

- Teflon Seal on Valve core
- Machined to ARI Standards
- Finger Tight Quick Seal Cap

***The World Standard***

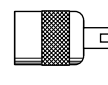

<b>Flare to Male NPT</b>	<b>48F</b> Male Connector  Page E8	<b>48IFHD</b> Male Connector  Page E16	<b>AVU1</b> Male Connector  Page E20	<b>149F/249F</b> Male Elbow  Page E10	<b>249IFHD/249IF</b> Male Elbow  Page E16	<b>AVE1</b> Male Elbow  Page E20
	<b>145F</b> Branch Tee  Page E9	<b>245IFHD</b> Branch Tee  Page E16	<b>151F</b> Run Tee  Page E11	<b>251IFHD</b> Run Tee  Page E17	<b>AVT3</b> Run Tee  Page E20	<b>159H/259F</b> 45° Male Elbow  Page E12
<b>256F</b> Adapter Tee  Page E12	<b>Flare to Flare</b>	<b>42F</b> Union  Page E7	<b>42IFHD</b> Union  Page E15	<b>AVU2</b> Union  Page E19	<b>144F</b> Union Tee  Page E9	<b>244IFHD</b> Union Tee  Page E16
<b>AVT2</b> Union Tee  Page E20		<b>155F</b> Union Elbow  Page E11	<b>255IFHD</b> Union Elbow  Page E17	<b>660FHD</b> Flare Union  Page E13	<b>147F</b> Cross  Page E9	<b>AVC1</b> Cross  Page E20
<b>Flare to Female NPT</b>	<b>46F</b> Female Connector  Page E8	<b>46IFHD</b> Female Connector  Page E15	<b>AVUR3</b> Female Connector  Page E21	<b>150F</b> Female Elbow  Page E11	<b>250IFHD</b> Female Elbow  Page E17	<b>252IFHD</b> Branch Tee  Page E17
	<b>Flare to Metric Straight Thread</b>	<b>48F-MI</b> Male Connector  Page E8	<b>149F-MI</b> Male Elbow  Page E10	<b>159F-MI</b> 45° Male Elbow  Page E12	<b>Flare to Straight Thread</b>	<b>AVU1F1</b> Male Connector  Page E20
<b>1495F</b> Male Elbow  Page E10		<b>1595F</b> 45° Male Elbow  Page E12	<b>Swivels</b>	<b>14FSV</b> Swivel Nut Connector  Page E6		<b>US5</b> Flare Adapter  Page E6
<b>AVUS4D</b> Swivel Connector  Page E21	<b>AVTS4</b> Swivel Run Tee  Page E21	<b>AVTS6</b> Swivel Branch Tee  Page E22				

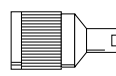
E

<b>Adapters</b>	<b>1F</b> Refrigerant Drum  Page E5	<b>661FHD</b> Reducer  Page E13	<b>664FHD</b> Female Flare to Pipe  Page E13	<b>88AC</b> Refrigerant Adapter  Page E23	<b>880AC</b> Refrigerant Adapter  Page E23	<b>881AC</b> Refrigerant Adapter  Page E23
	<b>Bulkheads</b>	<b>AVU2BH</b> Bulkhead Union  Page E19	<b>AVUS3BH</b> Solder Union  Page E19	<b>Flare to Solder</b>	<b>43F</b> Connector  Page E7	<b>AVUSE</b> Extended Copper Tube  Page E19
<b>AVTSL</b> Extended Solder Tee  Page E19		<b>AVUS3-40</b> 3 Way Solder  Page E21	<b>AVUS3-49</b> 9 Way Solder  Page E21		<b>AVUS</b> Solder Connector  Page E21	
<b>Auxiliary</b>	<b>14FL</b> Long Forged Nut  Page E5	<b>14FSX</b> Short Forged Nut  Page E5	<b>14FS</b> Forged Reducing Nut  Page E6	<b>41FL</b> Long Nut  Page E6	<b>41FS/41FX</b> Shorter Nut  Page E6, E7	<b>411F</b> Inverted Flare Nut  Page E15
	<b>411FS</b> Inverted Flare Nut Steel  Page E15	<b>411FF</b> Inverted Flare Piloted Nut  Page E15	<b>639F</b> Seal Plug  Page E13	<b>640F</b> CAP NUT  Page E13	<b>640QSFC</b> Seal Cap with Chain  Page E22	<b>640QSFCR</b> Seal Cap with Core Remover  Page E22
<b>3GF</b> Seal Bonnet  Page E5	<b>CR</b> Core Remover  Page E22	<b>VC</b> Valve Core  Page E22				



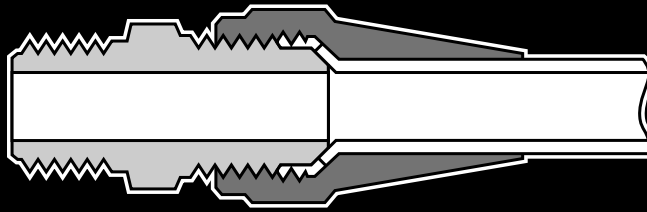

## SAE 45° Flared Fittings

E

### Advantages

This economical fitting resists mechanical pullout. Can be assembled and disassembled repeatedly. Manufactured from CA 360, CA 345 or CA 377 brass.

### Specifications

Listed with Underwriter's Laboratories for flammable liquid, marine, refrigeration and gas applications. Meets functional requirements of SAE J512 and J513. Refer to list of UL listed fittings on page M10 for specific configurations.

### Applications

Use with copper, brass, aluminum and welded steel hydraulic tubing that can be flared. Manufactured especially for hard-to-hold liquids and gases.

### Working Pressure Ranges

Temperature and type of tubing used are important factors. However, the following table is a good guide for proper selection. Temperature 73°F with copper tubing:

PSI	TUBE O.D. (IN.)	TUBE WALL (IN.)
2800	1/8	.030
1900	3/16	.030
1400	1/4	.030
1200	5/16	.032
1000	3/8	.032
750	1/2	.032
650	5/8	.035
550	3/4	.035
450	7/8	.035

### Temperature Ranges

From -65° to +250°F.

### Vibration

Short nut may be used when vibration is minimal. The long nut offers additional vibration capacity.

### Assembly Instructions

1. Cut tubing squarely and clean tube end thoroughly to remove burrs.
2. Place nut onto tube. Place threaded end of nut toward end of tube.
3. Flare tube end with flaring tool to provide 45° flare.
4. Clamp tube flare between nut and nose of fitting body by screwing nut on finger-tight. Tighten with a wrench an additional 1/4 to 1/2 turn past finger tight for a metal-to-metal seal.

Flare fittings are easy to disassemble and may be reassembled repeatedly, for a leak-proof connection.

### Order

By part number and name. SAE 45° flared bodies and nuts are separate items. Both numbers must be indicated when ordered.

### Nomenclature

Part numbers are constructed from symbols that identify the style and size of the fitting. The first series of numbers and letters identifies the style and type fitting. The second series of numbers describes the size.

#### Example:

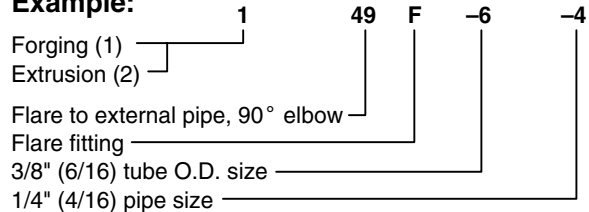

### Sizes

Tube sizes are determined by the numbers of sixteenths of an inch in the tube O.D.

### Special Fittings

Fitting configurations and/or sizes other than those shown in the catalog can be furnished. It is suggested that a print or sketch be submitted with the inquiry. Special UL stamped fittings are available. Please consult price list.

### Pricing

Only items priced in current supplementary price list PL3501 are carried in stock. Price and delivery for non-stock items furnished on request for specified quantity.

**Refrigerant Drum a Aapter 1F**

Ref. SAE 010165

PART NO.	TUBE O.D.	PIPE THREAD	C HEX	L	FLOW DIA. D
1F-4-8	1/4	1/2	1-1/8	1.12	.189
1F-4-12*	1/4	3/4	1-1/4	1.12	.189
1F-6-12*	3/8	3/4	1-1/4	1.24	.282
1F-8-12*	1/2	3/4	1-1/4	1.37	.407

Gasket Furnished with each 1F adapter

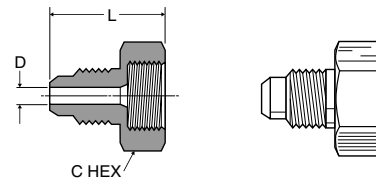

**Copper Flare Gasket 2GF**

Ref. SAE 010113

PART NO.	TUBE SIZE	A
2GF-3	3/16	.32
2GF-4	1/4	.36
2GF-5	5/16	.43
2GF-6	3/8	.56
2GF-8	1/2	.67
2GF-10	5/8	.78
2GF-12*	3/4	.97

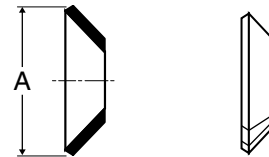

**Seal Bonnet 3GF**

Ref. SAE 010114

PART NO.	TUBE SIZE	A
3GF-3	3/16	.32
3GF-4	1/4	.37
3GF-5	5/16	.43
3GF-6	3/8	.56
3GF-8	1/2	.67
3GF-10	5/8	.78
3GF-12*	3/4	.97

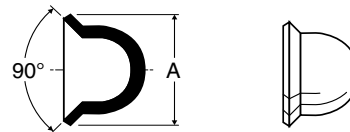

**Long Forged Nut 14FL**

Ref. SAE 010167

PART NO.	TUBE SIZE	STRAIGHT THREAD	C HEX	D	L
14FL-4	1/4	7/16-20	5/8	.257	.94
14FL-6	3/8	5/8-18	13/16	.382	1.06
14FL-8	1/2	3/4-16	15/16	.507	1.19
14FL-10	5/8	7/8-14	1-1/16	.632	1.44

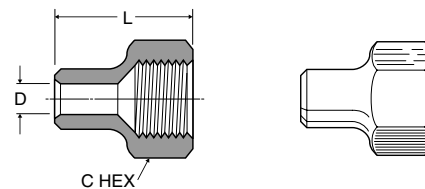

**Short Forged Nut 14FSX**

Ref. SAE 010166

PART NO.	TUBE SIZE	STRAIGHT THREAD	C HEX	D	L
14FSX-4	1/4	7/16-20	5/8	.257	.63
14FSX-5	5/16	1/2-20	11/16	.320	.67
14FSX-6	3/8	5/8-18	13/16	.382	.74
14FSX-8	1/2	3/4-16	15/16	.507	.86
14FSX-10	5/8	7/8-14	1-1/16	.632	.97
14FSX-12*	3/4	1-1/16-14	1-5/16	.757	1.17

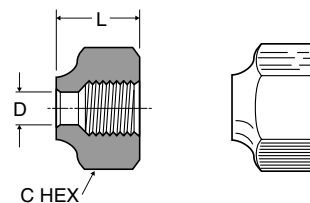

\*Comes standard with thread protectors



**Short Forged Reducing Nuts 14FS**

PART NO.	TUBE SIZE	STRAIGHT THREAD	C HEX	D	L
14FS-6-4	3/8 to 1/4	5/8-18	13/16	.257	.74
14FS-8-6	1/2 to 3/8	3/4-16	15/16	.382	.86
14FS-10-8	5/8 to 1/2	7/8-14	1-1/16	.507	.99

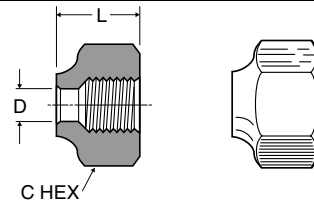

**Swivel Nut Valve Connector 14FSV**

Ref. SAE 010108

PART NO.	TUBE SIZE	STRAIGHT THREAD	C HEX	L
14FSV-4	1/4	7/16-20	5/8	1.31
14FSV-6	3/8	5/8-18	13/16	1.50
14FSV-8	1/2	3/4-16	15/16	1.75
14FSV-10	5/8	7/8-14	1-1/16	2.00

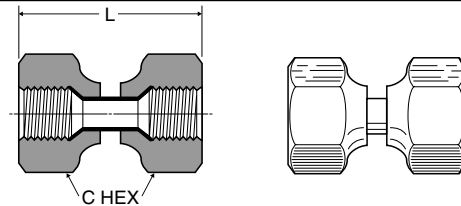

**E**

**Flare Adapter US5**

PART NO.	TUBE SIZE	STRAIGHT THREAD	C HEX	L
US5-4	1/4	7/16-20	5/8	1.50
US5-6	3/8	5/8-18	13/16	1.58
US5-8	1/2	3/4-16	15/16	1.80
US5-10	5/8	7/8-14	1-1/16	2.18

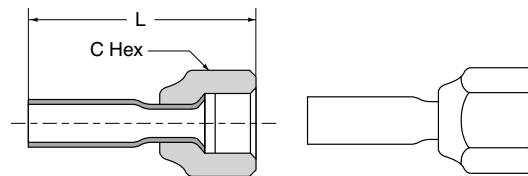

**Long Nut 41FL**

Ref. SAE 010111

PART NO.	TUBE SIZE	STRAIGHT THREAD	C HEX	D	L
41FL-2	1/8	5/16-24	3/8	.133	.75
41FL-3	3/16	3/8-24	7/16	.195	.81
41FL-4	1/4	7/16-20	9/16	.257	.94
41FL-5	5/16	1/2-20	5/8	.320	1.12
41FL-6	3/8	5/8-18	3/4	.382	1.31
41FL-8	1/2	3/4-16	7/8	.507	1.62
41FL-10	5/8	7/8-14	1-1/16	.632	1.88
41FL-12*	3/4	1-1/16-14	1-1/4	.757	2.19

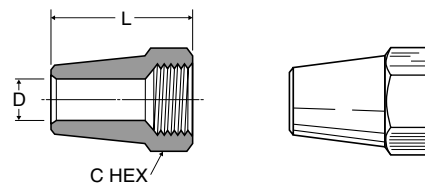

**Short Nut 41FS / Shorter Nut 41FX**

Ref. SAE 010110

PART NO.	TUBE SIZE	STRAIGHT THREAD	C HEX	D	L
41FS-2	1/8	5/16-24	3/8	.132	.50
41FS-3	3/16	3/8-24	7/16	.195	.62
41FS-4	1/4	7/16-20	9/16	.257	.75
41FS-5	5/16	1/2-20	5/8	.320	.88
41FS-6	3/8	5/8-18	3/4	.382	1.00
41FX-6	3/8	5/8-18	3/4	.382	.91
41FS-8	1/2	3/4-16	7/8	.507	1.12
41FX-8	1/2	3/4-16	7/8	.507	1.00
41FS-10	5/8	7/8-14	1-1/16	.632	1.31
41FX-10	5/8	7/8-14	1-1/16	.632	1.06
41FX-12	3/4	1-1/16-14	1-1/4	.757	1.17
41FS-12*	3/4	1-1/16-14	1-1/4	.757	1.50
41FS-14*	7/8	1-1/4-12	1-1/2	.882	1.62

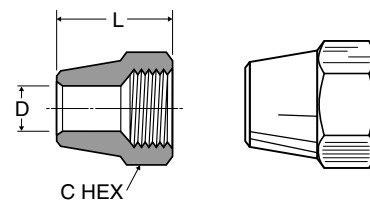

\*Comes standard with thread protectors

**Reducing Nuts 41FS**

PART NO.	TUBE SIZE	STRAIGHT THREAD	C HEX	D	L
41FS-6-4	3/8 to 1/4	5/8-18	3/4	.257	1.00
41FS-8-6	1/2 to 3/8	3/4-16	7/8	.382	1.09
41FS-10-8	5/8 to 1/2	7/8-14	1-1/16	.507	1.25

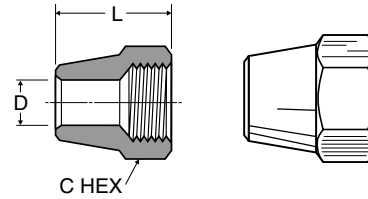

**Union 42F**

Ref. SAE 010101 \*Thread Protectors

PART NO.	TUBE SIZE	STRAIGHT THREAD	C HEX	L	D
42F-2	1/8	5/16-24	5/16	.90	.079
42F-3	3/16	3/8-24	3/8	1.04	.125
42F-4	1/4	7/16-20	7/16	1.17	.189
42F-5	5/16	1/2-20	1/2	1.32	.220
42F-6	3/8	5/8-18	5/8	1.48	.282
42F-8	1/2	3/4-16	3/4	1.79	.407
42F-10	5/8	7/8-14	7/8	2.10	.501
42F-12*	3/4	1-1/16-14	1-1/16	2.42	.626
42F-14*	7/8	1-1/4-12	1-1/4	2.72	.751

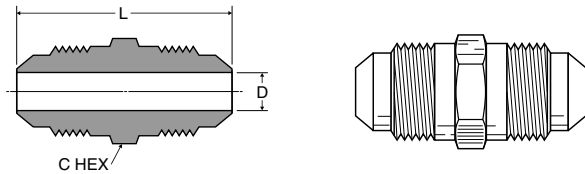

**Union Reducers 42F**

Ref. SAE 010101

PART NO.	1 TUBE SIZE	2 TUBE SIZE	1 STRAIGHT THREAD	2 STRAIGHT THREAD	C HEX	L	FLOW DIA. D1	FLOW DIA. D2
42F-6-4	1/4	3/8	7/16-20	5/8-18	5/8	1.36	.189	.282
42F-6-5	5/16	3/8	1/2-20	5/8-18	5/8	1.42	.220	.282
42F-8-4	1/4	1/2	7/16-20	3/4-16	3/4	1.54	.189	.407
42F-8-6	3/8	1/2	5/8-18	3/4-16	3/4	1.67	.282	.407
42F-10-6	3/8	5/8	5/8-18	7/8-14	7/8	1.86	.282	.501
42F-10-8	1/2	5/8	3/4-16	7/8-14	7/8	1.98	.407	.501

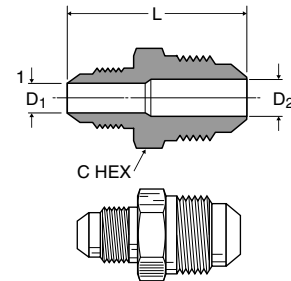

**Flare to Solder 43F**

Ref. SAE 010104

PART NO.	TUBE SIZE	SOLDER OD	STRAIGHT THREAD	C HEX	L	FLOW DIA. D
43F-4-4	1/4	1/4	7/16-20	7/16	.98	.189
43F-4-5	1/4	5/16	7/16-20	7/16	.98	.189
43F-4-6	1/4	3/8	7/16-20	1/2	.98	.189
43F-6-4	3/8	1/4	5/8-18	5/8	1.17	.189
43F-6-5	3/8	5/16	5/8-18	5/8	1.17	.252
43F-6-6	3/8	3/8	5/8-18	5/8	1.17	.282
43F-6-8	3/8	1/2	5/8-18	5/8	1.23	.282
43F-6-10	3/8	5/8	5/8-18	3/4	1.36	.282
43F-8-6	1/2	3/8	3/4-16	3/4	1.36	.314
43F-8-8	1/2	1/2	3/4-16	3/4	1.42	.407
43F-8-10	1/2	5/8	3/4-16	3/4	1.54	.407
43F-10-8	5/8	1/2	7/8-14	7/8	1.60	.440
43F-10-10	5/8	5/8	7/8-14	7/8	1.73	.501
43F-10-12*	5/8	3/4	7/8-14	7/8	1.86	.501
43F-10-14*	5/8	7/8	7/8-14	1	1.98	.501
43F-12-12*	3/4	3/4	1-1/16-14	1-1/16	2.04	.626
43F-12-14*	3/4	7/8	1-1/16-14	1-1/16	2.17	.626

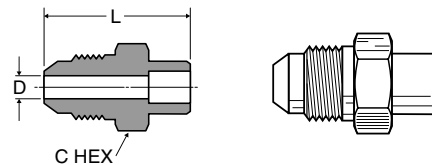

\*Comes standard with thread protectors

**Female Connector 46F**

Ref. SAE 010103

PART NO.	TUBE SIZE	PIPE THREAD	STRAIGHT THREAD	C HEX	L	FLOW DIA. D
46F-2-2	1/8	1/8	5/16-24	9/16	.91	.078
46F-3-2	3/16	1/8	3/8-24	9/16	.95	.125
46F-4-2	1/4	1/8	7/16-20	9/16	1.01	.189
46F-4-4	1/4	1/4	7/16-20	11/16	1.23	.189
46F-4-6	1/4	3/8	7/16-20	13/16	1.26	.189
46F-5-2	5/16	1/8	1/2-20	9/16	1.05	.220
46F-5-4	5/16	1/4	1/2-20	11/16	1.26	.220
46F-6-2	3/8	1/8	5/8-18	5/8	1.10	.282
46F-6-4	3/8	1/4	5/8-18	11/16	1.29	.282
46F-6-6	3/8	3/8	5/8-18	13/16	1.36	.282
46F-6-8	3/8	1/2	5/8-18	1	1.60	.282
46F-8-4	1/2	1/4	3/4-16	3/4	1.39	.407
46F-8-6	1/2	3/8	3/4-16	13/16	1.48	.407
46F-8-8	1/2	1/2	3/4-16	1	1.73	.407
46F-8-12*	1/2	3/4	3/4-16	1-1/4	1.79	.407
46F-10-6	5/8	3/8	7/8-14	7/8	1.57	.501
46F-10-8	5/8	1/2	7/8-14	1	1.80	.501
46F-10-12*	5/8	3/4	7/8-14	1-1/4	1.89	.501

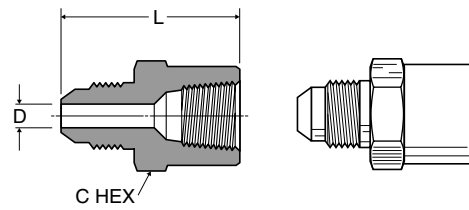

E

**Male Connector 48F**

Ref. SAE 010102

PART NO.	TUBE SIZE	PIPE THREAD	STRAIGHT THREAD	C HEX	L	FLOW DIA. D
48F-2-2	1/8	1/8	5/16-24	7/16	.91	.078
48F-3-2	3/16	1/8	3/8-24	7/16	.98	.125
48F-3-4	3/16	1/4	3/8-24	9/16	1.17	.125
48F-4-2	1/4	1/8	7/16-20	7/16	1.04	.189
48F-4-4	1/4	1/4	7/16-20	9/16	1.23	.189
48F-4-6	1/4	3/8	7/16-20	11/16	1.29	.189
48F-4-8	1/4	1/2	7/16-20	7/8	1.54	.189
48F-5-2	5/16	1/8	1/2-20	1/2	1.14	.220
48F-5-4	5/16	1/4	1/2-20	9/16	1.32	.220
48F-5-6	5/16	3/8	1/2-20	11/16	1.36	.220
48F-6-2	3/8	1/8	5/8-18	5/8	1.23	.220
48F-6-4	3/8	1/4	5/8-18	5/8	1.42	.282
48F-6-6	3/8	3/8	5/8-18	11/16	1.42	.282
48F-6-8	3/8	1/2	5/8-18	7/8	1.67	.282
48F-6-12*	3/8	3/4	5/8-18	1-1/16	1.79	.282
48F-8-4	1/2	1/4	3/4-16	3/4	1.60	.407
48F-8-6	1/2	3/8	3/4-16	3/4	1.60	.407
48F-8-8	1/2	1/2	3/4-16	7/8	1.79	.407
48F-8-12	1/2	3/4	3/4-16	1-1/16	1.92	.407
48F-10-4	5/8	1/4	7/8-14	7/8	1.79	.313
48F-10-6	5/8	3/8	7/8-14	7/8	1.79	.408
48F-10-8	5/8	1/2	7/8-14	7/8	1.98	.501
48F-10-12*	5/8	3/4	7/8-14	1-1/16	2.04	.501
48F-12-8*	3/4	1/2	1-1/16-14	1-1/16	2.17	.626
48F-12-12*	3/4	3/4	1-1/16-14	1-1/16	2.17	.626
48F-14-12*	7/8	3/4	1-1/4-12	1-1/4	2.35	.751

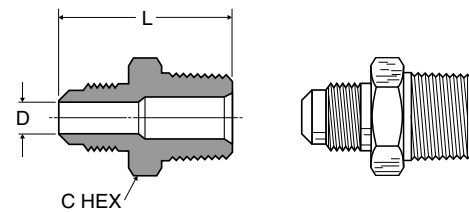

**Flare to Metric Adaptor 48F-X-MIX**

PART NUMBER	TUBE SIZE	METRIC THREAD	HEX	L	D
48F-8-M16	1/2	M16 X 1.5	7/8	1.60	.35
48F-10-M127	5/8	M27 x 2.0	1 1/4	1.87	.50
48F-12-M127*	3/4	M27 x 2.0	1 1/4	1.99	.63

Note: Fluorocarbon o-ring is standard

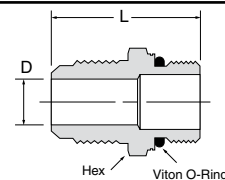

\*Comes standard with thread protectors



**Flare to SAE Straight Thread 485F**

PART NO.	TUBE SIZE	STRAIGHT THREAD	HEX	L	FLOW DIA. D
485F-12-8*	3/4	3/4-16	1 1/16	1.80	.397
485F-12-12*	3/4	1 1/16-12	1 1/4	2.03	.615

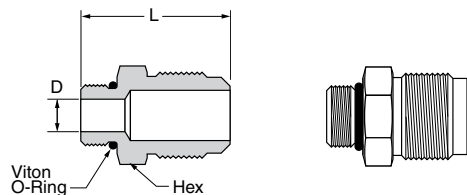

**Union Tee 144F-244F**

Ref. SAE 010401

PART NO.	TUBE SIZE	STRAIGHT THREAD	L	M	FLOW DIA. D
144F-3	3/16	3/8-24	1.46	.73	.125
144F-4	1/4	7/16-20	1.72	.86	.189
244F-4	1/4	7/16-20	1.72	.86	.189
144F-5	5/16	1/2-20	1.82	.91	.220
144F-6	3/8	5/8-18	2.08	1.04	.282
144F-8	1/2	3/4-16	2.46	1.23	.407
144F-10	5/8	7/8-14	2.78	1.39	.501

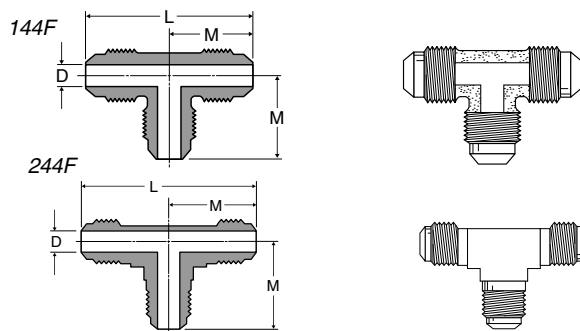

**Union Tee 144F-244F combination sizes**

PART NO.	1 TUBE SIZE	2 TUBE SIZE	3 TUBE SIZE	L	M	M1	FLOW DIA. D
144F-6-6-4	3/8	3/8	1/4	2.08	1.04	.89	.189
144F-8-8-6	1/2	1/2	3/8	2.40	1.20	1.10	.282

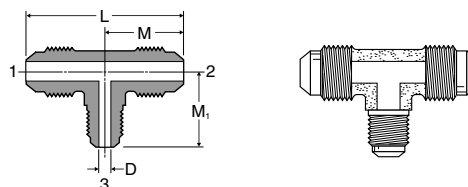

**Male Branch Tee 145F**

Ref. SAE 010425

PART NO.	TUBE SIZE	PIPE THREAD	STRAIGHT THREAD	L	M	N	FLOW DIA. D
145F-2-2	1/8	1/8	5/16-24	1.26	.63	.69	.079
145F-4-2	1/4	1/8	7/16-20	1.58	.79	.76	.189
145F-4-4	1/4	1/4	7/16-20	1.78	.89	.92	.189
145F-5-4	5/16	1/4	1/2-20	1.90	.95	.96	.220
145F-6-4	3/8	1/4	5/8-18	1.96	.98	1.05	.282
145F-6-6	3/8	3/8	5/8-18	2.00	1.00	.98	.282
145F-6-8	3/8	1/2	5/8-18	2.28	1.14	1.26	.282
145F-8-6	1/2	3/8	3/4-16	2.40	1.20	1.10	.407
145F-8-8	1/2	1/2	3/4-16	2.46	1.23	1.36	.407
145F-10-8	5/8	1/2	7/8-14	2.78	1.39	1.36	.501

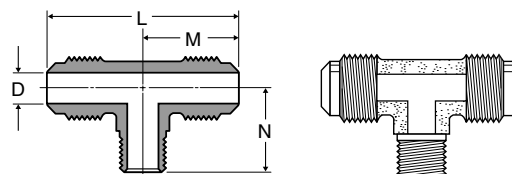

**Cross 147F**

Ref. SAE 010501

PART NO.	TUBE SIZE	STRAIGHT THREAD	M	FLOW DIA. D
147F-6	3/8	5/8-18	1.04	.282

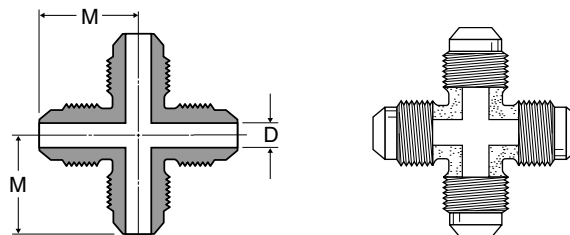

\*Comes standard with thread protectors





**Male Elbow 149F-249F**

Ref. SAE 010202

PART NO.	TUBE SIZE	PIPE THREAD	STRAIGHT THREAD	M	N	FLOW DIA. D
149F-2-2	1/8	1/8	5/16-24	.63	.69	.079
149F-3-2	3/16	1/8	3/8-24	.75	.75	.125
249F-3-2	3/16	1/8	3/8-24	.73	.73	.125
149F-4-2	1/4	1/8	7/16-20	.79	.76	.189
249F-4-2	1/4	1/8	7/16-20	.79	.76	.189
149F-4-4	1/4	1/4	7/16-20	.89	.92	.189
249F-4-4	1/4	1/4	7/16-20	.89	.92	.189
149F-4-6	1/4	3/8	7/16-20	.92	1.01	.189
249F-4-6	1/4	3/8	7/16-20	.92	1.01	.189
149F-4-8	1/4	1/2	7/16-20	1.02	1.26	.189
149F-5-2	5/16	1/8	1/2-20	.90	.79	.220
249F-5-2	5/16	1/8	1/2-20	.89	.77	.220
149F-5-4	5/16	1/4	1/2-20	.95	.95	.220
249F-5-4	5/16	1/4	1/2-20	.95	.92	.220
149F-5-6	5/16	3/8	1/2-20	.98	1.01	.220
149F-6-2	3/8	1/8	5/8-18	1.01	.90	.282
249F-6-2	3/8	1/8	5/8-18	1.01	.89	.220
149F-6-4	3/8	1/4	5/8-18	1.01	1.05	.282
249F-6-4	3/8	1/4	5/8-18	.98	1.04	.282
149F-6-6	3/8	3/8	5/8-18	1.04	1.07	.282
249F-6-6	3/8	3/8	5/8-18	1.04	1.07	.282
149F-6-8	3/8	1/2	5/8-18	1.15	1.26	.282
249F-6-8	3/8	1/2	5/8-18	1.14	1.26	.282
149F-6-12*	3/8	3/4	5/8-18	1.25	1.38	.282
149F-8-4	1/2	1/4	3/4-16	1.20	1.17	.407
149F-8-6	1/2	3/8	3/4-16	1.20	1.10	.407
249F-8-6	1/2	3/8	3/4-16	1.20	1.10	.407
149F-8-8	1/2	1/2	3/4-16	1.28	1.38	.407
249F-8-8	1/2	1/2	3/4-16	1.26	1.36	.407
149F-8-12*	1/2	3/4	3/4-16	1.38	1.38	.407
149F-10-4	5/8	1/4	7/8-14	1.41	1.25	.501
149F-10-6	5/8	3/8	7/8-14	1.41	1.25	.501
149F-10-8	5/8	1/2	7/8-14	1.40	1.39	.501
249F-10-8	5/8	1/2	7/8-14	1.39	1.36	.501
149F-10-12*	5/8	3/4	7/8-14	1.42	1.48	.501
149F-12-8*	3/4	1/2	1-1/16-14	1.60	1.48	.626
149F-12-12*	3/4	3/4	1-1/16-14	1.60	1.62	.626
149F-14-12*	7/8	3/4	1-1/4-12	1.73	1.67	.751

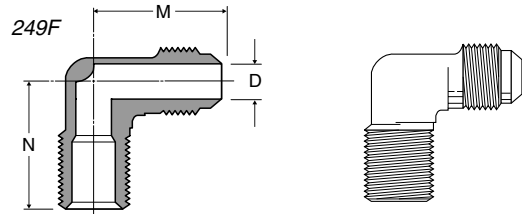
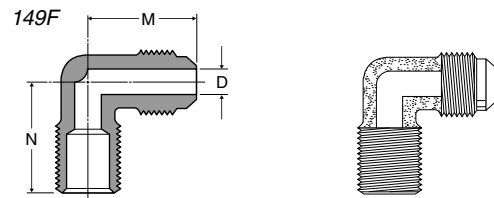

E

**Flare Elbow to SAE Metric Straight Thread 149F-X-MIX**

PART NUMBER	TUBE SIZE	METRIC THREAD	L	M	N	N1	D
149F-10-MI27	5/8	M27 x 2.0	1.95	1.46	2.12	1.63	.501

Note: Fluorocarbon o-ring is standard

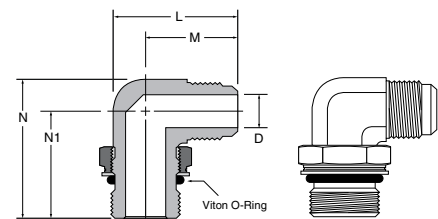

**Flare Elbow to SAE Straight Thread 1495F**

PART NO.	TUBE SIZE	STRAIGHT THREAD	HEX	L	N	FLOW DIA. D
1495F-12-8*	3/4	3/4-16	7/8	1.60	1.60	.398
1495F-12-12*	3/4	1-1/16-12	1 1/4	1.59	2.12	.616

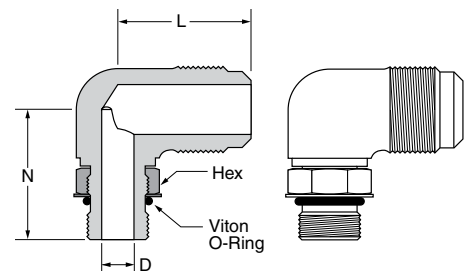

\*Comes standard with thread protectors



**Female Elbow 150F**

Ref. SAE 010203

PART NO.	TUBE SIZE	PIPE THREAD	STRAIGHT THREAD	M	N	FLOW DIA. D
150F-4-2	1/4	1/8	7/16-20	.86	.50	.189
150F-4-4	1/4	1/4	7/16-20	.95	.64	.189
150F-5-4	5/16	1/4	1/2-20	1.01	.64	.220
150F-6-2	3/8	1/8	5/8-18	1.08	.48	.282
150F-6-4	3/8	1/4	5/8-18	1.07	.67	.282
150F-6-6	3/8	3/8	5/8-18	1.14	.67	.282
150F-6-8	3/8	1/2	5/8-18	1.23	.86	.282
150F-8-6	1/2	3/8	3/4-16	1.25	.69	.407
150F-8-8	1/2	1/2	3/4-16	1.36	.92	.407
150F-8-12	1/2	3/4	3/4-16	1.51	.92	.407
150F-10-8*	5/8	1/2	7/8-14	1.48	.98	.501
150F-10-12*	5/8	3/4	7/8-14	1.64	.98	.501

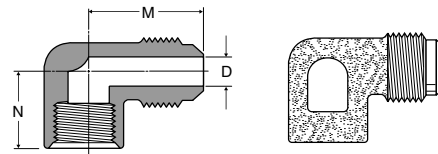

**Male Run Tee 151F**

Ref. SAE 010424

PART NO.	TUBE SIZE	PIPE THREAD	STRAIGHT THREAD	M	N	FLOW DIA. D
151F-4-2	1/4	1/8	7/16-20	.86	.76	.189
151F-4-4	1/4	1/4	7/16-20	.92	.89	.189
151F-5-4	5/16	1/4	1/2-20	.92	.95	.220
151F-6-4	3/8	1/4	5/8-18	1.04	1.04	.282
151F-6-6	3/8	3/8	5/8-18	.98	1.00	.282
151F-6-8	3/8	1/2	5/8-18	1.26	1.16	.282
151F-8-6	1/2	3/8	3/4-16	1.20	1.10	.407
151F-8-8	1/2	1/2	3/4-16	1.36	1.23	.407
151F-10-8	5/8	1/2	7/8-14	1.36	1.39	.501

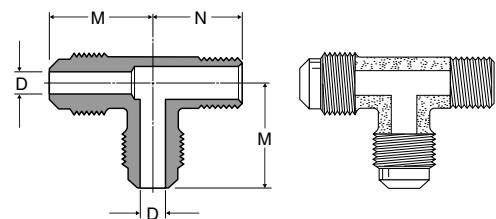

**Union Elbow 155F**

Ref. SAE 010201

PART NO.	TUBE SIZE	STRAIGHT THREAD	M	FLOW DIA. D
155F-2	1/8	5/16-24	.64	.079
155F-3	3/16	3/8-24	.73	.125
155F-4	1/4	7/16-20	.86	.189
155F-5	5/16	1/2-20	.92	.220
155F-6	3/8	5/8-18	1.04	.282
155F-8	1/2	3/4-16	1.20	.407
155F-10	5/8	7/8-14	1.39	.501
155F-12*	3/4	1-1/16-14	1.64	.626

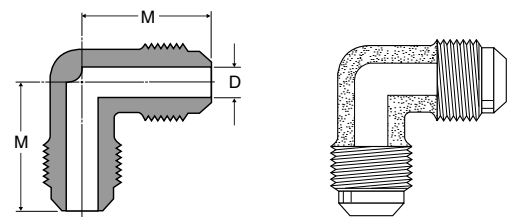

\*Comes standard with thread protectors



45° Elbow 159F-259F

Ref. SAE 010302

PART NO.	TUBE SIZE	PIPE THREAD	STRAIGHT THREAD	M	N	FLOW DIA. D
159F-4-2	1/4	1/8	7/16-20	.78	.56	.189
259F-4-2	1/4	1/8	7/16-20	.65	.62	.189
159F-4-4	1/4	1/4	7/16-20	.75	.84	.189
259F-4-4	1/4	1/4	7/16-20	.73	.84	.189
159F-5-2	5/16	1/8	1/2-20	.76	.65	.220
159F-5-4	5/16	1/4	1/2-20	.75	.81	.220
159F-6-2	3/8	1/8	5/8-18	.89	.67	.282
159F-6-4	3/8	1/4	5/8-18	.89	.86	.282
259F-6-4	3/8	1/4	5/8-18	.91	.86	.282
159F-6-6	3/8	3/8	5/8-18	.91	.93	.282
259F-6-6	3/8	3/8	5/8-18	.91	.93	.282
159F-8-4	1/2	1/4	3/4-16	1.06	.95	.407
159F-8-6	1/2	3/8	3/4-16	1.06	.95	.407
259F-8-6	1/2	3/8	3/4-16	1.04	.93	.407
159F-8-8	1/2	1/2	3/4-16	1.12	1.16	.407
159F-10-6	5/8	3/8	7/8-14	1.13	.95	.501
259F-10-6	5/8	3/8	7/8-14	1.20	1.15	.501
159F-10-8	5/8	1/2	7/8-14	1.21	1.16	.501
259F-10-8	5/8	1/2	7/8-14	1.21	.98	.501
159F-12-8*	3/4	1/2	1-1/16-14	1.28	1.16	.626

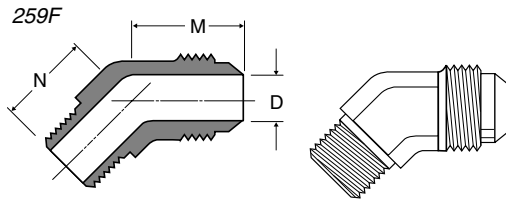
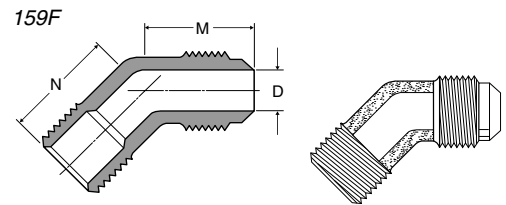

45° Flare Elbow to SAE Metric Straight Thread 159F-X-MIX

PART NUMBER	TUBE SIZE	METRIC THREAD	HEX	M	N	D
159F-8-MII6	1/2	M16 X 1.5	22mm	1.10	1.16	.36
159F-10-MI27	5/8	M27 x 2.0	1 1/4	1.21	1.50	.50

Note: Fluorocarbon o-ring is standard

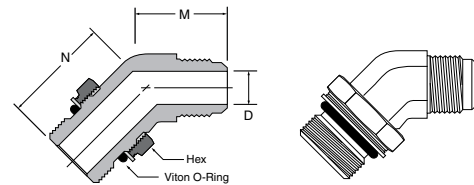

45° Flare to SAE Straight Thread 1595F

PART NO.	TUBE SIZE	STRAIGHT THREAD	HEX	L	N	FLOW DIA. D
1595F-8-8	1/2	3/4-16	7/8	1.00	1.16	.398
1595F-12-8*	3/4	3/4-16	7/8	1.41	1.30	.398
1595F-12-12*	3/4	1 1/16-12	1 1/4	1.41	1.45	.615

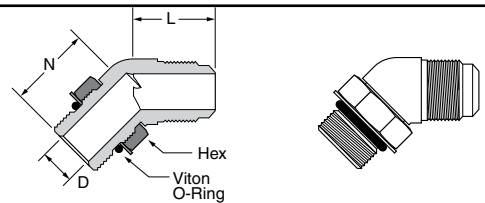

90° Swivel Elbow 166FSV

PART NO.	TUBE SIZE	STRAIGHT THREAD	C HEX	M	N	FLOW DIA. D
166FSV-4-4	1/4	7/16-20	9/16	.86	.93	.189
166FSV-6-6	3/8	5/8-18	3/4	1.04	1.12	.282
166FSV-8-8	1/2	3/4-16	7/8	1.20	1.29	.407
166FSV-10-10	5/8	7/8-14	1	1.39	1.50	.501
166FSV-12-12*	3/4	1-1/16-14	1-1/4	1.60	1.83	.626

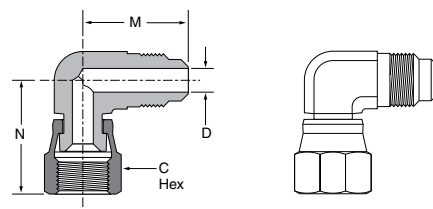

Adapter Tee 256F

PART NO.	TUBE SIZE	PIPE THREAD	STRAIGHT THREAD	M	N	N1	FLOW DIA. D
256F-4-2	1/4	1/8	7/16-20	.86	.77	.47	.220

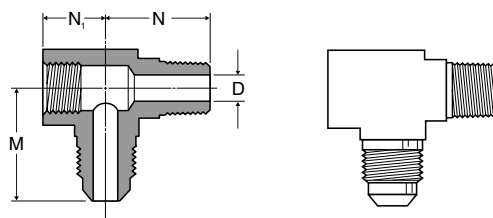

\*Comes standard with thread protectors

**Flared Seal Plug 639F**

Ref. SAE 010109

PART NO.	TUBE SIZE	STRAIGHT THREAD	C HEX	L
639F-4	1/4	7/16-20	7/16	.69
639F-5	5/16	1/2-20	1/2	.78
639F-6	3/8	5/8-18	5/8	.88
639F-8	1/2	3/4-16	3/4	1.06
639F-10	5/8	7/8-14	7/8	1.19

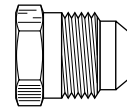
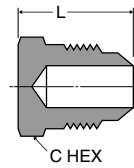

**Cap Nut 640F**

Ref. SAE 010112

PART NO.	TUBE SIZE	STRAIGHT THREAD	C HEX	L
640F-3†	3/16	3/8-24	1/2	.47
640F-4†	1/4	7/16-20	9/16	.53
640F-5†	5/16	1/2-20	5/8	.62
640F-6†	3/8	5/8-18	3/4	.69
640F-8†	1/2	3/4-16	7/8	.84
640F-10†	5/8	7/8-14	1-1/16	.97

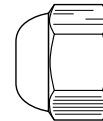
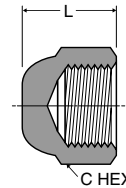

**Flared Union—Female Flare to Female Flare 660FHD**

Ref. SAE 010107

PART NO.	TUBE SIZE	STRAIGHT THREAD	C HEX	L	FLOW DIA. D
660FHD-4†	1/4	7/16-20	5/8	.98	.251
660FHD-6†	3/8	5/8-18	13/16	1.24	.376
660FHD-8†	1/2	3/4-16	15/16	1.43	.501
660FHD-10†	5/8	7/8-14	1-1/16	1.67	.626

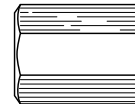
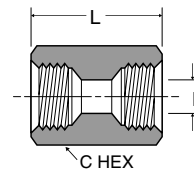

**Reducer—Male Flare to Female Flare 661FHD**

Ref. SAE 010105

PART NO.	1 TUBE SIZE	2 TUBE SIZE	1 STRAIGHT THREAD	2 STRAIGHT THREAD	C HEX	L	FLOW DIA. D
661FHD-4-6†	1/4	3/8	7/16-20	5/8-18	13/16	1.20	.189
661FHD-4-8†	1/4	1/2	7/16-20	3/4-16	15/16	1.36	.189
661FHD-6-4†	3/8	1/4	5/8-18	7/16-20	5/8	1.10	.282
661FHD-6-8†	3/8	1/2	5/8-18	3/4-16	15/16	1.42	.282
661FHD-8-6†	1/2	3/8	3/4-16	5/8-18	13/16	1.39	.407
661FHD-8-10†	1/2	5/8	3/4-16	7/8-14	1-1/16	1.67	.407
661FHD-10-8†	5/8	1/2	7/8-14	3/4-16	15/16	1.60	.501
661FHD-10-12**	5/8	3/4	7/8-14	1-1/16-14	1-5/16	1.95	.501
661FHD-12-10**	3/4	5/8	1-1/16-14	7/8-14	1-1/16	1.86	.626

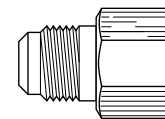
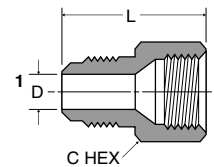

**Female Flare to Male Pipe Thread 664FHD**

Ref. SAE 010106

PART NO.	TUBE SIZE	PIPE THREAD	STRAIGHT THREAD	C HEX	L	FLOW DIA. D
664FHD-4-2†	1/4	1/8	7/16-20	5/8	.91	.220
664FHD-4-4†	1/4	1/4	7/16-20	5/8	1.01	.252
664FHD-6-4†	3/8	1/4	5/8-18	13/16	1.28	.345
664FHD-8-6†	1/2	3/8	3/4-16	15/16	1.31	.407

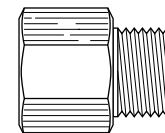
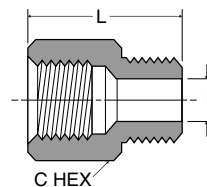

†Should be used with 2GF copper flare gasket.

\*Comes standard with thread protectors



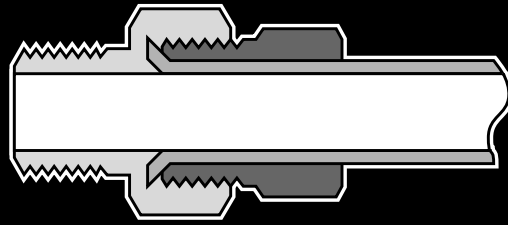

## Inverted Flared Fittings

E

### Advantages

Built to resist mechanical pullout. This economical fitting can be assembled and disassembled repeatedly. Readily available in a broad selection of styles to fill your specific needs. Manufactured from CA 360 or CA 345 brass.

### Specifications

Listed with Underwriter's Laboratories for flammable liquid and gas. Meets functional requirements of SAE, J512. Refer to list of UL listed fittings on page N10 for specific configurations.

### Applications

Use with copper, brass, aluminum and welded steel hydraulic tubing that can be flared. Manufactured especially for hard-to-hold liquids and gases.

### Working Pressure Ranges

Temperature and type of tubing used are important factors. However, the following table is a good guide for proper selection. Temperature 73°F with copper tubing:

PSI	TUBE O.D. (IN.)	TUBE WALL (IN.)
2800	1/8	.030
1900	3/16	.030
1400	1/4	.030
1200	5/16	.032
1000	3/8	.032
750	1/2	.032
650	5/8	.035
550	3/4	.035

### Temperature Ranges

From -65° to +250°F.

### Vibration

Will withstand minimal vibration movements.

### Assembly Instructions

1. Cut tubing squarely and clean tube end thoroughly to remove burrs.
2. Place nut onto tube. Place threaded end of nut toward end of tube.
3. On thin wall copper, welded or brazed tubing, use double flare to prevent pinch-off or cracked flares.
4. Clamp tube flare between nut and flare seat of body by screwing nut on finger-tight. Tighten with a wrench an additional 1/4 turn for a metal-to-metal seal.

Note: The seat dimensions are predicated on practical threading limitations and use of these fittings with double flared tubing.

### Order

By part number and name. Bodies and nuts are separate items and individual part numbers must be indicated when ordered.

### Nomenclature

Part numbers are constructed from symbols that identify the style and size of the fitting. The first series of numbers and letters identifies the style and type fitting. The second series of numbers describes the size.

#### Example:

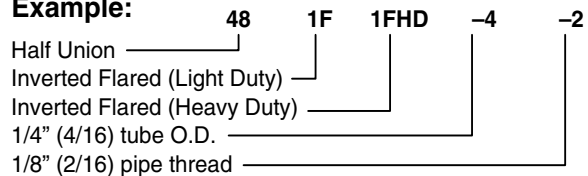

### Sizes

Tube sizes are determined by the numbers of sixteenths of an inch in the tube O.D.

### Special Fittings

Fitting configurations and/or sizes other than those shown in the catalog can be furnished. It is suggested that a print or sketch be submitted with the inquiry. Special UL stamped fittings are available. Please consult price list.

### Pricing

Only items priced in current supplementary price list PL3501 are carried in stock. Price and delivery for non-stock items furnished on request for specified quantity.

**Nut 41IF**

Ref. SAE 040110

PART NO.	TUBE SIZE	STRAIGHT THREAD	C HEX	L	D
41IF-2	1/8	5/16-28	5/16	.52	.133
41IF-3	3/16	3/8-24	3/8	.56	.196
41IF-4	1/4	7/16-24	7/16	.56	.259
41IF-5	5/16	1/2-20	1/2	.62	.321
41IF-6	3/8	5/8-18	5/8	.66	.384
41IF-8	1/2	3/4-18	3/4	.74	.508

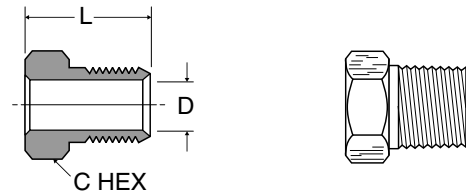

**Steel Nut-Zinc Chromate 41IFS**

Ref. SAE 040110

PART NO.	TUBE SIZE	STRAIGHT THREAD	C HEX	L	D
41IFS-3	3/16	3/8-24	3/8	.56	.196
41IFS-4	1/4	7/16-24	7/16	.56	.259
41IFS-5	5/16	1/2-20	1/2	.62	.321
41IFS-6	3/8	5/8-18	5/8	.66	.384
41IFS-8	1/2	3/4-18	3/4	.74	.508
41IFS-10	5/8	7/8-18	7/8	.80	.633
41IFS-12	3/4	1-1/16-16	1-1/16	.88	.759

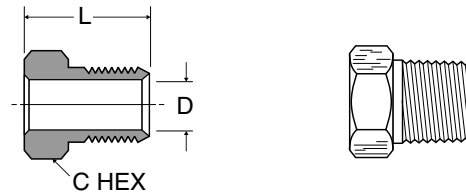

**Piloted Nut 41IFF for Single Flared Tubing**

Ref. SAE 040110

PART NO.	TUBE SIZE	STRAIGHT THREAD	C HEX	L	D
41IFF-2	1/8	5/16-28	5/16	.52	.133
41IFF-3	3/16	3/8-24	3/8	.56	.196
41IFF-4	1/4	7/16-24	7/16	.56	.259
41IFF-5	5/16	1/2-20	1/2	.62	.321
41IFF-6	3/8	5/8-18	5/8	.66	.384
41IFF-8	1/2	3/4-18	3/4	.74	.508

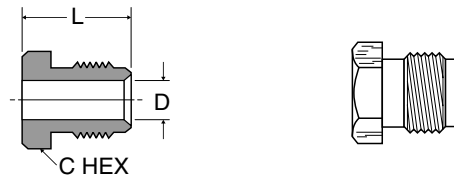

**Union 42IFHD**

Ref. SAE 040101

PART NO.	TUBE SIZE	STRAIGHT THREAD	C HEX	L	D
42IFHD-2	1/8	5/16-28	13/32	.60	.078
42IFHD-3	3/16	3/8-24	15/32	.63	.125
42IFHD-4	1/4	7/16-24	17/32	.63	.189
42IFHD-5	5/16	1/2-20	19/32	.71	.220
42IFHD-6	3/8	5/8-18	3/4	.81	.282
42IFHD-8	1/2	3/4-18	29/32	.92	.407

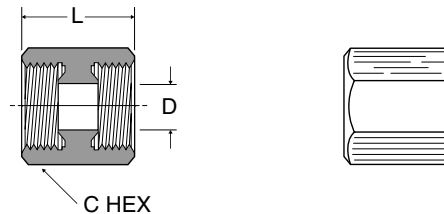

**Female Connector 46IFHD**

Ref. SAE 040103

PART NO.	TUBE SIZE	PIPE THREAD	STRAIGHT THREAD	C HEX	L	FLOW DIA. D
46IFHD-3-2	3/16	1/8	3/8-24	1/2	.76	.125
46IFHD-4-2	1/4	1/8	7/16-24	17/32	.78	.189
46IFHD-5-2	5/16	1/8	1/2-20	19/32	.79	.220
46IFHD-6-4	3/8	1/4	5/8-18	3/4	1.04	.282
46IFHD-8-6	1/2	3/8	3/4-18	29/32	1.10	.407

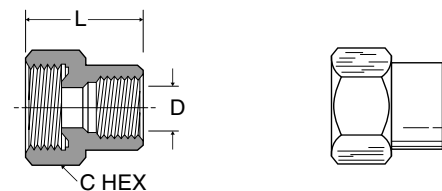

**Male Connector 48IFHD**

Ref. SAE 040102

PART NO.	TUBE SIZE	PIPE THREAD	STRAIGHT THREAD	C HEX	L	FLOW DIA. D
48IFHD-2-2	1/8	1/8	5/16-28	13/32	.63	.078
48IFHD-3-2	3/16	1/8	3/8-24	15/32	.70	.125
48IFHD-4-2	1/4	1/8	7/16-24	17/32	.74	.189
48IFHD-4-4	1/4	1/4	7/16-24	9/16	.89	.189
48IFHD-5-2	5/16	1/8	1/2-20	19/32	.79	.220
48IFHD-5-4	5/16	1/4	1/2-20	19/32	.98	.220
48IFHD-6-2	3/8	1/8	5/8-18	3/4	.89	.220
48IFHD-6-4	3/8	1/4	5/8-18	3/4	1.03	.282
48IFHD-6-6	3/8	3/8	5/8-18	3/4	1.03	.282
48IFHD-8-4	1/2	1/4	3/4-18	29/32	1.07	.346
48IFHD-8-6	1/2	3/8	3/4-18	29/32	1.07	.407
48IFHD-8-8	1/2	1/2	3/4-18	29/32	1.26	.407
48IFHD-10-8	5/8	1/2	7/8-18	1-1/16	1.32	.533
48IFHD-12-12	3/4	3/4	1-1/16-16	1 1/4	1.38	.626

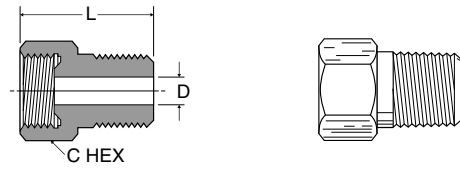

**E**

**Union Tee 244IFHD**

Ref. SAE 040401

PART NO.	TUBE SIZE	STRAIGHT THREAD	L	M	N	FLOW DIA. D
244IFHD-3	3/16	3/8-24	1.10	.55	.39	.125
244IFHD-4	1/4	7/16-24	1.13	.56	.42	.189
244IFHD-5	5/16	1/2-20	1.26	.63	.45	.220
244IFHD-6	3/8	5/8-18	1.48	.74	.56	.282
244IFHD-8	1/2	3/4-18	1.76	.88	.67	.407

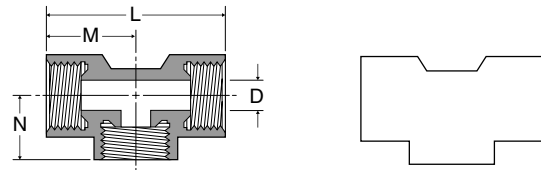

**Male Branch Tee 245IFHD**

Ref. SAE 040425

PART NO.	TUBE SIZE	PIPE THREAD	STRAIGHT THREAD	L	M	N	FLOW DIA. D
245IFHD-4-2	1/4	1/8	7/16-24	.85	.43	.64	.189
245IFHD-6-4	3/8	1/4	5/8-18	1.17	.58	.94	.282

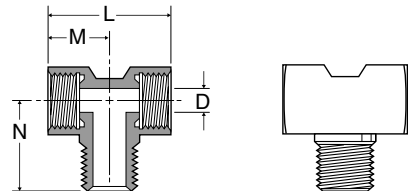

**Male Elbow 249IFHD-249IF**

Ref. SAE 040202

PART NO.	TUBE SIZE	PIPE THREAD	STRAIGHT THREAD	L	M	N	FLOW DIA. D
249IFHD-2-2	1/8	1/8	5/16-28	.79	.25	.58	.078
249IFHD-3-2	3/16	1/8	3/8-24	.85	.27	.61	.125
249IFHD-4-2	1/4	1/8	7/16-24	.92	.33	.65	.189
249IFHD-4-4	1/4	1/4	7/16-24	1.10	.28	.82	.189
249IFHD-5-2	5/16	1/8	1/2-20	.98	.47	.68	.220
249IFHD-5-4	5/16	1/4	1/2-20	1.16	.45	.86	.220
249IFHD-6-2	3/8	1/8	5/8-18	1.13	.53	.76	.220
249IF-6-4†	3/8	1/4	5/8-18	1.26	.45	.92	.282
249IFHD-6-4	3/8	1/4	5/8-18	1.32	.53	.95	.282
249IFHD-6-6	3/8	3/8	5/8-18	1.32	.50	.94	.282
249IFHD-8-4	1/2	1/4	3/4-18	1.48	.59	1.02	.407
249IF-8-6+	1/2	3/8	3/4-18	1.42	.53	.99	.407
249IFHD-8-6	1/2	3/8	3/4-18	1.48	.59	1.02	.407
249IFHD-8-8	1/2	1/2	3/4-18	1.67	.66	1.22	.407
249IFHD-10-6	5/8	3/8	7/8-18	1.62	.67	1.09	.533
249IFHD-10-8	5/8	1/2	7/8-18	1.82	.67	1.29	.533

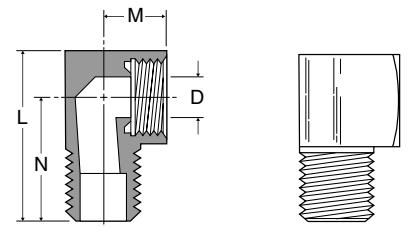

†Light Duty Series

**Female Elbow 250IFHD**

Ref. SAE 040203

PART NO.	TUBE SIZE	PIPE THREAD	STRAIGHT THREAD	M	N	FLOW DIA. D
250IFHD-3-2	3/16	1/8	3/8-24	.50	.49	.125
250IFHD-4-2	1/4	1/8	7/16-24	.53	.53	.189
250IFHD-5-2	5/16	1/8	1/2-20	.59	.59	.220
250IFHD-6-4	3/8	1/4	5/8-18	.67	.68	.282

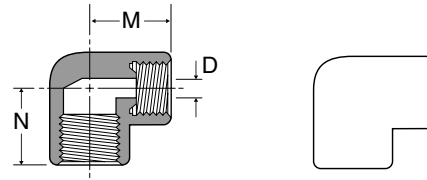

**Male Run Tee 251IFHD**

Ref. SAE 040424

PART NO.	TUBE SIZE	PIPE THREAD	STRAIGHT THREAD	M	M1	N	FLOW DIA. D
251IFHD-3-2	3/16	1/8	3/8-24	.39	.53	.72	.125
251IFHD-5-2	5/16	1/8	1/2-20	.45	.62	.85	.220
251IFHD-6-4	3/8	1/4	5/8-18	.56	.75	1.08	.282

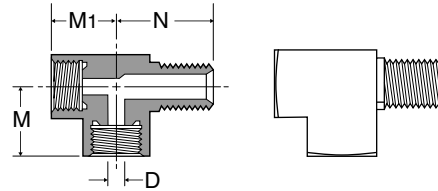

**Female Branch Tee 252IFHD**

Ref. SAE 040427

PART NO.	TUBE SIZE	PIPE THREAD	STRAIGHT THREAD	L	M	N	FLOW DIA. D
252IFHD-5-2	5/16	1/8	1/2-20	1.26	.63	.45	.220
252IFHD-6-4	3/8	1/4	5/8-18	1.48	.74	.56	.282

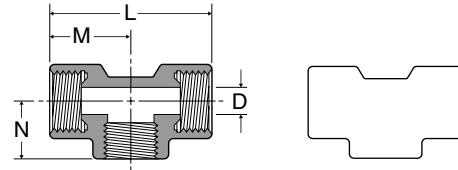

**Union Elbow 255IFHD**

PART NO.	TUBE SIZE	STRAIGHT THREAD	M	FLOW DIA. D
255IFHD-4	1/4	7/16-24	.55	.189

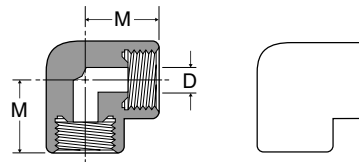

**45° Elbow 259IFHD**

Ref. SAE 040302

PART NO.	TUBE SIZE	PIPE THREAD	STRAIGHT THREAD	C HEX	L	FLOW DIA. D
259IFHD-3-2	3/16	1/8	3/8-24	17/32	.88	.125
259IFHD-4-2	1/4	1/8	7/16-24	9/16	.94	.189
259IFHD-5-2	5/16	1/8	1/2-20	5/8	1.00	.220
259IFHD-5-4	5/16	1/4	1/2-20	5/8	1.16	.220
259IFHD-6-4	3/8	1/4	5/8-18	13/16	1.34	.282
259IFHD-8-6	1/2	3/8	3/4-18	7/8	1.44	.407
259IFHD-10-8	5/8	1/2	7/8-18	1-1/16	1.75	.533

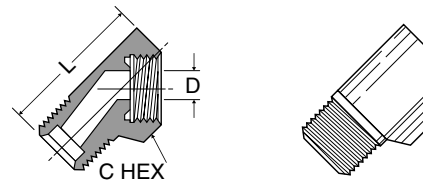



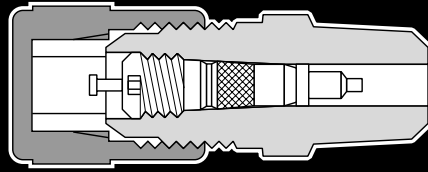

## Access Valves

E

### Advantages

Access Valves are designed to offer convenient low cost access ports for Refrigeration service. All Access Valves feature 1/4" SAE male flare access ports and are furnished with a finger tight quick seal cap. For greater flexibility, all Tees and Crosses are machined to receive an access core in all 1/4" SAE flare ends. This allows for 2 or more access connections in one fitting plus greater flexibility in the positioning of the valves. All Access Valves with pipe connections have internal ODS solder cups so that these valves may be installed in either of 2 ways.

### Applications

Access Valves may be installed in any position on either high or low side for quick testing, pressure checking, purging or charging.

### Valve Bodies

Straight Access Valve bodies are manufactured from brass rod CA360 or CA345. Shaped Access Valve bodies are manufactured from brass forge rod CA377. All Access Valve bodies are machined in accordance with ARI standard 720.

### Valve Core

Parker valve cores meet ARI standard 720 and are designed for use with all fluorocarbon refrigerants such as R-12, R-22 and R-502, R-134a and are resistant to oils, alkalies and dilute mineral acids.

### Working Pressure and Temperature Ranges

Up to 500 PSI  
-20°F to +220°F

### Order

By part number and name.

### Nomenclature

Part numbers are constructed from symbols that identify the style and size of the valve. The first series of letters identifies the style and type valve. The second series of numbers describes the size.

#### Example:

	X	AV	T1	-2
Packaged	_____	_____	_____	_____
Access Valve	_____	_____	_____	_____
Male Branch Tee	_____	_____	_____	_____
1/8" (2/16) Pipe Thread	_____	_____	_____	_____

### Sizes

Tube sizes are determined by the number of sixteenths of an inch in the tube O.D.

### Special Fittings

Fitting configurations and/or sizes other than those shown in the catalog can be furnished. It is suggested that a print or sketch be submitted with the inquiry.

### Pricing

Only items priced in current supplementary price list PL3501 are carried in stock. Price and delivery for non-stock items furnished on request for specified quantity.

**Extended Copper Tube AVUSE**

PART NO.	CONNECTION SIZE
AVUSE-2	1/8" O.D. Tube
AVUSE-3	3/16" O.D. Tube
AVUSE-4	1/4" O.D. Tube
AVUSE-5	5/16" O.D. Tube
AVUSE-6	3/8" O.D. Tube
AVUSE-8	1/2" O.D. Tube
AVUSE-9	1/8" O.D. Tube; Additional steps on body for 3/16", 1/4", 5/16", 3/8" O.D. Tube. 3/16", 1/4", or 5/16" Solder Fitting/Swaged Tube.
AVUSE-11	3/16" O.D. Tube; Additional steps on body for 1/4" or 3/8" Solder Fittings/Swaged Tubes 5/16" O.D. Tube.

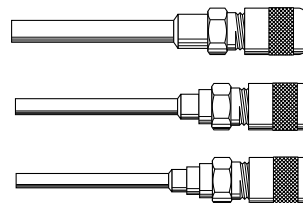

Product comes with valve core loose and should be torqued after brazing to ARI 720 standard.

**Solder Tee AVTS**

PART NO.	CONNECTION SIZE
AVTS-4	1/4" O.D. Tube or 3/8" Solder Fitting/Swaged Tube
AVTS-5	5/16" O.D. Tube or 3/8" Solder Fitting/Swaged Tube
AVTS-6	3/8" O.D. Tube or 1/2" Solder Fitting/Swaged Tube
AVTS-8	1/2" O.D. Tube or 5/8" Solder Fitting/Swaged Tube

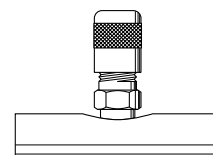

Product comes with valve core loose and should be torqued after brazing to ARI 720 standard.

**Extended Solder Tee AVTSL**

PART NO.	CONNECTION SIZE
AVTSL-6	3/8" O.D. Tube/Solder 5/16", 3/8" & 7/16" Tube

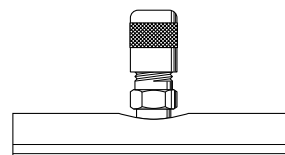

Product comes with valve core loose and should be torqued after brazing to ARI 720 standard.

**Full Union AVU2**

PART NO.	CONNECTION SIZE
AVU2-4	1/4" O.D. Flare Tube With Forged Flare Nut



**Bulkhead Union AVU2BH**

PART NO.	CONNECTION SIZE
AVU2BH-4	1/4" Bulkhead Access X 1/4" SAE With Forged Nut

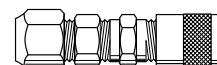

**Bulkhead Solder Union AVUS3BH**

PART NO.	CONNECTION SIZE
AVUS3BH-4	1/4" Bulkhead Access X 3 Way ODS



Product comes with valve core loose and should be torqued after brazing to ARI 720 standard.



**Forged Union Tee AVT2**

PART NO.	CONNECTION SIZE
AVT2-4	1/4" Access All Ends With 2 Forged Flare Nuts and One Core and Cap

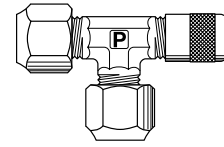

**Male Connector AVU1**

PART NO.	CONNECTION SIZE
AVU1-2	1/8" Male Pipe or 1/4" O.D. Solder
AVU1-4	1/4" Male Pipe or 5/16" O.D. Solder

Product comes with valve core loose and should be torqued after brazing to ARI 720 standard.

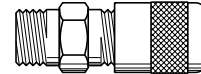

**Access Valve Assembly AVUIFI**

PART NO.	CONNECTION SIZE
AVUIFI-4	7/16-20 SAE Straight thread O-Ring Port Note: Standard o-ring is neoprene. Consult Brass Products Division for optional o-rings

Product comes with valve core loose and should be torqued after brazing to ARI 720 standard.

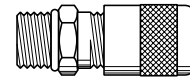

**Forged Male Elbow AVE1**

PART NO.	CONNECTION SIZE
AVE1-2	1/8" Male Pipe or 1/4" O.D. Solder

Product comes with valve core loose and should be torqued after brazing to ARI 720 standard.

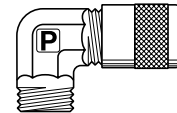

**Forged Male Run Tee AVT3**

PART NO.	CONNECTION SIZE
AVT3-2	1/8" Male Pipe or 1/4" O.D. Solder on Run x 1/4" Access on Run and Branch With One Core and Cap
AVT3-4	1/4" Male Pipe or 5/16" O.D. Solder on Run x 1/4" Access on Run and Branch With One Core and Cap

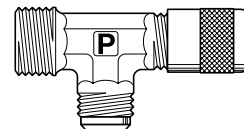

**Forged Male Cross AVC1**

PART NO.	CONNECTION SIZE
AVC1-4	1/4" Male Pipe or 5/16" O.D. Solder x 1/4" Access on all Flare Ends With One Core and Cap

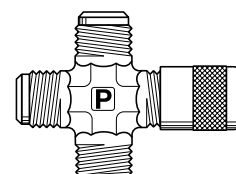

**E**

**Swivel Cross AVCS4D-4**

PART NO.	CONNECTION SIZE
AVCS4D-4	1/4" Forged Female Flare Swivel With Depressor x 1/4" Access on all Flare Ends with One Core and Cap

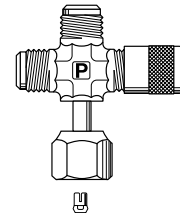

**Female Connector AVUR3**

PART NO.	CONNECTION SIZE
AVUR3-4	1/4" Female Flare with Copper Gasket

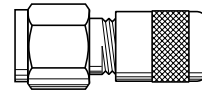

**3 Way Solder Connector AVUS3**

PART NO.	CONNECTION SIZE
AVUS3-40	For 3/16" O.D. Tube or 1/4" and 3/8" Solder Fitting/Swaged Tube

Product comes with valve core loose and should be torqued after brazing to ARI 720 standard.

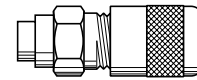

**9 Way Solder Connector AVUS3**

PART NO.	CONNECTION SIZE
AVUS3-49	For 3/16", 1/4", 5/16", 3/8" or 1/2" O.D. Tube. Also Fits 3/16", 1/4" and 5/16" Solder Fitting/Swaged Tube or 1/8" Hole May Be Punched in Larger Size Tube

Product comes with valve core loose and should be torqued after brazing to ARI 720 standard.

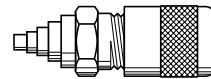

**Straight Solder Connector AVUS**

PART NO.	CONNECTION SIZE
AVUS-42	1/8" O.D. Tube or 1/4" Solder Fitting/Swaged Tube
AVUS-43	3/16" O.D. Tube or 1/4" Solder Fitting/Swaged Tube
AVUS-44	1/4" O.D. Tube or 3/8" Solder Fitting/Swaged Tube
AVUS-45	5/16" O.D. Tube or 1/2" Solder Fitting/Swaged Tube
AVUS-46	3/8" O.D. Tube or 1/2" Solder Fitting/Swaged Tube

Product comes with valve core loose and should be torqued after brazing to ARI 720 standard.

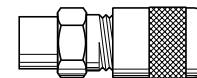

**Swivel Connector AVUS4D**

PART NO.	CONNECTION SIZE
AVUS4D-4	1/4" Forged Female Flare Swivel Nut with Depressor

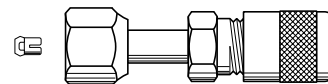

**Forged Female Run Swivel Tee AVTS4**

PART NO.	CONNECTION SIZE
AVTS4-4	1/4" Female Flare Swivel x 1/4" Access on Both Run and Branch
AVTS4D-4	1/4" Female Flare Swivel on Run with Depressor x 1/4" Access on Both Run and Branch

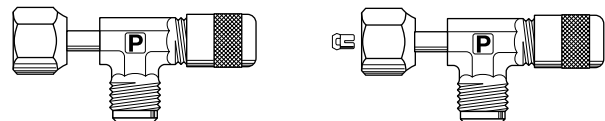

**Forged Female Branch Tee AVTS6**

PART NO.	CONNECTION SIZE
AVTS6-4	1/4" Female Flare Swivel x 1/4" Access on Both Ends
AVTS6D-4	1/4" Female Flare Swivel on Branch with Depressor x 1/4" Access on Both Ends

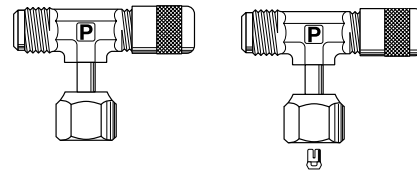

**Quick Seal Caps 640QSF**

PART NO.	CONNECTION SIZE
640QSF-4	1/4" SAE Seal Cap with Seal Gasket
640QSF-6	3/8" SAE Seal Cap with Seal Gasket

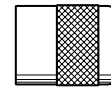

**Quick Seal Cap with Core Remover 640QSFCR**

PART NO.	CONNECTION SIZE
640QSFCR-4	1/4" SAE Seal Cap Core Remover with internal Seal Gasket

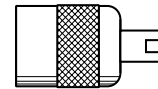

**Core Remover CR**

PART NO.	CONNECTION SIZE
CR-001	Standard Core Remover

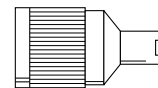

**Valve Cores VC**

PART NO.	CONNECTION SIZE
VC-001	Replacement Valve Cores For all 1/4" Access Valves



**E**

**Refrigerant adapter 88AC**

PART NO.	CONNECTION SIZE
88AC-8-2	1/8" male pipe to SAE J2197 Acme threaded male connector

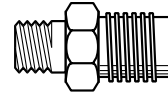

**Refrigerant adapter 880AC**

PART NO.	CONNECTION SIZE
880AC-8-4	1/4" female SAE flare to SAE J2197 Acme threaded male connector

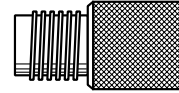

**Refrigerant adapter 881AC**

PART NO.	CONNECTION SIZE
881AC-8-4	1/4" SAE male flare to SAE J2197 Acme threaded female connector

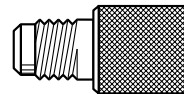



# Adapters



## Pipe Fittings

- SAE Standards
- Dryseal Threads
- Forgings & Extrusions



## Metric Adapters

- Economical
- Reusable
- Forgings & Extrusions



## ISO Port Adapters

- Meets ISO 6149-3 Requirements
- Meets SAE 2244-3 Requirements
- Viton O-rings Standard











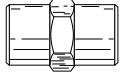



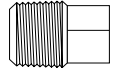
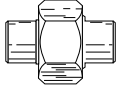

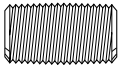
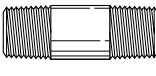
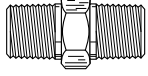
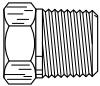
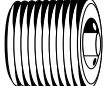



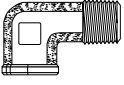
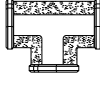
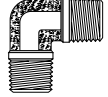
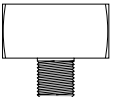
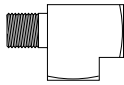
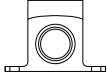

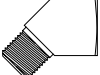
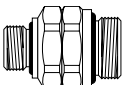
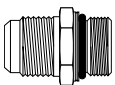

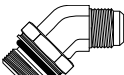

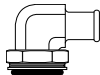
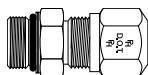
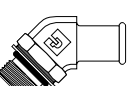

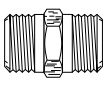
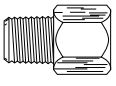
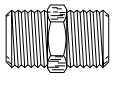

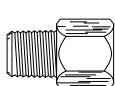
## Garden Hose Fittings



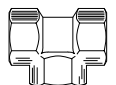

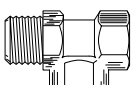





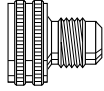
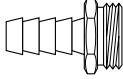

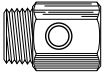
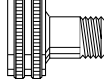
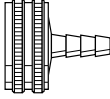

- Heavy Duty Construction
- Coupler option
- Use with Hose Clamp

***The World Standard***

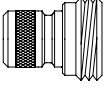

<b>Industrial Pipe Fittings</b>	<b>207ACBH</b> Anchor Coupling  Page F6	<b>207P</b> Pipe Coupling  Page F6	<b>208P</b> Reducer Coupling  Page F6	<b>209P</b> Pipe Bushing  Page F6	<b>210P</b> Lock Nut  Page F6	<b>211P</b> Square-head Plug  Page F7		
	<b>212P</b> Union  Page F7	<b>213P</b> Cap  Page F7	<b>215PN</b> Close Nipple  Page F7	<b>215PNL</b> Long Nipple  Page F7	<b>216P</b> Hex Nipple  Page F8	<b>218P</b> Hex-Head Plug  Page F8	<b>219P</b> Countersunk Plug  Page F8	
	<b>220P</b> Slotted-Head Plug  Page F8	<b>222P</b> Adapter  Page F9	<b>1200P-2200P</b> Union Elbow  Page F9	<b>1202P-2202P</b> Street Elbow  Page F9	<b>1203P-2203P</b> Union Tee  Page F10	<b>1204P</b> Male Elbow  Page F10	<b>2224P</b> Male Branch Tee  Page F10	
	<b>2225P</b> Street Tee  Page F10	<b>2200PDE</b> Drop-Ear Elbow  Page F11	<b>2201P</b> 45° Female Elbow  Page F11	<b>2205P</b> Cross  Page F11	<b>2214P</b> 45° Street Elbow  Page F11	<b>Metric Straight Thread Adapters</b>		
	<b>M16M22F8UHA8UB</b> Union  Page F14 & E18	<b>48F-MI</b> Flare Adapter  Page F18	<b>149F-MI</b> Flare Adapter  Page F18	<b>159F-MI</b> Flare Adapter  Page F18	<b>68HB-MI</b> Hose Barb Adapter  Page F19	<b>169HB-MI</b> Hose Barb Adapter  Page F19	<b>68NTA-MI</b> NTA Adapter  Page F19	
	<b>179HB-MI</b> Hose Barb Adapter  Page F19	<b>BSP Adapters</b>		<b>CD43</b> Street Elbow  Page F13	<b>DD44</b> Elbow  Page F13	<b>F3HF</b> Hex Nipple NPTF-BSPT  Page F13	<b>F3HG</b> Adapter-Male BSPT  Page F13	<b>FF33</b> BSPT Hex Nipple  Page F13
	<b>FF44</b> BSPP Hex Nipple  Page F14	<b>FG43</b> Adapter-Male BSPT  Page F14	<b>FHG4</b> Female-BSPP  Page F14	<b>GG44</b> Coupling BSPP  Page F15	<b>HHP3</b> BSPT Plug  Page F15	<b>HP3</b> BSPT Plug  Page F15	<b>KMMO04</b> BSPP Cross  Page F15	
<b>MMO444</b> BSPP Tee  Page F15	<b>MMS443</b> Branch Tee  Page F16	<b>MRO434</b> Run Tee  Page F16	<b>PTR34</b> Pipe Reducer  Page F16	<b>WGG44</b> Bulkhead Union  Page 16				

**F**

<b>Garden Hose Fittings</b>	<b>50GHSV</b> Swivel Connector 	<b>53GH, 54GH, 55GH</b> Hose Barb 	<b>69GH, 70GH, 71GH</b> Male Pipe 	<b>75GH</b> Connector 	<b>78GH, 79GH, 80GH, 81GH</b> Female Pipe 	<b>82GH, 83GH</b> Female Hose 
	Page F21	Page F21	Page F21	Page F21	Page F21	Page F21
<b>84GH</b> Filter Adapter 	<b>88GH</b> Swivel Connector 	<b>90GH</b> Swivel Connector 	<b>94GH</b> Hose Nut 	<b>95GH</b> Hose Nut Reducer 	<b>96GH</b> Hose Cap 	<b>98GH, 99GH</b> Hose to Pipe 
Page F21	Page F22	Page F22	Page F22	Page F22	Page F22	Page F22
<b>98GHSV, 99GHSV</b> Swivel Connector 	<b>101GHSV</b> Swivel Nut Connector 	<b>1163-60-BPD</b> Coupler 	<b>1163-61-BPD</b> Nipple 	<b>Auxiliary</b>	<b>112</b> Copper Ring 	<b>901GH</b> Rubber Washer 
Page F23	Page F23	Page F23	Page F23		Page F16	Page F23

**F**

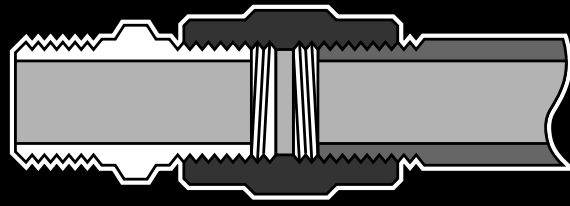

## Pipe Fittings

### Advantages

All pipe fitting threads are made to Dryseal standards.\* Connectors, unions, nuts and extruded elbows and tees are machined from CA 360 and CA 345 brass; forged elbows and tees are machined from CA 377 brass.

### Specifications

Meets functional requirements of the SAE J530 and SAE J531.

### Applications

Use with brass, copper or iron pipe. Manufactured for low and medium pressure line connection work.

### Working Pressure and Temperature Ranges

From -65° to +250°F. at 1000 psi.

### Vibration

Fair resistance to vibration and pipe movement depending upon conditions.

### Order

By part number and name.

### Nomenclature

Part numbers are constructed from symbols that identify the style and size of the fitting. The first series of numbers and letters identifies the style and type fitting. The second series of numbers describes the size.

#### Example:

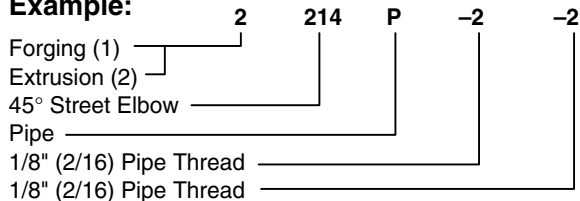

### Sizes

Pipe sizes are determined by the number of sixteenths of an inch in the pipe size.

### Special Fittings

Fitting configurations and/or sizes other than those shown in the catalog can be furnished. It is suggested that a print or sketch be submitted with the inquiry.

### Pricing

Only items prices in current supplementary price list PL3501 are carried in stock. Price and delivery for non-stock items furnished on request for specified quantity.

F

**Pipe thread assembly guide (turns method)  
for Dryseal threads with pre-applied Vibra Seal**

**Straight Fittings**

1. Tighten external thread into the internal thread.
2. Tighten an additional 2 revolutions with a wrench up to 1/2 in. male pipe thread. Above 1/2 in., 1 1/2 to 2 1/2 revolutions.

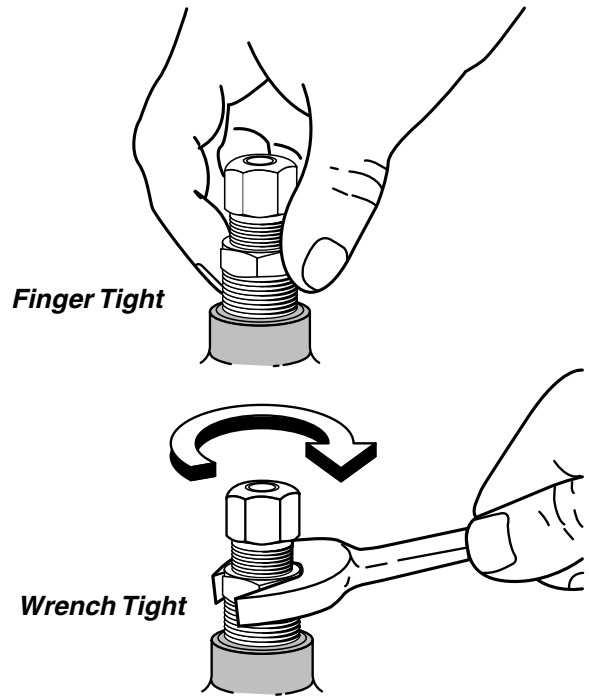

**F**

**Elbow or Tee Fittings**

1. Tighten external thread into the internal thread.
2. Tighten an additional 1 to 1 1/2 revolutions with a wrench.
3. Tighten fitting, Clockwise, to Align with Tubing (never counter clockwise).

*Note: To minimize the possibility of a leaking threaded joint after assembling male to female pipe threads, neither end should be backed out (loosened) once the assembly has been made.*

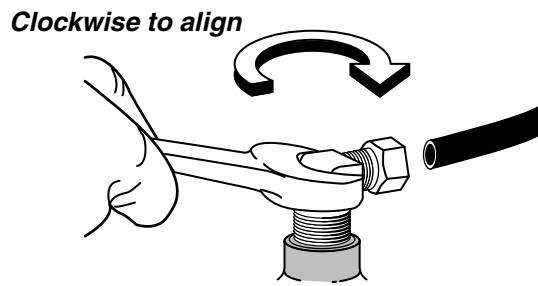
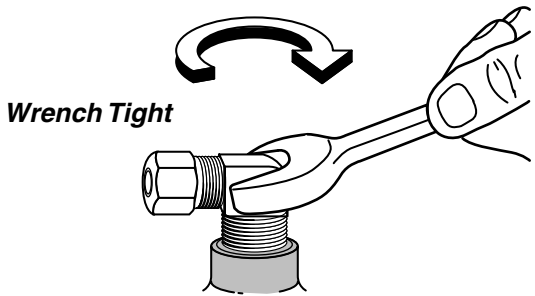
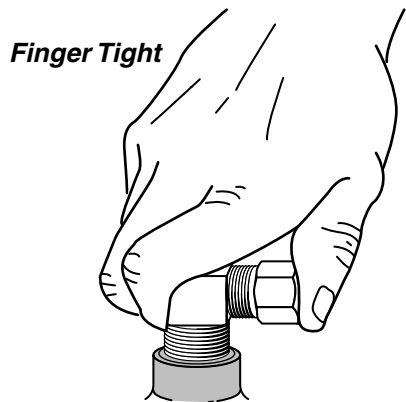

**Anchor Coupling 207ACBH**

PART NO.	FEAMLE PIPE THREAD	STRAIGHT THREAD	MAX. BULK HEAD P	B HEX	C HEX	L	BULKHEAD HOLE DIA. H	FLOW DIA. D
207ACBH-2	1/8	5/8-18	.89	7/8	15/16	1.50	5/8	.339
207ACBHS-2	1/8	5/8-18	.35	7/8	15/16	.96	5/8	.339
207ACBH-4	1/4	3/4-16	.81	1	1-1/8	1.50	3/4	.441
207ACBHS-4	1/4	3/4-16	.26	1	1	.94	3/4	.441
207ACBH-6	3/8	1-14	.62	1-1/8	1-1/4	1.31	1	.571
207ACBH-8	1/2	1-1/8-14	.75	1-1/4	1-3/8	1.50	1-1/8	.703
207ACBH-12	3/4	1-5/16-12	.65	1-1/2	1-1/2	1.50	1-5/16	.906
207ACBH-16*	1	1-5/8-14	1.00	2	2	1.68	1-5/8	1.140

\*Lock Washer not Available

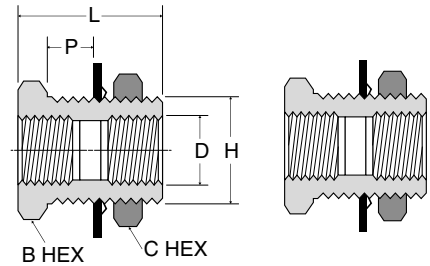

**Coupling 207P**

PART NO.	PIPE THREAD	C HEX	L	FLOW DIA. D
207P-2	1/8	9/16	.75	.339
207P-4	1/4	3/4	1.12	.441
207P-6	3/8	7/8	1.12	.571
207P-8	1/2	1-1/16	1.50	.703
207P-12	3/4	1-3/8	1.53	.906

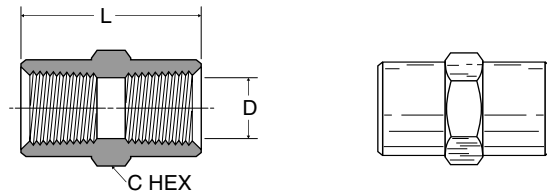

**Reducer Coupling 208P**

PART NO.	1 PIPE THREAD	2 PIPE THREAD	C HEX	L	FLOW DIA. D
208P-4-2	1/4	1/8	3/4	.97	.339
208P-6-4	3/8	1/4	7/8	1.16	.441
208P-8-4	1/2	1/4	1-1/16	1.28	.441
208P-8-6	1/2	3/8	1-1/16	1.38	.571
208P-12-6	3/4	3/8	1-3/8	1.32	.571
208P-12-8	3/4	1/2	1-3/8	1.50	.703

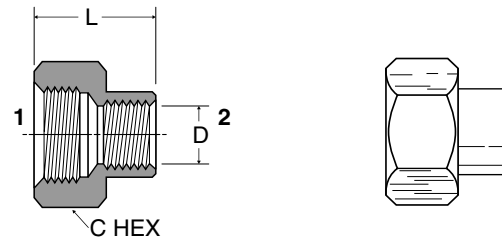

**Bushing 209P**

PART NO.	1 PIPE THREAD	2 PIPE THREAD	C HEX	L	FLOW DIA. D
209P-4-2	1/8	1/4	9/16	.75	.339
209P-6-2	1/8	3/8	11/16	.75	.339
209P-6-4	1/4	3/8	3/4	.75	.441
209P-8-2	1/8	1/2	7/8	1.00	.339
209P-8-4	1/4	1/2	7/8	1.00	.441
209P-8-6	3/8	1/2	7/8	1.00	.571
209P-12-2	1/8	3/4	1-1/8	1.00	.339
209P-12-4	1/4	3/4	1-1/8	1.00	.441
209P-12-6	3/8	3/4	1-1/8	1.00	.571
209P-12-8	1/2	3/4	1-1/8	1.00	.703
209P-16-8	1/2	1	1-3/8	1.31	.703
209P-16-12	3/4	1	1-3/8	1.31	.906

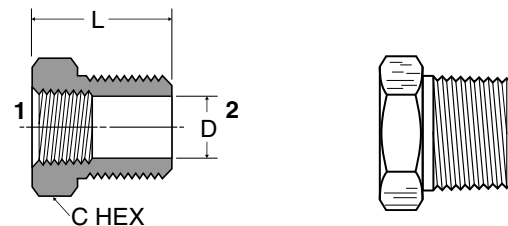

**Lock Nut 210P**

PART NO.	PIPE THREAD	C HEX	L
210P-2	1/8 NPSL	11/16	.19
210P-4	1/4 NPSL	7/8	.25
210P-6	3/8 NPSL	1	.25
210P-8	1/2 NPSL	1-1/8	.25



F

**Square-Head Plug 211P**

PART NO.	PIPE THREAD	C	L	M
211P-2	1/8	9/32	.59	.25
211P-4	1/4	3/8	.80	.29
211P-6	3/8	7/16	.83	.32
211P-8	1/2	9/16	1.07	.39
211P-12	3/4	5/8	1.14	.45

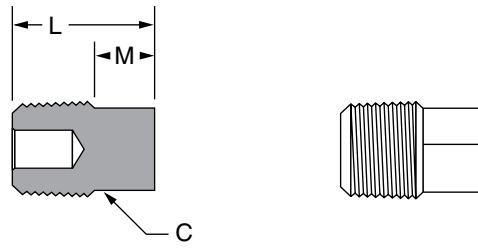

**Union 212P**

PART NO.	PIPE THREAD	C HEX	L	D
212P-4	1/4	1-3/16	1.54	.441
212P-6	3/8	1-1/4	1.76	.571

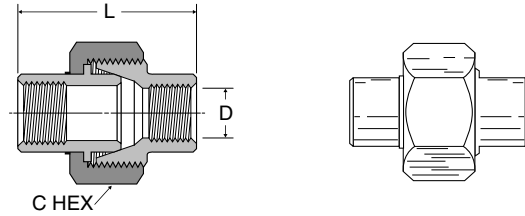

**Cap 213P**

PART NO.	PIPE THREAD	C HEX	L
213P-2	1/8	9/16	.50
213P-4	1/4	11/16	.63
213P-6	3/8	13/16	.63
213P-8	1/2	1-1/16	.87
213P-12	3/4	1-1/4	.89

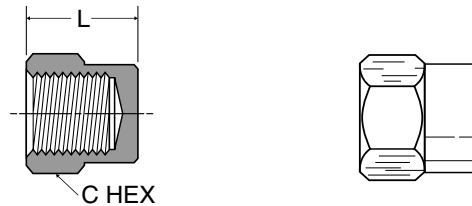

**Close Nipple 215PN**

PART NO.	PIPE THREAD	L	FLOW DIA. D
215PN-2	1/8	.75	.281
215PN-4	1/4	.88	.375
215PN-6	3/8	1.00	.500
215PN-8	1/2	1.13	.625
215PN-12	3/4	1.31	.750

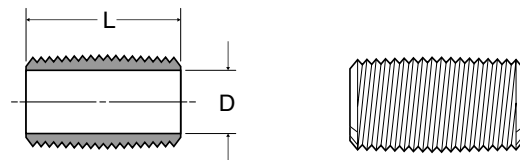

**Long Nipple 215PNL**

PART NO.	PIPE THREAD	L	FLOW DIA. D
215PNL-2-15	1/8	1-1/2	.250
215PNL-4-15	1/4	1-1/2	.375
215PNL-6-15	3/8	1-1/2	.500
215PNL-8-15	1/2	1-1/2	.625
215PNL-2-20	1/8	2	.250
215PNL-4-20	1/4	2	.375
215PNL-6-20	3/8	2	.500
215PNL-8-20	1/2	2	.625
215PNL-2-25	1/8	2-1/2	.250
215PNL-4-25	1/4	2-1/2	.375
215PNL-6-25	3/8	2-1/2	.500
215PNL-8-25	1/2	2-1/2	.625
215PNL-2-30	1/8	3	.250
215PNL-4-30	1/4	3	.375
215PNL-6-30	3/8	3	.500
215PNL-8-30	1/2	3	.625
215PNL-2-35	1/8	3-1/2	.250
215PNL-4-35	1/4	3-1/2	.375
215PNL-6-35	3/8	3-1/2	.500
215PNL-8-35	1/2	3-1/2	.625

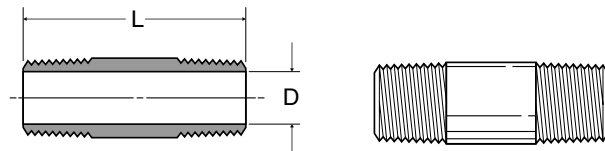

**Hex Nipple 216P**

PART NO.	PIPE THREAD	C HEX	L	FLOW DIA.D
216P-2	1/8	7/16	.97	.220
216P-4	1/4	9/16	1.38	.314
216P-6	3/8	11/16	1.41	.440
216P-8	1/2	7/8	1.81	.564
216P-12	3/4	1-1/16	1.81	.752

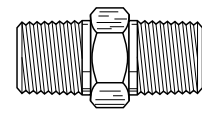
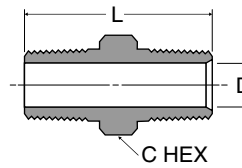

**Hex Nipple Reducers 216P**

PART NO.	1 PIPE THREAD	2 PIPE THREAD	C HEX	L	FLOW DIA. D
216P-4-2	1/4	1/8	9/16	1.19	.220
216P-6-2	3/8	1/8	11/16	1.22	.220
216P-6-4	3/8	1/4	11/16	1.41	.314
216P-8-4	1/2	1/4	7/8	1.62	.314
216P-8-6	1/2	3/8	7/8	1.62	.440
216P-12-8	3/4	1/2	1-1/16	1.80	.564

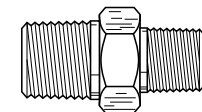
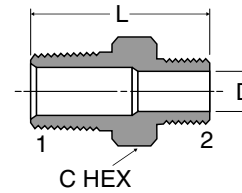

**F**

**Hex-Head Plug 218P**

PART NO.	PIPE THREAD	C HEX	L
218P-2	1/8	7/16	.560
218P-4	1/4	9/16	.747
218P-6	3/8	11/16	.780
218P-8	1/2	7/8	.970
218P-12	3/4	1-1/16	1.054

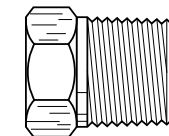
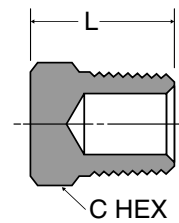

**Countersunk Hex-Head Plug 219P**

PART NO.	PIPE THREAD	C HEX	L
219P-2	1/8	3/16	.30
219P-4	1/4	1/4	.46
219P-6	3/8	5/16	.46
219P-8	1/2	3/8	.61
219P-12	3/4	9/16	.62

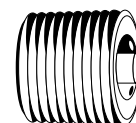
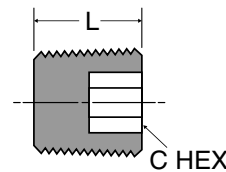

**Slotted-Head Plug 220P**

PART NO.	PIPE THREAD	L
220P-2	1/8	.31
220P-4	1/4	.42
220P-6	3/8	.43

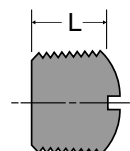

**Adapter 222P**

PART NO.	1 PIPE THREAD	2 PIPE THREAD	C HEX	L	FLOW DIA. D
222P-2-2	1/8	1/8	9/16	.88	.220
222P-4-2	1/4	1/8	3/4	1.06	.220
222P-4-4	1/4	1/4	3/4	1.25	.314
222P-6-2	3/8	1/8	7/8	1.10	.220
222P-6-4	3/8	1/4	7/8	1.25	.314
222P-6-6	3/8	3/8	7/8	1.25	.440
222P-8-4	1/2	1/4	1	1.47	.314
222P-8-6	1/2	3/8	1-1/16	1.47	.440
222P-8-8	1/2	1/2	1-1/16	1.66	.564
222P-12-6	3/4	3/8	1-3/8	1.50	.440
222P-12-8	3/4	1/2	1-3/8	1.69	.564
222P-12-12	3/4	3/4	1-3/8	1.69	.752

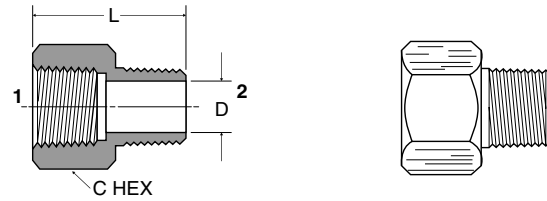

**90° Union Elbow 1200P-2200P**

PART NO.	PIPE THREAD	M	FLOW DIA. D
1200P-2-2	1/8	.56	.329
2200P-2-2	1/8	.55	.339
1200P-4-4	1/4	.81	.441
2200P-4-4	1/4	.78	.441
1200P-6-6	3/8	.84	.571
2200P-6-6	3/8	.84	.571
2200P-8-8	1/2	1.07	.703

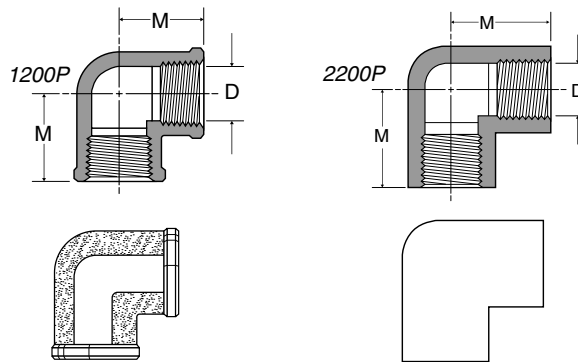

**90° Street Elbow 1202P-2202P**

PART NO.	1 PIPE THREAD	2 PIPE THREAD	M	N	FLOW DIA. D
1202P-2-2	1/8	1/8	.81	.56	.22
2202P-2-2	1/8	1/8	.62	.48	.22
2202PA-2-2*	1/8	1/8	.66	.48	.22
2202P-4-2	1/4	1/8	.72	.45	.23
1202P-4-4	1/4	1/4	1.08	.69	.31
2202P-4-4	1/4	1/4	.91	.45	.34
2202PA-4-4*	1/4	1/4	.91	.72	.31
2202P-4-6	1/4	3/8	.97	.78	.43
1202P-6-4	3/8	1/4	1.25	.78	.31
1202P-6-6	3/8	3/8	1.25	.78	.42
2202P-6-6	3/8	3/8	.98	.54	.41
2202PA-6-6*	3/8	3/8	.97	.78	.43
1202P-6-8	3/8	1/2	1.53	1.01	.56
1202P-8-6	1/2	3/8	1.25	.97	.42
2202P-8-8	1/2	1/2	1.25	1.03	.56
2202P-12-8	3/4	1/2	1.39	1.10	.56
2202P-12-12	3/4	3/4	1.39	1.10	.75

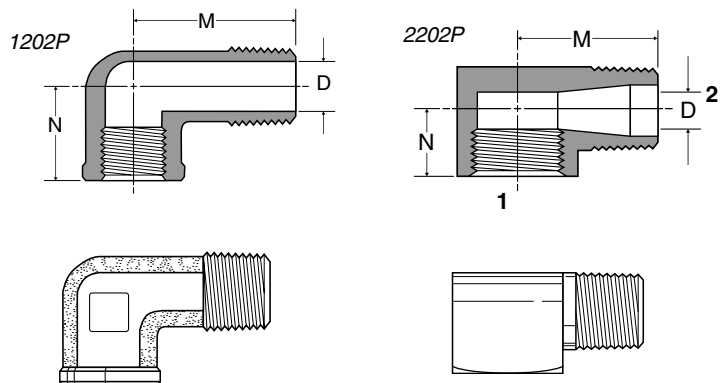

\*Meets SAE Dimensions



**Union Tee 1203P-2203P**

PART NO.	PIPE THREAD	L	M	FLOW DIA.D
1203P-2	1/8	1.12	.56	.339
2203P-2	1/8	1.06	.53	.339
1203P-4	1/4	1.38	.69	.441
2203P-4	1/4	1.52	.76	.441
2203P-6	3/8	1.68	.84	.571
1203P-8	1/2	2.14	1.07	.703
2203P-8	1/2	2.14	1.07	.703
2203P-12	3/4	2.28	1.14	.906

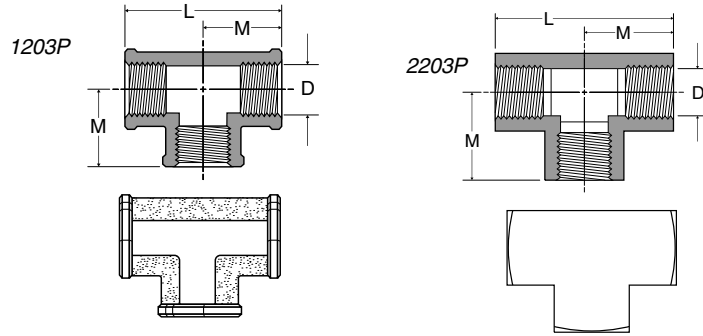

**Male Elbow 1204P**

PART NO.	PIPE THREAD	M	FLOW DIA.D
1204P-2	1/8	.71	.220
1204P-4	1/4	1.09	.312
1204P-6	3/8	1.09	.408
1204P-8	1/2	1.41	.502

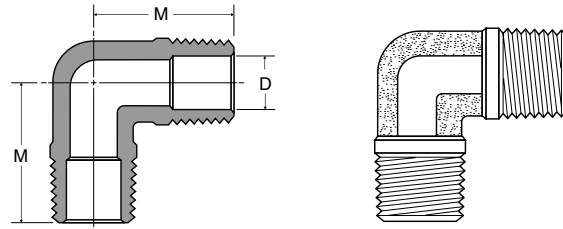

**Male Branch Tee 2224P**

PART NO.	PIPE THREAD	L	M	N	FLOW DIA.D
2224P-2	1/8	1.06	.53	.66	.220
2224P-4	1/4	1.52	.76	.91	.314
2224P-6	3/8	1.68	.84	.97	.440
2224P-8	1/2	2.18	1.09	1.25	.564
2224P-12	3/4	2.32	1.16	1.38	.752

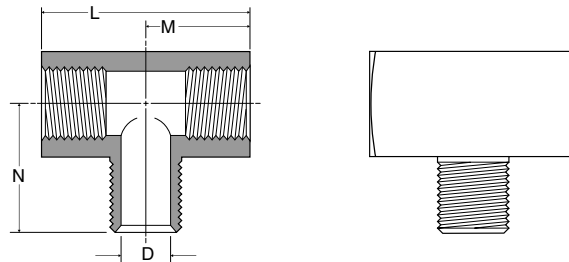

**Street Tee 2225P**

PART NO.	PIPE THREAD	M	N	FLOW DIA.D
2225P-2	1/8	.53	.66	.220
2225P-4	1/4	.76	.91	.314
2225P-6	3/8	.84	.98	.440
2225P-8	1/2	1.07	1.26	.564
2225P-12	3/4	1.14	1.38	.752

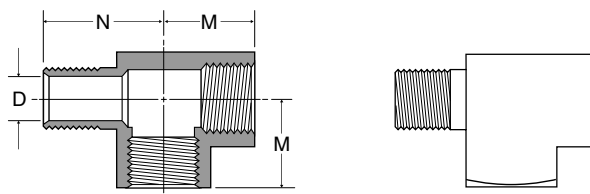

**F**

**Drop-ear 90° Elbow 2200PDE**

PART NO.	PIPE THREAD	L	M	FLOW DIA.D
2200PDE-2	1/8	1.38	1.00	.339

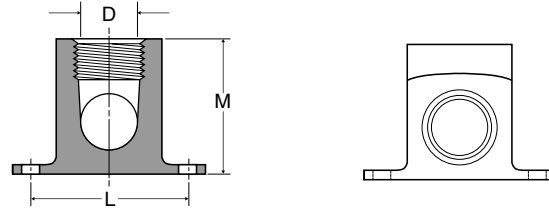

**45° Female Elbow 1201P-2201P**

PART NO.	PIPE THREAD	M	FLOW DIA.D
2201P-2-2	1/8	.43	.339
1201P-8-8	1/2	.89	.703

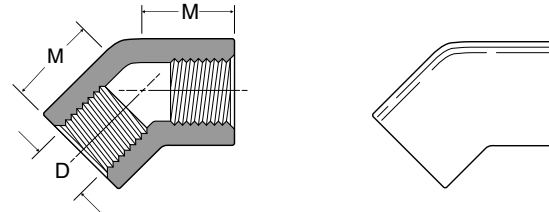

**Cross 2205P**

PART NO.	PIPE THREAD	M	FLOW DIA.D
2205P-2	1/8	.53	.339
2205P-4	1/4	.75	.441
2205P-6	3/8	.81	.571
2205P-8	1/2	1.07	.703
2205P-12	3/4	1.14	.906

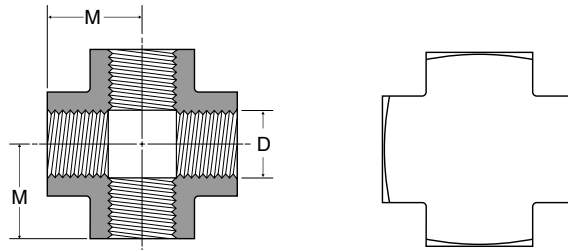

**F**

**45° Street Elbow 2214P**

PART NO.	PIPE THREAD	M	N	FLOW DIA.D
2214P-2-2	1/8	.38	.50	.220
2214P-4-4	1/4	.54	.70	.314
2214P-6-6	3/8	.56	.78	.440
2214P-8-8	1/2	.73	1.00	.564

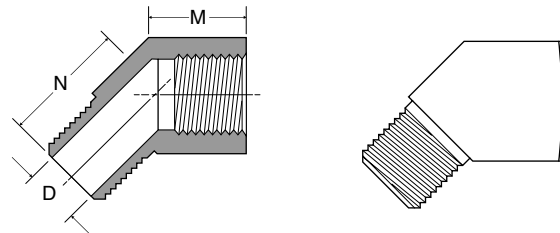

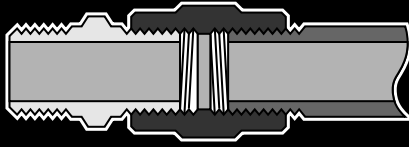

## Parker Brass Metric Adapters

### Advantages

To simplify the installation of pneumatic systems, Parker supplies a comprehensive range of adapters for NPT, BSPP, and BSPT pipe threads. Pipe nipples, pipe connectors, reducing connectors, pipe thread reducers, bulkhead female unions, elbows, tees, crosses and hex head plugs.

F

Parker brass adapters are produced from forgings and extrusions to meet exacting requirements. The hot forging process increases the density of the material, refines the grain structure and improves material strength.

### Applications

Use with brass, copper, or iron pipe. Manufactured for low- and medium-pressure line connection work.

### Working Pressure and Temperature Ranges

From -65° to +250° at 1000 psi.

### Vibration

Fair resistance to vibration and pipe movement depending upon conditions.

**CD43 90° Elbow Male-Female BSPT-BSPP**

PART NO.	BSPT 1	BSPP 2	C HEX	M	N
1/8CD43B	1/8	1/8	14	14	20
1/4CD43B	1/4	1/4	17	18	25
3/8CD43B	3/8	3/8	22	19	29
1/2CD43B	1/2	1/2	27	24	37

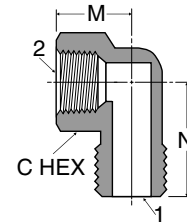

**DD44 Pipe 90° Elbow BSPP**

PART NO.	BSPP	C HEX	M
1/8DD44B	1/8	14	15
1/4DD44B	1/4	17	18
3/8DD44B	3/8	22	22
1/2DD44B	1/2	27	29

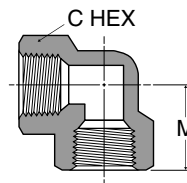

**F3HF Hex Nipple NPTF BSPT**

PART NO.	NPTF 1	BSPT 2	C HEX	L	FLOW D
1/8F3HF-B	1/8	1/8	7/16	1.07	.22
1/4F3HF-B	1/4	1/4	9/16	1.58	.31
3/8F3HF-B	3/8	3/8	11/16	1.61	.44
1/2F3HF-B	1/2	1/2	7/8	2.01	.56

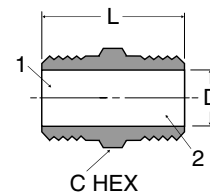

**F3HG Adapter NPTF Male BSPT**

PART NO.	NPTF 1	BSPT 2	C HEX	L	FLOW D
1/8F3HG-B	1/8	1/8	9/16	0.93	.22
1/4F3HG-B	1/4	1/4	3/4	1.35	.31
3/8F3HG-B	3/8	3/8	7/8	1.35	.44
1/2F3HG-B	1/2	1/2	1-1/16	1.76	.56

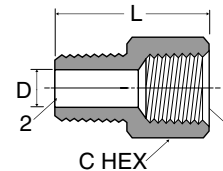

**FF33 Pipe Nipples BSPT**

PART NO.	BSPT	C HEX	L
1/8FF33B	1/8	10	19
1/4FF33B	1/4	14	27
3/8FF33B	3/8	17	28
1/2FF33B	1/2	22	36
3/4FF33B	3/4	27	40
1FF33B	1	36	46

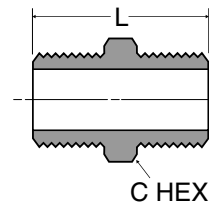

**FF33 Unequal Pipe Nipples BSPT**

PART NO.	BSPT 1	BSPT 2	C HEX	L
1/8x1/4FF33B	1/8	1/4	14	23
1/8x3/8FF33B	1/8	3/8	17	24
1/8x1/2FF33B	1/8	1/2	22	28
1/4x3/8FF33B	1/4	3/8	17	28
1/4x1/2FF33B	1/4	1/2	22	31
3/8x1/2FF33B	3/8	1/2	22	32
3/8x3/4FF33B	3/8	3/4	27	35
1/2x3/4FF33B	1/2	3/4	27	38
3/4x1FF33B	3/4	1	36	43

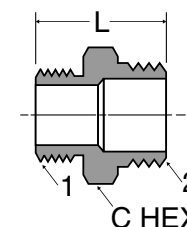

**FF44 Pipe Nipples BSPP**

PART NO.	BSPP	C HEX	L
1/8FF44B	1/8	14	19
1/4FF44B	1/4	17	22
3/8FF44B	3/8	22	24
1/2FF44B	1/2	27	31

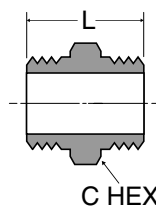

**Metric Straight Thread Union M16M22F8UHA8UB**

PART NUMBER	METRIC THD 1	METRIC THD 2	L (mm)	HEX (mm)	M (mm)	M1 (mm)	D (mm)
M16M22F8UHA8UB	M16X1.5	M22X1.5	43	27	10	12.5	9.0

Note: Fluorocarbon o-ring is standard

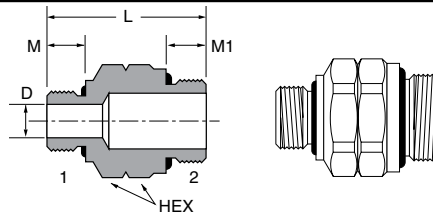

**FG43 Reducing Connector Female-Male BSPP-BSPT**

PART NO.	BSPT 1	BSPP 2	C HEX	L
1/4x1/8FG43B	1/8	1/4	17	23
3/8x1/8FG43B	1/8	3/8	22	25
3/8x1/4FG43B	1/4	3/8	22	28
1/2x1/8FG43B	1/8	1/2	27	29
1/2x1/4FG43B	1/4	1/2	27	32
1/2x3/8FG43B	3/8	1/2	27	31
3/4x1/2FG43B	1/2	3/4	32	39
1x3/4FG43B	3/4	1	41	38

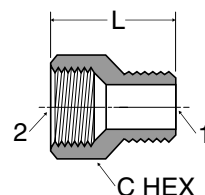

**FHG4 Adapter Male NPTF BSPP**

PART NO.	BSPP 1	NPTF 2	C HEX	L	FLOW D
1/8FHG4-B	1/8	1/8	0.562	0.870	.22
1/4FHG4-B	1/4	1/4	0.750	1.125	.31
3/8FHG4-B	3/8	3/8	0.875	1.125	.44
1/2FHG4-B	1/2	1/2	1.062	1.660	.60

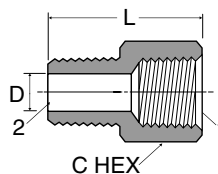

**Pipe to Metric Adaptor 222P-X-MIX**

PART NUMBER	NPTF	METRIC THREAD	HEX	L	M	D
222P-2-MI10	1/8-27	M10 x 1.0	9/16	.75	.34	.18
222P-2-MI14	1/8-27	M14 x 1.5	3/4	.91	.43	.30
222P-4-MI12	1/4-18	M12 x 1.5	11/16	1.09	.43	.24
222P-6-MI16	3/8-18	M16 x 1.5	7/8	1.10	.45	.35
222P-6-MI22	3/8-18	M22 x 1.5	1 1/16	1.05	.37	.47
222P-8-MI27	1/2-14	M27 x 2.0	1 1/4	1.32	.63	.60

Note: Fluorocarbon o-ring is standard

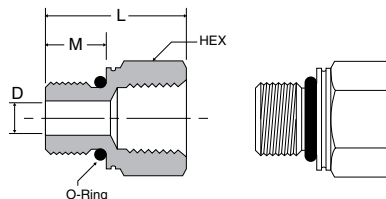

**F**

**GG44 Pipe Connector BSPP**

PART NO.	BSPP	C HEX	L
1/8GG44B	1/8	14	16
1/4GG44B	1/4	17	20
3/8GG44B	3/8	22	24
1/2GG44B	1/2	27	28
3/4GG44B	3/4	32	32
1GG44B	1	41	36

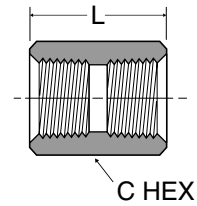

**GG44 Unequal Pipe Connector BSPP**

PART NO.	BSPP 1	BSPP 2	C HEX	L
1/8x1/4GG44B	1/8	1/4	17	18
1/8x3/8GG44B	1/8	3/8	22	20
1/8x1/2GG44B	1/8	1/2	27	22
1/4x3/8GG44B	1/4	3/8	22	22
1/4x1/2GG44B	1/4	1/2	27	24
3/8x1/2GG44B	3/8	1/2	17	26

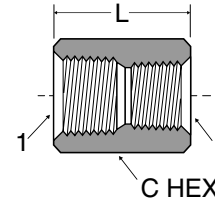

**HHP3 Hollow Hex Head Plug BSPT**

PART NO.	BSPT	C HEX	L
1/8HHP3B	1/8	5	8
1/4HHP3B	1/4	6	10
3/8HHP3B	3/8	8	11
1/2HHP3B	1/2	10	13

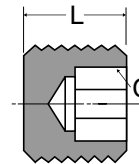

**HP3 Hex Plug BSPT**

PART NO.	BSPT	C HEX	L
1/8HP3B	1/8	10	12
1/4HP3B	1/4	14	16
3/8HP3B	3/8	17	17
1/2HP3B	1/2	22	21
3/4HP3B	3/4	27	24
1HP3B	1	36	27

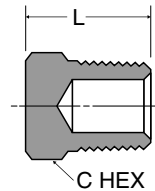

**KMMOO4 Pipe Cross BSPP**

PART NO.	BSPP	C HEX	L	M
1/8KMMOO4B	1/8	14	29	14.5
1/4KMMOO4B	1/4	17	36	18.0
3/8KMMOO4B	3/8	22	44	22.0
1/2KMMOO4B	1/2	27	58	29.0

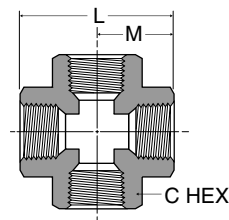

**MMO444 Pipe Tee BSPP**

PART NO.	BSPP	C HEX	L	M
1/8MMO444B	1/8	14	29	14.5
1/4MMO444B	1/4	17	36	18.0
3/8MMO444B	3/8	22	44	22.0
1/2MMO444B	1/2	27	58	29.0
3/4MMO444B	3/4	32	62	31.0
1MMO444B	1	40	85	42.5

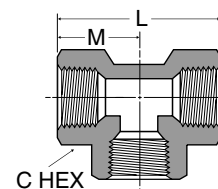

**F**

**MMS443 Branch Tee Female-Male-Female BSPP-BSPT-BSPP**

PART NO.	BSPP 1	BSPT 2	L	M	N
1/8MMS443B	1/8	1/8	29	14.5	17
1/4MMS443B	1/4	1/4	36	18.0	22
3/8MMS443B	3/8	3/8	48	24.0	25
1/2MMS443B	1/2	1/2	62	31.0	32

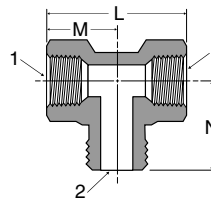

**MRO434 Run Tee Female-Female-Male BSPP-BSPP-BSPT**

PART NO.	BSPP 1	BSPT 2	C HEX	L	M	N
1/8MRO434B	1/8	1/8	14	32	15	17
1/4MRO434B	1/4	1/4	17	40	18	22
3/8MRO434B	3/8	3/8	24	49	24	25
1/2MRO434B	1/2	1/2	30	63	31	32

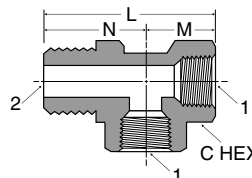

**PTR34 Pipe Thread Reducer male-female BSPT-BSPP**

PART NO.	BSPT 1	BSPP 2	C HEX	L
1/4x1/8PTR34B	1/4	1/8	14	16
3/8x1/8PTR34B	3/8	1/8	17	17
3/8x1/4PTR34B	3/8	1/4	17	17
1/2x1/8PTR34B	1/2	1/8	22	22
1/2x1/4PTR34B	1/2	1/4	22	22
1/2x3/8PTR34B	1/2	3/8	22	22
3/4x3/8PTR34B	3/4	3/8	27	23
3/4x1/2PTR34B	3/4	1/2	27	23
1x1/2PTR34B	1	1/2	36	27
1x3/4PTR34B	1	3/4	36	27

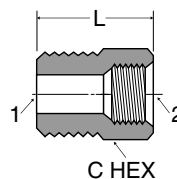

**F**

**WGG44 Bulkhead Female Union BSPP**

PART NO.	BSPP	STRAIGHT THREAD	C HEX	C4	L	W
1/8WGG44B	1/8	M16x1.5	19	22	22	12
1/4WGG44B	1/4	M20x1.5	24	24	22	12
3/8WGG44B	3/8	M23x1.5	27	27	24	12
1/2WGG44B	1/2	M27x1.5	32	32	28	14
3/4WGG44B	3/4	M34x1.5	41	41	31	13
1WGG44B	1	M45x2	55	55	36	12

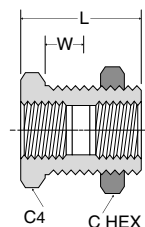

**Copper Rings for BSPP**

PART NO.	BSPP	A	B	C
112-5-10	1/8	16.0	9.9	1.5
112-8-13	1/4	19.0	13.5	1.5
112-12-17	3/8	24.0	16.9	1.5
112-15-21	1/2	27.0	21.2	2.0

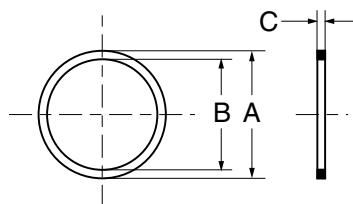

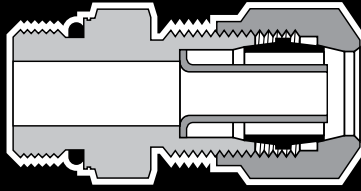

## ISO Port Adapters

### Advantages

To simplify the installation of hydraulic and pneumatic systems, Parker supplies a range of ISO Port Adapters for various sizes of metric threads and end configurations. These adapters include NPTF, flare, hose barb and NTA end configurations. Fluorocarbon o-rings are standard on all ISO adapters.

### Specifications

Meets dimensional requirements of ISO 6149-3 and SAE 2244-3.

### Applications

Use with brass, copper or J844 type A & B nylon tubing. Manufactured for low and medium pressure line connection work.

### Working Pressure and Temperature Ranges

Dependent on tubing or hose end connection

### Nomenclature

Part numbers are constructed from symbols that identify the style and size of the fitting. The first series of numbers and letters identifies the style and type fitting. The second series of numbers describes the size.

#### Example:

1 59 F - 10 MI - 27

Forging (1) \_\_\_\_\_

45° Male Elbow \_\_\_\_\_

45° Flare \_\_\_\_\_

5/8" (10/16) Tube Size \_\_\_\_\_

MI-Metric ISO Port \_\_\_\_\_

27mm Port Thread \_\_\_\_\_

F

### Special Fittings

Fitting configurations and / or sizes other than those shown in the catalog can be furnished. It is suggested that a print or sketch be submitted with the inquiry.

### Pricing

Only items priced in current supplementary price list PL3501 are carried in stock. Price and delivery for non-stock items furnished on request for specified quantity.



**Pipe to Metric Adaptor 222P-X-MIX**

PART NUMBER	NPTF	METRIC THREAD	HEX	L	M	D
222P-2-MI10	1/8-27	M10 x 1.0	9/16	.75	.34	.18
222P-2-MI14	1/8-27	M14 x 1.5	3/4	.91	.43	.30
222P-4-MI12	1/4-18	M12 x 1.5	11/16	1.09	.43	.24
222P-4-MI14	1/4-18	M14 x 1.5	3/4	1.09	.43	.30
222P-6-MI16	3/8-18	M16 x 1.5	7/8	1.16	.45	.35
222P-6-MI22	3/8-18	M22 x 1.5	1 1/16	1.05	.51	.47
222P-8-MI27	1/2-14	M27 x 2.0	1 1/4	1.32	.63	.60

Note: Fluorocarbon o-ring is standard  
 For working pressure and Temperature see Metric Adapters Section

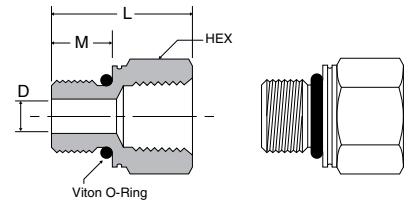

**Metric Straight Thread Union M16M22F8UHA8UB**

PART NUMBER	METRIC THD 1	METRIC THD 2	L (mm)	HEX (mm)	M (mm)	M1 (mm)	D (mm)
M16M22F8UHA8UB	M16X1.5	M22X1.5	43	27	10	12.5	9.0

Note: Fluorocarbon o-ring is standard  
 For working pressure and Temperature see Metric Adapters Section

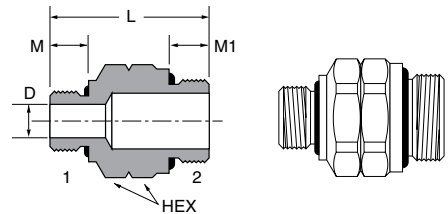

**F**

**Flare to Metric Adaptor 48F-X-MIX**

PART NUMBER	TUBE SIZE	METRIC THREAD	HEX	L	D
48F-8-MI16	1/2	M16 X 1.5	7/8	1.60	.35
48F-10-MI27	5/8	M27 x 2.0	1 1/4	1.87	.50
48F-12-MI27	3/4	M27 x 2.0	1 1/4	1.99	.63

Note: Fluorocarbon o-ring is standard  
 For working pressure and Temperature see SAE Flare Section

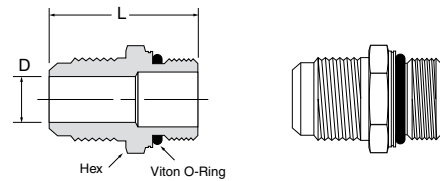

**Flare Elbow to Metric Adaptor 149F-X-MIX**

PART NUMBER	TUBE SIZE	METRIC THREAD	HEX	L	M	M1	N	N1	N2	D
149F-10-MI27	5/8	M27 x 2.0	7/8	1.95	1.46	.88	2.12	1.63	1.09	.50

Note: Fluorocarbon o-ring is standard  
 For working pressure and Temperature see SAE Flare Section

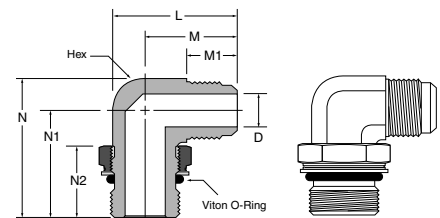

**45° Flare Elbow to Metric Adaptor 159F-X-MIX**

PART NUMBER	TUBE SIZE	METRIC THREAD	HEX	M	M1	N	D
159F-8-MI16	1/2	M16 X 1.5	13/16	1.10	.75	1.16	.36
159F-10-MI27	5/8	M27 x 2.0	1 1/8	1.21	.88	1.50	.50

Note: Fluorocarbon o-ring is standard  
 For working pressure and Temperature see SAE Flare Section

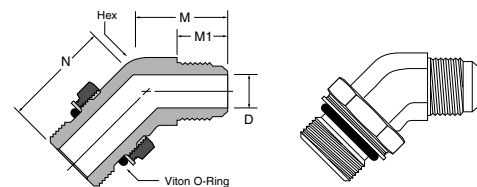

**Hose Barb to Metric Adaptor 68HB-X-MIX**

PART NUMBER	TUBE SIZE	METRIC THREAD	HEX	L	M	D
68HB-6-M12	3/8	M12 x 1.5	11/16	1.50	.78	.24
68HB-6-M14	3/8	M14 1.5	3/4	1.51	.78	.30
68HB-8-M12	1/2	M12 x 1.5	11/16	1.50	.78	.24
68HB-10-M127	5/8	M27 x 2.0	1 1/4	1.77	.78	.50

Note: Fluorocarbon o-ring is standard  
 For working pressure and Temperature see Hose Barb Section

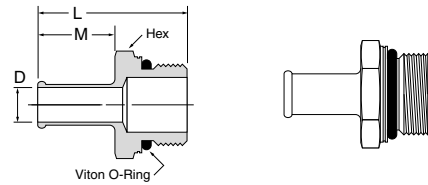

**Beaded Elbow to Metric Adaptor 169HB-X-MIX**

PART NUMBER	HOSE SIZE	METRIC THREAD	HEX	L	M	N	D
169HB-10-MI27	5/8	M27 x 2.0	7/8	1.41	.78	1.63	.50
169HB-16-MI27	1	M27 x 2.0	1	1.67	.97	1.68	.71

Note: Fluorocarbon o-ring is standard  
 For working pressure and Temperature see Hose Barb Section

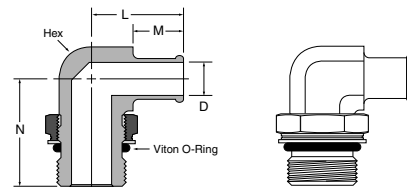

**NTA to Metric Adaptor 68NTA-X-MIX**

PART NUMBER	TUBE SIZE	METRIC THREAD	B HEX	C HEX	L	D
68NTA-4-MI10	1/4	M10 x 1.0	9/16	9/16	1.33	.140

Note: Fluorocarbon o-ring is standard  
 For working pressure and Temperature see Air Brake-NTA Section

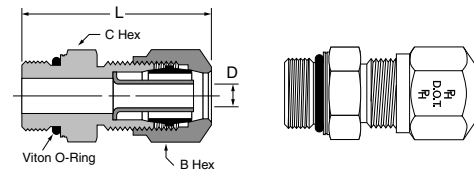

**Beaded Hose Barb 45° Elbow to Metric Thread 179HB-X-MIX**

PART NUMBER	HOSE SIZE	METRIC THREAD	HEX	L	M	N	D
179HB-12-MI18	3/4	M18 x 1.5	13/16	1.15	.78	1.16	.44
179HB-16-MI27	1	M27 x 2.0	1 1/16	1.51	.97	1.71	.71

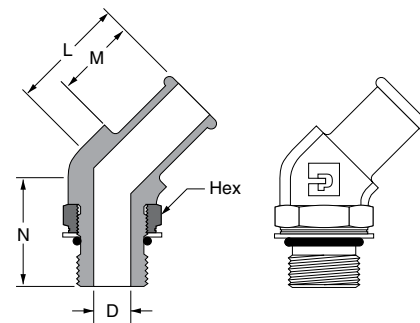

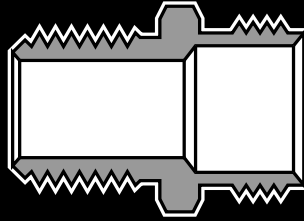

## Garden Hose Fittings

### Advantages

All fitting pipe threads are made to Dryseal standards. Connectors, unions, nuts and extruded elbows and tees are machined from CA 360 and CA 345 brass.

### Sizes

Pipe sizes are determined by the number of sixteenths of an inch in the pipe size.

### Temperature and Working Pressure Ranges

From +35°F. to +100°F. at 75 PSI maximum or the recommended working pressure of garden hose. (not to exceed 150 PSI.)

### Pricing

Only items priced in current supplementary price list PL3501 are carried in stock. Price and delivery for non-stock items furnished on request for specified quantity.

Note: 90GH is intended for use with 97HC hose clamp or crimped ferrule.

Note: All female connector ends should have a rubber washer (901GH-12) inserted prior to usage.

### Order

By part number and name.

### Nomenclature

Part numbers are constructed from symbols that identify the style and size of the fitting. The first series of numbers and letters identifies the style and type fitting. The second series of numbers describes the size.

**Example:**

	50GH	SV	-6	-12
Garden Hose	_____	_____	_____	_____
Swivel Connector	_____	_____	_____	_____
3/8" Tube O.D.	_____	_____	_____	_____
3/4" Hose Thread	_____	_____	_____	_____

**Swivel Connector SAE Flare to Female Hose Thread 50GHSV**

PART NO.	TUBE SIZE	HOSE THREAD	L	M	FLOW DIA.D
50GHSV-6-12	3/8	3/4	1.25	1.15	.297
50GHSV-8-12	1/2	3/4	1.34	1.15	.406

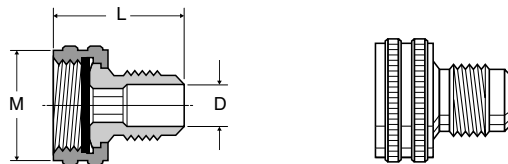

**Hose Barb to Male Hose Thread 53GH, 54GH & 55GH**

PART NO.	I.D. HOSE SIZE	HOSE THREAD	C HEX	L	FLOW DIA.D
53GH-8-12	1/2	3/4	1-1/16	1.88	.375
54GH-10-12	5/8	3/4	1-1/16	1.88	.500
55GH-12-12	3/4	3/4	1-1/16	1.88	.625

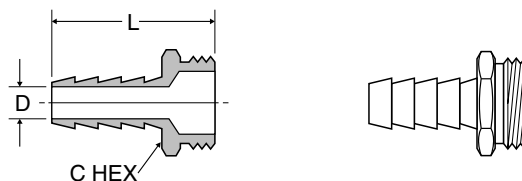

**Male Hose to Male Pipe 69GH, 70GH, 71GH**

PART NO.	HOSE THREAD	PIPE THREAD	C HEX	L	FLOW DIA.D
69GH-12-4	3/4	1/4	1-1/16	1.25	.410
69GH-12-6	3/4	3/8	1-1/16	1.25	.406
70GH-12-8	3/4	1/2	1-1/16	1.39	.531
71GH-12-12	3/4	3/4	1-1/16	1.41	.750

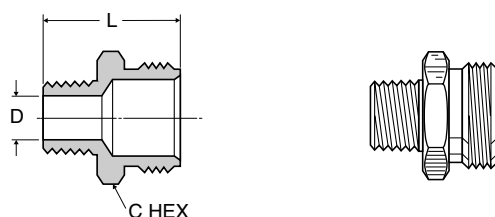

**Male Hose to Male Hose 75GH**

PART NO.	HOSE THREAD	C HEX	L	FLOW DIA.D
75GH-12	3/4	1-1/16	1.25	.750

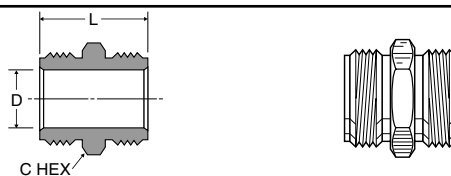

**Male Hose to Female Pipe 78GH, 79GH, 80GH & 81GH**

PART NO.	HOSE THREAD	PIPE THREAD	C HEX	L	FLOW DIA.D
78GH-12-4	3/4	1/4	1-1/16	.75	.422
79GH-12-6	3/4	3/8	1-1/16	.75	.562
80GH-12-8	3/4	1/2	1-1/16	.75	.687
81GH-12-12	3/4	3/4	1-3/16	1.28	.719

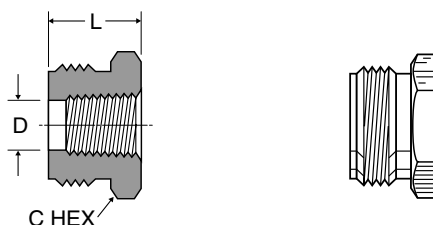

**Female Hose to Male Pipe 82GH & 83GH**

PART NO.	HOSE THREAD	PIPE THREAD	C HEX	L	FLOW DIA.D
82GH-12-8	3/4	1/2	1-3/16	1.20	.562
83GH-12-12	3/4	3/4	1-3/16	1.22	.750

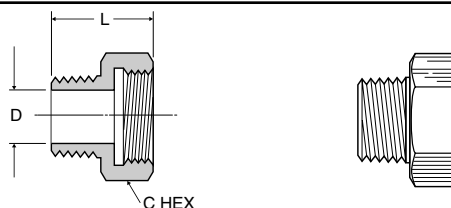

**Special Filter Adapter 84GH**

PART NO.	HOSE THREAD	PIPE THREAD	C HEX	L	FLOW DIA.D
84GH-8-8	1/2	1/2	15/16	1.53	.530

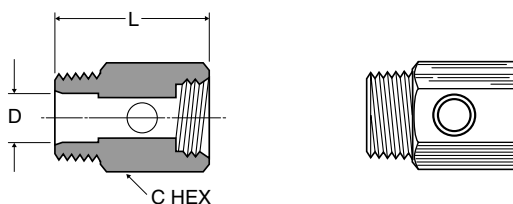

**F**

**Swivel Connector Female Garden Hose to Male Pipe 88GH**

PART NO.	HOSE THREAD	PIPE THREAD	L	M	FLOW DIA.D
88GH-12-4	3/4	1/4	1.69	1.15	.312
88GH-12-6	3/4	3/8	1.69	1.15	.406

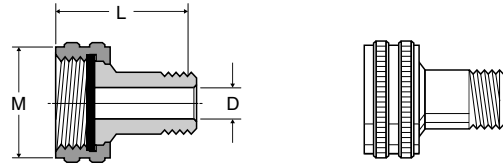

**Swivel Connector Female Garden Hose to Hose Barb 90GH**

PART NO.	HOSE THREAD	I.D. HOSE SIZE	L	M	FLOW DIA.D
90GH-12-3	3/4	3/16	1.29	1.15	.125
90GH-12-4	3/4	1/4	1.21	1.15	.187
90GH-12-6	3/4	3/8	1.21	1.15	.281
90GH-12-8	3/4	1/2	1.21	1.15	.375
90GH-12-10*	3/4	5/8	1.93	1.19	.500
90GH-12-12*	3/4	3/4	1.93	1.19	.625

\*Denotes hex body

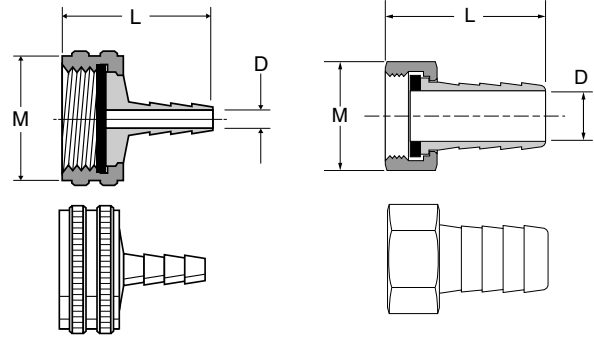

**F**

**Knurled Hose Nut 94GH**

PART NO.	HOSE THREAD	L	M	FLOW DIA.D
94GH-12	3/4	.57	1.15	.808

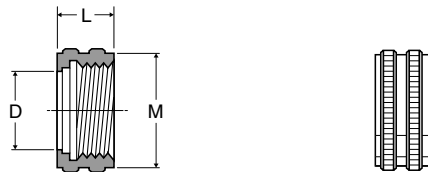

**Hose Nut Reducer 95GH**

PART NO.	HOSE THREAD	PIPE THREAD	C HEX	L
95GH-12-2	3/4	1/8	1-1/8	.63



**Hose Cap Nut 96GH**

PART NO.	HOSE THREAD	L	M
96GH-12	3/4	.50	1.15

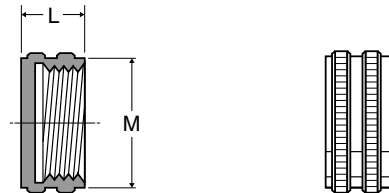

**Female Hose to Female Pipe 98GH & 99GH**

PART NO.	HOSE THREAD	PIPE THREAD	C HEX	L	M	FLOW DIA.D
98GH-12-8	3/4	1/2	1-3/16	1.14	1.01	.687
99GH-12-12	3/4	3/4	1-3/16	1.25	1.17	.750

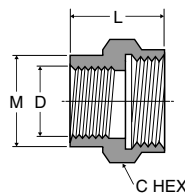

**Swivel Connector Female Hose to Female Pipe 98GHSV & 99GHSV**

PART NO.	HOSE THREAD	PIPE THREAD	C HEX	L	M	FLOW DIA.D
98GHSV-12-8	3/4	1/2	1	1.27	1.21	.687
99GHSV-12-12	3/4	3/4	1-3/16	1.34	1.21	.687

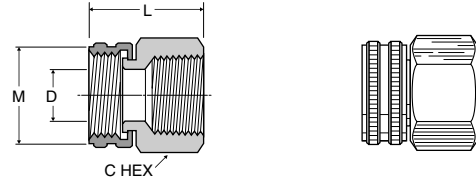

**Swivel Nut Connector 101GHSV**

PART NO.	HOSE THREAD	L	M	FLOW DIA.D
101GHSV-12	3/4	1.25	1.15	.625

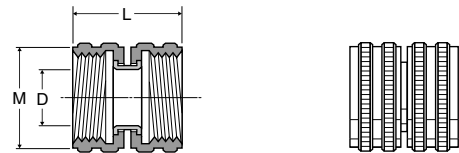

**Rubber Garden Hose Coupling Washer 901GH**

PART NO.	HOSE THREAD
901GH-12	3/4

NOTE: All female connector ends should have this rubber washer installed prior to usage.



**Hydraulic Quick Couplings/High Flow Couplings**

**Applications**

Parker Water Service Couplings are used anywhere water hoses are connected and disconnected frequently. They are used on a wide variety of applications including garden hoses, wash down systems, and mobile water tank lines. The unvalved design permits maximum flow with minimum pressure drop.

**Features**

- Brass and stainless steel construction for heavy duty service.
- Durable 4-ball locking mechanism for secure connections.
- Quality, temperature-resistant nitrile seals for a leak-free service life.

**Specifications**

Body Size	3/4"
Rated Pressure (PSI)	200
Rated Flow (GPM)	28
Temperature Range (std seals)	-40°F to +250°F

**High Flow Coupler 1163-60-BPD**

PART NO.	BODY SIZE	THREAD SIZE NH	A	C
1163-60-BPD	3/4	3/4-11 1/2	1.12	1.21

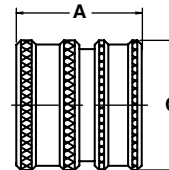

**High Flow Nipple 1163-61-BPD**

PART NO.	BODY SIZE	THREAD SIZE NH	D	E
1163-61-BPD	3/4	3/4-11 1/2	1.25	.50

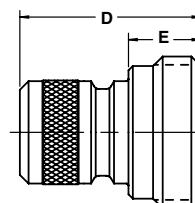

Notes

---

---

---

---

---

---

---

---

---

---

---

---

---

---

---

---

---

---

---

---

---

---

---

---

---

---

---



# ***Barbed Fittings***



## **Dubl-Barb Fittings**

- Compact
- One-piece
- Economical
- Reusable
- Use with Polyethylene Tubing











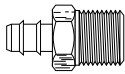
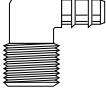
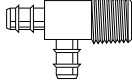
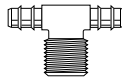
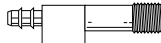
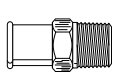
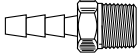
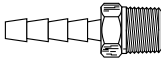
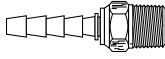

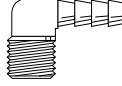
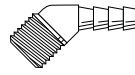
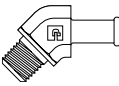
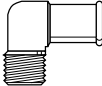
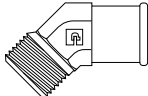
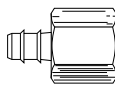
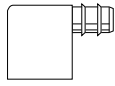

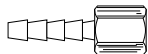
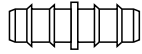
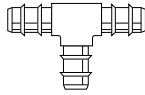
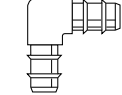

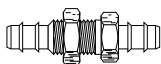

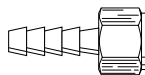
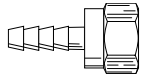
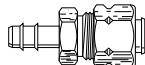
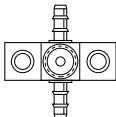

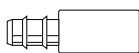
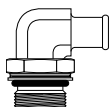
## **Hose Barb Fittings**

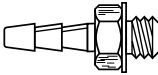
- All Brass Construction
- Straight and Metric Threads
- Beaded & Standard Hose Barbs
- Use with Hose Clamp
- Reusable

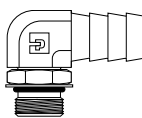
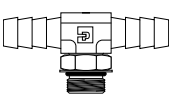
***The World Standard***

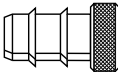

<b>Barb to Male NPT</b>	<b>28</b> Male Connector  Page G5	<b>229</b> Male Elbow  Page G7	<b>231</b> Run Tee  Page G7	<b>232</b> Branch Tee  Page G8	<b>228</b> Gauge Tee  Page G7	<b>68HB</b> Male Connector  Page G10
	<b>125HB</b> Male Connector  Page G11	<b>125HBL</b> Male Connector  Page G11	<b>125HBLSV</b> Swivel Connector  Page G11	<b>127HB</b> Ball-End Adapter  Page G12	<b>129HB</b> Male Elbow  Page G12	<b>139HB</b> 45° Male Elbow  Page G12
<b>179HB</b> 45° Male Elbow  Page G14	<b>269HB</b> Male Elbow  Page G14	<b>279HB</b> 45° Male Elbow  Page G14	<b>Barb to Female NPT</b>	<b>26</b> Female Connector  Page G5	<b>230</b> Female Elbow  Page G7	<b>237</b> Female Tee  Page G8
<b>126HBL</b> Female Connector  Page G11	<b>Barb to Barb</b>	<b>22</b> Union  Page G4		<b>224</b> Union Tee  Page G6	<b>225</b> Union Elbow  Page G6	<b>122HBL</b> Hose Mender  Page G10
<b>Bulkheads</b>		<b>22BH</b> Bulkhead Union  Page G4	<b>22CABH</b> Bulkhead Union  Page G5	<b>Swivels</b>	<b>128HBLSV</b> Female Ball-End  Page G12	<b>146HBLFSV</b> 45° Female Flare  Page G13
	<b>Adapters</b>	<b>22CA</b> Mixed Union  Page G4	<b>220</b> Adapter Tee  Page G6		<b>233</b> Mixed Tee  Page G8	<b>238</b> Solder Connector  Page G8
<b>169HB-MI</b> Male Elbow  Page G13		<b>179HB-MI</b> 45° Male Elbow  Page G14	<b>Barb to Straight Thread</b>	<b>27</b> Male Connector  Page G5	<b>685HB</b> Male Connector  Page G10	<b>1295HB</b> Male Elbow  Page G12
<b>1725HB</b> Tee  Page G13	<b>1795HB</b> 45° Elbow  Page G14	<b>Auxiliary</b>		<b>20</b> Plug  Page G4	<b>97HC</b> Clamp  Page G10	

G

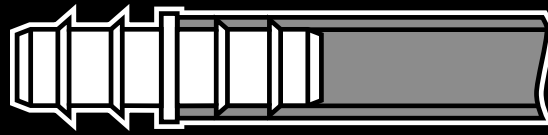

## Dubl-Barb® Fittings

### Advantages

Compact one-piece, push-on barbed fitting for a quick, economical way to connect polyethylene tubing. In addition to the styles shown, custom DUBL-BARB fittings to meet your exact requirements are available. Machined from CA 360 or CA 345 brass.

### Applications

Because of the many available variations in qualities of polyethylene tubing, DUBL-BARB® fittings are recommended for use with Parker Parflex® polyethylene tubing (or an equal grade). Parker Parflex® tubing is highly resistant to environmental stress cracking which is necessary for long life when coupled with expansion fittings.

### Working Pressure and Temperature Ranges

In tube sizes 1/4 to 3/8 working pressures up to 150 psi are practical at temperatures ranging from -65° to +90°F on tube size 1/2 working pressures up to 100 psi at temperatures ranging from -65° to +75°F.

### Assembly Instructions

Simply push tube over the two barbs — be sure tubing is cut squarely.

### Order

By part number and name.

### Nomenclature

Part numbers are constructed from symbols that identify the style and size of the fitting. The first series of numbers and letters identifies the style and type fitting. The second series of numbers describes the size.

#### Example:

Run Tee (Tube to — 231 — 8 — 6  
male pipe)  
1/2" (8/16) Tube O.D. —  
3/8" (6/16) Pipe Thread —

### Sizes

Tube sizes are determined by the numbers of sixteenths of an inch in the tube O.D.

### Special Fittings

Fitting configurations and/or sizes other than those shown in the catalog can be furnished. It is suggested that a print or sketch be submitted with the inquiry.

### Pricing

Only items priced in current supplementary price list PL3501 are carried in stock. Price and delivery for non-stock items furnished on request for specified quantity.

G

**Plug 20**

PART NO.	TUBE O.D.	TUBE I.D.	C DIA.	L	M
20-4	1/4	.170	.290	.56	.41
20-6	3/8	.250	.390	.68	.44
20-8	1/2	.377	.577	.81	.56

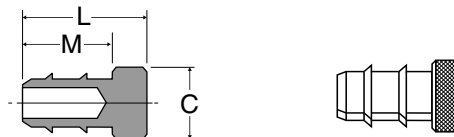

**Plug Adapter 20**

PART NO.	TUBE O.D. 1	TUBE I.D. 1	TUBE O.D. 2	TUBE I.D. 2	C DIA.	L
20-4-5/32	5/32	.096	1/4	.170	.290	.65

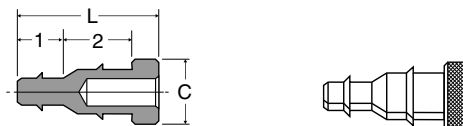

**Union 22**

PART NO.	TUBE O.D.	TUBE I.D.	L	M	FLOW DIA. D
22-5/32	5/32x5/32	.096x.096	.59	.28	.062
22-4	1/4x1/4	.170x.170	.84	.41	.120
22-6	3/8x3/8	.250x.250	.94	.44	.187
22-8	1/2x1/2	.375x.375	1.19	.56	.312

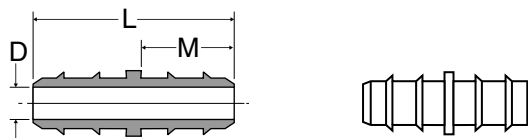

**Union Reducer 22**

PART NO.	TUBE O.D.	TUBE I.D.	L	M	N	FLOW DIA. D
22-4-5/32	1/4x5/32	.170x.096	.72	.41	.28	.062
22-4-6	1/4x3/8	.170x.250	.88	.44	.41	.120
22-4-8	1/4x1/2	.170x.375	1.06	.56	.41	.120
22-6-8	3/8x1/2	.250x.375	1.06	.56	.44	.187

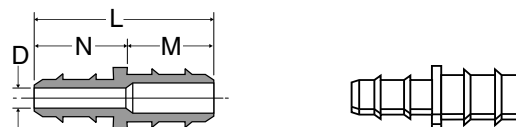

**Bulkhead Union 22BH**

PART NO.	TUBE O.D.	TUBE I.D.	ST. THD.	C HEX	P MAX.	L	M	FLOW DIA. D	BLKHD HOLE DIA.
22BH-4-4	1/4	.170	5/16-24	7/16	.219	1.38	.78	.120	5/16
22BH-6-6	3/8	.250	3/8-24	7/16	.375	1.63	1.00	.187	3/8

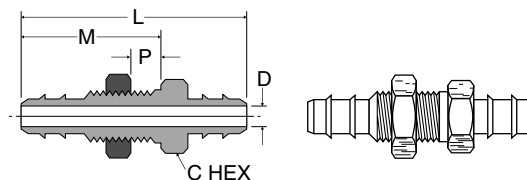

**Union 22CA**

Tube to Compress-Align

PART NO.	TUBE O.D.	TUBE I.D.	CA TUBE	C HEX	L	M	FLOW DIA. D
22CA-4-4	1/4	.170	1/4	7/16	1.15	.41	.120

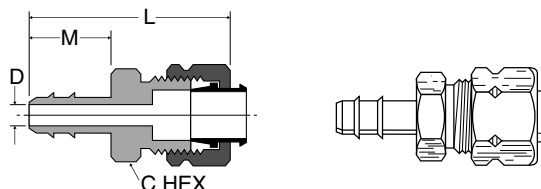

G

**Bulkhead Union 22CABH**

Tube to Compress-Align

PART NO.	TUBE O.D.	TUBE I.D.	CA TUBE	ST. THD.	C HEX	P MAX.	L	M	FLOW DIA. D	BULKHEAD HOLE DIA.
22CABH-4-4	1/4	.170	1/4	5/16-24	7/16	.219	1.53	.78	.120	5/16
22CABH-6-6	3/8	.250	3/8	3/8-24	9/16	.375	1.87	1.00	.187	3/8

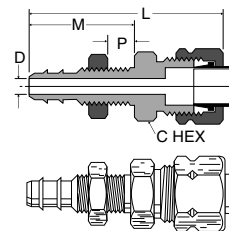

**Female Connector 26**

PART NO.	TUBE O.D.	TUBE I.D.	PIPE THREAD	C HEX	L	FLOW DIA. D
26-5/32-2	5/32	.096	1/8	1/2	.79	.062
26-4-2	1/4	.170	1/8	1/2	.91	.120
26-6-2	3/8	.250	1/8	1/2	.93	.187
26-6-4	3/8	.250	1/4	11/16	1.06	.187

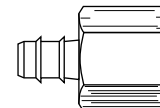
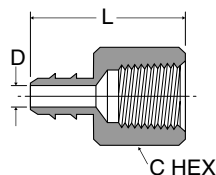

**Male Connector 27**

PART NO.	TUBE O.D.	TUBE I.D.	STRAIGHT THREAD	C HEX	L	FLOW DIA. D
27-1*	1/8	.062	10-32	1/4	.61	.052
27-2*	1/4	.125	10-32	1/4	.74	.093

\*For vinyl tubing only.

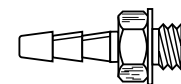
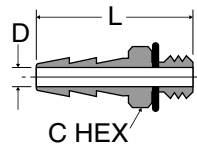

**Barb-to-Pipe Adapter 28**

PART NO.	TUBE O.D. 1	TUBE I.D. 1	TUBE O.D. 2	TUBE I.D. 2	PIPE THD.	C HEX	L	FLOW DIA. D
28-4-5/32-2	5/32	.096	1/4	.170	1/8	7/16	1.07	.062

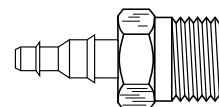
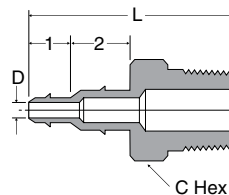

**Male Connector 28**

PART NO.	TUBE O.D.	TUBE I.D.	PIPE THREAD	C HEX	L	FLOW DIA. D
28-5/32-2	5/32	.096	1/8	7/16	.84	.062
28-4-1	1/4	.170	1/16	3/8	.93	.120
28-4-2	1/4	.170	1/8	7/16	.97	.120
28-4-4	1/4	.170	1/4	9/16	1.09	.120
28-4-10x32*	1/4	.170	10-32	1/4	.71	.093
28-6-2	3/8	.250	1/8	7/16	1.00	.187
28-6-4	3/8	.250	1/4	9/16	1.13	.187
28-8-4	1/2	.375	1/4	9/16	1.25	.312
28-8-6	1/2	.375	3/8	11/16	1.28	.312
28-8-8	1/2	.375	1/2	7/8	1.44	.312

\*Straight thread

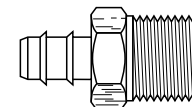
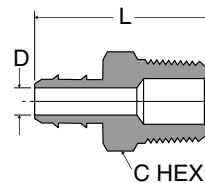

**Adapter Tee 220**

PART NO.	TUBE O.D.	TUBE I.D.	PIPE THREAD	L	N	FLOW DIA. D
220-4-2	1/4	.170	1/8	1.50	1.00	.120

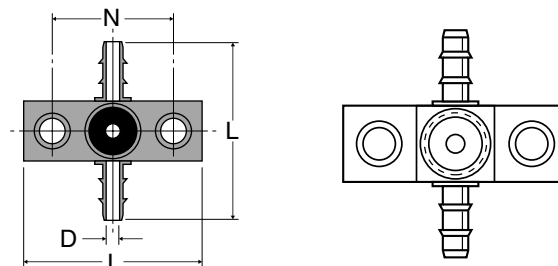

**Union Tee 224**

PART NO.	TUBE O.D.	TUBE I.D.	L	M	FLOW DIA. D
224-5/32	5/32	.096	1.00	.50	.062
224-4	1/4	.170	1.25	.63	.120
224-6	3/8	.250	1.38	.69	.187
224-8	1/2	.375	1.63	.81	.312

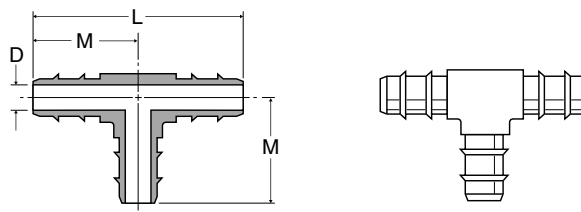

**Union Tee 224 Combination Sizes**

PART NO.	TUBE O.D.	TUBE I.D.	L	M	N	FLOW DIA. D	FLOW DIA. D1
224-4-4-5/32	1/4x5/32	.170x.096	1.25	.63	.50	.120	.062
224-6-6-5/32	3/8x5/32	.250x.096	1.38	.69	.50	.187	.062
224-6-6-4	3/8x1/4	.250x.170	1.38	.69	.62	.187	.120
224-8-8-4	1/2x1/4	.375x.170	1.62	.81	.65	.312	.120
224-8-8-6	1/2x3/8	.375x.250	1.62	.81	.69	.312	.187

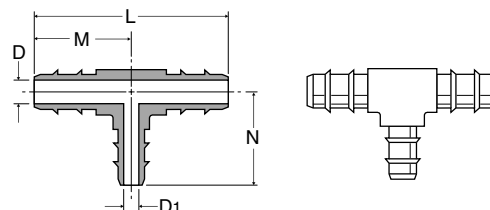

**Union Elbow 225**

PART NO.	TUBE O.D.	TUBE I.D.	M	FLOW DIA. D
225-5/32	5/32	.096	.50	.062
225-4-4	1/4	.170	.63	.120
225-6-6	3/8	.250	.69	.187
225-8-8	1/2	.375	.81	.312

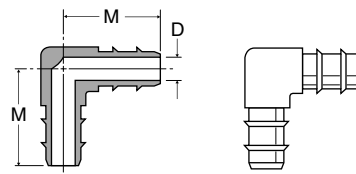

**Union Elbow 225 Combination Size**

PART NO.	TUBE O.D. 1	TUBE O.D. 2	TUBE I.D. 1	TUBE I.D. 2	M1	M2	FLOW DIA. D1	FLOW DIA. D2
225-4-5/32	1/4	5/32	.170	.096	.63	.50	.120	.062

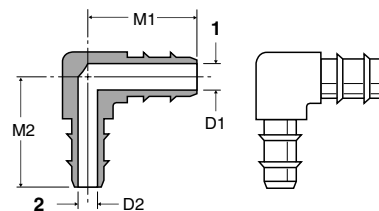

G

**Gauge Tee 228**

PART NO.	TUBE O.D.	TUBE I.D.	PIPE THREAD	L	M	N	FLOW DIA. D
228-4-2	1/4	.170	1/8	1.91	.66	.44	.120

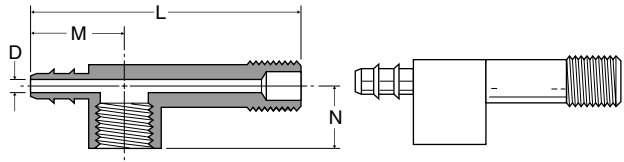

**Male Elbow 229**

PART NO.	TUBE O.D.	TUBE I.D.	PIPE THREAD	M	N	FLOW DIA. D
229-5/32-2	5/32	.096	1/8	.56	.63	.062
229-4-1	1/4	.170	1/16	.62	.60	.120
229-4-2	1/4	.170	1/8	.69	.63	.120
229-4-4	1/4	.170	1/4	.72	.72	.120
229-6-2	3/8	.250	1/8	.69	.69	.187
229-6-4	3/8	.250	1/4	.75	.75	.187
229-8-4	1/2	.375	1/4	.94	.74	.312
229-8-6	1/2	.375	3/8	.94	.81	.312

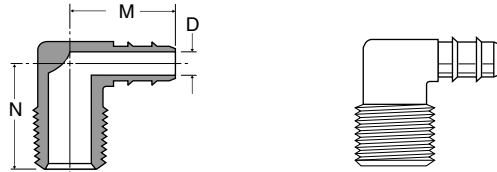

**90° Elbow Barb Adapter 229**

PART NO.	TUBE O.D. 1	TUBE I.D. 1	TUBE O.D. 2	TUBE I.D. 2	PIPE THREAD	M	FLOW DIA. D
229-4-5/32-2	5/32	.096	1/4	.170	1/8	.78	.062

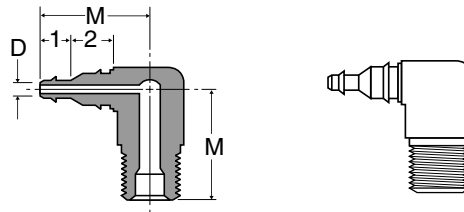

**Female Elbow 230**

PART NO.	TUBE O.D.	TUBE I.D.	PIPE THREAD	L	M	N	FLOW DIA. D
230-4-2	1/4	.170	1/8	.91	.66	.44	.120
230-6-4	3/8	.250	1/4	1.12	.78	.63	.187

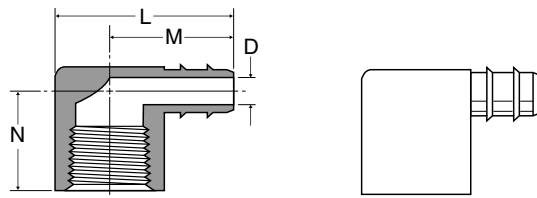

**Male Run Tee 231**

PART NO.	TUBE O.D.	TUBE I.D.	PIPE THREAD	L	M	N	FLOW DIA. D
231-4-2	1/4	.170	1/8	1.28	.66	.69	.120
231-6-2	3/8	.250	1/8	1.38	.69	.69	.187
231-6-4	3/8	.250	1/4	1.44	.75	.75	.187

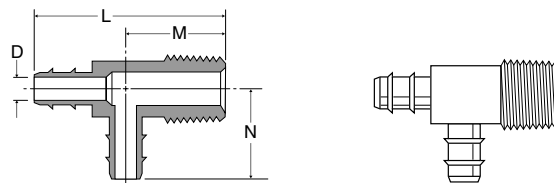

**Male Branch Tee 232**

PART NO.	TUBE O.D.	TUBE I.D.	PIPE THREAD	L	M	N	FLOW DIA. D
232-4-1	1/4	.170	1/16	1.33	.66	.65	.120
232-4-2	1/4	.170	1/8	1.38	.69	.66	.120
232-6-2	3/8	.250	1/8	1.38	.69	.69	.187
232-6-4	3/8	.250	1/4	1.50	.75	.75	.187

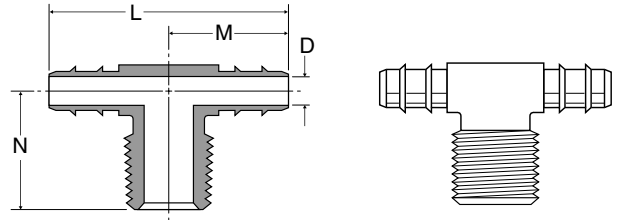

**Tee 233**

PART NO.	TUBE O.D.	TUBE I.D.	COMB. TUBE	L	M	N	FLOW DIA. D
233-4-4-4	1/4	.170	1/4	.73	.53	.74	.120
233-6-6-4	1/4	.170	3/8	.87	.59	.80	.120

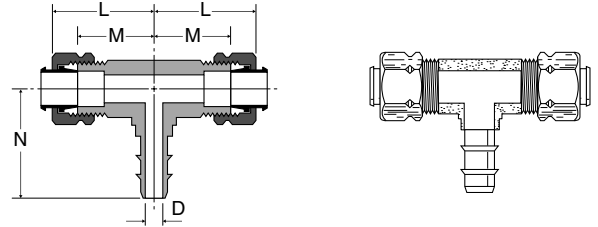

**Female Branch Tee 237**

PART NO.	TUBE O.D.	TUBE I.D.	PIPE THREAD	L	M	N	FLOW DIA. D
237-5/32-2	5/32	.096	1/8	1.06	.53	.44	.062
237-4-2	1/4	.170	1/8	1.34	.67	.49	.120

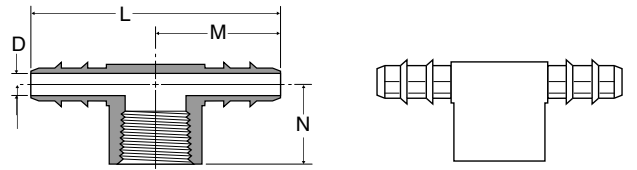

**Solder Connector 238**

PART NO.	TUBE O.D. 1	TUBE I.D. 1	L	M	FLOW DIA. D
238-4-4	1/4	.170	.91	.25	.120

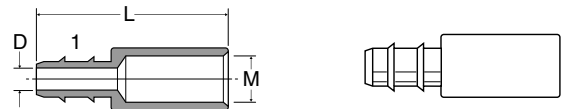

G

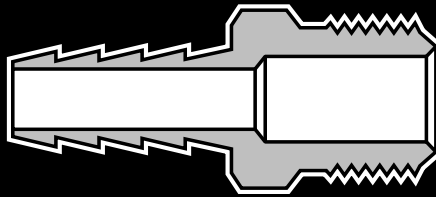

# Hose Barb Fittings

## Advantages

All Parker hose barb fitting pipe threads are made to Dryseal standards. Connectors, unions, nuts and extended elbows and tees are machined from CA 360 and CA 345 brass.

## Temperature and Working Pressure Ranges

From -40° to +160°F. at 150 PSI maximum.

Note: These fittings are intended for use with 97HC hose clamp, similar type clamp or a crimped ferrule.

## Assembly Instructions

1. Cut hose cleanly and squarely to length.
2. Slide clamp on hose.
3. Lubricate hose. Push hose on fitting until hose bottoms against stop ring or hex.
4. Position hose clamp as shown below and secure with a screwdriver or wrench. Maintain "A" dimension noted below for proper clamp positioning.

HOSE SIZE	HOSE CLAMP	A
3/16"	97 HC-3	1/4"
1/4"	97 HC-3	1/4"
5/16"	97 HC-6	1/4"
3/8"	97 HC-6	1/8"
1/2"	97 HC-8	1/8"
5/8"	97 HC-12	1/8"
3/4"	97 HC-12	1/8"

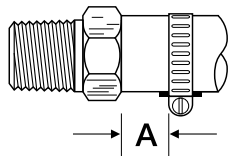

## Order

By part number and name.

## Nomenclature

Part numbers are constructed from symbols that identify the style and size of the fitting. The first series of numbers and letters identifies the style and type fitting. The second series of numbers describes the size.

## Example:

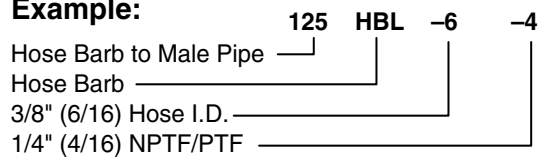

## Sizes

Pipe sizes are determined by the number of sixteenths of an inch in the pipe size.

## Special Fittings

Fitting configurations and/or sizes other than those shown in the catalog can be furnished. It is suggested that a print or sketch be submitted with the inquiry.

## Pricing

Only items priced in current supplementary price list PL3501 are carried in stock. Price and delivery for non-stock items furnished on request for specified quantity.





**Beaded Hose Barb to Male Pipe 68HB**

PART NO.	I.D. HOSE SIZE	PIPE THREAD	C HEX	L	M	FLOW DIA.D
68HB-6-6	3/8	3/8	11/16	1.53	.78	.281
68HB-8-4	1/2	1/4	5/8	1.56	.78	.375
68HB-8-6	1/2	3/8	11/16	1.53	.78	.406
68HB-8-8	1/2	1/2	7/8	1.73	.78	.406
68HB-10-6	5/8	3/8	3/4	1.62	.88	.501
68HB-10-8	5/8	1/2	7/8	1.92	.88	.501
68HB-12-8	3/4	1/2	7/8	1.98	.88	.564
68HB-12-12	3/4	3/4	1 1/16	2.04	.97	.625
68HB-16-12	1	3/4	1 1/8	2.12	1.00	.750
68HB-16-16	1	1	1.38	2.31	1.00	.812

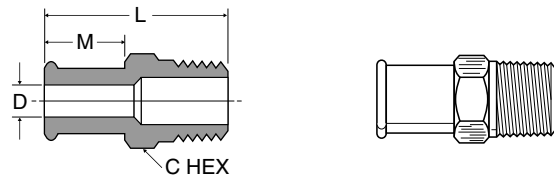

**Beaded Hose Barb to SAE Straight Thread 685HB**

PART NO.	I.D. HOSE SIZE	STRAIGHT THREAD	C HEX	L	M	FLOW DIA.D
685HB-4-4	1/4	7/16-20	9/16	1.40	.78	.18
685HB-6-4	3/8	7/16-20	9/16	1.39	.78	.18
685HB-8-8	1/2	3/4-16	7/8	1.48	.78	.40
685HB-10-8	5/8	3/4-16	7/8	1.56	.78	.40
685HB-12-8	3/4	3/4-16	7/8	1.75	.97	.40
685HB-12-12	3/4	1 1/16-12	1 1/4	1.82	.97	.62
685HB-16-8	1	3/4-16	1 1/8	1.79	.97	.40
685HB-16-12	1	1 1/16-12	1 1/4	1.99	.97	.62

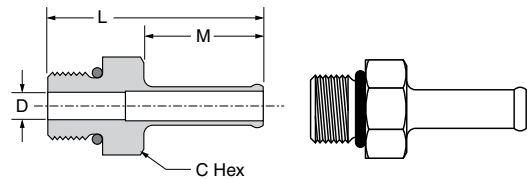

Note: Fluorocarbon o-ring is standard

**Hose Barb to Metric Adaptor 68HB-X-MIX**

PART NUMBER	TUBE SIZE	METRIC THREAD	HEX	L	M	D
68HB-6-MI12	3/8	M12 x 1.5	11/16	1.50	.78	.24
68HB-6-MI14	3/8	M14 1.5	3/4	1.51	.78	.30
68HB-8-MI12	1/2	M12 x 1.5	11/16	1.50	.78	.24

Note: Fluorocarbon o-ring is standard

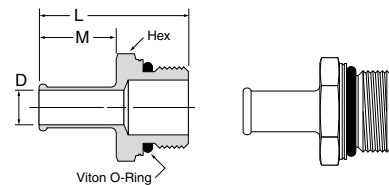

**Stainless Steel Worm Drive Clamp 97HC**

PART NO.	MAX. D	MIN. D	C HEX	H MAX.	W
97HC-3	.62	.25	.25	1.00	.31
97HC-6	.87	.38	.31	1.40	.50
97HC-8	1.00	.44	.31	1.53	.50
97HC-12	1.25	.50	.31	1.80	.50

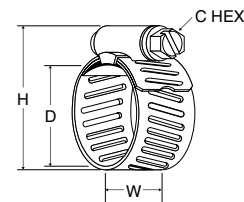

**Hose Mender 122HBL**

PART NO.	I.D. HOSE SIZE	C DIA.	L	M	O.D.	FLOW DIA. D
122HB-3*	3/16	5/16	1.44	.69	.227	.125
122HBL-4	1/4	3/8	2.00	.97	.290	.187
122HBL-5	5/16	7/16	2.00	.97	.353	.250
122HBL-6	3/8	1/2	2.00	.97	.415	.281
122HBL-8	1/2	5/8	2.00	.97	.530	.375
122HBL-12	3/4	7/8	2.00	.97	.790	.562

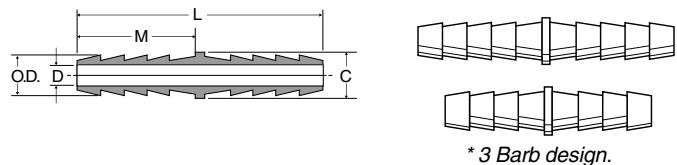

G

**Hose Barb to Male Pipe 125HB**

PART NO.	I.D. HOSE SIZE	PIPE THREAD	C HEX	L	M	O.D.	FLOW DIA. D
125HB-2-2	1/8	1/8	7/16	1.07	.50	.185	.093
125HB-3-2	3/16	1/8	7/16	1.25	.69	.227	.125
125HB-3-4	3/16	1/4	9/16	1.44	.69	.227	.125

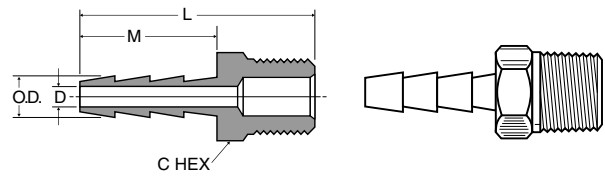

**Hose Barb to Male Pipe 125HBL**

PART NO.	I.D. HOSE SIZE	PIPE THREAD	C HEX	L	M	O.D.	FLOW DIA. D
125HBL-4-2	1/4	1/8	7/16	1.54	.97	.290	.187
125HBL-4-4	1/4	1/4	9/16	1.72	.97	.290	.187
125HBL-4-6	1/4	3/8	11/16	1.77	.97	.290	.187
125HBL-5-2	5/16	1/8	7/16	1.54	.97	.353	.250
125HBL-5-4	5/16	1/4	9/16	1.72	.97	.353	.250
125HBL-5-6	5/16	3/8	11/16	1.77	.97	.353	.250
125HBL-6-2	3/8	1/8	7/16	1.54	.97	.415	.281
125HBL-6-4	3/8	1/4	9/16	1.72	.97	.415	.281
125HBL-6-6	3/8	3/8	11/16	1.77	.97	.415	.281
125HBL-6-8	3/8	1/2	7/8	1.97	.97	.415	.281
125HBL-8-4	1/2	1/4	9/16	1.72	.97	.530	.375
125HBL-8-6	1/2	3/8	11/16	1.77	.97	.530	.375
125HBL-8-8	1/2	1/2	7/8	1.97	.97	.530	.375
125HBL-8-12	1/2	3/4	1-1/16	1.98	.97	.530	.375
125HBL-10-6	5/8	3/8	11/16	1.77	.97	.645	.468
125HBL-10-8	5/8	1/2	7/8	1.97	.97	.645	.468
125HBL-10-12	5/8	3/4	1-1/16	1.98	.97	.645	.468
125HBL-12-8	3/4	1/2	7/8	1.97	.97	.790	.562
125HBL-12-12	3/4	3/4	1-1/16	1.98	.97	.790	.562
125HBL-16-12	1	3/4	1-1/16	2.18	1.17	1.02	.750
125HBL-16-16	1	1	1-3/8	2.36	1.17	1.02	.875

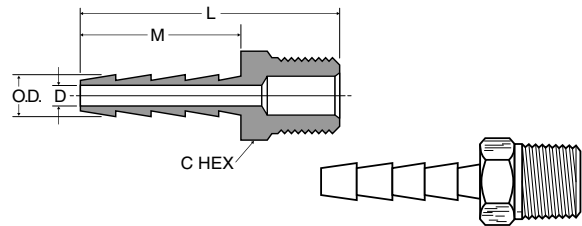

**Male Swivel Hose Barb 125HBLSV**

PART NO.	I.D. HOSE SIZE	PIPE THREAD	C HEX	L	M	O.D.	FLOW DIA. D
125HBLSV-4-4	1/4	1/4	11/16	2.14	.97	.290	.187
125HBLSV-6-4	3/8	1/4	11/16	2.14	.97	.415	.250
125HBLSV-6-6	3/8	3/8	11/16	2.14	.97	.415	.250
125HBLSV-8-8	1/2	1/2	7/8	2.48	.97	.530	.375

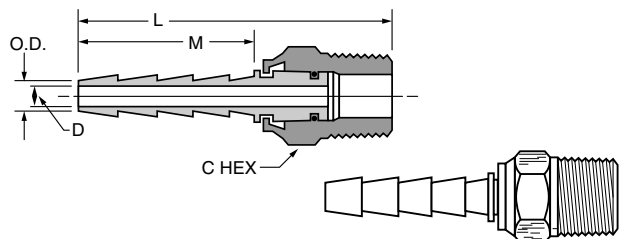

**Hose Barb to Female Pipe 126HBL**

PART NO.	I.D. HOSE SIZE	PIPE THREAD	C HEX	L	M	O.D.	FLOW DIA. D
126HBL-4-2	1/4	1/8	1/2	1.47	.97	.290	.187
126HBL-4-4	1/4	1/4	11/16	1.58	.97	.290	.187
126HBL-5-4	5/16	1/4	11/16	1.58	.97	.353	.250
126HBL-6-2	3/8	1/8	1/2	1.47	.97	.415	.281
126HBL-6-4	3/8	1/4	11/16	1.58	.97	.415	.281
126HBL-6-6	3/8	3/8	13/16	1.63	.97	.415	.281
126HBL-8-6	1/2	3/8	13/16	1.59	.97	.530	.375
126HBL-8-8	1/2	1/2	1	1.73	.97	.530	.375
126HBL-12-12	3/4	3/4	1-1/4	1.92	.97	.790	.562

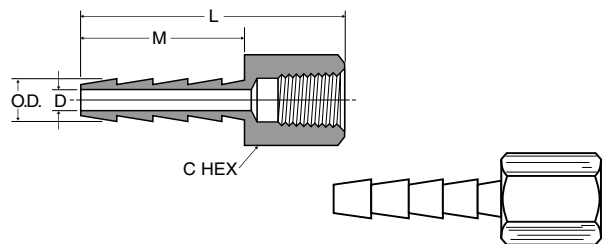

**Ball-End Joint Adapter to Male Pipe 127HB**

For use with 128HBLSV

PART NO.	MALE N.P.S.M. THREAD	MALE N.P.T. THREAD	C HEX	L	FLOW DIA. D
127HB-4-2	1/4	1/8	9/16	.91	.219
127HB-4-4	1/4	1/4	9/16	1.10	.281
127HB-6-4	3/8	1/4	11/16	1.10	.312
127HB-6-6	3/8	3/8	11/16	1.15	.406
127HB-8-6	1/2	3/8	7/8	1.25	.406
127HB-8-8	1/2	1/2	7/8	1.50	.531

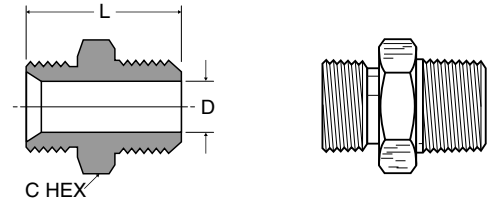

**Hose Barb to Swivel Female Ball-End 128HBLSV**

PART NO.	I.D. HOSE SIZE	FEMALE N.P.S.M. THREAD	C HEX	L	M	O.D.	FLOW DIA. D
128HBLSV-4-4	1/4	1/4	5/8	1.50	.97	.290	.187
128HBLSV-5-4	5/16	1/4	5/8	1.50	.97	.353	.250
128HBLSV-6-4	3/8	1/4	5/8	1.63	.97	.415	.250
128HBLSV-6-6	3/8	3/8	3/4	1.50	.97	.415	.281
128HBLSV-8-8	1/2	1/2	29/32	1.52	.97	.530	.375

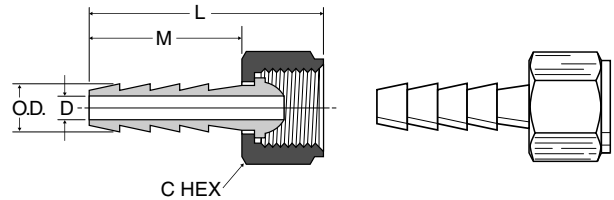

**Hose Barb 90° Elbow to Male Pipe 129HB**

PART NO.	I.D. HOSE SIZE	PIPE THREAD	L	M	N	O.D.	FLOW DIA. D
129HB-3-2	3/16	1/8	.97	.69	.66	.227	.173
129HB-4-2	1/4	1/8	1.04	.76	.66	.290	.187
129HB-4-4	1/4	1/4	1.06	.76	.86	.290	.187
129HB-4-6	1/4	3/8	1.30	.76	.84	.290	.187
129HB-5-2	5/16	1/8	1.06	.76	.66	.353	.234
129HB-5-4	5/16	1/4	1.12	.76	.84	.353	.234
129HB-5-6	5/16	3/8	1.19	.76	.84	.353	.234
129HB-6-2	3/8	1/8	1.32	.97	.94	.415	.281
129HB-6-4	3/8	1/4	1.32	.97	.94	.415	.281
129HB-6-6	3/8	3/8	1.50	.97	1.06	.415	.281
129HB-6-8	3/8	1/2	1.52	.97	1.25	.415	.281
129HB-8-4	1/2	1/4	1.53	.97	1.06	.530	.375
129HB-8-6	1/2	3/8	1.53	.97	1.06	.530	.375
129HB-8-8	1/2	1/2	1.53	.97	1.25	.530	.375
129HB-12-12	3/4	3/4	1.33	.79	1.27	.790	.562

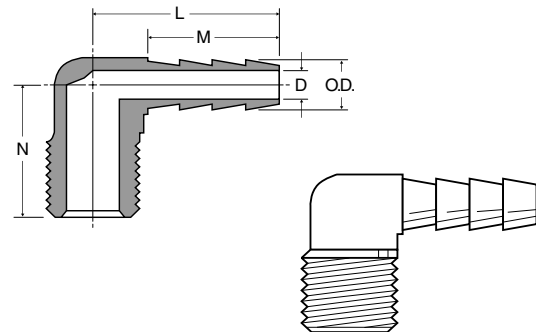

**Hose Barb Elbow to SAE Straight Thread 1295HB**

PART NO.	I.D. HOSE SIZE	STRAIGHT THREAD	B HEX	L	M	O.D.	FLOW DIA. D
1295HB-6-6	3/8	9/16-18	11/16	1.10	1.11	.410	.270

Note: Fluorocarbon o-ring is standard

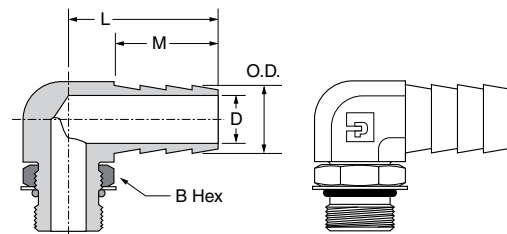

**Hose Barb 45° Elbow to Male Pipe 139HB**

PART NO.	I.D. HOSE SIZE	PIPE THREAD	L	M	N	O.D.	FLOW DIA. D
139HB-4-2	1/4	1/8	.91	.76	.68	.290	.187
139HB-4-4	1/4	1/4	1.00	.76	.68	.290	.187
139HB-6-4	3/8	1/4	1.00	.76	.68	.415	.281

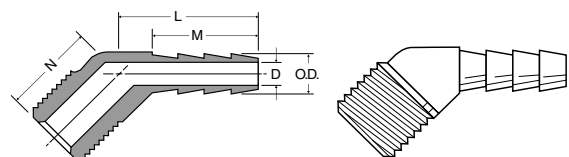

G

**Hose Barb to Swivel 45° Female Flare 146HBLFSV**

PART NO.	I.D. HOSE SIZE	STRAIGHT THREAD	C HEX	L	M	O.D.	FLOW DIA. D
146HBLFSV-4-4	1/4	7/16-20	9/16	1.55	.97	.290	.187
146HBLFSV-4-6	1/4	5/8-18	3/4	1.72	.97	.290	.187
146HBLFSV-6-6	3/8	5/8-18	3/4	1.72	.97	.415	.281

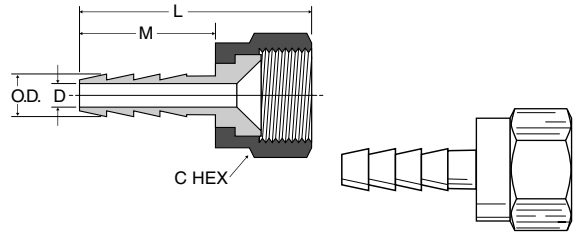

**Beaded Hose Barb Elbow to SAE Straight Thread 1695HB**

PART NUMBER	HOSE SIZE	STRAIGHT THREAD	HEX	L	M	N	D
1695HB-6-4	3/8	7/16-20	9/16	1.09	.78	1.10	.18
1695HB-8-6	1/2	9/16-18	9/16	1.10	.78	1.11	.30
1695HB-8-8	1/2	3/4-16	7/8	1.28	.78	1.47	.40
1695HB-10-8	5/8	3/4-16	7/8	1.47	.88	1.47	.40
1695HB-10-10	5/8	7/8-14	1	1.41	.88	1.60	.50
1695HB-12-8	3/4	3/4-16	7/8	1.47	.97	1.47	.40
1695HB-12-10	3/4	7/8-14	1	1.60	.97	1.62	.50
1695HB-12-12	3/4	1 1/16-12	1	1.60	.97	1.64	.62
1695HB-16-12	1	1 1/16-12	1 1/4	1.60	.97	1.75	.60

Note: Fluorocarbon o-ring is standard

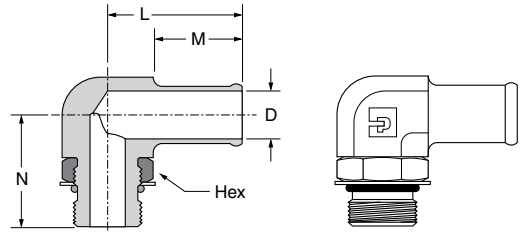

**Beaded Elbow to Metric Adaptor 169HB-X-MIX**

PART NUMBER	HOSE SIZE	METRIC THREAD	HEX	L	M	N	D
169HB-10-MI27	5/8	M27 x 2.0	7/8	1.41	.78	1.63	.50
169HB-16-MI27	1	M27 x 2.0	1	1.67	.97	1.68	.71
169HB-16-MI33	1	M33 x 2.0	1 5/16	1.75	.97	1.90	.84

Note: Fluorocarbon o-ring is standard

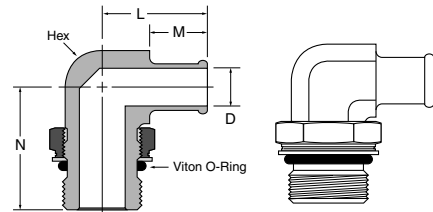

**Hose Barb Tee to SAE Straight Thread 1725HB**

PART NO.	I.D. HOSE SIZE	STRAIGHT THREAD	B HEX	L	M	O.D.	FLOW DIA. D
1725HB-6-6	3/8	9/16-18	11/16	2.20	1.10	.420	.280

Note: Fluorocarbon o-ring is standard

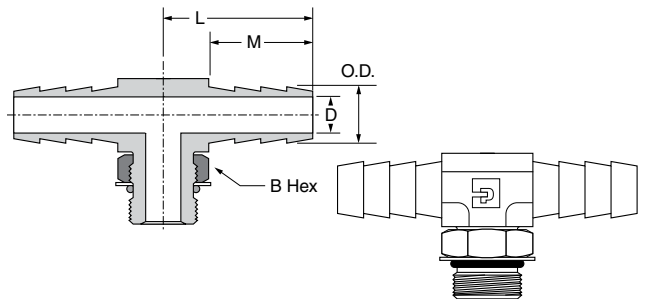

**Hose Barb Tee to Male Pipe 171HB**

PART NO.	I.D. HOSE SIZE	PIPE THREAD	L	L1	M	N	O.D.	FLOW DIA. D
171HB-4-4	1/4	1/4	1.10	.85	.76	1.10	.290	.187

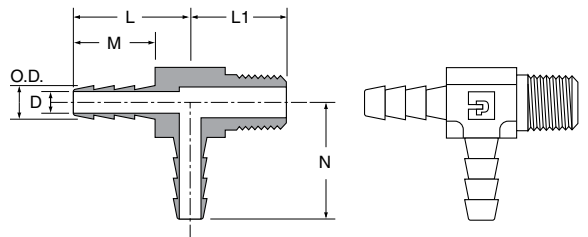

**Beaded Hose Barb 45° Elbow Tube to Male Pipe 179HB**

PART NO.	I.D. HOSE SIZE	NPTF THREAD	C HEX	L	M	N	O.D.	FLOW DIA. D
179HB-6-4	3/8	1/4-18	.75	1.09	.78	.93	.45	.28
179HB-6-6	3/8	3/8-18	.75	1.09	.78	.93	.45	.28
179HB-10-8	5/8	1/2-14	.81	1.19	.78	1.13	.70	.50
179HB-12-8	3/4	1/2-14	.81	1.19	.78	1.13	.83	.56

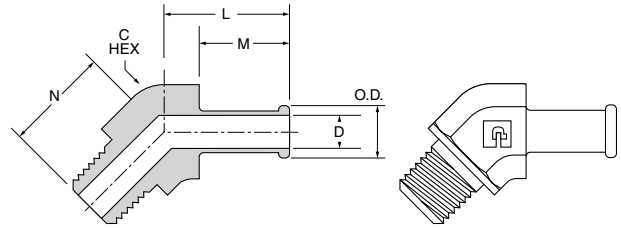

**Beaded Hose Barb 45° Elbow Tube to Straight Thread 1795HB**

PART NO.	I.D. HOSE SIZE	STRAIGHT THREAD	C HEX	L	M	N	FLOW DIA. D
1795HB-8-8	1/2	3/4-16	7/8	1.12	.78	1.16	.400
1795HB-10-8	5/8	3/4-16	7/8	1.22	.88	1.16	.398
1795HB-12-8	3/4	3/4-16	7/8	1.22	.88	1.16	.398
1795HB-12-12	3/4	1 1/16-12	1 1/4	1.35	.97	1.65	.620
1795HB-16-12	1	1 1/16-12	1 1/4	1.38	.97	1.47	.620
1795HB-16-14	1	1 3/16-12	1 3/8	1.25	.97	1.80	.720

Note: Fluorocarbon o-ring is standard

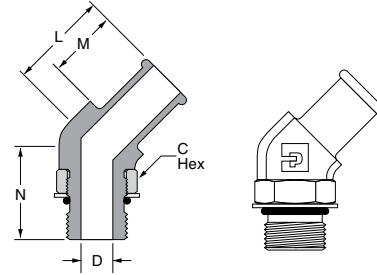

**Beaded Hose Barb 45 Elbow to Metric Thread 179HB-X-MIX**

PART NUMBER	HOSE SIZE	METRIC THREAD	HEX	L	M	N	D
179HB-12-MI18	3/4	M18 x 1.5	13/16	1.15	.78	1.16	.44
179HB-16-MI27	1	M27 x 2.0	1 1/16	1.51	.97	1.71	.71

Note: Fluorocarbon o-ring is standard

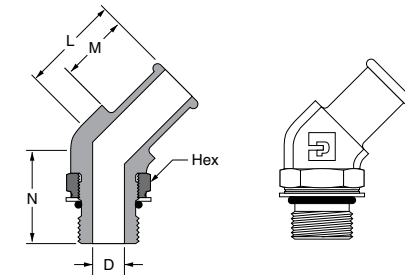

**Beaded Hose Barb 90° Elbow Tube to Male Pipe 269HB**

PART NO.	I.D. HOSE SIZE	PIPE THREAD	L	M	N	FLOW DIA. D
269HB-6-6	3/8	3/8	1.19	.78	.88	.281
269HB-8-4	1/2	1/4	1.16	.78	.99	.310
269HB-8-6	1/2	3/8	1.16	.78	1.08	.406
269HB-8-8	1/2	1/2	1.28	.78	1.25	.406
269HB-10-4	5/8	1/4	1.13	.78	.99	.312
269HB-10-6	5/8	3/8	1.16	.78	.99	.406
269HB-10-8	5/8	1/2	1.28	.78	1.25	.501
269HB-12-8	3/4	1/2	1.28	.78	1.25	.563
269HB-12-12	3/4	3/4	1.33	.78	1.27	.625

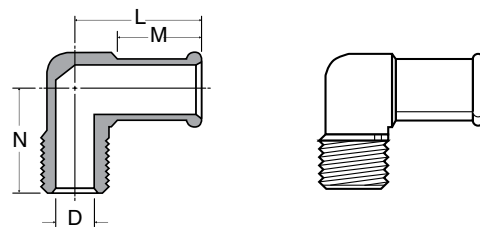

**Beaded Hose Barb 45° Elbow Tube to Male Pipe 279HB**

PART NO.	I.D. HOSE SIZE	NPTF THREAD	C HEX	L	M	N	O.D.	FLOW DIA. D
279HB-16-12	1	3/4-14	1.12	1.38	.97	1.13	1.06	.720

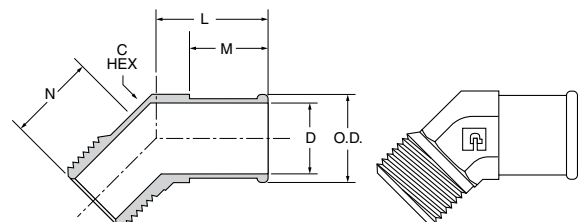



# Compression Style Transportation



## Air Brake Fittings

- Meets D.O.T. FMVSS 571.106
- Meets SAE J246 & J1131
- Reusable
- Use with Copper Tubing



## NTA Fittings

- Meets D.O.T. FMVSS 571.106
- Meets SAE J246 & J1131
- Staked in Tube Support
- Pre-applied Sealant



## Transmission Fittings

- Slotted Sleeve Prevents Over Torque
- Use with SAE J844 Tubing
- For Use in Pressure Protected Applications



## Air Brake Hose Ends











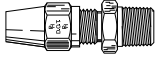
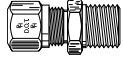
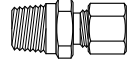
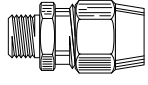
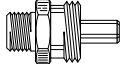

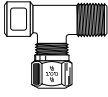
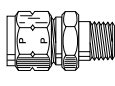
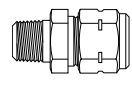
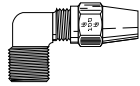
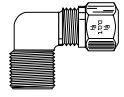
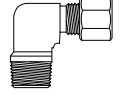
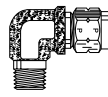
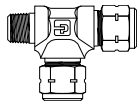
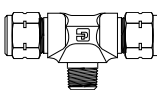
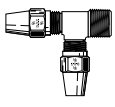

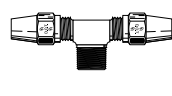
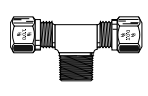
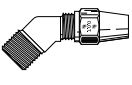
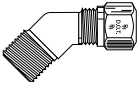
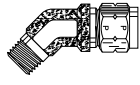
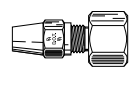
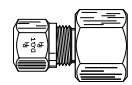
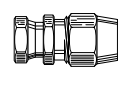
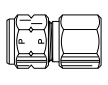
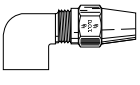
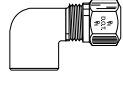
- Meets D.O.T. FMVSS 571.106
- Use with SAE J1402 Air Brake Hose

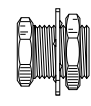
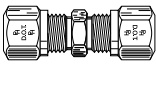
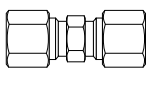
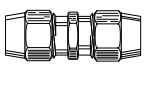
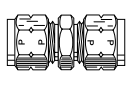
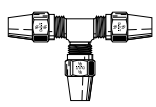
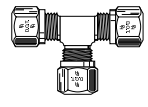
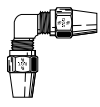





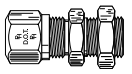
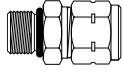

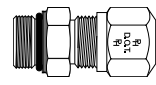



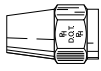



## Vibra-Lok

- Elastomeric Seal
- Excellent Vibration Resistance
- Viton Sleeve for High Temp
- Wide Range of Tubing

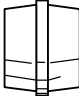
***The World Standard***

<b>Tube to Male NPTF</b>	<b>VS68AB</b> Male Connector  Page H15	<b>VS68NTA</b> Male Connector  Page H8	<b>68TF</b> Male Connector  Page H12	<b>68RB</b> Male Connector  Page H21	<b>68RB</b> Male Connector Body Only  Page H21	<b>68RBSG</b> Male Connector w/ Spring Guard  Page H21	
	<b>76RB</b> Adapter  Page H21	<b>VS176NTA</b> Adapter Tee  Page H8	<b>68VL</b> Male Connector  Page H25	<b>682VL</b> Tank Fitting  Page H25	<b>VS269AB</b> Male Elbow  Page H15	<b>VS269NTA</b> Male Elbow  Page H9	<b>269TF</b> Male Elbow  Page H12
	<b>169VL</b> Male Elbow  Page H25	<b>171VL</b> Male Run Tee  Page H26	<b>172VL</b> Male Branch Tee  Page H26	<b>VS271AB</b> Male Run Tee  Page H16	<b>VS271NTA</b> Male Run Tee  Page H9	<b>VS272AB</b> Male Branch Tee  Page H16	<b>VS272NTA</b> Male Branch Tee  Page H10
	<b>VS279AB</b> 45° Male Elbow  Page H16	<b>VS279NTA</b> 45° Male Elbow  Page H10	<b>179VL</b> 45° Male Elbow  Page H26	<b>Tube to Female NPTF</b>	<b>66AB</b> Female Connector  Page H14	<b>66NTA</b> Female Connector  Page H7	<b>66RBSV</b> Female Connector  Page H20
	<b>66VL</b> Female Connector  Page H24	<b>270AB</b> Female Elbow  Page H16	<b>270NTA</b> Female Elbow  Page H9		<b>170VL</b> Female Elbow  Page H26	<b>207ACBH</b> Anchor Coupling  Page H17	<b>Tube to Tube</b>
	<b>62NTA</b> Union  Page H6	<b>62TF</b> Union  Page H12	<b>62RB</b> Union  Page H20	<b>62VL</b> Union  Page H24	<b>264AB</b> Union Tee  Page H15	<b>264NTA</b> Union Tee  Page H8	
	<b>265AB</b> Union Elbow  Page H15	<b>265NTA</b> Union Elbow  Page H9	<b>Bulkhead Unions</b>	<b>62ABH</b> Bulkhead Union  Page H14	<b>62ANBH</b> Bulkhead Union  Page H6	<b>62NBH</b> Bulkhead Union  Page H7	<b>62NFBH</b> Bulkhead Union  Page H7
<b>66NBH</b> Bulkhead Union  Page H7	<b>Tube to Straight Thread</b>	<b>685VLV</b> Male Connector  Page H25		<b>1695VLV</b> Male Elbow  Page H26	<b>Tube to Metric Straight Thread</b>	<b>68NTA-MI</b> Adapter  Page H8	

H

<b>Auxiliary</b>	<b>61AB</b> Nut  Page H14	<b>61NTA</b> Nut  Page H6	<b>61TF</b> Nut  Page H12	<b>61RB</b> Nut  Page H20	<b>61RBSG</b> Spring Guard Nut  Page H20	<b>67RBSG</b> Nut & Spring  Page H20
	<b>61VL</b> Nut  Page H24	<b>60AB</b> Sleeve  Page H14	<b>60NTA</b> Sleeve  Page H6	<b>60TF</b> Sleeve  Page H12	<b>60RB</b> Sleeve  Page H20	<b>60VL</b> Sleeve  Page H24
<b>56RBSG</b> Spring  Page H20	<b>63NTA</b> Tube Support  Page H6					





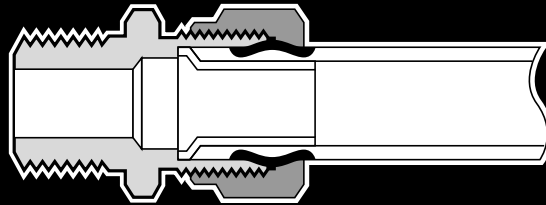

## Air Brake-NTA® Fittings

### NTA® Advantages

Meets D.O.T. FMVSS 571.106 air brake specifications. Utilizes ribbed sleeve for compression and positive grip. NTA® bodies (less tube supports) are interchangeable with AB (SAE J246) fitting bodies. NTA® fittings are pre-applied with Locite Vibra-Seal 516 on all male pipe threads.

### No Special Tools Needed

You can assemble tubing to Parker NTA® fittings, no need to flare. Machined from CA 360, CA 345 or CA 377 brass. Broad selection of styles available.

### Specifications

Meets functional requirements of the SAE automotive tube fitting standards: SAE J246 and SAE J1131.

### Applications

Use with SAE J844 Type A and B nylon tubing in air brake systems or in cab air controls. Acceptable for use with diesel oil fuels when used with Parker Parflex Division diesel fuel tubing. Electroless nickel plated bodies can be used with bio-diesel.

### Working Pressure Ranges

Up to 150 psi.

### Temperature Ranges

Fittings will withstand variations from -40° to +200°F.

### Order

By part number. Nuts and sleeves may be ordered as separate items

by their catalog number.

### Nomenclature

Part numbers are constructed from symbols that identify the style and size of the fitting. The first series of numbers and letters identifies the style and type fitting. The second series of numbers describes the size.

#### Example:

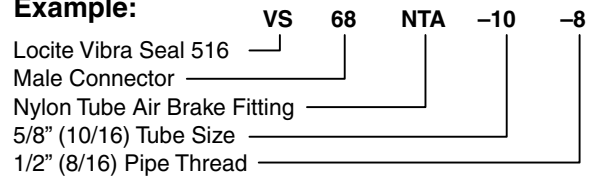

### Sizes

Tube sizes are determined by the numbers of sixteenths of an inch in the tube O.D.

### Special Fittings

Fitting configurations and/or sizes other than those shown in the catalog can be furnished. It is suggested that a print or sketch be submitted with the inquiry.

### Pricing

Only items priced in current supplementary price list PL3501 are carried in stock. Price and delivery for non-stock items furnished on request for specified quantity.

H

**Assembly Instructions**

1. Cut tubing squarely—maximum of 15° angle allowable.
  - Use of Parker tube cutter PTC-001 is recommended.
2. Check that port or mating part is clean and free of debris.
3. Insert tubing into fitting until it bottoms on seat.
4. Tighten nut with wrench until one thread remains visible on the fitting body; (this will allow for a number of remakes) or, the nut should be screwed down finger tight, then the wrench-tightened as indicated in the following table.

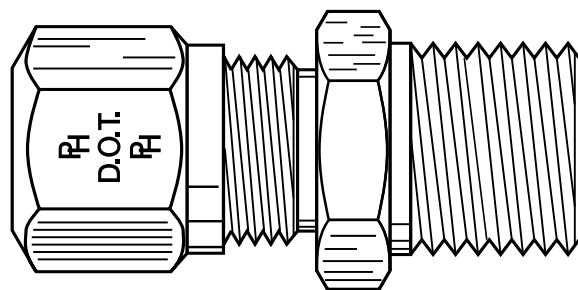
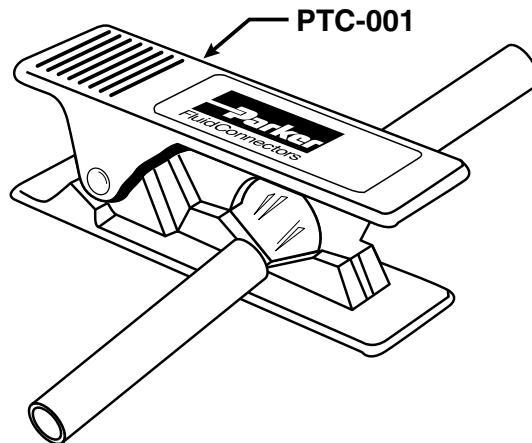

Tube Size	Additional Number of Turns From Hand-Tight
3/16	2-1/2
1/4	3
3/8 & 1/2	4
5/8 & 3/4	3-1/2

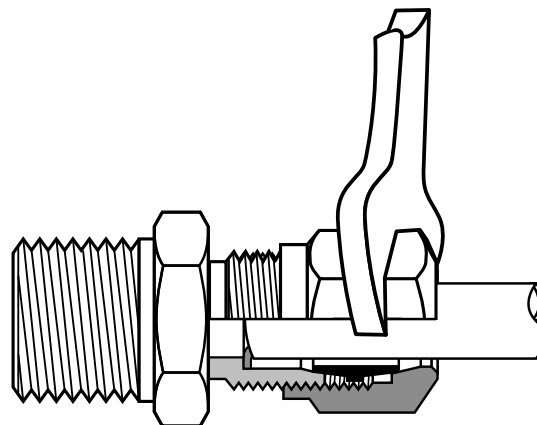

**Sleeve 60NTA**

Ref. SAE 100115

PART NO.	TUBE SIZE	A	D	L
60NTA-3*	3/16	.255	.194	.23
60NTA-4	1/4	.359	.256	.30
60NTA-6	3/8	.479	.384	.39
60NTA-8	1/2	.624	.509	.43
60NTA-10	5/8	.746	.634	.49
60NTA-12	3/4	.922	.760	.54

\*Meets D.O.T. FMVSS 571.106 specification. No applicable SAE specification for this tube size.



**Nut 61NTA**

Ref. SAE 100110

PART NO.	TUBE SIZE	STRAIGHT THREAD	C HEX	D	L
61NTA-3*	3/16	5/16-24	7/16	.194	.40
61NTA-4	1/4	7/16-24	9/16	.256	.45
61NTA-6	3/8	17/32-24	5/8	.384	.63
61NTA-8	1/2	11/16-20	13/16	.509	.72
61NTA-10	5/8	13/16-18	15/16	.634	.77
61NTA-12	3/4	1-18	1-1/8	.760	.81

\*Meets D.O.T. FMVSS 571.106 specification. No applicable SAE specification for this tube size.

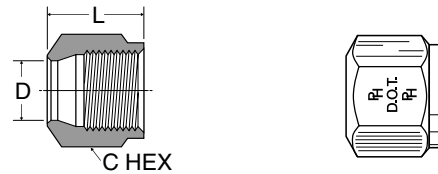

**Union 62NTA**

Ref. SAE 100101 BA

PART NO.	TUBE SIZE	STRAIGHT THREAD	B HEX	C HEX	L	M	FLOW DIA. D
62NTA-4	1/4	7/16-24	9/16	7/16	1.49	.83	.137
62NTA-6	3/8	17/32-24	5/8	9/16	2.00	1.08	.217
62NTA-8	1/2	11/16-20	13/16	11/16	2.32	1.29	.338
62NTA-10	5/8	13/16-18	15/16	13/16	2.39	1.41	.398
62NTA-12	3/4	1-18	1-1/8	1	2.60	1.58	.523

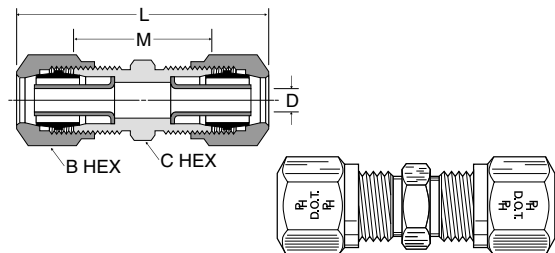

**Stainless Steel Insert 63NTA**

(For SAE J844 Tubing)

PART NO.	TUBE SIZE	L	O.D.
63NTA-4	1/4	.53	.163
63NTA-6	3/8	.64	.245
63NTA-8	1/2	.81	.370
63NTA-10	5/8	.86	.434
63NTA-12	3/4	1.04	.559

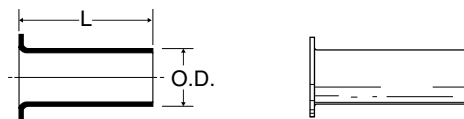

**Bulkhead Union 62ANBH**

(NTA® & Air Brake)

PART NO.	TUBE SIZE	STRAIGHT THREAD	B HEX	C HEX	L	M	FLOW DIA. D	BULKHEAD HOLE DIA.
62ANBH-4	1/4	7/16-24	9/16	9/16	2.28	1.38	.137	7/16
62ANBH-6	3/8	17/32-24	11/16	3/4	2.97	1.62	.217	17/32
62ANBH-8	1/2	11/16-20	13/16	1	3.36	1.88	.338	11/16

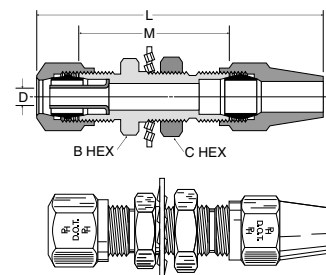

**Bulkhead Union 62NBH**

PART NO.	TUBE SIZE	STRAIGHT THREAD	B HEX	C HEX	L	M	FLOW DIA. D	BULKHEAD HOLE DIA.
62NBH-3*	3/16	5/16-24	7/16	7/16	1.80	1.21	.087	5/16
62NBH-4	1/4	7/16-24	9/16	9/16	2.04	1.38	.137	7/16
62NBH-6	3/8	17/32-24	11/16	3/4	2.54	1.62	.217	17/32
62NBH-8	1/2	11/16-20	13/16	1	2.92	1.88	.338	11/16
62NBH-10	5/8	13/16-18	15/16	1	2.99	2.01	.398	13/16

\*Meets D.O.T. FMVSS 571.106 specifications.  
No applicable SAE specification for this tube size.

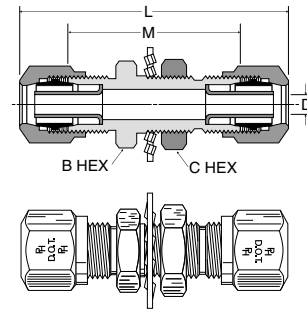

**Bulkhead Union 62NFBH**

PART NO.	TUBE SIZE	FLARE SIZE	STRAIGHT THREAD	B HEX	C HEX	L	M	FLOW DIA. D	BULKHEAD HOLE DIA.
62NFBH-4	1/4	1/4	7/16-24	9/16	9/16	2.04	1.38	.137	7/16
62NFBH-6	3/8	3/8	17/32-24	11/16	3/4	2.54	1.62	.217	5/8
62NFBH-8	1/2	1/2	11/16-20	13/16	1	2.92	1.88	.338	3/4
62NFBH-10	5/8	5/8	13/16-18	15/16	1	3.04	2.02	.398	7/8
62NFBH-10-6	5/8	3/8	11/16-20	7/8	3/4	2.43	1.90	.280	5/8
62NFBH-10-8	5/8	1/2	13/16-18	7/8	7/8	2.90	2.40	.400	3/4

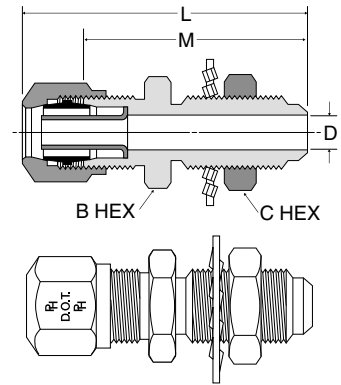

**Bulkhead Union 66NBH**

PART NO.	TUBE SIZE	PIPE THREAD	A STRAIGHT THREAD	E STRAIGHT THREAD	B HEX	C HEX	L	M	FLOW DIA. D	BULKHEAD HOLE DIA.
66NBH-8-6	1/2	3/8	11/16-20	7/8-14	1-1/16	1-1/16	1.94	1.42	.338	7/8

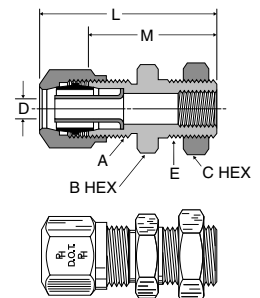

**Female Connector 66NTA**

Ref. SAE 100103 BA

PART NO.	TUBE SIZE	PIPE THREAD	STRAIGHT THREAD	C HEX	L	M	FLOW DIA. D
66NTA-4-2	1/4	1/8	7/16-24	9/16	1.17	.84	.137
66NTA-4-4	1/4	1/4	7/16-24	11/16	1.40	1.07	.137
66NTA-6-2	3/8	1/8	17/32-24	9/16	1.46	1.00	.217
66NTA-6-4	3/8	1/4	17/32-24	11/16	1.64	1.18	.217
66NTA-6-6	3/8	3/8	17/32-24	7/8	1.64	1.18	.217
66NTA-8-6	1/2	3/8	11/16-20	7/8	1.79	1.27	.338
66NTA-8-8	1/2	1/2	11/16-20	1-1/16	1.96	1.44	.338
66NTA-10-6	5/8	3/8	13/16-18	7/8	1.80	1.31	.398
66NTA-10-8	5/8	1/2	13/16-18	1-1/16	1.99	1.50	.398

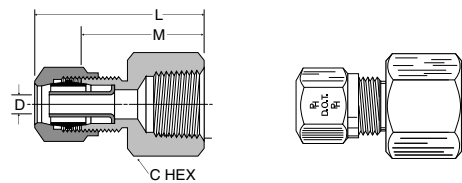

**Male Connector VS68NTA**

Ref. SAE 100102 BA

PART NO.	TUBE SIZE	PIPE THREAD	STRAIGHT THREAD	C HEX	L	M	FLOW DIA. D
VS68NTA-3-1*	3/16	1/16	5/16-24	3/8	1.16	.87	.087
VS68NTA-3-2*	3/16	1/8	5/16-24	7/16	1.15	.86	.087
VS68NTA-3-4*	3/16	1/4	5/16-24	9/16	1.35	1.05	.087
VS68NTA-4-2	1/4	1/8	7/16-24	7/16	1.22	.89	.137
VS68NTA-4-4	1/4	1/4	7/16-24	9/16	1.43	1.10	.137
VS68NTA-4-6	1/4	3/8	7/16-24	11/16	1.47	1.14	.137
VS68NTA-6-2	3/8	1/8	17/32-24	9/16	1.49	1.03	.217
VS68NTA-6-4	3/8	1/4	17/32-24	9/16	1.67	1.21	.217
VS68NTA-6-6	3/8	3/8	17/32-24	11/16	1.70	1.24	.217
VS68NTA-6-8	3/8	1/2	17/32-24	7/8	1.89	1.43	.217
VS68NTA-8-4	1/2	1/4	11/16-20	11/16	1.85	1.33	.338
VS68NTA-8-6	1/2	3/8	11/16-20	11/16	1.85	1.33	.338
VS68NTA-8-8	1/2	1/2	11/16-20	7/8	2.04	1.52	.338
VS68NTA-10-6	5/8	3/8	13/16-18	13/16	1.88	1.39	.398
VS68NTA-10-8	5/8	1/2	13/16-18	7/8	2.10	1.58	.398
VS68NTA-12-6	3/4	3/8	1-18	1	2.00	1.49	.440
VS68NTA-12-8	3/4	1/2	1-18	1	2.19	1.68	.523
VS68NTA-12-12	3/4	3/4	1-18	1-1/8	2.22	1.71	.523

\*Meets D.O.T. FMVSS 571.106 specifications. No applicable SAE specification for this tube size.

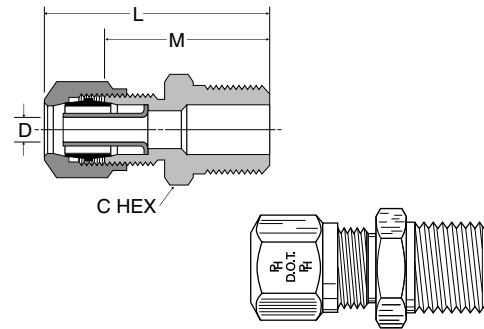

**NTA® to Metric Adaptor 68NTA-X-MIX**

PART NUMBER	TUBE SIZE	METRIC THREAD	B HEX	C HEX	L	D
68NTA-4-MI10	1/4	M10 x 1.0	9/16	9/16	1.33	.140

Note: Fluorocarbon o-ring is standard

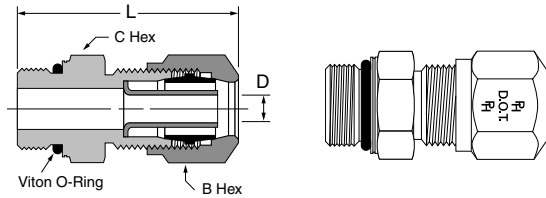

**Adapter Tee VS176NTA**

PART NO.	TUBE SIZE	PIPE THREAD	STRAIGHT THREAD	L	M	N	N1	FLOW DIA. D
VS176NTA-4-2	1/4	1/8	7/16-24	1.02	.69	.75	.66	.137

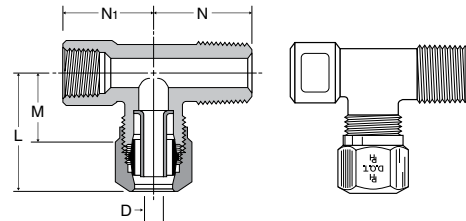

**Union Tee 264NTA**

Ref. SAE 100401 BA

PART NO.	TUBE SIZE	STRAIGHT THREAD	L	M	FLOW DIA. D
264NTA-4	1/4	7/16-24	.95	.62	.137
264NTA-6	3/8	17/32-24	1.24	.78	.217
264NTA-8	1/2	11/16-20	1.45	.93	.338
264NTA-10	5/8	13/16-18	1.58	1.09	.398

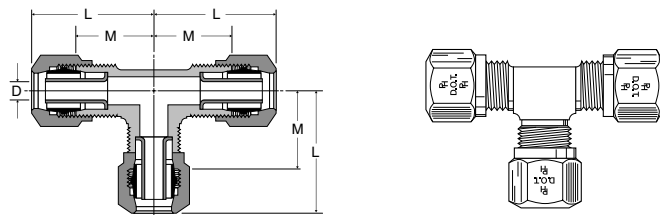

**Union Elbow 265NTA**

Ref. SAE 100201 BA

PART NO.	TUBE SIZE	STRAIGHT THREAD	L	M	FLOW DIA. D
265NTA-4	1/4	7/16-24	.95	.62	.137
265NTA-6	3/8	17/32-24	1.25	.79	.217
265NTA-8	1/2	11/16-20	1.45	.93	.338
265NTA-10	5/8	13/16-18	1.58	1.09	.398

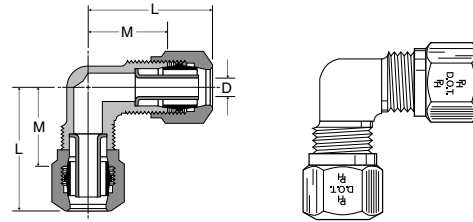

**Male Elbow VS269NTA**

Ref. SAE 100202 BA

PART NO.	TUBE SIZE	PIPE THREAD	STRAIGHT THREAD	L	M	N	FLOW DIA. D
VS269NTA-3-2*	3/16	1/8	5/16-24	.90	.60	.67	.087
VS269NTA-3-4*	3/16	1/4	5/16-24	.91	.62	.87	.087
VS269NTA-4-2	1/4	1/8	7/16-24	.95	.62	.66	.137
VS269NTA-4-4	1/4	1/4	7/16-24	1.00	.68	.87	.137
VS269NTA-4-6	1/4	3/8	7/16-24	1.16	.73	.86	.137
VS269NTA-6-2	3/8	1/8	17/32-24	1.19	.73	.75	.217
VS269NTA-6-4	3/8	1/4	17/32-24	1.25	.79	.92	.217
VS269NTA-6-6	3/8	3/8	17/32-24	1.30	.84	.91	.217
VS269NTA-6-8	3/8	1/2	17/32-24	1.40	.94	1.10	.217
VS269NTA-8-4	1/2	1/4	11/16-20	1.38	.86	.99	.338
VS269NTA-8-6	1/2	3/8	11/16-20	1.44	.92	.99	.338
VS269NTA-8-8	1/2	1/2	11/16-20	1.55	1.03	1.18	.338
VS269NTA-10-6	5/8	3/8	13/16-18	1.49	1.00	1.05	.398
VS269NTA-10-8	5/8	1/2	13/16-18	1.58	1.09	1.24	.398
VS269NTA-10-12	5/8	3/4	13/16-18	1.76	1.25	1.32	.400
VS269NTA-12-8	3/4	1/2	1-18	1.70	1.19	1.33	.523
VS269NTA-12-12	3/4	3/4	1-18	1.77	1.26	1.32	.523

\*Meets D.O.T. FMVSS 571.106 specifications. No applicable SAE specification for this tube size.

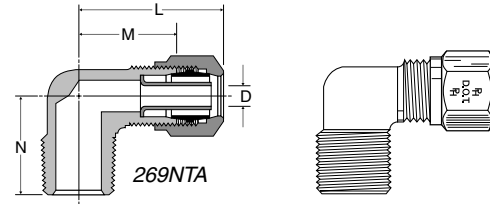

**Female Elbow 270NTA**

Ref. SAE 100203 BA

PART NO.	TUBE SIZE	PIPE THREAD	STRAIGHT THREAD	L	M	N	FLOW DIA. D
270NTA-3-2*	3/16	1/8	5/16-24	.96	.67	.52	.087
270NTA-4-2	1/4	1/8	7/16-24	1.02	.69	.52	.137
270NTA-4-4	1/4	1/4	7/16-24	1.11	.78	.71	.137
270NTA-6-2	3/8	1/8	17/32-24	1.29	.83	.59	.217
270NTA-6-4	3/8	1/4	17/32-24	1.35	.89	.77	.217
270NTA-6-6	3/8	3/8	17/32-24	1.39	.93	.77	.217
270NTA-8-6	1/2	3/8	11/16-20	1.55	1.03	.82	.338
270NTA-8-8	1/2	1/2	11/16-20	1.65	1.13	1.01	.338
270NTA-10-8	5/8	1/2	13/16-18	1.70	1.19	1.07	.398

\*Meets D.O.T. FMVSS 571.106 specification. No applicable SAE specification for this tube size.

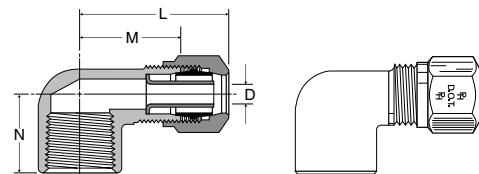

**Male Run Tee VS271NTA**

Ref. SAE 100424 BA

PART NO.	TUBE SIZE	PIPE THREAD	STRAIGHT THREAD	L	M	N	FLOW DIA. D
VS271NTA-4-2	1/4	1/8	7/16-24	.95	.62	.66	.137
VS271NTA-4-4	1/4	1/4	7/16-24	1.00	.68	.87	.137
VS271NTA-6-4	3/8	1/4	17/32-24	1.25	.79	.92	.217
VS271NTA-6-6	3/8	3/8	17/32-24	1.30	.84	.91	.217
VS271NTA-8-6	1/2	3/8	11/16-20	1.45	.93	.99	.338
VS271NTA-8-8	1/2	1/2	11/16-20	1.55	1.03	1.18	.338
VS271NTA-10-8	5/8	1/2	13/16-18	1.60	1.09	1.24	.398

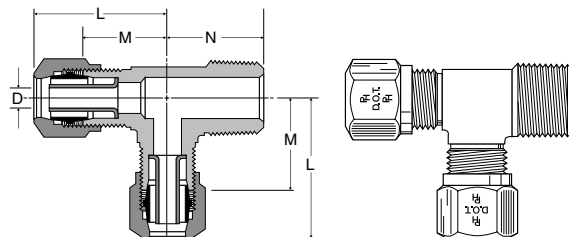

**Male Branch Tee VS272NTA**

Ref. SAE 100425 BA

PART NO.	TUBE 1	TUBE 2	PIPE THREAD	STRAIGHT THREAD	L1	L2	M1	M2	N	FLOW DIA. D
VS272NTA-3-2*	3/16	3/16	1/8	7/16-24	.90	.90	.61	.61	.66	.087
VS272NTA-4-2	1/4	1/4	1/8	7/16-24	.95	.95	.62	.62	.66	.137
VS272NTA-4-4	1/4	1/4	1/4	7/16-24	1.00	1.00	.68	.68	.87	.137
VS272NTA-6-2	3/8	3/8	1/8	17/32-24	1.18	1.18	.72	.72	.75	.217
VS272NTA-6-4	3/8	3/8	1/4	17/32-24	1.25	1.25	.91	.91	.92	.217
VS272NTA-6-4-4	3/8	1/4	1/4	7/16-24	.99	1.25	.67	.79	.91	.137
VS272NTA-6-6	3/8	3/8	3/8	17/32-24	1.30	1.30	.84	.84	.91	.217
VS272NTA-8-4	1/2	1/2	1/4	11/16-20	1.41	1.41	.89	.89	.99	.338
VS272NTA-8-6	1/2	1/2	3/8	11/16-20	1.45	1.45	.93	.93	.99	.338
VS272NTA-8-8	1/2	1/2	1/2	11/16-20	1.55	1.55	1.03	1.03	1.18	.338
VS272NTA-10-8	5/8	5/8	1/2	13/16-18	1.60	1.60	1.09	1.09	1.24	.398

\*Meets D.O.T. FMVSS 571.106 specifications. No applicable SAE specification for this tube size.

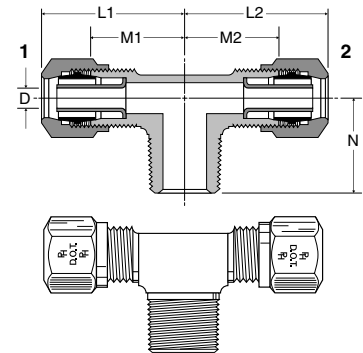

**45° Elbow VS279NTA**

Ref. SAE 100302 BA

PART NO.	TUBE SIZE	PIPE THREAD	STRAIGHT THREAD	L	M	N	FLOW DIA. D
VS279NTA-4-2	1/4	1/8	7/16-24	.81	.49	.63	.137
VS279NTA-4-4	1/4	1/4	7/16-24	.93	.60	.85	.137
VS279NTA-6-2	3/8	1/8	17/32-24	1.17	.71	.68	.217
VS279NTA-6-4	3/8	1/4	17/32-24	1.17	.71	.85	.217
VS279NTA-6-6	3/8	3/8	17/32-24	1.21	.75	.94	.217
VS279NTA-6-8	3/8	1/2	17/32-24	1.24	.78	1.16	.217
VS279NTA-8-4	1/2	1/4	11/16-20	1.36	.84	.94	.338
VS279NTA-8-6	1/2	3/8	11/16-20	1.36	.84	.94	.338
VS279NTA-8-8	1/2	1/2	11/16-20	1.39	.87	1.16	.338
VS279NTA-10-6	5/8	3/8	13/16-18	1.43	.94	.98	.398
VS279NTA-10-8	5/8	1/2	13/16-18	1.42	.93	1.16	.398
VS279NTA-12-8	3/4	1/2	1-18	1.61	1.10	1.18	.523

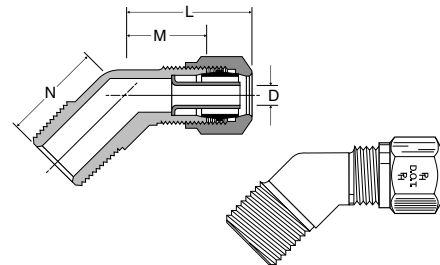

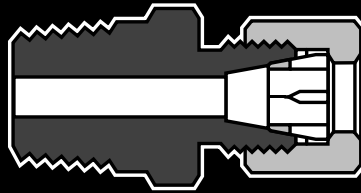

## Transmission Fittings

### Advantages

Parker Air Transmission Fittings utilize a specially designed slotted sleeve to help eliminate notch stress related to over-torque. The fitting design is ideally suited for use in pressure protected air transmission applications.

### Application

Use with SAE J844 type A nylon tubing in pressure protected air transmission applications. Electroless nickel plated bodies can be used with bio-diesel.

### Technical Data

- Working pressure from 0 to 150 psi
- Working temperature from -40° F to +220°F

### Assembly Instructions

1. Cut tubing squarely.
2. Insert tubing into fitting until bottomed.
3. Tighten nut 1 1/2 turns from finger tight.

### Order

By part number and name. Nuts and sleeves may be ordered as separate items by their catalog number.

### Nomenclature

Part numbers are constructed from symbols that identify the style and size of the fitting. The first series of numbers and letters identify the style and type of fitting. The second series describe the size.

#### Example:

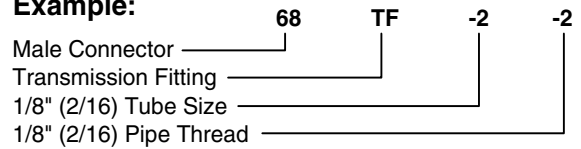

### Sizes

Tube sizes are determined by the number of sixteenths of an inch in the tube O.D.

### Special Fittings

Fitting configurations and/or sizes other than those shown in the catalog can be furnished. It is suggested that a print or sketch be submitted with the inquiry.

### Pricing

Only items priced in current supplementary price list PL3501 are carried in stock. Price and delivery for non-stock items furnished on request for specified quantities.

H



**Sleeve 60TF**

PART NO.	TUBE SIZE	A	D	L
60TF-2	1/8	.235	.130	0.17
60TF-5/32	5/32	.251	.165	0.18



**Nut 61TF**

PART NO.	TUBE SIZE	D	L	STRT THD	C HEX
61TF-2	1/8	.133	.32	5/16-24	3/8
61TF-5/32	5/32	.163	.32	5/16-24	3/8

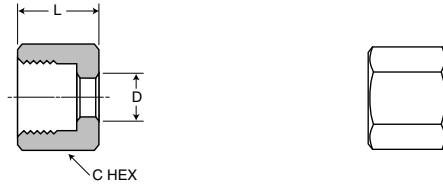

**Union 62TF**

PART NO.	TUBE SIZE	D	L	STRT THD	M	C HEX	B HEX
62TF-2	1/8	0.109	1.04	5/16-24	.68	5/16	3/8
62TF-5/32	5/32	0.068	1.04	5/16-24	.68	5/16	3/8

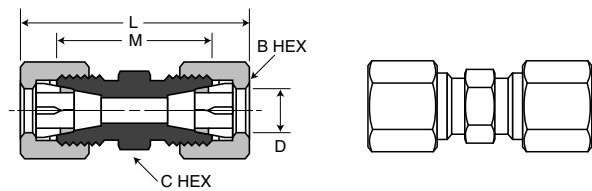

**Male Connector 68TF**

PART NO.	TUBE SIZE	PIPE THREAD	D	L	STRT THD	M	C HEX
68TF-2-1	1/8	1/16	.109	.96	5/16-24	.78	11/32
68TF-2-2	1/8	1/8	.109	.96	5/16-24	.78	7/16
68TF-5/32-1	5/32	1/16	.068	.84	5/16-24	.66	11/32
68TF-5/32-2	5/32	1/8	.068	.96	5/16-24	.78	7/16

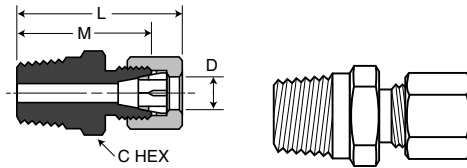

**Male Elbow 269TF**

PART NO.	TUBE SIZE	PIPE THREAD	D	L	STRT THD	M	N
269TF-2-2	1/8	1/8	.109	.79	5/16-24	.61	.66
269TF-5/32-2	5/32	1/8	.068	.79	5/16-24	.61	.66

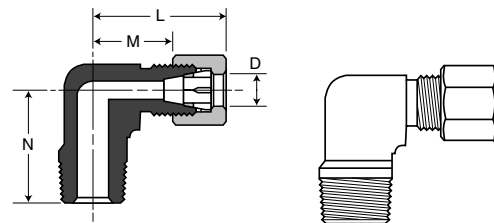

H

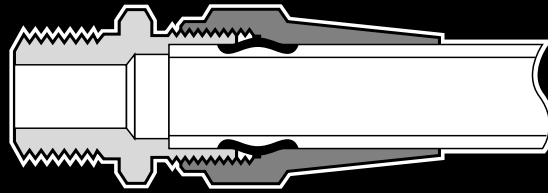

## Air Brake-AB Fittings

### AB Advantages

Easy to assemble, no flaring required. Extruded from CA 360 or CA 345 brass. Readily available in broad selection of configurations and sizes. AB fittings are pre-applied with Locite Vibra-Seal® 516 on all male pipe threads.

### Specifications

AB fittings meet DOT FMVSS571.106 performance specifications when assembled with 63NTA tube support (page 83) and SAE J844 nylon tubing. Meets functional requirements of SAE J246.

### Applications

Use with copper tubing in air brake systems. Air Brake bodies (with addition of NTA tube support) are interchangeable with NTA bodies for use with SAE J844 nylon tubing. Electroless nickel plated bodies can be used with bio-diesel.

### Working Pressure Ranges

Up to 400 psi.

### Temperature Ranges

Fittings will withstand variations from -65° to +250°F.

### Assembly Instructions

1. Cut tubing squarely and remove burrs.
2. Slide nut and sleeve onto tubing.
3. Insert tubing into fitting until bottomed on seat. The nut should be screwed down finger-tight, then wrench-tightened as indicated below (This will allow a number of remakes):

Tube Size	Additional Number of Turns from Hand-Tight
1/4, 3/8, 1/2	2
5/8, 3/4	3

### Order

By part number. Nuts and sleeves may be ordered as separate items by their catalog number.

### Nomenclature

Part numbers are constructed from symbols that identify the style and size of the fitting. The first series of numbers and letters identifies the style and type fitting. The second series of numbers describes the size.

#### Example:

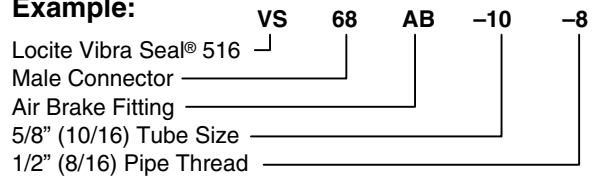

### Sizes

Tube sizes are determined by the numbers of sixteenths of an inch in the tube O.D.

### Special Fittings

Fitting configurations and/or sizes other than those shown in the catalog can be furnished. It is suggested that a print or sketch be submitted with the inquiry.

### Pricing

Only items priced in current supplementary price list PL3501 are carried in stock. Price and delivery for non-stock items furnished on request for specified quantity.

**Sleeve 60AB**

Ref. SAE 120115

PART NO.	TUBE SIZE	A	D	L
60AB-4	1/4	.322	.255	.250
60AB-6	3/8	.461	.382	.310
60AB-8	1/2	.594	.507	.380
60AB-10	5/8	.734	.632	.440
60AB-12	3/4	.874	.758	.500



**Nut 61AB**

Ref. SAE 120111

PART NO.	TUBE SIZE	STRAIGHT THREAD	C HEX	D	L
61AB-4	1/4	7/16-24	9/16	.256	.75
61AB-6	3/8	17/32-24	5/8	.384	1.13
61AB-8	1/2	11/16-20	13/16	.509	1.25
61AB-10	5/8	13/16-18	15/16	.634	1.38
61AB-12	3/4	1-18	1-1/8	.760	1.56

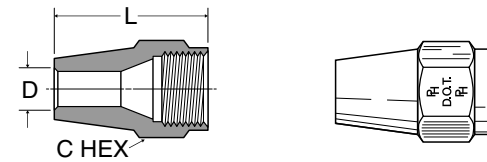

**Union 62AB**

Ref. SAE 120101 BA

PART NO.	TUBE SIZE	STRAIGHT THREAD	C HEX	L	M	FLOW DIA. D
62AB-4	1/4	7/16-24	7/16	1.98	.83	.189
62AB-6	3/8	17/32-24	9/16	2.87	1.08	.314
62AB-8	1/2	11/16-20	11/16	3.21	1.29	.405
62AB-10	5/8	13/16-18	13/16	3.59	1.41	.531
62AB-12	3/4	1-18	1	4.08	1.59	.656

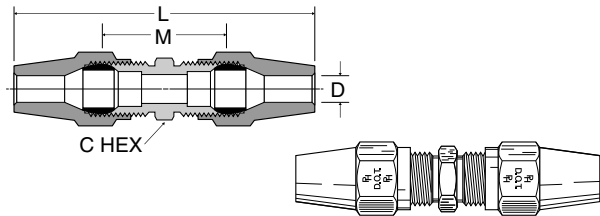

**Bulkhead Union 62ABH**

PART NO.	TUBE SIZE	STRAIGHT THREAD	C HEX	L	M	FLOW DIA. D	BULKHEAD HOLE DIA.
62ABH-4	1/4	7/16-24	9/16	2.53	1.38	.188	7/16
62ABH-6	3/8	17/32-24	3/4	3.41	1.62	.314	17/32
62ABH-8	1/2	11/16-20	1	3.80	1.88	.408	11/16

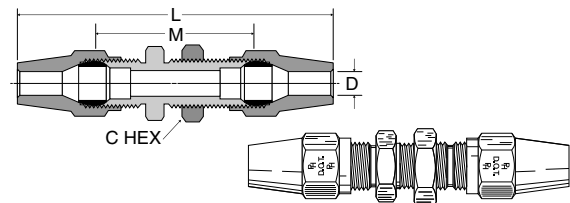

**Female Connector 66AB**

Ref. SAE 120103 BA

PART NO.	TUBE SIZE	PIPE THREAD	STRAIGHT THREAD	C HEX	L	M	FLOW DIA. D
66AB-4-2	1/4	1/8	7/16-24	9/16	1.42	.84	.188
66AB-4-4	1/4	1/4	7/16-24	11/16	1.65	1.07	.188
66AB-6-2	3/8	1/8	17/32-24	9/16	1.89	1.00	.314
66AB-6-4	3/8	1/4	17/32-24	11/16	2.07	1.18	.314
66AB-6-6	3/8	3/8	17/32-24	7/8	2.07	1.18	.314
66AB-8-6	1/2	3/8	11/16-20	7/8	2.23	1.27	.408
66AB-8-8	1/2	1/2	11/16-20	1-1/16	2.40	1.44	.408
66AB-10-6	5/8	3/8	13/16-18	7/8	2.40	1.31	.533
66AB-10-8	5/8	1/2	13/16-18	1-1/16	2.59	1.50	.533

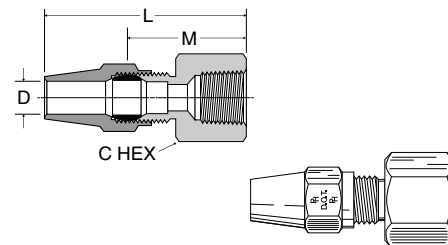

**Male Connector VS68AB**

Ref. SAE 120102 BA

PART NO.	TUBE SIZE	PIPE THREAD	STRAIGHT THREAD	C HEX	L	M	FLOW DIA. D
VS68AB-4-2	1/4	1/8	7/16-24	7/16	1.47	.89	.189
VS68AB-4-4	1/4	1/4	7/16-24	9/16	1.68	1.10	.189
VS68AB-4-6	1/4	3/8	7/16-24	11/16	1.72	1.14	.189
VS68AB-6-2	3/8	1/8	17/32-24	9/16	1.92	1.03	.189
VS68AB-6-4	3/8	1/4	17/32-24	9/16	2.10	1.21	.314
VS68AB-6-6	3/8	3/8	17/32-24	11/16	2.13	1.24	.314
VS68AB-6-8	3/8	1/2	17/32-24	7/8	2.32	1.43	.314
VS68AB-8-4	1/2	1/4	11/16-20	11/16	2.29	1.33	.314
VS68AB-8-6	1/2	3/8	11/16-20	11/16	2.29	1.33	.408
VS68AB-8-8	1/2	1/2	11/16-20	7/8	2.48	1.52	.408
VS68AB-10-6	5/8	3/8	13/16-18	13/16	2.48	1.39	.408
VS68AB-10-8	5/8	1/2	13/16-18	7/8	2.67	1.58	.533
VS68AB-12-8	3/4	1/2	1-18	1	2.92	1.68	.533
VS68AB-12-12	3/4	3/4	1-18	1-1/8	2.95	1.71	.658

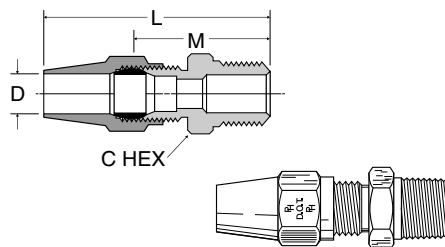

**Union Tee 264AB**

Ref. SAE 120401 BA

PART NO.	TUBE SIZE	STRAIGHT THREAD	L	M	FLOW DIA. D
264AB-4	1/4	7/16-24	1.20	.62	.189
264AB-6	3/8	17/32-24	1.67	.78	.314
264AB-8	1/2	11/16-20	1.89	.93	.408
264AB-10	5/8	13/16-18	2.18	1.09	.533

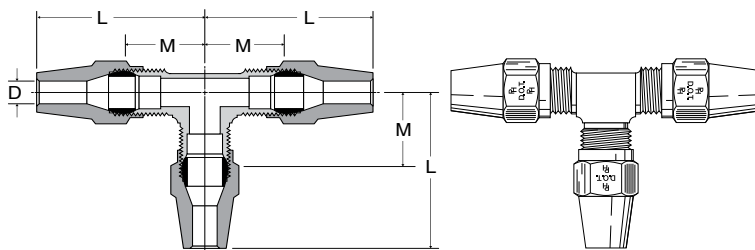

**Union Elbow 265AB**

Ref. SAE 120201 BA

PART NO.	TUBE SIZE	STRAIGHT THREAD	L	M	FLOW DIA. D
265AB-4	1/4	7/16-24	1.20	.62	.189
265AB-6	3/8	17/32-24	1.68	.79	.314
265AB-8	1/2	11/16-20	1.89	.93	.408
265AB-10	5/8	13/16-18	2.18	1.09	.533

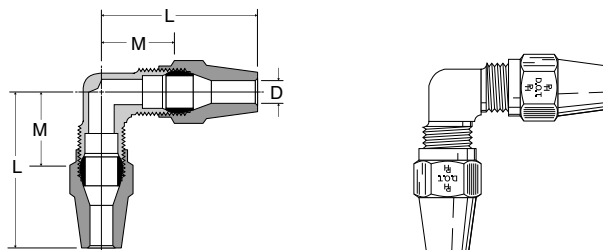

**Male Elbow VS269AB**

Ref. SAE 120202 BA

PART NO.	TUBE SIZE	PIPE THREAD	STRAIGHT THREAD	L	M	N	FLOW DIA. D
VS269AB-4-2	1/4	1/8	7/16-24	1.20	.62	.66	.189
VS269AB-4-4	1/4	1/4	7/16-24	1.26	.68	.87	.189
VS269AB-4-6	1/4	3/8	7/16-24	1.31	.73	.86	.189
VS269AB-6-2	3/8	1/8	17/32-24	1.62	.73	.75	.189
VS269AB-6-4	3/8	1/4	17/32-24	1.68	.79	.92	.314
VS269AB-6-6	3/8	3/8	17/32-24	1.73	.84	.91	.314
VS269AB-6-8	3/8	1/2	17/32-24	1.83	.94	1.10	.314
VS269AB-8-4	1/2	1/4	11/16-20	1.82	.86	.99	.314
VS269AB-8-6	1/2	3/8	11/16-20	1.88	.93	.99	.408
VS269AB-8-8	1/2	1/2	11/16-20	1.99	1.03	1.18	.408
VS269AB-10-6	5/8	3/8	13/16-18	2.09	1.00	1.05	.408
VS269AB-10-8	5/8	1/2	13/16-18	2.18	1.09	1.24	.533
VS269AB-12-8	3/4	1/2	1-18	2.33	1.19	1.32	.533
VS269AB-12-12	3/4	3/4	1-18	2.50	1.26	1.32	.533

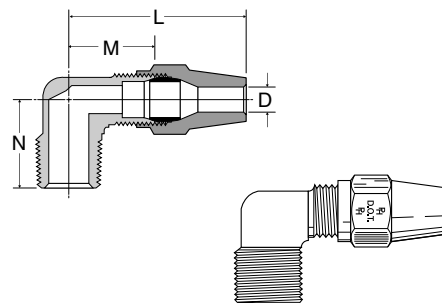

**Female Elbow 270AB**

Ref. SAE 120203 BA

PART NO.	TUBE SIZE	PIPE THREAD	STRAIGHT THREAD	L	M	N	FLOW DIA. D
270AB-4-2	1/4	1/8	7/16-24	1.27	.69	.52	.189
270AB-4-4	1/4	1/4	7/16-24	1.36	.78	.71	.189
270AB-6-2	3/8	1/8	17/32-24	1.72	.83	.59	.314
270AB-6-4	3/8	1/4	17/32-24	1.78	.89	.77	.314
270AB-6-6	3/8	3/8	17/32-24	1.82	.93	.77	.314
270AB-8-6	1/2	3/8	11/16-20	1.99	1.03	.82	.408
270AB-8-8	1/2	1/2	11/16-20	2.09	1.13	1.01	.408
270AB-10-8	5/8	1/2	13/16-18	2.28	1.19	1.07	.533

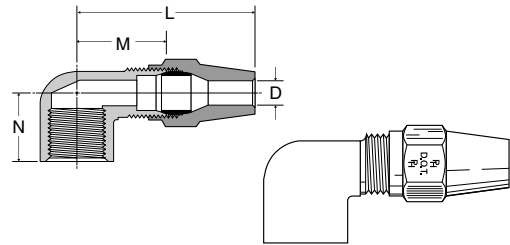

**Male Run Tee VS271AB**

Ref. SAE 120424 BA

PART NO.	TUBE SIZE	PIPE THREAD	STRAIGHT THREAD	L	M	N	FLOW DIA. D
VS271AB-4-2	1/4	1/8	7/16-24	1.20	.62	.66	.189
VS271AB-4-4	1/4	1/4	7/16-24	1.26	.68	.87	.189
VS271AB-6-4	3/8	1/4	17/32-24	1.68	.79	.92	.314
VS271AB-6-6	3/8	3/8	17/32-24	1.73	.84	.91	.314
VS271AB-8-6	1/2	3/8	11/16-20	1.89	.93	.99	.408
VS271AB-8-8	1/2	1/2	11/16-20	1.99	1.03	1.18	.408
VS271AB-10-8	5/8	1/2	13/16-18	2.18	1.09	1.24	.533

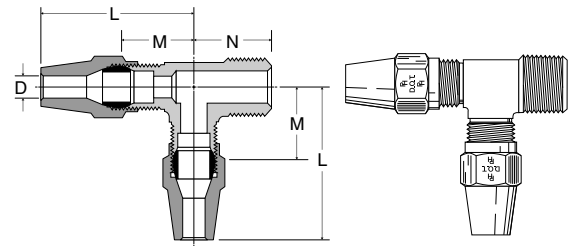

**Male Branch Tee VS272AB**

Ref. SAE 120425 BA

PART NO.	TUBE SIZE	PIPE THREAD	STRAIGHT THREAD	L	M	N	FLOW DIA. D
VS272AB-4-2	1/4	1/8	7/16-24	1.20	.62	.66	.189
VS272AB-4-4	1/4	1/4	7/16-24	1.26	.68	.87	.189
VS272AB-6-2	3/8	1/8	17/32-24	1.61	.72	.75	.189
VS272AB-6-4	3/8	1/4	17/32-24	1.68	.79	.92	.314
VS272AB-6-6	3/8	3/8	17/32-24	1.73	.84	.91	.314
VS272AB-8-6	1/2	3/8	11/16-20	1.89	.93	.99	.408
VS272AB-8-8	1/2	1/2	11/16-20	1.99	1.03	1.18	.408
VS272AB-10-8	5/8	1/2	13/16-18	2.18	1.09	1.24	.533

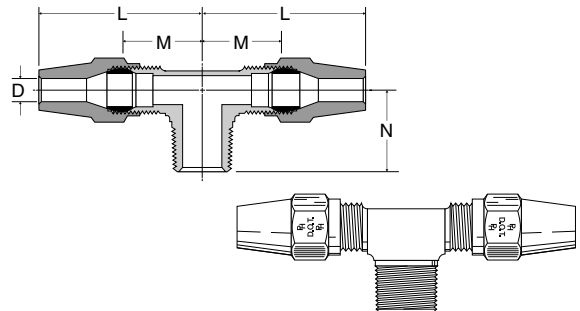

**45° Elbow VS279AB**

Ref. SAE 120302 BA

PART NO.	TUBE SIZE	PIPE THREAD	STRAIGHT THREAD	L	M	N	FLOW DIA. D
VS279AB-4-2	1/4	1/8	7/16-24	1.07	.49	.63	.189
VS279AB-4-4	1/4	1/4	7/16-24	1.18	.60	.85	.189
VS279AB-6-2	3/8	1/8	17/32-24	1.60	.71	.68	.189
VS279AB-6-4	3/8	1/4	17/32-24	1.64	.71	.85	.314
VS279AB-6-6	3/8	3/8	17/32-24	1.64	.75	.94	.314
VS279AB-6-8	3/8	1/2	17/32-24	1.67	.78	1.16	.314
VS279AB-8-6	1/2	3/8	11/16-20	1.80	.84	.94	.408
VS279AB-8-8	1/2	1/2	11/16-20	1.83	.87	1.16	.408
VS279AB-10-6	5/8	3/8	13/16-18	2.03	.94	.98	.408
VS279AB-10-8	5/8	1/2	13/16-18	2.13	1.05	1.16	.533
VS279AB-12-8	3/4	1/2	1-18	2.34	1.10	1.18	.533

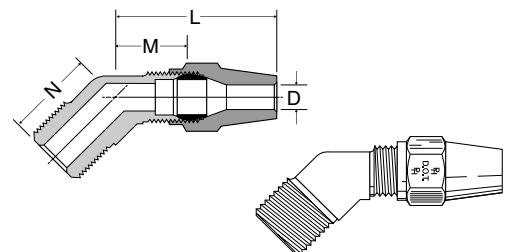

H

**Anchor Coupling 207ACBH**

PART NO.	FEAMLE PIPE THREAD	STRAIGHT THREAD	MAX. BULK HEAD P	B HEX	C HEX	L	BULKHEAD HOLE DIA. H	FLOW DIA. D
207ACBH-2	1/8	5/8-18	.89	7/8	15/16	1.50	5/8	.339
207ACBHS-2	1/8	5/8-18	.35	7/8	15/16	.96	5/8	.339
207ACBH-4	1/4	3/4-16	.81	1	1-1/8	1.50	3/4	.441
207ACBHS-4	1/4	3/4-16	.26	1	1	.94	3/4	.441
207ACBH-6	3/8	1-14	.62	1-1/8	1-1/4	1.31	1	.571
207ACBH-8	1/2	1-1/8-14	.75	1-1/4	1-3/8	1.50	1-1/8	.703
207ACBH-12	3/4	1-5/16-12	.65	1-1/2	1-1/2	1.50	1-5/16	.906
207ACBH-16*	1	1-5/8-14	1.00	2	2	1.68	1-5/8	1.140

\*Lock Washer not Available

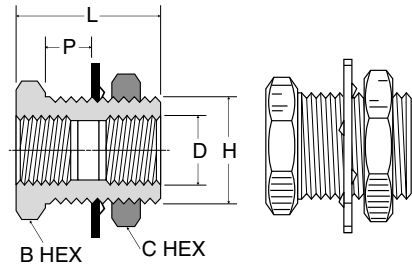

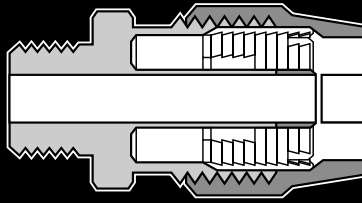

## Air Brake Hose Ends

### Advantages

Easy to assemble and disassemble. Extruded from CA360 or CA345 brass. Readily available in broad selection of configurations and sizes.

### Specifications

Air brake hose ends will meet D.O.T. FMVSS571.106 standards when used with SAE J1402 Air brake hose.

### Applications

Air brake hose connections. Electroless nickel plated bodies can be used with bio-diesel.

### Working pressure ranges

Up to 225 PSI

### Temperature ranges

-50°F to +212°F

### Order

By part number. Nuts, sleeves, bodies and springs may be ordered as separate items by their catalog number.

### Nomenclature

Part numbers are constructed from symbols that identify the style and size of the fitting. The first series of numbers and letters identifies the style and type fitting. The second series of numbers describes the size.

#### Example:

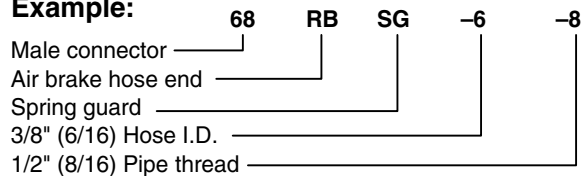

### Sizes

Hose sizes are determined by the number of sixteenths of an inch in the hose I.D.

### Special fittings

Fitting configuration and/or sizes other than those shown in the catalog can be furnished. It is suggested that a print or sketch be submitted with the inquiry.

### Pricing

Only items priced in current supplementary price list PL3501 are carried in stock. Price and delivery for non-stock items furnished on request for specified quantity.

H

**Parker 271**

Meets or exceeds the requirements of SAE J1402 Table A, and Dept. of Transportation FMVSS 106-74, Type A2.

PART NO.	HOSE SIZE	HOSE I.D.	HOSE O.D.	MIN. BURST PRESS.	MAX. WORKING PRESS.	MIN. BEND RADUS	APPROX. WT. LBS./FT.
271-6	-6	3/8	.750	900	225	1.75	.200
271-8	-8	1/2	.875	900	225	2.00	.260

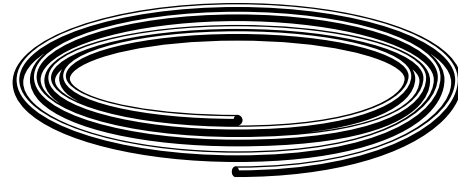

**Construction**

Tube - Synthetic rubber. Reinforcement - One or more fabric braids or spirals. Cover - Abrasion, oil and age resistant synthetic rubber.

**Identification**

Parker, part number, and appropriate SAE and DOT markings.

**Application**

Air brake systems.

**Temperature range**

-50°F thru +212°F (-46°C thru +100°C)

**Assembly instructions**

1. Slide nut onto hose.
2. Slide sleeve onto hose with tapered edge toward fitting body (see example).
3. Bottom hose into fitting.
4. Tighten nut until it contacts body hex.

Note: When reassembling fitting, body and nut should be inspected. Only reuse if parts are in proper condition. Sleeves should never be reused.

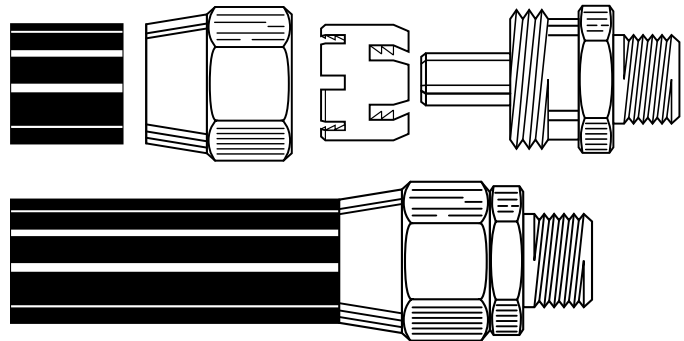



**Spring 56RBSG**

PART NO.	HOSE SIZE	L	D1	D2
56RBSG-6	3/8	2.75	.84	.78
56RBSG-8	1/2	3.00	1.03	.91

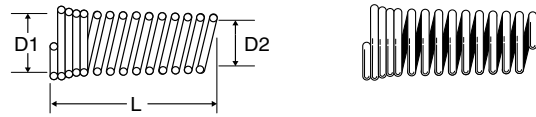

**Sleeve 60RB**

PART NO.	HOSE SIZE	L	A	D
60RB-6	3/8	.69	.90	.78
60RB-8	1/2	.69	1.03	.92

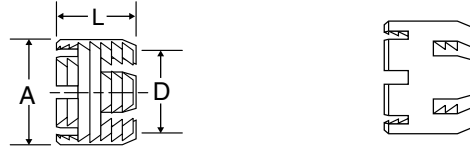

**Nut 61RB**

PART NO.	HOSE SIZE	STRAIGHT THREAD	HEX	L	D
61RB-6	3/8	31/32-20	1-1/16	1.12	.80
61RB-8	1/2	1-3/32-20	1-1/4	1.12	.93

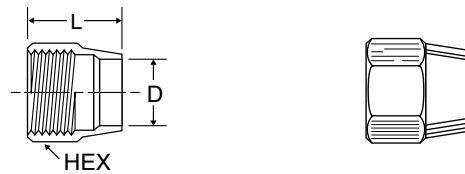

**Spring Guard Nut 61RBSG**

PART NO.	HOSE SIZE	STRAIGHT THREAD	HEX	L	D
61RBSG-6	3/8	31/32-20	1-1/16	1.22	.80
61RBSG-8	1/2	1-3/32-20	1-1/4	1.19	.92

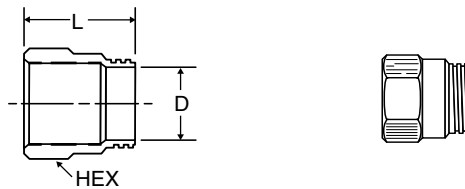

**Union 62RB**

PART NO.	HOSE SIZE	STRAIGHT THREAD	HEX	L	M	D
62RB-6	3/8	31/32-20	31/32	2.98	2.56	.281
62RB-8	1/2	1-3/32-20	1-1/8	2.99	2.55	.390

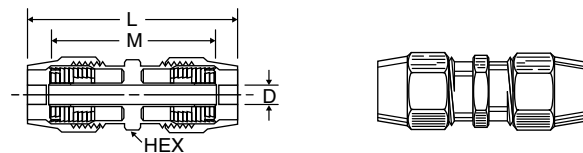

**Female Swivel Connector 66RBSV**

PART NO.	HOSE SIZE	STRAIGHT THREAD	HEX1	HEX2	L	M	D
66RBSV-6-3/4	3/8	3/4-20	31/32	7/8	2.30	2.09	.281
66RBSV-8-7/8	1/2	7/8-20	1-1/8	1"	2.36	2.14	.390

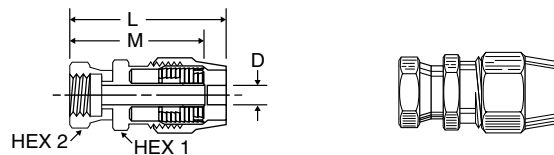

**Air Brake Hose Nut & Attached Spring 67RBSG**

PART NO.	L
67RBSG-6	3.50
67RBSG-8	3.75

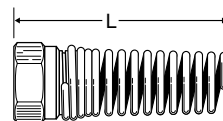

**H**

**Male Connector 68RB**

PART NO.	HOSE SIZE	STRAIGHT THREAD	PIPE THREAD	HEX	L	M	D
68RB-6-4	3/8	31/32-20	1/4	31/32	2.24	1.91	.281
68RB-6-6	3/8	31/32-20	3/8	31/32	2.24	1.91	.281
68RB-6-8	3/8	31/32-20	1/2	31/32	2.38	2.06	.281
68RB-8-6	1/2	1-3/32-20	3/8	1-1/8	2.24	1.91	.390
68RB-8-8	1/2	1-3/32-20	1/2	1-1/8	2.29	2.07	.390

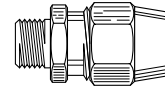
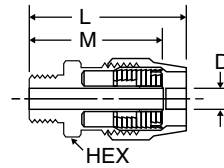

**Male Connector Body Only 68RB**

PART NO.	HOSE SIZE	STRAIGHT THREAD	PIPE THREAD	HEX	L	D
68RB-6-4B	3/8	31/32-20	1/4	31/32	1.91	.281
68RB-6-6B	3/8	31/32-20	3/8	31/32	1.91	.281
68RB-6-8B	3/8	31/32-20	1/2	31/32	2.06	.281
68RB-8-6B	1/2	1-3/32-20	3/8	1-1/8	1.91	.390
68RB-8-8B	1/2	1-3/32-20	1/2	1-1/8	2.07	.390

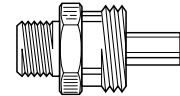
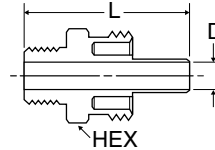

**Male Connector with Spring Guard 68RBSG**

PART NO.	HOSE SIZE	PIPE THREAD	HEX	L	M	D
68RBSG-6-4	3/8	1/4	31/32	4.8	1.91	.281
68RBSG-6-6	3/8	3/8	31/32	4.8	1.91	.281
68RBSG-6-8	3/8	1/2	31/32	4.9	2.06	.281
68RBSG-8-6	1/2	3/8	1-1/8	5.0	1.91	.390
68RBSG-8-8	1/2	1/2	1-1/8	5.2	2.07	.390

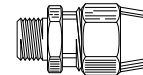
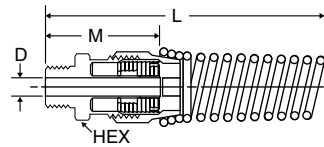

**Adapter 76RB**

PART NO.	PIPE THREAD	STRAIGHT THREAD	HEX	L	D
76RB-3/4-4	1/4	3/4-20	3/4	1.06	.31
76RB-3/4-6	3/8	3/4-20	3/4	1.12	.31
76RB-7/8-6	3/8	7/8-20	7/8	1.25	.44
76RB-7/8-8	1/2	7/8-20	7/8	1.47	.50

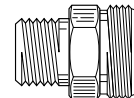
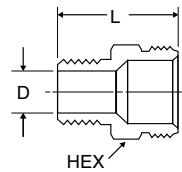

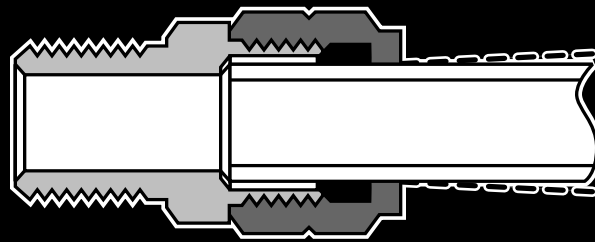

## Vibra-Lok Fittings

### Advantages

Vibra-Lok provides a positive reliable seal under vibration conditions, mechanical shock or tube movement. The sleeve cushions the tubing permitting the tube to flex back and forth in the fitting. Seal design compensates for tube mis-alignment and tube surface defects during assembly. Special Vibra-Lok sleeves resist deterioration and retain flexibility over a wide temperature range. Positive nut stop bottoms nut on body requiring only visual inspection — no torque measurement is needed. Manufactured from CA 360, CA 345 or CA 377 brass. With SAE straight threads on Vibra-Lok fittings this allows the fitting to adhere to the system design requirements outlined in the Genuine Parker Parts Program making it an approved product under GPP.

### Applications

Use with all seamed or seamless metal tubing: Copper, Aluminum, Steel (Bundy), Stainless Steel and Glass. Sleeves are compatible for gasoline, oil, diesel fuel, lubricants, vacuum, air and water service. Electroless nickel plated bodies can be used with bio-diesel.

### Threads

SAE J1926 straight threads and NPTF pipe threads are standard. Optional threads include ISO 6149 straight threads and British pipe threads.

### Working Pressures

See table on next page for maximum working pressures.

### Temperature Ranges

Fitting will withstand various temperatures depending on the sleeve used in the assembly.

Fluorocarbon sleeves are marked with a red stripe and will provide service from -15°F to +450°F.

Buna N sleeves are marked with a green stripe and will provide service from -30°F to +275°F.

### Vibration

Excellent resistance to vibration, mechanical, shock and tube movement.

### Order Information

By part number and name. For Fluorocarbon seal add "V" to basic part number. Example 68VLV-4-2.

### Nomenclature

Part numbers are constructed from symbols that identify the style and size of the fitting. The first series of numbers and letters identifies the style and type fitting. The second series of numbers describes the size.

#### Example:

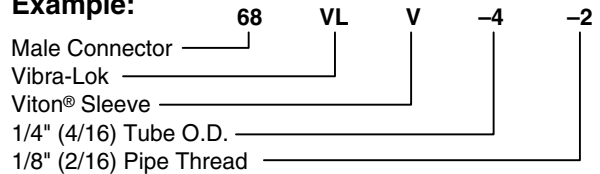

### Sizes

Tube sizes are determined by the number of sixteenths of an inch in tube O.D.

### Special Fittings

Fitting configurations and/or sizes other than those shown in the catalog can be furnished. It is suggested that a print or sketch be submitted with the inquiry.

### Pricing

Only items priced in current supplementary price list PL3501 are carried in stock. Price and delivery for nonstock items furnished on request for specified quantity.

### Remake Instructions

All Vibra-Lok fittings can be reassembled repeatedly. New sleeves can easily be added to retain original fitting performance.

**Assembly Instructions**

1. Cut the tube cleanly and squarely removing all burrs.
2. Slip tube nut and sleeve over tube.
3. Insert tubing in fitting body as far as it will go and tighten nut until stop is reached. The elastic sleeve ordinarily will extrude slightly around the tube at the end of the nut. This extrusion further aids in isolating the tube from the nut.

**Assembly Instructions for Higher Pressure Applications**

1. Consult pressure chart to determine if tubing should be belled for your particular application.
2. Slip the nut and sleeve over tubing. The sleeve should be positioned near end of tubing just behind the surface to be belled.
3. Bell tubing with standard 45° flaring tool or 90° punch. The size of bell should be approximately that shown.

**Pressure Chart**

In high pressure applications and sizes larger than 1/2" O.D., the tube end should be belled or flared.

CONDITION	TUBE O.D.	TUBE NOT BELLED	TUBE BELLED OR FLARED
STATIC PRESSURE	3/16"	500	1000
	1/4"	500	1000
	5/16"	450	900
	3/8"	350	700
	1/2"	200	500
MINOR SURGES AND/OR VIBRATIONS	5/8"	400	400
	3/16"	400	800
	1/4"	400	800
	5/16"	325	700
	3/8"	225	500
SEVERE VIBRATIONS OR SHOCK	1/2"	150	375
	5/8"	300	300
	3/16"	300	600
	1/4"	300	600
	5/16"	225	500
	3/8"	175	400
	1/2"	100	250
	5/8"		100

**Sleeve Position**

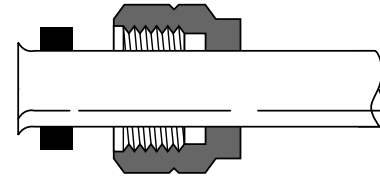

**Recommended Size of Bell**

TUBE O.D.	BELL DIA. C
1/8"	.190-.160
3/16"	.255-.225
1/4"	.318-.288
5/16"	.381-.351
3/8"	.444-.414
1/2"	.569-.539
5/8"	.694-.664
3/4"	.819-.789
7/8"	.944-.914

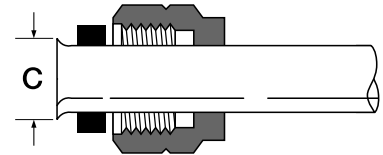

**Tube Length Calculator**

This table shows distance tube extends beyond face of Vibra-Lok fitting body on installation with bell on tubing and without bell on tubing.

O.D. of TUBE	A With BELL	B Without BELL
1/8"	3/16"	3/16"
3/16"	3/16"	7/32"
1/4"	3/16"	1/4"
5/16"	3/16"	1/4"
3/8"	3/16"	1/4"
1/2"	3/16"	11/32"
5/8"	3/16"	Tubing should be belled
3/4"	3/16"	
7/8"	1/4"	

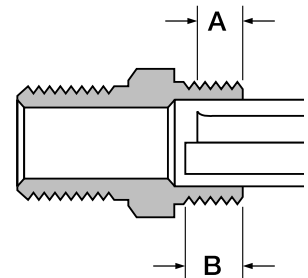

**Sleeve 60VL**

PART NO.	TUBE SIZE	A	D	L
60VL-2	1/8	.306	.100	.20
60VL-3	3/16	.359	.156	.20
60VL-4	1/4	.422	.219	.21
60VL-5	5/16	.484	.281	.24
60VL-6	3/8	.547	.344	.25
60VL-8	1/2	.688	.469	.36
60VL-10	5/8	.875	.594	.48
60VL-12	3/4	1.000	.720	.59

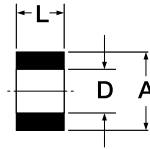

**Sleeve (Fluorocarbon) 60VLV**

PART NO.	TUBE SIZE	A	D	L
60VLV-3	3/16	.359	.156	.20
60VLV-4	1/4	.422	.219	.21
60VLV-5	5/16	.484	.281	.24
60VLV-6	3/8	.547	.344	.25
60VLV-8	1/2	.688	.469	.36
60VLV-10	5/8	.875	.594	.48
60VLV-12	3/4	1.000	.720	.59

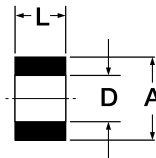

**Nut 61VL**

PART NO.	TUBE SIZE	STRAIGHT THREAD	C HEX	D	L
61VL-2	1/8	3/8-24	7/16	.156	.44
61VL-3	3/16	7/16-24	1/2	.218	.47
61VL-4	1/4	1/2-24	9/16	.281	.50
61VL-5	5/16	9/16-24	5/8	.344	.53
61VL-6	3/8	5/8-24	3/4	.406	.53
61VL-8	1/2	13/16-18	15/16	.531	.67
61VL-10	5/8	1-18	1-1/8	.656	.88
61VL-12	3/4	1-1/8-18	1-1/4	.781	.98

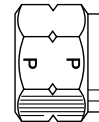
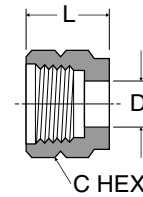

H

**Union 62VL**

PART NO.	TUBE SIZE	C HEX	L	M	FLOW DIA. D
62VL-4	1/4	9/16	1.39	.77	.188
62VL-5	5/16	5/8	1.49	.81	.250
62VL-6	3/8	11/16	1.49	.80	.312
62VL-8	1/2	7/8	1.90	.94	.437

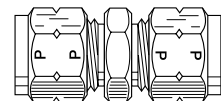
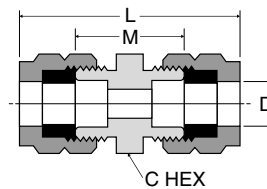

**Female Connector 66VL**

PART NO.	TUBE SIZE	PIPE THREAD	C HEX	L	M	FLOW DIA. D
66VL-4-2	1/4	1/8	9/16	1.09	.78	.188
66VL-5-4	5/16	1/4	11/16	1.32	.97	.250

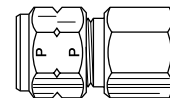
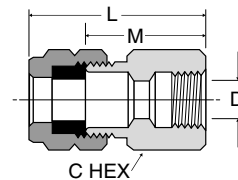

**Male Connector 68VL**

PART NO.	TUBE SIZE	PIPE THREAD	C HEX	L	M	FLOW DIA.D
68VL-2-2	1/8	1/8	7/16	1.12	.81	.093
68VL-3-2	3/16	1/8	1/2	1.10	.81	.125
68VL-4-2	1/4	1/8	9/16	1.15	.84	.188
68VL-4-4	1/4	1/4	9/16	1.34	1.03	.188
68VL-5-4	5/16	1/4	5/8	1.41	1.06	.250
68VL-6-2	3/8	1/8	11/16	1.22	.87	.235
68VL-6-4	3/8	1/4	11/16	1.41	1.06	.312
68VL-6-6	3/8	3/8	11/16	1.41	1.06	.312
68VL-8-6	1/2	3/8	7/8	1.64	1.16	.406
68VL-8-8	1/2	1/2	7/8	1.64	1.35	.406
68VL-10-8	5/8	1/2	1-1/16	2.10	1.44	.560
68VL-12-8	3/4	1/2	1-3/16	2.26	1.50	.530
68VL-12-12	3/4	3/4	1-3/16	2.26	1.50	.688

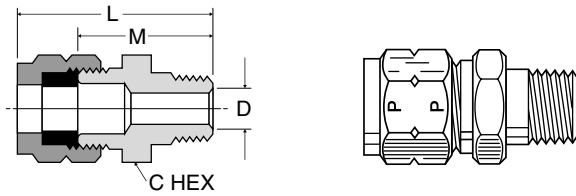

**Straight Through Tank Fitting 682VL**

PART NO.	TUBE SIZE	PIPE THREAD	C HEX	L	M	FLOW DIA.D
682VL-4-2	1/4	1/8	9/16	1.15	.84	.265
682VL-4-4	1/4	1/4	9/16	1.34	1.03	.265
682VL-5-4	5/16	1/4	5/8	1.41	1.06	.328
682VL-6-6	3/8	3/8	11/16	1.41	1.06	.406

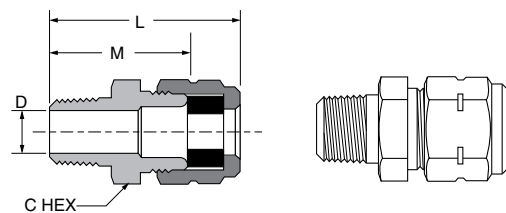

**Male Connector 685VLV**

PART NO.	TUBE SIZE	STRAIGHT THREAD	BODY HEX	L	M	N	D
685VLV-4-4	1/4	7/16-20	9/16	1.14	.83	.36	.18
685VLV-5-4	5/16	7/16-20	5/8	1.18	.83	.36	.18
685VLV-6-4	3/8	7/16-20	11/16	1.18	.83	.36	.18
685VLV-6-6	3/8	9/16-18	11/16	1.25	.90	.39	.30
685VLV-8-8	1/2	3/4-16	7/8	1.52	1.04	.44	.39
685VLV-10-10	5/8	7/8-14	1 1/16	1.84	1.20	.50	.50
685VLV-12-12	3/4	1 1/16-12	1 1/4	2.10	1.34	.59	.62

Note: Fluorocarbon seal & o-ring standard

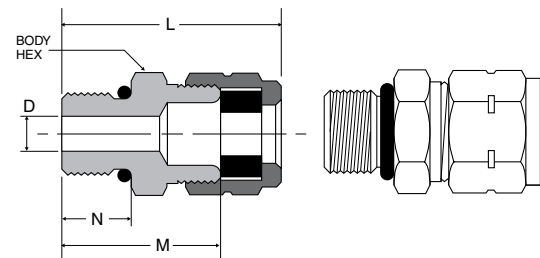

**Union Tee 164VL**

PART NO.	TUBE SIZE	B HEX	L	M	FLOW DIA.D
164VL-3	3/16	3/8	.98	.69	.160
164VL-4	1/4	1/2	1.06	.75	.190
164VL-5	5/16	15/32	1.22	.88	.250
164VL-8	1/2	13/16	1.64	1.16	.406

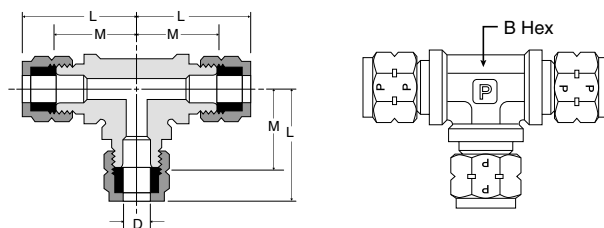

**Male Elbow 169VL**

PART NO.	TUBE SIZE	PIPE THREAD	L	M	N	FLOW DIA.D
169VL-3-2	3/16	1/8	.98	.69	.75	.156
169VL-4-2	1/4	1/8	1.00	.69	.78	.188
169VL-4-4	1/4	1/4	1.16	.84	1.00	.188
169VL-5-4	5/16	1/4	1.16	.81	1.00	.252
169VL-6-2	3/8	1/8	1.19	.84	.91	.235
169VL-6-4	3/8	1/4	1.19	.84	1.06	.312
169VL-6-6	3/8	3/8	1.29	.94	1.13	.312
169VL-8-6	1/2	3/8	1.48	1.00	1.06	.406
169VL-8-8	1/2	1/2	1.54	1.06	1.44	.406
169VL-10-8	5/8	1/2	1.92	1.28	1.47	.565

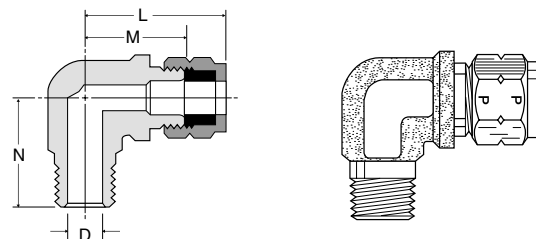

**Male Elbow 1695VLV**

PART NO.	TUBE SIZE	STRAIGHT THREAD	NUT HEX	BODY HEX	JAM NUT HEX	L	M	N1	N2	D
1695VLV-4-4	1/4	7/16-20	9/16	9/16	9/16	1.15	.84	1.07	.71	.18
1695VLV-5-4	5/16	7/16-20	5/8	9/16	9/16	1.16	.81	1.07	.71	.18
1695VLV-6-4	3/8	7/16-20	3/4	5/8	9/16	1.19	.84	1.10	.71	.18
1695VLV-6-6	3/8	9/16-18	3/4	5/8	11/16	1.29	.94	1.17	.78	.30
1695VLV-8-8	1/2	3/4-16	15/16	3/4	7/8	1.54	1.06	1.44	.89	.39
1695VLV-10-10	5/8	7/8-14	1 1/8	1.00	1.00	1.92	1.28	1.68	1.03	.50
1695VLV-12-12	3/4	1 1/16-12	1 1/4	1.00	1 1/4	2.04	1.28	1.82	1.17	.62

Note: Fluorocarbon seal & o-ring standard

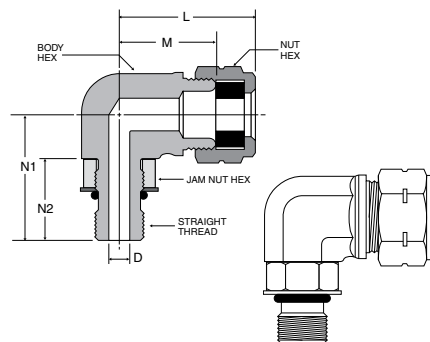

**Female Elbow 170VL**

PART NO.	TUBE SIZE	PIPE THREAD	L	M	N	FLOW DIA.D
170VL-4-2	1/4	1/8	.96	.65	.50	.188
170VL-5-4	5/16	1/4	1.16	.81	.70	.250

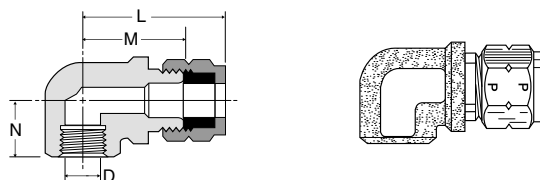

**Male Run Tee 171VL**

PART NO.	TUBE SIZE	PIPE THREAD	C HEX	L	M	FLOW DIA.D
171VL-4-2	1/4	1/8	9/16	1.03	.76	.188
171VL-4-4	1/4	1/4	9/16	1.12	1.03	.188

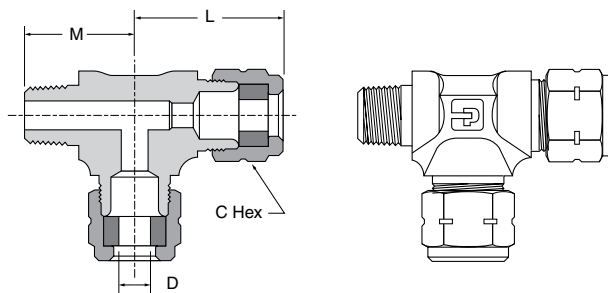

**Male Run Tee 172VL**

PART NO.	TUBE SIZE	PIPE THREAD	C HEX	L	M	FLOW DIA.D
172VL-4-2	1/4	1/8	9/16	1.06	.75	.188

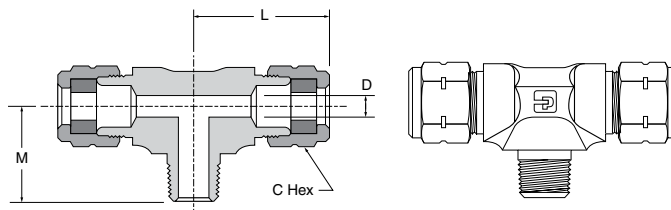

**45° Elbow 179VL**

PART NO.	TUBE SIZE	PIPE THREAD	L	M	N	FLOW DIA.D
179VL-4-2	1/4	1/8	1.06	.75	.69	.188
179VL-6-4	3/8	1/4	1.07	.72	.84	.315

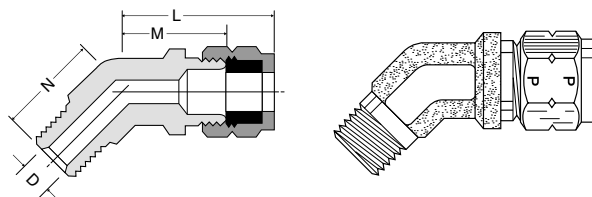

H



# ***Push to Connect Transportation***



## **Prestomatic**

- Meets D.O.T. FMVSS 571.106
- Meets SAE J2494
- Stainless Steel Tube support



## **PTC**

- Meets D.O.T. FMVSS 571.106
- Meets SAE J2494 – 3
- Composite Light Weight Bodies
- Brass componentry











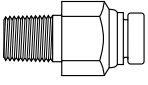



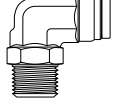
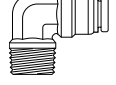
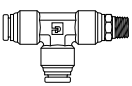
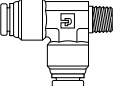
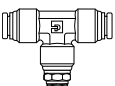
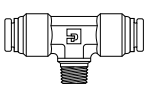
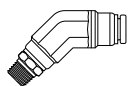
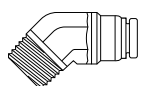
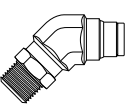
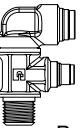

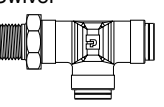

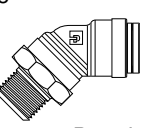
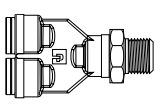
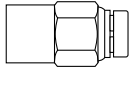
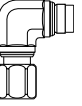
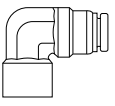

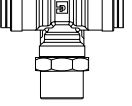
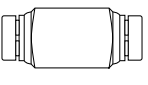
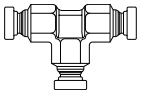
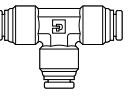
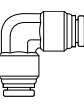
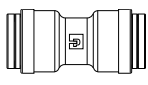
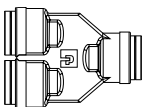
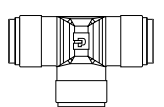
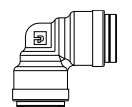
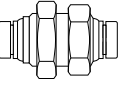
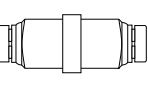
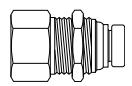
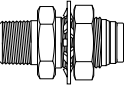
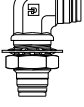
## **Metric Prestomatic**

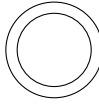
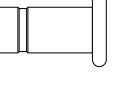
- Sizes 6mm and above Meets DIN 74324. Product only meets FMVSS 571.106 when used with SAE J844 metric tubing. If product is used with DIN tubing, it will not meet the FMVSS 571.106 performance requirements.
- Meets DOT FMVSS 571.106 when used with SAE J844 tubing
- Use with DIN 73378 virgin nylon or SAE J844 Tubing
- Universal Stud Design and Brass Body

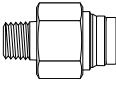
***The World Standard***

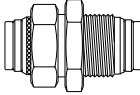
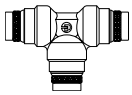
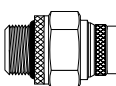

<b>Tube to Male NPT</b>	<b>68PMT</b> Male Connector  Page I8	<b>169PMNS</b> Male Elbow  Page I9	<b>169PMT</b> Male Elbow Swivel  Page I9	<b>169PMTL</b> Male Elbow Long  Page I10	<b>169PMTR</b> Male Elbow Swivel 90°  Page I9	<b>169PMTNS</b> Male Elbow  Page I10	
	<b>171PMT</b> Run Tee Swivel  Page I11	<b>171PMTNS</b> Male Run Tee  Page I11	<b>172PMT</b> Branch Tee Swivel  Page I12	<b>172PMTNS</b> Branch Tee  Page I12	<b>179PMT</b> 45° Elbow Swivel  Page I12	<b>179PMTNS</b> 45° Elbow  Page I13	<b>179PMTR</b> Male Elbow Swivel 45°  Page I12
	<b>189PMTR</b> Dual Port Elbow  Page I13	<b>369PTC</b> Male Elbow Swivel 90°  Page I15	<b>371PTC</b> Male Run Tee Swivel  Page I16	<b>372PTC</b> Male Branch Tee Swivel  Page I17	<b>379 PTC</b> Male Elbow Swivel 45°  Page I17	<b>368PTC</b> Union Y  Page I16	
<b>Tube to Female NPT</b>	<b>66PMT</b> Female Connector  Page I7	<b>170PMT</b> Female Elbow Swivel  Page I11	<b>170PMTNS</b> Female Elbow Swivel  Page I11	<b>370PTC</b> Female Elbow Swivel 90°  Page I15	<b>377PTC</b> Branch Tee  Page I17		
	<b>Tube to Tube</b>		<b>62PMT</b> Union  Page I7	<b>164PM</b> Union Tee  Page I8	<b>164PMT</b> Union Tee  Page I8	<b>165PMT</b> Union Elbow  Page I9	<b>32PTC</b> Union  Page I15
<b>362PTC</b> Union Y  Page I15		<b>364PTC</b> Union Tee  Page I16	<b>365PTC</b> Union Elbow  Page I16				
<b>Bulkhead Unions</b>	<b>62PMTBH</b> Bulkhead Union  Page I7	<b>62PMTBHR</b> Bulkhead Union  Page I6	<b>66PMTBH</b> Bulkhead Female  Page I7	<b>68PMTBH</b> Bulkhead Male  Page I8	<b>165PMTBH</b> Bulkhead Elbow  Page I9	<b>169PMTBH</b> Bulkhead Male Elbow  Page I10	
	<b>Auxiliary</b>	<b>ERHD</b> External Retainer  Page I6	<b>ES</b> External Seal  Page I6	<b>639PM/639PMT</b> Plug  Page I13			

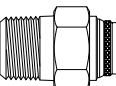
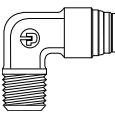
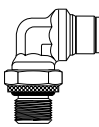
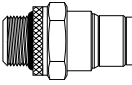
<p><b>Metric Tube to Male NPT</b></p>	<p><b>F2PMTB</b> Male Connector</p>  <p>Page I19</p>	<p><b>C2PMTB</b> Male Elbow</p>  <p>Page I20</p>	<p><b>Metric Tube to Metric Tube</b></p>	<p><b>HPMTB</b> Metric Union</p>  <p>Page I19</p>	<p><b>WPMTB</b> Bulkhead Union</p>  <p>Page I19</p>	<p><b>JPMTB</b> Metric Union Tee</p>  <p>Page I20</p>	
	<p><b>F8UPMTB</b> Male Connector</p>  <p>Page I20</p>	<p><b>C8UPMTB</b> Male Elbow</p>  <p>Page I21</p>		<p><b>S8UPMTB</b> Branch Tee</p>  <p>Page I21</p>	<p><b>V8UPMTB</b> 45° Male Elbow</p>  <p>Page I21</p>		
	<p><b>F3PMTB</b> Male Connector</p>  <p>Page I19</p>	<p><b>C3PMTB</b> Male Elbow</p>  <p>Page I20</p>					
	<p><b>169PMTNS-X-M</b> Male Elbow</p>  <p>Page I10</p>	<p><b>68PMT-X-M</b> Male Connector</p>  <p>Page I8</p>					
<p><b>Metric Tube to Metric Straight Thread</b></p>							
<p><b>Metric Tube to Male BSPT</b></p>							
<p><b>Tube to Metric Thread</b></p>							

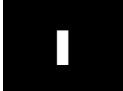

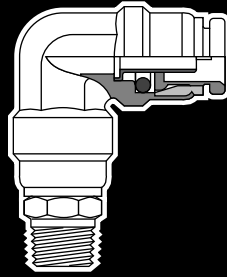

## Prestomatic Air Brake Push-In Fittings

### Advantages

Patented design of sizes 5/32" and above meet SAE J2494 and D.O.T. FMVSS 571.106 air brake performance specifications. No special tools are needed to assemble. Just bottom the tubing in the fitting body for a positive seal. Stainless steel tube support in sizes 1/4" and above assures maximum flow and performance requirements of SAE J2494-3. Any Prestomatic fitting without a tube support (PM designation) is designed for use in pressure protected air accessory lines that are isolated from the air brake system

### Application

Use with Parker Parflex SAE J844 type A & B nylon tubing. Designed for all D.O.T. truck and trailer applications. Consult the factory with any questions regarding special product applications. Prior to use, all applications should be carefully tested through the range of conditions which may be encountered.

### Features

1. All brass body.
2. Stainless steel tube support assures maximum flow and performance characteristics.
3. Elbows and tees are available in positionable or rigid dryseal pipe threads. Positioning feature is designed for installation and alignment purposes only and should not be used as a swivel.
4. Lubricated O-Ring Seal (Buna N) insures a quick, easy and positive seal.
5. Innovative Collet design insures positive grip on tubing.

6. Release Button offers quick and easy disconnections.

### Technical Data

- Working pressure from vacuum to 250 psi.
- Working temperature from -40° F to +200° F (Note: see tubing manufacturer's recommendations for pressure and temperature limitations).
- Buna N (Nitrile) O-Rings.

### Order

By part number and name.

### Nomenclature

Part numbers are constructed from symbols that identify the style and size of the fitting. The first series of numbers and letters identify the style and type of fitting. The Prestomatic series has a tube support and is designated with a "PMT" suffix.

#### Example:

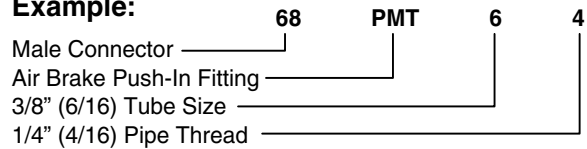

### Special Fittings

Fitting configurations and/or sizes other than those shown in the catalog can be furnished. It is suggested that a print or sketch be submitted with the inquiry. Price and delivery for non-stock items furnished on request for specified quantities.

### Pricing

Only items priced in current supplementary price list PL3501 are carried in stock. Price and delivery for non-stock items furnished on request for specified quantity.

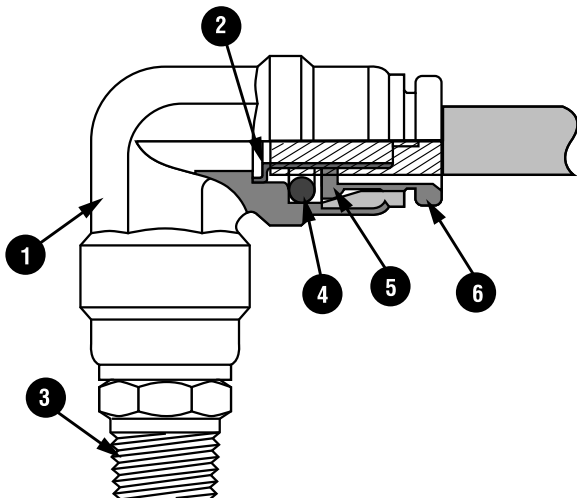

† U.S. Patent No. 5,683,120

**Assembly Instructions**

1. Cut tubing squarely—maximum of 15° angle allowable.
  - Use of Parker tube cutter PTC-001 is recommended.
2. Check that port or mating part is clean and free of debris.
3. Insert tubing into fitting until it bottoms.
  - Push twice to verify that tubing is inserted past collet and O-Ring.
4. Pull on tubing to verify it is fully inserted.
5. To disassemble, simply press release button, hold against body, and pull tubing out of fitting.

Note: in order to pass hot pull requirements of SAE FMVSS 571.106 and SAE J2494-3 a tube support must be present in the end of the fitting before final fitting assembly.

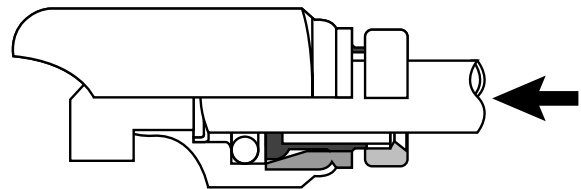
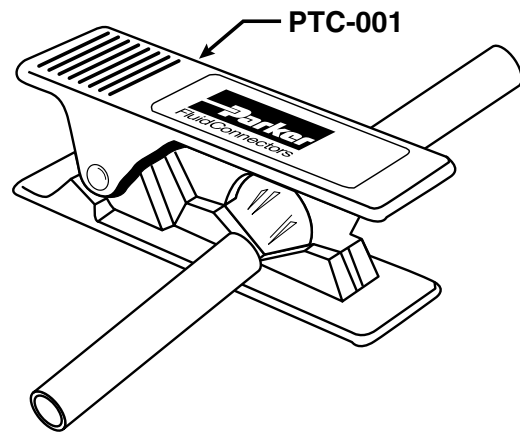

Insert tubing until it bottoms

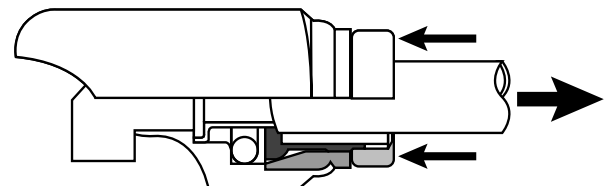

Depress button to remove tubing

<sup>†</sup> U.S. Patent No. 5,683,120

**Prestomatic<sup>†</sup> Retaining Ring Bulkhead Unions**

Prestomatic<sup>†</sup> retaining ring bulkhead unions feature a unique design that provides the user with an economical method to install and assemble a union connection through a bulkhead.

The retaining ring bulkhead unions feature a smaller envelope size than standard bulkhead union connectors and do not require a wrench to mount or assemble in cramped areas.

The external seal feature provides a moisture barrier and can also prevent external contamination from entering into an enclosed area.

To install, simply support the bulkhead union from behind and apply the external seal. Then push the external retainer against the external seal with an assembly tool and you have a reliable bulkhead connection in a confined area.

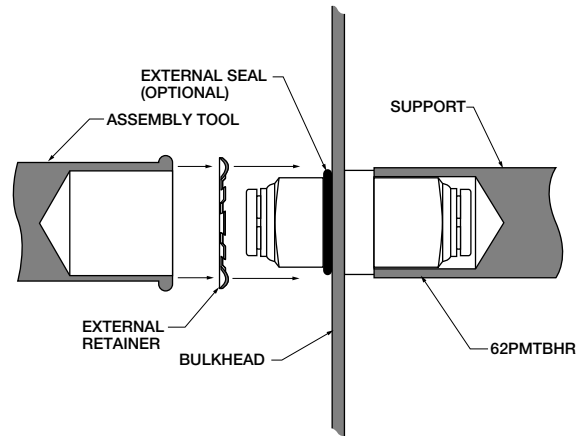

**Retaining Ring Bulkhead 62PMTBHR**

PART NO.	TUBE SIZE	O.D.	REC. HOLE SIZE	L	P MAX	A DIA
62PMTBHR-4	1/4	.500	.512	1.53	.26	.625
62PMTBHR-6	3/8	.750	.762	1.92	.36	.875
62PMTBHR-8	1/2	.875	.887	2.15	.43	1.000
62PMTBHR-10	5/8	1.000	1.012	2.54	.62	1.250

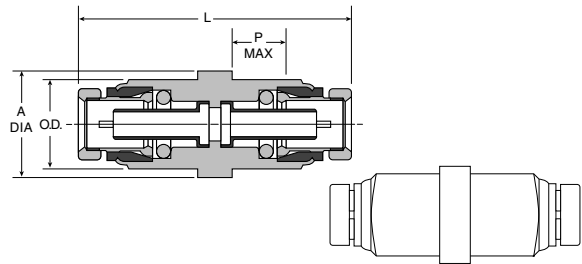

**External Retainer ERHD\***

PART NUMBER	TUBE SIZE	BULKHEAD UNION O.D.	A DIA	W
ERHD-50	1/4	.500	.83	.05
ERHD-75	3/8	.750	1.08	.05
ERHD-87	1/2	.875	1.20	.05
ERHD-100	5/8	1.000	1.33	.05

\*Material Carbon Spring Steel

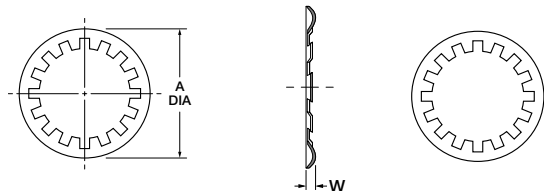

**External Seal ES\***

PART NUMBER	TUBE SIZE	BULKHEAD UNION O.D.	I.D.	W
ES-50	1/4	.500	.489	.07
ES-75	3/8	.750	.739	.07
ES-87	1/2	.875	.864	.07

\*Material is Nitrite (Buna N), 70 Durometer

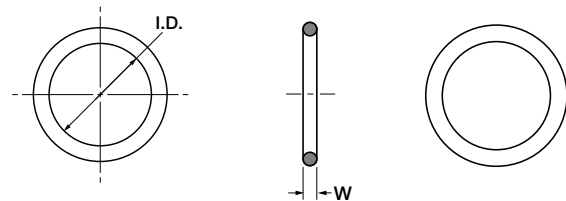

<sup>†</sup> U.S. Patent No. 5,683,120

**Union 62PMT**

PART NO.	TUBE SIZE	L	O.D.
62PMT-5/32	5/32	1.45	.38
62PMT-4	1/4	1.48	.50
62PMT-4-2	1/4-1/8	1.48	.50
62PMT-6	3/8	1.87	.75
62PMT-6-4	3/8-1/4	1.68	.75
62PMT-8	1/2	2.03	.88
62PMT-10	5/8	2.42	1.00

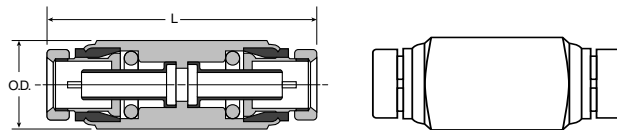

**Bulkhead Union 62PMTBH**

PART NO.	TUBE SIZE	O.D.	L	P MAX	HEX A	HEX B	BULKHEAD HOLE DIA.
62PMTBH-4	1/4	.56	1.69	.25	11/16	3/4	9/16
62PMTBH-6	3/8	.88	1.93	.44	1-1/16	1-1/16	7/8
62PMTBH-8	1/2	1.00	2.02	.58	1-1/4	1-1/4	1
62PMTBH-10	5/8	1.12	2.92	.81	1-1/4	1-3/8	1-1/8

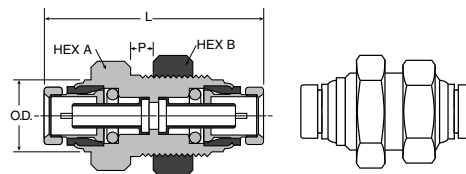

**Female Connector 66PMT**

PART NO.	TUBE SIZE	PIPE THREAD	L	HEX
66PMT-4-2	1/4	1/8	1.22	9/16
66PMT-4-4	1/4	1/4	1.43	11/16
66PMT-6-2	3/8	1/8	1.37	3/4
66PMT-6-4	3/8	1/4	1.58	3/4
66PMT-6-6	3/8	3/8	1.62	13/16
66PMT-8-4	1/2	1/4	1.69	7/8
66PMT-8-6	1/2	3/8	1.68	7/8
66PMT-8-8	1/2	1/2	1.91	1

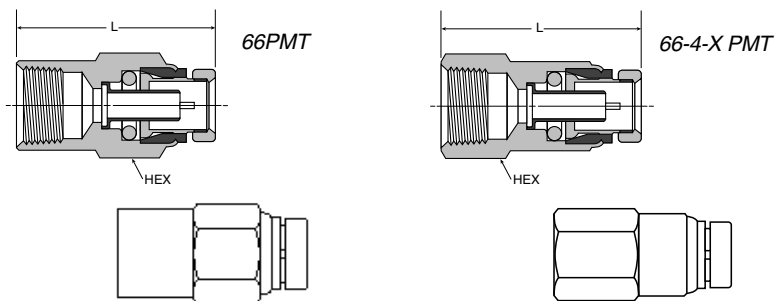

**Bulkhead Female Connector 66PMTBH**

PART NO.	TUBE SIZE	PIPE THREAD	L	HEX A	HEX B	BULKHEAD HOLE DIA.
66PMTBH-4-4	1/4	1/4	1.62	11/16	3/4	9/16
66PMTBH-6-6	3/8	3/8	1.87	1.06	1.06	7/8
66PMTBH-8-8	1/2	1/2	2.02	1-1/4	1-1/4	1

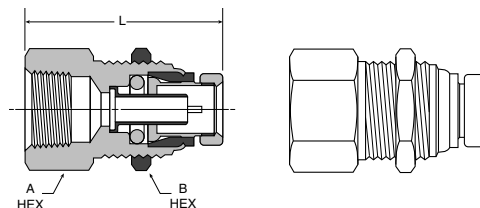

<sup>†</sup> U.S. Patent No. 5,683,120

**Male Connector 68PMT**

PART NO.	TUBE SIZE	PIPE THREAD	L	HEX
68PMT-5/32-1	5/32	1/16	.85	3/8
68PMT-5/32-2	5/32	1/8	.89	7/16
68PMT-4-2	1/4	1/8	1.06	1/2
68PMT-4-4	1/4	1/4	1.19	9/16
68PMT-4-6	1/4	3/8	1.27	3/4
68PMT-6-2	3/8	1/8	1.37	3/4
68PMT-6-4	3/8	1/4	1.43	3/4
68PMT-6-6	3/8	3/8	1.33	3/4
68PMT-6-8	3/8	1/2	1.38	7/8
68PMT-8-4	1/2	1/4	1.72	7/8
68PMT-8-6	1/2	3/8	1.52	7/8
68PMT-8-8	1/2	1/2	1.44	7/8
68PMT-10-6	5/8	3/8	1.88	1
68PMT-10-8	5/8	1/2	1.88	1
68PMT-12-8	3/4	1/2	2.03	1 3/16
68PMT-12-12	3/4	3/4	2.03	1 1/8

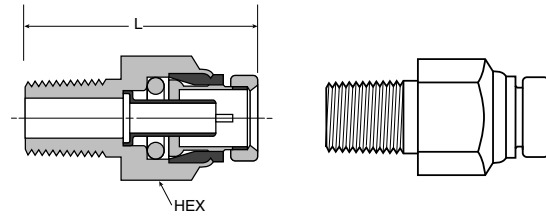

**Male Connector to Metric Adapter 68PMT-X-M**

PART NO.	TUBE SIZE	METRIC THREAD	L	B HEX	N
68PMT-4-M12	1/4	M12X1.5	1.19	11/16	.29
68PMT-4-M16	1/4	M16X1.5	1.29	7/8	.39
68PMT-6-M12	3/8	M12X1.5	1.40	3/4	.29
68PMT-6-M16	3/8	M16X1.5	1.35	7/8	.39
68PMT-6-M22	3/8	M22X1.5	1.23	1 1/16	.40
68PMT-8-M12	1/2	M12X1.5	1.45	7/8	.29
68PMT-8-M16	1/2	M16X1.5	1.52	7/8	.39
68PMT-8-M22	1/2	M22X1.5	1.31	1 1/16	.37
68PMT-10-M16	5/8	M16X1.5	1.78	1	.39

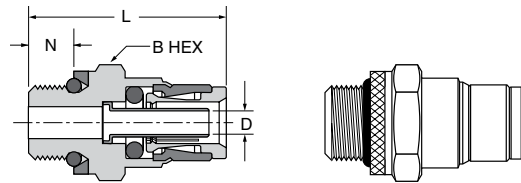

**Bulkhead Male Connector 68PMTBH**

PART NO.	TUBE SIZE	PIPE THREAD	L	P MAX	HEX A	HEX B	BULKHEAD HOLE DIA.
68PMTBH-6-8	3/8	1/2	2.37	.33	1-1/4	1-1/4	1
68PMTBH-8-8	1/2	1/2	2.38	.33	1-1/4	1-1/4	1

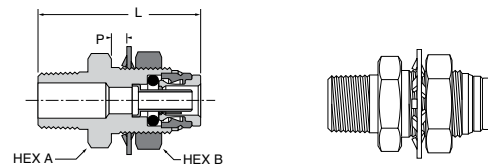

**Union Tee 164PMT**

PART NO.	TUBE 1 SIZE	TUBE 2 SIZE	L1	L2
164PMT-4	1/4	1/4	.85	.85
164PMT-6	3/8	3/8	1.21	1.21
164PMT-6-6-4	3/8	1/4	1.21	.93
164PMT-8	1/2	1/2	1.27	1.27
164PMT-10	5/8	5/8	1.63	1.62

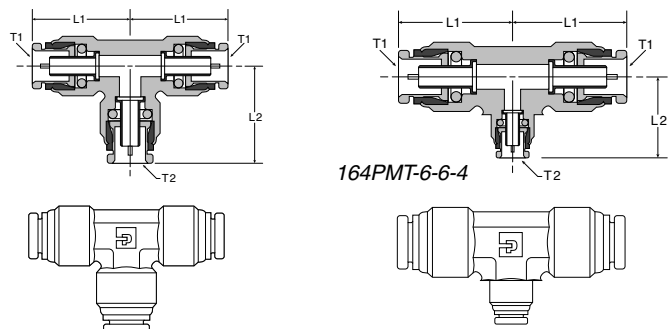

<sup>†</sup> U.S. Patent No. 5,683,120

**Union Elbow 165PMT**

PART NO.	TUBE SIZE	L
165PMT-4	1/4	.85
165PMT-6	3/8	1.11
165PMT-8	1/2	1.24
165PMT-10	5/8	1.57

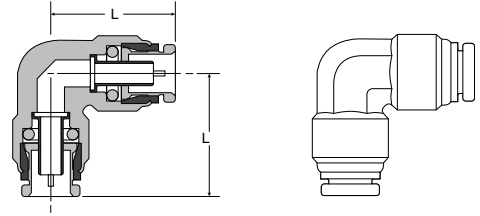

**Union Bulkhead Elbow 165PMTBH**

PART NO.	TUBE SIZE	L1	L2	C HEX	FLOW DIA. D	BULKHEAD HOLE DIA.
165PMTBH-8	1/2	1.29	2.45	1 1/4	.34	1

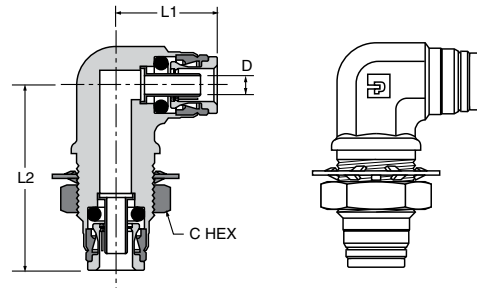

**Male Elbow 90° 169PMT**

PART NO.	TUBE SIZE	PIPE THREAD	L	N	WRENCH FLATS	B HEX
169PMT-4-2	1/4	1/8	.84	1.21	13/32	7/16
169PMT-4-4	1/4	1/4	.84	1.43	13/32	9/16
169PMT-4-6	1/4	3/8	.84	1.43	13/32	11/16
169PMT-6-2	3/8	1/8	1.11	1.41	9/16	9/16
169PMT-6-4	3/8	1/4	1.11	1.58	9/16	9/16
169PMT-6-6	3/8	3/8	1.11	1.58	9/16	11/16
169PMT-6-8	3/8	1/2	1.11	1.79	9/16	7/8
169PMT-8-4	1/2	1/4	1.27	1.73	11/16	5/8
169PMT-8-6	1/2	3/8	1.27	1.81	11/16	3/4
169PMT-8-8	1/2	1/2	1.27	1.96	11/16	7/8
169PMT-10-6	5/8	3/8	1.53	2.03	7/8	3/4
169PMT-10-8	5/8	1/2	1.53	2.18	7/8	7/8

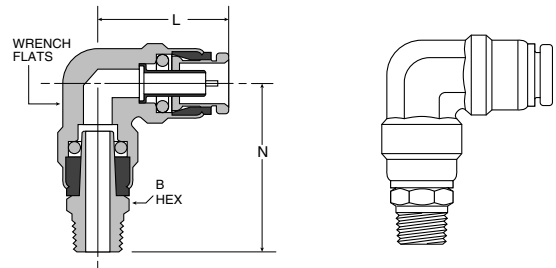

**Male Elbow Positional 90° 169PMTR**

PART NO.	TUBE SIZE	PIPE THREAD	B HEX	L	N	WRENCH FLATS
169PMTR-4-4	1/4	1/4	9/16	0.84	1.13	1/2
169PMTR-6-6	3/8	3/8	3/4	1.12	1.19	9/16
169PMTR-10-8	5/8	1/2	7/8	1.54	1.50	7/8

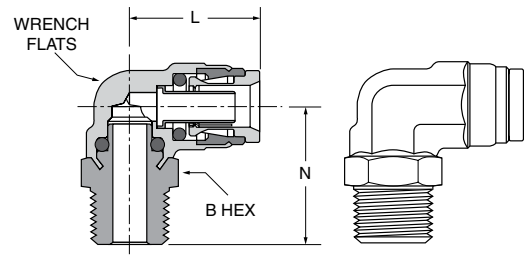

<sup>†</sup> U.S. Patent No. 5,683,120



**Male Elbow Long Rigid 90° 169PMTL**

PART NO.	TUBE SIZE	PIPE THREAD	L	N	WRENCH FLATS
169PMTL-6-4	3/8	1/4	1.06	1.63	9/16
169PMTL-6-8	3/8	1/2	1.19	2.50	7/8
169PMTL-6-6	3/8	3/8	1.19	2.50	7/8
169PMTL-8-8	1/2	1/2	1.22	2.50	7/8
169PMTL-10-8	5/8	1/2	1.46	2.50	7/8

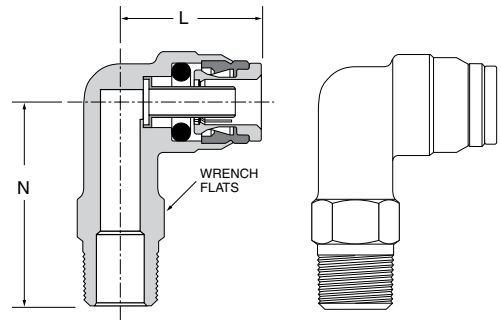

**Male Elbow Rigid 90° 169PMTNS/269PMT**

PART NO.	TUBE SIZE	PIPE THREAD	L	N	WRENCH FLATS
269PMT-5/32-1	5/32	1/16	.85	.66	7/16
269PMT-5/32-2	5/32	1/8	.85	.66	7/16
169PMTNS-4-2	1/4	1/8	.84	.72	1/2
169PMTNS-4-4	1/4	1/4	.84	.90	1/2
169PMTNS-4-6	1/4	3/8	.84	1.06	1/2
169PMTNS-6-2	3/8	1/8	1.05	.75	9/16
169PMTNS-6-4	3/8	1/4	1.05	.94	9/16
169PMTNS-6-6	3/8	3/8	1.05	.94	3/4
169PMTNS-6-8	3/8	1/2	1.12	1.26	11/16
169PMTNS-8-4	1/2	1/4	1.17	1.06	11/16
169PMTNS-8-6	1/2	3/8	1.22	1.06	11/16
169PMTNS-8-8	1/2	1/2	1.22	1.26	11/16
169PMTNS-10-6	5/8	3/8	1.46	1.11	7/8
169PMTNS-10-8	5/8	1/2	1.46	1.32	7/8
169PMTNS-12-8	3/4	1/2	1.81	1.44	1

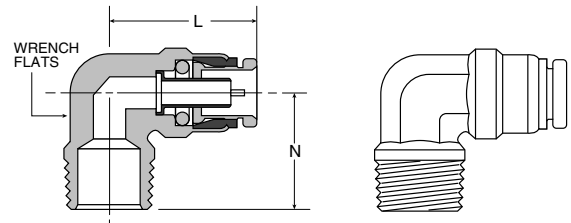

**Male Elbow to Metric Adjustable 169PMTNS-X-M**

PART NO.	TUBE SIZE	METRIC THREAD	WRENCH FLATS (MM)	B HEX (MM)	L	M	N
169PMTNS-4-M12	1/4	M12X1.5	10	17	.84	1.11	.37
169PMTNS-4-M16	1/4	M16X1.5	11	24	.96	1.27	.41
169PMTNS-4-M22	1/4	M22X1.5	19	30	1.09	1.53	.41
169PMTNS-6-M12	3/8	M12X1.5	16	17	1.10	1.15	.66
169PMTNS-6-M16	3/8	M16X1.5	19	24	1.23	1.27	.41
169PMTNS-8-M12	1/2	M12X1.5	16	17	1.21	1.31	.37
169PMTNS-8-M16	1/2	M16X1.5	16	24	1.26	1.34	.41
169PMTNS-8-M22	1/2	M22X1.5	19	30	1.26	1.59	.41
169PMTNS-12-M22	3/4	M22X1.5	27	30	1.77	1.59	.41

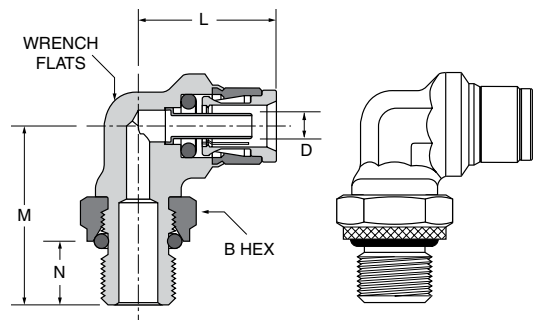

**Male Elbow Bulkhead 169PMTBH**

PART NO.	TUBE SIZE	PIPE THREAD	L	N	B HEX	C HEX	BULKHEAD HOLE DIA.
169PMTBH6-8	3/8	1/2	1.19	2.50	1-1/4	7/8	1
169PMTBH8-8	1/2	1/2	1.29	2.50	1-1/4	7/8	1

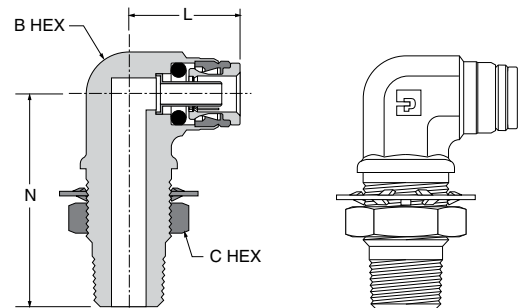

<sup>†</sup> U.S. Patent No. 5,683,120

**Female Elbow Swivel 90° 170PMT**

PART NO.	TUBE SIZE	PIPE THREAD	L	N	HEX	WRENCH FLATS
170PMT-4-2	1/4	1/8-27	.84	1.18	1/2	1/2

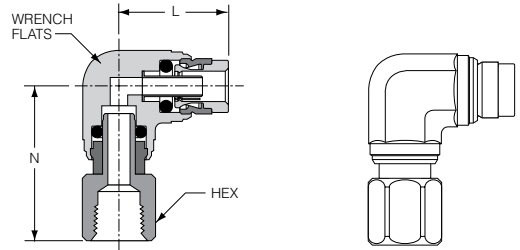

**Female Elbow Rigid 90° 170PMTNS**

PART NO.	TUBE SIZE	PIPE THREAD	L	N	WRENCH FLATS
170PMTNS-4-2	1/4	1/8	.84	.56	11/16
170PMTNS-4-4	1/4	1/4	1.00	.67	11/16
170PMTNS-6-2	3/8	1/8	1.12	.64	9/16
170PMTNS-6-4	3/8	1/4	1.25	1.00	11/16
170PMTNS-6-6	3/8	3/8	1.25	1.00	13/16
170PMTNS-8-4	1/2	1/4	1.25	.75	11/16
170PMTNS-8-6	1/2	3/8	1.32	.88	11/16
170PMTNS-8-8	1/2	1/2	1.70	.98	1

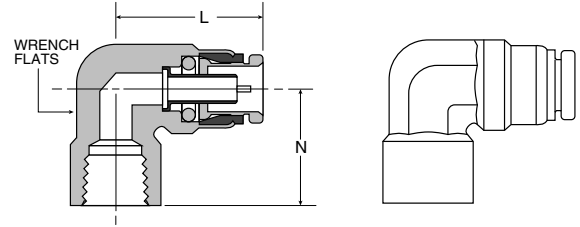

**Male Run Tee Swivel 171PMT**

PART NO.	TUBE SIZE	PIPE THREAD	L	N	HEX	WRENCH FLATS
171PMT-4-2	1/4	1/8	.85	1.25	7/16	1/2
171PMT-4-4	1/4	1/4	.85	1.48	9/16	1/2
171PMT-4-6	1/4	3/8	.85	1.43	11/16	1/2
171PMT-6-4	3/8	1/4	1.21	1.83	9/16	5/8
171PMT-6-6	3/8	3/8	1.21	1.83	11/16	5/8
171PMT-8-4	1/2	1/4	1.27	1.74	5/8	7/8
171PMT-8-6	1/2	3/8	1.27	1.83	3/4	7/8
171PMT-8-8	1/2	1/2	1.27	1.99	7/8	7/8

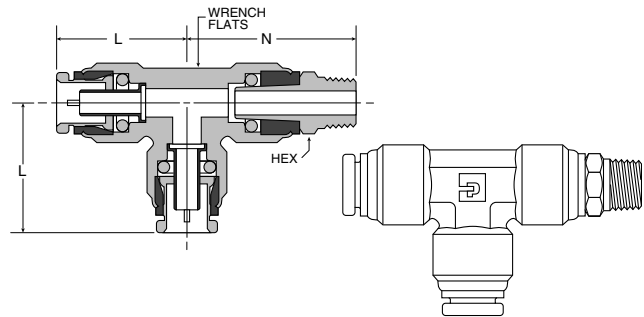

**Male Run Tee Rigid 171PMTNS**

PART NO.	TUBE 1 SIZE	TUBE 2 SIZE	PIPE THREAD	L1	L2	N	WRENCH FLATS
171PMTNS-4-2	1/4	1/4	1/8	.91	.91	.77	15/32
171PMTNS-4-4	1/4	1/4	1/4	.91	.91	.94	15/32
171PMTNS-4-6-4	1/4	3/8	1/4	.93	1.21	.97	5/8
171PMTNS-6-4	3/8	3/8	1/4	1.21	1.21	.97	5/8
171PMTNS-6-4-4	3/8	1/4	1/4	1.21	.93	.97	5/8
171PMTNS-6-4-6	3/8	1/4	3/8	1.22	.97	.93	5/8
171PMTNS-6-6	3/8	3/8	3/8	1.21	1.21	.97	5/8
171PMTNS-6-8	3/8	3/8	1/2	1.17	1.17	1.26	5/8
171PMTNS-8-4	1/2	1/2	1/4	1.28	1.28	1.06	7/8

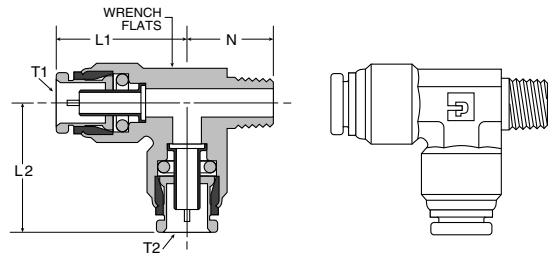

<sup>†</sup> U.S. Patent No. 5,683,120

**Male Branch Tee Swivel 172PMT**

PART NO.	TUBE SIZE	PIPE THREAD	L	N	HEX	WRENCH FLATS
172PMT-4-2	1/4	1/8	.85	1.25	7/16	1/2
172PMT-4-4	1/4	1/4	.85	1.43	9/16	1/2
172PMT-6-2	3/8	1/8	1.22	1.66	9/16	5/8
172PMT-6-4	3/8	1/4	1.22	1.83	5/8	5/8
172PMT-6-6	3/8	3/8	1.22	1.83	3/4	5/8
172PMT-8-4	1/2	1/4	1.27	1.73	5/8	7/8
172PMT-8-6	1/2	3/8	1.27	1.79	3/4	7/8
172PMT-8-8	1/2	1/2	1.27	1.97	7/8	7/8

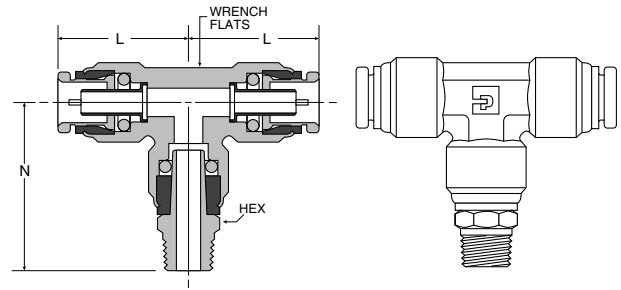

**Male Branch Tee Rigid 172PMTNS**

PART NO.	TUBE 1 SIZE	TUBE 2 SIZE	PIPE THREAD	L1	L2	N	WRENCH FLATS
172PMTNS-4-2	1/4	1/4	1/8	.91	.91	.78	1/2
172PMTNS-6-4	3/8	3/8	1/4	1.21	1.21	.97	5/8
172PMTNS-6-4-4	3/8	1/4	1/4	1.21	.93	.97	5/8
172PMTNS-6-6	3/8	3/8	3/8	1.21	1.21	.97	5/8
172PMTNS-6-8	3/8	3/8	1/2	1.17	1.17	1.26	7/8
172PMTNS-8-6	1/2	1/2	3/8	1.28	1.28	1.06	7/8
172PMTNS-8-6-8	1/2	3/8	1/2	1.25	1.25	1.25	7/8
172PMTNS-8-8	1/2	1/2	1/2	1.34	1.34	1.25	7/8

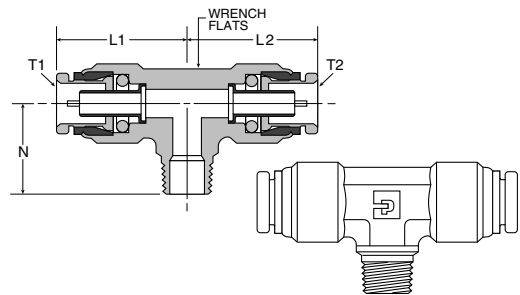

**Male Elbow Swivel 45° 179PMT**

PART NO.	TUBE SIZE	PIPE THREAD	L	N	HEX	WRENCH FLATS
179PMT-4-2	1/4	1/8	.79	1.16	7/16	9/16
179PMT-4-4	1/4	1/4	.89	1.46	9/16	9/16
179PMT-6-2	3/8	1/8	.99	1.44	5/8	3/4
179PMT-6-4	3/8	1/4	.99	1.61	5/8	3/4
179PMT-6-6	3/8	3/8	.99	1.61	5/8	3/4
179PMT-8-4	1/2	1/4	1.20	1.70	5/8	7/8
179PMT-8-6	1/2	3/8	1.20	1.78	3/4	7/8
179PMT-8-8	1/2	1/2	1.20	1.93	7/8	7/8

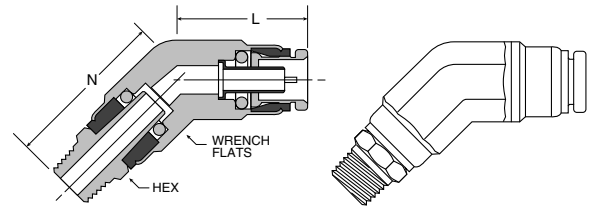

**Male Elbow Positional Swivel 45° 179PMTR**

PART NO.	TUBE SIZE	PIPE THREAD	B HEX	L	N	WRENCH FLATS
179PMTR-4-4	1/4	1/4	9/16	0.79	1.18	9/16
179PMTR-8-8	1/2	1/2	7/8	1.17	1.35	7/8

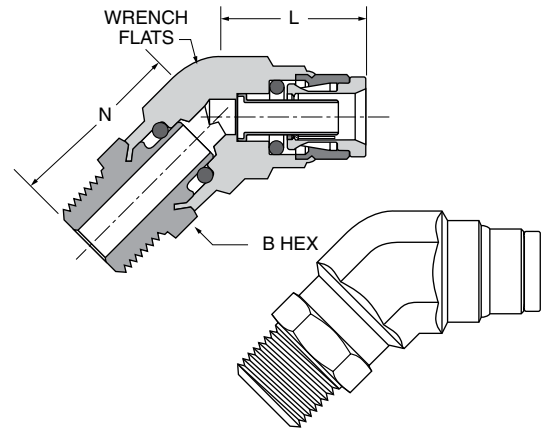

<sup>†</sup> U.S. Patent No. 5,683,120

**Male Elbow Rigid 45° 179PMTNS**

PART NO.	TUBE SIZE	PIPE THREAD	L	N	WRENCH FLATS
179PMTNS-4-2	1/4	1/8	.80	.56	9/16
179PMTNS-4-4	1/4	1/4	.80	.75	9/16
179PMTNS-6-2	3/8	1/8	.99	.55	3/4
179PMTNS-6-4	3/8	1/4	.99	.73	3/4
179PMTNS-6-6	3/8	3/8	.99	.73	3/4
179PMTNS-8-4	1/2	1/4	1.28	.81	13/16
179PMTNS-8-6	1/2	3/8	1.28	.81	13/16
179PMTNS-8-8	1/2	1/2	1.28	1.06	13/16
179PMTNS-10-6	5/8	3/8	1.22	.88	7/8
179PMTNS-10-8	5/8	1/2	1.22	1.00	7/8
179PMTNS-12-8	3/4	1/2	1.41	1.25	1

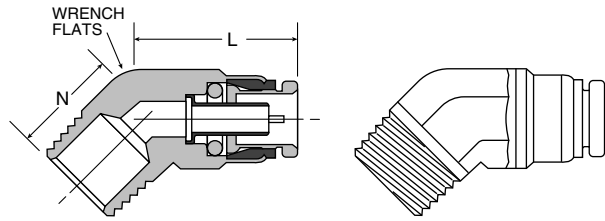

**Dual port 90 Male Elbow Positional 189PMTR**

PART NO.	TUBE 1 SIZE	TUBE 2 SIZE	PIPE THREAD	L1	L2	N1	N2	WRENCH FLATS
189PMTR6-4-6	3/8	1/4	3/8	2.12	1.05	1.21	1.19	11/16
189PMTR6-6-4	3/8	3/8	1/4	2.06	.98	1.12	1.20	9/16
189PMTR6-6-6	3/8	3/8	3/8	2.06	.98	1.12	1.20	9/16
189PMTR10-4-6	5/8	1/4	3/8	2.18	1.05	1.54	1.19	7/8
189PMTR10-6-6	5/8	3/8	3/8	2.31	1.12	1.54	1.18	7/8

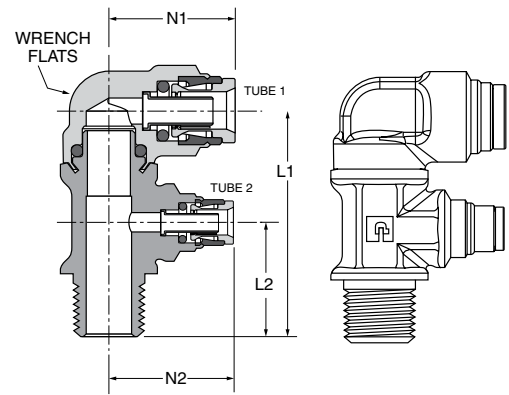

**Push-To-Connect Fitting Plug 639PM/639PMT**

PART NO.	TUBE SIZE	L	M	A	D
639PM-5/32BL	5/32	1.09	1.00	.39	.156
639PMT-4	1/4	1.14	.96	.48	.250
639PMT-6	3/8	1.33	1.15	.67	.375
639PMT-8	1/2	1.33	1.15	.81	.500

Specify color when ordering **Black (BL)** or **Blue (BU)**, example 639PMT-4BU  
 Note: use appropriate PM/PMT style connection as determined by part number.

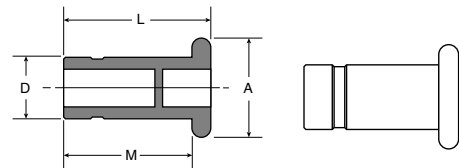

<sup>†</sup> U.S. Patent No. 5,683,120

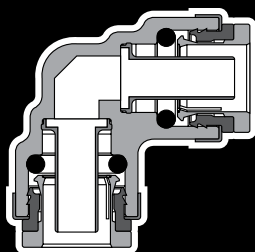

## PTC Composite Push-In Air Brake Fitting

### Advantages

The design of the Parker PTC Composite Air Brake Fitting Complies with the performance requirements of D.O.T. FMVSS 571.106 and SAE J2494-3.

No special tools are needed to assemble. Just bottom the tubing in the fitting for a positive seal. Tube support design assures maximum flow. Brass componentry includes a shoulder on the collet for increased side load capabilities, contamination resistance features and tight internal tolerances for a close fit and smooth operation.

### Application

Use with Parker Parflex SAE J844 type A & B nylon tubing. Designed for all D.O.T. truck and trailer applications. Consult the factory with any questions regarding special product applications. Prior to use, all applications should be carefully tested through the range of conditions which may be encountered.

### Features

1. Composite body - Strong, lightweight, compact and impact resistant
2. Rigid tube support stays in place for ease of and proper assembly.
3. All threads are per SAE J476, with a substantial hex to facilitate wrenching operations.
4. Lubricated O-Ring seal (Buna N) insures a quick, easy and positive seal.
5. Innovative Collet design insures positive grip on tubing.
6. Release button offers quick and easy disconnections.
7. Composite body can be rotated after assembly to align shaped fittings for proper orientation.

### Technical Data

- Working pressure from vacuum to 250 psi.
- Working temperature from -40° to +200°F (Note: see tubing manufacturer's recommendations for pressure and temperature limitations)
- Buna N (Nitrile) O-Rings

### Order

By part number and name

### Nomenclature

Part numbers are constructed from symbols that identify the style and size of the fitting. The first series of numbers and letters identify the style and type of fitting.

### Example:

Male Elbow 90° 369 PTC 6 4  
 Composite Push-In Air Brake Fitting  
 3/8" (6/16) Tube Size  
 1/4" (4/16) Pipe Thread

\* Thread sealant available upon request

### Special Fittings

Fitting configurations and/or sizes other than those shown in the catalog can be furnished. It is suggested that a print or sketch be submitted with the inquiry. Price and delivery for non-stock items furnished on request for specified quantities.

**Male Elbow Swivel 90° 369PTC**

PART NO.	TUBE SIZE	PIPE THREAD	B HEX	L	M
369PTC-4-2	1/4	1/8	9/16	.69	1.05
369PTC-4-4	1/4	1/4	9/16	.69	1.20
369PTC-4-6	1/4	3/8	3/4	.69	1.20
369PTC-6-2	3/8	1/8	3/4	.99	1.13
369PTC-6-4	3/8	1/4	3/4	.99	1.28
369PTC-6-6	3/8	3/8	3/4	.99	1.28
369PTC-6-8	3/8	1/2	7/8	.99	1.47
369PTC-8-4	1/2	1/4	15/16	1.11	1.39
369PTC-8-6	1/2	3/8	15/16	1.11	1.39
369PTC-8-8	1/2	1/2	15/16	1.11	1.58
369PTC-10-6	5/8	3/8	1-1/16	1.33	1.60
369PTC-10-8	5/8	1/2	1-1/16	1.33	1.79
369PTC-12-8	3/4	1/2	1-3/16	1.52	1.89
369PTC-12-12	3/4	3/4	1-3/16	1.52	1.99

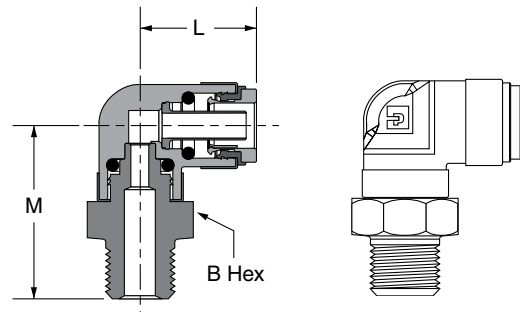

**Female Elbow Swivel 90° 370PTC**

PART NO.	TUBE SIZE	PIPE THREAD	B HEX	L	M
370PTC-4-2	1/4	1/8	5/8	.69	.89
370PTC-4-4	1/4	1/4	3/4	.69	1.05
370PTC-6-2	3/8	1/8	3/4	.99	.90
370PTC-6-4	3/8	1/4	3/4	.99	1.13
370PTC-6-6	3/8	3/8	13/16	.99	1.19
370PTC-8-6	1/2	3/8	15/16	1.11	1.30
370PTC-8-8	1/2	1/2	1-1/16	1.11	1.49
370PTC-10-8	5/8	1/2	1-1/16	1.33	1.67

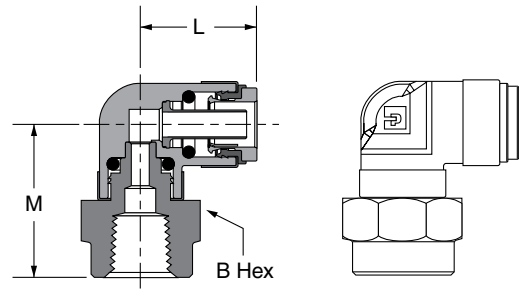

**Union 32PTC**

PART NO.	TUBE SIZE	L	O.D.
32PTC-6	3/8	1.61	.73
32PTC-8	1/2	1.75	.88
32PTC-10	5/8	2.15	1.02
32PTC-12	3/4	2.50	1.17

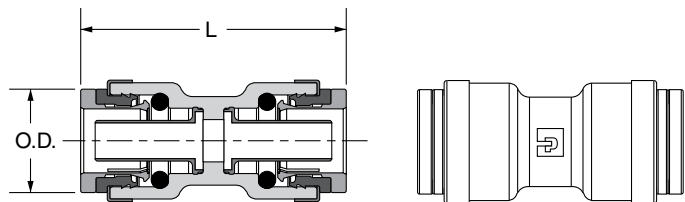

**Union Y 362PTC**

PART NO.	TUBE SIZE	L	N	N1
362PTC-4	1/4	1.49	1.03	.50
362PTC-6	3/8	1.99	1.41	.68
362PTC-8	1/2	2.18	1.72	.84

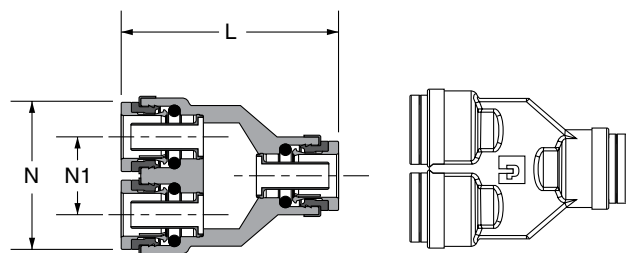

**Union Tee 364PTC**

PART NO.	TUBE SIZE	L	M
364PTC-4	1/4	1.42	.71
364PTC-6	3/8	1.99	.99
364PTC-8	1/2	2.25	1.13

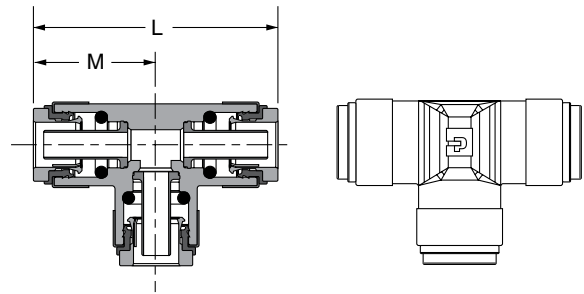

**Union Elbow 365PTC**

PART NO.	TUBE SIZE	L
365PTC-6	3/8	.99
365PTC-8	1/2	1.11

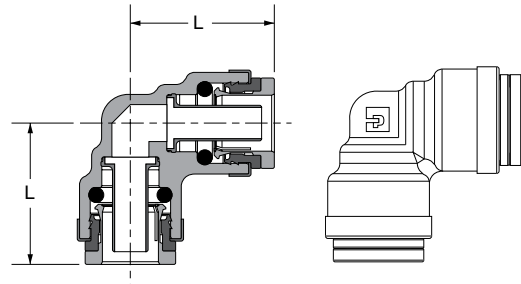

**Union Y Male Connector 368PTC**

PART NO.	TUBE SIZE	PIPE THREAD	L	C HEX	N	N1
368PTC-4-2	1/4	1/8	1.96	9/16	1.03	.50
368PTC-4-4	1/4	1/4	2.12	9/16	1.03	.50
368PTC-6-4	3/8	1/4	2.56	3/4	1.41	.68
368PTC-8-6	1/2	3/8	2.85	15/16	1.71	.84
368PTC-8-8	1/2	1/2	3.08	15/16	1.72	.84

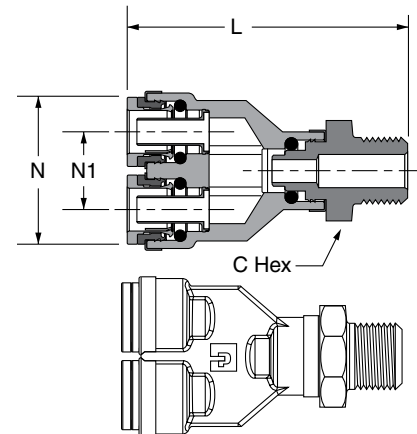

**Male Run Tee Swivel 371PTC**

PART NO.	TUBE SIZE 1	TUBE SIZE 2	PIPE THREAD	B HEX	L	M
371PTC-4-2	1/4	1/4	1/8	9/16	1.93	.71
371PTC-4-4	1/4	1/4	1/4	9/16	2.08	.71
371PTC-4-6	1/4	1/4	3/8	3/4	2.08	.71
371PTC-6-4	3/8	3/8	1/4	3/4	2.27	.99
371PTC-6-4-4	3/8	1/4	1/4	3/4	2.27	1.08
371PTC-6-6	3/8	3/8	3/8	3/4	2.27	.99
371PTC-8-4	1/2	1/2	1/4	15/16	2.55	1.13
371PTC-8-6	1/2	1/2	3/8	15/16	2.55	1.13
371PTC-8-8	1/2	1/2	1/2	15/16	2.74	1.13
371PTC-10-8	5/8	5/8	1/2	1-1/16	3.22	1.41

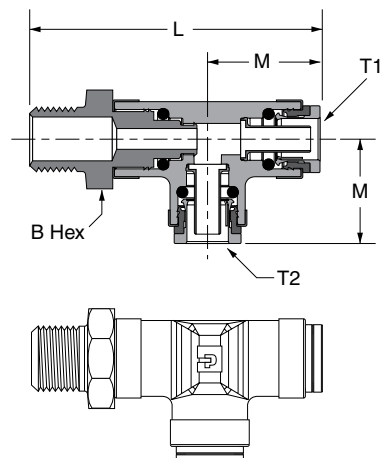

**Male Branch Tee Swivel 372PTC**

PART NO.	TUBE SIZE	PIPE THREAD	B HEX	L	M	N
372PTC-4-2	1/4	1/8	9/16	1.42	.73	1.22
372PTC-4-4	1/4	1/4	9/16	1.42	.71	1.37
372PTC-4-6	1/4	3/8	3/4	1.42	.71	1.37
372PTC-6-2	3/8	1/8	3/4	1.99	.99	1.17
372PTC-6-4	3/8	1/4	3/4	1.99	.99	1.32
372PTC-6-6	3/8	3/8	3/4	1.99	.99	1.32
372PTC-8-4-8	1/2x1/4	1/2	15/16	2.28	1.14	1.58
372PTC-8-6	1/2	3/8	15/16	2.25	1.13	1.39
372PTC-8-8	1/2	1/2	15/16	2.25	1.13	1.58
372PTC-10-8	5/8	1/2	1-1/16	2.82	1.41	1.81

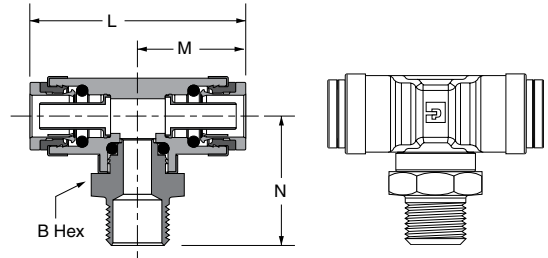

**Female Branch Tee Swivel 377PTC**

PART NO.	TUBE SIZE	PIPE THREAD	B HEX	L	M	N
377PTC-4-4	1/4	1/4	3/4	1.48	0.74	1.27

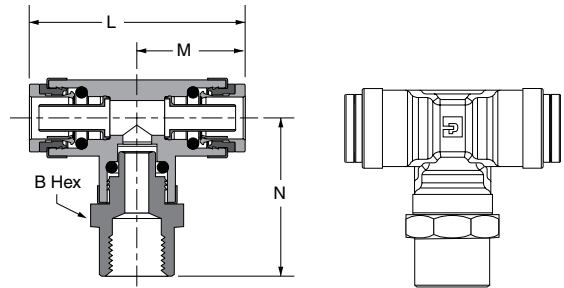

**Male Elbow Swivel 45° 379PTC**

PART NO.	TUBE SIZE	PIPE THREAD	B HEX	L	M
379PTC-4-2	1/4	1/8	9/16	.64	.97
379PTC-4-4	1/4	1/4	9/16	.64	1.12
379PTC-4-6	1/4	3/8	3/4	.64	1.12
379PTC-6-2	3/8	1/8	3/4	.87	1.01
379PTC-6-4	3/8	1/4	3/4	.87	1.16
379PTC-6-6	3/8	3/8	3/4	.87	1.16
379PTC-8-4	1/2	1/4	15/16	1.01	1.20
379PTC-8-6	1/2	3/8	15/16	1.01	1.20
379PTC-8-8	1/2	1/2	15/16	1.01	1.39
379PTC-10-6	5/8	3/8	1-1/16	1.18	1.42
379PTC-10-8	5/8	1/2	1-1/16	1.18	1.61
379PTC-12-8	3/4	1/2	1-3/16	1.35	1.69
379PTC-12-12	3/4	3/4	1-3/16	1.35	1.79

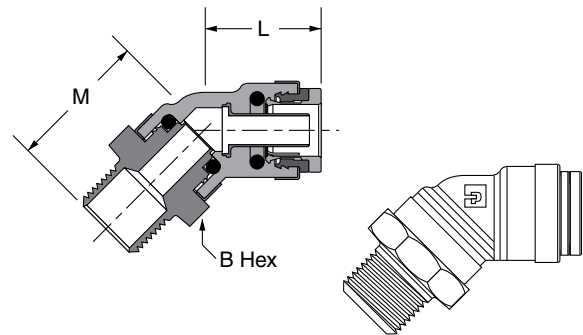



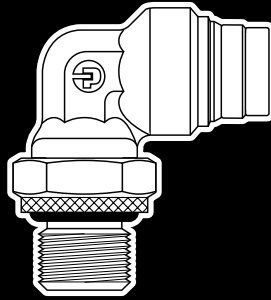

## Metric Prestomatic Air Brake Push-In Fittings

### Advantages

Patented design of sizes 6mm and above meet DIN 74324. Meets D.O.T. FMVSS571.106 performance specifications when used with SAE J844 metric tubing. No special tools are needed to assemble. Just bottom the tubing in the fitting body for a positive seal.

### Application

Use with DIN 73378 virgin nylon or SAE J844 tubing. Designed for DIN and D.O.T. truck and trailer applications. Consult the factory with any questions regarding special product applications. Prior to use, all applications should be carefully tested through the range of conditions which may be encountered.

### Features

1. All brass body.
2. Stainless steel tube support
3. Elbows and tees utilize the Universal Stud HOBS nut design.
4. Lubricated O-Ring Seal (Buna N) insures a quick, easy and positive seal.
5. Innovative Collet design insures positive grip on tubing.
6. Release Button offers quick and easy disconnections.

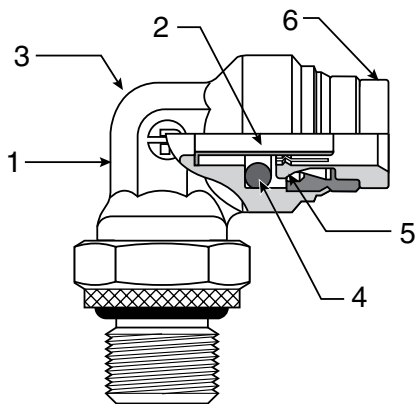

### Technical Data

- Working pressure up to 250 psi.
- Working temperature from -40° F to +200° F (Note: see tubing manufacturer's recommendations for pressure and temperature limitations).
- Buna N (Nitrile) O-Rings.
- **DIN 74324: Air brake systems thermoplastic tubes and pipe requirements and testing**
- **DIN 73378: Polymade tubing for motor vehicles.**

### Order

By part number and name.

### Nomenclature

Part numbers are constructed from symbols that identify the style and size of the fitting. The first series of numbers and letters identify the style and type of fitting. The Prestomatic series 6mm and above has a brass tube support and is designated with a "PMT" suffix.

### Example:

	F	8	U	PMTB	8	M22
Straight Male Connector	—	—	—	—	—	—
Metric Parallel	—	—	—	—	—	—
Universal Stud	—	—	—	—	—	—
Air Brake Push-In Fitting—Brass Body	—	—	—	—	—	—
8mm Tube Size	—	—	—	—	—	—
22mm Port Thread	—	—	—	—	—	—

### Special Fittings

Fitting configurations and/or sizes other than those shown in the catalog can be furnished. It is suggested that a print or sketch be submitted with the inquiry. Price and delivery for non-stock items furnished on request for specified quantities.

### Pricing

Only items priced in current supplementary price list PL3501 are carried in stock. Price and delivery for non-stock items furnished on request for specified quantity.

**Union HPMTB**

PART NO.	TUBE SIZE (mm)	L (mm)	O.D. (mm)
HPMTB6	6	45.2	15.9
HPMTB8	8	45.3	17.5
HPMTB10	10	51.7	22.2
HPMTB12	12	51.7	22.2

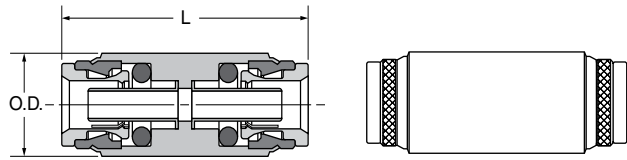

**Male Bulkhead Union WPMTB**

PART NO.	TUBE SIZE (MM)	METRIC THREAD	L (MM)	B HEX (MM)	C HEX (MM)	BULKHEAD HOLE DIA. (MM)
WPMTB6	6	M20X1.5	47.5	22	24	20
WPMTB8	8	M20X1.5	47.2	22	24	20
WPMTB10	10	M22X1.5	52.3	27	27	22
WPMTB12	12	M24X1.5	52.1	27	30	24

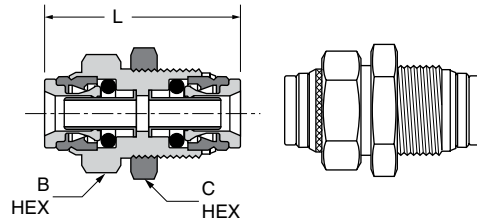

**Male Connector F2PMTB**

PART NO.	TUBE (mm)	PIPE THREAD	L (mm)	HEX (mm)	FLOW DIA. D(mm)
F2PMTB8-1/8	8	1/8	33.79	19	4.90
F2PMTB8-1/4	8	1/4	38.38	19	4.90
F2PMTB10-1/4	10	1/4	36.83	20	6.35

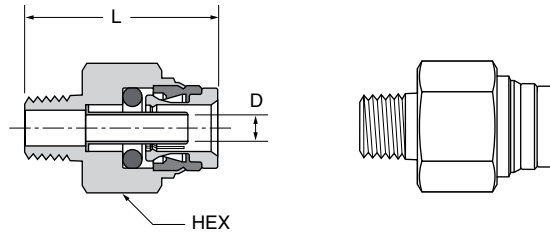

**Male Connector BSPT F3PMTB**

PART NO.	TUBE (mm)	BSPT THREAD	L (mm)	HEX (mm)
F3PMTB8-1/2	8	1/2	35.1	22
F3PMTB10-1/4	10	1/4	39.9	22
F3PMTB10-3/8	10	3/8	36.2	22
F3PMTB10-1/2	10	1/2	39.6	22
F3PMTB12-1/4	12	1/4	40.6	22
F3PMTB12-3/8	12	3/8	40.4	22
F3PMTB12-1/2	12	1/2	40.4	22

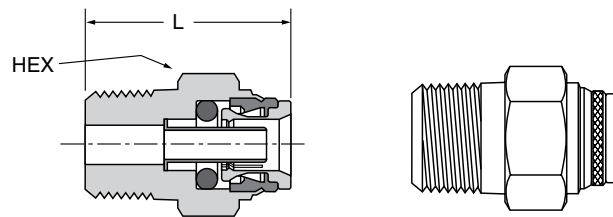

**Male Connector Metric Straight Thread F8UPMTB**

PART NO.	TUBE SIZE (mm)	METRIC THREAD	L (mm)	B HEX (mm)	M1 (mm)
F8UPMTB6-M10	6	M10x1	29.7	17	6.4
F8UPMTB6-M12	6	M12x1.5	29.1	17	7.5
F8UPMTB6-M14	6	M14x1.5	29.1	22	7.5
F8UPMTB6-M16	6	M16x1.5	31.6	22	10.0
F8UPMTB6-M22	6	M22x1.5	29.7	27	9.5
F8UPMTB8-M10	8	M10x1	31.4	22	6.4
F8UPMTB8-M12	8	M12x1.5	33.0	22	7.5
F8UPMTB8-M14	8	M14x1.5	33.0	22	7.5
F8UPMTB8-M16	8	M16x1.5	31.0	22	10.0
F8UPMTB8-M22	8	M22x1.5	28.8	27	9.5
F8UPMTB10-M10	10	M10x1	34.8	22	6.4
F8UPMTB10-M12	10	M12x1.5	36.9	22	7.5
F8UPMTB10-M14	10	M14x1.5	36.8	22	7.5
F8UPMTB10-M16	10	M16x1.5	37.5	22	10.0
F8UPMTB10-M22	10	M22x1.5	31.1	27	9.5
F8UPMTB12-M12	12	M12x1.5	37.3	22	7.5
F8UPMTB12-M14	12	M14x1.5	36.8	22	7.5
F8UPMTB12-M16	12	M16x1.5	39.7	22	10.0
F8UPMTB12-M22	12	M22x1.5	33.4	27	9.5
F8UPMTB16-M16	16	M16x1.5	39.7	27	10.0
F8UPMTB16-M22	16	M22x1.5	33.3	27	9.5

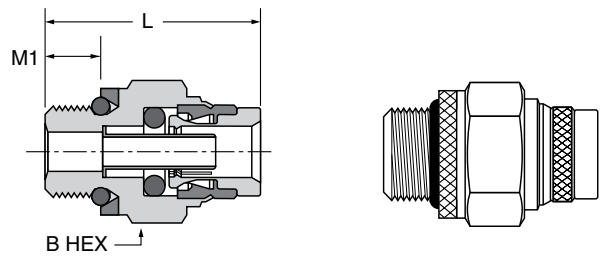

**Union Tee JPMTB**

PART NO.	TUBE 1 (mm)	TUBE 2 (mm)	L (mm)	M (mm)	N (mm)
JPMTB6	6	6	51.3	25.6	26.7
JPMTB8	8	8	53.2	26.6	26.7
JPMTB10	10	10	60.4	30.2	31.4
JPMTB12	12	12	63.3	31.7	35.0
JPMTB12-12-6	12	6	63.3	31.7	28.1
JPMTB12-12-8	12	8	63.3	31.7	32.9

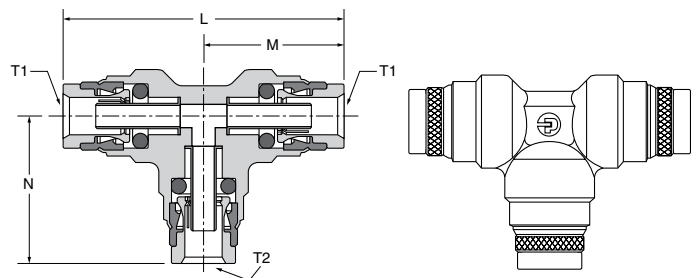

**Male Elbow Non-Swivel C2PMTB**

PART NO.	TUBE SIZE (MM)	PIPE THREAD	WRENCH FLATS (MM)	L (MM)	M (MM)	FLOW DIA. (MM)
C2PMTB8-1/4	8	1/4	16	28.5	26.9	4.83

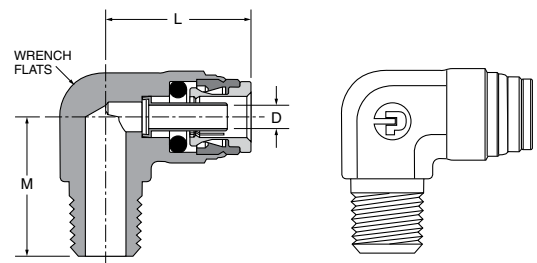

**Male Elbow Non-Swivel BSPT C3PMTB**

PART NO.	TUBE SIZE (MM)	BSPT THREAD	WRENCH FLATS (MM)	L (MM)	M (MM)
C3PMTB6-1/4	6	1/4	11	27.9	23.1
C3PMTB10-1/4	10	1/4	17	31.8	25.4
C3PMTB12-1/4	12	1/4	22	34.3	28.5
C3PMTB12-1/2	12	1/2	22	34.3	33.5

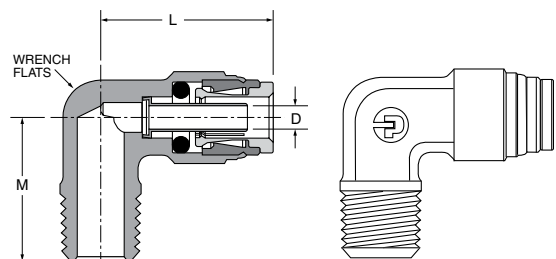

**Male Elbow Metric Straight Thread C8UPMTB**

PART NO.	TUBE SIZE (mm)	METRIC THREAD	WRENCH B		L (mm)	N (mm)	N1 (mm)
			FLATS (mm)	HEX (mm)			
C8UPMTB6-M10	6	M10x1	10	14	24.8	26.0	7.5
C8UPMTB6-M12	6	M12x1.5	10	17	24.8	28.2	9.5
C8UPMTB6-M16	6	M16x1.5	11	24	25.0	34.0	10.5
C8UPMTB6-M22	6	M22x1.5	19	30	28.1	41.4	10.5
C8UPMTB8-M12	8	M12x1.5	16	17	27.5	33.0	9.5
C8UPMTB8-M14	8	M14x1.5	16	19	26.7	33.5	9.5
C8UPMTB8-M16	8	M16x1.5	16	24	27.5	34.0	10.5
C8UPMTB8-M22	8	M22x1.5	19	30	32.0	40.4	10.5
C8UPMTB10-M12	10	M12x1.5	16	17	29.4	30.2	9.5
C8UPMTB10-M16	10	M16x1.5	19	24	30.3	33.5	10.5
C8UPMTB10-M22	10	M22x1.5	19	30	32.0	38.4	10.5
C8UPMTB12-M16	12	M16x1.5	16	24	31.2	35.6	10.5
C8UPMTB12-M22	12	M22x1.5	16	30	32.9	38.4	10.5
C8UPMTB16-M16	16	M16x1.5	19	24	30.6	36.4	10.5
C8UPMTB16-M22	16	M22x1.5	25	30	31.7	40.4	10.5

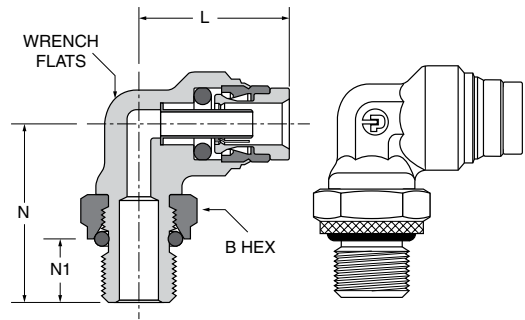

**Male Branch Tee Swivel Metric Straight Thread S8UPMTB**

PART NO.	TUBE SIZE (mm)	METRIC THREAD	WRENCH B		L (mm)	N (mm)	N1 (mm)
			FLATS (mm)	HEX (mm)			
S8UPMTB12-M16	12	M16x1.5	19	24	65.9	37.6	10.5
S8UPMTB12-M22	12	M22x1.5	23	30	65.9	35.6	10.5
S8UPMTB16-M22	16	M22x1.5	16	24	64.3	40.1	10.5

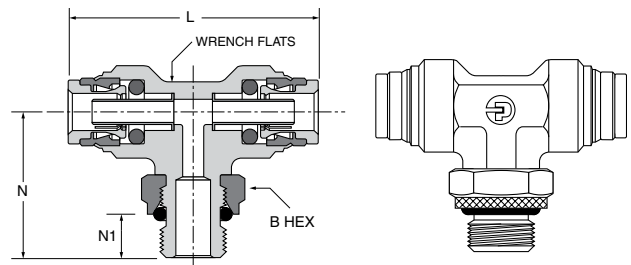

**Male Elbow 45° Metric Straight Thread V8UPMTB**

PART NO.	TUBE SIZE (mm)	METRIC THREAD	WRENCH B		L (mm)	N (mm)	N1 (mm)
			FLATS (mm)	HEX (mm)			
V8UPMTB10-M22	10	M22x1.5	22	30	31.7	28.5	10.5
V8UPMTB12-M22	12	M22x1.5	27	30	31.7	28.5	10.5

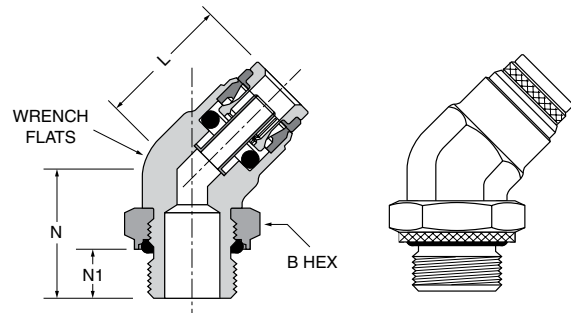





# **Cartridges & Manifolds**



## **SAE Encapsulated Cartridge**

- Meets Performance Requirements of D.O.T. FMVSS 571.106
- Meets Dimensional Standards of SAE J2494-4 in 6061-T6 Aluminum
- Eliminate the space and labor costs associated with pipe threads.
- Weight Reduction
- 3 barb design



## **Manifolds**

- Light Weight Body
- Push to Connect Ports
- O-ring Seal

***The World Standard***

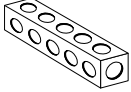
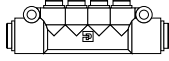
<b>Cartridges</b>	<p><b>PMTCE SAE</b> Encapsulated</p>  <p>Page J4</p>					
	<p><b>255MP</b> Brass Manifold</p>  <p>Page J5</p>	<p><b>24M</b> Composite Manifold</p>  <p>Page J6</p>				
<b>Manifolds</b>						

**J**

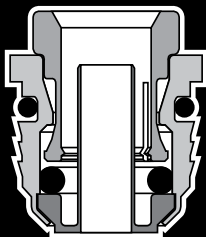

## Prestomatic SAE Encapsulated Cartridges

### Advantages

Parker Prestomatic<sup>†</sup> SAE Encapsulated Cartridges are a compact, economical design that allows the user to eliminate the space and labor required to install and assemble a conventional pipe thread fitting connection. Weight reduction and the elimination of pipe thread leakage related to improper assembly techniques are achieved. The SAE Cartridge design allows for faster and easier installation of components and assemblies. The external o-ring seals radially and does not require special chamfers at the top of the cavity to effect a seal. The SAE Cartridge includes a built in tube support. Once the SAE Cartridge is installed in a single step cavity, no special tools are needed for tube assembly. Just bottom the tubing into the cartridge body for a positive seal.

### Materials

Parker's Prestomatic SAE Encapsulated Cartridges have been developed for both soft metal and plastic cavity applications. Consult factory for specific cavity or housing materials that would be suitable for a particular application.

### Specifications

Cavity dimensions are per SAE Standard J2494-4. The Prestomatic SAE Encapsulated Cartridge is thoroughly tested to meet or exceed the performance requirements of DOT FMVSS 571.106. Cavity dimensions specified by SAE J2494-4 need to be adjusted slightly for optimum performance in material other than 6061-T6.

### Technical Data

- Working pressure from vacuum to 250 psi
- Working temperature from -40°F to +200°F (Note: See tubing manufacturer's recommendations for pressure and temperatures limitations.)

### Features

- Easy assembly
- Patented Prestomatic\* brass componentry which includes a shoulder for increased side load capabilities, contamination resistance features and tight internal tolerances for a close fit and smooth operation.
- Available in tube sizes 5/32", 1/4", 3/8", 1/2", 5/8" and 3/4"
- Available in elbows and straight configurations
- Built in Brass tube support assures maximum flow and performance characteristics

### Tube Assembly Instructions

1. Cut Parker Parflex thermoplastic squarely using Parker tube cutter PTC-001. Metal tubing should be cut square and free of burrs.
2. Insert end of tubing into cartridge until it bottoms. Pull on tubing to verify it is properly retained
3. To disassemble, simply hold release button against the body and remove tubing
4. To reassemble, lubricate leading end of tubing with light oil or petroleum jelly

### Order

By part number and name

### Nomenclature

Part numbers are constructed from symbols that identify the style and size of the cartridge

### Example:

Prestomatic SAE Cartridge **PMTCE**  
 1/4" (4/16) Tube Size **-4**

### Special Cartridges

Encapsulated cartridge configurations and /or sizes other than those shown in the catalog can be furnished. Non-standard o-ring materials are available. It is suggested that a print or sketch be submitted with the inquiry. Price and delivery for non-stock items furnished on request for specified quantities.

<sup>†</sup> U.S. Patent No. 5,683,120





**Prestomatic SAE Encapsulated Cartridge PMCE/PMTCE**

PART NO.	TUBE SIZE	CAVITY SIZE ±.002	L	M	O.D.	FLOW DIA. D
PMCE-5/32	5/32	.346	.57	.43	.44	.125
PMTCE-4	1/4	.504	.64	.44	.56	.140
PMTCE-4-8	1/4	.775	.66	.42	.87	.140
PMTCE-6	3/8	.650	.84	.64	.75	.217
PMTCE-6-8	3/8	.775	.84	.64	.87	.217
PMTCE-8	1/2	.775	.98	.77	.87	.338
PMTCE-10	5/8	.925	1.07	.86	1.00	.398
PMTCE-12	3/4	1.067	1.12	.93	1.19	.503

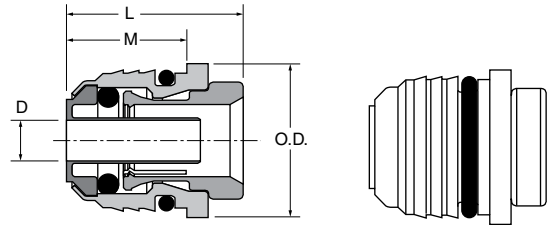

**Installation**

Apply force evenly over the top surface of the cartridge body until the cartridge shoulder bottoms out on the top of the cavity. The amount of force required will vary depending on the cartridge size and the material of the cavity.

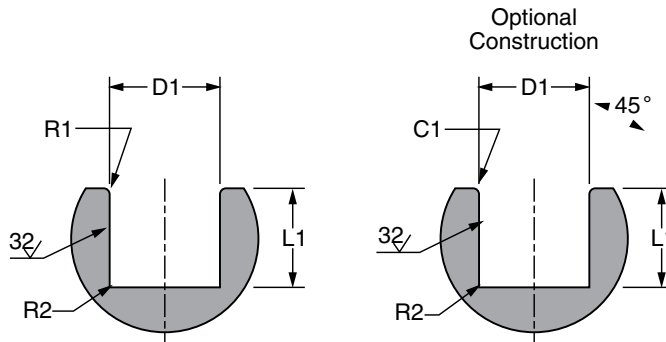
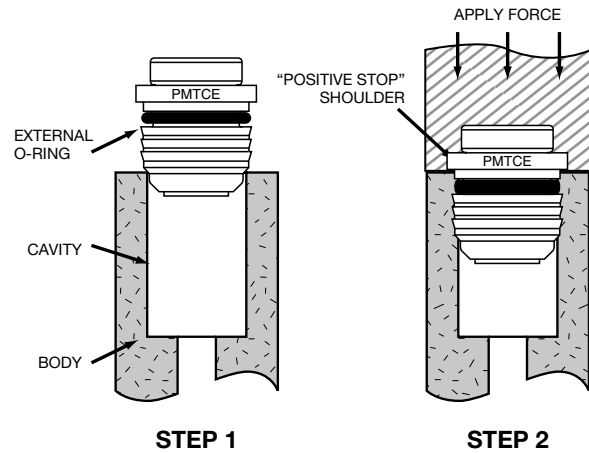

Nominal Tube OD (in)	D1 (mm) ±.05	D1 (in) ±.002	L1 (mm) MIN	L1 (in) MIN	R1 (mm) ±.05	R1 (in) ±.002	R2 (mm) ±.05	R2 (in) ±.002	C1 (mm) ±.05	C1 (in) ±.002
5/32	8.80	.346	11.40	.45	.50	.02	.50	.02	.50	.02
1/4	12.80	.504	12.70	.50	.50	.02	.50	.02	.50	.02
3/8	16.50	.650	16.50	.65	.50	.02	.50	.02	.50	.02
1/2	19.70	.775	19.80	.78	.50	.02	.50	.02	.50	.02
5/8	23.50	.925	22.40	.88	.80	.03	.50	.02	.80	.03
3/4	27.10	1.067	23.90	.94	.80	.03	.50	.02	.80	.03

Cavity material is to be 6061 T6 aluminum

† U.S. Patent No. 5,683,120

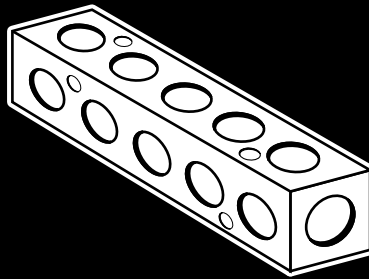

## Brass Manifold

### Advantages

Parker's Brass Manifold provides a convenient junction for the hook-up of multi-branch distribution lines. Porting is easy with five 1/8" and five 1/4" side ports. Two 3/8" inlet ports allow for maximum flow. Universal dual sided 7/32" mounting holes allow for easy manifold attachment.

Parker's all brass manifold can be readily identified, assuring high quality engineering and reliability. This economical manifold is machined from high quality CA360 brass.

### Applications

May be used for air, water or hydraulic requirements. Specific applications include injection molders (coolant lines), packaging equipment, air logic systems (panel builders) and specialized industrial machinery requiring multiple line connections.

### Temperature and Working Pressure Ranges

From -65° to +250°F at 1000 PSI maximum.

### Nomenclature

Part numbers are constructed from symbols that identify the size and type of manifold. The first series of numbers and letters identifies the style and type fitting. The second series of numbers describes the size.

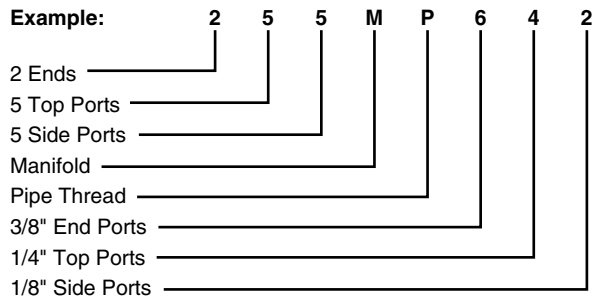

### Special Manifolds

Manifold configurations and /or sizes other than our cataloged manifold can be furnished. It is suggested that a print or sketch be submitted with the inquiry.

### Pricing

Price and delivery for non-stock items furnished on request for specified quantity.

### Brass Manifold 255M

PART NO.	PIPE THREAD A	PIPE THREAD B	PIPE THREAD C	G	MOUNTING HOLE DIA. H	J	K	L	M	N	D
255MP-6-4-2	3/8	1/8	1/4	1.25	.22	.88	1.13	6.25	1.45	.25	.25

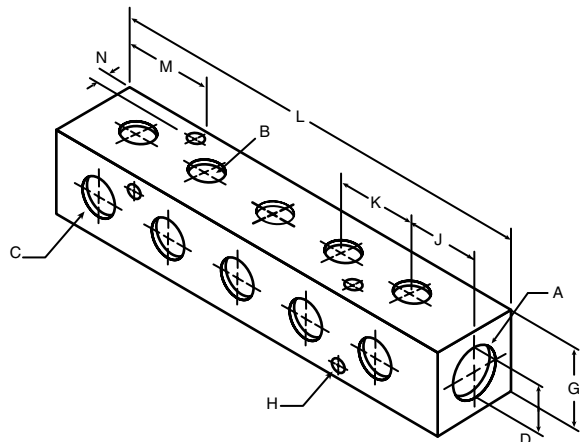

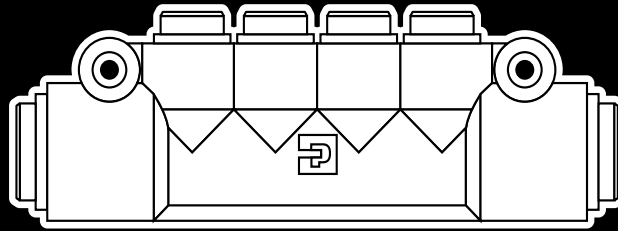

# Presto Manifold

## Advantages

Presto manifolds provide a convenient junction to connect multiple tubing lines for industrial and transportation applications. The glass reinforced body is lightweight yet durable. Presto manifolds contain 1/4, 3/8 and 1/2 O.D. tube inlet and outlet ports to allow for design and application flexibility. No special tools are needed to assemble. Just bottom the tubing in the port for a positive seal.

## Applications

Suitable for industrial or transportation applications requiring multiple branch connections using Parker Parflex series N Nylon for industrial applications, and Parker Parflex S.A.E. J844 type A & B nylon tubing for all transportation applications. Consult the factory with any questions regarding special product applications prior to use. All applications should be carefully tested through the range of conditions that may be encountered.

## Technical Data

- Body Material: Glass Filled Nylon
- O-Ring Material: Buna N (Nitrile)
- Working Pressure from: Vacuum to 150 PSI
- Working Temperature from: -40° to 200° F  
(Note: See tubing manufacturer's recommendation for pressure and temperature limitations).

## Special Manifolds

Presto Manifold sizes other than those shown in the catalog can be formulated upon request. Die tooling charges may apply to non-standards. It is suggested that a print or sketch with specified buy quantities be submitted with the inquiry.

## Assembly Instructions

1. Cut tubing squarely with Parker tube cutter PTC-001. Be certain that Manifold ports are clean and free of debris.
2. Insert tubing into port until it bottoms. Pull on tubing to verify that it is properly retained in the manifold.
3. To disassemble, simply hold release button against the manifold body and remove the tubing.
4. To reassemble, make certain that the Manifold ports are clean and free of debris and lubricate leading end of the tubing with light oil or petroleum jelly.

## Order

By part number and name.

## Nomenclature

Part numbers are constructed from symbols that identify the size and type of manifold. The first series of letters and numbers identify the style and type of manifold. The second series of numbers describe the tube O.D.

### Example:

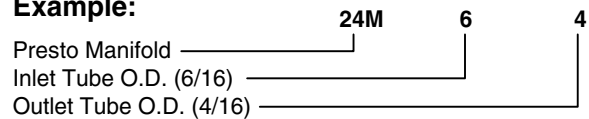

## Presto Manifold 24M

PART NO.	TUBE O.D. INLET	TUBE O.D. OUTLET	A	B	D	G	H	M	M1	N
24M-4-4	1/4	1/4	1.33	3.98	.21	2.75	.53	.90	.88	.89
24M-6-4	3/8	1/4	1.33	4.00	.21	2.75	.53	.90	.88	.89
24M-6-6	3/8	3/8	1.65	6.49	.22	4.55	.60	1.02	1.02	1.33
24M-8-8	1/2	1/2	1.65	6.49	.22	4.55	.60	1.02	1.02	1.33
24M-8-6446	1/2	3/8 - 1/4	1.65	6.49	.22	4.55	.64	1.02	1.02	1.17

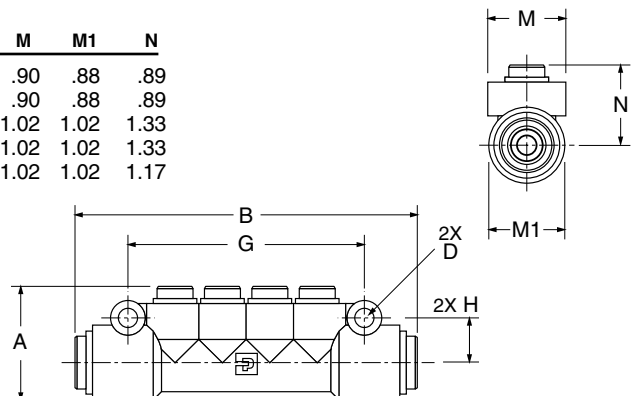

\*U.S. Patent Number 5,683,120



## Ball Valves

- Brass, Carbon Steel & Stainless Steel
- UL Listed
- 90° Valves
- Padlocking & Vented Options
- Handle Options
- Actuators
- Inch & Metric



## Needle Valves

- Metal to Metal Seats
- All Brass construction
- Fine Threaded for control and positive seal



## Truck Valves











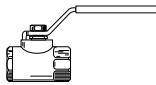
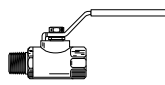
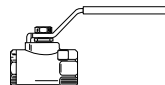
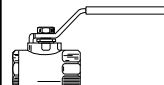
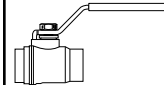
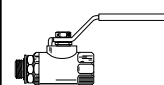
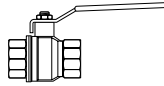
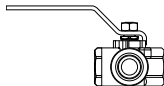
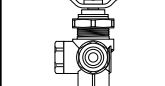

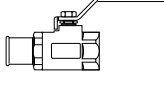

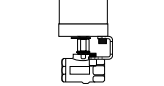
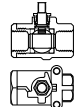
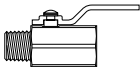
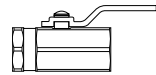
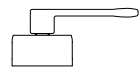
- Metal to Metal Seats
- All Brass construction
- -30° to +250° F

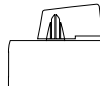
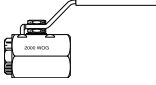
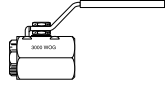
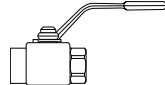
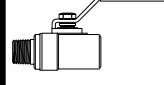

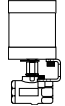
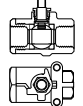
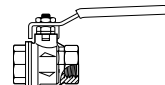

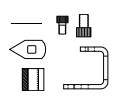
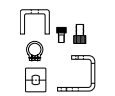
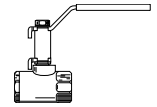
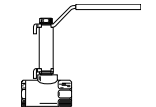
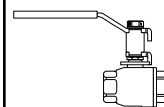

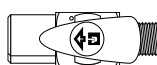
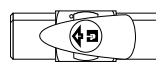
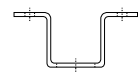
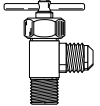
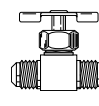
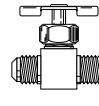
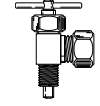





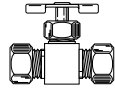
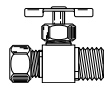

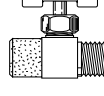
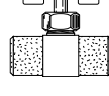
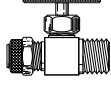

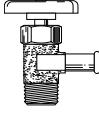
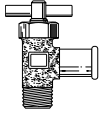
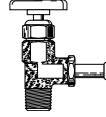
## Ground Plug Shutoff / Drain Cocks

- Metal to Metal Seats
- Economical
- External & Internal Seat

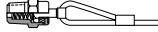
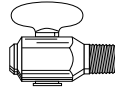

<b>Brass Ball Valves</b>	<b>XV500P</b> Female-Female  Page K5	<b>XV501P</b> Male-Female  Page K9	<b>XV502P</b> Panel Mount  Page K12	<b>XV506P</b> Straight Thread  Page K15	<b>XV509P</b> Solder End  Page K17	<b>XV510P</b> Straight Thread  Page K19	
	<b>XV520P</b> Economy Series  Page K22	<b>XV533P</b> 3-Female Pipe Ends  Page K24	<b>XV540P</b> 4-Female Pipe Ends  Page K24	<b>XV590/591P</b> 90° Ball Valve  Page K26	<b>XV500HB</b> Hose Barb  Page K27	<b>XV600P/XV633P</b> 6 Port Diversion  Page K29	<b>XV502P-ACT</b> Actuator  Page K47
	<b>XV502P-SUB</b> Sub Assembly  Page K48	<b>MV708</b> Micro Valve  Page K60	<b>MV709</b> Micro Valve  Page K60	<b>MV200</b> Mini Valve  Page K65	<b>MV608</b> Mini Valve  Page K65	<b>MV609</b> Mini Valve  Page K65	
	<b>Carbon Steel Valves</b>	<b>XV500/502CS</b> Female-Female  Page K31	<b>XV506CS</b> Straight Thread  Page K35	<b>XV500HP/506HP/507HP</b> High Pressure  Page K37	<b>Stainless Steel Valves</b>	<b>XV501SS</b> Male-Female  Page K41	<b>XV502SS</b> Female-Female  Page K43
		<b>XV502SS-ACT</b> Actuator  Page K47	<b>XV502SS-SUB</b> Sub Assembly  Page K48	<b>Metric Ball Valves</b>		<b>BVGC</b> Female-Female  Page K51	<b>BVGL</b> Female Long  Page K53
	<b>Auxiliary</b>	<b>ACT-P-KIT</b> Brass Actuator Kit  Page K49	<b>ACT-SS-Kit</b> Stainless Actuator Kit  Page K49		<b>STX-P-1-125</b> Stem Extension  Page K62	<b>STX-P-1-225</b> Stem Extension  Page K62	<b>STXSS-X-X</b> Stem Extension  Page K63
		<b>Plug Valves</b>	<b>PV607</b> Male-Male  Page K67	<b>PV608</b> Male-Female  Page K67	<b>PV609</b> Female-Female  Page K67	<b>PVMB</b> Mounting Bracket  Page K67	
<b>Needle Valves</b>			<b>NV101F</b> Flare-Male Pipe  Page K69	<b>NV102F</b> Flare-Flare  Page K69	<b>NV103F</b> Flare-Male Pipe  Page K69	<b>HV104C</b> Humidifier Valve  Page K69	<b>HV104C-Kit</b> Humidifier Kit  Page K69

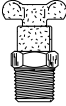
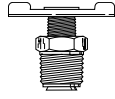
**K**

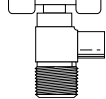
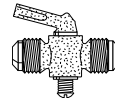
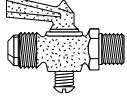
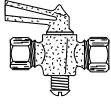
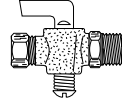
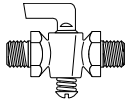
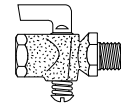
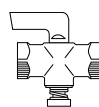
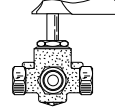
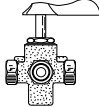
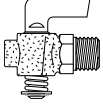
<p><b>NV104C/ NV104CA</b> Comp-Pipe</p>  <p>Page K70</p>	<p><b>NV105C/ NV105CA</b> Comp-Comp</p>  <p>Page K70</p>	<p><b>NV106C/ NV106CA</b> Comp-Pipe</p>  <p>Page K71</p>	<p><b>NV107P</b> Pipe-Pipe</p>  <p>Page K71</p>	<p><b>NV108P</b> Female-Male</p>  <p>Page K71</p>	<p><b>NV109P</b> Female-Female</p>  <p>Page K71</p>	<p><b>NV311P</b> Poly-Tite/Pipe</p>  <p>Page K71</p>	
<p><b>NV312P</b> Poly-Tite/Pipe</p>  <p>Page K72</p>	<p><b>Truck Valves</b></p>		<p><b>V404P</b> Hose-Pipe</p>  <p>Page K72</p>	<p><b>V404PH</b> Hose-Pipe</p>  <p>Page K72</p>	<p><b>SV404P</b> Hose-Pipe</p>  <p>Page K72</p>	<p><b>V405P</b> Female-Male</p>  <p>Page K72</p>	<p><b>V408NTA</b> Tube-Pipe</p>  <p>Page K73</p>
<p><b>V409F</b> Flare - Pipe</p>  <p>Page K73</p>	<p><b>V410NTA</b> Tube-Pipe</p>  <p>Page K73</p>	<p><b>V412F</b> Tube-Pipe</p>  <p>Page K73</p>	<p><b>LV91</b> Lanyard Valve</p>  <p>Page K73</p>	<p><b>Drain Cocks</b></p>		<p><b>DCR601</b> Internal Seal</p>  <p>Page K77</p>	<p><b>DC602</b> Internal Seal</p>  <p>Page K77</p>
<p><b>DC603</b> Internal Seal</p>  <p>Page K77</p>	<p><b>DC604</b> External Seal</p>  <p>Page K77</p>	<p><b>DC606</b> External Seal</p>  <p>Page K77</p>	<p><b>DC607</b> Bib Drain</p>  <p>Page K77</p>	<p><b>Shutoff Valves</b></p>		<p><b>V203F</b> Flare-Flare</p>  <p>Page K75</p>	<p><b>V204F</b> Flare-Pipe</p>  <p>Page K75</p>
<p><b>V303C/V303CA</b> Comp-Comp</p>  <p>Page K75</p>	<p><b>V304C/V304CA</b> Comp-Pipe</p>  <p>Page K75</p>	<p><b>V401P</b> Pipe-Pipe</p>  <p>Page K75</p>	<p><b>V402P</b> Female-Male</p>  <p>Page K76</p>	<p><b>V403P</b> Female-Female</p>  <p>Page K76</p>	<p><b>V406P</b> 3-Way</p>  <p>Page K76</p>	<p><b>V407P</b> 4-Way</p>  <p>Page K76</p>	
<p><b>DC601</b> Pipe</p>  <p>Page K76</p>							



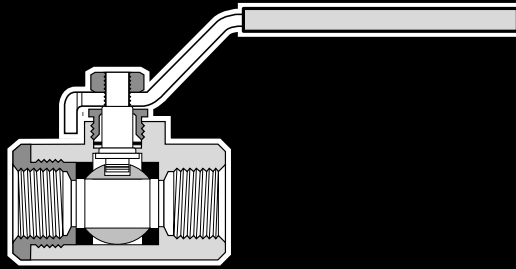

## Brass Ball Valves Series 500

### Advantages

Parker's forged body ball valve provides extended service life and resists failure caused by severe temperature applications. Optimum flow design assures maximum system efficiency. Highly inert PTFE seats and seals provide resistance to chemical corrosion. Parker also provides a blow-out proof stem, chrome plated brass ball and a specially designed handle enabling increased turning leverage for ease of opening and closing. Parker's ball valve can be readily identified assuring high quality engineering and reliability. This economical ball valve is available in female pipe sizes. Parker's ball valve bodies are machined from high quality CA 377 forgings.

### Applications

Parker's industrial ball valve product line is intended for general purpose use. Please be aware that ball valves are intended for use in the fully open or closed positions. Depending on application conditions, throttling of the valve may result in premature seal failure and/or inability to turn the valve handle.

For use as fuel line shutoffs for gasoline and diesel powered over the highway, off highway, and construction equipment vehicles. Water and air service lines on capital equipment and plant design plumbing that require total shutoff capability.

### Working Pressure and Temperature

Saturated steam service up to 150 PSI and 400° F  
 Vacuum, 29 Inches of Mercury  
 Vented up to 250 PSI

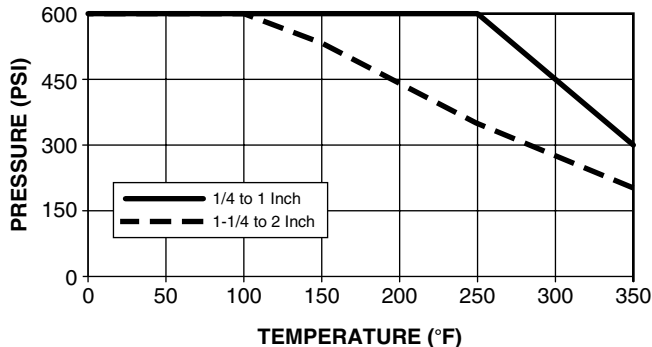

### Operating Instructions

Quarter turn is "ON" or "OFF".  
 (Provides positive stop action for full shutoff.)

**NOTE:** PERIODICALLY CHECK THE ADJUSTABLE PACKING NUT AND TIGHTEN AS REQUIRED.

Style	Type	Material	Size	Options
V	500	P	-4	-00
Style	V-Valve VP-Valve, Padlocking Handle VV-Valve, Vented VVP-Valve, Vented, Padlocking Handle			
Type	500-Female/Female PTF Ports			
Material	P- Brass PN-Nickel Plated			
Size	4-1/4" 6-3/8" 8-1/2" 12-3/4" 16-1"			
Options	01-Stainless Steel Ball & Stem 02-Stainless Steel Handle & Nut 03-Stainless Steel Ball, Stem, Handle & Nut 04-Tee Handle 08-Unmarked Yellow Vinyl Handle Cover 21-Oval Handle			

Style	Type	Material	Size
V	500	P	-20
Style	V-Valve VP-Valve, Padlocking Handle		
Type	500-Female/Female PTF Ports		
Material	P- Brass		
Size	20-1 1/4" 24-1 1/2" 32-2"		

### Flow Data

VALVE SIZE	CV
1/4	4.0
3/8	5.8
1/2	12.0
3/4	25.0
1	35.0
1-1/4	57.0
1-1/2	92.0
2	224.0

K

**Female-Female Pipe Ends XV500P**

PART NO.	PIPE THREAD [PTF]	B HEX	C HEX	H	L	M	N	FLOW DIA.D
XV500P-4	1/4	15/16	15/16	3.96	4.90	2.03	2.47	.375
XV500P-6	3/8	15/16	15/16	3.96	4.90	2.03	2.47	.375
XV500P-8	1/2*	1-1/16	1-1/16	3.96	5.00	2.20	2.58	.500
XV500P-12†	3/4**	1-1/4	1-5/16	3.96	5.25	2.42	2.81	.685
XV500P-16†	1**	1-1/2	1-9/16	3.96	5.34	2.75	3.08	.875

† Available in Full Flow Panel Mount see XV508P Series

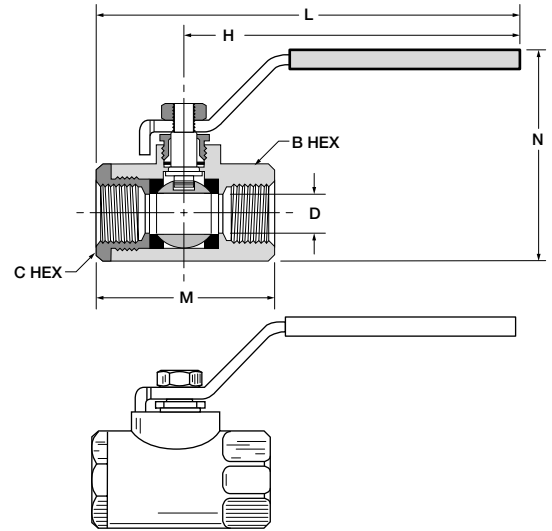

**Female-Female Pipe Ends XV500P-20, XV500P-24, XV500P-32**

PART NO.	PIPE THREAD [NPT]	OCTAGON	H	L	M	N	FLOW DIA.D
XV500P-20	1-1/4	1.93	6.22	8.05	3.66	3.01	1.18
XV500P-24	1-1/2	2.13	6.22	8.23	4.02	3.25	1.50
XV500P-32	2	2.69	6.22	8.58	4.76	3.52	1.89

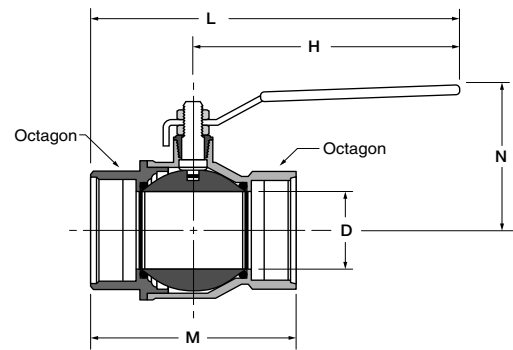

**Vented, Female Pipe Ends XVV500P**

PART NO.	PIPE THREAD	B HEX	C HEX	K	H	L	M	N	D FLOW Ø
XVV500P-4	1/4	15/16	15/16	1.11	3.96	4.90	2.03	2.47	.375
XVV500P-6	3/8	15/16	15/16	1.11	3.96	4.90	2.03	2.47	.375
XVV500P-8	1/2*	1-1/16	1-1/16	1.23	3.96	5.00	2.20	2.58	.500
XVV500P-12	3/4**	1-1/4	1-5/16	1.45	3.96	5.25	2.42	2.81	.685
XVV500P-16	1**	1-1/2	1-9/16	1.58	3.96	5.34	2.75	3.08	.875

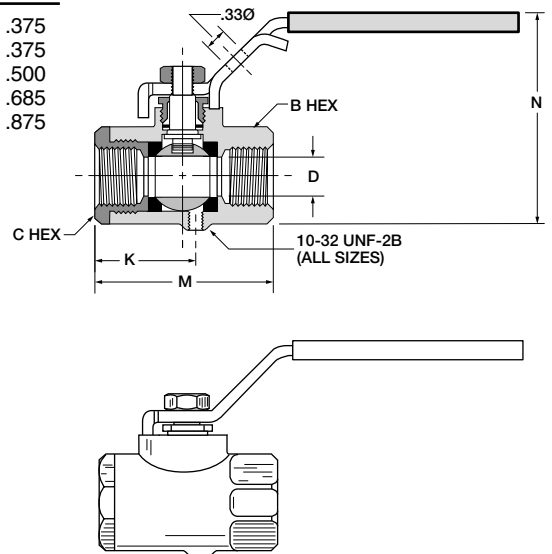

\*PTF special short. \*\*PTF special extra short



**Locking Handle, Female Pipe Ends XVP500P**

PART NO.	PIPE THREAD	B HEX	C HEX	H	L	M	N	D FLOW Ø
XVP500P-4	1/4	15/16	15/16	3.96	4.90	2.03	2.47	.375
XVP500P-6	3/8	15/16	15/16	3.96	4.90	2.03	2.47	.375
XVP500P-8	1/2*	1-1/16	1-1/16	3.96	5.00	2.20	2.58	.500
XVP500P-12	3/4**	1-1/4	1-5/16	3.96	5.25	2.42	2.81	.685
XVP500P-16	1**	1-1/2	1-9/16	3.96	5.34	2.75	3.08	.875
For use with 5/16" Ø shank lock; .33Ø								
XVP500P-20	1-1/4	1-15/16	1-15/16	6.22	8.05	3.66	4.04	1.180
XVP500P-24	1-1/2	2-1/8	2-1/8	6.22	8.23	4.02	4.52	1.500
XVP500P-32	2	2-11/16	2-11/16	6.22	8.60	4.76	5.07	1.890
For use with 9/32" Ø shank lock; .31Ø								

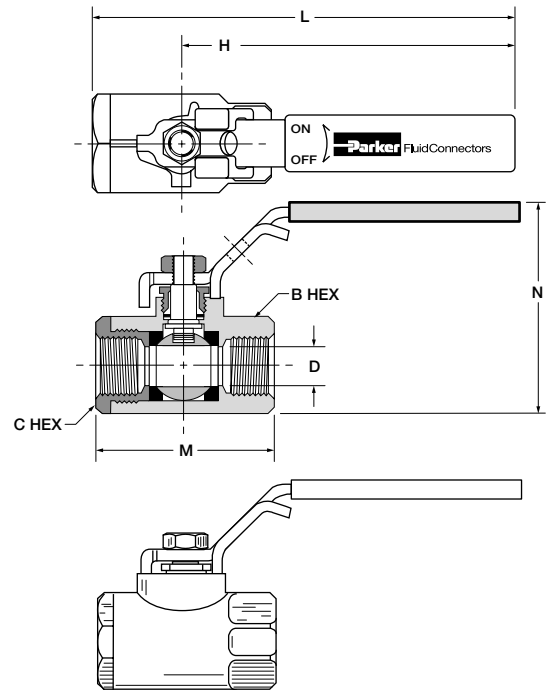

**OSHA 29 CFR Part 1910 Vented, Locking Handle, Female Pipe Ends XVVP500P**

PART NO.	PIPE THREAD	B HEX	C HEX	K	H	L	M	N	D FLOW Ø
XVVP500P-4	1/4	15/16	15/16	1.11	3.96	4.90	2.03	2.47	.375
XVVP500P-6	3/8	15/16	15/16	1.11	3.96	4.90	2.03	2.47	.375
XVVP500P-8	1/2*	1-1/16	1-1/16	1.23	3.96	5.00	2.20	2.58	.500
XVVP500P-12	3/4**	1-1/4	1-5/16	1.45	3.96	5.25	2.42	2.81	.685
XVVP500P-16	1**	1-1/2	1-9/16	1.58	3.96	5.34	2.75	3.08	.875
For use with 5/16" Ø shank lock									

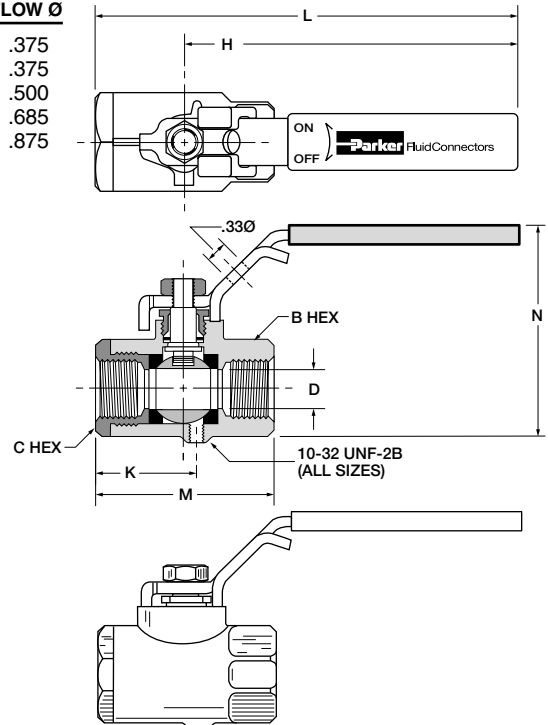

**K**

\*PTF special short. \*\*PTF special extra short

**Tee Handle, Female Pipe Ends XV500P-X-04**

PART NO.	PIPE THREAD	B HEX	C HEX	H	L	M	N	D FLOW Ø
XV500P-4-04	1/4	15/16	15/16	1.25	2.50	2.03	1.87	.375
XV500P-6-04	3/8	15/16	15/16	1.25	2.50	2.03	1.87	.375
XV500P-8-04	1/2*	1-1/16	1-1/16	1.25	2.50	2.20	1.98	.500
XV500P-12-04	3/4**	1-1/4	1-5/16	1.25	2.50	2.42	2.20	.685
XV500P-16-04	1**	1-1/2	1-9/16	1.25	2.50	2.75	2.48	.875

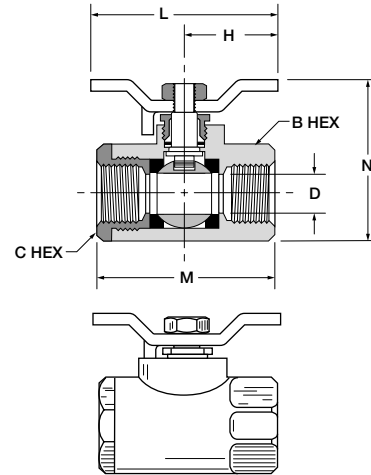

**Oval Handle, Female Pipe Ends XV500P-X-21**

PART NO.	PIPE THREAD	B HEX	C HEX	H	L	M	N	D FLOW Ø
XV500P-4-21	1/4	15/16	15/16	1.74	3.49	2.03	2.38	.375
XV500P-6-21	3/8	15/16	15/16	1.74	3.49	2.03	2.38	.375
XV500P-8-21	1/2*	1-1/16	1-1/16	1.74	3.49	2.20	2.49	.500
XV500P-12-21	3/4**	1-1/4	1-5/16	1.74	3.48	2.42	2.71	.685
XV500P-16-21	1**	1-1/2	1-9/16	1.74	3.48	2.75	2.99	.875

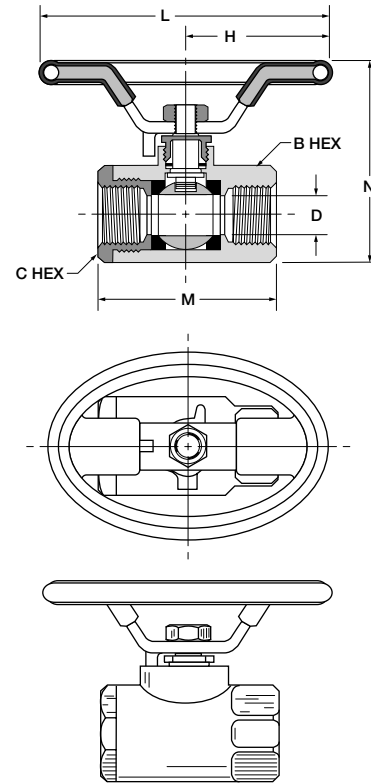

\*PTF special short. \*\*PTF special extra short



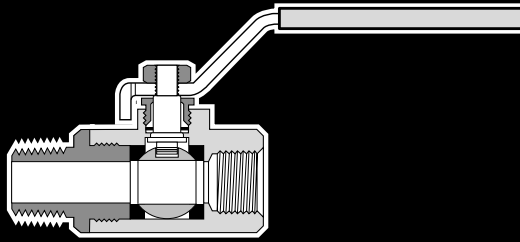

## Male/Female Ball Valves Series 501

### Advantages

Parker's forged body ball valve provides extended service life and resists failure caused by severe temperature applications. Optimum flow design assures maximum system efficiency. Highly inert PTFE seats and seals provide resistance to chemical corrosion. Parker also provides a blow-out proof stem, chrome plated brass ball and a specially designed handle enabling increased turning leverage for ease of opening and closing. Parker's ball valve can be readily identified assuring high quality engineering and reliability. This economical ball valve is available in 1/4", 3/8", 1/2", 3/4" and 1" female/male pipe sizes. Parker's ball valve bodies are machined from high quality CA 377 forgings.

### Applications

Parker's industrial ball valve product line is intended for general purpose use. Please be aware that ball valves are intended for use in the fully open or closed positions. Depending on application conditions, throttling of the valve may result in premature seal failure and/or inability to turn the valve handle.

For use as fuel line shutoffs for gasoline and diesel powered over highway, off highway, and construction equipment vehicles. Water and air service lines on capital equipment and plant design plumbing that require total shutoff capability.

### Working Pressure and Temperatures

Saturated steam service up to 150 PSI and 400° F  
 Vacuum, 29 Inches of Mercury  
 Vented up to 250 PSI

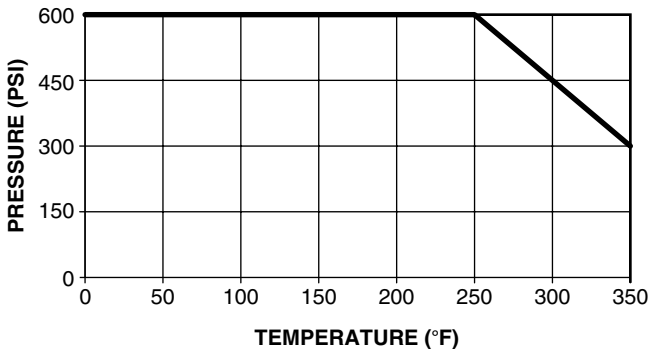

Style	Type	Material	Size	Options
V	501	P	-4	-00
Style	V-Valve VP-Valve, Padlocking Handle VV-Valve, Vented VVP-Valve, Vented, Padlocking Handle			
Type	501-Male/Female PTF Ports			
Material	P- Brass PN-Nickel Plated			
Size	4-1/4" 6-3/8" 8-1/2" 12-3/4" 16-1"			
Options	01-Stainless Steel Ball & Stem 02-Stainless Steel Handle & Nut 03-Stainless Steel Ball, Stem, Handle & Nut 04-Tee Handle 08-Unmarked Yellow Vinyl Handle Cover 21-Oval Handle			

### Flow Data

VALVE SIZE	CV
1/4	6.3
3/8	5.7
1/2	10.0
3/4	25.0
1	35.0

### Operating Instructions

Quarter turn is "ON" or "OFF".  
 (Provides positive stop action for full shutoff.)

**NOTE:** PERIODICALLY CHECK THE ADJUSTABLE PACKING NUT AND TIGHTEN AS REQUIRED.

K

**Male-Female Pipe Ends XV501P**

PART NO.	PIPE THREAD	B HEX	C HEX	H	L	M	N	D FLOW Ø
XV501P-4	1/4	15/16	15/16	3.96	5.46	2.59	2.47	.344
XV501P-6	3/8	15/16	15/16	3.96	5.46	2.59	2.47	.375
XV501P-8	1/2*	1-1/16	1-1/16	3.96	5.75	2.94	2.58	.500
XV501P-12	3/4**	1-1/4	1-5/16	3.96	5.83	3.00	2.81	.685
XV501P-16	1**	1-1/2	1-9/16	3.96	6.19	3.60	3.08	.875

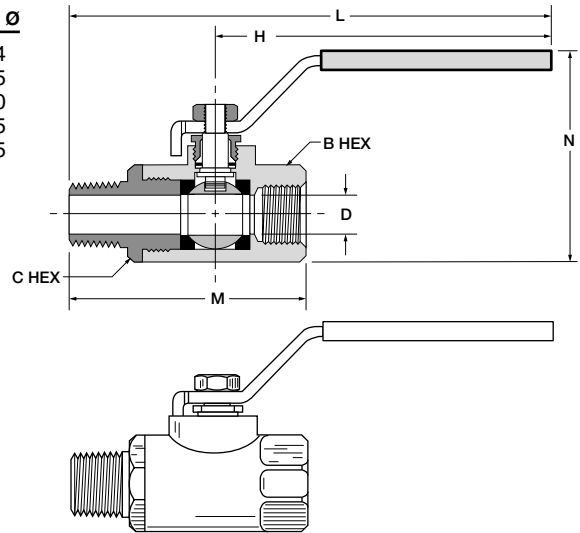

**Vented, Male-Female Pipe Ends XVV501P**

PART NO.	PIPE THREAD	B HEX	C HEX	K	H	L	M	N	D FLOW Ø
XVV501P-4	1/4	15/16	15/16	1.67	3.96	5.46	2.59	2.47	.344
XVV501P-6	3/8	15/16	15/16	1.67	3.96	5.46	2.59	2.47	.375
XVV501P-8	1/2*	1-1/16	1-1/16	1.98	3.96	5.75	2.95	2.58	.500
XVV501P-12	3/4**	1-1/4	1-5/16	2.03	3.96	5.83	3.00	2.81	.685
XVV501P-16	1**	1-1/2	1-9/16	2.43	3.96	6.19	3.60	3.08	.875

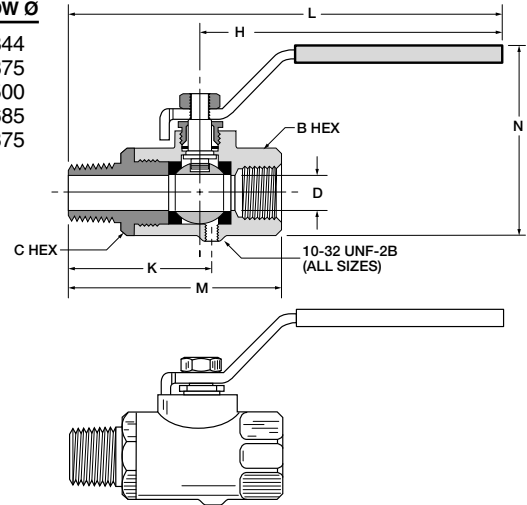

**Locking Handle, Male-Female Pipe Ends XVP501P**

PART NO.	PIPE THREAD	B HEX	C HEX	H	L	M	N	D FLOW Ø
XVP501P-4	1/4	15/16	15/16	3.96	5.46	2.59	2.47	.344
XVP501P-6	3/8	15/16	15/16	3.96	5.46	2.59	2.47	.375
XVP501P-8	1/2*	1-1/16	1-1/16	3.96	5.75	2.95	2.58	.500
XVP501P-12	3/4**	1-1/4	1-5/16	3.96	5.83	3.00	2.81	.685
XVP501P-16	1**	1-1/2	1-9/16	3.96	6.19	3.60	3.08	.875

For use with 5/16" Ø shank lock

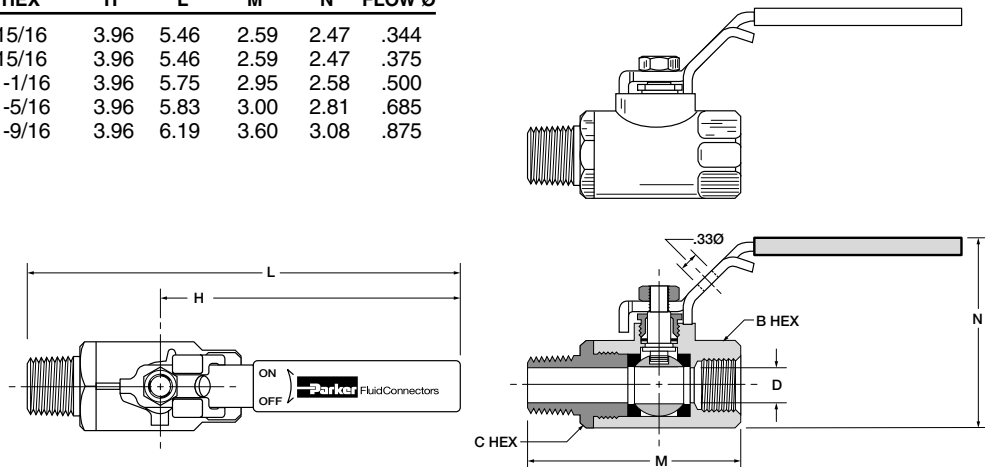

\*PTF special short. \*\*PTF special extra short



**OSHA 29 CFR Part 1910  
Vented, Locking Handle, Male-Female Pipe Ends XVVP501P**

PART NO.	PIPE THREAD	B HEX	C HEX	K	H	L	M	N	D FLOW Ø
XVVP501P-4	1/4	15/16	15/16	1.67	3.96	5.46	2.59	2.47	.344
XVVP501P-6	3/8	15/16	15/16	1.67	3.96	5.46	2.59	2.47	.375
XVVP501P-8	1/2*	1-1/16	1-1/16	1.98	3.96	5.75	2.95	2.58	.500
XVVP501P-12	3/4**	1-1/4	1-5/16	2.03	3.96	5.83	3.00	2.81	.685
XVVP501P-16	1**	1-1/2	1-9/16	2.43	3.96	6.19	3.60	3.08	.875

For use with 5/16" Ø shank lock

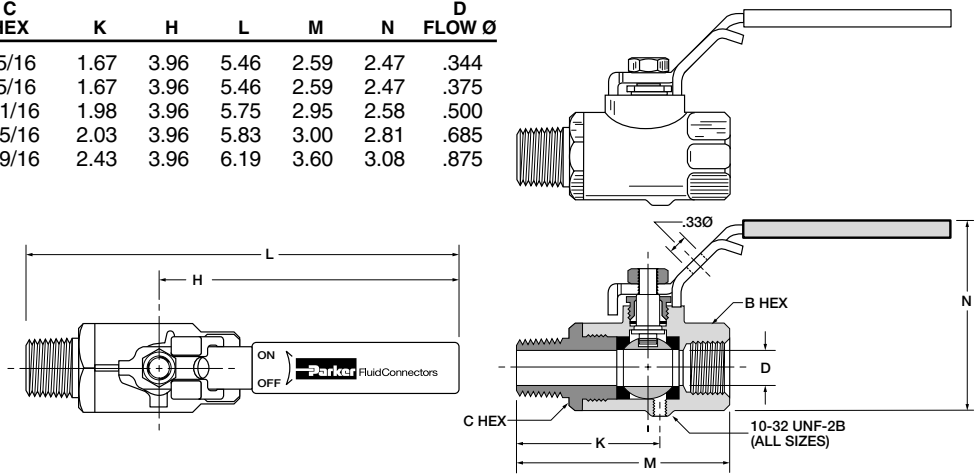

**Tee Handle, Male-Female Pipe Ends XV501P-X-04**

PART NO.	PIPE THREAD	B HEX	C HEX	H	L	M	N	D FLOW Ø
XV501P-4-04	1/4	15/16	15/16	1.25	2.50	2.59	1.87	.344
XV501P-6-04	3/8	15/16	15/16	1.25	2.50	2.59	1.87	.375
XV501P-8-04	1/2*	1-1/16	1-1/16	1.25	2.50	2.95	1.98	.500
XV501P-12-04	3/4**	1-1/4	1-5/16	1.25	2.50	3.00	2.20	.685
XV501P-16-04	1**	1-1/2	1-9/16	1.25	2.50	3.60	2.48	.875

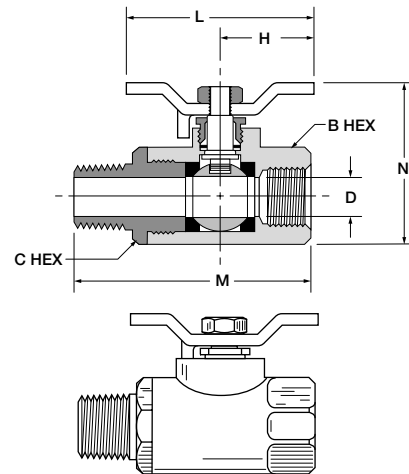

**Oval Handle, Male-Female Pipe Ends XV501P-X-21**

PART NO.	PIPE THREAD	B HEX	C HEX	H	L	M	N	D FLOW Ø
XV501P-4-21	1/4	15/16	15/16	1.74	3.49	2.59	2.38	.344
XV501P-6-21	3/8	15/16	15/16	1.74	3.49	2.59	2.38	.375
XV501P-8-21	1/2*	1-1/16	1-1/16	1.74	3.49	2.95	2.49	.500
XV501P-12-21	3/4**	1-1/4	1-5/16	1.74	3.48	3.00	2.71	.685
XV501P-16-21	1**	1-1/2	1-9/16	1.74	3.48	3.60	2.99	.875

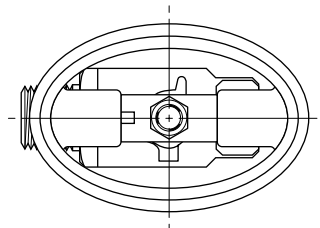
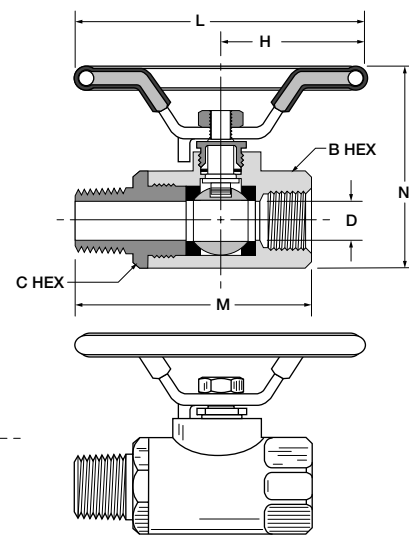

\*PTF special short. \*\*PTF special extra short

**K**

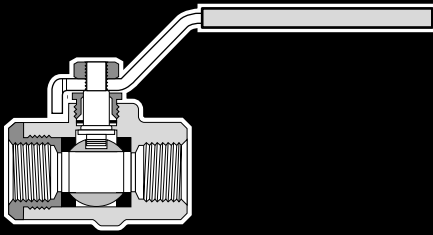

## Brass Panel Mount Ball Valves Series 502

### Advantages

Parker's forged body ball valve provides extended service life and resists failure caused by severe temperature applications. Optimum flow design assures maximum system efficiency. Highly inert PTFE seats and seals provide resistance to chemical corrosion. Parker also provides a blow-out proof stem, chrome plated brass ball and a specially designed handle enabling increased turning leverage for ease of opening and closing. Parker's ball valve can be readily identified assuring high quality engineering and reliability. This economical ball valve is available in female pipe sizes. Parker's ball valve bodies are machined from high quality CA 377 forgings.

### Applications

Parker's industrial ball valve product line is intended for general purpose use. Please be aware that ball valves are intended for use in the fully open or closed positions. Depending on application conditions, throttling of the valve may result in premature seal failure and/or inability to turn the valve handle.

For use as fuel line shutoffs for gasoline and diesel powered over the highway, off highway, and construction equipment vehicles. Water and air service lines on capital equipment and plant design plumbing that require total shutoff capability.

### Working Pressure and Temperature

Saturated steam service up to 150 PSI and 400° F  
 Vacuum, 29 Inches of Mercury  
 Vented up to 250 PSI

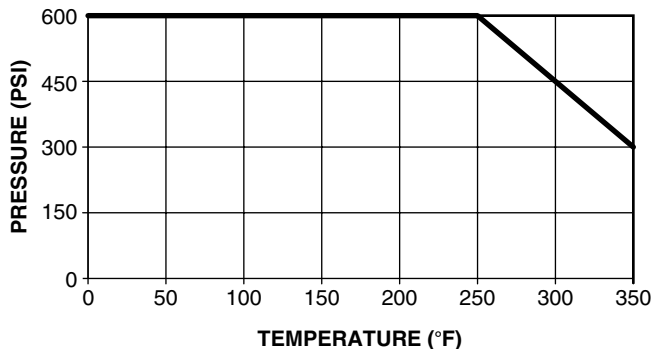

### Operating Instructions

Quarter turn is "ON" or "OFF".  
 (Provides positive stop action for full shutoff.)

**NOTE:** PERIODICALLY CHECK THE ADJUSTABLE PACKING NUT AND TIGHTEN AS REQUIRED.

Style	Type	Material	Size	Options
V	502	P	-4	-00
Style	V-Valve VP-Valve, Padlocking Handle VV-Valve, Vented VVP-Valve, Vented, Padlocking Handle			
Type	502-Female/Female PTF Ports			
Material	P- Brass PN-Nickel Plated			
Size	4-1/4" 6-3/8" 8-1/2" 12-3/4" 16-1"			
Options	01-Stainless Steel Ball & Stem 02-Stainless Steel Handle & Nut 03-Stainless Steel Ball, Stem, Handle & Nut 04-Tee Handle 08-Unmarked Yellow Vinyl Handle Cover 21-Oval Handle			

### Flow Data

VALVE SIZE	CV
1/4	4.0
3/8	5.8
1/2	12.0
3/4	25.0
1	35.0

### Mounting detail for all sizes

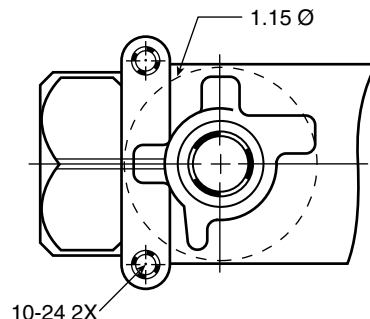

**Female-Female Pipe Ends, Panel Mount XV502P**

PART NO.	PIPE THD.	B HEX	C HEX	F	G	H	L	M	N	FLOW DIA. D
XV502P-4	1/4	15/16	15/16	.50	1.12	3.96	4.90	2.03	2.47	.375
XV502P-6	3/8	15/16	15/16	.50	1.12	3.96	4.90	2.03	2.47	.375
XV502P-8	1/2*	1-1/16	1-1/16	.50	1.12	3.96	5.00	2.20	2.58	.500
XV502P-12†	3/4**	1-1/4	1-5/16	.87	1.37	3.96	5.25	2.42	2.81	.685
XV502P-16†	1**	1-1/2	1-9/16	.87	1.37	3.96	5.34	2.75	3.08	.875

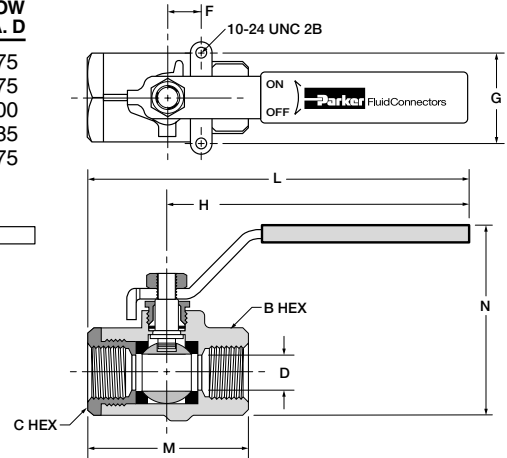
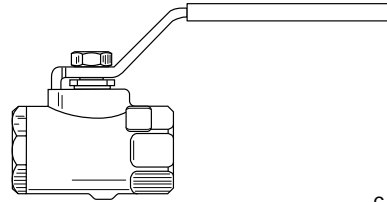

**Vented, Female-Female Pipe Ends, Panel Mount XVV502P**

PART NO.	PIPE THD.	B HEX	C HEX	F	G	K	H	L	M	N	D FLOW Ø
XVV502P-4	1/4	15/16	15/16	.50	1.12	1.11	3.96	4.90	2.03	2.47	.375
XVV502P-6	3/8	15/16	15/16	.50	1.12	1.11	3.96	4.90	2.03	2.47	.375
XVV502P-8	1/2*	1-1/16	1-1/16	.50	1.12	1.23	3.96	5.00	2.20	2.58	.500
XVV502P-12	3/4**	1-1/4	1-5/16	.87	1.37	1.45	3.96	5.25	2.42	2.81	.685
XVV502P-16	1**	1-1/2	1-9/16	.87	1.37	1.58	3.96	5.34	2.75	3.08	.875

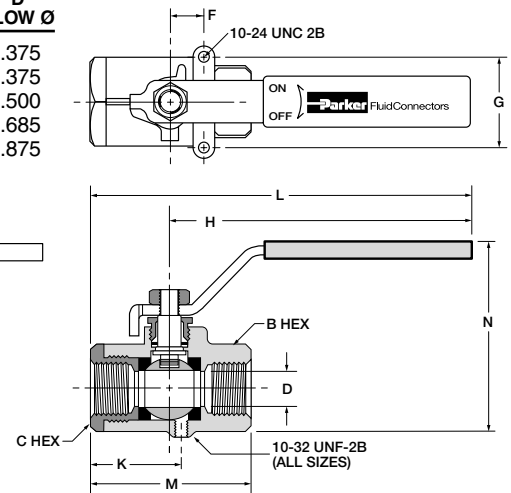
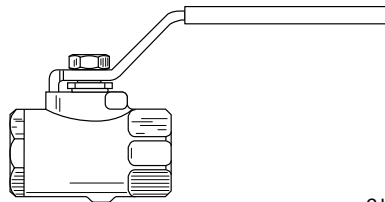

**Locking Handle, Female Pipe Ends, PanelMount XVP502P**

PART NO.	PIPE THD.	B HEX	C HEX	F	G	H	L	M	N	D FLOW Ø
XVP502P-4	1/4	15/16	15/16	.50	1.12	3.96	4.90	2.03	2.47	.375
XVP502P-6	3/8	15/16	15/16	.50	1.12	3.96	4.90	2.03	2.47	.375
XVP502P-8	1/2*	1-1/16	1-1/16	.50	1.12	3.96	5.00	2.20	2.58	.500
XVP502P-12	3/4**	1-1/4	1-5/16	.87	1.37	3.96	5.25	2.42	2.81	.685
XVP502P-16	1**	1-1/2	1-9/16	.87	1.37	3.96	5.34	2.75	3.08	.875

For use with 5/16" Ø shank lock

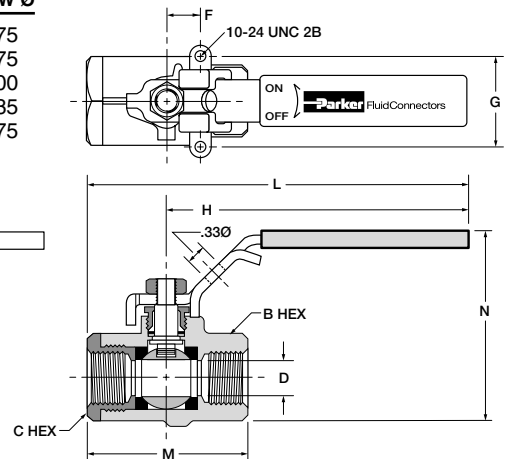
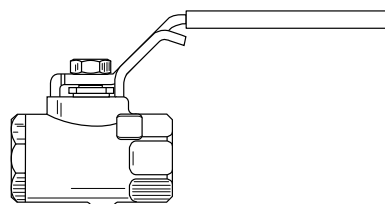

\*PTF special short. \*\*PTF special extra short

**K**



**OSHA 29 CFR Part 1910  
Vented, Locking Handle, Female Pipe Ends, Panel Mount XVVP502P**

PART NO.	PIPE THD.	B HEX	C HEX	F	G	K	H	L	M	N	D FLOW Ø
XVVP502P-4	1/4	15/16	15/16	.50	1.12	1.11	3.96	4.90	2.03	2.47	.375
XVVP502P-6	3/8	15/16	15/16	.50	1.12	1.11	3.96	4.90	2.03	2.47	.375
XVVP502P-8	1/2*	1-1/16	1-1/16	.50	1.12	1.23	3.96	5.00	2.20	2.58	.500
XVVP502P-12	3/4**	1-1/4	1-5/16	.87	1.37	1.45	3.96	5.25	2.42	2.81	.685
XVVP502P-16	1**	1-1/2	1-9/16	.87	1.37	1.58	3.96	5.34	2.75	3.08	.875

For use with 5/16" Ø shank lock

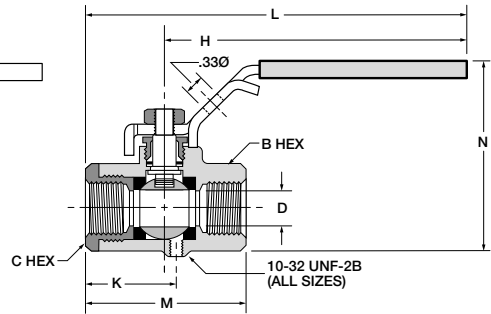
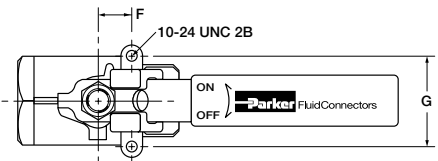
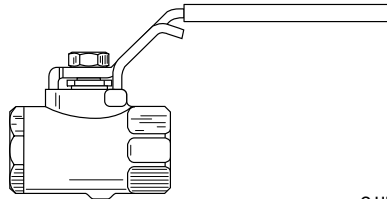

**Tee Handle, Female Pipe Ends, Panel Mount XV502P-X-04**

PART NO.	PIPE THD.	B HEX	C HEX	F	G	H	L	M	N	D FLOW Ø
XV502P-4-04	1/4	15/16	15/16	.50	1.12	1.25	2.50	2.03	1.87	.375
XV502P-6-04	3/8	15/16	15/16	.50	1.12	1.25	2.50	2.03	1.87	.375
XV502P-8-04	1/2*	1-1/16	1-1/16	.50	1.12	1.25	2.50	2.20	1.98	.500
XV502P-12-04	3/4**	1-1/4	1-5/16	.87	1.37	1.25	2.50	2.42	2.20	.685
XV502P-16-04	1**	1-1/2	1-9/16	.87	1.37	1.25	2.50	2.75	2.48	.875

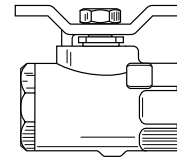
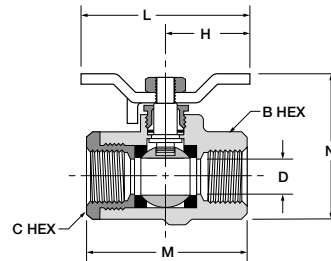
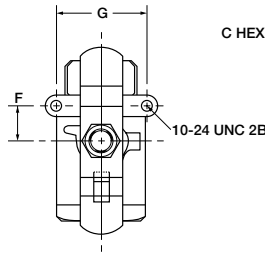

**Oval Handle, Female Pipe Ends, Panel Mount XV502P-X-21**

PART NO.	PIPE THD.	B HEX	C HEX	F	G	H	L	M	N	D FLOW Ø
XV502P-4-21	1/4	15/16	15/16	.50	1.12	1.74	3.49	2.03	2.38	.375
XV502P-6-21	3/8	15/16	15/16	.50	1.12	1.74	3.49	2.03	2.38	.375
XV502P-8-21	1/2*	1-1/16	1-1/16	.50	1.12	1.74	3.49	2.20	2.49	.500
XV502P-12-21	3/4**	1-1/4	1-5/16	.87	1.37	1.74	3.48	2.42	2.71	.685
XV502P-16-21	1**	1-1/2	1-9/16	.87	1.37	1.74	3.48	2.75	2.99	.875

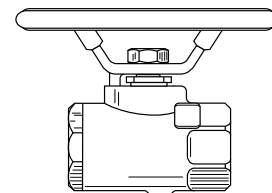
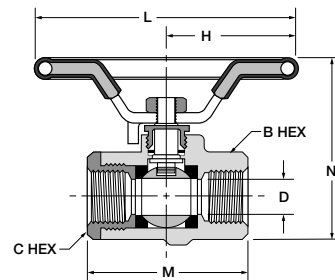
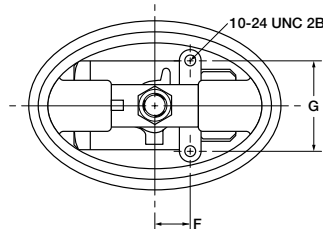

\*PTF special short. \*\*PTF special extra short





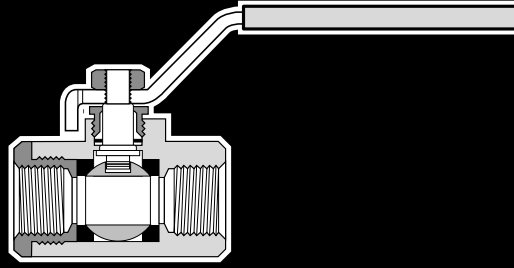

## Female/Female Straight Thread Brass Ball Valve Series 506

### Advantages

Parker's forged body ball valve provides extended service life and resists failure caused by severe temperature applications. Optimum flow design assures maximum system efficiency. Highly inert PTFE seats and seals provide resistance to chemical corrosion. Parker also provides a blow-out proof stem, chrome plated brass ball and a specially designed handle enabling increased turning leverage for ease of opening and closing. Parker's ball valve can be readily identified assuring high quality engineering and reliability. This ball valve is available in 1/4" through 2" female straight thread sizes. Parker's ball valve bodies are machined from high quality CA 377 forgings.

### Applications

Parker's industrial ball valve product line is intended for general purpose use. Please be aware that ball valves are intended for use in the fully open or closed positions. Depending on application conditions, throttling of the valve may result in premature seal failure and/or inability to turn the valve handle.

For use on construction equipment, chemical processing, plastic and rubber manufacturing, pumps and specialized industrial machinery requiring total shut-off capability.

### Working Pressure and Temperature

Saturated steam service up to 150 PSI and 400° F  
Vacuum, 29 Inches of Mercury

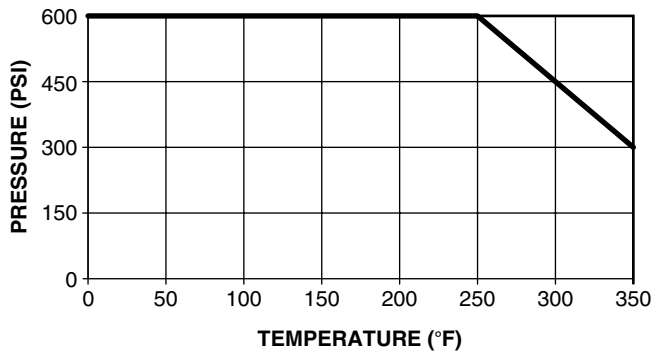

### Operating Instructions

Quarter turn is "ON" or "OFF".  
(Provides positive stop action for full shutoff.)

**NOTE:** PERIODICALLY CHECK THE ADJUSTABLE PACKING NUT AND TIGHTEN AS REQUIRED.

Style	Type	Material	Size	Options
V	506	P	-4	-00
Style	V-Valve VP-Valve, Padlocking Handle			
Type	506 Female/Female			
Material	P- Brass			
Size	4-1/4" 6-3/8" 8-1/2" 12-3/4" 16-1"			
Options	01-Stainless Steel Ball & Stem 02-Stainless Steel Handle & Nut 03-Stainless Steel Ball, Stem, Handle & Nut 04-Tee Handle 08-Unmarked Yellow Vinyl Handle Cover 21-Oval Handle			

### Flow Data

VALVE SIZE	CV
1/4	4.0
3/8	5.8
1/2	12.0
3/4	25.0
1	35.0

Style	Type	Material	Size
V	506	P	-20
Style	V-Valve		
Type	506 Female/Female		
Material	P- Brass		
Size	20 - 1 1/4" 24 - 1 1/2" 32 - 2"		

### Flow Data

VALVE SIZE	CV
1-1/4	57.0
1-1/2	92.0
2	224.0

**K**

**Female/Female, Straight Thread O-Ring Port XV506P**

PART NO.	STRT. THREAD	B HEX	C HEX	H	L	M	N	D FLOW Ø
XV506P-4	7/16-20	15/16	15/16	3.96	5.01	2.20	2.47	.375
XV506P-6	9/16-18	15/16	15/16	3.96	5.07	2.26	2.47	.375
XV506P-8	3/4-16	1-1/16	1-1/16	3.96	5.18	2.42	2.60	.500
XV506P-12	1-1/16-12	1-1/4	1-5/16	3.96	5.87	3.46	2.81	.685
XV506P-16	1-5/16-12	1-1/2	1-9/16	3.96	5.96	3.68	3.08	.875

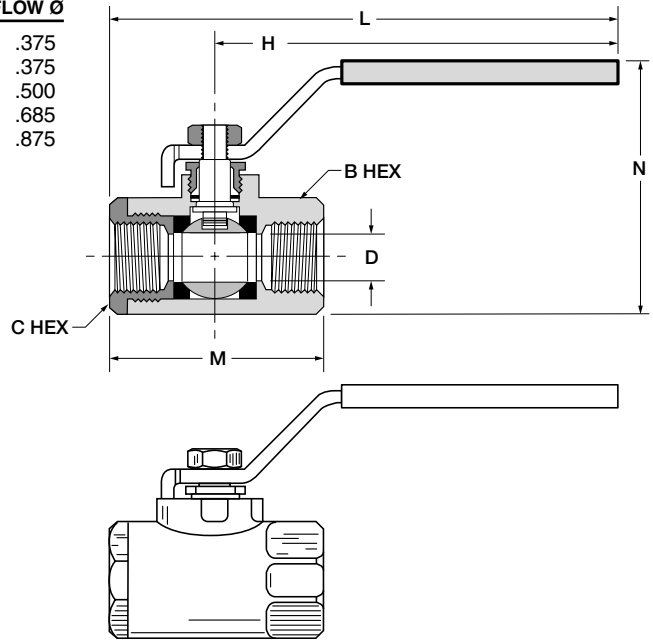

**Female/Female, Straight Thread O-Ring Port XV506P-20, XV506P-24, XV506P-32**

PART NO.	STRT. THREAD	B OCT	C OCT	H	L	M	N	D FLOW Ø
XV506P-20	1 5/8-12	1.93	1.93	6.22	8.05	3.66	3.01	1.18
XV506P-24	1 7/8-12	2.13	2.13	6.22	8.23	4.02	3.25	1.50
XV506P-32	2 1/2-12	2.85	2.85	6.22	8.60	4.76	3.52	1.89

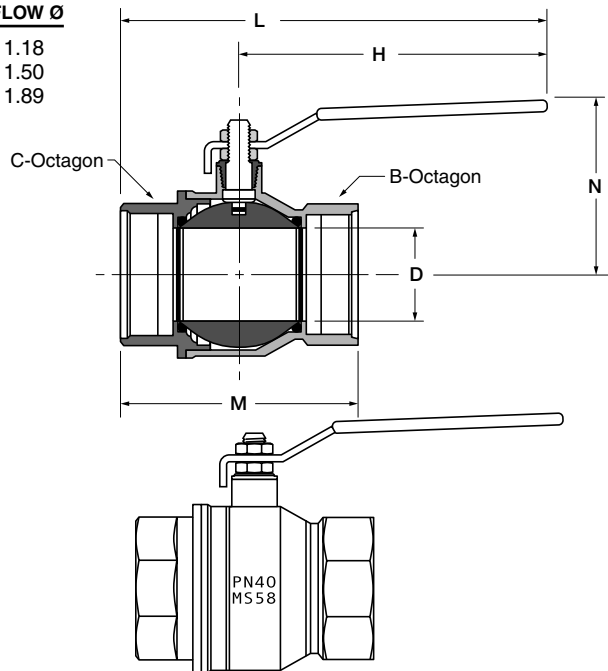

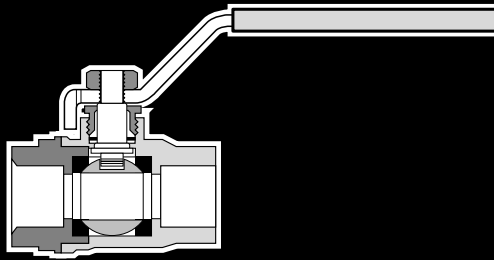

## Solder End Ball Valves Series 509

### Advantages

Parker forged body ball valve provides extended service life and resists failure caused by severe temperature applications. Optimum flow design assures maximum system efficiency. Highly inert PTFE seats and seals provide resistance to chemical corrosion. Parker also provides a blow-out proof stem, chrome plated brass ball and a specially designed handle enabling increased turning leverage for ease of opening and closing. The Parker series 509 is designed to be soft soldered into lines without disassembly. This allows the valve to be installed without disturbing the seats and seals in any way.

### Applications

Parker's industrial ball valve product line is intended for general purpose use. Please be aware that ball valves are intended for use in the fully open or closed positions. Depending on application conditions, throttling of the valve may result in premature seal failure and/or inability to turn the valve handle.

These valves are ideal for water and air service lines on capital equipment and plant design plumbing that require total shut-off capability. Use with ASTM B88 copper water tubing.

### Working Pressure and Temperature

Saturated steam service up to 150 PSI and 400° F. Solder temperature not to exceed 470°F.

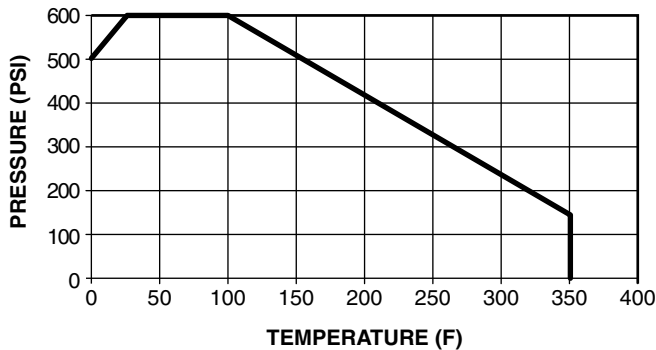

Joining Material	Melting Range Degrees F	Working Temp. Degrees F	Maximum Working Pressure (PSI)	
			Size 1/2"-1"	Size 1-1/4"-2"
50-50 Tin-Lead Solder	361-421	100	200	175
		150	150	125
		200	100	90
		250	85	75
95-5 Tin Antimony Solder	450-464	100	400	400
		150	400	350
		200	300	250
		250	200	175

Style	Type	Material	Size
V	509	P	-4
Style	V-Valve		
Type	509-Solder Ends		
Material	P- Brass		
Size	8-1/2" 12-3/4" 16-1" 20-1 1/4" 24-1 1/2" 32-2"		

### Flow Data

VALVE SIZE	CV
1/2"	26
3/4"	69
1"	91
1 1/4"	127
1 1/2"	299
2"	425

### Operating Instructions

Quarter turn is "ON" or "OFF".

(Provides positive stop action for full shutoff.)

**NOTE:** PERIODICALLY CHECK THE ADJUSTABLE PACKING NUT AND TIGHTEN AS REQUIRED.

K

**Solder Cup Ends XV509P**

PART NO.	TUBE SIZE	E	G	H	L	M	N	FLOW DIA. D
XV509P-8	1/2	.630	.49	3.94	5.00	2.24	1.69	.55
XV509P-12	3/4	.877	.75	4.72	6.10	2.85	1.97	.75
XV509P-16	1	1.128	.90	4.72	6.40	3.35	2.13	.94
XV509P-20	1 1/4	1.378	.96	6.22	8.13	3.82	3.01	1.18
XV509P-24	1 1/2	1.628	1.00	6.22	8.46	4.49	3.25	1.50
XV509P-32	2	2.128	1.10	6.22	8.94	5.43	3.52	1.89

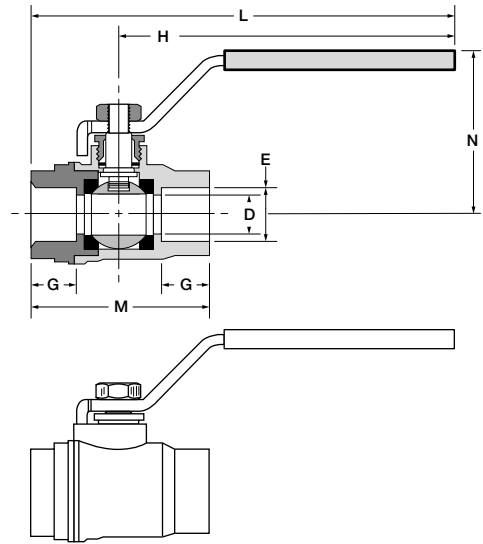

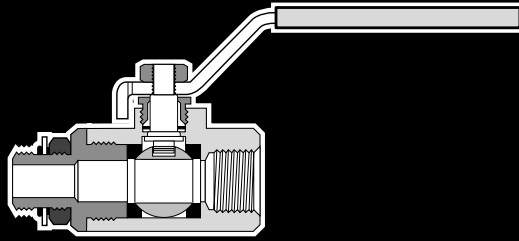

## Male/Female Straight Thread Ball Valves Series 510

### Advantages

Parker's forged body ball valve provides extended service life and resists failure caused by severe temperature applications. Optimum flow design assures maximum system efficiency. Highly inert PTFE seats and seals provide resistance to chemical corrosion. Parker also provides a blow-out proof stem, chrome plated brass ball and a specially designed handle enabling increased turning leverage for ease of opening and closing. Parker's ball valve can be readily identified assuring high quality engineering and reliability. This economical ball valve is available in 1/4", 3/8", 1/2", 5/8", 3/4" and 1" male/female straight thread sizes. Parker's ball valve bodies are machined from high quality CA 377 forgings.

### Applications

Parker's industrial ball valve product line is intended for general purpose use. Please be aware that ball valves are intended for use in the fully open or closed positions. Depending on application conditions, throttling of the valve may result in premature seal failure and/or inability to turn the valve handle.

For use on construction equipment, chemical processing, plastic and rubber manufacturing, pumps and specialized industrial machinery requiring total shut-off capability.

### Working Pressure and Temperature

Saturated steam service up to 150 PSI and 400° F  
 Vacuum, 29 Inches of Mercury  
 Vented up to 250 PSI

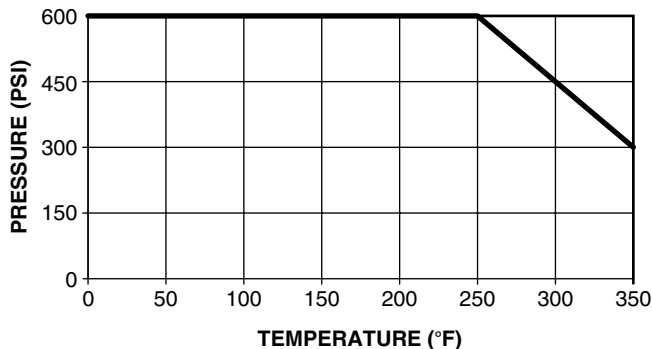

### Operating Instructions

Quarter turn is "ON" or "OFF".  
 (Provides positive stop action for full shutoff.)

**NOTE:** PERIODICALLY CHECK THE ADJUSTABLE PACKING NUT AND TIGHTEN AS REQUIRED.

Style	Type	Material	Size	Options
V	510	P	-4	-00
Style	V-Valve VP-Valve, Padlocking Handle			
Type	510 Male/Female Straight Thread O-Ring			
Material	P- Brass			
Size	4-1/4" 6-3/8" 8-1/2" 12-3/4" 16-1"			
Options	01-Stainless Steel Ball & Stem 02-Stainless Steel Handle & Nut 04-Tee Handle 08-Unmarked Yellow Vinyl Handle Cover 21-Oval Handle			

### Flow Data

VALVE SIZE	CV
1/4	0.8
3/8	2.1
1/2	5.3
5/8	7.6
3/4	13.0
1	33.0

K

**Male-Female, Straight Thread O-Ring Port XV510P**

PART NO.	STRT. THREAD	B HEX	C HEX	H	L	M	N	D FLOW Ø
XV510P-4	7/16-20	15/16	15/16	3.96	5.61	2.85	2.47	.188
XV510P-6	9/16-18	15/16	15/16	3.96	5.68	2.92	2.47	.281
XV510P-8	3/4-16	1-1/16	1-1/16	3.96	5.88	3.17	2.58	.422
XV510P-10	7/8-14	1-1/4	1-5/16	3.96	6.31	3.90	2.81	.500
XV510P-12	1-1/16-12	1-1/4	1-5/16	3.96	6.44	4.03	2.81	.656
XV510P-16	1-5/16-12	1-1/2	1-9/16	3.96	6.56	4.28	3.08	.875

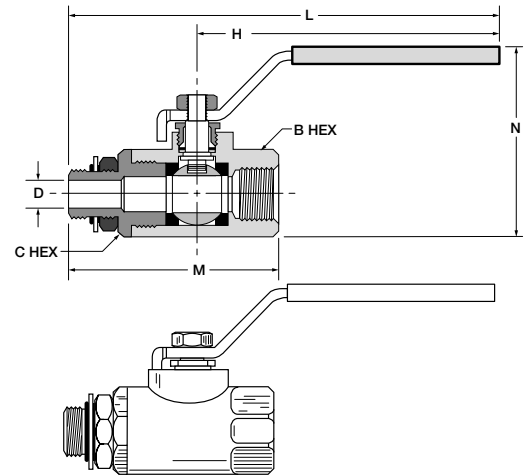

**Locking Handle, Straight Thread O-Ring Port XVP510P**

PART NO.	STRT. THREAD	B HEX	C HEX	H	L	M	N	D FLOW Ø
XVP510P-4	7/16-20	15/16	15/16	3.96	5.61	2.85	2.47	.188
XVP510P-6	9/16-18	15/16	15/16	3.96	5.68	2.92	2.47	.281
XVP510P-8	3/4-16	1-1/16	1-1/16	3.96	5.88	3.17	2.58	.422
XVP510P-10	7/8-14	1-1/4	1-5/16	3.96	6.31	3.90	2.81	.500
XVP510P-12	1-1/16-12	1-1/4	1-5/16	3.96	6.44	4.03	2.81	.656

For use with 5/16" Ø shank lock

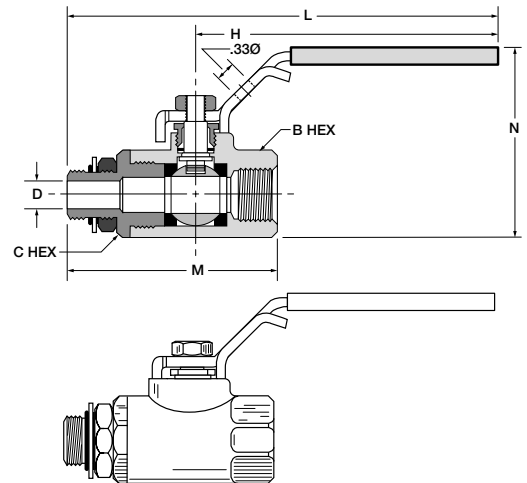

**Tee Handle, Straight Thread O-Ring Port XV510P-X-04**

PART NO.	STRT. THREAD	B HEX	C HEX	H	L	M	N	D FLOW Ø
XV510P-4-04	7/16-20	15/16	15/16	1.25	2.50	2.85	1.87	.188
XV510P-6-04	9/16-18	15/16	15/16	1.25	2.50	2.92	1.87	.281
XV510P-8-04	3/4-16	1-1/16	1-1/16	1.25	2.50	3.17	1.98	.422
XV510P-10-04	7/8-14	1-1/4	1-5/16	1.25	2.50	3.90	2.20	.500
XV510P-12-04	1-1/16-12	1-1/4	1-5/16	1.25	2.50	4.03	2.20	.656
XV510P-16-04	1-5/16-12	1-1/2	1-9/16	1.25	2.50	4.28	2.48	.875

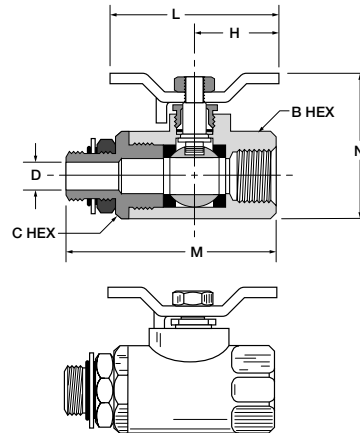

**Oval Handle, Straight Thread O-Ring Port XV510P-X-21**

PART NO.	STRT. THREAD	B & C HEX	H	L	M	N	D FLOW Ø
XV510P-4-21	7/16-20	15/16	1.74	3.49	2.85	2.38	.188
XV510P-6-21	9/16-18	15/16	1.74	3.49	2.92	2.38	.281
XV510P-8-21	3/4-16	1 1/16	1.74	3.49	3.17	2.49	.422

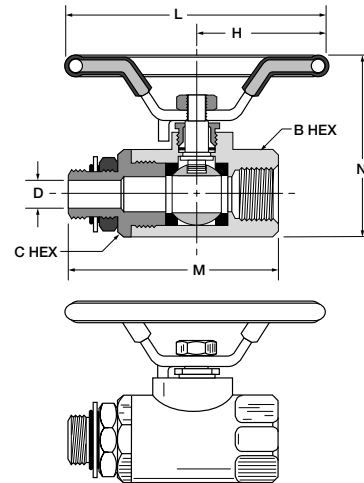

**K**

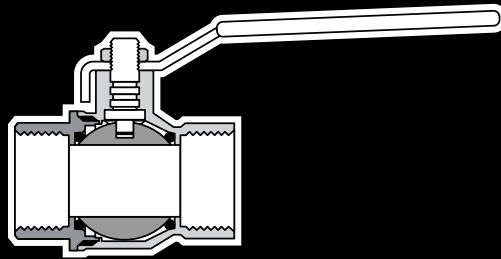

## Brass Ball Valves Series 520

### Advantages

Parker's forged body ball valve provides extended service life and resists failure caused by severe temperature applications. Full flow design assures maximum system efficiency. Highly inert PTFE seats provide resistance to chemical corrosion. Two Fluorocarbon o-rings at the stem provide maximum safety with no maintenance. The blow-out proof stem, chrome plated brass ball and a specially designed handle enable increased turning leverage for ease of opening and closing. Parker's ball valve can be readily identified, assuring high quality engineering and reliability. This economical ball valve is available in female pipe sizes.

### Applications

Parker's industrial ball valve product line is intended for general purpose use. Please be aware that ball valves are intended for use in the fully open or closed positions. Depending on application conditions, throttling of the valve may result in premature seal failure and/or inability to turn the valve handle.

For use as shutoffs for highway, off highway, and construction equipment vehicles. Water and air service lines on capital equipment and plant design plumbing that require total shutoff capability.

### Working Pressure and Temperature

Saturated steam service up to 150 PSI and 350° F  
Vacuum, 29 Inches of Mercury

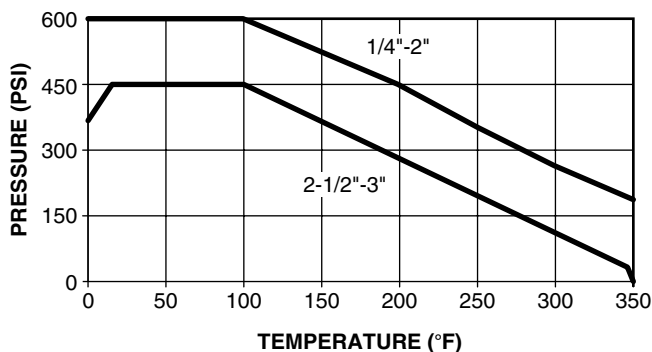

Style	Type	Material	Size
V	520	P	-4
Style	V-Valve		
Type	520-Female/Female NPT Ports		
Material	P- Brass		
Size	4-1/4" 6-3/8" 8-1/2" 12-3/4" 16-1"	20-1 1/4" 24-1 1/2" 32-2"	
Options	04-Tee Handle		

### Operating Instructions

Quarter turn is "ON" or "OFF".  
(Provides positive stop action for full shutoff.)

### U.L. Listed

U.L. Category:	
YSDT	LP-Gas Shut-off Valves
YRBX	Flammable Liquid Shut-off Valves
YRPV	Gas Shut-off Valves
YQNZ	Compressed Gas Shut-off Valves

**K**



**Brass Ball Valve XV520P**

PART NO.	PIPE THREAD	B OCTAGON	C OCTAGON	H	L	M	N	D FLOW Ø
XV520P-4	1/4-18	.79	.79	3.94	4.83	1.77	1.50	.310
XV520P-6	3/8-18	.79	.79	3.94	4.83	1.77	1.50	.400
XV520P-8	1/2-14	.98	.98	3.94	5.10	2.32	1.69	.600
XV520P-12	3/4-14	1.22	1.22	4.72	5.98	2.52	1.97	.790
XV520P-16	1-11.5	1.57	1.57	4.72	6.32	3.19	2.13	1.000
XV520P-20	1-1/4	1.93	1.93	6.22	8.05	3.66	2.82	1.250
XV520P-24	1-1/2	2.13	2.13	6.22	8.23	4.02	3.06	1.570
XV520P-32	2	2.69	2.69	6.22	8.58	4.76	3.33	2.000
XV520P-40	2-1/2	3.35	3.35	10.04	13.11	6.14	5.20	2.520
XV520P-48	3	3.89	3.89	10.04	13.52	6.97	5.51	3.000

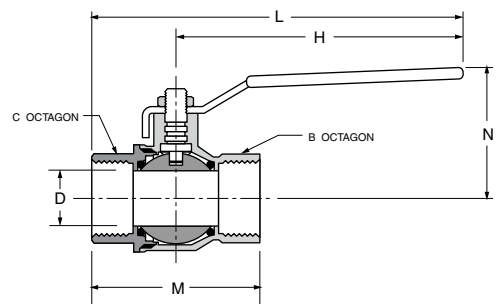
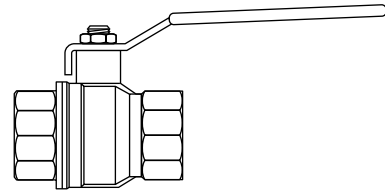

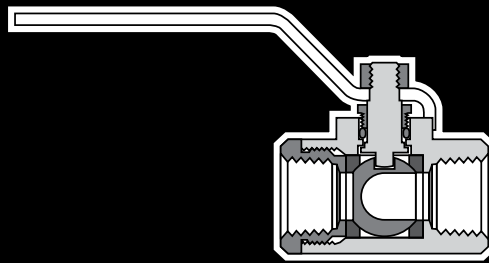

## Brass Ball Valves

### Series 533 3-Way Diversion / Series 540 4-Way

#### Advantages

Parker's forged body ball valve provides extended service life and resists failure caused by severe temperature applications. Optimum flow design assures maximum system efficiency. Highly inert PTFE seats and seals provide resistance to chemical corrosion. Parker's ball valve can be readily identified assuring high quality engineering and reliability. This ball valve is available with female PTF ports. Parker's ball valve bodies are machined from high quality CA 377 forgings.

#### Applications

Designed for applications requiring flow diversion making tank selection and fluid transfer easy.

For use on construction equipment, chemical processing, pumps and specialized industrial machinery.

**NOTE:** Diversion valves do not have off positions, therefore, the center port can not be used for shut-off purposes.

#### Working Pressure and Temperature

400 PSI and 250° F

Vacuum to 29 inches Hg

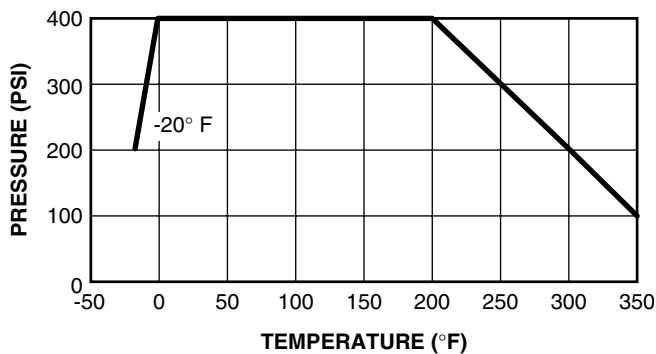

Style	Type	Material	Size	Options
V	533	P	-4	-00
<b>Style</b>	V-Valve			
<b>Type</b>	533 3-Way Diversion, 540 4-Way			
<b>Material</b>	P-Brass			
<b>Size</b>	4-1/4" 6-3/8" 8-1/2" 12-3/4" 16-1"			
<b>Options</b>	02-Stainless Steel Handle & Nut 08-Unmarked Yellow Vinyl Handle Cover			

#### XV533P Handle Positions

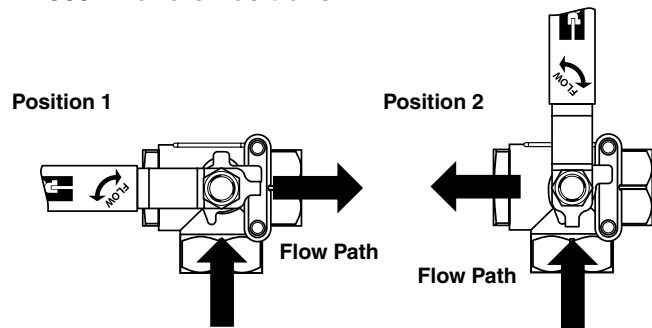

#### XV540P Handle Positions

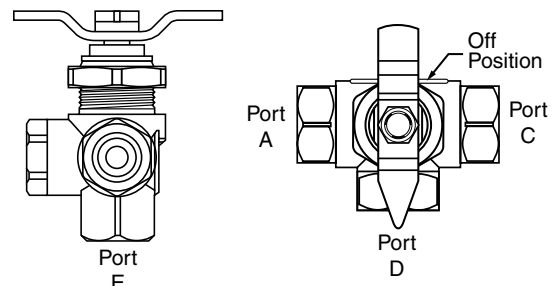

Pointer Over	Flow Path
A	A to E
Off	Closed
C	C to E
D	D to E

**NOTE:** PERIODICALLY CHECK THE ADJUSTABLE PACKING NUT AND TIGHTEN AS REQUIRED.



**Female-Female-Female Pipe Ends XV533P**

PART NO.	PIPE THREAD (PTF)	B HEX	E	F	G	H	K	L	M	N	FLOW DIA. D
XV533P-4	1/4	15/16	.50	1.08	1.12	3.96	1.03	2.47	2.03	1.94	.375
XV533P-6	3/8	15/16	.50	1.08	1.12	3.96	1.03	2.47	2.03	1.94	.375
XV533P-8	1/2	1-1/16	.50	1.18	1.12	3.96	1.11	2.58	2.20	1.98	.500
XV533P-12	3/4	1-1/4	.87	1.43	1.37	3.96	1.42	2.90	2.83	2.17	.685
XV533P-16	1	1-9/16	.87	1.62	1.37	3.96	1.58	3.21	3.16	2.32	.875

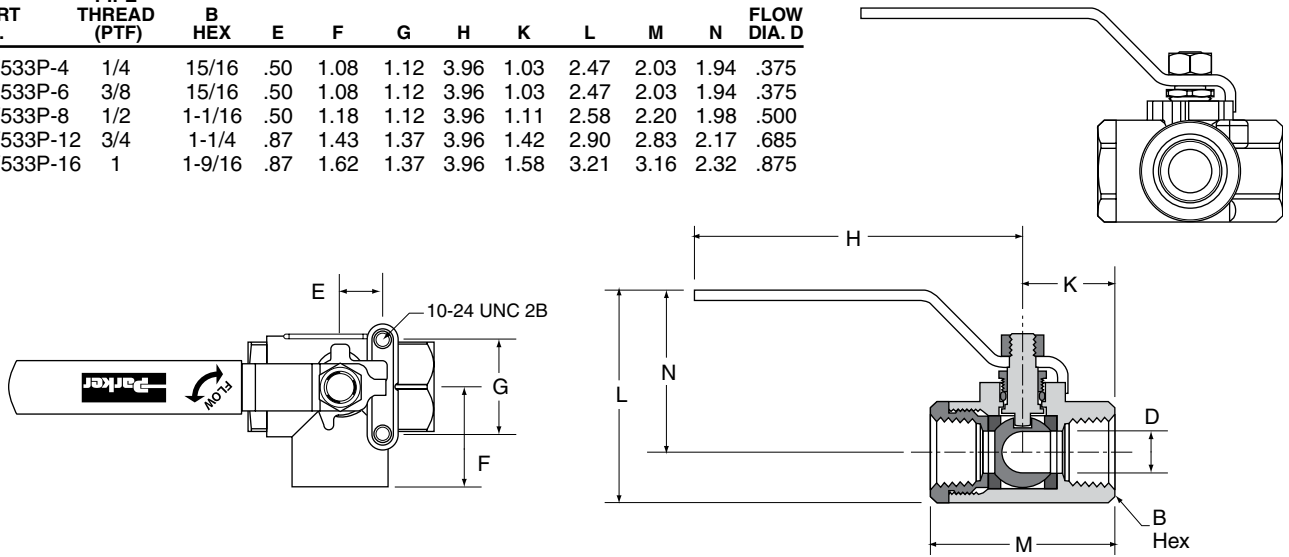

**Female-Female-Female-Female Pipe Ends XV540P**

PART NO.	PIPE THREAD (PTF)	B HEX	E	F	G	H	K	L	M	N	FLOW DIA. D
XV540P-4	1/4	7/8	.32	1.00	1.76	1.25	1.98	2.49	.52	1.07	.250

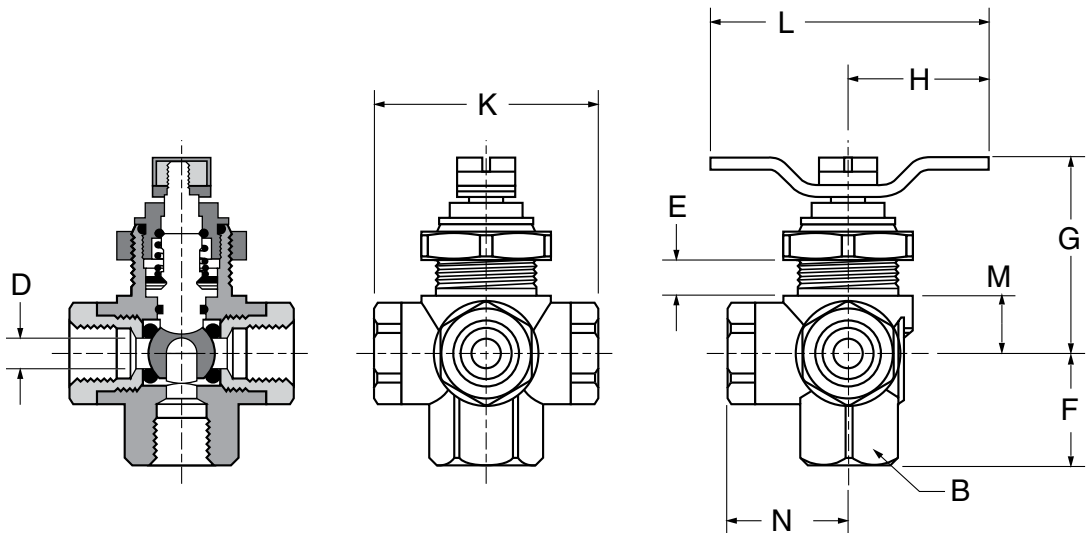

**K**

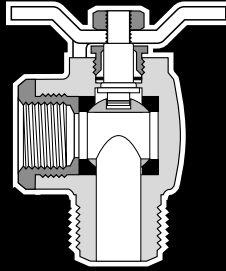

## 90° Ball Valves Series 590/591

### Advantages

Parker's forged body valve provides extended service life and resists failure caused by severe temperature applications. Optimum flow design assures maximum system efficiency. Highly inert PTFE seats and seals provide resistance to chemical corrosion. Parker also provides a blow-out proof stem and chrome plated brass ball on all series 590/591 valves. Parker's 590/591 series valve bodies are machined from high quality CA377 forgings.

### Applications

Parker's industrial ball valve product line is intended for general purpose use. Please be aware that ball valves are intended for use in the fully open or closed positions. Depending on application conditions, throttling of the valve may result in premature seal failure and/or inability to turn the valve handle.

For use as fuel line shutoffs for gasoline and diesel powered over the highway, off highway and construction equipment vehicles. Water and air service lines on capital equipment and plant design plumbing that require total shut-off capability.

### Working Pressure and Temperature

Saturated steam service up to 150 PSI and 400° F  
Vacuum, 29 Inches of Mercury

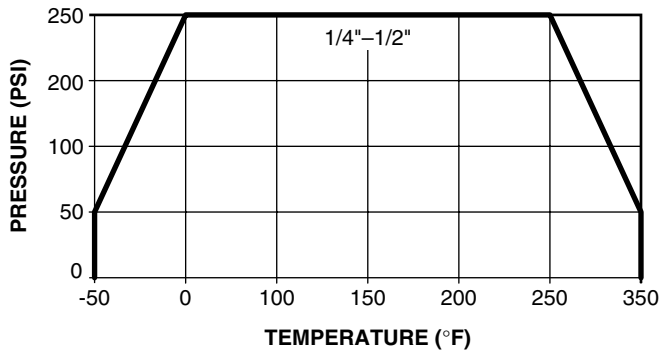

### Operating Instructions

Quarter turn is "on" or "off".  
(Provides positive stop action for full shut-off.)

**NOTE:** PERIODICALLY CHECK THE ADJUSTABLE PACKING NUT AND TIGHTEN AS REQUIRED.

Style	Type	Material	Size	Options
V	590	P	-8	-00
Style	V-Valve			
Type	590-90 Male/Female 591-90 Male/Male			
Material	P- Brass			
Size	4-1/4" 6-3/8" 8-1/2"			
Options	04-Lever Handle 08-Unmarked Yellow Vinyl Handle Cover			

Note: 90° Ball Valve Series 590/591 has a tee handle as standard. A Lever Handle is available as option 04.

**K**

**90° Flow, Male-Female Pipe Ends XV590P**

PART NO.	PIPE THREAD	PTF HEX	H	K	L	M	N	D FLOW Ø
XV590P-4	1/4	15/16	1.25	1.08	2.50	1.00	2.42	.375
XV590P-6	3/8	15/16	1.25	1.09	2.50	1.00	2.43	.375
XV590P-8	1/2*	1-1/16	1.25	1.30	2.50	1.08	2.67	.500

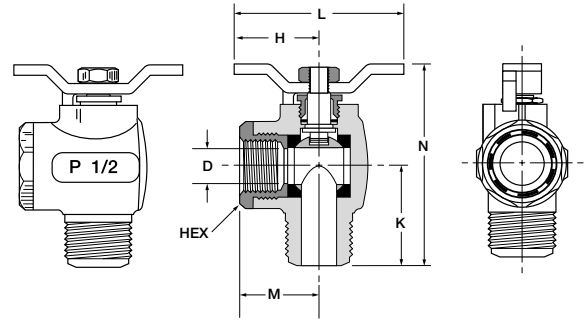

**Lever Handle, 90° Flow, Male-Female Pipe Ends XV590P-X-04**

PART NO.	PIPE THREAD	PTF HEX	H	K	L	M	N	D FLOW Ø
XV590P-4-04	1/4	15/16	3.96	1.08	4.96	1.00	3.02	.375
XV590P-6-04	3/8	15/16	3.96	1.09	4.96	1.00	3.03	.375
XV590P-8-04	1/2*	1-1/16	3.80	1.30	4.88	1.08	2.95	.500

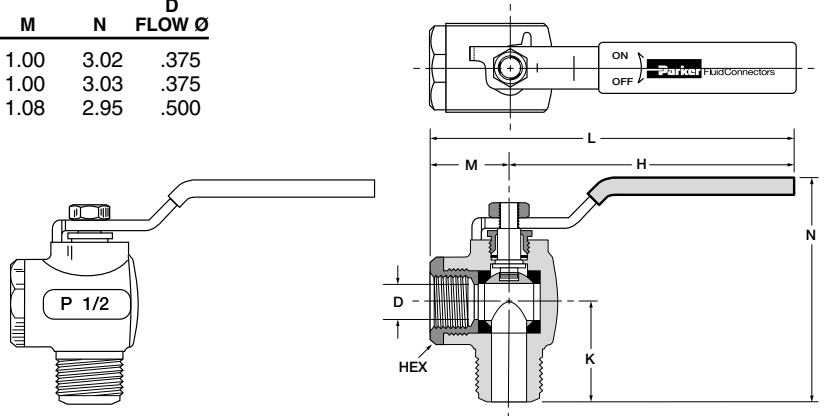

**90° Flow, Male-Male Pipe Ends XV591P**

PART NO.	PIPE THREAD	HEX	H	K	L	M	N	D FLOW Ø
XV591P-4	1/4	15/16	1.25	1.08	2.50	1.56	2.42	.375
XV591P-6	3/8	15/16	1.25	1.09	2.50	1.56	2.43	.375
XV591P-8	1/2	1-1/16	1.25	1.30	2.50	1.84	2.67	.500

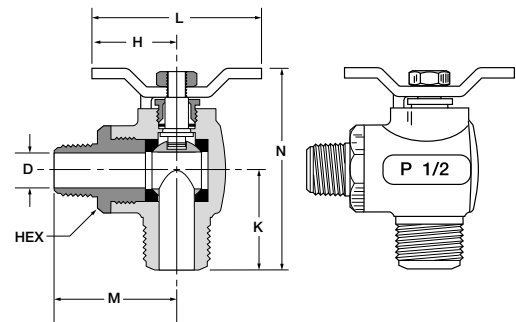

**Lever Handle, 90° Flow, Male-Male Pipe Ends XV591P-X-04**

PART NO.	PIPE THREAD	HEX	H	K	L	M	N	D FLOW Ø
XV591P-4-04	1/4	15/16	3.96	1.08	5.52	1.56	3.02	.375
XV591P-6-04	3/8	15/16	3.96	1.09	5.52	1.56	3.03	.375
XV591P-8-04	1/2	1-1/16	3.80	1.30	5.64	1.84	2.95	.500

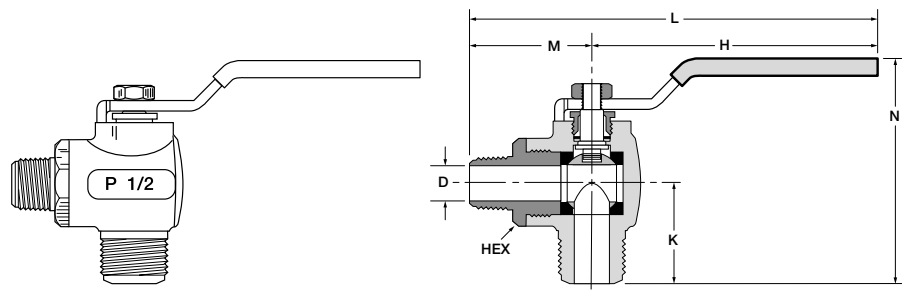

\*PTF special short

**K**

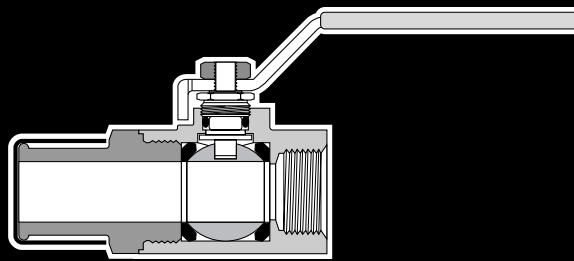

## Brass Hose Barb Ball Valves Series 500HB

### Advantages

Parker's forged body ball valve provides extended service life and resists failure caused by severe temperature applications. Optimum flow design assures maximum system efficiency. Highly inert PTFE seats and seals provide resistance to chemical corrosion. The hose barb end configuration eliminates as fitting and possible leak path. Parker also provides a blow-out proof stem, chrome plated brass ball and a specially designed handle enabling increased turning leverage for ease of opening and closing. Parker's ball valve can be readily identified assuring high quality engineering and reliability. Parker's ball valve bodies are machined from high quality CA 377 forgings.

### Applications

Parker's industrial ball valve product line is intended for general purpose use. Please be aware that ball valves are intended for use in the fully open or closed positions. Depending on application conditions, throttling of the valve may result in premature seal failure and/or inability to turn the valve handle. For use on construction equipment, chemical processing, plastic and rubber manufacturing, pumps, power units, and specialized industrial machinery requiring total shut-off capability.

### Working Pressure and Temperature

150 psi WOG and 350° F  
Saturated steam service up to 150 PSI and 350° F  
Vacuum, 29 Inches of Mercury

### Operating Instructions

Quarter turn is "ON" or "OFF".  
(Provides positive stop action for full shutoff.)

*Note: Periodically check the adjustable packing nut and tighten as required.*

### Brass Hose Barb Ball Valve XV500P-HB

PART NO.	PORT 1	PORT 2 PTF	B HEX	C HEX	H	L	M	N	FLOW DIA. D
XV500P-12-16HB	1	3/4*	1-1/4	1-5/16	3.96	6.25	3.41	2.81	.685

\*PTF special extra short

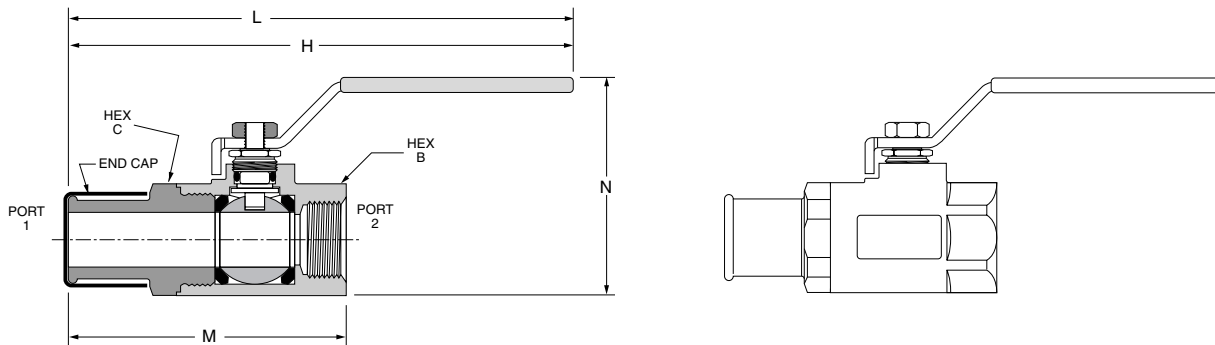

K

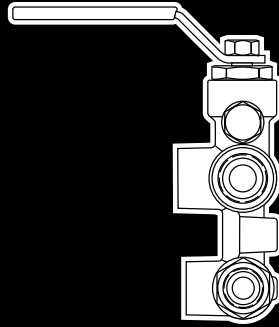

## Brass Ball Valves Series 600 Six Port Diversion

### Advantages

Parker's forged body ball valve provides extended service life and resists failure caused by severe temperature applications. Full flow design assures maximum system efficiency. Highly inert PTFE seats and seals provide resistance to chemical corrosion. Viton o-rings seal between the upper and lower halves protect against cross-contamination of fluids. Parker's ball valve can be readily identified assuring high quality engineering and reliability. This ball valve is available with female PTF ports. Parker's ball valve bodies are machined from high quality CA 377 forgings.

### Applications

This valve can be used on applications where a fluid return or spillback is required.

For use on construction equipment, chemical processing, diesel engines, filter banks, pumps and specialized industrial machinery.

NOTE: Diversion valves do not have off positions, therefore, the center ports can not be used for shut-off purposes.

### Working Pressure and Temperature

150 PSI and 250° F  
Vacuum, 29 Inches of Mercury

### Operating Instructions

Position handle in quarter-turn increments to desired flow configuration. Detent mechanism assists in accurately positioning handle.

### Series 600 Handle Positions

Position 1

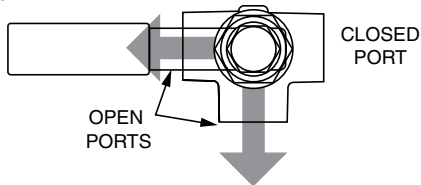

Position 2

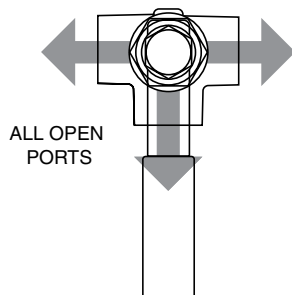

Position 3

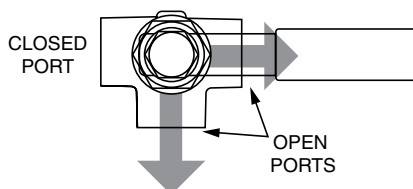

### Series 633 Handle Positions

Position 1

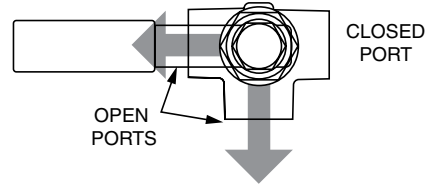

Position 2

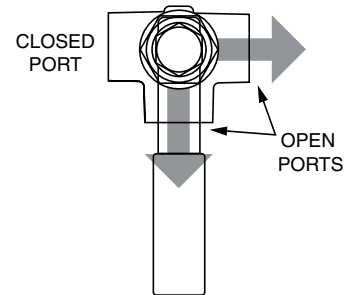

K

**Six Port Diversion Brass Valve XV600P**

PART NO.	PIPE THD. TOP PORT SPL SHORT	PIPE THD. BOTTOM PORT PTF	B HEX	C HEX	D1 FLOW	D2 FLOW	E	H	L	M	N	P	R	S	T	U	V	W	X
XV600P-8-6	1/2	3/8	1 1/16	15/16	.500	.375	.34	3.96	4.56	2.20	5.43	2.03	3.98	2.99	1.91	.73	.98	1.12	1.31

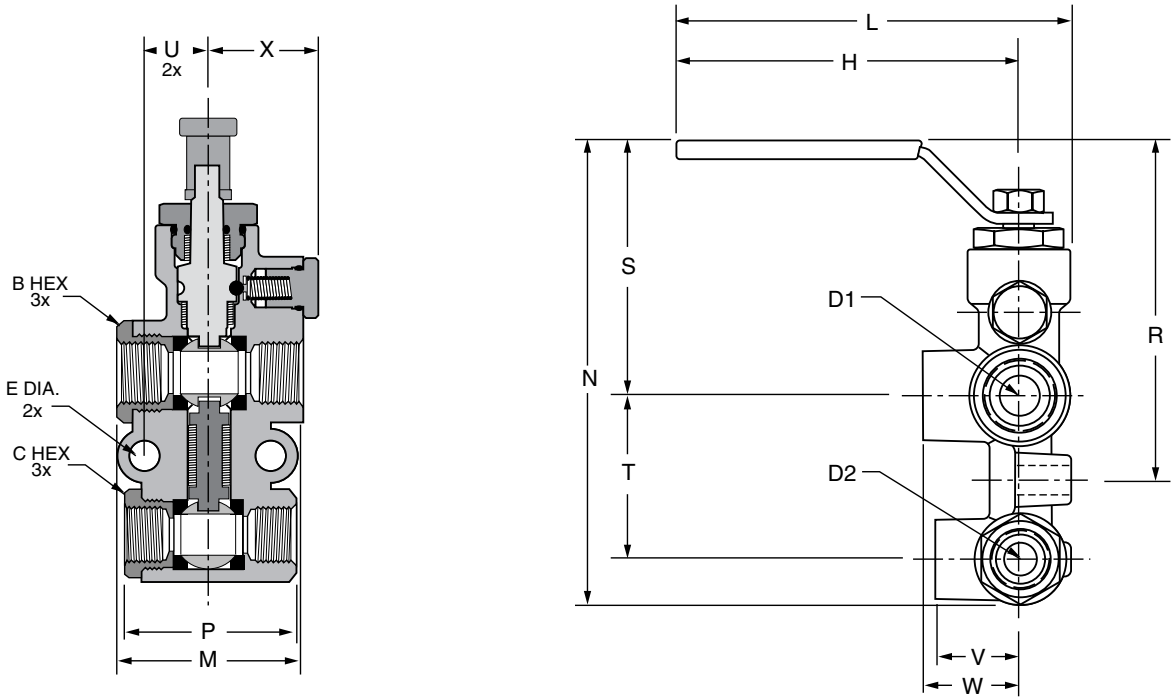

**Six Port Diversion Brass Valve XV633P**

PART NO.	PIPE THD. TOP PORT SPL SHORT	PIPE THD. BOTTOM PORT PTF	B HEX	C HEX	D1 FLOW	D2 FLOW	E	H	L	M	N	P	R	S	T	U	V	W	X
XV633P-8-6	1/2	3/8	1 1/16	15/16	.500	.375	.34	3.96	4.56	2.20	5.43	2.03	3.98	2.99	1.91	.73	.98	1.12	1.31

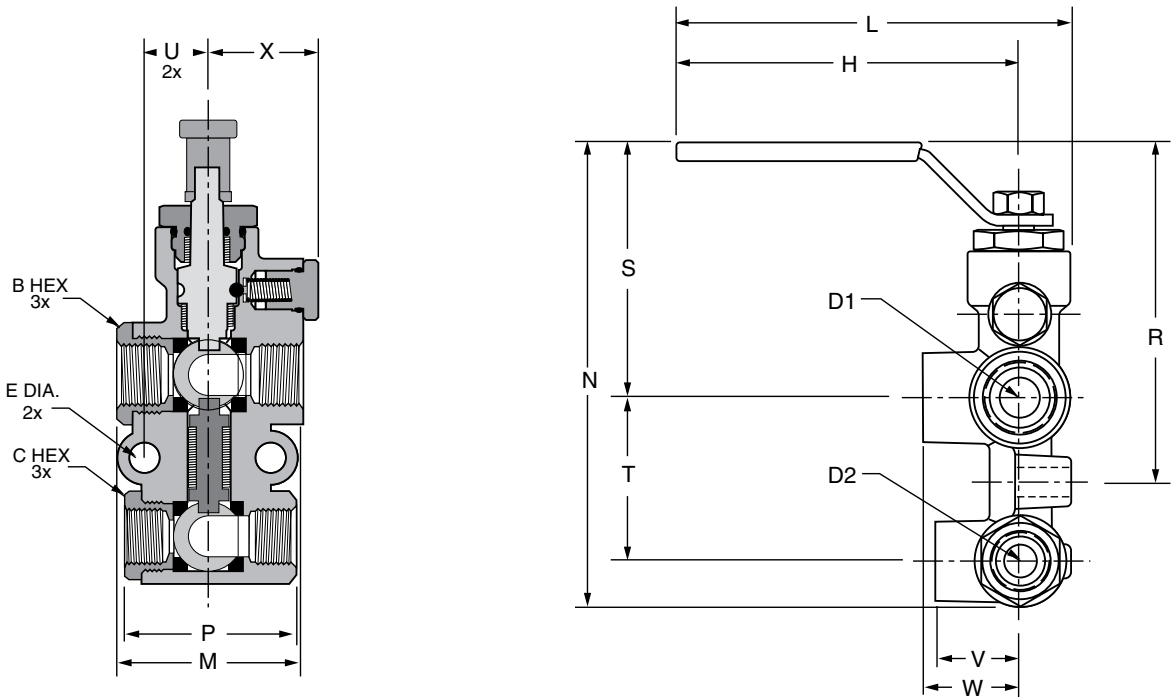



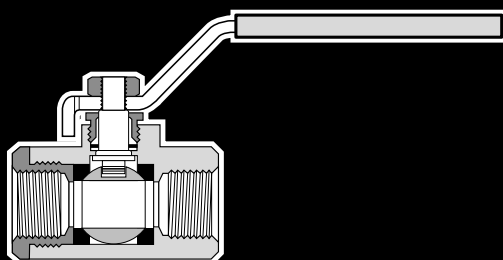

## Carbon Steel Ball Valves Series 500CS/502CS

### Advantages

Parker's carbon steel ball valves have a hex shaped body for easy installation. Highly inert PTFE seats and seals combined with an external phosphate coating provide superior corrosion resistance. Parker also provides a blow-out proof stem and a specially designed handle enabling increased turning leverage for ease of opening and closing. Parker's ball valve can be readily identified assuring high quality engineering and reliability. This economical ball valve is available in female pipe sizes.

### Applications

Parker's industrial ball valve product line is intended for general purpose use. Please be aware that ball valves are intended for use in the fully open or closed positions. Depending on application conditions, throttling of the valve may result in premature seal failure and/or inability to turn the valve handle.

For use as fuel line shutoffs for gasoline and diesel powered over the highway, off highway, and construction equipment vehicles. Hydraulic and general industrial applications on capital equipment and plant design plumbing that require total shutoff capability.

### Working Pressure and Temperature

Saturated steam service up to 150 PSI

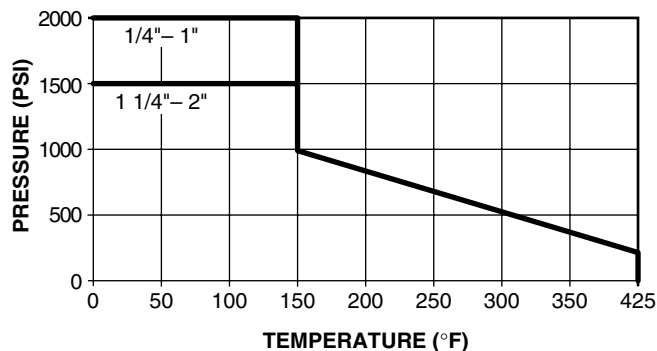

### Operating Instructions

Quarter turn is "ON" or "OFF".  
(Provides positive stop action for full shutoff.)

**NOTE:** PERIODICALLY CHECK THE ADJUSTABLE PACKING NUT AND TIGHTEN AS REQUIRED.

Style	Type	Material	Size	Options
V	500	CS	-4	-00
Style	V-Valve VP-Valve, Padlocking Handle			
Type	500-Female/Female PTF Ports			
Material	CS- Carbon Steel			
Size	4-1/4" 6-3/8" 8-1/2" 12-3/4" 16-1"			
Options	04-Tee Handle 21-Oval Handle			

Style	Type	Material	Size	Options
V	502	CS	-20	-00
Style	V-Valve VP-Valve, Padlocking Handle			
Type	502-Female/Female PTF Ports			
Material	CS- Carbon Steel			
Size	20-1 1/4" 24-1 1/2" 32-2"			
Options	04-Tee Handle 21-Oval Handle			

### Flow data

VALVE SIZE	CV
1/4	6.0
3/8	12.0
1/2	15.0
3/4	23.0
1	36.0
1 1/4	44.0
1 1/2	64.0
2	114.0

K

**Female-Female Pipe Ends XV500CS**

PART NO.	PIPE THREAD	B HEX	C HEX	H	L	M	N	D FLOW Ø
XV500CS-4	1/4	1-1/16	15/16	3.78	1.00	2.00	1.63	.400
XV500CS-6	3/8	1-1/16	15/16	3.78	1.00	2.00	1.63	.400
XV500CS-8	1/2	1-1/4	1-1/16	3.78	1.25	2.37	1.73	.540
XV500CS-12	3/4	1-5/8	1-3/8	5.10	1.50	2.90	2.08	.680
XV500CS-16	1	2	1-5/8	5.10	1.76	3.41	2.30	.880

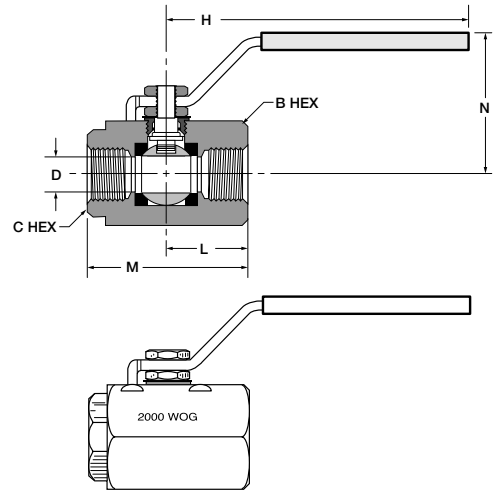

**Female-Female Pipe Ends, Panel Mount XV502CS**

PART NO.	PIPE THREAD	B HEX	C HEX	F	G	H	L	M	N	FLOW DIA. D
XV502CS-20	1-1/4	2	2-1/4	.94	1.50	6.10	1.87	3.80	2.76	1.000
XV502CS-24	1-1/2	2-5/16	2-1/2	.94	1.50	6.10	2.27	4.55	2.98	1.250
XV502CS-32	2	2-3/4	3	1.03	2.00	8.60	2.42	4.83	3.54	1.500

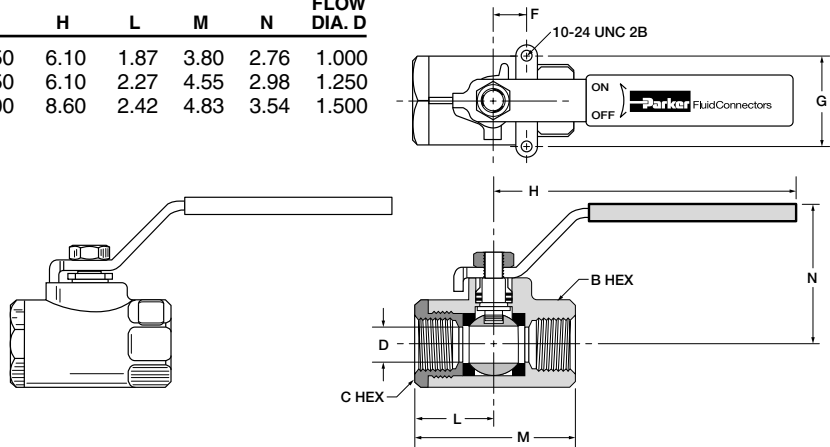

**Locking Handle, Female Pipe Ends XVP500CS**

PART NO.	PIPE THREAD	B HEX	C HEX	H	L	M	N	D FLOW Ø
XVP500CS-4	1/4	1-1/16	15/16	4.13	1.00	2.00	2.23	.400
XVP500CS-6	3/8	1-1/16	15/16	4.13	1.00	2.00	2.23	.400
XVP500CS-8	1/2	1-1/4	1-1/16	4.13	1.25	2.37	2.33	.540
XVP500CS-12	3/4	1-5/8	1-3/8	5.00	1.50	2.90	2.80	.680
XVP500CS-16	1	2	1-5/8	5.00	1.76	3.41	2.97	.880

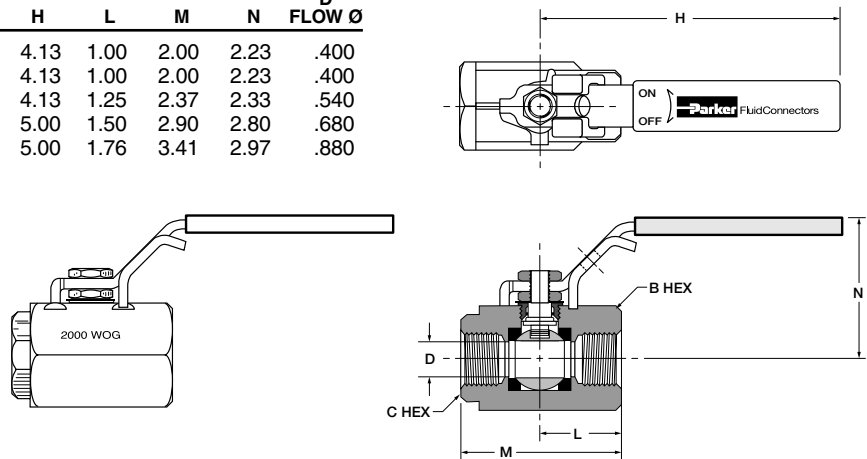

**Locking Handle, Female Pipe Ends, Panel Mount XVP502CS**

PART NO.	PIPE THREAD	B HEX	C HEX	F	G	H	L	M	N	FLOW DIA. D
XVP502CS-20	1-1/4	2	2-1/4	.94	1.50	7.50	1.87	3.80	3.15	1.000
XVP502CS-24	1-1/2	2-5/16	2-1/2	.94	1.50	7.50	2.27	4.55	3.37	1.250
XVP502CS-32	2	2-3/4	3	1.03	2.00	8.75	2.42	4.83	3.46	1.500

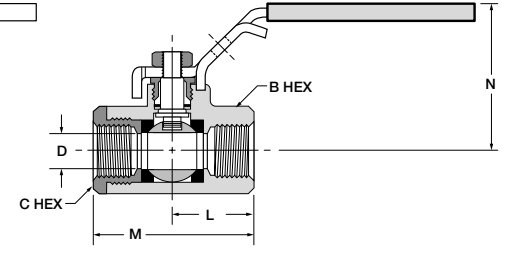
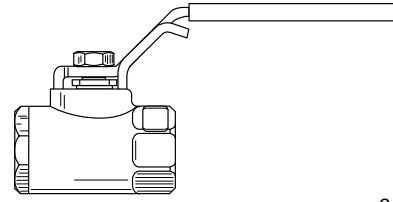
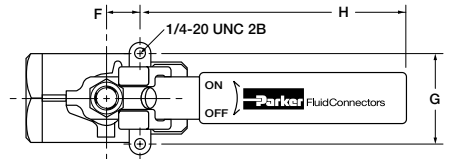

**Tee Handle, Female Pipe Ends XV500CS-X-04**

PART NO.	PIPE THREAD	B HEX	C HEX	H	L	M	N	D FLOW Ø
XV500CS-4-04	1/4	1-1/16	15/16	2.16	1.08	2.00	1.41	.400
XV500CS-6-04	3/8	1-1/16	15/16	2.16	1.08	2.00	1.41	.400
XV500CS-8-04	1/2	1-1/4	1-1/16	2.90	1.45	2.37	1.66	.540
XV500CS-12-04	3/4	1-5/8	1-3/8	3.63	1.81	2.90	2.06	.680
XV500CS-16-04	1	2	1-5/8	3.63	1.81	3.41	2.23	.880

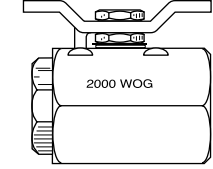
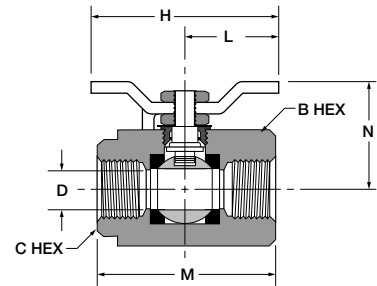

**Oval Handle, Female Pipe Ends XV500CS-X-21**

PART NO.	PIPE THREAD	B HEX	C HEX	H	L	M	N	D FLOW Ø
XV500CS-4-21	1/4	1-1/16	15/16	3.50	1.00	2.00	1.66	.400
XV500CS-6-21	3/8	1-1/16	15/16	3.50	1.00	2.00	1.66	.400
XV500CS-8-21	1/2	1-1/4	1-1/16	3.50	1.13	2.37	1.76	.540
XV500CS-12-21	3/4	1-5/8	1-3/8	5.00	1.46	2.90	2.13	.680
XV500CS-16-21	1	2	1-5/8	5.00	1.58	3.41	2.29	.880

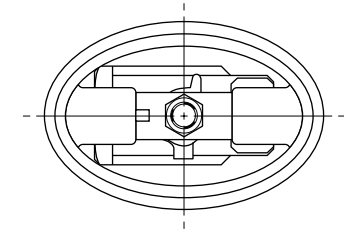
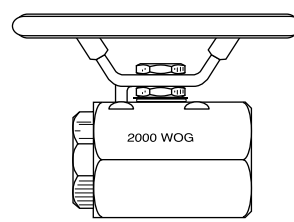
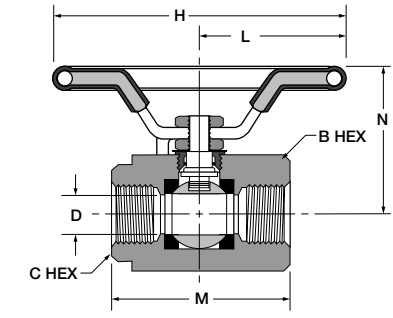

**K**

**Oval Handle, Female Pipe Ends, Panel Mount XV502CS-X-21**

PART NO.	PIPE THREAD	B HEX	C HEX	F	G	H	L	M	N	FLOW DIA. D
XV502CS-20-21	1-1/4	2	2-1/4	.94	1.50	5.07	2.53	3.80	3.04	1.000
XV502CS-24-21	1-1/2	2-5/16	2-1/2	.94	1.50	5.07	2.53	4.55	3.26	1.250
XV502CS-32-21	2	2-3/4	3	1.03	2.00	6.50	3.25	4.83	3.57	1.500

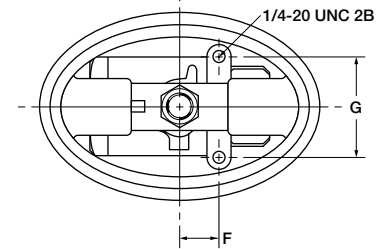
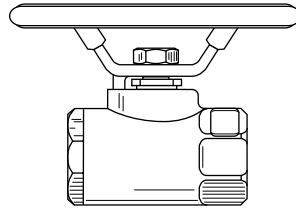
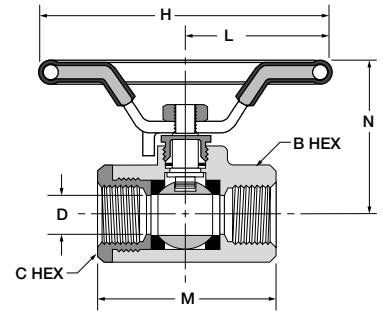

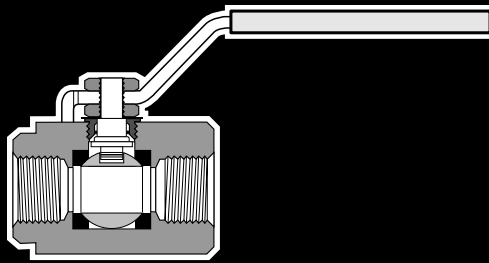

## Carbon Steel Ball Valves Series 506CS

### Advantages

Parker's carbon steel ball valves have a hex shaped body for easy installation. Highly inert PTFE seats and seals combined with an external phosphate coating provide superior corrosion resistance. Parker also provides a blow-out proof stem and a specially designed handle enabling increased turning leverage for ease of opening and closing. Parker's ball valve can be readily identified assuring high quality engineering and reliability. This economical ball valve is available in female SAE straight thread sizes. The full flow design allows for minimum flow restriction.

### Applications

Parker's industrial ball valve product line is intended for general purpose use. Please be aware that ball valves are intended for use in the fully open or closed positions. Depending on application conditions, throttling of the valve may result in premature seal failure and/or inability to turn the valve handle.

For use as fuel line shutoffs for gasoline and diesel powered over the highway, off highway, and construction equipment vehicles. Hydraulic and general industrial applications on capital equipment and plant design plumbing that require total shutoff capability.

### Working Pressure and Temperature

Saturated steam service up to 150 PSI

Vacuum, 29 inches of Mercury

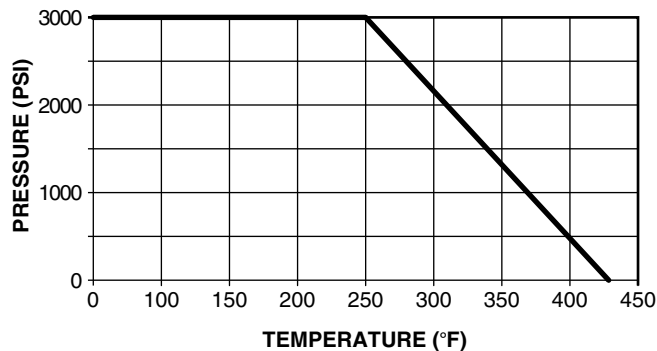

### Operating Instructions

Quarter turn is "ON" or "OFF".

(Provides positive stop action for full shutoff.)

Style	Type	Material	Size
V	506	CS	-4
Style	V-Valve VP-Valve, Padlocking Handle		
Type	506-Female/Female SAE Straight Thread Ports		
Material	CS-Carbon Steel		
Size	4-1/4" 6-3/8" 8-1/2" 12-3/4" 16-1"		

### Flow data

VALVE SIZE	CV
1/4	6.0
3/8	12.0
1/2	15.0
3/4	34.0
1	54.0

K

**Female-Female SAE Straight Thread Ports XV506CS**

PART NO.	STRAIGHT THREAD	B HEX	C HEX	H	L	M	N	D FLOW Ø
XV506CS-4	7/16-20	1-1/16	15/16	3.78	1.00	2.00	1.63	.400
XV506CS-6	9/16-18	1-1/16	15/16	3.78	1.00	2.00	1.63	.400
XV506CS-8	3/4-16	1-5/8	1-1/4	4.78	1.32	2.84	2.16	.500
XV506CS-12	1-1/16-12	1-7/8	1-5/8	4.78	1.66	3.71	2.35	.750
XV506CS-16	1-5/16-12	2-1/2	2-1/8	6.10	1.88	4.15	2.85	1.000

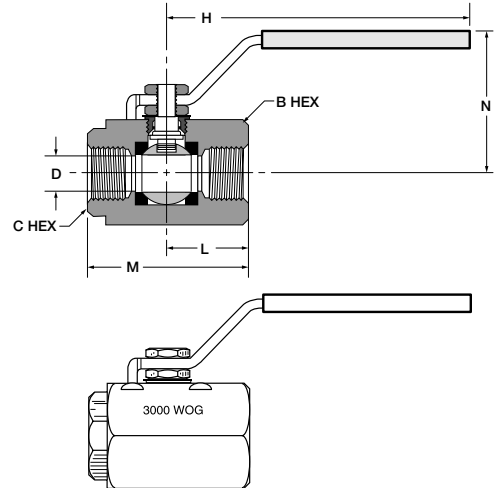

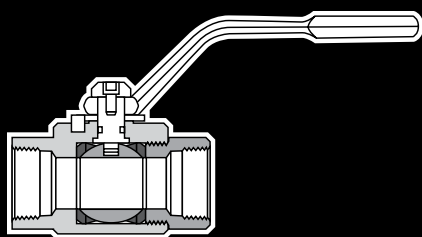

## High Pressure Carbon Steel Ball Valves Series 500HP, 506HP, 507HP

### Advantages

Parker's high pressure carbon steel ball valves feature a round or square body with hex shaped ports for easy installation. Delrin™ seats with Molybdenum disulphide (MoS<sub>2</sub>) results in lower actuation torque and will increase high duty life cycle expectancy. The stem seals are Nitrile O-Rings. All sizes are full ported, which means an unrestricted bore and minimum flow restriction. Available port configurations are NPT and SAE straight thread and ISO 6149 threads 1/4 inch through 2 inch.

### Applications

Parker's industrial ball valve product line is intended for general purpose use. Please be aware that ball valves are intended for use in the fully open or closed positions. Depending on application conditions, throttling of the valve may result in premature seal failure and/or inability to turn the valve handle.

For use as fuel line shutoffs for gasoline and diesel powered over the highway, off highway, and construction equipment vehicles. Hydraulic and general industrial applications on capital equipment and plant design plumbing that require total shutoff capability.

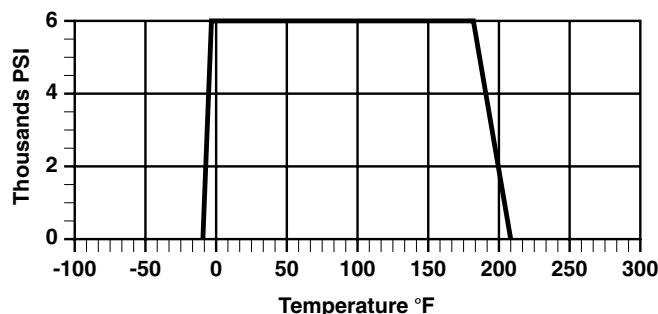

### Pressure Drop (PSI)

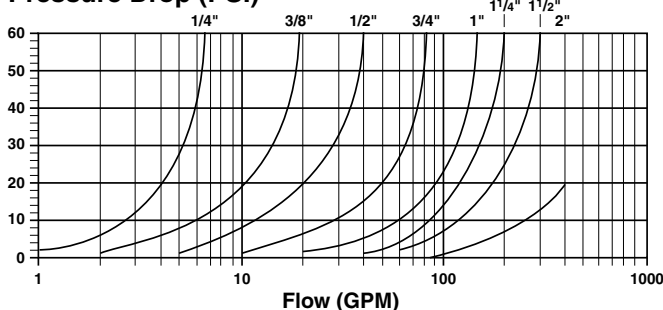

### Working Pressure and Temperature

#### Operating Instructions

Quarter turn is "ON" or "OFF".  
(Provides positive stop action for full shutoff.)

Style	Type	Material	Size
V	500	HP	-4
Style	V-Valve VP-Valve, Padlocking Handle		
Type	500-Female/Female NPT Ports		
Material	HP-High Pressure Carbon Steel		
Size	4-1/4" 6-3/8" 8-1/2" 12-3/4"	16-1" 20-1 1/4" 24-1 1/2" 32-2"	

Style	Type	Material	Size
V	506	HP	-20
Style	V-Valve VP-Valve, Padlocking Handle		
Type	506-Female/Female SAE Straight Thread Ports		
Material	HP-High Pressure Carbon Steel		
Size	4-1/4" 6-3/8" 8-1/2" 12-3/4"	16-1" 20-1 1/4" 24-1 1/2" 32-2"	

Style	Type	Material	Size
V	507	HP	-M18
Style	V-Valve		
Type	507-Female / Female ISO 6149 Ports		
Material	HP-High Pressure Carbon Steel		
Size	M18x1.5 M27x2		

K

**6000 PSI Female-Female Pipe Ends XV500HP-X**

PART NO.	PIPE THREAD [NPT]	B	C	H	L	M	N	FLOW DIA. D
XV500HP-4	1/4-18	.69	1.38	4.50	1.44	2.75	2.94	.240
XV500HP-6	3/8-18	.56	1.50	4.50	1.69	2.88	3.06	.390
XV500HP-8	1/2-14	.75	1.63	4.50	1.88	3.38	3.19	.510
XV500HP-12	3/4-14	.69	2.25	7.00	2.41	3.81	4.69	.790
XV500HP-16	1-11.5	.94	2.50	7.00	2.56	4.50	4.94	.950

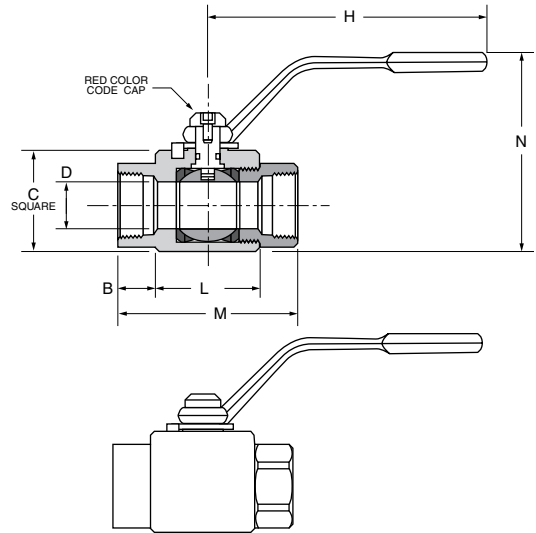

**6000 PSI Female-Female Pipe Ends XV500HP-X (LARGE)**

PART NO.	PIPE THREAD [NPT]	B	C	H	L	M	N	FLOW DIA. D
XV500HP-20	1 1/4-11.5	.85	3.25	10.00	3.15	4.84	6.31	1.26
XV500HP-24	1 1/2-11.5	.99	3.75	10.00	3.35	5.33	6.76	1.50
XV500HP-32	2-11.5	1.30	4.50	10.00	3.94	6.54	7.42	1.89

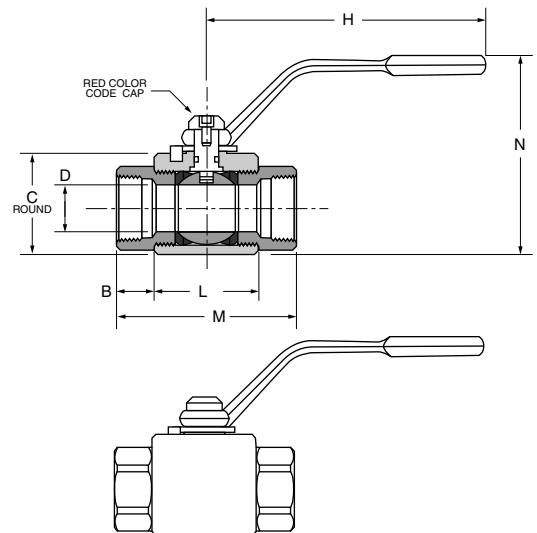

**6000 PSI Locking-Female-Female Pipe Ends XVP500HP-X**

PART NO.	PIPE THREAD [NPT]	B	C	H	L	M	N	FLOW DIA. D
XVP500HP-4	1/4-18	.69	1.38	4.50	1.44	2.75	2.94	.240
XVP500HP-6	3/8-18	.56	1.50	4.50	1.69	2.88	3.06	.390
XVP500HP-8	1/2-14	.75	1.63	4.50	1.88	3.38	3.19	.510
XVP500HP-12	3/4-14	.69	2.25	7.00	2.41	3.81	4.69	.790
XVP500HP-16	1-11.5	.94	2.50	7.00	2.56	4.50	4.94	.950

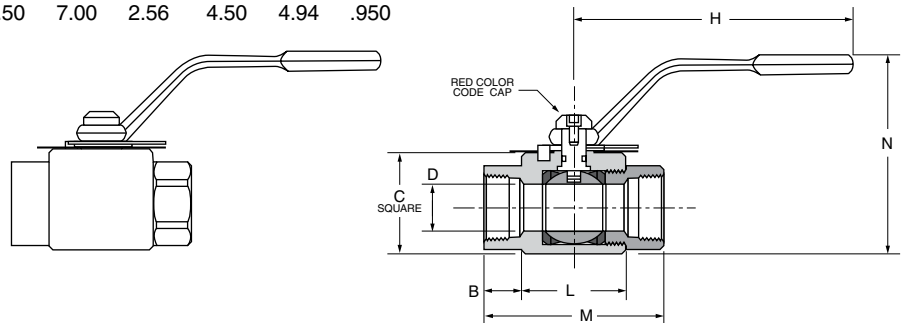



**6000 PSI Locking-Female-Female Pipe Ends XVP500HP-X (LARGE)**

PART NO.	PIPE THREAD [NPT]	B	C	H	L	M	N	FLOW DIA. D
XVP500HP-20	1 1/4-11.5	.85	3.25	10.00	3.15	4.84	6.31	1.26
XVP500HP-24	1 1/2-11.5	.99	3.75	10.00	3.35	5.33	6.76	1.50
XVP500HP-32	2-11.5	1.30	4.50	10.00	3.94	6.54	7.42	1.89

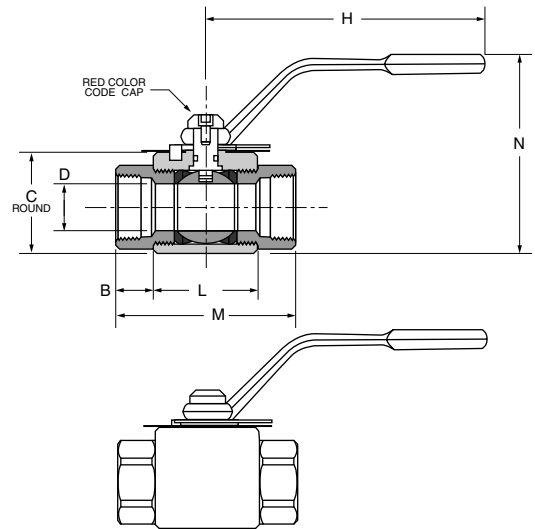

**6000 PSI Female-Female Straight Thread Ends XV506HP-X**

PART NO.	SAE J1926-1 THREAD	B	C	H	L	M	N	FLOW DIA. D
XV506HP-4	7/16-20 UNF	.69	1.38	4.50	1.44	2.75	2.94	.240
XV506HP-6	9/16-18 UNF	.56	1.50	4.50	1.69	2.88	3.06	.390
XV506HP-8	3/4-16 UNF	.75	1.63	4.50	1.88	3.38	3.19	.510
XV506HP-12	1 1/16-12 UNF	.69	2.25	7.00	2.41	3.81	4.69	.790
XV506HP-16	1 5/16-12 UNF	.94	2.50	7.00	2.56	4.50	4.94	.950

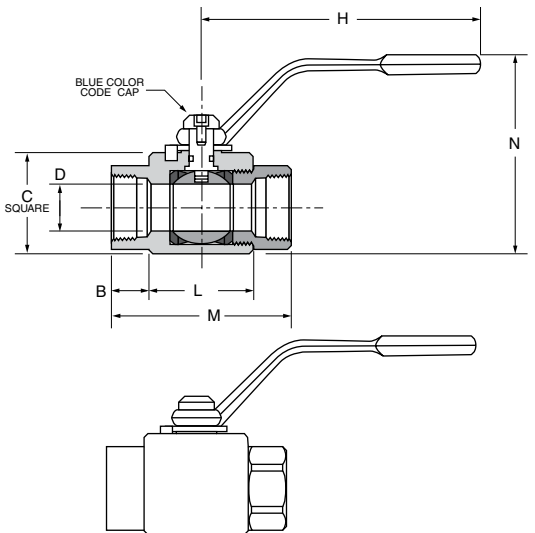

**6000 PSI Female-Female Straight Thread Ends XV506HP-X (LARGE)**

PART NO.	SAE J1926-1 THREAD	B	C	H	L	M	N	FLOW DIA. D
XV506HP-20	1 5/8-12 UNF	.85	3.25	10.00	3.15	4.84	6.31	1.26
XV506HP-24	1 7/8-12 UNF	.99	3.75	10.00	3.35	5.33	6.76	1.50
XV506HP-32	2 1/2-12 UNF	1.30	4.50	10.00	3.94	6.54	7.42	1.89

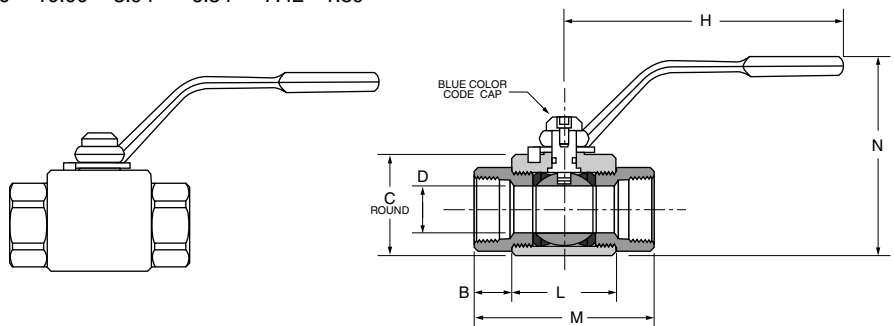

**6000 PSI Locking-Female-Female Straight Thread Ends XVP506HP-X**

PART NO.	SAE J1926-1 THREAD	B	C	H	L	M	N	FLOW DIA. D
XVP506HP-4	7/16-20 UNF	.69	1.38	4.50	1.44	2.75	2.94	.240
XVP506HP-6	9/16-18 UNF	.56	1.50	4.50	1.69	2.88	3.06	.390
XVP506HP-8	3/4-16 UNF	.75	1.63	4.50	1.88	3.38	3.19	.510
XVP506HP-12	1 1/16-12 UNF	.69	2.25	7.00	2.41	3.81	4.69	.790
XVP506HP-16	1 5/16-12 UNF	.94	2.50	7.00	2.56	4.50	4.94	.950

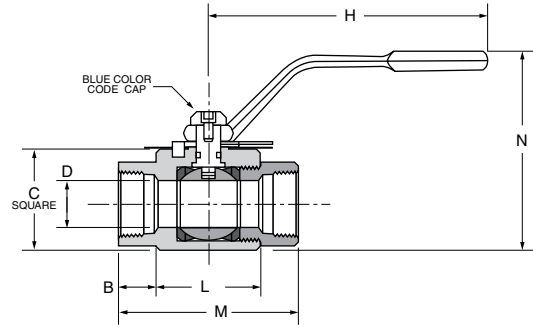
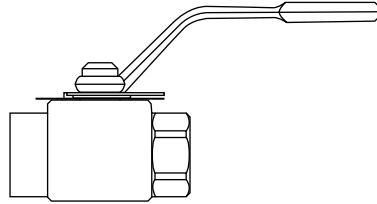

**6000 PSI Locking-Female-Female Straight Thread Ends XVP506HP-X (LARGE)**

PART NO.	SAE J1926-1 THREAD	B	C	H	L	M	N	FLOW DIA. D
XVP506HP-20	1 5/8-12 UNF	.85	3.25	10.00	3.15	4.84	6.31	1.26
XVP506HP-24	1 7/8-12 UNF	.99	3.75	10.00	3.35	5.33	6.76	1.50
XVP506HP-32	2 1/2-12 UNF	1.30	4.50	10.00	3.94	6.54	7.42	1.89

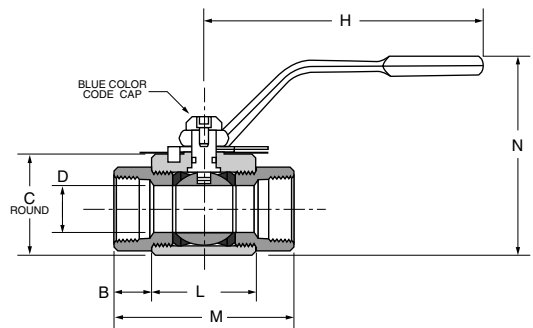
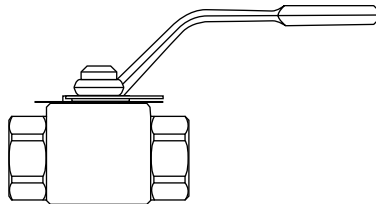

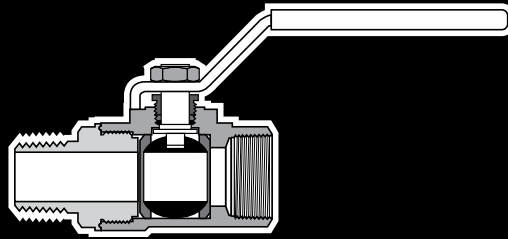

## Stainless Steel Ball Valves Series 501SS

### Advantages

Parker's Cast Body is manufactured from CF-8M Stainless Steel, the cast equivalent of 316 Stainless Steel. They are ideal for corrosive environments such as chemical plants and refineries. The full flow design assures maximum operating efficiency. The reinforced PTFE seats and seals, coupled with the 316 Stainless Ball and blow-out proof stem, result in the utmost reliability. This ball valve is available in 1/4", 3/8", 1/2", 3/4" and 1" female pipe sizes.

### Applications/Approvals

Parker's industrial ball valve product line is intended for general purpose use. Please be aware that ball valves are intended for use in the fully open or closed positions. Depending on application conditions, throttling of the valve may result in premature seal failure and/or inability to turn the valve handle.

Applications include chemical plants, refineries, steel mills, industrial fuel lines and agricultural equipment. Meets material requirements of NACE MR-01-75.

### Working Pressure/Temperature

Saturated steam service rating up to 150 PSI and 400° F.

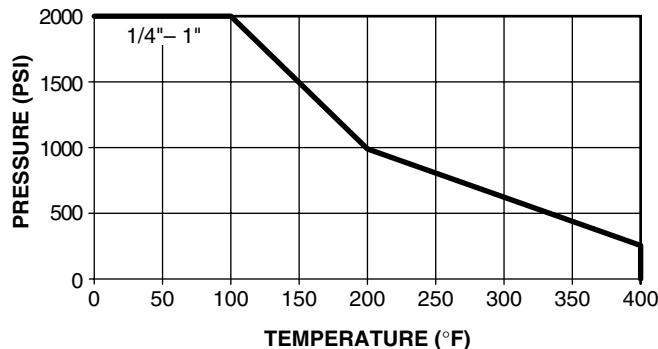

Style	Type	Material	Size	Options
V	501	SS	-4	-00
Style	V-Valve			
Type	501-Male/Female NPT Ports			
Material	SS-Stainless Steel			
Size	4-1/4" 6-3/8" 8-1/2" 12-3/4" 16-1"			

### Flow data

VALVE SIZE	CV
1/4	4.0
3/8	6.0
1/2	14.0
3/4	35.0
1	54.0

### Operating Instructions

Quarter turn is "ON" or "OFF".  
(Provides positive stop action for full shutoff.)

**NOTE:** PERIODICALLY CHECK THE ADJUSTABLE PACKING NUT AND TIGHTEN AS REQUIRED.

**K**

**Male-Female Pipe Ends XV501SS**

PART NO.	PIPE THREAD [NPT]	HEX	F	G	L	M	N	D FLOW Ø
XV501SS-4	1/4	15/16	.50	1.12	5.60	2.65	1.97	.280
XV501SS-6	3/8	15/16	.50	1.12	5.60	2.65	1.97	.375
XV501SS-8	1/2	1-1/16	.50	1.12	5.85	3.05	2.00	.500
XV501SS-12	3/4	1-3/8	.88	1.37	7.27	3.85	2.55	.720
XV501SS-16	1	1-5/8	.88	1.37	7.48	4.25	2.68	.940

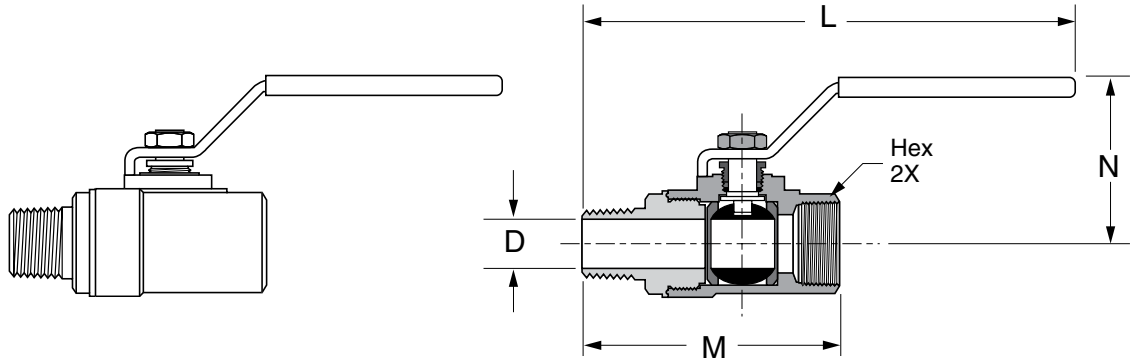
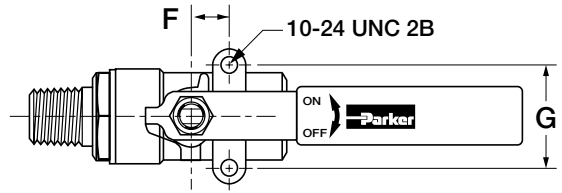

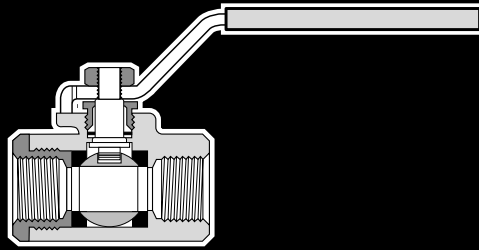

## Stainless Steel Ball Valves Series 502SS

### Advantages

Parker's Cast Body is manufactured from CF-8M Stainless Steel, the cast equivalent of 316 Stainless Steel. They are ideal for corrosive environments such as chemical plants and refineries. The full flow design assures maximum operating efficiency. The reinforced PTFE seats and seals, coupled with the 316 Stainless Ball and blow-out proof stem, result in the utmost reliability. These ball valves are available in 1/4", 3/8", 1/2" (502SS), and 3/4", 1", 1-1/4", 1-1/2" and 2" (500SS) female pipe sizes.

### Applications/Approvals

Parker's industrial ball valve product line is intended for general purpose use. Please be aware that ball valves are intended for use in the fully open or closed positions. Depending on application conditions, throttling of the valve may result in premature seal failure and/or inability to turn the valve handle.

Applications include chemical plants, refineries, steel mills, industrial fuel lines and agricultural equipment. Meets material requirements of NACE MR-01-75.

### Working Pressure/Temperature

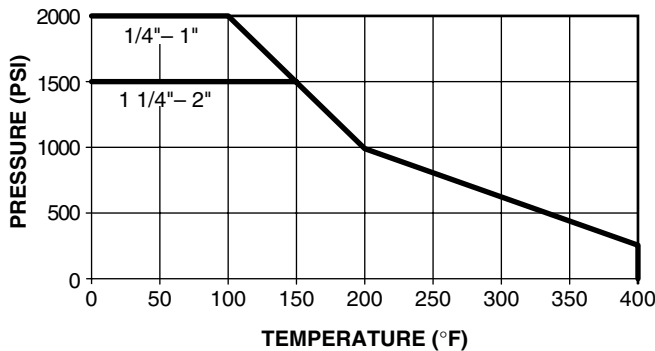

Saturated steam service rating up to 150 PSI and 400° F.

### Operating Instructions

Quarter turn is "ON" or "OFF".  
(Provides positive stop action for full shutoff.)

**NOTE:** PERIODICALLY CHECK THE ADJUSTABLE PACKING NUT AND TIGHTEN AS REQUIRED.

Style	Type	Material	Size	Options
V	502	SS	-4	-00
Style	V-Valve VP-Valve, Padlocking Handle			
Type	502-Panel Mount Female/Female PTF Ports			
Material	SS-Stainless Steel			
Size	4-1/4" 6-3/8" 8-1/2" 12-3/4"	16-1" 20-1 1/4" 24-1 1/2" 32-2"		
Options	20-Short Handle 21-Oval Handle 35-Welded Retainer Nut			

### Flow data 502SS

VALVE SIZE	CV
1/4	4.0
3/8	6.0
1/2	14.0
3/4	35.0
1	54.0
1 1/4	74.0
1 1/2	120.0
2	226.0

### 502SS Mounting detail

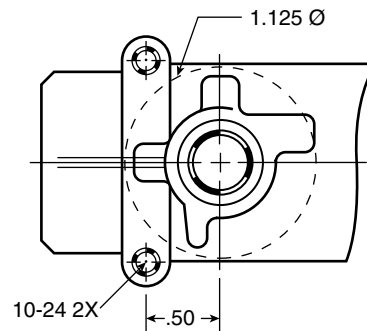

**K**

**Female Pipe Ends, Panel Mount XV502SS**

PART NO.	PIPE THREAD (NPT)	B/C HEX	F	G	H	I THREAD	L	M	N	FLOW DIA. D	PANEL HOLE DIA.
XV502SS-4	1/4	15/16	.500	1.125	4.00	10-24 UNC	5.03	2.07	2.52	.380	1.125
XV502SS-6	3/8	15/16	.500	1.125	4.00	10-24 UNC	5.03	2.07	2.52	.380	1.125
XV502SS-8	1/2	1-1/16	.500	1.125	4.00	10-24 UNC	5.13	2.27	2.65	.500	1.125
XV502SS-12	3/4	1-3/8	.875	1.375	5.00	10-24 UNC	6.67	3.35	3.46	.790	1.500
XV502SS-16	1	1-5/8	.875	1.375	5.00	10-24 UNC	6.77	3.54	3.74	1.000	1.500
XV502SS-20	1-1/4	2	1.000	1.500	7.00	1/4-20 UNC	9.00	4.00	4.55	1.250	2.000
XV502SS-24	1-1/2	2-3/8	1.000	1.500	7.00	1/4-20 UNC	7.19	4.38	5.42	1.500	2.000
XV502SS-32	2	3	1.000	1.500	7.00	1/4-20 UNC	9.75	5.50	5.68	2.000	2.000

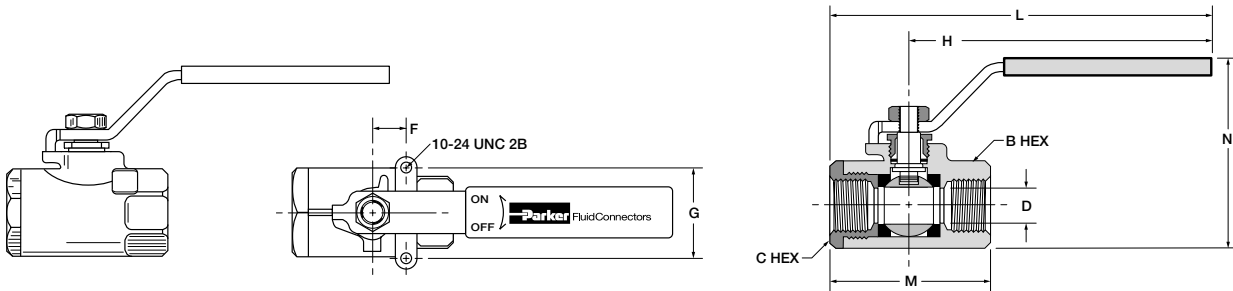

**Short Handle, Female Pipe Ends, Panel Mount XV502SS-X-20**

PART NO.	PIPE THREAD [NPT]	B/C HEX	G	H	L	M	N	FLOW DIA. D
XV502SS-4-20	1/4	15/16	1.12	2.28	3.32	2.07	2.53	.375
XV502SS-6-20	3/8	15/16	1.12	2.28	3.32	2.07	2.53	.375
XV502SS-8-20	1/2	1-1/16	1.12	2.22	3.37	2.25	2.63	.500

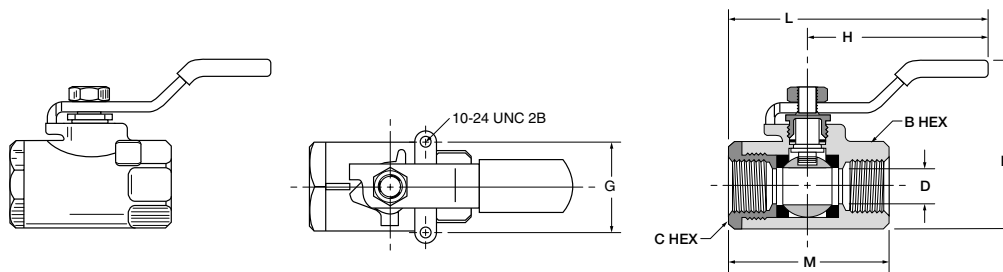

**Locking Handle, Female Pipe Ends, Panel Mount XVP502SS**

PART NO.	PIPE THREAD (NPT)	B/C HEX	F	G	H	I THREAD	L	M	N	FLOW DIA. D	PANEL HOLE DIA.
XVP502SS-4	1/4	15/16	.500	1.125	4.00	10-24 UNC	5.03	2.07	2.52	.380	1.125
XVP502SS-6	3/8	15/16	.500	1.125	4.00	10-24 UNC	5.03	2.07	2.52	.380	1.125
XVP502SS-8	1/2	1-1/16	.500	1.125	4.00	10-24 UNC	5.13	2.27	2.65	.500	1.125
XVP502SS-12	3/4	1-3/8	.875	1.375	5.00	10-24 UNC	6.67	3.35	3.46	.790	1.500
XVP502SS-16	1	1-5/8	.875	1.375	5.00	10-24 UNC	6.77	3.54	3.74	1.000	1.500
XVP502SS-20	1-1/4	2	1.000	1.500	7.00	1/4-20 UNC	9.00	4.00	4.55	1.250	2.000
XVP502SS-24	1-1/2	2-3/8	1.000	1.500	7.00	1/4-20 UNC	7.19	4.38	5.42	1.500	2.000
XVP502SS-32	2	3	1.000	1.500	7.00	1/4-20 UNC	9.75	5.50	5.68	2.000	2.000

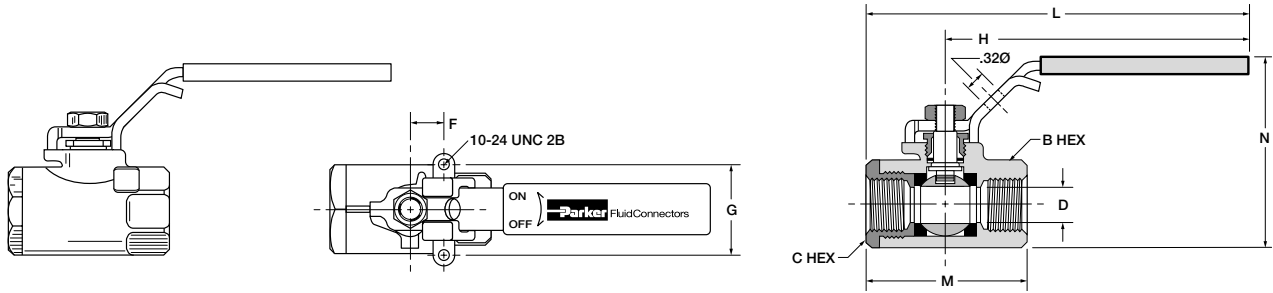

**Oval Handle, Female Pipe Ends, Panel Mount XV502SS-X-21**

PART NO.	PIPE THREAD (NPT)	B/C HEX	G	H	L	I THREAD	M	N	FLOW DIA. D	PANEL HOLE DIA.
XV502SS-4-21	1/4	15/16	1.125	1.74	3.48	10-24 UNC	2.07	2.43	.380	1.125
XV502SS-6-21	3/8	15/16	1.125	1.74	3.48	10-24 UNC	2.07	2.43	.380	1.125
XV502SS-8-21	1/2	1-1/16	1.125	1.74	3.48	10-24 UNC	2.27	2.54	.500	1.125
XV502SS-12-21	3/4	1-3/8	1.375	2.68	5.36	10-24 UNC	3.35	3.45	.790	1.500
XV502SS-16-21	1	1-5/8	1.375	2.68	5.36	10-24 UNC	3.54	3.74	1.000	1.500
XV502SS-20-21	1-1/4	2	1.500	3.27	6.53	1/4-20 UNC	4.00	4.54	1.250	2.000
XV502SS-24-21	1-1/2	2-3/8	1.500	3.27	6.53	1/4-20 UNC	4.38	4.93	1.500	2.000
XV502SS-32-21	2	3	1.500	3.27	6.53	1/4-20 UNC	5.50	5.67	2.000	2.000

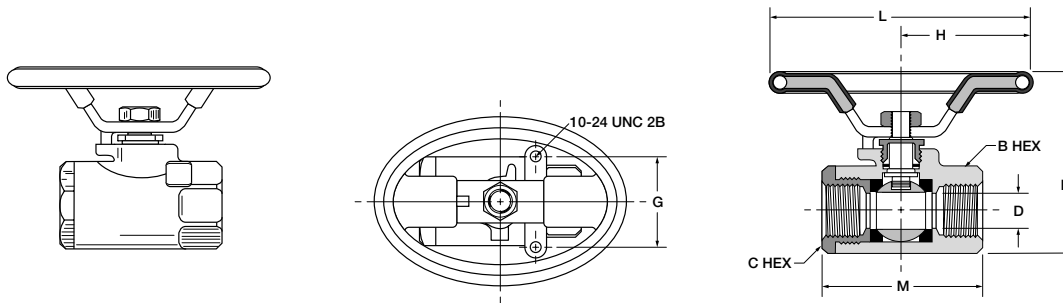

**K**

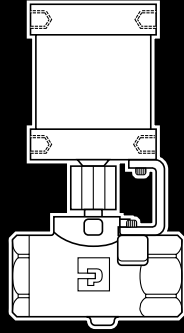

## Rotary Actuator Ball Valves Series ACT

### Parker... Leading the Industry

Parker combines many years of vane actuator experience with innovative product design to lead the industry in the development of reliable and efficient rotary actuators. When you specify Parker rotary vane actuators, you can rely on reduced maintenance costs and increased productivity.

### How Do Vane Actuators Work?

Parker vane actuators provide the maximum amount of output torque from the smallest possible envelope size. They convert fluid power pressure into rotary motion for a wide variety of industrial applications. Double vane units produce twice the torque output of single vane actuators from identical envelope dimensions and have a maximum rotation of 95°.

A short cylindrical chamber encloses a vane attached to a central shaft. Fluid pressure differential is applied through a stationary barrier (stator) within the cylinder to one side of the vane. The opposite side of the vane is connected to exhaust through the stator. This pressure differential produces rotation of the vane and central shaft. Due to vane actuator design there will always be some internal bypass in these units.

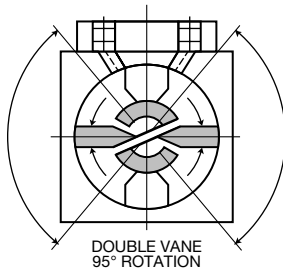

### Why Use Parker Vane Style Rotary Actuator Ball Valves?

- Provides uniform torque in both directions.
- Zero backlash allows precise positioning.
- Simplicity of design.
- Performs under the most adverse ambient conditions.
- No external linkage needed for rotary motion.
- Guaranteed zero external leakage.
- More efficient operation and longer time between servicing.

### Where Can Parker Rotary Actuator Ball Valves Be Used?

- Remote Valve Actuation
- Material Handling
- Machine Tool
- Rubber and Plastics
- Machinery
- Mobile Equipment
- Robotics
- Packaging
- Multi-Process Industry
- Military/Commercial Marine
- Food Processing
- Electronics Manufacturing
- Transfer Lines

### Act Series Features

- ON - OFF indicator
- Compact Profile
- Actuator ambient temperature with nitrile seals is -40° to 180°F
- 150 PSI maximum air pressure to actuator
- See specific part number for the minimum breakaway pressure
- Stainless steel ball and stem as standard

**K**



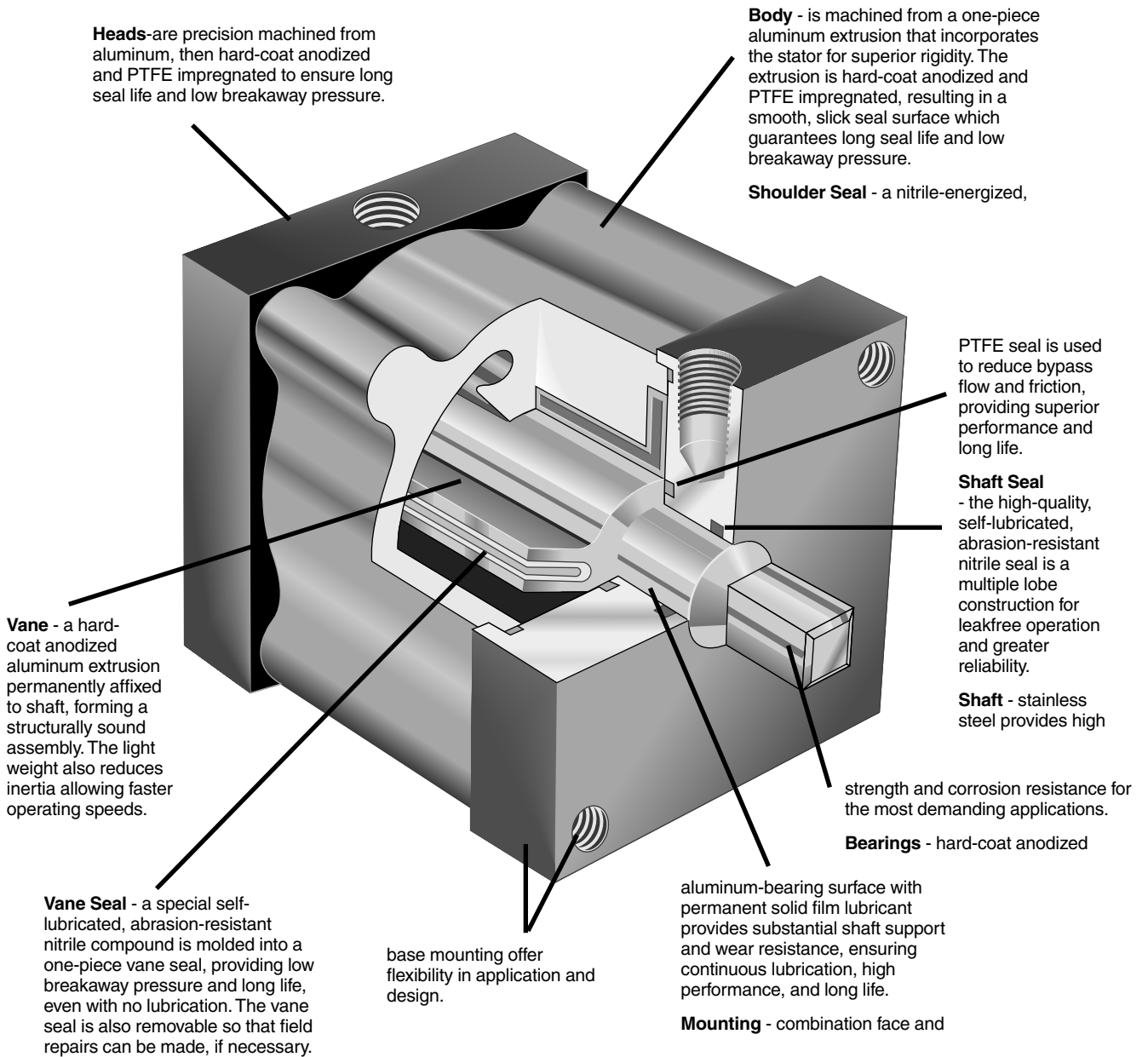

**K**

**Rotary Actuator, Female Pipe Ends XV502P-X-ACT**

PART . NO	SIZE	A MTG. HOLES	B	C	D	E	F	G	H HEX	I HEX	J UNC	K NPTF	L	FLOW DIA.	FLOW CV	MIN. ACT PRESSURE (PSI)
XV502P-4-ACT	1/4	1/4-20 UNC	5.25	4.47	1.91	2.03	1.00	1/4-18PTF	15/16	15/16	10-24	1/8-27	1.06	.375	4.0	50
XV502P-6-ACT	3/8	1/4-20 UNC	5.25	4.47	1.91	2.03	1.00	3/8-18PTF	15/16	15/16	10-24	1/8-27	1.06	.375	5.8	50
XV502P-8-ACT	1/2	1/4-20 UNC	5.38	4.54	1.98	2.20	1.09	1/2-14PTF*	1-1/16	1-1/16	10-24	1/8-27	1.19	.500	12.0	50
XV502P-12-ACT	3/4	1/4-20 UNC	5.57	4.63	2.07	2.42	1.29	3/4-14PTF**	1-5/16	1-1/4	10-24	1/8-27	1.38	.685	25.0	75
XV502P-16-ACT	1	1/4-20 UNC	5.85	4.76	2.20	2.75	1.38	1-11.5PTF**	1-9/16	1-1/2	10-24	1/8-27	1.67	.875	35.0	75

**Stainless Steel Rotary Actuator, Female Pipe Ends XV502SS-X-ACT**

PART . NO	SIZE	A MTG. HOLES	B	C	D	E	F	G	H / I HEX	J	K NPTF	L	FLOW DIA.	FLOW CV
XV502SS-4-ACT	1/4	1/4-20 UNC	5.41	4.61	2.05	2.07	1.04	1/4-18 NPT	15/16	10-24	1/8-27	1.10	.375	4.0
XV502SS-6-ACT	3/8	1/4-20 UNC	5.41	4.61	2.05	2.07	1.04	3/8-18 NPT	15/16	10-24	1/8-27	1.10	.375	6.0
XV502SS-8-ACT	1/2	1/4-20 UNC	5.53	4.64	2.08	2.27	1.17	1/2-14 NPT	1 1/16	10-24	1/8-27	1.28	.500	14.0

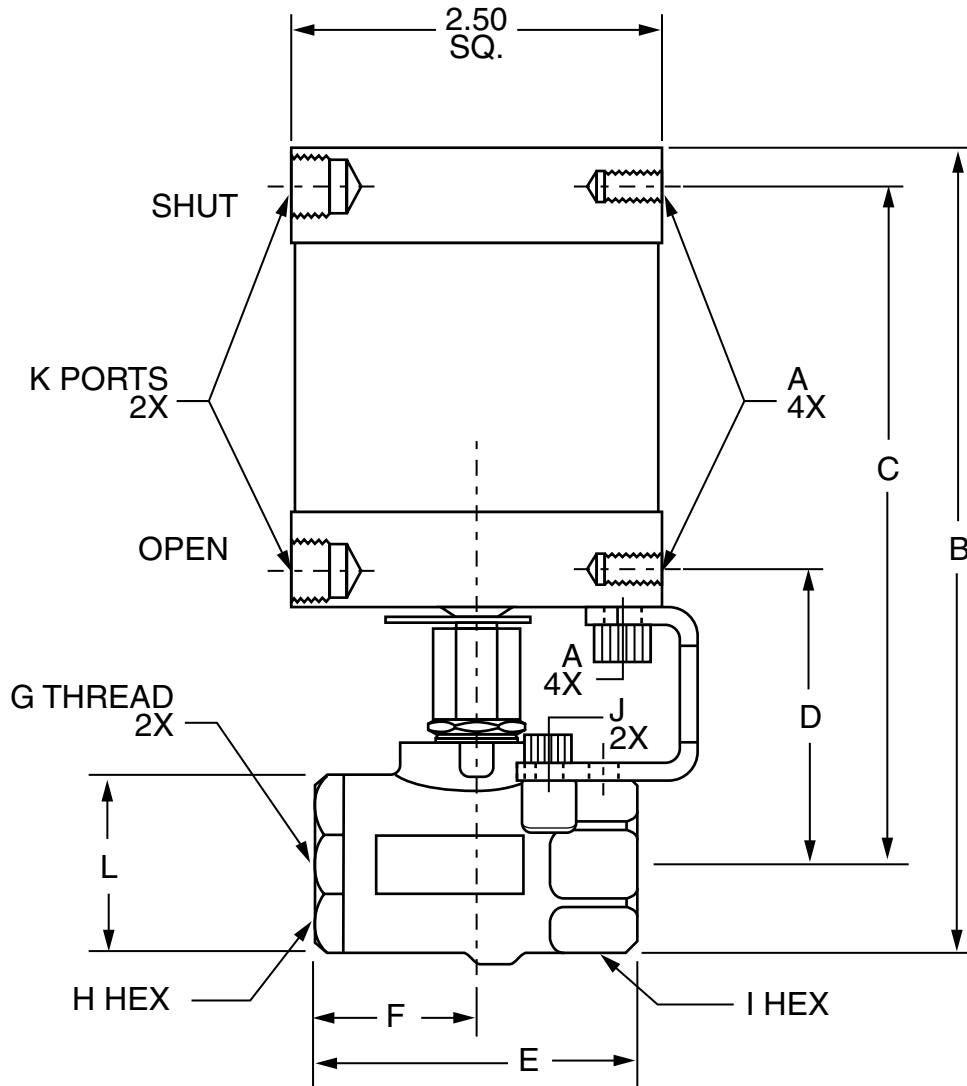

\*PTF special short. \*\*PTF special extra short

**Actuator Sub-Assembly XV502P-X-SUB**

PART NO	SIZE	A UNC	B	C	D	E	F	G	H HEX	I HEX	J	K
XV502P-4-SUB	1/4	10-24	1.68	1.15	.495	2.03	.50	1.12	15/16	15/16	1.06	1/4-18 PTF
XV502P-6-SUB	3/8	10-24	1.68	1.15	.495	2.03	.50	1.12	15/16	15/16	1.06	3/8-18 PTF
XV502P-8-SUB	1/2	10-24	1.78	1.19	.565	2.20	.50	1.12	1-1/16	1-1/16	1.19	1/2-14 PTF*
XV502P-12-SUB	3/4	10-24	2.09	1.40	.655	2.42	.87	1.37	1-5/16	1-1/4	1.38	3/4-14 PTF**
XV502P-16-SUB	1	10-24	2.38	1.54	.785	2.75	.87	1.37	1-9/16	1-1/2	1.67	1-11.5 PTF**

\* PTF Special Short

\*\* PTF Special Extra Short

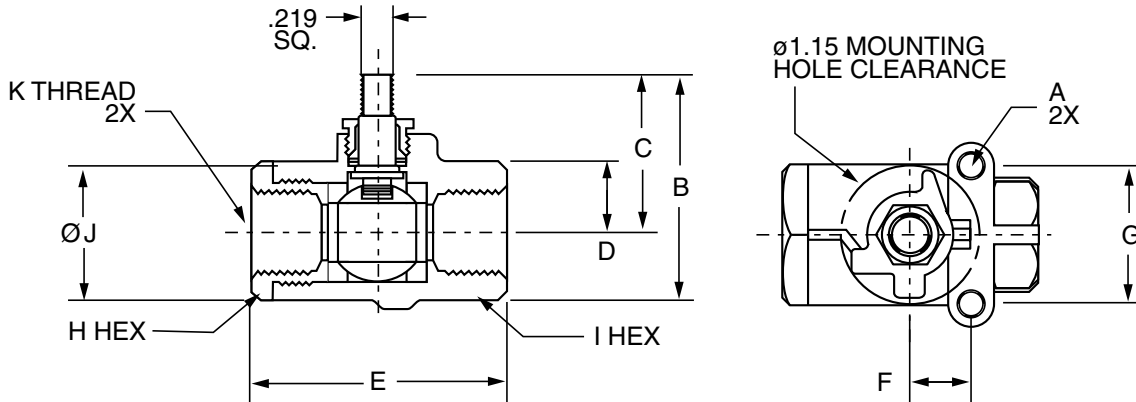

**Actuator Sub-Assembly XV502SS-X-SUB**

PART NO	SIZE	A UNC	B	C	D	E	F	G	H HEX	J	K
XV502SS-4-SUB	1/4	10-24	1.88	1.32	.63	2.07	.50	1.12	15/16	1.10	1/4-18 NPT
XV502SS-6-SUB	3/8	10-24	1.88	1.32	.63	2.07	.50	1.12	15/16	1.10	3/8-18 NPT
XV502SS-8-SUB	1/2	10-24	2.00	1.35	.66	2.27	.50	1.12	1-1/16	1.28	1/2-14 NPT

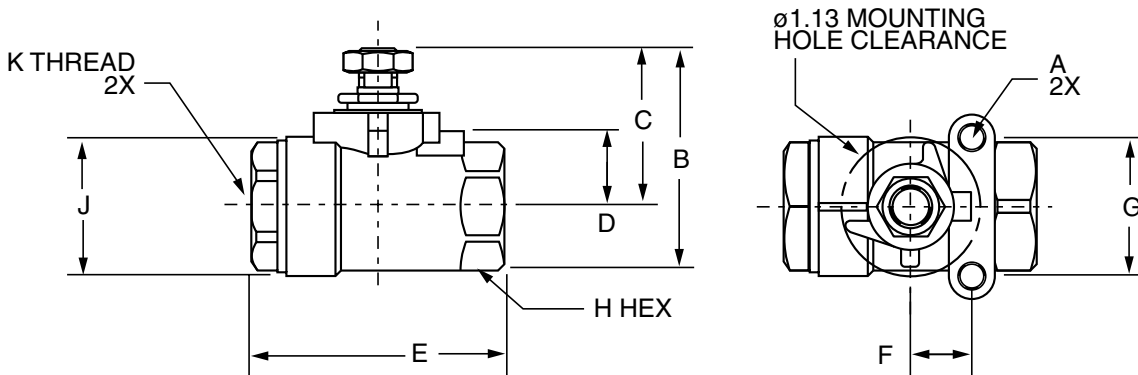

**K**

**ACT-P-X-KIT**

PART NO.	FOR USE WITH	A	B	C	D	E	F
ACT-P-1-KIT	XV502P-4, 6, 8-ACT	10-24 UNC	1/4-20 UNC	BRACKET	.60 LONG COUPLING	POSITION INDICATOR	POSITION LABEL
ACT-P-2-KIT	XV502P-12, 16-ACT	10-24 UNC	1/4-20 UNC	BRACKET	.55 LONG COUPLING	POSITION INDICATOR	POSITION LABEL

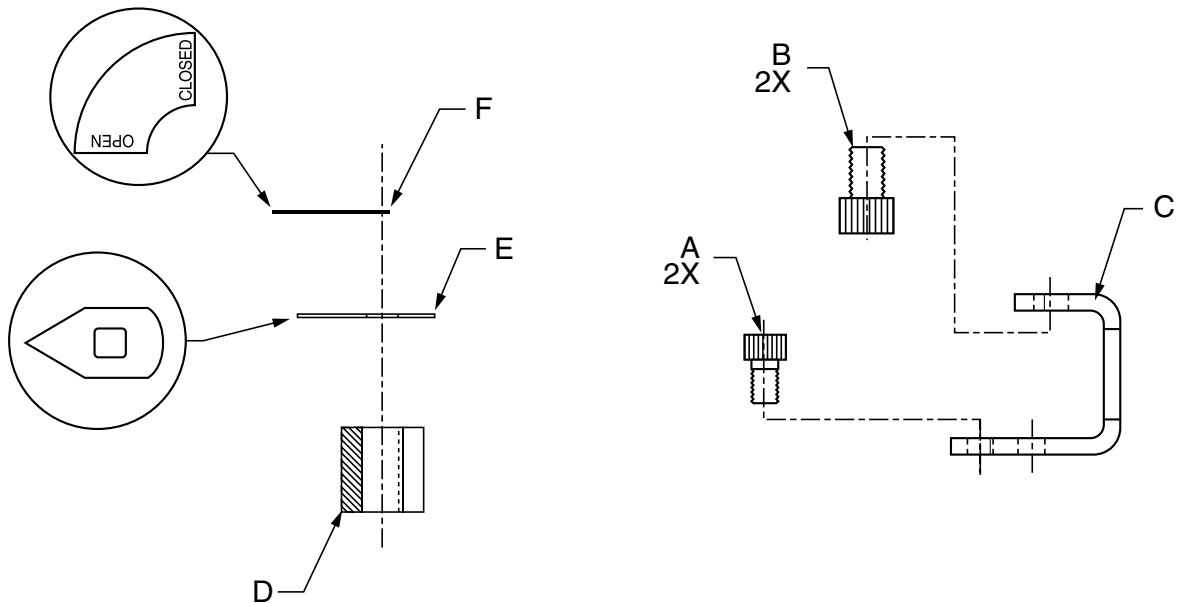

**ACT-SS-X-KIT**

PART NO.	FOR USE WITH	A	B	C	D	E	F
ACT-SS-1-KIT	XV502SS-4, 6, 8-ACT	10-24 UNC	1/4-20 UNC	BRACKET	CLIP	HANDLE YOKE	SNAP RING

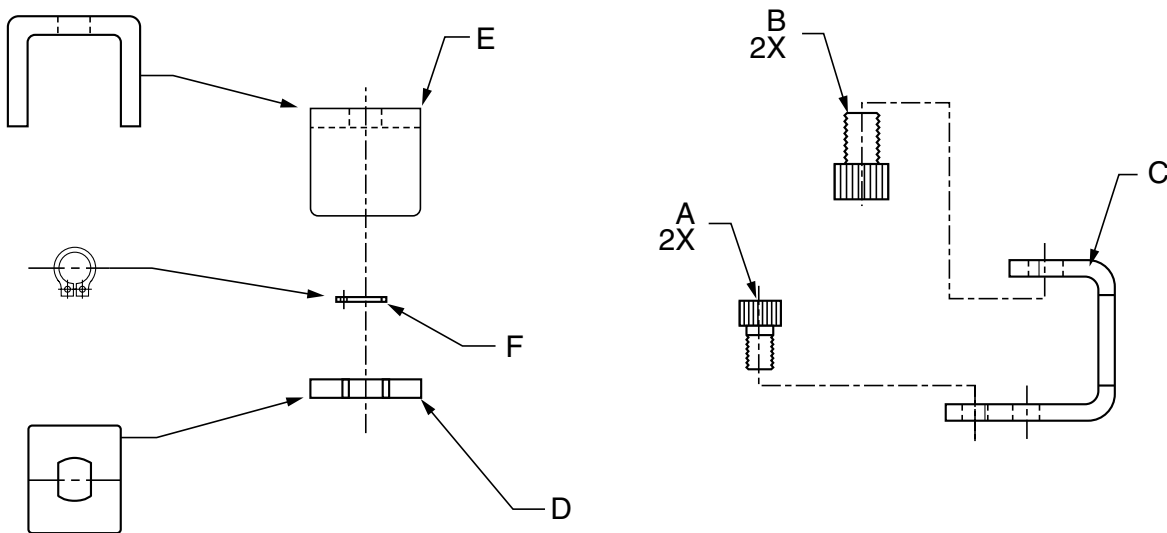

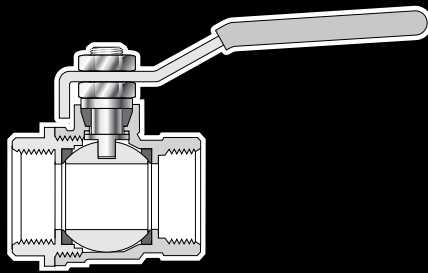

## Parker Metric Ball Valves Series BVGC

### Principle

Parker BVGC series economy ball valves are designed for use in a wide variety of fluid applications. Available with BSPP female/female\* short threads to ISO-228, they are full flow valves giving minimum pressure drop. The BVGC series has a double PTFE seal on the ball enabling the valve to be used with flow in either direction. All seals are treated with a silicone free lubricant enabling the valves to be used in water-based paint spray applications. BVGC series valves have an adjustable PTFE packing gland for easy maintenance and longer service life. For operator safety the BVGC series valves are fitted with anti-extrusion stems to prevent blow out and all valves are 100% pressure tested twice to ensure zero leakage. For other thread configurations please consult your Parker sales engineer.

### Operating pressures and temperatures

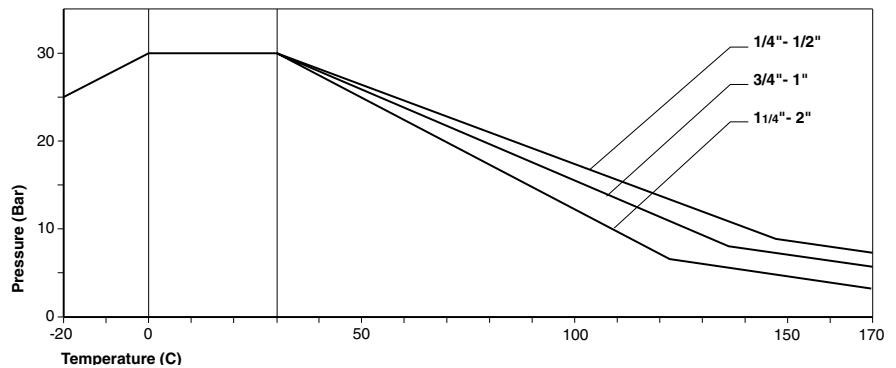

N.B. This chart gives general information. Only testing under operating conditions will finally determine which valve should be selected.

### Technical Features

BODY	LEVER HANDLE	COMPACT HANDLE	ANTI EXTRUSION STEM	STEM PACKAGING GLAND	BALL	ANTI FRICTION RING	FORCING NUT	THREADS
Brass Nickel Plated to DIN 17660 and UNI 5705 Spec.	Carbon Steel with Yellow PVC Coating	Aluminum with Yellow Epoxy Coating	Brass Nickel Plated	PTFE	Brass Chrome Plated	PTFE	Brass Nickel Plated	1/4" to 2" BSPP to ISO 228/ DIN 259

### Advantages

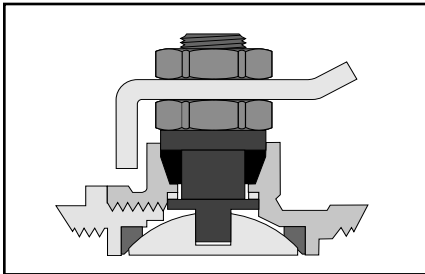

#### Adjustable packing

The PTFE packing gland and adjustable washer are designed to give longer service life and lower operating torques.

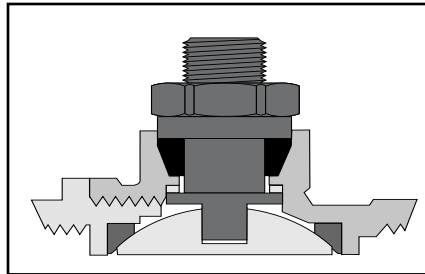

#### Anti extrusion stem

The BVGC series ball valves are fitted with an anti-extrusion stem to prevent blow out in the case of pressure peaks.

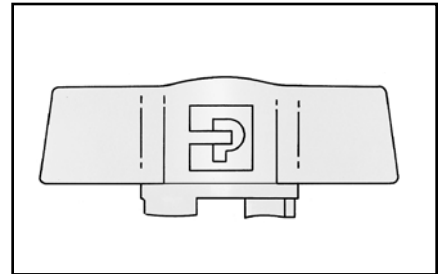

#### Compact handle

For applications where space is at a premium, the BVGC series valve is available with a compact handle in sizes up to 1".

K

**BVGC BSPP Female/Female Valve With Lever Handle**

PART NO.	DN MM	THREAD BSPP	C	H	L	L1	O
BVG4-1/4C	8	1/4	20	39.5	39	82	25.0
BVG4-3/8C	10	3/8	20	39.5	39	82	25.0
BVG4-1/2C	15	1/2	25	44.0	50	100	32.5
BVG4-3/4C	20	3/4	31	50.0	54	120	39.0
BVG4-1C	25	1	38	54.0	67	120	47.5
BVG4-1.1/4C	32	1.1/4	48	76.5	77	158	59.0
BVG4-1.1/2C	40	1.1/2	54	82.5	90	158	71.5
BVG4-2C	50	2	66	89.5	106	158	86.0

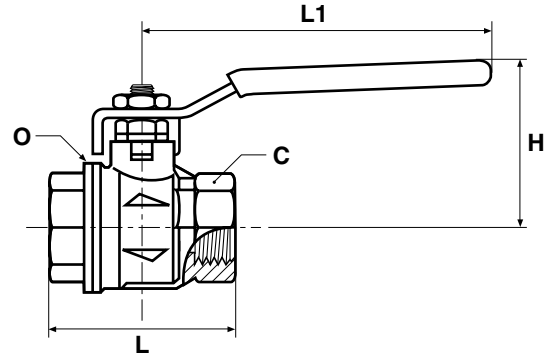

**BVGT4 BSPP Female/Female Valve With Compact Handle**

PART NO.	DN MM	THREAD BSPP	C	H	L	L1	O
BVGT4-1/4C	8	1/4	20	40	39	50	25.0
BVGT4-3/8C	10	3/8	20	40	39	50	25.0
BVGT4-1/2C	15	1/2	25	44	50	50	32.5
BVGT4-3/4C	20	3/4	31	49	54	60	39.0
BVGT4-1C	25	1	38	53	67	60	47.5

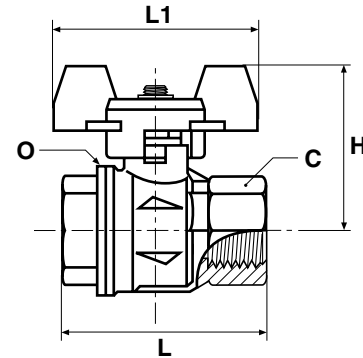

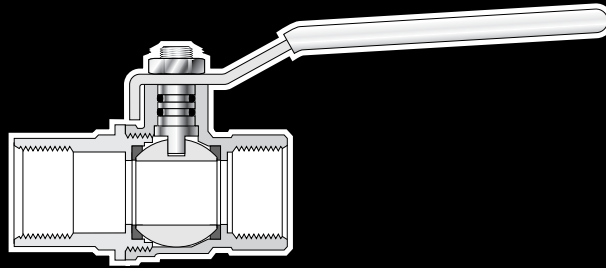

## Parker Metric Ball Valves Series BVGL

### Principle

Parker BVGL series valves are designed for use in fluid and gas applications and are DVGW approved. The valve dimensions are in accordance with DIN3357 for interchange-ability and are available with BSPP female/female\* long threads to DIN 2999 / ISO228. These full flow ball valves have a chrome plated ball with a double PTFE seal system enabling the valve to be used with flow in either direction. All seals are treated with a silicone free lubricant enabling the valves to be used in water based paint spray applications. BVGL series valves are fitted with an anti-extrusion stem with two Fluorocarbon seals for maximum safety and performance. After assembly all valves are 100% pressure tested twice to ensure zero leakage. For other thread configurations please consult us.

### Operating pressures and temperatures

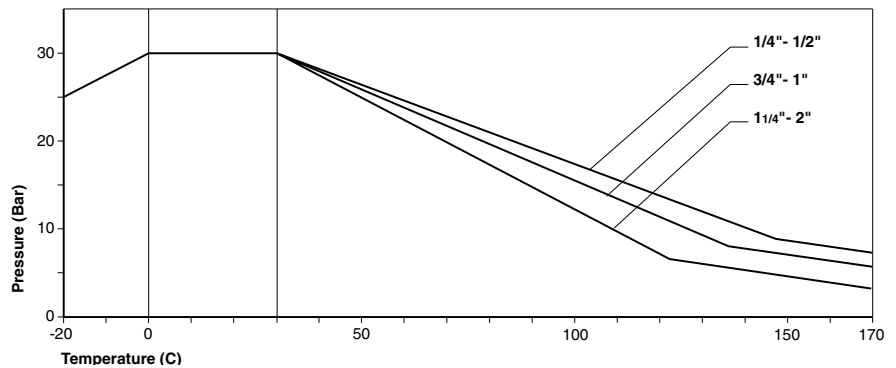

N.B. This chart gives general information. Only testing under operating conditions will finally determine which valve should be selected.

### Technical Features

BODY	LEVER HANDLE	COMPACT HANDLE	ANTI EXTRUSION STEM	STEM SEAL	BALL	ANTI FRICTION RING	FORCING NUT	VALVE DIMENSIONS
Brass Nickel Plated to DIN 17660 and UNI 5705 Spec.	Carbon Steel with Yellow PVC Coating	Aluminum with Yellow Epoxy Coating	Brass Nickel Plated	Two Viton O-Rings	Brass Chrome Plated	PTFE	Brass Nickel Plated	In Accordance with DIN 3357

### Advantages

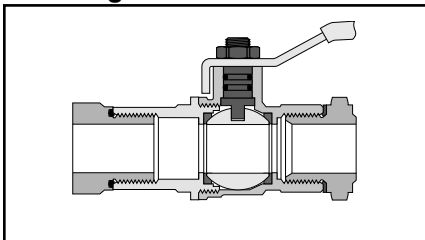

#### Long female threads

BVGL series valves are manufactured with long female threads in accordance to DIN 2999/ISO 228. This enables the valves to be used with Prestolok, Metru-Lok and brass adaptors but also Parker's range of steel hydraulic fittings, e.g. Triple-Lok, O-Lok, EO, and BSPP coned adaptors.

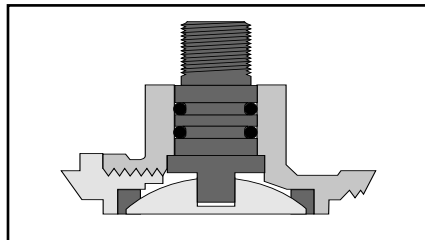

#### Anti extrusion stem

The BVGL series ball valves are fitted with an anti extrusion stem to prevent blow out in the case of pressure peaks. The stem is sealed with two Fluorocarbon O-rings for maximum safety and performance.

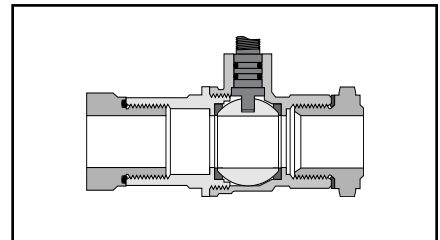

#### Full flow

All BVGL series valves are full-flow. This limits the turbulence created by the passage of fluid across the valve, minimizing pressure drop.

K

**BVGL BSPP Female/ Female Valve With Lever Handle**

PART NO.	DN MM	THREAD BSPP	C	H	L	L1	O
BVG4-1/4L	8	1/4	20	38	50	82	25.0
BVG4-3/8L	10	3/8	20	38	60	82	25.0
BVG4-1/2L	15	1/2	25	43	75	100	32.5
BVG4-3/4L	20	3/4	32	50	80	120	39.0
BVG4-1L	25	1	41	54	90	120	47.5
BVG4-1.1/4L	32	1 1/4	50	73	110	158	59.0
BVG4-1.1/2L	40	1 1/2	55	79	120	158	71.5
BVG4-2L	50	2	70	86	140	158	86.0

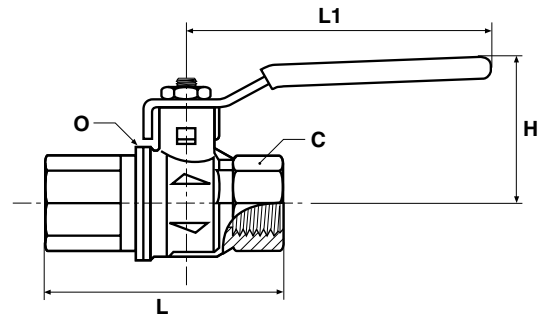

**BVGT4 BSPP Female/Female Valve With Compact Handle**

PART NO.	DN MM	THREAD BSPP	C	H	L	L1	O
BVGT4-1/4L	8	1/4	20	39	50	50	25.0
BVGT4-3/8L	10	3/8	20	39	60	50	25.0
BVGT4-1/2L	15	1/2	25	43	75	50	32.5
BVGT4-3/4L	20	3/4	32	47	80	60	39.0
BVGT4-1L	25	1	41	51	90	60	47.5

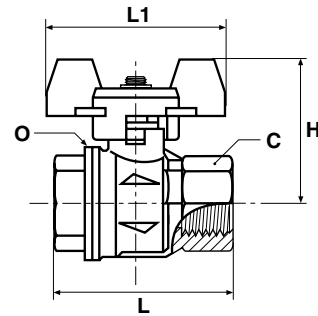



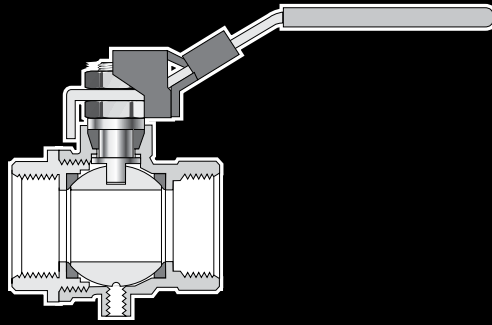

## Parker Metric Ball Valves Series BVGPLOCK

### Principle

Parker BVGPLOCK series of ball valves has been developed to meet the requirements of European Directive DI 89/392/CEE relating to the isolation of power supply and to meet the health and safety requirements for machines and materials in paragraphs L233-5 of the code du Travail.

The BVGPLOCK series of ball valves incorporate two specific safety features:

- An M5 threaded venting port enabling downstream pressure to be vented when the valve is closed.
- All valves are fitted with a locking mechanism enabling the valve to be padlocked in the closed position, thus preventing tampering or accidental opening of the valve during operation.

All seals are treated with a silicone free lubricant enabling them to be used in water based paint spray applications.

### Operating pressures and temperatures

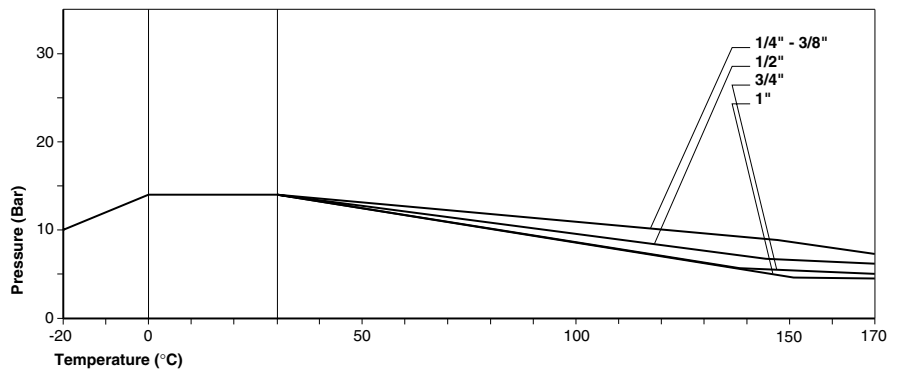

N.B. This chart gives general information. Only testing under operating conditions will finally determine which valve should be selected.

### Technical Features

BODY	LEVER HANDLE	ANTI EXTRUSION STEM	STEM PACKING GLAND	BALL	ANTI FRICTION RING	FORCING NUT	VALVE DIMENSIONS	PRESSURE
Brass nickel plated to DIN17660 and UNI5705 spec.	Carbon steel with yellow PVC coating	Brass nickel plated	PTFE	Brass chrome plated	PTFE	Brass nickel plated	In accordance with DIN3357	See chart below

K

**Advantages**

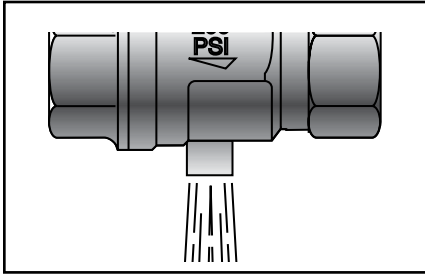

**Threaded Exhaust**

BVGPLOCK series ball valves are manufactured with an M5 threaded exhaust port, this safety feature enables the downstream air pressure to be vented when the valve is closed.

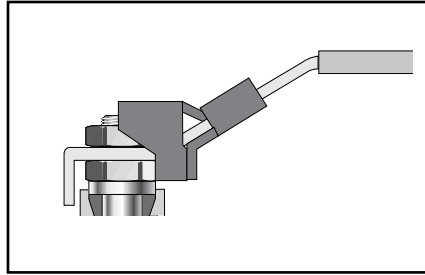

**Lockable Handle**

The BVGPLOCK series ball valves are fitted with a handle that can be locked in the closed position with a padlock. This safety feature ensures the valve cannot be accidentally opened, and only authorized personnel can operate the valve.

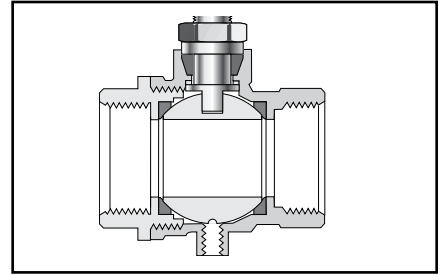

**DIN 2999 / ISO 228 Female Threads**

BVGPLOCK series valves are manufactured with long female threads in accordance to DIN2999/ISO228. This enables the valves to be used with Prestolok, Metrulok and brass adaptors but also Parker's range of steel hydraulic fittings and EO-fittings form "A" or "C" to DIN 3852.

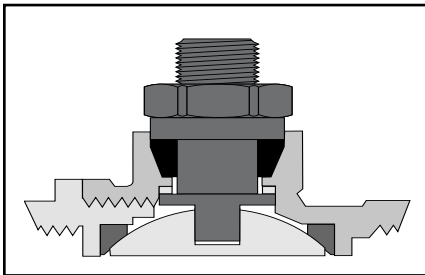

**Anti Extrusion Stem**

The BVGPLOCK series ball valves are fitted with an anti-extrusion stem to prevent blow out in the case of pressure peaks.

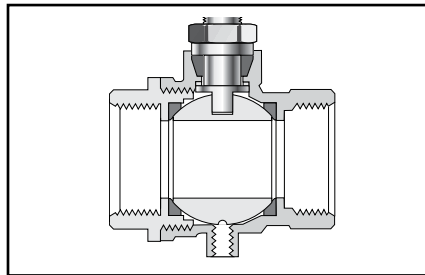

**Full Flow**

All BVGPLOCK series valves are full-flow. This limits the turbulence created by the passage of fluid across the valve, minimizing pressure drop.

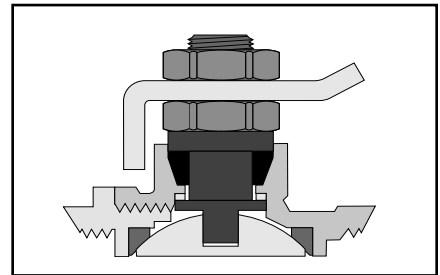

**Adjustable Packing**

The PTFE packing gland and adjustable washer are designed to give longer service life and lower operating torques.

**BVG4PLOCK BSPP Female/Female, Vented, Locking Handle**

PART NO.	D FLOW Ø	THREAD BSPP	C	G	H	I	L	L1
BVG4P-1/4 LOCK	8.0	1/4	20	22.5	47.5	12.0	45	96
BVG4P-3/8 LOCK	9.5	3/8	20	22.5	47.5	12.0	45	96
BVG4P-1/2 LOCK	15.0	1/2	25	29.5	52.0	15.5	59	96
BVG4P-3/4 LOCK	19.0	3/4	31	32.0	59.5	17.0	64	117
BVG4P-1 LOCK	24.0	1	40	40.5	63.5	21.0	81	117
BVG4P-1.1/4LOCK	32.0	1-1/4	49	46.5	76.5	23.0	93	158
BVG4P-1.1/2LOCK	40.0	1-1/2	54	51.0	82.5	23.0	102	158
BVG4P-2LOCK	50.0	2	69	60.5	89.5	26.5	121	158

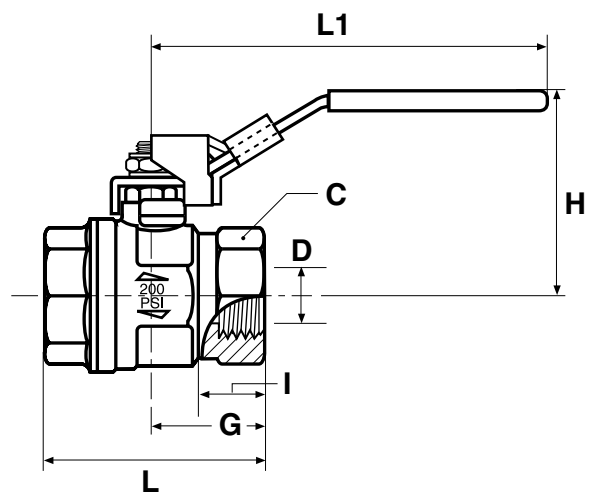

**BVG4-LOCK BSPP Female/Female, Locking Handle**

PART NO.	D FLOW Ø	THREAD BSPP	C OCTAGON	H	L1	L	G
BVG4-1/4 LOCK	8.0	1/4	20	46.5	96.0	50	22.6
BVG4-3/8 LOCK	9.5	3/8	20	46.5	96.0	60	22.6
BVG4-1/2 LOCK	15.0	1/2	25	51.3	96.0	75	29.5
BVG4-3/4 LOCK	19.0	3/4	31	59.5	117.1	80	32.0
BVG4-1 LOCK	24.0	1	40	63.5	117.1	90	40.4
BVG4-1.1/4LOCK	32.0	1-1/4	49	77.0	156.5	110	46.5
BVG4-1.1/2LOCK	40.0	1-1/2	54	83.0	156.5	120	51.1
BVG4-2LOCK	50.0	2	69	89.9	156.5	140	60.5

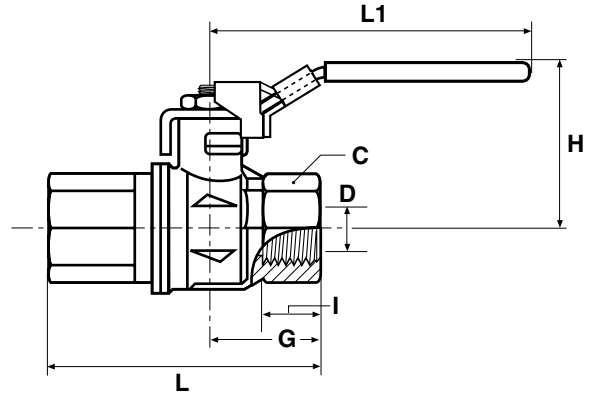

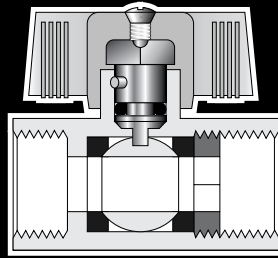

## Parker Metric Ball Valves Series MBVG

### Principle

The MBVG series ball valves with their compact design offer the solution to applications where space is an important factor. The body is of a particularly robust design. The integrity of the sealing on the ball is obtained by the use of PTFE seats. The valves are available with BSPP female threads ISO-228/1 (DIN 299) in : 1/4" & 3/8".

### Operating pressures and temperatures

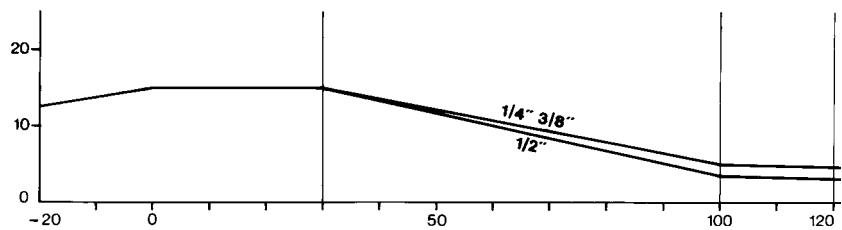

N.B. This chart gives general information. Only testing under operating conditions will finally determine which valve should be selected.

### Technical Features

BODY	HANDLE RETENTION SCREW	HANDLE	STEM	STEM SEAL	BALL	ANTI EXTRUSION GUIDE PIN	NUT	SEAT SEALS
Brass Chromium Plated	Brass Chromium Plated	Polyamide	Brass	Viton	Brass Chromium Plated	Stainless Steel	Brass	PTFE

### Advantages

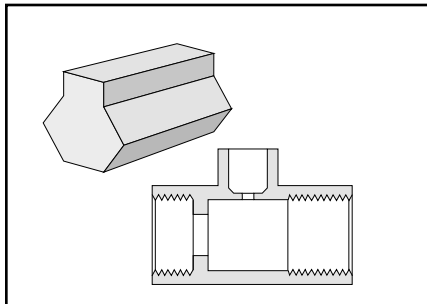

#### Design of the body

The valve is manufactured from a solid section which incorporates the stem housing in the body. This design allows excellent guidance of the stem, which increases its lifespan.

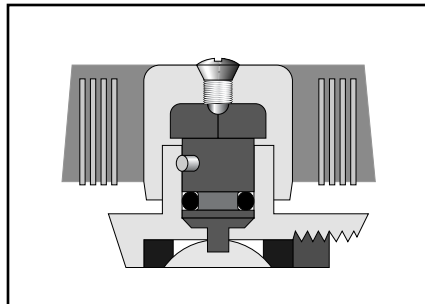

#### Stem tightness

A Fluorocarbon O-Ring assembled under compression automatically compensates for minute friction wear. Thus a high standard of seal is attained.

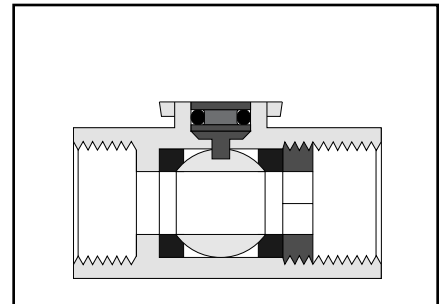

#### Tightness of the seals

The perfect tightness of the seals on the casing is obtained by the preset force of the nut, adjusted during assembly.

K

**MBVG BSPP Female/Female Valve**

PART NO.	DN MM	THREAD BSPP	C	H	L	L1
MBVG4-1/4	8	1/4	21	31.5	41.5	39
MBVG4-3/8	8	3/8	21	31.5	41.5	39
MBVG4-1/2	10	1/2	25	33.5	48.0	39

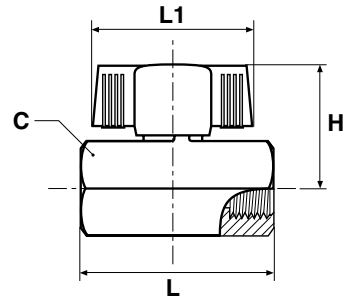

**K**

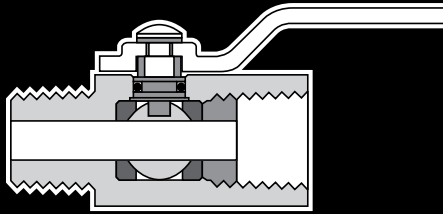

## Micro Ball Valve Series 708 / 709

### Advantages

The Parker Micro-Valve is designed to be used in confined and hard to reach applications. This miniature 2 way valve has a barstock body for extended service life and is offered with either male / female or female / female pipe ends. Features of the MV708 / 709 valves include chrome plate ball, PTFE seats, nitrile stem seal and a low profile chrome plated steel handle.

### Applications

Parker's industrial ball valve product line is intended for general purpose use. Please be aware that ball valves are intended for use in the fully open or closed positions. Depending on application conditions, throttling of the valve may result in premature seal failure and / or inability to turn the valve handle.

### Working Pressure and Temperatures

These valves are designed and built for use at pressures and temperatures within the stated ranges. Consult the factory for any use outside of these ranges.

Vacuum to 29 inches Hg

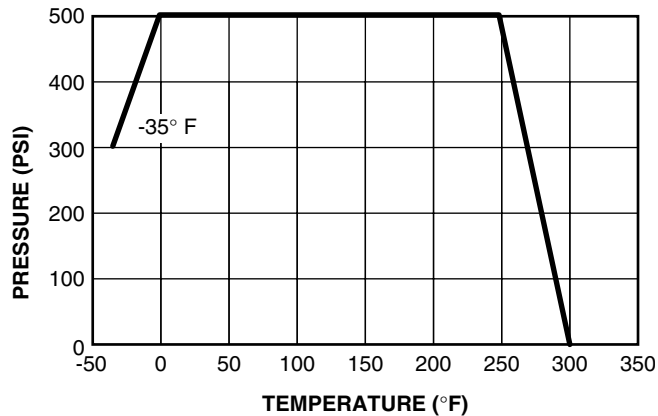

### Operating Instructions

Quarter turn is "ON" or "OFF".  
(Provides positive stop action for full shutoff.)

Style	Type	Size
MV	708 709	-4
Style	MV-Micro Valve	
Type	708 - Male / Female 709 - Female / Female	
Size	4-1/4"	

### Flow data

VALVE SIZE	MV708 CV	MV709 CV
1/4	.95	.95

**K**

**Male-Female Pipe Ends, Mini Ball Valve MV708**

PART NO.	PIPE THREAD	B HEX	H	L	M	N	P	FLOW DIA. D
MV708-2	1/8	9/16	1.18	.63	1.62	.93	.38	.180
MV708-4	1/4	11/16	1.52	.70	1.57	.79	.50	.210

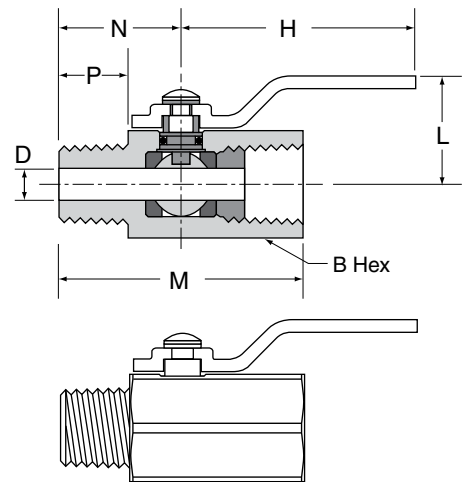

**Female Pipe Ends, Mini Ball Valve MV709**

PART NO.	PIPE THREAD	B HEX	H	L	M	N	FLOW DIA. D
MV709-2	1/8	9/16	1.18	.63	1.52	.68	.180
MV709-4	1/4	11/16	1.52	.70	1.57	.76	.210

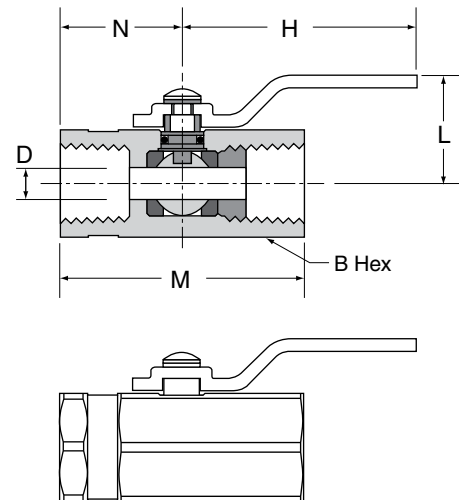

**K**

**Replacement Handles**

Valve	Plated Steel Lever w/Cover	S.S. Lever (No Cover)	S.S. Lever w/Cover	Tee (No Cover)	Oval (w/Cover)	Short Lever (No Cover)	Plated Steel Lkg. Lever w/Cover	S.S. Locking Lever w/Cover
<b>XV500P (501,502,506,510,590,591)</b>								
-4	2560-10082	2566-00105		2566-00147	2566-00215	2566-00231	2560-10080	2560-10081
-6	2560-10082	2566-00105		2566-00147	2566-00215	2566-00231	2560-10080	2560-10081
-8	2560-10082	2566-00105		2566-00147	2566-00215	2566-00231	2560-10080	2560-10081
-10	2560-10097	2566-00178		2566-00179			2566-10100	
-12	2560-10097	2566-00178		2566-00179	2566-00180	—	2560-10100	2560-10101
-16	2560-10097	2566-00178		2566-00179	2566-00180	—	2560-10100	2560-10101
-20	2566-00143	2566-00153		—	—	2566-00142	2566-00135	—
-24	2566-00143	2566-00153		—	—	2566-00142	2566-00135	—
-32	2566-00143	2566-00153		—	—	2566-00142	2566-00135	—
<b>XV501SS &amp; XV502SS</b>								
-4	—		2566-00132	—	2566-00108	2566-00146	—	2566-00138
-6	—		2566-00132	—	2566-00108	2566-00146	—	2566-00138
-8	—		2566-00132	—	2566-00108	2566-00146	—	2566-00138
-12	—		2566-00133	—	2566-00109	—	—	2566-00184
-16	—		2566-00133	—	2566-00109	—	—	2566-00184
<b>XV502SS</b>								
-20	—		2566-00134	—	2566-00110	—	—	2566-00185
-24	—		2566-00134	—	2566-00110	—	—	2566-00185
-32	—		2566-00134	—	2566-00110	—	—	2566-00185
<b>XV500CS &amp; XV502CS</b>								
-4	2566-00158			2566-00170	2566-00166		2566-00162	
-6	2566-00158			2566-00170	2566-00166		2566-00162	
-8	2566-00158			2566-00171	2566-00166		2566-00162	
-12	2566-00159			2566-00172	2566-00167		2566-00163	
-16	2566-00159			2566-00172	2566-00167		2566-00163	
-20	2566-00160				2566-00168		2566-00164	
-24	2566-00160				2566-00168		2566-00164	
-32	2566-00161				2566-00169		2566-00165	
<b>XV506CS</b>								
-4	2566-00158				2566-00166		2566-00162	
-6	2566-00158				2566-00166		2566-00162	
-8							2566-00234	
-12	—						2566-00235	
-16	—						2566-00236	

**Replacement Handle Nuts**

Valve	Plated Steel	Stainless Steel
XV500P-4	2567-00020	2567-00023
XV500P-6	2567-00020	2567-00023
XV500P-8	2567-00020	2567-00023
XV500P-12	2567-00055	2567-00057
XV500P-16	2567-00055	2567-00057
XV500P-20	2567-00051	2567-00052
XV500P-24	2567-00051	2567-00052
XV500P-32	2567-00051	2567-00052

**Replacement Handle Covers**

Valve	Lever	Short Lever	Tee
XV500P-4	2569-00108		2569-00155
XV500P-6	2569-00108		2569-00155
XV500P-8	2569-00108		2569-00155
XV500P-12	2569-00296		2569-00155
XV500P-16	2569-00296		2569-00155
XV500P-20	2569-00229	2569-00234	
XV500P-24	2569-00229	2569-00234	
XV500P-32	2569-00229	2569-00234	
XV502SS-4		2569-00203	
XV502SS-6		2569-00203	
XV502SS-8		2569-00203	





<b>STX</b>	Stem Extension Kit
<b>P</b>	For use on Brass Ball Valves
<b>1</b>	1: 1/4" thru 1/2" valves 2: 3/4" thru 1" valves
<b>125</b>	125: 1-1/4" extension length 225: 2-1/4" extension length

<b>STX</b>	Stem Extension Kit
<b>SS</b>	For use on Stainless Steel Ball Valves
<b>1</b>	1: 1/4" thru 1/2" valves 2: 3/4" thru 1" valves 3: 1-1/4"-2" valves
<b>125</b>	125: 1-1/4" extension length 225: 2-1/4" extension length

All stem extension kit componentry is made from high quality, corrosion resistant stainless steel

Note: Stem extensions cannot be used with series 509 and series 520.

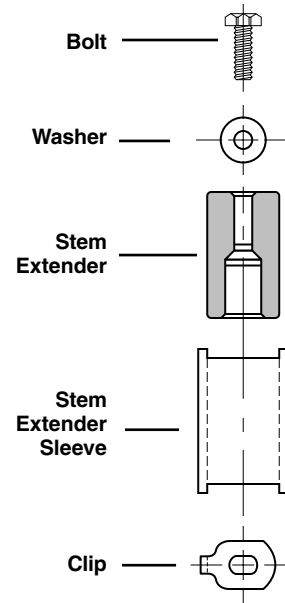

**Brass Valve Extension Dimensions STX-P-1-125**

PART NO.	VALVE SIZE	B HEX	C HEX	H	L	M	N	D FLOW Ø
STX-P-1-125	1/4	15/16	15/16	3.96	4.96	2.03	3.73	.375
STX-P-1-125	3/8	15/16	15/16	3.96	4.96	2.03	3.73	.375
STX-P-1-125	1/2	1-1/16	1-1/16	3.96	5.05	2.20	3.84	.500
STX-P-2-125	3/4	1-1/4	1-5/16	3.96	5.25	2.42	4.06	.685
STX-P-2-125	1	1-1/2	1-9/16	3.96	5.89	2.75	4.33	.875

Note: Drawing shows STX-P assembled to XV500P series-not included

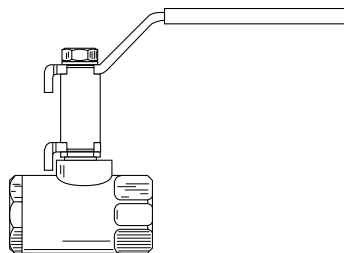

**Brass Valve Extension Dimensions STX-P-1-225**

PART NO.	VALVE SIZE	B HEX	C HEX	H	L	M	N	D FLOW Ø
STX-P-1-225	1/4	15/16	15/16	3.96	4.96	2.03	4.73	.375
STX-P-1-225	3/8	15/16	15/16	3.96	4.96	2.03	4.73	.375
STX-P-1-225	1/2	1-1/16	1-1/16	3.96	5.05	2.20	4.84	.500
STX-P-2-225	3/4	1-1/4	1-5/16	3.96	5.25	2.42	5.06	.685
STX-P-2-225	1	1-1/2	1-9/16	3.96	5.89	2.75	5.33	.875

Note: Drawing shows STX-P assembled to XV500P series-not included

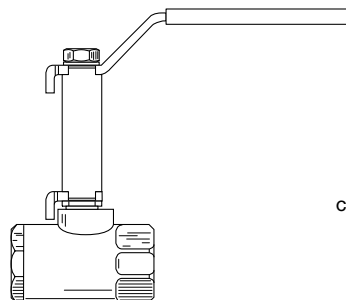

**Stainless Steel Valve Extension Dimensions STX-SS-1-X**

PART NO.	VALVE SIZE	B HEX	C HEX	H	L	M	N	D FLOW Ø
STX-SS-1-125	1/4	15/16	15/16	4.00	5.04	2.07	3.78	.375
STX-SS-1-125	3/8	15/16	15/16	4.00	5.04	2.07	3.78	.375
STX-SS-1-125	1/2	1-1/16	1-1/16	4.00	5.17	2.27	3.90	.500
STX-SS-1-225	1/4	15/16	15/16	4.00	5.04	2.07	4.78	.375
STX-SS-1-225	3/8	15/16	15/16	4.00	5.04	2.07	4.78	.375
STX-SS-1-225	1/2	1-1/16	1-1/16	4.00	5.17	2.27	4.90	.500

Note: Drawing shows STX-SS assembled to XV502SS series-not included

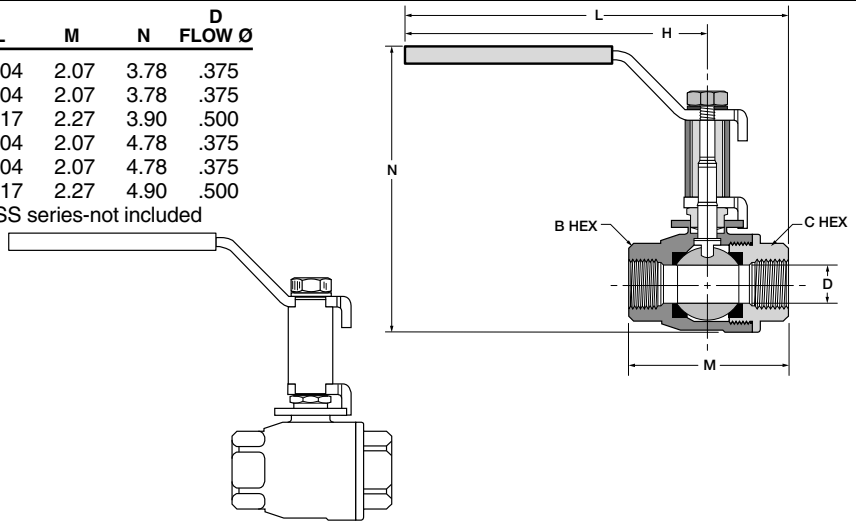

**Stainless Steel Valve Extension Dimensions STX-SS-2-X**

PART NO.	VALVE SIZE	B/C HEX	H	K	L	M	N	D FLOW Ø
STX-SS-2-125	3/4	1-1/16	4.94	1.52	6.40	2.98	4.66	.787
STX-SS-2-125	1	1-5/8	4.94	1.88	6.69	3.62	5.14	1.000
STX-SS-2-225	3/4	1-1/16	4.94	1.52	6.40	2.98	5.66	.787
STX-SS-2-225	1	1-5/8	4.94	1.88	6.69	3.62	6.14	1.000

Note: Drawing shows STX-SS assembled to XV500SS series-not included

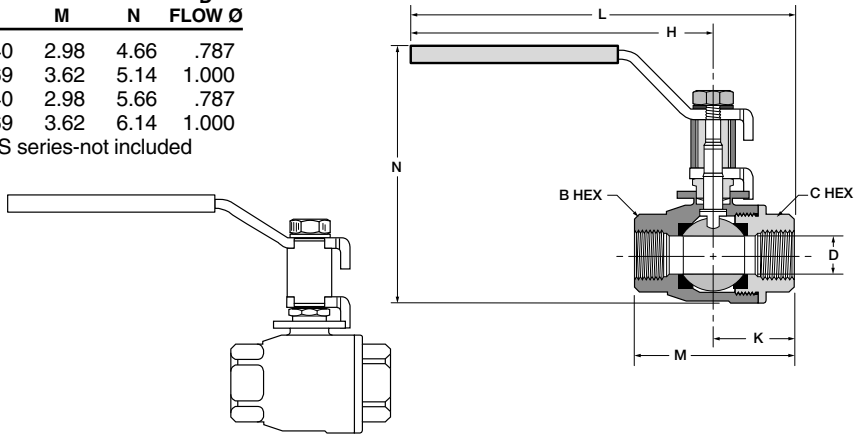

**Stainless Steel Valve Extension Dimensions STX-SS-3-X**

PART NO.	VALVE SIZE	B/C OCT	H	K	L	M	N	D FLOW Ø
STX-SS-3-125	1-1/4	2*	6.94	2.00	8.95	4.00	5.71	1.25
STX-SS-3-125	1-1/2	2-3/8	6.94	2.22	9.21	4.49	6.05	1.50
STX-SS-3-125	2	2-3/4	6.94	2.73	9.65	5.43	7.01	2.00
STX-SS-3-225	1-1/4	2*	6.94	2.00	8.95	4.00	6.71	1.25
STX-SS-3-225	1-1/2	2-3/8	6.94	2.22	9.21	4.49	7.05	1.50
STX-SS-3-225	2	2-3/4	6.94	2.73	9.65	5.43	8.01	2.00

\*Hex bolt

Note: Drawing shows STX-SS assembled to XV500SS series-not included

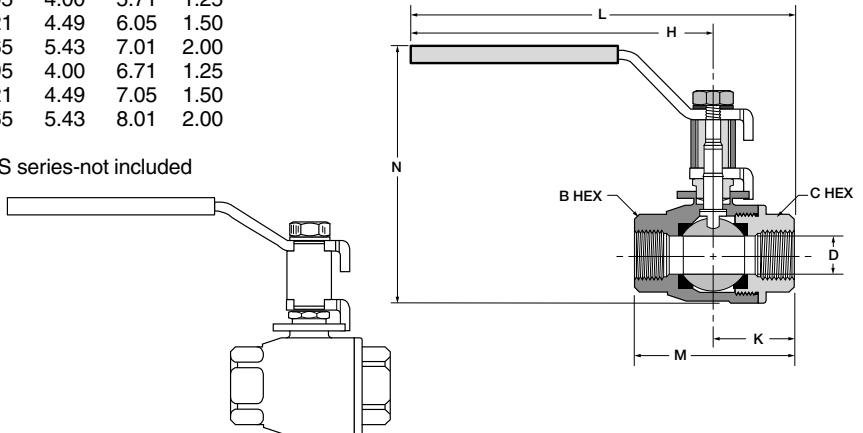

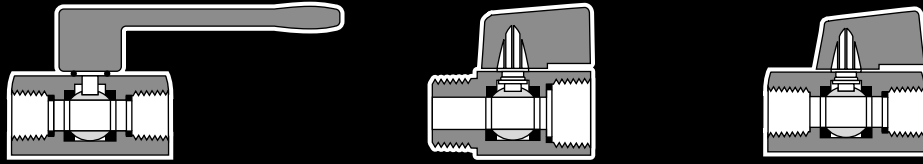

## Mini Ball Valves Series 200/608/609

### Advantages

The Parker Mini-Valve is to be used in confined and hard to reach applications. The Brass extruded body allows for extended service life and is chrome plated as standard. Features of the MV608/609 valves include blowout proof stem, hard chrome plate ball, PTFE seats, viton stem seals, and standard yellow handle. MV200 valve features a black lever handle. This economical ball valve is available in 1/8", 1/4", 3/8" and 1/2" sizes.

### Applications

Parker's industrial ball valve product line is intended for general purpose use. Please be aware that ball valves are intended for use in the fully open or closed positions. Depending on application conditions, throttling of the valve may result in premature seal failure and/or inability to turn the valve handle.

For use on water and air service lines on capital equipment and plant design plumbing that require total shutoff capability.

### Working Pressure and Temperatures

These valves are designed and built for use at pressures and temperatures within the stated ranges. Consult the factory for any use outside of these ranges.

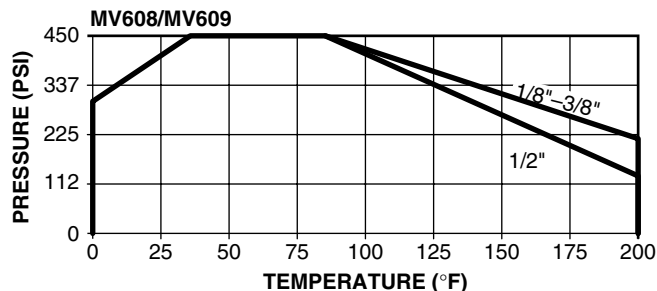
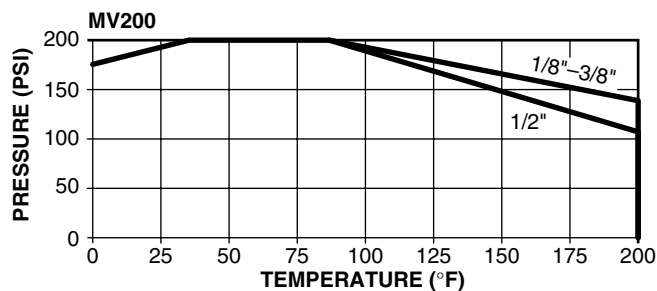

### Operating Instructions

Quarter turn is "ON" or "OFF".  
(Provides Positive stop action for full shutoff.)

Style	Type	Size
MV	608 609	-2
Style	MV-Mini Valve	
Type	608-Male/Female 609-Female/Female	
Handle Color	MV200 features a black lever handle MV608/MV609 features-yellow wedge handles	
Size	2-1/8" 4-1/4" 6-3/8" 8-1/2"	

Style	Type	Size
MV	200	-2
Style	MV-Mini Valve	
Type	200-Female/Female Lever Handle	
Size	2-1/8" 4-1/4" 6-3/8" 8-1/2"	

### Flow data

VALVE SIZE	MV200 CV	MV608 CV	MV609 CV
1/8	1.3	1.2	1.4
1/4	4.0	5.8	4.3
3/8	3.7	3.9	3.6
1/2	5.8	5.6	6.0

K

**Female Pipe Ends, Lever Handle, Mini Ball Valve MV200**

PART NO.	PIPE THREAD	HEX	B	C	H	L	FLOW DIA.D
MV200-2	1/8	.83	1.71	1.20	.91	2.83	.31
MV200-4	1/4	.83	1.71	1.20	.91	2.83	.31
MV200-6	3/8	.83	1.71	1.20	.91	2.83	.31
MV200-8	1/2	.98	2.11	1.28	1.10	2.83	.39

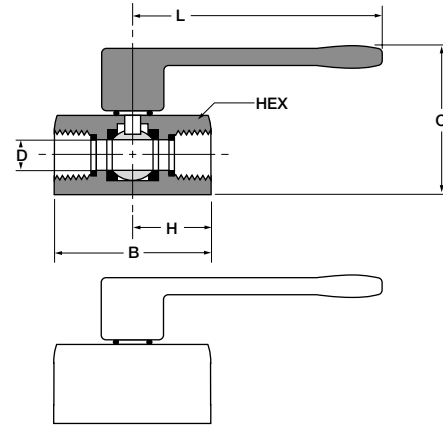

**Male-Female Pipe Ends, Compact Handle, Mini Ball Valve MV608**

PART NO.	PIPE THREAD	A HEX	B	C	FLOW DIA.D
MV608-2	1/8	.83	1.72	1.22	.20
MV608-4	1/4	.83	1.72	1.22	.31
MV608-6	3/8	.83	1.72	1.22	.31
MV608-8	1/2	.98	2.11	1.30	.39

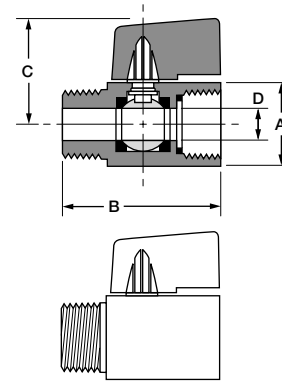

**Female Pipe Ends, Compact Handle, Mini Ball Valve MV609**

PART NO.	PIPE THREAD	A HEX	B	C	FLOW DIA.D
MV609-2	1/8	.83	1.71	1.22	.24
MV609-4	1/4	.83	1.71	1.22	.31
MV609-6	3/8	.83	1.71	1.22	.31
MV609-8	1/2	.98	2.11	1.30	.39
MV609-6-4	3/8x1/4	.83	1.71	1.22	.31

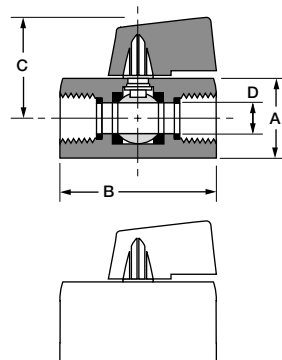

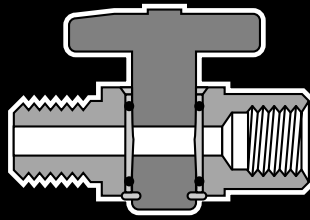

## Plug Valves Series PV

### Advantages

Compact design features internal nitrile seals and a one-piece extruded brass body, offering compatibility with a wide range of media. The one-piece stem/handle combination is constructed of glass reinforced acetal copolymer. Parker plug valves feature 1/4 turn shutoff allowing for ease of operation. All plug valves are 100% leak tested and are certified to be leak free to one SCCM.

### Materials

Extruded Bodies: CA 360  
 Stem/Handle: Acetal Copolymer  
 O-Rings: Nitrile (other compounds available)  
 Stop Pin: 420SS  
 Spiral Ring: 302SS

### Temperature and Working Pressure Ranges

From -40° to +175°F at 250 PSI maximum.

### Applications

Manufactured for use with air, water, oil and certain other fluids. Contact factory for special fluid requirements

### Installation Instructions

To assure sealability and reliable performance, the valve must be installed so that the flow media travels in the direction of the arrow on the valve handle.

### Order

By part number and name.

### Nomenclature

Part numbers are constructed from symbols that identify the style and size of the fitting. The first series of numbers and letters identifies the style and type fitting. The second series of numbers describes the size.

#### Example:

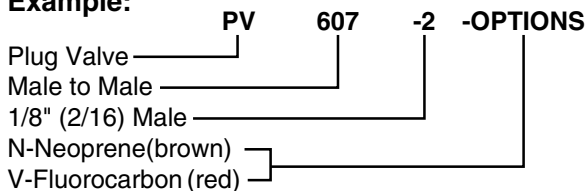

### Special Valves

Fitting configurations and/or sizes other than those shown in the catalog can be furnished. It is suggested that a print or sketch be submitted with the inquiry.

### Features

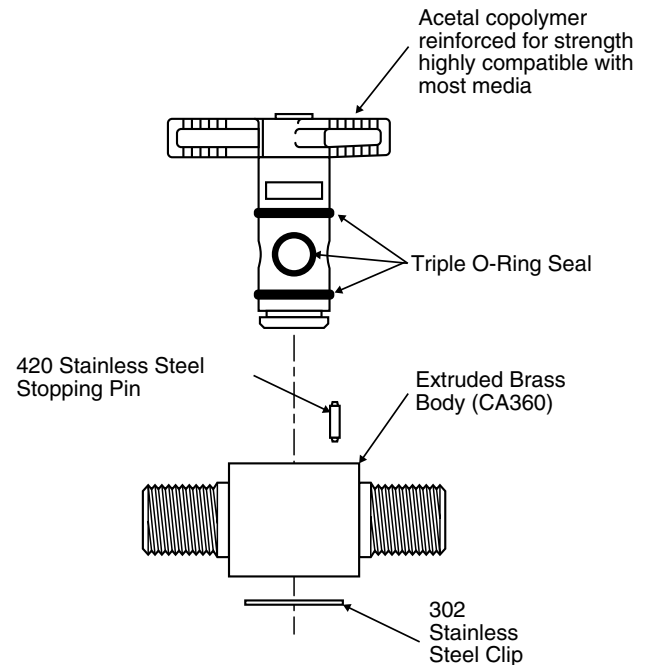

**K**

**Male Pipe to Male Pipe Plug Valve PV607**

PART NO.	PIPE THREAD	H	L	M	N	N1	FLOW DIA. D
PV607-2	1/8	.67	1.34	1.66	1.38	.51	.200
PV607-4	1/4	.67	1.34	2.02	1.38	.51	.200

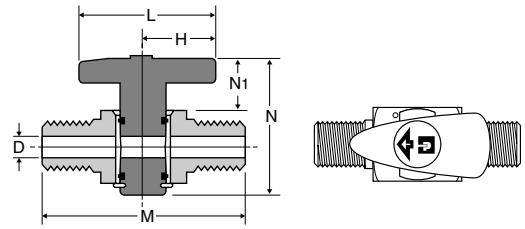

**Female Pipe to Male Pipe Plug Valve PV608**

PART NO.	PIPE THREAD	H	L	M	N	N1	FLOW DIA. D
PV608-2	1/8	.67	1.34	1.67	1.38	.51	.200
PV608-4	1/4	.67	1.34	2.06	1.38	.51	.200

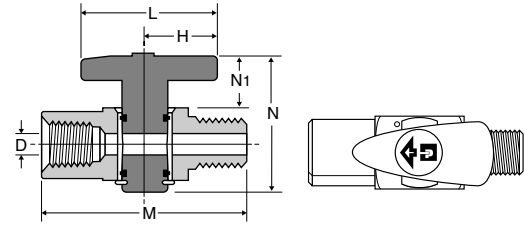

**Female Pipe to Female Pipe Plug Valve PV609**

PART NO.	PIPE THREAD	H	L	M	N	N1	FLOW DIA. D
PV609-2	1/8	.67	1.34	1.68	1.38	.51	.200
PV609-4	1/4	.67	1.34	2.10	1.38	.51	.200

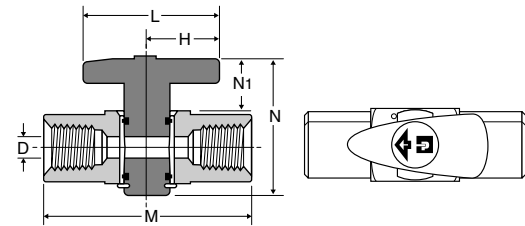

**Mounting Bracket PVMB-001**

PART NO.	H	L	M	N	N1	D
PVMB-001	.68	.75	1.86	.90	.45	.135

Note: 1" diameter hole required in panel when using mounting bracket

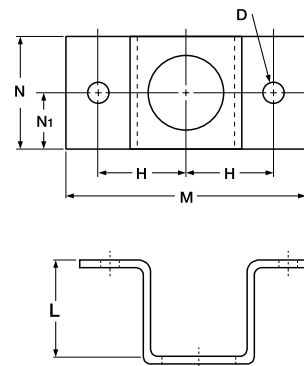

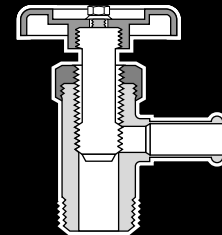
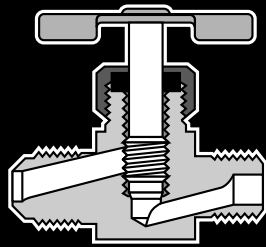

## Needle Valves, Truck Valves, Lanyard Valve

### Advantages

Parker Needle and Truck Valves have metal-to-metal seats, with fine-thread screwdown. This enables positive sealing up to the capacity of the valve.

The Lanyard Valves' compact design is ideally suited for releasing condensate from air tanks. Available with various lengths of cable. Brass construction with specially formulated low temperature seal which remains elastic to temperatures as low as -40°F. It is manufactured for use with low pressure air systems such as air tanks on heavy trucks. Consult division for use with other fluids.

### Working Pressure and Temperature

Valves are designed to withstand up to 150 PSI working pressure, unless otherwise noted. See specific part number for temperature range.

### Needle Valves Installation Instructions

Series NV valves should always be installed with the pressure against the seat. Refer to drawing to determine correct direction of flow.

### Lanyard Valve Operating Instructions

A pulling action exerted on the cable cocks the stem, allowing condensate to pass through the valve. Releasing the cable resets the stem which returns the valve to its closed position.

### Order

By part number and name.

### Nomenclature

Part numbers are constructed from symbols that identify the style and size of the fitting. The first series of numbers and letters identifies the style and type fitting. The second series of numbers describes the size.

<b>Example:</b>	NV	101	F	-4	-2
Needle Valve	_____	_____	_____	_____	_____
Angle Needle Valve	_____	_____	_____	_____	_____
Flared to Male Pipe	_____	_____	_____	_____	_____
1/4" (4/16) Tube O.D.	_____	_____	_____	_____	_____
1/8" (2/16) Pipe Thread	_____	_____	_____	_____	_____

<b>Example:</b>	LV91	-4	-060
Lanyard Valve	_____	_____	_____
1/4" Pipe Thread	_____	_____	_____
Length of Cable in inches	_____	_____	_____

### Special Valves

Valve configurations and/or sizes other than those shown in the catalog can be furnished. It is suggested that a print or sketch be submitted with the inquiry.

### Pricing

Only items priced in current supplementary price list PL3501 are carried in stock. Price and delivery for non-stock items furnished on request for specified quantity.

K

**Angle Needle Valve NV101F**

Flare to Male Pipe  
 Temperature Range: -45° to +250° F

PART NO.	TUBE SIZE	PIPE THREAD	H	L	M	N
NV101F-4-2	1/4	1/8	1.50	1.58	.75	.66
NV101F-6-4	3/8	1/4	1.38	1.86	.95	.90

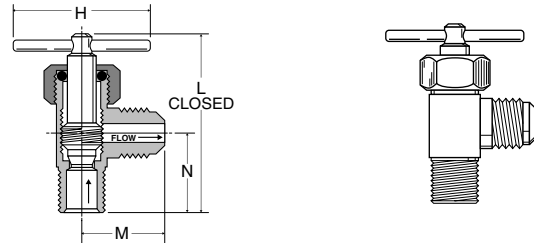

**Needle Valve NV102F**

Flare to Flare \*Provided with Pin Handle  
 Temperature Range: -45° to +250° F

PART NO.	TUBE SIZE	H	L	M
NV102F-4*	1/4	1.50	1.34	1.50
NV102F-6	3/8	1.38	1.55	1.86

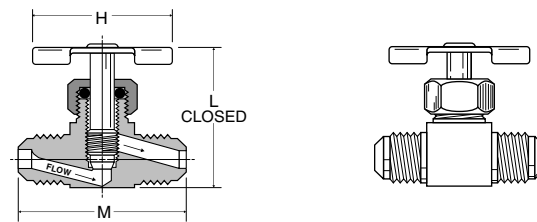

**Needle Valve NV103F**

Flare to Male Pipe \*Provided with Pin Handle  
 Temperature Range: -45° to +250° F

PART NO.	TUBE SIZE	PIPE THREAD	H	L	M
NV103F-4-2*	1/4	1/8	1.50	1.33	1.35
NV103F-6-4	3/8	1/4	1.38	1.56	1.73

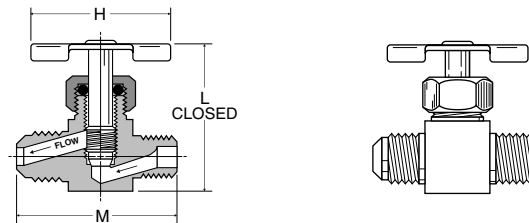

**Humidifier Valve HV104C**

Temperature Range: -45° to +250° F

PART NO.	TUBE SIZE	PIPE THREAD	H	L	M
HV104C-4-2	1/4	1/8	1.50	1.89	.53

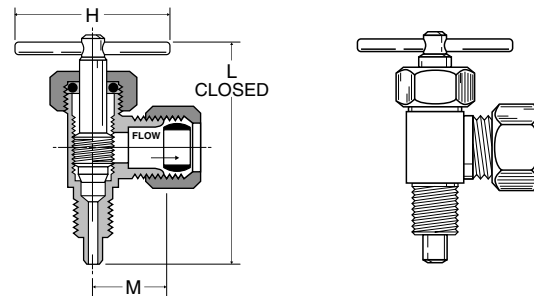

**Humidifier Valve clamp kit HV104C-kit**

Temperature Range: -30° to +250° F  
 Clamp fits 3/8" O.D. through 1.315" O.D. tube or pipe. Kit includes 60PT-4 and 63PT-4 for assembly with plastic or nylon tubing. For complete kit, specify entire part number as shown below:

PART NO.	TUBE SIZE	PIPE THREAD
HV104C-4-2 KIT	1/4	1/8

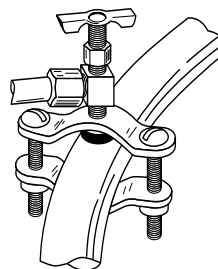



**Self-Piercing Humidifier Valve clamp kit SPV104C-kit**

Temperature Range: -30° to +250° F  
 Clamp fits 3/8" O.D. through 1.315" O.D. tube or pipe. Kit includes 60PT-4 and 63PT-4 for assembly with plastic or nylon tubing. For complete kit, specify entire part number as shown below:

PART NO.	TUBE SIZE	PIPE THREAD
SPV104C KIT	1/4	1/8

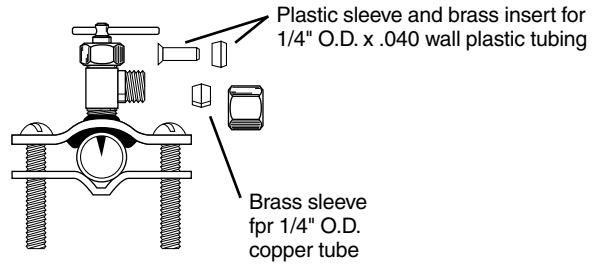

**Angle Needle Valve NV104C-NV104CA**

Compression to Male Pipe \*Provided with Pin Handle  
 Temperature Range: -45° to +250° F

PART NO.	TUBE SIZE	PIPE THREAD	H	L	M	N
NV104C-4-2*	1/4	1/8	1.50	1.54	.88	.67
NV104CA-4-2*	1/4	1/8	1.50	1.49	.77	.66
NV104C-4-4	1/4	1/4	1.38	1.80	.93	.75
NV104C-5-2*	5/16	1/8	1.50	1.63	.88	.68
NV104C-6-4	3/8	1/4	1.38	1.76	.94	.81

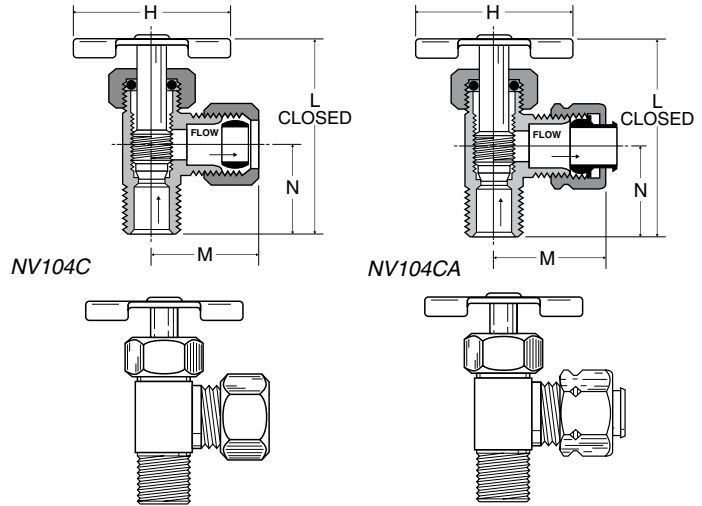

**Needle Valve NV105C-NV105CA**

Compression to Compression \*Provided with Pin Handle  
 Temperature Range: -45° to +250° F

PART NO.	TUBE SIZE	H	L	M
NV105C-4*	1/4	1.50	1.41	1.75
NV105C-5*	5/16	1.50	1.35	1.73
NV105C-6	3/8	1.38	1.55	1.93
NV105CA-4*	1/4	1.50	1.41	1.64
NV105CA-6	3/8	1.38	1.55	1.78

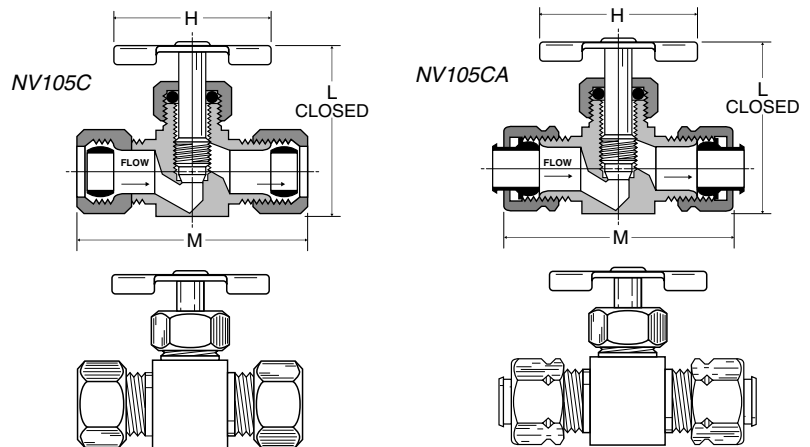

**K**

**Needle Valve NV106C-NV106CA**

Compression to Male Pipe \*Provided with Pin Handle  
 Temperature Range: -45° to +250° F

PART NO.	TUBE SIZE	PIPE THREAD	H	L	M
NV106C-4-2*	1/4	1/8	1.50	1.41	1.53
NV106C-4-4*	1/4	1/4	1.50	1.40	1.55
NV106C-5-2*	5/16	1/8	1.50	1.35	1.50
NV106C-6-4	3/8	1/4	1.38	1.56	1.75
NV106CA-4-2	1/4	1/8	1.50	1.41	1.47
NV106CA-4-4*	1/4	1/4	1.50	1.33	1.52
NV106CA-6-4	3/8	1/4	1.38	1.53	1.78

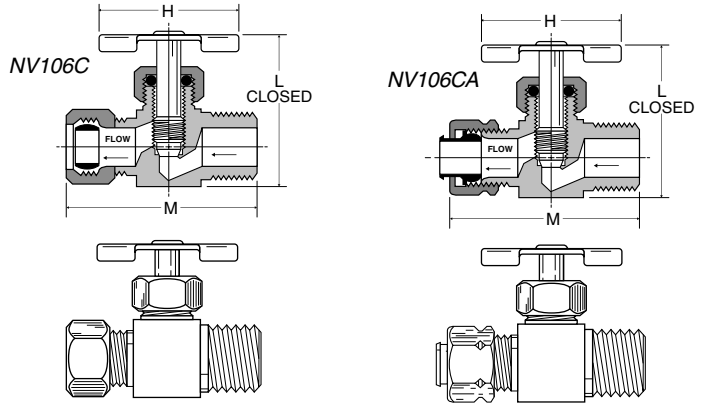

**Needle Valve NV107P**

Male Pipe to Male Pipe \*Provided with Pin Handle  
 Temperature Range: -45° to +250° F

PART NO.	PIPE THREAD	H	L	M
NV107P-2*	1/8	1.50	1.35	1.25
NV107P-4	1/4	1.38	1.54	1.65

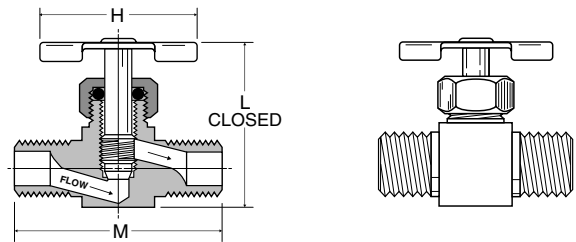

**Needle Valve NV108P**

Female Pipe to Male Pipe \*Provided with Pin Handle  
 Temperature Range: -45° to +250° F

PART NO.	PIPE THREAD	H	L	M
NV108P-2*	1/8	1.50	1.36	1.25
NV108P-4	1/4	1.38	1.56	1.61

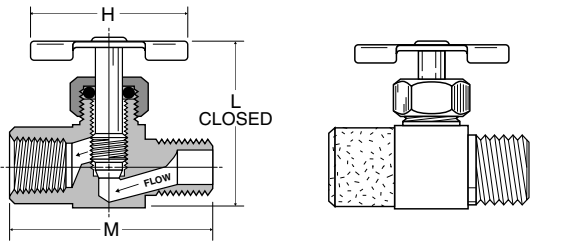

**Needle Valve NV109P**

Female Pipe to Female Pipe \*Provided with Pin Handle  
 Temperature Range: -45° to +250° F

PART NO.	PIPE THREAD	H	L	M
NV109P-2*	1/8	1.50	1.35	1.25
NV109P-4	1/4	1.38	1.53	1.60

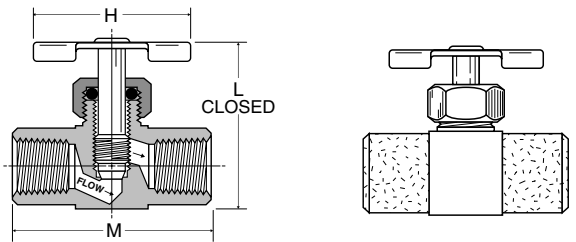

**Needle Valve NV311P**

Poly-Tite to Male Pipe  
 Temperature Range: 0° to +150° F

PART NO.	TUBE SIZE	PIPE THREAD	H	L	M	N
NV311P-4-2	1/4	1/8	1.07	1.17	.50	.63
NV311P-4-4	1/4	1/4	1.07	1.18	.50	.72
NV311P-6-4	3/8	1/4	1.07	1.19	.56	.72

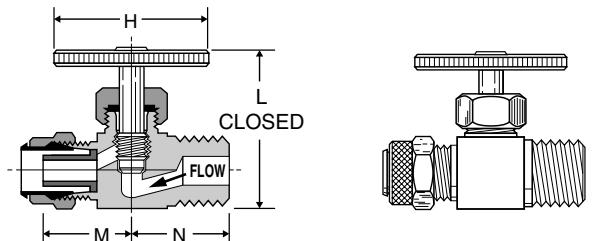

**Angle Needle Valve NV312P**

Ploy-Tite to Male Pipe  
 Temperature Range: 0° to +150° F

PART NO.	TUBE SIZE	PIPE THREAD	H	L	M	N
NV312P-4-2	1/4	1/8	1.07	1.53	.48	.68
NV312P-4-4	1/4	1/4	1.07	1.72	.56	.86
NV312P-6-4	3/8	1/4	1.07	1.68	.64	.86

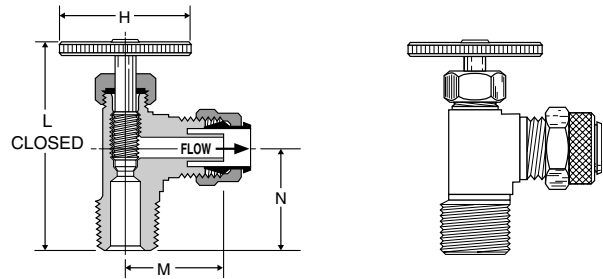

**Truck Valve V404P**

Hose to Male Pipe  
 Temperature Range: -30° to +250° F

PART NO.	HOSE I.D.	PIPE THREAD	FLOW	L	M	N
V404P-6-6	3/8	3/8	.281	2.35	1.36	.94
V404P-10-6	5/8	3/8	.406	2.75	1.31	1.15

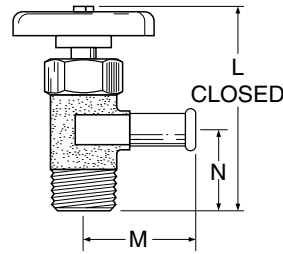

**Truck Valve V404PH**

Hose to Male Pipe with Pin Handle  
 Temperature Range: -30° to +250° F

PART NO.	HOSE I.D.	PIPE THREAD	FLOW	L	M	N
V404PH-10-6	5/8	3/8	.406	2.47	1.31	1.09

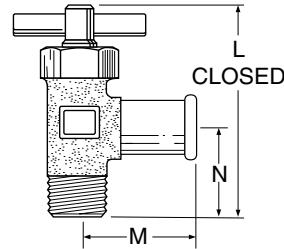

**Truck Valve SV404P**

Hose to Male Pipe  
 Temperature Range: -30° to +250° F

PART NO.	HOSE I.D.	PIPE THREAD	FLOW	L	M	N
SV404P-10-8	5/8	1/2	.468	3.71	2.31	1.34
SV404P-12-6	3/4	3/8	.438	3.73	2.31	1.34
SV404P-12-8	3/4	1/2	.562	3.73	2.31	1.34

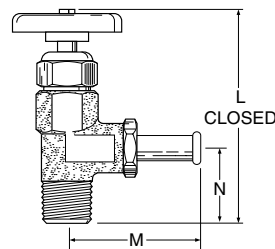

**Truck Valve V405P**

Female Pipe to Male Pipe  
 Temperature Range: -30° to +250° F

PART NO.	FEMALE MALE		FLOW	L	M	N
	PIPE THREAD	PIPE THREAD				
V405P-6-6	3/8	3/8	.406	2.72	.91	1.19
V405P-6-8	3/8	1/2	.406	2.95	.91	1.31
V405P-8-8	1/2	1/2	.562	3.15	1.17	1.34

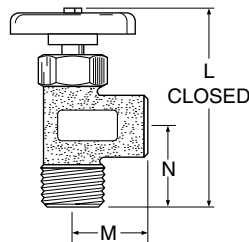

**K**

**Truck Valve V408NTA**

Tube to Male Pipe  
 Temperature Range: -30° to +250° F

PART NO.	TUBE SIZE	PIPE THREAD	FLOW	L	M	N
V408NTA-8-8	1/2	1/2	.328	3.28	1.15	1.19

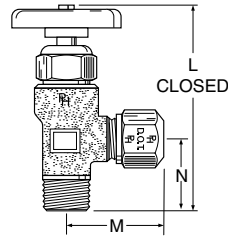

**Truck Valve V409F**

Flare to Male Pipe  
 Temperature Range: -30° to +250° F

PART NO.	TUBE SIZE	PIPE THREAD	FLOW	L	M	N
V409F-8-6	1/2	3/8	.406	3.07	1.31	1.00
V409F-8-8	1/2	1/2	.406	3.28	1.31	1.19
V409F-10-8	5/8	1/2	.500	3.47	1.50	1.25
V409F-12-8	3/4	1/2	.562	3.70	2.31	1.34

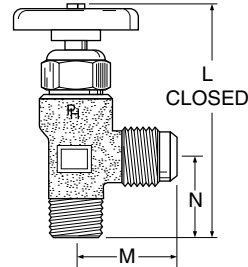

**Truck Valve V410NTA**

Tube to Male Pipe  
 Temperature Range: -30° to +250° F

PART NO.	TUBE SIZE	PIPE THREAD	FLOW	L	M	N
V410NTA-8-8	1/2	1/2	.328	3.58	1.38	1.31

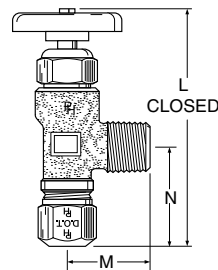

**Truck Valve V412F**

Tube to Male Pipe  
 Temperature Range: -30° to +250° F

PART NO.	TUBE SIZE	PIPE THREAD	FLOW	L	M	N
V412F-10-8	5/8	1/2	.500	3.60	1.38	1.31

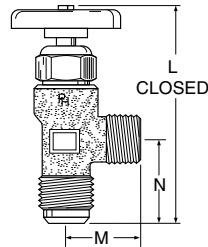

**Lanyard Valve LV91**

Temperature Range: -40° to +200° F

PART NO.	PIPE THREAD	CABLE LENGTH INCHES
LV91-4-036	1/4	36
LV91-4-048	1/4	48
LV91-4-060	1/4	60
LV91HF-4-SUB	1/4	--

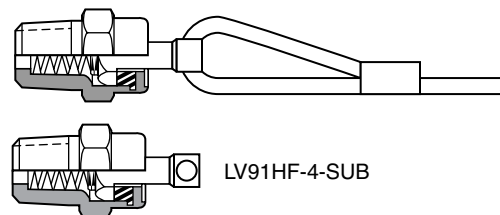

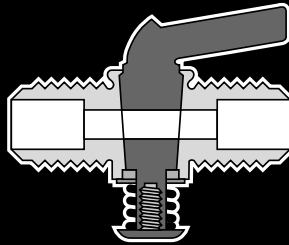

## Drain Cocks/Ground Plug Shutoff

### Drain Cock Advantages

Both external-seat and internal-seat drain cocks are manufactured to the highest quality standards. Hand-tightening provides a metal-to-metal seal.

### Ground Plug Shutoff Advantages

These economical valves are available in several styles. Brass castings or forged bodies for extra strength.

### Applications

Manufactured for use with low pressure air, water, gas and certain other fluids. (Note: lubricant may not be compatible with some fluids, contact factory for special fluid requirements.)

### Temperature and Working Pressure Ranges

System temperature and the type of tubing used should be considered. Ground plug shutoffs are designed to withstand 30 PSI working pressure. Drain cocks are designed to withstand 150 PSI working pressure, except where noted. See specific part number for temperature range.

### Order

By part number and name.

### Nomenclature

Part numbers are constructed from symbols that identify the style and size of the fitting. The first series of numbers and letters identifies the style and type fitting. The second series of numbers describes the size.

**Example:**

	DC	604	-2
Drain Cock	_____	_____	_____
External Seat	_____	_____	_____
1/8" (2/16) Pipe Thread	_____	_____	_____

**Example:**

	V	204	F	-4	-2
Valve	_____	_____	_____	_____	_____
Flared to Male Pipe	_____	_____	_____	_____	_____
Flared	_____	_____	_____	_____	_____
1/4" (4/16) Tube O.D.	_____	_____	_____	_____	_____
1/8" (2/16) Pipe Thread	_____	_____	_____	_____	_____

### Sizes

Tube sizes are determined by the number of sixteenths of an inch in the tube O.D.

### Special Valves

Fitting configurations and/or sizes other than those shown in the catalog can be furnished. It is suggested that a print or sketch be submitted with the inquiry.

### Pricing

Only items priced in current supplementary price list PL3501 are carried in stock. Price and delivery for non-stock items furnished on request for specified quantity.

**K**

**Ground Plug Shutoff V203F**

Flare to Flare  
 Temperature Range: +32° to +125° F

PART NO.	TUBE SIZE	L	M	FLOW DIA. D
V203F-6-6	3/8	2.26	2.14	.220
V203F-8-8	1/2	2.26	2.42	.281

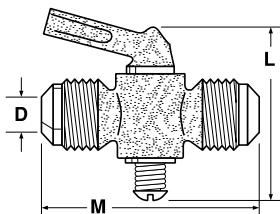

**Ground Plug Shutoff V204F**

Flare to Male Pipe  
 Temperature Range: +32° to +125° F

PART NO.	TUBE SIZE	PIPE THREAD	L	M	FLOW DIA. D
V204F-4-2	1/4	1/8	1.85	2.00	.188
V204F-6-4	3/8	1/4	1.85	2.05	.218

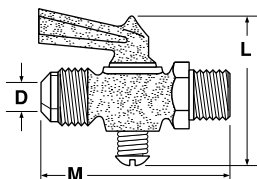

**Ground Plug Shutoff V303C / V303CA**

Compression to Compression  
 Temperature Range: +32° to +125° F

PART NO.	TUBE SIZE	L	M	FLOW DIA. D
V303C-4-4	1/4	1.88	2.33	.188
V303CA-4-4	1/4	1.90	1.75	.188
V303C-6-6	3/8	2.26	2.45	.218
V303CA-6-6	3/8	1.76	1.60	.218

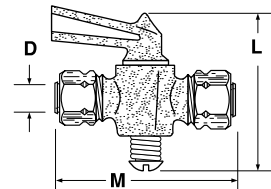
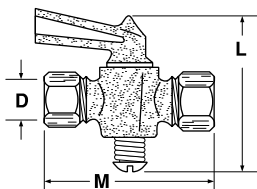

**Ground Plug Shutoff V304C / V304CA**

Compression to Male Pipe  
 Temperature Range: +32° to +125° F

PART NO.	TUBE SIZE	PIPE THREAD	L	M	FLOW DIA. D
V304C-4-2	1/4	1/8	1.90	2.29	.188
V304CA-4-2	1/4	1/8	1.88	2.00	.188
V304C-4-4	1/4	1/4	1.90	2.15	.188
V304CA-4-4	1/4	1/4	1.86	2.08	.188
V304C-6-4	3/8	1/4	1.83	2.24	.218
V304CA-6-4	3/8	1/4	1.83	2.11	.218

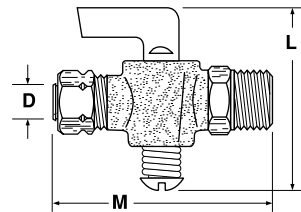
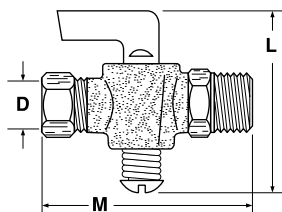

**Ground Plug Shutoff V401P**

Male Pipe to Male Pipe  
 Temperature Range: +32° to +125° F

PART NO.	PIPE THREAD	L	M	FLOW DIA. D
V401P-2-2	1/8	1.90	2.25	.188
V401P-4-4	1/4	1.90	1.98	.188

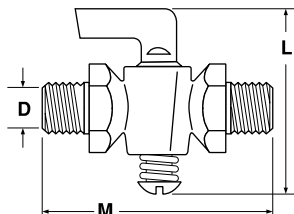

**Ground Plug Shutoff V402P**

Female Pipe to Male Pipe  
 Temperature Range: +32° to +125° F

PART NO.	FEMALE PIPE THREAD	PIPE THREAD	L	M	FLOW DIA. D
V402P-2-2	1/8	1/8	1.85	1.78	.218
V402P-4-4	1/4	1/4	1.86	2.26	.218
V402P-6-6	3/8	3/8	2.34	2.21	.245

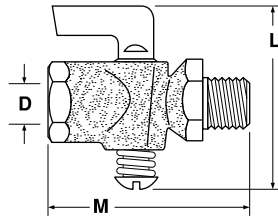

**Ground Plug Shutoff V403P**

Female Pipe to Female Pipe  
 Temperature Range: +32° to +125° F

PART NO.	FEMALE PIPE THREAD	L	M	FLOW DIA. D
V403P-2-2	1/8	1.90	1.51	.218
V403P-4-4	1/4	1.90	1.65	.188
V403P-6-6*	3/8	2.25	2.00	.250

\*Made from extruded bar stock

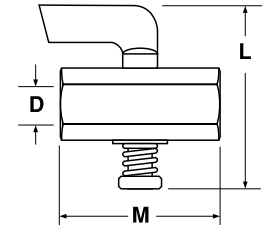
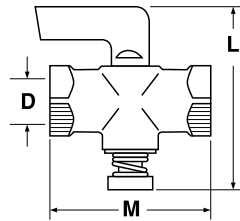

**Three-way valve V406P**

Female Pipe three ends  
 Temperature Range: -40° to +180° F

PART NO.	PIPE THREAD	L	FLOW DIA. D
V406P-4	1/4	3.10	.281

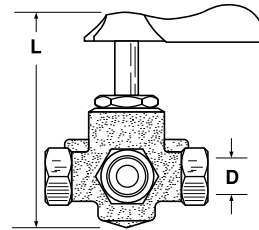

**Four-way valve V407P**

Female Pipe four ends  
 Temperature Range: -40° to +180° F

PART NO.	PIPE THREAD	L	FLOW DIA. D
V407P-4	1/4	3.30	.281

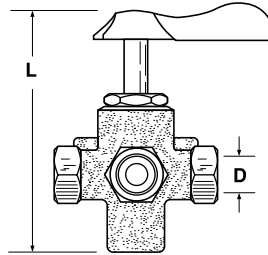

**Ground Plug Shutoff DC601**

Temperature Range: +32° to +125° F

PART NO.	PIPE THREAD	L	M	FLOW DIA. D
DC601-2	1/8	1.90	1.40	.170
DC601-4	1/4	1.90	1.52	.170
DC601-6	3/8	2.26	1.74	.281
DC601-8	1/2	2.29	1.82	.281

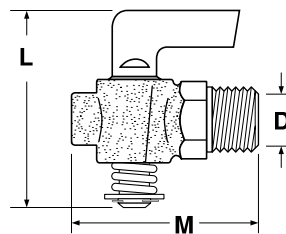

**K**

**Drain Cock DCR601**

Temperature Range: -30° to +250° F

PART NO.	PIPE THREAD	L	M	FLOW DIA. D
DCR601-4	1/4	1.41	1.73	.188

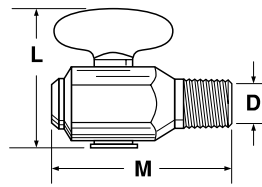

**Internal Seal Drain Cock DC602**

Temperature Range: -65° to +250° F

PART NO.	PIPE THREAD	C HEX	L	M
DC602-2	1/8	13/32	.92	1.25
DC602-4	1/4	9/16	.94	1.25

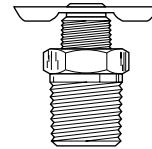
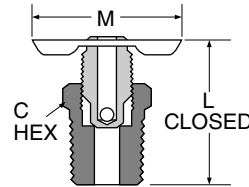

**Drain Cock DC603**

Temperature Range: -65° to +250° F

PART NO.	PIPE THREAD	C HEX	L	M
DC603-2	1/8	5/8	1.41	1.00
DC603-4	1/4	5/8	1.54	1.16
DC603-6	3/8	11/16	1.63	1.16

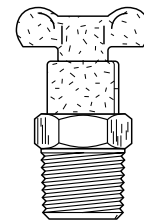
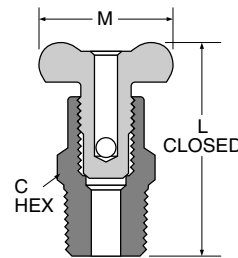

**External Seal Drain Cock DC604**

Temperature Range: -25° to +250° F

PART NO.	PIPE THREAD	C HEX	L	M
DC604-2*	1/8	7/16	.85	1.25
DC604-4	1/4	9/16	1.00	1.38
DC604-6*	3/8	11/16	1.22	1.68

\*When assembled handle wings are down facing

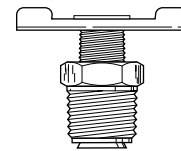
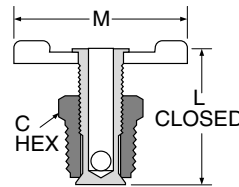

**External Seal Drain Cock DC606**

Temperature Range: -65° to +250° F

PART NO.	PIPE THREAD	C HEX	L	M
DC606-4	1/4-18	9/16	1.50	1.38

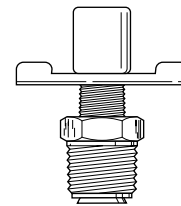
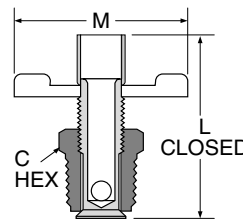

**Bib Drain Valve DC607**

Temperature Range: -65° to +250° F

PART NO.	HOSE SIZE	PIPE THREAD	FLOW	L	M	N
DC607-4	3/8	1/4	.31	1.32	.67	.71

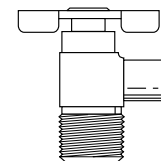
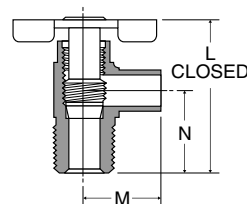



**Notes**

---



---



---



---



---



---



---



---



---



---



---



---



---



---



---



---



---



---



---



---



---



---



---



---



---

**K**





# ***Tube Fabricating Equipment***

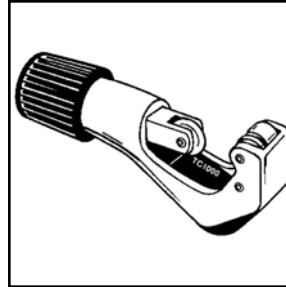





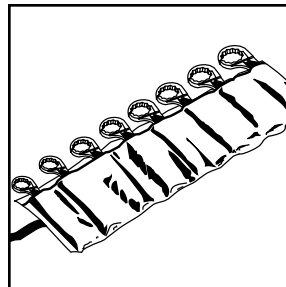
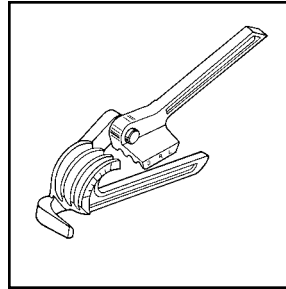



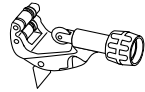
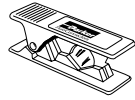
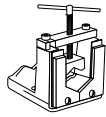

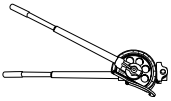
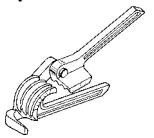
## **Tube Fabricating Equipment**

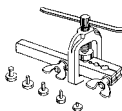
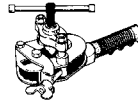
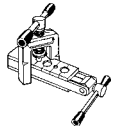
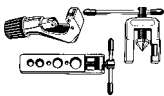
- Tube cutters
- Tube Benders
- Flaring Tools
- Flaring Tool Kits
- Swaging Tools
- Testing & Service Tools
- Deburring Tool

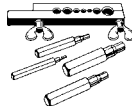
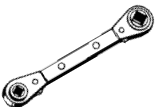

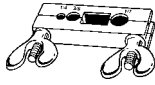
***The World Standard***

<p><b>Tube Cutters</b></p>	<p><b>Tube Cutters</b> Sizes 2 to 64</p>  <p>Page L3</p>	<p><b>Kloskut Cutters</b> Sizes 2 to 32</p>  <p>Page L4</p>	<p><b>PTC-001</b> Plastic Tube Cutter</p>  <p>Page L4</p>	<p><b>Sawing Vise</b></p>  <p>Page L14</p>	<p><b>Benders</b></p>	<p><b>Hand Benders</b></p>  <p>Page L5</p>
<p><b>Ratchet Benders</b></p>  <p>Page L5</p>	<p><b>Triple Headed</b></p>  <p>Page L6</p>	<p><b>Spring Type</b></p>  <p>Page L6</p>	<p><b>Flaring Tools</b></p>	<p><b>Combination Tools</b></p>  <p>Page L7</p>	<p><b>Rolo-Flair</b></p>  <p>Page L8</p>	<p><b>Metric Flaring</b></p>  <p>Page L9</p>
<p><b>Tubing Tool Kits</b></p>	<p><b>Combination Kits</b></p>  <p>Page L10</p>	<p><b>Swaging Tools</b></p>	<p><b>Punch-Type</b></p>  <p>Page L11</p>	<p><b>Swaging Kits</b></p>  <p>Page L11</p>	<p><b>Wrenches</b></p>	<p><b>Ratchet Wrenches</b></p>  <p>Page L12</p>
<p><b>Par-Lock Wrenches</b></p>  <p>Page L13</p>	<p><b>Testing and Service Tools</b></p>	<p><b>Pinch Off Tool</b></p>  <p>Page L12</p>	<p><b>Deburring Tools</b></p>	<p><b>In-Ex Deburring Tool</b></p>  <p>Page L14</p>		

L

	PART NO.	DESCRIPTION
--	----------	-------------

**Tube Cutters**

For hard or soft copper, aluminum, brass, thin wall steel, stainless steel, monel, titanium and other metal tubing

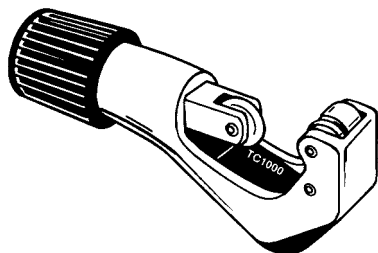

		Rollers have flare cut-off groove, fold away reamer and spare cutting wheel.
	<b>TC-1000-BPD</b>	For 1/8" to 1 1/8" (4 to 28 mm) O.D. tubing, (1/8" to 1" nom.). Length: 4 15/16" Weight: 6 1/2 oz.
	<b>312-FC-BPD</b>	For 1/4" to 1 5/8" (7 to 41 mm) O.D. tubing, (1/8" to 1 1/2" nom.). Length: 5 1/2" Weight: 7 oz.
	<b>TC-1020-BPD</b>	Combination tube constictor and cutter for 1/8" to 1 1/8" (4 to 28 mm) O.D. tubing. Includes roller for making brazed connections.
	<b>Replacement Parts:</b>	
	<b>S75015-BPD</b>	Standard cutting wheel
	<b>S75046-BPD</b>	Cutting wheel for stainless steel and hard temper tubing
	<b>S74762-BPD</b>	Screw for cutting wheel

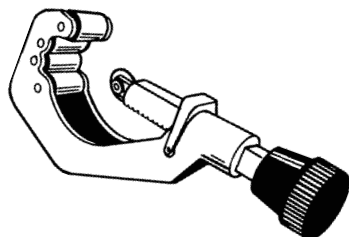

		Ratchet feed mechanism speeds up cutting operation. Extra wide rollers stabilize tubing. Spare cutting wheel included.
	<b>206-FB-BPD</b>	For 3/8" to 2 5/8" (10 to 66 mm) O.D. tubing, (1/4" to 2 1/2" nom.). Length (closed): 7 3/4" Weight: 2 lbs.
	<b>406-FA-BPD</b>	2" to 4" cutter for 2" to 4 1/8" (51 to 104 mm) O.D. tubing, (2" to 4" nom.) Length (closed): 11 1/4" Weight: 3 1/2" lbs.
	<b>Replacement Parts:</b>	
	<b>S74761-BPD</b>	Cutting wheel for 206-FB-BPD

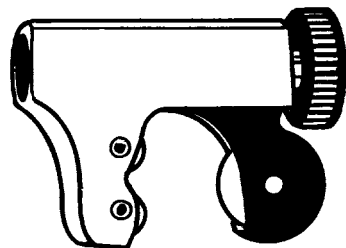

	<b>TC-1050-BPD</b>	For 1/8" to 5/8" (4 to 15 mm) O.D. tubing, (1/8" to 1/2" nom.) Requires only 1 1/4" swing radius. (Requires only 1 3/8" swing radius with 5/8" tube.)
		Repositioned rollers to bottom of tool allows for easier cutter engagement on tubing. Enclosed feed-screw minimized contamination, assuring continued free operation. Redesigned feed mechanism improves overall cutting action.
		Size: 1 3/4" x 1 1/4" x 1/2" Weight: 2 1/2 oz.
	<b>TC-2050-BPD</b>	For 3/16" to 7/8" (5 to 22 mm) O.D. tubing. (Requires only 1 11/16" swing radius.)
	<b>Replacement Parts:</b>	
	<b>S74762-BPD</b>	Screw for cutting wheel TC-1050-BPD
	<b>S32633-BPD</b>	Cutting wheel for TC-1050-BPD

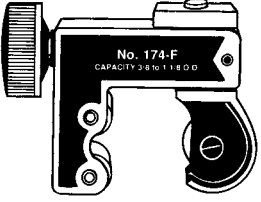

	PART NO.	DESCRIPTION
	<b>174-F-BPD</b>	For 3/8" to 1 1/8" (10 to 28 mm) O.D. tubing, (1/4" to 1" nom.). Requires only 1 15/16" swing radius. (Requires only 2 1/4" swing radius with 1 1/8" tube.)  Size: 2 11/16" x 2 1/32" x 1 1/8" Weight: 5 oz.  <b>Replacement Parts:</b>
	<b>S75015-BPD</b>	Cutting wheel
	<b>S75046-BPD</b>	Cutting wheel for stainless steel and hard temper tubing

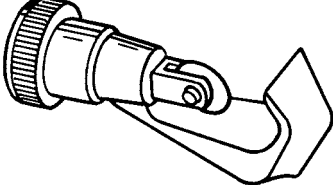
	<b>227-FA-BPD</b>	For 1/8" to 3/4" (4 to 19 mm) O.D. tubing, (1/8" to 5/8" nom.). Enclosed feed mechanism.  Length: 3 1/2" Weight: 5 oz.  <b>Replacement Parts:</b>
	<b>S32633-BPD</b>	Cutting wheel

## Kloskut® Tube Cutters

Adjustable tube cutters to produce square cut ends with no external burr and minimum internal burring when used on fully annealed copper, brass, aluminum, and steel tubing. Features a hardened and burnished tool-steel cutting wheel, flare cut-off grooves in rollers for removal of old flares, swing-away reamer for removing internal burrs.

Handle feeds and adjusts cutting wheel to uniformly cut tubing as the cutter is rotated.

NOTE: Tube cutters are not recommended for use with stainless steel tubing because of the work hardening effect. The use of a hacksaw with a "Tru-Kut" Sawing Vise or a rotary teeth saw is best recommended for stainless steel.

	<b>218B-BPD</b>	<b>Medium Kloskut</b> For tubing sizes -2 (1/8" O.D.) to -18(1 1/8" O.D.)  Weight: 11 oz.
	<b>1232-BPD</b>	<b>Large Kloskut</b> For tubing sizes -12 (3/4" O.D.) to -32 (2" O.D.) Die-cast aluminum frame.
	<b>218B Wheel-BPD</b>	<b>Cutter wheel for No. 218B Tube Cutter</b>
	<b>1232 Wheel-BPD</b>	<b>Cutter Wheel for No. 1232 Tube Cutter</b>

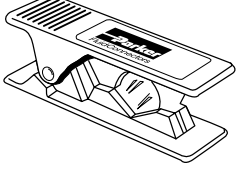
	<b>PTC-001</b>	<b>Plastic Tube Cutter</b> May be used with polyethylene, Polypropylene, nylon and other thermo-plastic tubing. For tube O.D. sizes 1/8" to 1/2"
	<b>PTC-001RB</b>	Replacement blades

## Hand Tube Benders

Sturdy, easy-to-use hand tools for fast accurate bending without kinks or visible flattening. Individual sizes in three modest from size 2 (1/8" O.D.) to 16 (1" O.D.). See Table O3 for part numbers and technical data.

### Medium Duty Hand Tube Benders

Designed and built for fast accurate bends and long service life.

Individual benders for six tube sizes 1/8, 3/16, 1/4, 5/16, 3/8, and 1/2 inch. Will bend copper, aluminum, annealed steel and stainless steel. Can be used in hands or mounted in a bench vise for heavier wall thickness tube. Simply align marks on slide block and radius block then bend tube to desired angle (up to 180°) by pulling steadily on slide block handle. Angles are indicated on radius block both front and back. (Detailed instructions are included with each bender.) This style of bender is also available in metric sizes. See Table O4 for part numbers and technical data.

### Ratchet Hand Tube Benders

Individual benders for two tubing sizes 5/8 and 3/4, and inches in copper, aluminum, annealed steel and stainless steel. Can be used in hands or mounted in a bench vise for heavier wall thickness tube. Position tube in bender, close latch and pull ratchet handle away from radius block until desired angle (up to 180°) is formed. Angles are indicated on radius block. (Detailed instructions are included with each bender.)

### 1" Hand Tube Bender

For tubing size 1" O.D. in soft copper and aluminum. Can be used in hands, but suggest mounting on bench vise - especially for heavier wall thickness tube. Align marks and bend tube to desired angle (up to 180°) by pulling steadily on operating handle. Handle may be repositioned for maximum leverage. Angles are indicated on radius block. (Detailed instructions are included with bender.)

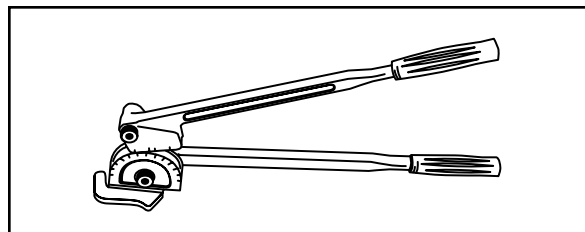

Medium Hand Tube Bender

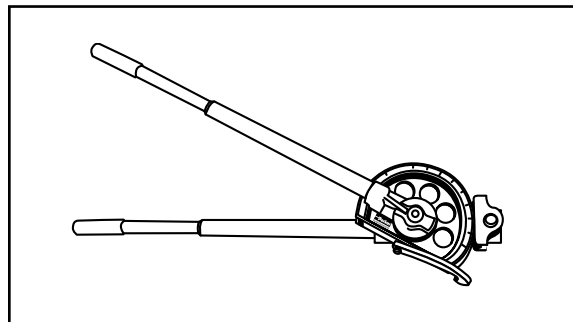

Ratchet Hand Tube Bender

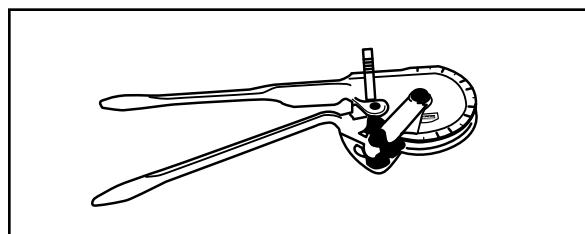

1" Hand Tube Bender

PART NUMBER	TYPE OF BENDER	SIZE	TUBE O.D. (IN.)	RADIUS TO TUBE CENTERLINE (INCHES)	MIN. WALL WITHOUT FLATTENING (INCHES)	RECOMMENDED MAX. WALL THICKNESS	
						COPPER ALUMINUM	STEEL STAINLESS STEEL (IN.)
2-2829S-BPD	MED. DUTY	2	1/8	7/16	0.012	ANY	0.032
3-2829S-BPD	MED. DUTY	3	3/16	9/16	0.020		0.032
4-2829S-BPD	MED. DUTY	4	1/4	9/16	0.028		0.083
5-2829S-BPD	MED. DUTY	5	5/16	15/16	0.032		0.083
6-2829S-BPD	MED. DUTY	6	3/8	15/16	0.032		0.083
8-2829S-BPD	MED. DUTY	8	1/2	1 1/2	0.042		0.083
10-2829S-BPD	MED. DUTY	10	5/8	2 1/2	0.042		0.049
12-2829S-BPD	MED. DUTY	12	3/4	3	0.049		0.065
10-2829-BPD	RATCHET	10	5/8	3	0.042	ANY	0.049
12-2829-BPD	RATCHET	12	3/4	3 3/4	0.049	ANY	0.065
16-2829-BPD	1"	16	1	3 1/2	0.065	ANY	Not Recommended

TUBE O.D. (mm)	PART NUMBER	BEND RADIUS	MAX. WALL STEEL/SS
5	2829-5mm-BPD	14.3	1.2
6	2829-6mm-BPD	14.3	1.6
8	2829-8mm-BPD	23.8	1.6
10	2829-10mm-BPD	23.8	2.1
12	2829-12mm-BPD	38.1	2.1
14	2829-14mm-BPD	38.1	2.1

PART NO.	DESCRIPTION
----------	-------------

### Tube Benders, Lever Type

For soft copper, aluminum, brass, steel and other metal tubing

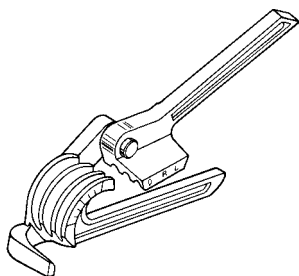

<b>Triple Header Benders</b>	
	Calibrated markings for making accurate left-hand, right-hand and offset bends. Ninety degree start requires less effort - making bending fast and easy.
<b>367-FH-BPD</b>	For 1/8", 3/16" and 1/4" (3, 4, and 6 mm) O.D. tubing, 9/16" radius to center of tube.
<b>368-FH-BPD</b>	For 1/4", 5/16" and 3/8" (6 and 8 mm) O.D. tubing, 15/16" radius to center of tube.

### Metric Tube Benders

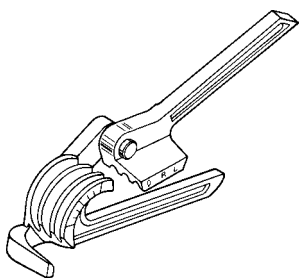

<b>Triple Header Benders</b>	
	For annealed copper, aluminum, steel, stainless steel and hard copper tubing of bending temper.
	Lever type, multiple size benders. Calibrated markings for making accurate left-hand, right-hand, and offset bends. Ninety degree start requires less effort; makes bending fast and easy.

BENDING RANGE				
Tube O.D. (Inches)(mm)	Radius to Center of Tube (Inches) (mm)			
<b>367-FH-BPD</b>	1/8, 3/16, 1/4	3, 4, 6	9/16	14.2
<b>368-FH-BPD</b>	1/4, 5/16, 3/8	6, 8	15/16	17.5

### Tube Benders, Spring Type

For soft copper and aluminum tubing

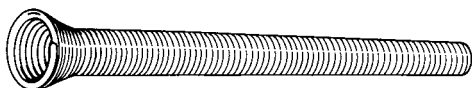

<b>For 1/4" to 5/8" O.D. tubing.</b>			
	Tools allow hand bending of soft tubing to any shape without collapsing walls. Special spring steel, nickel finished. End belled for quick tube removal.		
BENDER			
TUBE O.D. (INCHES)	LENGTH (INCHES)	WEIGHT (OZ.)	
<b>102-F-04-BPD</b>	1/4	10	3
<b>102-F-05-BPD</b>	5/16	10	3
<b>102-F-06-BPD</b>	3/8	10	4
<b>102-F-07-BPD</b>	7/16	12	6 1/4
<b>102-F-08-BPD</b>	1/2	12	6 1/2
<b>102-F-10-BPD</b>	5/8	12	8
<b>201-F-BPD</b>	Set of 8 benders for 1/4", 5/16", 3/8", 7/16", 1/2", 5/8", 3/4" and 7/8" O.D. tubing.		
<b>112-F-BPD</b>	Set of 3 benders for 1/4", 5/16" and 3/8" O.D. tubing.		
<b>163-F-BPD</b>	Set of 4 benders for 1/4", 3/8", 1/2" and 5/8" O.D. tubing.		



	PART NO.	DESCRIPTION
--	----------	-------------

**45° Flaring Tools**

For soft copper, aluminum and brass tubing

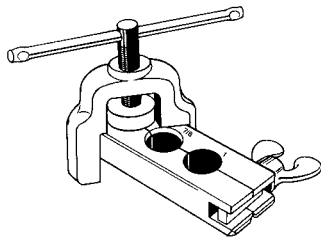

**103-FS-BPD**

Tools for flaring larger tubesizes. Quick slip-on yoke. Positive clamping action of flaring bar eliminates tube movement.  
Weight: 3 3/4 lbs.

**203-FA-BPD**

For 3/4", 7/8" and 1" O.D. tubing, (5/8" and 3/4" nom.).  
For 5/8", 3/4", 7/8" and 1 1/8" O.D. tubing, (1/2", 5/8", 3/4" and 1" nom.).

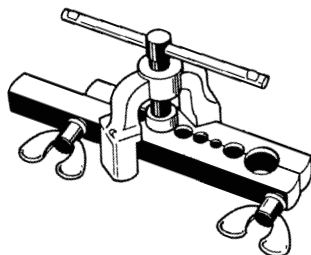

**195-FC-BPD**

For 3/16", 1/4", 5/16", 3/8", 7/16", 1/2" and 5/8" O.D. tubing, (1/8", 1/4", 3/8" and 1/2" nom.).

Self-centering yoke with swivel-type, hard chrome-finished flaring cone forms better flares with less effort. Design of yoke permits flaring where there is little space between nut and tube end.

Weight: 2 lbs.

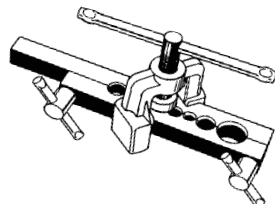

**296-FC-BPD**

For 3/16", 1/4", 5/16", 3/8", 1/2", and 5/8" O.D. tubing, (1/8", 1/4", 3/8" and 1/2" nom.).

Economical and fast operating. Swivel type, hard chrome-finished cone assures smooth flares. Bar is lighter than 195-FC-BPD and is not hardened.

Weight: 1 3/4 lbs.

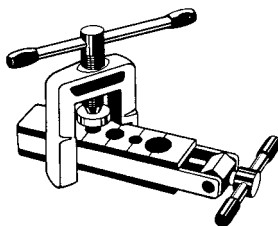

**300-FB-BPD**

For 3/16", 1/4", 5/16", 3/8", 1/2" and 5/8" O.D. tubing, (1/8", 1/4", 3/8", and 1/2" nom.).

Hard chrome-finished cone makes exceptionally smooth, high strength flares with a radius at base of flare - instead of the sharp angle formed by ordinary tools. Positive gripping and self-gauging of tube for exact flare size.

Weight: 1 5/8 lbs.

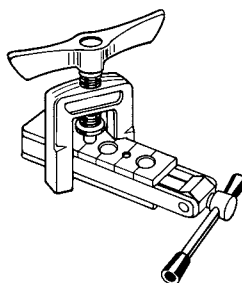

**500-FC-BPD**

For flaring and burnishing 3/16", 1/4", 5/16", 3/8", 1/2" and 5/8" O.D. tubing, (1/8", 1/4", 3/8" and 1/2" nom.).

Flares rolled out above die bar by super-smooth faceted cone. Automatically burnished flare face. Slip-on yoke permits use in tight quarters. Heat treated dies grip tubing without scoring.

Weight: 1 1/2 lbs.



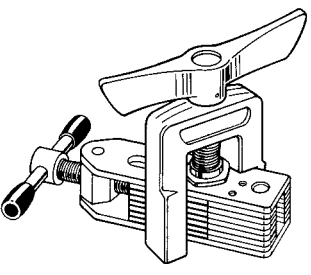
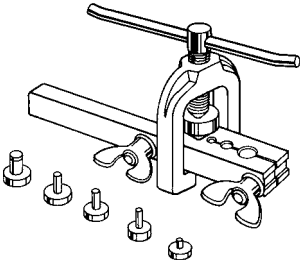
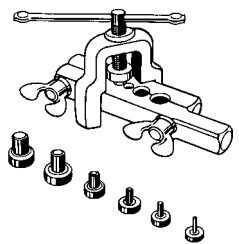
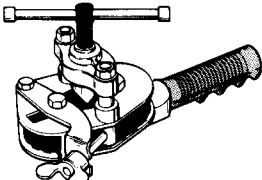

	PART NO.	DESCRIPTION
	<p><b>525-F-BPD</b></p>	<p>Flares and burnishes 3/16" to 5/8" (5 to 16 mm) O.D. tubing.</p> <p>Unique, self-adjusting, tube holding mechanism permits use in tight quarters. Faceted, hard chrome finished cone rolls out and burnishes perfect 45° flare above the tube holding mechanism.</p> <p>Weight: 1 3/4 lbs.</p>
	<p><b>93-FB-BPD</b></p>	<p>For 3/16", 1/4", 5/16", 3/8" and 1/2" O.D. tubing. Recommended for Bundy, GM and other brazed or welded soft steel tubing (wall thickness to .035"). Also makes single or double flares in soft copper or aluminum tubing. Forged steel yoke; swivel-type hard chrome-finished flaring cone.</p> <p>Weight: 3 lbs.</p>
	<p><b>195-FB-BPD</b></p>	<p>For 1/4", 5/16", 3/8", 1/2", 5/8" and 3/4" O.D. tubing. Designed for automotive air conditioning service. Makes double flares in soft copper or aluminum tubing (wall thickness to .035"). Easy operating, ball bearing, swivel-type, hard chrome-finished, flaring cone. Makes flare with double-thick, double-strength walls. Also makes single and oversize flares.</p> <p>Weight: 5 1/2 lbs.</p>
	<p><b>945TH-BPD</b></p>	<p><b>Rolo-flair® Manual Rotary Flaring Tool</b></p> <p>For soft metal tubing. Precision burnished 45° flares in tube sizes from 2 (1/8" O.D.) to 12 (3/4" O.D.) with an easy turn of the handle. For copper and aluminum alloy.</p> <p>Weight: 2 1/2 lbs.</p>



PART NO.	DESCRIPTION
----------	-------------

**Metric Flaring Tools**

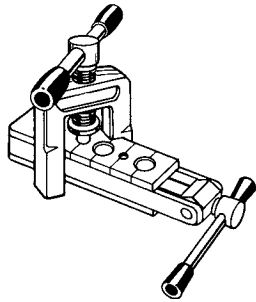

**293-F-BPD**

**Bubble Flaring Tool**

For 4.75 (3/16"), 6, 8 and 10 mm O.D. tubing

Flares soft double wall steel tubing with a wall thickness to .028". For soft copper and aluminum tubing.

Also forms international Standard bubble flare in one fast operation. Flares metric hydraulic brake lines used on European, Japanese and domestic automobiles and light trucks. Can also be used for industrial applications where movement or vibration is a problem.

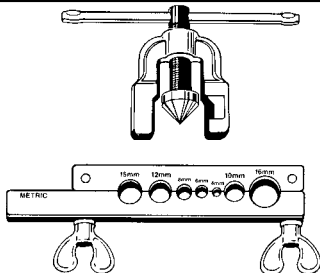

**395-FAM-BPD**

**45° Flaring Tool**

For 4, 6, 8, 10, 12, 15 and 16 mm O.D. tubing.

Flares soft copper, aluminum and brass.

Forged steel slip-on yoke and hardened flaring bar. Positive clamping action of bar prevents tube slippage. Self-centering yoke with swivel-type, hard chrome-finished flaring cone forms better flares with less effort. Design of yoke permits flaring where there is little space between nut and tube end.

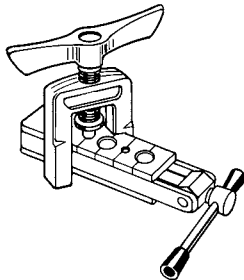

**500-FCM-BPD**

**45° Flaring Tool**

For flaring and burnishing 6, 8, 10, 12, 15 and 16 mm O.D. tubing.

For soft copper, aluminum and brass.

Flares rolled out above die bar by super-smooth faceted cone. Automatically burnishes flare face. Slip-on yoke permits use in tight quarters. Heat treated dies grip tubing without scoring.

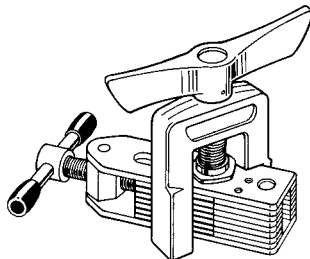

**525-F-BPD**

**45° Flaring Tool**

For flaring and burnishing 5 to 16 mm O.D. tubing.

For soft copper, aluminum and brass.

Unique, self-adjusting tube holding mechanism permits flaring any size tubing within the range of 5 to 16 mm O.D. Single opening design is compact and easy to use. Faceted, hard chrome-finished cone rolls out and burnishes perfect flares above the tube holding mechanism. Slip-on self-centering yoke.



PART NO. DESCRIPTION

**Tubing Tool Kits**

For soft copper, aluminum and brass tubing

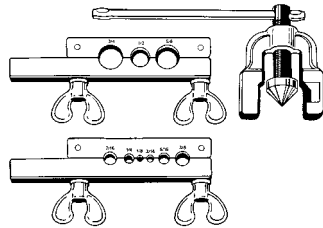

**375-FS-BPD**

**45° Flaring Kits**

Compact kits contain two flaring bars and one yoke. Self-centering forged steel yoke has slip-on feature. Swivel-type flaring cone reduces effort required. Positive clamping action of flaring bars eliminates tube movement. In plastic case.

For 1/8" 3/16", 1/4", 5/16", 3/8", 7/16", 1/2", 5/8", and 3/4" O.D. tubing, (1/8", 1/4", 3/8", 1/2" and 5/8" nom.).

Weight: 4 3/4 lbs.

**376-FS-BPD**

For 1/2", 5/8", and 3/4" O.D. tubing, (3/8", 1/2" and 5/8" nom.).

Weight: 2 lbs.

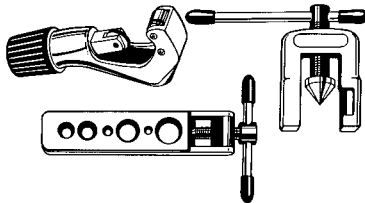

**124-FA-BPD**

Contains TC 1000 tube cutter, 500-FB flaring tool (same range as 300-FB).

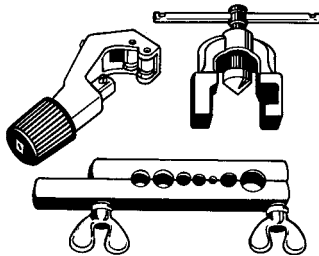

**1226-FA-BPD**

**45° Flaring and Cutting Kit**

Contains TC 1000 tube cutter for 1/8" to 1 1/8" O.D. tubing and 195-FC flaring tool for 3/16", 1/4", 5/16", 3/8", 7/16", 1/2" and 5/8" O.D. tubing, (1/8", 1/4", 3/8" and 1/2" nom.).

Weight: 3 lbs.

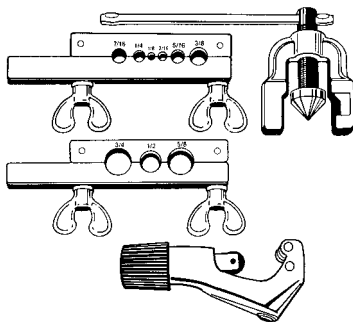

**120-F-BPD**

**45° Flaring and Cutting Kit**

Contains TC 1000 cutting tool and 375-FS multiple-size flaring tool for 1/8", 3/16", 1/4", 5/16", 3/8", 7/16", 1/2", 5/8" and 3/4" O.D. tubing, (1/8", 1/4", 3/8", 1/2" and 5/8" nom.). In plastic carrying case.

Weight: 5 1/4 lbs.

**121-F-BPD**

**All Purpose Tubing Tool Kit**

Contains tools listed above plus three 102-F bending springs for 1/4", 3/8" and 1/2" O.D. tubing; and our 123-C ratchet wrench with 1/4" ratchet, 3/16" and 1/4" Square opening and 1/2" hex in handle. In steel carrying case.

Weight: 5 3/4 lbs.

L

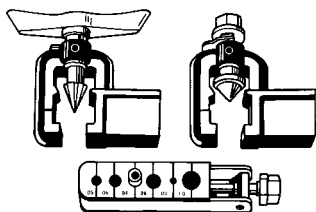

**402-FA-BPD**

**Flaring and Reaming Kit**

Contains 400-F flaring tool and 401-FA reaming yoke for 1/4" to 5/8" O.D. tubing. In plastic kit.

Weight: 3 1/8 lbs.

PART NO. DESCRIPTION

**Swaging Tools**

For soft copper, aluminum and brass tubing

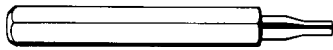

93-S-BPD

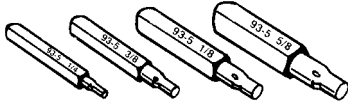

193-S-BPD

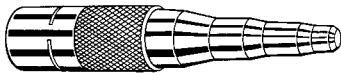

94-S-BPD

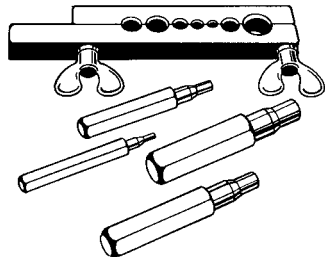

195-SA-BPD

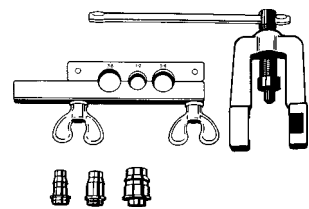

- 93-S-03-BPD
- 93-S-04-BPD
- 93-S-06-BPD
- 93-S-10-BPD
- 94-S-BPD

193-S-BPD

195-SA-BPD

75531-BPD

194-S-BPD

275-FS-BPD

**Punch-Type Swaging Tools**

Use these tools for making tubing connections without fittings. Enlarge end of tube, insert another tube, solder like a sweat fitting.

	O.D. SIZE (INCHES)	NOM. SIZE (INCHES)	WEIGHT
Swaging punch.	3/16		3 oz.
Swaging punch.	1/4	1/8	3 oz.
Swaging punch.	3/8	1/4	1/4 lb.
Swaging punch.	5/8	1/2	1/2 lb.
Swaging punch.	1/2	3/8	1 lb.
		5/8	1/2
		7/8	3/4

**Swaging Punch Kit**

Contains four swaging punches - 1/4", 3/8", 1/2" and 5/8" O.D., (1/8", 1/4", 3/8" and 1/2" nom.) in vinyl case.

Weight: 1 lb.

**Swaging Punch Kit**

Contains flaring bar and four swaging punches - 1/4", 3/8", 1/2" and 5/8" O.D., (1/8", 1/4", 3/8" and 1/2" nom.). In steel kit.

Weight: 2 lbs.

**Flaring bar only.**

Weight: 1 lb.

For 1/2", 5/8" and 7/8" O.D. tubing, (3/8", 1/2" and 3/4" nom.).

Screw-type swaging tool provides perfect swage alignment of tube every time. Adapters change quickly. In plastic kit.

Weight: 2 1/8 lbs.

**45° Flaring and Swaging Tool**

For 1/8", 3/16", 1/4", 5/16", 3/8", 7/16", 1/2", 5/8" and 3/4" O.D. tubing, (1/8", 1/4", 3/8", 1/2" and 5/8" nom.).

Includes five swage adapters for 3/16", 1/4", 5/16", 3/8", 1/2" and 3/4" O.D. tubing, (1/8", 1/4", 3/8", 1/2" and 5/8" nom.).

Flares or swages. Converts quickly. Screw-type-feed. Ideal close quarters tool. Swivel-type swaging adapters and spreader cone are hard chrome-finished for easy operation. Self-centering, slip-on forged steel yoke. In plastic kit.

Weight: 3 1/2 lbs.

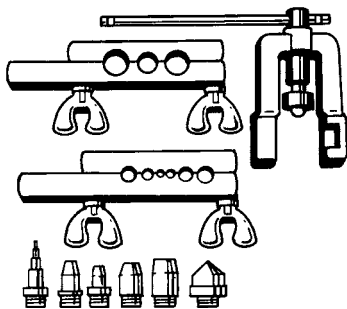

PART NO.	DESCRIPTION
----------	-------------

---

## Testing and Service Tools

---

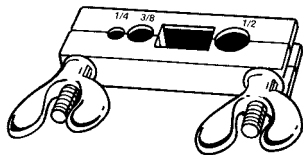

**105-FF-BPD**

**Pinch Off Tool**  
1/4", 3/8" and 1/2" O.D.

Temporarily closes soft copper, aluminum or steel tubing so no liquid or gas passes sealed part. Opens tubing and rounds it back to shape.

Weight: 3/4 lb.

## Ratchet Wrenches

For refrigeration/air conditioning service

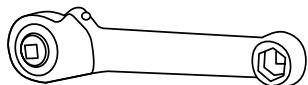

**123-C-BPD**

Steel forged. For use on small refrigerant cylinders, shut-off valves, packing gland wrenches, etc. Ratchet has 1/4" square drive and raised face. Handle has 3/16" and 1/4" square drives and 1/2" hex.

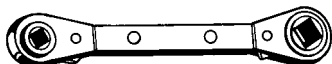

**124-C-BPD**

Combination wrench with the four sizes most needed for servicing automotive air conditioning:  
\* 9/16" hex for dust cap on Schrader type valves and plug oil check on York compressor

- \* 1/2" hex for mounting bolts on Tecumseh, York and Airtemp compressors
- \* 1/4" square for valve stem on York and Tecumseh service valves and old style compressor valves
- \* 3/16" square for valve on old style refrigerant charging tanks.

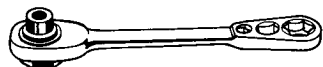

**125-C-BPD**

Rugged, steel forged wrench with four sizes covering almost any application.  
1/4" square ratchet for valve stem on York and tecumseh service valves, and old style compressor valves. Other end has 3/16" and 5/16" square openings, plus 9/16" hex opening for dust cap on Schrader type valves, and plug for oil chekc on York compressor.

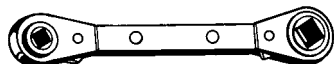

**127-C-BPD**

Compressor access valve wrench. Chrome plated. Has 1/4", 3/8", 3/16" and 5/16" square drive ratchets and is specially designed for use on compressors with access valves in hard to reach places. Reversible ratchets.

L

## Par-Lok® Wrench

360° Snap-action ratchet wrench for hex sizes from 3/8" to 2 1/4" across the flats and metric from 10mm to 22mm. Inch sizes meet government specifications and are listed as NSN-5120-00-474-7227.

### Install Tube Fittings Faster

Easy across ratchet wrench speeds fittings installation in tight locations. Rugged, snap-action jaws can be opened over tube lines, locked onto fitting hex and ratcheted within 1/8 turn. Full six point contact prevents fitting distortion common with wrench slippage. Ideal for tube line installations where compact runs require multiple fitting make-up, disassembly and remakes.

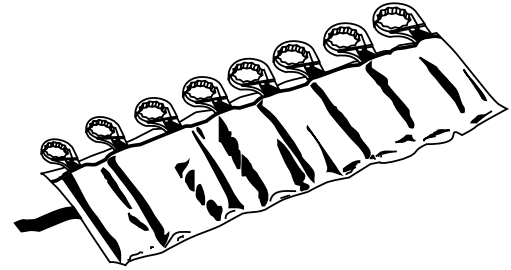

### Specifications

Most Par-Lok wrenches are available individually or in 3 different kit combinations. Par-Lok jaws are constructed from drop-forged, high carbon steel material with a black conversion coat finish. Par-Lok handles are made from heavy gauge steel material, heat treated and with a corrosion resistant black finish. Solid stainless steel rivets and tempered jaw springs are designed into every wrench for maximum strength.

INCH SIZES				METRIC SIZES	
PART NO.	HEX SIZE	PART NO.	HEX SIZE	PART NO.	HEX SIZE
860062-6-BPD	3/8	860062-18-BPD	1 1/8	860063-10-BPD	10 mm
860062-7-BPD	7/16	860062-20-BPD	1 1/4	860063-11-BPD	11 mm
860062-8-BPD	1/2	860062-22-BPD	1 3/8	860063-12-BPD	12 mm
860062-9-BPD	9/16	860062-24-BPD	1 1/2	860063-13-BPD	13 mm
860062-10-BPD	5/8	860062-26-BPD	1 5/8	860063-14-BPD	14 mm
860062-11-BPD	11/16	860062-30-BPD	1 7/8	860063-16-BPD	16 mm
860062-12-BPD	3/4	860062-32-BPD	2	860063-17-BPD	17 mm
860062-13-BPD	13/16	860062-36-BPD	2 1/4	860063-19-BPD	19 mm
860062-14-BPD	7/8	860062-KIT2-BPD	Full Kit-	860063-21-BPD	21 mm
860062-15-BPD	15/16		8 Wrenches	860063-22-BPD	22 mm
860062-16-BPD	1			860063-KIT-BPD	Full Kit-
860062-KIT-BPD	Full Kit-				10 Sizes



PART NO.	DESCRIPTION
----------	-------------

---

## In-Ex® Tube Deburring Tool

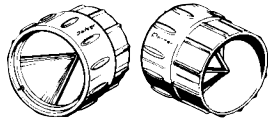

**226-BPD**

A quick twist of the wrist will deburr either the O.D. or the I.D. of the tube end. Parker's In-Ex deburrer can be used on annealed steel, stainless steel, copper and aluminum, for tube sizes 1/8" to 1 5/8" O.D.

Insert tube into the convexed end of the In-Ex for inside deburring and the opposite end for outside deburring. Rotate in either direction. Replacement blades can be ordered. See bulletin 4391-B226 for details.

Weight: 10 oz.

**226RB-BPD**

Replacement Blades

**208-FSS-BPD**

Reamer for aircraft grade stainless steel tubing. Black finish

Weight: 10 oz.

## Tru-Kut® Sawing Vise

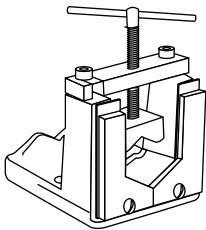

**710439-BPD**

Hacksaw guide will accommodate tube, pipe and hose from sizes 3 (3/16" O.D.) to 32 (2" O.D.). Assures square cut-offs within ± 1°. Use a fine tooth hacksaw blade for smoother cuts.

**How To Use:** Mount in vise or bolt to bench. Clamp tubing, pipe or hose into the Tru-Kut vise and cut off; guide ensures accurate square cuts.

## Rolo-Flair® for 45° Flare 945TH-BPD

DRAWING ITEM NUMBER	PARKER PART NUMBER	PART DESCRIPTION	NUMBER PIECES REQUIRED
1	642685	Wing Nut	1
2	642694	Hex Bolt	1
2-A	642696	Jam Nut	1
3	642759	Clamping Yoke	1
4-A	642698	Jam Nut	1
6	642764	Handle	1
7	642689	Spacer	2
8	642681	Hex Stud	2
9	2603-00006	Spacer	1
12	2600-03001	Top Plate	1
13	2600-03004	Flaring Die Sub-Assy.	1
13-A	2600-03045	Cross Yoke Sub-Assy.	1
		Burnishing Cone	1

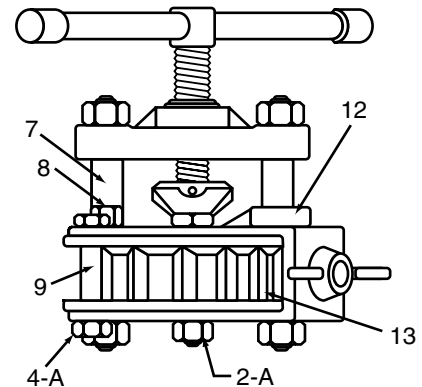

### Rolo-Flair® Repair Parts

We do not repair the flaring tool-however, we do offer repair parts-stock available in Otsego, Michigan, only.

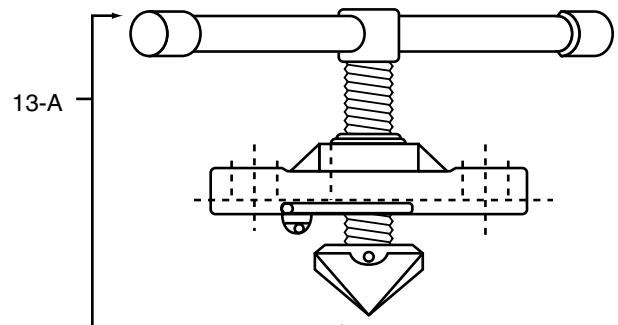
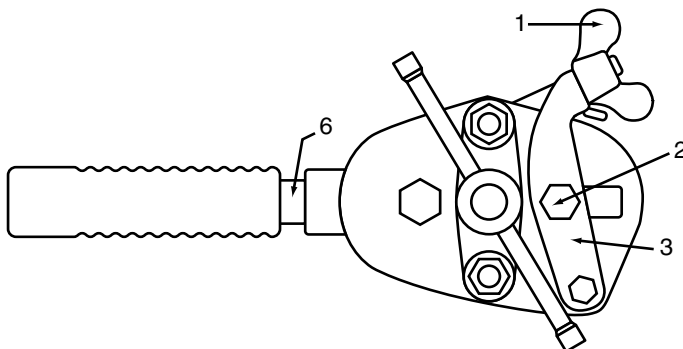

L

**Bins/Cabinets**

Compact, expandable, point-of-purchase display with drawers, Part No. 35B is suitable for production or maintenance inventory.

PART NO.	DESCRIPTION
9B	9 drawer cabinet
16B	16 drawer cabinet
20B	20 drawer cabinet
28B	28 drawer cabinet
35B	35 drawer cabinet
35BCL	Legs for 35B cabinet
35BCD-KIT	10 replacement drawers with 20 dividers
35BCD-DIVIDERS	Dividers only
40B	Cabinet stock bin
40B-Stand	Parker Brass Products Base Stand for 40B Cabinets. Stands are 12" high and designed for use with 40B Cabinets. Each Stand includes a 15 piece bolt and nut set package for assembly.

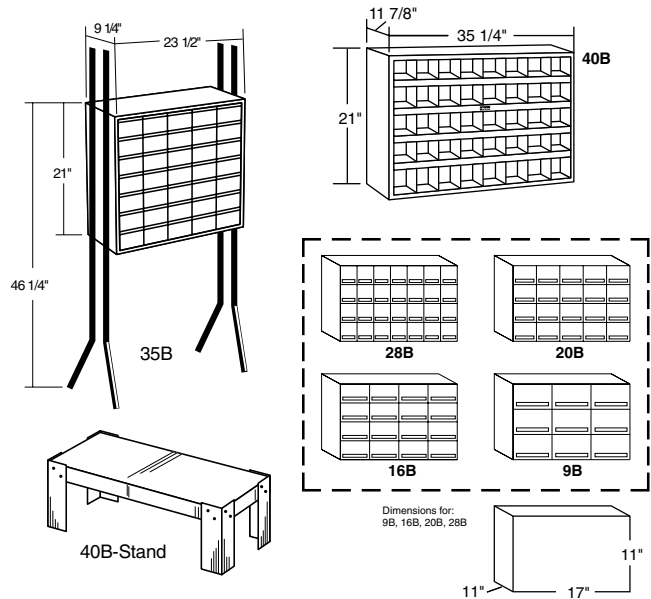

**Clear Plastic Shipping Bags PSB**

Reusable, clear polyethylene, zip-lock style bags with panels for marking part number, quantity, and availability information. Features easy visual part identification. Ideal for custom packaging of less than box quantities.

PART NO.	SIZE
4X6PSB	4" x 6"
6X8PSB	6" x 8"

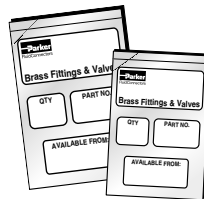

**Bin Labels**

Self adhesive Bin Labels for identifying Brass Fittings and valves stored in cabinets and bins. Ideal for use with Parker cabinets 40B and 35B. General line set includes all product lines, or labels can be ordered by individual product lines.

PRODUCT LINE	PART NO.	PRODUCT LINE	PART NO.
General Line	3501-B1	Vibra-Lok	3501-B9
45° Flared	3501-B2	Prestolok	3501-B10
Inv. Flared	3501-B3	Dubl-Barb	3501-B11
Compression	3501-B4	NTA	3501-B12
Pipe	3501-B5	Compress-Align	3501-B13
Garden Hose/Hose Barb	3501-B6	Poly-Tite	3501-B14
Valves (Ball/Plug/Needle/Truck)	3501-B7	Prestomatic	3501-B18
Air Brake Fittings/Hose Ends	3501-B8	Euro Brass Fittings & Valves	3550-B1

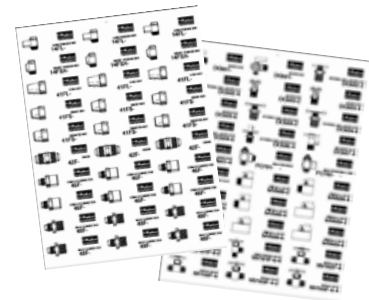

**Copper Tubing**

Copper tubing meets A.S.T.M. specification B-280 (copper tube for refrigeration field service)

PART NO.	TUBE O.D.	TUBE I.D.	WALL THICKNESS	FEET PER COIL
X50CT-2-30	1/8	.065	.030	50
X50CT-3-30	3/16	.128	.030	50
X50CT-4-30	1/4	.190	.030	50
X50CT-5-32	5/16	.249	.032	50
X50CT-6-32	3/8	.311	.032	50
X50CT-8-32	1/2	.436	.032	50









***General Technical***

---

***The World Standard***

## Manufacturing Techniques

### Parker Extruded fittings

Hexagon, round and shaped bars are extruded in the configuration required, drawn to size, cut to length and straightened. First a solid round billet (8 to 12 inches in diameter) is heated to the pliable state and forced by pressure of approximately 80,000 pounds per square inch through a die. The resulting continuous length of bar is cooled and then drawn through dies to the desired external size. (The drawing process also controls the temper.) After straightening, the bar is ready for machining.

The process produces a dense, nonporous material somewhat stronger in the longitudinal direction due to an orientated flow of the grain.

### Material used for Parker Brass Fittings

(Reference SAE J461)

Straight bodies:	barstock CA 360 or CA 345
Shape bodies:	extruded barstock CA 360
Shape bodies:	forged CA 377
Nuts:	barstock CA 360
Nuts:	forged CA 377

### Parker Forged Fittings

Material for forgings is extruded in round bars, cut to length and straightened. (At this point in the process, forging rod differs from round extruded machinable bars only in temper and chemical properties.) After straightening, the bars are cut again into slugs (short lengths), reheated to the pliable state and pressed under a pressure of approximately 25,000 pounds per square inch between upper and lower die cavities. After cooling the flash is trimmed away and the forging blank is ready for machining.

This process of forming under extreme pressure produces a uniformly dense material of exceptional strength. Because grain flow follows the contour, the fitting has high impact strength and is more resistant to mechanical shock and vibration.

***Of the major brass fittings producers, only Parker offers elbows and tees machined from both extruded and forged shapes.***

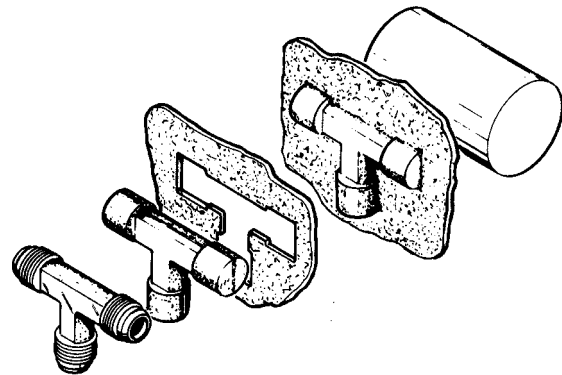
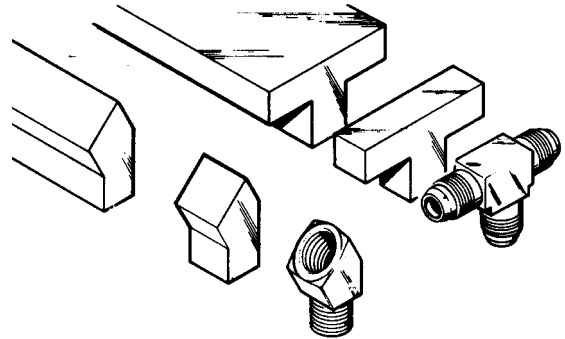

# Tubing Compatibility Chart



Fitting Line	Copper	Aluminum	Steel	Polyethylene E	Polyethylene FRPE	Nylon N	Nylon PAT	Nylon NR	Polypropylene PP	Polyurethane U	Polyurethane HU	Vinyl	Nylon SAE J844	Diesel Fuel FL	GPH Hose	SAE J1402	TFE	FEA	PFA
SAE 45 Flare	×	×	×																
Inverted Flare	×	×	×																
Compression	×	×		×†	×†	×†	×†	×†									×†	×†	×†
Compress-Align	×	×		×*	×*	×*	×*	×*									×*	×*	×*
Metru-Lok	×	×		×*		×	×	×											
Poly-Tite®	×			×		×**		×**				×							
Hi-Duty Fitting	×	×	×	×*	×*	×*	×*	×*											
Dubl-Barb®				×	×														
Prestolok				×		×			×	×									
Prestolok II				×		×			×	×									
Microlok				×		×			×	×	×								
Flow Controls				×		×													
Prestomatic						×							×	×					
PTC						×							×	×					
Cartridges				×		×							×	×					
Air Brake-AB	×																		
Air Brake-NTA®						×	×						×	×					
Transmission						×							×						
Air Brake Hose Ends																×			
Vibra-Lok	×	×	×																
Hose Barb																	×**		

Ratings are based on static pressure conditions  
 \* Tube support is recommended  
 \*\* Clamp required  
 ++ Brass sleeve recommended  
 † Plastic sleeve and brass tube support is recommended

## Tube Line Fabrication Guide for Leak Free Systems

Every hydraulic, pneumatic and lubrication system requires some form of tube line fabrication and fitting installation for completion. Proper fabrication and installation are essential for the overall efficiency, leak free performance, and general appearance of any system.

Start by planning ahead. After sizing the tube lines and selecting the appropriate style of fitting, consider the following in the design of your system:

1. Accessibility of joints
2. Proper routing of lines
3. Adequate tube line supports
4. Available fabricating tools

### Routing of Lines

Routing of lines is probably the most difficult yet most significant of these system design considerations. Proper routing involves getting a connecting line from one point to another through the most logical path.

Always try to leave fitting joints as accessible as possible. Hard to reach joints are hard to assemble and tighten properly. Inaccessible joints are also more difficult and time consuming to service.

The most logical path should have the following characteristics:

- **Avoid excessive strain on joint** — A strained joint will eventually leak. (See Figures A14 through A21.)
- **Allow for expansion and contraction** — Use a “U” bend or a hose in long lines to allow for expansion and contraction. (See Figure A22.)



- **Allow for motion under load** — Even some apparently rigid systems do move under load. (See Figure A23.)
- **Get around obstructions without using excessive amount of 90° bends** — Pressure drop due to one 90° bend is greater than that due to two 45° bends. (See Figures A24 and A25.)
- **Keep tube lines away from components that require regular maintenance.** (See Figures A26 and A27.)
- **Have a neat appearance and allow for easy troubleshooting, maintenance and repair.** (See Figures A28 and A29.)

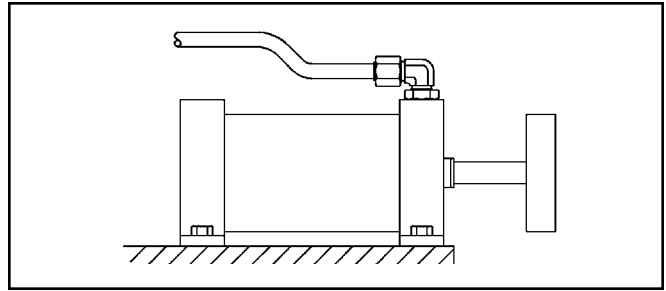

Fig. A23 — Bent Tube Allowing for Motion Under Load

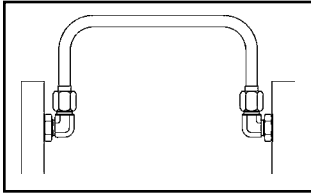

Fig. A14 — Correct Routing

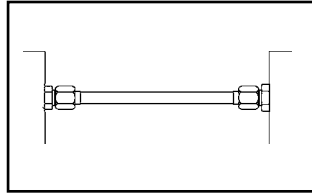

Fig. A15 — Incorrect Routing

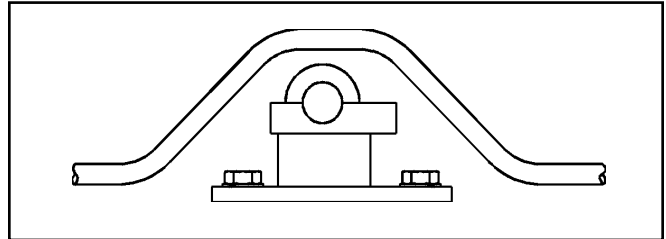

Fig. 24 — Correct

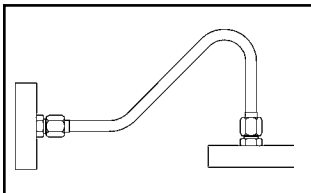

Fig. A16 — Correct Routing

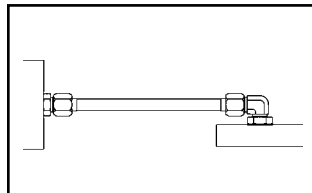

Fig. A17 — Incorrect Routing

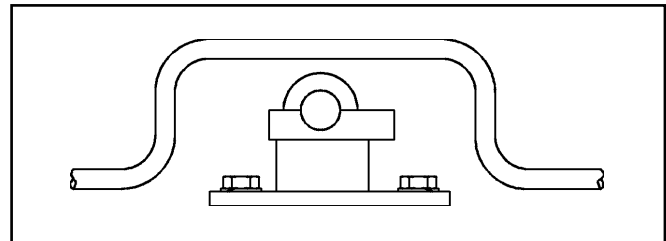

Fig. A25 — Incorrect

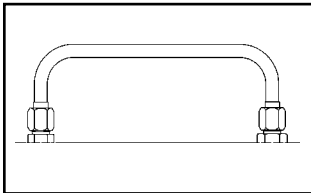

Fig. A18 — Correct Routing

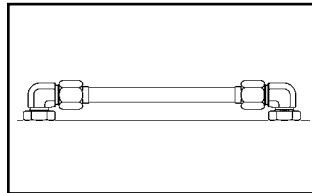

Fig. A19 — Incorrect Routing

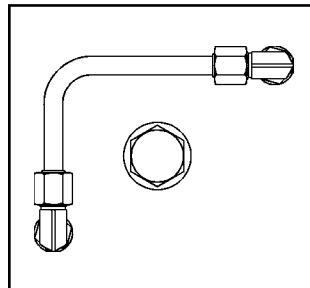

Fig. A26 — Correct

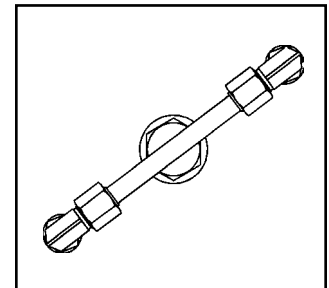

Fig. A27 — Incorrect

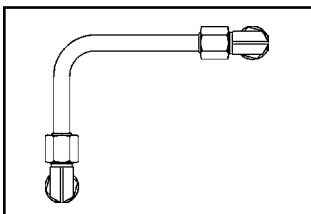

Fig. A20 — Correct Routing

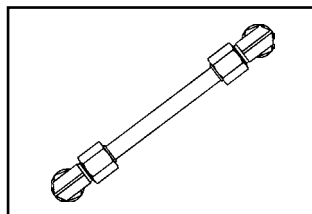

Fig. A21 — Incorrect Routing

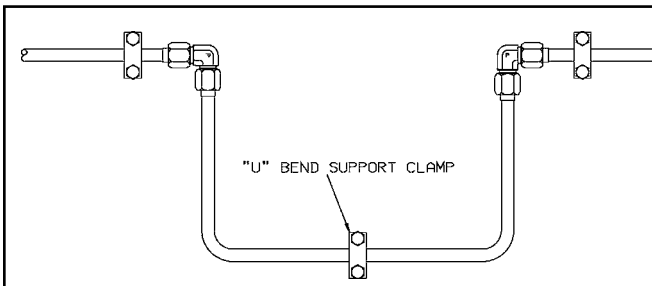

Fig. A22 — U-Bend Allowing Expansion and Contraction

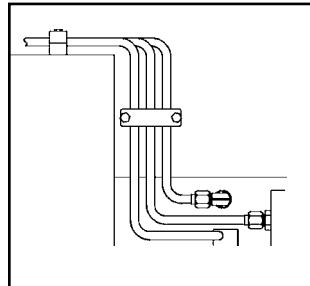

Fig. A28 — Correct

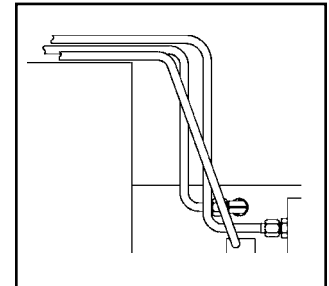

Fig. A29 — Incorrect

**N**

## Thread Specifications

### Dryseal Pipe Threads

All dryseal pipe threads are manufactured in accordance with the American National Standards Institute (ANSI) B1.20.3 specification and designed to seal pressure tight joints. The threads may incorporate the NPTF (National Standard Pipe Taper Fuel and Oil), PTF-SAE Short, PTF-SPL Short or PTF-SPL Extra Short form. Dryseal threads are used on brass products found within this catalog. Use of a thread sealant is recommended.

### Non-Dryseal Pipe Threads

All non-dryseal pipe threads are manufactured in accordance with the American National Standards Institute (ANSI) B1.20.1 specification. These tapered pipe threads are used on our carbon and stainless steel products. Use of a thread sealant is recommended.

### Nickel Plating

Nickel plating is available for all standard product fittings. Plating will increase male pitch diameters and decrease female pitch diameters of threads. This will affect the assembly characteristics on standard products.

Nickel plating provides a corrosion resistant coating which is desirable in many applications. Electrolytic nickel plating is the standard plating supplied unless otherwise specified. This will provide a uniform coverage of external surfaces; however, internal surfaces may be uncoated.

### Unified Threads

All threads in the columns headed "Straight Thread" found within this catalog are manufactured in accordance with the American National Standards Institute (ANSI) B1.1 specification.

### British Standard Pipe Threads BSPT and BSPP Pressure Tight

The British pipe threaded products found within this catalog intended for use where pressure tight joints are made on the threads are manufactured in accordance with British Standard (BS) 21 and International Standards Organization (ISO) 7-1. The threads are designated as follows:

- Rp: Internal parallel
- Rc: Internal taper
- Rs: Special external parallel
- R: External taper

Use of a thread sealant is recommended with the R series thread. An elastomeric peripheral seal should be used with the Rs thread.

### Non-Pressure Tight

All British Standard parallel pipe threads manufactured in this catalog according to BS2779 and ISO 228-1 are intended for use where pressure tight joints are not made on the threads. An elastomeric peripheral seal should be used. These threads are designated as follows:

- G: Internal Thread
- GA, External thread, tight tolerance classification
- GB, External thread, general purpose and assumed if no classification designation is given

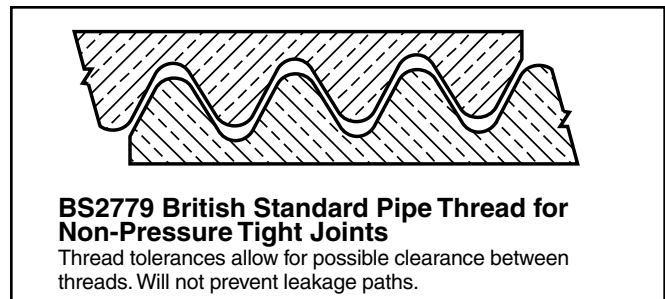
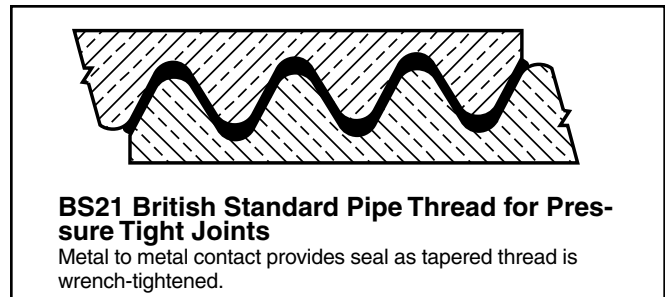
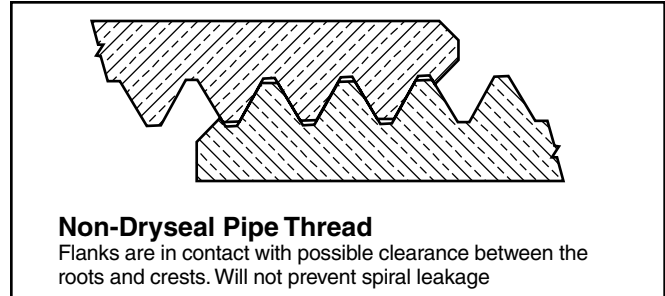
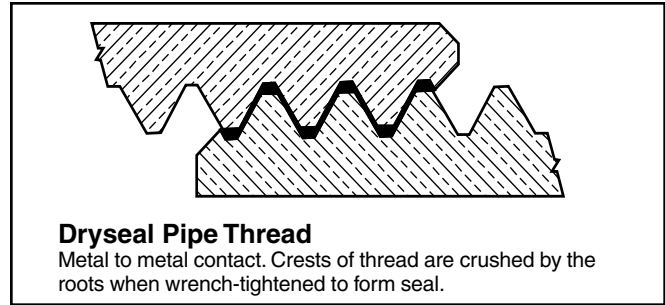

**Pipe Thread Assembly**

The two British Standard pipe thread forms used for Parker's standard product are manufactured in a tighter tolerance range than required by the standards in order to facilitate the assembly and mating of fittings produced by the two different standards. In general, BS21 threads do not necessarily mate with BS2779 threads at tolerance overlap conditions, but fittings located within this catalog can be assembled as follows:

External Thread	Mating Internal Thread
G-BS2779 (parallel)	G-BS2779 (parallel) Rp-BS21* (parallel)
Rs-BS21 (parallel)	Rp-BS21 (parallel) G-BS2779 (parallel)
R-BS21 (taper)	Rp-BS21 (parallel) Rc-BS21 (taper) G-BS2779 (parallel)

\*This thread must be manufactured within a reduced tolerance range to always assemble with the G series external thread.

**British Standard ISO Metric Screw Threads**

They are commonly used in miniature pneumatic applications because of the availability of small thread diameters and are also used extensively in the automotive industry. There are two forms of sealing on metric screw threads.

- O-ring sealing into a profiled port in accordance with ISO 6149.
- Peripheral sealing with a copper or bonded washer in accordance with ISO 261 and 262.

**Peripheral sealing of parallel threads**

Pressure-tight joints of screwed connections with parallel threads are achieved by placing a seal between the two machined faces

**Flat seals**

Washers and rings are manufactured in many different materials including copper, aluminium, fiber, plastics, etc.

The tightening torque at assembly must be carefully selected so as to avoid compressing the seal to the point of extrusion. As a general rule, the fitting should be tightened with an additional 1/4 wrench turn from the fingertight position.

**O-rings**

Depending upon the configuration of the female port or male thread, O-Ring seals are fitted with or without back-up washers, and can be fully retained in a captive seal.

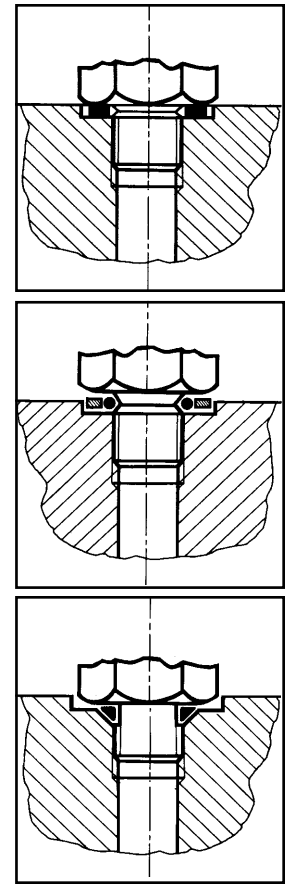

**Flaring Instructions**

In order to properly flare copping tubing for use with Parker 45° Flared Fittings and Inverted Flared Fittings, the following procedures and specifications should be met in preparation and make-up of flares.

**1) CUT TUBE WITH TUBE CUTTER:**

To minimize the burr and workhardening, use a light feed on the cutting wheel and make several revolutions.

**2) REAM THE TUBING:**

Cutting with a tube cutter will always create a burr. The burr must be removed to obtain maximum sealing surface. Remove only the burr, do not remove material from the original wall thickness. Also clean the tube end thoroughly to remove burrs.

**3) FLARE TUBING:**

Flare with a compression or generating type flaring tool. Follow tool manufacturer's instructions for: (A) positioning the tube in tool and (B) for the correct number of turns on the feed handle.

**4) INSPECT TUBING:**

The flare cone should be checked for a smooth surface on the I.D. of the cone and measure with micrometer over largest O.D. for proper size. (See dimensions below for flare size for each tubing size.)

Nominal Tube	A Single Flare Diameter		B Single Flare Radius	D Single Flare Wall Thickness
	in	in	in	in
	Max.	Min.	±0.01	Max.
1/8	0.181	0.171	0.02	0.035
3/16	0.249	0.239	0.02	0.035
1/4	0.325	0.315	0.02	0.049
5/16	0.404	0.388	0.02	0.049
3/8	0.487	0.471	0.02	0.065
7/16	0.561	0.545	0.02	0.065
1/2	0.623	0.607	0.02	0.083
9/16	0.676	0.660	0.02	0.083
5/8	0.748	0.732	0.02	0.095
3/4	0.916	0.900	0.02	0.109
7/8	1.041	1.025	0.02	0.109
1	1.157	1.141	0.02	0.120

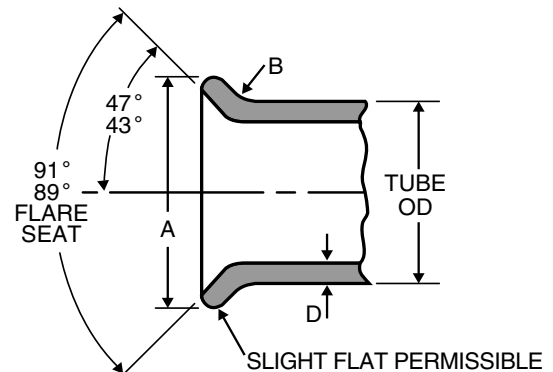

**N**

## Thread Designations and Standards for Threads Used in Fluid Connectors

Abbreviation	Description	Applicable Std.
<b>Straight Pipe</b>		
NPSC	American Standard Straight Pipe Threads in Pipe Couplings Couplings	ANSI B1.20.1 FED-STD-H28/7
NPSF	Dryseal American Standard Fuel Internal Straight Pipe Threads (generally used in soft or ductile materials to mate with NPTF external taper threads)	SAE J476 ANSI B1.20.3 FED-STD-H28/8
NPSI	Dryseal American Intermediate Internal Straight Pipe Threads (for brittle or hard materials; intended to mate with PTF-SAE short external taper threads)	SAE J476 ANSI B1.20.3 FED-STD-H28/8
NPSM	American Standard Straight Pipe Threads for Free-Fitting Mechanical Joints for Fixtures (these threads fit freely over NPTF threads. They are used in swivel nuts of 07 adapters)	ANSI B1.20.1 FED-STD-H28/7
<b>Taper Pipe</b>		
ANPT	Aeronautical National Taper Pipe Threads (similar to NPT with various additional requirements in gaging)	MIL-P-7105
NPT	American Standard Taper Pipe Threads for General Use	ANSI B1.20.1 FED-STD-H28/7
NPTF	Dryseal American Standard Taper Pipe Threads (used in all of our steel and brass fittings)	SAE J476 ANSI B1.20.3 FED-STD-H28/8
PTF — SAE Short	Dryseal SAE Short Taper Pipe Threads (mainly used in low pressure pneumatic and fuel applications)	SAE J476 ANSI B1.20.3 FED-STD-H28/8
PTF — SPL Short <sup>1)</sup>	Dryseal Special Short Taper Pipe Threads	ANSI B1.20.3
PTF — SPL Extra Short <sup>1)</sup>	Dryseal Special Extra Short Taper Pipe Threads	ANSI B1.20.3
<b>Unified Threads</b>		
UN	Unified Constant Pitch Threads (standard series: 4, 6, 8, 12, 16, 20, 28, 32)	ANSI B1.1 FED-STD-H28/2
UNC	Unified Coarse Threads	ANSI B1.1 FED-STD-H28/2
UNEF	Unified Extra Fine Threads	ANSI B1.1 FED-STD-H28/2
UNF	Unified Fine Threads	ANSI B1.1 FED-STD-H28/2
UNS	Unified Special Pitch Threads	ANSI B1.1 FED-STD-H28/3
UNJ	Unified Controlled Root Radius Threads	ANSI B1.15 FED-STD-H28/4

Table A48 — Thread Designations and Standards for Threads Used in Fluid Connectors (continued on the next page)

1) Used in some pneumatic components where shortened thread depth is required because of lack of enough material due to component size limitations.



Abbreviation	Description	Applicable Std.
<b>Metric Threads</b>		
M	Metric Screw Threads — M profile	ISO 261 ANSI B1.13M FED-STD-H28/21
M — Keg	Metric Taper Threads (mainly used in Germany)	DIN 158
<b>British Standard Pipe Threads</b>		
R (BSPT)	British Standard Taper Pipe Threads, External	BS 21 ISO 7/1
Rc (BSPT)	British Standard Taper Pipe Threads, Internal	BS 21 ISO 7/1
Rp or G (BSPP)	British Standard Pipe (Parallel) Threads	BS 2779 ISO 228/1
<b>Japanese Standard Pipe Threads</b>		
PF <sup>1)</sup>	JIS Parallel Pipe Threads	JIS B202 ISO 228/1
PT <sup>1)</sup>	JIS Taper Pipe Threads	JIS B203 ISO 7/1
PS	JIS Parallel Internal Pipe Threads (to mate with PT threads)	JIS B203

Table A48 (Cont'd) — Thread Designations and Standards for Threads Used in Fluid Connectors

1) PF and PT threads are functionally interchangeable with BSPP and BSPT threads, respectively. These are old designations. They are being replaced with G (for PF) and R and Rc (for PT) as documents are revised.

### Straight Thread Size Comparison Chart

	Tube O.D.										
	1/8	3/16	1/4	5/16	3/8	7/16	1/2	5/8	3/4	7/8	1
<b>SAE 45° Flared</b>	5/16 -24	3/8 -24	7/16 -20	1/2 -20	5/8 -18	11/16 -16	3/4 -16	7/8 -14	1-1/16 -14	1-1/4 -12	-
<b>Inverted Flared</b>	5/16 -28	3/8 -24	7/16 -24	1/2 -20	5/8 -18	11/16 -18	3/4 -18	7/8 -18	1-1/16 -16	1-3/16 -16	-
<b>Air Brake/NTA</b>	-	-	7/16 -24	-	17/32 -24	-	11/16 -20	13/16 -18	1 -18	-	1 1/4 -16
<b>Std. Comp./Compress-Align</b>	5/16 -24	3/8 -24	7/16 -24	1/2 -24	9/16 -24	5/8 -24	11/16 -20	13/16 -18	1 -18	1-1/8 -18	1 1/4 -18
<b>Poly-Tite</b>	5/16 -24	3/8 -24	3/8 -24	7/16 -24	1/2 -24	-	11/16 -20	-	-	-	-
<b>Vibra-Lok</b>	3/8 -24	7/16 -24	1/2 -24	9/16 -24	5/8 -24	-	13/16 -18	1 -18	1-1/8 -18	-	-
<b>V510 Ball Valves</b>	-	-	7/16 -20	-	9/16 -18	-	3/4 -16	7/8 -14	1-1/16 -12	-	1-5/16 -12
<b>Hi-Duty Flareless Tube Fittings</b>	5/16 -24	3/8 -24	7/16 -24	1/2 -20	9/16 -20	-	11/16 -16	7/8 -18	-	-	-

**N**

**S.A.E. Part Index**

<u>PART NO.</u>	<u>PAGE</u>	<u>PART NO.</u>	<u>PAGE</u>	<u>PART NO.</u>	<u>PAGE</u>	<u>PART NO.</u>	<u>PAGE</u>
SAE 010101 .....	E7	SAE 010203 .....	E11	SAE 060102 BA .....	A8	SAE 100302 BA .....	H10
SAE 010102 .....	E8	SAE 010302 .....	E12	SAE 060103 BA .....	A8	SAE 100401 BA .....	H8
SAE 010103 .....	E8	SAE 010401 .....	E9	SAE 060110 .....	A6	SAE 100424 BA .....	H9
SAE 010104 .....	E7	SAE 010424 .....	E11	SAE 060111 .....	A6	SAE 100425 BA .....	H10
SAE 010105 .....	E13	SAE 010425 .....	E9	SAE 060115 .....	A6	SAE 120101 BA .....	H14
SAE 010106 .....	E13	SAE 010501 .....	E9	SAE 060201 BA .....	A9	SAE 120102 BA .....	H15
SAE 010107 .....	E13	SAE 040101 .....	E15	SAE 060202 BA .....	A10	SAE 120103 BA .....	H14
SAE 010108 .....	E6	SAE 040102 .....	E16	SAE 060203 BA .....	A10	SAE 120111 .....	H14
SAE 010109 .....	E13	SAE 040103 .....	E15	SAE 060401 BA .....	A9	SAE 120115 .....	H14
SAE 010110 .....	E6	SAE 040110 .....	E15	SAE 060424 BA .....	A10	SAE 120201 BA .....	H15
SAE 010111 .....	E6	SAE 040201 .....	E17	SAE 060425 BA .....	A11	SAE 120202 BA .....	H15
SAE 010112 .....	E13	SAE 040202 .....	E16	SAE 100101 BA .....	H6	SAE 120203 BA .....	H16
SAE 010113 .....	E5	SAE 040203 .....	E17	SAE 100102 BA .....	H8	SAE 120302 BA .....	H16
SAE 010114 .....	E5	SAE 040302 .....	E17	SAE 100103 BA .....	H7	SAE 120401 BA .....	H15
SAE 010165 .....	E5	SAE 040401 .....	E16	SAE 100110 .....	H6	SAE 120424 BA .....	H16
SAE 010166 .....	E5	SAE 040424 .....	E17	SAE 100115 .....	H6	SAE 120425 BA .....	H16
SAE 010167 .....	E5	SAE 040425 .....	E16	SAE 100201 BA .....	H9		
SAE 010201 .....	E11	SAE 040427 .....	E17	SAE 100202 BA .....	H9		
SAE 010202 .....	E10	SAE 060101 BA .....	A7	SAE 100203 BA .....	H9		

**SAE Standards (Current)**

- J246:** Spherical and Flanged Sleeve (Compression) Tube Fittings  
Tubing: Copper and J844 Nylon  
Fittings: NTA and Air Brake
- J476:** Dryseal Pipe Threads
- J512:** Automotive Tube Fittings  
Tubing: Copper and Nylon  
Fittings: 45° Flare, Inverted Flare, Compression
- J513:** Refrigeration Tube Fittings  
Tubing: Annealed Copper  
Fittings: 45° Flare
- J530:** Automotive Pipe Fittings  
Fittings: Pipe
- J531:** Automotive Pipe, Filler and Drain Plugs  
Fittings: Pipe Plugs

- J844:** Nonmetallic Air Brake System Tubing  
Tubing: Non-reinforced Type A, reinforced Type B
- J1131:** Performance Requirements for SAE J844 Nonmetallic Tubing and Fitting Assemblies Used in Automotive Air Brake Systems  
Tubing: J844 Nylon  
Fittings: NTA and Prestomatic
- J1615:** Thread Sealants
- J2494:** Brass Body Push-to-Connect Fittings  
Tubing: J844 Nylon  
Fittings: Prestomatic



## U.L. LISTED FITTINGS

Many of the Brass Products Division's fittings have been listed by the Underwriter's Laboratory. The listings fall under 1 of 5 categories, depending upon application. Underwriter's requires that the smallest unit package carry the U.L. symbol and each carton be printed in accordance with the specification of each category. Fittings requiring gas listing must be stamped with the identification symbol **G** and our trademark.

### FLAMMABLE LIQUID APPLICATION MARINE APPLICATION

All cartons containing U.L. approved fittings for flammable liquid and marine applications will be labeled with the appropriate U.L. listing at no extra charge. The fitting will not be stamped with the UL or **G** symbols.

### GAS – MANUFACTURED, NATURAL AND L.P. (LIQUEFIED PETROLEUM) REFRIGERATION APPLICATION

U.L. listed fittings for gas or refrigeration application will be furnished only when specified on purchase order. Fittings will be stamped with the **G** symbol and cartons will be labeled with the appropriate U.L. listing.

### ORDERING INSTRUCTIONS FOR U.L. LISTINGS

The Brass Division labels all cartons with the appropriate U.L. listing. The gas identification symbol **G** will be stamped on each fitting only when the listing is required and specified on the purchase order.

## List of U.L. Fittings

### No **G** Marking Required

FITTINGS, FLAMMABLE LIQUID				
1F	60C	151F	176C	264CA
2GF	61C	155F	176CA	265C
3GF	61CA	159F	177C	265CA
14FL	61CL	164C	177CA	269C
14FSV	62C	164CA	244F	269CA
14FSX	62CA	165C	244IFHD	270C
41FL	62CABH	165CA	245IFHD	270CA
41FS	62CBH	168C	249F	639C
41FX	66C	168CA	249IF	639CA
41IF	66CA	169C	249IFHD	639F
41IFS	68C	169CA	250IFHD	640F
42F	68CA	170C	251IFHD	660FHD
42IFHD	144F	170CA	252IFHD	661FHD
46F	145F	171C	256IF	664FHD
46IFHD	147F	171CA	259IFHD	
48F	149F	172C	264C	
48IFHD	150F	172CA		
FITTINGS, FUEL EQUIPMENT, MARINE				
2GF	46F	147F	155F	660FHD
3GF	48F	149F	159F	661FHD
14FL	144F	150F	639F	664FHD
42F	145F	151F	640F	
SHUT-OFF VALVES, FLAMMABLE LIQUIDS, LP GAS AND COMPRESS GAS				
XV520P-4	XV520P-32			
XV520P-6	XV520P-40			
XV520P-8	XV520P-48			
XV520P-12	XV500P-20			
XV520P-16	XV500P-24			
XV520P-20	XV500P-32			
XV520P-24				

### **G** Marking Required

FITTINGS, REFRIGERATION		
1F	48F	159F
2GF	144F	244F
3GF	145F	249F
14FL	147F	639F
14FS	149F	640F
14FSV	150F	660FHD
42F	151F	661FHD
46F	155F	664FHD
FITTINGS, GAS		
1F	48F	249F
2GF	48IFHD	249IFHD
3GF	144F	250IFHD
14FL	145F	251IFHD
14FS	147F	252IFHD
14FSV	149F	255IFHD
14FSX	150F	259IFHD
41IF	151F	639F
41IFS	155F	640F
42F	159F	660FHD
42IFHD	244F	661FHD
46F	244IFHD	664FHD
46IFHD	245IFHD	

**N**

# Flow Curves

## FC701 Flow Curves

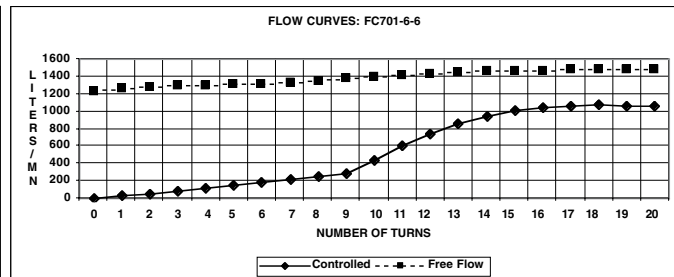
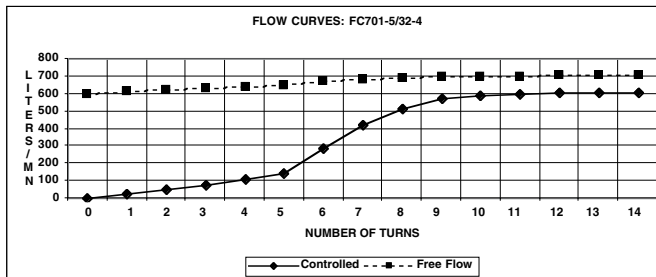
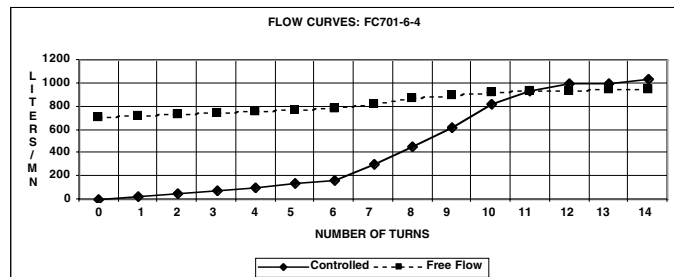
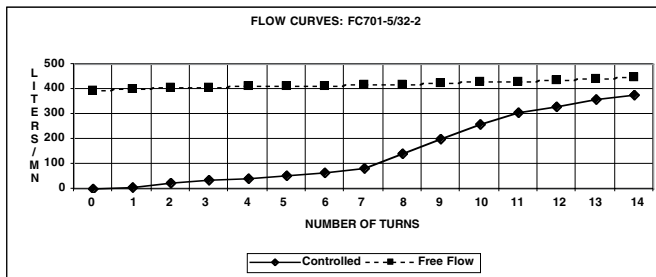
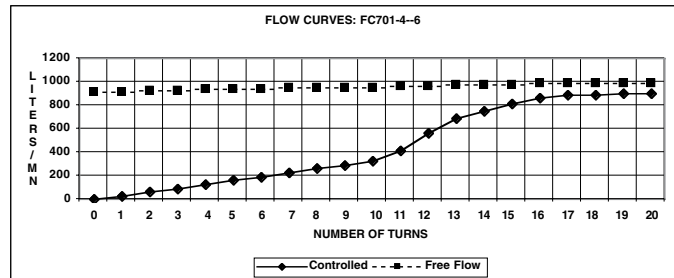
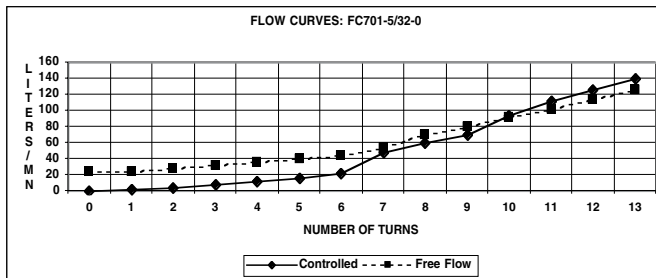
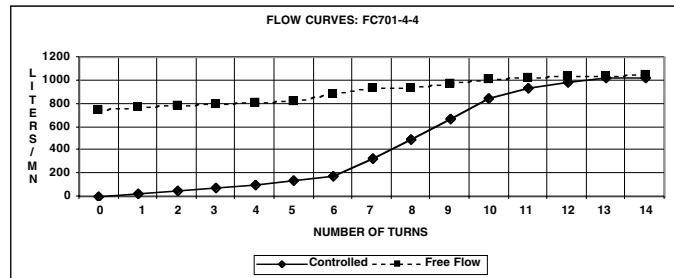
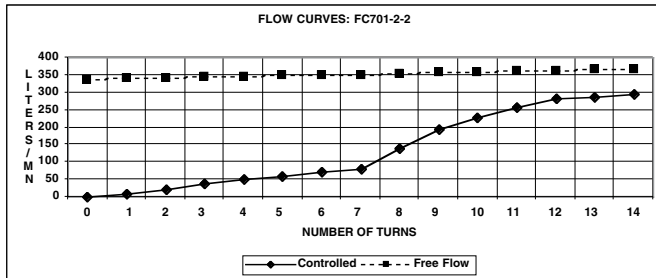
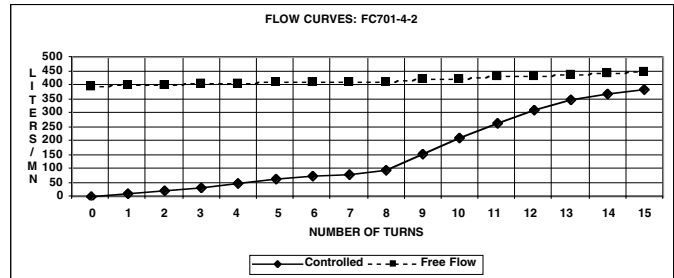
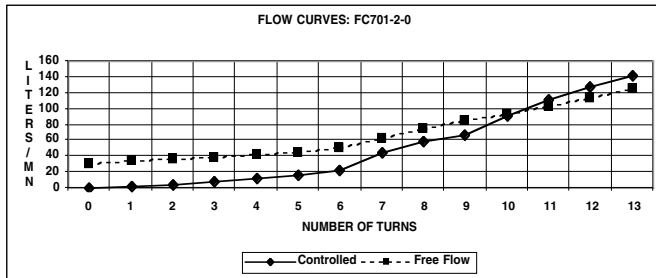

Note: All tests were conducted at 90PSI



FC701 Flow Curves

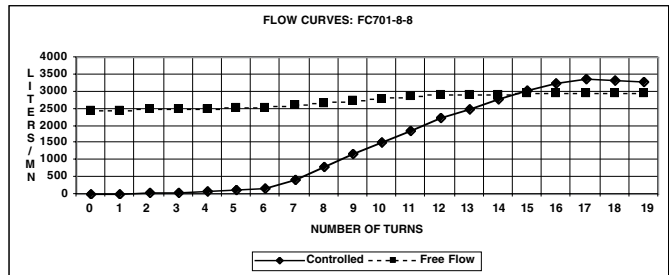
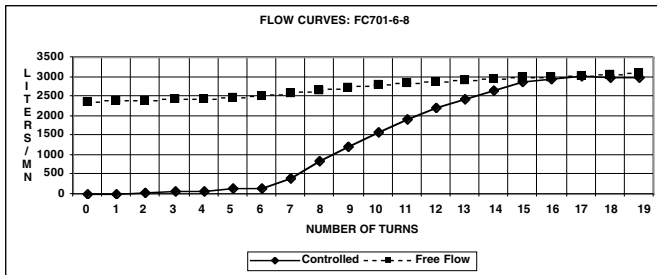

FC702 Flow Curves

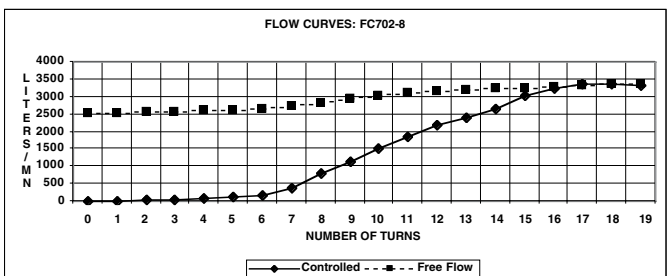
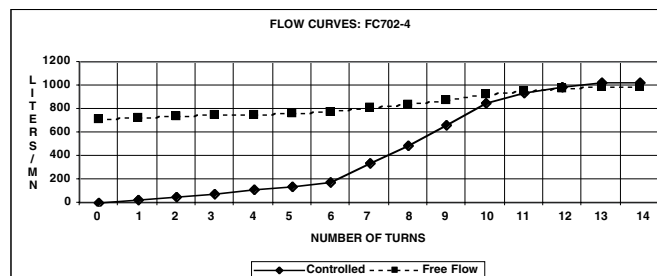
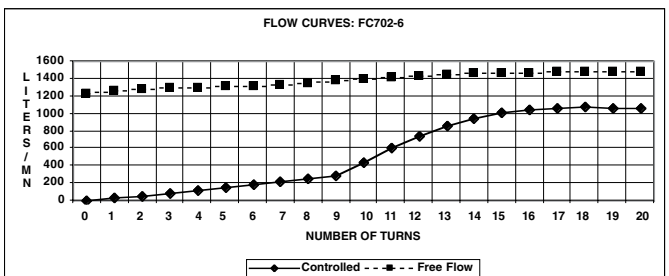
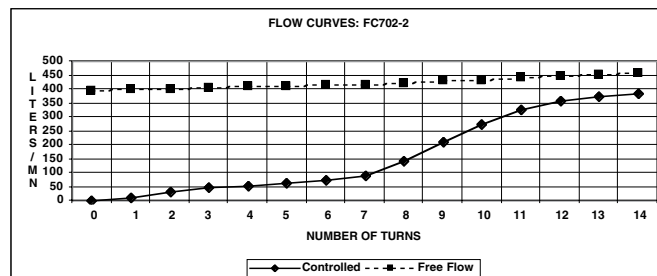

Note: All tests were conducted at 90PSI



FCS701 Flow Curves

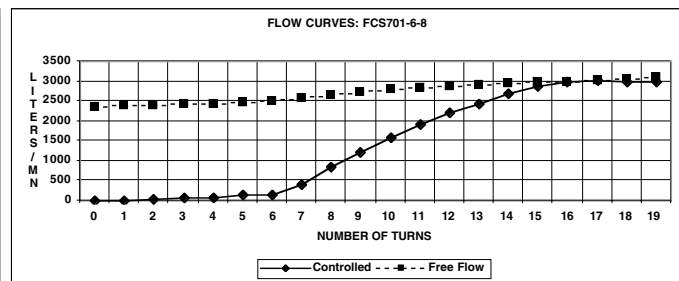
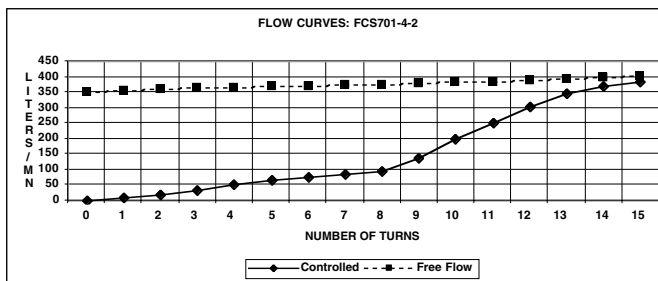
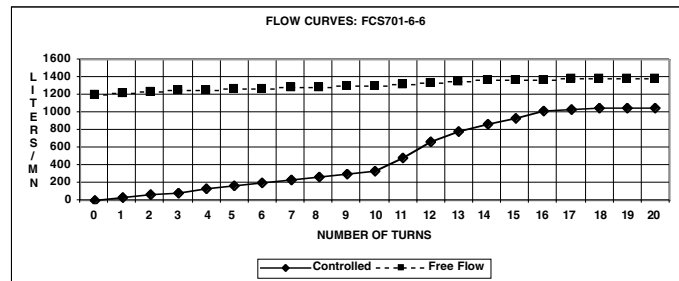
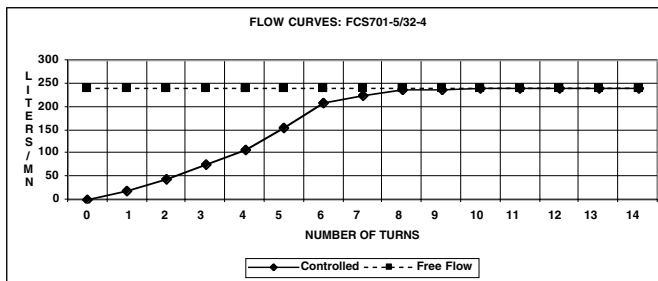
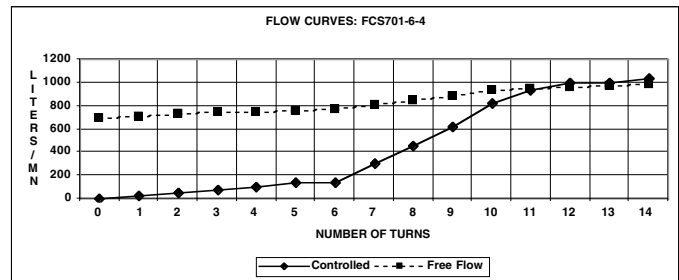
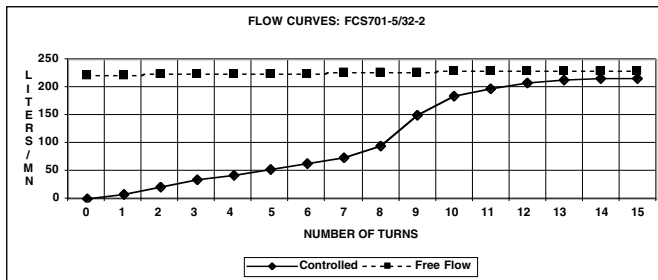
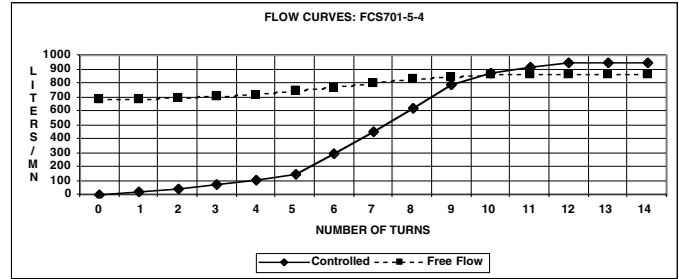
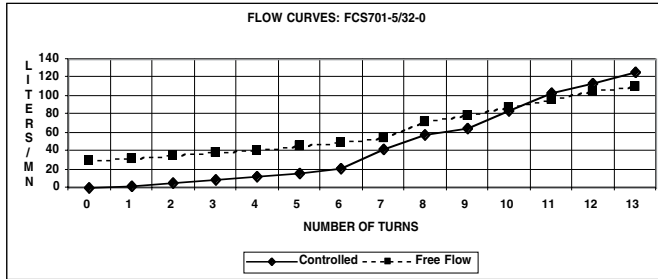
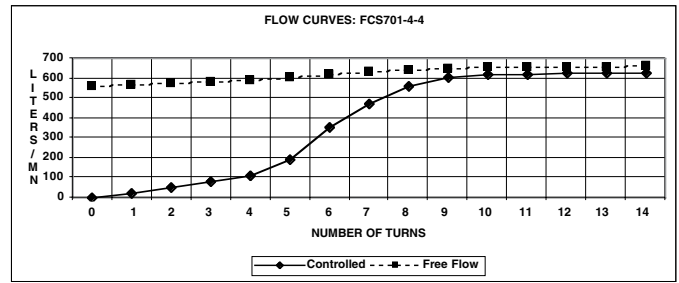
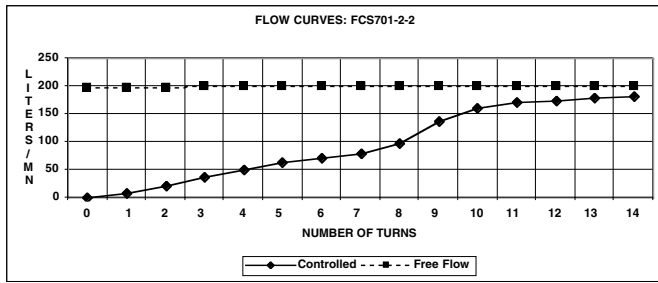

Note: All tests were conducted at 90PSI



# Metric Fitting Nomenclature

Parker fitting part numbers are constructed from symbols that identify the size, shape or style, type and material of the fitting.

FITTING TYPE	
M	Metru-Lok
P	Presto-Lok

FITTING MATERIAL	
B	Brass
K	Plastic

**F**

**3**

**B**

**M**

**B**

**4 -**

**1/8**

FITTING STYLE	
B	Nut
C	90° male elbow connector
C6	90° male elbow connector, swivel
CD	90° male/female elbow adapter
CD43	90° male/female BSPT/BSPP adapter
D	90° female elbow connector
DD	90° female elbow adapter
DD44	90° female BSPP elbow adapter (DD4 in USA)
E	90° elbow union connector
F	Straight thread stud connector (male connector)
FF	Straight thread long connector or male straight adapter
FG	Male to female adapter, straight
FF33	Male BSPT straight adapter
FF44	Male BSPP straight connector
FG	Male/female jump size adapter
FG43	Male/female BSPT/BSPP jump size adapter (F3G4 in USA)
FN	Cap
G	Female straight connector
GG44	Female BSPP straight adapter (GG4 in USA)
H	Straight union connector
HHP	Hollow hex head plug
HHP3	BSPT hollow hex head plug
HP3	BSPT hollow hex head plug
J	Union tee connector
K	Union cross connector
KMM00	Female cross adapter
KMM004	Female BSPP cross adapter
MMO	Female tee adapter
MMO444	Female BSPP tee adapter
MMS	Female/female/male tee adapter
MMS443	Female/female/male BSPP/BSPT/BSPT tee adapter
PN	Plug
PTR34	Male/female BSPT/BSPP reducing adapter
PTR44	Male/female BSPP reducing adapter (PTR4 in USA)
R	Male stud run tee connector
R6	Male run tee connector, swivel
S	Male stud branch tee connector
S6	Male branch tee connector, swivel
T	Sleeve
T2HF	Standpipe to male
T2HG	Standpipe to female
T23	Insert (for thin walled or plastic tube)
T23HF	Standpipe to male BSPT
T24HG	Standpipe to female
T28HF	Standpipe to metric straight thread
TE	Tube end size jumper
TR	Tube end reducer
W	Straight bulkhead union connector
WE	90° bulkhead union elbow connector
WGG	Straight female bulkhead adapter
WGG44	Straight female BSPP bulkhead adapter (WGG4 in USA)

ASSEMBLED FITTING	
Without	Unassembled fitting. i.e. fitting adapter for use with hose fittings, etc.
B	Assembled fitting except for Prestolok upgraded versions (plastic and brass)

TUBE SIZE	
DASH NO.	TUBE O.D.
4	4mm
6	6mm
8	8mm
10	10mm
12	12mm
14	14mm
16	16mm
18	18mm
20	20mm
22	22mm

PORT END THREAD SIZE RANGES				
METRIC				"8"
"3"		"4"		
STRAIGHT NPT	BSPT	BSPP	THREAD	
1/16	1/8	1/8	M3X0.5	
1/8	1/4	1/4	M5X0.8	
1/4	3/8	3/8	M10X1	
3/8	1/2	1/2	M12X1.5	
1/2	3/4	3/4	M14X1.5	
3/4		1	M16X1.5	
		1.1/4	M18X1.5	
		1.1/2	M22X1.5	
		2		

THREAD TYPE (PORT END)	
Without	NPT (brass, stainless) - NPTF (steel)
2	NPTF
3	BSPT (male only)
4	BSPP (male or female)
40	BSPP O-Ring and retaining ring (male) only
41	BSPP cutting seal (male only)
6	Swivel nut (swivel end)
63	Adjustable swivel connector with BSPT thread
64	Adjustable swivel connector with BSPP thread
68	Adjustable swivel connector with metric parallel thread
69	Adjustable swivel connector with metric taper thread
7	(Metric taper in USA)
8	Metric parallel
80	Metric parallel O-Ring and retaining ring (male only)
81	Metric parallel cutting seal (male only)
85	Metric parallel Eolastic seal (male only)
0	With O-Ring

**N**



# Flare and Thread Profiles

## SAE (JIC) 37° Flare Nose Sizes

Actual Size

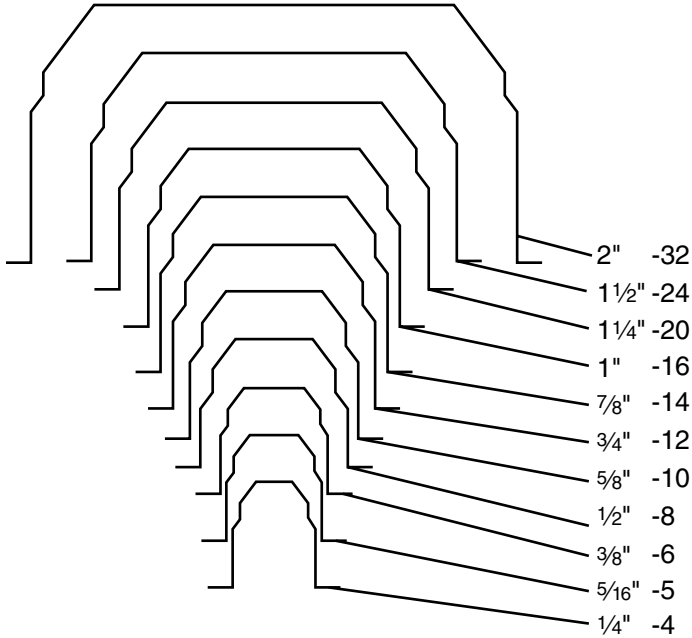

## SAE 45° Flare Nose Sizes

Actual Size

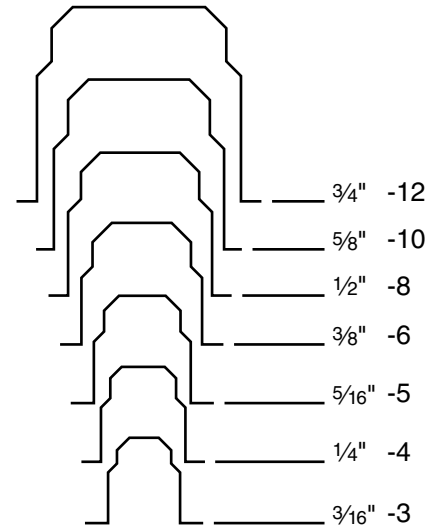

## Male Pipe Thread Sizes

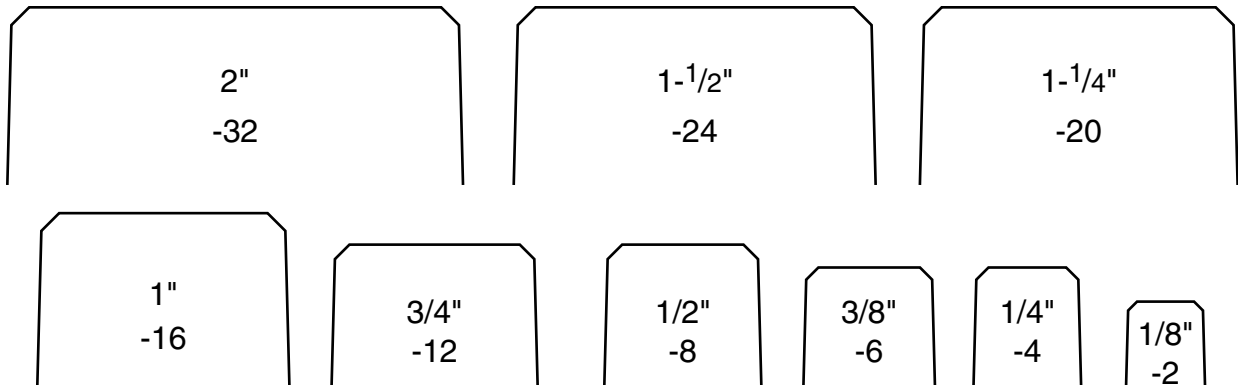

## Actual Outside Diameters of Tubing

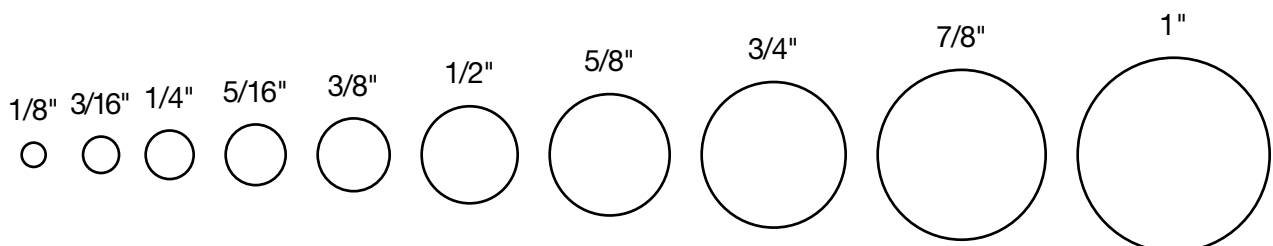



## Pressure Conversions

Kilopascals (KPa)	Megapascals (MPa)	Bar (bar)	Kilograms Per Square Centimeter (Kgf/cm <sup>2</sup> )	Pounds Per Square Inch (psi)	Pounds Per Square Inch (psi)	Kilopascals (KPa)	Megapascals (MPa)	Bar (bar)	Kilograms Per Square Centimeter (Kgf/cm <sup>2</sup> )
100	1.0	1	1.02	14.50	10	68.90	0.07	0.70	0.70
200	0.2	2	2.04	29.00	20	137.90	0.14	1.41	1.41
300	0.3	3	3.06	43.50	30	206.80	0.21	2.10	2.11
400	0.4	4	4.08	58.00	40	275.80	0.28	2.80	2.81
500	0.5	5	5.10	72.50	50	344.70	0.34	3.40	3.52
600	0.6	6	6.12	87.00	60	413.70	0.41	4.10	4.22
700	0.7	7	7.14	101.50	70	482.60	0.48	4.80	4.92
800	0.8	8	8.16	116.00	80	551.60	0.55	5.50	5.63
900	0.9	9	9.18	130.50	90	620.50	0.62	6.20	6.33
1000	1.0	10	10.20	145.00	100	689.00	0.70	6.90	7.00
2000	2.0	20	20.40	290.10	200	1379.00	1.40	13.80	14.10
3000	3.0	30	30.60	435.10	300	2068.00	2.10	20.70	21.10
4000	4.0	40	40.80	580.20	400	2758.00	2.80	27.60	28.10
5000	5.0	50	51.00	725.20	500	3447.00	3.40	34.50	35.20
6000	6.0	60	61.20	870.20	600	4137.00	4.10	41.40	42.20
7000	7.0	70	71.40	1015.30	700	4826.00	4.80	48.30	49.20
8000	8.0	80	81.60	1160.30	800	5516.00	5.50	55.20	56.30
9000	9.0	90	91.80	1305.30	900	6205.00	6.20	62.10	63.30
10000	10.0	100	102.00	1450.00	1000	6895.00	6.90	68.90	70.30
20000	20.0	200	204.00	2901.00	2000	13790.00	13.80	137.90	140.70
30000	30.0	300	306.00	4351.00	3000	20684.00	20.70	206.80	211.00
40000	40.0	400	408.00	5802.00	4000	27579.00	27.60	275.80	281.30
50000	50.0	500	510.00	7252.00	5000	34474.00	34.50	344.70	351.60
60000	60.0	600	612.00	8702.00	6000	41369.00	41.40	413.70	421.90
70000	70.0	700	714.00	10153.00	7000	48263.00	48.30	482.60	492.30
80000	80.0	800	816.00	11603.00	8000	55158.00	55.20	551.60	562.60
90000	90.0	900	918.00	13053.00	9000	62053.00	62.10	620.50	632.90
100000	100.0	1000	1020.00	14504.00	10000	68948.00	68.90	689.00	703.00
200000	100.0	2000	2040.00	29008.00	20000	137895.00	137.90	1379.00	1406.00
300000	300.0	3000	3060.00	43511.00	30000	206843.00	206.80	2068.00	2110.00
					40000	275790.00	275.80	2758.00	2813.00

## English/Metric Conversions

Inches x 25.4 = Millimeters (mm)

Inches x 2.54 = Centimeters (cm)

Inches x .254 = Decimeters (dm)

Feet x .3048 = Meters (m)

Yards x .9144 = Meters (m)

Psi x .0689 = Bars (Bar)

Bars x 100 = Kilopascals (kPa)

Psi x .0069 = Megapascals (MPa)

Pound Inches x .113 = Newton Meters (N•m)

Pound Feet x 1.356 = Newton Meters (N•m)

Millimeters x .0394 = Inches

Centimeters x .3937 = Inches

Meters x 3.281 = Feet

Meters x 1.0936 = Yards

Bars x 14.5 = Psi      Megapascals x 145 = Psi

Newton Meters x 8.85 = Pound Inches

Newton Meters x .737 = Pound Feet

### Millimeters to Fractions to Decimals

mm	Inches		mm	Inches		mm	Inches		mm	Inches	
	Fraction	Decimal		Fraction	Decimal		Fraction	Decimal		Fraction	Decimal
0.3969	1/64	0.0156	6.7469	17/64	0.2656	13.0969	33/64	0.5156	19.4469	49/64	0.7656
0.7938	1/32	0.0312	7.1438	9/32	0.2812	13.4938	17/32	0.5312	19.8438	25/32	0.7812
1.1906	3/64	0.0468	7.5406	19/64	0.2968	13.8906	35/61	0.5468	20.2406	51/64	0.7968
1.5875	1/16	0.0625	7.9375	5/16	0.3125	14.2875	9/16	0.5625	20.2375	13/16	0.8125
1.9844	5/64	0.0781	8.3344	21/64	0.3281	14.6844	37/64	0.5781	21.0344	53/64	0.8281
2.3812	3/32	0.0937	8.7312	11/32	0.3437	15.0812	19/32	0.5937	21.4312	27/32	0.8437
2.7781	7/64	0.1093	9.1281	23/64	0.3593	14.4781	39/64	0.6093	21.8281	55/64	0.8593
3.1750	1/8	0.1250	9.5250	3/8	0.3750	15.8750	5/8	0.6250	22.2250	7/8	0.8750
3.5719	9/64	0.1406	9.9219	25/64	0.3906	16.2719	41/64	0.6406	22.6219	57/64	0.8906
3.9688	5/32	0.1562	10.3188	13/32	0.4062	16.6688	21/32	0.6562	23.0188	29/32	0.9062
4.3656	11/64	0.1718	10.7156	27/64	0.4218	17.0656	43/64	0.6718	23.4156	59/64	0.9218
4.7625	3/16	0.1875	11.1125	7/16	0.4375	17.4625	11/16	0.6875	23.8125	15/16	0.9375
5.1594	13/64	0.2031	11.5094	29/64	0.4531	17.8594	45/64	0.7031	24.2094	61/64	0.9531
5.5562	7/32	0.2187	11.9062	15/32	0.4687	18.2562	23/32	0.7187	24.6062	31/32	0.9687
5.9531	15/64	0.2343	12.3031	31/64	0.4843	18.6531	47/64	0.7343	25.0031	63/64	0.9843
6.3500	1/4	0.2500	12.7000	1/2	0.5000	19.0500	3/4	0.7500	25.4000	1	1.0000



# Fluid Compatibility Guide

The following pages list general recommendations for the selection of valve materials. For specific cases, and for those not included in the Fluid Compatibility Chart, it is advisable to check with your Parker representative.

There are many specific environmental factors which might affect corrosion rate such as temperature, solution, concentration and presence of impurities. Therefore, we suggest that the information be used as a rough guide to material selection. If any questions exist regarding the expected performance of a material in a given application, actual tests should be performed to determine the suitability of the materials in question.

FLUID	BRASS	CARBON STEEL	316 S.S.	BUNA N (NITRILE)	NEOPRENE	EPR	FLUORO-CARBON	PTFE	ACETAL	NYLON
ACETALDEHYDE	P	G	E	P	G	G	P	E	U	
ACETAMINE	G	G	G	E	G			E		
ACETATE SOLVENTS	E	E	E	P			U	E	U	
ACETIC ACID VAPORS	U		U	U				E		
ACETIC ACID (10%)	P	P	E	U	P	G	U	E	U	U
ACETIC ACID (80%)	P	P	E	U	U	P	U	E	U	U
ACETIC ACID (AERATED)	P	P	E	G	G		P	E	U	
ACETIC ACID (AIR FREE)	P	P	E	G	G		U	E	U	
ACETIC ACID (CRUDE)	P	P	E	U	U		U	E	U	
ACETIC ACID (GLACIAL)			U	U	P	G	P	E		U
ACETIC ACID (PURE)	P	U	E	U	U		U	E	U	
ACETIC ANHYDRIDE	U	U	G	U	P	P	U	E	U	U
ACETONE	E	E	E	U	U	E	U	E	E	E
ACETOPHENONE	G	G	G	U	U	E	U			
ACETYL CHLORIDE	E	G	P	U	U	U	U	E		
ACETYLENE	G	E	E	G	P	E	E	E	E	
ACID FUMES	U	U	G	P	G			E		
ACRYLONITE	E	E	E	U	U	U	P	E		
AIR	E	E	E	E	E	E	E	E	E	
ALCOHOL, AMYL	G	G	E	P	P	E	G	E	E	
ALCOHOL, BUTYL	G	G	E	G	G	P	E	E	E	
ALCOHOL, DIACETONE	E	E	E	U	P	G	U	E		
ALCOHOL, ETHYL	G	G	G	E	G	E	E	E	E	
ALCOHOL, ISOPROPYL	G	G	G	P	G	E	E	E	E	
ALCOHOL, METHYL	E	G	E	G	E	E	P	E	E	
ALCOHOL, PROPYL	E	G	E	G	G	E	E	E		
ALCOHOLS, FATTY	G	G	E	G	G			E		
ALUM	U		G	G	G		G	E		
ALUMINA	U		E	E	E	E		E		
ALUMINUM ACETATE	G		E	U	U	E	U	E		
ALUMINUM BROMIDE				E	E	E	E			
ALUMINUM CHLORIDE DRY	U	P	P	G	G	E	E	E	E	
ALUMINUM CHLORIDE SOLUTION			U	G	G		E	E		U
ALUMINUM FLUORIDE	U	U	P	E	E	E	E	E		U
ALUMINUM HYDROXIDE	E	U	E	E	E	E	E	E		
ALUMINUM NITRATE	U	U	P	G	G	G	U	E		
ALUMINUM OXALATE			U					E		
ALUMINUM SALTS				E	E	E	E			
ALUMINUM SULFATE	P	U	G	E	E	E	E	E	E	P
AMINES	G	G	E	U	U	P	U	E	E	
AMLY CHLORIDE	G		E	U	P	U	U	E		
AMMONIUM BICARBONATE	G	P	G	G	E	E	E	E	E	
AMMONIA, ALUM			E	G	G			E		
AMMONIA, ANHYDROUS LIQUID	U	E	E	G	P	G	U	E		
AMMONIA, AQUEOUS	U	E	E	G	G		E	E		
AMMONIA, GAS, HOT	U	G	E	P	E	E	U	E		
AMMONIA LIQUOR			E					E		
AMMONIA SOLUTIONS	U	G	E	G	G	G	U	E		
AMMONIUM ACETATE	U		G	G	G	E	U	E		
AMMONIUM BROMIDE 5%			G					E		

**E-EXCELLENT**

**G-GOOD**

**P-POOR**

**U-UNSATISFACTORY**

**N**



FLUID	BRASS	CARBON STEEL	316 S.S.	BUNA N (NITRILE)	NEOPRENE	EPR	FLUORO-CARBON	PTFE	ACETAL	NYLON
AMMONIUM CARBONATE	G	G	G	P	E	E	G	E	E	
AMMONIUM CHLORIDE	U	U	P	G	E	E	E	E	E	U
AMMONIUM HYDROXIDE 28%	U	P	G	G	E	G	E	E	E	
AMMONIUM HYDROXIDE CONC.	U	P	G	P	E	E	E	E	E	
AMMONIUM MONOSULFATE			E				E	E	E	
AMMONIUM NITRATE	U	U	E	E	E	E	E	E	E	U
AMMONIUM OXALATE 5%			E				E	E	E	
AMMONIUM PERSULFATE	P	U	E	U	P	G	G	E	E	U
AMMONIUM PHOSPHATE	U	U	G	E	E	E	E	E	G	P
AMMONIUM PHOSPHATE DI-BASIC	P	U	G	E	E	E	E	E	E	
AMMONIUM PHOSPHATE TRI-BASIC	P	U	G	E	E	E	E	E	E	
AMMONIUM SULFATE	P	P	G	E	E	E	G	E	E	U
AMMONIUM SULFIDE	U	U	G	E	G	E	U	E	E	
AMMONIUM SULFITE	P	P	E	G	E	G	E	E	E	
AMYL ACETATE	G	P	G	U	U	G	U	E	E	P
AMYL BORATE				E	E	U	E	E	E	
AMYL CHLORONAPHTHALENE				U	U	U	E	E	E	
AMYL NAPHTHALENE				U	U	U	E	E	E	
ANILINE	U	P	G	U	U	P	P	E	E	P
ANILINE DYES	P	P	E	P	P	P	G	E	E	
ANIMAL OIL	G	G	G	E	G	G	E	E	E	
ANTIMONY TRICHLORIDE	U	U	U	P	E	G	G	E	E	
APPLE JUICE	P	U	G	E	E	G	E	E	E	
AQUA REGIA (STRONG ACID)	U	U	G	U	U	U	U	E	E	U
AROCOLOR 1248	G	U	U	U	U	G	E	E	E	
AROCOLOR 1254	G	U	U	U	U	G	E	E	E	
AROCOLOR 1260	G	U	U	E	E	E	E	E	E	
AROMATIC SOLVENTS	E	P	E	U	U	U		E	E	
ARSENIC ACID	U	U	G	E	E	G	E	E	E	U
ASPHALT EMULSION	E	G	E	U	P	U	E	E	E	
ASPHALT LIQUID	E	G	E	P	P	U	E	E	E	
ASTM OIL, NO. 1	E	E	E	E	E	U	E	E	E	
ASTM OIL, NO. 2	E	E	E	E	G	U	E	E	E	
ASTM OIL, NO. 3	E	E	E	E	U	U	E	E	E	
ASTM OIL, NO. 4	E	E	E	E	U	U	E	E	E	
ASTM REFERENCE FUEL A	U	G	E	E	G	U	E	E	E	
ASTM REFERENCE FUEL B	U	G	E	E	U	U	E	E	E	
ASTM REFERENCE FUEL C	U	G	E	G	U	U	E	E	E	
BARIUM CARBONATE	G	G	G	G	E	E	E	E	E	
BARIUM CHLORIDE	G	P	G	E	E	E	E	E	E	E
BARIUM CYANIDE	P		G	G	G	G	G	E	E	
BARIUM HYDRATE	U		E					E	E	
BARIUM HYDROXIDE	P	P	G	E	E	G	E	E	E	
BARIUM NITRATE			E		G			E	E	
BARIUM SALTS				E	E	E	E	E	E	
BARIUM SULFATE	P	P	E	E	E	G	E	E	E	E
BARIUM SULFIDE	U	P	G	E	E	G	E	E	E	
BEER	G	U	E	G	G	G	E	E	E	U
BEET SUGAR LIQUORS	E	G	E	E	E	G	E	E	E	
BENZALDEHYDE	E	E	E	U	U	E	U	E	E	E
BENZENE	G	G	G	U	U	U	G	E	E	E
BENZENESULFONIC ACID, 10%	U	U	U	U	G	U	E	E	E	
BENZLY CHLORIDE	U	U	G	U	U	U	E	E	E	
BENZOIC ACID	G	U	G	P	P	U	G	E	E	P
BENZYL ALCOHOL		U	E	U	G	G	E	E	E	
BERYLLIUM	G		G	G	G	G	G	E	E	
BLEACH LIQUOR				U	G	E	E	E	E	
BLEACHING POWDER WET	G		P	U	E	G	G	E	E	
BLOOD	G		E	G	G	G	G	E	E	
BORAX	U	P	E	G	U	E	E	E	E	E
BORAX LIQUORS	E	P	G		P	E	E	E	E	
BORDEAUX MIXTURE			E				E	E	E	
BORIC ACID	P	U		G	G	G	E	E	E	G
BRAKE FLUID	G		G	U	P	G	U	E	E	
BRINES, SATURATED	G	U	G	E	G	E	E	E	E	
BROMINE, DRY	G	U	U	U	U	U	G	E	E	
BROMINE, WET	U	U	U	U	U	U	G	E	E	

**E-EXCELLENT**

**G-GOOD**

**P-POOR**

**U-UNSATISFACTORY**



FLUID	BRASS	CARBON STEEL	316 S.S.	BUNA N (NITRILE)	NEOPRENE	EPR	FLUORO-CARBON	PTFE	ACETAL	NYLON
BUNKER OILS (FUEL)	G	G	E	G	G		E	E	E	
BUTADIENE	P	G	E	P	P	P	G	U		
BUTANE	E	G	E	G	G	U	E	E	E	
BUTTER	G	U	E	G	G			E		
BUTTERMILK	U	U	E	E	E	G	E	E	E	
BUTYL ACETATE	G		G	U	U	U	U	E		E
BUTYL ALCOHOL	E	P	E	G	G		G	E		
BUTYL AMINE	G	G	E	U	U		U	E		
BUTYL BUTYRATE				U	U	E	E			
BUTYL CARBITOL	E	P	E	U	U		U	E		
BUTYL CELLOSOLVE	E	P	E	U	U		G	E		
BUTYL STEARATE				G	U	U	E			
BUTYLENE	E	E	E	U	U	U	U	E		
BUTYRIC ACID	P	U	G	P	P	P	P	E	E	U
CALCINE LIQUORS				E	E	E	E			
CALCIUM ACETATE				G	G	E	U			
CALCIUM BISULFITE	P	U	G	E	E	U	E	E	E	
CALCIUM CARBONATE	P	U	G	E	E	G	E	E	E	
CALCIUM CHLORATE	U		G	G	G	G	G	E		
CALCIUM CHLORIDE	G	P	G	E	E	G	E	E	E	U
CALCIUM HYDROXIDE	P	P	G	E	G	E	E	E	E	
CALCIUM HYPOCHLORITE	U	U	P	P	P		E	E	E	U
CALCIUM NITRATE			G	G	G	G	G	E		
CALCIUM PHOSPHATE	P		G	G	G	G	G	E		
CALCIUM SALTS				E	E	E	E			
CALCIUM SILICATE	P		G	G	G	G	G	E		
CALCIUM SULFATE	P	P	G	E	E	G	E	E	E	U
CALCIUM SULFIDE	U	U	G	E	E	E	E			
CALICHE LIQUOR		G	E	G	G			E		
CAMPHOR	P		G	G	G	G	G	E		
CANE SUGAR LIQUORS	G	G	E	G	G	G	G	E		
CARBOLIC ACID	U	U	G	G	G	G	E	E	U	
CARBON BISULFIDE	P	G	G	U	U	U	E	E	E	
CARBON DIOXIDE, DRY	E	E	E	P	G	G	G	E	E	
CARBON DISULFIDE	U	P	E	U	U		E	E	E	
CARBON MONOXIDE	E	E	E	G	U	G	G	E		
CARBON TETRACHLORIDE, DRY	P	G	E	U	U	U	G	E	E	
CARBON TETRACHLORIDE, WET	U	U	G	U	U	U	G	E	E	
CARBONATED BEVERAGE	G	U	G	U	G	G	G	G	E	
CARBONATED WATER	G	G	E	E	E	E	E	E	E	
CASEIN	P			G	G	G	G	G	E	
CASTER OIL	E	G	E	E	G	G	E	E	E	
CAUSTIC POTASH			E	G	G			E		
CAUSTIC SODA		G	E	P		G	G	E		
CELLULOSE ACETATE	G		G	U	U	G	U	E		
CELLULUBE	E		E	U	U		U	E		
CHINA WOOD OIL	P	P	E	E	G	U	E	E	E	
CHLORACETIC ACID	P	U	U	U	P		P	E		U
CHLORINATED SOLVENTS	P	P	E	U	U	U	P	E	E	
CHLORINATED WATER	U	P	G	E		E	E	E	U	U
CHLORINE, WET	U	U	U	U	U			E		
CHLORINE GAS	P	G	G	P	U	U	G	E	E	
CHLORO BROMO METHANE	G	U	G	U	U		G	E		
CHLOROBENZENE, DRY	G	G	E	U	U	U	E	E	E	E
CHLOROBUTADIENE				U	U	U	E			
CHLOROFORM, DRY	G	G	E	U	U	U	G	E	E	U
CHLOROPHYLL, DRY	G		G	G	G	G	G	E		
CHLOROSULFONIC ACID, DRY	P	G	G	U	U	U	U	E		U
CHLOROSULFONIC ACID, WET	U	U	U	U	U		P	E		
CHLORPHENOL				U	U	U	E			
CHROME ALUM	P	G	E	G	G	G	G	E		
CHROMIC ACID <50%	U	U	P	U	U	P	P	E	U	U
CHROMIC ACID >50%	U	U	P	U	U	P	P	E		
CHROMIUM SULFATE	P		G	G	G	G	G	E	U	
CIDER			E					E		
CITRIC ACID	P	U	G	G	E	G	E	E		P
CITRUS JUICES	G	U	G	E	E		E	E	E	

E-EXCELLENT

G-GOOD

P-POOR

U-UNSATISFACTORY

**N**



FLUID	BRASS	CARBON STEEL	316 S.S.	BUNA N (NITRILE)	NEOPRENE	EPR	FLUORO-CARBON	PTFE	ACETAL	NYLON
COCA-COLA SYRUP			E	G	G		G	E		
COCONUT OIL	G	P	E	E	P	E	E	E	E	
COFFEE	E		G	E	E	E	E	G		
COFFEE EXTRACTS, HOT	G	P	E					E		
COKE OVEN GAS	P	G	E	P	U	U	G	E		
COOKING OIL	G	G	E	E	G	U	E	E	E	
COPPER ACETATE	U	U	E	P	P	G	U	E		
COPPER CARBONATE			E					E		
COPPER CHLORIDE	U	U	P	G	G		E	E		U
COPPER CYANIDE	U		E	E	E	G	G	E		E
COPPER NITRATE	U	U	G	E	E	G	E	E	E	U
COPPER SALTS					E	E	E	E		
COPPER SULFATE	U	U	G	E	E	E	E	E	E	P
CORN OIL	G	P	G	E	P	P	E	E	E	
COTTONSEED OIL	G	P	G	E	G	P	G	E	E	
CREOSOTE OIL	G	G	G	P	U	U	E	E	U	
CREOSOLS	U	G	G	U	U	U	U	E		
CRESYLIC ACID	P	P	G	U	U	U	G	E	U	U
CRUDE OIL, SOUR	P	G	E	E	G	U	E	E		
CRUDE OIL, SWEET	G	G	E	E	G		E	E		
CUPRIC NITRATE			E					E		
CUTTING OILS, WATER EMULSIONS	E	G	E	E	G		E	E	E	
CYANIDE PLATING SOLUTION	U		G	G	G	G	G	E		
CYCLOHEXANE	E	E	E	P	U	U	E	E	E	
CYCLOHEXANONE	G		E	U	U			E		
DECANE				E	U	U	E			
DENATURED ALCOHOL				E	E	E	E			
DETERGENTS, SYNTHETIC	G	U	G	G	G	G	E	E		
DEXTRIN	G		G	G	G	G	G	E		
DIACETONE ALCOHOL	E	E	E	U	P			E		
DICHLOROETHANE			P	U	U	U		E		
DICHLOROETHYL ETHER	G		G	U	U	U	U	E		
DIESEL OIL FUELS	E	E	E	E	P	U	E	E		
DIETHYL BENZENE			G	U	U	U		E		
DIETHYL SULFATE	G		G	P	P	P	G	E		
DIETHYLAMINE	G	E	E	G	P	P	U	E		
DIETHYLENE GLYCOL	G	E	E	E	E	E	G	E		
DIMETHYL FORMAMIDE	G		E	G	U	U	U	E		
DIMETHYL PHTHALATE			U	G	G		U	E		
DIOCTYL PHTHALATE	E		E	P	U		P	E		
DIOXANE	G		G	U	U	P	U	E		
DIPENTANE	E		E	G	U	U	G	E		
DISODIUM PHOSPHATE			G	G	G		G	E		
DOW CHEMICAL HD50-4					G	E	U			
DOW CORNING 200, 510, 550				G	E	E	E			
DOWTHERM	E	G	E	U	U	U	E	E	E	
DRILLING MUD	G	G	E	E	P	E	E	E	E	
DRY CLEANING FLUIDS	P	G	E	U	U		G	E	E	
DRYING OIL	P	P	G	E	G			E	E	
ENAMEL	E		E	G	G	U		E		
EPSOM SALTS	G	P	G	E	E		E	E	E	
ETHANE	G	P	G	E	G	U	E	E	E	
ETHANOL	E	U	U	U	E	E	U			
ETHANOLAMINE	U	G	E	G	P		U	E		
ETHERS	G	E	E	U	U	P	P	E	P	
ETHYL ACETATE	P	G	G	U	U	P	U	E	E	E
ETHYL ACRYLATE	G	P	E	U	U	P	U	E		
ETHYL ALCOHOL	G	G	G	E	E		E	E		
ETHYL BENZENE			G	P	U	U		E	E	
ETHYL BROMIDE	E		G	G	G	G	G	E		
ETHYL CHLORIDE, DRY	G	G	E	P	P	P	G	G	E	E
ETHYL CHLORIDE, WET	P	U	G	P	P	G	G	E		
ETHYL ETHER	G		E	U	U	U	U	E		
ETHYL HEXANOL			E	E	E	E	E			
ETHYL SILICATE	G		G	G	P	G	G	E		
ETHYL SULFATE			G	G	G	P	E	E	E	

E-EXCELLENT

G-GOOD

P-POOR

U-UNSATISFACTORY



FLUID	BRASS	CARBON STEEL	316 S.S.	BUNA N (NITRILE)	NEOPRENE	EPR	FLUORO-CARBON	PTFE	ACETAL	NYLON
ETHYLENE CHLORIDE			E	U	E		U	E		
ETHYLENE DICHLORIDE	U	U	G	U	U		U	E		
ETHYLENE GLYCOL	G	G	G	E	G		E	E		
ETHYLENE OXIDE	P	G	G	U	U		U	E		
FATTY ACIDS	P	U	E	G	G		U	E	E	U
FERRIC CHLORIDE	U	U	U	E	U		E	E		U
FERRIC HYDROXIDE			E	G				E		
FERRIC NITRATE	U	U	P	E	E		E	E	E	U
FERRIC SULFATE	U	U	G	E	E		E	E	E	U
FERROUS AMMONIUM CITRATE			U	G				E		
FERROUS CHLORIDE	G	U	G	E	E		E	E	E	U
FERROUS SULFATE	G	U	G	E	E		E	E	E	U
FERROUS SULFATE, SATURATED	P	P	E	P	P		G	E		
FERTILIZER SOLUTIONS	P	G	G	G	G			E	G	
FISH OILS	G	G	E	E	G		U	E	G	
FLUE GASES	G		E	P	P		U	E	P	
FLUOBORIC ACID			G	E	G			E		U
FLUORINE, DRY	U		U	U					E	
FLUOROSILICIC ACID	G	U	G	P	P		P	E		U
FOOD FLUIDS & PASTES	G	P	E	G	E			E		
FORMALDEHYDE, COLD	E	E	E	G	P		G	E	E	U
FORMALDEHYDE, HOT	G	U	P	G	G			E	E	U
FORMIC ACID, COLD	G	U	G	U	G		G	E	U	E
FORMIC ACID, HOT	G	U	G	U	E		E	E	U	
FRUIT JUICES	G	U	E	E	E		E	E	E	
FUEL OIL	G	G	E	E	P		U	E	E	
FUMARIC ACID			G	G	G			E		
FURFURAL	E	E	E	U	P		P	E	E	E
GALIC ACID 5%	P	U	G	G	G		P	E	E	
GAS, NATURAL	G	G	E	E	E		U	E	E	
GAS, ODORIZERS	E	G	G	G	G			E	E	
GAS MFG.	G	G	G	E				E	E	
GASOLINE, AVIATION	E	E	E	P	U			E	E	
GASOLINE, LEADED	E	E	E	P	U			E	E	
GASOLINE, MOTOR	E	E	E	P	U		U	E	E	
GASOLINE, REFINED	G	G	E	P	P		U	E	E	
GASOLINE, SOUR	G	G	E	P	U		U	E	E	
GASOLINE, UNLEADED	E	E	E	P	U			E	E	E
GELATIN	E	U	E	E	E			E	E	
GLUCOSE	E	G	E	E	E			E	E	
GLUG	E	G	E	E	G			E		
GLYCERINE	G	P	E	P	U		E	G	E	E
GLYCOL	G	P	G	G	E			E	E	P
GLYCOL AMINE	U		G	E			U	U		
GRAPHITE	G		G	G	G		G	G	E	
GREASE	P	E	E	E	G		U	E		
GULF-FR FLUID, EMULSION			E	E	G		U	E		
GULF-FR FLUID G			E	E	E		E	E		
GULF-FR FLUID P			U	U	U		G	G		
HELIUM GAS	G	E	E	G	G		G	G	E	
HEPTANE	E	G	E	E	G		U	E	E	
HEXANE	G	G	E	E	P		U	E	E	E
HEXANOL, TERTIARY	E	E	E	E	P		U	G	E	
HEXYL ALCOHOL	E	P	E	U	P			E	E	
HYDRAULIC OIL, PETROLEUM BASE	G	E	E	E	G		U	E	E	
HYDRAZINE	U	U	G	P	P		G	U	E	
HYDRIGEN SULFIDE, DRY	P	G	E	P	E		E	E	E	
HYDROCHLORIC ACID, AIR FREE	U	U	U	G	P			E	E	U
HYDROCYANIC ACID	U	U	E	G	G		G	E	E	
HYDROFLUORIC ACID	U	U	U		G					U
HYDROFLUOSILICIC ACID	E	U	P	G	G		G	E	E	U
HYDROGEN GAS, COLD	G	G	E	G	G		G	E	E	
HYDROGEN GAS, HOT	G	G	G	G	G			E		
HYDROGEN PEROXIDE, CONCENTRATED	U	U	G	U	U		G	G	E	U
HYDROGEN PEROXIDE, DILUTE	P	U	G	E	G		G	E	E	U
HYDROGEN SULFIDE, WET	U	P	G	P	G		G	E	E	

**E-EXCELLENT**

**G-GOOD**

**P-POOR**

**U-UNSATISFACTORY**

**N**



FLUID	BRASS	CARBON STEEL	316 S.S.	BUNA N (NITRILE)	NEOPRENE	EPR	FLUORO-CARBON	PTFE	ACETAL	NYLON
HYDROLUBE				E	G	E	E			
HYPO (SODIUM THIOSULFATE)	P	U	G	E	E	E	E	E	E	
HYPOCHLORITES, SODIUM	U	U	P	P			E	E		
ILLUMINATING GAS	E	E	E	P	P	U	E	E		
INK, NEWSPRINT	P	U	E	E	G	G	E	E	E	
IODINE, WET	U	U	U	G			E	E		
IODIFORM	P	G	E				E	E	E	
ISOPROPYL ACETATE			G	U	U	U		E		
ISOPROPYL ALCOHOL	G	G	G	P	G		E	E		
ISOPROPYL ETHER	E	E	E	P	P	U	U	E		
ISO-BUTANE			G	G	U	U		E		
ISO-OCTANE	E	E	E	E	P	U	E	E	E	
J P-4 FUEL	E	E	E	E	P		E	E	E	
J P-5 FUEL	E	E	E	G	P		E	E	E	
J P-6 FUEL	E	E	E	E	P		E	E	E	
KEROSENE	E	G	E	E	P	U	E	E	E	
KETCHUP	U	U	E	E	E		E	E	E	
KETONES	E	E	E	U	U	U	U	E	E	
LACTIC ACID, CONC. COLD	U	U	E	G	E	G	E	E	U	U
LACTIC ACID, CONC. HOT	U	U	G	P	P	G	G	E	U	U
LACTIC ACID, DILUTE COLD	U	U	E	G	E	G	E	E	U	U
LACTIC ACID, DILUTE HOT	U	U	E	P	U		U	E	U	U
LACTOSE	G		G	G	P	G	G	E		
LAQUER	E	P	E	U	U	U	U	E	E	E
LARD	G	E	E	G	P	P		E		
LARD OIL	G	P	G	E	G	G	E	E	E	
LEAD ACETATE	P	U	G	E	G	G	G	E	E	E
LEAD SULFATE	P		G	G	G	G	G	E		
LECITHIN	P		G	U	U	U	G	E		
LINOLEIC ACID	G	G	E	G	G	U	G	E	E	
LINSEED OIL	G	E	E	E	P	U	E	E	E	
LITHIUM CHLORIDE	G		G	G	G	G	G	E		
LPG	E	G	G	E	G	U	E	E	E	
LUBRICATING OIL	G	E	E	E	G	U	E	E	E	
LUDOX	U		G	G	G	G	G	E		
MAGNESIUM BISULFATE	G	G	E	G	G	G	G	E		
MAGNESIUM BISULFIDE	U		G	G	G	G	G	E		
MAGNESIUM CARBONATE	G		E	G	G	G	G	E		
MAGNESIUM CHLORIDE	G	P	G	E	E	E	E	E	E	E
MAGNESIUM HYDROXIDE	G	G	E	E	E	E	E	E	E	
MAGNESIUM HYDROXIDE HOT	U	G	E	G	G		E	E	E	
MAGNESIUM NITRATE			E	G	E		G	E		E
MAGNESIUM SALTS				E	E	E	E			
MAGNESIUM SULFATE	G	G	E	E	E	E	E	E	E	E
MALEIC ACID	G	G	G	G	G	U	E	E	E	
MALEIC ANHYDRIDE	G		G	U	U	U	G	E		
MALIC ACID	G	U	G	E	G		E	E	E	
MALT BEVERAGES			E	E	E	G	E	E		
MANGANESE CARBONATE			G	G				E		
MANGANESE SULFATE	G		E	G	G	G	G	E		
MAYONNAISE	U	U	E	E	E		E	E	E	
MEAT JUICES	U		E	G	G			E		
MELAMINE RESINS			P	G	G			E		
MERCURIC CHLORIDE	U	U	G	E	G	E	E	E		
MERCURIC CYANIDE	U	U	E	E	G		E	E		
MERCUROUS NITRATE	U		E				G	E		
MERCURY	U	E	E	E	E	E	E	E	E	
METHANE	E	G	E	E	G		E	E	E	
METHANOL	E	E		E	E	E	U			
METHANOL	G		E	G	G	U	G	E		
METHYL ACETATE	E	G	E	U	U	G	U	E		
METHYL ACETONE	E	E	E	E	U	E	U	E		
METHYL ALCOHOL	G	G	G	E	U		P	E		E
METHYL BROMIDE 100%	P	G	G	G	U	U	G	E		
METHYL CELLOSOLVE	E	G	E	P	U	G	U	E		
METHYL CELLULOSE			E	U	U			E		
METHYL CHLORIDE	G	G	E	U	U	U	G	E	E	

**E-EXCELLENT**

**G-GOOD**

**P-POOR**

**U-UNSATISFACTORY**





FLUID	BRASS	CARBON STEEL	316 S.S.	BUNA N (NITRILE)	NEOPRENE	EPR	FLUORO-CARBON	PTFE	ACETAL	NYLON
METHYL ETHER				E	U	U	E			
METHYL ETHYL KETONE	E	E	E	U	U	G	U	E	E	E
METHYL FORMATE	E	P	G	U	G	G	U	E		
METHYL ISOBUTYLE KETONE			E	U	U			E		
METHYLAMINE	U	G	E	U	U	G	U	E		
METHYLENE CHLORIDE	E	G	E	U	U	U	P	E		U
MILK & MILK PRODUCTS	G	U	E	E	E	E	E	E	E	
MIL-F-81912, JP-9	E	E	E	U	U	U	E			
MIL-H-5606	E	E	E	E	G	U	E			
MIL-H-6083	E	E	E	E	E	U	E			
MIL-H-7083	E	E	E	E	G	E	G			
MIL-H-8446	G	E	E	G	E	U	E			
MIL-L-2104 & 2104B	E	E	E	E	G	U	E			
MIL-L-7808	U	G	E	G	U	U	E			
MINE WATERS, ACID	P	U	P	E			E	E		
MINERAL OILS	G	G	E	E	G	U	E	E	E	
MINERAL SPIRITS	G	G	G	E	P		E	E	E	
MIXED ACIDS, COLD	U	P	G	U	U	U	G	E	U	
MLO-7277 & MLO-7557	G	E	E	U	U	U	E			
MOBILE HF	E	E	E	E	G	U	E			
MOLASSES, CRUDE	E	E	E	E	E		E	E	E	
MOLASSES, EDIBLE	E	P	E	E	E		E	E	E	
MOLYBDIC ACID			E				E	E		
MONOCHLORO BENZENE DRY			G	U	U		E	E		
MONOMETHYL HYDRAZINE				G	G	E				
MORPHOLINE	G		E	U	U	G	U	E		
MURIATIC ACID	U	U	U	G			E	E		
MUSTARD	E	G	E	E	E		E	E	E	
NAPHTHENIC ACID	G	E	G	G	U	U	E			
NAPHTHA	G	G	G	G	P	U	E	E	E	
NAPHTHALENE	G	G	G	U	U	U	E	E	E	
NATURAL GAS, SOUR	G	G	E	E	E	U	E	E		
NEATSFOOT OIL				E	U	G	E			
NICKEL ACETATE	U	G	E	G	G	E	U			
NICKEL AMMONIUM SULFATE	U	U	E	E	G	G	U	E		
NICKEL CHLORIDE	U	U	G	E	E	G	E	E	E	E
NICKEL NITRATE	U	U	G	E	E	E	E	E	E	
NICKEL SALTS				E	G	E	E			
NICKEL SULFATE	U	U	G	E	E	G	E	E	E	E
NITRIC ACID 100%	U	U	E	U	U	U	G	E	U	U
NITRIC ACID 10%	U	U	E	P	G		E	E	U	U
NITRIC ACID 30%	U	U	E	P	P	G	E	E	U	U
NITRIC ACID 80%	U	U	P	U	U	U	G	E	U	U
NITRIC ACID ANHYDROUS	U	U	E	U	U	U	E	E		
NITROBENZENE	U	G	E	U	U	P	P	E		E
NITROGEN	E	E	E	E	E	G	E	E	E	
NITROUS ACID 10%	U	U	G	P	E		E	E		
NITROUS GASES	U	G	E				E	E		
NITROUS OXIDE	G	G	G	G	G		E	E		
NOCOTINIC ACID	E	G	E	U	U	U	G	E		
OCTYL ALCOHOL	E	E	E	G	G	U	E			
OILS, ANIMAL	E	E	E	E	G	G	G	E		
OILS, PETROLEUM REFINED	G	E	E	E	G	U	E	E	E	
OILS, PETROLEUM SOUR	P	G	E	G	G	U	E	E		
OILS, WATER MIXTURE	E	G	E	E	G		E	E	E	
OILS & FATS			E	G		U		E		
OLAIC ACID			G	U	U		P	E		
OLEIC ACID	G	P	G	G	P	U	E	E	E	
OLEUM	P	G	G	U	U	U	P	E	U	
OLEUM SPIRITS	U		G	P	U	U	E	E		
OLIVE OIL	P	G	E	E	G	G	E	E	E	
ORTHO-DICHLOROBENZENE	G	G	E	U	U	U	E		E	
OTHER KETONES	E	E	E	U	U	U	U	E		
OXALIC ACID	G	U	G	P	G	G	E	E	P	U
OXYGEN	E	G	E	G	G	E	E	E	U	
OZONE, DRY	E	E	E	U	U	E	G	E		
OZONE, WET	G	P	E	U	U	G	G	E		

**E-EXCELLENT**

**G-GOOD**

**P-POOR**

**U-UNSATISFACTORY**

**N**



FLUID	BRASS	CARBON STEEL	316 S.S.	BUNA N (NITRILE)	NEOPRENE	EPR	FLUORO-CARBON	PTFE	ACETAL	NYLON
PAINTS & SOLVENTS	E	E	E	U	U	U	G	E		
PALM OIL	G	P	G	G	G	U	E	E	E	
PALMITIC ACID	G	P	G	G	G	G	E	E	E	
PAPER PULP	G		E	G	G	G	G	E		
PARAFFIN	E	G	E	E	P	U	E	E	E	
PARA-FORMALDEHYDE	G	G	G	G	G	U	U	E	E	
PARALDEHYDE			G	G	G	U		E		
PARA-DICHLOROBENZENE	G	E	E	U	U	U	E			
PARKER O LUBE	E	E	E	E	E	U	E			
PEANUT OIL	G	E	E	E	U	U	E			
PENTANE	E	G	E	E	G	U	E	E	E	
PERCHLORETHYLENE, DRY	P	G	E	U	U	U	E	E		
PERCHLORIC ACID-2N	U	U	G	U	G	G	E			
PETROLATUM (PETROLEUM JELLY)	G	P	G	E	G		E	E	E	
PHENOL	G	U	E	U	U	U	G	E	U	E
PHOSPHATE ESTER	U	E	E	U		E		E		
PHOSPHORIC ACID 10%	U	U	U	G	E	G	E	E	U	U
PHOSPHORIC ACID 50% COLD	U	U	G	G	G	G	E	E	U	U
PHOSPHORIC ACID 50% HOT	U	U	U	G	G	G	E	E	U	U
PHOSPHORIC ACID 85% COLD	G	G	E	P	P		G	E	U	U
PHOSPHORIC ACID 85% HOT	P	P	G	P	P			E	U	U
PHOSPHORIC ANHYDRIDE			E	U	U		G	E	G	
PHOSPHOROUS TRICHLORIDE	U	G	E	U	U	G	G	E		
PHTHALIC ACID	G	P	G	P	P		E	E	E	
PHTHALIC ANHYDRIDE	G	P	G	P	P		E	E	E	
PICRIC ACID	P	U	G	P	E	G	G	E		
PINE OIL	G	G	E	E	U	U	E	E	E	
PINEAPPLE JUICE	P	P	E	E	E		E	E	E	
PITCH			E	P	P	U		E		
PLATING SOLUTIONS, CHROME	E	U	E		U	E	E			
PLATING SOLUTIONS, OTHER		E	E	E	U	E	E			
PNEUMATIC SERVICE	E	E	E	E	E	E	E	E		
POLYSULFIDE LIQUOR	U		G	G	G	G	G	E		
POLYVINYL ACETATE	G		G	G	P	G		E		
POLYVINYL CHLORIDE	G		G		P	G		E		
POTASSIUM ACETATE	G	E	G	G	G	E	U			
POTASSIUM BICARBONATE			E	G				E		E
POTASSIUM BICHROMATE			E	G	G		G	E	G	
POTASSIUM BISULFATE			E	G	G		E	E		
POTASSIUM BISULFITE	P	U	G	E	E	G	E	E	E	
POTASSIUM BROMIDE	P	U	E	E	E	G	E	E	E	P
POTASSIUM CARBONATE	G	G	G	E	E	G	E	E	E	E
POTASSIUM CHLORATE	G	G	G	E	E	G	E	E	E	P
POTASSIUM CHLORIDE	P	P	G	E	E	E	E	E	E	P
POTASSIUM CHROMATE	G		G	G	E	G	G	E		
POTASSIUM CYANIDE	U	G	G	E	E	E	E	E	E	E
POTASSIUM DICHROMATE	U	P	G	E	E	G	E	E	E	U
POTASSIUM DIPHOSPHATE	G	E	E	E			E	E		
POTASSIUM FERRICYANIDE	U	P	E	E	E	G	E	E	E	
POTASSIUM FERROCYANIDE	G	P	G	E	E		E	E	E	
POTASSIUM HYDROXIDEDILUTE COLD	U	E	G	E	G		U	E		E
POTASSIUM HYDROXIDE DILUTE HOT	U	G	G	G	G			E		
POTASSIUM HYDROXIDE TO 70% COLD										
POTASSIUM HYDROXIDE TO 70% HOT	U	E	G	P	G	E		E		
POTASSIUM HYDROXIDE TO 70% HOT	U	E	G	P	G	E		E		
POTASSIUM IODIDE	U	P	G	E	E	G	E	E	E	
POTASSIUM NITRATE	G	G	G	E	E	G	E	E	E	P
POTASSIUM OXALATE			E					E		
POTASSIUM PERMANGANATE	G	G	E	E	E	G	E	E	E	U
POTASSIUM PHOSPHATE	P		G	E	E	E	E	E		
POTASSIUM PHOSPHATE DI-BASIC	G	E	E	E	E	G	E	E	E	
POTASSIUM PHOSPHATE TRI-BASIC		E	G	G	G	G		E		
POTASSIUM SALTS			E	E	E	E	E			
POTASSIUM SULFATE	G	G	E	E	E	E	E	E	E	P
POTASSIUM SULFIDE	G	G	E	E	G	G	G	E		
POTASSIUM SULFITE	G	G	E	G	G	E	G	E		
PRODUCER GAS	G	G	G	E	G	U	E	E	E	

**E-EXCELLENT**

**G-GOOD**

**P-POOR**

**U-UNSATISFACTORY**



FLUID	BRASS	CARBON STEEL	316 S.S.	BUNA N (NITRILE)	NEOPRENE	EPR	FLUORO-CARBON	PTFE	ACETAL	NYLON
PROPANE GAS	E	G	G	E	G	U	E	E	E	
PROPYL ACETATE	U	E	E	U	U	G	U			
PROPYL ALCOHOL	E	G	G	E	E		E	E		
PROPYL BROMIDE	G		G	G	G	G	G	E		
PROPYLENE	E	E	E	U	U	U	E			
PROPYLENE GLYCOL	G	G	G	E	E	G	E	E	P	
PYDRAUL	E	P	E	U	U		G	E		
PYRIDINE			G	U	U		U	E		
PYROGARD 42, 43, 53, 55				U	U	E	E			
PYROGARD D				E	G	E	E			
PYROLGALIC ACID	G	G	G	E	E		E	E	E	
QUENCH OIL	G	G	E	E	G		E	E	E	
QUININE, SULFATE, DRY			E					E		
R P-1 FUEL	E	E	E	G	P		E	E	E	
RESINS & ROSINS	E	P	E	P	P		E	E		
RESORCINOL			G					E		
ROAD TAR	E	E	E	G	P	U	E	E	E	
ROOF PITCH	E	E	E	G	P		E	E	E	
ROSin EMULSION	G	P	E	U	P		G	E		
RUBBER LATEX EMULSIONS	E	G	E				E	E	E	
RUBBER SOLVENTS	E	E	E	U	P		U	E	P	
SALAD OIL	G	P	G	E	E	G	E	E	E	
SALICYLIC ACID	P	U	E	E	E	G	E	E	E	
SALT	G	P	G	E	E		E	E	E	
SALT BRINE	G		G	E	U	G	G	E		
SAUERKRAUT ARINE			G					E		
SEA WATER	P	U	G	E	E	E	E	E	E	
SEWAGE	P	P	G	E	P	G	G	E		
SHELL IRUS 905				E	G	U	E			
SHELLAC	E	E	E	E	E			E		
SILICONE FLUIDS	G		G	G	G		G	E		
SILVER BROMIDE										
SILVER CYANIDE	U		E	G	G		G	E		
SILVER NITRATE	U	U	E	P	P	E	E	E	E	
SILVER PLATING SOL.			E	E	G			E		
SKYDROL 500	E	G	E	U	U		U	E		
SKYDROL 7000, TYPE 2	U	E	E	U	U	E	G			
SOAP SOLUTIONS	E	E	E	E	G	E	E	E		
SODIUM ACETATE	G	P	G	G	G	G	E	E	E	E
SODIUM ALUMINATE	G	P	E	E	E	G	E	E	E	
SODIUM BENZOATE			G					E		
SODIUM BICARBONATE	G	P	G	E	E	E	E	E	E	E
SODIUM BICHROMATE			G	U				E		
SODIUM BISULFATE 10%	G	U	E	E	E	G	E	E	E	P
SODIUM BISULFITE 10%	G	U	E	E	E	G	E	E	E	P
SODIUM BORATE	G	P	G	E	E	G	E	E	E	
SODIUM BROMIDE 10%	G	P	G	E	E	G	E	E	E	
SODIUM CARBONATE	G	G	E	E	E	G	E	E	E	E
SODIUM CHLORATE	G	P	G	E	E	G	E	E	E	P
SODIUM CHLORIDE	G	P	G	E	E	G	E	E	E	E
SODIUM CHROMATE	P	G	E	E	E	G	E	E	E	
SODIUM CITRATE			G					E		
SODIUM CYANIDE	U	G	E	E	E	G	E	E	E	E
SODIUM FERRICYANIDE			E					E		
SODIUM FLUORIDE	P	U	G	E	E	G	E	E	E	
SODIUM HYDROXIDE 20% COLD	E	E	E	E	E	G	G	E		E
SODIUM HYDROXIDE 20% HOT	E	G	E	G	G	G	P	E		
SODIUM HYDROXIDE 50% COLD	E	E	E	E	E	G	P	E		E
SODIUM HYDROXIDE 50% HOT	E	G	E	E	G	G	P	E		
SODIUM HYDROXIDE 70% COLD	E	E	E	G	P	G	P	E		
SODIUM HYDROXIDE 70% HOT	G	G	E	U	U	G	P	E		
SODIUM HYPOCHLORITE (BLEACH)	U	U	U				E	E		U
SODIUM HYPOSULFITE			G					E		
SODIUM LACTATE			E					E		
SODIUM METAPHOSPHATE	P	G	G	E	E	G		E		
SODIUM METASILICATE COLD	G	P	E	G	E		G	E		
SODIUM METASILICATE HOT	G	U	E					E		

**E-EXCELLENT**

**G-GOOD**

**P-POOR**

**U-UNSATISFACTORY**

**N**



FLUID	BRASS	CARBON STEEL	316 S.S.	BUNA N (NITRILE)	NEOPRENE	EPR	FLUORO-CARBON	PTFE	ACETAL	NYLON
SODIUM NITRATE	G	G	E	P	G	G	E	E	E	E
SODIUM NITRITE			G	P	U	E	G	E	G	
SODIUM PERBORATE	G	G	G	P	G	E	E	E	E	
SODIUM PEROXIDE	U	P	G	P	G	E	E	E	E	
SODIUM PHOSPHATE	P	P	G	G	P	E	E	E	G	
SODIUM PHOSPHATE DI-BASIC	P	P	G	E	E	E	E	E	E	
SODIUM PHOSPHATE TRI-BASIC	P	P	G	G	G	E	E	E	E	
SODIUM POLYPHOSPHATE			G	G	G	E		E		
SODIUM SALICYLATE			E					E		
SODIUM SALTS										
SODIUM SILICATE	G	G	G	E	E	G	E	E	E	E
SODIUM SILICATE, HOT	P	P	G			G		E		
SODIUM SULFATE	G	G	E	E	E	E	E	E		E
SODIUM SULFIDE	U	G	E	E	E	G	E	E	E	E
SODIUM SULFITE	P		G	E	E	G	G	E		
SODIUM TETRABORATE			E	E	E	G		E		
SODIUM THIOSULFATE	P	G	G	E	E	E	E	E	E	
SOYBEAN	G	P	E	E	G	G	E	E	E	
STANNIC CHLORIDE	P	U	U	E	E	G	E	E		
STARCH	G	P	G	E	E	P	E	E	E	
STEAM (212 F)	E	E	E	U	U	G	P	E	U	
STEARIC ACID	P	P	G	E	P	G	E	E	E	
STODDARD SOLVENT	G	E	E	E	G	U	E	E		
STYRENE	E	E	E	U	U	U	G	E		
SUCROSE SOLUTIONS	E	E	E	E	G	E	E			
SUGAR, SYRUPS & JAM	G		E	E	G			E		
SUGAR LIQUIDS	E	G	E	E	E	G	E	E	E	
SULFATE, BLACK LIQUOR	P	P	G	P	G	G	P	E	E	
SULFATE, GREEN LIQUOR	P	P	G	P	G		P	E	E	
SULFATE, WHITE LIQUOR	P	P	G	P	G		P	E	E	
SULFUR	U	P	G	U	P	G	G	E	E	
SULFUR, MOLTEN	U	P	G	U	P	G	G	E		
SULFUR CHLORIDES	G	U	U	U	U	P	E	E	E	
SULFUR DIOXIDE, DRY	G	G	E	U	U	E	E	E	E	
SULFUR DIOXIDE, WET	U		E	U	U	G		E		
SULFUR HEXAFLUORIDE	G		E		G			E		
SULFUR TRIOXIDE	G	G	G	U	U		G	E		
SULFUR TRIOXIDE, DRY	G	G	G	U	U	G	E	E		
SULFURIC ACID 0 TO 77%	P	U	P	U	G		E	E	P	U
SULFURIC ACID 100%	P	P	E	U	U	P	G	E	U	U
SULFUROUS ACID	U	U	G	P	P	P	E	E	P	
SUNSAFE	U	E	E	E	G	U	E			
TALL OIL	G	G	G	G	G	U	E	E		
TANNIC ACID	G	P	G	G	G	G	E	E	E	U
TANNING LIQUORS			G	G	U			E		
TAR & TAR OILS	E	E	E	P	U	U	E	E		
TARTARIC ACID	G	U		P	G	G	E	E	E	
TERPINEOL			G	G	U	U	E			
TERTIARY BUTYL ALCOHOL	E	E	E	G	G	G	E			
TETRACHLOROETHANE		G	E	U	U	U	E			
TETRACHLOROETHYLENE	U	G	U	U	U	E				
TETRAETHYL LEAD	G	P	G					E	E	
TITANIUM TETRACHLORIDE	G	E	G	G	U	U	E			
TOLUOL (TOLUENE)	E	E	E	U	U	U	G	E		E
TOMATO JUICE	P	P	E	E	E		E	E	E	
TRANSFORMER OIL	G	E	E	E	G		E	E	E	
TRANSMISSION FLUID, TYPE A	E	E	E	E	G	U	E			
TRIBUTYL PHOSPHATE	E	E	E	U	U	G	U	E		
TRICHLOROETHYLENE	G	G	G	U	U	U	G	E	E	U
TRICHLOROACETIC ACID	G		U	P	U		U	E		
TRICHLOROETHANE		G	E	U	U	U	E			
TRICRESYL PHOSPHATE		E	G	U	U	E	G			
TRITHANOLAMINE			G	P	G	G		E		
TRIETHYLAMINE	G		G	G	G			E		
TRISODIUM PHOSPHATE			G	E	E	G	G	E		
TUNG OIL	G	G	E	E	G	U	E	E	E	
TURBINE OIL #15		G	E	G	U	U	E		E	

E-EXCELLENT

G-GOOD

P-POOR

U-UNSATISFACTORY



FLUID	BRASS	CARBON STEEL	316 S.S.	BUNA N (NITRILE)	NEOPRENE	EPR	FLUORO-CARBON	PTFE	ACETAL	NYLON
TURPENTINE	G	G	G	G	U	U	E	E	E	E
UREA	G	P	G	P	G	G	U	E	E	
URIC ACID			E					E		
VARNISH	E	P	E	P	G	U	G	E	E	
VEGETABLE OILS	G	G	E	E	G	U	E	E	E	
VINEGAR	G	U	E	U	U	E	U	E		E
VINYL ACETATE	G		G		G	E		E		
WATER, ACID MINE	U	U	G	G	E	E	U	E		
WATER, DISTILLED	U	U	E	P	G	G	E	E	E	
WATER, FRESH	P	P	E	P	G	G	E	E	E	
WAXES	E	E	E	E	G	P	E	E	E	
WHISKEY & WINES	G	U	E	G	G	E	E	E	E	
XYLENE (XYLOR), DRY	E	G	E	U	U	U	G	E	E	E
ZINC BROMIDE	G		G	G	G	G	G	E		
ZINC CHLORIDE	U	U	U	G	G		E	E		U
ZINC HYDROSULFITE	P	E	E	E	E	E	E	E	E	
ZINC SULFATE	G	U	G	E	E	E	E	E	E	P

E-EXCELLENT

G-GOOD

P-POOR

U-UNSATISFACTORY



101GHSV ..... F23	163-F-BPD ..... L6	171HD ..... A45	215PN ..... F7
102-F-XX-BPD ..... L6	164C ..... A9	171P ..... A40	215PNL ..... F7
103-FS-BPD ..... L7	164CA ..... A16	171PMT ..... I11	216P ..... F8
105-FF-BPD ..... L12	164HD ..... A43	171PMTNS ..... I11	218B-BPD ..... L4
112-F-BPD ..... L6	164P ..... A38, A39	171VL ..... H26	218B WHEEL-BPD ..... L4
1163-60-BPD ..... F23	164PLP ..... B13	1725HB ..... G13	218P ..... F8
1163-61-BPD ..... F23	164PM ..... I8	172C ..... A11	219P ..... F8
120-F-BPD ..... L10	164PMT ..... I8	172CA ..... A18	22 ..... G4
1200P ..... F9	164PW ..... B37	172HD ..... A45	220 ..... G6
1201P ..... F11	164VL ..... H25	172P ..... A40	2200P ..... F9
1202P ..... F9	165C ..... A9	172PMT ..... I12	2200PDE ..... F11
1203P ..... F10	165CA ..... A17	172PMTNS ..... I12	2201P ..... F11
1204P ..... F10	165HD ..... A43	172VL ..... H26	2202P ..... F9
121-F-BPD ..... L10	165PLP ..... B14	174-F-BPD ..... L4	2203P ..... F10
1226-FA-BPD ..... L10	165PMT ..... I9	176C ..... A11	2205P ..... F11
122HBL ..... G10	165PMTBH ..... I9	176CA ..... A18	220P ..... F8
123-C-BPD ..... L12	165PW ..... B37	177C ..... A11	2214P ..... F11
1232-BPD ..... L4	166FSV ..... E12	177CA ..... A18	2224P ..... F10
1232 WHEEL-BPD ..... L4	168C ..... A9	177HD ..... A46	2225P ..... F10
124-C-BPD ..... L12	168CA ..... A17	177P ..... A40	222P ..... F9
124-FA-BPD ..... L10	1695HB ..... G13	1795HB ..... G14	222P-X-MI ..... F18
125-C-BPD ..... L12	1695VLV ..... H26	179C ..... A11	222P-X-MIX ..... F14
125HB ..... G11	169C ..... A10	179CA ..... A19	224 ..... G6
125HBL ..... G11	169CA ..... A17	179HB ..... G14	225 ..... G6
125HBLSV ..... G11	169HB-X-MI ..... F19	179HB-X-MI ..... F19, G14	226-BPD ..... L14
126HBL ..... G11	169HB-X-MIX ..... G13	179HD ..... A45	226RB-BPD ..... L14
127-C-BPD ..... L12	169HD ..... A44	179PMT ..... I12	227-FA-BPD ..... L4
127HB ..... G12	169LP ..... A39	179PMTNS ..... I13	228 ..... G7
128HBLV ..... G12	169P ..... A39	179PMTR ..... I12	229 ..... G7
1295HB ..... G12	169PLP ..... B15	179VL ..... H26	22BH ..... G4
129HB ..... G12	169PLPNS ..... B20	189PMTR ..... I13	22CA ..... G4
139HB ..... G12	169PMNS ..... I9	193-S-BPD ..... L11	22CABH ..... G5
144F ..... E9	169PMT ..... I9	194-S-BPD ..... L11	230 ..... G7
145F ..... E9	169PMTBH ..... I10	195-FB-BPD ..... L8	231 ..... G7
146HBLFSV ..... G13	169PMTL ..... I10	195-FC-BPD ..... L7	232 ..... G8
147F ..... E9	169PMTNS ..... I10	195-SA-BPD ..... L11	233 ..... G8
1495F ..... E10	169PMTNS-X-M ..... I10	1F ..... E5	237 ..... G8
149F ..... E10	169PMTR ..... I9	20 ..... G4	238 ..... G8
149F-X-MI ..... F18	169PS ..... A39	201-F-BPD ..... L6	244F ..... E9
149F-X-MIX ..... E10	169VL ..... H25	203-FA-BPD ..... L7	244IFHD ..... E16
14FL ..... E5	16B ..... M1	206-FB-BPD ..... L3	245IFHD ..... E16
14FS ..... E6	170C ..... A10	207ACBH ..... F6, H17	2491FHD ..... E16
14FSV ..... E6	170CA ..... A18	207P ..... F6	249F ..... E10
14FSX ..... E5	170HD ..... A45	208-FSS-BPD ..... L14	249IF ..... E16
150F ..... E11	170P ..... A40	208P ..... F6	24M ..... J12
151F ..... E11	170PMT ..... I11	209P ..... F6	250IFHD ..... E17
155F ..... E11	170PMTNS ..... I11	20B ..... M1	251IFHD ..... E17
1595F ..... E12	170VL ..... H26	210P ..... F6	252IFHD ..... E17
159F ..... E12	171C ..... A10	211P ..... F7	255IFHD ..... E17
159F-X-MI ..... F18	171CA ..... A18	212P ..... F7	255M ..... J11
159F-X-MIX ..... E12	171HB ..... G13	213P ..... F7	256F ..... E12

259F .....E12	368-FH-BPD..... L6	46F .....E8	62HDBH .....A43
259IFHD .....E17	368PL..... B30	46IFHD .....E15	62NBH.....H7
26 ..... G5	368PTC ..... I16	485F .....E9	62NFBH.....H7
264AB.....H15	369GC .....B45	48F .....E8	62NTA.....H6
264C.....A9	369PL.....B16	48F-X-MI .....F18	62P .....A32
264CA .....A16	369PLX.....B21	48F-X-MIX.....E8	62PBH.....A32
264NTA.....H8	369PTC .....I15	48IFHD .....E16	62PCA .....A15, A32
265AB.....H15	370GC .....B47	500-FC-BPD..... L7	62PCABH.....A15, A33
265C.....A9	370PL.....B22	500-FCM-BPD..... L9	62PLP.....B7
265CA .....A17	370PTC .....I15	50GHSV .....F21	62PLPBH.....B8
265NTA.....H9	371GC .....B48	525-F-BPD .....L8, L9	62PM .....I6
269C.....A10	371PL.....B23	53GH.....F21	62PMT.....I7
269CA .....A17	371PTC .....I16	54GH.....F21	62PMTBH.....I7
269HB .....G14	372GC .....B49	55GH.....F21	62PMTBHR.....I6
269P .....A39	372PL.....B26	56PSG .....A31	62PTBH.....A33
269TF .....H12	372PTC .....I17	56RBSG .....H20	62PW.....B36
27 ..... G5	375-FS-BPD..... L10	59CA .....A14	62PWBH.....B36
270AB.....H16	376-FS-BPD..... L10	59HD .....A46	62RB .....H20
270C.....A10	377PL.....B28	59P .....A31	62TF .....H12
270CA .....A18	377PTC .....I17	60AB.....H14	62VL .....H24
270NTA.....H9	379PTC .....I17	60C.....A6	639C .....A12
271 .....H19	391P .....A34	60NTA.....H6	639CA .....A19
275-FS-BPD..... L11	391PSS .....A34	60P .....A31	639F .....E13
279HB .....G14	392P .....A35	60PB.....A31	639PL.....B33
28 ..... G5	392PSS .....A35	60PT.....A6	639PM.....I13
2829-XXMM-BPD..... L5	393P .....A35	60RB .....H20	639PMT.....I13
28B.....M1	393PD .....A35	60TF .....H12	63NTA.....H6
293-F-BPD .....L9	393PDSS.....A36	60VL .....H24	63PL .....B8
296-FC-BPD.....L7	393PSS .....A35	60VLV.....H24	63PT .....A7, A15, A33
2GF .....E5	394P .....A36	61AB.....H14	640F .....E13
300-FB-BPD.....L7	394PD .....A36	61C.....A6	640QSF.....E22
312-FC-BPD.....L3	394PDSS.....A37	61CA .....A14	640QSFCR.....E22
32GC .....B42	394PSS .....A36	61CL .....A6	660FHD.....E13
32PL .....B7	395-FAM-BPD..... L9	61HD .....A43	661FHD.....E13
32PTC .....I15	398P .....A37	61NTA.....H6	664FHD.....E13
3501-B1.....M1	398PD .....A38	61P .....A31	66AB.....H14
3550-B.....M1	398PDSS.....A38	61PB.....A31	66C.....A8
35B.....M1	398PSS .....A37	61PN .....A31	66CA .....A15
35BCD-DIVIDERS.....M1	3GF .....E5	61PSGN .....A32	66GC .....B42
35BCD-KIT .....M1	402-FA-BPD..... L10	61RB .....H20	66HD .....A44
35BCL .....M1	406-FA-BPD..... L3	61RBSG .....H20	66NBH.....H7
362GC .....B51	40B .....M1	61TF .....H12	66NTA.....H7
362PL.....B28	411FF.....E15	61VL .....H24	66P .....A33
362PTC .....I15	411FS.....E15	62AB.....H14	66PLP.....B9
364GC .....B44	41FL .....E6	62ABH.....H14	66PLPBH.....B9
364PL.....B13	41FS.....E6, E7	62ANBH.....H6	66PMT.....I7
364PTC .....I16	41FX.....E6	62C.....A7	66PMTBH.....I7
365GC .....B44	41IF .....E15	62CA .....A14	66PW.....B36
365PL.....B14	42F .....E7	62CABH.....A14	66PWBH.....B36
365PTC .....I16	42IFHD.....E15	62CBH.....A7	66RBSV.....H20
367-FH-BPD.....L6	43F .....E7	62HD .....A43, A44	66VL .....H24

67PPL.....	B9	94-S-BPD .....	L11	C63LPG .....	B21	F3BMB .....	A21
67RBSG .....	H20	945TH-BPD .....	L8	C63PB .....	B16, B39	F3GC .....	B43
682C .....	A12	94GH .....	F22	C63PK .....	B17	F3HF .....	F13
682CA .....	A19	95GH .....	F22	C63SPK .....	B20	F3HG .....	F13
682VL .....	H25	96GH .....	F22	C64GC .....	B46	F3PB .....	B11, B38
685HB .....	G10	97HC .....	G10	C64PB .....	B17	F3PMTB .....	I19
685VLV .....	H25	97P .....	A34	C64PK .....	B18	F4BMB .....	A21
68C .....	A8	98GH .....	F22	C64SPB .....	B18	F4GC .....	B43
68CA .....	A16	98GHSV .....	F23	C64SPK .....	B19	F4PB .....	B12
68GC .....	B43	99GH .....	F22	C68GC .....	B46	F8BMB .....	A21
68HB .....	G10	99GHSV .....	F23	C68PB .....	B18	F8CG .....	B44
68HB-X-MI.....	F19	9B .....	M1	C68PK .....	B19	F8PB .....	B12
68HB-X-MIX .....	G10	ACT-P-X-KIT .....	K49	C68SPB .....	B19	F8UPMTB.....	I20
68HD .....	A44	ACT-SS-X-KIT .....	K49	C68SPK .....	B19	FA .....	D9
68NTA-X-MI .....	F19	AQRT .....	D21	C6PB .....	B16	FBMB .....	A21
68NTA-X-MIX .....	H8	AVC1 .....	E20	C8BMB .....	A23	FC .....	D9, D25
68P .....	A34	AVCS4D-4 .....	E21	C8UPMTB .....	I21	FC601.....	C18
68PLP .....	B10	AVE1 .....	E20	CAP .....	D12	FC602.....	C18
68PLP-X-10X32 .....	B11	AVT1 .....	E20	CBMB .....	A23	FC701.....	C5
68PM .....	I7	AVT2.....	E20	CD43 .....	F13	FC701 FLOW CURVES.....	N11
68PMT .....	I8	AVT3.....	E20	CF63GC .....	B47	FC702.....	C5
68PMT-X-M.....	I8	AVTS .....	E19	CF68GC .....	B47	FC702 FLOW CURVES.....	N12
68PMTBH .....	I8	AVTS4 .....	E21	COPPER RINGS BSPP .....	F16	FC705.....	C7
68RB .....	H21	AVTS6 .....	E22	COR4BMB.....	A25	FC800.....	C22
68RBSG .....	H21	AVTSL .....	E19	COR4PB.....	B31	FC806.....	C22
68TF .....	H12	AVU1 .....	E20	COR4PBD .....	B32	FC902.....	C14
68VL .....	H25	AVU2 .....	E19	COR8PB.....	B31	FCC701 .....	C7
69GH .....	F21	AVU2BH .....	E19	CORPB.....	B31	FCC703 .....	C7
70GH .....	F21	AVUIFI .....	E20	CORPBD .....	B31	FCM701.....	C6
710439-BPD.....	L14	AVUR3.....	E21	CR .....	E22	FCM703.....	C6
71GH .....	F21	AVUS .....	E21	CU .....	D9	FCS701 .....	C5
75531-BPD.....	L11	AVUS3.....	E21	DB .....	B36	FCS701 FLOW CURVES .....	N13
75GH .....	F21	AVUS3BH.....	E19	DC601 .....	K76	FCS703 .....	C6
76RB .....	H21	AVUS4D .....	E21	DC602 .....	K77	FE .....	D12, D25
78GH .....	F21	AVUSE .....	E19	DC603 .....	K77	FF .....	D10
79GH .....	F21	BMB.....	A27	DC604 .....	K77	FF33 .....	F13
80GH .....	F21	BPK .....	B8	DC606 .....	K77	FF44 .....	F14
81GH .....	F21	BTMB .....	A28	DC607 .....	K77	FG43 .....	F14
82GH .....	F21	BU .....	D11, D25	DCR601.....	K77	FHG4.....	F14
83GH .....	F21	BVG4-LOCK .....	K56	DD44 .....	F13	FNMB .....	A28
84GH .....	F21	BVG4PLOCK.....	K55	EBMB .....	A24	FNPB.....	B33, B40
860062-XX-BPD.....	L13	BVGC .....	K51	EGC.....	B44	FNPK.....	B33
860063-XX-BPD.....	L13	BVGL .....	K53	EPB .....	B14, B39	FPB .....	B11
880AC.....	E23	BVGTG .....	K51	EPK .....	B14	G4BMB.....	A22
881AC.....	E23	BVGTL.....	K53	ERHD .....	I6	G4PB.....	B9
88AC.....	E23	C2PMTB.....	I20	ES.....	I6, J7	GBMB.....	A22
88GH .....	F22	C3BMB .....	A23	EU .....	D5, D24	GG44.....	F15
901GH .....	F23	C3PB .....	B20	EUB .....	D29	GR .....	D27
90GH .....	F22	C3PMTB.....	I20	F23PB .....	B12	HBMB .....	A22
93-FB-BPD .....	L8	C63GC .....	B45	F28PB .....	B12	HGC .....	B42
93-S-XX-BPD .....	L11	C63LPB .....	B21	F2PMTB .....	I19	HHP3.....	F15



HP3.....F15	NV106C.....K71	R3BMB.....A24	SAE 040101.....E15
HPB.....B7, B38	NV106CA.....K71	R63GC.....B48	SAE 040102.....E16
HPK.....B7	NV107P.....K71	R63PB.....B23, B39	SAE 040103.....E15
HPL.....D30	NV108P.....K71	R63PK.....B24	SAE 040110.....E15
HPMTB.....I19	NV109P.....K71	R64PB.....B24	SAE 040201.....E17
HPN.....D32	NV311P.....A41, K71	R64PK.....B24	SAE 040202.....E16
HS3PK.....B34	NV312P.....A41, K72	R68GC.....B49	SAE 040203.....E17
HV104C.....K69	OR.....D27	R68PB.....B25	SAE 040302.....E17
HV104C-KIT.....K69	PBV4.....C20	R68PK.....B25	SAE 040401.....E16
J3PK.....B34	PBV4PB.....C20	RBMB.....A24	SAE 040424.....E17
J5PK.....B32	PCV4.....C16	RD.....D12	SAE 040425.....E16
J663PK.....B33	PLE2BF4-K.....B17	S32633-BPD.....L3, L4	SAE 040427.....E17
J6PK.....B32	PLHBF4-B.....B11	S3BMB.....A25	SAE 060101 BA.....A7
JBMB.....A24	PLR2BF4-K.....B23	S63GC.....B50	SAE 060102 BA.....A8
JGC.....B44	PLS2BF4-K.....B26	S63PB.....B26, B40	SAE 060103 BA.....A8
JPB.....B13, B39	PMB.....J7	S63PK.....B27	SAE 060110.....A6
JPK.....B13	PMCE.....J4	S64PB.....B27	SAE 060111.....A6
JPMTB.....I20	PMCEN-ES.....J7	S64PK.....B27	SAE 060115.....A6
KBMB.....A25	PMTCE.....J4	S68GC.....B50	SAE 060201 BA.....A9
KMMOO4.....F15	PMT CER-ES.....J7	S68PB.....B28	SAE 060202 BA.....A10
LV91.....K73	PNMB.....A28	S68PK.....B28	SAE 060203 BA.....A10
M16M22F8UHA8UB...F14, F18	PRB4.....C29	S74761-BPD.....L3	SAE 060401 BA.....A9
MBVG.....K58	PRB4PB.....C29	S74762-BPD.....L3	SAE 060424 BA.....A10
MC.....D5, D23	PRI4.....C29	S75015-BPD.....L3, L4	SAE 060425 BA.....A11
MCB.....D33	PRIPB.....C29	S75046-BPD.....L3, L4	SAE 100101 BA.....H6
ME.....D13, D24	PRS.....C30	S8UPMTB.....I21	SAE 100102 BA.....H8
MEB.....D31	PSB.....M1	SAE 010101.....E7	SAE 100103 BA.....H7
MES.....D7	PTC-001.....L4	SAE 010102.....E8	SAE 100110.....H6
MMO444.....F15	PTC-001RB.....L4	SAE 010103.....E8	SAE 100115.....H6
MMS443.....F16	PTF4.....C10	SAE 010104.....E7	SAE 100201 BA.....H9
MR.....D26	PTF4/8E6PB.....C13	SAE 010105.....E13	SAE 100202 BA.....H9
MRO434.....F16	PTF4/8PB.....C10	SAE 010106.....E13	SAE 100203 BA.....H9
MRS.....D7	PTFA4/8PB.....C10	SAE 010107.....E13	SAE 100302 BA.....H10
MT.....D26	PTFAL8.....C12	SAE 010108.....E6	SAE 100401 BA.....H8
MTB.....D30	PTFAL8PB.....C12	SAE 010109.....E13	SAE 100424 BA.....H9
MTS.....D8	PTFIPK.....C23	SAE 010110.....E6	SAE 100425 BA.....H10
MV200.....K65	PTFIWPK.....C24	SAE 010111.....E6	SAE 120101 BA.....H14
MV608.....K65	PTFL4/8.....C12	SAE 010112.....E13	SAE 120102 BA.....H15
MV609.....K65	PTFL4/8PB.....C12	SAE 010113.....E5	SAE 120103 BA.....H14
MV708.....K60	PTFMIPK.....C24	SAE 010114.....E5	SAE 120111.....H14
MV709.....K60	PTP4/8PB.....C26	SAE 010165.....E5	SAE 120115.....H14
NRV800.....C32	PTR34.....F16	SAE 010166.....E5	SAE 120201 BA.....H15
NRV808.....C32	PTS.....D21	SAE 010167.....E5	SAE 120202 BA.....H15
NS.....D27	PV607.....K67	SAE 010201.....E11	SAE 120203 BA.....H16
NV101F.....K69	PV608.....K67	SAE 010202.....E10	SAE 120302 BA.....H16
NV102F.....K69	PV609.....K67	SAE 010203.....E11	SAE 120401 BA.....H15
NV103F.....K69	PVMB-001.....K67	SAE 010302.....E12	SAE 120424 BA.....H16
NV104C.....K70	PWB-A.....C20	SAE 010401.....E9	SAE 120425 BA.....H16
NV104CA.....K70	PWR-HB.....C25	SAE 010424.....E11	SBMB.....A25
NV105C.....K70	PWS-B.....C27	SAE 010425.....E9	SC.....D21
NV105CA.....K70	PWS-M.....C27	SAE 010501.....E9	SC4U.....B32

SC4UD .....B32	V304CA .....K75	W68GC.....B43	XV590P-X-04 .....K26
SC8U.....B32	V401P.....K75	W68PL.....B11	XV591P .....K26
SC8UD .....B32	V402P.....K76	W68PLP .....B10	XV591P-X-04 .....K26
SPV104C-KIT .....K70	V403P.....K76	W68PW .....B37	XV600P .....K29
ST.....D13	V404P.....K72	WBMB .....A22	XV633P .....K29
STX-P-1-125 .....K62	V404PH.....K72	WBMPB.....A23, B8	XVP500CS .....K31
STX-P-1-225 .....K62	V405P.....K72	WE6PB .....B14	XVP500HP .....K37
STX-SS-1-X.....K63	V406P.....K76	WE6PK.....B15	XVP500P .....K6
STX-SS-2-X.....K63	V407P.....K76	WG4PB .....B9	XVP501P .....K9
STX-SS-3-X.....K63	V408NTA .....K73	WGG44 .....F16	XVP502CS .....K32
SV404P .....K72	V409F.....K73	WPB .....B8, B38	XVP502P .....K12
T23FPK .....B33	V410NTA .....K73	WPMTB .....I19	XVP502SS .....K44
T23HFB .....A26	V412F.....K73	WSV .....D20	XVP506HP .....K39
T23UB .....A29	V8UPMTB .....I21	WY.....D6	XVP510P .....K19
T24FPK .....B34	VC .....D16, E22	WYJ6PK .....B29	XVV500P .....K5
T24HGB .....A27	VEU .....D18	XV500CS .....K31	XVV501P .....K9
T28HFB .....A26	VFC .....D19	XV500CS-X-04 .....K32	XVV502P .....K12
T2ESPK.....B22	VFE .....D17	XV500CS-X-21 .....K32	XVVP500P .....K6
T2HFB .....A26	VMC .....D18	XV500HP.....K37	XVVP501P .....K10
T2HGB .....A27	VME.....D17	XV500P .....K5	XVVP502P .....K13
T2JPK.....B28	VS176NTA .....H8	XV500P-HB .....K27	XX-2829S-BPD .....L5
TAF .....D21	VS269AB .....H15	XV500P-X-04 .....K7	YJ2PK .....B29
TC-1000-BPD.....L3	VS269NTA .....H9	XV500P-X-21 .....K7	YJ52PK .....B30
TC-1020-BPD.....L3	VS271AB .....H16	XV501P .....K9	YJ563PK .....B30
TC-1050-BPD.....L3	VS271NTA .....H9	XV501P-X-04 .....K10	YJ564PK .....B31
TC-2050-BPD.....L3	VS272AB .....H16	XV501P-X-21 .....K10	YJ5PK .....B29
TCB .....D13	VS272NTA .....H10	XV501SS.....K41	YJ63GC .....B51
TCPR.....J10	VS279AB .....H16	XV502CS.....K31	YJ63PK .....B30
TEB .....D14	VS279NTA .....H10	XV502CS-X-21 .....K33	YJ64PK .....B31
TEPB.....B10	VS68AB .....H15	XV502P .....K12	YJ68GC .....B52
TEU .....D11	VS68NTA .....H8	XV502P-X-04 .....K13	YJGC .....B51
TFA .....D21	VTEU .....D19	XV502P-X-21 .....K13	YJPK .....B29
TMB.....A28	VTU .....D20	XV502P-X-ACT .....K47	
TMC.....D10	VUC.....D18	XV502P-X-SUB .....K48	
TPL.....D14	W169PLP .....B15	XV502SS.....K43	
TR2PK.....B10	W169PLPNS .....B20	XV502SS-X-20 .....K43	
TRBMB.....A29	W169PW .....B37	XV502SS-X-21 .....K44	
TRPB.....B10	W171PLP .....B22	XV502SS-X-ACT .....K47	
TS.....D21, D27	W171PW .....B38	XV502SS-X-SUB .....K48	
TS2PK .....B34	W172PLP .....B25	XV506CS.....K35	
TSC .....D15	W172PW .....B38	XV506HP.....K38	
TU.....D6, D26	W368GC.....B51	XV506P .....K15	
TUB .....D29	W368PL.....B30	XV507HP.....K39	
UC .....D8, D23	W369GC.....B45	XV509P .....K17	
UCB.....D31	W369PL.....B16	XV510P .....K19	
US5 .....E6	W369PLC .....B18	XV510P-X-04 .....K20	
V203F.....K75	W369PLX .....B21	XV510P-X-21 .....K20	
V204F.....K75	W371GC.....B48	XV520P .....K22	
V303C .....K75	W371PL.....B23	XV533P .....K24	
V303CA .....K75	W372GC.....B50	XV540P .....K24	
V304C .....K75	W372PL.....B26	XV590P .....K26	







## Parker Safety Guide for Selecting and Using Hose, Tubing, Fittings and Related Accessories

Parker Publication No. 4400-B.1

Revised: May, 2002

**WARNING: Failure or improper selection or improper use of hose, tubing, fittings, assemblies or related accessories (“Products”) can cause death, personal injury and property damage. Possible consequences of failure or improper selection or improper use of these Products include but are not limited to:**

- Fittings thrown off at high speed.
- High velocity fluid discharge.
- Explosion or burning of the conveyed fluid.
- Electrocutation from high voltage electric powerlines.
- Contact with suddenly moving or falling objects that are controlled by the conveyed fluid.
- Injections by high-pressure fluid discharge.
- Dangerously whipping Hose.
- Contact with conveyed fluids that may be hot, cold, toxic or otherwise injurious.
- Sparking or explosion caused by static electricity buildup or other sources of electricity.
- Sparking or explosion while spraying paint or flammable liquids.
- Injuries resulting from inhalation, ingestion or exposure to fluids.

Before selecting or using any of these Products, it is important that you read and follow the instructions below. Only Hose from Parker’s Stratoflex Products Division is approved for in flight aerospace applications, and no other Hose can be used for such in flight applications.

### 1.0 GENERAL INSTRUCTIONS

- 1.1 Scope:** This safety guide provides instructions for selecting and using (including assembling, installing, and maintaining) these Products. For convenience, all rubber and/or thermoplastic products commonly called “hose” or “tubing” are called “Hose” in this safety guide. All assemblies made with Hose are called “Hose Assemblies”. All products commonly called “fittings” or “couplings” are called “Fittings”. All related accessories (including crimping and swaging machines and tooling) are called “Related Accessories”. This safety guide is a supplement to and is to be used with, the specific Parker publications for the specific Hose, Fittings and Related Accessories that are being considered for use.
- 1.2 Fail-Safe:** Hose, and Hose Assemblies and Fittings can and do fail without warning for many reasons. Design all systems and equipment in a fail-safe mode, so that failure of the Hose or Hose Assembly or Fitting will not endanger persons or property.
- 1.3 Distribution:** Provide a copy of this safety guide to each person that is responsible for selecting or using Hose and Fitting products. Do not select or use Parker Hose or Fittings without thoroughly reading and understanding this safety guide as well as the specific Parker publications for the products considered or selected.
- 1.4 User Responsibility:** Due to the wide variety of operating conditions and applications for Hose and Fittings, Parker and its distributors do not represent or warrant that any particular Hose or Fitting is suitable for any specific end use system. This safety guide does not analyze all technical parameters that must be considered in selecting a product. The user, through its own analysis and testing, is solely responsible for:
- Making the final selection of the Hose and Fitting.
  - Assuring that the user’s requirements are met and that the application presents no health or safety hazards.
  - Providing all appropriate health and safety warnings on the equipment on which the Hose and Fittings are used.
  - Assuring compliance with all applicable government and industry standards.

- 1.5 Additional Questions:** Call the appropriate Parker technical service department if you have any questions or require any additional information. See the Parker publication for the product being considered or used, or call 1-800-CPARKER, or go to [www.parker.com](http://www.parker.com), for telephone numbers of the appropriate technical service department.

### 2.0 HOSE AND FITTING SELECTION INSTRUCTIONS

- 2.1 Electrical Conductivity:** Certain applications require that the Hose be nonconductive to prevent electrical current flow. Other applications require the Hose and the Fitting and the Hose/Fitting interface to be sufficiently conductive to drain off static electricity. Extreme care must be exercised when selecting Hose and Fittings for these or any other applications in which electrical conductivity or nonconductivity is a factor.
- The electrical conductivity or nonconductivity of Hose and Fittings is dependent upon many factors and may be susceptible to change. These factors include but are not limited to the various materials used to make the Hose and the Fittings, Fitting finish (some Fitting finishes are electrically conductive while others are nonconductive), manufacturing methods (including moisture control), how the Fittings contact the Hose, age and amount of deterioration or damage or other changes, moisture content of the Hose at any particular time, and other factors.
- The following are considerations for electrically nonconductive and conductive Hose. For other applications consult the individual catalog pages and the appropriate industry or regulatory standards for proper selection.
- 2.1.1 Electrically Nonconductive Hose:** Certain applications require that the Hose be nonconductive to prevent electrical current flow or to maintain electrical isolation. For these applications that require Hose to be electrically nonconductive, including but not limited to applications near high voltage electric lines, only special nonconductive Hose can be used. The manufacturer of the equipment in which the nonconductive Hose is to be used must be consulted to be certain that the Hose and Fittings that are selected are proper for the application. Do not use any Parker Hose or Fitting for any such application requiring nonconductive Hose, including but not limited to applications near high voltage electric lines, unless (i) the application is expressly approved in the Parker technical publication for the product, (ii) the Hose is marked “nonconductive”, and (iii) the manufacturer of the equipment on which the Hose is to be used specifically approves the particular Parker Hose and Fitting for such use.
- 2.1.2 Electrically Conductive Hose:** Parker manufactures special Hose for certain applications that require electrically conductive Hose. Parker manufactures special Hose for conveying paint in airless paint spraying applications. This Hose is labeled “Electrically Conductive Airless Paint Spray Hose” on its layline and packaging. This Hose must be properly connected to the appropriate Parker Fittings and properly grounded in order to dissipate dangerous static charge buildup, which occurs in all airless paint spraying applications. Do not use any other Hose for airless paint spraying, even if electrically conductive. Use of any other Hose or failure to properly connect the Hose can cause a fire or an explosion resulting in death, personal injury, and property damage. Parker manufactures a special Hose for certain compressed natural gas (“CNG”) applications where static electricity buildup may occur. Parker CNG Hose assemblies comply with AGA

Requirements 1-93, “Hoses for Natural Gas Vehicles and Fuel Dispensers”. This Hose is labeled “Electrically Conductive for CNG Use” on its layline and packaging. This Hose must be properly connected to the appropriate Parker Fittings and properly grounded in order to dissipate dangerous static charge buildup, which occurs in, for example, high velocity CNG dispensing or transfer. Do not use any other Hose for CNG applications where static charge buildup may occur, even if electrically conductive. Use of other Hoses in CNG applications or failure to properly connect or ground this Hose can cause a fire or an explosion resulting in death, personal injury, and property damage. Care must also be taken to protect against CNG permeation through the Hose wall. See section 2.6, Permeation, for more information. Parker CNG Hose is intended for dispenser and vehicle use at a maximum temperature of 180°F. Parker CNG Hose should not be used in confined spaces or unventilated areas or areas exceeding 180°F. Final assemblies must be tested for leaks. CNG Hose Assemblies should be tested on a monthly basis for conductivity per AGA 1-93.

- Parker manufactures special Hose for aerospace in flight applications. Aerospace in flight applications employing Hose to transmit fuel, lubricating fluids and hydraulic fluids require a special Hose with a conductive inner tube. This Hose for in flight applications is available only from Parker’s Stratoflex Products Division. Do not use any other Parker Hose for in flight applications, even if electrically conductive. Use of other Hoses for in flight applications or failure to properly connect or ground this Hose can cause a fire or an explosion resulting in death, personal injury, and property damage. These Hose assemblies for in flight applications must meet all applicable aerospace industry, aircraft engine, and aircraft requirements.
- 2.2 Pressure:** Hose selection must be made so that the published maximum recommended working pressure of the Hose is equal to or greater than the maximum system pressure. Surge pressures or peak transient pressures in the system must be below the published maximum working pressure for the Hose. Surge pressures and peak pressures can usually only be determined by sensitive electrical instrumentation that measures and indicates pressures at millisecond intervals. Mechanical pressure gauges indicate only average pressures and cannot be used to determine surge pressures or peak transient pressures. Published burst pressure ratings for Hose is for manufacturing test purposes only and is no indication that the Product can be used in applications at the burst pressure or otherwise above the published maximum recommended working pressure.
- 2.3 Suction:** Hoses used for suction applications must be selected to insure that the Hose will withstand the vacuum and pressure of the system. Improperly selected Hose may collapse in suction application.
- 2.4 Temperature:** Be certain that fluid and ambient temperatures, both steady and transient, do not exceed the limitations of the Hose. Temperatures below and above the recommended limit can degrade Hose to a point where a failure may occur and release fluid. Properly insulate and protect the Hose Assembly when routing near hot objects (e.g. manifolds). Do not use any Hose in any application where failure of the Hose could result in the conveyed fluids (or vapors or mist from the conveyed fluids) contacting any open flame, molten metal, or other potential fire ignition source that could cause burning or explosion of the conveyed fluids or vapors.
- 2.5 Fluid Compatibility:** Hose Assembly selection must assure compatibility of the Hose tube, cover, reinforcement, and Fittings with the fluid media used. See the fluid compatibility chart in the Parker publication for the product being considered or used. This information is offered only as a guide. Actual service life can only be determined by the end user by testing under all extreme conditions and other analysis. Hose that is chemically compatible with a particular fluid must be assembled using Fittings and adapters containing likewise compatible seals.
- 2.6 Permeation:** Permeation (that is, seepage through the Hose) will occur from inside the Hose to outside when Hose is used with gases, liquid and gas fuels, and refrigerants (including but not limited to such materials as helium, diesel fuel, gasoline, natural gas, or LPG). This permeation may result in high concentrations of vapors which are potentially flammable, explosive, or toxic, and in loss of fluid. Dangerous explosions, fires, and other hazards can result when using the wrong Hose for such applications. The system designer must take into account the fact that this permeation will take place and must not use Hose if this permeation could be hazardous. The system designer must take into account all legal, government, insurance, or any other special regulations which govern the use of fuels and refrigerants. Never use a Hose even though the fluid compatibility is acceptable without considering the potential hazardous effects that can result from permeation through the Hose Assembly. Permeation of moisture from outside the Hose to inside the Hose will also occur in Hose assemblies, regardless of internal pressure. If this moisture permeation would have detrimental effects (particularly, but not limited to refrigeration and air conditioning systems), incorporation of sufficient drying capacity in the system or other appropriate system safeguards should be selected and used.
- 2.7 Size:** Transmission of power by means of pressurized fluid varies with pressure and rate of flow. The size of the components must be adequate to keep pressure losses to a minimum and avoid damage due to heat generation or excessive fluid velocity.
- 2.8 Routing:** Attention must be given to optimum routing to minimize inherent problems (kinking

or flow restriction due to Hose collapse, twisting of the Hose, proximity to hot objects or heat sources).

- 2.9 Environment:** Care must be taken to insure that the Hose and Fittings are either compatible with or protected from the environment (that is, surrounding conditions) to which they are exposed. Environmental conditions including but not limited to ultraviolet radiation, sunlight, heat, ozone, moisture, water, salt water, chemicals, and air pollutants can cause degradation and premature failure.
- 2.10 Mechanical Loads:** External forces can significantly reduce Hose life or cause failure. Mechanical loads which must be considered include excessive flexing, twist, kinking, tensile or side loads, bend radius, and vibration. Use of swivel type Fittings or adapters may be required to insure no twist is put into the Hose. Unusual applications may require special testing prior to Hose selection.
- 2.11 Physical Damage:** Care must be taken to protect Hose from wear, snagging, kinking, bending smaller than minimum bend radius, and cutting, any of which can cause premature Hose failure. Any Hose that has been kinked or bent to a radius smaller than the minimum bend radius, and any Hose that has been cut or is cracked or is otherwise damaged, should be removed and discarded.
- 2.12 Proper End Fitting:** See instructions 3.2 through 3.5. These recommendations may be substantiated by testing to industry standards such as SAE J517 for hydraulic applications, or MIL-A-5070, AS1339, or AS3517 for hoses from Parker's Stratoflex Products Division for aerospace applications.
- 2.13 Length:** When establishing a proper Hose length, motion absorption, Hose length changes due to pressure, and Hose and machine tolerances and movement must be considered.
- 2.14 Specifications and Standards:** When selecting Hose and Fittings, government, industry, and Parker specifications and recommendations must be reviewed and followed as applicable.
- 2.15 Hose Cleanliness:** Hose components may vary in cleanliness levels. Care must be taken to insure that the Hose Assembly selected has an adequate level of cleanliness for the application.
- 2.16 Fire Resistant Fluids:** Some fire resistant fluids that are to be conveyed by Hose require use of the same type of Hose as used with petroleum base fluids. Some such fluids require a special Hose, while a few fluids will not work with any Hose at all. See instructions 2.5 and 1.5. The wrong Hose may fail after a very short service. In addition, all liquids but pure water may burn fiercely under certain conditions, and even pure water leakage may be hazardous.
- 2.17 Radiant Heat:** Hose can be heated to destruction without contact by such nearby items as hot manifolds or molten metal. The same heat source may then initiate a fire. This can occur despite the presence of cool air around the Hose.
- 2.18 Welding or Brazing:** When using a torch or arc-welder in close proximity to hydraulic lines, the hydraulic lines should be removed or shielded with appropriate fire resistant materials. Flame or weld spatter could burn through the Hose and possibly ignite escaping fluid resulting in a catastrophic failure. Heating of plated parts, including Hose Fittings and adapters, above 450°F (232°C) such as during welding, brazing, or soldering may emit deadly gases.
- 2.19 Atomic Radiation:** Atomic radiation affects all materials used in Hose assemblies. Since the long-term effects may be unknown, do not expose Hose assemblies to atomic radiation.
- 2.20 Aerospace Applications:** The only Hose and Fittings that may be used for in flight aerospace applications are those available from Parker's Stratoflex Products Division. Do not use any other Hose or Fittings for in flight applications. Do not use any Hose or Fittings from Parker's Stratoflex Products Division with any other Hose or Fittings, unless expressly approved in writing by the engineering manager or chief engineer of Stratoflex Products Division and verified by the user's own testing and inspection to aerospace industry standards.
- 2.21 Unlocking Couplings:** Ball locking couplings or other couplings with disconnect sleeves can unintentionally disconnect if they are dragged over obstructions or if the sleeve is bumped or moved enough to cause disconnect. Threaded couplings should be considered where there is a potential for accidental uncoupling.
- 3.0 HOSE AND FITTING ASSEMBLY AND INSTALLATION INSTRUCTIONS**
- 3.1 Component Inspection:** Prior to assembly, a careful examination of the Hose and Fittings must be performed. All components must be checked for correct style, size, catalog number, and length. The Hose must be examined for cleanliness, obstructions, blisters, cover looseness, kinks, cracks, cuts or any other visible defects. Inspect the Fitting and sealing surfaces for burrs, nicks, corrosion or other imperfections. Do NOT use any component that displays any signs of nonconformance.
- 3.2 Hose and Fitting Assembly:** Do not assemble a Parker Fitting on a Parker Hose that is not specifically listed by Parker for that Fitting, unless authorized in writing by the engineering manager or chief engineer of the appropriate Parker division. Do not assemble a Parker Fitting on another manufacturer's Hose or a Parker Hose on another manufacturer's Fitting unless (i) the engineering manager or chief engineer of the appropriate Parker division approves the Assembly in writing or that combination is expressly approved in the appropriate Parker literature for the specific Parker product, and (ii) the user verifies the Assembly and the application through analysis and testing. For Parker Hose that does not specify a Parker Fitting, the user is solely responsible for the selection of the proper Fitting and Hose Assembly procedures. See instruction 1.4. The Parker published instructions must be followed for assembling the Fittings on the Hose. These instructions are provided in the Parker Fitting catalog for the specific Parker Fitting being used, or by calling 1-800-CPARKER, or at www.parker.com.
- 3.3 Related Accessories:** Do not crimp or swage any Parker Hose or Fitting with anything but the listed swage or crimp machine and dies in accordance with Parker published instructions. Do not crimp or swage another manufacturer's Fitting with a Parker crimp or swage die unless authorized in writing by the engineering manager or chief engineer of the appropriate Parker division.
- 3.4 Parts:** Do not use any Parker Fitting part (including but not limited to socket, shell, nipple, or insert) except with the correct Parker mating parts, in accordance with Parker published instructions, unless authorized in writing by the engineering manager or chief engineer of the appropriate Parker division.
- 3.5 Reusable/Permanent:** Do not reuse any field attachable (reusable) Hose Fitting that has blown or pulled off a Hose. Do not reuse a Parker permanent Hose Fitting (crimped or swaged) or any part thereof. Complete Hose Assemblies may only be reused after proper inspection under section 4.0. Do not assemble Fittings to any previously used hydraulic Hose that was in service, for use in a fluid power application.
- 3.6 Pre-Installation Inspection:** Prior to installation, a careful examination of the Hose Assembly must be performed. Inspect the Hose Assembly for any damage or defects. Do NOT use any Hose Assembly that displays any signs of nonconformance.
- 3.7 Minimum Bend Radius:** Installation of a Hose at less than the minimum listed bend radius may significantly reduce the Hose life. Particular attention must be given to preclude sharp bending at the Hose to Fitting juncture. Any bending during installation at less than the minimum bend radius must be avoided. If any Hose is kinked during installation, the Hose must be discarded.
- 3.8 Twist Angle and Orientation:** Hose Assembly installation must be such that relative motion of machine components does not produce twisting.
- 3.9 Securement:** In many applications, it may be necessary to restrain, protect, or guide the Hose to protect it from damage by unnecessary flexing, pressure surges, and contact with other mechanical components. Care must be taken to insure such restraints do not introduce additional stress or wear points.
- 3.10 Proper Connection of Ports:** Proper physical installation of the Hose Assembly requires a correctly installed port connection insuring that no twist or torque is transferred to the Hose when the Fittings are being tightened or otherwise during use.
- 3.11 External Damage:** Proper installation is not complete without insuring that tensile loads, side loads, kinking, flattening, potential abrasion, thread damage, or damage to sealing surfaces are corrected or eliminated. See instruction 2.10.
- 3.12 System Checkout:** All air entrapment must be eliminated and the system pressurized to the maximum system pressure (at or below the Hose maximum working pressure) and checked for proper function and freedom from leaks. Personnel must stay out of potential hazardous areas while testing and using.
- 3.13 Routing:** The Hose Assembly should be routed in such a manner so if a failure does occur, the escaping media will not cause personal injury or property damage. In addition, if fluid media comes in contact with hot surfaces, open flame, or sparks, a fire or explosion may occur. See section 2.4.
- 4.0 HOSE AND FITTING MAINTENANCE AND REPLACEMENT INSTRUCTIONS**
- 4.1** Even with proper selection and installation, Hose life may be significantly reduced without a continuing maintenance program. The severity of the application, risk potential from a possible Hose failure, and experience with any Hose failures in the application or in similar applications should determine the frequency of the inspection and the replacement for the Products so that Products are replaced before any failure occurs. A maintenance program must be established and followed by the user and, at minimum, must include instructions 4.2 through 4.7.
- 4.2 Visual Inspection Hose/Fitting:** Any of the following conditions require immediate shut down and replacement of the Hose Assembly:
- Fitting slippage on Hose,
  - Damaged, cracked, cut or abraded cover (any reinforcement exposed);
  - Hard, stiff, heat cracked, or charred Hose;
  - Cracked, damaged, or badly corroded Fittings;
  - Leaks at Fitting or in Hose;
  - Kinked, crushed, flattened or twisted Hose; and
  - Blistered, soft, degraded, or loose cover.
- 4.3 Visual Inspection All Other:** The following items must be tightened, repaired, corrected or replaced as required:
- Leaking port conditions;
  - Excess dirt buildup;
  - Worn clamps, guards or shields; and
  - System fluid level, fluid type, and any air entrapment.
- 4.4 Functional Test:** Operate the system at maximum operating pressure and check for possible malfunctions and leaks. Personnel must avoid potential hazardous areas while testing and using the system. See section 2.2.
- 4.5 Replacement Intervals:** Hose assemblies and elastomeric seals used on Hose Fittings and adapters will eventually age, harden, wear and deteriorate under thermal cycling and compression set. Hose Assemblies and elastomeric seals should be inspected and replaced at specific replacement intervals, based on previous service life, government or industry recommendations, or when failures could result in unacceptable downtime, damage, or injury risk. See section 1.2.
- 4.6 Hose Inspection and Failure:** Hydraulic power is accomplished by utilizing high-pressure fluids to transfer energy and do work. Hoses, Fittings, and Hose Assemblies all contribute to this by transmitting fluids at high pressures. Fluids under pressure can be dangerous and potentially lethal and, therefore, extreme caution must be exercised when working with fluids under pressure and handling the Hoses transporting the fluids. From time to time, Hose Assemblies will fail if they are not replaced at proper time intervals. Usually these failures are the result of some form of misapplication, abuse, wear, or failure to perform proper maintenance. When Hoses fail, generally the high-pressure fluids inside escape in a stream which may or may not be visible to the user. Under no circumstances should the user attempt to locate the leak by "feeling" with their hands or any other part of their body. High-pressure fluids can and will penetrate the skin and cause severe tissue damage and possibly loss of limb. Even seemingly minor hydraulic fluid injection injuries must be treated immediately by a physician with knowledge of the tissue damaging properties of hydraulic fluid. If a Hose failure occurs, immediately shut down the equipment and leave the area until pressure has been completely released from the Hose Assembly. Simply shutting down the hydraulic pump may or may not eliminate the pressure in the Hose Assembly. Many times check valves, etc., are employed in a system and can cause pressure to remain in a Hose Assembly even when pumps or equipment are not operating. Tiny holes in the Hose, commonly known as pinholes, can eject small, dangerously powerful but hard to see streams of hydraulic fluid. It may take several minutes or even hours for the pressure to be relieved so that the Hose Assembly may be examined safely. Once the pressure has been reduced to zero, the Hose Assembly may be taken off the equipment and examined. It must always be replaced if a failure has occurred. Never attempt to patch or repair a Hose Assembly that has failed. Consult the nearest Parker distributor or the appropriate Parker division for Hose Assembly replacement information. Never touch or examine a failed Hose Assembly unless it is obvious that the Hose no longer contains fluid under pressure. The high-pressure fluid is extremely dangerous and can cause serious and potentially fatal injury.
- 4.7 Elastomeric seals:** Elastomeric seals will eventually age, harden, wear and deteriorate under thermal cycling and compression set. Elastomeric seals should be inspected and replaced.
- 4.8 Refrigerant gases:** Special care should be taken when working with refrigeration systems. Sudden escape of refrigerant gases can cause blindness if the escaping gases contact the eye and can cause freezing or other severe injuries if it contacts any other portion of the body.
- 4.9 Compressed natural gas (CNG):** Parker CNG Hose Assemblies should be tested after installation and before use, and at least on a monthly basis per AGA 1-93 Section 4.2 "Visual Inspection Hose/Fitting". The recommended procedure is to pressurize the Hose and check for leaks and to visually inspect the Hose for damage. Caution: Matches, candles, open flame or other sources of ignition shall not be used for Hose inspection. Leak check solutions should be rinsed off after use.

1. **Terms and Conditions of Sale:** All descriptions, quotations, proposals, offers, acknowledgments, acceptances and sales of Seller's products are subject to and shall be governed exclusively by the terms and conditions stated herein. Buyer's acceptance of any offer to sell is limited to these terms and conditions. Any terms of conditions in addition to, or inconsistent with those stated herein, proposed by Buyer in any acceptance of an offer by Seller, are hereby objected to. No such additional, different or inconsistent terms and conditions shall become part of the contract between Buyer and Seller unless expressly accepted in writing by Seller. Seller's acceptance of any offer to purchase by Buyer is expressly conditional upon Buyer's assent to all the terms and conditions stated herein, including any terms in addition to, or inconsistent with those contained in Buyer's offer. Acceptance of Seller's products shall in all events constitute such assent.

2. **Payment:** Payment shall be made by Buyer net 30 days from the date of shipment of the items purchased hereunder. Parker reserves the right to charge interest on all past due amounts. Any claims by Buyer for omissions or shortages in a shipment shall be waived unless the Seller receives notice, thereof within 30 days after Buyer's receipt of the shipment.

3. **Delivery:** Unless otherwise provided on the face hereof, delivery shall be made F.O.B. Seller's plant. Regardless of the method of delivery, however, risk of loss shall pass to Buyer upon Seller's delivery to a carrier. Any delivery dates shown are approximate only and Seller shall have no liability for any delays in delivery.

4. **Warranty:** Seller warrants that the items sold hereunder shall be free from defects in material or workmanship for a period of 365 days from the date of shipment to Buyer, or 2,000 hours of use, whichever expires first. THIS WARRANTY COMPRISES THE SOLE AND ENTIRE WARRANTY PERTAINING TO ITEMS PROVIDED HEREUNDER. SELLER MAKES NO OTHER WARRANTY, GUARANTEE, OR REPRESENTATION OF ANY KIND WHATSOEVER. ALL OTHER WARRANTIES, INCLUDING BUT NOT LIMITED TO, MERCHANTABILITY AND FITNESS FOR PURPOSE, WHETHER EXPRESS, IMPLIED, OR ARISING BY OPERATION OF LAW, TRADE USAGE, OR COURSE OF DEALING ARE HEREBY DISCLAIMED.

NOTWITHSTANDING THE FOREGOING, THERE ARE NO WARRANTIES WHATSOEVER ON ITEMS BUILT OR ACQUIRED WHOLLY OR PARTIALLY, TO BUYER'S DESIGNS OR SPECIFICATIONS.

5. **Limitation Of Remedy:** SELLER'S LIABILITY ARISING FROM OR IN ANY WAY CONNECTED WITH THE ITEMS SOLD OR THIS CONTRACT SHALL BE LIMITED EXCLUSIVELY TO REPAIR OR REPLACEMENT OF THE ITEMS SOLD OR REFUND OF THE PURCHASE PRICE PAID BY BUYER, AT SELLER'S SOLE OPTION. IN NO EVENT SHALL SELLER BE LIABLE FOR ANY INCIDENTAL, CONSEQUENTIAL OR SPECIAL DAMAGES OF ANY KIND OR NATURE WHATSOEVER, INCLUDING BUT NOT LIMITED TO LOST PROFITS ARISING FROM OR IN ANY WAY CONNECTED WITH THIS AGREEMENT OR ITEMS SOLD HEREUNDER, WHETHER ALLEGED TO ARISE FROM BREACH OF CONTRACT, EXPRESS OR IMPLIED WARRANTY, OR IN TORT, INCLUDING WITHOUT LIMITATION, NEGLIGENCE, FAILURE TO WARN OR STRICT LIABILITY.

6. **Changes, Reschedules and Cancellations:** Buyer may request to modify the designs or specifications for the items sold hereunder as well as the quantities and delivery dates thereof, or may request to cancel all or part of this order, however, no such requested modification or cancellation shall become part of the contract between Buyer and Seller unless accepted by Seller in a written amendment to this Agreement. Acceptance of any such requested modification or cancellation shall be at Seller's discretion, and shall be upon such terms and conditions as Seller may require.

7. **Special Tooling:** A tooling charge may be imposed for any special tooling, including without limitation, dies, fixtures, molds and patterns, acquired to manufacture items sold pursuant to this contract. Such special tooling shall be and remain Seller's property notwithstanding payment of any charges by Buyer. In no event will Buyer acquire any interest in apparatus belonging to Seller which is utilized in the manufacture of the items sold hereunder, even if such apparatus has been specially converted or adapted for such manufacture and notwithstanding any charges paid by Buyer. Unless otherwise agreed, Seller shall have the right to alter, discard or otherwise dispose of any special tooling or other property in its sole discretion at any time.

8. **Buyer's Property:** Any designs, tools, patterns, materials, drawings, confidential information or equipment furnished by Buyer or any other items which become Buyer's property, may be considered obsolete and may be destroyed by Seller after two (2) consecutive years have

elapsed without Buyer placing an order for the items which are manufactured using such property. Seller shall not be responsible for any loss or damage to such property while it is in Seller's possession or control.

9. **Taxes:** Unless otherwise indicated on the face hereof, all prices and charges are exclusive of excise, sales, use, property, occupational or like taxes which may be imposed by any taxing authority upon the manufacture, sale or delivery of the items sold hereunder. If any such taxes must be paid by Seller or if Seller is liable for the collection of such tax, the amount thereof shall be in addition to the amounts for the items sold. Buyer agrees to pay all such taxes or to reimburse Seller therefore upon receipt of its invoice. If Buyer claims exemption from any sales, use or other tax imposed by any taxing authority, Buyer shall save Seller harmless from and against any such tax, together with any interest or penalties thereon which may be assessed if the items are held to be taxable.

10. **Indemnity for Infringement of Intellectual Property Rights:** Seller shall have no liability for infringement of any patents, trademarks, copyrights, trade dress, trade secrets or similar rights except as provided in this Part 10. Seller will defend and indemnify Buyer against allegations of infringement of U.S. patents, U.S. trademarks, copyrights, trade dress and trade secrets (hereinafter 'Intellectual Property Rights'). Seller will defend at its expense and will pay the cost of any settlement or damages awarded in an action brought against Buyer based on an allegation that an item sold pursuant to this contract infringes in the Intellectual Property Rights of a third party. Seller's obligation to defend and indemnify Buyer is contingent on Buyer notifying Seller within ten (10) days after Buyer becomes aware of such allegations of infringement, and Seller having sole control over the defense of any allegations or actions including all negotiations for settlement or compromise. If an item sold hereunder is subject to a claim that it infringes the Intellectual Property Rights of a third party, Seller may, at its sole expense and option, procure for Buyer the right to continue using said item, replace or modify said item so as to make it noninfringing, or offer to accept return of said item and return the purchase price less a reasonable allowance for depreciation. Notwithstanding the foregoing, Seller shall have no liability for claims of infringement based on information provided by Buyer, or directed to items delivered hereunder for which the designs are specified in whole or part by Buyer, or infringements resulting from the modification, combination or use in a system of any item sold hereunder. The foregoing provisions of the Part 10 shall constitute Seller's sole and exclusive liability and Buyer's sole and exclusive remedy for infringement of Intellectual Property Rights.

If a claim is based on information provided by Buyer or if the design for an item delivered hereunder is specified in whole or in part by Buyer, Buyer shall defend and indemnify Seller for all costs, expenses or judgments resulting from any claim that such item infringes any patent, trademark, copyright, trade dress, trade secret or any similar right.

11. **Force Majeure:** Seller does not assume the risk of and shall not be liable for delay for failure to perform any of Seller's obligations by reason of circumstances beyond the reasonable control of Seller (hereinafter 'Events of Force Majeure'). Events of Force Majeure shall include without limitation, accidents, acts of God, strikes or labor disputes, acts, laws, rules or regulations of any government or government agency, fires, floods, delays or failures in delivery of carriers or suppliers, shortages of materials and any other cause beyond Seller's control.

12. **Entire Agreement/Governing Law:** The terms and conditions set forth herein, together with any amendments, modifications and any different terms or conditions expressly accepted by Seller in writing, shall constitute the entire Agreement concerning the items sold, and there are no oral or other representations or agreements which pertain thereto. This Agreement shall be governed in all respects by the law of the State of Ohio. No actions arising out of the sale of the items sold hereunder or this Agreement may be brought by either party more than two (2) years after the cause of action accrues.

## Aerospace

### Key Markets

- Commercial transports
- Military aircraft
- Regional transports
- Aircraft engines
- Business and general aviation

### Key Products

- Flight control systems and components
- Hydraulic systems and components
- Fuel systems and components
- Pneumatic systems and components
- Inert oxygen generating systems
- Fluid metering, delivery and atomization devices
- Wheels and brakes
- Couplings, fittings, hoses and tubes



## Automation

### Key Markets

- Factory automation
- Transportation and automotive
- Life sciences and medical
- Machine tools
- Semiconductor and electronics

### Key Products

- Pneumatic motion and control
- Air preparation
- Vacuum controls and sensors
- Electromechanical stepper and servo motors, drives, and controls
- Human machine interface
- Electric actuators, gantry robots, slides and linear motors
- Structural extrusion



## Climate & Industrial Controls

### Key Markets

- Refrigeration and air conditioning
- Transportation/mobile
- Process
- Industrial machinery
- Medical/life sciences
- Fuel cells
- Precision cooling

### Key Products

- Pressure regulators
- Check, ball and service valves
- Value-added systems
- Thermostatic and expansion valves
- Electronic controllers
- Contaminant controls
- Heating/air conditioning hose
- Gerotors



## Filtration

### Key Markets

- Industrial machinery
- Process
- Mobile
- Marine
- Oil & gas
- Power generation and energy
- Transportation
- Food and beverage

### Key Products

- Hydraulic, lubrication and coolant filters
- Process, chemical, water and microfiltration filters
- Compressed air and gas purification filters
- Condition monitoring
- Analytical gas generators
- Nitrogen, hydrogen and zero air generators
- Engine air, fuel, oil filtration and systems



## Fluid Connectors

### Key Markets

- Construction machinery
- Agriculture
- Transportation
- Mobile
- Industrial machinery
- Oil & gas

### Key Products

- Rubber and thermoplastic hose
- Industrial hose
- Tube fittings and adaptors
- Tubing and plastic fittings
- Brass fittings and valves
- Hose couplings
- Quick disconnects



## Hydraulics

### Key Markets

- Construction machinery
- Agriculture
- Industrial machinery
- Oil & gas
- Truck hydraulics
- Power generation and energy

### Key Products

- Hydraulic cylinders and accumulators
- Hydraulic valves and controls
- Hydraulic motors and pumps
- Power take-offs
- Hydraulic systems



## Instrumentation

### Key Markets

- Power generation
- Oil & gas
- Petrochemical
- Microelectronics
- Biopharmaceutical

### Key Products

- Medium/high pressure fittings and valves
- Instrumentation fittings, valves, manifolds and regulators
- High purity fittings, valves and regulators
- Fluoropolymer fittings, valves, pumps and regulators
- Analytical systems



## Seal

### Key Markets

- Transportation
- Energy, oil & gas
- Semiconductor
- Aerospace
- Fluid power
- Life sciences
- Telecommunications

### Key Products

- Elastomeric O-rings
- Homogeneous and inserted elastomeric shapes and diaphragms
- Metal and plastic retained composite seals
- Polymeric and plastic dynamic seals
- Rubber and plastic boots/bellows
- Extruded and precision-cut/fabricated elastomeric seals
- Thermoplastic engineered seals





# Parker FCG Sales Offices & Service Centers (PSC)

## Parker Fluid Connectors Group

### Regional Sales Offices & Service Centers

**Your complete source** for quality tube fittings, hose & hose fittings, brass fittings & valves, quick-disconnect couplings, and assembly tools, locally-available from a worldwide network of authorized distributors.

#### **Fittings & Couplings:**

Available in inch and metric sizes covering SAE, BSP, DIN, GAZ, JIS and ISO thread configurations, manufactured from steel, stainless steel, brass, aluminum, nylon and thermoplastic.

#### **Hose, Tubing and Bundles:**

Available in a wide variety of sizes and materials including rubber, wire-reinforced, thermoplastic, hybrid and custom compounds.

#### **Worldwide Availability:**

Parker operates Fluid Connectors manufacturing locations and sales offices throughout North America, South America, Europe and Asia-Pacific.

**For information**, contact the nearest Regional Sales office listed, or **call toll-free...**

**1-800-C-PARKER**  
**(1-800-272-7537)**

**Central Region**  
**Sales Office & Service Center**  
Hiawatha, IA  
(319) 393-1221  
(319) 393-1224 FAX

**Cleveland Region**  
**Sales Office**  
Cleveland, OH  
(216) 896-2404  
(216) 896-4022 FAX  
**Service Center**  
Toledo, OH  
(419) 878-7000  
(419) 878-7001 FAX  
(419) 878-7420 FAX (FCG Kit Operations)  
**Service Center**  
Louisville, KY  
(502) 937-1322  
(502) 937-4180 FAX

**Great Lakes Region**  
**Sales Office**  
Otsego, MI  
(269) 694-2550  
(269) 692-6634 FAX

**Minneapolis Region**  
**Sales Office**  
(763) 513-3535  
(763) 544-3418 FAX  
**Service Center**  
Minneapolis, MN  
(952) 469-5000  
(952) 469-5729 FAX

**Northeast Region**  
**Sales Office**  
Trenton, NJ  
(609) 586-5151  
(609) 586-6081 FAX

**Pacific Region**  
**Sales Office & Service Center**  
Portland, OR  
(503) 283-1020  
(503) 283-2201 FAX  
**Service Center**  
Buena Park, CA  
(714) 522-8840  
(714) 994-1183 FAX

**Southeast Region**  
**Service Center**  
Conyers, GA  
(770) 929-0330  
(770) 929-0230 FAX

**Southwest Region**  
**Sales Office**  
Mansfield, TX  
(817) 473-4431  
(817) 453-8022 FAX

**Canada**  
**Sales Office & Service Center**  
Grimsby, ONT  
(905) 945-2274  
(905) 945-2203 FAX  
**(Contact Grimsby for other Service Center locations.)**

10/08 PL 25M / Catalog 3501E

Parker Hannifin Corporation  
**Brass Products Division**  
300 Parker Drive  
Otsego, MI 49078  
Phone: (269) 694-9411  
Fax: (269) 694-4614  
www.parker.com



Your Local Authorized Parker Distributor