



Positioning and Identification Antenna

– 13.56 MHz, one-dimensional –

HG 98780-A

Englisch, Revision 10	Developed by: W.M.
Date: 23.07.2014	Author(s): RAD
Götting KG, Celler Str. 5, D-31275 Lehrte - Röddensen (Germany), Tel.: +49 (0) 51 36 / 80 96 -0, Fax: +49 (0) 51 36 / 80 96 -80, eMail: info@goetting.de, Internet: www.goetting.de	

Contents

1	Introduction	5
1.1	Accessories	5
1.2	Function	6
1.3	Positioning Pulse	6
2	Mounting	8
2.1	Transponders	8
2.1.1	Dimensions and Specifications	8
2.1.2	Mounting Instructions	8
2.2	Antenna HG 98780ZA/YA/XA/WA	9
2.3	Interface HG 06150ZA/XA (optional)	10
3	Installation / Commissioning	11
4	Components and Operation	12
4.1	Operation Conditions	12
4.2	Positioning Antenna on the Vehicle / Crane	12
4.2.1	HG 98780ZA/WA (with CAN-Bus and RS422 / RS232 interfaces) ..	12
4.2.1.1	Connection plan of the 12-pin socket	13
4.2.2	HG 98780YA/XA (with Profibus and RS232/RS422)	14
4.2.2.1	Dimensions	14
4.2.2.2	Pin Allocations	15
4.2.3	Switch-on Characteristics	16
4.2.4	Interfaces	16
4.2.4.1	Serial (RS 422 / RS 232)	16
4.2.4.1.1	List of system data to be output	16
4.2.4.1.2	List of commands	19
4.2.4.2	System Monitor	20
4.2.4.3	Positioning Pulse	20
4.2.4.4	CAN Bus	20
4.2.4.4.1	Description	20
4.2.4.4.2	CAN Message Object 1 (Transmission Object)	20
4.2.4.4.3	CAN Message Object 2 (A Identifier; Transmission Object)	21
4.2.4.4.4	CAN Message Object 3 (D Identifier; Transmission Object)	21
4.2.4.4.5	CAN Message Object 4 (Reference Transponder; Reception Object)	21
4.2.4.5	Profibus	22
4.2.4.5.1	Profibus Input Bytes	22
4.2.4.5.2	Output Bytes	23
4.2.5	Software download	23

4.3	Accessories (optional).....	24
4.3.1	Serial/parallel Converter HG 06150ZA/XA	24
5	Software	25
5.1	Terminal program	25
5.1.1	Parameter presettings	25
5.2	System monitor.....	26
5.2.1	How to start the monitor program	26
5.2.1.1	Procedure Monitor only	26
5.2.1.2	Procedures 3964R/transparent.....	26
5.2.2	Operating the monitor program	27
5.2.2.1	Main menu.....	28
5.2.2.2	(T)ime & Code	30
5.2.2.3	(S)erial Output	31
5.2.2.4	C(A)N Parameters	33
5.2.2.5	P(r)ofibus-Parameters.....	34
5.2.2.6	CS(V)	35
5.2.2.7	(B)oot Load.....	35
5.3	Software Update (Antenna Software)	36
5.3.1	Installation of the Program for Software Update	36
5.3.2	Software Update.....	37
6	Maintenance	40
7	Troubleshooting	41
8	Technical Data	42
8.1	Antenna.....	42
8.2	Parallel converter	44
9	Appendix.....	45
A	Effective Antenna Area	45
B	Positioning Accuracy.....	48
C	Attenuation of the Reception Level caused by Metal	50
D	Influence of Water.....	51
E	Mounting next to Massive Metal Structures	52
F	Procedure 3964R.....	52
F.1	Data direction antenna -> PLC.....	52
F.2	Data direction PLC -> Antenna	53
G	Procedure „transparent“	54
G.1	Data direction antenna -> PLC.....	54
G.2	Data direction PLC -> antenna.....	54
H	GSD File (Antenna HG 98780XA/YA with Profibus)	54

10	Handbook Conventions.....	55
11	List of Figures	56
12	List of Tables	58
13	Index	59
14	Copyright and Terms of Liability	60
	14.1 Copyright.....	60
	14.2 Exclusion of Liability	60
	14.3 Trade Marks and Company Names.....	60

1 Introduction

The described antennas are especially suited for outdoor applications, as the electronic units are sealed within the antenna cases. All important settings, adjustable values and software updates can be effected via a serial interface.

Unlike Transponder Positioning System S_113933 (128 kHz operating frequency), Transponder Positioning Antenna HG 98780-A is operating at 13.56 MHz. This ensures sufficient frequency separation to interference sources such as, e.g., drives, power converters and switching power supply.

Both systems supply a similarly structured output format in which additional system information can be configured by the user. This information can, for example, be saved in a visualization system and enables statements about the condition and availability/ accessibility of the transponders and antennas. This system description applies to devices with the firmware 98780B2 version 1.06 and higher.

1.1 Accessories

The following accessories are available for the one-dimensional Transponder Positioning Reader HG 98780-A:

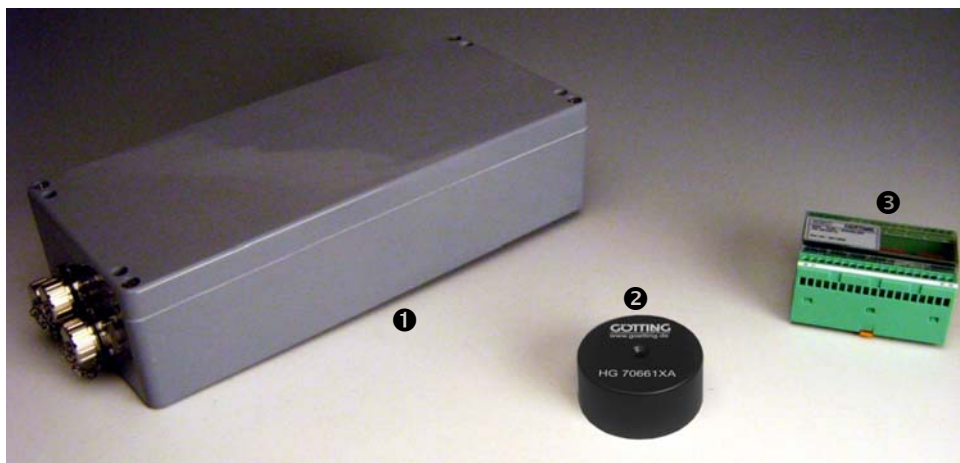

Figure 1 Components

1. Transponder reader with preamplifier and interpreter HG 98780-A with different interfaces (see Table 1 on page 6)
2. Transponder HG 70661 (on the pavement)
3. Optional interface HG 06150-A serial/parallel converter
4. Optional desktop reading and programming unit HG 81830VA (not shown in picture)

1.2 Function

As the antenna passes over the transponder, it energizes the latter with an energy field of 13.56 MHz. The transponder returns its code through frequency modulation to the antenna. An additional coil generates the positioning pulse. The interpreter which is integrated within the antenna decodes the transponder code.

Furthermore several antenna parameters, e. g. current consumption and supply voltage, are measured and, if desired, added to the serial output protocol.

The serial signal is made available via potentially separated RS 422 or RS 232 interfaces. In addition, the positioning pulse is dc-insulated. Furthermore, CAN Bus or Profibus interfaces are provided optionally.

As an option, the serial signal can be converted into a 16 bit parallel output signal (24 Volts switched) for the code within an external interface device. This interface device is suited for mounting rail (top-hat rail) installation and should be installed in a place protected from any environmental influences.

HG 98780-A				
Variant	Profibus	CAN Bus	RS 422	RS 232
ZA		X	X	
YA	X			X
XA	X		X	
WA		X		X

Table 1 Overview of G 98780 variants

1.3 Positioning Pulse

For the generation of the positioning pulse, it is necessary that the following preconditions are met:

- The reception voltage S (refer to Table 18 on page 28) must exceed the set threshold for `Level for Positioning` (refer to section 5.2.2.2 on page 30).
- A transponder code must be decoded without error.
- The measured voltage X must fall below a certain threshold (refer to Table 18 on page 28).

If the above listed preconditions are met, a positioning pulse with changeable duration is generated. For the generation of a new positioning pulse it is essential that the reception voltage S has fallen below the threshold set for `Threshold for Decoding` (refer to section 5.2.2.2 on page 30) first.

Thus only one pulse per transponder crossing is possible. Therefore, if a vehicle/crane stops above the transponder after the positioning pulse was generated and then changes its direction of travel, no renewed positioning pulse is generated during the center crossing!

Positioning Accuracy

As the field compensation for the corresponding measuring coil is not infinitely sharp and is also depending on the reading height (refer to Appendix, Section A on page 45), the positioning pulse is generated at different but reproducible locations, depending on the direction of travel. Since the antenna is not aware of its direction of travel, but depends on the physical effect of the field strength, only the vehicle/crane control can carry out the direction-dependent compensation. The appendix, section B on page 48 shows the locations of the positioning pulse related to the X and Y coordinates and the reading height.

2 Mounting

2.1 Transponders

2.1.1 Dimensions and Specifications

The maximum reading distance for all transponders can only be achieved when the minimum distance to metal surfaces is maintained. It is recommended to maintain the minimum distances within the metal-free area (Figure 2). The impact on positioning accuracy and range also depends on the size and distance of metal parts.

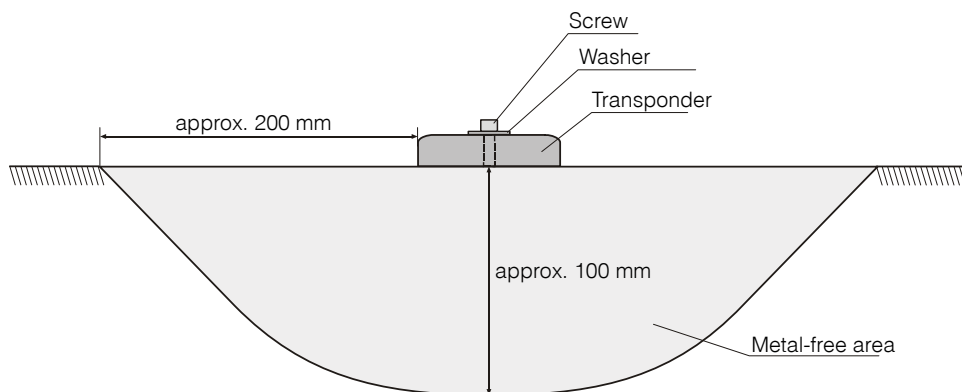

Figure 2 Minimum iron-free area around Puck Transponder HG 70661

As rule of thumb it can be said that if the metal-free area behind the transponder has to be at least of the same range as the reading distance between transponder and antenna. The reception of the transponder signal will be largely unattenuated (also refer to Table 24 on page 50). It is essential, that the transponder **does not dip into the meshes/loops of steel reinforcement grids**. Single metal rods, on the other hand, hardly have any influence on the performance.

2.1.2 Mounting Instructions

The Transponders may be mounted on even ground using a metal screw and a washer. The maximum fastening torque is not allowed to exceed 4 Nm. The diameter of the metal washer should not be max. 18 mm.

2.2 Antenna HG 98780ZA/YA/XA/WA

The antenna has four predrilled holes for four M5 screws.

ATTENTION! Make sure the antenna is mounted correctly with regards to its reading side!

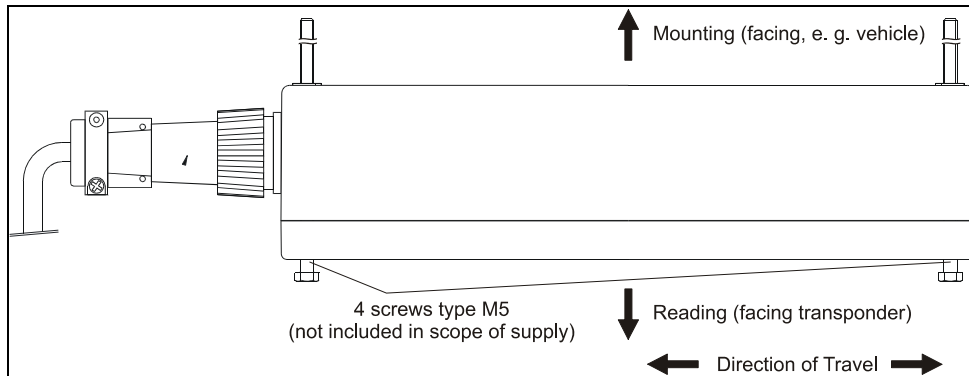

Figure 3 Mounting the antenna

In order to prevent any adverse effects on the system:

- The space above and around the antenna should be metal-free.
- Do not operate the reading antenna while the reading side is located directly above a metal surface, as this would mistune the antenna severely in such a way that the power consumption of the output stage would increase considerably.
- Perfect transponder readings are only guaranteed if the transponders are placed within max. ± 4 cm tolerance from the center line of the antenna! Outside these limits, the transponder readings become less reliable due to decreasing signal levels.

NOTE! Whenever the antenna is operated at temperatures below 0° C, it is necessary to use the integrated heater! As the warm-up time with heater at -20° C surrounding temperature is approx. 1 hour, the heater should be connected to a stand-by power supply.



2.3 Interface HG 06150ZA/XA (optional)

The optional interface has to be mounted in a climated enclosure on a mounting bar with the following connections:

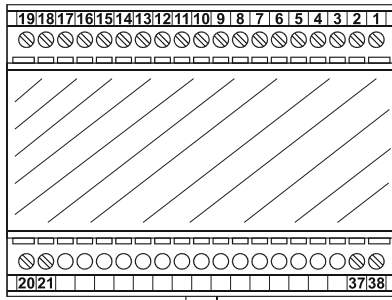

Figure 4 Outline of the interface mounting bar case

Interface connection plan				
1	Code Bit 1 (lowest Bit)	15	Code Bit 15	
2	Code Bit 2	16	Code Bit 16 (highest Bit)	
3	Code Bit 3	17	Data Ready	
4	Code Bit 4	18	Data Valid	
5	Code Bit 5			
6	Code Bit 6			
7	Code Bit 7			
8	Code Bit 8			
9	Code Bit 9			
10	Code Bit 10		Version ZA	Version XA
11	Code Bit 11	20	Rx+ (RS 422 input)	RxD (RS232 Input)
12	Code Bit 12	21	Rx- (RS 422 input)	not connected
13	Code Bit 13	37	+24 V operating voltage	
14	Code Bit 14	38	GND ground	

Table 2 Interface connection plan

3 Installation / Commissioning

NOTE! Check the operating voltage before connecting! The cable should not lie directly beside power supply cables.



Connect all necessary cables. For the next commissioning steps, connect a laptop with the serial interface of the antenna. Antenna variants with RS422 interface (HG 98780ZA/XA) require an appropriate interface converter. This interface converter is not included in the scope of supply of this system. For further information, please refer to the introduction in chapter 5 on page 25. Then start the monitor program as described in section 5.2 on page 26.

Default values In default the system uses the values of the file 1 (Mon3964r.txt; as listed in part 5.2.1 on page 26) with 9,600 Baud. Please keep in mind that another user could have changed these values.

1. Move a transponder into reception range.
The voltage S should increase significantly. The code should be detected immediately and the number of readings has to be continuously counted up to 65535. When moving the transponder in driving direction over the center axis of the antenna, a positioning pulse should be generated.
2. For setting the decoding thresholds (refer to section 5.2.2.2 „(T)ime & Code“ on page 30) it is useful, to record a complete test run along the transponder track. Antennas **HG 98780ZA** and **HG 98780WA** offer for this function the use of the serial interface (section 5.2.2.6 „CS(V)“ on page 35) or the CAN Bus Message Object 3 (section 4.2.4.4.4 on page 21 or 5.2.2.4 „C(A)N Parameters“ on page 33).
Antennas **HG 98780YA** and **HG 98780XA** offer for the same function the serial interface (refer to section 5.2.2.6 on page 35) or the Profibus interface (refer to section 5.2.2.5 on page 34). When using the Profibus interface, the necessary parameters from the 16 byte data block are `System Status`, `Code` and `U-Summe`.

Provided that the test run did not reveal any problems, changed parameters may be saved and the monitor program may be terminated. Changing certain parameters requires a complete system reset (switching the antenna off and on again), as described in the corresponding section for the monitor program (section 5.2). This procedure ensures that the system is commissioned correctly.

4 Components and Operation

4.1 Operation Conditions

Reference marks are the Puck Transponders HG 70661. The transponder data is configured to 32 Bit (Read/Write). Range and positioning accuracy of the system are influenced by:

- Steel reinforcements located around or behind the Transponder, refer to section C on page 50 in the appendix.
- Metal structures around the antenna.
- For influences of snow, ice and water refer to section D on page 51 in the appendix.

The following environmental conditions have no effect on the system:

- Oil, tar, earth, dirt, etc.
- Massive metal structures on one side of the Transponder or antenna, e.g. rails. Refer to section E on page 52 in the appendix.

4.2 Positioning Antenna on the Vehicle / Crane

4.2.1 HG 98780ZA/WA (with CAN-Bus and RS422 / RS232 interfaces)



Figure 5 Positioning antenna HG 98780ZA/WA

The antenna and the interpreter electronics are housed in a 360 x 160 x 91 mm casing. The reading area is the upper side of the casing. The cover is located on top of the casing, the 12-pin socket (Schaltbau M3) points in the vehicle's direction of travel.

The interpreter is mounted in a completely sealed unit, along with the heating. The connector is a 12-pin screw-in socket (Schaltbau, type M3) with gold plated pins.

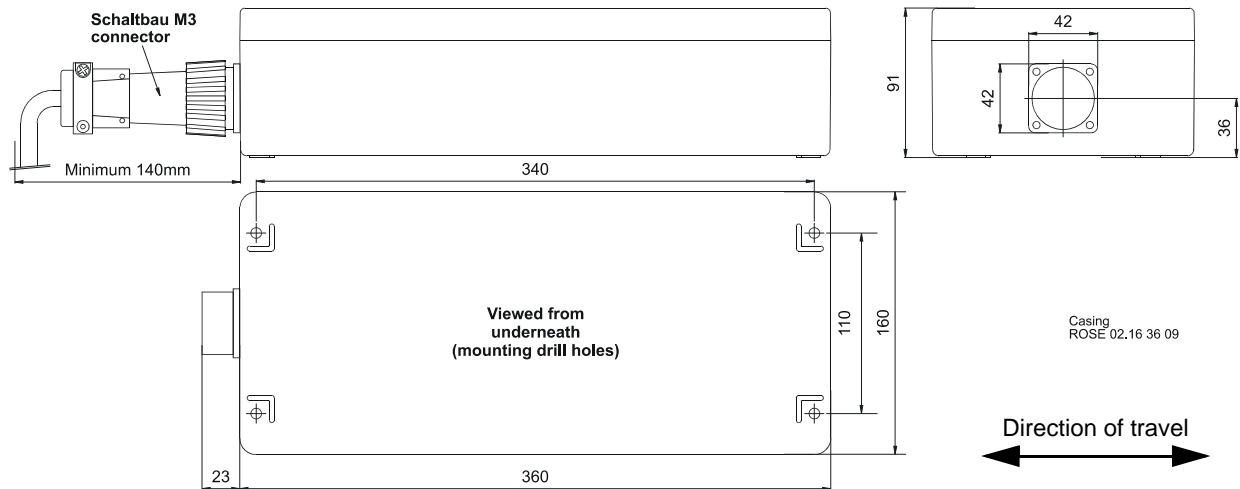

Figure 6 Outline antenna HG 98780ZA/WA (with casing dimensions)

4.2.1.1 Connection plan of the 12-pin socket

The allocation of contacts is as follows:

Contact	Description	
	HG 98780ZA	HG 98780WA
1	+24 V (antenna)	
2	GND (antenna)	
3	+24 V (heating)	
4	GND (heating)	
5	+RX (RS 422)	Rx (RS232)
6	-RX (RS 422)	n.c.
7	+TX (RS 422)	Tx (RS232)
8	-TX (RS 422)	n.c.
9	+20 mA positioning pulse	
10	-20 mA positioning pulse	
11	CAN+	
12	CAN-	
PE	signal ground	

Table 3 Connection plan of the 12-pin antenna socket (CAN bus)

Both positioning connections are separately and not internally connected to +24 V or GND, as a strict voltaic separation is essential for some of the systems. For safety reasons, a 20 mA current limitation has been implemented in the antenna for these outputs. In case a 24 V output is required, contact No. 9 may be connected to +24 V and contact No. 10 may be connected to GND via a 1 KOhm resistor.

4.2.2 HG 98780YA/XA (with Profibus and RS232/RS422)

4.2.2.1 Dimensions

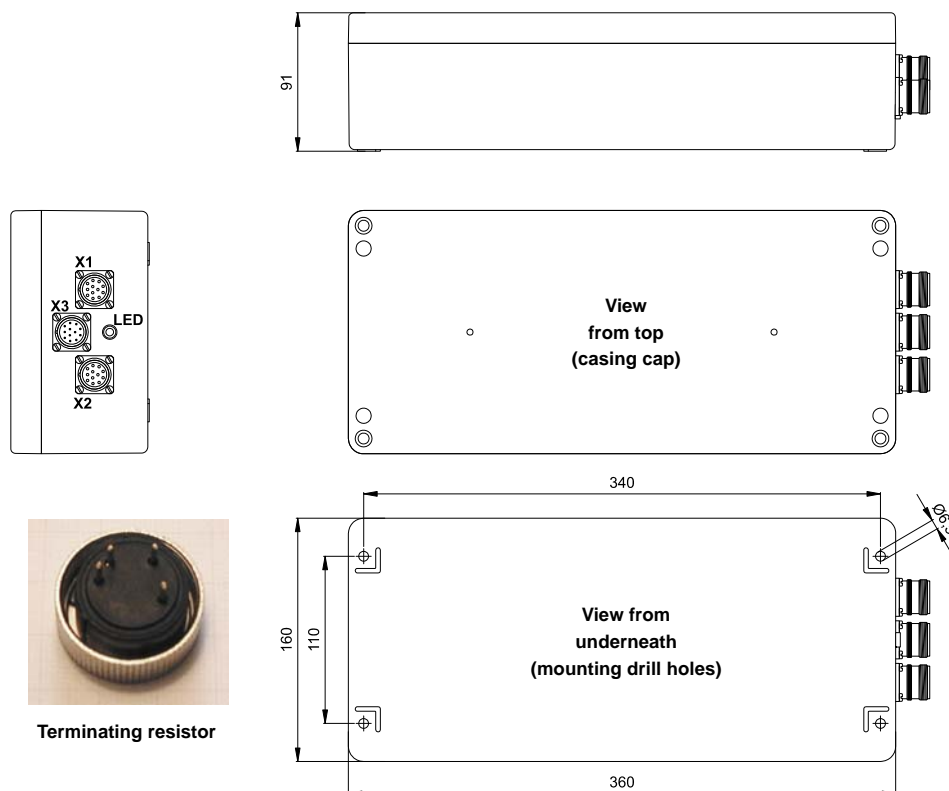

Figure 7 Outline of antenna HG 98780YA/XA (including housing dimensions and picture of the line termination resistance)

Antenna and interpreting electronics are housed in a 360 x 160 x 91 mm casing. The reading side of the antenna is the top of the casing with the casing cover. The three 12 pin built-in sockets (M23; gold-plated contacts) are facing in the direction of travel. For each antenna, a correspondingly suitable line termination resistance is included in the scope of supply.

Inside the casing are the completely sealed antenna electronics and the heater. For connecting the antenna, the sockets X1 and X2 (Profibus) or the connector X3 (Posi-Puls, RS232, power supply) are being used. The integrated LED indicates the Profibus status **Data exchange**.

For each antenna a connection set will be supplied, including 3 connectors, the terminating resistor and an inserter. **The particular cable diameters have to be indicated on order.**

4.2.2.2 Pin Allocations

The Profibus version of the antenna offers two 12 pin sockets for the bus function as well as one 12 pin connector for the power supply.

Contact	Allocation
1	signal ground
2	line A
3	n. c.
4	line B
5	n. c.
6	n. c.
7	+24 V DC (antenna)
8	GND (antenna)
9	shield
10	n. c.
11	n. c.
12	RTS
housing	shield

Table 4 Pin allocation of the 12 pin Profibus connectors (in duplicate)

Contact	Allocation	
	HG 98780YA	HG 98780XA
1	+24 V DC (antenna)	
2	GND (antenna)	
3	+24 V DC / 2 A (heater)	
4	GND (heater)	
5	Rx (RS232)	+RX (RS 422)
6	n. c.	-RX (RS 422)
7	Tx (RS232)	+TX (RS 422)
8	n. c.	-TX (RS 422)

Table 5 Pin allocation of the 12 pin connector for the antenna power supply (Profibus version) (Part 1 of 2)

Contact	Allocation	
	HG 98780YA	HG 98780XA
9	+20 mA Posi	
10	-20 mA Posi	
11	n. c.	
12	signal ground	
housing	shield	

Table 5 Pin allocation of the 12 pin connector for the antenna power supply (Profibus version) (Part 2 of 2)

4.2.3 Switch-on Characteristics

Once the supply voltage has been applied, the antenna requires 10 s until it reacts to data input, or outputs data protocols. During these 10 s, a software download may be started (also refer to section 4.2.5 on page 23).

4.2.4 Interfaces

4.2.4.1 Serial (RS 422 / RS 232)

The serial output may be configured in several ways. The transmission rate is adjustable between 9600 and 19200 Baud, the output protocol may be chosen as "transparent" or "3964R". Apart from that, the content of the telegrams is configurable, as the user may choose from a list of parameters.

Serial commands are used for activating a system monitor. The crossing of the antenna's center axis in direction of travel, is shown by the digital positioning output. Its transmission time is adjustable in blocks of milliseconds. In addition, it may be reduced to one impulse per crossing.

4.2.4.1.1 List of system data to be output

A telegram consists of max. 15 bytes. The minimum update rate at 9600 Baud is then calculated as follows

$$15 \frac{\text{Byte}}{\text{Telegram}} \times 11 \frac{\text{Bit}}{\text{Byte}} / 9600 \frac{\text{Bit}}{\text{s}} = 17,2 \frac{\text{ms}}{\text{Telegram}}$$

Figure 8 Formula: minimum update rate

As the transmission is binary, it is possible - when using the 3964R procedure - that further (DLE) characters are added by this procedure. All multiple-byte variables are output either with the highest byte or the lowest byte first (adjustable)!

The 8 bit check character is only output when using the transparent protocol. It then includes the start character. The check character (transparent protocol), cannot be removed from the data block. It is a matter of configuration, whether data telegrams are output permanently according to the set update rate or only during the period, when a transponder is within the field.

Table listing the data words of a telegram of 15 byte length:

Byte #	Length	Priority	Type	Description
1	1 Byte	0x01	Unsigned char	Start character ASCII-061: „=“
2,3,4,5	4 Byte	0x02	Unsigned long	32 Bit of the Transponder code
6,7	2 Byte	0x04	Unsigned int	Voltage induced by the Transponder within the frame antenna in Samples
8	1 Byte	0x08	Unsigned char	Supply voltage for the antenna [x 100 mV]
9	1 Byte	0x10	Unsigned char	Power consumption [x 10 mA]
10	1 Byte	0x20	Signed char	Temperature within the antenna [° C]
11,12	2 Byte	0x40	Unsigned int	Number of readings during the latest transponder crossing
13,14	2 Byte	0x80	Unsigned int	System status in binary encoding
(15)	1 Byte		Unsigned char	Check character (EXOR function over all characters), only for transparent protocol!

Table 6 Data words in a telegram of 15 (14) byte length

The following table shows a list of the binary codes used to describe the system status (for bytes # 13 and 14 from Table 3):

Priority	Name	Description
0x0001	HW_ERROR	Hardware error
0x0002	CODE_CRC_ERR	Reception of transponder code with CRC error
0x0004		
0x0008		
0x0010		
0x0020	PARAM_CRC_ER	Parameter block no longer save
0x0040		
0x0080	F_ERROR	Transmission oscillator not operating at set frequency
0x0100	REF_TRANS_ON	Note: reference transponder is activated.
0x0200	TRANS_IN_FIELD	Transponder within antenna field *)
0x0400	CODE_OK	Decoded code correct *)
0x0800		
0x1000	POSIPULS	Transponder has crossed the center of the antenna *)
0x2000		
0x4000		
0x8000		

Table 7 Possible system status messages

*) These bits are deleted as soon as the transponder has left the antenna field.

Example: Status 0x0600 stands for TRANS_IN_FIELD and CODE_OK

The status 0x0002 may also arise during ordinary transponder crossings, if the code transmission is aborted due to decreasing power output level. The message 0x0100 (REF_TRANS_ON) enables checking whether transmission of the corresponding switch-off command has been forgotten (in this case, it is no longer possible to read runway transponders correctly).

4.2.4.1.2 List of commands

One command telegram always consists of four bytes, including the actual command and the parameters. When using the procedure 'transparent' (also refer to Appendix, section G on page 54) it is, in addition, necessary to transfer one start character and a check sum (XOR operation of all bytes including the start character).

5 commands are defined:

No.	Description	Procedure	Start Char.	Command Byte	Parameter	Check Sum	
1	Switching into monitor mode (described in section 5.2 „System monitor“ on page 26)	3964R	HEX		$4D_{16}4F_{16}$	$4E_{16}49_{16}$	
			ASCII		MO	NI	
		transparent	HEX	$3D_{16}$	$4D_{16}4F_{16}$	$4E_{16}49_{16}$	38_{16}
			ASCII	=	MO	NI	8
2	Switch off reference transponder	3964R	HEX		$52_{16}54_{16}$	$30_{16}30_{16}$	
			ASCII		RT	00	
		transparent	HEX	$3D_{16}$	$52_{16}54_{16}$	$30_{16}30_{16}$	$3B_{16}$
			ASCII	=	RT	00	;
3	Switch on reference transponder	3964R	HEX		$52_{16}54_{16}$	$31_{16}31_{16}$	
			ASCII		RT	11	
		transparent	HEX	$3D_{16}$	$52_{16}54_{16}$	$31_{16}31_{16}$	$3B_{16}$
			ASCII	=	RT	11	;
4	Supply of the 16 programmable lower bits of the transponder code	3964R	HEX		$50_{16}4C_{16}$	Code in the format $tt_{16}tt_{16}$ For code „1234“ e. g. $12_{16}34_{16}$	
			ASCII		PL		
		transparent	HEX	$3D_{16}$	$50_{16}4C_{16}$		07_{16}
			ASCII	=	PL		
5	Supply of the 16 programmable higher bits of the transponder code and start of the programming procedure	3964R	HEX		$50_{16}48_{16}$	Code in the format $tt_{16}tt_{16}$ For code „1234“ e. g. $12_{16}34_{16}$	
			ASCII		PH		
		transparent	HEX	$3D_{16}$	$50_{16}48_{16}$		03_{16}
			ASCII	=	PH		

Table 8 List of System Commands

Further information regarding command no. ...

1. The monitor mode should not be used during normal operation (e. g. from an PLC), as the following output is not according to a transparent or 3964R protocol but only suitable for display on a VT52-terminal and used for the alteration of parameters.
2. An activated reference transponder is described by setting the corresponding bit in the system status "0x0100".
Please note that while the reference transponder is activated, the runway transponders cannot be processed unambiguously, i.e. they are either oppressed or their position is inaccurate.
3. The successful deactivation of the reference transponder is described by deleting the "0x0100" bit from the system status.

4.2.4.2 System Monitor

In monitor mode, the system is configurable via a menu. Please refer to section 5.2 „System monitor“ on page 26.

4.2.4.3 Positioning Pulse

The digital positioning output indicates the crossing of the center line of the antenna in direction of travel (x direction). Its duration is adjustable within a millisecond pattern.

4.2.4.4 CAN Bus

4.2.4.4.1 Description

Either Basic- or Full-CAN mode are configurable. The system monitor is used for setting the CAN parameters (also refer to section 5.2.2.4 on page 33). The internal CAN module is based on the CAN specifications V2.0 part B. It is possible to transmit either standard or extended frames (adjustable). The system monitor is used for setting the bit timing as well as the identifier.

It is possible to output 3 different CAN Message Objects and receive 1. Depending on the configuration, it is possible to distinguish between permanently output telegrams according to the set update rate or telegrams output only while a transponder is within the field. In addition, remote operation is selectable.

The objects are activated in the CAN menu by input of an address different from 0 (also refer to section 5.2.2.4 on page 33).

4.2.4.4.2 CAN Message Object 1 (Transmission Object)

Byte #	Length	Type	Description
1,2	2 Byte	Unsigned int	System status according to Table 7 on page 18
3,4,5,6	4 Byte	Unsigned long	32 Bit transponder code
7,8	2 Byte	Unsigned int	Number of code readings of the last transponder crossings

Table 9 Structure of the CAN Message Object 1

4.2.4.4.3 CAN Message Object 2 (A Identifier; Transmission Object)

Byte #	Length	Type	Description
1,2	2 Byte	Unsigned int	Sum voltage
3,4	2 Byte	Unsigned int	Number of code readings of the last transponder crossing
5	1 Byte	Unsigned char	Supply voltage
6	1 Byte	Unsigned char	Supply current
7	1 Byte	Signed char	Temperature

Table 10 Structure of the CAN Message Object 2

For interpreting the values of Message Objects 2 also refer to Table 6 on page 17. This Message Object is used for controlling parameters.

4.2.4.4.4 CAN Message Object 3 (D Identifier; Transmission Object)

Byte #	Length	Type	Description
1,2	2 Byte	Unsigned int	System status according to Table 7 on page 18
3,4	2 Byte	Unsigned int	Lower 16 bit of the transponder code
5,6	2 Byte	Unsigned int	Sum voltage
7,8	2 Byte	Unsigned int	Number of code readings

Table 11 Structure of the CAN Message Object 3

For interpreting the values of Message Object 3 also refer to Table 6 on page 17. This Message Object is used for commissioning, service and troubleshooting.

4.2.4.4.5 CAN Message Object 4 (Reference Transponder; Reception Object)

It is possible to activate and deactivate the reference transponder via the CAN bus. For this it is necessary to send a Message Object with the same address as Message Object 1 and a length of 5 bytes.

Byte #	Length	Type	Description
1,2,3,4	4 Byte	Unsigned long	Transponder code to be programmed (32 Bit)
5	1 Byte	Unsigned char	= 00: Reference transponder OFF = 01: Reference transponder ON = 02: Program Transponder

Table 12 Structure of the CAN Message Object 4

4.2.4.5 Profibus

4.2.4.5.1 Profibus Input Bytes

Number Input Bytes	Byte #	Length	Type	Byte Sequence *)	Description
6	1	2 Byte	Unsigned int	HiByte (LoByte)	System status in binary coding
	2			LoByte (HiByte)	
	3	4 byte	Unsigned long	HiByte (LoByte)	Transponder code
	4				
	5				
	6			LoByte (HiByte)	
7	7	1 Byte	Unsigned char		Supply voltage connected to the antenna [x 100 mV]
8	8	1 Byte	Unsigned char		Current consumption [x 10 mA]
9	9	1 Byte	Unsigned char		Temperature measured within the antenna [° C]
11	10	2 Byte	Unsigned int	HiByte (LoByte)	Number of code readings
	11			LoByte (HiByte)	
13	12	2 Byte	Unsigned int	HiByte (LoByte)	Voltage induced by the transponder within the frame antenna in samples
	13			LoByte (HiByte)	

*) = for correspondingly set Order of Data Transfer (refer to section 5.2.2.5 on page 34).

Table 13 Profibus Input Bytes

The description of these values is also included in Table 6 on page 17. Depending on the configuration of the master using the GSD files (refer to appendix, section H on page 54) the corresponding quantity of input bytes will be transmitted. Input bytes may have the values 6, 7, 8, 9, 11, 13 (also refer to Table 13).

4.2.4.5.2 Output Bytes

Output bytes are to be used according to the following table:

Number Input Bytes	Byte #	Length	Type	Byte Sequence	Description
1	1	1 Byte	Unsigned char		Instruction byte
5	2	4 Byte	Unsigned long	HiByte	Transponder code to be programmed
	3				
	4				
	5			LoByte	

Table 14 Profibus Output Bytes

Depending on the configuration of the master using the suitable GSD file (refer to Appendix, section H on page 54) the corresponding number of output bytes is transmitted. Values 1 and 5 are the options for the number of output bytes (refer to Table 14).

The instruction byte is defined as follows:

Priority	Name	Significance
0x01	SETREF	Switching the Reference Transponder ON/OFF
0x02	PROG	Transponder programming
0x04 0x08 0x10 0x20 0x40 0x80		Currently not allocated

Table 15 Significance of the instruction bit

Programming will be initiated by a rising edge of the PROG bit; i.e. first the transponder code which has to be programmed with PROG=0 should be transferred, subsequently the same transponder code with PROG=2. Thus the released programming process lasts approx. 100 ms. Afterwards the new code will be read directly and is available for the input bytes.

4.2.5 Software download

If necessary, the antennas may be updated via the serial interface. Please refer to chapter 5.3 „Software Update (Antenna Software)“ on page 36.

4.3 Accessories (optional)

4.3.1 Serial/parallel Converter HG 06150ZA/XA



Figure 9 Converter HG 06150XA for mounting bar installation

The serial/parallel converter has a casing which is suitable for mounting bar installation. To output the serial data via the RS 422 interface (ZA) or via RS232 (XA) the serial output of the antenna has to be set to transparent protocol with the data contents CODE and system status as follows: Enter the value 83 within the corresponding submenu for Telegram Content Mask (refer to section 5.2.2.3 on page 31). The Baud rate must be set to 19200 Baud.

Byte #	Length	Significance	Type	Description
1	1 Byte	0x01	ASCII-061 : „=“	Start pulse
2,3,4,5	4 Byte	0x02	Unsigned long	Transponder code
6,7	2 Byte	0x80	Unsigned int	System status
8	1 Byte		Unsigned char	Check character

Table 16 Output format when using the serial/parallel interface

Out of this data stream the **code** is converted into a 16 Bit parallel output. The code then contacts the outlets until the next code is received. In addition, 10 ms after the code bits are applied a data ready pulse of 100 ms is generated as the antenna passes over a transponder, i. e. the same transponder generates a new data ready pulse as it enters the field again (e. g. when switching tracks).

The validity of the voltage, i. e. if a transponder is actually within reception range, is displayed by the signal Data_Valid. If there is no transponder within the range, 0 V is output. The parallel outputs, Data_Ready and Data_Valid are switched contra +USPS (24V) and are not current limited. In addition they are not potentially separated.

5 Software

The system can be configured via the antenna software. To enter the program, you have to connect the serial interface of an ordinary PC via an interface converter with the serial interface of the antenna. For antenna variants with RS422 interface (i.e. HG 98780ZA/XA) an appropriate interface converter is required. Then start a terminal program on the PC.

NOTE!

The interface converter is not part of the system's scope of supply! However, it is available from several well-known distributors, as e. g. RS Components (<http://www.rs-components.com/rs/>). Please refer to the section „Industrial Interface Converters“ in the RS Components catalogue.



5.1 Terminal program

This section refers to the program **HyperTerminal**[®] (`Hypertrm.exe`), which is part of the scope of supply of Microsoft[®] Windows[®]. We usually use this program because many of our customers are already familiar with it and, due to the configuration files supplied by us, it is very easy to use.

Nevertheless, any other terminal program, that is capable of VT52 emulation, may be used. If you should use a different program, please read its manual and adjust it to the values described in section 5.1.1 below.

5.1.1 Parameter presettings

Dependent on whether you want to run the monitor program or the software update, different parameters are necessary. If you are using HyperTerminal, you do not need to enter these parameters and can move on to section 5.2 on page 26.

Terminal settings monitor program (see section 5.2)	
Baud rate	9600 or 19200 Baud depending on the system configuration
Terminal emulation	VT52
Parity	Even
Data bits	8
Stop bits	1
Character delay	1 ms
Line delay	0 ms
PC-Interface (Port)	COM1 may alter depending on the PC (see below.)

Table 17 Terminal settings monitor program

If you are using a different port than COM1 with HyperTerminal, then alter the port setting as follows:

1. Select **Properties** from the **File** menu (or click the Icon ). The following window shows up (partly German version):

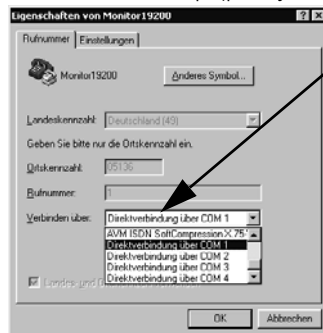

2. Choose the respective port via the **Direct to connection** in the submenu. Confirm with **OK**. Save the altered values if you are asked for it when closing HyperTerminal.

5.2 System monitor

In **monitor mode** it is possible to configure the system via a menu. To use the monitor mode you need to know which protocol is preset in your antenna.

5.2.1 How to start the monitor program

Depending on the currently active procedure, the monitor program is started differently (refer to section 5.2.2.3 on page 31).

5.2.1.1 Procedure Monitor only

If the antenna is set to the procedure „Monitor only“, the monitor mode is started 10 s after switch on. In this case not files have to be transmitted and section 5.2.1.2 may be ignored.

5.2.1.2 Procedures 3964R/transparent

The command to switch to monitor mode should be entered directly via a PC. To do so, start your terminal program. For the startup, a set of configuration files is necessary (small text files and HyperTerminal configuration files). These files are accessible for download in the latest version from our internet server at <http://www.goetting-agv.com/components/transponderconf>.

If HyperTerminal has been correctly installed, the terminal program can now be started directly by double clicking the respective *.ht file (`Monitor9600.ht` for 9600 Baud and `Monitor19200.ht` for 19200 Baud). If necessary, adapt the COM-port (refer to section 5.1.1).

In order to start the monitor mode, first of all you have to switch the antenna off and on again. After 10 s (resp. 26 s) you can transfer the appropriate *.txt file from the disk with your terminal program. The following four files are on the disk:

1. Mon3964r.txt
Transfer if the system is preset to procedure **3964R** with „**HighByte first**“. The file contains in hexadecimal notation the following characters:
0x02 0x4D 0x4F 0x4E 0x49 0x10 0x03 0x16
2. Mon6439r.txt
Transfer if the system is preset to procedure **3964R** with „**LowByte first**“. The file contains in hexadecimal notation the following characters:
0x02 0x4F 0x4D 0x49 0x4E 0x10 0x03 0x16
3. Montrans.txt
Transfer if the system is preset to procedure **Transparent** with „**HighByte first**“. The file contains in hexadecimal notation the following characters:
0x3D 0x4D 0x4F 0x4E 0x49 0x38
4. Transmon.txt
Transfer if the system is preset to procedure **Transparent** with „**LowByte first**“. The file contains in hexadecimal notation the following characters:
0x3D 0x4F 0x4D 0x49 0x4E 0x38

Transferring a file with HyperTerminal is done as follows:

1. Choose Send Text File from the menu Transfer. The following window will opened up (partly German version):



2. Switch to disk drive (in our example, the files are located on the hard disk) and select the respective *.txt file.
3. Click 'open'. The file will be transferred and (if the correct file has been selected) the monitor program will be started. The menus will then appear directly within the HyperTerminal Window. First, the main menu is displayed (Figure 10).

5.2.2 Operating the monitor program

Any change to the interface parameters will be activated after a system reset (switch the antenna off and on again). Afterwards it may be necessary to use a different file from the four given *.txt documents for the monitor call!

Once the transfer of the *.txt file (refer to section 5.2.1) has been completed, the monitor program will start with the main menu. If this is not the case, you have either based your settings on a wrong system configuration, or you are using a different terminal emulation, or you did not adjust the character delay to 1 ms, or you did not wait at least 10 s after activating the antenna.

5.2.2.1 Main menu

```

S:0568 X:+0000 Code: 00000000 Read: 0
U[/mV]:24000 I[/mA]: 150 T[Grd.C]:+28 E: 0200 N: 0
Ftx[/Hz]:105960 Prog_Code: 00000000

(W)rite Transponder Code
(T)ime & Code
(S)erial Output
C(A)N-Parameters
P(r)ofibus-Parameters

(P)assword
(L)oad Values to EEPROM
(E)rror ?
Cs(v) (38,4 KB Code(5d),Sum(4d),Tr(1),Co(1),+-(1),Po(1),Cnt(1d)<crLf>)
(B)oot Load
Serv(i)ce Menu
(Q)uit Monitor

Software Version 98780A11.00 / 31.OCT.2005 Serial Number: 9999999

```

Figure 10 Main menu of the monitor program

Each of the screen menus contains important system variables in the first three lines (refer also to Table 18), as they also appear in the output telegram (described in section 4.2.4.1.1 on page 16). The last line on the screen contains possible status messages, if e. g. predetermined value ranges have not been observed during input.

Description of the system variables	
S	Measured voltage of the sum coil within the cover of the casing in samples (max. 1023).
X	Measured voltage of the difference coil within the cover of the casing in samples (max. 1023).
Code	The 32 bits of the decoded transponder code.
Read	Number of readings per transponder crossing. This value is preserved until another transponder is detected. It is also deleted through Noise.
U [mV]	Supply voltage of the processor circuit board, measured exactly to 100 mV. Due to various protective measures, it is always slightly lower than the applied supply voltage.
I [mA]	Current consumed by the positioning unit, measured to 10 mA accurately.
T [Grd.C]	Approximate temperature inside the unit, measured in 5° C steps. The sensor is located near a cooling sheet.

Table 18 Description of the system variables (monitor program) (Abschnitt 1 von 2)

Description of the system variables	
E	System status expression in hexadecimal notation. The single bits are explained in Table 7 „Possible system status messages“ on page 18.
N	Number of reading errors per transponder crossing. This value is stored until a new transponder has been detected.
Ftx	Display of the transmission frequency divided by 128. This frequency is permanently monitored and considered for the system status word.
Prog_Code	Code to be programmed into the Transponder.

Table 18 Description of the system variables (monitor program) (Abschnitt 2 von 2)

Other menus are activated by pressing the (characters in brackets). Before altered values are transferred into the permanent memory, the pass word **815** has to be entered by pressing **P**. This prevents unintended alterations of values. With **L** the values are saved after their alteration and input of the password.

System status are explained in plain text upon pressing **E**. Typing **C** deletes the error display. Quit the menu by pressing **Q**.

The following sections describe one by one the menus

- **T**ime & Code (section 5.2.2.2 on page 30)
- **S**erial Output (section 5.2.2.3 on page 31)
- C**A**N Parameters (section 5.2.2.4 on page 33)
- P**R**ofibus-Parameters (section 5.2.2.5 on page 34)
- CS**V** (section 5.2.2.6 on page 35)
- **B**oot Load (section 5.2.2.7 on page 35).
- **Q**uit Monitor. With **Q** the monitor program is left, whenever the serial procedures 3964R or transparent are active. In procedure 'Monitor only' it is impossible to leave the monitor program.

5.2.2.2 (T)ime & Code

This menu enables the setting of timing values for the transponder decoding, the position calculation and the positioning pulse.

```
S:0544 X:+0000 Code: 00000000 Read: 0
U[/mV]:24000 I[/mA]: 150 T[Grd.C]:+28 E: 0200 N: 0
Ftx[/Hz]:105970 Prog_Code: 00000000

(L)evel for Positioning [10.1023]: 256
(T)hreshold Decoding [10.1023]: 256
(1) switch Reference Transponder: 0
(P)osi-Pulse Time [n*1ms]: 100

(Q)uit Menue
```

Figure 11 Menu: (T)ime & Code

With **L** the voltage threshold S for the release of the output of the positioning pulse is set in order to eliminate wrong outputs.

With **T** the voltage threshold S for the start of the code decoding is set in order to prevent decoding tries during a weak signal period.

With **1** it is possible to switch on the reference transponder for testing.

The duration of the positioning pulses can be set in a millisecond pattern by pressing **P**.

5.2.2.3 (S)erial Output

Alterations within this menu need to be made effective by resetting the system (turn the antenna off and then on). Dependent upon the alterations made, it may be necessary to use a different baud rate / text document to call up the monitor (section 5.2.1 on page 26).

```

S:0843   X:+0748   Code: 12345678   Read: 65535
U[/mV]:20200 I[/mA]: 200 T[Grd.C]:+28   E: 0600 N:      2
Ftx[/Hz]:105960   Prog_Code: 00000000

(B)audrate:                               9600
(P)rocedure                                3964R
(O)rder of Data Transfer (0= HiByte first): 0
(T)elegram Content Mask [0..FF]:          ff
(D)isplay Telegram Content
(C)har-Delaytime [1..220ms]:              220
(A)ck-Delaytime (3964R) [1.1680ms]:       1680
Co(n)tinuous Telegrams                    0
(S)erial Data Period [1..1000ms]:         8

(Q)uit Menue

```

Figure 12 Menu: (S)erial Output

Input of **[B]** enables switching between 9600 and 19200 baud.

Select the desired procedure – 3964R or transparent – by pressing **[P]**. For procedure 3964R, in addition, the acknowledgement delay time (**[A]**) is adjustable. If procedure 'Monitor only' is active, only baud rate and procedure can be selected. This is useful whenever the serial output is solely required for parameter setting and the data output is done via CAN or Profibus.

Via **[O]** it is possible to select whether the highest byte is to be output first or last. When connecting this equipment with a Siemens PLC, this parameter has to be 0 (High Byte first).

[T] influences the composition of the output telegram.

Based on the values given in Table 6 „Data words in a telegram of 15 (14) byte length“ on page 17, you can define the desired elements of your telegram **[T]** by hexadecimal addition. The sequence of the parameters cannot be influenced. It will always conform to the sequence in the table!

Example You only want to display the code and the status.
Add up the values 0x02 for the 32 code bits, 0x01 for STX as well as the value 0x80 for status. Enter 0B with **[T]**.

Using „(D)isplay Telegram Content“ it is possible to check the generated telegram (refer to Figure 13 on page 32). In this example the mask has the value 0xff. Press any key to return to the menu Serial Output.

```
S:0547 X:+0000 Code: 00000000 Read: 0
U[/mV]:24200 I[/mA]: 140 T[Grd.C]:+28 E: 0200 N: 0
Ftx[/Hz]:105960 Prog_Code: 00000000

STX      1 Bytes from Position: 1
CODE     4 Bytes from Position: 2
SUM_1    2 Bytes from Position: 6
Vcc      1 Bytes from Position: 8
Current  1 Bytes from Position: 9
Temp.    1 Bytes from Position: 10
CodesRd  2 Bytes from Position: 11
Status   2 Bytes from Position: 13

(Q)uit Menue
```

Figure 13 Output „(D)isplay Telegram Content“

The parameter „(C)har Delaytime“ is the so-called character delay for procedure 3964R (refer to appendix, section F „Procedure 3964R“ on page 52) and the time out period for incoming characters for the transparent procedure (refer to appendix, section G „Procedure „transparent““ on page 54).

(N) either activates the permanent output, according to the `Clock for Sampling` set in `Time&Code` (1; refer to 5.2.2.2 on page 30), or generates the output solely when a transponder is decoded within the reading range of the antenna (0).

With (S) the repetition rate of the serial output is set.

5.2.2.4 C(A)N Parameters

This menu enables setting the various CAN-Bus parameters. Before being able to use the CAN bus, it is necessary to activate this function by pressing **C**.

ATTENTION! In case the CAN bus is not connected, it is essential to deactivate this function, as transmission errors will lead to antenna reset while the CAN bus it activated!



```

SR = 00:          NO ERROR  /    /    /    /

(C)AN active                NO
E(X)tended CAN              STANDARD
(I)dentifier: TX/RX [0..2047]: 10
(A)-Identifier: TX [0..2047]:  0
(D)-Identifier: TX [0..2047]:  0
B(T)-Register [hex 0.7FFF]: 1e01
or
B(R)P Baudrate Prescaler [0..63]: 1
(S)JW Sync Jump Width [0..3]: 0
Tseg(1) [2..15]: 14
Tseg(2) [1..7]: 1
(3) set Values for Baudrate = 50kB
(4) set Values for Baudrate = 125kB
(5) set Values for Baudrate = 250kB
(6) set Values for Baudrate = 500kB
(7) set Values for Baudrate = 1MB
Co(n)tinuous Telegrams      0
CAN on Re(m)ote Request     0
Data (P)eriod [1..1000ms]:  8
(Q)uit Menue

```

Figure 14 Menu: C(A)N-Parameter

Entering **X** enables generation of telegrams either as standard frames according to CAN2.0A or as extended frames according to CAN2.0B. Correspondingly it is possible to either set the **I**dentifier (CAN address) as 11 bit value (0-2047) or as 29 bit value (0-536870911).

The identifier, that is adjustable via **I**, refers to transmitted frames for Message Object 1 (Table 9 on page 20) and to received frames for Message Object 4 for the reference transponder (Table 12 on page 21), respectively. The Identifier adjustable via **A** refers to Message Object 2 (Table 10 on page 21), **D**, accordingly, refers to Message Objects 3 (Table 11 on page 21). Entering 0 deactivates the corresponding Message Object.

T enables alteration of the so-called **Bit Timing Register** for different baud rates and sample points. It is possible to directly fill it with a 4 digit HEX value in the range between 0 to 7fff (according to the Siemens Processor Manual S. 23-10 – Ordering No. B158-H6651-G1-X-7600).

It is possible to alternatively alter each of the registers parameters separately; in addition, without knowledge of the exact meaning of the single timing parameters, one out of five possible baud rates can be selected

N either activates the permanent output, according to the `Clock for Sampling` set in `Time&Code` (1; refer to 5.2.2.2 on page 30), or generates the output solely when a transponder is decoded within the reading range of the antenna (0).

M activates remote operation. In this mode (independent of the settings of `Continuous Telegrams`), telegrams are no longer generated, but only to remote frames answered with the corresponding address.

With **P** the repetition rate of the data output can be selected.

The content of the CAN value status is shown in the upper line of the menu. These values are used for simple diagnosis. They are explained in above mentioned Processor Manual on page 23-7.

5.2.2.5 P(ro)ofibus-Parameters

This menu enables setting the Profibus parameters.

ATTENTION! In case the Profibus is not connected and if the antenna in question is a version HG 98780ZA/WA (in contrast to versions YA/XA), the Profibus must (!) be deactivated. If the Profibus is not deactivated, transmission errors will lead to an antenna reset!



Byte #	Master-Input	Profibus-Status:	NO_ERROR
0	02		
1	00		
2	00		
3	00		
4	00		
5	00		
6	f0		
7	0f		
8	1c	(P)rofibus active	YES
9	00	(A)ddress: [0..125]:	2
10	00	(O)rder of Data Transfer (0= HiByte first):	0
11	02		
12	0b	(Q)uit Menue	

Byte #	Master-Output
0	00
1	00
2	00
3	00
4	00

Figure 15 Menu: P(ro)ofibus-Parameters

On the left hand side of the screen, the bytes transmitted to the master as well as the bytes transmitted by the master are displayed. The description of these bytes is included in Table 13 on page 22.

The header shows the current Profibus status. The following messages are possible:

Profibus Status Messages	
NO_ERROR	Profibus not active / without error
DPS2_INI_ERROR	These messages indicate that the Profibus hardware is either not equipped or faulty
SPC_HW_ERROR	
USER_IO_DATA_LEN	
BUF_LEN_ERROR	Inadmissible buffer lengths were specified in the master. Use the GSD file that is included in the appendix, section H on page 54, or download this file from our website
PB_OFFLINE	No contact to the master

Table 19 Possible Profibus Status Messages

P activates and deactivates the Profibus. It will then be initialized with the slave address given under **A**.

O selects whether the respective highest byte will be output first or last (refer to Table 13 on page 22).

Q exits this menu and returns to the main menu. In case parameters were changed, it is necessary to save them at this point.

5.2.2.6 CS(V)

For means of diagnosis generating output of several values in **CSV Format** (Comma Separated Values; a text file especially formatted to be read by spreadsheet analysis programs) is possible. This output is continuous at 38.400 baud, 8 bit and even parity, until it is interrupted by hitting any key. This keystroke generates a reset of the antenna to the basic settings (not monitor mode) including the stored parameters.

Storing the CSV output is, e.g., possible using the program HyperTerminal® (also refer to section 5.1 on page 25). Use the function `Text aufzeichnen . . .` of menu `Übertragung` and insert an appropriate file name (should bear the file ending `.csv` in order to ensure that the spreadsheet calculation program will automatically recognize this file). Once the file is recorded, stored and closed under HyperTerminal®, it may be uploaded into a spreadsheet calculation program (e. g. Microsoft® Excel®, Sun® StarCalc®, ...).

When opening the file various options will be prompted by the spreadsheet calculation program. Make sure to state that the file consists of Comma Separated Values. Then it is possible to process the data for the generation of diagrams or save it as native spreadsheet calculation file.

5.2.2.7 (B)oot Load

The `Boot Load` offers the option of updating the software without interruption of the power supply. However, first the update program must be installed as described in section 5.3 on page 36.

Then hit the  key within the main menu and a display with the following commands will appear:

1. `Open HEX- Flasher` (Open the flash program)
2. `select the COM-Port` which is currently used for the connection between the PC and the antenna
3. `prepare file input` (Select the HEX file that is to be programmed)
4. `then press any key` (Return to Hyperterm and hit any key)
5. `close within 20 sec COM port and start HEX Flasher` (Close the COM port in Hyperterm within 20 sec. via the icon , return to the HEX-Flasher and start programming.

Once the programming process is finished, return to Hyperterm, wait for 10 sec. and re-connect to the COM Port (e. g. via icon ). Following this procedure, re-start the monitor mode (also refer to 5.2.1 on page 26).

5.3 Software Update (Antenna Software)

It is possible to update the software of the integrated interpreters via the serial interface using a portable PC. Following switching-on, the integrated download unit will check for approx. 10 seconds whether a download is to be carried out. In case a download is not generated, the unit will return to the normal operating program.

Data received during this period of 10 seconds are examined for their validity.

NOTE! Only the update program described below may be used for the software update!



5.3.1 Installation of the Program for Software Update

The program for the antenna software update is a 32-bit application for Microsoft® Windows®. Upon request, this program is available either on disc (described in the following paragraphs) or sent by e-mail. Please address your requests to the e-mail, phone, fax or mailing address given on the cover of this manual.

It is not necessary to install this program. It is sufficient to copy it onto the hard disc of your PC and execute it there. Follow these steps:

1. Insert the CD into the CD drive of the PC
2. Open Windows Explorer and navigate to the CD
3. Copy the directory ST-Flash including all sub-directories and files onto your hard disk, e.g. into the director 'programs'
4. When using Windows-Versions prior to Windows XP, it is now necessary to deactivate the writing protection for the two setting files. To do so, navigate to the newly created directory Programs\ST-Flash and mark the files `ST10-Flas-`

her.ini and Command.log. Open the function features ('Eigenschaften') within the file menu of the Explorer and deactivate the parameter Writing Protected.

5. In order to start the program now, carry out the file ST10-Flasher.exe.

5.3.2 Software Update

While the software update is carried out, no other programs may occupy the used serial interface (COM-Port). Thus, terminate any such connections in your Terminal program (e. g. Hyperterm).

Connect the antenna with your PC. For antenna variants with RS422 interface (HG 98780ZA/XA) it is essential to use an appropriate interface converter (not included in the antenna scope of supply; refer to the note on the top of page 25). Start the update program on your PC as described in section 5.3.1 on page 36.

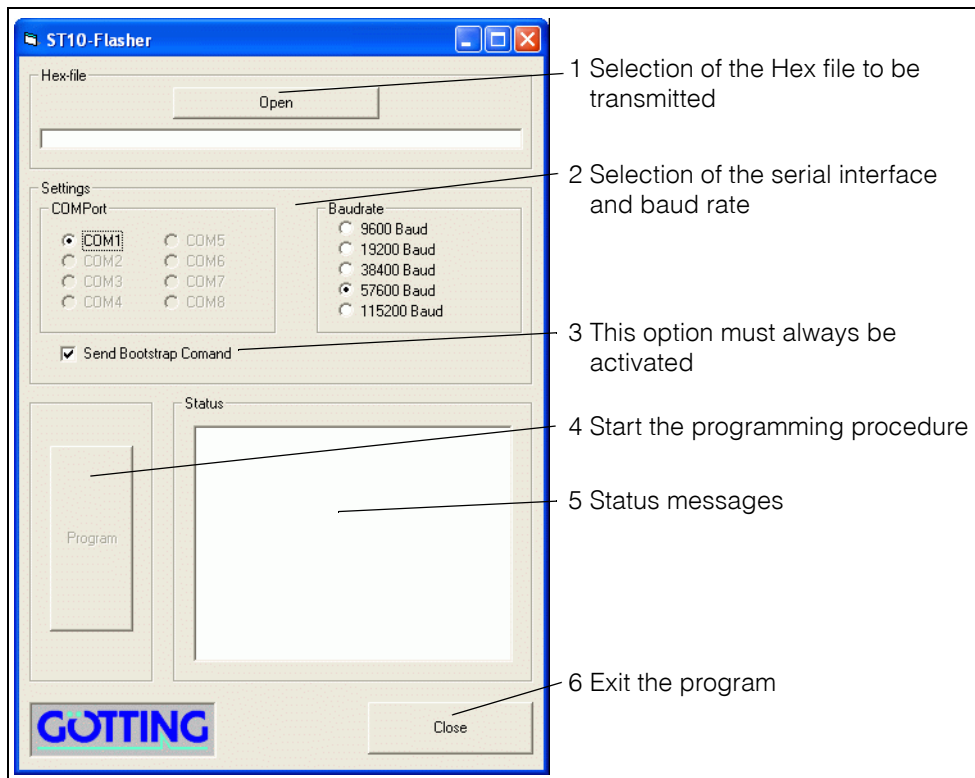
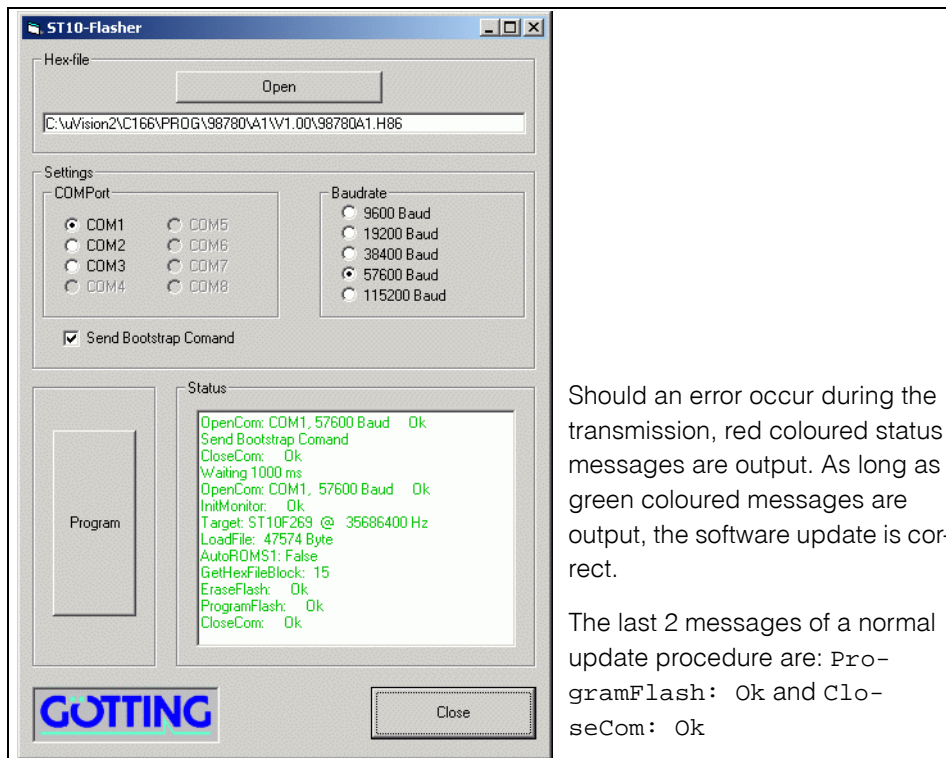

Figure 16 Update program: Operating Elements

Start the programming process by switching on the antenna and then click `Program` within a period of 10 seconds afterwards. A device reset follows and after a short period of time, the file is being transmitted.



Should an error occur during the transmission, red coloured status messages are output. As long as green coloured messages are output, the software update is correct.

The last 2 messages of a normal update procedure are: `ProgramFlash: Ok` and `CloseCom: Ok`

Figure 17 Update program: programming procedure

Once the programming process is completed, the program can be closed (`close`). From now on, the interpreter uses the new program.

6 Maintenance

The system is largely maintenance free. Any maintenance is limited to

- visual examination of the antennas (ensuring all screws, cables and plugs are correctly fastened)
- cleaning the ventilation openings if necessary.

Document regularly the power consumption and power supply of each antenna. These values can be obtained from any menu in the monitor program.

If necessary, update of the system software as described above (section 5.3 on page 36). Date and version of the current antenna software can be obtained from the main menu.

7 Troubleshooting

The following table contains a list of errors that might occur. For each error, a symptom description is given. In the third column you will find a description of how to locate and possibly correct the error.

If you should not be able to correct an occurring error, please use the table to locate the source of the error as exactly as possible (nature of malfunction, at which point in time did the error occur, etc.) before consulting us.

Error	Possible cause	Diagnosis/ Correction
No system function Even though a transponder is located within reception range, there is not serial output	- Power supply is not sufficient	Measure the voltage at the respectively labelled clamps in the clamping case.
No contact is possible, only unintelligible characters are sent.	<ol style="list-style-type: none"> 1. RS 422 T+(R+) exchanged with RS 422 T- (R-) by mistake 2. Signal ground not connected, a too high potential difference between antenna and receiver. 3. Incorrect setting of transfer parameters. 4. Incorrect transfer procedure selected. 	<ol style="list-style-type: none"> 1. Check the connections 2. Connect signal ground 3. Select only 9600 or 19200 baud, 8 bit, even parity. 4. Select the correct procedure, etc. with the PC and the system monitor.
Inaccurate values at low temperature.	<ol style="list-style-type: none"> 1. System needs a certain warm-up time in order to operate at sufficient accuracy in low ambient temperature. 2. Insufficient heating performance, loose cable connections 	Wait until the system has warmed up (ca. 60 minutes at -20° C). Measure the voltage 24 V at the corresponding clamps (+ 24 V heating).
No positioning pulse.	<ol style="list-style-type: none"> 1. Transponder defective 2. Loose cable connections 3. Wrong reading distance 4. Transponders are located outside the reading area of the antenna during the antenna crossing 5. Antenna defective 	Check the transponder (e. g. with the hand-held reader) and its location

Table 20 Troubleshooting

8 Technical Data

8.1 Antenna

Antenna HG 98780-A	
Casing	Refer to Figure 6 on page 13
Effective antenna area	refer to appendix, Section A on page 45
Power supply	24 V \pm 10 %, approx. 600 mA, approx. 2 A heating
Protection	- Power supply (pin 1) 1 A slow-reacting - Heating (pin 3) 3 A slow-reacting
Operating temperature	-25 to +50° C Warm-up time: Approx. 60 minutes at -20 °C surrounding temp. (provided heater is in operation) Automatic heater switch-on as soon as the temperatures are below 5 °C
Mechanical stability	5 g 11 ms / 2 g 10 to 55 Hz
Weight	Approx. 6 kg
Installation regulations	refer to Figure 3 on page 9
Protection	IP 67
Connectors - HG 98780ZA - HG 98780YA	- 12-pin M3 screw-in plug - 3 12-pin M23 built-in sockets
With Transponder HG 70661	
Reading distance (distance transponder – underside reading antenna)	In direction of travel a max. of \pm 40 mm crosswise to the center of the antenna: 50 to 90 mm
Nominal reading distance	75 mm
Nominal writing distance	75 mm
Position accuracy	refer to Section B on page 48
Max. pass-over speed	8 m/s
Output serial (RS422 resp. RS232)	The output requires 9.6 or 19.2 kbaud. The telegram content is configurable. 3964R or „transparent“ procedures are available.

Table 21 Technical Data Antenna HG 98780-A (Part 1 of 2)

Antenna HG 98780-A	
Output CAN (HG 98780ZA/WA)	According to ISO/DIS 11898 identifier, Data rate, Basic/Extended CAN; configurable via ser. interf.
Profibus (HG 98780YA/XA)	According to DIN 19245 / EN 50170 Autom. baud rate detection, supported baud rates: 9,6 kBd, 19,2 kBd, 93,75 kBd, 187,5 kBd, 500 kBd, 1,5 MBd, 3 MBd, 6 MBd, 12 MBd LED for Profibus status 'data exchange'
Output positioning pulse	20 mA current source, potentially separated

Table 21 Technical Data Antenna HG 98780-A (Part 2 of 2)

Electromagnetic Compatibility (EMC) of Antenna HG 98780-A		
Checking of		Preliminary Test Standards
Interference transmission		
	Radiated interference	EN 55 022 Class A
Interference immunity		
	Casing	
	Electromagnetical HF-field, amplitude-modulated	EN 61000-4-3
	Static electric discharge	EN 61000-4-2
Signal connections		
	High frequency asymmetrical	EN 61000-4-6 ^a
	Quick transients	EN 61000-4-4
DC connections		
	High frequency asymmetrical	EN 61000-4-6 ^a
	Impulse voltages	EN 61000-4-5

Table 22 EMC-Testing

a. Possible application for cable diameter 12 mm (e. g. Würth STARTEC 74271222)

NOTE!

In a surroundings with strong interferences a shielded connecting cable should be applied!



8.2 Parallel converter

Parallel converter HG 06150ZA/XA (optional)	
Casing	28-pin mounting bar 75 x 75 x 47,5 mm L x W x H
Supply	24 V \pm 10 %, approx. 50 mA
Operating temperature	0 to +50° C
Mechanical stability	5 g 11 ms / 2g 10 to 55 Hz
Protection	IP 55
Connector	screw terminal
Data input	RS 422 (ZA), RS232 (XA)
Data output	16+2, 24 V, 20 mA, not potentially separated

Table 23 Technical Data Parallel converter HG 06150ZA/XA (optional)

9 Appendix

A Effective Antenna Area

The following 4 diagrams show the intensity of the reception voltage over the area of the antenna reading side for different reading distances. The scaling of this voltage corresponds to the sum voltage S output by the antenna (refer to Table 18 on page 28). As long as this voltage is > 200, transponder codes are correctly received.

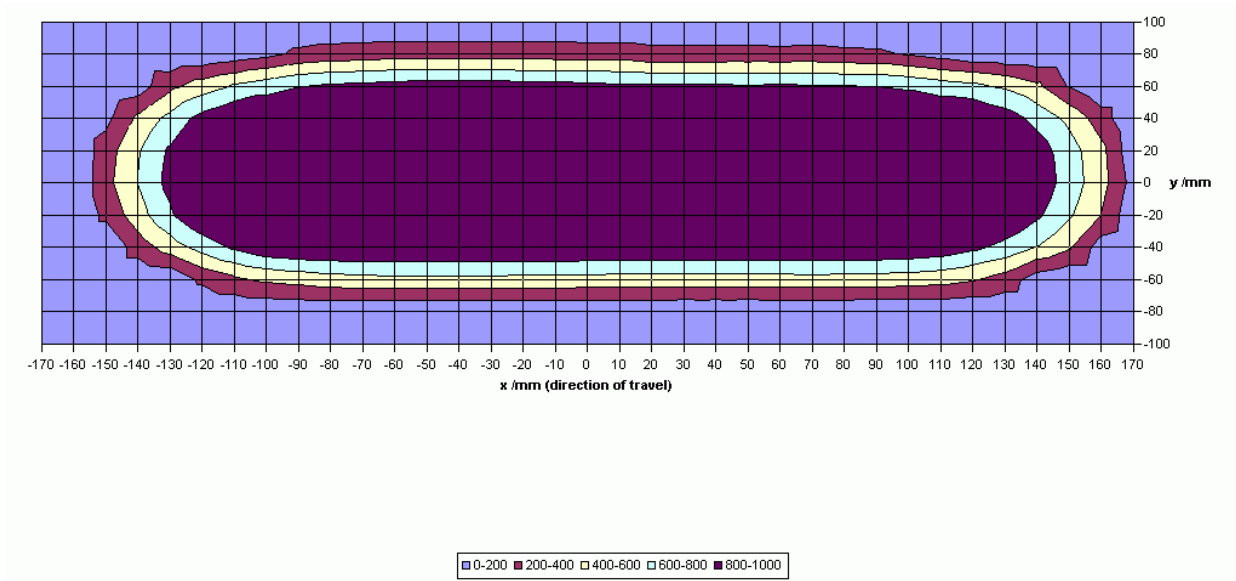

Figure 18 Diagram 1, Reception voltage S within the antenna area at a reading distance of 40 mm

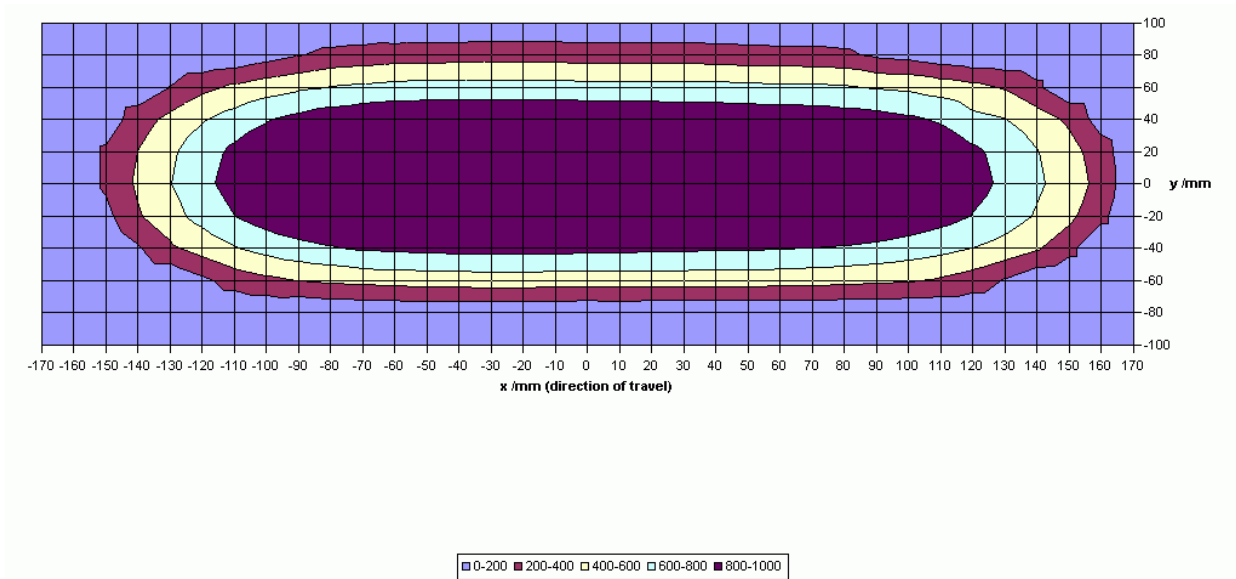

Figure 19 Diagram 2, Reception voltage S within the antenna area at reading distance 60 mm

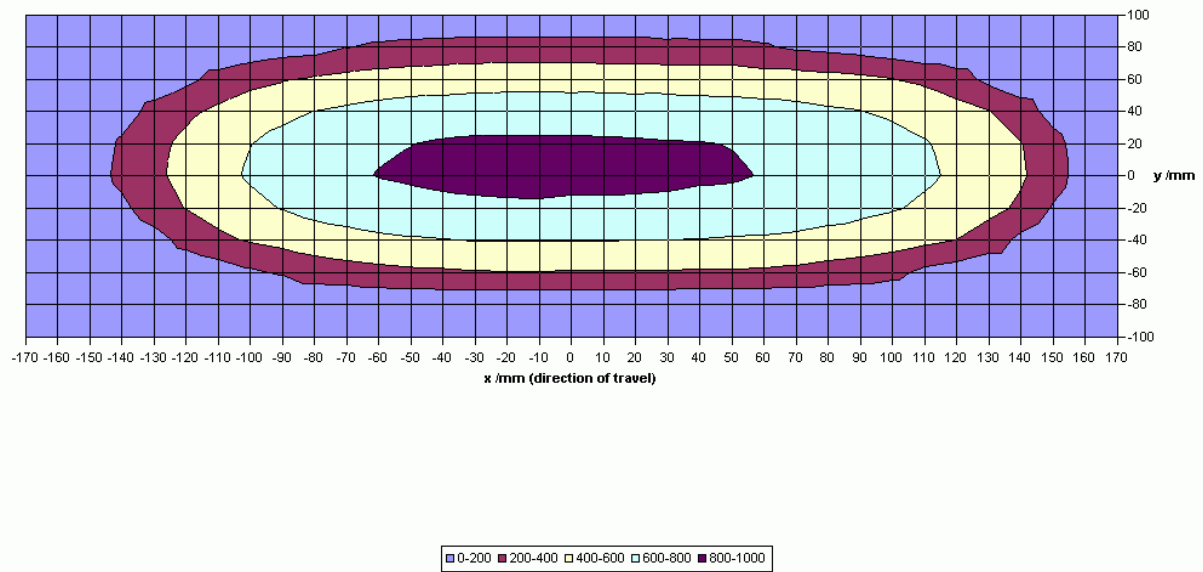

Figure 20 Diagram 3, Reception voltage S within the antenna area at reading distance 80 mm

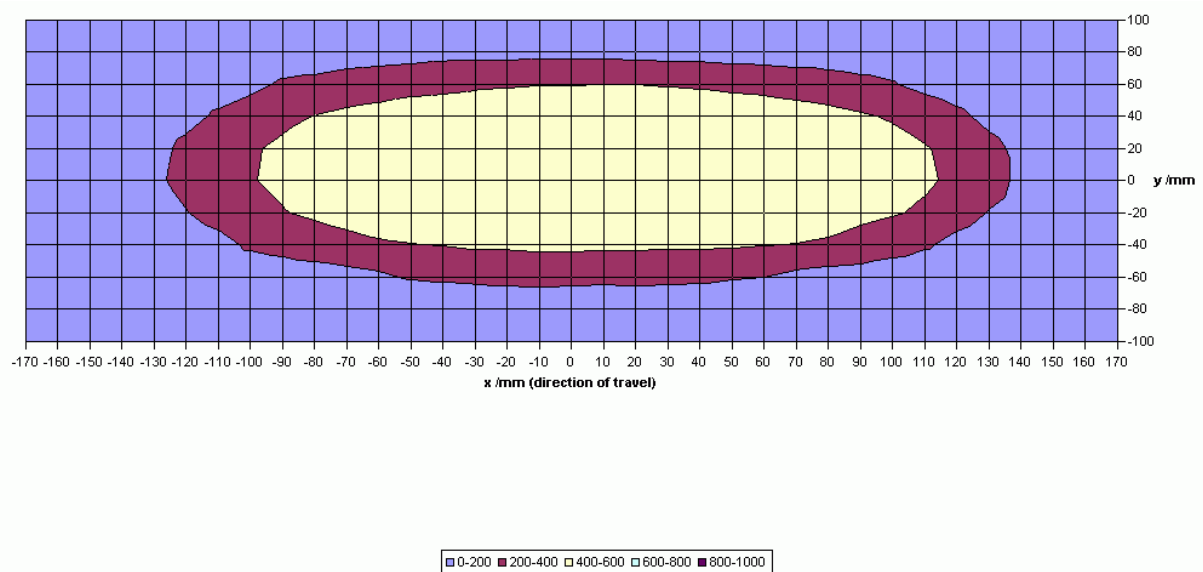

Figure 21 Diagram 4, Reception voltage S within the antenna area at reading distance 100 mm

The following two diagrams show the intensity of the positioning coil voltage within the antenna area for different reading distances. The voltage scaling corresponds the antenna voltage X (refer to Table 18 on page 28).

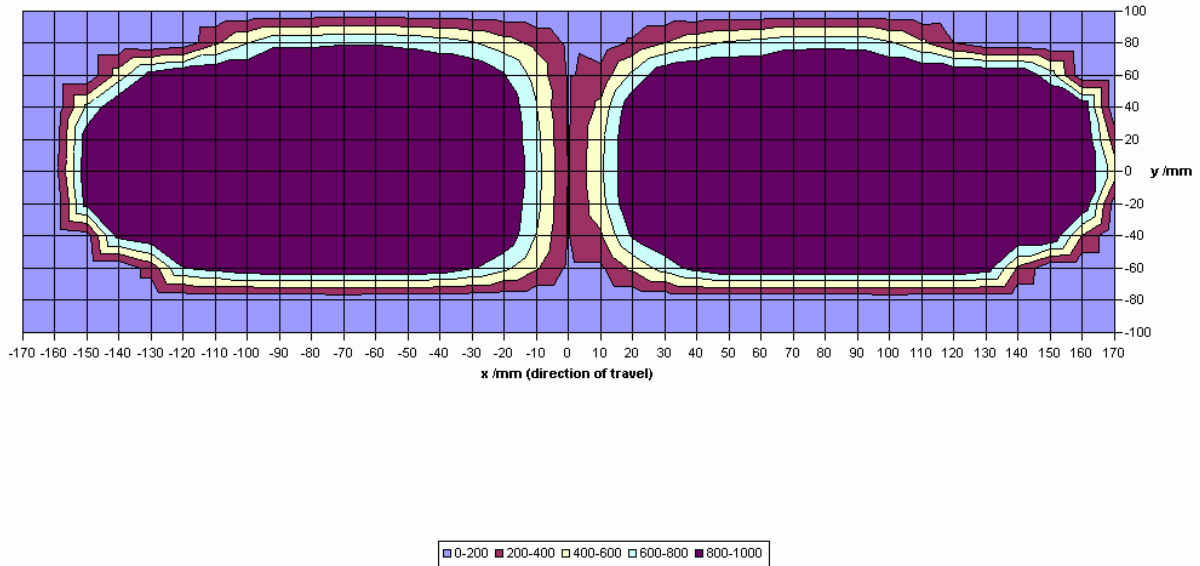

Figure 22 Diagram 5, Reception voltage X within the antenna area at reading distance 40 mm

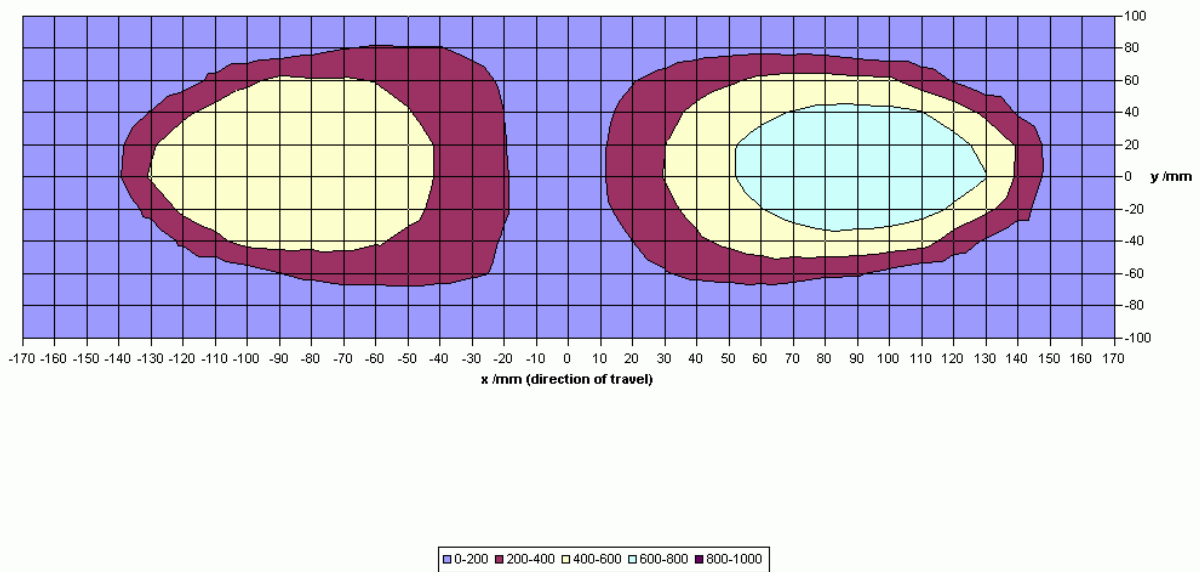

Figure 23 Diagram 6, Reception voltage X within the antenna area at reading distance 100 mm

B Positioning Accuracy

The following diagrams show the location of the generation of the Posipuls within the antenna area at different reading distances and approach from left and right.

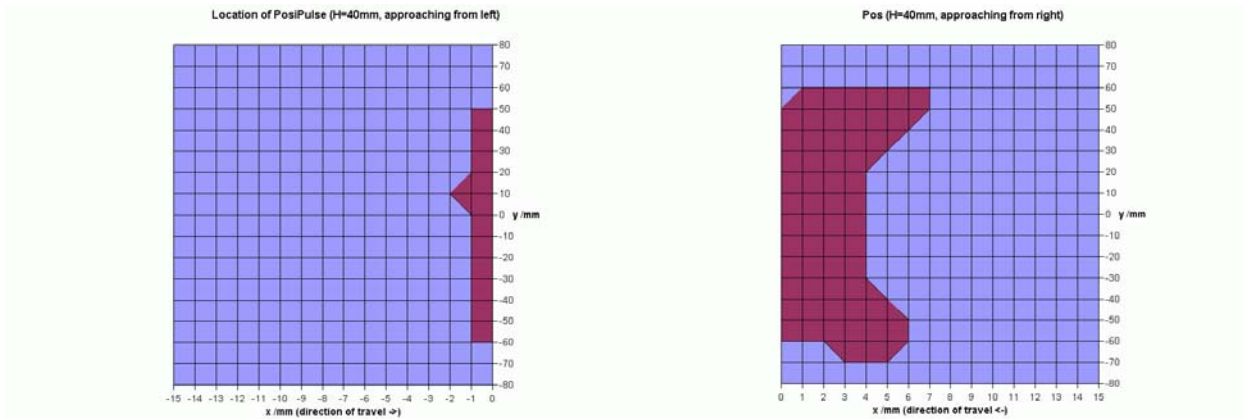

Figure 24 Diagram 1, Location of the generation of the Posipulse at reading distance 40 mm

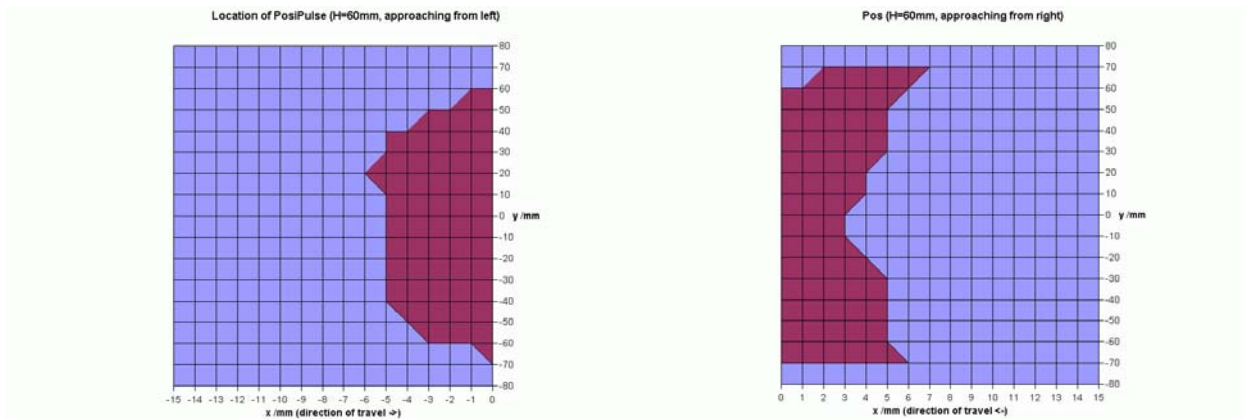

Figure 25 Diagram 2, Location of the generation of the Posipulse at reading distance 60 mm

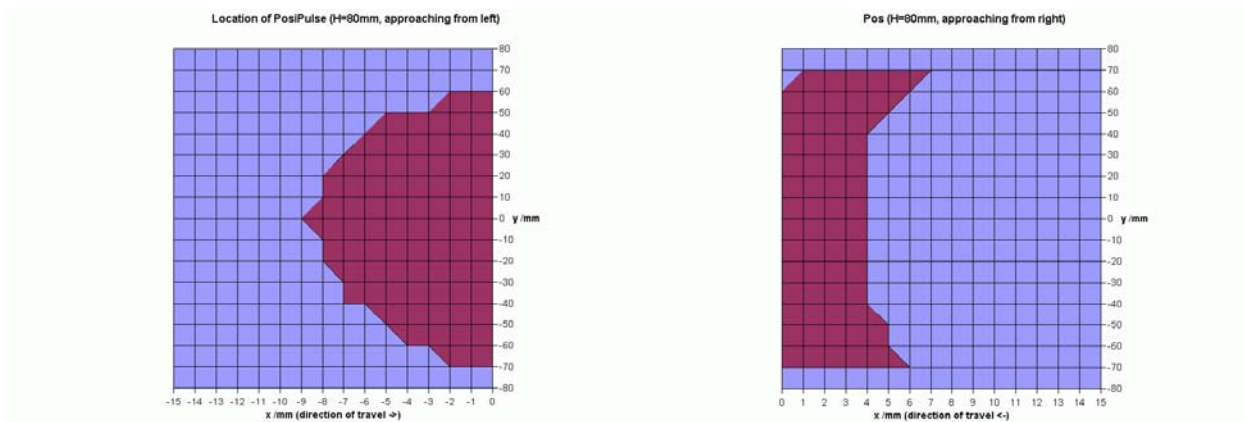

Figure 26 Diagram 3, Location of the generation of the Posipulse at reading distance 80 mm

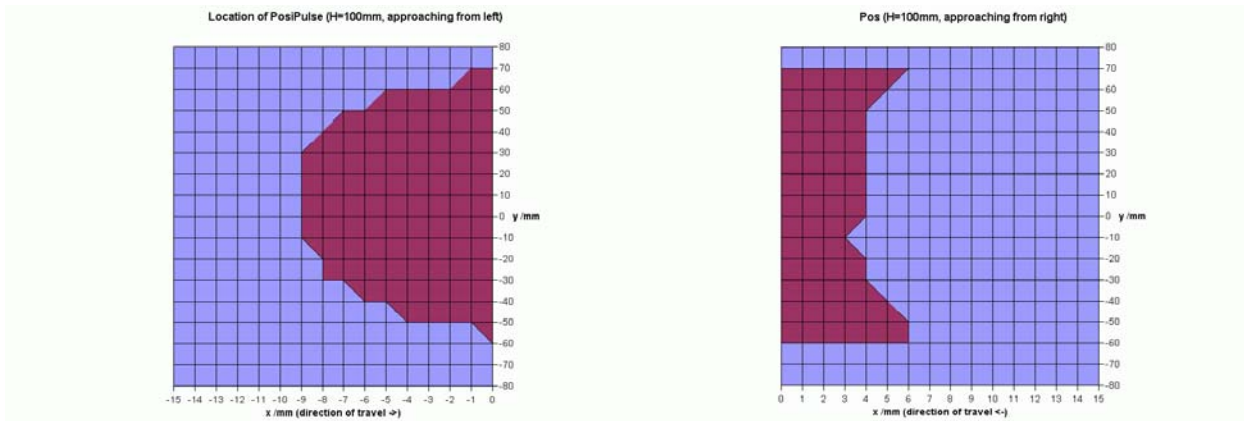

Figure 27 Diagram 4, Location of the generation of the Posipulse at reading distance 100 mm

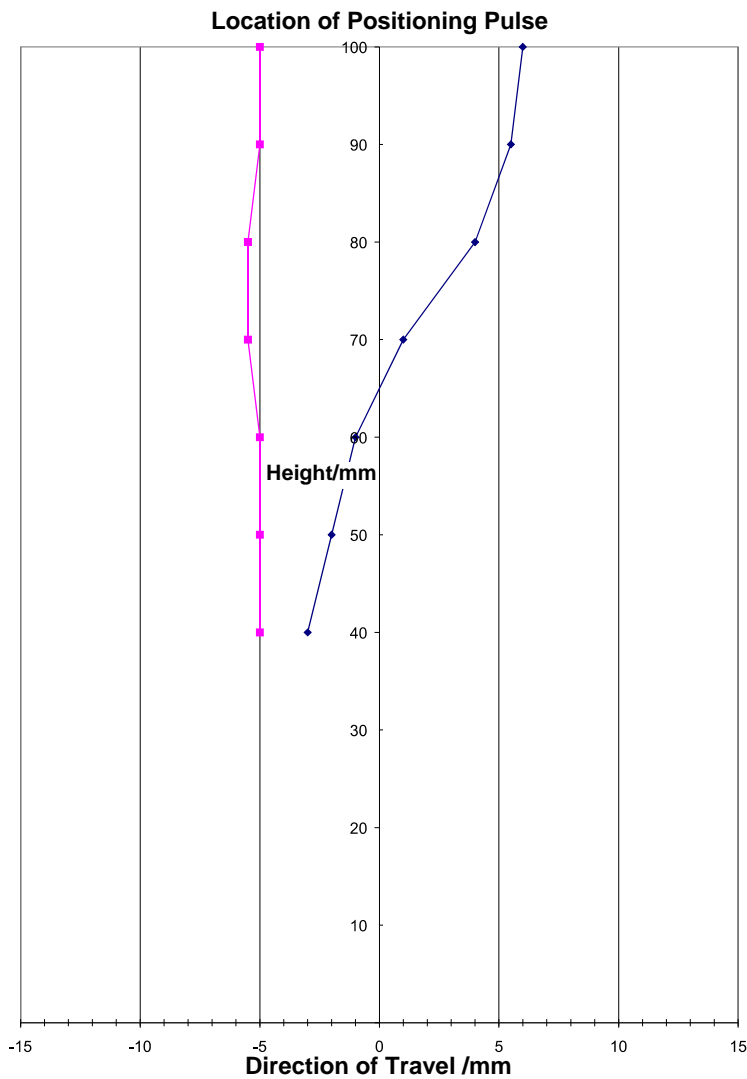

Figure 28 Diagram 5, Location of the generation of the Posipulse on the center axis at different reading distances

C Attenuation of the Reception Level caused by Metal

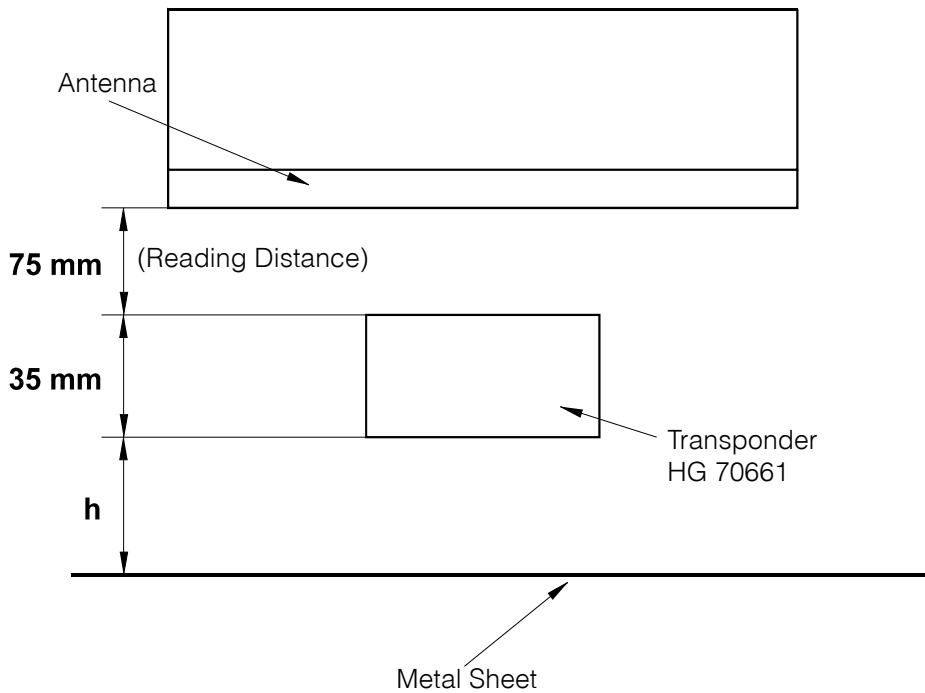

Figure 29 Attenuation of the reception level caused by metal

Height h [cm]	Signal [%]
0	34
1	56
2	70
3	78
4	83
5	88
6	94
7	93
8	96
9	97
10	99
↓	↓
∞	100

Table 24 Dependency of the signal strength on the distance between transponder and metal

D Influence of Water

Reading height was 80 mm [\cong 3.15 in] in all cases. The signal strength level at this distance in air represents 100 % in the following measurements. A road-salt/water mixture was used for replacing natural salt water. The water/salt mixture was saturated, meaning that salt was added to the water until the water was not able to dissolve additional salt.

Medium	Heights of Coverage above Transponder	Signal strength level
Air	80 mm [\cong 3.15 in]	100 %
Ice block	80 mm [\cong 3.15 in]	100 %
Shaved ice, simulating snow	80 mm [\cong 3.15 in]	100 %
Tap-water	80 mm [\cong 3.15 in]	80 %
Saturated salt/water mixture, using salt used for ice melting on roadways	about 5 mm [\cong 0.2 in]	70 %
	50 mm [\cong 1.97 in]	60 %
	80 mm [\cong 3.15 in]	30 %

Table 25 Dependency of the signal strength on different mediums between Transponder and antenna

Results

The antenna performed correctly in all tests under laboratory conditions. Ice and shaved ice („snow“) do not diminish signal strength. Water standing 80 mm above the transponder minimizes antenna reception by 20 %, but is normally not critical.

When submerged in saturated salt/water mixture the signal strength was reduced, but the reception of the transponder ID was still correct.

Tip! Install the transponder slightly elevated, so that it will not be completely submerged under salt-saturated water.



E Mounting next to Massive Metal Structures

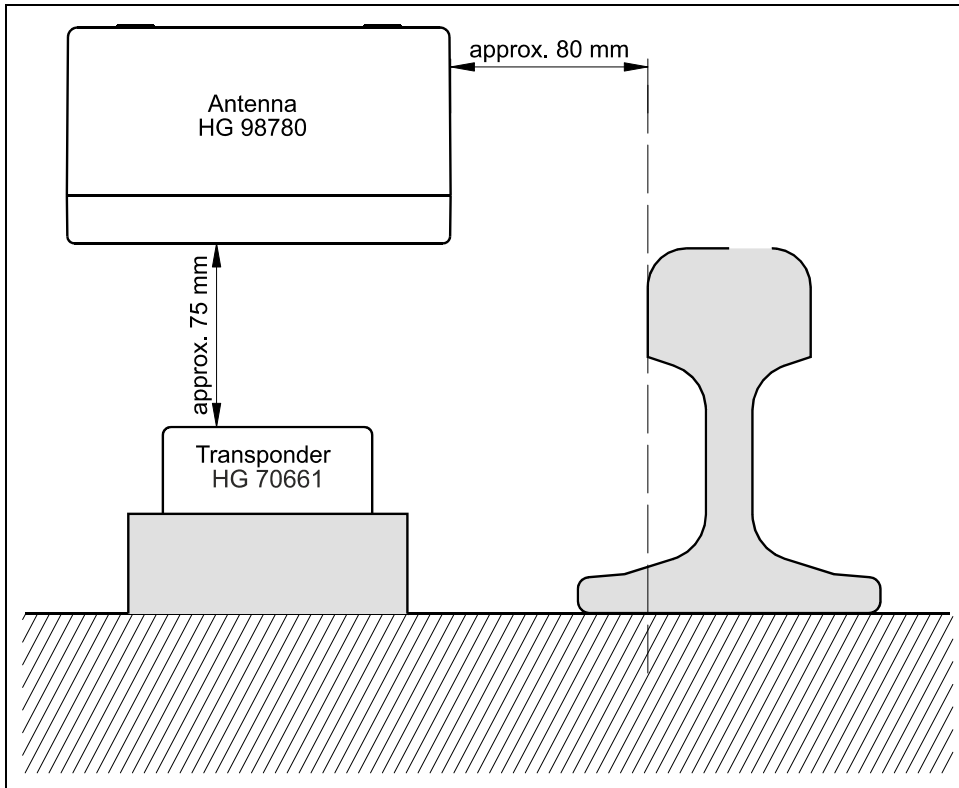

Figure 30 Recommended distances to massive metal structures

F Procedure 3964R

For the computer interconnection between antenna <-> PLC a 3964R-Protocol may be used. As the antenna outputs data cyclically, this results in some simplifications for the implementation of the 3964R. The following diagrams describe the procedure.

The following settings need to be observed:

- Transponder system has lower priority
- Data transfer is set to 1 start bit, 8 data bit, even parity, 1 stop bit, baud rate 9600 baud (default) or 19200 baud.

F.1 Data direction antenna -> PLC

In this direction the antenna data is transmitted cyclically. A set of data always starts with an "="-character (hex 0x3d). The cycle time is parameterizeable and should be an integer part, or a multiple thereof, of the transponder code's transmission time. For this system, the duration for the transponder code transmission is 8 ms. The minimum cycle duration depends upon the telegram length, therefore on the baud rate and the selected telegram content.

In the following status diagram

T_ZVZ stands for the programmable character delay and

T_{QVZ} for the programmable acknowledgement delay.

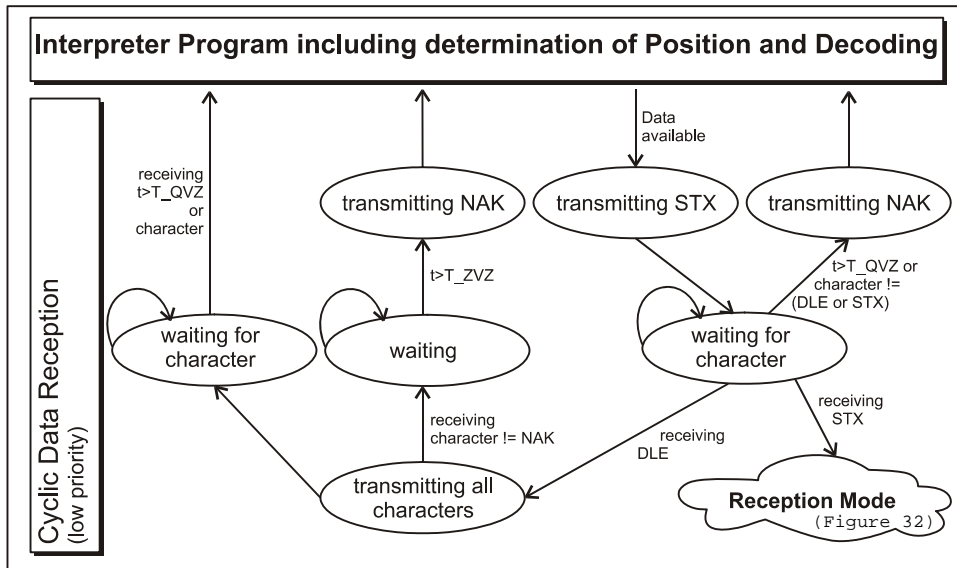

Figure 31 Status diagram procedure 3964R; Antenna -> PLC

F.2 Data direction PLC -> Antenna

In this direction, commands are transmitted only when required (e. g. when the reference transponder is activated). To overcome the frequent cyclical data output of the antenna, the 3964R of the antenna has a lower priority (see Figure 31).

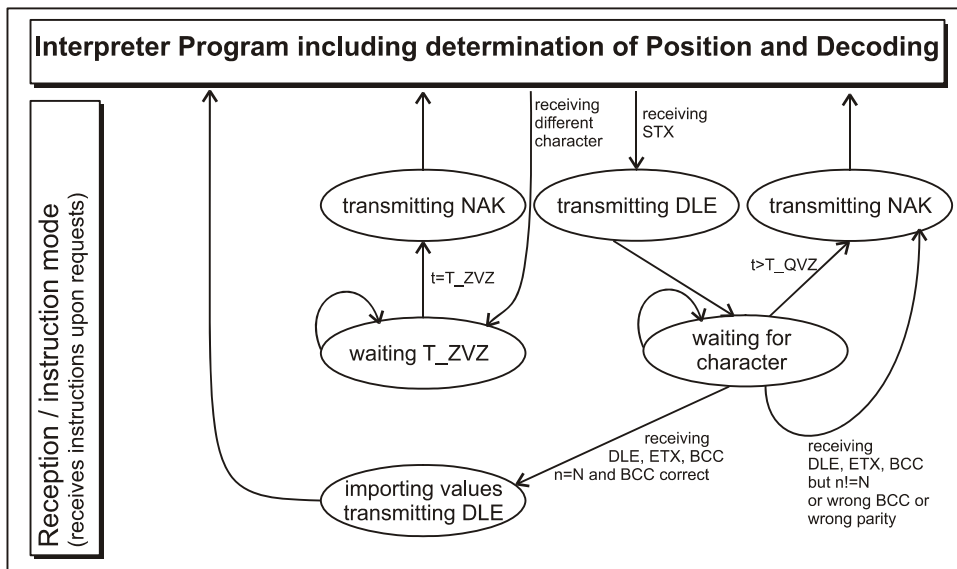

Figure 32 Status diagram procedure 3964R; PLC -> Antenna

G Procedure „transparent“

For the interconnection antenna <-> PLC a transparent protocol may be used. The following settings are necessary for the data transmission:

- 1 start bit, 8 data bit, even parity, 1 stop bit, baud rate 9600 Baud (default) or 19200 Baud.

G.1 Data direction antenna -> PLC

In this direction, antenna data is transmitted cyclically. The duration is parameterizable, it should take an integer part, or multiple thereof, of the transponder code transmission time. The minimum cycle duration depends upon the telegram length, therefore on the baud rate and the selected telegram content.

A set of data always starts with an “=“-character (hex 0x3d), followed by the accordingly selected parameters from the menu. The telegram is terminated with an 8 bit check character (incl. start character). This check character is the result of ex-oring all characters. The characters are transmitted without delay.

G.2 Data direction PLC -> antenna

Commands are transmitted in this direction upon request. Each command has to start with an “=“-character (hex 0x3d). The format of the commands is described in Table 8 „List of System Commands“ on page 19. The telegram is terminated with an 8 bit check character over all characters (incl. start character). The characters are transmitted without delay. The characters have to be received within the parameterizable character delay time. Otherwise the telegram will be chopped.

H GSD File (Antenna HG 98780XA/YA with Profibus)

The latest version of the GDS files can always be downloaded from our website at <http://www.goetting-agv.com/components/98780>.

10 Handbook Conventions

At the time this manual was printed, the following symbols and marks were used in all Götting KG documentations:

- ♦ For security advice, the following symbols stand for different degrees of danger and importance:

NOTE!



ATTENTION!



WARNING!



- ♦ Further information or advice are indicated as follows:

TIP!



- ♦ Program texts and variables are indicated through the use of the *Script Courier*.
- ♦ Whenever the pressing of letter keys is required for program entries, the required **L**etter **K**ey is indicated as such (for any programs of Götting KG small and capital letters are equally valid).
- ♦ Sections, drawings and tables are subsequential numbers throughout the complete document. In addition, each documents includes a list of contents showing the page numbers following the front. If a document exceeds 10 pages, it also has a drawings list and a list of tables on the last few pages. If required, in case a document is correspondingly long and complex, a index is added in the back.
- ♦ Each document shows a small table including meta information, such as developer, author, revision and date of issue, on the front page. The information regarding revision and date of issue are also included in the bottom line on each page of the document. This way it is possible to clear identify the source document for each bit of information.
- ♦ Online version (PDF) and printed handbook are always generated from the same source. Due to the consequent use of Adobe FrameMaker for these documentations, it is possible to use the cross hints and content entries (including page numbers of the index) of the PDF file for automatic transfer to the corresponding content.



11 List of Figures

Figure 1	Components.....	5
Figure 2	Minimum iron-free area around Puck Transponder HG 70661.....	8
Figure 3	Mounting the antenna	9
Figure 4	Outline of the interface mounting bar case.....	10
Figure 5	Positioning antenna HG 98780ZA/WA	12
Figure 6	Outline antenna HG 98780ZA/WA (with casing dimensions)	13
Figure 7	Outline of antenna HG 98780YA/XA (including housing dimensions and picture of the line termination resistance).....	14
Figure 8	Formula: minimum update rate	16
Figure 9	Converter HG 06150XA for mounting bar installation.....	24
Figure 10	Main menu of the monitor program.....	28
Figure 11	Menu: (T)ime & Code	30
Figure 12	Menu: (S)erial Output	31
Figure 13	Output „(D)isplay Telegram Content“	32
Figure 14	Menu: C(A)N-Parameter.....	33
Figure 15	Menu: P(r)ofibus-Parameters	34
Figure 16	Update program: Operating Elements	38
Figure 17	Update program: programing procedure.....	39
Figure 18	Diagram 1, Reception voltage S within the antenna area at a reading distance of 40 mm.....	45
Figure 19	Diagram 2, Reception voltage S within the antenna area at reading distance 60 mm.....	45
Figure 20	Diagram 3, Reception voltage S within the antenna area at reading distance 80 mm.....	46
Figure 21	Diagram 4, Reception voltage S within the antenna area at reading distance 100 mm.....	46
Figure 22	Diagram 5, Reception voltage X within the antenna area at reading distance 40 mm.....	47
Figure 23	Diagram 6, Reception voltage X within the antenna area at reading distance 100 mm.....	47
Figure 24	Diagram 1, Location of the generation of the Posipulse at reading distance 40 mm.....	48
Figure 25	Diagram 2, Location of the generation of the Posipulse at reading distance 60 mm.....	48
Figure 26	Diagram 3, Location of the generation of the Posipulse at reading distance 80 mm.....	48
Figure 27	Diagram 4, Location of the generation of the Posipulse at reading distance 100 mm.....	49
Figure 28	Diagram 5, Location of the generation of the Posipulse on the center	

	axis at different reading distances.....	49
Figure 29	Attenuation of the reception level caused by metal.....	50
Figure 30	Recommended distances to massive metal structures.....	52
Figure 31	Status diagram procedure 3964R; Antenna -> PLC	53
Figure 32	Status diagram procedure 3964R; PLC -> Antenna	53

12 List of Tables

Table 1	Overview of G 98780 variants	6
Table 2	Interface connection plan	10
Table 3	Connection plan of the 12-pin antenna socket (CAN bus)	13
Table 4	Pin allocation of the 12 pin Profibus connectors (in duplicate)	15
Table 5	Pin allocation of the 12 pin connector for the antenna power supply (Profibus version)	15
Table 6	Data words in a telegram of 15 (14) byte length	17
Table 7	Possible system status messages	18
Table 8	List of System Commands	19
Table 9	Structure of the CAN Message Object 1	20
Table 10	Structure of the CAN Message Object 2	21
Table 11	Structure of the CAN Message Object 3	21
Table 12	Structure of the CAN Message Object 4	21
Table 13	Profibus Input Bytes	22
Table 14	Profibus Output Bytes	23
Table 15	Significance of the instruction bit	23
Table 16	Output format when using the serial/parallel interface	24
Table 17	Terminal settings monitor program	25
Table 18	Description of the system variables (monitor program)	28
Table 19	Possible Profibus Status Messages	35
Table 20	Troubleshooting	41
Table 21	Technical Data Antenna HG 98780-A	42
Table 22	EMC-Testing	43
Table 23	Technical Data Parallel converter HG 06150ZA/XA (optional)	44
Table 24	Dependency of the signal strength on the distance between transponder and metal	50
Table 25	Dependency of the signal strength on different mediums between Transponder and antenna	51

13 Index**Numerics**

3964R 52

A

Antenna

Casing dimensions 13

Interfaces 16

Mounting 9

Socket connection plan 13

Technical Data 42

C

CAN 20

Company names 60

Components 5

Copyright 60

D

Data telegram 17

E

EMC 43

Exclusion of Liability 60

F

Functional description 6

H

HG

06150 5, 10, 24, 44

706660 5

98760 9, 14

98780 5, 12, 42

S_I13933 5

I

Installation 11

Interface 24

Mounting 10

Technical data 44

interfaces

CAN 20

positioning pulse 20

Profibus 22

L

LED 14

line termination resistance 14

M

Maintenance 40

Monitor program 26

Parameter presettings 25

Working with 27

O

output format 5

P

Positioning antenna 12

Positioning Pulse 20

Procedure „transparent“ 54

Procedure 3964R 52

Profibus 22

S

Software 25

Software update 36

Softwareupdate 36

Status messages 18

System monitor 26

T

Technical Data 42

Telegram 16

Terminal program 25

trade marks 60

transparent 54

Trouble shooting 41

U

Update rate 16

14 Copyright and Terms of Liability

14.1 Copyright

This manual is protected by copyright. All rights reserved. Violations are subject to penal legislation of the Copyright.

14.2 Exclusion of Liability

Any information given is to be understood as system description only, but is not to be taken as guaranteed features. Any values are reference values. The product characteristics are only valid if the systems are used according to the description.

This instruction manual has been drawn up to the best of our knowledge. Installation, setup and operation of the device will be on the customer's own risk. Liability for consequential defects is excluded. We reserve the right for changes encouraging technical improvements. We also reserve the right to change the contents of this manual without having to give notice to any third party.

14.3 Trade Marks and Company Names

Unless stated otherwise, the herein mentioned logos and product names are legally protected trade marks of Götting KG. All third party product or company names may be trade marks or registered trade marks of the corresponding companies.