

GF Signet pH and ORP Monitoring and Control

Product Brochure



pH/ORP

Introduction/Theory/Measurement

pH and Oxidation-Reduction Potential (ORP) are two of the most fundamental parameters that often must be controlled in order to maintain good water quality. Controlling pH helps ensure product quality, reduces corrosion and scaling in power plant equipment, and protects the environment by helping wastewater generators meet regulatory limits. In water treatment, ORP measurement helps monitor and control oxidation-reduction reactions and maintain proper levels of disinfection.

pH

pH is a quantitative measurement of the acidity or basicity of a substance. Solutions that are acidic have excess hydrogen ions (H^+) and can be corrosive, have a sour taste and react with bases to form water and salt. Basic solutions are characterized by an excess of hydroxide ions (OH^-), are slippery feeling, bitter tasting and react with acids to form water and salt.

Common acids include: hydrochloric acid, sulfuric acid, nitric acid, hydrofluoric acid. Common bases include: sodium hydroxide, potassium hydroxide, ammonium hydroxide.

ORP

ORP is the measurement of a solution's ability to oxidize or reduce another chemical species. Presence of oxidizers in a water system will cause the organics to be oxidized or destroyed.

Applications where ORP is used to determine the efficacy of chemical disinfectants and control of biological growths include swimming pools, aquatic life support systems and cooling towers.

Applications that use ORP for monitoring and controlling oxidation-reduction reactions include cyanide destruction, chromate reduction and chlorine scrubber monitoring using bisulfate.

Common oxidizers are: hypochlorous acid, sodium hypochlorite, ozone, peracetic acid and hypobromous acid. Common reducers include: sulfur dioxide, sodium sulfite, ferrous sulfate and ammonia.

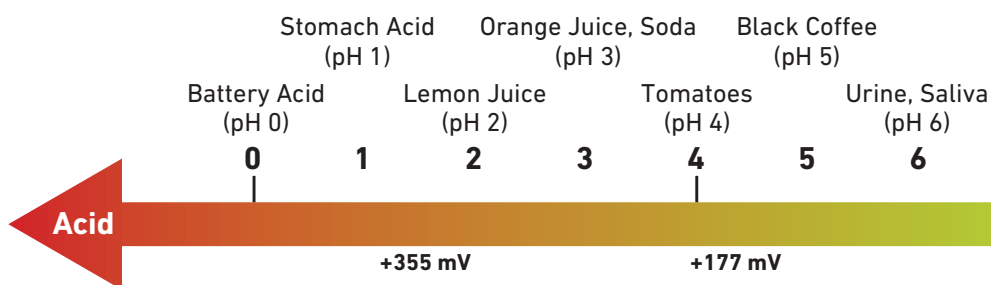

pH Measurement

pH is a potentiometric measurement where an electrical signal (in mV) is converted to a pH reading using the Nernst equation. The signal produced is the difference between the electrical potential of the reference electrode in contact with a highly concentrated salt solution and the electrical potential of the measuring electrode in contact with the solution being measured, and is a function of the pH value of the solution.

The measuring electrode is a special formulation glass membrane, sensitive to the hydrogen ions activity in solution. The pH glass will generate a potential which depends on the pH of the solution. Temperature affects the hydrogen ions activity in solution. To ensure accurate measurement all GF Signet pH sensors are equipped with a temperature sensor. The pH is automatically corrected for temperature using the Nernst equation.

All GF Signet pH sensors are combination electrodes. This means the reference and the measuring electrodes as well as temperature sensor are enclosed in the same body.

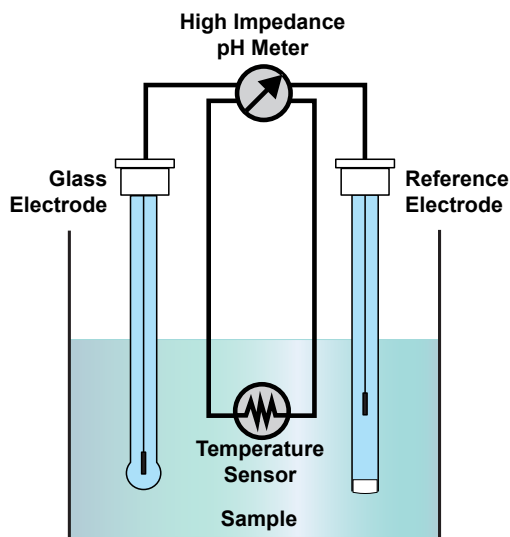

ORP Measurement

Similarly to the pH measurement, the ORP sensor consists of a measuring electrode in contact with the solution being measured and a reference electrode in contact with a highly concentrated salt solution.

The measuring electrode is an inert noble metal (platinum, sometimes gold) which will form a thin oxide layer on the surface when exposed to dissolved oxygen. This oxide layer facilitates the ORP measurement by attracting hydrolyzed oxidant or reductant molecules to the surface of the electrode. The amount of electrons exchanged per unit area (loss of electrons to an oxidant or accepting electrons from a reductant) will build up a surface charge that is equal to the ORP of the solution in mV.

ORP measurement is not specific. It cannot be used to determine the activity of a particular chemical or chemical species in solution. For this reason, it is not possible to correct ORP measurements for temperature changes. Temperature affects each individual chemical species differently. Therefore, ORP measurements are never temperature compensated.

A positive reading indicates an oxidizing solution, and a negative reading indicates a reducing solution.

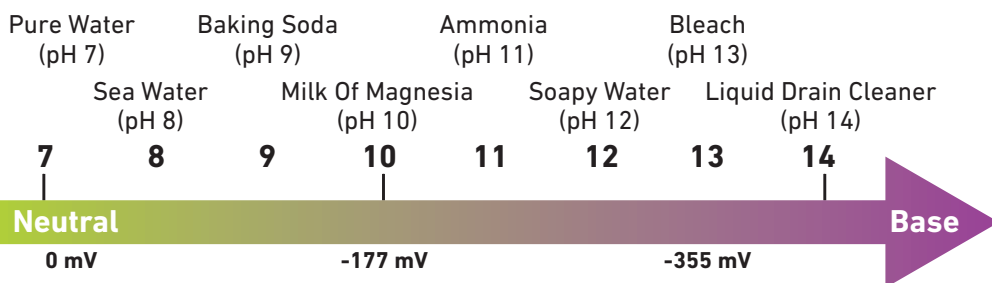

GF Signet offers the optimal system solution behind the scenes

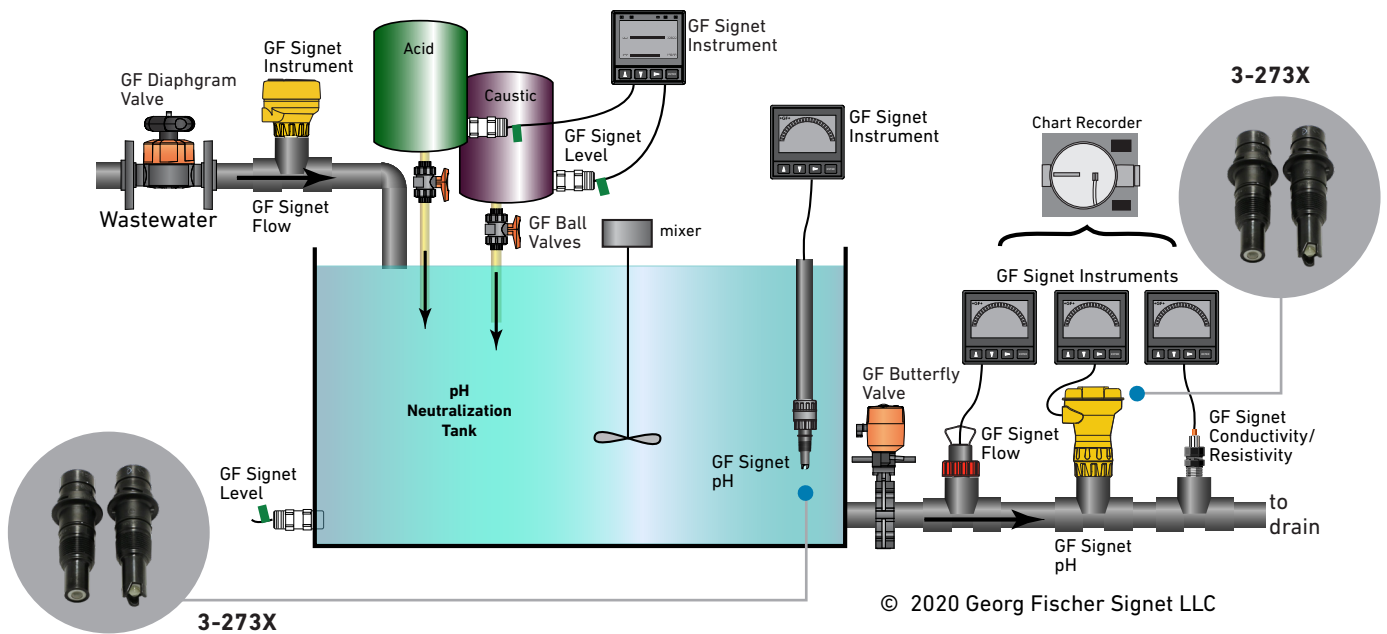

Example Application: Neutralization

The GF Signet Advantage

- Long lasting: In neutralization applications containing heavy metals, sulfides, organics or any other biological media due to the patented Interdigitated Axial Ion Path and enhanced reference chemistry
- Stable and reliable measurement: Enhanced reference chemistry protects against poisoning ions such as cyanide (CN^-) or sulfide (S^{2-})
- Low maintenance: Self-cleaning flat style electrodes suitable for dirty applications, and media with suspended solids
- Memory chip enabled for convenient data storage allows operators easy troubleshooting and convenient remote calibration to minimize system downtime and increase safety

Applications

GF Signet pH and ORP electrodes are versatile process sensors with unique designs targeting general purpose to harsh media applications while ensuring a long service life.

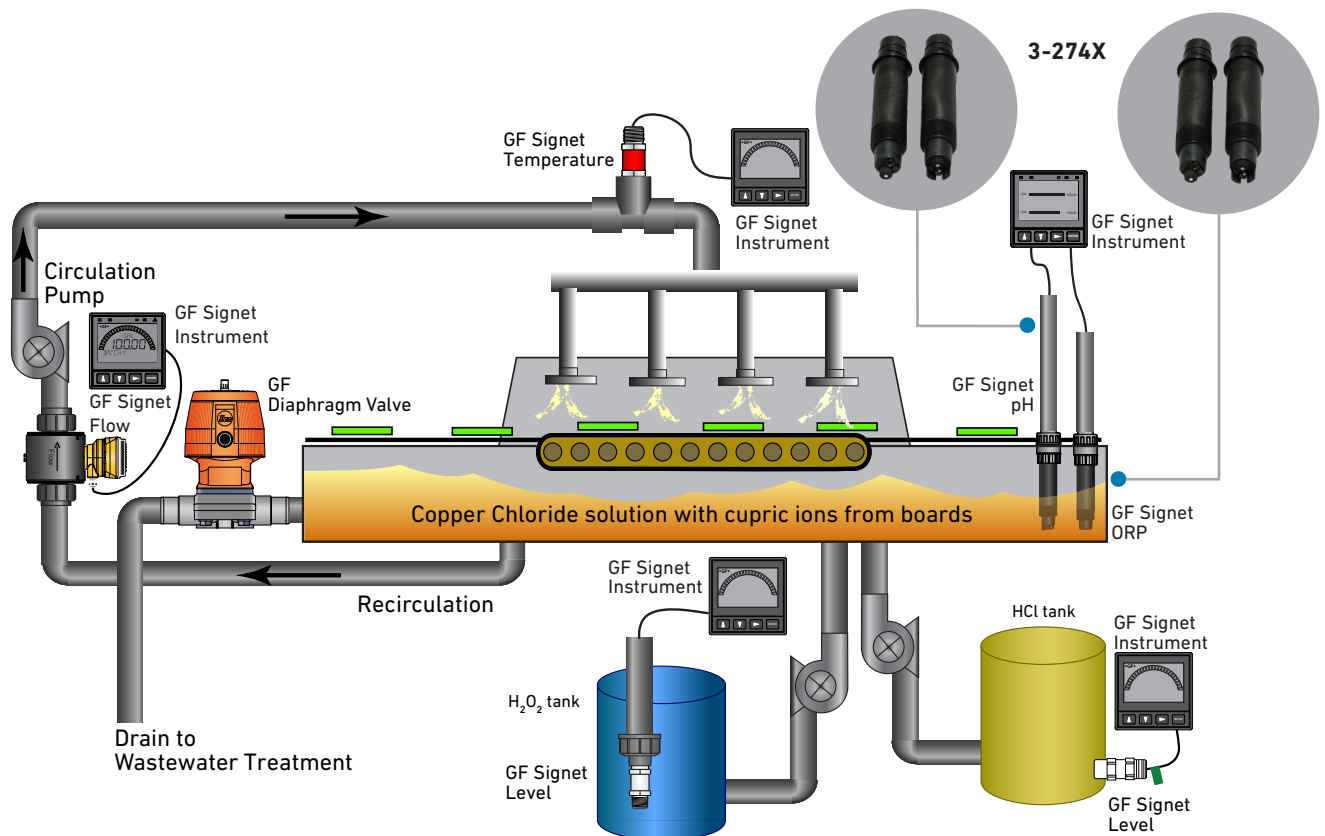

Example Application: Plating

© 2020 Georg Fischer Signet LLC

The GF Signet Advantage

- Long lasting: In the most harsh plating conditions due to ruggedized process glass, protected reference electrode and re-buildable design
- Highly accurate and reliable measurement: Due to built-in solution ground which eliminates ground loop measurement errors
- Great stability and less downtime: due to the differential design
- Low maintenance: Due to internal buffered electrolyte solution
- Cost effective: The electrode can be reconditioned in the field by refilling the reference electrolyte and replacing the double junction salt bridge
- Memory chip enabled for convenient data storage allows operators easy troubleshooting and convenient remote calibration to minimize system downtime and increase safety

GF Signet offers the optimal system solution behind the scenes

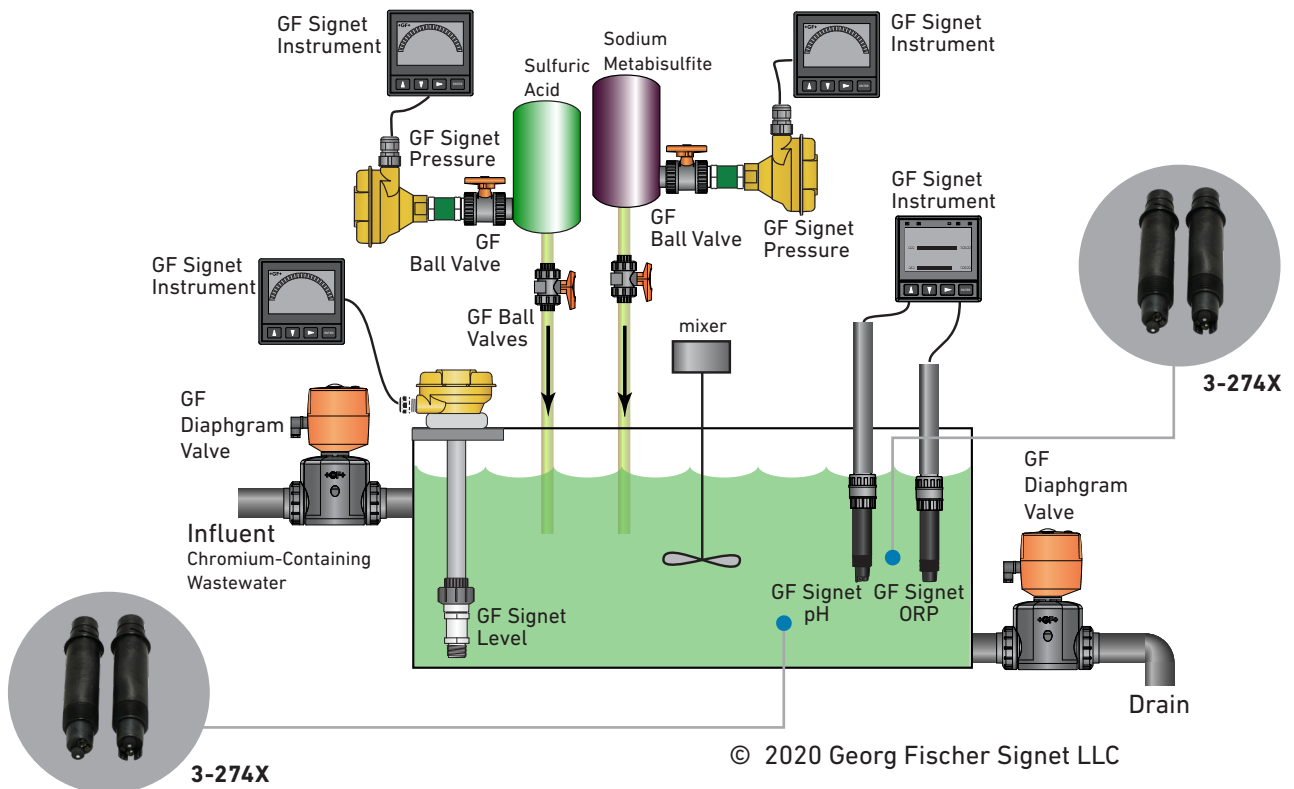

Example Application: Chromium Reduction





The GF Signet Advantage

- Long lasting: Due to ruggedized process glass, protected reference electrode and re-buildable design
- Highly accurate and reliable measurement: Due to built-in solution ground which eliminates ground loop measurement errors
- Great stability and less downtime: Due to the differential design
- Low maintenance: Due to internal buffered electrolyte solution
- Cost effective: The electrode can be reconditioned in the field by refilling the reference electrolyte and replacing the double junction salt bridge
- Memory chip enabled for convenient data storage allows operators easy troubleshooting and convenient remote calibration to minimize system downtime and increase safety

Applications

GF Signet pH/ORP electrodes can be used in a wide variety of fluid media types.

Specifications

					
	General Purpose	General Purpose	General Purpose/ Industrial	General Purpose/ Industrial	High Performance
Model	272X	275X-WTP	277X	273X	274X
Body Material	Ryton®(PPS)	PAS (Polyarylsulphone)	Ryton® (PPS)	Ryton® (PPS)	Ryton® (PPS)
Junction Material	UHMH Polyethylene	PTFE	PTFE	PTFE	PTFE
O-rings	FKM	FKM	FKM	FKM	EPR (EPDM)
Sensing Element	Glass (Protected Bulb or Flat)	Glass (Protected Bulb)	Glass (Protected Bulb or Flat)	Glass (Protected Bulb or Flat)	Glass (Protected Bulb or Flat)
Reference Junction	Single	Double	Double	Single	Double
Reference Electrolyte	KCl and AgCl gel	KCl and AgCl gel	KNO ₃ and KCl/AgCl gel	KCl and AgCl gel	Buffered KNO ₃ liquid
Temperature Element	Pt1000 or 3KΩ Balco	Pt1000 or 3KΩ Balco	Pt1000 or 3KΩ Balco	Pt1000	Pt1000 or 3KΩ Balco
Process Connection/ Thread	3/4" MNPT or ISO 7/1-R3/4	N/A	3/4" MNPT	3/4" MNPT or ISO 7/1-R3/4	1" MNPT
Insertion Length	1 - 1.4 in (25.4 - 35.5 mm)	2.75 - 3.4 in (70 - 86 mm)	1.3 - 1.7 in (32 - 43 mm)	1 - 1.4 in (25.4 - 35.5 mm)	1.13 in (28.7 mm)
ORP Version	2725	2757-WTP	2775 and 2777	2735	2745 and 2747
ORP Element	Platinum	Platinum	Platinum or Gold	Platinum	Platinum
Special Feature	Patented Interdigitated Axial Ion Path	Wet-Tap electrode	Large junction surface area	Patented Interdigitated Axial Ion Path and enhanced reference chemistry	Differential design
Compatible Signet Instruments	8900/9900/9950 0486 Profibus Concentrator	8900/9900/9950 0486 Profibus Concentrator	8900/9900/9950 0486 Profibus Concentrator	8900/9900/9950 0486 Profibus Concentrator	8900/9900/9950 0486 Profibus Concentrator
Standards and Approvals	Manufactured under: ISO 9001 and ISO 45001	Manufactured under: ISO 9001 and ISO 45001	Manufactured under: ISO 9001 and ISO 45001	Manufactured under: ISO 9001 and ISO 45001	Manufactured under: ISO 9001 and ISO 45001

Applications

	General Purpose 272X	General Purpose 275X-WTP	General Purpose/ Industrial 277X	General Purpose/ Industrial 273X	High Performance 274X
Clear Water Treatment					
Drinking Water	●	●			
Raw Water Feed	●	●			
Pool and Spa Control	●	●			
Boiler Feed Water	●	●			
Cooling Towers	●	●			
Reverse Osmosis	●	●			
Wastewater Treatment					
Neutralization	○		●	●	
Heavy Metal Removal / Recovery			○	○	●
Cyanide Destruction			○	○	●
Chromium Reduction			○	○	●
Aquatic Life Support Systems	●	●			
Aquaculture/Fish/Shrimp Farming	●	●	●		
Landfield Leachate	○		○	○	●
Food Industry	○		●	●	
Ground Water Remediation			○	○	●
Municipal Wastewater/ Sewage			●	○	
Industrial Processes					
Plating Baths			○	○	●
Metal and Surface Finishing			○	○	●
Fume Scrubbing			○	○	●
Leather/Dyeing			○	○	●
Pulp and Paper			○	○	●
Chemical Injection			○	○	●
Chemical Refineries			○	○	●
Pesticide Manufacturing			○	○	●
Fertilizer Manufacturing			○	○	●
Agriculture Nutrient Dosing	○		●	●	○
Hydrofluoric Acid (< 2%)	●			●	
Low Conductivity (20 to 100 µS/cm)	●				
Low Temperature (0 °C to 15 °C)	●	●			
High Temperature (60 °C to 110 °C)			●		●

- Key:**
- Best Performance, Longevity and Economical Value
 - Performance and longevity may depend on process conditions: metals present, overall concentration of chemicals, temperature and pH range

GF Signet 2724-2726 pH/ORP Electrodes General Purpose



Process electrodes designed for general use built with durable, robust bodies with process connections (NPT threads or ISO threads) built in. These sensors are suited for continuous monitoring and controlling of pH or ORP in a wide range of light/moderate duty applications.

Applications

Process sensors designed for general use provide a long lasting affordable solution in most industries, especially:

- Drinking Water
- Wastewater Treatment
- Neutralization
- Process Control
- Surface Water
- Aquatic and Animal Life Support Systems
- Pool and Spa Control
- Theme Park Water Rides
- Cooling Tower
- Aquaculture

Specifications

Operating Range	pH 0 to 14 pH (for long term monitoring recommended pH range: 0 to 11.0 pH) ORP \pm 2000 mV
Operating Temperature	0 °C to 85 °C (32 °F to 150 °F)
Operating Pressure	6.8 bar @ 0 to 65 °C (100 psi @ 32 to 150 °F) 4 bar @ 65 to 85 °C (58 psi 150 to 185 °F)
Wetted Materials	Ryton® (PPS), UHMWPE, FKM, glass membrane/Pt disk
Reference Junction	Single, UHMWPE

Compatible with all Signet pH/ORP instruments and SmartPro transmitters

Features

- Patented reference design for prolonged life in media containing moderate contamination
- Bulb and flat style HF resistant glass available
- Low conductivity media sensor available for liquids down to 20 μ S/cm
- Hemispherical and flat styles with either Pt1000 or 3 k Ω Balco RTD temperature sensor
- Quick temperature response
- Process connection NPT 3/4" suitable for in-line and immersion installation as well as Insertion design for use with any Signet 1/2" - 4" installation fitting, or threaded adapter
- Patented DryLoc® connector with corrosion resistant gold plated contacts ensures a robust connection to the sensor electronics
- Memory chip enabled for access to a wide range of unique features when connected to GF Signet 2751 Smart Sensor Electronics

Benefits

- Low cost pH solution for general purpose/ light duty applications
- Accurate and reliable measurement even in installations with high flow rates
- Small assembly, the electrode saves space in submersible or inline installations
- Low maintenance and easy to use
- Durable robust housing protects against mechanical damage and ensures excellent compatibility with a wide range of chemicals
- Memory chip enabled for convenient data storage allows operators easy troubleshooting and convenient remote calibration to minimize system downtime and increase safety and performance



For calibration information visit the Signet channel



GF Signet 2756-2757 Wet-Tap pH/ORP Electrodes and 3719 Wet-Tap Assembly

General Purpose

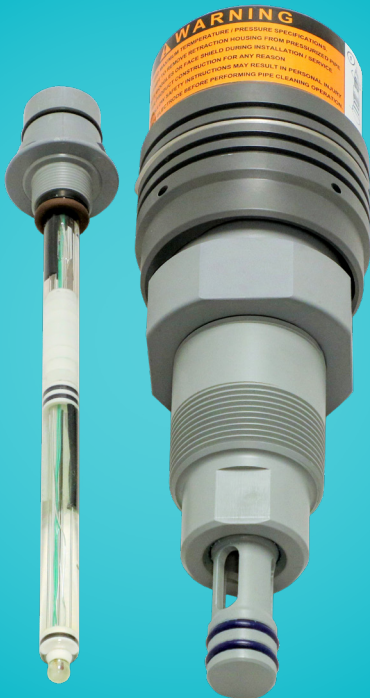

General purpose electrodes ideal for a wide range of applications where the removal and reinstallation of the electrode can be performed without the need for system shutdown.

Applications

Process sensors designed for general use provide a long lasting affordable solution in most industries, especially:

- Aquatic and Animal Life Support Systems
- Recreational Water Monitoring
- Water & Wastewater Monitoring
- Neutralization Systems
- Sanitization Systems
- Pool and Spa Control
- Effluent Monitoring

Specifications

Operating Range	pH 0 to 14 pH (for long term monitoring recommended pH range: 0 to 11.0 pH) ORP \pm 2000 mV
Operating Temperature	0 °C to 85 °C (32 °F to 185 °F)
Operating Pressure	6.9 bar @ 25 °C (100 psi and 77 °F)
Wetted Materials	PAS (polyarylsulphone), PTFE, FKM, glass membrane/Pt disk
Reference Junction	Double, PTFE

Compatible with all GF Signet pH/ORP instruments and SmartPro transmitters

Features

- Electrode removal without process shutdown when installed in the GF Signet 3719 pH/ORP Wet-Tap Assembly
- PTFE reference junction resists fouling and chemical attack
- General purpose bulb pH glass suitable in a wide range of applications
- Pt1000 or 3k Ω Balco RTD temperature element for quick temperature response
- Special design allows for installation at any angle, even inverted or horizontal
- Patented DryLoc[®] connector with corrosion resistant gold plated contacts ensures a robust connection to the sensor electronics
- Memory chip enabled for access to a wide range of unique features when connected to GF Signet 2751 Smart Sensor Electronics

Benefits

- No system downtime: The wet-tap assembly allows pH or ORP electrode removal and re-installation for maintenance even under process pressure without the need for system shutdown
- Space saving: 45 mm (1.75 in) short-stroke design
- Low maintenance and easy to use
- CPVC/PVC-C durable robust assembly protects against mechanical damage and ensures excellent compatibility with a wide range of chemicals
- Memory chip enabled for convenient data storage allows operators easy troubleshooting and convenient remote calibration to minimize system downtime and increase safety and performance



For calibration information visit the Signet channel



GF Signet 2734-2736 pH/ORP Electrodes

General Purpose/
Industrial



The 273X series of electrodes are cost-effective pH and ORP electrodes for industrial applications. These sensors are suitable for continuous monitoring of pH and ORP in a wide range of harsh process liquids.

Applications

Signet 2734-2736 are the robust pH and ORP electrodes for industrial water treatment, wastewater and metal. It monitors:

- Neutralization
- Influent and Effluent Monitoring
- Wastewater Treatment
- Groundwater Remediation
- Process Control
- Cooling Towers and Boiler Protection
- Leaching
- Metal Plating
- Surface Finishing
- Mining
- Agriculture Nutrient Dosing
- Textile Industries

Specifications

Operating Range	pH 0 to 14 pH (for long term monitoring recommended pH range 0 to 11.0 pH) ORP \pm 2000 mV
Operating Temperature	10 °C to 100 °C (50 °F to 212 °F)
Operating Pressure	0 to 6.9 bar @ 10 °C to 65 °C (0 to 100 psi @ 50 °F to 100 °F) Linearity Derated 6.9 to 4.0 bar @ 65 °C to 100 °C (100 to 58 psi @ 149 °F to 212 °F)
Wetted Materials	Ryton® (PPS), PTFE, FKM, glass membrane/Pt disk
Reference Junction	Single, PTFE

Compatible with all GF Signet pH/ORP instruments and SmartPro transmitters

Features

- Patented reference design for prolonged life in media containing moderate contamination
- Enhanced reference chemistry to block various poisoning ions
- Porous PTFE reference diaphragm resists fouling, clogging and chemical attack
- Hemispherical and flat styles with Pt1000 RTD temperature sensor
- HF resistant glass available in hemispherical and flat style
- Gel-compact electrolyte
- Ryton® (PPS) housing and FKM O-rings for superior chemical resistance in a wide range of chemicals
- Process connection NPT ¾" suitable for in-line and submersible installation as well as insertion design for use with any Signet ½" -4" installation fitting, or threaded adapter
- Patented DryLoc® connector with corrosion resistant gold plated contacts ensures a robust connection to the sensor electronics
- Memory chip enabled for access to a wide range of unique features when connected to GF Signet 2751 Smart Sensor Electronics

Benefits

- Long lasting solution in applications containing heavy metals, sulfides, organics or any other biological media due to the patented reference design and enhanced reference chemistry
- Stable and reliable measurement: Enhanced reference chemistry protects against poisoning ions such as CN⁻ or S²⁻
- Self-cleaning flat style electrodes suitable for applications with suspended solids and high flow rates
- Durable robust housing protects against mechanical damage and ensures excellent compatibility with a wide range of chemicals
- Memory chip enabled for convenient data storage allows operators easy troubleshooting and convenient remote calibration to minimize system downtime and increase safety and performance



For calibration information visit the Signet channel



GF Signet 2774-2777 pH/ORP Electrodes

General Purpose/
Industrial



The 277X series of electrodes are cost-effective pH and ORP electrodes for industrial applications. These sensors are suitable for continuous monitoring of pH and ORP in a wide range of harsh process liquids specially harsh, dirty and high concentrations of suspended solids media.

Applications

Signet 2774-2777 are the robust pH and ORP electrodes for industrial water treatment, wastewater and metal. It monitors:

- Neutralization
- Influent and Effluent Monitoring
- Wastewater Treatment
- Ground Water Remediation
- Process Control
- Cooling Towers and Boiler Protection
- Leaching
- Metal Plating
- Surface Finishing
- Mining
- Agriculture Nutrient Dosing
- Textile Industries

Specifications

Operating Range	pH 0 to 14 pH (for long term monitoring recommended pH range 0 to 11.0 pH) ORP \pm 2000 mV
Operating Temperature	0 °C to 85 °C (32 °F to 185 °F)
Operating Pressure	6.9 bar @ 0 to 85 °C (100 psi @ 0 to 185 °F)
Wetted Materials	Ryton® (PPS), PTFE, FKM, glass membrane/Pt disk
Reference Junction	Double, PTFE

Compatible with all GF Signet pH/ORP instruments and SmartPro transmitters

Features

- Double chamber reference system with potassium nitrate (KNO₃) in the front chamber to block various poisoning ions
- Large area porous PTFE reference diaphragm resists fouling, clogging and chemical attack
- Available for high temperature (up to 110 °C) media conditions
- Gel-compact electrolyte
- Ryton® (PPS) housing and FKM O-rings for superior chemical resistance in a wide range of chemicals
- Hemispherical and flat styles with either Pt1000 or 3 K Ω Balco RTD temperature sensor
- Process connection NPT 3/4" suitable for in-line and submersible installation
- Memory chip enabled for access to a wide range of unique features when connected to Signet 2751 Smart Sensor Electronics

Benefits

- Long lasting solution in applications containing heavy metals, sulfides, organics or any other biological media due to the extra barrier provided by the double junction
- Stable and reliable measurement: The double chamber reference protects against poisoning ions such as CN⁻ or S²⁻
- Low maintenance: Large surface area reference junction resists plugging and helps maintain a stable reference signal. Self-cleaning flat style electrodes suitable for high flow rates, and media with high concentrations of suspended solids
- Durable robust housing protects against mechanical damage and ensures excellent compatibility with a wide range of chemicals
- Memory chip enabled for convenient data storage allows operators easy troubleshooting and convenient remote calibration to minimize system downtime and increase safety and performance



For calibration information visit the Signet channel



GF Signet 2744-2747 pH/ORP Electrodes High Performance



Process electrodes built with superior glass formulation, 3-electrode differential design and protected reference electrode housed in a glass half-cell to withstand extreme pH conditions, elevated temperatures and poisoning ions. These sensors are suitable for continuous monitoring of pH and ORP in a wide range of heavy duty applications.

Applications

Suitable applications are media with high concentrations of poisoning ions, high pH, elevated temperatures and high concentration of suspended solids.

- Metal Plating Industries
- Surface Finishing
- Wastewater Treatment
- Ground Water Remediation
- Process Control
- Neutralization
- Pulp and Paper
- Textile Industries
- Chemical Refineries
- Heavy Metal Removal and Recovery
- Pesticide Manufacturing
- Fertilizer Manufacturing

Specifications

Operating Range	pH 0 to 14 pH ORP \pm 2000 mV
Operating Temperature	10 °C to 100 °C (50 °F to 212 °F)
Operating Pressure	0 to 6.9 bar @ 10 °C to 65 °C (0 to 100 psi @ 50 °F to 149 °F) 6.9 to 4.0 bar @ 65 °C to 100 °C (100 to 58 psi @ 149 °F to 212 °F)
Wetted Materials	Ryton® (PPS), PTFE, EPR (EPDM), glass membrane/platinum disk
Reference Junction	Double, PTFE

Compatible with all Signet pH/ORP instruments and SmartPro transmitters

Features

- Differential design for stable measurement in most aggressive applications
- Long service life even in severe or difficult chemical applications
- Solution ground ensures a steady and stable signal. Not susceptible to stray currents
- High performance glass that can withstand high pH caustic media as well as elevated temperature applications
- Refillable electrolyte chamber and replaceable double junction salt bridge
- Porous PTFE reference junction resists fouling, clogging and chemical attack
- Ryton® (PPS) housing and EPR (EPDM) O-rings for superior chemical resistance in a wide range of chemicals
- Bulb and flat styles with either Pt1000 or 3 K Ω Balco RTD temperature sensor
- Process connection NPT 1" suitable for in-line and immersion installation
- Memory chip enabled for access to a wide range of unique features when connected to GF Signet 2751 Smart Sensor Electronics

Benefits

- Long lasting solution in the most harsh media conditions: Due to ruggedized process glass, protected reference electrode and rebuildable design
- Highly accurate and reliable measurement: Due to built-in solution ground which eliminates ground loop measurement errors
- Great stability and less downtime: Due to the differential design
- Low maintenance: Due to internal buffered electrolyte solution
- Cost effective: The electrode can be reconditioned in the field by refilling the reference electrolyte and replacing the double junction salt bridge
- Durable robust housing protects against mechanical damage and ensures excellent compatibility with a wide range of chemicals
- Memory chip enabled for convenient data storage allows operators easy troubleshooting and convenient remote calibration to minimize system downtime and increase safety and performance



For calibration information visit the Signet channel



GF Signet 2751 DryLoc pH/ORP Smart Sensor Electronics



The Signet 2751 pH/ORP Smart Sensor Electronics featuring the DryLoc connector, is the solution for field-free calibration, out of range glass impedance and broken glass detection, alerting the operator to probe failure or maintenance needs.

Applications

Robust design for use in a submersible or in-line configuration in general purpose and harsh media conditions in all industries especially:

- Water and Wastewater Treatment
- Neutralization Systems
- Scrubber Control
- Effluent Monitoring
- Surface Finishing
- Flocculent Coagulation
- Heavy Metal Removal and Recovery
- Toxics Destruction
- Sanitization Systems
- Pool & Spa Control
- Aquatic and Animal Life Support Systems

* Users of 9950 Gen I and 9950 (Gen 2a) should update to 9950 (Gen 2b) to take full advantage of the 2751 features and benefits. Visit our website for the latest software update.

Specifications

Operating Range	pH -1 to 15 pH ORP \pm 2000 mV	
Operating Temperature	0 °C to 85 °C (32 °F to 185 °F)	
Response Time	pH	< 6 sec. for 95% of change
	ORP	Application dependent
Materials	In-line	PBT and polypropylene (retaining nut)
	Submersible	CPVC/PVC-C

Compatible with all Signet pH/ORP electrode models: 2724-2726; 2734-2736; 2744-2747; 2756-2757 Wet-Tap and 2774-2777

Features

- Probe health monitoring, glass impedance and broken glass detection
- Memory chip interface that allows for transferable calibration, runtime data, and manufacturing information
- In-line integral mount and submersible installation versions
- Automatic temperature compensation
- Auto configuration for pH or ORP operation
- Optional EasyCal calibration aid with automatic pH buffer recognition for 4, 7 and 10 pH and ORP solutions: quinhydrone saturated pH 4.01 or 7.00 buffers and Light's Solution
- Junction boxes for convenient wiring
- Patented DryLoc® connector provides a quick and secure connection to the sensor

Benefits

- Two different outputs: 4 to 20 mA loop output enables a low cost pH/ORP system solution while the digital (S³L) output allows for longer cable length and connection to the Signet SmartPro instruments
- Reduced operating costs: Remote to the sensor does not get thrown away when the electrode is due for replacement
- User-friendly connection: Easy DryLoc connect/disconnect
- Reduced system downtime, calibration time and calibration costs: Remote, transferable calibration eliminates the hassle of filed calibration by allowing calibration under lab conditions for increased sensor longevity and measurement accuracy
- Improved measurement performance: Probe health monitoring through automatic or manual glass impedance measurement, alerts user on broken glass or when set glass impedance is exceeded.
- Data management: Read and write capabilities for convenient historical data storage in the sensor's memory chip can be used for troubleshooting or predictive maintenance and process optimization



For calibration information visit the Signet channel



Technical Tips and Best Practices

Troubleshooting and Diagnostics: pH

The sensitive components of a pH sensor are:

- The glass measuring membrane
- The reference junction
- The reference electrode

The glass measuring membrane is fragile and prone to breaking. The pH glass can be damaged during electrode handling or in the process media that contains elevated concentrations of caustics or hydrofluoric acid. Broken glass failure can be recognized when the electrode measures a consistent pH in the range 6.5 to 7.5 pH in any media. This can be a very dangerous situation. For neutralization process (pH set point is typically at pH 7) the issue will not be detected.

GF Signet uses glass impedance measurement via 2751 Smart Sensor Electronics with 9900 or 9950 transmitters. In case of a broken glass, a Broken Glass alarm will be generated.

The reference junction can become contaminated with process solution. The purpose of the junction is to maintain contact between the reference system and the process liquid. Fouling and clogging of the junction will be seen as a sluggish, inaccurate measurement or even complete failure.

The reference electrode can become contaminated or poisoned with the process liquid during the diffusion of the sample through the junction. If chemicals from the process react with the elements of the reference electrode: potassium chloride (KCl) or the silver chloride (AgCl) altering their concentration, the electrical potential of the reference will change. This will be seen as an offset in the pH measurement that will affect the accuracy of the measurement.

Troubleshooting and Diagnostics: ORP

The sensitive components of an ORP sensor are:

- The platinum measuring element
- The reference junction
- The reference electrode

The platinum measuring element is prone to coating. The condition of the platinum electrode surface will dictate the electrode response time and accuracy of measurement. When the surface oxide layer becomes too thick, the active surface area will decrease. This will affect the amount of electrons exchanged per unit area, with the oxidizer or reducer molecules in the process liquid.

Also, the absorbed surface species causes a “memory effect”. If a sensor is placed in a less oxidizing solution after measuring a more oxidizing solution, it can take long time for the sensor to equilibrate to the new sample. Exposing the sensor to a conditioning solution will help reduce the memory effect.

The junction and reference electrode in an ORP sensor are the same and serve same purpose as in a pH electrode.



Maintenance

For an accurate pH and ORP measurement, it is very important the electrodes are kept clean. Fouling of the measuring electrode (glass for pH / platinum for ORP) and junction is the most common cause of error in any pH and ORP measurement. The measured potential is generated on the surface of the pH sensitive glass membrane (platinum surface for ORP). It is critical that the surface is maintained clean.

The reference junction should be free flowing at all times to ensure contact between the reference system and the process liquid.

Electrode Cleaning

Depending on the type of application and the accuracy needed, pH/ORP electrodes need to be hand cleaned periodically. The solution used to clean an electrode varies depending on the type of coating.

Electrode Conditioning

It is good practice to always condition the electrodes after exposing them to harsh cleaning agents as well as to regenerate the internal electrolyte and the measuring glass membrane (pH).

Electrode Calibration

Calibration ensures the pH or ORP electrodes continue to function properly and within required accuracy. A pH electrode is designed to measure pH based on the Slope and Offset (Nernst equation.) Electrodes change over time. This could be due to the changes in the electrical potential of the reference electrode and/or the condition of the measuring electrode. Because of aging and use, the electrode's performance will stray from the theoretical slope and offset over time. Calibration will adjust the electrode based on changes that may have occurred and ensures the readings are accurate and repeatable. Calibration also helps to identify when the electrode is worn out and needs to be replaced.

How often should an electrode be calibrated?

The frequency of calibration is only determined by the operator for a particular process and particular location. This frequency is determined and adjusted by checking the sensor after an initial operating time in the process. The sensor should be checked in calibration buffer solutions and determine if the output of the sensor is consistent with the initial calibration. If the readings are within acceptable limits, reinstall the sensor and repeat these steps in several days or weeks. Alternatively, a grab sample test using calibrated laboratory electrode can be performed. When the reading between the laboratory electrode and the process electrode are outside the accuracy range needed, then proceed with electrode cleaning, conditioning and calibration. A maintenance interval should be established based on performance and the condition of the electrode at each measuring point.

What calibration solutions should be used?

pH two point calibration

- Use pH 7.00 and pH 4.01 buffer solutions if the process liquid pH is between 0 to 8.5 pH
- Use pH 7.00 and pH 10.01 buffer solutions if the process liquid pH is greater than 8.5 pH

ORP one point calibration

- Always perform a one point calibration at a value closest to the ORP of the process liquid
- A pH 4.01 buffer solution with Quinhydrone will generate +264 mV at 25 °C while a pH 7.00 buffer saturated with Quinhydrone will generate +87 mV at 25 °C



For calibration information visit the Signet channel



Worldwide at home

Our sales companies and representatives ensure local customer support in over 100 countries.

www.gfsgnet.com

Argentina / Southern South America

Georg Fischer Central Plastics
Sudamérica S.R.L.
Buenos Aires, Argentina
Phone +54 11 4512 02 90
gfcentral.ps.ar@georgfischer.com
www.gfps.com/ar

Australia

George Fischer Pty Ltd
Riverwood NSW 2210 Australia
Phone +61 (0) 2 9502 8000
australia.ps@georgfischer.com
www.gfps.com/au

Austria

Georg Fischer
Rohrleitungssysteme GmbH
3130 Herzogenburg
Phone +43 (0) 2782 856 43-0
austria.ps@georgfischer.com
www.gfps.com/at

Belgium / Luxembourg

Georg Fischer NV/SA
1070 Bruxelles/Brüssel
Phone +32 (0) 2 556 40 20
be.ps@georgfischer.com
www.gfps.com/be

Brazil

Georg Fischer Sist. de Tub. Ltda.
04795-100 São Paulo
Phone +55 (0) 11 5525 1311
br.ps@georgfischer.com
www.gfps.com/br

Canada

Georg Fischer Piping Systems Ltd
Mississauga, ON L5T 2B2
Phone +1 (905) 670 8005
Fax +1 (905) 670 8513
ca.ps@georgfischer.com
www.gfps.com/ca

China

Georg Fischer Piping Systems Ltd
Shanghai 201319
Phone +86 21 3899 3899
china.ps@georgfischer.com
www.gfps.com/cn

Denmark / Iceland

Georg Fischer A/S
2630 Taastrup
Phone +45 (0) 70 22 19 75
info.dk.ps@georgfischer.com
www.gfps.com/dk

Finland

Georg Fischer AB
01510 VANTAA
Phone +358 (0) 9 586 58 25
Fax +358 (0) 9 586 58 29
info.fi.ps@georgfischer.com
www.gfps.com/fi

France

Georg Fischer SAS
95932 Roissy Charles de Gaulle Cedex
Phone +33 (0) 1 41 84 68 84
fr.ps@georgfischer.com
www.gfps.com/fr

Germany

Georg Fischer GmbH
73095 Albershausen
Phone +49 (0) 7161 302-0
info.de.ps@georgfischer.com
www.gfps.com/de

India

Georg Fischer Piping Systems Ltd
400 076 Mumbai
Phone +91 224007 2001
branchoffice@georgfischer.com
www.gfps.com/in

Indonesia

Georg Fischer Pte Ltd –
Representative Office
Phone +62 21 2900 8564
Fax +62 21 2900 8566
sgp.ps@georgfischer.com
www.gfps.com/sg

Italy

Georg Fischer S.p.A.
20063 Cernusco S/N (MI)
Phone +39 02 921 861
it.ps@georgfischer.com
www.gfps.com/it

Japan

Georg Fischer Ltd
556-0011 Osaka,
Phone +81 (0) 6 6635 2691
jp.ps@georgfischer.com
www.gfps.com/jp

Korea

GF Piping Systems
Georg Fischer Korea Co., Ltd.
Unit 2501, U-Tower
120 HeungdeokJungang-ro (Yeongdeok-dong)
Giheung-gu, Yongin-si, Gyeonggi-do, Korea
Phone: +82 31 8017 1450
Fax: +82 31 217 1454
kor.ps@georgfischer.com
www.gfps.com/kr

Malaysia

Georg Fischer (M) Sdn. Bhd.
No. 2, 4 & 6, Jalan Permata 3/KS 09
Taman Perindustrian Air Hitam
41200 Klang, Selangor
Phone +603 3122 5585
Fax +603 3122 5575
my.ps@georgfischer.com
www.gfps.com/my

Mexico / Northern Latin America

Georg Fischer S.A. de C.V.
Apodaca, Nuevo Leon
CP66636 Mexico
Phone +52 (81) 1340 8586
Fax +52 (81) 1522 8906
mx.ps@georgfischer.com
www.gfps.com/mx

Middle East

Georg Fischer
Piping Systems (Switzerland) Ltd
Dubai, United Arab Emirates
Phone +971 4 289 49 60
gcc.ps@georgfischer.com
www.gfps.com/int

Netherlands

Georg Fischer N.V.
8161 PA Epe
Phone +31 (0) 578 678 222
nl.ps@georgfischer.com
www.gfps.com/nl

Norway

Georg Fischer AS
1351 Rud
Phone +47 67 18 29 00
no.ps@georgfischer.com
www.gfps.com/no

Philippines

Georg Fischer Pte Ltd
Representative Office
Phone +632 571 2365
Fax +632 571 2368
sgp.ps@georgfischer.com
www.gfps.com/sg

Poland

Georg Fischer Sp. z o.o.
05-090 Sekocin Nowy
Phone +48 (0) 22 31 31 0 50
poland.ps@georgfischer.com
www.gfps.com/pl

Romania

Georg Fischer
Piping Systems (Switzerland) Ltd
020257 Bucharest - Sector 2
Phone +40 (0) 21 230 53 80
ro.ps@georgfischer.com
www.gfps.com/int

Russia

Georg Fischer
Piping Systems (Switzerland) Ltd
Moscow 125047
Phone +7 495 258 60 80
ru.ps@georgfischer.com
www.gfps.com/ru

Singapore

George Fischer Pte Ltd
11 Tampines Street 92, #04-01/07
528 872 Singapore
Phone +65 6747 0611
Fax +65 6747 0577
sgp.ps@georgfischer.com
www.gfps.com/sg

Spain / Portugal

Georg Fischer S.A.
28046 Madrid
Phone +34 (0) 91 781 98 90
es.ps@georgfischer.com
www.gfps.com/es

Sweden

Georg Fischer AB
117 43 Stockholm
Phone +46 (0) 8 506 775 00
info.se.ps@georgfischer.com
www.gfps.com/se

Switzerland

Georg Fischer
Rohrleitungssysteme (Schweiz) AG
8201 Schaffhausen
Phone +41 (0) 52 631 30 26
ch.ps@georgfischer.com
www.gfps.com/ch

Taiwan

Georg Fischer Co., Ltd
San Chung Dist., New Taipei City
Phone +886 2 8512 2822
Fax +886 2 8512 2823
www.gfps.com/tw

United Kingdom / Ireland

Georg Fischer Sales Limited
Coventry, CV2 2ST
Phone +44 (0) 2476 535 535
uk.ps@georgfischer.com
www.gfps.com/uk

USA / Caribbean

Georg Fischer LLC
9271 Jeronimo Road
92618 Irvine, CA
Phone +1 714 731 88 00
Fax +1 714 731 62 01
us.ps@georgfischer.com
www.gfps.com/us

International

Georg Fischer
Piping Systems (Switzerland) Ltd
8201 Schaffhausen/Switzerland
Phone +41 (0) 52 631 30 03
Fax +41 (0) 52 631 28 93
info.export@georgfischer.com
www.gfps.com/int

The technical data is not binding. They neither constitute expressly warranted characteristics nor guaranteed properties nor a guaranteed durability. They are subject to modification. Our General Terms of Sale apply.