

# ZONELINE® | UltimateV12™

VERTICAL AIR CONDITIONERS



**AZ9V SINGLE PACKAGED VERTICAL UNITS  
ENGINEERING DATA MANUAL**



**GE APPLIANCES**  
*a Haier company*

**AIR&WATER**  
SOLUTIONS

## ZONELINE® UltimateV12™



The GE Zoneline® UltimateV12™ brings a new level of intelligence and performance to our user friendly line of Vertical Terminal Air Conditioners.

The UltimateV12 is the next generation of VTAC featuring Inverter Technology and Adjustable Speed Makeup Air, enabling controlled and precise performance in a broad range of applications.

1 INSTA-PLATFORM™

2 SELF-CONTAINED DRAINAGE SYSTEM

3 FAST-CONNECT PLUMBING

4 SELF-ALIGNING,  
LOCK-IN-PLACE SYSTEM

5 QUICK-INSTALL  
PLENUM

9 ONBOARD  
DIAGNOSTICS

10 SmartHQ™ WIFI  
CAPABILITY

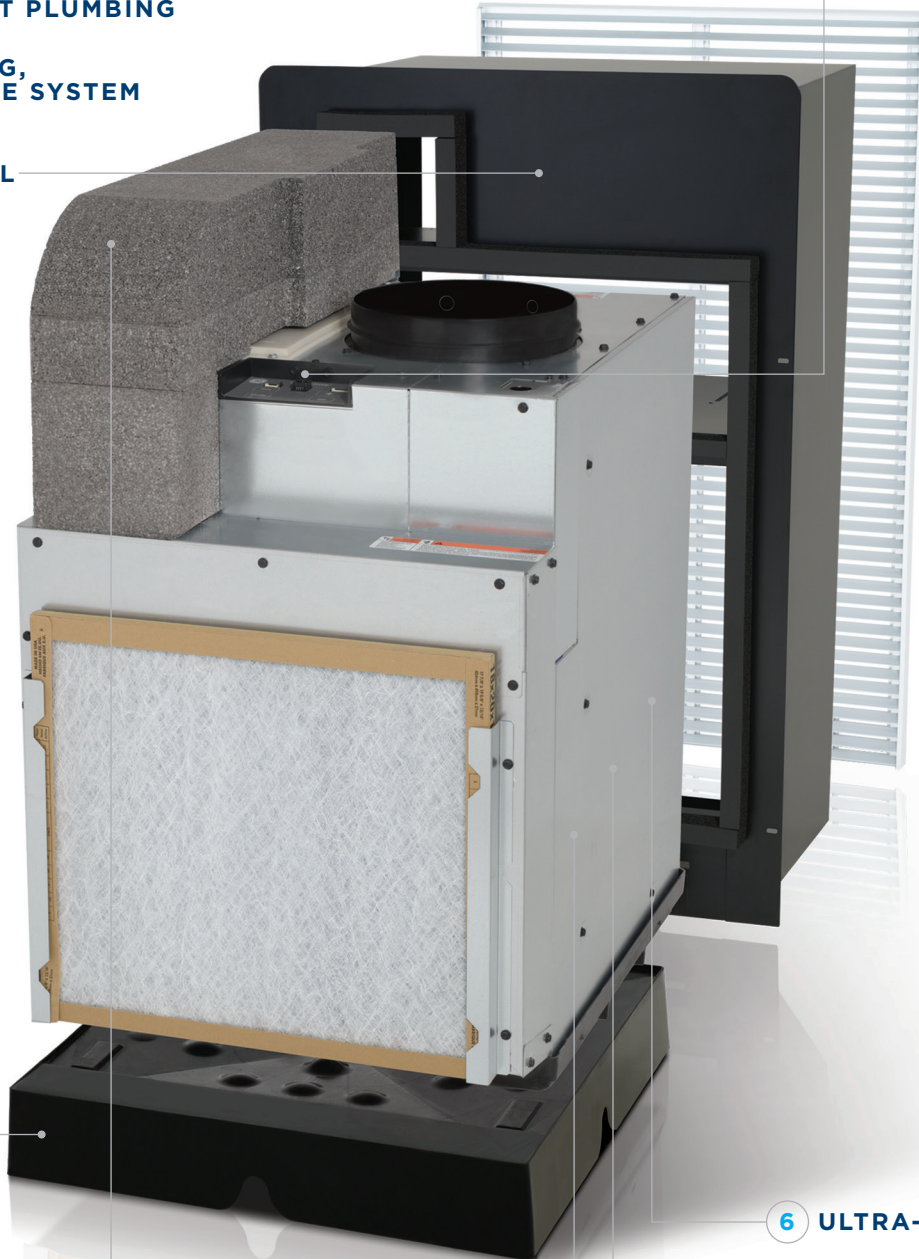

6 ULTRA-QUIET

7 REVERSE CYCLE  
DEFROST

8 CORROSION  
PROTECTION

11 INVERTER  
TECHNOLOGY

12 ADJUSTABLE SPEED  
MAKEUP AIR

## 12-INNOVATIVE FEATURES



**1 Insta-Platform™**  
One-piece design fully integrates with the wall plenum and aligns for a tight seal. Eliminates need for a customized platform construction on site

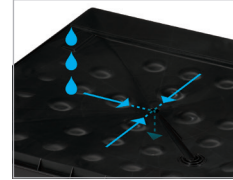

**2 Self-Contained Drainage System**  
Easy installation allows for simple chassis removal while leaving plumbing completely intact

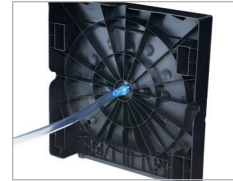

**3 Fast-Connect Plumbing**  
Thoughtful design enables platform build and rough plumbing completed in only minutes

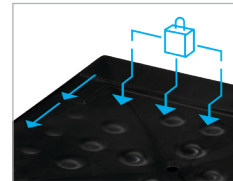

**4 Self-Aligning, Lock-in-Place System**  
Perfect fit and mistake proof when the chassis is placed on the platform



**5 Quick-Install Plenum**  
Plenum is easily installed from the interior of building, without the need for exterior building access. Caulking is required



**6 Ultra-quiet**  
Delivers quiet cooling power with a smooth sound for a good night's sleep



**7 Reverse Cycle Defrost**  
Exclusive technology increases efficiency, enabling the unit to run in heat pump mode longer



**8 Corrosion Protection**  
Exclusive rust-proof basepan and bulkhead provide another level of corrosion protection

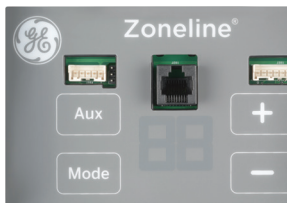

**9 Onboard Diagnostics**  
Electronic controls give clear and fast diagnostics data and fault codes, for quick and easy notifications



**10 SmartHQ™ WiFi Capability**  
An optional Smart HQ module\* gives property managers the ability to oversee units, increasing productivity and enhancing guests' experience



**11 Inverter Technology**  
Variable speed operation provides an advantage with shorter recovery time, improved efficiency, sound quality and dehumidification. Consistent room temperature allows for total room comfort



**12 Adjustable Speed Makeup Air**  
Makeup air and customizable variable speed fan technology provide the precise airflow for specific applications. For energy savings, Makeup air delivery can be cycled based on occupancy, using a compatible occupancy detecting thermostat. Optional MERV 13 filtration available

\*SmartHQ module part number PBX23W00Y0, PBX23W00Y1 or SHCM10PK (10 Pack). Service Subscription required.



**IMPORTANT NOTICE**

Equipment used as a primary source for heating or cooling is an integral part of the building in which it is installed. Proper application is essential for satisfactory performance over a wide range of operating conditions. It is strongly recommended that a professional engineer determine proper application.

If this unit is a replacement unit, its specifications and performance may differ from those of the unit it is replacing. For that reason, we again strongly recommend that a professional engineer determine proper application.



## SYSTEM FEATURES

The Zoneline Ultimate V12 Single Packaged Vertical air conditioner is designed with features and innovations making it the ideal unit to own.

- Excellent efficiency and dehumidification
- Permanently lubricated EC fan motors
- Standard size air filter (18" x 20" x 1") included
- Central desk control capability
- Inverter Technology
- Adjustable Speed Makeup Air
- HI and LOW fan speeds controlled by remote thermostat
- Corrosion protection treatment standard
- Slinger ring condensate removal
- Indoor frost control
- Automatic compressor random restart
- Compressor restart delay
- Electronic control diagnostics/ Service Modes
- Boost Heat
- Freeze/Heat Sentinel

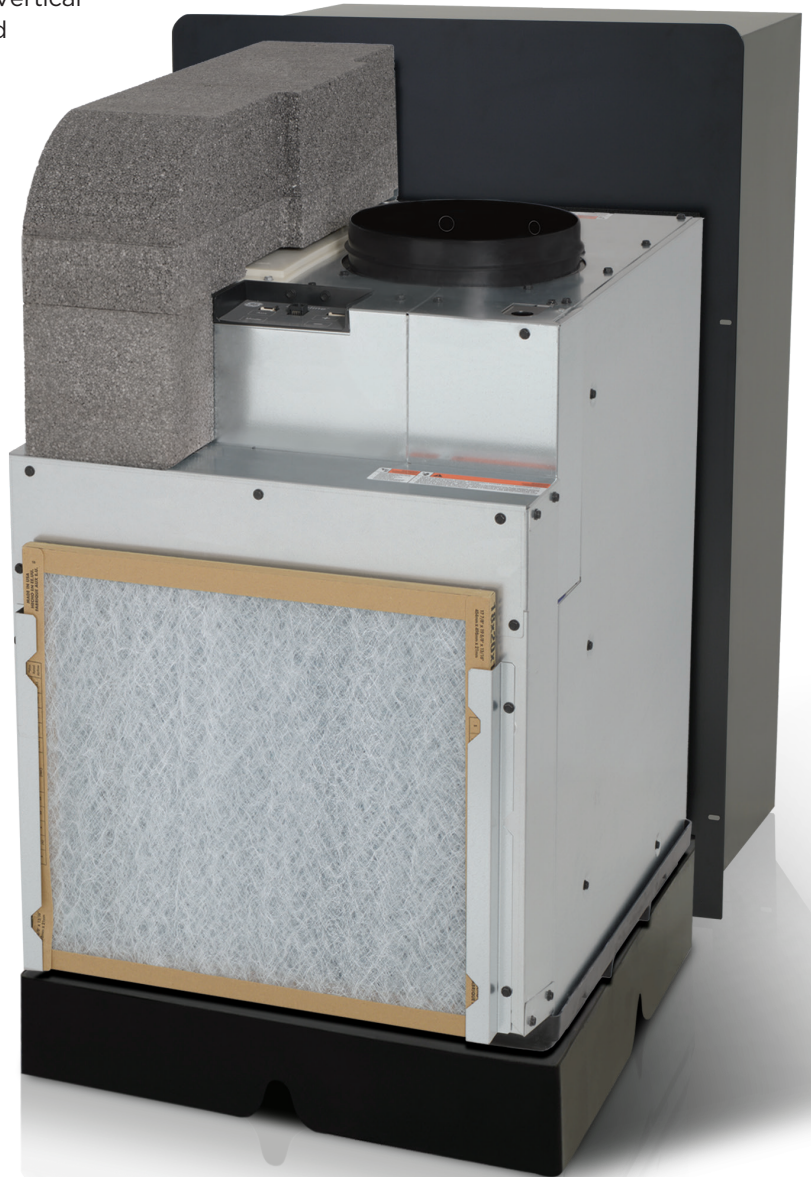

## INVERTER TECHNOLOGY THE REASONS WHY



Inverter Technology is the latest innovation in Zoneline Vertical Terminal Air Conditioning. By enabling variable speed operation, it improves:

- **Temperature Recovery Time**—ensuring occupant comfort by quickly reaching the desired setpoint temperature
- **Efficiency**—aligns compressor output to room needs thereby reducing energy consumption
- **Low Ambient Heat Pump**—the variable speed compressor and advanced defrost capability allows for the best in heat pump operation down to 0° F
- **Two-Way Thermostat Capability**—advanced thermostat communication allows for true compressor speed control and adjusts cooling & dehumidification outputs to precisely match room needs
- **Sound Quality**—operates at slower speeds longer and smoothly changes speed to avoid abrupt start-ups
- **Dehumidification**—with 3 selectable levels of enhanced dehumidification, it maintains comfortable room conditions using variable speed to reduce humidity, even in challenging environments

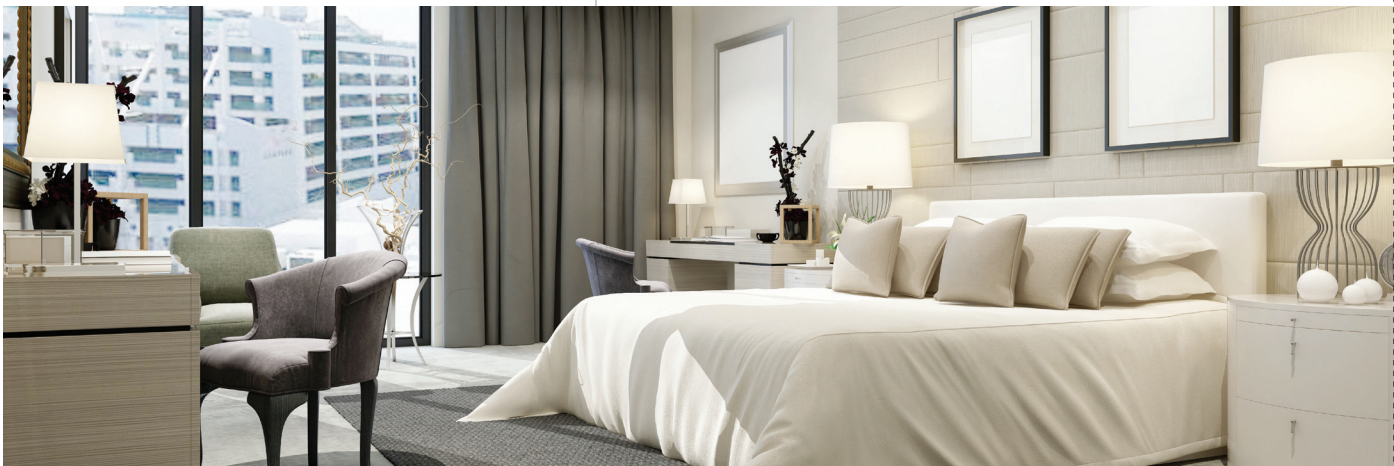

### UltimateV12 HEAT PUMP SAVINGS

- COP of 3.6 at rated conditions
- Heat Pump operates down to 0° F
- Minimizes use of costly back-up heat

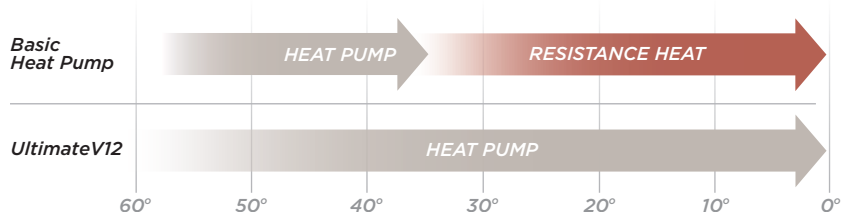

## ADJUSTABLE SPEED MAKEUP AIR

### MAKEUP DUCT INLET FAN



Open

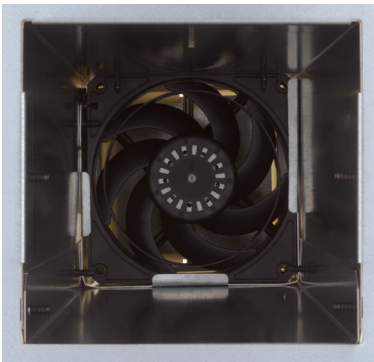

Closed

A dedicated variable speed fan allows for the delivery of room specific volumes of conditioned Makeup air of up to 70 CFM.

The RAK190V thermostat provides the ability to achieve energy savings by cycling Makeup air based on occupancy status.

The RAA13V is an optional MERV 13 filter that reduces dust, pollen, mold, bacteria, viruses and other airborne pathogens from entering the room. It provides cleaner Makeup air to improve overall indoor air quality, with easy access from the front side of unit.

### ADJUSTABLE SPEED MAKEUP AIR



NOTE: AZ9V models are not recommended for installation within two miles of coastal areas.

## FEATURES & BENEFITS

### EXCELLENT EFFICIENCY AND DEHUMIDIFICATION

GE Appliances recognizes the importance of energy efficiency and dehumidification in an air conditioning system and uses EER (Energy Efficiency Rating) as the required means of reporting the relative cooling efficiency of the unit. Additionally, IEER is used to report the overall unit efficiency comprised of partial load conditions.

The measurement of the efficiency of the heat pump output, when compared to electric resistance heat, is called the Coefficient of Performance (COP). The GE Zoneline single packaged vertical heat pump has outstanding COP ratings. This number provides a basis not only for comparing the heat pump output to electric resistance heat, but also the ability to directly compare heat pumps within the same range of capacity to one another.

### DEHUMIDIFICATION

In addition to efficiently maintaining room temperature, the AZ9V intelligently monitors room humidity and offers three selectable levels of advanced dehumidification to target a comfortable room humidity of less than 50% relative humidity (RH). The desired level of dehumidification is selected in the unit's auxiliary control settings. The chart below describes each level of dehumidification and when it will be active.

Auxiliary	Cycle Type		
	Dehumidification	Dehumidification + 1kW Reheat	Humidity Sentinel
d0 (None)	No	No	No
d1 (Low)	Yes, > 50% RH	No	No
d2 (Standard)	Yes, > 50% RH	Yes, > 70% RH	Yes, > 70% RH
d3 (Max)	Yes, > 50% RH	Yes, > 60% RH	Yes, > 60% RH

\* Note: You may see increased energy consumption with the use of standard or maximum settings

**Default Level**  
 Makeup Air Off: d0  
 Makeup Air On: min. d2

#### Dehumidification Cycle:

- Runs during stage 1 cooling requests (Y1)
- Adjusts EEVs, indoor fan speed, and compressor speed to optimize coil temperature

#### Dehumidification +1kW Reheat:

- Same as Dehumidification Cycle but adds 1kW electric heat
- Used only under very high humidity conditions
- Extended cycle lengths allow increased dehumidification time

#### Humidity Sentinel

- Same as Dehumidification Cycle + 1kW Reheat but only operates at a slower compressor speed
- Runs while unit is "idle" and room temperature is close to targeted temperature

### PERMANENTLY LUBRICATED EC FAN MOTORS

The Zoneline Vertical chassis has two permanently lubricated, totally enclosed fan motors. The motors are permanently lubricated to reduce maintenance, and totally enclosed to keep dirt and water out of the motor windings. These motors are EC type for precision speed control and efficient performance.

### CENTRAL DESK CONTROL (CDC)

AZ9V units are compatible with simple on/off 2-wire Central Desk Control (CDC) systems. The unit utilizes a 3 pin port to interface such a system. This requires the separate purchase of the RAKCDC connector accessory. The most common installation of this type of system is a switch mounted at the registration desk; and, upon guest check-in, the switch is activated to allow the air conditioner to operate.

Likewise, when the guest checks out, the device is switched to the "OFF" setting so the unit will not operate when the room is not rented.

In some resort areas, this feature is usually used with a normally open switch connected to sliding glass doors, and opening the doors causes a contact to close, turning the air conditioner off. This prevents the unit from running and wasting energy with the sliding glass door open.

### IMPORTANT CDC NOTES:

1. The unit requires the use of a normally open switch. Closing the circuit shuts off the system.
2. Both wires comprising the circuit must connect to the CDC terminals on the unit and to the controlling switch. Do not use a common buss (at the unit or at the switch panel) in the wiring.
3. A 24-volt transformer is contained within the Zoneline Vertical Unit. No external voltage may be applied to the unit through the CDC terminals.
4. Minimum wire size for CDC wiring:
 

WIRE SIZE # AWG	MAXIMUM ALLOWABLE LENGTH
#22	600 Ft.
#20	900 Ft.
#18	1,500 Ft.
#16	2,000 Ft.
5. Freeze Sentinel and Heat Sentinel still remain operational when the unit is connected to a CDC system.

### CDC PORT LOCATION

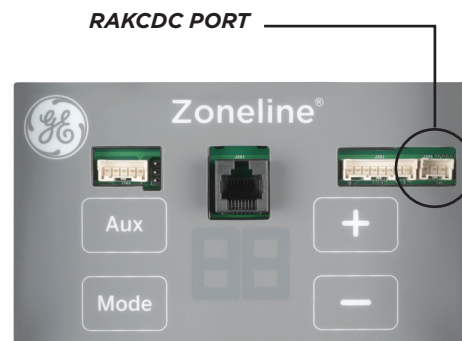



## FEATURES & BENEFITS

### CDC Typical Wiring

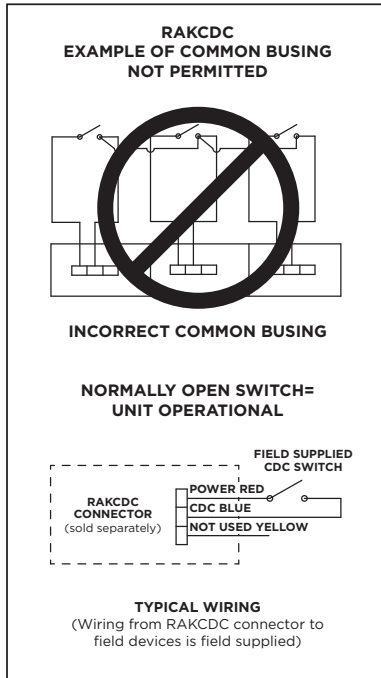

### INDOOR FAN MOTOR WITH HIGH AND LOW SPEED RANGES

Since the Zonline Vertical chassis discharge air may be routed through duct work for air distribution into one or more rooms, the units are equipped with 2 fan speed ranges that provides greater air movement to compensate for the additional duct length. GE Appliances recommends an HVAC engineer be consulted to determine the best fan speed for the application.

Higher CFMs tend to increase the operating sound level, both from fan noise and from the air noise in the duct. Higher CFMs also reduce the dehumidification rate of the unit, while lower CFMs provide quieter operation and better dehumidification. However, if the CFMs are not high enough to adequately move the air through the duct system, the unit will not be able to provide a comfortable room.

If the Zonline Vertical chassis is connected to a wall thermostat without the ability to provide two fan speeds, the fan speed will be determined by connecting the wire controlling the fan to the low speed fan terminal or the high speed fan terminal on the unit.



### CORROSION PROTECTION TREATMENT—STANDARD

- Painted Outdoor Fan Motor Casing
- Double Painted Compressor
- Coated Outdoor Coils With Stainless Steel End Brackets
- Durable Composite Base Pan

NOTE: AZ9V models are not recommended for installation within two miles of coastal areas.

### SLINGER RING CONDENSATE REMOVAL

Condensate water removed from the indoor air is dispersed into the air stream by the outdoor fan slinger ring and deposited on the hot outdoor coil. The water helps cool the refrigerant in the outdoor coil and increases the efficiency of the air conditioner, while reducing the condensate draining from the unit.

### INDOOR COIL FROST CONTROL

Under certain operating conditions, frost can form on the indoor coil of an air conditioner, reducing air flow and cooling. In order to prevent frost from forming, the Zonline Vertical chassis has an automatic frost control on the indoor coil. When frost begins to form on the coil, the compressor stops while the indoor fan continues to run, until the coil temperature increases and the frost dissipates.

At that time, the compressor resumes operation and cooling continues. The indoor fan remains running during the time the compressor is off to help warm the coil with room temperature air.

### AUTOMATIC COMPRESSOR RANDOM RESTART

In the event of a power interruption, all compressors attempting to restart immediately when power is restored can result in a power surge that can cause another power failure. The microprocessor in the Zonline Vertical chassis has a random restart logic system that prevents all compressors from restarting at the same instant.

### COMPRESSOR RESTART DELAY

Zonline Vertical units are designed to provide a minimum of three minutes of compressor off time to allow refrigerant pressures to equalize before attempting to restart. Attempting to restart against a high head pressure shortens compressor and overload protector life.

The units are also designed to provide a minimum of three minutes of compressor run time to prevent short cycling from disturbing the room occupant.

### FREEZE SENTINEL

- Detects low room temperature and turns heater to help protect against damage caused by freezing room temperatures.
- The electric heater turns on at 41°F and warms the room up to 46°F and shuts off.
- Freeze Sentinel may be turned off via the auxiliary control.

## FEATURES & BENEFITS

### HEAT SENTINEL

The property owner may choose to activate the Heat Sentinel feature on the Zoneline unit. If the Heat Sentinel is activated and room temperature reaches 85°F (even when the unit is in the “OFF” mode), the unit will automatically start the air conditioning operation and will shut off when the room temperature reaches 80°F. This will help dehumidify the air and lower high temperatures so the guest will not be entering an extremely hot room.

### HEAT PUMP OPERATION

Heat pumps save money compared to electric resistance heat, but if the unit cannot provide room occupant comfort, the savings may be of questionable benefit. GE Appliances has years of experience with designing Zoneline heat pumps to solve the problem of guest complaints.

The heat pump unit uses a three-stage heat (including auxiliary heat)/two-stage cooling thermostat, and will operate as specified by the remote thermostat being used as long as outdoor conditions will allow. If the remote thermostat asks for heat pump heating outside of unit heat pump operating conditions, the heating request will be met by utilizing back-up resistance heat.

The Zoneline Vertical chassis will operate in efficient heat pump mode down to a 0°F outdoor temperature. At temperatures below this, the unit will automatically switch to electric heat.

***The resistance heater and the heat pump do not operate simultaneously.***

### HEAT PUMP LOGIC

The chart below indicates the standard heating source of the AZ9V series heat pump models under various outdoor conditions. The unit is designed to provide heat pump savings without sacrificing room comfort.

Heat Setting Configuration		Outdoor Temperature		
All Electric Heat Mode (Aux Mode 8)	Heat Boost Mode (Aux Mode 9)	Above 85°F	Between 85°F and 0°F	Below 0°F
OFF	OFF	Full Resistance Heat	Heat Pump	Full Resistance Heat
OFF	ON	Full Resistance Heat	Heat Pump + Supplemental Heater*	Full Resistance Heat
ON	OFF/ON	Full Resistance Heat	Full Resistance Heat	Full Resistance Heat

\*Simultaneous supplemental heat (Boost Heat): 1.0kW @ 230V & 265V; 0.8kW @ 208V

### QUICK HEAT RECOVERY

Unit software will provide electric resistance heating as the first heat cycle following the unit having been set to either off or cool on the remote thermostat. This ensures occupant comfort by quickly reaching the desired setpoint temperature. All subsequent heating cycles will follow heat staging as dictated by the remote thermostat if required outdoor temperature conditions are met. Quick heat recovery is not influenced by heat pump logic.

### HEAT PUMP DEFROST

Zoneline heat pumps utilize a reverse-cycle, demand-defrost system to extend heat pump operation and increase savings from extended operation. The microprocessor determines the need for defrosting from criteria based on continuous compressor running time, outdoor air temperature and outdoor coil temperature. When defrosting is required, the unit reverses the flow of refrigerant to direct the hot gas into the outdoor coil to melt the frost buildup.

Before and after the reverse-cycle defrost, the unit shuts off the compressor to allow the refrigerant pressures to equalize through the system. During these periods of pressure equalization, the full resistance heat capacity of the unit is activated to help ensure room comfort conditions during the defrost cycle. The unit remains in the defrost cycle for a minimum of three minutes and up to a maximum of nine minutes. The defrost cycle terminates when the outdoor coil reaches a temperature of 68°F or the maximum time has been reached.

### BOOST HEAT

The AZ9V series offers a Boost Heat option feature that utilizes partial supplemental resistance heat at the same time as the heat pump operation. The boost heat feature changes stage one and stage two heating (heat pump) to be heat pump with partial resistance heat. Stage three heating stays as full resistance heat.

***NOTE: Heat Pump and full resistance heat shall never be on at the same time.***

### ELECTRONIC CONTROL DIAGNOSTICS/ SERVICE MODE

The Zoneline Vertical system continuously monitors the unit operation and in some cases the unit may take action and shut down until conditions are corrected. The electronic control will store/provide Error Codes to aid in diagnosis and correction to get the unit up and running quickly.

In addition to error codes, the unit is equipped with Service Modes that allow for independent testing of unit functionality. This allows for fan, heat, cool operations among other checks to be “forced” without signals from the remote thermostat or unit temperature sensors. This is a valuable tool that helps pinpoint operational problems and also helps distinguish unit malfunction from problems caused by remote thermostat.

See the product Use & Care/Mini-Manual for specifics on Error Codes, Service Modes, and how to use the system.

## COMPONENTS & INSTALLATION

Each Zoneline single packaged vertical unit requires a drain platform, wall plenum, exterior grille, unit, remote thermostat, filter and a return air grille, ductwork and supply registers.

The drain platform legs, ductwork and supply registers are field supplied. Each of the other components is ordered separately. The drain platform, wall plenum and exterior grille are specifically designed to interface with the GE Appliances Zoneline Vertical chassis and must be purchased from the same source as the unit. Custom exterior grilles may be used but must comply with the requirements shown on page 12.

The remote thermostat and the return air grille are offered as accessories by GE Appliances, but may be purchased from a source other than GE Appliances. If a non-GE Appliances thermostat is being used, it should meet the general thermostat requirements mentioned on page 14. Any custom return air grille being used should offer a louvered area as large as the GE Appliance offering or larger.

### WALL PLENUM

Since the unit itself does not install in the wall opening, the use of a plenum is necessary to contain and separate the outdoor air paths. The plenum must be able to hold

**WALL PLENUM  
(RAVWPT15B)  
Cutout:  
24"W X 40"H**



water in the bottom without leaking into the wall cavity. It also must have a “splitter” to separate the outdoor air paths and prevent the discharge air from being drawn back into the unit.

The wall plenum is the first component to be installed. GE Appliances model RAVWPT15B is available for use with wall thicknesses of 8” to 15.”

The plenum is to be installed square and level in the opening and secured to the wall construction with screws or nails in the sides located a minimum of 2” up from the bottom of the plenum. No nails or screws may be used in the bottom or top of the plenum to prevent water entering the wall cavity.

The plenum is not load bearing, so a proper header needs to be installed above the plenum the same as over any window opening in the wall. If the building construction is brick, concrete block or other non self-supporting material, a lintel must be installed over the plenum opening. The plenum must be caulked to the wall, both to the outdoor wall face and to the interior wall, along all four sides to prevent air and water infiltration.

### WALL PLENUM MODELS:

RAVWPT15B-For installations with walls 8” to 15” thick.

### DRAIN PLATFORM

The AZ9V Series requires the use of a separate drain platform accessory (RAVDPLAT). This accessory supports the chassis and positions it properly to seal to the wall plenum. Secondly, it serves as the drain pan for the chassis with connections for both a primary and secondary drain. This innovative accessory saves time and money by eliminating the need for field fabricated support platforms. It also greatly simplifies chassis removal from the closet because the plumbing connections are made to the platform as opposed to the chassis itself.

The drain platform height is determined based on the position of the RAVWPT15B wall plenum. The bottom edge of the drain platform is flush with the bottom edge of the wall plenum. Technically, the bottom edge could be set to floor level, but that would likely make connecting to a building drain system difficult. In most installations, it will be desired to raise the platform several inches off the floor. This can easily be done using 2”x4” lumber cut to length and positioned in the integrated support pockets of the RAVDPLAT. Only two support legs are needed as the exterior side is supported by the wall plenum.

The primary drain can be directed out either side or the front of the drain platform through sidewall notches in the platform. If the platform is elevated for drainpipe clearance below, the primary drain can run any direction desired. The secondary drain is to be piped through the wall plenum to the exterior of the building.

For further detail, please see the RAVDPLAT Installation Instructions.

## COMPONENTS & INSTALLATION

### STANDARD SIZE AIR FILTER

A number of filters, providing varying degrees of filtering efficiency, are available on the market today. GE Appliances has designed the Zonline Vertical chassis to accommodate a number of filter placement options. The filter provided with the unit is a standard size 18" W x 20" H x 1" D filter.

**The unit must not be operated without a filter in place, even during construction.**

GE Appliances provides three filter placement options for design and installation flexibility. Filter brackets are provided on the front of the Zonline vertical unit chassis (18" x 20" x 1"), which allows for the filter to be directly mounted to the unit.

An access panel, accessory model number RAVRG4, for the closet enclosure is the second filter placement option (20"x24"x1 to 2"). The access panel requires a cutout in the unit closet enclosure wall and provides access to the unit for servicing and removal. The bottom of the access panel should be at least 1" below the top edge of the drain platform to allow for easy removal of the Zonline Vertical Unit.

The third filter placement option is incorporated in a return air grille-RAVRG2. A 20" x 20" x 1" filter fits inside the grille. The RAVRG2 can be installed in a solid closet access door or in a closet side wall. A 20 3/8" x 20 3/8" cutout in the closet wall or door is required to install this option.

A different size filter may also be used in a field-supplied frame installed in a return air grille mounted in the closet enclosure door or wall.

**Only one filter is to be used in the installation.**

Multiple filters will reduce the air flow and affect unit performance. A clean filter is essential to efficient unit operation.

**The filter should be checked at least every 30 days and replaced if dirty.**

**GRILLE (RAVAL4)**  **EXTERIOR GRILLE**  
The architectural louver exterior grille is mounted to the exterior of the plenum and held in place with four screws inserted from inside enclosure closet. The grille is designed specifically for use with the Zonline Vertical

chassis, and **the use of any other grille must be approved by GE Appliances Air Conditioning Applications Engineering.**

### OUTDOOR CLEARANCES

Since the GE Zonline Vertical chassis is an air exchange system, it is critical that the exterior grille, which provides both intake and exhaust, not be covered or impeded in anyway.

Small or minor obstacles, such as poles or small shrubs, should be a minimum of two feet away (radius in all directions). Larger obstructions, such as a solid fence/wall and heat generating sources, like a condensing unit, should be kept away a minimum distance of six feet.

### EXTERIOR ARCHITECTURAL TREATMENTS AND SPECIAL OUTDOOR GRILLES

The architectural design of a building may dictate the use of special or oversized louvers for aesthetic reasons. Louvers other than standard Zonline exterior grilles may be used on the Zonline unit, however, these special louvers, or any special exterior architectural treatments of the building facade that may restrict the free circulation of condenser airflow, should be referred to GE Appliances Application Engineering for evaluation and approval. The following guidelines should be followed in selecting a louver:

1. The louver must have a minimum of 65% free area. ASHRAE defines "free area" as the minimum area of the opening in an air inlet or outlet through which air can pass. Percent (%) free area equals the X dimension divided by the Y dimension. (See examples below).
2. The louver should be attached to the wall case in a manner that will prevent recirculation of condenser discharge air into the air inlet. If the louver is not attached directly to the wall case, a field-supplied splitter or gasket is required between the chassis and the louver to prevent recirculation.

It is important that the above criteria be followed since a louver that is too restrictive or allows recirculation will reduce the unit's capacity and efficiency, increase the electrical current draw, cause intermittent operation due to the compressor overload protector shutting the compressor off, and cause failure of the compressor overload protector and shorten compressor life. Using the unit with a grille that is too restrictive or allows recirculation may constitute improper installation and will void the unit's warranty. Since the Zonline unit complies with Underwriters Laboratories® requirements, it may be necessary to send a full size sample louver section to an independent lab to be tested with the Zonline unit.

#### SAMPLE CALCULATIONS

$$\text{Free Area (\%)} = \frac{X}{Y} \times 100 \quad x = 1" \quad y = 1.5"$$

$$\text{F.A. \%} = \frac{1}{1.5} \times 100 = 66.7\%$$

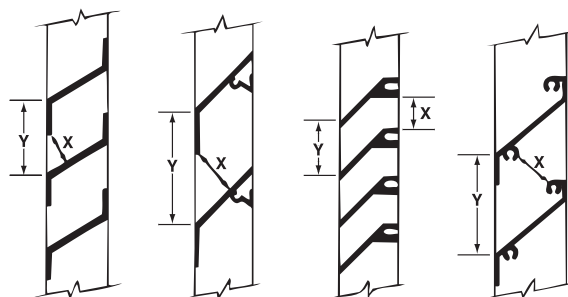

## COMPONENTS & INSTALLATION



### UNIT AND INSTALLATION NOTES

The unit is a one-piece package system that fits directly into a closet enclosure. Once the drain platform (RAVDPLAT) has been installed, the chassis can be positioned on the drain platform and pushed towards the exterior wall. The chassis will drop down slightly into the platform, securing it in place and engaging the gasket on the wall plenum (RAVWPT15B). Power, thermostat, and duct connections can then be made.

A 10" diameter flange on the top of the unit is used to connect to field-supplied, insulated, flexible or rigid transition duct with an adjustable ring clamp.

Flexible duct may be used for transitions only. Rigid duct must be used for 90-degree bends and tees. Do not use flexible duct for unsupported runs of five feet or more.

### POWER CONNECTION KIT

All AZ9V Series Vertical Units are equipped with universal heaters that are capable of different heater outputs. Heater output is determined by which unique direct connect power kit is being used. This increases the flexibility of a chassis where various heating requirements may need to be met at a site. This power connection is the only means of supplying power to the chassis. Please reference the chart on page 22 to determine the appropriate power connection kit for your project.

### RETURN AIR GRILLE, ACCESS PANEL OR LOUVERED CLOSET DOOR

The return air from the room to the unit may enter the closet through one of four ways.

A louvered door may be installed on the closet to allow return air to enter. When a louvered door is used, the filter would be installed in the filter bracket on the front panel of the unit.

A wall-mounted access panel may be used instead of a louvered door. The return air is through the access panel, model RAVRG4, which requires a 28 1/8" W x 55 7/8" H cutout in the wall, and there is a filter bracket behind the grille louvers.

A return air grille, model RAVRG2, may also be used and is designed to be installed in a 20-3/8" by 20-3/8" cutout in a flush closet door or closet sidewall. In this installation, a filter can fit into the bracket in the RAVRG2.

A field-supplied return air grille, with a minimum dimension of 20" W x 20" H, may be used if mounted in a cutout in the door or wall. When employing this method for return air, the filter is installed in the bracket mounted on the unit.



RAVRG2



RAVRG4

## COMPONENTS & INSTALLATION



### REMOTE THERMOSTAT

Zoneline Vertical units are controlled by a wall-mounted thermostat. AZ9V units are capable of operating with a standard 24VAC thermostat having 2 stage heat pump with

aux heat & 2 stage compressor cooling. Additionally, the unit is capable of operating in a two-way communication mode (available with the RAK190V thermostat). Two-way communication will enable even greater precision in temperature and humidity control by providing the AZ9V with exact temperature and relative humidity readings from the thermostat.

For a standard thermostat connection, low voltage wiring connections are made to the 8 pin harness included with each unit. For two-way communication, low voltage connections are made to the 5 pin connector included with each unit. The harnesses allow for a single point thermostat connection to simplify chassis removal and reinstallation. See diagrams below for terminal designations.

### THERMOSTAT WIRING DIAGRAM

#### 8-Pin

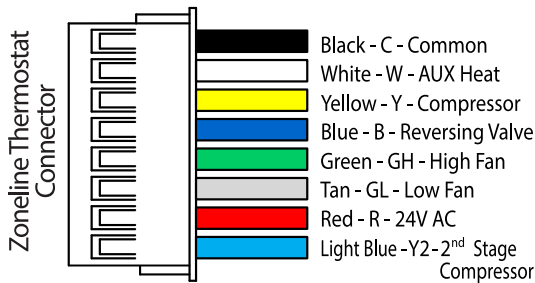

#### 5-Pin

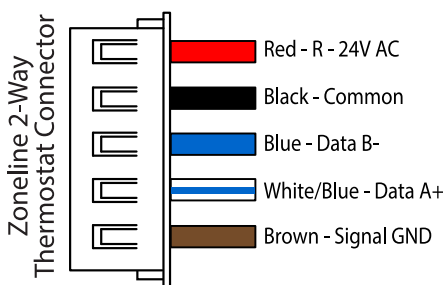

If a non-GE Appliances thermostat is used, the compatibility of the thermostat with the unit is the responsibility of the installer. The unit has an integral transformer, and no external voltage or transformer may be used.

Maximum wiring length and wire size: AWG 18 up to 66 feet—AWG 20 up to 66 feet.

### DUCTWORK & SUPPLY REGISTERS—FIELD SUPPLIED

Ductwork and supply registers are mentioned here as System Essential Components, because they are necessary to complete the installation. These components are field supplied per the HVAC engineer's design. Under no circumstances should the AZ9V unit be operated to an external static pressure (ESP) in excess of .3" W.C.

Please reference the chart below to determine actual airflow for a given ESP and fan selection. Medium CFM selection is our recommendation. Higher CFM levels tend to increase sensible capacity, enhance room circulation and increase duct noise. Lower CFM levels tend to increase latent capacity and reduce noise.

Airflow – CFM @ 230 Volt and @ 265 Volt					
ESP (in. water)	Indoor Fan CFM				
	Fan Boost Mode				
	ON		OFF		
	High CFM	Medium CFM	Medium CFM	Low CFM	
AZ9VH12	0.10	500	433	433	363
	0.15	485	416	416	333
	0.20	470	385	385	295
	0.25	440	350	350	230
	0.30	410	313	313	*

\* Do not operate unit in these conditions.

### ELECTRICAL INFORMATION—GENERAL

Zoneline Single Packaged Vertical Air Conditioners are to be connected to a single-phase 60 hertz power. Units with the voltage designator "D" in the 8th character of the model number may be operated on either nominal 230-volt or 208-volt power. Units with the voltage designator "E" in the 8th character of the model number are to be operated on nominal 265-volt power (A.K.A. 277-volt power). For all installations, feeder, sub-feeder, branch circuit and electrical protective devices must conform to all local codes. In the absence of a local code, the National Electrical Code should be followed.

Each unit should be installed on a single branch circuit. More than one unit per branch circuit is not recommended. All wiring, must conform to local electrical regulations and codes. When in doubt, consult the National Electrical Code.

# TYPICAL UTILITY CLOSET AND DIMENSIONS (FOR REFERENCE ONLY)

**IMPORTANT:** Plan and locate plenum, drains and thermostat cable carefully to avoid interference. Hard-to-reach locations will make installation and service difficult!

## SIDE VIEW

Note: It is recommended to leave additional space around the unit to ease installation and access for service.

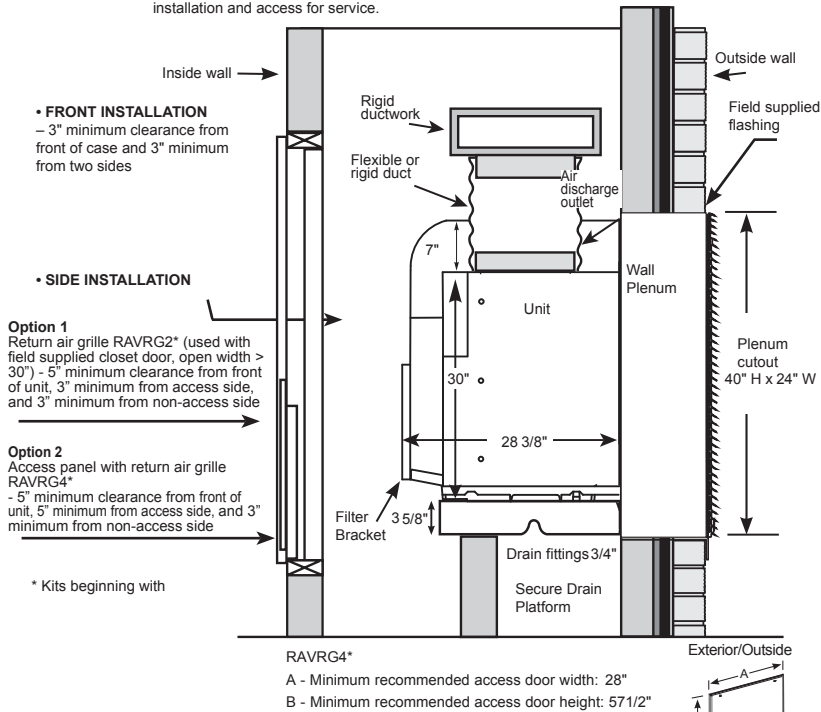

## FRONT INSTALL

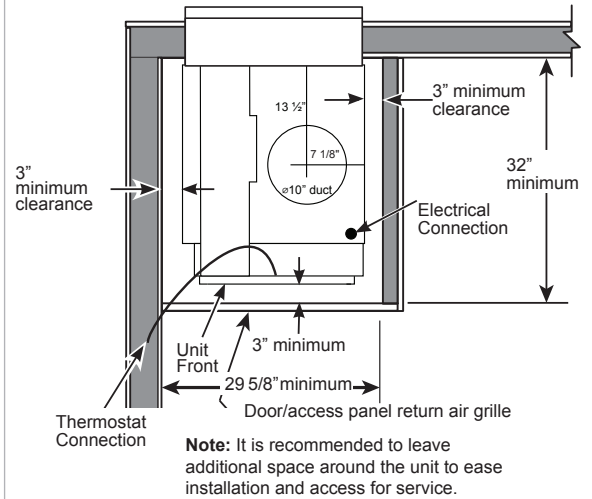

## SIDE INSTALL Option 1 (RAVRG2\* in Door or Closet Wall\*)

### Top View

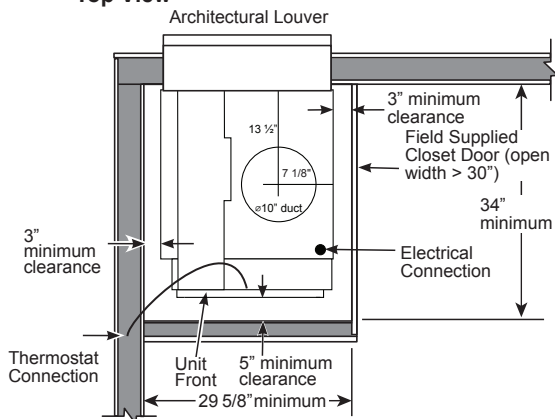

**NOTE:** Clearance and minimum dimensions are from interior walls of closet

\*Kits beginning with

### AVAILABLE ACCESSORIES

- Drain Platform-RAVDPLAT
- Architectural Louver-RAVAL4
- Wall Plenum-RAVWPT15B—telescopes from 8" to 15"
- Access Panel with Return Air Grille-RAVRG4
- Return Air Grille-RAVRG2
- Wall Thermostat

## SIDE INSTALL Option 2 (RAVRG4\*)

### Top View

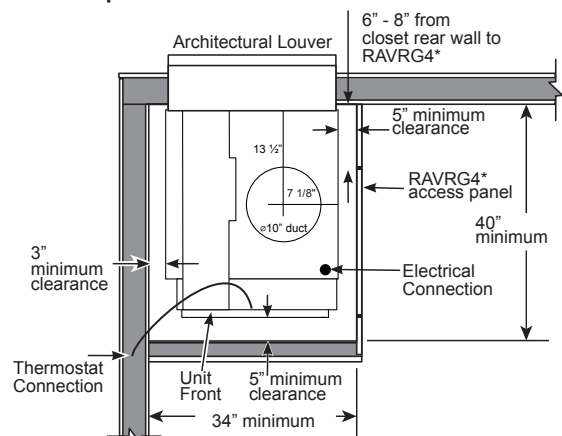

For RAVRG4\*: After installing RAVDPLAT per instructions, slide rear of unit through RAVRG4\* and rest it on platform in the closet. Rotate unit 90° so that rear of unit is facing the wall plenum. Follow remaining instructions for installing unit to wall plenum.

## AUXILIARY CONTROL

### SETTING THE AUXILIARY CONTROL

#### Auxiliary Controls-Aux Set Button

The electronic control for the unit comes preset from the factory to control the unit how “most” customers would prefer the unit to operate. The presets (called modes or functions) can be modified to accommodate for differences in installation parameters or personal preferences on how the unit should operate and perform.

If the owner modifies the auxiliary controls, it is then the owner that is responsible for ensuring the auxiliary controls are set to the desired function. There are 12 different modes (functions) that can be set using the auxiliary set button.

#### Modes of the Auxiliary Control

Mode 1 - Smart Fan Cool / Smart Fan Heat

Mode 2 - Temperature Units

Mode 3 - Freeze Sentinel/Heat Sentinel

Mode 4 - Constant **ON** Fan

Mode 5 - Temperature Limit Cool / Heat

Mode 6 - Thermostat

Mode 7 - Fan Boost Mode

Mode 8 - Electric Heat Only

Mode 9 - Heat Boost

Mode 0 - Makeup Air Mode

Mode E - Makeup Air Occupancy

Mode d - Dehumidification

To change operating or set up parameters the control must be in AUX Mode. With power applied to the unit, press the AUX SET button until the “AU” appears on the display.

The display will look like this when entering the **AUX** Mode :



Auxiliary Set Mode

While in **AUX** Mode, press the **MODE** button to scroll through the different modes. Continue to press the **MODE** button until the number corresponding to the mode to be modified is showing in the first digit of the display. Once the correct number is displayed, use the +/- buttons to change the second digit of the display for that mode to either “**ON**” for **On** OR “**OFF**” for **Off** depending on the desired function.

When the selection for a given mode is complete press the **MODE** button to continue setting other auxiliary control functions OR press the **AUX SET** button to confirm the selection and exit **AUX SET** mode.

#### Mode 1 Smart Fan - Cooling/Heating

Press **MODE** until a 1 first appears in the first digit of the display for **Smart Fan** cool mode. To change to Smart Fan heat mode, press **MODE** again.

Press the - pad to set the indoor fan to cycle on/off in the heating or cooling mode selected “**OFF**”.

Press the + pad to set the indoor fan to run continuously in the heating or cooling mode selected “**ON**”.

Press **AUX** to confirm your selection and exit **AUX** mode, or press **MODE** to continue setting other functions.

The default setting for Mode 1 is as follows:

Cooling: Continuous (ON)

Heating: Cycle (OFF)

**\*Note:** In cyclic cooling mode, the indoor fan will activate occasionally to verify air temperature in the room. In cyclic heating mode, the fan will continue to operate for several seconds after the heating function has stopped in order to increase unit efficiency.





## AUXILIARY CONTROL

### SETTING THE AUXILIARY CONTROL

#### Mode 2 Fahrenheit / Celsius

This feature allows the individual to switch the temperature units between Fahrenheit and Celsius on the display.

Press **MODE** until a 2 appears in the first digit of the display for Fahrenheit/Celsius mode.

Press the - pad to select Celsius or the + pad to select Fahrenheit. The individual will see an F for Fahrenheit or a C for Celsius in the second digit of the display based on the selection.

The default setting for Mode 2 is Fahrenheit.



#### Mode 3 Freeze Sentinel/Heat Sentinel

With power to the unit and **Freeze Sentinel** activated, the unit automatically provides heat without user interface. This prevents potential plumbing damage by turning the heater and indoor fan **ON** at 41°F and then **OFF** once the closet temperature reaches 46°F.

When **Heat Sentinel** is activated, the unit automatically provides cooling without user interface. This prevents an excessively hot room by turning the air conditioner **ON** at 85°F and then **OFF** once the room temperature reaches 80°F.

Press **MODE** until a 3 first appears in the first digit of the display for **Freeze Sentinel** mode. Press the - pad for **OFF** "L" or the + pad for **ON** "T". This is shown in the second digit of the display. Press **MODE** again to access the **Heat Sentinel** settings. Press the - pad for **OFF** "L" or the + pad for **ON** "T". Press **AUX** to lock in your selection and exit **AUX** mode, or press **MODE** to continue setting other functions.

In the default setting for Mode 3, **Heat Sentinel** is off, **Freeze Sentinel** is on.

**NOTE:** These functions are active whenever the unit is plugged in, even if the unit is not receiving thermostat signals.



#### Mode 4 Constant ON Fan

Press **MODE** until a 4 appears in the first digit of the display to set the fan to run continuously - **even if the unit is not receiving thermostat signals**.

Press the - pad for **OFF** "L" or the + pad for **ON** "T". This is shown in the second digit of the display.

Press **AUX** to lock in your selection and exit **AUX** mode or press **MODE** to continue setting other functions. The default setting for Mode 4 is **OFF**.



## AUXILIARY CONTROL

### SETTING THE AUXILIARY CONTROL

#### Mode 5 Temperature Limiting

Temperature limiting is a feature that reduces energy costs by limiting the lowest temperature that can be obtained in cooling and the highest temperature that can be obtained in heating. This is only applicable when using a 2-way thermostat (see Mode 6 for setup).

Press **MODE** until a 5 first appears in the first digit of the display for **Temperature Limiting** cool mode. To change to heat mode, press **MODE** again.

To set the temperature limits, press the + or - pad. The second digit of the display will be between 0 and 7 depending on the limit you want to set. The chart shows the limits available. Press **AUX** to lock in your selection and exit **AUX** mode, or press **MODE** to continue setting other functions.



Temperature Limiting Cool - Limit 2



Temperature Limiting Heat - Limit 5

TEMPERATURE LIMITS-COOL	TEMPERATURE LIMITS-HEAT
0 = 60°F to 85°	0 = 60°F to 65°
1 = 64°F to 85°F	1 = 60°F to 70°F
2 = 66°F to 85°F	2 = 60°F to 72°F
3 = 68°F to 85°F	3 = 60°F to 74°F
4 = 70°F to 85°F	4 = 60°F to 76°F
5 = 72°F to 85°F	5 = 60°F to 78°F
6 = 74°F to 85°F	6 = 60°F to 80°F
7 = 76°F to 85°F	7 = 60°F to 85°F

The default setting for Mode 5 is as follows:  
Cool: 2 (66°F to 85°F)  
Heat: 5 (60°F to 78°F)

#### Mode 6 Wall Thermostat

Setting this mode to **ON** will allow the unit to operate with a Class 2 Remote Control Wall Thermostat. Press **MODE** until a 6 appears in the first digit of the display for **Class 2** mode.

The default setting for Mode 6 is **ON**.

Press the + pad to turn the option **ON** "11" for "standard cool/heat" thermostats. Press the - pad for two-way thermostat "1" Press **AUX** to lock in your selection and exit **AUX** mode, or press **MODE** to continue setting other functions.



Two-way  
Thermostat



Standard Remote  
Control Wall  
Thermostat

#### Mode 7 Fan Boost Mode

This setting is used when the unit is installed with more restrictive ductwork where additional airflow is needed. This increases the fan speed to ensure proper circulation.

Press **MODE** until a 7 appears in the first digit of the display. Press the - pad for **OFF** "1" or the + pad for **ON** "11" This is shown in the second digit of the display. Press **AUX** to lock in your selection and exit **AUX** mode.



Fan Boost  
Mode OFF





Fan Boost  
Mode ON

## AUXILIARY CONTROL

### SETTING THE AUXILIARY CONTROL

#### Mode 8 All-Electric Heat

When this option is **ON** “

To set All-Electric Heat option, press **MODE** until an **8** appears in the first digit of the display. Press the - pad for **OFF** “

The default setting for Mode 8 is **OFF**.



Fan Boost  
Mode OFF



Fan Boost  
Mode ON

#### Mode 9 Heat Boost

When **Heat Boost** is **ON**, supplementary electric heat is added to the heat pump operation to help maintain a consistent, comfortable room temperature.

To set Heat Boost, press **MODE** until a **9** appears in the first digit of the display. Press the - pad for **OFF** “

The default setting for Mode 9 is **OFF**.



Fan Boost  
Mode OFF



Fan Boost  
Mode ON

#### Mode 0 Digital Makeup Air Module Fan Speed

Press **MODE** until a 0 appears in the first digit of the display for the Digital Makeup Air mode. To change the fan speeds, press the + or - pad.

The default setting for Mode 0 is 02.



Makeup Air Off  
Makeup Air Duct Closes



Makeup Air Speed 6

MAKEUP AIR SETTING	NO FILTER (CFM)	RAA13V (CFM)
00	0	0
01	30	25
02	40	30
03	50	40
04	60	50
05	70	60
06	*	70

\* Not Recommended

#### Mode E Digital Makeup Air Module Occupancy

To control the delivery of makeup air based on room occupancy status, press **MODE** until an E appears in the first digit of the display. Press the + or - pad to set occupancy detection to **OFF** “

The default setting for Mode E is **OFF** “

Occupancy  
Detection OFF



Occupancy  
Detection ON

## AUXILIARY CONTROL

### SETTING THE AUXILIARY CONTROL

#### Mode d Dehumidification

This setting allows for various approaches for dehumidifying a room during a cooling condition once the temperature is controlled.

**Note:** you may see increased power consumption with the "standard" or "max" settings.



No Additional  
Dehumidification



Max  
Dehumidification

SETTING	ADDITIONAL DEHUMIDIFICATION AFTER TEMPERATURE CONTROL
0	None
1	Low (target 50% RH)
2	Standard (target 50% RH, more aggressive above 70% RH)
3	Max (target 50% RH, more aggressive above 60% RH)

#### DEFAULTS

Makeup Air off: d0  
Makeup Air on: min. of d2

#### Mode P Engineering Revision Setup

This setting is used to configure the unit when the circuit board is replaced.

The first time the unit is powered after a service board is installed, the unit will automatically enter this mode. The UI will read **P1**. Press the + pad until the number matches the engineering revision as shown. The engineering revision is the last number in the model number. Press **AUX** to save and exit.

The engineering revision may be adjusted after the first power cycle using **AUX**. Press **MODE** until **P** appears in the first digit, and follow the steps described above.

Nomenclature Example

**AZ9VH12DBMH2**



Engineering Revision

# ACCESSORIES

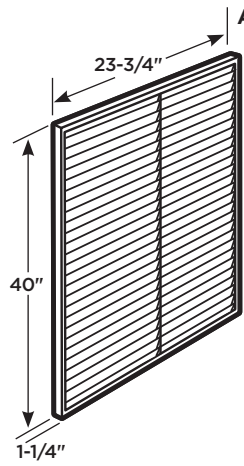

**ARCHITECTURAL LOUVER  
RAVAL4**

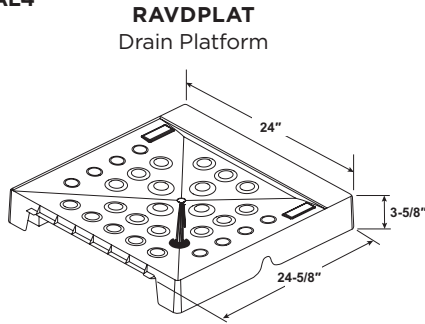

**RAVDPLAT  
Drain Platform**

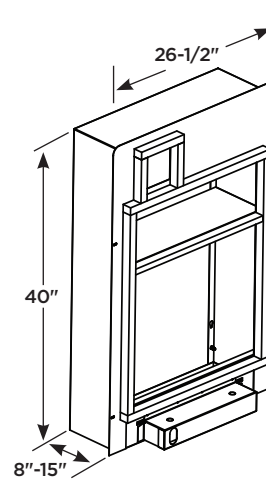

Cutout  
Dimensions:  
24" W x 40" H

**WALL PLENUM  
RAVWPT15B  
Telescopes  
from 8" to 15"**

**RETURN AIR GRILLE  
RAVRG2**  
Filter size: 20" x 20" Field supplied

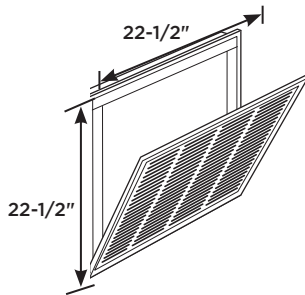

Cutout Dimensions:  
20-3/8" W x 20-3/8" H

OR

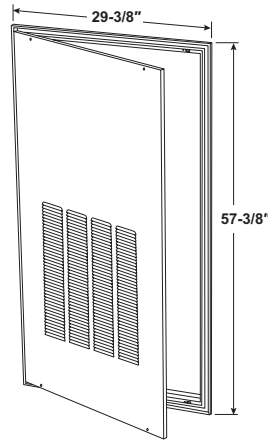

**ACCESS PANEL WITH  
RETURN AIR GRILLE  
RAVRG4**

Filter size: 20" x 24" x 1 or 2"  
Field supplied

Cutout  
Dimensions:  
28-1/8" W x 55-7/8" H

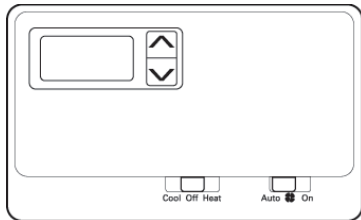

## WALL THERMOSTAT

MODEL TYPE	COMMUNICATION	KIT NUMBER
Two speed fan	8-wire	<b>RAK150VF2</b>
Two Way Communicating, Occupancy Detection, Energy Management	5-wire	<b>RAK190V</b>

Check the thermostat instructions for correct wiring and installation requirements.

## ACCESSORIES

### ESSENTIAL ACCESSORIES

Zoneline Vertical Air Conditioners require a set of essential accessories for proper operation. Once you have selected the size of unit needed, next you'll need to consider the following:

**POWER CONNECTIONS** - All AZ9V Zoneline Vertical units must be direct connected

#### POWER CONNECTION REQUIREMENTS (RESISTANCE HEAT)

230-208 VOLT	12,000 BTUh		
POWER CONNECTION KIT	RAK315D	RAK320D	RAK330D
Heater BTUh	8,360/6,838	11,770/9,629	17,060/13,952
Total Watts	2,568/2,122	3,568/2,940	5,118/4,207
Heater Watts	2,450/2,004	3,450/2,822	5,000/4,089
Total Heating Amps	10.7/9.6	15/13.6	21.7/19.7
MCA	15	20	30
Recommend Protective Device (MOCP)	15 amp time delay fuse or breaker	20 amp time delay fuse or breaker	30 amp time delay fuse or breaker

#### POWER CONNECTION REQUIREMENTS (RESISTANCE HEAT)

265 VOLT	12,000 BTUh		
POWER CONNECTION KIT	RAK515D	RAK520D	RAK530D
Heater BTUh	8,360	11,770	17,060
Total Watts	2,568	3,568	5,118
Heater Watts	2,450	3,450	5,000
Total Heating Amps	9.2	13	18.9
MCA	15	20	30
Recommend Protective Device (MOCP)	15 amp time delay fuse or breaker	20 amp time delay fuse or breaker	30 amp time delay fuse or breaker

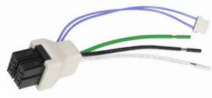

**RAK315D/320D/330D**  
RAK320D shown  
**230/208-VOLT UNIVERSAL DIRECT CONNECT POWER SUPPLY KIT**

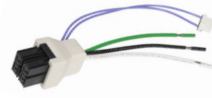

**RAK515D/520D/530D**  
RAK520D shown  
**265-VOLT UNIVERSAL DIRECT CONNECT POWER SUPPLY KIT**

### TELESCOPING WALL PLENUM AND DRAIN PLATFORM

#### RAVWPT15B

Plenum is easily installed from the interior without the need for exterior building access. Caulking is required. It conveniently expands from 8" to 15" for a custom fit.

Wall cut out 24" W x 40" H

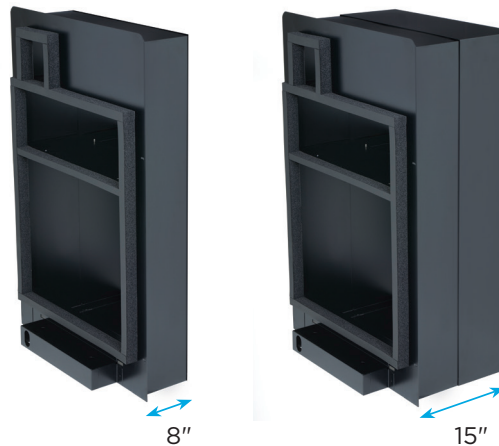

**RAVDPLAT**  
Drain Platform

### EXTERIOR GRILLE AND INTERIOR ACCESS PANELS



**ARCHITECTURAL LOUVER**  
**RAVAL4**  
Aluminum  
Outdoor Grille



**ACCESS PANEL WITH RETURN AIR GRILLE**  
**RAVRG4**  
Cut out:  
28-1/8" W x 55-7/8" H



**RAVRG2**  
Return Air Grille  
Cut out:  
20-3/8" W x 20-3/8" H

## ACCESSORIES

### COMPLETE ACCESSORY LIST (Must be ordered separately)

KIT NUMBER	DESCRIPTION
<b>RAK150VF2</b>	Two Fan Speed Thermostat for Two Stage Compressor
<b>RAK190V</b>	Two Way Communicating, Occupancy Detection, Energy Management Thermostat
<b>RAVAL4</b>	Exterior Grille
<b>RAVRG2</b>	Return Air Grille for Flush Door
<b>RAVRG4</b>	Access Panel with Return Air
<b>RAVWPT15B</b>	Wall Plenum for walls 8"-deep to 15" thick
<b>RAK315D</b>	230-208 Volt Direct Connect Power Supply Kit, 2.45/2 kW heat, 15 Amp
<b>RAK320D</b>	230-208 Volt Direct Connect Power Supply Kit, 3.45/2.82 kW heat, 20 Amp
<b>RAK330D</b>	230-208 Volt Direct Connect Power Supply Kit, 5/4.08 kW heat, 30 Amp
<b>RAK515D</b>	265-Volt Universal Direct Connect Power Supply Kit, 2.45 kW heat, 15 Amp
<b>RAK520D</b>	265-Volt Universal Direct Connect Power Supply Kit, 3.45 kW heat, 20 Amp
<b>RAK530D</b>	265-Volt Universal Direct Connect Power Supply Kit, 5 kW heat, 30 Amp
<b>RAVDPLAT</b>	Insta-Platform™
<b>SHCM10PK</b>	SmartHQ™ Connect Module - (10 pack)
<b>RAA13V</b>	MERV 13 Makeup Air Filter



**RAA13V**  
**MERV 13 FILTER**  
(OPTIONAL)

### REMOTE THERMOSTATS

The choice of fully integrated and multi-functional thermostats is designed to meet a wide range of commercial property applications.



**RAK150VF2**  
**2-STAGE COOL/HEAT**  
**THERMOSTAT**



(coming soon)  
**RAK190V**  
**ENERGY MANAGEMENT**  
**THERMOSTAT**  
**1-Way Communication Configuration**  
**2-Way Communication Configuration**  
For use with inverter models only

# VERTICAL AIR CONDITIONER SPECIFICATIONS

## IMPORTANT NOTICE

Equipment used as a primary source for heating or cooling is an integral part of the building in which it is installed. Proper application is essential for satisfactory performance over a wide range of operating conditions. It is strongly recommended that a professional engineer determine proper application.

If this unit is a replacement unit, its specifications and performance may differ from those of the unit it is replacing. For that reason, we again strongly recommend that a professional engineer determine proper application.

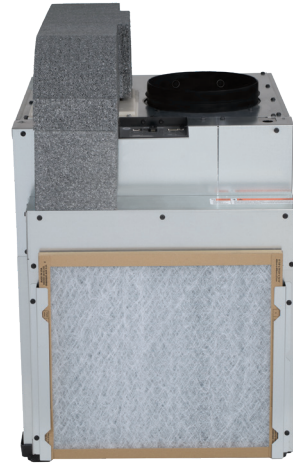

### GE AZ9V SERIES-230-208V\* AZ9VH12DBM

VOLTAGE	230-208
<b>FEATURES</b>	
Cooling BTUH	12,100
Cooling BTU Range (95F outdoor)	5,200-16,200
Max Cooling BTU (115F)	11,200
Max Cooling BTU (75F)	20,000
Cooling EER	11.6
IEER**	20
Cooling Watts	1,040
Cooling Amps	4.7
Sensible Heat Ratio(SHR)-nominal cool, high fan	75%
Dehumidification (pints per hour)-nominal cooling, high fan	3.16
Makeup air CFM	30-70 (no filter) 25-70 (with MERV13 Filter Kit)
Refrigerant	R-410A
Indoor CFM (hi/lo) (0.1 ESP)	465/380
<b>HEAT PUMP</b>	
Heat Pump BTU	11,400
Heating BTU Range @47F	4,500-13,000
Heat Pump COP @47F	3.6
Heating BTU @17F (nominal/max)	6,100/9,400
Heat Pump COP @17F (nominal/max)	2.2/2.1
Heat Pump Watts	925
Heat Pump Amps	4.4
<b>CASE DIMENSIONS</b>	
Width (in.)	23-5/8
Depth (in.)	28-3/8
Height (in.)	36-7/8
Net weight (lbs.)	145
Approx. ship. weight (lbs.)	158
Closet ID for front install (min.)	29-5/8"W x 32"D
Closet ID for side install using full door (min.)***	29-5/8"W x 34"D
Closet ID for side install using RAVRG4***	34"W x 40"D

### GE AZ9V SERIES-265V HEAT PUMP WITH BACKUP ELECTRIC HEAT AZ9VH12EBM

VOLTAGE	265
<b>FEATURES</b>	
Cooling BTU	12,200
Cooling BTU Range (95F outdoor)	5,200-16,200
Max Cooling BTU (115F)	11,200
Max Cooling BTU (75F)	20,000
Cooling EER	11.6
IEER**	20
Cooling Watts	1,050
Cooling Amps	4.2
Sensible Heat Ratio(SHR)-nominal cool, high fan	77%
Dehumidification (pints per hour)-nominal cooling, high fan	3.16
Makeup air CFM	30-70 (no filter) 25-70 (with MERV13 Filter Kit)
Refrigerant	R-410A
Indoor CFM (hi/lo) (0.1 ESP)	465/380
<b>HEAT PUMP</b>	
Heat Pump BTU	11,300
Heating BTU Range @47F	4,500-13,000
Heat Pump COP @47F	3.6
Heating BTU @17F (nominal/max)	6,100/9,400
Heat Pump COP @17F (nominal/max)	2.2/2.1
Heat Pump Watts	915
Heat Pump Amps	3.8
<b>CASE DIMENSIONS</b>	
Width (in.)	23-5/8
Depth (in.)	28-3/8
Height (in.)	36-7/8
Net weight (lbs.)	145
Approx. ship. weight (lbs.)	158
Closet ID for front install (min.)	29-5/8"W x 32"D
Closet ID for side install using full door (min.)***	29-5/8"W x 34"D
Closet ID for side install using RAVRG4***	34"W x 40"D



\*230V Performance Data Listed

\*\* Tested to proposed 2021 AHRI 390 standard

\*\*\* See installation instructions for side installation details

Specifications Subject to Change without Notice



## SPECIFICATIONS

The following are suggested specifications for the AZ9V Series single packaged vertical units:

The contractor shall furnish single packaged vertical units of the sizes and capacities shown on the schedule or in the specifications. The units shall be located as shown on the drawings and each shall consist of a chassis, appropriately sized wall plenum, outdoor grille, remote wall thermostat, drain platform, and closet access panel or door.

Units shall be listed by UL and shall be GE Appliances Vertical Zoneline models or equal. Unit dimensions shall not exceed 23-5/8"W x 28-3/8"L x 31 7/8" H.

### CHASSIS

The Zoneline UltimateV12 Vertical chassis shall be the standard product of the manufacturer and shall be shipped in protective cartons to prevent damage. Cartons shall be appropriately marked with factory wording sufficient to warn handlers against dropping, improper stacking, upending or rolling.

The chassis shall be slide-in type, ready to operate after installation.

The chassis shall be protected against the harmful effects of airborne chemicals and saltwater corrosion.

The chassis shall have a hermetically sealed refrigerant system with an external vibration isolated rotary compressor. Indoor coils shall have copper tubing with aluminum fins. Outdoor coils shall have copper tubing with aluminum fins treated to resist the effects of airborne chemicals and salt-water corrosion. All refrigerant coil fins will have the necessary enhancements to achieve EER and COP ratings of the unit. Refrigerant system metering shall be done with capillaries.

Airflow system shall consist of one permanently lubricated fan motor for the outdoor side and a separate permanently lubricated two-speed motor for the indoor blower.

Outdoor fan shall be multi-blade axial-flow design made of non-corrosive material. Indoor fan shall be blower type to optimize airflow and minimize air noise. All motors on the exterior side of the weather barrier shall be painted and enclosed to reduce the effects of moisture and corrosion.

Units will have a positive cooling condensate disposal system. The disposal system shall have a slinger ring on the outdoor fan to dispose of condensate water and to assist in cooling the outdoor coil.

Heat pump models shall be equipped with a temperature activated valve to allow condensate water generated during defrost cycles to drain into the specified drain system.

Unit indoor and outdoor airflows must match the capacity of the coils for efficient heat transfer and meet latent and sensible heat requirements. Water blow-off shall not occur on the indoor coil.

Unit shall have a sensor to prevent indoor coil freeze up.

### WALL PLENUM

Wall plenums shall be constructed of heavy gauge, zinc coated, phosphated steel with a baked-on enamel finish.

Plenums shall be installed through the exterior wall where shown on the plans and shall be of correct depth to allow sealing to exterior and interior walls.

### EXTERIOR GRILLES

Each unit shall be equipped with a standard exterior grille that has been designed to allow operation in high ambient conditions.

Special exterior grilles or custom louver sections supplied by others will conform to minimum free area requirements and shall be submitted to independent labs, if requested, for feasibility and air flow characteristics.

### ELECTRICAL

Units shall be designed to operate on 230/208 or 265-volts, 60 Hz, single-phase power.

Units shall have means of electrical connection listed by Underwriters Laboratories and compatible with the units' required voltage and ampacity in conformance with National Electrical Code (NEC) and all local codes.

### FEATURES

Unit must be compatible with 2-wire Central Desk Control systems.

Units must be compatible with Electronic Class-2 remote wall thermostats.

Unit shall be equipped with Freeze Sentinel to automatically activate the electric heaters (at 41°F) and appropriate fan motors to warm and circulate indoor air (to 46°F) to prevent damage due to freezing temperatures. Freeze Sentinel shall operate when unit is connected to a powered electrical circuit.

Unit shall be equipped with Heat Sentinel to automatically provide cooling at 85° F to prevent an excessively hot room. Once the room temperature reaches 80°F, the air conditioner will turn off. When activated, Heat Sentinel shall operate when unit is connected to a power electrical circuit.

## ZONELINE WARRANTY

Proof of original purchase date is needed to obtain service under warranty. For service in the U.S., call 1-844-GE4-PTAC (1-844-434-7822). In Canada, contact your local distributor.

### WHAT IS COVERED

#### LIMITED ONE-YEAR WARRANTY

For one year from date of original purchase, we will provide, free of charge, parts and service labor on site to repair or replace any part of the Zoneline unit that fails because of a manufacturing defect.

#### LIMITED ADDITIONAL FOUR-YEAR SEALED REFRIGERATING SYSTEM WARRANTY

For four years from the date of original purchase, we will provide, free of charge, parts and on site service labor to repair or replace any part of the sealed refrigerating system (the compressor, condenser, evaporator and all connecting tubing) that fails because of a manufacturing defect.

#### LIMITED 2ND THROUGH 5TH YEAR PARTS WARRANTY

For the second through the fifth year from date of original purchase, GE Appliances will provide, free of charge, parts that fail as a result of a manufacturing defect. Parts covered are fan motors, switches, heater, heater protectors, compressor overload, solenoids, circuit boards, auxiliary controls, thermistors, frost controls, capacitors, varistors and indoor blower bearing. This is a limited parts-only warranty, and does not include labor or transportation to and from the service shop.

### WHAT IS NOT COVERED

- Service trips to your site to teach you how to use the product.
- Improper installation.

If you have an installation problem, or if the air conditioner is of improper cooling capacity for the intended use, contact your dealer or installer. You are responsible for providing adequate electrical connecting facilities.

- Replacement of fuses or resetting of circuit breakers.
- In commercial locations, labor necessary to move the unit to a location where it is accessible for service by an individual technician.
- Failure of the product resulting from modifications to the product or due to unreasonable use including failure to provide reasonable and necessary maintenance.
- Failure or damage resulting from corrosion due to installation in an environment containing corrosive chemicals.
- Failure or damage resulting from corrosion due to installation in a coastal environment, except for models treated with special factory-applied anti-corrosion protection as designated in the model number.
- Damage to product caused by improper power supply voltage, accident, fire, floods or acts of God.
- Incidental or consequential damage to personal property caused by possible defects with this air conditioner.

#### WARRANTOR: GE APPLIANCES. LOUISVILLE, KY 40225

This warranty is extended to the original purchaser and any succeeding owner for products purchased for use within the USA and Canada. In Alaska, the warranty excludes the cost of shipping or service calls to your site.

Some states do not allow the exclusion or limitation of incidental or consequential damages. This warranty gives you specific legal rights, and you may also have other rights which vary from state to state. To know what your legal rights are in your state, consult your local or state consumer affairs office or your state's Attorney General.

Equipment used as a primary source for heating or cooling is an integral part of the building in which it is installed. Proper application is essential for satisfactory performance over a wide range of operating conditions. It is strongly recommended that a professional engineer determine proper application. If this unit is a replacement unit, its specifications and performance may differ from those of the unit it is replacing. For that reason, we again strongly recommend that a professional engineer determine proper application.

GE Appliances has a policy of continuous improvement on its products and reserves the right to change materials and specifications without notice.

## GE APPLIANCES VERTICAL ZONELINE HEAT PUMPS (ADDITIONAL SPECIFICATIONS)

Heat pump unit shall automatically switch from heat pump operation to electric resistance heat when it is unable to provide sufficient heat to maintain room temperature or when the outdoor temperature is 0° F or less.

In the event of a compressor failure during heat pump operation, the unit shall automatically switch to electric resistance heat to maintain selected room temperature regardless of outdoor temperatures.

Unit shall have an indoor coil temperature sensor to protect the compressor when the outdoor temperatures are too high for heat pump operation.

### ADDITIONAL SPECIFICATIONS SERVICE

Submit complete information with bid covering service availability, to whom service on units will be assigned, complete address and phone number, including phone number of emergency service personnel.

### STARTUP, ADJUST, DEMONSTRATE

Contractor shall be responsible for the initial starting of units, adjustments thereto, cleaning, etc., to place the units in required operating condition. Contractor shall demonstrate to the owner, or his representative, the operation of units for both summer and winter functions.

## ZONELINE SINGLE PACKAGED VERTICAL UNIT NOMENCLATURE

The Vertical Zoneline chassis is identified by a model number defining the type of unit, cooling capacity, electrical information and optional features included on the unit. When specifying or ordering the Zoneline chassis, use of this nomenclature will ensure receiving the correct unit.

### NOMENCLATURE

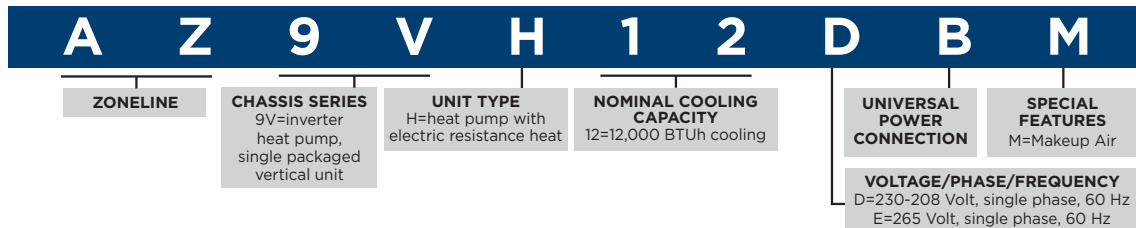

Visit: [zonline.com](https://www.zonline.com)

For Literature, REVIT, & CAD files visit:

<https://www.geappliances.com/ge/zonline/literature.htm>



---

**AIR&WATER**  
SOLUTIONS

GE is a trademark of the General Electric Company.  
Manufactured under trademark license.

Copyright ©2023 GE Appliances. All rights reserved.

Zonline, UltimateV12 and other names are trademarks  
or registered trademarks of GE Appliances in the United  
States and other countries.

Appliance Park  
Louisville, KY 40225  
geappliances.com  
zonline.com | 888.231.2548  
Pub No. 20-S0524-23  
OTGEA23172