

CARLO GAVAZZI
Automation Components



Our Products

Sense

Inductive sensors	8
Capacitive sensors	32
Conductive sensors	45
Ultrasonic sensors	49
Photoelectric sensors	56
Motion and presence sensors	81
Magnetic sensors	85
Intrinsic safety	92
Safety magnetic sensors	93
Safety light curtains	94
Environmental sensors	96

Switch

Solid state relays	102
Solid state relays accessories	132
Soft starters	137
Motor protection relays	141
Variable speed drives	143
Limit switches	147
Electromechanical relays	156
Sockets and modules	159

Control

Monitoring relays	162
Timers	174
Current transformers	179
Converters and Gateway	186
Digital panel meters	187
Energy management	191
Energy monitoring solution	201
PV monitoring solution	203
Counters	209
PID controllers	212
Switching power supplies	213
Safety modules	222
Configurable safety modules	226

Fieldbus

Dupline® General purpose	230
Dupline® DuplineSafe	243
Dupline® Irrigation	245
Dupline® Elevator	246
Dupline® Parking guidance system	248
Dupline® Home and Building automation	252

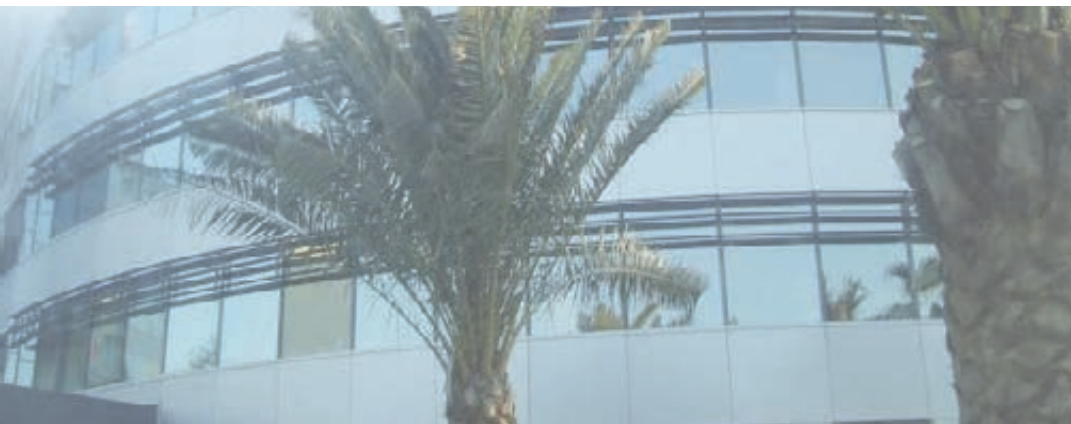
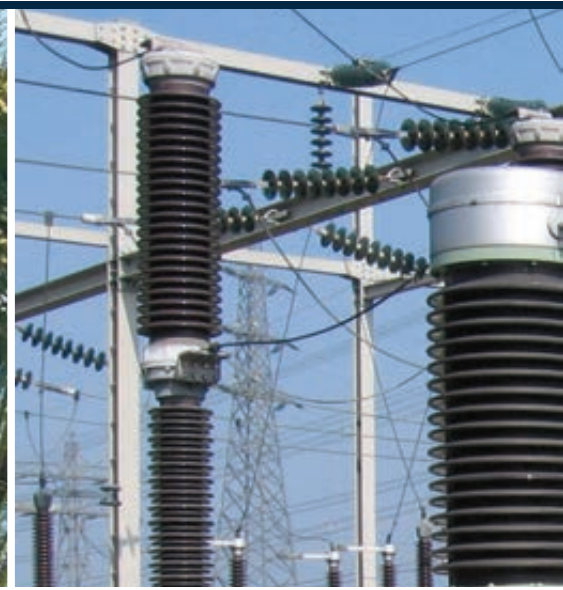
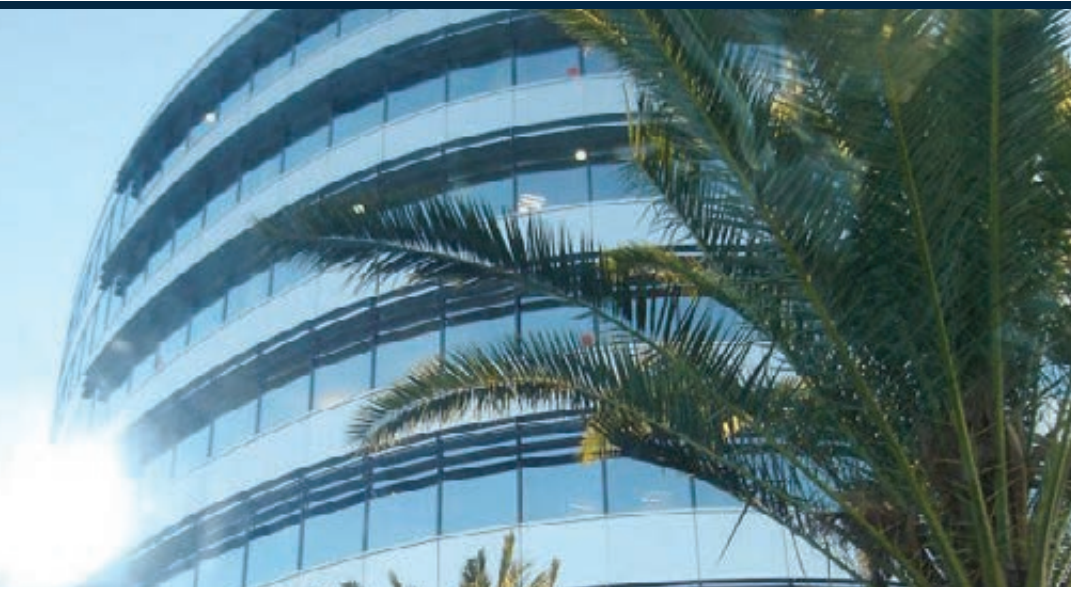

A complete product range

ABOUT CARLO GAVAZZI

Carlo Gavazzi Automation is a multinational electronics group active in the design, manufacture and marketing of electronic equipment targeted at the global markets of industrial and building automation.

Our history is full of firsts and our products are installed in a huge number of applications all over the world. With more than 80 years of successful operation, our experience is unparalleled.

We have our headquarters in Europe and numerous offices around the world.

Our R&D competence centres and production sites are located in Denmark, Italy, Lithuania, Malta and the People's Republic of China.

We operate worldwide through 22 of our own sales companies and also selected representatives in more than 65 countries, from the United States in the West to the Pacific Rim in the East.

Our core competence in automation spans four product lines: Sense, Switch, Control and Fieldbus.

Our wide array of products includes sensors, solid state relays, electronic motor controllers, monitoring relays, timers, energy management equipment, PV monitoring solution and fieldbus systems.

We focus our expertise on offering state-of-the-art product solutions in selected market segments.

Our customers include original equipment manufacturers of packaging machines, plastic-injection moulding machines, food and beverage production machines, conveying and materials handling equipment, door and entrance control systems, lifts and escalators, as well as heating, ventilation and air-conditioning devices.



A guarantee of reliability

Carlo Gavazzi products earned the independent approval of the relevant bodies which govern our industry and the many markets we serve.

They are developed and manufactured in full compliance with the most important international standard regulations.

Carlo Gavazzi manufacturing facilities operates in line with the requirements of ISO9001:2008 Quality Management Systems and ISO14001:2004 Environmental Management System standard.











Sense







Inductive sensors	8
Capacitive sensors	32
Conductive sensors	45
Ultrasonic sensors	49
Photoelectric sensors	56
Motion and presence sensors	81
Magnetic sensors	85
Intrinsic safety	92
Safety magnetic sensors	93
Safety light curtains	94
Environmental sensors	96



Inductive proximity sensors, NAMUR, DC



Types	M12		M18	
Housing	Steel	Plastic	Steel	Plastic
Flush mountable				
Dimensions short body (mm)	M12 x 1 x 30	M12 x 1 x 30	M18 x 1 x 30	M18 x 1 x 30
Dimensions long body (mm)	M12 x 1 x 50	M12 x 1 x 50	M18 x 1 x 50	M18 x 1 x 50
Thread (mm)	M12 x 1	M12 x 1	M18 x 1	M18 x 1
Operating frequency	1.4 kHz	1.4 kHz	500 Hz	500 Hz
Sensing distance (Sn)	2 mm	2 mm	5 mm	5 mm
References				
Short body cable	IA12ESF02UC	IA12CSF02UC	IA18ESF05UC	IA18CSF05UC
Long body cable	IA12ELF02UC	IA12CLF02UC	IA18ELF05UC	IA18CLF05UC
Short body plug	IA12ESF02UCM1	IA12CSF02UCM1	IA18ESF05UCM1	IA18CSF05UCM1
Long body plug	IA12ELF02UCM1	IA12CLF02UCM1	IA18ELF05UCM1	IA18CLF05UCM1
Non-flush mountable				
Dimensions short body (mm)	M12 x 1 x 30	M12 x 1 x 30	M18 x 1 x 30	M18 x 1 x 30
Dimensions long body (mm)	M12 x 1 x 50	M12 x 1 x 50	M18 x 1 x 50	M18 x 1 x 50
Thread (mm)	M12 x 1	M12 x 1	M18 x 1	M18 x 1
Operating frequency	1.2 kHz	1.2 kHz	200 Hz	200 Hz
Sensing distance (Sn)	4 mm	4 mm	8 mm	8 mm
References				
Short body cable	IA12ESN04UC	IA12CSN04UC	IA18ESN08UC	IA18CSN08UC
Long body cable	IA12ELN04UC	IA12CLN04UC	IA18ELN08UC	IA18CLN08UC
Short body plug	IA12ESN04UCM1	IA12CSN04UCM1	IA18ESN08UCM1	IA18CSN08UCM1
Long body plug	IA12ELN04UCM1	IA12CLN04UCM1	IA18ELN08UCM1	IA18CLN08UCM1
Characteristics flush and non-flush mountable				
Rated operating voltage	7 - 9 VDC	7 - 9 VDC	7 - 9 VDC	7 - 9 VDC
Degree of protection	IP 67	IP 67	IP 67	IP 67
Housing material	Stainless steel	Thermoplastic polyester	Stainless steel	Thermoplastic polyester
Operating temperature	-25°C to +70°C	-25°C to +70°C	-25°C to +70°C	-25°C to +70°C
LED colour	Yellow	Yellow	Yellow	Yellow
Approvals / Marks	CE - UL - CSA	CE - UL - CSA	CE - UL - CSA	CE - UL - CSA

Inductive proximity sensors, NAMUR, DC

Types	M30	
Housing	Steel	Plastic
Flush mountable		
Dimensions short body (mm)	M30 x 1.5 x 30	M30 x 1.5 x 30
Dimensions long body (mm)	M30 x 1.5 x 50	M30 x 1.5 x 50
Thread (mm)	M30 x 1	M30 x 1
Operating frequency	300 Hz	300 Hz
Sensing distance (Sn)	10 mm	10 mm
References		
Short body cable	IA30ESF10UC	IA30CSF10UC
Long body cable	IA30ELF10UC	IA30CLF10UC
Short body plug	IA30ESF10UCM1	IA30CSF10UCM1
Long body plug	IA30ELF10UCM1	IA30CLF10UCM1
Non-flush mountable		
Dimensions short body (mm)	M30 x 1.5 x 30	M30 x 1.5 x 30
Dimensions long body (mm)	M30 x 1.5 x 50	M30 x 1.5 x 50
Thread (mm)	M30 x 1.5	M30 x 1.5
Operating frequency	100 Hz	100 Hz
Sensing distance (Sn)	15 mm	15 mm
References		
Short body cable	IA30ESN15UC	IA30CSN15UC
Long body cable	IA30ELN15UC	IA30CLN15UC
Short body plug	IA30ESN15UCM1	IA30CSN15UCM1
Long body plug	IA30ELN15UCM1	IA30CLN15UCM1
Characteristics flush and non-flush mountable		
Rated operating voltage	7 - 9 VDC	7 - 9 VDC
Degree of protection	IP 67	IP 67
Housing material	Stainless steel	Thermoplastic polyester
Operating temperature	-25°C to +70°C	-25°C to +70°C
LED colour	Yellow	Yellow
Approvals / Marks	CE - UL - CSA	CE - UL - CSA





Inductive proximity sensors, 2-wire, DC, extended range





Types	M8 Extended Short body	M12 Extended - Short body	
Connections	2 m cable	2 m cable	M12 connector
Flush mountable			
Dimensions (mm)	M8 x 30	M12 x 49	M12 x 63
Thread (mm)	M8 x 1 x 30	M12 x 1 x 38	M12 x 1 x 38
Operating frequency	2 kHz	1 kHz	1 kHz
Sensing distance (Sn)	2 mm	4 mm	4 mm
References			
NO	IA08BSF02DO	IA12DSF04DO	IA12ASF04DOM1
NC	IA08BSF02DC	IA12DSF04DC	IA12ASF04DCM1

Non-flush mountable			
Dimensions (mm)	M8 x 30	M12 x 53	M12 x 67
Thread (mm)	M8 x 1 x 26	M12 x 1 x 38	M12 x 1 x 38
Operating frequency	2 kHz	800 Hz	800 Hz
Sensing distance (Sn)	4 mm	8 mm	8 mm
References			
NO	IA08BSN04DO	IA12DSN08DO	IA12ASN08DOM1
NC	IA08BSN04DC	IA12DSN08DC	IA12ASN08DCM1

Characteristics flush and non-flush mountable			
Rated operating voltage	10 - 30 VDC	10 - 40 VDC	10 - 40 VDC
Voltage drop	≤ 8 VDC @ max. load	≤ 3 VDC @ max. load	≤ 3 VDC @ max. load
Degree of protection	IP 67	IP 67	IP 67
Protection Short-circuit (S) Reverse polarity (P) Transients (T)	SPT	SPT	SPT
Output current	3 - 100 mA	5 - 100 mA	5 - 100 mA
Housing material	Stainless steel	Nickel-plated brass	Nickel-plated brass
Operating temperature	-25°C to +70°C	-25°C to +70°C	-25°C to +70°C
LED colour	Yellow	Yellow	Yellow
Approvals / Marks	CE - CSA	CE - UL - CSA	CE - UL - CSA

Inductive proximity sensors, 2-wire, DC, extended range





Types	M18 Extended - Short body		M30 Extended - Short body	
Connections	2 m cable	M18 connector	2 m cable	M18 connector
Flush mountable				
Dimensions (mm)	M18 x 42	M18 x 55	M30 x 44	M30 x 55
Thread (mm)	M18 x 1 x 30	M18 x 1 x 30	M30 x 1.5 x 30	M30 x 1.5 x 30
Operating frequency	500 Hz	500 Hz	400 Hz	400 Hz
Sensing distance (Sn)	8 mm	8 mm	15 mm	15 mm
References				
NO	IA18DSF08DO	IA18ASF08DOM1	IA30DSF15DO	IA30ASF15DOM1
NC	IA18DSF08DC	IA18ASF08DCM1	IA30DSF15DC	IA30ASF15DCM1





Non-flush mountable				
Dimensions (mm)	M18 x 50	M18 x 63	M30 x 56	M30 x 67
Thread (mm)	M18 x 1 x 30	M18 x 1 x 30	M30 x 1.5 x 30	M30 x 1.5 x 30
Operating frequency	400 Hz	400 Hz	200 Hz	200 Hz
Sensing distance (Sn)	14 mm	14 mm	22 mm	22 mm
References				
NO	IA18DSN14DO	IA18ASN14DOM1	IA30DSN22DO	IA30ASN22DOM1
NC	IA18DSN14DC	IA18ASN14DCM1	IA30DSN22DC	IA30ASN22DCM1

Characteristics flush and non-flush mountable

Rated operating voltage	10 - 40 VDC	10 - 40 VDC	10 - 40 VDC	10 - 40 VDC
Voltage drop	≤ 3 VDC @ max. load	≤ 3 VDC @ max. load	≤ 3 VDC @ max. load	≤ 3 VDC @ max. load
Degree of protection	IP 67	IP 67	IP 67	IP 67
Protection Short-circuit (S) Reverse polarity (P) Transients (T)	SPT	SPT	SPT	SPT
Output current	5 - 100 mA	5 - 100 mA	5 - 100 mA	5 - 100 mA
Housing material	Nickel-plated brass	Nickel-plated brass	Nickel-plated brass	Nickel-plated brass
Operating temperature	-25°C to +70°C	-25°C to +70°C	-25°C to +70°C	-25°C to +70°C
LED colour	Yellow	Yellow	Yellow	Yellow
Approvals / Marks	CE - UL - CSA	CE - UL - CSA	CE - UL - CSA	CE - UL - CSA





Inductive proximity sensors, 3-wire, DC





Types	M12 Standard - Short body		M12 Standard - Long body	
	2 m cable	M12 connector	2 m cable	M12 connector
Flush mountable				
Dimensions (mm)	M12 x 50	M12 x 51	M12 x 65	M12 x 66
Thread (mm)	M12 x 1 x 32	M12 x 1 x 30	M12 x 1 x 47	M12 x 1 x 45
Operating frequency	2 kHz	2 kHz	2 kHz	2 kHz
Sensing distance (Sn)	2 mm	2 mm	2 mm	2 mm
References				
NPN-NO	ICB12SF02NO	ICB12SF02NOM1	ICB12LF02NO	ICB12LF02NOM1
PNP-NO	ICB12SF02PO	ICB12SF02POM1	ICB12LF02PO	ICB12LF02POM1
NPN-NC	ICB12SF02NC	ICB12SF02NCM1	ICB12LF02NC	ICB12LF02NCM1
PNP-NC	ICB12SF02PC	ICB12SF02PCM1	ICB12LF02PC	ICB12LF02PCM1

Non-flush mountable				
Dimensions (mm)	M12 x 50	M12 x 51	M12 x 65	M12 x 66
Thread (mm)	M12 x 1 x 25	M12 x 1 x 23	M12 x 1 x 40	M12 x 1 x 38
Operating frequency	2 kHz	2 kHz	2 kHz	2 kHz
Sensing distance (Sn)	4 mm	4 mm	4 mm	4 mm
References				
NPN-NO	ICB12SN04NO	ICB12SN04NOM1	ICB12LN04NO	ICB12LN04NOM1
PNP-NO	ICB12SN04PO	ICB12SN04POM1	ICB12LN04PO	ICB12LN04POM1
NPN-NC	ICB12SN04NC	ICB12SN04NCM1	ICB12LN04NC	ICB12LN04NCM1
PNP-NC	ICB12SN04PC	ICB12SN04PCM1	ICB12LN04PC	ICB12LN04PCM1

Characteristics flush and non-flush mountable				
Rated operating voltage	10 - 36 VDC	10 - 36 VDC	10 - 36 VDC	10 - 36 VDC
Voltage drop	≤ 2.5 VDC @ 200 mA	≤ 2.5 VDC @ 200 mA	≤ 2.5 VDC @ 200 mA	≤ 2.5 VDC @ 200 mA
Degree of protection	IP 67	IP 67	IP 67	IP 67
Protection Short-circuit (S)	SPT	SPT	SPT	SPT
Reverse polarity (P)				
Transients (T)				
Output current	< 200 mA @ 50°C ≤ 150 mA @ 50-70°C	< 200 mA @ 50°C ≤ 150 mA @ 50-70°C	< 200 mA @ 50°C ≤ 150 mA @ 50-70°C	< 200 mA @ 50°C ≤ 150 mA @ 50-70°C
Housing material	Nickel-plated brass	Nickel-plated brass	Nickel-plated brass	Nickel-plated brass
Operating temperature	-25°C to +70°C	-25°C to +70°C	-25°C to +70°C	-25°C to +70°C
LED colour	Yellow	Yellow	Yellow	Yellow
Approvals / Marks	CE - UL - CSA	CE - UL - CSA	CE - UL - CSA	CE - UL - CSA





Inductive proximity sensors, 3-wire, DC, extended range





Types	M12 Extended - Short body		M12 Extended - Long body	
Connections	2 m cable	M12 connector	2 m cable	M12 connector
Flush mountable				
Dimensions (mm)	M12 x 50	M12 x 51	M12 x 65	M12 x 66
Thread (mm)	M12 x 1 x 32	M12 x 1 x 30	M12 x 1 x 47	M12 x 1 x 45
Operating frequency	2 kHz	2 kHz	2 kHz	2 kHz
Sensing distance (Sn)	4 mm	4 mm	4 mm	4 mm
References				
NPN-NO	ICB12SF04NO	ICB12SF04NOM1	ICB12LF04NO	ICB12LF04NOM1
PNP-NO	ICB12SF04PO	ICB12SF04POM1	ICB12LF04PO	ICB12LF04POM1
NPN-NC	ICB12SF04NC	ICB12SF04NCM1	ICB12LF04NC	ICB12LF04NCM1
PNP-NC	ICB12SF04PC	ICB12SF04PCM1	ICB12LF04PC	ICB12LF04PCM1

Non-flush mountable				
Dimensions (mm)	M12 x 50	M12 x 51	M12 x 65	M12 x 66
Thread (mm)	M12 x 1 x 25	M12 x 1 x 23	M12 x 1 x 40	M12 x 1 x 38
Operating frequency	2 kHz	2 kHz	2 kHz	2 kHz
Sensing distance (Sn)	8 mm	8 mm	8 mm	8 mm
References				
NPN-NO	ICB12SN08NO	ICB12SN08NOM1	ICB12LN08NO	ICB12LN08NOM1
PNP-NO	ICB12SN08PO	ICB12SN08POM1	ICB12LN08PO	ICB12LN08POM1
NPN-NC	ICB12SN08NC	ICB12SN08NCM1	ICB12LN08NC	ICB12LN08NCM1
PNP-NC	ICB12SN08PC	ICB12SN08PCM1	ICB12LN08PC	ICB12LN08PCM1

Characteristics flush and non-flush mountable				
Rated operating voltage	10 - 36 VDC	10 - 36 VDC	10 - 36 VDC	10 - 36 VDC
Voltage drop	≤ 2.5 VDC @ 200 mA	≤ 2.5 VDC @ 200 mA	≤ 2.5 VDC @ 200 mA	≤ 2.5 VDC @ 200 mA
Degree of protection	IP 67	IP 67	IP 67	IP 67
Protection Short-circuit (S) Reverse polarity (P) Transients (T)	SPT	SPT	SPT	SPT
Output current	≤ 200 mA @ 50°C ≤ 150 mA @ 50-70°C	≤ 200 mA @ 50°C ≤ 150 mA @ 50-70°C	≤ 200 mA @ 50°C ≤ 150 mA @ 50-70°C	≤ 200 mA @ 50°C ≤ 150 mA @ 50-70°C
Housing material	Nickel-plated brass	Nickel-plated brass	Nickel-plated brass	Nickel-plated brass
Operating temperature	-25°C to +70°C	-25°C to +70°C	-25°C to +70°C	-25°C to +70°C
LED colour	Yellow	Yellow	Yellow	Yellow
Approvals / Marks	CE - UL - CSA	CE - UL - CSA	CE - UL - CSA	CE - UL - CSA





Inductive proximity sensors, 3-wire, DC





Types	M18 Standard - Short body		M18 Standard - Long body	
	2 m cable	M12 connector	2 m cable	M12 connector
Flush mountable				
Dimensions (mm)	M18 x 54	M18 x 53	M18 x 74	M18 x 73
Thread (mm)	M18 x 1 x 30	M18 x 1 x 30	M18 x 1 x 50	M18 x 1 x 50
Operating frequency	1.5 kHz	1.5 kHz	1.5 kHz	1.5 kHz
Sensing distance (Sn)	5 mm	5 mm	5 mm	5 mm
References				
NPN-NO	ICB18SF05NO	ICB18SF05NOM1	ICB18LF05NO	ICB18LF05NOM1
PNP-NO	ICB18SF05PO	ICB18SF05POM1	ICB18LF05PO	ICB18LF05POM1
NPN-NC	ICB18SF05NC	ICB18SF05NCM1	ICB18LF05NC	ICB18LF05NCM1
PNP-NC	ICB18SF05PC	ICB18SF05PCM1	ICB18LF05PC	ICB18LF05PCM1

Non-flush mountable				
Dimensions (mm)	M18 x 54	M18 x 53	M18 x 74	M18 x 73
Thread (mm)	M18 x 1 x 17	M18 x 1 x 17	M18 x 1 x 37	M18 x 1 x 37
Operating frequency	1.5 kHz	1.5 kHz	1.5 kHz	1.5 kHz
Sensing distance (Sn)	8 mm	8 mm	8 mm	8 mm
References				
NPN-NO	ICB18SN08NO	ICB18SN08NOM1	ICB18LN08NO	ICB18LN08NOM1
PNP-NO	ICB18SN08PO	ICB18SN08POM1	ICB18LN08PO	ICB18LN08POM1
NPN-NC	ICB18SN08NC	ICB18SN08NCM1	ICB18LN08NC	ICB18LN08NCM1
PNP-NC	ICB18SN08PC	ICB18SN08PCM1	ICB18LN08PC	ICB18LN08PCM1

Characteristics flush and non-flush mountable				
Rated operating voltage	10 - 36 VDC	10 - 36 VDC	10 - 36 VDC	10 - 36 VDC
Voltage drop	≤ 2.5 VDC @ 200 mA	≤ 2.5 VDC @ 200 mA	≤ 2.5 VDC @ 200 mA	≤ 2.5 VDC @ 200 mA
Degree of protection	IP 67	IP 67	IP 67	IP 67
Protection Short-circuit (S)	SPT	SPT	SPT	SPT
Reverse polarity (P)				
Transients (T)				
Output current	≤ 200 mA @ 50°C ≤ 150 mA @ 50-70°C	≤ 200 mA @ 50°C ≤ 150 mA @ 50-70°C	≤ 200 mA @ 50°C ≤ 150 mA @ 50-70°C	≤ 200 mA @ 50°C ≤ 150 mA @ 50-70°C
Housing material	Nickel-plated brass	Nickel-plated brass	Nickel-plated brass	Nickel-plated brass
Operating temperature	-25°C to +70°C	-25°C to +70°C	-25°C to +70°C	-25°C to +70°C
LED colour	Yellow	Yellow	Yellow	Yellow
Approvals / Marks	CE - UL - CSA	CE - UL - CSA	CE - UL - CSA	CE - UL - CSA





Inductive proximity sensors, 3-wire, DC, extended range





Types	M18 Extended - Short body		M18 Extended - Long body	
Connections	2 m cable	M12 connector	2 m cable	M12 connector
Flush mountable				
Dimensions (mm)	M18 x 54	M18 x 53	M18 x 74	M18 x 73
Thread (mm)	M18 x 1 x 30	M18 x 1 x 30	M18 x 1 x 50	M18 x 1 x 50
Operating frequency	1.5 kHz	1.5 kHz	1.5 kHz	1.5 kHz
Sensing distance (Sn)	8 mm	8 mm	8 mm	8 mm
References				
NPN-NO	ICB18SF08NO	ICB18SF08NOM1	ICB18LF08NO	ICB18LF08NOM1
PNP-NO	ICB18SF08PO	ICB18SF08POM1	ICB18LF08PO	ICB18LF08POM1
NPN-NC	ICB18SF08NC	ICB18SF08NCM1	ICB18LF08NC	ICB18LF08NCM1
PNP-NC	ICB18SF08PC	ICB18SF08PCM1	ICB18LF08PC	ICB18LF08PCM1

Non-flush mountable				
Dimensions (mm)	M18 x 54	M18 x 53	M18 x 74	M18 x 73
Thread (mm)	M18 x 1 x 17	M18 x 1 x 17	M18 x 1 x 37	M18 x 1 x 37
Operating frequency	1.5 kHz	1.5 kHz	1.5 kHz	1.5 kHz
Sensing distance (Sn)	14 mm	14 mm	14 mm	14 mm
References				
NPN-NO	ICB18SN14NO	ICB18SN14NOM1	ICB18LN14NO	ICB18LN14NOM1
PNP-NO	ICB18SN14PO	ICB18SN14POM1	ICB18LN14PO	ICB18LN14POM1
NPN-NC	ICB18SN14NC	ICB18SN14NCM1	ICB18LN14NC	ICB18LN14NCM1
PNP-NC	ICB18SN14PC	ICB18SN14PCM1	ICB18LN14PC	ICB18LN14PCM1

Characteristics flush and non-flush mountable				
Rated operating voltage	10 - 36 VDC	10 - 36 VDC	10 - 36 VDC	10 - 36 VDC
Voltage drop	≤ 2.5 VDC @ 200 mA	≤ 2.5 VDC @ 200 mA	≤ 2.5 VDC @ 200 mA	≤ 2.5 VDC @ 200 mA
Degree of protection	IP 67	IP 67	IP 67	IP 67
Protection Short-circuit (S) Reverse polarity (P) Transients (T)	SPT	SPT	SPT	SPT
Output current	≤ 200 mA @ 50°C ≤ 150 mA @ 50-70°C	≤ 200 mA @ 50°C ≤ 150 mA @ 50-70°C	≤ 200 mA @ 50°C ≤ 150 mA @ 50-70°C	≤ 200 mA @ 50°C ≤ 150 mA @ 50-70°C
Housing material	Nickel-plated brass	Nickel-plated brass	Nickel-plated brass	Nickel-plated brass
Operating temperature	-25°C to +70°C	-25°C to +70°C	-25°C to +70°C	-25°C to +70°C
LED colour	Yellow	Yellow	Yellow	Yellow
Approvals / Marks	CE - UL - CSA	CE - UL - CSA	CE - UL - CSA	CE - UL - CSA

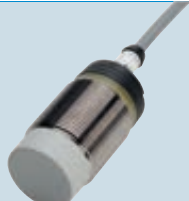





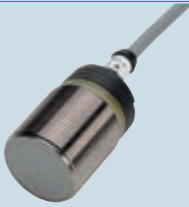

Inductive proximity sensors, 3-wire, DC

Types	M30 Standard - Short body		M30 Standard - Long body	
	2 m cable	M12 connector	2 m cable	M12 connector
Flush mountable				
Dimensions (mm)	M30 x 43.6	M30 x 55	M30 x 63.6	M30 x 75
Thread (mm)	M30 x 1.5 x 30	M30 x 1.5 x 30	M30 x 1.5 x 50	M30 x 1.5 x 50
Operating frequency	1 kHz	1 kHz	1 kHz	1 kHz
Sensing distance (Sn)	10 mm	10 mm	10 mm	10 mm
References				
NPN-NO	ICB30SF10NO	ICB30SF10NOM1	ICB30LF10NO	ICB30LF10NOM1
PNP-NO	ICB30SF10PO	ICB30SF10POM1	ICB30LF10PO	ICB30LF10POM1
NPN-NC	ICB30SF10NC	ICB30SF10NCM1	ICB30LF10NC	ICB30LF10NCM1
PNP-NC	ICB30SF10PC	ICB30SF10PCM1	ICB30LF10PC	ICB30LF10PCM1



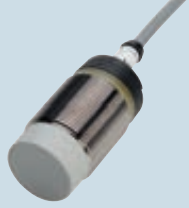

Non-flush mountable				
Dimensions (mm)	M30 x 55.6	M30 x 67	M30 x 75.6	M30 x 87
Thread (mm)	M30 x 1.5 x 30	M30 x 1.5 x 30	M30 x 1.5 x 30	M30 x 1.5 x 30
Operating frequency	1 kHz	1 kHz	1 kHz	1 kHz
Sensing distance (Sn)	15 mm	15 mm	15 mm	15 mm
References				
NPN-NO	ICB30SN15NO	ICB30SN15NOM1	ICB30LN15NO	ICB30LN15NOM1
PNP-NO	ICB30SN15PO	ICB30SN15POM1	ICB30LN15PO	ICB30LN15POM1
NPN-NC	ICB30SN15NC	ICB30SN15NCM1	ICB30LN15NC	ICB30LN15NCM1
PNP-NC	ICB30SN15PC	ICB30SN15PCM1	ICB30LN15PC	ICB30LN15PCM1



Characteristics flush and non-flush mountable				
Rated operating voltage	10 - 36 VDC	10 - 36 VDC	10 - 36 VDC	10 - 36 VDC
Voltage drop	≤ 2.5 VDC @ 200 mA	≤ 2.5 VDC @ 200 mA	≤ 2.5 VDC @ 200 mA	≤ 2.5 VDC @ 200 mA
Degree of protection	IP 67	IP 67	IP 67	IP 67
Protection Short-circuit (S)	SPT	SPT	SPT	SPT
Reverse polarity (P)				
Transients (T)				
Output current	≤ 200 mA @ 50°C ≤ 150 mA @ 50-70°C	≤ 200 mA @ 50°C ≤ 150 mA @ 50-70°C	≤ 200 mA @ 50°C ≤ 150 mA @ 50-70°C	≤ 200 mA @ 50°C ≤ 150 mA @ 50-70°C
Housing material	Nickel-plated brass	Nickel-plated brass	Nickel-plated brass	Nickel-plated brass
Operating temperature	-25°C to +70°C	-25°C to +70°C	-25°C to +70°C	-25°C to +70°C
LED colour	Yellow	Yellow	Yellow	Yellow
Approvals / Marks	CE - UL - CSA	CE - UL - CSA	CE - UL - CSA	CE - UL - CSA

Inductive proximity sensors, 3-wire, DC, extended range

Types	M30 Extended - Short body		M30 Extended - Long body	
Connections	2 m cable	M12 connector	2 m cable	M12 connector
Flush mountable				
Dimensions (mm)	M30 x 43.6	M30 x 55	M30 x 63.6	M30 x 75
Thread (mm)	M30 x 1.5 x 30	M30 x 1.5 x 30	M30 x 1.5 x 30	M30 x 1.5 x 30
Operating frequency	1 kHz	1 kHz	1 kHz	1 kHz
Sensing distance (Sn)	15 mm	15 mm	15 mm	15 mm
References				
NPN-NO	ICB30SF15NO	ICB30SF15NOM1	ICB30LF15NO	ICB30LF15NOM1
PNP-NO	ICB30SF15PO	ICB30SF15POM1	ICB30LF15PO	ICB30LF15POM1
NPN-NC	ICB30SF15NC	ICB30SF15NCM1	ICB30LF15NC	ICB30LF15NCM1
PNP-NC	ICB30SF15PC	ICB30SF15PCM1	ICB30LF15PC	ICB30LF15PCM1
Non-flush mountable				
Dimensions (mm)	M30 x 55.6	M30 x 67	M30 x 75.6	M30 x 87
Thread (mm)	M30 x 1.5 x 30	M30 x 1.5 x 30	M30 x 1.5 x 50	M30 x 1.5 x 50
Operating frequency	1 kHz	1 kHz	1 kHz	1 kHz
Sensing distance (Sn)	22 mm	22 mm	22 mm	22 mm
References				
NPN-NO	ICB30SN22NO	ICB30SN22NOM1	ICB30LN22NO	ICB30LN22NOM1
PNP-NO	ICB30SN22PO	ICB30SN22POM1	ICB30LN22PO	ICB30LN22POM1
NPN-NC	ICB30SN22NC	ICB30SN22NCM1	ICB30LN22NC	ICB30LN22NCM1
PNP-NC	ICB30SN22PC	ICB30SN22PCM1	ICB30LN22PC	ICB30LN22PCM1
Characteristics flush and non-flush mountable				
Rated operating voltage	10 - 36 VDC	10 - 36 VDC	10 - 36 VDC	10 - 36 VDC
Voltage drop	≤ 2.5 VDC @ 200 mA	≤ 2.5 VDC @ 200 mA	≤ 2.5 VDC @ 200 mA	≤ 2.5 VDC @ 200 mA
Degree of protection	IP 67	IP 67	IP 67	IP 67
Protection Short-circuit (S) Reverse polarity (P) Transients (T)	SPT	SPT	SPT	SPT
Output current	≤ 200 mA @ 50°C ≤ 150 mA @ 50-70°C	≤ 200 mA @ 50°C ≤ 150 mA @ 50-70°C	≤ 200 mA @ 50°C ≤ 150 mA @ 50-70°C	≤ 200 mA @ 50°C ≤ 150 mA @ 50-70°C
Housing material	Nickel-plated brass	Nickel-plated brass	Nickel-plated brass	Nickel-plated brass
Operating temperature	-25°C to +70°C	-25°C to +70°C	-25°C to +70°C	-25°C to +70°C
LED colour	Yellow	Yellow	Yellow	Yellow
Approvals / Marks	CE - UL - CSA	CE - UL - CSA	CE - UL - CSA	CE - UL - CSA



Inductive proximity sensors, 3-wire, DC

Types	M5 Standard - Short body		M8 Standard - Short body	
Connections	2 m cable	M5 connector	2 m cable	M8 connector
Flush mountable				
Dimensions (mm)	M5 x 26.5	M5 x 40	M8 x 30	M8 x 45
Thread (mm)	M5 x 1 x 20.5	M5 x 1 x 21	M8 x 1 x 30	M8 x 1 x 25
Operating frequency	2 kHz	2 kHz	2 kHz	2 kHz
Sensing distance (Sn)	1 mm (0.8 mm for IA05BSF10NCP)	1 mm	1.5 mm	1.5 mm
References				
NPN-NO	IA05BSF10NOP	IA05BSF10NOM5P	IA08BSF15NO	IA08BSF15NOM5
PNP-NO	IA05BSF10POP	IA05BSF10POM5P	IA08BSF15PO	IA08BSF15POM5
NPN-NC	IA05BSF10NCP	IA05BSF10NCM5P	IA08BSF15NC	IA08BSF15NCM5
PNP-NC	IA05BSF10PCP	IA05BSF10PCM5P	IA08BSF15PC	IA08BSF15PCM5

Non-flush mountable		
Dimensions (mm)	M8 x 30	M8 x 45
Thread (mm)	M8 x 1 x 27	M8 x 1 x 22
Operating frequency	2 kHz	2 kHz
Sensing distance (Sn)	2.5 mm	2.5 mm
References		
NPN-NO	IA08BSN25NO	IA08BSN25NOM5
PNP-NO	IA08BSN25PO	IA08BSN25POM5
NPN-NC	IA08BSN25NC	IA08BSN25NCM5
PNP-NC	IA08BSN25PC	IA08BSN25PCM5

Characteristics flush and non-flush mountable				
Rated operating voltage	10 - 30 VDC	10 - 30 VDC	10 - 30 VDC	10 - 30 VDC
Voltage drop	< 1.0 VDC (@ I _{max})	< 1.0 VDC (@ I _{max})	≤ 2.5 VDC (@ I _{max})	≤ 2.5 VDC (@ I _{max})
Degree of protection	IP 67	IP 67	IP 67	IP 67
Protection Short-circuit (S) Reverse polarity (P) Transients (T)	SP	SP	SP	SP
Output current	≤ 200 mA	≤ 200 mA	≤ 200 mA @ 25°C	≤ 200 mA @ 25°C
Housing material	Stainless steel	Stainless steel	Stainless steel	Stainless steel
Operating temperature	-25°C to +70°C	-25°C to +70°C	-25°C to +70°C	-25°C to +70°C
LED colour	Yellow	Yellow	Yellow	Yellow
Approvals / Marks	CE	CE	CE - UL - CSA	CE - UL - CSA



Inductive proximity sensors, 3-wire, DC



Types	M8 Standard - Long body		
Connections	2 m cable	M8 connector	M12 connector
Flush mountable			
Dimensions (mm)	M8 x 45	M8 x 60	M12 x 70
Thread (mm)	M8 x 1 x 45	M8 x 1 x 40	M12 x 1 x 43
Operating frequency	2 kHz	2 kHz	2 kHz
Sensing distance (Sn)	1.5 mm	1.5 mm	1.5 mm
References			
NPN-NO	IA08BLF15NO	IA08BLF15NOM5	IA08BLF15NOM1
PNP-NO	IA08BLF15PO	IA08BLF15POM5	IA08BLF15POM1
NPN-NC	IA08BLF15NC	IA08BLF15NCM5	IA08BLF15NCM1
PNP-NC	IA08BLF15PC	IA08BLF15PCM5	IA08BLF15PCM1

Non-flush mountable			
Dimensions (mm)	M8 x 45	M8 x 60	M12 x 70
Thread (mm)	M8 x 1 x 42	M12 x 1 x 37	M8 x 1 x 40
Operating frequency	2 kHz	2 kHz	2 kHz
Sensing distance (Sn)	2.5 mm	2.5 mm	2.5 mm
References			
NPN-NO	IA08BLN25NO	IA08BLN25NOM5	IA08BLN25NOM1
PNP-NO	IA08BLN25PO	IA08BLN25POM5	IA08BLN25POM1
NPN-NC	IA08BLN25NC	IA08BLN25NCM5	IA08BLN25NCM1
PNP-NC	IA08BLN25PC	IA08BLN25PCM5	IA08BLN25PCM1

Characteristics flush and non-flush mountable			
Rated operating voltage	10 - 30 VDC	10 - 30 VDC	10 - 30 VDC
Voltage drop	≤ 2.5 VDC (@ I _{max})	≤ 2.5 VDC (@ I _{max})	≤ 2.5 VDC (@ I _{max})
Degree of protection	IP 67	IP 67	IP 67
Protection Short-circuit (S) Reverse polarity (P) Transients (T)	S	S	S
Output current	< 200 mA @ 25°C	< 200 mA @ 25°C	< 200 mA @ 25°C
Housing material	Stainless steel	Stainless steel	Stainless steel
Operating temperature	-25°C to +70°C	-25°C to +70°C	-25°C to +70°C
LED colour	Yellow	Yellow	Yellow
Approvals / Marks	CE - UL - CSA	CE - UL - CSA	CE - UL - CSA





Inductive proximity sensors, 3-wire, DC, extended range



Types	M8 Extended - Short body	
Connections	2 m cable	M8 connector
Flush mountable		
Dimensions (mm)	M8 x 35	M8 x 50
Thread (mm)	M8 x 1 x 35	M8 x 1 x 30
Operating frequency	2 kHz	2 kHz
Sensing distance (Sn)	2 mm	2 mm
References		
NPN-NO	IA08BSF20NO	IA08BSF20NOM5
PNP-NO	IA08BSF20PO	IA08BSF20POM5
NPN-NC	IA08BSF20NC	IA08BSF20NCM5
PNP-NC	IA08BSF20PC	IA08BSF20PCM5

Non-flush mountable		
Dimensions (mm)	M8 x 35	M8 x 50
Thread (mm)	M8 x 1 x 32	M8 x 1 x 27
Operating frequency	1 kHz	1 kHz
Sensing distance (Sn)	4 mm	4 mm
References		
NPN-NO	IA08BSN40NO	IA08BSN40NOM5
PNP-NO	IA08BSN40PO	IA08BSN40POM5
NPN-NC	IA08BSN40NC	IA08BSN40NCM5
PNP-NC	IA08BSN40PC	IA08BSN40PCM5

Characteristics flush and non-flush mountable		
Rated operating voltage	10 - 30 VDC	10 - 30 VDC
Voltage drop	≤ 2.5 VDC @ 200 mA	≤ 2.5 VDC @ 200 mA
Degree of protection	IP 67	IP 67
Protection Short-circuit (S) Reverse polarity (P) Transients (T)	SPT	SPT
Output current	< 200 mA @ 25°C	< 200 mA @ 25°C
Housing material	Stainless steel	Stainless steel
Operating temperature	-25°C to +70°C	-25°C to +70°C
LED colour	Yellow	Yellow
Approvals / Marks	CE - UL - CSA	CE - UL - CSA





Inductive proximity sensors, 3-wire, DC



Types	M18 Standard - Short body		M18 Standard - Long body	
Connections	2 m cable	M12 connector	2 m cable	M12 connector
Flush mountable				
Dimensions (mm)	M18 x 41.6	M18 x 55	M18 x 61.6	M18 x 75
Thread (mm)	M18 x 1 x 30	M18 x 1 x 30	M18 x 1 x 50	M18 x 1 x 50
Operating frequency	1.5 kHz	1.5 kHz	1.5 kHz	1.5 kHz
Sensing distance (Sn)	5 mm	5 mm	5 mm	5 mm
References				
NPN-NO	IA18DSF05NO	IA18ASF05NOM1		
PNP-NO	IA18DSF05PO	IA18ASF05POM1	IA18DLF05PO	IA18ALF05POM1
NPN-NC	IA18DSF05NC	IA18ASF05NCM1		
PNP-NC	IA18DSF05PC	IA18ASF05PCM1	IA18DLF05PC	IA18ALF05PCM1

Non-flush mountable				
Dimensions (mm)	M18 x 49.6	M18 x 63		
Thread (mm)	M18 x 1 x 30	M18 x 1 x 30		
Operating frequency	1.5 kHz	1.5 kHz		
Sensing distance (Sn)	8 mm	8 mm		
References				
NPN-NO	IA18DSN08NO	IA18ASN08NOM1		
PNP-NO	IA18DSN08PO	IA18ASN08POM1		
NPN-NC	IA18DSN08NC	IA18ASN08NCM1		
PNP-NC	IA18DSN08PC	IA18ASN08PCM1		

Characteristics flush and non-flush mountable				
Rated operating voltage	10 - 40 VDC	10 - 40 VDC	10 - 40 VDC	10 - 40 VDC
Voltage drop	≤ 2.5 VDC	≤ 2.5 VDC	≤ 2.5 VDC	≤ 2.5 VDC
Degree of protection	IP 67	IP 67	IP 67	IP 67
Protection Short-circuit (S)				
Reverse polarity (P)	SPT	SPT	SPT	SPT
Transients (T)				
Output current	< 200 mA @ 50°C	< 200 mA @ 50°C	< 200 mA @ 50°C	< 200 mA @ 50°C
Housing material	Nickel-plated brass + plastic	Nickel-plated brass	Nickel-plated brass + plastic	Nickel-plated brass
Operating temperature	-25°C to +70°C	-25°C to +70°C	-25°C to +70°C	-25°C to +70°C
LED colour	Yellow	Yellow	Yellow	Yellow
Approvals / Marks	CE - UL - CSA	CE - UL - CSA	CE - UL - CSA	CE - UL - CSA



Inductive proximity sensors, 3-wire, DC

Types	M30 Standard - Short body		M30 Standard - Long body	
	2 m cable	M12 connector	2 m cable	M12 connector
Flush mountable				
Dimensions (mm)	M30 x 43.6	M30 x 55	M30 x 63.6	M30 x 75
Thread (mm)	M30 x 1.5 x 30	M30 x 1.5 x 30	M30 x 1.5 x 50	M30 x 1.5 x 50
Operating frequency	700 Hz	700 Hz	700 Hz	700 Hz
Sensing distance (Sn)	10 mm	10 mm	10 mm	10 mm
References				
NPN-NO	IA30DSF10NO	IA30ASF10NOM1		
PNP-NO	IA30DSF10PO	IA30ASF10POM1	IA30DLF10PO	IA30ALF10POM1
NPN-NC				
PNP-NC			IA30DLF10PC	





Non-flush mountable				
Dimensions (mm)	M30 x 55.6	M30 x 67		
Thread (mm)	M30 x 1.5 x 30	M30 x 1.5 x 30		
Operating frequency	700 Hz	700 Hz		
Sensing distance (Sn)	15 mm	15 mm		
References				
NPN-NO	IA30DSN15NO	IA30ASN15NOM1		
PNP-NO	IA30DSN15PO	IA30ASN15POM1		
NPN-NC				
PNP-NC				

Characteristics flush and non-flush mountable				
Rated operating voltage	10 - 40 VDC	10 - 40 VDC	10 - 40 VDC	10 - 40 VDC
Voltage drop	≤ 2.5 VDC	≤ 2.5 VDC	≤ 2.5 VDC	≤ 2.5 VDC
Degree of protection	IP 67	IP 67	IP 67	IP 67
Protection Short-circuit (S)				
Reverse polarity (P)	SPT	SPT	SPT	SPT
Transients (T)				
Output current	< 200 mA @ 50°C	< 200 mA @ 50°C	< 200 mA @ 50°C	< 200 mA @ 50°C
Housing material	Nickel-plated brass + plastic	Nickel-plated brass	Nickel-plated brass + plastic	Nickel-plated brass
Operating temperature	-25°C to +70°C	-25°C to +70°C	-25°C to +70°C	-25°C to +70°C
LED colour	Yellow	Yellow	Yellow	Yellow
Approvals / Marks	CE - UL - CSA	CE - UL - CSA	CE - UL - CSA	CE - UL - CSA





Inductive proximity sensors, 3-wire, DC, extended range





Types	M18 Extended - Short body		M30 Extended - Short body	
Connections	2 m cable	M12 connector	2 m cable	M12 connector
Flush mountable				
Dimensions (mm)	M18 x 41.6	M18 x 55	M30 x 43.6	M30 x 55
Thread (mm)	M18 x 1 x 30	M18 x 1 x 30	M30 x 1.5 x 30	M30 x 1.5 x 50
Operating frequency	1400 Hz	1400 Hz	700 Hz	700 Hz
Sensing distance (Sn)	8 mm	8 mm	15 mm	15 mm
References				
NPN-NO	IA18DSF08NO	IA18ASF08NOM1	IA30DSF15NO	IA30ASF15NOM1
PNP-NO	IA18DSF08PO	IA18ASF08POM1	IA30DSF15PO	IA30ASF15POM1
NPN-NC				
PNP-NC			IA30DSF15PC	
Non-flush mountable				
Dimensions (mm)	M18 x 49.6	M18 x 63	M30 x 55.6	M30 x 67
Thread (mm)	M18 x 1 x 30	M18 x 1 x 30	M30 x 1.5 x 30	M30 x 1.5 x 30
Operating frequency	700 Hz	700 Hz	500 Hz	500 Hz
Sensing distance (Sn)	14 mm	14 mm	22 mm	22 mm
References				
NPN-NO	IA18DSN14NO	IA18ASN14NOM1	IA30DSN22NO	IA30ASN22NOM1
PNP-NO	IA18DSN14PO	IA18ASN14POM1	IA30DSN22PO	IA30ASN22POM1
Characteristics flush and non-flush mountable				
Rated operating voltage	10 - 40 VDC	10 - 40 VDC	10 - 40 VDC	10 - 40 VDC
Voltage drop	≤ 2.5 VDC	≤ 2.5 VDC	≤ 2.5 VDC	≤ 2.5 VDC
Degree of protection	IP 67	IP 67	IP 67	IP 67
Protection Short-circuit (S)				
Reverse polarity (P)	SPT	SPT	SPT	SPT
Transients (T)				
Output current	< 200 mA @ 50°C	< 200 mA @ 50°C	< 200 mA @ 50°C	< 200 mA @ 50°C
Housing material	Stainless steel	Stainless steel	Nickel-plated brass + plastic	Nickel-plated brass
Operating temperature	-25°C to +70°C	-25°C to +70°C	-25°C to +70°C	-25°C to +70°C
LED colour	Yellow	Yellow	Yellow	Yellow
Approvals / Marks	CE - UL - CSA	CE - UL - CSA	CE - UL - CSA	CE - UL - CSA

Inductive proximity sensors, 2-wire, AC

Types	M12 Standard - Long body	
Connections	2 m cable	M12 connector
Flush mountable		
Dimensions (mm)	M12 x 66	M12 x 74.5
Thread (mm)	M12 x 1 x 50	M12 x 1 x 50
Operating frequency	25 Hz	25 Hz
Sensing distance (Sn)	2 mm	2 mm
References		
SCR-NO	EI1202TBOSL	EI1202TBOSL-6
SCR-NC	EI1202TBCSL	
Non-flush mountable		
Dimensions (mm)	M12 x 70	M12 x 78.5
Thread (mm)	M12 x 1 x 50	M12 x 1 x 50
Operating frequency	25 Hz	25 Hz
Sensing distance (Sn)	4 mm	4 mm
References		
SCR-NO	EI1204TBOSL	EI1204TBOSL-6
SCR-NC	EI1204TBCSL	
Characteristics flush and non-flush mountable		
Rated operating voltage	20 - 265 VAC	20 - 265 VAC
Voltage drop	≤ 8 VAC	≤ 8 VAC
Degree of protection	IP 67	IP 67
Protection Short-circuit (S) Reverse polarity (P) Transients (T)	T	T
Output current	< 500 mA	< 500 mA
Housing material	Stainless steel	Stainless steel
Operating temperature	-25°C to +70°C	-25°C to +70°C
LED colour	Yellow	Yellow
Approvals / Marks	CE - UL - CSA	CE - UL - CSA



Inductive proximity sensors, 2-wire, AC

Types	M18 Standard - Short body		M18 Standard - Long body	
Connections	2 m cable	M12 connector	2 m cable	M12 connector
Flush mountable				
Dimensions (mm)	M18 x 57	M18 x 55	M18 x 77	M18 x 75
Thread (mm)	M18 x 1 x 30	M18 x 1 x 30	M18 x 1 x 50	M18 x 1 x 50
Operating frequency	25 Hz	25 Hz	25 Hz	25 Hz
Sensing distance (Sn)	5 mm	5 mm	5 mm	5 mm
References				
SCR-NO	EI1805TBOSS	EI1805TBOSS-6	EI1805TBOSL	EI1805TBOSL-6
SCR-NC	EI1805TBCSS		EI1805TBCSL	



Non-flush mountable				
Dimensions (mm)	M18 x 65	M18 x 63	M18 x 85	M18 x 83
Thread (mm)	M18 x 1 x 30	M18 x 1 x 30	M18 x 1 x 50	M18 x 1 x 50
Operating frequency	25 Hz	25 Hz	25 Hz	25 Hz
Sensing distance (Sn)	8 mm	8 mm	8 mm	8 mm
References				
SCR-NO	EI1808TBOSS	EI1808TBOSS-6	EI1808TBOSL	EI1808TBOSL-6
SCR-NC	EI1808TBCSS		EI1808TBCSL	EI1808TBCSL-6

Characteristics flush and non-flush mountable				
Rated operating voltage	20 - 265 VAC	20 - 265 VAC	20 - 265 VAC	20 - 265 VAC
Voltage drop	≤ 8 VAC	≤ 8 VAC	≤ 8 VAC	≤ 8 VAC
Degree of protection	IP 67	IP 67	IP 67	IP 67
Protection Short-circuit (S) Reverse polarity (P) Transients (T)	T	T	T	T
Output current	< 500 mA	< 500 mA	< 500 mA	< 500 mA
Housing material	Stainless Steel	Stainless Steel	Stainless Steel	Stainless Steel
Operating temperature	-25°C to +70°C	-25°C to +70°C	-25°C to +70°C	-25°C to +70°C
LED colour	Yellow	Yellow	Yellow	Yellow
Approvals / Marks	CE - UL - CSA	CE - UL - CSA	CE - UL - CSA	CE - UL - CSA

Inductive proximity sensors, 2-wire, AC

Types	M30 Standard - Short body		M30 Standard - Long body	
Connections	2 m cable	M12 connector	2 m cable	M12 connector
Flush mountable				
Dimensions (mm)	M30 x 59		M30 x 79	M30 x 75.5
Thread (mm)	M30 x 1.5 x 30		M30 x 1.5 x 50	M30 x 1.5 x 50
Operating frequency	25 Hz		25 Hz	25 Hz
Sensing distance (Sn)	10 mm		10 mm	10 mm
References				
SCR-NO	EI3010TBOSS		EI3010TBOSL	EI3010TBOSL-6
SCR-NC	EI3010TBCSS		EI3010TBCSL	
Non-flush mountable				
Dimensions (mm)	M30 x 87.5	M30 x 67.5	M30 x 91	M30 x 71
Thread (mm)	M30 x 1.5 x 30	M30 x 1.5 x 30	M30 x 1.5 x 50	M30 x 1.5 x 50
Operating frequency	25 Hz	25 Hz	25 Hz	25 Hz
Sensing distance (Sn)	15 mm	15 mm	15 mm	15 mm
References				
SCR-NO	EI3015TBOSS	EI3015TBOSS-6	EI3015TBOSL	EI3015TBOSL-6
SCR-NC	EI3015TBCSS		EI3015TBCSL	
Characteristics flush and non-flush mountable				
Rated operating voltage	20 - 265 VAC	20 - 265 VAC	20 - 265 VAC	20 - 265 VAC
Voltage drop	≤ 8 VAC	≤ 8 VAC	≤ 8 VAC	≤ 8 VAC
Degree of protection	IP 67	IP 67	IP 67	IP 67
Protection Short-circuit (S) Reverse polarity (P) Transients (T)	T	T	T	T
Output current	< 500 mA	< 500 mA	< 500 mA	< 500 mA
Housing material	Stainless Steel	Stainless Steel	Stainless Steel	Stainless Steel
Operating temperature	-25°C to +70°C	-25°C to +70°C	-25°C to +70°C	-25°C to +70°C
LED colour	Yellow	Yellow	Yellow	Yellow
Approvals / Marks	CE - UL - CSA	CE - UL - CSA	CE - UL - CSA	CE - UL - CSA

Inductive proximity sensors, 2-Wire, AC

Types	M18 Standard Short body	M18 Standard - Long body		M30 Standard Long body
Connections	2 m cable	2 m cable	M12 connector	2 m cable
Flush mountable				
Dimensions (mm)	M18 x 57	M18 x 77		M30 x 79
Thread (mm)	M18 x 1 x 30	M18 x 1 x 50		M30 x 1.5 x 50
Operating frequency	25 Hz	25 Hz		25 Hz
Sensing distance (Sn)	5 mm	5 mm		10 mm

References				
SCR-NO	EI1805TBOPS	EI1805TBOPL		EI3010TBOPL





Non-flush mountable				
				
Dimensions (mm)		M18 x 85	M18 x 83	M30 x 91
Thread (mm)		M18 x 1 x 50	M18 x 1 x 50	M30 x 1.5 x 50
Operating frequency		25 Hz	25 Hz	25 Hz
Sensing distance (Sn)		8 mm	8 mm	15 mm





Dimensions (mm)		M18 x 85	M18 x 83	M30 x 91
Thread (mm)		M18 x 1 x 50	M18 x 1 x 50	M30 x 1.5 x 50
Operating frequency		25 Hz	25 Hz	25 Hz
Sensing distance (Sn)		8 mm	8 mm	15 mm

References				
SCR-NO		EI1808TBOPL		EI3015TBOPL
SCR-NC		EI1808TBCPL	EI1808TBCPL-6	

Characteristics flush and non-flush mountable				
Rated operating voltage	20 - 265 VAC	20 - 265 VAC	20 - 265 VAC	20 - 265 VAC
Voltage drop	≤ 8 VAC	≤ 8 VAC	≤ 8 VAC	≤ 8 VAC
Degree of protection	IP 67	IP 67	IP 67	IP 67
Protection Short-circuit (S) Reverse polarity (P) Transients (T)	T	T	T	T
Output current	< 500 mA	< 500 mA	< 500 mA	< 500 mA
Housing material	Thermoplastic polyester	Thermoplastic polyester	Thermoplastic polyester	Thermoplastic polyester
Operating temperature	-25°C to +70°C	-25°C to +70°C	-25°C to +70°C	-25°C to +70°C
LED colour	Yellow	Yellow	Yellow	Yellow
Approvals / Marks	CE - UL - CSA	CE - UL - CSA	CE - UL - CSA	CE - UL - CSA

Inductive proximity sensors, high temperature



Types	M5	M8	M12	
Connections	2 m cable	2 m cable	2 m cable or M12 connector	
Flush or non-flush mountable				
Dimensions (mm)	M5 x 30	M8 x 45	M12 x 40	M12 x 40
Thread (mm)	M5 x 0.5 x 25	M8 x 1 x 40	M12 x 1 x 40	M12 x 1 x 34
Sensing distance (Sn)	0.8 mm	1 mm	2 mm	4 mm
Output	≤ 5 mA	≤ 5 mA	≤ 20 mA	≤ 20 mA
References				
NPN-NO Cable	IA05BSF08NOHT-K	IA08BSF10NOHT-K		IA12ASN04NOHT-K
PNP-NO Cable	IA05BSF08POHT-K	IA08BSF10POHT-K	IA12ASF02POHT-K	IA12ASN04POHT-K
PNP-NO Plug			IA12ASF02POM1HT-K	IA12ASN04POM1HT-K
Specifications				
Rated operating voltage	10 - 30 VDC	10 - 30 VDC	10 - 30 VDC	10 - 30 VDC
Degree of protection	IP 67	IP 67	IP 67	IP 67
Protection	Short-circuit, reverse polarity	Short-circuit, reverse polarity	Short-circuit	Short-circuit
Housing material	Stainless steel	Stainless steel	Nickel-plated brass	Nickel-plated brass
Operating temperature	-25°C to +120°C	-25°C to +120°C	-40°C to +100°C	-40°C to +100°C
Approvals / Marks	CE	CE	CE	CE

Types	M18		M30	
Connections	2 m cable or M12 connector		2 m cable or M12 connector	
Flush or non-flush mountable				
Dimensions (mm)	M18 x 40	M18 x 40	M30 x 40	M30 x 40
Thread (mm)	M18 x 1 x 40	M18 x 1 x 32	M30 x 1.5 x 40	M30 x 1.5 x 28
Sensing distance (Sn)	5 mm	8 mm	10 mm	15 mm
Output	≤ 25 mA	≤ 25 mA	≤ 25 mA	≤ 25 mA
References				
PNP-NO Cable	IA18ASF05POHT-K	IA18ASN08POHT-K	IA30ASF10POHT-K	IA30ASN15POHT-K
PNP-NO Plug	IA18ASF05POM1HT-K	IA18ASN08POM1HT-K	IA30ASF10POM1HT-K	IA30ASN15POM1HT-K
Characteristics flush and non-flush mountable				
Rated operating voltage	10 - 30 VDC	10 - 30 VDC	10 - 30 VDC	10 - 30 VDC
Degree of protection	IP 67	IP 67	IP 67	IP 67
Protection	Short-circuit	Short-circuit	Short-circuit	Short-circuit
Housing material	Nickel-plated brass	Nickel-plated brass	Nickel-plated brass	Nickel-plated brass
Operating temperature	-40°C to +100°C	-40°C to +100°C	-40°C to +100°C	-40°C to +100°C
Approvals / Marks	CE	CE	CE	CE



Inductive proximity sensors, micro switch 2-wire DC

Types	Micro switch
Connections	2 m cable
	
Dimensions body (mm)	30 x 19 x 15
Thread (mm)	Ø 12 x 16
Sensing distance (Sn)	1 kHz
Output	4 mm
References	
NO	IG12FSF04DO
NC	IG12FSF04DC
Specifications	
Rated operating voltage	10 to 40 VDC
Voltage drop	≤ 3 VDC at max. load
Degree of protection	IP67
Protection Short-circuit (S)	
Reverse polarity (P)	SPT
Transients (T)	
Output current	≤ 5 - 100 mA
Housing material	Anodized Aluminium
Operating temperature	-25°C to +70°C
Approvals / Marks	CE







Inductive proximity sensors, switch, polyester housing

Types	Transistor NPN/PNP		Power MOSFET output AC types	
Connections	Terminals		Terminals	Terminals
Non-flush mountable				
Dimensions (mm)	40 x 40 x 118		40 x 40 x 118	40 x 40 x 118
Operating frequency	≤ 100 Hz		≤ 25 Hz AC; 40 Hz DC	≤ 25 Hz
Sensing distance (Sn)	30 mm		30 mm	30 mm
References				
NPN - NO / NC	IC40CNN30NAT1			
PNP - NO / NC	IC40CNN30PAT1			
AC / DC - NO			IC40CNN30COT1	
AC / DC - NC			IC40CNN30CCT1	
AC - NO / NC				IC40CNN30TAT1
Specifications				
Rated operating voltage	10 - 30 VDC		20 - 250 VAC / DC	20 - 250 VAC
Degree of protection	IP 67		IP 67	IP 67
Protection Short-circuit (S) Reverse polarity (P) Transients (T)	SP		S	
Output current	≤ 200 mA		5 - 200 mA @ 25°C	5 - 200 mA @ 25°C
Housing material	Thermoplastic polyester		Thermoplastic polyester	Thermoplastic polyester
Operating temperature	-25°C to +70°C		-25°C to +70°C	-25°C to +70°C
LED colour	Red, green		Red, green	Red, green
Approvals / Marks	CE		CE	CE

Inductive proximity sensors, loop detector



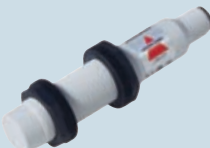



Types	Single loop	Dual loop
Connections	Plug 11 pin circular	Plug 11 pin circular
		
Adjustment	Auto	Auto
Manual fine-tune	Yes	Yes
Loop inductance	15-1500 μ H	15-1500 μ H
Input	1 Loop	2 Loop
Output	2 x SPDT, 1A / 250 VAC	2 x SPST, 1A / 250 VAC
References		
24 VAC / DC	LDP1SA1BM24	LDP2TA2BM24
115 VAC	LDP1SA1B115	LDP2TA2B115
230 VAC	LDP1SA1B230	LDP2TA2B230
Specifications		
Operating temperature	-40°C to +70°C	-40°C to +70°C
Mounting	11 pin circular plug	11 pin circular plug
Approvals / Marks	CE - UL	CE - UL

Capacitive proximity sensors, TRIPLESIELD™

Types	M18-DC TRIPLESIELD™		M18-AC TRIPLESIELD™	
Connections	2 m cable	M12 connector	2 m cable	M12 connector
Flush mountable				
Dimensions (mm)	M18 x 71.5	M18 x 83.5	M18 x 71.5	M18 x 83.5
Thread (mm)	z	M18 x 1 x 46.5	M18 x 1 x 46.5	M18 x 1 x 46.5
Operating frequency	30 Hz	30 Hz	10 Hz	10 Hz
Sensing distance (Sn)	3 - 8 mm (adjustable)	3 - 8 mm (adjustable)	3 - 8 mm (adjustable)	3 - 8 mm (adjustable)
References				
NPN - NO and NC	CA18CLF08NA	CA18CLF08NAM1		
PNP - NO and NC	CA18CLF08PA	CA18CLF08PAM1		
Thyristor (SCR) NO			CA18CLF08TO	CA18CLF08TOM6
Thyristor (SCR) NC			CA18CLF08TC	CA18CLF08TCM6
Non-flush mountable				
Dimensions (mm)	M18 x 79.5	M18 x 91.5	M18 x 79.5	M18 x 91.5
Thread (mm)	M18 x 1 x 46.5	M18 x 1 x 46.5	M18 x 1 x 46.5	M18 x 1 x 46.5
Operating frequency	30 Hz	30 Hz	10 Hz	10 Hz
Sensing distance (Sn)	3 - 12 mm (adjustable)	3 - 12 mm (adjustable)	3 - 12 mm (adjustable)	3 - 12 mm (adjustable)
References				
NPN - NO and NC	CA18CLN12NA	CA18CLN12NAM1		
PNP - NO and NC	CA18CLN12PA	CA18CLN12PAM1		
Thyristor (SCR) NO			CA18CLN12TO	CA18CLN12TOM6
Thyristor (SCR) NC			CA18CLN12TC	CA18CLN12TCM6
Characteristics flush and non-flush mountable				
Rated operating voltage	10 - 40 VDC	10 - 40 VDC	20 - 250 VAC	20 - 250 VAC
Voltage drop	≤ 2.5 VDC	≤ 2.5 VDC	≤ 10 VAC	≤ 10 VAC
Degree of protection	IP 67	IP 67	IP 67	IP 67
Protection Short-circuit (S)				
Reverse polarity (P)	SPT	SPT	T	T
Transients (T)				
Output current	< 200 mA	< 200 mA	< 500 mA	< 500 mA
Housing material	Thermoplastic polyester	Thermoplastic polyester	Thermoplastic polyester	Thermoplastic polyester
Operating temperature	-25°C to +80°C	-25°C to +80°C	-25°C to +80°C	-25°C to +80°C
LED colour	Yellow	Yellow	Yellow	Yellow
Approvals/Marks	CE - UL - CSA	CE - UL - CSA	CE - UL - CSA	CE - UL - CSA





Also available in Teflon, polypropylene and PVC housing.

Capacitive proximity sensors, TRIPLESIELD™







Types	M30-DC TRIPLESIELD™			
Connections	2 m cable	M12 connector	2 m cable	M12 connector
Flush mountable				
Dimensions (mm)	M30 x 63.6	M30 x 63.6	M30 x 63.6	M30 x 63.6
Thread (mm)	M30 x 1.5 x 50	M30 x 1.5 x 50	M30 x 1.5 x 50	M30 x 1.5 x 50
Operating frequency	50 Hz	50 Hz	50 Hz	50 Hz
Sensing distance (Sn)	2 - 16 mm (adjustable)	2 - 16 mm (adjustable)	2 - 16 mm (adjustable)	2 - 16 mm (adjustable)
References				
NPN - NO and NC	EC3016NPASL	EC3016NPASL-1	EC3016NPAPL	EC3016NPAPL-1
PNP - NO and NC	EC3016PPASL	EC3016PPASL-1	EC3016PPAPL	EC3016PPAPL-1
Non-flush mountable				
Dimensions (mm)	M30 x 75.6	M30 x 75.6	M30 x 75.6	M30 x 75.6
Thread (mm)	M30 x 1.5 x 50	M30 x 1.5 x 50	M30 x 1.5 x 50	M30 x 1.5 x 50
Operating frequency	50 Hz	50 Hz	50 Hz	50 Hz
Sensing distance (Sn)	4 - 25 mm (adjustable)	4 - 25 mm (adjustable)	4 - 25 mm (adjustable)	4 - 25 mm (adjustable)
References				
NPN - NO and NC	EC3025NPASL	EC3025NPASL-1	EC3025NPAPL	EC3025NPAPL-1
PNP - NO and NC	EC3025PPASL	EC3025PPASL-1	EC3025PPAPL	EC3025PPAPL-1
Characteristics flush and non-flush mountable				
Rated operating voltage	10 - 40 VDC	10 - 40 VDC	10 - 40 VDC	10 - 40 VDC
Voltage drop	≤ 2.5 VDC	≤ 2.5 VDC	≤ 2.5 VDC	≤ 2.5 VDC
Degree of protection	IP 67	IP 67	IP 67	IP 67
Protection Short-circuit (S) Reverse polarity (P) Transients (T)	SPT	SPT	SPT	SPT
Output current	< 200 mA	< 200 mA	< 200 mA	< 200 mA
Housing material	Stainless steel	Stainless steel	Thermoplastic polyester	Thermoplastic polyester
Operating temperature	-25°C to +80°C	-25°C to +80°C	-25°C to +80°C	-25°C to +80°C
LED colour	Yellow	Yellow	Yellow	Yellow
Approvals/Marks	CE - UL - CSA	CE - UL - CSA	CE - UL - CSA	CE - UL - CSA

Capacitive proximity sensors, TRIPLESIELD™





M30-DC TRIPLESIELD™

Types	Flush mountable		Non-flush mountable	
	2 m cable	M12 connector	2 m cable	M12 connector
Connections				
				
Dimensions (mm)	M30 x 81	M30 x 74	M30 x 81	M30 x 74
Thread (mm)	M30 x 1.5 x 59.5	M30 x 1.5 x 59.5	M30 x 1.5 x 45,5	M30 x 1.5 x 45,5
Operating frequency	50 Hz	50 Hz	50 Hz	50 Hz
Sensing distance (Sn)	2 - 16 mm (adjustable)	2 - 16 mm (adjustable)	4 - 25 mm (adjustable)	4 - 25 mm (adjustable)
References				
Standard				
NPN - NO and NC	CA30CAF16NA	CA30CAF16NAM1	CA30CAN25NA	CA30CAN25NAM1
PNP - NO and NC	CA30CAF16PA	CA30CAF16PAM1	CA30CAN25PA	CA30CAN25PAM1
Dust alarm				
PNP - NO	CA30CAF16PODU		CA30CAN25PODU	
PNP - NC	CA30CAF16PCDU		CA30CN25PCDU	
Temperature alarm				
PNP - NO	CA30CAF16POTA		CA30CAN25POTA	
PNP - NC	CA30CAF16PCTA		CA30CAN25PCTA	
Characteristics flush and non-flush mountable				
Rated operating voltage	10 - 40 VDC	10 - 40 VDC	10 - 40 VDC	10 - 40 VDC
Voltage drop	≤ 2.0 VDC	≤ 2.0 VDC	≤ 2.0 VDC	≤ 2.0 VDC
Degree of protection	IP 67, IP 68, IP 69K	IP 67, IP 68, IP 69K	IP 67, IP 68, IP 69K	IP 67, IP 68, IP 69K
Protection Short-circuit (S) Reverse polarity (P) Transients (T)	SPT	SPT	SPT	SPT
Output current	< 200 mA	< 200 mA	< 200 mA	< 200 mA
Housing material	PBT	PBT	PBT	PBT
Operating temperature	-30°C to +85°C	-30°C to +85°C	-30°C to +85°C	-30°C to +85°C
LED colour	Yellow and Green	Yellow and Green	Yellow and Green	Yellow and Green
Approvals/Marks	CE - cULus	CE - cULus	CE - cULus	CE - cULus







Capacitive proximity sensors, TRIPLESIELD™

Types	M30-AC TRIPLESIELD™			
Connections	2 m cable	M12 connector	2 m cable	M12 connector
Flush mountable				
Dimensions (mm)	M30 x 63.6	M30 x 63.6	M30 x 63.6	M30 x 63.6
Thread (mm)	M30 x 1.5 x 50	M30 x 1.5 x 50	M30 x 1.5 x 50	M30 x 1.5 x 50
Operating frequency	10 Hz	10 Hz	10 Hz	10 Hz
Sensing distance (Sn)	2 - 16 mm (adjustable)	2 - 16 mm (adjustable)	2 - 16 mm (adjustable)	2 - 16 mm (adjustable)
References				
Thyristor (SCR) NO or NC	EC3016TBAPL	EC3016TBAPL-6	EC3016TBASL	EC3016TBASL-6
Non-flush mountable				
Dimensions (mm)	M30 x 75.6	M30 x 75.6	M30 x 75.6	M30 x 75.6
Thread (mm)	M30 x 1.5 x 50	M30 x 1.5 x 50	M30 x 1.5 x 50	M30 x 1.5 x 50
Operating frequency	10 Hz	10 Hz	10 Hz	10 Hz
Sensing distance (Sn)	4 - 25 mm (adjustable)	4 - 25 mm (adjustable)	4 - 25 mm (adjustable)	4 - 25 mm (adjustable)
References				
Thyristor (SCR) NO or NC	EC3025TBAPL	EC3025TBAPL-6	EC3025TBASL	EC3025TBASL-6
Characteristics flush and non-flush mountable				
Rated operating voltage	20 - 250 VAC	20 - 250 VAC	20 - 250 VAC	20 - 250 VAC
Voltage drop	< 10 VAC	< 10 VAC	< 10 VAC	< 10 VAC
Degree of protection	IP 67	IP 67	IP 67	IP 67
Protection Short-circuit (S) Reverse polarity (P) Transients (T)	T	T	T	T
Output current	< 500 mA	< 500 mA	< 500 mA	< 500 mA
Housing material	Thermoplastic polyester	Thermoplastic polyester	Stainless steel	Stainless steel
Operating temperature	-25°C to +80°C	-25°C to +80°C	-25°C to +80°C	-25°C to +80°C
LED colour	Yellow	Yellow	Yellow	Yellow
Approvals/Marks	CE - UL - CSA	CE - UL - CSA	CE - UL - CSA	CE - UL - CSA



Capacitive proximity sensors, TRIPLESIELD™

Types	M12 teach-in TRIPLESIELD™		M18 teach-in TRIPLESIELD™	
Connections	2 m cable	M12 connector	2 m cable	M12 connector
Flush mountable				
Dimensions (mm)	M12 x 82.4	M12 x 84.7	M18 x 89.55	M18 x 89.2
Thread (mm)	M12 x 1 x 50	M12 x 1 x 50	M18 x 1 x 50	M18 x 1 x 50
Operating frequency	15 Hz	15 Hz	15 Hz	15 Hz
Sensing distance (Sn)	0.5 - 8 mm (Teach-in)	0.5 - 8 mm (Teach-in)	0.2 - 12 mm (Teach-in)	0.2 - 12 mm (Teach-in)
References				
NPN/PNP, NO/NC	CA12CLC08BP	CA12CLC08BPM1	CA18CLC12BP	CA18CLC12BPM1
Characteristics flush and non-flush mountable				
Rated operating voltage	10 - 40 VDC	10 - 40 VDC	10 - 40 VDC	10 - 40 VDC
Voltage drop	< 2.5 VDC	< 2.5 VDC	< 2.5 VDC	< 2.5 VDC
Degree of protection	IP 68	IP 68	IP 68	IP 68
Protection Short-circuit (S) Reverse polarity (P) Transients (T)	SPT	SPT	SPT	SPT
Output current	< 250 mA	< 250 mA	< 250 mA	< 250 mA
Housing material	Thermoplastic polyester	Thermoplastic polyester	Thermoplastic polyester	Thermoplastic polyester
Operating temperature	-25°C to +85°C	-25°C to +85°C	-25°C to +85°C	-25°C to +85°C
Special features	Teach-in , Humidity compensation NPN/PNP auto detection, remote setup, alarm output. On request: Dirt and moisture compensation	Teach-in , Humidity compensation NPN/PNP auto detection, remote setup, alarm output. On request: Dirt and moisture compensation	Teach-in , Humidity compensation NPN/PNP auto detection, remote setup, alarm output. On request: Dirt and moisture compensation	Teach-in , Humidity compensation NPN/PNP auto detection, remote setup, alarm output. On request: Dirt and moisture compensation
Approvals/Marks	CE - UL - CSA	CE - UL - CSA	CE - UL - CSA	CE - UL - CSA

Capacitive proximity sensors, TRIPLESIELD™

Types	M30 teach in TRIPLESIELD™		M30 AC/DC TRIPLESIELD™	
Connections	2 m cable	M12 connector	2 m cable	M12 connector
Flush mountable				
Dimensions (mm)	M30 x 99.2	M30 x 90.45	M30 x 63.6	M30 x 75.6
Thread (mm)	M30 x 1.5 x 50	M30 x 1.5 x 50	M30 x 1.5 x 50	M30 x 1.5 x 50
Operating frequency	15 Hz	15 Hz	10 Hz	10 Hz
Sensing distance (Sn)	0.5 - 30 mm (adjustable)	0.5 - 30 mm (adjustable)	2 - 16 mm (adjustable)	2 - 16 mm (adjustable)
References				
NPN/PNP, NO/NC	CA30CLC30BP	CA30CLC30BPM1		
Power MOFSET			CA30CLF16CP	CA30CLF16CPM6
Non-flush mountable				
Dimensions (mm)			M30 x 71.6	M30 x 83.6
Thread (mm)			M30 x 1.5 x 50	M30 x 1.5 x 50
Operating frequency			10 Hz	10 Hz
Sensing distance (Sn)			2 - 25 mm (adjustable)	2 - 25 mm (adjustable)
References				
Power MOFSET			CA30CLN25CP	CA30CLN25CPM6
Characteristics flush and non-flush mountable				
Rated operating voltage	10 - 40 VDC	10 - 40 VDC	20 - 250 VAC/DC	20 - 250 VAC/DC
Voltage drop	< 2.5 VDC	< 2.5 VDC	< 5.5 VAC/DC	< 5.5 VAC/DC
Degree of protection	IP 68	IP 68	IP 67	IP 67
Protection Short-circuit (S)				
Reverse polarity (P)	SPT	SPT	PT	PT
Transients (T)				
Output current	< 250 mA	< 250 mA	< 250 mA DC < 350 mA AC	< 250 mA DC < 350 mA AC
Housing material	Thermoplastic polyester	Thermoplastic polyester	Thermoplastic polyester	Thermoplastic polyester
Operating temperature	-20°C to +85°C	-20°C to +85°C	-25°C to +80°C	-25°C to +80°C
LED colour	Yellow	Yellow	Yellow	Yellow
Special features	Teach-in, Humidity compensation NPN/PNP auto detection, remote setup, alarm output. On request: Dirt and moisture compensation	Teach-in, Humidity compensation NPN/PNP auto detection, remote setup, alarm output. On request: Dirt and moisture compensation		
Approvals/Marks	CE - UL - CSA	CE - UL - CSA	CE - UL - CSA	CE - UL - CSA





Capacitive proximity sensors, TRIPLESIELD™

Types	M18 TRIPLESIELD™, chemical resistant		
Connections	2 m cable	2 m cable	2 m cable
Flush mountable			
Dimensions (mm)	M18 x 71.5	M18 x 71.5	M18 x 71.5
Thread (mm)	M18 x 1 x 46.5	M18 x 1 x 46.5	M18 x 1 x 46.5
Operating frequency	30 Hz	30 Hz	30 Hz
Sensing distance (Sn)	3 - 8 mm (adjustable)	3 - 8 mm (adjustable)	3 - 8 mm (adjustable)
References			
NPN-NO/NC	CA18HLF08NA	CA18GLF08NA	CA18FLF08NA
PNP-NO/NC	CA18HLF08PA	CA18GLF08PA	CA18FLF08PA



Non-flush mountable	
Dimensions (mm)	M18 x 71.5
Thread (mm)	M18 x 1 x 46.5
Operating frequency	30 Hz
Sensing distance (Sn)	3 - 12 mm (adjustable)
References	
NPN-NO/NC	CA18HLN12NA
PNP-NO/NC	CA18HLN12PA

Characteristics flush and non-flush mountable			
Rated operating voltage	10 - 40 VDC	10 - 40 VDC	10 - 40 VDC
Voltage drop	≤ 2.5 VDC	≤ 2.5 VDC	≤ 2.5 VDC
Degree of protection	IP 67	IP 67	IP 67
Protection Short-circuit (S) Reverse polarity (P) Transients (T)	SPT	SPT	SPT
Output current	< 200 mA	< 200 mA	< 200 mA
Housing material	Polypropylene	PVC	Teflon
Operating temperature	-25°C to +80°C	-25°C to +80°C	-25°C to +80°C
LED colour	Yellow	Yellow	Yellow
Approvals/Marks	CE	CE	CE





Capacitive proximity sensors, TRIPLESIELD™

Types	VC5510	VC5510 Time delay	CD50	CD50
Connections	1.5 m cable	1.5 m cable	2 m cable	2 m cable
Flush mountable				
Dimensions (mm)	55 x 35 x 15	55 x 35 x 15	50 x 30 x 7	50 x 30 x 7
Operating frequency	> 15 Hz	> 0.1 Hz	10 Hz	10 Hz
Sensing distance (Sn)	10 mm	10 mm	6 mm	5 mm
References				
NPN - NO	VC5510NNOP	VC5510NNOPT	CD50CNF06NO	CD50CNF05NO
NPN - NC	VC5510NNCP	VC5510NNCPT		
PNP - NO	VC5510PNOP	VC5510PNOPT		
PNP - NC	VC5510PNCP	VC5510PNCPT		
Sensing distance (Sn)			7 mm	
PNP - NO			CD50CNF07PO	
NPN - NC			CD50CNF07NC	
Sensing distance (Sn)			10 mm	
PNP - NO			CD50CNF10PO	
NPN - NC			CD50CNF10NC	
Characteristics flush and non-flush mountable				
Rated operating voltage	5 - 30 VDC	5 - 30 VDC	10 - 30 VDC	5 VDC
Voltage drop	≤ 1.5 VDC	≤ 1.5 VDC	≤ 1.5 V	≤ 1.5 V
Degree of protection	IP 65	IP 65	IP 67	IP 67
Output current	≤ 100 mA	≤ 100 mA	≤ 50 mA	≤ 50 mA
Housing material	PC/ABS	PC/ABS	Noryl, grey	Noryl, grey
Operating temperature	0°C to +50°C	0°C to +50°C	0°C to +60°C	0°C to +60°C
LED colour	Red	Red		
Approvals/Marks	CE - UL	CE - UL	CE	CE





Capacitive proximity sensors, TRIPLESIELD™

Types	CD46 teach-in TRIPLESIELD™	EC 5525 TRIPLESIELD™	
Connections	2 m cable	2 m cable	M12 connector
Flush or non-Flush mountable			
	Dimensions short body (mm)	46 x 28 x 5.5	55 x 35 x 15
Operating frequency	10 Hz	50 Hz	50 Hz
Sensing distance (Sn)	1.0 - 10 mm (Teach-in)	4 - 25 mm	4 - 25 mm
References			
NPN-NO/NC	CD46CNC10NP	EC5525NPAP	EC5525NPAP-1
PNP-NO/NC	CD46CNC10PP	EC5525PPAP	EC5525PPAP-1
Characteristics flush and non-flush mountable			
Rated operating voltage	10 - 30 VDC	10 - 40 VDC	10 - 40 VDC
Voltage drop	≤ 2.5 VDC	≤ 2.5 VDC	≤ 2.5 VDC
Degree of protection	IP 68	IP 67	IP 67
Protection Short-circuit (S) Reverse polarity (P) Transients (T)	SPT	SPT	SPT
Output current	≤ 200 mA	≤ 200 mA	≤ 200 mA
Housing material	PBT	Polycarbonate	Polycarbonate
Operating temperature	-25°C to +80°C	-25°C to +80°C	-25°C to +80°C
LED colour	Yellow, Green	Yellow	Yellow
Special features	Teach-in, remote setup, alarm output		
Approvals/Marks	CE - UL - CSA	CE - UL - CSA	CE - UL - CSA

Capacitive proximity sensors, TRIPLESIELD™

Types	M18 teach-in TRIPLESIELD™		M30 teach-in TRIPLESIELD™	
Connections	2 m cable	M12 connector	2 m cable	M12 connector
Flush or non-flush mountable				
Dimensions (mm)	M18 x 89.55	M18 x 89.2	M30 x 99.2	M30 x 99.45
Thread (mm)	M18 x 1 x 50	M18 x 1 x 50	M30 x 1.5 x 50	M30 x 1.5 x 50
Operating frequency	5 Hz	5 Hz	5 Hz	5 Hz
Sensing distance (Sn)	0.5 - 12 mm (Teach-in)	0.5 - 12 mm (Teach-in)	0.5 - 30 mm (Teach-in)	0.5 - 30 mm (Teach-in)
References				
NPN/PNP, NO/NC	CA18CLL12BP	CA18CLL12BPM1	CA30CLL30BP	CA30CLL30BPM1
Characteristics flush and non-flush mountable				
Rated operating voltage	10 - 40 VDC	10 - 40 VDC	10 - 40 VDC	10 - 40 VDC
Voltage drop	≤ 2.5 VDC	≤ 2.5 VDC	≤ 2.5 VDC	≤ 2.5 VDC
Degree of protection	IP 68	IP 68	IP 68	IP 68
Output current	≤ 250 mA	≤ 250 mA	≤ 250 mA	≤ 250 mA
Housing material	Thermoplastic polyester	Thermoplastic polyester	Thermoplastic polyester	Thermoplastic polyester
Operating temperature	-20°C to +85°C	-20°C to +85°C	-20°C to +85°C	-20°C to +85°C
Max. temperature on sensing face	120°C (248°F)	120°C (248°F)	120°C (248°F)	120°C (248°F)
LED colour	Yellow	Yellow	Yellow	Yellow
Special features	Single-step Teach-in, Humidity compensation NPN/PNP auto detection, remote setup, alarm output. On request: Dirt and moisture compensation	Single-step Teach-in, Humidity compensation NPN/PNP auto detection, remote setup, alarm output. On request: Dirt and moisture compensation	Single-step Teach-in, Humidity compensation NPN/PNP auto detection, remote setup, alarm output. On request: Dirt and moisture compensation	Single-step Teach-in, Humidity compensation NPN/PNP auto detection, remote setup, alarm output. On request: Dirt and moisture compensation
Approvals/Marks	CE - UL - CSA	CE - UL - CSA	CE - UL - CSA	CE - UL - CSA

Capacitive level sensors

Types	Capacitive level sensors for solid, fluid and granulated substances			
Connections	2 m cable	2 m cable	2 m cable	2 m cable
				
Dimensions (mm)	Ø32 x 101	Ø32 x 101	Ø32 x 101	M30 x 101
Thread	Smooth	Smooth	Smooth	M30 (with 2 nuts)
Operating frequency	1 Hz	1 Hz	1 Hz	1 Hz
Sensing distance (Sn)	4 - 12 mm (adjustable)	4 - 12 mm (adjustable)	4 - 12 mm (adjustable)	4 - 12 mm (adjustable)
References with ON delay				
Time delay	1 s - 10 m			1 s - 10 m
120 VAC	VC11RT12010M			
230 VAC	VC11RT23010M			
24 VAC/DC	VC11RT92410M			
24-230 VAC/DC	VC11RTM2410M			CA30CLN12MU10M
References with OFF delay				
Time delay	1 s - 10 m			1 s - 10 m
120 VAC	VC12RT12010M			
230 VAC	VC12RT23010M			
24 VAC/DC	VC12RT92410M			
24-230 VAC/DC	VC12RTM2410M			CA30CLN12MV10M
References without delay				
120 VAC	VC12RN120			
230 VAC	VC12RN230			
24 VAC/DC	VC12RN924			
24-230 VAC/DC	VC12RNM24			CA30CLN12MT
Specifications				
Consumption	≤ 1.5 W	≤ 1.5 W	≤ 1.5 W	≤ 2.5 W
Consumption M24 versions	≤ 2.5 W	≤ 2.5 W	≤ 2.5 W	
Hysteresis	1.5 mm at 7 mm sensing distance	1.5 mm at 7 mm sensing distance	1.5 mm at 7 mm sensing distance	3 - 20%
Output	Relay SPDT 2 A / 240 VAC	Relay SPDT 2 A / 240 VAC	Relay SPDT 2 A / 240 VAC	Relay SPDT 2 A / 240 VAC
Degree of protection	IP 67	IP 67	IP 67	IP 67
Housing material	Thermoplastic polyester	Thermoplastic polyester	Thermoplastic polyester	PBTP, grey
Operating temperature	-20°C to +70°C	-20°C to +70°C	-20°C to +70°C	-20°C to +70°C
LED colour	Red	Red	Red	Yellow
Approvals/Marks	CE	CE - CSA	CE	CE, CSA
UL508	cULus (M24 versions)	cULus (M24 versions)	cULus (M24 versions)	cULus
NEMA				1, 2, 4, 4X, 5, 6, 6P, 12

Capacitive level sensors

	Ø18 sensors for solid, fluid and granulated substances		Ø32 sensors
Types	2-wire, AC	3-wire, DC	2-wire, AC
Connections	2 m cable	2 m cable	2 m cable
			
Dimensions (mm)	Ø18 x 86	Ø18 x 86	Ø32 x 101
Thread	Smooth	Smooth	Smooth
Operating frequency	10 Hz	30 Hz	10 Hz
Sensing distance (Sn)	3 - 12 mm (adjustable)	3 - 12 mm (adjustable)	2 - 20 mm (adjustable)
References			
Thyristor (SCR) NO	CB18CLN12TOFT		
Thyristor (SCR) NO ATEX	CB18CLN12TOFTAX		
Thyristor (SCR) NC	CB18CLN12TCFT		
Thyristor (SCR) NC ATEX	CB18CLN12TCFTAX		
NPN - NO/NC		CB18CLN12NA	
NPN - NO/NC ATEX		CB18CLN12NAAX	
PNP - NO/NC		CB18CLN12PA	
PNP - NO/NC ATEX		CB18CLN12PAAX	
ON-delay			No
Thyristor (SCR) NO			CB32CLN20TO
Thyristor (SCR) NO ATEX			CB32CLN20TOAX
Thyristor (SCR) NC			CB32CLN20TC
Thyristor (SCR) NC ATEX			CB32CLN20TCAX
ON-delay			Yes
Thyristor (SCR) NO			CB32CLN20TOFT
Thyristor (SCR) NO ATEX			CB32CLN20TOFTAX
Thyristor (SCR) NC			CB32CLN20TCFT
Thyristor (SCR) NC ATEX			CB32CLN20TCFTAX
Specifications			
Rated operating voltage	20 - 250 VAC	10 - 40 VDC	20 - 250 VAC
Voltage drop	≤ 10 VAC	≤ 10 VAC	≤ 10 VAC
Time delay	30 s ON-delay		30 s ON-delay
Degree of protection	IP 67	IP 67	IP 67
Protection Short-circuit (S) Reverse polarity (P) Transients (T)	T	SPT	T
Output current	≤ 500 mA	≤ 200 mA	≤ 500 mA
Housing material	Thermoplastic polyester	Thermoplastic polyester	Thermoplastic polyester
Operating temperature	-25°C to +80°C	-25°C to +80°C	-20°C to +70°C
LED colour	Yellow	Yellow	Yellow
Approvals/Marks	CE - UL - CSA - ATEX	CE - UL - CSA - ATEX	CE - UL - CSA - ATEX

Capacitive level sensors

Types Ø32 level sensors TRIPLESIELD™ - ATEX

Connections	With ON delay	With OFF delay	Without time delay
-------------	---------------	----------------	--------------------



Dimensions (mm)	Ø32 x 101	Ø32 x 101	Ø32 x 101
Thread	Smooth	Smooth	Smooth
Operating frequency	5 Hz	5 Hz	5 Hz
Sensing distance (Sn)	4 - 20 mm (adjustable)	4 - 20 mm (adjustable)	4 - 20 mm (adjustable)

References

Cable length	2 m	2 m	2 m
120 VAC	CB32CLN20SUAX	CB32CLN20SVAX	CB32CLN20STAX
230 VAC	CB32CLN20RUAX	CB32CLN20RVAX	CB32CLN20RTAX
24 VAC/DC	CB32CLN20QUAX	CB32CLN20QVAX	CB32CLN20QTAX
Cable length	5 m	5 m	5 m
120 VAC	CB32CLN20SUAX5M	CB32CLN20SVAX5M	CB32CLN20STAX5M
230 VAC	CB32CLN20RUAX5M	CB32CLN20RVAX5M	CB32CLN20RTAX5M
24 VAC/DC	CB32CLN20QUAX5M	CB32CLN20QVAX5M	CB32CLN20QTAX5M
Cable length	10 m	10 m	10 m
120 VAC	CB32CLN20SUAX10M	CB32CLN20SVAX10M	CB32CLN20STAX10M
230 VAC	CB32CLN20RUAX10M	CB32CLN20RVAX10M	CB32CLN20RTAX10M
24 VAC/DC	CB32CLN20QUAX10M	CB32CLN20QVAX10M	CB32CLN20QTAX10M

Specifications

Consumption	< 1.5 W	< 1.5 W	< 1.5 W
Hysteresis	3 to 20% of sensing distance	3 to 20% of sensing distance	3 to 20% of sensing distance
Output	Relay SPDT, 2 A / 240 VAC	Relay SPDT, 2 A / 240 VAC	Relay SPDT, 2 A / 240 VAC
Time delay	1 s - 10 m	1 s - 10 m	
Degree of protection	IP 67	IP 67	IP 67
Housing material	PBT	PBT	PBT
Operating temperature	-20°C to +70°C	-20°C to +70°C	-20°C to +70°C
LED colour	Yellow	Yellow	Yellow
Approvals/Marks	CE - ATEX	CE - ATEX	CE - ATEX

Conductive level sensors

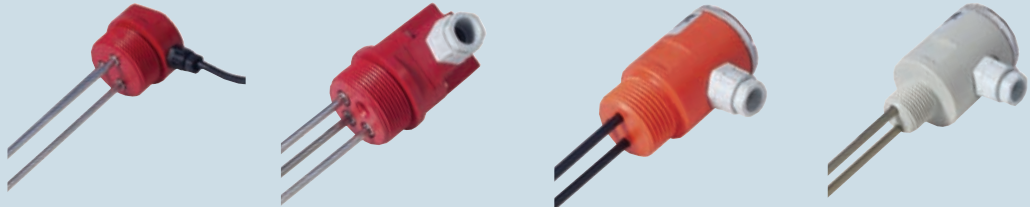
Types	VN / VNI		VNY / VNYI		VPC		VPP	
Connections	Cable (PVC) 2 m		Screw connection		Screw connection		Screw connection	
								
Electrodes								
Number of electrodes	1, 2, 3 or 4		1, 2, 3 or 4		1, 2 or 3		1, 2 or 3	
Diameter/length (mm)	D5/1000		D5/1000		D4/500		D4/500	
Material	Stainless steel		Stainless steel		Stainless steel		Stainless steel	
Isolation of electrodes	Yes (VNI)		Yes (VNYI)		Yes		Yes	
Isolation	Polyethylene		Polyethylene		Polyethylene		PVDF	
Housing								
Pipe thread	1½"		1½"		½" (VPC x05) or 1" (VPC x10)		½" (VPC x05) or 1" (VPC x10)	
Material	Nylon 6		Nylon 6		PVC		Polypropylene	
References								
1 electrodes	VN1	VNI1	VNY1	VNYI1	VPC105	VPC110	VPP105	VPP110
2 electrodes	VN2	VNI2	VNY2	VNYI2	VPC205	VPC210	VPP205	VPP210
3 electrodes	VN3	VNI3	VNY3	VNYI3	VPC310		VPP310	
4 electrodes	VN4	VNI4	VNY4	VNYI4				
Specifications								
Degree of protection	IP 67		IP 67		IP 67		IP 67	
Operating temperature	0°C to +90°C		0°C to +90°C		0°C to +60°C		0°C to +100°C	
Approvals/Marks	CE		CE		CE		CE	

Conductive level sensors

Types	VT / VTI	CLH	VH1 / VH2	A 94-10
Connections	Cable (Silicone)	Screw connection	Cable (Neoprene)	Cable (PVC)



Electrodes

Number of electrodes	1, 2, 3 or 4	2 or 4 + reference	1 (hanging)	2 (hanging)
Diameter/length (mm)	D5/1000	D4	D18/36.5 or D32/75.5	D22/75.0
Material	Stainless steel	Stainless steel	Stainless steel	Stainless steel
Isolation of electrodes	Yes (VTI)	Yes	No (VH1) - Yes (VH2)	No
Isolation	Teflon	Kynar, Polyolefine	Nylon 6	

Housing

Pipe thread	1½"	1½"		
Material	Teflon	Polypropylene	Nylon 6	Polyester

References

1 electrodes	VT1	VTI1	VH1 or VH2	
2 electrodes	VT2	VTI2		A 94-10
3 electrodes	VT3	VTI3		
4 electrodes	VT4	VTI4		
5 electrodes				

Specifications





Degree of protection	IP 67	IP 65	IP 67	IP 67
Operating temperature	0°C to +145°C	-20°C to +90°C	0°C to +90°C	0°C to +60°C
Approvals/Marks	CE	CE	CE	CE

Electrodes (Stainless steel ANSI316)





No Insulation		
1 m		CLE1
2 m		CLE2
Extension 1 m		CLE1X
Kynar (DVDP) Insulation		
1 m		CLE1K
2 m		CLE2K
Extension 1 m		CLE1KX
Polyolefine Insulation		
1 m		CLE1P
2 m		CLE2P
Extension 1 m		CLE1PX

* Electrodes shall be ordered separately





Conductive level sensors

Level controller				
Types	CLD1	CLD2	CLP2 Basic	CLP2
Connections	DIN rail	DIN rail	Plug 11 pin circular	Plug 11 pin circular
				
Function	Filling or emptying. Selectable by rotary switches. Conductive liquids	Filling or emptying. Selectable by rotary switches. Conductive liquids	Filling or emptying. Selectable by rotary switches. Conductive liquids	Filling or emptying. Selectable by rotary switches. Conductive liquids
Adjustable	Yes, Potentiometer	Yes, Potentiometer	Yes, Potentiometer	Yes, Potentiometer
Sensitivity	5 K Ω to 150 K Ω	250 Ω to 500 K Ω	5 K Ω to 150 K Ω	250 Ω to 500 K Ω
Functions switch	- Timer 1 to 30 sec. delay on filling or/and emptying	- Filling / Emptying - 3-levels: Low, Standard and High	- Filling / Emptying	- Filling / Emptying - 3-levels: Low, Standard and High
Input	1 + reference	2 + reference	2 + reference	2 + reference
Output	8A / 250 VAC SPST	8A / 250 VAC SPDT	8A / 250 VAC SPDT	8A / 250 VAC DPDT
Power Supply	24 V AC/DC	24 - 240 VAC/DC	24 VDC, 24VAC, 115 VAC or 230 VAC	24 VAC/DC, 115 VAC or 230 VAC
References				
24 240 VAC/DC		CLD2EB1BU24		
24 VDC			CLP2EB1B724	
24 VAC			CLP2EB1B024	
24 VAC/DC	CLD1EA1CM24			CLP2EA1CM24
115 VAC			CLP2EB1B115	CLP2EA1C115
230 VAC			CLP2EB1B230	CLP2EA1C230
Specifications				
Time delay	< 300 mS	< 2S	< 2S	< 300 mS
Housing material	ABS VO	PA66	NORYL PPO	NORYL PPO
Operating temperature	-20°C to +50°C	-20°C to +50°C	-20°C to +50°C	-20°C to +50°C
Output LED colour	Yellow	Yellow	Yellow	Yellow
Power LED colour	Green	Green	Green	Green
Approvals/Marks	CE - UL - CSA	CE - UL	CE - UL - CSA	CE - UL - CSA



Conductive level sensors

Level controller				
Types	CLD2	CLP2 Master-Slave	CLD4	CLP4
Connections	DIN rail	Plug 11 pin circular	DIN rail	Plug 11 pin circular
				
Function	Filling or emptying. Selectable by rotary switches. Conductive liquids	Filling or emptying. Selectable by rotary switches. Conductive liquids Master - Slave system	Filling, emptying or combinations. Selectable by rotary switches. Conductive liquids	Filling, emptying or combinations. Selectable by rotary switches. Conductive liquids
Adjustable	Yes, Potentiometer	Yes, Potentiometer	Yes, Potentiometer	Yes, Potentiometer
Sensitivity	250 Ω to 500 KΩ	250 Ω to 500 KΩ	250 Ω to 500 KΩ	250 Ω to 500 KΩ
Functions switch	- Filling / Emptying - 3-levels: Low, Standard and High	- Filling / Emptying - 3-levels: Low, Standard and High	- Tank - well - Direct in to out 2 probe - Low and High alarm - 2 system in one, filling and/ or emptying - 3-levels: Low, Standard and High	- Tank - well - Direct in to out 2 probe - Low and High alarm - 2 system in one, filling and/ or emptying - 3-levels: Low, Standard and High
Input	2 + reference	2 + reference	2 to 4 + reference	2 to 4 + reference
Output	8A / 250 VAC DPDT	8A / 250 VAC SPDT	8A / 250 VAC SPDT, SPST	8A / 250 VAC 2 X SPST
Power Supply	24 VAC/DC, 115 VAC or 230 VAC	24 VAC/DC, 115 VAC or 230 VAC	24 VAC/DC, 115 VAC or 230 VAC	24 VAC/DC, 115 VAC or 230 VAC
References				
24 VAC/DC	CLD2EA1CM24	CLP2FA1BM24	CLD4MA2DM24	CLP4MA2AM24
115 VAC	CLD2EA1C115	CLP2FA1B115	CLD4MA2D115	CLP4MA2A115
230 VAC	CLD2EA1C230	CLP2FA1B230	CLD4MA2D230	CLP4MA2A230
Specifications				
Time delay	< 300 mS	< 300 mS	< 300 mS	< 300 mS
Housing material	ABS VO	NORYL PPO	ABS VO	NORYL PPO
Operating temperature	-20°C to +50°C	-20°C to +50°C	-20°C to +50°C	-20°C to +50°C
Output LED colour	Yellow	Yellow	Yellow	Yellow
Power LED colour	Green	Green	Green	Green
Approvals/Marks	CE - UL - CSA	CE - UL - CSA	CE - UL - CSA	CE - UL - CSA



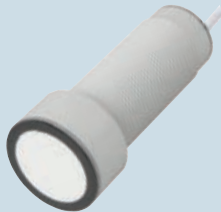

Ultrasonic sensors, 2 x digital outputs

Types	UA18CAD..TI	UA18CAD..MITI	UA30CAD35..TI	UA30CAD35..MITI
Connections	2 m cable	M12 connector	2 m cable	M12 connector
				
Dimensions (mm)	M18 x 85	M18 x 85	M30 x 90	M30 x 90
References				
Sensing distance (Sn)	50 - 400 mm	50 - 400 mm	250 - 3500 mm	250 - 3500 mm
Operating frequency	≤ 10 Hz	≤ 10 Hz	≤ 2 Hz	≤ 2 Hz
Blind zone	≤ 50 mm	≤ 50 mm	≤ 250 mm	≤ 250 mm
2 x NPN	UA18CAD04NPTI	UA18CAD04NPM1TI	UA30CAD35NPTI	UA30CAD35NPM1TI
2 x PNP	UA18CAD04PPTI	UA18CAD04PPM1TI	UA30CAD35PPTI	UA30CAD35PPM1TI
Sensing distance (Sn)	100 - 900 mm	100 - 900 mm		
Operating frequency	≤ 4 Hz	≤ 4 Hz		
Blind zone	≤ 100 mm	≤ 100 mm		
2 x NPN	UA18CAD09NPTI	UA18CAD09NPM1TI		
2 x PNP	UA18CAD09PPTI	UA18CAD09PPM1TI		
Sensing distance (Sn)	200 - 2200 mm	200 - 2200 mm		
Operating frequency	≤ 1 Hz	≤ 1 Hz		
Blind zone	≤ 200 mm	≤ 200 mm		
2 x NPN	UA18CAD22NPTI	UA18CAD22NPM1TI		
2 x PNP	UA18CAD22PPTI	UA18CAD22PPM1TI		
Specifications				
Rated operating voltage	15 - 30 VDC	15 - 30 VDC	12 - 30 VDC	12 - 30 VDC
Voltage drop	≤ 2.2 VDC	≤ 2.2 VDC	≤ 2.2 VDC	≤ 2.2 VDC
Degree of protection	IP 67	IP 67	IP 67	IP 67
Protection Short-circuit (S) Reverse polarity (P) Transients (T)	SPT	SPT	SPT	SPT
Load current	< 500 mA	< 500 mA	< 300 mA	< 300 mA
Load current - UL	< 100 mA	< 100 mA	< 100 mA	< 100 mA
Housing material	PBT	PBT	PBT	PBT
Operating temperature	-20°C to +60°C	-20°C to +60°C	-20°C to +70°C	-20°C to +70°C
LED colour	Yellow	Yellow	Yellow, green	Yellow, green
Approvals/Marks	CE - cULus	CE - cULus	CE - cULus	CE - cULus





Ultrasonic sensors, 2 x digital outputs

Types	UA30CAD60..TI	UA30CAD60..M1TI
Connections	2 m cable	M12 connector
		
Dimensions (mm)	M30 (Ø40) x 90	M30 (Ø40) x 90
References		
Sensing distance (Sn)	350 - 6000 mm	350 - 6000 mm
Operating frequency	≤ 1 Hz	≤ 1 Hz
Blind zone	≤ 350 mm	≤ 350 mm
2 x NPN	UA30CAD60NPTI	UA30CAD60NPM1TI
2 x PNP	UA30CAD60PPTI	UA30CAD60PPM1TI
Specifications		
Rated operating voltage	12 - 30 VDC	12 - 30 VDC
Voltage drop	≤ 2.2 VDC	≤ 2.2 VDC
Degree of protection	IP 67	IP 67
Protection Short-circuit (S) Reverse polarity (P) Transients (T)	SPT	SPT
Load current	< 300 mA	< 300 mA
Load current - UL	< 100 mA	< 100 mA
Housing material	PBT	PBT
Operating temperature	-20°C to +70°C	-20°C to +70°C
LED colour	Yellow, green	Yellow, green
Approvals/Marks	CE - cULus	CE - cULus



Ultrasonic sensors, 2 x digital outputs

Types	UA18EAD..TI	UA18EAD..MITI	UA30EAD35..TI	UA30EAD35..MITI
Connections	2 m cable	M12 connector	2 m cable	M12 connector
				
Dimensions (mm)	M18 x 85	M18 x 85	M30 x 90	M30 x 90
References				
Sensing distance (Sn)	50 - 400 mm	50 - 400 mm	350 - 3500 mm	350 - 3500 mm
Operating frequency	≤ 10 Hz	≤ 10 Hz	≤ 2 Hz	≤ 2 Hz
Blind zone	≤ 50 mm	≤ 50 mm	≤ 350 mm	≤ 350 mm
2 x NPN	UA18EAD04NPTI	UA18EAD04NPM1TI	UA30EAD35NPTI	UA30EAD35NPM1TI
2 x PNP	UA18EAD04PPTI	UA18EAD04PPM1TI	UA30EAD35PPTI	UA30EAD35PPM1TI
Sensing distance (Sn)	100 - 900 mm	100 - 900 mm		
Operating frequency	≤ 4 Hz	≤ 4 Hz		
Blind zone	≤ 100 mm	≤ 100 mm		
2 x NPN	UA18EAD09NPTI	UA18EAD09NPM1TI		
2 x PNP	UA18EAD09PPTI	UA18EAD09PPM1TI		
Sensing distance (Sn)	200 - 1500 mm	200 - 1500 mm		
Operating frequency	≤ 1 Hz	≤ 1 Hz		
Blind zone	≤ 200 mm	≤ 200 mm		
2 x NPN	UA18EAD15NPTI	UA18EAD15NPM1TI		
2 x PNP	UA18EAD15PPTI	UA18EAD15PPM1TI		
Specifications				
Rated operating voltage	15 - 30 VDC	15 - 30 VDC	12 - 30 VDC	12 - 30 VDC
Voltage drop	≤ 2.2 VDC	≤ 2.2 VDC	≤ 2.2 VDC	≤ 2.2 VDC
Degree of protection	IP 67	IP 67	IP 67	IP 67
Protection Short-circuit (S)				
Reverse polarity (P)	SPT	SPT	SPT	SPT
Transients (T)				
Load current	< 500 mA	< 500 mA	< 300 mA	< 300 mA
Load current - UL	< 100 mA	< 100 mA	< 100 mA	< 100 mA
Housing material	AISI 316L	AISI 316L	AISI 316L	AISI 316L
Operating temperature	-20°C to +60°C	-20°C to +60°C	-20°C to +70°C	-20°C to +70°C
LED colour	Yellow	Yellow	Yellow, green	Yellow, green
Approvals/Marks	CE - cULus	CE - cULus	CE - cULus	CE - cULus





Ultrasonic sensors, analog and digital output

Types	UA18CAD..TI	UA18CAD..MITI	UA30CAD35..TI	UA30CAD35..MITI
Connections	2 m cable	M12 connector	2 m cable	M12 connector
				
Dimensions (mm)	M18 x 85	M18 x 85	M30 x 90	M30 x 90
References				
Sensing distance (Sn)	50 - 400 mm	50 - 400 mm	250 - 3500 mm	250 - 3500 mm
Operating frequency	≤ 10 Hz	≤ 10 Hz	≤ 2 Hz	≤ 2 Hz
Blind zone	≤ 50 mm	≤ 50 mm	≤ 250 mm	≤ 250 mm
NPN, 4-20 mA	UA18CAD04NGTI	UA18CAD04NGM1TI	UA30CAD35NGTI	UA30CAD35NGM1TI
PNP, 4-20 mA	UA18CAD04PGTI	UA18CAD04PGM1TI	UA30CAD35PGTI	UA30CAD35PGM1TI
NPN, 0-10 V	UA18CAD04NKTI	UA18CAD04NKM1TI	UA30CAD35NKTI	UA30CAD35NKM1TI
PNP, 0-10 V	UA18CAD04PKTI	UA18CAD04PKM1TI	UA30CAD35PKTI	UA30CAD35PKM1TI
Sensing distance (Sn)	100 - 900 mm	100 - 900 mm		
Operating frequency	≤ 4 Hz	≤ 4 Hz		
Blind zone	≤ 100 mm	≤ 100 mm		
NPN, 4-20 mA	UA18CAD09NGTI	UA18CAD09NGM1TI		
PNP, 4-20 mA	UA18CAD09PGTI	UA18CAD09PGM1TI		
NPN, 0-10 V	UA18CAD09NKTI	UA18CAD09NKM1TI		
PNP, 0-10 V	UA18CAD09PKTI	UA18CAD09PKM1TI		
Sensing distance (Sn)	200 - 2200 mm	200 - 2200 mm		
Operating frequency	≤ 1 Hz	≤ 1 Hz		
Blind zone	≤ 200 mm	≤ 200 mm		
NPN, 4-20 mA	UA18CAD22NGTI	UA18CAD22NGM1TI		
PNP, 4-20 mA	UA18CAD22PGTI	UA18CAD22PGM1TI		
NPN, 0-10 V	UA18CAD22NKTI	UA18CAD22NKM1TI		
PNP, 0-10 V	UA18CAD22PKTI	UA18CAD22PKM1TI		
Specifications				
Rated operating voltage NG or PG NK or PK	15 - 30 VDC 15 - 30 VDC	15 - 30 VDC 15 - 30 VDC	12 - 30 VDC 15 - 30 VDC	12 - 30 VDC 15 - 30 VDC
Voltage drop	≤ 2.2 VDC	≤ 2.2 VDC	≤ 2.2 VDC	≤ 2.2 VDC
Degree of protection	IP 67	IP 67	IP 67	IP 67
Protection Short-circuit (S) Reverse polarity (P) Transients (T)	Digital output: SPT Supply: PT Analogue output: P	Digital output: SPT Supply: PT Analogue output: P	Digital output: SPT Supply: PT Analogue output: P	Digital output: SPT Supply: PT Analogue output: P
Load current	< 500 mA	< 500 mA	< 100 mA	< 100 mA
Load current - UL	< 100 mA	< 100 mA	< 100 mA	< 100 mA
Housing material	PBT	PBT	PBT	PBT
Operating temperature	-20°C to +60°C	-20°C to +60°C	-20°C to +70°C	-20°C to +70°C
LED colour	Yellow	Yellow	Yellow, green	Yellow, green
Approvals/Marks	CE - cULus	CE - cULus	CE - cULus	CE - cULus

Ultrasonic sensors, analog and digital output

Types	UA30CAD60..TI	UA30CAD60..M1TI
Connections	2 m cable	M12 connector
		
Dimensions (mm)	M30 (Ø40) x 90	M30 (Ø40) x 90
References		
Sensing distance (Sn)	350 - 6000 mm	350 - 6000 mm
Operating frequency	≤ 1 Hz	≤ 1 Hz
Blind zone	≤ 350 mm	≤ 350 mm
NPN, 4-20 mA	UA30CAD60NGTI	UA30CAD60NGM1TI
PNP, 4-20 mA	UA30CAD60PGTI	UA30CAD60PGM1TI
NPN, 0-10 V	UA30CAD60NKTI	UA30CAD60NKM1TI
PNP, 0-10 V	UA30CAD60PKTI	UA30CAD60PKM1TI
Specifications		
Rated operating voltage NG or PG NK or PK	12 - 30 VDC 15 - 30 VDC	12 - 30 VDC 15 - 30 VDC
Voltage drop	≤ 2.2 VDC	≤ 2.2 VDC
Degree of protection	IP 67	IP 67
Protection Short-circuit (S) Reverse polarity (P) Transients (T)	Digital output: SPT Supply: PT Analogue output: P	Digital output: SPT Supply: PT Analogue output: P
Load current	< 100 mA	< 100 mA
Load current - UL	< 100 mA	< 100 mA
Housing material	PBT	PBT
Operating temperature	-20°C to +70°C	-20°C to +70°C
LED colour	Yellow, green	Yellow, green
Approvals/Marks	CE - cULus	CE - cULus

Ultrasonic sensors, analog and digital output

Types	UA18EAD..TI	UA18EAD..MITI	UA30EAD35..TI	UA30EAD35..MITI
Connections	2 m cable	M12 connector	2 m cable	M12 connector
				
Dimensions (mm)	M18 x 85	M18 x 85	M30 x 93	M30 x 100
References				
Sensing distance (Sn)	50 - 400 mm	50 - 400 mm	350 - 3500 mm	350 - 3500 mm
Operating frequency	≤ 10 Hz	≤ 10 Hz	≤ 2 Hz	≤ 2 Hz
Blind zone	≤ 50 mm	≤ 50 mm	≤ 350 mm	≤ 350 mm
NPN, 4-20 mA	UA18EAD04NGTI	UA18EAD04NGM1TI	UA30EAD35NGTI	UA30EAD35NGM1TI
PNP, 4-20 mA	UA18EAD04PGTI	UA18EAD04PGM1TI	UA30EAD35PGTI	UA30EAD35PGM1TI
NPN, 0-10 V	UA18EAD04NKTI	UA18EAD04NKM1TI	UA30EAD35NKTI	UA30EAD35NKM1TI
PNP, 0-10 V	UA18EAD04PKTI	UA18EAD04PKM1TI	UA30EAD35PKTI	UA30EAD35PKM1TI
Sensing distance (Sn)	100 - 900 mm	100 - 900 mm		
Operating frequency	≤ 4 Hz	≤ 4 Hz		
Blind zone	≤ 100 mm	≤ 100 mm		
NPN, 4-20 mA	UA18EAD09NGTI	UA18EAD09NGM1TI		
PNP, 4-20 mA	UA18EAD09PGTI	UA18EAD09PGM1TI		
NPN, 0-10 V	UA18EAD09NKTI	UA18EAD09NKM1TI		
PNP, 0-10 V	UA18EAD09PKTI	UA18EAD09PKM1TI		
Sensing distance (Sn)	200 - 1500 mm	200 - 1500 mm		
Operating frequency	≤ 1 Hz	≤ 1 Hz		
Blind zone	≤ 200 mm	≤ 200 mm		
NPN, 4-20 mA	UA18EAD15NGTI	UA18EAD15NGM1TI		
PNP, 4-20 mA	UA18EAD15PGTI	UA18EAD15PGM1TI		
NPN, 0-10 V	UA18EAD15NKTI	UA18EAD15NKM1TI		
PNP, 0-10 V	UA18EAD15PKTI	UA18EAD15PKM1TI		
Specifications				
Rated operating voltage NG or PG NK or PK	15 - 30 VDC 15 - 30 VDC	15 - 30 VDC 15 - 30 VDC	12 - 30 VDC 15 - 30 VDC	12 - 30 VDC 15 - 30 VDC
Voltage drop	≤ 2.2 VDC	≤ 2.2 VDC	≤ 2.2 VDC	≤ 2.2 VDC
Degree of protection	IP 67	IP 67	IP 67	IP 67
Protection Short-circuit (S) Reverse polarity (P) Transients (T)	Digital output: SPT Supply: PT Analogue output: P	Digital output: SPT Supply: PT Analogue output: P	Digital output: SPT Supply: PT Analogue output: P	Digital output: SPT Supply: PT Analogue output: P
Load current	< 100 mA	< 100 mA	< 100 mA	< 100 mA
Load current - UL	< 100 mA	< 100 mA	< 100 mA	< 100 mA
Housing material	AISI 316L	AISI 316L	AISI 316L	AISI 316L
Operating temperature	-20°C to +60°C	-20°C to +60°C	-20°C to +70°C	-20°C to +70°C
LED colour	Yellow	Yellow	Yellow, green	Yellow, green
Approvals/Marks	CE - cULus	CE - cULus	CE - cULus	CE - cULus

Ultrasonic sensors, DC, analogue, remote teach

	Programmable RS232	Integrated amplifier
Types	UA30CLD..M7	UA12BLD..M1TR
Connections	M16 connector	M12 connector



Dimensions (mm)	M30 x 136	M12 x 79
-----------------	-----------	----------

References diffuse reflective

Operating frequency	5 - 30 Hz Programmable	20 Hz
Sensing distance (Sn)	150 - 1500 mm adj.	25 - 200 mm adj.
0-10 VDC	UA30CLD15FKM7	
4-20 mA	UA30CLD15FGM7	
NPN-NO/NC		UA12BLD02NPM1TR
PNP-NO/NC		UA12BLD02PPM1TR
Sensing distance (Sn)	250 - 2000 mm adj.	
0-10 VDC	UA30CLD20FKM7	
4-20 mA	UA30CLD20FGM7	
Sensing distance (Sn)	350 - 3500 mm adj.	
0-10 VDC	UA30CLD35FKM7	
4-20 mA	UA30CLD35FGM7	

Specifications

Rated operating voltage	19 - 30 VDC	10 - 30 VDC
Voltage drop	≤ 2.5 VDC	≤ 4.5 V
Degree of protection	IP 67	IP 65
Protection Short-circuit (S) Reverse polarity (P) Transients (T)	SPT	SPT
Load current	< 100 mA Analogue see type	< 100 mA
Housing material	PBTB	Stainless Steel
Operating temperature	-15°C to +70°C	-20°C to +70°C
LED colour	Yellow + Green	
Remarks	Hold/sync. input RS232	
Approvals/Marks	CE - UL - cUL	CE

	AUA - RT	Adapters UCC	UCP1 and UCP2
Types	AUA - RT	UCC	UCP1 and UCP2
Connections	M12 connector	Terminal block	Terminal block



Dimensions (mm)	17 x 56	38.5 x 80.5	38.5 x 80.5
-----------------	---------	-------------	-------------



Specifications

Programming adapter for remote teach sensors ending with "RT"

RS232 to RS485 adapter

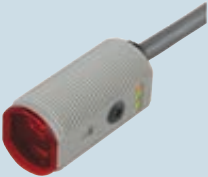

Programming adapter RS232

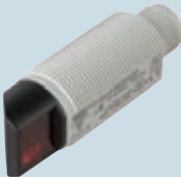
Photoelectric sensors

	M18, DC, axial type		M18, DC, radial type	
Types	PA18CA.	PA18CA.	PA18CR.	PA18CR.
Connections	2 m cable	M12 connector	2 m cable	M12 connector
				
Dimensions (mm)	M18 x 40	M18 x 44	M18 x 50	M18 x 54
Diffuse reflective				
Sensing distance (Sn)	50 - 1000 mm	50 - 1000 mm	50 - 800 mm	50 - 800 mm
NPN NO+NC	PA18CAD10NASA	PA18CAD10NAM1SA	PA18CRD08NASA	PA18CRD08NAM1SA
PNP NO+NC	PA18CAD10PASA	PA18CAD10PAM1SA	PA18CRD08PASA	PA18CRD08PAM1SA
Diffuse reflective WS				
Sensing distance (Sn)	0 - 400 mm	0 - 400 mm		
NPN NO+NC	PA18CAD04NAWS	PA18CAD04NAM1WS		
PNP NO+NC	PA18CAD04PAWS	PA18CAD04PAM1WS		
Retro reflective polariz.				
Sensing distance (Sn)	5 - 500 cm	5 - 500 cm	5 - 400 cm	5 - 400 cm
NPN NO+NC	PA18CAP50NASA	PA18CAP50NAM1SA	PA18CRP40NASA	PA18CRP40NAM1SA
PNP NO+NC	PA18CAP50PASA	PA18CAP50PAM1SA	PA18CRP40PASA	PA18CRP40PAM1SA
Retro reflective				
Sensing distance (Sn)	5 - 650 cm	5 - 650 cm	5 - 500 cm	5 - 500 cm
NPN NO+NC	PA18CAR65NASA	PA18CAR65NAM1SA	PA18CRR50NASA	PA18CRR50NAM1SA
PNP NO+NC	PA18CAR65PASA	PA18CAR65PAM1SA	PA18CRR50PASA	PA18CRR50PAM1SA
Through-beam emitter (E)				
Sensing distance (Sn)	1 - 20 m	1 - 20 m	1 - 16 m	1 - 16 m
	PA18CAT20	PA18CAT20M1	PA18CRT16	PA18CRT16M1
Through-beam receiver (R)				
Sensing distance (Sn)	1 - 20 m	1 - 20 m	1 - 16 m	1 - 16 m
NPN NO+NC	PA18CAT20NASA	PA18CAT20NAM1SA	PA18CRT16NASA	PA18CRT16NAM1SA
PNP NO+NC	PA18CAT20PASA	PA18CAT20PAM1SA	PA18CRT16PASA	PA18CRT16PAM1SA
Background suppression (BGS)				
Sensing distance (Sn)	10 - 200 mm	10 - 200 mm		
NPN NO+NC	PA18CAB20NASA	PA18CAB20NAM1SA		
PNP NO+NC	PA18CAB20PASA	PA18CAB20PAM1SA		
Specifications				
Operating frequency	500 Hz	500 Hz	500 Hz	500 Hz
Rated operating voltage	10 - 30 VDC	10 - 30 VDC	10 - 30 VDC	10 - 30 VDC
Voltage drop	≤ 2.0 VDC @ 100 mA	≤ 2.0 VDC @ 100 mA	≤ 2.0 VDC @ 100 mA	≤ 2.0 VDC @ 100 mA
Degree of protection	IP 67 + IP 69K	IP 67 + IP 69K	IP 67 + IP 69K	IP 67 + IP 69K
Protection Short-circuit(S) Rev. polarity(P), Transients(T)	SPT	SPT	SPT	SPT
Supply current	≤ 25 mA @ 24 VDC ≤ 40 mA @ 24 VDC	≤ 25 mA @ 24 VDC ≤ 40 mA @ 24 VDC	≤ 25 mA @ 24 VDC ≤ 40 mA @ 24 VDC	≤ 25 mA @ 24 VDC ≤ 40 mA @ 24 VDC
Housing material	ABS, PMMA, PBTB	ABS, PMMA, PBTB	ABS, PMMA, PBTB	ABS, PMMA, PBTB
Operating temperature	-25°C to +60°C	-25°C to +60°C	-25°C to +60°C	-25°C to +60°C
LED colour	Yellow, Green	Yellow, Green	Yellow, Green	Yellow, Green
Approvals/Marks	CE - cULus - ECOLAB	CE - cULus - ECOLAB	CE - cULus - ECOLAB	CE - cULus - ECOLAB



Photoelectric sensors

M18, DC, square type





Types	PH18.	PH18.	PH18.
Connections	2 m cable	M12 connector	Pigtail M12
			
Dimensions (mm)	15 x 21 (31.5) x 35	15 x 21 (31.5) x 35	15 x 21 (31.5) x 35
Diffuse reflective			
Sensing distance (Sn)	50 - 1000 mm	50 - 1000 mm	50 - 1000 mm
NPN NO+NC	PH18CND10NASA	PH18CND10NAM1SA	PH18CND10NAT1SA
PNP NC+NC	PH18CND10PASA	PH18CND10PAM1SA	PH18CND10PAT1SA
Retro reflective polariz.			
Sensing distance (Sn)	5 - 500 cm	5 - 500 cm	5 - 500 cm
NPN NO+NC	PH18CNP50NASA	PH18CNP50NAM1SA	PH18CNP50NAT1SA
PNP NO+NC	PH18CNP50PASA	PH18CNP50PAM1SA	PH18CNP50PAT1SA
Retro reflective			
Sensing distance (Sn)	5 - 650 cm	5 - 650 cm	5 - 650 cm
NPN NO+NC	PH18CNR65NASA	PH18CNR65NAM1SA	PH18CNR65NAT1SA
PNP NO+NC	PH18CNR65PASA	PH18CNR65PAM1SA	PH18CNR65PAT1SA
Through-beam emitter (E)			
Sensing distance (Sn)	1 - 20 m	1 - 20 m	1 - 20 m
	PH18CNT20	PH18CNT20M1	PH18CNT20T1
Through-beam receiver (R)			
Sensing distance (Sn)	1 - 20 m	1 - 20 m	1 - 20 m
NPN NO+NC	PH18CNT20NASA	PH18CNT20NAM1SA	PH18CNT20NAT1SA
PNP NO+NC	PH18CNT20PASA	PH18CNT20PAM1SA	PH18CNT20PAT1SA
Background suppression (BGS)			
Sensing distance (Sn)	8 - 200 mm	8 - 200 mm	8 - 200 mm
NPN NO+NC	PH18CNB20NASA	PH18CNB20NAM1SA	PH18CNB20NAT1SA
PNP NO+NC	PH18CNB20PASA	PH18CNB20PAM1SA	PH18CNB20PAT1SA
Specifications			
Operating frequency	500 Hz	500 Hz	500 Hz
Rated operating voltage	10 - 30 VDC	10 - 30 VDC	10 - 30 VDC
Voltage drop	≤ 2.0 VDC @ 100 mA	≤ 2.0 VDC @ 100 mA	≤ 2.0 VDC @ 100 mA
Degree of protection	IP 67 + IP 69K	IP 67 + IP 69K	IP 67 + IP 69K
Protection Short-circuit (S)			
Reverse polarity (P)	SPT	SPT	SPT
Transients (T)			
Supply current	≤ 25 mA @ 24 VDC	≤ 25 mA @ 24 VDC	≤ 25 mA @ 24 VDC
BGS, E + R	≤ 40 mA @ 24 VDC	≤ 40 mA @ 24 VDC	≤ 40 mA @ 24 VDC
Housing material	ABS, PMMA	ABS, PMMA	ABS, PMMA
Operating temperature	-25°C to +60°C	-25°C to +60°C	-25°C to +60°C
LED colour	Yellow, Green	Yellow, Green	Yellow, Green
Approvals/Marks	CE - cULus - ECOLAB	CE - cULus - ECOLAB	CE - cULus - ECOLAB

Photoelectric sensors





M18 metal, DC, integrated amplifier

Types	E.18..	E.18..-1
Connections	2 m cable	M12 connector
 		
Dimensions (mm)	M18 x 55	M18 x 67
Diffuse reflective		
Operating frequency	120 Hz	120 Hz
Sensing distance (Sn)	400 mm, adjustable	400 mm, adjustable
NPN NO+NC	EO1804NPAS	EO1804NPAS-1
PNP NC+NC	EO1804PPAS	EO1804PPAS-1
Retro reflective polariz.		
Operating frequency	100 Hz	100 Hz
Sensing distance (Sn)	2 m, adjustable	2 m, adjustable
NPN NO+NC	EP1820NPAS	EP1820NPAS-1
PNP NO+NC	EP1820PPAS	EP1820PPAS-1
Retro reflective		
Operating frequency	120 Hz	120 Hz
Sensing distance (Sn)	3 m, adjustable	3 m, adjustable
NPN NO+NC	ER1830NPAS	ER1830NPAS-1
PNP NO+NC	ER1830PPAS	ER1830PPAS-1
Through-beam emitter		
Sensing distance (Sn)	20 m	20 m
	ET1820	ET1820-1
Through-beam receiver		
Operating frequency	170 Hz	170 Hz
Sensing distance (Sn)	20 m, adjustable	20 m, adjustable
NPN NO+NC	ET1820NPAS	ET1820NPAS-1
PNP NO+NC	ET1820PPAS	ET1820PPAS-1
Fiber optic		
Operating frequency	120 Hz	120 Hz
Sensing distance (Sn)	Fibre dependent	Fibre dependent
NPN NO+NC	EF1801NPAS	EF1801NPAS-1
PNP NO+NC	EF1801PPAS	EF1801PPAS-1
Specifications		
Rated operating voltage	10 - 40 VDC	10 - 40 VDC
Voltage drop	≤ 2.5 VDC	≤ 2.5 VDC
Degree of protection	IP 67	IP 67
Protection Short-circuit (S)		
Rev. polarity (P)	SPT	SPT
Transients (T)		
Load current	< 200 mA	< 200 mA
Housing material	Nickel-plated brass	Nickel-plated brass
Operating temperature	-20°C to +60°C	-20°C to +60°C
LED colour	Yellow	Yellow
Approvals/Marks	CE	CE





Photoelectric sensors

	M18 plastic, AC, integrated amplifier		M18 metal, AC, integrated amplifier	
Types	PA18CL	PA18CL.M6	PA18AL	PA18AL..M6
Connections	2 m cable	M12 connector	2 m cable	M12 connector
				
Dimensions (mm)	M18 x 71.5	M18 x 83.5	M18 x 71.5	M18 x 83.5
Diffuse reflective				
Operating frequency	20 Hz	20 Hz	20 Hz	20 Hz
Sensing distance (Sn)	100 mm, fixed	100 mm, fixed		
Thyristor (SCR) NC	PA18CLD01TC	PA18CLD01TCM6		
Thyristor (SCR) NO	PA18CLD01TO	PA18CLD01TOM6		
Sensing distance (Sn)	200 mm, fixed	200 mm, fixed		
Thyristor (SCR) NC	PA18CLD02TC	PA18CLD02TCM6		
Thyristor (SCR) NO	PA18CLD02TO	PA18CLD02TOM6		
Sensing distance (Sn)	400 mm, fixed	400 mm, fixed		
Thyristor (SCR) NC	PA18CLD04TC	PA18CLD04TCM6		
Thyristor (SCR) NO	PA18CLD04TO	PA18CLD04TOM6		
Sensing distance (Sn)	400 mm, adjustable	400 mm, adjustable	400 mm, adjustable	400 mm, adjustable
Thyristor (SCR) NC	PA18CLD04TCSA	PA18CLD04TCM6SA	PA18ALD04TCSA	PA18ALD04TCM6SA
Thyristor (SCR) NO	PA18CLD04TOSA	PA18CLD04TOM6SA	PA18ALD04TOSA	PA18ALD04TOM6SA
Retro reflective polariz.				
Operating frequency	25 Hz	25 Hz	25 Hz	25 Hz
Sensing distance (Sn)	2 m, fixed	2 m, fixed	2 m, adjustable	2 m, adjustable
Thyristor (SCR) NC	PA18CLP20TC	PA18CLP20TCM6	PA18ALP20TCSA	PA18ALP20TCM6SA
Thyristor (SCR) NO	PA18CLP20TO	PA18CLP20TOM6	PA18ALP20TOSA	PA18ALP20TOM6SA
Retro reflective				
Operating frequency	20 Hz	20 Hz	20 Hz	20 Hz
Sensing distance (Sn)	3 m, fixed	3 m, fixed	3 m, adjustable	3 m, adjustable
Thyristor (SCR) NC	PA18CLR30TC	PA18CLR30TCM6	PA18ALR30TCSA	PA18ALR30TCM6SA
Thyristor (SCR) NO	PA18CLR30TO	PA18CLR30TOM6	PA18ALR30TOSA	PA18ALR30TOM6SA
Specifications				
Rated operating voltage	20 - 250 VAC	20 - 250 VAC	20 - 250 VAC	20 - 250 VAC
Voltage drop	≤ 10 VAC	≤ 10 VAC	≤ 10 VAC	≤ 10 VAC
Off state current	≤ 5 mA AC	≤ 5 mA AC	≤ 5 mA AC	≤ 5 mA AC
Degree of protection	IP 67	IP 67	IP 67	IP 67
Protection Short-circuit (S)				
Reverse polarity (P)	PT	PT	PT	PT
Transients (T)				
Load current	< 500 mA	< 500 mA	< 500 mA	< 500 mA
Housing material	Polyester (PBTP)	Polyester (PBTP)	Nickel-plated brass	Nickel-plated brass
Operating temperature	-20°C to +60°C	-20°C to +60°C	-20°C to +60°C	-20°C to +60°C
LED colour	Yellow	Yellow	Yellow	Yellow
Approvals/Marks	CE - UL - CSA	CE - UL - CSA	CE - UL - CSA	CE - UL - CSA

Photoelectric sensors



	Integrated amplifier		Integrated amplifier, transparent	
Types	PD30 - Advanced with teach			
Connections	2 m cable	M8 connector	2 m cable	M8 connector
				
Dimensions (mm)	10 x 30 x 20	10 x 30 x 20	10 x 30 x 20	10 x 30 x 20
Retro reflective				
Operating frequency	1000 Hz	1000 Hz	1000 Hz	1000 Hz
Sensing distance (Sn)	6 m, Teach-in	6 m, Teach-in	2 m, Teach-in	2 m, Teach-in
Mute NPN NO/NC	PD30CNR06NPMU	PD30CNR06NPM5MU	PD30CNG02NPMU	PD30CNG02NPM5MU
Mute PNP NO/NC	PD30CNR06PPMU	PD30CNR06PPM5MU	PD30CNG02PPMU	PD30CNG02PPM5MU
Dust NPN NO/NC	PD30CNR06NPDU	PD30CNR06NPM5DU		
Dust PNP NO/NC	PD30CNR06PPDU	PD30CNR06PPM5DU		
Remote NPN NO/NC	PD30CNR06NPRT	PD30CNR06NPM5RT	PD30CNG02NPRT	PD30CNG02NPM5RT
Remote PNP NO/NC	PD30CNR06PPRT	PD30CNR06PPM5RT	PD30CNG02PPRT	PD30CNG02PPM5RT
Retro reflective polarized				
Operating frequency	1000 Hz	1000 Hz		
Sensing distance (Sn)	6 m, Teach-in	6 m, Teach-in		
Mute NPN NO/NC	PD30CNP06NPMU	PD30CNP06NPM5MU		
Mute PNP NO/NC	PD30CNP06PPMU	PD30CNP06PPM5MU		
Dust NPN NO/NC	PD30CNP06NPDU	PD30CNP06NPM5DU		
Dust PNP NO/NC	PD30CNP06PPDU	PD30CNP06PPM5DU		
Remote NPN NO/NC	PD30CNP06NPRT	PD30CNP06NPM5RT		
Remote PNP NO/NC	PD30CNP06PPRT	PD30CNP06PPM5RT		
Through-beam emitter				
Sensing distance (Sn)	15 m, Teach-in	15 m, Teach-in		
NPN	PD30CNT15NMU	PD30CNT15NM5MU		
PNP	PD30CNT15PMU	PD30CNT15PM5MU		
Through-beam receiver mute function				
Operating frequency	1000 Hz	1000 Hz		
Sensing distance (Sn)	15 m, Teach-in	15 m, Teach-in		
Remote NPN NO/NC	PD30CNT15NPRT	PD30CNT15NPM5RT		
Remote PNP NO/NC	PD30CNT15PPRT	PD30CNT15PPM5RT		
Dust NPN NO/NC	PD30CNT15NPDU	PD30CNT15NPM5DU		
Dust PNP NO/NC	PD30CNT15PPDU	PD30CNT15PPM5DU		
Specifications				
Rated operating voltage	10 - 30 VDC	10 - 30 VDC	10 - 30 VDC	10 - 30 VDC
Voltage drop	≤ 2.4 VDC@100 mA	≤ 2.4 VDC@100 mA	≤ 2.4 VDC@100 mA	≤ 2.4 VDC@100 mA
Degree of protection	IP 67	IP 67	IP 67	IP 67
Protection Short-circuit (S)				
Reverse polarity (P)	SPT	SPT	SPT	SPT
Transients (T)				
Load current	≤ 100 mA	≤ 100 mA	≤ 100 mA	≤ 100 mA
Housing material	ABS	ABS	ABS	ABS
Operating temperature	-25°C to +55°C	-25°C to +55°C	-25°C to +55°C	-25°C to +55°C
LED colour	Yellow + Green	Yellow + Green	Yellow + Green	Yellow + Green
Approvals/Marks	CE cULus	CE cULus	CE cULus	CE cULus

Photoelectric sensors

	Integrated amplifier, diffuse reflective		Laser miniature, DC, integrated amplifier	
Types	PD30 - Advanced with teach		LD32	LD32
Connections	2 m cable	M8 connector	2 m cable	M8 connector
				
Dimensions (mm)	10 x 30 x 20	10 x 30 x 20	12 x 20 x 32	12 x 20 x 32
Diffuse reflective				
Operating frequency	1000 Hz	1000 Hz	4000 Hz	4000 Hz
Sensing distance (Sn)	1 m, Teach-in	1 m, Teach-in	150 mm, Teach-in	150 mm, Teach-in
NPN NO+NC			LD32CND15NPT	LD32CND15NPM5T
PNP NO+NC			LD32CND15PPT	LD32CND15PPM5T
Dust output				
NPN NO/NC	PD30CND10NPDU	PD30CND10NPM5DU		
PNP NO/NC	PD30CND10PPDU	PD30CND10PPM5DU		
Remote teach				
NPN NO/NC	PD30CND10NPRT	PD30CND10NPM5RT		
PNP NO/NC	PD30CND10PPRT	PD30CND10PPM5RT		
Diffuse reflective background suppress.				
Operating frequency	1000 Hz	1000 Hz	4000 Hz	4000 Hz
Sensing distance (Sn)	150 mm, Teach-in	150 mm, Teach-in	60 mm, Teach-in	60 mm, Teach-in
NPN NO+NC	PD30CNB15NPRT	PD30CNB15NPM5RT	LD32CNB06NPT	LD32CNB06NPM5T
PNP NO+NC	PD30CNB15PPRT	PD30CNB15PPM5RT	LD32CNB06PPT	LD32CNB06PPM5T
Retro reflective polarized				
Operating frequency			4000 Hz	4000 Hz
Sensing distance (Sn)			1 m, Teach-in	1 m, Teach-in
NPN NO+NC			LD32CNP10NPT	LD32CNP10NPM5T
PNP NO+NC			LD32CNP10PPT	LD32CNP10PPM5T
Specifications				
Rated operating voltage	10 - 30 VDC	10 - 30 VDC	10 - 30 VDC	10 - 30 VDC
Voltage drop	≤ 2.4 VDC@100 mA	≤ 2.4 VDC@100 mA	≤ 2.4 VDC	≤ 2.4 VDC
Degree of protection	IP 67	IP 67	IP 67	IP 67
Protection Short-circuit (S) Reverse polarity (P) Transients (T)	SPT	SPT	SPT	SPT
Load current	≤ 100 mA	≤ 100 mA	≤ 100 mA	≤ 100 mA
Housing material	ABS	ABS	ABS	ABS
Operating temperature	-25°C to +55°C	-25°C to +55°C	-25°C to +60°C	-25°C to +60°C
LED colour	Yellow + Green	Yellow + Green	Yellow + Green	Yellow + Green
Approvals/Marks UL508	CE cULus	CE cULus	CE	CE
Light Source			Laser Class 2	Laser Class 2

Photoelectric sensors

Integrated amplifier

Types	PD30 - Basic with potentiometer	
Connections	2 m cable	M8 connector
		
Dimensions (mm)	10 x 30 x 20	10 x 30 x 20
Retro reflective		
Operating frequency	1000 Hz	1000 Hz
Sensing distance (Sn)	6 m	6 m
NPN NO/NC	PD30CNR60NASA	PD30CNR60NAM5SA
PNP NO/NC	PD30CNR60PASA	PD30CNR60PAM5SA
Retro reflective polarized		
Operating frequency	1000 Hz	1000 Hz
Sensing distance (Sn)	6 m	6 m
NPN NO/NC	PD30CNP60NASA	PD30CNP60NAM5SA
PNP NO/NC	PD30CNP60PASA	PD30CNP60PAM5SA
Through-beam emitter		
Sensing distance (Sn)	15 m PD30CNT15	15 m PD30CNT15M5
Through-beam receiver		
Operating frequency	500 Hz	500 Hz
Sensing distance (Sn)	15 m	15 m
NPN NO/NC	PD30CNT15NASA	PD30CNT15NAM5SA
PNP NO/NC	PD30CNT15PASA	PD30CNT15PAM5SA
Specifications		
Rated operating voltage	10 - 30 VDC	10 - 30 VDC
Voltage drop	≤ 2.0 VDC@100 mA	≤ 2.0 VDC@100 mA
Degree of protection	IP 67	IP 67
Protection Short-circuit (S)		
Reverse polarity (P)	SPT	SPT
Transients (T)		
Load current	≤ 100 mA	≤ 100 mA
Housing material	ABS	ABS
Operating temperature	-25°C to +60°C	-25°C to +60°C
LED colour	Yellow + Green	Yellow + Green
Approvals/Marks	CE cULus	CE cULus

Photoelectric sensors

Integrated amplifier

Types

PD30 - Basic with potentiometer

Connections

2 m cable

M8 connector



Dimensions (mm)

10 x 30 x 20

10 x 30 x 20

Diffuse reflective

Operating frequency

1000 Hz

1000 Hz

Sensing distance (Sn)

1 m

1 m

NPN NO+NC

PD30CND10NASA

PD30CND10NAM5SA

PNP NO+NC

PD30CND10PASA

PD30CND10PAM5SA

Diffuse reflective background suppression, red light

Operating frequency

500 Hz

500 Hz

Sensing distance (Sn)

200 mm

200 mm

NPN NO+NC

PD30CNB20NASA

PD30CNB20NAM5SA

PNP NO+NC

PD30CNB20PASA

PD30CNB20PAM5SA

Diffuse reflective background suppression, infrared light

Operating frequency

500 Hz

500 Hz

Sensing distance (Sn)

200 mm

200 mm

NPN NO+NC

PD30CNB20NAIS

PD30CNB20NAM5IS

PNP NO+NC

PD30CNB20PAIS

PD30CNB20PAM5IS

Specifications

Rated operating voltage

10 - 30 VDC

10 - 30 VDC

Voltage drop

≤ 2.0 VDC@100 mA

≤ 2.0 VDC@100 mA

Degree of protection

IP 67

IP 67

Protection Short-circuit (S)

SPT

SPT

Reverse polarity (P)

Transients (T)

Load current

≤ 100 mA

≤ 100 mA

Housing material

ABS

ABS

Operating temperature

-25°C to +60°C

-25°C to +60°C

LED colour

Yellow + Green

Yellow + Green

Approvals/Marks

UL508

CE

cULus

CE

cULus

Photoelectric sensors

Through-beam, transistor output

Types	PB10..	PA12	PB18..	PE12..
Connections	5 m cable	M12 connector	5 m cable	5 m cable
				

Dimensions (mm)	Ø10	M12	Ø18	Ø12
-----------------	-----	-----	-----	-----

Through-beam emitter

Sensing distance (Sn)	20 m	20 m	15 m	15 m
Single channel	PB10CNT20	PA12BNT20	PB18CNT15	PE12CNT15
Channel 1	PB10C1T20	PA12B1T20		PE12C1T15
Channel 2	PB10C2T20	PA12B2T20		PE12C2T15
Channel 3	PB10C3T20	PA12B3T20		PE12C3T15

Through-beam receiver

Operating frequency	100 Hz (for 3 ch 30 Hz)	100 Hz (for 3 ch 30 Hz)	100 Hz	100 Hz
Sensing distance (Sn)	25 m	25 m	15 m	15 m
NPN NO Single channel	PB10CNT20NO	PA12BNT20NO	PB18CNT15NO	PE12CNT15NO
NPN NC Single channel	PB10CNT20NC	PA12BNT20NC	PB18CNT15NC	PE12CNT15NC
PNP NO Single channel	PB10CNT20PO	PA12BNT20PO	PB18CNT15PO	PE12CNT15PO
PNP NC Single channel	PB10CNT20PC	PA12BNT20PC	PB18CNT15PC	PE12CNT15PC
NPN NO Channel 1	PB10C1T20NO	PA12B1T20NO		PE12C1T15NO
NPN NC Channel 1	PB10C1T20NC	PA12B1T20NC		PE12C1T15NC
PNP NO Channel 1	PB10C1T20PO	PA12B1T20PO		PE12C1T15PO
PNP NC Channel 1	PB10C1T20PC	PA12B1T20PC		PE12C1T15PC
NPN NO Channel 2	PB10C2T20NO	PA12B2T20NO		PE12C2T15NO
NPN NC Channel 2	PB10C2T20NC	PA12B2T20NC		PE12C2T15NC
PNP NO Channel 2	PB10C2T20PO	PA12B2T20PO		PE12C2T15PO
PNP NC Channel 2	PB10C2T20PC	PA12B2T20PC		PE12C2T15PC
NPN NO Channel 3	PB10C3T20NO	PA12B3T20NO		PE12C3T15NO
NPN NC Channel 3	PB10C3T20NC	PA12B3T20NC		PE12C3T15NC
PNP NO Channel 3	PB10C3T20PO	PA12B3T20PO		PE12C3T15PO
PNP NC Channel 3	PB10C3T20PC	PA12B3T20PC		PE12C3T15PC





Specifications

Rated operating voltage	10 - 30 VDC	10 - 30 VDC	10 - 30 VDC	10 - 30 VDC
Voltage drop	≤ 1.5 VDC	≤ 1.5 VDC	≤ 1.5 VDC	≤ 1.5 VDC
Degree of protection	IP 67	IP 67	IP 67	IP 67
Protection Short-circuit (S) Reverse polarity (P) Transients (T)	SPT	SPT	SPT	SPT
Load current	≤ 100 mA	≤ 100 mA	≤ 100 mA	≤ 100 mA
Housing material	PC	PC	PTE	PC
Operating temperature	-20°C to +50°C	-20°C to +50°C	-20°C to +50°C	-20°C to +50°C
LED colour	Green (E), Yellow (R)	Green (E), Yellow (R)		Green (E), Yellow (R)
Approvals/Marks UL 508 UL 325	CE cULus cURus	CE UL - cUL UR - cURus	CE cULus cURus	CE cULus cURus

NB! For pig-tail connector versions add C2 after the part number



Photoelectric sensors

DC, integrated amplifier

Types	PD70	PD112	PA.	PB.
Connections	2 m cable or connector		2 m cable or connector	
				
Dimensions (mm)	11.6 x 11.6 x 70	112 x 45 x 25	36 x 18 x 63	18 x 75 x 36
Diffuse reflective background suppress.				
Operating frequency		Door Mode 16.7 Hz Industri mode 250 Hz	1000 Hz	1000 Hz
Sensing distance (Sn)		2.5 m, adjustable	150 mm, adjustable	150 mm, adjustable
Cable		2 m	2 m	2 m
NPN/PNP, NO+NC		-	PA15INPA/PA15IPPA	PB15INPA/PB15IPPA
NPN+PNP, NO/NC		PD112CNB25BP	-	-
Connector		M12	M12	M12
NPN/PNP, NO+NC		-	PB15INPA/PB15IPPA	PB15INPA-1/PB15IPPA-1
NPN+PNP, NO/NC		PD112CNB25BPM1		
Retro reflective polariz.				
Operating frequency			1000 Hz	1000 Hz
Sensing distance (Sn)			3 m, adjustable	3 m, adjustable
Cable			2 m	2 m
NPN/PNP, NO+NC			PA3PNPA/PA3PPPA	PB3PNPA/PB3PPPA
Connector			M12	M12
NPN/PNP, NO+NC			PB3PNPA/PB3PPPA	PB3PNPA-1/PB3PPPA-1
Through-beam				
Operating frequency	100 Hz			
Sensing distance (Sn)	12 m, adjustable			
Cable	2 m			
NPN NO (Receiver)	PD70CNT12NO			
NPN NC (Receiver)	PD70CNT12NC			
PNP NO (Receiver)	PD70CNT12PO			
PNP NC (Receiver)	PD70CNT12PC			
Mute High (Emitter)	PD70CNT12MH			
Mute Low (Emitter)	PD70CNT12ML			
Connector	M8			
NPN NO (Receiver)	PD70CNT12NOM5			
NPN NC (Receiver)	PD70CNT12NCM5			
PNP NO (Receiver)	PD70CNT12POM5			
PNP NC (Receiver)	PD70CNT12PCM5			
Mute High (Emitter)	PD70CNT12M5MH			
Mute Low (Emitter)	PD70CNT12M5ML			
Specifications				
Rated operating voltage	10 - 30 VDC	10 - 30 VDC	10 - 30 VDC	10 - 30 VDC
Voltage drop	≤ 1.8 VDC	≤ 2.5 VDC	≤ 2.5 VDC	≤ 2.5 VDC
Degree of protection	IP 67	IP 67	IP 67	IP 67
Protection Short-circuit (S)				
Reverse polarity (P)	SPT	SPT	SPT	SPT
Transients (T)				
Load current	≤ 100 mA	< 200 mA	< 200 mA	< 200 mA
Housing material	PC Black	PC Black	Aluminium	Reinforced ABS
Operating temperature	-25°C to +55°C	-25°C to +55°C	-25°C to +60°C	-25°C to +60°C
LED colour	Yellow, Receiver output Green, Emitter power ON	Yellow, Output Green, Power ON	Yellow	Yellow
Approvals/Marks	CE - cURus	CE - cULus	CE	CE

Photoelectric sensors

Integrated amplifier

Types	PC50	PC50..M1	PC50
Connections	2 m cable	M12 connector	2 m cable
			
Dimensions (mm)	17 x 50 x 50	17 x 50 x 50	17 x 50 x 50
Diffuse reflective			
Operating frequency	500 Hz	500 Hz	20 Hz
Sensing distance (Sn)	1 m, adjustable	1 m, adjustable	
NPN/PNP NO+NC	PC50CND10BA	PC50CND10BAM1	
Sensing distance (Sn)	2 m, adjustable	2 m, adjustable	
NPN/PNP NO+NC	PC50CND20BA	PC50CND20BAM1	
Sensing distance (Sn)			1 m, adjustable
Relay SPDT Multivoltage			PC50CND10RP
Sensing distance (Sn)			2 m, adjustable
Relay SPDT Multivoltage			PC50CND20RP
Diffuse reflective background suppress.			
Operating frequency	250 Hz	250 Hz	
Sensing distance (Sn)	500 mm, adjustable	500 mm, adjustable	
NPN/PNP NO+NC	PC50CNB50BA	PC50CNB50BAM1	
Retro reflective polarized			
Operating frequency	500 Hz	500 Hz	20 Hz
Sensing distance (Sn)	6 m, adjustable	6 m, adjustable	6 m, adjustable
NPN/PNP NO+NC	PC50CNP06BA	PC50CNP06BAM1	
Mute High	PC50CNP06BAMH	PC50CNP06BAM1MH	
Mute Low	PC50CNP06BAML	PC50CNP06BAM1ML	
Relay SPDT Multivoltage			PC50CNP06RP
Retro reflective			
Operating frequency	500 Hz	500 Hz	20 Hz
Sensing distance (Sn)	10 m, adjustable	10 m, adjustable	10 m, adjustable
NPN/PNP NO+NC	PC50CNR10BA	PC50CNR10BAM1	
Relay SPDT Multivoltage			PC50CNP10RP
Through-beam emitter			
Sensing distance (Sn)	20 m	20 m	20 m
	PC50CNT20B	PC50CNT20BM1	PC50CNT20R
Through-beam receiver			
Operating frequency	500 Hz	500 Hz	20 Hz
Sensing distance (Sn)	20 m, adjustable	20 m, adjustable	20 m, adjustable
NPN/PNP NO+NC	PC50CNT20BA	PC50CNT20BAM1	-
Relay SPDT Multivoltage			PC50CNT20RP
Specifications			
Rated operating voltage	10 - 30 VDC	10 - 30 VDC	12-240 VDC/24-240 VAC
Voltage drop	≤ 2.5 VDC	≤ 2.5 VDC	Relay SPDT
Degree of protection	IP 67	IP 67	IP 67
Protection Short-circuit (S)			
Reverse polarity (P)	SPT	SPT	PT
Transients (T)			
Load current	≤ 200 mA	≤ 200 mA	≤ 3 mA
Housing material	Reinforced ABS/PC	Reinforced ABS/PC	Reinforced ABS/PC
Operating temperature	-20°C to +60°C	-20°C to +60°C	-20°C to +60°C
LED colour	Yellow + Green	Yellow + Green	Yellow + Green
Approvals/Marks	CE - UL - CSA	CE - UL - CSA	CE - UL - CSA

Photoelectric sensors

Integrated amplifier colour sensors

Types	PD12CNC..BPT
Connections	M12 connector



Dimensions (mm)	61 x 26 x 115
-----------------	---------------

Diffuse reflective

Operating frequency	500 Hz
Sensing distance (Sn)	2 to 60 mm (fiber depend.)
NPN/PNP NO+PC	PD12CNC01BPM1T 1 Output
NPN/PNP NO+PC	PD12CNC04BPM1T 4 Output

Accessories: fibres

Dist. 18 mm	FPDC 01 SCC 100
Dist. 40-60 mm	FPDC 02 SCC 100
Dist. 4-6 mm	FPDC 03 SCC 100
Dist. 2-6 mm	FPDC 04 SCC 100
Dist. 4 mm	FPDC 05 SCC 100





General specifications

Rated operating voltage	24 VDC
Voltage drop	≤ 2.2 VDC
Degree of protection	IP 65
Protection Short-circuit (S)	
Reverse polarity (P)	SPT
Transients (T)	
Load current	< 100 mA
Housing material	Polycarbonate
Operating temperature	0°C to +40°C
LED colour	Yellow + Green
Approvals/Marks	CE - cUL

Photoelectric sensors



	Integrated amplifier		Fork sensor	
Types	PD60..	PD60..M5	PF80..	PF74..
Connections	2 m cable	M8 connector	M8 connector	5 m cable
				
Dimensions (mm)	13 x 30 x 60	13 x 30 x 60	12 x 37.5 x 80	15 x 60 x 74
Transparent detection				
Operating frequency	1000 Hz	1000 Hz		
Sensing distance (Sn)	0.8 m, Teach-in	0.8 m, Teach-in		
NPN/PNP NO+NC	PD60CNG08BPT	PD60CNG08BPM5T		
Sensing distance (Sn)	1.4 m, Teach-in	1.4 m, Teach-in		
NPN/PNP NO+NC	PD60CNG14BPT	PD60CNG14BPM5T		
Fibre optical sensor plastic fibres				
Operating frequency	1000 Hz	1000 Hz		
Sensing distance (Sn)	200 mm	200 mm		
NPN/PNP NO+NC	PD60CNX20BP	PD60CNX20BPM5		
Sensing distance (Sn)	200 mm, Teach-in	200 mm, Teach-in		
NPN/PNP NO+NC	PD60CNX20BPT	PD60CNX20BPM5T		
Fibre optical sensor glass fibres				
Operating frequency	1000 Hz	1000 Hz		
Sensing distance (Sn)	200 mm	200 mm		
NPN/PNP NO+NC	PD60CNV20BP	PD60CNV20BPM5		
Sensing distance (Sn)	200 mm, Teach-in	200 mm, Teach-in		
NPN/PNP NO+NC	PD60CNV20BPT	PD60CNV20BPM5T		
Contrast sensor				
Operating frequency	20 kHz	20 kHz		
Sensing distance (Sn)	18 mm (fibre depend.)	18 mm (fibre depend.)		
NPN/PNP NO+NC	PD60CNK18BPT	PD60CNK18BPM5T		
Fork sensor				
Operating frequency			10 kHz	≤ 1100Hz
Sensing distance (Sn)			3 mm, Slot width	30 mm, Slot width
NPN/PNP NO+NC			PF80FNT03BPM5T	
PNP N.O., NPN N.C.				PF74CNT30BC
PNP N.C., NPN N.O.				PF74CNT30BO
General specifications				
Rated operating voltage	10 - 30 VDC	10 - 30 VDC	10 - 30 VDC	19.2 - 28.8 VDC
Voltage drop	≤ 2.0 VDC	≤ 2.0 VDC	≤ 2.0 VDC @ 100 mA ≤ 1.0 VDC @ 10 mA	≤ 1.5 VDC @ 100 mA
Degree of protection	IP 65 (IP 67 CNG type)	IP 65 (IP 67 CNG type)	IP65	IP65
Protection Short-circuit (S)				
Reverse polarity (P)	SPT	SPT	ST	SPT
Transients (T)				
Load current	≤ 100 mA	≤ 100 mA	≤ 40 mA	≤ 30 mA
Housing material	PC	PC	Aluminium, black	PC, black
Operating temperature	0°C to +60°C	0°C to +60°C	-20°C to +60°C	-25°C to +60°C
LED colour	Red	Red	Yellow + Red	Yellow + Green
Approvals/Marks	CE - UL - cUL	CE - UL - cUL	CE	CE

Photoelectric sensors





	Integrated amplifier relay output			Through-beam relay output
Types	PM..	PM..	PD86	PD98
Connections	Terminals single relay	Terminal block mute input	Terminal block mute input	Terminal block mute input
				
Dimensions (mm)	25 x 65 x 81	25 x 65 x 81	86 x 44 x 39	98 x 56 x 37
Diffuse reflective				
Oper. freq. / Sens. dist. (Sn)	20 Hz			
Sensing distance (Sn)	0.8 m, adjustable			
Relay SPDT Multivoltage	PMD8RG / RGT PMD8RI / RIT			
Retro reflective polariz.				
Oper. freq. / Sens. dist. (Sn)	20 Hz / 12 m, fixed	20 Hz / 12 m, fixed	20 Hz / 12 m, fixed	
Relay SPDT Multivoltage	PMP12RG / PMP12RI			
Relay SPST (PC)			PMP12RGM / PMP12RIM	
Relay SPST (ZAMAK)			PD86CNP12QPMU PD86HNP12QPMU-01C	
Retro reflective				
Oper. freq. / Sens. dist. (Sn)	20 Hz / 10 m, fixed			
Relay SPDT Multivoltage	PMR10RG / RGT			
Relay SPST	PMR10RI / RIT			
Through-beam emitter				
Sensing distance (Sn)	20 m	20 m	30 m (15 m default)	
	PMT20G / PMT20I	PMT20GM / PMT20IM	PD98CNT30QMU*	
Through-beam receiver				
Oper. freq. / Sens. dist. (Sn)	20 Hz / 20 m, fixed	20 Hz / 20 m, fixed	25 Hz / 30 m (15 m default)	
Relay SPDT Multivoltage	PMT20RG / RGT PMT20RI / RIT			
Relay SPST				
General specifications				
Rated operating voltage	12 - 240 VDC / 24 - 240 VAC	24 VAC/DC ±20%	24 VAC/DC ±20%	12 V to 24 VAC/DC
Voltage drop	Relay SPDT	Relay SPST	Relay SPST	Relay DPDT
Degree of protection	IP 67	IP 67	IP 66	IP 54
Protection Short-circuit (S) Reverse polarity (P) Transients (T)	PT	PT	PT	PT
Load current	≤ 3 A	≤ 3 A	1 A (AC), 0.5 A (DC)	1 A (AC), 0.5 A (DC)
Housing material	PC/ABS	PC/ABS	PD86C.. : PC + PMMA PD86H.. : ZAMAK + PMMA	PC/ABS
Operating temperature	-25°C to +55°C	-25°C to +55°C	-25°C to +60°C	-25°C to +60°C
LED colour	Yellow	Yellow	Yellow + Green	Yellow (receiver)
Approvals/Marks	CE - UL - CSA	CE - UL325 - UL508	CE - UL325 - UL508	CE - UL325
Remarks	G = PG 13.5 Outlet I = ½"NPT Outlet T = Timer	G = PG 13.5 Outlet I = ½"NPT Outlet Mute input	Mute input	Mute input

* Item number set, emitter + receiver.

Photoelectric sensors

	Edge infrared photoelectric safety switch	Heavy duty infrared barrier	Through-beam relay output
Types	IREPSS 1	IRPHS20 / IRPHS60	PD180
Connections	Terminal block	Terminal block	Terminal block
			
Dimensions (mm)	34 x 190 x 32	60 x 130 x 52	180 x 51 x 49
Through-beam range			
Indoor sensing distance (max) m	10	20 / 60	15 / 30
General specifications			
Technology	Infrared	Infrared	Infrared
Supply voltage Receiver or Emitter	12/24 VAC/VDC (depending on jumper insertion)	12/24 VAC/VDC (depending on jumper insertion)	12 + 24 VAC/DC
Battery Supply Emitter			2 x 3,6 VDC, 2100 mAh Lithium Batteries size AA
Consumption	60 mA to 24 VAC (tx + rx)	110 mA to 24 VAC (tx + rx)	35 mA DC (55 mA DC with low battery alarm)
Output	changeover relay SPDT	NO and NC with double relay in series	2 x SPST
Contact rating	1A@24VAC (resistive load)	1A@24VAC (resistive load)	1A@30VDC (resistive load)
Approvals	CE	CE	CE - UL325
Conformity	EN 12453, EN 954-1, RoHS	EN 12453, EN 954-1, RoHS	EN 12445, EN12453, EN12978, RoHS
Test input			Emitter test input
Environmental specifications			
Wavelength	950 nm	950 nm	850 nm
Operating temperature	-20°C to +60°C	-20°C to +60°C	-25°C to +55°C
Degree of protection	IP 54	IP 66	IP 55
Mechanical specifications			
LED transmitter	Power signal	Power signal	None (energy saving)
LED receiver	Signal for alignment with transmitter	Signal for alignment with transmitter	Power ON - Green LED Output - Yellow LED
Optical adjustment		Horizontal 180°	Horizontal 200° Vertical ±30°
Mounting	Wall or ceiling mounted type	Wall mounted type	Wall mounted type
Weight	310g (couple)	940g (couple)	Emitter 270g Receiver 230g
Comments			Emitter is supplied with 2 x 3.6 VDC 2100 mAh Lithium Batteries

Photoelectric sensors

	Sensors	Amplifier 1-channel	Amplifier 2-channel	Amplifier 3-channel
Types	MPF..	MPF1..	MPF2..	MPF3..
Connections	10 m cable	Terminals	Terminals	Terminals
				
Dimensions (mm)	See sensor type	70 x 57 x 86	70 x 57 x 86	70 x 57 x 86
Amplifier				
		1-Channel	2-Channel	3-Channel
12-24 VAC/DC ±15% Low current		MPF1-912RSL	MPF2-912RSL	MPF3-912RSL
12-24 VAC/DC ±15%		MPF1-912RS	MPF2-912RS	MPF3-912RS
115 VAC ±15%		MPF1-115RS	MPF2-115RS	MPF3-115RS
230 VAC ±15%		MPF1-230RS	MPF2-230RS	MPF3-230RS
Through-beam emitter		Output and function selection		
Sensing distance (Sn)	15 m	No Dist Adjust		Dist Adjust
Ø12 x 20	MPFT15-4 (C)	Normal Mute	Inverted Mute	Normal Mute Inverted Mute
D11 x 24.5	MPFT11-D11-4 (C)			
D18 x 25	MPFT15-D18-4 (C)	RS	RSI	RSA RSAI
M14 x 23	MPFT15-M14-4 (C)	RSL	RSLI	RSLA RSLAI
Through-beam receiver				
Sensing distance (Sn)	15 m			
Ø12 x 20	MPFR-4 (C)			
D11 x 24.5	MPFR-D11-4 (C)			
D18 x 25	MPFR-D18-4 (C)			
M14 x 23	MPFR-M14-4 (C)			
General specifications				
Rated operating voltage	Powered by amplifier	See amplifier reference	See amplifier reference	See amplifier reference
Output		1 x 2 SPST in series	2 x 2 SPST in series	3 x 2 SPST in series
Low current resistive load		RS type: 2 A@240 VAC/30 VDC RSL type: 0.5 A@50 VAC/30 VAC	RS type: 2 A@240 VAC/30 VDC RSL type: 0.5 A@50 VAC/30 VAC	RS type: 2 A@240 VAC/30 VDC RSL type: 0.5 A@50 VAC/30 VAC
Operating frequency	Amplifier dependent	10 Hz	10 Hz	10 Hz
Degree of protection	IP 67	IP 40	IP 40	IP 40
Protection Short-circuit (S) Reverse polarity (P) Transients (T)	SPT	PT	PT	PT
Housing material -Amplifier -Sensor Ø12+D11+D18 -Sensor	PC + ABS PC + Stainless steel	PC	PC	PC
Operating temperature	-20°C to +60°C	-20°C to +60°C	-20°C to +60°C	-20°C to +60°C
LED colour		Yellow	Yellow	Yellow
Approvals/Marks	CE - UL325 - UL508	CE - UL325 - UL508	CE - UL325 - UL508	CE - UL325 - UL508
Remarks	C = Pigtail connector version			
Optical angle (degrees)	±5			

Photoelectric sensors

Sensors for amplifiers

Types	MOF..	MOF.. ATEX	MNF..	MDF..
Connections	10 m cable	Terminals	Terminals	Terminals
				

Dimensions (mm)	Ø 10 x 42	Ø 10 x 42	Ø 20 x 80	Ø 13.5 x 55
-----------------	-----------	-----------	-----------	-------------

Through-beam emitter

Sensing distance (Sn)	20 m	20 m		
Max. ±2° optical angle	MOFT20 MOFT20-M12-2	MOFT20AX MOFT20-M12-2AX		
Sensing distance (Sn)	50 m			
Max. ±2° optical angle	MOFT50 MOFT50-M12-2			
Sensing distance (Sn)	20 m	20 m		
Max. ±5° optical angle	MOFT20-5 MOFT20-M12-5	MOFT20-5AX MOFT20-M12-5AX		
Sensing distance (Sn)	20 m	20 m	15 m	30 m
Max. ±8° optical angle	MOFT20-8 MOFT20-M12-8 MOFT20-M14-8	MOFT20-8AX MOFT20-M12-8AX MOFT20-M14-8AX	MNFT15	MDFT30



Through-beam receiver

Operating frequency	Amplifier dependent	Amplifier dependent	Amplifier dependent	Amplifier dependent
Sensing distance (Sn)	See emitter	See emitter	See emitter	See emitter
Max. ±2° optical angle	MOFR MOFR-M12-2	MOFRAX MOFR-M12-2AX		
Max. ±5° optical angle	MOFR-5 MOFR-M12-5	MOFR-5AX MOFR-M12-5AX		
Max. ±8° optical angle	MOFR-8 MOFR-M12-8 MOFR-M14-8	MOFR-8AX MOFR-M12-8AX MOFR-M14-8AX	MNFR15	MDFR30





General specifications

Rated operating voltage	Powered by Amplifier	Powered by Amplifier	Powered by Amplifier	Powered by Amplifier
Output	On Amplifier	On Amplifier	On Amplifier	On Amplifier
Operating frequency	See Amplifier type: S142.. - S143.. - PAM..	See Amplifier type: S142.. - S143.. - PAM..	See Amplifier type: S142.. - S143.. - PAM..	See Amplifier type: S142.. - S143.. - PAM..
Degree of protection	IP66 - IP67	IP66 - IP67	IP67	IP67
Protection Short-circuit (S)	SPT	SPT	SPT	SPT
Reverse polarity (P)				
Transients (T)				
Housing material sensor	Ø10: PC M14 + M14: PC + SS	Ø10: PC M14 + M14: PC + SS	PC M14 + M14: PC + SS	Acetal, glass reinforced
Operating temperature	-20°C to +60°C	-20°C to +60°C	-20°C to +60°C	-20°C to +60°C
LED colour	None	None	None	None
Approvals/Marks	CE	CE - ATEX	CE	CE



Photoelectric sensors

Types	Amplifiers for sensors		
Connections	1 1-pole plug	1 1-pole plug	1 1-pole plug
			
Dimensions (mm)	35 x 80 x 81.5	35 x 80 x 81.5	35 x 80 x 81.5
Description	Standard amplifier with Sensor diagnostics and adjustable sensing distance	As S142A but with adjustable time delay	As S142A but with Master / Slave function for high neighbour immunity
References amplifier			
1 x SPDT relay	S142ARNN924	S142BRNN924	
1 x NPN Output	S142ARNO24	S142BRNO24	
1 x NPN Alarm Output	S142ARNN115 S142ARNN230	S142BRNN115 S142BRNN230	
1 x SPDT relay	S142ARNT924	S142BRNT924	
1 x NPN Output or alarm	S142ARNT024		
1 x Emitter mute input	S142ARNT115 S142ARNT230	S142BRNT115 S142BRNT230	
1 x PNP Output	S142APPT924	S142BPPT924	
1 x PNP Alarm Output	S142APPT115	S142BPPT115	
1 x Emitter mute input	S142APPT230	S142BPPT230	
1 x SPDT relay			S142CRXA924
A - Auto distance adjustment			S142CRXA115 S142CRXA230
M - Manual distance adjustment			S142CRXM924 S142CRXM115 S142CRXM230
General specifications			
Rated operating voltage			
924	24 VAC/DC	24 VAC/DC	24 VAC/DC
115	115 VAC	115 VAC	115 VAC
230	230 VAC	230 VAC	230 VAC
Relay load current resistive load	10 A @ 250 VAC / 25 VDC SPD	10 A @ 250 VAC / 25 VDC SPD	10 A @ 250 VAC / 25 VDC SPD
Transistor Load current	100 mA 40 VDC	100 mA 40 VDC	
Operation frequency	20 Hz	20 Hz, no timer	15 Hz @ 2 systems 4 Hz @ 6 systems
Degree of protection	IP 20	IP 20	IP 20
Protection Short-circuit (S)			
Reverse polarity (P)	SPT	SPT	S
Transients (T)			
Housing material	Noryl SE1, Light grey	Noryl SE1, Light grey	Noryl SE1, Light grey
Operating temperature	-20°C to +50°C	-20°C to +50°C	-20°C to +50°C
Approvals/Marks	CE - UL - CSA	CE - UL - CSA	CE - UL - CSA

Photoelectric sensors



Types	S1430 UAP..	S1430 RAL..	S1430 ROS..	PAM...
Connections	11-pole plug	11-pole plug	11-pole plug	Terminals
				
Dimensions (mm)	35 x 80 x 81.5	35 x 80 x 81.5	35 x 80 x 81.5	2, 3, 4, 5, 6 DIN housing
Description	3 input 3 transistors outputs	3 input 3 transistors outputs	3 input 3 double relay outputs	2-4-6-8 or 10 channel modular system
References amplifier				
12-30 VAC/DC $\pm 15\%$	S1430UAP912			
15-30 VAC/DC $\pm 10\%$		S1430RAL915	S1430ROS915	
No. of channels				2 channels
- NPN output, NO				PAM02AN3ANO/NC
- PNP output, NO				PAM02AN3APO/PC
No. of channels				4 channels
- NPN output, NO				PAM04AN3ANO/NC
- PNP output, NO				PAM04AN3APO/PC
No. of channels				6 channels
- NPN output, NO				PAM06AN3ANO/NC
- PNP output, NO				PAM06AN3APO/PC
References extension modules				
No. of channels				2 channels
- NPN output, NO				PAM02CN3ANO
- NPN output, NC				PAM02CN3ANC
- PNP output, NO				PAM02CN3APO
- PNP output, NC				PAM02CN3APC
No. of channels				4 channels
- NPN output, NO				PAM04CN3ANO
- NPN output, NC				PAM04CN3ANC
- PNP output, NO				PAM04CN3APO
- PNP output, NC				PAM04CN3APC
General specifications				
Rated operating voltage	See Amplifier type	See Amplifier type	See Amplifier type	18 - 33 VDC
Output	3 x Transistor NPN/PNP/NO/NC	3 x SPST	3 x SPST	One output per channel
Load current resistive load	100 mA, 40 VDC, NPN	1.5 A @ 100 VAC / 30 VDC	1.5 A @ 100 VAC / 30 VDC	20 mA, 33 VDC, NPN / PNP 8 A @ 250VAC / 24 VDC SPDT resistive load
Operation frequency	16 Hz	12.5 Hz	12.5 Hz	30 Hz @ 6 channels
Degree of protection	IP 20	IP 20	IP 20	IP 20
Protection Short-circuit (S)				
Reverse polarity (P)	SPT	PT	PT	SPT
Transients (T)				
Housing material	Noryl SE1, Light grey	Noryl SE1, Light grey	Noryl SE1, Light grey	
Operating temperature	-20°C to +50°C	-20°C to +50°C	-20°C to +50°C	-20°C to +50°C
LED colour	Yellow + Green + Red	Yellow + Green + Red	Yellow + Green + Red	Yellow + Green + Red
Approvals/Marks	Multiplexed system	Multiplexed system	Multiplexed system	Multiplexed system, Test functions, bargraph, mute input etc.

Photoelectric sensors

Types	Wireless entrapment protection device for industrial doors ESPE		
Connections	Main controller	Subcontroller	PB11
			
Dimensions (mm)	35 x 35 x 125	26 x 242 x 45	Ø11 x 24.5
Description	The Carlo Gavazzi main controller can control up to 4 subcontrollers	This flexible Carlo Gavazzi subcontroller can handle 2 safety edges and 1 door-in-door limit switch	
References			
Main controller	WSM 2 B A 2 D24		
Subcontroller	WSS 2 B A 2 BAT		
Photoelectric sensor Emitter	PB 11 CNT 15 WE		
Photoelectric sensor Receiver	PB 11 CNT 15 WR		
General specifications			
Rated operating voltage	12 - 24 VAC/DC	1 - 4 Lithium 3.6 VDC size AA batteries	From sub controller
Supply current	< 50 mA		
Relay load current	1A / 30 VDC		
resistive load	0.5 A / 30 VAC		
Communication frequency	2.4 GHz Duplex	2.4 GHz Duplex	
Response time	120 mS	120 mS	
Number of channels	16	16	
Communication distance	10 m wireless	10 m wireless	
Sensing distance			15 m
Subcontroller up-time		10 - 80 sec	
Test input	On main module		
Degree of protection	IP 66	IP 66	IP 67
Protection Short-circuit (S)			
Reverse polarity (P)	PT	P	
Transients (T)			
Housing material	ABS, Light grey	PC, Light grey	PA6 Glass reinforced
Operating temperature	-25°C to +55°C	-25°C to +55°C	-25°C to +55°C
LED colour	Green, Yellow, Red	Yellow	-
Approvals/Marks	CE - UL - FCC	CE - UL - FCC	CE - UL

Photoelectric level sensors

Integrated amplifier

Types	VPO.E.	VP ATEX	VP E.M
Connections	2 m cable	2 m cable	2 m cable
			
Dimensions (mm)	3/8" x 74	3/8" x 74	3/8" x 74
Light type	Unmodulated	Unmodulated	Unmodulated
References optical level sensor			
Operating frequency	30 Hz	30 Hz	30 Hz
Sensing dist. (Sn), Hor.	± 5 mm, fixed	± 5 mm, fixed	± 5 mm, fixed
Sensing dist. (Sn), Ver.	± 2.5 mm, fixed	± 2.5 mm, fixed	± 2.5 mm, fixed
Housing material	Polysulphone	Polysulphone	Polysulphone
NPN NO	VPO2E		VPO2EM
NPN NC	VP01E		VP01EM
PNP NO	VPO2EP	VPO2EPAX	VPO2EPM
PNP NC	VP01EP	VP01EPAX	VP01EPM
Housing material	Polyamide 12	Polyamide 12	Polyamide 12
NPN NO	VP04E		VP04EM
NPN NC	VP03E		VP03EM
PNP NO	VP04EP	VP04EPAX	VP04EPM
PNP NC	VP03EP	VP03EPAX	VP03EPM
Housing material	Polysulphone		
SCR NO	VP02-110TB		
SCR NC	VP01-110TB		
SCR NO	VP02-230TB		
SCR NC	VP01-230TB		
DC-types			
Rated operating voltage	10 - 40 VDC	10 - 40 VDC	10 - 40 VDC
Voltage drop	≤ 1.0 VDC	≤ 1.0 VDC	≤ 1.0 VDC
Off-state current	≤ 12 mA	≤ 12 mA	≤ 12 mA
Load current	< 200 mA	< 200 mA	< 200 mA
AC-types (SCR)			
Rated operating voltage	110 or 230 VAC	110 or 230 VAC	110 or 230 VAC
Voltage drop	≤ 9 VAC	≤ 9 VAC	≤ 9 VAC
Off-state current	≤ 7 mA	≤ 7 mA	≤ 7 mA
Load current	< 10 - 100 mA	< 10 - 100 mA	< 10 - 100 mA
AC-types (SCR)			
Degree of protection	IP 67	IP 67	IP 67
Protection Short-circuit (S)			
Reverse polarity (P)	PT	PT	PT
Transients (T)			
Operating temperature	-20°C to +80°C	-20°C to +80°C	-20°C to +80°C
LED colour	Yellow	Yellow	Yellow
Pressure	10 bar @ +60°C	10 bar @ +60°C	10 bar @ +60°C
Approvals/Marks	CE - UL - CSA	CE - UL - CSA	CE - UL - CSA

Photoelectric level sensors

Integrated amplifier

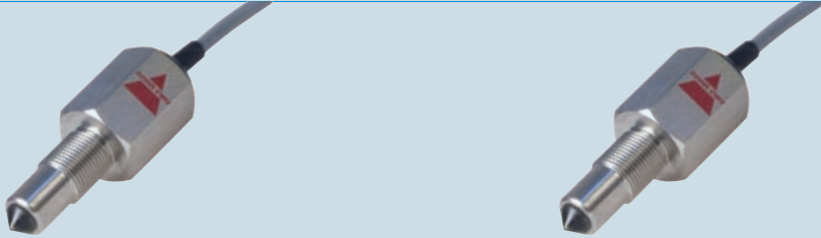
Types	VPA..../VPB....	VPA....-1/VPB....-1
Connections	2 m cable	M12 connector
		

Dimensions (mm)	3/8" x 70.5	3/8" x 90.5
Light type	Modulated	Modulated

References optical level sensor

Operating frequency	30 Hz	30 Hz
Sensing dist. (Sn), Hor.	± 5 mm, fixed	± 5 mm, fixed
Sensing dist. (Sn), Ver.	± 2.5 mm, fixed	± 2.5 mm, fixed
Housing material	Stainless steel/polysulphone	Stainless steel/polysulphone
NPN NO+NC	VPA1MNA	VPA1MNA-1
PNP NO+NC	VPA1MPA	VPA1MPA-1
Housing material	Stainless steel and glass	Stainless steel and glass
NPN NO+NC	VPA2MNA	VPA2MNA-1
PNP NO+NC	VPA2MPA	VPA2MPA-1
Housing material	Nickel-pl. brass/polysulphone	Nickel-pl. brass/polysulphone
NPN NO+NC	VPB1MNA	VPB1MNA-1
PNP NO+NC	VPB1MPA	VPB1MPA-1
Housing material	Nickel-plated brass and glass	Nickel-plated brass and glass
NPN NO+NC	VPB2MNA	VPB2MNA-1
PNP NO+NC	VPB2MPA	VPB2MPA-1

DC-types

Rated operational voltage	10 - 40 VDC	10 - 40 VDC
Voltage drop	≤ 2.5 VDC	≤ 2.5 VDC
Off-state current	≤ 7 mA	≤ 7 mA
Load current	< 200 mA	< 200 mA

General specifications

Degree of protection	IP 67	IP 67
Protection Short-circuit (S) Reverse polarity (P) Transients (T)	SPT	SPT
Operating temperature	-20°C to +80°C	-20°C to +80°C
LED colour	Yellow	No LED
Pressure	10 bar @ +60°C	10 bar @ +60°C
Approvals/Marks	CE - UL - CSA	CE - UL - CSA

Photoelectric sensors accessories

Reflectors, rectangular



Item Number	ER100	ER840	ER681	ER686
Dimensions (mm)	100 x 100 x 9.2	84.5 x 84.5 x 9	52 x 119 x 27	55.3 x 126 x 9
Mounting (screws not incl.)	2 x M3 screws	2 x M3.5 screws	4 x M4 screws	2 x M6 screws
Reduction factor	1.2	0.96	0.92	0.92

Reflectors, rectangular

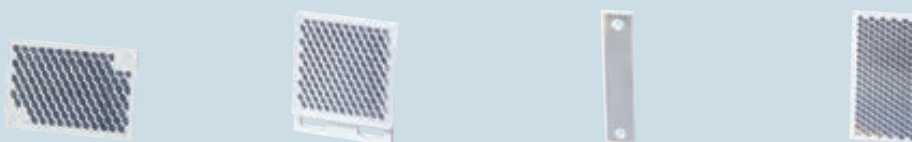

Item Number	ER4060	ER5060	ER42182	ER5080
Dimensions (mm)	60 x 41 x 8	55.5 x 61 x 8	186 x 46.5 x 8	80 x 54 x 8
Mounting (screws not incl.)	2 x M3.5 screws	2 x M4 screws	2 x M6 screws	Adhesive
Reduction factor	0.81	0.80	0.65	0.60

Reflectors, rectangular

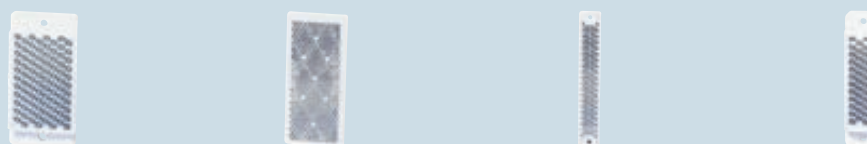

Item Number	ER483	ER8	ER665	ER530
Dimensions (mm)	32.5 x 65 x 8	82 x 37 x 5.5	18.5 x 120 x 65	19 x 72.5 x 8.4
Mounting (screws not incl.)	2 x M3.5 screws	Adhesive	2 x M4 screws	2 x M3.5 screws
Reduction factor	0.55	0.51	0.45	0.45

Reflectors, rectangular

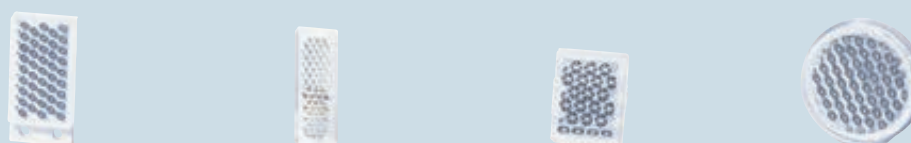

Item Number	ER390	ER1	ER640	ER692
Dimensions (mm)	23.5 x 47.5 x 8	51 x 17.5 x 5	13 x 17 x 5	Ø 35 x 5.5
Mounting (screws not incl.)	2 x M3.5 screws	Adhesive	Adhesive	Adhesive
Reduction factor	1.39	0.20	0.16	0.53

Reflectors, cylindrical

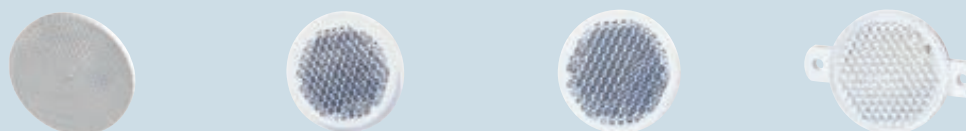

Item Number	ER4	ER460	ER420	ER423
Dimensions (mm)	Ø 84 x 7.4	Ø 46 x 6.5	Ø 42 x 6.3	Ø 41.5 x 6
Mounting (screws not incl.)	1 x M4 screw	Adhesive	Adhesive	2 x M3 screws
Reduction factor	1	0.55	0.54	0.54

Photoelectric sensors accessories

Reflectors, cylindrical

Micro cube reflectors for LD32

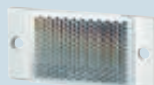
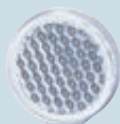

Item Number	ER689	EM 130-20	EM 120-20	EM 123-70
Dimensions (mm)	Ø 25 x 5.5	20 x 43	20 x 32	13.7 x 23
Mounting (screws not incl.)	Adhesive	2 x M3 screws	2 x M3.5 screws	2 x M2 screws
Reduction factor	0.39	1 (Micro Cube)	1 (Micro Cube)	1 (Micro Cube)

Reflectors, tape

Micro cube reflectors for LD32



Item Number	ERT25	EM 111-40	EM 121-41	EM 110-40
Dimensions (mm)	25 mm x 45.7 m	10.5 x 10.5	Ø20	Ø10
Mounting (screws not incl.)	Adhesive			
Reduction factor	0.23 (25 x 25 mm)	1 (Micro Cube)	1 (Micro Cube)	1 (Micro Cube)

Reflectors, tape

Accessories, photoelectric sensors



Item Number	ERT50	AMPF-MB1	AMPF-MB2	AMPF-MB3
Dimensions (mm)/Used for	50 mm x 45.7 m	MPFT15-4 & MPFR-4	MPFT15-4 & MPFR-4	MPFT15-4 & MPFR-4
Mounting (screws not incl.)	Adhesive			
Reduction factor/Description	0.34 (50 x 50 mm)	Plastic mounting bracket for wall mounting	Adaptor for fitting to an Ø18 mm rubber profile	Metal mounting bracket for harsh environment

Accessories, photoelectric sensors



Item Number	APA18-AK	APA18-RAR	610DC	APA3
Used for	M18 photoelectrics	M18 photoelectrics	S1430...	PA.. sensors
Description	Ø2, Ø4, and Ø8 mm aperture	90° mirror for angle detection	Plug conversion	Mounting bracket in anodized aluminium

Accessories, photoelectric sensors



Item Number	FPD..S.. / FPT..S..	FPD..S.. / FPT..S..	FGD..S.. / FGT..S..	MB-M01
Dimensions (mm)	1 mm fiber	0.25 to 1 mm fiber	1 mm fiber	
Used for	PD60CNX.. EF1810..	PD60CNX.. EF1810..	PD60CNV..	MOF.. sensors
Description	Plastic fibre optics. Separate fibre heads see datasheet	Plastic fibre optics. Various fibre heads see datasheet	Glass fibre optics. Various fibre heads see datasheet	Ball mounting bracket for flexible mounting

Photoelectric sensors accessories

Brackets

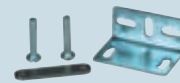

Item Number	APA-2	APB-1	MB02	APD32-MB3
Used for	PA.. sensors	PB	PM	PD32 - LD32
Description	Mounting bracket in steel, black	Mounting bracket in steel, black	Long mounting bracket for wall mounting in steel, chromated	Mounting bracket in steel, chromated

Brackets





Item Number	APD30 MB1	APD30 MB2	ACP50-1	MB18A
Used for	PD.. sensors	PD.. sensors	PC50.. sensors	M18 sensors
Description	Mounting bracket in steel, chromated	Mounting bracket in steel, chromated	Mounting bracket in steel, chromated	Mounting bracket in steel, chromated

Brackets



Item Number	APA18-MB1	APH18-MB1
Used for	PA18 sensors	PH18 sensors
Description	Mounting bracket in plast	Mounting bracket in plast

Motion sensors

	Standard range RAD series		Long range IRS series
Types	RAD 01	RAD 02	IRS 01
Connections	cable	cable	cable
			
Dimensions (mm)	118 x 80 x 53	118 x 80 x 53	137 x 188 x 91.5
Features	K-Band radar sensor compatible with all swinging and sliding automatic doors. 3-D adjustable position of the sensor offers precise orientation of the activation pattern. Microprocessor technology filters out possible weather condition interferences. IR remote controller can be added for easy adjustment.	K-Band radar sensor compatible with all swinging and sliding automatic doors. 3-D adjustable position of the sensor offers precise orientation of the activation pattern. Microprocessor technology filters out possible weather condition interferences. IR remote controller can be added for easy adjustment.	K-Band unidirectional long range motion sensor for trouble-free opening of all types of industrial automatic doors. To detect either people or vehicles, whether they are moving towards or away from the sensor. Microprocessor technology filters out possible weather condition interferences. IR remote controller can be added for easy adjustment.
Input specifications			
Detection Angle	V: 0 to 90° in 15° increments L: ±30° in 7.5° increments	V: 0 to 90° in 15° increments L: ±30° in 7.5° increments	V: ±45° in 15° increments L: ±45° in 15° increments
Detecting Area	mounting height 2.2 m Wide sensing field 4 m (W) x 2 m (D) Narrow sensing field 2 m (W) x 2.5 m (D)	mounting height 2.2 m 4 m (W) x 2 m (D) 2 m (W) x 2.5 m (D)	mounting height 2.5 m~7 m 2.5 m (W) x 8 m (D) 2.5 m (W) x 10 m (D)
Detection Mode	Bidirectional	Uni & Bidirectional	Uni & Bidirectional
Motion Detecting Speed	0.05~1 m/s	0.05~1 m/s	0.05~3.0 m/s along sensor axis
Adjustments			
Sensitivity	10 levels (1 to 10)	10 levels (1 to 10)	5 levels (1 to 5)
Hold Time	From 0.5 to 9 s in 10 steps	From 0.5 to 9 s in 10 steps	From 0.5 to 9 s in 10 steps
Immunity Detection	"Quasi-presence", normal, increased immunity	"Quasi-presence", normal, increased immunity	"Quasi-presence", normal, increased immunity, LTS
Direction Recognition	- Bidirectional detection	- Unidirectional approaching - Unidirectional departig - Uni & Bidirectional detection	- Unidirectional approaching - Unidirectional departig - Uni & Bidirectional detection
Operating Modes (or relays assignment)			- Differentiation between people and vehicles - People suppression - Vehicles suppression - People or vehicles with direction segregation
LTS			Lateral traffics suppression "toggle" type function
Output specifications			
Output Relay SPDT			
Max. contact voltage	24 VDC / 120 VAC	24 VDC / 120 VAC	24 VDC / 120 VAC
Max. contact current	1 A (resistive)	1 A (resistive)	1 A (resistive)
Max. switching power	30 W (DC) / 120 VA (AC)	30 W (DC) / 120 VA (AC)	30 W (DC) / 120 VA (AC)
Hold time	0.5~9 s (adjustable)	0.5~9 s (adjustable)	0.5~6 s (adjustable)
Electrical specifications			
Frequency emitted	24.125 GHz	24.125 GHz	24.125 GHz
Rated supply voltage	12~24 VAC ±10% 12~24 VDC +30% / -10%	12~24 VAC ±10% 12~24 VDC +30% / -10%	12~24 VAC ±10% 12~24 VDC +30% / -10%
Mains frequency	50 to 60 Hz	50 to 60 Hz	50 to 60 Hz
Power consumption	< 0.5 W	< 0.5 W	< 1.2 W
Approvals	CE - FCC - cURus	CE - FCC - cURus	CE - FCC - cURus
References			
Sensor	RAD 01	RAD 02	IRS 01
Remote controller	RAD 00 RC	RAD 00 RC	IRS 00 RC

Motion and presence sensors

Combined motion and presence detectors for pedestrian doors

Types	GUARDIAN 1	GUARDIAN 2
Connections	Terminal block	Terminal block
		
Dimensions (mm)	210 x 77 x 58	210 x 77 x 58
Technology	Digital video camera technology 640 x 480	Digital video camera technology 640 x 480
Door types	Streight sliding doors	Curved and Streight sliding doors

Features
The Guardian sensor is a unique motion and presence detector that provides maximum safety and protection in pedestrian sliding door installations. Equipped with the latest digital video camera technology, Guardian watches over the entrance and exit area safeguarding people within, while at the same time controlling the doors. Guardian is able to ignore cross traffic, and it has a brilliant capability of self-adjusting to changes in the environment and weather conditions

Input specifications

Mounting height	180 cm to 300 cm	180 cm to 300 cm
Motion zone sensing area	Hight 180 cm = 246 x 204 cm Hight 220 cm = 300 x 249 cm Hight 300 cm = 410 x 340 cm	Hight 180 cm = 246 x 204 cm Hight 220 cm = 300 x 249 cm Hight 300 cm = 410 x 340 cm
Presence zone sensing area	Hight 180 cm = 42 cm x door width Hight 220 cm = 51 cm x door width Hight 300 cm = 70 cm x door width	Hight 180 cm = 42 cm x door width Hight 220 cm = 51 cm x door width Hight 300 cm = 70 cm x door width
Maximum door radius vs. Mounting height		Hight 180 cm = Radius 130 cm Hight 220 cm = Radius 170 cm Hight 300 cm = Radius 200 cm
Sensitivity	Adjusting in 7 steps	Adjusting in 7 steps
Presence time	7 step rotary switch: (10, 30 sec.) 1min, 5 min (Not accordance to DIN18650)	7 step rotary switch: (10, 30 sec.) 1min, 5 min (Not accordance to DIN18650)
Ambient Light	10 lux - 50.000 lux	10 lux - 50.000 lux

Output specifications

Output function	Safety and Motion Zone: Relay - SPST Common relay data: 1A DC 30VDC 600.000 cycles @ 0.5A, 50 VAC/30 VDC	Safety and Motion Zone: Relay - SPST Common relay data: 1A DC 30VDC 600.000 cycles @ 0.5A, 50 VAC/30 VDC
-----------------	--	--

General specifications



Rated operating voltage	12 - 24 VAC	12 - 24 VAC
No load supply current	Max. 230 mA	Max. 230 mA
Test input. Active high	ON > 9 VAC/VDC OFF < 6 VAC/VDC	ON > 9 VAC/VDC OFF < 6 VAC/VDC
Test input. Active low	ON < 6 VAC/VDC OFF > 9 VAC/VDC	ON < 6 VAC/VDC OFF > 9 VAC/VDC
Type of ESPE	Type 2	Type 2
Environment protection	IP 64	IP 64
TÜV	In acc. with machinery directive 2006/42/EC, annex I DIN 18650-1 § 5.7.4, edition 2005 (prEN16005), EN13241-1, EN 12978	In acc. with machinery directive 2006/42/EC, annex I DIN 18650-1 § 5.7.4, edition 2005 (prEN16005), EN13241-1, EN 12978
UL-approved	cURus: UL325, CSA-C22.2 No. 247	cURus: UL325, CSA-C22.2 No. 247
Marking	CE	CE

References

Marking	GUARDIAN 1	GUARDIAN 2
---------	------------	------------

Sensors general accessories

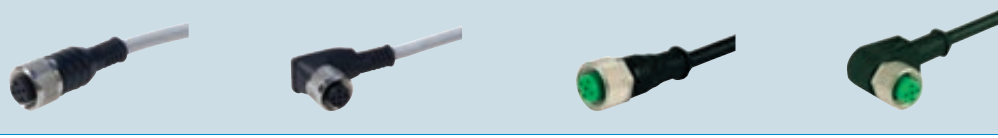
General Accessories, sensors

				
Dimensions (mm)	M8 connector	M8 connector	M8 connector	M8 connector
Used for	3-wire DC Sensors	3-wire DC Sensors	4-wire DC Sensors	4-wire DC Sensors
2 m cable	CONM53NF-S2	CONM53NF-A2	CONM54NF-S2	CONM54NF-A2
5 m cable	CONM53NF-S5	CONM53NF-A5	CONM54NF-S5	CONM54NF-A5
10 m cable			CONM54NF-S10	CONM54NF-A10
Description	High-end connector	High-end connector	High-end connector	High-end connector
				
Dimensions (mm)	M12 connector	M12 connector	M12 connector	M12 connector
Used for	2-, 3- or 4-wire DC	2-, 3- or 4-wire DC	2-, 3- or 4-wire DC	2-, 3- or 4-wire DC
2 m cable, 3-pin	CONG10-S2	CONG10-A2	CONM13NF-S2	CONM13NF-A2
5 m cable, 3-pin	CONG10-S5	CONG10-A5	CONM13NF-S5	CONM13NF-A5
10 m cable, 3-pin			CONM13NF-S10	CONM13NF-A10
2 m cable, 4-pin	CONG1A-S2	CONG1A-A2	CONM14NF-S2	CONM14NF-A2
5 m cable, 4-pin	CONG1A-S5	CONG1A-A5	CONM14NF-S5	CONM14NF-A5
10 m cable, 4-pin			CONM14NF-S10	CONM14NF-A10
2 m cable, 5-pin			CONM15NF-S2	CONM15NF-A2
5 m cable, 5-pin			CONM15NF-S10	CONM15NF-A5
10 m cable, 5-pin			-	CONM15NF-A10
Description	High-end connector	High-end connector	High-end connector	High-end connector
				
Dimensions (mm)	M12 connector	M12 connector	M8 connector	M8 connector
Used for	2-wire AC	2-wire AC	4-wire DC Sensors	4-wire DC Sensors
2 m cable, 3-pin	CONH6A-S2	CONH6A-A2		
5 m cable, 3-pin	CONH6A-S5	CONH6A-A5		
2 m cable			CONG5A-S2	CONG5A-A2
5 m cable			CONG5A-S5	CONG5A-A5
Description	High-end connector	High-end connector	Low-cost connector	Low-cost connector
				
Dimensions (mm)	-	65 x 27 x 130	M12 connector	M12 connector
Used for	Cylindrical 4 - 30 mm	Stand-alone sensors	2-, 3- or 4-wire DC	2-, 3- or 4-wire DC
Item number	AMB4-30	ST-03		
No cable 4-pin			CONM14NF-S	CONM14NF-A
Description	Universal sensor mounting bracket	Sensor tester for: NAMUR and 2-, 3- or 4-wire DC	Terminal connection	Terminal connection

Sensors general accessories

Brackets angled

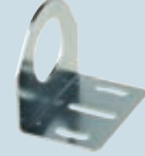



Steel, galvanized	AMB8-A	AMB12-A	AMB18-A	AMB30-A
Stainless steel AISI316L	-	AMB12-A316L	AMB18-A316L	-
Used for	M8 sensors	M12 sensors	M18 sensors	M30 sensors
Description	Mounting bracket	Mounting bracketd	Mounting bracket	Mounting bracket

Brackets straight



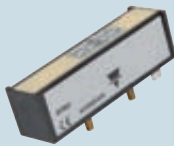

Steel, galvanized	AMB8-S	AMB12-S	AMB18-S	AMB30-S
Stainless steel AISI316L	-	AMB12-S316L	AMB18-S316L	-
Used for	M8 sensors	M12 sensors	M18 sensors	M30 sensors
Description	Mounting bracket	Mounting bracket	Mounting bracket	Mounting bracket

Proximity magnetic sensors, rectangular



	Rectangular		
Types	S series	SPB2 series	SPA1 series
			
Dimensions (mm)	11.5 x 79 x 21.2	25.5 x 85 x 24	16 x 90 x 20
Electrical specifications			
Max. switch. voltage contact	250 VAC [SA / SC 2, SB2 / -S5] 1500 VAC [SA / SC 8] 230 VAC [SS2, SBS2]	250 VAC	24 VDC [output 1 and 2]
Max. switch. current contact	1 A [SS2, SBS2] 3 A [SA2, SC2, SB2, SB2S5, SA8, SC8]	3 A	0.5 A [output 1] 4 A [output 2]
Max. switch. power contact	100 VA [SA / SC 2, SB2 / -S5] 120 VA [SA / SC 8] 60 VA [SS2, SBS2]	100 VA	5 VA [output 1] 100VA [output 2]
Power supply			24 VDC
General specifications			
Operating distance	5 - 32 mm	5 - 30 mm	12 mm
Output connection	PVC cable, 0.5 m (0.24 m Type S5)	Faston [SPB2] 2 m PVC Cable [SPB22MT]	PVC cable, 19 cm pig - Tail
Degree of protection	IP 67	IP 67 [SPB22MT] IP 65 [SPB2]	IP 67
Operating temperature	-25°C to +75°C	-25°C to +75°C	-25°C to +80°C
Housing material	Plastic	Plastic	ABS class V0
References			
Normally open	SA2 SA8		
Normally closed	SC2 SC8		
Change - Over	SS2		
Bistable	SB2 SB2S5	SPB2 SPB22MT	
Bistable CO	SBS2		
Normally closed, 2 outputs			SPA1S2 SPA1S3

Proximity magnetic sensors, rectangular

Rectangular





Types	M and MS series	MM series
		
Dimensions (mm)	8.3 x 37 x 16	6.1 x 23.5 x 14 [A6] 7 x 27 x 11 [A3, S1]
Electrical specifications		
Max. switch. voltage contact	100 VAC [MS1] 230 VAC [MSA1] 500 VAC [MA3, MC3]	100 VAC [S1, A6] 500 VAC [A3]
Max. switch. current contact	0.25 A [MS1] 0.5 A [MA3, MC3] 0.75 A [MSA1]	0.25 A [S1] 0.5 A [A3, A6]
Max. switch. power contact	5 VA [MS1] 10VA [MSA1, MA3, MC3]	5 VA [S1] 10 VA [A3, A6]
General specifications		
Operating distance	7 - 35 mm	10 - 40 mm
Output connection	PVC cable, 0.5 m (2 m, Type MSA1)	PVC cable [A3, S1] Twin lead cable [A6]
Degree of protection	IP 67	IP 67
Operating temperature	-25°C to +75°C	-25°C to +75°C
Housing material	Plastic	Plastic
References		
Normally open	MSA1 MA3	MMA3 MMA6
Normally closed	MC3	
Change - Over	MS1	MMS1

Proximity magnetic sensors, cylindrical

Cylindrical			
Types	FM... series	FMM... series	FMMP... series
			
Dimensions (mm)	Ø 9.3 [A3, C3, S1] M10 x 0.75 [A3S5, A6] M12 x 1 [C3S1, A9S1]	M8 x 1	Ø 6 x 25 [L25] Ø 6 x 33 [L33] Ø 6 x 38 [L38]
Electrical specifications			
Max. switch. voltage contact	100 VAC [S1, A6] 230 VAC [A9S1] 500 VAC [A3, C3, A3S5, C3S1]	100 VAC [A6, S1] 500 VAC [A3]	140 VAC
Max. switch. current contact	0.25 A [S1] 0.5 A [A3, C3, A6, A3S5, C3S1] 3 A [A9S1]	0.25 A [S1] 0.5 A [A3, A6]	1 A
Max. switch. power contact	5 VA [A3, C3, A3S5, C3S1] 60 VA [A9S1] 100 VA [S1, A6]	5 VA [S1] 10 VA [A3, A6]	10 VA
Max carry current			1.2 A
General specifications			
Operating distance	5 - 36 mm	8 - 27 mm	> 8 mm
Output connection	PVC cable 0.5 m for Ø 9.3 2 m for M10 and M12	PVC cable, 2 m	Twin lead cable, 0.5 m
Degree of protection	IP 67	IP 67	IP 67
Operating temperature	-25°C to +75°C	-25°C to +70°C	-20°C to +75°C
Housing material	Plastic [A3, C3, S1] Nickel plated brass [A6] Brass [A3S5, C3S1, A9S1]	Stainless steel [A3, S1] Nickel plated brass [A6]	Plastic
References			
Normally open	FMA3 FMA3S5 FMA6 FMA9S1	FMMA3 FMMA6	FMMPA7L25 FMMPA7L33 FMMPA7L38
Normally closed	FMC3 FMC3S1		
Change - Over	FMS1	FMMS1	

Proximity magnetic sensors, cylindrical

Cylindrical

Types	FMP... series	FS... series	FSLP... series	FSM... series
				
Dimensions (mm)	M12 x 1 x 100	Ø 13.5 [A2, A8, C2, C8, S2] M10 x 1.25 [A2S3, S2S1] M12 x 1 [A2S4, S2S4] M16 x 1.5 [B2]	Ø 16	M12 x 1 [A2, A7, S2] M16 x 1 [S2S2AT]

Electrical specifications

Max. switch. voltage contact	120 VAC / DC [C7] 175 VDC, 120 VAC [S1] 200 VDC, 140 VAC [A7] 230 VAC / DC [A9, C9, A9S1] 250 VAC / DC [B2]	230 VAC [S2, S2S1, S2S4] 250 VAC [A2, B2, C2, A2S3, A2S4] 1500 VAC [A8, C8]	100 VAC [A7] 250 VAC [B2]	24 VDC [A7] 230 VAC [S2, S2S2AT] 250 VAC [A2]
Max. switch. current contact	0.25 A [S1] 0.5 A [C7] 1 A [A7] 3 A [B2, A9, C9, A9S1]	1 A [S2, S2S4, S2S1] 3 A [A2, B2, C2, A8, C8, A2S3, A2S4]	0.4 A [A7] 3 A [B2]	0.5 A [S2S2AT] 1 A [S2] 3 A [A2] 50 mA [A7]
Max. switch. power contact	5 VA [S1] 10 VA [A7, C7] 60 VA [A9, C9, A9S1] 120 VA [B2]	60 VA [S2S1, S2S4, S2] 100 VA [A2, B2, C2, A2S3, A2S4] 120 VA [A8, C8]	10 VA [A7] 120 VA [B2]	30 VA [S2S2AT] 60 VA [S2] 100 VA [A2] (A7 negligible)

General specifications

Operating distance	7 - 26 mm	3 - 32 mm	18 - 25 mm (front); >10 - >15 mm (side)	2 - 19 mm
Output connection	PVC cable, 2 m	PVC cable, 2 m 0.5 m for Ø 13.5	PVC cable, 2 m	Silicone cable, 2 m [A7] Silicone cable, 0.5 m [S2S2AT] PVC cable, 2 m [A2, S2]
Degree of protection	IP 67	IP 67	IP 67	IP 67
Operating temperature	-25°C to +75°C	-25°C to +75°C	-30°C to +80°C	-25°C to +75°C [A2, A7, S2] -20°C to +150°C [S2S2AT]
Housing material	Plastic	Plastic [A2, A8, C2, C8, S2, B2] Brass [A2S3 / S4, S2S1 / S4]	Plastic	Brass [S2S2, S2S2AT] Nickel plated brass [A2, A7, S2]

References

Normally open	FMPA7 [black] FMPA9 [black] FMPA9S1 [black]	FSA2 FSA8 FSA2S32MT FSA2S42MT	FSLPA7	FSMA2 FSMA7
Normally closed	FMPC7 [red] FMPC9 [red]	FSC2 FSC8		
Change - Over	FMPS1 [blue]	FSS2 FSS2S12MT FSS2S42MT		FSMS2 FSMS2S2AT
Bistable	FMPB2 [grey]	FSB22MT	FSLPB2	

Proximity magnetic sensors, slot

Slot		
Types	ISY series	IM series
		

Dimensions (mm)	10 x 45 x 37	7 x 28 x 18.5
-----------------	--------------	---------------

Electrical specifications

Max. switch. voltage contact	100 VAC [S1] 500 VAC [C3]	100 VAC [S1] 500 VAC [C3]
Max. switch. current contact	0.25 A [S1] 0.5 A [C3]	0.25 A [S1] 0.5 A [C3]
Max. switch. power contact	5 VA [S1] 10 VA [C3]	5 VA [S1] 10 VA [C3]

General specifications

Output connection	PVC cable, 0.5 m	PVC cable, 0.5 m
Degree of protection	IP 67	IP 67
Operating temperature	-25°C to +75°C	-25°C to +75°C
Housing materials	Plastic	Plastic

References

Normally closed	ISYC3	IMC3
Change - Over	ISYS1	IMS1



Types

Shapes	Magnetic units CL series		
	Rectangular	Trapezoidal	Cylindrical
			



General specifications

Minimum separation:	Dimensions (mm)	References		Dimensions (mm)	References	
10	25 x 14 x 8	CL1				
20	44.5 x 12 x 9	CL2				
30	59 x 18 x 9	CL3				
50	76 x 25 x 18	CL4				
Not mandatory			Dimensions (mm)	References	Dimensions (mm)	References
			90 x 31 x 22.5	CL90	Ø 9.3 x 32	CL10
					Ø 13.5 x 65	CL11
					Ø 18 x 6	CL18
					Ø 23 x 9	CL23
					Ø 31 x 10	CL31
					Ø 20 x 10	CL20S1
					Ø 22.1 x 11.3	CL20S3

Level magnetic sensors













Cylindrical			
Types	ILM series	ILMM series	ILMP series
			
Float Diameter (mm)	Ø 53	Ø 28	Ø 25
Output functions			
	Normally open, Normally closed [2, 8] Change-over [S2]	Normally open and normally closed [5, 590, 5ATS1] Normally open [5S1] Normally closed [5S2, 5S2AT]	Normally open, normally closed
Electrical specifications			
Max. switch. voltage contact	230 VAC [S2] - 250 VAC [2] 1500 VAC [8]	240 VAC, 220 VDC	240 VAC, 200 VDC
Max. switch. current contact	1 A [S2] 3 A [2, 8]	0.5 A	0.5 A
Max. switch. power contact	60 VA [S2] - 100 VA [2] 120 VA [8]	50 VA	50 VA
General specifications			
Output connection	Silicone cable, 0.5 m	XLPE cable, 0.3 m 1,1 m [ATS1]	PVC cable, 0.3 m
Min. liquid specific gravity	0.75 kg / dm ³	0.75 kg / dm ³	
Max. pressure	20 kg / cm ²	10 kg / cm ²	2 kg / cm ²
Degree of protection	IP 67	IP 67	IP 67
Operating temperature	-25 to +120 °C [2, 8, S2]	-10 to +120°C [5, 590] -10 to +200°C [5ATS1, 5S2AT] -20 to +120°C [5S1, 5S2]	-20°C to +80°C
Housing materials	AISI 316 Stainless steel	AISI 304 stainless steel [5, 590 5ATS1] AISI316 stainless steel [5S2AT, 5S1, 5S2]	Plastic
References			
Normally open / Normally closed	ILM2 ILM8	ILMM5 ILMM590 ILMM5ATS1	ILMP5 ILMP5P
Change - Over	ILMS2		
Normally closed		ILMM5S2AT ILMM5S2	
Normally open		ILMM5S1	

Level magnetic sensors

				Cylindrical		
Types	ILMPU - ILU - ILMU series		ILSP series	FLM series - Flux Sensors		
						
Float Diameter (mm)	Ø 17.5 [ILMPU] Ø 31 [ILMU] Ø 45 [ILU]		Ø 44	Ø 20		
Electrical specifications						
Max. switch. voltage contact	240 VAC, 200 VDC [ILMPU5, ILMU5] 250 VAC [ILU2] 1000 VAC [ILU8]		230 VAC [S2] 250 VAC [2] 1500 VAC [8]	100 VAC		
Max. switch. current contact	0.5 A [ILMP, ILM] 1 A [ILUS2] 3 A [ILU2, ILU8]		1 A [S2] 3 A [2, 8]	0.4 A		
Max. switch. power contact	50 VA [ILMP, ILM] 60 VA [ILUS2] 100 VA [ILU2] 120 VA [ILU8]		60 VA [S2] 100 VA [2] 120 VA [8]	10 VA		
General specifications						
Output connection	XLPE cable, 0.3 m [ILMPU5] PVC cable, 0.3 m [ILMU5] Silicone cable, 0.5 m [ILU2, ILU8, ILUS2]		Silicone cable, 0.5 m	HT105 PVC cable ended with 6.35 mm female faston		
Operating distance D_{on}					+5 mm	
Release distance D_{off}					$D_{on} - 2$ mm	
Min. liquid specific gravity	0.70 kg / dm ³ [ILMPU, ILMU] 0.75 kg / dm ³ [ILU]		0.75 kg / dm ³			
Max. pressure	2 kg / cm ² [ILMPU, ILMU] 100 kg / cm ² [ILU]		0.6 kg / cm ²			
Degree of protection	IP 68		IP 67		IP 67	
Operating temperature	-20 to +80°C [ILMPU, ILMU] -25 to +100°C [ILU]		-25 to +100 °C		-30 to +105°C	
Housing materials	Non toxic polypropylene or plastic		Plastic		Stainless steel	
References						
Normally open / Normally closed	ILMPU5 ILMU5		ILSP2 ILSP8			
Normally open	ILU2 ILU8		FLMA1S1			
Change - Over	ILUS2		ILSPS2			

Intrinsic safety

Explosion proof sensors

Types	Cylindrical series FSQ	Rectangular series MQ	Level series ILM
			
Exter. Dimensions (mm) Float Dimensions (mm)	Ø16 x 110	37 x 16 x 8.3	Spherical Ø 53 [S], Cylindrical Ø 45x55 [C]
Category	2G, 2D	2G, 2D [MQx1EX] 1G, 1D [MQAOEX]	2G, 2D [ILMx2] 1G, 1D [ILMx0]
EX Identification	 II2GExmbIICT5Gb  II2DExmbIICT100°CDbIP67	 II2GExmbIICT5Gb [MQx1EX]  II2DExmbIICT100°CDbIP67 [MQx1EX]  II1GExialICT6Ga [MQAOEX]  II1DExialICT100°CDalIP67 [MQAOEX]	 II2GExmbIICT5Gb [ILMx2]  II2DExmbIICT100°CDbIP67 [ILMx2]  II1GExialICT6Ga [ILMx0]  II1DExialICT100°CDalIP67 [ILMx0]

General specifications

Max. switch. voltage contact	250 VAC	230 VAC/DC [MQA1EX, MQC1EX] 30 VAC/DC [MQAOEX] 150 VAC/DC [MQS1EX]	250 VAC/DC [ILMA2] 230 VAC/DC [ILMS2] 30 VAC/DC [ILMx0]
Max. switch. current contact	3A	0.25 to 0.75 A [MQx1EX] 120 mA [MQAOEX]	3 A [ILMA2]; 1A [ILMS2] 120 mA [ILMx0]
Max. switch. power contact	100 VA	5 to 10 VA [MQx1EX] - [MQAOEX]	100 VA [ILMA2] 60 VA [ILMS2]
Operating distance	8 - 30 mm	10 - 35 mm	-
Degree of protection	IP67	IP67	IP67
Temperature Class	T5	T5 [MQx1EX] T6 [MQAOEX]	T5 [ILMx2] T6 [ILMx0]
Body material	Stainless steel AISI 303	Self-exting. PP + 30% glass fiber	Stainless steel AISI 316
Approvals / mark	CE - TÜV Sud	CE - TÜV Sud	CE - TÜV Sud

References

Normally open	FSQA2B01SLEX FSQA2HFEX	MQA1EX MQAOEX	ILMA2SSLEX ILMA2CSLEX ILMAOSSLEX ILMAOCSLEX
Normally closed		MQC1EX	
Change - Over		MQS1EX	ILMS2SEX ILMS2CEX ILMSOSEX ILMSOCEX

Safety magnetic sensors

Safety magnetic sensors

Types

SMS...



Electrical specifications

Max. switch. voltage	100 VAC
Max. switch. power	5 VA
Max. switch. current	0.25 A

General specifications

External dimensions (mm)	88 x 25 x 13; M18x1 SMSA2; M30x1.5 SMSA3P
Suitable magnetic unit	CLS; CLSA2 (SMSA2P); CLSA2M (SMSA2M); CLSA3 (SMSA3P)
Output connection	Cable (PVC, AWG 22 to 26, L=2 m.); pig tail with M12 connector, L=0.3 m
Degree of protection	IP 67
Operating temperature	-25°C to +70°C
Housing material	Plastic; PBT + 30 % glass (SMSA2P and SMSA3P); Stainless Steel (SMSA2M)
Approvals / Marks	CE - (UL version is available for some items with different codification)

References

	Housing type / Material	Safety Aux. Outputs	Aux. Outputs	REFERENCES
	Rectangular / Plastic	1NO		SMS10
	Rectangular / Plastic	1NO	1NC	SMS10NC
0.3 m cable with M12 conn.	Rectangular / Plastic	1NO	1NC	SMS10NCCM1
	Rectangular / Plastic	1NO+1NC		SMS01
	Rectangular / Plastic	1NO+1NC		SMS02
LED on NC contact	Rectangular / Plastic	1NO+1NC		SMS02LD
Resistor on NO contact	Rectangular / Plastic	1NO+1NC		SMS02S1
	Rectangular / Plastic	2NO		SMS03
0.3 m cable with M12 conn.	Rectangular / Plastic	2NO		SMS03+CM1A4/03MT
	Rectangular / Plastic	2NO	1NC	SMS03NC
0.3 m cable with M12 conn.	Rectangular / Plastic	2NO	1NC	SMS03NCS1
	Cylindrical / Plastic	1NO+1NC		SMSA2P02
LED on NC contact	Cylindrical / Plastic	1NO+1NC		SMSA2P02LD
	Cylindrical / Plastic	2NO		SMSA2P03
	Cylindrical / Plastic	1NO		SMSA2P10
	Cylindrical / Plastic	2NO		SMSA2P30
	Cylindrical / Plastic	1NO+1NC		SMSA3P02
	Cylindrical / Plastic	2NO		SMSA3P03
	Cylindrical / Plastic	2NO		SMSA3P30
	Cylindrical / Stainless steel	1NO+1NC		SMSA2M02
	Cylindrical / Stainless steel	1NO		SMSA2M10

Types

CLS...



General specifications

Degree of protection	IP 67
Operating temperature	-25°C to +70°C
Housing material	Plastic; Stainless Steel (CLSA2M)
Approvals / Marks	CE - (UL version is available for some items with different codification)

References

	External dimensions (mm)	Shape	REFERENCES
	88 x 25 x 13	Rectangular	CLS
	Ø25.1 x 9.3	Cylindrical	CLSA2; CLSA2M
	Ø30 x 16	Cylindrical	CLSA3

Safety light curtains

Safety light curtains, safety category 2
hand resolution

Safety light curtains, safety category 2
presence resolution

Types

SC2...

SC2...



General specifications

Power supply	24 VDC \pm 20%	24 VDC \pm 20%
OSSD outputs	2 PNP	2 PNP
Output connections	M12 4-pole connector for TX M12 5-pole connector for RXM12 4-pole connector for TX M12 5-pole connector for RX	M12 4-pole connector for TX M12 5-pole connector for RXM12 4-pole connector for TX M12 5-pole connector for RX
Safety category	Type 2	Type 2
Auxiliary functions	Reset / Test ; Automatic Restart	Reset / Test ; Automatic Restart
Housing material	Painted aluminium (yellow RAL 1003)	Painted aluminium (yellow RAL 1003)
Ambient light rejection	IEC 61496-2	IEC 61496-2
Degree of protection	IP 65 (EN 60529)	IP 65 (EN 60529)
Operating temperature	0°C to +55°C	0°C to +55°C
Approvals/Marks	CE - TÜV - cULus listed	CE - TÜV - cULus listed

References

Resolution	Range	Protected height (mm)	No. of beams	Response time (ms)	REFERENCES	Protected height (mm)	No. of beams	Response time (ms)	REFERENCES
Hand 30 mm	0.2-19 m	150	8	8	SC2AR30150D19				
		300	16	9	SC2AR30300D19				
		450	24	11	SC2AR30450D19				
		600	32	12	SC2AR30600D19				
		750	40	14	SC2AR30750D19				
		900	48	15	SC2AR30900D19				
		1050	56	17	SC2AR301050D19				
		1200	64	18	SC2AR301200D19				
		1350	72	20	SC2AR301350D19				
Presence 90 mm	0.2-19 m	1500	80	21	SC2AR301500D19	300	5	9	SC2AR90300D19
						450	7	10	SC2AR90450D19
						600	9	11	SC2AR90600D19
						750	11	12	SC2AR90750D19
						900	13	13	SC2AR90900D19
						1050	15	14	SC2AR901050D19
						1200	17	15	SC2AR901200D19
						1350	19	16	SC2AR901350D19
						1500	21	17	SC2AR901500D19

Safety light curtains

	Safety light curtains, safety category 4 finger resolution	Safety light curtains, safety category 4 hand resolution
Types	SC4...	SC4...
		

General specifications



Power supply	24 VDC ±20%	24 VDC ±20%
OSSD outputs	2 PNP	2 PNP
Output connections	M12 4-pole connector for TX M12 8-pole connector for RX M12 4-pole connector for TX M12 8-pole connector for RX	M12 4-pole connector for TX M12 8-pole connector for RX M12 4-pole connector for TX M12 8-pole connector for RX
Safety category	Type 4	Type 4
Auxiliary functions	Reset / Test ; Selectable Manual/Auto. Restart ; Selectable EDM	Reset / Test ; Selectable Manual/Auto. Restart ; Selectable EDM
Housing material	Painted aluminium (yellow RAL 1003)	Painted aluminium (yellow RAL 1003)
Ambient light rejection	IEC 61496-2	IEC 61496-2
Degree of protection	IP 65 (EN 60529)	IP 65 (EN 60529)
Operating temperature	0°C to +55°C	0°C to +55°C
Approvals/Marks	CE - TÜV - cULus listed	CE - TÜV - cULus listed

References

Resolution	Range	Protected height (mm)	No. of beams	Response time (ms)	REFERENCES	Protected height (mm)	No. of beams	Response time (ms)	REFERENCES
Finger 14 mm	0.2 - 6 m	150	16	11	SC4ED14150D6				
		300	32	15	SC4ED14300D6				
		450	48	18	SC4ED14450D6				
		600	64	22	SC4ED14600D6				
		750	80	25	SC4ED14750D6				
		900	96	29	SC4ED14900D6				
		1050	112	33	SC4ED141050D6				
		1200	128	36	SC4ED141200D6				
Hand 30 mm	0.2 - 19 m					150	8	9	SC4ED30150D19
						300	16	11	SC4ED30300D19
						450	24	13	SC4ED30450D19
						600	32	14	SC4ED30600D19
						750	40	16	SC4ED30750D19
						900	48	18	SC4ED30900D19
						1050	56	19	SC4ED301050D19
						1200	64	21	SC4ED301200D19
						1350	72	23	SC4ED301350D19
						1500	80	25	SC4ED301500D19
				1650	88	26	SC4ED301650D19		



Environmental sensors

Environmental sensors - CGES series



Types	CGESHTD - CGESHTPD	CGESHTW - CGESHTPW	CGESAIRVEL
			
Dimensions (mm)	80 x 80 x 37.2 (probe 200 mm)	85 x 100 x 26	80 x 80 x 37.2 (cable length 1 m)
Function	Humidity and Temperature	Humidity and Temperature	Air Velocity measurement
Mounting	Duct mounting	Wall mounting	Duct mounting
Input specifications			
Relative humidity Working range Accuracy @ 20°C	10 to 95% ±3% RH	0 to 95% ±2% (40 to 60%RH) ±3% (10 to 90%RH)	
Temperature Sensor Accuracy @ 20°C	Pt1000 DIN A ±0.3°C	Pt1000 DIN A / Pt100 DIN A Vout: ±0.25°C / Aout: ±0.4°C	
Air Velocity Working range			0 to 10 m/s (0 to 2000 ft/min) 0 to 15 m/s (0 to 3000 ft/min) 0 to 20 m/s (0 to 4000 ft/min) ±0.2 m/s +3% of m.v.
Accuracy @ 20°C			
Electrical specifications			
Output	0-10 V or 4-20 mA (2 wires)	0-10 V or 4-20 mA (2 wires)	0-10 V or 4-20 mA
Supply Voltage	24 VAC ±20% / 15-35 VDC	24 VAC ±20% / 15-35 VDC	24 VAC/DC ±20%
Consumption DC supply AC supply	typical 8 mA typical 20 mAeff	typical 4 mA typical 15 mAeff	max. 150 mA max. 90 mA
General specifications			
Cable gland	M16 x 1.5 cable Ø4.5 - 10 mm		M16 x 1.5 cable Ø4.5 - 10 mm
Electrical connections	Screw terminals max. 1.5 mm ² (AWG 16)	Screw terminals max. 1.5 mm ² (AWG 16)	Screw terminals max. 1.5 mm ² (AWG 16)
Working temperature range	-5°C to 50°C	-5°C to 55°C	-10°C to 50°C
Storage temperature range	-25°C to 60°C	-25°C to 60°C	-30°C to 60°C
Degree of protection	IP 65; Nema 4	IP 20	IP 65; Nema 4
Conformity	EN 61000-6-1, EN 61000-6-3, EN 61326-1+A1+A2	EN 50081-1 FCC Part15 ClassB EN 50082-1 ICES-003 ClassB	EN 50081-1, EN 50082-1, EN 50082-2
Approvals/Marks	CE - RoHS	CE - RoHS	CE - RoHS
References			
For ordering key details, please refer to www.productselection.net			

Environmental sensors

Environmental sensors - CGES series

Types	CGESCO2VA - CGESCO2TVA - CGESCO2THVA	CGESCO2D
		
Dimensions (mm)	85 x 100 x 26	80 x 80 x 37.2 (probe 200 mm)
Function	CO ₂ , Relative Humidity and Temperature	CO ₂
Mounting	Wall mounting	Duct mounting
Input specifications		
Relative humidity Working range Accuracy @ 20°C	10 to 90% ±3% (30 to 70% RH) ±5% (10 to 90% RH)	
Temperature Sensor Accuracy @ 20°C	Pt1000 DIN A Vout: ±0.3°C / Aout: ±0.7°C	
CO ₂ Working range Accuracy @ 20°C 2000 ppm 5000 ppm	0 to 2000 ppm / 0 to 5000 ppm < ± 50 ppm +2% of m.v. < ± 50 ppm +3% of m.v.	0 to 2000 ppm / 0 to 5000 ppm < ± 50 ppm +2% of m.v. < ± 50 ppm +3% of m.v.
Electrical specifications		
Output	0-10 V or 4-20 mA or switching	0-10 V or 4-20 mA or switching
Supply Voltage	24 VAC ±20% / 15-35 VDC	24 VAC ±20% / 15-35 VDC
Consumption DC supply AC supply	<3 W <3 W	<3 W <3 W
General specifications		
Cable gland		M16 x 1.5 cable Ø4.5 - 10 mm
Electrical connections	Screw terminals max. 1.5 mm ² (AWG 16)	Screw terminals max. 1.5 mm ² (AWG 16)
Working temperature range	-5°C to 55°C	-5°C to 55°C
Storage temperature range	-20°C to 60°C	-20°C to 60°C
Degree of protection	IP 20	IP 65; Nema 4
Conformity	EN 61000-6-3, EN61326-1+A1+A2:05.2002 EN 61000-6-1	EN 61000-6-3 ÖVE EN61326-1+A1+A2:05.2002 EN 61000-6-1, FCC Part 15 ICES-003 ClassB
Approvals/Marks	CE - RoHS	CE - RoHS
References		
For ordering key details, please refer to www.productselection.net		

Environmental sensors

	Wind vane	Cup anemometer
Types	DWS-D-D...	DWS-V-D...
Connections	2 m cable	2 m cable
		
Dimensions (mm)	207 x 174	183 x 145
Use	Wind direction	Wind speed
References wind vane		
Wind indication	0° and 90° intervals DWS-D-DAC13	
Wind indication	±7° and left/right DWS-D-DDC13	
References cup anemometer		
Operating temperature		-20°C to 60°C
Heating		Yes DWS-V-DAC13
Operating temperature		0°C to 60°C
Heating		No DWS-V-DBC05
General specifications		
Rated operating voltage	12 - 24 VDC	12 - 24 VDC
Voltage drop	Typ. 4.9 VDC	Typ. 4.9 VDC
Degree of protection	IP 54	IP 54
Output frequency		10 Hz pr. m/s
Housing material	Body: Black PVC Rotor: Stainless steel	Body: Black PVC Rotor: Stainless steel
Approvals/Marks	CE	CE

Environmental sensors

	Solar irradiance sensor		Pyranometer
Types	PVS-1V	PVS-1A	PVS-2A
Connections			

Dimensions (mm)	57 x 48 x 15 (not including clamp)	62 x 48 x 15 (not including clamp)	162 x 215 x 40
Description	Solar irradiance sensor based on photovoltaic technology built with a solid aluminium case and anti-UV encapsulating resin	Solar irradiance sensor based on photovoltaic technology built with a solid aluminium case and anti-UV encapsulating resin	Global solar radiation sensor based on a thermopile transducer compliant with WMO (World Meteorological Organization) standards for environmental monitoring, provided with worldwide valid calibration certificate

Environmental specification

Operating temperature	-10°C to 80°C	-10°C to 80°C	-40°C to 80°C
Degree of protection	IP67	IP67	IP67

General specification

Technology	Crystalline calibrated cell	Crystalline calibrated cell	2nd Class Thermopile Pyranometer according to ISO9060
Output	80 mV @ 1000 W/m ² STC	4-20 mA	4-20 mA
Calibration	According to IEC 60904-2 and 60904-4 (calibration certificate as option)	According to IEC 60904-2 and 60904-4 (calibration certificate as option)	According to ISO9847 (calibration certificate included)
Solar irradiance range	0-1250 W/m ² 20-1250 W/m ²	0-1250 W/m ² 20-1250W/m ²	0-2000 W/m ² 20-2000 W/m ²
Connector	3 PIN Phoenix M8 IP67 connector (male and female included)	3 PIN Phoenix M8 IP67 connector (male and female included)	7 pin IP68 connector (male, female and 10 meters cable included)
Housing material	Aluminium	Aluminium	Aluminium
Power Supply	Self-powered	Powered by VMU-P module through the 4-20 mA current loop	10-28 VDC, power consumption < 0.1W
Approvals/Marks	CE	CE	CE

References

For ordering key details, please refer to www.productselection.net

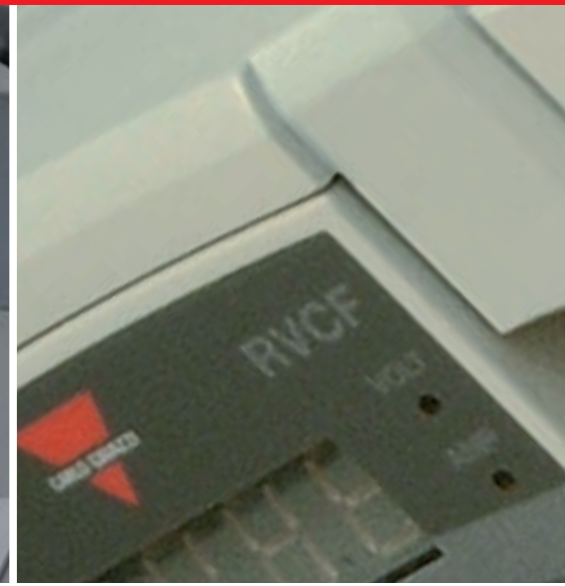



Switch



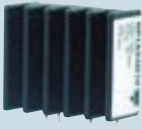

Solid state relays	102
Solid state relays accessories	132
Soft starters	137
Motor protection relays	141
Variable speed drives	143
Limit switches	147
Electromechanical relays	156
Sockets and modules	159

Solid state relays PCB type, 1-phase

	AC zero switching			DC switching
Types	RP1A - RP1B 3/5/5.5 A (AC)	RP..10A 10 A (AC)	RAP 3/5 A (AC)	RP1D 1 A, 4 A, 8 A (DC)
PCB mounting SSRs, AC and DC operating. Rated isolation voltage ≥ 4000 Vrms				
Dimensions H xWx D (mm)	25.4 x 43 x 10.5	37 x 43 x 22	25.4 x 43 x 10.5	25.4 x 43 x 10.5
Features	Standard AC switching SSR	With integral heatsink	LED indication High blocking voltage	DC switching SSR
Input specifications				
Control input range	3-32 VDC [RP1A23..] 3-32 VDC [RP1A40..] 4-32 VDC [RP1A48..] 1.5-32 VAC [RP1A23A6]	3-32 VDC [RP1A23..] 4-32 VDC [RP1A40..] 4-32 VDC [RP1A48..]	3.5-40 VDC [RAP40..] 4.5-40 VDC [RAP48..]	4.5 - 32 VDC
Max. input current	10 mA	10 mA	12 mA	15 mA
Output specifications				
Rated operational current				DC1: 1/4/8 ADC
AC 51 @ Ta=25°C	3 A [RP1...3] 5 A [RP1...5] 5.5 A [RP1...6]	10 A	3 A [RAP...A3] 5 A [RAP...A5]	
AC 53a @ Ta=25°C	2 A [RP1...3] 3 A [RP1...5] 5 A [RP1...6]	7 A	2.5 A [RAP...A3] 3 A [RAP...A5]	
Min. operational current	20 mA	10 mA	20 mA	1 mADC
Non rep. surge current (t=20 ms)	65 Ap [RP1...3] 80 Ap [RP1...5] 250 Ap [RP1...6]	250 Ap	60 Ap [RAP...A3] 90 Ap [RAP...A5]	
Off-state leakage current	≤ 1 mA	≤ 3 mA	≤ 1 mA	0.01 mADC
I ² t for fusing (t=10 ms)	20 A ² s [RP1...3] 50 A ² s [RP1...5] 340 A ² s [RP1...6]	340 A ² s	18 A ² s [RAP...A3] 40 A ² s [RAP...A5]	
Critical dV/dt off-state	250 V/ μ s [RP1...3] 500 V/ μ s [RP1...5] 500 V/ μ s [RP1...6]	1000 V/ μ s	100 V/ μ s	
General specifications				
Operational voltage range	12-265 Vrms [RP1A23..] 20-440 Vrms [RP1A40..] 20-530 Vrms [RP1A48..]	12-265 Vrms [RP1A23..] 20-440 Vrms [RP1A40..] 20-530 Vrms [RP1A48..]	10-440 Vrms [RAP40..] 20-530 Vrms [RAP48..]	1- 60 VDC [RP1D060...] 1 - 350 VDC [RP1D350...]
Blocking voltage	650 Vp [RP1A23..] 850 Vp [RP1A40..] 1000 Vp [RP1A48..]	650 Vp [RP1A23..] 850 Vp [RP1A40..] 1000 Vp [RP1A48..]	1000 Vp [RAP40..] 1200 Vp [RAP48..]	
Power factor	0.5	0.5	0.2	0.5
Operating temperature	-20°C to +70°C	-30°C to +80°C	-20°C to +70°C	-20°C to +80°C
Terminals	4 pins x \varnothing 0.1 mm	4 pins x \varnothing 0.1 mm	4 pins x \varnothing 0.1 mm	4 pins x \varnothing 0.1 mm
Approvals/Marks	CE - UR - cUR - VDE	CE - UR - cUR	CE - UR - CSA - VDE	CE - UR - cUR
References				
	3 A	10 A	3 A	1 A
	RP1A23D3	RP1A23D10	RAP40A3	RP1D350D1
	RP1A40D3	RP1A40D10	RAP48A3	
	RP1A48D3	RP1A48D10		4 A
	5 A		5 A	RP1D060D4
	RP1A23D5		RAP40A5	
	RP1A40D5		RAP48A5	
	RP1A48D5			8 A
	5.5 A			RP1D060D8
	RP1A23D6			
	RP1A23A6			
	RP1A40D6			
	RP1A48D6			

* Other options available on request: Instant-on switching (RP1B..), see Accessories for DIN-rail adaptor.

Solid state relays, 1-phase



Types	RGS1A..KKE	RGS1A..KGE	RGS1A..MKE
Single phase, chassis mounting with LED for control status indication, IP20 protection, 45-65 Hz operating frequency, > 4000 VACrms isolation voltage, 100 kArms short circuit current rating, certified motor ratings			
Dimensions (mm)	90 x 17.8 x 50.6	90 x 17.8 x 50.6	90 x 17.8 x 63.6
Features	17.8 mm wide solid state relay with integrated varistor on output, AC or DC control range, screw terminals with captivated clamp for power and control connections, E-type layout	17.8 mm wide solid state relay with integrated varistor on output, AC or DC control range, box clamp for power connections (up to 25 mm ² /AWG3), screw for control connections, E-type layout	17.8 mm wide solid state relay with integrated varistor on output, AC or DC control range, screw terminals with captivated clamp for power connections and pluggable spring for control, E-type layout
Input specifications			
Control input range	3-32 VDC [RG.23D..] / 4-32 VDC [RG.60D..] 20-275 VAC, 24-190 VDC [RG..A.]	4-32 VDC [RG..D..] 20-275 VAC, 24-190 VDC [RG..A..]	3-32 VDC [RG..23D..] / 4-32 VDC [RG..60D..] 20-275 VAC, 24-190 VDC [RG..A..]
Max. input current	11 mADC [RG..D..] 30 mAAC [RG..A.]	11 mADC [RG..D..] 30 mAAC [RG..A..]	11 mADC [RG..D..] 30 mAAC [RG..A..]
Output specifications			
Rated operational current AC-51 @ Ta=40°C	25 AAC [RG..25] / 50 AAC [RG..50/51] 75 AAC [RG..75] / 90 AAC [RG..90/91/92]	50 AAC [RG..50] 90 AAC [RG..92]	25 AAC [RG..25] / 50 AAC [RG..50] 90 AAC [RG..90/92]
AC-53a @ Ta=40°C	5 AAC [RG..25] / 10 AAC [RG..50/51] 14.8 AAC [RG..75] / 18 AAC [RG..90/91/92]	10 AAC [RG..50] 18 AAC [RG..92]	5 AAC [RG..25] / 10 AAC [RG..50] 18 AAC [RG..90/92]
Min. operational current	150 mAAC [RG..25] / 250 mAAC [RG..50/51] 400 mAAC [RG..75] / 500 mAAC [RG..90/91/92]	250 mAAC [RG..50] 500 mAAC [RG..92]	150 mAAC [RG..25] / 250 mAAC [RG..50] 500 mAAC [RG..90/92]
Non rep. surge current (t=10 ms)	325 Ap [RG..25] / 600 Ap [RG..50/51] 800 Ap [RG..75] / 1150 Ap [RG..90/91] 1900 Ap [RGS..92]	600 Ap [RG..50] 1900 Ap [RG..92]	325 Ap [RG..25] / 600 Ap [RG..50] 1150 Ap [RG..90] / 1900 Ap [RG..92]
Max. Off-state leak current	3 mAAC	3 mAAC	3 mAAC
I ² t for fusing (t=10 ms)	525 A ² s [RG..25] / 1800 A ² s [RG..50/51] 3200 A ² s [RG..75] / 6600 A ² s [RG..90/91] 18000 A ² s [RGS..92]	1800 A ² s [RG..50] 18000 A ² s [RG..92]	525 A ² s [RG..25] / 1800 A ² s [RG..50] 6600 A ² s [RG..90] / 18000 A ² s [RG..92]
Critical dV/dt (@ Tj init = 40°C)	1000 V/μs	1000 V/μs	1000 V/μs
General specifications			
Operational voltage range	24-240 VAC +10% [RG.23..] 42-600 VAC +10% [RG.60...]	42-600 VAC +10%	24-240 VAC +10% [RG..23..] 42-600 VAC +10% [RG..60..]
Blocking voltage	800 Vp [RG..23..] 1200 Vp [RG..60..] 1600 Vp [RG..60..51/91]	1200 Vp	800 Vp [RG..23..] 1200 Vp [RG..60..]
Power factor	≥ 0.5 at rated voltage	≥ 0.5 at rated voltage	≥ 0.5 at rated voltage
Operating temperature	-40°C to 80°C	-40°C to +80°C	-40°C to +80°C
Approvals/Marks	CE - cURus - CSA - VDE	CE - cURus - CSA - VDE	CE - cURus - CSA - VDE
References			
230 VAC, 800 Vp	25 AAC: RGS1A23X25KKE		25 AAC: RGS1A23X25MKE
	50 AAC: RGS1A23X50KKE		50 AAC: RGS1A23X50MKE
	75 AAC: RGS1A23X75KKE		
600 VAC, 1200 Vp	25 AAC: RGS1A60X25KKE		25 AAC: RGS1A60X25MKE
	50 AAC: RGS1A60X50KKE	50 AAC: RGS1A60X50KGE	50 AAC: RGS1A60X50MKE
	75 AAC: RGS1A60X75KKE		
	90 AAC: RGS1A60X90KKE		90 AAC: RGS1A60X90MKE
	90 AAC: RGS1A60X92KKE	90 AAC: RGS1A60X92KGE	90 AAC: RGS1A60X92MKE
600 VAC, 1600 Vp	50 AAC: RGS1A60X51KKE		
	90 AAC: RGS1A60X91KKE		

X must be replaced with D for DC control 3-32 VDC, 4-32 VDC (for 600 VAC versions)

X must be replaced with A for AC control 20-275 VAC, 24-190 VDC

RGS1B.. models for Instant On (Random) switching are available on request

Solid state relays, 1-phase

Types	RGS1A..MGE	RGS1A..KGU	RGS1A..DIN
Single phase, chassis mounting with LED for control status indication, IP20 protection, 45-65 Hz operating frequency, ≥ 4000 VACrms isolation voltage, 100 kArms short circuit current rating, certified motor ratings			
Dimensions (mm)	90 x 17.8 x 63.6	90 x 17.8 x 50.6	106 x 17.8 x 65
Features	17.8 mm wide solid state relay with integrated varistor on output, AC or DC control range, box clamps for power connections (25mm ² /AWG3) and pluggable spring for control, E-type layout	17.8 mm wide solid state relay with integrated varistor on output, AC or DC control range, box clamps for power and control connections, U-type layout	17.8 mm wide solid state relay mounted on DIN mountable module

Input specifications

Control input range	4-32 VDC [RG..D..] 20-275 VAC, 24-190 VDC [RG..A..]	3-32 VDC [RG..23D..] 4-32 VDC [RG..60D..] 20-275 VAC, 24-190 VDC [RG..A..]	3-32 VDC [RG..23D..] 4-32 VDC [RG..60D..] 20-275 VAC, 24-190 VDC [RG..A..]
Max. input current	11 mA DC [RG..D..] 30 mA AC [RG..A..]	11 mA DC [RG..D..] 30 mA AC [RG..A..]	11 mA DC [RG..D..] 30 mA AC [RG..A..]

Output specifications

Rated operational current AC-51 @ Ta=40°C	50 AAC [RG..50] 90 AAC [RG..92]	20 AAC [RG..20] 30 AAC [RG..30]	10 AAC [RG..20/25..DIN] 12 AAC [RG..50/90..DIN]
AC-53a @ Ta=40°C	10 AAC [RG..50] 18 AAC [RG..92]	5 AAC [RG..20] 8 AAC [RG..30]	5 AAC [RG..20/25..DIN] 5 AAC [RG..50/90..DIN]
Min. operational current	250 mA AC [RG..50] 500 mA AC [RG..92]	150 mA AC [RG..20] 250 mA AC [RG..30]	150 mA AC [RG..20/25..DIN] 250 mA AC [RG..50..DIN] 400 mA AC [RG..90..DIN]
Non rep. surge current (t=10 ms)	600 Ap [RG..50] 1900 Ap [RG..92]	325 Ap [RG..20] 600 Ap [RG..30]	325 Ap [RG..20/25..DIN] 600 Ap [RG..50..DIN] 1150 Ap [RG..90..DIN]
Max. Off-state leak current	3 mA AC	3 mA AC	3 mA AC
I ² t for fusing (t=10 ms)	1800 A ² s [RG..50] 18000 A ² s [RG..92]	525 A ² s [RG..20] 1800 A ² s [RG..30]	525 A ² s [RG..20/25..DIN] 1800 A ² s [RG..50..DIN] 6600 A ² s [RG..90..DIN]
Critical dV/dt (@ Tj init=40°C)	1000 V/μs	1000 V/μs	1000 V/μs

General specifications



Operational voltage range	42-600 VAC +10%	24-240 VAC +10% [RG..23..] 42-600 VAC +10% [RG..60...]	24-240 VAC +10% [RG..23..] 42-600 VAC +10% [RG..60...]
Blocking voltage	1200 Vp	800 Vp [RGS..23..] 1200 Vp [RGS..60..]	800 Vp [RG..23..] 1200 Vp [RG..60..]
Power factor	≥ 0.5 at rated voltage	≥ 0.5 at rated voltage	≥ 0.5 at rated voltage
Operating temperature	-40°C to +80°C	-40°C to +80°C	-40°C to +80°C
Approvals/Marks	CE - cURus - CSA - VDE	CE - cURus - CSA - VDE	CE - cURus - CSA - VDE

References

230 VAC, 800 Vp, E-type			10 AAC: RGS1A23X25KKEDIN 12 AAC: RGS1A23X50KKEDIN
600 VAC, 1200 Vp, E-type	50 AAC: RGS1A60X50MGE 90 AAC: RGS1A60X92MGE		10 AAC: RGS1A60X25KKEDIN 12 AAC: RGS1A60X50KKEDIN 12 AAC: RGS1A60D90KKEDIN
230 VAC, 800 Vp, U-type		20 AAC: RGS1A23X20KGU 30 AAC: RGS1A23X30KGU	10 AAC: RGS1A23D20KGUDIN
600 VAC, 1200 Vp, U-type		20 AAC: RGS1A60X20KGU 30 AAC: RGS1A60X30KGU	

X must be replaced with D for DC control 3-32 VDC, 4-32 VDC (for 600 VAC versions)
X must be replaced with A for AC control 20-275 VAC, 24-190 VDC
RGS1B.. models for Instant On (Random) switching are available on request





Solid state relays, 1-phase

	Industrial Housing DC Output Switching	Industrial Housing - AC Output Switching Integrated Current Measurement	
Types	RGS1D...KKE	RGS1S..EP	RGS1S..UP
Single phase, chassis mounting industrial relays with LED for control status indication and IP20 protection, Rated isolation voltage ≥ 4000 Vrms, 100 kArms Short Circuit Current Rating for AC switching versions			
Dimensions HxWxD (mm)	90 x 17.8 x 50.6	90 x 22.5 x 78	90 x 35.6 x 78
Features	17.8 mm wide solid state relay with IGBT output, integrated free wheeling diode, DC control voltage, screw terminals with captivated clamp, E-type layout	22.5 mm wide solid-state relay with thyristor output, integrated varistor, DC control, local or remote TEACH, detection of partial load failure (1/6), SSR and load malfunction, SSR overheat protection.	35 mm wide solid-state relay with thyristor output, integrated varistor, DC control, local or remote TEACH, detection of partial load failure (1/6), SSR and load malfunction, SSR overheat protection.
Input specifications			
Control input range	4.5-32 VDC	4-32 VDC	4-32 VDC
Max. input current	13.7 mADC	10 mADC at 24 VDC	10 mADC at 24 VDC
Supply voltage		24 VDC -15%, +20%	24 VDC -15%, +20%
Max. supply current		50 mADC	50 mADC
Alarm specifications			
Output type		NC PNP open collector max. 35 VDC / 50 mA	NC PNP open collector max. 35 VDC / 50 mA
Alarm Indication		Red LED (flash rate)	Red LED (flash rate)
Output specifications			
Rated operational current AC-51 @ Ta=40°C		20 AAC [RGS1S..20] 30 AAC [RGS1S..30 / 31] 90 AAC [RGS1S..92]	65 AAC
DC Rated operational current	15 ADC [RGS1D..15.] 25 ADC [RGS1D..25.]		
Minimum TEACH / operational current	20 mA	1.2 AAC [RGS1S..20/30/31] 5 AAC [RGS1S..92]	5 AAC
Minimum partial load current		0.2 AAC [RGS1S..20/30/31] 0.83 AAC [RGS1S..92]	0.83 AAC
Detectable partial load failure		>16.67% from current setpoint	>16.67% from current setpoint
Non rep. surge current (I _{sm}) (t=10 ms)	200 ADC [10µs]	325 Ap [RGS1S..20] - 600 Ap [RGS1S..30] 1150 Ap [RGS1S..31] - 1900 Ap [RGS1S..92]	1900 Ap
Max. Off-state leak current	1.5 mADC	3 mAAC	3 mAAC
I ² t for fusing (t=10 ms)		525 A ² s [RGS1S..20] - 1800 A ² s [RGS1S..30] 6600 A ² s [RGS1S..31] - 18000 A ² s [RGS1S..92]	18000 A ² s
Critical dV/dt (@ T _j init = 40°C)		1000 V/µs	1000 V/µs
General specifications			
Operational voltage range	24-1000 VDC [CE] 24-600 VDC [UL508]	42-600 VAC +10%	42-600 VAC +10%
Blocking voltage	1200 VDC	1200 Vp	1200 Vp
Power factor		≥ 0.9 at rated voltage	≥ 0.9 at rated voltage
Operating temperature	-40°C to +80°C	-25°C to +70°C	-25°C to +70°C
Approvals/Marks	CE - cURus - CSA	CE - cURus - CSA	CE - cURus - CSA
References			
1000 VDC	15 ADC: RGS1D1000D15KKE 25 ADC: RGS1D1000D25KKE		
600 VAC, 525 A ² s, E-type		20 AAC: RGS1S60D20GKEP	
600 VAC, 1800 A ² s, E-type		30 AAC: RGS1S60D30GKEP	
600 VAC, 6600 A ² s, E-type		30 AAC: RGS1S60D31GKEP	
600 VAC, 18000 A ² s, E-type		90 AAC: RGS1S60D92GGEP	
600 VAC, 18000 A ² s, U-type			65 AAC: RGS1S60D61GGUP



KK = screws for control terminals, screws for power terminals
 GG = box clamps for control terminals, screws for power terminals
 GG = box clamps for control terminals, box clamps for power terminals

CARLO GAVAZZI Automation Components. Specifications are subject to change without notice. Illustrations are for example only.

Solid state relays, 1-phase

Types	Industrial Housing Zero switching		Industrial Housing Zero / Instant-on switching	
	RS1A 10/25/40 A	RS1A..A 25/40 A	RAM1A 25/50/75/100/125 A	RM1A 25/50/75/100 A
Single phase, chassis mounting, industrial relays with LED status indication and IP 20 protection. AC operating frequency range 45-65 Hz. Rated isolation voltage ≥ 4000 Vrms				
Dimensions HxWxD (mm)	58.2 x 44.8 x 28.8	58.2 x 44.8 x 28.8	58.2 x 44.8 x 28.8	58.2 x 44.8 x 28.8
Features	Ideal for Ohmic loads	AC control Ohmic loads	Built-in snubber, VDE	Built-in Varistor
Input specifications				
Control input range	3-32 VDC [RS1A23D...] 4-32 VDC [RS.....D] 18-36 VAC/DC [RS...LA]	80-130 VAC [RS1A..A1] 200-260 VAC [RS1A..A2] 360-400 VAC [RS1A..A4]	3-32 VDC [RAM1A23D..] 4-32 VDC [RAM1A60D..] 20-280 VAC / 22-48 VDC [RAM..A.]	3-32 VDC [RAM1A23D..] 4-32 VDC [RM1A..D.] 20-280 VAC / 22-48 VDC [RM..A.]
Max. input current	12 mA [RS..D.] 15 mA [RS..LA.]	13 mA	12 mA [RAM1A..D.] 20 mA [RAM1A..A.]	12 mA [RM1A..D.] 20 mA [RM1A..A.]
Output specifications				
Rated operational current				
AC 51 @ $T_a=25^\circ\text{C}$	10/25/40 A	25/40 A	25/50/75/100/125 A	25/50/75/100 A
AC 53a @ $T_a=25^\circ\text{C}$			5/15/17/20/30 A	5/15/20/30 A
Min. operational current	150 mA	150 mA	150 mA	150 mA
Non rep. surge current (t=10 ms)	100 Ap [RS1A...10] 325 Ap [RS1A...23] 600 Ap [RS1A...40]	325 Ap [RS1A...25] 600 Ap [RS1A...40]	325 Ap [RAM1A..25] 600 Ap [RAM1A..50] 800 Ap [RAM1A..75] 1150 Ap [RAM1A..100] 1900 Ap [RAM1A..125]	325 Ap [RM1A..25] 600 Ap [RM1A..50] 1150 Ap [RM1A..75] 1900 Ap [RM1A..100]
Off-state leakage current	< 3 mA	< 3 mA	< 3 mA	< 3 mA
I ^t for fusing (t=10 ms)	≤ 50 A ² s [RS1A..10] ≤ 525 A ² s [RS1A..25] ≤ 1800 A ² s [RS1A..40]	≤ 525 A ² s [RS1A..25] ≤ 1800 A ² s [RS1A..40]	< 525 A ² s [RAM1A..25] < 1800 A ² s [RAM1A..50] < 3200 A ² s [RAM1A..75] < 6600 A ² s [RAM1A..100] < 18000 A ² s [RAM1A..125]	< 525 A ² s [RM1A..25] < 1800 A ² s [RM1A..50] < 6600 A ² s [RM1A..75] < 18000 A ² s [RM1A..100]
Critical dV/dt	500 V/ μs	500 V/ μs	1000 V/ μs	1000 V/ μs
General specifications				
Operational voltage range	42-265 Vrms [RS1A23..] 42-440 Vrms [RS1A40..] 42-530 Vrms [RS1A48..]	42-265 Vrms [RS1A23..] 42-440 Vrms [RS1A40..]	24-265 Vrms [RAM1A23..] 42-660 Vrms [RAM1A60..]	24-265 Vrms [RM1A23..] 42-440 Vrms [RM1A40..] 42-530 Vrms [RM1A48..] 42-660 Vrms [RM1A60..]
Blocking voltage	≥ 650 Vp [RS1A23..] ≥ 850 Vp [RS1A40..] ≥ 1200 Vp [RS1A48..]	≥ 650 Vp [RS1A23..] ≥ 850 Vp [RS1A40..]	< 650 Vp [RAM1A23..] < 1200 Vp [RAM1A60..]	< 650 Vp [RM1A23..] < 850 Vp [RM1A40..] < 1200 Vp [RM1A48..] < 1400 Vp [RM1A60..]
Power factor	≥ 0.95	≥ 0.95	≥ 0.5	≥ 0.5
Operating temperature	-20°C to +70°C	-30°C to +70°C	-40°C to +80°C	-20°C to +70°C
Terminals	Screw type with clamp	Screw type with clamp	Screw type with clamp	Screw type with clamp
Approvals/Marks	CE - UR - CSA	CE - UR - CSA	CE - UR - CSA - VDE	CE - UR - CSA
References				
	10 / 25 / 40 A	25 / 40 A	25 / 50 / 75 / 100 / 125 A	25 / 50 / 75 / 100 A
230 Vrms	RS1A23D.. RS1A23LA..	RS1A23A1.. RS1A23A2.. RS1A23A4..	RAM1A23D.. RAM1A23A..	RM1A23D.. RM1A23A..
400 Vrms	RS1A40D.. RS1A40LA..	RS1A40A2.. RS1A40A4..		RM1A40D.. RM1A40A..
480 Vrms	RS1A48D.. RS1A48LA..			RM1A48D.. RM1A48A..
600 Vrms			RAM1A60D.. RAM1A60A..	RM1A60D.. RM1A60A..

Solid state relays, 1-phase





	Industrial Housing Zero switching	Industrial Housing Peak switching	Industrial Housing Phase angle
Types	RM1A..M 25/50/75/100 A	RM1C 25/50/75/100 A	RM1E 25/50/100 A
Single phase, chassis mounting, industrial relays with LED status indication and IP20 protection AC operating frequency range 45-65 Hz. Rated isolation voltage ≥ 4000 Vrms			
Dimensions HxWxD (mm)	58.2 x 44.8 x 28.8	58.2 x 44.8 x 28.8	58.2 x 44.8 x 28.8
Features	Low voltage AC/DC control	Ideal for transformers	Analog Phase-angle control
Input specifications			
Control input range	4.25-36 VDC / 4.25-27 VAC	4.25-32 VDC	4-20 mA [RM1E..AA.] 0-10 VDC [RM1E..V.]
Max. input current	18 mA @ 24 VAC/DC	18 mA	0.15 mA [RM1E..V.]
Supply voltage range			24 VDC [RM1E..V.]
Max. supply input current			20 mA [RM1E..V.]
Output specifications			
Rated operational current			
AC 51 @ Ta=25°C	25 / 50 / 75 / 100 A	25 / 50 / 100 A	25 / 50 / 100 A
AC 53a @ Ta=25°C	5 / 15 / 20 / 30 A		5 / 15 / 20 A
AC 56a @ Ta=25°C		10/20/30 A	
Min. operational current	150 mA	150 mA	150 mA
Non rep. surge current (t=10 ms)	325 Ap [RM1A..M25] 600 Ap [RM1A..M50] 1150 Ap [RM1A..M75] 1900 Ap [RM1A..M100]	325 Ap [RM1C..25] 600 Ap [RM1C..50] 1150 Ap [RM1C..75] 1900 Ap [RM1C..100]	325 Ap [RM1E..25] 600 Ap [RM1E..50] 1150 Ap [RM1E..100]
Off-state leakage current	< 3 mA	< 3 mA	< 3 mA
I ² t for fusing (t=10 ms)	≤525 A ² s [RM1A..M25] ≤1800 A ² s [RM1A..M50] ≤6600 A ² s [RM1A..M75] ≤18000 A ² s [RM1A..M100]	≤525 A ² s [RM1C..25] ≤1800 A ² s [RM1C..50] ≤6600 A ² s [RM1C..75] ≤18000 A ² s [RM1C..100]	≤525 A ² s [RM1E..25] ≤1800 A ² s [RM1E..50] ≤6600 A ² s [RM1E..100]
General specifications			
Operational voltage range	24-265 Vrms [RM1A23M.] 42-440 Vrms [RM1A40M.] 42-530 Vrms [RM1A48M.] 42-660 Vrms [RM1A60M.]	100-440 Vrms [RM1C40D.] 340-660 Vrms [RM1C60D.]	90-280/ 90-265 Vrms [RM1E23AA/V..] 340-460 Vrms [RM1E40AA..] 90-550/ 200-550 Vrms [RM1E48AA/V..] 410-660 Vrms [RM1E60AA/V..]
Blocking voltage	≥650 Vp [RM1A23M.] ≥850 Vp [RM1A40M.] ≥1200 Vp [RM1A48M.] ≥1400 Vp [RM1A60M.]	850 Vp [RM1C40D..] 1400 Vp [RM1C60D..]	<650 Vp [RM1E23..] <850 Vp [RM1E40..] <1200 Vp [RM1E48..] <1400 Vp [RM1E60..]
Power factor	≥ 0.5	≥ 0.95	≥ 0.75
Operating temperature	-20°C to +70°C	-30°C to +80°C	-20°C to +70°C
Terminals	Screw type with clamp	Screw type with clamp	Screw type with clamp
Approvals/Marks	CE - UR - CSA	CE - UR - CSA	CE - UR - CSA
References 1-phase:			
	25 / 50 / 75 / 100 A	25 / 50 / 75 / 100 A	25 / 50 / 100 A
230 Vrms	RM1A23M..		RM1E23AA25** RM1E23AA50** RM1E23AA100**
400 Vrms	RM1A40M..	RM1C40D25 RM1C40D50 RM1C40D75	RM1E40AA25 RM1E40AA50 RM1E40AA100
480 Vrms	RM1A48M..		RM1E48AA25** RM1E48AA50** RM1E48AA100**
600 Vrms	RM1A60M..	RM1C60D25 RM1C60D50 RM1C60D100	RM1E60AA25** RM1E60AA50** RM1E60AA100**

** Replace "AA" by "V" for voltage controlled versions

CARLO GAVAZZI Automation Components. Specifications are subject to change without notice. Illustrations are for example only.

Solid state relays, 1 / 2-phase

Industrial Housing - AC Output Switching

Types	RA Sense 25/50/90/110 A	RA Low Noise 10/25 A	RA2A* 25/40 A	RA2A..C 25/40 A
Single Phase relays with special functions. 2 Phase industrial relays				
Dimensions HxWxD (mm)	58.2 x 44.8 x 28.8	58.2 x 44.8 x 28.8	57.8 x 44.5 x 31.7	57.8 x 44.5 x 34.8
Features	Detects supply and load failure	Complies with EN55022	Two independent poles	Two independent poles, faston terminals for power, pin connectors for control

Input Specifications

Control input range	7-32 VDC	3-32 VDC	4.5-32 VDC	4.5-32 VDC
Max. input current	4 mA	32 mA	2 x 10 mA	2x 10 mA
Control supply	20-32 VDC (40 mA)			
Alarm output	PNP NPN	VCC - 2 VDC (100 mA) 2 VDC (100 mA)		

Output Specifications

Rated operational current AC 51 @ Ta=40°C	25 A / 50 A / 90 A / 110 A	10 A / 25 A	25 A / 40 A per pole	25 A / 40 A per pole
AC 53a @ Ta=40°C			5 A / 15 A per pole	
Min. operational current	200 mArms	2 Arms	150 mArms [RA2A...25] 250 mArms [RA2A...40]	150 mArms [RA2A...25C] 250 mArms [RA2A...40C]
Non rep. surge current (t=10 ms)	325 Ap [RA..25..S] 600 Ap [RA..50..S] 1150 Ap [RA..90..S] 1900 Ap [RA..110..S]	90 Ap, t=20 ms [RA..10..L] 200 Ap, t=20 ms [RA..25..L]	325 Ap [RA2A..25] 600 Ap [RA2A..40] 325 Ap [RA2A..25M] 600 Ap [RA2A..40M]	325 Ap [RA2A...25C] 600 Ap [RA2A...40C]
Off-state leakage current	< 6 mArms	< 1 mArms	< 3 mArms	< 3 mArms
I ² t for fusing (t=10 ms)	525 A ² s [RA..25..S] 1800A ² s [RA..50..S] 6600 A ² s [RA..90..S] 18000 A ² s [RA..110..S]	120 A ² s [RA..10..L] 200A ² s [RA..25..L]	525 A ² s [RA2A..25] 1800 A ² s [RA2A..40] 525 A ² s [RA2A..25M] 1800A ² s [RA2A..40M]	525 A ² s [RA2A..25C] 1800 A ² s [RA2A..40C]



General specifications

Operational voltage range	60-140 Vrms [RA12..S] 170-250 Vrms [RA23..S] 150-440 Vrms [RA40..S] 180-530 Vrms [RA48..S]	180-265 Vrms [RA24..L] 340-530 Vrms [RA40..L]	24-265 Vrms [RA2A23..] 42-440 Vrms [RA2A40..] 42-530 Vrms [RA2A48..] 42-660 Vrms [RA2A60..]	24-265 Vrms [RA2A23..] 42-660 Vrms [RA2A60..]
Blocking voltage	650 Vp [RA12..S] 650 Vp [RA23..S] 1000 Vp [RA40..S] 1200 Vp [RA48..S]	650 Vp [RA24..L] 850 Vp [RA40..L]	650 Vp [RA2A23..] 850 Vp [RA2A40..] 1200 Vp [RA2A48..] 1200 Vp [RA2A60..]	650 Vp [RA2A23..] 1200 Vp [RA2A60..]
Power factor	≥ 0.5	1	≥ 0.95 [RA2A...] ≥ 0.50 [RA2A...M]	≥ 0.95 at rated voltage
Operating temperature	-20°C to +70°C	-20°C to +70°C	-20°C to +70°C	-20°C to +70°C
Terminals	Screw / 5 way plug	Screw type with clamp	FASTONS 6.35 mm	FASTONS 6.35mm / 4 way plug
Approvals/Marks	CE - UR - CSA	CE - UR - CSA - VDE	CE - UR - CSA	CE - cURus

References

	25 / 50 / 90 / 110 A	10 / 25 A	25 / 40 A per pole	25 / 40 A per pole
120 Vrms	RA12..06..S			
230 Vrms	RA23..06..S	RA2410-D06L	RA2A23..	RA2A23D..C
400 Vrms	RA40..10..S	RA2425-D06L	RA2A23..M	
480 Vrms	RA48..12..S	RA4010-D08L	RA2A40..	
		RA4025-D08L	RA2A40..M	
			RA2A48..	
			RA2A48..M	
			RA2A60..	RA2A60D..C
			RA2A60..M	



Solid state relays, 1 / 3-phase

	Industrial Housing Zero switching	Industrial Housing DC switching	Industrial Housing 3-phase switching
Types	RA 25/50/90/110 A	RD 1/5 A DC	RZ3A 25/55/75 A
Single phase and 3 phase industrial relays			
Dimensions HxWxD (mm)	58.2 x 44.8 x 28.8	58.2 x 44.8 x 28.8	74 x 103 x 41
Features	General purpose	Ideal for DC valve coils	3-phase switching
Input specifications			
Control input range	3-32 VDC [RA..D..] 10-90 VAC / DC [RA..LA..] 90-280 VAC / DC [RA..HA..]	3-32 VDC	4-32 VDC [RZ3A..D..] 24-275 Vrms [RZ3A..A.]
Max. input current	22 mA [RA..D..] 17 mA [RA..LA..] 6.5 mA [RA..HA..]	32 mA	23 / 15 mA
Output specifications			
Rated operational current			
AC 51 @ Ta=25°C	25 A, 50 A, 90 A, 110 A	DC1: 1A / 5A	25 / 55 / 75 Arms
AC 53a @ Ta=25°C	5 A, 15 A, 20 A, 30 A		5 / 15 / 20 Arms
Min. operational current	20 mA	1 mA	
Non rep. surge current (t=10 ms)	325 Ap [RA..25.] 600 Ap [RA..50.] 1150 Ap [RA..90.] 1900 Ap [RA..110.]		325 Ap [RZ3A..25..] 600 Ap [RZ3A..55..] 1150 Ap [RZ3A..75..]
Off-state leakage current	< 3 mA	< 1 mA	< 3 mA
I ² t for fusing (t=10 ms)	<525 A ² s [RA..25.] <1800 A ² s [RA..50.] <6600 A ² s [RA..90.] <18000 A ² s [RA..110.]		525 A ² s [RZ3A..25..] 1800 A ² s [RZ3A..55..] 6600 A ² s [RZ3A..75..]
General specifications			
Operational voltage range	24-280 Vrms [RA24.06..] 42-480 Vrms [RA44.08..] 42-530 Vrms [RA48.12..] 24-690 Vrms [RA60.16..]	3-60 VDC [RD0605..D] 3-200 VDC [RD2001..D] 3-350 VDC [RD3501..D]	24-440 Vrms [RZ3A40..] 42-530 Vrms [RZ3A48..] 42-660 Vrms [RZ3A60..]
Blocking voltage	<650 Vp [RA24.06..] <850 Vp [RA44.08..] <1200 Vp [RA48.12..] <1600 Vp [RA60.16..]		<850 Vp [RZ3A40..] <1200 Vp [RZ3A48..] <1600 Vp [RZ3A60..]
Power factor	≥ 0.5		
Operating temperature	-20°C to +70°C	-20°C to +70°C	-30°C to +80°C
Terminals	Screw / 5 way plug	Screw type with clamp	Screw type with clamp
Approvals/Marks	CE - UR - CSA	CE - CSA	CE - UR - CSA
References			
230 Vrms	RA24..-D..	200 VDC: RD2001-D	
	RA24..LA..	350 VDC: RD3501-D	
	RA24..HA..		
400 Vrms	RA44..-D..	60 VDC: RD0605-D	
	RA44..LA..		RZ3A40D..*
	RA44..HA..		RZ3A40A..*
480 Vrms	RA48..-D..		
	RA48..LA..		RZ3A48D..*
	RA48..HA..		RZ3A48A..*
600 Vrms	RA60..-D..		
			RZ3A60D..* RZ3A60A..*

* Add suffix 'P' for additional integrated Over Temperature Protection



Solid state relays, 1, 2 and 3-phase

Ready for use design - DIN rail mounting

Types	RMD1H	RMD2H	RMD3H
Hybrid relays. AC operating frequency range 45-65 Hz.			
Dimensions HxWxD (mm)	81 x 17.5 x 67.2	97 x 140.7 x 50.7	97 x 140.7 x 50.7
Features	Hybrid relay	2 pole switching hybrid relay	3 pole switching hybrid relay
Input specifications			
Control input range	4-32 VDC [RMD...D20] 24-275 VAC [RMD...A20]	24 VAC/DC +10/-15% [RMD2..LA..] 120 VAC/DC +10/-15% [RMD2..MA..] 240 VAC/DC +10/-15% [RMD2..HA..]	24 VAC/DC +10/-15% [RMD3..LA..] 120 VAC/DC +10/-15% [RMD3..MA..] 240 VAC/DC +10/-15% [RMD3..HA..]
Max. input current	5 mA [RMD..D20] 3 mA [RMD..A20]	400 mA	400 mA
Output specifications			
Rated operational current			
AC 51 @ Ta=25°C	20 A ACrms	30 AAC [RMD2..30] 40 AAC [RMD2..40]	30 AAC [RMD3..30] 40 AAC [RMD3..40]
Min. operational current	100 mA	150 mA	150 mA
General specifications			
Operational voltage range	195-253 Vrms	240 VAC -15% /+10% [RMD..24..] 277 VAC -15% /+10% [RMD..48..]	240 VAC -15% /+10% [RMD..24..] 277 VAC -15% /+10% [RMD..48..] 480 VAC + N [RMD..48..]
Power factor	≥ 0.9	≥ 0.9 at rated voltage	≥ 0.9 at rated voltage
Operating temperature	-5°C to +55°C	0°C to 70°C	0°C to 70°C
Terminals	Box clamp	Input 6.35 mm FASTON, Output screw	Input 6.35 mm FASTON, Output screw
Approvals/Marks	CE - cURus	CE - cURus	CE - cURus
References			
	RMD1H23D20	30 AAC	30 AAC
	RMD1H23A20	RMD2H24LA30	RMD3H24LA30
		RMD2H24MA30	RMD3H24MA30
		RMD2H24HA30	RMD3H24HA30
		40 AAC	RMD3H48LA30
		RMD2H24LA40	RMD3H48MA30
		RMD2H24MA40	RMD3H48HA30
		RMD2H24HA40	40 AAC
			RMD3H24LA40
			RMD3H24MA40
			RMD3H24HA40
			RMD3H48LA40
			RMD3H48MA40
			RMD3H48HA40

Solid state contactors, 1-phase



Ready for use design - DIN rail mounting, AC Output Switching

Types	RGC1A..15KKE	RGC1A..25KKE	RGC1A..30KKE
Single phase, semiconductor contactors with integrated heatsink, LED indication and IP20 protection, AC operating frequency 45-65 Hz, Rated isolation voltage ≥ 4000 Vrms, 100 kArms Short Circuit Current Rating, Motor ratings according to UL508			
Dimensions HxWxD (mm)	110 x 17.8 x 103.5	110 x 17.8 x 103.5	110 x 22.5 x 141
Features	17.8 mm wide solid state contactor, integrated output varistor, DC or AC control voltage, screw terminals for power and control, E-type layout	17.8 mm wide solid state contactor, integrated output varistor, DC or AC control voltage, screw terminals for power and control, E-type layout	22.5 mm wide solid state contactor, integrated output varistor, DC or AC control voltage, screw terminals for power and control, E-type layout
Input Specifications			
Input Specifications	3-32 VDC [RG.23D.] 4-32 VDC [RG.60D.] 20-275 VAC, 24-190 VDC [RG..A.]	3-32 VDC [RG.23D.] 4-32 VDC [RG.60D.] 20-275 VAC, 24-190 VDC [RG..A.]	3-32 VDC [RG.23D.] 4-32 VDC [RG.60D.] 20-275 VAC, 24-190 VDC [RG..A.]
Max. input current	11 mADC [RG..D.] 30 mAAC [RG..A.]	11 mADC [RG..D.] 30 mAAC [RG..A.]	11 mADC [RG..D.] 30 mAAC [RG..A.]
Output Specifications			
Rated operational current AC 51 @ Ta=40°C	20 AAC	25 AAC	30 AAC
AC 53a @ Ta=40°C	5 AAC	5 AAC	8 AAC [RGC..30.] 10 AAC [RGH..31.]
Min. operational current	150 mA [RGC..15.] 400 mA [RGH..15.]	250 mA	250 mA [RGC..30.] 400 mA [RGH..31.]
Non rep. surge current (t=10 ms)	325 Ap [RGC..15.] 1150 Ap [RGH..15.]	600 Ap	600 Ap [RGC..30.] 1150 Ap [RGH..31.]
Off-state leakage current	3 mAAC	3 mAAC	3 mAAC
I ² t for fusing (t=10 ms)	525 A ² s [RGC..15.] 6600 A ² s [RGH..15.]	1800 A ² s	1800 A ² s [RGC..30.] 6600 A ² s [RGH..31.]
Critical dV/dt (@ Tj init=40°C)	1000 V/μs	1000 V/μs	1000 V/μs
General specifications			
Operational voltage range	24-240 VAC +10% [RG.23..] 42-600 VAC +10% [RG.60..]	24-240 VAC +10% [RG.23..] 42-600 VAC +10% [RG.60..]	24-240 VAC +10% [RG.23..] 42-600 VAC +10% [RG.60..]
Blocking voltage	800 Vp [RGC.23.] 1200 Vp [RGC.60.] 1600 Vp [RGH.60.]	800 Vp [RGC.23.] 1200 Vp [RGC.60.]	800 Vp [RGC.23.] 1200 Vp [RGC.60.] 1600 Vp [RGH.60.]
Power factor	≥ 0.5 at rated voltage	≥ 0.5 at rated voltage	≥ 0.5 at rated voltage
Operating temperature	-40°C to +80°C	-40°C to +80°C	-40°C to +80°C
Approvals/Marks	CE - cULus - VDE - GL [RGC..15.]	CE - cULus - VDE - GL	CE - cULus - VDE - GL [RGC..30.]
References			
DC control voltage			
230 VAC, 800 Vp	RGC1A23D15KKE	RGC1A23D25KKE	RGC1A23D30KKE
600 VAC, 1200 Vp	RGC1A60D15KKE	RGC1A60D25KKE	RGC1A60D30KKE
600 VAC, 1600 Vp, 6600 A ² s	RGH1A60D15KKE		RGH1A60D31KKE
AC/DC control voltage			
230 VAC, 800 Vp	RGC1A23A15KKE	RGC1A23A25KKE	RGC1A23A30KKE
600 VAC, 1200 Vp	RGC1A60A15KKE	RGC1A60A25KKE	RGC1A60A30KKE
600 VAC, 1600 Vp, 6600 A ² s	RGH1A60A15KKE		RGH1A60A31KKE

Instant On (Random) Switching available on request (RGC1B60D...)

Solid state contactors, 1-phase

Ready for use design - DIN rail mounting, AC Output Switching

Types	RGC1A..15MKE	RGC1A..25MKE	RGC1A..30MKE
Single phase, semiconductor contactors with integrated heatsink, LED indication and IP20 protection, AC operating frequency 45-65 Hz, Rated isolation voltage \geq 4000 Vrms, 100kArms Short Circuit Current Rating, Motor ratings according to UL508			
Dimensions HxWxD (mm)	110 x 17.8 x 114.5	110 x 17.8 x 114.5	110 x 22.5 x 152
Features	17.8 mm wide solid state contactor, integrated varistor for overvoltage protection, DC or AC control voltage range, screw terminals with captivated clamp for power terminals and spring plug for control, E-type layout	17.8 mm wide solid state contactor, integrated varistor for overvoltage protection, DC or AC control voltage range, screw terminals with captivated clamp for power terminals and spring plug for control, E-type layout	22.5 mm wide solid state contactor, integrated varistor for overvoltage protection, DC or AC control voltage range, screw terminals with captivated clamp for power terminals and spring plug for control, E-type layout

Input specifications

Control input range	3-32 VDC [RG.23D.] / 4-32 VDC [RG.60D.] 20-275 VAC, 24-190 VDC [RG..A.]	3-32 VDC [RG.23D.] / 4-32 VDC [RG.60D.] 20-275 VAC, 24-190 VDC [RG..A.]	3-32 VDC [RG.23D.] / 4-32 VDC [RG.60D.] 20-275 VAC, 24-190 VDC [RG..A.]
Max. input current	11 mA DC [RG..D.] 30 mA AC [RG..A.]	11 mA DC [RG..D.] 30 mA AC [RG..A.]	11 mA DC [RG..D.] 30 mA AC [RG..A.]

Output specifications

Rated operational current			
AC 51 @ Ta=40°C	20 AAC	25 AAC	30 AAC
AC 53a @ Ta=40°C	5 AAC	5 AAC	8 AAC [RGC..30.] 10 AAC [RGH..31.]
Min. operational current	150 mA [RGC..15.] 400 mA [RGH..15.]	250 mA	250 mA [RGC..30.] 400 mA [RGH..31.]
Non rep. surge current (t=10 ms)	325 Ap [RGC...15..] 1150 Ap [RGH...15..]	600 Ap	600 Ap [RGC..30.] 1150 Ap [RGH..31.]
Off-state leakage current	3 mA AC	3 mA AC	3 mA AC
I ² t for fusing (t=10 ms)	525 A ² s [RGC..15.] 6600 A ² s [RGH..15.]	1800 A ² s	1800 A ² s [RGC..30.] 6600 A ² s [RGH..31.]
Critical dV/dt (@Tj init=40°C)	1000 V/ μ s	1000 V/ μ s	1000 V/ μ s

General specifications

Operational voltage range	24-240 VAC +10% [RG.23..] 42-600 VAC +10% [RG.60..]	24-240 VAC +10% [RG.23..] 42-600 VAC +10% [RG.60..]	24-240 VAC +10% [RG.23..] 42-600 VAC +10% [RG.60..]
Blocking voltage	800 Vp [RGC.23.] 1200 Vp [RGC.60.] 1600 Vp [RGH.60.]	800 Vp [RGC.23.] 1200 Vp [RGC.60.]	800 Vp [RGC.23.] 1200 Vp [RGC.60.] 1600 Vp [RGH.60.]
Power factor	\geq 0.5 at rated voltage	\geq 0.5 at rated voltage	\geq 0.5 at rated voltage
Operating temperature	-40°C to +80°C	-40°C to +80°C	-40°C to +80°C
Approvals/Marks	CE - cULus - VDE - GL [RGC..15.]	CE - cULus - VDE - GL	CE - cULus - VDE - GL [RGC..30.]



References

DC control voltage			
230 VAC, 800 Vp	RGC1A23D15MKE	RGC1A23D25MKE	RGC1A23D30MKE
600 VAC, 1200 Vp	RGC1A60D15MKE	RGC1A60D25MKE	RGC1A60D30MKE
600 VAC, 1600 Vp, 6600 A ² s	RGH1A60D15MKE		RGH1A60D31MKE
AC/DC control voltage			
230 VAC, 800 Vp	RGC1A23A15MKE	RGC1A23A25MKE	RGC1A23A30MKE
600 VAC, 1200 Vp	RGC1A60A15MKE	RGC1A60A25MKE	RGC1A60A30MKE
600 VAC, 1600 Vp, 6600 A ² s	RGH1A60A15MKE		RGH1A60A31MKE

Instant On (Random) Switching available on request (RGC1B60D...)

Solid state contactors, 1-phase

Ready for use design - DIN rail mounting, AC Output Switching

Types	RGC1A..15KGU	RGC1A..25KGU	RGC1A..30KGU
Single phase, semiconductor contactors with integrated heatsink, LED indication and IP20 protection, AC operating frequency 45-65 Hz, Rated isolation voltage \geq 4000 Vrms, 100 kArms Short Circuit Current Rating, Motor ratings according to UL508			
Dimensions HxWxD (mm)	110 x 17.8 x 103.5	110 x 17.8 x 103.5	110 x 22.5 x 141
Features	17.8 mm wide solid state contactor, integrated varistor for overvoltage protection, DC or AC control voltage range, screw terminals with captivated clamp for connection of control terminals and box clamps for power terminals, U-type layout	17.8 mm wide solid state contactor, integrated varistor for overvoltage protection, DC or AC control voltage range, screw terminals with captivated clamp for connection of control terminals and box clamps for power terminals, U-type layout	22.5 mm wide solid state contactor, integrated varistor for overvoltage protection, DC or AC control voltage range, screw terminals with captivated clamp for connection of control terminals and box clamps for power terminals, U-type layout

Input Specifications

Control input range	3-32 VDC [RG.23D.] 4-32 VDC [RG.60D.] 20-275 VAC, 24-190 VDC [RG..A.]	3-32 VDC [RG.23D.] 4-32 VDC [RG.60D.] 20-275 VAC, 24-190 VDC [RG..A.]	3-32 VDC [RG.23D.] 4-32 VDC [RG.60D.] 20-275 VAC, 24-190 VDC [RG..A.]
Max. input current	11 mADC [RG..D.] 30 mAAC [RG..A.]	11 mADC [RG..D.] 30 mAAC [RG..A.]	11 mADC [RG..D.] 30 mAAC [RG..A.]

Output Specifications

Rated operational current			
AC 51 @ $T_a=40^\circ\text{C}$	20 AAC	25 AAC	30 AAC
AC 53a @ $T_a=40^\circ\text{C}$	5 AAC	5 AAC	8 AAC
Min. operational current	150 mA	250 mA	250 mA
Non rep. surge current (t=10 ms)	325 Ap	600 Ap	600 Ap
Off-state leakage current	3 mAAC	3 mAAC	3 mAAC
I ² t for fusing (t=10 ms)	525 A ² s	1800 A ² s	1800 A ² s
Critical dV/dt (@ T _j init = 40°C)	1000 V/ μ s	1000 V/ μ s	1000 V/ μ s

General specifications

Operational voltage range	24-240 VAC +10% [RG.23..] 42-600 VAC +10% [RG.60..]	24-240 VAC +10% [RG.23..] 42-600 VAC +10% [RG.60..]	24-240 VAC +10% [RG.23..] 42-600 VAC +10% [RG.60..]
Blocking voltage	800 Vp [RGC.23.] 1200 Vp [RGC.60.]	800 Vp [RGC.23.] 1200 Vp [RGC.60.]	800 Vp [RGC.23.] 1200 Vp [RGC.60.]
Power factor	\geq 0.5 at rated voltage	\geq 0.5 at rated voltage	\geq 0.5 at rated voltage
Operating temperature	-40°C to +80°C	-40°C to +80°C	-40°C to +80°C
Approvals/Marks	CE - cULus - VDE - GL	CE - cULus - VDE - GL	CE - cULus - VDE - GL

References

DC control voltage			
230 VAC, 800 Vp	RGC1A23D15KGU	RGC1A23D25KGU	RGC1A23D30KGU
600 VAC, 1200 Vp	RGC1A60D15KGU	RGC1A60D25KGU	RGC1A60D30KGU
AC/DC control voltage			
230 VAC, 800 Vp	RGC1A23A15KGU	RGC1A23A25KGU	RGC1A23A30KGU
600 VAC, 1200 Vp	RGC1A60A15KGU	RGC1A60A20KGU	RGC1A60A30KGU

Instant On (Random) Switching available on request (RGC1860D...)

Solid state contactors, 1-phase

Ready for use design - DIN rail mounting, AC Output Switching

Types	RGCI A..40KGE RGCI A..42KGE	RGCI A..40MGE RGCI A..42MGE	RGCI A..60KGE RGCI A..62KGE	RGCI A..62MGE
Single phase, semiconductor contactors with integrated heatsink, LED indication and IP20 protection, AC operating frequency 45-65 Hz, Rated isolation voltage ≥ 4000 Vrms, 100 kArms Short Circuit Current Rating, Motor ratings according to UL508				

Dimensions HxWxD (mm)	110 x 35.6 x 141	110 x 35.6 x 152	110 x 69.1 x 141	110 x 69.1 x 152
Features	35 mm wide solid state contactor, integrated varistor, DC or AC control voltage, screw terminals for control, box clamp for power terminals, E-type layout	35 mm wide solid state contactor, integrated varistor, DC or AC control voltage, spring plug for control, box clamp for power terminals, E-type layout	70 mm wide solid state contactor, integrated varistor, DC or AC control voltage, screw terminals for control, box clamp for power terminals, E-type layout	70 mm wide solid state contactor, integrated varistor, DC or AC control voltage, spring plug for control, box clamp for power terminals, E-type layout

Input Specifications

Control input range	3-32 VDC [RG..23D..] 4-32 VDC [RG..60D..] 20-275 VAC, 24-190 VDC [RG..A..]	3-32 VDC [RG..23D..] 4-32 VDC [RG..60D..] 20-275 VAC, 24-190 VDC [RG..A..]	3-32 VDC [RG..23D..] 4-32 VDC [RG..60D..] 20-275 VAC, 24-190 VDC [RG..A..]	3-32 VDC [RG..23D..] 4-32 VDC [RG..60D..] 20-275 VAC, 24-190 VDC [RG..A..]
Max. input current	11 mA DC [RG..D..] 30 mA AC [RG..A..]	11 mA DC [RG..D..] 30 mA AC [RG..A..]	11 mA DC [RG..D..] 30 mA AC [RG..A..]	11 mA DC [RG..D..] 30 mA AC [RG..A..]

Output Specifications

Rated operational current AC 51 @ $T_a=40^\circ\text{C}$	40 AAC [RGC..40, RGH..40/41] 43 AAC [RGC..42]	40 AAC [RGC..40, RGH..41] 43 AAC [RGC..42]	60 AAC [RGC..60] 65 AAC [RGC..62, RGH..60]	65 AAC [RGC..62]
AC 53a @ $T_a=40^\circ\text{C}$	13 AAC [RGC..40, RGH..41] 16 AAC [RGC..42] 10 AAC [RGH..40]	13 AAC [RGC..40, RGH..41] 16 AAC [RGC..42]	14.8 AAC [RGC..60] 20 AAC [RGC..62] 18 AAC [RGH..60]	20 AAC [RGC..62]
Min. operational current	400 mA AC [RGC..40, RGH..41] 500 mA AC [RGC..42] 250 mA AC [RGH..40]	400 mA AC [RGC..40, RGH..41] 500 mA AC [RGC..42]	400 mA AC [RGC..60, RGH..60] 500 mA AC [RGC..62]	500 mA AC [RGC..62]
Non rep. surge current (t=10 ms)	800 Ap [RGC..40] 1900 Ap [RGC..42] 600 Ap [RGH..40] 1150 Ap [RGH..41]	800 Ap [RGC..40] 1900 Ap [RGC..42] 1150 Ap [RGH..41]	800 Ap [RGC..60] 1900 Ap [RGC..62] 1150 Ap [RGH..60]	1900 Ap [RGC..62]
Off-state leakage current	3 mA AC	3 mA AC	3 mA AC	3 mA AC
I ² t for fusing (t=10 ms)	3200 A ² s [RGC..40] 18000 A ² s [RGC..42] 1800 A ² s [RGH..40] 6600 A ² s [RGH..41]	3200 A ² s [RGC..40] 18000 A ² s [RGC..42] 6600 A ² s [RGH..41]	3200 A ² s [RGC..60] 18000 A ² s [RGC..62] 6600 A ² s [RGH..60]	18000 A ² s [RGC..62]

General specifications

Operational voltage range	24-240 VAC +10% [RG..23..] 42-600 VAC +10% [RG..60..]	24-240 VAC +10% [RG..23..] 42-600 VAC +10% [RG..60..]	24-240 VAC +10% [RG..23..] 42-600 VAC +10% [RG..60..]	24-240 VAC +10% [RG..23..] 42-600 VAC +10% [RG..60..]
Blocking voltage	800 Vp [RGC..23..] 1200 Vp [RGC..60..] 1600 Vp [RGH..60..]	800 Vp [RGC..23..] 1200 Vp [RGC..60..] 1600 Vp [RGH..60..]	800 Vp [RGC..23..] 1200 Vp [RGC..60..] 1600 Vp [RGH..60..]	800 Vp [RGC..23..] 1200 Vp [RGC..60..]
Power factor	≥ 0.5 at rated voltage	≥ 0.5 at rated voltage	≥ 0.5 at rated voltage	≥ 0.5 at rated voltage
Operating temperature	-40°C to +80°C	-40°C to +80°C	-40°C to +80°C	-40°C to +80°C
Approvals/Marks	CE - cULus - VDE	CE - cULus - VDE	CE - cULus - VDE	CE - cULus - VDE



References

230 VAC, 800 Vp, 3200 A ² s	RGCI A23X40KGE	RGCI A23X40MGE	RGCI A23X60KGE	
230 VAC, 800 Vp, 18000 A ² s	RGCI A23X42KGE	RGCI A23X42MGE	RGCI A23X62KGE	RGCI A23X62MGE
600 VAC, 1200 Vp, 3200 A ² s	RGCI A60X40KGE	RGCI A60X40MGE	RGCI A60X60KGE	
600 VAC, 1200 Vp, 18000 A ² s	RGCI A60X42KGE	RGCI A60X42MGE	RGCI A60X62KGE	RGCI A60X62MGE
600 VAC, 1600 Vp, 1800 A ² s	RGH1A60X40KGE			
600 VAC, 1600 Vp, 6600 A ² s	RGH1A60X41KGE	RGH1A60X41MGE	RGH1A60X60KGE	

X must be replaced with D for DC control 3-32 VDC, 4-32 VDC (for 600 VAC versions)
X must be replaced with A for AC control 20-275 VAC, 24-190 VDC
RGCI B.. models for Instant On (Random) switching are available on request

Solid state contactors, 1-phase



Ready for use design - DIN rail mounting

	AC Output Switching		DC Output Switching
Types	RGC1A..40KGU RGC1A..42KGU	RGC1A..60KGU RGC1A..62KGU	RGC1D1000D15KKE
Single phase, semiconductor contactors with integrated heatsink, LED indication and IP20 protection, Rated isolation voltage ≥ 4000 Vrms, 100 kArms short circuit current rating and Motor ratings according to UL508 for AC Output Switching			
Dimensions HxWxD (mm)	110 x 35.6 x 141	110 x 69.1 x 141	110 x 17.8 x 141
Features	35 mm wide solid state contactor, integrated varistor, DC or AC control voltage, screw terminals for control, box clamp for power terminals, U-type layout	70 mm wide solid state contactor, integrated varistor, DC or AC control voltage, screw terminals for control, box clamp for power terminals, U-type layout	17.8 mm wide solid state contactor for DC switching with integrated free wheeling diode, DC control, screw terminals for power and control, E-type layout
Input Specifications			
Control input range	3-32 VDC [RG..23D..] 4-32 VDC [RG..60D..] 20-275 VAC, 24-190 VDC [RG..A..]	3-32 VDC [RG..23D..] 4-32 VDC [RG..60D..] 20-275 VAC, 24-190 VDC [RG..A..]	4.5-32 VDC
Max. input current	11 mADC [RG..D..] 30 mAAC [RG..A..]	11 mADC [RG..D..] 30 mAAC [RG..A..]	13.7 mADC
Output Specifications			
Rated operational current			
AC-51 @ Ta = 40°C	40 AAC [RGC..40, RGH..41] 43 AAC [RGC..42]	60 AAC [RGC..60] 65 AAC [RGC..62, RGH..60]	
AC-53a @ Ta = 40°C	13 AAC [RGC..40, RGH..41] 16 AAC [RGC..42]	14.8 AAC [RGC..60] 20 AAC [RGC..62] 18 AAC [RGH..60]	
DC I @ 60°C			8 ADC
Min. operational current	400 mAAC [RGC..40, RGH..41] 500 mAAC [RGC..42]	400 mAAC [RGC..60, RGH..60] 500 mAAC [RGC..62]	20 mADC
Non rep. surge current (t=10 ms)	800 Ap [RGC..40] 1900 Ap [RGC..42] 1150 Ap [RGH..41]	800 Ap [RGC..60] 1900 Ap [RGC..62] 1150 Ap [RGH..60]	200 ADC (10us)
Off-state leakage current	3 mAAC	3 mAAC	3 mAAC
I ² t for fusing (t=10 ms)	3200A ² s [RGC..40] 18000 A ² s [RGC..42] 6600 A ² s [RGH..41]	3200A ² s [RGC..60] 18000 A ² s [RGC..62] 6600 A ² s [RGH..60]	1.5 mADC
Critical dV/dt (@ Tj init= 40°C)	1000 V/μs	1000 V/μs	1000 V/μs
General specifications			
Operational voltage range	24-240 VAC +10% [RG..23..] 42-600 VAC +10% [RG..60..]	24-240 VAC +10% [RG..23..] 42-600 VAC +10% [RG..60..]	24-1000 VDC [CE] 24-600 VDC [UL508]
Blocking voltage	800 Vp [RGC..23..] 1200 Vp [RGC..60..] 1600 Vp [RGH..60..]	800 Vp [RGC..23..] 1200 Vp [RGC..60..] 1600 Vp [RGH..60..]	1200 Vp
Power factor	≥ 0.5 at rated voltage	≥ 0.5 at rated voltage	
Operating temperature	-40°C to +80°C	-40°C to +80°C	-40°C to +80°C
Approvals/Marks	CE - cULus - VDE	CE - cULus - VDE	CE - cULus
References			
230 VAC, 800 Vp, 3200 A ² s	RGC1A23X40KGU	RGC1A23X60KGU	
230 VAC, 800 Vp, 18000 A ² s	RGC1A23X42KGU	RGC1A23X62KGU	
600 VAC, 1200 Vp, 3200 A ² s	RGC1A60X40KGU	RGC1A60X60KGU	
600 VAC, 1200 Vp, 18000 A ² s	RGC1A60X42KGU	RGC1A60X62KGU	
600 VAC, 1600 Vp, 6600 A ² s	RGH1A60X41KGU	RGH1A60X60KGU	
1000 VDC			RGC1D1000D15KKE

X must be replaced with D for DC control 3-32 VDC, 4-32 VDC (for 600 VAC versions). X must be replaced with A for AC control 20-275 VAC, 24-190 VDC
RGC1B.. models for Instant On (Random) switching are available on request

Solid state contactors, 1-phase

Ready for use design - DIN rail mounting
AC Output Switching with Integrated Over Temperature Protection

Types	RGC1A..25GKEP	RGC1A..30GKEP	RGC1A..40GG.P RGC1A..42GG.P
Single phase, semiconductor contactors with integrated heatsink, LED indication and IP20 protection, AC operating frequency 45-65 Hz, Rated isolation voltage ≥ 4000 Vrms, 100 kArms Short Circuit Current Rating, Motor ratings according to UL508			
Dimensions HxWxD (mm)	110 x 22.5 x 130	110 x 22.5 x 168	110x 35.6 x 168
Features	22.5 mm wide solid state contactor, integrated varistor for overvoltage protection and integrated over temperature for protection against over heating, screw terminals with captivated clamp for connection of power terminals and box clamps for control terminals	22.5 mm wide solid state contactor, integrated varistor for overvoltage protection and integrated over temperature for protection against over heating, screw terminals with captivated clamp for connection of power terminals and box clamps for control terminals	35 mm wide solid state contactor, integrated varistor for overvoltage protection and integrated over temperature for protection against over heating, box clamps for connection of power and control terminals
Input specifications			
Control input range	5-32 VDC [RG.D.] 20-275 VAC, 24-190 VDC [RG..A.]	5-32 VDC [RG.D.] 20-275 VAC, 24-190 VDC [RG..A.]	5-32 VDC [RG.D.] 20-275 VAC, 24-190 VDC [RG..A.]
Max. input current	24 mA DC [RG..D.] 35 mA AC [RG..A.]	24 mA DC [RG..D.] 35 mA AC [RG..A.]	24 mA DC [RG..D.] 35 mA AC [RG..A.]
Supply voltage			
Rated supply voltage	24 VDC -15%, +20%	24 VDC -15%, +20%	24 VDC -15%, +20%
Max. current rating	50 mA DC	50 mA DC	50 mA DC
Over temperature alarm			
Alarm output	PNP open collector normally closed, max. 24 VDC / 50 mA [RGC.D.P] Potential free normally closed, max. 24 VDC / 50 mA [RGC.A.P]	PNP open collector normally closed, max. 24 VDC / 50 mA [RGC.D.P] Potential free normally closed, max. 24 VDC / 50 mA [RGC.A.P]	PNP open collector normally closed, max. 24 VDC / 50 mA [RGC.D.P] Potential free normally closed, max. 24 VDC / 50 mA [RGC.A.P]
Output specifications			
Rated operational current			
AC 51 @ $T_a=40^\circ\text{C}$	25 AAC	30 AAC	40 AAC [RGC..40], 43 AAC [RGC..42]
AC 53a @ $T_a=40^\circ\text{C}$	5 AAC	8 AAC	13 AAC [RGC..40], 16 AAC [RGC..42]
Min. operational current	250 mA	250 mA	400 mA AC [RGC..40], 500 mA AC [RGC..42]
Non rep. surge current (t=10 ms)	600 Ap	600 Ap	800 Ap [RGC..40] 1900 Ap [RGC..42]
Off-state leakage current	3 mA AC	3 mA AC	3 mA AC
I^2t for fusing (t=10 ms)	1800 A ² s	1800 A ² s	3200 A ² s [RGC..40], 18000 A ² s [RGC..42]
Critical dV/dt off-state (@ T_j init = 40°C)	1000 V/ μ s	1000 V/ μ s	1000 V/ μ s
General specifications			
Operational voltage range	24-240 VAC +10% [RG.23..] 42-600 VAC +10% [RG.60..]	24-240 VAC +10% [RG.23..] 42-600 VAC +10% [RG.60..]	24-240 VAC +10% [RG.23..] 42-600 VAC +10% [RG.60..]
Blocking voltage	800 Vp [RGC.23.] 1200 Vp [RGC.60.]	800 Vp [RGC.23.] 1200 Vp [RGC.60.]	1200 Vp
Power factor	≥ 0.5 at rated voltage	≥ 0.5 at rated voltage	≥ 0.5 at rated voltage
Operating temperature	-40°C to +70°C	-40°C to +70°C	-40°C to +70°C
Approvals/Marks	CE - cULus - VDE	CE - cULus - VDE	CE - cULus - VDE
References			
DC control voltage			
230 VAC, 800 Vp		RGC1A23D30GKEP	
600 VAC, 1200 Vp	RGC1A60D25GKEP	RGC1A60D30GKEP	3200 A ² s: RGC1A60D40GGXP 18000 A ² s: RGC1A60D42GGXP
AC/DC control voltage			
600 VAC, 1200 Vp	RGC1A60A25GKEP	RGC1A60A30GKEP	3200 A ² s: RGC1A60A40GGXP 18000 A ² s: RGC1A60A42GGXP



X must be replaced with the following depending on the connection configuration required
Configuration X: E = E-type U = U-type

Solid state contactors, 1-phase

Ready for use design - DIN rail mounting, AC Output Switching

Integrated Over Temperature Protection

Integrated Fuse

Types	RGC1A..60GG.P RGC1A..62GG.P	RGC1A..90GG.P RGC1A..92GG.P	RGC1F..D..GGE
Single phase, semiconductor contactors with integrated heatsink, LED indication and IP20 protection, AC operating frequency 45-65Hz, Rated isolation voltage ≥4000Vrms, 100kArms Short Circuit Current Rating, Motor ratings according to UL508			
Dimensions HxWxD (mm)	110 x 69.1 x 168	126 x 69.1 x 168 (with fan)	110 x 35.6 x 168
Features	70 mm wide solid state contactor, integrated varistor for overvoltage protection and integrated over temperature for protection against over heating, box clamps for connection of power & control terminals	70 mm wide solid state contactor with attached fan, integrated varistor for overvoltage protection and integrated over temperature for protection against over heating, box clamps for connection of power & control terminals	35 mm wide solid state contactor with integrated fuse, additional monitoring features available with RGC1FS.. for SSR, load & fuse failure detection, integrated varistor for overvoltage protection, DC control voltage range, box clamps for connection of power & control terminals

Input specifications

Control input range	5-32 VDC [RG.D.] 20-275 VAC, 24-190 VDC [RG..A.]	5-32 VDC [RG.D.] 20-275 VAC, 24-190 VDC [RG..A.]	3-32 VDC [RGC1F..23.] 4.5-32 VDC [RGC1F..60.]
Max. input current	23 mADC [RG..D.]/35 mAAC [RG..A.]	23 mADC [RG..D.]/ 35 mAAC [RG..A.]	12 mA

Supply voltage

Rated supply voltage	24 VDC -15%, +20%	24 VDC -15%, +20%	24 VDC -15%, +20%
Max. current rating	50 mADC	50 mADC (fan rating 24 VDC / 50 mA)	80 mADC

Over temperature alarm

Alarm output	PNP open collector normally closed, max. 24 VDC / 50 mA [RGC.D.P] Potential free normally closed, max. 24 VDC / 50 mA [RGC.A.P]	PNP open collector normally closed, max. 24 VDC / 50 mA [RGC.D.P] Potential free normally closed, max. 24 VDC / 50 mA [RGC.A.P]	PNP open collector normally closed, max. 24 VDC / 50 mA [RGC1F..]
--------------	--	--	---

Output specifications

Rated operational current			
AC 51 @ Ta=40°C	60 AAC [RGC..60] 65 AAC [RGC..62]	85 AAC	20 AAC [RGC1F..20.]/30 AAC [RGC1F..30.]/40 AAC [RGC1F..40.]
AC 53a @ Ta=40°C	14,8 AAC [RGC..60] 20 AAC [RGC..62]	14,8 AAC [RGC..90] 20 AAC [RGC..92]	4.7 AAC [RGC1F..20.]/6 AAC [RGC1F..30.]/ 8 AAC [RGC1F..40.]
Min. operational current	400 mA [RGC..60] 500 mA [RGC..62]	400 mA [RGC..90] 500 mA [RGC..92]	200 mA
Non rep. surge current (I _{tsm}) (t=10 ms)	800 A _p [RGC..60] 1900 A _p [RGC..62]	800 A _p [RGC..90] 1900 A _p [RGC..92]	Integrated fuse
Off-state leakage current	3 mAAC	3 mAAC	
I ² t for fusing (t=10 ms)	3200 A ² s [RGC..60] 18000 A ² s [RGC..62]	6600 A ² s [RGC..90] 18000 A ² s [RGC..92]	Fuse - 740A ² s [RGC1F..20..] Fuse - 1400A ² s [RGC1F..30..] Fuse - 3100A ² s [RGC1F..40..]
Critical dV/dt off-state (@ T _j init = 40°C)	1000 V/μs	1000 V/μs	

General specifications

Operational voltage range	42-600 VAC +10% [RG.60...]	24-240 VAC +10% [RG.23..] 42-600 VAC +10% [RG.60..]	24-240 VAC +10% [RG.23..] 42-600 VAC +10% [RG.60..]
Blocking voltage	1200 Vp	800 Vp [RGC.23.]/1200 Vp [RGC.60.]	1200 Vp
Power factor	≥ 0.5 at rated voltage	≥ 0.5 at rated voltage	≥ 0.5 at rated voltage
Operating temperature	-40°C to +70°C	-40°C to +70°C	-40°C to +70°C
Approvals/Marks	CE - cULus - VDE	CE - cULus - VDE	CE - cULus (to 30AAC)

References

DC control voltage		RGC1A23D90GGXP	20 AAC RGC1FY23D20GGE 30 AAC RGC1FY23D20GGE 40 AAC RGC1FY23D20GGE
230 VAC, 800 Vp			
600 VAC, 1200 Vp	RGC1A60D60GGXP RGC1A60D62GGXP	RGC1A60D90GGXP RGC1A60D92GGXP	20 AAC RGC1FY60D20GGE 30 AAC RGC1FY60D20GGE 40 AAC RGC1FY60D20GGE
AC/DC control voltage			
600 VAC, 1200 Vp	RGC1A60A60GGXP RGC1A60A62GGXP	RGC1A60A90GGXP RGC1A60A92GGXP	



X and Y must be replaced with the following depending on the version required

Configuration X: E = E-type U = U-type
Version Y: A = fuse only S = fuse + monitoring

CARLO GAVAZZI Automation Components. Specifications are subject to change without notice. Illustrations are for example only.

Solid state contactors, 1-phase

Ready for use design - AC Output Switching, Integrated Current Measurement

Types	RGC1S..GKEP	RGC1S..25GKEP	RGC1S..26GGEp
Single phase, semiconductor contactors with integrated current measurement, E-type configuration, LED indication and IP20 protection, AC operating frequency 45-65 Hz, Rated isolation voltage ≥ 4000 Vrms, 100 kArms Short Circuit Current Rating			
Dimensions HxWxD (mm)	110 x 22.5 x 163	110 x 22.5 x 126	110 x 22.5 x 126
Features	22.5 mm wide solid state contactor, integrated varistor, DC control, local or remote TEACH, detection of partial load failure (1/6), SSR and load malfunction, SSR overheat protection	22.5 mm wide solid state contactor, integrated varistor, DC control, local or remote TEACH, detection of partial load failure (1/6), SSR and load malfunction, SSR overheat protection	22.5 mm wide solid state contactor, integrated varistor, DC control, local or remote TEACH, detection of partial load failure (1/6), SSR and load malfunction, SSR overheat protection

Input specifications

Control input range	4-32 VDC	4-32 VDC	4-32 VDC
Max. input current	10 mADC at 24 VDC	10 mADC at 24 VDC	10 mADC at 24 VDC

Supply voltage

Rated supply voltage	24 VDC -15%, +20%	24 VDC -15%, +20%	24 VDC -15%, +20%
Max. current rating	50 mADC	50 mADC	50 mADC

Alarm specifications

Output type	NC PNP open collector max. 35 VDC/50 mA	NC PNP open collector max. 35 VDC/50 mA	NC PNP open collector max. 35 VDC/50 mA
Alarm Indication	Red LED (flash rate)	Red LED (flash rate)	Red LED (flash rate)

Output specifications

Rated operational current			
AC 51 @ Ta=40°C	23 AAC [RGC1S..20] 30 AAC [RGC1S..30] 30 AAC [RGC1S..31]	25 AAC	25 AAC
Minimum TEACH / operational current	1.2 AAC	1.2 AAC	1.2 AAC
Minimum partial load current	0.2 AAC	0.2 AAC	0.2 AAC
Detectable partial load failure	>16.67% from current setpoint	>16.67% from current setpoint	>16.67% from current setpoint
Non. rep. surge current I _{tsm} (t=10ms)	325 Ap [RGC1S..20] 600 Ap [RGC1S..30] 1150 Ap [RGC1S..31]	600 Ap	1900 Ap
Max. off state leakage current	3 mAAC	3 mAAC	3 mAAC
I ² t for fusing (t=10ms)	525 A ² s [RGC1S..20] 1800 A ² s [RGC1S..30] 6600 A ² s [RGC1S..31]	1800 A ² s	18000 A ² s
Critical dV/dt (@ T _j init = 40°C)	1000 V/μs	1000 V/μs	1000 V/μs

General specifications

Operational voltage range	42-600 VAC +10%	42-600 VAC +10%	42-600 VAC +10%
Blocking voltage	1200 Vp	1200 Vp	1200 Vp
Power factor	≥ 0.9 at rated voltage	≥ 0.9 at rated voltage	≥ 0.9 at rated voltage
Operating temperature	-25°C to +70°C	-25°C to +70°C	-25°C to +70°C
Approvals/Marks	CE - cULus	CE - cULus	CE - cULus



References

600 VAC, 1200 Vp, 525A ² s	23 AAC: RGC1S60D20GKEP		
600 VAC, 1200 Vp, 1800A ² s	30 AAC: RGC1S60D30GKEP	25 AAC: RGC1S60D25GKEP	
600 VAC, 1200 Vp, 6600A ² s	30 AAC: RGC1S60D31GKEP		
600 VAC, 1200 Vp, 18000A ² s			25 AAC: RGC1S60D26GGEp

GK = screws for control terminals, box clamps for power terminals
GG = box clamps for control terminals, box clamps for power terminals

Solid state contactors, 1-phase



Ready for use design - AC Output Switching, Integrated Current Measurement

Types	RGC1S..41GG.P	RGC1S..61GG.P	RGC1S..90GGEP
Single phase, semiconductor contactors with integrated heatsink, LED indication and IP20 protection, AC operating frequency 45-65Hz, Rated isolation voltage $\geq 4000V_{rms}$, 100kArms Short Circuit Current Rating, Motor ratings according to UL508			
Dimensions HxWxD (mm)	110 x 35.6 x 163	110 x 69.1 x 163	126 x 69.1 x 163 (with fan)
Features	35mm wide solid-state contactor, integrated varistor, DC control, local or remote TEACH, detection of partial load failure (1/6), SSR and load malfunction, SSR overheat protection	70mm wide solid-state contactor, integrated varistor, DC control, local or remote TEACH, detection of partial load failure (1/6), SSR and load malfunction, SSR overheat protection	70mm wide solid-state contactor with integrated varistor, DC control, local or remote TEACH, detection of partial load failure (1/6), SSR and load malfunction, SSR overheat protection
Input specifications			
Control input range	4-32 VDC	4-32 VDC	4-32 VDC
Max. input current	10 mADC at 24 VDC	10 mADC at 24 VDC	10 mADC at 24 VDC
Supply voltage			
Supply Voltage	24 VDC -15%, +20%	24 VDC -15%, +20%	24 VDC -15%, +20%
Max. current rating	50 mADC	50 mADC	50 mADC (fan rating 24 VDC / 50 mA)
Alarm specifications			
Output type	NC PNP open collector max. 35 VDC / 50 mA	NC PNP open collector max. 35 VDC / 50 mA	NC PNP open collector max. 35 VDC / 50 mA
Alarm Indication	Red LED (flash rate)	Red LED (flash rate)	Red LED (flash rate)
Output specifications			
Rated operational current			
AC 51 @ $T_a=40^\circ C$	43 AAC	65 AAC	85 AAC
Minimum TEACH / operational current	1.2 AAC	5 AAC	5 AAC
Minimum partial load current	0.2 AAC	0.83 AAC	0.83 AAC
Detectable partial load failure	>16.67% from current setpoint	>16.67% from current setpoint	>16.67% from current setpoint
Non. rep. surge current I_{tsm} (t=10ms)	1900 A _p	1900 A _p	1900 A _p
Max. off state leakage current	3 mAAC	3 mAAC	3 mAAC
I ² t for fusing (t=10 ms)	18000 A ² s	18000 A ² s	18000 A ² s
Critical dV/dt (@ T _j init = 40°C)	1000 V/μs	1000 V/μs	1000 V/μs
General specifications			
Operational voltage range	42-600 VAC +10%	42-600 VAC +10%	42-600 VAC +10%
Blocking voltage	1200 V _p	1200 V _p	1200 V _p
Power factor	≥ 0.9 at rated voltage	≥ 0.9 at rated voltage	≥ 0.9 at rated voltage
Operating temperature	-25°C to +70°C	-25°C to +70°C	-25°C to +70°C
Approvals/Marks	CE - cULus	CE - cULus	CE - cULus
References			
600 VAC, 1200 V _p , E-type	43 AAC: RGC1S60D41GGEP	65 AAC: RGC1S60D61GGEP	85 AAC: RGC1S60D90GGEP
600 VAC, 1200 V _p , U-type	43 AAC: RGC1S60D41GGUP	65 AAC: RGC1S60D61GGUP	

GG = box clamps for control terminals, box clamps for power terminals

Solid state contactors, 1-phase

Ready for use design - DIN rail mounting

Types	RJ1P MB	RJ1P
Semiconductor contactors with integrated heatsink. AC operating frequency range 45-65 Hz. Rated isolation voltage ≥ 4000 Vrms		
Dimensions HxWxD (mm)	103 x 45 x 122	103 x 45 x 103
Features	SSR with fieldbus communication interface	Multifunction Phase-angle, Distributed full cycle and Burst control (1s, 3s and 10s)

Control specifications

Control input range	2-wire Modbus RTU	4-20 mA [RJ1P...I...] 0-10 VDC [RJ1P...V...]
Max. input current		50 mA [RJ1P...I...] 0-1 mA [RJ1P...V...]
Control supply		24 VAC/DC [RJ1P...V...]
Max. input current		23 mA [RJ1P...V...]

Output specifications

Rated operational current		
AC 51 @ $T_a=25^\circ\text{C}$	50 AACrms	50 AACrms
AC 53a @ $T_a=25^\circ\text{C}$		
Min. TEACH / operational current	500 mAACrms	150 mArms/ 500 mArms
Non-repet. surge current ($t=10$ ms)	1900 A _p	325/1900 A _p
Off-state leakage current	< 3 mArms	< 3 mArms
I^2t for fusing ($t=10$ ms)	18000 A ² s	525 A ² s / 18000 A ² s
On state voltage drop	1.6 Vrms	1.6 Vrms
Critical dV/dt off-state	1000 V/ μ s	1000 V/ μ s

General specifications

Operational voltage range	90-265 Vrms	90-265 Vrms [RJ1P23..] 200-550 Vrms [RJ1P48..] 410-660 Vrms [RJ1P60..]
Blocking voltage		650 V _p [RJ1P23..] 1200 V _p [RJ1P48..] 1200 V _p [RJ1P60..]
Power factor	≥ 0.9	≥ 0.9
Operating temperature	-30° to +70°C	-20° to +60°C
Terminals	Box clamp	Box clamp
Approvals/Marks	CE - UR - cUR	CE - UR - cUR

References

1-phase, zero switching	50 A	30 / 50 A
	RJ1P23MBT50EBC	RJ1P23V30E
230 V	RJ1P23MBT50ECS	RJ1P23I30E
	RJ1P23MBT50ECV	RJ1P23V50E
		RJ1P23I50E
	RJ1P48MBT50EBC	RJ1P48V30E
480 V	RJ1P48MBT50ECS	RJ1P48I30E
	RJ1P48MBT50ECV	RJ1P48V50E
		RJ1P48I50E
	RJ1P60MBT50EBC	RJ1P60V30E
600 V	RJ1P60MBT50ECS	RJ1P60I30E
	RJ1P60MBT50ECV	RJ1P60V50E
		RJ1P60I50E

Solid state contactors, 1-phase, 2-phase

Ready to use design - DIN rail mounting

Types

Solitron RN Full Cycle
1 pole 30/50 A

Solitron RN Sense*
1 pole 30/50 A

Semiconductor contactors with integrated heatsink.
AC operating frequency range 45-65 Hz.
Rated isolation voltage ≥ 4000 Vrms



Dimensions (mm)

120 x 45 x 110 (30A)
120 x 90 x 110 (50/63 A)

120 x 45 x 110 (30A)
120 x 90 x 110 (50A)

Features

High precision temperature control

High precision economy switching

Control specifications

Control input range

4-20 mA [RN.F.I.], 0-10 VDC [RN.F.V.]

7-32 VDC

Max. input current

50 mA [RN.F.I.], 0.1 mA [RN.F.V.]

4 mA

Control supply

12-32 VDC / 24 VAC [RN.V.]

20-32 VDC (≤ 40 mA)

Alarm output

PNP : VCC - 2 VDC (≤ 100 mA) / NPN: 2 VDC @ (≤ 100 mA)

Output specifications

Rated operational current

AC 51 @ $T_a=30^\circ\text{C}$

30 Arms [RN.F.30]
50 Arms [RN.F.50]

30 Arms [RN1S...30..]
50 Arms [RN1S...50..]

AC 53a @ $T_a=40^\circ\text{C}$

6 Arms [RN1S...30..]
12 Arms [RN1S...50..]

Min. operational current

500 mArms

200 mArms

Non rep. surge current
(I_{tsm}) ($t=10$ ms)

325 AP [RN..30]
600 AP [RN..50]

325 AP [RN.F.30..]
600 AP [RN.F.50..]

Off-state leakage current

< 6 mAAC

< 6 mAAC

I^2t for fusing ($t=10$ ms)

525 A²s [RN.F.30]
1800 A²s [RN.F.50]

525 A²s [RN.F.30..]
1800 A²s [RN.F.50..]

General specifications

Operational voltage range

85-140 Arms [RN..F12..], 85-265 Arms [RN..F23..]
190-530 Arms [RN..F48..]

120-265 Arms [RN1S23..], 150-440 Arms [RN1S40..]
180-530 Arms [RN1S48..]

Blocking voltage

800 V_P [RN..F12..], 800 V_P [RN..F23..]
1000 V_P [RN..F48..]

800 VP [RN1S23..], 1000 VP [RN1S40..]
1200 VP [RN1S48..]

Power factor

≥ 0.9

≥ 0.5

Operating temperature

-20°C to +70°C

-20°C to +70°C

Terminals

Screw captive wire clamp

Screw captive wire clamp

Approvals/Marks

CE - UR - CSA

CE - UR - CSA

References

30 A

RN1F12I30

RN1S23H30NO

RN1F12V30

RN1S23H30PO

RN1F23I30

RN1S40H30NO

RN1F23V30

RN1S40H30PO

RN1F48I30

RN1S48H30NO

RN1F48V30

RN1S48H30PO

50 A

RN1F12I50

RN1S23H50NO

RN1F12V50

RN1S23H50PO

RN1F23I50

RN1S40H50NO

RN1F23V50

RN1S40H50PO

RN1F48I50

RN1S48H50NO

RN1F48V50

RN1S48H50PO

* Other options available on request: Active low control input and normally closed alarm output.

Solid state contactors, 3-phase

Ready for use design - DIN rail mounting AC Output Switching

Types	RGCM2A..20.. 2 + 1 poles	RGC2A..25.. 2 + 1 poles	RGC2A..40.. 2 + 1 poles	RGC2A..75..F 2 + 1 poles
Semiconductor contactors with integrated heatsink, AC operating frequency range 45-65 Hz. Rated isolation voltage 4000 Vrms				

Dimensions HxWxD (mm)	105 x 45 x 105	110 x 54 x 103	110 x 72 x 126	141 x 72 x 141 (with fan)
Features	45 mm solid state contactor, enclosed heatsink, integrated varistors for over-voltage protection, 5 kArms SCCR, screw with clamp for power connection	54 mm solid state contactor, integrated varistors for over-voltage protection, 100 kArms SCCR, screw with clamp for power connection	72 mm solid state contactor, integrated varistors for over-voltage protection, 100 kArms SCCR, box clamp for power connection	72 mm solid state contactor, integrated overheat protection with EMR alarm output, 100 kArms SCCR, box clamp for power connection

Input Specifications				
Control input range	5-32 VDC [RGC..D.] 20-275 VAC 24-190 VDC [RGC..A.]	5-32 VDC [RGC..D.] 20-275 VAC 24-190 VDC [RGC..A.]	5-32 VDC [RGC..D.] 20-275 VAC 24-190 VDC [RGC..A.]	5-32 VDC [RG..D..DF] 5-32 VDC [RG..D..AF] 20-275 VAC [RG..A..AF]
Input current @ max. control voltage	31.5 mADC [RG..D.] 19 mAAC [RG..A.]	31.5 mADC [RG..D.] 19 mAAC [RG..A.]	31.5 mADC [RG..D.] 19 mAAC [RG..A.]	12.5 mADC [RG..D..DF] 5.5 mADC [RG..D..AF] 4.3 mAAC [RG..A..AF]
External supply voltage				24 VDC [RG..D..DF] 90-250 VAC [RG..D..AF] 90-250 VAC [RG..A..AF]
Max. supply current				150 mADC [RG..D..DF] 80 mADC [RG..D..AF] 80 mAAC [RG..A..AF]

Alarm Specifications				
Alarm output				EMR: 2A 230VAC/30VDC
Alarm condition				Over Temperature



Output Specifications				
Rated operational current AC-51 @ Ta = 40°C	20 AAC	27 AAC	40 AAC	75 AAC
AC-53a @ Ta = 40°C	7.6 AAC	11.5 AAC	16.5 AAC	28 AAC
Motor rating	3 kW @ 400 VAC 5 HP @ 600 VAC	5.5 kW @ 400 VAC 10 HP @ 600 VAC	7.5 kW @ 400 VAC 15 HP @ 600 VAC	11 kW @ 400 VAC 25 HP @ 600 VAC
Minimum operational current	250 mAAC	250 mAAC	400 mAAC	500 mAAC
Non. rep. surge current I _{tsm} (t=10ms)	600 Ap	600 Ap	1150 Ap	1750 Ap
I ² t for fusing (t=10ms)	1800 A ² s	1800 A ² s	6600 A ² s	15000 A ² s

General specifications				
Operational voltage range	42-600 VAC +10%	42-220 VAC +10% [RG..22.] 42-600 VAC +10% [RG..60.]	42-600 VAC +10%	42-600 VAC +10%
Blocking voltage	1200 Vp	800 Vp [RG..22.] 1200 Vp [RG..60.]	1200 Vp	1200 Vp
Power factor	≥ 0.5 at rated voltage	≥ 0.5 at rated voltage	≥ 0.5 at rated voltage	≥ 0.5 at rated voltage
Operating temperature	-40°C to +70°C	-40°C to +80°C	-40°C to +80°C	-40°C to +70°C [RG...DF] -40°C to +60°C [RG...AF]
Approvals / Marks	CE - cULus	CE - cULus	CE - cULus	CE - cULus

References				
DC control voltage				
220 VAC, 800 Vp		RGC2A22D25KKE		
600 VAC, 1200 Vp	RGCM2A60D20GKE	RGC2A60D25KKE	RGC2A60D40KGE	
AC/DC control voltage				
220 VAC, 800 Vp		RGC2A22A25KKE		
600 VAC, 1200 Vp	RGCM2A60A20GKE	RGC2A60A25KKE	RGC2A60A40KGE	
DC control voltage, DC external supply				RGC2A60D75GGEDF
DC control voltage, AC external supply				RGC2A60D75GGEAF
AC control voltage, AC external supply				RGC2A60A75GGEAF



Solid state contactors, 3-phase

Ready for use design - DIN rail mounting -
AC Output Switching with System Monitoring

Types	RGC2A..25..M 2 + 1 poles	RGC2A..40..M 2 + 1 poles	RGC2A..75..FM 2 + 1 poles
Semiconductor contactors with integrated heatsink, AC operating frequency 45-65 Hz. Rated isolation voltage output to heatsink of 4000 Vrms, 100 kArms Short Circuit Current Rating			
Dimensions HxWxD (mm)	110 x 54 x 118	110 x 72 x 141	141 x 72 x 141 (with fan)
Features	54 mm solid state contactor, EMR alarm output and electronic auxiliary output, screw with clamp for power connection	72 mm solid state contactor, EMR alarm output and electronic auxiliary output, box clamp for power connection	72 mm solid state contactor, EMR alarm output and electronic auxiliary output, box clamp for power connection
Input specifications			
Control input range	5-32 VDC [RG..D..DM] 5-32 VDC [RG..D..AM] 20-275 VAC [RG..A..AM]	5-32 VDC [RG..D..DM] 5-32 VDC [RG..D..AM] 20-275 VAC [RG..A..AM]	5-32 VDC [RG..D..DFM] 5-32 VDC [RG..D..AFM] 20-275 VAC [RG..A..AFM]
Control current @ max. control voltage	12.5 mADC [RG..D..DM] 5.5 mADC [RG..D..AM] 4.3 mAAC [RG..A..AM]	12.5 mADC [RG..D..DM] 5.5 mADC [RG..D..AM] 4.3 mAAC [RG..A..AM]	12.5 mADC [RG..D..DFM] 5.5 mADC [RG..D..AFM] 4.3 mAAC [RG..A..AFM]
External supply voltage	24 VDC [RG..D..DM] 90-250 VAC [RG..D..AM] 90-250 VAC [RG..A..AM]	24 VDC [RG..D..DM] 90-250 VAC [RG..D..AM] 90-250 VAC [RG..A..AM]	24 VDC [RG..D..DFM] 90-250 VAC [RG..D..AFM] 90-250 VAC [RG..A..AFM]
Max. supply current	60 mADC [RG..D..DM] 60 mAAC [RG..D..AM] 60 mAAC [RG..A..AM]	60 mADC [RG..D..DM] 60 mAAC [RG..D..AM] 60 mAAC [RG..A..AM]	150 mADC [RG..D..DFM] 80 mAAC [RG..D..AFM] 80 mAAC [RG..A..AFM]
Alarm specifications			
Alarm output	EMR; 2 A 250 VAC / 30 VDC	EMR; 2 A 250 VAC / 30 VDC	EMR; 2 A 250 VAC / 30 VDC
Alarm condition	Mains loss, Load loss, SSR open cct., SSR short cct., SSR over temperature	Mains loss, Load loss, SSR open cct., SSR short cct., SSR over temperature	Mains loss, Load loss, SSR open cct., SSR short cct., SSR over temperature
Output specifications			
Rated operational current AC-51 @ Ta = 40°C	27 AAC	40 AAC	75 AAC
Minimum operational current	250 mAAC	400 mAAC	500 mAAC
Non. rep. surge current I _{tsm} (t=10ms)	600 Ap	1150 Ap	1750 Ap
I ² t for fusing (t=10ms)	1800 A ² s	6600 A ² s	15000 A ² s
Off-state leakage current	3 mAAC	3 mAAC	3 mAAC
General specifications			
Operational voltage range	90-600 VAC +10%	90-600 VAC +10%	90-600 VAC +10%
Blocking voltage	1200 Vp	1200 Vp	1200 Vp
Operating temperature	-40°C to +80°C [RG...DM] -40°C to +60°C [RG...AM]	-40°C to +80°C [RG...DM] -40°C to +60°C [RG...AM]	-40°C to +70°C [RG...DFM] -40°C to +60°C [RG...AFM]
Approvals / Marks	CE - cULus	CE - cULus	CE - cULus
References			
600 VAC, 1200 Vp			
DC control voltage, DC external supply	RGC2A60D25GKEDM	RGC2A60D40GGEDM	RGC2A60D75GGEDFM
DC control voltage, AC external supply	RGC2A60D25GKEAM	RGC2A60D40GGEAM	RGC2A60D75GGEAFM
AC control voltage, AC external supply	RGC2A60A25GKEAM	RGC2A60A40GGEAM	RGC2A60A75GGEAFM

Solid state contactors, 3-phase

Ready for use design - DIN rail mounting, AC Output Switching

Types	RGCM3A..15.. 3 poles	RGC3A..20.. 3 poles	RGC3A..25.. / 30.. 3 poles
Semiconductor contactors with integrated heatsink, AC operating frequency 45-65 Hz. Rated isolation voltage output to heatsink of 4000 Vrms			
Dimensions HxWxD (mm)	105 x 45 x 105	110 x 54 x 103	110 x 72 x 126
Features	45 mm solid state contactor, enclosed heatsink, integrated varistors for over-voltage protection, 5 kArms SCCR, screw with clamp for power connection	54 mm solid state contactor, integrated varistors for over-voltage protection, 100 kArms SCCR, screw with clamp for power connection	72 mm solid state contactor, integrated varistors for over-voltage protection, 100 kArms SCCR, screw with clamp or box clamp for power connection

Input specifications

Control input range	5-32 VDC [RGC..D.] 20-275VAC, 24-190 VDC [RGC..A.]	5-32 VDC [RGC..D.] 20-275VAC, 24-190 VDC [RGC..A.]	5-32 VDC [RGC..D.] 20-275VAC, 24-190 VDC [RGC..A.]
Input current @ max. control voltage	31.5 mADC [RG..D.] 19 mAAC [RG..A.]	31.5 mADC [RG..D.] 19 mAAC [RG..A.]	31.5 mADC [RG..D.] 19 mAAC [RG..A.]

Output specifications

Rated operational current AC-51 @ Ta = 40°C	15.5 AAC	20 AAC	28 AAC [RGC3..25] 30 AAC [RGC3..30]
AC-53a @ Ta = 40°C	5.8 AAC	10 AAC	11 AAC [RGC3..25] 14 AAC [RGC3..30]
Motor rating	2.2 kW @ 400 VAC 3 HP @ 600 VAC	4 kW @ 400 VAC 10 HP @ 600 VAC	4 kW @ 400 VAC [RGC3..25] 5.5 kW @ 400 VAC [RGC3..30] 10 HP @ 600 VAC [RGC3..25] 15 HP @ 600 VAC [RGC3..30]
Minimum operational current	250 mAAC	250 mAAC	250 mAAC [RGC3..25] 400 mAAC [RGC3..30]
Non. rep. surge current I _{tsm} (t=10ms)	600 Ap	600 Ap	600 Ap [RGC3..25] 1150 Ap [RGC3..30]
I ² t for fusing (t=10ms)	1800 A ² s	1800 A ² s	1800 A ² s [RGC3..25] 6600 A ² s [RGC3..30]
Off-state leakage current	3 mAAC	3 mAAC	3 mAAC
Critical dV/dt (@ T _j init=40°C)	1000 V/us	1000 V/us	1000 V/us

General specifications



Operational voltage range	42-220 VAC + 10% [RG..22.] 42-600 VAC +10% [RG..60.]	42-220 VAC + 10% [RG..22.] 42-600 VAC +10% [RG..60.]	42-600 VAC +10%
Blocking voltage	800 Vp [RG..22.] 1200 Vp [RG..60.]	800 Vp [RG..22.] 1200 Vp [RG..60.]	1200 Vp
Power factor	≥ 0.5 at rated voltage	≥ 0.5 at rated voltage	≥ 0.5 at rated voltage
Operating temperature	-40°C to +70°C	-40°C to +80°C	-40°C to +80°C
Approvals/Marks	CE - cULus	CE - cULus	CE - cULus

References

DC control voltage			
220 VAC, 800 Vp	RGCM3A22D15GKE	RGC3A22D20KKE	
600 VAC, 1200 Vp	RGCM3A60D15GKE	RGC3A60D20KKE	28 AAC: RGC3A60D25KKE 30 AAC: RGC3A60D30KGE
AC/DC control voltage			
220 VAC, 800 Vp	RGCM3A22A15GKE	RGC3A22A20KKE	
600 VAC, 1200 Vp	RGCM3A60A15GKE	RGC3A60A20KKE	28 AAC: RGC3A60A25KKE 30 AAC: RGC3A60A30KGE



Solid state contactors, 3-phase

Ready for use design - DIN rail mounting, AC Output Switching

Types	RGC3A..40..F 3 poles	RGC3A..65..F 3 poles
Semiconductor contactors with integrated heatsink, AC operating frequency 45-65 Hz. Rated isolation voltage output to heatsink of 4000 Vrms, 100 kArms Short Circuit Current Rating		
Dimensions HxWxD (mm)	135 x 54 x 118 (with fan)	141 x 72 x 141 (with fan)
Features	54 mm solid state contactor + fan, integrated overheat protection with EMR alarm output, box clamp for power connection	72 mm solid state contactor + fan, integrated overheat protection with EMR alarm output, box clamp for power connection
Input specifications		
Control input range	5-32 VDC [RG..D..DF] 20-275 VAC [RG..A..AF]	5-32 VDC [RG..D..DF] 5-32 VDC [RG..D..AF] 20-275 VAC [RG..A..AF]
Input current @ max. control voltage	12.5 mADC [RG..D..DF] 4.3 mAAC [RG..A..AF]	12.5 mADC [RG..D..DF] 5.5 mADC [RG..D..AF] 4.3 mAAC [RG..A..AF]
External supply voltage	24 VDC [RG..D..DF] 90-250 VAC [RG..A..AF]	24 VDC [RG..D..DF] 90-250 VAC [RG..D..AF] 90-250 VAC [RG..A..AF]
Max. supply current	150 mADC [RG..D..DF] 80 mAAC [RG..A..AF]	150 mADC [RG..D..DF] 80 mAAC [RG..D..AF] 80 mAAC [RG..A..AF]
Alarm specifications		
Alarm output	EMR; 2 A 250 VAC / 30 VDC	EMR; 2 A 250 VAC / 30 VDC
Alarm condition	Over Temperature	Over Temperature
Output specifications		
Rated operational current AC-51 @ Ta = 40°C	42 AAC	66 AAC
AC-53a @ Ta = 40°C	17 AAC	25 AAC
Motor rating	7.5 kW @ 400 VAC 1.5 HP @ 600 VAC	11 kW @ 400 VAC 25 HP @ 600 VAC
Minimum operational current	400 mAAC	500 mAAC
Non. rep. surge current I _{tsm} (t=10ms)	1150 Ap	1750 Ap
I ² t for fusing (t=10ms)	6600 A ² s	15000 A ² s
Off-state leakage current	3 mAAC	3 mAAC
Critical dV/dt (@ T _j init=40°C)	1000 V/us	1000 V/us
General specifications		
Operational voltage range	42-600 VAC +10%	42-600 VAC +10%
Blocking voltage	1200 Vp	1200 Vp
Power factor	≥ 0.5 at rated voltage	≥ 0.5 at rated voltage
Operating temperature	-40°C to +70°C [RG..D..DF] -40°C to +60°C [RG..A..AF]	-40°C to +70°C [RG..D..DF] -40°C to +60°C [RG..A..AF]
Approvals / Marks	CE - cULus	CE - cULus
References		
600 VAC, 1200 Vp		
DC control voltage, DC external supply	RGC3A60D40GGEDF	RGC3A60D65GGEDF
DC control voltage, AC external supply	RGC3A60D40GGEAF	RGC3A60D65GGEAF
AC control voltage, AC external supply	RGC3A60A40GGEDF	RGC3A60A65GGEDF

Solid state contactors, 2/3-phase

Ready for use design - DIN rail mounting -
AC Output Switching with System Monitoring

Types	RGC3A..20..M 3 poles	RGC3A..25..M RGC3A..30..M 3 poles	RGC3A..65..FM 3 poles
Semiconductor contactors with integrated heatsink, AC operating frequency 45-65 Hz. Rated isolation voltage output to heatsink of 4000 Vrms, 100 kArms SCCR			
Dimensions HxWxD (mm)	110 x 54 x 118	110 x 72 x 141	141 x 72 x 141 (with fan)
Features	54 mm solid state contactor, EMR alarm output and electronic auxiliary output, screw with clamp for power connection	72 mm solid state contactor, EMR alarm output and electronic auxiliary output, screw with clamp or box clamp for power connection	72 mm solid state contactor + fan, EMR alarm output and electronic auxiliary output, box clamp for power connection

Input specifications

Control input range	5-32 VDC [RG..D..DM] 5-32 VDC [RG..D..AM] 20-275 VAC [RG..A..AM]	5-32 VDC [RG..D..DM] 5-32 VDC [RG..D..AM] 20-275 VAC [RG..A..AM]	5-32 VDC [RG..D..DFM] 5-32 VDC [RG..D..AFM] 20-275 VAC [RG..A..AFM]
Control current @ max. control voltage	12.5 mADC [RG..D..DM] 5.5 mADC [RG..D..AM] 4.3 mAAC [RG..A..AM]	12.5 mADC [RG..D..DM] 5.5 mADC [RG..D..AM] 4.3 mAAC [RG..A..AM]	12.5 mADC [RG..D..DFM] 5.5 mADC [RG..D..AFM] 4.3 mAAC [RG..A..AFM]
External supply voltage	24 VDC [RG..D..DM] 90-250 VAC [RG..D..AM] 90-250 VAC [RG..A..AM]	24 VDC [RG..D..DM] 90-250 VAC [RG..D..AM] 90-250 VAC [RG..A..AM]	24 VDC [RG..D..DFM] 90-250 VAC [RG..D..AFM] 90-250 VAC [RG..A..AFM]
Max. supply current	60 mADC [RG..D..DM] 60 mAAC [RG..D..AM] 60 mAAC [RG..A..AM]	60 mADC [RG..D..DM] 60 mAAC [RG..D..AM] 60 mAAC [RG..A..AM]	150 mADC [RG..D..DFM] 80 mAAC [RG..D..AFM] 80 mAAC [RG..A..AFM]

Alarm specifications

Alarm output	EMR; 2 A 250 VAC / 30 VDC	EMR; 2 A 250 VAC / 30 VDC	EMR; 2 A 250 VAC / 30 VDC
Alarm condition	Mains loss, Load loss, SSR open cct., SSR short cct., SSR over temperature	Mains loss, Load loss, SSR open cct., SSR short cct., SSR over temperature	Mains loss, Load loss, SSR open cct., SSR short cct., SSR over temperature

Output specifications

Rated operational current AC-51 @ Ta = 40°C	20 AAC	28 AAC [RGC3..25] 30 AAC [RGC3..30]	66 AAC
Minimum operational current	250 mAAC	250 mAAC [RGC3..25] 400 mAAC [RGC3..30]	500 mAAC
Non. rep. surge current I _{tsm} (t=10ms)	600 Ap	600 Ap [RGC3..25] 1150 Ap [RGC3..30]	1750 Ap
Off-state leakage current	3 mAAC	3 mAAC	3 mAAC
I ² t for fusing (t=10ms)	1800 A ² s	1800 A ² s [RGC3..25] 6600A ² s [RGC3..30]	15000 A ² s
Critical dV/dt (@ Tj init=40°C)	1000 V/us	1000 V/us	1000 V/us

General specifications



Operational voltage range	90-600 VAC +10%	90-600 VAC +10%	90-600 VAC +10%
Blocking voltage	1200 Vp	1200 Vp	1200 Vp
Operating temperature	-40°C to +80°C [RG...DM] -40°C to +60°C [RG...AM]	-40°C to +80°C [RG...DM] -40°C to +60°C [RG...AM]	-40°C to +70°C [RG...DFM] -40°C to +60°C [RG...AFM]
Approvals / Marks	CE - cULus	CE - cULus	CE - cULus

References

DC control voltage, DC external supply	RGC3A60D20GKEDM	28AAC: RGC3A60D25GKEDM 30AAC: RGC3A60D30GKEDM	RGC3A60D65GGEDFM
DC control voltage, AC external supply	RGC3A60D20GKEAM	28AAC: RGC3A60D25GKEAM 30AAC: RGC3A60D30GGEAM	RGC3A60D65GGEAFM
AC control voltage, AC external supply	RGC3A60A20GKEAM	28AAC: RGC3A60A25GKEAM 30AAC: RGC3A60A30GGEAM	RGC3A60A65GGEAFM

Solid state contactors, 3-phase

Ready for use design - DIN rail mounting,
4-20mA Proportional Controllers

Types	RGC2P60AA15C1 2 + 1 poles	RGC2P60AA25C1 2 + 1 poles	RGC2P60AA40C1 2 + 1 poles
3-phase semiconductor proportional controllers with integrated heatsink, AC operating frequency range 45-65 Hz. Rated isolation voltage 4000 Vrms, 100 kArms short circuit current rating			
Dimensions HxWxD (mm)	110 x 54 x 103	110 x 54 x 103	110 x 72 x 126
Features	54 mm solid state contactor with integrated varistors for over-voltage protection, screw with clamp for power connection	54 mm solid state contactor with integrated varistors for over-voltage protection, screw with clamp for power connection	72 mm solid state contactor, integrated varistors for over-voltage protection, box clamp for power connection
Input specifications			
Control input	4-20 mADC	4-20 mADC	4-20 mADC
Voltage drop	<10 VDC @ 20 mADC	<10 VDC @ 20 mADC	<10 VDC @ 20 mADC
Types			
Switching mode	1 Full Cycle [RGC..C1..]	1 Full Cycle [RGC..C1..]	1 Full Cycle [RGC..C1..]
Output specifications			
Rated operational current AC-51 @ Ta = 40°C	15 AAC	25 AAC	40 AAC
Minimum operational current	500 mAAC	500 mAAC	500 mAAC
Non. rep. surge current I _{tsm} (t=10ms)	600 Ap	600 Ap	1150 Ap
I ² t for fusing (t=10ms)	1800 A ² s	1800 A ² s	6600 A ² s
Off-state leakage current	5 mAAC	5 mAAC	5 mAAC
Critical dV/dt (@ T _j init=40°C)	1000 V/us	1000 V/us	1000 V/us
General specifications			
Operational voltage range	180-600 VAC +10%	180-600 VAC +10%	180-600 VAC +10%
Blocking voltage	1200 Vp	1200 Vp	1200 Vp
Power factor	≥ 0.7 at rated voltage	≥ 0.7 at rated voltage	≥ 0.7 at rated voltage
Operating temperature	-40°C to +70°C	-40°C to +70°C	-40°C to +70°C
Approvals / Marks	CE - cULus	CE - cULus	CE - cULus
References			
Control Input: 1 Full Cycle	4-20 mADC RGC2P60AA15C1	4-20 mADC RGC2P60AA25C1	4-20 mADC RGC2P60AA40C1

Solid state contactors, 3-phase

Ready for use design - DIN rail mounting -
Proportional Controllers with System Monitoring

Types	RGC2P..25..M 2 + 1 poles	RGC2P..40..M 2 + 1 poles	RGC2P..75..FM 2 + 1 poles
Semiconductor contactors with integrated heatsink, AC operating frequency 45-65 Hz. Rated isolation voltage output to heatsink of 4000 Vrms, 100 kArms short circuit current rating			

Dimensions HxWxD (mm)	110 x 54 x 118	110 x 72 x 141	141 x 72 x 141 (with fan)
Features	54 mm solid state contactor with integrated varistors for over-voltage protection, system monitoring, screw with clamp for power connection	72 mm solid state contactor with integrated varistors for over-voltage protection, system monitoring, box clamp for power connection	72 mm solid state contactor with fan and system monitoring, integrated varistors for over-voltage protection, box clamp for power connection

Input specifications			
Control input	0-20, 4-20, 12-20 mADC [RGC..I..] 0-10, 0-5, 1-5 VDC [RGC..V..] External potentiometer [RGC..V..]	0-20, 4-20, 12-20 mADC [RGC..I..] 0-10, 0-5, 1-5 VDC [RGC..V..] External potentiometer [RGC..V..]	0-20, 4-20, 12-20 mADC [RGC..I..] 0-10, 0-5, 1-5 VDC [RGC..V..] External potentiometer [RGC..V..]
Input impedance	<250 ohms [RGC..I..] 100k ohms [RGC..V..]	<250 ohms [RGC..I..] 100k ohms [RGC..V..]	<250 ohms [RGC..I..] 100k ohms [RGC..V..]
External supply voltage	24 VDC/AC	24 VDC/AC	24 VDC/AC [RGC..DFM] 90-250 VAC [RGC..AFM]
Max. supply current	90 mADC/AC	90 mADC/AC	175 mADC/AC [RGC..DFM] 60 mAAC [RGC..AFM]

Alarm specifications			
Alarm output	EMR; 2A 250VAC/30VDC	EMR; 2A 250VAC/30VDC	EMR; 2A 250VAC/30VDC
Alarm condition	Mains loss, Load loss, SSR open cct., SSR short cct., SSR over temperature	Mains loss, Load loss, SSR open cct., SSR short cct., SSR over temperature	Mains loss, Load loss, SSR open cct., SSR short cct., SSR over temperature

Types			
Switching mode	1 Full Cycle [RGC..C1..] 4 Full Cycles [RGC..C4..]	1 Full Cycle [RGC..C1..] 4 Full Cycles [RGC..C4..]	1 Full Cycle [RGC..C1..] 4 Full Cycles [RGC..C4..]



Output specifications			
Rated operational current AC-51 @ Ta = 40°C	27 AAC	40 AAC	75 AAC
Minimum operational current	500 mAAC	500 mAAC	500 mAAC
Non. rep. surge current I _{tsm} (t=10ms)	600 Ap	1150 Ap	1750 Ap
I ² t for fusing (t=10ms)	1800 A ² s	6600 A ² s	15000 A ² s
Off-state leakage current	5 mAAC	5 mAAC	5 mAAC
Critical dV/dt (@ Tj init=40°C)	1000 V/us	1000 V/us	1000 V/us

General specifications			
Operational voltage range	180-600 VAC +10%	180-600 VAC +10%	180-600 VAC +10%
Blocking voltage	1200 Vp	1200 Vp	1200 Vp
Power factor	≥ 0.7 at rated voltage	≥ 0.7 at rated voltage	≥ 0.7 at rated voltage
Operating temperature	-40°C to +70°C max. +60°C for 24 VAC supply	-40°C to +70°C max. +60°C for 24 VAC supply	-40°C to +70°C max. +60°C for 24 VAC supply
Approvals / Marks	CE - cULus	CE - cULus	CE - cULus

References			
Control Input:	0-20, 4-20, 12-20 mADC	0-20, 4-20, 12-20 mADC	0-20, 4-20, 12-20 mADC
1 Full Cycle, DC external supply	RGC2P60I25C1DM	RGC2P60I40C1DM	RGC2P60I75C1DFM
1 Full Cycle, AC external supply			RGC2P60I75C1AFM
4 Full Cycles, DC external supply	RGC2P60I25C4DM	RGC2P60I40C4DM	RGC2P60I75C4DFM
4 Full Cycles, AC external supply			RGC2P60I75C4AFM
Control Input:	0-10, 0-5, 1-5 VDC, Pot	0-10, 0-5, 1-5 VDC, Pot	0-10, 0-5, 1-5 VDC, Pot
1 Full Cycle, DC external supply	RGC2P60V25C1DM	RGC2P60V40C1DM	RGC2P60V75C1DFM
1 Full Cycle, AC external supply			RGC2P60V75C1AFM



Solid state contactors, 3-phase

Ready for use design - DIN rail mounting,
4-20mA Proportional Controllers

Types	RGC3P60AA20.. 3 poles	RGC3P60AA30.. 3 poles
3-phase semiconductor proportional controllers with integrated heatsink, AC operating frequency range 45-65 Hz. Rated isolation voltage 4000 Vrms, 100 kArms short circuit current rating		
Dimensions HxWxD (mm)	110 x 54 x 103	110 x 72 x 126
Features	54 mm solid state contactor with integrated varistors for over-voltage protection, screw with clamp for power connection	72 mm solid state contactor, integrated varistors for over-voltage protection, box clamp for power connection
Input specifications		
Control input	4-20 mADC	4-20 mADC
Voltage drop	<10 VDC @ 20 mADC	<10 VDC @ 20 mADC
Types		
Switching mode	Phase Angle [RGC..E] 1 Full Cycle [RGC..C1]	Phase Angle [RGC..E] 1 Full Cycle [RGC..C1]
Output specifications		
Rated operational current AC-51 @ Ta = 40°C	20 AAC	30 AAC
Minimum operational current	500 mAAC	500 mAAC
Non. rep. surge current I _{tsm} (t=10ms)	600 Ap	1150 Ap
I ² t for fusing (t=10ms)	1800 A ² s	6600 A ² s
Off-state leakage current	5 mAAC	5 mAAC
Critical dV/dt (@ T _j init=40°C)	1000 V/us	1000 V/us
General specifications		
Operational voltage range	180-600 VAC +10%	180-600 VAC +10%
Blocking voltage	1200 Vp	1200 Vp
Power factor	≥ 0.7 at rated voltage	≥ 0.7 at rated voltage
Operating temperature	-40°C to +70°C	-40°C to +70°C
Approvals / Marks	CE - cULus	CE - cULus
References		
Control Input:	4-20 mADC	4-20 mADC
Phase Angle	RGC3P60AA20E	RGC3P60AA30E
1 Full Cycle	RGC3P60AA20C1	RGC3P60AA30C1

Solid state contactors, 3-phase

Ready for use design - DIN rail mounting,
Proportional Controllers with System Monitoring

Types	RGC3P..20..EP RGC3P..20..M 3 poles	RGC3P..30..EP RGC3P..30..M 3 poles	RGC3P..65..EFP RGC3P..65..FM 3 poles
Semiconductor contactors with integrated heatsink, AC operating frequency 45-65 Hz. Rated isolation voltage output to heatsink of 4000 Vrms, 100 kArms short circuit current rating			
Dimensions HxWxD (mm)	110 x 54 x 118	110 x 72 x 141	141 x 72 x 141 (with fan)
Features	54 mm solid state contactor with integrated varistors for over-voltage protection, system monitoring, screw with clamp for power connection	72 mm solid state contactor with integrated varistors for over-voltage protection, system monitoring, box clamp for power connection	72 mm solid state contactor with fan and system monitoring, integrated varistors for over-voltage protection, box clamp for power connection

Input specifications			
Control input	0-20, 4-20, 12-20 mADC [RGC..I..] 0-10, 0-5, 1-5 VDC [RGC..V..] External potentiometer [RGC..V..]	0-20, 4-20, 12-20 mADC [RGC..I..] 0-10, 0-5, 1-5 VDC [RGC..V..] External potentiometer [RGC..V..]	0-20, 4-20, 12-20 mADC [RGC..I..] 0-10, 0-5, 1-5 VDC [RGC..V..] External potentiometer [RGC..V..]
Input impedance	<250 ohms [RGC..I..] 100k ohms [RGC..V..]	<250 ohms [RGC..I..] 100k ohms [RGC..V..]	<250 ohms [RGC..I..] 100k ohms [RGC..V..]
External supply voltage	24 VDC/AC [RGC..DM] 90-250 VAC [RGC..AM]	24 VDC/AC [RGC..DM] 90-250 VAC [RGC..AM]	24 VDC/AC [RGC..DFM] 90-250 VAC [RGC..AFM]
Max. supply current	90 mADC/AC [RGC..DM] 30 mAAC [RGC..AM]	90 mADC/AC [RGC..DM] 30 mAAC [RGC..AM]	175 mADC/AC [RGC..DFM] 60 mAAC [RGC..AFM]

Alarm specifications			
Alarm output	EMR; 2A 250 VAC / 30 VDC	EMR; 2A 250 VAC / 30 VDC	EMR; 2A 250 VAC / 30 VDC
Alarm condition	Mains loss, Load loss, SSR open cct., SSR short cct., SSR over temperature	Mains loss, Load loss, SSR open cct., SSR short cct., SSR over temperature	Mains loss, Load loss, SSR open cct., SSR short cct., SSR over temperature

Types			
Switching mode	Phase Angle [RGC..E..] 1 Full Cycle [RGC..C1..] 4 Full Cycles [RGC..C4..] 16 Full Cycles [RGC..C16..] Softstart [RGC..S..]	Phase Angle [RGC..E..] 1 Full Cycle [RGC..C1..] 4 Full Cycles [RGC..C4..] 16 Full Cycles [RGC..C16..] Softstart [RGC..S..]	Phase Angle [RGC..E..] 1 Full Cycle [RGC..C1..] 4 Full Cycles [RGC..C4..] 16 Full Cycles [RGC..C16..] Softstart [RGC..S..]

Output specifications			
Rated operational current AC-51 @ Ta = 40°C	20 AAC	30 AAC	66 AAC
Minimum operational current	500 mAAC	500 mAAC	500 mAAC
Non. rep. surge current I _{tsm} (t=10ms)	600 Ap	1150 Ap	1750 Ap
I ² t for fusing (t=10ms)	1800 A ² s	6600 A ² s	15000 A ² s
Off-state leakage current	5 mAAC	5 mAAC	5 mAAC
Critical dV/dt (@ Tj init = 40°C)	1000 V/us	1000 V/us	1000 V/us



General specifications			
Operational voltage range	180-600 VAC +10%	180-600 VAC +10%	180-600 VAC +10%
Blocking voltage	1200 Vp	1200 Vp	1200 Vp
Power factor	≥ 0.7 at rated voltage	≥ 0.7 at rated voltage	≥ 0.7 at rated voltage
Operating temperature	-40°C to +70°C max. +60°C for 24 VAC supply	-40°C to +70°C max. +60°C for 24 VAC supply	-40°C to +70°C max. +60°C for 24 VAC supply
Approvals / Marks	CE - cULus	CE - cULus	CE - cULus

References			
Phase Angle, DC external supply	RGC3P60Y20EDP	RGC3P60Y30EDP	RGC3P60Y65EDFP
Phase Angle, AC external supply		RGC3P60Y30EAP	RGC3P60Y65EAFP
X Full Cycle, DC external supply	RGC3P60Y20CXDM	RGC3P60Y30CXDM	RGC3P60Y65CXDFM
X Full Cycle, AC external supply		RGC3P60Y30CXAM	RGC3P60Y65CXAFM
Softstart + 16 Full Cycles, DC external supply	RGC3P60V20S16DM	RGC3P60V30S16DM	RGC3P60V65S16DFM
Digital Control Input:	5-10VDC	5-10VDC	5-10VDC
Softstart + ON/OFF, DC external supply	RGC3P60V20SDM	RGC3P60V30SDM	RGC3P60V65SDFM

X = '1', '4' or '16' full cycles
Y = '1' for 0-20mA, 4-20mA or 12-20mA or 'V' for 0-10V, 0-5V, 1-5V or pot





Solid state contactors for motor switching, 3-phase

Ready for use design - DIN rail mounting

Types	REC2B	REC3B	REC2R
Semiconductor contactors with integrated heatsink. AC operating frequency range 45-65 Hz. Rated isolation voltage ≥ 4000 Vrms			
Dimensions HxWxD (mm)	105 x 45 x 99.4	105 x 45 x 99.4	105 x 45 x 99.4
Features	2ph switching Electronic motor contactor	3ph switching Electronic motor contactor	2ph switching Electronic motor contactor for reversing
Control specifications			
Control input range	15-32 VDC [REC..D] 90-253 VAC [REC..A]	15-32 VDC [REC..D] 90-253 VAC [REC..A]	15-32 VDC [REC..D] 90-253 VAC [REC..A]
Max. input current	10 mADC [REC..D] 15 mAAC [REC..A]	10 mADC [REC..D] 15 mAAC [REC..A]	10 mADC [REC..D] 15 mAAC [REC..A]
Output specifications			
Rated operational current AC53a @ Ta= 40°C, 400 VAC	6.2 AAC [REC2B..20] 7.6 AAC [REC2B..30] 9.2 AAC [REC2B..40]	5.8 AAC [REC3B..20] 5.8 AAC [REC3B..21] 7.6 AAC [REC3B..30]	6.2 AAC [REC2R..20] 7.6 AAC [REC2R..30]
Motor Rating @ 400 VAC UL508/IEC60947-4-2 @40°C	3HP / 2.2 kW [REC2B..20] 3HP / 3.0 kW [REC2B..30] 3HP / 4.0 kW [REC2B..40]	2HP / 2.2 kW [REC3B..20] 2HP / 2.2 kW [REC3B..21] 3HP / 3.0 kW [REC3B..30]	3HP / 2.2 kW [REC2R..20] 3HP / 3.0 kW [REC2R..30]
Min. operational current	150 mA [RECB..20]	150 mA [REC3B..20]	150 mA [REC2R..20]
Non repet. surge current (I _{tsm}) (t=10 ms)	325 A _p [REC2B..20] 600 A _p [REC2B..30] 800 A _p [REC2B..40]	325 A _p [REC3B48..20] 600 A _p [REC3B60..20] 600 A _p [REC3..21] 800 A _p [REC3..30]	600 A _p
Max. Off-state leak current	< 3 mAAC	< 3 mAAC	< 3 mAAC
I ² t for fusing (t=10 ms)	525 A ² s [REC2..20] 525 A ² s [REC2..48..30] 1800 A ² s [REC2..60..30] 3200 A ² s [REC2..40]	525A ² s [REC3B48..20] 1800 A ² s [REC3B60..20] 1800 A ² s [REC3..21] 3200 A ² s [REC3..40]	1800 A ² s
Critical dV/dt (@ T _j init=40°C)	1000 V/μs	1000 V/μs	1000 V/μs
General specifications			
Operational voltage range	48 - 530 VAC [REC..48..] 48 - 600 VAC [REC..60..]	48 - 530 VAC [REC..48..] 48 - 600 VAC [REC..60..]	48 - 530 VAC [REC..48..] 48 - 600 VAC [REC..60..]
Blocking voltage	1200 V _p [REC..48..] 1600 V _p [REC..60..]	1200 V _p [REC..48..] 1600 V _p [REC..60..]	1200 V _p [REC..48..] 1600 V _p [REC..60..]
Power factor	≥ 0.5 at rated voltage	≥ 0.5 at rated voltage	≥ 0.5 at rated voltage
Operating temperature	-25°C to +60°C	-25°C to +60°C	-25°C to +60°C
Terminals	input screw/spring, output screw	input screw/spring, output screw	input screw/spring, output screw
Approvals/Marks	CE - cULus	CE - cULus	CE - cULus
References			
	2.2 kW	2.2 kW	2.2 kW
	REC2B48D20GKE	REC3B48D20GKE	REC2R48D20GKE
	REC2B48A20GKE	REC3B48A20GKE	REC2R48A20GKE
	3.0 kW	REC3B60D20GKE	3.0 kW
	REC2B48D30GKE	REC3B60A20GKE	REC2R48D30GKE
	REC2B48A30GKE	2.2 kW (high I _{tsm})	REC2R48A30GKE
	REC2B60D30GKE	REC3B48D21GKE	REC2R60D30GKE
	REC2B60A30GKE	3.0 kW	REC2R60A30GKE
	4.0 kW	REC3B48D30GKE	
	REC2B48D40GKE	REC3B48A30GKE	
	REC2B48A40GKE		

Solid state relays accessories

General accessories





Types	RPM1	RPM1P	RPM1V	RPM2
				
Dimensions HxWxD (mm)	84 x 12.5 x 42	84 x 12.5 x 42	84 x 12.5 x 42	82 x 25 x 39
Description	Din-rail adaptor for PCB relays. (Relay excluded)	Din-rail adaptor with sockets for plug-in PCB relays. (Relay excluded)	DIN-rail adaptor for PCB relays with LED and varistor across output terminals. (Relay excluded)	Din-rail adaptor for PCB relays with an operational voltage ≥ 230 V. (Relay excluded)
Pack Quantity	1	1	1	2

References

RPM1	RPM1P (no LED) RPM1PD (with LED)	RPM1V	RPM2
------	-------------------------------------	-------	------

Selection guide for SSR assemblies*

RP...M1	RP...M1P (no LED) RP...M1PD (with LED)	RP...M1V	RP...M2
---------	---	----------	---------

Types	DIN Adaptor	DIN Adaptor RG	Protection cover RM	Protection cover RA
				
Dimensions HxWxD (mm)	81 x 44 x 13.5	106 x 17.8 x 14	58 x 45 x 9	59 x 45 x 25.5
Description	DIN-rail adaptor for 1-phase SSR & heatsink assemblies. Integrated in heatsink kits.	DIN-rail adaptor for RGS relays.	Clip-on IP20 protection Cover for RAM, RM, RS	Protection cover for RA and RD serie
Pack Quantity	1	1	20	25

References

RHS00	RGS1DIN	RMIP20	BBR BBR-S (for RA..S series)
-------	---------	--------	---------------------------------

Selection guide for SSR assemblies*

R...H8	RGS...DIN
--------	-----------

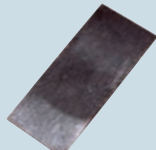
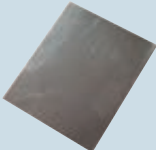
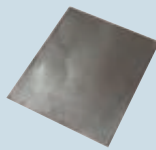
Types	Thermal paste	Thermal pad RG	Thermal Pad RM, RA	Thermal pad RZ3
				
Dimensions HxWxD (mm)		34.6 x 14 x 0.13	42 x 35 x 0.25	70 x 77 x 0.25
Description	2 ml syringe silicon based thermal compound	Graphite thermal pad for RG series	Graphite thermal pad for RA, RD, RM, RAM, RS series	Graphite thermal pad for RZ3 series
Pack Quantity	1	10	50	10





References





HTS02S	RGHT	KK071 CUT	RZHT
--------	------	-----------	------



* Conditions may apply. Please ask your Sales representative for further details.

Solid state relays accessories

Terminal Adaptors

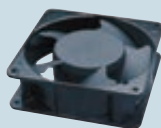

Types	RM fork terminal	RM fork terminal IP20	RM FASTON terminals	RM spacers
				
Dimensions HxWxD (mm)	35 x 16.5 x 25	35 x 16.5 x 29	4.8 / 6.3	M3 x 12
Description	RM, RS, RAM terminal adaptor for 16mm ² and 35mm ² cable	RM, RS, RAM terminal adaptor for 35mm ² cable, IP20	Screw FASTON terminals, flat or 45° angled for output (6.3mm) and input (4.8mm) RM, RS, RAM terminals	Standoff spacer for RM, RS, RAM series M3 control terminals
Pack Quantity	10	10	20	20
References	RM625FK (16mm ²) RM635FK (35mm ²)	RM635FKP	RM48F0 (4.8mm, flat) RM48F4 (4.8mm, 45°) RM63F0 (6.3mm, flat) RM63F4 (6.3mm, 45°)	RMSP03

Types	RG plug terminals	RG plug terminals	Overload Relay Adaptor	Varistors
				
Description	2 pole spring loaded plug terminal, 2,5mm ² for RG series	3 way, 2 pole box clamp plug terminal, 2,5mm ² for RGC3 series	Overload Relay Adaptor for REC and RGC3 series	Surge / transient voltage protection for SSRs
Pack Quantity	10	10	5	10
References	RGM25	RG3G25	REC3ADAPTOR	275V: RV02 420V: RV04 510V: RV05 625V: RV06 680V: RV07

Types	Cables	Fans	Screw Kits	Temperature limit switches
				
Dimensions HxWxD (mm)		40 x 40 x 20 (RHSF40) 60 x 60 x 20 (RHSF60) 120 x 120 x 38 (RHS301F)		6.5 x 5.5 x 3
Description	Cable for RM1E...V, RA2A..C and RA...S models with one-end terminated with a female plug for mounting on the SSR	RHSF40-24 to be mounted with RHS45C, RHS45B, RHS540, RHS542 RHSF60-24/240 to be mounted with RHS90A, RHS112A, RHS703 RHS301F115/230 to be mounted with RHS301 incl. bracket	Screw kits for assembling SSRs to heatsinks. M5x10mm to be used with RA, RD, RM, RAM, RS and RZ3 series. M4x15mm used for RHS38AD heatsink. M5x23/30mm to be used with RG series.	Temperature limit switches that may be fitted in the RZ3 housing between SSR and heatsink
	1	1	20	1
References	RCS3-100-1 [RM1E..V] RCS4-100-1 [RA2A..C] RCS4-400-1 [RA2A..C] RCS5-200-1 [RA..S]	RHSF40-24 (24VDC) RHSF60-24 (24VDC) RHSF60-230 (240VAC) RHS301F115 (115VAC) RHS301F230 (230VAC)	SRWKITM5X10MM SRWKITM4X15MM SRWKITM5X23MM SRWKITM5X30MM	UP62-70 UP62-80 UP62-90

Solid state relays accessories

DIN mount heatsinks for solid state relays

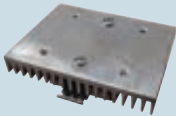

Types	RHS300	RHS37A	RHS10015
			

Dimensions HxWxD (mm) (SSR not included)	105 x 82 x 20	18 x 110 x 52	100 x 82 x 29
---	---------------	---------------	---------------

Description	Heatsink for 1x 3-phase RZ3 series	Heatsink for 1x 1-phase RG series	Heatsink for max. 2x 1-phase RA, RD, RM, RAM, RS series
-------------	------------------------------------	-----------------------------------	---

Thermal resistance**			
Without fan	5.40 °C/W (>30W)	4.00 °C/W (>20W)	4.00 °C/W (>30W)
With fan	Not available	Not available	Not available

Selection guide for heatsink assemblies*			
Without fan	R...H1	R...H51	R...H47
With fan	Not available	Not available	Not available

Types	RHS100	RHS45C	RHS52A
			

Dimensions HxWxD (mm) (SSR not included)	44 x 82 x 48	45 x 103 x 55	22.5 x 110 x 90
---	--------------	---------------	-----------------

Description	Heatsink for 1x 1-phase RA, RD, RM, RAM, RS series	Heatsink for 1x 1-phase RA, RD, RM, RAM, RS series	Heatsink for 1x 1-phase RG series
-------------	--	--	-----------------------------------

Thermal resistance**			
Without fan	3.10 °C/W (>25W)	2.20 °C/W (>45W)	2.00 °C/W (>45W)
With fan	Not available	Not Available	Not Available

Selection guide for heatsink assemblies*			
Without fan	R...H0	R...H15	R...H61
With fan	Not available	Not available	Not available

Types	RHS45B	RHS54..	RHS703..
			

Dimensions HxWxD (mm) (SSR not included)	45 x 103 x 80	54 x 110 x 51 54 x 135 x 51 (with fan)	72 x 110 x 75 72 x 141 x 75 (with fan)
---	---------------	---	---

Description	Heatsink for 1x 1-phase RA, RD, RM, RAM, RS series	Heatsink for max. 3x 1-phase RG series, 1x 1-phase RA, RD, RM, RAM, RS series: RHS540 (no fan) RHS540F40-24 (24VDC fan) Heatsink for max. 2x 1-phase RG series: RHS542 (no fan) RHS542F40-24 (24VDC fan)	Heatsink for max. 3x 1-phase RG series, 1x 1-phase RA, RD, RM, RAM, RS series: RHS703 (no fan) RHS703F60-24 (24VDC fan) RHS703F60-230 (240VAC fan)
-------------	--	---	---

Thermal resistance**			
Without fan	1.85 °C/W (>50W)	1.85 °C/W (>60W)	1.10 °C/W (>60W)
With fan	Not Available	0.65 °C/W	0.37 °C/W



Selection guide for heatsink assemblies*			
Without fan	R...H5	R...H65 [RHS540] R...H66 [RHS542]	R...H75 [RHS703]
With fan	Not available	R...H67 [RHS540F40-24] R...H68 [RHS542F40-24]	R...H76 [RHS703F60-24] R...H77 [RHS703F60-230]

* Conditions may apply. Please ask your Sales representative for further details.

** Refer to specific heatsink datasheet for further details on heatsink characteristics and assemblies.

Solid state relays accessories

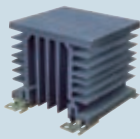
DIN mount heatsinks for solid state relays

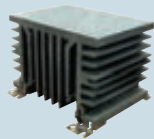

Types	RHS90A	RHS301..	RHS112A..
			
Dimensions HxWxD (mm) (SSR not included)	90 x 103 x 80	119 x 82 x 94 124 x 146 x 122 (with fan)	112 x 103 x 80 112 x 120 x 80 (with fan)
Description	Heatsink for 1x 1-phase RA, RD, RM, RAM, RS series	Heatsink for 1x 3-phase RZ3, 2x 1-phase RA, RD, RM, RAM, RS series: RHS301 [no fan] RHS301F115C [115VAC fan] RHS301F230C [230VAC fan]	Heatsink for 1x 3-phase RZ3, 2x 1-phase RA, RD, RM, RAM, RS series: RHS112A [no fan] RHS112AF60-24 [24VDC fan] RHS112AF60-230 [230VAC fan]

Thermal resistance**

Without fan	0.97 °C/W (>60W)	0.82 °C/W (>80W)	0.76 °C/W (>100W)
With fan	Not Available	0.28 °C/W	0.35 °C/W

Selection guide for heatsink assemblies*

Without fan	R...H16	R...H2 [RHS301]	R...H17
With fan	Not available	R...H10 [RHS301F115C] R...H12 [RHS301F230C]	R...H18 [RHS112AF60-24] R...H52 [RHS112AF60-230]

Types	RHS11267DIND	RHS28009F80-24P	RHS28011F80-24P
			
Dimensions HxWxD (mm) (SSR not included)	119 x 125 x 94	280 x 87 x 122	280 x 87 x 122
Description	Heatsink for 1x 3-phase RZ3 series, max 3x 1-phase RG series, 2x 1-phase RA, RD, RM, RAM, RS series	Heatsink for max. 9x 1-phase RG series or 4x 1-phase RA, RD, RM, RAM, RS series with integrated fan and overtemperature protection	Heatsink for max. 11x 1-phase RG series or 3x 1-phase RA, RD, RM, RAM, RS series with integrated fan and overtemperature protection

Thermal resistance**

Without fan	0.54 °C/W (>150W)	Not available	Not available
With fan	Not available	0.12 °C/W (24V DC)	0.12 °C/W (24 VDC)

Selection guide for heatsink assemblies*

Without fan	R...H78D	Not available	Not available
With fan	Not available	R...H41	R...H44

Thru wall mount heatsinks for solid state relays

Types	RHS10025D	RHS16225D	RHS16225LD
			
Dimensions HxWxD (mm) (SSR not included)	100 x 100 x 25	162 x 100 x 25	162 x 250 x 25
Description	Heatsink for max. 3x 1-phase RG series, 1x 1-phase RA, RD, RM, RAM, RS series	Heatsink for 1x 3-phase RZ3 series, max. 3x 1-phase RA, RD, RM, RAM, RS and RG series	Heatsink for 1x 3-phase RZ3 series, max. 3x 1-phase RA, RD, RM, RAM, RS and RG series

Thermal resistance**

Without fan	1.85 °C/W (>60W)	1.30 °C/W (>90W)	0.84 °C/W (>120W)
With fan	Not Available	Not Available	Not Available

Selection guide for heatsink assemblies*

Without fan	R...H49	R...H55	R...H55L
With fan	Not Available	Not Available	Not Available

* Conditions may apply. Please ask your Sales representative for further details.



** Refer to specific heatsink datasheet for further details on heatsink characteristics and assemblies.

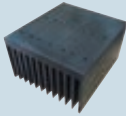

Solid state relays accessories

Thru wall mount heatsinks for solid state relays

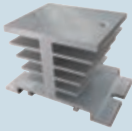
Types	RHS11267D	RHS30040D
		
Dimensions HxWxD (mm) (SSR not included)	112 x 125 x 67	300 x 200 x 40
Description	Heatsink for max. 3x 1-phase RG series or 1x 1-phase RA, RD, RM, RAM, RS series	Heatsink for max. 12x 1-phase RG series or 8x 1-phase RA, RD, RM, RAM, RS series
Thermal resistance**		
Without fan	0.54 °C/W (>150W)	0.40 °C/W (>180W)
With fan	Not Available	Not Available
Selection guide for heatsink assemblies*		
Without fan	R...H78	R...H57
With fan	Not Available	Not Available

Panel mount heatsinks for solid state relays

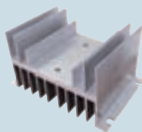
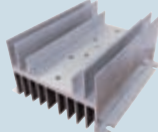
Types	RHS5050D	RHS38AD	RHS5840D
			
Dimensions WxHxD (mm) (SSR not included)	80 x 50 x 51	46 x 76 x 33	81 x 100 x 40
Description	Heatsink for 1x 1-phase RA, RD, RM, RAM, RS series	Heatsink for 1x 1-phase RA, RD, RM, RAM, RS series	Heatsink for max. 3x 1-phase RG series, 1x 1-phase RA, RD, RM, RAM, RS series
Thermal resistance**			
Without fan	3.50 °C/W (>25W)	2.85 °C/W (>40W)	1.80 °C/W (>60W)
With fan	Not available	Not available	Not available
Selection guide for heatsink assemblies*			
Without fan	R...H60	R...H53	R...H48
With fan	Not available	Not available	Not available



Types	RHS10067D	RHS10067LD	RHS320
			
Dimensions WxHxD (mm) (SSR not included)	121 x 76 x 67	121 x 140 x 67	240 x 100 x 93
Description	Heatsink for 1x 1-phase RA, RD, RM, RAM, RS series	Heatsink for 2x 1-phase RA, RD, RM, RAM, RS and RG series	Heatsink for 1x 3-phase RZ3 series, max. 3x 1-phase RA, RD, RM, RAM, RS and RG series
Thermal resistance**			
Without fan	1.70 °C/W (>20W)	0.88 °C/W (>80W)	0.40 °C/W (>120W)
With fan	Not available	Not available	Not available
Selection guide for heatsink assemblies*			
Without fan	R...H58	R...H58L	R...H13
With fan	Not available	Not available	Not available

* Conditions may apply. Please ask your Sales representative for further details.

** Refer to specific heatsink datasheet for further details on heatsink characteristics and assemblies.

Soft starters

Scroll Compressor soft starters

Types	RSBS	RSBD & RSBT (45mm)	RSBD & RSBT (120mm)
Soft starting of 1-Phase (RSBS) and 3-phase (RSBT) scroll compressors			
Dimensions (mm)	60.4* x 137 x 81.4	81 x 45 x 125 [RSBT.V11../V51..] 97.5 x 45 x 125 [RSBT.V21../V61..] 106 x 45 x 125 [RSBD..V51../V61..]	150 x 120 x 170
Features	Internally bypassed, Current Limit start Optional auxiliary relay output (Option V22), HP algorithm for high pressure starts	Compact 2- (RSBD) and 3- (RSBT) phase controlled soft starter for scroll compressors. Patented auto-adapt function for reduction of inrush current. Current balancing strategy on RSBD models. No user settings required HP algorithm optimised for multi-compressor systems	Patented Auto-adaptive algorithm Two - (RSBD) and Three phase (RSBT) Controlled versions Internally bypassed 2 Output relays for alarms and top of ramp indication Serial communication for energy variables, alarms, start/stop (RSB...CVC models)
Control specifications			
Control input range	230 VAC	Option E: 110 - 400 VAC [RSBD40../RSBT] Option F: 24 VAC / DC [RSBD40..]	24 VAC/DC & 110-400 VAC
Controlled phases	1	2 [RSBD40..] 3 [RSBT...]	2 [RSBD48..CV..] 3 [RSBT48..CV..]
Output specifications			
Rated operational current (Ie)	25 A [RSBS2325..] 32 A [RSBS2332..]	12/16/25/32/37/45 A [RSBD40..] 16/25/32 A [RSBT..]	55A [RSB.4855CV..] 70A [RSB.4870CV..] 95A [RSB.4895CV..]
Operational voltage	230 VAC (-15%, +10%)	RSBD40: 220 - 400 VAC (-15%, +10%) RSBT22: 220 VAC (-15%, +10%) RSBT40: 400 VAC (-15%, +10%)	220 - 480 VAC (-15%, +10%)
Overload current profile @ 40°C	25 A: AC-53b: 1.6 - 1:60 [RSBS2325..] 32 A: AC-53b: 1.4 - 1:60 [RSBS2332..]	RSBD40: AC-53b: 3.5-1:299 RSBT.16: AC-53b: 2.5-1:60 RSBT..25: AC-53b: 3.6-1:60 RSBT..32: AC-53b: 3.4-1:60	55 A: AC-53b: 3.5 - 1 : 299 70 A: AC-53b: 3.5 - 1 : 299 95 A: AC-53b: 3.5 - 1 : 299
Number of starts per hour	12 (evenly distributed)	12 (evenly distributed)	12 (evenly distributed)
Assigned compressor rating @400V	RSBS2325... / RSBS2332...**** 3.7 kW (5 HP) / 4 kW (5 HP)	RSBD4016/RSBD4025/RSBD4032/ RSBD4037/RSBD4050 5.5kW(5HP)/7.5kW(7.5HP)/11kW(10HP)/15kW (15HP)/18.5kW(20HP)/22kW(25HP) RSBT..16/RSBT..25/RSBT..32 7.5kW (7.5HP)/11.0kW(10HP)/15.0kW(15HP)	RSB.4855CV../ RSB.4870CV../ RSB.4895CV.. 22 kW (30 HP)/ 30 kW (40 HP)/ 45 kW (50 HP)
General specifications			
Internally bypassed	Yes	Yes	Yes
Operational frequency	50/60 Hz ±10%	50/60 Hz +/- 10 Hz	50/60 Hz +/- 10 Hz
Ramp up/Ramp down	< 600ms/0s	<1s/0s	<1s/0s
Default Current limit	40 Arms [RSBS2325..V2..] 45 Arms [RSBS2332..V2..]	3.5xIe [RSBD40..] 40Arms [RSBT..16]/90Arms [RSBT..25]/ 110Arms [RSBT..32]	192.5 Arms [RSB.4855CV..] 245.0 Arms [RSB.4870CV..] 332.5 Arms [RSB.4895CV..]
Operating temperature	-20° to +65°C (-4° to +149°F)	RSBD/RSBT.16: -20°C to 60°C (-4°F to +140°F) RSBT..25: -20°C to 55°C (-4°F to +131°F) RSBT..32: -20°C to 50°C (-4°F to +122°F)	-20° to +60°C (-4° to +140°F)
Storage temperature	-30° to +70°C (-22° to +158°F)	-40°C to +80°C (-40°F to +176°F)	-40°C to +85°C (-40°F to +185°F)
Wrong Phase sequence indication	N/A	Yes	Yes
Degree of Protection	IP20	IP20	IP20 (Housing) / IP10 (Terminals)
Approvals	CE - UL - cUL	RSBD: CE - cULus - CCC RSBT: CE - cULus** - VDE***	CE - UL - cUL

* For RSBS23...V22..., auxiliary terminal is 10.5mm protruding
** For options V50/ V51/ V61
*** Up to 15 AAC (Up to 32AAC for RSBT.HPV models only)
**** Assigned compressor rating @ 230V

Soft starters

Centrifugal pump soft starters

Types	RSWT...V00	RSWT...V10
Soft-starters with dedicated, self-learning algorithm for centrifugal pumps.		
Dimensions (mm)	RSWT4012/RSWT4016: 130 x 45 x 125 RSWT4025: 157 x 45 x 125	RSWT..12/RSWT..16: 130 x 45 x 125 RSWT..25: 157 x 45 x 125

Features	Three phase controlled, internally bypassed. Self-learning algorithm dedicated to centrifugal pumps. 1-knob adjustment for ramp-up and ramp-down.	Compact three phase controlled soft starter dedicated to centrifugal pumps. Self-learning algorithm for pump start and stop. Integrated overload protection (Class 10). Manual or auto-recovery of alarms.
----------	---	--

Control specifications

Control input range	Option E: 110 - 400 VAC Option F: 24 VAC/DC	Option E: 110 - 400 VAC [RSWT40..] Option F: 24 VAC/DC [RSWT40/RSWT60...] Option G: 100 - 240 VAC [RSWT60..]
Controlled phases	3	3

Output specifications



Rated operational current AC 53b	12/16/25A	12/16/25A
Operational voltage	220 - 400 VAC (-15%, +10%)	RSWT40: 220 - 400 VAC (-15%, +10%) RSWT60: 220 - 600 VAC (-15%, +10%)
Overload current profile @ 40°C	AC53b:4-6-174: RSWT4012/RSWT4016 AC53b:3.5-5:175: RSWT4025	AC53b:4-6-174: RSWT..12/RSWT..16 AC53b:3.5-5:175: RSWT..25
Number of starts per hour @40°C	20	20
Assigned motor rating @ 400 V	RSWT4012: 5.5kW (5HP) RSWT4016: 7.5kW (7.5HP) RSWT4025: 11kW (10HP)	RSWT..12: 5.5kW (5HP) RSWT..16: 7.5kW (7.5HP) RSWT..25: 11kW (10HP)

General specifications



Internally bypassed	Yes	Yes
Operational frequency	50/60 Hz +/- 10%	50/60 Hz +/- 10%
Ramp up/Ramp down	1 - 20s	1 - 20s/0 - 20s
Initial torque	Self-adjusted by RSWT	Self-adjusted by RSWT
Operating temperature	-20°C to 60°C (-4°F to +140°F)	-20°C to 60°C (-4°F to +140°F)
Storage temperature	-40°C to +80°C (-40°F to +176°F)	-40°C to +80°C (-40°F to +176°F)
Integrated overload protection	No	Yes (Class 10)
Degree of Protection	IP20	IP20
Approvals	CE - cULus - (CCC - pending)	CE - cULus - (CCC - pending)

Soft starters

Motor control - Soft start and stop

Types	RSHR 3-Phase	RSGD	RSDR
Soft starting and stopping of 3-phase motors. Starting / stopping time and initial torque can be independently adjusted			
Dimensions (mm)	158.5 x 90 x 90	106 x 45 x 125 [RSGD..12.. - RSGD..32..] 150 x 45 x 132 [RSGD..37.. - RSGD..45..]	RSDR40055B: 120.5 x 135 x 136 RSDR...6B - 97B: 145.5 x 203 x 167 RSDR..132B - 195B: 155.0 x 203 x 165 RSDR..230B - 500B: 196.0 x 204 x 320
Features	Three phase controlled. In Line or In Delta (6-wire) connection. Wrong Phase sequence detection. Motor PTC protection. Phase Loss Detection	Compact two phase controlled general purpose soft starter. Self-learning algorithm for better current balancing. Improved current reduction capability. Optional alarm and top of ramp relay output	Rotary knobs to adjust start/stop/initial torque parameters. Internally bypassed. Ramp-up/Ramp-down time up to 30s
Control specifications			
Control input range	24-550 VAC/DC (Option "C") 24-600 VAC/DC (Option "D")	Option E: 110 - 400 VAC [RSGD40..] Option F: 24 VAC/DC [RSGD40..] Option G: 100 - 240 VAC [RSGD60..]	24 VDC / 110 VAC (externally supplied)
Controlled phases	3	2	2
Output specifications			
Rated operational current AC 53b	25 A [RSHR..25...] 32 A [RSHR..32...]	12/16/25/32/37/45 A	55/ 66/ 80/ 97/ 132/ 160/ 195/ 230/ 280/ 350/ 430/ 500
Operational voltage	127/220 VAC [RSHR22..] 230/400 VAC [RSHR40..] 277/480 VAC [RSHR48..] 346/600 VAC [RSHR60..] 220-480 VAC [RSHRM] 400-480 VAC [RSHRM]	RSGD40: 220 - 400 VAC (-15%, +10%) RSGD60: 220 - 600 VAC (-15%, +10%)	RSDR40: 230 - 460 VAC (-15%, +10%)
Overload current profile @ 40°C	25 A: AC-53a: 4-4:50-7 [RSHR2225.../ RSHR4025...] 25 A: AC-53a: 4-4:50-3 [RSHR4825.../ RSHR6025.../RSHRM] 32 A: AC-53a: 4-4:50-50 [RSHR..32...]	12/16/25 A: AC-53b: 3 - 5 : 175 32/37 A: AC-53b: 4 - 6 : 354 45 A: AC-53b: 3.5 - 5 : 355	AC53b: 3-5:355
Number of starts per hour @40°C	7 [RSHR2225.../RSHR4025...] 3 [RSHR4825.../RSHR6025.../RSHRM] 50 [RSHR..32...]	20: [RSGD..12/RSGD..16/RSGD..25] 10: [RSGD..32/RSGD..37/RSGD..45]	10 for (light loads) 5 for (Heavy loads)
Assigned motor rating @ 400 V	In Line Connection/In Delta Connection RSHR4025CV.. 11 kW [10 HP] / 20 kW [20 HP] RSHR4032CV.. 15 kW [20 HP] / 22kW [30 HP]	RSGDxx12/RSGDxx16/ RSGDxx25 3 kW (3 HP) / 4 kW (5 HP) / 5.5 kW (7.5 HP) 5.5 kW (5.0 HP) / 7.5 kW (7.5 HP) / 11 kW (10 HP) RSGDxx32/RSGDxx37/ RSGDxx45 9 kW (10 HP) / 9kW (10 HP) / 11 kW (15 HP) 15 kW (15 HP) / 18.5 kW (20 HP) / 22 kW (25 HP)	RSDR40055B (30 kW/42 HP) RSDR40066B (37 kW/54 HP) RSDR40080B (45 kW/60 HP) RSDR40097B (55 kW/75 HP) RSDR40132B (75 kW/110 HP) RSDR40160B (90 kW/130 HP) RSDR40195B (110 kW/160 HP) RSDR40230B (132 kW/190 HP) RSDR40280B (160 kW/230 HP) RSDR40350B (200 kW/290 HP) RSDR40430B (250 kW/350HP) RSDR40500B (280 kW/400 HP)
General specifications			
Internally bypassed	No	Yes	Yes
Operational frequency	50/60 Hz ±10%	50/60 Hz ± 10%	50/60 Hz +/- 2 Hz
Ramp up/Ramp down	1-10s / 0-30s; 0-1s / 0-1s [RSHR...V38]	1 - 20s/0 - 20s	1 - 30s/0 - 30s
Initial torque	0-70%	0 - 85%	30 - 100%
Operating temperature	-20°C to +60°C (-4°F to +140°F)	-20°C to 60°C (-4°F to +140°F)	0°C to 60°C (+32°F to +140°F)
Storage temperature	-50°C to +85°C (-58°F to +185°F)	-40°C to +80°C (-40°F to +176°F)	-25°C to +60°C (-13°F to +140°F)
Wrong Phase sequence indication	Yes	Yes	No
Degree of Protection	IP 20	IP20	IP20 - RSDR40055B up to RSDR40097B IP00 - RSDR40132B up to RSDR40500B
Approvals	CE - UL - cUL - CCC	CE - cULus - CCC	CE - cULus*





Soft starters

	Proportional controller	Reversing
Types	RSC..AA..+RSO...	RR2A
Phase angle control of 3-phase motors (AC53a) and heaters (AC51a). Reversing motor relay (RR..)		
Dimensions (mm)	65 x 103 x 74	41 x 103 x 74
Features	Proportional output for motor/heater control according to user controlled analogue input	Reversing with interlock, optoisolation 2-pole change-over, built-in transient overvoltage protection, interlocking reversing, LED status indication
Control specifications		
Control input range	0-20 mA (A-input) 4-20 mA (B-input)	10-40 VDC
Max. input current	20 mA	20 mA
Control supply	10 - 32 VDC	-
Max. supply current	180 mA	-
Output specifications		
Rated operational current		
AC 51a	16Arms [RSO..10] 25Arms [RSO..25] 50Arms [RSO..50] 90Arms [RSO..90] 110Arms [RSO..110]	-
AC 53a	5 Arms [RSO..25] 15 Arms [RSO..50] 30 Arms [RSO..90] 40 Arms [RSO..110]	5 Arms [RR2A40D150/RR2A48D220] 11 Arms [RR2A40D400/RR2A48D550]
Overload current profile		5A: AC-53a : 6-6 : 100-60 11A: AC-53a : 8-3 : 100-40**
Operational voltage	150-250 Vrms [RSO22..] 220-420 Vrms [RSO40..] 400-510 Vrms [RSO48..] 400-625 Vrms [RSO60..]	400 Vrms [RR2A40D...] 480 Vrms [RR2A48D...]
General specifications		
Connections	Screw type with clamp	Screw type with clamp
Operating temperature	-20°C to +70°C	-20°C to +80°C
Storage temperature	-40°C to +100°C	-40°C to +100°C
Approvals/Marks	CE - UL - CSA	CE - UL - cUL
Reference		
	Control module	5 A
	RSC-AAM60	RR2A40D150 (1.5 kW)
	Output module: 400 VAC	RR2A40D400 (4.0 kW)
	25 A: RSO4025 (4 kW*)	11 A
	50 A: RSO4050 (11 kW*)	RR2A48D220 (2.2 kW)
	90 A: RSO4090 (15 kW*)	RR2A48D550 (5.5 kW)
	110 A: RSO40110 (22 kW*)	

* Output module can be 200, 400, 480, 600 VAC
* Correct heatsink assembly required. For further details please consult datasheet.
** Applicable when device is mounted to heatsink type RHS301





Motor protection relays

DMPU series



Types	Main module	Measurement module (5A)	Measurement module (65A)	I/O module
				
Dimensions HxWxD (mm)	35.5 x 90 x 63.2	53.5 x 90 x 63.2	53.5 x 90 x 92	17.5 x 90 x 63.2
Features	Motor start/stop, reverse, start/delta, ANSI motor protection functions, remote control and management, warning, dataloggers	3-phase voltage and split-core current measurement	3-phase voltage and pass through current measurement	Connected to DMPUC-PRB or DMPUC-MTB adds 2 inputs and 2 outputs to the system. Up to 10 modules can be used
Technical specifications				
Power supply	24 VDC \pm 20%	24 VDC from the main module	24 VDC from the main module	24 VDC from the main module
Inputs	3, configurable as contact or temperature	3-phase voltage: 100 to 690 V 3-phase current: 5A (for higher current use CTD currents transformers series)	3-phase voltage: 100 to 690 V 3-phase current: up to 65 A	2, configurable as contact or temperature
Outputs		2 x SPST relay	2 x SPST relay	2 x SPST relay
Communication	Profibus DPV1 (DMPUC-PRB), Modbus TCP/IP (DMPUC-MTB), Modbus RTU (all)	Via cable to the main module	Via cable to the main module	Plugged in to the main module
General specifications				
Operating temperature	-25° to +55°C (-13°F to 131°F)	-25° to +55°C (-13°F to 131°F)	-25° to +55°C (-13°F to 131°F)	-25° to +55°C (-13°F to 131°F)
Degree of Protection	IP 20	IP 20	IP 20	IP 20
Mounting	DIN-rail	DIN-rail	DIN-rail	DIN-rail
Approvals	CE, cULus listed, C-TIC	CE, cULus listed, C-TIC	CE, cULus listed, C-TIC	CE, cULus listed, C-TIC
References				
	DMPUC-PRB DMPUC-MTB	DMPUC-05	DMPUC-65	DMPUC-R2

Motor protection relays

DMPU series

Types	Operator interface	Earth leakage module	Core balance transformers	Programming software
				
Dimensions HxWxD (mm)	96 x 48 x 88.5	17.5 x 90 x 63.2	Hole Ø 35, 70, 120 or 210	
Features	Provides 2x8 characters lines display and 4 fully programmable keys	Connected to DMPUC-PRB or DMPUC-MTB adds direct earth leakage measurement and protection according to EN 60947-2. Ranges: 30 mA to 30A	Core balance transformers for DMPUC-EL	Set parameters, program the control and monitoring functions of the system, monitor data, download dataloggers. Program operator interface pages and key functions
Technical specifications				
Power supply	24 VDC ±20%	24 VDC from the main module	None	
Inputs		Earth leakage, for transformers 250/1 to 1000/1, 3 as contact		Motor data, desired functions
Outputs		1 x SPST relay dedicated to earth leakage alarm		Configuration file, dataloggers in Excel format files
Communication	RS485 Modbus RTU ports	Plugged in to the main module		Using Modbus RTU or TCP/IP port of the main module
General specifications				
Operating temperature	-25° to +60°C (-13°F to 140°F)	-25° to +55°C (-13°F to 131°F)		
Degree of Protection	Front: IP65 Connections: IP20	IP 20		
Mounting	Front panel	DIN-rail	Back panel	Windows XP, Windows Vista, Windows 7
Approvals	cULus listed	CE, cULus, C-TIC (with CTG)	CE, cULus, C-TIC (with DMPUC-EL)	
References				
	DMPUC-HMI	DMPUC-EL	CTG035 CTG070 CTG120 CTG210	DMPU-PS DMPU-PSHMI





Variable speed drives

VariFlex ² variable speed drives - RVEF series				Accessories
Types	Size A	Size B	Braking unit	
Drives, Inverters				
Dimensions (mm)	132 x 77 x 130.5	132 x 118 x 148	132 x 77 x 130.5	
Features	Maximum overload of 150% of rated current for 60s, conforms to EN 61800-3 for the 2 nd environment, parameters accessible via keypad, knob and PC, optional RS485 serial communications, optional copy card for drive-to-drive parameter transfer and storage and optional remote keypad, built-in PID control	Maximum overload of 150% of rated current for 60s, conforms to EN 61800-3 for the 2 nd environment, parameters accessible via keypad, knob and PC, optional RS485 serial communications, optional copy card for drive-to-drive parameter transfer and storage and optional remote keypad, built-in PID control	External braking unit for RVEF frequency drives, with 240 VAC and 480 VAC inverter voltage. Applicable motor rated capacity up to 2.2 kW	
Technical specifications				
AC supply voltage	1-ph, 100-120 VAC; 1-ph, 200-240 VAC; 3-ph, 200-240 VAC;	1-ph, 200-240 VAC; 3-ph, 200-240 VAC; 3-ph, 380-480 VAC;		
AC supply frequency	50/60 Hz	50/60 Hz		
Output voltage	3-ph, 0-240 V	3-ph, 0-240 V 3-ph, 0-480 V		
Output frequency	0-200 Hz	0-200 Hz		
100% RMS output current	1.7 A [RVEFA...020] 3.1 A [RVEFA...040] 4.2 A [RVEFA...075]	7.5 A [RVEFB120150 - RVEFB320150] 10.5 A [RVEFB120220 - RVEFB320220] 2.3 A [RVEFB340075] 3.8 A [RVEFB340150] 5.2 A [RVEFB340220]		
Input displacement factor (cos φ)	> 0.97	> 0.97		
General specifications				
Operating temperature	-10°C to +50°C	-10°C to +50°C	-10°C to +50°C	
Storage temperature	-20°C to +60°C	-20°C to +60°C	-20°C to +70°C	
Degree of Protection	IP 20	IP 20	IP 20	
Power connections	Screw terminals	Screw terminals		
Control connections	Screw terminals	Screw terminals		
Drive connections			Screw terminals	
Mounting	DIN-rail or panel mounting	DIN-rail or panel mounting	DIN-rail or panel mounting	
Integrated cooling fan	yes	yes		
Switching frequency	4 to 16 kHz	4 to 16 kHz		
Approvals	CE - cULus	CE - cULus	CE - cULus	
Braking unit				
Rate discharge current			240 V : 7.5 A	480 V : 3 A
Max. discharge current			240 V : 15 A	480 V : 7.5 A
References				
100 - 120 VAC, 1-phase	RVEFA110020 (0.20 kW-0.25 HP) RVEFA110040 (0.40 kW-0.50 HP) RVEFA110075 (0.75 kW-1.00 HP)			
200 - 240 VAC, 1-phase	RVEFA120020(F) (0.20 kW-0.25 HP) RVEFA120040(F) (0.40 kW-0.50 HP) RVEFA120075(F) (0.75 kW-1.00 HP)	RVEFB120150(F) (1.50 kW-2.00 HP) RVEFB120220(F) (2.20 kW-3.00 HP)		RVFTBU230
200 - 240 VAC, 3-phase	RVEFA320020 (0.20 kW-0.25 HP) RVEFA320040 (0.40 kW-0.50 HP) RVEFA320075 (0.75 kW-1.00 HP)	RVEFB320150 (1.50 kW-2.00 HP) RVEFB320220 (2.20 kW-3.00 HP)		
380 - 480 VAC, 3-phase		RVEFB340075(F) (0.75 kW-1.00 HP) RVEFB340150(F) (1.50 kW-2.00 HP) RVEFB340220(F) (2.20 kW-3.00 HP)		RVFTBU480

(F): equipped with built-in filter

Variable speed drives

VariFlex² variable speed drives - RVDF series

Types	Size A IP20	Size B IP20	Size A IP65	Size B IP65
Drives, Inverters				
Dimensions (mm)	132 x 72 x 118	140 x 118 x 171	205 x 134 x 174	295 x 232 x 181
Features	Maximum overload of 150% for 60 s, conforms to EN61800-3 for the 2 nd environment. Parameters settings by keypad	Maximum overload of 150% for 60 s, conforms to EN61800-3 for the 2 nd environment. Parameters settings by keypad	Maximum overload of 150% for 60 s, conforms to EN61800-3 for the 2 nd environment. Parameters settings by keypad. IP65 models with power switch, reverse / forward switch and potentiometer	Maximum overload of 150% for 60 s, conforms to EN61800-3 for the 2 nd environment. Parameters settings by keypad. IP65 models with power switch, reverse / forward switch and potentiometer

Technical specifications

AC supply voltage	1-ph, 100-120 VAC 1-ph, 200-240 VAC	1-ph, 200-240 VAC 3-ph, 380-480 VAC	1-ph, 200-240 VAC	1-ph, 200-240 VAC 3-ph, 380-480 VAC
AC supply frequency	50/60 Hz	50/60 Hz	50/60 Hz	50/60 Hz
Output voltage	3-ph, 0-240 VAC	3-ph, 0-240 VAC 3-ph, 0-480 VAC	3-ph, 0-240 VAC	3-ph, 0-240 VAC 3-ph, 0-480 VAC
Output frequency	0-200 Hz	0-200 Hz	0-200 Hz	0-200 Hz
100% RMS output current	1.4 A [RV DFA...020] 2.3 A [RV DFA...040] 4.2 A [RV DFA...075]	7.5 A [RVDFB1...150] 10.5 A [RVDFB1...220] 2.3 A [RVDFB3...075] 3.8 A [RVDFB3...150] 5.2 A [RVDFB3...220]	1.4 A [RV DFA...020] 2.3 A [RV DFA...040] 4.2 A [RV DFA...075]	7.5 A [RVDFB1...150] 10.5 A [RVDFB1...220] 2.3 A [RVDFB3...075] 3.8 A [RVDFB3...150] 5.2 A [RVDFB3...220]
Input displacement factor (cos φ)	> 0.97	> 0.97	> 0.97	> 0.97

General specifications



Operating temperature	-10°C to +50°C	-10°C to +50°C	-10°C to +50°C	-10°C to +50°C
Degree of Protection	IP 20	IP 20	IP 65	IP 65
Power connections	Screw terminals	Screw terminals	Screw terminals	Screw terminals
Control connections	Screw terminals	Screw terminals	Screw terminals	Screw terminals
Mounting	DIN-rail or panel mounting	DIN-rail or panel mounting	Panel mounting	Panel mounting
Integrated cooling fan	yes	yes	yes	yes
Switching frequency	4 to 16 kHz	4 to 16 kHz	4 to 16 kHz	4 to 16 kHz
Approvals	CE - cULus	CE - cULus	CE - cULus	CE - cULus

References

100-120 VAC, 1-phase	RV DFA110020 RV DFA110040 RV DFA110075			
200-240 VAC, 1-phase	RV DFA120020F RV DFA120040F RV DFA120075F	RVDFB120150F RVDFB120220F	RV DFA120020FES RV DFA120040FES RV DFA120075FES	RVDFB120150FES RVDFB120220FES
380-480 VAC, 3-phase		RVDFB340075F RVDFB340150F RVDFB340220F		RVDFB340075FES RVDFB340150FES RVDFB340220FES

Variable speed drives

VariFlex² variable speed drives - RVCF series

Types	Size A	Size B	Size C
Drives, Inverters			
Dimensions (mm)	163 x 90 x 147	187.1 x 128 x 148	260 x 186 x 195
Features	Maximum overload of 150% of rated current for 60s, conforms to EN 61800-3 for the 2 nd environment, parameters accessible via keypad, knob and PC, optional serial communications, optional copy card for drive-to-drive parameter transfer and storage and optional keypad extension cable. Built-in PLC function and PID control	Maximum overload of 150% of rated current for 60s, conforms to EN 61800-3 for the 2 nd environment, parameters accessible via keypad, knob and PC, optional serial communications, optional copy card for drive-to-drive parameter transfer and storage and optional keypad extension cable. Built-in PLC function and PID control	Maximum overload of 150% of rated current for 60s, conforms to EN 61800-3 for the 2 nd environment, parameters accessible via keypad, knob and PC, optional serial communications, optional copy card for drive-to-drive parameter transfer and storage and optional keypad extension cable. Built-in PLC function and PID control

Technical specifications

AC supply voltage	3-ph, 380-480 VAC	3-ph, 200-240 VAC 3-ph, 380-480 VAC	3-ph, 200-240 VAC 3-ph, 380-480 VAC
AC supply frequency	50/60 Hz	50/60 Hz	50/60 Hz
Output voltage	3-ph, 0-480 V	3-ph, 0-240 V 3-ph, 0-480 V	3-ph, 0-240 V 3-ph, 0-480 V
Output frequency	0-650 Hz	0-650 Hz	0-650 Hz
100% RMS output current	2.3A [RVCF3400075] 3.8A [RVCF3400150]	17.5A [RVCFB3200370] 5.2A [RVCFB3400220] 8.8A [RVCFB3400370]	26A [RVCF3200550] 35A [RVCF3200750] 13A [RVCF3400550] 17.5A [RVCF3400750] 25A [RVCF3401100]
Input displacement factor (cos φ)	> 0.97	> 0.97	> 0.97

General specifications

Operating temperature	-10°C to +50°C	-10°C to +50°C	-10°C to +50°C
Storage temperature	-20°C to +60°C	-20°C to +60°C	-20°C to +60°C
Degree of Protection	IP 20	IP 20	IP 20
Power connections	Screw terminals	Screw terminals	Screw terminals
Control connections	Screw terminals	Screw terminals	Screw terminals
Mounting	DIN-rail or panel mounting	DIN-rail or panel mounting	Panel mounting
Integrated cooling fan	yes	yes	yes
Switching frequency	2 to 16 kHz	2 to 16 kHz	2 to 16 kHz
Approvals	CE - cULus	CE - cULus	CE - cULus

References

220-240 VAC, 3-phase		RVCFB3200370 (3.70 kW - 5.00 HP)	RVCF3200550 (5.50 kW - 7.50 HP) RVCF3200750 (7.50 kW - 10.0 HP)
380-480 VAC, 3-phase	RVCF3400075(F) (0.75 kW - 1.00 HP) RVCF3400150(F) (1.50 kW - 2.00 HP)	RVCFB3400220(F) (2.20 kW - 3.00 HP) RVCFB3400370(F) (3.70 kW - 5.00 HP)	RVCF3400550(F) (5.50 kW - 7.50 HP) RVCF3400750(F) (7.50 kW - 10.0 HP) RVCF3401100(F) (11.0 kW - 15.0 HP)

(F): equipped with built-in filter

Variable speed drives

VariFlex² variable speed drives - RVCF series

Types	Size D	Size E
Drives, Inverters		
Dimensions (mm)	360 x 265 x 247.5	553 x 269 x 303.6

Features	Size D	Size E
	Maximum overload of 150% of rated current for 60s, conforms to EN 61800-3 for the 2 nd environment, parameters accessible via keypad, knob and PC, optional serial communications, optional copy card for drive-to-drive parameter transfer and storage and optional keypad extension cable. Built-in PLC function and PID control	Maximum overload of 150% of rated current for 60s, conforms to EN 61800-3 for the 2 nd environment, parameters accessible via keypad, knob and PC, optional serial communications, optional copy card for drive-to-drive parameter transfer and storage and optional keypad extension cable. Built-in PLC function and PID control

Technical specifications

AC supply voltage	3-ph, 200-240 VAC 3-ph, 380-480 VAC	3-ph, 200-240 VAC 3-ph, 380-480 VAC
AC supply frequency	50/60 Hz	50/60 Hz
Output voltage	3-ph, 0-240 V 3-ph, 0-480 V	3-ph, 0-240 V 3-ph, 0-480 V
Output frequency	0-650 Hz	0-650 Hz
100% RMS output current	48 A [RVCFD3201100] 64 A [RVCFD3201500] 80 A [RVCFD3201850] 32 A [RVCFD3401500] 40 A [RVCFD3401850] 48 A [RVCFD3402200]	96 A [RVCFE3202200] 130 A [RVCFE3203000] 64 A [RVCFE3403000] 80 A [RVCFE3403700]
Input displacement factor (cos φ)	> 0.97	> 0.97

General specifications

Operating temperature	-10°C to +50°C	-10°C to +50°C
Storage temperature	-20°C to +60°C	-20°C to +60°C
Degree of Protection	IP 20	IP 00
Power connections	Screw terminals	Screw terminals
Control connections	Screw terminals	Screw terminals
Mounting	Panel mounting	Panel mounting
Integrated cooling fan	yes	yes
Switching frequency	2 to 16 kHz	2 to 16 kHz
Approvals	CE - cULus	CE - cULus

References

220-240 VAC, 3-phase	RVCFD3201100 (11.0 kW - 15.0 HP) RVCFD3201500 (15.0 kW - 20.0 HP) RVCFD3201850 (18.5 kW - 25.0 HP)	RVCFE3202200 (15.0 kW - 20.0 HP)
380-480 VAC, 3-phase	RVCFD3401500 (15.0 kW - 20.0 HP) RVCFD3401850 (18.5 kW - 25.0 HP) RVCFD3402200 (22.0 kW - 30.0 HP)	

Limit switches - Miniature type

Head Types	PO Plain plunger	PY Nylon roller plunger	P8 Cross nylon roller plunger	RT Ø14 Nylon roller lever
				

Dimensions HxWxD (mm)	35 x 60 x 16 1m PVC cable	35 x 70 x 16 1m PVC cable	35 x 70 x 16 1m PVC cable	35 x 92 x 29.5 1m PVC cable
-----------------------	------------------------------	------------------------------	------------------------------	--------------------------------

PS31M (metal*) References contact block

Snap 1NO+1NC	⊕	PS31M-CS11PO-M00	PS31M-CS11PY-M00	PS31M-CS11P8-M00	PS31M-CS11RT-M00
Slow 1NO+1NC	⊕	PS31M-CT11PO-M00	PS31M-CT11PY-M00	PS31M-CT11P8-M00	PS31M-CT11RT-M00

				
--	---	---	---	---

Dimensions WxHxD (mm)	31.5 x 60 x 16 1m PVC cable	31.5 x 70 x 16 1m PVC cable	31.5 x 70 x 16 1m PVC cable	31.5 x 92 x 29.5 1m PVC cable
-----------------------	--------------------------------	--------------------------------	--------------------------------	----------------------------------

PS21M (metal*) References contact block

Snap 1NO+1NC	⊕	PS21M-CS11PO-M00	PS21M-CS11PY-M00	PS21M-CS11P8-M00	PS21M-CS11RT-M00
Slow 1NO+1NC	⊕	PS21M-CT11PO-M00	PS21M-CT11PY-M00	PS21M-CT11P8-M00	PS21M-CT11RT-M00

Head Types	Plain plunger with fixing nuts	Roller plunger with fixing nuts	Cross roller plunger with fixing nuts	R1 Adjustable lever with Ø18 nylon roller
				

Dimensions (mm) WxHxD	35 x 74 x 16 1m PVC cable	35 x 84.8 x 16 1m PVC cable	35 x 84.8 x 16 1m PVC cable	35 x 86...158 x 38.9 1m PVC cable
-----------------------	------------------------------	--------------------------------	--------------------------------	--------------------------------------

PS31M (metal*) References contact block

Snap 1NO+1NC	⊕	PS31M-CS11PO-M0L	PS31M-CS11PY-M0L	PS31M-CS11P8-M0L	PS31M-CS11RT-M0L
Slow 1NO+1NC	⊕	PS31M-CT11PO-M0L	PS31M-CT11PY-M0L	PS31M-CT11P8-M0L	PS31M-CT11RT-M0L

				
--	---	---	---	---

Dimensions WxHxD (mm)	31.5 x 74 x 16 1m PVC cable	31.5 x 84.8 x 16 1m PVC cable	31.5 x 84.8 x 16 1m PVC cable	31.5 x 86...158 x 38.9 1m PVC cable
-----------------------	--------------------------------	----------------------------------	----------------------------------	--

PS21M (metal*) References contact block

Snap 1NO+1NC	⊕	PS21M-CS11PO-M0L	PS21M-CS11PY-M0L	PS21M-CS11P8-M0L	PS21M-CS11RT-M0L
Slow 1NO+1NC	⊕	PS21M-CT11PO-M0L	PS21M-CT11PY-M0L	PS21M-CT11P8-M0L	PS21M-CT11RT-M0L

General specifications (for all types)

Mechanical life	>10 000 000 cycles	Rated thermal current (Ith)	10 A (IEC947-5-1)
Operating frequency	3600 cycles/h	Rated insulation voltage (Ui)	400 VAC (IEC947-5-1)
Operating Speed	1...1500 mm/s	Insulation resistance (500 VDC)	2 MΩ
Rated operating current (Ie)	1.5 A/230 V (Cat. AC15)	Degree of protection	IP 67
	1.1 A/24 V (Cat. DC13)	Approvals	CE - UL (upon request)

* Also available in thermoplastic (T type)

Limit switches - Limit type

Head Types **PO** Plain plunger **PR** Roller plunger **RH** Plastic roller plunger **RT** Nylon roller lever

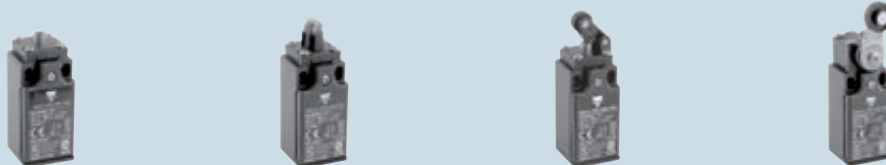

Family: L

	PS21	PS21	PS21	PS21
	Thermoplastic*	Thermoplastic*	Thermoplastic*	Thermoplastic*
Dimensions WxHxD (mm)	30.3 x 73 x 30	30.3 x 84 x 30	30.3 x 92 x 30	30.3 x 106 x 45

References contact block

Snap 1NO+1NC	⊕	PS21L-PS11PO-T00	PS21L-PS11PR-T00	PS21L-PS11RH-T00	PS21L-PS11RT-T00
Slow 1NO+1NC	⊕	PS21L-PT11PO-T00	PS21L-PT11PR-T00	PS21L-PT11RH-T00	PS21L-PT11RT-T00
Slow Ov.**1NO+1NC	⊕	PS21L-PO11PO-T00	PS21L-PO11PR-T00	PS21L-PO11RH-T00	PS21L-PO11RT-T00
Slow 2NO		PS21L-PT20PO-T00	PS21L-PT20PR-T00	PS21L-PT20RH-T00	PS21L-PT20RT-T00
Slow 2NC	⊖	PS21L-PT02PO-T00	PS21L-PT02PR-T00	PS21L-PT02RH-T00	PS21L-PT02RT-T00
Snap 2NC	⊖	PS21L-PS02PO-T00	PS21L-PS02PR-T00	PS21L-PS02RH-T00	PS21L-PS02RT-T00

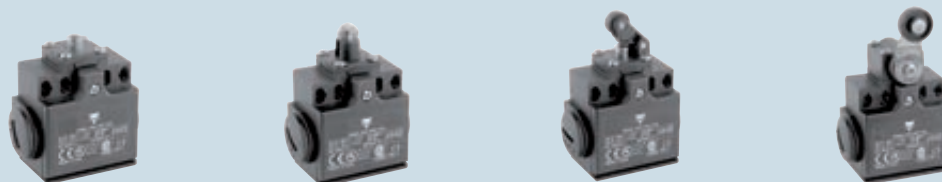

Family: L

	PS42	PS42	PS42	PS42
	Thermoplastic*	Thermoplastic*	Thermoplastic*	Thermoplastic*
Dimensions HxWxD (mm)	57 x 66 x 33	57 x 77 x 33	57 x 85 x 33	57 x 99 x 45

References contact block

Snap 1NO+1NC	⊕	PS42L-PS11PO-T00	PS42L-PS11PR-T00	PS42L-PS11RH-T00	PS42L-PS11RT-T00
Slow 1NO+1NC	⊕	PS42L-PT11PO-T00	PS42L-PT11PR-T00	PS42L-PT11RH-T00	PS42L-PT11RT-T00
Slow Ov.**1NO+1NC	⊕	PS42L-PO11PO-T00	PS42L-PO11PR-T00	PS42L-PO11RH-T00	PS42L-PO11RT-T00
Slow 2NO		PS42L-PT20PO-T00	PS42L-PT20PR-T00	PS42L-PT20RH-T00	PS42L-PT20RT-T00
Slow 2NC	⊖	PS42L-PT02PO-T00	PS42L-PT02PR-T00	PS42L-PT02RH-T00	PS42L-PT02RT-T00
Snap 2NC	⊖	PS42L-PS02PO-T00	PS42L-PS02PR-T00	PS42L-PS02RH-T00	PS42L-PS02RT-T00

Limit switches - Limit type

Head types

W1 Adjustable lever with Ø50 rubber roller

R1 Adjustable lever with Ø18 nylon roller

BE Ø18 nylon roller lever

LW Stainless steel spring cat whisker



Family: L

	PS21	PS21	PS21	PS21
	Thermoplastic*	Thermoplastic*	Thermoplastic*	Thermoplastic*
Dimensions WxHxD (mm)	30.3 x (126.5-186.5) x 52	30.3 x (98.5-170.5) x 45.5	30.3 x 114 x 33	30.3 x 188 x 30

References contact block

Snap 1NO+1NC	⊕	PS21L-PS11W1-T00	PS21L-PS11R1-T00	PS21L-PS11BE-T00	PS21L-PS11LW-T00
Slow 1NO+1NC	⊕	PS21L-PT11W1-T00	PS21L-PT11R1-T00	PS21L-PT11BE-T00	PS21L-PT11LW-T00
Slow Ov.**1NO+1NC	⊕	PS21L-PO11W1-T00	PS21L-PO11R1-T00	PS21L-PO11BE-T00	PS21L-PO11LW-T00
Slow 2NO		PS21L-PT20W1-T00	PS21L-PT20R1-T00	PS21L-PT20BE-T00	PS21L-PT20LW-T00
Slow 2NC	⊖	PS21L-PT02W1-T00	PS21L-PT02R1-T00	PS21L-PT02BE-T00	PS21L-PT02LW-T00
Snap 2NC	⊖	PS21L-PS02W1-T00	PS21L-PS02R1-T00	PS21L-PS02BE-T00	PS21L-PS02LW-T00



Family: L

	PS42	PS42	PS42	PS42
	Thermoplastic*	Thermoplastic*	Thermoplastic*	Thermoplastic*
Dimensions HxWxD (mm)	57 x (118.5-177) x 33	57 x (91.5-163.5) x 33	57 x 107 x 33	57 x 181 x 45

References contact block

Snap 1NO+1NC	⊕	PS42L-PS11W1-T00	PS42L-PS11R1-T00	PS42L-PS11BE-T00	PS42L-PS11LW-T00
Slow 1NO+1NC	⊕	PS42L-PT11W1-T00	PS42L-PT11R1-T00	PS42L-PT11BE-T00	PS42L-PT11LW-T00
Slow Ov.**1NO+1NC	⊕	PS42L-PO11W1-T00	PS42L-PO11R1-T00	PS42L-PO11BE-T00	PS42L-PO11LW-T00
Slow 2NO		PS42L-PT20W1-T00	PS42L-PT20R1-T00	PS42L-PT20BE-T00	PS42L-PT20LW-T00
Slow 2NC	⊖	PS42L-PT02W1-T00	PS42L-PT02R1-T00	PS42L-PT02BE-T00	PS42L-PT02LW-T00
Snap 2NC	⊖	PS42L-PS02W1-T00	PS42L-PS02R1-T00	PS42L-PS02BE-T00	PS42L-PS02LW-T00

General specifications (for all types)

Degree of protection	IP 65 (plastic body) IP 66 (metal body)	Rated operational current	
Rated insulation voltage plastic body	(Ui)	le/AC-15 230 VAC	3.1 A
	according to IEC 60947-1 and EN 60947-1	500 V	le/AC-13 24 VDC
according to UL 508, CSA C22-2 n°14	A 600, Q 600	Electrical durability (according to IEC 60947-5-1 annex C)	
Rated insulation voltage metal body	(Ui)	max. switching frequency Cycles/h	3600
	according to IEC 60947-1 and EN 60947-1	400 V (plastic body)	load factor
according to UL 508, CSA C22-2 n°14	500 V (PS31, PS43)	Air temperature near the device	
	A 300, Q 300 (PS21, PS42)	during operation	-25 to +70°C
	A 600, Q 600 (PS31, PS43)	for storage	-30 to +80°C
Conventional enclosed thermal voltage (Uimp)	6 kV	Approvals	CE - UL - CSA

* also available in metal (M type)

** Ov. : overlapping travel paths

Limit switches - Limit type

Head types	PO Plain plunger	PR Roller plunger	RH Plastic roller lever	RT Nylon roller lever
				

Family: L

	PS43 Metal	PS43 Metal	PS43 Metal	PS43 Metal
Dimensions HxWxD (mm)	66 x 102.5 x 43	66 x 115.5 x 43	67 x 129.5 x 43	66 x 128.5 x 61.5

References contact block

Snap 1NO+1NC	↔	PS43L-PS11PO-M00	PS43L-PS11PR-M00	PS43L-PS11RH-M00	PS43L-PS11RT-M00
Slow 1NO+1NC	↔	PS43L-PT11PO-M00	PS43L-PT11PR-M00	PS43L-PT11RH-M00	PS43L-PT11RT-M00
Slow Ov.**1NO+1NC	↔	PS43L-PO11PO-M00	PS43L-PO11PR-M00	PS43L-PO11RH-M00	PS43L-PO11RT-M00
Slow 2NO		PS43L-PT20PO-M00	PS43L-PT20PR-M00	PS43L-PT20RH-M00	PS43L-PT20RT-M00
Slow 2NC	↔	PS43L-PT02PO-M00	PS43L-PT02PR-M00	PS43L-PT02RH-M00	PS43L-PT02RT-M00
Snap 2NC	↔	PS43L-PS02PO-M00	PS43L-PS02PR-M00	PS43L-PS02RH-M00	PS43L-PS02RT-M00
Slow 1NO+2NC	↔	PS43L-PT12PO-M00	PS43L-PT12PR-M00	PS43L-PT12RH-M00	PS43L-PT12RT-M00
Slow 2NO+1NC	↔	PS43L-PT21PO-M00	PS43L-PT21PR-M00	PS43L-PT21RH-M00	PS43L-PT21RT-M00
Slow 3NC	↔	PS43L-PT03PO-M00	PS43L-PT03PR-M00	PS43L-PT03RH-M00	PS43L-PT03RT-M00
Slow 3NO		PS43L-PT30PO-M00	PS43L-PT30PR-M00	PS43L-PT30RH-M00	PS43L-PT30RT-M00



Family: L

	PS31 Thermoplastic*	PS31 Thermoplastic*	PS31 Thermoplastic*	PS31 Thermoplastic*
Dimensions HxWxD (mm)	41 x 104 x 40.5	41 x 117 x 40.5	41 x 121 x 40.5	41 x 130 x 59

References contact block

Snap 1NO+1NC	↔	PS31L-PS11PO-T00	PS31L-PS11PR-T00	PS31L-PS11RH-T00	PS31L-PS11RT-T00
Slow 1NO+1NC	↔	PS31L-PT11PO-T00	PS31L-PT11PR-T00	PS31L-PT11RH-T00	PS31L-PT11RT-T00
Slow Ov.**1NO+1NC	↔	PS31L-PO11PO-T00	PS31L-PO11PR-T00	PS31L-PO11RH-T00	PS31L-PO11RT-T00
Slow 2NO		PS31L-PT20PO-T00	PS31L-PT20PR-T00	PS31L-PT20RH-T00	PS31L-PT20RT-T00
Slow 2NC	↔	PS31L-PT02PO-T00	PS31L-PT02PR-T00	PS31L-PT02RH-T00	PS31L-PT02RT-T00
Snap 2NC	↔	PS31L-PS02PO-T00	PS31L-PS02PR-T00	PS31L-PS02RH-T00	PS31L-PS02RT-T00
Slow 1NO+2NC	↔	PS31L-PT12PO-T00	PS31L-PT12PR-T00	PS31L-PT12RH-T00	PS31L-PT12RT-T00
Slow 2NO+1NC	↔	PS31L-PT21PO-T00	PS31L-PT21PR-T00	PS31L-PT21RH-T00	PS31L-PT21RT-T00
Slow 3NC	↔	PS31L-PT03PO-T00	PS31L-PT03PR-T00	PS31L-PT03RH-T00	PS31L-PT03RT-T00
Slow 3NO	↔	PS31L-PT30PO-T00	PS31L-PT30PR-T00	PS31L-PT30RH-T00	PS31L-PT30RT-T00

* also available in metal (M type)

** Ov. : overlapping travel paths

Limit switches - Limit type

Head types

W1 Adjustable lever with Ø50 rubber roller

R1 Adjustable lever with Ø18 nylon roller

BE Ø50 nylon roller lever

LW Stainless steel spring cat whisker



Family: L

	PS43	PS43	PS43	PS43
	Metal	Metal	Metal	Metal
Dimensions HxWxD (mm)	62 x (147.5-203.5) x 62.5	62 x (133.5-189.5) x 60	62 x 142.5 x 66	62 x 195,5 x 43

References contact block

Snap 1NO+1NC	⊕	PS43L-PS11W1-M00	PS43L-PS11R1-M00	PS43L-PS11W0-M00	PS43L-PS11LW-M00
Slow 1NO+1NC	⊕	PS43L-PT11W1-M00	PS43L-PT11R1-M00	PS43L-PT11W0-M00	PS43L-PT11LW-M00
Slow Ov.**1NO+1NC	⊕	PS43L-PO11W1-M00	PS43L-PO11R1-M00	PS43L-PO11W0-M00	PS43L-PO11LW-M00
Slow 2NO		PS43L-PT20W1-M00	PS43L-PT20R1-M00	PS43L-PT20W0-M00	PS43L-PT20LW-M00
Slow 2NC	⊕	PS43L-PT02W1-M00	PS43L-PT02R1-M00	PS43L-PT02W0-M00	PS43L-PT02LW-M00
Snap 2NC	⊕	PS43L-PS02W1-M00	PS43L-PS02R1-M00	PS43L-PS02W0-M00	PS43L-PS02LW-M00
Slow 1NO+2NC	⊕	PS43L-PT12W1-M00	PS43L-PT12R1-M00	PS43L-PT12W0-M00	PS43L-PT12LW-M00
Slow 2NO+1NC	⊕	PS43L-PT21W1-M00	PS43L-PT21R1-M00	PS43L-PT21W0-M00	PS43L-PT21LW-M00
Slow 3NC	⊕	PS43L-PT03W1-M00	PS43L-PT03R1-M00	PS43L-PT03W0-M00	PS43L-PT03LW-M00
Slow 3NO		PS43L-PT30W1-M00	PS43L-PT30R1-M00	PS43L-PT30W0-M00	PS43L-PT30LW-M00



Family: L

	PS31	PS31	PS31	PS31
	Thermoplastic*	Thermoplastic*	Thermoplastic*	Thermoplastic*
Dimensions HxWxD (mm)	50 x (149-205) x 65	41 x (135-191) x 60	50 x 144 x 64.5	41 x 195 x 40.5

References contact block

Snap 1NO+1NC	⊕	PS31L-PS11W1-T00	PS31L-PS11R1-T00	PS31L-PS11W0-T00	PS42L-PS11LW-T00
Slow 1NO+1NC	⊕	PS31L-PT11W1-T00	PS31L-PT11R1-T00	PS31L-PT11W0-T00	PS42L-PT11LW-T00
Slow Ov.**1NO+1NC	⊕	PS31L-PO11W1-T00	PS31L-PO11R1-T00	PS31L-PO11W0-T00	PS31L-PO11LW-T00
Slow 2NO		PS31L-PT20W1-T00	PS31L-PT20R1-T00	PS31L-PT20W0-T00	PS31L-PT20LW-T00
Slow 2NC	⊕	PS31L-PT02W1-T00	PS31L-PT02R1-T00	PS31L-PT02W0-T00	PS31L-PT02LW-T00
Snap 2NC	⊕	PS31L-PS02W1-T00	PS31L-PS02R1-T00	PS31L-PS02W0-T00	PS31L-PS02LW-T00
Slow 1NO+2NC	⊕	PS31L-PT12W1-T00	PS31L-PT12R1-T00	PS31L-PT12W0-T00	PS31L-PT12LW-T00
Slow 2NO+1NC	⊕	PS31L-PT21W1-T00	PS31L-PT21R1-T00	PS31L-PT21W0-T00	PS31L-PT21LW-T00
Slow 3NC	⊕	PS31L-PT03W1-T00	PS31L-PT03R1-T00	PS31L-PT03W0-T00	PS31L-PT03LW-T00
Slow 3NO	⊕	PS31L-PT30W1-T00	PS31L-PT30R1-T00	PS31L-PT30W0-T00	PS31L-PT30LW-T00

General specifications (for all types)

Degree of protection	IP 65 (plastic body) IP 66 (metal body)	Rated operational current	
Rated insulation voltage plastic body	(U _i)	I _e /AC-15 230 VAC	3.1 A
according to IEC 60947-1 and EN 60947-1	500 V	I _e /AC-13 24 VDC	2.8 V
according to UL 508, CSA C22-2 n°14	A 600, Q 600	Electrical durability (according to IEC 60947-5-1 annex C)	
Rated insulation voltage metal body	(U _i)	max. switching frequency Cycles/h	3600
according to IEC 60947-1 and EN 60947-1	400 V (PS21, PS42)	load factor	0.5
	500 V (PS31, PS43)	Air temperature near the device	
according to UL 508, CSA C22-2 n°14	A 300, Q 300 (PS21, PS42)	during operation	-25 to +70°C
	A 600, Q 600 (PS31, PS43)	for storage	-30 to +80°C
Conventional enclosed thermal voltage (U _{imp})	6 kV	Approvals	CE - UL - CSA

* also available in metal (M type)

** Ov. : overlapping travel paths

Limit switches - Safety type

Head types

Key Actuator 90° adj. head (key must be ordered separately)

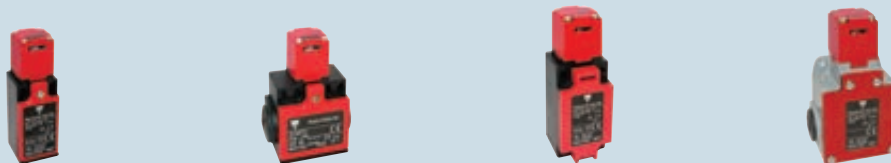

Family: S

	PS21	PS42	PS31	PS43
	Thermoplastic*	Thermoplastic*	Thermoplastic*	Thermoplastic*
Dimensions HxWxD (mm)	30.3 x 90 x 30	57 x 83 x 33	41.3 x 109.5 x 41	43 x 104.5 x 66

References contact block

Snap 1NO+1NC	⊕	PS21S-PS1105-T00	PS42S-PS1105-T00	PS31S-PS1105-T00	PS43S-PS1105-Y00
Snap 2NC	⊕	PS21S-PS0205-T00	PS42S-PS0205-T00	PS31S-PS0205-T00	PS43S-PS0205-Y00
Slow 1NO+1NC	⊕	PS21S-PT1105-T00	PS42S-PT1105-T00	PS31S-PT1105-T00	PS43S-PT1105-Y00
Slow Ov.**1NO+1NC	⊕	PS21S-PO1105-T00	PS42S-PO1105-T00	PS31S-PO1105-T00	PS43S-PO1105-Y00
Slow 2NC	⊕	PS21S-PT0205-T00	PS42S-PT0205-T00	PS31S-PT0205-T00	PS43S-PT0205-Y00
Slow 2NO+1NC	⊕			PS31S-PT2105-T00	PS43S-PT2105-Y00
Slow 1NO+2NC	⊕			PS31S-PT1205-T00	PS43S-PT1205-Y00
Slow 3NC	⊕			PS31S-PT0305-T00	PS43S-PT0305-Y00

Head types

Key actuator fully turnable head (key must be ordered separately)

Hinge Switch Operated lever*

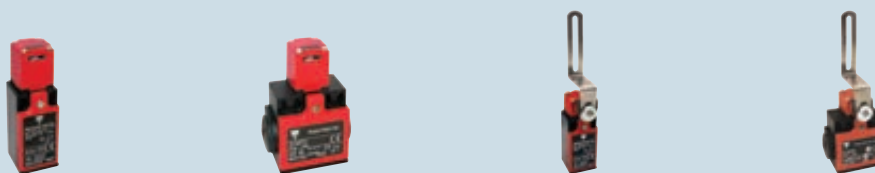

Family: S / H

	PS21	PS42	PS21	PS42
	Thermoplastic*	Thermoplastic*	Thermoplastic*	Thermoplastic*
Dimensions HxWxD (mm)	30.3 x 98.6 x 30	57 x 91.5 x 33	30.3 x 157 x 42	57 x 150 x 42

References contact block

Snap 1NO+1NC	⊕	PS21S-PS1109-T00	PS42S-PS1109-T00	PS21H-PS11HC-T00	PS42H-PS11HC-T00
Snap 2NC	⊕	PS21S-PS0209-T00	PS42S-PS0209-T00	PS21H-PS02HC-T00	PS42H-PS02HC-T00
Slow 1NO+1NC	⊕	PS21S-PT1109-T00	PS42S-PT1109-T00	PS21H-PT11HC-T00	PS42H-PT11HC-T00
Slow Ov.**1NO+1NC	⊕	PS21S-PO1109-T00	PS42S-PO1109-T00	PS21H-PO11HC-T00	PS42H-PO11HC-T00
Slow 2NC	⊕	PS21S-PT0209-T00	PS42S-PT0209-T00	PS21H-PT02HC-T00	PS42H-PT02HC-T00

Head types

Hinge shaft Zinc plated steel

Hinge Shaft Stainless steel

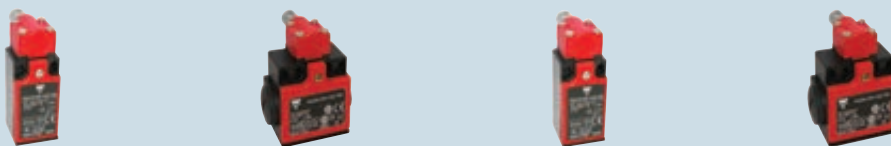

Family: H

	PS21	PS42	PS21	PS42
	Thermoplastic*	Thermoplastic*	Thermoplastic*	Thermoplastic*
Dimensions HxWxD (mm)	30.3 x 79.5 x 51.2	57 x 72.5 x 52.5	30.3 x 79.5 x 51.2	30.3 x 72.5 x 52.5

References Contact Block

Snap 1NO+1NC	⊕	PS21H-PS11HZ-T00	PS42H-PS11HZ-T00	PS21H-PS11HS-T00	PS42H-PS11HS-T00
Snap 2NC	⊕	PS21H-PS02HZ-T00	PS42H-PS02HZ-T00	PS21H-PS02HS-T00	PS42H-PS02HS-T00
Slow 1NO+1NC	⊕	PS21H-PT11HZ-T00	PS42H-PT11HZ-T00	PS21H-PT11HS-T00	PS42H-PT11HS-T00
Slow Ov.**1NO+1NC	⊕	PS21H-PO11HZ-T00	PS42H-PO11HZ-T00	PS21H-PO11HS-T00	PS42H-PO11HS-T00
Slow 2NC	⊕	PS21H-PT02HZ-T00	PS42H-PT02HZ-T00	PS21H-PT02HS-T00	PS42H-PT02HS-T00

* also available in metal (M type)

** Ov. : overlapping travel paths

Limit switches - Safety type

Head types

Pull wire activated head 16m cable max



Family: R

	PS31	PS43
	Metal	Metal
Dimensions HxWxD (mm)	40 x 162.75 x 43	63 x 158.25 x 43.3

References contact block

	PS31R-PS11N7-Y00	PS43R-PS11N7-Y00
Snap 1NO+1NC	PS31R-PS02N7-Y00	PS43R-PS02N7-Y00
Snap 2NC	PS31R-PT11N7-Y00	PS43R-PT11N7-Y00
Slow 1NO+1NC	PS31R-PO11N7-Y00	PS43R-PO11N7-Y00
Slow Ov.**1NO+1NC	PS31R-PT02N7-Y00	PS43R-PT02N7-Y00
Slow 2NC	PS31R-PT21N7-Y00	PS43R-PT21N7-Y00
Slow 2NO+1NC	PS31R-PT12N7-Y00	PS43R-PT12N7-Y00
Slow 1NO+2NC	PS31R-PT03N7-Y00	PS43R-PT03N7-Y00
Slow 3NC		

Head types

Pull wire activated head with pull button reset - 16m cable max



Family: H

	PS31	PS43
	Metal	Metal
Dimensions HxWxD (mm)	40 x 162.75 x 43	63 x 158.25 x 44

References contact block

	PS31R-PS11N7-YK0	PS43R-PS11N7-YK0
Snap 1NO+1NC	PS31R-PS02N7-YK0	PS43R-PS02N7-YK0
Snap 2NC	PS31R-PT11N7-YK0	PS43R-PT11N7-YK0
Slow 1NO+1NC	PS31R-PO11N7-YK0	PS43R-PO11N7-YK0
Slow Ov.**1NO+1NC	PS31R-PT02N7-YK0	PS43R-PT02N7-YK0
Slow 2NC	PS31R-PT21N7-YK0	PS43R-PT21N7-YK0
Slow 2NO+1NC	PS31R-PT12N7-YK0	PS43R-PT12N7-YK0
Slow 1NO+2NC	PS31R-PT03N7-YK0	PS43R-PT03N7-YK0
Slow 3NC		

General specifications (for all types)

Degree of protection	IP 65 (plastic body) IP 66 (metal body)	Rated operational current
Rated insulation voltage plastic body	(U _i)	I _e /AC-15 230 VAC 3.1 A
according to IEC 60947-1 and EN 60947-1	500 V	I _e /AC-13 24 VDC 2.8 V
according to UL 508, CSA C22-2 n°14	A 600, Q 600	Electrical durability (according to IEC 60947-5-1 annex C)
Rated insulation voltage metal body	(U _i)	max. switching frequency Cycles/h 3600
according to IEC 60947-1 and EN 60947-1	400 V (PS21, PS42)	load factor 0.5
	500 V (PS31, PS43)	Air temperature near the device
according to UL 508, CSA C22-2 n°14	A 300, Q 300 (PS21, PS42)	during operation -25 to +70°C
	A 600, Q 600 (PS31, PS43)	for storage -30 to +80°C
Conventional enclosed thermal voltage (U _{imp})	6 kV	Approvals
		CE - UL - CSA

* also available in metal (Y type) ** Ov. : overlapping travel paths

Limit switches - Safety type with pull button reset

Head Types	PO Steel plunger	PR Steel plunger with nylon roller	R3 Plastic roller lever on metal plunger	RT Lever with nylon roller
				

Family: K

	PS21	PS21	PS21	PS21
	Thermoplastic*	Thermoplastic*	Thermoplastic*	Thermoplastic*
Dimensions HxWxD (mm)	30.3 x 88 x 36.5	30.3 x 99 x 36.5	30.3 x 107 x 36.5	39 x 106 x 45

References contact block

Snap 1NO+1NC	⊕	PS21K-PS11PO-T00	PS21K-PS11PR-T00	PS21K-PS11R3-T00	PS43S-PS1105-Y00
Snap 2NC	⊕	PS21K-PS02PO-T00	PS21K-PS02PR-T00	PS21K-PS02R3-T00	PS43S-PS0205-Y00
Slow 1NO+1NC	⊕	PS21K-PT11PO-T00	PS21K-PT11PR-T00	PS21K-PT11R3-T00	PS43S-PT1105-Y00
Slow 2NC	⊕	PS21K-PT02PO-T00	PS21K-PT02PR-T00	PS21K-PT02R3-T00	PS21K-PT02RT-T00





Family: K

	PS42	PS42	PS42	PS42
	Thermoplastic*	Thermoplastic*	Thermoplastic*	Thermoplastic*
Dimensions HxWxD (mm)	57 x 81 x 36.5	57 x 92 x 36.5	57 x 100 x 36.5	57 x 99 x 45

References contact block

Snap 1NO+1NC	⊕	PS42K-PS11PO-T00	PS42K-PS11PR-T00	PS42K-PS11R3-T00	PS42K-PS11RT-T00
Snap 2NC	⊕	PS42K-PS02PO-T00	PS42K-PS02PR-T00	PS42K-PS02R3-T00	PS42K-PS02RT-T00
Slow 1NO+1NC	⊕	PS42K-PT11PO-T00	PS42K-PT11PR-T00	PS42K-PT11R3-T00	PS42K-PT11RT-T00
Slow 2NC	⊕	PS42K-PT02PO-T00	PS42K-PT02PR-T00	PS42K-PT02R3-T00	PS42K-PT02RT-T00

Head Types	R4 Roller Lever, external side actuation	LR Roller Lever Ø22, side actuation
		

Family: K

	PS21	PS42
	Thermoplastic*	Thermoplastic*
Dimensions HxWxD (mm)	44 x 107 x 36.5	57 x 112 x 36.5

References contact block

Snap 1NO+1NC	⊕	PS21K-PS11R4-T00	PS42K-PS11LR-T00
Snap 2NC	⊕	PS21K-PS02R4-T00	PS42K-PS02LR-T00
Slow 1NO+1NC	⊕	PS21K-PT11R4-T00	PS42K-PT11LR-T00
Slow 2NC	⊕	PS21K-PT02R4-T00	PS42K-PT02LR-T00

General specifications (for all types)

Degree of protection	IP 65	Rated operational current	
Rated insulation voltage plastic body <small>according to IEC 60947-1 and EN 60947-1</small>	(U _i)	I _e /AC-15 230 VAC	3.1 A
	500 V	I _e /AC-13 24 VDC	2.8 V
Rated insulation voltage metal body <small>according to IEC 60947-1 and EN 60947-1</small>	(U _i)	Electrical durability <small>(according to IEC 60947-5-1 annex C)</small>	
	400 V	max. switching frequency Cycles/h	3600
Conventional enclosed thermal voltage (U _{imp})	500 V	load factor	0.5
	A 300, Q 300 (PS21, PS42)	Air temperature near the device	
	A 600, Q 600 (PS31, PS43)	during operation	-25 to +70°C
		for storage	-30 to +80°C
	6 kV	Approvals	CE - UL - CSA

* Also available in metal (Y type) other types available

Limit switches - Safety type

Head types	Safety hinge	Safety hinge	Safety hinge
			

Family: PS38H

Material body	PS38H M12 connector Thermoplastic	PS38H 2m cable Thermoplastic	PS38H 2m cable back output Thermoplastic
Dimensions WxHxD (mm)	60 x 110 x 15	60 x 110 x 15	60 x 110 x 15





References contact block

Slow action T22: 2NO + 2NC	PS38H-IT2205-T01	PS38H-CT2205-T01	PS38H-CT2205-T02
Slow action T13: 1NO + 3NC	PS38H-IT1305-T01	PS38H-CT1305-T01	PS38H-CT1305-T02

General specifications (for all types)

Conformance	IEC 947-5-1 and European EN 60947-5-1 standards.Safety system of machinery up to SIL 3 or PLe according to EN ISO 13849-1.	IEC 947-5-1 and European EN 60947-5-1 standards.Safety system of machinery up to SIL 3 or PLe according to EN ISO 13849-1.	IEC 947-5-1 and European EN 60947-5-1 standards.Safety system of machinery up to SIL 3 or PLe according to EN ISO 13849-1.
Air temperature near the device	Operation - 20°C to + 80°C Storage - 20°C to + 80°C	Operation - 20°C to + 80°C Storage - 20°C to + 80°C	Operation - 20°C to + 80°C Storage - 20°C to + 80°C
Degree of protection	IP67	IP67	IP67
Mechanical durability	1.000.000 operations	1.000.000 operations	1.000.000 operations
Operation frequency	1.200 cycles/h	1.200 cycles/h	1.200 cycles/h
B10d	2.000.000 cycles	2.000.000 cycles	2.000.000 cycles
Positive opening operation (according to IEC 947-5-1)	All NC contacts are positive opening operation (min. actuating torque 0,5 Nm)	All NC contacts are positive opening operation (min. actuating torque 0,5 Nm)	All NC contacts are positive opening operation (min. actuating torque 0,5 Nm)
Rated insulation voltage Ui	30 V	400 V	400 V
Protection against electrical shocks (according to IEC 536)	Class II	Class II	Class II
Thermal current Ith	2 A	4 A	4 A
Rated operational current	24 VDC - 2A	24 - 120 - 250 - 400 VCA 4 A 24 VDC 2A / 125 VDC 0,4 A / 250 VDC 0,3 A	24 - 120 - 250 - 400 VCA 4A 24 VDC 2 A / 125 VDC 0,4 A / 250 VDC 0,3 A
Approvals	CE - UL - CSA	CE - UL - CSA	CE - UL - CSA

Industrial and Midi industrial relays

	Industrial relays		Midi industrial relays	
Types	RCP 8 (2 Poles)	RCP 11 (3 Poles)	RMI 2-10 (2 Poles)	RMI 4-5 (4 Poles)
				
Dimensions HxWxD (mm)	56 x 35.5 x 35.5	56 x 35.5 x 35.5	36 x 21.5 x 28	36 x 21.5 x 28
No. of Contacts	2 Change-over (octal)	3 change-over (undecad)	2 Change-over	4 Change-over
Contact rating	10 A	10 A	10 A	5 A
Features standard with	Test button / Flag / LED	Test button / Flag / LED	Test button / Flag / LED	Test button / Flag / LED

Output specifications

Max. load AC1	12 A / 250 VAC	12 A / 250 VAC	12 A / 250 VAC	6 A / 250 VAC
Min. load	100 mA / 12 VDC	100 mA / 125 VDC	100 mA / 5 VDC	100 mA / 5 VDC
Electrical life	> 100.000 cycles	> 100.000 cycles	> 100.000 cycles	> 100.000 cycles
Switching power	2500 VA (resistive)	2500 VA (resistive)	2500 VA (resistive)	1250 VA (resistive)

General specifications

Voltage ranges VDC	6 - 12 - 24 - 48 - 60 - 100 - 110	6 - 12 - 24 - 48 - 60 - 100 - 110	5 - 6 - 9 - 12 - 24 - 36 - 48 - 60 - 100 - 110 - 220 - 240	5 - 6 - 9 - 12 - 24 - 36 - 48 - 60 - 100 - 110 - 220 - 240
Voltage ranges VAC	6 - 12 - 24 - 48 - 115/120 - 230	6 - 12 - 24 - 48 - 115/120 - 230	6 - 12 - 24 - 36 - 48 - 115/120 - 220 - 240 - 380	6 - 12 - 24 - 36 - 48 - 115/120 - 220 - 240 - 380
Insulation according to	EN 61810-5	EN 61810-5	EN 61810-5	EN 61810-5
Consumption	1.5 W DC-2.5 VA AC	1.5 W DC-2.5 VA AC	1 W DC-1.5 VA AC	1 W DC-1.5 VA AC
Approvals / Conformity	UL - CSA - TÜV - IMQ	UL - CSA - TÜV - IMQ	UL - CSA - TÜV - IMQ	UL - CSA - TÜV - IMQ

References

5 VDC			RMIA/B2-105 DC	RMIA/B4-55 DC
6 VAC	RCP80026 VDC	RCP110036 VDC	RMIA/B2-106 AC	RMIA/B4-56 AC
6 VDC	RCP80026 VAC	RCP110036 VAC	RMIA/B2-106 DC	RMIA/B4-56 DC
12 VAC	RCP800212 VAC	RCP1100312 VAC	RMIA/B2-1012 AC	RMIA/B4-512 AC
12 VDC	RCP800212 VDC	RCP1100312 VDC	RMIA/B2-1012 DC	RMIA/B4-512 DC
24 VAC	RCP800224 VAC	RCP1100324 VAC	RMIA/B2-1024 AC	RMIA/B4-524 AC
24 VDC	RCP800224 VDC	RCP1100324 VDC	RMIA/B2-1024 DC	RMIA/B4-524 DC
48 VAC	RCP800248 VAC	RCP1100348 VAC	RMIA/B2-1048 AC	RMIA/B4-548 AC
48 VDC	RCP800248 VDC	RCP1100348 VDC	RMIA/B2-1048 DC	RMIA/B4-548 DC
60 VDC	RCP800260 VDC	RCP1100360 VDC	RMIA/B2-1060 DC	RMIA/B4-560 DC
100 VDC	RCP8002100 VDC	RCP11003100 VDC	RMIA/B2-10100 DC	RMIA/B4-5100 DC
110 VDC	RCP8002110 VDC	RCP11003110 VDC	RMIA/B2-10110 DC	RMIA/B4-5110 DC
115/120 VAC	RCP8002115/120 VAC	RCP11003115/120 VAC	RMIA/B2-10115 AC	RMIA/B4-5115 AC
230 VAC	RCP8002230 VDC	RCP11003230 VDC	RMIA/B2-10230 AC	RMIA/B4-5230 AC

	Industrial relays sockets		Midi industrial relays sockets	
Types	ZPD 8XA ZPD 11XA	ZPD 8A ZPD 11A	ZMI 2NA ZMI 4NA	ZMI 2 / 3 / 4SA
				

General specifications

Dimensions HxWxD (mm)	65 X 27 X 38	65 X 27 X 38	42.5 x 75 x 27	42.5 x 75 x 27
Rated volt. / Rated curr.	10 A @ 400 VAC	10 A @ 400 VAC	10 A @ 300 VAC	10/12 A @ 300 VAC
Insulation voltage	> 3 kV	> 3 kV	> 4 kV	> 4 kV
Socket material	Self-ext. PA6 + GF (V1)	Self-ext. PA6 + GF (V1)	Self-ext. PA6 + GF (V2)	Self-ext. PA6 + GF (V2)
Mounting	DIN-rail	DIN-rail	DIN-rail	DIN-rail
Degree of protection	IP 20	IP 20	IP 20	IP 20
Approvals	CE - UL - CSA (10 A 300 VCA)	CE - UL	CE - UL - IMQ - RINA	CE - UL - CSA





References

For RCP 8 / RCP 11	ZPD 8XA / ZPD 11XA	ZPD 8A / ZPD 11A		
For RMI2-10 / RMI4-5			ZPD 8A / ZPD 11A	ZMI 2 / 3 / 4SA



Switch

Midi industrial relays

Midi industrial relays





Types	RPY 1	RPY 2	RPY 3	RPY 4
				
Dimensions HxWxD (mm)	36 x 21.5 x 28	36 x 21.5 x 28	36 x 31.5 x 28	36 x 41.5 x 28
No. of Contacts	Faston or PCB	Faston or PCB	Faston or PCB	Faston or PCB
Contact rating	1 Change-over	2 Change-over	3 Change-over	4 Change-over
Terminal types	16 A	10 A	10 A	10 A
Output specifications				
Max. load AC1	16 A	10 A	10 A	10 A
Electrical life	1 x 10 ⁵	1 x 10 ⁵	1 x 10 ⁵	1 x 10 ⁵
Switching power	1 HP at 240 VAC 1/2 HP at 120 VAC	3/4 HP at 240 VAC 1/3 HP at 120 VAC	3/4 HP at 240 VAC 1/3 HP at 120 VAC	3/4 HP at 240 VAC 1/3 HP at 120 VAC
General specifications				
Voltage ranges VDC	6 - 9 - 12 - 24 - 36 - 48 100 - 110 - 220 - 240	6 - 9 - 12 - 24 - 36 - 48 100 - 110 - 220 - 240	6 - 9 - 12 - 24 - 36 - 48 100 - 110 - 220	6 - 9 - 12 - 24 - 36 - 48 100 - 110 - 220
Voltage ranges VAC	6 - 12 - 24 - 36 - 48 - 110 120 - 120 - 220 - 240 - 380	6 - 12 - 24 - 36 - 48 - 110 120 - 120 - 220 - 240 - 380	6 - 12 - 24 - 36 - 48 - 110 120 - 120 - 220 - 240 - 380	6 - 12 - 24 - 36 - 48 - 110 120 - 120 - 220 - 240 - 380
Insulation Coil / Contact	2000/1200 VAC	2000/1200 VAC	2000/1200 VAC	2000/1200 VAC
Consumption	DC=0.9 W - AC=1.2 VA	DC=0.9 W - AC=1.2 VA	DC=1.4 W - AC=2 VA	DC=1.5 W - AC=2.5 VA
Approvals / Conformity	UL - CSA - TÜV	UL - CSA - TÜV	UL - CSA - TÜV	UL - CSA - TÜV
References				
Consult your Carlo Gavazzi Partner or Distributor	Several options available: Led, diode, etc...	Several options available: Led, diode, etc...	Several options available: Led, diode, etc...	Several options available: Led, diode, etc...



Midi industrial relays sockets

Types	ZPY08A	ZPY11A	ZPY14A
			
General specifications			
Dimensions HxWxD (mm)	27.8 x 30 x 69.8	27.8 x 40 x 69.8	27.8 x 50.5 x 69.8
Rated volt. / Rated curr.	10 A @ 300 VAC	10 A @ 300 VAC	10 A @ 300 VAC
Insulation voltage	> 4 kW	> 4 kW	> 4 kW
Socket material	PA6 - V2	PA6 - V2	PA6 - V2
Mounting	DIN Rail	DIN Rail	DIN Rail
Degree of protection	IP 00	IP 00	IP 00
Approvals	UL - cUL - CSA	UL - cUL - CSA	UL - cUL - CSA
References			
Consult your Carlo Gavazzi Partner or Distributor	For Relays: RPYA 001 and RPYA 002	For Relays: RPYA 003	For Relays: RPYA 004





Power relays

Power relays

Types	NA (1/2 Poles)	NB (1/2 Poles)	NF (1/2 Poles)	NP (1/2 Poles)
				
Dimensions HxWxD (mm)	36 x 50.5 x 33.5	55 x 50.5 x 54.5	36 x 50.5 x 54.5	36 x 50.5 x 33.5
No. of Contacts	1 Normally open 2 Normally open	1 Normally open 2 Normally open	1 Normally open 2 Normally open	1 Normally open 2 Normally open
Contact rating	30 A	30 A	30 A	30 A
Terminal types	Faston	Bolt	Faston	PCB
Output specifications				
Max. load AC1	30 A (1NO) - 25 A (2NO)	30 A (1NO) - 25 A (2NO)	30 A (1NO) - 25 A (2NO)	30 A (1NO) - 25 A (2NO)
Electrical life	1 x 10 ⁵	1 x 10 ⁵	1 x 10 ⁵	1 x 10 ⁵
Switching power	7500 VA / 840 W	7500 VA / 840 W	7500 VA / 840 W	7500 VA / 840 W
General specifications				
Voltage ranges VDC	3 - 6 - 12 - 24 - 48 100 - 110 - 200	3 - 6 - 12 - 24 - 48 100 - 110 - 200	3 - 6 - 12 - 24 - 48 100 - 110 - 200	3 - 6 - 12 - 24 - 48 100 - 110 - 200
Voltage ranges VAC	6 - 12 - 24 - 48 - 120 - 220	6 - 12 - 24 - 48 - 120 - 220	6 - 12 - 24 - 48 - 120 - 220	6 - 12 - 24 - 48 - 120 - 220
Insulation according to	4000 VAC	4000 VAC	4000 VAC	4000 VAC
Consumption	DC=1.9 W - AC=2.7 VA	DC=1.9 W - AC=2.7 VA	DC=1.9 W - AC=2.7 VA	DC=1.9 W - AC=2.7 VA
Approvals / Conformity	UL - cUL	UL - cUL	UL - cUL	UL - cUL

Types	CF (2 Poles)	CS (2 Poles)
		
Dimensions (mm) WxHxD	26.42 x 68.58 x 34.54	26.42 x 52.32 x 34.54
No. of Contacts	2 Normally open 2 Change-over	2 Normally open 2 Change-over
Contact rating	30 A	30 A
Terminal types	Faston	PCB
Output specifications		
Max. load AC1	30 A (2NO) - 20 A (2CO)	30 A (2NO) - 20 A (2CO)
Electrical life	1 x 10 ⁵	1 x 10 ⁵
Switching power	8310 VA / 840 W	8310 VA / 840 W
General specifications		
Voltage ranges VDC	6 - 12 - 24 - 48	6 - 12 - 24 - 48
Voltage ranges VAC	24 - 120 - 208 - 240 - 277	24 - 120 - 208 - 240 - 277
Insulation according to	4000 VAC	4000 VAC
Consumption	DC=1.7 W - AC=4 VA	DC=1.7 W - AC=4 VA
Approvals / Conformity	UL - cUL	UL - cUL

Sockets and Modules

Types	ZD 35/2A	ZD 50/2A	ZD 35/3A	ZD 50/3A
				

General specifications

Rated volt. / Rated curr.	12 A @ 300 VAC	12 A @ 300 VAC	12 A @ 300 VAC	12 A @ 300 VAC
Insulation voltage	> 5 kV	> 5 kV	> 5 kV	> 5 kV
Socket material	Self-ext. PA 6 + GF (V1)	Self-ext. PA 6 + GF (V1)	Self-ext. PA 6 + GF (V1)	Self-ext. PA 6 + GF (V1)
Mounting	DIN-rail	DIN-rail	DIN-rail	DIN-rail
Degree of protection	IP 20	IP 20	IP 20	IP 20
Approvals	UL - CSA (12 A, 300 VCA)	UL - CSA (12 A, 300 VCA)	UL - CSA (12 A, 300 VCA)	UL - CSA (12 A, 300 VCA)

References

For relay:	MZ 1P 5/10 A	MZ B 1P 5/10 A	MZ 1P 5/10 A	MZ B 1P 5/10 A
	M15 M 8 A	MZ 2P 5/10 A	M15 M 8 A	MZ 2P 5/10 A
	M25 1P 12 A	MZ 1P 16 A	M25 1P 12 A	MZ 1P 16 A
	LC 10 A	M15 M 8 A	LC 10 A	M15 M 8 A
		M25 1P 16 A		M25 1P 16 A
		M25 2P 8 A		M25 2P 8 A
	LC 5/16 A		LC 5/16 A	

For detailed informations consult your Carlo Gavazzi Partner or Distributor

Hold down spring to be ordered separately:
 • SZD15 for M15/M25 relays
 • SZD20 for LC relays
 • SZD25 for MZ relays

Hold down spring to be ordered separately:
 • SZD15 for M15/M25 relays
 • SZD20 for LC relays
 • SZD25 for MZ relays

Hold down spring to be ordered separately:
 • SZD15 for M15/M25 relays
 • SZD20 for LC relays
 • SZD25 for MZ relays

Hold down spring to be ordered separately:
 • SZD15 for M15/M25 relays
 • SZD20 for LC relays
 • SZD25 for MZ relays

Types

Additional modules for ZMI and ZD sockets

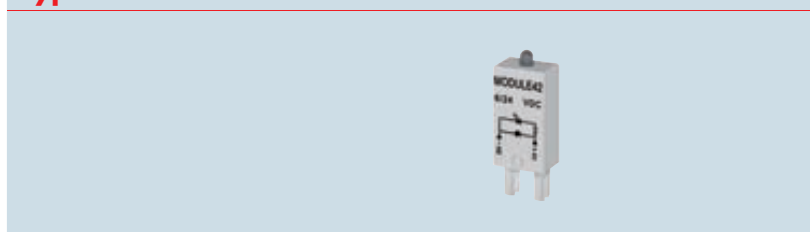

General specifications

Dimensions (mm) WxHxD	23 x 12.5 x 8.5
Terminal material	CuSn
Degree of protection	IP 40
Operating temperature	-40°C to +70°C
Ambient humidity	85RH non condensing
Approvals / Conformity	No approvals

References

Consult your Carlo Gavazzi Partner or Distributor

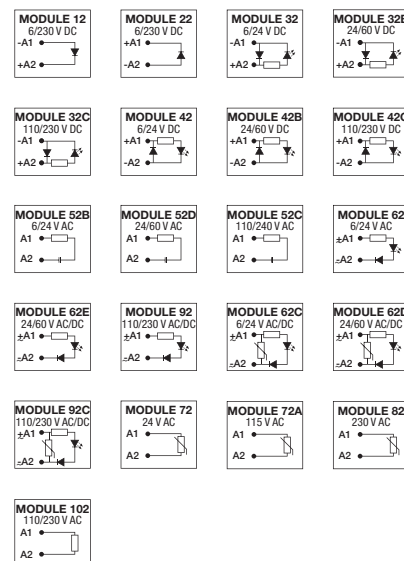



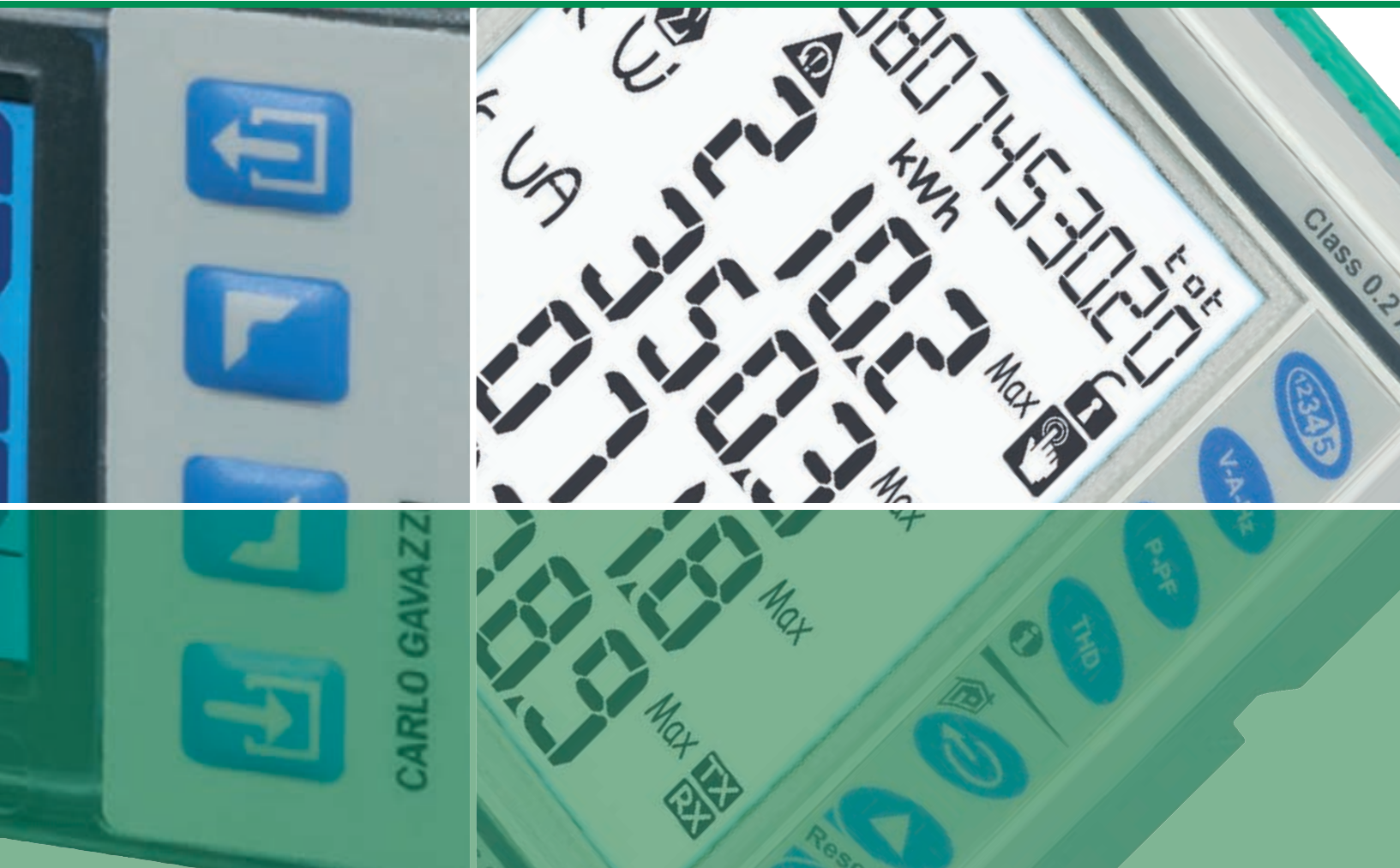

Control



Monitoring relays	162
Timers	174
Current transformers	179
Converters and Gateway	186
Digital panel meters	187
Energy management	191
Energy monitoring solution	201
PV monitoring solution	203
Counters	209
PID controllers	212
Switching power supplies	213
Safety modules	222
Configurable safety modules	226

Monitoring relays

Current relays

Types	DIA 01 PIA 01	DIA 53	DIB 01 PIB 01
			
Dimensions HxWxD (mm)	80 x 22.5 x 99.5 [D] 80 x 36 x 94 [P]	81 x 17.5 x 67.2 (Mini-D)	80 x 22.5 x 99.5 [D] 80 x 36 x 94 [P]
Function	Over current monitoring relay. 1-phase AC / DC. Direct input or on CT 5A. Setpoint adjustable. Hysteresis adjustable	Over current monitoring relay. 1-phase AC. Setpoint adjustable. 2-wire connection. Reaction time < 50 ms for F versions. 12 mm hole for insulated current carrying wire	Over or under current monitoring relay. 1-phase AC / DC TRMS. Direct input or on CT 10A. Setpoint adjustable. Hysteresis adjustable. Delay time adjustable. 12 mm hole for insulated current carrying wire [100 A]

Input specifications

Measuring range	0.5-5 A AC/DC	2-20 AAC [20A] 5-50 AAC [50A] 10-100 AAC [100A]	0.1-5 mA AC / DC [5MA] 1-50 mA AC / DC [50MA] 10-500 mA AC / DC [500MA] 0.1-5 A AC / DC [5A] 1-10 A AC / DC [10A] 2-100 A AC [100A]
-----------------	---------------	---	--

Output specifications

	1 x SPDT relay	Static output	1 x SPDT relay
Max. load AC1	8 A / 250 VAC		8 A / 250 VAC
Max. load DC12	5 A / 24 VDC	100 mA	5 A / 24 VDC
Electrical life	>1 x 10 ⁵ operations		>1 x 10 ⁵ operations

General specifications



Power supply	24-48 V AC / DC [D48] 115 / 230 VAC [B23]	40 VDC max. Powered by the measured current	24-48 V AC / DC [D48] 115 / 230 VAC [B23] 24 VDC / 24-240 VAC [M24]
Approvals / Marks	CE - UL - CSA	CE - UL - CSA	CE - UL - CSA

References

DIA01C D48 5A	DIA53S 724 20A	DIB01C ... 5MA
PIA01C D48 5A	DIA53S 724 50A	DIB01C ... 50MA
DIA01C B23 5A	DIA53S 724 100A	DIB01C ... 500MA
PIA01C B23 5A	DIA53S 724 20A F	DIB01C ... 5A
	DIA53S 724 50A F	DIB01C ... 10A
	DIA53S 724 100A F	DIB01C M24 100A
		PIB01C ... 5MA
		PIB01C ... 50MA
		PIB01C ... 500MA
		PIB01C ... 5A
		PIB01C ... 10A
		... = insert code for Power Supply





Monitoring relays

Current relays

Types	DIB 71	DIB 02 PIB 02	DIC 01 PIC 01
			
Dimensions HxWxD (mm) DIN RAIL housing Plug-in housing	81 x 35.5 x 67.2 [Mini-D]	80 x 22.5 x 99.5 [D] 80 x 36 x 94 [P]	80 x 45 x 99.5 [D] 80 x 36 x 94 [P]
Function	Over or under current monitoring relay. 1-phase AC / DC TRMS. Direct input or on CT 5A. Setpoint adjustable. Hysteresis adjustable. Delay time adjustable	Over or under current monitoring relay. 1-phase AC / DC TRMS. Input on shunt or CT MI / MP. Setpoint adjustable. Hysteresis adjustable. Delay time adjustable	Process signal monitoring relay. 1-phase AC / DC TRMS. Direct input, CT A82 or CT MI / MP. 2 setpoints separately adjustable. Hysteresis adjustable. 2 delay functions separately adjustable
Input specifications			
Measuring range	0.1-5 mA AC / DC [5MA] 1-50 mA AC / DC [50MA] 10-500 mA AC / DC [500 MA] 0.1-5 A AC / DC [5A]	6-150 mV AC / DC 0.4 - 4Vp	0.5-20 mA AC / DC 0.1-10 V AC / DC 0.4 - 4Vp
Output specifications			
	1 x SPDT relay	1 x SPDT relay	1 x SPDT relay [P] 2 x SPDT relays [D]
Max. load AC1	5 A / 250 VAC	8 A / 250 VAC	5 A / 250 VAC
Max. load DC12	5 A / 24 VDC	5 A / 24 VDC	5 A / 24 VDC
Electrical life	>1 x 10 ⁵ operations	>1 x 10 ⁵ operations	>1 x 10 ⁵ operations
General specifications			
Power supply	24 / 48 VAC [B48] 115 / 230 VAC [B23]	24-48 V AC / DC [D48] 115 / 230 VAC [B23]	24-48 V AC / DC [D48] 115 / 230 VAC [B23]
Approvals / Marks	CE - UL - CSA	CE - UL - CSA	CE - UL - CSA
References			
	DIB71C B48 5MA	DIB02C D48 150MV	DIC01D D48 AV0
	DIB71C B48 50MA	PIB02C D48 150MV	PIC01C D48 AV0
	DIB71C B48 500MA	DIB02C B23 150MV	DIC01D B23 AV0
	DIB71C B48 5A	PIB02C B23 150MV	PIC01C B23 AV0
	DIB71C B23 5MA		
	DIB71C B23 50MA		
	DIB71C B23 500MA		
	DIB71C B23 5A		





Monitoring relays

Voltage relays

Types	DUA 01 PUA 01	DUA 52	DUA 55	DUB 01 PUB 01
				
Dimensions HxWxD (mm) DIN RAIL housing Plug-in housing	80 x 22.5 x 99.5 [D] 80 x 36 x 94 [P]	81 x 17.5 x 67.2 [Mini-D]	81 x 17.5 x 67.2 [Mini-D]	80 x 22.5 x 99.5 [D] 80 x 36 x 94 [P]
Function	Over current and voltage monitoring relay. 1-phase AC / DC. Setpoint adjustable. Hysteresis adjustable	Under voltage monitoring relay for DC battery. Setpoint adjustable. Hysteresis adjustable. Measures its own power supply	Over and under voltage monitoring relay. 1-phase (measures its own power supply) AC TRMS	Over or under voltage monitoring relay. 1-phase AC / DC TRMS. Setpoint adjustable. Hysteresis adjustable. Delay time adjustable.
Input specifications				
Measuring range	2-500 V AC / DC 0.4 -4 Vp	8-28 VDC [724] 38-58 VDC [748]	208 / 220 / 230 / 240 VAC	0.1-10 V AC / DC [10V] 2-500 V AC / DC [500V]
Output specifications				
	1 x SPDT relay	1 x SPDT relay	1 x SPDT relay	1 x SPDT relay
Max. load AC1	8 A / 250 VAC	5 A / 250 VAC	5 A / 250 VAC	8 A / 250 VAC
Max. load DC12	5 A / 24 VDC	5 A / 24 VDC	5 A / 24 VDC	5 A / 24 VDC
Electrical life	>1 x 10 ⁵ operations	>1 x 10 ⁵ operations	>1 x 10 ⁵ operations	>1 x 10 ⁵ operations
General specifications				
Power supply	24-48 V AC / DC [D48] 115 / 230 VAC [B23]	8-28 VDC [724] 38-58 VDC [748]	208-480 VAC	24-48 V AC / DC [D48] 115 / 230 VAC [B23]
Approvals / Marks	CE - UL - CSA	CE - UL - CSA	CE - UL - CSA	CE - UL - CSA
References				
	DUA01C D48 500V	DUA52 C724	DUA55 CM44	DUB01C D48 10V
	PUA01C D48 500V	DUA52 C748		DUB01C D48 500V
	DUA01C B23 500V			PUB01C D48 10V
	PUA01C B23 500V			PUB01C D48 500V
				DUB01C B23 10V
				DUB01C B23 500V
				PUB01C B23 10V
				PUB01C B23 500V





Monitoring relays

Voltage relays

Types	DUB 71	DUB 02 PUB 02	DUB 03 PUB 03	DUC 01 PUC 01
				
Dimensions HxWxD (mm) DIN RAIL housing Plug-in housing	81 x 35.5 x 67.2 [Mini-D]	80 x 22.5 x 99.5 [D] 80 x 36 x 94 [P]	80 x 22.5 x 99.5 [D] 80 x 36 x 94 [P]	80 x 45 x 99.5 [D] 80 x 36 x 94 [P]
Function	Over or under voltage monitoring relay. 1-phase AC/DC TRMS. Setpoint adjustable. Hysteresis adjustable. Delay time adjustable	Over and under voltage monitoring relay. 1-phase (measures its own power supply) AC TRMS. Over and under voltage setpoints separately adjustable. Hysteresis adjustable. Delay time adjustable (ON/OFF)	Over or under voltage monitoring relay. 1-phase (measures its own power supply) AC/DC TRMS. Setpoint adjustable. Hysteresis adjustable. Delay time adjustable	Over and under voltage monitoring relay. 1-phase AC/DC TRMS. 2 setpoints separately adjustable. Hysteresis adjustable. 2 delay functions separately adjustable
Input specifications				
Measuring range	0.1-10 V AC/DC [10V] 2-500 V AC/DC [500V]	24/115/230 VAC	24/48/115/240 V AC/DC	2-500 V AC/DC [500V]
Output specifications				
	1 x SPDT relay	1 x SPDT relay	1 x SPDT relay [P]	1 x SPDT relay [C] 2 x DPDT relay [D]
Max. load AC1	5 A / 250 VAC	8 A / 250 VAC	8 A / 250 VAC	8 A / 250 VAC
Max. load DC12	5 A / 24 VDC	5 A / 24 VDC	5 A / 24 VDC	5 A / 24 VDC
Electrical life	>1 x 10 ⁵ operations	>1 x 10 ⁵ operations	>1 x 10 ⁵ operations	>1 x 10 ⁵ operations
General specifications				
Power supply	24/48 VAC [B48] 115 / 230 VAC [B23]	24/115/230 VAC	12-240 V AC/DC	24-48 V AC/DC [D48] 115 / 230 VAC [B23]
Approvals / Marks	CE - UL - CSA	CE - UL - CSA	CE - UL - CSA	CE - UL - CSA
References				
	DUB71C B48 10V	DUB02C T23	DUB03C W24	DUC01D D48 500V
	DUB71C B48 500V	PUB02C T23	PUB03C W24	PUC01C D48 500V
	DUB71C B23 10V			DUC01D B23 500V
	DUB71C B23 500V			PUC01C B23 500V

Monitoring relays

3-phase voltage relays

Types	DPA 01 PPA 01	DPA 51 DPA 71	DPA 03 PPA 03	DPA 53
				
Dimensions HxWxD (mm)				
DIN RAIL housing	80 x 22.5 x 99.5 [D]	81 x 17.5 x 67.2 [Mini-D] 81 x 35.5 x 67.2 [Mini-D]	80 x 22.5 x 99.5 [D]	81 x 17.5 x 67.2 [Mini-D]
Plug-in housing	80 x 36 x 94 [P]		80 x 36 x 94 [P]	
Function	Phase sequence, total and partial phase loss monitoring relay. 3-phase AC (measures its own power supply). Regenerated voltage	Phase sequence, total and partial phase loss monitoring relay. 3-phase AC (measures its own power supply). Regenerated voltage	Under voltage, phase sequence, total and partial phase loss monitoring relay. 3-phase (measures its own power supply) AC TRMS	Under voltage, phase sequence, total and partial phase loss monitoring relay. 3-phase (measures its own power supply) AC TRMS

Input specifications

Measuring range	208-240 VAC [M23] 208-415 VAC [P] [M44] 208-480 VAC [D] [M44] 380-415 VAC [P] [M48] 380-480 VAC [D] [M48] 380-600 VAC [M60] 380-690 VAC [M69]	208-240 VAC [M23] 208-480 VAC [M44] 380-480 VAC [M48]	208-240 VAC [M23] 380-415 VAC [P] [M48] 380-480 VAC [D] [M48] 600-690 VAC [M69]	208-240 VAC [M23] 380-480 VAC [M48]
-----------------	---	---	--	--

Output specifications

	1 x SPDT relay [C] 1 x DPDT relay [D]	1 x SPDT relay [C] 1 x DPDT relay [D]	1 x SPDT relay	1 x SPDT relay
Max. load AC1	8 A / 250 VAC	5 A / 250 VAC	8 A / 250 VAC	5 A / 250 VAC
Max. load DC12	5 A / 24 VDC	5 A / 24 VDC	5 A / 24 VDC	5 A / 24 VDC
Electrical life	>1 x 10 ⁵ operations	>1 x 10 ⁵ operations	>1 x 10 ⁵ operations	>1 x 10 ⁵ operations

General specifications



Power supply	208-240 VAC [M23] 208-415 VAC [P] [M44] 208-480 VAC [D] [M44] 380-415 VAC [P] [M48] 380-480 VAC [D] [M48] 380-600 VAC [M60] 380-690 VAC [M69]	208-240 VAC [M23] 208-480 VAC [M44] 380-480 VAC [M48]	208-240 VAC [M23] 380-415 VAC [P] [M48] 380-480 VAC [D] [M48] 600-690 VAC [M69]	208-240 VAC [M23] 380-480 VAC [M48]
Approvals / Marks	CE - UL - CSA	CE - UL - CSA	CE - UL - CSA	CE - UL - CSA

References

	DPA01D M23	DPA51C M44	DPA03C M23	DPA53C M23
	PPA01D M23	DPA71D M23	PPA03C M23	DPA53C M48
	DPA01C M44	DPA71D M48	DPA03C M48	
	PPA01C M44		PPA03C M48	
	DPA01D M48		DPA03C M69	
	PPA01D M48			
	DPA01C M60			
	DPA01C M69			



Monitoring relays

3-phase voltage relays

Types	DPA 55	DPB 01 PPB 01	DPB 51
			
Dimensions HxWxD (mm) DIN RAIL housing Plug-in housing	81 x 17.5 x 67.2 [Mini-D]	80 x 22.5 x 99.5 [D] 80 x 36 x 94 [P]	90 x 17.5 x 67.2 [Mini-D]
Function	Over and under voltage, phase sequence, total and partial phase loss monitoring relay. 3-phase (measures its own power supply) AC TRMS. Two tolerance voltage windows	Over and under voltage monitoring relay with phase loss and phase sequence. 3-phase +N (measures its own power supply) AC TRMS. N versions without phase sequence detection. W4 versions supplied between L and N. 2 setpoints separately adjustable. Delay time adjustable.	Over and under voltage monitoring relay with phase loss and phase sequence. 3-phase +N (measures its own power supply) AC TRMS. 2 setpoints separately adjustable. Delay time adjustable.
Input specifications			
Measuring range	208-480 VAC	208-240 VAC [M23] 380-415 VAC [P] [M48] 380-480 VAC [D] [M48]	208-480 VAC
Output specifications			
	1 x SPDT relay	1 x SPDT relay	1 x SPDT relay
Max. load AC1	5 A / 250 VAC	8 A / 250 VAC	5 A / 250 VAC
Max. load DC12	5 A / 24 VDC	5 A / 24 VDC	5 A / 24 VDC
Electrical life	>1 x 10 ⁵ operations	>1 x 10 ⁵ operations	>1 x 10 ⁵ operations
General specifications			
Power supply	208-480 VAC	208-240 VAC [M23] 380-415 VAC [P] [M48] 380-480 VAC [D] [M48] [W]	208-480 VAC
Approvals / Marks	CE - UL - CSA	CE - UL - CSA	CE - UL - CSA
References			
	DPA55C M44	DPB01C M23 PPB01C M23 DPB01C M23 N PPB01C M23 N DPB01C M48 PPB01C M48 DPB01C M48 W4 PPB01C M48 W4 DPB01C M48 N PPB01C M48 N DPB01C M48 N W4 PPB01C M48 N W4	DPB51C M44

Monitoring relays

3-phase voltage relays

Types	DPB 71	DPB 02 PPB 02	DPC 01 PPC 01
			
Dimensions HxWxD (mm) DIN RAIL housing Plug-in housing	81 x 35.5 x 67.2 [Mini-D]	80 x 22.5 x 99.5 [D] 80 x 36 x 94 [P]	80 x 45 x 99.5 [D] 80 x 36 x 94 [P]
Function	Over and under voltage monitoring relay with phase loss and phase sequence. 3-phase +N (measures its own power supply) AC TRMS. 2 setpoints separately adjustable. Delay time adjustable.	Asymmetry monitoring relay with phase sequence / phase loss. 3-phase +N (measures its own power supply) AC TRMS. Adjustable asymmetry. Delay time adjustable.	Over and under voltage monitoring relay with phase loss / phase sequence, asymmetry and tolerance. 3-phase +N (measures its own power supply) AC TRMS. Setpoint separately adjustable by function

Input specifications

Measuring range	208-240 VAC [M23] 380-480 VAC [M48]	208-240 VAC [M23] 380-415 VAC [P] [M48] 380-480 VAC [D] [M48]	208-240 VAC [M23] 380-415 VAC [P] [M48] 380-480 VAC [D] [M48] 600-690 VAC [M69] Frequency 50-60 Hz 100-115 VAC [M11 400Hz] 208-240 VAC [M23 400Hz] 380-415 VAC [M48 400Hz] 440-480 VAC [M49 400Hz] 600-690 VAC [M69 400Hz] Frequency 50-400 Hz
-----------------	--	---	--

Output specifications

	1 x SPDT relay	1 x SPDT relay	2 x SPDT relay
Max. load AC1	5 A / 250 VAC	8 A / 250 VAC	8 A / 250 VAC
Max. load DC12	5 A / 24 VDC	5 A / 24 VDC	5 A / 24 VDC
Electrical life	>1 x 10 ⁵ operations	>1 x 10 ⁵ operations	>1 x 10 ⁵ operations



General specifications

Power supply	208-240 VAC [M23] 380-480 VAC [M48]	208-240 VAC [M23] 380-415 VAC [P] [M48] 380-480 VAC [D] [M48]	100-115 VAC [M11] 208-240 VAC [M23] 380-415 VAC [P] [M48] 380-480 VAC [D] [M48] 440-480 VAC [M49] 600-690 VAC [M69]
Approvals / Marks	CE - UL - CSA	CE - UL - CSA	CE - UL - CSA

References

	DPB71C M23	DPB02C M23	DPC01D M23
	DPB71C M48	PPB02C M23	PPC01D M23
		DPB02C M48	DPC01D M48
		PPB02C M48	PPC01D M48
			DPC01D M69
			DPC01D M11 400HZ
			DPC01D M23 400HZ
			DPC01D M48 400HZ
			DPC01D M49 400HZ
			DPC01D M69 400HZ

Monitoring relays

	3-phase multifunction voltage relays		Interface protection relays
Types	DPC 71 PPC 71	DPC 02	DPC 72
			
Dimensions (mm) HxWxD			
DIN RAIL housing	81 x 35.5 x 67.2 [D]	80 x 45 x 99.5 [D]	90 x 71.6 x 66.3 [D]
Plug-in housing	81.2 x 35.5 x 75 [P]		

Function	Over and under voltage monitoring relay with phase loss / phase sequence, asymmetry and tolerance. 3-phase +N (measures its own power supply) AC TRMS. Setpoints separately adjustable by function	Over and under voltage / over and under frequency with phase loss and phase sequence monitoring relay. 3-phase+N (measures its own power supply) AC TRMS. Setpoints separately adjustable. Separately adjustable delay times. Adjustable frequency range	Digital interface protection relay with over and under voltage / over and under frequency, phase loss and phase sequence controls. Frequency derivative monitoring [B001, B003], voltage quality [B002], RS485 port, event counter, datastamping and auto-test function. 3-phase (measures its own power supply) AC TRMS. Setpoints separately adjustable. Separately adjustable delay times. Programmable via PC (DpcSoft free configuration software)
----------	--	--	---

Input specifications

Measuring range	208-240 VAC [M23] 380-415 VAC [P] [M48] 380-480 VAC [D] [M48]	Voltage: 208-240 VAC [M23] 380-415 VAC [M48] 440-480 VAC [M49] 600-690 VAC [M69] Frequency: 50/60 Hz	Voltage: 380-415 VAC [M48] Frequency: 45-65 Hz
-----------------	---	--	---

Output specifications

	2 x SPDT relays	2 x SPDT relays	1 x DPDT relays
Max. load AC1	5 A / 250 VAC	8 A / 250 VAC	8 A / 250 VAC
Max. load DC12	5 A / 24 VDC	5 A / 24 VDC	5 A / 24 VDC
Electrical life	>1 x 10 ⁵ operations	>1 x 10 ⁵ operations	>1 x 10 ⁵ operations

General specifications



Power supply	208-240 VAC [M23] 380-415 VAC [P] [M48] 380-480 VAC [D] [M48]	208-240 VAC [M23] 380-415 VAC [M48] 440-480 VAC [M49] 600-690 VAC [M69]	380-415 VAC [M48]
Approvals / Marks	CE - UL - CSA	CE - UL - CSA - ENEL DK 5950 [B003]	CE - VDE 0126-1-1 [B002]

References



DPC71D M23	DPC02D M23	DPC72D M48 B001
PPC71D M23	DPC02D M48	DPC72D M48 B002
DPC71D M48	DPC02D M49	
PPC71D M48	DPC02D M69	
	DPC02D M23 B003	
	DPC02D M48 B003	

Monitoring relays

Interface protection relays



Types	PI96	PI-DIN
		
Dimensions HxWxD (mm)	96 x 96 x 85.9	90 x 71.6 x 66.3
Description	Single or three-phases systems monitoring relay interface protection with energy metering and logging of max-min and avg values for: V_{LL} , V_{LN} , VA, VAR, PF, kWh, THD	Single or three-phases systems monitoring relay interface protection
Measuring input		
Voltage range	230 V _{LN} , 400 V _{LL}	230 V _{LN} , 400 V _{LL}
Frequency range	47.5 to 51.5 Hz	47.5 to 51.5 Hz
Current range	I _n 5A, I _{max} 6A (bigger currents CT)	None
Display	LCD, 4 lines 4 DGT, 1 line 10 DGT	LCD, 2 lines 4 DGT, 1 line 8 DGT
Input specifications		
VDE-AR-N-4105	-	2 digitals
CEI 0-21	6 digitals	4 digitals
Output specifications		
Type	4 x SPST relays (N.O.)	2 x SPDT relays
Max. load AC1	5 A @ 250 Vac	8 A @ 250 Vac
Serial communication protocol	RS485-RS232	RS485
Protocol	Modbus RTU	Modbus RTU
General specifications		
Power supply	115..230 VCA -20% +15% (48..62Hz) Option 24 VCC -20% +10%	115..230 VCA -20% +15% (48..62Hz) Option 24 VCC -20% +10%
Approvals / Marks	CE - CEI 0 - 21	CE - VDE V 0126-1-1:2013 - VDE AR N 4105 - CEI 0 - 21
References		
CEI 0-21 (AC aux power)	PI960021HI6R4S1XX	PIDIN0021HI4R2S1XX
CEI 0-21 (DC aux power)	PI960021LI6R4S1XX	PIDIN0021LI4R2S1XX
VDE V 0126-1-1:2013 (AC aux power)		PIDIN0126HI2R2S1XX
VDE V 0126-1-1:2013 (DC aux power)		PIDIN0126LI2R2S1XX

Monitoring relays



	Frequency relays		Cos ϕ relays
Types	DFB 01 PFB 01	DFC 01	DWA 01 PWA 01
			
Dimensions HxWxD (mm)	80 x 22.5 x 99.5 [D] 80 x 36 x 94 [P]	80 x 45 x 99.5 [D]	80 x 22.5 x 99.5 [D] 80 x 36 x 94 [P]
DIN RAIL housing			
Plug-in housing			
Function	Frequency monitoring relay. 1-phase AC (measures its own power supply). 2 setpoints separately adjustable. Delay time adjustable	Frequency monitoring relay. 1-phase AC (measures its own power supply). 2 setpoints separately adjustable. 2 separately adjustable delay times. 2 separate relay outputs	Cos ϕ monitoring relay. 1- or 3-phase AC (measures its own power supply). Direct input or through external CT. Power ON delay adjustable
Input specifications			
Measuring range	50 / 60 Hz	50 / 60 Hz	cos ϕ : 0.1-0.99
Output specifications			
	1 x SPDT relay	2 x SPDT relay	1 x SPDT relay
Max. load AC1	8 A / 250 VAC	8 A / 250 VAC	8 A / 250 VAC
Max. load DC12	5 A / 24 VDC	5 A / 24 VDC	5 A / 24 VDC
Electrical life	>1 x 10 ⁵ operations	>1 x 10 ⁵ operations	>1 x 10 ⁵ operations
General specifications			
Power supply	24-240 VAC	24-48 VAC [B48] 115-230 VAC [B23]	208-240 VAC [M23] 380-415 VAC [P] [M48] 380-480 VAC [D] [M48]
Approvals / Marks	CE - UL - CSA	CE - UL - CSA	CE - UL - CSA
References			
	DFB01C M24	DFC01D B48	DWA01C M23 5A
	PFB01C M24	DFC01D B23	PWA01C M23 5A
			DWA01C M48 5A
			PWA01C M48 5A

Monitoring relays

Power and power factor relays



Types	DWB 01 PWB 01	DWB 02 PWB 02	DWB 03 PWB 03
			
Dimensions HxWxD (mm)			
DIN RAIL housing	80 x 45 x 99.5 [D]	80 x 45 x 99.5 [D]	80 x 45 x 99.5 [D]
Plug-in housing	80 x 36 x 94 [P]	80 x 36 x 94 [P]	80 x 36 x 94 [P]
Function	Power factor monitoring relay. 1- or 3-phase (measures its own power supply) AC TRMS. Direct input or through external CT. 2 separately adjustable setpoints. Delay time adjustable. Power ON delay adjustable	Active power monitoring relay. 1- or 3-phase (measures its own power supply) AC TRMS. Direct input or through external CT. 2 separately adjustable setpoints. Delay time adjustable. Power ON delay adjustable	Active power monitoring relay. 1- or 3-phase AC TRMS power direction (measures its own power supply). Direct input or through external CT. 2 separately adjustable setpoints. Delay time adjustable. Power ON delay adjustable
Input specifications			
Measuring range	$\cos\phi$: 0.1-0.99	208-690 VAC 0.5-5 AAC 1-10 AAC 0.4 - 4 Vp	208-690 VAC 0.5-5 AAC 1-10 AAC 0.4 - 4 Vp
Output specifications			
Max. load AC1	1 x SPDT relays 8 A / 250 VAC	1 x SPDT relays 8 A / 250 VAC	1 x SPDT relays 8 A / 250 VAC
Max. load DC12	5 A / 24 VDC	5 A / 24 VDC	5 A / 24 VDC
Electrical life	>1 x 10 ⁵ operations	>1 x 10 ⁵ operations	>1 x 10 ⁵ operations
General specifications			
Power supply	208-240 VAC [M23] 380-415 VAC [P] [M48] 380-480 VAC [D] [M48] 600-690 VAC [M69]	208-240 VAC [M23] 380-415 VAC [P] [M48] 380-480 VAC [D] [M48] 600-690 VAC [M69]	208-240 VAC [M23] 380-415 VAC [P] [M48] 380-480 VAC [D] [M48] 600-690 VAC [M69]
Approvals / Marks	CE - UL - CSA	CE - UL - CSA	CE - UL - CSA
References			
	DWB01C M23 10A	DWB02C M23 10A	DWB03C M23 10A
	PWB01C M23 10A	PWB02C M23 10A	PWB03C M23 10A
	DWB01C M48 10A	DWB02C M48 10A	DWB03C M48 10A
	PWB01C M48 10A	PWB02C M48 10A	PWB03C M48 10A
	DWB01C M69 10A	DWB02C M69 10A	DWB03C M69 10A

Monitoring relays, timers

	Temperature relays	Pump alternating relays	Timers, Delay on operate
Types	DTA 01 PTA 01 DTA 02 PTA 02	DLA 71 DLA 73	DAA 01 PAA 01
			
Dimensions HxWxD (mm)	80 x 22.5 x 99.5 [D] 80 x 36 x 94 [P]	81 x 35.5 x 67.2 [Mini-D]	80 x 22.5 x 99.5 [D] 80 x 36 x 94 [P]
DIN RAIL housing			
Plug-in housing			
Function	Motor temperature monitoring relays. PTC insulated input. Automatic set-point. Short circuit detection. Latch, test and reset function (DTA02, PTA02)	Pump alternating relay. For 2 or 3 pumps. Differential or sequential mode. Automatic rotation of the pumps. Output relay managed by one independent input contact (DLA73)	Delay on operate (manual start)
Input specifications			
Time range			0.1 s - 1 s / 1 s - 10 s 6 s - 60 s / 60 s - 600 s 0.1 h - 1 h / 1 h - 10 h 10 h - 100 h
Output specifications			
	1 x SPDT relay 1 x SPST relay [DTA01]	2 x SPST relay [DLA71] [2P] 3 x SPST relay [DLA71] [3P] 3 x SPST relay [DLA73]	1 x SPDT relay [C] 2 x SPDT relays [D]
Max. load AC1	8 A / 250 VAC	5 A / 250 VAC	8 A / 250 VAC
Max. load DC12	5 A / 24 VDC	5 A / 24 VDC	5 A / 24 VDC
Electrical life	>1 x 10 ⁵ operations	>1 x 10 ⁵ operations	>1 x 10 ⁵ operations
General specifications			
Power supply	24-48 VAC / DC [D48] 115 VAC [115] 230 VAC [230]	24 / 48 VAC [B48] 115 / 230 VAC [B23]	24 VDC / 24-240 VAC [C] 24-240 VAC / DC [D]
Approvals / Marks	CE - UL - CSA	CE - UL - CSA	CE - UL - CSA
References			
	DTA01C D48	DLA71D B48 2P	DAA01C M24
	PTA01C D48	DLA71T B48 3P	PAA01C M24
	DTA01C 115	DLA71D B23 2P	DAA01D M24
	PTA01C 115	DLA71T B23 3P	PAA01D M24
	DTA01C 230	DLA73T B23 2P	
	PTA01C 230	DLA73T B48 2P	
	DTA02C D48		
	PTA02C D48		
	DTA02C 115		
	PTA02C 115		
	DTA02C 230		
	PTA02C 230		

Timers

Delay on operate

Types	DAA 51 DAA 71	FAA 01 FAA 08	HAA 08 HAA 14
			
Dimensions HxWxD (mm)			
DIN RAIL housing	81 x 17.5 x 67.2 [Mini-D]		
Plug-in housing	81 x 35.5 x 67.2 [Mini-D]	48 x 48 x 83.4	28 x 21.5 x 64
Function	Delay on operate (automatic start)	Delay on operate. Symmetrical recycler. Interval. One shot	Delay on operate. Symmetrical recycler with ON or OFF first. Interval

Input specifications

Time range	0.1 s - 1 s	Full scale 12	Full scale 30	0.1 s - 1 s
	1 s - 10 s	0.02 - 1.2 s	0.05 - 3 s	1 s - 10 s
	6 s - 60 s	0.2 - 12 s	0.5 - 30 s	6 s - 60 s
	60 s - 600 s	2 - 120 s	5 - 300 s	60 s - 600 s
	0.1 h - 1 h	0.2 - 12 m	0.5 - 30 m	0.1 h - 1 h
	1 h - 10 h	2 - 120 m	5 - 300 m	1 h - 10 h
	10 h - 100 h	0.2 - 12 h	0.5 - 30 h	10 h - 100 h
		2 - 120 h	5 - 300 h	

Output specifications

	1 x SPDT relay [C] 1 x DPDT relay [D]	1 x DPDT relay 11-pin [01] 8-pin [08]	1 x 4PDT relay [Q] 1 x DPDT relay [D] 14-pin [14] 8-pin [08]
Max. load AC1	5 A / 250 VAC	5 A / 250 VAC	5 A / 250 VAC
Max. load DC12	5 A / 24 VDC	5 A / 24 VDC	5 A / 24 VDC
Electrical life	>1 x 10 ⁵ operations	>1 x 10 ⁵ operations	>1 x 10 ⁵ operations

General specifications

Power supply	24 VDC / 24-240 VAC [CM24] 24-240 VAC / DC [DM24] 12-240 VAC / DC [DW24]	12-240 VAC / DC	24-240 VAC / DC
Approvals / Marks	CE - UL - CSA - RINA	CE - UL - CSA	CE - UL - CSA



References

DAA51C M24	FAA01D W24	HAA14Q M24
DAA71D M24	FAA08D W24	HAA08D M24
DAA71D W24		

Timers





	Delay on release		True delay on release
Types	DBA 02 PBA 02	DBA 52	D/PBB 01 D/PBB 02
			
Dimensions HxWxD (mm)			
DIN RAIL housing	80 x 22.5 x 99.5 [D]	81 x 17.5 x 67.2 [Mini-D]	80 x 22.5 x 99.5 [D]
Plug-in housing	80 x 36 x 94 [P]		80 x 36 x 94 [P]
Function	Delay on release	Delay on release	True delay on release
Input specifications			
Time range	0.1 s - 1 s / 1 s - 10 s 6 s - 60 s / 60 s - 600 s 0.1 h - 1 h / 1 h - 10 h 10 h - 100 h	0.1 s - 1 s / 1 s - 10 s 6 s - 60 s / 60 s - 600 s 0.1 h - 1 h / 1 h - 10 h 10 h - 100 h	D/PBB01: 0.1 s - 1 s / 1 s - 10 s 6 s - 60 s / 60 s - 600 s D/PBB02: 60 s - 600 s / 0.1 h - 1 h 1 h - 10 h
Output specifications			
	1 x SPDT relay	1 x SPDT relay	1 x SPDT relay [C] 1 x DPDT relay [D]
Max. load AC1	8 A / 250 VAC	5 A / 250 VAC	8 A / 250 VAC
Max. load DC12	5 A / 24 VDC	5 A / 24 VDC	5 A / 24 VDC
Electrical life	>1 x 10 ⁵ operations	>1 x 10 ⁵ operations	>1 x 10 ⁵ operations
General specifications			
Power supply	24 VDC / 24-240 VAC	24 VDC / 24-240 VAC	24-240 VAC / DC [M24] 12-24 VDC [724]
Approvals / Marks	CE - UL - CSA	CE - UL - CSA	CE - UL - CSA
References			
	DBA02C M24	DBA52C M24	DBB01C M24
	PBA02C M24		PBB01C M24
			DBB01D M24
			PBB01D M24
			DBB01C 724
			PBB01C 724
			DBB01D 724
			PBB01D 724
			DBB02C M24
			PBB02C M24
			DBB02D M24
			PBB02D M24

Timers

	True delay on release	Recycler	
Types	DBB 51	DCB 01 PCB 01	DCB 51
			
Dimensions HxWxD (mm) DIN RAIL housing Plug-in housing	81 x 17.5 x 67.2 [Mini-D]	80 x 22.5 x 99.5 [D] 80 x 36 x 94 [P]	81 x 17.5 x 67.2 [Mini-D]
Function	True delay on release	Asymmetrical recycler with ON and OFF time first. One shot. Two state delay on operate	Asymmetrical recycler with ON or OFF first
Input specifications			
Time range	1 s - 10 s [10S] 6 s - 60 s [1M] 60 s - 600 s [10M]	0.1 - 1 s / 1 - 10 s 6 - 60 s / 60 s - 600 s 0.1 h 1 h / 1 h - 10 h 10 h - 100 h	0.1 - 1 s / 1 - 10 s 6 - 60 s / 60 s - 600 s 0.1 h 1 h / 1 h - 10 h 10 h - 100 h
Output specifications			
	1 x SPDT relay	1 x SPDT relay [C] 2 x SPDT relays [D]	1 x SPDT relay
Max. load AC1	5 A / 250 VAC	8 A / 250 VAC	5 A / 250 VAC
Max. load DC12	5 A / 24 VDC	5 A / 24 VDC	5 A / 24 VDC
Electrical life	>1 x 10 ⁵ operations	>1 x 10 ⁵ operations	>1 x 10 ⁵ operations
General specifications			
Power supply	24 VDC / 24-240 VAC	24 VDC / 24-240 VAC [C] 24-240 VAC / DC [D]	24 VDC / 24-240 VAC
Approvals / Marks	CE - UL - CSA - RINA	CE - UL - CSA	CE - UL - CSA
References			
	DBB51C M24 10S	DCB01C M24	DCB51C M24
	DBB51C M24 1M	PCB01C M24	
	DBB51C M24 10M	DCB01D M24	
		PCB01D M24	

Timers

Multifunction

Types	DMB 01 PMB 01	DMB 51 PMB 71	FMB 01	DMC 01 PMC 01
				
Dimensions HxWxD (mm)				
DIN RAIL housing	80 x 22.5 x 99.5 [D]	81 x 17.5 x 67.2 (Mini-D) 81 x 35.5 x 67.2 (Mini-D)		80 x 22.5 x 99.5 [D] 80 x 45 x 99.5 [D] 80 x 36 x 94 [P]
Plug-in housing	80 x 36 x 94 [P]		48 x 48 x 83.4	
Function	Multifunction: <ul style="list-style-type: none"> • Delay on operate - manual start • Delay on release • Interval - manual start • Symmetrical recycler • Double interval • Interval on trigger open 	Multifunction: <ul style="list-style-type: none"> • Delay on operate - manual start • Delay on release • Interval - manual start • Symmetrical recycler • Double interval • Interval on trigger open 	Multifunction: (Trigger, Gate and Reset inputs) <ul style="list-style-type: none"> • Delay on operate - manual start • Delay on release • Interval - manual start • Symmetrical recycler • Double interval • Interval on trigger open 	Multifunction: <ul style="list-style-type: none"> • Delay on operate - manual start • Delay on operate - automatic and manual start • Delay on release • Interval - manual start • Interval - automatic and manual start • Interval - manual start with no time reset • Interval - automatic and manual start with no time reset

Input specifications

Time range	0.1 s - 1 s / 1 s - 10 s 6 s - 60 s / 60 s - 600 s 0.1 h - 1 h / 1 h - 10 h 10 h - 100 h	0.1 s - 1 s / 1 s - 10 s 6 s - 60 s / 60 s - 600 s 0.1 h - 1 h / 1 h - 10 h 10 h - 100 h	Full scale: 12 0.02 - 1.2 s / 0.2 - 12 s 2 - 120 s / 0.2 - 12 m 2 - 120 m / 0.2 - 12 h 2 - 120 h Full scale: 30 0.05 - 3 s / 0.5 - 30 s 5 - 300 s / 0.5 - 30 m 5 - 300 m / 0.5 - 30 h 5 - 300 h	0.1 s - 1 s / 1 s - 10 s 6 s - 60 s / 60 s - 600 s 0.1 h - 1 h / 1 h - 10 h 10 h - 100 h
------------	---	---	--	---

Output specifications

	1 x SPDT relay [C] 1 x DPDT relay [D]	1 x SPDT relay [C] 1 x DPDT relay [D]	1 x DPDT relay	1 x SPDT relay [C] 2 x SPDT relay [D]
Max. load AC1	8 A / 250 VAC	5 A / 250 VAC	5 A / 250 VAC	8 A / 250 VAC
Max. load DC12	5 A / 24 VDC	5 A / 24 VDC	5 A / 24 VDC	5 A / 24 VDC
Electrical life	>1 x 10 ⁵ operations	>1 x 10 ⁵ operations	>1 x 10 ⁵ operations	>1 x 10 ⁵ operations



General specifications

Power supply	24 VDC & 24-240 VAC [C] 24-240 VAC/DC [D]	24 VDC & 24-240 VAC [M24] 12-240 VAC/DC [W24]	12-240 VAC/DC	24 VDC [724] 24 / 48 VAC [B48] 115 / 230 VAC [B23] 24 VAC [024] 115 VAC [115] 230 VAC [230]
Approvals / Marks	CE - UL - CSA - RINA	CE - UL - CSA - RINA	CE - UL - CSA	CE - UL - CSA

References





	DMB01C M24	DMB51C M24	FMB01D W24	DMC01C xxx
	PMB01C M24	DMB51C W24		PMC01C yyy
	DMB01D M24	DMB71D M24		DMC01D xxx
	PMB01D M24	DMB71D W24		PMC01D yyy
				xxx= 724, B23, B48 yyy= 724, 024, 115, 230

Timers

	Mini-E timers	Star delta	
Types	EAS EBS ECS	DAC 01 PAC 01	DAC 51
			
Dimensions HxWxD (mm)	56 x 22.5 x 49 ^[Mini-E]	80 x 22.5 x 99.5 [D]	81 x 17.5 x 67.2 ^[Mini-D]
DIN RAIL housing	56 x 22.5 x 44 ^[Mini-E] [F]		
Plug-in housing		80 x 36 x 94 [P]	
Function	EAS - Delay on operate (automatic start). EBS - Interval (automatic start). ECS - Symmetrical recycler (ON/OFF automatic start) thyristor output. Screw or fast-ON connection. DIN-rail or chassis mounting	Star delta	Star delta
Input specifications			
Time range	[10S]: 0.5 s - 10 s [1M]: 0.1 m - 1 m [10M]: 1 m - 10 m	0.1 s - 1 s / 1 s - 10 s 6 s - 60 s / 60 s - 600 s	0.1 s - 1 s / 1 s - 10 s 6 s - 60 s / 60 s - 600 s
Star to delta relay (neutral centre position)		50 - 130 ms between star to delta position	50 - 130 ms between star to delta position
Output specifications			
	Static output 500 mA, 700 mA [F]	1 x SPDT relay (with neutral centre position)	1 x SPDT relay (with neutral centre position)
Max. load AC1		8 A / 250 VAC	5 A / 250 VAC
Max. load DC12		5 A / 24 VDC	5 A / 24 VDC
Electrical life		>1 x 10 ⁵ operations	>1 x 10 ⁵ operations
General specifications			
Power supply	24-230 VAC / DC [EAS] 24-230 VAC [EBS], [ECS]	24-240 VAC / DC [M24] 380-415 VAC [M40]	24-240 VAC / DC
Approvals / Marks	CE - UL - CSA	CE - UL - CSA	CE - UL - CSA
References			
	EAS S M23 ...	DAC01C M24	DAC51C M24
	EAS S M23 ... F	PAC01C M24	
	EBS S M23 ...	DAC01C M40	
	EBS S M23 ... F	PAC01C M40	
	ECS S M23 A ...		
	ECS S M23 B ...		
	ECS S M23 A ... F		
	ECS S M23 B ... F		
	... = insert code for Time Range		

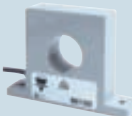
Current transformers

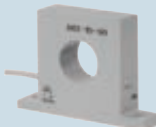
Current transformers for monitoring relays

Types	MI	MP	A 82	E 83
				
Dimensions HxWxD (mm)	45 x 52 x 16 [5 / 20] 67.5 x 95 x 20 [100 / 500]	45 x 120 x 16 [5 / 20] 114 x 150 x 23 [100 / 500]	67.5 x 95 x 20	56 x 22.5 x 49
Function	1-phase AC. Output voltage. Cable hole	3-phase AC. Output voltage. Cable hole	1-phase AC. Output 0 / 4-20 mA DC, 0-10 VDC (A82-30). Cable hole. Led indication	1-phase AC. Output 4-20 mA DC. Cable hole. DIN-rail mounting
Input specifications				
Input current	0.5 - 5 AAC [5] 2 - 20 AAC [20] 10 - 100 AAC [100] 50 - 500 AAC [500]	0.5 - 5 AAC [5] 2 - 20 AAC [20] 10 - 100 AAC [100] 50 - 500 AAC [500]	0 - 25 AAC [25] 0 - 50 AAC [50] 0 - 100 AAC [100] 0 - 250 AAC [250] 0 - 500 AAC [500]	0 - 5 AAC 0 - 10 AAC 0 - 15 AAC 0 - 20 AAC 0 - 25 AAC 0 - 30 AAC 0 - 50 AAC
Max. current continuously	20 AAC [5] 50 AAC [20] 250 AAC [100] 750 AAC [500]	20 AAC [5] 50 AAC [20] 250 AAC [100] 750 AAC [500]	600 AAC	100 AAC
Dielectric voltage	6 kV ACrms	6 kV ACrms	6 kV ACrms	
Output specifications				
Output value	0.4 - 4 Vp The output voltage is proportional to the input current	0.4 - 4 Vp The output voltage is proportional to the highest current value in the 3 conductors which are drawn through the holes of the current metering transformer	A82 - 10: 0-20 mA DC A82 - 20: 4-20 mA DC A82 - 30: 0-10 VDC The output current (A82-10, A82-20) and voltage (A82-30) are proportional to the input current	4 - 20 mA DC The output current is proportional to the input current
Output tolerance	± 5% @ In	± 5% @ In	± 2% @ 50 Hz	± 2% @ 50 Hz
Rated insulation voltage (cable)	250 VACrms	250 VACrms	250 VACrms	
General specifications				
Cable hole diameter	10.5 mm [5 / 20] 27 mm [100 / 500]	3 x 12 mm [5 / 20] 3 x 27 mm [100 / 500]	27 mm	12 mm
Connection cable	2 m PVC 2 x 0.5 mm ²	2 m PVC 2 x 0.5 mm ²	A82-10, A82-30: 2m, 3x0.25 m ² A82-20: 2m, 2x0.25 m ²	Screw terminal 2 x 1.5 mm ²
Operating temperature	-20°C to +60°C	-20°C to +60°C	-20°C to +50°C	-20°C to +50°C
References				
	MI 5	MP 3005	A 82-XX 25	E 83-20 50
	MI 20	MP 3020	A 82-XX 50	
	MI 100	MP 3100	A 82-XX 100	
	MI 500	MP 3500	A 82-XX 250	
			A 82-XX 500	
			XX = 10: 0-20 mA DC = 20: 4-20 mA DC = 30: 0-10 VDC	

Current transformers

Current transformers

Types	TADK	TADK2	CTD 1	CTD 2
				
Dimensions HxWxD (mm)	115.5 x 75 x 44	115.5 x 75 x 44	86 x 56 x 42	86 x 56 x 42

Input specifications

	Current transformer 1-phase AC	Current transformer 1-phase AC	Current transformer 1-phase AC	Current transformer 1-phase AC
Operating frequency	48 to 62 Hz	48 to 62 Hz	48 to 62 Hz	48 to 62 Hz
Max. system voltage	0.72 kV	0.72 kV	0.72 kV	0.72 kV
Rated insulation level	3 kV/1 min @ 50 Hz	3 kV/1 min @ 50 Hz	3 kV/1 min @ 50 Hz	3 kV/1 min @ 50 Hz
Security factor	≤ 5	≤ 5	≤ 5	≤ 5

Output specifications

Secondary current	5 A standard (1 A on request)	5 A standard (1 A on request)	5 A 1 A	5 A 1 A
-------------------	----------------------------------	----------------------------------	------------	------------

General specifications

Class	0.5	0.5	0.5 / 1 / 3	0.5 / 1 / 3
Bus-bar size (mm)	no (wounded primary)	25 x 5 (fixed bar)	20 x 5	32 x 5 x 30 x 10
Standards	IEC 60185	IEC 60185	EN 60044-1	EN 60044-1

Primary current





	Burden (VA)				Burden (VA)				Burden (VA)				Burden (VA)			
	Class	0.5	1	3	Class	0.5	1	3	Class	0.5	1	3	Class	0.5	1	3
Accuracy class depending on the burden of the secondary circuit	1 A	10			1 A	10			50 A		1	1.25	40 A			1.25
	5 A	10			5 A	10			60 A		1	1.25	50 A			1.5
	10 A	10			10 A	10			70 A		1.5	1.75	60 A			2
	15 A	10			15 A	10			75 A	1	1.25	1.75	70 A			2.5
	25 A	10			25 A	10			80 A	1.25	1.5	2	75 A		1.75	2.5
	40 A	10			40 A	10			100 A	1.5	1.75	2.25	80 A		2	2.75
					50 A	10			120 A	1.75	2	2.5	100 A		2.5	3
					60 A	10			125 A	2	2.25	2.75	120 A		2.75	3.75
					80 A	10			150 A	2.25	2.5	3	125 A	2	2.75	3.75
					100 A	10			160 A	2.5	2.75	3.25	150 A	3	4	5
					150 A	10			200 A	3	3.25	3.75	160 A	3	4	5
					200 A	10			250 A	4.5	4.75	5.25	200 A	4	5	6.5
					250 A	10			300 A	5	5.5	6	250 A	5.5	7	8
													300 A	7	8.5	9.5
													400 A	12	13.5	14.5
												500 A	14	15.5	16.5	
												600 A	17.5	19	20	

General specifications

For ordering key details, please refer to www.productselection.net

Current transformers

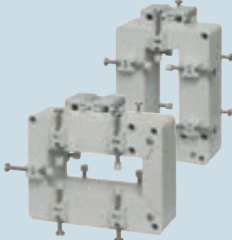
Current transformers

Types	CTD 3	CTD 4	CTD 8V CTD 8H	CTD 8Q
				
Dimensions HxWxD (mm)	109 x 77 x 42	113 x 90 x 42	132.9 x 87 x 60	144 x 129 x 55

Input specifications

	Current transformer 1-phase AC	Current transformer 1-phase AC	Current transformer 1-phase AC	Current transformer 1-phase AC
Operating frequency	48 to 62 Hz	48 to 62 Hz	48 to 62 Hz	48 to 62 Hz
Max. system voltage	0.72 kV	0.72 kV	0.72 kV	0.72 kV
Rated insulation level	3 kV/1 min @ 50 Hz	3 kV/1 min @ 50 Hz	3 kV/1 min @ 50 Hz	3 kV _{RMS} , 50 Hz, 1min
Security factor	≤ 5	≤ 5	≤ 5	≤ 5

Output specifications

Secondary current	5 A 1 A	5 A 1 A	5 A 1 A	5 A 1 A
-------------------	------------	------------	------------	------------

General specifications

Class	0.5 / 1 / 3	0.5 / 1 / 3 / 5P5	0.5 / 1 / 3	0.5
Bus-bar size (mm)	51 x 15	64 x 20	81 x 31	55 x 100
Standards	EN 60044-1	EN 60044-1	EN 60044-1	EN 60044-1

Primary current





	Burden (VA)			Burden (VA)			Burden (VA)			Burden (VA)					
	Class	0.5	1	3	Class	0.50	1	3	Class	0.5	1				
Accuracy class depending on the burden of the secondary circuit	50 A			1.75	150 A			2.5	5	150 A		2	1000 A	15	
	60 A			2	200 A			3.25	6	200 A		4	1500 A	15	
	70 A			2.25	250 A	2.5	4.5	2		250 A		5	2000 A	15	
	75 A			3	300 A	3	4	3		300 A		2	6	2500 A	15
	80 A			3	400 A	6	9	3		400 A	3	5	8	3000 A	15
	100 A		2	3.5	500 A	10	12.5	4		500 A	5	7	10	4000 A	15
	120 A		2.25	4	600 A	11	13.5	4		600 A	6	10	12		
	125 A		2.5	4.5	700 A	12.5	15	5		700 A	6	10	12		
	150 A	2.25	3	6	750 A	13	15.5	5		750 A	8	12	15		
	160 A	2.5	3.5	6.5	800 A	14	16.5	5		800 A	8	12	15		
	200 A	3	4.5	8.5	1000 A	17.5	20	6		1000 A	10	15	20		
	250 A	3.5	6.5	10.5	1200 A	20	22.5	6		1200 A	12	15	20		
	300 A	7	10	13	1250 A	20	22.5	6		1250 A	12	15	20		
	400 A	9	14	17	1500 A	27.5	30	8		1500 A	15	20	25		
	500 A	14	18	21	1600 A	27.5	30	8		1600 A	15	20	25		
	600 A	17	21	24						2000 A	20	25	30		
700 A	22	26	29						2500 A	25	30	40			
750 A	24	28	31												
800 A	25	29	32												

General specifications

For ordering key details, please refer to www.productselection.net

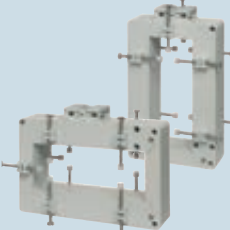
Current transformers

Current transformers

Types	CTD 9V CTD 9H	CTD 10V CTD 10H	CTD 11V CTD 11H	CTD 12V CTD 12H
				

Dimensions HxWxD (mm)	177.9 x 91.7 x 60	177.9 x 106.7 x 60	178 x 98 x 55	178 x 125 x 55
-----------------------	-------------------	--------------------	---------------	----------------

Input specifications

	Current transformer 1-phase AC	Current transformer 1-phase AC	Current transformer 1-phase AC	Current transformer 1-phase AC
Operating frequency	48 to 62 Hz	48 to 62 Hz	48 to 62 Hz	48 to 62 Hz
Max. system voltage	0.72 kV	0.72 kV	0.72 kV	0.72 kV
Rated insulation level	3 kV/1 min @ 50 Hz	3 kV/1 min @ 50 Hz	3 kV _{RMS} , 50 Hz	3 kV _{RMS} , 50 Hz
Security factor	≤ 5	≤ 5	≤ 5	≤ 5

Output specifications

Secondary current	5 A 1 A	5 A 1 A	5 A 1 A	5 A 1 A
-------------------	------------	------------	------------	------------

General specifications

Class	0.5 / 1 / 3	0.5 / 1 / 3	0.5	0.5
Bus-bar size (mm)	125 x 36	126 x 51	125 x 53	125 x 53
Standards	EN 60044-1	EN 60044-1	EN 60044-1	EN 60044-1

Primary current



	Burden (VA)			Burden (VA)			Burden (VA)		Burden (VA)	
	Class	0.5	1	3	Class	0.50	1	3	Class	0.5
Accuracy class depending on the burden of the secondary circuit	400 A		3	6	400 A	1	7	10	1000 A	15
	500 A	2	4	8	500 A	3	10	14	1500 A	15
	600 A	4	6	10	600 A	5	12	17	2000 A	15
	700 A	4	8	10	700 A	8	15	20	2500 A	15
	750 A	4	8	10	750 A	10	15	20	3000 A	15
	800 A	4	8	10	800 A	10	15	20	4000 A	15
	1000 A	6	10	13	1000 A	12	20	25		
	1200 A	8	12	15	1200 A	15	25	30		
	1250 A	8	12	15	1250 A	15	25	30		
	1500 A	10	15	18	1500 A	20	30	40		
	1600 A	10	15	18	1600 A	20	30	40		
	2000 A	15	20	24	2000 A	25	40	50		
	2500 A	20	25	30	2500 A	30	50	60		
	3000 A	25	30	35	3000 A	30	50	60		
3200 A	25	30	35	3200 A	30	50	60			

General specifications

For ordering key details, please refer to www.productselection.net

Current transformers

Split core current transformers

Types	CTD 5S	CTD 6S	CTD 8S
			

Dimensions HxWxD (mm)	93.9 x 83 x 60	113.9 x 107 x 60	132.9 x 87 x 60
-----------------------	----------------	------------------	-----------------

Input specifications

	Split core current transformer 1-phase AC	Split core current transformer 1-phase AC	Split core current transformer 1-phase AC
Operating frequency	58 to 62 Hz	58 to 62 Hz	58 to 62 Hz
Max. system voltage	0.72 kV	0.72 kV	0.72 kV
Rated insulation level	3 kV _{RMS} , 50 Hz, 1min	3 kV _{RMS} , 50 Hz, 1min	3 kV _{RMS} , 50 Hz, 1min
Security factor	≤ 5	≤ 5	≤ 5

Output specifications

Secondary current	5 A 1 A	5 A 1 A	5 A 1 A
-------------------	------------	------------	------------

General specifications

Class	1	1	1
Bus-bar size (mm)	27 x 32	52 x 51	81 x 31
Standards	EN 60044-1	EN 60044-1	EN 60044-1



Primary current

	Burden (VA)			Burden (VA)			Burden (VA)		
	Class	1	3	Class	1	3	Class	1	3
Accuracy class depending on the burden of the secondary circuit	100 A		1.5	150 A		1.5	150 A		1.5
	125 A	1.5	1.5	200 A	1.5	2	200 A		1.5
	150 A	1.5	2.5	250 A	1.5	3.75	250 A		2
	200 A	1.5	5	300 A	1.5	5	300 A		2
	250 A	1.5	5	400 A	2.5	5	400 A	3	5
	300 A	2.5	7.5	500 A	5	10	500 A	5	7
	400 A	5	10	600 A	7.5	15	600 A	6	10
				700 A	7.5	15	700 A	6	10
				750 A	7.5	15	750 A	8	12
				800 A	10	15	800 A	8	12
				1000 A	10	15	1000 A	10	15
							1200 A	12	15
							1250 A	12	15
							1500 A	15	20
							1600 A	15	20
						2000 A	20	25	
						2500 A	25	30	

References



For ordering key details, please refer to www.productselection.net



Current transformers

	Split core current transformers		Active current sensor			
Types	CTD 9S	CTD 10S	ROG 400			
						
Dimensions HxWxD (mm)	177.9 x 91.7 x 60	177.9 x 106.7 x 60	54 x 29 x 17			
Input specifications						
	Split core current transformer 1-phase AC	Split core current transformer 1-phase AC	Split core AC current sensor 1-phase AC			
Operating frequency	58 to 62 Hz	58 to 62 Hz	45 to 65 Hz			
Max. system voltage	0.72 kV	0.72 kV				
Rated insulation level	3 kV _{RMS} , 50 Hz, 1min	4 kV _{RMS} , 50 Hz, 1min	3 kV _{RMS} , 50 Hz			
Security factor	≤ 5	≤ 5				
Output specifications						
Secondary current	5 A 1 A	5 A 1 A	4 to 20 mA DC			
General specifications						
Class	1	1				
Bus-bar size (mm)	126 x 36	126 x 51	40			
Standards	EN 60044-1	EN 60044-1				
Primary current						
Accuracy class depending on the burden of the secondary circuit	Burden (VA)		Burden (VA)			
	Class	1	3	Class	1	3
	400 A		3	400 A	1	7
	500 A	2	4	500 A	3	10
	600 A	4	6	600 A	5	12
	700 A	4	8	700 A	8	15
	750 A	4	8	750 A	10	15
	800 A	4	8	800 A	10	15
	1000 A	6	10	1000 A	12	20
	1200 A	8	12	1200 A	15	25
	1250 A	8	12	1250 A	15	25
	1500 A	10	15	1500 A	20	30
	1600 A	10	15	1600 A	20	30
	2000 A	15	20	2000 A	25	40
	2500 A	20	25	2500 A	30	50
3000 A	25	30	3000 A	30	50	
3200 A	25	30	3200 A	30	50	
						400 AAC
References						
For ordering key details, please refer to www.productselection.net						





Current transformers

Split core current sensors for EM21 72V

Types	CTV-1X	CTV-2X	CTV-3X
			
Input / output specifications			
Primary current 50/60 Hz	60 A (1-70 A)	100 A (1-120 A)	200 A
Secondary output	333 mV	333 mV	333 mV
General specifications			
Accuracy	1%	1%	1%
Linearity	0.5%	0.5%	0.5%
Phase error at nominal current	$\leq 4^\circ$	$\leq 2^\circ$	$\leq 2^\circ$
Max. system voltage	660 V	660 V	660 V
Opening angle	180°	180°	180°
Certifications	CE - cURus	CE - cURus	CE - cURus
References			
	CTV1X60A333MV	CTV2x100A333MV	CTV3X200A333MX



Types	CTV-4X	CTV-8X
		
Input / output specifications		
Primary current 50/60 Hz	400 A (20-480 A max)	800 A (1-1000 A max)
Secondary output	333 mV	333 mV
General specifications		
Accuracy	1%	1%
Linearity	0.5%	
Phase error at nominal current	$\leq 2^\circ$	$\leq 2^\circ$
Max. system voltage	660 V	660 V
Opening angle	180°	
Certifications	CE - cURus	CE - cURus
References		
	CTV4X400A333MV	CTV8X800A333MV

Converters and gateway



	Serial converter		Ethernet gateway	M-bus converter
Types	SIU-PC2	SIU-PC3	SIU-TCP2	VMU-B
				
Dimensions HxWxD (mm)	Front: 100 x 67	Front: 60 x 37.5	Front: 78 x 65	Front: 90 x 17.5
Function	RS422 / RS485 to RS232 converter	RS422 / RS485 to USB converter	Ethernet to RS232 / 485 Gateway	Modbus to M-bus converter
Port 1				
Port Connections	RS232 9-pole, female	USB type A	Ethernet, 10 / 100 Mbps RJ45	RS485
Baud rate	Max 230400 Baud	Max 961.6 kBaud	Max 230400 Baud	
Port 2				
Port Connections	RS422, RS485 2-wire and 4-wire communication	RS232, RS485 2-wire communication	RS232, RS485 2-wire and 4-wire communication	M-bus
General specifications				
Power supply	12 to 30 VDC Suggested adapter: SPD12-101 (120 to 240 VAC/DC)	Self supplied by USB port	9 to 30 VDC AD5V1A: AC / DC power supply adapter (on request)	18 to 260 VAC/DC
Approvals / Marks	CE - FCC	CE - FCC	CE	CE
References				
	SIU PC2	SIU PC3	SIU TCP2	VMUBM1US1B1X01
	SIU PC2I (2kV insulated)			

Digital panel meters

Ammeters, voltmeters and frequency meters



Types	DI3 DIN	DI3 72	LDI 3
			
Dimensions HxWxD (mm)	89 x 52.5 x 58.5	72 x 72 x 75.5	48 x 96 x 83
Function	3-digit meter. 1-phase AC, DC. Voltmeter, ammeter frequency meter	Microprocessor based indicator. AC / DC Ammeter, Voltmeter. Freq. meter 3-digit display red LED. Height: 14.2 mm	Microprocessor based indicator. AC / DC Ammeter, Voltmeter. Freq. meter 3-digit display
Input specifications			
Range code	1 A / 100 VAC [AV1] 5 A / 500 VAC [AV5] 1 A / 60 mV / 100 V / 500 VDC [AV6] 1 Hz to 1000 Hz [F1K]	[AV1]: 1 AAC / 100 VAC [AV5]: 5 AAC / 500 VAC [AV6]: 1 ADC / 60 mV / 100 V / 500 VDC	[AV1]: 1 AAC / 100 VAC [AV5]: 5 AAC / 500 VAC [AV6]: 1 ADC / 60 mV / 100 V / 500 VDC [F1K]: 1 to 1000Hz
Accuracy	0.5% FS (0.1% FS frequency meter)	±0.5% FS	±0.5% FS (±0.3% FS frequency meter)
Indication	Max.	999 [AV1 / AV5], 000 [AV1 / AV5]	999
	Min.	000 [AV1 / AV5] -99 [AV6]	000 [AV1 / AV5] -99 [AV6]
Range selection / decimal point pos.	Selectable by DIP-switch	Selectable by DIP-switch	Selectable by DIP-switch
Display refresh time	1 time/s	1 time/s	1 time/s
General specifications			
Power supply	24 VAC [A] 48 VAC [B] 115 VAC [C] 230 VAC [D]	24 VAC [A], 48 VAC [B], 115 VAC [C], 230 VAC [D]	24 VAC [A], 48 VAC [B], 115 VAC [C], 230 VAC [D]
Option		IP65[EX]	IP65[IX], tropicalization [XT]
Safety Standards	EN 61010-1, IEC 61010-1, VDE0411	EN 61010-1, IEC 61010-1, VDE0411	EN 61010-1, IEC 61010-1, VDE0411
Approvals / Marks	CE - CSA	CE - CSA	CE - c CSA us
References			
For ordering key details, please refer to www.productselection.net			

Digital panel meters

	Ammeters and voltmeters		Thermometer and ohmmeter
Types	LDI 35 AV0	LDI 35 AV2	LDI 35 CF
			
Dimensions HxWxD (mm)	48 x 96 x 83	48 x 96 x 83	48 x 96 x 83
Function	Microprocessor based indicator/controller, AC / DC ammeter, voltmeter, 3½-digit or 3-digit + dummy zero display	Microprocessor based indicator/controller, AC / DC ammeter, voltmeter, 3½-digit or 3-digit + dummy zero display	Microprocessor based indicator/controller, Temperature resistance Measur. in °C or °F, 3½-digit or 3-digit + dummy zero display
Input specifications			
Range code	Current: 2 mA DC, 20 mA DC Voltage: 200 mV DC, 20 VDC, 200 VDC [AV0]	Current: 2 A AC / DC, 5 A AC / DC Voltage: 200 V AC / DC, 500 V AC / DC [AV2]	Pt100, Ni100 [CFX]; Pt1000 [CFP]; TC-J-LK-S-T [CFX/CFP]; 200.0Ω [CFX]; 2000Ω [CFP]
Accuracy	±0.3% FS	DC: ±0.3% FS, AC: ±0.5% FS	TC, PT100/1000, resistance ±0.3% FS, Ni 100 ±0.5% FS
Indication	Max.	3½-dgt: 1999, 3+0-dgt: 9990	Depending on range and type of the temperature probe
	Min.	3½-dgt: -1999, 3+0-dgt: -1990	
Resistance			0 to 200 Ω (2000 Ω)
Range election / decimal point pos.	Programmable	Programmable	Programmable
Display refresh time	4 times/s	4 times/s	4 times/s
Functions			
	Password protection. Scaling factor. Diagnostics. Digital filter programm. Max. data hold.	Password protection. Scaling factor. Diagnostics. Digital filter programm. Max. data hold.	Password protection. Scaling factor. Diagnostics. Digital filter programm. Max. data hold.
Output specifications			
Setpoints	1 optional alarm [1] 5 A / 250 VAC / DC. Excit. output 40 mA / 15 VDC [AX]	1 optional alarm [1] 5 A / 250 VAC / DC. Excit. output 40 mA / 15 VDC [AX]	1 optional alarm [1] 5 A / 250 VAC / DC. Excit. output 40 mA / 15 VDC [AX]
General specifications			
Power supply	120 [E], 230 [D], 240[F], 24 [A], 48 [B], 115 [C] VAC, 9-32 [3] VDC, 40-150 [6] VDC	120 [E], 230 [D], 240[F], 24 [A], 48 [B], 115 [C] VAC, 9-32 [3] VDC, 40-150 [6] VDC	120 [E], 230 [D], 240[F], 24 [A], 48 [B], 115 [C] VAC, 9-32 [3] VDC, 40-150 [6] VDC
Option	IP65[IX], excit. out [AX], tropicalization [XT]	IP65[IX], excit. out [AX], tropicalization [XT]	IP65[IX], excit. out [AX], tropicalization [XT]
Safety Standards	EN 61010-1, IEC 61010-1, VDE0411	EN 61010-1, IEC 61010-1, VDE0411	EN 61010-1, IEC 61010-1, VDE0411
Approvals / Marks	CE - c CSA us	CE - c CSA us	CE - c CSA us
References			
For ordering key details, please refer to www.productselection.net			

Digital panel meters

Ammeters and voltmeters

Types	LDM 30	LDM 35 H	LDM 40
			
Dimensions HxWxD (mm)	48 x 96 x 83	48 x 96 x 83	48 x 96 x 83
Function	3-digit + dummy 0 μ P-based indicator, red LED display	3 1/2-digit μ P-based indicator and controller, 3 1/2-DGT or 3-DGT + dummy 0 red LED display	4-digit μ P-based indicator and controller
Input specifications			
Range code	1A/100VAC [AV1]; 5A/500VAC [AV5]	(0.2-2-20 mA, 0.2-2-20 V) [LSE]; (0.2- 2-5 A, 20-200-500 V) [HSX]; DC and AC TRMS	(0.2-2-20 mA, 0.2-2-20 V) [LSE]; (0.2- 2-5 A, 20-200-500 V) [HSX]; DC and AC TRMS
Accuracy	$\pm 0.5\%$ FS, ± 1 DGT	DC: $\pm(0.3\%$ RDG + 3DGT) AC: $\pm(0.5\%$ RDG + 3DGT)	DC: $\pm(0.1\%$ RDG + 2DGT) AC: $\pm(0.3\%$ RDG + 2DGT)
Indication	Max.	9990	9999
	Min.	000	0 (AC) -9999 (DC) 4-digit LED red
Range selection / decimal point pos.	Selectable by dipswitch	Programmable	Programmable
Display refresh time	2 times/s	5 times/s	5 times/s
Functions			
		Signal / display scaling, Digital filter. Peak and valley	Signal / display scaling, Digital filter. Peak and valley
Output specifications			
		Up to 2 Alarm relay, [1-2]	Up to 2 Alarm relay, [1-2], Analogue 0 to 20mA, 0 to 10V [AV], RS485
General specifications			
Power supply	24 / 48V AC [B], 115 / 230V AC [D]	90 to 260V AC / DC [H], 18 to 60V AC / DC [L]	90 to 260V AC / DC [H], 18 to 60V AC / DC [L]
Option	Tropicalization [XT], IP65 [IX]	Tropicalization [TX]	Tropicalization [T]
Safety Standards	EN61010-1 IEC61010-1	EN61010-1 IEC61010-1	EN61010-1 IEC61010-1
Approvals / Marks	CE - c UR us - c CSA us	CE - c UR us - c CSA us	CE - c UR us - c CSA us
References			
For ordering key details, please refer to www.productselection.net			

Digital panel meters

Modular meter and conditioner

Types	UDM 35	UDM40/USC	UDM 60
			

Dimensions HxWxD (mm)	48 x 96 x 105	44 x 113 x 107 (USC) 48 x 96 x 105 (UDM40)	48 x 96 x 105
Function	MODULAR Microprocessor-based indicator / controller AC/DC Ammeter / Voltmeter / resistance / temperature measurement	MODULAR Microprocessor-based indicator / controller AC/DC Ammeter / Voltmeter / resistance / temperature measurement	MODULAR 6-DGT μ P-based controller

Input specifications

Range code	0.2-2-20 mA DC / AC 0.2-2-20V DC / AC [LSX] + AUX 13 VDC [LSE] or 25 VDC [LSF]; 0.2-2-5 A DC / AC; 20-200-500 V DC / AC [HSX]; TC: J-K-S-T-E, Pt100-250-500- 1000 [TRX]; 0.02-0.2-2-20 k Ω [TRX] 0.001 Hz to 50 Hz for DC signal [TF1] 0.001 Hz to 50 Hz for AC signal [TF2]	0.2-2-20 mA DC / AC 0.2-2-20 V DC / AC [LSX] + AUX 13 VDC [LSE] or 25 VDC [LSF]; 0.2-2-5 A DC / AC; 20-200-500 V DC / AC [HSX]; TC: J-K-S-T-E, Pt100-250-500- 1000 [TRX]; 0.02-0.2-2-20 k Ω [TRX] 0.001 Hz to 50 Hz for DC signal [TF1] 0.001 Hz to 50 Hz for AC signal [TF2]	Speed, frequency, rate, period, totalizer 0.001 Hz to 50 Hz for DC signal [TF1] 0.001 Hz to 50 Hz for AC signal [TF2]
Accuracy	0.1% RDG	0.1% RDG	$\pm(0.001\%RDG + 3DGT)$
Indication	Max. 1999 Min. 0 (AC) -1999 (DC), 3 1/2-digit LED red	Max. 9999 Min. 0 (AC) -9999 (DC), 4-digit LED. Colours: red, green, orange	Max. 9 999 999 Min. 0 6-DGT, LCD backlighted display
Range election / decimal	Programmable	Programmable	Programmable
Display refresh time	5 times/s	5 times/s	

Functions

	Password protection. Scaling factor. Min Max data storage. Programmable digital filter. Range selection. Programmable via PC	Password protection. Scaling factor. Min Max data storage. 16 linearization points. Programm. digital filter. Range selection. Programmable via PC	Signal/display scaling. Analogue output scaling. Digital filter. Peak and valley. Linearization. Combination of the inputs according to predefined functions. Pulse metering and totalizing
--	---	--	---

Output specifications

Setpoints	Analogue 0 to 20 mA, 0 to 10V [AV] Serial RS485 [SX], Serial RS232 [SY], Single relay output [R1], Dual relay output [R2], Dual relay + dual open coll. output [R4], Four relay output [R5]	Analogue 0 to 20 mA, 0 to 10V [AV] Serial RS485 [SX], Serial RS232 [SY], Single relay output [R1], Dual relay output [R2], Dual relay + dual open coll. output [R4], Four relay output [R5]	Analogue 0 to 20 mA, 0 to 10V [AV] Serial RS485 [SX], Serial RS232 [SY], Single relay output [R1], Dual relay output [R2], Dual relay + dual open coll. output [R4], Four relay output [R5]
-----------	--	--	--



General specifications

Power supply	90 to 260 AC / DC [H], 18 to 60 VAC / DC [L] 10 to 28 VDC[3]	90 to 260 AC / DC [H], 18 to 60 VAC / DC [L] 10 to 28 VDC[3]	90 to 260 AC / DC [H], 18 to 60 VAC / DC [L] 10 to 28 VDC[3]
Option	Tropicalization [TX]	Tropicalization [TX]	Tropicalization [TX]
Safety Standards	EN 61010-1, IEC 61010-1	EN 61010-1, IEC 61010-1	EN 61010-1, IEC 61010-1
Approvals / Marks	CE - c UR us - c CSA us	CE - c UR us - c CSA us	CE - c UR us - c CSA us



References

For ordering key details, please refer to www.productselection.net



Energy management

	Energy meter / Energy analyzer	Energy meters	
Types	EM10 DIN / EM11 DIN	EM21 72D / 72V	EM21 72R
			
Dimensions HxWxD (mm)	90 x 18 x 67	72 x 72 x 65	72 x 72 x 65
Description	1-DIN module		
Function	1-phase energy meter kWh (EM10) 1-phase energy analyzer (EM11) V _{LN} , A, Hz, W, W _{amd} , var, PF, kWh, kvarh. TRMS method	3-phase energy analyzer with double mounting capability, panel and DIN rail, W, var, PF, Phase-sequence, VLL, VLN, A TRMS method	3-phase energy analyzer with double mounting capability, panel and DIN rail, W, var, PF, Phase-sequence, VLL, VLN, A TRMS method
Input specifications			
Range code	120 VAC [AV7] 230 VAC [AV8] Ib: 5 A, I _{max} : 32 AAC; 1-phase	120 / 230 VAC, 400 VAC In: 5 A; I _{max} : 6 A (72 D) 3-phase by CTV current sensor (72V)	120 / 230 VAC, 400 VAC In: 5 A; I _{max} : 6 A 3-phase by included current sensor
Accuracy	±0.5% RDG (V, A) (EM11)	±0.5% RDG (V, A)	±0.5% RDG (V) ±1% RDG (A)
Active energy	Class 1 (EN62053-21) +	Class 1 (EN62053-21) Class B (EN50470-3)	Class 2 (EN62053-21) Class A (EN50470-3)
Reactive energy	Class B (EN50470-3) (EM10 / EM11) Class 2 (EN62053-23) (EM11)	Class 2 (EN62053-23)	
Display	4 DGT (inst. variables) (EM11) 5+1 DGT (energies), LCD	3 DGT (inst. variables) 6+1 DGT (energies), LCD	3 DGT (inst. variables) 6+1 DGT (energies), LCD
Output specifications			
Out 1 (Pulse)	1-open collector	1 static opto-mosfet	1 static opto-mosfet
Out 1 (Alarm)	1-relay (EM11)	None	None
Out 2 (Serial communication)		RS485 (2-wire, Modbus) M-BUS by means of VMU-B	RS485 (2-wire, Modbus) M-BUS by means of VMU-B
Inputs		None	None
General specifications			
Power supply	Self power supply [X]	Self power supply	Self power supply
Approvals / Marks	CE - MID certification	CE	CE
References			
For ordering key details, please refer to www.productselection.net			



Energy management

	Energy meter Energy analyzer EM210	Quick-fit dual energy meter EM270	3-phase current transformer TCD
Types			
Dimensions HxWxD (mm)	72 x 72 x 65	72 x 72 x 65	TCD1: 75x72x66,8 TCD2: 105x72x50 TCD3: 135x78x50
Description	3-phase energy analyzer with double mounting capability, panel and DIN rail.	Quick fit energy meter with daisy chaining of voltage and serial connections and fast RJ connection of TCD 3-phase current transformers. Managing of two 3-phase or six 1-phase loads	3-phase current transformers for EM270 quick fit meter. Connection to the meter by means of RJ11 connector (included).
Function	4-DIN module and 72x72 panel mounting; kWh (imported and exported), W, var, PF, Phase-sequence, VLL, VLN, A; TRMS method	4-DIN module and 72x72 panel mounting; kWh and W per load, var, VLL, VLN, A; TRMS method; Virtual sum of the two 3-phase or six 1-phase loads	Suitable to be installed downstream the circuit breakers (same width). Automatic setting of the CT ratio in the meter.
Input specifications			
Range	120 / 230 VAC, 400 VAC In: 5 A; I _{max} : 6 A	120 / 230 VAC, 400 VAC In: from 160 to 630 A by TCD	TCD1: 160 A TCD2: 250 A TCD3: 630 A
Accuracy	±0.5% RDG (V, A)	±0.5% RDG (V, A)	Equivalent to class 0.5 (EN60044-1)
Active energy	Class 1 (EN62053-21) Class B (EN50470-3)	Equivalent to Class 1 (EN62053-21)	-
Reactive energy	Class 2 (EN62053-23)	Equivalent to Class 2 (EN62053-23)	-
Display	3 DGT (inst. variables) 6+1 DGT (energies), LCD	3 DGT (inst. variables) 6+1 DGT (energies), LCD	-
Output specifications			
Out 1 (Pulse)	1 static opto-mosfet	2 static opto-mosfet	-
Out 1 (Alarm)	None	None	-
Out 2 (Serial communication)	RS485 (2-wire, Modbus) M-BUS by means of VMU-B	RS485 (2-wire, Modbus)	-
Inputs	None	None	-
General specifications			
Power supply	Self power supply	Self power supply	n.a.
Approvals / Marks	CE, cULus, MID	CE	CE
References			
For ordering key details, please refer to www.productselection.net			



Energy management

	Multifunction meter	Energy meter	Energy analyzer
Types	WM10 DIN	EM23 DIN	EM24 DIN
			
Dimensions HxWxD (mm)	90 x 71 x 64.5	90 x 71 x 64.5	90 x 71 x 65
Description			4 DIN modules
Function	3-phase multifunction meter W, var, PF, Hz, A, VLN, VLL TRMS method	3-phase energy analyzer W, var, A, kWh, kvarh TRMS method	3-phase energy analyzer Sys: VLL, VLN, , var, VA, Wdmd, W, VAdmd, Hz, kWh, kvarh, hour counter, gas and water Max: Admd, Wdmd, VAdmd. Single-phase: VLL, VLN, A, W, var, VA, PF, Admd, kWh, kvarh. TRMS method
Input specifications			
Range code	400 VLLAC Ib: 10 A; I _{max} 65 A 3-phase	400 VLLAC Ib: 10 A; I _{max} 65 A 3-phase	120 / 208 VL-L [AV6]; 400 VL-L [AV5] In: 1 / 5 A, I _{max} : 10 AAC; 120 / 208 VL-L [AV0]; 230 VL-L [AV2] 400 VL-L [AV9] Ib: 10 A, I _{max} : 64 AAC; 3-phase
Accuracy			±0.5% RDG (V, A)
Active energy	Class 1 (EN62053-21) +	Class 1 (EN62053-21) +	Class 1 (EN62053-21) +
Reactive energy	Class B (EN50470-3) Class 2 (EN62053-23)	Class B (EN50470-3) Class 2 (EN62053-23)	Class B (EN50470-3) Class 2 (EN62053-23)
Display	3 x 3 DGT (inst. variables)	3 x 3 DGT (inst. variables) 6+1 DGT (energies) LCD	3x4 DGT (inst. variables) 8 DGT (energies), LCD
Output specifications			
Out 1 (Pulse)	None	1-open collector	2-open collector / relay
Out 1 (Alarm)	None	None	2-relay / open collector
Out 2 (Serial communication)	None	None	RS485 (2-wire) / M-BUS
Inputs	None	None	3 digital input
General specifications			
Power supply	Self power supply	Self power supply	Self power supply [X]. Auxiliary power supply: 18 to 60 VAC / DC [L]; 115 / 230 VAC [D], according to the model
Approvals / Marks	CE	CE - MID certification	CE - MID certification
References			
For ordering key details, please refer to www.productselection.net			

Energy management

	Energy meters		Power analyzer
Types	EM3-DIN	EM4-DIN	WM22 DIN
			
Dimensions HxWxD (mm)	90 x 162.5 x 63	90 x 162.5 x 63	90 x 162.5 x 63
Description	MODULAR	MODULAR	MODULAR
Function	2-phase, 3-phase unbalanced 3 or 4 wires energy meter. Direct connection up to 100 A. 6+1 digits electromechanical display	3-phase energy meter. Direct connection up to 100 A. Back-lighted LCD display. 31 / 2 digits instantaneous variables read out, 8+ 7½ dgt energy read out. Measurement of system and phase variables, energy by timeperiods, m3 H2O and m3 GAS	3-phase power analyzer. Direct connection up to 100 A. Back-lighted LCD display. 4 x 31 / 2 digits instantaneous variables read out, 7½ digits energy read out. Measurement of system and phase variables. Measurement of THD
Input specifications			
Range code	208 V _{L-L} [AV8], 220 V _{L-L} [AV2], 400 V _{L-L} [AV9], 660 V _{L-L} [AV3] / 20(00) AAC. 3-phase unbalanced load [3]	100 V _{L-L} [AV6], 208 V _{L-L} [AV4], 400 V _{L-L} [AV5], 660 V _{L-L} [AV7] 5(10) AAC; 208 V _{L-L} [AV0] [AV8 self p.s.], 220 V _{L-L} [AV2], 400 V _{L-L} [AV1] [AV9 self p.s.], 660 V _{L-L} [AV3] 20(100) AAC	100 V _{L-L} [AV6], 208 V _{L-L} [AV4], 400 V _{L-L} [AV5], 660 V _{L-L} [AV7] 5(10) AAC; 208 V _{L-L} [AV0], 400 V _{L-L} [AV1], 220 V _{L-L} [AV2] 660 V _{L-L} [AV3] 20(100) AAC
Accuracy			±0.5% RDG (A,V)
Active energy	Class 2: (EN61036)	Class 1: (EN61036)	Class 1: (EN61036)
Reactive energy	Class 3: (EN61268)	Class 2: (EN61268)	Class 2: (EN61268)
Display	6+1 digits (electromechanical)	3½-digit backlighted LCD (8-digit for energy)	1000 samples /s @ 50Hz
Output specifications			
Out 1 (Pulse)	Dual pulse outputs (NPN transistor) [O]	Dual pulse output module (NPN trans.) [O]	Dual pulse output module (NPN trans.) [O]
Out 1 (Alarm)		1 alarm output module [O] (NPN trans.) 30 VDC/100 mA Max	1 alarm + 1 pulse output module [O] (NPN tr) 30 VDC/100 mA Max
Out 2 (Serial communication)	None	RS422/485 serial port [SO]	1 analogue output : 0 to 20 mADC [A1], or 0 to 10 VDC [V1]
Inputs		2 digital inputs module [D]	RS422/485 serial port [SO]
General specifications			
Power supply	Self power supply [X]: 400 VAC, 208 VAC V _{L-L} , Auxiliary power supply: 230 VAC [D], 115 VAC [C]	Self power supply: [X] 400 VAC, 208 VAC, 220 VAC V _{L-L} , Auxiliary power supply: 230[D], 115[C], 48[B], 24 [A]VAC, 18 to 60 VDC [4], 77 to 143 VDC [5]	Self power supply: [X] 400 VAC 208 VAC V _{L-L} , Auxiliary power supply: 230[D], 115[C], 48[B], 24 [A]VAC, 18 to 60 [4], 77 to 143 VDC [5]
Approvals / Marks	CE	CE	CE
References			
For ordering key details, please refer to www.productselection.net			

Energy management

	Multifunction meters		Power analyzer
Types	WM12-DIN	WM14 DIN	WM14 Advanced
			
Dimensions HxWxD (mm)	90 x 107.8 x 64.5	90 x 107.8 x 64.5	90 x 107.8 x 64.5
Function	3-phase multifunction power indicator. System: V_{LL} , V_{LN} , An, VA, VA_{dmd} , W_{dmd} , W, var, PF, Hz. Max: A, W_{dmd} . Single phase: V_{LL} , V_{LN} , A, VA, W, var, PF	3-phase power analyzer. System: V_{LL} , An, PF, W, var, VA, W_{dmd} , VA_{dmd} , Hz, kWh, kvarh, hour meter; Max: A, A_{dmd} , W_{dmd} ; Single phase: V_{LL} , V_{LN} , A, A_{dmd} , PF, W, var, VA	3-phase power analyzer. System: V_{LL} , V_{LN} , An, PF, W, var, VA, W_{dmd} , VA_{dmd} , Hz, kWh, kvarh, hour meter; Max: W_{dmd} , VA_{dmd} . Single phase: V_{LL} , V_{LN} , A, A_{dmd} , PF, W, var, VA, THD (A,V); Max: V_{LN} , A, A_{dmd} , W. Min: V_{LN} , A, PF
Input specifications			
Range code	400 / 660 V_{L-L} / 5(6) AAC [AV5] 100 / 208 V_{L-L} / 5(6) AAC [AV6]	400 / 660 V_{L-L} / 5(6) AAC [AV5] 100 / 208 V_{L-L} / 5(6) AAC [AV6]	400 / 660 V_{L-L} / 5(6) AAC [AV5], 100 / 208 V_{L-L} / 5(6) AAC [AV6]
Accuracy	$\pm 0.5\%$ FS (V, A)	0.5 FS (V, A), 1 (kWh), 2 (kvarh)	0.5 FS (V, A), 1 (kWh), 2 (kvarh)
Display	3x3-digit LED	3x3-digit, LED 8+1-digit (energies)	3x3-digit, LED 8+-digit (energies)
Display refresh time	1.5 times/s	1.5 times/s	5 times/s (2 times/s FFT on)
Output specifications			
Serial communication output	RS485 port (on request) [S]	RS485 port (on request) [S]	RS485 port (on request) [S]
Alarm output			2 (relays) with PLC-type control function on 16 variables (AND / OR) [R]
Pulse output			2 (open collector) [O]
General specifications			
Power supply	24 VAC [A], 48 VAC [B], 115 VAC [C], 230 VAC [D], 18 to 60 VDC [3]	24 VAC [A] 48 VAC [B] 115 VAC [C] 230 VAC [D] 18 to 60 VDC [3]	18 to 60 VAC / DC [L], 90 to 260 VAC / DC [H]
Approvals / Marks	CE - cURus	CE - cURus - cCSAus	CE - cURus
Note			Advanced version [AX]
References			
For ordering key details, please refer to www.productselection.net			

Energy management

Multifunction meter

Power analyzers

Types **WM12 96** **WM14 96 Basic/Profibus** **WM14 96 Advanced**



Dimensions HxWxD (mm) 96 x 96 x 46 96 x 96 x 46 96 x 96 x 46

Function

WM12 96: 3-phase multifunction indicator.
System: V_{LL} , V_{LN} , A, An, VA, VA_{dmd} , W, W_{dmd} , var, PF, Hz.
Max: A, W_{dmd}
Single phase: V_{LL} , V_{LN} , A, VA, W, var, PF

WM14 96 Basic/Profibus: 3-phase power analyzer.
System: V_{LL} , An, PF, W, var, VA, W_{dmd} , VA_{dmd} , Hz, kWh, kvarh, hour meter;
Max: A, A_{dmd} , W_{dmd} ;
Single phase: V_{LL} , V_{LN} , A, A_{dmd} , PF, W, var, VA

WM14 96 Advanced: 3-phase power analyzer.
System: V_{LL} , V_{LN} , An, PF, W, var, VA, W_{dmd} , VA_{dmd} , Hz, kWh, kvarh, hour meter;
Max: W_{dmd} , VA_{dmd} .
Single phase: V_{LL} , V_{LN} , A, A_{dmd} , PF, W, var, VA, THD (A,V);
Max: V_{LN} , A, A_{dmd} , W.
Min: V_{LN} , A, PF

Input specifications

Range code	400 / 660 V_{L-L} / 5(6) AAC [AV5], 100 / 208 V_{L-L} / 5(6) AAC [AV6]	400 / 660 V_{L-L} / 5(6) AAC [AV5], 100 / 208 V_{L-L} / 5(6) AAC [AV6]	400 / 660 V_{L-L} / 5(6) AAC [AV5], 100 / 208 V_{L-L} / 5(6) AAC [AV6]
Accuracy	0.5 FS (V, A)	0.5 FS (V, A) 1 (kWh) 2 (kvarh)	0.5 FS (V, A), 1 (kWh), 2 (kvarh)
Display	3x3-digit, LED	3x3-digit, LED 8+1-digit (energies)	3x3-digit, LED 8+1-digit (energies)
Display refresh time	1.5 times/s	1.5 times/s	5 times/s (2 times/FFT on)

Output specifications

Serial communication output	RS 485 port (on request) [S]	RS 485 port (on request) [S] Profibus DP port [DG] (on request)	RS422/485 (on request) [S1]
Alarm output			2 (relays) with PLC-type control function on 16 variables (AND / OR) [R]
Pulse output			2 (open collector) [O]



General specifications

Power supply	24 VAC [A], 48 VAC [B], 115 VAC [C], 230 VAC [D], 18 to 60 VDC [3]	24 VAC [A], 48 VAC [B], 115 VAC [C], 230 VAC [D], 18 to 60 VDC [3], 90 to 260 AC / DC [H] DG version only	18 to 60 VAC / DC [L], 90 to 260 VAC / DC [H]
Approvals/Marks	CE - cURus - cCSAus	CE - cURus (no DG version)	CE - cURus Advanced version [AX]



References

For ordering key details, please refer to www.productselection.net



Energy management

	Energy analyzer	Modular power quality analyzers	
Types	EM26 96	WM30 96	WM40 96
			
Dimensions HxWxD (mm)	96 x 96 x 61	96 x 96 x 50	96 x 96 x 50
Description		MODULAR	MODULAR
Function	3-phase energy analyzer Sys: V _{LL} , V _{LN} , A _n , var, VA, W, W _{dmd} , VA _{dmd} , VA, Hz, %THD-V, %THD-A, kWh, kvarh, hour counter, gas and water Max: A _{dmd} , W _{dmd} , VA _{dmd} . Single-phase: V _{LL} , V _{LN} , A, W, var, VA, PF, Admd. kWh, kvarh; TRMS method	3-phase power quality analyzer System: V _{LN} , V _L , VA, W, var, PF, Hz, THD total/partial kWh and kvarh Single phase: V _{LN} , V _L , VA, AL, A _n , W, var, PF, THD; Phase-sequence-asymmetry loss	3-phase power quality analyzer System: V _{LN} , V _{LL} , VA, W, var, PF, Hz, THD. Total/partial kWh and kvarh (multi-tariff), K-factor Single phase: V _{LN} , V _L , VA, AL A _n (calculated or measured), W, var, PF, THD, TDD; Phasesequence-asymmetry-loss Load profile, event stamping, data logger, utility and hour counters
Input specifications			
Range code	120 / 208 V _{LL} [AV6], 400 / 660 V _{LL} [AV5] In: 1 / 5A, I _{max} : 10AAC 3-phase unbal. load	400 / 690 V _{LL} AC1(2)A [AV4] 400 / 690 V _{LL} AC5(6)A [AV5] 100 / 208 V _{LL} AC5(6)A [AV6] 100 / 208 V _{LL} AC1(2)A [AV7]	400 / 690 V _{LL} AC1(2)A [AV4] 400 / 690 V _{LL} AC5(6)A [AV5] 100 / 208 V _{LL} AC5(6)A [AV6] 100 / 208 V _{LL} AC1(2)A [AV7]
Accuracy	±0.5% RDG (V, A) 1 (kWh), 2 (kvarh)	±0.2% RDG (V, A) C (kWh), 2 (kvarh)	±0.2% RDG (V, A) Class C (kWh), EN50470-3 Class 2 (kvarh), EN62053-23
Display	3x4-digit (inst. variables) 8-digit (energies) LCD	4x4-digit backligh. LCD 9+1-digit (energies)	4x4-digit backligh. LCD 9+1-digit (energies)
Display refresh time	1.5 times/s	≤ 100 ms	≤ 100 ms
Output specifications			
Serial communication output	RS485 (2-wire) [S1]	Modbus RS485/232 port + RTC [S1], BACnet SMTP [B3]	Modbus RS485/232 port + RTC [S1], BACnet SMTP [B3] Optical port (ANSI type 2)
Internet/Ethernet port		Modbus TCP Ethernet port [E2], BACNet-IP [B1], Ethernet/IP [E6]	Modbus TCP Ethernet port [E2], BACNet-IP [B1], Ethernet/IP [E6]
Alarm output	2-relay [R2] / open collector [O3]	Up to 4 freely configuration virtual alarms	Up to 16 freely configuration virtual alarms
Pulse output	3-open collector [O3] / relay [B2]	Up to 2 digital output modules	Up to 8 digital outputs
Digital input	3 digital inputs [I3]		Up to 6 digital inputs
Analogue output		Up to 2 analogue output modules	Up to 4 analogue outputs
General specifications			
Power supply	18 to 60 VAC / DC [L] 90 to 260 VAC / DC [H]	18 to 60 VAC / DC [L] 90 to 260 VAC / DC [H]	18 to 60 VAC / DC [L] 90 to 260 VAC / DC [H]
Approvals / Marks	CE - cULus (only H)	CE - cULus "Listed"	CE - cULus "Listed"
References			
For ordering key details, please refer to www.productselection.net			

Energy management



	Modular power quality analyzer	Modular power quality analyzer/transducers	
Types	WM3 96	WM5 96	PQT H
			
Dimensions HxWxD (mm)	96 x 96 x 124	96 x 96 x 124	90 x 90 x 140
Description	MODULAR	MODULAR	MODULAR
Function	3-phase power quality analyzer System: V_{LN} , V_{LL} , An, VA, V_{Admd} , W, W_{dmd} , var, PF, Hz, THD, total/partial kWh, kvarh (4 tariff) Single phase: V_{LN} , V_{LL} , A, W, var, PF, THD	Smart power quality analyzer. Sys: V_{LN} , V_{LL} , An, W, var, VA, PF, Hz, kWh, kvarh, Single-phase: V_{LN} , V_{LL} , A, W, var, VA, PF, THD-V, THD-A THD and single H up to the 63rd H (V, A)	Smart power quality transducer. Sys: V_{LN} , V_{LL} , An, W, var, VA, PF, Hz, kWh, kvarh, Single-phase: V_{LN} , V_{LL} , A, W, var, VA, PF, THD-V, THD-A THD and single H up to the 63rd H (V, A)
Input specifications			
Range code	433 VAC-1/5 AAC [AV5] 690 VAC-1/5 AAC [AV7]	120/208VL-L [AV6], 400/690VL-L [AV5] In: 1/5A, I _{max} : 10AAC	120/208VL-L [AV6], 400/690VL-L [AV5] In: 1/5A, I _{max} : 10AAC
Accuracy	±0.5% RDG (V, A)	±0.2% RDG (V, A)	±0.2% RDG (V, A)
Active energy	1 (kWh)	Class 0.5 (EN62053-22)	Class 0.5 (EN62053-22)
Reactive energy	2 (kvarh)	Class 2 (EN62053-23)	Class 2 (EN62053-23)
Display	4x4-digit backligh. LCD 4x9-digit (energies)	WM5: 4x4-digit backlighted LCD WM5: 4x9-digit (energy)	
Sampling Rate	10 times /s	10 times /s	10 times /s
Output specifications			
Serial communication output	RS 422 / 485 port RS232 port + RTC	RS422 / 485, RS232+RTC modules. Optical port (ANSI C12.18/Modbus)	RS422 / 485, RS232+RTC modules. Optical port (ANSI C12.18/Modbus)
Internet / Ethernet port		Internet / Ethernet comm. with WEB server capability [E2]	Internet / Ethernet comm. with WEB server capability [E2]
Alarm output	Up to 2 single / dual open collector or relay modules	Up to 16, by: single / dual or quadruple open collector or relay modules	Up to 16, by: single / dual or quadruple open collector or relay modules
Pulse output	Up to 2 single / dual open collector or relay modules	Up to 16, by: single / dual or quadruple open collector or relay modules	Up to 16, by: single / dual or quadruple open collector or relay modules
Digital input	Up to 3 digital inputs	Up to 12 (W_{dmd} , V_{Admd} sync.; tariff, contact status reading)	Up to 12 (W_{dmd} , V_{Admd} sync.; tariff, contact status reading)
Analogue output	Up to 2 single / dual analog output modules	Up to 8, by single / dual (mA/V) output modules	Up to 8, by single / dual (mA/V) output modules
General specifications			
Power supply	18 to 60 VAC / DC [L] 90 to 260 VAC / DC [H]	18 to 60 VAC / DC [L], 90 to 260 VAC / DC [H]	18 to 60 VAC / DC [L], 90 to 260 VAC / DC [H]
Approvals / Marks	CE - cURus - CSA	CE - cURus - CSA	CE - cURus - CSA
References			
For ordering key details, please refer to www.productselection.net			

Energy management



		Compact power transducers		Transducer
Types	CPT DIN	CPT DIN Advanced	CVT DIN	
				
Dimensions HxWxD (mm)	45 x 83.5 x 98.5	45 x 83.5 x 98.5	89 x 71.5 x 58.5	
Description	3-phase compact power transducer	3-phase compact power transducer	Single phase transducer	
Function	4-digit data format instantaneous variable, 8+1-digit format energy variables, 5+2-digit data format hours. TRMS method. Sys: V _{LL} , An, PF, W, var, VA, W _{dmd} , VA _{dmd} , Hz, kWh, kvarh, hour meter; Max: W _{dmd} ; Single-ph: V _{LL} , V _{LN} , A, A _{dmd} , PF, W, var, VA	4-digit data format instantaneous variable, 8+1-digit format energies, 5+2-digit format hours. TRMS method. Sys: V _{LL} , V _{LN} , An, PF, W, var, VA, W _{dmd} , VA _{dmd} , Hz, kWh, kvarh, hour; Max: W _{dmd} , VA _{dmd} . Sing. ph: V _{LL} , V _{LN} , A, A _{dmd} , PF, W, var, VA, THD, (A,V); Max: V _{LN} , A, A _{dmd} , W. Min: V _{LN} , A, PF	1-phase AC, DC. Measurements V, A, Hz	
Input specifications				
Range code	120 / 208VAC [AV6], 400 / 690VAC [AV5], 1AAC and 5AAC	120 / 208VAC [AV6], 400 / 690VAC [AV5], 1AAC and 5AAC	1 A / 100 VAC [AV1], 60 mVDC / 10 VDC [AV2], 5 A / 100 VAC [AV4], 5 A / 500 VAC [AV5], 200VDC / 1ADC [AV6], 45 to 55Hz [F1], 55 to 65Hz [F2], 350 to 450Hz [F3]	
Accuracy	±0.5% RDG (A,V)	±0.5% RDG (A,V)	0.5% FS	
Active energy	kWh: class 1	kWh: class 1 (EN62053-21)		
Reactive energy	kvarh: class 2	kvarh: class 2 (EN62053-23)		
Sampling Rate	1.5 times/s	1.5 times/s		
Output specifications				
Serial communication	RS422/485 [S1], RS232 [S2]	RS422/485 [S1], RS232 [S2]		
Alarm output		2 (relays) with PLC-type control function on 16 variables (AND / OR) [R2]		
Pulse output		2 (open collector) [O2]		
Analogue output		Up to 3: 20 mA [A1-3], 10 VDC [V1-3]	0 to 20 mA [1], 4 to 20 mA [2], 0 to 10 V [3], 0 to ±1 V [4]	
General specifications				
Power supply	18 to 60 VAC / DC [L], 90 to 260 VAC / DC [H]	18 to 60 VAC / DC [L], 90 to 260 VAC / DC [H]	24 VAC [A], 48 VAC [B], 115 VAC [C], 230 VAC [D]	
Approvals / Marks	CE - cURus - CSA	CE - cURus - CSA	CE	
Note	Basic version [BX]	Advanced version [AX]		
References				
For ordering key details, please refer to www.productselection.net				

Energy management

DC energy analyzers



Types	VMU-E	VMU-X
		
Dimensions	1-DIN module	1-DIN module
Description	DC energy analyzer: V, A, W, kWh	Power supply module for VMU-E unit
Input specifications		
Range code	400 VDC 20 A [AV00] (up 1000 A with external shunt) 400 VDC 1000A [AV10] (by 10 V current sensor)	
Accuracy	±0.5% RDG (V, A)	
Energy	Class 1	
Display	6 DGT, LCD, h 7mm	
Output specifications		
Out 1 (Pulse)		1 opto-mosfet
Out 1 (Alarm)		1 opto-mosfet
Serial communication		RS485
General specifications		
Power supply	Self power supply through VMU-X unit [X]	38 to 265 VAC/DC [X]
Approvals / Marks	CE	CE
References		
For ordering key details, please refer to www.productselection.net		

Energy monitoring solution



	Web-server	Modem
Types	VMU-C EM	VMU-W
		
Dimensions	2-DIN module	2-DIN module
Description	Web-server which controls and supervises any electrical installation acquiring information from energy meters, power analyzers and VMU I/O modules. It provides information via Internet, so data are available anywhere.	Modem based on "UMM" (Universal Mobile Modem) communication technology for data communication when wired Internet is not available. Suitable to be used in combination with VMU-C only.
Type	Micro PC	Universal Mobile Modem
Storage memory	4 GB	
Back-up memory	Micro-SD / Micro-SDHC / USB	
Mobile communication specifications		
SIM card		SIM (25 x 15mm) for data communication (M2M)
Compatibility		Modem compatible with quad-band GSM-GPRS-EDGE standards; dual-band UMTS-HSPA
Supported services		Internet communication; SMS
Communication port and Output specifications		
RS485	1 port for VMU I/O modules, 1 port for power analyzers and energy meters	
Ethernet	1 port for Internet / LAN connection	
USB	1 USB "A" (for USB stick) and 1 USB "mini-A" (service port)	
LED		
Status and colour	One LED with different colours for internal BUS communication, communication ports, alarms and power supply	Single colour green for ON/OFF. Single colour blue for communication link status.
Antenna		
Connector		RP-SMA female
Type		Stilo antenna included (available cable connected adhesive mount antenna as option)
Connections		
RS485	3 screw terminals per port	
Ethernet	RJ-45 connector (10 / 100 Base-T)	
USB	High Speed USB 2.0	
Power supply		
Voltage Supply	From 12 to 28 VDC	From 12 to 28 VDC
Power Consumption	5 W	≤ 5W
Approvals/Marks		
	CE, cULus listed	CE, cULus listed, R&TTE 99 / 5 / CE, FCC / IC / PTCRB
References		
For ordering key details, please refer to www.productselection.net		

Energy monitoring solution

VMU I/O optional modules





Types	VMU-M EM	VMU-P EM	VMU-O EM
			
Dimensions	1-DIN module	1-DIN module	1-DIN module
Description	Master unit 6-DGT readout	Environment variable measurement unit	Inputs / outputs unit
Function	VMU-M performs the local bus management of VMU-P both measuring units and VMU-O I/O unit	2 temperatures, 1 analogue and 1 pulse rate output.	VMU-O allows to add, for every single unit, available in the local bus two digital inputs and two relay outputs
Input specifications			
Range code	2 Pt100 or Pt1000, 3-wires (-50.0 to +200.0°C) or one digital input and one pulse input, for local management.	2 Pt100 or Pt1000, 3-wires 1 analogue input (20mA or 120 mV). 1 pulse rate input (0 to 1000 Hz max.) [2TIW]	2 digital inputs for "Protection trip detection or others"
Accuracy	±(0.5%RDG + 5DGT)	±(0.2%RDG + 1DGT)	
Output specifications			
Alarm	Real and virtual alarm management of all variables coming from VMU-M and VMU-P with local event logging.		2 digital outputs for alarm notification of local alarms or as a digital input status changing. SPST relay type.
Serial communication	Local bus: up to 1 VMU-P and 3 VMU-O units RS485 communication port (Modbus).	Local bus: one VMU-P unit per bus	Local bus: up to 3 VMU-O units
Others		Front multicolour LED to show the status of the unit	Front multicolour LED to show the status of the unit
General specifications			
Power supply	12 to 28 VDC power supply	Self-power supply from VMU-M unit	Self-power supply from VMU-M unit
Approvals / Marks	cULus approved	cULus approved	cULus approved
References			
For ordering key details, please refer to www.productselection.net			

PV monitoring solution

	Web-server		Modem
Types	Eos-Box	VMU-C	VMU-W
			
Dimensions HxWxD (mm)	225 x 225 x 45	17.5 x 90 x 67	2-DIN module
Description	Eos-Box is a web server that controls and supervises the whole installation, acquiring information from: Eos-Array groups; inverters; energy meters; interface protection. The Eos-Box provides information via the internet, so the data is available wherever you are. Eos-Box is also capable of M2M communication by interacting with its HTTP API.	VMU-C is a Web-server which controls and supervises a photovoltaic installation acquiring information from Eos-Array groups, inverters and energy meters. The VMU-C provides information via Internet so data are available wherever you are. VMU-C is also capable of M2M communication by scheduling FTP uploads or by interacting with its HTTP API.	Modem based on "UMM" (Universal Mobile Modem) communication technology for data communication when wired Internet is not available. This unit is suitable to be used in combination with VMU-C only.
Type	Embedded PC	Micro PC	Universal Mobile Modem
Storage memory	8 GB DOM	4 GB	
Back-up memory	Industrial CompactFlash™	Micro-SD / Micro-SDHC / USB	
Mobile communication specifications			
SIM card			SIM (25 x 15mm) for data communication (M2M)
Compatibility			Modem compatible with quad-band SM-GPRS-EDGE standards; dual-band UMTS-HSPA
Supported services			Internet communication; SMS
Communication port and Output specifications			
RS485	3 ports for Eos Array bus management 1 port for inverter and meters	1 port for Eos-Arrays, 1 port for inverters and energy meters	
Ethernet	1 for internet / LAN connection; 1 for local access	1 port for Internet / LAN connection	
USB	3, for local access	1 USB "A" (for USB stick) and 1 USB "mini-A" (service port)	
LED			
Status and colour	Green for power-on. Orange for DOM memory access	One led with different colors for internal BUS communication, communication ports, alarms and power supply	Single colour green for ON/OFF. Single colour blue for communication link status.
Antenna			
Connector			RP-SMA female
Type			Stilo antenna included (available cable connected adhesive mount antenna as option)
Connections			
RS485	3 pole detachable screw terminal block per port	3 screw terminals per port	
Ethernet	RJ-45 connector (10 / 100 Base-T)	RJ-45 connector (10 / 100 Base-T)	
USB	High speed USB 2.0	High Speed USB 2.0	
General specifications			
Voltage Supply	100 to 240 VAC	From 12 to 28 VDC	From 12 to 28 VDC
Power Consumption	70 W	≤ 5 W	≤ 5 W
Approvals / Marks	CE	CE - cULus listed	CE, cULus listed, R&TTE 99 / 5 / CE, FCC / IC / PTCRB
References			
	EOSBOXDXXX	For ordering key details, please refer to www.productselection.net	



PV monitoring solution

EOS-Array solar control solution

Types	VMU-M	VMU-S	VMU-P	VMU-O...AT
				
Dimensions HxWxD (mm)	1-DIN module	1-DIN module	1-DIN module	1-DIN module
Description	Master unit 6-DGT readout	String unit, with built-in protection fuseholder	Environment variable measurement unit	Inputs/outputs unit
Function	VMU-M performs the local bus management of VMU-S, VMU-P both measuring units and VMU-O I/O unit	Variables measuring unit, DC current, voltage, power and energy metering. String control and efficiency measurement	PV module temperature, air temperature, sun irradiation and wind speed metering	VMU-O allows to add, for every single unit, available in the local bus two digital inputs and two relay outputs
Input specifications				
Range code	2 Pt100 or Pt1000, 3-wire (-50.0 to +200.0°C) or one digital input and one pulse input. [T2]	Direct connections 16 A / 1000 VDC [AV10]. Measurements: V, A, W, Wh	2 Pt100 or Pt1000, 3-wire (PV and air temperature). 1 irradiance input (up to 120 mV [2TIW] or 4-20mA [2TCW]). 1 wind speed input (0 to 1000 Hz max.)	2 digital inputs for "Protection trip detection or others" [I2]
Accuracy	±(0.5% RDG + 5DGT)	±(0.5% RDG + 2DGT)	±(0.2% RDG + 1DGT)	
Output specifications				
Alarm	Real and virtual alarm management of all variables coming from VMU-M, VMU-S, and VMU-P with event logging			2 digital outputs for alarm notification as string alarm or as a digital input status changing. SPST relay type. [R2]
Serial communication	Local bus: up to 15 mixed VMU-S, VMU-P and VMU-O units RS485 communication port (Modbus) [S1]	Local bus: up to 15 VMU-S units in the same bus [S]	Local bus: one VMU-P unit per bus [S]	Local bus: up to 7 VMU-O units
Others	Data logger (V, A, W, PV cell and air temperature, irradiation, wind speed) DC/AC efficiency	Diagnostics functions: anti-theft control, fuse blow detection, wrong PV panel connection. Front multicolour LED to show the status of the unit	Front multicolour LED to show the status of the unit	Front multicolour LED to show the status of the unit
General specifications				
Power supply	12 to 28 VDC power supply [A]	Self-power supply from VMU-M unit [X]	Self-power supply from VMU-M unit [X]	Self-power supply from VMU-M unit [X]
Approvals / Marks	CE - cULus Listed	CE - cULus Listed	CE - cULus Listed	CE - cULus Listed
References				
For ordering key details, please refer to www.productselection.net				



PV monitoring solution

EOS-Array Lite solar control solution

Types	VMU-ML	VMU-S0	VMU-P
			
Dimensions HxWxD (mm)	1-DIN module	1-DIN module	1-DIN module
Description	Master unit 6-DGT readout	String unit, with built-in protection fuseholder	Environment variable measurement unit
Function	VMU-ML performs the local bus management of VMU-S0, VMU-P both measuring units and VMU-O output unit	Variables measuring unit, DC current and voltage	PV module temperature, air temperature, sun irradiation
Input specifications			
Range code		Direct connections 16 A / 1000 VDC [AV10]. Measurements: V, A	1 Pt100 or Pt1000, 3-wire (PV and air temperature). 1 irradiation input (up to 120mV [1TI] or 4-20mA [2TCW])
Accuracy		±(0.5%RDG + 2DGT)	±(0.2%RDG + 1DGT)
Output specifications			
Alarm	Single real or virtual alarm management of all variables coming from VMU-ML, VMU-S0, and VMU-P with event logging		
Serial communication	Local bus: up to 15 mixed VMU-S0, VMU-P and VMU-O units RS485 communication port (Modbus) [S1]	Local bus: up to 15 VMU-S0 units in the same bus [S]	Local bus: one VMU-P unit per bus [S]
Others	Front dual colour LED to show the status of the unit	Diagnostics functions: wrong PV panel connection	Front multicolor LED to show the status of the unit
General specifications			
Power supply	12 to 28 VDC power supply [A]	Self-power supply from VMU-ML unit [X]	Self-power supply from VMU-ML unit [X]
Approvals / Marks	CE - cULus Listed	CE - cULus Listed	CE - cULus Listed
References			
For ordering key details, please refer to www.productselection.net			





PV monitoring solution

EOS-Array solar control solution

Types	VMU-O	VMUAT
		
Dimensions HxWxD (mm)	1-DIN module	1-DIN module
Description	Outputs unit	Optical fiber anti-theft sensor
Function	VMU-O allows to add, for every single unit, available in the local bus, one relay outputs	
Input specifications		
Range code	-	Optical fiber plastic type PF0221000
Output specifications		
Alarm	1 digital output for alarm notification as string alarm. SPST relay type. [R1]	NPN or PNP
Serial communication	Local bus: up to 7 VMU-O units	
Others	Front multicolor LED to show the status of the unit	
General specifications		
Power supply	Self-power supply from VMU-ML unit [X]	Self power supply through VMU-O AT unit [X]
Approvals / Marks	CE - cULus Listed	CE
References		
For ordering key details, please refer to www.productselection.net		

PV monitoring solution

Surge arresters for AC lines

Types	DSF A/P	DSB A 52	DSB P 53	DSB P 54
				
Dimensions HxWxD (mm)	90 x 18 x 72 [51] 90 x 36 x 72 [52] 90 x 54 x 72 [53] 90 x 72 x 72 [54]	90 x 36 x 72	90 x 54 x 72	90 x 72 x 72
Description	No backup fuse Surge arresters for AC lines single or 3phase network types TN-S; TT; IT; TN-C. Removable cartridges. No leakage current	Surge arresters for AC lines single phase. Removable cartridges.	Surge arresters for AC lines three phase. Removable cartridges.	Surge arresters for AC lines three phase. Removable cartridges.

Output specifications

Out (Alarm)	1 x SPDT relay	1 x SPDT relay (option)	1 x SPDT relay (option)	1 x SPDT relay (option)
-------------	----------------	-------------------------	-------------------------	-------------------------





General specifications

SPD class	Class II	Class II	Class II	Class II
Max. continuous voltage Uc	150 VAC 300 VAC 385 VAC 460 VAC 550 VAC 750 VAC	275 VAC / 350 VDC 385 VAC / 500 VDC	275 VAC / 350 VDC 385 VAC / 500 VDC 440 VAC / 580 VDC	275 VAC / 350 VDC 385 VAC / 500 VDC 440 VAC / 580 VDC
I _n (8/20)	20 kA 10 kA [DSF5xCA750]	20 kA / pole	20 kA / pole	20 kA / pole
I _{max} (8/20)	50 kA 25 kA [DSF5xCA750]	40 kA / pole	40 kA / pole	40 kA / pole
I _{imp} (10/350)	-	-	-	-
Response time	< 25 ns	< 25 ms with GDT 25 ms (L-N), 100 ms (N-PE) without GDT	< 25 ms	< 25 ms with GDT 25 ms (L-N), 100 ms (N-PE) without GDT
Back-up fuse	Not required up to 200 kArms	125 A gL	125 A gL	125 A gL
Mounitng	DIN rail	DIN rail	DIN rail	DIN rail
Temperature range	-40°C to +80°C -40°F to +176°F	-40°C to +80°C -40°F to +176°F	-40°C to +80°C -40°F to +176°F	-40°C to +80°C -40°F to +176°F
Approvals / Marks	CE, UR (UL 1449 3rd ED.), CSA	CE: IEC61643	CE: IEC61643	CE: IEC61643

References





For ordering key details, please refer to www.productselection.net

PV monitoring solution

	Surge arresters for PV systems		Surge arresters for communication lines	
Types	DSF D	DSC	DSB S	DSB DP
				
Dimensions HxWxD (mm)	90 x 36 x 72 [52] 90 x 54 x 72 [53]	90 x 18 x 72 [51] 90 x 36 x 72 [52] 90 x 54 x 72 [53] 90 x 72 x 72 [54]	90 x 12 x 71.5	90 x 12 x 71.5
Description	No backup fuse, 2-pole [52] or 3-pole [53] surge arresters for P.V. installations. No leakage	Class I and II Surge arresters for DC systems.	Surge arresters for RS485 communication lines. Removable cartridges.	Surge arresters for Dupline® and Smarthouse® communication lines. Removable cartridges.
Output specifications				
Out (Alarm)	1 x SPDT relay	1 x SPDT relay	None	None
General specifications				
SPD class	Class II	Class I, II	Class C1/C2/C3 (IEC 60643-21)	Class C1/C2/C3 (IEC 60643-21)
Max. continuous voltage U _c	600 VDC [600, 1200] 1000 VDC [1000] 1200 VDC [1200]	1000 V	6 VDC	18 VDC
I _n (8/20)	20 kA [600, 1200] 12.5 kA [1000]	20 kA / pole	10 kA / pole	10 kA / pole
I _{max} (8/20)	40 kA [600, 1200] 25 kA [1000]	40 kA / pole	20 kA / pole	20 kA / pole
I _{imp} (10/350)	-	12.5 kA / pole	-	-
Response time	< 25 ns	<25 ns	<1 ns	<1 ns
Back-up fuse	Not required up to 200 kArms	N.A.		
Mounitng	DIN rail	DIN rail	DIN rail	DIN rail
Temperature range	-40°C to +80°C -40°F to +176°F	-40°C to +80°C -40°F to +176°F	-40°C to +80°C -40°F to +176°F	-40°C to +80°C -40°F to +176°F
Approvals / Marks	CE, UR (UL 1449 3 rd ED.), UTE C 61-740-51, CSA	CE: IEC616431; UTE C61-740-51	CE: IEC 60643-21	CE: IEC 60643-21
References				
	DSF52XD600PV	DSC54CD1000PV	DSB51XXP	DSB51XXDP
	DSF52CD600PV	DSC54XD1000PV		
	DSF52XD1000PV			
	DSF52CD1000PV			
	DSF53XD1200PV			
	DSF53CD1200PV			

Counters

Electromechanical counters

Types	EMCT46/EMCT47	E2CT4	E1CT4	ECH4
				
Version	Micro	Mini	Standard	Combination time and energy meter
Dimensions HxWxD (mm)	13.8x25x35.2 20x30x36.2	24x48x53.8	24x48x49	48x48x38

Technical data

Number of digit	6/7	5	6	7/8
Reset	no	yes	no	no
Digit height, visible (mm)	4 x 1.7 / 4 x 1.2	4 x 1.7	4 x 1.7	4 x 1.7
Panel cut-out (mm)	e.g. 27x 14	45 x 22 / 31 x 20	45 x 22 / 31 x 20	46 x 46 X Ø50.5
Mounting type	Panel / PCB	Panel / base mount / PCB	Panel / base mount / PCB	Panel / DIN-rail
Max. protection	up to IP 65	IP 41	IP 41	IP 52 front side
Pulse voltage min. / max.	1.5 to 24 VDC	24 to 230 VAC 12 to 24 VDC	24 to 230 VAC 12 to 24 VDC	0 to 260 VAC 0 to 260 VDC
Max. count frequency	10 Hz	10 Hz	10 Hz	10 Hz
Min. power consumption	70 mW	130 mW	50 mW	1 W / 3 V

References

	EMCT46xxxxxx	E2CT4xxxxxx	E1CT4xxxxxx	ECH4
	EMCT47xxxxxx			

Electronic counters

Types	FKA	DCT86	DMF861	DMF862
				
Version	LCD-Panel mount	LCD-Panel mount	LCD-Panel mount	LCD-Panel mount
Dimensions HxWxD (mm)	DIN 48 X 24	DIN 48 X 24	DIN 48 X 24	DIN 48 X 24

Function

Totaliser	yes			
Pulse counter		yes	yes	2 pulse counters, Pulse counter and timer, Pulse and frequency meter or 2 timers
Position display for encoders			yes	
Frequency meter/Tachometer			yes	
Timer			yes	

Technical data



Number of digit	8	6	6	6
Time range	manual / electric	manual / electric	manual / electric	manual / electric
Digit height, visible (mm)	8	8	8	8
Panel cut-out(mm)	45 x 22	45 x 22	45 x 22	45 x 22
Max. protection	IP 65 front side	IP 65 front side	IP 65 front side	IP 65 front side
Min. power consumption (W/VA)	12000	60000	60000	60000
Power supply	Lithium battery	10 to 30 VDC	10 to 30 VDC	10 to 30 VDC
Count inputs	NPN/PNP 10 to 260 VAC/DC	NPN/PNP	NPN/PNP	NPN/PNP

References

	FKAxxxxxx	NI-DCT86xxxxxx	NI-DMF861xxxxxx	NI-DMF862xxxxxx
--	-----------	----------------	-----------------	-----------------

Counters

Digital multifunction





Types	DMF1461	DMF1462
		
Version	LED - Panel mount	LED - Panel mount
Dimensions HxWxD (mm)	DIN 96 x 48	DIN 96 x 48
Function		
Pulse counter	Yes	2 pulse counters, Pulse counter and timer, Pulse and frequency meter or 2 timers
Position display for encoders	Yes	
Frequency meter / Tachometer	Yes	
Timer	Yes	
Technical data		
Number of digit	6	6
Reset	manual / electric	manual / electric
Preset	-	-
Digit height, visible (mm)	14	14
Panel cut-out (mm)	92 x 45	92 x 45
Max. protection	IP65 front side	IP65 front side
Max. count frequency (Hz)	60000	60000
Supply voltage	90...260 VAC / 10...30 VDC	90...260 VAC / 10...30 VDC
Count inputs	Schmitt-Trigger	Schmitt-Trigger

References



DMF1461xxx0

DMF1462xx0

Hour meter electromechanical

Types	E1HM4	E2HM4	E2HM35	E1HM35
				
Version	Panel mount	Panel mount	Panel mount	DIN rail
Dimensions HxWxD (mm)	DIN 48x24 - DIN 25x53	DIN 48x48	Ø71.1x37.3	90x36x66
Technical data				
Number of digit	7/8	7/8	6	7
Time range	0.01~99999.99h	0.01~99999.99h	0.01~99999.99h	0.01~99999.99h
Digit height, visible (mm)	4	4	3.5	3.5
Panel cut-out(mm)	45x22 / 50x25	46x46	Ø56.7	-
Max. protection	IP65 front side	IP65 front side	IP65 front side	IP65 front side
Min. power consumption (W/VA)	0.5 / 1.2	0.5 / 1.2	0.8 / 0.4	1 / 2.5
Voltage range	20...264 VAC 10...130 VDC / 24 VDC	20...264 VAC - 100...130 VAC 10...30 VDC	115...230 VAC 10...80 VDC	230 VAC 10...27 VDC
References				
	E1HM4xxxxxx	E2HM4xxxxxx	E2HM35xxxxxx	E1HM35xxxxxx

Counters

	Hour meter electronic LCD		Electronic time preset counters
Types	FSA01	FSA02	DMF61 / DMF62
			
Version	LCD panel mount	LCD panel mount	LCD panel mount
Dimensions HxWxD (mm)	DIN 24 x 48	DIN 24 x 48	DIN 48 x 48
Technical data			
Number of digit	7	8	2 x 6
Time range	0.01 h; h.min	0.01 h; h.min	
Max. Count frequency (Hz)			s. min. h or hh.mm.ss
Preset			61 : 1 / 62 : 2
Reset	manual	manual	electronic
Digit height, visible (mm)	8	8	
Panel cut-out (mm)	45 x 22	45 x 22	45 x 45
Mounting type	Panel mount	Panel mount	Panel mount
Max. protection	IP 65 front side	IP 65 front side	IP 65 front side
Power supply	Lithium battery (>8years)	Lithium battery (>8years)	90 to 260 VAC 11 to 30 VDC
Output			Relay or Optocoupler
Input			2 count inputs, gate, reset, lock, MPI, 4 optional inputs
References			
	FSA01xxxxxx	FSA02xxxxxx	DMF6101xxxx0 DMF6201xxxx0

PID controllers

PID controller – PDI series

Types	PDI 380, PDI 390	PDI 408, PDI 409	PDI 430	PDI 720
				
Dimensions HxWxD (mm)	75 x 33 x 64	48 x 48 x 98	48 x 48 x 98	72 x 72 x 97

Function	PDI 380, PDI 390	PDI 408, PDI 409	PDI 430	PDI 720
	Digital controller. Up to 4 configurable set points. Configurable multi input. ON/OFF, single/double action PID or Neutral Zone control. Fast Autotuning and Selftuning. Up to 2 configurable outputs (relay, SSR). Soft Start and LbA functions. Led shift index. Multi-level parameters programming, password protected. Programming KEY	Digital controller. Up to 4 configurable set points. Configurable multi input. ON/OFF, single/double action PID or Neutral Zone control. Fast Autotuning and Selftuning. Up to 3 configurable outputs (relay, SSR). Soft Start and LbA functions. Multilevel parameters programming, password protected. Programming KEY	Dual display digital controller. Up to 4 configurable set points. Universal input. ON/OFF, single/double action PID or Neutral Zone control. Fast Autotuning and Selftuning. Up to 4 configurable outputs (relay, SSR or 2 normalized analogue signal outputs). Input signal retransmission. Motorized actuators control. Soft Start and LbA functions. RS485 communication. CT input for HB alarm. Additional dig. in. Multi-level parameters programming, password protected. Programming KEY	Single display digital controller. Up to 4 configurable set points. Configurable multi input. ON/OFF, single/double action PID or Neutral Zone control. Fast Autotuning and Selftuning. Up to 3 configurable outputs (relay, SSR). Soft Start and LbA functions. Led shift index. RS485 communication. Additional digital input. Multi-level parameters programming, password protected. Programming KEY

Input specifications

Overall accuracy	±0.5% f.s., ±1% TC-S	±0.5% f.s., ±1% TC-S	±0.15% f.s.	±0.5% f.s., ±1% TC-S
Input signal	TC (J, K, S, I R), Pt100, mV [C] TC (J, K, S, I R), PTC, NTC, mV [E] 0 / 4-20 mA [I] 0 / 1-5 0 / 2-10 VDC [V]	TC (J, K, S, IR), PTC, NTC, mV [E] TC (J, K, S, IR), Pt100, mV [C] 0 / 4-20 mA [I] 0-1 V, 0 / 1-5 V, 0 / 2-10 V [V]	Pt100, TC (J, K, S, B, C, E, L, N, R, T, IR), PTC, NTC, mv, V, mA (1 Programmable digital input)	Pt100, TC (J, K, S, IR), mV [C] PTC, NTC, mV, TC (J, K, S, IR) [E] 0/4-20 mA [I], 0/1-5V, 0/2-10V [V]
Sampling rate	8 per second	8 per second	8 x per second	8 x per second
Display	PDI 380 Single display 4 digit 7-segment LED, h 12 mm PDI 390 Dual display 4+4 digit 7-segment LED, h 7 mm	PDI 408 Single display 4 digit 7-segment LED, h 12 mm PDI 409 Dual display 4+4 digit 7-segment LED, h 7 mm	4+4 digit 7-segment LED, h 7 mm	4 digit 7-segment LED, h 14 mm

Output specifications

Output 1	Relay [R], 8 mA / 8 VDC for SSR [O]	Relay [R], 8 mA / 8 VDC for SSR [O]	Relay [R], 7 mA / 14 VDC for SSR [O] 0/4-20 mA [C], 0/2-10 V [V]	Relay [R], 8 mA / 8 VDC for SSR [O]
Output 2	No [X] Relay [R], 8 mA / 8 VDC for SSR [O]	No [X], Relay [R], 8 mA / 8 VDC for SSR [O]	No [X], Relay [R], 7 mA / 14 VDC for SSR [O] 0/4-20 mA [C], 0/2-10 V [V]	No [X], Relay [R], 8 mA / 8 VDC for SSR [O]
Output 3		No [X], Relay [R], 8 mA / 8 VDC for SSR [O]	No [X], Relay [R], 7 mA / 14 VDC for SSR [O]	No [X], Relay [R], 8 mA / 8 VDC for SSR [O]
Output 4			No [X], Relay [R], 7 mA / 14 VDC for SSR [O]	

Options

Serial Communication				No [X], RS485 [S]
Serial Communication and/or digital input			No [X], RS485 [S], RS485 + DI [I]	No [X], DI [I]
Heater Break Alarm			No [X], CT input [H]	

Others



Power supply	12 VAC / DC [F], 24 VAC / DC [L] 100-240 VAC [H]	24 VAC / DC [L] 100-240 VAC [H]	24 VAC / DC [L] 100-240 VAC [H]	24 VAC / DC [L] 100-240 VAC [H]
Approvals	CE - cURus	CE - cURus	CE - cURus	CE - cURus

References

For ordering key details, please refer to www.productselection.net

Switching power supplies

Single phase switching power supplies

Types	5 / 10 / 18W				30 / 60W			90 / 100W			
											
Dimensions HxWxD (mm)	90 x 22.5 x 114				90 x 40.5 x 114			90 x 54 x 114			
Output specifications											
Voltage	5 VDC	12 VDC	15 VDC	24 VDC	12 VDC	24 VDC	48 VDC	12 VDC	24 VDC	48 VDC	
Current SPD 5 W	1 A	420 mA	340 mA	210 mA							
Current SPD 10 W	2 A	840 mA	670 mA	420 mA							
Current SPD 18 W	3 A	1.5 A	1.2 A	750 mA							
Current SPD 30 W					2.5 A	1.25 A	625 mA				
Current SPD 60 W					5 A	2.5 A	1.25 A				
Current SPD 90 W									3.8 A		
Current SPD 100 W								8.4 A	4.2 A	2.1 A	
Line regulation		±1%				±0.5%			±1%		
Load regulation		±2%				±0.5%			±1%		
Efficiency	75%	77%	77%	77%	86%	89%	89%		85%		
Input specifications											
Voltage range	Multi voltage: 90 to 265 VAC or 120 to 370 VDC				Multi voltage: 85 to 264 VAC or 90 to 375 VDC			Multi voltage: 90 to 264 VAC or 120 to 375 VDC			
Frequency range	47 to 63 Hz				47 to 63 Hz			47 to 63 Hz			
General specifications											
Ambient temperature	-40°C to +71°C				-40°C to +71°C			-35°C to +71°C			
Storage	-40°C to +85°C				-40°C to +85°C			-40°C to +85°C			
Derating (>60°C)	3 % /°C				2.5 % /°C			2.5 % /°C			
Approvals / Marks	cULus - TÜV - CE - Class I DIV2				cULus - TÜV - CE - Class I DIV2			cULus - TÜV - CE - Class I DIV2			
Installation	DIN Rail				DIN Rail			DIN Rail			
Connection	Screw terminals / Spring terminals (B)				Screw terminals / Spring terminals (B)			Screw terminals / Spring terminals (B)			
Main features											
	Adjustable output voltage. Internal noise filter. Short circuit protection. Overload protection (110-135%)				Adjustable output voltage. Internal noise filter. Short circuit protection. Overload protection (110-135 %). Output "Power ready" signal VDC (only model 24 VDC).			Adjustable output voltage. Internal noise filter. Short circuit protection. Overload protection (102-108%), PFC. Overvoltage protection (102-106%). Output "Power ready" signal VDC.			
LED indicator for "power on"	Yes				Yes			Yes			
LED indicator for DC "too low"	Yes				No - SPD24 with transistor output			Yes with relay output			
References											
5 VDC											
Screw terminals	SPD05051 / SPD05101 SPD05181										
Spring terminals	SPD05051B / SPD05101B SPD05181B										
12 VDC											
Screw terminals	SPD12051 / SPD12101 SPD12181			SPD12301 / SPD12601				SPD121001			
Spring terminals	SPD12051B / SPD12101B SPD12181B			SPD12301B / SPD12601B							
24 VDC											
Screw terminals	SPD24051 / SPD24101 SPD24181			SPD24301 / SPD24601				SPD24901L / SPD241001L			
Spring terminals	SPD24051B / SPD24101B SPD24181B			SPD24301B / SPD24601B							
48 VDC											
Screw terminals	SPD48301 / SPD48601						SPD481001				
Spring terminals	SPD48301B / SPD48601B										

Switching power supplies

Single phase switching power supplies

Types	120W / 120W(N)	240W	300W	480W
				

Dimensions HxWxD (mm)	124.5 x 64 x 123.6	124.5 x 83.5 x 123.6	124.5 x 83.5 x 123.6	124.5 x 175.5 x 123.6
-----------------------	--------------------	----------------------	----------------------	-----------------------

Output specifications

Voltage	12 VDC	24 VDC	48 VDC	24 VDC	48 VDC	24 VDC	48 VDC	24 VDC	48 VDC
Current	10 A	5 A	2.5 A	10 A	5 A	12.5 A	6.25 A	20 A	10 A
Line regulation		±0.5%	±0.5%		±0.5%		±0.5%		±0.5%
Load regulation		±1%	±1%		±1%		±1%		±1%
Efficiency	84%	86%	86%	89%	90%	89%	90%	89%	90%

Input specifications

Voltage range	Autoselect: 90 to 132 VAC, 180 to 264 VAC, 120 to 375 VDC	Autoselect: 90 to 132 VAC, 180 to 264 VAC, 120 to 375 VDC	Autoselect: 90 to 132 VAC, 180 to 264 VAC, 120 to 375 VDC	Autoselect: 90 to 132 VAC, 186 to 264 VAC, 120 to 370 VDC
Frequency range	47 to 63 Hz	47 to 63 Hz	47 to 63 Hz	47 to 63 Hz
PFC	0.7	0.75	0.75	0.99

General specifications

Ambient temperature	-35°C to +71°C	-40°C to +71°C	-30°C to +71°C	-40°C to +71°C
Storage	-40°C to +85°C	-40°C to +85°C	-40°C to +85°C	-40°C to +85°C
Derating (>60°C)	2.5 %/°C	2.5 %/°C	2.5 %/°C	2.5 %/°C > 56°C
Approvals / Marks	cULus - TÜV - CE - Classl DIV2	cULus - TÜV - CE - Classl DIV2	cULus - TÜV - CE - Classl DIV2	cULus - TÜV - CE - Classl DIV2
Installation	DIN Rail	DIN Rail	DIN Rail	DIN Rail
Connection	Screw terminals / Spring terminals (B)	Screw terminals / Spring terminals (B)	Screw terminals / Spring terminals (B)	Screw terminals / Spring terminals (B)

Main features





	Adjustable output voltage. Internal noise filter. Short circuit protection. Overload protection (110-145%). Parallel connection up to 3 supplies and PFC function on (N) model only	Adjustable output voltage. Internal noise filter. Short circuit protection. Overload protection (110-145%). Parallel connection up to 3 supplies standard. PFC function integrated.	Parallel function, PFC and Output ready	Adjustable output voltage. Internal noise filter. Short circuit protection. Overload protection (120-140%). Parallel connection up to 3 supplies standard. PFC function integrated.
LED indicator for "power on"	Yes	Yes	Yes, 24 V with output ready	Yes
LED indicator for DC "too low"	Yes - with relay output (SPD24 only)	Yes - with relay output (SPD24 only)	Yes	Yes - with relay output (SPD24 only)

References



12 VDC				
Screw terminals	SPD121201 SPD121201N			
Detatch. screw terminals	SPD121201B SPD121201BN			
24 VDC				
Screw terminals	SPD241201 SPD241201N	SPD242401	SPD243001	SPD244801
Detatch. screw terminals	SPD241201B SPD241201BN	SPD242401B	SPD243001B	SPD244801B
48 VDC				
Screw terminals	SPD481201 SPD481201N	SPD482401	SPD483001	SPD484801
Detatch. screw terminals	SPD481201B SPD481201BN	SPD482401B	SPD483001B	SPD484801B

Switching power supplies

Three phase switching power supplies





Types	SPD 120W 3-ph	SPD 240W 3-ph	SPD 480W 3-ph	SPD 960W 3-ph				
								
Dimensions HxWxD (mm)	124 x 74.3 x 118.8	124 x 89.0 x 118.8	124 x 150 x 118.8	126.2 x 275.8 x 118.8				
Output specifications								
Voltage	12 VDC 24 VDC	24 VDC 48 VDC	24 VDC 48 VDC	24 VDC 48 VDC				
Current	10 A 5 A	10 A 5 A	20 A 10 A	40 A 20 A				
Line regulation	±1%		±1%		±1%		±1%	
Load regulation	±1%		±1%		±1%		±1%	
Efficiency	87% 89%	90% 91%	90% 91%	92% 93%				
Input specifications								
Voltage range	340 to 575 VAC 480 to 820 VDC	340 to 575 VAC 480 to 820 VDC	340 to 575 VAC 480 to 820 VDC	340 to 575 VAC 480 to 820 VDC				
Frequency range	47 to 63 Hz		47 to 63 Hz		47 to 63 Hz		47 to 63 Hz	
PFC	0.55		0.55		0.65		0.80	
General specifications								
Ambient temperature	-40°C to +71°C		-25°C to +71°C		-30°C to +71°C		-40°C to +71°C	
Storage	-40°C to +85°C		-25°C to +85°C		-40°C to +85°C		-40°C to +85°C	
Derating	2.5 % /°C > 61°C		2.5 % /°C > 61°C		2.5 % /°C > 61°C		3.5 % /°C > 61°C	
Approvals / Marks	cULus - TÜV - CE		cULus - TÜV - CE		cULus - TÜV - CE		cULus - TÜV - CE	
Installation	DIN Rail		DIN Rail		DIN Rail		DIN Rail	
Connection	Screw terminals		Screw terminals		Screw terminals / Detach conn.		Screw terminals	
Main features								
	Can be used as Bi or Three phase, Parallel function and PFC		Can be used as Bi or Three phase, Parallel function and PFC		Can be used as Bi or Three phase, Parallel function and PFC		Can be used as Bi or Three phase. Active parallel function and PFC	
LED indicator for "power on"	Yes, 24 V with output ready		Yes, 24 V with output ready		Yes, 24 V with output ready		Yes, 24 V with output ready	
LED indicator for DC "too low"	Yes		Yes		Yes		Yes	
References								
12 VDC								
Screw terminals	SPD121203							
24 VDC								
Screw terminals	SPD241203	SPD242403	SPD244803 SPD244803B	SPD249603 SPD249603L (without parallel function and output ready)				
48 VDC								
Screw terminals		SPD482403	SPD484803 SPD484803B	SPD489603				

Switching power supplies, redundant modules

Types	Bi-phase switching power supplies			Redundant modules	
	100W			SPD Redundant Module	SPM Redundant Module
					
Dimensions HxWxD (mm)	90 x 54 x 114			90 x 54 x 114	91 x 35 x 56
Output specifications					
Voltage	12 VDC	24 VDC	48 VDC	24 VDC	24 VDC
Current	8.4 A	4.2 A	2.1 A	20 A	10 A
Line regulation	±1%				
Load regulation	±1%				
Efficiency	86%	87%	89%		
Input specifications					
Voltage range	340 to 575 VAC, 480 to 820 VAC			21 to 28VDC	21 to 48 VDC
Frequency range	47 to 63Hz				
PFC	0.55				
General specifications					
Ambient temperature	-40°C to +71°C			-40°C to +71°C	
Storage	-40°C to +85°C			-40°C to +85°C	
Derating (>60°C)	2.5% /°C				
Approvals / Marks	cULus - TÜV - CE - Class I DIV2			cULus - TÜV - CE	
Installation	DIN Rail			DIN Rail	DIN Rail
Connection	Screw terminals			Screw terminals	Screw terminals
Main features					
	Parallel function, PFC and Output ready			2 Relay outputs for remote monitoring	
LED indicator for "power on"	Yes - with relay output (SPD24 only)			Yes - with relay output (SPD24 only)	
LED indicator for DC "too low"	Yes				
References					
12 VDC					
Screw terminals	SPD121002				
24 VDC					
Screw terminals	SPD241002			SPD24RM20	SPM2RM2410
48 VDC					
Screw terminals	SPD481002				

Switching power supplies

Low profile DIN rail mounting

Types	SPM 1	SPM 3	SPM 4	SPM 5
				
Dimensions HxWxD (mm)	91 x 18 x 55.5	91 x 52 x 55.5	91 x 71 x 55.5	91 x 90 x 55.5
Output specifications				
Voltage	5 VDC, 12 VDC, 15 VDC, 24 VDC	5 VDC, 12 VDC, 15 VDC, 24 VDC	5 VDC, 12 VDC, 15 VDC, 24 VDC	5 VDC, 12 VDC, 15 VDC, 24 VDC, 24 VDC (S ver.)
Current	1.5 A - 0.83 A 0.67 A - 0.42 A	3.0 A - 2.1 A 2.0 A - 1.3 A	7.0 A - 4.5 A 4.0 A - 2.5 A	12 A - 6 A - 5 A 4.2 A - 3.8 A
Line regulation	±1%	±1%	±1%	±1%
Load regulation	±1%	±1%	±1%	±1%
Input specifications				
Voltage range	Autoselec. 90 to 264 VAC, 120 to 370 VDC	Autoselec. 90 to 264 VAC, 120 to 370 VDC	Autoselec.: 90 to 264 VAC, 120 to 370 VDC	Autoselec.: 90 to 264 VAC, 120 to 370 VDC
Frequency range	47 to 63Hz	47 to 63Hz	47 to 63Hz	47 to 63Hz
General specifications				
Ambient temperature	-25°C to +71°C	-25°C to +71°C	-25°C to +71°C	-25°C to +71°C
Storage	-25°C to +85°C	-25°C to +85°C	-25°C to +85°C	-25°C to +85°C
Derating (>60°C)	2.5 % /°C	2.5 % /°C	2.5 % /°C	2.5 % /°C
Approvals / Marks	cULus - TÜV - CE - ClassI DIV2	cULus - TÜV - CE - ClassI DIV2	cULus - TÜV - CE - ClassI DIV2	cULus - TÜV - CE - ClassI DIV2
Installation	DIN Rail	DIN Rail	DIN Rail	DIN Rail
Connection	Screw terminals	Screw terminals	Screw terminals	Screw terminals
Main features				
		Adjustable output voltage	Adjustable output voltage	Adjustable output voltage
LED indicator for "power on"	Yes	Yes	Yes	Yes
LED indicator for DC "too low"	Yes	Yes	Yes	Yes
References				
5 VDC	SPM1-051	SPM3-051	SPM4-051	SPM5-051
12 VDC	SPM1-121	SPM3-121	SPM4-121	SPM5-121
15 VDC	SPM1-151	SPM3-151	SPM4-151	SPM5-151
24 VDC	SPM1-241	SPM3-241	SPM4-241	SPM5-241
24 VDC (class 2 UL)				SPM5-241S



Switching power supplies

Enclosed switching power supplies

Types	SPPC 25 W	SPPC 35 W	SPPC 50 W	SPPC 75 W
				
Dimensions HxWxD (mm)	79 x 51 x 28.8	101.6 x 63.5 x 33	99 x 82 x 35	129 x 98 x 38
Output specifications				
Voltage	5V, 12V, 24V	5V, 12V, 24V	5V, 12V, 15V, 24V, 48V	5V, 12V, 24V, 48V
Current	5A, 2.1A, 1.1A	6A, 3A, 1.5A	8A, 4.2A, 3.4A, 2.2A, 1.12A	12A, 6A, 3.2A, 1.62A
Line regulation	±0.5%	±0.5%	±0.5%	±0.5%
Load regulation	±2.0%, ±1.0%, ±1.0%	±1.0%	±1.0%	±2.0%
Efficiency (typ)	115VAC 230VAC	76%, 80%, 84% 78%, 82%, 85%	79%, 83%, 86% 80%, 84%, 87%	79%, 84%, 87%, 88% 80%, 85%, 88%, 89%
Input specifications				
Voltage range	90 ~ 264VAC 127 ~ 370VDC	90 ~ 264VAC 127 ~ 370VDC	90VAC~264VAC 27~370VDC	90VAC~264VAC 127~370VDC
Frequency range	47-63Hz	47-63Hz	47Hz~63Hz	47Hz~63Hz
General specifications				
Ambient temperature	-25°C to +70°C	-25°C to +70°C	-25°C to +70°C	-25°C to +70°C
Storage	-40°C to +85°C	-40°C to +85°C	-40°C to +85°C	-40°C to +85°C;
Derating (>50°C)	2% /°C	2% /°C	1.5% /°C	1.5% /°C
Cooling	Free air convection	Free air convection	Free air convection	Free air convection
Approvals / Marks	UL60950-1 2 nd Ed; IEC 60950-1:2005 (2 nd Ed); EN60950-1:2006	UL60950-1 2 nd Ed; IEC 60950-1:2005 (2 nd Ed) ; EN60950-1:2006	UL60950-1 2 nd Ed; IEC 60950-1:2005 (2 nd Ed); EN60950-1:2006	UL60950-1 2 nd Ed; IEC 60950-1:2005 (2 nd Ed); EN60950-1:2006
Installation	Screw terminal	Screw terminal	Screw terminal	Screw terminal
Main features				
Mounting	Horizontal and Vertical (DIN rail mounting accessories available)	Horizontal and Vertical (DIN rail mounting accessories available)	Horizontal and Vertical (DIN rail mounting accessories available)	Horizontal and Vertical (DIN rail mounting accessories available)
References				
5 VDC	SPPC 525 1	SPPC 535 1	SPPC 550 1	SPPC 575 1
12 VDC	SPPC 1225 1	SPPC 1235 1	SPPC 1250 1	SPPC 1275 1
15 VDC			SPPC 1550 1	
24 VDC	SPPC 2425 1	SPPC 2435 1	SPPC 2450 1	SPPC 2475 1
48 VDC			SPPC 4850 1	SPPC 4875 1

Switching power supplies

Enclosed switching power supplies

Types	SPPC 150 W					SPPC 150 W (PFC) Power Factor Correction				
										
Dimensions HxWxD (mm)	199 x 98 x 38					194 x 99 x 50				
Output specifications										
Voltage	5 VDC	12 VDC	15 VDC	24 VDC	48 VDC	5 VDC	12 VDC	15 VDC	24 VDC	48 VDC
Current	26 A	12.5 A	10 A	6.5 A	3.3A	30 A	12.5 A	10 A	6.3 A	3.2 A
Line regulation	± 0.5%					± 0.5%				
Load regulation	±1%					±1%				
Efficiency (typ)	up to 85%					up to 87%				
Built-in active PFC						PFC > 0.98 @ 115 VAC ; PFC > 0.95 @ 230 VAC				
Input specifications										
Voltage input range	88 - 132 VAC 176 - 264 VAC 124 - 186 VDC 248 - 370 VDC					88 - 264 VAC 124 - 370 VDC				
Frequency range	47- 63 Hz					47- 63 Hz				
General specifications										
Ambient temperature	-25°C to +70°C					-25°C to +70°C				
Storage	-40°C to +85°C					-30°C to +85°C				
Output short circuit	Long-term, Auto recovery					Long-term, Auto recovery				
Derating (>50°C)	2.5% / °C					2.5% / °C				
Approvals / Marks	CE - cURus - RoHS					CE - cURus - RoHS - CB				
Installation	Screw terminal					Screw terminal				
Main features										
Mounting	Horizontal and Vertical (DIN rail mounting accessories available)					Horizontal and Vertical (DIN rail mounting accessories available)				
References										
5 VDC	SPPC-5150 1					SPPC-5150 1F				
12 VDC	SPPC-12150 1					SPPC-12150 1F				
15 VDC	SPPC-15150 1					SPPC-15150 1F				
24 VDC	SPPC-24150 1					SPPC-24150 1F				
48 VDC	SPPC-48150 1					SPPC-48150 1F				

Switching power supplies

Compact enclosed switching power supplies

Types	SPPC 200 W	SPPC 240 W	SPPC 320 W
			
Dimensions HxWxD (mm)	199 x 99 x 50	199 x 99 x 50	199 x 99 x 50
Output specifications			
Voltage	5V, 12V, 24V, 48V	12V, 24V	5V, 12V, 24V, 48V
Current	40A, 16.7A, 8.4A, 4.2A	20A, 10A	55A, 25A, 13A, 6.7A
Line regulation	±0.5%	±0.5%	±0.5%
Load regulation	±1.0%	±1.0%	±1.0%
Efficiency (typ)	79%, 84%, 86%, 87.5%	84%, 86%	79%, 84.5%, 87%, 87.5%
Built-in active PFC	(115VAC): PF>0.98 (230VAC): PF>0.96	(115VAC): PF>0.98 (230VAC): PF>0.96	(115VAC): PF>0.98 (230VAC): PF>0.96
Input specifications			
Voltage range	85 ~ 264VAC 120 ~ 370VDC	85 ~ 264VAC 120 ~ 370VDC	85 ~ 264VAC 120 ~ 370VDC
Frequency range	47-63Hz	47-63Hz	47-63Hz
General specifications			
Ambient temperature	-25°C to +70°C	-25°C to +70°C	-25°C to +70°C
Storage	-40°C to +85°C	-40°C to +85°C	-40°C to +85°C
Derating (>50°C)	2% /°C	2% /°C	2% /°C
Cooling	Forced air (built-in DC fan controlled by load and internal temperature)	Forced air (built-in DC fan controlled by load and internal temperature)	Forced air (built-in DC fan controlled by load and internal temperature)
Approvals / Marks	UL60950-1 2 nd Ed; IEC 60950-1:2005 (2 nd Ed); EN60950-1:2006	UL60950-1 2 nd Ed; IEC 60950-1:2005 (2 nd Ed); EN60950-1:2006	UL60950-1 2 nd Ed; IEC 60950-1:2005 (2 nd Ed); EN60950-1:2006
Installation	Screw terminal	Screw terminal	Screw terminal
Main features			
Mounting	Horizontal and Vertical (DIN rail mounting accessories available)	Horizontal and Vertical (DIN rail mounting accessories available)	Horizontal and Vertical (DIN rail mounting accessories available)
References			
5 VDC	SPPC 5200 1FC		SPPC 5320 1FC
12 VDC	SPPC 12200 1FC	SPPC 12240 1FC	SPPC 12320 1FC
15 VDC			
24 VDC	SPPC 24200 1FC	SPPC 24240 1FC	SPPC 24320 1FC
48 VDC	SPPC 48200 1FC		SPPC 48320 1FC





Switching power supplies

Compact enclosed switching power supplies



Types	SPPC 480 W	SPPC 600 W	SPPC 800 W
			
Dimensions HxWxD (mm)	218 x 116.5 x 41	218 x 116.5 x 41	226 x 116.5 x 41
Output specifications			
Voltage	12V, 24V, 36V, 48V	12V, 24V, 36V, 48V	24V, 48V
Current	34A, 22A, 14A, 11A	(100~127VAC): 34A, 22A, 14A, 11A (128~264VAC): 42A, 26.5A, 17.5A, 13.6A	(100~127VAC): 27A, 14A (128~264VAC): 33A, 16.5A
Line regulation	±0.5%, ±0.5%, ±0.5%, ±0.2%	±0.5%	±0.5%
Load regulation	±1.0%	±1.0%	±1.0%
Efficiency (typ)	88%, 89%, 90%, 90%	88%, 89%, 90%, 90%	88%, 89%
Built-in active PFC	(115VAC): PF>0.98 (230VAC): PF>0.96	(115VAC): PF>0.98 (230VAC): PF>0.96	(115VAC): PF>0.98 (230VAC): PF>0.96
Input specifications			
Voltage range	90~264VAC 127~370VAC	90~264VAC 127~370VAC	90~264VAC 127~370VAC
Frequency range	47-63Hz	47-63Hz	47-63Hz
General specifications			
Ambient temperature	-30°C to +70°C	-30°C to +70°C	-30°C to +70°C
Storage	-40°C to +85°C	-40°C to +85°C	-40°C to +85°C
Derating (>50°C)	2% /°C	2% /°C	2% /°C
Cooling	Forced air (built-in DC fan controlled by load and internal temperature)	Forced air (built-in DC fan controlled by load and internal temperature)	Forced air (built-in DC fan controlled by load and internal temperature)
Approvals / Marks	UL60950-1 2 nd Ed; IEC 60950-1:2005 (2 nd Ed); EN60950-1:2006	UL60950-1 2 nd Ed; IEC 60950-1:2005 (2 nd Ed); EN60950-1:2006	UL60950-1 2 nd Ed; IEC 60950-1:2005 (2 nd Ed); EN60950-1:2006
Installation	Screw terminal	Screw terminal	Screw terminal
Main features			
Mounting	Horizontal and Vertical (DIN rail mounting accessories available)	Horizontal and Vertical (DIN rail mounting accessories available)	Horizontal and Vertical (DIN rail mounting accessories available)
References			
12 VDC	SPPC 12480 1FC	SPPC 12600 1FC	
24 VDC	SPPC 24480 1FC	SPPC 24600 1FC	SPPC 24800 1FC
36 VDC	SPPC 36480 1FC	SPPC 36600 1FC	
48 VDC	SPPC 48480 1FC	SPPC 48600 1FC	SPPC 48800 1FC

Safety modules

Emergency stop and safety gates





Types	NES02D	NES13D	NDS12B	NA13CT
				
Dimensions HxWxD (mm)	99 x 22.5 x 114	99 x 22.5 x 114	99 x 22.5 x 114	99 x 22.5 x 114
Safety category	Up to category 4 (EN ISO 13849-1:2008)	Up to category 4 (EN ISO 13849-1:2008)	Up to category 2 (EN 13849-1: 2007)	3 (EN 954-1)
Performance level	e	e		
Function	Category 0 emergency stop module safety gates (mech. switches)	Category 0 emergency stop module safety gates (mech. switches)	Category 1 emergency stop module	Category 1 emergency stop module
Output specifications				
	2 x NO safety relay	3 x NO safety relay + 1 NC relay	1 x NO safety relay instant 1 x NO safety relay delayed 1 x NO auxiliary relay instant	3 x NO safety relay + 1 NC relay
Max. load AC1	6 A @ 230 VAC	6 A @ 230 VAC	5 A @ 230 VAC	6 A @ 230 VAC
Max. load DC12	6 A @ 24 VDC	6 A @ 24 VDC	5 A @ 24 VDC	
Electrical life	> 10 ⁵ operations	> 10 ⁵ operations	> 10 ⁵ operations	> 10 ⁵ operations
Input specifications				
Type	2 x NO, voltage free	2 x NO, voltage free	2 x NO, voltage free	
General specifications				
Power supply	24 VAC / DC -15% +10%	24 VAC / DC -15% +10%	24 VAC / DC ±10%	18 VAC ±10% 24 VDC ±10%
Screw Terminals	Fixed [SA, SC] Detachable [DA, DC]	Fixed [SA, SC] Detachable [DA, DC]	Fixed [SA] Detachable [DA]	Fixed
Start	Automatic / Manual [SA, DA] Monitored manual [SC, DC]	Automatic / Manual [SA, DA] Monitored manual [SC, DC]	Automatic / Manual	Automatic / Manual
Approvals / Marks	CE - UL - TÜV	CE - UL - TÜV	CE	CE - UL
References				
	NES02DB24SA	NES13DB24SA	NDS12BB24SA	NA13CT
	NES02DB24SC	NES13DB24SC	NDS12BB24DA	
	NES02DB24DA	NES13DB24DA		
	NES02DB24DC	NES13DB24DC		

Safety modules



	Two hand device	Safety mat & edge	
Types	ND12D	NSE02C	NST02C
			
Dimensions HxWxD (mm)	99 x 22.5 x 114	80 x 22.5 x 99.5	80 x 22.5 x 99.5
Safety category	4 (EN 954-1)	3 (EN 13849-1: 2007)	3 (EN 13849-1: 2007)
Performance level		b (EN ISO 13849-1:2008)	b (EN ISO 13849-1:2008)
Function	Two hand device	Safety mat & edge module	Safety mat module
Output specifications			
	2 x NO safety relay	2 x NO safety relay	2 x NO safety relay
Max. load AC1	8 A @ 230 VAC	5 A @ 230 VAC	5 A @ 230 VAC
Max. load DC12		5 A @ 24 VDC	5 A @ 24 VDC
Electrical life	> 10 ⁵ operations	> 10 ⁵ operations	> 10 ⁵ operations
Input specifications			
Type	2 x NO, 2 x NC, voltage free	2-wire mats or safety edges	4-wire mats (SM...)
General specifications			
Power supply	24 VAC/DC -15% +10% 110 VAC -15% +10% [110CG] 230 VAC -15% +10% [230CG]	24 VAC/DC ±15%	24 VAC/DC ±15%
Screw Terminals	Fixed	Fixed	Fixed
Start	Automatic	Automatic / Manual [SA, DA] Monitored manual [SC, DC]	Automatic / Manual [SA, DA] Monitored manual [SC, DC]
Approvals / Marks	CE - UL - TÜV	CE - TÜV	CE - TÜV
References			
	ND12D	NSE02CB24SA	NST02CB24SA
	ND12D110CG	NSE02CB24SC	NST02CB24SC
	ND12D230CG		

Safety modules



Safety gates (magnetic sensors)

Types	NSO02	NSO13	NSC02	NSC13
				
Dimensions HxWxD (mm)	99 x 22.5 x 114	99 x 22.5 x 114	99 x 22.5 x 114	99 x 22.5 x 114
Safety category	Up to category 4 (EN ISO 13849-1:2008)	Up to category 4 (EN ISO 13849-1:2008)	Up to category 4 (EN ISO 13849-1:2008)	Up to category 4 (EN ISO 13849-1:2008)
Performance level				
Function	Safety gates module	Safety gates module	Safety gates module	Safety gates module
Output specifications				
	2 x NO safety relay	3 x NO safety relay + 1 NC relay	2 x NO safety relay	3 x NO safety relay + 1 NC relay
Max. load AC1	6 A @ 230 VAC	6 A @ 230 VAC	5 A @ 230 VAC	6 A @ 230 VAC
Max. load DC12	6 A @ 24 VDC	6 A @ 24 VDC	6 A @ 24 VDC	6 A @ 24 VDC
Electrical life	> 10 ⁵ operations	> 10 ⁵ operations	> 10 ⁵ operations	> 10 ⁵ operations
Input specifications				
Type	2 x NO, SMS or mechanical	2 x NO, SMS or mechanical	1 x NO, 1 x NC, SMS or mechanical	1 x NO, 1 x NC, SMS or mechanical
General specifications				
Power supply	24 VAC/DC -15% +10%	24 VAC/DC -15% +10%	24 VAC/DC -15% +10%	24 VAC/DC -15% +10%
Screw Terminals	Fixed [SA, SC] Detachable [DA, DC]	Fixed [SA, SC] Detachable [DA, DC]	Fixed [SA, SC] Detachable [DA, DC]	Fixed [SA, SC] Detachable [DA, DC]
Start	Automatic / Manual [SA, DA] Monitored manual [SC, DC]	Automatic / Manual [SA, DA] Monitored manual [SC, DC]	Automatic / Manual [SA, DA] Monitored manual [SC, DC]	Automatic / Manual [SA, DA] Monitored manual [SC, DC]
Approvals / Marks	CE - UL - TÜV	CE - UL - TÜV	CE - UL - TÜV	CE - UL - TÜV
References				
	NSO02DB24SA	NSO13DB24SA	NSC02DB24SA	NSC13DB24SA
	NSO02DB24SC	NSO13DB24SC	NSC02DB24SC	NSC13DB24SC
	NSO02DB24DA	NSO13DB24DA	NSC02DB24DA	NSC13DB24DA
	NSO02DB24DC	NSO13DB24DC	NSC02DB24DC	NSC13DB24DC

Safety modules



	Safety light curtains	Lift levelling	Standstill monitor	Exstensions
Types	NLG02D NLG13D	NA12DLIFT	MF1C	NE14D
				
Dimensions HxWxD (mm)	99 x 22.5 x 114	99 x 22.5 x 114	80 x 45 x 99.5	99 x 22.5 x 114
Safety category	Up to category 4 (EN 954-1)		3 (EN 954-1)	Up to category 4
Performance level	^e (EN ISO 13849-1:2008)			^e (EN ISO 13849-1:2008)
Function	Light curtains safety modules	Lift levelling module (EN 81-1, 81-2, EN 12015, EN 12016)	Standstill monitor safety module 1-phase or 3-phase	Extension safety module
Output specifications				
	2 x NO safety relay [NLG02] 3 x NO safety relay + 1 NC relay [NLG13]	2 x NO safety relay	2 x NO safety relay	4 x NO safety relay + 1NC (feedback)
Max. load AC1	6 A @ 230 VAC	6 A @ 230 VAC	8 A @ 230 VAC	8 A @ 230 VAC
Max. load DC12	6 A @ 24 VDC			
Electrical life	> 10 ⁵ operations	> 10 ⁵ operations	> 10 ⁵ operations	> 10 ⁵ operations
Input specifications				
Type	2 x NO min 10 mA / 17 V max 60 mA / 38 V [NLG02] max 30 mA / 38 V	2 x NO	Up to 500 VAC	2 x NO, voltage free
General specifications				
Power supply	24 VDC - 15% +10%	24 VAC/DC ±15%	24 VAC/DC ±15%	24 VAC/DC -15% +10% 110 VAC -15% +10% [110CG] 230 VAC -15% +10% [230CG]
Screw Terminals	Fixed [SA, SC] Detachable [DA, DC]	Fixed	Fixed	Fixed
Start	Automatic / Manual [SA, DA] Monitored manual [SC, DC]			
Approvals / Marks	CE - UL - TÜV	CE - TÜV	CE - UL - TÜV	CE - UL - TÜV
References				
	NLG02D724SA	NA2DLIFT	MF1C	NE14D
	NLG02D724SC			NE14D110CG
	NLG02D724DA			NE14D230CG
	NLG02D724DC			
	NLG13D724SA			
	NLG13D724SC			
	NLG13D724DA			
	NLG13D724DC			

Configurable Safety Modules



Types	CERTUS Master Module		
	CMM		
			
Dimensions HxWxD (mm)	99 x 22.5 x 114		
Safety category	4		
Safety level	SIL 3, according to IEC 61508 SIL CL 3, according to IEC 62061 PLe and Cat. 4, according to ISO/EN 13489-1		
Performance level	e		
Function	Can stand-alone managing and monitoring different safety sensors and commands at the same time. Manages up to 14 expansion units		
Safety inputs and outputs specifications			
CMM as a stand alone unit	- 8 digital inputs, PNP active high according to EN 61131-2 - 2 pairs of solid state programmable safety outputs (OSSD), PNP active high 400mA at 24VDC max		
Max. digital inputs with expansion modules	128		
Max. digital outputs with expansion modules	16 pairs (OSD)		
Max. n° of expansion modules	14		
Non-Safety inputs and outputs specifications			
Test outputs	4		
Programmable digital signal outputs	2		
Input for Start/Restart interlock and EDM	2		
General specifications			
Rated voltage	24VDC±20% / supply from class II		
Digital inputs	PNP active high , according to EN 61131-2		
OSSD	PNP active high - 400mA@24VDC		
Enclosure protection class	IP 20		
Terminal blocks protection class	IP 2x		
Types	I/O Expansion Modules		
	C 8I 20	C 8I / C 16I	C 12I 8TO
			
Dimensions HxWxD (mm)	99 x 22.5 x 114		
Safety category	4		
Performance level	e		
Function	expansion modules		
General specifications			
PFHd (IEC 61508:1998)	5.72E-9	5.75E-9 (C 8I); 7.09E-9 (C 16I)	3.24E-9
Rated voltage	24VDC ± 20%		
Dissipated power	3W max		
Digital inputs	8 / PNP active high according to EN 61131-2	8 (C 8I) / 16 (C 16I)	12 / PNP active high according to EN 61131-2
Test output	4 for sensor monitoring and checking short-circuits and overloads	4 for sensor monitoring and checking short-circuits and overloads	8 for sensor monitoring and checking short-circuits and overloads

Configurable Safety Modules

OSSD + standard Relay Expansion Modules

Types	C 2OSSD / C 4OSSD	C 2R / C 4R
		
Dimensions HxWxD (mm)	99 x 22.5 x 114	
Safety category	4	
Performance level	e	
Function	expansion modules	
General specifications		
PHFd (IEC 61508:1998)	3.16E-9 (C 2OSSD) / 3.44E-9 (C 4OSSD)	
Rated voltage	24VDC ± 20%	
Dissipated power	3W max	
Digital output	2 (C 2OSSD); 4 (C 4OSSD)	
Switching voltage	240VAC	
Switching current	6A max	
Contacts	2 NO + 1 NC (C 2R) connectable to 1 OSSD pair 4 NO + 2 NC (C 4R) connectable to 2 OSSD pairs	

Data and Diagnostics Communication + Bus Transfer Expansion Modules

Types	C DDC	C BT
		
Dimensions HxWxD (mm)	99 x 22.5 x 114	
Safety category	4	
Performance level	e	
Function	Communication with most common industrial fieldbus system	Interface expansion module allowing the connection of remote expansions. Ideal solution for the interconnection of the safety functions of several machines in a production line
General specifications		
Connection	Shielded cable compatible with RS485	
Max connection distance	100m	
Max number of CBT modules per system	5	
References	C PFBUS - Profibus C DNET - DeviceNET C CAN - CANopen C EIP - Ethernet IP C ECAT - EtherCAT C PFNET - PROFINET C OMMS - Universal Serial Bus	C BT1 – 1 connection (1 input or 1 output) C BT2 – 2 connections (1 input and 1 output) The C BT1 is placed at the beginning or at the end of the network connected with a single cable, whilst the C BT2 goes in the middle.

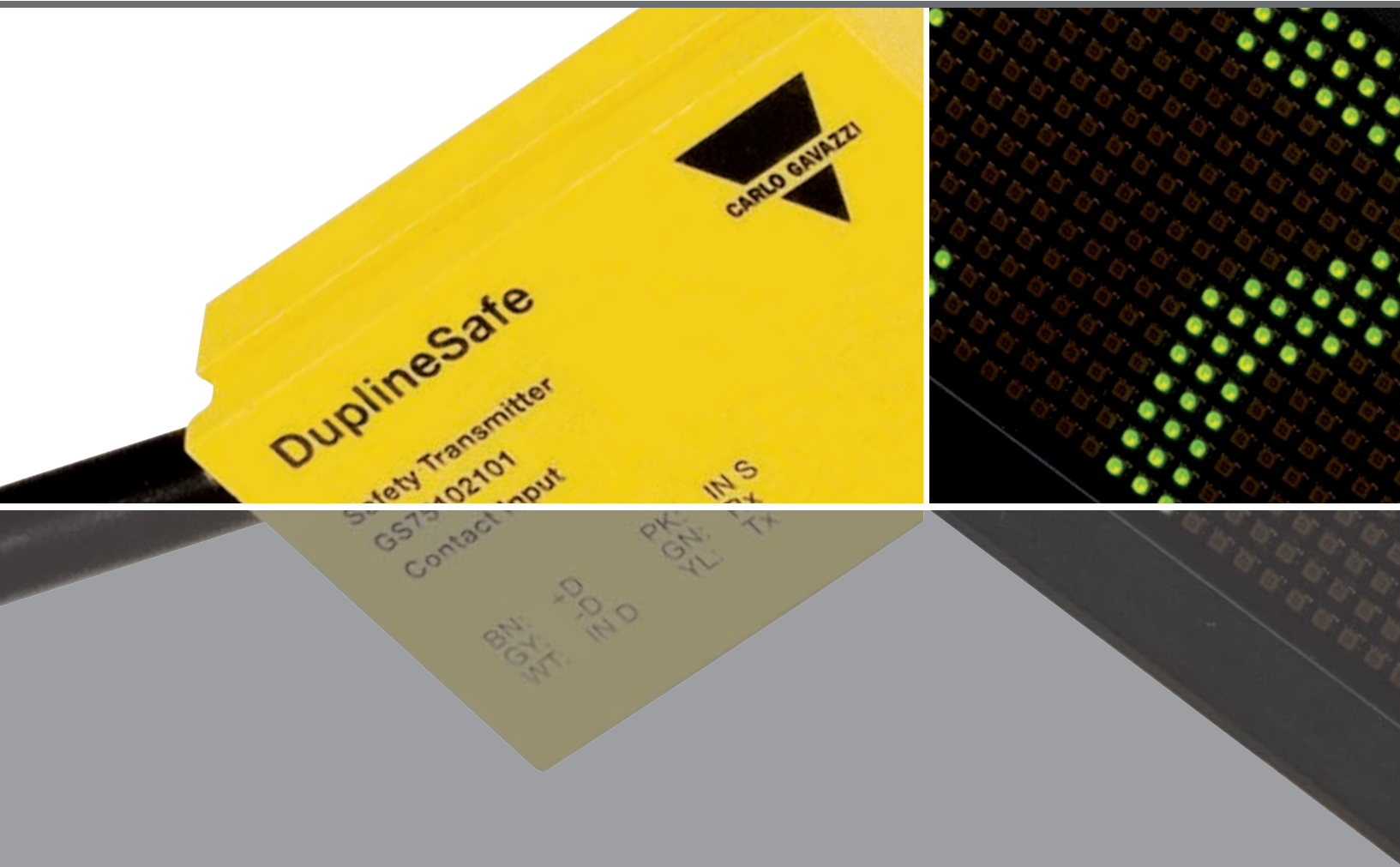

Fieldbus

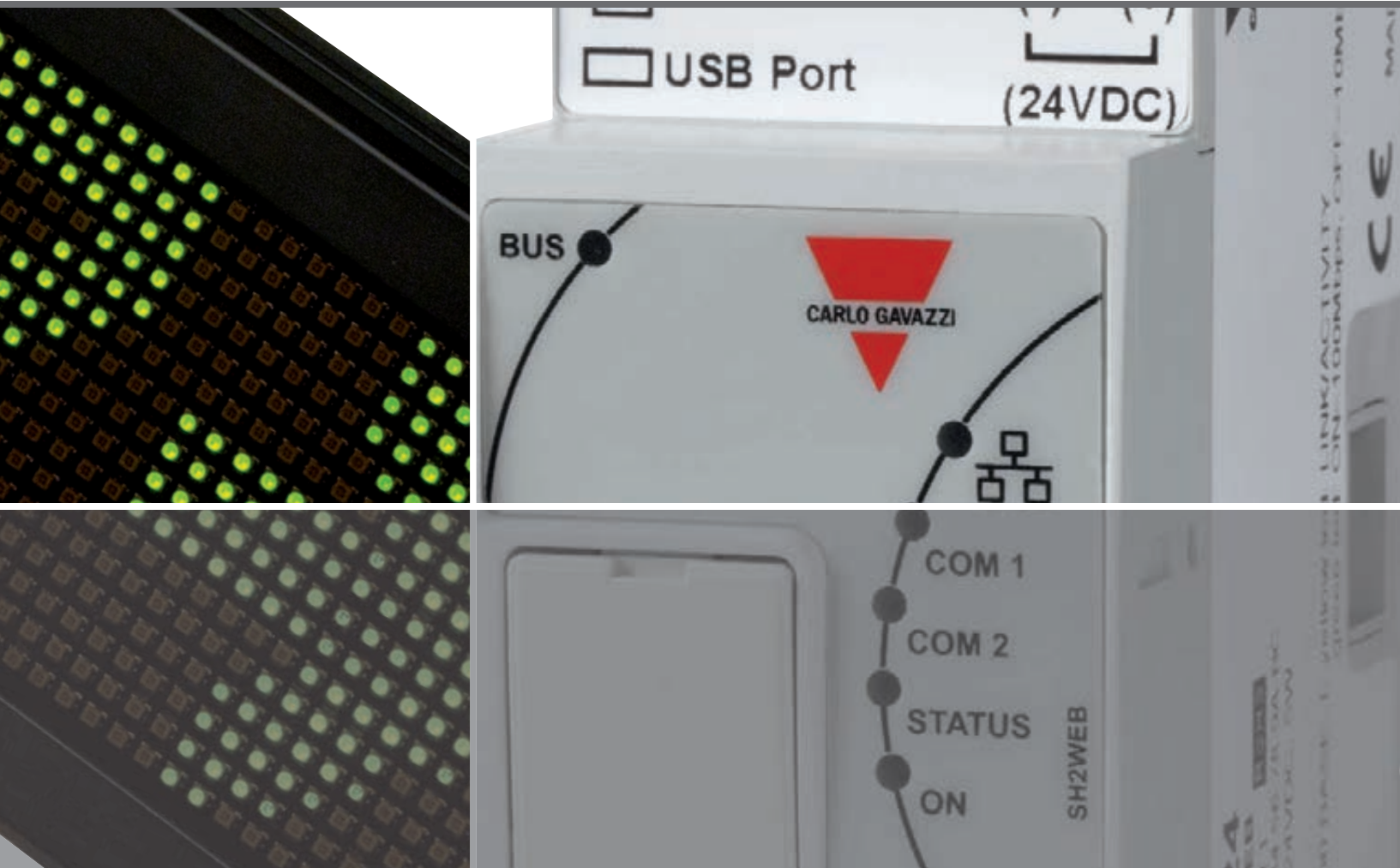

Dupline® General purpose	230
Dupline® DuplineSafe	243
Dupline® Irrigation	245
Dupline® Elevator	246
Dupline® Parking guidance system	248
Dupline® Home and Building automation	252

Dupline® General purpose

Channel generators/interfaces

Types	G3490	G3496	G3800
			

Dimensions (mm)	77 x 72 x 70	77 x 72 x 70	77 x 144 x 70
Functions	Standard channel generator	Plug & Play RS232/RS485 Interface with built-in protocols for specific PLC brands and Modbus	Controller and Modbus Interface with built-in GSM Modem (option) or external Radio Modem Logger (option)
Housing type	DIN-Rail, H4	DIN-Rail, H4	DIN-Rail, H8

Electrical specifications

Number of channels	Selectable	Selectable	Selectable
Features/Signal types		Possibility for 3-wire operation with DC-power on the 3 rd wire	4 x Contact/PNP input +4 x PNP 10-30 VDC output 2 x RS232+1 x RS485. Possibility for alarms, monitoring and control via SMS messages
Power Supply	024 = 24 VAC 115 = 115 VAC 230 = 230 VAC 824 = 15-30 VDC	700 = 20-30 VDC	800 = 10-30 VDC 230 = 115-230 VAC

General specifications

Degree of protection	IP 20	IP 20	IP 20
Operating temperature	-20°C to +50°C	0°C to +50°C	0°C to +50°C
Storage temperature	-50°C to +85°C	-50°C to +85°C	-20°C to +85°C
Remarks		Built-in protocol for specific PLC brands for easy interfacing	Up to 32 controllers can be networked together via RS485 or Ethernet via converter module

References

Channel Generator	G3490 0000	
Optolink		G3496 0000
LG		G3496 0001
GE-Fanuc		G3496 0002
Mitsubishi		G3496 0003
Omron		G3496 0004
Modbus		G3496 0005
Allen-Bradley		G3496 0006
Schneider		G3496 0007
Koyo		G3496 0008
Matsushita		G3496 0009
Siemens		G3496 0010
Toshiba		G3496 0011
IDEC		G3496 0012
-GSM Modem, -RS485		G3800 0015
+GSM Modem, -RS485		G3800 1015
-GSM Modem, +RS485		G3800 0016
+GSM Modem, +RS485		G3800 1016
-GSM Modem, +RS485, +Logging		G3800 0036
+GSM Modem, +RS485, +Logging		G3800 1036

Dupline® General purpose

	Channel generators/interfaces		Digital input modules	
Types	G3891	GT150	G3410 5501	G3420



Dimensions (mm)	77 x 144 x 70	55 x 70 x 15 mm	77 x 72 x 70	77 x 72 x 70
Functions	Gateways to Fieldbus systems (Profibus-DP, DeviceNet etc.)	Dupline® Modbus RTU Interface module for Text Displays and Touch screens	Dupline® powered transmitter with 8 monostable volt-free contacts	Input module for external supply with optoisolated inputs
Housing type	DIN-Rail, H8	Closed plastic housing with 25p male sub-D	DIN-Rail, H4	DIN-Rail, H4

Electrical specifications

Number of channels	Selectable		8	8
Features/Signal types		Supports Modbus RTU function code 3 and code 16	Volt-free input contacts	Contact/NPN Voltage (6-265 VAC/DC)
Power Supply	230 = 115/230 VAC	Powered by RS485 port	Powered by Dupline®	024 = 24 VAC 115 = 115 VAC 230 = 230 VAC 800 = 10-30 VDC

General specifications





Degree of protection	IP 20	IP 20	IP 20	IP 20
Operating temperature	0°C to +50°C	-20°C to +60°C	-20°C to +50°C	-20°C to +50°C
Storage temperature	-20°C to +85°C	-50°C to +85°C	-50°C to +85°C	-50°C to +85°C
Remarks	Low power consumption			

References





GT150			
Profibus-DP with C. G.	G3891 0020		
Profibus-DP analogue output multiplex	G3891 0021		
DeviceNet	G3891 0050		
Lonworks	G3891 0051		
Modbus / TCP	G3891 0052		
Profibus-DP passive	G3891 0120		
8 channel		G3410 5501	
Contact/NPN			G3420 5501
Voltage			G3420 5502

Dupline® General purpose





Digital input modules

Types	G4420 7401	G5010	G6391 0240	G8810 2201
				
Dimensions (mm)	36 x 85 x 58	49 x 22.5 x 56	34.2 x 37.5 x 36.8	28 x 14 x 10
Functions	Input module for counting of pulses from energy meters, item detectors etc	Dupline powered single input Module	Plug-in module to EM4 or WM22 with 2 S0 input contacts for measuring water, gas etc	Small-sized 2-channel monostable transmitter
Housing type	DIN-Rail, H2	DIN-Rail, Mini-E	Plug-in	Plug-in
Electrical specifications				
Number of channels	4	1	2	2
Features/Signal types	Contact input (DIN 43 864). Max. count frequency: 14 Hz	Contact input	Reads actual internal value of total energy and/or reactive energy from EM4/WM22 and transmits to Dupline®. 2 x S0 contact input	2 contact inputs for push buttons
Power Supply	230 = 230 VAC 724 = 15-30 VDC	Powered through the Dupline® network	Powered through the Dupline® network and EM4/WM22	Supplied by Dupline®
General specifications				
Degree of protection	IP 40	IP 20	IP 20	IP 65
Operating temperature	-20°C to +60°C	-20°C to +50°C	0°C to +50°C	-40°C to +70°C
Storage temperature	-20°C to +85°C	-50°C to +85°C	-20°C to +85°C	-40°C to +70°C
Remarks	Decentral counting. Counter values stored in non-volatile memory			Address coding by GAP 1605
References				
4 channel Counter	G4420 7401			
1 channel		G5010 1106		
2 channels		G5010 2206		G8810 2201
2 channel plug-in module			G6391 0240	

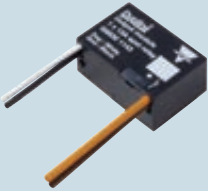

Dupline® General purpose

	Digital I/O modules		Digital output modules	
Types	G3440 4443	G3440 5543	G3430 / G3830	G34305545
				
Dimensions (mm)	77 x 72 x 70	77 x 72 x 70	77 x 72 x 70 77 x 144 x 70 (H8)	77 x 72 x 70
Functions	Combined I/O module for external supply with optoisolated inputs and relay outputs	I/O module for digital signals	Output modules for external supply with isolated outputs	Central relay module with 8 x SPST relays for resistive loads
Housing type	DIN-Rail, H4	DIN-Rail, H4	DIN-Rail, H4 DIN-Rail, H8 (G3830 5543)	DIN-Rail, H4
Electrical specifications				
Number of channels	4	6	1, 2, 4, 8	8
Features/Signal types	2 x 6-265 VAC/DC inputs + 2 x SPST relay outputs	4 opto isolated inputs and 2 SPST relay outputs	10 A SPDT relay 5 A SPST relay 0.7 A NPN transistor 0.7 A PNP transistor	8 x 16 A/250 VAC relays Inrush current: <130 A
Power Supply	024 = 24 VAC 115 = 115 VAC 230 = 230 VAC 824 = 15-30 VDC	230 = 230 VAC	024 = 24 VAC 115 = 115 VAC 230 = 230 VAC 800 = 10-30 VDC 824 = 15-30 VDC	024 = 24 VAC 115 = 115 VAC 230 = 230 VAC
General specifications				
Degree of protection	IP 20	IP 20	IP 20	IP 20
Operating temperature	-20°C to +50°C	-20°C to +50°C	-20°C to +50°C	-5°C to +50°C
Storage temperature	-50°C to +85°C	-50°C to +85°C	-50°C to +85°C	-50°C to +85°C
Remarks				Total module load max. 32 A
References				
2 input + 2 output SPST	G3440 4443			
4 input + 2 output SPST		G3440 5543		
1 x 10 A SPDT			G3430 1149	
2 x 10 A SPDT			G3430 2249	
4 x 5 A SPST			G3430 4443	
4 x 16 A SPST			G3430 4445	
8 x 5 A SPST			G3830 5543	
8 x 0.7 A NPN			G3430 5511	
8 x 0.7 A PNP			G3430 5521	
8 x 16 A SPST (Max. 32 A)				G3430 5545

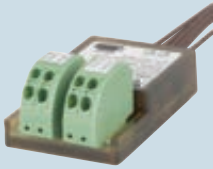

Dupline® General purpose

	Digital output modules	Analogue input modules		
Types	G8830 1143	G3429 6470	G3210 1161	G3210 1111
				
Dimensions (mm)	26 x 39 x 17	77 x 72 x 70	77 x 36 x 70	77 x 36 x 70
Functions	Decentral relay module with 1 x SPST relay for control of lights	Universal analogue input module for external supply	Analogue input module powered from Dupline® and input signal	Dupline®- powered Analogue input module for Pt100 temperature sensor
Housing type	Compact regular, with solid cables. For decentral installation	DIN-Rail, H4	DIN-Rail, H2	DIN-Rail, H2
Electrical specifications				
Number of channels	1	Selectable	1	1
Features/Signal types	1 x 13 A/250 VAC relay Inrush current: <130 A	4 x isolated analogue input. Input type individually configurable (0-20 mA, 4-20 mA, 0-10 VDC)	1 x 4-20 mA input	1 x Pt100 3-wire input Ranges: (-50°C to +40°C) (+30°C to +120°C) (-10°C to +100°C)
Power Supply	Powered through the Dupline® network	024 = 24 VAC 115 = 115 VAC 230 = 230 VAC 800 = 10-30 VDC	Powered through the Dupline® network and 4-20 mA input signal	Powered through the Dupline® network
General specifications				
Degree of protection	IP 20	IP 20	IP 20	IP 20
Operating temperature	0°C to +50°C	0°C to +50°C	0°C to +50°C	0°C to +50°C
Storage temperature	-50°C to +85°C	-20°C to +85°C	-50°C to +85°C	-50°C to +85°C
Remarks	Recommended minimum load 100 mA / 12 V	Protocol freely selectable (Analink, Multiplexed BCD or 8-bit)	Uses Analink 8-bit protocol	Uses Analink 8-bit protocol. Built-in cable compensation
References				
Universal analogue output	G3429 6470			
Dupline powered analogue input	G3210 1161			
-50°C to +40°C	G3210 1111			
+30°C to +120°C	G3210 1112			
-10°C to +100°C	G3210 1113			
1 x 13 A SPST	G8830 1143			



Dupline® General purpose

	Analogue output modules	Decentral analogue input modules		
Types	G3439 6470	G8810 6265	G8810 6311	G8810 6312
				
Dimensions (mm)	77 x 72 x 70	50 X 30 X 18	50 X 30 X 18	50 X 30 X 18
Functions	Universal analogue output module for external supply	Decentral analogue module with 3 x 0-10 VDC inputs designed for HVAC systems	Decentral analogue module with 2 x 0-10 VDC, 1 x thermistor and 1 x variable resistor inputs designed for HVAC systems	Decentral analogue module with 1 x thermistor and 1 x variable resistor inputs designed for HVAC systems
Housing type	DIN-Rail, H4	Compact housing for decentral installation	Compact housing for decentral installation	Compact housing for decentral installation
Electrical specifications				
Number of channels	Selectable	3	4	2
Features/Signal types	4 x analogue outputs. Output type configurable for 0-20 mA, 4-20 mA or 0-10 VDC	3 x 0-10 VDC input	2 x 0-10 VDC input 1 x thermistor 10k3 input 1 x variable resistor 1 - 11 KΩ input	1 x thermistor 10k3 input 1 x variable resistor 1 - 11 KΩ input
Power Supply	024 = 24 VAC 115 = 115 VAC 230 = 230 VAC 800 = 10-30 VDC	Powered from external 15 - 30 VDC	Powered from external 15 - 30 VDC	Dupline® powered
General specifications				
Degree of protection	IP 20	IP 20	IP 20	IP 20
Operating temperature	0°C to +50°C	0°C to +50°C	0°C to +50°C	0°C to +50°C
Storage temperature	-20°C to +85°C	-20°C to +85°C	-20°C to +85°C	-20°C to +85°C
Remarks	Protocol freely selectable (Analink, Multiplexed BCD or 8-bit)	Analink protocol 8 bit resolution	Analink protocol 8 bit resolution	Analink protocol 8 bit resolution
References				
Universal analogue output	G3439 6470			
Decentral 3 x input		G8810 6265		
Decentral 4 x input			G8810 6311	
Decentral 2 x input Bus powered				G8810 6312





Dupline® General purpose

	Digital sensors		Temperature Sensor
Types	G6110 1145	G8910 1101	G8911 1010
			
Dimensions (mm)	M18 x 55	Ø11 x 68	67 x 35 x 15
Functions	Dupline® powered inductive proximity switch	Dupline® powered magnet proximity switch	Temperature sensor for outdoor use. With built-in PT1000 transducer
Housing type	M18	Cylindrical	Flat pack sensor housing
Electrical specifications			
Number of channels	1	1	1
Features/Signal types	Detects proximity of metal objects	Detects proximity of magnet	1 x Analink Range: -30°C to +60°C
Power Supply	Powered through the Dupline® network	Powered through the Dupline® network	Powered through the Dupline® network
General specifications			
Degree of protection	IP 67	IP 67	IP 67
Operating temperature	-25°C to +70°C	-20°C to +50°C	-25°C to +70°C
Storage temperature	-30°C to +80°C	-20°C to +70°C	-55°C to +85°C
Remarks	Available with cable or M12 connector. Flush mounting	Available in Ø 11 plastic housing or with M14 metal thread	8-bit resolution
References			
Cable	G6110 1145		
M12 plug	G6110 1145-1		G8911 1010
Ø11		G8910 1101	
M14		G8910 1101-G	



Dupline® General purpose

Types	Repeater		Optolink interface	
Housing	D3892 0000	G3491 0000	G3491 0090	
				
Dimensions (mm)	77 x 144 x 70	77 x 72 x 70	77 x 72 x 70	
Functions	Dupline® signal Repeater for extension of transmission distance	RS232 to fibre optic interface	RS232 to fibre opto-link interface	
Housing type	DIN-Rail, H8	DIN-Rail, H4	DIN-Rail, H4	
Electrical specifications				
Number of channels	Adjusts automatically	Adjusts automatically	Adjusts automatically	
Features/Signal types	All Dupline® signal types. Regenerates the Dupline® signal carrier through channel-generator output	Reads/controls up to 63 Dupline® systems which are networked through optolinks (G3491 0000)	Used as interface between computer or PLC with RS232 and a fibre optic Lan-ring	
Power Supply	024 = 24 VAC 115 = 115 VAC 230 = 230 VAC	024 = 24 VAC 115 = 115 VAC 230 = 230 VAC	024 = 24 VAC 115 = 115 VAC 230 = 230 VAC	
General specifications				
Degree of protection	IP 20	IP 20	IP 20	
Operating temperature	0°C to +50°C	0°C to +50°C	0°C to +50°C	
Storage temperature	-50°C to +85°C	-50°C to +85°C	-20°C to +85°C	
Remarks		Operates with G3491 0090	Operates with G3491 0000	
References				
Repeater (Booster)	D3892 0000			
Dupline® fibre interface	G3491 0000			
RS232 to optolink interface	G3491 0090			

Dupline® General purpose

	Converters		Display modules	Power supply
Types	G3491 0040	G3492 / G3493	G5460 6606	G3485 0000
				
Dimensions (mm)	77 x 72 x 70	77 x 72 x 70	96 x 96 x 78	77 x 72 x 70
Functions	Private line Modem for long distance transmission of Dupline® signals	Optical repeater for converting Dupline® from electrical to optical transmission media	LED status indicator for 16 Dupline® channels	3-wire power supply, used when multiple Dupline® modules are supplied through a DCbus
Housing type	DIN-Rail, H4	DIN-Rail, H4	Panel mounting	DIN-Rail, H4
Electrical specifications				
Number of channels	Adjusts automatically	Adjusts automatically	16	Selectable
Features/Signal types	Digital, 8-bit analogue, non-multiplexed 3 1/2 digit BCD analogue	All Dupline® signal types	Each of the 16 LED's indicates the status of the digital channels assigned to it	Supply current ≤ 4 A (up to 25°C) or ≥ 3 A (up to 50°C)
Power Supply	024 = 24 VAC 115 = 115 VAC 230 = 230 VAC	230 = 115/230 VAC	024 = 24 VAC 115 = 115 VAC 230 = 230 VAC	15-30 VDC
General specifications				
Degree of protection	IP 20	IP 20	IP 40	IP 20
Operating temperature	0°C to +50°C	0°C to +50°C	0°C to +50°C	-5°C to +50°C
Storage temperature	-20°C to +85°C	-20°C to +85°C	-20°C to +60°C	-20°C to +85°C
Remarks	Operates pair-wise	Operates pair-wise. Runs on 0/125, 62.5/125 or 100/140 micro m with STN connectors		Multiple units can be connected in parallel to increase length and size of a Dupline® system
References				
Long distance modem	G3491 0040			
Optical/electrical converter	G3492 0000			
Electrical/optical converter	G3493 0000			
LED indicator for Dupline	G5460 6606			
3-wire power supply	G3485 0000 700			

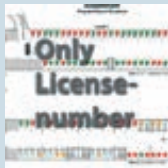

Dupline® General purpose

Software				
Types	DUPDATAACC	DUP-SERV-ADD	DUP-SERV-SW	DUP-PGS-SWxx
				
Functions	Software package with DDE-driver and ActiveXdriver for G3800. Controller and interface unit	A data logging, visualization and alarm handling software package to be installed in a windows based PC	A data logging, visualization and alarm handling software package to be installed in a windows based PC	A data logging, visualization and alarm handling software package to be installed in a windows based PC





Electrical specifications				
Features/Signal types	All Dupline® signal types. Copy and paste of dynamic Dupline links into EXCEL spreadsheets	Works only with G3800 xx36. Log and control energy consumption, analogue values and digital events and alarms	Works only with G3800 xx36. Log and control energy consumption, analogue values and digital events and alarms	Client/server program that is developed to the GP34960005 Carpark Master Module together with Moxa RS485/ethernet connectors

References	
DDE-Server	DUPDATAACC
Dupline-Online One License	DUP-SERV-SW
ADD-License to Dupline-Online	DUP-SERV-ADD
Dupline-Online two license	DUP-SERV-SW2
Dupline Carpark 250 parking spaces	DUP-PGS-SW250
Dupline Carpark 500 parking spaces	DUP-PGS-SW500
Dupline Carpark 1000 parking spaces	DUP-PGS-SW1000
Dupline Carpark 2000 parking spaces	DUP-PGS-SW2000
Dupline Carpark 3000 parking spaces	DUP-PGS-SW3000
Dupline Carpark 4000 parking spaces	DUP-PGS-SW4000
Dupline Carpark 5000 parking spaces	DUP-PGS-SW5000
Dupline Carpark 6000 parking spaces	DUP-PGS-SW6000
Dupline Carpark 7000 parking spaces	DUP-PGS-SW7000
Dupline Carpark 8000 parking spaces	DUP-PGS-SW8000
Dupline Carpark 9000 parking spaces	DUP-PGS-SW9000
Dupline Carpark 10000 parking spaces	DUP-PGS-SW10000

Dupline® General purpose





Accessories			
Types	GAP1605	GTU8	G3282 2002 230
			
Dimensions (mm)	120 x 65 x 22	145 x 90 x 28	77 x 36 x 70
Functions	Dupline® coding device for assigning addresses to Dupline® I/O modules and sensors	Dupline® test unit for monitoring and control of Dupline® channels	Dupline® bus separator
Housing type	Handheld	Handheld	H2 Housing
Electrical specifications			
Number of channels	NA	Adjusts automatically	2
Features/Signal types		Digital, multiplexed BCD, 8-bit analogue signals and split I/O. Also prepared to calibrate sensors in Carpark system	Disconnect the secondary side of the Dupline® bus when a short-circuit is detected
Power Supply	9 V battery	Powered through the Dupline® network	230 V
General specifications			
Degree of protection	IP 40	IP 40	IP 20
Operating temperature	0°C to +50°C	0°C to +50°C	0°C to +50°C
Storage temperature	-20°C to +60°C	-20°C to +85°C	-20°C to +85°C
Remarks	Options for latching digital signals and for reading multiplexed BCD values		
References			
Programmer	GAP1605		
Display			
Monitoring and control unit	GTU8		
Bus separator	G3282 2002 230		

Dupline® General purpose





Accessories				
Types	ADAPT 1605	ANT1	ANT2	D3212 4000
				
Dimensions (mm)	25 x 50 x 100		15 x 35 x 120	36 x 70 x 77
Functions	Codings adaptor between GAP1605 and Dupline® modules without standard connection plug	GSM antenna 900 MHz	Active antenna used for radio controlled clock	Synchronizer module for analogue modules
Housing type	Handheld box		Glued plastic casing	H2 housing
Electrical specifications				
Features/Signal types	4 clip-on terminals for Dupline® modules. Includes a M12 plug for modules like G8911 1010		Input signal is 77.5 kHz	Max. 112 analogue signals with up to 12 bit resolution
Power Supply		Powered by G3800 XXXX	Powered by G3800 XXXX	Powered by Dupline®
General specifications				
Degree of protection	IP 20	IP 67	IP 40	IP 40
Operating temperature	0°C to +50°C	-25°C to +60°C	0°C to +50°C	-20°C to +50°
Storage temperature	-20°C to +60°C	-20°C to +60°C	-20°C to +60°C	-50°C to +85°C
Remarks				Transmits always on A1-A4
References				
Adaptor	ADAPT 1605			
Antenna		ANT1	ANT2	
Synchronizer				D3212 4000

Dupline® General purpose





Accessories

Types	DT01/DT02	ETHCONV 2	ETHCONV 3	ETHCONV 4
				
Dimensions (mm)	17.5 x 70 x 77	22 x 75.2 x 80	22 x 90 x 100.4	29 x 89.2 x 118.5
Functions	Cable termination unit	Ethernet to RS232 converter	Ethernet to RS232 converter	Ethernet to RS485 converter
Housing type	H1 housing	Metal housing	Metal housing	Plast housing
Electrical specifications				
Number of channels		1	2	2
Features/Signal types	Removes distortion caused by reflection	1 port RJ45 10/100 Mbit TCP/IP based ethernet	2 port RJ45 10/100 Mbit TCP/IP based ethernet	2 port RJ45 10/100 Mbit TCP/IP based ethernet
Power Supply	No power needed	12-48 VDC/130 mA	12-30 VDC/305 mA	12-30 VDC/305 mA
General specifications				
Degree of protection	IP 20	IP 20	IP 20	IP 30
Operating temperature	-20°C to +50°C	0°C to +55°C	0°C to +55°C	0°C to +55°C
Storage temperature	-50°C to +85°C	-40°C to +75°C	-40°C to +75°C	-40°C to +75°C
Remarks		Automatic dedicated installation tool available	Automatic dedicated installation tool available	Automatic dedicated installation tool available
References				
Standard Dupline®	DT01			
Hi-line Dupline®	DT02			
1 Channel		ETHCONV2		
2 Channels			ETHCONV3	ETHCONV4





Dupline® DuplineSafe

	Optical fibre Converter	Output module	Gateway / interface	
Types	GS3492/GS3493	GS3830 0143	GS3891 0125	GSTI 50
				
Dimensions (mm)	77 x 72 x 70	144 x 77 x 70	144 x 77 x 70	55 x 70 x 15
Functions	Optical repeater for converting DuplineSafe from electrical to optical transmission media	DuplineSafe relay output module. Monitors up to 63 DuplineSafe inputs	Profibus-DP Gateway passive with Safety mapping	Dupline® Modbus interface module with Safety mapping
Housing type	DIN-Rail, H4	DIN-rail mounting H8	DIN-rail mounting H8	Compact plastic housing
Electrical specifications				
Number of channels	Adjusts automatically	2		
Features/Signal types	All Dupline® signal types	2 x NO Relays Force Guided contact	Reads/controls up to 128 inputs/outputs through Profibus-DP, Communication speed up to 12 MBaud	
Power Supply	230 = 115/230 VAC	230 VAC ± 15%	115 = 115 VAC 230 = 230 VAC	Powered by the RS485 com port
General specifications				
Degree of protection	IP 20	IP 20	IP 20	IP 20
Pollution degree	0°C to +50°C	3 (IEC 60664)		
Operating temperature	-20°C to +85°C	-25°C to +50°C	0°C to +50°C	-20°C to +60°C
Storage temperature		-30°C to +70°C	-20°C to +85°C	-30°C to +85°C
Humidity (non condensing)		20 to 80%	20 to 80%	
Remarks	Operates pair-wise. Runs on 50/125, 62.5/125 or 100/140 micro m with STN connectors	Approved according to IEC/EN 61508, EN 62061 and ISO/EN 13849-1 PL e	Certified by PNO	Supports Modbus RTU function code 3 and code 16
References				
Optical/electrical converter	GS3492 0000			
Electrical/optical converter	GS3493 0000			
Output relay		GS3830 0143		
Gateway / interface			GS3891 0125	GSTI 50



Dupline® DuplineSafe

	Input module	Repeater	Configuration tool	
Types	GS7510 2101	GS3892 0000	GS7380 0080	GS7380 0081
				
Dimensions (mm)	57.5 x 36.0 x 16.4	77 x 144 x 70	28 x 90 x 145	25 x 50 x 100
Functions	Bus-powered safety input module	DuplineSafe signal repeater for extension of transmission distance	Configuration and test unit for DuplineSafe	USB Configuration unit for DuplineSafe
Housing type		DIN-Rail H8	Handheld	Handheld
Electrical specifications				
Number of channels	2	Adjusts automatically		
Features/Signal types	1 x NC contact	Regenerates the Dupline® signal carrier through channel generator output		Windows based programming tool for safety output relay module and safety input modules
Power Supply	Powered through the Dupline® network	024 = 024 VAC 115 = 115 VAC 230 = 230 VAC	9 V battery 6LR61	Supplied by the USB port
General specifications				
Degree of protection	IP 67	IP 40	IP 40	IP 40
Pollution degree	3 (IEC 60664)			3 (IEC 60664)
Operating temperature	-40°C to +50°C	0°C to +50°C	-10°C to +45°C	0°C to +50°C
Storage temperature	-40°C to +70°C	-50°C to +85°C	-20°C to +70°C	-20°C to +60°C
Humidity (non condensing)	20 to 80%			
Remarks	Approved according to IEC/EN 61508, EN 62061 and ISO/EN 13849-1 PL e		Adapt 7380 is included	
References				
		GS3892 0000	GS7380 0080	GS7380 0081
Cable connection	GS7510 2101			
Cable connection cULus approved	GS7510 2192			
Plug connector	GS7510 2101-1			
Plug connector cULus approved	GS7510 2192-1			

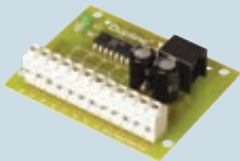

Dupline® Irrigation

	Digital I/O modules		Converter	Tools
Types	GH3440 4412	GH6440 4412	GH3485 0000	GHTU8
				
Dimensions (mm)	77 x 72 x 70	80 x 77 x 50	77 x 72 x 70	145 x 90 x 28
Functions	I/O module for irrigation valve control	I/O module for irrigation valve control	Dupline® to Hi-Line converter	Dupline test unit for monitoring and control of Dupline® channels. Used for Hi-line modules
Housing type	DIN-Rail, H4	Fully molded housing for under ground installation	DIN-Rail, H4	Handheld
Electrical specifications				
Number of channels	4	4	Adjusts automatically	Adjusts automatically
Features/Signal types	2 outputs for control of 3-wire 12 VDC latching valve, and 2 contact inputs	2 outputs for control of 3-wire 12 VDC latching valve, and 2 contact inputs	Converts the Dupline® signal to Hi-Line 28 VDC level for control of irrigation valves (see GH3440 4412 and GH6440 4412)	Digital, multiplexed BCD and 8-bit analogue signals
Power Supply	Powered through Hi-Line signal (see GH34850000)	Powered through Hi-Line signal (see GH34850000)	724 = 20-30 VDC	Powered through the Dupline® network
General specifications				
Degree of protection	IP 20	IP 67	IP 20	IP 40
Operating temperature	0°C to +50°C	0°C to +50°C	0°C to +50°C	0°C to +50°C
Storage temperature	-50°C to +85°C	-50°C to +85°C	-50°C to +85°C	-20°C to +85°C
Remarks				Options for latching digital signals and for reading multiplexed BCD values
References				
2 outputs and 2 inputs	GH3440 4412	GH6440 4412		
Converter			GH3485 0000	
Monitoring and control unit				GHTU8





Dupline® Elevator

	Input module	Output module	Input/output module
Types	G2120	G2130	G2140 4421
			
Dimensions (mm)	Open PCB 72.3 x 59	Open PCB 74 x 59	Open PCB 54 x 40
Functions	8 contact inputs for push buttons or transistors. LED indications for supply and carrier	8 outputs for control of floor indicators and lamps. LED indications for supply and carrier	2 push button inputs. 2 PNP-transistor outputs. LED indications for supply and carrier
Housing type	Snap locks or DIN-rail (vertical or horizontal)	Snap locks or DIN-rail (vertical or horizontal)	Snap locks or DIN-rail (vertical or horizontal)
Electrical specifications			
Number of channels	8	8	4
Features/Signal types	3-wire operation with DC-power on wire 3	3-wire operation with DC-power on wire 3	3-wire operation with DC-power on wire 3
Power Supply	700 = 10 - 30 VDC	700 = 10 - 30 VDC	700 = 10 - 30 VDC
General specifications			
Operating temperature	-20°C to +50°C	-20°C to +50°C	-20°C to +50°C
References			
NPN	G2120 5501 700	G2130 5511 700	
PNP	G2120 5502 700	G2130 5521 700	G2140 4421 700





Dupline® Elevator

	Input/output module	Master modules	
Types	G2140 55.0	G2196	G3496
			
Dimensions (mm)	Open PCB 74 x 59	Open PCB 86 x 54	77 x 72 x 70
Functions	4 push-button inputs 4 transistor outputs LED indications for supply and carrier	128 signals RS 485/RS 232 interface to control system LED indications for supply, carrier and RS485Tx	Plug & Play RS232/RS485 Interface with built-in protocols for specific PLC brands and Modbus
Housing type	Snap locks or DIN-rail (vertical or horizontal)	Snap locks or DIN-rail (vertical or horizontal)	DIN-Rail, H4
Electrical specifications			
Number of channels	8	128 inputs and 128 outputs	Selectable
Features/Signal types	3-wire operation with DC-power on wire 3	3-wire operation with DC-power on wire 3	Possibility for 3-wire operation with DC-power on the 3 rd wire
Power Supply	700 = 10 - 30 VDC	700 = 20 - 30 VDC	700 = 20 - 30 VDC
General specifications			
Degree of protection			IP 20
Operating temperature	-20°C to +50°C	-20°C to +60°C	0°C to +50°C
Storage temperature			-50°C to +85°C
Remarks			Built-in protocol for specific PLC brands for easy interfacing
References			
NPN	G2140 5510 700		
PNP	G2140 5520 700		
Standard protocol		G2196 0000 700	G3496 0000
Lucky Goldstar K-series		G2196 0001 700	G3496 0001
GE-Fanuc 90-30 series		G2196 0002 700	G3496 0002
Mitsubishi FX & A-series		G2196 0003 700	G3496 0003
Omron		G2196 0004 700	G3496 0004
Modbus RTU Slave		G2196 0005 700	G3496 0005
Allen-Bradley			G3496 0006
Schneider			G3496 0007
Koyo			G3496 0008
Matsushita			G3496 0009
Siemens			G3496 0010
Toshiba			G3496 0011
IDEC			G3496 0012



Dupline® Parking guidance system

	Sensors	Carpark monitor	Passive indicators	Bus controlled indicators
Types	GP6220../GP6240..	GP3482 9091	GP6289..	GP6265..
				
Dimensions (mm)	Ø118 x 76	77 x 72 x 70	Ø118 x 76	Ø118 x 76
Functions	Ultrasonic sensors for detection of cars with or without LED indication	Configurable device for monitoring of free parking bays in an carpark	Passive indicator for sensor	3 coloured bus controlled indicator
Housing type	Direct mounting on ceiling	Mounting on DIN rail	Direct mounting on ceiling	Direct mounting on ceiling
Electrical specifications				
Number of channels	2-3	-	-	1 - 2
Features/Signal types	1 x signal for occupancy. 1 x signal for common calibration	Programmable device with builtin RS485 for displays. 120 sensors can be connected to the Monitor module	No programming. Only wire connected	Colours can be controlled via the Dupline® bus
Power Supply	3-wire system with Dupline® and sensor supply	Dupline® 3-wire system with power for the L1 and L2 bus		3-wire system with Dupline® and LED supply
General specifications				
Degree of protection	IP 34	IP 20	IP 34	IP 34
Operating temperature	-40°C to +70°C	-40°C to +50°C	-40°C to +70°C	-40°C to +70°C
Storage temperature	-40°C to +85°C	-50°C to +85°C	-50°C to +85°C	-50°C to +85°C
References				
Red/Green LED	GP6220 2201		GP6289 0101	
Red/Blue LED	GP6220 2202		GP6289 0102	
Without LED	GP6240 2224			
Red/Green/Orange LED	GP6220 3301			GP6265 2301 GP6265 2301-1
Red/Green/Blue LED	GP6220 3302			GP6265 2302
Red/Blue/Orange LED	GP6220 3303			GP6265 2303
Red/Green LED US-version	GP6220 2201-US		GP6289 0101-US	
Red/Blue LED US-version	GP6220 2202-US		GP6289 0102-US	
Without LED US-version	GP6240 2224-US			
Red/Green/Orange LED US-version	GP6220 3301-US			GP6265 2301-US GP6265 2301-1-US
Red/Green/Blue LED US-version	GP6220 3302-US			GP6265 2302-US
Red/Blue/Orange LED US-version	GP6220 3303-US			GP6265 2303-US
Dupline® Carpark monitor		GP3482 9091 724		



Dupline® Parking guidance system

	Carpark interface		Master Zone Counter	
Types	GP3496 0005	GP32900003	GP32900030	GPMZC-SET
				
Dimensions (mm)	77 x 72 x 70	35 x 90 x 63,5	35 x 90 x 63,5	105 x 90 x 63,5
Functions	Interface for Modbus-RTU with the function of a slave	Channel Generator function for L ₁ or L ₂	Controller in the Dupline® zone counting system	Master Zone Counter up to 3840 places
Housing type	Mounting on DIN rail	Mounting on DIN rail	Mounting on DIN rail	Mounting on DIN rail
Electrical specifications				
Power Supply	20-30 VDC 3-wire system	15-24 VDC ±20% 3-wire system	15-24 VDC ±20%	15-24 VDC ±20%
Features				
	RS232/RS422/RS485 port for making an interface to the control system. Multidropping of up to 16 devices on RS485	Channel Generator and power function for supplying the L ₁ or the L ₂ bus	Controller unit with webserver included. Ethernet port + 2 x RS485 ports	Complete zone count solution comprised of 1 x GP3290 0030 700 and 2 x GP3290 0003 700
General specifications				
Degree of protection	IP 20	IP 20	IP 20	IP 20
Operating temperature	-40°C to +50°C	-20°C to +50°C	-20°C to +50°C	-20°C to +50°C
Storage temperature	-50°C to +85°C	-30°C to +70°C	-30°C to +70°C	-30°C to +70°C
References				
Dupline® Master Module	GP3496 0005 700			
Dupline® Carpark Master Zone Counter	GPMZC-SET			
Channel Generator with power on the 3 wire	GP3290 0003 700			
Carpark Controller with webserver	GP3290 0030 700			



Dupline® Parking guidance system

Displays			
Types	GP67630106	GP67630107-08	GP67630109-11
			
Dimensions (mm)	145 x 145 x 60	145 x 240 x 60	145 x 335 x 60
Functions	Able to show green arrow, red cross or single digit	Able to show green arrow, red cross or single digit, together with disabled sign	3 character display with high flexibility to show digits, arrow, cross and disabled sign
Housing type	Aluminium box with plexiglass front	Aluminium box with plexiglass front	Aluminium box with plexiglass front
Electrical specifications			
Power Supply	18-24 VDC / 15-25 W	18-24 VDC / 30-50 W	18-24 VDC / 40-60 W
Features			
	Guides the driver by showing moving green arrow or red cross for a lane or area in the carpark	Guides the disabled driver by showing moving green arrow or red cross for a lane or area in the carpark	Guides the driver or disabled driver by showing moving green arrow or red cross as well as number of free spaces for a lane or area in the carpark
General specifications			
Degree of protection	IP 55	IP 55	IP 55
Pollution degree	3 (IEC 60664)	3 (IEC 60664)	3 (IEC 60664)
Operating temperature	-15°C to +50°C	-15°C to +50°C	-15°C to +50°C
Humidity	0 to 90% non condensing	0 to 90% non condensing	0 to 90% non condensing
References			
1 segment display	GP67630106		
2 segment display		GP67630107	
		GP67630108	
3 segment display			GP67630109
			GP67630110
			GP67630111

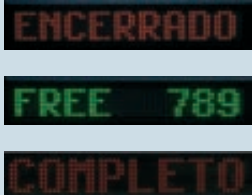

Dupline® Parking guidance system

Displays			
Types	GP67630116	GP6763 0112 - 14	GP6763 0115
			
Dimensions (mm)	145 x 430 x 60	145 x 910 x 60 (113+114) 145 x 815 x 60 (112)	210 x 1170 x 60
Functions	4 character display with high flexibility to show digits, arrow and cross	8 character display. 113+114 has also disabled, red cross or green arrow function	9 character display. 113+114 has also disabled, red cross or green arrow function
Housing type	Aluminium box with plexiglass front	Aluminium box with plexiglass front	Aluminium box with plexiglass front
Electrical specifications			
Power Supply	18-24 VDC / 60-100 W	18 - 24 VDC 35-50 W power consumption	18 - 24 VDC Typical 35 W power consumption
Features			
	Guides the driver by showing moving green arrow or red cross as well as number of free spaces for a lane or area in the carpark	Show a text on max. 8 character. The text is of costumers own choice. RS 485 communication	Show a text on max. 9 character. The text is of costumers own choice. RS 485 communication
General specifications			
Degree of protection	IP 55	IP 55	IP 55
Pollution degree	3 (IEC 60664)	3 (IEC 60664)	3 (IEC 60664)
Operating temperature	-15°C to +50°C	-15°C to +50°C	-15°C to +50°C
Humidity	0 to 90% non condensing	0 to 90% non condensing	0 to 90% non condensing
References			
4 segment display	GP6763 0116		
		GP6763 0112	
8 segment display		GP6763 0113	
		GP6763 0114	
9 segment display			GP6763 0115

Dupline® Home and Building automation





Switches			
Supply	Bus	Wireless	Bus
			
Dimensions (mm)	44 x 44 / 55 x 55	44 x 44 / 55 x 55	55 x 55
Functions	Light switch for building automation applications	Wireless light switch for building automation applications	Light switch for building automation applications
Electrical specifications			
Number of switches	4	4	4
Power Supply	Powered by bus	Supplied by battery, type Lithium button 2450 3V	Powered by bus
General specifications			
Colour	Black/white	Black/white	White/light grey/anthracite
Mounting	Wallbox Btcino, Niko, Fuga / Elko, Gira, Jung	Wallbox Btcino, Niko, Fuga / Elko, Gira, Jung	Wallbox Elko
LEDs	White / blue	4 red / 4 blue	Blue
Degree of protection	IP 20	IP 20	IP 20
Pollution degree	3 (IEC 60664)	3 (IEC 60664)	3 (IEC 60664)
Operating temperature	-20°C to +50°C	-20°C to +50°C	-20°C to +50°C
Storage temperature	-30°C to +60°C	-30°C to +60°C	-30°C to +60°C
Humidity (non condensing)	20 to 80%	20 to 80%	20 to 80%
Other functions			
Remarks	Approved according to UL60950		
References			
44 x 44 Wallbox Btcino, Niko, Fuga	B4X-LS4-U	SHA4XWLS4	
55 x 55 Wallbox Elko, Gira, Jung	B5X-LS4-U	SHE5XWLS4	
White			BEW-LS4-U
Anthracite			BEA-LS4-U
44 x 44 Wallbox Btcino, Niko, Fuga Temperature and humidity	SHA4XLS4TH		
55 x 55 Wallbox Elko, Gira, Jung Temperature and humidity	SHE5XLS4TH		

Dupline® Home and Building automation

Temperature			
Supply	Bus	Bus	Bus
			
Dimensions (mm)	44 x 44 / 55 x 55	55 x 55	67 x 35 x 15
Functions	Temperature controller with display	Temperature controller with display	Temperature sensor for indoor and outdoor applications
Electrical specifications			
Number of switches	4	4	
Power Supply	Powered by bus	Powered by bus	Powered by bus
General specifications			
Colour	Black/white	White/light grey/anthracite	Light grey
LEDs	4 white / 4 blue	Blue	
Mounting	Wallbox Btcino, Niko, Fuga / Elko, Gira, Jung	Wallbox Elko	Direct wall mounting
Connection			Cable / plug
Degree of protection	IP 20	IP 20	IP 67
Pollution degree	3 (IEC 60664)	3 (IEC 60664)	
Operating temperature	-10°C to +50°C	0°C to +50°C	-40°C to +60°C
Storage temperature	-20°C to +70°C	-20°C to +70°C	-55°C to +85°C
Humidity (non condensing)	20 to 80%	20 to 80%	20 to 80%
Remarks	3 setpoints	3 setpoints	
References			
44 x 44 Wallbox Btcino, Niko, Fuga	SHA4XTEMDIS		
55 x 55 Wallbox Elko, Gira, Jung	SHESXTEMDIS		GH3485 0000
White		SHEKWTEMDIS	
Anthracite		SHEKATEMDIS	
Cable, 2 m			BSI-TEMANAB-U
Plug, M12			BSI-TEMANA-U

Dupline® Home and Building automation

Movement / Presence sensors

Function	PIR / Luxmeter	PIR / Luxmeter	PIR / Luxmeter	PIR / Luxmeter
				
Dimensions (mm)	44 x 44 / 55 x 55	104 x 55 x 57	Ø 76 x 25	67 x 52 x 34
Functions	PIR sensor for detecting presence and/or movement in indoor installations	PIR sensor for detecting presence and/or movement in indoor installations	PIR sensor for detecting presence and/or movement in indoor installations	PIR sensor for detecting presence and/or movement in indoor /outdoor installations

Electrical specifications

Power Supply	Powered by bus	Powered by bus	Powered by bus	Powered by bus
--------------	----------------	----------------	----------------	----------------





General specifications

Colour	White / Black	White	White	White
LEDs	White / blue	Red	Blue	Red
Mounting	Wallbox Btcino, Niko, Fuga / Elko, Gira, Jung	Wall mounting	LK ceilingbox PL52 or PL55	Wall mounting
Degree of protection	IP 20	IP 40		IP 64 / IP 20
Pollution degree	3 (IEC 60664)	3 (IEC 60664)		
Operating temperature	0°C to +50°C	0°C to +50°C	0°C to +50°C	-20°C to +50°C
Storage temperature	-20°C to +70°C	-20°C to +70°C	-20°C to +70°C	-30°C to +70°C
Humidity (non condensing)	20 to 80%	20 to 80%	20 to 80%	
Main features	Operating distance: 8m Angle: 90°	Operating distance: 12m Angle: 90°	Operating distance: ≤ 8m Angle: 90°	Operating distance: 0.5-15m Angle: 90°



References

	BSD-PIR90-U	BSB-PIR90-U	
Luxmeter	SHSDP90L	SHSBP90L	
Outdoor			BSP-PIR90-U
Indoor			BSP-PIR90A-U
Outdoor + luxmeter			SHSPP90L
Indoor + luxmeter			SHSPP90LA
44 x 44 Wallbox Btcino, Niko, Fuga	B4X-PIR90-U		
55 x 55 Wallbox Elko, Gira, Jung	B5X-PIR90-U		
44 x 44 Wallbox Btcino, Niko, Fuga + luxmeter	SHA4XP90L		
55 x 55 Wallbox Elko, Gira, Jung + luxmeter	SHE4XP90L		



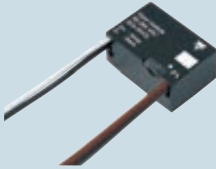

Dupline® Home and Building automation

	Movement / presence sensors	Lux	Light switch interfaces	
Function	PIR / Luxmeter	Luxmeter	Input module	Input/output
				
Dimensions (mm)	Ø 90 x 40	55 x 53 x 36	28 x 28 x 10	28 x 28 x 10
Functions	PIR sensor for detecting presence and/or movement in indoor installations with a built-in luxmeter	Luxmeter for indoor / outdoor installations	Input module for voltage free outputs	Input / output module for voltage free outputs and PNP transistor inputs
Electrical specifications				
Power Supply	Powered by bus	Powered by bus	Powered by bus	Powered by bus
Inputs			4/8	4
Outputs				4 PNP
General specifications				
Colour	White	White		
LEDs	Blue			
Mounting	Ceiling mounting	Wall mounting	In a junction box or behind a switch/pushbutton input	In a junction box or behind a switch/pushbutton input
Degree of protection	IP 20	IP 44		
Pollution degree	3 (IEC 60664)			
Operating temperature	0°C to +50°C	-30°C to +60°C	0°C to +50°C	0°C to +50°C
Storage temperature	-20°C to +70°C		-20°C to +70°C	-20°C to +70°C
Humidity (non condensing)	20 to 80%		20 to 80%	20 to 80%
Main features	Operating distance: ≤ 7.5m Angle: 360° Lens: dual detecting zones	Measuring range: 0 to 20 kLux		
References				
	SHSQP360L	BSH-LUX-U		
4 contacts			BDB-INCON4-U	
8 contacts			BDB-INCON8-U	
Output voltage 3.3 V				BDB-IOCP8-U
Output voltage 8 V				BDB-IOCP8A-U





Dupline® Home and Building automation

	Input modules		Smoke	Water
Function	Digital	Voltage	Smoke detector	Water sensor
				
Dimensions (mm)	107 x 50 x 110	28 x 28 x 10	Ø 100 x 54 mm	70 x 39 x 15.5
Functions	Input module for voltage free outputs or NPN transistor outputs.	Opto-isolated input voltage module, 90-265 VAC	Smoke detector for home/building applications	Water detection sensor for home/building applications
Electrical specifications				
Inputs	4-contact or NPN transistor inputs	90-265VAC		
Power Supply	Powered by bus	Powered by bus	Powered by bus / 9 VDC battery	Powered by bus
General specifications				
Colour			White	White
LEDs	Green, yellow, red		Red	
Mounting	DIN-rail mounting		Ceiling mounting	Wall mounting
Degree of protection		IP 20	IP 43	IP 67
Pollution degree		3 (IEC 60664)		
Operating temperature	-20°C to +50°C	-20° to +50°	0°C to +50°C	-20° to +50°C
Storage temperature	-50°C to +85°C	-50° to +70°C	-5°C to +85°C	-50°C to +85°C
Humidity (non condensing)	20 to 80%	20 to 80%	20 to 80%	20 to 80 %
Main features		Programmable via the SH tool	Detection area: 60 m ²	Input for Felson probe
References				
	BDD-INCON4-U	BDA-INVOL-U		BSF-WAT-U
Battery backup			BSG-SMOA-U	
No battery backup			BSG-SMO-U	

Dupline® Home and Building automation





	Weather			Analogue
Function	Cup anemometer	Weather station	Keypad	Output module
				
Dimensions (mm)	183 x 137 x 145	96 × 77 × 118	130 x 50 x 8	50 x 30 x 18
Functions	Anemometer for building automation applications	Weather station for measurement of temperature, wind speed, brightness and precipitation	Programmable keypad for building access control and alarm control in indoor and outdoor applications	Output module with 2 analogue outputs
Electrical specifications				
Inputs		90-265VAC	12 pushbuttons	
Outputs				2 x 0-10 VDC
Power Supply	Powered by bus	Powered by bus	9-17 VDC	24 VDC
General specifications				
Colour		White	Black / White	
LEDs			Yellow, red, green, programmable	
Mounting	Wall mounting	Wall mounting	Wall box mounting	Inside wall box or environmental sensor housings
Degree of protection	IP 54	IP 44	IP 67	IP 20
Pollution degree	2 (IEC 60664-1, par. 4.6.2)			2(IEC 60664-1, par. 4.6.2)
Operating temperature	-20° to +60°C	-30° to +50°	-15°C to +60°C	0° to +50°C
Storage temperature	-20° to +60°C	-30° to +70°C	-30° to 80°C	-50°C to +85°C
Humidity (non condensing)	20 to 80%	5 to 95%	100%	20 to 90 %
Main features	Measuring range: 2 to 25 m/s Heating system	GPS receiver	28 user-programmable codes, Buzzer output	
References				
	BSN-ANE-U	SHOWEAGPS	BACC-KEYPAD-DC-U	SHPOUTV224

Dupline® Home and Building automation





	Analogue input modules			Touch displays
Function	Input module	Input module	Input module	
				
Dimensions (mm)	50 x 30 x 18	50 x 30 x 18	50 x 30 x 18	187 x 147 / 147 x 107
Functions	Input module with 3 analogue inputs	Input module with 4 analogue inputs	Input module with 2 analogue inputs	High definition 7" and 4.3" colour touchscreens
Electrical specifications				
Inputs	3 x 0-10 VDC	2 x 0-10 VDC, 1 x thermistor 10K3 input 1 x variable resistor 1-11 KΩ	1 x thermistor 10K3 1 x variable resistor 1-11 KΩ	
Power Supply	24 VDC	24 VDC	Bus	24 VDC ± 20%
General specifications				
Colour				
LEDs				
Mounting	Inside wall box or environmental sensor housings	Inside wall box or environmental sensor housings	Inside wall box or environmental sensor housings	
Degree of protection	IP 20	IP 20	IP 20	
Pollution degree	2 (IEC 60664-1, par. 4.6.2)	2 (IEC 60664-1, par. 4.6.2)	2 (IEC 60664-1, par. 4.6.2)	
Operating temperature	0° to +50°C	0° to +50°C	0° to +50°C	
Storage temperature	-50°C to +85°C	-50°C to +85°C	-50°C to +85°C	
Humidity (non condensing)	20 to 90 %	20 to 90 %	20 to 90 %	
Main features				Windows CE, 7", 800 x 480 pixel / 4.3", 480 x 272 pixel, Ethernet port
References				
	SHPINV324	SHPINV2T1P124	SHPINT1P1	
7", 800 x 480 pixel				BTM-T7-24
4.3", 480 x 272 pixel				BTM-T4-24

Dupline® Home and Building automation





Relay modules

Output type	Bistable relay	Bistable relay	Bistable relay	Bistable relay
				
Dimensions (mm)	26 x 39 x 17	50 x 30 x 18	2 DIN module	2 DIN module
Functions	Small sized remote relay output	Wireless relay output module with energy measurement	Two-relay output module with energy measurement	Four-relay output module
Electrical specifications				
Outputs	1	1	2	4
Power Supply	Bus	230 VAC	230 VAC	Bus
General specifications				
Mounting	Decentralized	DIN-rail (2 modules)	DIN-rail (2 modules)	DIN-rail (2 modules)
LEDs		Green, blue	Green, yellow, red	Green, yellow, red
Degree of protection		Front: IP 50, Screw terminal: IP 20	Front: IP 50, Screw terminal: IP 20	Front: IP 50, Screw terminal: IP 20
Pollution degree	3 (IEC 60664)	2 (IEC 60664-1, par. 4.6.2)	2 (IEC 60664-1, par. 4.6.2)	2 (IEC 60664-1, par. 4.6.2)
Operating temperature	-20° to +50°C	-20° to +50°C	-20° to +50°C	-20° to +50°C
Storage temperature	-50°C to +85°C	-50°C to +85°C	-50°C to +85°C	-50°C to +85°C
Humidity (non condensing)	20 to 80 %	20 to 80 %	20 to 80 %	20 to 80 %
Main features	Load: 13A, 250VAC	Load: 13A , 250VAC, Wireless	Load: 16A, 230VAC x 2 Energy reading, Local bus	Load: 16A, 230VAC x 4 Local bus
References				
	BDA-RE13A-U	SHDWRE16AE230	SH2RE16A2E230	SH2RE16A4



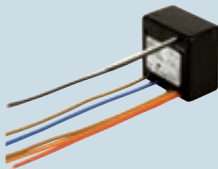

Dupline® Home and Building automation

	Output modules	Dimmer modules		Transparent module
Output type	Bistable relay	Power mosfet	Power mosfet	
				
Dimensions (mm)	2 DIN module	2 DIN module	2 DIN module	8.5 x 90 x 67
Functions	Four-solid-state relay output module	Power dimmer up to 500W for R, L, C load and LED lamps	Analogue output dimmer for adjustable ballast with 1 to 10 V input	Transparent module for simplifying the wiring of the smart-house installation
Electrical specifications				
Outputs	4	1	4	
Power Supply	24 VDC ± 20%	230 VAC	24 VDC ± 20%	No power supply needed
General specifications				
Mounting	DIN-rail (2 modules)	DIN-rail (2 modules)	DIN-rail (2 modules)	DIN-rail
LEDs	Green, yellow, red	Green, yellow, red	Green, yellow, red	
Degree of protection	Front: IP 50 Screw terminal: IP 20	Front: IP 50 Screw terminal: IP 20	Front: IP 50 Screw terminal: IP 20	Front: IP 40 Screw terminal: IP 20
Pollution degree	2 (IEC 60664-1, par. 4.6.2)	2 (IEC 60664-1, par. 4.6.2)	2 (IEC 60664-1, par. 4.6.2)	2 (IEC 60664-1, par. 4.6.2)
Operating temperature	-20° to +50°C	-20° to +50°C	-20° to +50°C	-20° to +50°C
Storage temperature	-50°C to +85°C	-50°C to +85°C	-50°C to +85°C	-30°C to +70°C
Humidity (non condensing)	20 to 80 %	20 to 80 %	20 to 80 %	20 to 80 %
Main features	Load: 10 W x 4 Local bus	Local bus / Energy reading		
References				
	SH2SSTRI424		SH2D10V424	SH1DUPFT
With energy reading		SH2D500WE230		
Without energy reading		SH2D500W1230		

Dupline® Home and Building automation

	Rollerblind modules			Digital input module
				
Dimensions (mm)	50 x 50 x 30	2 DIN module	2 DIN module	2 DIN module
Functions	Decentralized module for up/down control of one rollerblind motor	Relay output module for up/down control of two AC rollerblind motors	Relay output module for up/down control of two DC rollerblind motors	Input module, configurable as contact or pulse counter
Electrical specifications				
Outputs	1 SPST relay & 1 SPDT relay	2 SPST + 2 SPDT relay	2 SPST + 2 SPDT relay	
Power Supply	230 VAC ± 15%	24 VDC ± 20%	24 VDC ± 20%	24 VDC ± 20%
Motor type	AC	AC	DC	
Inputs				4
Input types				Voltage free, NPN, PNP, counter
General specifications				
Mounting	Eurobox	DIN-rail (2 modules)	DIN-rail (2 modules)	DIN-rail (2 modules)
LEDs		Green, yellow, red	Green, yellow, red	Green, yellow, red
Degree of protection		Front: IP 50, Screw terminal: IP 20	Front: IP 50, Screw terminal: IP 20	Front: IP 50, Screw terminal: IP 20
Pollution degree	3 (IEC 60664)	2 (IEC 60664-1, par. 4.6.2)	2 (IEC 60664-1, par. 4.6.2)	2 (IEC 60664-1, par. 4.6.2)
Operating temperature	-20° to +50°C	-20° to +50°C	-20° to +50°C	-20° to +50°C
Storage temperature	-50°C to +85°C	-50°C to +85°C	-50°C to +85°C	-50°C to +85°C
Humidity (non condensing)	20 to 80 %	20 to 80 %	20 to 80 %	20 to 80 %
Main features	Up/down control, tilting, local bus	Up/down control, tilting, local bus	Up/down control, tilting, local bus	Load: 16A, 230VAC x 4 Local bus
References				
	SHDRODC230	SH2ROAC224	SH2RODC224	SH2INDI424

Dupline® Home and Building automation

	Universal mobile modem	Bus generators		Master unit (CPU)
				
Dimensions (mm)	2 DIN module	2 DIN module	2 DIN module	2 DIN module
Functions	Universal modem extension for Sx2WEB24	Master channel generator	Wireless base unit for generating wireless network	Input module, configurable as contact or pulse counter
Electrical specifications				
Power Supply	24 VDC ± 20%	24 VDC ± 20%	24 to 240 VAC/DC	24 VDC ± 20%
General specifications				
Mounting	DIN-rail (2 modules)	DIN-rail (2 modules)	DIN-rail (2 modules)	DIN-rail (2 modules)
LEDs	Green, blue	Green, yellow	Green, yellow, blue	Green, yellow, blue, red
Degree of protection	Front: IP 40, Screw terminal: IP 20	Front: IP 50, Screw terminal: IP 20	Front: IP 50, Screw terminal: IP 20	Front: IP 40 Screw terminal: IP 20
Pollution degree	2 (IEC 60664-1, par. 4.6.2)	2 (IEC 60664-1, par. 4.6.2)	2 (IEC 60664-1, par. 4.6.2)	2 (IEC 60664-1, par. 4.6.2)
Operating temperature	-20° to +50°C	-20° to +50°C	-20° to +50°C	-20° to +50°C
Storage temperature	-30°C to +70°C	-50°C to +85°C	-50°C to +85°C	-30°C to +70°C
Humidity (non condensing)	90% @ 40°C	20 to 80 %	20 to 80 %	90% @ 40°C
Main features	Quad band: GSM, GPRS, EDGE Dual-band UMTS, GPRS, HSPA Available for Europe, Africa and Asia	Dupline® busgenerator. Connection of up to 250 slave modules	Wireless busgenerator. Connection of up to 250 slave modules. Based on IEEE 802.15.4, @ 2.4 GHz	Home automation master unit with datalogging capability. Linux based PC with 2 USB ports, ethernet port, 2 RS485 ports, local bus
References				
	SH2UMMF124	SH2MCG24	SH2WBU230	SH2WEB24

Dupline® Home and Building automation

BACnet building controller

Environmental sensors



Dimensions (mm)	2 DIN module	80 x 90 x 26	80 x 90 x 26	80 x 90 x 26
Functions	BACnet controller converting Dupline and Energy Meter data points to BACnet/IP objects	Room sensors for CO ₂ temperature and %RH measurement - with display	Room sensors for CO ₂ temperature and %RH measurement - with led indication	Room sensors for CO ₂ temperature and %RH measurement

Electrical specifications

Power Supply	24 VDC ± 20%	Bus	Bus	Bus
--------------	--------------	-----	-----	-----

General specifications

Mounting	DIN-rail (2 modules)	Wall mounting	Wall mounting	Wall mounting
Indication	Led: green, yellow, blue, red	Display	Led: red, green, blue	None
Degree of protection	Front: IP 40, Screw terminal: IP 20	IP 20	IP 20	IP 20
Pollution degree		2 (IEC 60664-1, par. 4.6.2)	2 (IEC 60664-1, par. 4.6.2)	2 (IEC 60664-1, par. 4.6.2)
Operating temperature	-20° to +50°C	-20° to +50°C	-20° to +50°C	-20° to +50°C
Storage temperature	-30°C to +70°C	-40°C to +70°C	-40°C to +70°C	-40°C to +70°C
Humidity (non condensing)	90% @ 40°C	0 to 90 %	0 to 90 %	0 to 90 %
Main features	Automatically creates BACnet/ IP objects for all Dupline and energy meter data points. Ethernet port for BACnet/IP communication	CO ₂ measuring range: 0 to 2000 ppm CO ₂ measurement: Dual source infrared NDIR technology Temperature measuring range: -20 to +50°C (-4 to 122°F) Humidity measuring range: 0 to 100 %RH	CO ₂ measuring range: 0 to 2000 ppm CO ₂ measurement: Dual source infrared NDIR technology Temperature measuring range: -20 to +50°C (-4 to 122°F) Humidity measuring range: 0 to 100 %RH	CO ₂ measuring range: 0 to 2000 ppm CO ₂ measurement: Dual source infrared NDIR technology Temperature measuring range: -20 to +50°C (-4 to 122°F) Humidity measuring range: 0 to 100 %RH

References

	SB2WEB24		
Display, CO ₂ + temperature		SHSUCOTD	
Display, CO ₂ + temperature + humidity		SHSUCOTH	
Display, temperature + humidity		SHSUTHD	
Display, temperature		SHSUTD	
RGB Led, CO ₂ + temperature			SHSUCOTL
RGB Led, temperature + humidity			SHSUCOHL
CO ₂ + temperature			SHSUCOT
CO ₂ + temperature + humidity			SHSUCOTH
Temperature + humidity			SHSUTH
Temperature			SHSUT



OUR SALES NETWORK IN EUROPE

AUSTRIA - Carlo Gavazzi GmbH
Keizergasse 374, A-1230 Wien
Tel: +43 1 888 4112
Fax: +43 1 889 10 53
office@carlogavazzi.at

BELGIUM - Carlo Gavazzi NV/SA
Mechelsesteenweg 311, B-1800 Vilvoorde
Tel: +32 2 257 4120
Fax: +32 2 257 41 25
sales@carlogavazzi.be

DENMARK - Carlo Gavazzi Handel A/S
Over Hadstenvvej 40, DK-8370 Hadsten
Tel: +45 89 60 6100
Fax: +45 86 98 15 30
handel@gavazzi.dk

FINLAND - Carlo Gavazzi OY AB
Petaksentie 2-4, FI-00630 Helsinki
Tel: +358 9 756 2000
Fax: +358 9 756 20010
myynti@gavazzi.fi

FRANCE - Carlo Gavazzi Sarl
Zac de Paris Nord II, 69, rue de la Belle
Etoile, F-95956 Roissy CDG Cedex
Tel: +33 1 49 38 98 60
Fax: +33 1 48 63 27 43
french.team@carlogavazzi.fr

GERMANY - Carlo Gavazzi GmbH
Pfnorstr. 10-14
D-64293 Darmstadt
Tel: +49 6151 81000
Fax: +49 6151 81 00 40
info@gavazzi.de

GREAT BRITAIN - Carlo Gavazzi UK Ltd
4.4 Frimley Business Park,
Frimley, Camberley, Surrey GU16 7SG
Tel: +44 1 252 339600
Fax: +44 1 252 326 799
sales@carlogavazzi.co.uk

ITALY - Carlo Gavazzi SpA
Via Milano 13, I-20020 Lainate
Tel: +39 02 931 761
Fax: +39 02 931 763 01
info@gavazziacbu.it

NETHERLANDS - Carlo Gavazzi BV
Wijkemeerweg 23,
NL-1948 NT Beverwijk
Tel: +31 251 22 9345
Fax: +31 251 22 60 55
info@carlogavazzi.nl

NORWAY - Carlo Gavazzi AS
Melkeveien 13, N-3919 Porsgrunn
Tel: +47 35 93 0800
Fax: +47 35 93 08 01
post@gavazzi.no

PORTUGAL - Carlo Gavazzi Lda
Rua dos Jerónimos 38-B,
P-1400-212 Lisboa
Tel: +351 21 361 7060
Fax: +351 21 362 13 73
carlogavazzi@carlogavazzi.pt

SPAIN - Carlo Gavazzi SA
Avda. Iparraguirre, 80-82,
E-48940 Leioa (Bizkaia)
Tel: +34 94 480 4037
Fax: +34 94 480 10 61
gavazzi@gavazzi.es

SWEDEN - Carlo Gavazzi AB
V:a Kyrkogatan 1,
S-652 24 Karlstad
Tel: +46 54 85 1125
Fax: +46 54 85 11 77
info@carlogavazzi.se

SWITZERLAND - Carlo Gavazzi AG
Verkauf Schweiz/Vente Suisse
Sumpfstrasse 3,
CH-6312 Steinhausen
Tel: +41 41 747 4535
Fax: +41 41 740 45 40
info@carlogavazzi.ch

OUR SALES NETWORK IN THE AMERICAS

USA - Carlo Gavazzi Inc.
750 Hastings Lane,
Buffalo Grove, IL 60089, USA
Tel: +1 847 465 6100
Fax: +1 847 465 7373
sales@carlogavazzi.com

CANADA - Carlo Gavazzi Inc.
2660 Meadowvale Boulevard,
Mississauga, ON L5N 6M6, Canada
Tel: +1 905 542 0979
Fax: +1 905 542 22 48
gavazzi@carlogavazzi.com

MEXICO - Carlo Gavazzi Mexico S.A. de C.V.
Calle La Montaña no. 28, Fracc. Los Pastores
Naucalpan de Juárez, EDOMEX CP 53340
Tel & Fax: +52.55.5373.7042
mexicosales@carlogavazzi.com

BRAZIL - Carlo Gavazzi Automação Ltda.Av.
Brig. Luís Antônio, 3067
Jd. Paulista São Paulo
CEP 01401-000
Tel: +55 11 3052 0832
Fax: +55 11 3057 1753
info@carlogavazzi.com.br

OUR SALES NETWORK IN ASIA AND PACIFIC

SINGAPORE - Carlo Gavazzi Automation
Singapore Pte. Ltd.
61 Tai Seng Avenue
#05-06 UE Print Media Hub
Singapore 534167
Tel: +65 67 466 990
Fax: +65 67 461 980
info@carlogavazzi.com.sg

MALAYSIA - Carlo Gavazzi Automation
(M) SDN. BHD.
D12-06-G, Block D12,
Pusat Perdagangan Dana 1,
Jalan PJU 1A/46, 47301 Petaling Jaya,
Selangor, Malaysia.
Tel: +60 3 7842 7299
Fax: +60 3 7842 7399
sales@gavazzi-asia.com

CHINA - Carlo Gavazzi Automation
(China) Co. Ltd.
Unit 2308, 23/F.,
News Building, Block 1, 1002
Middle Shennan Zhong Road,
Shenzhen, China
Tel: +86 755 83699500
Fax: +86 755 83699300
sales@carlogavazzi.cn

HONG KONG - Carlo Gavazzi
Automation Hong Kong Ltd.
Unit 3 12/F Crown Industrial Bldg.,
106 How Ming St., Kwun Tong,
Kowloon, Hong Kong
Tel: +852 23041228
Fax: +852 23443689

OUR COMPETENCE CENTRES AND PRODUCTION SITES

DENMARK - Carlo Gavazzi Industri A/S
Hadsten

MALTA - Carlo Gavazzi Ltd
Zejtun

ITALY - Carlo Gavazzi Controls SpA
Belluno

LITHUANIA - Uab Carlo Gavazzi Industri Kaunas
Kaunas

CHINA - Carlo Gavazzi Automation
(Kunshan) Co., Ltd.
Kunshan

HEADQUARTERS

Carlo Gavazzi Automation SpA
Via Milano, 13 - I-20020
Lainate (MI) - **ITALY**
Tel: +39 02 931 761
info@gavazziautomation.com



CARLO GAVAZZI
Automation Components

Energy to Components!

www.gavazziautomation.com

