

A dramatic, blue-toned photograph of a sunset over the ocean. The sun is low on the horizon, creating a bright glow and sunbeams that fan out across the water. The water is dark blue with white foam from a wave in the foreground. Bubbles are visible in the lower part of the image, suggesting an underwater perspective. The sky is filled with soft, wispy clouds.

# Gamakatsu®

2020 CATALOG  
WORLD'S FINEST HOOKS

[www.gamakatsu.com](http://www.gamakatsu.com)

# 2020 New Products

## G Finesse Stinger

Tournament pro and Gamakatsu pro staff, Brent Ehrler, developed and fine-tuned the new G Finesse Stinger for use with the popular Neko and Wacky rig techniques. The G Finesse Stinger follows in the footsteps of similar, game-changing G Finesse hooks engineered by Gamakatsu. It features Tournament Grade Wire (TGW) which is thinner and stronger than anything else on the market, and an application of Nano Smooth Coat to decrease penetration resistance. This hook can be perfectly positioned exactly where you want it, and even moved, without damaging the bait. When the bite is tough, G Finesse opens new ways to stick it to'em. *Available in size 6 through 1/0oz. Page 16.*



## G Finesse Weedless Stinger

We heard from pro staff, Brent Ehrler, and many others, that anglers were spending far too much time tying custom weed guards with wire or heavy monofilament on their Neko rigs... because they couldn't find the right finesse hook with the right weed guard already attached. Problem solved! The G Finesse Stinger Weedless is just what the tournament trail needed. Titanium wire weed guard, Nano Smooth Coat and Tournament Grade Wire.

*Available in size 6 through 1/0 oz. Page 16.*

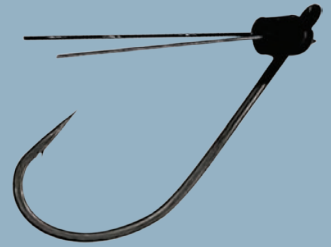

## B10 Stinger, TGW, Nano Smooth Coat

Our newest fly hook from our Executive series. Built using our thinner and stronger Tournament Grade Wire (TGW) and applied with our Nano Smooth Coat for less penetration resistance.

*Available in sizes 6, 4, 2, 1, 1/0 oz. Page 74.*



## Nautilus Circle Heavy Duty

To go ringed or not to go ringed... that is the question! And we've got the answer, whichever you prefer. The standard Nautilus HD hook features a ringless eye and 30% heavier wire than the regular Nautilus. (Roughly 50% less heavy than the Super Nautilus.) Whether you simply prefer the stealthiness of having less metal in the water or just have great confidence in the loop knots you've tied for years, the standard Nautilus HD hook will do the trick. You can feel the superiority by just holding it in your hand. Be careful when checking the sharpness; it doesn't differentiate between fish or fingers. *Available in 2/0 to 6/0 oz. with an NS black finish. Page 53.*



## Nautilus Circle Heavy Duty with Solid Ring

The new solid, one-piece ringed version of the Nautilus HD hook allows live bait to swim more freely, keeping it alive longer and enticing more prey to engulf its goodness. At that point, the finest high carbon steel penetrates deep and locks in tight for the battle ahead. The Ringed Nautilus HD features 30% heavier wire than the regular Nautilus and 50% less than the Super Nautilus. While its core credibility has been proven in the southern California Bluefin Tuna fisheries, there is absolute evidence of its prowess in many other heavyweight bouts with monster gamefish worldwide. Therefore, you owe it to yourself to try the Nautilus HD Ringed for all live bait techniques and bottomfish applications. Big blues and channel cats? Absolutely! Sturgeon? Oh yeah. Halibut? It's a no-brainer. Tie one on without a single regret. *Available in 2/0 to 3/0 in 5-packs, and 4/0 to 6/0 in 4-packs. Page 53.*



## Treble Stinger Rig, Fluorocarbon Leader

Bass and walleye will certainly grab hold of this stealthier version of our trailing stinger rig. We've pre-tied two inches of premium, 16-pound test fluorocarbon line instead of the coated steel wire. It works well with a wide variety of baits; however, it is most suited for trolling baits or any scenarios where fish are coming from behind and just striking the tail of the bait. Many anglers consider it mandatory for cold weather angling when fish are sluggish. *Available in sizes 12 through 8. Three per pack. oz. Page 62.*



## TW Hook

The TW stands for "Trout Worm" and is the perfect hook for those soft plastic finesse worms that require a delicate presentation. It has the right gap to accommodate the worm and hold the fish.

*Available in Bronze in new sizes 6 and 8 oz. Page 34.*



# 2020 New Products

## Tuned Tuna Plug, Ringed

Angler preferences can differ on whether to use a ringed hooked or not. And that's just fine with us because we manufacture both. Our Tuned Tuna Plug hook is now available with a welded ring. The ring provides more freedom for the hook(s) to swing unencumbered. Anglers have also found success using the ringed Tuned Tuna Plug hook for stiff rigs, thus eliminating the need for a shackle. Without reservation, they're ready for battle.

*Available in 10/0 to 12/0 in oz. packs of two. Page 59.*

## Assist 520, Ringed

In our relentless pursuit of perfection, and simplicity, we added a welded ring to our tournament-winning Assist 520 hook. The constant jiggling motion is tough on looped monofilament, fluorocarbon, and braid. We took every nuance of uncertainty out of the technique by adding a welded ring. Not only is it nearly unbreakable, but the ring is also much faster and easier to connect to the jig eye using a split ring.

*Available in 3/0 to 6/0 oz. sizes in packs of two.*

*Rigged with 160 lb. (3/0, 4/0) and 220 lb. (5/0, 6/0) braided line. Page 57.*

## Assist 620 Heavy Duty with Solid Ring

When you pursue the fish of a lifetime, chances are it's going to be really, really big; and have really, really, really sharp teeth. Take no chances! We call these "heavy-duty" Assist 620 hooks but they'll live up to tenacious-duty, gargantuan-duty or leviathan-duty equally as well. There's nothing stronger. One-piece solid rings make connections easy.

*Available in 6/0 to 8/0 oz. in packs of one. Rigged with 270 lb. (5/0, 6/0) and 400 lb. (7/0, 8/0) braided line. Page 57.*

## Jig 30 Extra Wide Gap

Designed for a wide variety of popular techniques, emerging trends, and do-it-yourself lead jig head pouring. The new 30° hook eye angle compliments the 60° and 90° jig hooks that have been the standard for decades. This extra wide gap (EWG) will handle larger baits too. The points are incredibly sticky-sharp right out of the package. Fits most 30° lead molds.

*Available in 3/0 to 7/0 oz., in NS black color. Available in bulk packs of 25 and 100. Page 45.*

## Bottom Knocker Offset

Anglers on the other side of the "big pond" have been boasting about the advantages of using an offset bottom knocker for many years now. We put them in the hands of several of our most trusted pros and tackle testers in the U.S. and waited to hear what they had to say. What a surprise, they slay bigmouths here in the States as well. Notice the finesse football head designed for fishing deep structure, and the fact that the hook eye is offset to tantalize the "lay down" action. And of course, the genuine Gamakatsu hook is as sharp as they come.

*Available in 4-packs, in 3/8, 1/2, 5/8 and 3/4 ounce sizes. Page 69.*

## Finesse Jig Head Offset

If you're familiar with the Ned rig technique, you probably haven't seen this before: An offset eye, countersunk into the jig head, with a premium forged steel Gamakatsu hook. Well, now you have. Reduce time rigging and spend more time fishing. This all-in-one design is tough to beat when bass are spooked or finicky in overfished conditions.

*Available in 4-packs, in 3/32, 1/8, 3/16, and 1/4 ounce sizes. Page 69.*

## Octopus Straight Eye NSB

West coast anglers love salmon. Salmon love herring. Herring love to rip and tear apart when you rig them with traditional hooks. Hence, the reason we designed the new Octopus Straight Eye hook. The ultra-thin, yet ultra-strong, wire slides through soft baits without damaging the tender tissue. The hook eye is narrower and smoother too, so it can slide through as well. The result is a herring with that perfect spin, followed by a chrome bright chinook or coho in the net shortly thereafter.

*Available in 8 to 4/0 sizes. oz. Page 22.*



# 2020 New Products



## Trucker Mesh Hat

Classic trucker cap style built with the quality and fit you've come to expect from Gamakatsu. Navy brim and crown with raised Gamakatsu logo lettering in white embroidery. White mesh panel and snapback, adjustable sizing clasp. *Page 80.*



## Triple Black Flat Bill Hat

Make a subtle statement, in a powerful way. Black on black on black with a raised Gamakatsu embroidered logo off-centered to the side. One size fits all snapback closure. 65/35 polyester/cotton. *Page 80.*

## G-Box 3500 Deep Utility Case

Our designers continue to expand the offering of G-Boxes because anglers keep expanding their requests for more of these intuitive storage solutions. The new G-Box 3500 is nearly 2.4" deep, so big-lipped and fat-bodied, baits fit with ease. It's 7.4" wide to accommodate stick baits, long spinners and spinner blades. The clear top lets you see what's inside and the one-handed, easy-opening design makes access exceptionally convenient. Of course, the dividers are fully adjustable too. Complete dimensions: 10" x 7.4" x 2.4".

*Page 83.*



## < Dry Bag Backpack 20L

When you need guaranteed watertight storage for long walks out to the boat, down the beach or deep into the woods, just let this Dry Bag Backpack 20L carry the load. 100% waterproof with sealed seams and breathable back padding for comfort. Top rolls and clips securely to prevent leakage. The front zippered pocket protects valuables. Compacts tightly for storage when not in use. Large enough for any overnight or multi-day trip. *Page 85.*

## Dry Bag 10L >

For extreme conditions where rain, waves, boat spray, or unforeseen accidents could really dampen the fun, store your gear in our Dry Bag 10L. 100% waterproof with sealed seams and convenient shoulder strap for easy carrying. Top rolls and clip securely to prevent leakage. The front zippered pocket is perfect for wallets, phones, licenses, or other valuables. Compacts tightly for storage when not in use. *Page 85.*



## < Backpack Tackle Storage

When you need to carry enough tackle for wherever your angling adventure may lead you, strap on our new Backpack Tackle Storage solution. Made from 1680 Denier Ballistic Nylon, it's tough, light and easy to carry. The interior pouch can be adjusted from one large compartment to two smaller ones. Exterior carry pockets on both sides are designed to hold fishing rods or water bottles. Includes two (2) G3600 and one (1) G3500D G-Boxes. Dimensions: 17" x 12" x 8". *Page 85.*



## G Finesse by Aaron Martens

**G Finesse...A Ground-Breaking Achievement In Hook Design**  
Gamakatsu entered the market on the promise of the sharpest hooks produced. It was Gamakatsu that created the "super sharp" hook category and continues to add new application-specific hooks to its offering every year.

"Over my entire career fishing Gamakatsu I envisioned making the best finesse hook in the world. **Gamakatsu's New G Finesse Series** combine **Ultra Sharp Tournament Grade Wire** with **Nano Smooth Technology** for the ultimate in hook penetration. This new technology will take my finesse fishing to a whole new level". ~ **Aaron Martens**

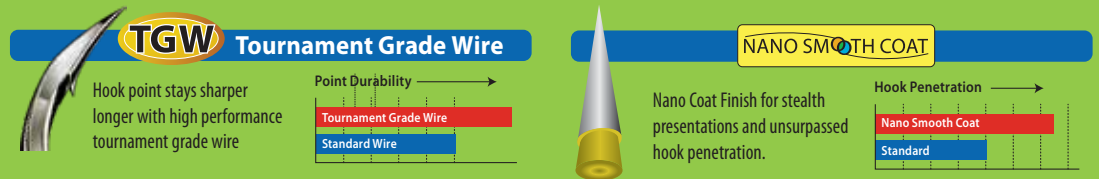

### G Finesse Heavy Cover Worm

The new Aaron Martens Signature G Finesse Heavy Cover Worm hook does what others can't. Extreme versatility. Martens says it best, "This hook let's me do so much, easily the most versatile soft plastics hook on the market". Featuring Aaron's custom designed keeper that holds plastics tight for endless casts without rips or tears. The rock solid keeper is made of non-corrosive tin, not plastic or lead, so it won't wear out or add unwanted weight. Like all G Finesse hooks, tournament grade wire and Nano Smooth Coat finish perfect the design. *Available in sizes 2, 1, 1/0, 2/0, 3/0, 4/0.*



### G Finesse Treble Hook ... Thinner, Stronger, Sharper, Better.

Gamakatsu continues to expand its ground-breaking G Finesse series hooks with the G Finesse Treble Hook. Designed by Tournament pro, Aaron Martens, the G Finesse Treble redefines "sharp" and "effective".

Gamakatsu's G Finesse Treble Hook is patterned after traditional O'Shaughnessy style hooks. Aaron has long been a proponent of the O'Shaughnessy hook style with its distinctive acute angle at the bottom of the hook. Martens believes the addition of the O'Shaughnessy bend, hooks and holds fish better than round bend designs. He should know, a past B.A.S.S. Angler of the Year, had three second place finishes in Bassmaster's Classics and is always in the hunt on the pro tours. When you fish as much as Aaron does, small details make a big difference. *The G Finesse Treble Hooks is available in sizes 6,5,4,3,2, 1, 1/0. Nano Smooth Coat finish.*



### G Finesse Treble Hook MH Hook

G Finesse for big, tough fish that live in the heaviest cover. Aaron Martens frequently chases them and he asked us for medium heavy G Finesse treble to meet those needs. We answered. The new G Finesse Treble MH features a tougher medium heavy, tournament grade wire for additional strength. The same Nano Smooth Coat finish and short shank promote instant hook penetration. *Available in Sizes 6, 5, 4, 3, 2, 1, 1/0.*



### G Finesse Drop Shot Hook

"I've increased my hook-up percentage by 40% ... I rarely miss a fish with this new drop shot hook. These are the sharpest, strongest, most advanced hooks of their kind on the market."

Martens has been instrumental in the development of Gamakatsu's new G Finesse Drop Shot Hook. Completely "pro-designed", Gamakatsu's new G Finesse series is a giant leap forward in fishing hook technology. "The new G Finesse Drop Shot Hook is like Gamakatsu's standard Drop Shot Hook except that I had them pull the point more towards the eye to open up the gap. Also, the hook wire, called TGW (Tournament Grade Wire) is a smaller diameter, 20% thinner, but just as strong as their other hooks." *Gamakatsu's G Finesse Drop Shot Hooks are available in sizes, 2, 1, 1/0 and 2/0. Nano Smooth Coat finish.*



# G Finesse by Shinichi Fukae



## G Finesse Swivel Shot

Drop-shot fishing for bass is nothing new but Gamakatsu's approach to it is. Our all-new Swivel Shot eliminates line twist that's commonly associated with drop shotting and vastly improves rigging efficiency. Gamakatsu's produced a revolutionary new "Twist Free" design using a premium swivel above the hook. The hook, a super-sharp Gamakatsu offset point Octopus hook, is strong enough to winch big bass out of slop --- another unique attribute of their Swivel Shot system. The Easy-Change weight system below the hook improves rigging efficiency and easy leader length adjustments without retying your rig. Pro Sennichi Fukae was instrumental in the development and testing of Gamakatsu's Swivel Shot and shared that it has been an essential element in his tournament success. Without a doubt, the Swivel Shot is an enormous leap forward in drop shot fishing that's sure to maximize angler's efficiency, increase hook-ups and land trophy-sized bass without the worry posed by conventional drop shot hooks and rigging. *Available in NS Black. Sizes: 2 - 3/0*



## G Finesse Swivel Shot Drop Shot

The original G Finesse Swivel Shot changed the game and professional anglers were eager to play. Some, like Shin Fukae, recognized the G Finesse advantage but didn't want to break from tradition entirely. The G Finesse Swivel Shot Drop Shot features our top of the line Tournament Grade Wire Drop Shot hook. Both the hook and swivel system feature the benefits of a Nano Smooth Coat finish. *Available in sizes 2, 1, 1/0 and 2/0.*



## G Finesse Swivel Shot Worm

It's more than just a new hook. It's the origination of a revolutionary new technique made possible by Gamakatsu's industry-changing G Finesse series. Pro Staff Shinichi Fukae spent the last year perfecting the concept and proving its power. We've combined our G Finesse Worm Light w/ Tin Keeper hook with the G Finesse Swivel Shot System to create the first ever Swivel Shot Worm. Unique in form, function and finesse. Texas Rig the Swivel Shot Worm to be fished in and around cover. The light wire allows for threading extremely small diameter worms, held firmly in place by the near weightless, tin keeper. The hook also features our unique Nano Smooth Coat Finish. Adding the "twist-free" advantage of the Swivel Shot allows super fast rigging without tangles. You can be assured the presentation is always perfect, and that translates into more strikes and more bent rods. *Available in sizes 1, 1/0, 2/0. Nano Smooth Coat finish.*



## G Finesse Tricky Head.

From the master finesse magician himself, Shin Fukae, comes the new Tricky Head jig head. It's the newest innovation from G Finesse. Designed to be fished with the popular shaky head technique, it brings several additional advantages to the tackle box. The Tricky Head is snag free. The weighted lead head is uniquely shaped to remain vertical during presentation, allowing the jig to bounce in and around structure while the worm or swimbait is held firmly in place by a lockdown tin keeper. You've got to see it to believe it. *Available in black or plain lead, in sizes 1/16, 3/32, 1/8 or 3/16 oz.*



## G Finesse Weedless Wacky

Gamakatsu's Tournament-winning Pro Staffer, Shinichi Fukae, never rests. On the heels of last year's new Swivel Shot Drop Shot hook, he worked tirelessly with Gamakatsu's engineers to develop the new G Finesse Weedless Wacky hook. Look closely and you'll see, it's not an ordinary weedless design. The weed guards are not plastic, they're titanium wire—solidly encased and directly molded to the hook shank. They won't come loose and they don't vibrate or add resistance. The extremely thin gauge wire retains its shape, yet is flexible enough to compress with even the gentlest nibbles. Bass won't feel a thing, until of course, the precision sharpened Gamakatsu hook does its job. The G Finesse Weedless Wacky hook features Gamakatsu's exclusive Nano Smooth Coat finish to add stealth and reduce friction for effortless hook penetration. The hook itself features Tournament Grade Wire (TGW) that is a smaller diameter, yet stronger, than other Drop Shot hooks. *Available in sizes 2, 1, 1/0, 2/0 and 3/0*



## G Finesse Worm Light with Tin Keeper

When conditions require finesse, the pros use new G Finesse Worm Light hooks. The light wire allows for threading of extremely small diameter worms with ease. Even the most fragile plastics are less likely to tear, saving on baits and increasing fishing time. The non-corrosive tin keeper doesn't add weight. Like all G Finesse hooks, the Worm Light hook penetrates with significantly less force making them substantially more effective. *Available in sizes 1, 1/0, and 2/0, all with Nano Smooth Coat Finish.*



## G Finesse Gamakatsu Tournament Snap

Gamakatsu's Tournament Snap is better by design. Primarily used on plugs for bass, walleye, salmon, strippers, steelhead, trout, panfish and other species, Gamakatsu's Tournament Snap is stainless steel and enables a full range of movement, enhancing the effectiveness of whatever plug is used. Better yet, and unlike other plug snaps, Gamakatsu's Tournament Snap will not accidentally open. The clever design of the Tournament Snap stays closed at all times as the plug eye is threaded onto the snap. It's easy and effective! Tested extensively and used under rigorous tournament conditions. *Gamakatsu's Tournament Snaps are available in two sizes, (M) Medium and (L) Large.*



## G Finesse Jig Head Wacky

Gamakatsu's Jig Head Wacky is a vast improvement over other wacky jigs. The nickel/titanium weed guard is the first indication that Gamakatsu's raised the bass fishing bar. This weed guard is small but mighty as it effectively clears hazards yet maintains its shape and rigidity under the most demanding use. The jig head is an improvement as well. Better designed to resist snags the hook eye is recessed to prevent getting hung-up in structure. Even the hook is different, a custom addition that's based on a shiner hook but modified for the Jig Head Wacky. The result is a much higher ratio of hook-ups and landed fish than any other comparable brand.

*Available in Black and Green Pumpkin. Sizes: 1/0-1/16, 1/0-3/32, 1/0-1/8, 1/0-3/16*



## G Finesse by Mike McClelland



### Mike McClelland Inspired G Finesse Hybrid Worm

The G Finesse Hybrid Worm is the brainchild of pro-staffer; Mike McClelland. He's spent more than a few hours on the water, competing in over 234 tournaments, including 10 times at the Bassmaster Classic. Mike knows the subtleties of rigging worms and soft plastic like no one else, so he and Gamakatsu's designers combined the best of his current favorite Gamakatsu worm hook and incorporated a distinctive new acute hook angle to keep baits aligned perfectly straight. Hence, the "Hybrid" name. The Nano Smooth Coat finish makes it easy to thread the thinnest finesse baits or the fattest Senkos with ease. Add industry-changing Tournament Grade Wire (TGW) to the package and things couldn't be more perfect. Take our word for it, or better yet, fish it yourself. *The G Finesse Hybrid Worm is available in sizes 1/0 to 8/0.*



## G Finesse by Brent Ehrler



### G Finesse Stinger

Tournament pro and Gamakatsu pro staff, Brent Ehrler, developed and fine-tuned the new G Finesse Stinger for use with the popular Neko and Wacky rig techniques. The G Finesse Stinger follows in the footsteps of similar, game-changing G Finesse hooks engineered by Gamakatsu. It features Tournament Grade Wire (TGW) which is thinner and stronger than anything else on the market, and an application of Nano Smooth Coat to decrease penetration resistance. This hook can be perfectly positioned exactly where you want it, and even moved, without damaging the bait. When the bite is tough, G Finesse opens new ways to stick it to'em. *Available in size 6 through 1/0.*



### G Finesse Weedless Stinger

We heard from pro staff, Brent Ehrler, and many others, that anglers were spending far too much time tying custom weed guards with wire or heavy monofilament on their Neko rigs... because they couldn't find the right finesse hook with the right weed guard already attached. Problem solved! The G Finesse Stinger Weedless is just what the tournament trail needed. Titanium wire weed guard, Nano Smooth Coat and Tournament Grade Wire. *Available in size 6 through 1/0.*



# History of Gamakatsu

Gamakatsu started producing fish hooks in 1955. At that time, they were the smallest hook manufacturer in Japan and all of their hooks were made by hand. In 1963 they introduced a new automated heating facility which catapulted them to the forefront of the Japanese market. In 1974, they introduced fully automated hook making machines and found it necessary to build a second factory in order to meet the demand they had created.

In 1976, being well established as the leading Japanese hook manufacturer, Gamakatsu started building a new factory to produce high quality fishing rods for the Japanese market.

After upgrading the hook manufacturing machines in 1986, they expanded their product line. As a result, Gamakatsu Co. Ltd became a major manufacturer with a full line of high quality fishing rods, hooks, apparel, and fishing related items by 1987.

In 1988, after upgrading the automated tempering facilities and expanding the hook factory, Gamakatsu Co. Ltd opened Gamakatsu International Co., Ltd. in Thailand and Gamakatsu Shantou Co. Ltd. in China in 1989.

When anglers purchase Gamakatsu hooks, they are buying an original product made by GAMAKATSU. Many hook suppliers are using fabricated Japanese sounding names bought from several different manufacturers.

## Market Leader GAMAKATSU

Gamakatsu is the leading fish hook manufacturer in Japan. They are constantly testing new materials, trying to improve their product which already sets the standard for the rest of the industry.

In 1992 Gamakatsu USA Inc. was established to provide Gamakatsu brand hooks to the U.S. market. Obviously, Gamakatsu is well on it's way of achieving their goal of becoming the market leader in the USA and the world!

## Environment has our attention

Since 1955, Gamakatsu has strictly stuck to the theme of "Nature and Technology". We work hard to develop new, hi-tech products that benefit the outdoorsman without adversely effecting the environment.

---

*Gamakatsu's policy of technical development has always been "the best of quality". We are always searching for new ways to make our existing products better in addition to constantly looking for unique products which are not yet available. We believe that only this attitude can give our customers the best they deserve!*

---

## All over the world

Gamakatsu products are used worldwide. With offices located around the world, Gamakatsu is able to research its markets and develop unique products that meet the needs of even the most demanding anglers.

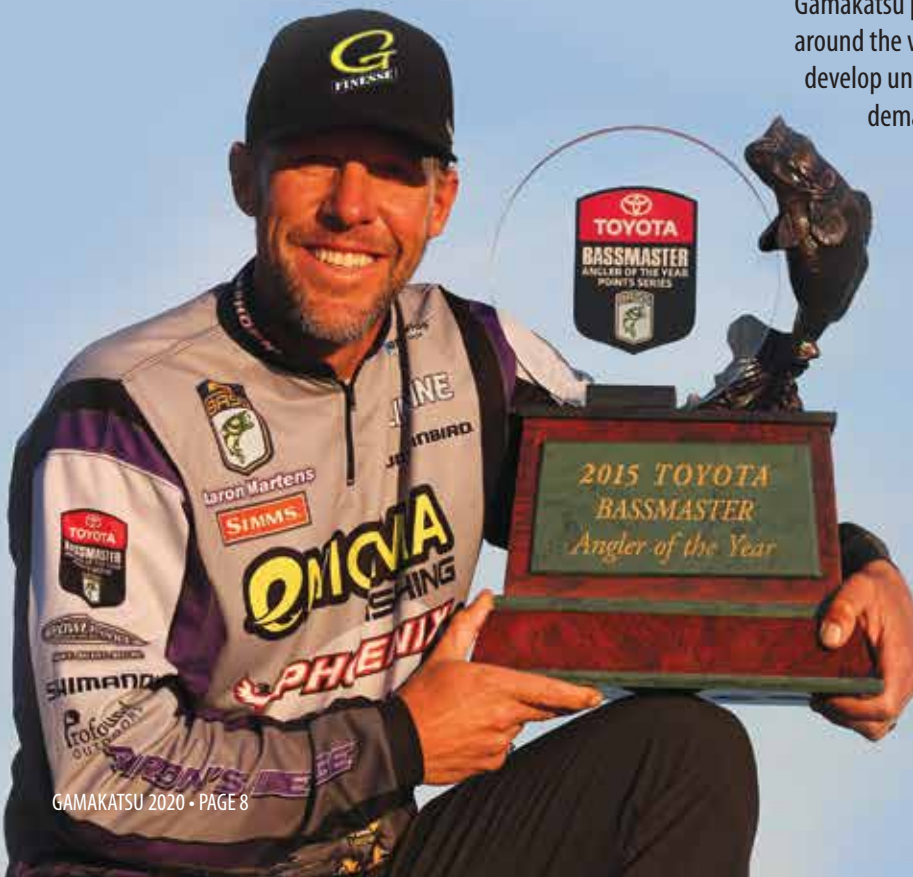

**Aaron Martens**  
Gamakatsu Pro



# History of Gamakatsu

## Invention of hooks

20,000 years ago, the invention of the fish hook marked the beginning of sport fishing. The first hooks were made of wood or bones. As technology improved, so did the hooks. Records show that copper hooks were made in Banchen 7,000 years ago and artificial flies were used in Egypt 4,000 years ago. Fishing was also a popular form of entertainment in ancient China.

Today, modern materials and manufacturing techniques have resulted in hundreds of styles of extremely high quality hooks, designed for specific types of fish and fishing methods.

## Quality of hooks

Gamakatsu hooks are the corner stone of the Gamakatsu company, and are famous worldwide. Material and technology are what makes these hooks superior to all other brands. The Gamakatsu company, in conjunction with a material manufacturer, developed a material known as High Carbon steel specifically for the manufacture of fish hooks. This material not only contains a higher percentage of carbon, but also has very few impurities. As a result, GAMAKATSU has earned Anglers' trust throughout the world. The life of a fish hook is measured by the sharpness, hardness, and viscosity of the point. Using low quality materials results in points that are weak and not truly sharp. In order to use High Carbon steel, Gamakatsu developed a unique electronic tempering process which enables hooks to be tempered in a stable condition. As a result, Gamakatsu is able to manufacture consistently high quality, extremely sharp hooks in large quantities.

## Hook producing

The methods used in creating Gamakatsu hooks is what makes it so superior to all other brands. First, only the most premium grade of high carbon steel is used. This insures against any blemishes in the metal which can weaken the hook.

Secondly, Gamakatsu has the most advanced tempering system in the world. Every hook is heated to the exact temperature that is perfect for that particular style and size then cooled in oil. This process produces hooks which are super strong, but not brittle. It is extremely difficult to achieve a balance between strength and flexibility, and it took many years for Gamakatsu to perfect this process.

Finally, and perhaps most importantly, our sharpening process is the most modern in the world, and results in a perfectly conical point that is unequaled in sharpness.

## Simply the best

Gamakatsu's dedication to producing the highest quality fish hook made, as well as the innovation they bring to the industry has kept the company at the forefront of the premium hook market. Among the innovative ideas that Gamakatsu has introduced are:

- Durability - A unique tempering process allowing us to make a hook of superior strength and durability.
- Strength - Hooks made of high carbon steel for superior strength.
- Sharpness - Conically needle honed points that are sharp from the package and stay sharp.
- Color Variation - Colored hooks in red, blue, green, gold, nickel, bronze, black, shrimp and fluorescent colors F-red, F-chartreuse, F-pink, F-orange, F-glow, F-green, F-purple to match the color of your lure or bait.
- Style Variation - Innovative hook designs like the extra wide gap (EWG) that hook and hold fish better.

Gamakatsu makes a hook for any and every fishing situation. So go ahead, tie on a Gamakatsu because it is "Simply the best!"

## DISTRIBUTED BY:

### Western United States



P.O. Box 1797 • Tacoma, WA 98401  
3900-C1 Industry Drive. E, Tacoma, WA 98424  
253-922-8373 • Fax 800-223-9383

### Eastern United States



3655 Kennesaw 75 Pkwy, STE 135, Kennesaw GA 30144  
770-919-1722 • Fax 770-919-8141

# Gamakatsu colors and characteristics ...

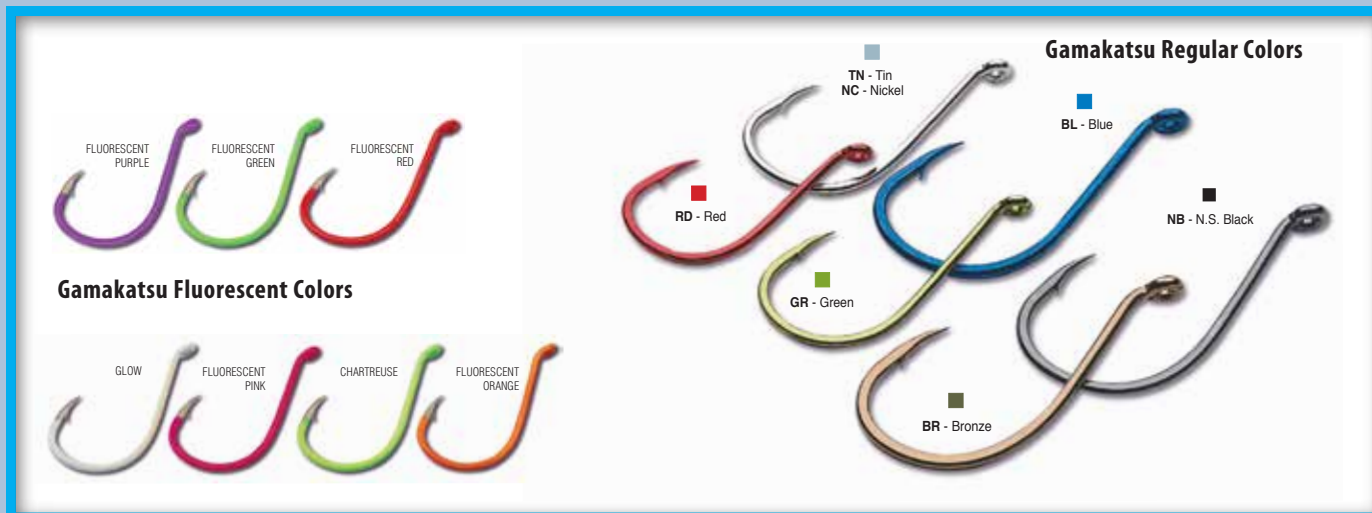

NICKEL

BRONZE

NS BLACK

RED

GREEN

BLUE

F-RED

CHARTREUSE

F-PINK

F-ORANGE

GLOW

F-GREEN

F-PURPLE

ULTRA VIOLET



EYE



OPEN EYE



BARB



BARBLESS



OUT-BARB



EWG - EXTRA WIDE GAP



WELDED EYE



MAGIC EYE



BARB(S) ON SHANK



FORGED



OFF-SET POINT



CIRCLE HOOK



TIN KEEPER



TITANIUM WEEDGUARD

NANO SMOOTH COAT

TGW

Tournament Grade Wire

G FINESSÉ

SuperLine

HYPERSHIELD

NO BARB

GAMAKATSU NAUTILUS HOOKS

# Table of contents

	Contents	Page
<b>G FINESSE</b>	G Finesse Drop Shot	13
	G Finesse Heavy Cover Worm	13
	G Finesse Treble	13
	G Finesse Treble MH	13
	G Finesse Swivel Shot	14
	G Finesse Swivel Shot Drop Shot	14
	G Finesse Swivel Shot Worm	14
	G Finesse Weedless Wacky	14
	G Finesse Worm Light with Tin Keeper	15
	G Finesse Jig Head Wacky	15
	G Finesse Tricky Head	15
	G Finesse Tournament Snap	15
	G Finesse Hybrid Worm	16
	G Finesse Stinger <b>NEW</b>	16
	G Finesse Weedless Stinger <b>NEW</b>	16
<b>TREBLE DOUBLE</b>	Treble Hooks	17-20
	Feathered Treble Hooks	20
	Double Hooks	20
<b>ALL PURPOSE</b>	Octopus Hooks / Octopus Circle <b>NEW</b>	22-27
	Walleye Wide Gap	28
	Shiner Hooks	28
	Siwash Hooks, Open Eye/Closed Eye	29
	Trailer Hook Sp	29
	Spinner Bait Trailer Hooks	29
	Spinner Bait Hooks	29
	Big River Bait Hooks	30-31
	Baitholder Hooks	31
	Walleye and Steelhead Assortment	32
	Crappie Hook Assortment	32
	Catfish Hook Assortment	32
<b>FRESHWATER</b>	TW Hook	34
	Single Egg Hooks, Barb On Shank	34
	Aberdeen Hooks	34
	G-Stinger	34
	Split Shot/Drop Shot Hooks	34
	Split Shot Drop Shot Weedless	34
	Finesse Wide Gap	35
	Finesse Wide Gap Weedless	35
	Wicked Wacky	35
	Worm Hooks, Skip Gap	36
	Finesse Heavy, Heavy and Super Heavy Cover	36
	Worm Oversize G-Mag	37
	Worm EWG	37
	Worm Superline, EWG	37-38
	EWG Monster	39
	EWG Monster, Weighted	39
	Superline Spring Lock and Weighted Spring Lock	40
	Superline Spring Lock Monster, Weighted	41
	Worm Hooks	42-44
	Jig Hooks <b>NEW</b>	45-47
Ice Fishing and Carp Series	47-48	
Big Cat Circle - Catfish Series	48	

	Contents	Page
<b>SALTWATER</b>	Live Bait Hooks	50-52
	Nautilus Circle Hooks <b>NEW</b>	52-54
	Octopus, Circle 4x Strong SE	54
	Octopus, Circle 4x Strong SE Inline	55
	Double Assist 520	55
	Assist Hook 510	56
	Tuned Assist HD	56
	Magnum Assist	56
	Steel Assist With Magic Eye Swivel	56
	Assist 520, Ringed <b>NEW</b>	57
	Assist 620 Heavy Duty with Solid Ring <b>NEW</b>	57
	Big Eye Circle Hooks	58
	Single 510	58
	O'Shaughnessy	59
	Tuned Tuna Plug with Ring <b>NEW</b>	59
	Tuned Tuna With Welded Eye	60
	Magic Eye Tuna Plug 3x	60
	<b>RIGS, SNELLS, JIG HEADS</b>	Single Egg Snells
Walleye LG Two Hook Rig		62
Treble Stinger Rig, Wire Leader		62
Treble Stinger Rig, Fluorocarbon Leader <b>NEW</b>		62
EWG Walleye Snell		62
Walleye Snell with Glowbead		62
Baitholder Snells		63
Catfish Rig		63
Catfish Rig Circle		63
Drop Shot Rigs		64
Mooching Rigs (Slip and Solid Tie)		64
Two Hook Bait Rig		64
Salmon/Steelhead Leader		64
Jigging Rigs		64-65
Sockeye Rig		65
Top and Bottom Rig		65
Fluke Rig with Teaser		65
Striper Rigs		66
Wacky Head		66
Skip Gap Head		67
Stand Up Alien Head		67
Superline Swim Bait Head		67
Jig Heads <b>NEW</b>		68-69
Fly Hooks <b>NEW</b>		73-79
Hats, Patches, Stickers <b>NEW</b>		80
Shirts, Jackets, Hoodies	81	
Samurai Fisherman: Shirts, Hats	82	
Tackle Boxes <b>NEW</b>	83-84	
Dry Bag, Tackle Bags <b>NEW</b>	85	
Finger Protector	86	
Gamakatsu Luxxe Fishing Line	86	
Gamakatsu Aluminum HD Pliers	86	
Regions	87	





Aaron Martens

"Over my entire career fishing Gamakatsu I envisioned making the best finesse hook in the world. **Gamakatsu's New G Finesse Series** combine **Ultra Sharp Tournament Grade Wire** with **Nano Smooth Technology** for the ultimate in hook penetration. This new technology will take my finesse fishing to a whole new level".

~ Aaron Martens

### G Finesse Drop Shot

SIZES	2	1	1/0	2/0
Nano Smooth Coat	LS 338209(6)	338210(6)	338211(6)	338212(6)

EYE   
 FORGED   
 BARB

Tournament Grade Wire   
 NANO SMOOTH COAT

Martens has been instrumental in the development of Gamakatsu's new G Finesse Drop Shot Hook. Completely "pro-designed", Gamakatsu's new G Finesse series is a giant leap forward in fishing hook technology.

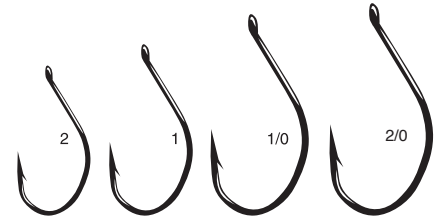

### G Finesse Heavy Cover Worm

SIZES	2	1	1/0	2/0	3/0	4/0
Nano Smooth Coat	LS 357209(4)	357210(4)	357211(4)	357212(4)	357213(4)	357214(4)

WELDED EYE   
 FORGED

BARB   
 TIN KEEPER

Tournament Grade Wire   
 NANO SMOOTH COAT

Aaron Martens designed Finesse Heavy Cover, now available in Tournament Grade Wire (TGW), Nano Smooth Coat finish and Aaron's custom designed Tin Keeper.

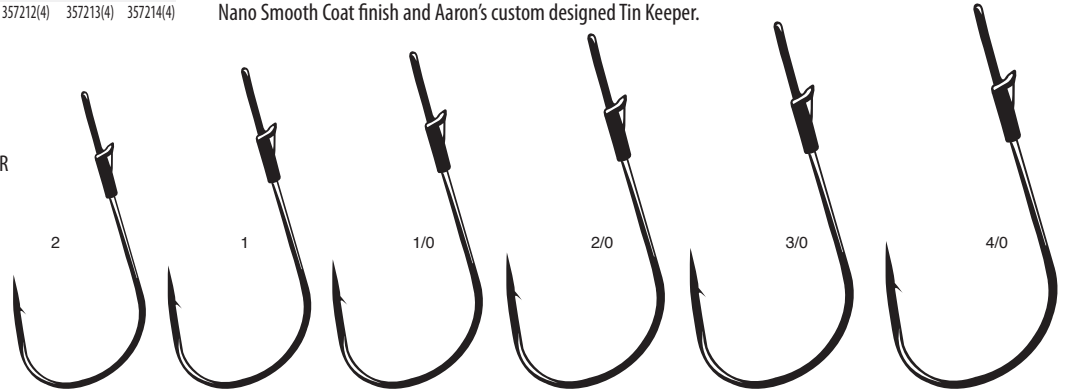

### G Finesse Treble

SIZES	6	5	4	3	2	1	1/0
Nano Smooth Coat	LS 339207(6)	339207.5(6)	339208(6)	339208.5(6)	339209(6)	339210(6)	339211(6)

FORGED   
 BARB   
 MAGIC EYE

Tournament Grade Wire   
 NANO SMOOTH COAT

Gamakatsu's G Finesse Treble Hook is patterned after traditional O'Shaughnessy style hooks. Aaron has long been a proponent of the O'Shaughnessy hook style with its distinctive acute angle at the bottom of the hook. Martens believes the addition of the O'Shaughnessy bend, hooks and holds fish better than round bend designs.

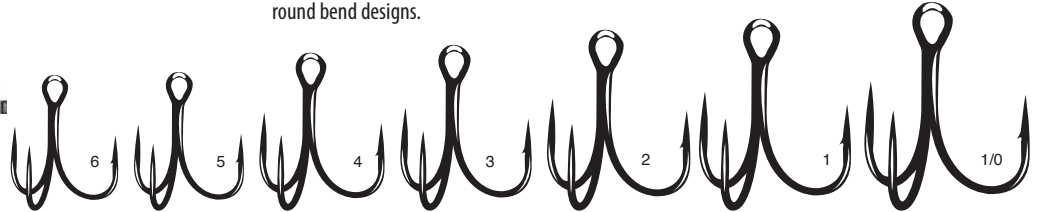

### G Finesse Treble MH

SIZES	6	5	4	3	2	1	1/0
Nano Smooth Coat	LS 347207(6)	347207.5(6)	347208(6)	347208.5(6)	347209(6)	347210(6)	347211(6)

FORGED   
 BARB   
 MAGIC EYE

Tournament Grade Wire   
 NANO SMOOTH COAT

Aaron Martens designed G Finesse Treble MH features a tougher medium heavy Tournament Grade Wire (TGW) for additional strength and Nano Smooth Coat Technology for instant hook penetration.

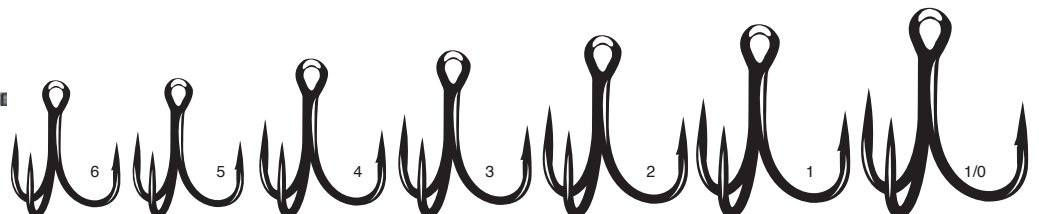



Shinichi Fukae

**Swivel Shot Drop Shot Features**

- A.** High quality swivel above the hook to minimize line twist.
- B.** Easy-Change Weight System.
- C.** Nano Smooth Coat finish for stealth presentations and unsurpassed hook penetration.
- D.** Tournament Grade Wire - hook points stays sharper longer.

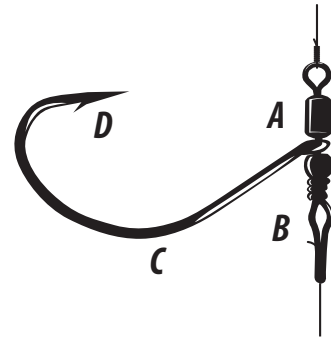

Designed and endorsed by Pro Shinichi Fukae

**G Finesse Swivel Shot**

SIZES	2	1	1/0	2/0	3/0
NS Black	LS 316409(3)	316410(3)	316411(3)	316412(3)	316413(3)

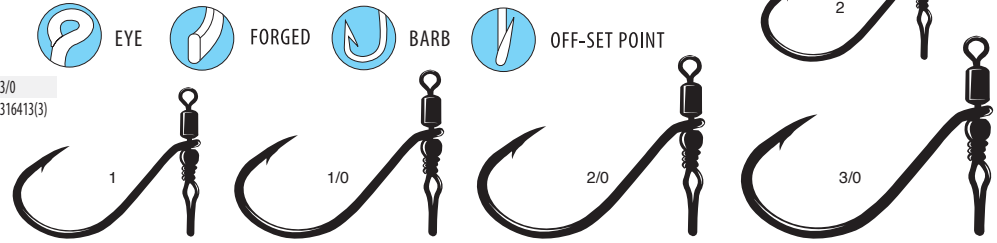

**G Finesse Swivel Shot Drop Shot**

SIZES	2	1	1/0	2/0
Nano Smooth Coat	LS 352209(3)	352210(3)	352211(3)	352212(3)



Tournament Grade Wire

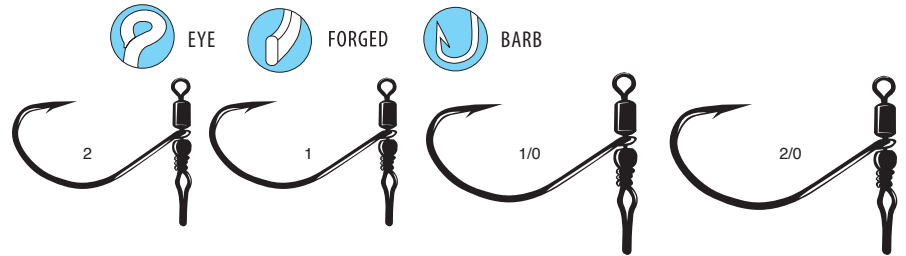

**G Finesse Swivel Shot Worm**

SIZES	1	1/0	2/0
Nano Smooth Coat	LS 362210(3)	362211(3)	362212(3)

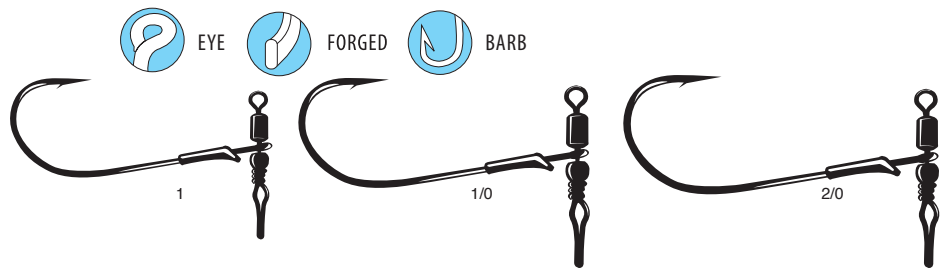

**G Finesse Weedless Wacky**

SIZES	2	1	1/0	2/0	3/0
Nano Smooth Coat	LS 367209(4)	367210(4)	367211(4)	367212(4)	367213(4)



Tournament Grade Wire

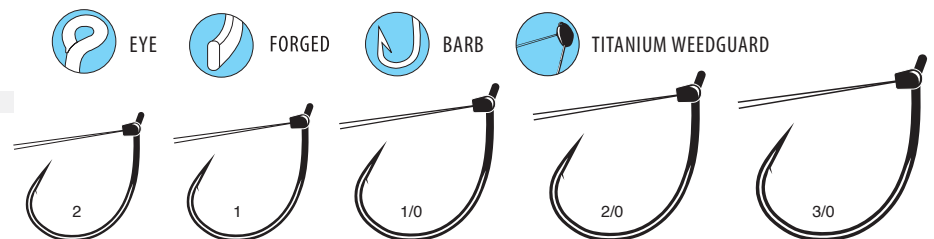

## G Finesse Worm Light with Tin Keeper

SIZES	1	1/0	2/0
Nano Smooth Coat	LS 358210(4)	358211(4)	358212(4)



NANO SMOOTH COAT

When conditions require finesse, the pros use new G Finesse Worm Light hooks. The light wire allows for threading of extremely small diameter worms with ease. Even the most fragile plastics are less likely to tear, saving on baits and increasing fishing time. The non-corrosive tin keeper doesn't add weight. Like all G Finesse hooks, the Worm Light hook penetrates with significantly less force making them substantially more effective.

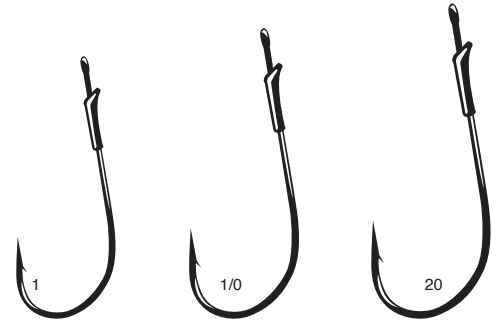

## G Finesse Jig Head Wacky

SIZES	1/0-1/16	1/0-3/32	1/0-1/8	1/0-3/16
Black	LS 312411-BK-1/16(3)	312411-BK-3/32(3)	312411-BK-1/8(3)	312411-BK-3/16(3)
Green Pumpkin	LS 312411-GP-1/16(3)	312411-GP-3/32(3)	312411-GP-1/8(3)	312411-GP-3/16(3)

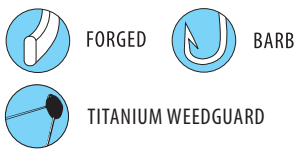

Gamakatsu's Jig Head Wacky is a vast improvement over other wacky jigs. The nickel/titanium weed guard is the first indication that Gamakatsu's raised the bass fishing bar. This weed guard is small but mighty as it effectively clears hazards yet maintains its shape and rigidity under the most demanding use. The jig head is an improvement as well. Better designed to resist snags the hook eye is recessed to prevent getting hung-up in structure. Even the hook is different, a custom addition that's based on a shiner hook but modified for the Jig Head Wacky. The result is a much higher ratio of hook-ups and landed fish than any other comparable brand.



TGW

Tournament Grade Wire

NANO SMOOTH COAT

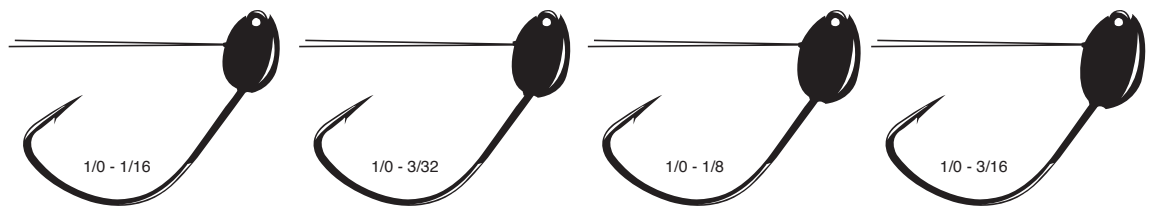

## G Finesse Tricky Head

SIZES	3/0-1/16	3/0-3/32	3/0-1/8	3/0-3/16
Plain Lead	LS 370413-1/16(3)	370413-3/32(3)	370413-1/8(3)	370413-3/16(3)
Black	LS 370413-BK-1/16(3)	370413-BK-3/32(3)	370413-BK-1/8(3)	370413-BK-3/16(3)



From the master finesse magician himself, Shin Fukae, comes the new Tricky Head jig head. It's the newest innovation from G Finesse. Designed to be fished with the popular shaky head technique, it brings several additional advantages to the tackle box. The Tricky Head is snag free. The weighted lead head is uniquely shaped to remain vertical during presentation, allowing the jig to bounce in and around structure while the worm or swimbait is held firmly in place by a lockdown tin keeper. You've got to see it to believe it. Available in black or plain lead.

- A. Weedless Keel shape design glides effortlessly over and through structure
- B. Lock Down Keeper won't tear finesse plastics. Rig straight and secure every time

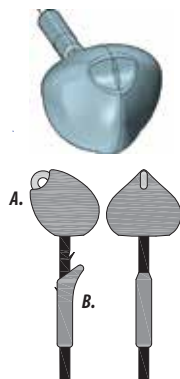

## G Finesse Tournament Snap

SIZES	Medium (60 lb.)	Large (80 lb.)
LS	333000-M(10)	333000-L(10)

Tournament Snap design intensifies the lures swimming action

High quality stress relieved stainless steel.

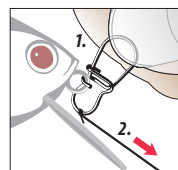

1. **TWIST & CLICK** - Hook the open end of the Tournament Snap inside the lure eye. Twist and click into place.
2. **PULL** - Keep you line tight and pull at a 90 degree angle away from the lure to finish setting.



## G Finesse by Mike McClelland

### G Finesse Hybrid Worm

Gamakatsu Hybrid Worm is the definitive choice for all of my soft plastic rigs on tour. The unique hybrid design helps me hook and land more fish than ever before. When combined with Tournament Grade Wire and Nano Smooth Coat technology, Hybrid Worm is the ultimate fish catching machine. ~ Mike McClelland



Mike McClelland

SIZES	1/0	2/0	3/0	4/0	5/0	6/0	7/0	8/0
Nano Smooth Coat	LS 366211(4)	366212(4)	366213(4)	366214(4)	366215(4)	366216(4)	366217(4)	366218(4)

The G Finesse Hybrid Worm is the brainchild of pro-staffer, Mike McClelland. He's spent more than a few hours on the water, competing in over 234 tournaments, including 10 times at the Bassmaster Classic. Mike knows the subtleties of rigging worms and soft plastic like no one else, so he and Gamakatsu's designers combined the best of his current favorite Gamakatsu worm hook and incorporated a distinctive new acute hook angle to keep baits aligned perfectly straight. Hence, the "Hybrid" name. The Nano Smooth Coat finish makes it easy to thread the thinnest finesse baits or the fattest Senkos with ease. Add industry-changing Tournament Grade Wire (TGW) to the package and things couldn't be more perfect. Take our word for it, or better yet, fish it yourself.



Tournament Grade Wire



FORGED



BARB

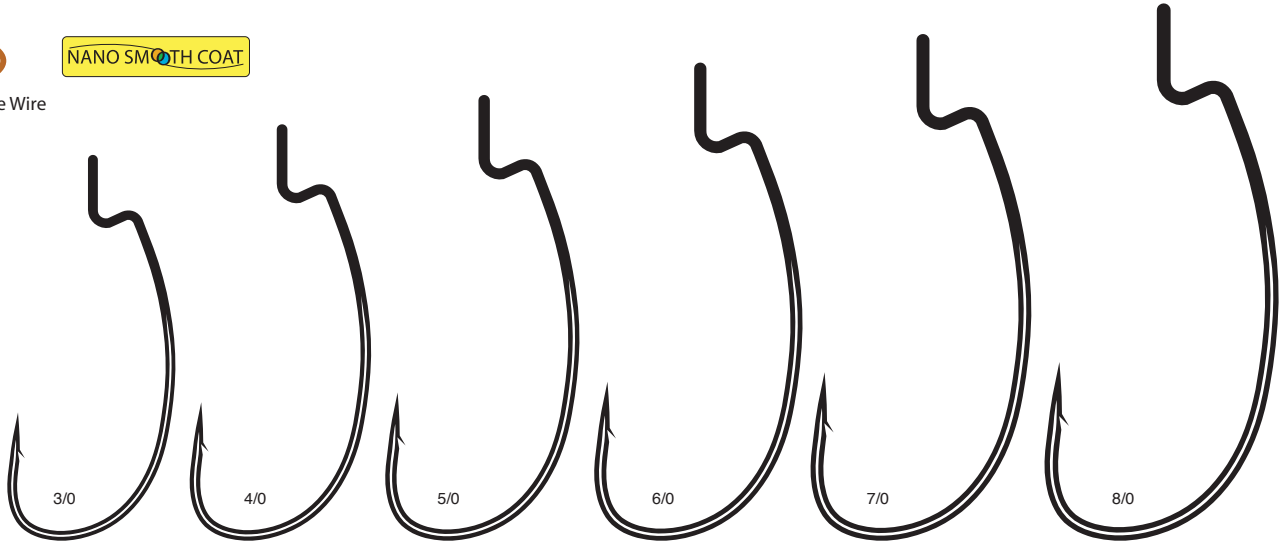

## G Finesse by Brent Ehrler

### G Finesse Stinger

NEW

SIZES	6	4	2	1	1/0
Nano Smooth Coat	LS 374207(6)	374208(6)	374209(6)	374210(6)	374211(6)



EYE



FORGED



BARB

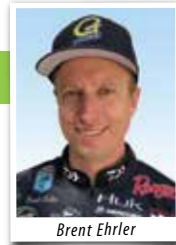

Brent Ehrler

Tournament pro and Gamakatsu pro staff, Brent Ehrler, developed and fine-tuned the new G Finesse Stinger for use with the popular Neko and Wacky rig techniques. The G Finesse Stinger follows in the footsteps of similar, game-changing G Finesse hooks engineered by Gamakatsu. It features Tournament Grade Wire (TGW) which is thinner and stronger than anything else on the market, and an application of Nano Smooth Coat to decrease penetration resistance. This hook can be perfectly positioned exactly where you want it, and even moved, without damaging the bait. When the bite is tough, G Finesse opens new ways to stick it to'em.



Tournament Grade Wire

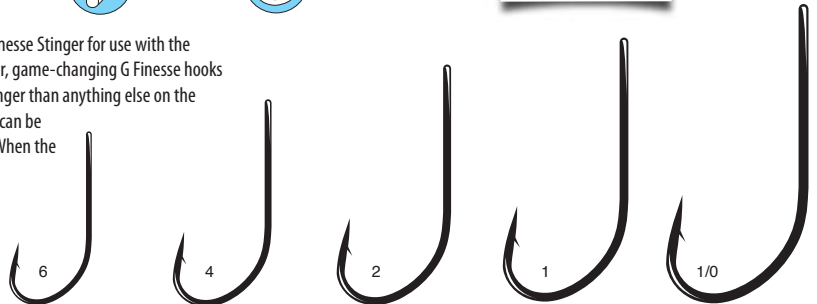

### G Finesse Weedless Stinger

NEW

SIZES	6	4	2	1	1/0
Nano Smooth Coat	LS 375207(4)	375208(4)	375209(4)	375210(4)	375211(4)



EYE



FORGED



BARB



TITANIUM WEEDGUARD

We heard from pro staff, Brent Ehrler, and many others, that anglers were spending far too much time tying custom weed guards with wire or heavy monofilament on their Neko rigs... because they couldn't find the right finesse hook with the right weed guard already attached. Problem solved! The G Finesse Stinger Weedless is just what the tournament trail needed. Titanium wire weed guard, Nano Smooth Coat and Tournament Grade Wire.



Tournament Grade Wire

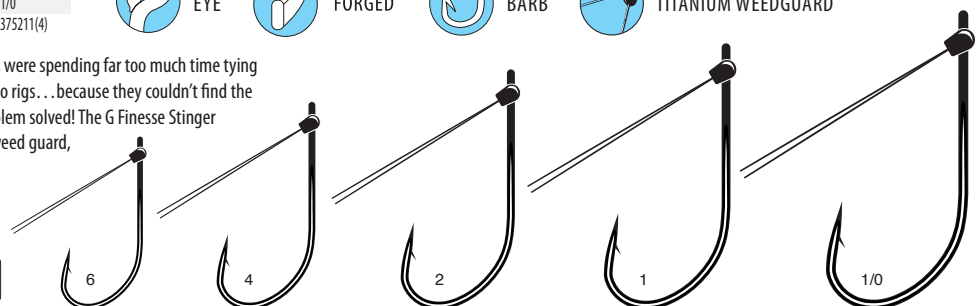





Treble Hooks  
Double Hook

Gamakatsu®

### Trout Treble



SIZES	18	16	14
Red	LS 273301(4)	273302(4)	273303(4)
Gold	LS 273201(4)	273202(4)	273203(4)

Developed for that discerning trout fishermen in mind. With the advances and popularity of artificial dough and paste type baits, it was only a matter of time that an added extra edge was needed. These high quality, sticky sharp trebles fit the bill. The light wire design will allow your bait to float higher and keep it more in the strike zone. Also, the fine wire design will allow for quick and deeper hook penetration.

### Treble Round Bend



**FORGED**

**BARB**

SIZES	12	10	8	7 <small>NEW SIZE</small>	6	5	4	3	2	1	1/0	2/0
NS Black	LS		47406(12)	47406.5(12)	47407(12)	47407.5(10)		47408.5(8)	47409(8)	47410(8)		
NS Black	2S		47406-2S	47406.5-2S	47407-2S	47407.5-2S	47408-2S	47408.5-2S	47409-2S	47410-2S	<< NEW	
Tim	LS		47006(12)	47007(12)	47007(12)	47007(12)	47008(11)	47009(9)	47010(7)	47011(6)	47012(5)	
Bronze	LS	47104(12)	47105(12)	47106(12)	47107(12)	47107.5(11)	47108(11)	47108.5(9)	47109(9)	47110(7)	47111(6)	47112(5)
Bronze	2S		47106-2S	47107-2S	47107-2S	47108-2S	47108-2S	47109-2S	47110-2S	47111-2S	47112-2S	
Red	LS	47304(10)	47305(10)	47306(10)	47307(10)	47307.5(9)	47308(9)	47308.5(8)	47309(8)			

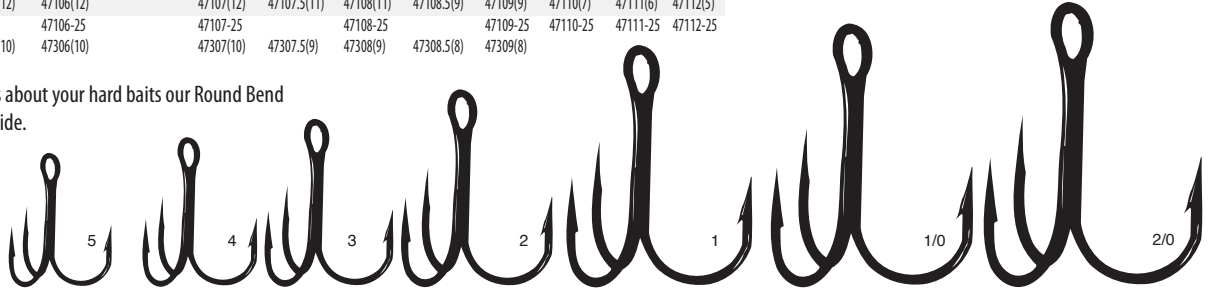

When you want to get serious about your hard baits our Round Bend Treble is the standard worldwide.



### Treble 2x Strong, Round Bend



**FORGED**

**BARB**

SIZES	6	4	2	1	1/0
NS Black	LS 57407(12)	57408(11)	57409(9)	57410(7)	57411(6)
Red	LS 57307(10)	57308(9)	57309(8)	57310(7)	57311(5)

Anytime your situation requires a stout Round Bend Treble our 2X strong is the answer.

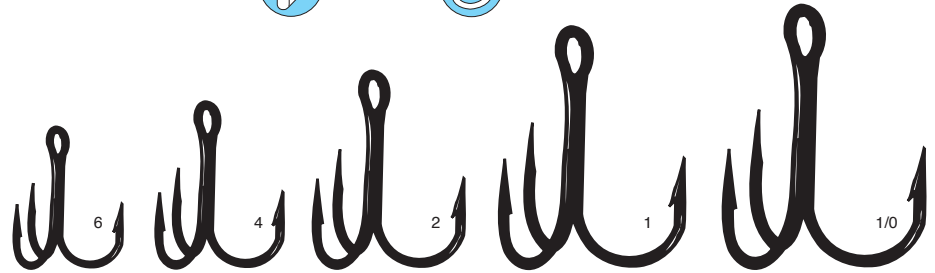
The perfect hook for hard charging Stripers or Peacock Bass.



### Treble (Magic Eye), Round Bend

SIZES	6	4	2
NS Black	LS 261407(12)	261408(11)	261409(9)

**FORGED**

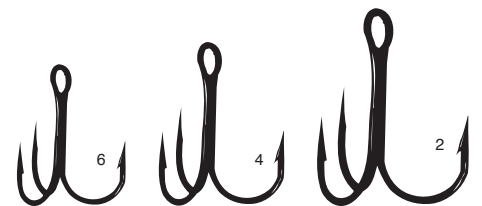
**BARB**

The special eye shape easily opens split rings, eliminating the need for split ring pliers and saving your fingernails. Just insert it into the split ring, give a twist and simply slide the new hook on while pushing the old one off.

### Treble Short Shank, (Magic Eye), Round Bend

SIZES	6	4	2	1	1/0
NS Black	LS 298407(12)	298408(11)	298409(9)	298410(7)	298411(6)

Developed for the discerning hard bait angler. Featuring our award winning "Magic Eye". When rigged, the Short Shank hook points run parallel to the bait creating a perfect balance point. This is the ideal treble hook for optimal lure performance.

**FORGED**

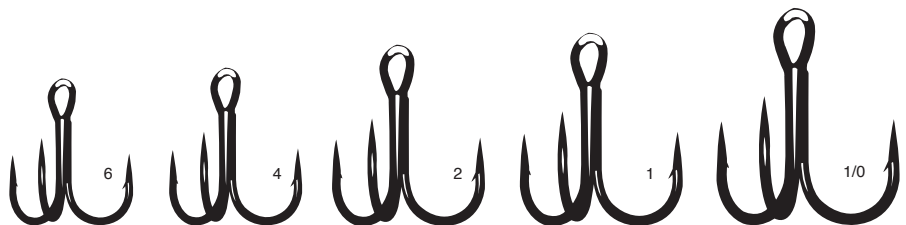
**BARB**

### Treble EWG, Short Shank, (Magic Eye)

SIZES	6	4	2	1	1/0
NS Black	LS 330407(6)	330408(6)	330409(6)	330410(6)	330411(6)



FORGED



BARB



EWG - EXTRA WIDE GAP



For crankbaits of all types --- there's nothing better --- it's the perfect replacement hook. First, we opened the points of this treble up slightly for even better hooking performance. The Short Shank EWG Treble converts those fish that slash at your bait into sure hook-ups. The shorter shank and wide gap design provides less room for fish to throw the hook. In fact, this attribute actually wedges the fish between the hook and the crankbait...it's the ultimate in fish holding, which means fish landing performance. That's not all. It also features Gamakatsu's exclusive "Magic Eye" that makes changing hooks a breeze. The hook's inline points run parallel to the bait creating a perfect balance point so your crankbaits run true.

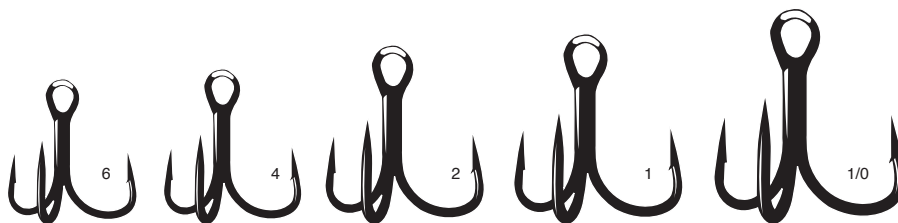

### Treble EWG, Short Shank, 2X Strong (Magic Eye)

SIZES	6	4	2	1	1/0
NS Black	LS 317407(6)	317408(6)	317409(6)	317410(6)	317411(6)

All the attributes of the Short Shank EWG Treble just beefed up to 2X Strong dimensions for tackle-busting big game species like striper, musky and peacock bass.



FORGED



BARB



EWG - EXTRA WIDE GAP



### Treble 23 (Magic Eye), 2x Strong, Round Bend

SIZES	1/0	2/0	3/0	4/0	5/0
NS Black	LS 245411(4)	245412(4)	245413(4)	245414(4)	245415(4)
Red	LS 245311(4)	245312(4)	245313(4)	245314(4)	245315(4)

Our popular Magic Eye Treble in 2x strong.



FORGED



BARB

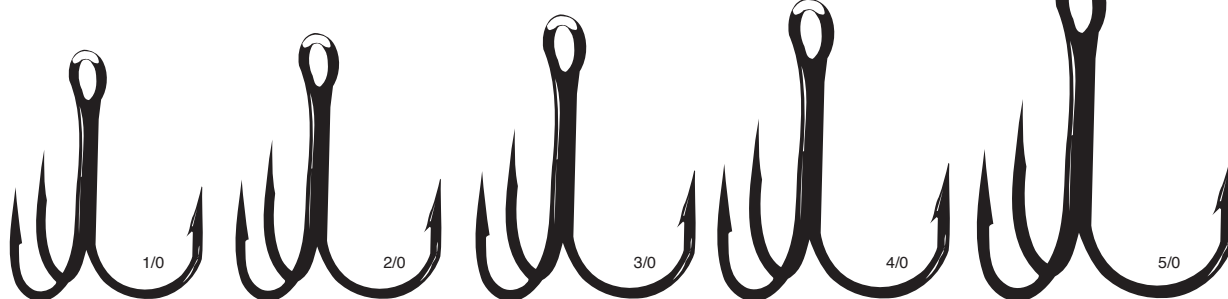

### Treble 4x Strong

SIZES	6	4	2	1	1/0	2/0	3/0	4/0	5/0
Tin	LS			62010(5)	62011(5)	62012(4)	62013(4)	62014(3)	62015(3)
NS Black	LS 62407(8)	62408(7)	62409(6)	62410(5)	62411(5)	62412(4)	62413(4)	62414(3)	62415(3)



FORGED



BARB

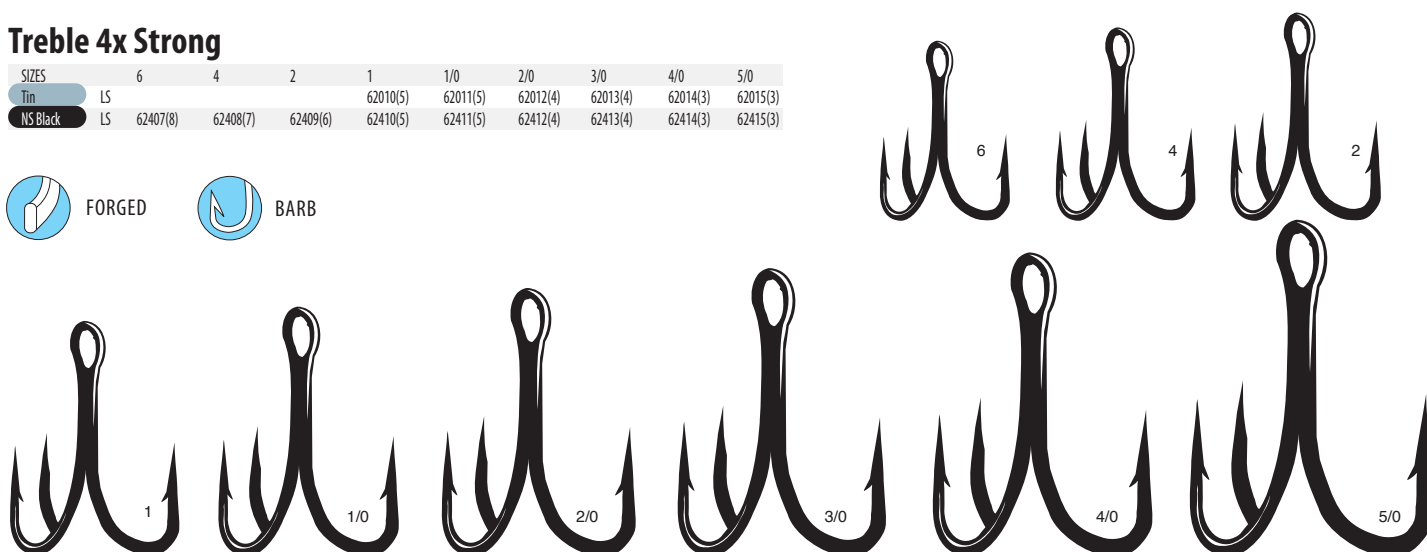

### Treble Round Bend Barbless

SIZES	8	6	4	2	1	1/0
Bronze	LS 64106(12)	64107(12)	64108(11)	64109(9)	64110(7)	64111(6)

**NO BARB**



### Treble Extra Wide Gap (EWG)

SIZES	6	4	2
Bronze	LS 77107(12)	77108(11)	77109(9)
NS Black	LS 77407(12)	77408(11)	77409(9)
Red	LS 77307(10)	77308(9)	77309(8)



### Feathered Treble

SIZES	6	4	2
NS Black (White and White)	LS 216407-WW(2)	216408-WW(2)	216409-WW(2)
NS Black (White and Red)	LS 216407-WR(2)	216408-WR(2)	216409-WR(2)



Add one of our Feathered Trebles to the back of any topwater bait and watch your lure come to life. Beautifully hand tied on our premium Round Bend treble.



### Double 22 Medium Shank

SIZES	10	8
NS Black	LS 302405(12)	302406(12)



Medium shank length designed with a straight eye manufactured in durable Nicel Silver Black.

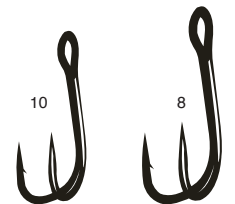

### EWG Double

SIZES	3/0	4/0
NS Black	LS 226413(3)	226414(3)

The perfect hook for all your soft bodied frogs. The angle of the hook makes it ride weedless. The wide gap increases your hook up ratio.

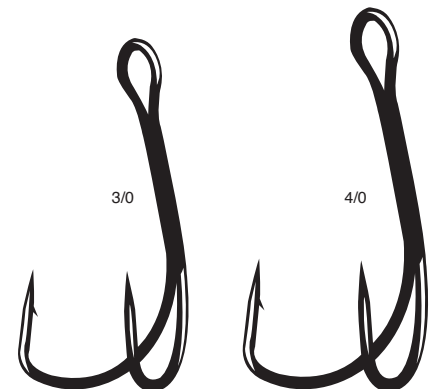



## All Purpose Hooks

Gamakatsu®

## Octopus



Our most versatile hook, known for its durability and strength. The Octopus hook comes in a wide variety of colors and finishes including fluorescent.

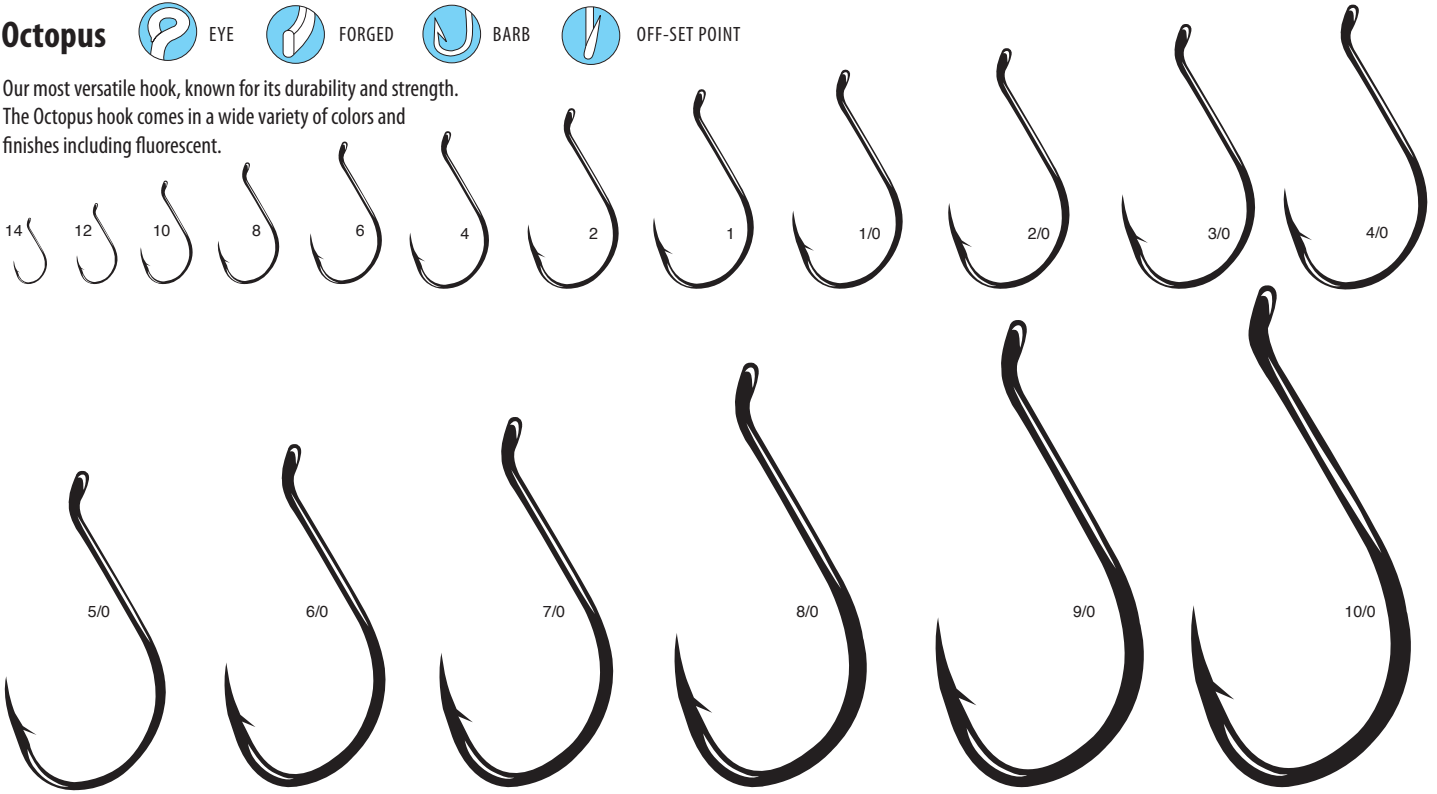

SIZES	14	12	10	8	6	4	2	1	1/0	2/0	3/0	4/0	5/0	6/0	7/0	8/0	9/0	10/0	
Nickel	LS			02005(10)	02006(10)	02007(10)	02008(10)	02009(8)	02010(8)	02011(6)	02012(6)	02013(6)	02014(6)	02015(6)	02016(6)	02017(6)	02018(6)	02019(5)	02020(5)
	25			02006-25	02007-25	02008-25	02009-25	02010-25	02011-25	02012-25	02013-25	02014-25	02015-25	02016-25	02017-25	02018-25	02019-25	02020-25	
	100			02007-100	02008-100	02009-100	02010-100	02011-100	02012-100	02013-100	02014-100	02015-100	02016-100	02017-100					
Bronze	LS			02106(10)	02107(10)	02108(10)	02109(8)	02110(8)	02111(6)	02112(6)	02113(6)	02114(6)	02115(6)						
	25			02106-25	02107-25	02108-25	02109-25	02110-25	02111-25	02112-25	02113-25	02114-25	02115-25						
	100			02106-100	02107-100	02108-100	02109-100	02110-100	02111-100	02112-100	02113-100	02114-100	02115-100						
Ns Black	LS	02403(10)	02404(10)	02405(10)	02406(10)	02407(10)	02408(10)	02409(8)	02410(8)	02411(6)	02412(6)	02413(6)	02414(6)	02415(6)	02416(6)	02417(6)	02418(6)	02419(5)	02420(5)
	25			02406-25	02407-25	02408-25	02409-25	02410-25	02411-25	02412-25	02413-25	02414-25	02415-25	02416-25	02417-25				
	100			02406-100	02407-100	02408-100	02409-100	02410-100	02411-100	02412-100	02413-100	02414-100	02415-100	02416-100	02417-100	02418-100	02419-100	02420-100	
Red	LS	02303(10)	02304(10)	02305(10)	02306(10)	02307(10)	02308(10)	02309(8)	02310(8)	02311(6)	02312(6)	02313(6)	02314(6)	02315(6)	02316(6)	02317(6)	02318(6)	02319(5)	02320(5)
	25			02306-25	02307-25	02308-25	02309-25	02310-25	02311-25	02312-25	02313-25	02314-25	02315-25	02316-25	02317-25				
	100			02306-100	02307-100	02308-100	02309-100	02310-100	02311-100	02312-100	02313-100	02314-100	02315-100	02316-100	02317-100				
Green	LS			02306-G(10)	02307-G(10)	02308-G(10)	02309-G(8)	02310-G(8)	02311-G(6)	02312-G(6)									
	25			02306-G-25	02307-G-25	02308-G-25	02309-G-25	02310-G-25	02311-G-25	02312-G-25									
	100			02306-G-100	02307-G-100	02308-G-100	02309-G-100	02310-G-100	02311-G-100	02312-G-100									
Blue	LS			02306-B(10)	02307-B(10)	02308-B(10)	02309-B(8)	02310-B(8)	02311-B(6)	02312-B(6)									
	25			02306-B-25	02307-B-25	02308-B-25	02309-B-25	02310-B-25	02311-B-25	02312-B-25									
	100			02306-B-100	02307-B-100	02308-B-100	02309-B-100	02310-B-100	02311-B-100	02312-B-100									
F-Red	LS			02606-FR(7)	02607-FR(7)	02608-FR(7)	02609-FR(6)	02610-FR(6)	02611-FR(5)	02612-FR(5)	02613-FR(5)								
	25			02606-C-25	02607-C-25	02608-C-25	02609-C-25												
Chartreuse	LS			02606-C(7)	02607-C(7)	02608-C(7)	02609-C(6)	02610-C(6)	02611-C(5)	02612-C(5)	02613-C(5)								
	25			02606-C-25	02607-C-25	02608-C-25	02609-C-25												
F-Pink	LS			02606-P(7)	02607-P(7)	02608-P(7)	02609-P(6)	02610-P(6)	02611-P(5)	02612-P(5)	02613-P(5)								
	25			02606-OR(7)	02607-OR(7)	02608-OR(7)	02609-OR(6)	02610-OR(6)	02611-OR(5)	02612-OR(5)	02613-OR(5)								
F-Orange	LS			02606-GL(7)	02607-GL(7)	02608-GL(7)	02609-GL(6)	02610-GL(6)	02611-GL(5)	02612-GL(5)	02613-GL(5)								
	25			02606-LG(7)	02607-LG(7)	02608-LG(7)	02609-LG(6)												
Glow	LS			02606-LG(7)	02607-LG(7)	02608-LG(7)	02609-LG(6)												
	25			02606-PU(7)	02607-PU(7)	02608-PU(7)	02609-PU(6)												
F-Green	LS			02606-UV(7)	02607-UV(7)	02608-UV(7)	02609-UV(6)	02610-UV(6)	02611-UV(5)	02612-UV(5)	02613-UV(5)								
	25			02606-UV(7)	02607-UV(7)	02608-UV(7)	02609-UV(6)	02610-UV(6)	02611-UV(5)	02612-UV(5)	02613-UV(5)								

## Octopus Straight Eye



**NEW**

West coast anglers love salmon. Salmon love herring. Herring love to rip and tear apart when you rig them with traditional hooks. Hence, the reason we designed the new Octopus Straight Eye hook. The ultra-thin, yet ultra-strong, wire slides through soft baits without damaging the tender tissue. The hook eye is narrower and smoother too, so it can slide through as well. The result is a herring with that perfect spin, followed by a chrome bright chinook or coho in the net shortly thereafter.

SIZES	8	6	4	2	1	1/0	2/0	3/0	4/0	
Ns Black	LS	387406(10)	387407(10)	387408(10)	387409(8)	387410(8)	387411(6)	387412(6)	387413(6)	387414(6)
	25	387406-25	387407-25	387408-25	387409-25	387410-25	387411-25	387412-25	387413-25	387414-25

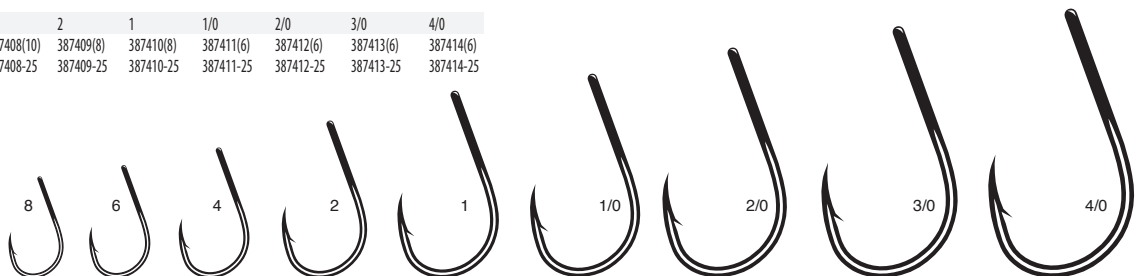

## Octopus Barbless

Specially designed bend allows the hook to penetrate quickly and hold, while still complying with the barbless hook regulations.



EYE



FORGED



BARBLESS



OFF-SET POINT



SIZES	4	2	1	1/0	2/0	3/0	4/0	5/0	6/0	7/0	8/0	9/0	10/0
<b>Nickel</b>	LS 75008(10)	75009(8)	75010(8)	75011(6)	75012(6)	75013(6)	75014(6)	75015(6)	75016(6)	75017(6)	75018(6)	75019(5)	75020(5)
	25 75008-25	75009-25	75010-25	75011-25	75012-25	75013-25	75014-25	75015-25	75016-25	75017-25			
<b>Red</b>	LS 75308(10)	75309(8)	75310(8)	75311(6)	75312(6)	75313(6)	75314(6)	75315(6)					
	25 75308-25	75309-25	75310-25	75311-25	75312-25	75313-25	75314-25	75315-25					
	100 75308-100	75309-100	75310-100	75311-100	75312-100	75313-100	75314-100	75315-100					
<b>NS Black</b>	LS 75408(10)	75409(8)	75410(8)	75411(6)	75412(6)	75413(6)	75414(6)	75415(6)					
	25 75408-25	75409-25	75410-25	75411-25	75412-25	75413-25	75414-25	75415-25					



## Octopus Light

Gamakatsu answered the call for a fine wire Octopus hook, the Octopus Light for use in drop shot and trout fishing. Gamakatsu's Octopus Light features an offset beak point for optimal penetration with bait or plastics. The smaller diameter hook wire enhances hook penetration and is a certain advantage when fishing timid or light-biting fish.

SIZES	8	6	4	2	1	1/0	2/0	3/0
<b>NS Black</b>	LS 341406(10)	341407(10)	341408(10)	341409(8)	341410(8)	341411(6)	341412(6)	341413(6)
<b>Red</b>	LS 341306(10)	341307(10)	341308(10)	341309(8)	341310(8)	341311(6)	341312(6)	341313(6)



EYE



FORGED



BARBLESS



OFF-SET POINT

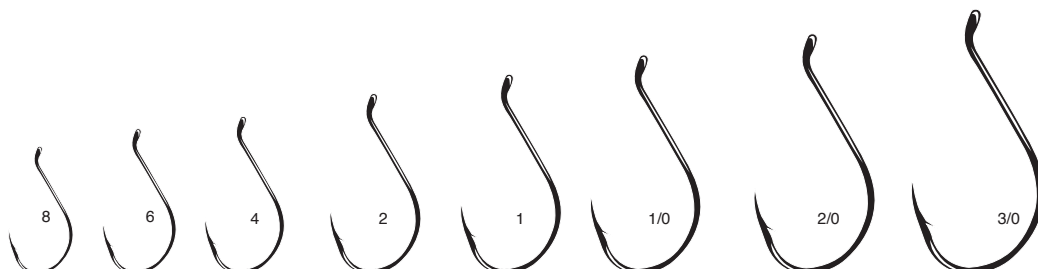

### Octopus Straight Eye, 4x Strong

One of the more versatile hooks in our line up, this hook is built to handle big fish. Used for everything from Catfish to Tarpon, the offset beak point penetrates quickly and can be used on either bigger live baits or for chunk baits.

SIZES	1/0	2/0	3/0	4/0	5/0	6/0	7/0	8/0	9/0	10/0
Ns Black	LS 98411(6)	98412(6)	98413(6)	98414(6)	98415(6)	98416(6)	98417(6)	98418(6)	98419(5)	98420(5)
Ns Black	25				98415-25	98416-25	98417-25	98418-25		

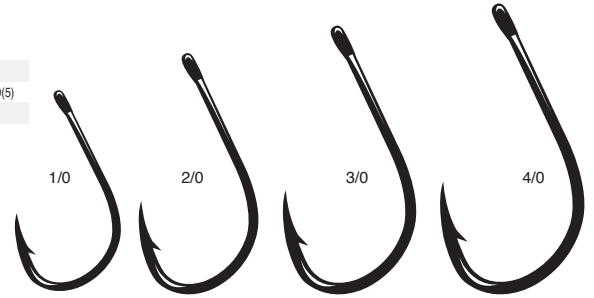

### Octopus Straight Eye, 4x Strong (Inline-point)

Same hook as the 4x Octopus Straight Eye, but without any offset. This makes a great trolling hook and will upgrade any trolling lures.

SIZES	4/0	5/0	6/0	7/0	8/0	9/0	10/0
Ns Black	LS 263414(6)	263415(6)	263416(6)	263417(6)	263418(6)	263419(5)	263420(5)

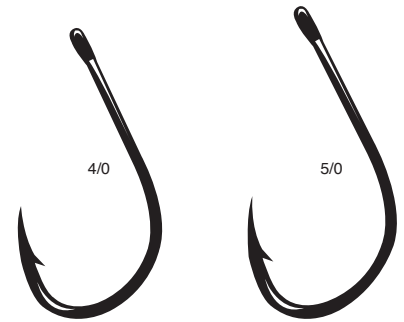



### Octopus Circle (Offset-point)

Specially designed to set in the corner of the fish's mouth, making it a great choice for the fresh and saltwater fisherman still wanting to use bait.

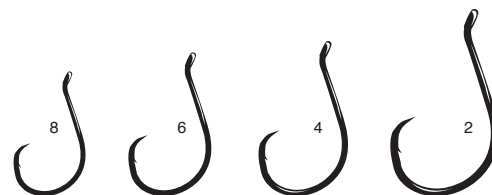

SIZES	8	6	4	2	1	1/0	2/0	3/0	4/0	5/0	6/0	7/0	8/0
NS Black	LS 208406(10)	208407(10)	208408(10)	208409(8)	208410(8)	208411(6)	208412(6)	208413(6)	208414(6)	208415(6)	208416(6)	208417(6)	208418(6)
NS Black	25 pk	208406-25	208407-25	208408-25	208409-25	208410-25	208411-25	208412-25	208413-25	208414-25	208415-25	208416-25	208417-25

### Octopus Circle (Inline-point) **TOURNAMENT LEGAL**

Same design as the Octopus Circle, but without any offset to conform with some Billfish tournament regulations and some fisheries that require non-offset circle hooks.



SIZES	4	2	1	1/0	2/0	3/0	4/0	5/0	6/0	7/0	8/0
NS Black	LS 221408(10)	221409(8)	221410(8)	221411(6)	221412(6)	221413(6)	221414(6)	221415(6)	221416(6)	221417(6)	221418(6)
Red	LS 221308(10)	221309(8)	221310(8)	221311(6)	221312(6)	221313(6)	221314(6)	221315(6)	221316(5)	221317(5)	221318(4)

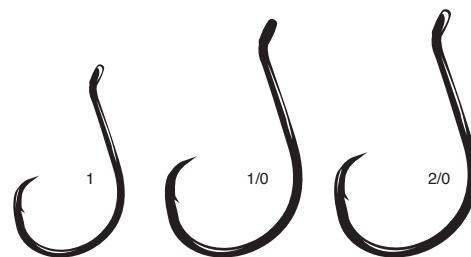

### Octopus Circle (Inline-point) Barbless **TOURNAMENT LEGAL**



SIZES	3/0	4/0	5/0
NS Black	LS 224413(6)	224414(6)	224415(6)

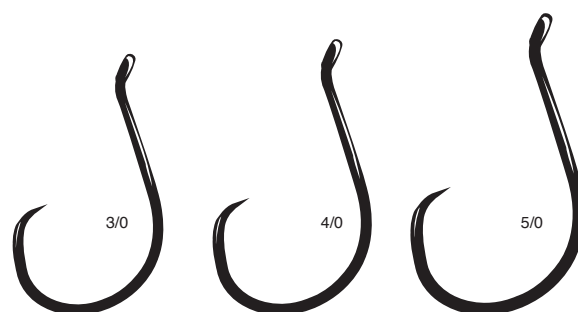

### Octopus Circle Straight Eye (Inline-point) **TOURNAMENT LEGAL**

SIZES	6	4	2	1	1/0	2/0	3/0	4/0	5/0	6/0	7/0	8/0	
NS Black	LS	265407(10)	265408(10)	265409(8)	265410(8)	265411(6)	265412(6)	265413(6)	265414(6)	265415(6)	265416(6)	265417(6)	265418(6)
NS Black	25 pk	265407-25	265408-25	265409-25	265410-25	265411-25	265412-25	265413-25	265414-25	265415-25	265416-25	265417-25	265418-25
NS Black	100 pk						265413-100	265414-100	265415-100	265416-100			

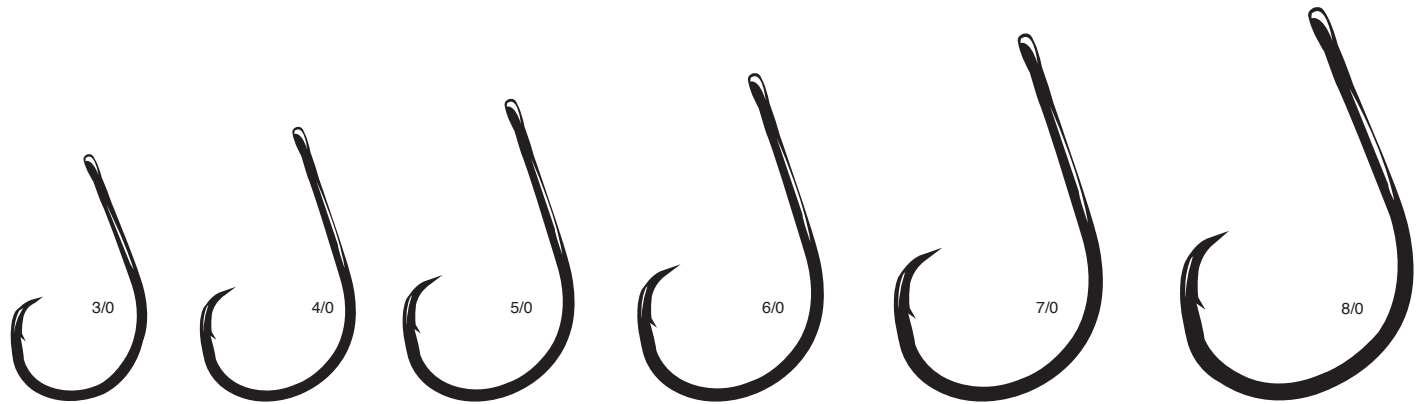
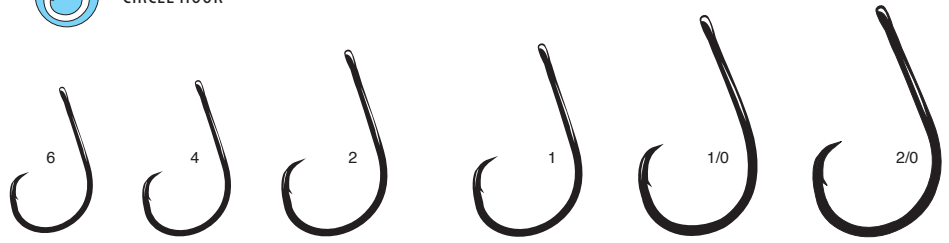

### Octopus Circle 4x Strong, Straight Eye

This hook is designed for heavier lines and bigger fish. The offset point makes it a good choice for many chunk bait situations.



SIZES	1/0	2/0	3/0	4/0	5/0	6/0	7/0	8/0	
NS Black	LS	209411(6)	209412(6)	209413(6)	209414(6)	209415(6)	209416(6)	209417(6)	209418(6)
NS Black	25				209415-25	209416-25	209417-25	209418-25	

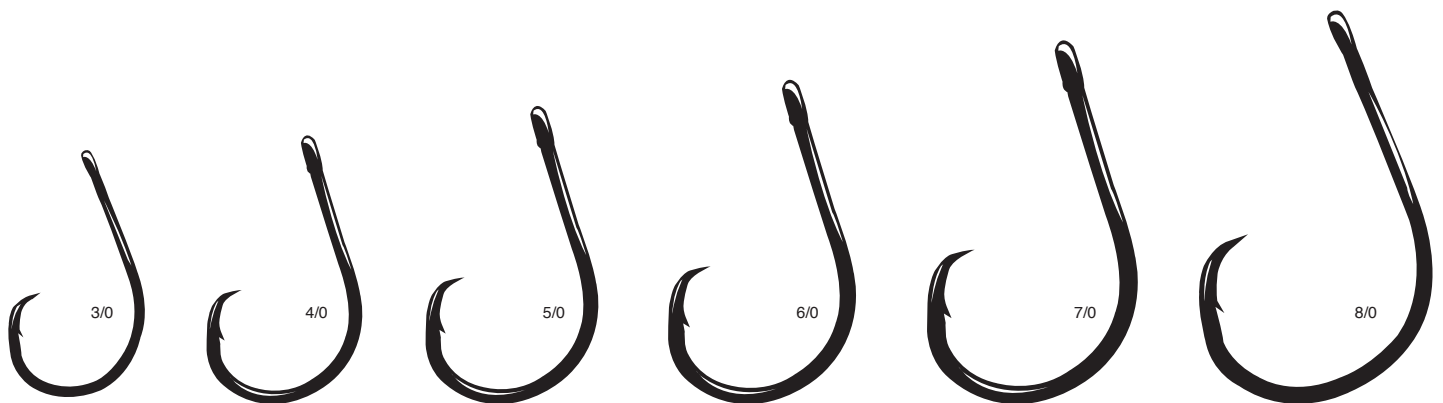
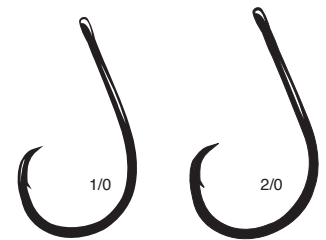

## Octopus Circle 4x Strong, Straight Eye (Inline-point), TOURNAMENT LEGAL

To comply with new angling regulations in the Gulf of Mexico, we've redesigned and reinforced our most popular circle hook. The new 4X Strong Circle Hook is built for the toughest battles in the deep sea. The straight eye, NS black finish and inline point (not offset) complies with the new rules, but doesn't reduce the hook's effectiveness. This is the new "go-to" hook charter captains and professional anglers are using for deep dropping and reef and wreck fishing. Heavy up your rods, reels and line, because the 4X Strong Circle Hook will never give up when it comes to pulling snapper and monster grouper out of their fortified hangouts.

SIZES	1/0	2/0	3/0	4/0	5/0	6/0	7/0	8/0	9/0	10/0
NS Black	LS 360411(6)	360412(6)	360413(6)	360414(6)	360415(6)	360416(6)	360417(6)	360418(6)	360419(5)	360420(5)

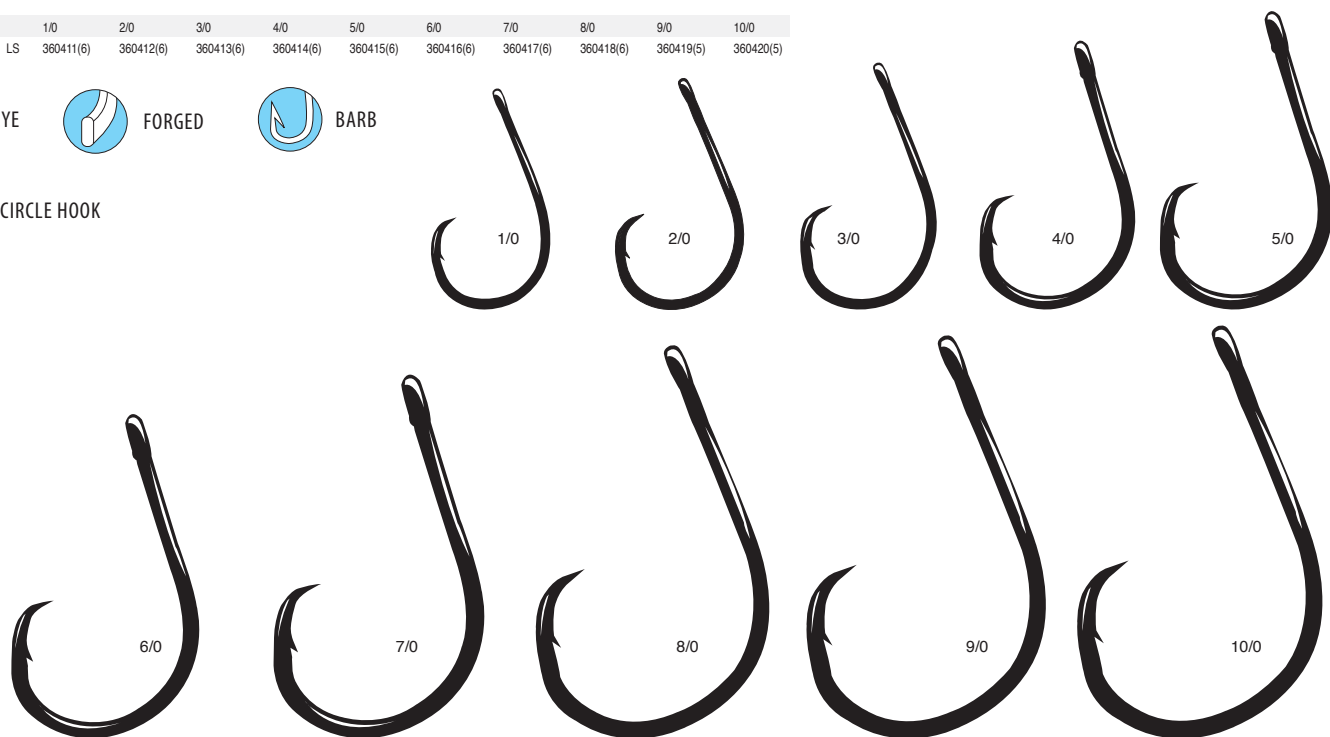

## Octopus Circle 1x Strong, Out Barb

Will Gamakatsu's new Octopus Circle "Outbarb" 1xStrong hook change angling forever? There's a strong possibility, and for good reason. Traditional hooks place the barb on the inside of the hook bend. With certain techniques, like jigging, chunk baiting, and bottom fishing, if your line becomes limp or goes slack it could get entangled by the hook barb and possibly be nicked or cut. The outbarb design eliminates that risk. But there's more. Tests have proven that when an outbarb is combined with Gamakatsu's circle hook design, it results in deeper penetration and a higher hook retention rate. Think about it: a barb on the inner side of a hook bend is somewhat protected. A barb on the outside of the hook bend will come into contact with whatever flesh it touches and prevent movement in the opposite direction from which it entered. Consistently, Gamakatsu researchers and prostaffers documented increased retention of hooked species.

SIZES	3/0	4/0	5/0	6/0	7/0	8/0	10/0	12/0
NS Black	LS 363413(6)	363414(6)	363415(6)	363416(6)	363417(5)	363418(5)	363420(3)	363422(3)

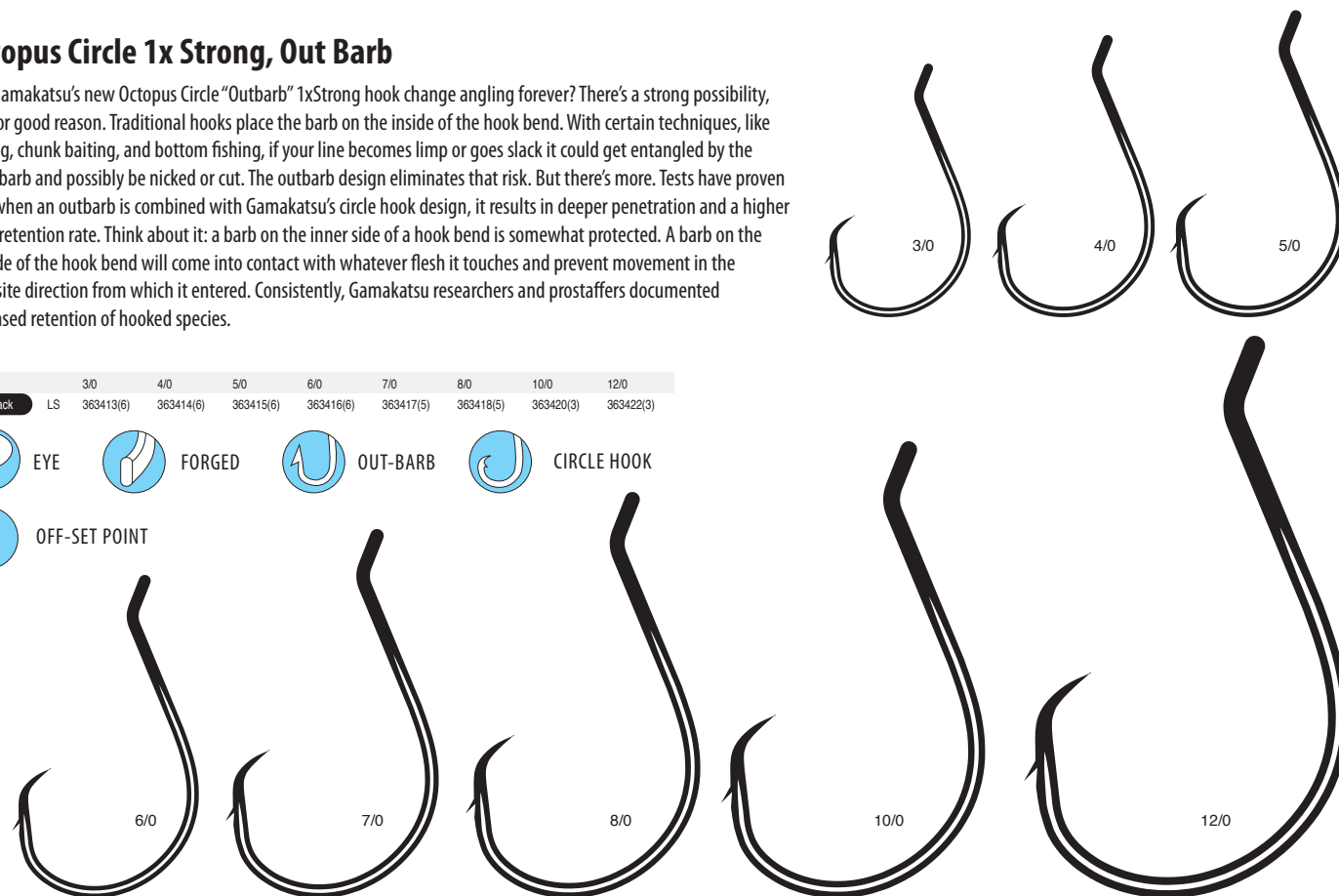

### Walleye Wide Gap

SIZES	8	6	4	2	1	1/0	2/0
NS Black	LS 202406(10) 25 202406-25	202407(10) 202407-25	202408(10) 202408-25	202409(8) 202409-25	202410(8) 202410-25	202411(6) 202411-25	202412(6) 202412-25

In-line needle point design won't roll or twist when trolled. Light weight for live bait presentations. Forged for extra strength.

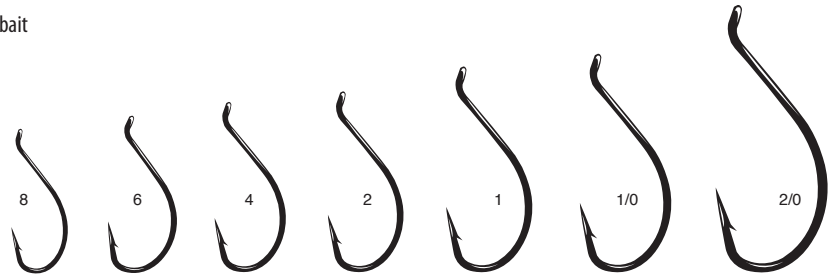

### Shiner Straight Eye

SIZES	6	4	2	1	1/0	2/0	3/0	4/0	5/0
NS Black	LS 51407(8) 25 51407-25	51408(7) 51408-25	51409(7) 51409-25	51410(6) 51410-25	51411(6) 51411-25	51412(6) 51412-25	51413(5) 51413-25	51414(4) 51414-25	51415(4)

Great hook for live shiners, crawdads, and shrimp. This style is also very popular for many different types of Catfish baits.

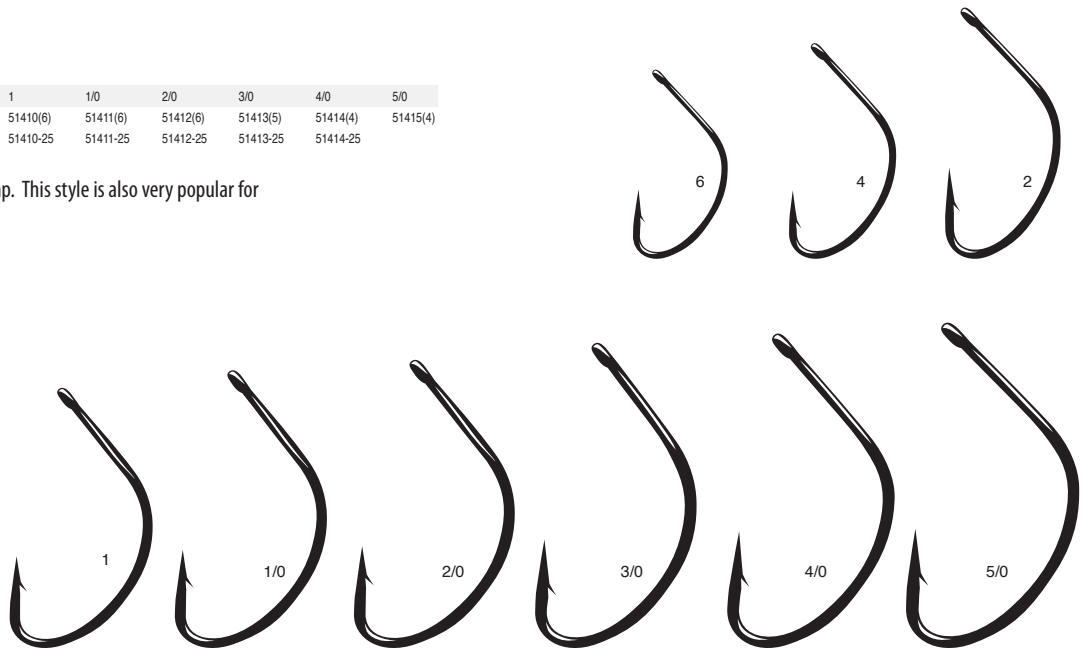
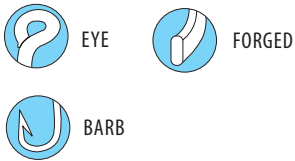

### Shiner Upturned Eye

SIZES	1	1/0	2/0	3/0	4/0
NS Black	LS 52410(6) 25 52410-25	52411(6) 52411-25	52412(6) 52412-25	52413(5) 52413-25	52414(4) 52414-25

Same great shape, only with an upturned eye, makes it great for snelling.

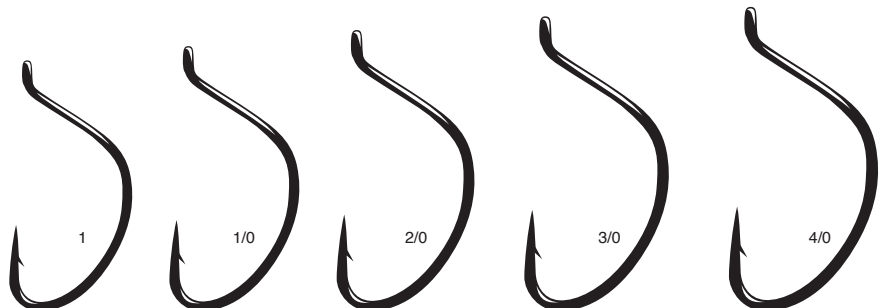

## Siwash Open Eye

SIZES	10	8	6	4	2	1	1/0	2/0	3/0	4/0	5/0	6/0	7/0	8/0
Opn Nickel	LS 10005(10)	10006(10)	10007(10)	10008(10)	10009(8)	10010(8)	10011(6)	10012(6)	10013(6)	10014(6)	10015(6)	10016(5)	10017(4)	10018(3)
	25						10011-25	10012-25	10013-25	10014-25	10015-25	10016-25		
Bulk	10005-100	10006-100	10007-100	10008-100	10009-100	10010-100	10011-100	10012-100	10013-100	10014-50	10015-50			
Red	LS						10311(6)	10312(6)	10313(6)	10314(6)	10315(6)			

A must have replacement hook for your favorite spinner, spoon, or plug. The open eye makes for fast and easy attachment and the closed eye is a popular hook for spinnerbait trailers.



OPEN EYE



BARB

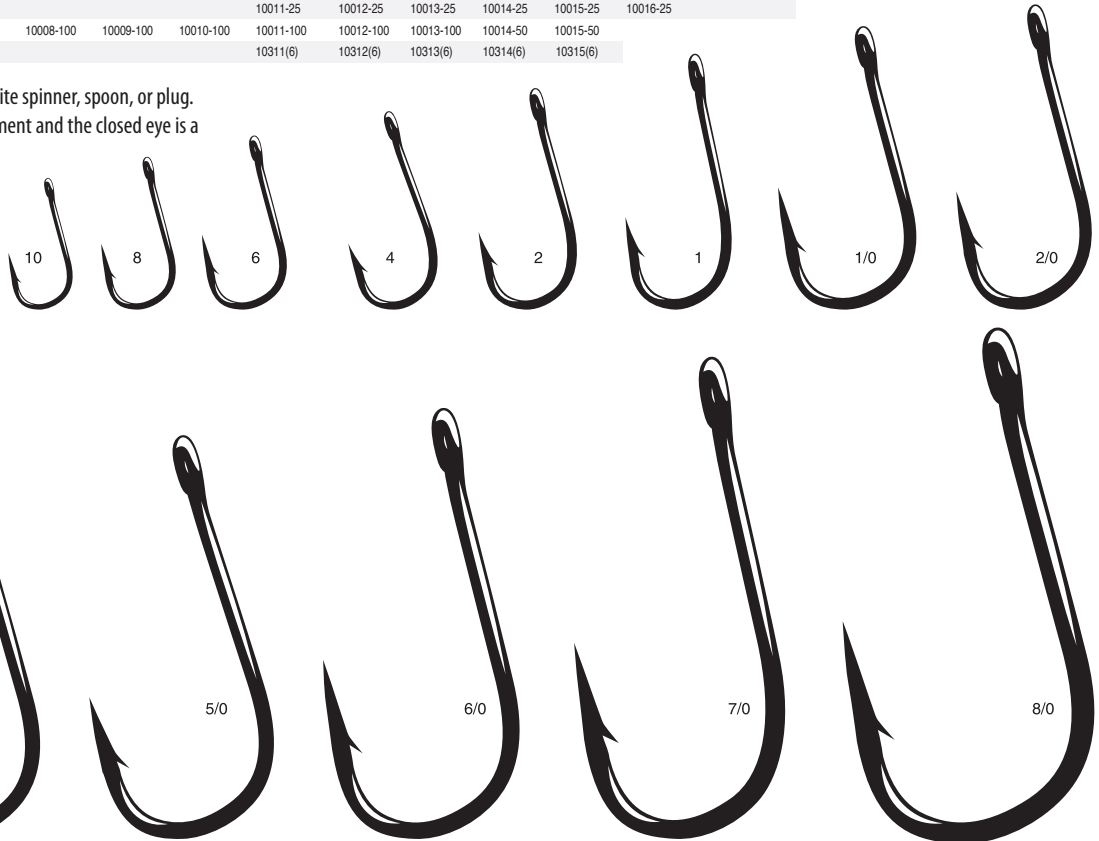

## Trailer Hook Sp

SIZES	1	1/0	2/0	3/0
NS Black	LS 284410(5)	284411(4)	284412(4)	284413(4)
Red	LS 284310(5)	284311(4)	284312(4)	284313(4)



EYE



BARB

Speed up the process of attaching a trailer hook to your spinnerbait or buzzbait with our Trailer Sp. The hook features a rubberized coating molded on to the eye. Attaching is fast and secure.

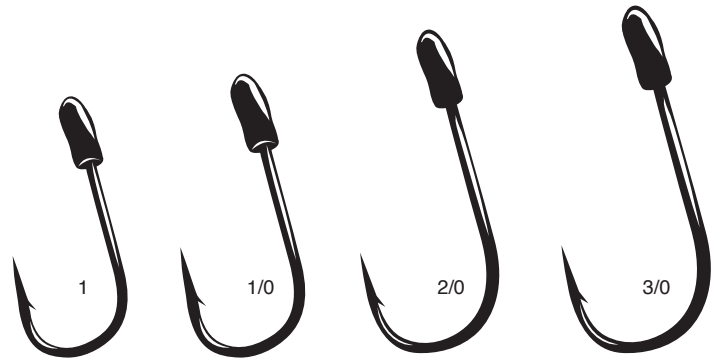

## Spinner Bait Trailer

Give any spinner bait or buzzbait that extra edge.

SIZES	1/0	2/0	3/0
Nickel	LS 210011(5)	210012(5)	210013(5)
Red	LS 210311(5)	210312(5)	210313(5)



EYE



BARB

Tube Included

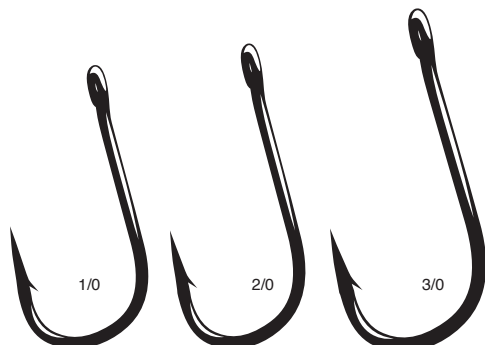

## Spinner Bait

SIZES	3/0	4/0	5/0
Nickel	25 55013-25	55014-25	55015-25
	100 55013-100	55014-100	55015-100



EYE



BARB

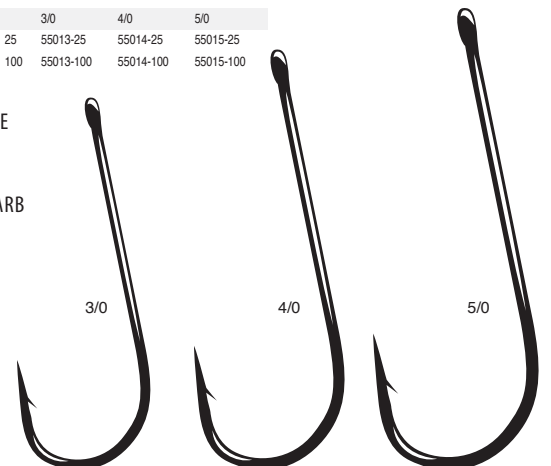

### Barbless Big River Bait



SIZES	2/0	3/0	4/0	5/0	6/0
NS Black	LS 376412(6)	376413(6)	376414(6)	376415(6)	376416(6)
NS Black	25 pk 376412-25	376413-25	376414-25	376415-25	376416-25

The innovative design has overtaken bait fisheries from coast to coast. Now the Big River Hook is available as barbless to comply with conservation initiatives and new regulations. No need to pinch the barb on these forged shank hooks. The large gap and unique shape enable instant penetration and holding power. Corrosion resistant and available in all popular sizes.



### Big River Bait



SIZES	6	4	2	1	1/0	2/0	3/0	4/0	5/0	6/0	7/0	8/0	9/0	10/0	12/0
NS Black	LS 225407(10)	225408(10)	225409(8)	225410(8)	225411(6)	225412(6)	225413(6)	225414(6)	225415(6)	225416(6)	225417(6)	225418(5)	225419(4)	225420(3)	225422(3)
NS Black	25 pk 225407-25	225408-25	225409-25	225410-25	225411-25	225412-25	225413-25	225414-25	225415-25	225416-25	225417-25	225418-25			
Red	LS 225307	225308	225309	225310	225311(6)	225312(6)	225313(6)	225314(6)	225315(6)	225416(6)					
Red	25 pk 225307-25	225308-25	225309-25	225310-25	225311-25	225312-25	225313-25	225314-25	225315-25	225416-25					

The Big River Bait hook is forged for extra strength with an up eye for easy snelling. The large gap allows for quick penetration and the unique bend offers great holding power. The NS black finish is durable and corrosion resistant.

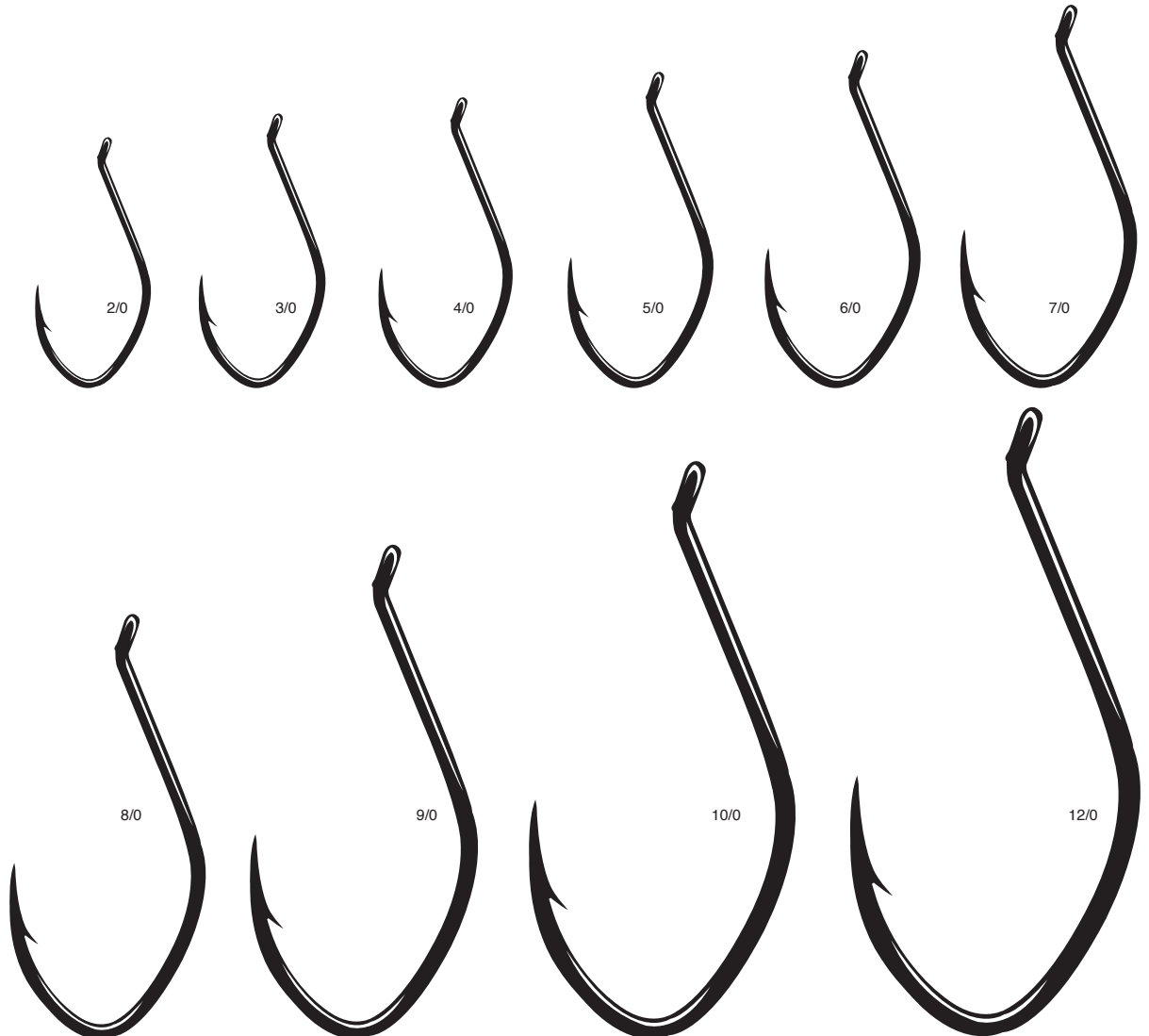
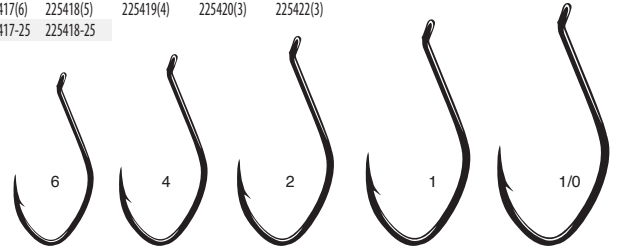

## Big River Bait Open Eye



OPEN EYE



FORGED



BARB

SIZES	1/0	2/0	3/0	4/0	5/0	6/0	7/0
<b>NS Black</b>	LS 225911(5)	225912(5)	225913(5)	225914(5)	225915(5)	225916(5)	225917(4)
	25 225911-25	225912-25	225913-25	225914-25	225915-25	225916-25	

The reception to our Big River Bait Hook has been so strong that angler's immediately began asking for a siwash-style hook they could use on their spinners, spoons and plugs for salmon. The answer... this fast penetrating hook holds better than conventional hook designs. When fished barbless (which requires pinching the barb down) it's the best barbless hook you'll find. The unique Big River hook design locks fish in place when hooked. Forged for exceptional strength and built Gamakatsu sharp the Big River Open Eye is sure to make great lures even better.

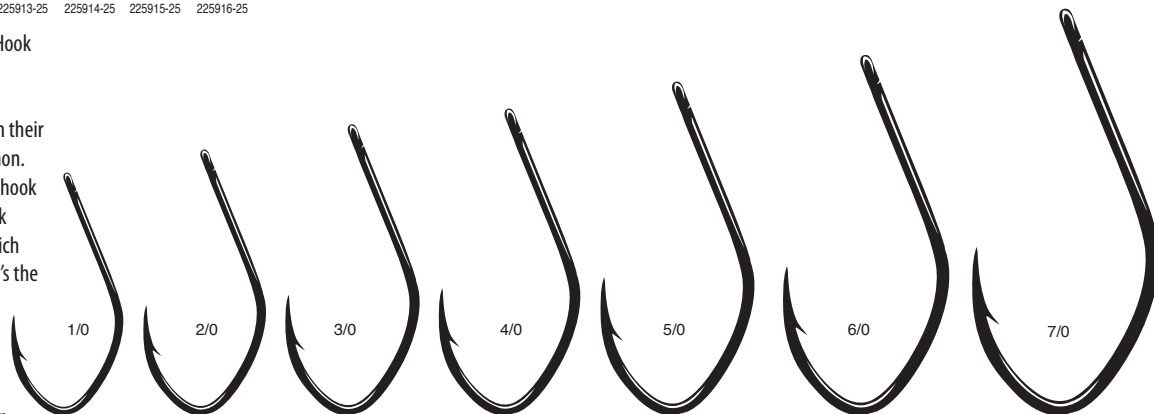

## Big River Bait Open Eye Barbless



OPEN EYE



FORGED



SIZES	1/0	2/0	3/0	4/0	5/0	6/0	7/0
<b>NS Black</b>	LS 340411(5)	340412(5)	340413(5)	340414(5)	340415(5)	340416(5)	340417(4)

The advantage of the Big River Open Eye over conventional siwash hooks, is the unique hook design that features an additional bend at the bottom of the hook. This innovative design feature hooks and holds fish tight.

The "Open Eye" feature allows this hook to be easily attached to a split ring, barrel swivel, welded ring or hook hanger simply by closing the eye with a pair of pliers.

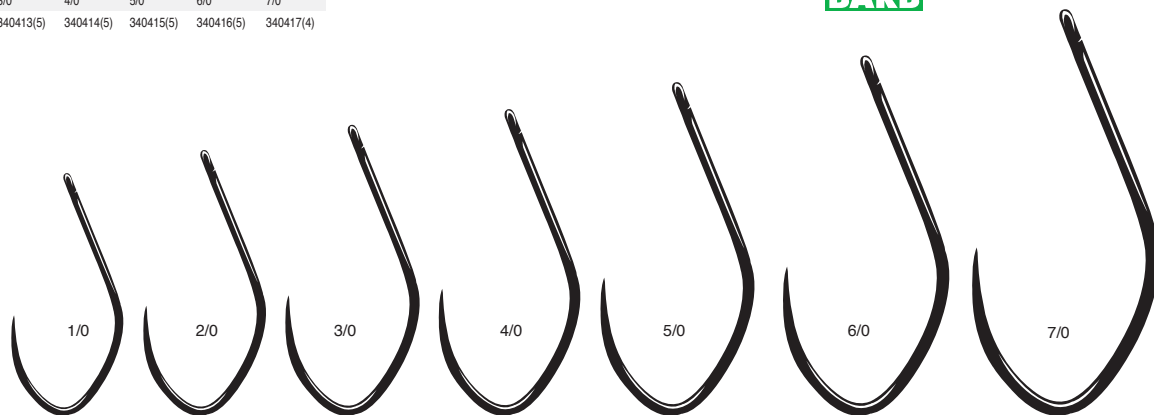

## Baitholder Hooks (See page 63 for snells.)

SIZES	14	12	10	8	6	4	2	1	1/0	2/0	3/0	4/0	5/0	6/0
<b>BRONZE</b>	LS 05103(10)	05104(10)	05105(10)	05106(10)	05107(10)	05108(10)	05109(8)	05110(8)						
	100 05103-100	05104-100	05105-100	05106-100	05107-100	05108-100	05109-100	05110-100						
	SNL 05603(10)	05604(10)	05605(10)	05606(10)	05607(10)	05608(10)	05609(8)	05610(8)						
<b>NS BLACK</b>														
	LS						05409(8)	05410(8)	05411(7)	05412(7)	05413(6)	05414(6)	05415(5)	05416(5)
	25						05409-25	05410-25	05411-25	05412-25	05413-25	05414-25	05415-25	05416-25

The ever popular baitholder hook is used for a variety of fish and comes in either a bronze finish or a corrosion resistant NS Black finish for use in saltwater. It also comes in a handy snell pack.



EYE



FORGED



BARB



OFF-SET POINT



BARB(S) ON SHANK

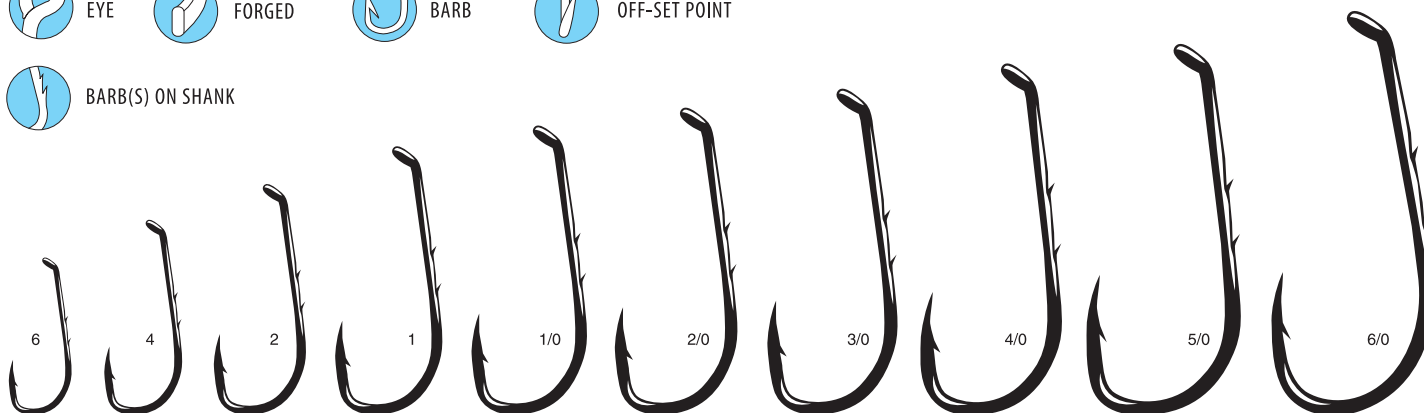

### Walleye And Steelhead Assortment

SIZES	8	6	4	2	
Assort	25	02506	02507	02508	02509

- 5 COLORS:  
 GREEN  
 BLUE  
 RED  
 BRONZE  
 BLACK

5 hooks per color,  
 25 hooks total

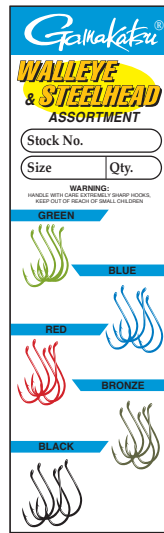

### Fluorescent Walleye And Steelhead Assortment

SIZES	8	6	4	2	
Assort	20	02706	02707	02708	02709

- 5 COLORS:  
 F-RED  
 F-PINK  
 F-ORANGE  
 CHARTREUSE  
 GLOW

4 hooks per color,  
 20 hooks total

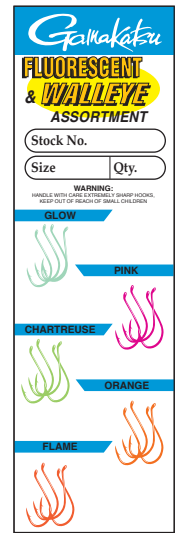

### Crappie Assortment

SIZES	8	6	4	2	
5 COLORS	LS	02606	02607	02608	02609

3 hooks per color,  
 15 hooks total

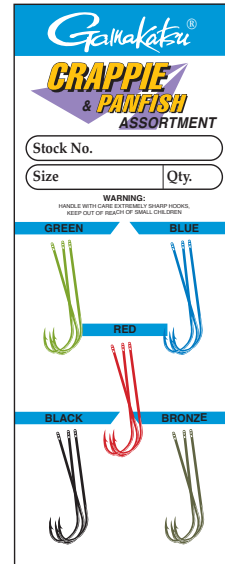

### EWG Worm Hook Assortment

SIZES	VARIOUS	
Assort	25	257000

A 25 pack featuring 5 each of the best all around worm hook sizes and colors. It includes 2 Red and 3 NS Black hooks in 3/0 and 4/0 Superline EWG, and the standard EWG in 2/0, 3/0 and 4/0.

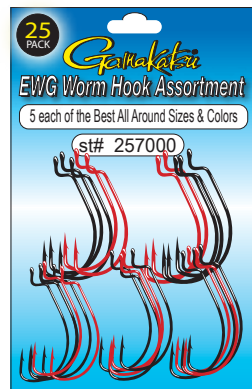

### Catfish Hook Assortment

SIZES	VARIOUS	
Assort	20	258000

A 20 pack featuring 5 each of the best all around Catfish hooks. This pack includes 8/0 and 6/0 Octopus Circle Hooks, 4/0 Shiner Hooks, and 1/0 NS Black Baitholder hooks.

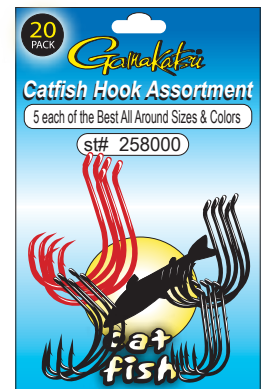





Fresh Water Hooks

Gamakatsu®

### TW Hook

SIZES	16	14	12	10	8	6
Bronze	LS 262102(10)	262103(10)	262104(10)	262105(10)	262106(10)	262107(10)

NEW SIZE

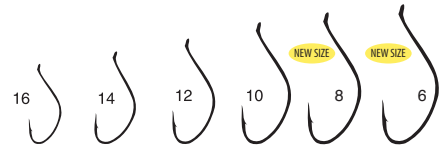

The TW stands for "Trout Worm" and is the perfect hook for those soft plastic finesse worms that require a delicate presentation. It has the right gap to accommodate the worm and hold the fish.

### Single Egg Hooks, Barb On Shank *(See page 62 for snells.)*

SIZES	14	12	10	8	6
Red	LS 04303(10)	04304(10)	04305(10)	04306(10)	04307(10)
	SNL 04803(10)	04804(10)	04805(10)	04806(10)	04807(10)
Gold	LS 04203(10)	04204(10)	04205(10)	04206(10)	04207(10)
	SNL 04703(10)	04704(10)	04705(10)	04706(10)	04707(10)

A premier bait hook for single eggs. Also great for floating trout bait.



### Aberdeen

SIZES	8	6	4	2	1
BRONZE	LS 09106(10)	09107(10)	09108(10)	09109(8)	09110(8)



Designed with a long shank, as a light wire bait hook.

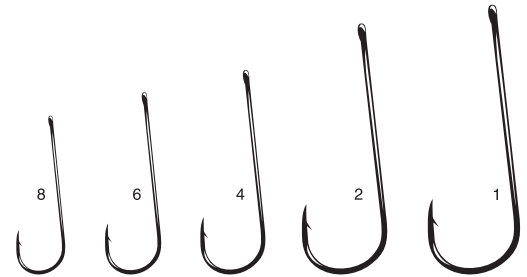

### G-Stinger

SIZES	1	1/0	2/0
NS Black	LS 219410(4)	219411(4)	219412(4)



FORGED BARB



The ultimate utility hook. Easily attaches to any hook or lure. Great for spinnerbaits, buzz baits, jerkbaits and jigging spoons, braided line, sizes 1-2/0 have a 50 lb. loop.

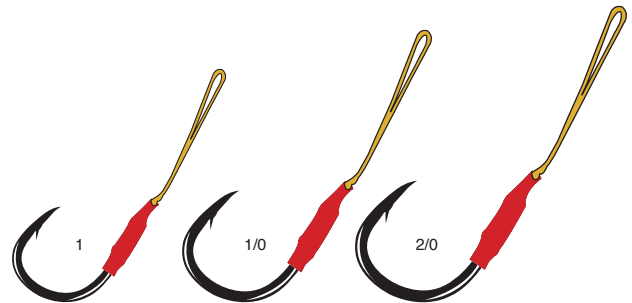

### Split Shot/Drop Shot

The ultimate hook for nose hooking a Roboworm, small Gitzit, or any number of soft plastic drop shot baits. When it's time to get serious about finesse fishing this hook will amaze you.

SIZES	4	2	1	1/0	2/0	3/0
NS Black	LS 50408(6)	50409(6)	50410(6)	50411(6)	50412(6)	50413(6)
NS Black	2S 50408-2S	50409-2S	50410-2S	50411-2S	50412-2S	50413-2S
Red	LS 50308(6)	50309(6)	50310(6)	50311(6)		
Red	2S 50308-2S	50309-2S	50310-2S	50311-2S		

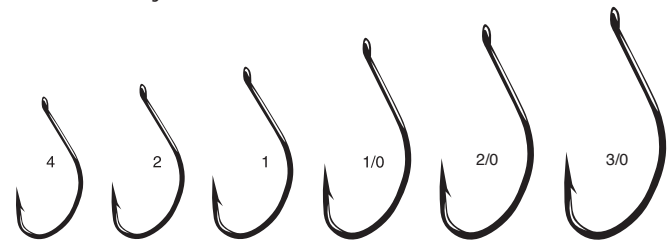

### Split Shot/Drop Shot Weedless

Gamakatsu has done it... again! Another fishing hook first with the introduction of the new Weedless Split Shot/Drop Shot Hook. The wide gap hook design is paired to a hair-trigger hand-tied, weed-guard for instant hook-ups. The weed guard maintains its shape and consistency fish-after-fish and is ultra-effective in staying weedless with exposed hook riggings.

SIZES	4	2	1	1/0	2/0	3/0
NS Black	LS 50908(5)	50909(5)	50910(5)	50911(5)	50912(5)	50913(4)

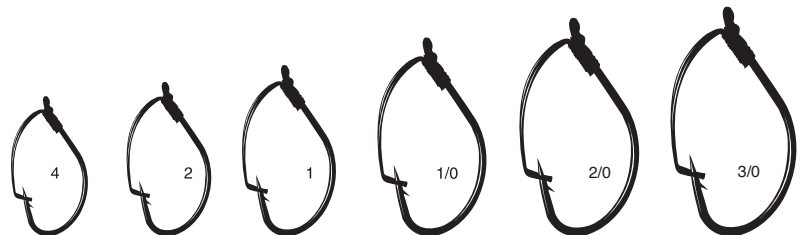

## Finesse Wide Gap

The perfect hook for wacky rigging for bass, also great for free drifting for salmon and steelhead with small baits.

SIZES	4	2	1	1/0	2/0	3/0	4/0	5/0	6/0
NS Black	LS 230408(6)	230409(6)	230410(6)	230411(6)	230412(6)	230413(5)	230414(5)	230415(5)	230416(5)
NS Black	25 pk 230408-25	230409-25	230410-25	230411-25	230412-25	230413-25	230414-25	230415-25	230416-25
Red	LS 230308(6)	230309(6)	230310(6)	230311(6)	230312(6)	230313(5)	230314(5)		
Red	25 pk 230308-25	230309-25	230310-25	230311-25	230312-25	230313-25	230314-25		



## Finesse Wide Gap Weedless

Featuring an innovative nylon weed guard, allowing you to pitch your wacky rig into the heaviest cover.

SIZES	4	2	1	1/0	2/0	3/0	4/0	5/0	6/0
NS Black	LS 230908(5)	230909(5)	230910(5)	230911(5)	230912(5)	230913(4)	230914(4)	230915(4)	230916(4)

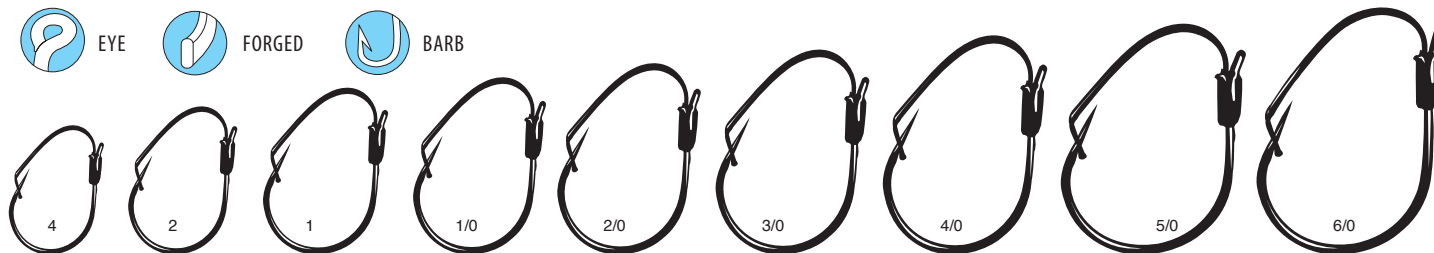

## Wicked Wacky

SIZES	1/0	2/0	3/0	4/0	5/0
NS Black	LS 306411(3)	306412(3)	306413(3)	306414(3)	306415(3)

The new standard in wacky hook designs. Built on Gamakatsu proven Shiner hook, the Wicked Wacky features a durable hand tied weed guard that provides anglers the confidence to throw their wacky rig in and around heavy cover. In addition the Wicked Wacky takes the power drop shot to a new level. Gamakatsu designed an innovative hollow tube, hand tied on the shank. Simply run the tag end of your line through the tube, tie on your weight, and pitch into the heaviest cover for a whole new power drop shot presentation.

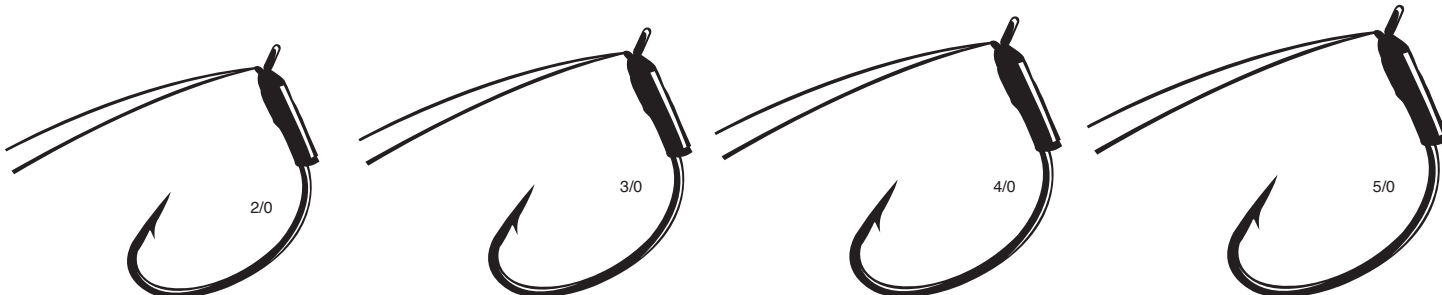
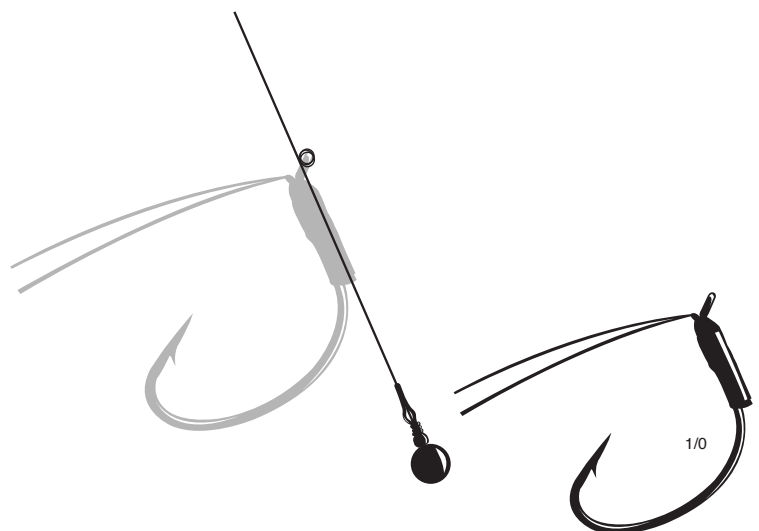

## Worm, Skip Gap

SIZES	1/0	2/0	3/0	4/0	5/0
NS Black	LS 266411(6)	266412(6)	266413(5)	266414(5)	266415(5)
NS Black	ZS 266411-25	266412-25	266413-25	266414-25	266415-25

There is no better hook for skipping plastics under docks and cover. The Skip Gap is a multiple use hook that is perfect for a variety of soft plastic baits. Top water buzz frogs, Texas rigging, Carolina rigging, the Skip Gap can do it all!

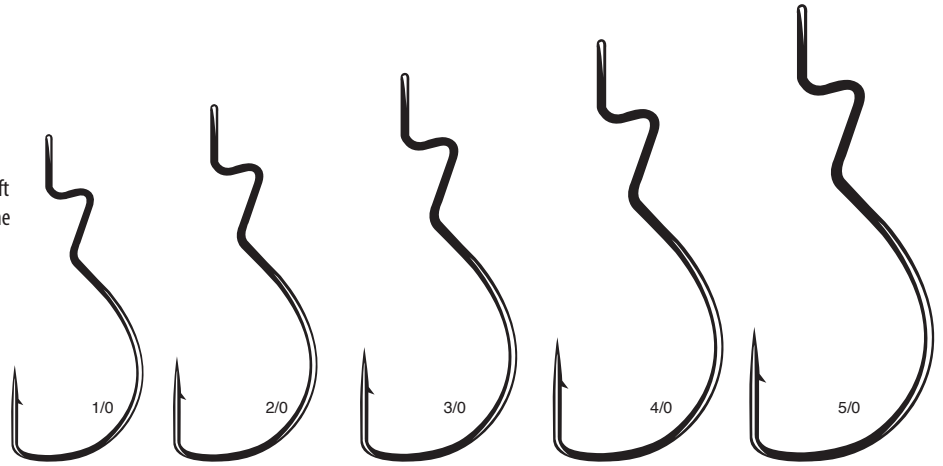

## Finesse Heavy Cover Worm with Tin Keeper

SIZES	1	1/0	2/0	3/0
NS Black	LS 311410(4)	311411(4)	311412(4)	311413(4)



The Finesse Heavy Cover Worm Hook is a light wire, finesse hook that features the first wide gap straight shank hook for finesse worm fishing. Just like all the Heavy Cover Hooks the Finesse features a welded eye and wire keeper that assures your worm doesn't slide down the hook.

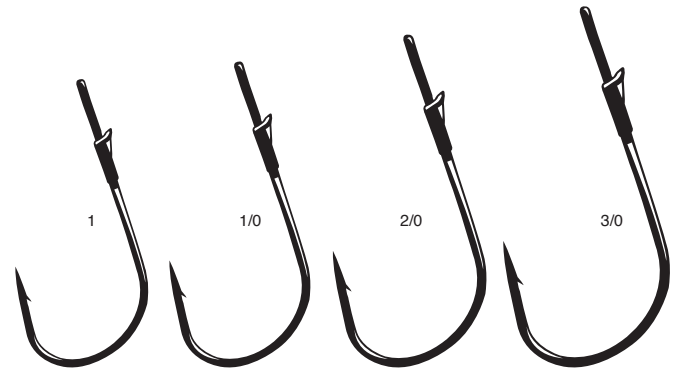

## Heavy Cover Worm with Tin Keeper

SIZES	3/0	4/0	5/0
NS Black	LS 304413(4)	304414(4)	304415(4)



The new standard in Flip hooks has arrived. The new Heavy Cover Worm hook has been built to the highest standards to fight the biggest fish in the heaviest cover. The Heavy Cover Worm features our rock solid welded eye, perfect for tying a Snell knot with braid. Gamakatsu has worked with our top pros to design an improved keeper. Instead of a bulky heat shrink barb, the Heavy Cover Worm features a small wire keeper. The keeper has a small compact profile and is strategically placed for superior holding power.

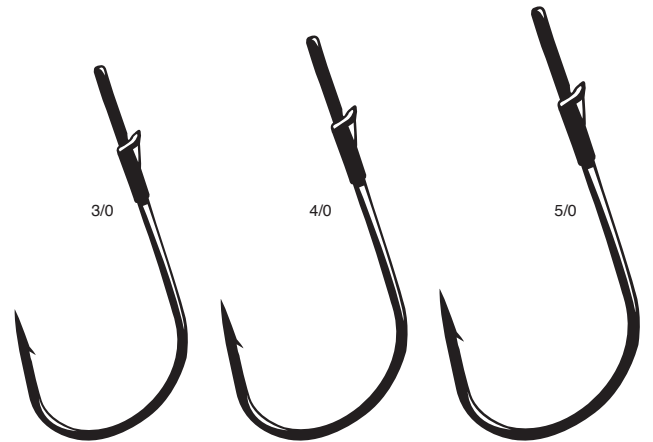

## Super Heavy Cover Worm with Tin Keeper

SIZES	3/0	4/0	5/0
NS Black	LS 310413(4)	310414(4)	310415(4)



The Super Heavy Cover Worm Hook is indestructible with a welded eye and extra heavy duty cold-forged hook wire that will not flex. It's perfect for flipping into heavy cover or punching through thick overhead cover. The addition of an oversized barb holds hooked fish solid and the punch wire/keeper firmly secures worms so they stay rigged cast-after-cast.

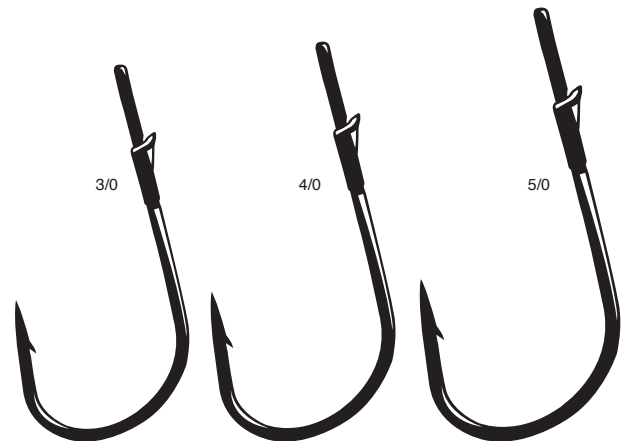

## Worm, Oversize G-Mag



SIZES ONE SIZE ONLY 8/0

**No Black** LS 213418(5)

Designed to rig magnum size tubes, worms, and big swim baits.

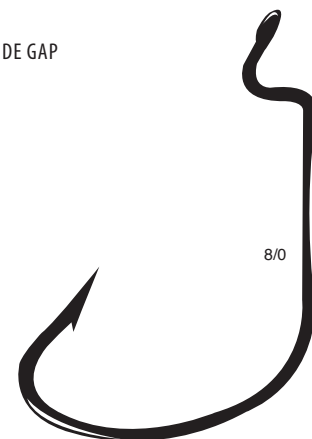

## Worm, Extra Wide Gap (EWG)

SIZES		4	2	1	1/0	2/0	3/0	4/0	5/0
<b>No Black</b>	LS	58408(6)	58409(6)	58410(6)	58411(6)	58412(6)	58413(5)	58414(5)	58415(5)
	25	58408-25	58409-25	58410-25	58411-25	58412-25	58413-25	58414-25	58415-25
	100	58408-100	58409-100	58410-100	58411-100	58412-100	58413-100	58414-100	58415-100
<b>Red</b>	LS	58308(6)	58309(6)	58310(6)	58311(6)	58312(6)	58313(5)	58314(5)	58315(5)
	25	58308-25	58309-25	58310-25	58311-25	58312-25	58313-25	58314-25	58315-25

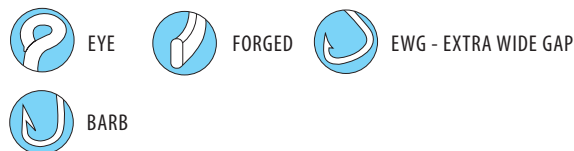

Our most popular and versatile hook, the legendary EWG worm hook is the gold standard in high performance wide gap hook designs. This hook fishes a Senko to perfection. Use it to pitch a Brush Hog or Sweet Beaver to shoreline targets. It's great for Texas rigging or Carolina rigging a 10" worm. A soft plastic jerkbait fisherman's dream hook.

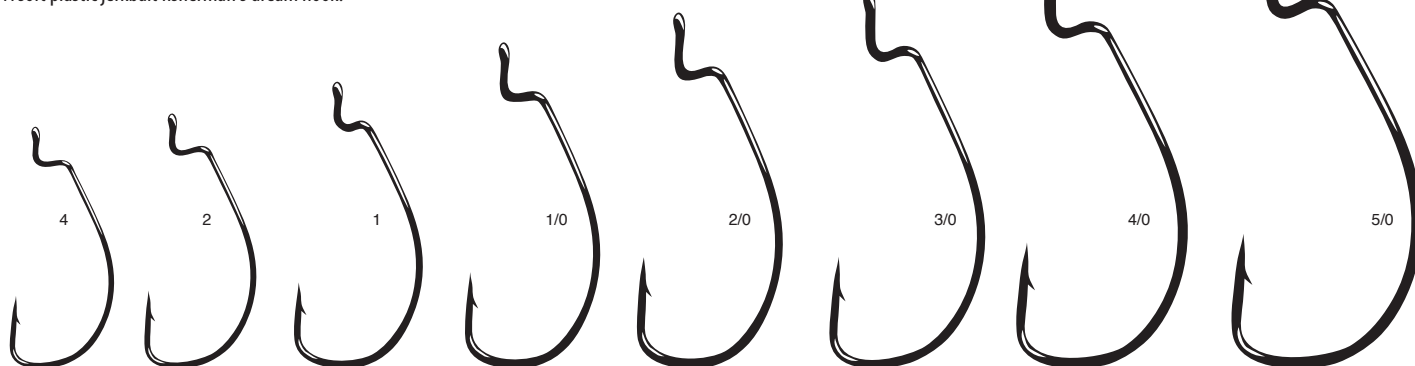

## Worm, Superline Extra Wide Gap (EWG)

SIZES		2/0	3/0	4/0	5/0	6/0
<b>No Black</b>	LS	74412(5)	74413(5)	74414(4)	74415(4)	74416(3)
	25	74412-25	74413-25	74414-25	74415-25	74416-25
	100	74412-100	74413-100	74414-100	74415-100	
<b>Red</b>	LS	74312(5)	74313(5)	74314(4)	74315(4)	74316(3)

*SuperLine*

An EWG on steroids. This high carbon heavy wire hook was designed to fish braided line in heavy cover. For serious flipping in the tulle's, overhead mats, or pads. The EWG Superline will increase your strike to hook ratio when you need to get nasty.

Perfect when you require a quicker descent rate without increasing size or adding weights. Want to turn up the heat with a Senko? Go with a Superline for that deadly quick descent!

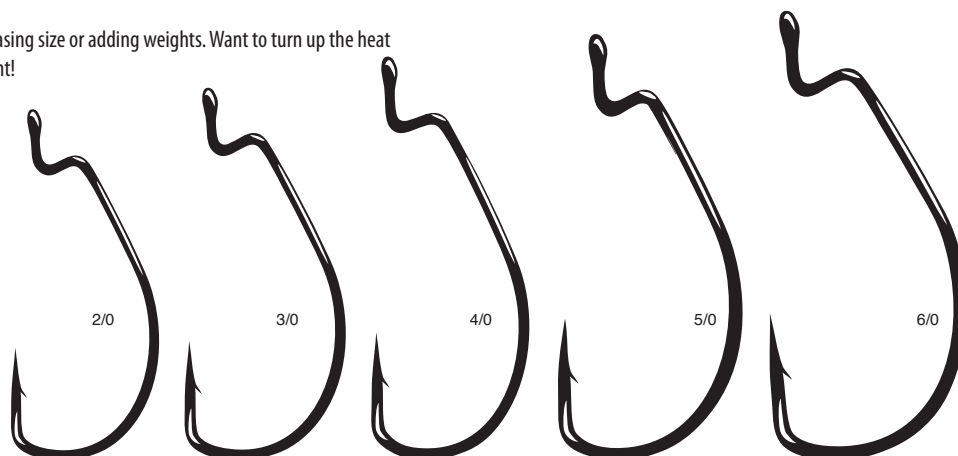

### Worm, Superline Extra Wide Gap (EWG), Weighted

SIZES	2/0 - 1/16	2/0 - 1/8	3/0 - 1/16	3/0 - 1/8	4/0 - 1/16	4/0 - 1/8	5/0 - 1/16	5/0 - 1/8	
NS Black	LS	74412-1/16(S)	74412-1/8(S)	74413-1/16(S)	74413-1/8(S)	74414-1/16(S)	74414-1/8(S)	74415-1/16(S)	74415-1/8(S)

The Weighted EWG Superline is a perfect compliment to the EWG arsenal. Do you need more casting distance with a soft plastic frog? This hook will get you back in the junk. Want to flip into heavy cover without the hassle of pegging a bullet sinker? Consider the EWG Weighted Superline your new best friend. The Lead is strategically placed and milled to perfection.



EYE   
 FORGED   
 BARB   
 EWG - EXTRA WIDE GAP   
 **SuperLine**

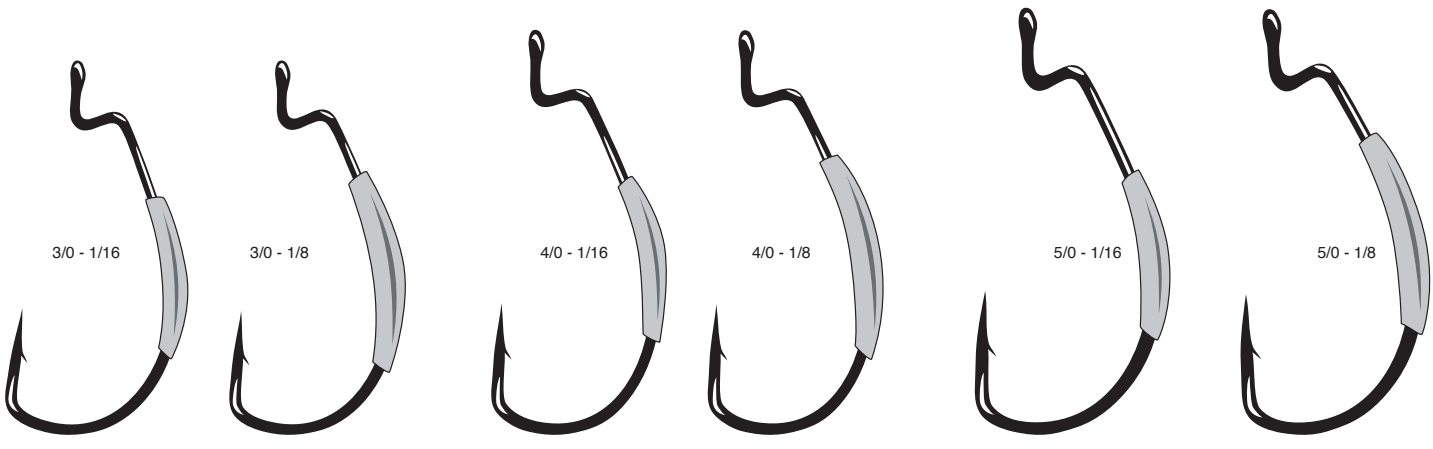

### Worm, Superline EWG With Ring

SIZES	2/0	4/0	
NS Black	LS	74412R(4)	74414R(4)

EYE   
 FORGED   
 BARB   
 EWG - EXTRA WIDE GAP

**SuperLine**

There are times when calling up fish requires a little something extra. For this purpose we designed the EWG Ringed Superline. Need to fish a Horny Toad in the slop and want it to walk? Our solid piece ring allows the bait to swing freely. Fishing a Fluke for schooling smallmouth or big spots and want that super erratic action? This is your hook. Handles braided line and heavy monofilament with ease.

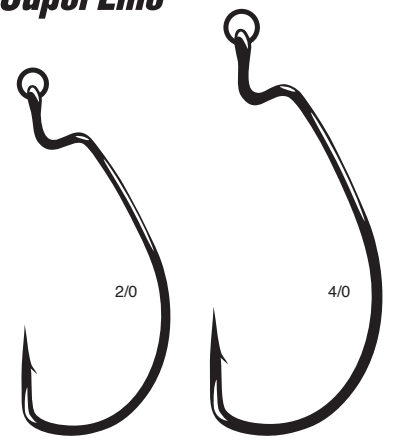

## Extra Wide Gap (EWG) Monster

SIZES	5/0	6/0	7/0
NS Black	LS 283415(5)	283416(4)	283417(4)

When only a high carbon heavy wire hook will do your choice should be the EWG Monster. Hard core doesn't even begin to describe the Monster. Slings a Mission Fish back in the cover? We now have the perfect hook. Loading for bear with a giant Gitzit, Double Wide Beaver, or oversized Slug-O? The Monster has you covered. Headed to El Salto, Clear Lake, or the California Delta for double digit behemoths? Gamakatsu Monster is the choice when you are taking no prisoners. Heavy line, heavy rods, big baits, and big fish is EWG Monster time!

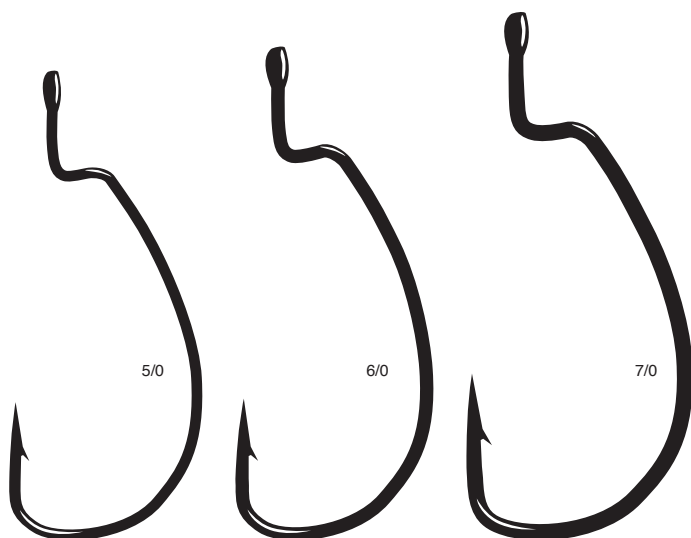

## Extra Wide Gap (EWG) Monster, Weighted

SIZES	5/0 - 1/8	5/0 - 1/4	6/0 - 3/16	6/0 - 1/4	7/0 - 1/4	7/0 - 3/8
NS Black	LS 283415-1/8(3)	283415-1/4(3)	283416-3/16(3)	283416-1/4(3)	283417-1/4(3)	283417-3/8(3)

On the heels of the EWG Monster we have introduced the Weighted Monster. When the situation calls for a bulletproof weighted hook, look no further than the Monster Weighted. Strategically placed milled weights are perfectly balanced and serve as a keel for large swimbaits or any oversized offering. The hook also features a slightly higher hook point in relation to the eye to help aid in hook setting power.

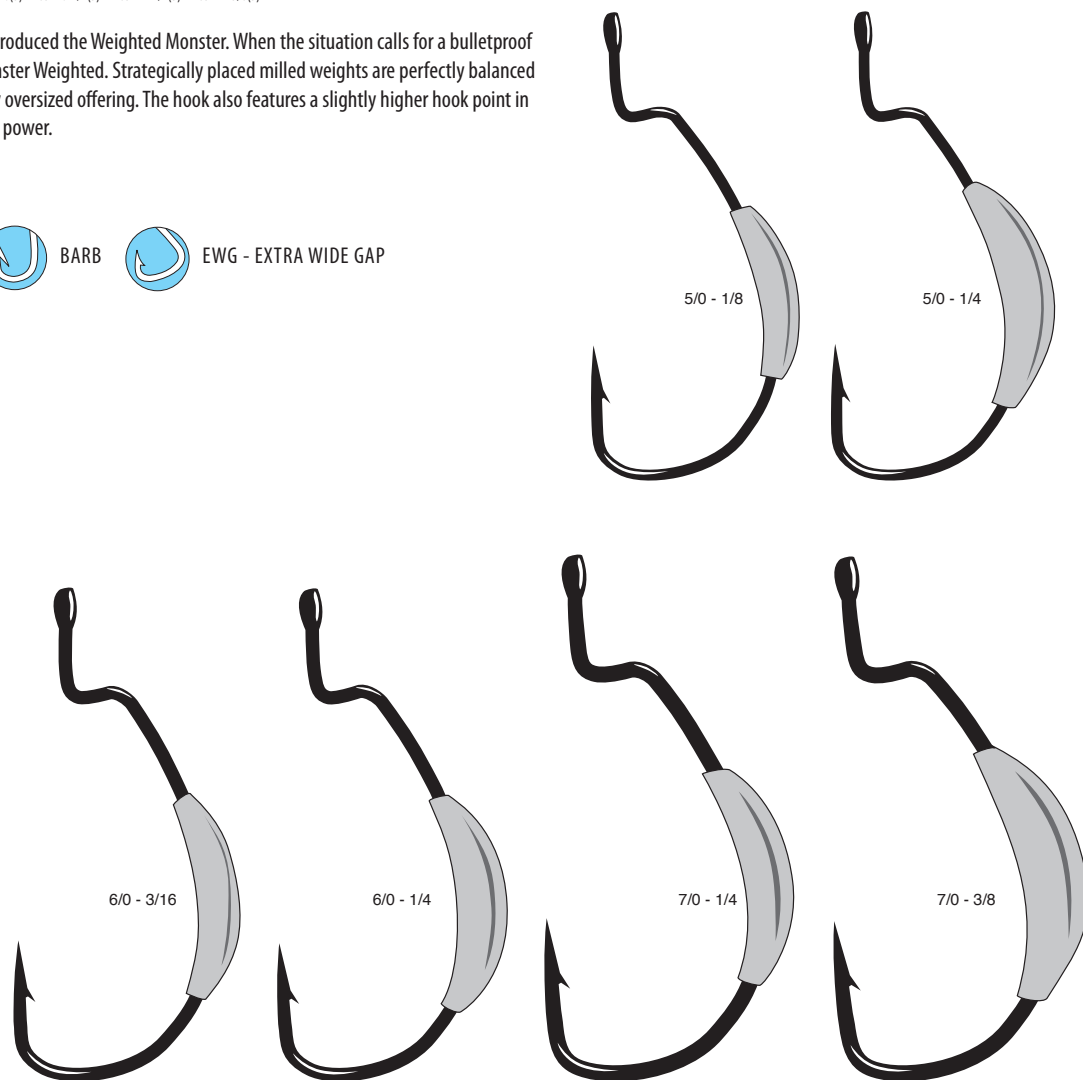





### Superline Spring Lock

*SuperLine*

SIZES	3/0	4/0	5/0	6/0	7/0	
No Black	LS	296413(3)	296414(3)	296415(3)	296416(2)	296417(2)

The new Superline Spring Lock is based on the proven Superline EWG. The Spring Lock features a 28 degree eye with a stress relieved stainless steel center point spring lock. This is the ideal soft plastic hook when the situation requires your bait to stay locked and secure.



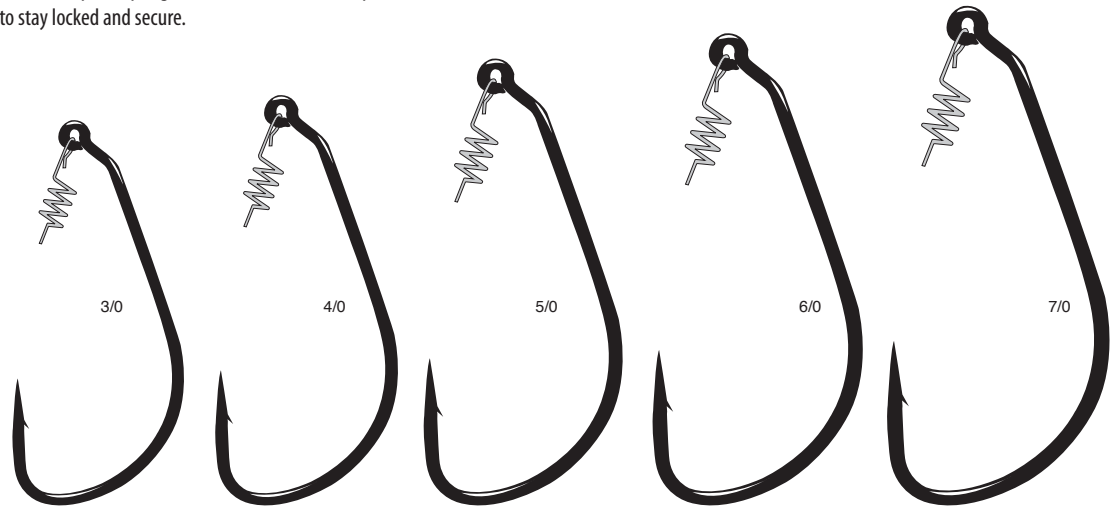

-  EYE
-  FORGED
-  BARB
-  EWG - EXTRA WIDE GAP



### Superline Spring Lock, Weighted

SIZES	3/0 - 1/16	3/0 - 1/8	4/0 - 1/16	4/0 - 1/8	5/0 - 3/16	5/0 - 1/4	6/0 - 3/16	6/0 - 1/4	7/0 - 1/4	7/0 - 3/8	
No Black	LS	296413-1/16(4)	296413-1/8(4)	296414-1/16(4)	296414-1/8(4)	296415-3/16(4)	296415-1/4(4)	296416-3/16(4)	296416-1/4(4)	296417-1/4(4)	296417-3/8(4)

We designed the EWG Spring-Lock to be the perfect hook for paddle tail swim baits. Based on the proven Superline EWG hook, the Spring Lock features a new 28 degree eye with a stress relieved stainless steel center point spring lock so baits stay locked and secure. Beautifully milled, strategically placed weights help your bait track perfectly at any depth. Offered in a variety of sizes and weights to take your paddle tail swim bait fishing to a new level.

-  EYE
-  FORGED
-  BARB
-  EWG - EXTRA WIDE GAP

*SuperLine*

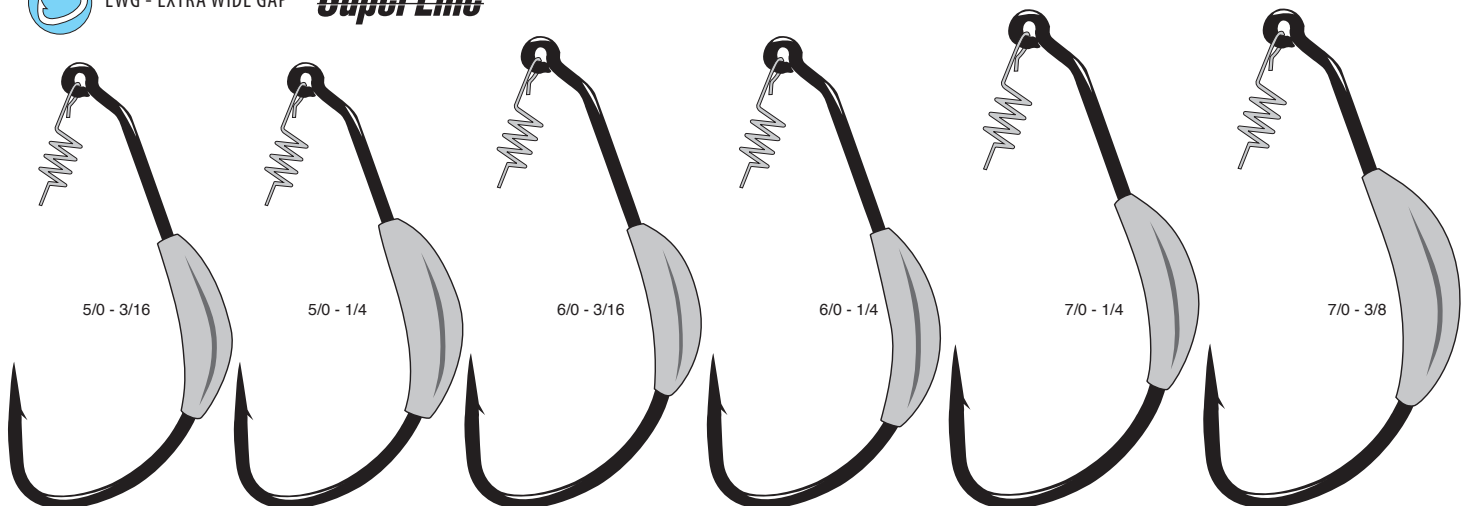
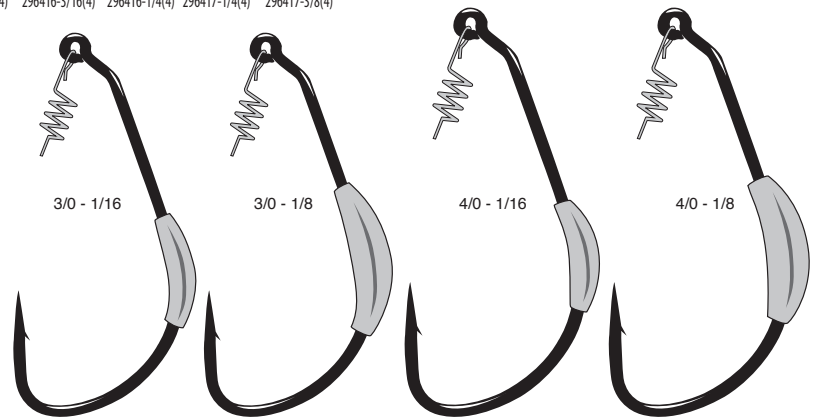



## Superline Spring Lock Monster, Weighted

SIZES	9/0 - 3/8	10/0 - 3/8	12/0 - 3/8	9/0 - 1/2	10/0 - 1/2	12/0 - 1/2
LS Black	LS 371419-3/8(3)	371420-3/8(2)	371422-3/8(2)	371419-1/2(3)	371420-1/2(2)	371422-1/2(2)

Go big or go home. When conditions call for big baits, Gamakatsu's new Spring Lock Monster is precisely designed to hold and position them perfectly straight and firmly attached. Weighted with 3/8 or 1/2 ounce lead, the Spring Lock Monster stands up to aggressive casts and viciously hard hook sets. The "center point" spring lock is easy to start and tighten. Baits stay straight every time and all the time. 9/0, 10/0 or 12/0 hook sizes await trophy-caliber catches.

 EYE  
  FORGED  
  BARB  
  EWG - EXTRA WIDE GAP  
 **SuperLine**

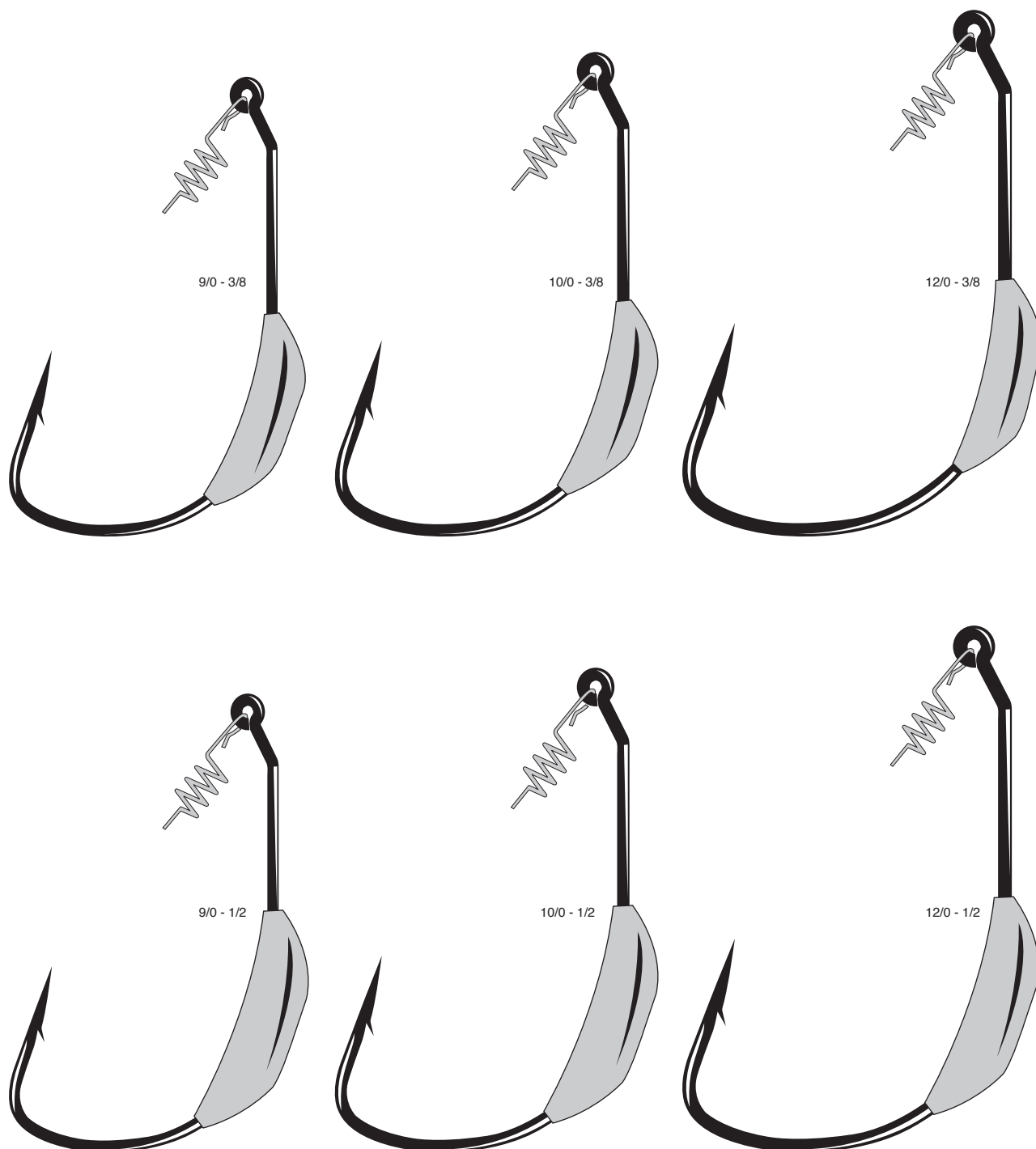

### Worm, G-Lock

SIZES	4	2	1	1/0	2/0	3/0	4/0	5/0
<b>Ns Black</b> LS	204408(6)	204409(6)	204410(6)	204411(6)	204412(6)	204413(5)	204414(5)	204415(5)
<b>Ns Black</b> 25				204411-25	204412-25	204413-25	204414-25	204415-25

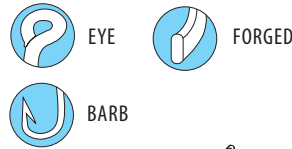

The unique G-Lock hook locks soft plastics tight and secure in any situation. Designed to be used in heavy cover.

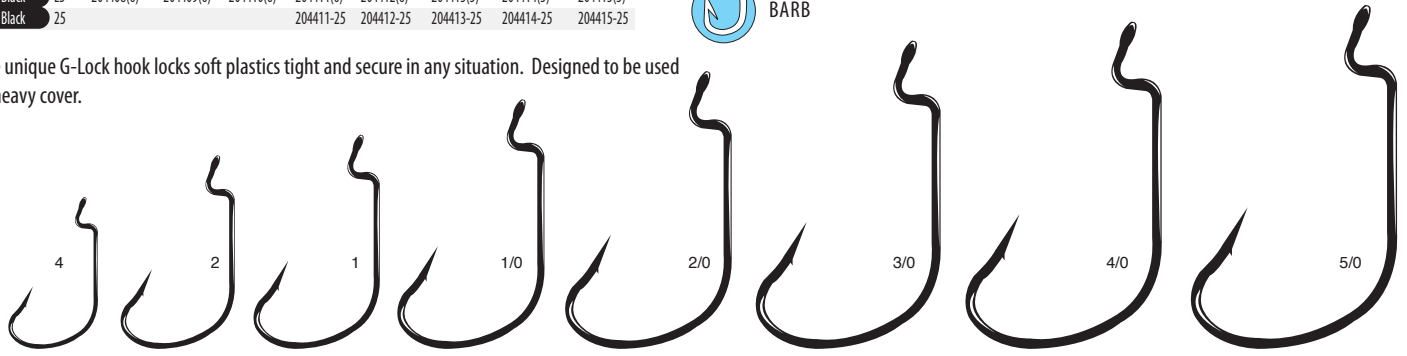

### Worm, Deep Throat Wide Gap

SIZES	1/0	2/0	3/0	4/0	5/0
<b>Ns Black</b> LS	242411(6)	242412(6)	242413(5)	242414(5)	242415(5)
<b>Ns Black</b> 25 pk	242411-25	242412-25	242413-25	242414-25	242415-25

The deeper throat, extended point, and locking offset make this a good hook for soft plastic frog baits.

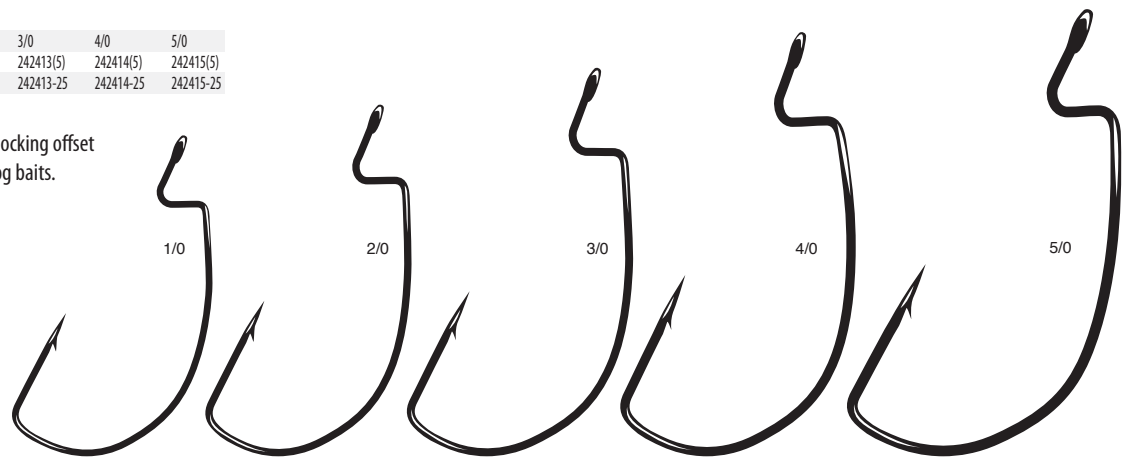
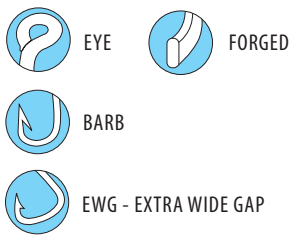

### Worm, Super Deep Throat Wide Gap

SIZES	3/0	4/0	5/0
<b>Ns Black</b> LS	243413(5)	243414(4)	243415(4)
<b>Ns Black</b> 25 pk	243413-25	243414-25	243415-25

Deep Throat design, only heavier wire for "super lines".

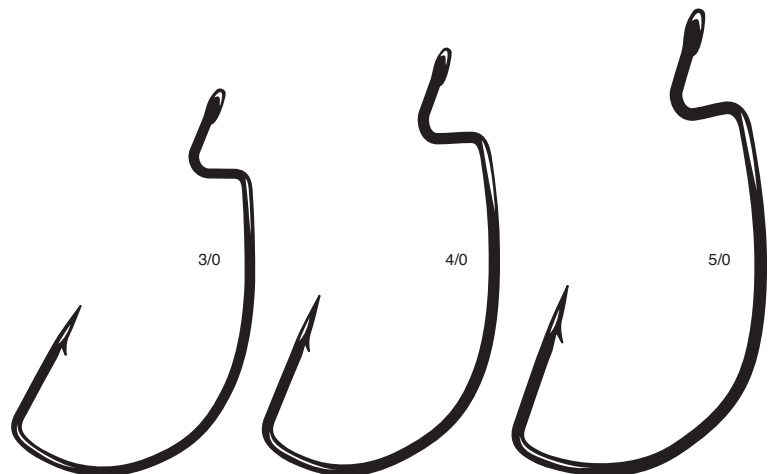

### Worm, Offset Shank, O'Shaughnessy Bend

SIZES	2	1	1/0	2/0	3/0	4/0	5/0
<b>Bronze</b>	LS 07109(6)	07110(6)	07111(6)	07112(6)	07113(5)	07114(5)	07115(5)
	25 07109-25	07110-25	07111-25	07112-25	07113-25	07114-25	07115-25
	100 07109-100	07110-100	07111-100	07112-100	07113-100	07114-100	07115-100
<b>Ns Black</b>	LS 07409(6)	07410(6)	07411(6)	07412(6)	07413(5)	07414(5)	07415(5)
	25 07409-25	07410-25	07411-25	07412-25	07413-25	07414-25	07415-25
	100 07409-100	07410-100	07411-100	07412-100	07413-100	07414-100	07415-100

This is our standard offset shank worm hook. The O'Shaughnessy bend is preferred by our top pro Aaron Martens for a variety of soft plastic rigging.

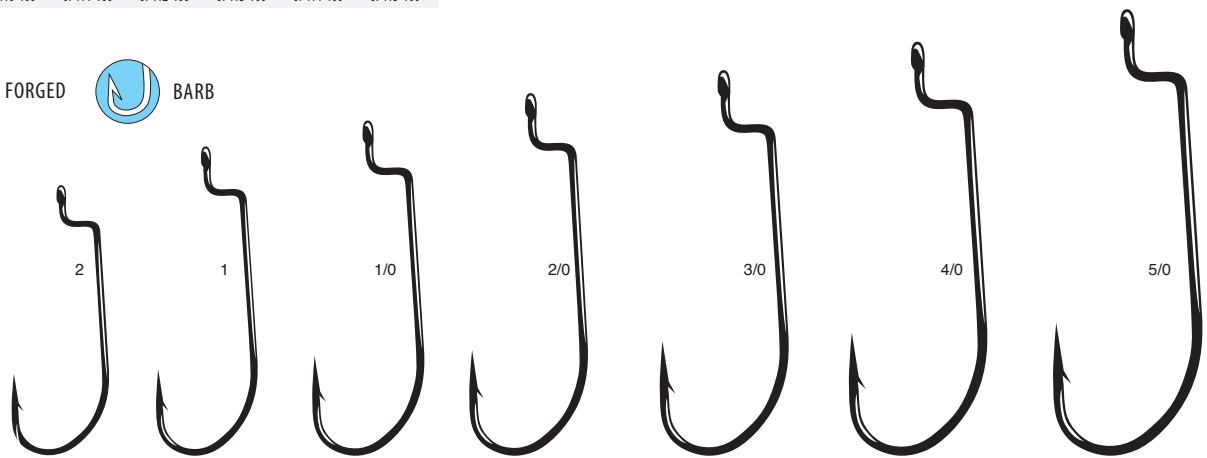

### Worm, Offset Shank, Round Bend

SIZES	1/0	2/0	3/0	4/0	5/0
<b>Bronze</b>	LS 54111(6)	54112(6)	54113(5)	54114(5)	54115(5)
	25 54111-25	54112-25	54113-25	54114-25	54115-25
	100 54111-100	54112-100	54113-100	54114-100	54115-100
<b>Ns Black</b>	LS 54411(6)	54412(6)	54413(5)	54414(5)	54415(5)
	25 54411-25	54412-25	54413-25	54414-25	54415-25
	100 54411-100	54412-100	54413-100	54414-100	54415-100
<b>Red</b>	LS 54311(6)	54312(6)	54313(5)	54314(5)	

Our standard offset shank hook with a round bend to give a larger bite area. Perfect for Carolina rigging, or any time you need a stealthy presentation.

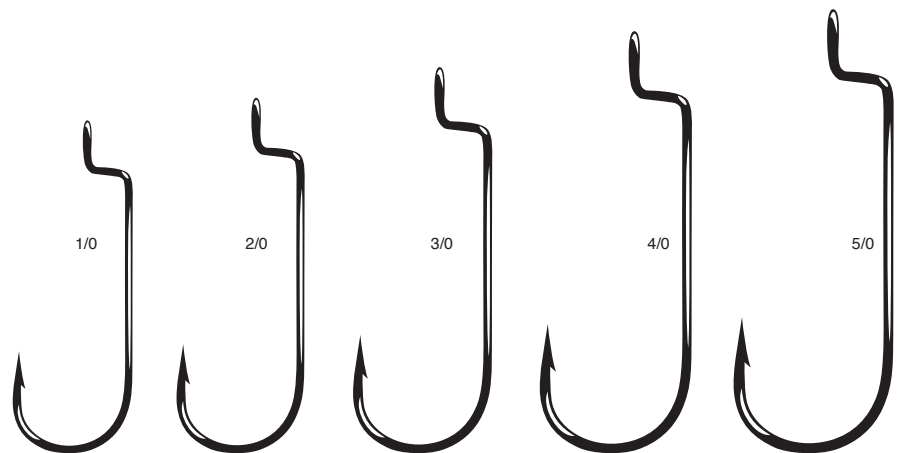

### Worm, Straight Shank, O'Shaughnessy Bend

SIZES	2	1	1/0	2/0	3/0	4/0	5/0
<b>Bronze</b>	LS 01109(6)	01110(6)	01111(6)	01112(6)	01113(5)	01114(5)	01115(5)
	25 01109-25	01110-25	01111-25	01112-25	01113-25	01114-25	01115-25
	100 01109-100	01110-100	01111-100	01112-100	01113-100	01114-100	01115-100
<b>Ns Black</b>	LS 01409(6)	01410(6)	01411(6)	01412(6)	01413(5)	01414(5)	01415(5)
	25 01409-25	01410-25	01411-25	01412-25	01413-25	01414-25	01415-25
	100 01409-100	01410-100	01411-100	01412-100	01413-100	01414-100	01415-100

Our standard straight shank worm hook.



### Worm, Straight Shank, Light Wire

SIZES	2	1	1/0	2/0
<b>Ns Black</b>	LS 49409(6)	49410(6)	49411(6)	49412(6)
	25 49409-25	49410-25	49411-25	49412-25
	100 49409-100	49410-100	49411-100	49412-100

We have all you finesse fishermen covered with this worm hook. The Light Wire excels when the bite gets tough.

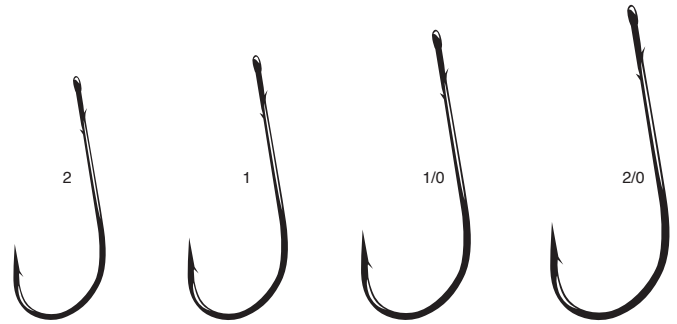

### Worm, Straight Shank Round Bend

SIZES	1/0	2/0	3/0	4/0	5/0
<b>Bronze</b>	LS 48111(6)	48112(6)	48113(5)	48114(5)	
	25 48111-25	48112-25	48113-25	48114-25	
	100 48111-100	48112-100	48113-100	48114-100	
<b>Ns Black</b>	LS 48411(6)	48412(6)	48413(5)	48414(5)	48415(5)
	25 48411-25	48412-25	48413-25	48414-25	48415-25
	100 48411-100	48412-100	48413-100	48414-100	48415-100

Perfect round bend for a wider bite area and superior holding power.

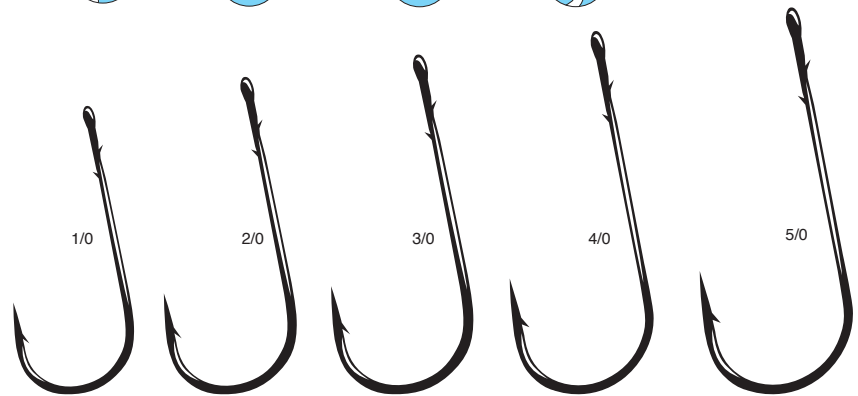

### Worm, Straight Shank, Wire Guard

SIZES	2	1	1/0	2/0	3/0	4/0	5/0
<b>Bronze</b>	LS 65109(4)	65110(4)	65111(4)	65112(4)	65113(3)	65114(3)	65115(3)

Like our popular standard worm hook, only with a weed guard.

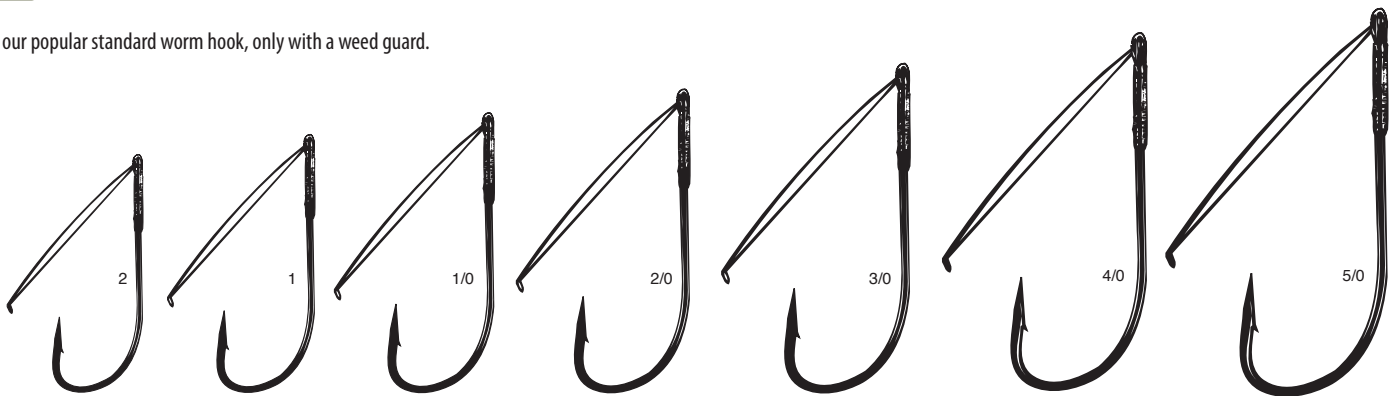





### Jig 30° Extra Wide Gap (EWG)

SIZES	3/0	4/0	5/0	6/0	7/0
NS Black 25	382413-25	382414-25	382415-25	382416-25	382417-25
NS Black 100	382413-100	382414-100	382415-100	382416-100	382417-100

Designed for a wide variety of popular techniques, emerging trends, and do-it-yourself lead jig head pouring. The new 30° hook eye angle compliments the 60° and 90° jig hooks that have been the standard for decades. This extra wide gap (EWG) will handle larger baits too. The points are incredibly sticky-sharp right out of the package. Fits most 30° lead molds

**NEW**

-  EYE
-  FORGED
-  BARB
-  EWG - EXTRA WIDE GAP

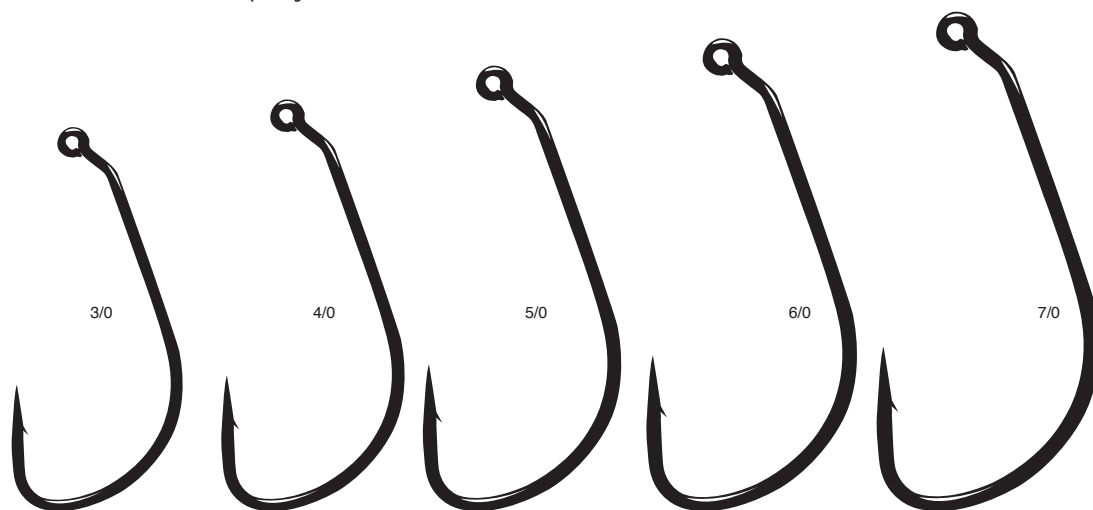

### Jig 60° Extra Wide Gap (EWG)

SIZES	3/0	4/0
NS BLACK 25	201413-25	201414-25
100	201413-100	201414-100

Designed with an extra wide gap for the larger bodied plastics and skirts. The extra wide gap gives you more surface area for better hook ups.

-  EYE
-  FORGED
-  BARB
-  EWG - EXTRA WIDE GAP

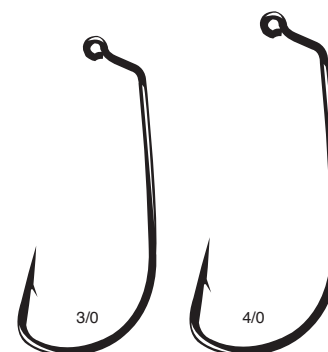

### Jig 60° Flat Eye, Light Wire, Round Bend

SIZES	3/0	4/0	5/0
NS BLACK 25	61413-25	61414-25	61415-25
100	61413-100	61414-100	61415-100

A light wire version for those finesse applications and lighter jigs.

-  EYE
-  FORGED
-  BARB

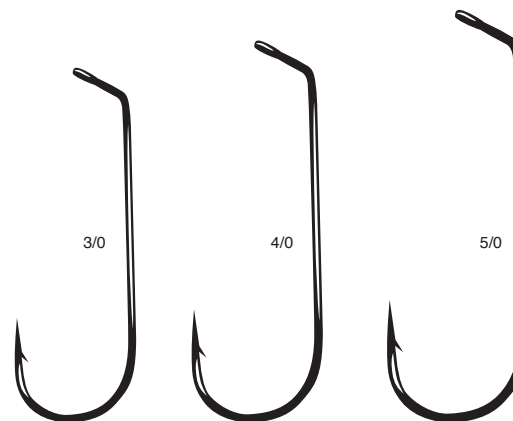

### Jig 60° Flat Eye, Round Bend

SIZES	2/0	3/0	4/0	5/0
NS BLACK 25	59412-25	59413-25	59414-25	59415-25
100	59412-100	59413-100	59414-100	59415-100

A heavy wire hook in a corrosion resistant NS Black finish for use in fresh or saltwater.

-  EYE
-  FORGED
-  BARB

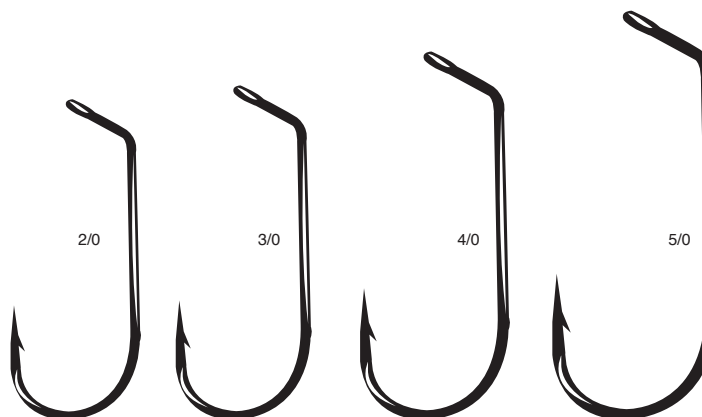

### Jig 60° Round Bend

SIZES	2	1	1/0	2/0	3/0	4/0	5/0
BRONZE	25 29109-25	29110-25	29111-25	29112-25	29113-25	29114-25	29115-25
	100 29109-100	29110-100	29111-100	29112-100	29113-100	29114-100	

Our standard flipping and pitching jig hook. With the advantage of the round bend for a better bite area.

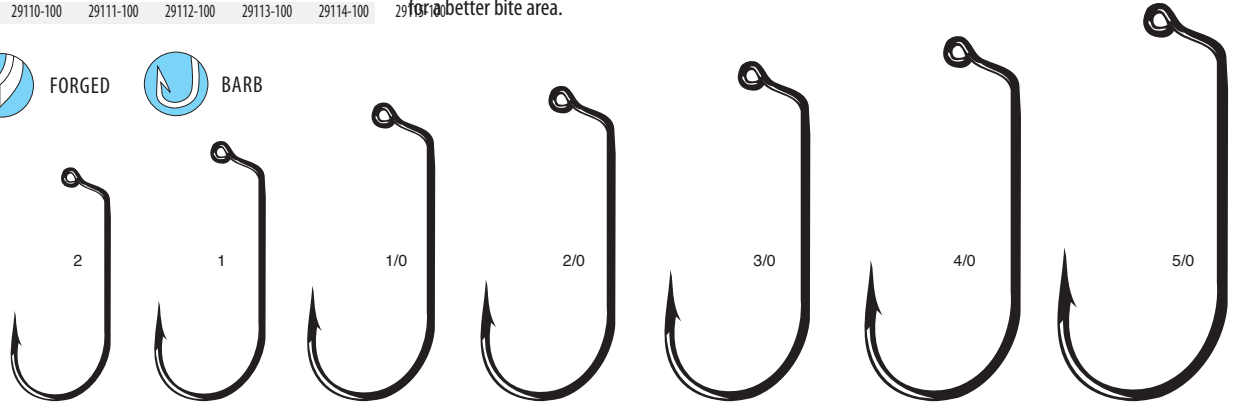

### Jig 90°

SIZES	1	1/0	2/0	3/0	4/0	5/0
BRONZE	25 11110-25	11111-25	11112-25	11113-25	11114-25	11115-25
	100 11110-100	11111-100	11112-100	11113-100	11114-100	11115-100

Our standard 90 degree jig hook, with a traditional O'Shaughnessy bend.

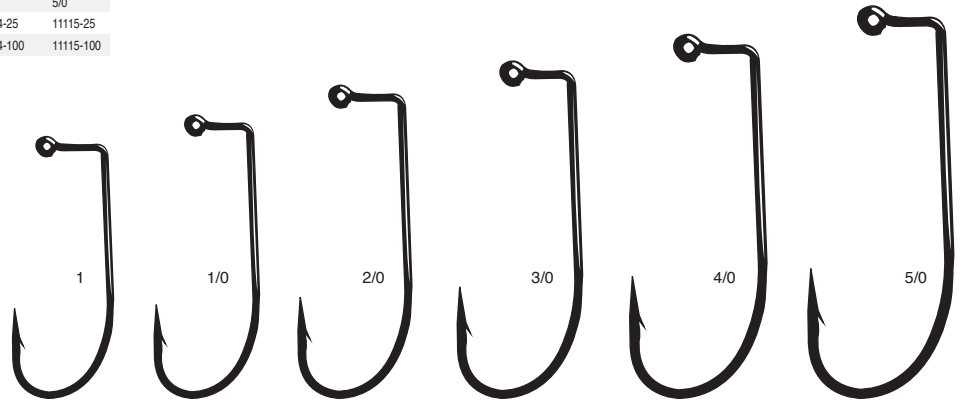

### Jig 90° Heavy Wire, Round Bend

SIZES	2	1	1/0	2/0	3/0	4/0	5/0	6/0	7/0	8/0
NS BLACK	25 60409-25	60410-25	60411-25	60412-25	60413-25	60414-25	60415-25	60416-25	60417- 25	60418- 25
	50								60417- 50	60418- 50
	100 60409-100	60410-100	60411-100	60412-100	60413-100	60414-100	60415-100	60416-100		

Our most popular jig hook, and most versatile. Made with a heavy wire and is saltwater ready.

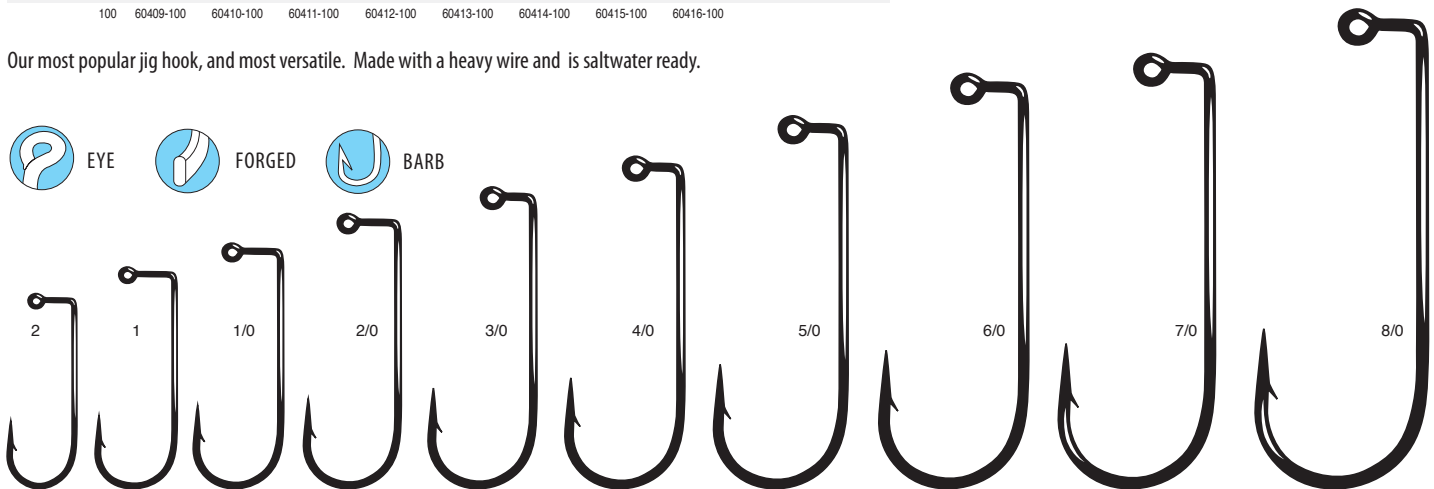

### Jig 90° 2x Strong, Round Bend

SIZES	1	1/0
NS BLACK	25 255410-25 255411-25	100 255410-100 255411-100

A heavier wire version of the popular 604 series jig hook. This hook was designed for Salmon and Steelhead jigs and is very stout for big fish in big water.

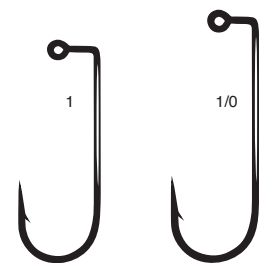

### Jig 900 Round Bend

SIZES	2	1	1/0	2/0	3/0	4/0	5/0
NS Black	25 11409-25	11410-25	11411-25	11412-25	11413-25	11414-25	11415-25
	100 11409-100	11410-100	11411-100	11412-100	11413-100	11414-100	11415-100

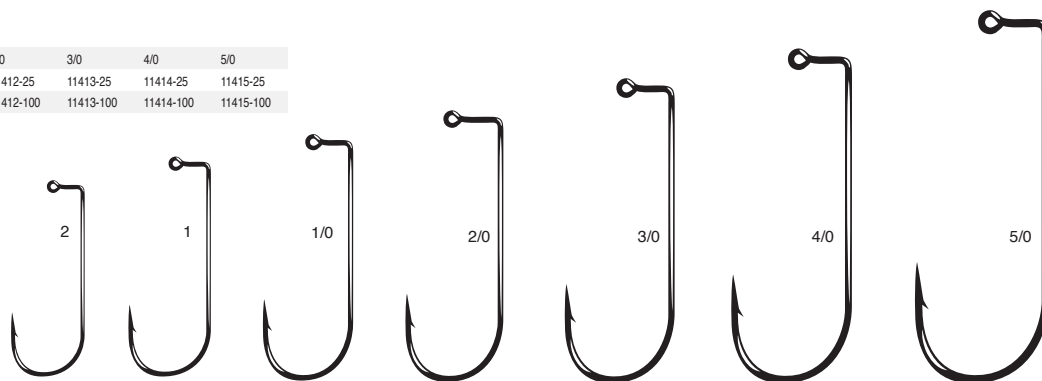
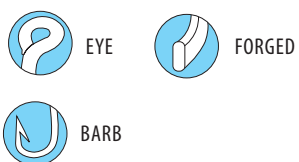

## Freshwater Hooks - ICE FISHING SERIES

**Micro V Gap •**  
Natural & Man Made Baits  
10 pk: Color: NSB

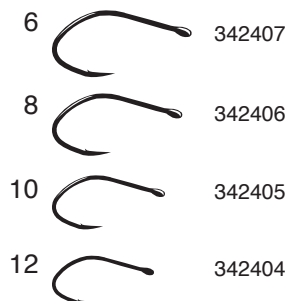

**Micro Perfect Gap •**  
Minnow and Soft Plastics  
10 pk: Color: NSB

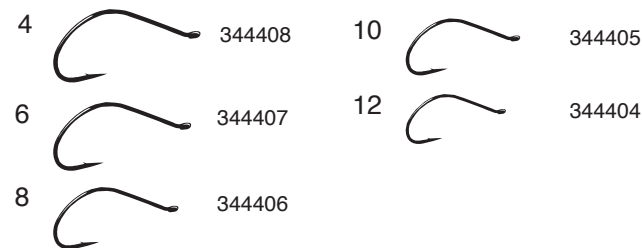

**Micro Wide Gap •**  
Minnow and Soft Plastics  
10 pk: Color: NSB

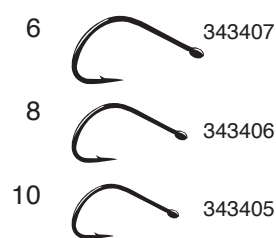

### Gamakatsu Micro Gap hooks

Offering sport fisherman the ultimate in design, the finest quality forged steel and unparalleled workmanship. Originally designed for finesse presentations for ice fishing, the Micro Gap selections are perfectly suited to many fly tying techniques as well. The fine wire design penetrated with less pressure, lessening tissue damage allowing for easier catch and release fisheries. All Micro Gap hooks are finished in NS black.

*The **Micro Perfect Gap** hook has an up-eye design for easy snelling and optimal gap for minnows or small plastics.*

*The **Micro Wide Gap** features a straight hook eye for minnow and soft plastics.*

*The **Micro V Gap** also features a straight hook eye, but adds a deep V bend to improve retention.*

### G-Carp Super Hook •

Natural & Man Made Baits  
10 pk: Color: NSC

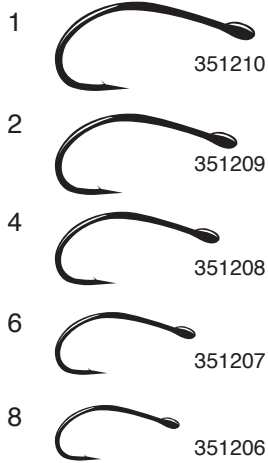

### G-Carp Specialist RX •

Natural & Man Made Baits  
10 pk: Color: NSC

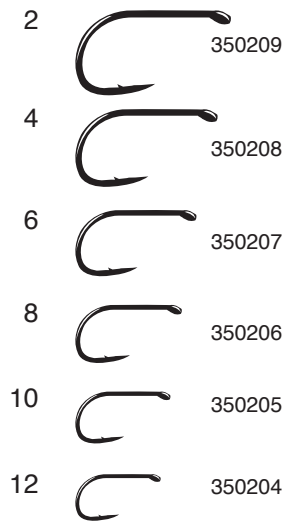

### G-Carp Specialist R •

Natural & Man Made Baits  
10 pk: Color: NSC

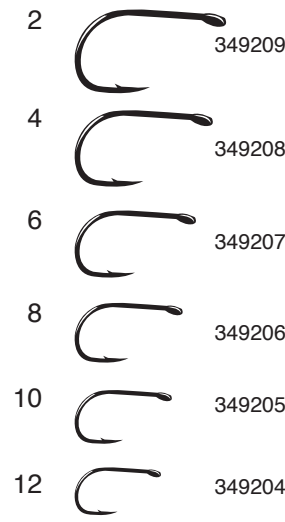

### G-Carp Hump Back •

Natural & Man Made Baits  
10 pk: Color: NSC

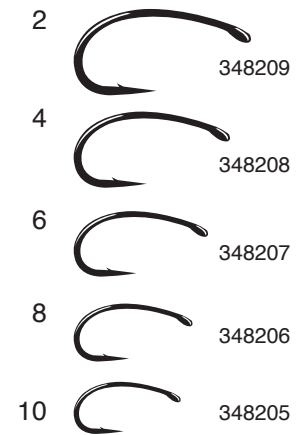

## Gamakatsu G-Carp Hooks

We've dialed in our carp hook selection to make it the best selling line of hooks in many European countries. There's two simple points that are critical for carp – hide the hook and hold the bait. That's why we've carefully shaped all the new G Carp hooks to hide perfectly concealed within every type of bait. Furthermore, we've included unique micro barbs to grab onto soft dough balls and putty baits and hold them in place. All G Carp hooks are forged for strength and feature the innovative **Nano Smooth Coat** for fast penetration.

## Big Cat Circle

SIZES	1/0	2/0	3/0	4/0	5/0	6/0	7/0	8/0	10/0	12/0	
Ns BLACK	LS	356411(6)	356412(6)	356413(6)	356414(6)	356415(6)	356416(6)	356417(5)	356418(5)	356420(3)	356422(3)

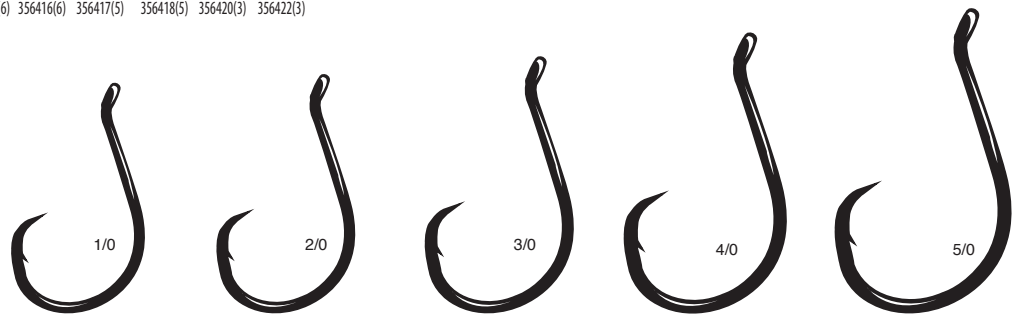
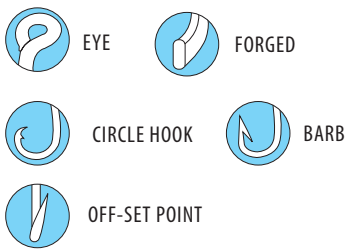

There's a new dog in the fight for cat fishermen. The new Gamakatsu Big Cat Circle Hook is designed specifically for tough-lipped, thick-mouthed catfish. The offset, precision sharpened hook point penetrates quickly even with light hook sets. It features an "up eye" so snelling is fast and easy. 2X strong forged steel is plenty of power for the biggest Blues -- even Wels and Mekong cats if you ever get the opportunity. It's the right hook for the job because it never stops working

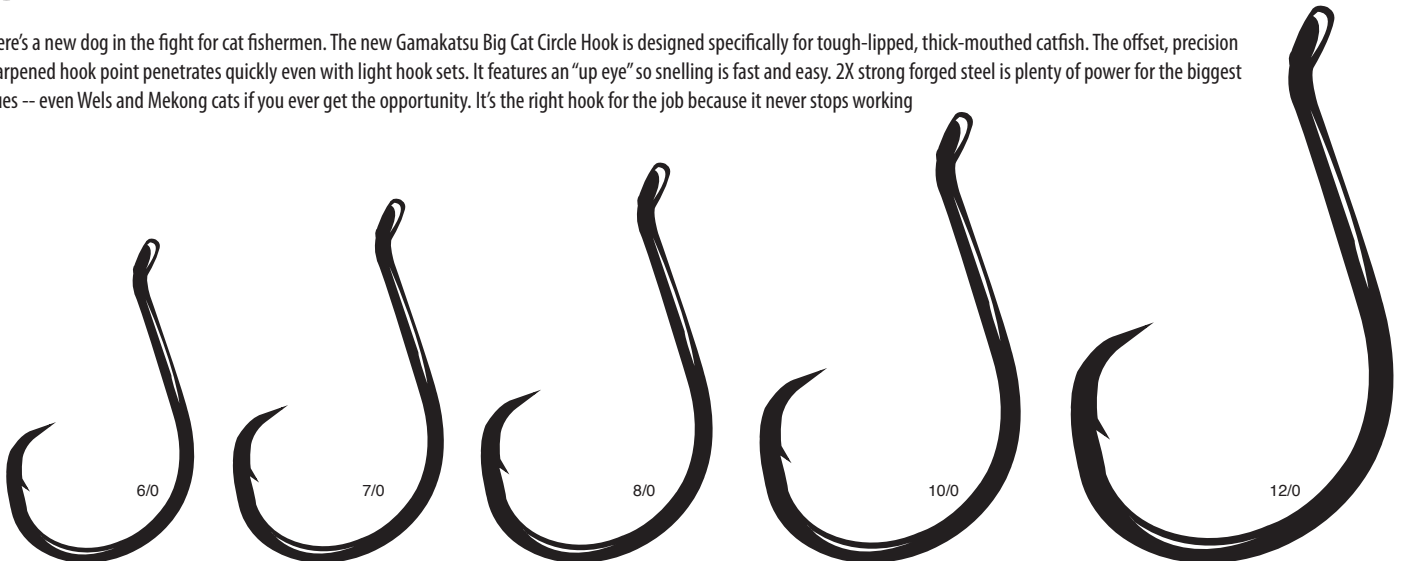





Saltwater Hooks

Gamakatsu®

### Live Bait with Solid Ring

SIZES	2	1	1/0	2/0	3/0	4/0
<b>No Black</b>	LS 18409R(7)	18410R(6)	18411R(6)	18412R(5)	18413R(5)	18414R(4)
<b>No Black</b>	2S 18409R-2S	18410R-2S	18411R-2S	18412R-2S	18413R-2S	18414R-2S

Our standard Live Bait hook with a solid one piece ring for a natural presentation. Much smoother than any welded ringed hook, these are designed for larger baits and heavier lines.

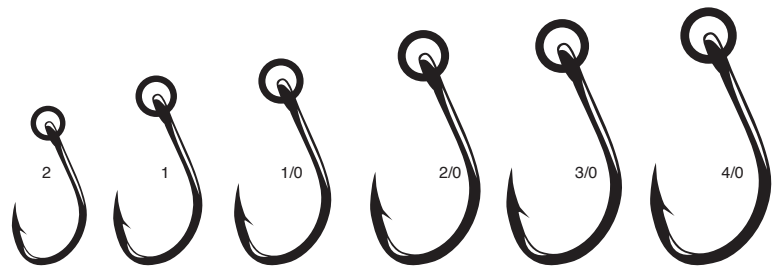

### Live Bait Light Wire with Solid Ring

SIZES	6	4	2	1
<b>No Black</b>	LS 220407R(7)	220408R(7)	220409R(7)	220410R(6)
<b>No Black</b>	2S 220407R-2S	220408R-2S	220409R-2S	220410R-2S

Super smooth solid one piece ring attached to the Light Wire Live Bait hook. The perfect hook for small live baits and delicate presentations.

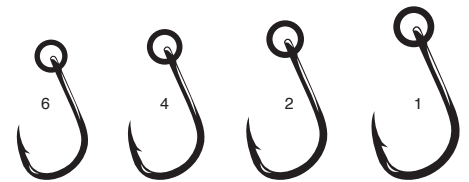

### Live Bait Heavy Duty with Solid Ring

SIZES	1/0	2/0	3/0	4/0	5/0	6/0
<b>No Black</b>	LS 00411R(5)	00412R(5)	00413R(5)	00414R(4)	00415R(4)	00416R(4)
<b>No Black</b>	2S 00411R-2S	00412R-2S	00413R-2S	00414R-2S	00415R-2S	00416R-2S

A heavier Live Bait hook with a ring. Designed for bigger baits and heavier lines.

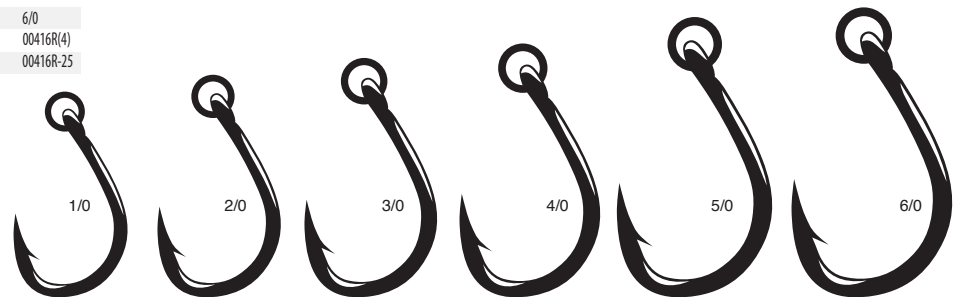

### Live Bait Light Wire

SIZES	6	4	2	1	1/0	2/0	3/0
<b>No Black</b>	LS 220407(8)	220408(7)	220409(7)	220410(6)	220411(6)	220412(5)	220413(5)

Designed with a light wire and reduced weight for a more natural presentation. Forged for strength.

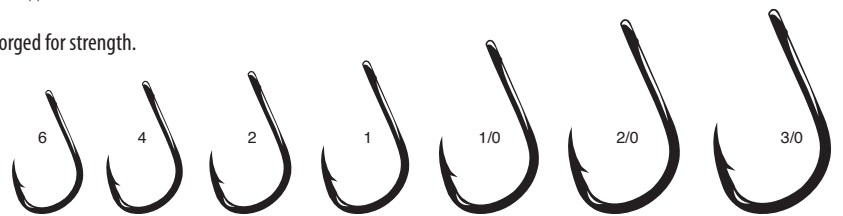
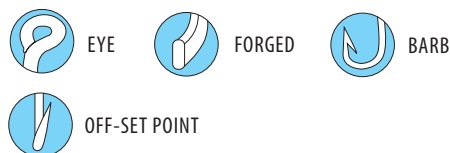

### Live Bait

SIZES	12	10	8	6	4	2	1	1/0	2/0	3/0	4/0	5/0	6/0	7/0	8/0	9/0	
<b>Ns Black</b>	LS 18404(9)	18405(9)	18406(8)	18407(8)	18408(7)	18409(7)	18410(6)	18411(6)	18412(5)	18413(4)	18414(4)	18415(4)	18416(3)	18417(3)	18418(2)	18419(2)	
	25	18406-25	18407-25	18408-25	18409-25	18410-25	18411-25	18412-25	18413-25	18414-25	18415-25	18416-25	18417-25	18418-25	18419-25		
	Bulk	18404-100	18405-100	18406-100	18407-100	18408-100	18409-100	18410-100	18411-100	18412-100	18413-100	18414-100	18415-100	18416-100	18417-100	18418-50	18419-50

Our most versatile Live Bait Hook. Sticky sharp, super strong and designed to handle tough saltwater fish.

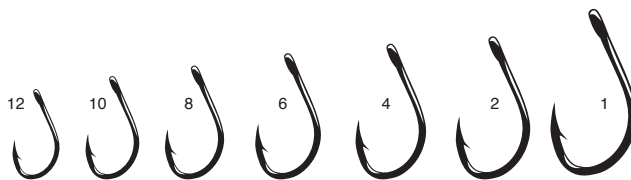

### Live Bait Heavy Duty

SIZES	1/0	2/0	3/0	4/0	5/0	6/0	7/0	8/0	9/0	10/0	11/0	12/0	
<b>Ns Black</b>	LS 00411(8)	00412(7)	00413(7)	00414(6)	00415(6)	00416(5)	00417(5)	00418(4)	00419(4)	00420(3)	00421(3)	00422(2)	
	25	00411-25	00412-25	00413-25	00414-25	00415-25	00416-25	00417-25	00418-25	00419-25	00420-25	00421-25	00422-25
	Bulk	00411-100	00412-100	00413-100	00414-100	00415-100	00416-100	00417-100	00418-50	00419-50	00420-50	00421-50	00422-40

Heavy wire and forged for extra strength, this hook is the go to hook for big fish on big baits.

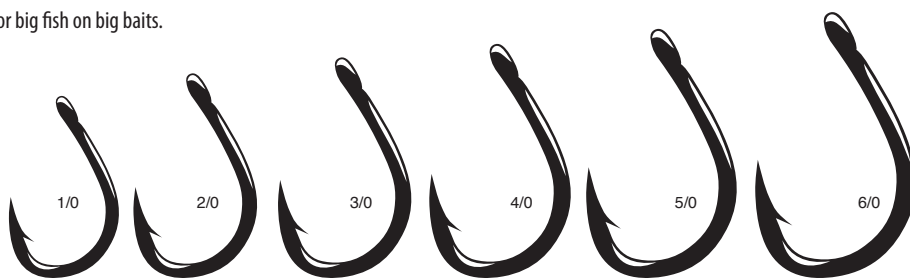

### Live Bait Heavy Duty Circle, **TOURNAMENT LEGAL**

SIZES	5/0	6/0	7/0	8/0	9/0	10/0	11/0	12/0
Ns Black	LS 210415(6)	210416(5)	210417(5)	210418(4)	210419(3)	210420(3)	210421(2)	210422(2)

Same design as the Live Bait Heavy Duty, but with a non-offset circle hook point. The perfect hook for giant fish on big chunk baits.

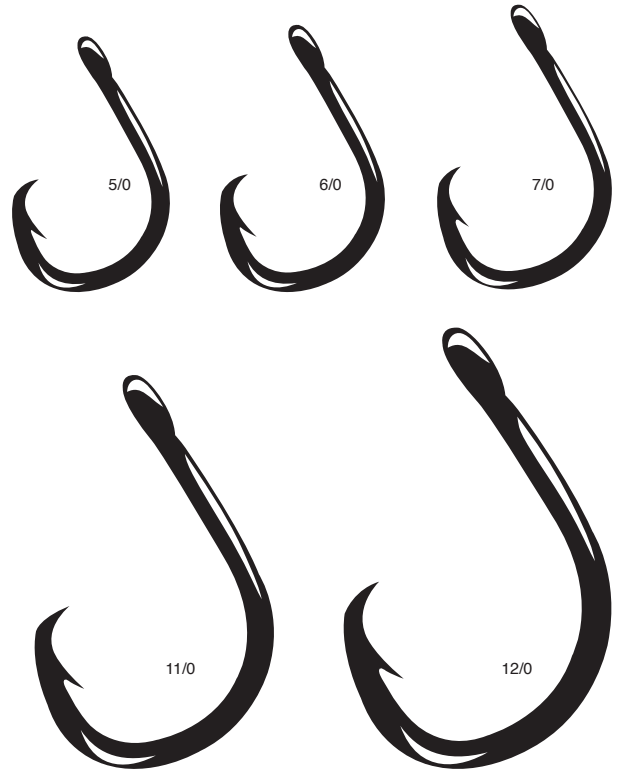

### Nautilus Light

Sizes	2	1	1/0	2/0	3/0	4/0	5/0	6/0	7/0	8/0
Ns Black	332409(8)	332410(8)	332411(7)	332412(6)	332413(5)	332414(5)	332415(4)	332416(3)	332417(3)	332418(3)

A light wire hook that was developed for fishing fragile live baits. Produced from forged high carbon steel, it features a straight eye and offset point for superior hooking performance. The unique circle hook shape is designed to hook and hold which is precisely why more saltwater anglers make Gamakatsu their hook-of-choice. Superior strength, sharpness and design add-up to make a sure bet for live bait and chunk bait anglers from coast-to-coast.

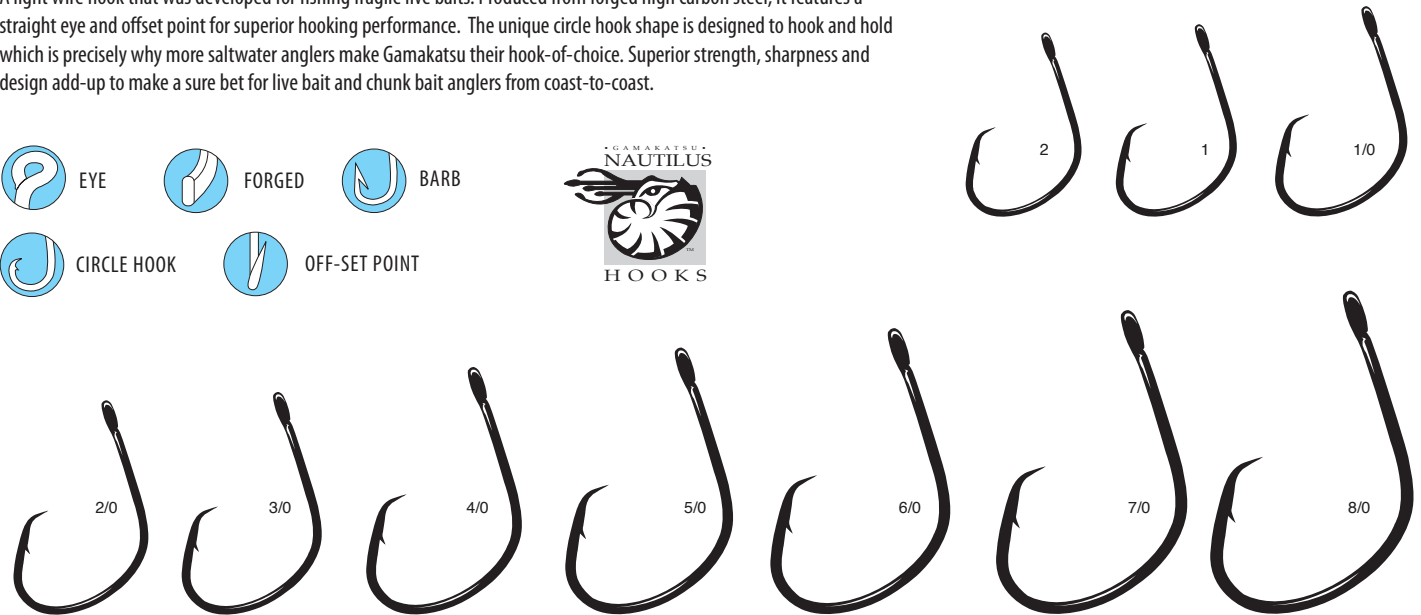
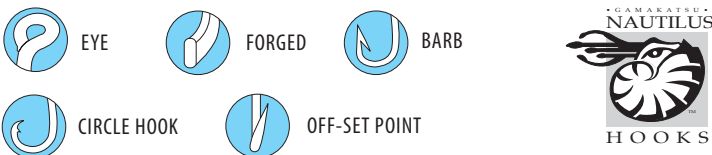

### Nautilus Circle

SIZES		1	1/0	2/0	3/0	4/0	5/0	6/0
LS	42410(8)	42411(7)	42412(7)	42413(6)	42414(6)	42415(5)	42416(5)	
NS Black	25	42410-25	42411-25	42412-25	42413-25	42414-25	42415-25	42416-25

One of the meanest circle hook designs around. The Nautilus grabs its prey and simply doesn't let go. This hook can be used for live bait or chunk bait presentations and has proven its strength many times.

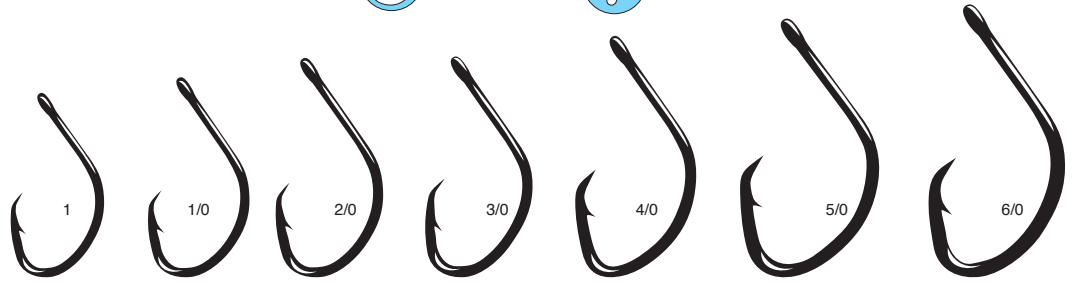
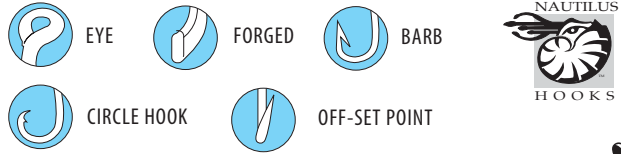

### Nautilus Circle With Solid Ring

The most popular circle hook with solid ring, grabs its prey and simply does not let go.

SIZES		2/0	3/0	4/0	5/0	6/0
LS	42412R(5)	42413R(5)	42414R(4)	42415R(4)	42416R(4)	
NS Black	25	42412R-25	42413R-25	42414R-25	42415R-25	42416R-25

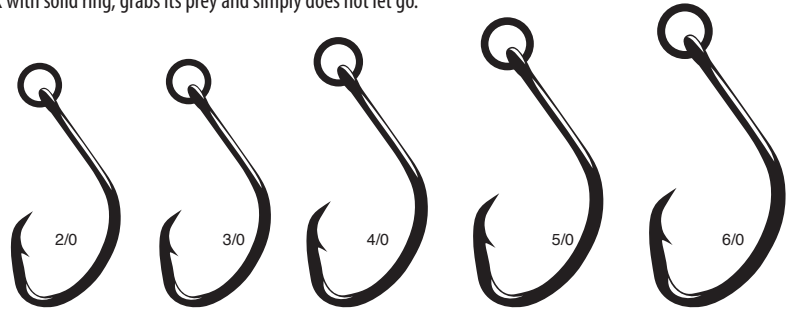
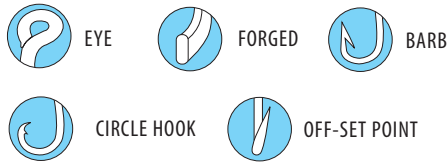

### Nautilus Circle Heavy Duty NEW

SIZES		2/0	3/0	4/0	5/0	6/0
LS	377412(7)	377413(6)	377414(6)	377415(5)	377416(5)	
NS Black	25	377412-25	377413-25	377414-25	377415-25	377416-25

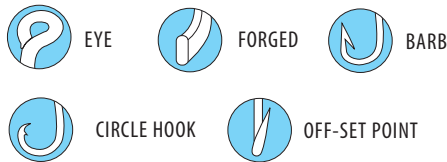

To go ringed or not to go ringed... that is the question! And we've got the answer, whichever you prefer. The standard Nautilus HD hook features a ringless eye and 30% heavier wire than the regular Nautilus. (Roughly 50% less heavy than the Super Nautilus.) Whether you simply prefer the stealthiness of having less metal in the water or just have great confidence in the loop knots you've tied for years, the standard Nautilus HD hook will do the trick. You can feel the superiority by just holding it in your hand. Be careful when checking the sharpness; it doesn't differentiate between fish or fingers.

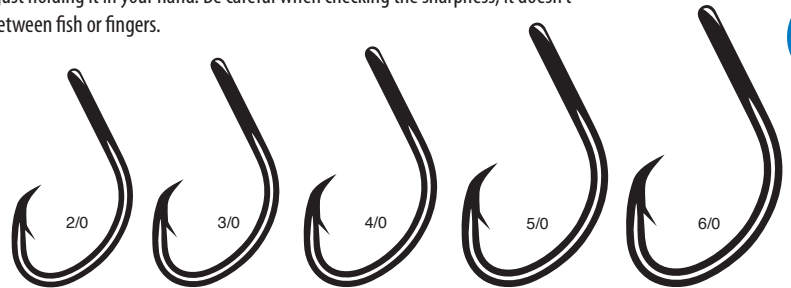

### Nautilus Circle Heavy Duty With Solid Ring NEW

SIZES		2/0	3/0	4/0	5/0	6/0
LS	377412R(5)	377413R(5)	377414R(4)	377415R(4)	377416R(4)	
NS Black	25	377412R-25	377413R-25	377414R-25	377415R-25	377416R-25

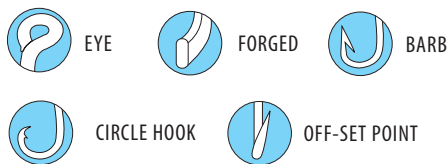



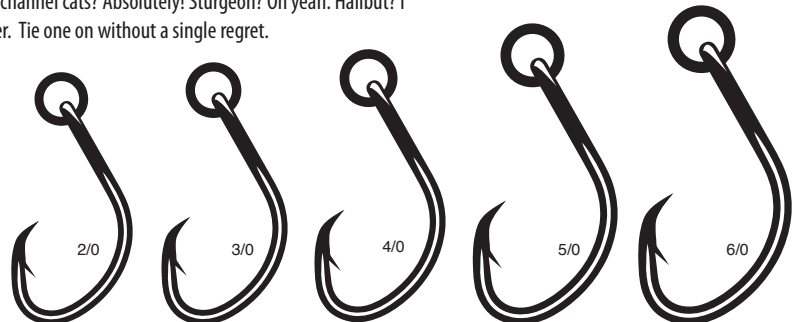

The new solid, one-piece ringed version of the Nautilus HD hook allows live bait to swim more freely, keeping it alive longer and enticing more prey to engulf its goodness. At that point, the finest high carbon steel penetrates deep and locks in tight for the battle ahead. The Ringed Nautilus HD features 30% heavier wire than the regular Nautilus and 50% less than the Super Nautilus. While its core credibility has been proven in the southern California Bluefin Tuna fisheries, there is absolute evidence of its prowess in many other heavyweight bouts with monster gamefish worldwide. Therefore, you owe it to yourself to try the Nautilus HD Ringed for all live bait techniques and bottomfish applications. Big blues and channel cats? Absolutely! Sturgeon? Oh yeah. Halibut? It's a no-brainer. Tie one on without a single regret.



### Super Nautilus Circle

SIZES	4/0	5/0	6/0	7/0	8/0	10/0	11/0
NS Black	LS 272414(6)	272415(6)	272416(6)	272417(5)	272418(4)	272420(3)	272421(2)

Made of high carbon steel, it's a heavier wire hook than our standard "Nautilus" and forged for quality and added strength. This hook has become a favorite amongst demanding saltwater fishermen.

-  EYE
-  FORGED
-  BARB
-  CIRCLE HOOK
-  OFF-SET POINT



### Octopus Circle, 4x Strong, Straight Eye

SIZES	1/0	2/0	3/0	4/0	5/0	6/0	7/0	8/0
NS Black	LS 209411(6)	209412(6)	209413(6)	209414(6)	209415(6)	209416(6)	209417(6)	209418(6)
NS Black	25				209415-25	209416-25	209417-25	209418-25

This hook is designed for heavier lines and bigger fish. The offset point makes it a good choice for many chunk bait situations.

-  EYE
-  FORGED
-  BARB
-  CIRCLE HOOK
-  OFF-SET POINT

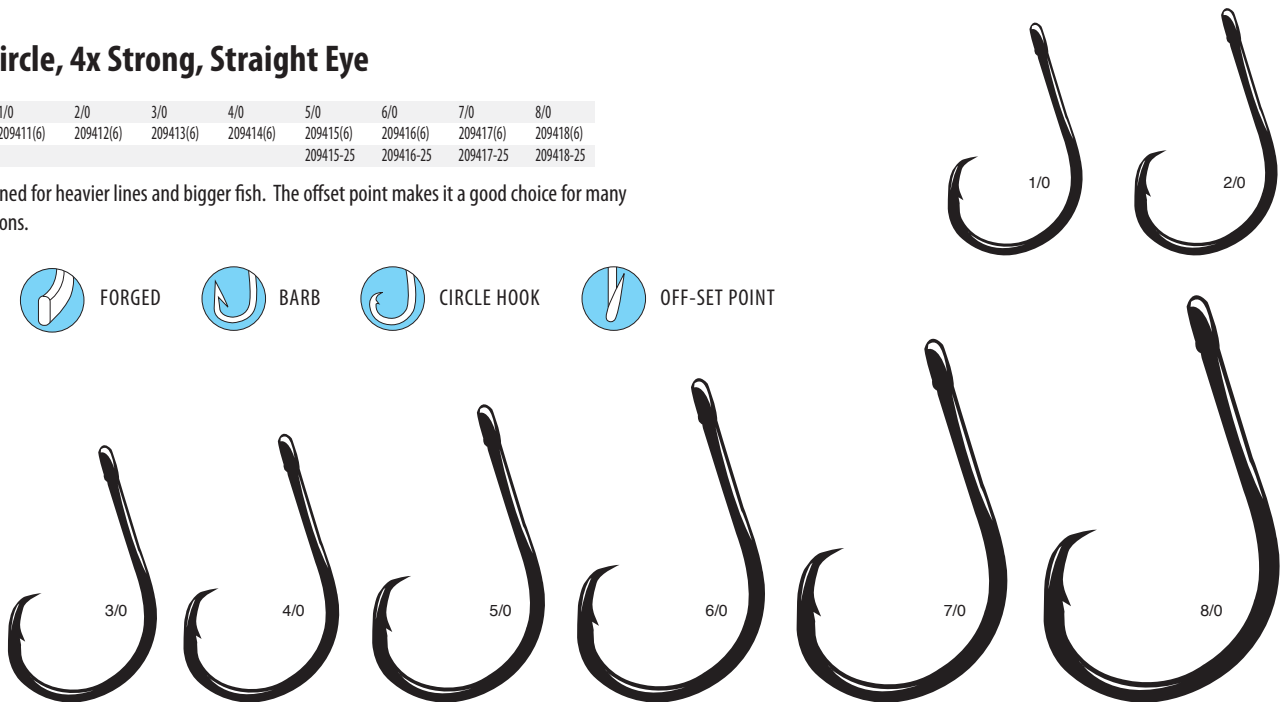

## Octopus Circle, 4x Strong, Straight Eye (Inline-point) **TOURNAMENT LEGAL**

To comply with new angling regulations in the Gulf of Mexico, we've redesigned and reinforced our most popular circle hook. The new 4X Strong Circle Hook is built for the toughest battles in the deep sea. The straight eye, NS black finish and inline point (not offset) complies with the new rules, but doesn't reduce the hook's effectiveness. This is the new "go-to" hook charter captains and professional anglers are using for deep dropping and reef and wreck fishing. Heavy up your rods, reels and line, because the 4X Strong Circle Hook will never give up when it comes to pulling snapper and monster grouper out of their fortified hangouts.

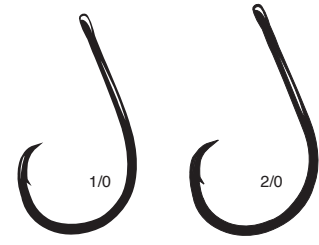

SIZES	1/0	2/0	3/0	4/0	5/0	6/0	7/0	8/0	9/0	10/0
NS Black	LS 360411(6)	360412(6)	360413(6)	360414(6)	360415(6)	360416(6)	360417(6)	360418(6)	360419(5)	360420(5)

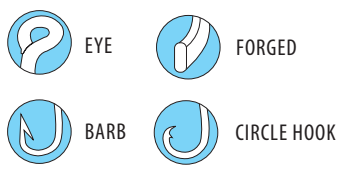

## Double Assist 520

SIZES	2/0	4/0
Tin	LS 368512(2)	368514(2)



New vertical jigging techniques like "slow pitch" and "shore" jigging are gaining attention at a rapid rate. Many of the top anglers are using two assist hooks instead of one. Think about it, you're doubling your odds of hooking short or soft biters. Gamakatsu's Double Assist hooks are designed for fast and easy replacement on all types of butterfly, flat fall and "iron" jigs. The 6" super strong braided line loop can be adjusted to position each hook at the exact desired length, even or offset. Red heat shrink tubing on the hook shank is an added attractor and prevents chafing and bite-offs. And there's no concern of knots coming undone. Hooks are forged and barbed. Available in 2/0 and 4/0 in packages of two.

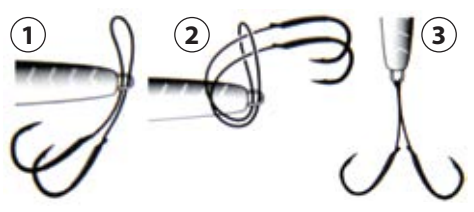

### Assist 510

SIZES	1	1/0	2/0	3/0	4/0
Tin	LS 219510(4)	219511(4)	219512(3)	219513(3)	219514(2)



FORGED



BARB

The Assist 510 features a curved point with an outbarb that will not nick the leader if it were to catch the line. No vertical jig should be fished without one. The super strong braided line loop easily attaches to any jig. One of the first Assist hooks introduced in this country and still the best designed.

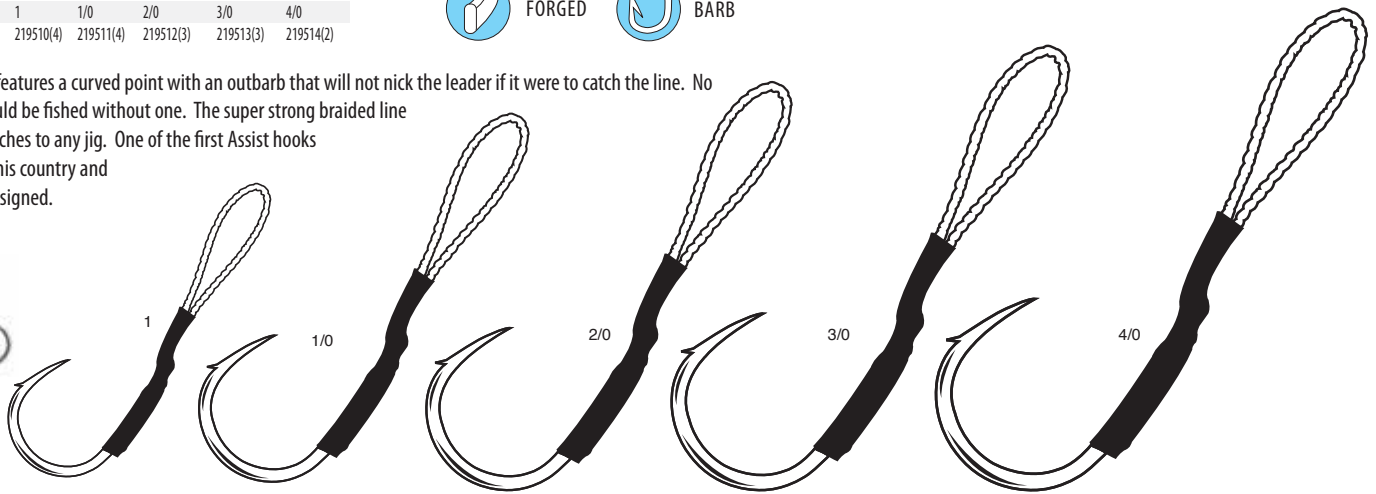

### Tuned Assist Hd

SIZES	8/0	10/0
Tin	LS 270518(1)	270520(1)

This new addition to our Assist hook line up is for deep jigging and big fish. These heavy duty assist hooks come in two sizes, 8/0 and 10/0 with 270lb braided line. Both feature a solid ring at the top for easy and secure attachment to the jig.

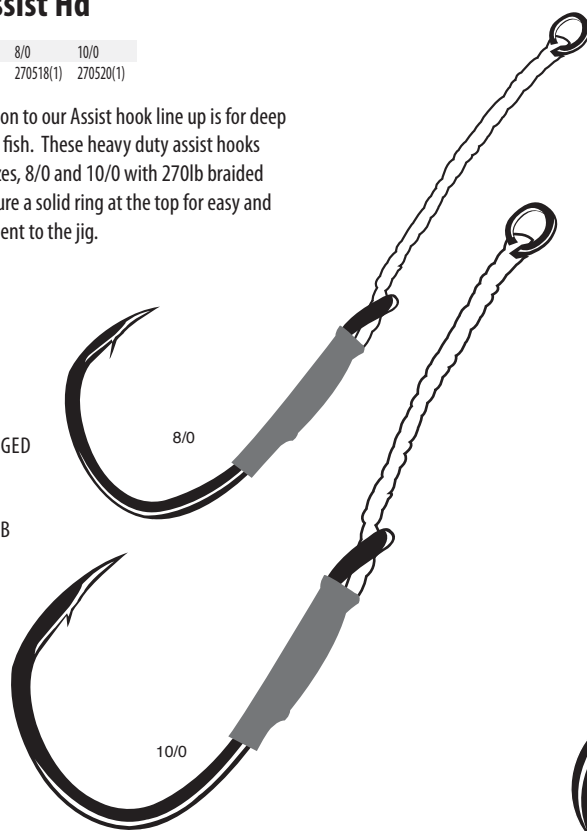
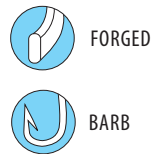

### Magnum Assist

SIZES	8/0	10/0
NS Black	LS 256418(2)	256420(2)

Featuring a 200lb. braided line loop and our 4x Strong Octopus hook in 8/0 and 10/0, the Magnum Assist is perfect for larger Halibut jigs and deep drop speed jigs.

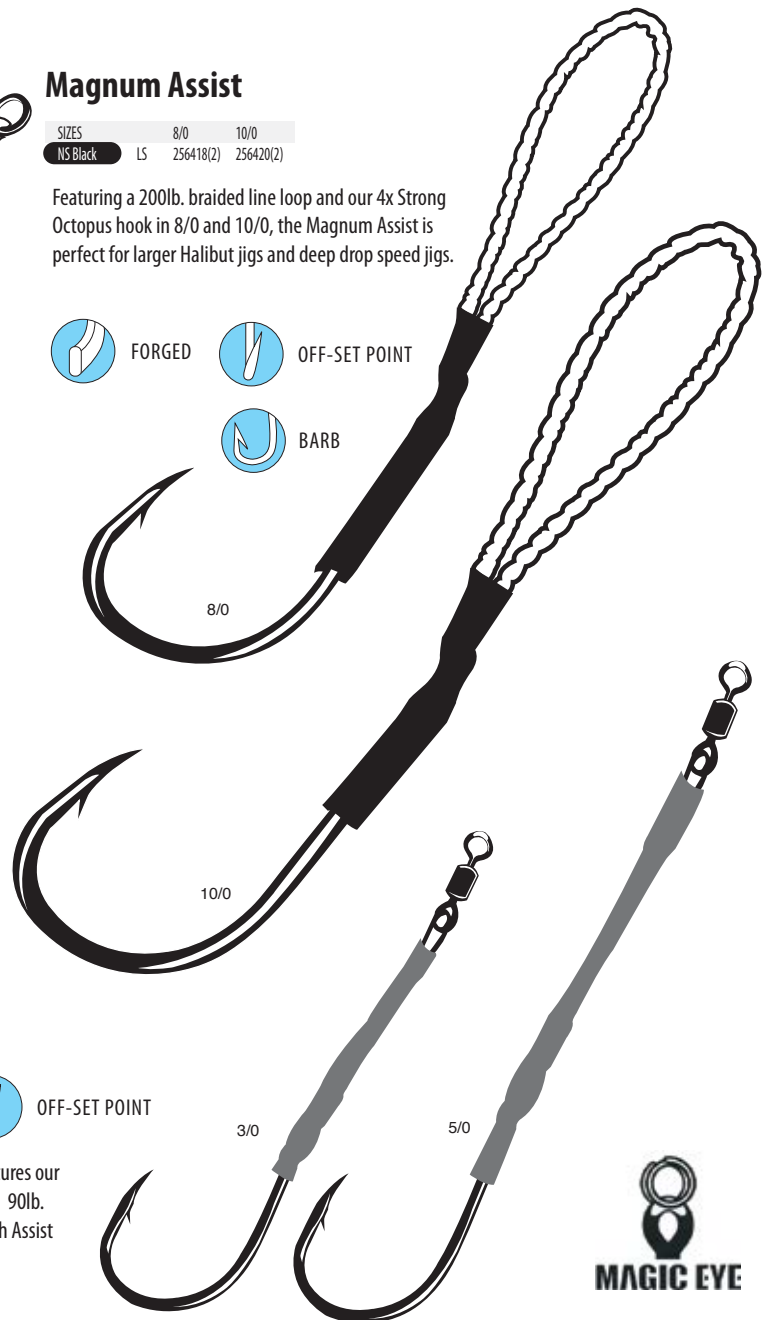
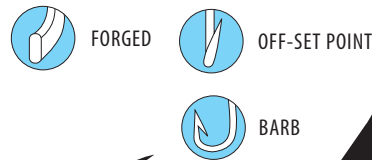

### Steel Assist With Magic Eye Swivel

SIZES	3/0	5/0
NS Black	LS 269413(2)	269415(2)



FORGED



BARB



OFF-SET POINT

Don't sacrifice your favorite jig to toothy fish like Wahoo and Mackerel. This Assist Hook features our Magic Eye Swivel for fast and easy attachment to the split ring on any jig. No pliers needed. 90lb. wire and a 4x Strong Straight Eye Octopus hook make this the ultimate big game, toothy fish Assist hook. Comes in a 3/0 short version and 5/0 long version for bigger jigs.





### Assist 520, Ringed

SIZES	3/0	4/0	5/0	6/0
Tin	LS 380513(2)	380514(2)	380515(2)	380516(2)



FORGED



BARB

NEW

In our relentless pursuit of perfection, and simplicity, we added a welded ring to our tournament-winning Assist 520 hook. The constant jigging motion is tough on looped monofilament, fluorocarbon, and braid. We took every nuance of uncertainty out of the technique by adding a welded ring. Not only is it nearly unbreakable, but the ring is also much faster and easier to connect to the jig eye using a split ring.

Rigged with 160 lb. (3/0, 4/0) and 220 lb. (5/0, 6/0) braided line.



### Assist 620 Heavy Duty with Solid Ring

SIZES	5/0	6/0	7/0	8/0
Hypershield	LS 381515(1)	381516(1)	381517(1)	381518(1)



FORGED



BARB

NEW



When you pursue the fish of a lifetime, chances are it's going to be really, really big; and have really, really, really sharp teeth. Take no chances! We call these "heavy-duty" Assist 620 hooks but they'll live up to tenacious-duty, gargantuan-duty or leviathan-duty equally as well. There's nothing stronger. One-piece solid rings make connections easy.

Rigged with 270 lb. (5/0, 6/0) and 400 lb. (7/0, 8/0) braided line.



**Big Eye Circle** **TOURNAMENT LEGAL**

Our standard circle hook designed with a big eye for rigging heavier monos or dacrons. Also good for chunking for tuna and halibut.

SIZES	6/0	7/0	8/0	9/0	10/0	11/0	12/0
TIN	LS 12050(5)	12051(4)	12052(4)	12053(3)	12054(3)	12055(2)	12056(2)



-  EYE
-  FORGED
-  BARB
-  CIRCLE HOOK



**Single 510**

SIZES	1	1/0	2/0	3/0	4/0
Tin	LS 232510(6)	232511(5)	232512(5)	232513(4)	232514(4)
Tin	25 pk 232510-25	232511-25	232512-25	232513-25	232514-25

Single 510 has an open eye so it can be used as a replacement hook for spoons, plugs and other lures. It features a sticky sharp curved point with an outbarb for fast penetration and secure hook ups.

-  OPEN EYE
-  FORGED
-  BARB



## O'Shaughnessy

SIZES	1/0	2/0	3/0	4/0	5/0	6/0	7/0	8/0	9/0	10/0
Tin	13011(6)	13012(5)	13013(5)	13014(4)	13015(4)	13016(3)	13017(3)	13018(2)	13019(2)	13020(2)
Tin	13011-100	13012-100	13013-100	13014-100	13015-100	13016-50	13017-50	13018-30	13019-30	13020-20

Traditional saltwater style for trolling or general purpose bait fishing.

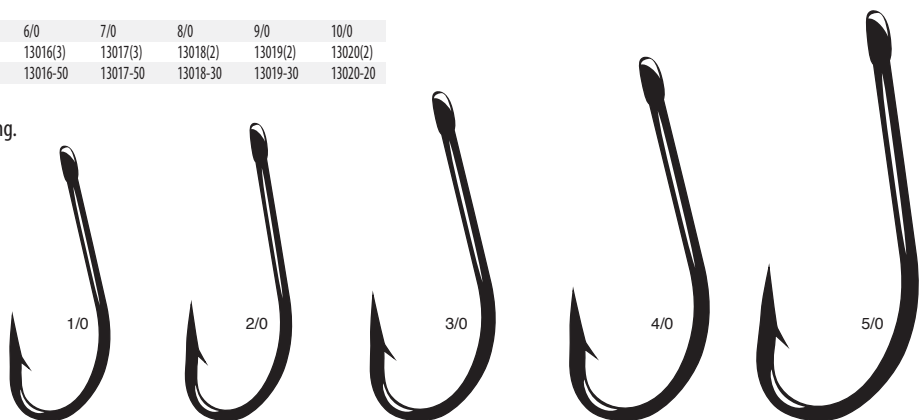

## Tuned Tuna Plug with Ring

**NEW**



SIZES	10/0	11/0	12/0
TIN	LS 379520(2)	379521(2)	379522(2)

Angler preferences can differ on whether to use a ringed hooked or not. And that's just fine with us because we manufacture both. Our Tuned Tuna Plug hook is now available with a welded ring. The ring provides more freedom for the hook(s) to swing unencumbered. Anglers have also found success using the ringed Tuned Tuna Plug hook for stiff rigs, thus eliminating the need for a shackle. Without reservation, they're ready for battle.



### Tuned Tuna With Welded Eye

SIZES	8/0	9/0	10/0	11/0
TIN	LS 369018(3)	369019(3)	369020(2)	369021(2)

A great hook for Stiff Rigs and other trolling applications. The forged needle point helps ensure a solid hook set. New welded eye will not open or flex.

-  WELDED EYE
-  FORGED
-  BARB

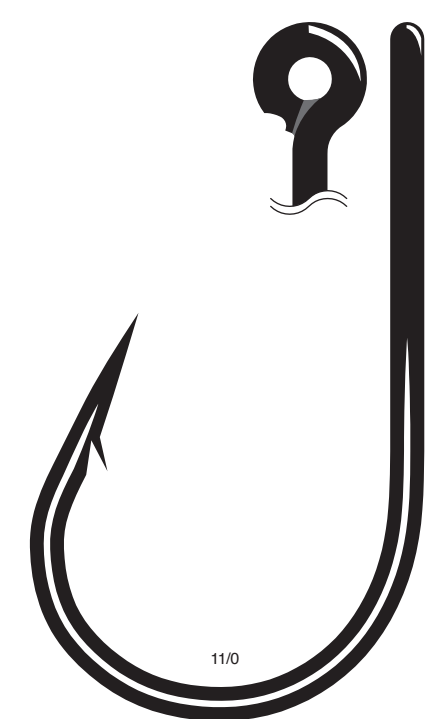
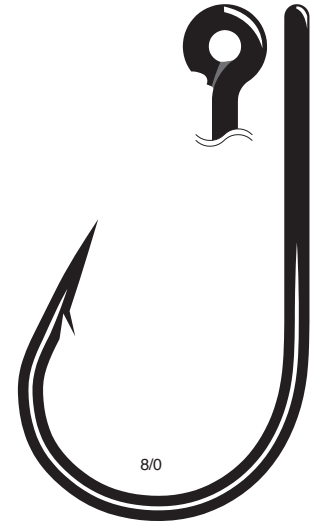

### Magic Eye Tuna Plug 3X

SIZES	3/0	4/0	5/0	6/0	7/0
TIN	LS 365513(5)	365514(5)	365515(5)	365516(4)	365517(4)

You've likely heard about the advantages of using tandem Gamakatsu double, single-point hooks instead of factory trebles on your favorite tuna plugs. Hookup ratios increase and releases are far kinder to our finned friends. Magic Eye Tuna Plug 3X Hooks make rigging the system dramatically easier because the hook eyes are beveled so they slide right on a split ring without needing special pliers or tools. It's faster, easier and foolproof. Attach with hook points opposed.

-  FORGED
-  BARB





**Rigs, Snells,  
Jig Heads, Floats**

**Gamakatsu<sup>®</sup>**

## Single Egg Hooks, Barb On Shank Snell

SIZES	14	12	10	8	6
<b>Red</b>	LS 04303(10)	04304(10)	04305(10)	04306(10)	04307(10)
	SNL 04803(10)	04804(10)	04805(10)	04806(10)	04807(10)
<b>Gold</b>	LS 04203(10)	04204(10)	04205(10)	04206(10)	04207(10)
	SNL 04703(10)	04704(10)	04705(10)	04706(10)	04707(10)

A premier bait hook for salmon eggs. Also great for floating dough baits.

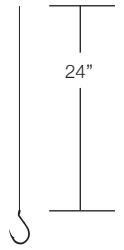

## Walleye LG Two Hook Rig

Hook Size	6	4
Line Size	8	10
<b>Ns Black</b>	LS 278307-08(10)	278308-10(10)

Two hook rig with adjustable top hook. Includes glowbead and tube.

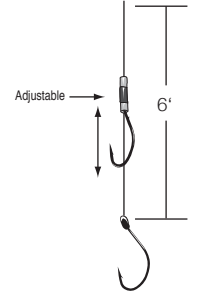
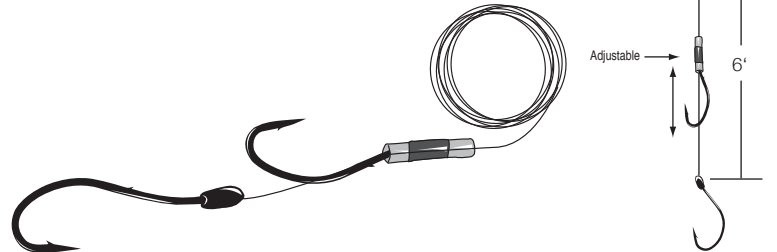

## Treble Stinger Rig, Wire Leader

Hook Size	12	10	8	6
<b>Ns Black</b>	364404(3)	364405(3)	364406(3)	364407(3)

It's widely known that trailing stinger rigs are the ticket for catching short-biting walleyes when jigging in cold water conditions. For years, seasoned anglers have painstakingly tied their own stinger rigs using premium Gamakatsu hooks. Now, we've done all the work for you. Gamakatsu Treble Hook Stinger Rigs are 100% ready to use and will outlast most others on the market. A coated steel wire is machine crimped and then dipped in a durable rubberized coating; allowing it to hang perfectly behind your jig or bait. And since they're connected to a premium Gamakatsu treble hook, they'll stay sticky sharp, fish after fish, after fish. Save time. Save money. Keep fishing longer with Gamakatsu Treble Hook Stinger Rigs.



## Treble Stinger Rig, Fluorocarbon Leader

**NEW**

Hook Size	12	10	8
<b>Red</b>	378304(3)	378305(3)	378306(3)

Bass and walleye will certainly grab hold of this stealthier version of our trailing stinger rig. We've pre-tied two inches of premium, 16-pound test fluorocarbon line instead of the coated steel wire. It works well with a wide variety of baits; however, it is most suited for trolling baits or any scenarios where fish are coming from behind and just striking the tail of the bait. Many anglers consider it mandatory for cold weather angling when fish are sluggish.

## EWG Walleye Snell

Hook Size	Line (LB)	Stock #
6	8	228307-08(3)
4	8	228308-08(3)
2	8	228309-08(3)

Red wide gap baitholder hook with 7 feet of premium clear 8 lb. monofilament. A molded glow bead secures and covers the snell for extra knot strength and added attraction.



## Walleye Snell with Glowbead

Our Walleye Snell blends all of the premium components walleye anglers have come to expect from the premium hook leader. Featuring our sticky sharp Octopus hook in the most popular walleye catching colors. All tied on a 7' premium Japanese 8 lb. monofilament.

SIZES	6-08	4-08	2-08
<b>F-Red</b>	297607-FR-08(5)	297608-FR-08(5)	297609-FR-08(5)
<b>Chartreuse</b>	297607-C-08(5)	297608-C-08(5)	297609-C-08(5)
<b>F-Pink</b>	297607-P-08(5)	297608-P-08(5)	297609-P-08(5)
<b>F-Orange</b>	297607-OR-08(5)	297608-OR-08(5)	297609-OR-08(5)
<b>Glow</b>	297607-GL-08(5)	297608-GL-08(5)	297609-GL-08(5)
<b>Red</b>	297607-R-08(5)	297608-R-08(5)	297609-R-08(5)

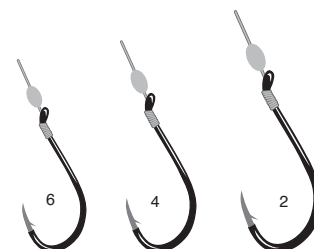
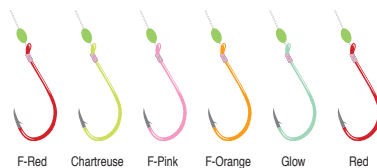

### Baitholder Snell

SIZES	14	12	10	8	6	4	2	1
BRONZE	LS 05103(10)	05104(10)	05105(10)	05106(10)	05107(10)	05108(10)	05109(8)	05110(8)
	100 05103-100	05104-100	05105-100	05106-100	05107-100	05108-100	05109-100	05110-100
	SNL 05603(10)	05604(10)	05605(10)	05606(10)	05607(10)	05608(10)	05609(8)	05610(8)

The ever popular Baitholder hook available in pre packed snells.

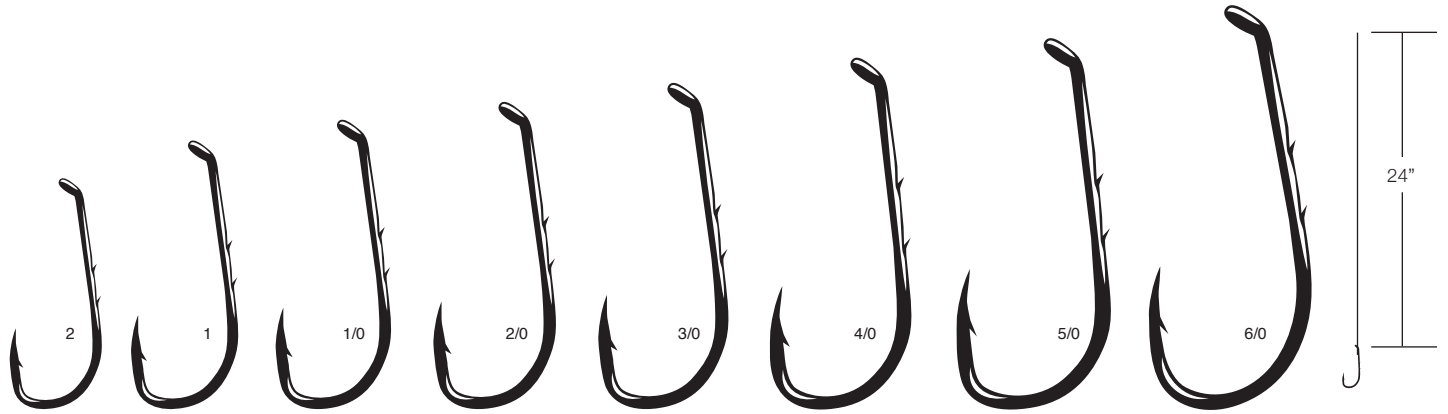
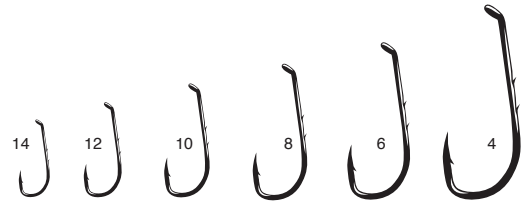

### Catfish Rig

SIZES	5/0	6/0	7/0	8/0
NS Black	299415-50(2)	299416-50(2)	299417-50(2)	299418-50(2)

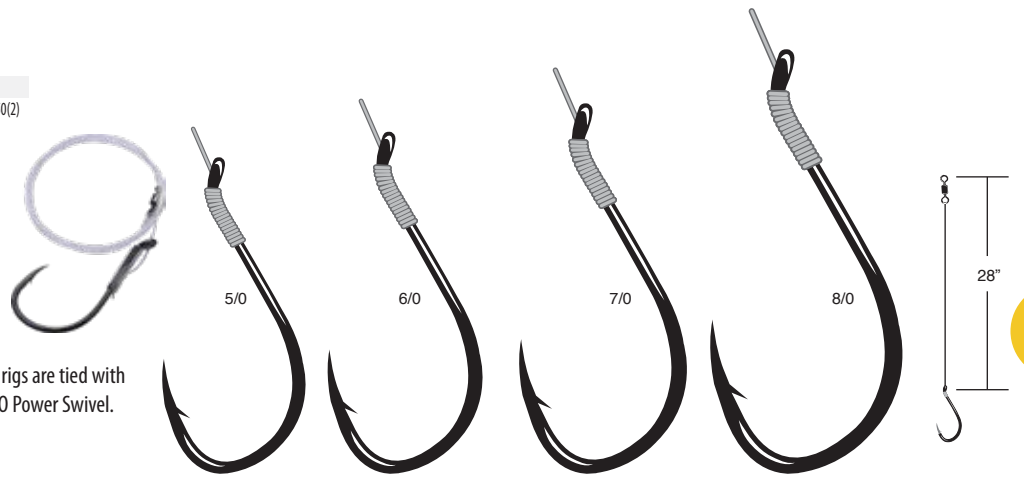
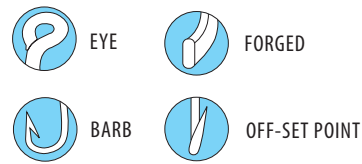

The new Catfish Rigs are pre-tied and ready to fish. Both rigs are tied with 28" of 50 lb. premium Japanese monofilament and a SPRO Power Swivel.

### Catfish Rig Circle

SIZES	5/0	6/0	7/0	8/0
NS Black	300415-50(2)	300416-50(2)	300417-50(2)	300418-50(2)

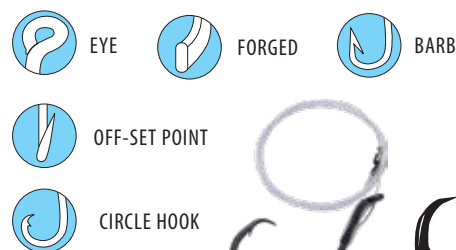

# Rigs, Snells, Jig Heads, Floats

## Drop Shot Rigs

Hook Size	4	2	1
Line Size	6	8	8
Ns Black	LS 214408-06(3)	214409-08(3)	214410-08(3)

Each leader is 6' long with the hook tied in the middle using high quality clear monofilament.



"3 rigs per pack!"

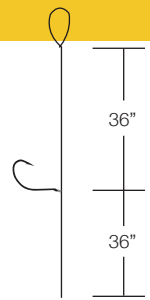

## Mooching Rig (Slip Tie)

Line (LB.)	Hook Size	Nickel	Red
20	2/0, 3/0	215023-20(3)	
20	3/0, 4/0	215034-20(3)	
25	2/0, 3/0	215023-25(3)	
25	3/0, 4/0	215034-25(3)	
30	3/0, 4/0	215034-30(3)	215334-30(3)
30	4/0, 5/0	215045-30(3)	215345-30(3)
30	5/0, 6/0	215056-30(3)	215356-30(3)
40	4/0, 5/0	215045-40(3)	215345-40(3)
40	5/0, 6/0	215056-40(3)	215356-40(3)

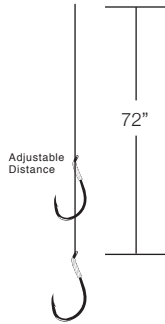
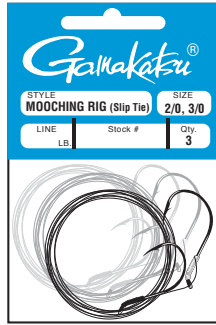

"3 individually packed leaders, 6 ft. rig!"

## Mooching Rig (Solid Tie)

Line (LB.)	Hook Size	Stock#
15	2/0, 3/0	218023-15(3)
15	3/0, 4/0	218034-15(3)
20	2/0, 3/0	218023-20(3)
20	3/0, 4/0	218034-20(3)
25	2/0, 3/0	218023-25(3)
25	3/0, 4/0	218034-25(3)
30	3/0, 4/0	218034-30(3)
30	4/0, 5/0	218045-30(3)
30	5/0, 6/0	218056-30(3)
40	4/0, 5/0	218045-40(3)
40	5/0, 6/0	218056-40(3)

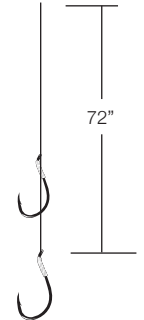
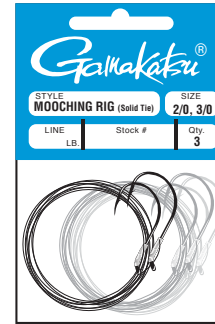

"3 individually packed leaders, 6 ft. rig!"

## Mooching Rig (Slip Tie) Barbless

Hook Size	Line (LB)	Stock #
3/0, 4/0	25	337034-25(3)
3/0, 4/0	30	337034-30(3)
4/0, 5/0	30	337045-30(3)
5/0, 6/0	30	337056-30(3)
4/0, 5/0	40	337045-40(3)
5/0, 6/0	40	337056-40(3)

As barbless hook regulations expand, Gamakatsu has met the challenge with a better designed, sharper and stronger Barbless Octopus hook. Designed expressly for the application, Gamakatsu's Barbless Octopus hooks feature a slightly wider gap that provides better fish-holding benefits than traditional barbed Octopus hooks. These hooks comply with state regulations requiring "barbless hooks". Proven effective for a variety of species, Gamakatsu's Barbless hooks are now available in pre-tied mooching rigs. Tied on premium monofilament line with 6 foot leaders, Gamakatsu Barbless Mooching Rigs are packaged individually.

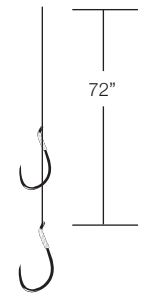

"3 individually packed leaders, 6 ft. rig!"

## Two Hook Bait Rig

Hook Size	Line (LB)	Stock #
3/0, 4/0	25	233334-25(3)
3/0, 4/0	30	233334-30(3)
4/0, 5/0	30	233345-30(3)
5/0, 6/0	30	233356-30(3)
4/0, 5/0	40	233345-40(3)
5/0, 6/0	40	233356-40(3)
6/0, 7/0	40	233367-40(3)

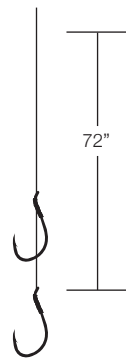
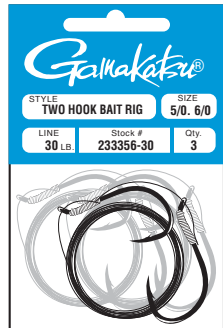

"3 rigs per pack!"



Two red hooks snelled about 1 inch apart to 6 ft piece of premium monofilament. Perfect for

## Salmon/steelhead Leader

"3 individually packed leaders, 6 ft. rig!"

Line (LB.)	Hook Size	Stock#
8	2	217309-08(3)
8	1	217310-08(3)
10	1	217310-10(3)
10	1/0	217311-10(3)
12	1/0	217311-12(3)
12	2/0	217312-12(3)
15	2/0	217312-15(3)
20	3/0	217313-20(3)
30	3/0	217313-30(3)
30	4/0	217314-30(3)
40	4/0	217314-40(3)
30	5/0	217315-30(3)
40	5/0	217315-40(3)

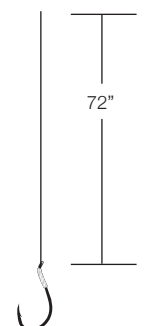

## Jigging Rig, Gold

SIZES	8	6	4
Fish Skin Rig	64306(1)	64307(1)	64308(1)
Glow Rig	62306-G(1)	62307-G(1)	62308-G(1)

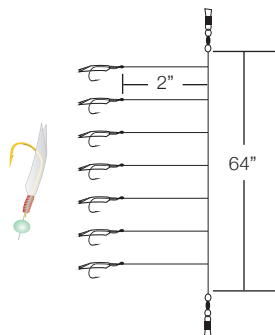

## Jigging Rig, Nickel, Smelt/herring

SIZES	5	4
Fish Skin Rig	58108(1)	58109(1)

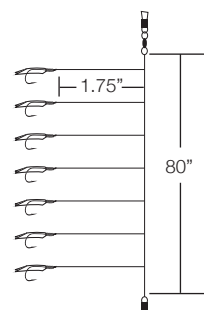



### Jigging Rig, Special Assorted Hook

SIZES	5
Fish Skin	Rig 207307 (Gold, Nickel, Red, Green)(1)

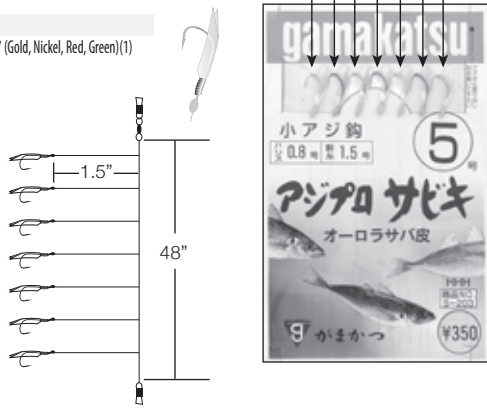

### Jigging Rig, Special Weighted Assorted Hook

SIZES	5
Fish Skin	Rig 206307 (Gold, Nickel)(1)

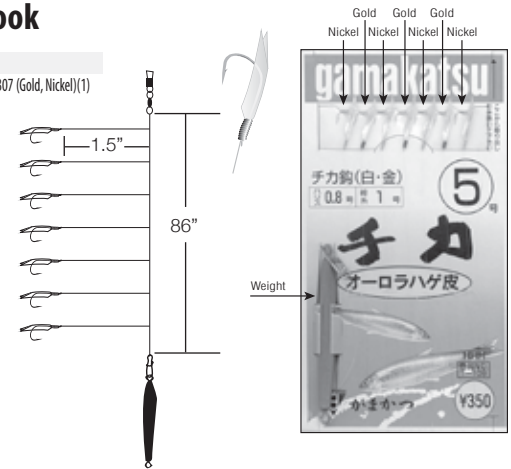

### Sockeye Rig

Hook Size	Line (lb)	Stock #
3/0 Chartreuse	30	372313-C-30(3)
3/0 Flame Red	30	372313-FR-30(3)

When the sockeye start running, you better be ready to get in the game fast. With our Sockeye Rigs, you are geared up in seconds. Tied on 30 lbs. leaders with sticky sharp 3/0 Red Octopus hooks, available in 2 colors - chartreuse or flame red. Nothing is easier or faster, except maybe your limit. We've done the work for you to maximize your time on the water.



### Top And Bottom Rig

Hook Size	Line (lb)	Stock #
2	30	238409(1)

Designed primarily for bottom fishing, this rig uses two size 2 NS Black Baitholder hooks attached to a 40lb. leader so they stick out about 4" from the main line and are spaced about 10" apart. It includes a barrel swivel at the top of the rig and a cross lock for easy weight attachment at the bottom.

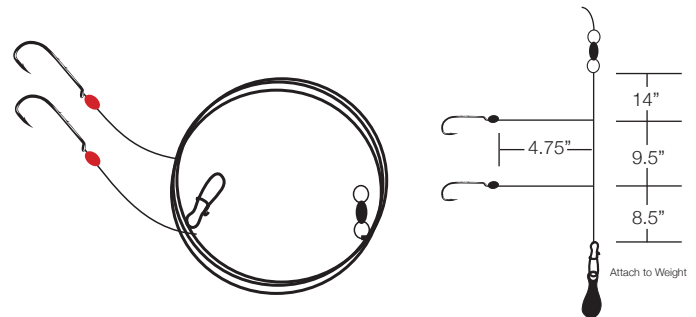

### Fluke Rig With Teaser

Hook Size	Line (lb)	Stock #
2/0 White/Red	40	239412-RW(1)
2/0 White/Chartreuse	40	239412-CW(1)

Two different color combination fluke rigs available in a size 2/0 hooks with a 40 lb. leader. The Fluke Rigs feature a spinner blade and a teaser made with synthetic hair material that is more tooth resistant and durable in saltwater. The teasers are in either red and white or a chartreuse and white combination with either red or green beads to match. They also feature a 3 way swivel with a crosslock to attach the weight.

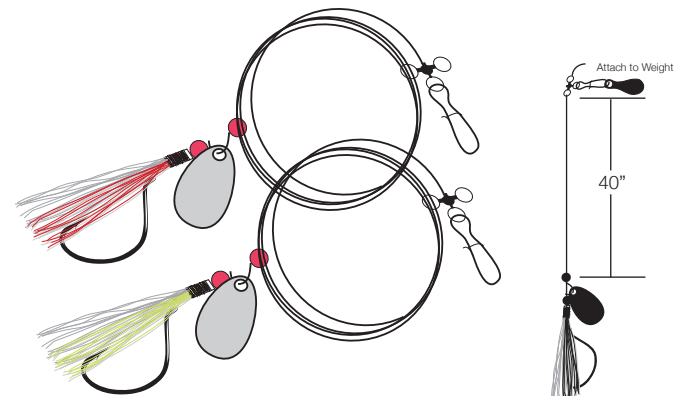

## Striper Rig

Hook Sizes	4/0	5/0	6/0	7/0	8/0
NS Black	305414-40(2)	305415-40(2)	305416-40(2)	305417-40(2)	305418-40(2)

Striper fishermen are a demanding group. Striper anglers have asked for a dependable pre-tied rig to meet their needs and Gamakatsu has answered. The Striper Rig features a proven Octopus hook, tied on 28" of premium 40 lb. monofilament. The rig also includes a high quality #4 SPRO barrel swivel rated at 130 lb. This rig is sure to give any striper fisherman the confidence they need to catch that trophy of a lifetime.



## Striper Rig With Sliding Sinker Lock

Hook Size	Line (lb)	Stock #
5/0	80	241415(2)

This rig features a 5/0 NS Black Baitholder hook snelled to a 80 lb. clear leader with a 100 lb. barrel swivel and a sliding sinker lock that goes on the main line above the swivel.

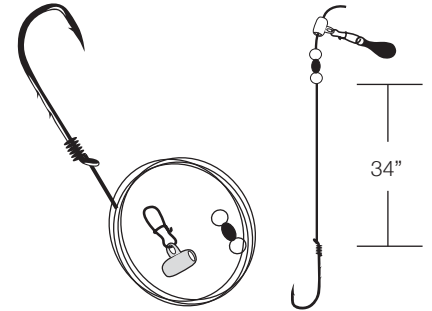

## Wacky Head

SIZES	2	2	2
WEIGHT	LS 1/32	1/16	1/8
	282309-1/32(4)	282309-1/16(4)	282309-1/8(4)



Gamakatsu is known for its innovative and functional designs, the "Wacky Head" jig is no exception. With its unique flat shape, the "Wacky Head" will entice the finickiest of biters with its side to side rolling type action. Also to add to its attraction is the red epoxy head, and a short shank wide gap designed hook.

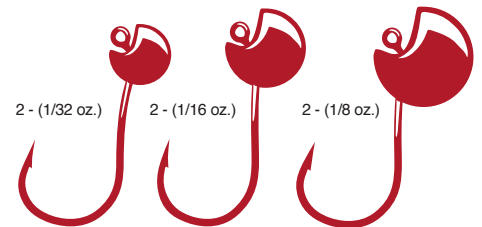

### Skip Gap Head



SIZES	3/0-1/8	3/0-3/16	4/0-3/16	4/0-1/4
Brown	293413-BR-1/8(4)	293413-BR-3/16(4)	293414-BR-3/16(4)	293414-BR-1/4(4)
Green Pumpkin	293413-GP-1/8(4)	293413-GP-3/16(4)	293414-GP-3/16(4)	293414-GP-1/4(4)

Gamakatsu has developed its own jig head based on the Skip Gap worm hook. It has the same innovative bend that holds your bait secure on the hook. There are no barbs or pegs that can tear apart a small finesse worm. The unique bend lends itself to simplicity and will change the way you shakily fish.

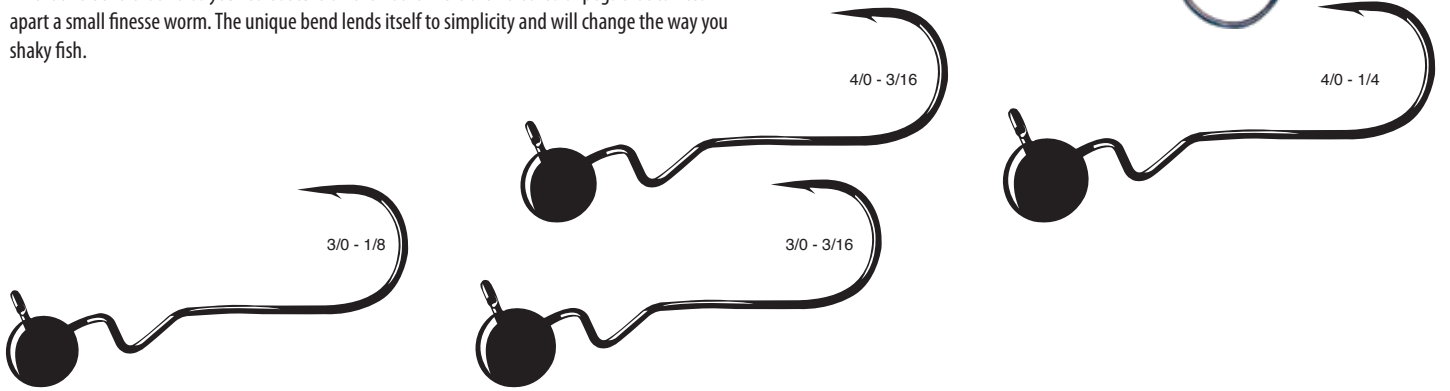

### Stand Up Alien Head



SIZES	3/0-1/8	3/0-3/16	3/0-1/4	3/0-5/16
Black	309413-BK-1/8(4)	309413-BK-3/16(4)	309413-BK-1/4(4)	309413-BK-5/16(4)
Green Pumpkin	309413-GP-1/8(4)	309413-GP-3/16(4)	309413-GP-1/4(4)	309413-GP-5/16(4)

Looking for the quintessential stand-up jig head? Gamakatsu's developed the answer with its all-new Stand-Up Alien Head. Perfect for rock or hard bottom fishing, The innovative keeper pin holds plastics without tearing. The benefit is a better presentation, more casts and more mileage out of your plastics. Features a NS Black finesse hook and is available in Green Pumpkin and Black jig heads.

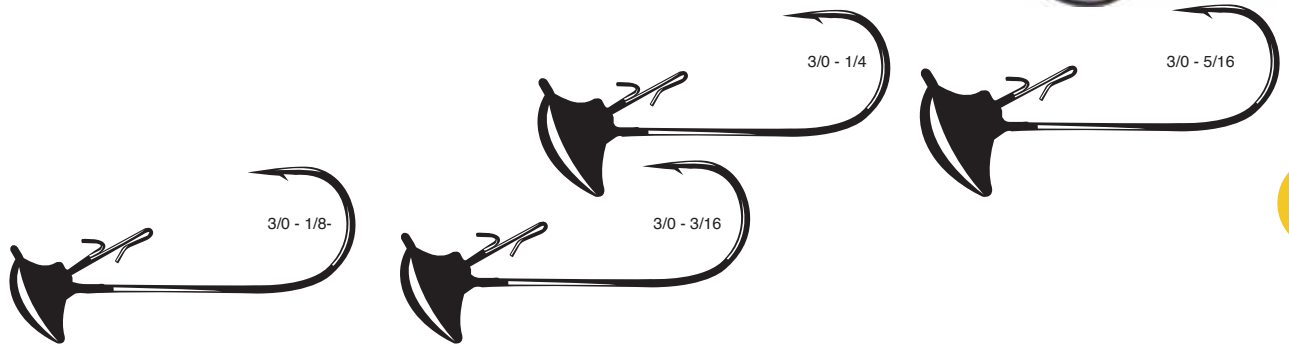

### Superline Swim Bait Head

SIZES	4/0 - 1/8	4/0 - 3/16	4/0 - 1/4	5/0 - 3/8	5/0 - 1/2
Clear	LS 353414-1/8(3)	353414-3/16(3)	353414-1/4(3)	353415-3/8(3)	353415-1/2(3)
Pearl White	LS 353414-PW-1/8(3)	353414-PW-3/16(3)	353414-PW-1/4(3)	353415-PW-3/8(3)	353415-PW-1/2(3)



Until now, you simply couldn't find a premium, swim bait jig head with a premium Gamakatsu hook. The new Superline Swim Bait Head changes all that. The head profile is streamlined for a natural action. Choose premium painted heads or unpainted for anglers that prefer a do-it-yourself custom look. A heavy wire, 60-degree Superline hook performs optimally with braided line and heavy monofilament. Completing the package, The Spring Lock keeper holds all soft plastic swim baits secure and tight.

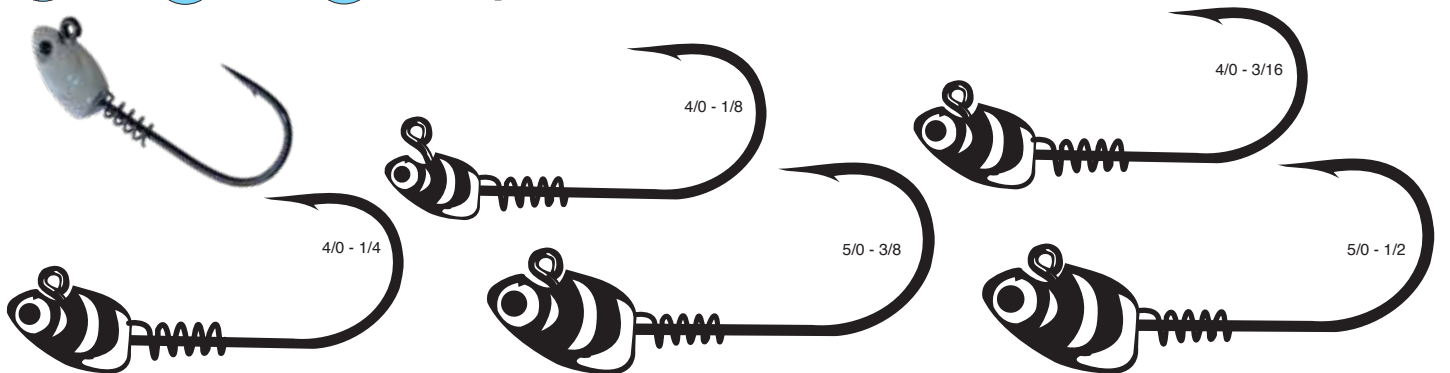

## Round 26

SIZES	1/0	1/0	2/0	2/0	3/0	3/0	
WEIGHT	LS	1/16	1/8	3/16	1/4	3/16	1/4
		500411-1/6(S)	500411-1/8(S)	500412-3/16(S)	500412-1/4(S)	500413-3/16(S)	500413-1/4(S)



EYE



FORGED



BARB

The standard round head design makes this a very versatile jig head. It features our 604 series jig hook which is very popular with Salmon and Steelhead anglers and also has two keeper type rings behind the head to hold soft plastic baits firmly in place.

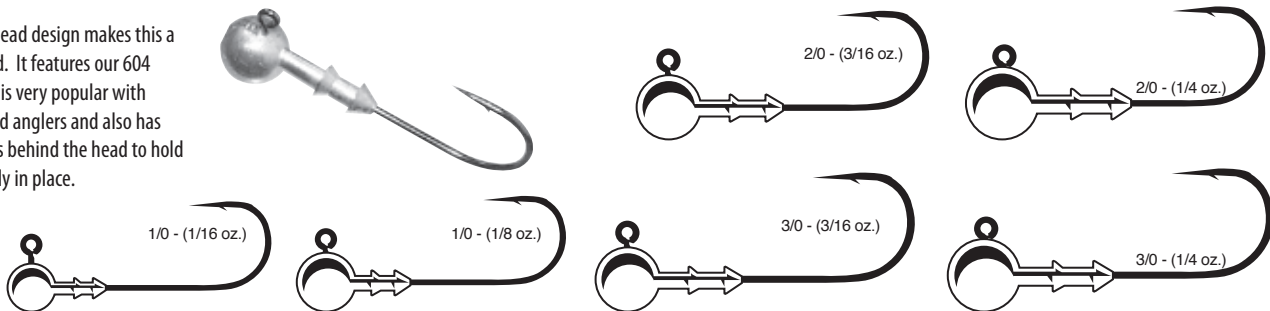

## Cobra 27

SIZES	1/0	2/0	3/0	
WEIGHT	LS	1/4	3/8	1/2
		504411-1/4(S)	504412-3/8(S)	504413-1/2(S)



EYE



FORGED



BARB

5 Nylon Brush Guards Included

Named for its unique head design, the Cobra 27 comes with optional nylon brush guards for weedless presentations. It features a very stout 60 degree jig hook and is great for building your own Bass jigs or for fishing plastic baits in saltwater for inshore fish like Redfish and Speckled Trout.

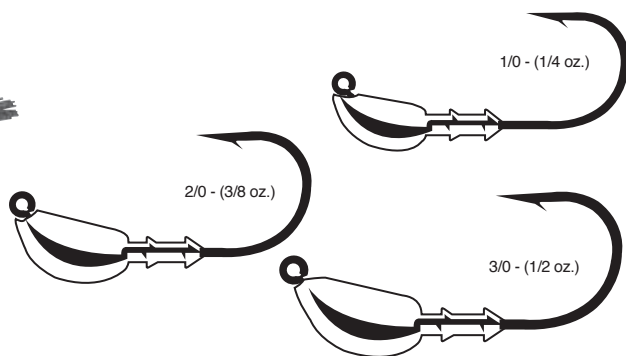

## Football 24

SIZES	1/0	2/0	2/0	3/0	5/0	5/0	
WEIGHT	LS	3/16	1/4	3/8	1/2	3/4	1
		502411-3/16(S)	502412-1/4(S)	502412-3/8(S)	502413-1/2(S)	502415-3/4(S)	502415-1(S)



EYE



FORGED



BARB

The Football 24 is the choice when fishing around rock or ledges. It is designed to be very snag resistant.

The 24 is the way to go when dragging a Hula Grub or Beaver on deep structure. The 24 features a fine wire hook for fast penetration.

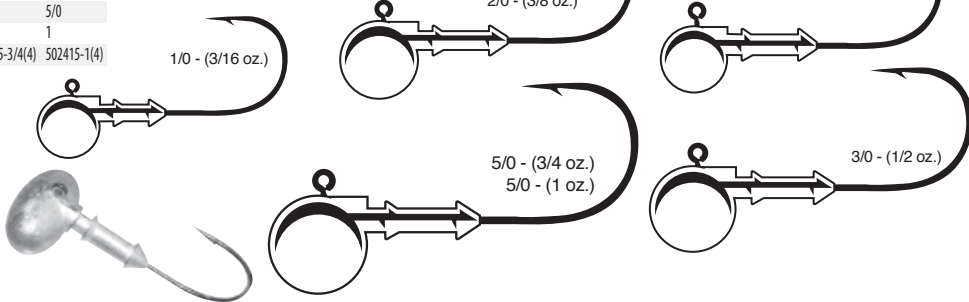

## Darter 26

SIZES	2/0	2/0	3/0	3/0	
WEIGHT	LS	1/8	3/16	1/4	3/8
		505412-1/8(S)	505412-3/16(S)	505413-1/4(S)	505413-3/8(S)



EYE



FORGED



BARB

5 Nylon Brush Guards Included

This jig comes with optional nylon brush guards and features a heavy duty 90 degree jig hook. The streamlined head design makes it ideal in both fresh and saltwater applications.

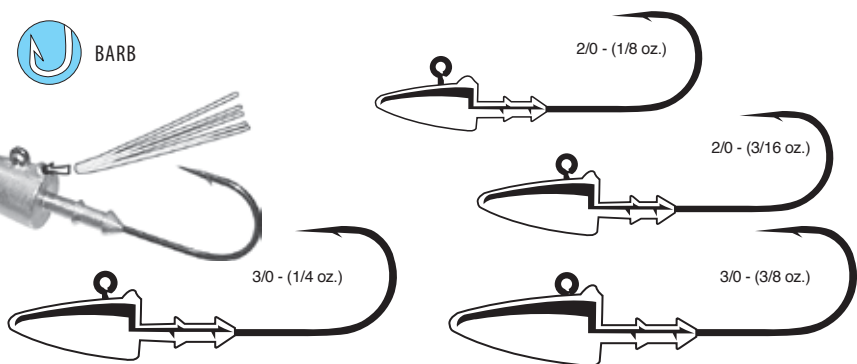

## Tube Head

SIZES	2	2	2	
WEIGHT	LS	1/32	1/16	1/8
		503409-1/32(S)	503409-1/16(S)	503409-1/8(S)



EYE



FORGED



BARB

The ultimate finesse tube head design for precise presentations and smaller baits. Comes on a strong, sticky sharp NS black hook that ensures solid hook ups.

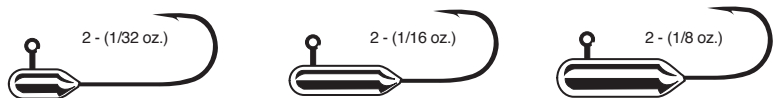

### Round 211

SIZES	2	2	2
WEIGHT	LS 1/32	1/16	1/8
	501409-1/32(5)	501409-1/16(5)	501409-1/8(5)

SIZES	1	1	1
WEIGHT	LS 1/32	1/16	1/8
	501410-1/32(5)	501410-1/16(5)	501410-1/8(5)

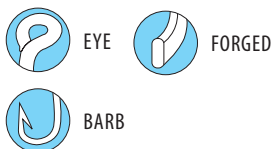

2 - (1/32 oz.)

2 - (1/16 oz.)

2 - (1/8 oz.)

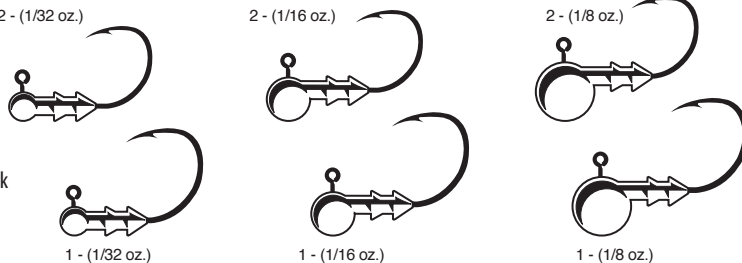

1 - (1/32 oz.)

1 - (1/16 oz.)

1 - (1/8 oz.)

A totally unique design with a short shank and a matte black beak point. Great for live and finesse baits.

### Finesse Jig Head

SIZES	1	1	1
WEIGHT	LS 1/16	3/32	1/8
	506410-1/16(4)	506410-3/32(4)	506410-1/8(4)

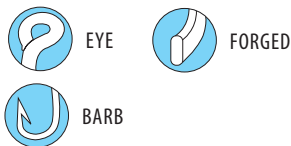

When new tournament techniques emerge, our pro-staff are usually holding the rod. Case in point, the new Finesse Jig Head is designed to optimize the "Ned Rig." It's all about precise positioning of small soft plastics in a manner that translates into that slow, gliding fall that big bass can't resist. The spring keeper and light wire #1 hook are critical features. Lead heads are unpainted allowing for easy customization.

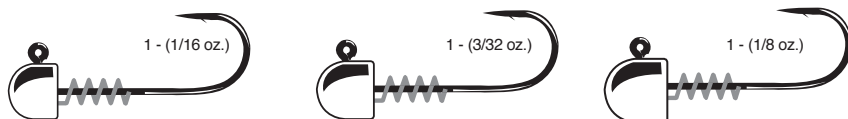

1 - (1/16 oz.)

1 - (3/32 oz.)

1 - (1/8 oz.)

### Crappie Jig Head

SIZES	2	2	2
WEIGHT	LS 1/16	3/32	1/8
	507409-1/16(5)	507409-3/32(5)	507409-1/8(5)

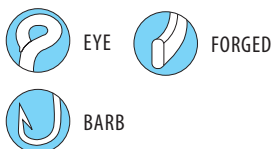

Designed for tournament focused crappie anglers. This premium design, specialized Crappie Jig Head, features a sticky sharp Gamakatsu hook fully molded through the lead head. The smooth eye won't burr even the lightest line. A heavy-duty spring lock keeper encircles the shank for nearly half its length. Soft plastics won't move a millimeter with this innovation. #2 light wire jig hooks in NS black.

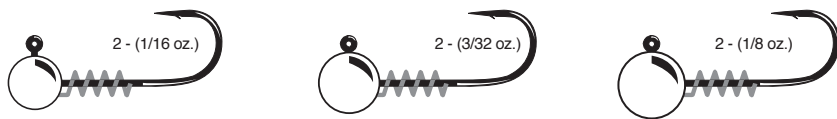

2 - (1/16 oz.)

2 - (3/32 oz.)

2 - (1/8 oz.)

### Finesse Jig Head Offset

SIZES	1/0	1/0	1/0	1/0
WEIGHT	LS 3/32	1/8	3/16	1/4
	386411-3/32(4)	386411-1/8(4)	386411-3/16(4)	386411-1/4(4)

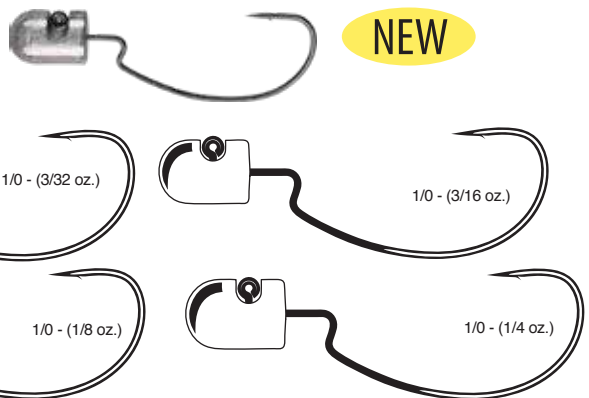
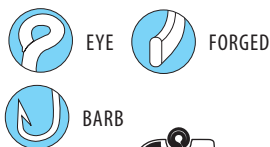

1/0 - (3/32 oz.)

1/0 - (3/16 oz.)

1/0 - (1/8 oz.)

1/0 - (1/4 oz.)

If you're familiar with the Ned rig technique, you probably haven't seen this before: An offset eye, countersunk into the jig head, with a premium forged steel Gamakatsu hook. Well, now you have. Reduce time rigging and spend more time fishing. This all-in-one design is tough to beat when bass are spooked or finicky in overfished conditions.

### Bottom Knocker Offset

SIZES	1/0	1/0	1/0	1/0
WEIGHT	LS 3/8	1/2	5/8	3/4
	383411-3/8(4)	383411-1/2(4)	383411-5/8(4)	383411-3/4(4)

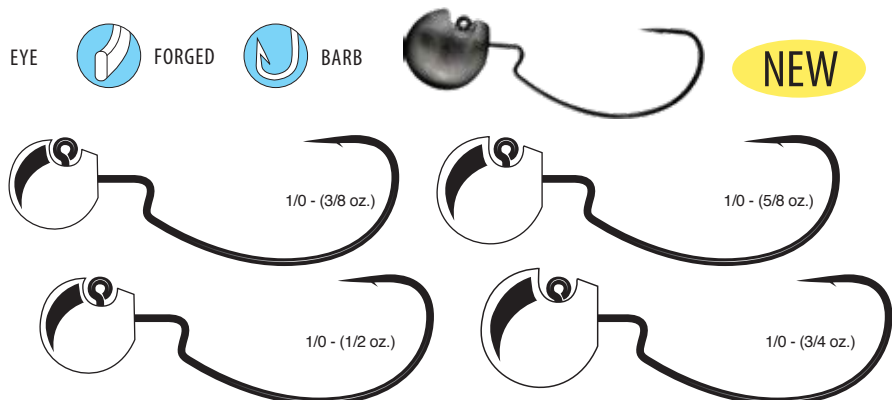

1/0 - (3/8 oz.)

1/0 - (5/8 oz.)

1/0 - (1/2 oz.)

1/0 - (3/4 oz.)

Anglers on the other side of the "big pond" have been boasting about the advantages of using an offset bottom knocker for many years now. We put them in the hands of several of our most trusted pros and tackle testers in the U.S. and waited to hear what they had to say. What a surprise, they slay bigmouths here in the States as well. Notice the finesse football head designed for fishing deep structure, and the fact that the hook eye is offset to tantalize the "lay down" action. And of course, the genuine Gamakatsu hook is as sharp as they come.





Fly Hooks

Gamakatsu®

**Skip Gibson**

5145 Bigelow Rd, Bozeman, MT. 59718  
 Ph: 406-556-0822 Fx: 406-556-0823  
 skipflyh20@aol.com  
 ID, WY, MT

**Bob Lamson**

152 Gates Rd, Lebanon, CT. 06249  
 Ph: 860-423-2911 Fx: 973-423-4500  
 flyfishrep@earthlink.net  
 ME, VT, MA, RI, CT, NH, NY (North of Route 84)

**Ken Lagerveld**

175 Tamboer Drive  
 North Haledon, NJ. 07508  
 Ph: 973-216-8979 Fx: 860-423-7825  
 flyrodrep@aol.com  
 NJ, Metro NY (NYC, Long Island and area north of NYC to Route 84) PA, Maryland, Delaware, Virginia

**Dan Marshall - Northwest Outdoor Sales**

3409 140th St Ct NW, Gig Harbor, WA  
 Ph: 800-445-8150 Fx: 253-445-8153  
 flymandan1@yahoo.com  
 OR, WA, AK

**Marty Holding - L H French Co**

Ph: 801-302-8448 Cl: 801-580-7290  
 Fx: 801-302-8449 mhold84829@aol.com  
 UT, MT, Southern Idaho

**Len Vinci - L H French Co**

Ph: 916-543-8690 Cl: 916-718-3926  
 Fx: 916-543-8698 lvinci@wavecable.com  
 Northern CA, Northern NV

**Guy Tillotson - Grand Slam Group LLC**

1686 Blue Point Ave, B-10, Naples, FL 34102  
 Cl: 904-347-3138  
 flyfishrep@aol.com  
 FL, GA, NC, SC

**Tom Jindra - Grand Slam Group LLC**

2501 Prancer St, New Orleans, LA 70131  
 Ph: 504-392-7511 Fx: 504-324-1889  
 tomjindra@cox.net | www.tomjindra.com  
 AL, AR, LA, MS, TN, TX

**Tom Timmerberg**

6604 Devonshire Ave 1 So, St Louis, MO 63109  
 Ph: 314-255-3692 tomtimmerberg@hotmail.com  
 MO, KS, IL, MN, WI, IA

**Ben Hunting**

6777 Old Darby Trail NE, Ada, MI 49301  
 Ph: 616-901-1926 benhunting@comcast.net  
 OH, MI, IN, KY

**Gamakatsu** has been making premium quality hooks since 1955. Every hook is made using Gamakatsu's own high quality, high carbon steel and is meticulously crafted to the highest of standards. Unlike other hook manufacturers, Gamakatsu hooks are made in their own facility which is one of the most technologically advanced in the world and their consistency is unmatched. What you'll find in this catalog are 35 styles of super sharp, super strong fly hooks made for the serious fly tyer and fly angler who will settle for nothing but the best. While an investment in a good fly rod, fly reel, fly line and the knowledge on how to properly use them can enhance the fly fishing experience, the hook is the one piece of equipment at the end of it all that has to hang on to the object of pursuit. Don't settle for anything less than Gamakatsu quality.

**The Executive Series - The most advanced fly hook available.**

Executive Series fly hooks offer some very unique designs like the R10B Retainer Bend and the C13U Keel Balance. Hooks like the S10 series of hooks have beak points that allow for effortless penetration, especially with light tippets and a slightly wider gap. They also have a shank length just a little longer than standard dry fly hooks. While the R10B and C13U are matte black, the B10S Stinger hooks and the rest of the Executive series have a beautiful NS Black finish that not only looks good, but is also very corrosion resistant. There's no other hook series like it.

- Corrosion Resistant N.S. Black Finish
- Beak Points
- Unique Designs

**Traditional Series - A necessity for patterns of time honored tradition.**

The Traditional Series hooks are mostly all bronze finished, have needle points, and are designed to match up in style and size with other popular hook brands. The key difference being the quality of the steel used in them and the sharpness of the hook. The Traditional Series hooks also feature the traditional Salmon/Steelhead tapered loop up eye hooks, but in non-traditional finishes like Red in addition to the traditional NS Black finish. The styles all match, but the quality is unmatched.

- Traditional Sizing
- Traditional Bronze Finish
- Gamakatsu Strength and Sharpness

**Saltwater Series - The most complete line of salt water fly hooks.**

By far and away the finest selection of Saltwater fly hooks available. 9 styles featuring our most popular SC15 and other hooks ranging in sizes from 18 to 10/0. The SC15 is used for many different patterns but is also a great hook for tube flies. The SP11-3L3H makes a great popper hook. There's a hook style for every saltwater application imaginable. Every Saltwater Series fly hook is made from the highest quality high carbon steel and has a durable tin plating or NS black finish for corrosion resistance. Because of the steel used, even the 3x strong hooks are surprisingly light for their size and their strength is unparalleled. These hooks will hold a point much better than stainless steel hooks and are sticky sharp right out of the bag. No sharpening is ever needed before fishing with a Gamakatsu hook and because they're not stainless, they will eventually corrode out of a fish's mouth if the hook is taken deep and cannot be removed. From the flats to blue water, there's no hook selection better than this.

- Corrosion Resistant Tin Finish
- Nine styles to choose from
- Innovative designs





**S10 •**

**Standard Down Eye**

Multi-use Dries and Wets  
25 pk & 100 pk: Color: NSB

6		08407-25 08407-100
8		08406-25 08406-100
10		08405-25 08405-100
12		08404-25 08404-100
14		08403-25 08403-100
16		08402-25 08402-100
18		08401-25 08401-100

**S10-B •**

**Standard Down Eye Barbless**

Multi-use Dries and Wets  
25 pk & 100 pk: Color: NSB

6		41407-25 41407-100
8		41406-25 41406-100
10		41405-25 41405-100
12		41404-25 41404-100
14		41403-25 41403-100
16		41402-25 41402-100

**S10S •**

**Straight Eye Dry**

Multi-use and Specialty Dry Flies  
25 pk & 100 pk: Color: NSB

4		33408-25 33408-100
6		33407-25 33407-100
12		33404-25 33404-100
14		33403-25 33403-100

**Jig Nymph • J20**

Beads and Slotted Beads  
20 pk: Color: MB

10		354405-20
12		354404-20
14		354403-20
16		354402-20

**R10-B •**

**Retainer Bend Barbless**

Multi-use. Unique Bend holds fish firm  
25 pk & 100 pk: Color: MB

10		85405-25 85405-100
12		85404-25 85404-100
14		85403-25 85403-100
16		85402-25 85402-100
18		85401-25 85401-100
20		85400-25 85400-100

**R18-B •**

**Barbless 2x Strong**

Multi-use. Unique Bend holds fish firm  
Nano Smooth Coat  
20 pk: Color:

<b>NANO SMOOTH COAT</b>		
8		346206-20
10		346205-20
12		346204-20
14		346203-20
16		346202-20

**R17-B •**

**Retainer Bend Barbless 3x Fine**

Multi-use. Unique Bend holds fish firm  
Nano Smooth Coat  
20 pk: Color:

<b>NANO SMOOTH COAT</b>		
12		335204-20
14		335203-20
16		335202-20
18		335201-20
20		335200-20
22		335299-20
24		335298-20

**Jig Nymph • J20**

**Barbless**

Beads and Slotted Beads  
20 pk: Color: MB

10		355405-20
12		355404-20
14		355403-20
16		355402-20

**Numbering System**

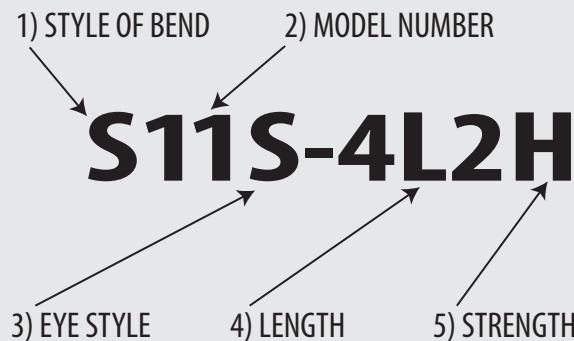

**1) STYLE OF BEND**

(S) Sproat (L) Limerick (P) Perfect (T) Tapered (C) Curve  
(R) Retainer (B) Bend

**2) MODEL NUMBER**

**3) EYE STYLE**

(S) Straight (U) Up

**4) LENGTH**

(L) Long (S) Short

**5) STRENGTH**

(F) Fine (H) Hard/Strong

**Examples:**

2H = 2x Hard/Strong

1F = 1x Fine

S11S-4L2H = Sproat Bend, Model 11, Straight Eye, 4X Long and 2X Strong

**B10S •**

**Stinger, 1x Strong Forged**

Hair Bugs, Streamers

25 pk & 100 pk: Color: NSB

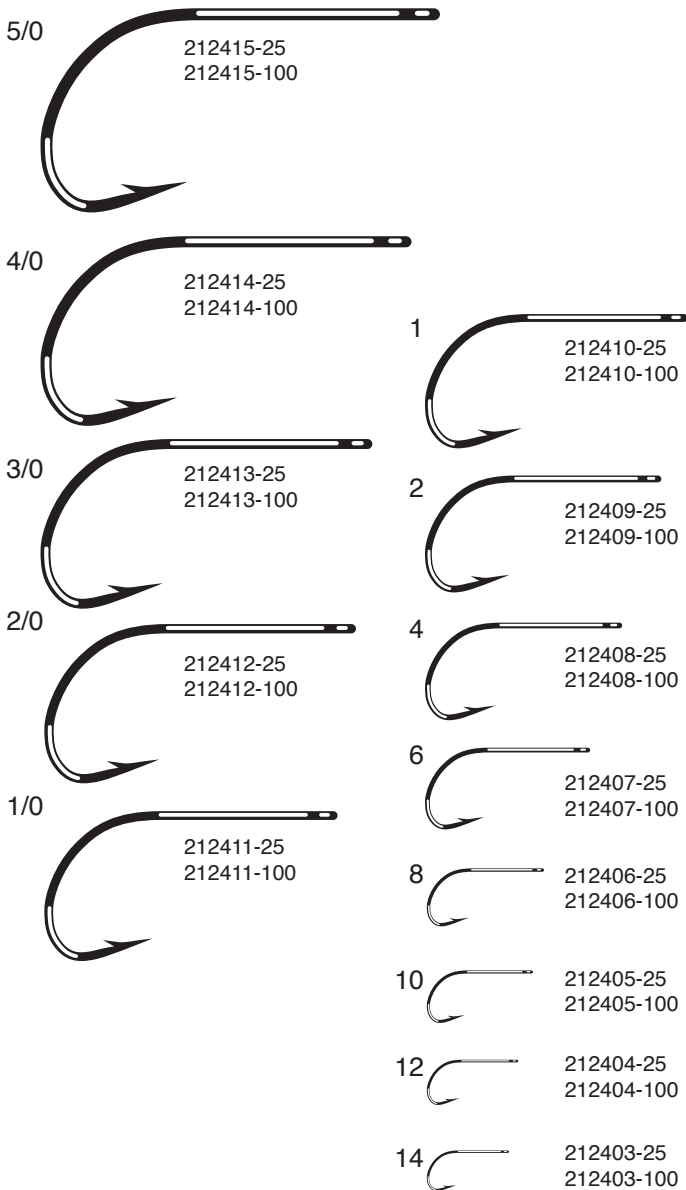

**C14S •**

**Glo Bug**

Glo Bugs and other Egg Patterns

25 pk & 100 pk: Color: NSB

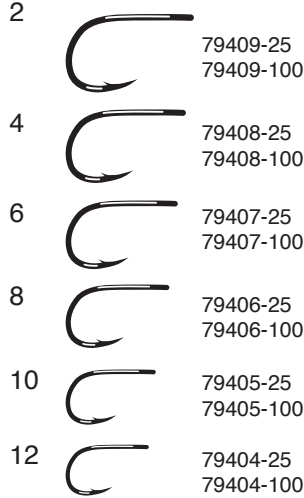

**C16-B •**

**Crippled Emerger**

Emerger Patterns, Multi-use

25 pk & 100 pk: Color: NSB

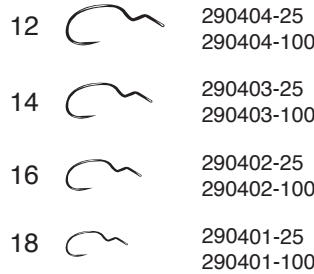

**C13U •**

**Keel Balance**

Multi-use and Keel Style dry Flies

25 pk & 100 pk: Color: MB

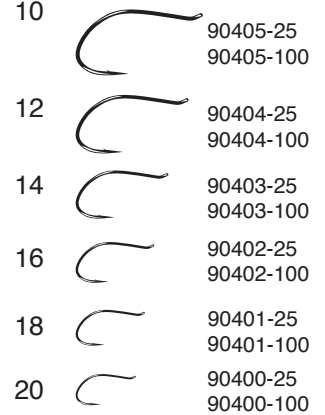

**C15-BV •**

**Vertical Eye, Emerger,**

**Barbless**

25 pk & 100 pk: Color: NSB

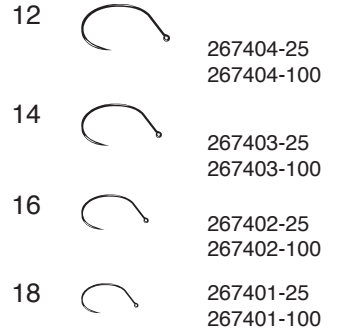

**C12-BM •**

**Barbless Midge, Large Eye**

25 pk & 100 pk: Color: NSB

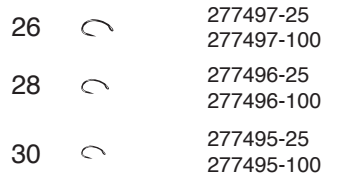

**B10S Stinger •**

**Tournament Grade Wire, Nano Smooth Coat**

Hair Bugs, Streamers

**NEW**

Built using our thinner and stronger Tournament Grade Wire (TGW) and applied with our Nano Smooth Coat for less penetration resistance. This hook was designed to to give you amazing results on your next adventure.

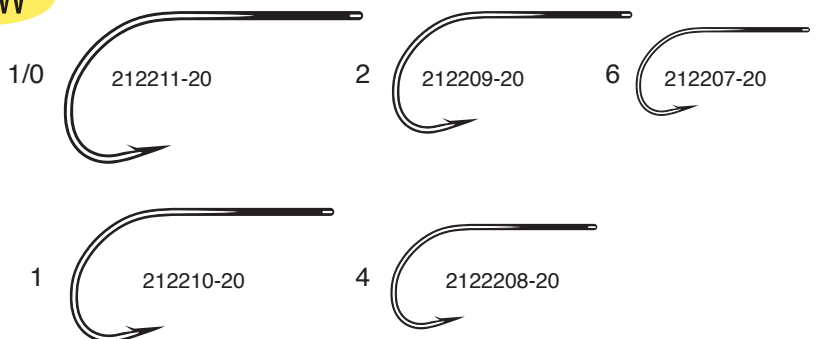

Tournament Grade Wire



**S11-4L2H •**

Streamer, 4x long, 2x strong  
Streamers and Large Wet Flies  
25 pk & 100 pk: Color: BR, NSB

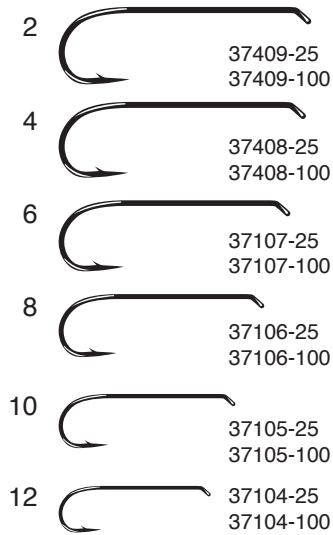

**S11S-4L2H •**

Straight Eye Streamer,  
4x long, 2x strong  
Woolly Buggers, Streamers and Large  
Wet Flies  
25 pk & 100 pk: Color: BR

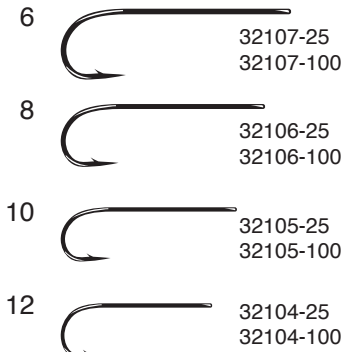

**L11S-3H •**

Salmon & Steelhead 3x strong  
Heavy Salmon/Steelhead Flies  
and tube fly trailer.  
Size 10 added to our existing  
sizes.  
20 pk: Color: NSB

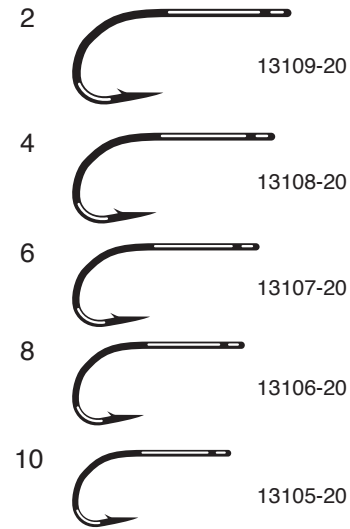

**C12 •**

Down Eye Scud  
Scud and Shrimp Patterns  
25 pk & 100 pk: Color: BR

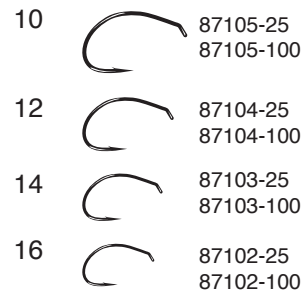

**C12U •**

Caddis  
Caddis and other Pupae Patterns  
25 pk & 100 pk: Color: BR

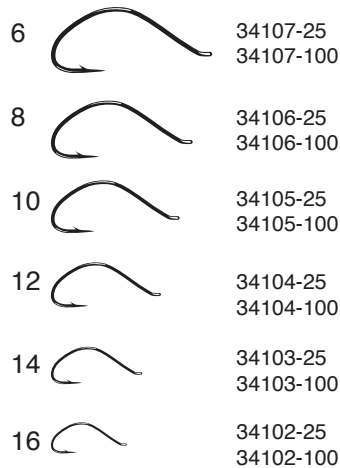

**C12-B •**

Down Eye Scud  
Barbless, Red  
Scud and Shrimp patterns  
25 pk & 100 pk: Color: RD

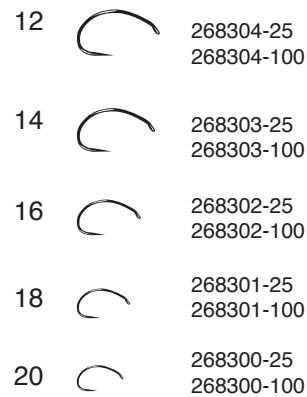

## Fly Hooks - Traditional Series

### T10-3H •

#### Salmon Dry 1x Fine

Salmon/Steelhead Dry Flies

20 pk: Color: NSB

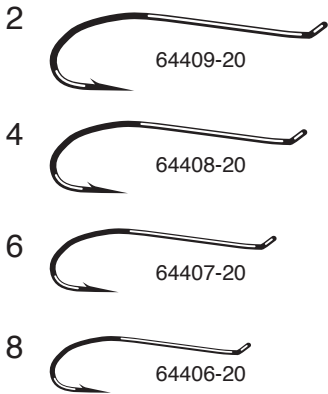

### T10-6H •

#### Salmon Tapered Loop Up-eye

Salmon/Steelhead Wet Flies

10 pk: Color: NSB, RD  
Sizes: 1/0, 2/0

20 pk: Colors: NSB, RD  
Sizes: 8 - 1

634 = NS Black

733 = Color

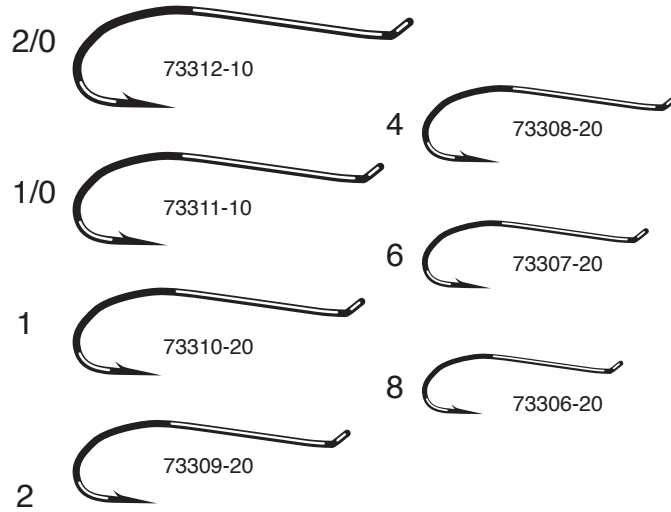

### Russian River Fly

#### Streamers

Meets Russian River Regulations

25 pk, 100 pk: Color: BR, RD

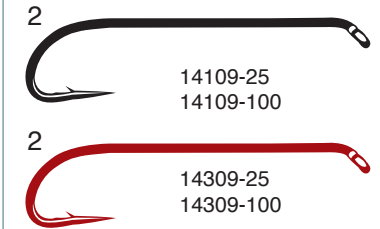

### Double 22 Medium Shank

SIZES	10	8
NS Black	LS 302405(12)	302406(12)



FORGED



BARB

Medium shank length designed with a straight eye manufactured in durable Nickel Silver Black.



## Fly Hooks - Saltwater Series

### SL12-S 1X Short •

#### Big Game • Wide Gap

Tarpon and Billfish Flies • Loose pk, 100 pk: Color: NSB

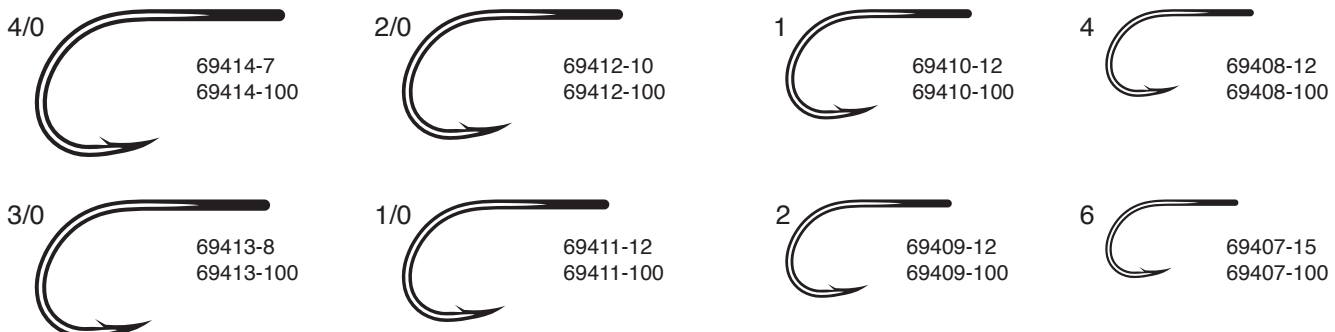

**SL12S •**

**Big Game • Wide Gap**

Tarpon and Billfish Flies

Loose: Color: TN Sizes: 2, 1/0, 2/0, 4/0, 6/0, 8/0, 10/0

50 pk: Color: TN Sizes: 8/0, 10/0

100 pk: Color: TN Sizes: 2, 1/0, 2/0, 4/0, 6/0

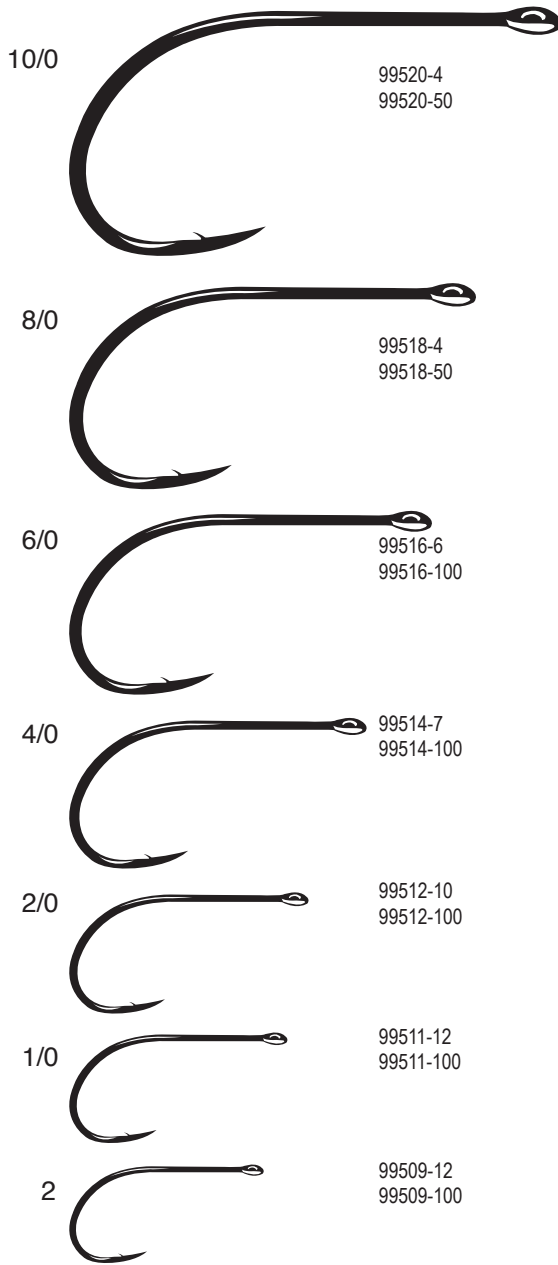

**SL45 •**

**Bone Fish**

Small Bone Fish Flies

Loose: Color: MB Sizes: 10-4



**SC15-2H •**

**Wide Gap • 2x Strong**

Tarpon and Billfish Flies

Loose: Color: TN Sizes: 3/0 - 5/0

100 pk: Color: TN Sizes: 3/0 - 5/0

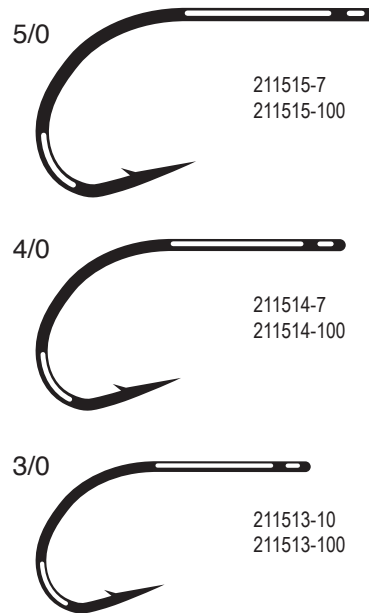

**SL11-3H •**

**3x strong**

Standard Bonefish/Tarpon Flies and Billfish Flies

Loose: Color: TN Sizes: 8 - 4/0

100 pk: Color: TN Sizes: 8 - 4/0

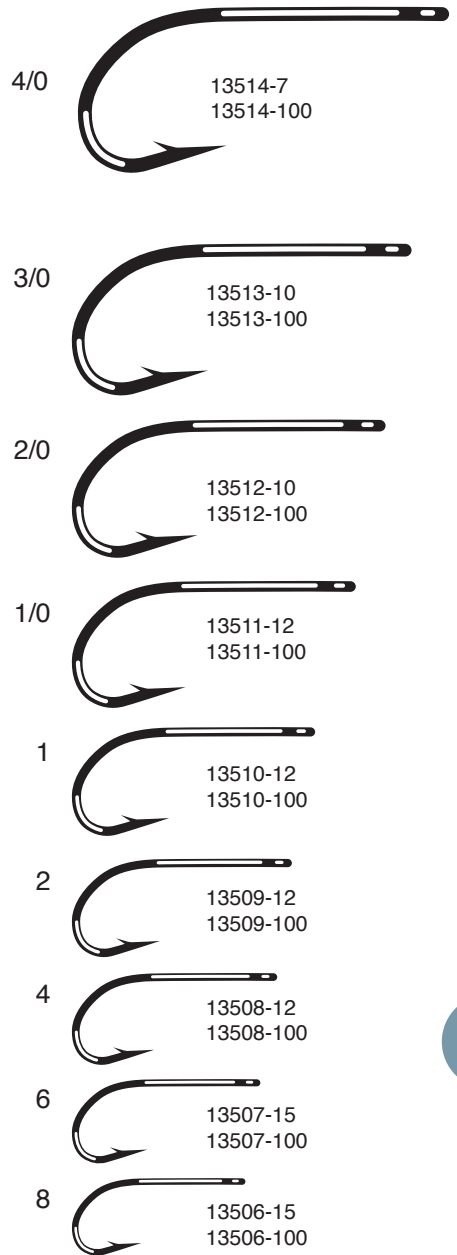

**SS15 •**

**Standard**

Standard Inshore Flies and Surface Patterns

Loose: Color: TN Sizes: 10 - 3/0

50 pk: Color: TN Sizes: 3/0

100 pk: Color: TN Sizes: 10 - 3/0



**SP11-3L3H •**

**Perfect Bend**

Longer Saltwater Streamers, Poppers and Billfish Flies

Loose: Color: TN Sizes: 8 - 3/0

100 pk: Color: TN Sizes: 8 - 3/0



**SC15 •**

**Wide Gape**

Shrimp, Small Tarpon Flies, Tube Fly Trailer

Loose: Color: TN Sizes: 8 - 3/0

100 pk: Color: TN Sizes: 8 - 3/0



**SC17 •**

**Tarpon Fly**

Multi-use Dries and Wets

Loose pk & 100 pk: Color: NB



DESCRIPTION	GAMAKATSU Model #	MUSTAD	TIEMCO	DAIICHI	DAI-RIKI
Standard Down Eye	S10	94840	5210	1170	300
Standard Down Eye Barbless	S10B	94845	900BL	1190	
Straight Eye Dry	S10S	94859	101	1110	310
Retainer Bend Barbless	R10-B				
Retainer Bend Barbless 3X Fine	R17B				
Retainer Bend Barbless 2X Strong	R18B				
Stinger 1x Strong Forged	B10S	37187		2720	
Glo Bug	C14S	9479	105	1510	
Keel Balance	C13U				
Vertical Eye Emerger Barbless	C15-BV				
Emerger Patterns Multi Use	C16-B				
Barbless Midge Large Eye	C12-BM				
Jig Nymph Barbed	J-20				
Jig Nymph Barbless	J-20		C403BL		
Salmon Steelhead 3x Strong	L11S-3H	3406	800	2451	
Streamer 4x Long 2x Strong	S11-4L2H	79580	9395	2220	700
Streamer 4x Long 2x Strong SE	S11S-4L2H	9674	9395	2220	
Scud	C12	80250	2487	1130	
Caddis	C12U	37160	205BL	1140	
Scud, Barbless	C12-B		2487BL		
Salmon Steelhead Dry 1x Fine	T10-3H	90240	7989	2421	
Salmon Steelhead Wet	T10-6H	36890	7999	2161	899
Russian River Fly	Russian River	36717			
Double Hook Medium Shank	Double 22				
Saltwater Big Game	SL12S				
Bone Fish	SL45				
Saltwater 3x Strong	SL11-3H				
Standard Saltwater	SS15	34007	811S	2546	930
Saltwater Perfect Bend	SP11-3L3H				
Saltwater Wide Gap	SC15				
Saltwater Wide Gap 2x Strong	SC15-2H				
Tarpon Fly	SC17				
TGW / Nano Smooth	B10S				
Saltwater	SL12-S 1X Short				



**Trucker Mesh Cap**

Mid-profile cap made from cotton twill fabric. Breathable nylon mesh in back. Embroidered logo. Black with white mesh. Velcro closure. Item #H010



**NEW**

**Trucker Mesh Cap**

Mid-profile cap made from cotton twill fabric. Breathable nylon mesh in back. Embroidered logo. Navy with white mesh. Velcro closure. Item #H014



**Knit Beanie**

8" cap stretches to most head sizes. Made of cotton/poly knit blend. Embroidered logo. Black Item #B001



**Low Profile Visor**

100% garment washed cotton. Embroidered Logo. Adjustable Velcro closure in back. Black, Item #V002



**Pro Cotton Cap**

100% cotton material. Embroidered logos on both front and back. Velcro closure. Black, Item #H007



**G Finesse Flat Bill**

100% cotton material. Embroidered logo. Snap Back. Black, Item #H011



**Alaska Hat**

100% cotton material. Embroidered logo. Flex Fit. Black, Item #H012-S/M Black, Item #H012-L/XL



**Flat Bill Triple Black**

100% cotton material. Embroidered logo. Adjustable Snap Back Closure. Triple Black, Item #H013

**NEW**



**G Finesse Cap**

100% cotton material. Embroidered logo. Flex Fit. Black, Item #H009



**G Finesse Decal**

Yellow #21  
White #20  
Solid #19



**Tuna Boat Decal**

9 inch - white #14  
9 inch - red #18  
9 inch -blue #15

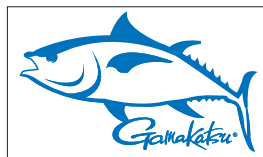

**Embroidered Patch**

4 1/2 inch  
#24



**Small Boat Decal**

7 inch  
White #7  
Blue #7-B  
Lime Green #7-LG



**Large Boat Decal**

18 inch  
White #1  
Blue #2



**Small Decal Sheet**

Aprox 3", 2", 1.25"  
White #23-W  
Blue #23-B





**T-Shirt**

100% cotton short sleeve t-shirt.  
Screen printed logo. White. Sizes M-2XL.  
Item #T001



**T-Shirt with Pocket**

100% cotton short sleeve t-shirt with pocket.  
Screen printed logo. White. Sizes M-2XL.  
Item #T002



**Luxe T-Shirt White**

100% cotton Beefy T short sleeve. Screen  
Printed logo. White. Sizes L  
Item #53358-23-0



**G Finesse T-Shirt**

100% cotton short sleeve .  
Screen printed design.  
Sizes M-XL.  
Item #T007W



**Performance T-Shirt, Black**

Long sleeve, dry wicking performance material.  
Screen Printed logo.  
Sizes S,M, L, XL, XXL  
Item #T008B



**Performance T-Shirt, White**

Long sleeve, dry wicking performance material.  
Screen Printed logo.  
Sizes S,M, L, XL, XXL  
Item #T008W



**Softshell Performance Jacket**

Polyester stretch fabric bonded to soft  
microfleece inside. Embroidered logo.  
Wind and water resistant.  
Black. Sizes M-2XL.  
Item # J001



**Fleece Performance Jacket**

13 oz fleece material with nylon  
capped shoulders. Full zipper.  
Adjustable waist. Embroidered logo.  
Gray with black trim. Sizes M-2XL.  
Item #F001



**Hooded Sweatshirt**

9.3 oz cotton/poly material  
shoulders. Adjustable drawstring.  
Kangaroo pouch. Screen printed  
logo. Navy. Sizes M-2XL.  
Item #S002



**Hooded Sweatshirt**

9.3 oz cotton/poly material  
shoulders. Adjustable drawstring.  
Kangaroo pouch. Screen printed  
logo. Athletic gray. Sizes M-2XL.  
Item #S001



**Japanese Chara**

100% cotton short sleeve t-shirt with pocket.  
Screen printed logo. Black. Sizes M-XL.  
Item #T006B



**Samurai Fisherman**

100% cotton short sleeve t-shirt.  
Screen printed design. Black. Sizes M-2XL.  
Item #T004B

**Samurai Fisherman  
Trucker Mesh Cap**

Mid-profile cap made from cotton twill fabric. Breathable nylon mesh in back. Embroidered logo. Black with black mesh. Snap Back closure. Item #H008



**Samurai Fisherman**

100% cotton short sleeve t-shirt.  
Screen printed design. White. Sizes M-2XL.  
Item #T004W

**Long Sleeve Samurai Fisherman**

100% cotton long sleeve t-shirt.  
Screen printed design. White. Sizes M-2XL.  
Item #T005W



### G-Box 3200, Utility Case

- Size 8.1" x 5.7" x 1.6".
  - Great for terminal tackle and small lures.
  - Micro Rib System- Micro Adjustable Dividers.
  - Easily opened with one hand.
  - Does not open when dropped.
  - Tackle stays in place and does not go to other compartments.
  - Rounded corners easy to get out of tackle bags or boat compartments.
- Item #G3200

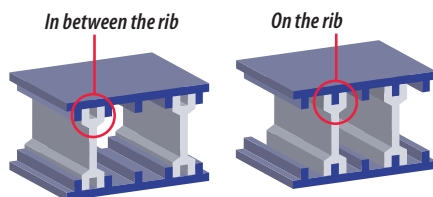

Micro Rib System - Micro Adjustable Dividers

### G-Box 3600, Utility Case

- Size 10.8" x 7.4" x 1.7".
  - Great for plastic baits and hardbaits.
  - Micro Rib System- Micro Adjustable Dividers.
  - Easily opened with one hand.
  - Does not open when dropped.
  - Adjustable Layout Vertically and Horizontally.
  - Tackle stays in place and does not go to other compartments.
  - Rounded corners easy to get out of tackle bags or boat compartments.
- Item #G3600



### G-Box 3500D Deep Utility Case

**NEW**

- Size 10" x 7.4" x 2.4".
  - Great for plastic baits and hardbaits.
  - Micro Rib System- Micro Adjustable Dividers.
  - Easily opened with one hand.
  - Does not open when dropped.
  - Adjustable Layout Vertically and Horizontally.
  - Tackle stays in place and does not go to other compartments.
  - Rounded corners easy to get out of tackle bags or boat compartments.
- Item #G3500D



Our designers continue to expand the offering of G-Boxes because anglers keep expanding their requests for more of these intuitive storage solutions. The new G-Box 3500 is nearly 2.4" deep, so big-lipped and fat-bodied, baits fit with ease. It's 7.4" wide to accommodate stick baits, long spinners and spinner blades. The clear top lets you see what's inside and the one-handed, easy-opening design makes access exceptionally convenient. Of course, the dividers are fully adjustable too.

### G-Box 3700, Utility Case

- Size 14" x 9" x 2".
  - Great for terminal tackle and small lures.
  - Micro Rib System- Micro Adjustable Dividers.
  - Easily opened with one hand.
  - Does not open when dropped.
  - Tackle stays in place and does not go to other compartments.
  - Rounded corners easy to get out of tackle bags or boat compartments.
- Item #G3700



### G-Box 250, Duo Side Case

- Size 7" x 4.2" x 1.6".
- Great for Rigs, Hooks, Flies and Jig Heads.
- Easy to See Slit Foam on one side.
- Micro Rib System- Micro Adjustable Dividers on other side.
- Easily opened with one hand.
- Product stays in place and organized.
- Rounded corners easy to get out of tackle bags or boat compartments.

Item #G250DS



### G-Box 3200, Slit Foam Case

- Size 8.1" x 5.7" x 1.6".
- Great for plastic baits and hardbaits.
- Micro Rib System- Micro Adjustable Dividers.
- Easily opened with one hand.
- Does not open when dropped.
- Adjustable Layout Vertically and Horizontally.
- Tackle stays in place and does not go to other compartments.
- Rounded corners easy to get out of tackle bags or boat compartments.

Item #G3200SF



### G-Box 3600, Slit Foam Case

- Size 10" x 7.5" x 1.1".
- Great for Rigs, Hooks, Flies and Jig Heads.
- Easy to See Slits.
- Easily opened with one hand.
- Product stays in place and organized.
- Rounded corners easy to get out of tackle bags or boat compartments.

Item #G3600SF



### G Finesse Dry Backpack

- Waterproof PVC Material.
- Backpack design with adjustable waist strap.
- Velcro and latch closure sinches down for water tight transport.

Item #BAG001

Secure your gear and keep it dry with our Waterproof Backpack. Double sealed seams are impervious to moisture even when submerged. The top closures open wide for easy access, then roll down tight and buckles quick to protect contents. Padded shoulder straps and waist belt complete the package.



### Dry Bag Backpack 20L

NEW

- Waterproof PVC Material.
- Backpack design with adjustable straps.
- Velcro and latch closure sinches down for water tight transport.

Item #BAG004

When you need guaranteed watertight storage for long walks out to the boat, down the beach or deep into the woods, just let this Dry Bag Backpack 20L carry the load. 100% waterproof with sealed seams and breathable back padding for comfort. Top rolls and clips securely to prevent leakage. The front zippered pocket protects valuables. Compacts tightly for storage when not in use. Large enough for any overnight or multi-day trip.



NEW

### Dry Bag 10L

- Waterproof PVC Material.
- Convenient shoulder strap.
- Velcro and latch closure sinches down for water tight transport.

Item #BAG003

For extreme conditions where rain, waves, boat spray, or unforeseen accidents could really dampen the fun, store your gear in our Dry Bag 10L. 100% waterproof with sealed seams and convenient shoulder strap for easy carrying. Top rolls and clip securely to prevent leakage. The front zippered pocket is perfect for wallets, phones, licenses, or other valuables. Compacts tightly for storage when not in use.

### Backpack Tackle Storage

NEW

- Backpack design with adjustable waist strap.
- Comfortable 3d mesh padding.

Item #BAG005

When you need to carry enough tackle for wherever your angling adventure may lead you, strap on our new Backpack Tackle Storage solution. Made from 1680 Denier Ballistic Nylon, it's tough, light and easy to carry. The interior pouch can be adjusted from one large compartment to two smaller ones. Exterior carry pockets on both sides are designed to hold fishing rods or water bottles. Compacts tightly for storage when not in use. Includes two (2) G3600 and one (1) G3500D G-Boxes. Dimensions: 17" x 12" x 8".



### Gamakatsu Luxxe fishing line

A PE based filament, that is much stronger than classic braided line.

It is a 4 strand braided line, along with the PE fibers makes it more abrasion resistant and has less memory. In turn the benefits are less tangles, and better casting distances.

Available in the following test # 8, 10, 12, 14, 16.

TEST#	8	10	12	14	16
164 YD Spool	19511-08	19511-10	19511-12	19511-14	19511-16



### Gamakatsu Finger Protector

Protects your finger from the abuse of stripping line all day. One size. Item #GF003(1)



### Gamakatsu Aluminum Heavy Duty Pliers

5 x Heavy  
Item #P001(1)



Split Ring Opener



Hook Removal



Crimping



Braided or Mono Line Cutting and more ...

### GAMAKATSU USA

P.O. Box 1797 Tacoma, WA 98401  
253-922-8373 • Fax 800-223-9383

### SPRO Corporation

3655 Kennesaw 75 Pkwy, Suite 135  
Kennesaw, GA 30144  
770-919-1722 • FAX 770-919-8141

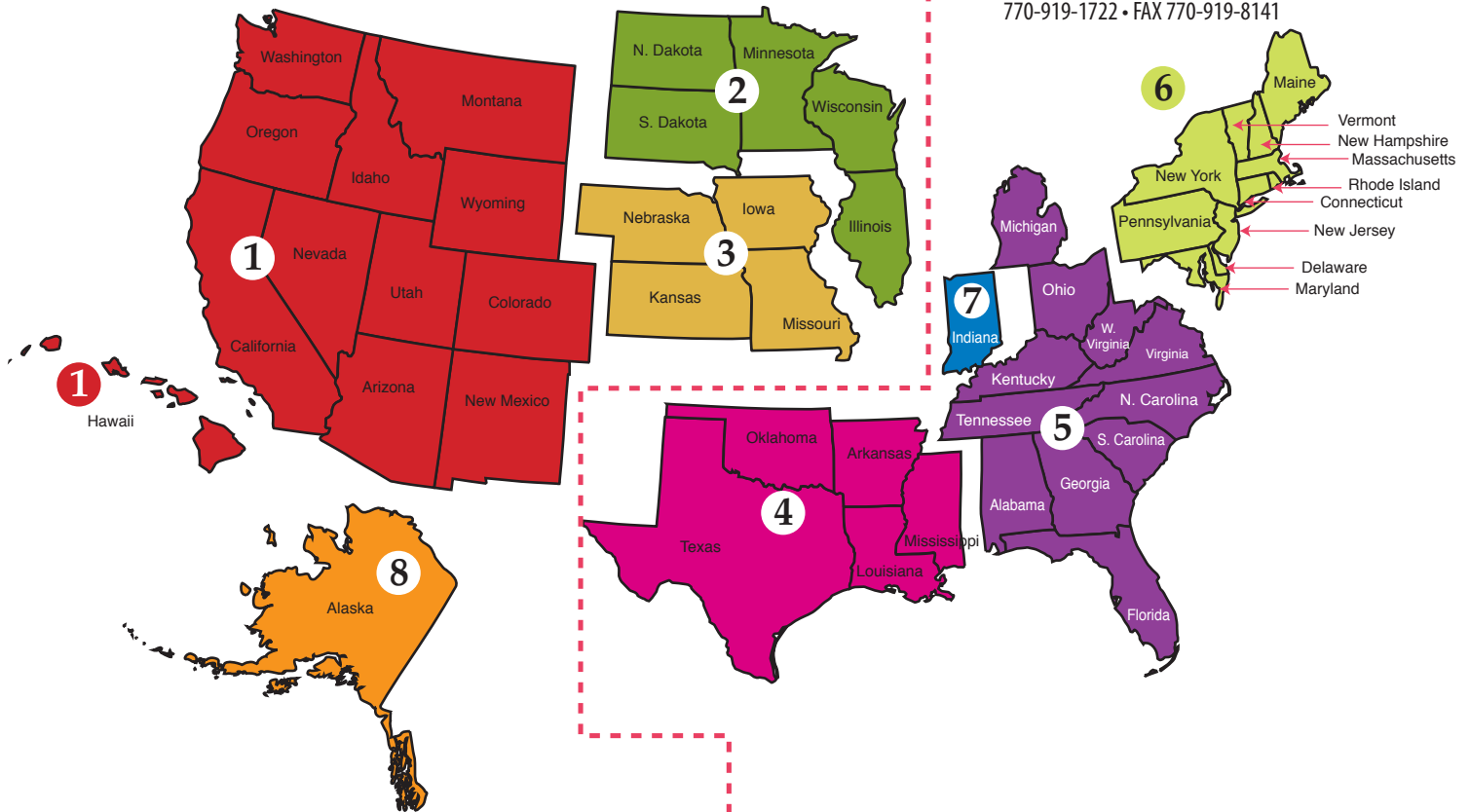

### Regions 1, 2, 3, 8 Call: Gamakatsu USA ... 253-922- 8373 or the following representatives:

#### REGION 1: L.H. French Company

1071 West 251st Street • Harbor City, CA 90710  
310-326-6543 (Corporate Office)

17019 NE 136 Place • Redmond, WA 98052

425-869-7909 (Northwest Office)

TERRITORY: Washington, Oregon, Idaho, Montana, Wyoming, California,  
Nevada, Utah, Colorado, Arizona, New Mexico, Hawaii

#### REGION 2: Schueler LaFond and Associates

334 E. Colfax St. A-1 • Paltine, IL 60067

847-991-6119

TERRITORY: Wisconsin, Minnesota, N. Dakota, S. Dakota, Illinois

#### REGION 3: Alexander and Townsend, Inc.

503 N. Mur-Len Road, Suite A • Olathe, KS 66062

913-829-3266

TERRITORY: Missouri, Iowa, Nebraska, Kansas

#### REGION 8: Skyline Sales & Service

20734 Crabtree St. • Chugiak, AK 99567

907-688-9993

TERRITORY: Alaska

### Regions 4, 5, 6, 7 Call: SPRO Corporation ... 770-919-1722 or the following representatives:

#### REGION 4: Frontier Marketing

6227 Paddle Wheel • Katy, TX 77449

281-345-4650

TERRITORY: Arkansas, Louisiana, Mississippi, Oklahoma, Texas

#### REGION 5 : Outdoor Brand Team

645 Hwy T-14, Pella, IA 50219

641-780-2510

TERRITORY: Alabama, Florida, Georgia, Kentucky, Michigan, North Carolina, Ohio, South  
Carolina, Tennessee, Virginia and West Virginia

#### REGION 6: Sheridan - Nisitro Marketing

9 Academy Road • Hatboro, PA 19040

215-674-5222

TERRITORY: Delaware, Maryland, Maine, Vermont, New Hampshire, Massachusetts, New York,  
New Jersey, Connecticut, Pennsylvania, and Rhode Island

#### REGION 7: Heinzman and Associates

11 Terry Drive • Jacksonville, IL 62650

217-245-2504

TERRITORY: Indiana



**WORLD'S FINEST HOOKS**  
[www.gamakatsu.com](http://www.gamakatsu.com)