

SPLIT

9 types 65 models

























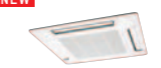



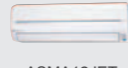































- 040 **INVERTER SPLIT ALL TYPE LINEUP**
- 042 **CONSTANT SPEED SPLIT ALL TYPE LINEUP**
- 044 **FEATURE EXPLANATION**
- 046 **INVERTER: Models by Country**
 - For Singapore
 - For Thailand
 - For Vietnam
- 062 **INVERTER: Common Models**
 - WALL MOUNTED
 - COMPACT CASSETTE
 - CASSETTE
 - FLOOR/CEILING
 - CEILING
 - SLIM DUCT
 - MEDIUM STATIC PRESSURE DUCT
- 078 **CONSTANT SPEED: Common Models**
 - WALL MOUNTED
 - COMPACT CASSETTE
 - CASSETTE
 - FLOOR/CEILING
 - CEILING
 - COMPACT DUCT
 - MEDIUM STATIC PRESSURE DUCT
 - HIGH STATIC PRESSURE DUCT











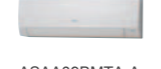
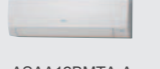





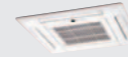







Energy saving design to provide a comfortable indoor environment while being environment-friendly.

An air conditioner that is people-friendly is also environment-friendly. Fujitsu General offers a broad lineup of products from large living rooms to bedrooms and children's rooms. We make your room more comfortable with a wide range of air conditioner types from ceiling wall type with automatic filters and cleaning functions to wall mounted type that improve the air cleaning function. Of course these models feature highly efficient operation that conserves electricity.



INVERTER : Models by Country		2.5	3.5	4.1	5.3	7.1	8.8	10.5	13.2	15.8	16.5	25.0
Capacity (kW)		9	12	14	18	24	30	36	45	54	60	90
Model Code		9	12	14	18	24	30	36	45	54	60	90
 for Singapore	Heating & Cooling 											
	ASYG09LUCA ASYG12LUCA ASYG14LUCA											
	Cooling only 											
ASAA09JGC ASAA12JGC												
Cooling only 												
ASAG18JFCA ASAG24JFCA ASAG30JFCA												
CASSETTE 												
AUAG24LRLA-A AUAG36LRLC-A												
 for Thailand	Cooling only 											
	ASMA09JET ASMA12JET											
Cooling only 												
ASMG09JLTA ASMG12JLTA												
 for Vietnam	Heating & Cooling 											
	ASAG09LLTB-V ASAG12LLTA-V											
Cooling only 												
ASAG09JLTB-V ASAG12JLTB-V												

INVERTER : Common Models		2.5	3.5	4.1	5.3	7.1	8.8	10.5	13.2	15.8	16.5	25.0
Capacity (kW)		9	12	14	18	24	30	36	45	54	60	90
Model Code		9	12	14	18	24	30	36	45	54	60	90
WALL MOUNTED	Cooling only 											
	ASAG09JLCA ASAG12JLCA											
Cooling only 												
ASAA18JCC ASAA24JCC ASAA30JCC												
COMPACT CASSETTE / CASSETTE 												
AUAG12LVLB AUAG18LVLB AUAG24LVLA AUAG30LRLA AUAG36LRLA AUAG45LRLA AUAG54LRLA												
FLOOR CEILING / CEILING 												
ABAG18LVTA ABAG24LVTA ABAG30LRTA ABAG36LRTA ABAG45LRTA												
SLIM DUCT 												
ARAG12LLLB ARAG18LLLB												
MEDIUM STATIC PRESSURE DUCT 												
ARAG24LMTA ARAG30LMLA ARAG36LMLA ARAG45LMLA												

CONSTANT SPEED : Common Models		2.5	3.5	4.1	5.3	7.1	8.8	10.5	13.2	15.8	16.5	25.0
Capacity (kW)		9	12	14	18	24	30	36	45	54	60	90
Model Code												
WALL MOUNTED	Cooling only 	 ASAA09BMTA-A	 ASAA12BMTA-A									
	Cooling only 				 ASAA18FMTA-A	 ASAA24FMTA-A						
	Cooling only				 ASYA18AET	 ASYA24AET						
COMPACT CASSETTE / CASSETTE	Heating & Cooling / Cooling only				 AUY18ABAB AUY18RBAB	 AUY25ABAR AUY25RLD-W	 AUY30ABAR AUY30RLD-W	 AUY45ABAS [3phase] AUY45RLB3W [3phase]	 AUY54ABAS [3phase] AUY54RLB3W [3phase]			
FLOOR CEILING / CEILING	Heating & Cooling / Cooling only				 ABY18ABAJ ABY18RBAJ	 ABY24ABAJ ABY24RBAJ	 ABY30ABA-W ABY30RBA-W	 ABY36ABA3W [3phase] ABY36RBA3W [3phase]	 ABY45ABA3W [3phase] ABY45RBA3W [3phase]	 ABY54ABA3W [3phase] ABY54RBA3W [3phase]		
COMPACT DUCT	Cooling only 				 ARY18FUAL							
MEDIUM STATIC PRESSURE DUCT	Heating & Cooling / Cooling only					 ARY25ALC ARY25RLC	 ARY30ALC ARY30RLC	 ARY36ALD3 [3phase] ARY36RLC3 [3phase]	 ARY45ALC3 [3phase] ARY45RLC3 [3phase]			
HIGH STATIC PRESSURE DUCT	Heating & Cooling / Cooling only									 ARY60AUAK [3phase] ARY60RUAK [3phase]	 ARY90ELC3 [3phase] ARY90TLC3 [3phase]	

FEATURE EXPLANATION

Energy Saving Function

Return
Set temperature auto return
The setting temperature automatically returns to the previously set temperature.

Economy
Economy mode
Limits the maximum operation current, and performs operation with the power consumption suppressed.

Set Temp.
Room temperature set point limitation
The minimum and maximum temperature range can be set giving further energy saving while considering the comfort of the occupants.

Saving
Energy saving mode
This mode raises the set temperature slightly in the cooling mode and lowers the set temperature in the heating mode to economically control the operation of the unit.

Comfortable Function

Diffuser
Power diffuser
An additional louver that opens based on monitoring sensors to quickly enhance immediate comfort needs.

Powerful
Powerful mode
Operation at maximum air flow and compressor speed, and quickly makes the room comfortable.

HEAT 10°C
10°C HEAT operation
The room temperature can be set to go no lower than 10°C, thus ensuring that the room does not get too cold when not occupied.

Low Noise
Low noise mode
Sound noise level of outdoor unit can be selected.

Auto Changeover
Auto-changeover
The unit automatically switches between heating and cooling modes based on your temperature setting and the room temperature.

Up/Down
Up / down swing flaps
The up / down flaps automatically swing up and down.

Double
Double swing automatic
Complex swing action of flaps enables automatically to swing both horizontal and vertical directions.

Adjust
Automatic fan speed
The micro-computer automatically adjusts the airflow effectively to follow the changes of room temperature.

Restart
Auto restart
In the event of a temporary power failure, the air conditioner will automatically restart in the same operating mode as before, once power supply is restored.

Duct
Connectable fresh air duct
Outside air can be introduced by attaching field supplied duct to fresh air knockout and optional part.

Intake
Fresh air intake
Fresh air can be taken in by a fan which can be connected using external control unit.

Distributing
Connectable distributing duct
Systems are capable of attaching field-supplied branch ducts distributing the airflow.

Convenient Function

Auto OFF
Auto off timer
Automatically stops operation when a fixed time has elapsed from the start of operation.

Sleep
Sleep timer
The micro-computer gradually changes the room temperature automatically to afford a comfortable night's sleep.

Program
Program timer
This digital timer allows selection of one of four options: ON, OFF, ON → OFF or OFF → ON.

Weekly
Weekly timer
Different ON-OFF times can be set for each day.

+Setback
Weekly + setback timer
Weekly + Setback timer can set temperature for two times spans and for each day of the week.

Filter
Filter sign
Indicates the filter cleaning period by lamp.

Clean Function

ION
Ion deodorization filter
The filter deodorizes by powerfully decomposing absorbed odors using the oxidizing and reducing effects of ions generated by the ultra-fine-particle ceramic.

AF
Apple-catechin filter
The Apple-catechin filter uses static electricity to clean fine particles and dust in the air.

Washable
Washable panel
Since the front panel is easy to remove, maintenance is also easy.

ALL DC All DC models

i-PAM i-PAM control models
i-PAM inverter control is a technology which reduces loss by adjusting the current waveform to a better sine waveform.

V-PAM V-PAM control models
V-PAM inverter control reduces the effects of magnetic flux and increases the maximum speed and efficiency of the compressor by vector control technology.

Feature Summary

INVERTER	CASSETTE	CONSTANT SPEED
WALL MOUNTED		WALL MOUNTED
A ASYG09/12/14LCA	G AUAG24LRLA-A, AUAG36LRLC-A, AUAG30/36/45/54LRLA	L ASAA09BMTA-A, ASAA12BMTA-A
B ASAA09/12JGC, ASMA09/12JET	FLOOR / CEILING	M ASAA18/24FMTA-A, ASYA18/24AET
C ASAG09/12JLCA, ASMG09/12JLTA, ASAG09LLTB-V, ASAG12LLTA-V, ASAG09/12JLTB-V	U ABAG18/24LVTA	COMPACT CASSETTE
D ASAG18/24/30JFCA	CEILING	N AUY18ABAB, AUY18RBAB
E ASAA18/24/30JCC	I ABAG30/36/45LRTA	CASSETTE
COMPACT CASSETTE	SLIM DUCT	O AUY25/30ABAR, AUY45/54ABAS(3phase), AUY25RLD-W, AUY30RLD-W, AUY45/54RLB3W(3phase)
F AUAG12/18LVLB, AUAG24LVLA	ARAG12/18LLLB	FLOOR/CEILING
	MEDIUM STATIC PRESSURE DUCT	P ABY18/24ABAJ, ABY18/24RBAJ
	K ARAG24LMTA, ARAG30/36/45LMLA	
		CEILING
		O ABY30ABA-W, ABY36/45/54ABA3W(3phase), ABY30RBA-W, ABY36/45/54ABA3W(3phase), ABY30RBA-W, ABY36/45/54RBA3W(3phase)
		COMPACT
		R ARY18FUAL
		MEDIUM STATIC PRESSURE DUCT
		S ARY25/30ALC, ARY36ALD3(3phase), ARY45ALC3(3phase), ARY25/30RLC, ARY36/45RLC3(3phase), ARY25/30ALC, ARY36ALD3(3phase), ARY45ALC3(3phase), ARY25/30RLC, ARY36/45RLC3(3phase)
		HIGH STATIC PRESSURE DUCT
		T ARY60AUAK(3phase), ARY60RUAK(3phase), ARY90ELC3(3phase) / ARY90TLC3(3phase)

	INVERTER											CONSTANT SPEED										
	A	B	C	D	E	F	G	H	I	J	K	L	M	N	O	P	Q	R	S	T		
Energy Saving Function	•		•	•		•	•	•	•	•	•											
Room temperature set point limitation	○																					
Set temperature auto return	○																					
Energy saving mode															•				•	•	•	
Power diffuser				•	•								•									
Powerful mode	•		•										•									
10°C HEAT operation	•					•		•	•													
Low Noise mode	•							○ (45/54 Types)		○ (45/54 Types)												
Auto-changeover	•	•	•	•	•	•	•	•	•	•	•	•	•	•	•	•	•	•	•	•	•	
Up / down swing flaps	•	•	•				•					•		•	•							
Double swing automatic				•	•			•	•				•			•	•					
Automatic fan speed	•	•	•	•	•	•	•	•	•	•	•	•	•	•	•	•	•	•	•	•	•	
Auto restart	•	•	•	•	•	•	•	•	•	•	•	•	•	•	•	•	•	•	•	•	•	
Connectable fresh air duct							•		•	•				•	•		•		•			
Fresh air intake							○	○		○	○								○	○	○ (60 Types)	
Connectable distributing duct							•			•				•	•					•		
Auto off timer	○																					
Sleep timer	•	•	•	•	•	•	•	•	•	•	•	•	•	•	•	•	•	•	•	•	•	
Program timer	•	•	•	•	•	•	•	•	•	•	•	•	•	•	•	•	•	•	•	•	•	
Weekly timer	•														•						• (-90 Types)	
Weekly + setback timer	○	○		○	○	○	•	○	○	•	•	○							•	•	• (60 Types)	
Filter sign	•	•	•	•	•	•	•	•	•	•	•	•	•	•	•	•	•	•	•	•	•	
Ion deodorization filter	•	•		•	•																	
Apple-catechin filter	•	•		•	•																	
Washable panel		•	•	•	•								•	•								

○: Optional function



Model : ASYG09LUCA / ASYG12LUCA / ASYG14LUCA



Thin & Slim design

Thin and slim design is realized by Ø5mm heat exchanger and high efficiency wind blower.



H282 X W870 X D185

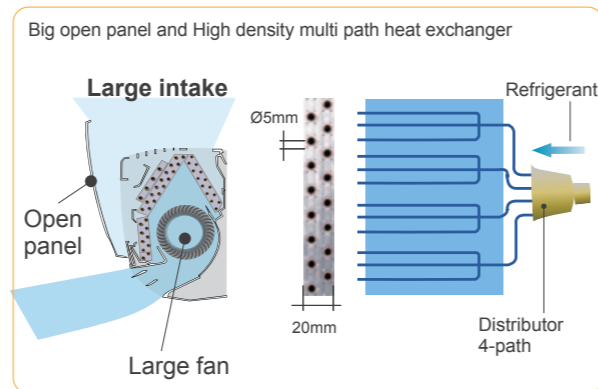

Powerful operation

20 minutes continuous operation by maximum airflow and maximum compressor speed is possible. Rapid cooling and heating makes the room comfortable quickly.

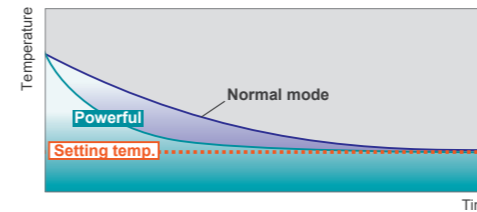

Low noise mode for outdoor unit

Low noise mode of outdoor unit can be selected by wireless remote controller.

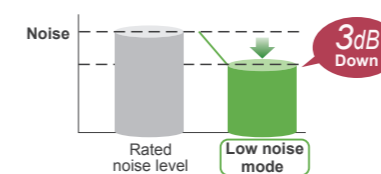

Low ambient operation

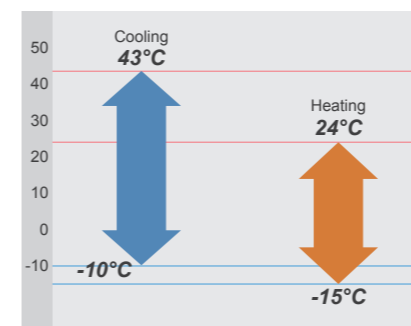

3 Mode timer (Weekly/Program/Sleep)

Weekly timer can be easily set by wireless remote controller. ON, OFF can be set up to 4 times in 1 day and up to 28 times in 1 week. For other modes, program timer and sleep timer can be also selected by one push.

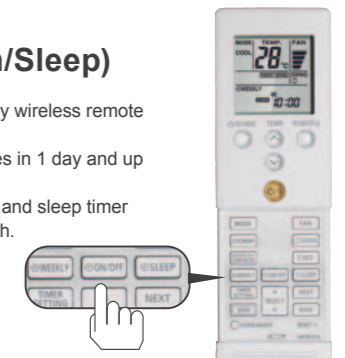

Economy operation

Setting temp. is shifted by 1°C automatically.

Ex. : Cooling operation

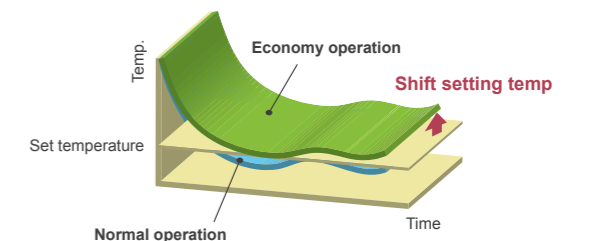

Optional parts

- Wired Remote Controller: UTY-RNNYM, UTY-RVNYM
- Simple Remote Controller: UTY-RSNYM
- Communication Kit: UTY-TWBXF
- External Connect Kit: UTY-XWZXZ5

Specifications

Model No.	Indoor unit		ASYG09LUCA	ASYG12LUCA	ASYG14LUCA
	Outdoor unit		AOYG09LUC	AOYG12LUC	AOYG14LUC
Power Source	V/Ø/Hz		230/1/50	230/1/50	230/1/50
Capacity	Cooling	kW	2.5(0.5~3.2)	3.5(0.9~4.0)	4.2(0.9~5.0)
		BTU/h	8,500(1,700-10,900)	11,900(3,100-13,600)	14,300(3,100-17,100)
	Heating	kW	3.2(0.5~4.2)	4.0(0.9~5.6)	5.4(0.9~6.0)
		BTU/h	10,900(1,700-14,300)	13,600(1,700-19,100)	18,400(1,700-20,500)
Input Power	Cooling/Heating	kW	0.555/0.680	0.905/0.930	1.235/1.380
EER	Cooling		4.50	3.87	3.40
COP	Heating	W/W	4.71	4.30	3.91
Running Current	Cooling/Heating	A	3.1/3.4	4.6/4.7	5.8/6.3
Moisture Removal		l/h	1.3	1.8	2.1
Sound Pressure	Indoor (High)	dB(A)	42	43	45
	Outdoor		48	50	50
Airflow Rate (High)	Indoor	m³/h	800	850	900
	Outdoor		1,720	1,940	1,940
Net Dimension HxWxD	Indoor	mm	282x870x185	282x870x185	282x870x185
	Outdoor	kg(lbs)	9.5(21)	9.5(21)	9.5(21)
Net Weight	Indoor	mm	540x660x290	540x790x290	540x790x290
	Outdoor	kg(lbs)	25.0(55)	33.0(73)	34.0(75)
Piping Connections (Small / Large)			6.35/9.52	6.35/9.52	6.35/12.70
Drain Pipe Diameter (I.D./O.D.)		mm	16.0/29.0	16.0/29.0	16.0/29.0
Max Pipe Length (Pre-Charge)		m	20(15)	20(15)	20(15)
Max Height Difference			15	15	15
Operation Range	Cooling	°CDB	-10 to 43	-10 to 43	-10 to 43
	Heating		-15 to 24	-15 to 24	-15 to 24
Refrigerant			R410A	R410A	R410A

Dimensions Models: ASYG09LUCA / ASYG12LUCA / ASYG14LUCA

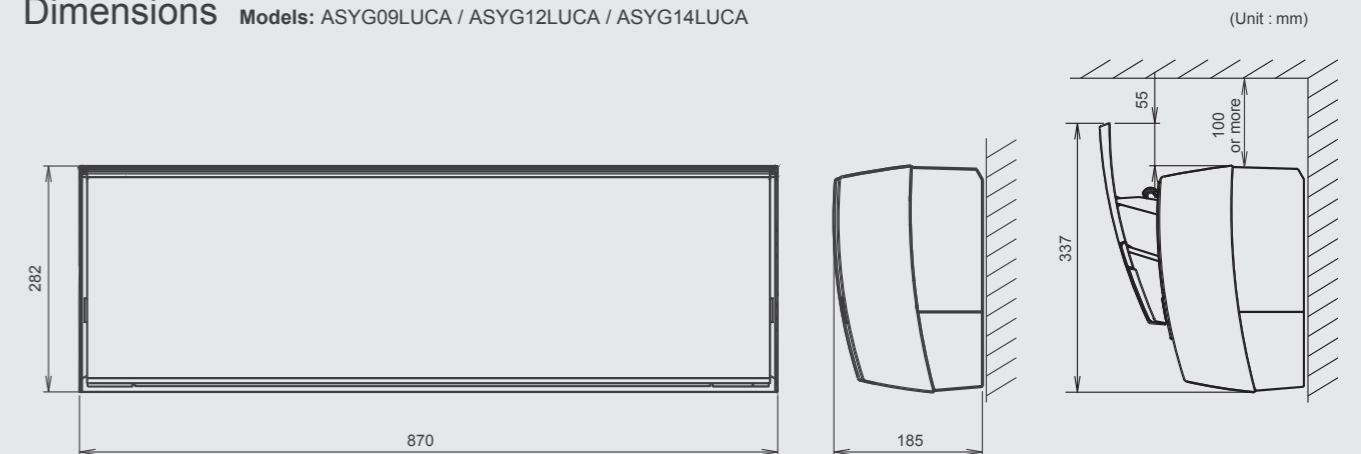



Model : ASAA09JGC / ASAA12JGC



High Efficient Compact Design

Compact design is realized by high density multi-path heat exchanger.

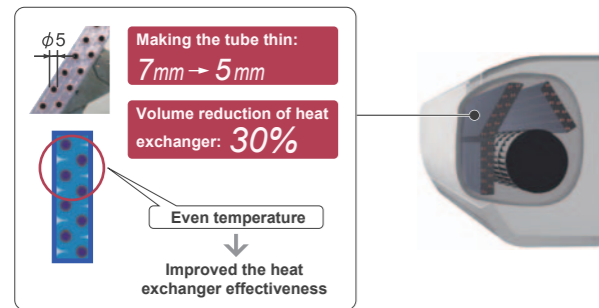

Super Quiet Operation

Top class low noise operation by new airflow construction. Our quiet operation makes the more comfortable environment in a bed room and a study room, etc.

Fan speed
Quiet

Noise level
22dB(A)

Air conditioner filter features

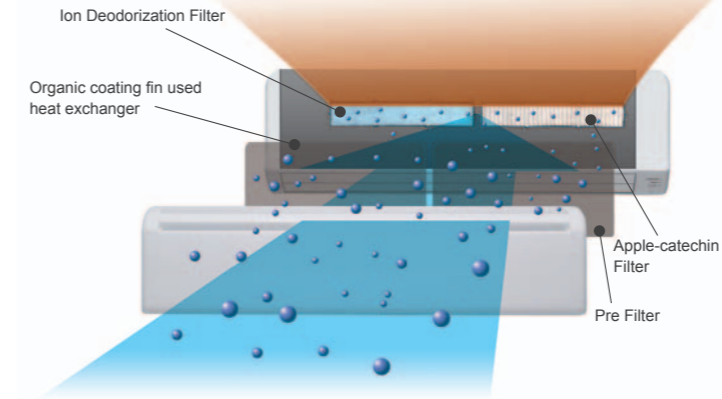

Antibacterial deodorizing pre-filter with special ceramic powder

Air conditioner filter features

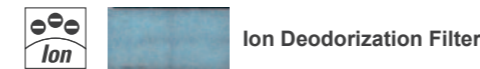

The filter deodorizes by powerfully decomposing absorbed odors using the oxidizing and reducing effects of ions generated by the ultra-fine-particle ceramic.

✦ Using different filters at both sides

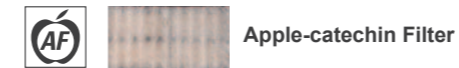

The Apple-catechin filter uses static electricity to clean fine particles and dust in the air.

Easy maintenance

Removable & washable panel



Low ambient operation

(Heat pump type)

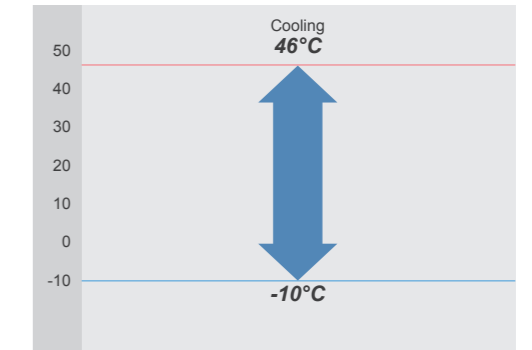

Optional parts

- Wired Remote Controller: UTY-RNNYM
- Simple Remote Controller: UTY-RSNYM
- Sub Interface Board: UTY-XCBXE
- External Connect Kit: UTY-XWZX

Specifications

Model No.	Indoor unit		ASAA09JGC	ASAA12JGC
	Outdoor unit		AOAR09JGC	AOAR12JGC
Power Source	V/∅/Hz		230/1/50	230/1/50
Capacity	Cooling	kW	2.5	3.5
		BTU/h	8,500	11,900
Input Power	Cooling	kW	0.7	1.03
EER	Cooling	W/W	3.57	3.4
Running Current	Cooling	A	3.5	4.9
Moisture Removal			1.3	1.8
Sound Pressure	Indoor (High)	dB(A)	43	43
	Outdoor		48	49
Airflow Rate (High)	Indoor	m³/h	750	750
	Outdoor		1,870	1,830
Net Dimension H×W×D	Indoor	mm	260x790x198	260x790x198
		kg(lbs)	7.5 (17)	7.5 (17)
Net Weight	Outdoor	mm	540x660x290	540x660x290
		kg(lbs)	28.0 (62)	30.0 (66)
Piping Connections (Small / Large)			6.35/9.52	6.35/9.52
Drain Pipe Diameter (I.D./O.D.)			16.0/29.0	16.0/29.0
Max Pipe Length (Pre-Charge)			15(10)	20(15)
Max Height Difference			10	15
Operation Range	Cooling	°CDB	18 to 46	18 to 46
Refrigerant			R410A	R410A

Dimensions Models: ASAA09JGC / ASAA12JGC

(Unit : mm)

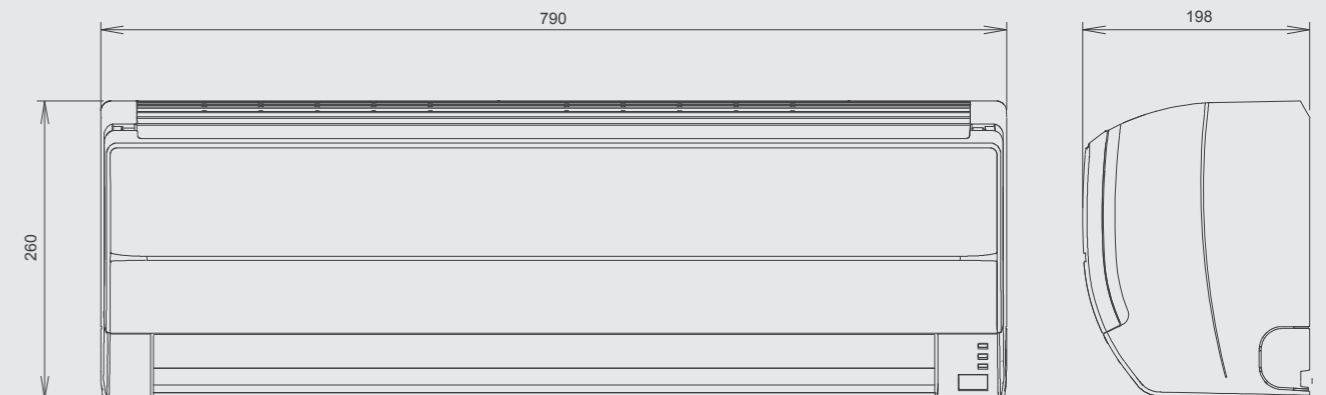



Model : ASAG18JFCA / ASAG24JFCA / ASAG30JFCA



Comfort airflow

Power diffuser

"Horizontal airflow" does not blow cool air directly at the occupants in the room

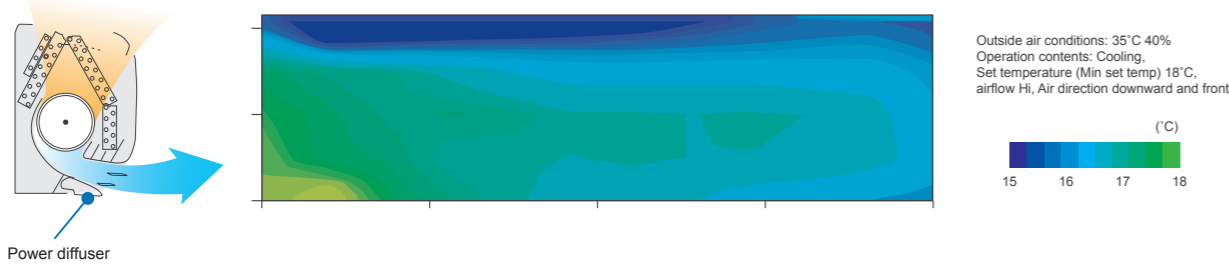

Air conditioner filter features

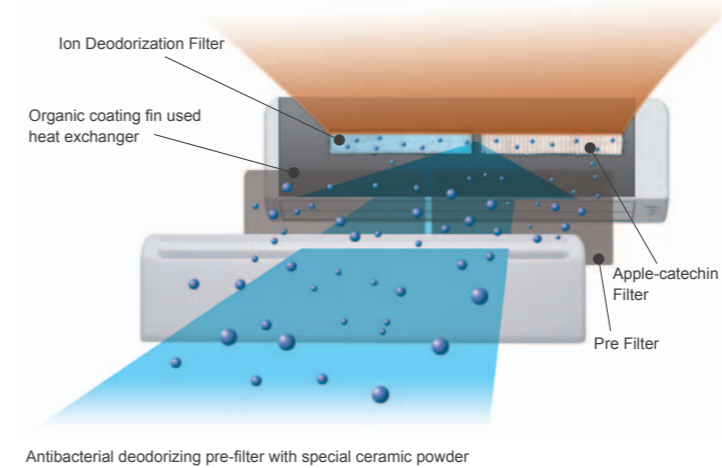

Air conditioner filter features

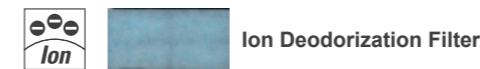

The filter deodorizes by powerfully decomposing absorbed odors using the oxidizing and reducing effects of ions generated by the ultra-fine-particle ceramic.

✚ Using different filters at both sides

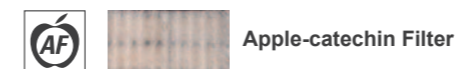

The Apple-catechin filter uses static electricity to clean fine particles and dust in the air.

Economy operation

Setting temp. is shifted by 1°C automatically.

Ex. : Cooling operation

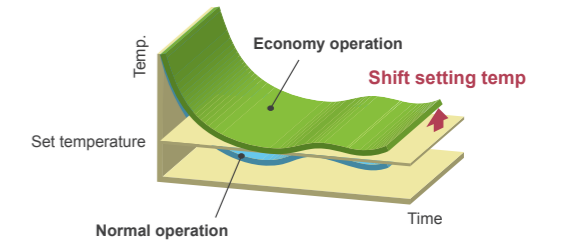

Flexible Installation

	18 type	24 type	30 type
Max. Piping Length	25m	30m	50m
Max. Height	20m	20m	30m

Easy maintenance

Simplification of drain pan cleaning improves maintenance-ability.

Optional parts

- Wired Remote Controller: UTY-RNNYM
- Simple Remote Controller: UTY-RSNYM
- External Connect Kit: UTY-XWZX

Specifications

Model No.	Indoor unit		ASAG18JFCA	ASAG24JFCA	ASAG30JFCA
	Outdoor unit		AOAG18JFC	AOAG24JFC	AOAG30JFT
Power Source	V/∅/Hz		230/1/50	230/1/50	230/1/50
Capacity	Cooling	kW	5.2(0.9-6.0)	6.9(0.9-8.0)	7.9(2.9-9.0)
		BTU/h	17,700	23,500	27,000
Input Power	Cooling	kW	1.52	2.06	2.36
EER	Cooling	W/W	3.42	3.35	3.35
Running Current	Cooling	A	6.8	9.1	10.4
Moisture Removal		l/h	2.6	2.7	3.2
Sound Pressure	Indoor (High)	dB(A)	43	49	49
	Outdoor		50	55	53
Airflow Rate (High)	Indoor	m ³ /h	900	1,120	1,120
	Outdoor		2,150	2,460	3,600
Net Dimension H×W×D	Indoor	mm	320x998x238	320x998x238	320x998x238
	Outdoor		kg(lbs)	14.0(31)	14.0(31)
Net Weight	Indoor	mm	620x790x290	620x790x290	830x900x330
	Outdoor		kg(lbs)	41.0(90)	41.0(90)
Piping Connections (Small / Large)			6.35/12.7	6.35/15.88	9.52/15.88
Drain Pipe Diameter (I.D./O.D.)		mm	12.0/16.0	12.0/16.0	12.0/16.0
Max Pipe Length (Pre-Charge)		m	25(15)	30(15)	50(20)
Max Height Difference			20	20	30
Operation Range	Cooling	°CDB	-10 to 46	-10 to 46	-10 to 46
Refrigerant			R410A	R410A	R410A

Dimensions Models: ASAG18JFCA / ASAG24JFCA / ASAG30JFCA

(Unit : mm)

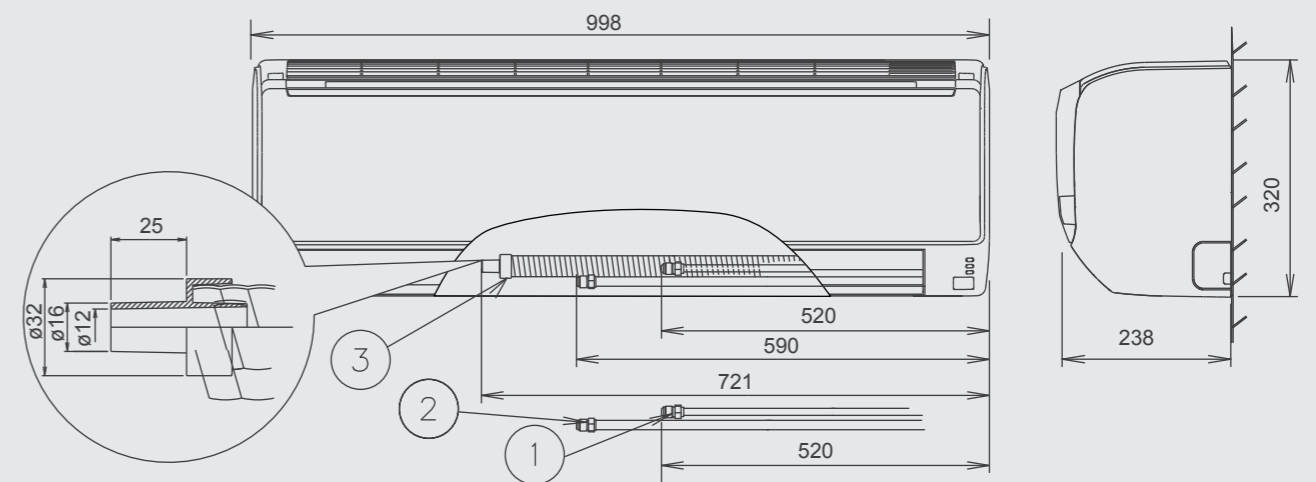

- ① Refrigerant piping flare connection (Liquid)
- ② Refrigerant piping flare connection (Gas)
- ③ Drain piping connection (Drain hose)



NEW Model : AUAG24LRLA-A / AUAG36LRLC-A



Top Class High EER

The EER figures in this two models can be found in tick 3 in 24 Btu model and tick 2 in 36 Btu model in the energy-saving program in Singapore.

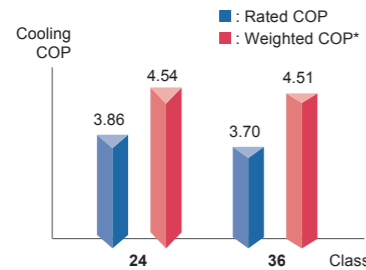

*Weighted COP=0.4xCOP_{100%}+0.6xCOP_{50%}

Long-Reach And Wide Angle Air Flow

The airflow can be travelled in all directions and at far distance. It enables to produce the best performance in sizable spaces such as office and school.

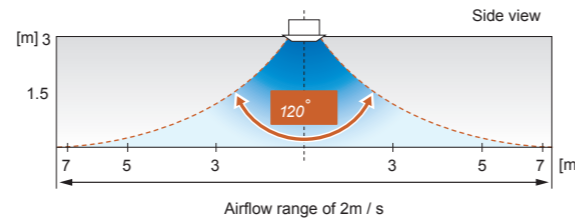

Simultaneous use of Wireless and Wired Remote Controller

Wired and wireless remote controllers can be simultaneously used, which enables to utilize the benefits of both remote controllers.

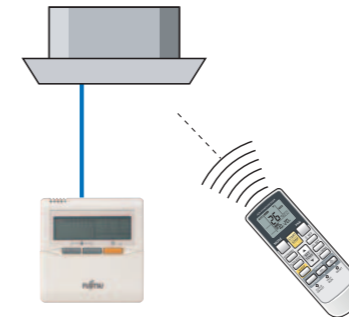

Economy Operation

Economy operation automatically increases the temperature setting by 1 degree which helps to save power consumption.

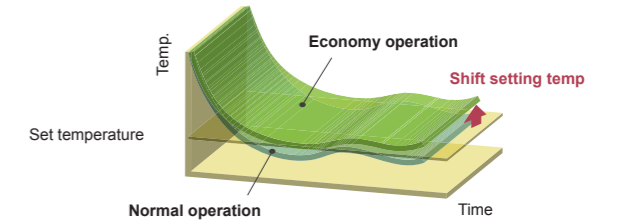

Flexible Installations

Long piping and operability in high ambient temperature enables to enhance the installation flexibility.

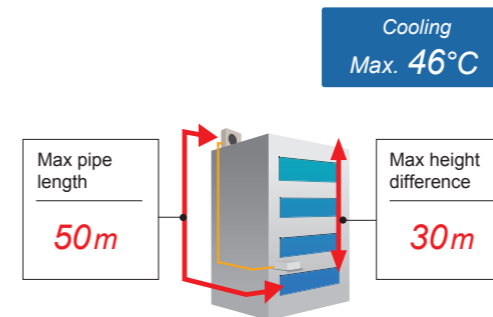

Optional parts

- Wired Remote Controller: UTY-RNNYM
- Simple Remote Controller: UTY-RSNYM
- IR Receiver Kit: UTY-LRHYA2 (For AUAG36LRLC-A)
- Wide Panel: UTG-AGYA-W (For AUAG36LRLC-A)
- Panel Spacer: UTG-BGYA-W (For AUAG36LRLC-A)
- Air Outlet Shutter Plate: UTR-YDZB (For AUAG24LRLA-A), UTR-YDZC (For AUAG36LRLC-A)
- Insulation Kit For High Humidity: UTZ-KXGC (For AUAG24LRLA-A), UTZ-KXGA (For AUAG36LRLC-A)
- External Connect Kit: UTY-XWZX
- External Control Set: UTY-ZWZXZ2 (For AUAG36LRLC-A), UTY-ZWZXZ3 (For AUAG36LRLC-A)
- Fresh Air Intake Kit: UTD-ECS5A, UTZ-VXAA (For AUAG24LRLA-A), UTZ-VXGA (For AUAG36LRLC-A)

Specifications

Model No.	Indoor unit		AUAG24LRLA-A	AUAG36LRLC-A
	Outdoor unit		AOAG24LBTA-A	AOAG36LBTB-A
Power Source	V/∅/Hz		230/1/50	230/1/50
Capacity	Cooling	kW (Min-Max)	7.10 (2.80-10.00)	10.00 (4.00-14.00)
		Btu/h (Min-Max)	24,200 (9,500-34,100)	34,100 (13,700-47,800)
EER	Heating	kW (Min-Max)	8.00 (2.70-11.20)	11.20 (4.20-16.20)
		Btu/h (Min-Max)	27,200 (9,200-38,200)	38,200 (14,300-55,300)
Input Power	Cooling/Heating	kW (Max)	1.84 (3.88) / 1.86 (3.88)	2.70 (4.70) / 2.60 (4.70)
Running Current	Cooling/Heating	A (Max)	8.1 (17.0) / 8.2 (17.0)	11.8 (20.5) / 11.4 (20.5)
Moisture Removal		l/h	2.1	3.6
Sound Pressure (Cooling)	Indoor (High)	dB(A)	40	46
	Outdoor		51	53
Airflow Rate (Cooling)	Indoor (High)	m ³ /h	1,600	1,900
	Outdoor		3,600	6,750
Net Dimension HxWxD	Indoor unit	mm	288x840x840 / 50x950x950	288x840x840 / 50x950x950
	Outdoor unit	mm	830 x 900 x 330	1,260 x 900 x 330
Net Weight	Indoor unit	kg(lbs)	23.0(50) / 5.5(12)	26.0(57) / 5.5(12)
	Outdoor unit	kg(lbs)	61.0(135)	86.0(190)
Piping Connections (Small / Large)		mm	9.52/15.88	9.52/15.88
Drain Pipe Diameter (I.D./O.D.)		mm	25/32	25/32
Max Pipe Length (Pre-Charge)		m	50 (20)	50 (20)
Max Height Difference			30	30
Operation Range	Cooling	°CDB	-15 to 46	-15 to 46
	Heating		-15 to 24	-15 to 24
Refrigerant			R410A	R410A
Cassette Grille			UTG-UGYA-W	UTG-UGYA-W

Dimensions

Models: AUAG24LRLA-A / AUAG36LRLC-A

(Unit : mm)

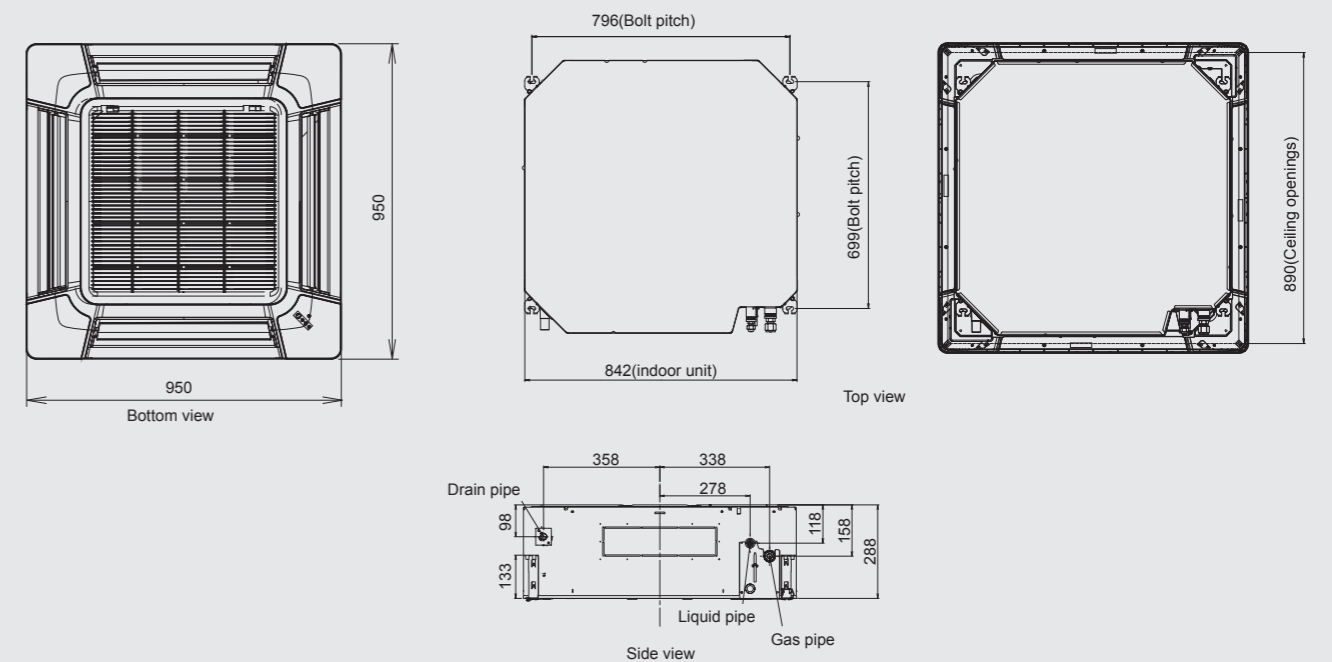

INVERTER

WALL MOUNTED

For Thailand



Model : ASMA09JET / ASMA12JET



High Efficient Compact Design

Compact design is realized by high density multi-path heat exchanger.

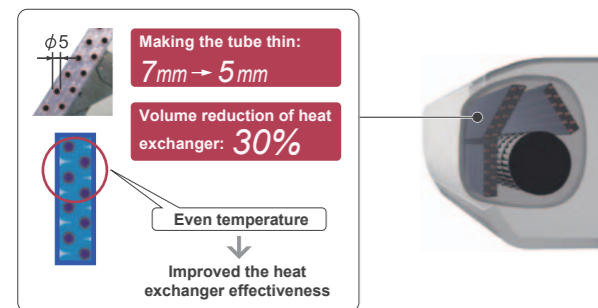

Super Quiet Operation

Top class low noise operation by new airflow construction. Our quiet operation makes the more comfortable environment in a bed room and a study room, etc.

Fan speed
Quiet

Noise level
22dB(A)

Air conditioner filter features

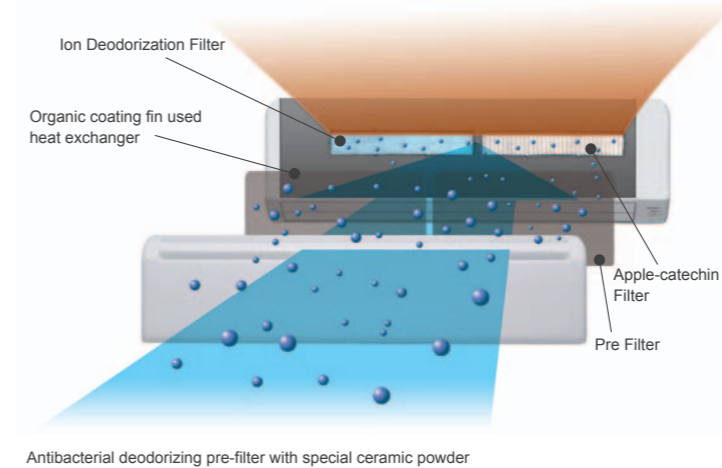

Antibacterial deodorizing pre-filter with special ceramic powder

Easy maintenance

Removable & washable panel



Low ambient operation

(Heat pump type)

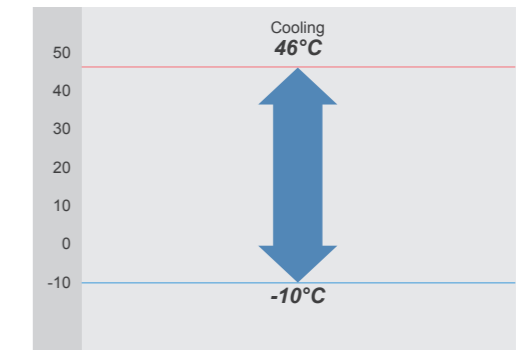

Air conditioner filter features

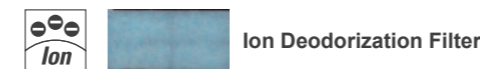

The filter deodorizes by powerfully decomposing absorbed odors using the oxidizing and reducing effects of ions generated by the ultra-fine-particle ceramic.

+ Using different filters at both sides

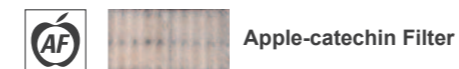

The Apple-catechin filter uses static electricity to clean fine particles and dust in the air.

Optional parts

- Wired Remote Controller: UTY-RNNYM
- Simple Remote Controller: UTY-RSNYM
- Sub Interface Board: UTY-XCBXE
- External Connect Kit: UTY-XWZX

Specifications

Model No.	Indoor unit		ASMA09JET	ASMA12JET
	Outdoor unit		AOMR09JET	AOMR12JET
Power Source	V/∅/Hz		220/1/50	220/1/50
Capacity	Cooling	kW	2.5(0.5-3.2)	3.4(0.9-4.0)
		BTU/h	8,500	11,600
Input Power	Cooling	kW	0.72	0.97
EER	Cooling	W/W	3.47	3.51
Running Current	Cooling	A	3.7	4.7
Moisture Removal	l/h		1.3	1.8
Sound Pressure	Indoor (High)	dB(A)	43	43
	Outdoor		48	49
Airflow Rate (High)	Indoor	m³/h	750	720
	Outdoor		1,870	1,830
Net Dimension H×W×D	Indoor	mm	260x790x198	260x790x198
		kg(lbs)	7.5(17)	7.5(17)
Net Weight	Outdoor	mm	540x660x290	540x660x290
		kg(lbs)	28.0(62)	30.0(66)
Piping Connections (Small / Large)	mm		6.35/9.52	6.35/9.52
Drain Pipe Diameter (I.D./O.D.)	mm		13.8/15.8 to 16.7	13.8/15.8 to 16.7
Max Pipe Length (Pre-Charge)	m		15(10)	20(15)
Max Height Difference	m		10	15
Operation Range	Cooling	°CDB	18 to 46	18 to 46
Refrigerant			R410A	R410A

Dimensions Models: ASMA09JET / ASMA12JET

(Unit : mm)

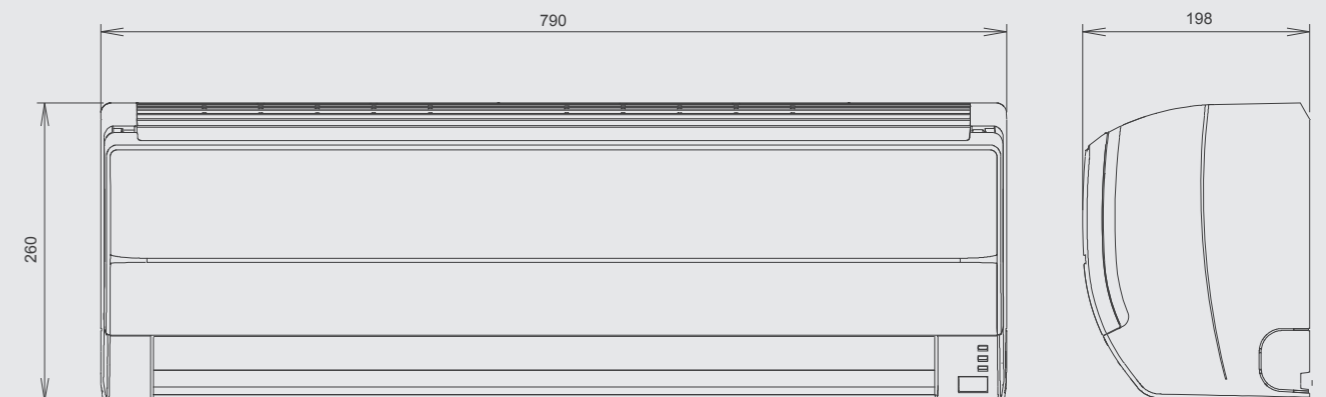



Model : ASMG09JLTA / ASMG12JLTA



Wireless R.C.



High Efficient Compact Design

Compact design is realized by high density multi-path heat exchanger.

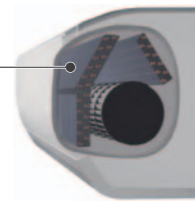
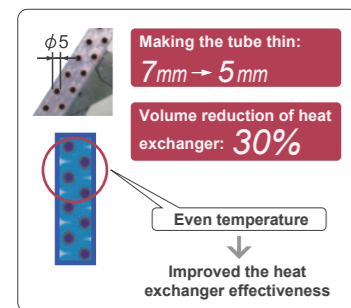

Super Quiet Operation

Top class low noise operation by new airflow construction. Our quiet operation makes the more comfortable environment in a bed room and a study room, etc.

Fan speed
Quiet

Noise level
22dB(A)

Powerful operation

Reach the setting temperature quickly.

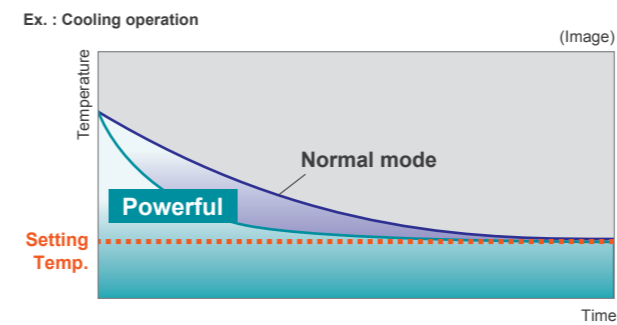

Economy operation

Setting temp. is shifted by 1°C automatically.

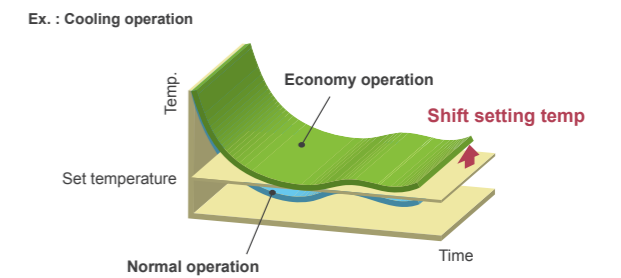

More Convenient Timer

You can set an integrated ON-OFF or OFF-ON timer suitable for your life style. (Setting time: 0.5, 1, 1.5, 2, 2.5, ----9.5, 10, 11, 12 hours)

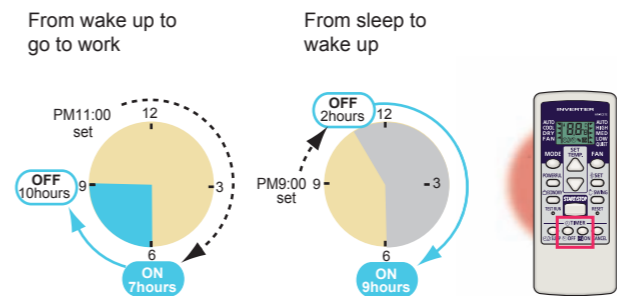

Easy maintenance

Removable & washable panel



Optional parts

Protective net: UTZ-NXCA

Specifications

Model No.	Indoor unit		ASMG09JLTA		ASMG12JLTA	
	Outdoor unit		AOMG09JLTA		AOMG12JLTA	
Power Source	V/∅/Hz		220/1/50		220/1/50	
Capacity	Cooling	kW	2.5(0.9-3.0)		3.2(0.9-3.8)	
		BTU/h	8,500		10,900	
Input Power	Cooling	kW	0.72		0.93	
EER	Cooling	W/W	3.47		3.44	
Running Current	Cooling	A	3.6		4.8	
Moisture Removal	l/h		1.3		1.8	
Sound Pressure	Indoor (High)	dB(A)	43		43	
	Outdoor		47		50	
Airflow Rate (High)	Indoor	m³/h	720		720	
	Outdoor		1,670		1,830	
Net Dimension H×W×D	Indoor	mm	262x820x206		262x820x206	
		kg(lbs)	7.0(15)		7.0(15)	
Net Weight	Outdoor	mm	540x660x290		540x660x290	
		kg(lbs)	25.0(55)		28.0(62)	
Piping Connections (Small / Large)	mm		6.35/9.52		6.35/9.52	
Drain Pipe Diameter (I.D./O.D.)	mm		13.8/15.8 to 16.7		13.8/15.8 to 16.7	
Max Pipe Length (Pre-Charge)	m		20(15)		20(15)	
Max Height Difference	m		15		15	
Operation Range	Cooling	°CDB	18 to 46		18 to 46	
Refrigerant			R410A		R410A	

Dimensions Models: ASMG09JLTA / ASMG12JLTA

(Unit : mm)

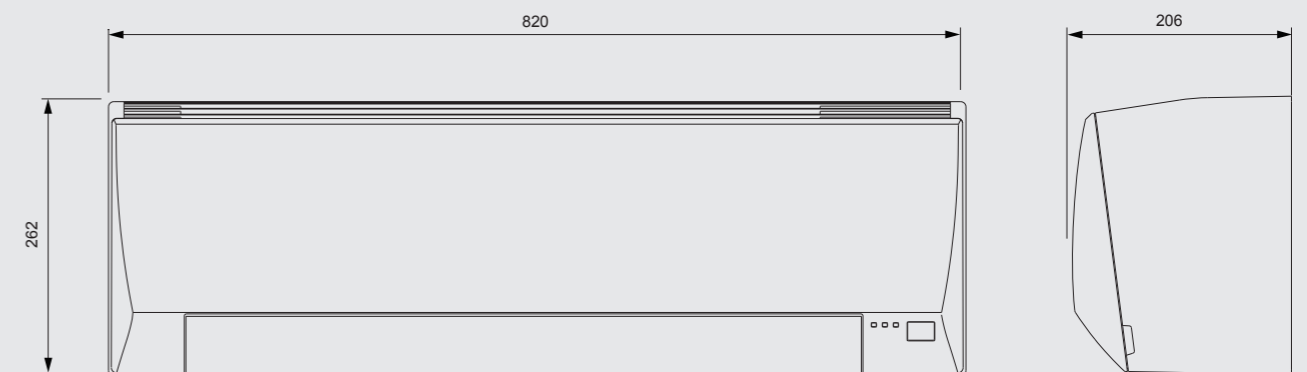



NEW Model : ASAG09LLTB-V / ASAG12LLTA-V

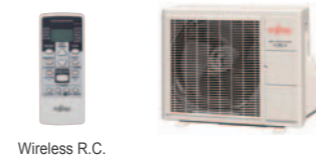

High Efficient Compact Design

Compact design is realized by high density multi-path heat exchanger.

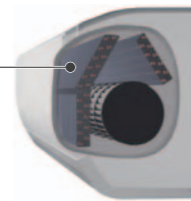
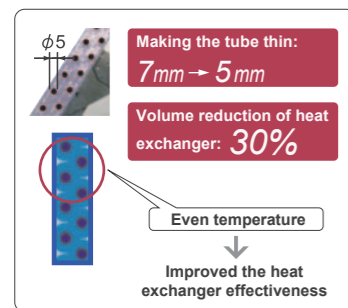

Super Quiet Operation

Top class low noise operation by new airflow construction. Our quiet operation makes the more comfortable environment in a bed room and a study room, etc.

Fan speed
Quiet

Noise level
22dB(A)

Powerful operation

Reach the setting temperature quickly.

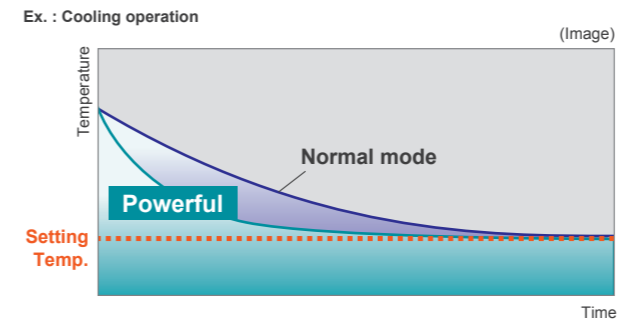

Economy operation

Setting temp. is shifted by 1°C automatically.

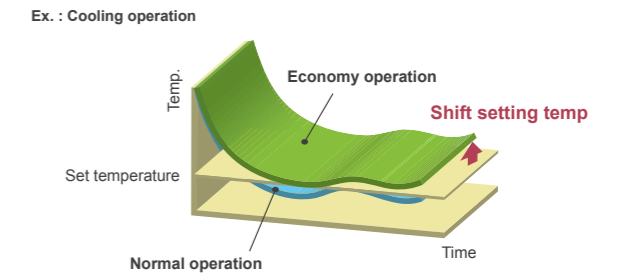

Easy maintenance

Removable & washable panel



More Convenient Timer

You can set an integrated ON-OFF or OFF-ON timer suitable for your life style. (Setting time: 0.5, 1, 1.5, 2, 2.5, ----9.5, 10, 11, 12 hours)

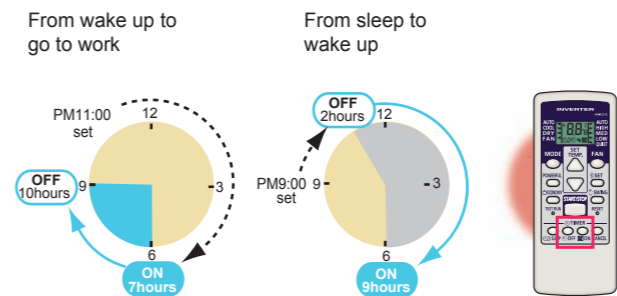

Optional parts

Protective net: UTZ-NXCA

Specifications

Model No.	Indoor unit		ASAG09LLTB-V		ASAG12LLTA-V	
	Outdoor unit		AOAG09LLTB-V		AOAG12LLTA-V	
Power Source	V/∅/Hz		220/1/50		220/1/50	
Capacity	Cooling	kW	2.50 (0.9-3.0)		3.40 (0.9-3.8)	
		BTU/h	8,500		11,600	
	Heating	kW	3.00 (0.9-3.8)		4.00 (0.9-5.0)	
		BTU/h	10,200		13,600	
Input Power	Cooling/Heating	kW	0.720/0.740		1.060/1.130	
EER	Cooling		3.47		3.21	
COP	Heating	W/W	4.05		3.54	
Running Current	Cooling/Heating	A	3.6/3.6		5.3/5.5	
Moisture Removal		l/h	1.3		1.8	
Sound Pressure	Indoor (High)	dB(A)	43		43	
	Outdoor		47		50	
Airflow Rate (High)	Indoor	m³/h	720		720	
	Outdoor		1,670		1,830	
Net Dimension HxWxD	Indoor	mm	262x820x206		262x820x206	
		kg(lbs)	7.0 (15)		7.0 (15)	
Net Weight	Outdoor	mm	540x660x290		540x660x290	
		kg(lbs)	25.0 (55)		28.0 (62)	
Piping Connections (Small / Large)		mm	6.35/9.52		6.35/9.52	
Drain Pipe Diameter (I.D./O.D.)		mm	13.8/15.8 to 16.7		13.8/15.8 to 16.7	
Max Pipe Length (Pre-Charge)		m	20(15)		20(15)	
Max Height Difference			15		15	
Operation Range	Cooling	°CDB	18 to 46		18 to 46	
	Heating		-15 to 24		-15 to 24	
Refrigerant			R410A		R410A	

Dimensions Models: ASAG09LLTB-V / ASAG12LLTA-V

(Unit : mm)

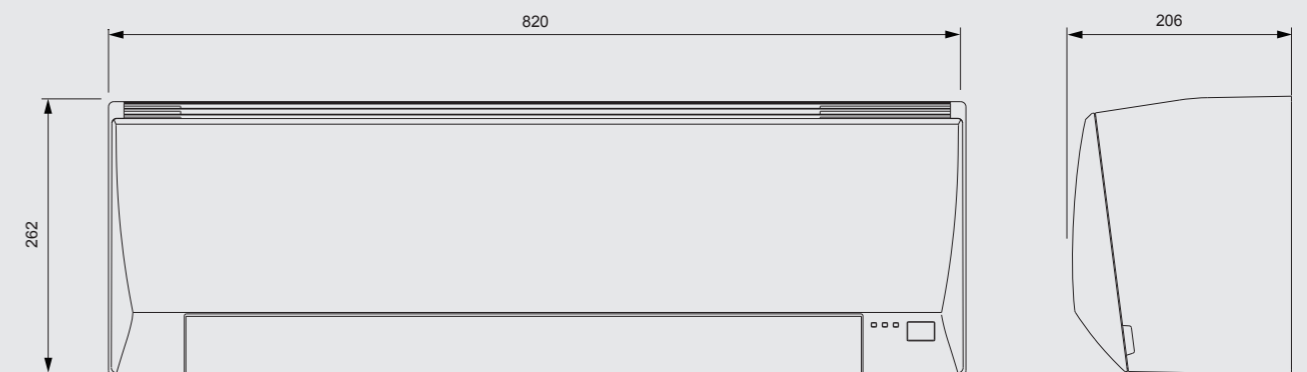



NEW Model : ASAG09JLTB-V / ASAG12JLTB-V

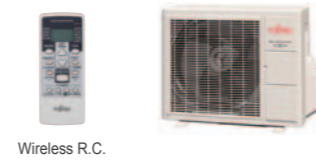

Wireless R.C.



High Efficient Compact Design

Compact design is realized by high density multi-path heat exchanger.

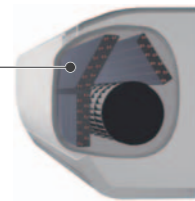
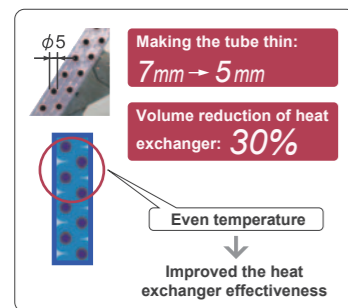

Super Quiet Operation

Top class low noise operation by new airflow construction. Our quiet operation makes the more comfortable environment in a bed room and a study room, etc.

Fan speed **Quiet**
Noise level **22dB(A)**

Powerful operation

Reach the setting temperature quickly.

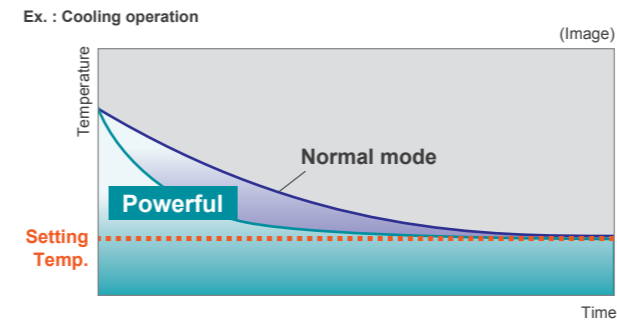

Economy operation

Setting temp. is shifted by 1°C automatically.

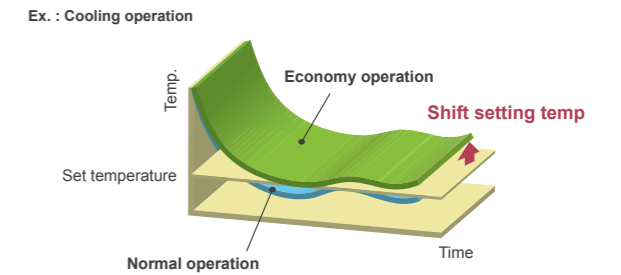

More Convenient Timer

You can set an integrated ON-OFF or OFF-ON timer suitable for your life style. (Setting time: 0.5, 1, 1.5, 2, 2.5, ----9.5, 10, 11, 12 hours)

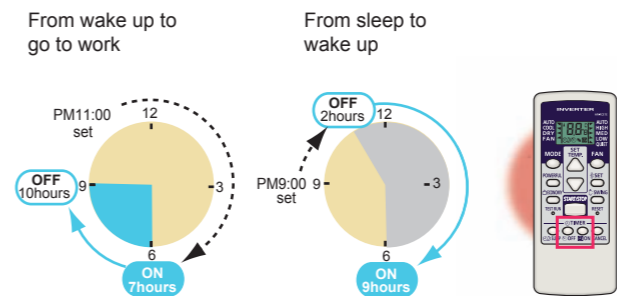

Easy maintenance

Removable & washable panel



Optional parts

Protective net: UTZ-NXCA

Specifications

Model No.	Indoor unit		ASAG09JLTB-V	ASAG12JLTB-V
	Outdoor unit		AOAG09JLTB-V	AOAG12JLTB-V
Power Source		V/∅/Hz	220/1/50	220/1/50
Capacity	Cooling	kW	2.50 (0.9-3.0)	3.40 (0.9-3.8)
		BTU/h	8,500	11,600
Input Power	Cooling	kW	0.720	1.060
EER	Cooling	W/W	3.47	3.21
Running Current	Cooling	A	3.6	5.3
Moisture Removal		l/h	1.3	1.8
Sound Pressure	Indoor (High)	dB(A)	43	43
	Outdoor		47	50
Airflow Rate (High)	Indoor	m³/h	720	720
	Outdoor		740	1,830
Net Dimension HxWxD	Indoor	mm	262x820x206	262x820x206
		kg(lbs)	7.0 (15)	7.0 (15)
Net Weight	Outdoor	mm	540x660x290	540x660x290
		kg(lbs)	25.0 (55)	28.0 (62)
Piping Connections (Small / Large)			6.35/9.52	6.35/9.52
Drain Pipe Diameter (I.D./O.D.)		mm	13.8/15.8 to 16.7	13.8/15.8 to 16.7
Max Pipe Length (Pre-Charge)		m	20(15)	20(15)
Max Height Difference			15	15
Operation Range	Cooling	°CDB	18 to 46	18 to 46
Refrigerant			R410A	R410A

Dimensions Models: ASAG09JLTB-V / ASAG12JLTB-V

(Unit : mm)

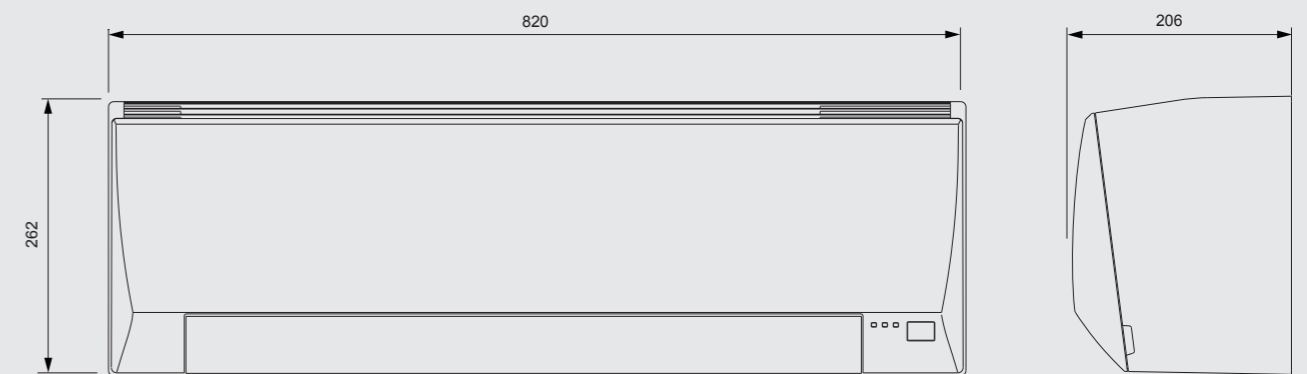

Model : ASAG09JLCA / ASAG12JLCA

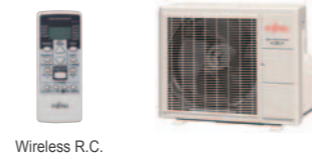

Wireless R.C.



High Efficient Compact Design

Compact design is realized by high density multi-path heat exchanger.

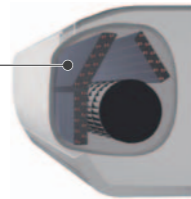
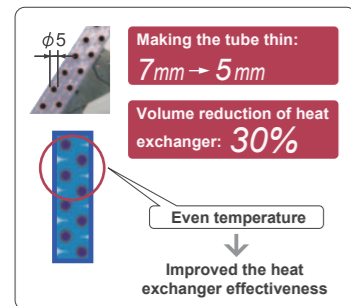

Super Quiet Operation

Top class low noise operation by new airflow construction. Our quiet operation makes the more comfortable environment in a bed room and a study room, etc.

Fan speed
Quiet

Noise level
22dB(A)

Powerful operation

Reach the setting temperature quickly.

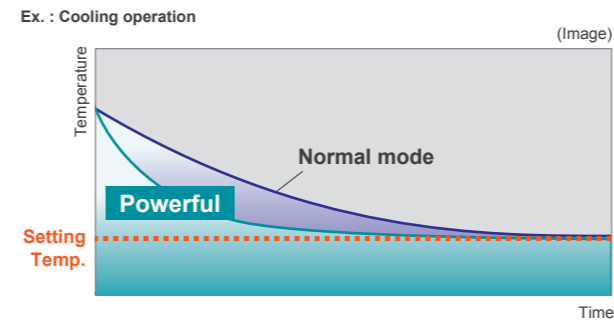

Economy operation

Setting temp. is shifted by 1°C automatically.

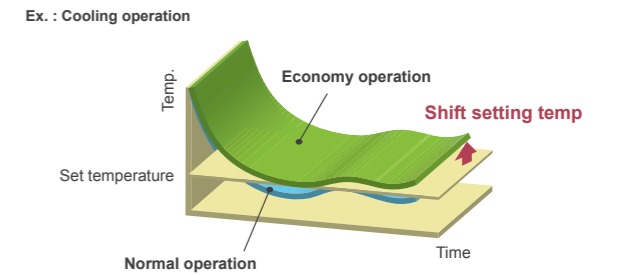

Easy maintenance

Removable & washable panel



More Convenient Timer

You can set an integrated ON-OFF or OFF-ON timer suitable for your life style. (Setting time: 0.5, 1, 1.5, 2, 2.5, -----9.5, 10, 11, 12 hours)

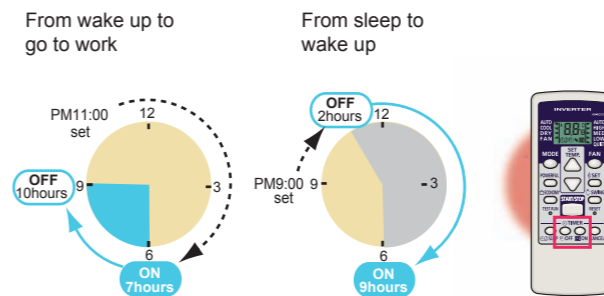

Optional parts

Protective net: UTZ-NXCA

Specifications

Model No.	Indoor unit		ASAG09JLCA	ASAG12JLCA
	Outdoor unit		AOAG09JLCA	AOAG12JLCA
Power Source	V/∅/Hz		230/1/50	230/1/50
Capacity	Cooling	kW	2.5	3.5
		BTU/h	8,500	11,900
Input Power	Cooling	kW	0.73	1.095
EER	Cooling	W/W	3.42	3.20
Running Current	Cooling	A	3.8	5.1
Moisture Removal		l/h	1.3	1.8
Sound Pressure	Indoor (High)	dB(A)	43	43
	Outdoor		48	52
Airflow Rate (High)	Indoor	m³/h	720	720
	Outdoor		1,710	1,850
Net Dimension H×W×D	Indoor	mm	262x820x206	262x820x206
	Outdoor	kg(lbs)	7.0 (15)	7.0 (15)
Net Weight	Indoor	mm	535x663x293	535x663x293
	Outdoor	kg(lbs)	24.0 (53)	26.0 (57)
Piping Connections (Small / Large)		mm	6.35/9.52	6.35/9.52
Drain Pipe Diameter (I.D./O.D.)		mm	13.8/15.8 to 16.7	13.8/15.8 to 16.7
Max Pipe Length (Pre-Charge)		m	15(10)	15(10)
Max Height Difference			10	10
Operation Range	Cooling	°CDB	18 to 46	18 to 46
Refrigerant			R410A	R410A

Dimensions Models: ASAG09JLCA / ASAG12JLCA

(Unit : mm)

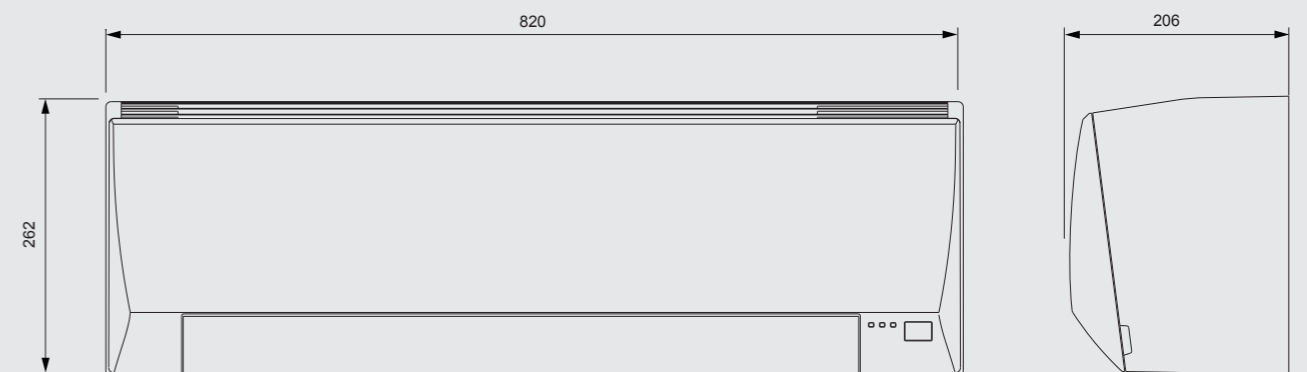

INVERTER

WALL MOUNTED

Model : ASAA18JCC / ASAA24JCC / ASAA30JCC



Comfort airflow

Power diffuser

"Horizontal airflow" does not blow cool air directly at the occupants in the room

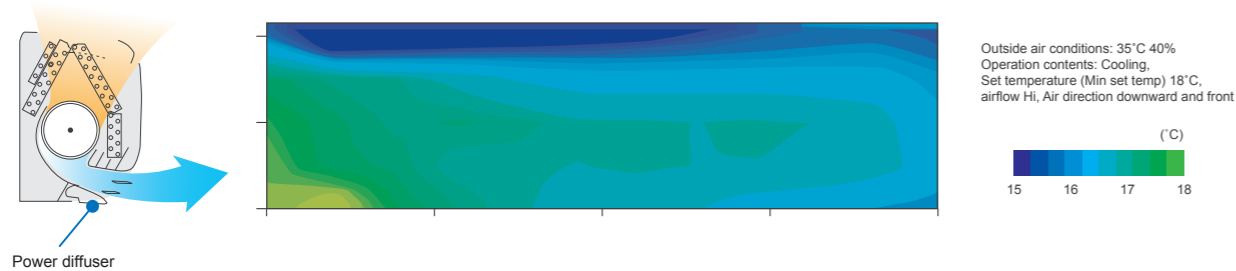

Air conditioner filter features

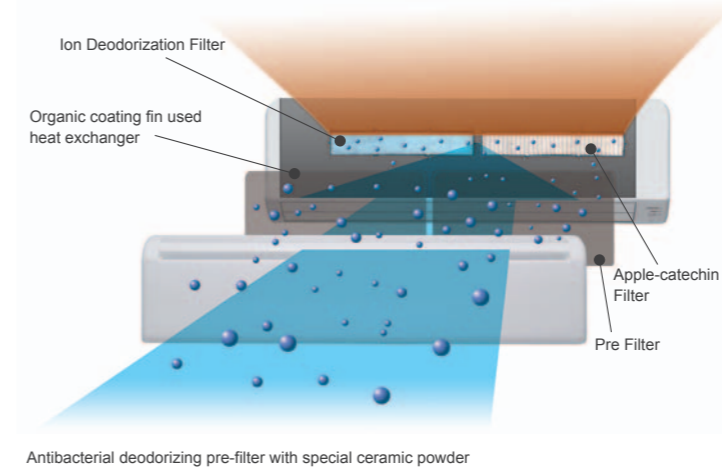

Air conditioner filter features

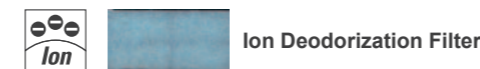

The filter deodorizes by powerfully decomposing absorbed odors using the oxidizing and reducing effects of ions generated by the ultra-fine-particle ceramic.

✚ Using different filters at both sides

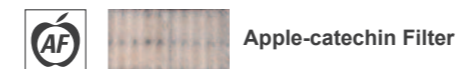

The Apple-catechin filter uses static electricity to clean fine particles and dust in the air.

Flexible Installation

	18 type	24 type	30 type
Max. Piping Length	25m	30m	50m
Max. Height	20m	20m	30m

Easy maintenance

Simplification of drain pan cleaning improves maintenance-ability.

Low ambient operation

(Heat pump type)

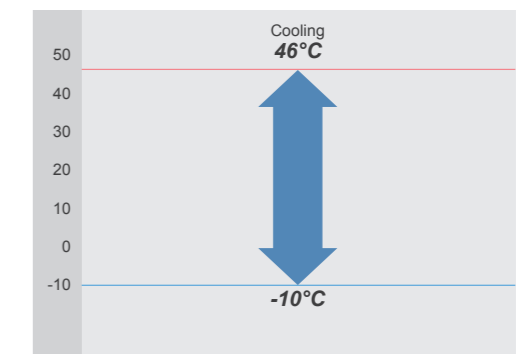

Optional parts

Wired Remote Controller: UTB-YUD
External Connect Kit: UTY-XWZX

Specifications

Model No.	Indoor unit		ASAA18JCC	ASAA24JCC	ASAA30JCC
	Outdoor unit		AOAR18JCC	AOAR24JCC	AOAR30JCT
Power Source	V/∅/Hz		230/1/50	230/1/50	230/1/50
Capacity	Cooling	kW	5.2	7.1	8.0
		BTU/h	17,700	24,200	27,300
Input Power	Cooling	kW	1.48	2.45	2.66
EER	Cooling	W/W	3.51	2.9	3.01
Running Current	Cooling	A	6.6	10.8	11.7
Moisture Removal		l/h	2.8	3.0	3.0
Sound Pressure	Indoor (High)	dB(A)	43	47	49
	Outdoor		50	56	53
Airflow Rate (High)	Indoor	m³/h	900	1,100	1,100
	Outdoor		2,070	2,640	3,600
Net Dimension H×W×D	Indoor	mm	320x998x228	320x998x228	320x998x228
		kg(lbs)	14.0 (31)	14.0 (31)	14.0 (31)
Net Weight	Outdoor	mm	620x790x298	620x790x298	830x900x330
		kg(lbs)	40.0 (88)	40.0 (88)	58.0 (128)
Piping Connections (Small / Large)		mm	6.35/12.7	6.35/15.88	9.52/15.88
Drain Pipe Diameter (I.D./O.D.)		mm	16.0/29.0	16.0/29.0	16.0/29.0
Max Pipe Length (Pre-Charge)		m	30(15)	30(15)	30(20)
Max Height Difference			20	20	20
Operation Range	Cooling	°CDB	18 to 46	18 to 46	18 to 46
Refrigerant			R410A	R410A	R410A

Dimensions Models: ASAA18JCC / ASAA24JCC / ASAA30JCC

(Unit : mm)

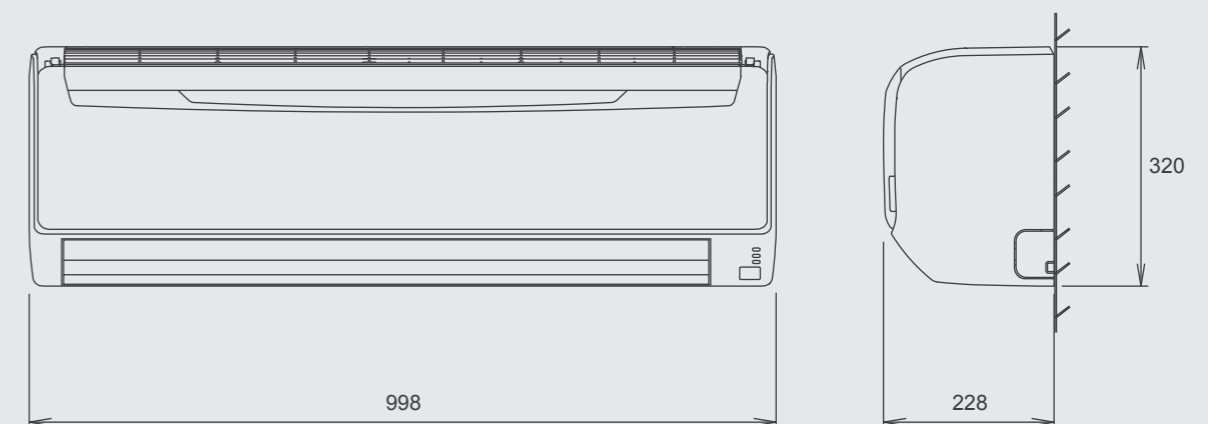

Model : AUAG12LVLB / AUAG18LVLB / AUAG24LVLA



Grille is an option



Wireless R.C.



2-stage turbo fan

High efficiency design by 2 stage structure

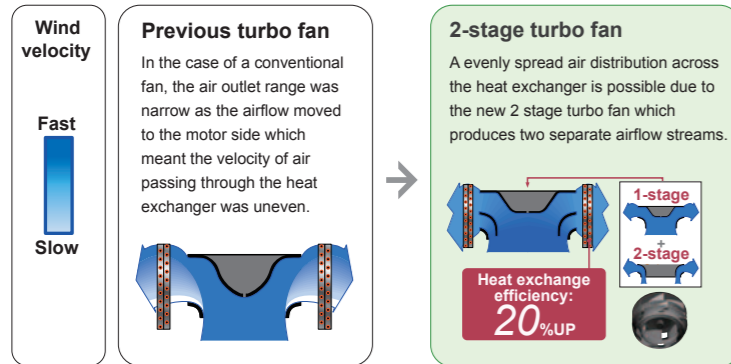

Quiet quality

Optimization of wing form (laminar wing type) and wing number (7 blades each)

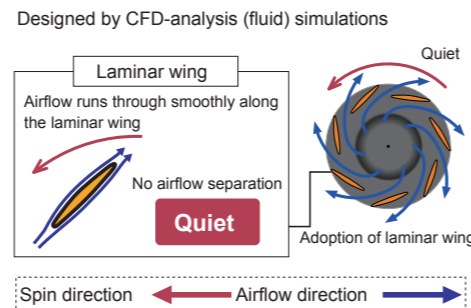

Easy maintenance

1 Maintenance of fan motor and fan

Maintenance of the fan motor and fan can be done easily after taking off the panel as the bell mouth of the fan can be removed easily.

A : Fan motor B : 2-stage turbo fan
C : Bell-mouth D : Panel

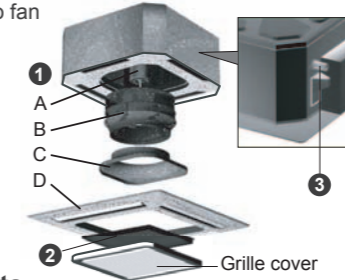

2 Long life filter

: standard equipment

3 Adaptation of transparent drainage parts

During installation, maintenance and operation, the drain pump and kit can be checked easily.

High lift drain pump



Low ambient operation

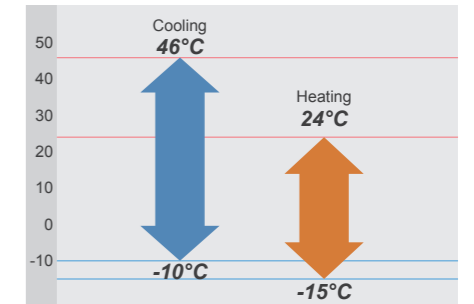

Compact design

Worlds first 24,000Btu model in the compact cassette category (Easy installation by taking off ceiling panel of 600 x 600 size)

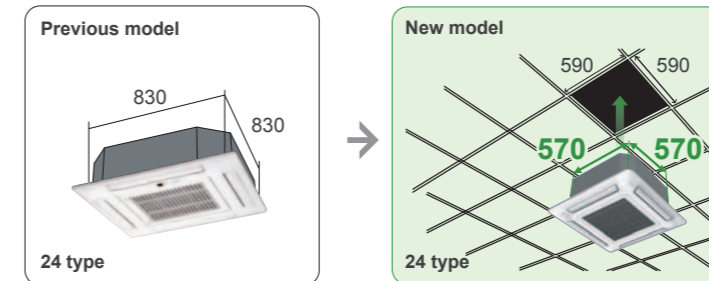

Optional parts

- Air Outlet Shutter Plate: UTR-YDZB
- Wired Remote Controller: UTY-RNNYM
- Insulation Kit For High Humidity: UTZ-KXGC
- External Connect Kit: UTY-XWZX
- External Control Set: UTD-ECS5A
- Fresh Air Intake Kit: UTZ-VXAA
- Simple Remote Controller: UTY-RSNYM

Specifications

Model No.	Indoor unit		AUAG12LVLB	AUAG18LVLB	AUAG24LVLA
	Outdoor unit		AOAG12LBLA	AOAG18LBLA	AOAG24LALA
Power Source	V/∅/Hz		230/1/50	230/1/50	230/1/50
Capacity	Cooling	kW	3.50	5.20	6.80
		BTU/h	11,950	17,700	23,200
	Heating	kW	4.10	6.00	8.00
		BTU/h	14,000	20,500	27,300
Input Power	Cooling/Heating	kW	0.99/1.11	1.55/1.66	2.21/2.26
EER	Cooling		3.54	3.35	3.08
COP	Heating	W/W	3.69	3.61	3.54
Running Current	Cooling/Heating	A	4.5/5.1	7.0/7.4	9.7/9.9
Moisture Removal		l/h	1.2	2.2	2.7
Sound Pressure	Indoor (High)	dB(A)	37	38	49
	Outdoor		47	50	52
Airflow Rate (High)	Indoor	m³/h	600	680	930
	Outdoor		1,700	2,000	2,470
Net Dimension HxWxD	Indoor / Grille	mm	245x570x570/50x700x700	245x570x570/50x700x700	245x570x570/50x700x700
	Outdoor	kg(lbs)	15.0(33)/2.6(6)	15.0(33)/2.6(6)	16.0(35)/2.6(6)
Net Weight		mm	578x790x300	578x790x300	578x790x315
		kg(lbs)	40.0(88)	40.0(88)	44.0(97)
Piping Connections (Small / Large)			6.35/9.52	6.35/12.70	6.35/15.88
Drain Pipe Diameter (I.D./O.D.)		mm	19.4/25.4	19.4/25.4	19.4/25.4
Max Pipe Length (Pre-Charge)		m	25(15)	25(15)	30(15)
Max Height Difference			15	15	15
Operation Range	Cooling	°CDB	-10 to 46	-10 to 46	-10 to 46
	Heating		-15 to 24	-15 to 24	-15 to 24
Refrigerant			R410A	R410A	R410A
Cassette Grille			UTG-UFYD-W	UTG-UFYD-W	UTG-UFYD-W

Dimensions

Models: AUAG12LVLB / AUAG18LVLB / AUAG24LVLA

(Unit : mm)

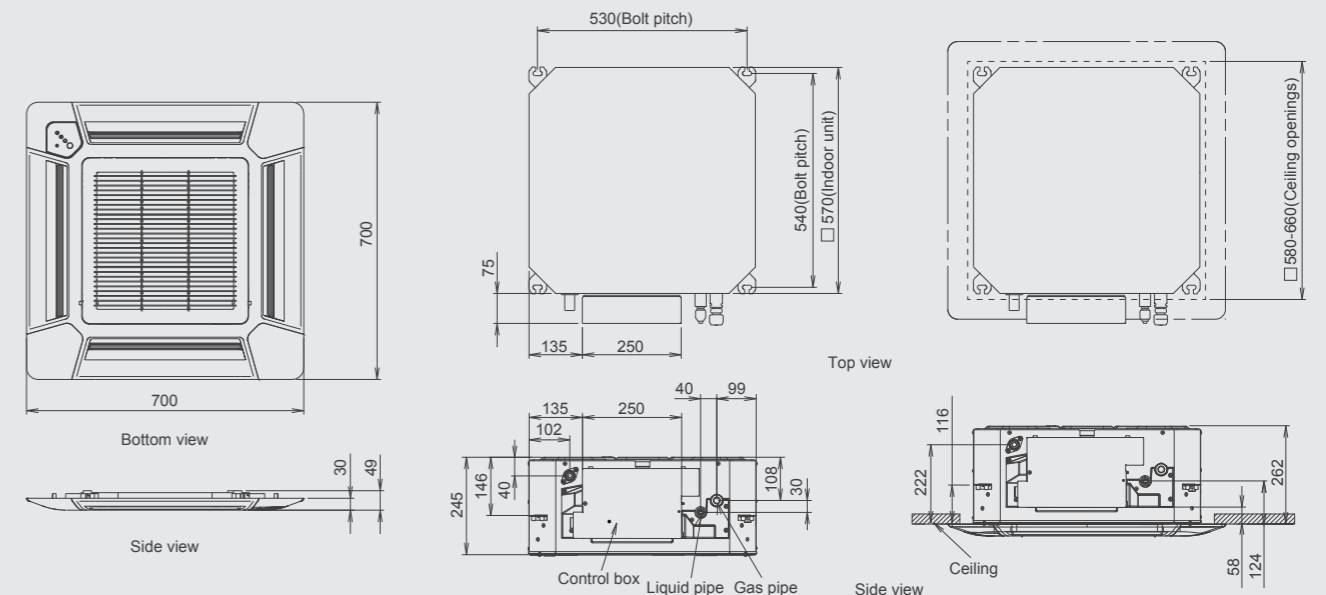

Model : AUAG30LRLA / AUAG36LRLA / AUAG45LRLA / AUAG54LRLA



High efficiency turbo fan with 3-dimensional blade

Previous turbo fan: Air passing through the heat exchanger was uneven and the air would only flow close to the ceiling.

New turbo fan: High efficiency airflow distribution has been achieved by the introduction of a 3 dimensional blade which increases the air passing over the heat exchanger.

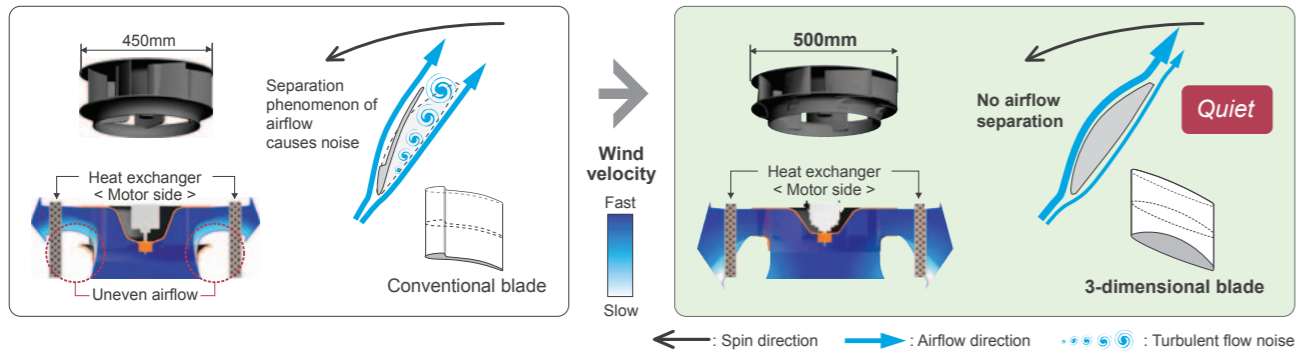

Improvement of the airflow distribution

New louvre: The louvre design distributes air leaving a space between the chassis and the ceiling allowing far and wide air flow distribution.

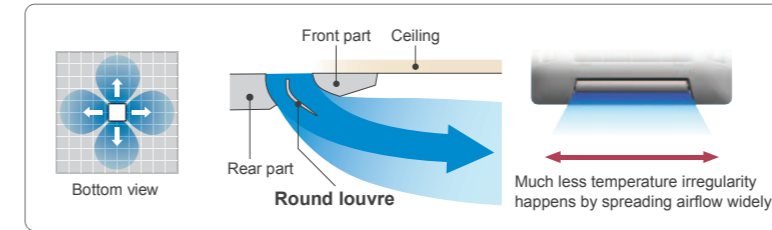

Adjustment of hanger position is possible after installation

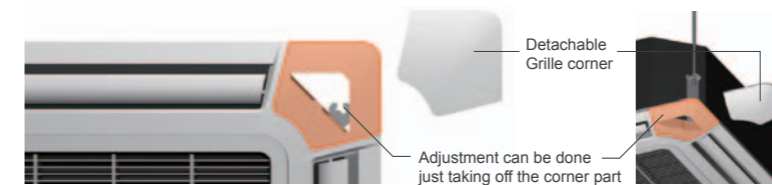

Low noise mode of outdoor unit (45/54 types)

2 stage low noise mode can be selected. (Option)

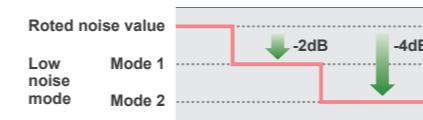

High lift drain pump

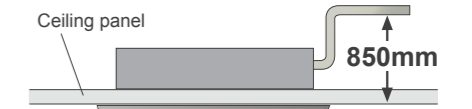

Low ambient operation

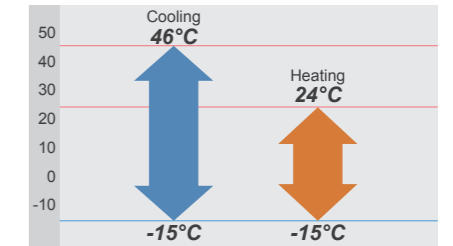

Optional parts

- Wired Remote Controller: UTY-RNNYM
- Simple Remote Controller: UTY-RSNYM
- IR Receiver Kit: UTY-LRHYA2
- Wide Panel: UTG-AGYA-W
- Panel Spacer: UTG-BGYA-W
- Air Outlet Shutter Plate: UTR-YDZC
- Insulation Kit For High Humidity: UTZ-KXGA
- External Connect Kit: UTY-XWZX
- External Control Set: UTY-XWZXZ2
- Fresh Air Intake Kit: UTY-XWZXZ3
- External Control Set: UTD-ECS5A
- Fresh Air Intake Kit: UTZ-VXGA

Specifications

Model No.	Indoor unit		AUAG30LRLA	AUAG36LRLA	AUAG45LRLA	AUAG54LRLA
	Outdoor unit		AOAG30LBTA	AOAG36LBTA	AOAG45LBTA	AOAG54LBTA
Power Source	V/∅/Hz		230/1/50	230/1/50	230/1/50	230/1/50
Capacity	Cooling	kW	8.50	10.00	12.50	13.3
		BTU/h	29,000	34,100	42,700	45,400
	Heating	kW	10.00	11.20	14.00	16.0
		BTU/h	34,100	38,200	47,800	54,600
Input Power	Cooling/Heating	kW	2.65/2.77	3.12/3.02	3.90/3.77	4.42/4.69
EER	Cooling		3.21	3.21	3.21	3.01
COP	Heating	W/W	3.61	3.71	3.71	3.41
Running Current	Cooling/Heating	A	11.6/12.2	13.7/13.3	17.0/16.5	19.3/20.5
Moisture Removal		l/h	2.5	3.5	4.5	5.0
Sound Pressure	Indoor (High)	dB(A)	40	43	46	47
	Outdoor		53	54	55	55
Airflow Rate (High)	Indoor	m³/h	1,600	1,800	1,900	2,000
	Outdoor		3,600	3,800	6,750	6,750
Net Dimension HxWxD	Indoor / Grille	mm	288x840x840/50x950x950	288x840x840/50x950x950	288x840x840/50x950x950	288x840x840/50x950x950
	Net Weight	kg(lbs)	26.0(57)/5.5(12)	26.0(57)/5.5(12)	27.0(60)/5.5(12)	27.0(60)/5.5(12)
Piping Connections (Small / Large)		mm	830x900x330	830x900x330	1290x900x330	1290x900x330
		kg(lbs)	61.0(135)	61.0(135)	88.0(194)	88.0(194)
Drain Pipe Diameter (I.D./O.D.)		mm	9.52/15.88	9.52/15.88	9.52/15.88	9.52/15.88
Max Pipe Length (Pre-Charge)		m	25.0/32.0	25.0/32.0	25.0/32.0	25.0/32.0
Max Height Difference			50(20)	50(20)	50(20)	50(20)
Operation Range	Cooling	°CDB	30	30	30	30
	Heating		-15 to 46	-15 to 46	-15 to 46	-15 to 46
Refrigerant			-15 to 24	-15 to 24	-15 to 24	-15 to 24
Cassette Grille			R410A	R410A	R410A	R410A
			UTG-UGYA-W	UTG-UGYA-W	UTG-UGYA-W	UTG-UGYA-W

Dimensions

Models: AUAG30LRLA / AUAG36LRLA / AUAG45LRLA / AUAG54LRLA

(Unit : mm)

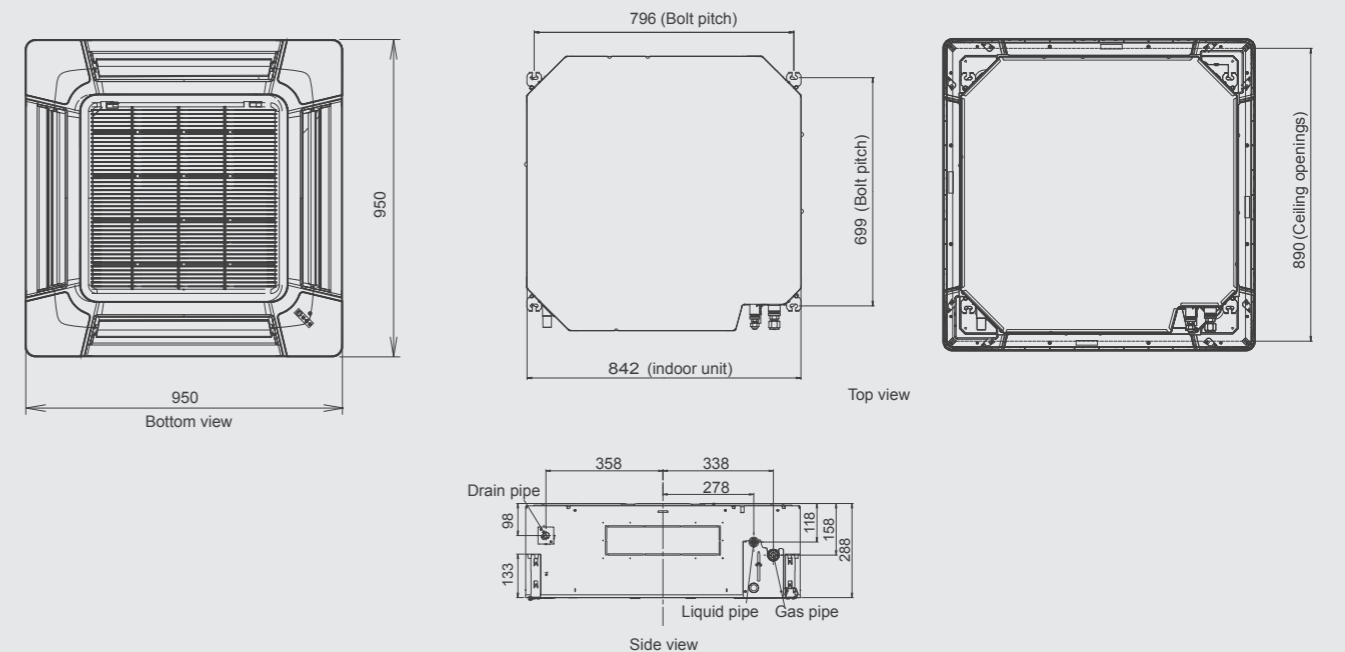

INVERTER

FLOOR/CEILING UNIVERSAL

Model : ABAG18LVTA / ABAG24LVTA



Wireless R.C.



Flexible installation

Example for floor installation

Floor console



Example for ceiling installation

Under ceiling



Double auto swing

A combination of right/left and up/down directional swing allows 3-dimensional air direction control

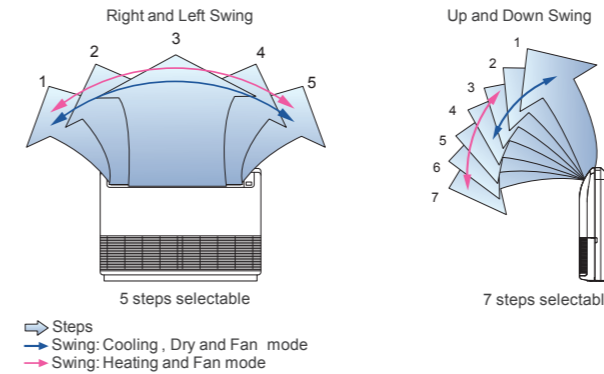

Low ambient operation

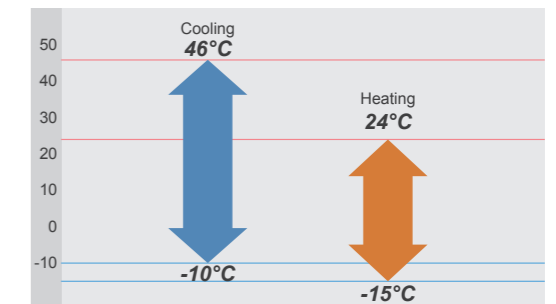

Easy installation

Main work settings can be done easily from the remote controller at installation

Main work settings

- High ceiling setting
- Auto restart
- Temperature adjustment when cooling / heating

Conventional type
Setting by DIP switch inside control box

Setting by wireless or wired remote controller
(Optional parts)

Optional parts

- Wired Remote Controller: UTY-RNNYM
- Simple Remote Controller: UTY-RSNYM
- External Connect Kit: UTY-XWZX

Specifications

Model No.	Indoor unit		ABAG18LVTA		ABAG24LVTA	
	Outdoor unit		AOAG18LBLA		AOAG24LALA	
Power Source	V/∅/Hz		230/1/50		230/1/50	
Capacity	Cooling	kW	5.20		6.80	
		BTU/h	17,700		23,200	
	Heating	kW	6.00		8.00	
		BTU/h	20,500		27,300	
Input Power	Cooling/Heating	kW	1.55/1.66		2.21/2.26	
EER	Cooling		3.35		3.08	
COP	Heating	W/W	3.61		3.54	
Running Current	Cooling/Heating	A	7.0/7.4		9.7/9.9	
Moisture Removal		l/h	2.0		2.7	
Sound Pressure	Indoor (High)	dB(A)	43		48	
	Outdoor		50		52	
Airflow Rate (High)	Indoor	m³/h	780		980	
	Outdoor		2,000		2470	
Net Dimension HxWxD	Indoor	mm	199x990x655		199x990x655	
		kg(lbs)	27.0(60)		27.0(60)	
Net Weight	Outdoor	mm	578x790x300		578x790x315	
		kg(lbs)	40.0(88)		44.0(97)	
Piping Connections (Small / Large)		mm	6.35/12.70		6.35/15.88	
Drain Pipe Diameter (I.D./O.D.)		mm	25.0/32.0		25.0/32.0	
Max Pipe Length (Pre-Charge)		m	25(15)		30(15)	
Max Height Difference			15		20	
Operation Range	Cooling	°CDB	-10 to 46		-10 to 46	
	Heating		-15 to 24		-15 to 24	
Refrigerant			R410A		R410A	

Dimensions Models: ABAG18LVTA / ABAG24LVTA

(Unit : mm)

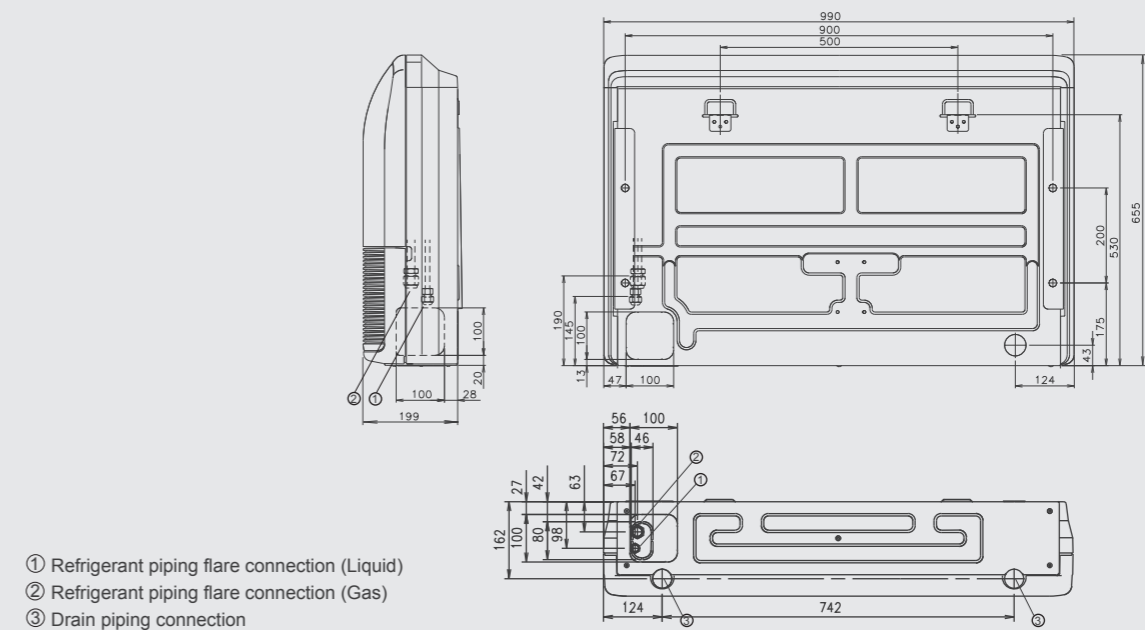

Model : ABAG30LRTA / ABAG36LRTA / ABAG45LRTA

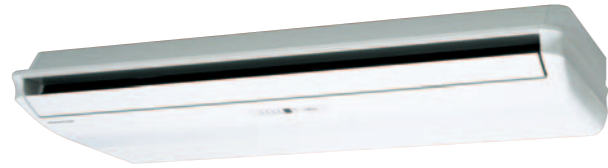

Installation

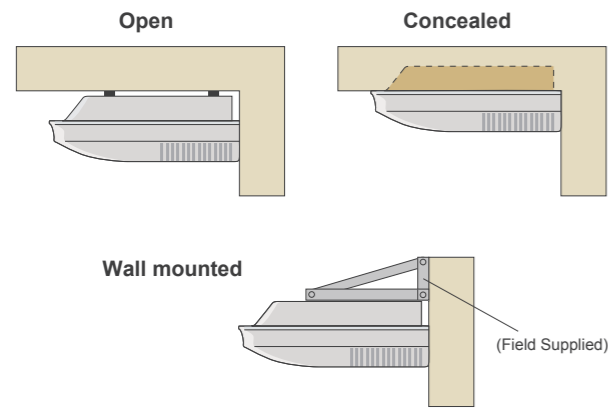

Multi auto swing

A combination of right/left and up/down directional swing allows 3-dimensional air direction control.

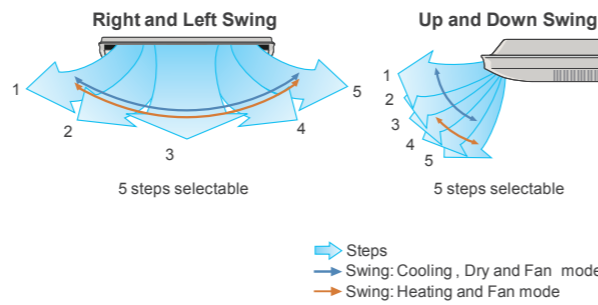

Condensate lift-up mechanism (Option)

Optional drain lift-up mechanism allows flexible installation.

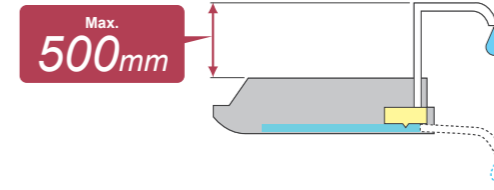

Easy installation

Main work settings can be done easily from the remote controller at installation

- Main work settings**
- High ceiling setting
 - Auto restart
 - Temperature adjustment when cooling / heating

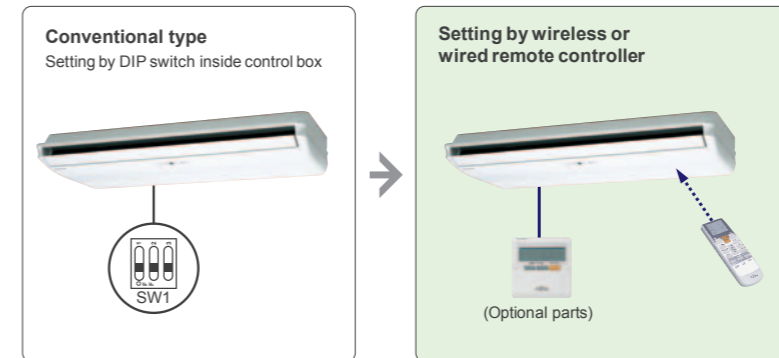

Fresh air intake

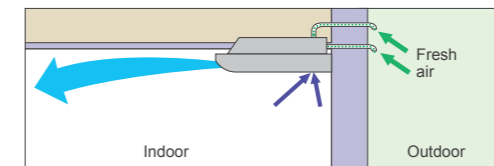

Low noise mode of outdoor unit (45/54 types)

2 stage low noise mode can be selected.(Option)



Low ambient operation

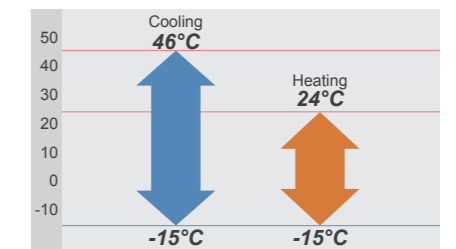

Optional parts

- Wired Remote Controller: UTY-RNNYM
- Simple Remote Controller: UTY-RSNYM
- Drain Pump Unit: UTR-DPB24T
- External Connect Kit: UTY-XWZX
- UTY-XWZXZ2
- UTY-XWZXZ3
- External Control Set: UTD-ECS5A
- Flange: UTD-RF204

Specifications

Model No.	Indoor unit		ABAG30LRTA	ABAG36LRTA	ABAG45LRTA
	Outdoor unit		AOAG30LBTA	AOAG36LBTA	AOAG45LBTA
Power Source	V/∅/Hz		230/1/50	230/1/50	230/1/50
Capacity	Cooling	kW	8.50	9.40	12.10
		BTU/h	29,000	32,100	41,300
	Heating	kW	10.00	11.20	13.30
		BTU/h	34,100	38,200	45,400
Input Power	Cooling/Heating	kW	2.54/2.77	2.93/3.02	3.77/3.68
EER	Cooling		3.35	3.21	3.21
COP	Heating	W/W	3.61	3.71	3.61
Running Current	Cooling/Heating	A	11.1/12.2	12.8/13.2	16.4/16.1
Moisture Removal		l/h	2.5	3.0	4.0
Sound Pressure	Indoor (High)	dB(A)	45	47	49
	Outdoor		53	55	55
Airflow Rate (High)	Indoor	m³/h	1,660	1,900	2,100
	Outdoor		3,600	3,800	6,750
Net Dimension HxWxD	Indoor	mm	240×1660×700	240×1660×700	240×1660×700
	Outdoor	kg(lbs)	46.0(101)	46.0(101)	46.0(101)
Net Weight	Indoor	mm	830×900×330	830×900×330	1290×900×330
	Outdoor	kg(lbs)	61.0(135)	61.0(135)	88.0(194)
Piping Connections (Small / Large)			9.52/15.88	9.52/15.88	9.52/15.88
Drain Pipe Diameter (I.D./O.D.)		mm	22.0/25.6	22.0/25.6	22.0/25.6
Max Pipe Length (Pre-Charge)		m	50(20)	50(20)	50(20)
Max Height Difference			30	30	30
Operation Range	Cooling	°CDB	-15 to 46	-15 to 46	-15 to 46
	Heating		-15 to 24	-15 to 24	-15 to 24
Refrigerant			R410A	R410A	R410A

Dimensions Models: ABAG30LRTA / ABAG36LRTA / ABAG45LRTA

(Unit : mm)

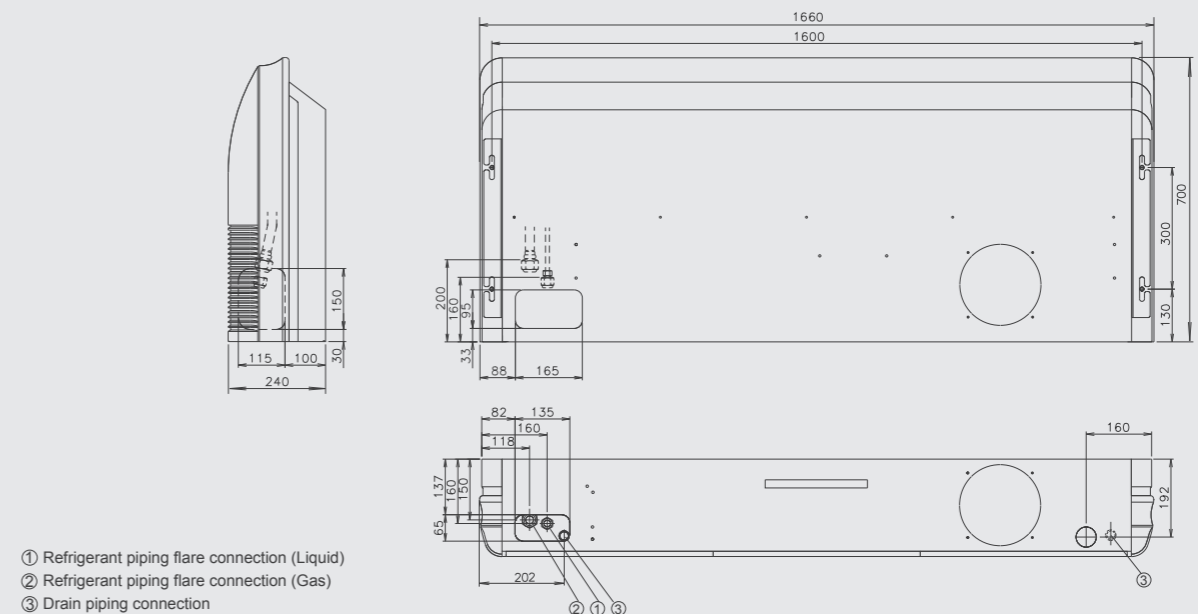

- ① Refrigerant piping flare connection (Liquid)
- ② Refrigerant piping flare connection (Gas)
- ③ Drain piping connection

Model : ARAG12LLLB / ARAG18LLLB



Slim design

This model is slim design, it can install at the place where a ceiling is narrow.

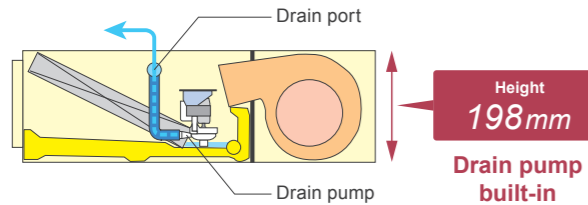

Flexible installation

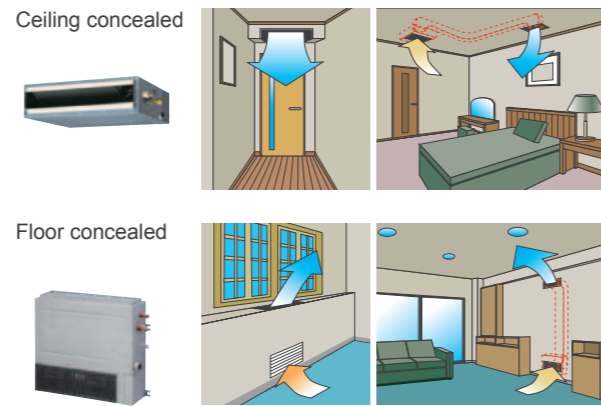

Drain pump is standard accessory

It allows flexible installation.

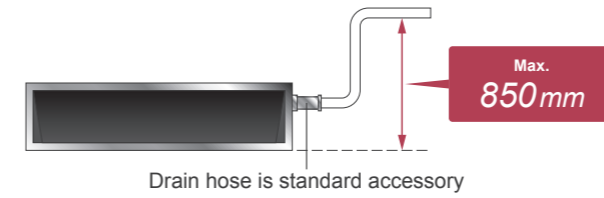

Auto Louver Grille Kit (Option)

Simple flat Auto Louver will provide comfort airflow and harmonize with luxury interior.

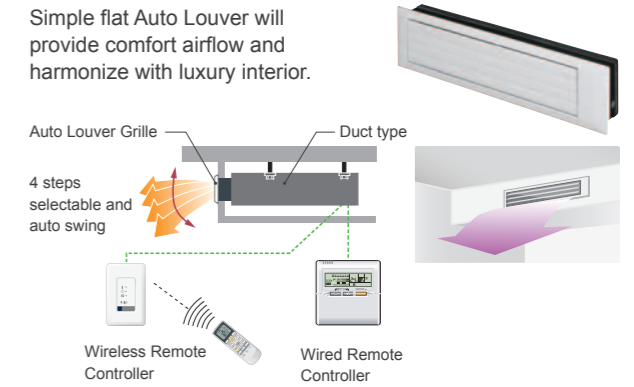

Selectable with a wide range of static pressure

By using DC fan motor, it is possible to change the static pressure range 0 to 90Pa. The change of static pressure range is possible by remote controller.



Air-intake

Air intake direction can be selected to match the installation site.

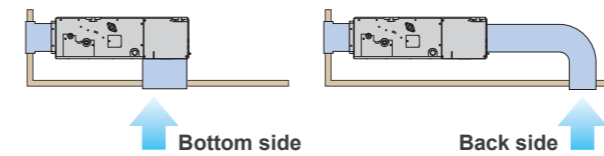

Optional parts

- Wired Remote Controller: UTY-RNNYM
- Simple Remote Controller: UTY-RSNYM
- IR Receiver Unit: UTY-LRHYM
- Remote Sensor Unit: UTY-XSZX
- External Control Set: UTD-ECS5A
- Auto Louver Grille Kit: UTD-GXSA-W (For ARAG12LLLB)
UTD-GXSB-W (For ARAG18LLLB)

Specifications

Model No.	Indoor unit		ARAG12LLLB	ARAG18LLLB
	Outdoor unit		AOAG12LBLA	AOAG18LBLA
Power Source	V/∅/Hz		230/1/50	230/1/50
Capacity	Cooling	kW	3.50	5.20
		BTU/h	11,950	17,700
	Heating	kW	4.10	6.00
		BTU/h	14,000	20,500
Input Power	Cooling/Heating	kW	0.99/1.11	1.62/1.66
EER	Cooling		3.54	3.21
COP	Heating	W/W	3.69	3.61
Running Current	Cooling/Heating	A	4.5/5.1	7.2/7.4
Moisture Removal		l/h	1.3	2.0
Sound Pressure	Indoor (High)	dB(A)	29	32
	Outdoor		48	50
Airflow Rate (High)	Indoor	m³/h	650	940
	Outdoor		1,780	2,000
Net Dimension HxWxD	Indoor	mm	198x700x620	198x900x620
		kg(lbs)	19.0(42)	23.0(51)
Net Weight	Outdoor	mm	578x790x300	578x790x300
		kg(lbs)	40.0(88)	40.0(88)
Piping Connections (Small / Large)			6.35/9.52	6.35/12.70
Drain Pipe Diameter (I.D./O.D.)		mm	25.0/32.0	25.0/32.0
Max Pipe Length (Pre-Charge)		m	25(15)	25(15)
Max Height Difference			15	15
Operation Range	Cooling	°CDB	-10 to 46	-10 to 46
	Heating		-15 to 24	-15 to 24
Refrigerant			R410A	R410A

Dimensions Models: ARAG12LLLB / ARAG18LLLB

(Unit : mm)

*Service accessibility must be allowed for when installing the product. Please consult the installation manual for the necessary service access size.

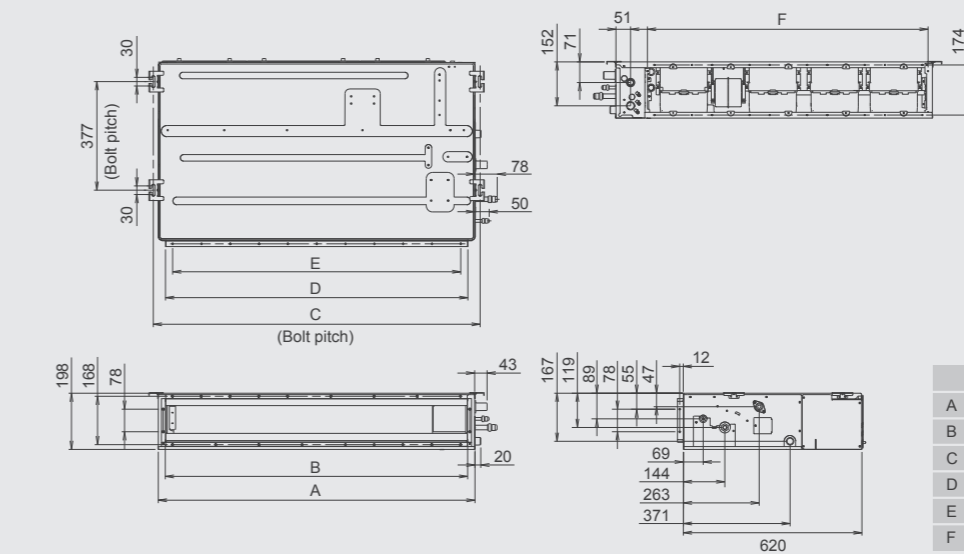

	ARAG12LLLB	ARAG18LLLB
A	700	900
B	650	850
C	734	934
D	650	850
E	P100x6=600	P100x8=800
F	574	774

Model : ARAG24LMTA / ARAG30LMLA / ARAG36LMLA / ARAG45LMLA



Slim & Compact design

In the case of bottom return air connection, not only does the indoor unit design allow for installation in a narrow ceiling space of up to 270mm, Further space savings have been achieved by mounting the electrical control box internally inside the chassis.

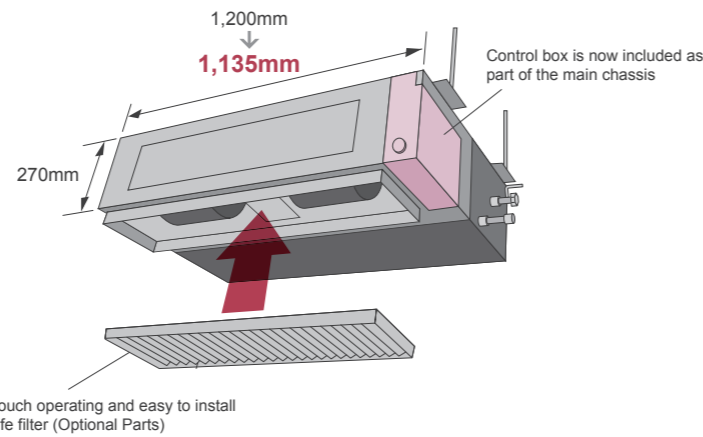

Easy maintenance

Structural improvement is attained by making the bottom panel two pieces, front and rear. The internal fan casing is also manufactured in two pieces, namely upper and lower. The maintenance of the motor and fan can be easily carried out by removing the rear panel and the lower part of the casing while leaving the main chassis installed.

See below for the case of rear suction type

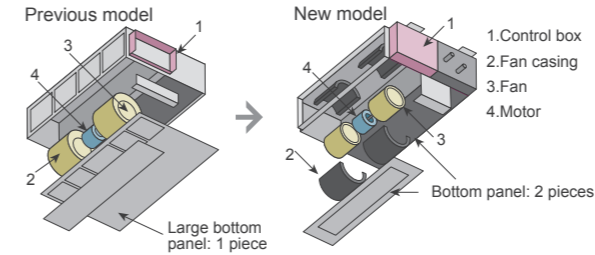

Two-direction drain piping

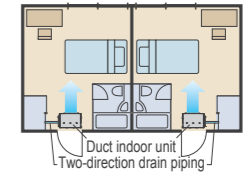

Low ambient operation

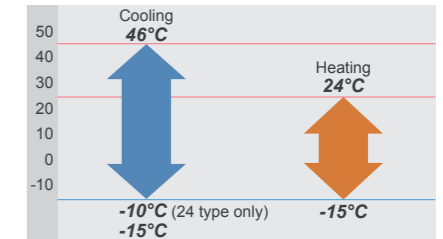

Easy installation

Main work settings can be done easily from the remote controller at installation

- Main work settings**
- High ceiling setting
 - Auto restart
 - Temperature adjustment when cooling / heating

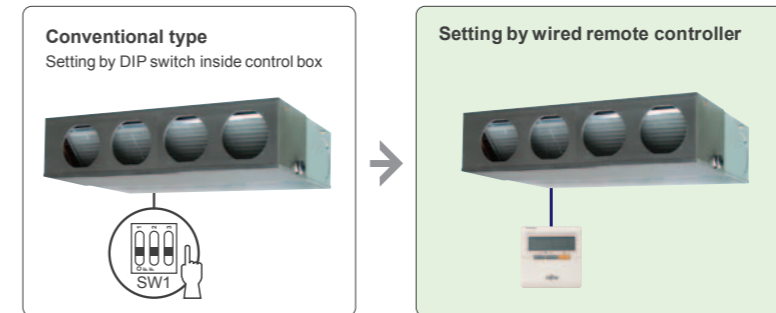

Optional parts

- Wired Remote Controller: UTY-RNNYM
- Simple Remote Controller: UTY-RSNYM
- Flange (Round): UTD-RF204
- Flange (Square): UTD-SF045T
- Long Life Filter: UTD-LF25NA
- Remote Sensor Unit: UTY-XSZX
- External Connect Kit: UTY-XWZXZ2, UTY-XWZXZ3
- External Control Set: UTD-ECS5A
- Drain Pump Unit: UTZ-PX1NBA
- IR Receiver Kit: UTY-LRHYM

Specifications

Model No.	Indoor unit		ARAG24LMTA	ARAG30LMLA	ARAG36LMLA	ARAG45LMLA
	Outdoor unit		AOAG24LALA	AOAG30LBTA	AOAG36LBTA	AOAG45LBTA
Power Source	V/∅/Hz		230/1/50	230/1/50	230/1/50	230/1/50
Capacity	Cooling	kW	6.80	8.50	9.40	12.10
		BTU/h	23,200	29,000	32,100	41,300
	Heating	kW	8.00	10.00	11.20	13.30
		BTU/h	27,300	34,100	38,200	45,400
Input Power	Cooling/Heating	kW	2.21/2.26	2.65/2.68	2.93/3.1	3.77/3.68
EER	Cooling		3.08	3.21	3.18	3.21
COP	Heating	W/W	3.54	3.73	3.61	3.61
Running Current	Cooling/Heating	A	9.7/9.9	11.6/11.7	13.0/13.6	16.5/16.1
Moisture Removal		l/h	2.5	2.5	3.0	4.0
Sound Pressure	Indoor (High)	dB(A)	31	39	39	42
	Outdoor		52	53	54	55
Airflow Rate (High)	Indoor	m³/h	1,100	2,100	2,100	2,100
	Outdoor		2,470	3,600	3,800	6,750
Net Dimension HxWxD	Indoor	mm	270x1,135x700	270x1,135x700	270x1,135x700	270x1,135x700
		kg(lbs)	38.0(84)	40.0(88)	40.0(88)	40.0(88)
Net Weight	Outdoor	mm	578x790x315	830x900x330	830x900x330	1290x900x330
		kg(lbs)	44.0(97)	61.0(135)	61.0(135)	88.0(194)
Piping Connections (Small / Large)		mm	6.35/15.88	9.52/15.88	9.52/15.88	9.52/15.88
Drain Pipe Diameter (I.D./O.D.)		mm	36.0/38.0	36.0/38.0	36.0/38.0	36.0/38.0
Max Pipe Length (Pre-Charge)		m	30(15)	50(20)	50(20)	50(20)
Max Height Difference			20	30	30	30
Operation Range	Cooling	°CDB	-10 to 46	-15 to 46	-15 to 46	-15 to 46
	Heating		-15 to 24	-15 to 24	-15 to 24	-15 to 24
Refrigerant			R410A	R410A	R410A	R410A

Dimensions

Models: ARAG24LMTA / ARAG30LMLA / ARAG36LMLA / ARAG45LMLA

(Unit : mm)

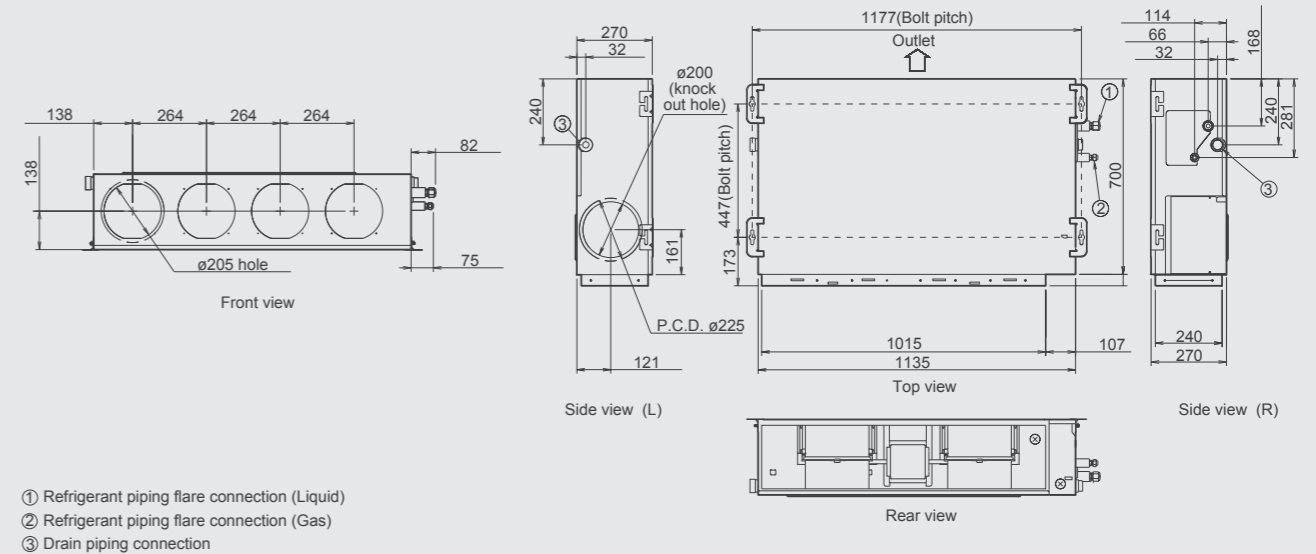

- ① Refrigerant piping flare connection (Liquid)
- ② Refrigerant piping flare connection (Gas)
- ③ Drain piping connection

CONSTANT SPEED WALL MOUNTED

NEW Model : ASAA09BMTA-A / ASAA12BMTA-A



Wireless R.C.



More Comfort Airflow

Airflow volume is increased more than current model and comfortable cooling is delivered to every corner of the room.



Operation range up to 46°C

Improved operation range up to 46°C ambient temperature for Indian market.

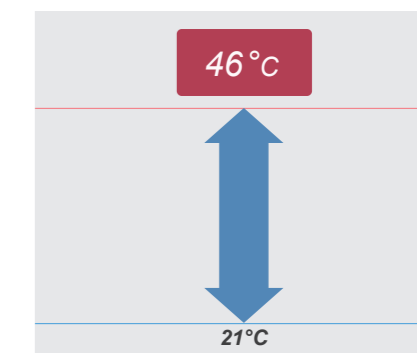

High efficient compact design

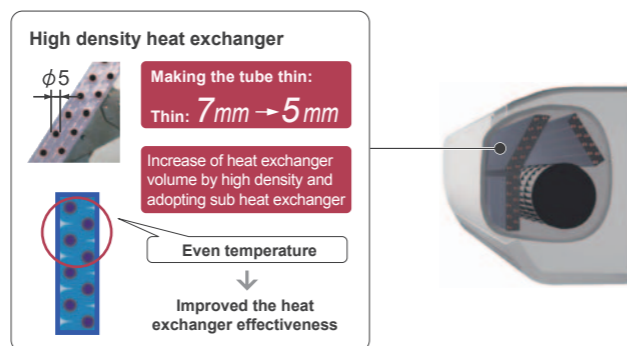
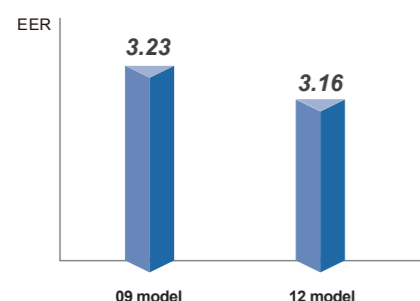

More Convenient Timer

From wake up to go to work

From sleep to wake up

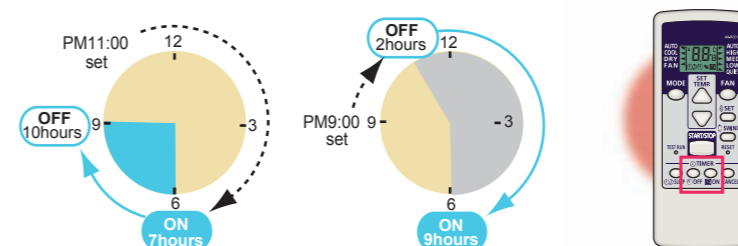

Adopting new refrigerant R32

R32 refrigerant is highly environmentally friendly for the reduction of the global warming potential than other refrigerant.



Specifications

Model No.	Indoor unit		ASAA09BMTA-A	ASAA12BMTA-A
	Outdoor unit		AOAA09BMTAA	AOAG12BMTAA
Power Source	V/∅/Hz		220-230-240/1/50	220-230-240/1/50
Capacity	Cooling	kW	2.55-2.55-2.55	3.25-3.25-3.25
		BTU/h	8,700-8,700-8,700	11,000-11,000-11,000
Input Power	Cooling	kW	0.77-0.79-0.82	1.01-1.03-1.06
EER	Cooling	W/W	3.31-3.23-3.11	3.22-3.16-3.07
Running Current	Cooling	A	3.6-3.5-3.5	4.7-4.6-4.6
Moisture Removal		l/h	1.0	1.3
Sound Pressure*	Indoor (High)	dB(A)	39-39-39	39-39-39
	Outdoor		51-51-51	51-51-51
Airflow Rate (High)	Indoor	m³/h	640	640
	Outdoor		1,880	1,780
Net Dimension H×W×D	Indoor	mm	262x820x206	262x820x206
		kg(lbs)	7.5 (17)	7.5 (17)
Net Weight	Outdoor	mm	540x680x252	540x680x252
		kg(lbs)	23.0 (51)	26.0 (57)
Piping Connections (Small / Large)			6.35/9.52	6.35/9.52
Drain Pipe Diameter (I.D./O.D.)		mm	13.8 / 15.8 to 16.7	13.8 / 15.8 to 16.7
Max Pipe Length (Pre-Charge)		m	15(7.5)	15(7.5)
Max Height Difference			5	5
Operation Range	Cooling	°CDB	21 to 46	21 to 46
Refrigerant			R32	R32

*:Specifications of sound pressure level are provisional for your reference. The contents of formal specifications might be different from these.

Dimensions Models: ASAA09BMTA-A / ASAA12BMTA-A

(Unit : mm)

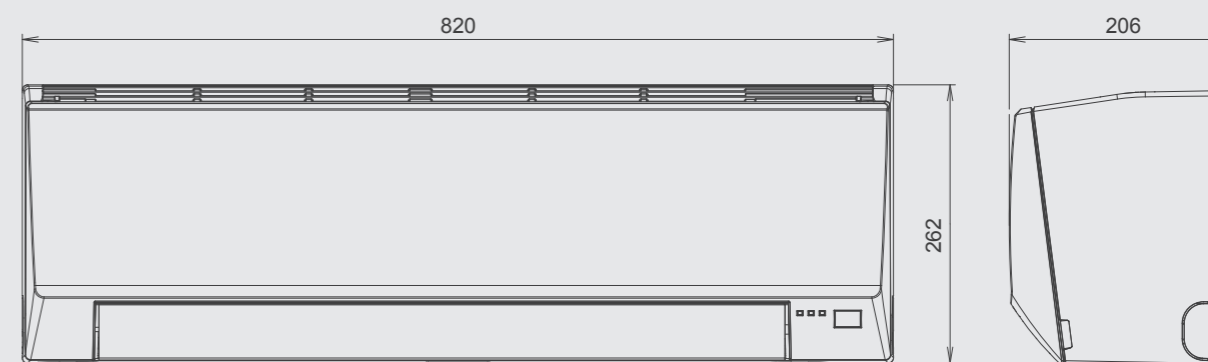

CONSTANT SPEED WALL MOUNTED

NEW Model : ASAA18FMTA-A / ASAA24FMTA-A



Improve Energy Efficiency

The higher EER is achieved than our previous models*: 230V

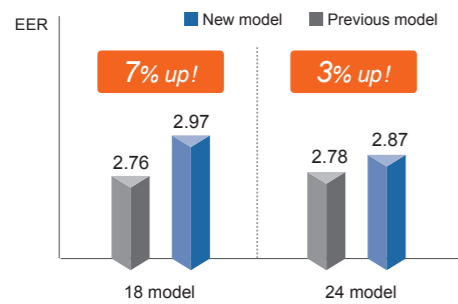

Quiet Operation

Quiet operation sound is able to expand the applications of the air conditioners.



Flexible Piping Installation

Sufficient pipe length and height difference is provided, which enables to enhance the flexibility of installation.

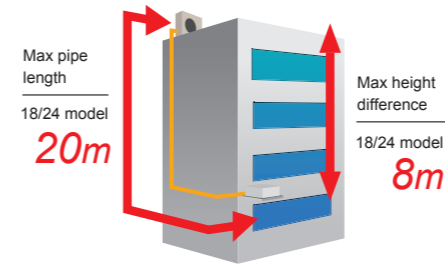

Operation In High Ambient Temperature

The operation is secured under the ambient temperature of up to 52 degrees Celsius in cooling operation.



Washable Front Panel

The front panel is easily detachable and is washable, which enables to the air conditioner always clean.



Power Diffuser

Power diffuser makes it possible for the air flow to reach every corner of the room.

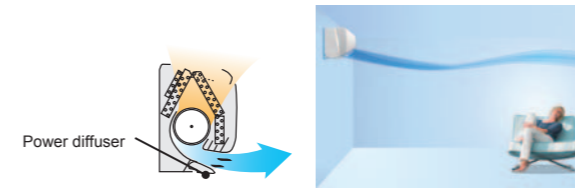

Optional parts

- Wired Remote Controller: UTB-YUD
- Simple Remote Controller: UTY-RSNYM
- External Connect Kit: UTY-XWZX

Specifications

Model No.	Indoor unit		ASAA18FMTA-A		ASAA24FMTA-A	
	Outdoor unit		AOAA18FMTAHA		AOAA24FMTAHA	
Power Source	V/∅/Hz		220 - 230 - 240 / 1 / 50		220 - 230 - 240 / 1 / 50	
Capacity	Btu/h		18,400 - 18,400 - 18,400		24,400 - 24,400 - 24,400	
	kW		5.40 - 5.40 - 5.40		7.15 - 7.15 - 7.15	
Input Power	kW		1.79 - 1.82 - 1.87		2.44 - 2.49 - 2.60	
EER	kW/kW		3.02 - 2.97 - 2.89		2.93 - 2.87 - 2.75	
Current	A		8.2 - 8.2 - 8.2		11.8 - 12.0 - 12.6	
Noise (Indoor)	High	dB(A)	44 - 44 - 44		47 - 47 - 47	
Noise (Outdoor)			dB(A)		53 - 54 - 54	
Airflow Rate (Indoor)	H/M/L/Q	m³/h	(under consideration)		(under consideration)	
Net Dimension H x W x D			Indoor unit	mm	320 x 998 x 238	
	Outdoor unit	kg(lbs)	13.0(29)		13.0(29)	
		mm	650 x 830 x 320		650 x 830 x 320	
	kg(lbs)	47.0(103)		55.0(121)		
Piping Connections (Liquid / Gas)	mm		6.35 / 15.88		6.35 / 15.88	
Drain Hose			12(I.D.) / 16(O.D.)		12(I.D.) / 16(O.D.)	
Max Pipe Length (Pre-Charge)	m		20 (7.5)		20 (7.5)	
Max Height Difference			8		8	
Operation Range	°CDB		21 to 52		21 to 52	
Refrigerant			R410A		R410A	

Dimensions Models: ASAA18FMTA-A / ASAA24FMTA-A

(Unit : mm)

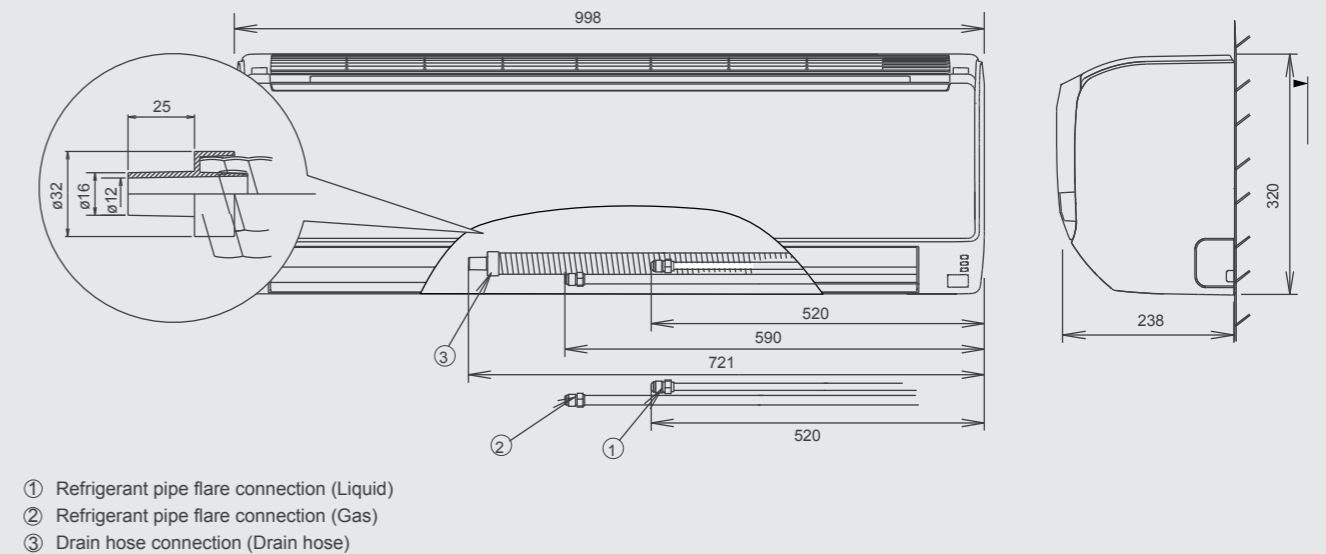

CONSTANT SPEED WALL MOUNTED

Model : ASYA18AET / ASYA24AET



Wireless R.C.



Flexible installation

Previous model (18/24AET)

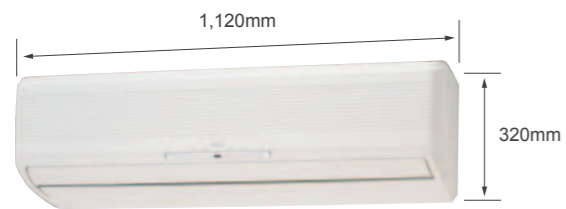

New model

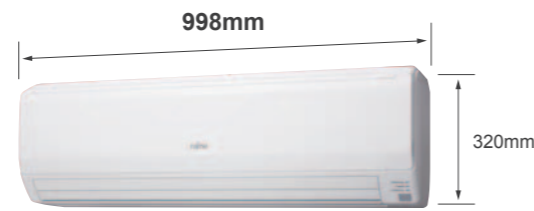

High EER (24AET)



Powerful mode function

Operates at maximum air flow in the cooland fan operation modes, and quickly makes the room comfortable.

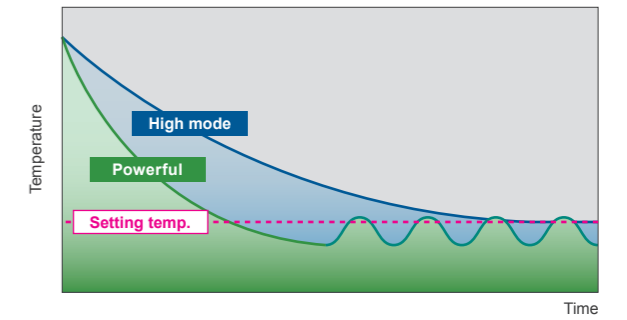

Multi airflow

Large independently driven power diffuser used

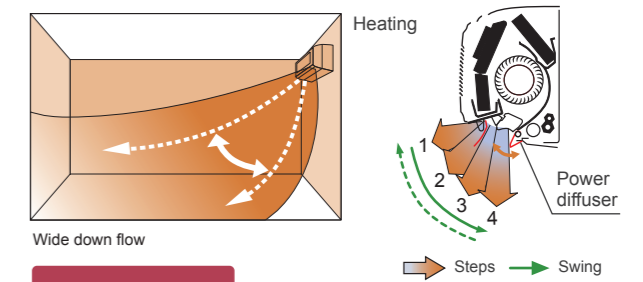
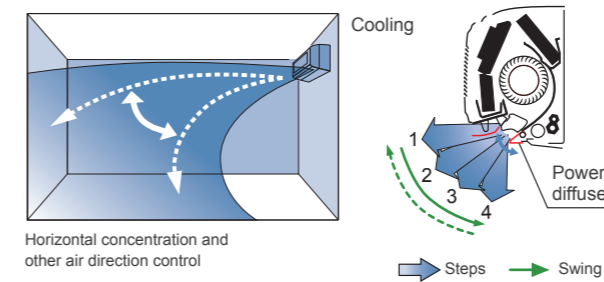

Large independently driven power diffuser

Optional parts

Wired Remote Controller: UTB-YUD

Specifications

Model No.	Indoor unit		ASYA18AET	ASYA24AET
	Outdoor unit		AOYR18AE	AOYR24AE
Power Source	V/∅/Hz		220-240/1/50	220-240/1/50
Capacity	Cooling	kW	5.3	7.11
		BTU/h	18,100	24,200
Input Power	Cooling	kW	1.92	2.56
EER	Cooling	W/W	2.76	2.78
Running Current	Cooling	A	8.9	12.2
Moisture Removal		l/h	2.0	2.5
Sound Pressure	Indoor (High)	dB(A)	43	46
	Outdoor		53	54
Airflow Rate (High)	Indoor	m ³ /h	985	1,090
	Outdoor		3,120	3,120
Net Dimension HxWxD	Indoor	mm	320x998x238	320x998x238
	Outdoor	kg(lbs)	14.0 (31)	14.0 (31)
Net Weight	Indoor	mm	650x830x320	650x830x320
	Outdoor	kg(lbs)	46.0 (101)	57.0 (125)
Piping Connections (Small / Large)			9.52/15.88	9.52/15.88
Drain Pipe Diameter (I.D./O.D.)		mm	16.0/28.0	16.0/28.0
Max Pipe Length (Pre-Charge)		m	20(7.5)	20(7.5)
Max Height Difference			8	8
Operation Range	Cooling	°CDB	21 to 52	21 to 52
Refrigerant			R22	R22

Dimensions Models: ASYA18AET / ASYA24AET

(Unit : mm)

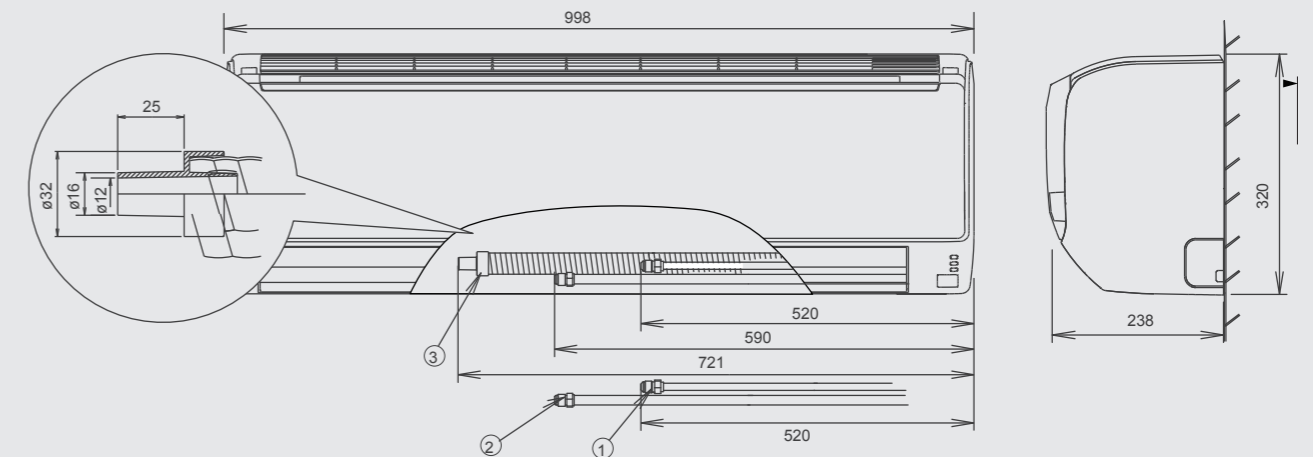

- ① Refrigerant pipe flare connection (Liquid)
- ② Refrigerant pipe flare connection (Gas)
- ③ Drain hose connection (Drain hose)

Model : AUY18ABAB / AUY18RBAB



Wireless R.C.



Comfortable air flow

4 step swing

Auto air flow direction and auto swing

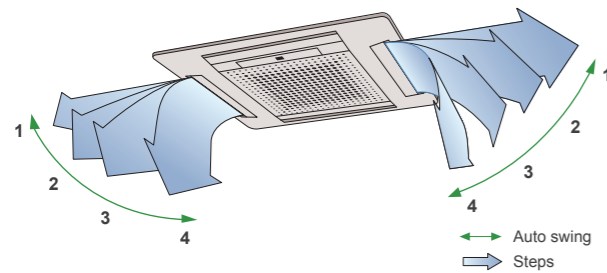

2-4 way air flow system

Select 2-way, 3-way or 4-way air flow to suit your needs.

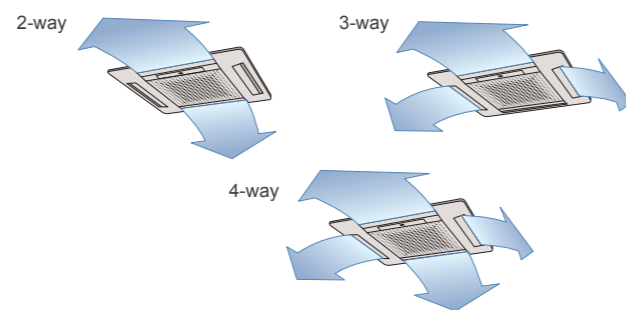

Duct connection hole opening

Fresh air can be introduced through this opening

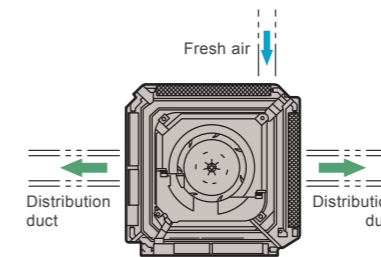

Conditioned air can be distributed by means of a distribution duct

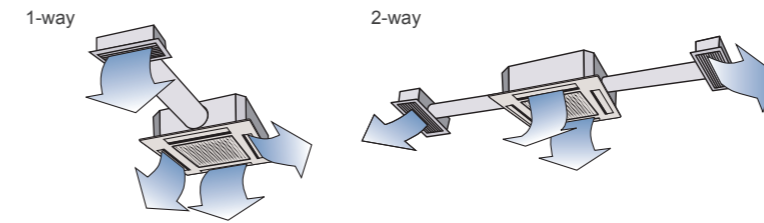

Compact size

Compact grille fits European ceiling panel (650 x 650 mm)

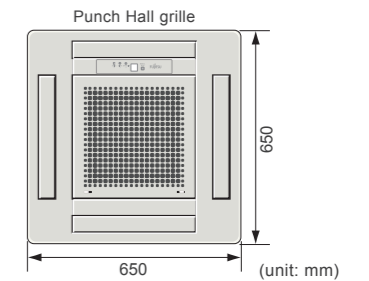

Condensate pump lift to 400mm

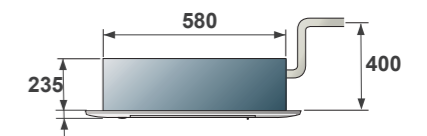

Additional grille (optional parts)

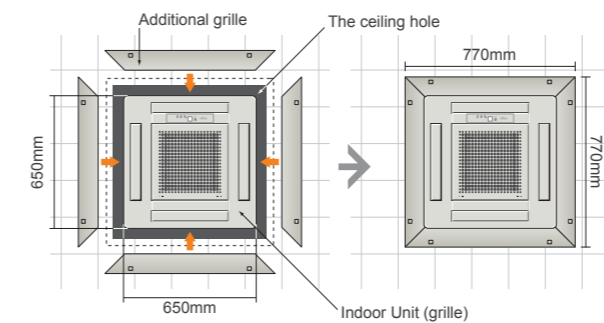

Optional parts

Additional Grille: UTG-AGDA-W

Specifications

Model No.	Indoor unit		AUY18ABAB	AUY18RBAB
	Outdoor unit		AOY18ANCKL	AOY18RNCKL
Power Source	V/∅/Hz		220-240/1/50	220-240/1/50
Capacity	Cooling	kW	4.95-5.10	4.85-5.00
		BTU/h	16,900-17,400	16,600-17,100
	Heating	kW	—	5.30-5.45
		BTU/h	—	18,100-18,600
Input Power	Cooling/Heating	kW	1.80-1.90 / —	1.75-1.85 / 1.85-1.95
EER	Cooling		2.75-2.68	2.77-2.70
COP	Heating	W/W	—	2.86-2.79
Running Current	Cooling/Heating	A	8.50-8.00	8.5-8.0 / 9.0-8.5
Moisture Removal		l/h	2.1	2.1
Sound Pressure	Indoor (High)	dB(A)	44	44
	Outdoor		52	52
Airflow Rate (High)	Indoor	m³/h	650	650
	Outdoor		3,500	3,500
Net Dimension HxWxD	Indoor	mm	235x580x580+70	235x580x580+70
		kg(lbs)	18.0 (40)	18.0 (40)
Net Weight	Outdoor	mm	650x830x320	650x830x320
		kg(lbs)	51.0 (112)	56.0 (123)
Piping Connections (Small / Large)			6.35/12.70	6.35/12.70
Drain Pipe Diameter (I.D./O.D.)		mm	25.0/32.0	25.0/32.0
Max Pipe Length (Pre-Charge)		m	20(7.5)	20(10)
Max Height Difference			8	8
Operation Range	Cooling	°CDB	10 to 43	10 to 43
	Heating		—	-5 to 24
Refrigerant			R22	R22
Cassette Grille			UTG-UDYD-W	UTG-UDYD-W

Dimensions Models: AUY18ABAB / AUY18RBAB

(Unit : mm)

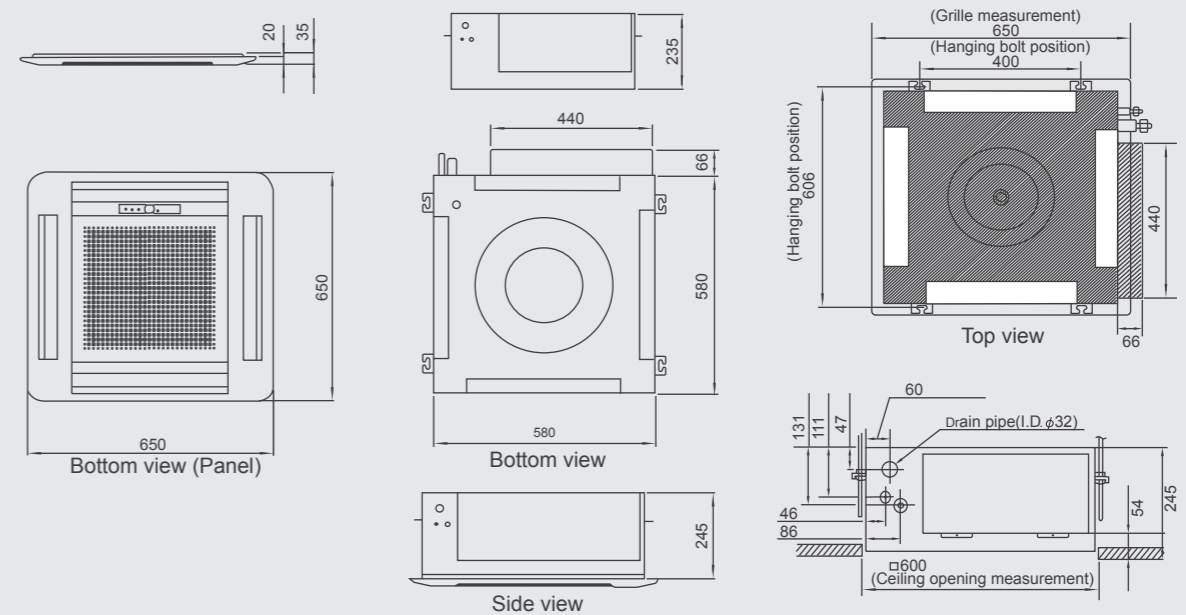

Model : AUY25ABAR / AUY30ABAR / AUY45ABAS [3phase] / AUY54ABAS [3phase]
 AUY25RLD-W / AUY30RLD-W / AUY45RLB3W [3phase] / AUY54RLB3W [3phase]



Wired type (With Weekly Timer) For AUY25ABAR AUY25RLD For AUY30ABAR AUY30RLD-W For AUY45/54ABAS AUY45/54RLB3W



Comfortable airflow

4 step swing

Auto air flow direction and auto swing

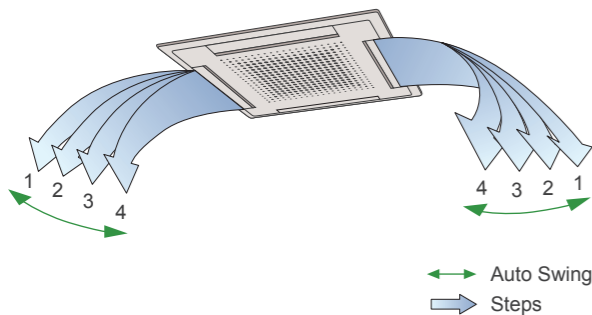

Auto Swing Steps

2-4 way air flow system

Select 2-way, 3-way or 4-way air flow to suit your needs.

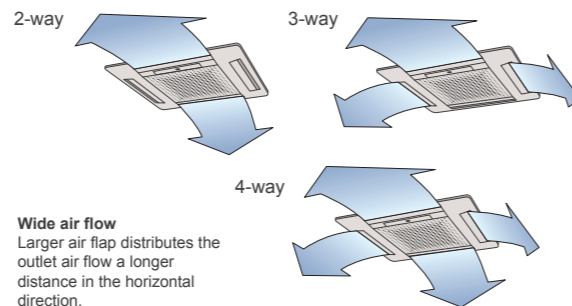

Wide air flow Larger air flap distributes the outlet air flow a longer distance in the horizontal direction.

Flexible installation

Installation is done by "Standard setting" with more than 300mm (250mm) of space. "Slender setting" lets it suitable for minimum 265mm (215mm) installation space.

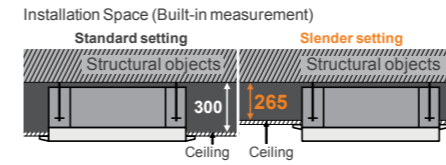

	25/30	36/45/54
Standard setting	250mm	300mm
Slender setting	215mm	265mm

Easy maintenance

The control box is easily accessible for maintenance work. Wide opening for easy access.

Detachable, washable filter and intake grille

Wide opening and long-life filter

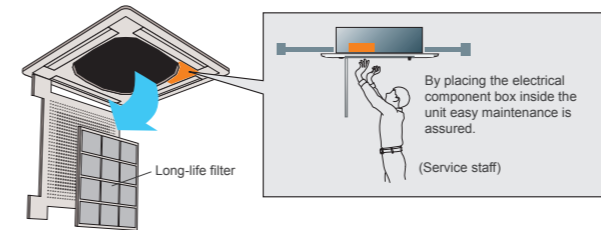

Long-life filter

High efficiency, long-life filter extends the cleaning cycle.

Duct connection hole opening

Conditioned air can be distributed by means of a distribution duct

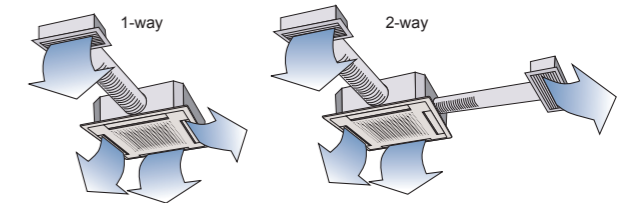

Fresh air can be introduced through this opening

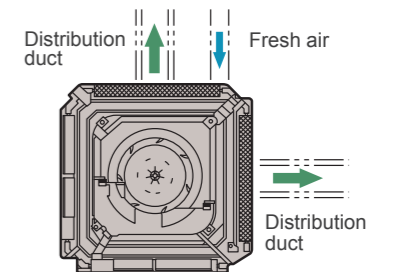

Condensate pump lift to 800mm

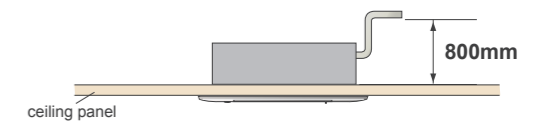

Optional parts

Additional Grille: UTG-AGEA-W

Specifications

Model No.	Indoor unit		AUY25ABAR	AUY30ABAR	AUY45ABAS	AUY54ABAS	AUY25RLD-W	AUY30RLD-W	AUY45RLB3W	AUY54RLB3W
	Outdoor unit		AOY25ANAL	AOY30AMBL	AOY45APA3L	AOY54APA3L	AOY25RNAL	AOY30RMBL	AOY45RPA3L	AOY54RPA3L
Power Source	V/∅/Hz		220-240/1/50	220-240/1/50	380-415/3/50	380-415/3/50	220-240/1/50	220-240/1/50	380-415/3/50	380-415/3/50
Capacity	Cooling	kW	7.00-7.10	8.60-8.80	12.40-12.70	13.90-14.10	6.95-7.05	8.30-8.60	12.4-12.7	13.9-14.1
		BTU/h	23,900-24,200	29,400-30,000	42,500-43,500	47,500-48,000	23,700-24,100	28,300-29,400	42,300-43,300	47,400-48,000
Input Power	Heating	kW	—	—	—	—	7.75-8.00	9.30-9.50	13.4-13.7	15.4-15.8
		BTU/h	—	—	—	—	26,500-27,300	31,700-32,400	45,700-46,800	52,500-53,900
EER	Cooling/Heating	W/W	2.66-2.75 / —	3.20-3.30 / —	4.35-4.45 / —	5.20-5.25 / —	2.60-2.70 / 2.38-2.53	3.25-3.35 / 3.15-3.30	4.35-4.45 / 4.45-4.50	5.20-5.25 / 5.30-5.30
COP	Heating	W/W	—	—	—	—	2.67-2.61	2.55-2.57	2.85-2.85	2.67-2.69
Running Current	Cooling/Heating	A	13.00-12.70 / —	14.70-14.50 / —	8.10-8.30 / —	9.00-8.90 / —	12.3-12.3 / 11.3-11.7	15.0-14.8 / 14.5-14.5	8.1-8.3 / 8.4-8.4	8.9-9.0 / 9.0-9.1
Moisture Removal		l/h	2.5	4.0	6.0	6.0	2.5	4.0	6.0	5.5
Airflow Rate (High)	Indoor	m³/h	1,100	1,200	1,650	1,780	1,100	1,200	1,650	1,780
Net Dimension HxWxD	Indoor / Grille	mm	246x830x830	246x830x830	296x830x830	296x830x830	246x830x830	246x830x830	296x830x830	296x830x830
		kg(lbs)	34.0 (75)	34.0 (75)	40.0 (88)	40.0 (88)	34.0 (75)	34.0 (75)	40.0 (88)	40.0 (88)
Net Weight	Outdoor	mm	700x900x350	900x900x350	1,152x940x370	1,152x940x370	700x900x350	900x900x350	1,152x940x370	1,152x940x370
		kg(lbs)	67.0 (147)	79.0 (174)	102.0 (224)	112.0 (246)	70.0 (154)	80.0 (176)	110.0 (243)	120.0 (264)
Piping Connections (Small / Large)		mm	9.52/15.88	9.52/15.88	9.52/19.05	9.52/19.05	9.52/15.88	9.52/15.88	9.52/19.05	9.52/19.05
Drain Pipe Diameter (I.D./O.D.)		mm	25.0/32.0	25.0/32.0	25.0/32.0	25.0/32.0	25.0/32.0	25.0/32.0	25.0/32.0	25.0/32.0
Max Pipe Length (Pre-Charge)		m	25(7.5)	30(7.5)	50(20)	50(20)	25(7.5)	30(7.5)	50(20)	50(20)
Max Height Difference		m	15	15	30	30	15	15	30	30
Operation Range	Cooling	°CDB	0 to 43	0 to 43	0 to 52	0 to 52	0 to 43	0 to 43	0 to 52	0 to 52
	Heating	°CDB	—	—	—	—	-5 to 21	-5 to 21	-8 to 21	-8 to 21
Refrigerant			R22	R22	R22	R22	R22	R22	R22	R22

Dimensions

Models: AUY25ABAR / AUY30ABAR/AUY25RLD-W/AUY30RLD-W

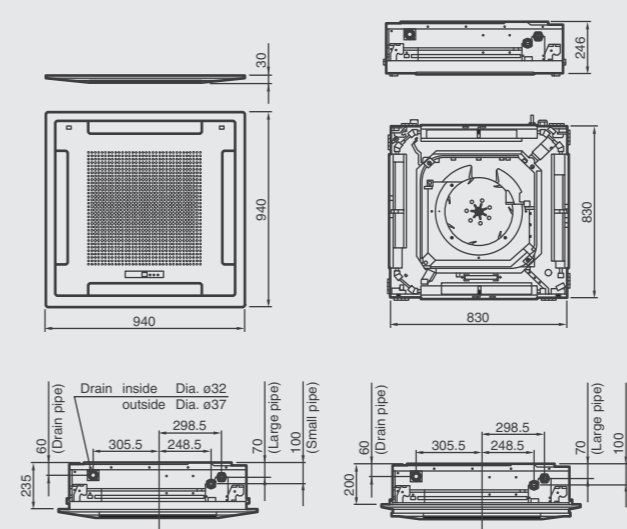

Models: AUY45ABAS/AUY45RLB3W/AUY54ABAS/AUY54RLB3W

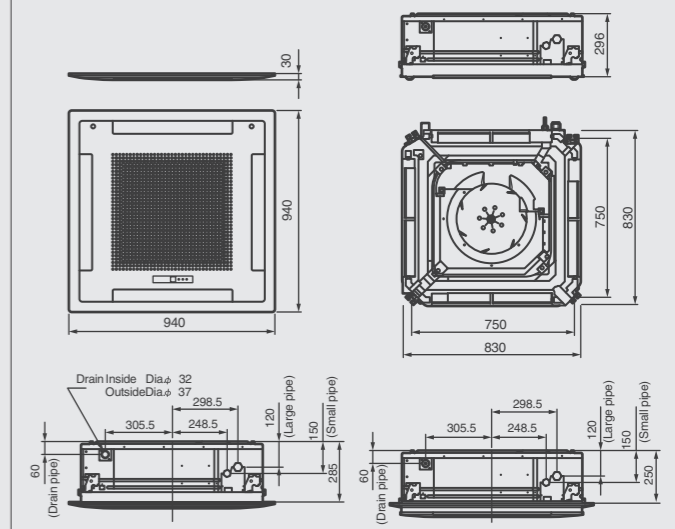

CONSTANT SPEED

FLOOR/CEILING UNIVERSAL

Model : ABY18ABAJ / ABY24ABAJ
 ABY18RBAJ / ABY24RBAJ



Wireless R.C.



Flexible installation

Example for floor installation

Floor console



Example for ceiling installation

Under ceiling



Double auto swing

A combination of up/down and right/left directional swing allows three-dimensional air direction control.

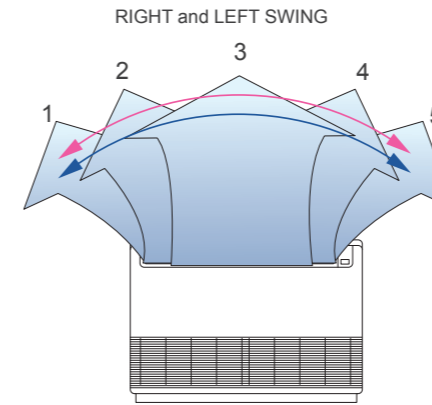

RIGHT and LEFT SWING

UP and DOWN SWING

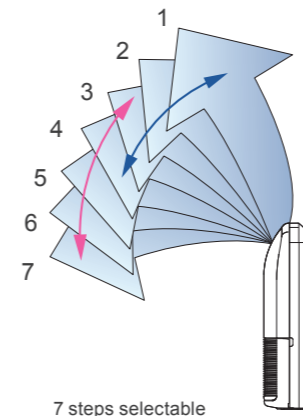

7 steps selectable

Super vane

Double Louvre Super vane with newly developed special configuration boosts airflow sending cool air quickly to every corner of the room.

Auto-closing louvre

When operation is stopped, the louvres will automatically close. (This function is available on all non-ducted models.)

Compact design

Symmetrical, slim and compact design.

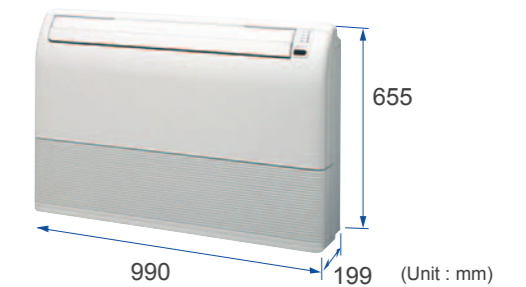

Specifications

Model No.	Indoor unit		ABY18ABAJ	ABY24ABAJ	ABY18RBAJ	ABY24RBAJ
	Outdoor unit		AOYR18ADTH	AOYR24ADTH	AOY18RNAKH	AOY24RNAKH
Power Source	V/Ø/Hz		220-240/1/50	220-240/1/50	220-240/1/50	220-240/1/50
Capacity	Cooling	kW	5.40-5.50	6.80-6.90	5.30-5.40	6.60-6.80
		BTU/h	18,400-18,800	23,200-23,600	18,100-18,400	22,500-23,200
	Heating	kW	—	—	5.50-5.60	7.60-7.80
		BTU/h	—	—	18,800-19,100	25,900-26,600
Input Power	Cooling/Heating	kW	1.84-1.89 / —	2.53-2.67 / —	1.83-1.91/1.70-1.75	2.60-2.78/2.53-2.68
EER	Cooling		2.93-2.91	2.69-2.58	2.90-2.83	2.54-2.45
COP	Heating	W/W	—	—	3.24-3.20	3.00-2.91
Running Current	Cooling/Heating	A	8.4-8.4 / —	12.2-12.8 / —	8.5-8.5/7.8-7.8	12.4-12.8/12.4-12.8
Moisture Removal		l/h	2.0	3.4	1.7	2.5
Sound Pressure	Indoor (High)	dB(A)	47(at 240V)	50(at 240V)	47(at 240V)	49(at 240V)
	Outdoor		53(at 240V)	54(at 240V)	53(at 240V)	54(at 240V)
Airflow Rate (High)	Indoor	m³/h	800(at 240V)	900(at 240V)	800(at 240V)	900(at 240V)
	Outdoor		3,200(at 240V)	3,200(at 240V)	3,200(at 240V)	3,200(at 240V)
Net Dimension HxWxD	Indoor	mm	199x990x655	199x990x655	199x990x655	199x990x655
	Outdoor	mm	650x830x320	650x830x320	650x830x320	650x830x320
Net Weight	Indoor	kg(lbs)	30.0 (66)	30.0 (66)	30.0 (66)	30.0 (66)
	Outdoor	kg(lbs)	46.0 (101)	57.0 (125)	56.0 (123)	68.0 (150)
Piping Connections (Small / Large)		mm	9.52/15.88	9.52/15.88	9.52/15.88	9.52/15.88
Drain Pipe Diameter (I.D./O.D.)						
Max Pipe Length (Pre-Charge)		m	20(7.5)	20(7.5)	20(7.5)	20(7.5)
Max Height Difference			8	8	8	8
Operation Range	Cooling	°CDB	21 to 52	21 to 52	0 to 52	0 to 52
	Heating		—	—	0 to 24	0 to 24
Refrigerant			R22	R22	R22	R22

Dimensions

Models: ABY18ABAJ / ABY24ABAJ / ABY18RBAJ / ABY24RBAJ

(Unit : mm)

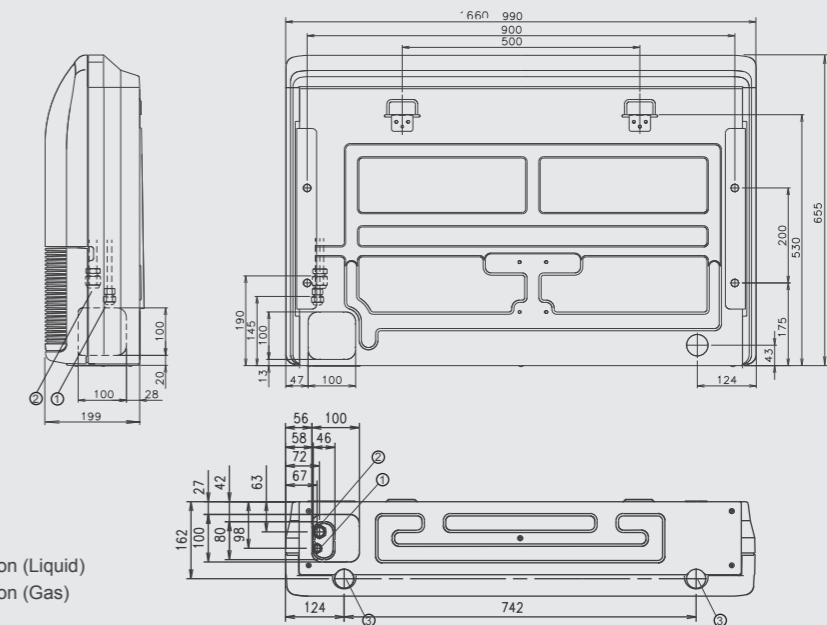

- ① Refrigerant piping flare connection (Liquid)
- ② Refrigerant piping flare connection (Gas)
- ③ Drain piping connection

Model : ABY30ABA-W / ABY36ABA3W [3phase] / ABY45ABA3W [3phase] / ABY54ABA3W [3phase]
 ABY30RBA-W / ABY36RBA3W [3phase] / ABY45RBA3W [3phase] / ABY54RBA3W [3phase]

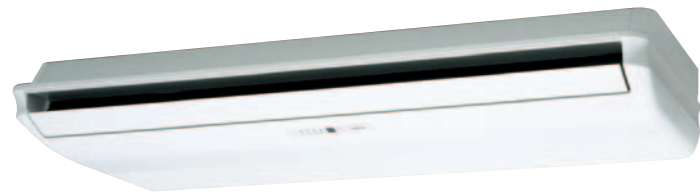

Wired R.C. For ABY30ABA-W / ABY30RBA-W For ABY36/45/54ABA3W / ABY36/45/54RBA3W



Installation

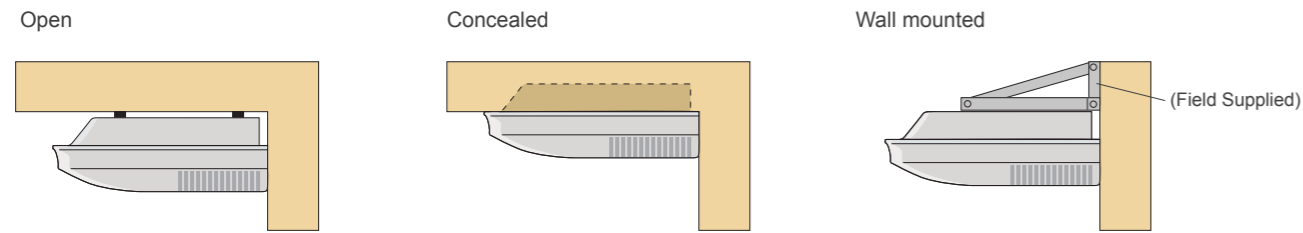

Open
 General installation pattern which suspends the indoor unit from the ceiling.

Concealed
 Installation pattern where part of the indoor unit is embedded into the ceiling.

Wall mounted
 Installation which fixes the indoor unit to the wall by the use of wall brackets (Field supplied). This type of installation can be used when the ceiling space is insufficient.

Double auto swing and wide airflow

Auto airflow direction and auto swing

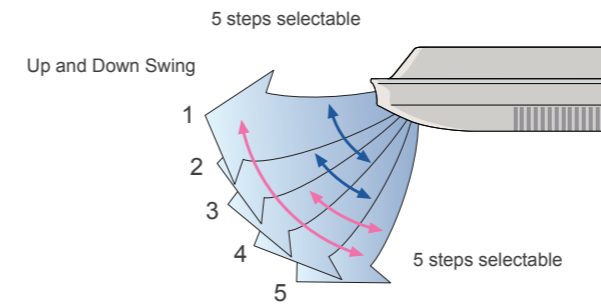
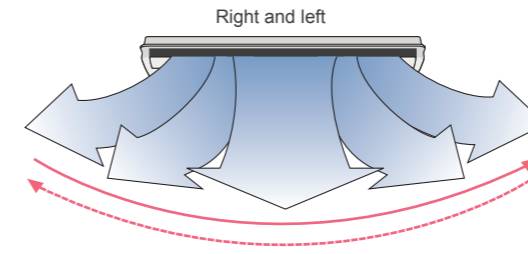

Long Airflow

Long Airflow ensures comfort to every corner of a large room.

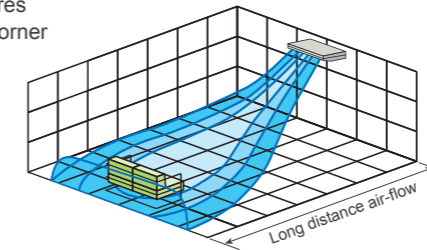

Slim & Compact design

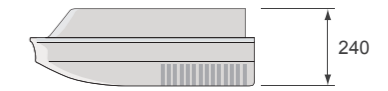

Condensate lift-up mechanism (Option)

Optional drain lift-up mechanism allows flexible installation.

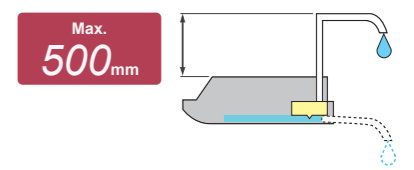

Fresh air intake

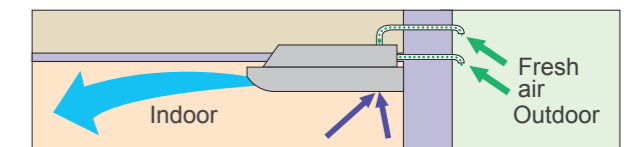

Long-life filter

High efficiency long-life filter doubles the life of the filter compared to standard filters.

Optional parts

Drain Pump Unit: UTR-DPB24T
 Flange: UTD-RF204

Specifications

Model No.	Indoor unit		ABY30ABA-W	ABY36ABA3W	ABY45ABA3W	ABY54ABA3W	ABY30RBA-W	ABY36RBA3W	ABY45RBA3W	ABY54RBA3W
	Outdoor unit		AOY30AMBH	AOY36APA3L	AOY45APA3L	AOY54APA3L	AOY30RMCL	AOY36RPA3L	AOY45RPA3L	AOY54RPA3L
Power Source	V/∅/Hz		220-240/1/50	380-415/3/50	380-415/3/50	380-415/3/50	220-240/1/50	380-415/3/50	380-415/3/50	380-415/3/50
Capacity	Cooling	kW	8.60-8.80	10.30-10.50	12.40-12.70	13.90-14.10	8.30-8.60	10.30-10.50	12.40-12.70	13.90-14.10
		BTU/h	29,400-30,000	32,520-36,000	42,500-43,500	47,500-48,000	29,400-30,000	35,200-35,800	42,300-43,300	47,400-48,000
Input Power	Heating	kW	—	—	—	—	9.30-9.50	10.50-10.70	13.40-13.70	15.40-15.80
		BTU/h	—	—	—	—	30,100-31,000	35,800-36,500	45,700-46,800	52,500-53,900
EER	Cooling	—	3.20-3.30 / —	3.80-3.90 / —	4.45-4.57 / —	5.20-5.25 / —	3.25-3.35 / 2.95-3.10	4.00-4.10 / 3.45-3.50	4.35-4.45 / 4.45-4.50	5.20-5.25 / 5.30-5.30
COP	Heating	W/W	2.69-2.67	2.71-2.69	2.79-2.78	2.67-2.69	2.55-2.57	2.58-2.56	2.85-2.85	2.67-2.69
Running Current	Cooling/Heating	A	14.70-14.50 / —	7.00-7.20 / —	7.50-7.50 / —	9.00-8.90 / —	15.0-14.8 / 13.6-13.9	7.0-7.0 / 6.2-6.3	8.1-8.3 / 8.4-8.4	9.0-8.9 / 9.1-9.0
Moisture Removal		l/h	4.0	4.0	5.5	6.0	4.0	5.5	5.5	
Airflow Rate (High)	Indoor	m ³ /h	1,270	1,660	1,850	2,100	1,270	1,660	1,850	2,100
Net Dimension HxWxD	Indoor	mm	240x1,660x700	240x1,660x700	240x1,660x700	240x1,660x700	240x1,660x700	240x1,660x700	240x1,660x700	240x1,660x700
	Outdoor	mm	900x900x350	1,152x940x370	1,152x940x370	1,152x940x370	900x900x350	1,152x940x370	1,152x940x370	1,152x940x370
Net Weight		kg(lbs)	84.0 (185)	94.0 (207)	102.0 (224)	112.0 (246)	80.0 (176)	100.0 (220)	110.0 (242)	120.0 (264)
Piping Connections (Small / Large)		mm	9.52/15.88	9.52/19.05	9.52/19.05	9.52/19.05	9.52/15.88	9.52/19.05	9.52/19.05	9.52/19.05
Drain Pipe Diameter (I.D./O.D.)		mm	22.0/25.6	22.0/25.6	22.0/25.6	22.0/25.6	22.0/25.6	22.0/25.6	22.0/25.6	22.0/25.6
Max Pipe Length (Pre-Charge)		m	30(7.5)	50(12.5)	50(12.5)	50(12.5)	25(7.5)	50(12.5)	50(12.5)	50(12.5)
Max Height Difference		m	15	30	30	30	15	30	30	
Operation Range	Cooling	°CDB	21 to 52	0 to 52	0 to 52	0 to 52	0 to 43	0 to 52	0 to 52	0 to 52
Refrigerant	Heating	°CDB	—	—	—	—	-5 to 21	-8 to 21	-8 to 21	-8 to 21
			R22	R22	R22	R22	R22	R22	R22	R22

Dimensions

Models: ABY30ABA-W / ABY36ABA3W / ABY45ABA3W / ABY54ABA3W
 ABY30RBA-W / ABY36RBA3W / ABY45RBA3W / ABY54RBA3W

(Unit : mm)

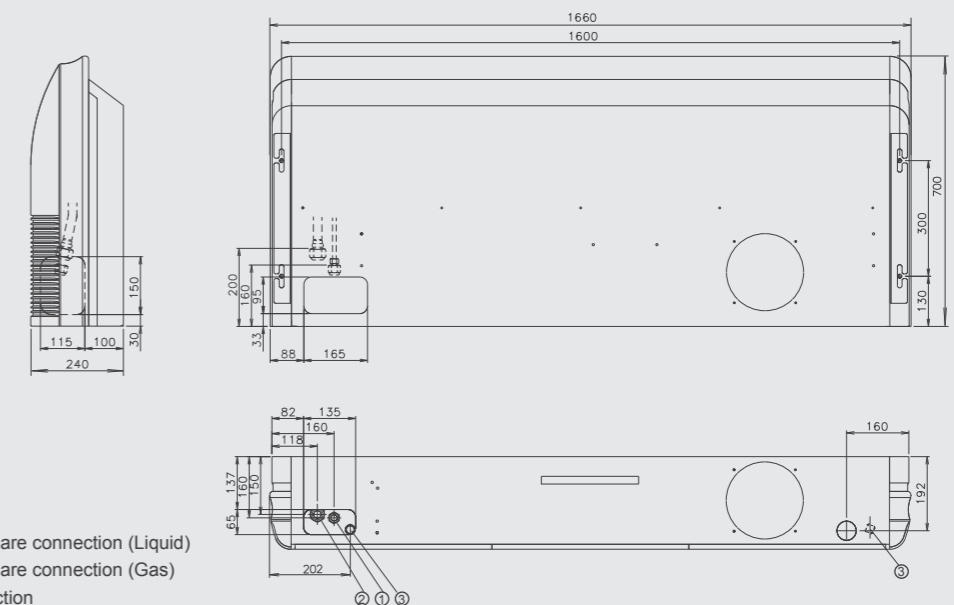

- ① Refrigerant piping flare connection (Liquid)
- ② Refrigerant piping flare connection (Gas)
- ③ Drain piping connection

CONSTANT SPEED

COMPACT DUCT

Model : ARY18FUAL

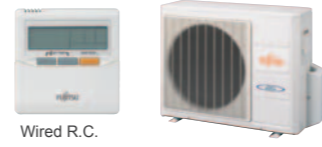

Compact design

Ultra-slim duct air conditioner for easy installation

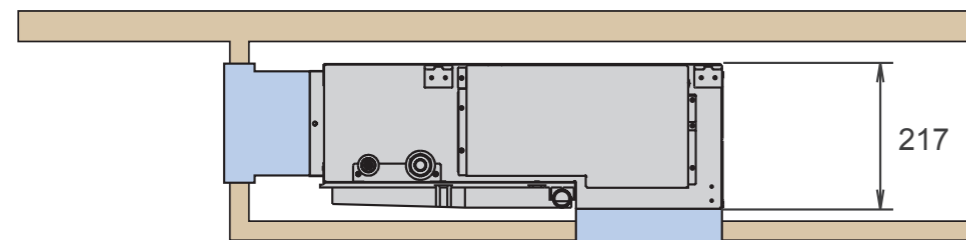

Slim size (217mm) allows installation even where the space behind the ceiling is narrow.

Two-direction drain piping

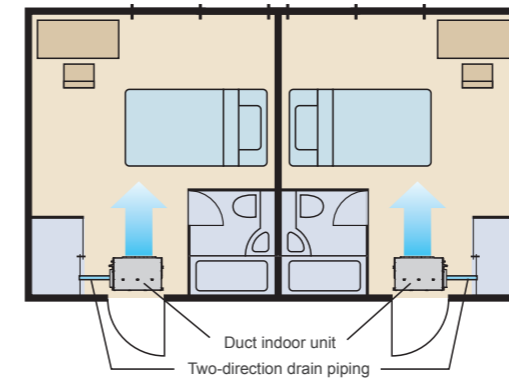

Flexible installation

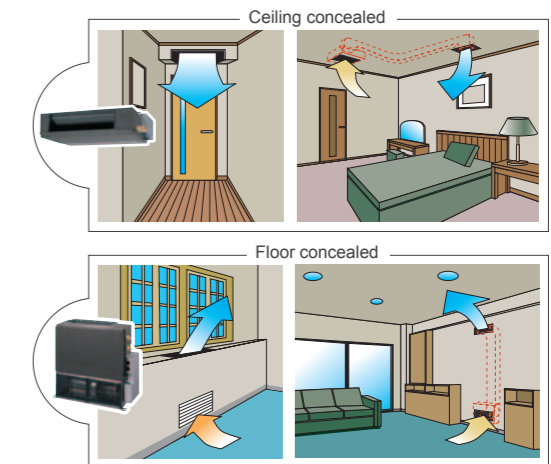

Air-intake

Air intake direction can be selected to match the installation site.

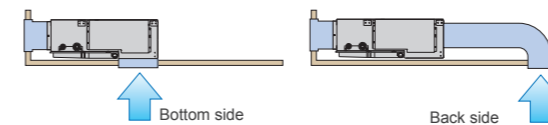

Optional function for comfort

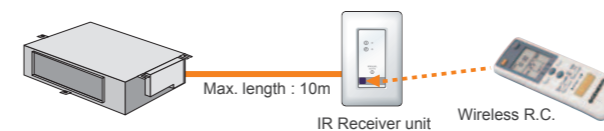

Filter (Accessory)

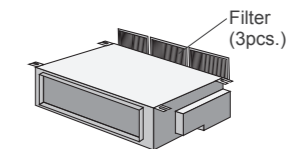

Optional parts

- Simple Remote Controller: UTB-YPB
- Remote Sensor Unit: UTD-RS100 / UTY-XSZX
- IR Receiver Unit: UTY-LRJY1
- Drain Pump Unit: UTZ-PX1BBA

Specifications

Model No.	Indoor unit		ARY18FUAL
	Outdoor unit		AOY18FNDN
Power Source	V/∅/Hz		220-240/1/50
Capacity	Cooling	kW	5.30-5.40
		BTU/h	18,100-18,400
Input Power	Cooling	kW	1.90-2.00
EER	Cooling	W/W	2.79-2.70
Running Current	Cooling	A	9.0-8.9
Moisture Removal		l/h	1.6
Sound Pressure	Indoor (High)	dB(A)	43
	Outdoor		53
Airflow Rate (High)	Indoor	m ³ /h	960
	Outdoor		3,400
Net Dimension HxWxD	Indoor	mm	217x953x595
	Outdoor	kg(lbs)	25.0(55)
Net Weight		mm	650x830x320
		kg(lbs)	51.0(113)
Piping Connections (Small / Large)		mm	6.35/15.88
Drain Pipe Diameter (I.D./O.D.)		mm	21.5/26.0
Max Pipe Length (Pre-Charge)		m	20
Max Height Difference			8
Operation Range	Cooling	°CDB	21 to 52
Refrigerant			R410A

Dimensions Models: ARY18FUAL

(Unit : mm)

*Service accessibility must be allowed for when installing the product. Please consult the installation manual for the necessary service access size.

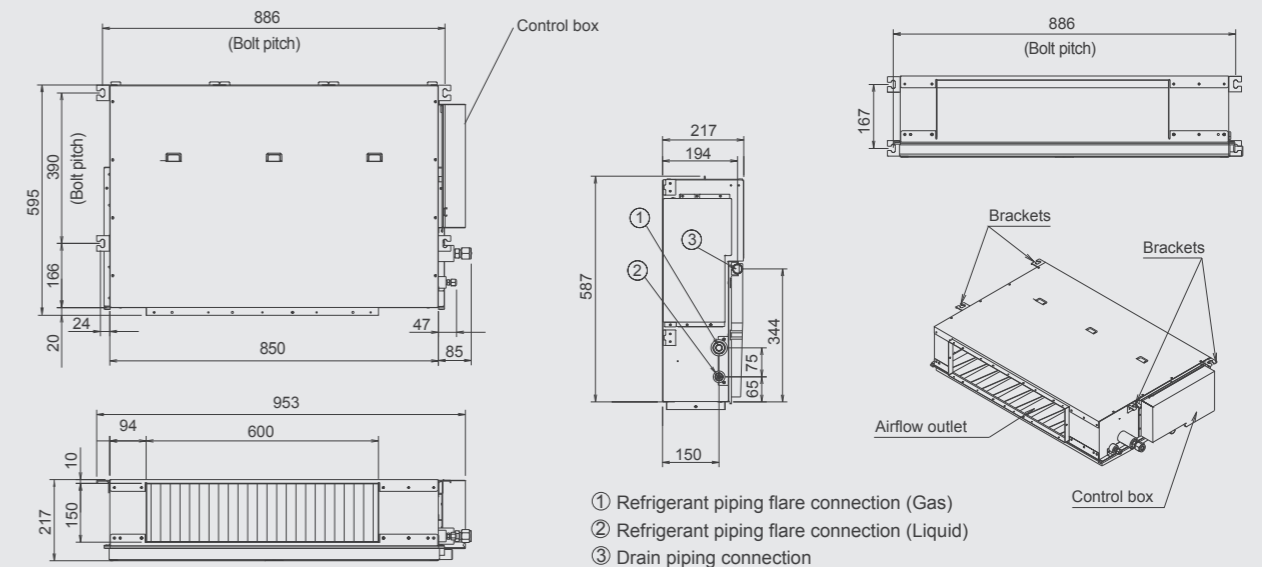

- ① Refrigerant piping flare connection (Gas)
- ② Refrigerant piping flare connection (Liquid)
- ③ Drain piping connection

Model : ARY25ALC / ARY30ALC / ARY36ALD3 [3phase] / ARY45ALC3 [3phase]
 ARY25RLC / ARY30RLC / ARY36RLC3 [3phase] / ARY45RLC3 [3phase]



Slim & Compact design

In the case of bottom return air connection, not only does the indoor unit design allow for installation in a narrow ceiling space of up to 270mm, Further space savings have been achieved by mounting the electrical control box internally inside the chassis.

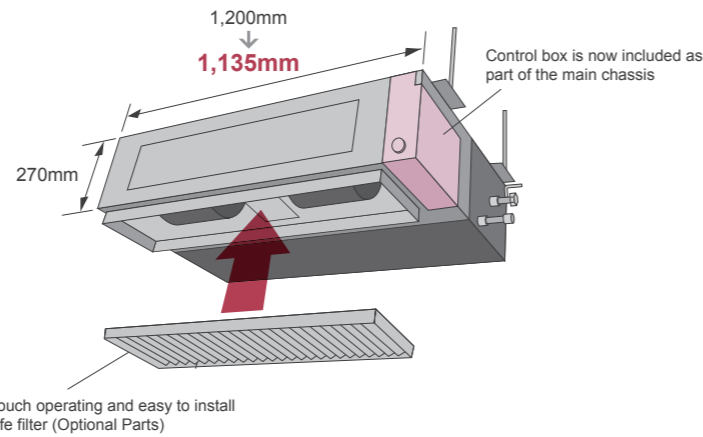

Two-direction drain piping

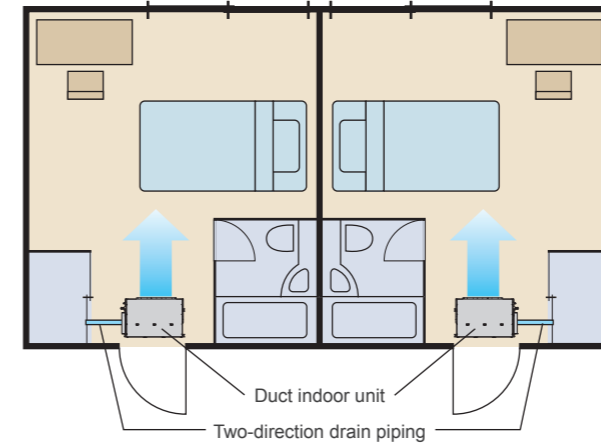

Easy maintenance

See below for the case of rear suction type

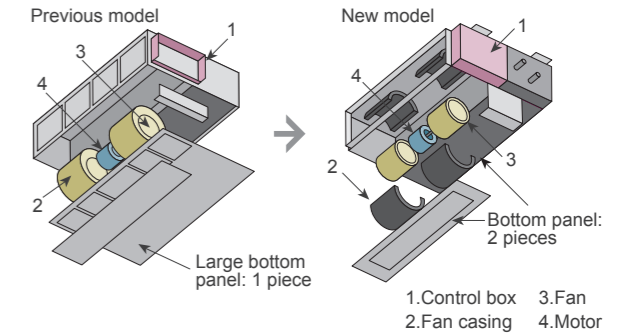

Structural improvement is attained by making the bottom panel two pieces, front and rear. The internal fan casing is also manufactured in two pieces, namely upper and lower. The maintenance of the motor and fan can be easily carried out by removing the rear panel and the lower part of the casing while leaving the main chassis installed.

Installation styles

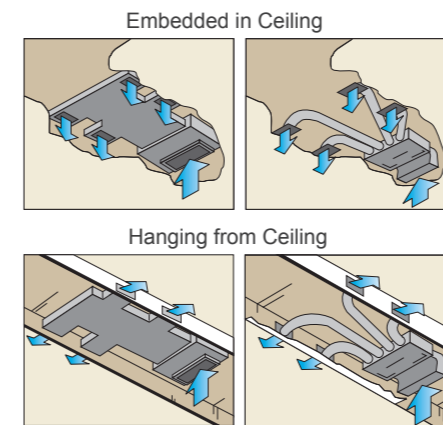

Optional parts

- Simple Remote Controller: UTY-RSNYM
- Flange: UTD-RF204 / UTD-SF045T
- Drain Pump Unit: UTZ-PX1NBA
- Long Life Filter: UTD-LF25NA
- External Control Set: UTD-ECS5A

Specifications

Model No.	Indoor unit		ARG25ALC	ARG30ALC	ARG36ALD3	ARG45ALC3	ARG25RLC	ARG30RLC	ARG36RLC3	ARG45RLC3
	Outdoor unit		AOG25ANBL	AOG30AMBH	AOG36APA3L	AOG45APA3L	AOG25RNBL	AOG30RMBL	AOG36RPA3L	AOG45RPA3L
Power Source	V/∅/Hz		220-240/1/50	220-240/1/50	380-415/3/50	380-415/3/50	220-240/1/50	220-240/1/50	380-415/3/50	380-415/3/50
Capacity	Cooling	kW	7.00-7.10	8.60-8.80	10.30-10.50	12.40-12.70	6.95-7.05	8.30-8.60	10.30-10.50	12.40-12.70
		BTU/h	23,900-24,200	29,400-30,000	35,200-36,000	42,500-43,500	23,200-24,100	28,300-29,400	35,200-35,800	42,300-43,300
	Heating	kW	—	—	—	—	7.75-8.00	9.30-9.50	10.50-10.70	13.40-13.70
		BTU/h	—	—	—	—	26,400-27,300	31,700-32,400	35,800-36,500	45,700-46,800
Input Power	Cooling/Heating	kW	2.64-2.77 / —	3.30-3.40 / —	3.90-4.00 / —	4.50-4.57 / —	2.70-2.80 / 2.45-2.55	3.40-3.55 / 3.05-3.20	4.20-4.30 / 3.35-3.40	4.50-4.57 / 4.25-4.35
EER	Cooling	—	2.65-2.56	2.61-2.59	2.64-2.63	2.76-2.78	2.52-2.52	2.44-2.42	2.45-2.44	2.76-2.78
COP	Heating	W/W	—	—	—	—	3.04-3.02	3.05-2.97	3.13-3.15	3.15-3.15
Running Current	Cooling/Heating	A	13.00-13.00 / -	15.8-16.3 / -	6.60-6.60 / -	8.10-8.30 / -	212.6-12.6/11.6-11.6	15.9-15.7 / 14.5-14.7	7.4-7.2 / 6.2-6.3	8.1-8.3 / 7.8-8.1
Moisture Removal	l/h	—	2.5	4.0	3.1	4.0	2.5	4.0	5.0	6.0
Airflow Rate (High)	Indoor	m ³ /h	1,100	1,750	2,000	2,200	1,094	1,650	1,800	1,840
		mm	270x1,120x700	270x1,120x700	270x1,120x700	270x1,120x700	270x1,120x700	270x1,120x700	270x1,120x700	270x1,120x700
Net Dimension HxWxD	Indoor	kg(lbs)	43.0 (95)	43.0 (95)	45.0 (99)	45.0 (99)	43.0 (95)	43.0 (95)	45.0 (99)	45.0 (99)
		mm	643x840x336	900x900x350	1,152x940x370	1,152x940x370	643x840x336	900x900x350	1,152x940x370	1,152x940x370
Net Weight	Outdoor	kg(lbs)	65.0 (143)	79.0 (174)	94.0 (207)	102.0 (224)	69.0 (152)	80.0 (176)	100.0 (220)	110.0 (243)
		mm	952/15.88	952/15.88	952/19.05	952/19.05	952/15.88	952/19.05	952/15.88	952/19.05
Piping Connections (Small / Large)	mm		36.0/38.0	36.0/38.0	36.0/38.0	36.0/38.0	36.0/38.0	36.0/38.0	36.0/38.0	36.0/38.0
Drain Pipe Diameter (I.D./O.D.)	mm		25(7.5)	30(7.5)	50(10)	50(20)	25(7.5)	30(7.5)	50(10)	50(20)
Max Pipe Length (Pre-Charge)	m		15	15	30	30	15	15	30	30
Max Height Difference	°CDB	—	21 to 43	0 to 43	0 to 52	0 to 52	0 to 43	0 to 43	0 to 52	0 to 52
		—	—	—	—	-5 to 21	-5 to 21	-8 to 21	-8 to 21	
Refrigerant	—		R22	R22	R22	R22	R22	R22	R22	R22

Dimensions

Models: ARY25ALC / ARY30ALC / ARY36ALD3 / ARY45ALC3
 ARY25RLC / ARY30RLC / ARY36RLC3 / ARY45RLC3

(Unit : mm)

*Service accessibility must be allowed for when installing the product.
 Please consult the installation manual for the necessary service access size.

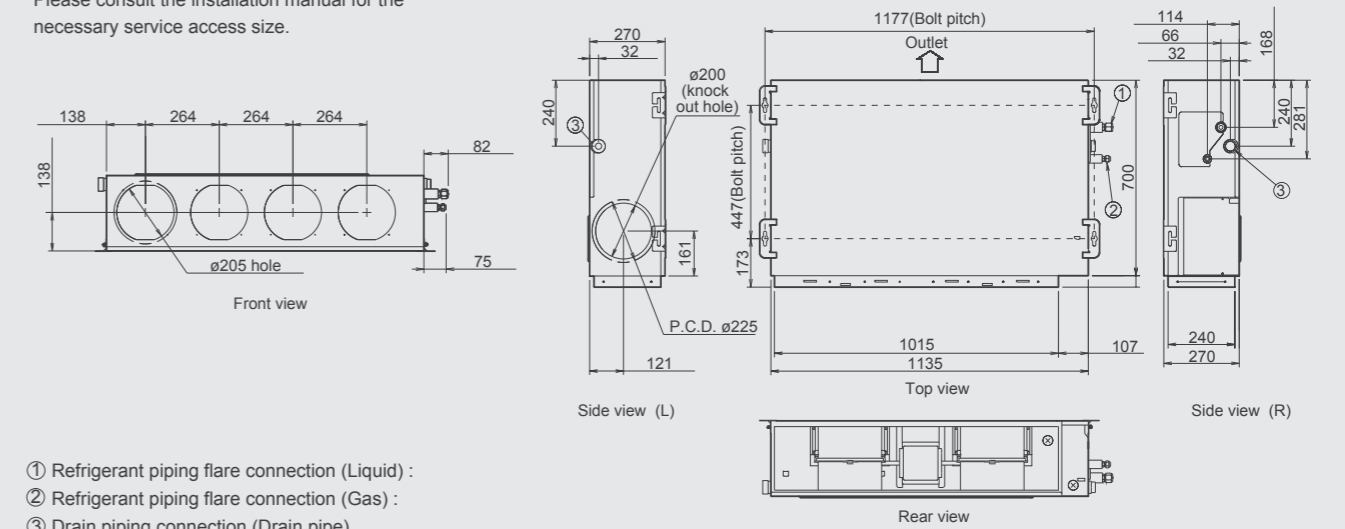

- ① Refrigerant piping flare connection (Liquid) :
- ② Refrigerant piping flare connection (Gas) :
- ③ Drain piping connection (Drain pipe)

CONSTANT SPEED

HIGH STATIC PRESSURE DUCT

Model : ARY60AUAK [3phase] / ARY60RUAK [3phase]

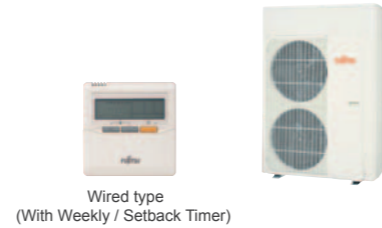

Model : ARY90ELC3 [3phase] / ARY90TLC3 [3phase]



Design also corresponding to high static pressure

Model: ARY90TLC3

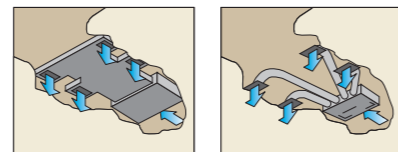
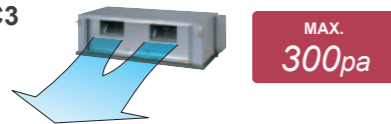

Low noise

Turbulent air flow is reduced by cutting off the corners of conventional indoor unit front panel and fan case

Low noise is realized by adopting plastic case, plastic fan.

Plastic fan [45dB(A)]
(ARY60AUAK / ARY60RUAK)

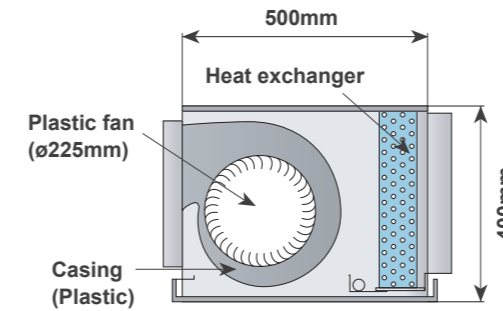

(ARY60AUAK / ARY60RUAK)

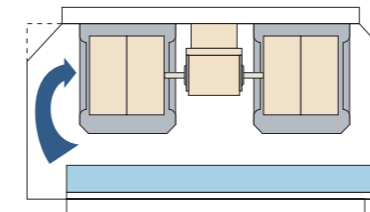

* Model : Material (At 100Pa :
Actual noise measurement value)

Pursuance of amenity performance

Various remote controllers and sensors can be selected

1.Wired Remote Controller with Thermo Sensor

- Room temperature sensor selection
- WEEKLY timer
- Temperature SET BACK timer
- Group control system
- Child lock
- Dual remote controllers
- <Optional parts>
- AUTO restart

- Energy saving
- Auto changeover (for heating)
- Hot start (for heating)

2.Simple Remote Controller (Optional Parts)

3.Remote Sensor (Optional Parts)

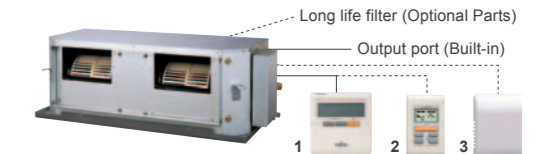

Optional parts

- Simple Remote Controller: UTY-RSNYM
 Long-Life Filter: UTD-LF60KA (For ARY60AUAK / ARY60RUAK)
 Remote Sensor Unit: UTY-XSZX
 External Control Set: UTD-ECS5A (For ARY60AUAK / ARY60RUAK)
 IR Receiver Unit: UTY-LRHY1

Specifications

Model No.	Indoor unit		ARY60AUAK	ARY60RUAK	ARY90ELC3	ARY90TLC3
	Outdoor unit		AOY60APAGT	AOY60RPAGT	AOY90EPD3L	AOY90TPC3L
Power Source	V/∅/Hz		380-415/3/50	380-415/3/50	380-415/3/50	380-415/3/50
Capacity	Cooling	kW	16.40-17.00	16.40-17.00	25.40-25.40	24.80-25.40
		BTU/h	56,000-58,000	56,000-58,000	86,700-86,700	84,700-86,700
	Heating	kW	—	17.80-18.20	—	28.90-29.50
		BTU/h	—	61,000-62,100	—	98,500-100,500
Input Power	Cooling/Heating	kW	5.80-5.90 / —	5.90-6.00 / 5.05-5.25	10.50-10.50 / —	12.20-12.50 / 12.20-12.50
EER	Cooling	—	2.83-2.88	2.78-2.83	2.42-2.42	2.03-2.03
COP	Heating	W/W	—	3.52-3.47	—	2.37-2.36
Running Current	Cooling/Heating	A	9.80-9.80 / —	9.80-9.80 / 8.70-8.70	17.50-17.00 / —	19.50-19.50 / 19.50-19.50
Moisture Removal		l/h	6.5	6.5	7.0	7.5
Airflow Rate (High)	Indoor	m³/h	3,600	3,600	4,300	4,300
		mm	400x1,150x585	400x1,150x585	450x1,550x700	450x1,550x700
Net Dimension HxWxD	Indoor	kg(lbs)	50.0 (110)	50.0 (110)	85.0 (187)	85.0 (187)
		mm	1,355x940x370	1,355x940x370	1,380x1,300x650	1,380x1,300x650
Net Weight	Outdoor	kg(lbs)	121.0 (266)	129.0 (284)	243.0 (535)	245.0 (539)
		mm	9.52/19.05	9.52/19.05	12.7/28.58	12.7/28.58
Piping Connections (Small / Large)		mm	50(7.5)	50(20)	50(30)	50(30)
Max Pipe Length (Pre-Charge)		m	30	30	30	30
Max Height Difference		°CDB	0 to 52	0 to 52	0 to 46	0 to 46
Operation Range	Cooling	—	—	-8 to 24	—	-10 to 21
Refrigerant	Heating	—	—	—	—	—
			R22	R22	R407C	R407C

*The measurement static pressure of ARY60AU/RU is 100Pa and ARY90EL/TL is 196Pa.

Dimensions Models:

Model: ARY60AUAK / ARY60RUAK

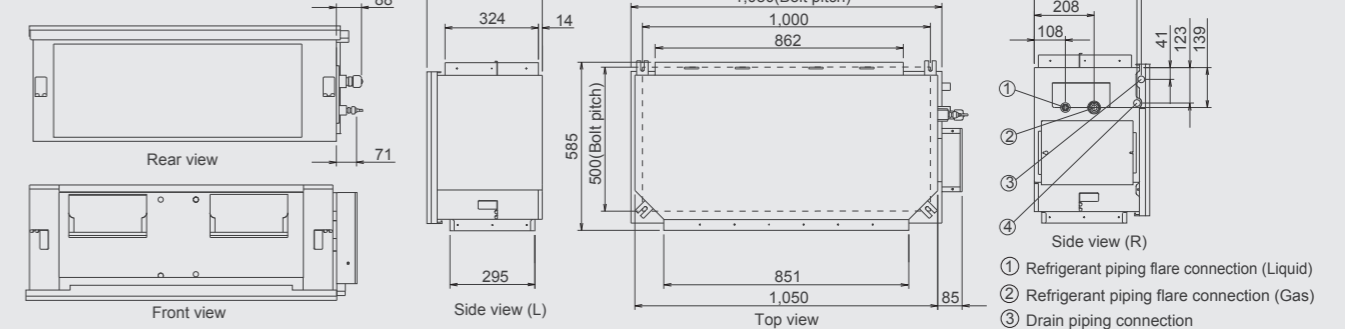

Model: ARY90ELC3 / ARY90TLC3

