



Pre-Engineered ILP Automatic Suppression Unit

Designed for use with:

3M™ Novec™ 1230 Fire Protection Fluid

DESIGN, INSTALLATION, OPERATION, AND MAINTENANCE MANUAL

Firetrace International

8435 N. 90th Street, Suite 2 • Scottsdale, AZ 85258 USA • +1-480-607-1218 • +1-480-315-1316 (Fax) • www.firetrace.com

DIOM 800020-000



10/27/2017

FM Approvals File: 3053686

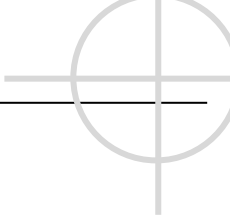

THIS PAGE INTENTIONALLY LEFT BLANK

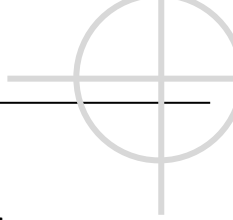
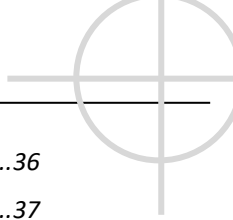
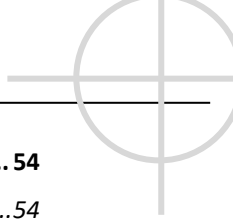

Table of Contents

SECTION	Page Number
FOREWARD	9
<i>General</i>	9
<i>Safety Messages</i>	9
<i>Safety Precautions</i>	10
Section 1: General Information	11
1.1 <i>Introduction</i>	11
1.2 <i>3M™ Novec™ 1230 Fire Protection Fluid</i>	11
1.2.1 <i>Cleanliness</i>	11
1.2.2 <i>Thermal Decomposition Products</i>	12
1.2.3 <i>Quality Requirements</i>	12
1.2.4 <i>Agent Properties</i>	12
Section 2: System Description	13
2.1 <i>General Description</i>	13
2.2 <i>Cylinders</i>	14
2.3 <i>Cylinder Valves</i>	15
2.4 <i>Firetrace Detection Tubing</i>	16
2.5 <i>Manual Release</i>	17
2.6 <i>Cylinder Mounting Bracket</i>	18
2.7 <i>Heavy Duty Mounting Bracket</i>	19
2.8 <i>Discharge Network</i>	20
2.8.1 <i>Pipe, Fittings, and Pipe Supports</i>	20
2.8.1.1 <i>Pipe Requirements</i>	20
2.8.1.2 <i>Pipe Fittings and Pipe Joining</i>	20
2.8.1.3 <i>Pipe Supports</i>	20
2.8.2 <i>Flexible Hoses and Fittings</i>	21
2.8.2.1 <i>Flexible Hoses</i>	21
2.8.2.2 <i>Flexible Hose Fittings</i>	22
2.8.3 <i>Nozzles</i>	24
2.9 <i>Pressure Switches</i>	25
2.9.1 <i>Valve Mounted Pressure Switch</i>	25
2.9.2 <i>End of Line Pressure Switch</i>	27
2.9.3 <i>Pressure Switch Assembly</i>	29
2.10 <i>Electric Solenoid Assembly</i>	31
2.11 <i>Indication and Activation Kit</i>	33
Section 3: Design	35
3.1 <i>Introduction</i>	35
3.2 <i>Operating Specifications</i>	35
3.2.1 <i>Temperature Range</i>	35
3.2.2 <i>Operating Pressure</i>	35



3.3	<i>Design Procedure</i>	36
3.4	<i>Design Concentration</i>	37
3.4.1	Minimum Design Concentrations	37
3.4.2	Actual Concentration	38
3.5	<i>Protected Enclosure</i>	38
3.5.1	Enclosure Size	40
3.5.2	Ventilation and Unclosable Openings.....	40
3.5.3	Pressure Relief Vent Area	41
3.6	<i>Discharge Network</i>	41
3.6.1	Discharge Piping and Pipe Fitting Specifications	41
3.6.2	Discharge Piping and Pipe Fitting Limitations.....	42
3.6.3	Discharge Pipe Bends.....	42
3.6.4	Nozzle Area Coverage	43
3.7	<i>Firetrace Detection Tubing</i>	44
Section 4:	Installation	46
4.1	<i>Introduction</i>	46
4.2	<i>Firetrace Novec 1230 ILP Unit</i>	46
4.3	<i>Discharge Network</i>	46
4.4	<i>Detection Network</i>	47
4.4.1	Firetrace Detection Tubing	47
4.4.2	Tube Fittings	47
4.4.3	End of Line Accessories.....	47
4.4.3.1	Pressure Gauge	47
4.4.3.2	Pressure Switch.....	47
4.4.3.3	Plug	47
Section 5:	Operation	48
5.1	<i>System Activation</i>	48
Section 6:	Maintenance	49
6.1	<i>General</i>	49
6.2	<i>Maintenance Schedule</i>	49
6.2.1	Monthly	49
6.2.2	Semi-Annual.....	50
6.2.3	Five-Year	50
6.3	<i>Firetrace Detection Tubing Maintenance</i>	51
6.4	<i>Cylinder Maintenance</i>	51
Section 7:	Recharge	52
7.1	<i>General</i>	52
7.2	<i>Recharge</i>	52
Section 8:	Post Discharge	53
8.1	<i>Ventilation</i>	53
8.2	<i>Remove from Service</i>	53
8.3	<i>Recharge</i>	53
8.4	<i>Return to Service</i>	53



Appendix A – Parts List	54
<i>Firetrace Novec 1230 ILP Automatic Suppression Unit Assemblies</i>	<i>54</i>
<i>Heavy Duty Brackets</i>	<i>54</i>
<i>Discharge Network</i>	<i>54</i>
<i>Detection Network.....</i>	<i>56</i>
<i>Miscellaneous</i>	<i>57</i>
Appendix B – System Commissioning Form	59
Appendix C – SDS.....	60

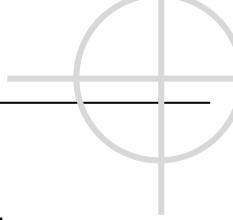

List of Tables

Table	Page Number
Table 1 – Thermal Decomposition Products.....	12
Table 2 – Agent Quality Specifications	12
Table 3 – Cylinder Specifications	14
Table 4 – Unit Assembly Dimensions.....	14
Table 5 - Firetrace Detection Tubing Properties.....	16
Table 6 – Firetrace Detection Tube Part Numbers	16
Table 7 – Manual Release Part Numbers.....	17
Table 8 – 940205 Cylinder Mounting Bracket Dimensions.....	18
Table 9 – 940505 Cylinder Mounting Bracket Dimensions.....	18
Table 10 – 941005 Cylinder Mounting Bracket Dimensions.....	18
Table 11 – Heavy Duty Mounting Bracket Dimensions	19
Table 12 – Copper Fitting Part Numbers for 940205 Unit Assembly.....	20
Table 13 – Copper Fitting Part Numbers for 940505/941005 Unit Assembly	20
Table 14 – Flexible Hose Part Numbers for 940205 Unit Assembly	21
Table 15 – Flexible Hose Part Numbers for 940505/941005 Unit Assembly.....	22
Table 16 – Flexible Hose Fitting Part Numbers for 940205 Unit Assembly	23
Table 17 – Flexible Hose Fitting Part Numbers for 940505/941005 Unit Assembly.....	23
Table 18 – Nozzle Part Numbers	24
Table 19 – Valve Mounted Pressure Switch Part Number.....	26
Table 20 – Pressure Switch Properties	26
Table 21 – End of Line Pressure Switch Part Number	28
Table 22 – End of Line Pressure Switch Properties.....	28
Table 23 –Pressure Switch Assembly Part Number	29
Table 24 – Pressure Switch Assembly Properties	30
Table 25 – Electric Solenoid Assembly Part Number.....	32
Table 26 – Electric Solenoid Assembly Properties	32
Table 27 – Indication and Activation Kit Part Number	34
Table 28 – Pressure-Temperature Relationship	36
Table 29 – Class A Minimum Design Concentrations	37
Table 30 – Class B Minimum Design Concentrations.....	37
Table 31 – Enclosure Volume Limitations for 940205 Unit Assembly	39
Table 32 – Enclosure Volume Limitations for 940505 Unit Assembly	39
Table 33 – Enclosure Volume Limitations for 941005 Unit Assembly	40

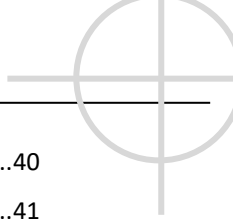
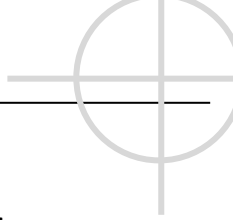
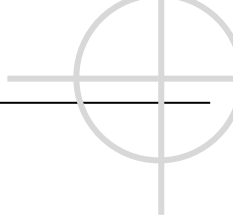

Table 34 – Enclosure Size Limitations for Firetrace Novec 1230 ILP Units	40
Table 35 – Discharge Piping Specifications	41
Table 36 – Discharge Pipe Fitting Specifications.....	41
Table 37 – Discharge Piping Limitations	42
Table 38 – Pipe Fitting Limitations.....	42
Table 39 –Pipe Bend Radius and Equivalent Length	43
Table 40 – Nozzle Area Coverage Limitations.....	43
Table 41 – Firetrace Detection Tubing Limitations.....	45
Table 42 – Cylinder Maintenance	51
Table 43 – Firetrace Novec 1230 ILP Units	54
Table 44 – Heavy Duty Brackets	54
Table 45 – Small ILP Discharge Network Copper Fittings	54
Table 46 – Medium/Large ILP Discharge Network Copper Fittings	54
Table 47 – Small ILP Discharge Network Flexible Hoses.....	55
Table 48 – Medium/Large ILP Discharge Network Flexible Hoses.....	55
Table 49 – Small ILP Discharge Network Flexible Hose Fittings.....	55
Table 50 – Medium/Large ILP Discharge Network Flexible Hose Fittings	55
Table 51 – Nozzles	56
Table 52 – Firetrace Detection Tubing.....	56
Table 53 – Tube Fittings.....	56
Table 54 – End of Line Accessories	57
Table 55 – Installation Accessories	57
Table 56 – Auxiliary Accessories	57
Table 57 – Indication and Activation Kits	58



List of Figures

Figure	Page Number
Figure 1 – Unit Assembly	14
Figure 2 – Cylinder Valves.....	15
Figure 3 – Manual Releases	17
Figure 4 – Cylinder Mounting Bracket Bolt Pattern.....	18
Figure 5 – Heavy Duty Mounting Bracket Bolt Pattern.....	19
Figure 6 – Flexible Hoses	21
Figure 7 – Flexible Hose Fittings	22
Figure 8 – Nozzles	24
Figure 9 – Valve Mounted Pressure Switch	25
Figure 10 – Valve Mounted Pressure Switch Wiring Schematic	26
Figure 11 – End of Line Pressure Switch	27
Figure 12 – End of Line Pressure Switch Wiring Schematic	28
Figure 13 – Pressure Switch Assembly	29
Figure 14 – Pressure Switch Assembly Wiring Schematic	30
Figure 15 – Electric Solenoid Assembly	31
Figure 16 – Electric Solenoid Assembly Wiring Schematic	32
Figure 17 – Indication and Activation Kit.....	33
Figure 18 – Typical Nozzle Configuration Guideline	44
Figure 19 – Tubing Configuration Guideline	45



FOREWARD

General

This manual is written for the fire protection professional that designs, installs, and maintains Firetrace Pre-Engineered ILP Automatic Suppression Units with 3M™ Novec™ 1230 Fire Protection Fluid. It is intended to communicate details and procedures required for proper design, installation, operation, and maintenance.

Firetrace assumes no responsibility for the design or function of any systems other than those addressed in this manual. The technical data contained herein is limited strictly for informational purposes only.

Pre-Engineered ILP Automatic Suppression Units with 3M™ Novec™ 1230 Fire Protection Fluid are to be designed, installed, inspected, tested, maintained, and recharged by qualified trained personnel in accordance with the following:

- All instructions, limitations, etc. contained in this manual, DIOM 800020
- All information contained on the agent cylinder nameplate(s)
- NFPA 2001: Standard on Clean Agent Fire Extinguishing Systems
- FM Approvals Listing
- Local authority having jurisdiction

Safety Messages

The following notations are used throughout this manual. Always read and obey all safety messages. They are essential to the safe use of the equipment described in this manual.

DANGER

Identifies immediate hazards and provides specific instructions or procedures, which if not correctly followed **COULD** result in severe personal injury or death.

WARNING

Identifies specific instructions or procedures, which if not correctly followed, **COULD** result in severe personal injury or death.

CAUTION

Identifies specific instructions or procedures, which if not correctly followed, **COULD** result in minor personal injury or equipment or property damage.

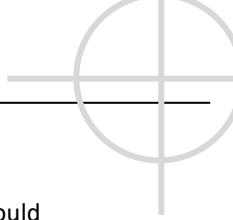

Safety Precautions

Safety precautions are essential when any electrical or mechanical equipment is involved. These precautions should be followed when handling, servicing, and recharging Firetrace Pre-Engineered ILP Automatic Suppression Units and equipment. The following safety precautions should always be followed:

- Read and understand this entire manual and any other documents referenced herein.
- Secure the manual near the Firetrace fire suppression unit after installation.
- Periodic checks by trained personnel are required to ensure safe operation.
- All Firetrace Pre-Engineered ILP Automatic Suppression Units are factory equipped with discharge port plugs. The discharge port plugs are only to be removed when the Firetrace ILP Unit is connected into the discharge piping or when performing charging, testing, or salvaging operations in accordance with the procedures contained in this manual.
- Ensure the lever on the Firetrace ILP Unit ball valve is in the “OFF” position when not connected into the discharge piping or when performing charging, testing, or salvaging operations in accordance with the procedures contained in this manual.
- Never assume that a cylinder is empty. Treat all cylinders as if they are fully charged.
- Wear safety glasses when working with pressurized cylinders and charging equipment.
- It is recommended to wear leather gloves to avoid any cryogenic burns.
- Follow all safety procedures included on the cylinder nameplate and in this manual.

Questions regarding the information contained in this manual can be addressed to:

Firetrace International
8435 N. 90th Street, Suite 2
Scottsdale, AZ 85258 USA
Phone: +1.480.607.1218
Fax: +1.480.315.1316
Web: www.firetrace.com

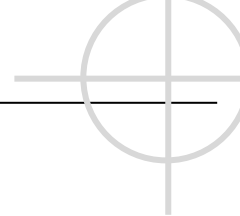

Section 1: General Information

1.1 Introduction

The Firetrace Pre-Engineered ILP Automatic Suppression Units with 3M™ Novec™ 1230 Fire Protection Fluid are approved by FM Approvals. These units are designed for total flooding applications using 3M™ Novec™ 1230 Fire Protection Fluid in accordance with NFPA 2001: Standard on Clean Agent Fire Extinguishing Systems.

The Firetrace Pre-Engineered ILP Automatic Suppression Units with 3M™ Novec™ 1230 Fire Protection Fluid have been tested to limits established by FM Approvals in compliance with the requirements specified in FM 5600 Approval Standard for Clean Agent Extinguishing Systems and as detailed in this manual.

The pre-engineered concept of automatic fire suppression systems minimizes the amount of engineering involved in system design. When the discharge piping and nozzles are installed within the limitations stated in this manual, no hydraulic calculations are required to determine pressure drop, agent flow, or discharge time.

The hazard being protected by a Firetrace Pre-Engineered ILP Automatic Suppression Unit can be any size, shape, or volume; provided that the protected enclosure is within the limitations described in this manual. Once fully installed, the Firetrace Pre-Engineered ILP Automatic Suppression Unit becomes a self-contained unit, meaning that it is equipped with all the components necessary to detect and suppress Class B fires.

Since the units are listed as automatic units (e.g. no manual or electric means is necessary for activation), only one extinguisher unit can be used to protect one enclosure. The listed automatic units are not designed to provide simultaneous actuation of two or more units, therefore listed extinguisher units **cannot** be combined to protect a larger enclosure.

Local authorities having jurisdiction should be consulted as to the acceptability for particular hazards and requirements covering installation.

1.2 3M™ Novec™ 1230 Fire Protection Fluid

Firetrace Pre-Engineered ILP Automatic Suppression Units utilize 3M™ Novec™ 1230 Fire Protection Fluid, referenced as Novec 1230 or FK-5-1-12.

Novec 1230 is a fluorinated ketone depicted by the chemical formula $CF_3CF_2C(O)CF(CF_3)_2$ (1,1,1,2,2,4,5,5,5-nonafluoro-4-(trifluoromethyl)-3-pentanone). Novec 1230 is a colorless low odor fluid which leaves no residue, and is an extremely effective fire suppression agent. Novec 1230 is low in toxicity and electrically non-conductive.

Novec 1230 is included in NFPA 2001. It has been evaluated and approved for use in occupied areas as a total flooding agent (when used as specified under the U.S. Environmental Protection Agency (EPA) SNAP Program rules). Refer to the SNAP Program rules for more information.

1.2.1 Cleanliness

Novec 1230 is a colorless fluid which leaves no residue. This minimizes downtime and clean up after a unit discharge. Most materials such as steel, aluminum, stainless steel, brass, plastics, rubber, and electronic components, are not affected by exposure to Novec 1230. The agent is also environmentally friendly, having an ozone depletion potential (ODP) of 0.00 and an atmospheric lifetime of 5 days.

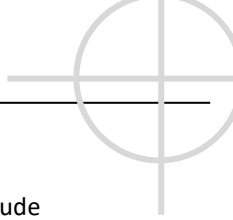

1.2.2 Thermal Decomposition Products

When exposed to extreme temperatures, Novec 1230 will form thermal decomposition products, which include halogen acids. There is a direct correlation between agent discharge time and the quantity of thermal decomposition products (TDP) created. The type of fire and the amount of agent exposed to open flame are also critical factors in creation of TDP. Test results have shown that when the agent is rapidly discharged, the amount of thermal decomposition products formed is minimal. See Table 1 – Thermal Decomposition Products for a list of thermal decomposition products.

Table 1 – Thermal Decomposition Products

Substance	Condition
Carbon Monoxide	During Combustion
Carbon Dioxide	During Combustion
Hydrogen Fluoride	During Combustion

1.2.3 Quality Requirements

Strict agent quality specifications must be maintained, see Table 2 – Agent Quality Specifications.

Table 2 – Agent Quality Specifications

FK-5-1-12 - Mole % (Minimum)	99
Acidity - PPM by Weight (Maximum)	3
Water Content - % by Weight (Maximum)	0.001

1.2.4 Agent Properties

For hazard information, decomposition information, and physical properties of Novec 1230, please refer to the Safety Data Sheet located in Appendix C.

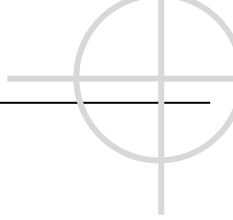

Section 2: System Description

2.1 General Description

Firetrace Pre-Engineered ILP Automatic Suppression Units are intended to be designed and installed to protect hazards within the limitations as stated in this manual ONLY. The equipment described in this manual is approved by FM Approvals, in accordance with FM 5600 Approval Standard for Clean Agent Extinguishing Systems. The authority having jurisdiction should follow the information specified by this manual, NFPA 2001: Standard on Clean Agent Fire Extinguishing Systems, and any other applicable standards.

Firetrace Pre-Engineered ILP Automatic Suppression Units consists of the following major components:

- Cylinder/Valve Assembly
- Cylinder Mounting Bracket
- Firetrace Detection Tubing (FDT) and fittings (no substitute)
- Pressure Switch
- Discharge Piping and Fittings (furnished by others)

Once installed, the Pre-Engineered ILP Automatic Suppression Unit becomes a self-contained, self-actuating unit that does not require an external source of power.

The unit utilizes a UL recognized component (per UL standard 521) Linear Heat Detector (See Certificate of Compliance 20140705-S35465) known as Firetrace Automatic Fire Detection Tubing. When pressurized with dry nitrogen, it will allow the fire suppression valve to remain in the closed position. The tubing acts as a continuous linear thermal detector that ruptures upon direct flame impingement or at temperatures above 383 °F (195 °C). Once the detection tubing is ruptured, the valve automatically opens, allowing the Novec 1230 agent to flow through the discharge piping, distributing the extinguishing agent through the nozzle(s) into the protected enclosure.

Firetrace Pre-Engineered ILP Automatic Suppression Units are designed for use in total flooding applications only, where the hazard is normally unoccupied. Firetrace Pre-Engineered ILP Automatic Suppression Units can be used, but are not limited, to protect the following:

- Electrical and electronic cabinets
- Data processing areas and cabinets
- Exhaust cabinets
- UPS units
- Generator enclosures
- Computer/data storage cabinets
- Telecommunication areas
- Laboratory fume hoods
- Pump enclosures
- Flammable chemicals storage cabinets
- Transformer cabinets
- CNC & VMC machining centers
- Many other applications

Novec 1230 should not be used where the following materials may be present:

- Pyrotechnic chemicals containing their own oxygen supply
- Reactive metals
- Metal hydrides
- Chemicals capable of undergoing autothermal decompositions

For hazards beyond the scope described above, it is recommended that the designer consult with Firetrace, NFPA 2001, and the local authority having jurisdiction as to the suitability on the use of Novec 1230 for a particular hazard, for personnel exposure effects from the design concentration, and for installation requirements.

2.2 Cylinders

Novec 1230 is stored in the pre-engineered clean agent unit cylinders. The steel cylinders are available in the following nominal capacities: 2.5 lb, 5 lb, and 10 lb. Additionally, an enhanced durability coating is available for the exterior of the unit cylinders. Refer to Table 3 – Cylinder Specifications, Figure 1 – Unit Assembly, and Table 4 – Unit Assembly Dimensions for additional details.

Table 3 – Cylinder Specifications

Nominal Capacity	Volume		Cylinder Specification	Cylinder Service Pressure		Cylinder Test Pressure	
	in ³	cm ³		psig	kPa	psig	kPa
2.5 lb	75	1229	DOT 4B240	240	1,655	480	3,310
5 lb	145	2376	DOT 4B240	240	1,655	480	3,310
10 lb	300	4916	DOT 4B360	360	2,482	720	4,964

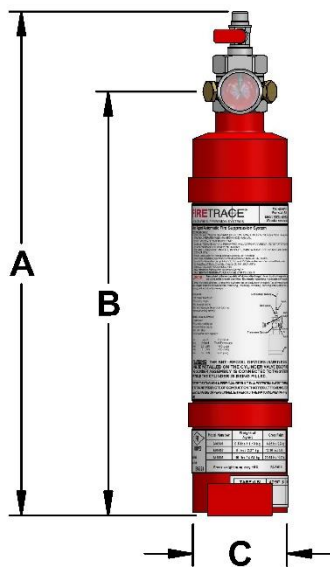

Figure 1 – Unit Assembly

Table 4 – Unit Assembly Dimensions

Unit Assembly Part Number	Agent		Dimension "A"		Dimension "B"		Dimension "C"	
	lb	kg	in	cm	in	cm	in	cm
940205	2.5	1.13	15.7	39.8	13.2	33.5	2.9	7.4
940505	5	2.27	16.7	42.3	13.6	34.6	4.3	10.9
941005	10	4.54	16.9	42.9	13.8	35.1	6.4	16.2

2.3 Cylinder Valves

Each cylinder is equipped with a nickel plated brass valve. The cylinder valves are backpressure type valves. A piston in the valve bore is equipped with a rubber seal that keeps the Novec 1230 clean agent under pressure within the cylinder. A small hole in the piston allows cylinder pressure to equalize on both sides of the piston. Since the surface area above the piston is greater than the surface area below the piston, the net force seals the piston against the primary valve seal. When the pressure above the piston is relieved by any means, there is only cylinder pressure acting against the piston seal and the piston slides to its fully open position, allowing for agent discharge.

The valve is equipped with a pressure gauge to monitor cylinder pressure and a quarter turn ball valve that interfaces with the Firetrace Detection Tubing. The ball valve must be kept closed at all times when the cylinder is not in service.

The 940205 unit assembly is equipped with a small ILP valve containing two 1/4 in NPT discharge ports. The 940505 and 941005 unit assemblies are equipped with a medium ILP valve containing two 1/2 in NPT discharge ports. Refer to Figure 2 – Cylinder Valves for additional valve information.

NOTE: All Firetrace Novec 1230 ILP Units utilize a straight siphon tube. All Firetrace Novec 1230 ILP Units are to be installed only in a vertical (valve on top) position.

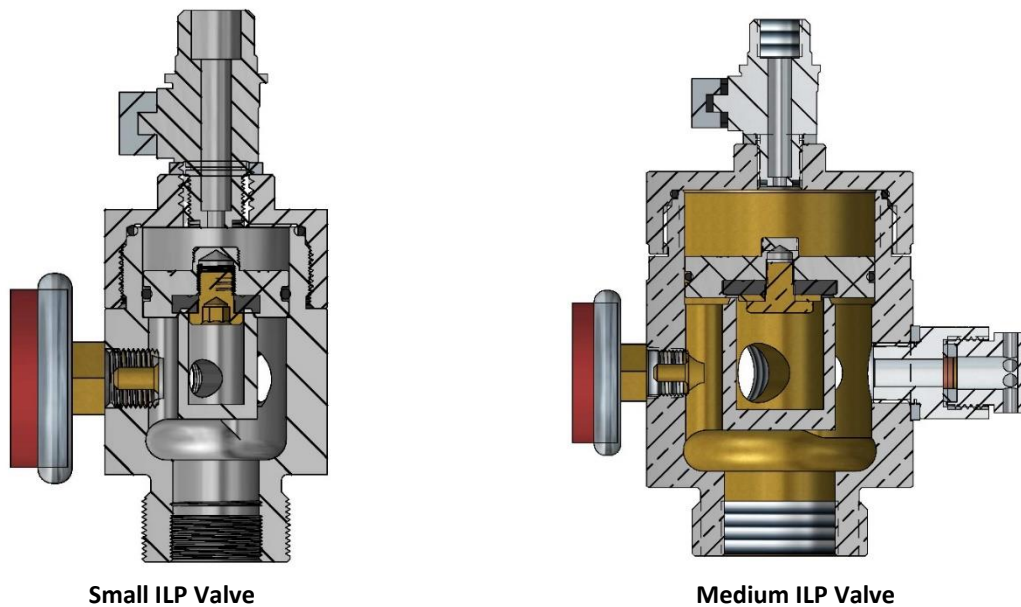
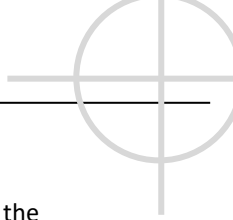

Figure 2 – Cylinder Valves

CAUTION

All cylinder valves are factory equipped with discharge port plugs. The discharge port plugs **SHALL** be installed in the valve discharge ports at all times, unless the discharge ports are connected to the discharge piping.



2.4 Firetrace Detection Tubing

The Firetrace Detection Tubing is a linear, pneumatic, fire detection device that responds to a combination of the heat and radiant energy from a fire. The tubing is a UL recognized component per UL Standard 521 (see Certificate of Compliance 20140705-S35465). The Firetrace detection tubing performs two functions: heat detection and system activation. One end of the tubing is installed to the top of the cylinder valve. The tubing is then installed throughout the enclosure and finally pressurized with nitrogen.

The Firetrace detection tubing is heat sensitive and in a fire situation, is designed to rupture at any point along its length upon direct flame impingement or when the temperature reaches above 383 °F [195 °C]. The rupture of the tubing releases the nitrogen pressure causing the unit to actuate. The actuation results in a complete discharge of the Novec 1230 clean agent through the discharge piping and is distributed by the nozzle(s) throughout the protected enclosure. Refer to Table 5 - Firetrace Detection Tubing Properties and Table 6 – Firetrace Detection Tube Part Numbers for additional information.

Table 5 - Firetrace Detection Tubing Properties

Hydrostatic Burst Pressure	Minimum Burst Pressure	1100 psig [75 bar]
	Typical Burst Pressure	1300 psig [88 bar]
Electrical Properties	Volume Resistivity	1014 (per DIN 53481)
	Dielectric Strength	40k V/mm (per DIN 53481)

Table 6 – Firetrace Detection Tube Part Numbers

Firetrace Detection Tubing Part Number	Description
200005	Firetrace Detection Tubing, 4/6 mm, 1 ft
204025	Firetrace Detection Tubing, 4/6 mm, 25 ft
204050	Firetrace Detection Tubing, 4/6 mm, 50 ft
204100	Firetrace Detection Tubing, 4/6 mm, 100 ft
204328	Firetrace Detection Tubing, 4/6 mm, 328 ft

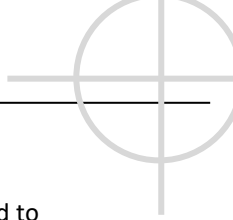

2.5 Manual Release

The manual release is used as an optional part of the system detection line network. The manual release is used to manually release the nitrogen pressure in the tubing, causing the system to actuate. The actuation results in a complete discharge of the unit assembly.

The tube fitting on the body of the manual release allows for easy installation onto the system detection line network. The pull tab on the plunger prevents accidental activation of the manual release. The port on the body of the manual release is used to pressurize the tubing and allows for installation of a pressure gauge to monitor system pressure, refer to Figure 3 – Manual Releases and Table 7 – Manual Release Part Numbers for additional information.

CAUTION

Do not remove the pull tab until ready to actuate system discharge.

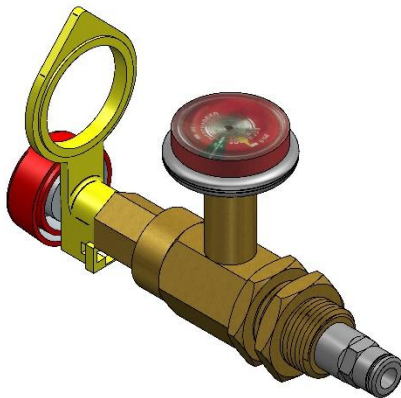

Manual Release

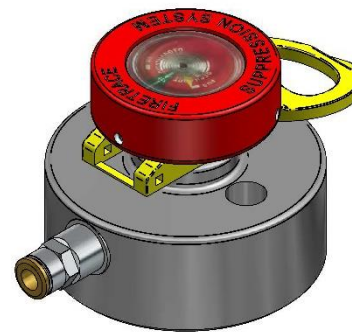

2nd Gen Manual Release

Figure 3 – Manual Releases

Table 7 – Manual Release Part Numbers

Manual Release Part Numbers	Description
600064*	Manual Release, Novec 1230
601014	2 nd Gen Manual Release, Novec 1230

* This is an optional component and is not part of an FM Approved System.

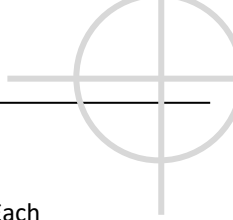

2.6 Cylinder Mounting Bracket

The cylinder mounting brackets are manufactured from steel with a primed and powder coated paint finish. Each cylinder mounting bracket is designed to fit properly around the cylinder. The cylinder mounting bracket is equipped with finger tabs which allow easy access. The cylinder mounting bracket must be secured to a surface appropriate for retaining the weight of the cylinder in the event of a discharge. This precaution is intended to safely support the weight of the cylinder and the reaction force of the Novec 1230 discharge.

All cylinders must be mounted vertically only, with the valve on top. Please refer to Figure 4 – Cylinder Mounting Bracket Bolt Pattern, Table 8 – 940205 Cylinder Mounting Bracket Dimensions, Table 9 – 940505 Cylinder Mounting Bracket Dimensions, and Table 10 – 941005 Cylinder Mounting Bracket Dimensions for cylinder mounting bracket dimensions.

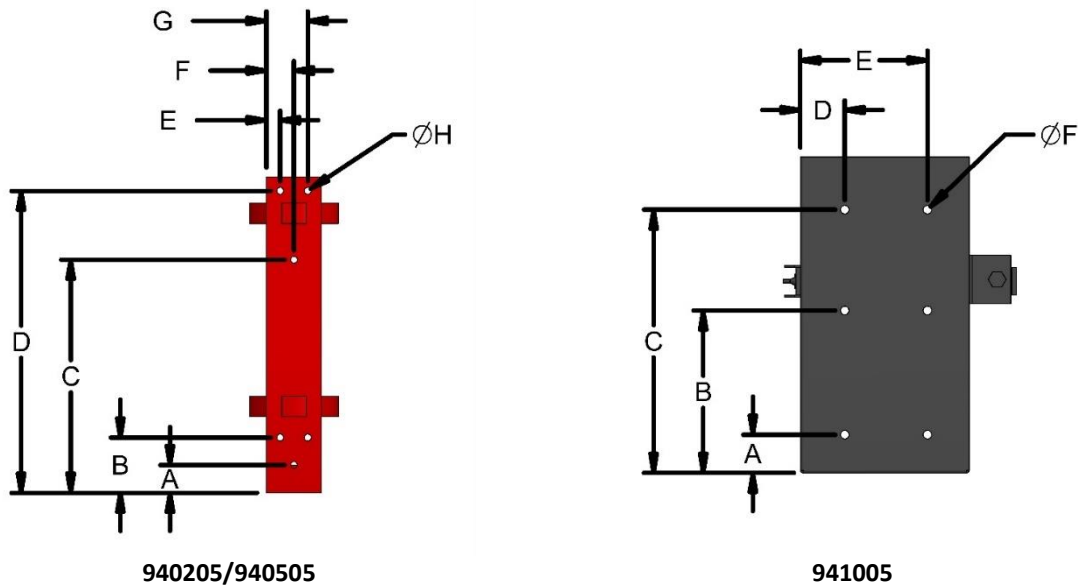

Figure 4 – Cylinder Mounting Bracket Bolt Pattern

Table 8 – 940205 Cylinder Mounting Bracket Dimensions

"A"		"B"		"C"		"D"		"E"		"F"		"G"		"H"	
in	cm	in	cm	in	cm	in	cm	in	cm	in	cm	in	cm	in	cm
1.0	2.7	2.0	5.2	8.4	23.0	10.9	28.0	.5	1.3	1.0	2.7	1.5	3.8	1/4	0.6

Table 9 – 940505 Cylinder Mounting Bracket Dimensions

"A"		"B"		"C"		"D"		"E"		"F"		"G"		"H"	
in	cm	in	cm	in	cm	in	cm	in	cm	in	cm	in	cm	in	cm
1.0	2.7	2.0	5.2	8.4	23.0	10.9	28.0	.5	1.3	1.0	2.7	1.5	3.8	1/4	0.6

Table 10 – 941005 Cylinder Mounting Bracket Dimensions

"A"		"B"		"C"		"D"		"E"		"F"	
in	cm	in	cm	in	cm	in	cm	in	cm	in	cm
1.4	3.6	5.9	15.0	9.4	23.9	1.6	4.1	4.6	11.7	7/16	0.8

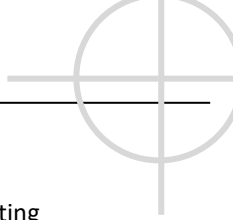

2.7 Heavy Duty Mounting Bracket

Additionally, the cylinder mounting brackets are available in a heavy duty configuration. The heavy duty mounting brackets are manufactured of higher strength steel with a primed and powder coated paint finish. The heavy duty mounting brackets provide greater stability against vibration.

The heavy duty mounting brackets are equipped with band clamps designed to fit properly around the cylinder. The heavy duty mounting bracket must be secured to a surface appropriate for retaining the weight of the cylinder in the event of a discharge. This precaution is intended to safely support the weight of the cylinder and the reaction force of the Novec 1230 discharge.

All cylinders must be mounted vertically only, with the valve up. Please refer to Figure 5 – Heavy Duty Mounting Bracket Bolt Pattern and Table 11 – Heavy Duty Mounting Bracket Dimensions for cylinder mounting bracket dimensions.

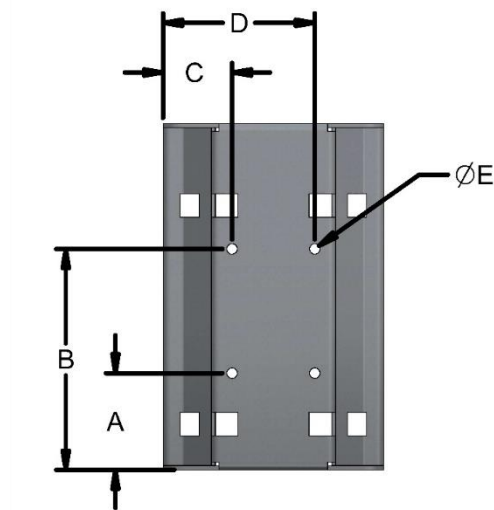
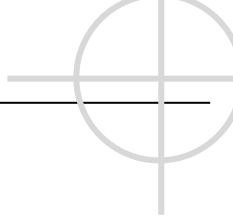

Figure 5 – Heavy Duty Mounting Bracket Bolt Pattern

Table 11 – Heavy Duty Mounting Bracket Dimensions

Part Number	Dimension "A"		Dimension "B"		Dimension "C"		Dimension "D"		Dimension "E"	
	in	cm	in	cm	in	cm	in	cm	in	cm
111404	4.1	10.4	8.1	20.6	1.9	4.8	2.6	6.6	.3	0.8
111403	4.1	10.4	8.1	20.6	2.1	5.3	3.8	9.7	.4	1.0
111402	3.5	8.9	8.0	20.3	2.5	6.4	5.5	14.0	.4	1.0



2.8 Discharge Network

2.8.1 Pipe, Fittings, and Pipe Supports

All piping must be installed in accordance with good commercial practices and applicable national standards.

2.8.1.1 Pipe Requirements

Piping used for Firetrace ILP Units must be copper. Piping shall be in accordance with the requirements of NFPA 2001 or the local authority having jurisdiction.

NOTE: All piping must be thoroughly cleaned to remove burrs and swabbed with a degreasing solvent to remove all traces of cutting oils and chips.

2.8.1.2 Pipe Fittings and Pipe Joining

Piping, fittings, and pipe supports shall be in accordance with the latest edition of NFPA 2001 available from National Fire Protection Association. Temperature and pressure ratings of the fittings must not be exceeded. The method of joining all pipe must be in accordance with the latest requirements listed in NFPA 2001. Refer to Table 12 – Copper Fitting Part Numbers for 940205 Unit Assembly and Table 13 – Copper Fitting Part Numbers for 940505/941005 Unit Assembly for acceptable fittings.

Table 12 – Copper Fitting Part Numbers for 940205 Unit Assembly

Copper Fitting Part Number	Description
200143	Copper Compression Fitting, Valve/Nozzle to 5/16 in Pipe
200101	Copper Compression Fitting, 5/16 in Pipe Bulkhead
200111	Copper Compression Fitting, 5/16 in Pipe Elbow
200121	Copper Compression Fitting, 5/16 in Pipe in Tee

Table 13 – Copper Fitting Part Numbers for 940505/941005 Unit Assembly

Copper Fitting Part Number	Description
200144	Copper Compression Fitting, Valve/Nozzle to 1/2 in Pipe
200145	Copper Compression Fitting, 1/2 in Pipe Bulkhead
200112	Copper Compression Fitting, 1/2 in Pipe Elbow
200122	Copper Compression Fitting, 1/2 in Pipe in Tee

2.8.1.3 Pipe Supports

Piping shall be securely supported by listed and/or approved hangers. Pipe supports must be installed with allowance for expansion and contraction and must be rated to support the dead weight of the piping and the thrust forces of the Novec 1230 discharge.

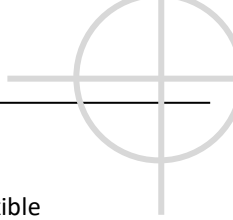

2.8.2 Flexible Hoses and Fittings

Flexible hoses and flexible hose fittings are available as an optional part for the system discharge network. Flexible hoses and flexible hose fittings shall be in accordance with the latest edition of NFPA 2001 or the local authority having jurisdiction. Temperature and pressure rating of the flexible hoses and flexible hose fittings shall not be exceeded.

2.8.2.1 Flexible Hoses

The flexible hoses are constructed with synthetic, high tensile textile cord reinforcement. Both ends are fitted with swivel adapters for easy installation. The flexible hoses have a maximum operating pressure of 300 psig [20.7 bar] and a minimum bend radius of 4 in [10.2 cm]. The 940205 unit assembly uses 3/8 in flexible hoses. The 940505 and 941005 unit assemblies use 1/2 in flexible hoses. Refer to Figure 6 – Flexible Hoses, Table 14 – Flexible Hose Part Numbers for 940205 Unit Assembly, and Table 15 – Flexible Hose Part Numbers for 940505/941005 Unit Assembly for additional information.

NOTE: This is an optional component and is not part of an FM Approved System.

NOTE: When using flexible hoses for the discharge network, the total length of piping shall not exceed the maximum length found in Section 3.6.

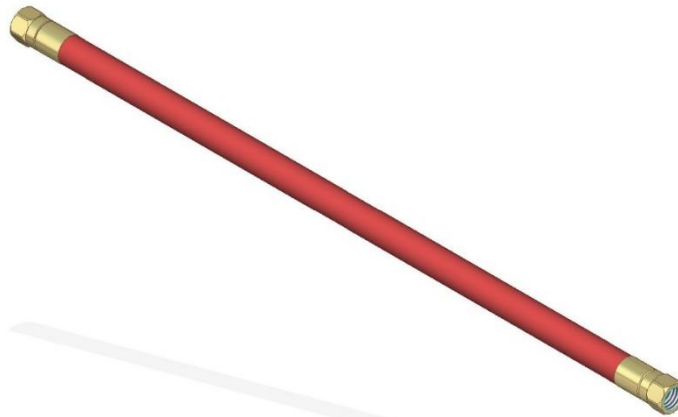

Figure 6 – Flexible Hoses

Table 14 – Flexible Hose Part Numbers for 940205 Unit Assembly

Flexible Hose Part Number	Description
202816 [†]	3/8 in Flexible Hose, 1 ft
201816 [†]	3/8 in Flexible Hose, 2 ft
201817 [†]	3/8 in Flexible Hose, 3 ft
201818 [†]	3/8 in Flexible Hose, 4 ft
201819 [†]	3/8 in Flexible Hose, 7 ft

[†] This is an optional component and is not part of an FM Approved System.

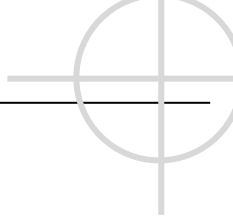

Table 15 – Flexible Hose Part Numbers for 940505/941005 Unit Assembly

Flexible Hose Part Number	Description
202820 [‡]	1/2 in Flexible Hose, 1 ft
201820 [‡]	1/2 in Flexible Hose, 2 ft
201821 [‡]	1/2 in Flexible Hose, 4 ft
201822 [‡]	1/2 in Flexible Hose, 6 ft
201823 [‡]	1/2 in Flexible Hose, 8 ft
201824 [‡]	1/2 in Flexible Hose, 10 ft

2.8.2.2 Flexible Hose Fittings

The flexible hose fittings are constructed of zinc plated steel. The flexible hose fittings allow for easy installation between the Firetrace Novec 1230 ILP Units, the flexible hoses, and the system nozzles. The flexible hose fittings have a minimum burst rating of 3000 psig [206.8 bar]. Refer to Table 16 – Flexible Hose Fitting Part Numbers for 940205 Unit Assembly and Table 17 – Flexible Hose Fitting Part Numbers for 940505/941005 Unit Assembly for additional information.

NOTE: This is an optional component and is not part of an FM Approved System.



Figure 7 – Flexible Hose Fittings

[‡] This is an optional component and is not part of an FM Approved System.

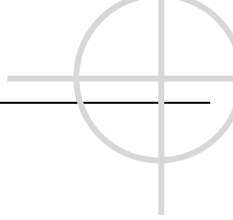

Table 16 – Flexible Hose Fitting Part Numbers for 940205 Unit Assembly

Flexible Hose Fitting Part Number	Description
850016 [§]	Fitting, 3/8 in Hose to Valve Union
850017 [§]	Fitting, 3/8 in Hose Union
850018 [§]	Fitting, 3/8 in Hose Elbow
850019 [§]	Fitting, 3/8 in Hose Tee
850020 [§]	Fitting, 3/8 in Hose to Nozzle Union Bulkhead
850021 [§]	Fitting, 3/8 in Hose to Nozzle Elbow Bulkhead

Table 17 – Flexible Hose Fitting Part Numbers for 940505/941005 Unit Assembly

Flexible Hose Fitting Part Number	Description
850022 [§]	Fitting, 1/2 in Hose to Valve Union
850023 [§]	Fitting, 1/2 in Hose Union
850024 [§]	Fitting, 1/2 in Hose Elbow
850025 [§]	Fitting, 1/2 in Hose Tee
850026 [§]	Fitting, 1/2 in Hose to Nozzle Union Bulkhead
850027 [§]	Fitting, 1/2 in Hose to Nozzle Elbow Bulkhead

[§] This is an optional component and is not part of an FM Approved System.

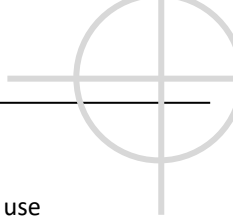

2.8.3 Nozzles

Discharge nozzles are made of nickel plated brass with female pipe threads. Nozzles are available in two sizes for use with Firetrace ILP Novec 1230 Units. The small nozzles contain a G1/4 thread. The medium nozzles contain a 1/2 in NPT thread. The 940205 unit assembly uses the small nozzle, see Figure 8 – Nozzles. The 940205 unit assembly can be designed using 1, 2, or 4 small nozzles. The 940505 and 941005 unit assemblies use the medium nozzles, Figure 8 – Nozzles. The 940505 and 941005 unit assemblies can be designed using 2 or 4 medium nozzles. The coverage for each nozzle must not exceed its maximum length and area of coverage. Refer to Section 3 for nozzle coverage information.

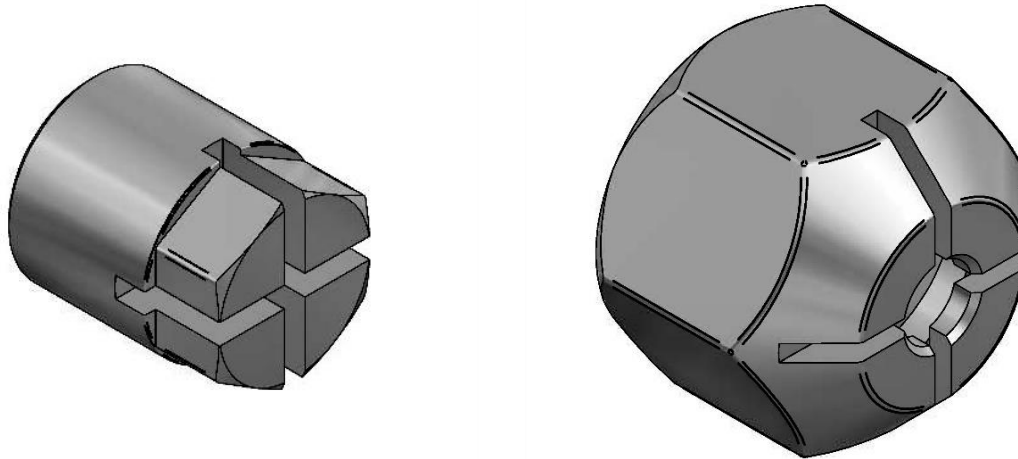

Small Nozzle

Medium Nozzle

Figure 8 – Nozzles

Table 18 – Nozzle Part Numbers

Nozzle Part Number	Connection Size	Unit Assembly
500015	G1/4 in	940205
500017	1/2 in NPT	940505/941005

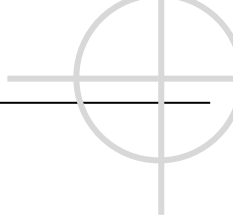

2.9 Pressure Switches

2.9.1 Valve Mounted Pressure Switch

The valve mounted pressure switch is an optional part of the unit assembly. It is factory installed into the pressure switch port of the cylinder valve. The valve mounted pressure switch is used to monitor unit pressure, unit actuation, or it can be used to energize or de-energize electrically operated equipment. If the unit to which the pressure switch is attached to loses pressure and reaches a pressure of 135 ± 10 psig [9.3 ± 0.7 bar] or below, the switch contacts will operate. Refer to Figure 9 – Valve Mounted Pressure Switch, Table 19 – Valve Mounted Pressure Switch Part Number, Figure 10 – Valve Mounted Pressure Switch Wiring Schematic, and Table 20 – Pressure Switch Properties for additional information.

The pressure switch is single pole, double throw (SPDT) and can be wired in either the normally open (NO), normally closed (NC) configurations, where the normal condition is at atmospheric pressure. When the unit is pressurized, the contacts switch over.

When the pressure switch is used on a standard supervisory input circuit, there will be no distinction between a wiring fault and device actuation. The pressure switch shall be installed onto a circuit suitable for unit supervision in accordance with NFPA 70 National Electric Code and NFPA 72 National Fire Alarm and Signaling Code.

This device is only to be utilized when accepted by the authority having jurisdiction. All other uses of this switch should be approved by the authority having jurisdiction.

NOTE: All detection devices and auxiliary alarm and control devices must be electrically compatible with each other. They must be approved by the authority having jurisdiction.

NOTE: Firetrace recommends that all units be equipped with a pressure switch and connected into a notification or shutdown device, in the event of a discharge.

CAUTION

Never use the pressure switch as a handle to transport the unit.



Figure 9 – Valve Mounted Pressure Switch

Table 19 – Valve Mounted Pressure Switch Part Number

Pressure Switch Part Number	Description
400001	Valve Mounted Pressure Switch

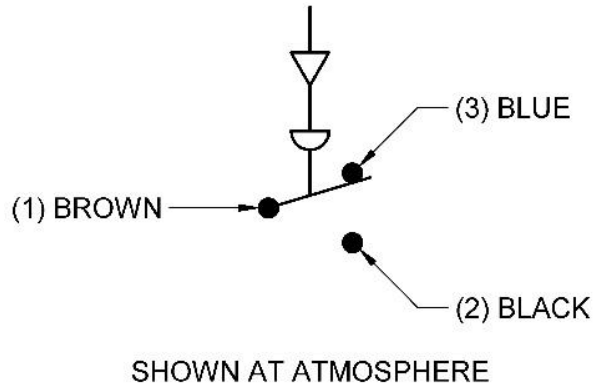
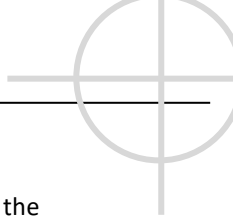

Figure 10 – Valve Mounted Pressure Switch Wiring Schematic

Table 20 – Pressure Switch Properties

Electrical Rating		Temperature Range
28 VDC – 15 A		-20 °F to 150 °F [-28.9 °C to 65.6 °C]
NO (1 and 3): 120 VAC – 10 A 240 VAC – 5 A	NC (1 and 2): 120 VAC – 25 A 240 VAC – 5 A	



2.9.2 End of Line Pressure Switch

The end of line pressure switch is available as an optional part for the system detection network. The thread on the end of the pressure switch allows for easy installation into the threads of the end of line adapter. The provided washer ensures that the pressure switch will fully depress the Schrader core installed within the end of line adapter. The provided O-ring ensures that there will be an adequate seal between the pressure switch and the end of line adapter.

The end of line pressure switch is used to monitor system pressure, system discharge, or it can be used to energize or de-energize electrically operated equipment. If the detection network to which the pressure switch is attached to loses pressure and reaches a pressure of 135 ± 10 psig [9.3 ± 0.7 bar] or below, the switch contacts will operate. Refer to Figure 11 – End of Line Pressure Switch, Table 21 – End of Line Pressure Switch Part Number, Figure 12 – End of Line Pressure Switch Wiring Schematic, and Table 22 – End of Line Pressure Switch Properties for additional information.

The pressure switch is single pole, double throw (SPDT) and can be wired in either the normally open (NO), normally closed (NC) configurations, where the normal condition is at atmospheric pressure. When the unit is pressurized, the contacts switch over.

When the pressure switch is used on a standard supervisory input circuit, there will be no distinction between a wiring fault and device actuation. The pressure switch shall be installed onto a circuit suitable for unit supervision in accordance with NFPA 70 National Electric Code and NFPA 72 National Fire Alarm and Signaling Code.

This device is only to be utilized when accepted by the authority having jurisdiction. All other uses of this switch should be approved by the authority having jurisdiction.

NOTE: All detection devices and auxiliary alarm and control devices must be electrically compatible with each other. They must be approved by the authority having jurisdiction.

NOTE: Firetrace recommends that all units be equipped with a pressure switch and connected into a notification or shutdown device, in the event of a discharge.

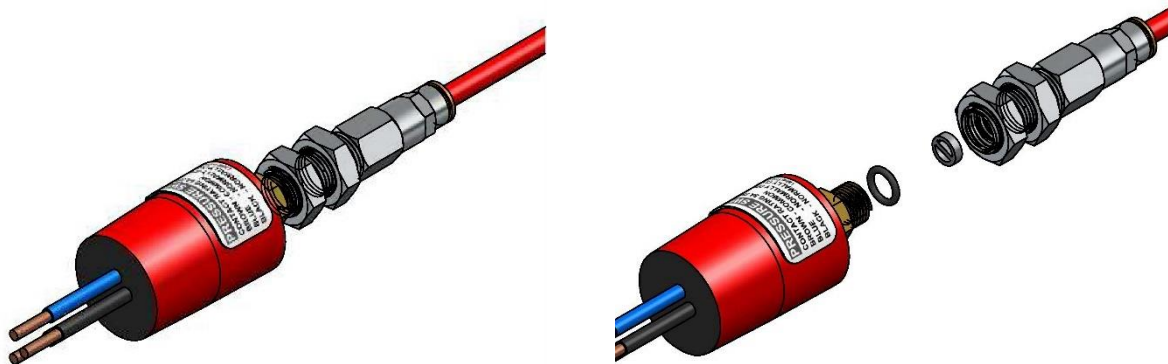
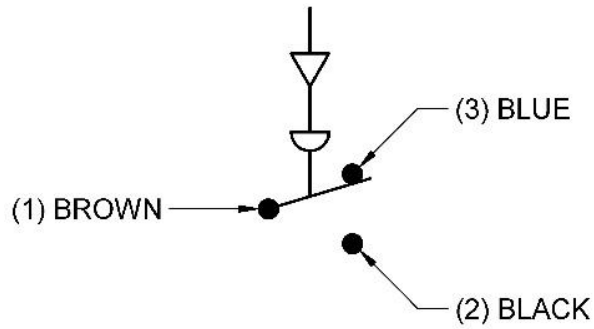

Figure 11 – End of Line Pressure Switch

Table 21 – End of Line Pressure Switch Part Number

Pressure Switch Part Number	Description
400004	End of Line Pressure Switch



SHOWN AT ATMOSPHERE
Figure 12 – End of Line Pressure Switch Wiring Schematic

Table 22 – End of Line Pressure Switch Properties

Electrical Rating		Temperature Range
28 VDC – 15 A		-20 °F to 150 °F [-28.9 °C to 65.6 °C]
NO (1 and 3): 120 VAC – 10 A 240 VAC – 5 A	NC (1 and 2): 120 VAC – 25 A 240 VAC – 5 A	

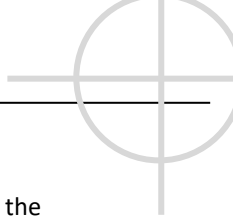

2.9.3 Pressure Switch Assembly

The pressure switch assembly is available as an optional part for the system detection network. The fitting on the exterior of the pressure switch assembly enclosure allows for the detection tubing to be easily installed into the assembly.

The pressure switch assembly is used to monitor system pressure, system discharge, or it can be used to energize or de-energize electrically operated equipment. If the detection network to which the pressure switch is attached to loses pressure and reaches a pressure of 135 ± 10 psig [9.3 ± 0.7 bar] or below, the switch contacts will operate. Refer to Figure 13 – Pressure Switch Assembly, Table 23 –Pressure Switch Assembly Part Number, Figure 14 – Pressure Switch Assembly Wiring Schematic, and Table 24 – Pressure Switch Assembly Properties for additional information.

The pressure switch is single pole, double throw (SPDT) and can be wired in either the normally open (NO), normally closed (NC) configurations, where the normal condition is at atmospheric pressure. When the unit is pressurized, the contacts switch over.

When the pressure switch is used on a standard supervisory input circuit, there will be no distinction between a wiring fault and device actuation. The pressure switch shall be installed onto a circuit suitable for unit supervision in accordance with NFPA 70 National Electric Code and NFPA 72 National Fire Alarm and Signaling Code.

This device is only to be utilized when accepted by the authority having jurisdiction. All other uses of this switch should be approved by the authority having jurisdiction.

NOTE: All detection devices and auxiliary alarm and control devices must be electrically compatible with each other. They must be approved by the authority having jurisdiction.

NOTE: Firetrace recommends that all units be equipped with a pressure switch and connected into a notification or shutdown device, in the event of a discharge.



Figure 13 – Pressure Switch Assembly

Table 23 –Pressure Switch Assembly Part Number

Pressure Switch Part Number	Description
400441	Pressure Switch Assembly

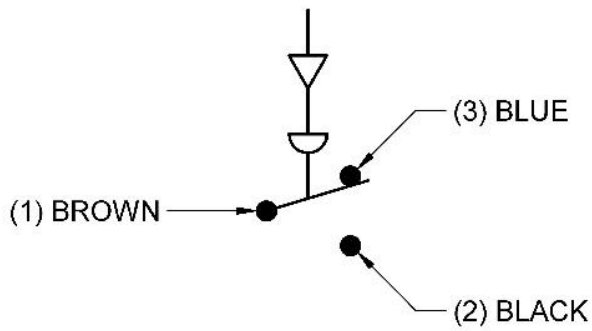

SHOWN AT ATMOSPHERE

Figure 14 – Pressure Switch Assembly Wiring Schematic

Table 24 – Pressure Switch Assembly Properties

Electrical Rating		Temperature Range
28 VDC – 15 A		-20 °F to 150 °F [-28.9 °C to 65.6 °C]
NO (1 and 3): 120 VAC – 10 A 240 VAC – 5 A	NC (1 and 2): 120 VAC – 25 A 240 VAC – 5 A	

NOTE: All detection devices and auxiliary alarm and control devices must be electrically compatible with each other. They must be approved by the authority having jurisdiction.

NOTE: Firetrace recommends that all units be equipped with a pressure switch and connected into a notification or shutdown device, in the event of a discharge.

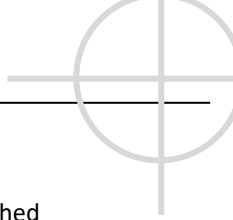

2.10 Electric Solenoid Assembly

The electric solenoid assembly is available as an optional part for the system detection network. The fitting attached to the electric solenoid allows for the detection tubing to be easily installed into the electric solenoid assembly.

The electric solenoid assembly is used to release pressure from the detection tubing, resulting in actuation of the Firetrace Novec 1230 ILP Unit. Refer to Figure 15 – Electric Solenoid Assembly, Table 25 – Electric Solenoid Assembly Part Number, Figure 16 – Electric Solenoid Assembly Wiring Schematic, and Table 26 – Electric Solenoid Assembly Properties for additional information.

The electric solenoid is normally closed and requires electrical energy to remain open. The electric solenoid assembly is available in 12 VDC, 24 VDC, 120 VAC, and 240 VAC configurations.

The electric solenoid assembly shall be installed in accordance with NFPA 70 National Electric Code and NFPA 72 National Fire Alarm and Signaling Code.

This device is only to be utilized when accepted by the authority having jurisdiction. All other uses of this electric solenoid assembly should be approved by the authority having jurisdiction.

NOTE: All detection devices and auxiliary alarm and control devices must be electrically compatible with each other. They must be approved by the authority having jurisdiction.

NOTE: Detection networks equipped with an electric solenoid assembly require the use of a solenoid connector cable.

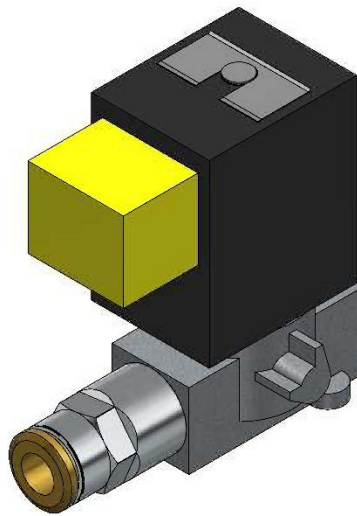

Figure 15 – Electric Solenoid Assembly

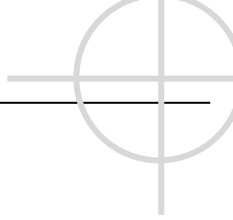

Table 25 – Electric Solenoid Assembly Part Number

Electric Solenoid Assembly Part Number	Description
400312**	12 VDC Electric Solenoid Assembly
400324**	24 VDC Electric Solenoid Assembly
400316**	120 VAC Electric Solenoid Assembly
400327**	240 VAC Electric Solenoid Assembly

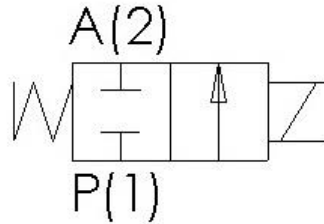
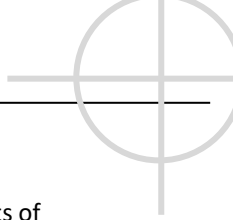

Figure 16 – Electric Solenoid Assembly Wiring Schematic

Table 26 – Electric Solenoid Assembly Properties

Maximum Allowable Pressure	725 psig [50 bar]
Opening Time	10 ms
Closing Time	10 ms
Fluid Temperature	32 °F to 266 °F [0 °C to 130 °C]

** This is an optional component and is not part of an FM Approved System.



2.11 Indication and Activation Kit

The indication and activation kit is available as an optional part for the system detection network. The kit consists of a notification module and a system interface module. The notification module provides indication for “Fire/Activation” (Red LED and Audible Alarm), “Service” (Yellow LED), and “Power” (Green LED). The notification module can also be equipped with a system activation switch. The system interface module is equipped with a fitting that allows for the detection tubing to be easily installed into the system interface module.

When equipped with a system activation switch, the indication and activation kit is used to release pressure from the detection tubing, resulting in actuation of the Firetrace Novec 1230 ILP Unit. Refer to Figure 17 – Indication and Activation Kit and Table 27 – Indication and Activation Kit Part Number for additional information.

The indication and activation kit is available in 12 VDC or 24 VDC configurations.

NOTE: The indication and activation kit requires the use of a 2 amp fuse box. Fuse box is not included as part of the kit.

The indication and activation kit shall be installed in accordance with NFPA 70 National Electric Code and NFPA 72 National Fire Alarm and Signaling Code.

This device is only to be utilized when accepted by the authority having jurisdiction. All other uses of the indication and activation kit should be approved by the authority having jurisdiction.

NOTE: All detection devices and auxiliary alarm and control devices must be electrically compatible with each other. They must be approved by the authority having jurisdiction.

NOTE: Detection networks equipped with an indication and activation kit require the use of a 2 amp fuse box.

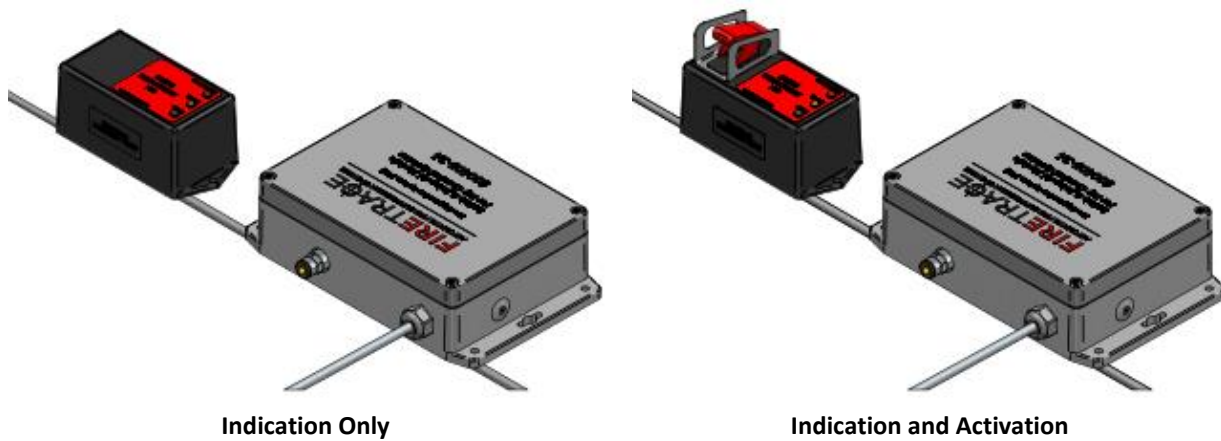

Figure 17 – Indication and Activation Kit

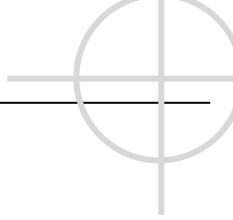
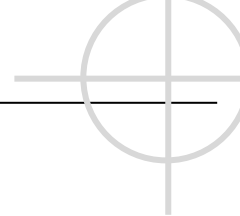

Table 27 – Indication and Activation Kit Part Number

Indication and Activation Kit Part Number	Description
600410-12 ^{††}	12 VDC Indication Kit, 195 psig, Bottom Cable
600420-12 ^{††}	12 VDC Indication and Activation Kit, 195 psig, Bottom Cable
600408-12 ^{††}	12 VDC Indication Kit, 195 psig, Rear Cable
600409-12 ^{††}	12 VDC Indication and Activation Kit, 195 psig, Rear Cable
600410-24 ^{††}	24 VDC Indication Kit, 195 psig, Bottom Cable
600420-24 ^{††}	24 VDC Indication and Activation Kit, 195 psig, Bottom Cable
600408-24 ^{††}	24 VDC Indication Kit, 195 psig, Rear Cable
600409-24 ^{††}	24 VDC Indication and Activation Kit, 195 psig, Rear Cable

^{††} This is an optional component and is not part of an FM Approved System.



Section 3: Design

3.1 Introduction

The Firetrace Pre-Engineered Novec 1230 ILP Automatic Suppression Units design limitations were established and tested by Firetrace. The ILP units are Approved by FM Approvals.

These units were subjected to numerous performance and fire tests (as specified in FM 5600), in order to verify the suitability of the fire suppression units and to establish design limitations for the following parameters:

- Enclosure volume
- Nozzle height
- Discharge time and flow rates
- Nozzle area coverage
- Nozzle placement
- Design concentrations and design factors
- Firetrace detection tube placement

The Pre-Engineered concept minimizes the amount of engineering required when evaluating a design for a specific application. Provided that the discharge piping and nozzles are installed within the limits outlined in this manual, no calculations are required for pressure drop, flow rates, or discharge time. When the additional limitations (enclosure volume, area coverage, maximum height, design concentration, agent quantity, detection tubing placement) are also met, the system installation can be understood to comply with the design requirements, NFPA 2001, and FM Approvals. Therefore, no discharge tests or concentration measurements should be required for evaluating a system design.

Systems shall be installed and maintained in accordance with NFPA 2001, all applicable codes and regulations, and this manual. It is important that the limitations stated in this manual are followed.

NOTE: Firetrace Pre-Engineered ILP Automatic Suppression Units are designed and approved as an automatic unit. Firetrace ILP Units are not designed to provide simultaneous actuation of two or more units. Under the approval, only one Firetrace Pre-Engineered ILP Automatic Suppression Unit can be used to protect one enclosure, units shall not be combined to protect a larger enclosure.

CAUTION

Clean agent shall NOT be used on fires involving the following materials:

1. Certain chemicals or mixtures of chemicals, such as cellulose nitrate and gunpowder, which are capable of rapid oxidation in the absence of air.
2. Reactive metals.
3. Metal hydrides.
4. Chemicals capable of undergoing autothermal decomposition.

3.2 Operating Specifications

3.2.1 Temperature Range

Firetrace Pre-Engineered Novec 1230 ILP Automatic Suppression Units and equipment are designed to be stored and operated at the ambient temperature range of 0 °F to 130 °F [-17.8 °C to 54.4 °C].

3.2.2 Operating Pressure

The normal operating pressure for Firetrace Pre-Engineered Novec 1230 ILP Automatic Suppression Units is 195 psig at 70 °F [13.4 bar at 21.1 °C].

Firetrace Pre-Engineered Novec 1230 ILP Automatic Suppression Units are designed for an operating temperature range of 0 °F to 130 °F [-17.8 °C to 54.4 °C]. Table 28 – Pressure-Temperature Relationship, shows the pressure gauge reading based on a charging pressure of 195 psig at 70 °F [13.4 bar at 21.1 °C].

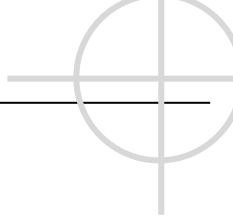

Table 28 – Pressure-Temperature Relationship

Temperature		Pressure	
°F	°C	psig	bar
0	-17.8	139	9.6
10	-12.2	147	10.1
20	-6.7	155	10.7
30	-1.1	163	11.2
40	4.4	171	11.8
50	10.0	179	12.3
60	15.5	187	12.9
70	21.1	195	13.4
80	26.7	203	14.0
90	32.2	211	14.5
100	37.8	219	15.1
110	43.3	227	15.7
120	48.9	235	16.2
130	54.4	243	16.8

3.3 Design Procedure

In addition to the applicable requirements specified in Chapter 5 of NFPA 2001, the following steps should be used to design a system utilizing a Firetrace Pre-Engineered Novec 1230 ILP Automatic Suppression Unit:

- a. Conduct a survey and analysis of the hazard to be protected.
- b. Determine the length, width, and height of the enclosure and calculate the volume. All of these parameters must be within the dimensional limitations specified in this manual.
- c. Determine the anticipated minimum and maximum ambient temperatures within the enclosure.
- d. Determine the minimum design concentration required for the hazard.
- e. Determine the integrity of the enclosure and if any openings must be closed at the time of agent discharge.
- f. Determine the cylinder size required, based on enclosure volume limitations and enclosure size.
- g. Evaluate personnel safety exposure limitations as specified in NFPA 2001, based on the total quantity of Novec 1230 agent being used at the maximum ambient temperature expected within the enclosure.
- h. Determine the quantity of nozzles required, based on the size and configuration of the enclosure.
- i. Determine the location where the Firetrace Novec 1230 ILP Unit and nozzles will be installed.
- j. Determine the routing and quantity of discharge piping required. Discharge piping and fittings used in the design must be within the limitations specified in this manual.
- k. Determine the arrangement and placement of the Firetrace detection tubing. Tubing parameters must be within the limitations specified in this manual.
- l. Determine any auxiliary equipment required to ensure proper protection of the enclosure.
- m. Prepare system drawings, bill of materials, and any additional documentation deemed necessary, following the applicable section of Chapter 5 of NFPA 2001.

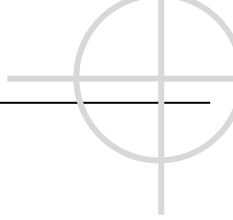

3.4 Design Concentration

3.4.1 Minimum Design Concentrations

The minimum design concentrations to be used with Firetrace Pre-Engineered Novec 1230 ILP Automatic Suppression Units include a minimum safety factor (SF), as specified in NFPA 2001. A 7.27% commercial grade heptane design concentration was used for all of the Class B fire tests conducted. An additional multiplication factor (MF) of 1.243 must be used to establish minimum design concentrations for all other Class B fuels.

Minimum design concentrations to be used with Firetrace Pre-Engineered Novec 1230 ILP Automatic Suppression Units can be found in Table 29 – Class A Minimum Design Concentrations and Table 30 – Class B Minimum Design Concentrations. For all other Class B fuels not shown in Table 30 – Class B Minimum Design Concentrations, the minimum design concentration can be calculated as follows:

$$MDC = EC * SF * MF$$

- where: MDC = minimum design concentration
- EC = minimum extinguishing concentration, determined using the cup burner test method
- SF = safety factor, 1.3
- MF = multiplication factor, 1.243 for Firetrace Novec 1230 ILP Units

The maximum volume limitations and minimum temperature specifications MUST be followed in order to maintain the correct safety factor. It is recommended that the designer consult with Firetrace, NFPA 2001, and the local authority having jurisdiction, as to the suitability on the use of Novec 1230 for a particular hazard, for personnel exposure effects from the design concentrations, and for installation requirements.

Table 29 – Class A Minimum Design Concentrations

Fuel	Extinguishing Concentration (%)	Minimum Design Concentration (%)
Class A	3.5	4.5

NOTE: FM Approved system is only approved for Class B hazards.

Table 30 – Class B Minimum Design Concentrations

Fuel	Extinguishing Concentration* (%)	Minimum Safety Factor	Multiplication Factor	Minimum Design Concentration (%)
Acetone	4.3	1.3	1.243	6.95
Ethanol	5.5	1.3	1.243	8.89
n-Heptane	4.5	1.3	1.243	7.27
Methanol	6.5	1.3	1.243	10.50
1-Propanol	5.4	1.3	1.243	8.73
Toluene	3.5	1.3	1.243	5.85**

*Class B extinguishing concentration values were derived using the cup burner test method and using data received from 3M™.
 **Minimum design concentrations cannot be less than 5.58% for any Class B fuel.

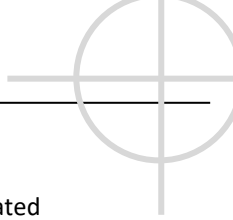

3.4.2 Actual Concentration

To calculate the actual concentration (C_{tmax}) achieved in the protected enclosure, at the maximum anticipated ambient temperature, the following equation should be used:

$$C_{tmax} = \frac{100}{(V/W * 1/s) + 1}$$

where: W = agent being used (lb)

V = volume of the protected enclosure (ft³)

s = specific volume of superheated Novec 1230 vapor (ft³/lb)

s can be approximated by using the following formula:

$$s = .9856 + .002441 * t$$

Where: t = maximum anticipated ambient temperature (°F)

CAUTION

Care must be taken to ensure that the actual concentration, at the maximum anticipated ambient temperature in the protected enclosure does not exceed the values specified in NFPA 2001.

3.5 Protected Enclosure

Firetrace Pre-Engineered Novec 1230 ILP Automatic Suppression Units are designed to enable a single cylinder to protect an enclosure of any size or shape, provided that the enclosure parameters do not exceed the limitations stated in the manual. Table 31 – Enclosure Volume Limitations for 940205 Unit Assembly, Table 32 – Enclosure Volume Limitations for 940505 Unit Assembly, and Table 33 – Enclosure Volume Limitations for 941005 Unit Assembly list the enclosure volume limitations for Firetrace Pre-Engineered Novec 1230 ILP Automatic Suppression Units.

NOTE: Firetrace Pre-Engineered ILP Automatic Suppression Units are designed and approved as an automatic unit. Firetrace ILP Units are not designed to provide simultaneous actuation of two or more units. Under the approval, only one Firetrace Pre-Engineered ILP Automatic Suppression Unit can be used to protect one enclosure, units shall not be combined to protect a larger enclosure.

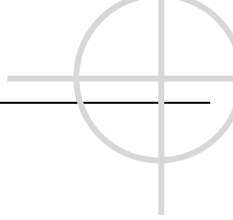

Table 31 – Enclosure Volume Limitations for 940205 Unit Assembly

Design Temperature		Maximum Enclosure Volume		Concentration
°F	°C	ft ³	m ³	%
0	-17.8	31	0.88	7.27
10	-12.2	32	0.91	7.27
20	-6.7	32	0.91	7.27
30	-1.1	33	0.93	7.27
40	4.4	34	0.96	7.27
50	10.0	35	0.99	7.27
60	15.5	36	1.02	7.27
70	21.1	36	1.02	7.27
80	26.7	37	1.05	7.27
90	32.2	38	1.08	7.27
100	37.8	39	1.10	7.27
110	43.3	39	1.10	7.27
120	48.9	40	1.13	7.27
130	54.4	41	1.16	7.27

Table 32 – Enclosure Volume Limitations for 940505 Unit Assembly

Design Temperature		Maximum Enclosure Volume		Concentration
°F	°C	ft ³	m ³	%
0	-17.8	62	1.76	7.27
10	-12.2	64	1.81	7.27
20	-6.7	65	1.84	7.27
30	-1.1	67	1.90	7.27
40	4.4	69	1.95	7.27
50	10.0	70	1.98	7.27
60	15.5	72	2.04	7.27
70	21.1	73	2.07	7.27
80	26.7	75	2.12	7.27
90	32.2	76	2.15	7.27
100	37.8	78	2.21	7.27
110	43.3	79	2.24	7.27
120	48.9	81	2.29	7.27
130	54.4	83	2.35	7.27

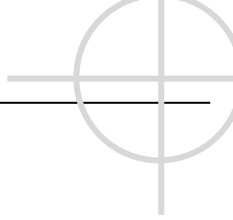

Table 33 – Enclosure Volume Limitations for 941005 Unit Assembly

Design Temperature		Maximum Enclosure Volume		Concentration
°F	°C	ft ³	m ³	%
0	-17.8	125	3.54	7.27
10	-12.2	128	3.62	7.27
20	-6.7	131	3.71	7.27
30	-1.1	135	3.82	7.27
40	4.4	138	3.91	7.27
50	10.0	141	3.99	7.27
60	15.5	144	4.08	7.27
70	21.1	147	4.16	7.27
80	26.7	150	4.25	7.27
90	32.2	153	4.33	7.27
100	37.8	156	4.42	7.27
110	43.3	159	4.50	7.27
120	48.9	163	4.62	7.27
130	54.4	166	4.70	7.27

3.5.1 Enclosure Size

Table 34 – Enclosure Size Limitations for Firetrace Novec 1230 ILP Units below list the enclosure volume limitations for Firetrace Pre-Engineered Novec 1230 ILP Automatic Suppression Units.

Table 34 – Enclosure Size Limitations for Firetrace Novec 1230 ILP Units

Unit Assembly	Total Area Coverage		Maximum Height	
	ft ²	m ²	ft	m
940205	25	2.32	10	3.05
940505	25	2.32	10	3.05
941005	25	2.32	10	3.05

3.5.2 Ventilation and Unclosable Openings

Openings in the protected enclosure must be sealed. When the unit is discharged into an enclosure, normal gaps and openings under doorways must not impact system performance. Doors and normal vents that are required in the enclosure must be closed prior to, or at the time of unit discharge. Doors or closures that normally swing to a closed position and are not held open do not require a system generated mechanism to operate. Doors and closures, including ventilation, which are held open while operating must have devices installed to close at the start or prior to unit discharge. All doors should be closed and ventilation fans shut down prior to discharge.

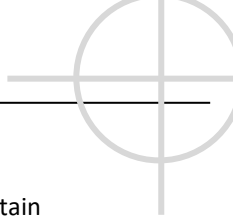

3.5.3 Pressure Relief Vent Area

In the event of a discharge, the protected enclosure must have sufficient structural strength and integrity to contain the agent discharge. If the pressure difference across the enclosure boundaries presents a threat to the hazard enclosure, venting shall be provided to prevent excessive pressures.

Guidance to determine the pressure relief vent area can be found in the FSSA Application Guide to Estimating Enclosure Pressure & Pressure Relief Vent Area for Use with Clean Agent Fire Extinguishing Systems and shall be in accordance with NFPA 2001 requirements.

3.6 Discharge Network

3.6.1 Discharge Piping and Pipe Fitting Specifications

All Firetrace Pre-Engineered Novec 1230 ILP Automatic Suppression Units shall use copper tubing for the agent distribution system. See Table 35 – Discharge Piping Specifications and Table 36 – Discharge Pipe Fitting Specifications for specifications of the discharge piping and pipe fittings to be used with Firetrace Novec 1230 ILP Units. Refer to Section 4.2 of NFPA 2001 for alternate discharge network options.

Table 35 – Discharge Piping Specifications

Unit Assembly	Material	Outer Diameter	Wall Thickness
940205	soft annealed copper (AS B-280*, for air conditioning and refrigeration service)	5/16 in	.032 in
940505		1/2 in	.032 in
941005		1/2 in	.032 in

*The use of AS B-280 soft annealed copper, as specified in this manual, complies with ASME B 31.1 requirements of NFPA 2001.

Table 36 – Discharge Pipe Fitting Specifications

Material	Connection Type	Minimum Pressure Rating**
Brass	Flareless Bite*	1000 psig

*Use Parker Intru-Lok, Camozzi, or equivalent
**Minimum pressure rating for use with Firetrace Novec 1230 ILP Units

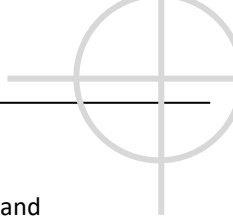

3.6.2 Discharge Piping and Pipe Fitting Limitations

Table 37 – Discharge Piping Limitations and Table 38 – Pipe Fitting Limitations below show the discharge piping and pipe fitting limitations for Firetrace Pre-Engineered Novec 1230 ILP Automatic Suppression Units.

Table 37 – Discharge Piping Limitations

Unit Assembly	Discharge Ports Used	Nozzles per Discharge Port	Total Nozzles Used	Maximum Length of Discharge Piping	
				ft	m
940205	1	1	1	4	1.22
	2	1	2	8	2.44
	2	2	4	8	2.44
940505	2	1	2	8	2.44
	2	2	4	8	2.44
941005	2	1	2	8	2.44
	2	2	4	8	2.44

Table 38 – Pipe Fitting Limitations

Unit Assembly	Discharge Ports Used	Nozzles per Discharge Port	Total Nozzles Used	Maximum Elbows per Discharge Port	Maximum Tees per Discharge Port
940205	1	1	1	1	0
	2	1	2	2	0
	2	2	4	3	1
940505	2	1	2	2	0
	2	2	4	3	1
941005	2	1	2	2	0
	2	2	4	3	1

3.6.3 Discharge Pipe Bends

Wherever possible, pipe bends should be used in lieu of 90° elbows. It is recommended that a pipe bender be used when forming the 90° bends. Refer to Table 39 –Pipe Bend Radius and Equivalent Length when forming pipe bends, to minimize the chance of flattening the pipe.

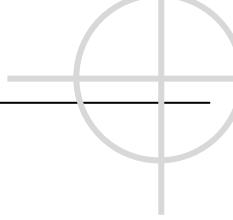

Table 39 – Pipe Bend Radius and Equivalent Length

Pipe Outer Diameter (OD)	Minimum Bend Radius* to Pipe Centerline	Equivalent Length** for 90° Bend***
5/16 in	11/16 in	1-1/8 in
1/2 in	1-1/2 in	2-3/8 in

* The minimum bend radii were derived from Parker Industrial Tube Fittings Catalogue 4300, dated March 1991.
 ** The equivalent length is to be subtracted from the maximum length of piping as stated under
 Table 37 – Discharge Piping Limitations.
 ***90° pipe bends are not required to be subtracted from the maximum number of elbows stated under Table 38 – Pipe Fitting Limitations.

3.6.4 Nozzle Area Coverage

The 940205 unit assembly can be installed using 1, 2, or 4 nozzles to suit the hazard configuration. The 940505 and 941005 unit assemblies can be designed using 2 or 4 nozzles to suit the hazard configuration. Table 40 – Nozzle Area Coverage Limitations below shows the nozzle area coverage limitations for Firetrace Pre-Engineered Novec 1230 ILP Automatic Suppression Units. The maximum enclosure height for nozzle installation is 10 ft [3.05 m]. The minimum enclosure height for nozzle installation is 1.6 ft [0.3 m].

Each Firetrace ILP unit is equipped with two discharge ports, whether one or both discharge ports are used is dependent on the size and shape of the enclosure, and the number of nozzles required to cover the protected hazard. See Figure 18 – Typical Nozzle Configuration Guideline for typical examples of configurations that meet the stated limitations.

Table 40 – Nozzle Area Coverage Limitations

Unit Assembly	Discharge Ports Used	Nozzles per Discharge Port	Total Nozzles Used	Maximum Area Coverage per Nozzle		Maximum Height	
				ft	m	ft	m
940205	1	1	1	5 ft x 5 ft 25 ft ²	1.52 m x 1.52 m 2.32 m ²	10	3.05
	2	1	2	5 ft x 2.5 ft 12.5 ft ²	1.52 m x 0.76 m 1.16 m ²	10	3.05
	2	2	4	2.5 ft x 2.5 ft 6.25 ft ²	0.76 m x 0.76 m 0.58 m ²	10	3.05
940505	2	1	2	5 ft x 2.5 ft 12.5 ft ²	1.52 m x 0.76 m 1.16 m ²	10	3.05
	2	2	4	2.5 ft x 2.5 ft 6.25 ft ²	0.76 m x 0.76 m 0.58 m ²	10	3.05
941005	2	1	2	5 ft x 2.5 ft 12.5 ft ²	1.52 m x 0.76 m 1.16 m ²	10	3.05
	2	2	4	2.5 ft x 2.5 ft 6.25 ft ²	0.76 m x 0.76 m 0.58 m ²	10	3.05

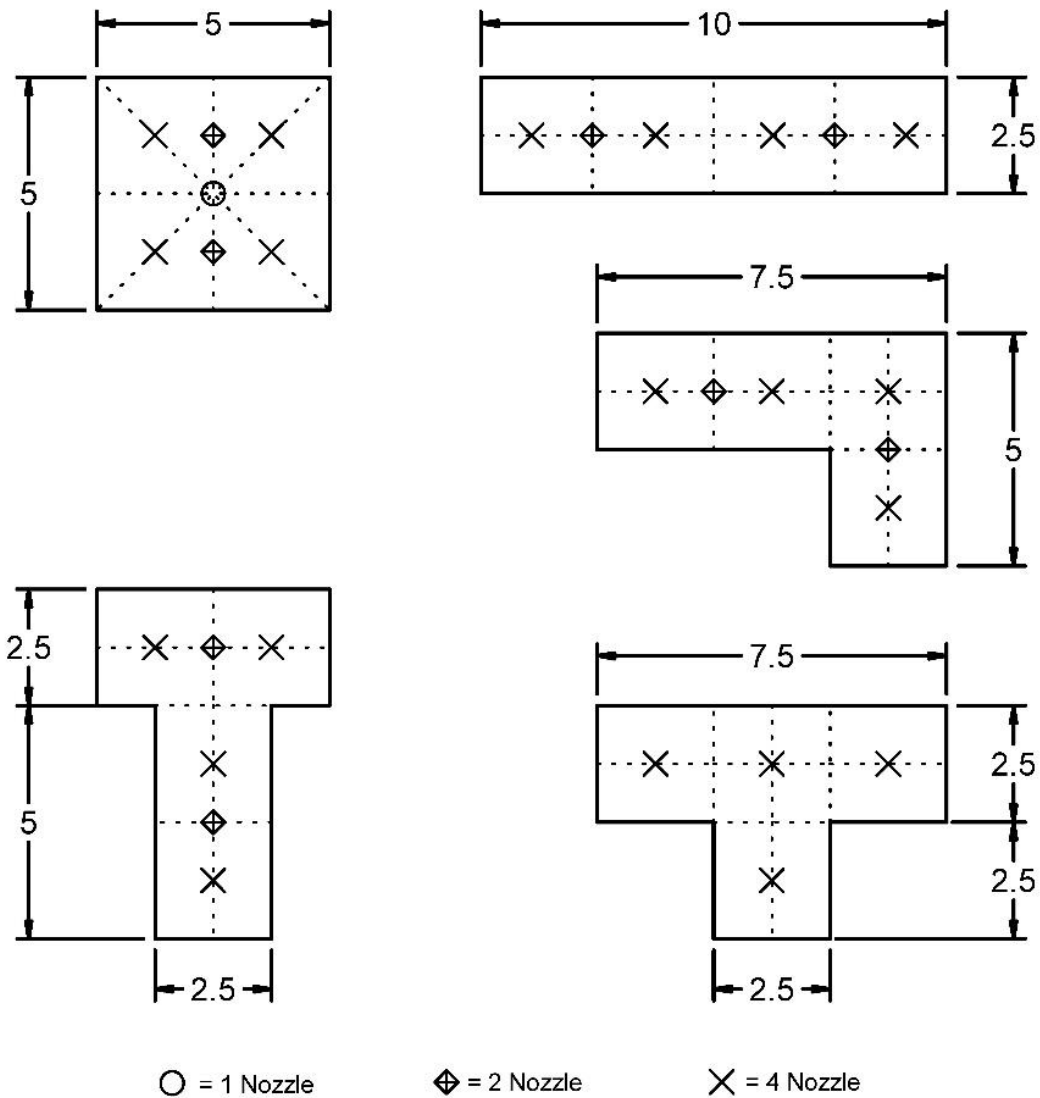
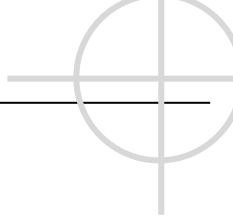

Figure 18 – Typical Nozzle Configuration Guideline

3.7 Firetrace Detection Tubing

Location of the Firetrace detection tubing is critical to the response time in the event of a fire. The Firetrace detection tubing should be installed throughout the enclosure and routed in close proximity to all potential fire sources. The Firetrace detection tubing should not be placed horizontally adjacent to a potential fire source.

In order to protect the overall height of a protected enclosure, the tubing must be installed in height increments of 3.28 ft [1 m]. In order to protect the overall area of a protected enclosure, the tubing must be installed in passes. The maximum distance between passes is 21.12 in [53.8 cm]. The maximum distance allowed from any wall to the tubing is 10.56 in [26.82 cm]. The minimum bend radius shall not exceed 6 in [15.24 cm]. The maximum length of Firetrace detection tubing that can be used for Firetrace Novec 1230 ILP Units is 120 ft [36.58m]. Refer to Table 41 – Firetrace Detection Tubing Limitations and Figure 19 – Tubing Configuration Guideline below for Firetrace detection tubing limitations and a guideline for typical tubing configurations.

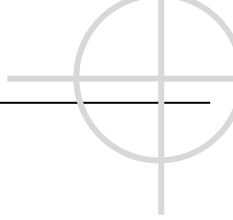

Table 41 – Firetrace Detection Tubing Limitations

Description	Limitation	
Maximum length	120 ft	36.58 m
Maximum height between layers	3.28 ft	1 m
Maximum distance between passes	21.12 in	53.8 cm
Minimum distance from wall	10.56 in	26.82 cm
Minimum bend radius	6 in	15.24 cm

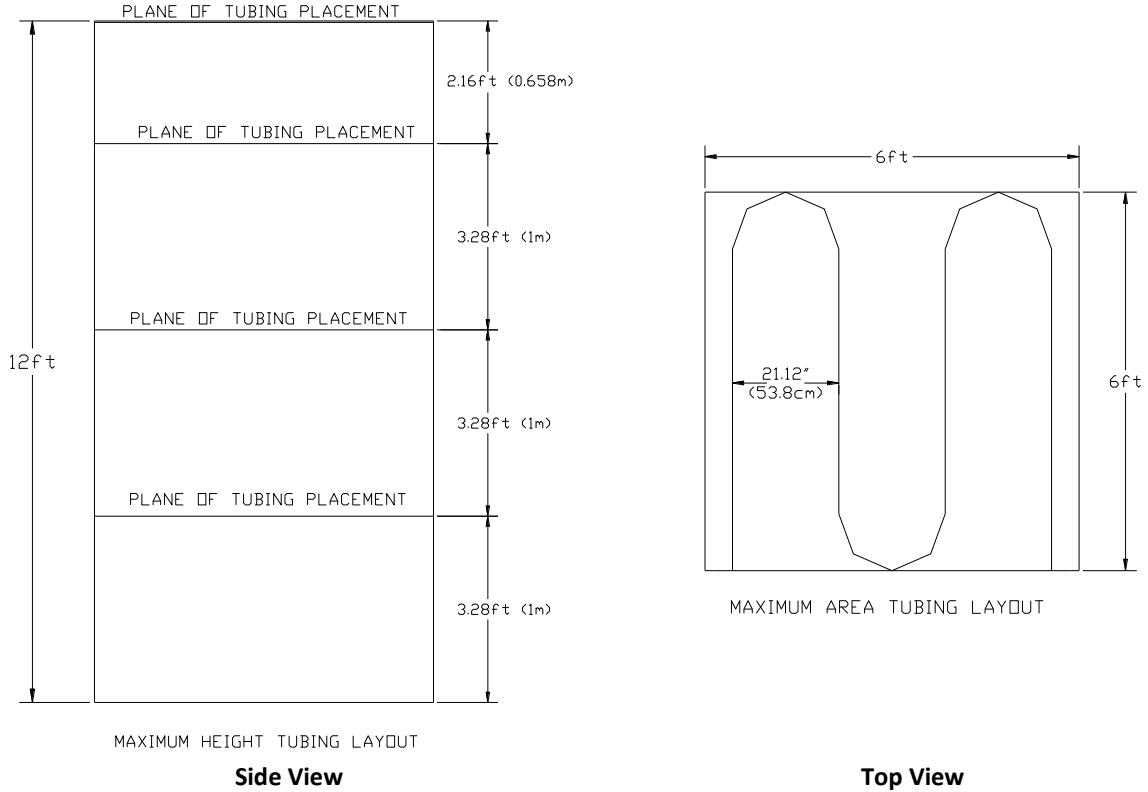

Figure 19 – Tubing Configuration Guideline



Section 4: Installation

4.1 Introduction

This section provides installation instructions for components and limitations described in Section 2: System Description and Section 3: Design of this manual. All components should be installed to facilitate proper inspection, testing, recharging, and any other required service or maintenance, as may be necessary. Equipment must not be subjected to severe weather conditions, mechanical damage, chemical damage, or other damage which could render the equipment inoperative.

Firetrace Pre-Engineered Novec 1230 ILP Suppression Units and equipment must be handled, installed, and serviced only by qualified and trained personnel, in accordance with the instructions contained in this manual and on the cylinder nameplate, as well as NFPA 2001, FM 5600, and any other regulations and codes that may apply.

WARNING

Pressurized (charged) cylinders are extremely hazardous and if not handled properly are capable of causing property damage, bodily injury, or death. Always wear safety glasses and ensure the discharge port plugs are properly installed before installing, servicing, or other general handling of ILP Units.

4.2 Firetrace Novec 1230 ILP Unit

WARNING

Ensure the ball valve, located on the top of the cylinder valve, is maintained in the “OFF” position. Ensure that the discharge port plugs are installed until the unit is mounted and ready for connection to the discharge piping.

The Firetrace Novec 1230 ILP Unit should be located as close as possible to the protected enclosure. In some cases, the unit can be mounted inside the protected enclosure. The unit shall be located in a readily accessible location to allow for ease of inspection, service, and maintenance. The unit shall be located in an environment protected from the weather and where the temperature range is between 0 °F to 130 °F [-17.8 °C to 54.4 °C].

The cylinder and bracket must be mounted in the vertical plane with the cylinder valve on top, and oriented so that the pressure gauge is facing out and away from the mounting wall to facilitate visual inspection.

Mount the cylinder where it will not be subjected to accidental damage or movement. Suitable protection must be installed, where necessary, to prevent damage or movement.

The steps below should be followed to ensure proper installation of the Firetrace Novec 1230 ILP Unit:

1. Install the cylinder mounting bracket to a structural support using two or more mounting holes.
2. Position the cylinder in the bracket with the pressure gauge facing out.
3. Secure the cylinder in place using the bracket straps or band clamps.

4.3 Discharge Network

The steps below should be followed to ensure proper installation of the discharge network:

1. Following the guidelines and limitations outlined in Section 3.6, determine whether one or two discharge ports will be used. If two discharge ports are to be used, verify that the pipe length from each discharge port does not exceed a 10% imbalance.
2. Following the guidelines and limitations outlined in Section 3, determine whether one, two, or four nozzles will be used and install the nozzles.
3. Remove the discharge port plug(s), as required, and install male connection fittings in the discharge port(s), as required.
4. Install the discharge piping and fittings between the discharge port(s) and nozzle(s). Secure the discharge network with the appropriate clamps, as required.

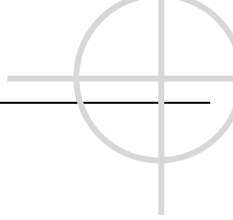

4.4 Detection Network

4.4.1 Firetrace Detection Tubing

Location and spacing of the tubing is critical to the response time in the event of a fire. The tubing should be placed above the hazard areas being protected. In addition to the guidelines and limitations outlined in Section 3.7, the steps below should be followed to ensure proper installation of the detection network:

1. Secure the Firetrace detection tubing by using mounting tabs. The mounting tabs should be placed at 1.5 ft [0.46 m] intervals.
2. Use the appropriate rubber/plastic grommets when the detection tubing is routed through sharp holes in order to prevent damage to the tubing.

NOTE: Do not kink, bend, or crush Firetrace detection tubing. Damage to the tubing can result in leakage and/or accidental discharge of the Firetrace Novec 1230 ILP Unit.

NOTE: Do not install tubing in extreme environments where the maximum ambient temperature exceeds 176 °F [80 °C].

4.4.2 Tube Fittings

All detection tube fittings must be secured in the following manner:

1. Cut the tube end, ensuring the cut is clean, square, and free from burrs.
2. Thoroughly clean the tubing, starting from the cut end, to approximately 2 in [5.08 cm] from the cut end. Remove all dirt, grease, or grime and ensure no debris is left in the tube. This will ensure a proper seal inside the fitting.
3. Slide the tubing into the opening of the fitting, until it reaches the inner wall.
4. Lightly pull on the tubing. The brass outer ring should move outward slightly.

4.4.3 End of Line Accessories

The end of line adapter is used to install auxiliary accessories to the detection network. One end of the end of line adapter contains a tube fitting. Install the end of line adapter to the end of the Firetrace detection tubing using the instructions outlined in Section 4.4.2.

NOTE: End of line Adapters are not designed to provide a lasting seal without the use of auxiliary accessories.

4.4.3.1 Pressure Gauge

Verify that the threaded connection of the pressure gauge contains a lubricated O-ring. The pressure gauge is then installed into the inner threads of the end of line adapter. Hand tighten until the O-ring is completely inside.

NOTE: The pressure gauge must be installed with its included O-ring to ensure a proper seal.

4.4.3.2 Pressure Switch

Verify that the threaded connection of the pressure switch contains a lubricated O-ring. Insert the pressure switch washer into the inner threads of the end of line adapter. Install the pressure switch into the inner threads of the end of line adapter. Hand tighten until an audible “click” can be heard.

NOTE: The pressure switch washer must be installed into the inner threads of the end of line adapter. Without properly installing the pressure switch washer, the pressure switch will not be active.

NOTE: The pressure switch must be installed with its included O-ring to ensure a proper seal.

4.4.3.3 Plug

Verify that that threaded connection of the plug contains a lubricated O-ring. Install the plug into the inner threads of the end of line adapter. Hand tighten until the O-ring is completely inside.

NOTE: The plug must be installed with its included O-ring to ensure a proper seal.



Section 5: Operation

5.1 System Activation

WARNING

Ensure the ball valve, located on the top of the cylinder valve, is maintained in the “OFF” position.

The steps below should be followed to ensure proper system activation of the Firetrace Novec 1230 ILP Unit:

1. Install the detection tubing throughout the enclosure. Ensure all necessary fittings and accessories are installed in accordance with the procedures specified in Section 4.
2. With the unit ball valve in the closed position, thread the tube fitting into the ball valve attached to the top of the cylinder valve.
3. Install one end of the Firetrace detection tubing into the fitting in accordance with the procedures specified in Section 4.
4. Ensure the end of line adapter is installed in the opposite end of the detection tubing. Verify no accessories are installed in the end of line adapter.
5. Attach the filling adapter into the end of line adapter.
6. Attach a regulated nitrogen supply onto the filling adapter.
7. Pressurize the detection tubing to 195 psig [13.4 bar].
8. Remove the nitrogen supply and filling adapter from the end of line adapter.
9. Thread the pressure gauge into the end of line adapter and verify that the tubing is pressurized to at least 195 psig at 70 °F [13.4 bar at 21.1 °C]. (Pressure may have to be adjusted for temperatures higher or lower than 70 °F [21.1 °C]).
10. With the gauge still installed in the end of line adapter, test for leakage:
 - a) Apply a soapy water solution to the cylinder valve connection, end of line adapter connection, and the pressure gauge connection.
 - b) Observe for bubble leaks.
 - c) After approximately 30 minutes, verify the pressure gauge reading. Any decrease in pressure is an indication of a leak.
 - d) If the system is determined to contain a leak, refer to Section 4: Installation and verify that installation procedures were properly followed for all fittings and accessories.
11. If the end of line pressure switch is to be installed, remove the pressure gauge from the end of line adapter and install the end of line pressure switch in accordance with the procedures specified in Section 4.
12. After confirming that there is no leakage within the detection tubing, SLOWLY rotate the ball valve lever counter clockwise, to the “ON” position.
13. Tamperproof the Firetrace Novec 1230 ILP Unit by removing the ball valve lever face and securing the ball valve lever in the “ON” position with the tamperproof device.
14. If a pressure switch is installed on the valve or on the end of line adapter, ensure the proper electrical connections are made, in accordance with NFPA 70 National Electric Code, NFPA 72 National Fire Alarm and Signaling Code, and any other applicable codes and regulations that may apply.
15. The Firetrace Pre-Engineered Novec 1230 ILP Automatic Suppression Unit is now ready for use.

NOTE: All detection devices and auxiliary alarm and control devices must be electrically compatible with each other. They must be approved by the authority having jurisdiction.

WARNING

Only open the ball valve AFTER the tubing has been pressurized. Opening the ball valve without pressurizing the tubing may cause actuation of the unit, resulting in system discharge.

WARNING

Ball valve must SLOWLY be opened. Opening the ball valve abruptly, may cause actuation of the unit, resulting in system discharge.

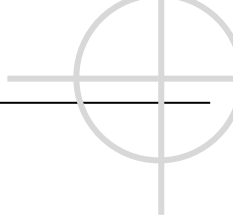

Section 6: Maintenance

6.1 General

Firetrace Pre-Engineered Novec 1230 ILP Automatic Suppression Units must be handled, installed, inspected, and serviced only by qualified and trained personnel in accordance with the instructions contained in this manual, cylinder nameplates, NFPA 2001, FM 5600, and any other codes and regulations that may apply.

A regular program of systematic maintenance must be established for continuous, proper operation of all Firetrace Novec 1230 ILP units. A periodic maintenance schedule must be followed and an inspection log maintained. At a minimum, the log must record: (1) inspection interval, (2) inspection procedure performed, (3) maintenance performed, if any, as a result of inspection, and (4) name of inspector performing task.

For any deficiencies that are found, appropriate corrective actions shall be taken immediately.

NOTE: Any maintenance requiring depressurization, filling, or pressurization shall only be performed at an authorized Firetrace service location. Service at any other location will void any warranty. Please contact Firetrace directly for a list of authorized Firetrace service locations.

WARNING

Pressurized (charged) cylinders are extremely hazardous and if not handled properly are capable of causing property damage, bodily injury, or death. Always wear safety glasses and ensure the discharge port plugs are properly installed before installing, servicing, or other general handling of ILP Units.

6.2 Maintenance Schedule

6.2.1 Monthly

The following are to be performed on a monthly basis by the owner or designated personnel:

1. Verify the Firetrace Novec 1230 ILP Unit is in its proper location.
2. Verify the tamperproof device is intact.
3. Confirm the maintenance tag or certificate is in its proper location.
4. Verify that the Firetrace Novec 1230 ILP Unit shows no physical damage or degradation that might prevent operation.
5. Verify the pressure gauge is in the operable range.
6. Verify nozzle blow off caps (if used) are intact and undamaged.
7. Verify the protected equipment and hazard has not been replaced, modified, or relocated.
8. If a pressure switch is installed:
 - a) Check connection for any leakage.
 - b) Verify the proper electrical connections are made.

NOTE: All electrical connections are to be in accordance with NFPA 70 National Electric Code and NFPA 72 National Fire Alarm and Signaling Code, and any other applicable codes and regulations.

NOTE: This system consists of components tested within limitations contained in this manual. The designer of this system must be consulted prior to any planned changes to either the system or the area being protected. An authorized Firetrace distributor must be consulted after the system has discharged.

NOTE: Firetrace recommends replacement of the tubing at various intervals, depending on the application and exposure.

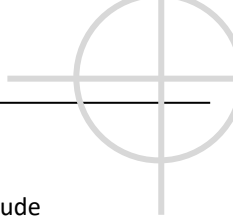

6.2.2 Semi-Annual

The semi-annual maintenance is to be performed by an authorized Firetrace distributor. Maintenance should include a repetition of the monthly maintenance as well as verification of the Firetrace Novec 1230 ILP Unit weight. The Firetrace Novec 1230 ILP unit weight should be verified using the following steps:

1. Remove the tamperproof device from the ball valve lever.
2. Rotate the ball valve lever clockwise, to the “OFF” position.
3. Depressurize the Firetrace detection tubing:
 - a) Remove accessory installed into the end of line adapter.
 - b) Attach the filling adapter into the end of line adapter.
4. Remove the Firetrace detection tubing from the tube fitting attached to the top of the cylinder valve.
5. Remove the discharge piping from the discharge outlet ports.
6. Install the discharge outlet port plugs into both discharge outlet ports.
7. Remove the cylinder from the cylinder mounting bracket.
8. Weigh the Firetrace Novec 1230 ILP Unit.
 - a) Compare the measured weight with the weight specified on the cylinder labels. If the Firetrace Novec 1230 ILP Unit shows a loss in agent quantity of more than 5 percent, the unit shall be refilled or replaced.
9. Verify pressure reading on the pressure gauge installed to the Firetrace Novec 1230 ILP Unit.
 - a) If the Firetrace Novec 1230 ILP Unit shows a pressure loss (adjusted for temperature) of more than 10 percent, the unit shall be refilled or replaced.
 - b) Reinstall the Firetrace Novec 1230 ILP Unit and pressurize the detection tubing, see Section 4 and Section 5 for instructions.

NOTE: This system consists of components tested within limitations contained in this manual. The designer of this system must be consulted prior to any planned changes to either the system or the area being protected. An authorized Firetrace distributor must be consulted after the system has discharged.

NOTE: Any maintenance requiring depressurization, filling, or pressurization shall only be performed at an authorized Firetrace service location. Service at any other location will void any warranty. Please contact Firetrace directly for a list of authorized Firetrace service locations.

WARNING

Only depressurize tubing **AFTER** the ball valve has been closed. Depressurizing the tubing without closing the ball valve may cause actuation of the unit, resulting in system discharge.

WARNING

Only open the ball valve **AFTER** the tubing has been pressurized. Opening the ball valve without pressurizing the tubing may cause actuation of the unit, resulting in system discharge.

WARNING

Ball valve must **SLOWLY** be opened. Opening the ball valve abruptly, may cause actuation of the unit, resulting in system discharge.

WARNING

Pressurized (charged) cylinders are extremely hazardous and if not handled properly are capable of causing property damage, bodily injury, or death. Always wear safety glasses and ensure the discharge port plugs are properly installed before installing, servicing, or other general handling of ILP Units.

6.2.3 Five-Year

The five-year maintenance is to be performed by an authorized Firetrace distributor. Maintenance should include a repetition of the monthly and semi-annual maintenance, a complete external visual inspection of the cylinder, per the guidelines detailed in Section 7 of NFPA 2001, and evaluation of the Firetrace detection tubing for damage and pliability.

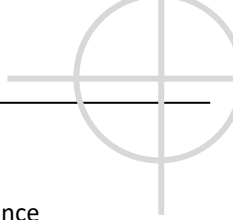

6.3 Firetrace Detection Tubing Maintenance

Firetrace detection tubing maintenance is to be performed by an authorized Firetrace distributor. Maintenance should include a complete external visual inspection of the tubing during every monthly inspection. The tubing shall show no signs of physical damage or degradation, including but not limited to abrasion, distortion, cuts, dirt accumulation. For any deficiencies that are found, appropriate corrective actions shall be taken immediately.

In addition to a monthly visual inspection, a five-year inspection is to be performed to evaluate the tubing for damage and pliability. If any concerns are noted, replacement of the Firetrace detection tubing would be recommended.

After 10 years of continuous use, the Firetrace detection tubing should be replaced in its entirety. However, if all routine maintenance is followed and inspection of the tubing determines the tubing to be in good condition and does not show signs of damage or degradation, the tubing can remain in service.

NOTE: If a fire situation is experienced, any sections of tubing that have ruptured or have been damaged during a fire must be replaced. Sections can be replaced by splice connections.

6.4 Cylinder Maintenance

Firetrace Pre-Engineered Novec 1230 ILP Automatic Suppression Units are assembled with cylinders manufactured to DOT-4B specifications, and therefore fall under DOT regulations for retest, prior to any refilling procedures.

Under DOT regulations, cylinders manufactured to DOT-4B specifications are required to be hydrostatically tested and stamped prior to recharge and shipment, if the last hydrostatic test date has expired.

Cylinders requiring hydrostatic testing must be tested in accordance with 49 CFR 173.34. The periodic hydrostatic test must be performed by an authorized tester, having a current identification number issued by the Associated Administrator for Hazardous Material Safety of DOT. The periodic hydrostatic test must also include an internal and external examination, in accordance with CGA pamphlet C-6, C-6.1, C-6.2, and C-6.3, as applicable. The periodic hydrostatic test procedures also require measurement of the volumetric expansion of the container. As a result, only the water jacket volumetric expansion method or the direct expansion method are acceptable.

As an alternate to the periodic hydrostatic test, cylinders may be given a complete external visual inspection, in accordance with 49 CFR 173.34(e)(13). The visual inspection shall be made only by competent persons. A person who performs the visual examination specified in 49 CFR 173.34(e)(13) is not required to have an identification number issued by the Associated Administrator for Hazardous Material Safety of DOT.

Table 42 – Cylinder Maintenance below outlines the testing that can be performed to meet DOT regulations.

Table 42 – Cylinder Maintenance

Test Method	First Test Due	Subsequent Test Due	Special Marking
Full hydrostatic test. Including determination of cylinder expansion	5 years	5 years	Test Date Month/Year
External visual inspection per 49 CFR 173.34(e)(13) AND CGA pamphlet C-6, Section 3.	5 years	5 years	Test date Month/Year followed by "E"



Section 7: Recharge

7.1 General

Firetrace Pre-Engineered Novec 1230 ILP Automatic Suppression Units must be handled, installed, inspected, and serviced only by qualified and trained personnel in accordance with the instructions contained in this manual, cylinder nameplates, NFPA 2001, FM 5600, and any other codes and regulations that may apply.

NOTE: Any maintenance requiring depressurization, filling, or pressurization shall only be performed at an authorized Firetrace service location. Service at any other location will void any warranty. Please contact Firetrace directly for a list of authorized Firetrace service locations.

WARNING

Pressurized (charged) cylinders are extremely hazardous and if not handled properly are capable of causing property damage, bodily injury, or death. Always wear safety glasses and ensure the discharge port plugs are properly installed before installing, servicing, or other general handling of ILP Units.

7.2 Recharge

The steps below should be followed to ensure proper recharge of an empty Firetrace Novec 1230 ILP Unit:

1. Fill the cylinder with the appropriate amount of agent. Refer to Table 4, for correct agent amount.
2. Clean the threads of the cylinder with a small brush or dry cloth.
3. Thread the siphon tube into the bottom of the valve.
4. Insert bottom end of siphon tube into the cylinder, and thread the valve into the cylinder.
5. With the discharge port plugs in place, use the ball valve attached to the top of the valve to pressurize the Firetrace Novec 1230 ILP Unit to 195 psig at 70 °F [13.4 bar at 21.1 °C].
6. Shake the system thoroughly to ensure the nitrogen is absorbed by the Novec 1230.
7. Close the ball valve and leak test the Firetrace Novec 1230 ILP Unit. If a leak detector is unavailable, a 48-hour holding period should be used to evaluate whether there is a leak.
8. The Firetrace Novec 1230 ILP Unit is now ready to be transported to the installation site.

NOTE: Any maintenance requiring depressurization, filling, or pressurization shall only be performed at an authorized Firetrace service location. Service at any other location will void any warranty. Please contact Firetrace directly for a list of authorized Firetrace service locations.

WARNING

Only depressurize tubing **AFTER** the ball valve has been closed. Depressurizing the tubing without closing the ball valve may cause actuation of the unit, resulting in system discharge.

WARNING

Ball valve must **SLOWLY** be opened. Opening the ball valve abruptly, may cause actuation of the unit, resulting in system discharge.

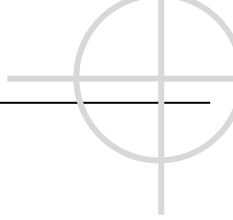

Section 8: Post Discharge

8.1 Ventilation

Before inspecting the enclosure after a Firetrace Novec 1230 ILP Unit discharge, ventilate the enclosure thoroughly. Ventilation paths should be examined to prevent exposure to high concentrations of agent. Additionally, the proper safety equipment shall be utilized to prevent unnecessary exposure.

Novec 1230 does not leave a residue, thus, there are no clean-up operations resulting from Firetrace Novec 1230 ILP Unit discharge.

8.2 Remove from Service

An authorized Firetrace distributor must be consulted after a system has discharged. The Firetrace Novec 1230 ILP Unit must be removed and recharged. The Firetrace Novec 1230 ILP unit should be removed using the following steps:

1. Remove the Firetrace detection tubing from the tube fitting attached to the top of the cylinder valve.
2. Remove the discharge piping from the discharge outlet ports.
3. Install the discharge outlet port plugs into both discharge outlet ports.
4. Remove the cylinder from the cylinder mounting bracket.
5. Have Firetrace Novec 1230 ILP Unit recharged by a qualified Firetrace service location.

NOTE: Any maintenance requiring depressurization, filling, or pressurization shall only be performed at an authorized Firetrace service location. Service at any other location will void any warranty. Please contact Firetrace directly for a list of authorized Firetrace service locations.

8.3 Recharge

For Firetrace Pre-Engineered Novec 1230 ILP Automatic Suppression Unit recharge instructions, refer to Section 7.

8.4 Return to Service

Please follow guidelines provided in Section 4 and Section 5 for returning a system to service.

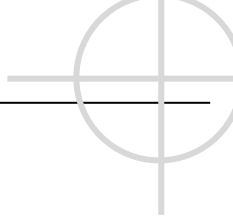

Appendix A – Parts List

Firetrace Novec 1230 ILP Automatic Suppression Unit Assemblies

Table 43 – Firetrace Novec 1230 ILP Units

Part Number	Description
940205	Small Novec 1230 ILP Suppression Unit (2.5 lb)
940505	Medium Novec 1230 ILP Suppression Unit (5 lb)
941005	Large Novec 1230 ILP Suppression Unit (10 lb)

Heavy Duty Brackets

Table 44 – Heavy Duty Brackets

Part Number	Description
111404	Small Heavy Duty Bracket
111403	Medium Heavy Duty Bracket
111402	Large Heavy Duty Bracket

Discharge Network

Table 45 – Small ILP Discharge Network Copper Fittings

Part Number	Description
200143	Copper Compression Fitting, Valve/Nozzle to 5/16 in Pipe
200101	Copper Compression Fitting, 5/16 in Pipe Bulkhead
200111	Copper Compression Fitting, 5/16 in Pipe Elbow
200121	Copper Compression Fitting, 5/16 in Pipe Tee

Table 46 – Medium/Large ILP Discharge Network Copper Fittings

Part Number	Description
200144	Copper Compression Fitting, Valve/Nozzle to 1/2 in Pipe
200145	Copper Compression Fitting, 1/2 in Pipe Bulkhead
200112	Copper Compression Fitting, 1/2 in Pipe Elbow
200122	Copper Compression Fitting, 1/2 in Pipe Tee

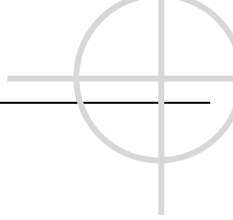

Table 47 – Small ILP Discharge Network Flexible Hoses

Part Number	Description
202816 ^{**}	3/8 in Flexible Hose, 1 ft
201816 ^{**}	3/8 in Flexible Hose, 2 ft
201817 ^{**}	3/8 in Flexible Hose, 3 ft
201818 ^{**}	3/8 in Flexible Hose, 4 ft
201819 ^{**}	3/8 in Flexible Hose, 7 ft

Table 48 – Medium/Large ILP Discharge Network Flexible Hoses

Part Number	Description
202820 ^{**}	1/2 in Flexible Hose, 1 ft
201820 ^{**}	1/2 in Flexible Hose, 2 ft
201821 ^{**}	1/2 in Flexible Hose, 4 ft
201822 ^{**}	1/2 in Flexible Hose, 6 ft
201823 ^{**}	1/2 in Flexible Hose, 8 ft
201824 ^{**}	1/2 in Flexible Hose, 10 ft

Table 49 – Small ILP Discharge Network Flexible Hose Fittings

Part Number	Description
850016 ^{**}	Fitting, 3/8 in Hose to Valve Union
850017 ^{**}	Fitting, 3/8 in Hose Union
850018 ^{**}	Fitting, 3/8 in Hose Elbow
850019 ^{**}	Fitting, 3/8 in Hose Tee
850020 ^{**}	Fitting, 3/8 in Hose to Nozzle Union Bulkhead
850021 ^{**}	Fitting, 3/8 in Hose to Nozzle Elbow Bulkhead

Table 50 – Medium/Large ILP Discharge Network Flexible Hose Fittings

Part Number	Description
850022 ^{**}	Fitting, 1/2 in Hose to Valve Union
850023 ^{**}	Fitting, 1/2 in Hose Union
850024 ^{**}	Fitting, 1/2 in Hose Elbow
850025 ^{**}	Fitting, 1/2 in Hose Tee
850026 ^{**}	Fitting, 1/2 in Hose to Nozzle Union Bulkhead
850027 ^{**}	Fitting, 1/2 in Hose to Nozzle Elbow Bulkhead

^{**} Not part of an FM Approved System

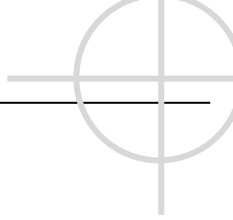

Table 51 – Nozzles

Part Number	Description
500015	Small Clean Agent Nozzle, G1/4
500017	Medium Clean Agent Nozzle, 1/2 NPT
510017 ^{§§}	Small Nozzle Cap
510018 ^{§§}	Medium Nozzle Cap
510019 ^{§§}	Medium Blow-Off Cap

Detection Network

Table 52 – Firetrace Detection Tubing

Part Number	Description
200005	Firetrace Detection Tubing, 4/6 mm, 1 ft
204025	Firetrace Detection Tubing, 4/6 mm, 25
204050	Firetrace Detection Tubing, 4/6 mm, 50 ft
204100	Firetrace Detection Tubing, 4/6 mm, 100 ft
204328	Firetrace Detection Tubing, 4/6 mm, 328 ft

Table 53 – Tube Fittings

Part Number	Description
200157	Fitting, Tube Tee, 4/6 mm
200158	Fitting, Tube Union, 4/6 mm
200159	Fitting, Tube to Threads Elbow, 4/6 mm
200177	Fitting, Tube Tee to Threads, 4/6 mm
200178	Fitting, Tube Elbow, 4/6 mm
200179	Fitting, Tube to Threads Union, 4/6 mm
200203 ^{§§}	Fitting, Tube Plug, 4/6 mm
200169	In Line Adapter w/ Tube Tee, 4/6 mm

^{§§} Not part of an FM Approved System

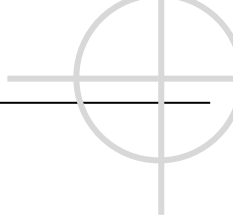

Table 54 – End of Line Accessories

Part Number	Description
200168	End of Line Adapter w/ Tube Union, 4/6 mm
400028	Pressure Gauge w/ O-Ring, 195 psig
310303	End of Line Adapter Plug
400004	End of Line Pressure Switch
600064***	Manual Release w/ 195 psig Gauge and Tube Union, 4/6 mm
601014	2 nd Gen Manual Release w/ 195 psig Gauge and Tube Union, 4/6 mm

Miscellaneous

Table 55 – Installation Accessories

Part Number	Description
200150	Rubber Grommets for Detection Tubing (Qty. 2)
200151	Plastic Grommets for Detection Tubing (Qty. 2)
200171	Mounting tabs for Detection Tubing, 4/6 mm (Qty. 12)
201006***	Magnetic Mounting Clips for Detection Tubing, 4/6 mm (Qty. 6)
201133***	Heavy Duty Mounting Clips for Detection Tubing (Qty. 6)
600213***	Detection Tubing Charge Kit
600210***	Tube Cutter
201132***	Tamperproof Device, "ON" position
201137***	Tamperproof Device, "OFF" position
120305***	Accessory Mounting Brackets

Table 56 – Auxiliary Accessories

Part Number	Description
400001	Valve Mounted Pressure Switch
400441***	Pressure Switch Assembly Box
400312***	12 VDC Electric Solenoid Assembly
400324***	24 VDC Electric Solenoid Assembly
400316***	120 VAC Electric Solenoid Assembly
400327***	240 VAC Electric Solenoid Assembly
600096***	Black Audible Alarm, Battery Operated (requires pressure switch)

*** Not part of an FM Approved System

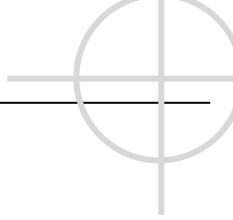
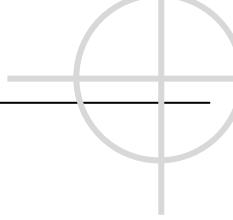

Table 57 – Indication and Activation Kits

Part Number	Description
600410-12 ⁺⁺⁺	12 VDC Indication Kit, 195 psig, Bottom Cable
600420-12 ⁺⁺⁺	12 VDC Indication and Activation Kit, 195 psig, Bottom Cable
600408-12 ⁺⁺⁺	12 VDC Indication Kit, 195 psig, Rear Cable
600409-12 ⁺⁺⁺	12 VDC Indication and Activation Kit, 195 psig, Rear Cable
600410-24 ⁺⁺⁺	24 VDC Indication Kit, 195 psig, Bottom Cable
600420-24 ⁺⁺⁺	24 VDC Indication and Activation Kit, 195 psig, Bottom Cable
600408-24 ⁺⁺⁺	24 VDC Indication Kit, 195 psig, Rear Cable

⁺⁺⁺ Not part of an FM Approved System.



Appendix B – System Commissioning Form

<h1 style="margin: 0;">FIRETRACE[®]</h1> <p style="margin: 0;">POWER TO INNOVATE. FLEXIBILITY TO ADAPT. 8435 N. 90th Street, Suite 2, Scottsdale, AZ 85258 USA · +1.480.607.1218 · +1.480.315.1316 · www.firetrace.com</p>			
Firetrace Pre-Engineered Novec 1230 ILP Automatic Suppression Unit			
System Commissioning Form			
System Serial Number:		Installation Date:	
Installed by:		Company:	
Description		Performed by	Date
Mounting Bracket installed using two or more mounting holes.			
Cylinder positioned in mounting bracket with the pressure gauge facing out.			
Cylinder secured in place using bracket straps or band clamps.			
Nozzle(s) secured in optimal location.			
Nozzle(s) within limitations outlined in Section 3 of DIOM manual.			
Necessary Discharge port plug(s) removed and adapters installed.			
Discharge piping installed between discharge port(s) and nozzle(s).			
Discharge piping secured in place.			
Discharge piping is within limitations outlined in Section 3 of DIOM manual.			
Tubing and fittings installed and secured throughout the protected enclosure.			
Tube fitting threaded into ball valve attached to the top of the cylinder valve.			
Detection tubing inserted into tube fitting.			
Detection network is within limitations outlined in section 3 of DIOM manual.			
Detection network pressurized to 195 psig.			
Pressure gauge or equivalent installed into end of line adapter.			
Leak check conducted on detection network.			
Ball valve on top of cylinder valve rotated to "ON" position.			
Tamperproof device installed on ball valve lever.			
Electrical connections properly made in accordance with NFPA 70 and NFPA 72.			

Appendix C – SDS

3M™ Novec™ 1230 Fire Protection Fluid 06/06/16



Safety Data Sheet

Copyright, 2016, 3M Company.

All rights reserved. Copying and/or downloading of this information for the purpose of properly utilizing 3M products is allowed provided that: (1) the information is copied in full with no changes unless prior written agreement is obtained from 3M, and (2) neither the copy nor the original is resold or otherwise distributed with the intention of earning a profit thereon.

Document Group:	16-3425-2	Version Number:	28.03
Issue Date:	06/06/16	Supersedes Date:	11/02/15

SECTION 1: Identification

1.1. Product identifier

3M™ Novec™ 1230 Fire Protection Fluid

Product Identification Numbers

ID Number	UPC	ID Number	UPC
98-0212-3203-2		98-0212-3217-2	0 00 51135 71645 8
98-0212-3414-5			

1.2. Recommended use and restrictions on use

Recommended use

Streaming and Flooding Fire Protection

1.3. Supplier's details

MANUFACTURER:	3M
DIVISION:	Electronics Materials Solutions Division
ADDRESS:	3M Center, St. Paul, MN 55144-1000, USA
Telephone:	1-888-3M HELPS (1-888-364-3577)

1.4. Emergency telephone number

1-800-364-3577 or (651) 737-6501 (24 hours)

SECTION 2: Hazard identification

2.1. Hazard classification

Not classified as hazardous according to OSHA Hazard Communication Standard, 29 CFR 1910.1200.

2.2. Label elements

Signal word

Not applicable.

Symbols

Not applicable.

Pictograms

Not applicable.

2.3. Hazards not otherwise classified
None.

SECTION 3: Composition/information on ingredients

Ingredient	C.A.S. No.	% by Wt
1,1,1,2,2,4,5,5,5-Nonafluoro-4-(trifluoromethyl)-3-pentanone	756-13-8	> 99.5

SECTION 4: First aid measures

4.1. Description of first aid measures

Inhalation:

Remove person to fresh air. If you are concerned, get medical advice.

Skin Contact:

Wash with soap and water. If signs/symptoms develop, get medical attention.

Eye Contact:

Flush with large amounts of water. Remove contact lenses if easy to do. Continue rinsing. If signs/symptoms persist, get medical attention.

If Swallowed:

Rinse mouth. If you feel unwell, get medical attention.

4.2. Most important symptoms and effects, both acute and delayed

See Section 11.1. Information on toxicological effects.

4.3. Indication of any immediate medical attention and special treatment required

Not applicable

SECTION 5: Fire-fighting measures

5.1. Suitable extinguishing media

Product is a fire-extinguishing agent. Material will not burn. Use a fire fighting agent suitable for the surrounding fire.

5.2. Special hazards arising from the substance or mixture

Exposure to extreme heat can give rise to thermal decomposition.

Hazardous Decomposition or By-Products

<u>Substance</u>	<u>Condition</u>
Carbon monoxide	During Combustion
Carbon dioxide	During Combustion
Toxic Vapor/Gas	During Combustion

5.3. Special protective actions for fire-fighters

When fire fighting conditions are severe and total thermal decomposition of the product is possible, wear full protective clothing, including helmet, self-contained, positive pressure or pressure demand breathing apparatus, bunker coat and pants, bands around arms, waist and legs, face mask, and protective covering for exposed areas of the head.

SECTION 6: Accidental release measures

6.1. Personal precautions, protective equipment and emergency procedures

Evacuate area. Ventilate the area with fresh air. For large spill, or spills in confined spaces, provide mechanical ventilation to disperse or exhaust vapors, in accordance with good industrial hygiene practice. Refer to other sections of this SDS for information regarding physical and health hazards, respiratory protection, ventilation, and personal protective equipment.

6.2. Environmental precautions

Avoid release to the environment. For larger spills, cover drains and build dikes to prevent entry into sewer systems or bodies of water.

6.3. Methods and material for containment and cleaning up

Contain spill. Working from around the edges of the spill inward, cover with bentonite, vermiculite, or commercially available inorganic absorbent material. Mix in sufficient absorbent until it appears dry. Remember, adding an absorbent material does not remove a physical, health, or environmental hazard. Collect as much of the spilled material as possible. Place in a closed container approved for transportation by appropriate authorities. Seal the container. Dispose of collected material as soon as possible.

SECTION 7: Handling and storage**7.1. Precautions for safe handling**

Contents may be under pressure, open carefully. Do not breathe thermal decomposition products. For industrial or professional use only. Do not use in a confined area with minimal air exchange. Do not eat, drink or smoke when using this product. Wash thoroughly after handling. Avoid release to the environment.

7.2. Conditions for safe storage including any incompatibilities

Protect from sunlight. Store in a well-ventilated place. Store at temperatures not exceeding 38C/100F Store away from strong bases. Store away from other materials. Store away from amines.

SECTION 8: Exposure controls/personal protection**8.1. Control parameters****Occupational exposure limits**

If a component is disclosed in section 3 but does not appear in the table below, an occupational exposure limit is not available for the component.

Ingredient	C.A.S. No.	Agency	Limit type	Additional Comments
1,1,1,2,2,4,5,5Nonfluoro-4-(trifluoromethyl)-3-pentanone	756-13-8	Manufacturer determined	TWA:150 ppm(1940 mg/m3)	

ACGIH : American Conference of Governmental Industrial Hygienists

AIHA : American Industrial Hygiene Association

CMRG : Chemical Manufacturer's Recommended Guidelines

OSHA : United States Department of Labor - Occupational Safety and Health Administration

TWA: Time-Weighted-Average

STEL: Short Term Exposure Limit

CEIL: Ceiling

8.2. Exposure controls**8.2.1. Engineering controls**

Provide appropriate local exhaust when product is heated. For those situations where the material might be exposed to extreme overheating due to misuse or equipment failure, use with appropriate local exhaust ventilation sufficient to maintain levels of thermal decomposition products below their exposure guidelines. Use general dilution ventilation and/or local exhaust ventilation to control airborne exposures to below relevant Exposure Limits and/or control dust/fume/gas/mist/vapors/spray. If ventilation is not adequate, use respiratory protection equipment.

8.2.2. Personal protective equipment (PPE)

Eye/face protection

Eye protection not required.

Skin/hand protection

No protective gloves required.

Respiratory protection

Use a positive pressure supplied-air respirator if there is a potential for over exposure from an uncontrolled release, exposure levels are not known, or under any other circumstances where air-purifying respirators may not provide adequate protection. If thermal degradation products are expected, use a full facepiece supplied-air respirator.

SECTION 9: Physical and chemical properties**9.1. Information on basic physical and chemical properties**

General Physical Form:	Liquid
Specific Physical Form:	Liquid
Odor, Color, Grade:	Clear colorless liquid with low odor
Odor threshold	<i>No Data Available</i>
pH	<i>Not Applicable</i>
Melting point	-108 °C
Boiling Point	49 °C [@ 760 mmHg]
Flash Point	No flash point
Evaporation rate	> 1 [<i>Ref Std:</i> BUOAC=1]
Flammability (solid, gas)	Not Applicable
Flammable Limits(LEL)	None detected
Flammable Limits(UEL)	None detected
Vapor Pressure	40.4 kPa [@ 25 °C]
Vapor Density	11.6 [<i>Ref Std:</i> AIR=1]
Specific Gravity	1.6 [@ 68 °F] [<i>Ref Std:</i> WATER=1]
Solubility in Water	Nil
Solubility- non-water	<i>No Data Available</i>
Partition coefficient: n-octanol/ water	<i>No Data Available</i>
Autoignition temperature	<i>Not Applicable</i>
Decomposition temperature	<i>No Data Available</i>
Viscosity	0.6 centipoise [@ 25 °C]
Molecular weight	<i>No Data Available</i>
Volatile Organic Compounds	1600 g/l [<i>Test Method:</i> calculated SCAQMD rule 443.1]
Percent volatile	100 %
VOC Less H2O & Exempt Solvents	1600 g/l [<i>Test Method:</i> calculated SCAQMD rule 443.1]

SECTION 10: Stability and reactivity**10.1. Reactivity**

This material may be reactive with certain agents under certain conditions - see the remaining headings in this section.

10.2. Chemical stability

Stable.

10.3. Possibility of hazardous reactions

Hazardous polymerization will not occur.

10.4. Conditions to avoid

Light

10.5. Incompatible materials

Strong bases

Amines

Alcohols

10.6. Hazardous decomposition products**Substance**

Hydrogen Fluoride

Condition

At Elevated Temperatures - extreme conditions of heat

Refer to section 5.2 for hazardous decomposition products during combustion.

If the product is exposed to extreme condition of heat from misuse or equipment failure, toxic decomposition products that include hydrogen fluoride and perfluoroisobutylene can occur. Extreme heat arising from situations such as misuse or equipment failure can generate hydrogen fluoride as a decomposition product.

SECTION 11: Toxicological information

The information below may not be consistent with the material classification in Section 2 if specific ingredient classifications are mandated by a competent authority. In addition, toxicological data on ingredients may not be reflected in the material classification and/or the signs and symptoms of exposure, because an ingredient may be present below the threshold for labeling, an ingredient may not be available for exposure, or the data may not be relevant to the material as a whole.

11.1. Information on Toxicological effects**Signs and Symptoms of Exposure**

Based on test data and/or information on the components, this material may produce the following health effects:

Inhalation:

No known health effects.

Skin Contact:

Contact with the skin during product use is not expected to result in significant irritation.

Eye Contact:

Contact with the eyes during product use is not expected to result in significant irritation.

Ingestion:

May be harmful if swallowed.

Toxicological Data

If a component is disclosed in section 3 but does not appear in a table below, either no data are available for that endpoint or the data are not sufficient for classification.

Acute Toxicity

Name	Route	Species	Value
1,1,1,2,2,4,5,5,5-Nonafluoro-4-(trifluoromethyl)-3-pentanone	Dermal	Rat	LD50 > 2,000 mg/kg
1,1,1,2,2,4,5,5,5-Nonafluoro-4-(trifluoromethyl)-3-pentanone	Inhalation-Vapor (4 hours)	Rat	LC50 > 1,227 mg/l

1,1,1,2,2,4,5,5-Nonafluoro-4-(trifluoromethyl)-3-pentanone	Ingestion	Rat	LD50 > 2,000 mg/kg
--	-----------	-----	--------------------

ATE = acute toxicity estimate

Skin Corrosion/Irritation

Name	Species	Value
1,1,1,2,2,4,5,5-Nonafluoro-4-(trifluoromethyl)-3-pentanone	Rabbit	No significant irritation

Serious Eye Damage/Irritation

Name	Species	Value
1,1,1,2,2,4,5,5-Nonafluoro-4-(trifluoromethyl)-3-pentanone	Rabbit	No significant irritation

Skin Sensitization

Name	Species	Value
1,1,1,2,2,4,5,5-Nonafluoro-4-(trifluoromethyl)-3-pentanone	Guinea pig	Not sensitizing

Respiratory Sensitization

For the component/components, either no data are currently available or the data are not sufficient for classification.

Germ Cell Mutagenicity

Name	Route	Value
1,1,1,2,2,4,5,5-Nonafluoro-4-(trifluoromethyl)-3-pentanone	In Vitro	Not mutagenic
1,1,1,2,2,4,5,5-Nonafluoro-4-(trifluoromethyl)-3-pentanone	In vivo	Not mutagenic

Carcinogenicity

For the component/components, either no data are currently available or the data are not sufficient for classification.

Reproductive Toxicity

Reproductive and/or Developmental Effects

Name	Route	Value	Species	Test Result	Exposure Duration
1,1,1,2,2,4,5,5-Nonafluoro-4-(trifluoromethyl)-3-pentanone	Inhalation	Not toxic to female reproduction	Rat	NOAEL 3,000 ppm	pre mating & during gestation
1,1,1,2,2,4,5,5-Nonafluoro-4-(trifluoromethyl)-3-pentanone	Inhalation	Not toxic to male reproduction	Rat	NOAEL 3,000 ppm	pre mating & during gestation
1,1,1,2,2,4,5,5-Nonafluoro-4-(trifluoromethyl)-3-pentanone	Inhalation	Not toxic to development	Rat	NOAEL 3,000 ppm	pre mating & during gestation

Target Organ(s)

Specific Target Organ Toxicity - single exposure

Name	Route	Target Organ(s)	Value	Species	Test Result	Exposure Duration
1,1,1,2,2,4,5,5-Nonafluoro-4-(trifluoromethyl)-3-pentanone	Inhalation	nervous system	All data are negative	Rat	NOAEL 100,000 ppm	2 hours
1,1,1,2,2,4,5,5-Nonafluoro-4-(trifluoromethyl)-3-pentanone	Inhalation	cardiac sensitization	All data are negative	Dog	Sensitization Negative	17 minutes

Specific Target Organ Toxicity - repeated exposure

Name	Route	Target Organ(s)	Value	Species	Test Result	Exposure
------	-------	-----------------	-------	---------	-------------	----------

						Duration
1,1,1,2,2,4,5,5,5-Nonafluoro-4-(trifluoromethyl)-3-pentanone	Inhalation	liver kidney and/or bladder	Some positive data exist, but the data are not sufficient for classification	Rat	NOAEL 3,000 ppm	90 days
1,1,1,2,2,4,5,5,5-Nonafluoro-4-(trifluoromethyl)-3-pentanone	Inhalation	heart endocrine system hematopoietic system muscles nervous system respiratory system vascular system	All data are negative	Rat	NOAEL 3,000 ppm	90 days

Aspiration Hazard

For the component/components, either no data are currently available or the data are not sufficient for classification.

Please contact the address or phone number listed on the first page of the SDS for additional toxicological information on this material and/or its components.

SECTION 12: Ecological information**Ecotoxicological information**

<u>Test Organism</u>	<u>Test Type</u>	<u>Result</u>
Green algae, Selenastrum capricornutum	72 hours Effect Concentration 50%	7.7 mg/l
Zebra Fish, Brachydanio rerio	96 hours Lethal Concentration 50%	>1200 mg/l
Water flea, Daphnia magna	48 hours Effect Concentration 50%	>1200 mg/l
Green algae, Selenastrum capricornutum	72 hours No obs Effect Conc	1.2 mg/l

Please contact the address or phone number listed on the first page of the SDS for additional ecotoxicological information on this material and/or its components.

Chemical fate information

Please contact the address or phone number listed on the first page of the SDS for additional chemical fate information on this material and/or its components.

SECTION 13: Disposal considerations**13.1. Disposal methods**

Dispose of contents/ container in accordance with the local/regional/national/international regulations.

Dispose of waste product in a permitted industrial waste facility. As a disposal alternative, incinerate in a permitted waste incineration facility. Proper destruction may require the use of additional fuel during incineration processes. Combustion products will include HF. Facility must be capable of handling halogenated materials.

Empty drums/barrels/containers used for transporting and handling hazardous chemicals (chemical substances/mixtures/preparations classified as Hazardous as per applicable regulations) shall be considered, stored, treated & disposed of as hazardous wastes unless otherwise defined by applicable waste regulations. Consult with the respective regulating authorities to determine the available treatment and disposal facilities.

EPA Hazardous Waste Number (RCRA): Not regulated

SECTION 14: Transport Information

For Transport Information, please visit <http://3M.com/Transportinfo> or call 1-800-364-3577 or 651-737-6501.

SECTION 15: Regulatory information

15.1. US Federal Regulations

Contact 3M for more information.

311/312 Hazard Categories:

Fire Hazard – No Pressure Hazard – No Reactivity Hazard – No Immediate Hazard – No Delayed Hazard - No

15.2. State Regulations

Contact 3M for more information.

15.3. Chemical Inventories

The components of this product are in compliance with the new substance notification requirements of CEPA.

The components of this material are in compliance with the China "Measures on Environmental Management of New Chemical Substance". Certain restrictions may apply. Contact the selling division for additional information.

The components of this material are in compliance with the provisions of the Korean Toxic Chemical Control Law. Certain restrictions may apply. Contact the selling division for additional information.

The components of this material are in compliance with the provisions of Japan Chemical Substance Control Law. Certain restrictions may apply. Contact the selling division for additional information.

The components of this material are in compliance with the provisions of Philippines RA 6969 requirements. Certain restrictions may apply. Contact the selling division for additional information.

The components of this product are in compliance with the chemical notification requirements of TSCA.

Contact 3M for more information.

15.4. International Regulations

Contact 3M for more information.

This SDS has been prepared to meet the U.S. OSHA Hazard Communication Standard, 29 CFR 1910.1200.

SECTION 16: Other information**NFPA Hazard Classification**

Health: 3 Flammability: 0 Instability: 1 Special Hazards: None

National Fire Protection Association (NFPA) hazard ratings are designed for use by emergency response personnel to address the hazards that are presented by short-term, acute exposure to a material under conditions of fire, spill, or similar emergencies. Hazard ratings are primarily based on the inherent physical and toxic properties of the material but also include the toxic properties of combustion or decomposition products that are known to be generated in significant quantities.

HMIS Hazard Classification

Health: 3 Flammability: 0 Physical Hazard: 1 Personal Protection: X - See PPE section.

Hazardous Material Identification System (HMIS® IV) hazard ratings are designed to inform employees of chemical hazards in the workplace. These ratings are based on the inherent properties of the material under expected conditions of normal use and are not intended for use in emergency situations. HMIS® IV ratings are to be used with a fully implemented HMIS® IV program. HMIS® is a registered mark of the American Coatings Association (ACA).

Document Group: 16-3425-2 Version Number: 28.03

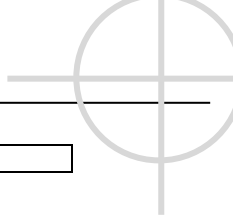
**Issue Date:**

06/06/16

Supersedes Date:

11/02/15

Reason for Reissue

Conversion to GHS format SDS.

DISCLAIMER: The information in this Safety Data Sheet (SDS) is believed to be correct as of the date issued. 3M MAKES NO WARRANTIES, EXPRESSED OR IMPLIED, INCLUDING, BUT NOT LIMITED TO, ANY IMPLIED WARRANTY OF MERCHANTABILITY OR FITNESS FOR A PARTICULAR PURPOSE OR COURSE OF PERFORMANCE OR USAGE OF TRADE. User is responsible for determining whether the 3M product is fit for a particular purpose and suitable for user's method of use or application. Given the variety of factors that can affect the use and application of a 3M product, some of which are uniquely within the user's knowledge and control, it is essential that the user evaluate the 3M product to determine whether it is fit for a particular purpose and suitable for user's method of use or application.

3M provides information in electronic form as a service to its customers. Due to the remote possibility that electronic transfer may have resulted in errors, omissions or alterations in this information, 3M makes no representations as to its completeness or accuracy. In addition, information obtained from a database may not be as current as the information in the SDS available directly from 3M

3M USA SDSs are available at www.3M.com