

GENERAL CATALOG

SUMMARY





Symbols & Nomenclatures

Símbolos y Nomenclaturas



Nomenclatures / Nomenclaturas

C3	Internal clearance greater than normal	Juego radial mayor que el normal
C4	Internal clearance greater than C3	Juego radial mayor que C3
M	Machined brass cage	Jaula de latón
N	Snap ring groove in outer ring	Ranura en aro exterior
NR	Snap ring groove and snap ring in outer ring	Ranura y anillo elástico en aro exterior
P	Polyamide cage	Jaula de poliamida
RS	Rubbing seal on one side	Tapa retén en una cara
2RS	Rubbing seals on both sides	Tapa retén en las dos caras
Z	Shield on one side	Tapa en una cara
ZZ	Shields on both sides	Tapas en las dos caras

Symbols / Símbolos

	New reference	Nueva referencia
	Active ABS	ABS activo
	Passive ABS	ABS pasivo

Abbreviations / Abreviaturas

	Differential	Diferencial
	Gearbox	Caja de Cambios
	Wheel end	Rueda
AC	Air Conditioning	Aire Acondicionado
ALT	Alternator	Alternador
CL	Clutch	Embrague
KP	King Pin	Pivote de mangueta
SB	Satellit Box	Planetario
SM	Suporte mola	Suporte mola
SS	Suspensión	Suspensión
ST	Steering	Dirección
V	Various	Varios

Index

Índice

01 \	Single row tapered roller bearings Rodamientos de rodillos cónicos	6
02 \	Double row tapered roller bearings Rodamientos de rodillos cónicos de doble hilera	54
03 \	Thrust tapered roller bearings Rodamientos axiales cónicos	62
04 \	Deep groove ball bearings Rodamientos radiales de bolas	66
05 \	Angular contact ball bearings Rodamientos de bolas de contacto angular	86
06 \	Thrust ball bearings Rodamientos axiales de bolas	108
07 \	Insert bearings Rodamientos autoalineables	122
08 \	Cylindrical roller bearings Rodamientos de rodillos cilíndricos	126
09 \	Special needle roller bearings Rodamientos de agujas especiales	142
10 \	Wheel end hub units Unidades de buje	152
11 \	F-Box Rebuild Kit Kit de reparación F-Box	176
12 \	Passenger car wheel bearing kits Kits de rueda para turismos	208
13 \	Fersa Accessories Accesorios Fersa	228
14 \	Lists & Cross part number Listados y cruces de referencias	238

GENERAL CATALOG

SUMMARY

OUR NEW CATALOG HAS THE COMPLETE INFORMATION OF OUR CURRENT BEARING PRODUCTS, AS WELL AS OUR NEW PART NUMBERS AND PRODUCT LINES.

CON ESTE NUEVO CATÁLOGO FERSA LES FACILITA UNA COMPLETA INFORMACIÓN SOBRE TODOS LOS RODAMIENTOS QUE ACTUALMENTE TENEMOS EN NUESTRA GAMA INCLUYENDO NUEVAS FAMILIAS Y REFERENCIAS.



Thanks to the efforts of our R&D department, together with our customers' collaboration, we have increased our new part numbers, providing better service to our customers and distributors in the five continents.

You will find a cross part numbers list with the sector's main manufacturers, as well as a list by dimensions, for easier identification, in the catalog's last pages.

Please visit our webpage for the latest updated information

www.fersa.com

We hope this information is of service to you.





Gracias al esfuerzo de nuestro departamento de I+D y a la estrecha colaboración con nuestros clientes hemos conseguido incrementar el número de referencias para dar el mejor servicio posible a nuestros clientes y distribuidores en los cinco continentes.

La parte final contiene un completo listado de cruces de nuestras referencias con los principales fabricantes del mercado, así como un listado dimensional para facilitar su identificación.

Les invitamos a consultar nuestra web:

www.fersa.com

donde encontrarán la información actualizada.

Esperamos que esta información sea de su interés.

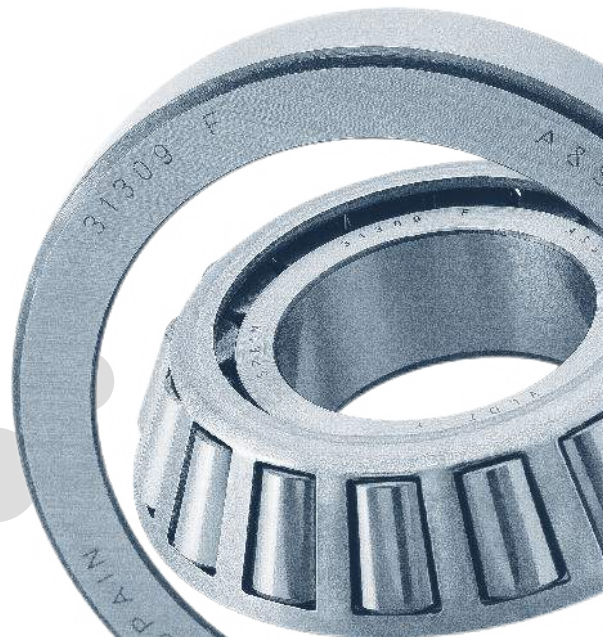

Single row tapered roller bearing

Rodamientos de rodillos cónicos

01.1 \	Metric series / Series métricas	8
01.2 \	Inch series / Series pulgadas	14
01.3 \	Special design bearings / Serie especial	32
01.4 \	Flange side bearings / Rodamientos con valona	44
01.5 \	U type bearings / Rodamientos tipo U	46
01.6 \	Steering bearings / Rodamientos de dirección	48
01.7 \	Interior Sets / Conjuntos interiores	50

01



01.1 \ Metric series Series métricas

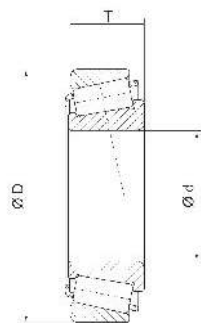

Fersa	d (mm)	D (mm)	T (mm)
302 SERIES			
30202 F	15,000	35,000	11,750
30203 F	17,000	40,000	13,250
30204 F	20,000	47,000	15,250
30205 F	25,000	52,000	16,250
30205 FR	25,000	52,000	16,250
30206 F	30,000	62,000	17,250
30207 F	35,000	72,000	18,250
30207 / 37 F	37,000	72,000	18,250
30207 / 80 F	35,000	80,000	18,250
30208 F	40,000	80,000	19,750
30209 F	45,000	85,000	20,750
30210 F	50,000	90,000	21,750
30211 F	55,000	100,000	22,750
30212 F	60,000	110,000	23,750
30213 F	65,000	120,000	24,750
30214 F	70,000	125,000	26,250
30215 F	75,000	130,000	27,250
30216 F	80,000	140,000	28,250
30217 F	85,000	150,000	30,500
30218 F	90,000	160,000	32,500
30219 F	95,000	170,000	34,500
30220 F	100,000	180,000	37,000
30221 F	105,000	190,000	39,000
30222 F	110,000	200,000	41,000
30224 F	120,000	215,000	43,500
30226 F	130,000	230,000	43,750

303 SERIES			
303 / 28 F	28,000	68,000	19,750
30302 F	15,000	42,000	14,250
30303 F	17,000	47,000	15,250
30304 F	20,000	52,000	16,250
30305 F	25,000	62,000	18,250
30306 F	30,000	72,000	20,750
30307 F	35,000	80,000	22,750

Fersa	d (mm)	D (mm)	T (mm)
30308 F	40,000	90,000	25,250
30309 F	45,000	100,000	27,250
30310 F	50,000	110,000	29,250
30311 F	55,000	120,000	31,500
30312 F	60,000	130,000	33,500
30313 F	65,000	140,000	36,000
30314 F	70,000	150,000	38,000
30315 F	75,000	160,000	40,000
30316 F	80,000	170,000	42,500
30320 F	100,000	215,000	51,500

313 SERIES			
31303 F	17,000	47,000	15,250
31305 F	25,000	62,000	18,250
31306 F	30,000	72,000	20,750
31307 F	35,000	80,000	22,750
31308 F	40,000	90,000	25,250
31309 F	45,000	100,000	27,250
31310 F	50,000	110,000	29,250
31311 F	55,000	120,000	31,500
31312 F	60,000	130,000	33,500
31313 F	65,000	140,000	36,000
31314 F	70,000	150,000	38,000
31315 F	75,000	160,000	40,000
31316 F	80,000	170,000	42,500
31318 F	90,000	190,000	46,500

320 SERIES			
320/22 XF	22,000	44,000	15,000
320/28 XF	28,000	52,000	16,000
320/32 XF	32,000	58,000	17,000
320/32 XR	32,000	58,000	17,000
32004 XF	20,000	42,000	15,000
32004 XR	20,000	42,000	15,000
32005 XF	25,000	47,000	15,000
32005 XR	25,000	47,000	15,000
32006 XF	30,000	55,000	17,000

01.1 \ Metric series Series métricas

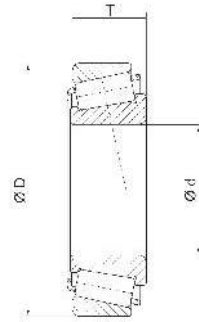

Fersa	d (mm)	D (mm)	T (mm)
32007 X 30/32007 XF	30,000	62,000	18,000

320 SERIES			
32007 X 34/32007 XF	34,000	62,000	18,000
32007 XF	35,000	62,000	18,000
32007 XR	35,000	62,000	18,000
32008 XF	40,000	68,000	19,000
32009 XF	45,000	75,000	20,000
32009 XR	45,000	75,000	20,000
32010 XF	50,000	80,000	20,000
32010 XR	50,000	80,000	20,000
32011 XF	55,000	90,000	23,000
32012 XF	60,000	95,000	23,000
32013 XF	65,000	100,000	23,000
32014 XF	70,000	110,000	25,000
32015 XF	75,000	115,000	25,000
32016 XF	80,000	125,000	29,000
32017 XF	85,000	130,000	29,000
32018 XF	90,000	140,000	32,000
32019 XF	95,000	145,000	32,000
32020 XF	100,000	150,000	32,000
32021 XF	105,000	160,000	35,000
32022 XF	110,000	170,000	38,000
32024 XF	120,000	180,000	38,000
32026 XF	130,000	200,000	45,000
32028 XF	140,000	210,000	45,000
32038 XF	190,000	290,000	64,000

322 SERIES			
32204 F	20,000	47,000	19,250
32204 FR	20,000	47,000	19,250
32205 BF	25,000	52,000	19,250
32205 F	25,000	52,000	19,250
32206 F	30,000	62,000	21,250
32207 F	35,000	72,000	24,250
32208 F	40,000	80,000	24,750
32209 F	45,000	85,000	24,750

Fersa	d (mm)	D (mm)	T (mm)
32210 F	50,000	90,000	24,750
32211 F	55,000	100,000	26,750
32212 F	60,000	110,000	29,750
32213 F	65,000	120,000	32,750
32214 F	70,000	125,000	33,250
32215 F	75,000	130,000	33,250
32216 F	80,000	140,000	35,250
32217 F	85,000	150,000	38,500
32218 F	90,000	160,000	42,500
32219 F	95,000	170,000	45,500
32220 F	100,000	180,000	49,000
32220 FR	100,000	180,000	49,000
32221 F	105,000	190,000	53,000
32222 F	110,000	200,000	56,000
32226 F	130,000	230,000	67,750

323 SERIES			
323/38 F	38,000	90,000	35,250
32304 F	20,000	52,000	22,250
32305 F	25,000	62,000	25,250
32306 BF	30,000	72,000	28,750
32306 C	30,000	72,000	28,750
32306 F	30,000	72,000	28,750
32307 F	35,000	80,000	32,750
32308 C	40,000	90,000	35,250
32308 F	40,000	90,000	35,250
32309 BF	45,000	100,000	38,250
32309 F	45,000	100,000	38,250
32310/55	55,000	110,000	42,250
32310 F	50,000	110,000	42,250
32311 F	55,000	120,000	45,500
32312 BF	60,000	130,000	48,500
32312 F	60,000	130,000	48,500
32313 BF	65,000	140,000	51,000
32313 F	65,000	140,000	51,000
32314 BF	70,000	150,000	54,000

01.1 \ Metric series Series métricas

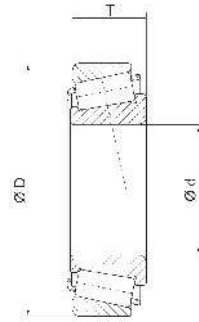

Fersa	d (mm)	D (mm)	T (mm)
32314 F	70,000	150,000	54,000
32315 F	75,000	160,000	58,000
32316 F	80,000	170,000	61,500
32317 F	85,000	180,000	63,500

329 SERIES			
32911 F	55,000	80,000	17,000
32914 F	70,000	100,000	20,000
32919 F	95,000	130,000	23,000
32924 F	120,000	165,000	29,000

330 SERIES			
33006 F	30,000	55,000	20,000
33010 F	50,000	80,000	24,000
33011 F	55,000	90,000	27,000
33013 F	65,000	100,000	27,000
33014 F	70,000	110,000	31,000
33015 F	75,000	115,000	31,000
33016 F	80,000	125,000	36,000
33017 F	85,000	130,000	36,000
33018 F	90,000	140,000	39,000
33019 F	95,000	145,000	39,000
33020 F	100,000	150,000	39,000
33020 F 561694	100,000	150,000	39,000
33021 F	105,000	160,000	43,000
33021 F 0266488	105,000	160,000	43,000
33022 F	110,000	170,000	47,000

331 SERIES			
33108 F	40,000	75,000	26,000
33109 F	45,000	80,000	26,000
33110 F	50,000	85,000	26,000
33111 F	55,000	95,000	30,000

01.2 \ Inch series Series pulgadas

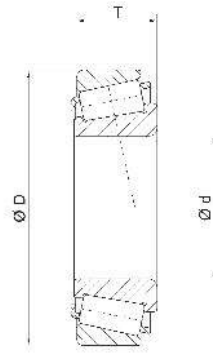

Fersa	d (mm)	D (mm)	T (mm)
4 A/6	19,050	44,450	12,700
336/332	41,275	80,000	21,000
342 A/332	41,275	80,000	28,574
344/332	40,000	80,000	21,000
355 X/352	44,450	90,119	23,000
359 A/354 X	46,038	85,000	20,638
359 S/354 X	46,038	85,000	20,638
365/362	50,000	90,000	20,000
368 A/362 A	50,800	88,900	20,638
368 A/362 X	50,800	90,000	25,000
368 S/362	51,592	90,000	20,000
368 S/362 A	51,592	88,900	20,638
369 A/362 A	47,625	88,900	20,638
369 A/363	47,625	90,000	20,000
369 S/362	47,625	90,000	20,000
369 S/362 A	47,625	88,900	20,638
369 S/363	47,625	90,000	20,000
385/382	55,000	98,425	21,000
385/382 A	55,000	96,838	21,000
385 A/382	50,800	98,425	21,000
385 A/382 A	50,800	96,838	21,000
386 A/382 A	47,625	96,838	21,000
387/382	57,150	98,425	21,000
387/382 A	57,150	96,838	21,000
387/382 S	57,150	96,838	25,400
387 A/382	57,150	98,425	21,000
387 A/382 A	57,150	96,838	21,000
387 A/382 S	57,150	96,838	25,400
387 A/383 A	57,150	100,000	21,000
387 AS/382 A	57,150	96,838	21,000
387 AS/382 S	57,150	96,838	25,400
387 S/382	57,150	98,425	21,000
387 S/382 S	57,150	96,838	25,400
387 S/383 A	57,150	100,000	21,000
388 A/382	57,531	98,425	21,000
389 A/382 A	53,975	96,838	21,000

Fersa	d (mm)	D (mm)	T (mm)
389 A/383 A	53,975	100,000	21,000
389 AS/382	53,975	98,425	21,000
390/394 A	57,150	110,000	22,000
392/394 A	61,912	110,000	22,000
395/394 A	63,500	110,000	22,000
395 A/394 A	66,675	110,000	22,000
395 S/394 A	66,675	110,000	22,000
399 A/394 A	68,262	110,000	22,000
399 AS/394 A	68,262	110,000	22,000
418/414	38,100	88,500	26,988
419/414	41,275	88,500	26,988
455/453 X	50,800	104,775	30,162
462/453 X	57,150	104,775	30,162
462 A/453 X	57,150	104,775	30,162
469/453 X	57,150	104,775	30,162
476/472	60,000	120,000	29,795
482/472	69,850	120,000	29,795
482/472 A	69,850	120,000	29,002
482/472 X	69,850	123,825	30,162
482 E/472	69,850	120,000	46,751
484/472	70,000	120,000	29,795
484/472 A	70,000	120,000	29,002
495/492	82,550	133,350	33,338
495/492 A	82,550	133,350	30,162
495/493	82,550	136,525	30,162
495 A/492 A	76,200	133,350	30,162
495 A/493	76,200	136,525	30,162
496/493	80,962	136,525	30,162
497/492 A	85,725	133,350	30,162
497/493	85,725	136,525	30,162
498/492 A	84,138	133,350	30,162
498/493	84,138	136,525	30,162
527/522	44,450	101,600	34,925
527 S/522	44,983	101,600	34,925
528/522	47,625	101,600	34,925
529/520 X1	50,800	100,000	34,925

01.2 \ Inch series Series pulgadas

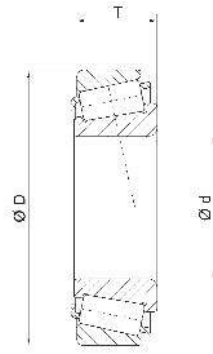

Fersa	d (mm)	D (mm)	T (mm)
529/522	50,800	101,600	34,925
529 X/522	50,800	101,600	34,925
536/532 X	47,625	107,950	36,512
537/532 X	50,800	107,950	36,512
538/532	54,988	111,125	38,100
538/532 A	54,990	111,130	38,100
539/532 A	53,975	111,125	38,100
539/532 X	53,975	107,950	36,512
555 S/552 A	57,150	123,825	38,100
557 S/552 A	53,970	123,820	38,100
559/552 A	63,500	123,825	38,100
566/563	69,850	127,000	36,512
567/563	73,025	127,000	36,512
567 X/563	73,025	127,000	36,512
568/563	73,817	127,000	36,512
575/572	76,200	139,992	36,512
575/572 A	53,970	123,820	38,100
575/572 X	76,200	139,700	36,512
576/572	73,025	139,992	36,512
580/572	82,550	139,992	36,512
582/572	82,550	139,992	36,513
580/572 A	82,550	139,982	35,250
580/572 X	82,550	139,700	36,512
594/592 A	95,250	152,400	39,688
594/593 X	95,250	150,000	35,992
594 A/592 A	95,250	152,400	39,688
594 A/593 X	95,250	150,000	35,992
594 R/592 A	95,250	152,400	39,688
598/592 A	92,075	152,400	39,688
598 A/592 A	92,075	152,400	39,688
598 A/593 X	92,075	150,000	35,992
619/612	50,800	120,650	41,275
621/612	53,975	120,650	41,275
641/632	66,675	136,525	41,275
641/633	66,675	130,175	41,275
644/632	71,438	136,525	41,275

Fersa	d (mm)	D (mm)	T (mm)
659/653	76,200	146,050	41,275
663/653	82,550	146,050	41,275
665/653	85,000	146,000	41,000
665 A/653	85,725	146,050	41,275
681/672	92,075	168,275	41,275
681 A/672	92,075	168,275	41,275
683/672	95,250	168,275	41,275
687/672	101,600	168,275	41,275
740/742	80,962	150,089	44,450
749/742	85,026	150,089	44,450
749 A/742	82,550	150,089	44,450
749 S/742	85,026	150,089	44,450
759/752	88,900	161,925	47,625
1280/1220	22,225	57,150	22,225
1380/1328	22,225	52,388	19,368
1680/1620	33,338	66,675	20,638
1779/1729 X	23,812	56,896	19,368
1780/1729	25,400	56,896	19,368
1985/1922	28,575	57,150	19,845
1985/1930	28,575	56,896	19,845
1985/1931	28,575	60,325	19,845
1985/1932	28,575	58,738	19,050
1986/1931	25,400	60,325	19,845
1986/1932	25,400	58,738	19,050
1988/1922	28,575	57,150	19,845
1988/1931	28,575	60,325	19,845
2580/2520	31,750	66,421	25,400
2580/2523	31,750	69,850	23,812
2585/2523	33,338	69,850	23,812
2689/2631	28,575	66,421	23,812
2780/2720	36,487	76,200	23,812
2780/2729	36,487	76,200	23,812
2788/2720	38,100	76,200	23,812
2788/2729	38,100	76,200	23,812

01.2 \ Inch series Series pulgadas

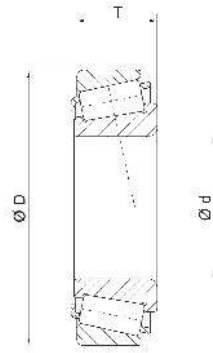

Fersa	d (mm)	D (mm)	T (mm)
2789/2720	39,688	76,200	23,812
2789/2729	39,688	76,200	23,812
3381/3320	38,100	80,167	29,370
3382/3320	39,688	80,167	29,370
3384/3320	41,275	80,167	29,370
3386/3320	39,688	80,167	29,370
3386/3325	39,688	79,975	29,370
3477/3420	33,338	79,375	29,370
3478/3420	34,925	79,375	29,370
3490/3420	38,100	79,375	29,370
3577/3520	41,275	84,138	30,162
3577/3525	41,275	87,312	30,162
3578/3520	44,450	84,138	30,162
3578/3525	44,450	87,312	30,162
3585/3525	41,275	87,312	30,162
3586/3525	45,237	79,975	30,162
3767/3720	52,388	93,264	30,162
3775/3720	50,800	93,264	30,162
3776/3720	44,983	93,264	30,162
3778/3720	47,625	93,264	30,162
3780/3720	50,800	93,264	30,162
3780/3727	50,800	93,662	30,162
3782/3720	44,450	93,264	30,162
3784/3720	50,800	93,264	30,162
3784/3727	50,800	93,662	30,162
3872/3820	34,000	85,000	30,000
3877/3820	41,275	85,725	30,162
3878/3820	36,512	85,725	30,162
3980/3920	60,325	112,712	30,162
3982/3920	63,500	112,712	30,162
3982/3927 X	63,500	110,000	30,162
3984/3920	66,675	112,712	30,162
3984/3925	66,675	112,712	30,162
3994/3920	66,675	112,712	30,162
3994/3927 X	66,675	110,000	30,162

Fersa	d (mm)	D (mm)	T (mm)
3979/JM 511910	57,150	110,000	29,000
JF 4049/JF 4010	40,000	85,000	33,000
4367 X/4335	39,688	90,488	39,688
4388/4335	41,275	90,488	39,688
JF 4549/JF 4510	45,000	95,000	36,000
JW 4549/JW 4510	45,000	95,000	29,000
4580/4535	50,800	104,775	39,687
JF 5049/JF 5010	50,000	100,000	36,000
JW 5049/JW 5010	50,000	105,000	32,000
5395/5335	49,212	103,188	43,658
JW 5549/JW 5510	55,000	115,000	34,000
5566/5535	55,562	122,238	43,658
5760/5735	76,200	135,733	44,450
JF 6049/JF 6010	60,000	115,000	40,000
JW 6049/JW 6010	60,000	125,000	37,000
A 6075/A 6157	19,050	39,992	12,014
6280/6220	53,975	127,000	50,800
6379/6320	65,088	135,755	53,975
6386/6320	66,675	135,755	53,975
6461/6420	76,200	149,225	53,975
6461 A/6420	76,200	149,220	53,970
6466/6420	76,200	149,225	53,975
JD 6549/JD 6510	65,000	110,000	31,000
JF 7049/JF 7010	70,000	130,000	43,000
JF 7049 A/JF 7010	70,000	130,000	43,000
JW 7049/JW 7010	70,000	140,000	39,000
JW 8049/JW 8010	80,000	160,000	45,000
9278/9220	68,262	161,925	49,212
9285/9220	76,200	161,925	49,212
9380/9321	73,000	171,000	49,000
JF 9549/JF 9510	95,000	160,000	46,000
02474/02420	28,575	68,262	22,225
02475/02420	31,750	68,262	22,225
02872/02820	28,575	73,025	22,225
05066/05185	16,993	47,000	14,382

01.2 \ Inch series Series pulgadas

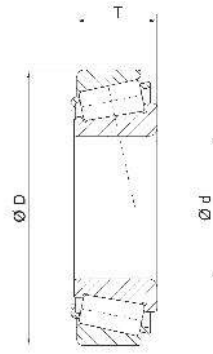

Fersa	d (mm)	D (mm)	T (mm)
07087/07204	22,225	51,994	15,011
07087/07210 X	22,225	50,800	15,011
07087 X/07210 X	22,225	50,800	15,011
07097/07204	25,000	51,994	15,011
07100/07196	25,400	50,005	13,495
07100/07204	25,400	51,994	15,011
07100 S/07196	25,400	50,005	13,495
07100 S/07210 X	25,400	50,800	15,011
09067/09195	19,050	49,225	18,034
09067/09196	19,050	49,225	21,209
09074/09194	19,050	49,225	23,020
09074/09195	19,050	49,225	19,845
09074/09196	19,050	49,225	23,020
09081/09195	20,625	49,225	19,845
09081/09196	20,625	49,225	23,020
JF 10049/JF 10010	100,000	165,000	47,000
JP 10049/JP 10010	100,000	145,000	24,000
JP 10049/JP 10010 A	100,000	145,000	24,000
11162/11300	41,275	76,200	18,009
11163/11300	41,275	76,200	18,009
11590/11520	15,875	42,862	14,288
LM 11749/LM 11710	17,462	39,878	13,843
LM 11949/LM 11910	19,050	45,237	15,494
LM 11949 RS/LM 11910	19,050	45,237	15,494
JP 12049/JP 12010	120,000	170,000	27,000
JP 12049 A/JP 12010	120,000	170,000	27,000
M 12649/M 12610	21,430	50,005	17,526
M 12649 F/M 12610 F	21,430	50,005	17,026
LM 12748/LM 12710	21,430	45,237	15,494
LM 12749/LM 12710	21,986	45,237	15,494
LM 12749/LM 12711	21,986	45,974	15,494
JP 13049/JP 13010	130,000	185,000	29,000
13685/13621	38,100	69,012	19,050
13686/13621	38,100	69,010	26,190
13687/13620	38,100	69,012	19,050

Fersa	d (mm)	D (mm)	T (mm)
13687/13621	38,100	69,012	19,050
14116/14276	30,226	69,012	19,845
14118/14274	30,000	69,012	19,845
14118/14283	30,000	72,085	22,385
14123 AA/14274	31,750	69,012	26,983
14123 AA/14276	31,750	69,012	26,983
14125 A/14274	31,750	69,012	19,845
14125 A/14276	31,750	69,012	19,845
14125 A/14283	31,750	72,085	22,385
14130/14274	33,338	69,012	19,845
14130/14276	33,338	69,012	19,845
14131/14274	33,338	69,012	19,845
14131/14276	33,338	69,012	19,845
14136 A/14276	34,925	69,012	26,983
14137 A/14274	34,925	69,012	19,845
14137 A/14276	34,925	69,012	19,845
14137 AS/14276	34,925	69,012	19,845
14138 A/14274	34,925	69,012	19,845
14138 A/14276	34,925	69,012	19,845
14138 A/14283	34,925	72,085	22,385
14585/14525	34,925	68,262	20,638
15100/15245	25,400	62,000	19,050
15100/15250	25,400	63,500	20,638
15100/15250 X	25,400	63,500	20,638
15101/15245	25,400	62,000	19,050
15101/15250	25,400	63,500	20,638
15101/15250 X	25,400	63,500	20,638
15103/15243	26,000	61,000	19,000
15103/15244	26,000	62,000	19,000
15103/15245	26,000	62,000	19,000
15103/15250	26,000	63,000	20,000
15103/15250 X	26,000	63,000	20,000
15103 S/15243	26,162	61,912	19,050
15103 S/15245	26,162	62,000	19,050

01.2 \ Inch series Series pulgadas

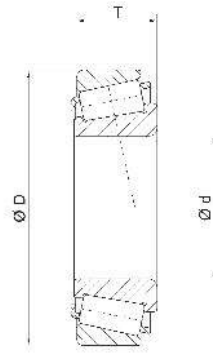

Fersa	d (mm)	D (mm)	T (mm)
15106/15245	26,988	62,000	19,050
15106/15250	26,988	63,500	20,638
15106/15250 X	26,988	63,500	20,638
15112/15245	28,575	62,000	19,050
15112/15250	28,575	63,500	20,638
15112/15250 X	28,575	63,500	20,638
15117/15245	29,987	62,000	19,050
15118/15245	30,213	62,000	19,050
15118/15250	30,213	63,500	20,638
15118/15250 X	30,213	63,500	20,638
15123/15244	31,750	62,000	19,749
15123/15245	31,750	62,000	18,161
15123/15250 X	31,750	63,500	19,749
15126/15245	31,750	62,000	19,050
15126/15250 X	31,750	63,500	20,638
15578/15520	25,400	57,150	17,462
15579 X/15520	25,987	57,150	17,462
15580/15520	26,988	57,150	17,462
J 15585/15520	28,000	57,150	17,462
16150/16284	38,100	72,238	20,638
17887/17831	45,230	79,985	19,842
18590/18520	41,275	73,025	16,667
18690/18620	46,038	79,375	17,462
18790/18720	50,800	85,000	17,462
19150/19268	38,100	68,262	15,875
21075/21212	19,050	53,975	22,225
23690/23620	34,925	73,025	26,988
24780/24720	41,275	76,200	22,225
24780/24721	41,275	76,200	25,400
24781/24720	41,275	76,200	22,225
24781/24721	41,275	76,200	25,400
25576/25520	42,862	82,931	23,812
25577/25520	42,875	82,931	23,812
25577/25521	42,875	83,058	23,812

Fersa	d (mm)	D (mm)	T (mm)
25577/25522	42,875	83,058	23,876
25577/25523	42,875	82,931	26,988
25578/25520	42,862	82,931	23,812
25578/25521	42,862	83,058	23,812
25578/25522	42,862	83,058	23,876
25578/25523	42,862	82,931	26,988
25580/25520	44,450	82,931	23,812
25580/25521	44,450	83,058	23,812
25580/25522	44,450	83,058	23,876
25580/25523	44,450	82,931	26,988
25581/25520	44,450	82,931	23,813
25584/25520	44,983	82,931	23,812
25584/25521	44,983	83,058	23,813
25584/25547 RB	44,983	99,995	25,400
25584 A/25520	44,987	82,931	23,812
25590/25520	45,618	82,931	23,812
25590/25521	45,618	83,058	23,812
25590/25522	45,618	83,058	23,876
25590/25523	45,618	82,931	26,988
25877/25820	34,925	73,025	23,812
25877/25821	34,925	73,025	23,812
25878/25820	34,925	73,025	23,812
25880/25820	36,487	73,025	23,812
25880/25821	36,487	73,025	23,812
JL 26749 F/JL 26710	32,000	53,000	14,500
26878/26823	38,100	76,200	25,400
26882/26820	41,275	80,167	25,400
26882/26822	41,275	79,375	23,812
26884/26823	42,875	76,200	25,400
27687/27620	82,550	125,412	25,400
27690/27620	83,345	125,412	25,400
27695/27620	85,000	125,412	25,400
28137/28317	34,925	80,035	21,433
28579/28520	49,987	89,980	24,750
28580/28520	50,800	89,980	24,750

01.2 \ Inch series Series pulgadas

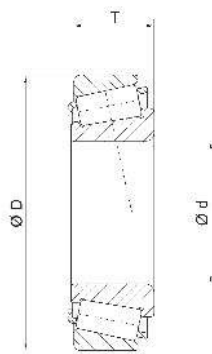

Fersa	d (mm)	D (mm)	T (mm)
28580/28521	50,800	92,075	24,608
28580/28527 RB	50,800	99,995	24,607
28584/28521	52,388	92,075	24,608
28680/28622	55,560	97,630	24,600
28682/28621	57,150	96,838	24,608
28682/28622	57,150	97,630	24,608
28985/28920	60,325	101,600	25,400
28985/28921	60,325	100,000	25,400
29585/29520	63,500	107,950	25,400
29586/29520	63,500	107,950	25,400
29586/29522	63,500	107,950	25,400
29590/29520	66,675	107,950	25,400
29590/29522	66,675	107,950	25,400
29675/29620	69,850	112,712	25,400
29675/29630	69,850	120,650	25,400
29685/29620	73,025	112,712	25,400
29688/29620	73,000	112,000	25,000
LM 29748/LM 29710	38,100	65,088	18,034
LM 29748/LM 29711	38,100	65,088	18,034
LM 29749/LM 29710	38,100	65,088	18,034
LM 29749/LM 29711	38,100	65,088	19,812
31593/31520	34,925	76,200	29,370
31594/31520	34,925	76,200	29,370
33262/33462	66,675	117,475	30,162
33262 A/33461	66,675	117,475	30,163
33275/33462	69,850	117,475	30,162
33275/33472	69,850	120,000	29,794
33281/33462	71,438	117,475	30,162
33281/33472	71,438	120,000	29,794
33287/33462	73,025	117,475	30,162
33287/33472	73,025	120,000	29,794
33885/33822	44,450	95,250	27,783
33889/33821	50,800	95,250	27,783
33889/33822	50,800	95,250	27,783
33891/33821	52,388	95,250	27,783

Fersa	d (mm)	D (mm)	T (mm)
33895/33821	53,975	95,250	27,783
33895/33822	53,975	95,250	27,783
34300/34478	76,200	121,442	24,608
34300/34500	76,200	127,000	26,988
34301/34500	76,200	127,000	26,988
34306/34478	77,788	121,442	24,608
37425/37625	107,950	158,750	23,020
37431/37625	109,538	158,750	23,020
37431 A/37625	109,538	158,750	23,020
39250/39412	63,500	104,775	21,433
39580/39520	57,150	112,712	30,162
39580/39528	57,150	119,985	32,750
39581/39520	57,150	112,712	30,162
39585/39520	63,500	112,712	30,162
39590/39520	66,675	112,712	30,162
41125/41286	28,575	72,626	24,608
42350/42584	88,900	148,430	28,575
42362/42584	92,075	148,430	28,575
42368/42584	93,662	148,430	28,575
42381/42584	96,838	148,430	28,575
42688/42620	76,200	127,000	30,162
43112/43312	28,000	79,000	25,000
44131/44348	33,000	88,000	25,000
44162/44348	41,275	88,500	25,400
L 44643/L 44610	25,400	50,292	14,224
L 44643 RS/L 44610	25,400	50,292	14,224
L 44645/L 44613	25,987	51,986	15,011
L 44649/L 44610	26,988	50,292	14,224
45280/45220	44,450	104,775	30,162
45284/45220	50,800	104,775	30,162
45285 A/45220	50,800	104,775	30,162
45285 A/45221	50,800	104,775	30,162
45289/45220	57,150	104,775	30,162
45291/45220	57,150	104,775	30,162
L 45449/L 45410	29,000	50,292	14,224

01.2 \ Inch series Series pulgadas

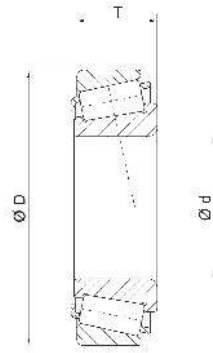

Fersa	d (mm)	D (mm)	T (mm)
47487/47420	69,850	120,000	32,545
47490/47420	71,438	120,000	32,545
47686/47620	82,550	133,350	33,338
47687/47623 A	82,550	136,525	44,450
47679/47620	76,200	133,350	30,162
47890/47820	92,075	146,050	33,338
48190/48120	107,950	161,925	34,925
48290/48220	127,000	182,562	39,689
48684/48620	142,875	200,025	41,275
LM 48548/LM 48510	34,925	65,088	18,034
LM 48548/LM 48514 XP	34,925	68,262	18,034
LM 48548 RS/LM 48510	34,925	65,088	18,034
49162/49368	41,275	93,662	31,750
49175/49368	44,450	93,662	31,750
49585/49520	50,800	101,600	31,750
52400/52618	101,600	157,162	36,512
L 52149/L 52110	107,950	146,050	21,433
53176/53375	44,450	95,250	30,958
53177/53375	44,450	95,250	30,958
53178/53375	44,450	95,250	30,958
53178/53377	44,450	95,250	30,958
55175 C/55437	44,450	111,125	30,162
55187 C/55437	47,625	111,125	30,162
55200 C/55437	50,800	111,125	30,162
55206 C/55437	52,388	111,125	30,162
55212 C/55437	53,970	111,120	30,160
56425/56650	107,950	165,100	36,512
59162/59412	41,275	104,775	36,512
59175/59412	44,450	104,775	36,512
64450/64700	114,300	177,800	41,275
65237/65500	60,325	127,000	44,450
66589/66520	59,972	122,238	33,338
LM 67048/LM 67010	31,750	59,131	15,875
LM 67048/LM 67014	31,750	61,986	15,875

Fersa	d (mm)	D (mm)	T (mm)
LM 67048/LM 67014 X	31,750	61,986	15,875
LM 67048 RS/LM 67010	31,750	59,131	15,875
LM 67049/LM 67011	31,750	59,131	17,780
LM 67049 A/LM 67010	31,750	59,131	15,875
LM 67049 A/LM 67014	31,750	61,986	15,875
67885/67820	190,500	266,700	47,625
JL 68145/JL 68111 Z	35,000	60,000	15,875
L 68149/L 68110	34,987	59,131	15,875
L 68149/L 68111	34,987	59,975	15,875
L 68149/L 68116	34,987	65,088	15,875
L 68149 R/L 68110	34,987	59,131	15,875
68462/68712	117,475	180,975	34,925
JL 69345/JL 69310 Z	38,000	63,000	17,000
JL 69349/JL 69310	38,000	63,000	17,000
69354/69630	89,992	160,096	30,124
72187/72487	47,625	123,825	36,512
72187 C/72487	47,000	123,000	36,000
72188 C/72487	47,625	123,825	25,400
72200 C/72487	50,800	123,825	36,512
72201 C/72487	50,800	123,825	36,512
72212/72487	53,975	123,825	36,512
72212 C/72487	53,975	123,825	36,512
72218 C/72487	55,562	123,825	36,512
72225 C/72487	57,150	123,825	36,512
77375/77675	95,000	171,000	47,000
78215 C/78551	53,975	140,030	36,513
78225 C/78551	57,150	140,030	36,513
LM 78349/LM 78310 A	34,987	61,975	16,700
HM 81649/HM 81610	15,987	46,975	21,000
M 84249/M 84210	25,400	59,530	23,368
M 84548/M 84510	25,400	57,150	19,431
M 86647/M 86610	28,575	64,292	21,433
M 86648 A/M 86610	30,955	64,292	21,432
M 86649/M 86610	30,162	64,292	21,433

01.2 \ Inch series Series pulgadas

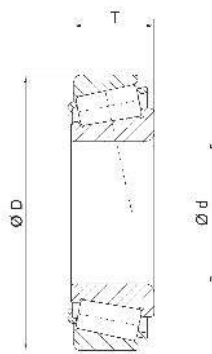

Fersa	d (mm)	D (mm)	T (mm)
M 88043/M 88010	30,162	68,262	22,225
M 88043/M 88011	30,162	68,262	22,225
M 88046/M 88010	31,750	68,262	22,225
M 88048/M 88010	33,338	68,262	22,225
JHM 88540/JHM 88513	30,000	72,000	29,370
HM 88542/HM 88510	31,750	73,025	29,370
HM 88547/HM 88510	33,338	73,025	29,370
HM 88648/HM 88610	35,717	72,233	25,400
HM 88649/HM 88610	34,925	72,233	25,400
HM 89443/HM 89410	33,338	76,200	29,370
HM 89443/HM 89411	33,338	76,200	29,370
HM 89446/HM 89410	34,925	76,200	29,370
HM 89448/HM 89410	36,512	76,200	29,370
HM 89449/HM 89410	36,512	76,200	29,370
LM 102949/LM 102910	45,242	73,431	19,558
JLM 104945/JLM 104910	50,000	82,000	21,500
JLM 104946/JLM 104910	50,000	82,000	21,500
JLM 104948/JLM 104910	50,000	82,000	21,500
JLM 104948/LM 104911	50,000	82,550	21,500
LM 104949/JLM 104910	50,800	82,000	21,976
LM 104949/LM 104911	50,800	82,550	21,976
LM 104949/LM 104912	50,800	82,931	21,590
HM 204043/HM 204010	39,987	90,975	32,000
JM 205149/JM 205110	50,000	90,000	28,000
JM 207049/JM 207010	55,000	95,000	29,000
JM 207049 A/JM 207010	55,000	95,000	29,000
JH 211749/JH 211710	65,000	120,000	39,000
HM 212044/HM 212011	60,325	122,238	38,100
HM 212047/HM 212011	63,500	122,238	38,100
HM 212049/HM 212010	66,675	122,238	38,100
HM 212049/HM 212011	66,675	122,238	38,100
H 212749/H 212710	65,987	123,975	41,500
HM 215249/HM 215210	75,987	131,975	39,000
LL 217849/LL 217810	88,900	121,442	15,083

Fersa	d (mm)	D (mm)	T (mm)
HM 218248/HM 218210	89,974	146,975	40,000
HM 220149/HM 220110	99,975	156,975	42,000
M 238849/M 238810	187,325	269,875	55,563
LM 300849/LM 300811	40,987	67,975	17,500
JHM 318448/JHM 318410	90,000	155,000	44,000
LL 319349/LL 319310	95,250	128,587	15,875
LM 330448/LM 330410	152,400	203,200	41,275
H 414242/H 414210	66,675	136,525	41,275
H 414245 X/H 414210	68,262	136,525	41,275
LM 501349/LM 501310	41,275	73,431	19,558
LM 501349/LM 501314	41,275	73,431	21,430
LM 503349/LM 503310	45,987	74,976	18,000
LM 503349 A/LM 503310	45,987	74,976	18,000
JLM 506849/JLM 506810	55,000	90,000	23,000
JLM 506849 A/JLM 506811	55,000	90,000	25,000
JLM 508748/JLM 508710	60,000	95,000	24,000
JM 511945/3920	65,000	112,712	29,020
JM 511945/JM 511910	65,000	110,000	28,000
JM 511946/JM 511910	65,000	110,000	28,000
HM 516448 /HM 516414 B	82,550	136,525	12,319
HM 516449 A/HM 516410	82,550	133,350	39,687
HM 516449 C/HM 516410	82,550	133,350	39,688
JHM 516849/JHM 516810	85,000	140,000	39,000
HM 518445/HM 518410	88,900	152,400	39,688
JHM 522649/JHM 522610	110,000	180,000	47,000
JM 515649/JM 515610	80,000	130,000	35,000
LM 603049/LM 603011	45,242	77,788	19,842
LM 603049/LM 603012	45,242	77,788	21,430
LM 603049/LM 603014	45,242	79,975	19,842
JM 612949/JM 612910	70,000	115,000	29,000
L 623149/L 623110	114,300	152,400	21,432
HM 624749/HM 624710	120,650	190,500	46,038
JLM 704649/JLM 704610	50,000	84,000	22,000
JLM 710949 C/JLM 710910	65,000	105,000	24,000

01.2 \ Inch series Series pulgadas

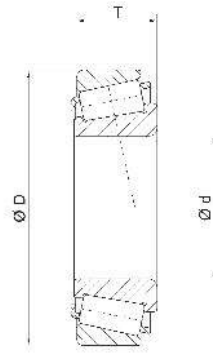

Fersa	d (mm)	D (mm)	T (mm)
L 713049/L 713010	69,850	101,600	19,050
JLM 714149/JLM 714110	75,000	115,000	25,000
JM 714249/JM 714210	75,000	120,000	31,000
H 715332/H 715311	60,325	136,525	46,038
H 715334/H 715311	61,912	136,525	46,038
H 715336/H 715311	63,500	136,525	46,038
H 715340/H 715311	65,088	136,525	46,038
H 715341/H 715311	66,675	136,525	46,038
H 715343/H 715311	68,262	136,525	46,038
H 715345/H 715311	71,438	136,525	46,038
H 715345/H 715313 W	71,000	136,000	49,000
JM 716649/JM 716610	85,000	130,000	30,000
JM 718149/JM 718110	90,000	145,000	35,000
JM 718149 A/JM 718110	90,000	145,000	35,000
JM 719149/JM 719113	95,000	150,000	35,000
JHM 720249/JHM 720210	100,000	160,000	41,000
JM 720249/JM 720210	100,000	155,000	36,000
HM 801346/HM 801310	38,100	82,550	29,370
HM 801346 X/HM 801310	38,100	82,550	29,370
M 802048/M 802011	41,275	82,550	26,543
HM 803145/HM 803110	41,275	88,900	30,163
HM 803146/HM 803110	41,275	88,900	30,162
HM 803149/HM 803110	44,450	88,900	30,162
M 804048/M 804010	47,625	88,900	25,400
M 804049/M 804010	47,625	88,900	25,400
HM 804840/HM 804810	41,275	95,250	30,162
HM 804843/HM 804810	44,450	95,250	30,162
HM 804846/HM 804810	47,625	95,250	30,162
LM 806649/LM 806610	53,975	88,900	19,050
LM 806649/LM 806610	53,975	88,900	19,050
HM 807040/HM 807010	44,450	104,775	36,512
HM 807044/HM 807010	49,212	104,775	36,512
JHM 807045/JHM 807012	50,000	105,000	37,000
HM 807046/HM 807010	50,800	104,775	36,512

Fersa	d (mm)	D (mm)	T (mm)
HM 807048/HM 807010	54,487	104,775	36,512
HM 807049/HM 807010	53,975	104,775	36,512
JLM 813049/JLM 813010	70,000	110,000	26,000
HM 813840/HM 813811	55,562	127,000	36,512
HM 813841/HM 813810	60,325	127,000	36,512
HM 813841/HM 813811	60,325	127,000	36,512
HM 813842/HM 813810	63,500	127,000	36,512
HM 813843/HM 813810	61,912	127,000	36,512
HM 813844/HM 813810	66,670	127,000	36,512
HM 813849/HM 813810	71,438	127,000	36,512
HM 813849/HM 813811	71,438	127,000	36,512
L 814749/L 814710	76,200	109,538	19,050
LM 814849/LM 814810	77,788	117,475	25,400
JL 819349/JL 819310	95,000	135,000	20,000
JM 822049/JM 822010	110,000	165,000	35,000
HM 903245/HM 903210	41,275	95,250	30,958
HM 903249/HM 903210	44,450	95,250	30,958
HM 905843/HM 905810	44,987	104,986	32,512
L 910349/L 910310	63,485	94,975	17,000
HM 911244/HM 911210	59,987	130,175	34,100
HM 911244/HM 911216	59,987	134,983	33,449
HM 911245/HM 911210	60,325	130,175	36,512
H 913842/H 913810	61,912	146,050	41,275
H 913843/H 913810	61,912	146,050	41,275
H 913849/H 913810	69,850	146,050	41,275
H 924033/H 924010	101,600	214,312	55,562
H 914841/H 914811	68,262	152,400	47,625



01.3 \ Special design bearings Serie especial

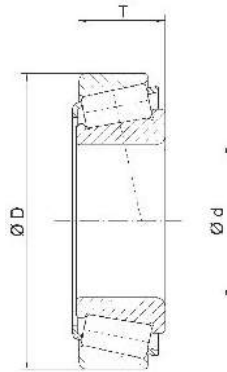

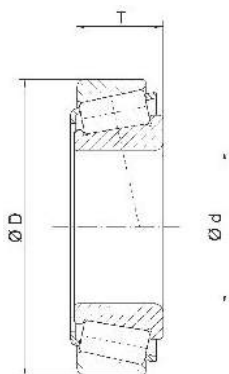

Fersa	d (mm)	D (mm)	T (mm)
F 15001	25,000	62,000	18,250
F 15002	30,000	72,000	20,750
F 15003	40,987	67,975	17,500
F 15014	35,000	80,000	22,750
F 15028	22,000	41,000	14,500
F 15029	29,000	50,292	14,224
F 15036	35,000	60,000	15,875
F 15040	35,000	60,000	13,000
F 15046	60,000	130,000	39,000
F 15047	50,800	100,000	35,000
F 15048	75,000	180,000	63,500
F 15051 C	70,000	130,000	57,000
F 15051 R	70,000	130,000	57,000
F 15054/3720	50,000	93,264	30,162
F 15055/LM 29710	38,100	65,088	18,034
F 15056	28,000	52,000	15,750
F 15063	22,000	47,000	20,750
F 15071	75,000	160,000	58,000

01.3 \ Special design bearings Serie especial



Fersa	d (mm)	D (mm)	T (mm)
F 15075	88,000	140,000	32,000
F 15076	105,000	170,000	38,000
F 15080	34,925	73,025	26,988
F 15082	65,000	145,000	36,000
F 15083	65,000	145,000	39,500
F 15088	60,000	95,000	27,000
F 15089	22,000	47,000	20,750
F 15104	85,000	150,000	30,500
F 15109	39,688	80,167	29,370
F 15112	42,000	76,000	23,812
F 15114	70,000	150,000	41,275
F 15115	89,975	146,975	40,000
F 15116	70,000	150,000	39,800
F 15117	40,000	90,000	28,750
F 15119	65,000	150,000	38,000
F 15133	57,165	140,000	28,250
F 15156	80,000	140,000	39,250
F 15157	38,100	90,000	35,250
F 15158	60,000	135,000	37,000
F 15159	65,000	165,000	40,000
F 15165	109,538	158,750	23,020
F 15183	65,000	165,000	36,000
F 15184	62,000	147,000	50,000

Fersa	CROSS REF.				
F 15075	SKF FAG	331958 Q 529065			
F 15076	SKF FAG	331126 Q 528946			
F 15080	SKF FAG	330865 C / 332046AD 511687			GENERAL MOTORS (Omega * Suprema)
F 15082	SKF FAG	330633 C 509333 A			MERCEDES BENZ (HL5)
F 15083	SKF FAG	331075 521618			MERCEDES BENZ (HL5)
F 15088	NTN	CR 1252			NISSAN (Junior)
F 15089	SKF FAG SNR	1861071 528935 EC 10059			RENAULT (4 * 5)
F 15104	SKF	30217J2/QVB478			ZF (16S-151 * 16S-181 * 16S-221 * 16S-251)
F 15109	KOYO	57620			FULLER (RTLO 16918)
F 15112	KOYO	ST 4276 C / ST 4276 A			FULLER (RTO 13707DLL)
F 15114	TIMKEN	NP 550563 / NP 546683			ZF (AV 132)
F 15115	FAG	580779 A			FRUEHAUF (SMB)
F 15116	SKF	BT1B 329012			VOLVO (VT 2009 B * VT 2014 B * VT 2214 B * VTO 2214 B * VT 2514 B * VTO 2514 OD * VT 2814 B * VTO 2814 B)
F 15117	SKF	BT1 0097 C		ST	VOLVO (FH * NH)
F 15119	SKF FAG	BT1B 328406 A / 30314 / QVB01 568980			SCANIA (GR 801 * GR 875 * GR 900 * GRS 895 * GRS 900 * GRS 905)
F 15133	TIMKEN	NP 988748 / NP 247732			MERCEDES BENZ (G 100-12)
F 15156	FAG	804358			VOLVO (VM17 * VM23)
F 15157	FAG	543805		KP	VOLVO
F 15158	FAG	562830 A			MERCEDES BENZ (HD4 * HL4)
F 15159	FAG	575725.F51			MERCEDES BENZ (HD4 * HL4 * HO4)
F 15165	FAG	548866 A			ZF (APL 345 * 35)
F 15183	FAG	Z 540669.TR1PW			MERCEDES BENZ (HD4 * HL4 * HO4)
F 15184	SKF FAG	BT1B 639425 579381			SCANIA (R 560 * R 660 * RB 660 * RB 662 * RP 730 * RP 731 * RP 735 * RV 761)

01.3 \ Special design bearings Serie especial

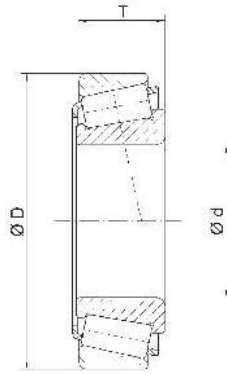

Fersa	d (mm)	D (mm)	T (mm)
F 15190	75,000	140,000	34,250
F 15193	70,000	150,000	64,000
F 15197	35,000	72,000	24,000
F 15199	20,000	52,000	19,250
F 15200	100,000	160,000	42,000
F 15201	50,000	83,000	20,500
F 15202	35,000	89,000	38,000
F 15203	30,000	72,000	24,000
F 15208	99,975	156,975	42,000
F 15239	105,000	160,000	43,000
F 15245	60,000	130,000	33,800
F 15252	82,000	140,000	36,500
F 15253	65,000	152,000	48,000
F 15254	70,000	165,000	57,000
F 15255	60,000	150,000	51,000
F 15256	55,000	140,000	45,000
F 15257	80,000	165,000	57,000
F 15258	60,000	100,000	30,000
F 15267	100,000	160,000	44,000
F 15270	60,000	125,000	37,000

Fersa	CROSS REF.			
F 15190	FAG	Z 580616 TR1		 MERCEDES BENZ (G211-16 * G230-12 * G231-16 * G241-16 * G280-16 * G281-12 * G330-12)
F 15193	SKF FAG	VKHB 2280 / BT1 008 572813 4		 MERCEDES BENZ (ACTROS MP2 * MP3 * AXOR * AXOR 2)
F 15197	TIMKEN	NP 353549 / NP 673396		 LAND ROVER (Defender)
F 15199	KOYO	57355		 NISSAN (Sentra * Tsuru)
F 15200	FAG	T5ED100.576376		 DAF (1347)
F 15201	KOYO	TR 100802		 TOYOTA (Hiace * Hilux)
				 TOYOTA (Burbuja)
F 15202	KOYO	TR 070904 1		 TOYOTA (Fortune * Hiace * Hilux * Landcruiser)
F 15203	KOYO	STA 3072		 TOYOTA (Hiace * Hilux)
F 15208	SKF FAG	VKHB 2329 567549		 MERCEDES BENZ (ACTROS)
				 MAN (E 2000 * F 90 * F 2000 * M 90 * M 2000)
F 15239	SKF FAG	33021 / QVB 401 33021. 580938		 MAN (LION S COACH * LION S STAR)
				
F 15245	NTN	ECO CR 12A 06 1		 MERCEDES BENZ (G211-16 * G230-12 * G 231-16 * G241-16 * G280-16 * G281-12 * G330-12)
F 15252	TIMKEN SKF	NP 569484/ NP 644537 BT1-0163		 ROR (LM)
F 15253	FAG	801794 B		 MERCEDES BENZ (HL6 * HL7 * HL8)
F 15254	FAG	805015		 MERCEDES BENZ (HL6)
F 15255	FAG	805096		 MERCEDES BENZ (HD4 * HL4) MAN (HY-0925 * HY-1130)
F 15256	FAG	805097		 MERCEDES BENZ (HD4 * HL4)
F 15257	FAG	801400/801400		 MERCEDES BENZ (HL7 * HL8) MAN (HY-1344 * HY-1350 * HYD-1370)
F 15258	FAG	523361		 MERCEDES BENZ (HL2)
F 15267	FAG	805312		 MERCEDES BENZ (ACTROS MP2 * MP3)
F 15270	FAG	805050		 MERCEDES BENZ (HL2)

01.3 \ Special design bearings Serie especial

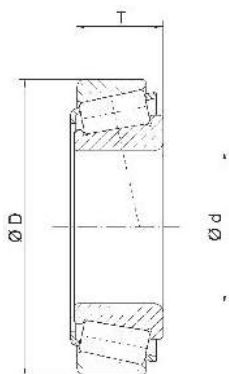

Fersa	d (mm)	D (mm)	T (mm)
F 15271	70,000	150,000	74,000
F 15272	106,000	160,000	35,000
F 15273	60,000	115,000	39,000
F 15278	42,000	92,075	24,607
F 15279	101,600	160,000	35,000
F 15280	44,983	112,712	34,512
F 15291	76,200	171,450	49,212
F 15295	53,975	95,200	34,400
F 15298	60,000	130,000	35,250
F 15304	63,500	107,950	25,400
F 15308	26,988	50,292	14,224
F 15309	30,000	62,000	20,000
F 15313	25,000	62,000	17,250
F 15314	45,000	88,000	16,750
F 15315	25,000	55,000	13,750
F 15316	25,000	66,000	22,050
F 15317	35,000	75,000	60,000
F 15322	65,000	120,000	32,750
F 15323	55,000	95,000	30,000
F 15326	85,000	150,000	38,500
F 15329	60,000	95,000	26,500
N F 15327	68,262	161,925	47,500
N F 15328	69,850	161,925	47,500
F 15332	55,000	117,000	38,000

Fersa	CROSS REF.				
F 15271	FAG SKF TIMKEN	801785 VKHB 2307 SET 1328			MERCEDES BENZ (ACTROS MP2 * MP3)
F 15272	FAG SKF	528595 331974			MAN (TGA * TGS) MERCEDES BENZ (ACTROS MP2 * MP3)
F 15273	FAG	581541			MERCEDES BENZ (HO7) SCANIA (RB662 * RBP735 * RBP736)
F 15278	KOYO	57508 L2/28521			ZF (S5-420)
F 15279	SKF TIMKEN	BT1 0779 NP 331249			VOLVO (RS 1128 B * RSS 1332 A * RTS 2370 A * RTS 2370 B)
F 15280	FAG SKF	518713 331264			MERCEDES BENZ (HL 2)
F 15291	TIMKEN	NP725688/NP560412			VOLVO (RS 1128 B * RSS 1332 A * RTS 2370 A * RTS 2370 B)
F 15295	KOYO	LM 806649/57591N			FULLER (RTLO-16918)
F 15298	FAG	563007/801464			MERCEDES BENZ (G281-12)
F 15304	NSK	29586 A/29522			ISUZU (N-SERIES * F-SERIES)
F 15308	SKF	BT1-0227/ QVA621+L44610/QVA621			VOLKSWAGEN (DSG 6-Speeds)
F 15309	SKF	BT1-0222 A/ QVA621+32007 X/ QCL7CVA606			VOLKSWAGEN (DSG 6-Speeds)
F 15313	TIMKEN SNR	NP417384/Y30206M EC 42226			RENAULT (PK6)
F 15314	TIMKEN FAG	NP 238750/NP 929800 571752			OPEL (M32)
F 15315	TIMKEN	NP 854792/NP 430273			OPEL (M32)
F 15316	TIMKEN SNR	NP868033/NP666556 EC42228501			RENAULT (PF6)
F 15317	SKF	BTH-0001			IFOR WILLIAMS
F 15322	FAG	Z-504376.02			MERCEDES BENZ (HL2)
F 15323	FAG	805189			MERCEDES BENZ (ACCELO)
F 15326	FAG	F-805576.04			VOLVO (AT2412C * AT2512C)
F 15329	KOYO	32012 J/IB			VOLKSWAGEN (CRAFTER)
N F 15327	TIMKEN	NP927527/NP547156			
N F 15328	TIMKEN	NP478770/NP547156			
F 15332	NTN	33212.1/ECO CR-1187.1			MERCEDES BENZ (G211-12)

01.3 \ Special design bearings Serie especial

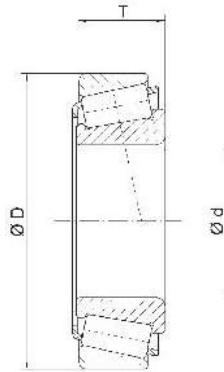

Fersa	d (mm)	D (mm)	T (mm)
F 15334	60,000	110,000	34,000
F 15336	25,000	55,000	13,750
F 15337	25,000	52,000	16,300
F 15338	28,000	55,000	13,750
F 15339	25,000	51,400	13,200
F 15340	41,000	73,000	21,000
F 15341	95,000	126,000	18,100
F 15342	27,000	51,400	13,200
F 15345	85,000	150,000	30,500
F 15346	60,000	115,000	40,000
F 15347	60,000	110,000	29,750
F 15348	60,000	110,000	38,000
F 15361	70,000	165,000	57,000
F 15366	68,000	140,000	49,000
F 15367	68,000	152,000	47,000
F 15376	53,000	82,000	14,000
F 15377	60,000	89,000	15,000
F 15381	35,000	65,000	35,000
F 15382	45,000	88,000	17,000
F 15383	45,000	82,000	23,000
F 15384	34,000	73,000	23,000
F 15385	120,000	181,000	48,000

Fersa	CROSS REF.			
F 15334	NTN	ECO CR-12A17.1		 MERCEDES BENZ (G211-12)
F 15336	SNR	EC 42192 Y S02 H206		 FIAT * GM (M20 * M32)
F 15337	SNR	EC 42224 S01 H206		 RENAULT (PK4 * PK5)
F 15338	SNR	EC 42193 Y S02 H206		 FIAT * GM (M20 * M32)
F 15339	SNR	EC 42310 S01 H200		 FIAT * GM (M20 * M32)
F 15340	SNR	EC 42217 S01 H206		 FIAT * GM (M32)
F 15341	SNR	EC 12606 S01 H106		 RENAULT (AD8 * PF1 * PK1 * PK5 * PK6 * PK9)
F 15342	TIMKEN	NP030522/NP378917		 FIAT * GM (M32)
F 15345	SKF	VKT 9000 30217J2/QVB478/ BT1-1010		 VOLVO (VT1708B * VT2009B * VT2214B * VT2412B * VT2514B * VTO2214 * AT2512C * AT2812C * ATO3112C)
F 15346	FAG	558841.04.LTR1		 VOLVO (VT1708B * VT2009B * VT2214B * VT2412B * VT2514B * VTO2214 * AT2512C * AT2812C * ATO3112C)
F 15347	FAG	F-580794.TR1		 VOLVO (VT1708B * VT2009B * VT2214B * VT2412B * VT2514B * VTO2214 * AT2512C * AT2812C * ATO3112C)
F 15348	FAG	F-580791.TR1		 VOLVO (VT1708B * VT2009B * VT2214B * VT2412B * VT2514B * VTO2214 * AT2512C * AT2812C * ATO3112C * R1400 * SR1400 * SR1700 * SR1900)
F 15361	FAG	546439		 DAF (1347 * 1339) MAN (HY-1175 * HY-1350 (Ø425 mm))
F 15366	TIMKEN	NP802577/NP896994		 MERITOR (M517X)
F 15367	TIMKEN	NP003658/NP096839		 MERITOR (M517X)
F 15376	TIMKEN	NP925485/NP312842		 MERCEDES BENZ (Transfer case)
F 15377	TIMKEN	NP604623/NP577617		 MERCEDES BENZ (Transfer case)
F 15381	SNR	FC 12033		 RENAULT (Clio I * II * Express * Thalia * Twingo * Super 5 * Renault 9 * 11 * 19)
F 15382	FAG	F-571752.03.TR1-DY-H73		 GM (M30 * M32)
F 15383	TIMKEN	SET 702		 FORD (2009-2007 F450 Super Duty * F550 Super Duty * Twin I-Beam)
F 15384	TIMKEN	SET 703		 FORD (2009-2007 F450 Super Duty * F550 Super Duty * Twin I-Beam)
F 15385	FAG	33024/588641		 DANA (D170 * D190)

01.3 \ Special design bearings Serie especial

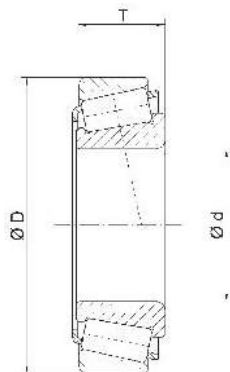

Fersa	d (mm)	D (mm)	T (mm)
F 15386	60,000	125,000	37,000
F 15388	114,000	177,000	41,000
N F 15389	70,000	150,000	50,000
N F 15426	75,000	165,000	57,000
N F 15462	65,000	110,000	34,000
N F 15463	80,000	130,000	37,000
N F 15479	25,000	62,000	21,250
N F 15483	50,800	100,000	46,200
N F 15484	50,800	100,000	48,200
N F 15485	53,975	140,030	39,512
N F 15498	70,000	150,000	54,000







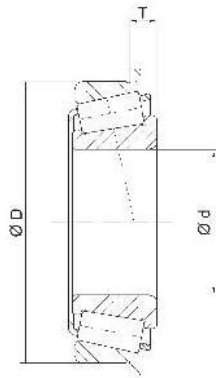





















A series of horizontal dotted lines for taking notes or comments.

01.4 \ Flange side bearings Rodamientos con valona



Fersa	d (mm)	D (mm)	T (mm)
11163/11300 B	41,275	76,200	7,292
30208 BF	40,000	80,000	7,750
30210 BF	50,000	90,000	8,750
33113 B	65,000	110,000	13,000
34300/34478 B	76,200	121,442	11,907
45285 A/45220 B	50,800	110,230	30,160
65237/65500 B	60,325	127,000	16,670
F 15090	25,000	59,000	4,100
F 15108	21,986	45,000	6,500
F 15161	45,000	110,000	12,000
F 15191	80,000	139,992	14,288
F 15192	60,000	130,000	12,250
F 15196	25,000	54,000	9,250
F 15198	31,750	62,000	7,938
F 15212	50,800	104,775	12,000
F 15246	80,000	130,000	5,500
F 15265	65,000	140,000	13,500
F 15310	40,000	68,000	8,000
F 15311	30,000	55,500	7,000
F 15312	27,000	62,000	6,700
HM 807046/HM 807010 BT	50,800	104,775	12,000
JHM 803148/JHM 803113 B	45,000	90,000	9,000
LM 67048/LM 67010 BA	31,750	58,877	6,833
LM 67048/LM 67010 BCE	31,750	59,131	6,375
M 88043/M 88010 B	30,162	68,262	8,730



Fersa	CROSS REF.				
11163/11300 B					
30208 BF					
30210 BF					
33113 B					
34300/34478 B					
45285 A/45220 B					ZF
65237/65500 B					
F 15090	SNR	EC 12567 H206			RENAULT (JC5)
F 15108	TIMKEN	XC 06536 CD / JXC 06536 DC			
F 15161	TIMKEN	JXC 25690 C / JXC 25690 DC			MERCEDES BENZ (G04/160 * G0170-6 * G0190-6 * G0210-6 * G0230-6 * G0240-6)
F 15191	FAG	568742 A			ZF (16S 181 * 16S 182 * 16S 200 A * 16S 251 * 16S 252)
F 15192	FAG	805046 / 801464			MERCEDES BENZ (G211 16 * G221 9 * G241 16 * G330)
F 15196	NTN	ETA CR 05A225TPX1			RENAULT
F 15198	TIMKEN	NP 390444 / NP 750997			LAND ROVER (Defender * Discovery * Range Rover)
F 15212	NTN	4T 45285 APX1 / 4T CR 1091 PX1			ZF (65-150C * 9S-109 * 16S-109)
F 15246	FAG	575194			ZF (16S-151)
F 15265	TIMKEN	NP 881387 / NP 304907			MERCEDES BENZ (G04/160 * G0170-6 * G0190-6 * G0210-6 * G0230-6 * G0240-6)
F 15310	SKF	32008 X/ QVA621+BT1-0336/ QCL7CVA606			VOLKSWAGEN (DSG 6-Speeds)
F 15311	TIMKEN	NP765903 / NP919474			VOLKSWAGEN (VAG)
F 15312	TIMKEN	NP 806712 / NP 326808			SAAB (5 Speeds)
JHM 803148/13 B					
LM 67048/10 BA					
LM 67048/10 BCE					
M 88043/M 88010 B					





A series of horizontal dotted lines spanning the width of the page, intended for writing or drawing.

01.7 Interior Sets

Conjuntos interiores

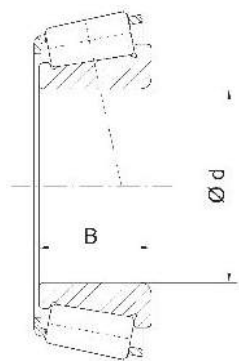

Fersa	d (mm)	B (mm)
CONE 4367 X	39,688	40,386
CONE 4395	42,070	40,386
CONE 33113 F	65,000	34,000
CONE 64452 A	114,970	41,270
CONE F 15084	24,000	28,500
CONE F 15101	28,000	32,000
CONE F 15110	32,000	29,500
CONE F 15111	55,000	29,800
CONE F 15113	50,000	41,275
CONE F 15131	38,100	29,771
CONE F 15132	45,000	30,045
CONE F 15134	65,000	31,000
CONE F 15150 A	40,000	38,000
CONE F 15213	32,000	33,000
CONE F 15244	50,000	41,000
CONE F 15249	39,688	40,386
CONE F 15269	55,000	29,800
CONE F 15292	39,688	43,050
CONE F 15327	68,260	44,250
CONE F 15328	69,850	51,750
CONE F 15333	52,000	24,000
CONE F 15356	40,000	35,000

Fersa	CROSS REF.				
CONE 4367 X					MERCEDES BENZ (G210-16 * G211-12 * G221-9 * G240-16 * G260-16)
CONE 4395					ZF (165-151 * 165-181 * 165-221 * 85-180)
CONE 33113 F					VOLVO (AT 2412 C * VT 2014 B * VT 2514 B)
CONE 64452 A					DANA (R170/R190)
CONE F 15084	KOYO	ST 2455			ZF (55-420)
CONE F 15101	TIMKEN	JXC 6839 CD			ZF (56-85)
CONE F 15110	TIMKEN	JXC 25662 C			ZF (95-109 * 65-150 C) MERCEDES BENZ (G100-12)
CONE F 15111	KOYO	ST 4276 C/A			MERCEDES BENZ (G240-16 * G241-16 * G260-16 * G280-16)
CONE F 15113	NTN	ETA CIR 1010 1			MERCEDES BENZ (G240-16 * G241-16 * G260-16 * G280-16 * G281-12 * G330-12)
CONE F 15131	TIMKEN	NP 457202			MERCEDES BENZ (G100-12)
CONE F 15132	TIMKEN	NP 057427			MERCEDES BENZ (G100-12)
CONE F 15134	TIMKEN	JXC 19089 DA			MERCEDES BENZ (G100-12)
CONE F 15150 A	FAG	576503			VOLVO (AT 2412 C * VT 2014 B * VT 2514 B)
CONE F 15213	SKF	BT1B 329154/Q/CL7C			ZF (85-109 * 165-109)
CONE F 15244	NTN	ETA CIR 1006.1			MERCEDES BENZ (G210 16 * G211 16 * G230 16 * G 231 16)
CONE F 15249	NTN	ECO CIR 0805.2			MERCEDES BENZ (G211-16 * G230-12 * G 231-16 * G241-16 * G280-16 * G281-12 * G330-12)
CONE F 15269	NTN	ETA CIR-1106			MERCEDES BENZ (G281-16 * G330-12)
CONE F 15292	NTN	ETA CIR-0810.1			MERCEDES BENZ (G221-9* G0240-6)
CONE F 15327	TIMKEN	NP 927527			DANA (R170/R190)
CONE F 15328	TIMKEN	NP 478770			DANA (R170/R190)
CONE F 15333	NTN	ETA CIR 1012			MERCEDES BENZ (G211-12)
CONE F 15356	SKF	BT1-0445			SCANIA (GR 905)

01.7 \ Interior Sets Conjuntos interiores

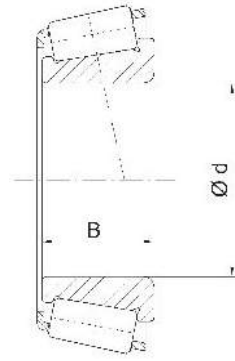

Fersa	d (mm)	B (mm)
N CONE F 15385	120,000	48,000
N CONE F 15388	114,950	41,280



A series of horizontal dotted lines for writing notes or comments.

Double row tapered roller bearings

Rodamientos de rodillos cónicos de doble hilera

02.1 \	Special double row tapered roller bearings / Rodamientos de rodillos cónicos de doble hilera especiales	56
02.2 \	Pinion module / Módulo de Piñón	60

02

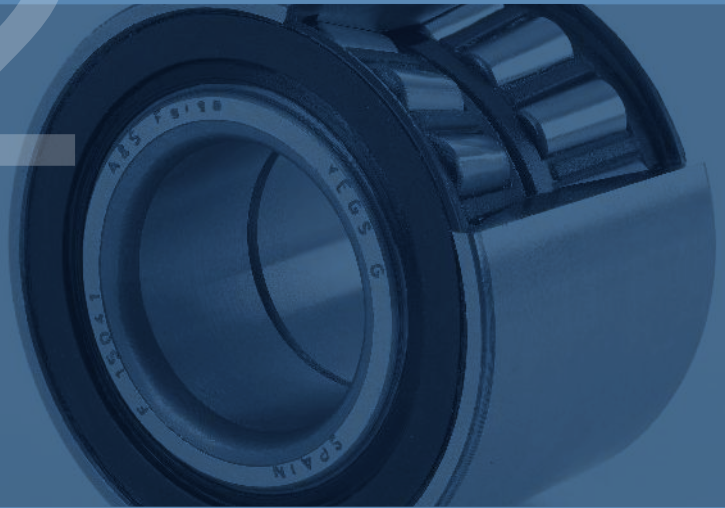

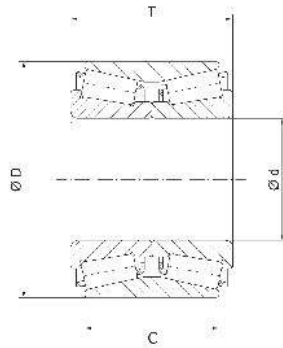

02.1 \ Special double row tapered roller bearings Rodamientos de rodillos cónicos de doble hilera especiales

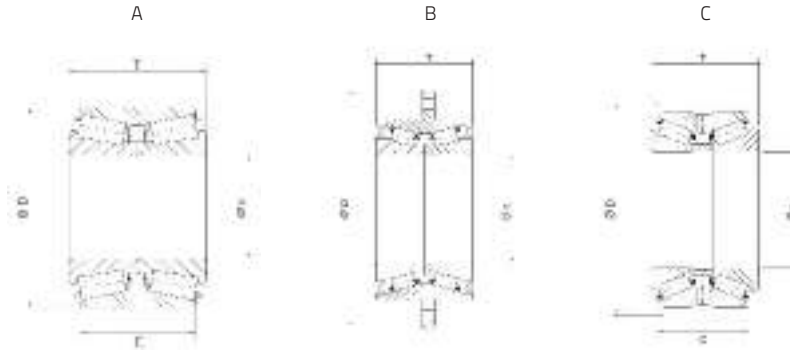

Fersa	d (mm)	D (mm)	C / T (mm)	TYPE
F 15015	41,000	68,000	35,000 / 40,000	A
F 15041	25,000	52,000	37,000	A
F 15042	25,000	52,000	43,000	A
F 15043	25,000	55,000	43,000	A
F 15044	35,000	65,000	35,000	A
F 15045	39,000	68,000	37,000	A
F 15050	25,000	52,000	37,000	A
F 15067	29,000	53,000	37,000	A
F 15068	49,000	84,000	48,000	A
F 15128	27,000	53,000	43,000	A
F 15129	40,000	75,000	50,000	A
F 15130	42,000	80,000	38,000	A
F 15146	54,000	142,000	62,000	B
F 15149	40,000	80,000	38,000	A
F 15151	27,000	52,000	45,000 / 50,000	A
F 15154	45,000	115,000	53,000	B
F 15160	43,000	77,000	41,500 / 45,500	A

Type / Tipo





Fersa	CROSS REF.				
F 15015	NSK	41KWD01G3			SUZUKI (Grand Vitara * Vitara * X 90)
F 15041	SKF FAG SNR	BT2B445539BA / VC025 546467 FC 12025 S09			CITROËN (AX * C2 * C3 * Saxo * Visa * Xsara * ZX) DACIA (Logan) NISSAN (Aprio * Micra * Note * Platina) PEUGEOT (106 * 205 * 206 * 306 * 309 * 1007) RENAULT (Super 5 * 9 * 11 * 19) Clio * Megane * Modus * Tahlia * Twingo * Chamade)
F 15042	SNR	FC 12180 S04			RENAULT (Extra * Express * 21 * Rapid)
F 15043	SNR	FC 12271 S03			MERCEDES BENZ (Clase A) NISSAN (Kubistar) RENAULT (Kangoo * Laguna * Express)
F 15044	FAG TIMKEN SNR	546238 JRM 3535 A / JRM 3565 XD FC 12033S01			RENAULT (Clio * Express * Tahlia * Twingo * Super 5 * 9 * 11 * 19)
F 15045	TIMKEN	JRM 3939 / JRM 3968 XD			AUDI (80 * 90 * Coupe) VOLKSWAGEN (Golf * Jetta * Passat * Santana)
F 15050	SNR	FC 12784 S03			RENAULT (Clio * Megane * Super 5 * 9 * 11 * 19)
F 15067	SKF NATIONAL	BTH 1206 AB 516007			FORD (Ecostport * Fiesta * Focus * Fusion) MAZDA (2)
F 15068	TIMKEN	JXC 25469CA / JXC 25469 DB			FORD (Transit)
F 15128	KOYO SNR	DAC 2753 FC 40650 S01			CHEVROLET (Corsa) OPEL (Corsa * Tigra)
F 15129	NSK	40KWD02			MITSUBISHI (L200) NISSAN (Urvan)
F 15130	NSK NATIONAL	42KWD08A 516005			NISSAN (Frontier * Infiniti * Pathfinder * Urvan * Xterra)
F 15146	NSK	54KWH02			TOYOTA (Hiace)
F 15149	NTN	DAC 4T CR1			
F 15151					NISSAN (Tsuru III)
F 15154	SKF	BTF 1125 B			FORD (Transit)
F 15160	NSK	43 KWD 07AU42CA			TOYOTA (Hilux)

02.1 \ Special double row tapered roller bearings

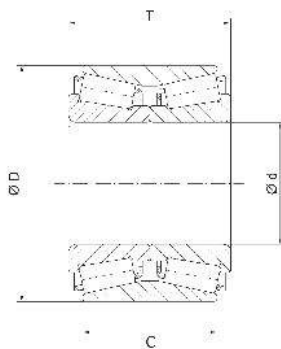
Rodamientos de rodillos cónicos de doble hilera especiales









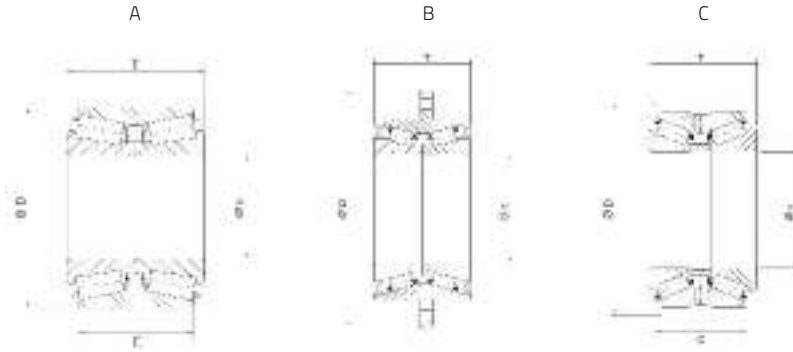



















Fersa	d (mm)	D (mm)	C / T (mm)	TYPE
F 15168	49,000	84,000	48,000	A
F 15173	35,000	68,000	48,000	A
F 15174	45,300	80,000	48,000	A
F 15175	25,000	55,000	45,000	A
F 15187	40,000	73,000	55,000	A
F 15218	42,000	82,000	40,000	A
F 15268	47,000	88,000	55,000	A
F 15302	55,000	90,000	55,000	A
F 15317	55,000	75,000	60,000	A
F 15324	54,000	158,000	51,000	B
 F 15330	69,850	126,000	54,626 / 63,880	C
F 15360	30,000	62,000	48,000	A
 F 15380	69,000	116,000	58,275 / 71,880	C



Type / Tipo



Fersa	CROSS REF.				
F 15168	SKF	BTHB 329129 ABC			OPEL (Movano) RENAULT (Master) CITROËN (Jumper) FIAT (Ducato) PEUGEOT (Boxer) NISSAN (Interstar)
F 15173	SNR	FC 40772 S02			NISSAN (Primastar) OPEL (Vivaro) RENAULT (Space * Traffic)
F 15174	SNR	FC 40096 S05			RENAULT (Mascott * Master) OPEL (Movano) NISSAN (Interstar)
F 15175	SNR	FC 40858 S02			RENAULT (Clio * Megane * Modus)
F 15187	SKF	BTH 1024			IVECO (Daily I)
F 15218	NSK	4UA20/KWD 10			TOYOTA (Hilux)
F 15268	NSK	47 KWD 02 AP			FORD (Ranger) MAZDA (Drifter)
F 15302	SKF	BTH 1219 AB			IVECO (Daily IV)
F 15317	SKF	BTH 0001			IFOR WILLIAMS
F 15324	SKF	VKBA 7425			TOYOTA (Fortuner * Hilux)
F 15330	KOYO	57518/TR1312/1YD			EATON (RTLO-16918)
F 15360	SNR	FC41645			CITROËN (C3 * C4 * DS3)
F 15380	KOYO	57518/TR1312			EATON (13 Speeds Models)



.....

.....

.....

.....

.....

.....

.....

.....

02.2 \ Pinion module Módulo de Piñón

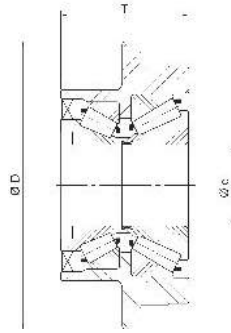

Fersa	d (mm)	D (mm)	T (mm)
F 15321	68,000	260,000	107,000
F 15371	68,000	272,000	100,000



A series of horizontal dotted lines for writing notes.

03

Thrust tapered roller bearings

Rodamientos axiales cónicos

03

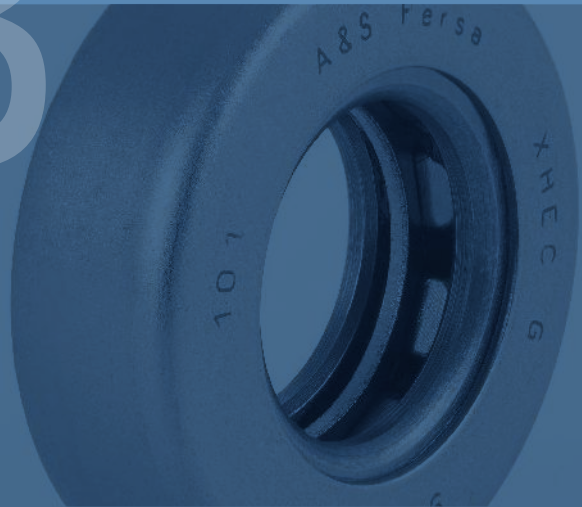

03 \ Thrust tapered roller bearings Rodamientos axiales cónicos

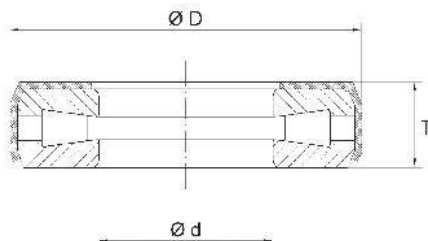

Fersa	d (mm)	D (mm)	T (mm)	TYPE
T 94	24,054	48,021	15,088	A
T 101	25,654	50,800	15,875	A
T 113	28,829	55,562	15,875	A
T 119	30,416	55,562	15,875	A
T 126	32,004	55,562	15,875	A
T 138	35,179	66,675	19,446	B
T 139	35,179	58,738	15,875	A
T 144	36,754	66,675	19,446	B
T 149	38,303	65,883	19,431	A
T 151	38,354	72,619	21,433	B
T 152	38,354	72,619	20,638	B
T 163	41,529	72,619	21,433	B
T 177	45,000	73,000	20,000	B
T 182	46,279	82,956	23,812	B
T 188	46,879	82,956	23,812	B
T 1004	50,000	78,000	22,000	B
T 199	51,054	74,612	15,875	A
T 200	50,800	109,538	22,225	A
T 200 A	50,800	109,538	22,225	A
T 1006	50,100	78,000	22,000	A
T 1008	45,500	73,000	20,000	A



Type / Tipo

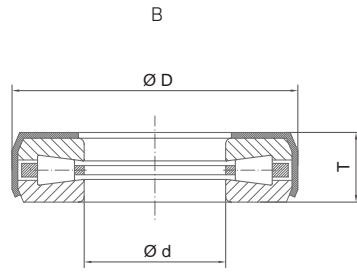
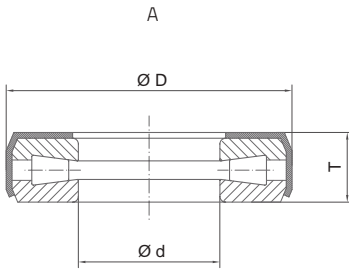

Deep groove ball bearings

Rodamientos radiales de bolas

04.1 \	Standard ball bearings / Rodamientos de bolas estándar	68
04.2 \	Special ball bearings / Rodamientos de bolas especiales	82

04

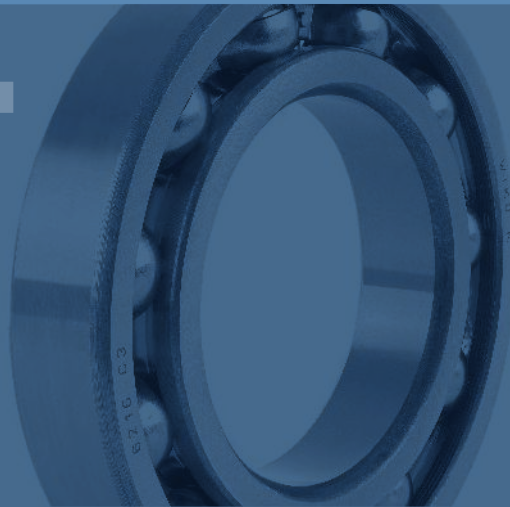

04.1 \ Standard ball bearings

Rodamientos de bolas estándar

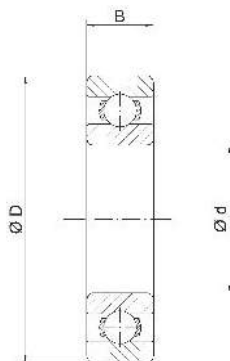

Serie	Fersa	d (mm)	D (mm)	B (mm)
600 SERIE				
607	607 2RS/C3 607 ZZ/C3	7,000	19,000	6,000
608	608 2RS/C3 608 ZZ/C3	8,000	22,000	7,000
609	609 2RS/C3 609 ZZ/C3	9,000	24,000	7,000

620 SERIE				
626	626 2RS/C3 626 ZZ/C3	6,000	19,000	6,000
628	628 2RS/C3 628 ZZ/C3	8,000	24,000	8,000
629	629 2RS/C3 629 ZZ/C3	9,000	26,000	8,000

6000 SERIE				
6000	6000 6000 2RS 6000 2RS/C3 6000 Z 6000 ZZ 6000 ZZ/C3	10,000	26,000	8,000
6001	6001 6001 2RS 6001 2RS/C3 6001 Z 6001 ZZ 6001 ZZ/C3	12,000	28,000	8,000
6002	6002 6002 2RS 6002 2RS/C3 6002 Z 6002 ZZ 6002 ZZ/C3	15,000	32,000	9,000
6003	6003 6003 2RS 6003 2RS/C3 6003 Z 6003 ZZ 6003 ZZ/C3	17,000	35,000	10,000

Suffixes / Sufijos

C3 Internal clearance greater than normal / Juego radial mayor que el normal

C4 Internal clearance greater than C3 / Juego radial mayor que C3

RS Rubbing seal at one side / Tapa retén en una cara

2RS Rubbing seals at both sides / Tapa retén en las dos caras

Z Shield at one side / Tapa en una cara

ZZ Shields at both sides / Tapas en las dos caras

NR Snap ring groove and snap ring / Ranura y anillo elástico en aro exterior

04

Serie	Fersa	d (mm)	D (mm)	B (mm)
6004	6004	20,000	42,000	12,000
	6004 C3			
	6004 RS			
	6004 2RS			
	6004 2RS/C3			
	6004 2RS NR			
	6004 Z			
	6004 ZZ			
6005	6005	25,000	47,000	12,000
	6005 2RS			
	6005 2RS NR			
	6005 2RS/C3			
	6005 Z			
	6005 ZZ			
6005 ZZ/C3				
6006	6006	30,000	55,000	13,000
	6006 2RS			
	6006 2RS/C3			
	6006 Z			
	6006 ZZ			
	6006 ZZ NR			
6006 ZZ/C3				
6006/32	6006/32 2RS/C3	32,000	55,000	13,000
6007	6007	35,000	62,000	14,000
	6007 2RS			
	6007 2RS/C3			
	6007 Z			
	6007 ZZ			
6007 ZZ/C3				
6008	6008	40,000	68,000	15,000
	6008 2RS			
	6008 2RS/C3			
	6008 Z			
	6008 ZZ			
	6008 ZZ NR			
6008 ZZ/C3				
6009	6009	45,000	75,000	16,000
	6009 C3			
	6009 NR			
	6009 2RS			
	6009 2RS/C3			

04.1 \ Standard ball bearings Rodamientos de bolas estándar

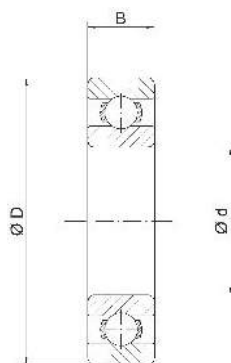

Serie	Fersa	d (mm)	D (mm)	B (mm)
6000 SERIE				
609	6009 Z 6009 ZZ 6009 ZZ/C3 6009 ZZ NR	45,000	75,000	16,000
6010	6010 6010 2RS 6010 2RS/C3 6010 Z 6010 ZZ 6010 ZZ/C3	50,000	80,000	16,000
6011	6011 6011 2RS 6011 2RS/C3 6011 Z 6011 ZZ 6011 ZZ/C3	55,000	90,000	18,000
6012	6012 6012 2RS 6012 2RS/C3 6012 Z 6012 ZZ 6012 ZZ/C3	60,000	95,000	18,000
6013	6013 6013 C3 6013 2RS 6013 2RS/C3 6013 Z 6013 ZZ 6013 ZZ/C3	65,000	100,000	18,000
6014	6014 6014 2RS 6014 2RS/C3 6014 Z 6014 ZZ 6014 ZZ/C3 6014 C3	70,000	110,000	20,000
6015	6015 6015 2RS 6015 2RS/C3 6015 Z 6015 ZZ 6015 ZZ/C3	75,000	115,000	20,000
6016	6016 2RS/C3	80,000	125,000	22,000
6017	6017 NR	85,000	130,000	22,000

Suffixes / Sufijos

C3 Internal clearance greater than normal / Juego radial mayor que el normal

C4 Internal clearance greater than C3 / Juego radial mayor que C3

RS Rubbing seal at one side / Tapa retén en una cara

2RS Rubbing seals at both sides / Tapa retén en las dos caras

Z Shield at one side / Tapa en una cara

ZZ Shields at both sides / Tapas en las dos caras

NR Snap ring groove and snap ring / Ranura y anillo elástico en aro exterior

Serie	Fersa	d (mm)	D (mm)	B (mm)
61900 SERIE				
61904	61904 2RS	20,000	37,000	9,000
61909	61909 2RS	45,000	68,000	12,000
61915	61915 C3	75,000	105,000	16,000
6200 SERIE				
62/22	62/22 2RS/C3	22,000	50,000	14,000
6200	6200 6200 2RS 6200 2RS/C3 6200 Z 6200 ZZ 6200 ZZ/C3	10,000	30,000	9,000
6201	6201 6201 2RS 6201 2RS/C3 6201 Z 6201 ZZ 6201 ZZ/C3	12,000	32,000	10,000
6202	6202 6202 2RS 6202 2RS/C3 6202 Z 6202 ZZ/C3 6202 ZZ NR	15,000	35,000	11,000
6203	6203 6203 2RS 6203 2RS/C3 6203 Z 6203 ZZ 6203 ZZ/C3	17,000	40,000	12,000
6203/12	6203/12 2RS	12,000	40,000	12,000
6204	6204 6204 2RS 6204 2RS/C3 6204 Z 6204 ZZ/C3 6204 ZZ NR	20,000	47,000	14,000
6205	6205 6205 2RS 6205 2RS NR 6205 2RS/C3 6205 Z	25,000	52,000	15,000

04.1 \ Standard ball bearings

Rodamientos de bolas estándar

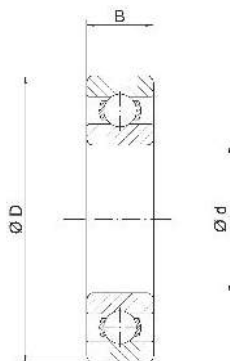

Serie	Fersa	d (mm)	D (mm)	B (mm)
6205	6205 ZZ 6205 ZZ/C3 6205 ZZ NR	25,000	52,000	15,000
6205 B12 D56	6205 B12 D56	25,000	56,000	12,000

6200 SERIE				
6206	6206 6206 2RS 6206 2RS/C3 6206 Z 6206 ZZ 6206 ZZ/C3 6208 Z NR 6206 ZZ NR	30,000	62,000	16,000
6207	6207 6207 C3 6207 2RS 6207 2RS/C3 6207 Z 6207 Z NR 6207 ZZ 6207 ZZ/C3	35,000	72,000	17,000
6207/33	6207/33	33,000	72,000	17,000
6208	6208 6208 2RS 6208 2RS/C3 6208 Z 6208 ZZ 6208 ZZ/C3 6208 Z NR 6208 NR	40,000	80,000	18,000
6209	6209 6209 C3 6209 2RS 6209 2RS/C3 6209 Z 6209 ZZ 6209 ZZ/C3 6209 ZZ NR	45,000	85,000	19,000
6210	6210 6210 C3 6210 2RS 6210 2RS/C3 6210 Z 6210 ZZ 6210 Z NR	50,000	90,000	20,000

Suffixes / Sufijos

C3 Internal clearance greater than normal / Juego radial mayor que el normal

C4 Internal clearance greater than C3 / Juego radial mayor que C3

RS Rubbing seal at one side / Tapa retén en una cara

2RS Rubbing seals at both sides / Tapa retén en las dos caras

Z Shield at one side / Tapa en una cara

ZZ Shields at both sides / Tapas en las dos caras

NR Snap ring groove and snap ring / Ranura y anillo elástico en aro exterior

Serie	Fersa	d (mm)	D (mm)	B (mm)
6210	6210 ZZ NR 6210 ZZ/C3	50,000	90,000	20,000
6211	6211 6211 2RS 6211 2RS/C3 6211 Z 6211 ZZ 6211 ZZ/C3 6211 ZNR 6211 C3	55,000	100,000	21,000
6212	6212 6212 C3 6212 2RS 6212 2RS/C3 6212 2RS NR 6212 Z 6212 ZNR/C3 6212 ZZ 6212 ZZ/C3	60,000	110,000	22,000
6213	6213 6213 C3 6213 2RS 6213 2RS/C3 6213 2RS NR/C3 6213 NR 6213 Z 6213 ZMNR/C3 6213 ZZ 6213 ZZ/C3	65,000	120,000	23,000
6214	6214 6214 2RS 6214 2RS/C3 6214 Z 6214 ZZ 6214 ZZ/C3 6214 C3	70,000	125,000	24,000
6215	6215 6215 2RS 6215 2RS/C3 6215 NR/C3 6215 NR/C3 6215 Z 6215 ZZ 6215 ZZ/C3	75,000	130,000	25,000
6216	6216 6216 C3 6216 2RS 6216 2RS/C3 6216 NR/C3	80,000	140,000	26,000

04.1 \ Standard ball bearings

Rodamientos de bolas estándar

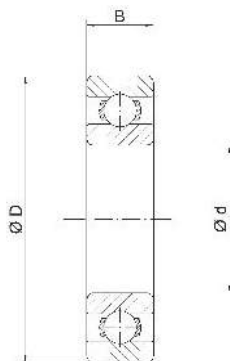

Serie	Fersa	d (mm)	D (mm)	B (mm)
6216	6216 C3	80,000	140,000	26,000
	6216 C4			
	6216 Z			
	6216 ZZ			
	6216 ZZ/C3			
6217	6217	85,000	150,000	28,000
	6217 C3			
6217/80	6217/80 C3	80,000	150,000	28,000
6218	6218	90,000	160,000	30,000
	6218 C3			

62200 SERIE				
62201	62201 2RS/C3	12,000	32,000	14,000
62202	62202 2RS/C3	15,000	35,000	14,000
62204	62204 2RS	20,000	47,000	18,000
62205	62205 2RS	25,000	52,000	18,000
62206	62206 2RS	30,000	62,000	20,000
62207	62207 2RS	35,000	72,000	23,000
62208	62208 2RS	40,000	80,000	23,000
62212	62212 2RS	60,000	110,000	28,000

62300 SERIE				
62304	62304 2RS/C3	20,000	52,000	21,000
62305	62305	25,000	62,000	24,000
	62305 C3			
	62305 2RS/C3			
62306	62306 2RS/C3	30,000	72,000	27,000

63 / SERIE				
63/22	63/22	22,000	56,000	16,000
	63/22 C3			
63/28	63/28	28,000	68,000	18,000
	63/28 C3			
	63/28 2RS/C3			
63/32	63/32 2RS	32,000	75,000	20,000
	63/32 C3			
	63/32 2RS NR			
	63/32 NR/C3			

Suffixes / Sufijos

C3 Internal clearance greater than normal / Juego radial mayor que el normal

C4 Internal clearance greater than C3 / Juego radial mayor que C3

RS Rubbing seal at one side / Tapa retén en una cara

2RS Rubbing seals at both sides / Tapa retén en las dos caras

Z Shield at one side / Tapa en una cara

ZZ Shields at both sides / Tapas en las dos caras

NR Snap ring groove and snap ring / Ranura y anillo elástico en aro exterior

Serie	Fersa	d (mm)	D (mm)	B (mm)
6300 SERIE				
6300	6300 6300 2RS 6300 2RS/C3 6300 Z 6300 ZZ 6300 ZZ/C3	10,000	35,000	11,000
6301	6301 6301 2RS 6301 2RS/C3 6301 Z 6301 ZZ 6301 ZZ/C3	12,000	37,000	12,000
6302	6302 6302 2RS 6302 2RS/C3 6302 Z 6302 ZZ 6302 ZZ/C3	15,000	42,000	13,000
6303	6303 6303 2RS 6303 2RS/C3 6303 Z 6303 ZZ 6303 ZZ/C3	17,000	47,000	14,000
6303/15	6303/15 2RS	15,000	47,000	14,000
6304	6304 6304 2RS 6304 2RS/C3 6304 2RS NR 6304 Z 6304 ZZ 6304 ZZ/C3	20,000	52,000	15,000
6304 B12	6304 B12	20,000	52,000	12,000
6304 B12 D56	6304 B12 D56	20,000	56,000	12,000
6304/17	6304/17 2RS	17,000	52,000	15,000
6304/17 B16	6304/17 B16 2RS	17,000	52,000	16,000
6304/17 B17	6304/17 B17 2RS	17,000	52,000	17,000
6305	6305 6305 2RS 6305 C3 6305 2RS NR 6305 2RS/C3 6305 NR 6305 Z	25,000	62,000	17,000

04.1 \ Standard ball bearings

Rodamientos de bolas estándar

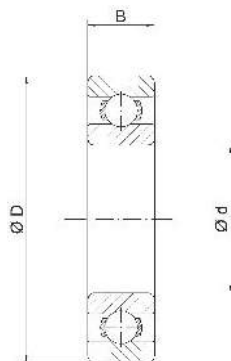

Serie	Fersa	d (mm)	D (mm)	B (mm)
6305	6305 ZZ 6305 ZZ/C3 6305 Z NR 6305 ZZ NR	25,000	62,000	17,000
6306	6306 6306 2RS 6306 2RS NR 6306 2RS/C3 6306 C5 6306 NR 6306 NR/C3 6306 Z 6306 ZZ 6306 Z NR 6306 ZZ NR 6306 ZZ/C3	30,000	72,000	19,000
6306/25	6306/25 2RS/C3	25,000	72,000	19,000
6307	6307 6307 2RS 6307 2RS NR 6307 2RS C3 6306 ZZ NR 6307 Z 6307 ZZ 6307 ZZ/C3 6307 Z NR 6307 ZZ NR	35,000	80,000	21,000
6307 B23	6307 B23 6307 B23 NR	35,000	80,000	23,000
6308	6308 6308 2RS 6308 2RS/C3 6308 2RS NR 6308 NR 6308 Z 6308 ZZ 6308 ZZ/C3 6308 Z NR 6308 ZZ NR	40,000	90,000	23,000
6309	6309 6309 2RS 6309 2RS/C3 6309 C3 6309 NR 6309 Z 6309 ZZ	45,000	100,000	25,000

Suffixes / Sufijos

C3 Internal clearance greater than normal / Juego radial mayor que el normal

C4 Internal clearance greater than C3 / Juego radial mayor que C3

RS Rubbing seal at one side / Tapa retén en una cara

2RS Rubbing seals at both sides / Tapa retén en las dos caras

Z Shield at one side / Tapa en una cara

ZZ Shields at both sides / Tapas en las dos caras

NR Snap ring groove and snap ring / Ranura y anillo elástico en aro exterior

Serie	Fersa	d (mm)	D (mm)	B (mm)
6309	6309 ZZ/C3	45,000	100,000	25,000
6310	6310 6310 2RS 6310 2RS/C3 6310 NR/C3 6310 Z 6310 ZZ 6310 ZZ/C3	50,000	110,000	27,000
6311	6311 6311 C3 6311 2RS 6311 2RS/C3 6311 NR 6311 Z 6311 ZZ 6311 ZZ/C3	55,000	120,000	29,000
6312	6312 6312 2RS 6312 2RS/C3 6312 2RS NR 6312 C3 6312 NR/C3 6312 Z 6312 ZZ 6312 ZZ/C3	60,000	130,000	31,000
6313	6313 6313 2RS 6313 2RS/C3 6313 C3 6313 C4 6313 Z 6313 ZZ 6313 ZZ/C3	65,000	140,000	33,000
6314	6314 6314 2RS 6314 2RS/C3 6314 NR/C3 6314 Z 6314 ZZ 6314 ZZ/C3	70,000	150,000	35,000
6315	6315 6315 2RS 6315 2RS/C3 6315 Z	75,000	160,000	37,000

04.1 \ Standard ball bearings

Rodamientos de bolas estándar

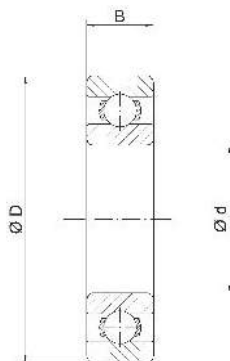

Serie	Fersa	d (mm)	D (mm)	B (mm)
6315	6315 ZZ 6315 ZZ/C3	75,000	160,000	37,000

63010 SERIE

63010	63010 2RS	50,000	80,000	23,000
--------------	-----------	--------	--------	--------

6400 SERIE

6403	6403 6403 C3 6403 2RS 6403 2RS/C3 6403 Z 6403 ZZ 6403 ZZ/C3	17,000	62,000	17,000
6404	6404 6404 2RS 6404 2RS/C3 6404 Z 6404 ZZ 6404 ZZ/C3	20,000	72,000	19,000
6405	6405 6405 2RS 6405 2RS/C3 6405 Z 6405 ZZ 6405 ZZ/C3	25,000	80,000	21,000
6406	6406 6406 2RS 6406 2RS/C3 6406 Z 6406 ZZ 6406 ZZ/C3	30,000	90,000	23,000
6407	6407 6407 2RS 6407 2RS/C3 6407 Z 6407 ZZ 6407 ZZ/C3	35,000	100,000	25,000

Suffixes / Sufijos

C3 Internal clearance greater than normal / Juego radial mayor que el normal

C4 Internal clearance greater than C3 / Juego radial mayor que C3

RS Rubbing seal at one side / Tapa retén en una cara

2RS Rubbing seals at both sides / Tapa retén en las dos caras

Z Shield at one side / Tapa en una cara

ZZ Shields at both sides / Tapas en las dos caras

NR Snap ring groove and snap ring / Ranura y anillo elástico en aro exterior

Serie	Fersa	d (mm)	D (mm)	B (mm)
6408	6408	40,000	110,000	27,000
	6408 2RS			
	6408 2RS/C3			
	6408 Z			
	6408 ZZ			
	6408 ZZ/C3			
6409	6409	45,000	120,000	29,000
	6409 2RS			
	6409 2RS/C3			
	6409 Z			
	6409 ZZ			
	6409 ZZ/C3			
6410	6410	50,000	130,000	31,000
	6410 2RS			
	6410 2RS/C3			
	6410 Z			
	6410 ZZ			
	6410 ZZ/C3			
6411	6411	55,000	140,000	33,000
	6411 2RS			
	6411 2RS/C3			
	6411 Z			
	6411 ZZ			
	6411 ZZ/C3			
6412	6412	60,000	150,000	35,000
	6412 2RS			
	6412 2RS/C3			
	6412 Z			
	6412 ZZ			
	6412 ZZ/C3			
6413	6413	65,000	160,000	37,000
	6413 2RS			
	6413 2RS/C3			
	6413 Z			
	6413 ZZ			
	6413 ZZ/C3			
6414	6414	70,000	180,000	42,000
	6414 2RS			
	6414 2RS/C3			
	6414 Z			
	6414 ZZ			
	6414 ZZ/C3			

04.1 \ Standard ball bearings

Rodamientos de bolas estándar

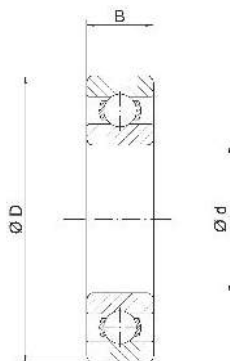

Serie	Fersa	d (mm)	D (mm)	B (mm)
6415	6415 6415 2RS 6415 2RS/C3 6415 Z 6415 ZZ 6415 ZZ/C3	75,000	190,000	45,000

RMS SERIE				
RMS 9	RMS 9 RMS 9 2RS/C4	28,575	71,438	20,638

16000 SERIE				
16014	16014	70,000	110,000	13,000
16017/90	16017/90 C3 16017/90 C3+SPACER	90,000	130,000	14,000





A series of horizontal dotted lines for writing, spanning the width of the page.

04.2 \ Special ball bearings Rodamientos de bolas especiales

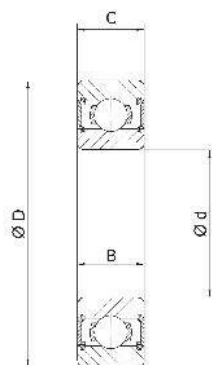



Fersa	d (mm)	D (mm)	C / B (mm)	TYPE
F 18009	45,000	85,000	23,000	ESP
F 18011	30,000	65,000	21,000	A
F 18015	15,000	35,000	13,000	A
F 18018	25,000	62,020	17,500	B
F 18019	25,000	59,000	17,500	B
F 18020	17,000	62,000	17,600 / 17,000	A
F 18021	28,000	66,000	18,000	B
F 18022	25,000	69,000	20,000	A
F 18023	35,000	75,000	20,000	B
F 18024	25,995	68,000	14,500 / 21,550	C
F 18032	50,000	90,000	20,000	A
F 18033	50,000	90,000	20,000	A
F 18036	85,000	150,000	28,000	B
F 18037	85,000	160,000	33,000	B
F 18038	36,487	68,000	15,000	A
F 18039	36,513	68,000	15,000	B
F 18041	50,000	90,000	20,000	A
F 18042	55,000	120,000	29,000	A
F 18043	28,000	75,000	21,000	D
F 18046 2RS	12,000	32,000	10,000 / 15,350	ESP

*ESP For more special drawing details, contact with Fersa / Para más información técnica, contactar con Fersa.

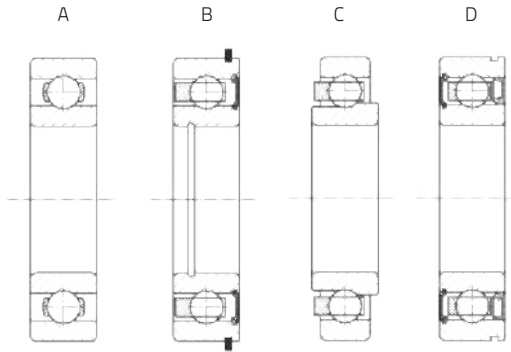
Type / Tipo



Fersa	CROSS REF.				
F 18009	FAG SKF SNR IRB	4209 BTVH 4209 ATN9 / MT33 VB2669 4209 A IR 8566			
F 18011	FAG SKF IRB	543909 BB1B 630374 / C4 IR 8014			FIAT (124)
F 18015					
F 18018	SNR	AB12888 505			RENAULT (Super 5 * R9 * R11 * R19 * Clio I * Express I * Express II * Extra MK I * Extra MK II * Rapid)
F 18019	SNR	AB41386			RENAULT (Super 5 * R9 * R11 * R19 * Clio I * Clio II * Express I * Express II * Extra MK I * Extra MK II * Kangoo * Kangoo FL * Lutécia * Mégane * Mégane Classic * Mégane Scénic * Rapid * Tahlia * Twingo)
F 18020	NSK	B17 126 DDWC3		ALT	BOSCH
F 18021	FAG	566195			MERCEDES BENZ (MB 180)
F 18022	SNR	AB12516			RENAULT (Traffic)
F 18023	SKF	440682			
F 18024	FAG	536906C			AUDI (A3 * S3 * TT)
F 18032	SKF SNR KOYO	6210ZNRB 6210NRZB 6210NRZ			
F 18033					
F 18036	KOYO	6217 3BBNCS 9			EATON
F 18037					
F 18038					
F 18039	INA KOYO	F 45385 83549			CASE NEW HOLLAND (30 * TS)
F 18041	NSK	BL 210 ZNR C3		V	KOMATSU (Various)
F 18042	FAG NTN	800574A TMB 311 X13 C3			MERCEDES BENZ (G 60 * G 85-6)
F 18043	SKF	BB1B 445924 C			PEUGEOT (605 * 806)
F 18046 2RS		S 88501			

04.2 \ Special ball bearings Rodamientos de bolas especiales

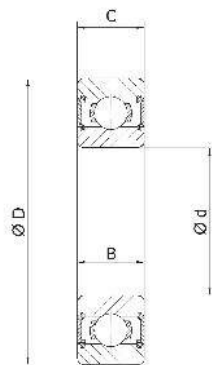

Fersa	d (mm)	D (mm)	C / B (mm)	TYPE
F 18046 ZZ	12,000	32,000	10,000 / 15,350	ESP
F 18047	30,000	75,000	21,000	D
F 18048	32,000	80,000	23,000	D
F 18049	50,000	90,000	22,000 / 16,000	ESP
F 18050	40,000	94,000	26,000	ESP
F 18051	40,000	90,000	23,000	ESP
F 18053	70,000	140,000	26,000	A
F 18054	55,000	116,000	28,000	A
F 18055	60,000	130,000	31,000	A
F 18056	55,000	120,000	29,000	A
F 18058	25,000	55,000	15,000	A
F 18059	80,000	140,000	26,000	A
F 18060	72,000	130,000	25,000	A
F 18062	25,000	62,000	19,000	A
F 18066	90,000	140,000	24,000	B
F 18067	22,000	62,000	21,000	D
N F 18069	33,000	75,000	21,500	ESP
N F 18074	30,600	59,000	16,700	A
N F 18075	35,000	85,000	23,000	D
N F 18076	40,000	92,000	25,500	D
N F 18082	28,000	72,000	27,600	D
N F 18083	35,000	77,000	23,300	D







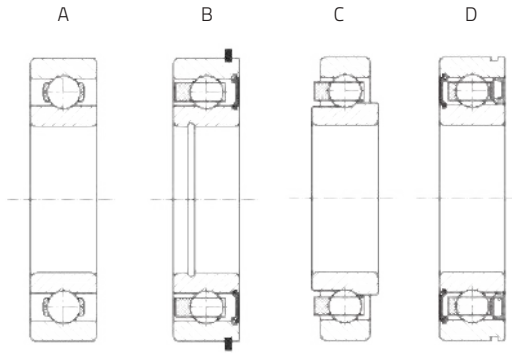















*ESP For more special drawing details, contact with Fersa / Para más información técnica, contactar con Fersa.

Type / Tipo



04

Fersa	CROSS REF.				
F 18046 ZZ		S 88501			
F 18047	NTN	30 TM11NC3 UR UMMS			CHEVROLET (Cheyenne Blazer)
F 18048	NTN	32 TM11NC3 UR UMMS 806			
F 18049		600110			
F 18050	KOYO	DG 4094 W			TOYOTA (Hiace)
F 18051	NSK	40 BW06CG50			TOYOTA (Hilux * SW4)
F 18053	SKF	VKT 8692 / BB1 3076			VOLVO (VT 2009 B * VT 2014 B * VT 2214 B * VTO 2214 B * VT 2514 B * VTO 2514 OD * VT 2814 B * VTO 2814 B)
F 18054	SKF	BB1 3357			ZF (6S-850)
F 18055	SKF	BB1 3359			ZF (6S-1000)
F 18056	SKF	BB1 3356			ZF (6S-1000)
F 18058	NSK	B25-299DWA18		ST	MERCEDES BENZ
F 18059	SKF	BB1-3346			VOLVO (AT2412C)
F 18060	NTN	6215/72 C3			MERCEDES BENZ (G211-12)
F 18062	KOYO	83C062D		FAN	DAF
F 18066	FAG	544872 E23			DAF
F 18067	SKF	BB1 3339 CB			AUDI (A1)
N F 18069	FAG	561388			VOLKSWAGEN 091
N F 18074	NACHI	031BC05NC2			TOYOTA Land Cruiser * Hiace
N F 18075	NACHI	35BCS34-2MT2N			TOYOTA Hiace
N F 18076	NACHI	40TM05NXC3			TOYOTA Land Cruiser
N F 18082	SNR	AB41658S06			CITROEN Jumper FIAT Ducato
N F 18083	SNR	AB41659YS05			CITROEN Jumper FIAT Ducato



Angular contact ball bearings

Rodamientos de bolas de contacto angular

05.1 \	Special double row angular contact ball bearings / Rodamientos de bolas de doble hilera de contacto angular especiales	88
05.2 \	Standard double row angular contact ball bearings / Rodamientos de bolas de doble hilera de contacto angular estándar	102
05.3 \	Four point angular contact ball bearings / Rodamientos de bolas de cuatro puntos de contacto angular	104
05.4 \	Air conditioning / Aire acondicionado	106

05

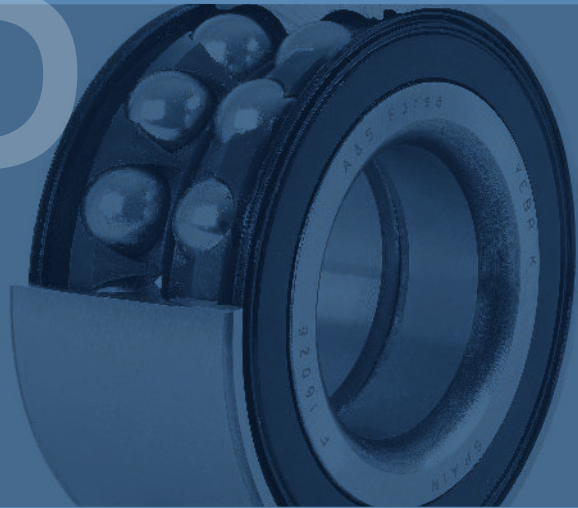

05.1 \ Special double row angular contact ball bearings

Rodamientos de bolas de doble hilera de contacto angular especiales

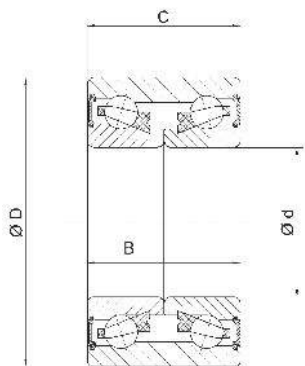
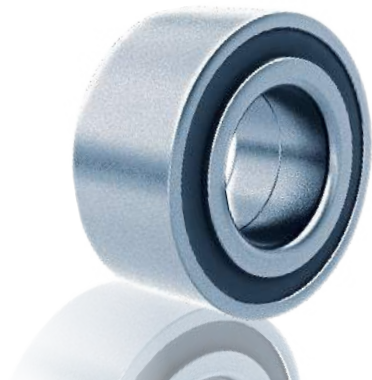

Fersa	d (mm)	D (mm)	C / B (mm)	TYPE
F 16001	30,000	60,030	37,000	A
F 16002	35,000	68,000	37,000	A
F 16004	25,000	56,000	32,000	A
F 16010	30,000	117,000	61,300 / 37,000	B
F 16018	34,000	62,000	37,000	A
F 16019	34,000	64,000	37,000	A
F 16020	34,000	66,000	37,000	A
F 16021	35,000	65,000	35,000	A
F 16022	35,000	66,000	32,000	A
F 16023	35,000	66,000	37,000	A
F 16026	35,000	72,000	33,000	A
F 16027	35,000	72,040	33,000	A
F 16029	37,000	72,000	33,000	A

Type / Tipo

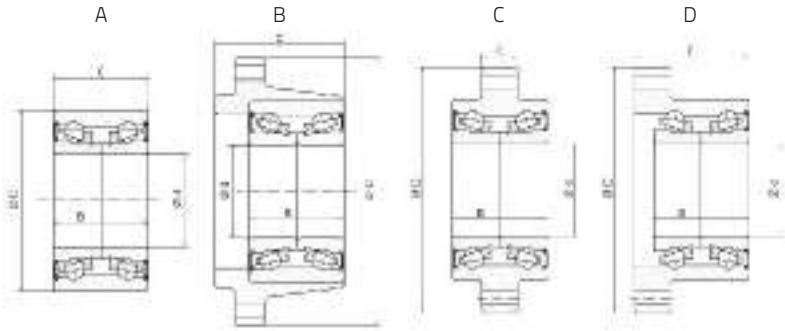

Fersa	CROSS REF.			
F 16001	SKF FAG SNR IRB INA	BA2B 633313 C 545312 GB 10790 S05 IR 8040 F 45721		 DELOREAN (DMC 12) FIAT (124 * 128 * Strada * Uno * X 1/9) LADA (Samara * Signet) LANCIA (Zagato) YUGO
F 16002	SKF FAG SNR IRB INA	BAH 0031 BAH 0031 D 541153 A 567918 GB 10840 S04 IR 8026 F 45951		 FIAT (Duna * Fiorino) SKODA (FAVORIT * FELICIA) VW (CADDY)
F 16004	SKF	BAH 5000 AA		 CITROËN (Ax * Saxo) PEUGEOT (106)
F 16010	SKF SNR IRB	BAF 0013 AD TGB 40490 IR 8505		 ALFA ROMEO (1445 * 146)
F 16018	SKF FAG IRB	BAHB 311316 B 561447 IR 8051		 AUDI (50) VOLKSWAGEN (Derby * Polo)
F 16019	SKF FAG IRB SNR	309726 DA 532066 IR 8041 GB 10884		 DAEWOO (Nexia * Cielo * Lanos * Racer) GM (Aveo) PONTIAC (G3 * Optima) VOLKSWAGEN (Atlantic * Caribe)
F 16020	SKF FAG IRB INA	BAHB 636114 A 580400 IR 8622 F 110487.1		 OPEL (Astra * Combo * Corsa * Kadett * Tigr * Vectra) GM (Chevy)
F 16021	FAG IRB SNR	546238 IR 8042 GB12438S01		 CITROËN (Xantia) RENAULT (Clio * Express)
F 16022	SKF IRB	BAH 5001 A IR 8091		 CITROËN (Ax * Saxo) PEUGEOT (106)
F 16023	SKF FAG	BAH 0023 544307		 VOLKSWAGEN (Golf * Jetta * Lupo * Polo) SEAT (Arosa)
F 16026	SKF FAG IRB SNR	BA2B 446762 B 548083 IR 8055 GB 12094 S10		 CITROËN (AX * C15 * ZX * Xsara) FIAT (Tipo) PEUGEOT (Partner)
F 16027	SKF	BAH 0013 D		 FIAT (LINEA * TEMPRA)
F 16029	SKF IRB SNR	BAH 0051 B IR 8740 GB 40547		 CITROËN (C2 * C3 * Saxo * Xsara) PEUGEOT (106 * 206 * 306)

05.1 \ Special double row angular contact ball bearings



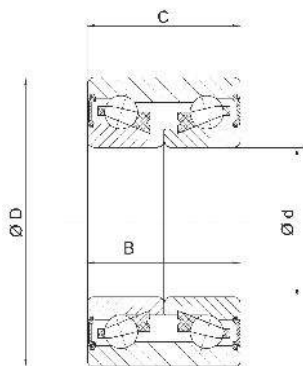
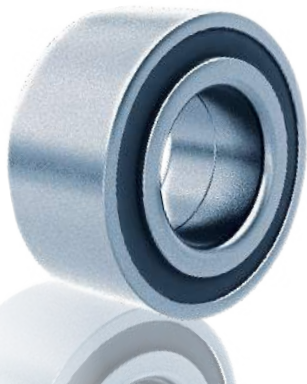





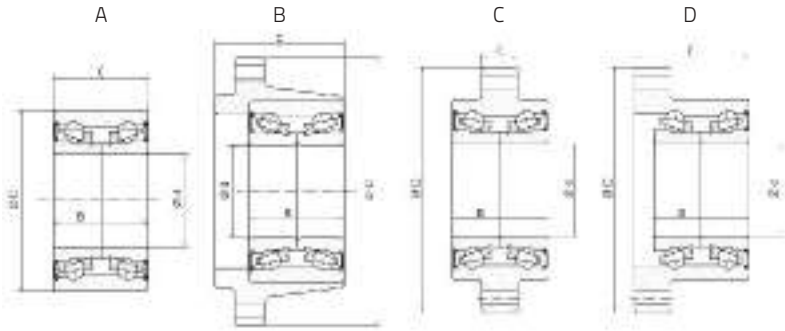











Rodamientos de bolas de doble hilera de contacto angular especiales



Fersa	d (mm)	D (mm)	C / B (mm)	TYPE
F 16030	37,000	72,000	37,000	A
F 16031	37,000	72,040	37,000	A
F 16032	37,000	74,000	45,000	A
F 16033	37,000	139,000	64,000 / 45,000	D
F 16034	37,990	74,020	33,000 / 36,000	A
F 16035	39,000	68,000	37,000	A
F 16036	39,000	72,000	37,000	A
F 16037	39,000	74,000	39,000	A
F 16038	39,000 / 41,000	75,000	37,000	A
F 16039	40,000	72,000	37,000	A

Type / Tipo



Fersa	CROSS REF.			
F 16030	SKF IRB SNR IRB	BAH 0094 IR 8066 GB 40706 F 113175		 NISSAN (Platina) RENAULT (Clio * Kangoo * Laguna I * MEGANE * SCENIC * SAFRANE)
F 16031	SKF FAG IRB SNR	BAH 0012 AD 562398 A IR 8088 GB 12131 S03		 ALFA ROMEO (33)
F 16032	SKF FAG IRB NATIONAL	309946 AC 541521 C IR 8513 511020		 BMW (518 * 520 * 524 * 525 * 530 * 535)
F 16033	SKF IRB	BAFB 447318 B IR 8591		 BMW (518 * 520 * 524 * 525 * 530 * 535 * 730 * 735 * 740 * 750 * 840 * 850)
F 16034	SKF FAG IRB NATIONAL	BAH 0041 D 574795A IR 8655 514002		 LEXUS (ES250) NISSAN (SUNNY * ALMERA * LUCINO * SENTRA * TSUBAME * TSURU III) TOYOTA (RAV4)
F 16035	SKF FAG IRB INA NATIONAL	BAHB 311315 BD 540733 IR 8052 F 45747.2 510024		 AUDI (80 * Coupe * 90) FORD (Escort * Ghia * Tempo * Topaz) MERCURY (Cougar * Mystique) VOLKSWAGEN (Corsar * Golf * Jetta * Passat * Santana)
F 16036	SKF FAG IRB SNR INA NATIONAL	BA2B 309639 BA / BAHB 311396 B 542186 A IR 8085 GB 41599 / GB 12776 F 45920.2 513113		 BMW (316 * 318 * 320 * 324 * 325 * M3 * Z3) CHEVROLET (Astra * Zafira) DAEWOO (Cielo * Lanos * NEXIA * Nubira * ESPERO) FORD (Courier * Ecosport * ESCORT * Fiesta * Focus * Fusion * Ikon * KA * PUMA * ORION) LOTUS (ELAN) MAZDA (2) PONTIA (Optima) VOLKSWAGEN (CROSSFOX * GOL * LUPO * POINTER * SAVEIRO * VAN)
F 16037	SKF FAG SNR NATIONAL	BAHB 636096 A 579557 IR 8603 510052		 CHEVROLET (OPTRA) DAEWOO (Leganza) OPEL (ASTRA * CALIBRA * OMEGA * VECTRA) SAAB (9 3 CONVERTIBLE * 9 5 * 900)
F 16038	SKF FAG IRB SNR	BAHB 633815 AA 567447 B IR 8530 GB 12399501		 AUDI (A4 * A6 * 80 * CABRIO * Coupe 90) SKODA (Super B) VOLKSWAGEN (Passat * Santana)
F 16039	SKF FAG IRB SNR NATIONAL	BAHB 311443 B 566719 IR 8095 GB 12320502 510004		 SEAT (CORDOBA * INCA * IBIZA * TOLEDO) VW (CABRIO * CADDY * CORRADO * DERBY * Golf * Jetta * Passat * POLO CLASSIC * VENTO)

05.1 \ Special double row angular contact ball bearings



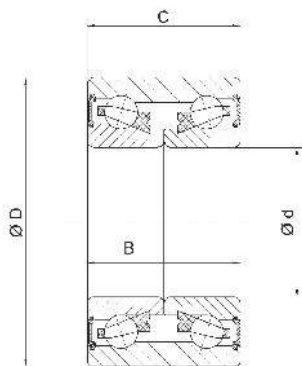
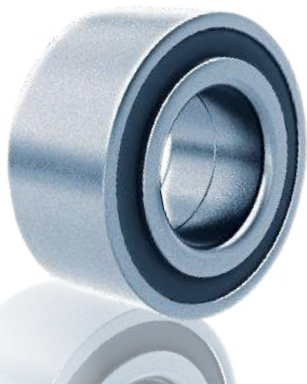





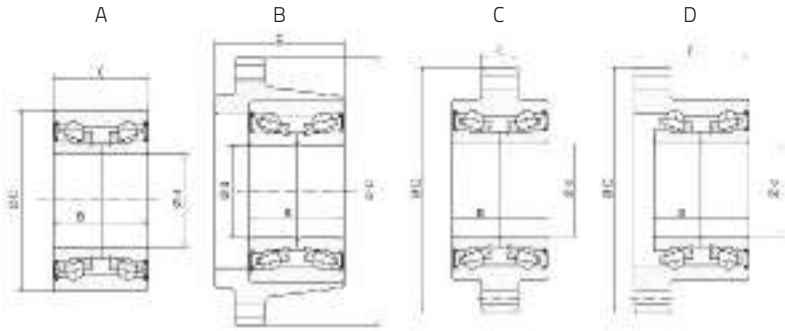















Rodamientos de bolas de doble hilera de contacto angular especiales



Fersa	d (mm)	D (mm)	C / B (mm)	TYPE
F 16040	40,000	74,000	40,000	A
F 16041	40,000	76,040	38,000 / 41,000	A
F 16042	40,000	80,000	30,200	A
F 16043	40,000	80,000	38,100	A
F 16044	39,980	108,000	17,000 / 32,000	C
F 16045	42,000	75,000	37,000	A
F 16046	42,000	75,000	37,000	A
F 16048	42,000	82,000	36,000	A
F 16051	42,000	84,000	39,000	A
F 16052	43,000	79,000	38,000 / 41,000	A
F 16054	43,000 / 45,000	82,000	37,000	A
F 16055	40,000	75,000	37,000	A

Type / Tipo



Fersa	CROSS REF.			
F 16040	SKF FAG IRB	BAH 0049 C 801136 IR 8668		 AUDI (A3 * S3 * TT) SEAT (LEON * TOLEDO) SKODA (OCTAVIA * ROOMSTER) VW (BORA * Golf * NEW BEETLE * Jetta)
F 16041	NSK SNR NATIONAL	40BWD05CA60 IR 8583 513053		 HONDA (ACCORD) MG (ZR) ROVER (25 * 200 * 400 * CABRIO * Coupe)
F 16042	FAG IRB SNR	565636 IR 8006 Y44FB.10394 S02		 PEUGEOT (204 * 304 * 305)
F 16043	SNR	GB 10800		 TALBOT (HORIZON * 1300)
F 16044	SNR IRB	TGB 10872 S02 IR 8048		 RENAULT (Space)
F 16045	SKF SNR	BAHB 311424 B GB 12010		 BMW (318, 320i, 323, 325, 328 (E36))
F 16046	FAG IRB	545495 IR 8509		 ALFA ROMEO (75 * 90 * GTV) BMW (316 * 318 * 320 * 324 * 325 * M3 * TOURING * CABRIO * Z1 * Z4)
F 16048	SKF FAG IRB SNR NATIONAL	BAH 0171 561481 IR 8086 GB 12163 S04 513073		 CITROËN (Berlingo) PEUGEOT (206 * 207 * 306 * 307 * 308 * 405 * 505 * 604 * PARTNER)
F 16051	SKF FAG IRB SNR	BAH 0177 543359 B IR 8101 GB 40549 / GB 10702 S03		 RENAULT (20 * 30 * Traffic) VAUXHALL (Arena)
F 16052	SNR NSK NATIONAL	XGB 41999 43BWD08CA103 510030		 ACCURA (EL) HONDA (Civic) MG (ZS) ROVER (45 * 400)
F 16054	SKF IRB NATIONAL	BAH 0011 AB IR 8737 510019		 AUDI (A4 * A8 * ALLROAD * V8 * A8 * Coupe * CABRIO * 80 * 100 * 200) SKODA (SuperB) VOLKSWAGEN (Passat)
F 16055	SKF IRB NATIONAL	BAHB 633966 BB IR 8593 510029		 FORD (Contour * Cougar * Escape * Mondeo) JAGUAR (X TYPE) MERCURY (Cougar * Mystique) VOLVO (S40 * V40)

05.1 \ Special double row angular contact ball bearings



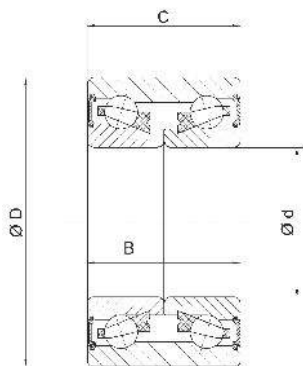





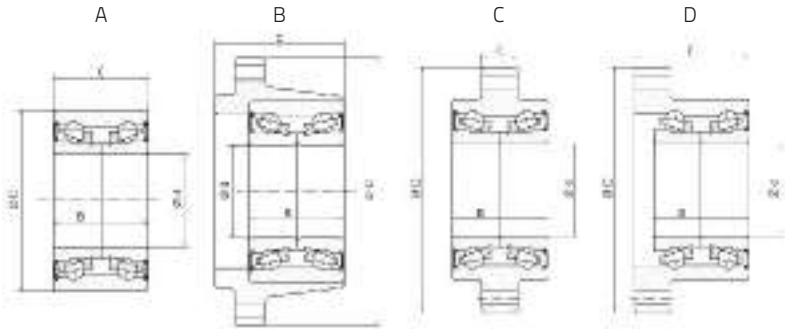

Rodamientos de bolas de doble hilera de contacto angular especiales



Fersa	d (mm)	D (mm)	C / B (mm)	TYPE
F 16056	44,000	82,500	37,000	A
F 16057	38,100	70,000	37,000	A
F 16058	38,000	74,000	50,000	A
F 16059	45,000	84,000	39,000	A
F 16063	45,000	85,000	30,200	A
F 16066	40,000	84,020	38,000	A
F 16068	38,000	72,020	33,000 / 36,000	A
F 16076	51,000	91,000	44,000	A
F 16077	28,000	61,000	42,000	A
F 16078	43,000	82,000	45,000	A
F 16079	40,000	74,000	42,000	A
F 16080	40,000	74,000	36,000	A
F 16081	42,000	76,000	35,000 / 38,000	A
F 16082	45,000	84,000	39,000	A
F 16083	34,000	67,000	37,000	A

Type / Tipo



Fersa	CROSS REF.				
F 16056	SKF IRB SNR NATIONAL	BAH 0174 IR 8618 GB 40246 S02 510087			CITROËN (EVASION * JUMPY) FIAT (SCUDO * ULYSSE) LANCIA (Zeta) LAND ROVER (FREELANDER) PEUGEOT (806 * EXPERT)
F 16057	SKF FAG NATIONAL	BAHB 636193 C 805921 510055			DODGE (ATOS * ATTITUDE) HYUNDAI (ACCENT * ATOS * Coupe * GETZ * LANTRA * Tiburon * Verna) KIA (RIO) PEUGEOT (GRAND RAID * PARTNER)
F 16058	NSK NATIONAL	38BWD06D A CA 01 510008			NISSAN (PULSAR * SUNNY * HIKARI * TSURU II)
F 16059	SKF	BAHB 636149 BC / BAHB 636149 D			MERCEDES (124 * 190 * Clase C * CLK * Clase E * Clase V * VITO * SL * SLK) CHRYSLER (CROSSFIRE)
F 16063	IRB	IR 8597			FORD (Transit)
F 16066	SNR	GB 40250 S01			RENAULT (LAGUNA * Megane * SAFRANE)
F 16068	KOYO NATIONAL	DAC 3872W 8CS81 510007			TOYOTA (COROLLA)
F 16076	SNR	GB 41688 P			
F 16077	KOYO NATIONAL	DAC 286142 AW 513031			TOYOTA (Corolla * Hiace * MR2) CHEVROLET (NOVA)
F 16078	KOYO NSK NATIONAL	DAC 43820045 43 BWD 06 510006			TOYOTA (Camry * Sienna * RAV 4) LEXUS (LX470)
F 16079	KOYO NSK	DAC 40740042 B 40 BWD 12			TOYOTA (ALVIS * AVENSIS * CELICA * COROLLA * MR2 * Prius * WISH LIMUSINA) PONTIAC (Vibe)
F 16080	NSK NATIONAL	40 BWD 15 A 510061			NISSAN (Almera * Sentra) MITSUBISHI (LANCER)
F 16081	NSK IRB NATIONAL	40 BWD 06 IR 8650 510009			NISSAN (ALTIMA * PRIMERA * PRAIRIE * MAXIMA)
F 16082	TIMKEN FAG	TKR 8572 547103E			MERCEDES BENZ (190 * Clase C * Clase E * SL * SLK) PEUGEOT (605)
F 16083	FAG	803775			OPEL (COMBO * Corsa * MERIVA * Tigra) GM (Corsa * Corsa NOVO * MERIVA * MONTANA * TORNADO)

05.1 \ Special double row angular contact ball bearings

Rodamientos de bolas de doble hilera de contacto angular especiales

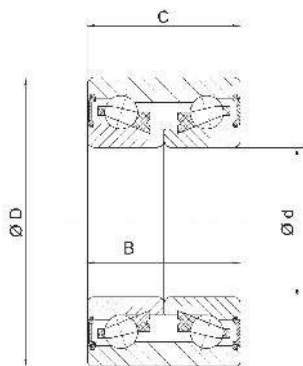

Fersa	d (mm)	D (mm)	C / B (mm)	TYPE
F 16084	44,990	84,070	39,000	A
F 16085	45,000	80,000	45,000	A
F 16086	43,000	80,000	38,000	A
F 16088	42,000	80,000	45,000	A
F 16089	40,000	74,000	40,000	A
F 16090	40,000	80,000	34,000 / 36,000	A
F 16091	40,000	74,000	34,000 / 36,000	A
F 16093	35,000	66,000	33,000	A
F 16094	27,000	134,000	67,600 / 50,000	D
F 16095	28,000	119,000	52,000 / 42,000	D
F 16107	42,000	80,000	37,000	A
F 16108	40,000	84,060	39,700 / 38,800	A
F 16109	49,000	88,000	46,000	A
F 16110	39,000	72,000	37,000	A
F 16115	36,000	68,000	33,000	A

Type / Tipo

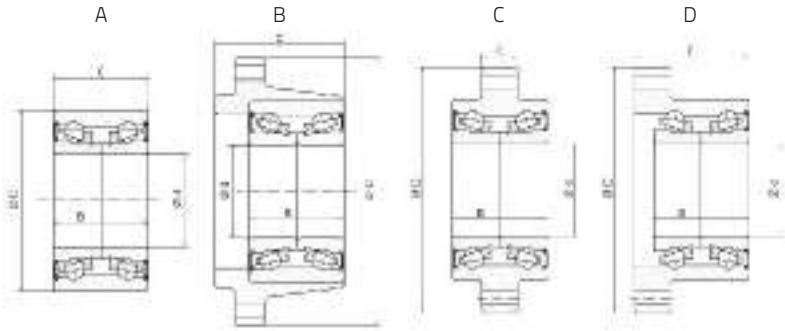

Fersa	CROSS REF.			
F 16084	FAG	547103 E		 MERCEDES BENZ PEUGEOT (190 * Vito 605)
F 16085	FAG NSK NATIONAL	564725 AB 42BWD06CA98 510051		 VW (TRANSPORTER)
F 16086	FAG	579943		 FORD (GALAXY) SEAT (ALHAMBRA) VW (SHARAN)
F 16088	SKF FAG SNR NATIONAL	BAH 0028 AA 579943 B GB 35457 510010		 KIA (CARENS * SHUMA * SEPHIA * Spectra) MAZDA (323 * 626 * 6 * MVP * MX 5 * MX 6 * XEDOS 6 * XEDOS 9) FORD (Focus * Fusion * LINCOLN * MKX) LINCOLN (MKZ * Zephir) MERCURY (MILLAN) VOLVO (C 30 * C 70 * S 40 * V 50)
F 16089	SKF	BAH 0049		 KIA (SHUMA * SEPHIA) MAZDA (323 * MX 5 * MX 6)
F 16090	SKF KOYO NATIONAL	BAHB 636187 A DAC 4060 M1 513036		 HYUNDAI (SONATA) MITSUBISHI (GALANT * ECLIPSE * Space * WAGON * Space * RUNNER) EAGLE (Summit Wagon * Talon) PLYMOUTH (Colt * Laser)
F 16091	KOYO NATIONAL	DAC 40740034 / 36 510016		 MITSUBISHI (CARISMA * COLT * LANCER * MIRAGE MONTERO) DODGE (COLT) EAGLE (SUMMIT) PLYMOUTH (COLT) SUZUKI (XL 7 4X2 4X4)
F 16093	SKF SNR	BAH 0015 E GB 12306502		 FIAT (PANDA * PUNTO * SEICENTO * TIPO CINQUECENTO)
F 16094	NSK	27 BWK 04D3		 NISSAN (NX)
F 16095	NSK	28 BWK 12		 TOYOTA (Corolla)
F 16107	SKF SNR	BAH 0004 AA GB 12955504		 ALFA ROMEO (145 * 146 * 155 * 164 * GTV * SPIDER) FIAT (BRAVO * Coupe * CROMA * MAREA) LANCIA (DELTA * KAPPA * THEMA)
F 16108	SNR	XGB 40492 S01 P		 RENAULT (Laguna)
F 16109	SNR NSK	GB 40279S01 49BWD01BCA116		 MERCEDES (Clase M)
F 16110	SKF SNR	BAH 0106 D XGB 35447		 FORD (Fiesta * Fusion * Focus) VW (SAVEIRO)
F 16115	NATIONAL	510001		 SUZUKI (Swift)

05.1 \ Special double row angular contact ball bearings



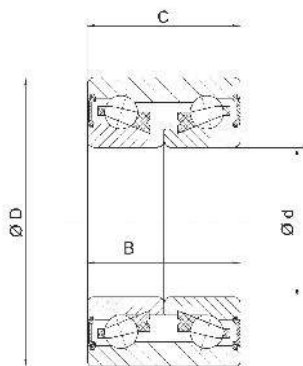

Rodamientos de bolas de doble hilera de contacto angular especiales

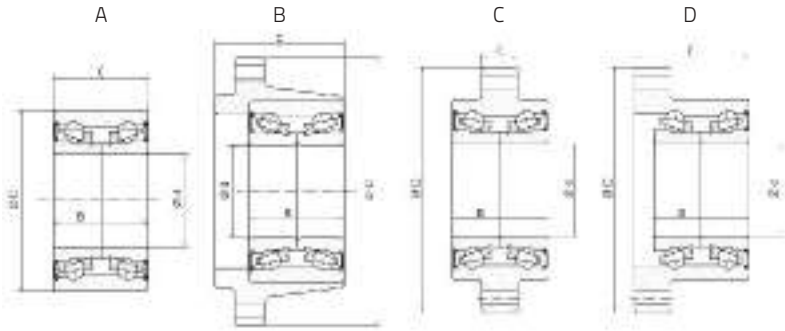

Fersa	d (mm)	D (mm)	C / B (mm)	TYPE
F 16117	38,000	73,000	40,000	A
F 16118	43,000 / 45,000	85,000	37,000	A
F 16120	38,000	71,020	33,000 / 33,000	A
F 16121	45,000	88,020	39,000	A
F 16123	45,000	86,000	39,000	A
F 16124	38,000	72,000	40,000	A
F 16128	45,000	86,000	39,000	A
F 16129	25,000	52,000	42,000	A
F 16193	43,000	78,000	44,000	A
F 16194	42,000	76,000	39,000	A
F 16195	42,000	76,000	37,000 / 40,000	A
F 16196	43,000	76,000	43,000	A
F 16197	42,000	76,000	33,000	A
F 16198	40,000	76,000	33,000	A
F 16199	47,000	81,000	53,000	A
F 16200	35,000	64,000	37,000	A
F 16201	35,000	72,000	34,000	A

Type / Tipo



Fersa	CROSS REF.				
F 16117	NTN NATIONAL	DE 08A48LLCS46PX1/ L260 510015			HONDA (CIVIC IV V * CR V * LOGO)
F 16118	SKF	BAHB 636214 A			AUDI (A4 * A8)
F 16120	KOYO	DAC3871W2CS70			TOYOTA (Corolla)
F 16121	SNR	GB 40300			RENAULT (AVANTTIME * Espace III)
F 16123	SNR	GB 40575 S02			NISSAN (Primastar * Opel Vivaro)
F 16124	SNR NACHI	GB 35275 38BVV07 10G			HONDA (CIVIC I II III * ROVER 200)
F 16128	SNR	XGB 40575 S02 P			NISSAN (Primastar) OPEL (Vivaro) RENAULT (Space)
F 16129	SNR NTN	GB 35098 AU 0501			OPEL (AGILA) SUZUKI (IGNIS)
F 16193	NTN NATIONAL	AU 0933 510089			HONDA (Civic)
F 16194	NSK NATIONAL	27 BWK 04D3 513058			CHRYSLER (Petit Cruiser) DODGE (Neon) FORD (COUGAR * MUSTANG * TAURUS * THUNDERBIRD * WINDSTAR) LINCOLN (Mark VIII) MERCURY (Cougar * Sable)
F 16195	SKF FAG KOYO NATIONAL	BAHB309796A 547059 DAC4276W 513006			CHRYSLER (DART K * LEBARON * NEW YORKER * PHANTOM * SHADOW * VOLARE K) DODGE (CARAVAN) PLYMOUTH (VOYAGER)
F 16196	NSK NATIONAL	43 BWD 12A JB 5C01 510060			NISSAN (Altima * Maxima * X-Trail) INFINITI (i30 * i 35)
F1 6197	NATIONAL	510057			DODGE (Neon) CHRYSLER (PT CRUISER)
F 16198	NATIONAL	510032			DODGE (Neon)
F 16199	KOYO NATIONAL	DAC4781W 510028			NISSAN (Quest)
F 16200	SKF KOYO NATIONAL	BAH 0042 DAC3564A1 510014			CITROËN (Evasion Jumpy) DAIHATSU (CHARADE)
F 16201	NKE LEMKEN SNR CLAAS KOYO NATIONAL SKF	3198750 F214101-1 GB-40582 939717.0 DAC 35720034 A 510014 VKBA 857D			HONDA (Accord * Civic * Prelude)

05.2 \ Standard double row angular contact ball bearings Rodamientos de bolas de doble hilera de contacto angular estándar

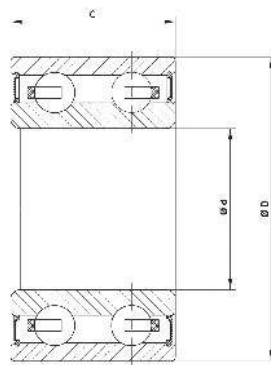

Fersa	d (mm)	D (mm)	C (mm)
3206 B 2RS/C3	30,000	62,000	23,800
3207 B 2RS/C3	35,000	72,000	27,000
3208 B 2RS/C3	40,000	80,000	30,200
3210 B 2RS/C3	50,000	90,000	30,200
3212 B 2RS/C3	60,000	110,000	36,500
3307 B 2RS/C3	35,000	80,000	34,900
3308 DP	40,000	90,000	36,000



A series of horizontal dotted lines for writing notes, starting below the pencil icon and extending across the width of the page.



A series of horizontal dotted lines spanning the width of the page, intended for writing.



A large area of the page is filled with horizontal dotted lines, providing a template for writing or drawing.

05.4 \ Air conditioning Aire acondicionado

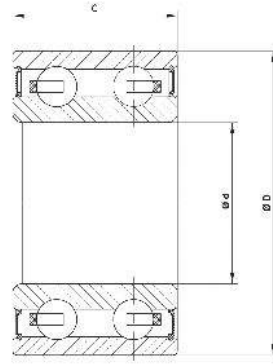

Fersa	d (mm)	D (mm)	C / B (mm)
F 16097	30,000	52,000	22,000
F 16098	30,000	55,000	23,000
F 16099	35,000	50,000	20,000
F 16100	35,000	55,000	20,000
F 16101	35,000	52,000	22,000
F 16102	40,000	62,000	24,000
F 16103	40,000	62,000	20,625
F 16104	30,000	62,000	27,000
F 16189	40,000	57,000	24,000
F 16190	40,000	62,000	20,600 / 24,000



Fersa		CROSS REF.		COMPRESSOR TYPE
F 16097	NACHI NSK KOYO NTN	30 BG 05S 2G - 2DS 30 BD 5222 FX DAC 3052- 32 RR9 DS 10Z	Toyota, Daihatsu, HINO, Honda, Mitsubishi, Mazda, FUJI, Isuzu, Jaguar, Chrysler, BMW USA, GM, Honda USA, John Deere, Rover, Toyota UK, Fiat, Hyundai, Kia, Mercedes Benz, Porsche	Denso
F 16098	NACHI NSK KOYO	30 BG 05S 5G - 2DS 30 BD 40 A - T1Z DDF1 30 BG 05 S5G - 2DST2	Ford, Hyundai, Kia, Mitsubishi	Behr - Bosch - Diesel Kiki - Nihon - York
F 16099	NACHI NSK	35 BG 05S 7G - 2DS 35 BD 5020 DUK	Ford, Mitsubishi, Nissan, Honda	Delphi - Mitsubishi - Sanden - Seiko Seiki
F 16100	NACHI NSK KOYO NTN	35 BG 05S 10G - 2DL 35 BD 219T - 1Z DDU K8 DAC 3555 RD 3H - 83 A 694 30 BG 04 S15G - 2DST	GM, Nissan, Chrysler, Kia, Hyundai, Honda	Diesel - Kiki - Matsushita - Nihon - Sanden - Seltec
F 16101	NACHI NSK	35 BG 52 22 - 2DS 35 BD 52 22 DF X7	Mercedes Benz, Audi, Volkswagen	Delphi - Denso
F 16102	NACHI NSK KOYO NTN	40 BG S1 1G - 2DS DF 0865 83 A 5518 40 BD 219T 12 DDU	Toyota, Daihatsu, Mitsubishi, Rover, Volkswagen BRASIL, Fiat BRASIL	Denso - Hitachi - Nihon - Sanden - Seiko Seiki
F 16103	NACHI NSK	40 BG 620 20 - 2DL 40 BD 49V	GM , Daewoo	Keihin - Seiko Seiki
F 16104	NACHI KOYO NTN	30 BG S 12G - 2DS BD 30 - 11 A 5206 #37	Chrysler	Chrysler - White
F 16189	NACHI NSK KOYO NTN	40 BG 05S 2G - 2DS 40 BD 45 T12 DDU 40 BD 45 T12 2TS2 - DF 0882 LL BCS	Mitsubishi, Volkswagen	Mitsubishi - Sanden
F 16190	NACHI NSK KOYO NTN	40 BG S 12G - 2DS 40 BD 49 AWT12 DDU 40 BD 49 AW 5908 - 2RSWE	Ford, Hino, Mazda, Chrysler	Denso



.....

.....

.....

.....

.....

Thrust ball bearings

Rodamientos axiales de bolas

06.1 \	Thrust ball bearings / Rodamientos axiales de bolas	110
06.2 \	Clutch release bearings / Rodamientos de embrague	112
06.3 \	CLAC M Series / Series CLAC M	114

06

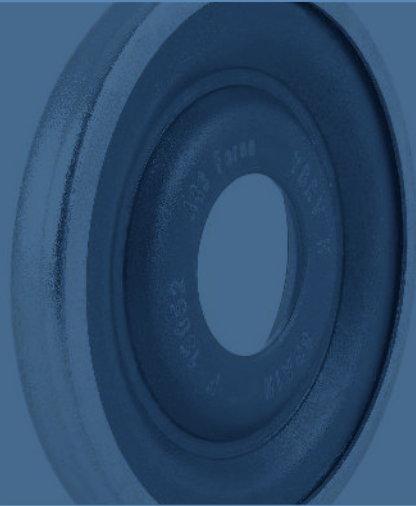

06.3 \ CLAC M Series Series CLAC M



FERSA	TYPE	SACHS	BRAND	OEM
N CLAC M 001	MECHANIC	3100026531	RENAULT TRUCKS	74 21 371 759
			VOLVO	20569155 * 3192220 * 3192221
N CLAC M 002	MECHANIC	3100026432	VOLVO	1655732 * 1655843 * 1668921 * 1668923 * 16698334 * 1672944 * 20569157 * 3192222
N CLAC M 003	MECHANIC	3100026431	RENAULT TRUCKS	74 20 730 007
			VOLVO	20569151 * 20569159 * 3192218
N CLAC M 004	MECHANIC	3100 026 433	VOLVO	1655732 * 1655825 * 1667258 * 1668923 * 1669833 * 1672946 * 20571928 * 3192223 * 8112159
N CLAC M 005	MECHANIC	3151 602 005 3151 170 131 3151 654 313	MERCEDES BENZ	A 001 250 08 15 * 000 250 95 15 * 001 250 08 15
N CLAC M 006	MECHANIC	3151 272 631 3151 000 374 3151 654 310	MERCEDES BENZ	000 250 70 15 * 001 250 22 15 * 001 250 61 15 * 1250225
N CLAC M 007	MECHANIC	3151 000 396	MERCEDES BENZ	A 002 250 65 15 * 002 250 65 15 * 001 250 99 15 * 002 250 00 15
N CLAC M 008	MECHANIC	3151 258 031	MERCEDES BENZ	002 250 37 15 * 002 250 41 15 * 002 250 47 15 * 002 250 67 15 * 002 250 78 15 * 002 250 81 15 * 002 250 98 15 * 003 250 59 15
N CLAC M 009	MECHANIC	3151 000 335 3151 654 312	MERCEDES BENZ	002 250 49 15 * 002 250 83 15 * 003 250 14 15 * 002 250 44 15 * 002 250 63 15 * 003 250 48 15 * 003 250 69 15

Fersa	LUK	APPLICATION	
N CLAC M 001	500 1071 20	RENAULT TRUCKS	C * K
		VOLVO	FH * FH II * FH12 * FH16 II * FM * FM12 * FM7 * FM9 * FMX * FMX II * NH12
N CLAC M 002	500 0611 20	VOLVO	B10 * F10 * F12 * F16 * FH16 * FL10 * FL7 * B10
N CLAC M 003	500 1004 20	RENAULT TRUCKS	MAGNUM
		VOLVO	FH12 * FM12 * FM9
N CLAC M 004	500 0608 20	VOLVO	B10 * B12 * F10 * FL10 * FL7 * FS7
N CLAC M 005	500 0422 20 F 562529	MERCEDES BENZ	T2/LN 1 BUS * T2/LN 1 TRUCK * T2/LN 1 LCV
N CLAC M 006	500 0573 10	MERCEDES BENZ	LK/LN2 * LP * MK * NG"
N CLAC M 007	500 0806 20	MERCEDES BENZ	ATEGO * ATEGO 2 * INTOURO * LK/LN2 * TOURINO (O 510) * TOURO (O 500)
N CLAC M 008	500 0889 10		
N CLAC M 009	500 1072 20	MERCEDES BENZ	CAPACITY * CITARO (O 530) * CONECTO (O 345) * INTEGRO (O 550) * O 403 * TOURISMO (O 350) * TOURO (O 500) * TRAVEGO (O 580)

06.3 \ CLAC M Series Series CLAC M



FERSA	TYPE	SACHS	BRAND	OEM
N CLAC M 011	MECHANIC	3151 000 144	MAN	36.30550-0001 * 81.30550-0096 * 81.30550-0101 * 81.30550-0102 * 81.30550-0104 * 81.30550-0114
			DAF	1615927 * 1634627
			IVECO	1805282 * 1904756 * 1905282 * 1905756 * 1908518 * 42102103 * 42104476 * 42104650 * 42114856 * 42543362 * 42556650 * 5003 05439 * 5003 17617 * 5003 17671 * 5003 35068 * 5003 72212 * 5003 97755 * 5040 70593 * 5041 20865 * 5041 58912 * 5042 22042 * 5043 85079 * 98436188
			MERCEDES BENZ	000 254 30 08
			RENAULT	50 01 858 682 * 50 01 864 270 * 50 01 873 287
			IVECO	93812506 * 93812453 * 1905290 * 2992027 * 500380426 * 504132388
N CLAC M 012	MECHANIC		FIAT	93812506 * 1904749 * 93812488 * 98471635 * 2992027
			RENAULT	82 01 108 206 * 82 01 246 083

Fersa	LUK	APPLICATION	
N CLAC M 011	500 0525 10	MAN	HOCL * LION'S COACH * LION'S STAR * NL * SÜ * TGA * TGL * TGM * TGS * TGX
		IVECO	EUROSTAR * EUROTECH MH * EUROTECH MP * EUROTECH MT * EUROTRAKKER * P/PA-Haubenfahrzeuge * STRALIS * STRALIS * TRAKKER * TRAKKER * TURBOSTAR
		NEOPLAN	Cityliner * Starliner * Tourliner * Trendliner
		RENAULT TRUCKS	MAGNUM * PREMIUM
N CLAC M 012	500 0635 30	IVECO	DAILY CITYS * DAILY I * II * III * IV * V * VI * DAILY LINE
		OPEL	MOVANO B
		NISSAN	NV400
		RENAULT	MASTER III
		RENAULT TRUCKS	MASCOTT

07

Insert bearings

Rodamientos autoalineables

07

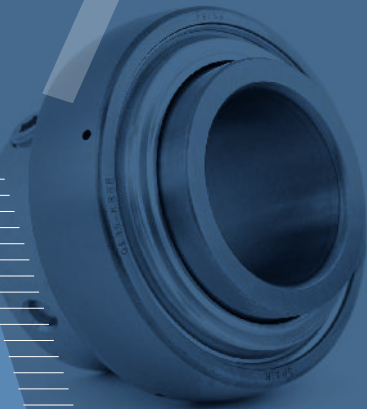

07 \ Insert bearings Rodamientos autoalineables

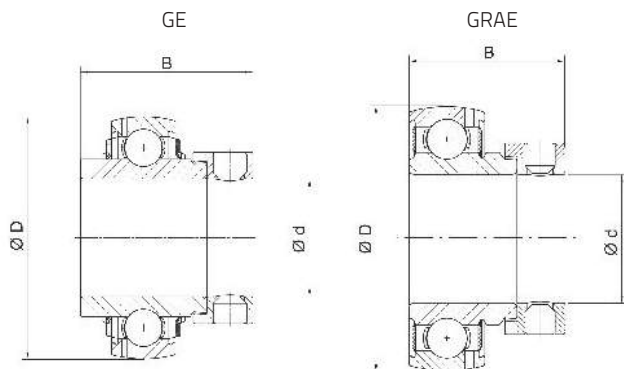

Fersa	d (mm)	D (mm)	B (mm)
GE SERIE			
GE 25 KRRB	25,000	52,000	44,500
GE 30 KRRB	30,000	62,000	48,500
GE 35 KRRB	35,000	72,000	51,300
GE 40 KRRB	40,000	80,000	56,500
GE 45 KRRB	45,000	85,000	56,500
GE 50 KRRB	50,000	90,000	62,800
GRAE SERIE			
GRAE 25 NPPB	25,000	52,000	31,000
GRAE 30 NPPB	30,000	62,000	35,800
GRAE 35 NPPB	35,000	72,000	39,000
GRAE 40 NPPB	40,000	80,000	43,800
GRAE 45 NPPB	45,000	85,000	43,800





A series of horizontal dotted lines for writing, spanning most of the page width.

Cylindrical roller bearings

Rodamientos de rodillos cilíndricos

08.1 \	Standard cylindrical bearings / Rodamientos cilíndricos estándar	128
08.2 \	Special cylindrical bearings / Rodamientos cilíndricos especiales	132

08

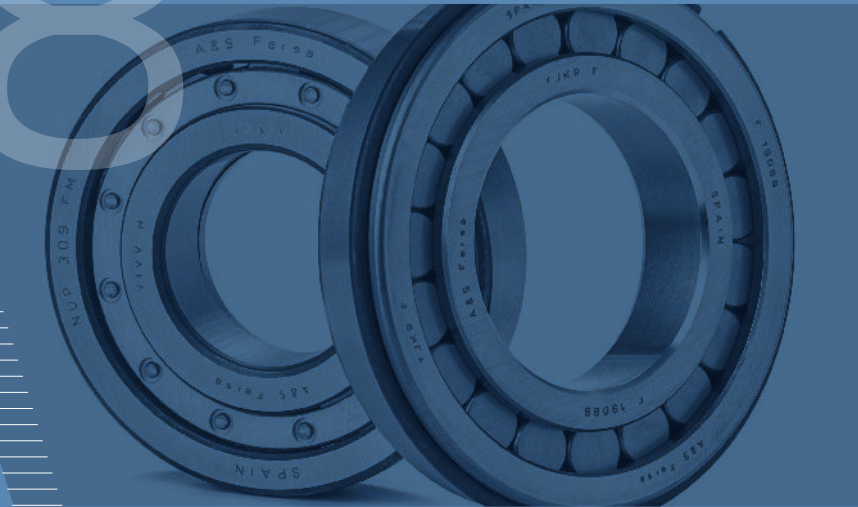

08.1 \ Standard cylindrical bearings Rodamientos cilíndricos estándar

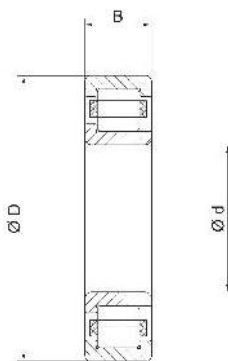

Fersa	d (mm)	D (mm)	B (mm)
N SERIE			
N 206 FM	30,000	62,000	16,000
N 211 FMNR/C4	55,000	100,000	21,000
N 307 FM	35,000	80,000	21,000

NJ SERIE			
NJ 206 FP	30,000	62,000	16,000
NJ 208 FM	40,000	80,000	18,000
NJ 210 FM/C3	50,000	90,000	20,000
NJ 215 F/C3	75,000	130,000	25,000
NJ 215 FP/C3	75,000	130,000	25,000
NJ 305 F	25,000	62,000	17,000
NJ 306 FM	30,000	72,000	19,000
NJ 308 FM	40,000	90,000	23,000
NJ 309 FM	45,000	100,000	25,000
NJ 309 FP	45,000	100,000	25,000
NJ 310 FM	50,000	110,000	27,000
NJ 405 FM	25,000	80,000	21,000
NJ 406 FM	30,000	90,000	23,000
NJ 406 FM/C3	30,000	90,000	23,000
NJ 416 FM/C3	80,000	200,000	48,000
NJ 1014 FM	70,000	110,000	20,000
NJ 1024 FM	120,000	180,000	28,000
NJ 2205 FM/C3	25,000	52,000	18,000
NJ 2206 FM	30,000	62,000	20,000
NJ 2206 FP	30,000	62,000	20,000
NJ 2210 FP	50,000	90,000	23,000
NJ 2222 FM/C3	110,000	200,000	53,000
NJ 2309 FM	45,000	100,000	36,000
NJ 2313 FM	65,000	140,000	48,000
NJ 2315 FM/C4	75,000	160,000	55,000
NJ 2322 FM/C3	110,000	240,000	80,000

Type / Tipo

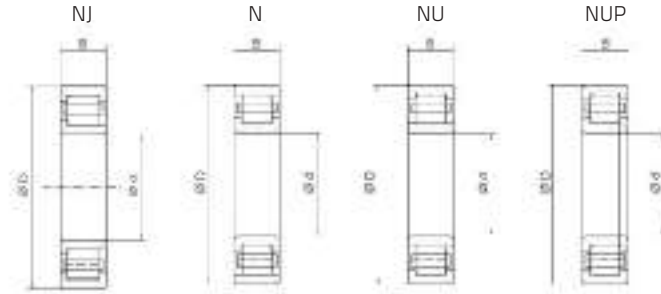

Suffixes / Sufijos

- C3** Internal clearance greater than normal / Juego radial mayor que el normal
- M** Machined brass cage / Jaula de latón
- N** Snap ring groove in outer ring / Ranura en aro exterior
- NR** Snap ring groove and snap ring in outer ring / Ranura y anillo elástico en aro exterior
- P** Polyamide cage / Jaula de poliamida

Fersa	d (mm)	D (mm)	B (mm)
NU SERIE			
NU 202 FM/C3	15,000	35,000	11,000
NU 202 FP/C3	15,000	35,000	11,000
NU 206 FM	30,000	62,000	16,000
NU 208 FMN	40,000	80,000	18,000
NU 208 FMN/C3	40,000	80,000	18,000
NU 208 FN	40,000	80,000	18,000
NU 208 FN/C3	40,000	80,000	18,000
NU 209 FN	45,000	85,000	19,000
NU 209 FMN	45,000	85,000	19,000
NU 209 FMN/C3	45,000	85,000	19,000
NU 209 FN/C3	45,000	85,000	19,000
NU 308 FM	40,000	90,000	23,000
NU 309 FM	45,000	100,000	25,000
NU 309 FMN	45,000	100,000	25,000
NU 309 FMNR/C3	45,000	100,000	25,000
NU 310 FM	50,000	110,000	27,000
NU 310 FM/C3	50,000	110,000	27,000
NU 310 FMN/C3	50,000	110,000	27,000
NU 1008 FM	40,000	68,000	15,000
NU 1011 FM	55,000	90,000	18,000
NU 2207 FM	35,000	72,000	23,000
NU 2215 FM	75,000	130,000	31,000
NU 2216 FM	80,000	140,000	33,000
NU 2306 F	30,000	72,000	27,000
NU 2306 F/C3	30,000	72,000	27,000
NU 2306 FM/C3	30,000	72,000	27,000
NU 2307 F	35,000	80,000	31,000
NU 2307 F/C3	35,000	80,000	31,000
NU 2307 FM/C3	35,000	80,000	31,000

NUP SERIE			
NUP 206 FM	30,000	62,000	16,000
NUP 208 FM	40,000	80,000	18,000
NUP 209 FM	45,000	85,000	19,000

08.1 \ Standard cylindrical bearings

Rodamientos cilíndricos estándar

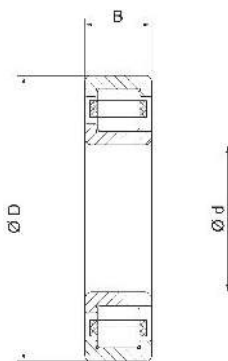

Fersa	d (mm)	D (mm)	B (mm)
NUP 211 FM/C3	55,000	100,000	21,000
NUP 212 FM	60,000	110,000	22,000
NUP 213 FPNR/C3	65,000	120,000	23,000
NUP 304 FM/C3	20,000	52,000	15,000
NUP 304 FP/C3	20,000	52,000	15,000
NUP 307 FP/C3	35,000	80,000	21,000
NUP 308 FM	40,000	90,000	23,000
NUP 308 FM/C3	40,000	90,000	23,000
NUP 308 FMNR/C3	40,000	90,000	23,000
NUP 308 FP	40,000	90,000	23,000
NUP 309 FM	45,000	100,000	25,000
NUP 309 FM/C3	45,000	100,000	25,000
NUP 309 FMN	45,000	100,000	25,000
NUP 309 FN/C3	45,000	100,000	25,000
NUP 309 FP	45,000	100,000	25,000
NUP 310 FM/C3	50,000	110,000	27,000
NUP 310 FNR/C3	50,000	110,000	27,000
NUP 310 FP	50,000	110,000	27,000
NUP 311 F	55,000	120,000	29,000
NUP 311 FMNR/C3	55,000	120,000	29,000
NUP 312 FNR/C3	60,000	130,000	31,000
NUP 312 FMNR/C3	60,000	130,000	31,000
NUP 314 FM/C3	70,000	150,000	35,000
NUP 314 FMNR/C3	70,000	150,000	35,000
NUP 1009 FP P6	45,000	75,000	16,000
NUP 2205 FM/C3	25,000	52,000	18,000
NUP 2206 FP	30,000	62,000	20,000
NUP 2212 FM/C3	60,000	110,000	28,000
NUP 2212 FMNR/C3	60,000	110,000	28,000
NUP 2212 FP/C3	60,000	110,000	28,000



Type / Tipo

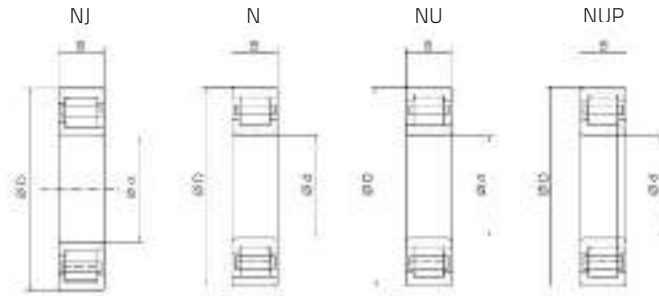

Suffixes / Sufijos

- C3** Internal clearance greater than normal / Juego radial mayor que el normal
- M** Machined brass cage / Jaula de latón
- N** Snap ring groove in outer ring / Ranura en aro exterior
- NR** Snap ring groove and snap ring in outer ring / Ranura y anillo elástico en aro exterior
- P** Polyamide cage / Jaula de poliamida



08.2 \ Special cylindrical bearings Rodamientos cilíndricos especiales

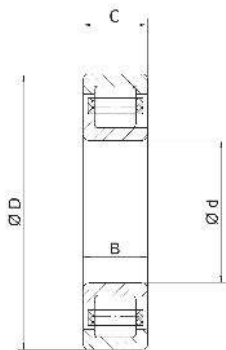

Type / Tipo

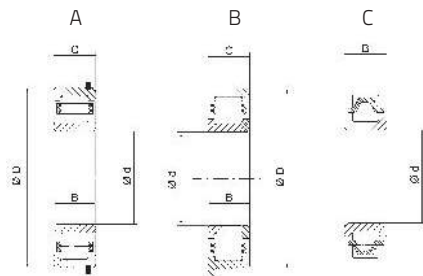

Fersa	d (mm)	D (mm)	T (mm)	TYPE
F 19001	45,000	100,000	36,000	A
F 19002	45,000	100,000	25,000	D
F 19003	45,000	100,000	25,000	D
F 19004	25,000	52,000	18,000 / 20,600	D
F 19005	-	54,600	22,000	G
F 19006	40,000	90,000	23,000	D
F 19008	80,000	150,000	27,500 / 28,000	B
F 19009	60,000	130,000	31,000	B
F 19010	65,000	140,000	33,350	B
F 19011	60,000	110,000	22,000	B
F 19012	35,000	80,000	23,000	A
F 19013	40,000	90,000	27,000 / 24,900	D
F 19014	38,000	90,000	23,000 / 22,000	D
F 19015	45,000	95,000	28,000 / 32,000	A
F 19016	63,000	-	34,800	C
F 19019	30,000	-	26,000	C
F 19020	35,000	80,000	22,000	D
F 19022	84,980	150,000	27,500 / 28,000	B
F 19023	25,000	52,000	18,000	D
F 19024	30,000	59,000	13,000 / 15,000	A
F 19025	30,000	62,000	20,000	E
F 19026	50,000	90,000	23,000	E
F 19029	25,000	52,000	21,000	A

Type / Tipo

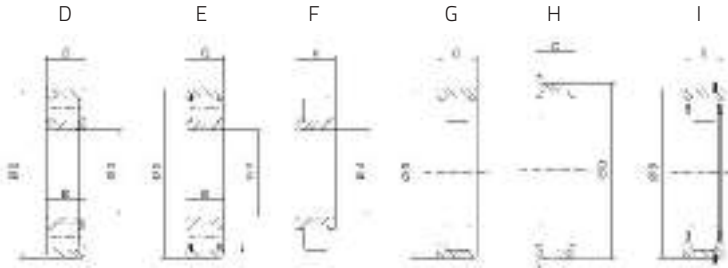

Fersa	CROSS REF.				
F 19001	FAG	805262			SCANIA (R780 * R782 * RV 761)
F 19002	SKF	NJ 309 VHNRC4			SCANIA (R751 * R752 * RV 770 * RV760)
F 19003	SKF	NUP 309 NR.C4			
F 19004	NACHI	NUPK 2205 S13			
F 19005		TJ 600 167			
F 19006	SKF	NJ 308 VH.NR.C4			SCANIA (R640 * R651 * R652 * R653 * RB652)
F 19008	SKF FAG	BC1B 319552 566616 B			ZF (85-1350 * 16K-130 * 16K-160 * 16K-190 * 16S-130 * 16S-160 * 16S-190 * 16S-1300 * 16S-1600 * 16S-1650)
F 19009	SKF FAG	635245 540106			ZF (85-1350 * 16K-130 * 16K-160 * 16K-190 * 16S-130 * 16S-160 * 16S-190 * 16S-1300 * 16S-1600 * 16S-1650)
F 19010	FAG	805449			ZF (16S-130 * 16S-160 * 16S-190 * 16S-1300 * 16S-1600 * 16S-1650 * 16S-1900)
F 19011	SKF FAG	315070 B 512099 TVP2			MERCEDES BENZ (G3-50 * G3-60D)
F 19012	FAG	510148 A			MERCEDES BENZ (1113 * 1214 * 1218 * 1414 * 1418 * 1618)
F 19013	INA	F210540			MERCEDES BENZ (HL4)
F 19014	SKF	BC1B 246747			SCANIA (R641 * R642)
F 19015	SKF INA	314984 F 45814			MERCEDES BENZ (HL5)
F 19016	INA	F 90836.1A			ZF (16K-160 * 16K-190 * 16S-130 * 16S-1300 * 16S-1600)
F 19019	FAG INA	512533 31173			ZF (4K-120,4K 121 * 5K-90 * 5K-91,5K 110 * 5S-111)
F 19020	INA	F 45864.1			MERITOR (RS 230 + MS 235 * RS23 240 + MS 245)
F 19022	FAG	NUP 524213M			ZF (4K 120,4K 121 * 5K 90 * 5K 91,5K 110 * 5S 111)
F 19023	NACHI	NUPK 2205 S1 NR			
F 19024	RHP	RJ 2022			
F 19025	SKF	2206 VF 153B			
F 19026	SKF	N 2210 W			
F 19029	SKF	BC1B 635251			FIAT (Duna * Uno * Spacio * Vivace * Brio * 147)

08.2 \ Special cylindrical bearings Rodamientos cilíndricos especiales

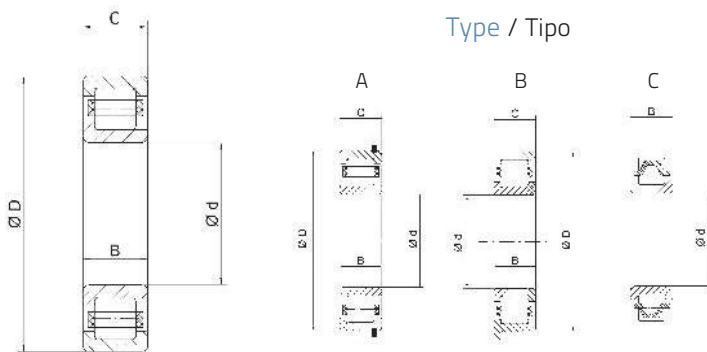

Type / Tipo

Fersa	d (mm)	D (mm)	T (mm)	TYPE
F 19030	49,930	80,000	15,000	E
F 19031	30,000	61,935	19,050	E
F 19032	24,000	-	17,000	F
F 19033	40,000	90,000	25,000	E
F 19034	40,000	90,000	23,000	E
F 19035	35,000	72,000	20,600	E
F 19037	35,000	-	25,000	C
F 19038	63,000	-	37,500	C
F 19039	80,000	140,000	33,500	B
F 19040	25,000	62,000	17,000 / 19,000	E
F 19042	60,000	110,000	28,000	A
F 19043	34,993	80,000	23,000	A
F 19044	45,000	100,000	25,000	A
F 19045	30,000	61,935	23,813	E
F 19046	50,000	100,000	25,000	B
F 19047	60,000	116,000	28,000	B
F 19048	36,000	-	20,000	F
F 19055	15,875	47,000	14,000	A
F 19061	67,000	-	32,000	C
F 19062	67,000	-	38,000	C
F 19063	45,000	100,000	31,000	E
F 19064	65,000	140,000	33,000	B
F 19065	40,000	-	29,000	C
F 19066	35,000	62,000	16,700 / 19,000	A
F 19067	38,000	83,000	25,400	E
F 19068	-	62,000	16,000	G
F 19069	-	80,000	26,500	G

Type / Tipo

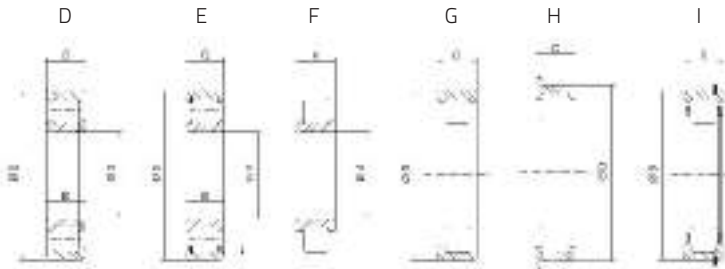

Fersa	CROSS REF.				
F 19030	FLT	CBK 238			
F 19031	FLT	CBK 239			
F 19032	TORRINGTON	544740 B			
F 19033	TORRINGTON	RU 9008 UM			MERITOR (900)
F 19034	TORRINGTON	MU 1308 UM			EATON (RS440)
F 19035	TORRINGTON	RU 1570 UM			DANA SPICER (N400)
F 19037	INA	F-88545			ZF (16K-160 * 16K-190 * 16S-130 * 16S-1300 * 16S-1600)
F 19038	INA	F-88816.2			ZF (16S-160 * 16S-190)
F 19039	SKF FAG	BC1B 312219 805450			ZF (16S 1650)
F 19040	TORRINGTON	MU1305TDM			EATON (16244)
F 19042	FAG	804339			ZF (S5 680 * S6 680)
F 19043	FAG	510148 B			MERCEDES BENZ (HL4)
F 19044	FAG INA	508204 E.TVP 561521			MERCEDES BENZ (G3-36 * G3-40 * G3-50 * G3-60)
F 19045	SNR	ETR 122205			
F 19046	SKF	BC1B 322467			MERCEDES BENZ (G3-45 * G3-55)
F 19047	SKF	BC1B 322172 A			MERCEDES BENZ (G3-45 * G3-55)
F 19048	INA	F-93666.2		SB	FORD (6600 * 6610)
F 19055	RHP	RJ 2023			
F 19061	INA	F-211413.2			ZF (16S-150 * 16S-151)
F 19062	INA	F-211408.5			ZF (16S-220 * 16S-221)
F 19063	SKF	BC1B 320308 A			ROCKWELL (U167 * U177 * U180)
F 19064	SKF	BC1B 319546C / VB017			
F 19065	SKF	BC1B 246037 A			VOLVO (R1400 * R1700 * SR1400 * SR1700 * SR2000 * SR2400)
F 19066	INA	F-43710.1		SS	VOLKSWAGEN (Transporter)
F 19067	LBC	4302712			
F 19068	TORRINGTON	M 1206 EL			GMC (1500 * 3000)
F 19069	INA	F-237594			MERCEDES BENZ (G3/60 * G3/85)

08.2 \ Special cylindrical bearings Rodamientos cilíndricos especiales

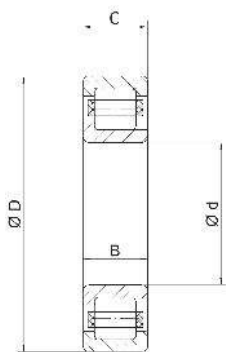

Type / Tipo

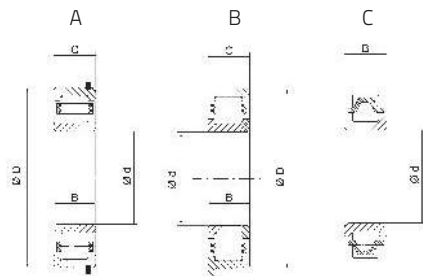

Fersa	d (mm)	D (mm)	T (mm)	TYPE
F 19070	50,000	110,000	32,300 / 27,000	A
F 19071	50,000	110,000	32,300 / 27,000	A
F 19075	30,000	-	23,000	C
F 19076	38,000	94,000	33,000 / 31,500	D
F 19077	35,000	80,000	21,000	E
F 19078	30,000	80,000	21,000	E
F 19079		55,000	20,000	G
F 19080	45,000	100,000	36,000	A
F 19081	45,000	100,000	31,000	A
F 19083	30,000	80,000	21,000	E
F 19084	35,000	90,000	23,000	E
F 19085	45,000	100,000	25,000	E
F 19086	35,000	72,000	26,988	E
F 19087	77,000	101,000	29,000	C
F 19088	60,000	110,000	22,000	E
F 19089	40,000	94,000	30,000	A
F 19090	37,000	57,000	31,000	C
F 19091	30,000	72,000	19,000	D
F 19093	25,000	57,000	18,000	A
F 19094	38,000	89,600	25,400	A
F 19095	28,500	47,600	32,000	C
F 19096	30,000	62,000	24,000	A
F 19097	55,000	104,000	27,000	A
F 19099	35,000	80,000	26,000	E
F 19100	35,000	80,000	21,000	E
F 19101	55,000	100,000	21,000	A

Type / Tipo

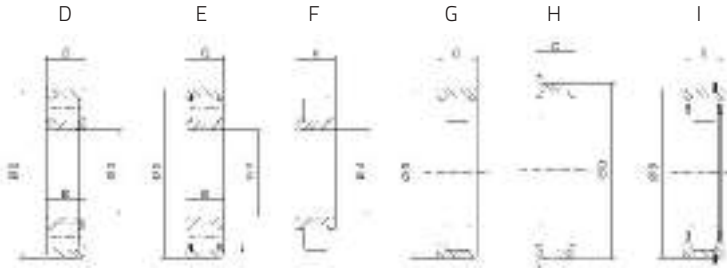

Fersa	CROSS REF.				
F 19070	SKF	BC1 0058			EATON FULLER (FSV 8209A)
F 19071	SKF	BC1 0125			EATON FULLER (FSV 8209A)
F 19075	INA	87486			ZF (85-1350 * 16K-130 * 16S-130 * 16S-1300 * 16S-1350)
F 19076	FAG	580989			SCANIA (R560 * R660)
F 19077	TORRINGTON	MU 1307 TM			DANA (14136)
F 19078	TORRINGTON	MUS 1307 TM			EATON (D600)
F 19079	NACHI	31 RUKSS2N C3			
F 19080	SKF	NJG 2309 VH/C3 VB027			VOLVO (EV90 * EV91)
F 19081	FAG SKF	563809 BC1B 322722			DAF (1347)
F 19083	TORRINGTON	MUS1307UM			EATON (21065T)
F 19084	TORRINGTON	MUB1308UM			EATON (DP440P * DT440P)
F 19085	TORRINGTON	BS500192S			FULLER (RTL0 16918)
F 19086	TORRINGTON	MUB5207UM			EATON (23070T * 23070P)
F 19087	INA	F-229852			EATON FULLER (10 speeds)
F 19088	TORRINGTON	MU 1212 RUMW3			EATON (RTL0 16918)
F 19089	FAG	575867			MAN (HY-1175)
F 19090	INA	F 224451.04			MERCEDES BENZ (G60 * G85)
F 19091	INA	F-53597			MERCEDES BENZ
F 19093	KOYO	05NU0618-IVH	LCV		HINO (300) VOLKSWAGEN (Vochobus)
F 19094	TORRINGTON	BS226539V			EATON FULLER (10 speeds)
F 19095	TORRINGTON	BS 500082			FULLER (RTL0 16918)
F 19096	INA	F-110214.1			MERCEDES BENZ (HL2)
F 19097	INA	F-221302.01			SCANIA (1408178)
F 19099	TORRINGTON	MUB7307UM			DANA (DS402 * RS402)
F 19100	TORRINGTON	MUB1307UBM			DANA (127484)
F 19101	TORRINGTON	MSN 211 REX			EATON (20899)



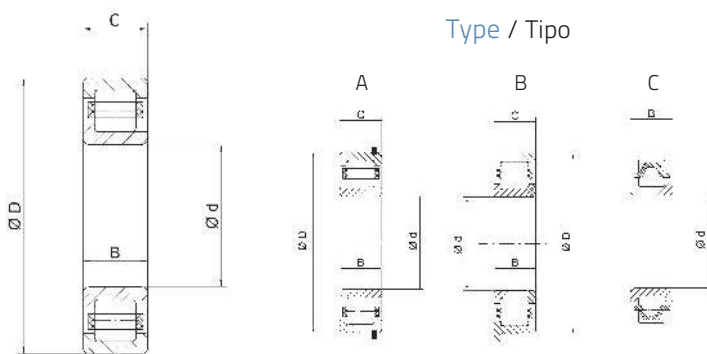





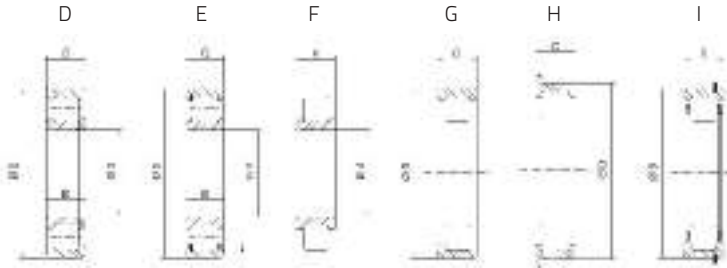



08.2 \ Special cylindrical bearings Rodamientos cilíndricos especiales



Fersa	d (mm)	D (mm)	T (mm)	TYPE
F 19105	65,000	160,000	37,000	A
F 19106	65,000	160,000	37,000	A
F 19107	45,000	100,000	25,000	E
F 19108	55,000	100,000	21,000	A
F 19111	40,000	60,000	26,000	I
F 19112	40,000	90,000	23,000	D
F 19116	37,000	80,000	26,000	A
F 19117	-	100,000	25,000	I
F 19118	30,000	-	23,000	C
F 19119	40,000	90,000	23,000	E
F 19120	30,000	80,000	26,000	E
F 19121	45,000	85,000	19,000	A

Type / Tipo



Fersa	CROSS REF.				
F 19105	FAG	539090 A			VOLVO (R61 * SR61 * SR62)
F 19106	FAG	524625			VOLVO (SR62)
F 19107	BOWER	MU 1309 UM			EATON (AXLE MODEL 23105-D)
F 19108	BOWER	MA 1211 EL			SPICER (4954 * CM49 * CM4954 * ES066-7B * ES42-5 * ES43-5 * ES46-5A * ES52-5 * ES52-7 * ES53-5 * ES56-5A * ES56-7 * ES65-7 * ES066-7)
F 19111	INA	F-89034			ZF (9S-75)
F 19112	FAG	520550			VOLVO (EV87 * EV 80 * EV80B)
F 19116	INA	F-237594 + F-226559.41			MERCEDES BENZ (G60-6 * G85-6)
F 19117	TORRINGTON	MB1212GEXR			SPICER (ES066-7B * ES52-7 * ES56-7 * ES65-7 * ES066-7)
F 19118	TORRINGTON	MU5206L			SPICER (4954 * CM49 * CM4954 * ES066-7B * ES42-5 * ES43-5 * ES46-5A * ES52-5 * ES52-7 * ES53-5 * ES56-7 * ES65-7 * ES066-7 * ES56-5A)
F 19119	TORRINGTON	MU1308TVWS			EATON (5/7/8/9/10/13/15 speeds)
F 19120	TORRINGTON	MUSB 7307 UM			EATON (DS341(P) * RS341 * DA402(P) * DS402(P) * RA402 * RS402 * DS403(P) * RS403 * DS451-P * RS451)
F 19121	TORRINGTON	MA 1209 EL			EATON (4D3*34DP*34DS*34DT*38D3*38DP*38DS*38DT*42D3*42DP*42DT*50DP*50DT*DP340*DS340*DT340*DC341(P)*DP341(P)*DS341(P)*DT341(P)*DP380-*DS380(P)*DT380(P)*DC381(P)*DP381(P)*DS381(P)*DT381(P)*DC386-P*DP386-P*DS386-P*DT386-P*DP400(P)*DS400-P*DT400(P)*DC401-P*DP401(P)*DS401-P*DT401(P)*DA402(P)*DC402(P)*DP402(P)*DS402(P)*DT402(P)*DS403(P)*DC406-P*DP406-P*DS406-P*DT406-P*DC451-P*DP451-P*DS451-P*DT451-P*DC3416-P*DP3416-P*DS3416-P*DT3416-P*DC4026-P*DP4026-P*DS4026-P*DT4026-P)
					MACK (TR107*TRDXL107*TRL1076*TRL1078*TRL10760*TRL10780)

08

08.2 \ Special cylindrical bearings Rodamientos cilíndricos especiales

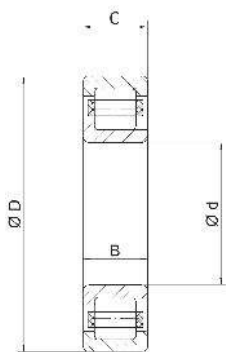

Type / Tipo

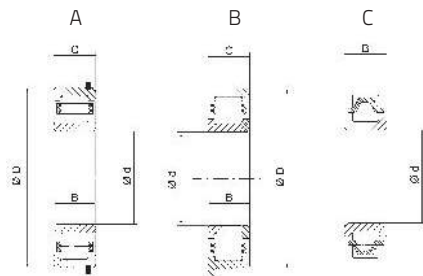







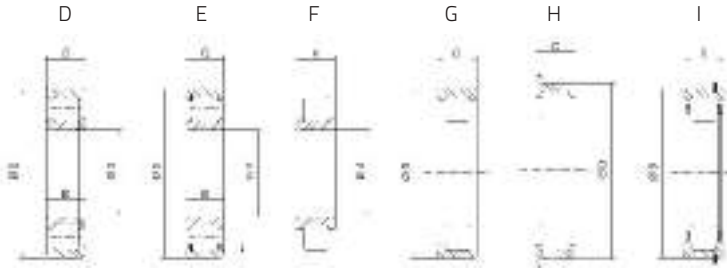



Fersa	d (mm)	D (mm)	T (mm)	TYPE
N F 19130	60,000	110,000	22,000	E
N F 19131	40,000	90,000	23,000	E
N F 19134	27,762	62,000	18,000	E
N F 19166	25,000	59,000	24,000	D
N F 19167	34,000	64,000	22,000	I
N F 19169	85,000	151,500	34,000	
N F 19170	65,000	121,000	33,000	
N F 19171	60,000	113,000	31,000	
N F 19172	105,000	198,000	46,000	



Type / Tipo



Fersa	CROSS REF.				
N F 19130					EATON , FM-14E310B-LAS * FM-15E310B-LAS * FO-10E310C-VAS * FO-12E310C-VAS * FO-14E310C-LAS * FO-14E310C-VAS * FO-16E310C-LAS * FO-16E310C-VAS * FOM-14E310C-LAS * FOM-14E310C-VAS * FOM-15E310C-LAS * FOM-15E310C-VAS * FOM-16E310C-LAS * FOM-16E310C-VAS
N F 19131	SKF	WUB 61308 UM			EATON , S21-170D * S23-170D * S25-170D*S21-190*S21-190D * S23-190*S23-190D * S26-190 * S26-190D * S30-190 * S30-190D * R50-170D * R40-170D * R46-170D * R52-190 * R52-190D * R60-190 * R60-190D
N F 19134	TORRINGTON	MUB1305UDM			MERITOR , RS-13-120 * RS-15-120 * RS-15-125
N F 19166	NACHI	25RT59SN			TOYOTA , Land Cruiser * Cruiser Prado * Tundra * Hilux * Fortuner
N F 19167	NACHI	34RUKS64NR			TOYOTA
N F 19169	RUVILLE	85UZS419T2XSX	INDUSTRIAL	REDUCER	
N F 19170	RUVILLE	65UZS418T2XSX	INDUSTRIAL	REDUCER	
N F 19171	RUVILLE	60UZS417SX	INDUSTRIAL	REDUCER	
N F 19172	RUVILLE	623GXX	INDUSTRIAL	REDUCER	

08



.....

.....

.....

.....

.....

.....

09

Special needle roller bearings

Rodamientos de agujas especiales

09

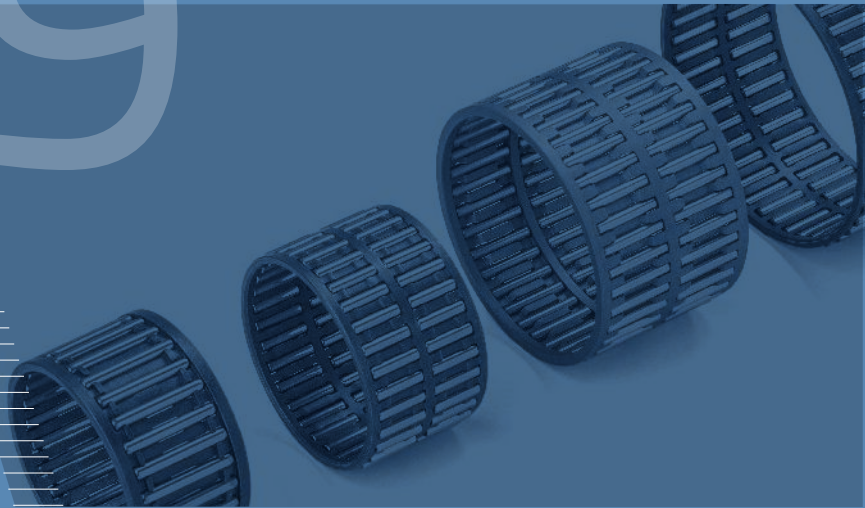

09\ Special needle roller bearings Rodamientos de agujas especiales

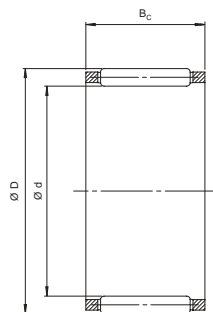

Fersa	d (mm)	D (mm)	B _c (mm)
N F 17003 K	40,000	60,000	3,000
F 17031 K	75,000	83,000	55,000
F 17032 K	78,000	86,000	35,000
F 17033 K	42,000	50,000	51,000
F 17034 K	89,000	97,000	40,000
F 17035 K	85,000	93,000	53,000
F 17038 K	92,000	100,000	53,000
F 17039 K	96,000	104,000	55,000
F 17040 K	90,000	98,000	40,500
F 17041 K	45,000	57,000	21,000
F 17043 K	65,000	70,000	20,000
F 17044 K	70,000	76,000	20,000
F 17045 K	50,000	55,000	20,000
F 17046 K	55,000	60,000	20,000
F 17051 K	82,000	90,000	37,000
F 17052 K	62,000	70,000	37,000
F 17053 K	70,000	78,000	37,000
F 17054 K	45,000	53,000	21,000
F 17056 K	60,000	68,000	32,000

Fersa	CROSS REF.			
N F 17003 K				
F 17031 K	INA	F-57368.01		 MERCEDES BENZ (G4-110 * G131-9 * G180-16 * G200-16 * G210-16 * G211-12 * G211-16 * G230-16 * G240-16 * G260-16 * G04-130 * G04-160) ZF (4K-120 * 4S-120 * 8S-180)
F 17032 K	INA	F-92625		 MERCEDES BENZ (G4-110 * G100-12 * G180-16 * G200-16 * G210-16 * G211-16 * G230-16 * G240-16 * G260-16 * G280-16 * G04-160 * G0210-6)
F 17033 K	INA	F-207054		 MERCEDES BENZ (G155-9 * G200-16 * G210-16 * G211-16 * G221-9 * G230-16 * G231-16 * G240-16 * G241-16 * G260-16 * G280-16)
F 17034 K	INA	F-219518		 MERCEDES BENZ (G131-9 * G210-16 * G211-16 * G221-9 * G230-16 * G231-16 * G240-16 * G260-16)
F 17035 K	INA	F-95451.02		 MERCEDES BENZ (G125-16 * G155-9 * G210-16 * G211-16 * G240-16 * G260-16)
F 17038 K	INA	F-211412.03		 ZF (16S-150 * 16S-151)
F 17039 K	INA	F-212874.01		 ZF (16S-150 * 16S-151)
F 17040 K	INA	F-212875.01		 ZF (16S-150 * 16S-151)
F 17041 K	INA	F-217112		 ZF (16S-150 * 16S-151)
F 17043 K				 EATON (FS-5306A * FS-6206A * F-6306A)
F 17044 K				 EATON (FS-5306A * FS-6206A * F-6306A)
F 17045 K				 EATON (FS-5306A * FS-6206A * F-6306A)
F 17046 K				 EATON (FS-5306A * FS-6206A * F-6306A)
F 17051 K	INA	F-58242		 ZF (5K-110 * 5S-110)
F 17052 K	INA	F-58723		 ZF (5K-110 * 5S-110 * 5S-130)
F 17053 K	INA	F-87259		 ZF (4K-120 * 4S-120 * 5K-110 * 5S-110 * 5S-65 * 5S-85)
F 17054 K	INA	K 45x53x21 A		 ZF (4S-120 * 4S-150 * 5K-110 * 5S-110 * 16K-130 * 16K-160 * 16S-112 * 16S-130 * 16S-150 * 16S-160 * 16S-190 * 16S-200 * AK5-45 * AK 6-80 * AK6-90 * S4-90 * S5-45 * S6-65 * S6-72 * S6-90)
F 17056 K	INA	F-205901.01		 ZF (9S-75)

09\ Special needle roller bearings Rodamientos de agujas especiales

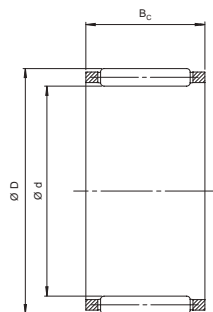



Fersa	d (mm)	D (mm)	B _c (mm)
F 17057 K	67,000	75,000	37,000
F 17058 K	67,000	75,000	44,000
F 17059 K	60,000	68,000	41,700
F 17060 K	50,800	60,325	25,400
F 17061 K	60,000	68,000	39,000
F 17062 K	75,000	83,000	35,000
F 17063 K	75,000	83,000	23,000
F 17064 K	75,000	83,000	40,000
F 17076 K	72,000	80,000	40,000
F 17077 K	72,000	80,000	29,800
F 17078 K	32,000	40,000	49,200
F 17079 K	50,000	56,010	43,700
F 17080 K	86,000	94,000	45,000
F 17089 K	63,000	71,000	50,800
F 17090 K	60,000	68,000	40,000
F 17091 K	85,000	93,000	63,000
F 17092 K	95,000	103,000	60,000
F 17093 K	42,000	50,000	30,000
F 17094 K	92,000	100,000	27,000
F 17095 K	90,000	98,000	46,000
F 17096 K	84,000	90,000	39,500
F 17097 K	75,000	83,000	48,000
F 17098 K	82,000	90,000	60,000
F 17099 K	62,000	70,000	40,000

Fersa	CROSS REF.			
F 17057 K	INA	F-209976		 MERCEDES BENZ (G100-12) ZF (9S-75 * S5-42)
F 17058 K	INA	F-209977		 VOLVO (R800) ZF (9S-75 * S5-42)
F 17059 K	INA	F-210326.01		 VOLVO (R800) ZF (9S-75 * S5-42)
F 17060 K				
F 17061 K	INA	F-202742		 ZF (6S-150 C * 8S-140 * 8S-180 * 9S-75 * 9S-109 * 16S-109)
F 17062 K				 ZF (6S-150 C * 9S-109 * 16S-109 * S6-36)
F 17063 K	INA	F-202961.1		 ZF (6S-150 C * 9S-109 * 16S-109)
F 17064 K				 MERCEDES BENZ (G4-65) ZF (4S-120 * 4S-120 * 5S-90 * 5S-92 * 8S-140 * 9S-140)
F 17076 K	INA	F-204691		 MERCEDES BENZ (G6-80 * G85)
F 17077 K	INA	F-224446		 MERCEDES BENZ (G6-80 * G60-6 * G85)
F 17078 K	INA	F-224448.K-HLA		 MERCEDES BENZ (G6-80 * G60-6 * G85)
F 17079 K	INA	F-225955		 MERCEDES BENZ (G85)
F 17080 K	INA	F-227124.K-HLA		 MERCEDES BENZ (G60-6 * G85)
F17089 K				 MERCEDES BENZ (G85 * G60)
F 17090 K				 VOLVO (R51 * R52 * R52B) MERCEDES BENZ (G6-60 * G3/55-6/8,5)
F 17091 K	INA	F-227349		 VOLVO (VT 2514 B)
F 17092 K	INA	F-227348		 VOLVO (VT 2514 B)
F 17093 K	INA	F-203535		 VOLVO (VT 2514 B)
F 17094 K	INA	F-208939.03		 VOLVO (VT 2514 B)
F 17095 K	INA	F-203030		 VOLVO (VT 2514 B)
F 17096 K	INA	F-227638		 MERCEDES BENZ (G241-16)
F 17097 K	INA	F-227511.06		 MERCEDES BENZ (G211-16 * G241-16)
F 17098 K	INA	F-87934		 ZF (16S-160*16S-190)
F 17099 K	INA	K 62x70x40 ZW		 ZF (5S111GP * 5S111GP+GV90/1)

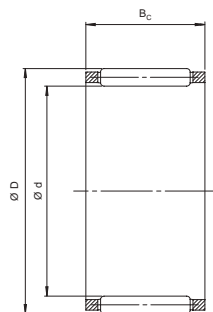
09\ Special needle roller bearings Rodamientos de agujas especiales



Fersa	d (mm)	D (mm)	B _c (mm)
F 17100 K	80,000	88,000	35,000
F 17101 K	70,000	78,000	43,000
F 17102 K	65,000	73,000	33,000
F 17103 K	57,000	63,000	37,000
F 17104 K	75,000	83,000	33,000
F 17105 K	38,000	46,000	32,000
F 17106 K	40,000	48,000	20,000
F 17107 K	60,000	68,000	25,000
F 17108 K	60,000	68,000	23,000
F 17109 K	55,000	60,000	30,000
F 17110 K	73,000	79,000	50,000
F 17111 K	47,000	53,000	25,000
F 17112 K	55,000	63,000	20,000
F 17113 K	65,000	70,000	30,000
F 17114 K	25,000	33,000	25,000
N F 17116 K	75,000	83,000	23,000
N F 17117 K	80,000	105,000	4,000
N F 17120 K	57,150	66,675	38,100
N F 17121 K	75,000	83,000	46,000
N F 17122 K	84,000	90,000	55,000
N F 17123 K	75,000	83,000	48,000
N F 17124 K	85,000	93,000	60,000

Fersa	CROSS REF.				
F 17100 K	INA	F-88416			ZF (5S-111GP * 5S-111GP+GV90/1)
F 17101 K	INA	F-58637			ZF (5S-111GP * 5S-111GP+GV90/1)
F 17102 K	INA	F-84156			ZF (5S-90GP * 5S-90GPA * 5S-92GP)
F 17103 K	INA	F-53960			ZF (5S-90GP * 5S-90GPA * 5S-92GP)
F 17104 K	INA	F-59437			ZF (5S-90GP * 5S-90GPA * 5S-92GP)
F 17105 K	INA	F-239307			ZF (AT2412C * AT2412 D * AT2512C * AT2612D * AT2812C * AT2812D)
F 17106 K	INA	FW404820			EATON (FS-6406 * FS-8406)
F 17107 K					ZF (9S-1310)
F 17108 K	INA	F-203531.1			ZF (9S-109 * ST700 * 6S-150C)
F 17109 K					EATON (Fuller 6 speeds)
F 17110 K	INA	F-208323			SPICER (ES066-7B * ES52-7 * ES56-7 * ES65-7 * ES066-7 * 4954 * CM49 * CM4954 * ES43-5 * ES52-5 * ES53-5 * ES46-5A * ES56-5A)
F 17111 K	INA	K47x53x25A			SPICER (ES066-7B * ES52-7 * ES56-7 * ES65-7 * ES066-7)
F 17112 K	INA	K55x63x20B			SPICER (ES066-7B * ES52-7 * ES56-7 * ES65-7 * ES066-7)
F 17113 K					SPICER (ES066-7B * ES52-7 * ES56-7 * ES65-7 * ES066-7)
F 17114 K	TORRINGTON	WJ162116			EATON / SPICER (7,8,9,10 & 13 Speed models)
 F 17116 K					MERITOR, (MD-34-14X * MD-40-14X * MT-44-14X)
 F 17117 K					MERITOR, (MD-34-14X * MD-40-14X * MT-44-14X)
 F 17120 K					
 F 17121 K					
 F 17122 K					DETROIT (DT12-DA * DT12-OA) MERCEDES BENZ (G281-12 * G330-12)
 F 17123 K					DETROIT (DT12-DA * DT12-OA) MERCEDES BENZ (G281-12 * G330-12)
 F 17124 K					DETROIT (DT12-DA * DT12-OA) MERCEDES BENZ (G281-12 * G330-12)

09\ Special needle roller bearings Rodamientos de agujas especiales

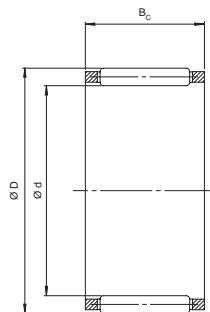

Fersa	d (mm)	D (mm)	B_c (mm)
N F 17125 K	85,000	93,000	73,000
N F 17126 K	25,000	39,000	20,000
N F 17127 K	42,000	50,000	40,000
N F 17128 K	84,000	90,000	48,000
N F 17129 K	64,000	72,000	45,000



A series of horizontal dotted lines for writing notes or additional information.

Wheel end hub units

Unidades de buje

10.1 \	Wheel end hub / Hub de rueda	154
10.2 \	Wheel end kit / Kit de rueda	158
10.3 \	Wheel end module / Modulo de rueda	164
10.4 \	Wheel hub assembly / Rodamientos integrales	168

10



10.1 \ Wheel end hub Hub de rueda

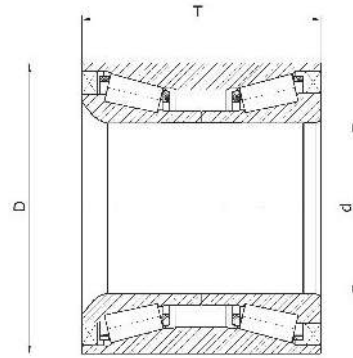



Fersa		d (mm)	D (mm)	T (mm)	WEIGHT (kg)
	F 15097	68,000 / 68,200	127,000 / 132,000	115,000	6,500
	F 15100	82,000	140,000	115,000	6,450
	F 15120	60,000	108,000	75,000	2,830
	F 15121	55,000	90,000	60,000	1,400
	F 15122	90,000	160,000	125,000	10,240
	F 15124	90,000	160,000	125,000	10,260
	F 15125	78,000	130,000	90,000	4,360
	F 15126	82,000	140,000	110,000	6,595
	F 15127	78,000	130,000	90,500	4,345

Fersa	CROSS REF.		OEM		
F 15097	FAG	201037 / 571762. H195	1413785 / 1439070 / 1443078 / 1476945 / 1724482 / 1868087		SCANIA (93 * 113 * 143 * K3 * K4 * SERIE 3 * SERIE 4)
	SKF	BTH 0018 A / VKBA 5314			SCANIA (SERIE 3)
	TIMKEN	SET 1231 / NP 078914			
F 15100	FAG SKF	805003A.H195 BTH 0022 / BTH 0055 / VKBA 5412	014 981 51 05 / 014 981 93 05 / 014 981 99 05 / 017 981 50 05		MERCEDES BENZ (TE * TL * TZ) GIGANT (D SERIE * G SERIE) SCHMITZ CARGOBULL (SPR * SCS * SKO)
F 15120	FAG KOYO	201050 DU60108 8	015 981 19 05		MERCEDES BENZ (ACTROS MP2 * ATEGO 2 * AXOR 2)
F 15121	FAG SKF	713 6908 40 BTH 1011 / VKBA 3552	7180066		IVECO (Daily I)
F 15122	FAG	201059 / 805012.06. H195	1905487 / 2996882 / 7179751 / 7183074 / 7183075 / 7189050 / 7189648		IVECO (STRALIS * EUROTECH * EUROSTAR)
	SKF TIMKEN	BTH 0053 / VKBA 5397 NP 318274-90UA7 / SET 1242			IRISBUS (EURORIDER)
F 15124	TIMKEN SKF FAG	SET 1257 VKBA 5413 201072	42537774 / 42539148 / 42546141 / 500054527		IRISBUS (RECREO * PROWAY * MAGELYS * EVADYS * CROSSWAY) IVECO (CITYCLASS * MAGELYS)
F 15125	FAG	803194 A	013 981 22 05 / 013 981 23 05 / 013 981 98 05		MERCEDES BENZ (ATEGO * ATEGO 2 * TOURINO)
F 15126	FAG SKF TIMKEN	805011 C VKBA 5409 SET 1237	2994058 / 7184079 / 7184080		IVECO (EUROCARGO) MERITOR (TC)
F 15127	FAG	805092 C	7182915 / 81.93420.0336 / 81.93420.0379 / 81.93420.6083 / 81.93420.6099 / 8510 3257		IVECO (EUROCARGO) MAN (TGL * TGM * L 2000) VOLVO (FL 6)
					IVECO (EUROPOLIS ELÉCTRICO)

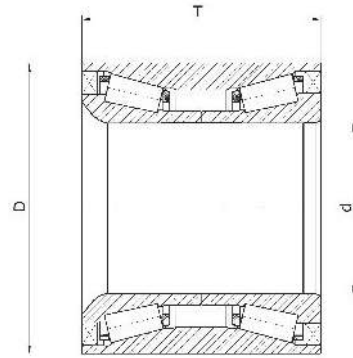



10.1 \ Wheel end hub Hub de rueda



Fersa		d (mm)	D (mm)	T (mm)	WEIGHT (kg)
	F 15300	82,000	140,000	115,000	6,500
	F 15414	82,000	140,000	115,000	6,590









A series of horizontal dotted lines for writing notes or specifications.

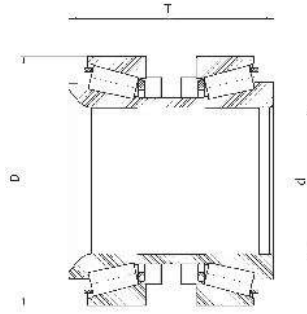





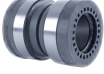
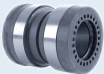



Fersa	CROSS REF.		OEM		
					
F 15300	FAG	805003CA.H195	81.93420.0344 / 81.93420.0354		MAN (TGL * TGM)
F 15414	SKF	BTH 0058B / VKBA 5432	81 93420 6095 / 81.35701-6034 / 81.35701-6035 / 81.93420-0344 / 81.93420-0354		MAN (FOCL * TGL I * TGM I)



10.2 \ Wheel end kit Kit de rueda







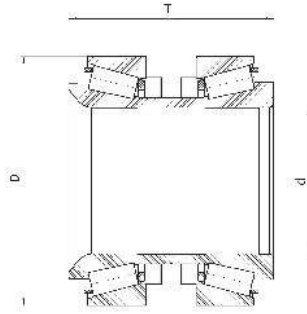

Fersa		d (mm)	D (mm)	T (mm)	WEIGHT (kg)
	F 200004	105,000	160,000	140,000	6,855
	F 200005	110,000	170,000	146,000	8,530
	F 200013	68,000 / 68,200	125,000	115,000	4,45
	F 200014	93,800 / 94,000	148,000	135,000	5,40
	F 200015	57,800 / 58,000	110,000	115,000	3,64
	F 200016	69,800 / 70,000	125,000	114,000	4,86

Fersa	CROSS REF.		OEM		
F 200004	FAG SKF TIMKEN	803750 B VKBA 5408 BT2-0130A SET 1335	36934200009 / 5031 26457 / 81.93420.0320 / 81.93420.0342		MAN (TGA * TGM * TGS * TGX * M 2000)
					BOVA (FUTURA * LEXIO * MAGIG * SINERGY) MAN (LIONS COACH * LIONS CITY * HOCL * NG NL * NU * SL * ÜL) MERCEDES (CITARO) NEOPLAN (STARLINER * CITYLINER * EUROLINER) VOLVO (7700 * 8500 * 8700 *)
F 200005	FAG SKF	804162 A VKBA 5416	81.93420.0346 / 81.93420.6098		MAN (TGA * TGM * TGS)
F 200013	FAG SKF TIMKEN	566426.H195 VKBA 5425 SET 1312	20382168 / 20518092 / 20518093 / 20518637 / 20558950 / 20581399 / 20728008 / 20967831 / 21021391 / 2051 8637 / 2096 7831 / 2102 1391 / 3988673 / 3988674 / 3988675 / 74 20 518 637 / 74 20 967 831 / 74 21 021 391		VOLVO (FE * FH * FM * FM 7 * FM 9 * FM 12 * FH 12 * FH 16 * NH 12) RENAULT (Magnum * Premium 2 * Kerax)
					VOLVO (B6 * 7300 * 7700 * 8500 * 8700 * 9700 * 9900)
F 200014	FAG SKF TIMKEN	566425.H195 VKBA 5423 SET 1314	1075 408 / 20517952 / 20518661 / 20535231 / 20558966 / 20967828 / 21036050 / 2079 2439 / 2079 2440 / 2079 2440 / 3988 774 / 74 20 792 439		VOLVO (FE * FH * FM * FM 7 * FM 9 * FM 12 * FH 12, FH 16 * NH 12 * FL 6 * FL 7 * FL 10 * FL 12 *) RENAULT (Magnum * Premium 2 * Kerax) DAF (XF)
					VOLVO (B6 * 7300 * 7700 * 8500 * 8700 * 9700 * 9900)
F 200015	FAG SKF TIMKEN	566427.H195 VKBA 5424 SET 1311	20518617 / 20967830 / 20589393 / 20589394 / 21021381 74 20 518 617 / 74 21 021 381		VOLVO (FM 9 * FH 12 * FM 12 * FH 16 * FE * FH * FM) RENAULT (MAGNUM DXI * PREMIUM 2)
					VOLVO (B6 * 7700 * 8500 * 8700 * 9700 * 9900)
F 200016	FAG	566074.H195	1691621 / 1699327		DAF (65CF * 75CF * 85CF * CF65 * CF65II * CF65IV * CF75 * CF75II * CF75IV * CF85 * CF85II * CF85IV * LF55 * LF55IV * XF95 * XF95II * XF105)

10.2 \ Wheel end kit Kit de rueda

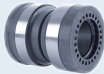
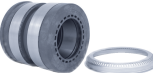
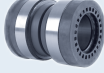

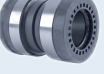
Fersa	d (mm)	D (mm)	T (mm)	WEIGHT (kg)
 F 200017	99,800 / 100,000	148,000	135,000	6,00
 F 200018	82,000	138,000	130,000	6,10
 F 200019	69,800 / 70,00	119,700 / 124,7	110,500	4,50
 F 200025	88,000	138,000	120,000	5,10
 F 200028	120,000	175,030	123,000	7,20
 F 200029	82,000	138,000	110,000	5,80
 F 200031	100,000	148,000	141,000	5,70
 F 200032	105,000	160,000	140,000	8,120
 F 200035	78,000	130,000	135,000	5,00

Fersa	CROSS REF.		OEM		
F 200017	FAG	566283.H195	1801594		DAF (65CF * 75CF * 85CF * CF65 * CF65II * CF65IV * CF75 * CF75II * CF75IV * CF85 * CF85II * CF85IV * LF55 * LF55IV * XF95 * XF95II * XF105)
F 200018	FAG	566193.H195	1801593		DAF (CF 75 * 85 CF * CF 85 * XF 95 * XF 105)
F 200019	FAG	566834.H195	1801595		DAF (65CF * 75CF * 85CF * CF65 * CF65II * CF65IV * CF75 * CF75II * CF75IV * CF85 * CF85II * CF85IV * LF55 * LF55IV * XF95 * XF95II * XF105)
F 200025	FAG	570530.H195	03 200 1020 00 / 03 434 3019 00 / 03 434 3020 00 / 03 434 3021 00 / 03 434 3022 00		SAF (B9-19K * B9-19W * B9-22K01 * B9-22W * BA9-22K01 * B9-19K * B19-19W * B19-22K01 * B19-22W * B19-22W-6 * BINL9-22K01 * S11-3720 * S11-4218 * S11-4220 * S7-3015 * S9-3718 * S9-4220 * S11-19 * S11-22 * S19-19 * S19-22 * SIL11-22 * SL11-4220 * SZL11-4220 * SL9-3718 * SL9-4218 * SZL11-4218 * Z)
F 200028	FAG	566830.H195	03 434 3010 00 / 03 434 3012 00 / 04 200 1016 01 / 04 200 1016 02		SAF (SK * SKRS * SKRZ)
F 200029	FAG	569868.H195	03 434 3018 00 / 04 200 1019 00		SAF (SKRB * SKRLB)
F 200031	FAG	566847.H195	03 434 3011 00		SAF (SKRLS * SKRLZ)
F 200032	SKF TIMKEN FAG	VKBA 5408 BT2-0130A SET 1335 803750 B	000 350 1349 / 1850970 / 85110616 / 0735 371 966+4472 298 146		ZF (AV / AVN-132)
F 200035	FAG	568879 * 631903.H195	7421102685 * 7421363715 * 21102685 * 21363715		VOLVO (FH II) RENAUL TRUCK (C SERIES)

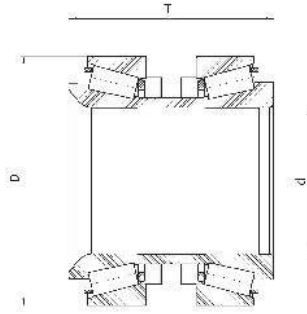

10.2 \ Wheel end kit Kit de rueda



Fersa	d (mm)	D (mm)	T (mm)	WEIGHT (kg)
 N F 200037	110,00	170,00	146,00	9,10
 N F 200041	57,80	115,00	115,00	4,20





A series of horizontal dotted lines for taking notes or drawing.

Fersa	CROSS REF.		OEM		
N F 200037	FAG SKF	F-581863 VKBA 5455	2117621 * 2742995		SCANIA (L,P,G,R,T, S SERIES)
N F 200041	FAG	F-588258 F-611766 675522.AM	21024196 * 21024196 * 21954677 * 22479742		VOLVO (FH * FH II * FM) RENAUL TRUCK (C)

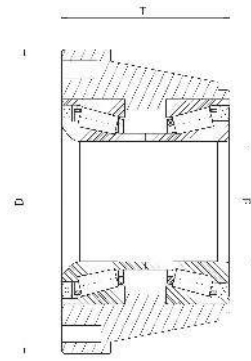

10.3 \ Wheel end module Modulo de rueda





Fersa		d (mm)	D (mm)	T (mm)	WEIGHT (kg)
	F 300001	82,000	196,000	113,000	15,300
	F 300003	70,000	195,000	110,000	11,220
	F 300005	70,000	196,000	140,000	13,200
	F 300006	45,000	120,000	84,900	4,000
	F 300007	60,000	168,000	102,000	9,300
	F 300010	60,000	168,000	100,000	9,400
	N F 300013	55,000	140,000	95,000	5,800

Fersa	CROSS REF.		OEM		
F 300001	FAG SKF	564734.H195 VKBA 5549	1002689 / 1003457 / 100167600 / 100167601 / 3 200 2001 51 / 3 434 3650 00 / 4 200 2001 00 / 4 200 2001 01		SAF (9019 1122) SCHMITZ CARGOBULL (SKI * SPR * SCS * SKO)
F 300003	SNR	HD5001*HUR	81.93420.0344 / 81.93420.0354		RENAULT TRUCKS (KERAX * MAGNUM * MEDIUM * PREMIUM)
F 300005	FAG SKF	801974AE.H195 BTF 0110 / VKBA 5377 / BTF 0021 A	42541578 / 5006207845 / 81.93420.0288 / 81.93420.0330 / 81.93420.0349		MAN (TGA * TGM * TGS * TGX * E 2000 * F 2000 * M 2000)
					IVECO (EUROPOLIS * CITYCLASS) MAN (LIONS COACH * LIONS CITY * LIONS STAR * HOCL * NG * NL * NÜ * NM * UN * RH * SG * SL * SÜ * TOURLINER * ÜL)
F 300006	FAG SKF	713690850 VKBA 3553 / BTFB 328755 D	9381 0034		IVECO (Daily I)
F 300007	FAG FAG TIMKEN	805531 805532.01.H195 SET 1197	20550678 / 5010587029 / 1156414 / 1400061 / 41156414		RENAULT (MIDLUM) DAF (LF 55)
					DAF (SB120)
F 300010	FAG	805532.01.H195	20523899		ALEXANDER DENNIS (Enviro200) VDL (AMBASSADOR ALE 120- 205/225 * Citea LLE -120)
N F 300013	SKF	VKBA 5463 / BTF-0146	1703800		DAF , (LF45)

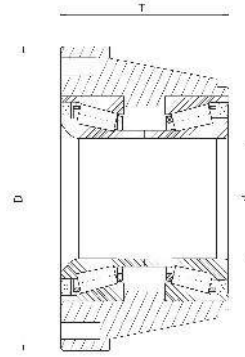



10.3 \ Wheel end module Modulo de rueda



Fersa	d (mm)	D (mm)	T (mm)	WEIGHT (kg)
 N F 300014	55,000	145,000	95,000	5,900
 N F 300016	60,000	168,000	105,500	9,550
 N F 300017	60,000	174,000	122,000	10,298





A series of horizontal dotted lines for taking notes or comments.

Fersa	CROSS REF.		OEM		
N F 300014	SKF FAG	VKBA 5411 BTF-0074A 201082	81.93420-0337		MAN (V * VO)
N F 300016	SKF FAG	VKBA 5414 201081	81.93420.0535 * 81.93420.0345		MAN (VO)
N F 300017	FAG	805738.H195	20710952 * 5010598290 * 5010566173		VOLVO (FL * FL II * FL III * y RVI D * Midlum)





Area with horizontal dotted lines for additional entries.

10.4 \ Wheel hub assembly Rodamientos integrales

Fersa	APPLICATION	BRAND	OEM P/N
 F 400001		MERCEDES BENZ	000 350 2335 * 000 350 0535
 F 400002		DAF	1691621 * 1699327 * 1818004
 F 400003		DAF	1657637 * 1812161 * 2019802
 F 400004		DAF	1389061 * 1391617 * 1818003
 F 400006		VOLVO * RENAULT TRUCK	20820420 * 20819822 * 20499882 * 7420820420
 F 400007		VOLVO * RENAULT TRUCK	85105696 * 3988833
 F 400008		VOLVO * RENAULT TRUCK	85107753 * 20535263
			
 F 400009		VOLVO * RENAULT TRUCK	85114470 * 85111791 * 85111448 * 20535202
			
 F 400010		VOLVO * RENAULT TRUCK	85111789 * 85107749
 F 400011		MERCEDES BENZ	972 330 0125 * 972 330 0225 * 972 330 0325 * 972 330 0425 * 972 330 0525 * 972 330 0625
 F 400013		VOLVO	21024160 * 20534904 * 7421024160 * 7420534904
 F 400014		VOLVO	20518092
 F 400015		SCANIA	2290532 * 2085471



























Fersa	POSITION	REMARK
F 400001	Trailer axle / Eje de trailer	Brake disc screws included / Tornillos de disco de freno incluidos
F 400002	Front axle / Eje delantero	Brake disc / Disco de freno
F 400003	Rear axle / Eje trasero	Brake disc / Disco de freno
F 400004	Rear axle / Eje trasero	Brake disc / Disco de freno
F 400006	Rear axle / Eje trasero	Drum brake / Freno de tambor
F 400007	Rear axle / Eje trasero	Brake disc * 27 mm bolts / Disco de freno * pernos 27 mm With ABS/ Con ABS
F 400008	Rear axle / Eje trasero	Brake disc * 25 mm bolts / Disco de freno * pernos 25 mm With ABS/ Con ABS
F 400009	Front axle / Eje delantero	Brake disc / Disco de freno With ABS/ Con ABS
F 400010	Front axle / Eje delantero	Brake disc / Disco de freno With ABS/ Con ABS
F 400011	Front axle / Eje delantero	Brake disc / Disco de freno With ABS/ Con ABS
F 400013	Front axle / Eje delantero	Drum brake / Freno de tambor
F 400014	Front axle / Eje delantero	Drum brake / Freno de tambor
F 400015	Front axle / Eje delantero	Drum brake / Freno de tambor

10.4 \ Wheel hub assembly Rodamientos integrales

Fersa	APPLICATION	BRAND	OEM P/N
 F 400016		SCANIA	1864430 * 2290526
 F 400018		VOLVO	21328181 * 21328177 * 20820402 * 7421328181
 F 400019		VOLVO	1078053 * 20517164 * 85104301
 F 400021		VOLVO	20535244 * 20535245 * 20518053 * 21336855 * 21336856 * 21336857
 F 400022		VOLVO	20476519 * 20518054
 F 400023		DAF	1613331 * 1812160
 F 400029		MERCEDES BENZ	943 330 08 25 * 943 330 12 25 * 943 330 13 25 * 943 334 00 01
 F 400030		VOLVO * RENAULT TRUCK	20819826 * 85109244 * 7420819826 * 7485109244
			
 F 400031		VOLVO * ZF	21062580 * 4472335745
			
 F 400032		VOLVO * RENAULT TRUCK	21550437 * 7421102556
 F 400034		MERCEDES BENZ	970 350 0335
 N F 400036		BPW	09 801 06 07 0
 N F 400037		BPW	09 801 06 05 0

Fersa	POSITION	REMARK
F 400016	Front axle / Eje delantero	Brake disc / Disco de freno
F 400018	Rear axle / Eje trasero	Drum brake / Freno de tambor With ABS/ Con ABS
F 400019	Rear axle / Eje trasero	Drum brake / Freno de tambor With ABS/ Con ABS
F 400021	Rear axle / Eje trasero	Drum brake / Freno de tambor With ABS/ Con ABS
F 400022	Rear axle / Eje trasero	Drum brake / Freno de tambor With ABS/ Con ABS
F 400023	Front axle / Eje delantero	Brake disc / Disco de freno
F 400029	Front axle / Eje delantero	Brake disc / Disco de freno
F 400030	Rear axle / Eje trasero	Brake disc / Disco de freno With ABS/ Con ABS
F 400031	Rear axle / Eje trasero	Brake disc / Disco de freno ABS included assembled in the seal / ABS incluido en el retén montado
F 400032	Front axle / Eje delantero	Brake disc / Disco de freno With ABS/ Con ABS
F 400034	Rear axle / Eje trasero	Brake disc / Disco de freno
N F 400036	Trailer axle / Eje de trailer	Drum brake / Freno de tambor
N F 400037	Trailer axle / Eje de trailer	Disc brake / Disco de freno

10.4 \ Wheel hub assembly Rodamientos integrales

Fersa	APPLICATION	BRAND	OEM P/N
 N F 400038		BPW	09 801 06 03 0
 N F 400039		BPW	09 801 07 32 0
 N F 400040		BPW	09 801 06 58 0
 N F 400041		MERCEDES BENZ	943 330 11 25 * 943 330 12 25 * 943 334 07 01
 N F 400042		VOLVO	21228155
 N F 400043		SCANIA	2290531
 N F 400044		SCANIA	2326676
 N F 400046		ROR	14225425 * 21225425
 N F 400047		VOLVO	21940776
 N F 400048		ROR	21225494 * 14225494
 N F 400049		SAF	03.307.3056.03 * 03.307.3056.01 * 03.307.3056.00
 N F 400050		MERCEDES BENZ	943 330 08 25
 N F 400051		VOLVO	21102535

Fersa	POSITION	REMARK
N F 400038	Trailer axle / Eje de trailer	Drum brake / Freno de tambor
N F 400039	Trailer axle / Eje de trailer	Disc brake / Disco de freno
N F 400040	Trailer axle / Eje de trailer	Disc brake / Disco de freno
N F 400041	Trailer axle / Eje de trailer	Disc brake / Disco de freno
N F 400042	Trailer axle / Eje de trailer	Drum brake / Freno de tambor
N F 400043	Front axle / Eje delantero	Drum brake / Freno de tambor
N F 400044	Front axle / Eje delantero	Drum brake / Freno de tambor
N F 400046	Rear axle / Eje trasero	Disc brake / Disco de freno
N F 400047	Rear axle / Eje trasero	Disc brake / Disco de freno
N F 400048	Trailer axle / Eje de trailer	Disc brake / Disco de freno
N F 400049	Front axle / Eje delantero	Disc brake / Disco de freno
N F 400050	Trailer axle / Eje de trailer	Disc brake / Disco de freno
N F 400051	Rear axle / Eje trasero	Disc brake / Disco de freno

Fersa	POSITION	REMARK
N F 400052	Rear axle / Eje trasero	Disc brake / Disco de freno
N F 400055	Trailer axle / Eje de trailer	Disc brake / Disco de freno
N F 400056	Trailer axle / Eje de trailer	Disc brake / Disco de freno
N F 400057	Trailer axle / Eje de trailer	Disc brake / Disco de Freno
N F 400058	Trailer axle / Eje de trailer	Disc brake / Freno de tambor
N F 400060	Trailer axle / Eje de trailer	Disc brake / Disco de freno



F-Box Rebuild Kit

Kit de reparación F-box

11.1\	Fersa differential Rebuild Kit / EUROPEAN RANGE Kit de reparación para diferencial	178
11.2\	Fersa transmission Rebuild Kit / EUROPEAN RANGE Kit de reparación para caja de cambios	180
11.3\	Fersa differential Rebuild Kit / AMERICAN RANGE Kit de reparación para diferencial	182
11.4\	Fersa transmission Rebuild Kit / AMERICAN RANGE Kit de reparación para caja de cambios	194
11.5\	Fersa wheel end repair kit Kit de reparación de rueda de vehículo industrial	206

11



11.1 \ Differential Rebuild Kit / EUROPEAN RANGE

Kit de reparación para diferencial



Fersa	BRAND	MODEL
N FDRK 1346	DAF	1346
N FDRK 1347	DAF	1347
N FDRK CRAFTER	VOLKSWAGEN	Crafter
N FDRK EV91	VOLVO	EV91 * RS13565V
N FDRK HL5	MERCEDES BENZ	HL5
N FDRK HL6	MERCEDES BENZ	HL6
N FDRK HL7	MERCEDES BENZ	HL7
N FDRK HL8	MERCEDES BENZ	HL8
N FDRK MAN HY1175	MAN	MAN HY1175 * 1350 (Ø425 mm)
N FDRK MS17X	MERITOR * VOLVO	MS17X * RSS1344C
N FDRK MS18X	MERITOR	MS18X
N FDRK MS140	MERITOR	MS140
N FDRK MS185	MERITOR	MS185
N FDRK MS240	MERITOR	MS240
N FDRK R660	SCANIA	R660
N FDRK R780	SCANIA	R780
N FDRK R885	SCANIA	R885
N FDRK RB660	SCANIA	RB660
N FDRK RB662	SCANIA	RB662
N FDRK RBP835	SCANIA	RBP835
N FDRK RP835	SCANIA	RP835
N FDRK RTS2370 INTERM	VOLVO	RTS2370A * RTS2370B (Intermediate)
N FDRK RTS2370 REAR	VOLVO	RTS2370A * RTS2370B (Rear)
N FDRK U177 - IVECO	MERITOR	U177
N FDRK U177 - VOLVO	MERITOR * VOLVO	U177 * RS1228B * RSS1344B
N FDRK U177 - BUS	MERITOR	U177
N FDRK U180	MERITOR	U180



11.2 \ Transmission Rebuild Kit / EUROPEAN RANGE

Kit de reparación para caja de cambios



Fersa	BRAND	MODEL
N FTRK 101 432 1X	SPICER/TTC TRANSMISSIONS	CM60 * CM5252 * CM5952 * ES42-5 * ES43-5
N FTRK DT12-DB	DETROT/MERCEDES BENZ	DT12-DB // G211-12
N FTRK DT12-OB	DETROT/MERCEDES BENZ	DT12-OB // G230-12
N FTRK DT12-DA	DETROT/MERCEDES BENZ	DT12-DA // G281-12
N FTRK DT12-OA	DETROT/MERCEDES BENZ	DT12-OA // G330-12
N FTRK G240-16	MERCEDES BENZ	G240-16
N FTRK G85-6	MERCEDES BENZ	G85-6
N FTRK G131-9	MERCEDES BENZ	G131-9
N FTRK G210-16	MERCEDES BENZ	G210-16
N FTRK G0210-6	MERCEDES BENZ	G0210-6
N FTRK GRS 900	SCANIA	GRS 900
N FTRK GRS 905	SCANIA	GRS 905
N FTRK VT2214B	VOLVO	VT2214B
N FTRK ZF 1269.298.991	ZF	1.269.298.991
N FTRK ZF 1272.298.946	ZF	1.272.298.946
N FTRK ZF 1292.298.905	ZF	1.292.298.905
N FTRK ZF 1295.298.946	ZF	1.295.298.946
N FTRK ZF 1295.298.947	ZF	1.295.298.947
N FTRK ZF 9S1310	ZF	9S-1310 * 9S-1110
N FTRK 510	VOLVO	AT2412C * AT2412D * AT02512C * AT02612D
N FTRK 510A	VOLVO	AT2412C * AT2412D * AT02512C * AT02612D
N FTRK 511	VOLVO	AT2512C * AT2612D * AT2812C * AT2812D * AT03112C * AT03112D
N FTRK 511A	VOLVO	AT2512C * AT2612D * AT2812C * AT2812D * AT03112C * AT03112D



11.3 \ Differential Rebuild Kit / AMERICAN RANGE

Kit de reparación para diferencial



Fersa	BRAND	MODEL
N FDRK 1	EATON	34R3 * 34RP * 34RT * 38R3 * 38RP * 38RT * 42R3 * 42RP * 42RT * 50RP * 50RT * RP340 * RS340 * RT340 * RC341 * RP341 * RT341 * RP380(P) * RS380 * RT380(P) * RC381 * RP381(P) * RT381(P) * DS385 * RC386 * RP386-P * RT386-P * RP400(P) * RS400 * RT400(P) * RC401 * RP401(P) * RT401(P) * RC402 * RP402(P) * RT402(P) * RC406 * RP406-P * RT406-P * RC451 * RP451-P * RT451-P * RC3416 * RP3416-P * RT3416-P * RC4026 * RP4026-P * RT4026-P * 1880 * 1881 * 7800 * 7801 * 7810 * 8800 * 8802 * 8803 * 17200 * 17201 * 17202 * 17220 * 17221 * 17222 * 17221 * 17300 * 17301 * 17302 * 17320 * 17321 * 17322 * 17401 * 17421 * 17500 * 17501 * 17800 * 17810 * 18200 * 18201 * 18202 * 18207 * 18220 * 18221 * 18227 * 18300 * 18301 * 18302 * 18320 * 18321 * 18322 * 18500 * 18501 * 18502 * 18503 * 18800 * 18802 * 18803 * 18812 * 18813 * 19060-T * 21060-T * 21221 * 21321 * 21421
N FDRK 1A	EATON	34RP * 34RS * 34RSB * 38RP * 38RS * 38RSB * RS340 * RS341 * RS380 * RS381 * RS386 * RS400 * RS401 * RS402 * RS403 * RS406 * RS451 * RS3416 * RS4026 * 17100 * 17101 * 17120 * 17121 * 17123 * 18100 * 18101 * 18103 * 18120 * 18121 * 18123 * 21121
N FDRK 9RB	MERITOR	L100A
N FDRK 9RC	MERITOR	H120 * L100 * L100A * L101 * L110 * L110A * SLHD * SQHD
N FDRK 11FA	MERITOR	SRDD
N FDRK 11R	MERITOR	SQDD * SRDD
N FDRK 18D	EATON	42RS * 19120 * 19121 * 19123 * 20120 * 20121 * 20123 * 26120 * 26121 * 26123
N FDRK 18E	EATON	44RSB * RS440 * RS446 * RS460 * RS466 * RS480 * 23120 * 23121 * 26120 * 26121 * 26123
N FDRK 23	EATON	30R3 * 30RP * 30RS * 30RT * 1618 * 1619 * 6802 * 6803 * 16220 * 16320 * 16321 * 16500 * 16501 * 16800 * 16802 * 16803
N FDRK 23B	EATON	30RS
N FDRK 23D	EATON	16120 * 16123 * 16220 * 16244 * 16247 * 16344 * 19050-P * 19050-T
N FDRK 24	EATON	350 * 1350 * 3800 * 3802 * 13800 * 13802 * 13803 * 15040-P * 15040-T * 15101 * 15200 * 15201 * 15300 * 15301
N FDRK 50	MERITOR	R170 * RL170 * S170 * W170
N FDRK 50A	MERITOR	R171 * R173
N FDRK 64F	EATON	34D3 * 34DP * 34DS * 34DT * 38D3 * 38DP * 38DS * 38DT * 42D3 * 42DP * 42DT

Fersa	BRAND	MODEL
N FDRK 64FC	EATON	34DS * 38DS
N FDRK 64FD	EATON	34DS * 38DS
N FDRK 64FE	EATON	34D3 * 34DP * 34DS * 34DT * 38D3 * 38DP * 38DS * 38DT * 42D3 * 42DP * 42DT
N FDRK 72	EATON	502 * 503 * 9502 * 9503 * 9512 * 19200 * 19201 * 19202 * 19300 * 19301 * 19500 * 19501 * 19502 * 19503 * 19512 * 19513 * 19515 * 20000 * 20200 * 20201 * 20300 * 20301 * 20500 * 20501 * 20502 * 20503 * 23202 * 23302
N FDRK 72A	EATON	44DT * 44RPB * 44RT * 44RTB * 19220 * 19221 * 19223 * 19320 * 19321 * 19323 * 20220 * 20221 * 20223 * 20320 * 20321 * 20323 * 23220 * 23221 * 23320 * 23321 * 26220 * 26221 * 26223 * 26320 * 26321 * 26323 * 33321
N FDRK 72B	EATON	44RT * RP440 * RT440 * RP446-P * RS446 * RT446-P * RP460 * RT460 * RP466-P * RS466 * RT466-P * RP480 * RT480 * RP485 * RT485 * RP550 * RT550 * RC4616 * RC5216 * 19220 * 19221 * 19321 * 20220 * 20221 * 20320 * 20321 * 23080-P * 23080-T * 23220 * 23221 * 23320 * 23321 * 26085-P * 26085-T * 26220 * 26221 * 26223 * 26320 * 26321 * 26323 * 33321
N FDRK 111	WHITE	124C * 134C
N FDRK 117	MACK	RAD23 * AWR48 * CRD78 * CRD94 * CRD116 * CRD117 * RAD303 * RAD305 * RAD500 * RAS500 * RAD501 * RAD507 * RAD508 * RAD509 * RAD512 * RAD529 * RAD529CW * RADL529 * RAD530 * RAD530C * RAD606 * RAD606C * RAD705 * CRD781 * RADF1000 * RADP1000 * RADP1001 * CRD1161 * CRD1171 * RAD5291 * RADL5291
N FDRK 117A	MACK	CRD116 * CRD117 * CRD1161 * CRD1171
N FDRK 170	GMC	T150 * T170
N FDRK 172F	MERITOR	SSHD * SSHP * STHD * SUHD
N FDRK 172R	MERITOR	PL143 * R100 * R100A * R110 * R110A * R112 * R113 * R114 * R115 * R120 * R140 * R141 * R143 * R155 * RT140 * U140 * SSHD * SSHP * STHD * SUHD
N FDRK 187F	MERITOR	STDD
N FDRK 187R	MERITOR	STDD
N FDRK 191F	INTERNATIONAL HARVESTER/ NAVISTAR	RA341
N FDRK 191R	DANA	F155-S * F170-S * RA29 * RA35 * RA39 * RA341

11.3 \ Differential Rebuild Kit / AMERICAN RANGE

Kit de reparación para diferencial



Fersa	BRAND	MODEL
N FDRK 192FB	DANA	G340-S * G380-S * RA351 * RA355 * RA386 * RA387
N FDRK 192FC	INTERNATIONAL HARVESTER/ NAVISTAR	RA351 * RA355 * RA386 * RA387
N FDRK 192R	INTERNATIONAL HARVESTER/ NAVISTAR	RA42 * RA43 * RA44 * RA47 * RA48 * RA351 * RA355 * RA386 * RA387
N FDRK 192RA	INTERNATIONAL HARVESTER/ NAVISTAR	RA42 * RA43 * RA44 * RA47 * RA48 * RA351 * RA355 * RA386 * RA387
N FDRK 192RB	DANA	J175-S * J190-S * J210-S * J220-S * J230-S * J230-SB * J340-S * J380-S * J400-S * RA42 * RA43 * RA44 * RA47 * RA48 * RA351 * RA355 * RA386 * RA387 * RA472
N FDRK 193	EATON	50DP * 50DT * DP340 * DS340 * DT340 * DP380-P * DS380(P) * DT380(P) * DP400(P) * DS400-P * DT400(P)
N FDRK 193A	EATON	DS340 * DS380(P) * DS400-P
N FDRK 194F	MERITOR	SL100 * SL100P * SQ100 * SQ100P * SQHP * SQR100 * SQR100P
N FDRK 194RA	MERITOR	SQHP
N FDRK 194RB	MERITOR	SL100 * SL100P * SQ100 * SQ100P * SQR100 * SQR100P
N FDRK 195	INTERNATIONAL HARVESTER/ NAVISTAR	RA15
N FDRK 196	EATON	DS341(P) * DS381(P) * DS401-P * DA402(P) * DS402(P) * DS403(P) * DS451-P
N FDRK 198	INTERNATIONAL HARVESTER/ NAVISTAR	RA57 * RA429
N FDRK 200F	INTERNATIONAL HARVESTER/ NAVISTAR	RA472
N FDRK 200FA	DANA	J340-S * J380-S * J400-S * RA472
N FDRK 201F	INTERNATIONAL HARVESTER/ NAVISTAR	RA474
N FDRK 201FA	DANA	W440-S * W460-S * RA474
N FDRK 201R	DANA	W230-S * W440-S * W460-S * RA57 * RA429 * RA474
N FDRK 202	EATON	7500 * 9000 * 10000 * 12000 * RA25 * RA30
N FDRK 203F	MERITOR	SR170 * SR270 * SR280 * SU170 * SU270 * SU280 * SW170 * SW270 * SW280
N FDRK 204F	MERITOR	SUDD

Fersa	BRAND	MODEL
N FDRK 205	MACK	SW29 * SW30 * SW31 * CRD93 * CRDLP93 * CRD113
N FDRK 206	MACK	SWD32 * CRDLP92 * CRDPC112
N FDRK 207	EATON	DC341(P) * DP341(P) * DT341(P) * DC381(P) * DP381(P) * DT381(P) * DC401-P * DP401(P) * DT401(P) * DC402(P) * DP402(P) * DT402(P) * DC451-P * DP451-P * DT451-P
N FDRK 208	EATON	DS440-P * DS460-P * DS461-P * DS462-P * DS463-P * DS480-P * DS521-P * DS581-P * DS601(P) * DS651-P
N FDRK 208A	EATON	44DS * 44DSM * DS440-P * DS460-P * DS480-P
N FDRK 209	EATON	DP440-P * DT440-P * DP460-P * DT460-P * DP480-P * DT480-P
N FDRK 209A	EATON	44DP * 44DT
N FDRK 210	EATON	DP440-P * DT440-P * DP460-P * DT460-P * DP480-P * DT480-P
N FDRK 211F	EATON	DC460-P * DC461-P * DD461-P * DP461-P * DT461-P * DC462-P * DD462-P * DP462-P * DT462-P * DC463-P * DD463-P * DP463-P * DT463-P * DC480-P * DP485-P * DT485-P * DC521-P * DD521-P * DP521-P * DT521-P * DP550 * DP580-P * DT580-P * DD581-P * DD601(P) * DP601-P * DT601-P * DP650-P * DT650-P * DD651(P) * DP651-P * DT651-P * DP652-P
N FDRK 211FA	EATON	DP550 * DP580-P * DT580-P * DP650-P * DT650-P
N FDRK 212F	MACK	SW559 * SWW59 * SS65 * SW65 * SWD69 * SWW69 * SWW69W * SW80 * SWS92 * SWS93 * CRDP95 * SWWP95 * SWS592 * SWW592 * SWD691 * SWP801
N FDRK 212R	MACK	SW559 * SWW59 * SS65 * SW65 * SWD69 * SWW69 * SWW69W * SW80 * SWS92 * SWS93 * SWWP95 * CRD96 * SWS592 * SWW592 * SWD691 * SWP801
N FDRK 213	DANA	G155-T * G160-D * G160-T * F175-D * G175-R * G175-T * G185-S * G190-S
N FDRK 214	DANA	M185-D * M185-T * M190-T * M200-D * M200-T * M210-T * M220-D * M220-T * M230-T
N FDRK 216	MERITOR	RS-15-220 * RS-17-220 * RS-17-224 * RS-19-220 * RS-19-224
N FDRK 217F	MERITOR	RT-34-144 * RT-38-144 * MT-40-143 * RT-40-145 * RT-44-145
N FDRK 217R	MERITOR	RS-16-141 * RS-17-141 * RS-17-144 * RS-17-145 * RS-19-144 * RS-19-145 * RS-21-145 * RT-34-144 * RT-34-145 * RT-38-144 * RT-40-140 * RT-40-145 * RT-44-145
N FDRK 218	MERITOR	RS-13-120 * RS-15-120 * RS-15-125

11.3 \ Differential Rebuild Kit / AMERICAN RANGE

Kit de reparación para diferencial



Fersa	BRAND	MODEL
N FDRK 219R	EATON	RDS40 * 44RS * RC460 * RC461 * RD461 * RP461 * RT461 * RC462 * RD462 * RP462 * RT462 * RC463 * RD463 * RP463 * RT463 * RC480 * RC521 * RD521 * RP521 * RT521 * RP580 * RS580 * RT580 * RD581 * RC601 * RP601 * RT601 * RP650 * RS650 * RT650 * RC651 * RP651 * RT651 * RP652 * RP4616-P * RT4616-P * RP5216-P * RT5216-P * RP6016-P * RT6016-P * RP6516-P * RT6516-P * 19227 * 19237 * 23080-P * 23080-T * 23082-P * 23082-T * 23085-C * 23085-T * 23227 * 23327 * 23420 * 23421 * 23427 * 23430 * 23433 * 23437 * 26080-P * 26080-T * 26085-P * 26085-T * 26421 * 30055-P * 35055-P * 35227 * 35327
N FDRK 220F	EATON	SP461 * TP461 * SP462 * TP462 * SP463 * TP463 * SP521 * TP521 * SP601 * TP601 * SP651 * TP651
N FDRK 220FA	EATON	SP550 * TP550 * SP580 * TP580 * SP650 * TP650
N FDRK 221	EATON	19050-D * 19050-S
N FDRK 222F	EATON	DS341(P) * DA402(P) * DS402(P) * DS403(P) * DS451-P
N FDRK 222R	EATON	RS341 * RA402 * RS402 * RS403 * RS451
N FDRK 223F	DANA	N340-S * N400-I
N FDRK 223R	DANA	N175 * N190 * N340-S * N400-I
N FDRK 224	MERITOR	RS-17-144 * RS-19-144 * RS-21-145
N FDRK 225	MERITOR	RS-21-230
N FDRK 400	EATON	15040-S
N FDRK 401	EATON	23105-C * 26105-C * 30105-C
N FDRK 402	EATON	23105-S * 26105-S * 30105-S
N FDRK 403	EATON	19055-P * 19055-T * 21065-P * 21065-T * 21065-Y * 22065-P * 22065-T * 22220 * 22221 * 22320 * 22321 * 22420 * 22421 * 22427
N FDRK 404F	EATON	DST40(P) * DST41(P) * DA344 * DS344 * DA404(P) * DS404(P) * DA405(P) * DS405(P) * DA454(P) * DS454(P)
N FDRK 404FA	EATON	DST40(P) * DST41(P) * DS344 * DA404(P) * DS404(P) * DA405(P) * DS405(P)
N FDRK 404R	EATON	RA344 * RS344 * RA404 * RS404 * RA405 * RS405 * RA454 * RS454 * 17060-S * 19060-S * 21060-S * 22060-S
N FDRK 405F	EATON	DDT40-P * DDT41(P) * DD404(P) * DD405(P) * DD454(P)
N FDRK 405FA	EATON	DDT40-P * DDT41(P) * DD404(P) * DD405(P)

Fersa	BRAND	MODEL
N FDRK 405R	EATON	RD404 * RD405 * RD454 * 19060-D * 21060-D * 22060-D
N FDRK 406	EATON	19055-D * 19055-S * 21065-D * 21065-S * 22065-D * 22065-S
N FDRK 407	EATON	23070-D * 23070-S
N FDRK 408	EATON	23070-P * 23070-T
N FDRK 409	EATON	23105-D
N FDRK 410	EATON	21080-D * 21080-S * 21090-D * 23080-D * 23080-S * 23085-D * 23085-S * 26080-D * 26085-D * 26085-S
N FDRK 411	EATON	13600 * 13602
N FDRK 411F	DANA	S400-S
N FDRK 411R	DANA	S400-S
N FDRK 412	EATON	RS341 * RA402 * RS402 * RS403 * RS451 * 22120 * 22121
N FDRK 413	EATON	44RS * 44RSM * 19227 * 19327 * 19420 * 19426 * 23227 * 23327 * 23420 * 26420 * 26426 * 35227 * 35327
N FDRK 414	DANA	S135-S * S150-S
N FDRK 415	EATON	19100 * 20100 * 23121
N FDRK 416	DANA	S230-S * S230-SB * S230-SL * S260-SB
N FDRK 417	EATON	19054 * 22054
N FDRK 418	EATON	23054 * 26054 * 30054 * 35054
N FDRK 419	EATON	190C4 * 190P4 * 190T4 * 220C4 * 220P4 * 220T4
N FDRK 420	EATON	230C4 * 260C4 * 300C4 * 300P4 * 350C4 * 350P4 * 350T4
N FDRK 421	EATON	230P4 * 230T4 * 260P4 * 260T4 * 300T4
N FDRK 422	EATON	DS386-P * DS406-P * DS416-P * DS4026-P
N FDRK 423	EATON	DS4616-P * DS5216-P
N FDRK 424	EATON	DC386-P * DP386-P * DT386-P * DC406-P * DP406-P * DT406-P * DC3416-P * DP3416-P * DT3416-P * DC4026-P * DP4026-P * DT4026-P
N FDRK 425	EATON	DS446-P * DS466-P

11.3 \ Differential Rebuild Kit / AMERICAN RANGE

Kit de reparación para diferencial



Fersa	BRAND	MODEL
N FDRK 426	EATON	DP446-P * DS446-P * DT446-P * DP466-P * DS466-P * DT466-P * DC4616-P * DP4616-P * DT4616-P * DC5216-P * DP5216-P * DT5216-P * DP6016-P * DT6016-P * DP6516-P * DT6516-P
N FDRK 427	EATON	DSH40(P) * DSP40(P) * DSP41(P) * DDH44(P)
N FDRK 427A	"DANA EATON"	D40-145S * D40-145X * DSH40(P) * DSP40(P) * DSP41(P)
N FDRK 428	EATON	DDH40(P) * DDP40(P) * DDP41(P) * DSH44(P)
N FDRK 428A	EATON	DDH40(P) * DDP40(P) * DDP41(P)
N FDRK 429	EATON	RSH40 * RSP40 * RSP41 * RDH44 * RSH44 * P20060-S * P22060-S * 22060-SH * 23060-SH
N FDRK 430	EATON	RDH40 * RDP40 * RDP41 * P20060-D * P22060-D
N FDRK 431	EATON	DSS40(P)
N FDRK 432	EATON	DC461-P * DD461-P * DP461-P * DT461-P * DC462-P * DD462-P * DP462-P * DT462-P * DC463-P * DD463-P * DP463-P * DT463-P * DC521-P * DD521-P * DP521-P * DT521-P * DD581-P * DD601(P) * DP601-P * DT601-P * DD651(P) * DP651-P * DT651-P * DP652-P
N FDRK 433	EATON	DS461-P * DS462-P * DS463-P * DS463-P * DS521-P * DS581-P * DS601(P) * DS651-P
N FDRK 434	DANA	S14-110 * S14-111 * S16-130 * S16-132
N FDRK 435	EATON	DDS40(P) * DDS41(P)
N FDRK 436	DANA	D40-170D * D40-170DP * D50-170D * D50-170DP * D46-170D * D46-170DP
N FDRK 436A	DANA	D40-170D * D40-170DP * D50-170D * D50-170DP * D46-170D * D46-170DP
N FDRK 437	DANA	D52-190DP * D52-190P * D60-190DP * D60-190P * D46-590DHP * D46-590HP * D52-590DP * D52-590P * D60-590DP * D60-590P * D70-590DP * D70-590P
N FDRK 437A	DANA	D52-190DP * D52-190P * D60-190DP * D60-190P * D46-590DHP * D46-590HP * D52-590DP * D52-590P * D60-590DP * D60-590P * D70-590DP * D70-590P
N FDRK 438	DANA	S21-170 * S23-170 * S25-170 * R50-170 * R40-170 * R46-170
N FDRK 438A	DANA	S21-170 * S23-170 * S25-170 * R50-170 * R40-170 * R46-170
N FDRK 439	DANA	S21-170 * S23-170 * S25-170 * R50-170 * R40-170 * R46-170
N FDRK 439A	DANA	S21-170 * S23-170 * S25-170 * R50-170 * R40-170 * R46-170

Fersa	BRAND	MODEL
N FDRK 441	DANA	S21-190 * S21-190D * S23-190 * S23-190D * S26-190 * S26-190D * S30-190 * S30-190D * R52-190 * R52-190D * R60-190 * R60-190D
N FDRK 441A	DANA	S21-190 * S21-190D * S23-190 * S23-190D * S26-190 * S26-190D * S30-190 * S30-190D * R52-190 * R52-190D * R60-190 * R60-190D
N FDRK 442	DANA	D40-170 * D50-170P * D40-170P * D46-170 * D46-170H * D46-170HP * D46-170P * D50-170
N FDRK 442A	DANA	D40-170 * D50-170P * D40-170P * D46-170 * D46-170H * D46-170HP * D46-170P * D50-170
N FDRK 443	DANA	S21-170D * S23-170D * S25-170D * S21-190 * S21-190D * S23-190 * S23-190D * S26-190 * S26-190D * S30-190 * S30-190D * R50-170D * R40-170D * R46-170D * R52-190 * R52-190D * R60-190 * R60-190D
N FDRK 443A	DANA	S21-170D * S23-170D * S25-170D * S21-190 * S21-190D * S23-190 * S23-190D * S26-190 * S26-190D * S30-190 * S30-190D * R50-170D * R40-170D * R46-170D * R52-190 * R52-190D * R60-190 * R60-190D
N FDRK 444	DANA	S21-170D * S23-170D * S25-170D * R50-170D * R40-170D * R46-170D
N FDRK 444A	DANA	S21-170D * S23-170D * S25-170D * R50-170D * R40-170D * R46-170D
N FDRK 445	EATON	RDT40 * RST40 * RDT41 * RST41
N FDRK 446	EATON	RST40 * RST41
N FDRK 447	EATON	RST40 * RST41
N FDRK 448	EATON	RST40 * RST41
N FDRK 449	EATON	R5540 * R5461 * R5462 * R5463 * R5521 * R5581 * R5601 * R5651 * R54616 * R55216
N FDRK 451	EATON	21080-D * 21080-S * 21090-D * 23080-D * 23080-S * 23090-D * 23090-S * 26080-D * 26090-D * 26090-S
N FDRK 452	DANA	S17-140 * S19-140 * R40-145S
N FDRK 453	DANA	S23-190DE * S23-190E * S26-190DE * S26-190E * S30-190DE * S30-190E * S23-590 * S23-590D * S26-590 * S26-590D * S30-590 * S30-590D * S35-590 * S35-590D * R46-590 * R46-590D * R52-590 * R52-590D * R60-590 * R60-590D * R70-590 * R70-590D
N FDRK 453A	DANA	S23-190DE * S23-190E * S26-190DE * S26-190E * S30-190DE * S30-190E * S23-590 * S23-590D * S26-590 * S26-590D * S30-590 * S30-590D * S35-590 * S35-590D * R46-590 * R46-590D * R52-590 * R52-590D * R60-590 * R60-590D * R70-590 * R70-590D

11.3 Differential Rebuild Kit / AMERICAN RANGE

Kit de reparación para diferencial



Fersa	BRAND	MODEL
N FDRK 454	DANA	S21-170DE * S21-170D * S23-170DE * S23-170E * S25-170DE * S25-170E
N FDRK 454A	DANA	S21-170DE * S21-170D * S23-170DE * S23-170E * S25-170DE * S25-170E
N FDRK 500	MACK	CRDP200 * CRD202
N FDRK 501	MACK	CRD201 * CRD203
N FDRK 502	MACK	CRD93 * CRD113
N FDRK 503	MACK	CRD93A
N FDRK 504	MACK	CRDP32
N FDRK 505	MACK	CRD33
N FDRK 506	MACK	CRD118
N FDRK 507	MACK	C150 * CRD150 * CRDPC150 * CRDPC1501
N FDRK 508	MACK	C151 * CRD151 * CRD1511
N FDRK 600	MERITOR	QT140 * QT143 * QT145 * QT148
N FDRK 601	MERITOR	RC-26-720
N FDRK 650F	ALLIANCE / DETROIT / FREIGHTLINER	ART34-4 * ART40-4 * ART44-4
N FDRK 650FA	ALLIANCE / DETROIT / FREIGHTLINER	ART34-4 * ART40-4 * ART44-4
N FDRK 650R	ALLIANCE / DETROIT / FREIGHTLINER	ARS17.5-4 * ARS19-4 * ARS20-4 * ARS23-4 * ART34-4 * ART40-4 * ART44-4
N FDRK 651	ALLIANCE / DETROIT / FREIGHTLINER	ARS13-2 * ARS15-2 * ARS17.5-2 * ARS19-2 * ARS21-2
N FDRK 700	GMC	H052 * H072
N FDRK 701	GMC	H110 * H130
N FDRK 702	GMC	H150 * H170
N FDRK 801	VOLVO	EV-80 * EV-87
N FDRK 802	VOLVO	EV-80 * EV-87
N FDRK 900F	MERITOR	SLHD * SQHD

Fersa	BRAND	MODEL
N FDRK 1910	MERITOR	SFDD4640
N FDRK 1918	MERITOR	H140
N FDRK 1925	MERITOR	R200 * U240 * U340
N FDRK 1925A	MERITOR	R200 * U240 * U340
N FDRK 1926	MERITOR	L140 * L145
N FDRK 1984	MERITOR	R162 * R164 * S162
N FDRK 2108	MERITOR	59722 * 59723 * 59733
N FDRK 2111	MERITOR	C100 * C102 * C103
N FDRK 4095	MERITOR	SSHP
N FDRK 4100	MERITOR	
N FDRK 4125	MERITOR	SR170 * SR270 * SR280 * SU170 * SU270 * SU280 * SW170 * SW270 * SW280
N FDRK 4130	MERITOR	SR170 * SU170 * SW170
N FDRK 4135	MERITOR	SR170 * SR270 * SR280 * SU170 * SU270 * SU280 * SW170 * SW270 * SW280
N FDRK 4140	MERITOR	SR170 * SR270 * SR280 * SU170 * SU270 SU280 * SW170 * SW270 * SW280
N FDRK 4145	MERITOR	SR170 * SR270 * SR280 * SU170 * SU270 * SU280 * SW170 * SW270 * SW280
N FDRK 4155	MERITOR	SR270 * SR280 * SU270 * SU280 * SW270 * SW280
N FDRK 4155A	MERITOR	SR270 * SR280 * SU270 * SU280 * SW270 * SW280
N FDRK 4180	MERITOR	SQDD
N FDRK 4190	MERITOR	SRDD * STDD
N FDRK 4220	MERITOR	SRDD * STDD
N FDRK 4240	MERITOR	SUDD
N FDRK 4245	MERITOR	SUDD
N FDRK 4255	MERITOR	SFDD4640

11.3 Differential Rebuild Kit / AMERICAN RANGE

Kit de reparación para diferencial



Fersa	BRAND	MODEL
N FDRK 4260	MERITOR	SFDD4640
N FDRK 4270	MERITOR	SFDD4640
N FDRK 4290	MERITOR	D140
N FDRK 4295	MERITOR	D140
N FDRK 4300	MERITOR	D140
N FDRK 4310	MERITOR	F140 * F145 * F146 * F147 * F149
N FDRK 4315	MERITOR	F105 * F106
N FDRK 4325	MERITOR	H170
N FDRK 4330	MERITOR	H172 * H173 * L172 * L173 * P174
N FDRK 4345	MERITOR	RS-16-140 * RS-17-140
N FDRK 4350	MERITOR	RS-16-140 * RS-17-140
N FDRK 4355	MERITOR	RT-40-140
N FDRK 4356	MERITOR	RT-40-140
N FDRK 4360	MERITOR	RS-15-210
N FDRK 4375	MERITOR	RS-23-240
N FDRK 4390	MERITOR	RS-17-144 * RS-19-144 * RS-21-145 * RT-34-144 * RT-38-144 * RT-40-145 * RT-44-145
N FDRK 4395	MERITOR	RT-34-144 * RT-34-145 * RT-38-144 * MT-40-143 * RT-40-145 * RT-44-145
N FDRK 4396	MERITOR	RT-34-144 * RT-34-145 * RT-38-144 * MT-40-143 * RT-40-145 * RT-44-145
N FDRK 4405	MERITOR	RT-34-144 * RT-38-144 * MT-40-143 * RT-40-145 * RT-44-145
N FDRK 4406	MERITOR	RT-34-144 * RT-38-144 * MT-40-143 * RT-40-145 * RT-44-145
N FDRK 4415	MERITOR	RC-23-160 * RS-20-160 * RS-21-160 * RS-23-160 * RS-23-161 * RS-24-160 * RS-25-160 * RS-26-160 * RT-40-160 * RT-46-160 * RT-46-164 * RT-50-160 * RT-50-164 * RT-52-160 * RT-52-164
N FDRK 4420	MERITOR	RT-40-160 * RT-46-160 * RT-46-164 * RT-50-160 * RT-50-164 * RT-52-160 * RT-52-164

Fersa	BRAND	MODEL
N FDRK 4422	MERITOR	RT-40-160 * RT-46-160 * RT-46-164 * RT-50-160 * RT-50-164 * RT-52-160 * RT-52-164
N FDRK 4423	MERITOR	RT-40-160 * RT-46-160 * RT-46-164 * RT-50-160 * RT-50-164 * RT-52-160 * RT-52-164
N FDRK 4426	MERITOR	RC-23-160 * RS-20-160 * RS-21-160 * RS-23-160 * RS-23-161 * RS-24-160 * RS-25-160 * RS-26-160 * RT-40-160 * RT-46-160 * RT-46-164 * RT-50-160 * RT-50-164 * RT-52-160 * RT-52-164
N FDRK 4428	MERITOR	RC-23-160 * RS-20-160 * RS-21-160 * RS-23-160 * RS-23-161 * RS-24-160 * RS-25-160 * RS-26-160 * RT-40-160 * RT-46-160 * RT-46-164 * RT-50-160 * RT-50-164 * RT-52-160 * RT-52-164
N FDRK 4435	MERITOR	RS-23-180 * RS-23-185 * RS-23-186 * RS-26-180 * RS-26-185 * RS-30-180 * RS-30-185 * RT-48-180 * RT-48-185 * RT-52-180 * RT-52-185 * RT-58-180
N FDRK 4436	MERITOR	RS-23-180 * RS-23-185 * RS-23-186 * RS-26-180 * RS-26-185 * RS-30-180 * RS-30-185 * RT-48-180 * RT-48-185 * RT-52-180 * RT-52-185 * RT-58-180
N FDRK 4437	MERITOR	RS-23-180 * RS-23-185 * RS-23-186 * RS-26-180 * RS-26-185 * RS-30-180 * RS-30-185 * RT-48-180 * RT-48-185 * RT-52-180 * RT-52-185 * RT-58-180
N FDRK 4438	MERITOR	RS-23-180 * RS-23-185 * RS-23-186 * RS-26-180 * RS-26-185 * RS-30-180 * RS-30-185 * RT-48-180 * RT-48-185 * RT-52-180 * RT-52-185 * RT-58-180
N FDRK 4440	MERITOR	RT-48-180 * RT-48-185 * RT-48-380 * RT-52-180 * RT-52-185 * RT-52-380 * RT-58-180 * RT-58-185 * RT-70-380
N FDRK 4441	MERITOR	RS-23-380 * RS-26-380 * RS-30-380 * RT-48-180 * RT-48-185 * RT-48-380 * RT-52-180 * RT-52-185 * RT-52-380 * RT-58-180 * RT-70-380
N FDRK 4442	MERITOR	RS-23-380 * RS-26-380 * RS-30-380 * RT-48-180 * RT-48-185 * RT-48-380 * RT-52-180 * RT-52-185 * RT-52-380 * RT-58-180 * RT-58-185 * RT-70-380
N FDRK 4450	MERITOR	RS-23-380 * RS-26-380 * RS-30-380 * RT-48-380 * RT-52-380
N FDRK 4461	MERITOR	MT-40-143
N FDRK 4753	MERITOR	MS-10-113 * MS-11-113 * MS-12-113
N FDRK 4841	MERITOR	MD-34-14X * MD-40-14X * MT-44-14X
N FDRK 4842	MERITOR	MD-34-14X * MD-40-14X
N FDRK 4843	MERITOR	MS-17-14X * MS-19-14X * MS-21-14X * MD-34-14X * MD-40-14X * MT-44-14X
N FDRK 4844	MERITOR	MS-17-14X * MS-19-14X * MS-21-14X * MD-34-14X * MD-40-14X * MT-44-14X

11.4 \ Transmission Rebuild Kit / AMERICAN RANGE

Kit de reparación para caja de cambios



Fersa	BRAND	MODEL
N FTRK 1000	EATON/FULLER	T-955 * T-955LL * RT-906 * RT-9508 * RTO-9508 * RTO-909 * RTO-9509 * RT-913 * RT-9513 * RT-915
N FTRK 1000AUX	EATON/FULLER	RT-11613 AUX * RTF-11613 AUX * RTOF-11613 AUX * RTOF-11813 AUX * RTOO-11613 AUX * RTOOF-11613 AUX * RTOX-11613 AUX * RTOXF-11613 AUX
N FTRK 127	NEW PROCESS TRANSMISSIONS	435 * 435FE * 435FL * 435GL * 436
N FTRK 127F	NEW PROCESS TRANSMISSIONS	435 * 436
N FTRK 127G	NEW PROCESS TRANSMISSIONS	435 * 436
N FTRK 130	SPICER/TTC TRANSMISSIONS	8516 * 8716
N FTRK 132	CLARK	320-V * 325-V * 327-V * 328-V
N FTRK 133	CLARK	380-V * 380-VO * 381-V * 385-V * 387-V * 388-V
N FTRK 139	SPICER/TTC TRANSMISSIONS	8542 * 8544 * 8742 * 8744 * 8842 * 8844
N FTRK 140	SPICER/TTC TRANSMISSIONS	8552 * 8554
N FTRK 141	SPICER/TTC TRANSMISSIONS	8553 * 8555 * 8753 * 8755
N FTRK 145	EATON/FULLER	RT-6610
N FTRK 145A	EATON/FULLER	RT-6610 * RTO-6610
N FTRK 146	EATON/FULLER	RT-6613 * RTO-6613
N FTRK 147	SPICER/TTC TRANSMISSIONS	1052 * 1062 * 1064 * 1252 * 1253 * 1262 * 1263 * SST5 * SST6
N FTRK 148	CLARK	280-V * 280-VO * 280-VO18 * 280-VO3 * 280-VO4 * 282-V * 282-V11 * 282-V55 * 285-V * 285-V54 * 285-V9
N FTRK 149	EATON/FULLER	RTF-12513 * RTO-12513 * RTOF-12513
N FTRK 149AUX	EATON/FULLER	RT-14613 AUX * RT-15613 AUX * RTF-14613 AUX * RTF-15613 AUX * RTO-14613 AUX * RTO-14813 AUX * RTO-15613 AUX * RTO-15813 AUX * RTOF-14613 AUX * RTOF-14813 AUX * RTOF-15613 AUX * RTOF-15813 AUX * RTOO-14613 AUX * RTOOF-14613 AUX * RTOX-14613 AUX * RTOXF-14613 AUX
N FTRK 152	SPICER/TTC TRANSMISSIONS	1010 * SST10

Fersa	BRAND	MODEL
N FTRK 155	SPICER/TTC TRANSMISSIONS	8341L * R8341C * R8341L * RP8341
N FTRK 1555	EATON/FULLER	RTO-11613 AUX * RTO-11813 AUX
N FTRK 156	INTERNATIONAL HARVESTER/NAVISTAR INDEX	T32 * T33 * T34 * T35 * T36 * T494 * T495 * T496
N FTRK 157A	GMC	CH465 * SM465
N FTRK 157B	GMC	CH465 * SM465
N FTRK 157L	GMC	CH465 * SM465
N FTRK 158	SPICER/TTC TRANSMISSIONS	1241
N FTRK 159	EATON/FULLER	RT-12515 * RTF-12515 * RTO-12515 * RTOF-12515
N FTRK 159A	EATON/FULLER	RT-12515 * RTF-12515 * RTO-12515 * RTOF-12515 * RTX-12515 * RTXF-12515
N FTRK 160	EATON/FULLER	RT-12509 * RTF-12509 * RTO-12509 * RTOF-12509 * RTX-12509 * RTXF-12509 * RT-12510 * RTF-12510 * RTO-12510 * RTOF-12510 * RTX-12510 * RTXF-12510
N FTRK 174	NEW PROCESS TRANSMISSIONS	4590(IH)
N FTRK 177	NEW PROCESS TRANSMISSIONS	7531 * 7550 * 7551 * 7590 * 7591
N FTRK 180	SPICER/TTC TRANSMISSIONS	5052 * 5252 * 5552 * 5852 * CM50 * CM55 * CM5052 * CM5252 * CM5552 * CM5852 * CM5952 * ES60-5 * ES62-5
N FTRK 181	SPICER/TTC TRANSMISSIONS	1107 * SST7
N FTRK 183	INTERNATIONAL HARVESTER/NAVISTAR INDEX	T698 * T699
N FTRK 184	EATON/FULLER	RTO-1157DLL
N FTRK 185	MACK	TR107 * TRL1076 * TRL1078
N FTRK 1858	EATON/FULLER	RT-11509 * RTF-11509 * RTO-11509 * RTOF-11509 * RTX-11509 * RTXF-11509
N FTRK 186	SPICER/TTC TRANSMISSIONS	6052 * 6252 * 6253 * CM60 * CM62 * CM6052 * CM6253 * ES65-5 * ES70-5
N FTRK 1867	EATON/FULLER	RTO-11607LL * RTOF-11607LL

11.4 \ Transmission Rebuild Kit / AMERICAN RANGE

Kit de reparación para caja de cambios



Fersa	BRAND	MODEL
N FTRK 187	MACK	TRXL107 * TRXL107A * TRDL1070 * TRXL1071 * TRXL1071A
N FTRK 1874	EATON/FULLER	RT-15613 * RTF-15613 * RTO-15613 * RTO-15813 * RTOF-15613 * RTOF-15813
N FTRK 1876	EATON/FULLER	RT-8609
N FTRK 1877	EATON/FULLER	T-8607A * T-8607B * TX-8607B
N FTRK 188	EATON/FULLER	RTO-1157DL
N FTRK 189	SPICER/TTC TRANSMISSIONS	1007 * 1020 * 1214 * 1272 * SST14 * SST20
N FTRK 190	CLARK	280-VHD * 282-VHD * 282-VHD12 * 282-VHD13 * 282-VHD2 * 285-VHD * 285-VHD13 * 285-VHD2
N FTRK 191	SPICER/TTC TRANSMISSIONS	1207 * SST6+1
N FTRK 192	SPICER/TTC TRANSMISSIONS	1352 * 1362 * 1364 * 1452 * 1453 * 1463 * SST6
N FTRK 193	SPICER/TTC TRANSMISSIONS	1372 * SST7
N FTRK 194	SPICER/TTC TRANSMISSIONS	1412 * 1414 * 1420 * PSO150-16 * PSO165-16 * PSO175-16 * SST12 * SST14
N FTRK 1993	EATON/FULLER	RTO-15618 AUX * RTOF-15618 AUX
N FTRK 2	SPICER/TTC TRANSMISSIONS	8051 * 8055 * 8251 * 8255
N FTRK 201	EATON/FULLER	RTO-11607L * RTOF-11607L
N FTRK 202	EATON/FULLER	RT-11608 * RT-8608L * RTF-11608 * RTF-8608L * RT-11609A * RT-12609A * RTF-11609A * RTF-12609A * RTO-11609A * RTO-11609B * RTO-12609A * RTO-12609B * RTOF-11609A * RTOF-11609B * RTOF-12609A * RTOF-12609B * RTX-11609A * RTX-11609B * RTX-11609P * RTX-11609R * RTX-12609A * RTX-12609B * RTX-12609P * RTX-12609R * RTXF-11609A * RTXF-11609B * RTXF-11609P * RTXF-11609R * RTXF-12609A * RTXF-12609B * RTXF-12609P * RTXF-12609R * RT-11610 * RT-12610 * RTF-11610 * RTF-12610 * RTO-11610 * RTO-12610 * RTOF-11610 * RTOF-12610 * RTX-11610 * RTX-12610 * RTXF-11610 * RT-11613 * RTF-11613 * RTOF-11613 * RTOF-11813 * RTOO-11613 * RTOOF-11613 * RTOX-11613 * RTOXF-11613 * RT-15615 * RTF-15615 * RTO-15615 * RTOF-15615 * RTX-15615 * RTXF-15615
N FTRK 203	EATON/FULLER	RTO-11608L * RTOF-11608LL * RTX-11608LL * RTXF-11608LL * RT-11615 * RTF-11615 * RTO-11615 * RTOF-11615 * RTX-11615 * RTXF-11615

Fersa	BRAND	MODEL
N FTRK 2041	EATON/FULLER	FS-5106A * FS-6206A
N FTRK 2043	EATON/FULLER	RTO-14708LL * RTOF-14708LL * RTX-14708LL * RTXF-14708LL * RT-14715 * RT-15715 * RTF-14715 * RTF-15715 * RTO-14715 * RTO-15715 * RTOF-14715 * RTOF-15715 * RTX-14715 * RTX-15715 * RTXF-14715 * RTXF-15715
N FTRK 2045	EATON/FULLER	RTO-11707DLL * RTO-11707LL * RTOF-11707LL
N FTRK 2047	EATON/FULLER	RT-7608LL
N FTRK 2048	EATON/FULLER	RT-6609
N FTRK 2049	EATON/FULLER	RT-11709A * RT-11709H * RT-12709A * RT-12709H * RTF-11709H * RTF-12709H * RT-11710B * RT-12710B * RTF-11710B * RTF-12710B
N FTRK 205	EATON/FULLER	RT-14609A * RTF-14609A * RTO-14609A * RTO-14609B * RTOF-14609A * RTOF-14609B * RTX-14609A * RTX-14609B * RTX-14609P * RTX-14609R * RTXF-14609A * RTXF-14609B * RTXF-14609P * RTXF-14609R * RT-14610 * RTF-14610 * RTO-14610 * RTOF-14610 * RTX-14610 * RTXF-14610
N FTRK 206	EATON/FULLER	RT-14613 * RTF-14613 * RTO-14613 * RTO-14813 * RTOF-14613 * RTOF-14813 * RTOO-14613 * RTOOF-14613 * RTOX-14613 * RTOXF-14613
N FTRK 207	EATON/FULLER	RTO-14608LL * RTOF-14608LL * RTX-14608LL * RTXF-14608LL * RT-14615 * RTF-14615 * RTO-14615 * RTOF-14615 * RTX-14615 * RTXF-14615
N FTRK 208	CLARK	CL450 * CL455 * CL457 * FS-4005A * FS-4005B * FS-4005C
N FTRK 208D	CLARK	CL450 * CL455 * CL457 * FS-4005A * FS-4005B * FS-4005C
N FTRK 210	SPICER/TTC TRANSMISSIONS	4054 * CM40 * CM4054
N FTRK 213	MACK	TRTXL1070
N FTRK 2130	EATON/FULLER	FS-7206
N FTRK 213SD	MACK	TRTXL107 * TRTXL1070
N FTRK 214	MACK	T2090 * T2060 * T2070 * T2080 * T2100 * T2130 * T2180
N FTRK 214MK	MACK	T2060 * T2070 * T2090 * T2100 * T2130
N FTRK 214MK1	MACK	T2180
N FTRK 219	SPICER/TTC TRANSMISSIONS	ES42-5

11.4 \ Transmission Rebuild Kit / AMERICAN RANGE

Kit de reparación para caja de cambios



Fersa	BRAND	MODEL
N FTRK 221	SPICER/TTC TRANSMISSIONS	4954 * CM49 * CM4954 * ES43-5 * ES52-5 * ES53-5
N FTRK 222	SPICER/TTC TRANSMISSIONS	ES066-7B * ES52-7 * ES56-7 * ES65-7 * ES066-7
N FTRK 2275	EATON/FULLER	RT-14709A * RT-14709H * RTF-14709H * RTO-14709A * RTO-14709B * RTO-14709H * RTX-16709B * RTX-16709H * RTXF-14709H * RTXF-16709B * RTXF-16709H
N FTRK 2277	EATON/FULLER	RT-14710B * RTF-14710B * RTX-14710B * RTX-14710C * RTX-15710B * RTX-15710C * RTX-16710B * RTX-16710C * RTXF-14710C * RTXF-15710B * RTXF-15710C * RTXF-16710B * RTXF-16710C
N FTRK 2280	EATON/FULLER	RT-14613 * RT-15613 * RTF-14613 * RTF-15613 * RTO-14613 * RTO-14813 * RTO-15613 * RTO-15813 * RTOF-14613 * RTOF-14813 * RTOF-15613 * RTOF-15813 * RTOO-14613 * RTOOF-14613 * RTOX-14613 * RTOXF-14613
N FTRK 2281	EATON/FULLER	RT-11613 * RTF-11613 * RTO-11613 * RTO-11813 * RTOF-11613 * RTOF-11813 * RTOO-11613 * RTOOF-11613 * RTOX-11613 * RTOXF-11613
N FTRK 2282	EATON/FULLER	RT-13609A * RTF-13609A * RTX-13609A * RTX-13609B * RTX-13609P * RTX-13609R * RTXF-13609A * RTXF-13609B * RTXF-13609P * RTXF-13609R
N FTRK 2283	EATON/FULLER	RTXF-12610 * RTO-11613 * RTO-11813
N FTRK 2284	EATON/FULLER	RT-13709H * RTF-13709H * RTO-11709A * RTO-11709B * RTO-12709A * RTO-12709B * RTX-11709A * RTX-11709B * RTX-11709H * RTX-12709A * RTX-12709B * RTX-12709H * RTX-13709H * RTXF-11709H * RTXF-12709H * RTXF-13709H * RT-13710B * RTF-13710B * RTL-13710B * RTLF-13710B * RTX-11710B * RTX-11710C * RTX-12710B * RTX-12710C * RTX-13710B * RTX-13710C * RTXF-11710B * RTXF-11710C * RTXF-12710B * RTXF-12710C * RTXF-13710B * RTXF-13710C
N FTRK 2285	EATON/FULLER	RTLO-12713A * RTLOF-12713A
N FTRK 2286	EATON/FULLER	RTLO-14713A * RTLOF-14713A
N FTRK 2287	EATON/FULLER	RTLO-16713A * RTLOF-16713A
N FTRK 2288	EATON/FULLER	RTLO-14718B * RTLO-16718B * RTLOF-14718B * RTLOF-16718B
N FTRK 23	CLARK	250-V * 250-VO * 251-V * 251-VO * 264-V * 264-VO * 264-VO48 * 264-VO49 * 265-V * 265-VO * 267-V * 267-VO * 268-V * 269-V * 269-V35 * 2621-V * 2621-V1 * 2651-V * 2651-V1
N FTRK 2338	EATON/FULLER	RTLO-14613B AUX * RTLOF-14613B AUX * RTLO-14618A AUX * RTLO-16618A AUX * RTLOF-14618A AUX * RTLOF-16618A AUX

Fersa	BRAND	MODEL
N FTRK 2340	EATON/FULLER	RT-14613 AUX * RT-15613 AUX * RTF-14613 AUX * RTF-15613 AUX * RTO-14613 AUX * RTO-14813 AUX * RTO-15613 AUX * RTO-15813 AUX * RTOF-14613 AUX * RTOF-14813 AUX * RTOF-15613 AUX * RTOF-15813 AUX * RTOO-14613 AUX * RTOOF-14613 AUX * RTOX-14613 AUX * RTOXF-14613 AUX
N FTRK 23B	CLARK	250-V18 * 251-V018 * 259-V * 269-V * 2621-V * 2621-V1 * 2622-V12 * 2622-V7 * 2651-V * 2651-V1 * 2653-V * 2653-V10 * 2653-V5 * 2653-V9 * 2653-V0
N FTRK 2464	EATON/FULLER	FSO-8206
N FTRK 2490	EATON/FULLER	FS-8206A
N FTRK 27	NEW PROCESS TRANSMISSIONS	540 * 540C * 540D * 540G * 540GD * 540GL * 540GO * 541 * 541FD * 541FL * 541FO * 541G * 541GD * 541GD24 * 541GL * 541GO * 541GO-11 * 542 * 542FD * 542FL * 542FO
N FTRK 2759	EATON/FULLER	RTLO-14713A AUX * RTLOF-14713A AUX
N FTRK 2761	EATON/FULLER	RT-12610
N FTRK 2768	EATON/FULLER	RTLO-12713A AUX * RTLOF-12713A AUX
N FTRK 2769	EATON/FULLER	RTLO-16713A AUX * RTLOF-16713A AUX * RTLO-14718B AUX * RTLO-16718B AUX * RTLO-18718B AUX * RTLOF-14718B AUX * RTLOF-16718B AUX * RTLOF-18718B AUX
N FTRK 2771	EATON/FULLER	T-11607A * T-11607B * T-14607A * T-14607B * TX-14607B
N FTRK 2772	EATON/FULLER	RTLO-11610B * RTLO-11610B-T2 * RTLO-12610B * RTLO-12610B-T2 * RTLO-13610B * RTLO-13610B-T2 * RTLOF-11610B * RTLOF-11610B-T2 * RTLOF-12610B * RTLOF-12610B-T2 * RTLOF-13610B * RTLOF-13610B-T2
N FTRK 2773	EATON/FULLER	RTLO-14610B * RTLO-14610B-T2 * RTLO-15610B * RTLO-15610B-T2 * RTLO-16610B * RTLO-16610B-T2 * RTLO-17610B * RTLO-17610B-T2 * RTLO-18610B * RTLO-18610B-T2 * RTLOF-14610B * RTLOF-14610B-T2 * RTLOF-15610B * RTLOF-15610B-T2 * RTLOF-16610B * RTLOF-16610B-T2 * RTLOF-17610B * RTLOF-17610B-T2 * RTLOF-18610B
N FTRK 28	SPICER/TTC TRANSMISSIONS	4652 * 4752 * 4753 * 4756 * 4852 * 4853 * 5650 * 5652 * 750 * 5752 * 5753 * 5756 * 5850 * 5853
N FTRK 2847	EATON/FULLER	RTO-11709MLL * RTO-14709MLL * RTOF-11709MLL * RTOF-14709MLL
N FTRK 2855	EATON/FULLER	RTO-13707DLL * RTO-13707MLL * RTOF-13707DLL * RTOF-13707MLL

11.4 \ Transmission Rebuild Kit / AMERICAN RANGE

Kit de reparación para caja de cambios



Fersa	BRAND	MODEL
N FTRK 2865	EATON/FULLER	RTLO-18718B * RTLO-18718B-T2 * RTLOF-18718B * RTLOF-18718B-T2
N FTRK 29	NEW PROCESS TRANSMISSIONS	541 * 541DD11 * 541DD12 * 541DD13 * 541DD14 * 541DD15 * 541DD16 * 541DD17 * 541FD * 541FL * 541FO * 541G * 541GD * 541GD24 * 541GL * 541GO * 541GO-11 * 542 * 542D * 542FD * 542FL * 542FO * 542GD * 542GL * 542L
N FTRK 2924	EATON/FULLER	FR-11210B * FR-12210B * FR-13210B * FR-14210B * FR-15210B * FR-9210B * FRF-11210B * FRF-12210B * FRF-13210B * FRF-14210B * FRF-15210B * FRF-9210B * FRO-11210B * FRO-11210C * FRO-12210B * FRO-12210C * FRO-13210B * FRO-13210C * FRO-14210B * FRO-14210C * FRO-15210B * FRO-15210C * FRO-16210B * FRO-16210C * FRO-17210C * FRO-18210C * FROF-11210B * FROF-11210C * FROF-12210B * FROF-12210C * FROF-13210B * FROF-13210C * FROF-14210B * FROF-14210C * FROF-15210B * FROF-15210C * FROF-16210B * FROF-16210C * FRW-15210B * FRWF-15210B * RTO-15210C * RTO-16210C * RTOF-15210C * RTOF-16210C
N FTRK 2996	EATON/FULLER	RTLO-14613B * RTLOF-14613B * RTLO-14618A * RTLO-16618A * RTLOF-14618A * RTLOF-16618A
N FTRK 2997	EATON/FULLER	RTO-15618 * RTOF-15618
N FTRK 2998	EATON/FULLER	RTLO-14610A
N FTRK 29B	NEW PROCESS TRANSMISSIONS	542 * 542FD * 542FL * 542FO
N FTRK 2A	SPICER/TTC TRANSMISSIONS	8051 * 8055 * 8251 * 8255
N FTRK 3	SPICER/TTC TRANSMISSIONS	8031 * 8035 * 8341 * 8345
N FTRK 3132	EATON/FULLER	FR-11210B * FR-12210B * FR-13210B * FR-14210B * FR-15210B * FR-9210B * FRF-11210B * FRF-12210B * FRF-13210B * FRF-14210B * FRF-15210B * FRF-9210B * FRO-11210B * FRO-11210C * FRO-12210B * FRO-12210C * FRO-13210B * FRO-13210C * FRO-14210B * FRO-14210C * FRO-15210B * FRO-15210C * FRO-16210B * FRO-16210C * FRO-17210C * FRO-18210C * FROF-11210B * FROF-11210C * FROF-12210B * FROF-12210C * FROF-13210B * FROF-13210C * FROF-14210B * FROF-14210C * FROF-15210B * FROF-15210C * FROF-16210B * FROF-16210C * RTO-15210C * RTO-16210C * RTOF-15210C * RTOF-16210C
N FTRK 3233	EATON/FULLER	RTO-14908LL * RTO-16908LL * RTOF-14908LL * RTOF-16908LL * RTO-14915 * RTO-16915 * RTOF-14915 * RTOF-16915
N FTRK 3256	EATON/FULLER	RTO-11908LL * RTO-14908LL * RTOF-11908LL * RTOF-14908LL * RT-14915 * RTF-14915 * RTO-14915 * RTOF-14915

Fersa	BRAND	MODEL
N FTRK 3273	EATON/FULLER	RT-8908LL * RTF-8908LL
N FTRK 3283	EATON/FULLER	RTO-11909ALL * RTO-11909MLL * RTO-14909ALL * RTO-14909MLL * RTOF-11909ALL * RTOF-11909MLL * RTOF-14909ALL * RTOF-14909MLL
N FTRK 3286	EATON/FULLER	RTLO-18913A * RTLO-18913A-T2 * RTLOF-18913A * RTLOF-18913A-T2
N FTRK 3322	EATON/FULLER	RT-8709B * RTF-8709B * RT-9710B * RTF-9710B
N FTRK 3340	EATON/FULLER	RTLO-14918B * RTLO-16918B * RTLO-16918B-T2 * RTLO-18918B * RTLO-18918B-T2 * RTLO-20918B * RTLO-20918B-T2 * RTLOF-14918B * RTLOF-16918B * RTLOF-16918B-T2 * RTLOF-18918B * RTLOF-18918B-T2 * RTLOF-20918B * RTLOF-20918B-T2
N FTRK 3343	EATON/FULLER	RTLO-12913A * RTLO-14913A * RTLO-16913A * RTLO-18913A * RTLOF-12913A * RTLOF-14913A * RTLOF-16913A * RTLOF-18913A
N FTRK 3344	EATON/FULLER	RTLO-16713A AUX * RTLOF-16713A AUX
N FTRK 3346	EATON/FULLER	RTLO-16713A * RTLOF-16713A
N FTRK 3348	EATON/FULLER	RTLO-14913A * RTLOF-14913A
N FTRK 3351	EATON/FULLER	RTLO-12913A * RTLOF-12913A
N FTRK 3355	EATON/FULLER	RTLO-14918B * RTLO-14918B-T2 * RTLOF-14918B * RTLOF-14918B-T2
N FTRK 3413	EATON/FULLER	RTO-14909ALL * RTO-16909ALL * RTOF-14909ALL * RTOF-16909ALL
N FTRK 3423	EATON/FULLER	FS-5406A * FS-5406N * FS-6406A * FS-6406N * FSB-5406B * FSO-6406A * FSO-8406A
N FTRK 3426	EATON/FULLER	RTLO-16913A-T2 * RTLO-18913A-T2 * RTLOF-16913A-T2 * RTLOF-18913A-T2
N FTRK 3440	EATON/FULLER	F-5405B-DM3 * F-5505B-DM3 * F-6405B-DM3 * F-6505B-DM3 * FO-5406B-DM3 * FO-5506B-DM3 * FO-6406A-ASX * FO-6406B-DM3 * FO-6506B-DMW * FO-8406A-ASX
N FTRK 3460	EATON/FULLER	RTLO-20913A * RTLOF-20913A
N FTRK 3462	EATON/FULLER	RTLO-22918B * RTLOF-22918B
N FTRK 3487	EATON/FULLER	RTO-14710B-AS2 * RTO-14710C-AS2 * RTO-16710B-AS2 * RTO-16710C-AS2
N FTRK 3488	EATON/FULLER	RTO-10710B-AS2 * RTO-12710B-AS2

11.4 \ Transmission Rebuild Kit / AMERICAN RANGE

Kit de reparación para caja de cambios



Fersa	BRAND	MODEL
N FTRK 3512	EATON/FULLER	FO-16D313E-LEP * FOM-16D313E-LEP * RTLO-16913L-DM3 * RTLOM-16913L-DM3 * RTLO-14918A-AS2 * RTLO-14918A-AS3 * RTLO-16918A-AS2 * RTLO-16918A-AS3 * RTLO-18918A-AS2 * RTLO-18918A-AS3 * RTLO-20918A-AS2 * RTLO-20918A-AS3
N FTRK 3514	EATON/FULLER	RTLO-22918A-AS2 * RTLO-22918A-AS3
N FTRK 3522	EATON/FULLER	FM-14D310B-LST * FM-15D310B-LST * RT-14910B-AS2 * RTLO-18610B-T2 * RTO-10910B-AS2 * RTO-10910B-AS3 * RTO-10910B-DM2 * RTO-10910B-DM3 * RTO-12910B-AS2 * RTO-12910B-AS3 * RTO-12910B-DM2 * RTO-12910B-DM3 * RTO-14910B-AS2 * RTO-14910B-AS3 * RTO-14910B-DM2 * RTO-14910B-DM3 * RTO-14910C-AS2 * RTO-14910C-AS3 * RTO-16910B-AS2 * RTO-16910B-AS3 * RTO-16910B-DM2 * RTO-16910B-DM3 * RTO-16910C-AS2 * RTO-16910C-AS3 * RTO-18910B-AS2 * RTO-18910B-AS3 * RTOM-16910B-DM3
N FTRK 3534	EATON/FULLER	RTLO-14918B-AS * RTLO-16918B-AS * RTLO-18918B-AS * RTLO-20918B-AS
N FTRK 3553	EATON/FULLER	RTL-14710B * RTL-14710B
N FTRK 3586	EATON/FULLER	RTLC-16609E * RTLFC-16609E
N FTRK 3596	EATON/FULLER	RTOC-16709A * RTOFC-16709A * RTLO-16713A-T2 * RTLOF-16713A-T2
N FTRK 3598	EATON/FULLER	RTLOC-16909A-T2 * RTLOFC-16909A-T2 * RTOC-16909A * RTOFC-16909A
N FTRK 3660	EATON/FULLER	RTO-11708LL * RTOF-11708LL * RTX-11708LL * RTXF-11708LL * RT-11715 * RTF-11715 * RTO-11715 * RTOF-11715 * RTX-11715 * RTXF-11715
N FTRK 390F	CLARK	390-V * 397-V * CL550 * CL551 * CL557 * CL558
N FTRK 390G	CLARK	390-V * 397-V * CL550 * CL551 * CL557 * CL558
N FTRK 390H	CLARK	390-V * 397-V * CL550 * CL551 * CL557 * CL558
N FTRK 3941	EATON/FULLER	FO-14E313A-MHP * FO-16E313A-MHP * FO-16E313A-VHP * FO-18E313A-MHP * FO-18E313A-VHP * FO-20E313A-MHP * FO-20E313A-VHP * FO-14E318B-MXP * FO-14E318B-VXP * FO-16E318B-MXP * FO-16E318B-VXP * FO-18E318B-MXP * FO-18E318B-VXP * FO-20E318B-MXP * FO-20E318B-VXP * FO-22E318B-MXP * FO-22E318B-VXP
N FTRK 3942	EATON/FULLER	FO-10E308LL-VCS * FO-11E308LL-VCS * FO-12E308LL-VCS * FO-14E308LL-VCS * FO-16E308LL-VCS * FO-17E308LL-VCS * FO-10E309ALL-VMS * FO-11309ALL-VMS * FO-12E309ALL-VMS * FO-14E309ALL-VMS * FO-16E309ALL-VMS * FO-17E309ALL-VMS

Fersa	BRAND	MODEL
N FTRK 395F	EATON/FULLER	FS-5005A * FS-5005B * FS-5005C
N FTRK 395G	EATON/FULLER	FS-5005A * FS-5005B * FS-5005C
N FTRK 395H	EATON/FULLER	FS-5005A * FS-5005B * FS-5005C
N FTRK 4	SPICER/TTC TRANSMISSIONS	8031 * 8035 * 8341 * 8345
N FTRK 400	EATON/FULLER	2-A-92
N FTRK 401	EATON/FULLER	AT-1202
N FTRK 4010	EATON/FULLER	FM-14E310B-LAS * FM-15E310B-LAS * FO-10E310C-VAS * FO-12E310C-VAS * FO-14E310C-LAS * FO-14E310C-VAS * FO-16E310C-LAS * FO-16E310C-VAS * FOM-14E310C-LAS * FOM-14E310C-VAS * FOM-15E310C-LAS * FOM-15E310C-VAS * FOM-16E310C-LAS * FOM-16E310C-VAS
N FTRK 4057	EATON/FULLER	RTOC-18909A
N FTRK 48	CLARK	305-V * 307-V * 315-V * 318-V
N FTRK 500	MACK	TRDXL107
N FTRK 501	MACK	TRL10760 * TRL10780
N FTRK 502	MACK	TRXL1070 * TRXL10710
N FTRK 503	MACK	T2050
N FTRK 504	MACK	TC150
N FTRK 505	MACK	T309L
N FTRK 505MK	MACK	T309L
N FTRK 506	MACK	T310
N FTRK 507	MACK	T318
N FTRK 507MK	MACK	T318
N FTRK 510	VOLVO	AT2412C * AT2412D * ATO2512C * ATO2612D
N FTRK 510A	VOLVO	AT2412C * AT2412D * ATO2512C * ATO2612D
N FTRK 511	VOLVO	AT2512C * AT2612D * AT2812C * AT2812D * ATO3112C * ATO3112D

11.4 \ Transmission Rebuild Kit / AMERICAN RANGE

Kit de reparación para caja de cambios



Fersa	BRAND	MODEL
N FTRK 511A	VOLVO	AT2512C * AT2612D * AT2812C * AT2812D * ATO3112C * ATO3112D
N FTRK 5356	MERITOR/ROCKWELL	RM9-115 * RM9-125 * RM10-115 * RM10-125
N FTRK 5357	MERITOR/ROCKWELL	RM9-135 * RM9-145 * RM9-155 * RM10-135 * RM10-145 * RM10-155 * RM10-165
N FTRK 5358	MERITOR/ROCKWELL	RM13-145
N FTRK 5406	MERITOR/ROCKWELL	M-15G9 * M-15G10 * MO-14G9 * MO-15G9 * MO-16G10
N FTRK 58	EATON/FULLER	T-905
N FTRK 58A	EATON/FULLER	T-11605A * T-11605B * T-11605C * T-11605D * T-11605F * T-11605M * TO-11605A * TO-11605B * TO-11605C * TO-11605D
N FTRK 65	MACK	TRQP72 * TRQ720 * TRQP720 * TRQ7210 * TRQL7220
N FTRK 70	SPICER/TTC TRANSMISSIONS	6041
N FTRK 700	SPICER/TTC TRANSMISSIONS	LLPS145-10 * LLPSO140-10 * LLPSO150-10 * LPS100-10 * LPS125-10 * PS125-9 * LPS135-10 * LPS145-10 * LPSO125-10 * LPSO140-10 * LPSO150-10 * PS100-10 * PS135-10 * PS145-10 * PS95-9 * PSO100-10 * PSO125-10 * PSO140-10 * PSO140-9 * PSO150-10 * PSO150-9 * PSO165-10
N FTRK 7000	EATON/FULLER	FS-4205A * FS-4205B * FS-4205C
N FTRK 7013	EATON/FULLER	FS-4205A * FS-4205B * FS-4205C
N FTRK 702	SPICER/TTC TRANSMISSIONS	PS110-7 * PS145-7
N FTRK 703	SPICER/TTC TRANSMISSIONS	AMO1000 * AMO1750 * APO1000 * APO1750
N FTRK 7032	EATON/FULLER	FS-5205A * FS-5205B * FS-5205C
N FTRK 7033	EATON/FULLER	FS-5205A * FS-5205B * FS-5205C
N FTRK 7035	EATON/FULLER	FS-6205A * FS-6205B * FS-6305A * FS-6305B
N FTRK 704	SPICER/TTC TRANSMISSIONS	ES46-5A * ES56-5A
N FTRK 705	SPICER/TTC TRANSMISSIONS	PS105-7LL * PS130-6L
N FTRK 7052	EATON/FULLER	FS-5306A * FS-6306A
N FTRK 706	SPICER/TTC TRANSMISSIONS	PS97-7

11.5 \ Wheel end repair Kit Kit de reparación de rueda de vehículo industrial



Fersa	BRAND	MODEL
N FWRK BPW 001	BPW	SH../SKH.. ECO-Plus 8-9 t
N FWRK BPW 003	BPW	SH../SKH.. ECO-Plus 8-9 t
N FWRK BPW 004	BPW	H../R.. KH../KR.. NH../NR.. SH../SKH.. ECO/ECO-MAXX 10-12 t
N FWRK ROR 001	ROR	LM, LC
N FWRK ROR 002	ROR	TA, TC
N FWRK ROR 003	ROR	TM
N FWRK SAF 001	SAF	KERZ, KRS, KRZ, RZ, RSM, SK RLS, SKRLZ, SK ZRLZ, SKRS, SKRSP, SKRZ, SKRZP



A series of horizontal dotted lines for writing notes.



12

Passenger car wheel bearing kits

Kits de rueda para turismos

12



12\ Passenger car wheel bearing kits Kits de rueda para turismos



KA



KB



KC



KD

Fersa				
KA 001	LM 11749/10	L 45449/10	ALFA ROMEO (33 * ALFASUD)	▪
KA 002	LM 11749/10	L 44649/10	ALFA ROMEO (ALFETTA), TOYOTA (CARINA * CELICA * COROLLA * STARLET)	▪
KA 003	LM 11949/10	L 45449/10	ALFA ROMEO (75 * 90 * ALFETTA * GIULIETTA * GTV)	▪
KA 004	LM 11949/10	LM 67048/10	ALFA ROMEO (6 * 75 * RZ * SZ)	▪
KA 005	LM 11949/10	L 45449/10	AUDI (A4 * A6 * COUPE * 80 * CABRIO * 90 * 100), SEAT (INCA), WV (CADDY)	▪
KA 006	REPLACED BY KA 069 / SUSTITUIDO POR EL KA 069			
KA 007	LM 11749/10	L 45449/10	DAEWOO (ESPERO * LANOS * NEXIA * NUBIRA), OPEL(ASCONA * CORSA * KADETT * MANTA * REKORD * TGRA * VECTRA)	▪
KB 008	F 15041		CITROËN (AX * SAXO * VISA * XSARA * ZX), PEUGEOT (106 * 205 * 306 * 309)	▪
KA 009	32010 XF	32010 XF	CITROËN (C25), FIAT (DUCATO), PEUGEOT (J5)	▪
KA 010	32008 XF	32006 XF	CITROËN (C25), FIAT (DUCATO), PEUGEOT (J5)	▪
KB 011	F 15166		CITROËN (C35), FIAT (242).	▪
KB 012	F 15166		CITROËN (C35), FIAT (242).	▪
KA 013	32008 XF	32006 XF	CITROËN (JUMPER), FIAT (DUCATO), PEUGEOT (BOXER)	▪
KA 014	LM 11749/10	L 44649/10	FORD (ESCORT * FIESTA)	▪
KA 015	F 15036	F 15036	FORD (ESCORT * FIESTA * ORION)	▪
KA 016	REPLACED BY KA 075 / SUSTITUIDO POR EL KA 075			
KA 017	LM 11749/10	L 44649/10	FORD (CORTINA * ESCORT * TAUNUS)	▪
KA 018	F 15036	F 15036	FORD (SIERRA)	▪
KA 019	F 15036	F 15036	FORD (ESCORT * FIESTA)	▪
KA 020	F 15040	F 15040	FORD (ESCORT * FIESTA * ORION)	▪
KA 021	F 15029	F 15029	FORD (ESCORT * FIESTA * ORION)	▪
KA 022	F 15055	F 15055	HYUNDAI (ACCENT * ATOS * LANTRA * PONY), MITSUBISHI (COLT * CORIA * LANCER * MIRAGE * SPACEWAGON * TREDIA)	▪
KA 023	M 12649/10	LM 48548/10	HYUNDAI (H-100 * H-1 * STAREX), MITSUBISHI (L-200 * L-300 * L-400)	▪
KA 024	32008 XF	32008 XF	LADA (NIVA)	▪
KA 025	LM 11949/10	LM 67048/10	MERCEDES (SL * 8)	▪
KA 026	LM 300849/11	LM 503349 A/10	MERCEDES (SEDAN * KOMBI * COUPE * SL * CLASE S)	▪
KA 027	M 12649/10	LM 48548/10	MERCEDES (SEDAN * KOMBI * COUPE * SL * CLASE S * T-1)	▪
KA 028	LM 11949/10	LM 67048/10	MERCEDES (190 * SEDAN * KOMBI * COUPE * SL * CLASE E)	▪
KA 029	M 12649/10	LM 48548/10	MERCEDES (SEDAN * KOMBI * COUPE * SL * CLASE S)	▪



KF

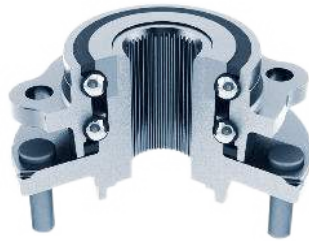

KV

- KA Single row tapered roller bearings / Rodamientos de rodillos cónicos
- KB Double row tapered roller bearings / Rodamientos cónicos de doble hilera
- KC Ball bearings / Rodamientos de bolas
- KD Double row ball bearings / Rodamientos de bolas de doble hilera
- KF Double row angular contact ball bearings / Rodamientos de bolas de doble hilera de contacto angular
- KV 2nd and 3rd generation wheel hub units / Rodamientos de rueda con brida de 2ª y 3ª generación

Fersa				 
KA 030	LM 11749/10	LM 67048/10	MERCEDES (190)	▪
KA 031	32009 XF	32009 XF	MERCEDES-BENZ MB	▪
KA 032	30306 F	30209 F	MERCEDES (100)	▪
KA 033	LM 503349 A /10	32009 XF	MERCEDES (100)	▪
KA 034	LM 11949/10	L 44649/10	NISSAN (MICRA)	▪
KA 035	LM 501349/10	30209 F	NISSAN (PATROL)	▪
KA 036	LM 11949/10	LM 67048/10	NISSAN (280 * LAUREL * SILVIA)	▪
KA 037	32010 XF	32010 XF	NISSAN (L35)	▪
KA 038	LM 11749/10	L 45449/10	DAEWOO (ESPERO * LANOS * NEXIA * NUBIRA), OPEL(ASCONA * CORSA * KADETT * MANTA * REKORD * TIGRA * VECTRA)	▪
KA 039	LM 11949/10	LM 67048/10	OPEL (COMMDORE * MONZA * KADETT * REKORD * SENATOR)	▪
KA 040	LM 11749/10	L 44649/10	OPEL (ASCONA * KADETT * MANTA * OLIMPIA * REKORD)	▪
KA 041	32005 XR	320/32 XF	PEUGEOT (504 * 505 * 604), TALBOT (TAGORA)	▪
KA 042	F 15063	30203 F	RENAULT (4 * 5 * 6 * 8 * 10)	▪
KA 043	30204 F	30205 F	RENAULT (4 * 5 * 6 * 12 * 15 * 16 * 17)	▪
KA 044	32004 XF	32005 XR	RENAULT (FUEGO * 18 * 16 * 15 * 14 * 12 * 6 * 5 * 4)	▪
KB 045	F 15041		RENAULT (SUPER 5 * 9 * 11 * 19)	▪
KB 046	F 15042		RENAULT (EXPRESS * 21)	▪
KB 047	F 15043		NISSAN (KUBISTAR), RENAULT (KANGOO * LAGUNA * EXPRESS)	▪
KB 048	F 15044		RENAULT (CLIO * EXPRESS * THALIA * TWINGO * SUPER 5 * 9 * 11 * 19)	▪
KA 049	30205 F	32007 XF	RENAULT (TRAFFIC)	▪
KA 050	LM 603049/11	LM 603049/11	LAND ROVER (90 * 100 * 110 * RANGE ROVER)	▪
KA 051	11162/300	359 A/354 X	LAND ROVER (88 * 109)	▪
KA 052	LM 603049/11	LM 603049/11	LAND ROVER	▪
KA 053	LM 603049/11	LM 603049/11	LAND ROVER (DEFFENDER)	▪
KA 054	30204 F	LM 67048/10	SKODA (FAVORIT)	▪
KA 055	LM 11949/10	15579 X/20	FIAT (124 * 1200 * 1600)	▪
KA 056	LM 11949/10	LM 67048/10	FIAT (ARGENTA * 125 * 132)	▪
KA 057	LM 11949/10	J 15585/20	FIAT (131), SEAT(131)	▪
KA 058	32006 XF	32008 XF	CITROËN (C25)	▪
KA 059	LM 11749/10	L 44649/10	TALBOT (1307 * 1510)	▪
KA 060	30204 F	L 44649/10	TALBOT (1100 * 1307 1200)	▪
KA 061	F 15003	F 15003	SUZUKI (SAMURAI * SJ 413)	▪

12 \ Passenger car wheel bearing kits Kits de rueda para turismos



KA



KB



KC



KD

Fersa				
KB 062	F 15015		SUZUKI (VITARA * X-90)	▪
KA 063	30204 F	L 44649/10	TALBOT (SIMCA, RANCHO, 1307)	▪
KA 064	LM 11949/10	LM 67048/10	TALBOT (180)	▪
KA 065	LM 11749/10	L 45449/10	DAIHATSU (CHARMANT), TOYOTA (CELICA * CARINA)	▪
KA 066	LM 11949/10	LM 67048/10	TOYOTA (CARINA * CELICA * COROLLA)	▪
KA 067	LM 11949/10	LM 67048/10	TOYOTA (CELICA)	▪
KA 068	LM 11749/10	L 44649/10	VOLVO (66 * 340-360)	▪
KA 069	LM 11749/10	L 45449/10	ALFA ROMEO (50 * 60 * 75 * 80); AUDI (50 * 60 * 75 * 80 * 100 * COUPE, PORSCHE (924), SEAT (AROSA * CORDOBA * IBIZA * TOLEDO), SKODA (FAVORIT * FELICIA), WV (CADDY * CORRADO * DERBI * GOLF * JETTA * KAEFFER * PASSAT * POLO * SANTANA * SCIROCCO * VENTO)	▪
KA 070	M 12649/10	LM 48548/10	TOYOTA (HYLUX * 4 RUNNER * HIACE I)	▪
KA 071	L 45449/10	LM 300849/11	WV (LT 28-35)	▪
KA 072	32010 XF	32010 XF	WV (LT 28-35)	▪
KA 073	32004 XF	32005 XR	CITROËN (VISA * LNA)	▪
KA 074	F 15135	F 15135	FORD (FIESTA)	▪
KA 075	LM 11749/10	L 45449/10	FORD (CAPRI * CONSUL * ESCORT * GRANADA * ORION))	▪
KA 076	F 15036	F 15036	FORD (SIERRA)	▪
KA 077	LM 11949/10	L 45449/10	ALFA ROMEO (ARNA), NISSAN (CHERRY)	▪
KB 078	F 15041		CITROËN (SAXO), PEUGEOT (106)	▪
KA 079	32010 XF	32010 XF	CITROËN (C25)	▪
KA 080	32206 F	33108 F	CITROËN (JUMPER)	▪
KA 081	F 15036	F 15036	FORD (SIERRA)	▪
KA 082	F 15036	F 15036	FORD (SIERRA)	▪
KA 083	LM 11949/10	LM 67048/10	FORD (ESCORT RANCHERA)	▪
KA 084	18790/20	387 A/382 A	FORD (TRANSIT)	▪
KA 085	LM 11949/10	32007 XR	FORD (TRANSIT)	▪
KA 086	LM 11749/10	L 44649/10	HYUNDAI (PONY), MITSUBISHI (COLT * CELESTE)	▪
KA 087	LM 11749/10	L 45449/10	MERCEDES (CLASE G)	▪
KA 088	30204 F	30205 F	PEUGEOT (304 * 204)	▪
KA 089	30204 F	30205 F	PEUGEOT (304 * 204 * 305)	▪
KB 090	F 15050		RENAULT (CLIO * MEGANE * SUPER 5 * 9 * 11 * 19)	▪
KA 091	32005 XR	320/32 XF	RENAULT (TRAFFIC)	▪
KF 092	F 16046		ALFA ROMEO (75 * 90 * GTV)	▪



KF

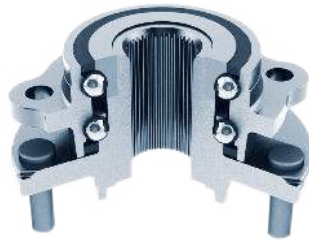

KV

- KA Single row tapered roller bearings / Rodamientos de rodillos cónicos
- KB Double row tapered roller bearings / Rodamientos cónicos de doble hilera
- KC Ball bearings / Rodamientos de bolas
- KD Double row ball bearings / Rodamientos de bolas de doble hilera
- KF Double row angular contact ball bearings / Rodamientos de bolas de doble hilera de contacto angular
- KV 2nd and 3rd generation wheel hub units / Rodamientos de rueda con brida de 2ª y 3ª generación

Fersa			 
KF 093	REPLACED BY KF 092 / SUSTITUIDO POR EL KF 092		
KF 094	F 16031		ALFA ROMEO (33) ■
KF 095	F 16035		AUDI (80 * COUPE * 90), WV (GOLF * JETTA * PASSAT * SANTANA) ■
KF 096	F 16038		AUDI (A4 * A6 * 80 * CABRIO, COUPE * 90), WV (PASSAT * SANTANA) SKODA (SUPERB) ■
P KV 097	REPLACED BY KV 194 / SUSTITUIDO POR EL KV 194		
KF 098	F 16054		AUDI (A4 * A6 * V8 * A8 * COUPE * 80 * 90) ■
KF 099	F 16041		HONDA (ACCORD), MG (MG-ZR), ROVER (25 * 200 * 400 * CABRIO * COUPE) ■
KV 100	F 16008		HONDA (CIVIC * CRX * LOGO), ROVER (200) ■
KF 101	F 16052		MG (ZS), ROVER (45 * 400) ■
KF 102	F 16053		HONDA (CIVIC * CRX * HR-V) ■
KV 103	F 16015		BMW (SERIE 3 * СЕРИЯ 3) ■
KF 104	F 16036		BMW (316 * 318 * 320 * 324 * 325) ■
A KV 105	F 16060		BMW (518 * 520 * 525 * 524 * 530 * 535 * 750 * 850) ■
KF 106	F 16046		BMW (316 * 318 * 320 * 324 * 325 * M3 * TOURING * CABRIO) ■
KF 107	F 16032		BMW (518 * 520 * 525 * 524 * 530 * 535) ■
P KV 108	F 16033		BMW (518 * 520 * 525 * 524 * 530 * 535 * 730 * 735 * 740 * 750 * 840 * 850) ■
KF 109	F 16036		BMW (316 * 318 * 320 * 324 * 325 * M3 * TOURING * CABRIO) ■
KF 110	F 16046		BMW (316 * 318 * 320 * 324 * 325 * M3 * TOURING * CABRIO * Z1 * Z4) ■
KF 111	F 16022		CITROËN (AX * SAXO), PEUGEOT (106) ■
KF 112	F 16004		CITROËN (AX * SAXO), PEUGEOT (106) ■
KF 113	F 16056		CITROËN (EVASION * JUMPY), FIAT (SCUDO * ULYSSE), LANCIA (ZETA), PEUGEOT (806 * EXPERT) ■
KV 114	F 16016		CITROËN (BERLINGO * XANTIA), PEUGEOT (406 * PARTNER) ■
KF 115	F 16036		FORD (ESCORT * FIESTA * ORION * PUMA) ■
KF 116	F 16055		FORD (COUGAR * MONDEO) ■
KD 117	F 18009		FORD (TRANSIT) ■
KD 118	F 18009		FORD (MONDEO) ■
KF 119	F 16091		MITSUBISHI (CARISMA * COLT * LANCER * MONTERO) ■
KV 120	F 16006		MITSUBISHI (LANCER, COLT, CARISMA, MONTERO) ■
KF 121	F 16090		MITSUBISHI (GALANT * ECLIPSE * SPACE WAGON * SPACE RUNNER) ■

12\ Passenger car wheel bearing kits Kits de rueda para turismos



KA



KB



KC



KD

Fersa				
KV 122	F 16014		MITSUBISHI (SPACE-.WAGON)	▪
KV 123	F 16014		MITSUBISHI (SPACE-.WAGON)	▪
KF 124	F 16059		MERCEDES (124 * 190 * CLASE C * CLK * CLASE E * SL * SLK)	▪
KB 125	F 15167		MERCEDES (KOMBI * CLASE E)	▪
KA 126	U 497/U 460 L + COLLAR		MERCEDES (CLASE G * HENSCHEL * T1)	▪
KF 127	F 16059		MERCEDES (CLASE V * VITO)	▪
KF 128	F 16081		NISSAN (PRIMERA * PRAIRIE * MAXIMA)	▪
KF 129	F 16058		NISSAN (SUNNY)	▪
KF 130	F 16034		NISSAN (SUNNY * ALMERA)	▪
KA 131	32209 F	32209 F	NISSAN (PATROL)	▪
KC 132			NISSAN (BLUEBIRD * VANETTE * LAUREL * SILVIA)	▪
KF 133	F 16019		DAEWOO (NEXIA * CIELO)	▪
KF 134	F 16036		DAEWOO (NEXIA * CIELO * ESPERO)	▪
P KV 135	F 16028		OPEL (OMEGA * SENATOR) VAUXHALL (CARLTON * SENATOR * OMEGA)	▪
KF 136	F 16032		OPEL (CALIBRA * OMEGA * SENATOR * VECTRA)	▪
KF 137	F 16020		OPEL (ASTRA * COMBO * CORSA * KADETT * TIGRA * VECTRA)	▪
KF 138	F 16037		OPEL (ASTRA * CALIBRA * OMEGA * VECTRA)	▪
KF 139	F 16042		PEUGEOT (204 * 304 * 305)	▪
KF 140	F 16049		PEUGEOT (504 * 505)	▪
KF 141	F 16050		PEUGEOT (504 * 505)	▪
KF 142	F 16026		CITROËN (AX * C15)	▪
KF 143	F 16048		CITROËN (BERLINGO)	▪
KV 144	F 16017		CITROËN (BX)	▪
KF 145	F 16029		CITROËN (C2 * C3 * SAXO * XSARA), PEUGEOT (106 * 206 * 306)	▪
KC 146			RENAULT (4 * 6)	▪
KC 147			RENAULT (5 * 12)	▪
KC 148			RENAULT (4 * 5)	▪
KC 149			DACIA (1300), RENAULT (12 * 15 * 18)	▪
KF 150	F 16025		RENAULT (14)	▪
KF 151	F 16021		CITROËN (XANTIA)	▪
KV 152	F 16044		RENAULT (SPACE)	▪
KF 153	F 16051		RENAULT (20 * 30 * TRAFFIC)	▪



KF

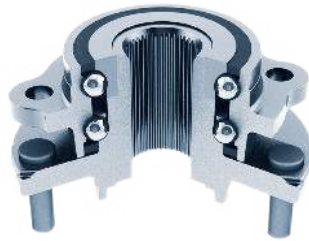

KV

- KA Single row tapered roller bearings / Rodamientos de rodillos cónicos
- KB Double row tapered roller bearings / Rodamientos cónicos de doble hilera
- KC Ball bearings / Rodamientos de bolas
- KD Double row ball bearings / Rodamientos de bolas de doble hilera
- KF Double row angular contact ball bearings / Rodamientos de bolas de doble hilera de contacto angular
- KV 2nd and 3rd generation wheel hub units / Rodamientos de rueda con brida de 2ª y 3ª generación

Fersa				 
KV 154	F 16005		RENAULT (SPACE * LAGUNA * FUEGO)	▪
KF 155	F 16030		RENAULT (LAGUNA I * MEGANIE * SCENIC * SAFRANE)	▪
P KV 156	F 16061		RENAULT (SPACE)	▪
P KV 157	F 16007		RENAULT (21)	▪
KF 158	F 16031		DACIA (LOGAN), RENAULT (CLIO * SPACE * KANGOO * LAGUNA * MEGANE * SCENIC * EXPRESS * THALIA * 19 * 21)	▪
KF 159	F 16024		SKODA (FAVORIT * FELICIA), WV (CADDY)	▪
KF 160	F 16002		FIAT (DUNA * FIORINO)	▪
KF 161	F 16001		FIAT (UNO)	▪
KV 162	F 16062		FIAT (DUNA * REGATA * FIORINO)	▪
KV 163	F 16003		FIAT (PANDA)	▪
KV 164	F 16010		ALFA ROMEO (145 * 146)	▪
KF 165	F 16027		FIAT (LINEA * TEMPRA)	▪
KF 166	F 16031		ALFA ROMEO (145)	▪
KF 167	F 16031		FIAT (DOBLO * FIORINO)	▪
KF 168	F 16027		FIAT (LINEA * TEMPRA), LANCIA (DELTHA)	▪
KA 169	30305 F	32208 F	IVECO (DAILY)	▪
KA 170	32011 XF	32011 XF	IVECO (DAILY)	▪
KA 171	18690/18620	368 A/362 A	IVECO (DAILY)	▪
KF 172	F 16043		TALBOT (HORIZON * 1300)	▪
KF 173	F 16009		TOYOTA (CAMRY * CARINA)	▪
KC 174			TOYOTA (LITEACE)	▪
KF 175	F 16024		VOLVO (440 * 460)	▪
KF 176	F 16024		VOLVO (440)	▪
KV 177	F 16012		VOLVO (440)	▪
P KV 178	F 16013		VOLVO (440)	▪
KF 179	F 16019		WV (CADDY * GOLF)	▪
KF 180	F 16018		AUDI (50), WV (DERBY)	▪
KF 181	F 16023		SEAT (AROSA), WV (GOLF)	▪
KF 182	F 16039		SEAT (CORDOBA)	▪
KF 183	F 16039		SEAT (TOLEDO), WV (CORRADO * GOLF * PASSAT)	▪
KF 184	F 16040		AUDI (A3 * TT), SEAT (LEON * TOLEDO) SKODA (OCTAVIA * ROOMSTER), WV (BORA * GOLF * NEW BEETLE)	▪
KF 185	F 16035		AUDI (COUPE * 80 * 90), WV (GOLF * JETTA * PASSAT * SANTANA)	▪

12\ Passenger car wheel bearing kits Kits de rueda para turismos



KA



KB



KC



KD

Fersa				
KA 186	30208 F		MITSUBISHI (L-200 * L-300 * MONTERO)	▪
KA 187	L 45449/10	L 45449/10	MITSUBISHI (COLT * LANCER * MIRAGE)	▪
KC 188			MITSUBISHI (COLT * CELESTE * GALANT * SAPPORO)	▪
KA 189	LM 12749/10	L 68149/11	MERCEDES (CLASE C * CLK * SEDAN * CABRIO * CLASE E * SLK)	▪
KA 190	LM 102949/10	LM 102949/10	HYUNDAI (GALLOPER), MITSUBISHI (L-200 * L-300 * MONTERO)	▪
KB 191	F 15067		FORD (FIESTA * FOCUS * FUSION), MAZDA (2)	▪
KB 192	F 15044		RENAULT (CLIO * EXPRESS * THALIA * TWINGO * SUPER 5 * 9 * 11 * 19)	▪
KB 193	F 15041		DACIA (LOGAN), NISSAN (MICRA * NOTE), RENAULT (CLIO * LOGAN * MEGANE * MODUS * THALIA * TWINGO * 19 * CHAMADE)	▪
P KV 194	F 16065		AUDI (A3 * TT), SEAT (LEON * TOLEDO) SKODA (OCTAVIA * ROOMSTER), VW (BORA * GOLF * NEW BEETLE)	▪
KF 195	F 16066		RENAULT (LAGUNA * MEGANE * SAFRANE)	▪
KV 196	F 16067		OPEL (ASTRA * ZAFIRA)	▪
KF 197	F 16068		TOYOTA (COROLLA)	▪
A KV 198	F 16069		OPEL (ASTRA)	▪
A KV 199	F 16070		OPEL (ASTRA * ZAFIRA)	▪
KA 200	33108 F	32206 F	CITROËN (C25), FIAT (DUCATO), PEUGEOT (J5)	▪
KF 201	F 16036		FORD (FIESTA * FOCUS * FUSION), MAZDA (2)	▪
A KV 202	F 16073		OPEL (ASTRA * VECTRA)	▪
KF 203	F 16024		SEAT (IBIZA * MALAGA * RONDA)	▪
KV 204	F 16072		FIAT (PANDA), SEAT (MARBELLA)	▪
KC 205	6306 2RS		FSO (125 * POLONEZ), LADA (NIVA)	▪
KA 206	30304 F	30206 F	ARO TV * MOSKVICH	
KA 207	30208 F	30208 F	ARO TV * MOSKVICH	
KA 208	30209 F	30209 F	ARO TV * MOSKVICH	
KC 209	6306 2RS	6306 2RS	ARO TV * MOSKVICH	
KA 210	L 44645/ L 44613	L 44645/ L 44613	FIAT (126 * 500 * 600), FSO (126), SEAT (600)	▪
KA 211	U 399/U 360 L + COLLAR		VOLVO (140 * 164 * 240 * 260 * 740 * 760 * P-1800)	▪
KA 212	U 399/U 360 L + COLLAR		VOLVO (740 * 760 * 780 * 940 * 960)	▪
KA 213	05-02-4911	01-03-4016	FIAT (126 * 500 * 600), FSO (126), SEAT (600)	▪



KF

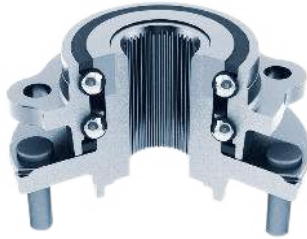

KV

- KA Single row tapered roller bearings / Rodamientos de rodillos cónicos
- KB Double row tapered roller bearings / Rodamientos cónicos de doble hilera
- KC Ball bearings / Rodamientos de bolas
- KD Double row ball bearings / Rodamientos de bolas de doble hilera
- KF Double row angular contact ball bearings / Rodamientos de bolas de doble hilera de contacto angular
- KV 2nd and 3rd generation wheel hub units / Rodamientos de rueda con brida de 2ª y 3ª generación

Fersa				 
KA 214	JL 69349/ JL 69310	JL 69349/ JL 69310	MAZDA (121 * 323)	▪
KV 215	F 16136		CITROËN (BX), PEUGEOT (405)	▪
KF 216	REPLACED BY KF 182 / SUSTITUIDO POR EL KF 182			
KB 217	F 15137		NISSAN (SUNNY)	▪
P KV 218	F 16137		ALFA ROMEO (145 * 146 * 155)	▪
P KV 219	F 16138		CITROËN (XSARA * ZX), PEUGEOT (205 * 306)	▪
KV 220	F 16139		FORD (FIESTA * COUGAR * MONDEO)	▪
P KV 221	F 16140		FORD (FIESTA * COUGAR * MONDEO)	▪
P KV 222	F 16141		FORD (MONDEO)	▪
KC 223	6007 2RS/C3	6007 2RS/C3	SUZUKI (ALTO * SWIFT)	▪
KC 224	6204 2RS/C3	6205 2RS/C3	SUZUKI (ALTO * SWIFT), DAEWOO (TICO)	▪
KF 225	F 16088		KIA (CARENS * SHUMA * SEPHIA), MAZDA (323 * 626 * 6 * MVP * MX-5 * MX-6 * XEDOS 6 * XEDOS 9)	▪
KV 226	F 16142		MAZDA (323 * 626)	▪
KF 227	F 16089		KIA (SHUMA * SEPHIA), MAZDA (323 * MX-5 * MX-6)	▪
KV 228	F 16143		MITSUBISHI (GALANT)	▪
KV 229	F 16144		HONDA (ACCORD), ROVER (600)	▪
KV 230	F 16145		HYUNDAI (ACCENT)	▪
KV 231	F 16146		HYUNDAI (ACCENT)	▪
KV 232	F 16147		MAZDA (323 * MX-3)	▪
KF 233	F 16085		WV (TRANSPORTER)	▪
KV 234	F 16148		VOLVO (S70 * V70 * C70 * 850)	▪
KV 235	F 16149		OPEL (ASTRA * MERIVA * VECTRA)	▪
P KV 236	F 16150		CITROËN (EVASION * JUMPY), FIAT (SCUDO * ULYSSE), LANCIA (ZETA), PEUGEOT (806 * EXPERT)	▪
P KV 237	F 16151		ALFA ROMEO (145 * 146), FIAT (BRAVA * BRAVO * BARCETTA * MAREA)	▪
P KV 238	F 16152		BMW (SERIE 5 * СЕРИЯ 5 * Z8)	▪
P KV 239	F 16153		BMW (SERIE 5 * СЕРИЯ 5)	▪
KF 240	F 16086		FORD (GALAXY), SEAT (ALHAMBRA), WV (SHARAN)	▪
KF 241	F 16086		FORD (GALAXY), SEAT (ALHAMBRA), WV (SHARAN)	▪
KV 242	F 16154		VOLVO (S40 * V40)	▪
P KV 243	F 16155		RENAULT (LAGUNA)	▪
KV 244	F 16156		RENAULT (LAGUNA)	▪
KV 245	F 16188		VOLVO (S70 * V70 * C70 * 850)	▪

12 \ Passenger car wheel bearing kits Kits de rueda para turismos



KA



KB



KC



KD

Fersa				
P KV 246	F 16157		RENAULT (MEGANE * SCENIC)	▪
KV 247	F 16158		OPEL (ASTRA * ZAFIRA)	▪
KA 248	LM 11949/10	L 45449/10	AUDI (A4 * CABRIO), SEAT (INCA), WV (CADDY)	▪
KV 249	F 16159		VOLVO (S70 * V70 * C70)	▪
KV 250	F 16160		AUDI (A4 * A6 * A8), SEAT (EXEO), WV (PASSAT)	▪
A KV 251	F 16161		ALFA ROMEO (146 * 145 * MITO), CITROËN (NEMO), FORD (KA), LANCIA (DELTHA * LYBRA * MUSSA * Y * YPSILON), FIAT (BARCETTA * BRAVA * BRAVO * FIORINO * MAREA * MULTIPLA * PALIO * PANDA * PUNTO * ESTILO * 500)	▪
P KV 252	F 16162		OPEL (ASTRA * COMBO * ZAFIRA * MERIVA * VECTRA), SAAB (9-3 * 9-5 * 900)	▪
KC 253			FIAT (ARGENTA * 124 * 125 * 131 * 132), FSO (125P)	▪
KA 254	LM 67049/14	LM 67049/14	AUSTIN (MINI), ROVER (MINI)	▪
KA 255	JLM 104945/10	JLM 104945/10	RENAULT (MASTER)	▪
KC 256	6207 C3	F 19074	WV (TRANSPORTER)	▪
KA 257	F 15164	F 15164	FORD (SCORPIO * MONDEO * SIERRA)	▪
KV 258	F 16163		RENAULT (SPACE * FUEGO * MEGANE * SCENIC * EXPRESS * SAFRANE * 18 * 21 * 25 * 30)	▪
KF 259	F 16034		TOYOTA (CAMRY * CARINA * CELICA * MR2 * RAV4)	▪
KV 260	F 16164		HONDA (ACCORD * CIVIC)	▪
KF 261	F 16031		ALFA ROMEO (164), FIAT (CROMA * TEMPRA), LANCIA (DEDRA * DELTA * PRISMA * THEMA)	▪
KB 262	REPLACED BY KB 192 / SUSTITUIDO POR EL KB 192			
KB 263	F 15068		FORD (TRANSIT)	▪
KF 264	F 16107		ALFA ROMEO (145 * 146 * 155 * 164 * GTV * SPIDER), FIAT (BRAVO * COUPE * CROMA * MAREA), LANCIA (DELTA * KAPPA * THEMA)	▪
KC 265			SUZUKI (JIMNY * SAMURAI * SJ)	▪
KA 266	30208 F		NISSAN (PICK UP * TERRANO * URBAN)	▪
KV 267	F 16165		NISSAN (MICRA)	▪
KA 268	32209 F		NISSAN (PATROL)	▪
KA 269	32205 BF	32007 XF	RENAULT (TRAFFIC)	▪
KF 270	F 16093		FIAT (PUNTO)	▪
KV 271	F 16166		VOLVO (S70 * V70 * C70 * 850)	▪
KA 272	32011 XF	32011 XF	CITROËN (JUMPER), FIAT (DUCATO), PEUGEOT (BOXER)	▪
KA 273	33205 F	LM 501349/10	MERCEDES (T1, * SPRINTER), WV (LT)	▪
KF 274	F 16132		BMW (3 * 5)	▪



KF

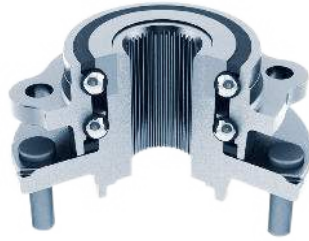

KV

- KA Single row tapered roller bearings / Rodamientos de rodillos cónicos
- KB Double row tapered roller bearings / Rodamientos cónicos de doble hilera
- KC Ball bearings / Rodamientos de bolas
- KD Double row ball bearings / Rodamientos de bolas de doble hilera
- KF Double row angular contact ball bearings / Rodamientos de bolas de doble hilera de contacto angular
- KV 2nd and 3rd generation wheel hub units / Rodamientos de rueda con brida de 2ª y 3ª generación

Fersa				
KV 275	F 16167		CITROËN (SAXO), PEUGEOT (106)	▪
P KV276	F 16168		AUDI (A6), SKODA (SUPERB), WV (PASSAT * SANTANA)	▪
P KV277	F 16108		RENAULT (LAGUNA)	▪
KB 278	F 15168		OPEL (MOVANO), RENAULT (MASTER)	▪
KV 279	F 16169		OPEL (ASTRA, ZAFIRA)	▪
KF 280	F 16109		MERCEDES (CLASE M)	▪ ▪
KF 281	F 16002		FIAT (PALIO * SIENA * STRADA)	▪
A KF 282	F 16110		FORD (FIESTA * FUSION * FOCUS)	▪
P KV 283	F 16111		ALFA ROMEO (146 * 145 * MITO), CITROËN (NEMO), FORD (KA), LANCIA (DELTHA * LYBRA * MUSSA * Y * YPSILON) FIAT (BARCETTA * BRAVA * BRAVO * FIORINO * MAREA * MULTIPLA * PALIO * PANDA * PUNTO * ESTILO * 500)	▪
P KV 284	F 16170		SEAT (AROSA * CORDOBA * IBIZA), WV (LUPO * POLO)	▪
P KV 285	F 16171		AUDI (A2), WV (LUPO)	▪
A KV 286	F 16172		AUDI (A2), SEAT (CORDOBA * IBIZA), SKODA (FABIA), WV (FOX * POLO)	▪
P KV 287	F 16173		AUDI (A2), SEAT (CORDOBA * IBIZA), SKODA (FABIA), WV (FOX * POLO)	▪
P KV 288	F 16112		FIAT (PANDA * SEICENTO * 500), FORD (KA)	▪
P KV 289	F 16113		CITROËN (BERLINGO * C3 * C4 * C5), PEUGEOT (207 * 307 * 308 * 3008 * PARTNER)	▪
P KV 290	F 16174		CITROËN (C4), PEUGEOT (307)	▪
KV 291	F 15154		FORD (TRANSIT)	▪
KF 292	F 16083		OPEL (COMBO * CORSA * MERIVA * TIGRA)	▪
KB 293	F 15168		OPEL (MOVANO), RENAULT (MASTER)	▪
P KV294	F 16175		CITROËN (C8), FIAT (JULYSSE), LANCIA (PHEDRA), PEUGEOT (807)	▪
KB 295	F 15168		CITROËN (JUMPER), FIAT (DUCATO), PEUGEOT (BOXER)	▪
KB 296	F 15121		CITROËN (JUMPER), FIAT (DUCATO), PEUGEOT (BOXER)	▪
P KV 297	F 16176		BMW (SERIE 3 * СЕРИЯ 3 * Z3 * Z4)	▪
KF 298	F 16068		TOYOTA (COROLLA)	▪
KF 299	F 16057		HYUNDAI (ACCENT * ATOS * COUPE * GETZ * LANTRA), KIA (RIO)	▪
KF 300	F 16114		FORD (TRANSIT)	▪
KF 301	F 16115		SUZUKI (SWIFT)	▪
KF 302	F 16116		VOLVO (S40)	▪
KF 303	F 16046		BMW (Z1 * Z3)	▪

12\ Passenger car wheel bearing kits

Kits de rueda para turismos



KA



KB



KC



KD

Fersa				
KF 304	F 16117		HONDA (CIVIC IV-V, CR-V, LOGO)	▪
KV 305	F 16177		CITROËN (XSARA), PEUGEOT (306)	▪
KF 306	F 16054		AUDI (A4,A8,ALLROAD, V8, A8, COUPE, CABRIO, 80, 100, 200) SKODA (SUPERB), WV (PASSAT)	▪
KF 307	F 16054		AUDI (A4,A8,ALLROAD, V8, A8, COUPE, CABRIO, 80, 100, 200) SKODA (SUPERB), WV (PASSAT)	▪
KF 308	F 16118		AUDI (A4,A8)	▪
KF 309	F 16119		RENAULT (LAGUNA * MEGANE * SAFRANE)	▪
KF 310	F 16120		TOYOTA (PASEO)	▪
KF 311	F 16105		LEXUS (RX), TOYOTA (AVENSIS)	▪
KF 312	F 16121		RENAULT (AVANTTIME, ESPACE III)	▪
KF 313	F 16122		CITROËN (XM), PEUGEOT (605, 607)	▪
KF 314	F 16051		RENAULT (TRAFFIC)	▪
KF 315	F 16123		NISSAN (PRIMASTAR), OPEL (VIVARO)	▪
KF 316	F 16119		TOYOTA (CAMRY, MR2, PICNIC)	▪
KF 317	F 16090		HYUNDAI (SONATA), MITSUBISHI (SPACE WAGON, TREDIA)	▪
KB 318	F 15172		NISSAN (SERENA * VANETTE * 300Z)	▪
KF 319	F 16191		OPEL (AGILA)	▪
KF 320	F 16124		HONDA (CIVIC I-II-III), ROVER (200)	▪
KF 321	F 16125		NISSAN (MICRA)	▪
KV 322	F 16178		FORD (FOCUS, C-MAX)	▪
KV 323	F 15177		FORD (TRANSIT)	▪
KV 324	F 15178		FORD (TRANSIT)	▪
KV 325	F 15179		FORD (TRANSIT)	▪
KV 326	F 15180		FORD (TRANSIT)	▪
KF 327	F 16036		FORD (ESCORT, FIESTA, PUMA, ORION)	▪
KV 328	F 16179		FORD (MONDEO), JAGUAR (X-TYPE),	▪
KV 329	F 16126		FORD (MONDEO), JAGUAR (X-TYPE),	▪
KV 330	F 16180		OPEL (ASTRA)	▪
KV 331	F 16181		OPEL (ASTRA, ZAFIRA)	▪
KV 332	F 16182		OPEL (ASTRA, ZAFIRA)	▪
KV 333	F 16183		OPEL (ASTRA)	▪
KF 334	F 16127		NISSAN (PRIMASTAR), OPEL (VIVARO), RENAULT (SPACE, VEL SATIS, TRAFFIC)	▪
KV 335	F 16184		OPEL (SIGNUM, VECTRA)	▪
KV 336	F 16185		FIAT (CROMA), OPEL (SIGNUM, VECTRA), SAAB (9-3)	▪



KF

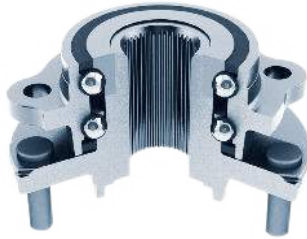

KV

- KA Single row tapered roller bearings / Rodamientos de rodillos cónicos
- KB Double row tapered roller bearings / Rodamientos cónicos de doble hilera
- KC Ball bearings / Rodamientos de bolas
- KD Double row ball bearings / Rodamientos de bolas de doble hilera
- KF Double row angular contact ball bearings / Rodamientos de bolas de doble hilera de contacto angular
- KV 2nd and 3rd generation wheel hub units / Rodamientos de rueda con brida de 2ª y 3ª generación

Fersa				 
KV 337	F 16186		OPEL (CORSA, TIGRA)	▪
KB 338	F 15128		OPEL (CORSA, TIGRA)	▪
KB 339	F 15173		NISSAN (PRIMASTAR), OPEL (VIVARO), RENAULT (SPACE, TRAFFIC)	▪
P KV 340	F 16128		NISSAN (PRIMASTAR), OPEL (VIVARO), RENAULT (SPACE)	▪
KF 341	F 16129		OPEL (AGILA)	▪
KF 342	F 16130		OPEL (AGILA)	▪
P KV 343	F 16187		FIAT (CROMA), OPEL (SIGNUM, VECTRA), SAAB (9-3)	▪
KB 344	F 15174		RENAULT (MASTER), OPEL (MOVANO)	▪
KB 345	F 15043		MERCEDES (CLASE A),	▪
P KV 346	F 16131		CITROËN (NEMO), FIAT (BRAVO, FIORINO, IDEA)	▪
KA 347	F 15164	F 15164	FORD (SCORPIO, ESCORT, SIERRA)	▪
KF 348	F 16132		BMW (3 * 7 * 850 * X3 * Z3 * Z4)	▪
KA 349	30304 F	30206 F	SKODA (105, 130, RAPID)	▪
KB 350	F 15175		RENAULT (CLIO, MEGANE, MODUS)	▪
P KV 351	F 16133		DACIA (LOGAN, SANDERO), NISSAN (MICRA), RENAULT (CLIO)	▪
KF 352	F 16134		TOYOTA (COROLLA)	▪
KV 353	F 16192		TOYOYA (YARIS)	▪
P KV 354	F 16135		CITROËN (C2, C3, DS3), PEUGEOT (207, 1007)	▪
KB 356	F 15187		IVECO (DAILY I)	▪
KB 357			CITROËN (C4), PEUGEOT (307)	▪
P KV 358			AUDI (A3), SEAT (ALTEA, LEON), SKODA (OCTAVIA)	▪
P KV 359			AUDI (A3), SKODA (OCTAVIA)	▪
P KV 360			AUDI (A3), SEAT (ALTEA * LEON), SKODA (OCTAVIA * YETI), VW (CADDY III * GOLF V * TOURAN)	▪
P KV 361			AUDI (A3 * TT), SEAT (ALHAMBRA * ALTEA * TOLEDO), SKODA (OCTAVIA * SUPERB), VW (EOS * GOLF * JETTA * PASSAT * SCIROCCO * SHARAN * TIGUAN * TOURAN)	▪
KB 362	F 15121		IVECO (DAILY I * II)	▪
P KV 363			JEEP (GRAND CHEROKEE II)	▪
KB 364			RENAULT (MEGANE II, SCENIC, GRAND SCENIC)	▪
KB 365			KIA (CARNIVAL)	▪
P KV 366			RENAULT (CLIO III * MEGANE * MODUS * SCENIC * GRAND SCENIC * TWINGO)	▪
P KV 367			AUDI (A3 * TT), SEAT (ALTEA * ALHAMBRA * TOLEDO), SKODA (OCTAVIS * SUPER-B * YETI), VW (EOS * GLOF * JETTA * PASSAT(SCIROCCO * TIGUAN * TOURAN)	▪

12 \ Passenger car wheel bearing kits Kits de rueda para turismos



KA



KB



KC



KD

Fersa				
KB 368	F 15041		CITROËN (C2 * C3 *), PEUGEOT (1007)	▪
KB 369			CITROËN (C3 * C4 * DS3), PEUGEOT (207 * 307)	▪
KF 370	F 16079		TOYOTA (AVENSIS * COROLLA)	▪
KF 371			RENAULT (CLIO * KANGOO * SCENIC * MEGANE)	▪
KB 372	F 15121		CITROËN (JUMPER), FIAT (DUCATO), PEUGEOT (BOXER)	▪
KV 373			FIAT (BRAVO * STYLO), LANCIA (DELTA III)	▪
KV 374			MINI	▪
KV 375			RENAULT (LAGUNA)	▪
KF 376	F 16019		CHEVROLET-DAEWOO (LANOS * KALOS)	▪
KV 377			ALFA ROMEO (147 * 156 * GT)	▪
KV 378			BMW (SERIE 3 * 5 * СЕРИЯ 3 * 5 * X3 * X5)	▪
KF 380			NISSAN (ALMERA TINO * MAXIMA * PRIMERA * X-TRAIL)	▪
KF 381			NISSAN (ALMERA * MICRA)	▪
KF 382	F 16079		TOYOTA (ALVIS * AVENSIS * CELICA * COROLLA * MR2 * WISH LIMUSNIA)	▪
KA 383	F 15029	F 15029	FORD (ESCORT, FIESTA * KA * PUMA * STREET KA)	▪
KB 384	F 15067		FORD (FIESTA V * FOCUS * FUSION)	▪
			FORD (TOURNEO CONNECT)	▪
KV 386			FORD (FOCUS C-MAX * C-MAX * FOCUS II)	▪
KV 387			FORD (TRANSIT TOURNEO * TRANSIT AUTOBUS)	▪
KF 388			HYUNDAI (COUPE * ELANTRA * MATRIX), KIA (CERATO)	▪
KA 389	L 44649/10	LM 11949/10	KIA (RIO), MAZDA (626 II Hatchback)	▪
KB 390			FIAT (DUCATO)	▪
KF 391			CITROËN (JUMPER), FIAT (DUCATO), PEUGEOT (BOXER)	▪
KA 392	LM 300849/11	LM 603049/11	NISSAN (PATHFINDER * TERRANO I-II * PICK UP)	▪
KA 393	JL 69349/10	JL 69349/10	KIA (PRIDE * RIO), MAZDA (121 * DEMIO)	▪
KV 394			WV (MULTIVAN, TUAREG * TRANSPORTER *)	▪
KV 395			AUDI (A4) SEAT (EXEO)	▪
KF 396			BMW (5 * 6 * 7)	▪
KA 397	JL 69349/10	LM 102949/10	KIA (SPORTAGE)	▪
KV 398			ALFA ROMEO (147)	▪
KV 399			CITROËN (C5 * C6), PEUGEOT (308 * 407 * 508 * 607)	▪
KB 400			NISSAN (VANETTE * SERENA * TERRANO)	▪
KV 401			VOLVO (XC-90)	▪
KB 402	F 15174		OPEL (MOVANO), RENAULT (MASTER)	▪



KF

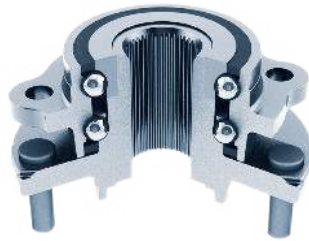

KV

- KA Single row tapered roller bearings / Rodamientos de rodillos cónicos
- KB Double row tapered roller bearings / Rodamientos cónicos de doble hilera
- KC Ball bearings / Rodamientos de bolas
- KD Double row ball bearings / Rodamientos de bolas de doble hilera
- KF Double row angular contact ball bearings / Rodamientos de bolas de doble hilera de contacto angular
- KV 2nd and 3rd generation wheel hub units / Rodamientos de rueda con brida de 2ª y 3ª generación

Fersa				 
KV 403			CITROËN (XANTIA), PEUGEOT (406)	▪
KA 404			ISUZU (TROOPER * D-MAX), OPEL (CAMPO * FRONTERA * MONTERREY)	▪
KA 405	L 68149/11	L 68149/11	CHEVROLET-DAEWOO (MATIZ * SPARK)	▪
KA 406			MERCEDES (CLS * CLASE E * SL)	▪
KA 407			KIA (CARNIVAL)	▪
P KV 408			MITSUBISHI (COLT), SMART (FORFOUR)	▪
P KV 409			FIAT (DOBLO * FIORINO * STYLO)	▪
P KV 410			CITROËN (C5 * C6), PEUGEOT (407 * 607)	▪
P KV 411			ALFA ROMEO (147 * 156 * GT), LANCIA (THESIS)	▪
KV 412			HYUNDAI (ACCENT * LANTRA * COUPE)	▪
KA 413	30205 F	30204 F	CHEVROLET-DAEWOO (MATIZ * SPARK)	▪
KA 414			MERCEDES (CLASE C * CLC * CLK * SLK * CLASE E)	▪
KA 415	LM 11749/10	L 44649/10	HYUNDAI (ATOS * PONY), MITSUBISHI (CELESTE * COLT * CORDIA * GALANT * LANCER * APSCEWAGON * TREDIA)	▪
KB 416			SUBARU (IMPREZA * FORESTER * LEGACY I-II)	▪
KF 417			SUZUKI (JIMNY)	▪
KF 418			BMW (1 * 3 * Z4)	▪
KC 419			SUZUKI (VITARA * X-90)	▪
P KV 420			SEAT (INCA), VW (CADDY)	▪
P KV 421			AUDI (Q7), PORSCHE (CAYENNE) VW (TOUAREG)	▪
KB 422			MERCEDES (G * SPRINTER) VW (LT)	▪
KA 423			MITSUBISHI (STORM * STRADA * L200 * L300 * L400)	▪
KB 424			CITROËN (JUMPER), FIAT (DUCATO), PEUGEOT (BOXER)	▪
P KV 425			AUDI (A6 * A8), VW (TOUAREG)	▪
KF 426			HONDA (ACCORD * CIVIC * CR-V * PRELUDE * STREAM * S2000)	▪
KV 427			TOYOTA (LAND CRUISER)	▪
KF 428			CHEVROLET (NUBIRA * LACETTI * OPTRA * TACUMA * VIVANT)	▪
KF 429			TOYOTA (ECHO * BIOS * YARIS * VITZ * YARIS VERSO)	▪
KA 430			NISSAN (PATROL)	▪
KV 431			BMW (5 * 6)	▪
KV 432			BMW (1 * 3 * Z4)	▪
KF 433			SAAB (9-3 * 9-5)	▪

12\ Passenger car wheel bearing kits Kits de rueda para turismos



KA



KB



KC



KD

Fersa				
P KV 434			CITROËN (C8), FIAT (JULYSSE), LANCIA (PHEDRA), PEUGEOT (807)	▪
P KV 435			CITROËN (C2 * C3), PEUGEOT (206 * 1007)	▪
KB 436			MERCEDES (CLASE E RANCHERA FAMILIAR)	▪
P KV 437			OPEL (CORSA)	▪
KV 438			HIUNDAI (ELANTRA * MATRIX)	▪
KV 439			CHRYSLER (VOYAGER), DODGE (CARAVAN)	▪
P KV 440			RENAULT (AVANTIME * SPACE II-III)	▪
KF 441			LANDROVER (FREELANDER)	▪
KF 442			NISSAN (X-TRAIL)	▪
KB 443				▪
KC 444			SUZUKI (CARRY * S J)	▪
P KV 445			CITROËN (C5)	▪
KF 446	F 16040		AUDI (A3 * TT), SEAT (LEON), VW (GOLF)	▪
P KV 447			ALFA ROMEO (147 * 156 * GT)	▪
KF 448	F 16036		DAEWOO (LANOS * NUBIRA)	▪
P KV 449			MG, ROVER (45 * 25 * 400 * 200)	▪
KF 450			MERCEDES (CLASE A * Vaneo)	▪
KV 451			TOYOTA (AVENSIS 2.0 TD 97-03)	▪
P KV 452			MG ROVER (75)	▪
KF 453	F 16063		FORD (TRANSIT)	▪
P KV 454			VOLVO (C30 * S40 * V50 * C70)	▪
KA 455	LM 300849/11	LM 12749/10	VW (TRANSPORTER)	▪
KF 456	F 16034		TOYOTA (CARINA * CELICA * COROLLA)	▪
KV 457			MG, ROVER (45 * 25 * 400 * 200)	▪
P KV 458			CITROËN (BERLINGO * XSARA), PEUGEOT (PARTNER)	▪
P KV 459			CITROËN (XSARA), PEUGEOT (306)	▪
P KV 460			CITROËN (BERLINGO * XSARA), PEUGEOT (PARTNER)	▪
P KV 461			OPEL (CORSA)	▪
P KV 462			MINI	▪
KC 463			SUZUKI (VITARA)	▪
KB 464			CITROËN (BERLINGO * C4), PEUGEOT (308 * 3008 * 5008 * PARTNER)	▪
KF 465	F 16027		FIAT (TIPO)	▪
KF 466	F 16034		TOYOTA (CARINA * CELICA * RAV4)	▪
KV 467			VOLVO (S60 * V70 * XC70 * S80)	▪



KF

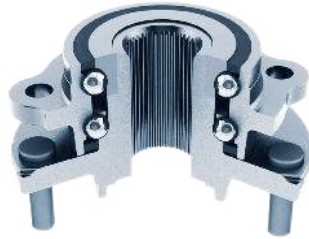

KV

- KA Single row tapered roller bearings / Rodamientos de rodillos cónicos
- KB Double row tapered roller bearings / Rodamientos cónicos de doble hilera
- KC Ball bearings / Rodamientos de bolas
- KD Double row ball bearings / Rodamientos de bolas de doble hilera
- KF Double row angular contact ball bearings / Rodamientos de bolas de doble hilera de contacto angular
- KV 2nd and 3rd generation wheel hub units / Rodamientos de rueda con brida de 2ª y 3ª generación

Fersa				
KF 468	F 16093		FIAT (PANDA * SEICENTO * TIPO * CINQUECENTO)	▪
KB 469			MERCEDES (CLASE E)	▪
KF 470	F 16036		BMW (3 * Z3)	▪
P KV 471			ALFA ROMEO (156), FIAT (BRAVO * STYLO), LANCIA (DELTA)	▪
P KV 472			BMW (5 * 6 * 7 * X5)	▪
P KV 473			CITROËN (JUMPY), FIAT (SCUDO), PEUGEOT (EXPERT)	▪
P KV 474			FIAT (PUNTO)	▪
KF 475			HIUNDAI (i10), KIA (PICANTO)	▪
KA 476	32207 F	32205 BF	RENAULT (TRAFFIC * MASTER)	▪
KC 477			LADA (NIVA)	▪
KV 478			VOLVO (S60 * V70 * S80)	▪
KF 479	F 16038		AUDI (A6)	▪
P KV 480			VOLVO (S60 * V70 * XC70 * S80)	▪
KV 481			DAEWOO (LEGANZA)	▪
KV 482			TOYOTA (VIOS * YARIS * VITZ * YARIS VERSO)	▪
KA 483	JL 69349/310	LM 102949/10	MAZDA (B-SERIE * B-СЕРИЯ * E-SERIE * E-СЕРИЯ)	▪
P KV 484			FORD (TOURNEO * TRAFFIC)	▪
KV 485			HYUNDAI (COUPE)	▪
KV 486			AUDI (A3 * TT), SEAT (ALTEA * ALHAMBRA * LEON), SKODA (OCTAVIA * SUPERB * YETI), VW (CADDY * GOLF * PASSAT * SHARAN * TIGUAN)	▪
KF 487			HYUNDAI (SANTA FÉ * ix35 * SONATA V * TRAJET * TUCSON * XG), KIA (SPORTAGE)	▪
KC 488			TOYOTA (HILUX * LAND CRUISER * HICAE * 4 RUNNER), VW (TARO)	▪
KV 489			KIA (SEPHIA * SHUMA)	▪
KV 490			MITSUBISHI (GALANT)	▪
KB 491			MITSUBISHI (MONTERO)	▪
P KV 492			RENAULT (LAGUNA)	▪
P KV 493			JAGUAR (S-TYPE)	▪
KF 494			JAGUAR (XJ * S-TYPE)	▪
KF 495			SUZUKI (BALENO)	▪
KB 496	F 15015		SUZUKI (GRAND VITARA * VITARA * X-90)	▪
KV 497			MAZDA (323 * 626 * 6 * MPV * PREMACY * XEDOS 90)	▪
KF 498			TOYOTA (COROLLA * PRIUS)	▪
KA 499	1988/1922	LM 11949/10	FORD (CAPRI * CORSAIR * CORTINA * ESCORT * ZEPHIR * ZODIAC * ZODIAK)	▪

12 \ Passenger car wheel bearing kits

Kits de rueda para turismos



KA



KB



KC



KD

Fersa				
KF 500			CITROËN (2CV * DYANE * MEHARI)	▪
KV 501			HONDA (CITY * JAZZ)	▪
KA 502	LM 67048/10	LM 11949/10	PORSCHE (911 * 924 * 944)	▪
KV 503			NISSAN (PRIMERA)	▪
KF 504			SAAB (9-3 * 9-5 * 900)	▪
P KV 505			MG ROVER (45 * 25 * 400 * 200 * COUPE * GT)	▪
KV 506			SAAB (9-5)	▪
P KV 507			CITROËN (C1), PEUGEOT (107), TOYOTA (AYGO)	▪
KF 508			HYUNDAI (ELANTRA * SONATA), KIA (MAGENTIS)	▪
KF 509			SUZUKI (ALTO * IGNIS * SWIFT * WAGON)	▪
P KV 510			ALFA ROMEO (MITO), FIAT (PUNTO * 500)	▪
P KV 511			AUDI (A6)	▪
P KV 512			BMW (1 * 3 * 3 TOURING)	▪
KV 513			HYUNDAI (ACCENT)	▪
KV 514			VOLVO (850)	▪
KA 515	LM 503349 A/10	32206 F	MERCEDES (100)	▪
KF 516			VOLVO (S40 * V40)	▪
KA 517	LM 501349/10	LM 503349 A/10	JAGUAR (XJ)	▪
P KV 518			SKODA (FABIA); VW (POLO)	▪
KF 519	F 16054		AUDI (A4 * AVANT * CABRIO)	▪
P KV 520			NISSAN (KUBISTAR), RENAULT (KANGOO)	▪
KV 521			KIA (CLARENS * CLARUS)	▪
KC 522			SUZUKI (JIMNY)	▪
P KV 523			FIAT (STYLO)	▪
KV 524			OPEL (CORSA)	▪
P KV 525			HONDA (CITY * JAZZ * CR-V)	▪
KV 526			HYUNDAI (MATRIX * ELANTRA)	▪
KV 527			SUZUKI (GRAND VITARA)	▪
KV 528			TOYOTA (RAV 4 III * AURISAVENSIS * COROLLA)	▪
KF 529			MITSUBISHI (CARISMA * SPACE STAR)	▪
KV 530			NISSAN (SUNNY * ALMERA)	▪
KV 531			CHEVROLET DAEWOO (TACUMA * VIVANT)	▪
KV 532			BMW (7)	▪
KA 533			JAGUAR (XJ)	▪
P KV 534			ALFA ROMEO (166)	▪





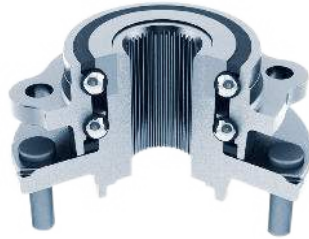

KF



KV

- KA Single row tapered roller bearings / Rodamientos de rodillos cónicos
- KB Double row tapered roller bearings / Rodamientos cónicos de doble hilera
- KC Ball bearings / Rodamientos de bolas
- KD Double row ball bearings / Rodamientos de bolas de doble hilera
- KF Double row angular contact ball bearings / Rodamientos de bolas de doble hilera de contacto angular
- KV 2nd and 3rd generation wheel hub units / Rodamientos de rueda con brida de 2ª y 3ª generación

Fersa				 
P KV 535			RENAULT (LAGUNA)	▪
P KV 536			ALFA ROMEO(145 * 146 * GTV * SPIDER), FIAT (BRAVO * MAREA), LANCIA (KAPPA * LYBRA)	▪
KV 537			TOYOTA (COROLLA)	▪
KV 538			TOYOTA (CARISMA * SAPCE WAGON)	▪
P KV 539			DACIA (LOGAN)	▪
KF 540			MAZDA (3)	▪
P KV541			SUZUKI (GRAND VITARA)	▪
KA 542	LM 11749/10	L 44649/10	KIA (PRIDE), MAZDA (121)	▪
KF 543			CITROËN (XM) PEUGEOT (605)	▪
KV 544			FIAT (PANDA), LANCIA (Y10)	▪
KA 545			HYUNDAI (LANTRA * PONY)	▪
P KV 546			RENAULT (SAFRANE)	▪
P KV 547			ALFA ROMEO (GTV * SPIDER)	▪
P KV 548			CITROËN (BERLINGO * XSARA), PEUGEOT (PARTNER)	▪
P KV 549			FORD (MONDEO)	▪



Fersa Accessories





Accesorios Fersa

13.1\	Fersa tools / Herramientas Fersa	230
13.2\	Grease / Grasa	232
13.3\	Complements / Complementos	234

13

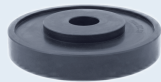

13.1 \ Fersa tools Herramientas Fersa

Fersa	PICTURE	BRAND	REMARKS
PRESS TOOL KITS / KIT DE HERRAMIENTAS PARA PRENSA			
BTA 001		VOLVO	F 200013 \ F 200014 \ F 200015
BTA 003		BPW	32310 F \ 33116 F
BTA 005		DAF	F 200016 \ F 200017 \ F 200018 \ F 200019
BTA 006		Universal	For complete disassembly and assembly with press \ Para el desmontaje y montaje de rodamientos con prensa
BTA 007		SCANIA	F 15097 \ HM 218248/10
BTC 038		SCANIA	Disassembly and Assembly F 15097 / Desmontaje y Montaje F15097

Fersa	PICTURE	BRAND	REMARKS
BTC 032		Mercedes Benz	Disassembly F 15100 / Desmontaje F 15100
BTC 041		Mercedes Benz	Assembly F 15100 / Montaje F 15100
BTC 047		SAF	ABS Assembler SAF 148mm
BTC 081		SAF	ABS Assembler SAF 156mm

HYDRAULIC BUSHINGS EXTRACTOR \ EXTRACTOR HIDRÁULICO DE BUJES

BTA 009		Universal	The Hydraulic Bushings Extractor is a set that includes the plate extractor and Fersa links. These, together with the cylinder and the manual hydraulic pump, facilitate the quick and safe removal up to a maximum of 23 tons. \ El Extractor Hidráulico de Bujes es un conjunto que incluye la placa extractora y los acoplamientos de Fersa. Estos, unidos al cilindro y la bomba hidráulica manual, facilitan una extracción rápida y segura, hasta un máximo de 23 toneladas.
---------	---	-----------	--

INNER RING EXTRACTOR / EXTRACTOR DE CONOS

By Part Number / Por referencia		Universal	Make to order, designs adapted to each part number / Fabricación bajo encargo, diseños adaptados a cada referencia.
---------------------------------	---	-----------	---

NLGI Consistency / Consistencia NLGI	Oil Viscosity (cSt at 40 °C) / Viscosidad del aceite (cST a 40 °C)	Welding Load (4 balls) / Carga de Soldadura (4bolas)	Color / Colour	Service Temperature / Temperatura de uso
2	150	>2500 N	Light Brown / Ambar	-20 / 120 °C 4 / 248 °F
3	150	>2500 N	Light Brown / Ambar	-20 / 120 °C 4 / 248 °F
3	150-220	>3150N	Blue / Azul	-20 / 160 °C 4 / 320 °F



13.3 \ Complements Complementos





Maintenance bearings Kit Kit de mantenimiento de rodamientos

Fersa	
	KRBC F 200013
	KRBC F 200014
	KRBC F 200015
	KRBC F 200032

Oil Seals Retenes

Fersa	PICTURE	BRAND	OEM
N KRRE-181		BPW	05.3700.76.70
N KRRE-204		BPW	02.5664.74.00
N KRRE-274		ROR	21200321A

Fersa	PICTURE	BRAND	OEM
N KRRE-281		VALX	502021001
N KRRE-282		BPW	02.5664.57.00

ABS
ABS

Fersa	PICTURE	BRAND	OEM
N ABS F 300001		SAF	4.029.1063.00
N ABS F 400008		VOLVO	20424109



Lists & Cross part number

Listados y cruces de referencias

14.1 \	Fersa special part number numerical list / Lista numérica de referencias especiales de Fersa	240
14.2 \	Fersa dimensional list / Lista dimensional Fersa	246
14.3 \	Cross part number / Cruces de referencias	268

Nomenclatures / Nomenclaturas		
AIR	Air conditioning	Aire acondicionado
BB	Standard ball bearing	Rodamientos de bolas estándar
BB4PAC	Four point angular contact ball bearing	Rodamiento de bolas de cuatro puntos de contacto angular
BBC	Clutch release bearing	Rodamiento de embrague
BBDRAC	Standard double row angular contact ball bearing	Rodamientos de bolas de doble hilera de contacto angular estándar
BBDRACS	Special double row angular contact ball bearing /	Rodamiento de doble hilera de bolas de contacto angular especial
BBS	Special ball bearing	Rodamiento de bolas especial
BBT	Thrust ball bearing	Rodamiento axial de bolas
CONE	Inner rings	Conjuntos interiores
CRB	Standard cylindrical bearing	Rodamiento cilíndrico estándar
CRBS	Special cylindrical bearing	Rodamiento cilíndrico especial
FBOX	F-Box Rebuild Kit	Kit de reparación F-box
IB	Insert Bearings	Rodamiento autoalineables
KIT	Passenger car wheel bearing kit	Kit de rueda de turismo
NRBS	Special needle roller bearing	Rodamientos de agujas especiales
PHA	Wheel hub assembly	Rodamientos integrales
PM	Pinion Module	Módulo de Piñón
TRBDR	Double row tapered roller bearing	Rodamientos cónicos de doble hilera
TRBF	Flange side bearing	Rodamiento con valona
TRBI	Inch series	Series pulgadas
TRBM	Metric series	Series métricas
TRBS	Special tapered roller bearing	Rodamiento de rodillos cónicos especial
TRBSt	Steering bearing	Rodamiento de dirección
TRBT	Thrust tapered roller bearing	Rodamiento axiales cónicos
U Series	U type bearing	Rodamiento de tipo U
WH	Wheel end Hub	Hub de rueda de camión
WK	Wheel end Kit	Kit de rueda de camión
WM	Wheel end module	Modulo de rueda de camión





14.1 \ Fersa special part number numerical list

Lista numérica de referencias especiales de Fersa

Fersa		PG.
F 15000 SERIE		
F 15001	TRBS	32
F 15002	TRBS	32
F 15003	TRBS	32
F 15004	BBT	110
F 15005	BBC	112
F 15014	TRBS	32
F 15015	TRBDR	56
F 15028	TRBS	32
F 15029	TRBS	32
F 15031	BBT	110
F 15034	BBT	110
F 15036	TRBS	32
F 15040	TRBS	32
F 15041	TRBDR	56
F 15042	TRBDR	56
F 15043	TRBDR	56
F 15044	TRBDR	56
F 15045	TRBDR	56
F 15046	TRBS	32
F 15047	TRBS	32
F 15048	TRBS	32
F 15050	TRBDR	56
F 15051 C	TRBS	32
F 15051 R	TRBS	32
F 15052	BBC	112
F 15054/3720	TRBS	32
F 15055/LM 29710	TRBS	32
F 15056	TRBS	32
F 15057	BBT	110
F 15058	BBT	110
F 15059	BBT	110
F 15060	BBT	110
F 15063	TRBS	32
F 15064	BBT	110
F 15067	TRBDR	56
F 15068	TRBDR	56
F 15071	TRBS	32
F 15075	TRBS	34
F 15076	TRBS	34
F 15080	TRBS	34
F 15082	TRBS	34
F 15083	TRBS	34
CONE F 15084	CONE	50
F 15088	TRBS	34
F 15089	TRBS	34
F 15090	TRBF	44
F 15091	BBT	110
F 15097	WH	154
F 15100	WH	154
CONE F 15101	CONE	50
F 15104	TRBS	34
F 15108	TRBF	44
F 15109	TRBS	34
CONE F 15110	CONE	50

Fersa		PG.
CONE F 15111	CONE	50
F 15112	TRBS	34
CONE F 15113	CONE	50
F 15114	TRBS	34
F 15115	TRBS	34
F 15116	TRBS	34
F 15117	TRBS	34
F 15118	BBC	112
F 15119	TRBS	34
F 15120	WH	154
F 15121	WH	154
F 15122	WH	154
F 15124	WH	154
F 15125	WH	154
F 15126	WH	154
F 15127	WH	154
F 15128	TRBDR	56
F 15129	TRBDR	56
F 15130	TRBDR	56
CONE F 15131	CONE	50
CONE F 15132	CONE	50
F 15133	TRBS	34
CONE F 15134	CONE	50
F 15139	BBC	112
F 15140	BBC	112
F 15141	BBC	112
F 15146	TRBDR	56
F 15149	TRBDR	56
CONE F 15150 A	CONE	50
F 15151	TRBDR	56
F 15154	TRBDR	56
F 15156	TRBS	34
F 15157	TRBS	34
F 15158	TRBS	34
F 15159	TRBS	34
F 15160	TRBDR	56
F 15161	TRBF	44
F 15165	TRBS	34
F 15168	TRBDR	58
F 15173	TRBDR	58
F 15174	TRBDR	58
F 15175	TRBDR	58
F 15183	TRBS	34
F 15184	TRBS	34
F 15187	TRBDR	58
F 15190	TRBS	36
F 15191	TRBF	44
F 15192	TRBF	44
F 15193	TRBS	36
F 15196	TRBF	44
F 15197	TRBS	36
F 15198	TRBF	44
F 15199	TRBS	36
F 15200	TRBS	36
F 15201	TRBS	36

Fersa		PG.
F 15202	TRBS	36
F 15203	TRBS	36
F 15208	TRBS	36
F 15209	BBC	112
F 15210	BBC	112
F 15211	BBC	112
F 15212	TRBF	44
CONE F 15213	CONE	50
F 15218	TRBDR	58
F 15224	BBC	112
F 15239	TRBS	36
CONE F 15244	CONE	50
F 15245	TRBS	36
F 15246	TRBF	44
CONE F 15249	CONE	50
F 15252	TRBS	36
F 15253	TRBS	36
F 15254	TRBS	36
F 15255	TRBS	36
F 15256	TRBS	36
F 15257	TRBS	36
F 15258	TRBS	36
F 15265	TRBF	44
F 15267	TRBS	36
F 15268	TRBDR	58
CONE F 15269	CONE	50
F 15270	TRBS	36
F 15271	TRBS	38
F 15272	TRBS	38
F 15273	TRBS	38
F 15278	TRBS	38
F 15279	TRBS	38
F 15280	TRBS	38
F 15291	TRBS	38
CONE F 15292	CONE	50
F 15295	TRBS	38
F 15298	TRBS	38
F 15300	WH	156
F 15302	TRBDR	58
F 15304	TRBS	38
F 15308	TRBS	38
F 15309	TRBS	38
F 15310	TRBF	44
F 15311	TRBF	44
F 15312	TRBF	44
F 15313	TRBS	38
F 15314	TRBS	38
F 15315	TRBS	38
F 15316	TRBS	38
F 15317	TRBS	58
F 15321	PM	38
F 15322	TRBS	38
F 15323	TRBS	38
F 15324	TRBDR	58
F 15326	TRBS	38

Fersa		PG.
CONE F 15327	CONE	50
CONE F 15328	CONE	50
F 15329	TRBS	38
F 15330	TRBDR	38
F 15332	TRBS	38
CONE F 15333	CONE	50
F 15334	TRBS	40
F 15336	TRBS	40
F 15337	TRBS	40
F 15338	TRBS	40
F 15339	TRBS	40
F 15340	TRBS	40
F 15341	TRBS	40
F 15342	TRBS	40
F 15345	TRBS	40
F 15346	TRBS	40
F 15347	TRBS	40
F 15348	TRBS	40
CONE F 15356	CONE	50
F 15357	TRBS	112
F 15360	TRBS	58
F 15361	TRBS	40
CONE F 15362	CONE	50
F 15366	TRBS	40
F 15367	TRBS	40
F 15371	PM	40
F 15376	TRBS	40
F 15377	TRBS	40
F 15380	TRBDR	40
F 15381	TRBDR	40
F 15382	TRBS	40
F 15383	TRBS	40
F 15384	TRBS	40
F 15385	TRBS	40
CONE F 15385	TRBS	52
F 15386	TRBS	42
F 15388	TRBS	42
CONE F 15388	TRBS	52
F 15389	TRBS	42
F 15414	WH	156
F 15426	TRBS	42
F 15462	TRBS	42
F 15463	TRBS	42
F 15479	TRBS	42
F 15483	TRBS	42
F 15484	TRBS	42
F 15485	TRBS	42
F 15498	TRBS	42

F 16000 SERIE		
F 16001	BBDRACS	88
F 16002	BBDRACS	88
F 16004	BBDRACS	88
F 16010	BBDRACS	88
F 16018	BBDRACS	88

14.1 \ Fersa special part number numerical list

Lista numérica de referencias especiales de Fersa

Fersa		PG.
F 16019	BBDRACS	88
F 16020	BBDRACS	88
F 16021	BBDRACS	88
F 16022	BBDRACS	88
F 16023	BBDRACS	88
F 16026	BBDRACS	88
F 16027	BBDRACS	88
F 16029	BBDRACS	88
F 16030	BBDRACS	90
F 16031	BBDRACS	90
F 16032	BBDRACS	90
F 16033	BBDRACS	90
F 16034	BBDRACS	90
F 16035	BBDRACS	90
F 16036	BBDRACS	90
F 16037	BBDRACS	90
F 16038	BBDRACS	90
F 16039	BBDRACS	90
F 16040	BBDRACS	92
F 16041	BBDRACS	92
F 16042	BBDRACS	92
F 16043	BBDRACS	92
F 16044	BBDRACS	92
F 16045	BBDRACS	92
F 16046	BBDRACS	92
F 16048	BBDRACS	92
F 16051	BBDRACS	92
F 16052	BBDRACS	92
F 16054	BBDRACS	92
F 16055	BBDRACS	92
F 16056	BBDRACS	94
F 16057	BBDRACS	94
F 16058	BBDRACS	94
F 16059	BBDRACS	94
F 16063	BBDRACS	94
F 16066	BBDRACS	94
F 16068	BBDRACS	94
F 16076	BBDRACS	94
F 16077	BBDRACS	94
F 16078	BBDRACS	94
F 16079	BBDRACS	94
F 16080	BBDRACS	94
F 16081	BBDRACS	94
F 16082	BBDRACS	94
F 16083	BBDRACS	94
F 16084	BBDRACS	96
F 16085	BBDRACS	96
F 16086	BBDRACS	96
F 16088	BBDRACS	96
F 16089	BBDRACS	96
F 16090	BBDRACS	96
F 16091	BBDRACS	96
F 16093	BBDRACS	96
F 16094	BBDRACS	96
F 16095	BBDRACS	96

Fersa		PG.
F 16097	AIR	106
F 16098	AIR	106
F 16099	AIR	106
F 16100	AIR	106
F 16101	AIR	106
F 16102	AIR	106
F 16103	AIR	106
F 16104	AIR	106
F 16107	BBDRACS	96
F 16108	BBDRACS	96
F 16109	BBDRACS	96
F 16110	BBDRACS	96
F 16115	BBDRACS	96
F 16117	BBDRACS	98
F 16118	BBDRACS	98
F 16120	BBDRACS	98
F 16121	BBDRACS	98
F 16123	BBDRACS	98
F 16124	BBDRACS	98
F 16128	BBDRACS	98
F 16129	BBDRACS	98
F 16189	AIR	106
F 16190	AIR	106
F 16193	BBDRACS	98
F 16194	BBDRACS	98
F 16195	BBDRACS	98
F 16196	BBDRACS	98
F 16197	BBDRACS	98
F 16198	BBDRACS	98
F 16199	BBDRACS	98
F 16200	BBDRACS	98
F 16201	BBDRACS	98
F 16202	BBDRACS	100
F 16203	BBDRACS	100
F 16204	BBDRACS	100
F 16205	BBDRACS	100
F 16207	BBDRACS	100
F 16208	BBDRACS	100
F 16209	BBDRACS	100
F 16210	BBDRACS	100
F 16211	BBDRACS	100
F 16213	BBDRACS	100
F 16214	BBDRACS	100
F 16215	BBDRACS	100
F 16216	BBDRACS	100
F 16217	BBDRACS	100
F 16218	BBDRACS	100
F 16219		

F 17000 K SERIE		
F 17003 K	NRBS	144
F 17031 K	NRBS	144
F 17032 K	NRBS	144
F 17033 K	NRBS	144

Fersa		PG.
F 17034 K	NRBS	144
F 17035 K	NRBS	144
F 17038 K	NRBS	144
F 17039 K	NRBS	144
F 17040 K	NRBS	144
F 17041 K	NRBS	144
F 17043 K	NRBS	144
F 17044 K	NRBS	144
F 17045 K	NRBS	144
F 17046 K	NRBS	144
F 17051 K	NRBS	144
F 17052 K	NRBS	144
F 17053 K	NRBS	144
F 17054 K	NRBS	144
F 17056 K	NRBS	144
F 17057 K	NRBS	146
F 17058 K	NRBS	146
F 17059 K	NRBS	146
F 17060 K	NRBS	146
F 17061 K	NRBS	146
F 17062 K	NRBS	146
F 17063 K	NRBS	146
F 17064 K	NRBS	146
F 17076 K	NRBS	146
F 17077 K	NRBS	146
F 17078 K	NRBS	146
F 17079 K	NRBS	146
F 17080 K	NRBS	146
F 17089 K	NRBS	146
F 17090 K	NRBS	146
F 17091 K	NRBS	146
F 17092 K	NRBS	146
F 17093 K	NRBS	146
F 17094 K	NRBS	146
F 17095 K	NRBS	146
F 17096 K	NRBS	146
F 17097 K	NRBS	146
F 17098 K	NRBS	146
F 17099 K	NRBS	146
F 17100 K	NRBS	148
F 17101 K	NRBS	148
F 17102 K	NRBS	148
F 17103 K	NRBS	148
F 17104 K	NRBS	148
F 17105 K	NRBS	148
F 17106 K	NRBS	148
F 17107 K	NRBS	148
F 17108 K	NRBS	148
F 17109 K	NRBS	148
F 17110 K	NRBS	148
F 17111 K	NRBS	148
F 17112 K	NRBS	148
F 17113 K	NRBS	148
F 17114 K	NRBS	148
F 17116 K	NRBS	148

Fersa		PG.
F 17117 K	NRBS	148
F 17120 K	NRBS	148
F 17121 K	NRBS	148
F 17122 K	NRBS	148
F 17123 K	NRBS	148
F 17124 K	NRBS	148
F 17125 K	NRBS	150
F 17126 K	NRBS	150
F 17127 K	NRBS	150
F 17128 K	NRBS	150
F 17129 K	NRBS	150

F 18000 SERIE		
F 18009	BBS	82
F 18011	BBS	82
F 18012	BBC	112
F 18013	BBC	112
F 18015	BBS	82
F 18018	BBS	82
F 18019	BBS	82
F 18020	BBS	82
F 18021	BBS	82
F 18022	BBS	82
F 18023	BBS	82
F 18024	BBS	82
F 18031	BBC	112
F 18032	BBS	82
F 18033	BBS	82
F 18036	BBS	82
F 18037	BBS	82
F 18038	BBS	82
F 18039	BBS	82
F 18040	BBC	112
F 18041	BBS	82
F 18042	BBS	82
F 18043	BBS	82
F 18046 2RS	BBS	82
F 18046 ZZ	BBS	84
F 18047	BBS	84
F 18048	BBS	84
F 18049	BBS	84
F 18050	BBS	84
F 18051	BBS	84
F 18052	BBS	84
F 18053	BBS	84
F 18054	BBS	84
F 18055	BBS	84
F 18056	BBS	84
F 18058	BBS	84
F 18059	BBS	84
F 18060	BBS	84
F 18062	BBS	84
F 18066	BBS	84
F 18067	BBS	84
F 18069	BBS	84

14.1 \ Fersa special part number numerical list

Lista numérica de referencias especiales de Fersa

Fersa		PG.
F 18074	BBS	84
F 18075	BBS	84
F 18076	BBS	84
F 18082	BBS	84
F 18083	BBS	84

F 19000 SERIE		
F 19001	CRBS	132
F 19002	CRBS	132
F 19003	CRBS	132
F 19004	CRBS	132
F 19005	CRBS	132
F 19006	CRBS	132
F 19008	CRBS	132
F 19009	CRBS	132
F 19010	CRBS	132
F 19011	CRBS	132
F 19012	CRBS	132
F 19013	CRBS	132
F 19014	CRBS	132
F 19015	CRBS	132
F 19016	CRBS	132
F 19019	CRBS	132
F 19020	CRBS	132
F 19022	CRBS	132
F 19023	CRBS	132
F 19024	CRBS	132
F 19025	CRBS	132
F 19026	CRBS	132
F 19029	CRBS	132
F 19030	CRBS	134
F 19031	CRBS	134
F 19032	CRBS	134
F 19033	CRBS	134
F 19034	CRBS	134
F 19035	CRBS	134
F 19037	CRBS	134
F 19038	CRBS	134
F 19039	CRBS	134
F 19040	CRBS	134
F 19042	CRBS	134
F 19043	CRBS	134
F 19044	CRBS	134
F 19045	CRBS	134
F 19046	CRBS	134
F 19047	CRBS	134
F 19048	CRBS	134
F 19055	CRBS	134
F 19061	CRBS	134
F 19062	CRBS	134
F 19063	CRBS	134
F 19064	CRBS	134
F 19065	CRBS	134
F 19066	CRBS	134

Fersa		PG.
F 19067	CRBS	134
F 19068	CRBS	134
F 19069	CRBS	134
F 19070	CRBS	136
F 19071	CRBS	136
F 19075	CRBS	136
F 19076	CRBS	136
F 19077	CRBS	136
F 19078	CRBS	136
F 19079	CRBS	136
F 19080	CRBS	136
F 19081	CRBS	136
F 19083	CRBS	136
F 19084	CRBS	136
F 19085	CRBS	136
F 19086	CRBS	136
F 19087	CRBS	136
F 19088	CRBS	136
F 19089	CRBS	136
F 19090	CRBS	136
F 19091	CRBS	136
F 19093	CRBS	136
F 19094	CRBS	136
F 19095	CRBS	136
F 19096	CRBS	136
F 19097	CRBS	136
F 19099	CRBS	136
F 19100	CRBS	136
F 19101	CRBS	136
F 19105	CRBS	138
F 19106	CRBS	138
F 19107	CRBS	138
F 19108	CRBS	138
F 19111	CRBS	138
F 19112	CRBS	138
F 19116	CRBS	138
F 19117	CRBS	138
F 19118	CRBS	138
F 19119	CRBS	138
F 19120	CRBS	138
F 19121	CRBS	138
F 19130	CRBS	140
F 19131	CRBS	140
F 19134	CRBS	140
F 19166	CRBS	140
F 19167	CRBS	140
F 19169	CRBS	140
F 19170	CRBS	140
F 19171	CRBS	140
F 19172	CRBS	140

F 200000 SERIE		
F 200004	WK	158
F 200005	WK	158
F 200013	WK	158

14.2 \ Fersa dimensional list Lista dimensional Fersa

d	D	T	FERSA		PG.
-	44,450	9,525	6	TRBSt	48
-	49,146	19,050	6 CE	TRBSt	48
-	49,225	11,509	13 C	TRBSt	48
-	54,600	22,000	F 19005	CRBS	132
-	55,000	20,000	F 19079	CRBS	136
-	57,092	17,094	14 XS	TRBSt	48
-	62,000	16,000	F 19068	CRBS	134
-	80,000	26,500	F 19069	CRBS	134
-	100,000	25,000	F 19117	CRBS	138
6,000	19,000	6,000	626	BB	68
7,000	19,000	6,000	607	BB	68
8,000	22,000	7,000	608	BB	68
8,000	24,000	8,000	628	BB	68
9,000	24,000	7,000	609	BB	68
9,000	26,000	8,000	629	BB	68
10,000	26,000	8,000	6000	BB	68
10,000	30,000	9,000	6200	BB	71
10,000	35,000	11,000	6300	BB	75
12,000	28,000	8,000	6001	BB	68
12,000	32,000	10,000	6201	BB	71
12,000	32,000	14,000	62201	BB	74
12,000	32,000	10,000 / 15,350	F 18046 2RS	BBS	82
12,000	32,000	10,000 / 15,350	F 18046 ZZ	BBS	84
12,000	37,000	12,000	6301	BB	75
12,000	40,000	12,000	6203/12	BB	71
12,200	36,600	11,000	F 15034	BBT	110
15,000	32,000	9,000	6002	BB	68
15,000	35,000	11,000	6202	BB	71
15,000	35,000	11,000	NU 202 FM/C3	CRB	129
15,000	35,000	11,000	NU 202 FP/C3	CRB	129
15,000	35,000	11,750	30202 F	TRBM	8
15,000	35,000	13,000	F 18015	BBS	82
15,000	35,000	14,000	62202	BB	74
15,000	42,000	13,000	6302	BB	75
15,000	42,000	14,250	30302 F	TRBM	8
15,000	47,000	14,000	6303/15	BB	75
15,875	42,862	14,288	11590/11520	TRBI	20
15,875	47,000	14,000	F 19055	CRBS	134
15,987	46,975	21,000	HM 81649/ HM 81610	TRBI	27

d	D	T	FERSA		PG.
16,300	56,000	9,000	F 15052	BBC	112
16,993	47,000	14,382	05066/05185	TRBI	19
17,000	35,000	10,000	6003	BB	68
17,000	40,000	12,000	6203	BB	71
17,000	40,000	13,250	30203 F	TRBM	8
17,000	47,000	14,000	6303	BB	75
17,000	47,000	15,250	30303 F	TRBM	8
17,000	47,000	15,250	31303 F	TRBM	9
17,000	52,000	15,000	6304/17	BB	75
17,000	52,000	16,000	6304/17 B16	BB	75
17,000	52,000	17,000	6304/17 B17	BB	75
17,000	62,000	17,000	6403	BB	78
17,000	62,000	17,000 / 17,600	F 18020	BBS	82
17,462	39,878	13,843	LM 11749/ LM 11710	TRBI	20
19,050	39,992	12,014	A 6075/A 6157	TRBI	19
19,050	44,450	12,700	4 A/6	TRBI	14
19,050	45,237	15,494	LM 11949 RS/ LM 11910	TRBI	20
19,050	45,237	15,494	LM 11949/ LM 11910	TRBI	20
19,050	49,225	18,034	09067/09195	TRBI	20
19,050	49,225	19,845	09074/09195	TRBI	20
19,050	49,225	21,209	09067/09196	TRBI	20
19,050	49,225	23,020	09074/09194	TRBI	20
19,050	49,225	23,020	09074/09196	TRBI	20
19,050	53,975	22,225	21075/21212	TRBI	22
20,000	37,000	9,000	61904	BB	71
20,000	42,000	12,000	6004	BB	69
20,000	42,000	15,000	32004 XF	TRBM	9
20,000	42,000	15,000	32004 XR	TRBM	9
20,000	47,000	14,000	6204	BB	71
20,000	47,000	15,250	30204 F	TRBM	8
20,000	47,000	18,000	62204	BB	74
20,000	47,000	19,250	32204 F	TRBM	10
20,000	47,000	19,250	32204 FR	TRBM	10
20,000	47,000	25,150	F 16219	CRB	100
20,000	47,000	25,150	F 16219		100
20,000	52,000	12,000	6304 B12	BB	75
20,000	52,000	15,000	6304	BB	75
20,000	52,000	15,000	NUP 304 FM/C3	CRB	130

d	D	T	FERSA		PG.
20,000	52,000	15,000	NUP 304 FP/C3	CRB	130
20,000	52,000	16,250	30304 F	TRBM	8
20,000	52,000	19,250	F 15199	TRBS	36
20,000	52,000	21,000	62304	BB	74
20,000	52,000	22,250	32304 F	TRBM	11
20,000	56,000	12,000	6304 B12 D56	BB	75
20,000	72,000	19,000	6404	BB	78
20,625	49,225	19,845	09081/09195	TRBI	20
20,625	49,225	23,020	09081/09196	TRBI	20
21,430	45,237	15,494	LM 12748/ LM 12710	TRBI	20
21,430	50,005	17,026	M 12649 F/ M 12610 F	TRBI	20
21,430	50,005	17,526	M 12649/M 12610	TRBI	20
21,986	45,000	6,500	F 15108	TRBF	44
21,986	45,237	15,494	LM 12749/ LM 12710	TRBI	20
21,986	45,974	15,494	LM 12749/ LM 12711	TRBI	20
22,000	41,000	14,500	F 15028	TRBS	32
22,000	44,000	15,000	320/22 XF	TRBM	9
22,000	47,000	20,750	F 15063	TRBS	32
22,000	47,000	20,750	F 15089	TRBS	34
22,000	50,000	14,000	62/22	BB	71
22,000	56,000	16,000	63/22	BB	74
22,000	62,000	21,000	F 18067	BBS	84
22,225	50,800	15,011	07087 X/07210 X	TRBI	20
22,225	50,800	15,011	07087/07210 X	TRBI	20
22,225	51,994	15,011	07087/07204	TRBI	20
22,225	52,388	19,368	1380/1328	TRBI	17
22,225	57,150	22,225	1280/1220	TRBI	17
23,812	56,896	19,368	1779/1729 X	TRBI	17
24,000	-	17,000	F 19032	CRBS	134
24,000	-	28,500	CONE F 15084	CONE	50
24,054	48,021	15,088	T 94	TRBT	64
25,000	39,000	20,000	F 17126 K	NRBS	150
25,000	47,000	12,000	6005	BB	69
25,000	47,000	15,000	32005 XF	TRBM	9
25,000	47,000	15,000	32005 XR	TRBM	9
25,000	51,400	13,200	F 15339	TRBS	40
25,000	51,994	15,011	07097/07204	TRBI	20
25,000	52,000	15,000	6205	BB	71

d	D	T	FERSA		PG.
25,000	52,000	16,250	30205 F	TRBM	8
25,000	52,000	16,250	30205 FR	TRBM	8
25,000	52,000	16,300	F 15337	TRBS	40
25,000	52,000	18,000	62205	BB	74
25,000	52,000	18,000	F 19023	CRBS	132
25,000	52,000	18,000	NJ 2205 FM/C3	CRB	128
25,000	52,000	18,000	NUP 2205 FM/C3	CRB	130
25,000	52,000	19,250	32205 BF	TRBM	10
25,000	52,000	19,250	32205 F	TRBM	10
25,000	52,000	21,000	F 19029	CRBS	132
25,000	52,000	22,000	33205 F	TRBM	13
25,000	52,000	31,000	GRAE 25 NPPB	IB	124
25,000	52,000	37,000	F 15041	TRBDR	56
25,000	52,000	37,000	F 15050	TRBDR	56
25,000	52,000	42,000	F 16129	BBDRACS	98
25,000	52,000	43,000	F 15042	TRBDR	56
25,000	52,000	44,500	GE 25 KRRB	IB	124
25,000	52,000	18,000 / 20,600	F 19004	CRBS	132
25,000	54,000	9,250	F 15196	TRBF	44
25,000	55,000	13,750	F 15315	TRBS	38
25,000	55,000	13,750	F 15336	TRBS	40
25,000	55,000	15,000	F 18058	BBS	84
25,000	55,000	43,000	F 15043	TRBDR	56
25,000	55,000	45,000	F 15175	TRBDR	58
25,000	56,000	12,000	6205 B12 D56	BB	72
25,000	56,000	32,000	F 16004	BBDRACS	88
25,000	57,000	18,000	F 19093	CRBS	136
25,000	59,000	4,100	F 15090	TRBF	44
25,000	59,000	17,500	F 18019	BBS	82
25,000	59,000	24,000	F 19166	CRBS	140
25,000	62,000	17,000	6305	BB	75
25,000	62,000	17,000	NJ 305 F	CRB	128
25,000	62,000	17,250	F 15313	TRBS	38
25,000	62,000	18,250	30305 F	TRBM	8
25,000	62,000	18,250	31305 F	TRBM	9
25,000	62,000	18,250	F 15001	TRBS	32
25,000	62,000	19,000	F 18062	BBS	84
25,000	62,000	21,250	F 15479	TRBS	42
25,000	62,000	24,000	62305	BB	74
25,000	62,000	25,250	32305 F	TRBM	11

14.2 \ Fersa dimensional list Lista dimensional Fersa

d	D	T	FERSA		PG.
25,000	62,000	17,000 / 19,000	F 19040	CRBS	134
25,000	62,020	17,500	F 18018	BBS	82
25,000	66,000	22,050	F 15316	TRBS	38
25,000	69,000	20,000	F 18022	BBS	82
25,000	72,000	19,000	6306/25	BB	76
25,000	80,000	21,000	6405	BB	78
25,000	80,000	21,000	NJ 405 FM	CRB	128
25,400	33,338	25,400	F 17114 K	NRBS	148
25,400	50,005	13,495	07100 S/07196	TRBI	20
25,400	50,005	13,495	07100/07196	TRBI	20
25,400	50,292	14,224	L 44643 RS/ L 44610	TRBI	25
25,400	50,292	14,224	L 44643/L 44610	TRBI	25
25,400	50,800	15,011	07100 S/07210 X	TRBI	20
25,400	51,994	15,011	07100/07204	TRBI	20
25,400	56,896	19,368	1780/1729	TRBI	17
25,400	57,150	17,462	15578/15520	TRBI	22
25,400	57,150	19,431	M 84548/M 84510	TRBI	27
25,400	58,738	19,050	1986/1932	TRBI	17
25,400	59,530	23,368	M 84249/M 84210	TRBI	27
25,400	60,325	19,845	1986/1931	TRBI	17
25,400	62,000	19,050	15100/15245	TRBI	21
25,400	62,000	19,050	15101/15245	TRBI	21
25,400	63,500	20,638	15100/15250	TRBI	21
25,400	63,500	20,638	15100/15250 X	TRBI	21
25,400	63,500	20,638	15101/15250	TRBI	21
25,400	63,500	20,638	15101/15250 X	TRBI	21
25,654	50,800	15,875	T 101	TRBT	64
25,987	51,986	15,011	L 44645/L 44613	TRBI	25
25,987	57,150	17,462	15579 X/15520	TRBI	22
25,995	68,000	14,500 / 21,550	F 18024	BBS	82
26,000	61,000	19,000	15103/15243	TRBI	21
26,162	61,912	19,050	15103 S/15243	TRBI	21
26,162	62,000	19,050	15103 S/15245	TRBI	21
26,988	50,292	14,224	F 15308	TRBS	38
26,988	50,292	14,224	L 44649/L 44610	TRBI	25
26,988	57,150	17,462	15580/15520	TRBI	22
26,988	62,000	19,050	15106/15245	TRBI	21
26,988	63,500	20,638	15106/15250	TRBI	22
26,988	63,500	20,638	15106/15250 X	TRBI	22

d	D	T	FERSA		PG.
27,000	51,400	13,200	F 15342	TRBS	40
27,000	52,000	45,000 / 50,000	F 15151	TRBDR	56
27,000	53,000	43,000	F 15128	TRBDR	56
27,000	66,000	6,700	F 15312	TRBF	44
27,000	134,000	67,600 / 50,000	F 16094	BBDRACS	96
27,762	62,000	18,000	F 19134	CRBS	140
28,000	52,000	15,750	F 15056	TRBS	32
28,000	52,000	16,000	320/28 XF	TRBM	9
28,000	55,000	13,750	F 15338	TRBS	40
28,000	57,150	17,462	J 15585/15520	TRBI	22
28,000	61,000	42,000	F 16077	BBDRACS	94
28,000	66,000	18,000	F 18021	BBS	82
28,000	68,000	18,000	63/28	BB	74
28,000	68,000	19,750	303/28 F	TRBM	8
28,000	72,000	27,600	F 18082	BBS	84
28,000	75,000	21,000	F 18043	BBS	82
28,000	119,000	52,000 / 42,000	F 16095	BBDRACS	96
28,000	120,000	63,500	F 16210	BBDRACS	100
28,000	-	32,000	CONE F 15101	CONE	50
28,313	-	-	5 BC	TRBSt	48
28,500	47,600	32,000	F 19095	CRBS	136
28,575	56,896	19,845	1985/1930	TRBI	17
28,575	57,150	19,845	1985/1922	TRBI	17
28,575	57,150	19,845	1988/1922	TRBI	17
28,575	58,738	19,050	1985/1932	TRBI	17
28,575	60,325	19,845	1985/1931	TRBI	17
28,575	60,325	19,845	1988/1931	TRBI	17
28,575	62,000	19,050	15112/15245	TRBI	22
28,575	63,500	20,638	15112/15250	TRBI	22
28,575	63,500	20,638	15112/15250 X	TRBI	22
28,575	64,292	21,432	M 86647/M 86610	TRBI	27
28,575	66,421	23,812	2689/2631	TRBI	17
28,575	68,262	22,225	02474/02420	TRBI	19
28,575	71,438	20,638	RMS 9	BB	80
28,575	72,626	24,608	41125/41286	TRBI	25
28,575	73,025	22,225	02872/02820	TRBI	19
28,575	79,375	25,400	43112/43312	TRBI	25
28,829	55,562	15,875	T 113	TRBT	64
29,000	50,292	14,224	F 15029	TRBS	32

d	D	T	FERSA		PG.
29,000	50,292	14,224	L 45449/L 45410	TRBI	25
29,000	53,000	37,000	F 15067	TRBDR	56
29,987	62,000	19,050	15117/15245	TRBI	22
30,000	52,000	22,000	F 16097	AIR	106
30,000	55,000	13,000	6006	BB	69
30,000	55,000	17,000	32006 XF	TRBM	9
30,000	55,000	20,000	33006 F	TRBM	12
30,000	55,000	23,000	F 16098	AIR	106
30,000	55,500	7,000	F 15311	TRBF	44
30,000	59,000	13,000 / 15,000	F 19024	CRBS	132
30,000	60,030	37,000	F 16001	BBDRACS	88
30,000	61,935	19,050	F 19031	CRBS	134
30,000	61,935	23,813	F 19045	CRBS	134
30,000	62,000	16,000	6206	BB	72
30,000	62,000	16,000	N 206 FM	CRB	128
30,000	62,000	16,000	NJ 206 FP	CRB	128
30,000	62,000	16,000	NU 206 FM	CRB	129
30,000	62,000	16,000	NUP 206 FM	CRB	129
30,000	62,000	17,250	30206 F	TRBM	8
30,000	62,000	18,000	32007 X 30/ 32007 XF	TRBM	10
30,000	62,000	20,000	62206	BB	74
30,000	62,000	20,000	F 15309	TRBS	38
30,000	62,000	20,000	F 19025	CRBS	132
30,000	62,000	20,000	NJ 2206 FM	CRB	128
30,000	62,000	20,000	NJ 2206 FP	CRB	128
30,000	62,000	20,000	NUP 2206 FP	CRB	130
30,000	62,000	21,250	32206 F	TRBM	10
30,000	62,000	23,800	3206 B 2RS/C3	BBDRAC	102
30,000	62,000	24,000	F 19096	CRBS	136
30,000	62,000	25,000	33206 F	TRBM	13
30,000	62,000	27,000	F 16104	AIR	106
30,000	62,000	35,800	GRAE 30 NPPB	IB	124
30,000	62,000	48,000	F 15360	TRBS	58
30,000	62,000	48,500	GE 30 KRRB	IB	124
30,000	65,000	21,000	F 18011	BBS	82
30,000	69,012	19,845	14118/14274	TRBI	21
30,000	72,000	19,000	6306	BB	76
30,000	72,000	19,000	F 19091	CRBS	136
30,000	72,000	19,000	NJ 306 FM	CRB	128

d	D	T	FERSA		PG.
30,000	72,000	20,750	30306 F	TRBM	8
30,000	72,000	20,750	31306 F	TRBM	9
30,000	72,000	20,750	F 15002	TRBS	32
30,000	72,000	24,000	F 15203	TRBS	36
30,000	72,000	27,000	62306	BB	74
30,000	72,000	27,000	NU 2306 F	CRB	129
30,000	72,000	27,000	NU 2306 F/C3	CRB	129
30,000	72,000	27,000	NU 2306 FM/C3	CRB	129
30,000	72,000	28,750	32306 BF	TRBM	11
30,000	72,000	28,750	32306 C	TRBM	11
30,000	72,000	28,750	32306 F	TRBM	11
30,000	72,000	29,370	JHM 88540/ JHM 88513	TRBI	28
30,000	72,085	22,385	14118/14283	TRBI	21
30,000	75,000	21,000	F 18047	BBS	84
30,000	80,000	21,000	F 19078	CRBS	136
30,000	80,000	21,000	F 19083	CRBS	136
30,000	80,000	26,000	F 19120	CRBS	138
30,000	90,000	23,000	6406	BB	78
30,000	90,000	23,000	NJ 406 FM	CRB	128
30,000	90,000	23,000	NJ 406 FM/C3	CRB	128
30,000	117,000	61,300 / 37,000	F 16010	BBDRACS	88
30,000	120,000	63,500	F 16209	BBDRACS	100
30,000	-	23,000	F 19075	CRBS	136
30,000	-	23,812	F 19118	CRBS	138
30,000	-	26,000	F 19019	CRBS	132
30,162	64,292	21,432	M 86649/M 86610	TRBI	27
30,162	68,262	8,730	M 88043/M 88010 B	TRBF	44
30,162	68,262	22,225	M 88043/M 88010	TRBI	28
30,162	68,262	22,225	M 88043/M 88011	TRBI	28
30,213	62,000	19,050	15118/15245	TRBI	22
30,213	63,500	20,638	15118/15250	TRBI	22
30,213	63,500	20,638	15118/15250 X	TRBI	22
30,226	69,012	19,845	14116/14276	TRBI	21
30,416	55,562	15,875	T 119	TRBT	64
30,600	59,000	16,700	F 18074	BBS	84
30,955	64,292	21,432	M 86648 A/ M 86610	TRBI	27
31,750	58,877	15,875	LM 67048/ LM 67010 BA	TRBF	44

14.2\ Fersa dimensional list

Lista dimensional Fersa

d	D	T	FERSA		PG.
31,750	59,131	6,375	LM 67048/ LM 67010 BCE	TRBF	44
31,750	59,131	15,875	LM 67048 RS/ LM 67010	TRBI	27
31,750	59,131	15,875	LM 67048/ LM 67010	TRBI	27
31,750	59,131	15,875	LM 67049 A/ LM 67010	TRBI	27
31,750	61,986	15,875	LM 67048/ LM 67014	TRBI	27
31,750	61,986	15,875	LM 67048/ LM 67014 X	TRBI	27
31,750	61,986	15,875	LM 67049 A/ LM 67014	TRBI	27
31,750	62,000	7,938	F 15198	TRBF	44
31,750	62,000	18,161	15123/15245	TRBI	22
31,750	62,000	19,050	15126/15245	TRBI	22
31,750	62,000	19,749	15123/15244	TRBI	22
31,750	63,500	19,749	15123/15250 X	TRBI	22
31,750	63,500	20,638	15126/15250 X	TRBI	22
31,750	66,421	25,400	2580/2520	TRBI	17
31,750	68,262	22,225	02475/02420	TRBI	19
31,750	68,262	22,225	M 88046/M 88010	TRBI	28
31,750	69,012	19,845	14125 A/14274	TRBI	21
31,750	69,012	19,845	14125 A/14276	TRBI	21
31,750	69,012	26,983	14123 AA/14274	TRBI	21
31,750	69,012	26,983	14123 AA/14276	TRBI	21
31,750	69,850	23,812	2580/2523	TRBI	17
31,750	72,085	22,385	14125 A/14283	TRBI	21
31,750	73,025	29,370	HM 88542/ HM 88510	TRBI	27
32,000	40,000	49,200	F 17078 K	NRBS	146
32,000	53,000	14,500	JL 26749 F/ JL 26710	TRBI	23
32,000	55,000	13,000	6006/32	BB	69
32,000	58,000	17,000	320/32 XF	TRBM	9
32,000	58,000	17,000	320/32 XR	TRBM	9
32,000	75,000	20,000	63/32	BB	74
32,000	80,000	23,000	F 18048	BBS	84
32,000	-	29,500	CONE F 15110	CONE	50
32,000	-	33,000	CONE F 15213	CONE	50
32,004	55,562	15,875	T 126	TRBT	64
33,000	72,000	17,000	6207/33	BB	72
33,000	75,000	21,500	F 18069	BBS	84
33,297	-	-	11 BC	TRBSt	48

d	D	T	FERSA		PG.
33,337	88,500	25,400	44131/44348	TRBI	25
33,338	66,675	20,638	1680/1620	TRBI	17
33,338	68,262	22,225	M 88048/M 88010	TRBI	28
33,338	69,012	19,845	14130/14274	TRBI	21
33,338	69,012	19,845	14130/14276	TRBI	21
33,338	69,012	19,845	14131/14274	TRBI	21
33,338	69,012	19,845	14131/14276	TRBI	21
33,338	69,850	23,812	2585/2523	TRBI	17
33,338	73,025	29,370	HM 88547/ HM 88510	TRBI	28
33,338	76,200	29,370	HM 89443/ HM 89410	TRBI	28
33,338	76,200	29,370	HM 89443/ HM 89411	TRBI	28
33,338	79,375	29,370	3477/3420	TRBI	18
34,000	62,000	18,000	32007 X 34/ 32007 XF	TRBM	10
34,000	62,000	37,000	F 16018	BBDRACS	88
34,000	64,000	22,000	F 19167	CRBS	140
34,000	64,000	37,000	F 16019	BBDRACS	88
34,000	66,000	37,000	F 16020	BBDRACS	88
34,000	67,000	37,000	F 16083	BBDRACS	94
34,925	65,088	18,034	LM 48548 RS/ LM 48510	TRBI	26
34,925	65,088	18,034	LM 48548/ LM 48510	TRBI	26
34,925	68,262	18,034	LM 48548/ LM 48514 XP	TRBI	26
34,925	68,262	20,638	14585/14525	TRBI	21
34,925	69,012	19,845	14137 A/14274	TRBI	21
34,925	69,012	19,845	14137 A/14276	TRBI	21
34,925	69,012	19,845	14137 AS/14276	TRBI	21
34,925	69,012	19,845	14138 A/14274	TRBI	21
34,925	69,012	19,845	14138 A/14276	TRBI	21
34,925	69,012	26,983	14136 A/14276	TRBI	21
34,925	72,085	22,385	14138 A/14283	TRBI	21
34,925	72,233	25,400	HM 88649/ HM 88610	TRBI	28
34,925	73,025	23,812	25877/25820	TRBI	23
34,925	73,025	23,812	25877/25821	TRBI	23
34,925	73,025	23,812	25878/25820	TRBI	23
34,925	73,025	23,812	F 15384	TRBS	40
34,925	73,025	26,988	23690/23620	TRBI	22
34,925	73,025	26,988	F 15080	TRBS	34

d	D	T	FERSA		PG.
34,925	76,200	29,370	31593/31520	TRBI	24
34,925	76,200	29,370	31594/31520	TRBI	24
34,925	76,200	29,370	HM 89446/ HM 89410	TRBI	28
34,925	79,375	29,370	3478/3420	TRBI	18
34,925	80,035	21,433	28137/28317	TRBI	24
34,925	85,725	30,162	3872/3820	TRBI	18
34,987	59,131	15,875	L 68149 R/L 68110	TRBI	27
34,987	59,131	15,875	L 68149/L 68110	TRBI	27
34,987	59,975	15,875	L 68149/L 68111	TRBI	27
34,987	61,975	16,700	LM 78349/LM 78310 A	TRBI	27
34,987	64,975	18,100	U 298/U 261 L	U Series	46
34,987	65,088	15,875	L 68149/L 68116	TRBI	27
34,993	80,000	23,000	F 19043	CRBS	134
35,000	50,000	20,000	F 16099	AIR	106
35,000	52,000	22,000	F 16101	AIR	106
35,000	55,000	20,000	F 16100	AIR	106
35,000	60,000	13,000	F 15040	TRBS	32
35,000	60,000	15,875	F 15036	TRBS	32
35,000	60,000	15,875	JL 68145/ JL 68111 Z	TRBI	27
35,000	62,000	14,000	6007	BB	69
35,000	62,000	18,000	32007 XF	TRBM	10
35,000	62,000	18,000	32007 XR	TRBM	10
35,000	62,000	16,700 / 19,000	F 19066	CRBS	134
35,000	64,000	37,000	F 16200	BBDRACS	98
35,000	65,000	35,000	F 15044	TRBDR	56
35,000	65,000	35,000	F 15381	TRBS	40
35,000	65,000	35,000	F 16021	BBDRACS	88
35,000	66,000	32,000	F 16022	BBDRACS	88
35,000	66,000	33,000	F 16093	BBDRACS	96
35,000	66,000	37,000	F 16023	BBDRACS	88
35,000	68,000	37,000	F 16002	BBDRACS	88
35,000	68,000	48,000	F 15173	TRBDR	58
35,000	72,000	17,000	6207	BB	72
35,000	72,000	18,250	30207 F	TRBM	8
35,000	72,000	20,600	F 19035	CRBS	134
35,000	72,000	23,000	62207	BB	74
35,000	72,000	23,000	NU 2207 FM	CRB	129
35,000	72,000	24,000	F 15197	TRBS	36

d	D	T	FERSA		PG.
35,000	72,000	24,250	32207 F	TRBM	10
35,000	72,000	26,988	F 19086	CRBS	136
35,000	72,000	27,000	3207 B 2RS/C3	BBDRAC	102
35,000	72,000	28,000	33207 F	TRBM	13
35,000	72,000	33,000	F 16026	BBDRACS	88
35,000	72,000	33,000	F 16204	BBDRACS	100
35,000	72,000	34,000	F 16201	BBDRACS	98
35,000	72,000	39,000	GRAE 35 NPPB	IB	124
35,000	72,000	51,300	GE 35 KRRB	IB	124
35,000	72,040	33,000	F 16027	BBDRACS	88
35,000	75,000	20,000	F 18023	BBS	82
35,000	75,000	60,000	F 15317	TRBS	58
35,000	77,000	23,300	F 18083	BBS	84
35,000	80,000	18,250	30207/80 F	TRBM	8
35,000	80,000	21,000	6307	BB	76
35,000	80,000	21,000	F 19077	CRBS	136
35,000	80,000	21,000	F 19100	CRBS	136
35,000	80,000	21,000	N 307 FM	CRB	128
35,000	80,000	21,000	NUP 307 FP/C3	CRB	130
35,000	80,000	22,000	F 19020	CRBS	132
35,000	80,000	22,750	30307 F	TRBM	8
35,000	80,000	22,750	31307 F	TRBM	9
35,000	80,000	22,750	F 15014	TRBS	32
35,000	80,000	23,000	6307 B23	BB	76
35,000	80,000	23,000	F 19012	CRBS	132
35,000	80,000	26,000	F 19099	CRBS	136
35,000	80,000	31,000	NU 2307 F	CRB	129
35,000	80,000	31,000	NU 2307 F/C3	CRB	129
35,000	80,000	31,000	NU 2307 FM/C3	CRB	129
35,000	80,000	32,750	32307 F	TRBM	11
35,000	80,000	34,900	3307 B 2RS/C3	BBDRAC	102
35,000	85,000	23,000	F 18075	BBS	84
35,000	89,000	38,000	F 15202	TRBS	36
35,000	90,000	23,000	F 19084	CRBS	136
35,000	100,000	25,000	6407	BB	78
35,000	-	25,000	F 19037	CRBS	134
35,179	58,738	15,875	T 139	TRBT	64
35,179	66,675	19,446	T 138	TRBT	64
35,717	72,233	25,400	HM 88648/ HM 88610	TRBI	28
36,000	66,000	35,000	F 16211	BBDRACS	100

14.2\ Fersa dimensional list

Lista dimensional Fersa

d	D	T	FERSA		PG.
36,000	68,000	33,000	F 16115	BBDRACS	96
36,000	-	20,000	F 19048	CRBS	134
36,487	68,000	15,000	F 18038	BBS	82
36,487	73,025	23,812	25880/25820	TRBI	23
36,487	73,025	23,812	25880/25821	TRBI	24
36,487	76,200	23,812	2780/2720	TRBI	17
36,487	76,200	23,812	2780/2729	TRBI	17
36,512	76,200	29,370	HM 89448/ HM 89410	TRBI	28
36,512	76,200	29,370	HM 89449/ HM 89410	TRBI	28
36,512	85,725	30,162	3878/3820	TRBI	18
36,513	68,000	15,000	F 18039	BBS	82
36,754	66,675	19,446	T 144	TRBT	64
37,000	57,000	31,000	F 19090	CRBS	136
37,000	72,000	18,250	30207/37 F	TRBM	8
37,000	72,000	33,000	F 16029	BBDRACS	88
37,000	72,000	37,000	F 16030	BBDRACS	90
37,000	72,040	37,000	F 16031	BBDRACS	90
37,000	74,000	45,000	F 16032	BBDRACS	90
37,000	80,000	26,500	F 19116	CRBS	138
37,000	139,000	64,000 / 45,000	F 16033	BBDRACS	90
37,990	74,020	33,000 / 36,000	F 16034	BBDRACS	90
38,000	46,000	32,000	F 17105 K	NRBS	148
38,000	63,000	17,000	JL 69345/ JL 69310 Z	TRBI	27
38,000	63,000	17,000	JL 69349/JL 69310	TRBI	27
38,000	69,000	39,000	F 16218	BBDRACS	100
38,000	70,000	38,000	F 16215	BBDRACS	100
38,000	71,020	33,000 / 33,000	F 16120	BBDRACS	98
38,000	72,000	40,000	F 16124	BBDRACS	98
38,000	72,020	33,000 / 36,000	F 16068	BBDRACS	94
38,000	73,000	40,000	F 16117	BBDRACS	98
38,000	74,000	50,000	F 16058	BBDRACS	94
38,000	83,000	25,400	F 19067	CRBS	134
38,000	89,600	25,400	F 19094	CRBS	136
38,000	90,000	35,250	323/38 F	TRBM	11
38,000	90,000	23,000 / 22,000	F 19014	CRBS	132

d	D	T	FERSA		PG.
38,000	94,000	33,000 / 31,500	F 19076	CRBS	136
38,090	67,300 / 72,500	18,200	F 15091	BBT	110
38,100	65,088	18,034	F 15055/LM 29710	TRBS	32
38,100	65,088	18,034	LM 29748/ LM 29710	TRBI	24
38,100	65,088	18,034	LM 29749/ LM 29710	TRBI	24
38,100	65,088	19,812	LM 29748/ LM 29711	TRBI	24
38,100	65,088	19,812	LM 29749/ LM 29711	TRBI	24
38,100	68,262	15,875	19150/19268	TRBI	22
38,100	69,010	26,190	13686/13621	TRBI	20
38,100	69,012	19,050	13685/13621	TRBI	20
38,100	69,012	19,050	13687/13620	TRBI	20
38,100	69,012	19,050	13687/13621	TRBI	21
38,100	70,000	37,000	F 16057	BBDRACS	94
38,100	72,238	20,638	16150/16284	TRBI	22
38,100	76,200	23,812	2788/2720	TRBI	17
38,100	76,200	23,812	2788/2729	TRBI	17
38,100	76,200	25,400	26878/26823	TRBI	24
38,100	79,375	29,370	3490/3420	TRBI	18
38,100	80,167	29,370	3381/3320	TRBI	18
38,100	82,550	29,370	HM 801346 X/ HM 801310	TRBI	30
38,100	82,550	29,370	HM 801346/ HM 801310	TRBI	30
38,100	88,500	26,988	418/414	TRBI	15
38,100	90,000	35,250	F 15157	TRBS	34
38,100	-	29,771	CONE F 15131	CONE	50
38,303	65,883	19,431	T 149	TRBT	64
38,354	72,619	20,638	T 152	TRBT	64
38,354	72,619	21,433	T 151	TRBT	64
39,000	68,000	37,000	F 15045	TRBDR	56
39,000	68,000	37,000	F 16035	BBDRACS	90
39,000	72,000	37,000	F 16036	BBDRACS	90
39,000	72,000	37,000	F 16110	BBDRACS	96
39,000	74,000	39,000	F 16037	BBDRACS	90
39,000 / 41,000	75,000	37,000	F 16038	BBDRACS	90
39,100	74,000	34,000	F 16205	BBDRACS	100
39,688	73,025	19,395	U 399/U 360 L	U Series	46
39,688	76,200	23,812	2789/2720	TRBI	17

d	D	T	FERSA		PG.
39,688	76,200	23,812	2789/2729	TRBI	18
39,688	79,967	19,395	U 399/U 365 L	U Series	46
39,688	79,975	29,370	3386/3325	TRBI	18
39,688	80,167	29,370	3382/3320	TRBI	18
39,688	80,167	29,370	3386/3320	TRBI	18
39,688	80,167	29,370	F 15109	TRBS	34
39,688	90,488	39,688	4367 X/4335	TRBI	19
39,688	-	40,386	CONE 4367 X	CONE	50
39,688	-	40,386	CONE F 15249	CONE	50
39,688	-	43,050	CONE F 15292	CONE	50
39,980	108,000	17,000 / 32,000	F 16044	BBDRACS	92
39,987	90,975	32,000	HM 204043/ HM 204010	TRBI	28
40,000	48,000	20,000	F 17106 K	NRBS	148
40,000	57,000	24,000	F 16189	AIR	106
40,000	60,000	3,000	F 17003 K	NRBS	144
40,000	60,000	26,000	F 19111	CRBS	138
40,000	62,000	20,625	F 16103	AIR	106
40,000	62,000	24,000	F 16102	AIR	106
40,000	62,000	20,600 / 24,000	F 16190	AIR	106
40,000	68,000	15,000	6008	BB	69
40,000	68,000	15,000	NU 1008 FM	CRB	129
40,000	68,000	19,000	32008 XF	TRBM	10
40,000	72,000	37,000	F 16039	BBDRACS	90
40,000	73,000	55,000	F 15187	TRBDR	58
40,000	74,000	36,000	F 16080	BBDRACS	94
40,000	74,000	40,000	F 16040	BBDRACS	92
40,000	74,000	40,000	F 16089	BBDRACS	96
40,000	74,000	42,000	F 16079	BBDRACS	94
40,000	74,000	34,000 / 36,000	F 16091	BBDRACS	96
40,000	75,000	8,000	F 15310	TRBF	44
40,000	75,000	26,000	33108 F	TRBM	12
40,000	75,000	37,000	F 16055	BBDRACS	92
40,000	75,000	39,000	F 16217	BBDRACS	100
40,000	75,000	50,000	F 15129	TRBDR	56
40,000	76,000	33,000	F 16198	BBDRACS	98
40,000	76,040	38,000 / 41,000	F 16041	BBDRACS	92
40,000	80,000	7,750	30208 BF	TRBF	44
40,000	80,000	18,000	6208	BB	72

d	D	T	FERSA		PG.
40,000	80,000	18,000	NJ 208 FM	CRB	128
40,000	80,000	18,000	NU 208 FMN	CRB	129
40,000	80,000	18,000	NU 208 FMN/C3	CRB	129
40,000	80,000	18,000	NU 208 FN	CRB	129
40,000	80,000	18,000	NU 208 FN/C3	CRB	129
40,000	80,000	18,000	NUP 208 FM	CRB	129
40,000	80,000	18,000	QJ 208 FM	BB4PAC	104
40,000	80,000	18,000	QJ 208 FM/C3	BB4PAC	104
40,000	80,000	19,750	30208 F	TRBM	8
40,000	80,000	21,000	344/332	TRBI	14
40,000	80,000	23,000	62208	BB	74
40,000	80,000	24,750	32208 F	TRBM	10
40,000	80,000	30,200	3208 B 2RS/C3	BBDRAC	102
40,000	80,000	30,200	F 16042	BBDRACS	92
40,000	80,000	32,000	33208 F	TRBM	13
40,000	80,000	38,000	F 15149	TRBDR	56
40,000	80,000	38,100	F 16043	BBDRACS	92
40,000	80,000	43,800	GRAE 40 NPPB	IB	124
40,000	80,000	56,500	GE 40 KRRB	IB	124
40,000	80,000	34,000 / 36,000	F 16090	BBDRACS	96
40,000	84,020	38,000	F 16066	BBDRACS	94
40,000	84,060	39,700 / 38,800	F 16108	BBDRACS	96
40,000	85,000	33,000	JF 4049/JF 4010	TRBI	19
40,000	90,000	23,000	6308	BB	76
40,000	90,000	23,000	F 18051	BBS	84
40,000	90,000	23,000	F 19006	CRBS	132
40,000	90,000	23,000	F 19034	CRBS	134
40,000	90,000	23,000	F 19112	CRBS	138
40,000	90,000	23,000	F 19119	CRBS	138
40,000	90,000	23,000	F 19131	CRBS	140
40,000	90,000	23,000	NJ 308 FM	CRB	128
40,000	90,000	23,000	NU 308 FM	CRB	129
40,000	90,000	23,000	NUP 308 FM	CRB	130
40,000	90,000	23,000	NUP 308 FM/C3	CRB	130
40,000	90,000	23,000	NUP 308 FMNR/C3	CRB	130
40,000	90,000	23,000	NUP 308 FP	CRB	130
40,000	90,000	25,000	F 19033	CRBS	134
40,000	90,000	25,250	30308 F	TRBM	9
40,000	90,000	25,250	31308 F	TRBM	9

14.2\ Fersa dimensional list

Lista dimensional Fersa

d	D	T	FERSA		PG.
40,000	90,000	28,750	F 15117	TRBS	34
40,000	90,000	35,250	32308 C	TRBM	11
40,000	90,000	35,250	32308 F	TRBM	11
40,000	90,000	36,500	3308 DP	BBDRAC	102
40,000	90,000	27,000 / 24,900	F 19013	CRBS	132
40,000	92,000	25,500	F 18076	BBS	84
40,000	94,000	26,000	F 18050	BBS	84
40,000	94,000	30,000	F 19089	CRBS	136
40,000	110,000	27,000	6408	BB	79
40,000	-	29,000	F 19065	CRBS	134
40,000	-	35,000	CONE F 15356	CONE	50
40,000	-	38,000	CONE F 15150 A	CONE	50
40,987	67,975	17,500	F 15003	TRBS	32
40,987	67,975	17,500	LM 300849/ LM 300811	TRBI	29
41,000	68,000	35,000 / 40,000	F 15015	TRBDR	56
41,000	73,000	21,000	F 15340	TRBS	40
41,275	73,025	16,667	18590/18520	TRBI	22
41,275	73,431	19,558	LM 501349/ LM 501310	TRBI	29
41,275	73,431	21,430	LM 501349/ LM 501314	TRBI	29
41,275	76,200	7,292	11163/11300 B	TRBF	44
41,275	76,200	18,009	11162/11300	TRBI	20
41,275	76,200	18,009	11163/11300	TRBI	20
41,275	76,200	22,225	24780/24720	TRBI	22
41,275	76,200	22,225	24781/24720	TRBI	22
41,275	76,200	25,400	24780/24721	TRBI	22
41,275	76,200	25,400	24781/24721	TRBI	22
41,275	79,375	23,812	26882/26822	TRBI	24
41,275	80,000	21,000	336/332	TRBI	14
41,275	80,000	28,574	342 A/332	TRBI	14
41,275	80,167	25,400	26882/26820	TRBI	24
41,275	80,167	29,370	3384/3320	TRBI	18
41,275	82,550	26,543	M 802048/ M 802011	TRBI	30
41,275	84,138	30,162	3577/3520	TRBI	18
41,275	85,725	30,162	3877/3820	TRBI	18
41,275	87,312	30,162	3577/3525	TRBI	18
41,275	87,312	30,162	3585/3525	TRBI	18
41,275	88,500	25,400	44162/44348	TRBI	25

d	D	T	FERSA		PG.
41,275	88,500	26,988	419/414	TRBI	15
41,275	88,900	30,162	HM 803145/ HM 803110	TRBI	30
41,275	88,900	30,162	HM 803146/ HM 803110	TRBI	30
41,275	90,488	39,688	4388/4335	TRBI	19
41,275	93,662	31,750	49162/49368	TRBI	26
41,275	95,250	30,162	HM 804840/ HM 804810	TRBI	30
41,275	95,250	30,958	HM 903245/ HM 903210	TRBI	31
41,275	104,775	36,512	59162/59412	TRBI	26
41,500	66,000	16,000	F 15004	BBT	110
41,529	72,619	21,433	T 163	TRBT	64
41,530	72,200	21,400	F 15064	BBT	110
42,000	50,000	30,000	F 17093 K	NRBS	146
42,000	50,000	40,000	F 17127 K	NRBS	150
42,000	50,000	51,000	F 17033 K	NRBS	144
42,000	75,000	37,000	F 16045	BBDRACS	92
42,000	75,000	37,000	F 16046	BBDRACS	92
42,000	76,000	23,812	F 15112	TRBS	34
42,000	76,000	33,000	F 16197	BBDRACS	98
42,000	76,000	39,000	F 16194	BBDRACS	98
42,000	76,000	35,000 / 38,000	F 16081	BBDRACS	94
42,000	76,000	37,000 / 40,000	F 16195	BBDRACS	98
42,000	78,000	45,000	F 16203	BBDRACS	100
42,000	80,000	36,000	F 16207	BBDRACS	100
42,000	80,000	37,000	F 16107	BBDRACS	96
42,000	80,000	38,000	F 15130	TRBDR	56
42,000	80,000	39,000	F 16213	BBDRACS	100
42,000	80,000	45,000	F 16088	BBDRACS	96
42,000	80,000	45,000	F 16214	BBDRACS	100
42,000	82,000	36,000	F 16048	BBDRACS	92
42,000	82,000	40,000	F 15218	TRBDR	58
42,000	84,000	39,000	F 16051	BBDRACS	92
42,000	92,075	24,607	F 15278	TRBS	38
42,070	-	40,386	CONE 4395	CONE	50
42,862	82,931	23,812	25576/25520	TRBI	22
42,862	82,931	23,812	25578/25520	TRBI	23
42,862	82,931	26,988	25578/25523	TRBI	23
42,862	83,058	23,812	25578/25521	TRBI	23

d	D	T	FERSA		PG.
42,862	83,058	23,876	25578/25522	TRBI	23
42,875	76,200	25,400	26884/26823	TRBI	24
42,875	82,931	23,812	25577/25520	TRBI	22
42,875	82,931	26,988	25577/25523	TRBI	23
42,875	83,058	23,812	25577/25521	TRBI	22
42,875	83,058	23,876	25577/25522	TRBI	23
43,000	76,000	43,000	F 16196	BBDRACS	98
43,000	77,000	41,500 / 45,500	F 15160	TRBDR	56
43,000	78,000	44,000	F 16193	BBDRACS	98
43,000	79,000	38,000 / 41,000	F 16052	BBDRACS	92
43,000	80,000	38,000	F 16086	BBDRACS	96
43,000	82,000	45,000	F 16078	BBDRACS	94
43,000 / 45,000	82,000	37,000	F 16054	BBDRACS	92
43,000 / 45,000	85,000	37,000	F 16118	BBDRACS	98
43,655	-	-	35 BC	TRBSt	48
44,000	82,500	37,000	F 16056	BBDRACS	94
44,450	82,931	23,812	25580/25520	TRBI	23
44,450	82,931	23,813	25581/25520	TRBI	23
44,450	82,931	26,988	25580/25523	TRBI	23
44,450	83,058	23,812	25580/25521	TRBI	23
44,450	83,058	23,876	25580/25522	TRBI	23
44,450	84,138	30,162	3578/3520	TRBI	18
44,450	87,312	30,162	3578/3525	TRBI	18
44,450	88,900	30,162	HM 803149/ HM 803110	TRBI	30
44,450	90,119	23,000	355 X/352	TRBI	14
44,450	93,264	30,162	3782/3720	TRBI	18
44,450	93,662	31,750	49175/49368	TRBI	26
44,450	95,250	27,783	33885/33822	TRBI	24
44,450	95,250	30,162	HM 804843/ HM 804810	TRBI	30
44,450	95,250	30,958	53176/53375	TRBI	26
44,450	95,250	30,958	53177/53375	TRBI	26
44,450	95,250	30,958	53178/53375	TRBI	26
44,450	95,250	30,958	53178/53377	TRBI	26
44,450	95,250	30,958	HM 903249/ HM 903210	TRBI	31
44,450	101,600	34,925	527/522	TRBI	15
44,450	104,775	30,162	45280/45220	TRBI	25
44,450	104,775	36,512	59175/59412	TRBI	26

d	D	T	FERSA		PG.
44,450	104,775	36,512	HM 807040 HM 807010	TRBI	30
44,450	111,125	30,162	55175 C/55437	TRBI	26
44,983	82,931	23,812	25584/25520	TRBI	23
44,983	83,058	23,813	25584/25521	TRBI	23
44,983	93,264	30,162	3776/3720	TRBI	18
44,983	99,995	25,400	25584/25547 RB	TRBI	23
44,983	101,600	34,925	527 S/522	TRBI	15
44,983	112,712	34,512	F 15280	TRBS	38
44,987	79,975	24,000	U 497/ U 460 L	U Series	46
44,987	82,931	23,812	25584 A/25520	TRBI	23
44,987	104,986	32,512	HM 905843 HM 905810	TRBI	31
44,990	84,070	39,000	F 16084	BBDRACS	96
45,000	53,000	21,000	F 17054 K	NRBS	144
45,000	57,000	21,000	F 17041 K	NRBS	144
45,000	68,000	12,000	61909	BB	71
45,000	73,000	20,000	T 177	TRBT	64
45,000	75,000	16,000	6009	BB	69
45,000	75,000	16,000	NUP 1009 FP P6	CRB	130
45,000	75,000	20,000	32009 XF	TRBM	10
45,000	75,000	20,000	32009 XR	TRBM	10
45,000	80,000	26,000	33109 F	TRBM	12
45,000	80,000	45,000	F 16085	BBDRACS	96
45,000	84,000	39,000	F 16059	BBDRACS	94
45,000	84,000	39,000	F 16082	BBDRACS	94
45,000	84,000	45,000	F 16216	BBDRACS	100
45,000	85,000	19,000	6209	BB	72
45,000	85,000	19,000	F 19121	CRBS	138
45,000	85,000	19,000	NU 209 FMN	CRB	129
45,000	85,000	19,000	NU 209 FMN/C3	CRB	129
45,000	85,000	19,000	NU 209 FN	CRB	129
45,000	85,000	19,000	NU 209 FN/C3	CRB	129
45,000	85,000	19,000	NUP 209 FM	CRB	129
45,000	85,000	19,000	QJ 209 FM	BB4PAC	104
45,000	85,000	19,000	QJ 209 FM/C3	BB4PAC	104
45,000	85,000	20,750	30209 F	TRBM	8
45,000	85,000	23,000	F 18009	BBS	82
45,000	85,000	24,750	32209 F	TRBM	10
45,000	85,000	30,200	F 16063	BBDRACS	94
45,000	85,000	32,000	33209 F	TRBM	13

14.2 \ Fersa dimensional list Lista dimensional Fersa

d	D	T	FERSA		PG.
45,000	85,000	43,800	GRAE 45 NPPB	IB	124
45,000	85,000	56,500	GE 45 KRRB	IB	124
45,000	86,000	39,000	F 16123	BBDRACS	98
45,000	86,000	39,000	F 16128	BBDRACS	98
45,000	88,000	16,750	F 15314	TRBS	38
45,000	88,000	17,500	F 15382	TRBS	40
45,000	88,020	39,000	F 16121	BBDRACS	98
45,000	90,000	9,000	JHM 803148/ JHM 803113 B	TRBF	44
45,000	95,000	29,000	JW 4549/JW 4510	TRBI	19
45,000	95,000	36,000	JF 4549/JF 4510	TRBI	19
45,000	95,000	28,000 / 32,000	F 19015	CRBS	132
45,000	100,000	25,000	6309	BB	76
45,000	100,000	25,000	F 19002	CRBS	132
45,000	100,000	25,000	F 19003	CRBS	132
45,000	100,000	25,000	F 19044	CRBS	134
45,000	100,000	25,000	F 19085	CRBS	136
45,000	100,000	25,000	F 19107	CRBS	138
45,000	100,000	25,000	NJ 309 FM	CRB	128
45,000	100,000	25,000	NJ 309 FP	CRB	128
45,000	100,000	25,000	NU 309 FM	CRB	129
45,000	100,000	25,000	NU 309 FMN	CRB	129
45,000	100,000	25,000	NU 309 FMNR/C3	CRB	129
45,000	100,000	25,000	NUP 309 FM	CRB	130
45,000	100,000	25,000	NUP 309 FM/C3	CRB	130
45,000	100,000	25,000	NUP 309 FMN	CRB	130
45,000	100,000	25,000	NUP 309 FN/C3	CRB	130
45,000	100,000	25,000	NUP 309 FP	CRB	130
45,000	100,000	25,000	QJ 309 FM	BB4PAC	104
45,000	100,000	25,000	QJ 309 FM/C3	BB4PAC	104
45,000	100,000	27,250	30309 F	TRBM	9
45,000	100,000	27,250	31309 F	TRBM	9
45,000	100,000	31,000	F 19063	CRBS	134
45,000	100,000	31,000	F 19081	CRBS	136
45,000	100,000	36,000	F 19001	CRBS	132
45,000	100,000	36,000	F 19080	CRBS	136
45,000	100,000	36,000	NJ 2309 FM	CRB	128
45,000	100,000	38,250	32309 BF	TRBM	11
45,000	100,000	38,250	32309 F	TRBM	11
45,000	110,000	12,000	F 15161	TRBF	44

d	D	T	FERSA		PG.
45,000	115,000	53,000	F 15154	TRBDR	56
45,000	120,000	29,000	6409	BB	79
45,000	120,000	84,900	F 300006	WM	164
45,000	-	30,045	CONE F 15132	CONE	50
45,230	79,985	19,842	17887/17831	TRBI	22
45,237	79,975	30,162	3586/3525	TRBI	18
45,242	73,431	19,558	LM 102949/ LM 102910	TRBI	28
45,242	77,788	19,842	LM 603049/ LM 603011	TRBI	29
45,242	77,788	21,430	LM 603049/ LM 603012	TRBI	29
45,242	79,975	19,842	LM 603049/ LM 603014	TRBI	29
45,300	80,000	48,000	F 15174	TRBDR	58
45,500	73,000	20,000	T 1008	TRBT	64
45,618	82,931	23,812	25590/25520	TRBI	23
45,618	82,931	23,812	F 15383	TRBS	40
45,618	82,931	26,988	25590/25523	TRBI	23
45,618	83,058	23,812	25590/25521	TRBI	23
45,618	83,058	23,876	25590/25522	TRBI	23
45,987	74,976	18,000	LM 503349 A/ LM 503310	TRBI	29
45,987	74,976	18,000	LM 503349/ LM 503310	TRBI	29
46,030	73,660	15,875	F 18012	BBC	112
46,030	73,660	18,000	F 18013	BBC	112
46,038	79,375	17,462	18690/18620	TRBI	22
46,038	85,000	20,638	359 A/354 X	TRBI	14
46,038	85,000	20,638	359 S/354 X	TRBI	14
46,279	82,956	23,812	T 182	TRBT	64
47,000	53,000	25,000	F 17111 K	NRBS	148
47,000	81,000	53,000	F 16199	BBDRACS	98
47,000	88,000	55,000	F 15268	TRBDR	58
47,625	88,900	20,638	369 A/362 A	TRBI	14
47,625	88,900	20,638	369 S/362 A	TRBI	14
47,625	88,900	25,400	M 804048/ M 804010	TRBI	30
47,625	88,900	25,400	M 804049/ M 804010	TRBI	30
47,625	90,000	20,000	369 A/363	TRBI	14
47,625	90,000	20,000	369 S/362	TRBI	14
47,625	90,000	20,000	369 S/363	TRBI	14
47,625	93,264	30,162	3778/3720	TRBI	18

d	D	T	FERSA		PG.
47,625	95,250	30,162	HM 804846/ HM 804810	TRBI	30
47,625	96,838	21,000	386 A/382 A	TRBI	14
47,625	101,600	34,925	528/522	TRBI	15
47,625	107,950	36,512	536/532 X	TRBI	16
47,625	111,125	30,162	55187 C/55437	TRBI	26
47,625	123,825	25,400	72188 C/72487	TRBI	27
47,625	123,825	36,512	72187 C/72487	TRBI	27
47,625	123,825	36,512	72187/72487	TRBI	27
47,879	82,956	23,812	T 188	TRBT	64
49,000	84,000	48,000	F 15068	TRBDR	56
49,000	84,000	48,000	F 15168	TRBDR	58
49,000	88,000	46,000	F 16109	BBDRACS	96
49,000	88,000	48,000	F 16208	BBDRACS	100
49,212	103,188	43,658	5395/5335	TRBI	19
49,212	104,775	36,512	HM 807044/ HM 807010	TRBI	30
49,930	80,000	15,000	F 19030	CRBS	134
49,987	89,980	24,750	28579/28520	TRBI	24
50,000	55,000	20,000	F 17045 K	NRBS	144
50,000	56,010	43,700	F 17079 K	NRBS	146
50,000	78,000	22,000	T 1004	TRBT	64
50,000	80,000	16,000	6010	BB	70
50,000	80,000	20,000	32010 XF	TRBM	10
50,000	80,000	20,000	32010 XR	TRBM	10
50,000	80,000	23,000	63010	BB	78
50,000	80,000	24,000	33010 F	TRBM	12
50,000	82,000	21,500	JLM 104945/ JLM 104910	TRBI	28
50,000	82,000	21,500	JLM 104946/ JLM 104910	TRBI	28
50,000	82,000	21,500	JLM 104948/ JLM 104910	TRBI	28
50,000	82,550	21,500	JLM 104948/ LM 104911	TRBI	28
50,000	83,000	20,500	F 15201	TRBS	36
50,000	84,000	22,000	JLM 704649/ JLM 704610	TRBI	29
50,000	85,000	26,000	33110 F	TRBM	12
50,000	90,000	8,750	30210 BF	TRBF	44
50,000	90,000	20,000	6210	BB	72
50,000	90,000	20,000	365/362	TRBI	14
50,000	90,000	20,000	F 18032	BBS	82
50,000	90,000	20,000	F 18033	BBS	82

d	D	T	FERSA		PG.
50,000	90,000	20,000	F 18041	BBS	82
50,000	90,000	20,000	NJ 210 FM/C3	CRB	128
50,000	90,000	21,750	30210 F	TRBM	8
50,000	90,000	23,000	F 19026	CRBS	132
50,000	90,000	23,000	NJ 2210 FP	CRB	128
50,000	90,000	24,750	32210 F	TRBM	11
50,000	90,000	28,000	JM 205149/ JM 205110	TRBI	28
50,000	90,000	30,200	3210 B 2R5/C3	BBDRAC	102
50,000	90,000	32,000	33210 F	TRBM	13
50,000	90,000	40,000	F 16202	BBDRACS	100
50,000	90,000	62,800	GE 50 KRRB	IB	124
50,000	90,000	16,000 / 22,000	F 18049	BBS	84
50,000	93,264	30,162	F 15054/3720	TRBS	32
50,000	100,000	25,000	F 19046	CRBS	134
50,000	100,000	36,000	JF 5049/JF 5010	TRBI	19
50,000	105,000	32,000	JW 5049/JW 5010	TRBI	19
50,000	105,000	37,000	JHM 807045/ JHM 807012	TRBI	30
50,000	110,000	27,000	6310	BB	77
50,000	110,000	27,000	NJ 310 FM	CRB	128
50,000	110,000	27,000	NU 310 FM	CRB	129
50,000	110,000	27,000	NU 310 FM/C3	CRB	129
50,000	110,000	27,000	NU 310 FMN/C3	CRB	129
50,000	110,000	27,000	NUP 310 FM/C3	CRB	130
50,000	110,000	27,000	NUP 310 FNR/C3	CRB	130
50,000	110,000	27,000	NUP 310 FP	CRB	130
50,000	110,000	29,250	30310 F	TRBM	9
50,000	110,000	29,250	31310 F	TRBM	9
50,000	110,000	42,250	32310 F	TRBM	11
50,000	110,000	32,300 / 27,000	F 19070	CRBS	136
50,000	110,000	32,300 / 27,000	F 19071	CRBS	136
50,000	130,000	31,000	6410	BB	79
50,000	-	41,000	CONE F 15244	CONE	50
50,000	-	41,275	CONE F 15113	CONE	50
50,100	78,000	22,000	T 1006	TRBT	64
50,800	60,325	25,400	F 17060 K	NRBS	146
50,800	82,000	21,976	LM 104949/ JLM 104910	TRBI	28
50,800	82,550	21,590	LM 104949/ LM 104911	TRBI	28

14.2 \ Fersa dimensional list Lista dimensional Fersa

d	D	T	FERSA		PG.
50,800	82,931	21,590	LM 104949/ LM 104912	TRBI	28
50,800	85,000	17,462	18790/18720	TRBI	22
50,800	88,900	20,638	368 A/362 A	TRBI	14
50,800	89,980	24,750	28580/28520	TRBI	24
50,800	90,000	25,000	368 A/362 X	TRBI	14
50,800	92,075	24,608	28580/28521	TRBI	24
50,800	93,264	30,162	3775/3720	TRBI	18
50,800	93,264	30,162	3780/3720	TRBI	18
50,800	93,264	30,162	3784/3720	TRBI	18
50,800	93,662	30,162	3780/3727	TRBI	18
50,800	93,662	30,162	3784/3727	TRBI	18
50,800	95,250	27,783	33889/33821	TRBI	24
50,800	95,250	27,783	33889/33822	TRBI	25
50,800	96,838	21,000	385 A/382 A	TRBI	14
50,800	98,425	21,000	385 A/382	TRBI	14
50,800	99,995	24,607	28580/28527 RB	TRBI	24
50,800	100,000	34,925	529/520 X1	TRBI	15
50,800	100,000	35,000	F 15047	TRBS	32
50,800	100,000	46,200	F 15483	TRBS	42
50,800	100,000	48,200	F 15484	TRBS	42
50,800	101,600	31,750	49585/49520	TRBI	26
50,800	101,600	34,925	529 X/522	TRBI	16
50,800	101,600	34,925	529/522	TRBI	16
50,800	104,775	12,000	F 15212	TRBF	44
50,800	104,775	12,000	HM 807046/ HM 807010 BT	TRBF	44
50,800	104,775	30,162	45284/45220	TRBI	25
50,800	104,775	30,162	45285 A/45220	TRBI	25
50,800	104,775	30,162	45285 A/45221	TRBI	25
50,800	104,775	30,162	455/453 X	TRBI	15
50,800	104,775	36,512	HM 807046/ HM 807010	TRBI	30
50,800	104,775	39,687	4580/4535	TRBI	19
50,800	107,950	36,512	537/532 X	TRBI	16
50,800	109,538	22,225	T 200	TRBT	64
50,800	109,538	22,225	T 200 A	TRBT	64
50,800	110,230	11,907	45285 A/45220 B	TRBF	44
50,800	111,125	30,162	55200 C/55437	TRBI	26
50,800	120,650	41,275	619/612	TRBI	16
50,800	123,825	36,512	72200 C/72487	TRBI	27
50,800	123,825	36,512	72201 C/72487	TRBI	27

d	D	T	FERSA		PG.
51,000	91,000	44,000	F 16076	BBDRACS	94
51,054	74,612	15,875	T 199	TRBT	64
51,592	88,900	20,638	368 S/362 A	TRBI	14
51,592	90,000	20,000	368 S/362	TRBI	14
52,000	---	24,000	CONE F 15333	CONE	50
52,388	92,075	24,608	28584/28521	TRBI	24
52,388	93,264	30,162	3767/3720	TRBI	18
52,388	95,250	27,783	33891/33821	TRBI	25
52,388	111,125	30,162	55206 C/55437	TRBI	26
52,400	83,800 / 89,000	20,300	F 15057	BBT	110
52,400	86,000 / 91,000	20,550	F 15031	BBT	110
53,870	123,820	38,100	557 S/552 A	TRBI	16
53,975	88,900	19,050	LM 806649/ LM 806610	TRBI	30
53,975	95,200	34,400	F 15295	TRBS	38
53,975	95,250	27,783	33895/33821	TRBI	25
53,975	95,250	27,783	33895/33822	TRBI	25
53,975	96,838	21,000	389 A/382 A	TRBI	14
53,975	98,425	21,000	389 AS/382	TRBI	15
53,975	100,000	21,000	389 A/383 A	TRBI	15
53,975	104,775	36,512	HM 807049/ HM 807010	TRBI	31
53,975	107,950	36,512	539/532 X	TRBI	16
53,975	111,125	30,162	55212 C/55437	TRBI	26
53,975	111,125	38,100	539/532 A	TRBI	16
53,975	120,650	41,275	621/612	TRBI	16
53,975	123,825	36,512	72212 C/72487	TRBI	27
53,975	123,825	36,512	72212/72487	TRBI	27
53,975	127,000	50,800	6280/6220	TRBI	19
53,975	140,030	36,513	78215 C/78551	TRBI	27
53,975	140,030	39,512	F 15485	TRBS	42
53,980	82,000	14,650	F 15376	TRBS	40
54,000	142,000	62,000	F 15146	TRBDR	56
54,000	158,000	51,000	F 15324	TRBDR	58
54,487	104,775	36,512	HM 807048/ HM 807010	TRBI	31
54,988	111,125	38,100	538/532	TRBI	16
55,000	60,000	20,000	F 17046 K	NRBS	144
55,000	60,000	30,000	F 17109 K	NRBS	148
55,000	63,000	20,000	F 17112 K	NRBS	148
55,000	80,000	17,000	32911 F	TRBM	12

d	D	T	FERSA		PG.
55,000	90,000	18,000	6011	BB	70
55,000	90,000	18,000	NU 1011 FM	CRB	129
55,000	90,000	23,000	32011 XF	TRBM	10
55,000	90,000	23,000	JLM 506849/ JLM 506810	TRBI	29
55,000	90,000	25,000	JLM 506849 A/ JLM 506811	TRBI	29
55,000	90,000	27,000	33011 F	TRBM	12
55,000	90,000	55,000	F 15302	TRBDR	58
55,000	90,000	60,000	F 15121	WH	154
55,000	91,500	25,000	F 15141	BBC	112
55,000	95,000	29,000	JM 207049 A/ JM 207010	TRBI	28
55,000	95,000	29,000	JM 207049/ JM 207010	TRBI	28
55,000	95,000	30,000	33111 F	TRBM	12
55,000	95,000	30,000	F 15323	TRBS	38
55,000	96,838	21,000	385/382 A	TRBI	14
55,000	98,425	21,000	385/382	TRBI	14
55,000	100,000	21,000	6211	BB	73
55,000	100,000	21,000	F 19101	CRBS	136
55,000	100,000	21,000	F 19108	CRBS	138
55,000	100,000	21,000	N 211 FMNR/C4	CRB	128
55,000	100,000	21,000	NUP 211 FM/C3	CRB	130
55,000	100,000	21,000	QJ 211 FM	BB4PAC	104
55,000	100,000	21,000	QJ 211 FM/C3	BB4PAC	104
55,000	100,000	22,750	30211 F	TRBM	8
55,000	100,000	26,750	32211 F	TRBM	11
55,000	100,000	35,000	33211 F	TRBM	13
55,000	104,000	27,000	F 19097	CRBS	136
55,000	110,000	42,250	32310/55	TRBM	11
55,000	115,000	34,000	JW 5549/JW 5510	TRBI	19
55,000	116,000	28,000	F 18054	BBS	84
55,000	117,000	38,000	F 15332	TRBS	38
55,000	120,000	29,000	6311	BB	77
55,000	120,000	29,000	F 18042	BBS	82
55,000	120,000	29,000	F 18056	BBS	84
55,000	120,000	29,000	NUP 311 F	CRB	130
55,000	120,000	29,000	NUP 311 FMNR/C3	CRB	130
55,000	120,000	31,500	30311 F	TRBM	9
55,000	120,000	31,500	31311 F	TRBM	9
55,000	120,000	45,500	32311 F	TRBM	11

d	D	T	FERSA		PG.
55,000	140,000	33,000	6411	BB	79
55,000	140,000	45,000	F 15256	TRBS	36
55,000	140,000	95,000	F 300013	WM	164
55,000	145,000	95,000	F 300014	WM	166
55,000	-	29,800	CONE F 15111	CONE	50
55,000	-	29,800	CONE F 15269	CONE	50
55,560	97,630	24,600	28680/28622	TRBI	24
55,562	122,238	43,658	5566/5535	TRBI	19
55,562	123,825	36,512	72218 C/72487	TRBI	27
55,562	127,000	36,512	HM 813840/ HM 813811	TRBI	31
57,000	63,000	37,000	F 17103 K	NRBS	148
57,800 / 58,000	110,000	115,000	F 200015	WK	158
57,150	66,675	38,100	F 17120 K	NRBS	148
57,150	96,838	21,000	387 A/382 A	TRBI	14
57,150	96,838	21,000	387 AS/382 A	TRBI	14
57,150	96,838	21,000	387/382 A	TRBI	14
57,150	96,838	24,608	28682/28621	TRBI	24
57,150	96,838	25,400	387 A/382 S	TRBI	14
57,150	96,838	25,400	387 AS/382 S	TRBI	14
57,150	96,838	25,400	387 S/382 S	TRBI	14
57,150	96,838	25,400	387/382 S	TRBI	14
57,150	97,630	24,608	28682/28622	TRBI	24
57,150	98,425	21,000	387 A/382	TRBI	14
57,150	98,425	21,000	387 S/382	TRBI	14
57,150	98,425	21,000	387/382	TRBI	14
57,150	100,000	21,000	387 A/383 A	TRBI	14
57,150	100,000	21,000	387 S/383 A	TRBI	14
57,150	104,775	30,162	45289/45220	TRBI	25
57,150	104,775	30,162	45291/45220	TRBI	25
57,150	104,775	30,162	462 A/453 X	TRBI	15
57,150	104,775	30,162	462/453 X	TRBI	15
57,150	104,775	30,162	469/453 X	TRBI	15
57,150	110,000	22,000	390/394 A	TRBI	15
57,150	110,000	29,147	3979/JM 511910	TRBI	18
57,150	112,712	30,162	39580/39520	TRBI	25
57,150	112,712	30,162	39581/39520	TRBI	25
57,150	119,985	32,750	39580/39528	TRBI	25
57,150	123,825	36,512	72225 C/72487	TRBI	27
57,150	123,825	38,100	555 S/552 A	TRBI	16

14.2\ Fersa dimensional list

Lista dimensional Fersa

d	D	T	FERSA		PG.
57,150	140,030	36,513	78225 C/78551	TRBI	27
57,165	140,000	28,250	F 15133	TRBS	34
57,531	98,425	21,000	388 A/382	TRBI	14
57,800	115,000	115,000	F 200041	WK	162
59,972	122,238	33,338	66589/66520	TRBI	26
59,987	130,175	34,100	HM 911244/ HM 911210	TRBI	31
59,987	134,983	33,449	HM 911244/ HM 911216	TRBI	31
60,000	68,000	23,000	F 17108 K	NRBS	148
60,000	68,000	25,000	F 17107 K	NRBS	148
60,000	68,000	32,000	F 17056 K	NRBS	144
60,000	68,000	39,000	F 17061 K	NRBS	146
60,000	68,000	40,000	F 17090 K	NRBS	146
60,000	68,000	41,700	F 17059 K	NRBS	146
60,000	89,000	15,200	F 15377	TRBS	40
60,000	95,000	18,000	6012	BB	70
60,000	95,000	23,000	32012 XF	TRBM	10
60,000	95,000	24,000	JLM 508748/ JLM 508710	TRBI	29
60,000	95,000	26,500	F 15329	TRBS	38
60,000	95,000	27,000	F 15088	TRBS	34
60,000	96,500	25,600	F 15140	BBC	112
60,000	96,500	29,600	F 15139	BBC	112
60,000	96,600	30,800	F 15357	BBC	112
60,000	100,000	30,000	33112 F	TRBM	13
60,000	100,000	30,000	F 15258	TRBS	36
60,000	108,000	75,000	F 15120	WH	154
60,000	110,000	22,000	6212	BB	73
60,000	110,000	22,000	F 19011	CRBS	132
60,000	110,000	22,000	F 19088	CRBS	136
60,000	110,000	22,000	F 19130	CRBS	140
60,000	110,000	22,000	NUP 212 FM	CRB	130
60,000	110,000	22,000	QJ 212 FM	BB4PAC	104
60,000	110,000	22,000	QJ 212 FM/C3	BB4PAC	104
60,000	110,000	23,750	30212 F	TRBM	8
60,000	110,000	28,000	62212	BB	74
60,000	110,000	28,000	F 19042	CRBS	134
60,000	110,000	28,000	NUP 2212 FM/C3	CRB	130
60,000	110,000	28,000	NUP 2212 FMNR/C3	CRB	130
60,000	110,000	28,000	NUP 2212 FP/C3	CRB	130
60,000	110,000	29,750	32212 F	TRBM	11

d	D	T	FERSA		PG.
60,000	110,000	29,750	F 15347	TRBS	40
60,000	110,000	34,000	F 15334	TRBS	40
60,000	110,000	36,500	3212 B 2RS/C3	BBDRAC	102
60,000	110,000	38,000	33212 F	TRBM	13
60,000	110,000	38,000	F 15348	TRBS	40
60,000	112,000	33,000	F 15005	BBC	112
60,000	113,000	31,000	F 19171	CRBS	140
60,000	115,000	39,000	F 15273	TRBS	38
60,000	115,000	40,000	F 15346	TRBS	40
60,000	115,000	40,000	JF 6049/JF 6010	TRBI	19
60,000	116,000	28,000	F 19047	CRBS	134
60,000	120,000	29,795	476/472	TRBI	15
60,000	125,000	37,000	F 15270	TRBS	36
60,000	125,000	37,000	F 15386	TRBS	42
60,000	125,000	37,000	JW 6049/JW 6010	TRBI	19
60,000	130,000	12,250	F 15192	TRBF	44
60,000	130,000	31,000	6312	BB	77
60,000	130,000	31,000	F 18055	BBS	84
60,000	130,000	31,000	F 19009	CRBS	132
60,000	130,000	31,000	NUP 312 FMNR/C3	CRB	130
60,000	130,000	31,000	NUP 312 FNR/C3	CRB	130
60,000	130,000	33,500	30312 F	TRBM	9
60,000	130,000	33,500	31312 F	TRBM	9
60,000	130,000	33,800	F 15245	TRBS	36
60,000	130,000	35,250	F 15298	TRBS	38
60,000	130,000	39,000	F 15046	TRBS	32
60,000	130,000	48,500	32312 BF	TRBM	11
60,000	130,000	48,500	32312 F	TRBM	11
60,000	135,000	37,000	F 15158	TRBS	34
60,000	150,000	35,000	6412	BB	79
60,000	150,000	51,000	F 15255	TRBS	36
60,000	168,000	100,000	F 300010	WM	164
60,000	168,000	102,000	F 300007	WM	164
60,000	168,000	105,500	F 300016	WM	166
60,000	174,000	122,000	F 300017	WM	166
60,325	100,000	25,400	28985/28921	TRBI	24
60,325	101,600	25,400	28985/28920	TRBI	24
60,325	112,712	30,162	3980/3920	TRBI	18
60,325	122,238	38,100	HM 212044/ HM 212011	TRBI	28

d	D	T	FERSA		PG.
60,325	127,000	16,670	65237/65500 B	TRBF	44
60,325	127,000	36,512	HM 813841/ HM 813810	TRBI	31
60,325	127,000	36,512	HM 813841/ HM 813811	TRBI	31
60,325	127,000	44,450	65237/65500	TRBI	26
60,325	130,175	36,512	HM 911245/ HM 911210	TRBI	31
60,325	136,525	46,038	H 715332/ H 715311	TRBI	30
61,912	110,000	22,000	392/394 A	TRBI	15
61,912	127,000	36,512	HM 813843/ HM 813810	TRBI	31
61,912	136,525	46,038	H 715334/ H 715311	TRBI	30
61,912	146,050	41,275	H 913842/ H 913810	TRBI	31
61,912	146,050	41,275	H 913843/ H 913810	TRBI	31
62,000	70,000	37,000	F 17052 K	NRBS	144
62,000	70,000	40,000	F 17099 K	NRBS	146
62,000	147,000	50,000	F 15184	TRBS	34
62,000	260,000	107,000	F 15321	PM	38
63,000	71,000	50,800	F 17089 K	NRBS	146
63,000	-	34,800	F 19016	CRBS	132
63,000	-	37,500	F 19038	CRBS	134
63,485	94,975	17,000	L 910349/L 910310	TRBI	31
63,500	100,000	23,000	F 18040	BBC	112
63,500	102,000	20,570	F 18031	BBC	112
63,500	103,000	21,400	F 15118	BBC	112
63,500	104,775	21,433	39250/39412	TRBI	25
63,500	107,950	25,400	29585/29520	TRBI	24
63,500	107,950	25,400	29586/29520	TRBI	24
63,500	107,950	25,400	29586/29522	TRBI	24
63,500	107,950	25,400	F 15304	TRBS	38
63,500	110,000	22,000	395/394 A	TRBI	15
63,500	110,000	30,162	3982/3927 X	TRBI	18
63,500	112,712	30,162	39585/39520	TRBI	25
63,500	112,712	30,162	3982/3920	TRBI	18
63,500	122,238	38,100	HM 212047/ HM 212011	TRBI	28
63,500	123,825	38,100	559/552 A	TRBI	16
63,500	127,000	36,512	HM 813842/ HM 813810	TRBI	31
63,500	136,525	46,038	H 715336/ H 715311	TRBI	30

d	D	T	FERSA		PG.
63,500	99,900 / 105,000	23,000	F 15058	BBT	110
64,000	72,000	45,000	F 17129 K	NRBS	150
65,000	70,000	20,000	F 17043 K	NRBS	144
65,000	70,000	30,000	F 17113 K	NRBS	148
65,000	73,000	33,000	F 17102 K	NRBS	148
65,000	96,500	22,500	F 15209	BBC	112
65,000	100,000	18,000	6013	BB	70
65,000	100,000	23,000	32013 XF	TRBM	10
65,000	100,000	27,000	33013 F	TRBM	12
65,000	101,700	21,750	F 15211	BBC	112
65,000	105,000	24,000	JLM 710949 C/ JLM 710910	TRBI	30
65,000	110,000	13,000	33113 B	TRBF	44
65,000	110,000	28,000	JM 511945/ JM 511910	TRBI	29
65,000	110,000	28,000	JM 511946/ JM 511910	TRBI	29
65,000	110,000	31,000	JD 6549/JD 6510	TRBI	19
65,000	110,000	34,000	33113 F	TRBM	13
65,000	110,000	34,000	F 15462	TRBS	42
65,000	112,712	29,020	JM 511945/3920	TRBI	29
65,000	120,000	23,000	6213	BB	73
65,000	120,000	23,000	NUP 213 FPNR/C3	CRB	130
65,000	120,000	24,750	30213 F	TRBM	8
65,000	120,000	32,750	32213 F	TRBM	11
65,000	120,000	32,750	F 15322	TRBS	38
65,000	120,000	39,000	JH 211749/ JH 211710	TRBI	28
65,000	120,000	41,000	33213 F	TRBM	13
65,000	121,000	33,000	F 19170	CRBS	140
65,000	140,000	33,000	6313	BB	77
65,000	140,000	33,000	F 19064	CRBS	134
65,000	140,000	33,350	F 19010	CRBS	132
65,000	140,000	36,000	30313 F	TRBM	9
65,000	140,000	36,000	31313 F	TRBM	9
65,000	140,000	48,000	NJ 2313 FM	CRB	128
65,000	140,000	51,000	32313 BF	TRBM	11
65,000	140,000	51,000	32313 F	TRBM	11
65,000	145,000	36,000	F 15082	TRBS	34
65,000	145,000	39,500	F 15083	TRBS	34
65,000	147,100	13,500	F 15265	TRBF	44
65,000	150,000	38,000	F 15119	TRBS	34

14.2\ Fersa dimensional list

Lista dimensional Fersa

d	D	T	FERSA		PG.
65,000	152,000	48,000	F 15253	TRBS	36
65,000	160,000	37,000	6413	BB	79
65,000	160,000	37,000	F 19105	CRBS	138
65,000	160,000	37,000	F 19106	CRBS	138
65,000	165,000	36,000	F 15183	TRBS	34
65,000	165,000	40,000	F 15159	TRBS	34
65,000	-	31,000	CONE F 15134	CONE	50
65,000	111,700 / 113,600	22,100	F 15060	BBT	110
65,088	135,755	53,975	6379/6320	TRBI	19
65,088	136,525	46,038	H 715340/ H 715311	TRBI	30
65,987	123,975	41,500	H 212749/ H 212710	TRBI	28
66,675	107,950	25,400	29590/29520	TRBI	24
66,675	107,950	25,400	29590/29522	TRBI	24
66,675	110,000	22,000	395 A/394 A	TRBI	15
66,675	110,000	22,000	395 S/394 A	TRBI	15
66,675	110,000	30,162	3994/3927 X	TRBI	18
66,675	112,712	30,162	39590/39520	TRBI	25
66,675	112,712	30,162	3984/3920	TRBI	18
66,675	112,712	30,162	3984/3925	TRBI	18
66,675	112,712	30,162	3994/3920	TRBI	18
66,675	117,475	30,162	33262 A/33461	TRBI	24
66,675	117,475	30,162	33262/33462	TRBI	24
66,675	122,238	38,100	HM 212049/ HM 212010	TRBI	28
66,675	122,238	38,100	HM 212049/ HM 212011	TRBI	28
66,675	127,000	36,512	HM 813844/ HM 813810	TRBI	31
66,675	130,175	41,275	641/633	TRBI	16
66,675	135,755	53,975	6386/6320	TRBI	19
66,675	136,525	41,275	641/632	TRBI	16
66,675	136,525	41,275	H 414242/ H 414210	TRBI	29
66,675	136,525	46,038	H 715341/ H 715311	TRBI	30
67,000	75,000	37,000	F 17057 K	NRBS	146
67,000	75,000	44,000	F 17058 K	NRBS	146
67,000	-	32,000	F 19061	CRBS	134
67,000	-	38,000	F 19062	CRBS	134
68,000	140,000	49,450	F 15366	TRBS	40
68,000	272,000	100,500	F 15371	PM	40

d	D	T	FERSA		PG.
68,000 / 68,200	125,000	115,000	F 200013	WK	158
68,000 / 68,200	127,000 / 132,000	115,000	F 15097	WH	154
68,260	-	44,250	CONE F 15327	CONE	50
68,262	110,000	22,000	399 A/394 A	TRBI	15
68,262	110,000	22,000	399 AS/394 A	TRBI	15
68,262	136,525	41,275	H 414245 X/ H 414210	TRBI	29
68,262	136,525	46,038	H 715343/ H 715311	TRBI	30
68,262	152,400	47,625	F 15367	TRBS	40
68,262	152,400	47,625	H 914841/ H 914811	TRBI	31
68,262	161,925	49,212	9278/9220	TRBI	19
69,800 / 70,000	125,000	114,000	F 200016	WK	158
69,800 / 70,000	119,700 / 124,700	110,500	F 200019	WK	160
69,840	112,200 / 113,800	22,100	F 15059	BBT	110
69,850	101,600	19,050	L 713049/L 713010	TRBI	30
69,850	112,712	25,400	29675/29620	TRBI	24
69,850	116,980	71,880	F 15380	TRBDR	40
69,850	117,475	30,162	33275/33462	TRBI	24
69,850	120,000	29,002	482/472 A	TRBI	15
69,850	120,000	29,794	33275/33472	TRBI	24
69,850	120,000	29,795	482/472	TRBI	15
69,850	120,000	32,545	47487/47420	TRBI	26
69,850	120,000	46,751	482 E/472	TRBI	15
69,850	120,650	25,400	29675/29630	TRBI	24
69,850	123,825	30,162	482/472 X	TRBI	15
69,850	126,000	63,880	F 15330	TRBDR	38
69,850	127,000	36,512	566/563	TRBI	16
69,850	146,050	41,275	H 913849/ H 913810	TRBI	31
69,850	-	51,750	CONE F 15328	CONE	50
70,000	76,000	20,000	F 17044 K	NRBS	144
70,000	78,000	37,000	F 17053 K	NRBS	144
70,000	78,000	43,000	F 17101 K	NRBS	148
70,000	100,000	20,000	32914 F	TRBM	12
70,000	110,000	13,000	16014	BB	80
70,000	110,000	20,000	6014	BB	70
70,000	110,000	20,000	NJ 1014 FM	CRB	128
70,000	110,000	25,000	32014 XF	TRBM	10

d	D	T	FERSA		PG.
70,000	110,000	26,000	JLM 813049/ JLM 813010	TRBI	31
70,000	110,000	31,000	33014 F	TRBM	12
70,000	115,000	29,000	JM 612949/ JM 612910	TRBI	29
70,000	120,000	29,002	484/472 A	TRBI	15
70,000	120,000	29,795	484/472	TRBI	15
70,000	120,000	37,000	33114 F	TRBM	13
70,000	125,000	24,000	6214	BB	73
70,000	125,000	26,250	30214 F	TRBM	8
70,000	125,000	33,250	32214 F	TRBM	11
70,000	125,000	41,000	33214 F	TRBM	13
70,000	130,000	43,000	JF 7049 A/JF 7010	TRBI	19
70,000	130,000	43,000	JF 7049/JF 7010	TRBI	19
70,000	130,000	57,000	F 15051 C	TRBS	32
70,000	130,000	57,000	F 15051 R	TRBS	32
70,000	140,000	26,000	F 18053	BBS	84
70,000	140,000	39,000	JW 7049/JW 7010	TRBI	19
70,000	150,000	35,000	6314	BB	77
70,000	150,000	35,000	NUP 314 FM/C3	CRB	130
70,000	150,000	35,000	NUP 314 FMNR/C3	CRB	130
70,000	150,000	38,000	30314 F	TRBM	9
70,000	150,000	38,000	31314 F	TRBM	9
70,000	150,000	39,800	F 15116	TRBS	34
70,000	150,000	41,275	F 15114	TRBS	34
70,000	150,000	50,000	F 15389	TRBS	42
70,000	150,000	54,000	32314 BF	TRBM	11
70,000	150,000	54,000	32314 F	TRBM	12
70,000	150,000	54,000	F 15498	TRBS	42
70,000	150,000	64,000	F 15193	TRBS	36
70,000	150,000	74,000	F 15271	TRBS	38
70,000	165,000	57,000	F 15254	TRBS	36
70,000	165,000	57,000	F 15361	TRBS	40
70,000	180,000	42,000	6414	BB	79
70,000	195,000	110,000	F 300003	WM	164
70,000	196,000	140,000	F 300005	WM	164
71,438	117,475	30,162	33281/33462	TRBI	24
71,438	120,000	29,794	33281/33472	TRBI	24
71,438	120,000	32,545	47490/47420	TRBI	26
71,438	127,000	36,512	HM 813849/ HM 813810	TRBI	31

d	D	T	FERSA		PG.
71,438	127,000	36,512	HM 813849/ HM 813811	TRBI	31
71,438	136,525	41,275	644/632	TRBI	16
71,438	136,525	46,038	H 715345/H 715311	TRBI	30
71,438	136,525	49,213	H 715345/ H 715313 W	TRBI	30
72,000	80,000	29,800	F 17077 K	NRBS	146
72,000	80,000	40,000	F 17076 K	NRBS	146
72,000	130,000	25,000	F 18060	BBS	84
73,000	79,000	50,000	F 17110 K	NRBS	148
73,025	112,712	25,400	29685/29620	TRBI	24
73,025	117,475	30,162	33287/33462	TRBI	24
73,025	120,000	29,794	33287/33472	TRBI	24
73,025	127,000	36,512	567 X/563	TRBI	16
73,025	127,000	36,512	567/563	TRBI	16
73,025	139,992	36,512	576/572	TRBI	16
73,817	112,712	25,400	29688/29620	TRBI	24
73,817	127,000	36,512	568/563	TRBI	16
75,000	83,000	23,000	F 17063 K	NRBS	146
75,000	83,000	23,000	F 17116 K	NRBS	148
75,000	83,000	33,000	F 17104 K	NRBS	148
75,000	83,000	35,000	F 17062 K	NRBS	146
75,000	83,000	40,000	F 17064 K	NRBS	146
75,000	83,000	46,000	F 17121 K	NRBS	148
75,000	83,000	48,000	F 17097 K	NRBS	146
75,000	83,000	48,000	F 17123 K	NRBS	148
75,000	83,000	55,000	F 17031 K	NRBS	144
75,000	105,000	16,000	61915	BB	70
75,000	115,000	20,000	6015	BB	70
75,000	115,000	25,000	32015 XF	TRBM	10
75,000	115,000	25,000	JLM 714149/ JLM 714110	TRBI	30
75,000	115,000	31,000	33015 F	TRBM	12
75,000	120,000	31,000	JM 714249/ JM 714210	TRBI	30
75,000	125,000	37,000	33115 F	TRBM	13
75,000	130,000	25,000	6215	BB	73
75,000	130,000	25,000	NJ 215 F/C3	CRB	128
75,000	130,000	25,000	NJ 215 FP/C3	CRB	128
75,000	130,000	27,250	30215 F	TRBM	8
75,000	130,000	31,000	NU 2215 FM	CRB	129
75,000	130,000	33,250	32215 F	TRBM	11

14.2 \ Fersa dimensional list Lista dimensional Fersa

d	D	T	FERSA		PG.
75,000	130,000	41,000	33215 F	TRBM	13
75,000	140,000	34,250	F 15190	TRBS	36
75,000	160,000	37,000	6315	BB	77
75,000	160,000	40,000	30315 F	TRBM	9
75,000	160,000	40,000	31315 F	TRBM	9
75,000	160,000	55,000	NJ 2315 FM/C4	CRB	128
75,000	160,000	58,000	32315 F	TRBM	12
75,000	160,000	58,000	F 15071	TRBS	32
75,000	165,000	57,000	F 15426	TRBS	42
75,000	180,000	63,500	F 15048	TRBS	32
75,000	190,000	45,000	6415	BB	80
75,987	131,975	39,000	HM 215249/H M 215210	TRBI	28
76,200	109,538	19,050	L 814749/L 814710	TRBI	31
76,200	121,442	11,907	34300/34478 B	TRBF	44
76,200	121,442	24,608	34300/34478	TRBI	25
76,200	127,000	26,988	34300/34500	TRBI	25
76,200	127,000	26,988	34301/34500	TRBI	25
76,200	127,000	30,162	42688/42620	TRBI	25
76,200	133,350	30,162	495 A/492 A	TRBI	15
76,200	133,350	33,338	47679/47620	TRBI	26
76,200	135,733	44,450	5760/5735	TRBI	19
76,200	136,525	30,162	495 A/493	TRBI	15
76,200	139,700	36,512	575/572 X	TRBI	16
76,200	139,982	35,250	575/572 A	TRBI	16
76,200	139,992	36,512	575/572	TRBI	16
76,200	146,050	41,275	659/653	TRBI	16
76,200	149,220	53,975	6461 A/6420	TRBI	19
76,200	149,225	53,975	6461/6420	TRBI	19
76,200	149,225	53,975	6466/6420	TRBI	19
76,200	161,925	49,212	9285/9220	TRBI	19
76,200	171,450	49,212	9380/9321	TRBI	19
76,200	171,450	49,212	F 15291	TRBS	38
77,000	101,000	29,200	F 19087	CRBS	136
77,788	117,475	25,400	LM 814849/LM 814810	TRBI	31
77,788	121,442	24,608	34306/34478	TRBI	25
78,000	86,000	35,000	F 17032 K	NRBS	144
78,000	110,000	8,700	F 15224	BBC	112
78,000	130,000	90,000	F 15125	WH	154
78,000	130,000	90,500	F 15127	WH	154

d	D	T	FERSA		PG.
78,000	130,000	135,000	F 200035	WK	160
80,000	88,000	35,000	F 17100 K	NRBS	148
80,000	105,000	4,000	F 17117 K	NRBS	148
80,000	110,000	16,000	F 18052	BBS	84
80,000	125,000	22,000	6016	BB	70
80,000	125,000	29,000	32016 XF	TRBM	10
80,000	125,000	36,000	33016 F	TRBM	12
80,000	130,000	5,500	F 15246	TRBF	44
80,000	130,000	35,000	JM 515649/JM 515610	TRBI	29
80,000	130,000	37,000	33116 F	TRBM	13
80,000	130,000	37,000	F 15463	TRBS	42
80,000	139,992	14,288	F 15191	TRBF	44
80,000	140,000	26,000	6216	BB	73
80,000	140,000	26,000	F 18059	BBS	84
80,000	140,000	28,250	30216 F	TRBM	8
80,000	140,000	33,000	NU 2216 FM	CRB	129
80,000	140,000	33,500	F 19039	CRBS	134
80,000	140,000	35,250	32216 F	TRBM	11
80,000	140,000	39,250	F 15156	TRBS	34
80,000	140,000	46,000	33216 F	TRBM	13
80,000	140,000	46,000	33216 F 573810	TRBM	13
80,000	150,000	28,000	6217/80	BB	74
80,000	150,000	27,500 / 28,000	F 19008	CRBS	132
80,000	160,000	45,000	JW 8049/JW 8010	TRBI	19
80,000	165,000	57,000	F 15257	TRBS	36
80,000	170,000	42,500	30316 F	TRBM	9
80,000	170,000	42,500	31316 F	TRBM	9
80,000	170,000	61,500	32316 F	TRBM	12
80,000	200,000	48,000	NJ 416 FM/C3	CRB	128
80,962	136,525	30,162	496/493	TRBI	15
80,962	150,089	44,450	740/742	TRBI	17
82,000	90,000	37,000	F 17051 K	NRBS	144
82,000	90,000	60,000	F 17098 K	NRBS	146
82,000	138,000	110,000	F 200029	WK	160
82,000	138,000	130,000	F 200018	WK	160
82,000	140,000	36,500	F 15252	TRBS	36
82,000	140,000	110,000	F 15126	WH	154
82,000	140,000	115,000	F 15100	WH	154
82,000	140,000	115,000	F 15300	WH	156

d	D	T	FERSA		PG.
82,000	140,000	115,000	F 15414	WH	156
82,000	196,000	113,000	F 300001	WM	164
82,550	125,412	25,400	27687/27620	TRBI	24
82,550	133,350	30,162	495/492 A	TRBI	15
82,550	133,350	33,338	47686/47620	TRBI	26
82,550	133,350	39,687	HM 516449 A/ HM 516410	TRBI	29
82,550	133,350	39,688	HM 516449 C/ HM 516410	TRBI	29
82,550	136,525	30,162	495/493	TRBI	15
82,550	136,525	39,687	HM 516448/ HM 516414 B	TRBI	29
82,550	136,525	44,453	47687/47623 A	TRBI	26
82,550	139,700	36,512	580/572 X	TRBI	16
82,550	139,982	35,250	580/572 A	TRBI	16
82,550	139,992	36,512	580/572	TRBI	16
82,550	139,992	36,513	582/572	TRBI	16
82,550	146,050	41,275	663/653	TRBI	17
82,550	150,089	44,450	749 A/742	TRBI	17
83,345	125,412	25,400	27690/27620	TRBI	24
84,000	90,000	39,500	F 17096 K	NRBS	146
84,000	90,000	48,000	F 17128 K	NRBS	150
84,000	90,000	55,000	F 17122 K	NRBS	148
84,138	133,350	30,162	498/492 A	TRBI	15
84,138	136,525	30,162	498/493	TRBI	15
84,970	125,410	25,400	27695/27620	TRBI	24
84,980	150,000	27,500 / 28,000	F 19022	CRBS	132
85,000	93,000	53,000	F 17035 K	NRBS	144
85,000	93,000	60,000	F 17124 K	NRBS	148
85,000	93,000	63,000	F 17091 K	NRBS	146
85,000	93,000	73,000	F 17125 K	NRBS	150
85,000	130,000	22,000	6017	BB	70
85,000	130,000	29,000	32017 XF	TRBM	10
85,000	130,000	30,000	JM 716649/ JM 716610	TRBI	30
85,000	130,000	36,000	33017 F	TRBM	12
85,000	140,000	39,000	JHM 516849/ JHM 516810	TRBI	29
85,000	140,000	41,000	33117 F	TRBM	13
85,000	150,000	28,000	6217	BB	74
85,000	150,000	28,000	F 18036	BBS	82
85,000	150,000	30,500	30217 F	TRBM	8

d	D	T	FERSA		PG.
85,000	150,000	30,500	F 15104	TRBS	34
85,000	150,000	30,500	F 15345	TRBS	40
85,000	150,000	38,500	32217 F	TRBM	11
85,000	150,000	38,500	F 15326	TRBS	38
85,000	150,000	49,000	33217 F	TRBM	13
85,000	151,500	34,000	F 19169	CRBS	140
85,000	160,000	33,000	F 18037	BBS	82
85,000	180,000	63,500	32317 F	TRBM	12
85,026	150,089	44,450	749 S/742	TRBI	17
85,026	150,089	44,450	749/742	TRBI	17
85,725	146,050	41,275	665 A/653	TRBI	17
85,725	146,050	41,275	665/653	TRBI	17
85,725	133,350	30,162	497/492 A	TRBI	15
85,725	136,525	30,162	497/493	TRBI	15
86,000	94,000	45,000	F 17080 K	NRBS	146
88,000	138,000	120,000	F 200025	WK	160
88,000	140,000	32,000	F 15075	TRBS	34
88,900	121,442	15,083	LL 217849/ LL 217810	TRBI	28
88,900	148,430	28,575	42350/42584	TRBI	25
88,900	152,400	39,688	HM 518445/ HM 518410	TRBI	29
88,900	161,925	47,625	759/752	TRBI	17
89,000	97,000	40,000	F 17034 K	NRBS	144
89,974	146,975	40,000	HM 218248/ HM 218210	TRBI	28
89,975	146,975	40,000	F 15115	TRBS	34
89,992	160,096	30,124	69354/69630	TRBI	27
90,000	98,000	40,500	F 17040 K	NRBS	144
90,000	98,000	46,000	F 17095 K	NRBS	146
90,000	130,000	14,000	16017/90	BB	80
90,000	140,000	24,000	F 18066	BBS	84
90,000	140,000	32,000	32018 XF	TRBM	10
90,000	140,000	39,000	33018 F	TRBM	12
90,000	145,000	35,000	JM 718149 A/ JM 718110	TRBI	30
90,000	145,000	35,000	JM 718149/ JM 718110	TRBI	30
90,000	150,000	45,000	33118 F	TRBM	13
90,000	155,000	44,000	JHM 318448/ JHM 318410	TRBI	29
90,000	160,000	30,000	6218	BB	74

14.2\ Fersa dimensional list

Lista dimensional Fersa

d	D	T	FERSA		PG.
90,000	160,000	32,500	30218 F	TRBM	8
90,000	160,000	42,500	32218 F	TRBM	11
90,000	160,000	125,000	F 15122	WH	154
90,000	160,000	125,000	F 15124	WH	154
90,000	190,000	46,500	31318 F	TRBM	9
92,000	100,000	27,000	F 17094 K	NRBS	146
92,000	100,000	53,000	F 17038 K	NRBS	144
92,075	146,050	33,338	47890/47820	TRBI	26
92,075	148,430	28,575	42362/42584	TRBI	25
92,075	150,000	35,992	598 A/593 X	TRBI	16
92,075	152,400	39,688	598 A/592 A	TRBI	16
92,075	152,400	39,688	598/592 A	TRBI	16
92,075	168,275	41,275	681 A/672	TRBI	17
92,075	168,275	41,275	681/672	TRBI	17
92,500	133,000	29,200	F 18068	CRB	112
93,662	148,430	28,575	42368/42584	TRBI	25
93,800 / 94,000	148,000	135,000	F 200014	WK	158
95,000	103,000	60,000	F 17092 K	NRBS	146
95,000	126,000	18,100	F 15341	TRBS	40
95,000	130,000	23,000	32919 F	TRBM	12
95,000	135,000	20,000	JL 819349/ JL 819310	TRBI	31
95,000	145,000	32,000	32019 XF	TRBM	10
95,000	145,000	39,000	33019 F	TRBM	12
95,000	150,000	35,000	JM 719149/ JM 719113	TRBI	30
95,000	160,000	46,000	JF 9549/JF 9510	TRBI	19
95,000	170,000	34,500	30219 F	TRBM	8
95,000	170,000	45,500	32219 F	TRBM	11
95,250	128,587	15,875	LL 319349/ LL 319310	TRBI	29
95,250	150,000	35,992	594 A/593 X	TRBI	16
95,250	150,000	35,992	594/593 X	TRBI	16
95,250	152,400	39,688	594 A/592 A	TRBI	16
95,250	152,400	39,688	594 R/592 A	TRBI	16
95,250	152,400	39,688	594/592 A	TRBI	16
95,250	168,275	41,275	683/672	TRBI	17
95,250	171,450	47,625	77375/77675	TRBI	27
96,000	104,000	55,000	F 17039 K	NRBS	144
99,800 / 100,000	148,000	135,000	F 200017	WK	160

d	D	T	FERSA		PG.
96,838	148,430	28,575	42381/42584	TRBI	25
99,975	156,975	42,000	F 15208	TRBS	36
99,975	156,975	42,000	HM 220149/ HM 220110	TRBI	29
100,000	145,000	24,000	JP 10049/JP 10010	TRBI	20
100,000	145,000	24,000	JP 10049/ JP 10010 A	TRBI	20
100,000	148,000	141,000	F 200031	WK	160
100,000	150,000	32,000	32020 XF	TRBM	10
100,000	150,000	39,000	33020 F	TRBM	12
100,000	150,000	39,000	33020 F 561694	TRBM	12
100,000	155,000	36,000	JM 720249/ JM 720210	TRBI	30
100,000	160,000	41,000	JHM 720249/ JHM 720210	TRBI	30
100,000	160,000	42,000	F 15200	TRBS	36
100,000	160,000	44,000	F 15267	TRBS	36
100,000	165,000	47,000	JF 10049/JF 10010	TRBI	20
100,000	180,000	37,000	30220 F	TRBM	8
100,000	180,000	49,000	32220 F	TRBM	11
100,000	180,000	49,000	32220 FR	TRBM	11
100,000	180,000	63,000	33220 F	TRBM	13
100,000	215,000	51,500	30320 F	TRBM	9
101,600	157,162	36,512	52400/52618	TRBI	26
101,600	160,000	35,000	F 15279	TRBS	38
101,600	168,275	41,275	687/672	TRBI	17
101,600	214,312	55,562	H 924033/ H 924010	TRBI	31
105,000	160,000	35,000	32021 XF	TRBM	10
105,000	160,000	43,000	33021 F	TRBM	12
105,000	160,000	43,000	33021 F 0266488	TRBM	12
105,000	160,000	43,000	F 15239	TRBS	36
105,000	160,000	140,000	F 200004	WK	158
105,000	160,000	140,000	F 200032	WK	160
105,000	170,000	38,000	F 15076	TRBS	34
105,000	190,000	39,000	30221 F	TRBM	8
105,000	190,000	53,000	32221 F	TRBM	11
105,000	198,000	46,000	F 19172	CRBS	140
106,000	140,000	25,000	F 15210	BBC	112
106,000	160,000	35,000	F 15272	TRBS	38
107,950	146,050	21,433	L 521949/10	TRBI	26
107,950	158,750	23,020	37425/37625	TRBI	25

14.3 \ Cross part number Cruces de referencias

COMPETITOR	Fersa	PG.
BOWER		
47687/47623 A	47687/47623 A	26
MA 1211 EL	F 19108	138
MA 1211 V1/M1211 V	F 19108	138
MA1211EL	F 19108	138
MU 1309 UM	F 19107	138
MU 1309 UM V1	F 19107	138
MUB1305UDM	F 19134	140

DT		
116451	33018 F	12
116.673	32312 F	11
360016	F 15272	38
360024	32313 BF	11

FAG		
33014	33014 F	12
61915	61915 C3	70
201009	JM 714249/JM 714210	30
201029	JF 9549/JF 9510	19
201034	F 15100	154
201037	F 15097	154
201040	JF 4549/JF 4510	19
201043	F 300003	164
201047	JF 4549/JF 4510	19
201050	F 15120	154
201052	33209 F	13
201059	F 15122	154
201067	JM 714249/JM 714210	30
201069	F 15193	36
201072	F 15124	154
201072	F 15124	154
501493	F 15357	112
511134	F 19015	132
511482	HM 911244/HM 911216	31
511687	F 15080	34
512392	47487/47420	26
512533	F 19019	132
518713	F 15280	38
520550	F 19112	138
521618	F 15083	34
523361	F 15258	36
524850	JM 515649/JM 515610	29
527053	HM 807048/HM 807010	31

COMPETITOR	Fersa	PG.
527813	F 15193	36
528546	T 177	64
528595	F 15272	38
528935	F 15089	34
528946	F 15076	34
528983	F 15051 R	32
529065	F 15075	34
532066	F 16019	88
534459	F 15166	34
534565	F 15051 C	32
535000	F 15209	112
535001	F 15210	112
538971	JF 7049 A/JF 7010	19
540106	F 19009	132
540484	F 15036	32
540669	F 15183	34
540733	F 16035	90
540763	F 16201	98
540783	F 15071	32
542245	F 15159	34
543562	F 15048	32
543805	F 15157	34
543909	F 18011	82
544307	F 16023	88
545312	F 16001	88
545495	F 16046	92
546238	F 16021	88
546439	F 15361	40
546467	F 15041	56
546485	62305 2RS/C3	74
547059	F 16195	98
548083	F 16026	88
561447	F 16018	88
561481	F 16048	92
563147	F 15059	110
563809	F 19081	136
565362	F 19091	136
565636	F 16042	92
566195	F 18021	82
566646	CONE F 15084	50
566719	F 16039	90
566949	F 19063	134
566968	F 15462	42
567549	F 15208	36

COMPETITOR	Fersa	PG.
FAG		
567918	F 16002	88
568879	F 200035	160
568968	JF 6049/JF 6010	19
568980	F 15119	34
572428	F 15029	32
572772	F 16211	100
572813	F 15193	36
574368	F 15116	34
575194	F 15246	44
575867	F 19089	136
576503	CONE F 15150 A	50
576513	T 152	64
579381	F 15184	34
579557	F 16037	90
580400	F 16020	88
580616	F 15190	36
580989	F 19076	136
581541	F 15273	38
584183	F 16205	100
801136	F 16040	92
801400	F 15257	36
801785	F 15271	38
803621	F 15104	34
803775	F 16083	94
803837	F 15043	56
804339	F 19042	134
804358	F 15156	34
805008	F 200017	160
805045	6217/80 C3	74
805050	F 15270	36
805096	F 15255	36
805097	F 15256	36
805189	F 15323	38
805248	HM 220149/HM 220110	29
805262	F 19001	132
805308	F 15463	42
805312	F 15267	36
805449	F 19010	132
805450	F 19039	134
805531	F 300007	164
805532	F 300010	164
805921	F 16057	94
805937	F 15389	42

COMPETITOR	Fersa	PG.
808918	F 200025	160
848132	F 15056	32
713606040	KV 377	222
713606050	KA 004	210
713606060	KV 547	227
713606120	KA 002	210
713606140	KA 003	210
713606160	KF 094	213
713606200	KA 001	210
713606260	KF 092	212
713606290	KV 534	226
713606300	KV 398	222
713606340	KV 447	224
713606350	KV 474	225
713606400	KF 510	226
713610020	KF 184	215
713610040	KF 183	215
713610070	KF 308	220
713610100	KF 182	215
713610130	KF 180	215
713610140	KF 179	215
713610160	KF 095	213
713610160	KF 185	215
713610210	KV 284	219
713610220	KV 194	216
713610230	KA 069	212
713610240	KA 005	210
713610290	KF 096	213
713610310	KF 181	215
713610320	KV 284	219
713610340	KF 233	217
713610350	KF 306	220
713610360	KF 479	225
713610370	KA 248	218
713610390	KV 250	218
713610420	KF 098	213
713610450	KF 240	217
713610460	KF 241	217
713610470	KV 287	219
713610480	KV 425	223
713610490	KV 286	219
713610500	KV 276	219
713610530	KV 285	219
713610580	KV 518	226

14.3 \ Cross part number Cruces de referencias

COMPETITOR	Fersa	PG.
FAG		
713610610	KV 359	221
713610620	KV 367	221
713610640	KF 421	223
713610660	KV 420	223
713610690	KV 358	221
713610700	KV 395	222
713610710	KF 519	226
713610730	KF 182	215
713610760	KV 394	222
713610770	KV 360	221
713610810	KV 511	226
713610830	KV 361	221
713611410	KA 455	224
713611480	KA 071	212
713611550	KC 256	218
713611570	KA 072	212
713612110	KA 502	226
713613040	KF 130	214
713613070	KA 131	214
713613080	KA 430	223
713613090	KF 129	214
713613130	KA 036	211
713613160	KA 035	211
713613210	KB 217	217
713613220	KC 132	214
713613230	KA 077	212
713613280	KA 034	211
713613340	KV 530	226
713613410	KA 266	218
713613490	KB 318	220
713613590	KA 268	218
713613640	KV 267	218
713613720	KV 503	226
713613750	KA 392	222
713613780	KF 381	222
713613790	KF 321	220
713613810	KF 380	222
713613830	KF 128	214
713613870	KF 442	224
713614010	KA 349	221
713614030	KF 159	215
713614210	KA 054	211
713615030	KF 227	217

COMPETITOR	Fersa	PG.
713615090	KF 225	217
713615130	KA 393	222
713615150	KA 214	217
713615210	KA 389	222
713615230	KA 542	227
713615510	KV 226	217
713615530	KV 232	217
713617030	KF 304	220
713617040	KF 102	213
713617070	KV 229	217
713617090	KF 099	213
713617160	KF 320	220
713617260	KV 100	213
713617270	KV 260	218
713617350	KV 505	226
713617360	KF 101	213
713617400	KV 457	224
713617410	KV 449	224
713617450	KF 426	223
713617840	KF 525	226
713617850	KV 501	226
713618020	KF 259	218
713618020	KF 456	224
713618040	KF 310	220
713618100	KA 065	212
713618110	KA 066	212
713618110	KA 067	212
713618170	KV 451	224
713618210	KC 174	215
713618270	KF 173	215
713618310	KF 466	224
713618370	KF 352	221
713618400	KC 488	225
713618550	KF 298	219
713618560	KF 197	216
713618570	KV 537	227
713618630	KV 401	222
713618660	KF 429	223
713618670	KV 353	221
713618680	KV 482	225
713618740	KA 067	212
713618760	KF 309	213
713618770	KF 370	222
713618780	KF 382	222

COMPETITOR	Fersa	PG.
FAG		
713618860	KF 316	220
713618870	KV 507	226
713618900	KA 070	212
713618970	KV 528	226
713619010	KA 545	227
713619050	KV 230	217
713619060	KV 231	217
713619080	KV 120	213
713619090	KF 119	213
713619100	KA 086	212
713619130	KA 022	210
713619140	KA 190	216
713619150	KF 317	220
713619170	KF 121	213
713619210	KC 188	216
713619230	KA 187	216
713619240	KA 186	216
713619280	KV 228	217
713619290	KB 491	225
713619300	KA 023	210
713619410	KV 122	214
713619420	KV 123	214
713619430	KV 490	225
713619450	KV 336	220
713619470	KV 513	226
713619480	KV 412	223
713619490	KV 412	223
713619540	KA 423	223
713620010	KA 052	211
713620020	KA 053	211
713620030	KF 441	224
713620130	KA 254	218
713620140	KA 050	211
713620310	KF 452	224
713622140	KB 443	224
713622150	KB 416	223
713623020	KA 061	212
713623030	KB 062	212
713623050	KC 223	217
713623060	KF 301	219
713623090	KC 265	218
713623100	KC 444	224
713623150	KC 419	223

COMPETITOR	Fersa	PG.
713623300	KC 224	217
713623430	KC 522	226
713623440	KC 463	224
713623560	KF 417	223
713625120	KA 413	223
713625140	KA 405	223
713626040	KV 489	225
713626080	KV 521	226
713626090	KB 365	221
713626100	KA 407	223
713626110	KA 397	222
713626480	KA 397	222
713630030	KF 155	215
713630050	KF 195	216
713630060	KF 313	220
713630090	KV 275	219
713630100	KC 146	214
713630120	KC 147	214
713630130	KC 148	214
713630150	KC 149	214
713630160	KF 150	214
713630170	KV 152	214
713630180	KB 048	211
713630180	KB 192	216
713630200	KA 042	211
713630210	KA 043	211
713630220	KA 044	211
713630250	KB 090	213
713630260	KB 046	211
713630270	KB 047	211
713630300	KB 193	216
713630310	KV 157	215
713630330	KA 255	218
713630350	KV 156	215
713630370	KF 314	220
713630430	KA 476	225
713630440	KA 091	212
713630480	KA 049	211
713630510	KV 546	227
713630530	KV 114	213
713630540	KV 305	220
713630550	KA 269	218
713630560	KV 258	218
713630570	KV 236	217

14.3 \ Cross part number Cruces de referencias

COMPETITOR	Fersa	PG.
FAG		
713630580	KF 113	213
713630630	KV 243	217
713630640	KV 244	217
713630650	KV 246	218
713630710	KF 312	220
713630730	KV 440	224
713630760	KF 289	219
713630770	KV 445	224
713630780	KB 344	221
713630790	KB 293	219
713630800	KB 278	219
713630810	KB 402	222
713630820	KV 290	219
713630830	KF 277	219
713630840	KF 351	221
713630850	KF 366	221
713630870	KV 492	225
713630880	KV 535	227
713630900	KF 375	222
713630920	KF 371	222
713630950	KB 350	221
713630970	KB 364	221
713630980	KV 520	226
713630990	KF 539	227
713640010	KV 294	219
713640030	KV 435	224
713640080	KF 543	227
713640100	KF 500	226
713640180	KF 143	214
713640190	KF 111	213
713640250	KV 219	217
713640260	KV 144	214
713640280	KF 112	213
713640310	KF 354	221
713640320	KB 368	222
713640330	KB 424	223
713640390	KB 295	219
713640400	KB 296	219
713640420	KV 460	224
713640450	KV 548	227
713640460	KV 458	224
713640470	KB 357	221
713640480	KB 369	222

COMPETITOR	Fersa	PG.
713640500	KF 399	222
713640510	KV 410	223
713640540	KF 473	225
713644010	KA 404	223
713644020	KV 279	219
713644030	KV 247	218
713644040	KV 196	216
713644060	KV 199	216
713644070	KV 198	216
713644080	KF 292	219
713644090	KV 343	221
713644100	KF 342	221
713644110	KF 341	221
713644120	KF 340	221
713644130	KF 315	220
713644140	KB 339	221
713644150	KF 137	214
713644160	KF 133	214
713644170	KF 134	214
713644180	KF 153	214
713644190	KF 138	214
713644220	KB 338	221
713644230	KV 337	221
713644260	KV 336	220
713644270	KV 335	220
713644290	KF 334	220
713644310	KV 333	220
713644320	KV 332	220
713644330	KV 331	220
713644340	KV 330	220
713644480	KA 040	211
713644510	KA 038	211
713644520	KA 039	211
713644540	KV 135	214
713644550	KV 235	217
713644560	KV 202	216
713644570	KV 252	218
713644650	KF 136	214
713644660	KF 376	222
713644670	KF 448	224
713644690	KV 531	226
713644770	KV 481	225
713644830	KF 428	223
713644850	KV 524	226

COMPETITOR	Fersa	PG.
FAG		
713649240	KF 104	213
713649250	KF 107	213
713649260	KF 396	222
713649270	KF 106	213
713649280	KF 348	221
713649300	KF 110	213
713649320	KF 109	213
713649330	KF 470	225
713649350	KV 374	222
713649370	KV 462	224
713649380	KV 432	223
713649390	KF 418	223
713649410	KV 239	217
713650060	KF 145	214
713650070	KB 078	212
713650140	KA 041	211
713650160	KF 142	214
713650210	KA 089	212
713650250	KV 215	217
713650260	KF 141	214
713650270	KA 073	212
713650290	KB 008	210
713650310	KA 079	212
713650330	KA 272	218
713650410	KA 058	211
713650420	KA 013	210
713650430	KA 080	212
713650520	KV 403	223
713650540	KV 459	224
713660030	KV 514	226
713660040	KV 271	218
713660050	KF 176	215
713660080	KV 234	217
713660110	KA 068	212
713660120	KV 242	217
713660130	KF 302	219
713660190	KF 175	215
713660210	KV 467	224
713660230	KA 211	216
713660260	KA 212	216
713660280	KV 177	215
713660310	KV 249	218
713660340	KV 480	225

COMPETITOR	Fersa	PG.
713660370	KV 245	217
713660380	KF 516	226
713660410	KV 178	215
713661020	KV 408	223
713665020	KF 433	223
713665020	KF 504	226
713665300	KV 506	226
713667020	KA 515	226
713667030	KB 422	223
713667050	KF 127	214
713667060	KV 297	219
713667070	KV 431	223
713667140	KV 105	213
713667180	KV 108	213
713667190	KV 532	226
713667220	KV 238	217
713667230	KF 303	219
713667300	KA 033	211
713667310	KF 450	224
713667320	KB 345	221
713667370	KA 028	210
713667380	KA 087	212
713667400	KA 025	210
713667420	KA 029	210
713667430	KA 027	210
713667450	KA 030	211
713667470	KA 189	216
713667520	KA 026	210
713667560	KA 126	214
713667570	KA 032	211
713667580	KB 125	214
713667600	KA 273	218
713667740	KF 280	219
713667780	KV 472	225
713667790	KF 378	222
713667800	KA 406	223
713667820	KA 414	223
713667870	KF 124	214
713667890	KF 300	219
713670020	KV 439	224
713670030	KV 363	221
713678020	KA 020	210
713678030	KB 191	216
713678040	KF 115	213

14.3 \ Cross part number Cruces de referencias

COMPETITOR	Fersa	PG.
FAG		
713678040	KF 327	220
713678050	KF 116	213
713678080	KA 018	210
713678090	KA 019	210
713678100	KF 282	219
713678110	KF 201	216
713678120	KA 499	225
713678140	KA 017	210
713678150	KA 075	212
713678190	KA 015	210
713678250	KA 014	210
713678280	KA 082	212
713678290	KA 257	218
713678300	KA 083	212
713678320	KA 021	210
713678340	KV 220	217
713678360	KV 222	217
713678400	KD 117	213
713678400	KD 118	213
713678410	KF 329	220
713678420	KA 084	212
713678430	KV 328	220
713678440	KF 549	227
713678500	KA 085	212
713678600	KF 453	224
713678610	KB 263	218
713678650	KV 291	219
713678660	KV 326	220
713678670	KV 325	220
713678700	KV 221	217
713678730	KV 323	220
713678730	KV 324	220
713678750	KA 081	212
713678760	KA 076	212
713678770	KA 347	221
713678790	KV 322	220
713678870	KF 385	222
713678890	KV 484	225
713678900	KV 387	222
713680110	KA 063	212
713680160	KF 172	215
713690010	KV 163	215
713690060	KF 465	224

COMPETITOR	Fersa	PG.
713690070	KF 261	218
713690080	KF 468	224
713690090	KA 024	210
713690110	KA 213	216
713690120	KA 055	211
713690130	KA 056	211
713690150	KA 057	211
713690160	KF 161	215
713690170	KF 160	215
713690180	KC 477	225
713690190	KC 205	216
713690200	KC 253	218
713690210	KA 210	216
713690230	KV 164	215
713690240	KV 162	215
713690260	KV 204	216
713690320	KB 011	210
713690330	KA 009	210
713690360	KV 544	227
713690380	KA 169	215
713690420	KB 012	210
713690430	KA 010	210
713690470	KA 170	215
713690490	KA 200	216
713690500	KF 165	215
713690500	KF 168	215
713690510	KF 166	215
713690540	KF 264	218
713690550	KV 237	217
713690600	KV 218	217
713690610	KF 167	215
713690670	KF 281	219
713690700	KF 536	227
713690710	KV 251	218
713690730	KV 409	213
713690750	KF 346	221
713690760	KV 411	223
713690780	KF 270	218
713690800	KF 373	222
713690810	KF 471	225
713690830	KB 356	221
713690840	KB 362	221
713690850	F 300006	164
713690860	KF 288	219

COMPETITOR	Fersa	PG.
FAG		
713690920	KV 523	226
713690930	KB 390	222
713690940	KB 372	222
713696100	KF 203	216
713697030	KA 517	226
713697040	KA 533	226
713697070	KF 494	225
7220688100	F 15048	32
26-1789A	F 17108 K	148
30305A	30305 F	8
32210A	32210 F	11
32314 A	32314 F	12
33020. 561694	33020 F 561694	12
33021. 580938	F 15239	36
33024/588641	F 15385	40
4209 BT VH	F 18009	82
500636B	T 1008	64
508204 E.TVP	F 19044	134
509333 A	F 15082	34
510148 A	F 19012	132
510148 B	F 19043	134
512099 TVP2	F 19011	132
512099TVP2	F 19011	132
518772A	L 45449/L 45410	25
521471 A	F 15046	32
522380/33211	F 15047	32
524625B.M	F 19106	138
524851A	JM 718149 A/JM 718110	30
527056C	F 19096	136
528548 B	T 1004	64
528983 B	F 15051 R	32
530689 B	F 15141	112
536906C	F 18024	82
539090M	F 19105	138
539351A	F 19037	134
539859D	F 19010	132
540484A.H49A	F 15036	32
540669.TR1PW	F 15183	34
541153 A	F 16002	88
541521 C	F 16032	90
542186 A	F 16036	90
543359 B	F 16051	92
544872.E23	F 18062	84

COMPETITOR	Fersa	PG.
547103 E	F 16082	94
547103 E	F 16084	96
548866 A	F 15165	34
558841.04.LTR1	F 15346	40
562398 A	F 16031	90
562495C	F 15108	44
562830 A	F 15158	34
562830A	F 15158	34
563007/801464	F 15298	38
563809 A	F 19081	136
564725 AB	F 16085	96
564734.H195	F 300001	164
566074.H195	F 200016	158
566193.H195	F 200018	160
566283.01.H195	F 200017	160
566283.H195	F 200017	160
566425.H195	F 200014	158
566426.H195	F 200013	158
566427.H195	F 200015	158
566616 B	F 19008	132
566830.H195	F 200028	160
566834.H195	F 200019	160
566847.H195	F 200031	160
567447 B	F 16038	90
568742 A	F 15191	44
569868.H195	F 200029	160
570530.H195	F 200025	160
571762.01.H195	F 15097	154
571762.H195	F 15097	154
572813 A	F 15193	36
574795A	F 16034	90
574821 A	F 15040	32
575725.F51	F 15159	34
576791.H131AB	F 15386	42
579205.H195	F 300003	164
579943 B	F 16086	96
580616 TR1	F 15190	36
580779 A	F 15115	34
581079 C	F 200013	158
6206.2RSR.C3	6206 2RS/C3	72
6213 2RSR NR/C3	6213 2RS NR/C3	73
631903.H195	F 200035	160
675522.AM	F 200041	162
713 6261 40	F 16207	100

14.3 \ Cross part number Cruces de referencias

COMPETITOR	Fersa	PG.
FAG		
713 6308 10	F 15174	58
713 6911 10	F 15302	58
800574 A	F 18042	82
800792 D	F 200014	158
801794 B	F 15253	36
801974.12.H195	F 300005	164
801974AE.H195	F 300005	164
803194 A	F 15125	154
803194.26	F 15125	154
803750 B	F 200004	158
804162 A	F 200005	158
804358A	F 15156	34
805003A.H195	F 15100	154
805003CA.H195	F 15300	156
805011 C	F 15126	154
805012.06.H195	F 15122	154
805015/801400	F 15254	36
805046/801464	F 15192	44
805092 C	F 15127	154
805092.07	F 15127	154
805532.01.H195	F 300010	164
F-568895.TR1	F 15311	44
F-571752.03.TR1-DY-H	F 15382	40
F-571752.03.TR1-DY-H73	F 15382	40
F-580791.TR1	F 15348	40
F-580794.TR1	F 15347	40
F-581863	F 200037	162
F-585057.02	F 15388	42
F-588258	F 200041	162
F-611766	F 200041	162
F-805576.04	F 15326	38
K.33885.33822	33885/33822	24
K27695-27620-DY-KBC	27695/27620	24
NUP 524213 M	F 19022	132
NUP311EN-M1-C3	NUP 311 FMNR/C3	130
QJ309-TVP-C3	QJ 309 FM/C3	104
T2EE060	JF 6049/JF 6010	19
T2EE100	JF 10049/JF 10010	20
T5ED060	F 15273	38
T5ED100.576376	F 15200	36
Z 579943.06	F 16086	96
Z-504376.02	F 15322	38

COMPETITOR	Fersa	PG.
Z-512099.ZL-TVP2	F 19011	132
Z-524625.02.ZL-M	F 19106	138
Z-524625.03.ZL	F 19106	138
Z-527056.03	F 19096	136
Z-539090.01	F 19105	138
Z-539090.ZL-M	F 19105	138
Z-539859.ZL	F 19010	132
Z-539859.ZL	F 19010	132

FLT		
CBK 238	F 19030	134

INA		
31173	F 19019	132
87486	F 19075	136
553935	F 18052	84
561521	F 19044	134
722013010	F 17101 K	148
722018510	F 17098 K	146
722020710	F 19016	132
722073010	F 15116	34
463 0002 10	FTRK ZF 1292.298.905	180
463 0003 10	FTRK ZF 1272.298.946	180
463 0007 10	FTRK ZF 1295.298.946	180
463 0008 10	FTRK ZF 1295.298.947	180
712 1572 10	F 18021	82
722 0183 10	F 19075	136
722 0545 10	5395/5335	19
722 0547 10	6218 C3	74
722 0553 10	4580/4535	19
722 0555 10	61915 C3	70
722 0652 10	F 15191	44
F 110487.1	F 16020	88
F 113021	F 18040	112
F 113175	F 16030	90
F 113519	F 15141	112
F 210540	F 19013	132
F 211408.5	F 19062	134
F 211413.2	F 19061	134
F 224451.04	F 19090	136
F 230271	F 17089 K	146
F 237594	F 19069	134
F 43710.1	F 19066	134
F 44501	F 19031	134

COMPETITOR	Fersa	PG.
F 45385	F 18039	82
F 45721	F 16001	88
F 45747.2	F 16035	90
F 45814	F 19015	132
F 45815	F 15139	112
F 45815.1	F 15140	112
F 45864.1	F 19020	132
F 45920.2	F 16036	90
F 45951	F 16002	88
F 64843.1	F 15034	110
F 88545	F 19037	134
F 88816.2	F 19038	134
F 90836.1A	F 19016	132
F 93666.2	F 19048	134
F-110214.1	F 19096	136
F-110390	F 16219	100
F-202742	F 17061 K	146
F-202961.1	F 17063 K	146
F-203030	F 17095 K	146
F-203531.1	F 17108 K	148
F-203535	F 17093 K	146
F-204691	F 17076 K	146
F-205901.01	F 17056 K	144
F-207054	F 17033 K	144
F-208323	F 17110 K	148
F-208939.03	F 17094 K	146
F-209976	F 17057 K	146
F-209977	F 17058 K	146
F-210326.01	F 17059 K	146
F-211412.03	F 17038 K	144
F-212874.01	F 17039 K	144
F-212875.01	F 17040 K	144
F-217112	F 17041 K	144
F-219518	F 17034 K	144
F-221302.01	F 19097	136
F-224446	F 17077 K	146
F-224448.K-HLA	F 17078 K	146
F-225955	F 17079 K	146
F-226559.02-0010	F 19069	134
F-227124.K-HLA	F 17080 K	146
F-227348	F 17092 K	146
F-227349	F 17091 K	146
F-227511.06	F 17097 K	146
F-227638	F 17096 K	146

COMPETITOR	Fersa	PG.
F-229852	F 19087	136
F-237594 + F-226559	F 19116	138
F-237594 + F-226559.41	F 19116	138
F-239307	F 17105 K	148
F-390645.NCF	F 19033	134
F-44343	F 15059	110
F-45073	RMS 9	80
F-45809	F 19011	132
F-45809.01.ZL	F 19011	132
F-45809.01.ZL-AM	F 19011	132
F45818	F 19043	134
F-45818.01	F 19043	134
F45917	F 19002	132
F-53597	F 19091	136
F-53960	F 17103 K	148
F-57368.01	F 17031 K	144
F-58242	F 17051 K	144
F-58637	F 17101 K	148
F-58723	F 17052 K	144
F-59437	F 17104 K	148
F-80318	F 17090 K	146
F-84156	F 17102 K	148
F-87259	F 17053 K	144
F-87629	F 19019	132
F-87934	F 17098 K	146
F-88416	F 17100 K	148
F-89034	F 19111	138
F-92625	F 17032 K	144
F-93249	F 19005	132
F-934249.01	F 19005	132
F-95451.02	F 17035 K	144
FW404820	F 17106 K	148
K 45X53X21 A	F 17054 K	144
K 62X70X40 ZW	F 17099 K	146
K75X83X40 ZW	F 17064 K	146
V 54276	F 19045	134

IRB

IR 128	F 15005	112
IR 164	F 18012	112
IR 2043	F 15036	32
IR 2056	365/362	14
IR 2562	F 15029	32

14.3 \ Cross part number Cruces de referencias

COMPETITOR	Fersa	PG.
IRB		
IR 8006	F 16042	92
IR 8014	F 18011	82
IR 8026	F 16002	88
IR 8040	F 16001	88
IR 8041	F 16019	88
IR 8042	F 16021	88
IR 8048	F 16044	92
IR 8051	F 16018	88
IR 8052	F 16035	90
IR 8055	F 16026	88
IR 8065	F 16023	88
IR 8066	F 16030	90
IR 8085	F 16036	90
IR 8086	F 16048	92
IR 8088	F 16031	90
IR 8091	F 16022	88
IR 8095	F 16039	90
IR 8101	F 16051	92
IR 8505	F 16010	88
IR 8509	F 16046	92
IR 8513	F 16032	90
IR 8530	F 16038	90
IR 8566	F 18009	82
IR 8583	F 16041	92
IR 8591	F 16033	90
IR 8593	F 16055	92
IR 8597	F 16063	94
IR 8603	F 16037	90
IR 8618	F 16056	94
IR 8622	F 16020	88
IR 8650	F 16081	94
IR 8655	F 16034	90
IR 8668	F 16040	92
IR 8737	F 16054	92
IR 8740	F 16029	88
IR174	F 18031	112
IR174	F 18031	112

ISO		
T2BC055	32911 F	12
T2CC050	JLM 104948/JLM 104910	28
T2CC120	32924 F	12
T2CD025	32205 F	10

COMPETITOR	Fersa	PG.
T2CE040	33108 F	12
T2CE050	33010 F	12
T2CE055	33011 F	12
T2CE065	33013 F	12
T2CE075	33015 F	12
T2CE085	33017 F	12
T2CE090	33018 F	12
T2CE095	33019 F	12
T2CE100	33020 F	12
T2CE100	33020 F 561694	12
T2DB017	30203 F	8
T2DB020	30204 F	8
T2DD020	32204 F	10
T2DD050	JM 205149/JM 205110	28
T2DD055	JM 207049/JM 207010	28
T2DD055A	JM 207049 A/JM 207010	28
T2DD065	JD 6549/JD 6510	19
T2DE025	33205 F	13
T2DE030	33206 F	13
T2DE035	33207 F	13
T2DE040	33208 F	13
T2DE105	33021 F	12
T2DE110	33022 F	12
T2ED045	JF 4549/JF 4510	19
T2ED050	JF 5049/JF 5010	19
T2ED060	F 15273	38
T2ED065	JH 211749/JH 211710	28
T2ED070	JF 7049/JF 7010	19
T2ED070A	JF 7049 A/JF 7010	19
T2ED095	JF 9549/JF 9510	19
T2EE040	JF 4049/JF 4010	19
T2EE060	JF 6049/JF 6010	19
T2EE100	JF 10049/JF 10010	20
T2FB015	30302 F	8
T2FB017	30303 F	8
T2FB020	30304 F	8
T2FB025	30305 F	8
T2FB030	30306 F	8
T2FB035	30307 F	8
T2FB040	30308 F	9
T2FB050	30310 F	9
T2FB055	30311 F	9
T2FB060	30312 F	9
T2FD020	32304 F	11

COMPETITOR	Fersa	PG.
ISO		
T2FD025	32305 F	11
T2FD030	32306 F	11
T2FD040	32308 F	11
T2FD045	32309 BF	11
T2FD050	32310 F	11
T2FD055	32311 F	11
T2FD060	32312 F	11
T2FE035	32307 F	11
T2GB065	30313 F	9
T2GB070	30314 F	9
T2GB075	30315 F	9
T2GB080	30316 F	9
T2GD065	32313 F	11
T2GD070	32314 F	12
T2GD075	32315 F	12
T2GD080	32316 F	12
T2GD085	32317 F	12
T3CB055	JLM 506849/JLM 506810	29
T3CC020	32004 XF	9
T3CC025	30205 F	8
T3CC045	32009 XF	10
T3CC050	32010 XF	10
T3CC055	32011 XF	10
T3CC080	32016 XF	10
T3CC090	32018 XF	10
T3CD040	32008 XF	10
T3CE045	33109 F	12
T3CE050	33110 F	12
T3CE055	33111 F	12
T3CE060	33112 F	13
T3DB030	30206 F	8
T3DB035	30207 F	8
T3DB040	30208 F	8
T3DB045	30209 F	8
T3DB050	30210 F	8
T3DB055	30211 F	8
T3DC030	32206 F	10
T3DC035	32207 F	10
T3DC040	32208 F	10
T3DC045	32209 F	10
T3DC050	32210 F	11
T3DC055	32211 F	11
T3DC065	JM 511946/JM 511910	29

COMPETITOR	Fersa	PG.
T3DD080	JM 515649/JM 515610	29
T3DD085	JHM 516849/JHM 516810	29
T3DE045	33209 F	13
T3DE050	33210 F	13
T3DE055	33211 F	13
T3DE065	33113 F	13
T3DE070	33114 F	13
T3DE075	33115 F	13
T3DE080	33116 F	13
T3DE085	33117 F	13
T3DE090	33118 F	13
T3EB060	30212 F	8
T3EB065	30213 F	8
T3EB070	30214 F	8
T3EB080	30216 F	8
T3EB085	30217 F	8
T3EC060	32212 F	11
T3EC065	32213 F	11
T3EC070	32214 F	11
T3EC080	32216 F	11
T3EC080	33216 F 573810	13
T3EC085	32217 F	11
T3EE060	33212 F	13
T3EE065	33213 F	13
T3EE070	33214 F	13
T3EE075	33215 F	13
T3EE080	33216 F	13
T3EE085	33217 F	13
T3FB090	30218 F	8
T3FB095	30219 F	8
T3FB100	30220 F	8
T3FB105	30221 F	8
T3FB110	30222 F	8
T3FC090	32218 F	11
T3FC095	32219 F	11
T3FC100	32220 F	11
T3FC105	32221 F	11
T3FC110	32222 F	11
T3FE100	33220 F	13
T4CB100	JP 10049/JP 10010	20
T4CB120	JP 12049/JP 12010	20
T4CB120A	JP 12049 A/JP 12010	20
T4CB130	JP 13049/JP 13010	20
T4CC025	32005 XF	9

14.3 \ Cross part number Cruces de referencias

COMPETITOR	Fersa	PG.
ISO		
T4CC028	320/28 XF	9
T4CC030	32006 XF	9
T4CC032	320/32 XF	9
T4CC035	32007 XF	10
T4CC060	32012 XF	10
T4CC065	32013 XF	10
T4CC070	32014 XF	10
T4CC075	32015 XF	10
T4CC085	32017 XF	10
T4CC095	32019 XF	10
T4CC100	32020 XF	10
T4CD065	JLM 710949 C/JLM 710910	30
T4CD070	JLM 813049/JLM 813010	31
T4CD075	JM 714249/JM 714210	30
T4DB075	30215 F	8
T4DC070	JM 612949/JM 612910	29
T4DC075	32215 F	11
T4DC090	JM 718149/JM 718110	30
T4DC090A	JM 718149 A/JM 718110	30
T4DC095	JM 719149/JM 719113	30
T4DC100	JM 720249/JM 720210	30
T4DC105	32021 XF	10
T4DC110	32022 XF	10
T4DC120	32024 XF	10
T4DD100	JHM 720249/JHM 720210	30
T4FB120	30224 F	8
T4FB130	30226 F	8
T4FD050	JHM 807045/JHM 807012	30
T5CD025	32205 BF	10
T5FD030	32306 BF	11
T5FD045	32309 F	11
T5FD060	32312 BF	11
T5GD065	32313 BF	11
T5GD070	32314 BF	11
T7FB025	31305 F	9
T7FB030	31306 F	9
T7FB035	31307 F	9
T7FB040	31308 F	9
T7FB045	31309 F	9
T7FB050	31310 F	9
T7FB055	31311 F	9
T7FB060	31312 F	9

COMPETITOR	Fersa	PG.
T7FC045	JW 4549/JW 4510	19
T7FC050	JW 5049/JW 5010	19
T7FC055	JW 5549/JW 5510	19
T7FC060	JW 6049/JW 6010	19
T7FC070	JW 7049/JW 7010	19
T7FC080	JW 8049/JW 8010	19
T7GB065	31313 F	9
T7GB070	31314 F	9
T7GB075	31315 F	9
T7GB090	31318 F	9
TCCE080	33016 F	12
TCFB045	30309 F	9

JOST		
JAE0250302801	F 400001	168

KBC		
3780 F1	F 15054/3720	32
RCHL 38KW01C9	F 15055/LM 29710	32
TR285216G	F 15056	32

KOYO		
57355	F 15199	36
57518	F 15330	38
57620	F 15109	34
83549	F 18039	82
573315	F 15036	32
4304555	F 17109 K	148
05NU0618-IVH	F 19093	136
2DACF028G 6R	F 16210	100
30 BG 05 S5G - 2DST2	F 16098	106
32012 J/IB	F 15329	38
40 BD 45 T12	F 16189	106
40 BD 49 AW	F 16190	106
45CLM806649LFTL2/Z	F 15295	38
57414 / LM 300811	F 15003	32
57508 L2/28521	F 15278	38
57518/TR1312	F 15380	40
57518/TR1312/1YD	F 15330	38
60UJZS4175X	F 19171	140
6210NRZ	F 18032	82
6217 3BBNCS 9	F 18036	82
623GXX	F 19172	140
65UZS418T2XSX	F 19170	140

COMPETITOR	Fersa	PG.
KOYO		
83 A 5518	F 16102	106
83C062D	F 18066	84
85UZ5419T2XSX	F 19169	140
BD 30 - 11 A	F 16104	106
CT 1310	F 15118	112
CT1310 ARSEDCS23	F 18031	112
DAC 3869W 3CS84	F 16218	100
DAC2753	F 15128	56
DAC286142 AW	F 16077	94
DAC3052- 32 RR9 DS 1	F 16097	106
DAC3052- 32 RR9 DS 10Z	F 16097	106
DAC3555 RD 3H - 83 A	F 16100	106
DAC3555 RD 3H - 83 A 694	F 16100	106
DAC3564A1	F 16200	98
DAC35720034 A	F 16201	98
DAC3871W2CS70	F 16120	98
DAC3872W 8CS81	F 16068	94
DAC3872W10CS42	F 16124	98
DAC3874W 6CS84	F 16034	90
DAC3972AWC4 CS49	F 16036	90
DAC40440036	F 16080	94
DAC4060 M1	F 16090	96
DAC40740034 / 36	F 16091	96
DAC40740036	F 16080	94
DAC40740042 B	F 16079	94
DAC4276W	F 16195	98
DAC43820045	F 16078	94
DAC4584W-1CS81	F 16216	100
DAC4781W	F 16199	98
DG 4094 W	F 18050	84
DU5496-6	F 15324	58
DU60108 8	F 15120	154
HIC 57620/3320	F 15109	34
LM 806649/57591N	F 15295	38
SB1716BBNS	F 18037	82
ST 2455	CONE F 15084	50
ST 4276 C / ST 4276	F 15112	34
ST 4276 C / ST 4276 A	F 15112	34
ST 4276 C/A	CONE F 15111	50
STA 3072	F 15203	36
TR 0506 R	F 15001	32

COMPETITOR	Fersa	PG.
TR 070904 1	F 15202	36
TR 100802	F 15201	36
TR0607J-1	F 15203	36
TRA 0607 R	F 15002	32

LUK

500 0418 21	CLAC M 010	116
500 0422 20	CLAC M 005	114
500 0525 10	CLAC M 011	118
500 0573 10	CLAC M 006	114
500 0608 20	CLAC M 004	114
500 0611 20	CLAC M 002	114
500 0635 30	CLAC M 012	118
500 0806 20	CLAC M 007	114
500 0889 10	CLAC M 008	114
500 1004 20	CLAC M 003	114
500 1071 20	CLAC M 001	114
500 1072 20	CLAC M 009	114
500 1158 10	CLAC M 013	120
500 1171 10	CLAC M 014	120

NACHI

031BC05NC2	F 18074	84
25RT59SN	F 19166	140
30 BG 055 2G - 2DS	F 16097	106
30 BG 055 5G - 2DS	F 16098	106
30 BG S 12G - 2DS	F 16104	106
31 RUKS52N C3	F 19079	136
34RUKS64NR	F 19167	140
35 BG 055 10G 2DL	F 16100	106
35 BG 055 7G 2DS	F 16099	106
35 BG 52 22 2DS	F 16101	106
35BSC34-2MT2N	F 18075	84
35BG05S16G-2DL	F 16100	106
38 BVV07 10G	F 16124	98
40 BG 055 2G - 2DS	F 16189	106
40 BG 620 20 - 2DL	F 16103	106
40 BG S 12G - 2DS	F 16190	106
40 BG S1 1G - 2DS	F 16102	106
40TM05NXC3	F 18076	84
NUPK 2205 S1 NR	F 19023	132
NUPK 2205 S13	F 19004	132

14.3 \ Cross part number Cruces de referencias

COMPETITOR	Fersa	PG.
NATIONAL		
510002	F 16120	98
510004	F 16039	90
510006	F 16078	94
510007	F 16068	94
510008	F 16058	94
510009	F 16081	94
510010	F 16088	96
510014	F 16200	98
510015	F 16117	98
510016	F 16091	96
510019	F 16054	92
510024	F 16035	90
510028	F 16199	98
510029	F 16055	92
510030	F 16052	92
510032	F 16198	98
510051	F 16085	96
510052	F 16037	90
510055	F 16057	94
510057	F 16197	98
510060	F 16196	98
510061	F 16080	94
510087	F 16056	94
510089	F 16193	98
511020	F 16032	90
513006	F 16195	98
513021	F 16023	88
513031	F 16077	94
513036	F 16090	96
513053	F 16041	92
513058	F 16194	98
513073	F 16048	92
513113	F 16036	90
514002	F 16034	90
516005	F 15130	56
516007	F 15067	56

NSK		
27 BWK 04D3	F 16094	96
28 BWK 12	F 16095	96
28KW01655A	F 15056	32
29586 A/29522	F 15304	38
30 BD 40 A - T1Z DDF	F 16098	106

COMPETITOR	Fersa	PG.
30 BD 40 A - T1Z DDF1	F 16098	106
30 BD 5222 FX	F 16097	106
35 BD 219T - 1Z DDU	F 16100	106
35 BD 219T - 1Z DDU K8	F 16100	106
35 BD 5020 DUK	F 16099	106
35 BD 52 22 DF X7	F 16101	106
35BWD01C	F 16201	98
36BWD04CA5	F 16115	96
38BWD06D A CA 01	F 16058	94
38BWD09ACA128	F 16120	98
38BWD28DCA98-01LB	F 16214	100
38KW01C9	F 15055/LM 29710	32
40 BD 45 T12 DDU	F 16189	106
40 BD 49 AWT12 DDU	F 16190	106
40 BD 49V	F 16103	106
40 BW06CG50	F 18051	84
40 BWD 06	F 16081	94
40 BWD 12	F 16079	94
40 BWD 15 A	F 16080	94
40 BWD 17DCA116*SA01	F 16217	100
40BWD05CA60	F 16041	92
40KWD02	F 15129	56
41KWD01G3	F 15015	56
42 BWD 06CA98	F 16085	96
42KWD08A	F 15130	56
43 BWD 06	F 16078	94
43 BWD 12A JB 5C01	F 16196	98
43 KWD 07AU42CA	F 15160	56
43BWD08CA103	F 16052	92
47 KWD 02 AP	F 15268	58
49BWD01BCA116	F 16109	96
49BWD03CA	F 16208	100
4UA20/KWD 10	F 15218	58
50KW01	F 15054/3720	32
54KWH02	F 15146	56
AU 0501 NTN	F 16129	98
B17 126 DDWC3	F 18020	82
B17-99 D	6304/17 B17 2RS	75
B25-299DWA18	F 18058	84
BL 210 ZNR C3	F 18041	82
DF 0865	F 16102	106
HR32210J	32210 F	11
R35-24	F 15202	36
R35-24	F 15202	36

COMPETITOR	Fersa	PG.
NTN		
2TS2 - DF 0882 LL BC	F 16189	106
2TS2 - DF 0882 LL BCS	F 16189	106
30 BG 04 S15G - 2DST	F 16100	106
30 TM11NC3 UR UMMS	F 18047	84
32 TM11NC3 UR UMMS 8	F 18048	84
32 TM11NC3 UR UMMS 806	F 18048	84
32205/20	F 15199	36
33212.1/ECO CR-1187.	F 15332	38
33212.1/ECO CR-1187.1	F 15332	38
40 BD 219T 12 DDU	F 16102	106
4T 45285 APX1/4T CR	F 15212	44
4T 45285 APX1/4T CR 1091 PX1	F 15212	44
5206 #37	F 16104	106
5908 - 2RSWE	F 16190	106
6215/72 C3	F 18060	84
6TM-SF1740NRCS154	F 18037	82
6TM-SF1741NRCS176	F 18036	82
AU 0501	F 16129	98
AU 0933	F 16193	98
CR 1252	F 15088	34
DAC 4T CR1	F 15149	56
DE 08A48LLCS46PX1 /	F 16117	98
DE 08A48LLCS46PX1 / L260	F 16117	98
ECO CIR 0805.2	CONE F 15249	50
ECO CIR 0810.1	CONE F 15292	50
ECO CR 12A 06 1	F 15245	36
ECO CR-12A17.1	F 15334	40
ETA CIR 1006.1	CONE F 15244	50
ETA CIR 1010 1	CONE F 15113	50
ETA CIR 1012	CONE F 15333	50
ETA CIR 1104	CONE F 15111	50
ETA CIR-1106	CONE F 15269	50
ETA CR 05A225TPX1	F 15196	44
TMB 311 X13 C3	F 18042	82

OPTIMAL		
100002	KA 069	212
100003	KF 421	223
100007	KV 425	223
100013	KV 394	222

COMPETITOR	Fersa	PG.
100014	KF 095	213
100022	KF 182	215
100053	KV 250	218
100090	KF 096	213
100098	KF 098	213
100099	KF 306	220
100206	KF 233	217
101010	KF 179	215
101016	KF 181	215
101017	KV 359	221
101024	KF 183	215
101025	KV 518	226
101027	KV 287	219
101029	KV 285	219
101044	KF 180	215
101064	KA 071	212
101108	KA 455	224
101111	KF 308	220
101113	KF 184	215
101147	KF 185	215
101250	KA 502	226
101699	KV 360	221
102008	KA 005	210
102011	KV 276	219
102019	KV 361	221
102019	KV 367	221
102041	KF 479	225
102055	KA 248	218
102060	KA 072	212
102071	KV 395	222
102075	KV 284	219
102077	KV 286	219
102079	KV 420	223
102094	KC 256	218
102097	KF 519	226
102115	KV 194	216
102213	KV 358	221
102497	KV 511	226
131129	KF 240	217
132131	KF 241	217
191272	KA 070	212
192274	KC 488	225
200012	KA 038	211
200020	KA 039	211

14.3 \ Cross part number Cruces de referencias

COMPETITOR	Fersa	PG.
OPTIMAL		
201031	KV 247	218
201032	KF 134	214
201033	KV 196	216
201035	KV 198	216
201040	KF 133	214
201043	KV 199	216
201084	KV 135	214
201085	KF 315	220
201087	KF 342	221
201089	KF 340	221
201095	KF 292	219
201210	KF 137	214
201228	KF 138	214
201262	KA 404	223
201517	KV 343	221
201621	KV 333	220
201623	KV 332	220
201691	KV 335	220
201996	KA 040	211
202021	KB 338	221
202023	KV 337	221
202059	KV 279	219
202101	KB 339	221
202140	KV 235	217
202142	KV 202	216
202168	KF 136	214
202218	KV 252	218
202224	KF 341	221
202286	KV 524	226
202519	KV 336	220
202625	KV 330	220
202627	KV 331	220
300004	KA 075	212
300052	KA 014	210
300062	KA 083	212
301006	KA 019	210
301018	KA 015	210
301034	KA 018	210
301038	KA 081	212
301039	KF 201	216
301045	KF 282	219
301118	KA 085	212
301132	KF 115	213

COMPETITOR	Fersa	PG.
301132	KF 327	220
301151	KA 499	225
301180	KA 020	210
301182	KF 116	213
301183	KF 329	220
301185	KV 291	219
301230	KA 074	212
301280	KA 017	210
301511	KF 549	227
301574	KF 385	222
301583	KV 387	222
301667	KV 322	220
302057	KB 191	216
302057	KB 384	222
302058	KA 021	210
302058	KA 383	222
302074	KA 076	212
302076	KA 082	212
302120	KA 347	221
302122	KA 257	218
302124	KA 084	212
302164	KF 453	224
302166	KB 263	218
302172	KD 117	213
302176	KD 118	213
302186	KV 220	217
302188	KV 221	217
302192	KV 222	217
302197	KV 328	220
302255	KV 325	220
302257	KV 326	220
302577	KV 484	225
302901	KV 324	220
302903	KV 323	220
400051	KF 280	219
400107	KF 127	214
401028	KA 027	210
401042	KA 028	210
401047	KF 450	224
401048	KA 030	211
401078	KA 189	216
401100	KA 087	212
401126	KA 029	210
401137	KA 273	218

COMPETITOR	Fersa	PG.
OPTIMAL		
401157	KA 414	223
401214	KA 033	211
401222	KA 025	210
401501	KA 406	223
402030	KA 026	210
402050	KA 126	214
402063	KB 345	221
402080	KB 125	214
402116	KF 124	214
402117	KB 422	223
402143	KA 515	226
402216	KA 032	211
402243	KF 300	219
402467	KV 408	223
501088	KV 105	213
501112	KV 105	213
501121	KV 238	217
501133	KV 532	226
501136	KV 108	213
501136	KV 297	219
501158	KF 378	222
501161	KV 374	222
501513	KV 432	223
501653	KV 431	223
502066	KF 107	213
502068	KF 104	213
502070	KF 396	222
502072	KF 106	213
502109	KF 303	219
502123	KV 239	217
502125	KF 470	225
502135	KF 274	218
502135	KF 348	221
502138	KF 109	213
502148	KF 110	213
502163	KV 462	224
502252	KV 472	225
502691	KF 418	223
600308	KF 143	214
600334	KF 111	213
600410	KA 063	212
601253	KF 354	221
601306	KF 142	214

COMPETITOR	Fersa	PG.
601323	KF 313	220
601348	KF 543	227
601384	KA 041	211
601440	KF 500	226
601446	KF 172	215
601495	KF 139	214
601675	KF 399	222
601916	KF 145	214
601953	KF 289	219
602251	KV 435	224
602314	KV 219	217
602320	KB 008	210
602322	KF 112	213
602337	KV 114	213
602340	KV 144	214
602345	KV 460	224
602347	KV 275	219
602386	KV 459	224
602388	KV 215	217
602390	KF 141	214
602406	KF 140	214
602414	KA 073	212
602509	KV 548	227
602645	KV 305	220
602669	KB 368	222
602681	KV 410	223
602745	KB 464	224
602746	KV 458	224
602835	KV 507	226
602858	KB 078	212
602859	KA 089	212
602883	KB 369	222
602893	KB 357	221
602955	KV 445	224
602956	KV 290	219
681303	KF 113	213
681325	KA 272	218
681375	KB 295	219
681375	KB 390	222
681471	KB 296	219
681471	KB 372	222
681504	KA 009	210
681506	KA 079	212
681640	KB 011	210

14.3 \ Cross part number Cruces de referencias

COMPETITOR	Fersa	PG.
OPTIMAL		
681913	KF 473	225
681923	KB 356	221
682263	KV 294	219
682305	KV 236	217
682327	KA 013	210
682329	KA 080	212
682420	KA 010	210
682437	KB 424	223
682492	KA 200	216
682508	KA 058	211
682642	KB 012	210
682925	KB 362	221
700245	KF 371	222
700310	KF 155	215
701247	KF 334	220
701302	KB 048	211
701302	KB 192	216
701302	KF 151	214
701307	KF 195	216
701326	KV 152	214
701332	KC 149	214
701374	KC 148	214
701404	KF 153	214
701424	KF 314	220
701432	KF 150	214
701726	KA 255	218
701837	KF 539	227
701852	KF 312	220
701860	KB 278	219
701860	KB 293	219
701914	KF 277	219
701975	KF 375	222
701977	KF 351	221
701978	KF 366	221
702312	KB 045	211
702312	KB 193	216
702313	KV 546	227
702316	KB 046	211
702321	KV 246	218
702328	KA 044	211
702350	KA 043	211
702352	KB 090	213
702355	KV 243	217

COMPETITOR	Fersa	PG.
702357	KV 244	217
702380	KV 154	215
702380	KV 258	218
702426	KB 047	211
702436	KA 476	225
702456	KA 091	212
702494	KV 157	215
702514	KV 156	215
702586	KA 269	218
702692	KA 049	211
702815	KV 520	226
702817	KA 043	211
702846	KB 344	221
702846	KB 402	222
702866	KV 440	224
702899	KB 193	216
702957	KV 535	227
702958	KV 492	225
702982	KB 350	221
702983	KB 364	221
800304	KF 160	215
800398	KF 166	215
800400	KF 261	218
800408	KF 161	215
801267	KF 471	225
801342	KV 163	215
801354	KF 203	216
801360	KF 465	224
801362	KF 168	215
801364	KF 270	218
801376	KF 165	215
801382	KF 161	215
801402	KA 056	211
801428	KF 094	213
801438	KA 003	210
801450	KF 468	224
801500	KF 264	218
801538	KA 213	216
801543	KF 159	215
801554	KA 004	210
801618	KA 349	221
801644	KA 169	215
801656	KA 024	210
801698	KA 057	211

COMPETITOR	Fersa	PG.
OPTIMAL		
801730	KF 167	215
801750	KA 169	215
801836	KF 346	221
801836	KF 461	224
801838	KF 437	224
801838	KF 510	226
801880	KF 281	219
801950	KF 288	219
801961	KV 398	222
801970	KV 411	223
801972	KF 536	227
801974	KF 373	222
802265	KV 523	226
802302	KV 474	225
802315	KV 237	217
802318	KV 162	215
802324	KV 162	215
802330	KV 164	215
802378	KV 218	217
802394	KV 204	216
802444	KV 544	227
802454	KC 205	216
802464	KA 210	216
802480	KC 253	218
802485	KV 547	227
802542	KF 092	212
802590	KC 477	225
802612	KV 447	224
802652	KA 001	210
802732	KA 054	211
802748	KA 170	215
802839	KV 251	218
802870	KV 377	222
802888	KV 534	226
802980	KV 409	223
880419	KA 052	211
880421	KA 053	211
880812	KA 050	211
880912	KF 441	224
881237	KF 452	224
881489	KA 533	226
881592	KA 254	218
881704	KF 099	213

COMPETITOR	Fersa	PG.
881725	KF 101	213
882483	KV 505	226
882487	KV 457	224
882491	KA 517	226
882896	KV 449	224
891311	KV 506	226
891477	KF 302	219
891484	KF 175	215
891486	KF 176	215
891544	KV 514	226
891628	KV 245	217
891628	KV 271	218
891630	KF 504	226
891731	KF 516	226
891822	KA 068	212
891869	KV 249	218
891878	KV 467	224
891887	KF 433	223
892458	KA 212	216
892460	KA 211	216
892470	KV 177	215
892472	KV 178	215
892587	KV 401	222
892735	KV 234	217
892843	KV 242	217
892872	KV 478	225
892929	KV 480	225
911377	KF 304	220
911383	KF 102	213
911385	KV 229	217
911600	KF 320	220
911802	KF 426	223
912122	KV 501	226
912527	KF 525	226
912530	KV 100	213
912532	KV 260	218
920752	KA 086	212
921215	KF 508	226
921555	KA 397	222
921895	KF 487	225
921906	KF 388	222
922181	KV 521	226
922219	KV 336	220
922441	KA 545	227

14.3 \ Cross part number Cruces de referencias

COMPETITOR	Fersa	PG.
OPTIMAL		
922488	KV 438	224
922488	KV 526	226
922489	KV 485	225
922697	KV 513	226
922781	KV 230	217
922783	KV 231	217
922787	KV 489	225
922921	KV 412	223
940371	KF 225	217
941237	KF 540	227
941636	KA 214	217
941700	KF 227	217
941874	KA 393	222
941941	KB 365	221
942566	KA 389	222
942569	KV 226	217
942770	KA 542	227
942773	KV 232	217
942942	KA 407	223
951409	KF 119	213
951449	KF 317	220
951604	KF 121	213
951606	KA 022	210
951708	KA 023	210
951722	KA 190	216
952405	KV 120	213
952415	KV 122	214
952417	KV 123	214
952593	KC 188	216
952608	KV 228	217
952661	KA 186	216
952710	KA 187	216
952769	KB 491	225
952936	KA 423	223
960578	KF 129	214
960638	KF 128	214
961229	KF 381	222
961411	KA 430	223
961479	KF 321	220
961503	KA 036	211
961648	KF 130	214
961753	KB 318	220
961801	KA 392	222

COMPETITOR	Fersa	PG.
961904	KA 035	211
962435	KA 266	218
962548	KV 267	218
962682	KA 034	211
962684	KC 132	214
962703	KV 503	226
962712	KV 530	226
962718	KB 217	217
962776	KA 077	212
962905	KA 268	218
971391	KF 133	214
971391	KF 376	222
971393	KF 134	214
971393	KF 448	224
971451	KA 061	212
971455	KC 223	217
971575	KF 301	219
971612	KB 062	212
971612	KB 496	225
971707	KB 443	224
971723	KF 509	226
971767	KV 541	227
971917	KA 405	223
971940	KF 428	223
972389	KA 007	210
972453	KC 224	217
972571	KC 265	218
972571	KC 522	226
972573	KC 444	224
972688	KC 419	223
972709	KB 416	223
972918	KA 413	223
981199	KF 370	222
981407	KF 466	224
981475	KF 309	220
981475	KF 316	220
981535	KA 002	210
981572	KF 456	224
981616	KF 259	218
981704	KV 528	226
981790	KA 065	212
981799	KF 311	220
981814	KA 066	212
981814	KA 067	212

COMPETITOR	Fersa	PG.
OPTIMAL		
981851	KF 310	220
981856	KF 298	219
981868	KF 197	216
981938	KF 429	223
982195	KV 482	225
982685	KC 174	215
982766	KF 173	215
982780	KF 352	221
982857	KV 537	227
982939	KV 353	221
982948	KV 451	224
991863	KV 363	221
991898	KV 439	224
991902	KV 490	225

PFI		
B17-52D	6304/17 2RS	75

QH		
QWB 1000	KF 240	217
QWB 1001	KV 236	217
QWB 1002	KF 304	220
QWB 1003	KF 102	213
QWB 1005	KA 272	218
QWB 1039	KV 245	217
QWB 1039	KV 271	218
QWB 1049	KV 114	213
QWB 1052	KV 537	227
QWB 1055	KV 194	216
QWB 1057	KF 127	214
QWB 1068	KF 450	224
QWB 1069	KB 345	221
QWB 1070	KA 189	216
QWB 1071	KV 547	227
QWB 1076	KV 336	220
QWB 1079	KV 231	217
QWB 1081	KV 230	217
QWB 1084	KF 155	215
QWB 1085	KB 278	219
QWB 1086	KB 402	222
QWB 1088	KB 193	216
QWB 1089	KF 184	215
QWB 1096	KF 277	219

COMPETITOR	Fersa	PG.
QWB 1098	KF 288	219
QWB 1099	KV 411	223
QWB 1101	KV 251	218
QWB 1102	KF 346	221
QWB 1103	KF 536	227
QWB 1106	KF 452	224
QWB 1109	KV 492	225
QWB 1112	KV 196	216
QWB 1113	KV 198	216
QWB 1114	KV 199	216
QWB 1115	KV 279	219
QWB 1116	KF 441	224
QWB 1117	KV 247	218
QWB 1118	KF 264	218
QWB 1124	KV 457	224
QWB 1126	KF 201	216
QWB 1127	KF 282	219
QWB 1128	KB 191	216
QWB 1131	KV 246	218
QWB 1132	KV 440	224
QWB 1133	KV 157	215
QWB 1136	KV 530	226
QWB 1137	KV 276	219
QWB 113C	KA 014	210
QWB 1142	KF 316	220
QWB 1146	KF 241	217
QWB 114C	KA 499	225
QWB 1150	KF 145	214
QWB 1152	KV 275	219
QWB 1154	KF 308	220
QWB 1155	KA 248	218
QWB 115C	KA 017	210
QWB 1160	KV 286	219
QWB 1179	KB 422	223
QWB 1189	KV 221	217
QWB 1193	KV 532	226
QWB 1194	KF 348	221
QWB 1195	KF 280	219
QWB 1196	KA 273	218
QWB 1197	KA 033	211
QWB 1198	KA 515	226
QWB 1199	KA 032	211
QWB 1200	KV 238	217
QWB 1202	KV 234	217

14.3 \ Cross part number Cruces de referencias

COMPETITOR	Fersa	PG.
QH		
QWB 1211	KF 292	219
QWB 1212	KB 338	221
QWB 1222	KF 470	225
QWB 1223	KF 303	219
QWB 1228	KV 290	219
QWB 1231	KF 302	219
QWB 1233	KV 242	217
QWB 1234	KV 178	215
QWB 1236	KV 328	220
QWB 1237	KV 460	224
QWB 1240	KV 177	215
QWB 1241	KV 249	218
QWB 1242	KV 472	225
QWB 1251	KF 340	221
QWB 1252	KF 315	220
QWB 1253	KB 339	221
QWB 1254	KF 351	221
QWB 1257	KV 284	219
QWB 1258	KV 291	219
QWB 1259	KV 325	220
QWB 1260	KV 326	220
QWB 1261	KF 329	220
QWB 1263	KF 375	222
QWB 1264	KF 371	222
QWB 1265	KF 289	219
QWB 1266	KV 445	224
QWB 1270	KV 395	222
QWB 1273	KV 294	219
QWB 1274	KB 078	212
QWB 1275	KV 459	224
QWB 1276	KV 305	220
QWB 1277	KV 535	227
QWB 1280	KF 525	226
QWB 1282	KF 433	223
QWB 1282	KF 504	226
QWB 1283	KV 420	223
QWB 1284	KF 176	215
QWB 1285	KA 405	223
QWB 1286	KA 413	223
QWB 1287	KV 377	222
QWB 1305	KV 484	225
QWB 1358	KV 507	226
QWB 1368	KV 322	220

COMPETITOR	Fersa	PG.
QWB 155C	KA 038	211
QWB 159C	KA 254	218
QWB 177C	KC 253	218
QWB 194C	KD 117	213
QWB 194C	KD 118	213
QWB 200	KF 180	215
QWB 201	KA 069	212
QWB 212	KA 002	210
QWB 224	KA 059	211
QWB 224	KA 063	212
QWB 227	KF 500	226
QWB 231	KF 172	215
QWB 239	KA 055	211
QWB 241	KA 210	216
QWB 242	KA 056	211
QWB 249	KA 213	216
QWB 254	KC 205	216
QWB 255	KA 027	210
QWB 256	KA 025	210
QWB 259	KA 026	210
QWB 285	KA 040	211
QWB 286	KC 147	214
QWB 289	KA 041	211
QWB 301	KA 042	211
QWB 302	KC 146	214
QWB 302	KC 148	214
QWB 309	KF 150	214
QWB 310	KA 044	211
QWB 313	KC 149	214
QWB 328	KF 179	215
QWB 342	KA 068	212
QWB 347	KA 036	211
QWB 354	KC 132	214
QWB 356	KC 488	225
QWB 360	KC 174	215
QWB 365	KA 066	212
QWB 365	KA 067	212
QWB 366	KA 065	212
QWB 376	KC 188	216
QWB 407	KA 071	212
QWB 411	KA 051	211
QWB 414	KA 075	212
QWB 414	KA 083	212
QWB 417	KF 133	214

COMPETITOR	Fersa	PG.
QH		
QWB 418	KA 019	210
QWB 419	KA 050	211
QWB 420	KA 015	210
QWB 422	KF 160	215
QWB 422	KF 161	215
QWB 422	KF 203	216
QWB 422	KV 162	215
QWB 429	KA 005	210
QWB 430	KB 048	211
QWB 430	KB 192	216
QWB 436	KF 134	214
QWB 443	KA 003	210
QWB 445	KA 089	212
QWB 455	KF 354	221
QWB 457	KA 211	216
QWB 459	KA 073	212
QWB 461	KF 141	214
QWB 467	KV 152	214
QWB 474	KA 255	218
QWB 475	KA 476	225
QWB 479	KF 153	214
QWB 481	KA 009	210
QWB 482	KB 012	210
QWB 486	KB 011	210
QWB 490	KF 320	220
QWB 493	KA 349	221
QWB 494	KC 256	218
QWB 496	KA 072	212
QWB 497	KA 091	212
QWB 498	KF 314	220
QWB 500	KV 144	214
QWB 503	KB 008	210
QWB 508	KA 030	211
QWB 509	KV 204	216
QWB 510	KF 095	213
QWB 510	KF 185	215
QWB 513	KF 396	222
QWB 514	KF 107	213
QWB 515	KV 163	215
QWB 521	KA 455	224
QWB 527	KA 076	212
QWB 528	KA 082	212
QWB 532	KA 347	221

COMPETITOR	Fersa	PG.
QWB 533	KA 257	218
QWB 534	KV 105	213
QWB 539	KA 034	211
QWB 545	KA 010	210
QWB 556	KA 077	212
QWB 560	KB 047	211
QWB 566	KB 046	211
QWB 568	KA 081	212
QWB 569	KA 018	210
QWB 570	KF 136	214
QWB 596	KA 039	211
QWB 599	KA 212	216
QWB 602	KA 389	222
QWB 603	KV 135	214
QWB 605	KA 001	210
QWB 608	KA 049	211
QWB 629	KA 043	211
QWB 634	KF 111	213
QWB 635	KF 112	213
QWB 654	KA 028	210
QWB 659	KA 029	210
QWB 662	KB 090	213
QWB 666	KA 169	215
QWB 671	KF 092	212
QWB 678	KV 215	217
QWB 682	KF 468	224
QWB 685	KA 170	215
QWB 687	KV 156	215
QWB 691	KA 004	210
QWB 692	KA 023	210
QWB 696	KA 020	210
QWB 697	KA 021	210
QWB 698	KF 182	215
QWB 699	KA 542	227
QWB 703	KF 173	215
QWB 704	KF 352	221
QWB 707	KA 054	211
QWB 712	KF 099	213
QWB 716	KA 190	216
QWB 722	KA 214	217
QWB 725	KA 024	210
QWB 734	KV 218	217
QWB 735	KF 465	224
QWB 736	KV 164	215

14.3 \ Cross part number Cruces de referencias

COMPETITOR	Fersa	PG.
QH		
QWB 740	KA 058	211
QWB 742	KV 260	218
QWB 747	KA 186	216
QWB 754	KB 125	214
QWB 756	KA 084	212
QWB 759	KF 175	215
QWB 763	KB 217	217
QWB 766	KF 259	218
QWB 766	KF 456	224
QWB 773	KA 087	212
QWB 779	KF 106	213
QWB 781	KF 143	214
QWB 783	KF 124	214
QWB 785	KC 419	223
QWB 786	KV 108	213
QWB 786	KV 297	219
QWB 787	KF 109	213
QWB 790	KF 543	227
QWB 798	KF 142	214
QWB 803	KA 187	216
QWB 812	KB 062	212
QWB 813	KA 126	214
QWB 817	KF 115	213
QWB 817	KF 327	220
QWB 822	KC 477	225
QWB 828	KA 079	212
QWB 830	KV 219	217
QWB 831	KF 110	213
QWB 842	KA 086	212
QWB 844	KV 544	227
QWB 846	KF 261	218
QWB 850	KV 100	213
QWB 853	KF 166	215
QWB 854	KF 270	218
QWB 855	KF 165	215
QWB 855	KF 168	215
QWB 859	KF 116	213
QWB 860	KV 220	217
QWB 861	KV 222	217
QWB 863	KA 085	212
QWB 864	KF 453	224
QWB 865	KB 263	218
QWB 871	KF 195	216

COMPETITOR	Fersa	PG.
QWB 876	KV 235	217
QWB 877	KV 202	216
QWB 878	KF 138	214
QWB 879	KV 252	218
QWB 880	KF 183	215
QWB 890	KF 227	217
QWB 891	KV 226	217
QWB 896	KC 223	217
QWB 904	KC 444	224
QWB 906	KF 104	213
QWB 915	KA 061	212
QWB 926	KV 228	217
QWB 928	KF 130	214
QWB 931	KF 129	214
QWB 933	KV 503	226
QWB 935	KF 137	214
QWB 939	KV 267	218
QWB 941	KF 321	220
QWB 942	KA 269	218
QWB 944	KF 094	213
QWB 951	KV 244	217
QWB 952	KV 243	217
QWB 954	KV 546	227
QWB 956	KF 128	214
QWB 958	KF 121	213
QWB 959	KF 301	219
QWB 963	KA 404	223
QWB 965	KV 229	217
QWB 974	KF 113	213
QWB 978	KV 514	226
QWB 993	KA 502	226
QWB 994	KF 101	213
QWB 995	KA 080	212
QWB 996	KA 013	210
QWB 997	KF 233	217
QWB 998	KV 505	226

RBC TYSON

H 715345/H 715313 W	H 715345/H 715313 W	30
---------------------	----------------------------	----

RHP

15/W65	F 15211	112
RJ 2022	F 19024	132
RJ 2023	F 19055	134

COMPETITOR	Fersa	PG.
RUVILLE		
4001	KB 344	221
4001	KB 402	222
4002	KB 011	210
4003	KB 012	210
4006	KB 278	219
4006	KB 293	219
4013	KB 356	221
4014	KB 362	221
4017	KB 295	219
4017	KB 390	222
4023	KA 255	218
4024	KA 476	225
4025	KA 091	212
4026	KA 070	212
4027	KC 488	225
4033	F 15302	58
4034	KA 023	210
4037	KB 424	223
4038	KB 296	219
4038	KB 372	222
4042	KA 009	210
4043	KA 010	210
4045	KF 314	220
4052	KD 117	213
4056	KA 049	211
4058	KA 169	215
4059	KA 169	215
4065	KA 170	215
4070	KD 118	213
4072	KA 033	211
4073	KA 032	211
4076	KA 273	218
4077	KA 079	212
4078	KA 058	211
4080	KA 084	212
4081	KA 269	218
4083	KA 200	216
4085	KB 263	218
4086	KF 453	224
4087	KA 085	212
4088	KA 515	226
4089	KC 174	215
4091	KA 266	218

COMPETITOR	Fersa	PG.
4094	KA 272	218
4095	KA 013	210
4096	KA 080	212
4099	KF 315	220
5010	KF 396	222
5012	KF 107	213
5015	KV 105	213
5016	KF 104	213
5017	KV 105	213
5019	KF 106	213
5022	KV 108	213
5022	KV 297	219
5023	KF 109	213
5024	KF 110	213
5025	KF 348	221
5026	KV 532	226
5027	KF 274	218
5028	KF 470	225
5029	KV 239	217
5030	KV 238	217
5031	KF 303	219
5032	KV 472	225
5033	KF 378	222
5037	KV 431	223
5040	KV 432	223
5041	KF 418	223
5102	KA 025	210
5103	KA 026	210
5105	KA 027	210
5107	KF 124	214
5108	KA 030	211
5110	KA 126	214
5111	KA 087	212
5112	KA 029	210
5114	KA 028	210
5115	KB 125	214
5118	KA 189	216
5126	KF 280	219
5127	KF 127	214
5128	KF 300	219
5131	KF 450	224
5132	KB 345	221
5136	KA 414	223
5138	KA 406	223

14.3 \ Cross part number Cruces de referencias

COMPETITOR	Fersa	PG.
RUVILLE		
5202	KA 083	212
5205	KA 499	225
5208	KA 017	210
5212	KA 014	210
5216	KA 015	210
5217	KA 075	212
5219	KA 019	210
5220	KA 074	212
5221	KA 018	210
5223	KF 329	220
5224	KV 328	220
5228	KA 076	212
5229	KA 081	212
5232	KA 347	221
5233	KA 257	218
5234	KA 082	212
5236	KA 020	210
5237	KA 021	210
5237	KA 383	222
5239	KF 115	213
5239	KF 327	220
5242	KF 116	213
5243	KV 220	217
5244	KV 221	217
5245	KV 222	217
5254	KF 201	216
5255	KF 282	219
5256	KB 191	216
5256	KB 384	222
5258	KV 325	220
5259	KV 326	220
5260	KV 291	219
5261	KF 549	227
5262	KV 322	220
5266	KV 324	220
5267	KV 323	220
5303	KA 040	211
5307	KA 007	210
5314	KF 133	214
5314	KF 376	222
5315	KF 134	214
5315	KF 448	224
5316	KA 039	211

COMPETITOR	Fersa	PG.
5318	KV 135	214
5320	KF 136	214
5322	KV 235	217
5323	KV 202	216
5325	KF 137	214
5326	KF 138	214
5327	KV 252	218
5328	KA 404	223
5330	KV 247	218
5331	KV 196	216
5332	KV 198	216
5333	KV 199	216
5334	KV 279	219
5335	KF 342	221
5336	KF 341	221
5337	KB 338	221
5338	KV 337	221
5339	KF 292	219
5340	KV 343	221
5341	KV 336	220
5343	KV 335	220
5347	KV 333	220
5348	KV 332	220
5349	KV 331	220
5350	KV 330	220
5401	KF 184	215
5404	KA 069	212
5408	KC 256	218
5410	KF 421	223
5412	KF 180	215
5414	KF 179	215
5415	KF 185	215
5416	KF 095	213
5417	KA 071	212
5418	KA 072	212
5423	KF 181	215
5424	KA 455	224
5428	KF 182	215
5433	KF 233	217
5434	KF 183	215
5441	KF 240	217
5442	KF 241	217
5443	KF 098	213
5444	KV 276	219

COMPETITOR	Fersa	PG.
RUVILLE		
5445	KV 284	219
5446	KB 422	223
5448	KV 194	216
5449	KF 159	215
5450	KA 248	218
5452	KV 285	219
5454	KV 358	221
5455	KV 361	221
5455	KV 367	221
5456	KV 359	221
5457	KV 425	223
5458	KV 394	222
5466	KV 250	218
5502	KF 312	220
5503	KA 043	211
5506	KA 044	211
5507	KF 375	222
5508	KC 149	214
5509	KF 153	214
5510	KC 148	214
5511	KV 152	214
5513	KB 045	211
5513	KB 193	216
5515	KV 154	215
5515	KV 258	218
5516	KF 155	215
5517	KB 046	211
5519	KB 090	213
5521	KF 150	214
5522	KA 043	211
5524	KV 156	215
5526	KV 157	215
5527	KB 047	211
5529	KB 048	211
5529	KB 192	216
5538	KF 195	216
5542	KV 546	227
5546	KV 244	217
5547	KV 243	217
5554	KV 440	224
5556	KV 246	218
5561	KF 277	219
5566	KV 492	225

COMPETITOR	Fersa	PG.
5567	KV 535	227
5569	KF 340	221
5570	KB 339	221
5572	KF 371	222
5574	KF 334	220
5575	KF 351	221
5576	KF 366	221
5577	KB 350	221
5579	KB 364	221
5580	KF 539	227
5582	KV 520	226
5600	KA 063	212
5604	KF 172	215
5705	KA 005	210
5708	KF 096	213
5716	KF 308	220
5725	KF 479	225
5727	KV 395	222
5728	KF 519	226
5731	KV 286	219
5732	KV 287	219
5742	KV 511	226
5801	KA 056	211
5802	KA 213	216
5804	KA 210	216
5807	KF 161	215
5808	KA 057	211
5810	KV 162	215
5811	KC 253	218
5812	KF 160	215
5813	KV 163	215
5814	KV 204	216
5817	KV 162	215
5818	KF 261	218
5821	KV 218	217
5822	KV 164	215
5824	KF 465	224
5825	KF 468	224
5829	KV 544	227
5830	KF 161	215
5831	KF 165	215
5832	KF 166	215
5834	KF 270	218
5835	KF 168	215

14.3 \ Cross part number Cruces de referencias

COMPETITOR	Fersa	PG.
RUVILLE		
5837	KF 167	215
5838	KV 236	217
5839	KV 237	217
5841	KF 281	219
5842	KF 288	219
5843	KF 437	224
5843	KF 510	226
5844	KF 346	221
5844	KF 461	224
5845	KF 536	227
5846	KV 251	218
5853	KV 409	223
5854	KF 373	222
5855	KF 471	225
5856	KV 523	226
5859	KV 474	225
5903	KF 140	214
5907	KF 139	214
5908	KA 041	211
5911	KA 089	212
5912	KA 073	212
5913	KF 141	214
5914	KF 142	214
5915	KV 144	214
5917	KF 145	214
5919	KB 008	210
5922	KV 215	217
5924	KF 543	227
5929	KV 219	217
5931	KF 113	213
5933	KV 460	224
5937	KV 114	213
5938	KB 078	212
5940	KV 305	220
5942	KV 290	219
5943	KV 548	227
5944	KF 289	219
5946	KV 294	219
5947	KF 399	222
5948	KV 458	224
5949	KV 410	223
5950	KB 369	222
6002	KA 001	210

COMPETITOR	Fersa	PG.
6004	KA 002	210
6006	KA 003	210
6013	KF 092	212
6015	KF 264	218
6018	KF 094	213
6019	KA 004	210
6023	KV 547	227
6025	KV 411	223
6026	KV 377	222
6027	KV 534	226
6030	KV 398	222
6052	KV 447	224
6103	KF 441	224
6109	KA 254	218
6119	KV 505	226
6122	KV 457	224
6123	KF 101	213
6126	KF 452	224
6129	KV 449	224
6250	KV 374	222
6251	KV 462	224
6300	KA 068	212
6415	KF 504	226
6418	KF 433	223
6503	KA 211	216
6505	KA 212	216
6510	KV 177	215
6511	KF 175	215
6515	KV 178	215
6516	KF 176	215
6517	KV 245	217
6517	KV 271	218
6518	KV 514	226
6520	KV 234	217
6522	KV 242	217
6524	KF 302	219
6525	KF 516	226
6526	KV 249	218
6527	KV 467	224
6528	KV 478	225
6530	KV 480	225
6532	KV 401	222
6600	KF 500	226
6603	KF 354	221

COMPETITOR	Fersa	PG.
RUVILLE		
6607	KB 368	222
6613	KF 143	214
6614	KF 111	213
6615	KF 112	213
6626	KV 275	219
6628	KF 313	220
6630	KV 459	224
6631	KV 445	224
6632	KV 435	224
6706	KA 502	226
6804	KC 132	214
6809	KA 036	211
6810	KA 077	212
6815	KA 034	211
6818	KF 129	214
6819	KB 217	217
6824	KV 267	218
6826	KF 128	214
6827	KV 503	226
6829	KV 530	226
6830	KF 130	214
6839	KB 318	220
6840	KF 321	220
6850	KA 035	211
6852	KA 268	218
6854	KA 430	223
6900	KV 537	227
6901	KA 065	212
6902	KA 066	212
6902	KA 067	212
6910	KF 173	215
6914	KF 352	221
6924	KF 310	220
6926	KF 466	224
6929	KF 429	223
6930	KV 353	221
6936	KF 309	220
6936	KF 316	220
6937	KF 197	216
6938	KF 298	219
6950	KF 259	218
6951	KV 482	225
6964	KF 311	220

COMPETITOR	Fersa	PG.
7008	KA 389	222
7009	KA 214	217
7012	KA 542	227
7022	KF 227	217
7023	KV 226	217
7024	KV 232	217
7026	KA 393	222
7032	KF 225	217
7200	KC 205	216
7201	KA 024	210
7202	KC 477	225
7300	KA 086	212
7305	KC 188	216
7306	KA 190	216
7307	KA 186	216
7307	KA 423	223
7308	KA 022	210
7309	KA 187	216
7310	KF 317	220
7314	KF 121	213
7316	KV 228	217
7317	KV 122	214
7318	KV 123	214
7319	KB 491	225
7322	KF 119	213
7323	KV 120	213
7325	KV 490	225
7412	KF 099	213
7413	KF 320	220
7414	KF 525	226
7415	KV 100	213
7416	KV 260	218
7425	KF 304	220
7428	KV 229	217
7434	KF 102	213
7701	KC 444	224
7702	KA 061	212
7705	KF 509	226
7706	KF 301	219
7708	KC 224	217
7709	KC 223	217
7711	KC 265	218
7711	KC 522	226
7712	KB 062	212

14.3 \ Cross part number Cruces de referencias

COMPETITOR	Fersa	PG.
RUVILLE		
7712	KB 496	225
7713	KC 419	223
7800	KA 349	221
7803	KA 054	211
7805	KV 518	226
8000	KA 050	211
8001	KA 052	211
8002	KA 053	211
8109	KB 443	224
8110	KB 416	223
8260	KF 203	216
8261	KV 420	223
8302	KA 517	226
8303	KA 533	226
8401	KA 545	227
8402	KV 230	217
8403	KV 231	217
8411	KV 412	223
8420	KV 438	224
8420	KV 526	226
8452	KA 413	223
8453	KA 405	223
8601	KV 439	224
8604	KV 363	221
8900	KA 397	222
8909	KF 487	225

SACHS		
CLAC M 008	114	114
CLAC M 008	114	114
CLAC M 003	114	114
CLAC M 002	114	114
CLAC M 004	114	114
CLAC M 001	114	114
CLAC M 010	116	116
CLAC M 011	118	118
CLAC M 013	120	120
CLAC M 009	114	114
CLAC M 006	114	114
CLAC M 007	114	114
CLAC M 014	120	120
CLAC M 005	114	114
CLAC M 008	114	114

COMPETITOR	Fersa	PG.
CLAC M 006	114	114
CLAC M 012	118	118
CLAC M 005	114	114
CLAC M 013	120	120
CLAC M 013	120	120

SCANIA		
1528356	F 15273	38

SKF		
307438	F 15210	112
314984	F 19015	132
315823	F 19006	132
315824	F 19002	132
316790	F 19012	132
331075	F 15083	34
331264	F 15280	38
331933	F 15051 R	32
331974	F 15272	38
332330	F 15051 C	32
440682	F 18023	82
518995	33015 F	12
635245	F 19009	132
1861071	F 15089	34
2206 VF 153B	F 19025	132
239697 Q	F 15046	32
30217J2/QVB478	F 15104	34
30307XR N	F 15014	32
309726 DA	F 16019	88
309726 DA	F 16019	88
309946 AC	F 16032	90
309946 AC	F 16032	90
315070 B	F 19011	132
315070 B	F 19011	132
32008 X/ QVA621+BT1-0	F 15310	44
32008 X/ QVA621+BT1-0336/ QCL7CVA606	F 15310	44
32017 X/Q	32017 XF	10
32021X	32021 XF	10
32312 J2/Q	32312 F	11
33020/QVB091	33020 F 561694	12
33021 / QVB 401	F 15239	36
33021 / QVB 401	F 15239	36

COMPETITOR	Fersa	PG.
SKF		
33021/QVB401	33021 F 0266488	12
330356 A/Q	F 15322	38
330633 C	F 15082	34
330633 C	F 15082	34
330865C / 332046AD	F 15080	34
331126 Q	F 15076	34
331305A/Q	F 15047	32
331474/Q	F 15258	36
331958 Q	F 15075	34
332532/CL7A	F 15183	34
4209 ATN9 / MT33 VB2	F 18009	82
4209 ATN9 / MT33 VB2669	F 18009	82
4395/2/QL7CVQ492	CONE 4395	50
441442 D / Q	F 15166	34
546268J	F 19039	134
6003 ZZ	6003 ZZ	68
6006/32-2RS1/VB005	6006/32 2RS/C3	69
6017NR	6017 NR	70
6206 2RS	6206 2RS	72
6206 2RS1/C3	6206 2RS/C3	72
6210 ZNBR	F 18032	82
63/22 C3	63/22 C3	74
BA2B 309639 BA / BAH	F 16036	90
BA2B 309639 BA / BAHB 311396 B	F 16036	90
BA2B 446762 B	F 16026	88
BA2B 633313 C	F 16001	88
BAF 0013 AD	F 16010	88
BAF 4104 BBX	F 16209	100
BAFB 447318 B	F 16033	90
BAH 0004 AA	F 16107	96
BAH 0011 AB	F 16054	92
BAH 0012 AD	F 16031	90
BAH 0013 D	F 16027	88
BAH 0015 E	F 16093	96
BAH 0023	F 16023	88
BAH 0028 AA	F 16088	96
BAH 0031	F 16002	88
BAH 0031 D	F 16002	88
BAH 0041 D	F 16034	90
BAH 0042	F 16200	98
BAH 0049	F 16089	96

COMPETITOR	Fersa	PG.
BAH 0049 C	F 16040	92
BAH 0051 B	F 16029	88
BAH 0069	F 16203	100
BAH 0094	F 16030	90
BAH 0106 D	F 16110	96
BAH 0117	F 16207	100
BAH 0164	F 16204	100
BAH 0171	F 16048	92
BAH 0174	F 16056	94
BAH 0177	F 16051	92
BAH 5000 AA	F 16004	88
BAH 5001 A	F 16022	88
BAHB 309796A	F 16195	98
BAHB 311315 BD	F 16035	90
BAHB 311316 B	F 16018	88
BAHB 311424 B	F 16045	92
BAHB 311443 B	F 16039	90
BAHB 633528	F 16002	88
BAHB 633815 AA	F 16038	90
BAHB 633966 BB	F 16055	92
BAHB 636096 A	F 16037	90
BAHB 636114 A	F 16020	88
BAHB 636149 BC/ BAHB	F 16059	94
BAHB 636149 BC/ BAHB 636149 D	F 16059	94
BAHB 636187 A	F 16090	96
BAHB 636193 C	F 16057	94
BAHB 636214 A	F 16118	98
BB1 3076	F 18053	84
BB1 3339 CB	F 18067	84
BB1 3346	F 18059	84
BB1 3356	F 18056	84
BB1 3357	F 18054	84
BB1 3359	F 18055	84
BB1-3339CB	F 18067	84
BB1B 445924 C	F 18043	82
BB1B 630374 / C4	F 18011	82
BC1 0058	F 19070	136
BC1 0125	F 19071	136
BC1B 242820 CM	F 19105	138
BC1B 246037 A	F 19065	134
BC1B 246747	F 19014	132
BC1B 312219	F 19039	134

14.3 \ Cross part number Cruces de referencias

COMPETITOR	Fersa	PG.
SKF		
BC1B 319546C / VB017	F 19064	134
BC1B 319552	F 19008	132
BC1B 320297 C	F 19035	134
BC1B 320308 A	F 19063	134
BC1B 322172 A	F 19047	134
BC1B 322201 B	F 19033	134
BC1B 322467	F 19046	134
BC1B 322722	F 19081	136
BC1B 326120/HB1	F 19089	136
BC1B 635251	F 19029	132
BCAB 326332B	F 15028	32
BT1 0097 C	F 15117	34
BT1 0163	F 15252	36
BT1 0779	F 15279	38
BT1-0222 A/ QVA621+32	F 15309	38
BT1-0222 A/ QVA621+32007 X/ QCL7CVA606	F 15309	38
BT1-0227/ QVA621+L446	F 15308	38
BT1-0227/ QVA621+L44610/ QVA621	F 15308	38
BT1-0445	CONE F 15356	50
BT1-0548A	32024 XF	10
BT1B 243150 / QL7C	F 15071	32
BT1B 328227 CA/Q	F 15040	32
BT1B 328274A	F 15361	40
BT1B 328406 A / 3031	F 15119	34
BT1B 328406 A / 30314 / QVB01	F 15119	34
BT1B 329012	F 15116	34
BT1B 329013 A/Q	F 15029	32
BT1B 329154/Q/CL7C	CONE F 15213	50
BT1B 332541 AB/Q	F 15036	32
BT1B 332600	F 15159	34
BT1B 639416 A/Q	F 15115	34
BT1B 639425	F 15184	34
BT1B332532/CL7A	F 15183	34
BT2-0130A	F 200004	158
BT2B 445539 CC	F 15041	56
BT2B 445539BA / VC02	F 15041	56
BT2B 445539BA / VC025	F 15041	56
BTF 0021 A	F 300005	164

COMPETITOR	Fersa	PG.
BTF 0110	F 300005	164
BTF 0110 / VKBA 5377	F 300005	164
BTF 0110 / VKBA 5377 / BTF 0021 A	F 300005	164
BTF 1125 B	F 15154	56
BTFB 328755 D	F 300006	164
BTH 0018 A	F 15097	154
BTH 0018 A / VKBA 53	F 15097	154
BTH 0018 A / VKBA 5314	F 15097	154
BTH 0022	F 15100	154
BTH 0022 / BTH 0055	F 15100	154
BTH 0022 / BTH 0055 / VKBA 5412	F 15100	154
BTH 0053	F 15122	154
BTH 0053 / VKBA 5397	F 15122	154
BTH 0055	F 15100	154
BTH 0058B	F 15414	156
BTH 0075	F 15300	156
BTH 1011	F 15121	154
BTH 1011 / VKBA 3552	F 15121	154
BTH 1024	F 15187	58
BTH 1206 AB	F 15067	56
BTH 1219 AB	F 15302	58
BTH-0001	F 15317	58
BTH-0010 D	F 15125	154
BTHB 329129 ABC	F 15168	58
FW183	F 16019	88
N 2210 W	F 19026	132
NJ 308 VH.NR.C4	F 19006	132
NJ 309 VHNRC4	F 19002	132
NJG 2309 VH/C3 VB027	F 19080	136
NJG 2309 VHNRC3	F 19001	132
NUPK 2205 S1 NR	F 19023	132
NUPK 2205 S13	F 19004	132
NUPK 309 NR.C4	F 19003	132
RBT1B 328915	CONE F 15150 A	50
VKBA 1301	KV 135	214
VKBA 1310	KA 034	211
VKBA 1315	KF 175	215
VKBA 1317	KF 104	213
VKBA 1318	KF 107	213
VKBA 1319	KF 396	222
VKBA 1320	KF 106	213
VKBA 1322	KA 542	227

COMPETITOR	Fersa	PG.
SKF		
VKBA 1324	KA 024	210
VKBA 1325	KC 477	225
VKBA 1326	KF 136	214
VKBA 1327	KF 111	213
VKBA 1328	KF 112	213
VKBA 1331	KV 215	217
VKBA 1333	KA 021	210
VKBA 1337	KA 029	210
VKBA 1340	KF 259	218
VKBA 1341	KF 456	224
VKBA 1344	KF 173	215
VKBA 1346	KF 352	221
VKBA 1347	KB 125	214
VKBA 1355	KF 096	213
VKBA 1356	KF 098	213
VKBA 1356	KF 306	220
VKBA 1358	KF 182	215
VKBA 1362	KF 129	214
VKBA 1363	KB 217	217
VKBA 1366	KA 022	210
VKBA 1367	KA 187	216
VKBA 1369	KA 023	210
VKBA 1371	KC 188	216
VKBA 1374	KF 099	213
VKBA 1375	KV 260	218
VKBA 1377	KF 320	220
VKBA 1379	KV 100	213
VKBA 1385	KA 169	215
VKBA 1386	KA 169	215
VKBA 1387	KA 171	215
VKBA 1393	KA 170	215
VKBA 1396	KA 087	212
VKBA 1400	KA 502	226
VKBA 1401	KF 468	224
VKBA 1402	KF 465	224
VKBA 1403	KF 261	218
VKBA 1406	KV 156	215
VKBA 1410	KF 203	216
VKBA 1412	KF 543	227
VKBA 1413	KB 048	211
VKBA 1430	KA 054	211
VKBA 1431	KA 020	210
VKBA 1432	KF 115	213

COMPETITOR	Fersa	PG.
VKBA 1432	KF 327	220
VKBA 1436	KV 177	215
VKBA 1437	KV 178	215
VKBA 1438	KF 165	215
VKBA 1439	KF 166	215
VKBA 1440	KV 164	215
VKBA 1441	KV 218	217
VKBA 1442	KF 161	215
VKBA 1443	KV 544	227
VKBA 1444	KA 079	212
VKBA 1445	KA 058	211
VKBA 1446	KA 058	211
VKBA 1447	KF 094	213
VKBA 1458	KV 108	213
VKBA 1459	KF 109	213
VKBA 1460	KF 110	213
VKBA 1462	KA 200	216
VKBA 1463	KA 200	216
VKBA 1465	KA 085	212
VKBA 1466	KF 453	224
VKBA 1467	KB 263	218
VKBA 1470	KA 126	214
VKBA 1475	KV 219	217
VKBA 1480	KF 116	213
VKBA 1481	KV 220	217
VKBA 1482	KV 221	217
VKBA 1484	KV 222	217
VKBA 1487	KA 003	210
VKBA 1488	KF 264	218
VKBA 1491	KF 183	215
VKBA 1494	KV 157	215
VKBA 1495	KF 176	215
VKBA 1498	KA 189	216
VKBA 1643	KV 439	224
VKBA 1915	KA 190	216
VKBA 1928	KA 393	222
VKBA 1930	KC 223	217
VKBA 1931	KC 224	217
VKBA 1933	KF 301	219
VKBA 1948	KF 225	217
VKBA 1949	KV 226	217
VKBA 1950	KF 227	217
VKBA 1953	KA 131	214
VKBA 1956	KA 186	216

14.3 \ Cross part number Cruces de referencias

COMPETITOR	Fersa	PG.
SKF		
VKBA 1964	KA 067	212
VKBA 1965	KA 067	212
VKBA 1966	KC 174	215
VKBA 1970	KF 121	213
VKBA 1971	KC 265	218
VKBA 1972	KC 444	224
VKBA 1973	KF 317	220
VKBA 1978	KA 061	212
VKBA 1985	KA 404	223
VKBA 1992	KA 545	227
VKBA 1999	KF 128	214
VKBA 310	KV 204	216
VKBA 3201	KF 130	214
VKBA 3202	KV 530	226
VKBA 3205	KA 392	222
VKBA 3206	KA 266	218
VKBA 3216	KF 310	220
VKBA 3218	KV 228	217
VKBA 3219	KB 062	212
VKBA 3220	KC 419	223
VKBA 3222	KV 503	226
VKBA 3225	KV 267	218
VKBA 3234	KV 451	224
VKBA 3235	KB 443	224
VKBA 3236	KB 416	223
VKBA 3237	KF 316	220
VKBA 3245	KF 304	220
VKBA 3246	KF 102	213
VKBA 3250	KV 229	217
VKBA 3255	KA 007	210
VKBA 3256	KF 133	214
VKBA 3257	KF 134	214
VKBA 3266	KV 230	217
VKBA 3267	KV 231	217
VKBA 3269	KV 531	226
VKBA 3271	KV 513	226
VKBA 3272	KF 381	222
VKBA 3279	KV 489	225
VKBA 3284	KA 397	222
VKBA 3298	KV 232	217
VKBA 3305	KV 120	213
VKBA 3307	KV 490	225
VKBA 3308	KF 466	224

COMPETITOR	Fersa	PG.
VKBA 3309	KF 119	213
VKBA 3311	KB 318	220
VKBA 3319	KA 035	211
VKBA 3321	KA 268	218
VKBA 3325	KB 491	225
VKBA 3326	KV 122	214
VKBA 3327	KV 123	214
VKBA 3331	KA 430	223
VKBA 3401	KV 514	226
VKBA 3403	KF 137	214
VKBA 3404	KA 033	211
VKBA 3405	KA 032	211
VKBA 3406	KF 233	217
VKBA 3407	KA 269	218
VKBA 3408	KF 158	215
VKBA 3409	KV 202	216
VKBA 3410	KF 138	214
VKBA 3412	KF 504	226
VKBA 3413	KF 270	218
VKBA 3414	KF 168	215
VKBA 3415	KV 271	218
VKBA 3416	KF 167	215
VKBA 3418	KV 234	217
VKBA 3420	KA 052	211
VKBA 3421	KA 053	211
VKBA 3422	KV 235	217
VKBA 3423	KF 113	213
VKBA 3424	KV 236	217
VKBA 3426	KA 515	226
VKBA 3427	KF 308	220
VKBA 3428	KA 272	218
VKBA 3429	KA 013	210
VKBA 3430	KA 080	212
VKBA 3434	KA 273	218
VKBA 3435	KB 422	223
VKBA 3440	KV 546	227
VKBA 3441	KF 159	215
VKBA 3442	KV 237	217
VKBA 3443	KF 516	226
VKBA 3444	KV 238	217
VKBA 3445	KV 239	217
VKBA 3446	KF 470	225
VKBA 3447	KF 274	218
VKBA 3449	KF 240	217

COMPETITOR	Fersa	PG.
SKF		
VKBA 3450	KF 241	217
VKBA 3451	KV 532	226
VKBA 3452	KF 348	221
VKBA 3455	KF 184	215
VKBA 3456	KV 194	216
VKBA 3457	KV 457	224
VKBA 3458	KV 242	217
VKBA 3459	KV 547	227
VKBA 3460	KV 505	226
VKBA 3461	KF 101	213
VKBA 3468	KV 243	217
VKBA 3469	KV 244	217
VKBA 3472	KA 533	226
VKBA 3473	KA 517	226
VKBA 3477	KV 114	213
VKBA 3480	KV 275	219
VKBA 3486	KF 127	214
VKBA 3488	KV 245	217
VKBA 3489	KV 276	219
VKBA 3490	KF 313	220
VKBA 3491	KV 246	218
VKBA 3492	KF 277	219
VKBA 3495	KF 195	216
VKBA 3496	KB 192	216
VKBA 3497	KV 440	224
VKBA 3499	KF 303	219
VKBA 3500	KB 278	219
VKBA 3501	F 15174	58
VKBA 3501	KB 402	222
VKBA 3502	KV 411	223
VKBA 3503	KV 377	222
VKBA 3504	KF 312	220
VKBA 3510	KV 196	216
VKBA 3511	KV 198	216
VKBA 3512	KV 247	218
VKBA 3513	KV 199	216
VKBA 3514	KV 279	219
VKBA 3515	KV 279	219
VKBA 3519	KA 248	218
VKBA 3520	KF 450	224
VKBA 3521	KB 345	221
VKBA 3522	KF 280	219
VKBA 3523	KV 467	224

COMPETITOR	Fersa	PG.
VKBA 3524	KV 478	225
VKBA 3525	KB 193	216
VKBA 3526	KV 249	218
VKBA 3527	KF 441	224
VKBA 3528	KF 281	219
VKBA 3530	KF 201	216
VKBA 3531	KF 282	219
VKBA 3532	KB 191	216
VKBA 3535	KF 479	225
VKBA 3536	KV 250	218
VKBA 3538	KF 346	221
VKBA 3540	KV 251	218
VKBA 3541	KV 534	226
VKBA 3542	KV 492	225
VKBA 3543	KF 433	223
VKBA 3545	KV 459	224
VKBA 3546	KV 305	220
VKBA 3548	KV 284	219
VKBA 3550	KV 285	219
VKBA 3551	KB 356	221
VKBA 3552	F 15121	154
VKBA 3552	KB 362	221
VKBA 3553	F 300006	164
VKBA 3554	KF 145	214
VKBA 3555	KV 252	218
VKBA 3556	KB 078	212
VKBA 3561	KV 535	227
VKBA 3562	KV 403	223
VKBA 3567	KV 286	219
VKBA 3568	KV 518	226
VKBA 3569	KV 287	219
VKBA 3570	KV 420	223
VKBA 3571	KF 342	221
VKBA 3572	KF 341	221
VKBA 3574	KF 378	222
VKBA 3575	KF 329	220
VKBA 3576	KV 328	220
VKBA 3577	KF 288	219
VKBA 3578	KF 536	227
VKBA 3580	KV 398	222
VKBA 3581	KF 283	219
VKBA 3583	KV 409	223
VKBA 3584	KF 289	219
VKBA 3585	KV 290	219

14.3 \ Cross part number Cruces de referencias

COMPETITOR	Fersa	PG.
SKF		
VKBA 3587	KV 114	213
VKBA 3588	KV 291	219
VKBA 3589	KV 325	220
VKBA 3590	KV 326	220
VKBA 3592	KV 460	224
VKBA 3594	KV 445	224
VKBA 3595	KV 548	227
VKBA 3596	KF 155	215
VKBA 3598	KF 373	222
VKBA 3599	KF 471	225
VKBA 3600	KF 292	219
VKBA 3601	KB 338	221
VKBA 3602	KV 337	221
VKBA 3603	KF 452	224
VKBA 3605	KF 519	226
VKBA 3606	KV 395	222
VKBA 3607	KF 446	224
VKBA 3608	KF 375	222
VKBA 3610	KV 449	224
VKBA 3613	KB 293	219
VKBA 3614	KB 344	221
VKBA 3615	KF 371	222
VKBA 3616	KF 315	220
VKBA 3617	KB 339	221
VKBA 3618	KF 340	221
VKBA 3619	KV 506	226
VKBA 3620	KV 343	221
VKBA 3624	KV 336	220
VKBA 3625	KF 549	227
VKBA 3627	KV 401	222
VKBA 3628	KF 300	219
VKBA 3632	KV 480	225
VKBA 3635	KV 294	219
VKBA 3637	KF 351	221
VKBA 3638	KF 366	221
VKBA 3639	KB 350	221
VKBA 3640	KB 295	219
VKBA 3641	KB 296	219
VKBA 3642	KB 424	223
VKBA 3643	KV 359	221
VKBA 3644	KV 367	221
VKBA 3645	KF 421	223
VKBA 3646	KV 394	222

COMPETITOR	Fersa	PG.
VKBA 3647	KF 302	219
VKBA 3648	KF 334	220
VKBA 3650	KV 333	220
VKBA 3651	KV 332	220
VKBA 3652	KV 330	220
VKBA 3653	KV 331	220
VKBA 3654	KV 323	220
VKBA 3655	KV 324	220
VKBA 3656	KV 358	221
VKBA 3657	KF 354	221
VKBA 3658	KB 368	222
VKBA 3659	KV 435	224
VKBA 3660	KV 322	220
VKBA 3661	KV 386	222
VKBA 3662	KB 436	224
VKBA 3664	KB 469	225
VKBA 3665	KV 105	213
VKBA 3666	KA 383	222
VKBA 3667	KV 297	219
VKBA 3668	KF 348	221
VKBA 3670	KV 431	223
VKBA 3673	KV 462	224
VKBA 3674	KV 374	222
VKBA 3675	KV 472	225
VKBA 3676	KB 364	221
VKBA 3677	KV 520	226
VKBA 3680	KB 357	221
VKBA 3681	KV 432	223
VKBA 3682	KF 418	223
VKBA 3683	KF 399	222
VKBA 3685	KV 408	223
VKBA 3688	KF 494	225
VKBA 3689	KB 390	222
VKBA 3690	KB 372	222
VKBA 3691	KV 447	224
VKBA 3693	KV 410	223
VKBA 3697	KV 507	226
VKBA 3703	KF 321	220
VKBA 3729	KF 298	219
VKBA 3730	KF 197	216
VKBA 3731	KV 537	227
VKBA 3775	KA 423	223
VKBA 3780	KF 227	217
VKBA 3785	KF 448	224

COMPETITOR	Fersa	PG.
SKF		
VKBA 3786	KF 376	222
VKBA 3789	KV 481	225
VKBA 3792	KA 415	223
VKBA 3794	KV 412	223
VKBA 3796	KA 413	223
VKBA 3799	KF 495	225
VKBA 3901	KA 405	223
VKBA 3902	KF 428	223
VKBA 3907	KF 299	219
VKBA 3909	F 16207	100
VKBA 3909	KF 508	226
VKBA 3922	KB 496	225
VKBA 3923	KC 463	224
VKBA 3929	KF 429	223
VKBA 3930	KV 353	221
VKBA 3931	KV 482	225
VKBA 3934	KV 521	226
VKBA 3935	KB 365	221
VKBA 3936	KA 407	223
VKBA 3945	KF 309	220
VKBA 3951	KF 426	223
VKBA 3959	KF 498	225
VKBA 3965	KF 509	226
VKBA 3969	KF 417	223
VKBA 3970	KC 522	226
VKBA 3973	KV 538	227
VKBA 3979	KF 370	222
VKBA 3981	KF 380	222
VKBA 3991	KF 351	221
VKBA 3995	KB 400	222
VKBA 3997	KF 442	224
VKBA 502	KA 068	212
VKBA 504	KA 014	210
VKBA 505	KA 017	210
VKBA 506	KA 040	211
VKBA 513	KA 002	210
VKBA 517	KA 025	210
VKBA 523	KA 083	212
VKBA 526	KA 039	211
VKBA 527	KA 066	212
VKBA 528	KA 075	212
VKBA 529	KA 069	212
VKBA 5314	F 15097	154

COMPETITOR	Fersa	PG.
VKBA 532	KA 001	210
VKBA 534	KA 065	212
VKBA 5343	JF 7049/JF 7010	19
VKBA 5377	F 300005	164
VKBA 539	KA 499	225
VKBA 5397	F 15122	154
VKBA 540	KA 041	211
VKBA 5408	F 200004	158
VKBA 5409	F 15126	154
VKBA 5412	F 15100	154
VKBA 5413	F 15124	154
VKBA 5413	F 15124	154
VKBA 5415	F 15125	154
VKBA 5416	F 200005	158
VKBA 5418	F 15127	154
VKBA 5419	F 15300	156
VKBA 542	KA 005	210
VKBA 5420	F 300003	164
VKBA 5423	F 200014	158
VKBA 5424	F 200015	158
VKBA 5425	F 200013	158
VKBA 543	KA 074	212
VKBA 5431	F 200017	160
VKBA 5432	F 15414	156
VKBA 5437	F 200025	160
VKBA 5453	F 200016	158
VKBA 5455	F 200037	162
VKBA 5457	F 300007	164
VKBA 546	KA 089	212
VKBA 547	KA 088	212
VKBA 548	KA 043	211
VKBA 551	KA 063	212
VKBA 552	KA 063	212
VKBA 5549	F 300001	164
VKBA 559	KF 161	215
VKBA 562	KA 210	216
VKBA 564	KA 042	211
VKBA 571	KA 211	216
VKBA 575	KF 095	213
VKBA 576	KF 185	215
VKBA 577	KF 180	215
VKBA 593	KF 179	215
VKBA 5931	F 400040	172
VKBA 5932	F 400041	172

14.3 \ Cross part number Cruces de referencias

COMPETITOR	Fersa	PG.
SKF		
VKBA 596	KA 027	210
VKBA 607	KC 253	218
VKBA 614	KA 026	210
VKBA 618	KF 139	214
VKBA 622	KF 140	214
VKBA 625	KV 162	215
VKBA 629	KC 146	214
VKBA 636	KC 148	214
VKBA 638	KF 150	214
VKBA 639	KC 147	214
VKBA 6500	KV 458	224
VKBA 6507	KV 335	220
VKBA 6515	KB 384	222
VKBA 6516	KV 523	226
VKBA 652	KA 044	211
VKBA 6520	KF 385	222
VKBA 6521	KV 484	225
VKBA 6525	KV 387	222
VKBA 6530	KA 414	223
VKBA 6537	KA 406	223
VKBA 654	KA 043	211
VKBA 6540	KF 510	226
VKBA 6541	KV 474	225
VKBA 6543	KV 454	224
VKBA 6544	KB 369	222
VKBA 6546	KV 425	223
VKBA 6548	KV 511	226
VKBA 6549	KB 464	224
VKBA 6550	KF 461	224
VKBA 6551	KF 437	224
VKBA 6553	KV 524	226
VKBA 6556	KV 360	221
VKBA 6558	KV 361	221
VKBA 6561	KF 539	227
VKBA 6575	KF 473	225
VKBA 6623	KV 486	225
VKBA 663	KF 133	214
VKBA 6632	KF 512	226
VKBA 6643	KF 319	220
VKBA 673	KC 132	214
VKBA 675	KC 174	215
VKBA 678	KF 500	226
VKBA 6803	KV 501	226

COMPETITOR	Fersa	PG.
VKBA 6812	KF 388	222
VKBA 6814	KV 485	225
VKBA 6825	KF 525	226
VKBA 6831	KF 382	222
VKBA 6837	KV 438	224
VKBA 6838	KV 526	226
VKBA 684	KA 036	211
VKBA 685	KF 160	215
VKBA 686	KA 015	210
VKBA 687	KA 019	210
VKBA 6873	KV 527	226
VKBA 6875	KV 528	226
VKBA 6891	KF 487	225
VKBA 6913	KF 529	226
VKBA 6931	KF 475	225
VKBA 6972	KF 540	227
VKBA 6978	KV 541	227
VKBA 7005	F 15302	58
VKBA 708	KA 349	221
VKBA 713	KA 086	212
VKBA 718	KA 004	210
VKBA 723	KC 149	214
VKBA 728	KA 073	212
VKBA 729	KF 141	214
VKBA 733	KA 212	216
VKBA 734	KV 163	215
VKBA 736	KF 134	214
VKBA 738	KF 172	215
VKBA 740	KA 018	210
VKBA 741	KA 081	212
VKBA 7425	F 15324	58
VKBA 743	KV 144	214
VKBA 749	KA 254	218
VKBA 752	KA 077	212
VKBA 756	KA 030	211
VKBA 757	KF 124	214
VKBA 801	KA 072	212
VKBA 802	KA 071	212
VKBA 813	KB 011	210
VKBA 814	KB 012	210
VKBA 826	KA 070	212
VKBA 827	KC 488	225
VKBA 828	KA 476	225
VKBA 829	KA 255	218

COMPETITOR	Fersa	PG.
SKF		
VKBA 830	KA 091	212
VKBA 837	KA 051	211
VKBA 838	KA 050	211
VKBA 844	KA 009	210
VKBA 845	KA 010	210
VKBA 846	KA 010	210
VKBA 869	KB 045	211
VKBA 882	KF 142	214
VKBA 890	KV 103	213
VKBA 897	KA 076	212
VKBA 898	KA 082	212
VKBA 904	KA 389	222
VKBA 906	KF 181	215
VKBA 908	KF 314	220
VKBA 909	KF 153	214
VKBA 910	KC 256	218
VKBA 912	KA 455	224
VKBA 915	KF 143	214
VKBA 918	KA 347	221
VKBA 919	KA 257	218
VKBA 922	KD 117	213
VKBA 925	KA 056	211
VKBA 926	KA 055	211
VKBA 927	KA 213	216
VKBA 929	KA 057	211
VKBA 938	KV 105	213
VKBA 940	KV 162	215
VKBA 941	KA 028	210
VKBA 944	KA 038	211
VKBA 949	KA 214	217
VKBA 958	KD 118	213
VKBA 959	KA 084	212
VKBA 961	KB 008	210
VKBA 964	KF 092	212
VKBA 966	KV 152	214
VKBA 967	KV 154	215
VKBA 968	KV 258	218
VKBA 969	KB 090	213
VKBA 973	KC 205	216
VKBA 975	KB 046	211
VKBA 976	KB 047	211
VKBA 977	KA 049	211
VKBA857	F 16201	98

COMPETITOR	Fersa	PG.
VKHB 2001	32308 F	11
VKHB 2002	32311 F	11
VKHB 2003	32312 F	11
VKHB 2004	32309 F	11
VKHB 2007	32306 F	11
VKHB 2013	6386/6320	19
VKHB 2014	537/532 X	16
VKHB 2015	32209 F	10
VKHB 2016	32206 F	10
VKHB 2017	32210 F	11
VKHB 2018	32207 F	10
VKHB 2019	32211 F	11
VKHB 2020	32208 F	10
VKHB 2023	JM 205149/JM 205110	28
VKHB 2024	JF 7049 A/JF 7010	19
VKHB 2026	32216 F	11
VKHB 2028	33215 F	13
VKHB 2029	HM 218248/HM 218210	28
VKHB 2030	32218 F	11
VKHB 2031	32219 F	11
VKHB 2033	32215 F	11
VKHB 2036	39580/39520	25
VKHB 2040	594/592 A	16
VKHB 2041	580/572	16
VKHB 2042	683/672	17
VKHB 2043	663/653	17
VKHB 2044	33014 F	12
VKHB 2046	33015 F	12
VKHB 2047	33013 F	12
VKHB 2048	33018 F	12
VKHB 2050	HM 215249/HM 215210	28
VKHB 2051	33213 F	13
VKHB 2053	HM 220149/HM 220110	29
VKHB 2054	2789/2720	17
VKHB 2055	1380/1328	17
VKHB 2056	33109 F	12
VKHB 2057	33205 F	13
VKHB 2058	32304 F	11
VKHB 2059	33111 F	12
VKHB 2060	32011 XF	10
VKHB 2061	33211 F	13
VKHB 2063	32307 F	11
VKHB 2065	33208 F	13
VKHB 2066	33214 F	13

14.3 \ Cross part number Cruces de referencias

COMPETITOR	Fersa	PG.
SKF		
VKHB 2067	33209 F	13
VKHB 2068	33210 F	13
VKHB 2070	32310 F	11
VKHB 2071	F 15051 C	32
VKHB 2072	32314 F	12
VKHB 2075	33895/33822	25
VKHB 2080	32217 F	11
VKHB 2081	32214 F	11
VKHB 2082	33019 F	12
VKHB 2083	598 A/592 A	16
VKHB 2088	39581/39520	25
VKHB 2089	3585/3525	18
VKHB 2124	33020 F	12
VKHB 2132	F 15051 R	32
VKHB 2137	JM 714249/JM 714210	30
VKHB 2140	33016 F	12
VKHB 2141	681 A/672	17
VKHB 2143	687/672	17
VKHB 2145	33020 F	12
VKHB 2145	33020 F 561694	12
VKHB 2146	33021 F	12
VKHB 2146	33021 F 0266488	12
VKHB 2147	JF 10049/JF 10010	20
VKHB 2151	LM 48548/LM 48510	26
VKHB 2152	M 12649/M 12610	20
VKHB 2153	LM 501349/LM 501310	29
VKHB 2154	32014 XF	10
VKHB 2155	33015 F	12
VKHB 2156	33011 F	12
VKHB 2157	32016 XF	10
VKHB 2158	33117 F	13
VKHB 2159	33113 F	13
VKHB 2160	32021 XF	10
VKHB 2161	32019 XF	10
VKHB 2162	33021 F	12
VKHB 2163	33022 F	12
VKHB 2164	30220 F	8
VKHB 2165	33220 F	13
VKHB 2167	30210 F	8
VKHB 2168	30215 F	8
VKHB 2169	32017 XF	10
VKHB 2170	32018 XF	10
VKHB 2171	32314 BF	11

COMPETITOR	Fersa	PG.
VKHB 2172	F 15272	38
VKHB 2173	33212 F	13
VKHB 2175	39590/39520	25
VKHB 2177	33116 F	13
VKHB 2178	33118 F	13
VKHB 2179	33206 F	13
VKHB 2182	33207 F	13
VKHB 2184	JF 4549/JF 4510	19
VKHB 2186	JHM 720249/JHM 720210	30
VKHB 2188	32008 XF	10
VKHB 2189	30205 F	8
VKHB 2190	33108 F	12
VKHB 2191	32010 XF	10
VKHB 2192	JF 9549/JF 9510	19
VKHB 2195	6379/6320	19
VKHB 2198	30311 F	9
VKHB 2199	32013 XF	10
VKHB 2200	47487/47420	26
VKHB 2201	30309 F	9
VKHB 2202	30307 F	8
VKHB 2204	30216 F	8
VKHB 2205	JM 515649/JM 515610	29
VKHB 2208	567/563	16
VKHB 2212	32221 F	11
VKHB 2214	33113 F	13
VKHB 2215	30221 F	8
VKHB 2216	32024 XF	10
VKHB 2222	33115 F	13
VKHB 2225	33217 F	13
VKHB 2226	JM 718149 A/JM 718110	30
VKHB 2227	HM 518445/HM 518410	29
VKHB 2228	JF 6049/JF 6010	19
VKHB 2232	33216 F	13
VKHB 2233	33112 F	13
VKHB 2234	32012 XF	10
VKHB 2236	32309 BF	11
VKHB 2237	L 68149/L 68110	27
VKHB 2239	18690/18620	22
VKHB 2243	JM 511946/JM 511910	29
VKHB 2246	18790/18720	22
VKHB 2247	32924 F	12
VKHB 2248	30218 F	8
VKHB 2249	33209 F	13
VKHB 2255	JF 5049/JF 5010	19

COMPETITOR	Fersa	PG.
SKF		
VKHB 2262	30305 F	8
VKHB 2267	32006 XF	9
VKHB 2270	LM 11949/LM 11910	20
VKHB 2271	LM 12749/LM 12710	20
VKHB 2272	LM 300849/LM 300811	29
VKHB 2275	32010 XF	10
VKHB 2276	387 A/382	14
VKHB 2277	387 A/382 A	14
VKHB 2279	F 15115	34
VKHB 2280 / BT1 0084	F 15193	36
VKHB 2281	32022 XF	10
VKHB 2282	32015 XF	10
VKHB 2283	30312 F	9
VKHB 2284	32214 F	11
VKHB 2286	HM 212049/HM 212011	28
VKHB 2287	JH 211749/JH 211710	28
VKHB 2288	32213 F	11
VKHB 2294	32305 F	11
VKHB 2296	30209 F	8
VKHB 2297	32220 F	11
VKHB 2304	30313 F	9
VKHB 2306	32020 XF	10
VKHB 2307	F 15271	38
VKHB 2309	25590/25520	23
VKHB 2310	3780/3720	18
VKHB 2311	33287/33462	24
VKHB 2315	F 15252	36
VKHB 2321	33017 F	12
VKHB 2326	33116 F	13
VKHB 2329	F 15208	36
VKHB 2331	33118 F	13
VKHB 2332	H 212749/H 212710	28
VKHB 2333	495/493	15
VKHB 2334	30217 F	8
VKHB 2338	JLM 714149/JLM 714110	30
VKHB 2347	32212 F	11
VKHB 2401 S	32310 F	11
VKHB 2402 S	32924 F	12
VKHB 2403 S	33116 F	13
VKHB 2404 S	33118 F	13
VKHB 2405 S	33213 F	13
VKHB 2406 S	33215 F	13
VKHB 2407 S	HM 218248/HM 218210	28

COMPETITOR	Fersa	PG.
VKHB 2408 S	HM 518445/HM 518410	29
VKHB 2409 S	32216 F	11
VKHB 2410 S	32218 F	11
VKHB 2412 S	JM 515649/JM 515610	29
VKHB 2413 S	JM 718149 A/JM 718110	30
VKHC 5903	F 400001	168
VKHC 5904	F 400002	168
VKHC 5905	F 400003	168
VKHC 5906	F 400004	168
VKHC 5907	F 400006	168
VKHC 5908	F 400007	168
VKHC 5909	F 400008	168
VKHC 5910	F 400009	168
VKHC 5911	F 400010	168
VKHC 5915	F 400015	168
VKHC 5916	F 400016	170
VKHC 5917	F 400018	170
VKHC 5918	F 400019	170
VKHC 5919	F 400021	170
VKHC 5920	F 400022	170
VKHC 5921	F 400023	170
VKHC 5922	F 400029	170
VKHC 5926	F 400034	170
VKHC 5927	F 400036	170
VKHC 5928	F 400037	170
VKHC 5930	F 400039	172
VKHC 5932	F 400038	172
VKKBA 5507	HM 218248/HM 218210	28
VKT 8438	F 15239	36
VKT 8439	32016 XF	10
VKT 8446	6017 NR	70
VKT 8490	30217 F	8
VKT 8491	CONE 33113 F	50
VKT 8600	39580/39528	25
VKT 8601	575/572 X	16
VKT 8602	482/472	15
VKT 8603	33208 F	13
VKT 8611	6215 NR/C3	73
VKT 8621	F 19105	138
VKT 8622	33017 F	12
VKT 8625	JF 5049/JF 5010	19
VKT 8627	H 913842/H 913810	31
VKT 8628	F 19080	136
VKT 8629	F 15071	32

14.3 \ Cross part number Cruces de referencias

COMPETITOR	Fersa	PG.
SKF		
VKT 8631	JW 7049/JW 7010	19
VKT 8633	31315 F	9
VKT 8634	32015 XF	10
VKT 8645	HM 911245/HM 911210	31
VKT 8647	30208 F	8
VKT 8648	33212 F	13
VKT 8652	NUP 309 FN/C3	130
VKT 8690	32212 F	11
VKT 8692	F 18053	84
VKT 8699	CONE F 15150 A	50
VKT 8701	F 15116	34
VKT 8707	6211 C3	73
VKT 8718	F 15119	34
VKT 8719	6312 C3	77
VKT 8720	30312 F	9
VKT 8721	JD 6549/JD 6510	19
VKT 8749	32020 XF	10
VKT 8750	H 913843/H 913810	31
VKT 8756	32017 XF	10
VKT 8757	30217 F	8
VKT 8759	31311 F	9
VKT 8761	31313 F	9
VKT 8776	F 15048	32
VKT 8779	F 19014	132
VKT 8782	F 15046	32
VKT 8783	F 19006	132
VKT 8784	F 19002	132
VKT 8796	F 19001	132
VKT 8798	33018 F	12
VKT 8806	6217 C3	74
VKT 8853	F 19070	136
VKT 8863	33115 F	13
VKT 8864	32313 BF	11
VKT 8871	32021 XF	10
VKT 8875	F 19089	136
VKT 8886	F 15047	32
VKT 8906	F 19061	134
VKT 8937	6216 C3	73
VKT 8940	6218 C3	74
VKT 8950	33021 F	12
VKT 8955	4580/4535	19
VKT 8956	CONE 4395	50
VKT 8957	CONE F 15213	50

COMPETITOR	Fersa	PG.
VKT 8999	F 19081	136
VKT 9000	F 15345	40
VKT 9010	F 15348	40
VKT8418	JW 5049/JW 5010	19
SNR		
4209 A	F 18009	82
6210NRZB	F 18032	82
AB12516	F 18022	82
AB12888 S05	F 18018	82
AB41386	F 18019	82
AB41658S06	F 18082	84
AB41659YS05	F 18083	84
AP 40016	F 15052	112
AP 40277 S01	F 15224	112
EC 10059	F 15063	32
EC 12567 H206	F 15090	44
EC 12606 S01 H106	F 15341	40
EC 35483	F 15479	42
EC 42192 Y S02 H206	F 15336	40
EC 42193 Y S02 H206	F 15338	40
EC 42217 S01 H206	F 15340	40
EC 42224 S01 H206	F 15337	40
EC 42226	F 15313	38
EC 42310 S01 H200	F 15339	40
EC42228S01	F 15316	38
ETR 122205	F 19045	134
FC 12025 S09	F 15041	56
FC 12033	F 15381	40
FC 12033S01	F 15044	56
FC 12180 S04	F 15042	56
FC 12271 S03	F 15043	56
FC 12784 S03	F 15050	56
FC 40096 S05	F 15174	58
FC 40650 S01	F 15128	56
FC 40858 S02	F 15175	58
FC41645	F 15360	58
GB 10790 S05	F 16001	88
GB 10800	F 16043	92
GB 10840 S04	F 16002	88
GB 10884	F 16019	88
GB 12010	F 16045	92
GB 12094 S10	F 16026	88
GB 12131 S03	F 16031	90

COMPETITOR	Fersa	PG.
SNR		
GB 12136	F 16023	88
GB 12163 S04	F 16048	92
GB 12306S02	F 16093	96
GB 12320S02	F 16039	90
GB 12399S01	F 16038	90
GB 12438 S01	F 16021	88
GB 12955S04	F 16107	96
GB 35098	F 16129	98
GB 35275	F 16124	98
GB 35457	F 16088	96
GB 40246 S02	F 16056	94
GB 40250 S01	F 16066	94
GB 40279S01	F 16109	96
GB 40300	F 16121	98
GB 40547	F 16029	88
GB 40549 / GB 10702	F 16051	92
GB 40549 / GB 10702 S03	F 16051	92
GB 40575 S02	F 16123	98
GB 40706	F 16030	90
GB 41599 / GB 12776	F 16036	90
GB 41688 P	F 16076	94
HDB001	32019 XF	10
HDB002	33019 F	12
HDB003	30221 F	8
HDB004	33113 F	13
HDB005	33118 F	13
HDB006	32017 XF	10
HDB007	33022 F	12
HDB008	33021 F	12
HDB009	32310 F	11
HDB010	33215 F	13
HDB011	33211 F	13
HDB012	32216 F	11
HDB013	33020 F	12
HDB014	32314 F	12
HDB015	32311 F	11
HDB016	32024 XF	10
HDB017	30220 F	8
HDB018	33117 F	13
HDB019	32020 XF	10
HDB020	33208 F	13
HDB021	33116 F	13

COMPETITOR	Fersa	PG.
HDB022	33213 F	13
HDB023	HM 218248/HM 218210	28
HDB024	HM 518445/HM 518410	29
HDB025	32308 F	11
HDB026	32312 F	11
HDB028	32309 F	11
HDB029	32306 F	11
HDB030	32209 F	10
HDB031	32206 F	10
HDB032	32210 F	11
HDB033	32207 F	10
HDB034	32211 F	11
HDB035	32208 F	10
HDB036	32218 F	11
HDB037	32215 F	11
HDB038	32304 F	11
HDB039	32307 F	11
HDB040	30314 F	9
HDB042	32217 F	11
HDB043	30215 F	8
HDB044	30205 F	8
HDB045	30311 F	9
HDB046	30309 F	9
HDB047	30307 F	8
HDB048	30216 F	8
HDB049	30312 F	9
HDB050	32214 F	11
HDB051	32213 F	11
HDB054	33015 F	12
HDB055	33013 F	12
HDB056	33018 F	12
HDB057	33109 F	12
HDB058	33111 F	12
HDB059	32011 XF	10
HDB060	33214 F	13
HDB061	33209 F	13
HDB062	33210 F	13
HDB063	32014 XF	10
HDB064	33011 F	12
HDB065	32016 XF	10
HDB066	32021 XF	10
HDB067	32018 XF	10
HDB068	33212 F	13
HDB069	33206 F	13

14.3 \ Cross part number Cruces de referencias

COMPETITOR	Fersa	PG.
SNR		
HDB070	33207 F	13
HDB071	32008 XF	10
HDB072	33108 F	12
HDB073	32010 XF	10
HDB074	33216 F	13
HDB075	32013 XF	10
HDB076	32221 F	11
HDB077	33115 F	13
HDB078	33217 F	13
HDB080	30305 F	8
HDB081	32006 XF	9
HDB082	32206 F	10
HDB083	LM 11949/LM 11910	20
HDB084	LM 12749/LM 12710	20
HDB085	32022 XF	10
HDB086	32015 XF	10
HDB088	32305 F	11
HDB089	32220 F	11
HDB090	32219 F	11
HDB092	JM 515649/JM 515610	29
HDB138	33205 F	13
HDS001	F 300003	164
HDS103	F 15100	154
N 2206 VF 153B	F 19025	132
N 2210 W	F 19026	132
NF-12190	F 19035	134
NF12192S01	F 19063	134
R 140.01	KB 344	221
R 140.02	KB 011	210
R 140.03	KB 012	210
R 140.06	KB 293	219
R 140.13	KB 356	221
R 140.14	KB 362	221
R 140.17	KB 295	219
R 140.17	KB 390	222
R 140.23	KA 255	218
R 140.24	KA 476	225
R 140.25	KA 091	212
R 140.26	KA 070	212
R 140.27	KC 488	225
R 140.34	KA 023	210
R 140.37	KB 424	223
R 140.38	KB 296	219

COMPETITOR	Fersa	PG.
R 140.42	KA 009	210
R 140.43	KA 010	210
R 140.44	KA 010	210
R 140.52	KD 117	213
R 140.56	KA 049	211
R 140.58	KA 169	215
R 140.59	KA 169	215
R 140.60	KA 171	215
R 140.65	KA 170	215
R 140.72	KA 033	211
R 140.73	KA 032	211
R 140.76	KA 273	218
R 140.77	KA 079	212
R 140.78	KA 058	211
R 140.79	KA 058	211
R 140.80	KA 084	212
R 140.81	KA 269	218
R 140.83	KA 200	216
R 140.84	KA 200	216
R 140.85	KB 263	218
R 140.86	KF 453	224
R 140.87	KA 085	212
R 140.88	KA 515	226
R 140.91	KA 266	218
R 140.94	KA 272	218
R 140.95	KA 013	210
R 140.96	KA 080	212
R 141.03	KB 372	222
R 141.05	KF 385	222
R 141.09	KV 387	222
R 150.10	KF 396	222
R 150.12	KF 107	213
R 150.16	KF 104	213
R 150.17	KV 105	213
R 150.19	KF 106	213
R 150.22	KV 108	213
R 150.23	KF 109	213
R 150.24	KF 110	213
R 150.26	KV 532	226
R 150.27	KF 348	221
R 150.28	KF 470	225
R 150.29	KV 239	217
R 150.30	KV 238	217
R 150.31	KF 303	219

COMPETITOR	Fersa	PG.
SNR		
R 150.32	KV 472	225
R 150.33	KF 378	222
R 150.37	KV 431	223
R 150.40	KV 432	223
R 150.41	KF 418	223
R 150.42	KF 512	226
R 151.02	KA 025	210
R 151.03	KA 026	210
R 151.05	KA 027	210
R 151.07	KF 124	214
R 151.08	KA 030	211
R 151.10	KA 126	214
R 151.11	KA 087	212
R 151.12	KA 029	210
R 151.14	KA 028	210
R 151.15	KB 125	214
R 151.24	KA 189	216
R 151.25	KF 300	219
R 151.26	KF 280	219
R 151.27	KF 127	214
R 151.31	KF 450	224
R 151.32	KB 345	221
R 151.36S	KA 414	223
R 151.38	KA 406	223
R 152.02	KA 083	212
R 152.05	KA 499	225
R 152.08	KA 017	210
R 152.12	KA 014	210
R 152.16	KA 015	210
R 152.17	KA 075	212
R 152.19	KA 019	210
R 152.20	KA 074	212
R 152.21	KA 018	210
R 152.23	KF 329	220
R 152.24	KV 328	220
R 152.28	KA 076	212
R 152.28	KA 082	212
R 152.32	KA 347	221
R 152.33	KA 257	218
R 152.36	KA 020	210
R 152.37	KA 021	210
R 152.39	KF 115	213
R 152.39	KF 327	220

COMPETITOR	Fersa	PG.
R 152.42	KF 116	213
R 152.43	KV 220	217
R 152.44	KV 221	217
R 152.45	KV 222	217
R 152.54	KF 201	216
R 152.55	KF 282	219
R 152.56	KB 191	216
R 152.56	KB 384	222
R 152.58	KV 325	220
R 152.59	KV 326	220
R 152.60	KV 291	219
R 152.61	KF 549	227
R 152.62	KV 322	220
R 152.64	KA 383	222
R 152.66	KV 323	220
R 152.66	KV 324	220
R 152.69	KV 386	222
R 152.70	KV 484	225
R 153.03	KA 040	211
R 153.07	KA 007	210
R 153.14	KF 133	214
R 153.15	KF 134	214
R 153.16	KA 039	211
R 153.19	KV 135	214
R 153.20	KF 136	214
R 153.22	KV 235	217
R 153.23	KV 202	216
R 153.25	KF 137	214
R 153.26	KF 138	214
R 153.27	KV 252	218
R 153.30	KV 247	218
R 153.31	KV 196	216
R 153.32	KV 198	216
R 153.33	KV 199	216
R 153.34	KV 279	219
R 153.35	KF 342	221
R 153.36	KF 341	221
R 153.37	KB 338	221
R 153.38	KV 337	221
R 153.39	KF 292	219
R 153.40	KV 343	221
R 153.41	KV 336	220
R 153.42	KA 404	223
R 153.43	KV 335	220

14.3 \ Cross part number Cruces de referencias

COMPETITOR	Fersa	PG.
SNR		
R 153.46	KF 319	220
R 153.47	KV 333	220
R 153.48	KV 332	220
R 153.49	KV 331	220
R 153.50	KV 330	220
R 153.51	KV 524	226
R 153.55	KF 437	224
R 153.57	KF 461	224
R 154.01	KF 184	215
R 154.08	KC 256	218
R 154.10	KF 421	223
R 154.12	KF 180	215
R 154.13	KA 069	212
R 154.14	KF 179	215
R 154.15	KF 095	213
R 154.15	KF 185	215
R 154.17	KA 071	212
R 154.18	KA 072	212
R 154.23	KF 181	215
R 154.24	KA 455	224
R 154.28	KF 182	215
R 154.33	KF 233	217
R 154.34	KF 183	215
R 154.41	KF 240	217
R 154.42	KF 241	217
R 154.43	KF 098	213
R 154.44	KV 276	219
R 154.45	KV 284	219
R 154.46	KB 422	223
R 154.49	KF 159	215
R 154.50	KA 248	218
R 154.52	KV 285	219
R 154.54	KV 361	221
R 154.54	KV 367	221
R 154.55	KV 358	221
R 154.56	KV 359	221
R 154.56	KV 486	225
R 154.57	KV 425	223
R 154.58	KV 394	222
R 154.61	KV 360	221
R 155.00	KC 146	214
R 155.01	KC 147	214
R 155.03	KA 043	211

COMPETITOR	Fersa	PG.
R 155.05	KA 042	211
R 155.06	KA 044	211
R 155.07	KF 375	222
R 155.08	KC 149	214
R 155.09	KF 153	214
R 155.10	KC 148	214
R 155.11	KV 152	214
R 155.13	KB 045	211
R 155.14	KF 314	220
R 155.15	KV 154	215
R 155.16	KF 155	215
R 155.17	KB 046	211
R 155.18	KV 258	218
R 155.19	KB 090	213
R 155.21	KF 150	214
R 155.22	KA 043	211
R 155.24	KV 156	215
R 155.26	KV 157	215
R 155.27	KB 047	211
R 155.31	KF 151	214
R 155.32	KB 048	211
R 155.32	KB 192	216
R 155.42	KV 546	227
R 155.44	KF 195	216
R 155.46	KV 244	217
R 155.47	KV 243	217
R 155.52	KF 312	220
R 155.54	KV 440	224
R 155.56	KV 246	218
R 155.61	KF 277	219
R 155.63	KB 193	216
R 155.64	KB 278	219
R 155.65	KB 402	222
R 155.66	KV 492	225
R 155.67	KV 535	227
R 155.69	KF 340	221
R 155.70	KB 339	221
R 155.71	KF 315	220
R 155.72	KF 371	222
R 155.74	KF 334	220
R 155.75	KF 351	221
R 155.76	KF 366	221
R 155.77	KB 350	221
R 155.78	KB 364	221

COMPETITOR	Fersa	PG.
SNR		
R 155.80	KF 539	227
R 155.82	KV 520	226
R 156.00	KA 063	212
R 156.04	KF 172	215
R 157.05	KA 005	210
R 157.08	KF 096	213
R 157.16	KF 308	220
R 157.20	KV 194	216
R 157.24	KF 306	220
R 157.25	KF 479	225
R 157.26	KV 250	218
R 157.27	KV 395	222
R 157.28	KF 519	226
R 157.31	KV 286	219
R 157.32	KV 287	219
R 157.42	KV 511	226
R 157.46	KF 446	224
R 157.49	KV 518	226
R 158.00	KA 055	211
R 158.01	KA 056	211
R 158.02	KA 213	216
R 158.04	KA 210	216
R 158.07	KF 161	215
R 158.08	KA 057	211
R 158.10	KV 162	215
R 158.11	KC 253	218
R 158.13	KV 163	215
R 158.14	KV 204	216
R 158.17	KV 162	215
R 158.18	KF 261	218
R 158.21	KV 218	217
R 158.22	KV 164	215
R 158.24	KF 465	224
R 158.25	KF 468	224
R 158.28	KF 160	215
R 158.29	KV 544	227
R 158.31	KF 165	215
R 158.32	KF 166	215
R 158.34	KF 270	218
R 158.35	KF 168	215
R 158.37	KF 167	215
R 158.39	KV 237	217
R 158.41	KF 281	219

COMPETITOR	Fersa	PG.
R 158.42	KF 288	219
R 158.43	KF 510	226
R 158.44	KF 346	221
R 158.45	KF 536	227
R 158.46	KV 251	218
R 158.53	KV 409	223
R 158.54	KF 373	222
R 158.55	KF 471	225
R 158.56	KV 523	226
R 158.58	KF 283	219
R 158.59	KV 474	225
R 159.03	KF 140	214
R 159.07	KF 139	214
R 159.08	KA 041	211
R 159.11	KA 089	212
R 159.12	KA 073	212
R 159.13	KF 141	214
R 159.14	KF 142	214
R 159.15	KV 144	214
R 159.17	KF 145	214
R 159.19	KB 008	210
R 159.22	KV 215	217
R 159.24	KF 543	227
R 159.29	KV 219	217
R 159.31	KF 113	213
R 159.32	KV 236	217
R 159.37	KV 114	213
R 159.38	KB 078	212
R 159.40	KV 305	220
R 159.42	KV 290	219
R 159.43	KV 403	223
R 159.43	KV 548	227
R 159.44	KF 289	219
R 159.46	KV 294	219
R 159.47	KF 399	222
R 159.48	KB 357	221
R 159.49	KV 410	223
R 159.50	KV 458	224
R 159.53	KB 369	222
R 159.54	KB 464	224
R 159.55	KF 473	225
R 159.89	KB 193	216
R 160.02	KA 001	210
R 160.13	KF 092	212

14.3 \ Cross part number Cruces de referencias

COMPETITOR	Fersa	PG.
SNR		
R 160.15	KF 264	218
R 160.18	KF 094	213
R 160.20	KF 264	218
R 160.23	KV 547	227
R 160.25	KV 411	223
R 160.27	KV 534	226
R 160.30	KV 398	222
R 160.36	KA 002	210
R 160.38	KA 003	210
R 160.44	KA 004	210
R 160.48	KV 377	222
R 160.51	KV 447	224
R 161.03	KF 441	224
R 161.09	KA 254	218
R 161.19	KV 505	226
R 161.22	KV 457	224
R 161.23	KF 101	213
R 161.26	KF 452	224
R 161.29	KV 449	224
R 162.50	KV 374	222
R 162.51	KV 462	224
R 163.19	KA 068	212
R 164.15	KF 504	226
R 164.18	KF 433	223
R 164.25	KV 506	226
R 165.03	KA 211	216
R 165.05	KA 212	216
R 165.10	KV 177	215
R 165.11	KF 175	215
R 165.15	KV 178	215
R 165.16	KF 176	215
R 165.17	KV 271	218
R 165.18	KV 514	226
R 165.20	KV 234	217
R 165.22	KV 242	217
R 165.23	KV 245	217
R 165.24	KF 302	219
R 165.25	KF 516	226
R 165.26	KV 249	218
R 165.27	KV 467	224
R 165.28	KV 478	225
R 165.30	KV 480	225
R 165.37	KV 454	224

COMPETITOR	Fersa	PG.
R 166.00	KF 500	226
R 166.03	KF 354	221
R 166.07	KB 368	222
R 166.13	KF 143	214
R 166.14	KF 111	213
R 166.15	KF 112	213
R 166.24	KV 114	213
R 166.26	KV 275	219
R 166.28	KF 313	220
R 166.29	KV 460	224
R 166.30	KV 459	224
R 166.31	KV 445	224
R 166.32	KV 435	224
R 167.06	KA 502	226
R 168.04	KC 132	214
R 168.09	KA 036	211
R 168.10	KA 077	212
R 168.15	KA 034	211
R 168.18	KF 129	214
R 168.19	KB 217	217
R 168.24	KV 267	218
R 168.26	KF 128	214
R 168.27	KV 503	226
R 168.29	KV 530	226
R 168.30	KF 130	214
R 168.40	KF 321	220
R 168.41	KA 131	214
R 168.42	KB 318	220
R 168.50	KA 035	211
R 168.54	KA 430	223
R 168.59	KA 392	222
R 168.61	KB 400	222
R 168.62	KF 380	222
R 168.63	KF 381	222
R 168.65	KF 442	224
R 169.00	KV 537	227
R 169.01	KA 065	212
R 169.02	KA 066	212
R 169.02	KA 067	212
R 169.04	KC 174	215
R 169.08	KF 456	224
R 169.10	KF 173	215
R 169.14	KF 352	221
R 169.20	KV 451	224

COMPETITOR	Fersa	PG.
SNR		
R 169.23	KA 067	212
R 169.24	KF 310	220
R 169.26	KF 466	224
R 169.29	KF 429	223
R 169.30	KV 353	221
R 169.36	KF 316	220
R 169.37	KF 197	216
R 169.38	KF 298	219
R 169.50	KF 259	218
R 169.51	KV 482	225
R 169.59	KV 507	226
R 169.60	KF 309	220
R 169.61	KF 382	222
R 169.68	KF 370	222
R 170.08	KA 389	222
R 170.09	KA 214	217
R 170.12	KA 542	227
R 170.22	KF 227	217
R 170.23	KV 226	217
R 170.24	KV 232	217
R 170.26	KA 393	222
R 170.32	KF 225	217
R 170.49	KF 540	227
R 172.00	KC 205	216
R 172.01	KA 024	210
R 172.02	KC 477	225
R 173.00	KA 086	212
R 173.05	KC 188	216
R 173.06	KA 190	216
R 173.07	KA 186	216
R 173.09	KA 187	216
R 173.10	KF 317	220
R 173.14	KF 121	213
R 173.15	KA 022	210
R 173.16	KV 228	217
R 173.17	KV 122	214
R 173.18	KV 123	214
R 173.19	KB 491	225
R 173.20	KA 423	223
R 173.22	KF 119	213
R 173.23	KV 120	213
R 173.25	KV 490	225
R 173.31	KV 538	227

COMPETITOR	Fersa	PG.
R 174.12	KF 099	213
R 174.13	KF 320	220
R 174.14	KF 525	226
R 174.16	KV 260	218
R 174.19	KV 100	213
R 174.25	KF 304	220
R 174.28	KV 229	217
R 174.34	KF 102	213
R 174.40	KF 426	223
R 177.01	KC 444	224
R 177.02	KA 061	212
R 177.06	KF 301	219
R 177.08	KC 224	217
R 177.09	KC 223	217
R 177.11	KC 265	218
R 177.12	KB 062	212
R 177.13	KC 419	223
R 177.15	KC 463	224
R 177.33	KB 496	225
R 177.37	KF 509	226
R 178.00	KA 349	221
R 178.03	KA 054	211
R 180.00	KA 050	211
R 180.01	KA 052	211
R 180.02	KA 053	211
R 181.09	KB 443	224
R 181.10	KB 416	223
R 182.60	KF 203	216
R 182.61	KV 420	223
R 183.02	KA 517	226
R 183.03	KA 533	226
R 184.01	KA 545	227
R 184.02	KV 230	217
R 184.03	KV 231	217
R 184.05	KF 299	219
R 184.07	KV 336	220
R 184.09	KV 513	226
R 184.11	KV 412	223
R 184.12	KF 508	226
R 184.13	KF 388	222
R 184.14	KF 487	225
R 184.15	KV 526	226
R 184.16	KV 438	224
R 184.24	KV 485	225

14.3 \ Cross part number Cruces de referencias

COMPETITOR	Fersa	PG.
SNR		
R 184.33	KA 415	223
R 184.52	KA 413	223
R 184.53	KA 405	223
R 184.55	KF 428	223
R 186.01	KV 439	224
R 189.00	KA 397	222
R 189.02	KV 489	225
R 189.05	KV 521	226
R 189.07	KB 365	221
R 189.08	KA 407	223
R 190.00	KF 376	222
R 190.01	KF 448	224
R 190.03	KV 531	226
TGB 10872 S02	F 16044	92
TGB 40490	F 16010	88
XGB 40492 S01 P	F 16108	96
XGB 40575 S02 P	F 16128	98
XGB 41793 S01	F 16213	100
XGB 41999	F 16052	92
XGB35270	F 16215	100
Y44FB.10394 S02	F 16042	92

TIMKEN		
14116/14276	14116/14276	21
29688/29620	29688/29620	24
32021 XF	32021 XF	10
43112/43312	43112/43312	25
44131/44348	44131/44348	25
47687/47623 A	47687/47623 A	26
72187C/72487	72187 C/72487	27
72200C/NP611140	72200 C/72487	27
77375/77675	77375/77675	27
HM801346X/ HM801310	HM 801346 X/HM 801310	30
HMB13844/HM813810	HM 813844/HM 813810	31
HMB13849/HM813810	HM 813849/HM 813810	31
JH211749/JH211710	JH 211749/JH 211710	28
JL22349 /10	F 15028	32
JRM 3535 A / JRM 356	F 15044	56
JRM 3535 A / JRM 3565 XD	F 15044	56
JRM 3939 / JRM 3968	F 15045	56
JRM 3939 / JRM 3968 XD	F 15045	56

COMPETITOR	Fersa	PG.
JXC 19089 DA	CONE F 15134	50
JXC 25469CA / JXC 25	F 15068	56
JXC 25469CA / JXC 25469 DB	F 15068	56
JXC 25662 C	CONE F 15110	50
JXC 25690 C/JXC 2569	F 15161	44
JXC 25690 C/JXC 25690 DC	F 15161	44
JXC 6839 CD	CONE F 15101	50
MB1212GEXR	F 19117	138
MUSB1307UM	F 19083	136
NP 057427	CONE F 15132	50
NP 078914	F 15097	154
NP 086391	F 15156	34
NP 237087	CONE F 15362	50
NP 318274-90UA7	F 15122	154
NP 318274-90UA7 / SE	F 15122	154
NP 318274-90UA7 / SET 1242	F 15122	154
NP 353549 / NP 673339	F 15197	36
NP 353549 / NP 673396	F 15197	36
NP 374995	CONE 64452 A	50
NP 390444 / NP 75099	F 15198	44
NP 390444 / NP 750997	F 15198	44
NP 457202	CONE F 15131	50
NP 478770	CONE F 15328	50
NP 550563/NP 546683	F 15114	34
NP 569484/NP 644537	F 15252	36
NP 656227/NP 896049	F 15109	34
NP 793154	F 15125	154
NP 806712/NP 326808	F 15312	44
NP 854792/NP 430273	F 15315	38
NP 881387/NP 304907	F 15265	44
NP 927527	CONE F 15327	50
NP 988748 / NP 24773	F 15133	34
NP 988748 / NP 247732	F 15133	34
NP003658/NP096839	F 15367	40
NP022042/NP579116	594 A/592 A	16
NP030522/NP378917	F 15342	40
NP123221/NP787333	F 15383	40
NP171276/NP943289	JM 714249/JM 714210	30
NP237087	CONE F 15362	50
NP238750/NP929800	F 15314	38
NP242732/NP611140	72218 C/72487	27

COMPETITOR	Fersa	PG.
TIMKEN		
NP259742/NP378917	F 15339	40
NP273671 90UA6	F 15097	154
NP285701/NP341513	F 15313	38
NP293601/NP934397	JM 716649/JM 716610	30
NP331249	F 15279	38
NP331249/Y32021X	F 15279	38
NP374995	CONE 64452 A	50
NP380290/NP533133	497/493	15
NP417384/Y30206M	F 15313	38
NP478770/NP547156	CONE F 15328	50
NP523912/NP611140	72212 C/72487	27
NP579116/NP022042	594 A/592 A	16
NP604623/NP577617	F 15377	40
NP656227/NP896049	F 15109	34
NP718852/NP022178	F 15337	40
NP725688/NP560412	F 15291	38
NP765903/NP919474	F 15311	44
NP797735/NP430273	F 15338	40
NP799449/NP105857	567/563	16
NP802577/NP896994	F 15366	40
NP846736/NP166419	65237/65500	26
NP868033/NP666556	F 15316	38
NP903590/NP640324	F 15384	40
NP925485/NP312842	F 15376	40
NP927527/NP547156	F 15327	38
NP928171/NP718759	598/592 A	16
NP930036/NP193660	555 S/552 A	16
NP970652/NP563664	JP 10049/JP 10010	20
SET 1	LM 11749/LM 11710	20
SET 10	U 399/U 360 L-A	46
SET 1010	27690/27620	24
SET 1015	30206 F	8
SET 1016	30207 F	8
SET 1017	30208 F	8
SET 1018	30209 F	8
SET 1019	30210 F	8
SET 102	3585/3525	18
SET 1020	30212 F	8
SET 1021	30214 F	8
SET 1022	30216 F	8
SET 1023	30217 F	8
SET 1024	30218 F	8
SET 1025	30220 F	8

COMPETITOR	Fersa	PG.
SET 1026	30221 F	8
SET 1029	30306 F	8
SET 103	3982/3920	18
SET 1030	30307 F	8
SET 1031	30309 F	9
SET 1032	30312 F	9
SET 1033	30313 F	9
SET 1034	30314 F	9
SET 1035	31312 F	9
SET 1040	32010 XF	10
SET 1041	32011 XF	10
SET 1042	32012 XF	10
SET 1043	32013 XF	10
SET 1044	32014 XF	10
SET 1045	32015 XF	10
SET 1046	32016 XF	10
SET 1047	32017 XF	10
SET 1049	32019 XF	10
SET 105	33287/33462	24
SET 1050	32020 XF	10
SET 1052	32022 XF	10
SET 1053	32024 XF	10
SET 1058	32209 F	10
SET 1059	32210 F	11
SET 106	LM 78349/LM 78310 A	27
SET 1060	32211 F	11
SET 1061	32212 F	11
SET 1062	32213 F	11
SET 1063	32214 F	11
SET 1064	32215 F	11
SET 1065	32216 F	11
SET 1066	32217 F	11
SET 1067	32218 F	11
SET 1068	32219 F	11
SET 1069	32220 F	11
SET 107	JLM 104948/JLM 104910	28
SET 1070	32221 F	11
SET 1072	32304 F	11
SET 1074	32306 F	11
SET 1075	32307 F	11
SET 1076	32308 F	11
SET 1078	32309 F	11
SET 1079	32310 F	11
SET 108	JHM 807045/JHM 807012	30

14.3 \ Cross part number Cruces de referencias

COMPETITOR	Fersa	PG.
TIMKEN		
SET 1080	32311 F	11
SET 1081	32312 F	11
SET 1082	32313 F	11
SET 1083	32314 F	12
SET 1084	32316 F	12
SET 1085	32924 F	12
SET 1086	33011 F	12
SET 1088	33014 F	12
SET 1089	33015 F	12
SET 109	683/672	17
SET 1090	33018 F	12
SET 1091	33019 F	12
SET 1092	33020 F	12
SET 1093	33021 F	12
SET 1094	33022 F	12
SET 1096	33108 F	12
SET 1097	33109 F	12
SET 1098	33111 F	12
SET 1099	33112 F	13
SET 11	JL 69349/JL 69310	27
SET 110	6379/6320	19
SET 1100	33113 F	13
SET 1101	33115 F	13
SET 1102	33116 F	13
SET 1103	33117 F	13
SET 1104	33118 F	13
SET 1106	33206 F	13
SET 1107	33207 F	13
SET 1108	33208 F	13
SET 1109	33209 F	13
SET 111	48290/48220	26
SET 1110	33210 F	13
SET 1111	33211 F	13
SET 1112	33212 F	13
SET 1113	33213 F	13
SET 1114	33214 F	13
SET 1115	33215 F	13
SET 1116	33216 F	13
SET 1117	33217 F	13
SET 1119	3490/3420	18
SET 1122	37431 A/37625	25
SET 1123	387 A/382	14
SET 1124	39580/39528	25

COMPETITOR	Fersa	PG.
SET 1125	395 S/394 A	15
SET 1127	4580/4535	19
SET 113	HM 215249/HM 215210	28
SET 1133	5395/5335	19
SET 1135	575/572	16
SET 1137	580/572 X	16
SET 1138	594 A/592 A	16
SET 114	H 212749/H 212710	28
SET 1141	665 A/653	17
SET 1143	9278/9220	19
SET 1144	9285/9220	19
SET 1146	H 414242/H 414210	29
SET 1148	H 715332/H 715311	30
SET 1150	HM 204043/HM 204010	28
SET 1152	HM 212049/HM 212010	28
SET 1158	HM 807048/HM 807010	31
SET 1163	JF 6049/JF 6010	19
SET 1164	JF 7049/JF 7010	19
SET 1165	JF 7049 A/JF 7010	19
SET 1166	JF 9549/JF 9510	19
SET 1169	JHM 720249/JHM 720210	30
SET 117	64450/64700	26
SET 1176	JM 207049/JM 207010	28
SET 1177	JM 207049 A/JM 207010	28
SET 1178	JM 511946/JM 511910	29
SET 1179	JM 515649/JM 515610	29
SET 118	JLM 506849/JLM 506810	29
SET 1180	JM 612949/JM 612910	29
SET 1182	JM 718149/JM 718110	30
SET 1183	JM 719149/JM 719113	30
SET 1184	JM 822049/JM 822010	31
SET 1192	JW 5549/JW 5510	19
SET 1193	JW 6049/JW 6010	19
SET 12	LM 12749/LM 12710	20
SET 1207	32015 XF	10
SET 121	18790/18720	22
SET 1216	L 910349/L 910310	31
SET 122	25580/25522	23
SET 1227	LM 806649/LM 806610	30
SET 123	3780/3720	18
SET 1231	F 15097	154
SET 1231 / NP 078914	F 15097	154
SET 1237	F 15126	154
SET 1242	F 15122	154

COMPETITOR	Fersa	PG.
TIMKEN		
SET 1254	F 15252	36
SET 1257	F 15124	154
SET 1257	F 15124	154
SET 1263	F 15127	154
SET 1265	F 15321	38
SET 1277	F 15126	154
SET 1296	JF 5049/JF 5010	19
SET 1297	JF 4549/JF 4510	19
SET 1298	32018 XF	10
SET 1299	F 15115	34
SET 13	L 68149/L 68110	27
SET 1300	F 15051 R	32
SET 1301	F 15051 C	32
SET 1303	33020 F 561694	12
SET 1304	33216 F 573810	13
SET 1306	33021 F 0266488	12
SET 1308	JF 10049/JF 10010	20
SET 1309	33220 F	13
SET 1310	F 15100	154
SET 1311	F 200015	158
SET 1312	F 200013	158
SET 1314	F 200014	158
SET 1321	F 15300	156
SET 1328	F 15271	38
SET 1334	F 300001	164
SET 1335	F 200004	158
SET 1336	F 300005	164
SET 1343	33017 F	12
SET 1346	F 200016	158
SET 1349	F 15120	154
SET 1350	F 300003	164
SET 1351	F 200019	160
SET 1352	F 200017	160
SET 1368	F 15302	58
SET 1370	F 200025	160
SET 1372	F 200028	160
SET 1373	F 15267	36
SET 14	L 44643/L 44610	25
SET 15	07100/07196	20
SET 16	LM 12749/LM 12711	20
SET 17	L 68149/L 68111	27
SET 2	LM 11949/LM 11910	20
SET 20	U 399/U 365 L-C	46

COMPETITOR	Fersa	PG.
SET 205	469/453 X	15
SET 21	1988/1922	17
SET 210	527/522	15
SET 212	537/532 X	16
SET 214	559/552 A	16
SET 215	575/572 X	16
SET 216	594/592 A	16
SET 226	1380/1328	17
SET 229	2780/2720	17
SET 230	2788/2720	17
SET 2312	F 200013	158
SET 2346	F 200016	158
SET 2351	F 200019	160
SET 2352	F 200017	160
SET 238	JF 4049/JF 4010	19
SET 24	JL 68145/JL 68111 Z	27
SET 240	JW 5049/JW 5010	19
SET 241	6386/6320	19
SET 243	JD 6549/JD 6510	19
SET 244	JF 7049 A/JF 7010	19
SET 251	15103 S/15243	21
SET 252	15106/15250 X	22
SET 253	18590/18520	22
SET 26	JLM 104946/JLM 104910	28
SET 260	25877/25821	23
SET 262	27687/27620	24
SET 263	28580/28521	24
SET 267	29685/29620	24
SET 268	LM 29749/LM 29711	24
SET 270	33885/33822	24
SET 271	33889/33822	25
SET 272	33895/33822	25
SET 276	39580/39520	25
SET 278	39581/39520	25
SET 279	39585/39520	25
SET 28	J 15585/15520	22
SET 281	42381/42584	25
SET 289	52400/52618	26
SET 293	55200 C/55437	26
SET 3	M 12649/M 12610	20
SET 302	68462/68712	27
SET 304	72212 C/72487	27
SET 307	09074/09194	20
SET 308	M 84548/M 84510	27

14.3 \ Cross part number Cruces de referencias

COMPETITOR	Fersa	PG.
TIMKEN		
SET 309	M 86649/M 86610	27
SET 312	HM 89449/HM 89410	28
SET 315	JM 205149/JM 205110	28
SET 317	HM 220149/HM 220110	29
SET 318	LM 300849/LM 300811	29
SET 320	JLM 508748/JLM 508710	29
SET 321	25877/25820	23
SET 322	495 A/493	15
SET 323	JHM 522649/JHM 522610	29
SET 324	JLM 714149/JLM 714110	30
SET 325	JM 714249/JM 714210	30
SET 328	M 802048/M 802011	30
SET 330	HM 803146/HM 803110	30
SET 336	JL 819349/JL 819310	31
SET 339	HM 911245/HM 911210	31
SET 340	H 913842/H 913810	31
SET 341	H 913843/H 913810	31
SET 342	JLM 710949 C/JLM 710910	30
SET 349	567/563	16
SET 354	15103 S/15245	21
SET 355	15579 X/15520	22
SET 357	28584/28521	24
SET 359	78215 C/78551	27
SET 36	LM 603049/LM 603012	29
SET 361	JM 716649/JM 716610	30
SET 362	02474/02420	19
SET 363	55175 C/55437	26
SET 364	37431 A/37625	25
SET 365	395 A/394 A	15
SET 37	LM 603049/LM 603011	29
SET 38	LM 104949/LM 104911	28
SET 4	L 44649/L 44610	25
SET 401	580/572	16
SET 402	582/572	16
SET 403	594 A/592 A	16
SET 404	598 A/592 A	16
SET 405	663/653	17
SET 406	3782/3720	18
SET 407	28682/28622	24
SET 408	39590/39520	25
SET 409	45280/45220	25
SET 410	45284/45220	25
SET 411	47686/47620	26

COMPETITOR	Fersa	PG.
SET 412	HM 212047/HM 212011	28
SET 413	HM 212049/HM 212011	28
SET 414	HM 218248/HM 218210	28
SET 415	HM 518445/HM 518410	29
SET 416	45291/45220	25
SET 417	47890/47820	26
SET 418	H 715334/H 715311	30
SET 419	H 715343/H 715311	30
SET 42	JLM 506849 A/JLM 506811	29
SET 420	H 715345/H 715311	30
SET 421	HM 516449 A/10	29
SET 422	HM 516449 C/HM 516410	29
SET 423	6461/6420	19
SET 424	555 S/552 A	16
SET 425	567/563	16
SET 426	47679/47620	26
SET 43	15123/15245	22
SET 45	LM 501349/LM 501310	29
SET 46	JL 26749 F/JL 26710	23
SET 47	LM 102949/LM 102910	28
SET 5	LM 48548/LM 48510	26
SET 50	02872/02820	19
SET 508	687/672	17
SET 51	15106/15245	21
SET 52	25580/25520	23
SET 53	25580/25523	23
SET 54	25590/25520	23
SET 55	25590/25523	23
SET 56	LM 29748/LM 29710	24
SET 57	31594/31520	24
SET 6	LM 67048/LM 67010	27
SET 61	11590/11520	20
SET 62	17887/17831	22
SET 63	M 88048/M 88010	28
SET 64	HM 903249/HM 903210	31
SET 65	M 86647/M 86610	27
SET 66	368 S/362	14
SET 67	HM 88649/HM 88610	28
SET 68	497/493	15
SET 69	LM 501349/LM 501314	29
SET 70	LM 29749/LM 29710	24
SET 73	15101/15245	21
SET 74	387 A/382 A	14
SET 75	387 A/382 S	14



A series of horizontal dotted lines spanning the width of the page, providing a guide for handwriting practice. The lines are evenly spaced and extend from the left margin to the right margin.