

[Kimball Houton Stark, Chief Engineer, F.A.D. Andrea, Inc. (Jul. 01, 1923, 1st ed.) How to Build Hazeltine's
Neutrodyne Circuit Radio Receiver. F.A.D. Andrea, Inc. Reproduced for educational purposes only. Fair Use
relied upon. Source: <http://www.umberto-alessio.it/Vacuum%20Tubes%20Books/Theory%20Books/How%20to%20Build%20Hazeltine%27s%20Neutrodyne%20Circuit%20Radio%20Receiver%20-%20FADA%201923.pdf>]



How to build
**HAZELTINE'S NEUTRODYNE CIRCUIT
RADIO RECEIVER**

F. A. D. ANDREA, INC.

**1581 JEROME AVENUE
NEW YORK CITY**

PRICE 50 CENTS



How to build
**HAZELTINE'S NEUTRODYNE CIRCUIT
RADIO RECEIVER**

F. A. D. ANDREA, INC.

**1581 JEROME AVENUE
NEW YORK CITY**

How to Build Hazeltine's Neutrodyne Circuit Radio Receiver

*Complete assembly, wiring, adjusting and tuning
information for building both four and five
tube Hazeltine "Neutrodyne"
circuit radio receivers*

By KIMBALL HOUTON STARK
Chief Engineer F. A. D. Andrea, Inc.

Copyright, 1923
F. A. D. ANDREA, INC.
New York

FIRST EDITION JULY, 1923
SECOND EDITION AUGUST, 1923
THIRD EDITION SEPT., 1923
FOURTH EDITION OCT., 1923

HAZELTINE'S NEUTRODYNE CIRCUIT



POSSIBLY the most important development in radio engineering in recent years is the introduction of the "Neutrodyne" receiving and amplifying circuit. For the first time really efficient radio frequency amplification is possible.

Technically the "Neutrodyne" circuit neutralizes the inherent coupling capacities of both the vacuum tubes and their associated circuits. This eliminates distorting regeneration, local re-radiation and other radio receiver circuit disadvantages.

The "Neutrodyne" circuit is the result of several years' research work by Professor L. A. Hazeltine, Professor of Electrical Engineering at Stevens Institute of Technology, Hoboken, N. J.

Professor Hazeltine is one of the world's noted consulting radio engineers. His work in radio has been of great value to the art, and a fitting addition to his achievements is the development of the "Neutrodyne" circuit. The American

Institute of Electrical Engineers have honored Professor Hazeltine by making him a Fellow member. Professor Hazeltine is also a member of the American Society of Mechanical Engineers and a Fellow member of the Institute of Radio Engineers.



Eminent authorities are of the opinion that the Hazeltine "Neutrodyne" circuit will revolutionize radio broadcast reception.

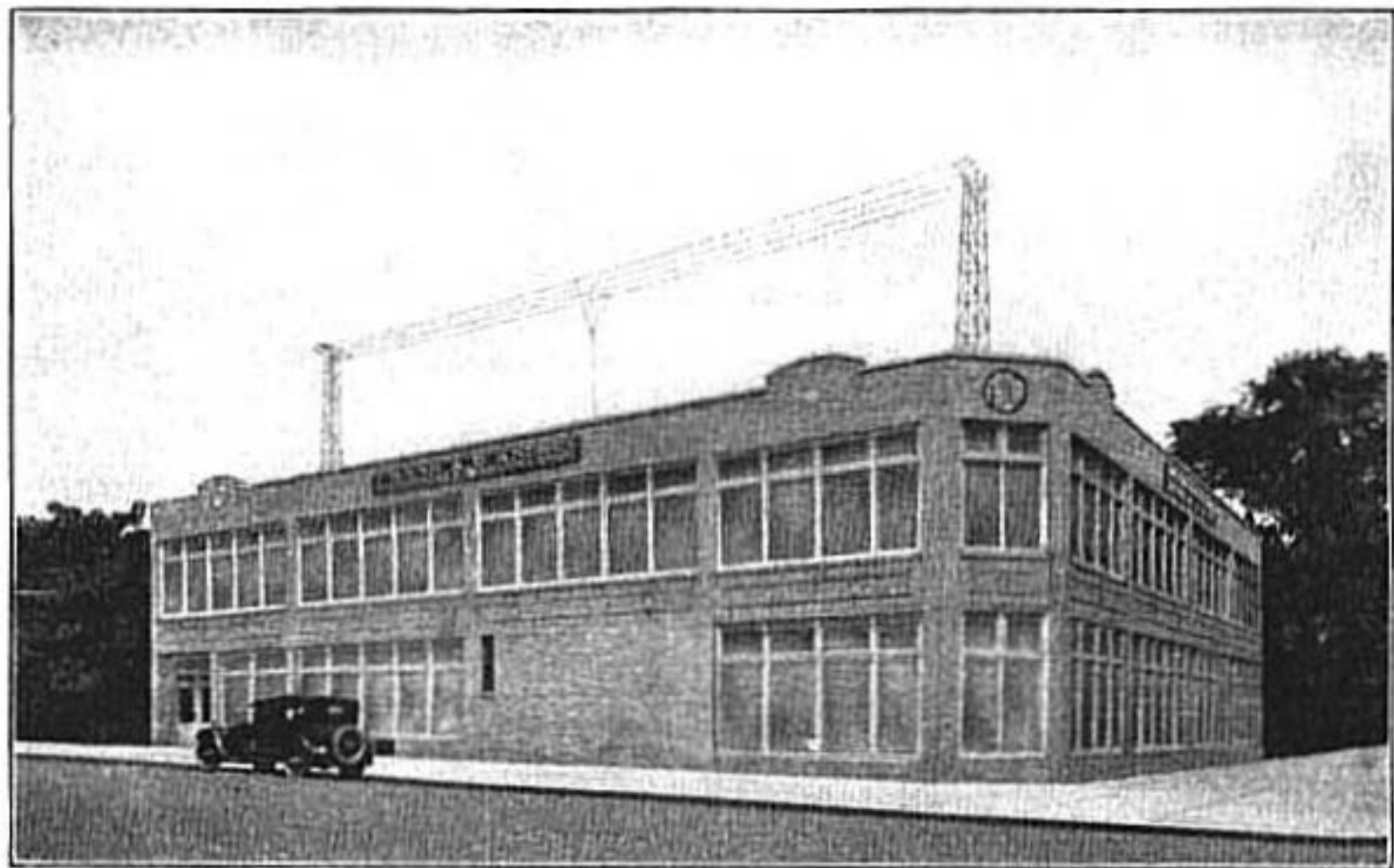

**The Modern Factory Where Fada Radio Instruments
and Parts Are Manufactured.**

How to Build "Neutrodyne" Radio Receivers

Complete assembly, wiring, adjusting and tuning information for building both four and five tube Hazeltine "Neutrodyne" circuit radio receivers.

By **KIMBALL HOUTON STARK**

Chief Engineer F.A.D. Andrea, Inc.

ON March 2nd, 1923, Professor Louis A. Hazeltine delivered a lecture before the Radio Club of America at Columbia University, New York City, entitled "Tuned Radio Frequency Amplification with Neutralization of Capacity Coupling".

Intensive development work for several months previous to the date of the lecture experimentally verified the importance of the "Neutrodyne" principle.

In fact, there appeared on the radio market at about the time of the lecture two types of radio receivers utilizing the "Neutrodyne" circuit. During the past several months these complete "Neutrodyne" receivers have demonstrated in every part of the United States their superiority for both local and long distance radio broadcast reception. On this page are shown interior and exterior views of the "One-Sixty" Neutrodyne receiver illustrative of one of the types of "Neutrodyne" receivers being made on a commercial basis.



Interior view of the "One-Sixty" Hazeltine Neutrodyne receiver showing arrangement of wiring and "Neutroformer" units.

for accurate and complete details which would enable them to build their own receivers of this type.

This booklet is published to supply that information and tells in simple and understandable language how to construct, adjust and operate both four and five tube "Neutrodyne" circuit radio receivers.

There is no greater thrill than the moment when after the constructional work one is ready to listen-in on the new set for signals. An added joy of the owner of a radio set is to hear the broadcasted concerts from stations hundreds or even thousands of miles away. It's this "long distance receiving" that causes the "radio bug" to stay awake 'til midnight and after, much to the chagrin of friend wife.

Literally thousands and thousands of people who like to "construct their own" radio equipment, after knowing the success of the "Neutrodyne" circuit receivers have been waiting



The front panel appearance of the "One-Sixty" Hazeltine Neutrodyne receiver is symmetrical and clean-cut.

Materials Necessary for Neutrodyne Receiver Construction

It may be well at this time to give the experimenter the benefit of several months' laboratory work in developing the "Neutrodyne" circuit.

Basically the "Neutrodyne" circuit accomplishes a feat which has long baffled the best of all radio engineers. Efficient radio frequency amplification has been a laboratory achievement up until the advent of this circuit. The inherent disadvantages of attempting to combine pure radio frequency amplification with the almost impossible problem of eliminating undesirable regeneration and oscillation has been the bugaboo of both engineer and home experimenter.

Publication of constructional information on the "Neutrodyne" circuit has accordingly been withheld until actual how-to-build-it models could be built and it was felt that the layman could, with pictures and complete data, get satisfactory results from home-made "Neutrodyne" receivers.

The "Neutrodyne" radio receiver requires several special pieces of apparatus. The tuned radio frequency transformers or "Neutroformers" and the special very low capacity variable condensers or "Neutrodon" are the most important units in the circuit.

The "Neutroformer" is a special tuned radio frequency transformer. The design is especially important. The several characteristics of the unit, such as the distributed capacity and inductance of the windings, mechanical arrangement of the coils, mutual inductance, position of taps and the co-efficient of coupling have been determined very accurately in the laboratory.

The "Neutrodon" is a very special variable condenser of extremely low capacity of the order of one to ten micro-micro-farads. The neutralizing adjustment of the circuit is focused in these "Neutrodon" condensers and they must have practically no losses at radio frequencies.

Three "Neutroformers" and two "Neutrodon" are necessary in constructing either a four or five tube receiver. These parts are packed in a combination package as pictured on this page and can be obtained from most radio merchants or direct from the manufacturer.

Of course other standard parts are needed in addition to these special "Neutrodyne" parts. Complete lists of these materials for both types of receiving sets will be found on pages 27 and 28 of this booklet.

It is suggested that the readers carefully study the information given on page 18 before finally deciding which to construct; *i.e.*, a four or five tube "Neutrodyne" receiver.



A standard combination package of Hazeltine "Neutrodyne" parts which will enable the home radio experimenter to build successful "Neutrodyne" circuit receivers.

Using Fada Templates and Drilling the Receiver Panels

Attached to the rear pages of this booklet will be found two full size paper panel drilling templates. These templates greatly aid the constructional work as they are made very accurately and can be trimmed to size and pasted directly on the panel and all holes drilled to sizes mentioned.

Bakelite, Formica or Radion hard rubber panels can be purchased, either 24 or 26 inches long, and 7 inches wide by $\frac{3}{8}$ inch thick, at most every radio store. The 24 inch panel is for the four tube set and the 26 inch panel for the five tube set.

Carefully trim the paper template to exact size of the panel and paste the corners down onto the panel securely with library paste. A small prick punch can then be used to locate the centers of the holes. After this a hand drill should be used to drill the holes in the panel. Care should be taken in locating the centers of the holes thru the template accurately, and particularly in the case of the "Neutroformer" mounting holes.

The holes on the template which are marked "countersunk" can be countersunk by using a larger drill and hand brace if necessary, or where one has it, a regular countersink.

A combination square and dividers may be of assistance if one desires to lay out the panel drilling by scaling the dimensions from the panel template and scribing these dimensions directly on the panel.

The home experimenter can have the engraving placed on the panel by giving the work out to a shop which has regular engraving machines, or can roughly engrave his own panel by carefully making the lines and letters with a sharp scribe and after-

ward filling in these lines with white enamel. Of course, the most desirable way is to purchase the panel from any good radio instrument shop completely drilled and engraved.



Showing "Neutrodome" receiver panel in the process of being drilled, using the paper template supplied with this book.

Assembly of Parts on the Panel

The assembly details of either the four or five tube sets are practically the same, so this data will be taken up in the order of assembling each individual unit on the receiver panels or baseboards.

The only tools required for assembly work are screw drivers (thin and coarse blades) hand drill and drills, small hammer, prick punch, combination square, dividers, and a small wrench for fastening the telephone jacks.

NEUTROFORMERS—The three "Neutroformers" are mounted in the center of the panel height. The panel drilling is such that all three of these "Neutroformers" are mounted approximately at a 60 degree angle from the horizontal. Accurately this angle is 54.7 degrees. This angle is very important and one should not attempt to construct a "Neutrodyne" set without carefully following the paper template layout.



The photograph on page 18 shows the general relation of the "Neutroformers" to the rest of the set. Each of the "Neutroformers" have a tap in the winding on the outside.

After the "Neutroformers" are screwed onto the panel with the condenser shaft protruding from the panel, the adjusting dials should be fastened onto the shafts nicely so that they do not rub against the panel when rotated.



RHEOSTATS AND FILAMENT SWITCH—On both four and five tube "Neutrodyne" sets a regular vernier rheostat is recommended to control the detector tube filament current. This is the rheostat at the extreme right hand end of the front of the four tube set and the second rheostat from the right hand end of the five tube panel. Detailed instruction for mounting the vernier rheostat follows:

1. Remove the entire vernier attachment which will be found attached to the rheostat shaft with a set screw.
2. This releases and allows the removal of the rheostat shaft, the knob and pointer. The rheostat base with resistance strips can then be fastened on the rear of the panel with the machine screws and nuts furnished. The knob and shaft should be inserted thru the panel from the front.
3. Rotate the knob and shaft until the pointer is at the desired off position at the left side.
4. Now press the vernier attachment on the end of the shaft and press it down on the shaft until it rests firmly against the contact strip and until the outer end of the contact lever makes good contact to the resistance strip.
5. Adjust the contact lever pressure so that the lever makes just strong enough contact to permit rotating the vernier disc without causing the main lever to jump from one turn to the next on the resistance strip. Then secure firmly to the shaft with a set screw.

The same general procedure should be followed in mounting the power tube rheostat, except the vernier attachment, of course, is replaced by the ordinary contact lever. The power tube rheostat controls the filament current of the three amplifier tubes used. As will be noted from the accompanying drawing, the sockets used should be of a type that allows room for mounting the rheostats between the sockets and the panel.

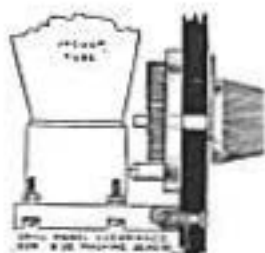

The filament circuit, or "A" battery switch is fastened to the panel by removing the knurled nut and after inserting the threaded stem of the switch thru the panel, replacing the knurled nut and turning it up tight.



BINDING POSTS—Seven binding posts are used on either the four or five tube "Neutrodyne" set. After inserting the binding posts thru the panel, terminal clips should be placed over the screws and then the binding post nuts tightened down securely.

TUBE SOCKETS—In the four tube "Neutrodyne" set only single tube sockets are used, while in the five tube set two single and a triple socket are required. The sockets may be securely fastened to the panel with the flat head machine screws furnished. One should use care in tightening up on the machine screws so that the heads of the screws will not be injured and that the screws exposed on the front of the panel will not appear unsightly.



Before assembly of the sockets on the panel it may be well to see that all contact springs are firmly attached to the socket base and bent up into the socket shell so that good contact will be assured when the vacuum tubes are inserted.

TELEPHONE JACKS—Two telephone jacks are used on these receiving sets. One of these is of the "single open circuit" automatic filament control type and the other a "single closed circuit" type.



On the four tube set the "automatic" type, or the one with the three contact springs, should be fastened onto the left hand end of the panel. The jack with two contact springs, of course, must then be fastened on the four tube panel under the number 3 "Neutroformer" tuning dial.

On the five tube set the reverse arrangement is followed. The three spring jack is at the right hand of the panel, and the two spring or "closed circuit" jack is mounted directly under the vernier tube rheostat knob.

Before assembling the jacks on the panel the contact springs should be examined to see that proper contact is made when the telephone plug is inserted.

BASEBOARDS—The wooden baseboard is fastened to the panel by three wood screws. It should be carefully located, even with the bottom of the front panel and the screw holes started with a small drill. Using a small starting hole and rubbing soap on the wood screws will allow screwing the baseboard and panel together very firmly. The baseboard should be shellaced or varnished to prevent the absorption of moisture and the consequent warping and splitting.

NEUTRODON CONDENSERS—These two "Neutrodons" are mounted on the baseboard between the first and second and the second and third "Neutroformers". Use a combination square and line the bakelite "Neutrodon" bases up square and true with the edges of the baseboard if you desire a neat looking finished instrument. Then fasten this bakelite base down to the baseboard using two wood screws.

The adjustable brass tubes of the "Neutrodons" should be placed about in the center of the glass tubes and under the fastening down clamp.

AUDIO FREQUENCY TRANSFORMERS—Two audio frequency amplifying transformers are used on either the four or five tube sets. As will be seen by examining the rear view photographs of these two types of receivers as shown on pages 18 and 19, the mounting of the transformers on the baseboards is different. On the four tube set they are spaced apart on the left hand end of the baseboard, while on the five tube set they are closer together and at the left hand end of the receiver baseboard.



Care should be taken in mounting the audio transformers to arrange the terminals such that all wiring to the transformers is as short and direct as possible.

Wiring Up the Assembled NEUTRODYNE Receiver

THE FOUR TUBE SET. It is best to fasten the baseboard to the panel when assembling in order to properly locate the holes for fastening, etc. After the entire receiver is assembled, however, the baseboard should be removed from the panel in order to facilitate the wiring. This will mean that the receiver is wired up complete without the baseboard, with the exception of the audio transformers and "Neutrodons" which are actually fastened to the baseboard.

A complete wiring diagram for the four tube "Neutrodyne" receiver is shown on page 11. One should study this diagram carefully before proceeding with the wiring to get in mind the general plan of the connections. The tuner, first radio frequency unit, and second radio frequency unit on the diagram are respectively the left hand, center and right hand "Neutroformers".

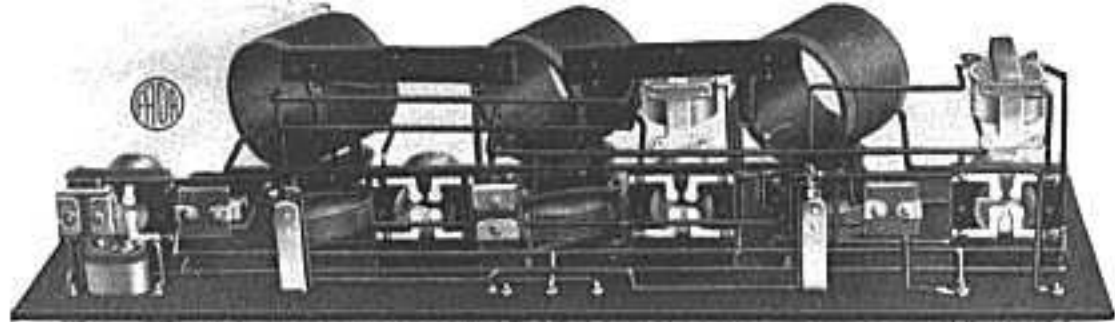

Showing the wiring of the four tube "Neutrodome" set from the bottom with the baseboard removed.

The fixed condenser on the diagram shown connected in parallel with the audio frequency transformer secondary between the first two vacuum tubes should have a capacity of .0002 micro-farads. The other two fixed condensers shown should have a capacity of .006 micro-farads. The neutralizing capacities on the diagram are the "Neutrodon" condensers.

It is usually best to begin wiring by connecting up all of the negative vacuum tube socket terminals and then extending this same wire to the ground binding post.

In like manner the positive filament connections can be made, the positive terminals of two of the amplifying tubes being connected together. The wiring of the detector tube, power rheostat, vernier rheostat and filament current switch, to the 6 volt or "A" battery bind posts can then be completed.

The next units to wire up are the fixed condensers and the telephone jacks. The fixed condensers can be wired in the circuit and by using No. 14 solid copper wire, the wires soldered to each terminal of the fixed condensers will support them solidly and eliminate the necessity of fastening the fixed condensers down to the baseboard with wood screws.

Now the "Neutroformer" connections can be made. It will be noted that all three "Neutroformer" secondary windings have a small loop or tap. It is very important that no connection be made to the tap of No. 1 or the left hand "Neutroformer" looking from the panel front. The lead from the No. 2 and 3 "Neutroformer" tap should go direct to one terminal respectively of the second and third "Neutrodons" as shown in the wiring diagram.



**SCHEMATIC WIRING DIAGRAM
OF FIVE TUBE
NEUTRODYNE CIRCUIT RECEIVER**

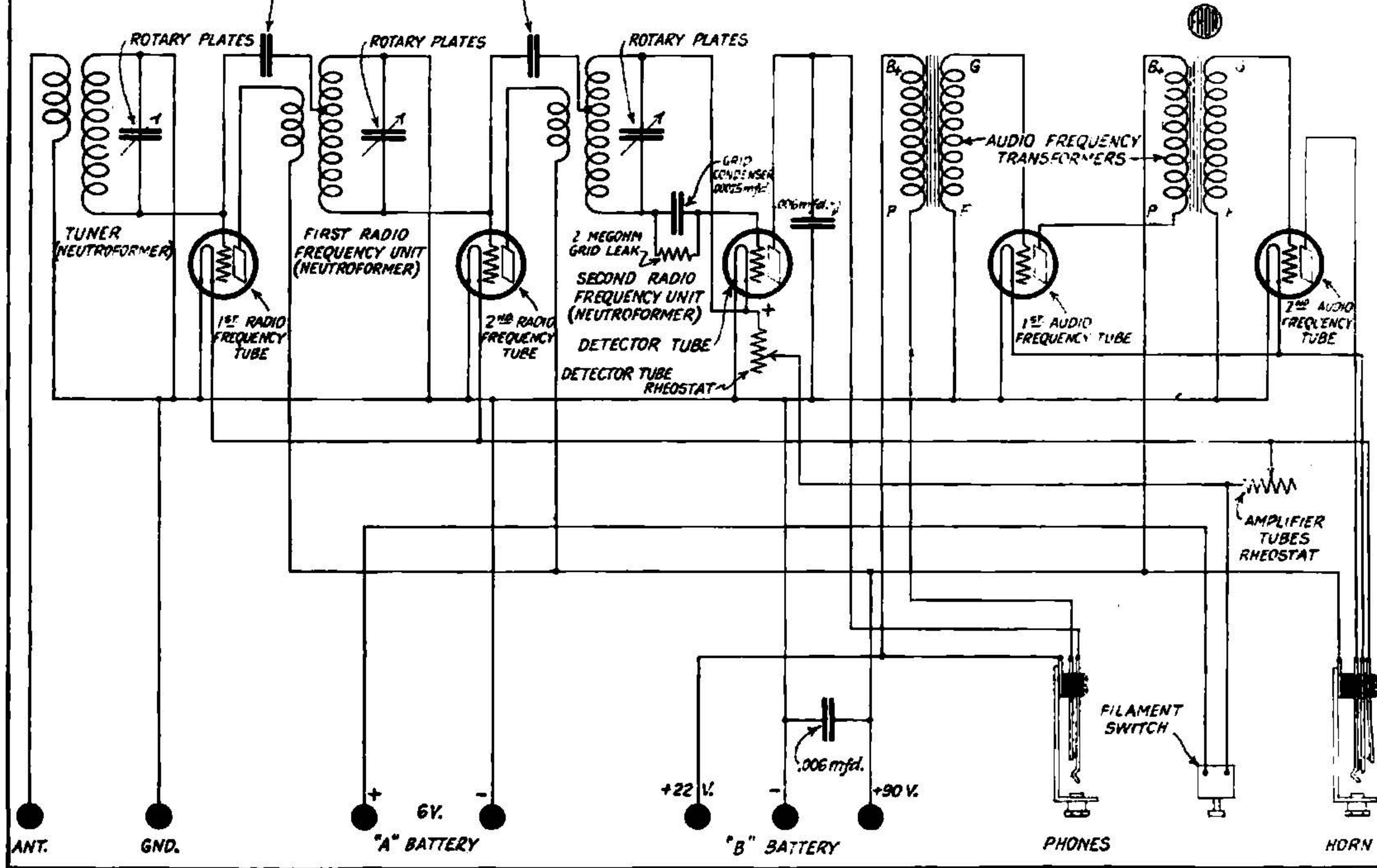

[13]

Final connections can be made to the audio frequency transformers, "Neutrodons", binding posts, etc., after the baseboard has been replaced on the panel.

FIVE TUBE SET. The five tube "Neutrodyne" set wiring is practically the same as the four tube set except, of course, the socket layout and the position of the audio frequency transformers. It will also be noted from the five tube wiring diagram on page 13 that only two fixed condensers are used in addition to the grid condenser. These two fixed condensers should each have a capacity of .006 micro-farads.

Grid condensers and grid leaks are shown on both four and five tube wiring diagrams. These are not absolutely necessary and if both are dispensed with, the connecting wire from the rotary plates of the third "Neutroformer" variable condenser should be connected to the negative and not to the positive side of the detector tube filament circuit.

GENERAL WIRING HINTS. The general procedure in wiring is to cover each wire with insulating tubing after it has been cut to exact length. The bending of the wires can be done after the insulating tubing is placed on the wires. The bending of the wires should be done carefully, all corners being slightly rounded, but with the leads at right angles and square to each other.

All soldering should be very carefully done and under no consideration should acid be used as a soldering flux. The most desirable flux to use is a mixture of alcohol and resin. The no-corrode soldering pastes on the market are permissible if the joints are carefully cleaned, immediately after soldering, with alcohol or gasoline. Another point of importance in soldering is to use a soldering copper that is hot enough. Cold soldering means high frequency resistance and poor mechanical strength in connections.

Another wiring hint of value is the plan of checking off with ink very carefully each wire on the wiring diagrams after it has been connected in place. This gives one a ready check on the wiring and helps in being sure that all connections are properly made.

On both four and five tube wiring diagrams no wire is shown jumping another wire with a semi-circle. The plan shows each wire passing across the others and only connecting to cross wires when represented by a solid black dot. Check this carefully with your wiring.

The drawing at the bottom of this page is of assistance in connecting up the audio amplifying transformers as it shows the correct polarity of the windings and should in every case be followed out.

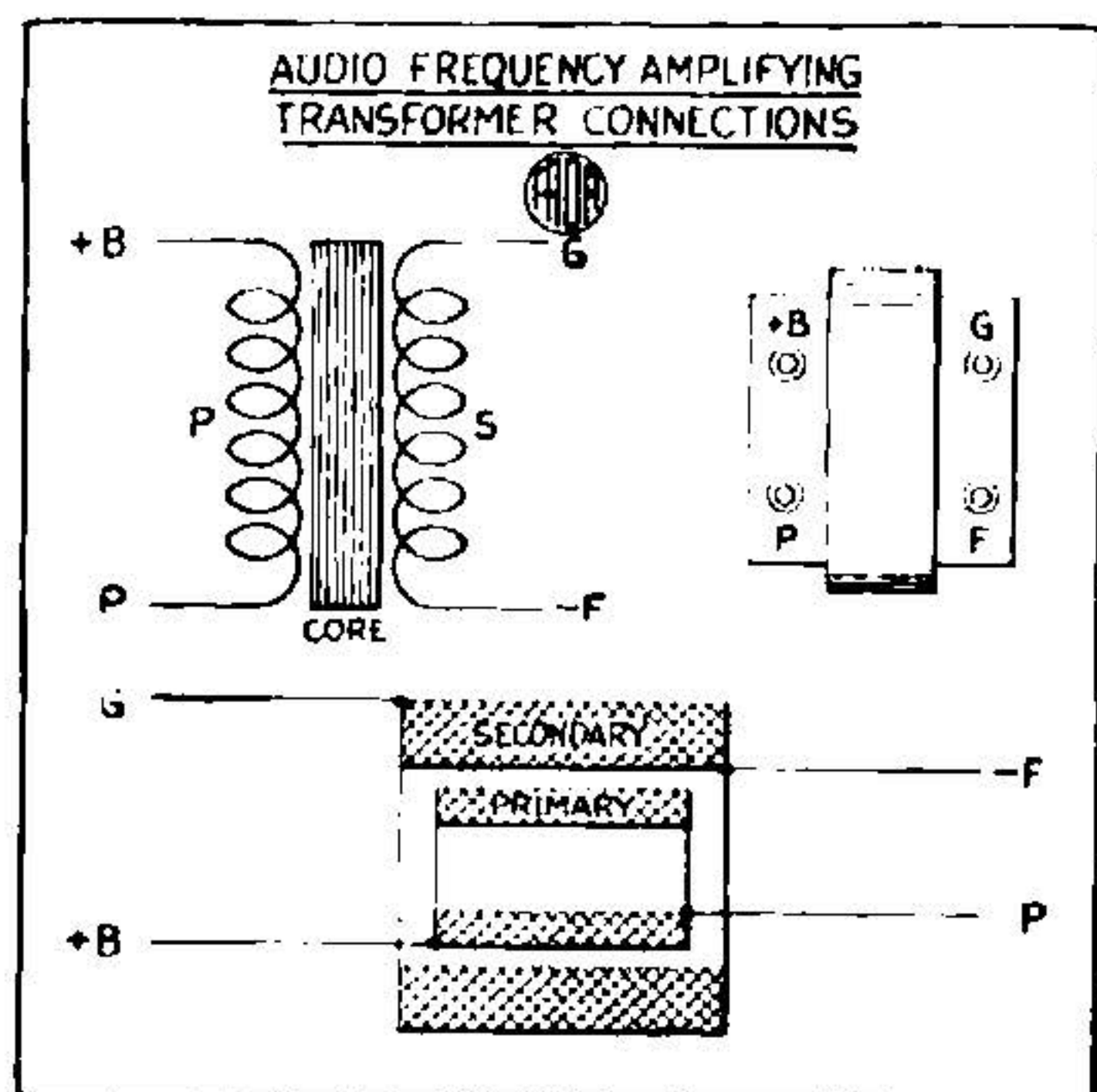

Adjusting the Neutrodyne Circuit

After the "Neutrodyne" circuit receiver is completely wired up it must be adjusted to neutralize the vacuum tube and stray circuit capacities before it can function properly.

The adjusting process consists of exciting the coupled receiver circuits with a strong signal and then neutralizing the tube and circuit capacities, preventing that signal from being heard thru the circuits. This adjustment is one for a minimum signal or inaudible signal, and can accordingly be made very exact, proving the neutralization of the capacity coupling of the circuit. In that this process is carried on with the vacuum tube filament circuits inoperative or cold, it can be readily seen that the process is one of actual circuit capacity neutralization, and not a method of preventing or reducing regeneration.

The balancing-out procedure as it is called, requires an external circuit made up as in the drawing below. It consists of an inductance and a variable condenser excited by a buzzer and coupled to the input or antenna terminal of the completed receiver. It is usually desirable to place this adjusting circuit 10 or 15 feet away from the actual receiver and lead a single wire over to the antenna binding post. To complete the circuit arrangement a wire is run from the ground to the ground binding post of the receiver.

With the adjusting or balancing-out circuit connected as above and with the "A" and "B" battery connections made as shown in the drawing on page 21, we are ready to balance out our receiver. The method is as follows:

1. Insert three UV-201-A vacuum tubes in the amplifying tube sockets and one UV-200 tube in the detector tube socket. The detector tube socket is the one, in both receivers, directly behind the vernier rheostat. Start the buzzer of the adjusting circuit going and then light the vacuum tube filaments by pulling out the filament switch button. See that the power rheostat is turned as far to the left as possible. Adjust the vernier detector tube rheostat to a point just before a decided "sizzling" and "frying" sound is heard in the telephones which have been plugged into the "phones" telephone jack.

2. Now rotate all three "Neutroformer" dials on the front of the panel about in step with each other, and pick up the buzzer signals. The variable condensers of the adjusting circuit should be placed approximately at 15 to 20 degrees, or at an approximate wavelength setting on the scale of 250 meters. All of the receiver dials should then be carefully turned until the buzzer signals come in loudest. All three dials will then be found to have about the same setting.

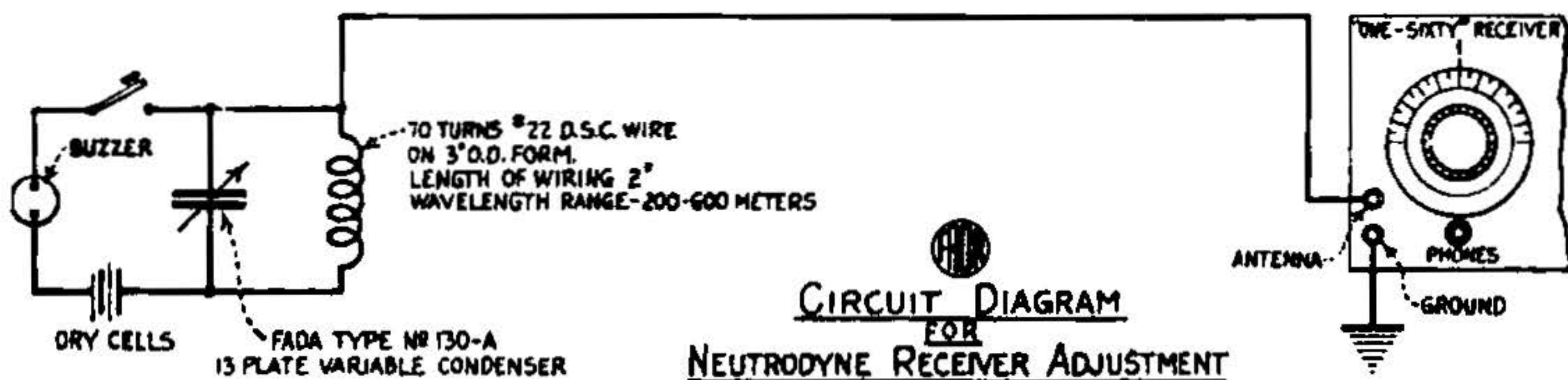

Circuit diagram for adjusting the "Neutrodyne" circuit such that both vacuum tube and stray circuit capacities are neutralized.

3. Completely remove from its socket the first radio frequency amplifier tube. On the five tube set this is the one on the extreme left and on the four tube set it is the second one from the left.

4. Now re-adjust all three "Neutroformer" dials carefully until the signals again come in at their loudest.

5. Now take the tube you removed from the first radio frequency socket and place a small piece of paper over one of its filament contact pins so that it will remain in position when the tube is again inserted in its socket.

6. Placing the tube back in its socket will connect the plate and grid of the tube in circuit but will not allow its filament to light as the small piece of paper over the pin prevents contact. With the tube back again in the socket without the filament lit, signals will undoubtedly still be heard in the phones. The strength of these signals can however be varied from loud to weak by moving the brass tube of the first "Neutrodon" or the one placed at the left on the baseboard. This adjustment should be made to a point where the signals are very weak or disappear entirely, and no sound is heard. Now by entirely removing the tube from its socket signals will come in loud. Immediately replacing the tube in its socket (with the paper still in place) the signals will disappear or be very weak. This is the desired condition and the "Neutrodon" condenser, after being very carefully adjusted to this minimum signal point may be permanently fastened by soldering the brass tube to the brass clamp in the center.

This covers the neutralizing adjustment for the first radio frequency tube. Identically the same procedure is followed out with the second radio frequency tube, having all other tubes, including the first radio frequency tube in their sockets and lighted, but putting the paper over the contact pin of the second tube and adjusting the second "Neutrodon" while the second radio frequency tube is in its socket and with its filament unlit. In balancing out the second radio frequency tube, the above numerical instructions can be followed as before beginning with number 2. It is important when adjusting either "Neutrodon" that all three "Neutroformer" dials should be adjusted for maximum signals before final neutralization adjustments are made.

The picture on page 17 shows the layout of the adjusting circuit in general and the second "Neutrodon" condenser being adjusted.

The "Neutrodon" condenser, as will be noted from the picture on page 26, has three terminals. Ordinarily the connections are made to the two terminals at each end. Some times, however, one can not seem to obtain a good minimum signal balance in this way. Then it is recommended that one of the connections of the "Neutroformer" be made to the center terminal. This gives a greater capacity range to the "Neutrodon" and by proceeding with the adjusting as above a good minimum or inaudible signal adjustment can be obtained.

A further test to see that the circuit is properly adjusted is to try to pick up broadcasted signals from local stations with the complete receiver hooked up and with all tubes operating as covered on page 21. By rotating the dials over the range of the receiver one should be able to receive the broadcasted signals without hearing beat notes, whistling, etc., which are the usual indications of regeneration and oscillation. If under any circumstances these conditions prevail the entire receiver should be carefully re-adjusted, wiring sepa-

rated as much as possible which should eliminate the trouble. If beat notes, etc., are heard it is proof that the circuit is not functioning according to the "Neutrodyne" principle and most satisfactory results cannot be obtained. The experimenter is cautioned in particular to make sure that his receiver is adjusted properly and that no parasitic disturbance is caused by improper neutralization of the circuit.

A very accurate method of adjusting or neutralizing these circuits is the one used in the testing laboratories of one of the commercial companies who are manufacturing "Neutrodyne" receivers.

This method is to use an oscillating circuit whose wavelength is adjustable by variable condensers, which circuit when oscillating is modulated by an electrically maintained tuning fork system.

The home experimenter can readily construct such an oscillating circuit and can use an ordinary buzzer to modulate the circuit and get quite satisfactory results.

The reason for using the tuning fork system is to obtain a constant tone in the ear phones and care should be used to see that the buzzer contacts are clean and

that the buzzer is operating smoothly.



Showing the five tube "Neutrodyne" receiver being adjusted for complete neutralization.

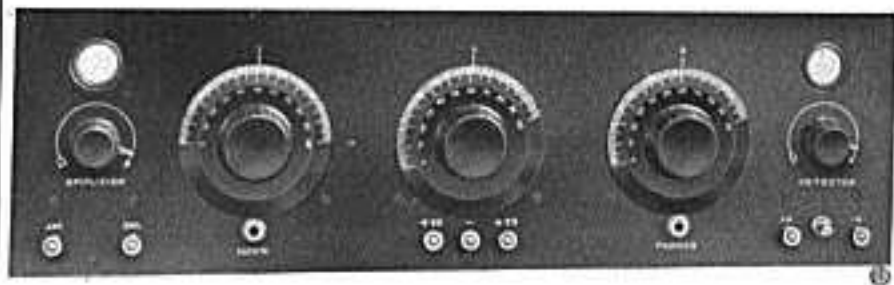

Photograph of panel front of home-made four tube "Neutrodyne" receiver giving two stages of tuned radio frequency amplification, vacuum tube detector, and two stages of audio frequency amplification.

When using such a system as this to adjust the "Neutrodyne" circuit, an added advantage is also gained in that as an oscillating circuit is used as a test circuit, the receiver can be checked for prevention of oscillations very accurately and quickly because if it is oscillating, beat notes will be picked up from the test oscillating circuits.

This same check is, however, obtained as described above by actually listening to broadcasted signals from nearby stations, and it is recommended that the experimenter always check his receiver in this manner.

Four and Five Tube Neutrodyne Receivers

This booklet gives in detail constructional information for both four and five tube "Neutrodyne" receivers.

It was felt to be the best plan to furnish information about both of these different receivers as some experimenters may desire to construct one rather than the other.

Generally speaking, there will not be a great advantage in signal strength when using the five tube set. The five tube receiver differs from the four tube in that the two radio frequency amplifying tubes are used for radio frequency amplification only, whereas in the four tube set one of them is also used simultaneously as an audio frequency amplifier.

The four tube receiving set will probably be found a little harder to adjust, but when functioning properly will give very satisfactory results.

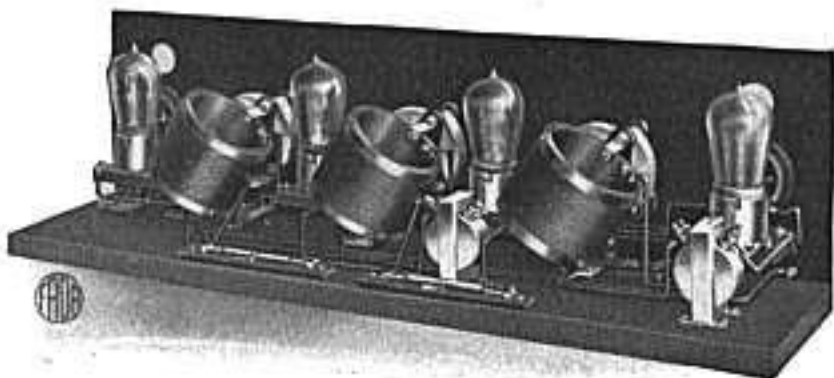

Rear view photograph of the four tube "Neutrodyne" receiving set. Note that the audio transformers are spaced well apart on the baseboard. This reduces the length of the wiring and reduces the capacity of the circuit.

The front panel layout of the five tube "Neutrodyne" set is somewhat different, three of the vacuum tubes being placed at the right hand end of the panel.

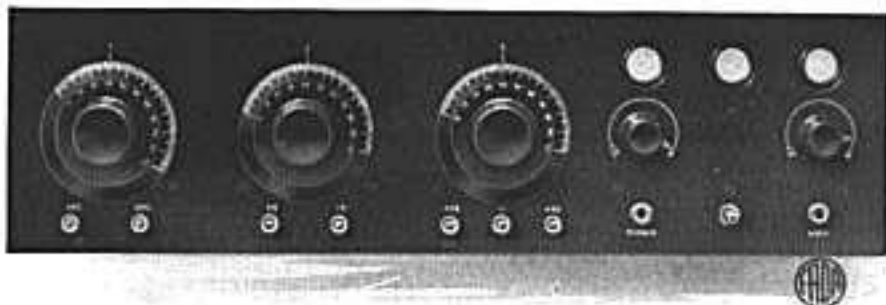

Equipment Necessary for a Receiver Installation

Certain additional equipment is necessary before one can make a complete operating installation of a "Neutrodyne" radio receiver. These various instruments and parts are listed below.

1. One "Neutrodyne" Radio receiver.
2. Three Amplifying Vacuum Tubes (preferably UV-201-A's).
3. One Detector Vacuum Tube (preferably UV-200).
4. One Storage Battery (6 volt).
5. Three "B" Batteries (45 volts each).
6. One Telephone Head Set.
7. Two Telephone Plugs.
8. One Loud Speaking Instrument (if desired).
9. Antenna Materials.
10. One Storage Battery Charger (if desired).

The average home user of a radio receiving set is not content to listen in to local and long distance broadcasting programs using the telephone head set only. It's much more fun and pleasure to bring in the speech and music loud enough for a whole gathering of people to hear and enjoy. In consequence the loud speaker instrument was included in the above list.

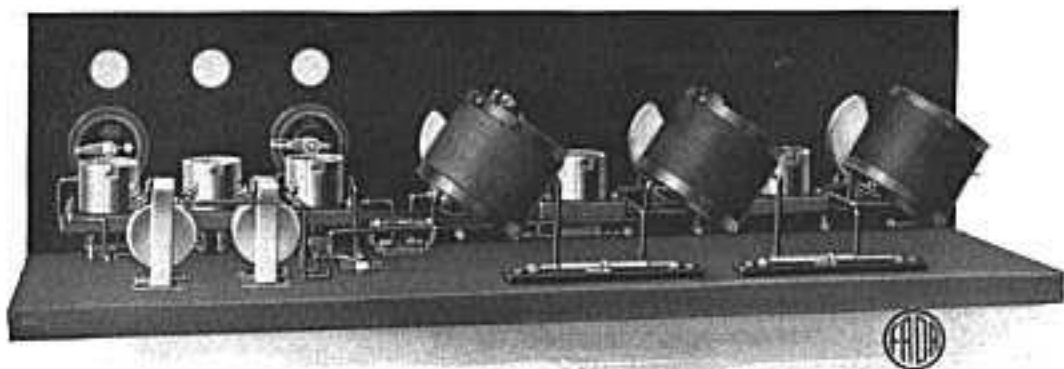

The rear view of the five tube home-made "Neutrodyne" receiving set. Audio frequency amplifying transformers on this set are both placed to the rear of the triple tube socket.

The Antenna and Ground System

The radio antenna may be likened to the "barrel under the rain spout" as it serves to collect the radio energy from the air. From the antenna this energy is led down a lead-in wire to the receiving equipment and then made over into music and speech for entertainment.

The simplest and yet most satisfactory antenna for radio receiving sets consists of a single strand of wire 60 to 100 feet in length, insulated at each end by an antenna insulator and supported 30 or 40 feet above the earth. From this antenna wire a lead-in wire should be run down to a point on the outside of the building near where the receiver will be placed on the inside of the building. A lead-in insulator, or porcelain tube as is usually used, should extend thru the wall of the building or sometimes the window sill, and thru this the lead-in wire should be run, connecting to the antenna binding post on the receiving instrument. When the outdoor antenna is used such as this, it is desirable to connect the antenna or lightning protective device to a point on the lead-in wire just before it enters the porcelain lead-in tube and from the other side of the lightning protective device a wire should run directly to an outside water pipe or iron rod driven into the ground.

The line drawing at the bottom of the page shows in general the outdoor antenna arrangement.

The outside antenna is always recommended for use with these "Neutrodyne" receivers. If it is desired, however, one can use an indoor antenna and obtain very good results. Such an indoor antenna may consist of from 30 to 60 feet of insulated wire (ordinary annunciator wire is suitable) running the length of the rooms. Care should be taken to run the wire in as straight a line as possible (tho it may turn in going from one room to another) directly away from the receiving equipment. The inside antenna may also be concealed behind the picture moldings of the rooms and in this way does not detract from the tasteful appearance of the home. Do not loop the indoor antenna around a single room. The effective length of the antenna in every case is the "air line" distance from the receiving set to the far end of the antenna.

From the ground binding post on the receiver, a wire should run directly to a ground connection. In the home the best inside ground connection is to attach a ground wire securely to the cold water pipes by soldering. The ground connection is very important

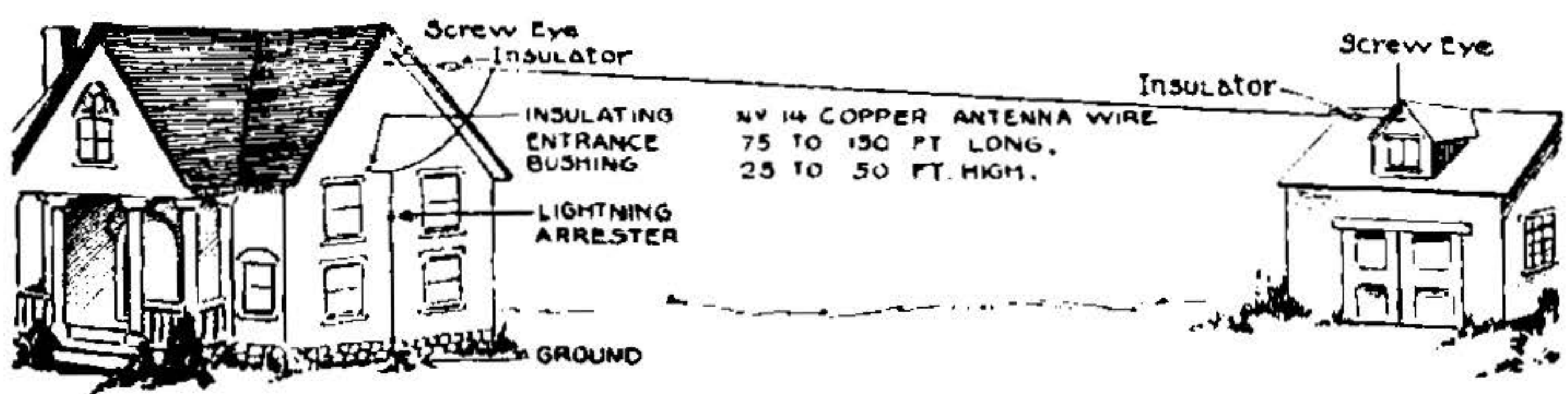

Drawing showing the usual arrangement of a single wire outdoor receiving antenna.

and a good connection can only be secured by carefully cleaning and soldering the joint. Again beware of acid for a soldering flux as it will cause severe corrosion and an inefficient connection.

Connecting Up the Neutrodyne Circuit Receiver

Connecting the "A" and "B" batteries to the "Neutrodyne" receiver is a simple task. An enlarged drawing at the bottom of the page shows the battery connections of the four tube home made receiver. This will make the connections practically self-explanatory and the five tube battery connections are arranged identically the same way.

Both the "A" and "B" batteries have a certain polarity, that is, there is a positive terminal (marked +) and a negative terminal (marked -) to each battery. On both the "A" and "B" batteries the positive terminal is usually painted red or has a red connection wire attached to it.

From the positive terminal on the "A" battery a wire should be connected directly to the positive (+) "A" battery binding post on the front of the panel. From the other or negative (-) terminal of the "B" battery, a wire should connect directly to the negative "A" battery binding post on the panel.

The "B" batteries are made in blocks of 45 volts each. Three of these batteries are connected as shown in the drawing. The negative (-) and positive (+) terminals of the "B" batteries will be found marked in the insulated wax on the top of the batteries. To make the series battery connections the wires should connect from the

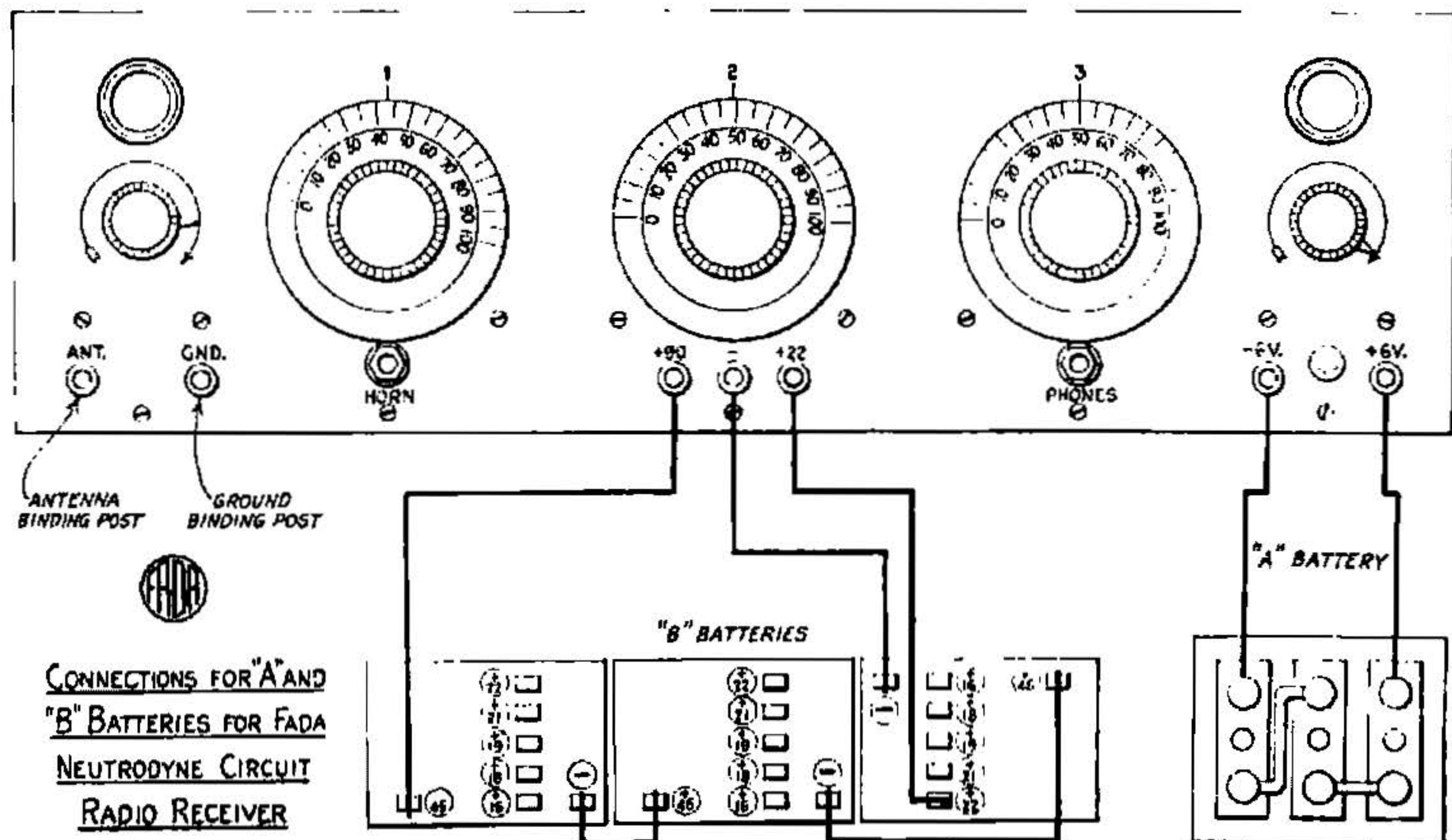

positive (+) terminal of one battery to the negative (-) terminal of the second battery, and from the positive (+) terminal of the second battery to the negative (-) terminal of the third battery. This will leave a positive and a negative "B" battery terminal, and wires should connect from the negative (-) terminal to the center binding post on the receiver between the two binding posts marked +90 and +22, and from the remaining positive "B" battery terminal to the binding post on the panel front marked +90.

Now only one "B" battery binding post on the receiver remains unconnected. A connection wire should go from this binding post to the clip terminal (marked $22\frac{1}{2}$ volts) of the first "B" battery. The first "B" battery is the one to which the wire from the center or negative binding post is connected.

Best results are often obtained by a detector voltage as low as 15 or as high as 35. Likewise, the amplifier voltage may be as low as 90 and as high as 130 volts. Trial alone will determine which is best.

How to Tune Neutrodyne Radio Receivers

The "Neutrodyne" radio receivers have many advantages over the ordinary receiver in tuning or in selecting one station from another. This method of tuning "Neutrodyne" receivers is much different than that used for the ordinary receiver. Accordingly these tuning instructions should be studied very carefully and the manner of adjusting thoroly understood, otherwise the receiver may seemingly be inefficient, the fault, however, being with the operator.



The procedure of tuning a "Neutrodyne" receiver, providing antenna, ground and all battery connections have been properly made, is as follows:

1. Insert the recommended vacuum tubes in their respective sockets and with the power rheostat at its correct position for the type of tubes you are using, and with the vernier rheostat knob turned to the left as far as possible, and with the plug of the loud speaker inserted in the "horn" jack, pull out the knob of the filament switch on the panel front, causing the three amplifier tube filaments to light.

2. Turn the vernier rheostat knob to the right slowly. When the filament current is turned on the first indication that the receiver is functioning properly will be indicated by hearing a slight noise in the phones. As the rheostat knob is turned further to the right this slight sensitivity indication does not increase in volume until a point near the end of the rheostat adjustment is reached. At this point will begin a comparatively loud "hissing" and "frying" noise which is objectionable. For the best signal reception the rheostat should be turned back slightly to a point just before this "hissing" and "frying" starts. The coarse adjustment of the rheostat enables you to quickly adjust the rheostat and then very accurately adjust it by using the smooth running vernier.

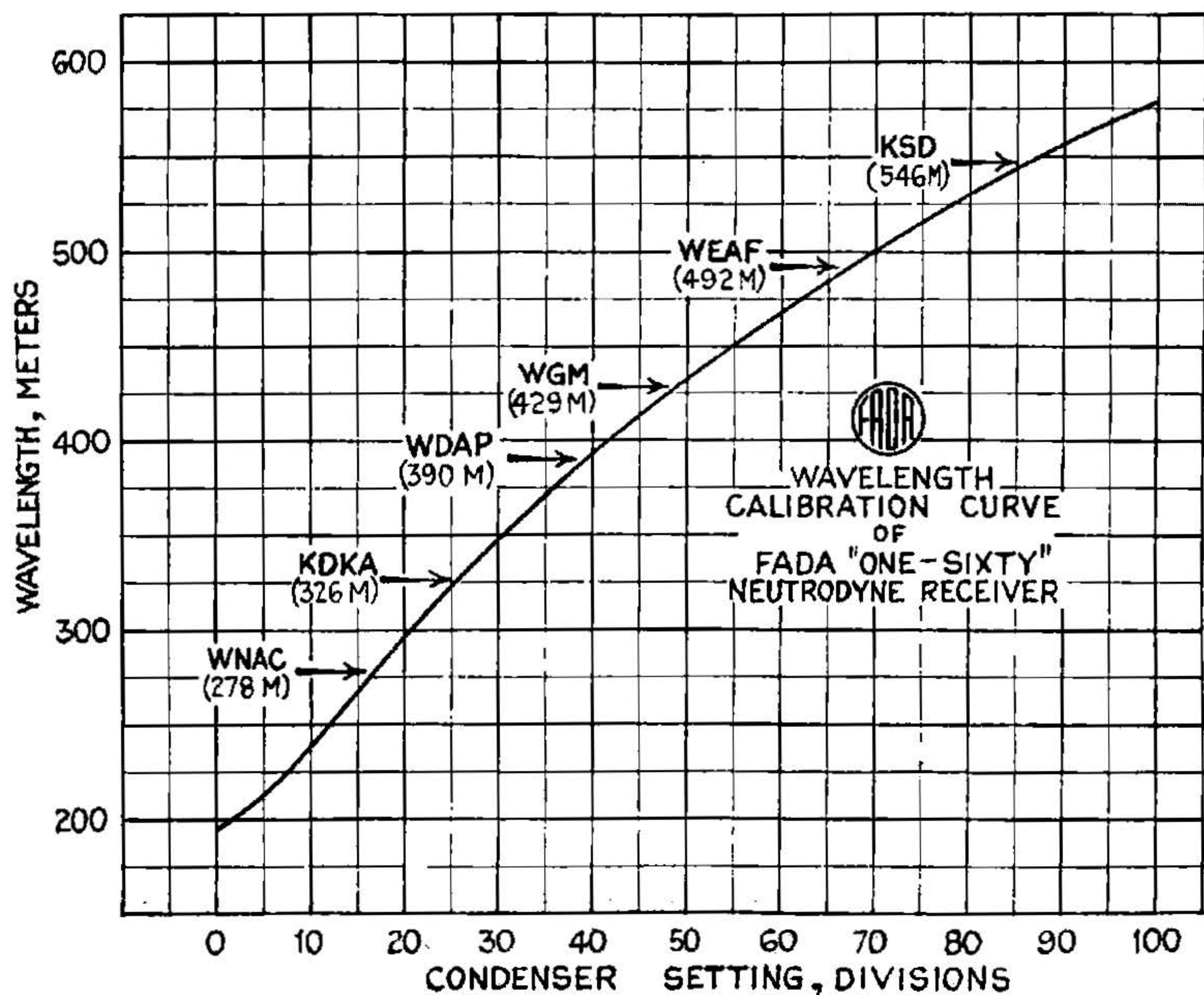

3. With detector tube at approximately its right operating point, set "Neutroformer" dials 2 and 3 at the same dial setting. Select any particular dial setting, but as shown by the curve at the bottom of page 23, take for instance the wavelength of station WEAJ on 492 meters. Dial settings for this particular station are approximately 66 or 67. Setting dials 2 and 3 at this point, now rotate dial 1 very, very slowly over its entire range from 0 to 100. If any broadcasting station is operating at the particular time on a wavelength of 492 meters, it should be heard at a maximum when the setting of dial 1 is approximately in the range of 10 or 15 above or below these settings of dials 2 and 3.

4. When signals from any particular broadcasting station are coming in, it is advisable to slightly re-adjust dials 1, 2 and 3 and possibly also the vernier rheostat in order to increase the intensity of the signals.

In tuning, the dials should not be moved faster than a few degrees per second. With either the head telephones or loud speaker plugged in the "phone" or "horn" jack, it may be found that the tuning adjustment will need to be changed slightly when shifting from one jack to another.

Dials 2 and 3 should be rotated slowly at the same time, and about in step with each other. Then with dials 2 and 3 on the setting for a particular station, dial 1 is rotated until signals come in with maximum strength and clarity.

Sharpness of tuning of "Neutrodyne" circuit receivers when using short indoor antennas is much greater than when using an outdoor antenna and care should be taken in adjusting the receiver, particularly dial 1, when an indoor antenna or loop is used.

In tuning, "Neutrodyne" circuit receivers, the broadcasting stations will not be picked up by hearing "beat notes" and the usual regenerative whistling. As the dials are rotated from division to division the program of different stations will be heard, first gradually, then with greater intensity, and clarity as all adjustments are properly made for that particular station.

A receiver log chart is provided on pages 29, 30 and 31 so that the various dial settings may be recorded for different stations. As the user succeeds in picking up programs from various stations, notations should be made in the log book of the call letters and dial settings and if at a later date one desires to listen to the same station, it is merely necessary to reset the dials to these same positions. If the particular station is operating at the given time the signals will be heard. This is a feature possessed by practically no other radio receiver developed up to the present minute.

The wavelength calibration curve of the Fada "One-Sixty" neutrodyne receiver, which uses "Neutroformers" practically identical with the ones furnished for home construction, will greatly aid in tuning the four or five tube "Neutrodyne" receivers.

Using Dry Cell Tubes With the Neutrodyne Circuit

There are several kinds of vacuum tubes on the market which can be used with dry cells. Among these are the UV-199's, WD-11's, WD-12's and the DV-6's. Such tubes operate with a very low filament current consumption. The four and five tube "Neutrodyne" circuit receivers described in this booklet were not designed particularly to operate with such tubes. It is recommended that wherever possible either UV-201 and UV-201-A amplifier tubes be used together with a UV-200 detector tube.

These "Neutrodyne" receivers will, however, function fairly well using the dry cell tubes mentioned above. Adapters may be used to allow placing tubes in the regular standard sockets.

The radio experimenter may find with these dry cell tubes that by varying the various constants of the circuit, or by using a negative grid bias or "C" battery, good reception can be had on both local and long distance stations. One should not, however, expect the volume of signals from UV-199 tubes for instance as when using UV-201 or UV-201-A tubes, as the current that the tube is capable of handling is very much smaller.

Neutrodyne Receivers and Loop Antenna Reception

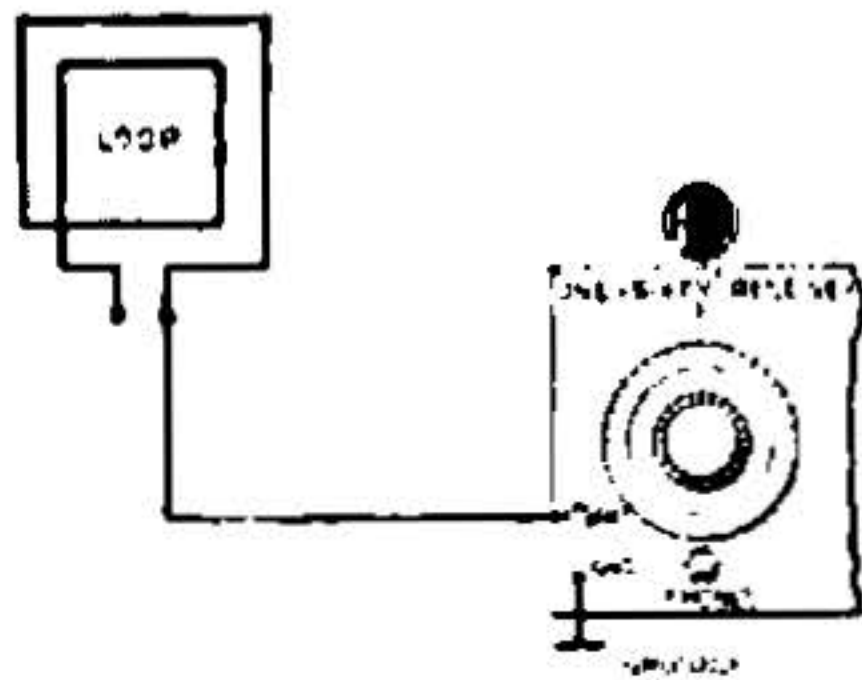

For best all around results it is recommended that "Neutrodyne" receivers be used with the regular indoor or outdoor antenna from 30 to 80 feet long. This will give maximum signal intensity and where the antenna is erected to have a directional effect, signals from

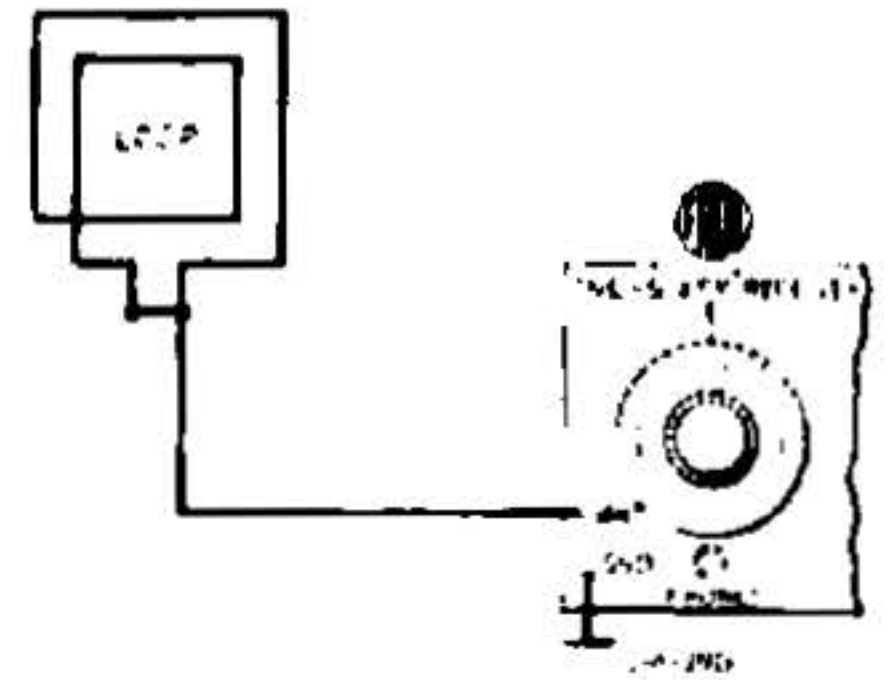

certain directions will be received with exceedingly good volume.

Many people, however, desire to use the smaller antenna device called a loop. The big disadvantage of the loop method is the fact that it being so much smaller, it can only collect an infinitely small amount of energy and hence requires enormous amplification in order to bring the signals up to a point where they will operate a loud speaker.

Four and five tube "Neutrodyne" receivers described were not primarily designed for loop reception. Loop antennas have, however, been used with these receivers in experimental work and quite satisfactory results have been obtained. Many purchasers of commercial "Neutrodyne" receivers on the market have, however, reported exceedingly good results using a loop, but such good success cannot be consistently guaranteed.

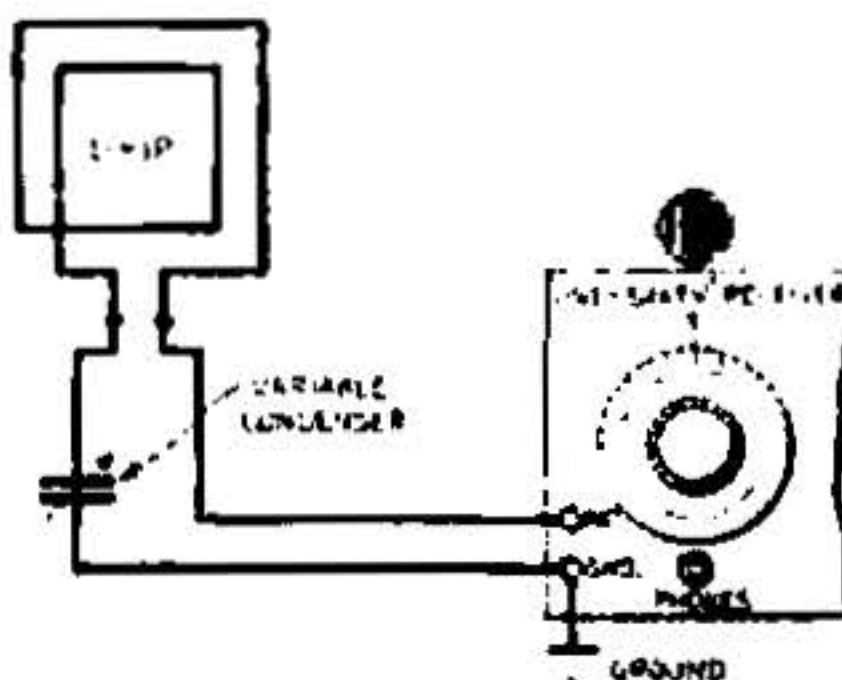

For those who would like to experiment with loop reception the wiring diagrams given on this page are suggested. One may find that one type of connection works better than the other. This is an interesting field for home experimentation.

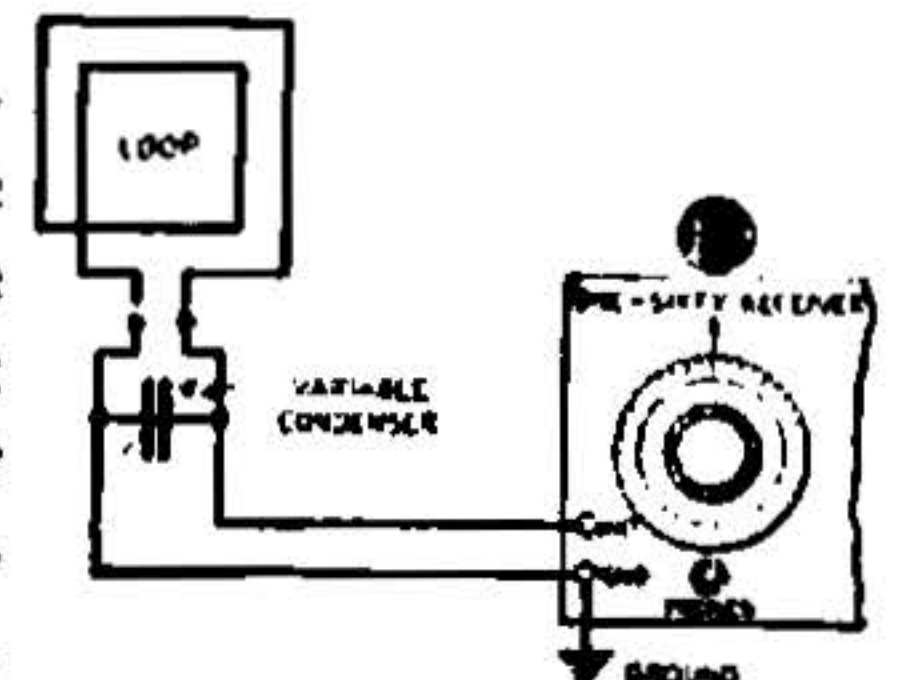

The Fada "Neutroformer"



The Fada "Neutroformer" is the basis around which has been written this constructional booklet. It is really one of the most important parts of Hazeltine's "Neutrodyne" circuit and needs to be constructed accordingly.

The Fada "Neutroformer" is made by using a standard Fada rotary variable air condenser and mounting on this a special radio frequency amplifying transformer. The construction of this transformer is such that its distributed capacity and inductance of the windings, mutual inductance, co-efficient of the coupling, turn step up ratio and mechanical disposition of the windings are exceedingly important. These characteristics have been accurately determined after months of research work and are accurately measured and calibrated in the laboratory. Before shipment

each transformer is connected so as to form a closed circuit and calibrated for frequency such that any given three "Neutroformers" will function at practically identical dial settings for a given wavelength.

Mechanically Fada "Neutroformers" are given great care. The condenser is very carefully adjusted and the transformer inductances are wound on genuine bakelite tubing, using silk covered wire to afford maximum insulation. Overall dimensions $6\frac{1}{2}'' \times 3\frac{3}{4}'' \times 3\frac{1}{4}''$.

No. 163-A Fada "Neutroformer"

\$7.50

The Fada "Neutrodon"

The Fada "Neutrodon" is a special variable condenser having an exceedingly small capacity of the order of from 1 to 10 micro-micro farads. The entire adjustment of the "Neutrodyne" circuit is focused in this "Neutrodon" condenser and the condenser should be one having extremely small losses at high frequencies. The Fada "Neutrodon" is mounted on a genuine bakelite XX block and consists of a special glass tubing over which slides a brass tube. This brass tube forms a capacity to the wires between the end terminals and inside of the glass tubing. The brass tube may be secured at any given adjustment by tightening down on its screw clamp, and more permanently by soldering.

Three terminals are provided, affording three different ranges of capacity in the one condenser by varying the connections to the three terminals. Overall dimensions— $5'' \times \frac{3}{4}'' \times \frac{3}{8}''$.

164-A Fada "Neutrodons"

Each \$1.25



Fada-Hazeltine Neutrodyne Parts



To make it most easy for the home experimenter to purchase materials for constructing "Neutrodyne" receivers, a combination package has been arranged in which is included three Fada-Hazeltine No. 163-A "Neutroformers", two No. 164-A "Neutrodons", and this complete instruction book on "How to Build Hazeltine's Neutrodyne Circuit Radio Receivers".

These parts are packed in a single cardboard carton and form the nucleus for "Neutrodyne" receiver construction.

One should not attempt to construct "Neutrodyne" circuit receivers without using parts of this

kind made by companies licensed to manufacture these parts under Professor Hazeltine's patents. The technical details involved in designing equipment for "Neutrodyne" receivers generally are of such a nature that only companies authorized by Professor Hazeltine and given complete information regarding design and development are in a position to manufacture "Neutrodyne" parts that will really function properly. Overall dimensions of package—14" x 7" x 4". Shipping weight—4 lbs.

165-A Fada-Hazeltine "Neutrodyne" parts

\$25.00

Complete Sets of Fada Parts for Neutrodyne Receivers

In addition to the Fada "Neutroformers" and "Neutrodons" and the combination package of "Neutroformers" and "Neutrodons", provision has been made to supply complete knock-down sets of materials for the construction of either four or five tube "Neutrodyne" sets according to the instructions in this book.

These sets of parts include every item necessary for building the receivers. Detailed lists with prices per item follow:

Parts for Four Tube Neutrodyne Receivers

Quantity	Material	Price
1	Panel, Bakelite 24" x 7" x $\frac{3}{8}$ " drilled, machined and engraved	\$7.50
1	Base-Board, Oak 24" x 6" x $\frac{3}{4}$ "75
4	Single Sockets, Type 118-A	4.00
3	Neutroformers, Type 163-A	22.50

Quantity	Material	Price
2	Neutrodons Type 164-A.	\$ 2.50
2	Audio Transformers	12.00
1	"A" Battery Switch	.75
3	Dials, Type 137-A	3.60
1	Rheostat, Type 121-A	1.20
1	Rheostat, Type 150-A	1.25
7	Binding Posts, Type 116-A	.84
1	Radio Jack, Closed Circuit	.75
1	Radio Jack, Three Spring Automatic	1.00
22 ft.	Insul. tubing	1.76
22 ft.	Wire No. 14 Tinned Copper	.20
2	Fixed Condensers, .006 mfd.	1.50
1	Fixed Condenser, .0002 mfd.	.40
1	Grid Leak, 2 megohms	.75
1	Fixed Grid Condenser .00025 mfd.	.65
1	Handbook, "How to Build Hazeltine's Neutrodyne Circuit Radio Receivers"	—
1	Package of Screws, Nuts, Terminals, etc.	.10
	Total	\$64.00

Parts for Five Tube Neutrodyne Receivers

Quantity	Material	Price
1	Panel, Bakelite 26" x 7" x $\frac{3}{16}$ " drilled, machined and engraved	\$ 8.00
1	Base Board, Oak 26" x 6" x $\frac{3}{16}$ "	1.00
1	Triple Socket, Type 123-A	2.70
2	Single Sockets, Type 118-A	2.00
3	Neutroformers, Type 163-A	22.50
2	Neutrodons, Type 164-A	2.50
2	Audio Transformers	12.00
1	"A" Battery Switch	.75
3	Dials, Type 137-A	3.60
1	Rheostat, Type 121-A	1.20
1	Rheostat, Type 150-A	1.25
7	Binding Posts, Type 116-A	.84
1	Radio Jack, Closed Circuit	.75
1	Radio Jack, Three Spring Automatic	1.00
27 ft.	Insul. Tubing	2.26
27 ft.	Wire No. 14 Tinned Copper	.25
2	Condensers, .006 mfd.	1.50
1	Grid Leak, 2 megohms	.75
1	Grid Leak Condenser .00025 mfd.	.65
1	Handbook, "How to Build Hazeltine's Neutrodyne Circuit Radio Receivers"	—
1	Package of Screws, Nuts, Terminals, etc.	.10
	Total	\$65.60

