

# Modicon X80 I/O platform

Catalog

January 2015



# How can you fit a 6000-page catalog in your pocket ?

Schneider Electric provides you with the complete set of industrial automation catalogs all on a handy USB key for PC or in an application for tablets



## Digi-Cat, a handy USB key for PC



- > Convenient to carry
- > Always up-to-date
- > Environmentally friendly
- > Easy-to-share format

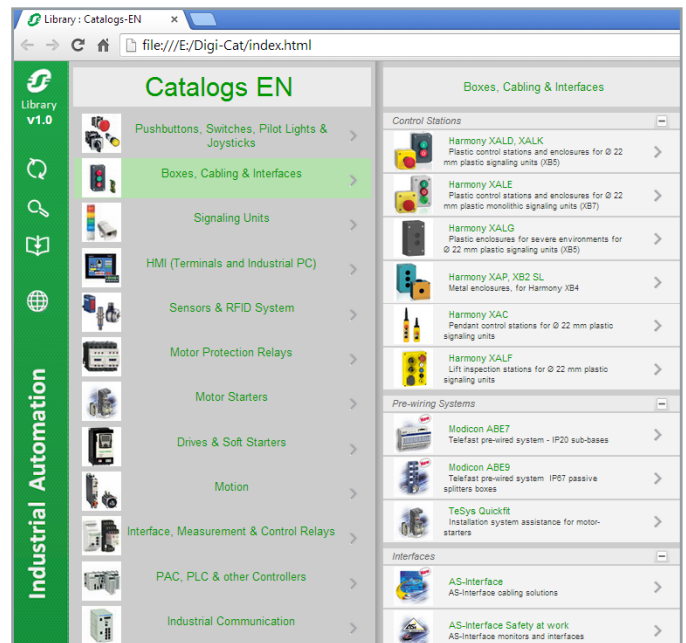

Contact your local representative to get your own Digi-Cat



## e-Library, the app for tablets

If you have an iPad®:

- > Go to the App Store and search for e-Library
- > or scan the QR code



If you have an Android tablet:

- > Go to the Google Play Store™ and search for eLibrary
- > or scan the QR code



# General contents

Presentation.....	1
Racks and power modules.....	2
I/O modules.....	3
Communication.....	4
Ruggedized modules.....	5
Connection interfaces.....	6
Compatibility with OsiSense XU/XS.....	7
Standards and certifications.....	8
Services, index.....	9



---

- General presentation..... page 1/2
- Composition ..... page 1/4
- Architectures, software configuration..... page 1/5
- Compatibility..... page 1/6



# Modicon X80 I/O platform

Compact, robust, sustainable

1

## Modicon X80 I/O, a new Remote I/O system

The Modicon X80 I/O platform serves as a common platform for Modicon M340, Modicon Quantum Ethernet I/O, Modicon M580 PACs and future Modicon Mx80 controllers. With a common platform, a much smaller stock of spare parts needs to be held, and maintenance and training costs are significantly reduced. A common configuration tool is used for all PAC modules using Unity Pro with a high level of services such as bit forcing, structured device DDT, etc. This platform offers a wide choice between several Schneider Electric I/O modules (discrete, analog, expert, communication).



Common I/O platform for Modicon M340, M580, Quantum Ethernet I/O



ATEX zone 2/22 and IECEx



### Compact

- > With the latest I/O technology, the Modicon X80 I/O platform is extremely compact
- > Reduction in cabinet dimensions, with up to 64 discrete I/Os for some modules



Modicon X80 I/O platform

### Robust

- > Offering more than required by the standards
- > Certified for ATEX zone 2/22 and IECEx (depending on the model, see pages 8/2 to 8/7)

Characteristics	Modicon X80 I/O platform	IEC standards Values required by
<b>Mechanical constraints</b>		
Shocks	30 g	> 15 g min.
Vibrations	3 g	> 1 g min.
<b>Electrical immunity</b>		
Radiated field	15 V/m	> 10 V/m min.
Electrostatic discharges	8 kV	> 6 kV min.
<b>Environmental immunity</b>		
Temperature	0...60°C	> 0...55°C
Modicon X80 ruggedized I/O offer	-25...70°C	-

### Sustainable

- > Common X80 I/O modules reduce training and maintenance costs
- > Hot swappable
- > Existing solutions for migrating from legacy I/O to the Modicon X80 I/O platform

**+** Common I/O platform



### Certifications and standards

Depending on the model, the Modicon X80 modules respect the following standards:

- > Marine standards: ABS, BV, GL, RMRS, DNV, RINA, LR and PRS compliant
  - > International standards: CE, UL/CSA, RCM, EAC and IEC61850-3 compliant
- For further information, see pages 8/2 to 8/7.

#### Marine standards



ABS



BV



DNV



GL



LR



RINA



RMRS



PRS

#### International standards



CE



UL



CSA



RCM



EAC

## IEC 61850-3

### Market segments

> The Unity Pro function block software libraries make the Modicon X80 I/O platform ideally suited for the following market segments:



Water & waste water



Mining, minerals & metals



Food & beverage



Oil & gas



1



Modicon X80 I/O platform with Modicon M580 processor



Modicon X80 I/O platform with Modicon M340 processor



Modicon X80 EIO drop with CRA bus terminal module



Ethernet Modbus/TCP DIO drop with PRA module

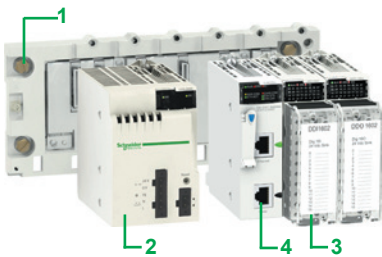

## Presentation

The Modicon X80 I/O platform serves as the common base for automation platforms by simply adding a dedicated processor (1).

It may also:

- form part of a Quantum and Modicon M580 Ethernet I/O architecture as an Ethernet RIO (EIO) drop with a CRA bus terminal module
- form an Ethernet Modbus/TCP DIO drop with a PRA module

The Modicon X80 I/O platform is available in single-rack or multi-rack configuration.

This platform may also accept automation platform-dedicated modules (communication, application, etc.).

One Modicon X80 drop may support two racks separated by a cumulative distance of up to 30 metres/98.42 feet.

This platform, common to several automation platforms, can reduce maintenance and training costs as it comprises:

- a single range of spare parts in stock
- training common to several PLCs

Based on the latest I/O technology, the Modicon X80 I/O platform offers:

- high-quality ruggedness and compactness
- compliance with international certifications (ATEX, IEC, etc.)
- a wide selection of modules: discrete or analog I/O, expert modules, communication modules, etc.

This platform is programmed and configured using Unity Pro software.

Bit forcing simplifies simulation and structured data simplifies diagnostics.

## Description

### Modicon X80 I/O platform

The Modicon X80 I/O platform, which can be used in-rack and/or in remote I/O drops (RIO), Ethernet remote I/O drops (EIO), and/or distributed I/O drops (DIO) depending on the type of PLC (M580, M340, Quantum, etc.), comprises the following elements:

- 1 X-bus racks with 4, 6, 8, or 12 slots or Ethernet + X-bus racks with 4, 8, or 12 slots
- 2 AC or DC power supply modules
- 3 discrete and analog I/O modules
- 4 RTU (Remote Terminal Unit) serial link, AS-Interface, and other communication modules

The additional modules offered include:

- Ethernet (Modbus/TCP, Ethernet/IP) communication and supplementary modules dedicated to several automation platforms such as Modicon M340 or Modicon M580
- communication via optical transceiver modules
- application-specific modules: counting, motion control, SSI encoder, time stamping
- CAPP (Collaborative Automation Partner Program) partner modules: weighing, Wi-Fi

### Treatment for harsh environments

With "ruggedized" modules, the Modicon X80 I/O platform may be used in harsh environments or within a range of operating temperatures from - 25 to + 70 °C/- 13 to + 158 °F (see page 5/2).

(1) See the compatibility guide on page 1/6.



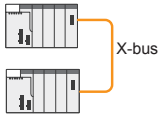

Multi-rack configuration with M340 processor

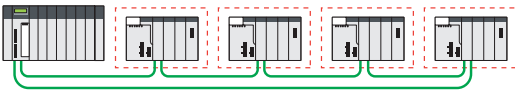

Ethernet network  
Quantum Ethernet I/O with Modicon X80 EIO drop



Ethernet network  
Modicon M580 platform with Modicon X80 EIO drop

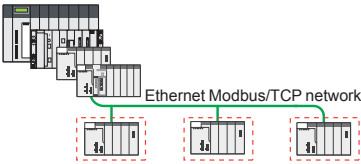

Ethernet Modbus/TCP network  
Ethernet Modbus/TCP DIO drop connected to an automation system platform



Unity Pro

### Architectures based on the Modicon X80 I/O platform

#### Single-rack or multi-rack configuration with Modicon M580 or M340 processor

This configuration comprises:

- a Modicon X80 I/O primary rack with a Modicon M340 processor
- a Modicon X80 I/O secondary rack

This configuration may comprise four racks with **BMXP342000** processors separated by a cumulative distance of up to a maximum of 30 metres/98.42 feet. It can comprise up to seven racks with M580 processors.

#### Quantum Ethernet I/O with Modicon X80 EIO drop

This architecture comprises:

- a Quantum Ethernet I/O platform comprising a processor and dedicated modules
- one or more Modicon X80 EIO drops with a standard or performance CRA drop adapter

This configuration may include:

- 16 drops with **140CPU6●1●●** processors
- 31 drops with **140CPU6●2●●** processors

#### Modicon M580 with Modicon X80 EIO drop

This architecture comprises:

- a Modicon M580 automation platform comprising a processor and dedicated modules
- one or more Modicon X80 EIO drops with a standard or performance BMXCRA drop adapter on an X-bus rack or
- one or more Modicon X80 EIO drops with a BMECRA drop adapter on an Ethernet + X-bus rack

#### Ethernet Modbus/TCP DIO drop connected to an automation system platform

This architecture comprises:

- a Quantum/Premium/M580/M340 automation platform
- one or more Ethernet Modbus/TCP DIO drops with a **BMXPRA0100** peripheral I/O remote adapter, a power supply and I/O

### Software configuration

Unity Pro programming software is required to set up the Modicon X80 I/O platform.

The Unity Pro function block software libraries make it possible to meet the needs of specialist applications in various fields of application such as:

- Water and Waste Water (WWW)
- Food & Beverage (F&B)
- Mining, Minerals, Metals (MMM)
- Oil & Gas (O&G)

# Modicon X80 I/O platform

Product compatibility according to the network architecture

Product type	Reference	Local rack Modicon M340		EIO Quantum drop with Modicon X80 EIO drop with CRA drop adaptor type	
		Single-rack or multi-rack	"standard" BMXCRA31200	"performance" BMXCRA31210	

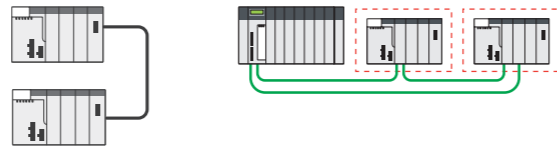

Racks	X-bus	BMXXBE1000/BMXXBE1000H	BMXXBE2005	BMXXBP0400/BMXXBP0400H	BMXXBP0600/BMXXBP0600H	BMXXBP0800/BMXXBP0800H	BMXXBP1200	BMXXEM010
	Ethernet + X-bus	BMEXBP0400/BMEXBP0400H	BMEXBP0800/BMEXBP0800H	BMEXBP1200/BMEXBP1200H				
Power supply modules		BMXCPS2000	BMXCPS2010	BMXCPS3020/BMXCPS3020H	BMXCPS3500/BMXCPS3500H	BMXCPS3540T		
I/Os	Analog	BMXAMI0410/BMXAMI0410H	BMXAMI0800	BMXAMI0810/BMXAMI0810H	BMXAMM0600/BMXAMM0600H	BMXAMO0210/BMXAMO0210H	BMXAMO0410/BMXAMO0410H	BMXAMO0802
		BMXART0414/BMXART0414H	BMXART0814/BMXART0814H	BMXDAI0805	BMXDAI1602/BMXDAI1602H	BMXDAI1603/BMXDAI1603H	BMXDAI1604/BMXDAI1604H	BMXDAI0814
		BMXDAO1605/BMXDAO1605H	BMXDDI1602/BMXDDI1602H	BMXDDI1603/BMXDDI1603H	BMXDDI1604T	BMXDDI3202K	BMXDDI6402K	BMXDDM16022/BMXDDM16022H
		BMXDDM16025/BMXDDM16025H	BMXDDM3202K	BMXDDO1602/BMXDDO1602H	BMXDDO1612/BMXDDO1612H	BMXDDO3202K	BMXDDO6402K	BMXDRA0804T
		BMXDRA0805/BMXDRA0805H	BMXDRA1605/BMXDRA1605H	BMEAHIO812	BMEAHIO0412			
		HART						

Compatible Not compatible

(1) Supports only one X-bus rack extension.

Local rack Modicon M580		M580 EIO drop with X-bus BMXXBP backplane and CRA drop adaptor type		M580 EIO drop with Ethernet + X-bus BMEXBP backplane and CRA drop adaptor	Ethernet Modbus TCP DIO drop with PRA connected to a Quantum/Premium/M580/M340 platform
X-bus BMXXBP rack	Ethernet + X-bus BMEXBP rack	"standard" BMXCRA31200	"performance" BMXCRA31210	BMECRA31210	BMXPRA0100

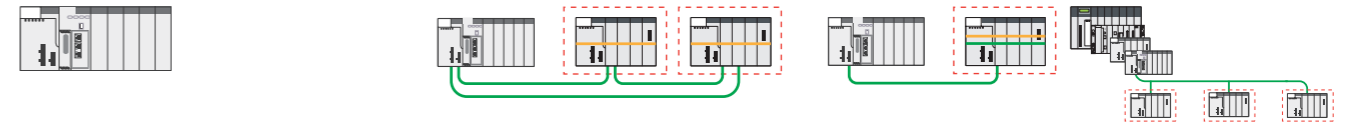

				(1)	
				(1)	

# Modicon X80 I/O platform

Product compatibility according to the network architecture

Product type	Reference	Local rack Modicon M340	
		EIO Quantum drop with Modicon X80 EIO drop with CRA drop adaptor type	
		Single-rack or multi-rack	"standard" BMXCRA31200    "performance" BMXCRA31210

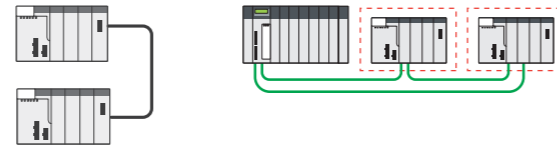

Application-specific modules	Module	Reference	Local rack Modicon M340	EIO Quantum drop with Modicon X80 EIO drop with CRA drop adaptor type
Application-specific modules	SSI encoder	BMXEAE0300/BMXEAE0300H	Compatible	Compatible
	Counter	BMXEHC0200/BMXEHC0200H	Compatible	Compatible
		BMXEHC0800/BMXEHC0800H	Compatible	Compatible
	Time stamping	BMXERT1604T	Compatible	Compatible
	PTO (Pulse Train Output)	BMXMSP0200	Compatible	Compatible
Communication modules	Weighing	PMESWT0100	Compatible	Compatible
	Ethernet	BMXNOC0401	Compatible	Compatible
		BMENOC03*1	Compatible	Compatible
		BMXNOE0100/BMXNOE0100H	Compatible	Compatible
		BMXNOE0110/BMXNOE0110H	Compatible	Compatible
	Serial link	BMXNOM0200/BMXNOM0200H	Compatible	Compatible
	RTU	BMXNOR0200H	Compatible	Compatible
	AS-Interface	BMXEIA0100	Compatible	Compatible
	Optical fibre	BMXNRP0200	Compatible	Compatible
		BMXNRP0201	Compatible	Compatible
	Wi-Fi	PMXNOW0300	Compatible	Compatible
	Communication heads	BMXCRA31200	Compatible	Compatible
BMXCRA31210/BMXCRA31210C		Compatible	Compatible	
BMECRA31210/BMECRA31210C		Compatible	Compatible	
BMXPRA0100		Compatible	Compatible	
CPUs	M340	BMXP341000/BMXP341000H	Compatible	Compatible
		BMXP342000	Compatible	Compatible
		BMXP342010	Compatible	Compatible
		BMXP3420102	Compatible	Compatible
		BMXP342020H	Compatible	Compatible
		BMXP3420302/BMXP3420302H	Compatible	Compatible
		M580	BMEP581020/BMEP581020H	Compatible
	BMEP582020/BMEP582020H		Compatible	Compatible
	BMEP582040/BMEP582040H		Compatible	Compatible
	BMEP583020		Compatible	Compatible
	BMEP583040		Compatible	Compatible
	BMEP584020		Compatible	Compatible
	BMEP584040		Compatible	Compatible

Compatible    Not compatible

Local rack Modicon M580		M580 EIO drop with X-bus BMXXBP backplane and CRA drop adaptor type		M580 EIO drop with Ethernet + X-bus BMEXP backplane and CRA drop adaptor	Ethernet Modbus TCP DIO drop with PRA connected to a Quantum/Premium/M580/M340 platform
X-bus BMXXBP rack	Ethernet + X-bus BMEXP rack	"standard" BMXCRA31200	"performance" BMXCRA31210	BMECRA31210	BMXPRA0100

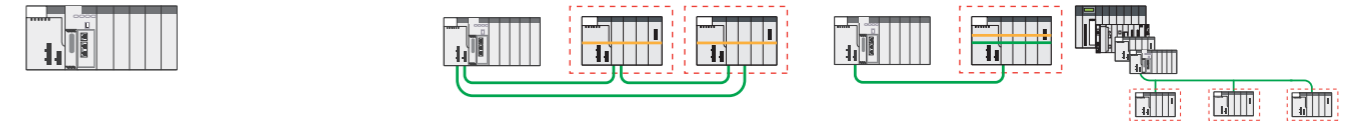

Application-specific modules	Module	Reference	Local rack Modicon M580	M580 EIO drop with X-bus BMXXBP backplane and CRA drop adaptor type	M580 EIO drop with Ethernet + X-bus BMEXP backplane and CRA drop adaptor	Ethernet Modbus TCP DIO drop with PRA connected to a Quantum/Premium/M580/M340 platform
Application-specific modules	SSI encoder	BMXEAE0300/BMXEAE0300H	Compatible	Compatible	Compatible	Compatible
Application-specific modules	Counter	BMXEHC0200/BMXEHC0200H	Compatible	Compatible	Compatible	Compatible
		BMXEHC0800/BMXEHC0800H	Compatible	Compatible	Compatible	Compatible
	Time stamping	BMXERT1604T	Compatible	Compatible	Compatible	Compatible
	PTO (Pulse Train Output)	BMXMSP0200	Compatible	Compatible	Compatible	Compatible
	Weighing	PMESWT0100	Compatible	Compatible	Compatible	Compatible
Communication modules	Ethernet	BMXNOC0401	Compatible	Compatible	Compatible	Compatible
		BMENOC03*1	Compatible	Compatible	Compatible	Compatible
		BMXNOE0100/BMXNOE0100H	Compatible	Compatible	Compatible	Compatible
		BMXNOE0110/BMXNOE0110H	Compatible	Compatible	Compatible	Compatible
	Serial link	BMXNOM0200/BMXNOM0200H	Compatible	Compatible	Compatible	Compatible
	RTU	BMXNOR0200H	Compatible	Compatible	Compatible	Compatible
	AS-Interface	BMXEIA0100	Compatible	Compatible	Compatible	Compatible
	Optical fibre	BMXNRP0200	Compatible	Compatible	Compatible	Compatible
		BMXNRP0201	Compatible	Compatible	Compatible	Compatible
	Wi-Fi	PMXNOW0300	Compatible	Compatible	Compatible	Compatible
	Communication heads	BMXCRA31200	Compatible	Compatible	Compatible	Compatible
		BMXCRA31210/BMXCRA31210C	Compatible	Compatible	Compatible	Compatible
BMECRA31210/BMECRA31210C		Compatible	Compatible	Compatible	Compatible	
BMXPRA0100		Compatible	Compatible	Compatible	Compatible	
CPUs	M340	BMXP341000/BMXP341000H	Compatible	Compatible	Compatible	Compatible
		BMXP342000	Compatible	Compatible	Compatible	Compatible
		BMXP342010	Compatible	Compatible	Compatible	Compatible
		BMXP3420102	Compatible	Compatible	Compatible	Compatible
		BMXP342020H	Compatible	Compatible	Compatible	Compatible
		BMXP3420302/BMXP3420302H	Compatible	Compatible	Compatible	Compatible
		M580	BMEP581020/BMEP581020H	Compatible	Compatible	Compatible
	BMEP582020/BMEP582020H		Compatible	Compatible	Compatible	Compatible
	BMEP582040/BMEP582040H		Compatible	Compatible	Compatible	Compatible
	BMEP583020		Compatible	Compatible	Compatible	Compatible
	BMEP583040		Compatible	Compatible	Compatible	Compatible
	BMEP584020		Compatible	Compatible	Compatible	Compatible
	BMEP584040		Compatible	Compatible	Compatible	Compatible



---

## Single-rack configuration

- Presentation, description, function ..... page 2/2
- References ..... page 2/4

## Multi-rack configuration

- Presentation, description ..... page 2/6
- References ..... page 2/8

## Power supply modules

- Presentation, description, function ..... page 2/10
- References ..... page 2/11



### Presentation

The Modicon X80 I/O platform is compatible with two types of backplanes: dual Ethernet and X-bus backplanes or X-bus backplanes (1). One Ethernet switch is embedded inside the backplane with connectivity to some slots on the backplane, and not all slots have Ethernet connectivity.

The X-bus functionality is preserved and conforms to the legacy implementation and specification. The X-bus will be used in a subset of modules on the Ethernet backplane.

The backplanes provide power supply for the modules in the rack.

**BMXXBP●●00** racks are basic elements in Modicon X80 I/O platform single-rack and multi-rack configurations. They provide a rack number to X-bus slots. They also perform the following functions:

- Mechanical function: they are used to install modules in a PLC station (power supply, processor, discrete, analog and application-specific I/O). These racks can be mounted on a panel, plate or DIN rail:
  - Inside enclosures
  - On machine frames, etc.
- Electrical function: the racks incorporate X-bus (proprietary bus). They are used to:
  - Distribute the power supplies required for each module in the same rack
  - Distribute data and service signals for the entire PLC station
  - Hot swap modules during operation

**BMEXBP●●00** provide the following services to X-bus slots:

- Provide rack number
- Provide interconnection to the slots in main and extended backplanes

The Ethernet interface is the main communication medium in the Ethernet backplane. The Ethernet modules on the Ethernet backplane are attached to one of several ports. The modules lead to the Ethernet switch chip embedded inside the Ethernet backplane.

The Ethernet backplane provides the following services to ETH slots:

- Provide ETH connection to ETH slots
- Provide point-to-point lane connection

### Description

#### X-bus backplanes

**BMXXBP●●00** racks are available in 4, 6, 8 or 12-slot versions and comprise:

- 1 A metal frame that performs the following functions:
  - Holds the X-bus electronic card and helps it withstand EMI and ESD type interference
  - Holds the modules
  - Gives the rack mechanical rigidity
- 2 An earth terminal for earthing the rack
- 3 4 holes (big enough for M6 screws) for mounting the rack on a frame
- 4 2 fixing points for the shielding connection bar
- 5 Tapped holes to take the locking screw on each module
- 6 A connector for a rack expansion module, marked **XBE**
- 7 40-way female ½ DIN connectors forming the electrical connection between the rack and each module, marked **CPS, 00...11** (the rack is delivered with each connector protected by a cover which needs to be removed before inserting the module)
- 8 Slots for anchoring the module pins

(1) Mandatory PV02 or later version.

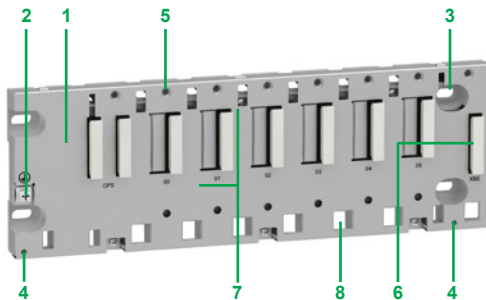

BMXXBP0600 rack with 6 slots

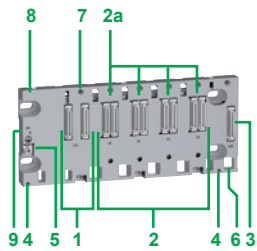

BMEXBP0400 backplane

### Description (continued)

#### Dual Ethernet and X-bus backplanes

The quantity of X-bus and Ethernet slots found on a backplane depends on the backplane size.

The **BMEXBP0400/BMEXBP0800** are 4/8-slot dual Ethernet and X-bus backplanes with:

- 1 CPS slot for power supply
- 2 4 slots (**BMEXBP0400**) / 8 slots (**BMEXBP0800**) with:
  - 2a 4/8 Ethernet and X-bus connectors for mixed modules
- 3 Extension: 1 connector for a X-bus backplane expansion
- 4 2 fixing points for the shielding connection bar
- 5 Protective earth screw
- 6 Slots for anchoring the module pin
- 7 Tapped holes for the locking screw on each module
- 8 4 holes for M4, M5, M6 or UNC #6-32 screws (from 4.32 mm to 6.35 mm/0.170 to 0.250 in.)
- 9 Rack fastened to 35 mm/1.38 in. wide and 15 mm/0.59 in. deep DIN rails. Mounting on a 35 mm/1.38 in. wide and 7.5 mm/0.295 in. deep DIN rail is possible (in this case, the product withstands less mechanical stress).

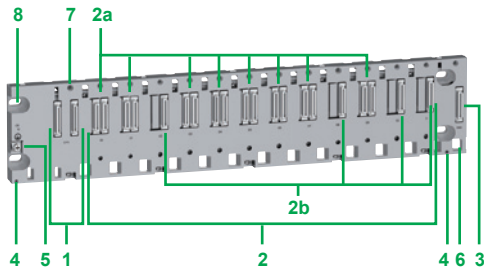

BMEXBP1200 backplane

The **BMEXBP1200** is a 12-slot dual Ethernet and X-bus backplane with:

- 1 CPS slot for power supply
- 2 12 slots with:
  - 2a 8 Ethernet and X-bus connectors for mixed modules
  - 2b 4 X-bus connectors for X-bus modules
- 3 Extension: 1 connector for an X-bus backplane expansion
- 4 2 fixing points for the shielding connection bar
- 5 Protective earth screw
- 6 Slots for anchoring the module pin
- 7 Tapped holes for the locking screw on each module
- 8 4 holes for M4, M5, M6 or UNC #6-32 screws (from 4.32 mm to 6.35 mm/0.170 to 0.250 in.)

#### To be ordered separately:

A **BMXXSP●●00** cable shielding connection kit, used to protect against electrostatic discharge when connecting the shielding on cordsets for connecting:

- Analog, counter and motion control modules
- A Magelis XBT operator interface to the processor (via **BMXXCAUSBH0●●** shielded USB cable)

The **BMXXSP●●00** shielding system comprises:

- 9 A metal bar that takes the clamping rings and the earthing terminal
- 10 Two sub-bases to be mounted on the rack
- 11 An earthing terminal (not included)
- 12 Not included in the shielding connection kit, the **STBXSP30●0** clamping rings (sold in lots of 10, cross-section 1.5...6 mm<sup>2</sup>/16...10 AWG or 5...11 mm<sup>2</sup>/10...7 AWG)

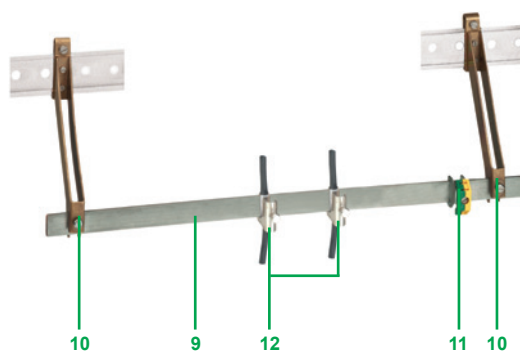

BMXXSP●●00 cable shielding connection kit

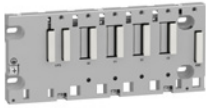

BMXXBP0400

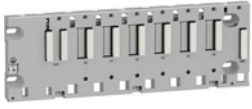

BMXXBP0600

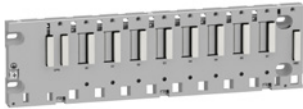

BMXXBP0800

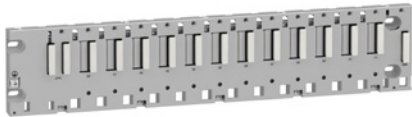

BMXXBP1200

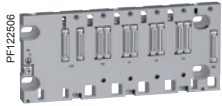

BMEXBP0400

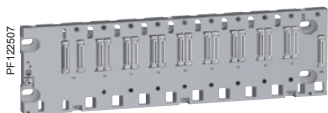

BMEXBP0800

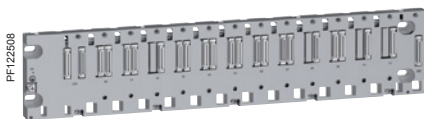

BMEXBP1200

### X-bus racks

Description	Type of module to be inserted	No. of slots (1)	Power consumption (2)	Reference	Weight kg/lb
X-bus racks	BMXCPS power supply, <b>BMXP34</b> or <b>BMEP58</b>	4	1 W	<b>BMXXBP0400</b>	0.630/ 1.389
	processor, I/O modules, communication modules and application-specific modules (counter, motion control and serial)	6	1.5 W	<b>BMXXBP0600</b>	0.790/ 1.742
		8	2 W	<b>BMXXBP0800</b>	0.950/ 2.094
		12	–	<b>BMXXBP1200</b>	1.270/ 2.780

### Ethernet + X-bus racks (3) (4)

Description (5)	Type of module to be inserted	Ethernet connectors	X-bus connectors	Power consumption (6)	Reference (3)	Weight kg/lb
4-slot Ethernet + X-bus backplane	BMXCPS power supply, <b>BMEP58</b> processor, I/O modules, communication modules and application-specific modules (counter, motion control and serial)	4	4	2.8 W	<b>BMEXBP0400</b>	0.719/ 1.500
8-slot Ethernet + X-bus backplane		8	8	3.9 W	<b>BMEXBP0800</b>	1.064/ 2.350
12-slot backplane (8 Ethernet + X-bus/4 X-bus)		8	12	3.9 W	<b>BMEXBP1200</b>	1.398/ 3.080

- (1) Number of slots taking the processor module, I/O modules, communication modules and application-specific modules (excluding power supply module).
- (2) Power consumption of anti-condensation resistor(s).
- (3) In an M580 architecture, Ethernet backplanes can be used for RIO drop Ethernet (EIO) but not as expansion racks anywhere. For expansion racks, it is necessary to use BMXXBP0400/0600/0800/1200 racks.
- (4) For multi-rack configuration, see page 2/6.
- (5) Number of slots for maximum number of modules excluding power supply rack expansion modules.
- (6) Power consumption of anti-condensation resistor(s).





STBXSP3000 + STBXSP3000

(1)

### Accessories

Description	For use with	Reference	Weight kg/lb
<b>Shielding connection kits</b> comprising: - 1 metal bar - 2 support sub-bases	BM●XBP0400 rack	<b>BMXXSP0400</b>	0.280/ 0.617
	BMXXBP0600 rack	<b>BMXXSP0600</b>	0.310/ 0.683
	BM●XBP0800 rack	<b>BMXXSP0800</b>	0.340/ 0.750
	BM●XBP1200 rack	<b>BMXXSP1200</b>	0.400/ 0.882
<b>Spring clamping rings</b> Sold in lots of 10	Cables, cross-section 1.5...6 mm <sup>2</sup> /16...10 AWG	<b>STBXSP3010</b>	0.050/ 0.110
	Cables, cross-section 5...11 mm <sup>2</sup> /10...7 AWG	<b>STBXSP3020</b>	0.070/ 0.154
<b>Protective covers</b> (replacement parts) Sold in lots of 5	Unoccupied slots on BMXXBP●●00 rack	<b>BMXXEM010</b>	0.005/ 0.011

(1) The earthing terminal is not included in the shielding connection kits.

2

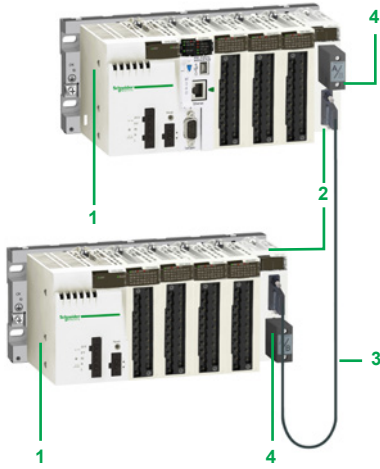

Modicon M340 + expansion rack



Modicon M580 + expansion rack

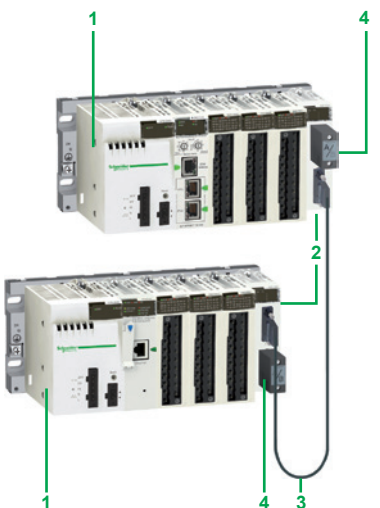

Modicon X80 drop + expansion rack

### Composition of a multi-rack configuration

Multi-rack configurations are made up of **BM●XBP●●00** racks. They comprise:

- 2 racks maximum for a station with **BMXP341000** processor
- 4 racks maximum for a station with **BMXP3420●●●** or **BMXP3420●●●CL** processor
- 4 racks maximum for a station with **BMEP581020** or **BMEP5820●0** processor
- 8 racks maximum for a station with **BMEP5830●0** or **BMEP5840●0** processor

Each rack is equipped with:

- 1 A **BMXCPS●●●●●** power supply
- 2 A **BMXXBE1000** rack expansion module. This module, inserted in the right-hand end of the rack (**XBE** slot, see page 2/2) does not occupy rack slots **00...11** (4, 6, 8 or 12 slots are still available)
- 3 The **BMXXBE1000** rack expansion modules are connected to each other by X-bus cordsets

### X-bus

The racks, distributed on the X-bus, are connected to each other by X-bus extension cordsets **3** with a total length of **30 m/98.42 ft maximum**.

The racks are connected in a daisy chain using **BMXXBC●●0K** (1) X-bus extension cordsets connected to the two 9-way SUB-D connectors **7** and **8** on the front panels of the **BMXXBE1000** rack expansion modules **2**.

### Line terminators 4

Both expansion modules at the ends of the daisy chain must have a line terminator **4 TSXTLYEX** on the unused 9-way SUB-D connector.

*Note: The processor module is always positioned in the rack at address 0. However, in an X-bus daisy chain, the order of the racks has no effect on operation. For example, the order of the daisy chain can be 0-1-2-3, 2-0-3-1 or 3-1-2-0, etc.*

### Composition of an expansion backplane configuration

The Modicon M580 CPU supports from 4 to 8 local racks (depending upon the CPU performance level), using existing X80 I/O modules and accessories. The Modicon M580 CPU can be installed in the first rack (#0) and this can be a dual bus rack. The M580 PLC will support up to 7 **BMXXBP●●●●●** PV02 or higher backplanes (racks) of 4, 6, 8 or 12 slots. The main backplane (rack #0) will support the CPU.

To extend the configuration using additional racks, users can use a bus extender module (**BMXXBE1000**) and X-bus cables. The backplane extender should be plugged to the dedicated connector on the right side of the backplane. It will not occupy any module slot. The XBE extender module will not be hot-swappable, like the rest of the X80 I/O platform. Each backplane has to include a power supply module and will support up to 12 modules.

An expansion rack can be connected on: the main backplane and the X80 drop (EIO).

The rack's address is assigned as follows:

- Each rack will be assigned a physical address using 4 micro switches located in the bus extender module
- The main rack containing the CPU will be assigned the address 0
- The other racks will be assigned addresses 1 to 7

Each rack is equipped with:

- 1 A **BMXCPS●●●●●** power supply
- 2 A **BMXXBE1000** rack expansion module. This module, inserted in the right-hand end of the rack (XBE slot) does not occupy rack slots **00...11** (4, 6, 8 or 12 slots are still available)
- 3 The **BMXXBE1000** rack expansion modules are connected to each other by X-bus cordsets
- 4 Line terminators: Both expansion modules at the ends of the daisy chain must have a line terminator **4 TSXTLYEX** on the unused 9-way SUB-D connector.

(1) **BMXXBC●●0K** extension cordsets, length 0.8 m/2.62 ft, 1.5 m/4.92 ft, 3 m/9.84 ft, 5 m/16.40 ft or 12 m/39.37 ft, with angled connectors or **TSXCBY●08K** extension cordsets, length 1 m/3.28 ft, 3 m/9.84 ft, 5 m/16.40 ft, 12 m/39.37 ft, 18 m/59.05 ft or 28 m/91.86 ft, with straight connectors.

### Ethernet racks

The Modicon M580 CPU supports dual bus backplanes (Ethernet and X-bus), and the processors support Ethernet ring or star architecture on their Ethernet port.

**BMEP58●●2●** supports Ethernet star or ring architectures (RSTP loop is supported on ports 2 and 3). The embedded scanner allows scanning distributed equipments. The CPU directly drives these devices ("NOC" embedded function).

**BMEP58●●4●** supports an embedded scanner that allows scanning X80 drops on Ethernet RIO (EIO) and distributed equipment.

Modicon M580 CPUs have an additional third Ethernet port dedicated to the connection of a service tool such as a PC, an HMI, a network analyser. This port is labeled "ETH 1". It does not support RSTP.

The Modicon M580 CPU will be able to communicate on the main Ethernet backplane. The M580 CPU cannot be installed in an expansion rack.

It is necessary to use an Ethernet backplane:

Reference	Description
<b>BMEXBP0400</b>	Standard 4 -slot backplane
<b>BMEXBP0800</b>	Standard 8-slot backplane
<b>BMEXBP1200</b>	Standard 12-slot backplane
<b>BMEPBP0400H</b>	Ruggedized 4-slot backplane
<b>BMEPBP0800H</b>	Ruggedized 8-slot backplane
<b>BMEPBP1200H</b>	Ruggedized 12-slot backplane

### Premium X-bus extension: making migration as simple as possible

The Modicon M580 CPU supports revamping of an existing Premium installation by replacing the Premium rack 0 (CPU and communication modules) with an M580 rack, it is also possible to combine Premium racks **TSXRKY4EX/6EX/8EX/12EX** with X80

I/O based on an X-bus rack. The majority of existing configurations are supported. The number of expanded racks allowed depends on which CPU is being used:

- The **BMEP581020**, **BMEP582020**, and **BMEP582040** CPUs support a main local rack and up to 3 expansion racks. If you are using 4, 6, or 8-slot Premium expansion racks, you can install 2 physical racks at each assigned rack address, allowing up to 6 Premium expansion racks (up to 6 backplanes and 100 m/328.083 ft. between 2 drops).

- The **BMEP583020**, **BMEP583040**, **BMEP584020**, and **BMEP584040** CPUs support a main local rack with up to 7 expansion racks. If you are using 4, 6, or 8-slot Premium expansion racks, you can install 2 physical racks at each assigned rack address, allowing up to 14 Premium expansion racks.

The maximum number of supported X-bus drops is as follows:

- 4 for **BMEP581●●●/2●●●**
- 8 for **BMEP583●●●/4●●●**

The maximum number of X-bus drops is calculated as follows:

- Max number = 1 (CPU rack: **BMXXBP●●00** or **BMEXBP●●00**) + ½ Nb. **TSXRKY4/6/8EX** racks + Nb. **TSXRKY12EX** racks + Nb. **BMXXBP●●00** racks

### Description

The front panel of the **BMXXBE1000** rack expansion module comprises:

- 5 A screw for locking the module in its slot (at the far right-hand end of the rack)
- 6 A display block with 5 LEDs:
  - RUN LED (green): module running
  - COL LED (red): several racks have the same address, or rack address 0 does not contain the **BMXP34●●●0** or **BMXP58●0●●0** processor module
  - LEDs 0, 1, 2 and 3 (green): rack address 0, 1, 2 or 3
- 7 A 9-way female SUB-D connector, marked X-bus, for the incoming X-bus cordset
  - 3 connected to the upstream rack, or if it is the first rack, for the **A/** line terminator included in the **TSXTLYEX 4** pack
- 8 A 9-way female SUB-D connector, marked X-bus, for the outgoing X-bus cordset
  - 3 to the downstream rack, or if it is the last rack, for the **B/** line terminator included in the **TSXTLYEX 4** pack

### On the right-hand side panel

A flap for accessing the 3 rack addressing micro-switches: 0...3.

### Installation rules for **BM●XBP●●●0** racks

Rules for installing racks in enclosures (see our website [www.schneider-electric.com](http://www.schneider-electric.com)).

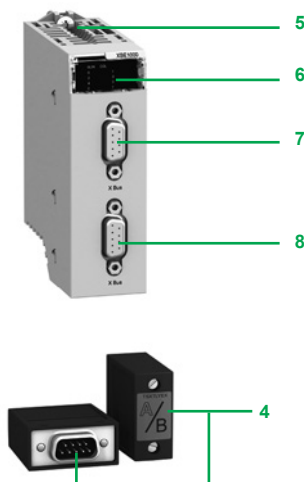
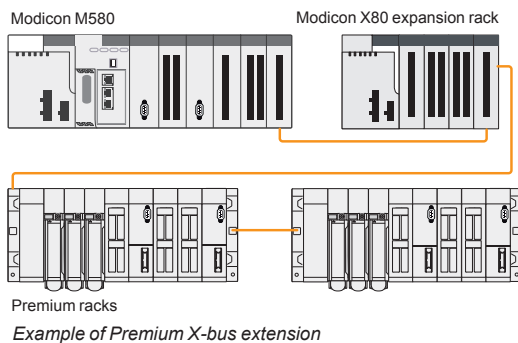

2



BMXXBE1000

Rack expansion			
Description	Use	Reference	Weight kg/lb
<b>Modicon X80 I/O rack expansion module</b>	Standard module for mounting in each rack (XBE slot) and used to interconnect: - Up to 2 racks with BMXP341000 processor module - Up to 4 racks with BMXP342000 processor module - Up to 3 racks with BMEP581020/20000 processor module - Up to 7 racks with BMEP583000/4000 processor module - 1 rack with X80 drop (EIO)	<b>BMXXBE1000</b>	0.178/ 0.392
<b>Modicon X80 I/O rack expansion kit</b>	Complete kit for 2-rack configuration comprising: - 2 BMXXBE1000 rack expansion modules - 1 BMXXBC008K extension cordset, length 0.8 m/2.62 ft - 1 TSXTLYEX line terminator (set of 2)	<b>BMXXBE2005</b>	0.700/ 1.543



BMXXBC000K

Cordsets and connection accessories										
Description	Use	Composition	Type of connector	Length m/ft	Reference	Weight kg/lb				
<b>X-bus extension cordsets</b> total length 30 m/98.42 ft max.	Between 2 BMXXBE1000 rack expansion modules	2 x 9-way SUB-D connectors	Angled	0.8/	<b>BMXXBC008K</b>	0.165/				
				2.62		0.363				
				1.5/	<b>BMXXBC015K</b>	0.250/				
				4.92		0.551				
				3/	<b>BMXXBC030K</b>	0.420/				
				9.84		0.926				
				5/	<b>BMXXBC050K</b>	0.650/				
				16.40		1.433				
				12/	<b>BMXXBC120K</b>	1.440/				
				39.37		3.175				
				Straight				1/	<b>TSXCBY010K</b>	0.160/
								3.28		0.353
								3/	<b>TSXCBY030K</b>	0.260/
9.84	0.573									
5/	<b>TSXCBY050K</b>	0.360/								
16.40		0.794								
12/	<b>TSXCBY120K</b>	1.260/								
39.37		2.778								
18/	<b>TSXCBY180K</b>	1.860/								
59.05		4.101								
28/	<b>TSXCBY280KT</b>	2.860/								
91.86		6.305								
<b>Cable reel</b>	Length of cable to be fitted with TSXCBYK9 connectors	Cable with ends with flying leads, 2 line testers	-	100/	<b>TSXCBY1000</b>	12.320/				
				328.08		27.161				

(1) Cable supplied with a set of 2 TSXTVSY100 electrical transient suppressors.



TSXTLYEX

### Cordsets and connection accessories (continued)

Description	Use	Composition	Sold in lots of	Reference	Weight kg/lb
<b>Line terminators</b>	Required on both BMXXBP●●●●0 modules located at either end of the daisy chain	2 x 9-way SUB-D connectors marked A/ and /B	2	<b>TSXTLYEX</b>	0.050/ 0.110
<b>X-bus straight connectors</b>	For TSXCBY1000 cables	2 x 9-way SUB-D straight connectors	2	<b>TSXCBYK9</b>	0.080/ 0.176
<b>Connector assembly kit</b>	Fitting TSXCBYK9 connectors	2 crimping pliers, 1 pen (1)	–	<b>TSXCBYACC10</b>	–

(1) To fit the connectors on the cable, you also need a wire stripper, a pair of scissors and a digital ohmmeter.

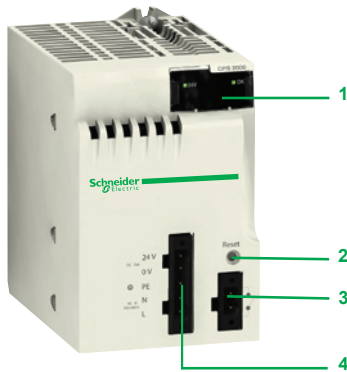

### Presentation

**BMXCPS●●●●** power supply modules provide the power supply for each **BMEXBP●●00** or **BMXXBP●●00** Modicon X80 I/O rack and the modules installed on it.

The Modicon X80 I/O power supply module offer comprises:

- Three power supply modules for DC line supplies:
  - 24 V  $\bar{\bar{}}$  isolated power supply module, **BMXCPS2010**
  - 24...48 V  $\bar{\bar{}}$  isolated power supply module, **BMXCPS3020**
  - 125 V  $\bar{\bar{}}$  power supply module, **BMXCPS3540T** (extended operating temperature -25 to +70 °C/-13 to +158 °F)
- Two power supply modules for AC line supplies:
  - 100...240 V  $\sim$ , 20 W power supply module, **BMXCPS2000**
  - 100...240 V  $\sim$ , 36 W power supply module, **BMXCPS3500**

### Description

The power supply module is selected according to:

- The electrical line supply: 24 V  $\bar{\bar{}}$ , 48 V  $\bar{\bar{}}$ , 125 V  $\bar{\bar{}}$ , or 100...240 V  $\sim$
- The required power (see the power consumption table available on our website [www.schneider-electric.com](http://www.schneider-electric.com)) (1)

**BMXCPS●●●●** power supply modules have the following on the front panel:

- 1 A display block comprising:
  - OK LED (green), lit if rack voltages are present and correct
  - 24 V LED (green), lit when the sensor voltage is present (BMXCPS2000/3500/3540T AC power supply modules only)
- 2 A pencil-point RESET pushbutton for a cold restart of the application
- 3 A 2-way connector that can take a removable terminal block (cage clamp or spring-type) for connecting the alarm relay
- 4 A 5-way connector that can take a removable terminal block (cage clamp or spring-type) for connecting the following:
  - $\bar{\bar{}}$  or  $\sim$  line supply
  - Protective earth ground
  - Dedicated 24 V  $\bar{\bar{}}$  power supply for the input sensors (for BMXCPS2000/3500/3540T AC power supply modules only)

**Included with each power supply module:**

- Set of two cage clamp removable terminal blocks (5-way and 2-way) **BMXTSCPS10**

**To be ordered separately** (if necessary):

- Set of two spring-type removable terminal blocks (5-way and 2-way) **BMXTSCPS20**

### Functions

#### Alarm relay

The alarm relay incorporated in each power supply module has a volt-free contact accessible on the front panel, on the 2-way connector.

The operating principle is as follows:

In normal operation, with the PLC in RUN, the alarm relay is energized and its contact is closed (state 1).

The relay de-energizes and its associated contact opens (state 0) whenever the application stops, even partially, due to any of the following:

- Occurrence of a detected blocking fault
- Incorrect rack output voltages
- Loss of supply voltage

(1) This power consumption calculation for the rack can also be performed by the Unity Pro programming software.

### Functions (continued)

#### RESET pushbutton

The power supply module in each rack has a RESET button on the front panel which, when pressed, triggers an initialization sequence on the processor and the modules in the rack it supplies.

Pressing this pushbutton triggers a sequence of service signals, which is the same as that for:

- A power break, when the pushbutton is pressed
- A power-up, when the pushbutton is released

In terms of the application, these operations represent a cold start (forcing the I/O modules to state 0 and initializing the processor).

#### Sensor power supply

**BMXCPS2000/3500** AC power supply modules and **BMXCPS3540T** DC power supply modules have an integrated 24 V  $\overline{\text{DC}}$  supply for powering the input sensors.

Connection to this 24 V  $\overline{\text{DC}}$  sensor power supply is via the 5-way connector on the front panel.

The available power depends on the power supply module (0.45 A or 0.9 A).

### References

Each **BMEXBP●●00** or **BMXXBP●●00** rack must be equipped with a power supply module. These modules are inserted in the first two slots of each rack (marked CPS).

The power required to supply each rack depends on the type and number of modules installed in the rack. It is therefore necessary to draw up a power consumption table for each rack in order to determine which

**BMXCPS●●●0** power supply module is the most suitable for each rack (please consult our website [www.schneider-electric.com](http://www.schneider-electric.com)).



BMXCPS2010/3020



BMXCPS2000/3500

#### Power supply modules (1)

Line supply	Available power (2)				Nominal current 24 V $\overline{\text{DC}}$ rack (3)	Reference	Weight kg/lb
	3.3 V $\overline{\text{DC}}$ (3)	24 V $\overline{\text{DC}}$ rack (3)	24 V $\overline{\text{DC}}$ sensors (4)	Total			
24 V $\overline{\text{DC}}$ isolated	8.3 W	16.8 W	–	16.8 W	0.7 A	<b>BMXCPS2010</b>	0.290/ 0.639
24...48 V $\overline{\text{DC}}$ isolated	15 W	31.2 W	–	31.2 W	1.3 A	<b>BMXCPS3020</b>	0.340/ 0.750
100...150 V $\overline{\text{DC}}$	15 W	31.2 W	21.6 W	36 W (5)	1.3 A	<b>BMXCPS3540T</b> (5)	0.340/ 0.750
100...240 V $\sim$	8.3 W	16.8 W	10.8 W	20 W	0.7 A	<b>BMXCPS2000</b>	0.300/ 0.661
	15 W	31.2 W	21.6 W	36 W	1.3 A	<b>BMXCPS3500</b>	0.360/ 0.794

#### Separate part

Description	Type	Composition	Reference	Weight kg/lb
Set of 2 removable connectors	Spring-type	One 5-way terminal block and one 2-way terminal block	<b>BMXXTSCPS20</b>	0.015/ 0.033

#### Replacement part

Description	Type	Composition	Reference	Weight kg/lb
Set of 2 removable connectors	Cage clamp	One 5-way terminal block and one 2-way terminal block	<b>BMXXTSCPS10</b>	0.020/ 0.044

(1) Include a set of 2 cage clamp removable connectors. Spring-type connectors available separately under reference **BMXXTSCPS20**.

(2) The sum of the power consumed on each voltage (3.3 V  $\overline{\text{DC}}$  and 24 V  $\overline{\text{DC}}$ ) must not exceed the total power of the module. See the power consumption table available on our website [www.schneider-electric.com](http://www.schneider-electric.com).

(3) 3.3 V  $\overline{\text{DC}}$  and 24 V  $\overline{\text{DC}}$  rack voltages for powering modules in the Modicon X80 I/O rack.

(4) 24 V  $\overline{\text{DC}}$  sensor voltage for powering the input sensors (voltage available via the 2-way removable connector on the front panel).

(5) Extended operating temperature -25 to +70 °C/-13 to +158 °F (with power derating at extreme temperatures: 27 W between -25 and 0 °C/-13 and 0 °F and between 60 and 70 °C/140 and 158 °F).





## Discrete I/O modules

*Selection guide* ..... page 3/2

- Presentation, description ..... page 3/8
- Connections ..... page 3/9
- Functions ..... page 3/10
- Complementary characteristics ..... page 3/11
- References ..... page 3/12

## Analog I/O modules

*Selection guide* ..... page 3/14

- Presentation ..... page 3/18
- Description ..... page 3/19
- Connections, combinations ..... page 3/20
- Complementary characteristics ..... page 3/21
- References ..... page 3/22

## HART analog I/O modules

*Selection guide* ..... page 3/24

- Presentation, description ..... page 3/26
- References ..... page 3/27

## BMXEHC0200/0800 counter modules

- Presentation, description ..... page 3/28
- Functions ..... page 3/29
- References ..... page 3/31

## BMXEAE0300 SSI encoder interface module

- Presentation, description ..... page 3/32
- Functions, references ..... page 3/33

## BMXMSP0200 motion control module

- Presentation, description ..... page 3/34
- Operation, references ..... page 3/35

## MFB motion control

- Presentation, functions ..... page 3/36
- Setup ..... page 3/37

# Modicon X80 I/O platform

Discrete I/O modules  
Input modules

## Applications

### 8-channel input modules

Connection via cage clamp, screw clamp, or spring-type removable block terminal



Type	~	~	---
Voltage	200...240 V	100...120 V	24 V, 48 V
Current per channel	10.4 mA (for U = 220 V to 50 Hz)	5 mA	3.5 mA, 2.5 mA
Modularity (Number of channels and commons)	8 isolated inputs and 1 common	8 isolated channels and no common point	16 isolated inputs and 1 common
Connection	Via 20-way cage clamp, screw clamp, or spring-type removable terminal block BMXFTB2000/2010/2020		
Isolated inputs	IEC/EN 61131-2 conformity	Type 2	Type 3, Type 3, Type 1
	Logic	-	Positive (sink)
	Type of input	Capacitive	Capacitive, Current sink
	Sensor compatibility IEC/EN 60947-5-2	2-wire ~	2-wire ~, 2-wire ---, 3-wire --- PNP any type
Sensor power supply (ripple included)	170...264 V	85...132 V (no sensor power monitoring)	19...30 V, 38...60 V
Protection of inputs	Use one 0.5 A fast-blow fuse per group of channels		
Maximum dissipated power	4.73 W	2.35 W	2.5 W, 3.6 W
Operating temperature	0...60 °C/0...140 °F		
Compatibility with TeSys Quickfit installation system	-		
Compatibility with Modicon Telefast ABE7 pre-wired system	Passive connection sub-bases	-	
	Adapter sub-bases with relays	-	

## References

**BMXDAI0805** | **BMXDAI0814** | **BMXDDI1602** | **BMXDDI1603**

## Pages

3/12

### 16-channel input modules

Connection via cage clamp, screw clamp, or spring-type removable block terminal



Type	~ or ---	~	---
Voltage	24 V (~ or ---)	48 V, 100...120 V	125 V
Current per channel	3 mA (~ or ---)	5 mA	2.4 mA
Modularity (Number of channels and commons)	16 isolated inputs and 1 common		
Connection	Via BMXFTB2000/2010/2020 20-way cage clamp, screw clamp, or spring-type removable block terminal		
Isolated inputs	Type 1 (~)	Type 3	-
	Negative (source) (---)	-	Positive (sink)
	Resistive	Capacitive	Current sink
	2-wire ---/~, 3-wire --- PNP or NPN any type	2-wire ~	-
Sensor power supply (ripple included)	19...30 V ---, 20...26 V ~	40...52 V, 85...132 V	88...150 V
Protection of inputs	Use one 0.5 A fast-blow fuse per group of channels		
Maximum dissipated power	3 W	4 W, 3.8 W	8.5 W (at 40 °C/104 °F)
Operating temperature	0...60 °C/0...140 °F		
Compatibility with TeSys Quickfit installation system	-		
Compatibility with Modicon Telefast ABE7 pre-wired system	-		

## References

**BMXDAI1602** | **BMXDAI1603** | **BMXDAI1604** | **BMXDDI1604T**

## Pages

3/12

# Modicon X80 I/O platform

Discrete I/O modules  
Input modules and mixed I/O modules

## Applications

## 32 or 64-channel high-density input modules

Connection via 40-way connectors with preassembled cordsets



<b>Type</b>		---	
<b>Voltage</b>		24 V	
<b>Current per channel</b>	Inputs	2.5 mA	1 mA
	Outputs	–	–
<b>Modularity</b> (Number of channels and commons)		32 isolated inputs and 2 commons	64 isolated inputs and 4 commons
<b>Connection</b>		Via one 40-way connector	Via two 40-way connectors
<b>Isolated inputs</b>	IEC/EN 61131-2 conformity	Type 3	Non-IEC
	Logic	Positive (sink)	
	Type of input	Current sink	
	Sensor compatibility IEC/EN 60947-5-2	2-wire ---, 3-wire --- PNP any type	–
<b>Sensor power supply</b> (ripple included)		19...30 V	
<b>Protection of inputs</b>		Use one 0.5 A fast-blow fuse per group of channels	
<b>Isolated outputs</b>	Fallback	–	
	IEC/EN 61131-2 conformity	–	
	Protection	–	
		Logic	
<b>Preactuator power supply</b> (ripple included)		–	
<b>Output fuse protection</b>		–	
<b>Maximum dissipated power</b>		3.9 W	4.3 W
<b>Operating temperature</b>		0...60 °C/0...140 °F	
<b>Compatibility with TeSys Quickfit installation system</b>		LU9 G02 splitter boxes (8 motor starters) and BMXFCC●●1/●●3 preassembled cordsets. See pages 3/9 and 3/13.	
<b>Compatibility with Modicon Telefast ABE7 pre-wired system</b>	Passive connection sub-bases	Depending on model, 8 or 16-channel passive sub-bases, with or without LED, with common or 2 terminals per channel. See pages 6/2 and 6/8.	
	Adapter sub-bases with relays	Depending on model, active sub-bases with solid state or electromagnetic relays (fixed or removable), 16 channels, with common or 2 terminals per channel (screw or spring-type connection). See pages 6/2 and 6/8.	

<b>References</b>	<b>BMXDDI3202K</b>	<b>BMXDDI6402K</b>
-------------------	--------------------	--------------------

<b>Pages</b>	3/12
--------------	------

## 16 or 32-channel mixed I/O modules

Connection via cage clamp, screw clamp, or spring-type removable block terminal



---		--- and ~ (outputs only)		---	
Inputs: 24 V --- Solid-state outputs: 24 V --- 3.5 mA		Inputs: 24 V --- Relay outputs: 24 V --- or 24...240 V ~ 3.5 mA		Inputs: 24 V --- Solid-state outputs: 24 V --- 2.5 mA	
0.5 A		2 A (--- or ~)		0.1 A	
8 isolated inputs and 1 common, 8 isolated outputs and 1 common		8 isolated inputs and 1 common, 8 isolated outputs and 1 common		16 isolated inputs and 1 common, 16 isolated outputs and 1 common	
Via BMXF2B2000/2010/2020 20-way cage clamp, screw clamp, or spring-type removable terminal block Type 3		Via BMXF2B2000/2010/2020 20-way cage clamp, screw clamp, or spring-type removable terminal block Type 3		Via one 40-way connector	
Positive (sink)		–		Positive (sink)	
Current sink		–		Current sink	
2-wire ---, 3-wire --- PNP any type		–		2-wire ---, 3-wire --- PNP any type	
19...30 V		19...30 V		19...30 V	
Use one 0.5 A fast-blow fuse per group of channels		Use one 0.5 A fast-blow fuse per group of channels		Use one 0.5 A fast-blow fuse per group of channels	
Configurable output fallback, continuous monitoring of output control, and resetting of outputs in case of internal detected fault		Configurable output fallback, continuous monitoring of output control, and resetting of outputs in case of internal detected fault		Configurable output fallback, continuous monitoring of output control, and resetting of outputs in case of internal detected fault	
Yes		Not protected		Protected	
Protected		–		Positive	
Positive		19...30 V --- 24...240 V ~		19...30 V	
Use a 2 A fast-blow fuse		Use a 12 A fast-blow fuse		Use a 2 A fast-blow fuse	
3.7 W		3.1 W		4 W	
0...60 °C/0...140 °F		0...60 °C/0...140 °F		0...60 °C/0...140 °F	
–		–		LU9 G02 splitter boxes (8 motor starters) and BMXFCC●●1/●●3 preassembled cordsets. See pages 3/9 and 3/13.	
–		–		Depending on model, 8 or 16-channel passive sub-bases, with or without LED, with common or 2 terminals per channel. See pages 6/2 and 6/8.	
–		–		Depending on model, active sub-bases with solid state or electromagnetic relays (fixed or removable), 16 channels, with common or 2 terminals per channel (screw or spring-type connection). See pages 6/2 and 6/8.	

<b>References</b>	<b>BMXDDM16022</b>	<b>BMXDDM16025</b>	<b>BMXDDM3202K</b>
-------------------	--------------------	--------------------	--------------------

<b>Pages</b>	3/13
--------------	------

# Modicon X80 I/O platform

## Discrete I/O modules Output modules

### Applications

32 or 64-channel high-density output modules  
Connection via 40-way connectors with preassembled cordsets



<b>Type</b>	transistor
<b>Voltage</b>	24 V
<b>Current per channel</b>	0.1 A
<b>Modularity</b> (Number of channels and commons)	32 protected outputs and 2 commons      64 protected outputs and 4 commons
<b>Connection</b>	Via one 40-way connector      Via two 40-way connectors
<b>Isolated outputs</b>	Fallback  IEC/EN 61131-2 conformity  Protection  Logic
<b>Preactuator power supply</b> (ripple included)	19...30 V $\overline{\text{DC}}$
<b>Output fuse protection</b>	Use one 2 A fast-blow fuse per group of channels
<b>Maximum dissipated power</b>	3.6 W      6.85 W
<b>Operating temperature</b>	0...60 °C/0...140 °F
<b>Compatibility with TeSys Quickfit installation system</b>	LU9 G02 splitter boxes (8 motor starters) and BMXFCC●●1/●●3 preassembled cordsets. See pages 3/9 and 3/13.
<b>Compatibility with Modicon Telefast ABE7 pre-wired system</b>	Passive connection sub-bases  Adapter sub-bases with relays

Configurable output fallback, continuous monitoring of output control, and resetting of outputs in case of internal detected fault	
Yes	
Yes	
Positive	
19...30 V $\overline{\text{DC}}$	
Use one 2 A fast-blow fuse per group of channels	
3.6 W      6.85 W	
0...60 °C/0...140 °F	
LU9 G02 splitter boxes (8 motor starters) and BMXFCC●●1/●●3 preassembled cordsets. See pages 3/9 and 3/13.	
Depending on model, passive sub-bases with 8 or 16 channels, with or without LED, with common or with 2 terminals per channel. See pages 6/2 and 6/8.	
Depending on model, active sub-bases with solid state or electromagnetic relays (fixed or removable). 16 channels with 1 common or 2 terminals per channel, screw or spring-type connection. See pages 6/2 and 6/8.	

**References**

**BMXDDO3202K**      **BMXDDO6402K**

**Pages**

3/12

16-channel output modules      8 or 16-channel output modules  
Connection via cage clamp, screw clamp, or spring-type removable block terminal



transistor	triac	relay	relay	
24 V	100...240 V	100...150 V	24 V $\overline{\text{DC}}$ , 24...240 V $\sim$	
0.5 A	0.6 A	0.3 A (lth)	2 A (lth)	
16 protected outputs and 1 common	16 non-protected outputs and 4 commons	8 non-protected outputs, without common	16 non-protected outputs and 2 commons	
Via BMXF TB2000/2010/2020 20-way cage clamp, screw clamp, or spring-type removable block terminal				
Configurable output fallback, continuous monitoring of output control, and resetting of outputs in case of internal detected fault		Configurable output fallback		
Yes		Yes		
Yes		-		
Positive (source)	Negative (sink)	-		
19...30 V	100...240 V	100...150 V	19...30 V $\overline{\text{DC}}$	24...240 V $\sim$
Use one 6.3 A fast-blow fuse per group of channels	Use one 3 A fast-blow fuse per group of channels	Use one 0.5 A, 250 V DC fast-blow fuse on each relay	Use one 3 A fast-blow fuse on each channel	Use one 12 A fast-blow fuse on each group of channels
4 W      2.26 W	-	3.17 W	2.7 W	3 W
0...60 °C/0...140 °F		-25...70 °C/-13...158 °F		0...60 °C/0...140 °F
-				
-				
-				

**BMXDDO1602**      **BMXDDO1612**      **BMXDAO1605**      **BMXDRA0804T**      **BMXDRA0805**      **BMXDRA1605**

3/12

### Presentation

Discrete I/O modules in the Modicon X80 I/O offer are standard modules occupying a single slot on the rack. These modules are equipped with either of the following:

- A connector for a screw or spring-type 20-way removable terminal block
- One or two 40-way connectors

This wide range of "discrete" I/O can be used to meet whatever requirements arise in terms of:

- Functions, AC or DC I/O, positive or negative logic
- Modularity, 8, 16, 32 or 64 channels per module

The inputs receive signals from the sensors and perform the following functions:

- Acquisition
- Adaptation
- Electrical isolation
- Filtering
- Protection against interference signals

The outputs memorize commands issued by the processor to enable control of the preactuators via the decoupling and amplification circuits.

### Description

**BMXD●/D●O/DRA** discrete I/O modules are standard format (1 slot). They have an IP 20 case to protect the electronics, and are locked into position with a captive screw.

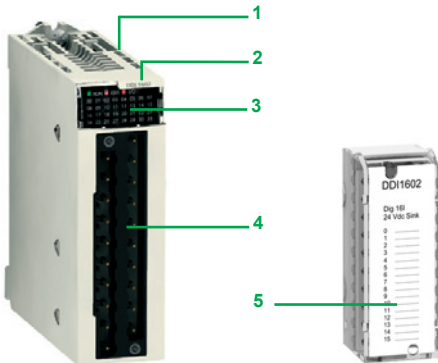

Module for connection via 20-way removable terminal block

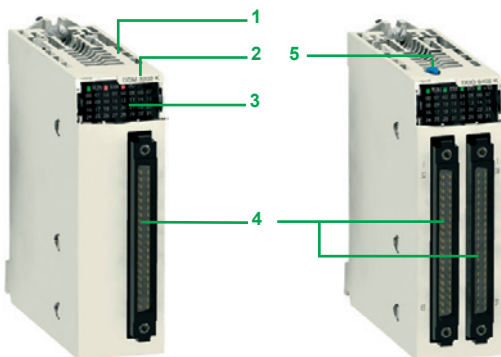

32 and 64-channel modules for connection via one or two 40-way connector(s)

#### I/O modules connected via 20-way removable terminal block

- 1 Rigid body providing support and protection for the electronic card
- 2 Module reference marking (a label is also visible on the right-hand side of the module)
- 3 Channel status display block
- 4 Connector taking the 20-way removable terminal block for connection of sensors or preactuators

#### To be ordered separately:

- 5 A **BMXFTB20●0** 20-way removable terminal block (identification label supplied with each I/O module) or a preassembled cordset with a 20-way removable terminal block at one end and flying leads at the other (see page 3/9).

#### I/O modules connected via 40-way connector(s)

- 1 Rigid body providing support and protection for the electronic card
- 2 Module reference marking (a label is also visible on the right-hand side of the module)
- 3 Channel status display block
- 4 One or two 40-way connectors (32 or 64 channels) (1) for connection of sensors or preactuators
- 5 With the 64-channel module, a pushbutton which, with successive presses, displays the state of channels 0...31 or 32...63 on the display block 3 (see page 3/10)

#### To be ordered separately, depending on the type of module:

One or two preassembled cordset(s) with a 40-way connector (see page 3/9)

(1) Fujitsu FCN 40-way connector

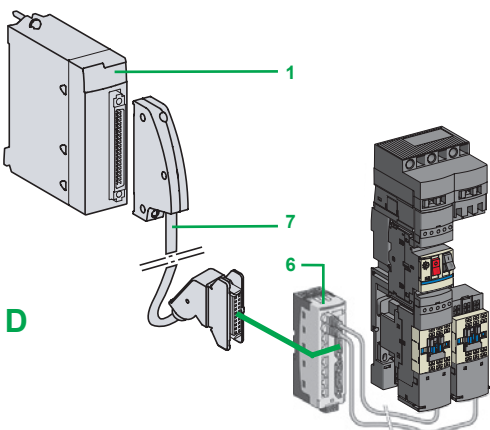
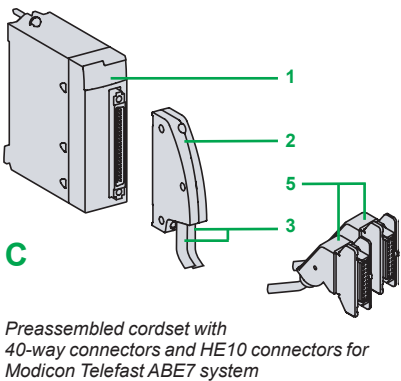
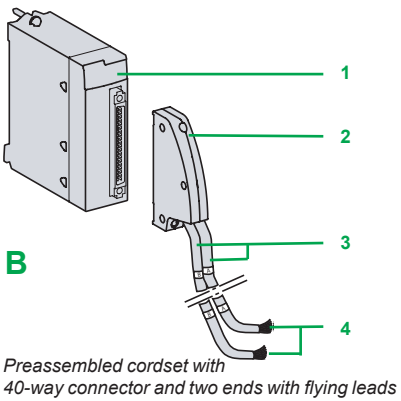
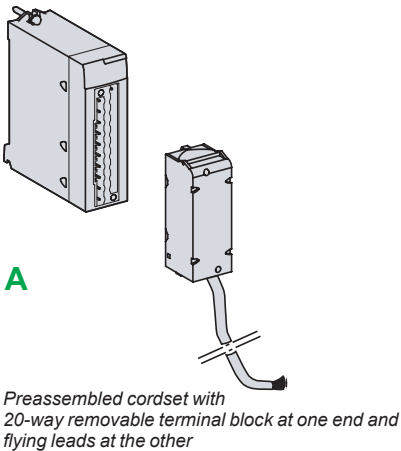

### Connecting modules with removable terminal blocks

There are three types of 20-way removable terminal block:

- Screw clamp terminal block
- Cage clamp terminal block
- Spring-type terminal block

Each removable terminal block can take:

- Bare wires
- Wires equipped with **DZ5CE** cable ends

**A:** One version of the removable terminal block is equipped with 3, 5 or 10 m cordsets with color-coded flying leads (**BMXFTW●●1**). Use limited to voltages of  $\leq 48$  V.

### Cage clamp terminal blocks

The capacity of each terminal is:

- Minimum: One 0.34 mm<sup>2</sup> wire (AWG 22)
- Maximum: One 1 mm<sup>2</sup> wire (AWG 18)

**BMXFTB2000** cage clamp connectors are equipped with captive screws (maximum tightening torque 0.5 N.m/0.37 lb-ft).

### Screw clamp terminal blocks

The capacity of each terminal is:

- Minimum: One or two 0.34 mm<sup>2</sup> wires (AWG 22)
- Maximum: Two 1.5 mm<sup>2</sup> wires (AWG 15)

**BMXFTB2010** screw clamp connectors are equipped with captive screws (maximum tightening torque 0.5 N.m/0.37 lb-ft).

### Spring terminals

The capacity of each terminal in the **BMXFTB2020** spring-type terminal blocks is:

- Minimum: One 0.34 mm<sup>2</sup> wire (AWG 22)
- Maximum: One 1 mm<sup>2</sup> wire (AWG 18)

### Connecting modules with 40-way connectors

#### Preassembled cordsets with 40-way connector at one end and flying leads at the other

**B:** Preassembled cordsets can be used for easy direct wire-to-wire connection between the I/O of modules with 40-way connectors **1** and the sensors, preactuators or intermediate terminal blocks.

These preassembled cordsets comprise:

- At one end, a 40-way connector **2** with either of the following:
  - One sheath containing 20 wires with a cross-section of 0.34 mm<sup>2</sup> (AWG 22) (**BMXFCW●●1**)
  - Two sheaths **3**, each containing 20 wires with a cross-section of 0.34 mm<sup>2</sup> (AWG 22) (**BMXFCW●●3**)
- At the other end, color-coded flying leads **4** conforming to standard DIN47100.

#### Preassembled cordsets with 40-way connector and HE 10 connector(s)

**C:** Two types of cordset can be used for connecting the I/O of modules **1** with 40-way connectors to Modicon Telefast ABE7 rapid wiring connection and adaptation interfaces, (see page 6/8).

These preassembled cordsets comprise:

- At one end, a 40-way connector **2** with either of the following:
  - One sheath containing 20 wires (**BMXFCC●●1**)
  - Two sheaths **3** each containing 20 wires (**BMXFCC●●3**)
- At the other end, one or two HE 10 connectors **5**.

### Connection to TeSys Quickfit system

**D:** **1** **BMXDDI3202K/6402K** input modules, **BMXDDO3202K/6402K** output modules and **BMXDDM3202K** mixed I/O modules with 40-way connectors are designed, amongst other things, for use in conjunction with the TeSys Quickfit mounting system via the **LU9G02 splitter module 6** (for 8 motor starters).

The splitter modules are easily connected using **7** **BMXFCC●●1/●●3** preassembled cordsets.

### Functions (1)

The discrete I/O modules provide the following functions:

- **Hot swapping:** Due to their special integrated devices, I/O modules (including application-specific modules) can be removed or added while the power is on.
- **I/O assignment:** The channels of discrete I/O modules are grouped into blocks of 4, 8 or 16 consecutive channels depending on the type of module. Each group of channels can be assigned to a specific application task, namely master or fast.
- **Protection of DC inputs:** The 24 V  $\overline{DC}$  and 48 V  $\overline{DC}$  inputs are constant-current type. This characteristic limits the current consumed at the inputs.
- **Protection of DC outputs:** Active transistor outputs can withstand overloads, short-circuits, reverse polarity and inductive over-voltage.
- **Reactivation of DC outputs:** If a line fault has caused an output to trip, the output can be reactivated using this parameter if no other terminal line fault is present. Reactivation is controlled by means of a group of 8 channels. It can be programmed or automatic.
- **RUN/STOP command:** An input can be configured to control the RUN/STOP changeover for the PLC.
- **Output fallback:** This parameter defines the fallback mode used by the DC transistor outputs when the PLC stops. It can assume the “fallback” value at state 0 or state 1 for the corresponding group of 8 channels or the “maintain” value representing the state of the outputs before the PLC stops.
- **I/O module diagnostics:** Each discrete I/O module is equipped with a display block on the front panel centralizing the information necessary for module control, diagnostics and maintenance.

#### Diagnostics via Unity Pro:

Using the integrated diagnostics in Unity Pro, local diagnostics on the module front panel is complemented by system diagnostics based on predefined screens at global hardware configuration level, module level and channel level.

#### Remote diagnostics using a web browser on a “Thin Client” PC:

In addition, the diagnostics described above can be performed remotely using a simple web browser thanks to the standard web server integrated in the Modicon X80 I/O platform (processor with integrated Ethernet port or Ethernet module), using the “ready-to-use” Rack Viewer function.

- **Compatibility with 2-wire and 3-wire sensors:** The discrete input modules can be used in conjunction with OsiSense XS inductive proximity sensors (for compatibility, see page 7/4) and with OsiSense XU photo-electric sensors (for compatibility, see page 7/2).

Run		Err		I/O		+32	
0	1	2	3	4	5	6	7
8	9	10	11	12	13	14	15
16	17	18	19	20	21	22	23
24	25	26	27	28	29	30	31

Display block for module BMXDDO6402K

(1) For further information, please consult our website at [www.schneider-electric.com](http://www.schneider-electric.com).

### Complementary characteristics

The following characteristics complement those introduced in the selection guide on pages 3/2 to 3/7.

#### DC input modules BMXDDI16●●/1604T/3202K/6402K and BMXDAI1602

- Input impedance at nominal voltage: 6.4 to 19.2 k $\Omega$ , depending on model
- Reverse polarity: Protection for modules BMXDDI1602/1603/3202K
- Paralleling of inputs (1): Yes, for modules BMXDDI1602/1603
- Dielectric strength between groups of channels: 500 V  $\overline{\text{---}}$  for modules BMXDDI3202K/6402K
- Temperature derating for module BMXDDI1604T: No derating up to 40°C/104°F, a maximum of 25% of inputs at state 1 at 70°C/158°F

#### AC input modules BMXDAI16●●/08●●

- Input frequency: 47 to 63 Hz
- Current peak on activation at nominal voltage: 5 to 240 mA depending on model
- Input impedance at nominal voltage and F = 55 Hz: 6 to 21 k $\Omega$ , depending on model

#### Triac output modules BMXDAO1605

- Current via common: 2.4 A
- Current for the 4 commons together: 4.8 A

#### DC transistor output modules BMXDDO16●●/3202K/6402K

- Dielectric strength between groups of channels: 500 V  $\overline{\text{---}}$  for modules BMXDDO3202K/6402K

#### Relay output modules BMXDRA080●●/1605

- Protection against AC inductive overvoltage: Use an RC circuit or ZNO surge limiter appropriate to the voltage in parallel on each output.
- Protection against DC inductive overvoltage: Use a discharge diode on each output.

#### Mixed I/O relay module BMXDDM16025

- Input impedance at nominal voltage: 6.8 k $\Omega$
- Dielectric strength between groups of inputs: 500 V  $\overline{\text{---}}$

#### DC mixed I/O modules BMXDDM16022/3202K

- Input impedance at nominal voltage: 6.8 to 9.6 k $\Omega$ , depending on model
- Reverse polarity on the inputs: Protection
- Paralleling of outputs: Yes, for a maximum of 2 outputs for module BMXDDM16022 and a maximum of 3 outputs for module BMXDDM3202K

(1) This characteristic allows several inputs to be wired in parallel on the same module or on different modules for input redundancy.





# Modicon X80 I/O platform

## Discrete I/O modules

### Input modules and output modules



BMXDDI160●●  
BMXDAI●●●●



BMXDDI3202K



BMXDDI6402K

### References

#### Discrete input modules (1)

Type of current	Input voltage	Connection via (2)	IEC/EN 61131-2 conformity	No. of channels (common)	Reference	Weight kg/lb	
⎓	24 V (positive logic)	Screw or spring-type 20-way removable terminal block	Type 3	16 isolated inputs (1 x 16)	BMXDDI1602	0.115/0.254	
		One 40-way connector	Type 3	32 isolated inputs (2 x 16)	BMXDDI3202K	0.110/0.243	
		Two 40-way connectors	Non-IEC	64 isolated inputs (4 x 16)	BMXDDI6402K	0.145/0.320	
⎓	24 V (negative logic)	Screw or spring-type 20-way removable terminal block	Non-IEC	16 isolated inputs (1 x 16)	BMXDAI1602	0.115/0.254	
		48 V (positive logic)	Screw or spring-type 20-way removable terminal block	Type 1	16 isolated inputs (1 x 16)	BMXDDI1603	0.115/0.254
			Screw or spring-type 20-way removable terminal block	Type 3	16 isolated inputs (1 x 16)	BMXDDI1604T	0.144/0.317
~	24 V	Screw or spring-type 20-way removable terminal block	Type 1	16 isolated inputs (1 x 16)	BMXDAI1602	0.115/0.254	
		Screw or spring-type 20-way removable terminal block	Type 3	16 isolated inputs (1 x 16)	BMXDAI1603	0.115/0.254	
	100...120 V	Screw or spring-type 20-way removable terminal block	Type 3	16 isolated inputs (1 x 16)	BMXDAI1604	0.115/0.254	
		Screw or spring-type 20-way removable terminal block	Type 2	8 isolated inputs (1 x 8)	BMXDAI0805	0.152/0.335	
	100...120 V	Screw or spring-type 20-way removable terminal block	Type 3	8 isolated inputs (8 x 1)	BMXDAI0814	0.115/0.254	



BMXDDO16●2



BMXDRA0805/1605



BMXDDO3202K



BMXDDO6402K

#### Discrete output modules (1)

Type of current	Output voltage	Connection via (2)	IEC/EN 61131-2 conformity	No. of channels (common)	Reference	Weight kg/lb
⎓ transistor	24 V/0.5 A (positive logic)	20-way removable terminal block, screw or spring-type	Yes	16 protected outputs (1 x 16)	BMXDDO1602	0.120/0.265
		20-way removable terminal block, screw or spring-type	–	16 protected outputs (1 x 16)	BMXDDO1612	0.120/0.265
	24 V/0.1 A (positive logic)	One 40-way connector	Yes	32 protected outputs (2 x 16)	BMXDDO3202K	0.110/0.243
Two 40-way connectors		Yes	64 protected outputs (4 x 16)	BMXDDO6402K	0.150/0.331	
~ triac	100...240	20-way removable terminal block, screw or spring-type	–	16 outputs (4 x 4)	BMXDAO1605	0.140/0.309
⎓ relay	100...150 V ⎓/0.3 A	20-way removable terminal block, screw or spring-type	Yes	8 non-protected outputs	BMXDRA0804T	0.178/0.392
⎓ or ~ relay	24 V ⎓/2 A 24...240 V ~/2 A	20-way removable terminal block, screw or spring-type	Yes	8 non-protected outputs (without common)	BMXDRA0805	0.145/0.320
		20-way removable terminal block, screw or spring-type	Yes	16 non-protected outputs (2 x 8)	BMXDRA1605	0.150/0.331

(1) Typical consumption: See the power consumption table available on our website [www.schneider-electric.com](http://www.schneider-electric.com).  
 (2) 64-channel modules have 2 connectors and therefore require 2 connection cables.



BMXDDM1602 • BMXDDM3202K

### References (continued)

#### Discrete mixed I/O modules (1)

Number of connection I/O		No. of input channels (common)	No. of output channels (common)	IEC/EN 61131-2 conformity	Reference	Weight kg/lb
16	Screw or spring-type 20-way removable terminal block	8 (positive logic) (1 x 8)	8, transistor 24 V $\overline{\text{---}}$ /0.5 A (1 x 8)	Inputs, type 3	<b>BMXDDM16022</b>	0.115/ 0.254
			8, relay 24 V $\overline{\text{---}}$ or 24...240 V $\sim$ (1 x 8)	Inputs, type 3	<b>BMXDDM16025</b>	0.135/ 0.298
32	One 40-way connector	16 (positive logic) (1 x 16)	16, transistor 24 V $\overline{\text{---}}$ /0.1 A (1 x 16)	Inputs, type 3	<b>BMXDDM3202K</b>	0.110/ 0.243



BMXFTB2000

#### Removable terminal blocks

Description	For use with	Type	Reference	Weight kg/lb
20-way removable terminal blocks	For module with 20-way removable terminal block	Cage clamp	<b>BMXFTB2000</b>	0.093/ 0.205
		Screw clamp	<b>BMXFTB2010</b>	0.075/ 0.165
		Spring	<b>BMXFTB2020</b>	0.060/ 0.132



BMXFTW01

#### Preassembled cordsets for 16-channel I/O modules with removable terminal block

Description	Composition	Cross-section	Length m/ft	Reference	Weight kg/lb
Preassembled cordsets with one end with flying leads for 16-channel I/O modules Operating voltage $\leq$ 48 V	One 20-way spring-type removable terminal block (BMXFTB2020) and one end with color-coded flying leads	0.324 mm <sup>2</sup> / AWG 22	3/9.84	<b>BMXFTW301</b>	0.850/ 1.874
			5/16.40	<b>BMXFTW501</b>	1.400/ 3.086
			10/32.81	<b>BMXFTW1001</b>	2.780/ 6.129



BMXFCW01



BMXFCW03



BMXFCC01

#### Preassembled cordsets for 16, 32 and 64-channel I/O modules with 40-way connectors

Description	No. of sheaths	Composition	Cross-section	Length m/ft	Reference	Weight kg/lb
Preassembled cordsets with one end with flying leads	1 x 20 wires (16 channels)	One 40-way connector and one end with color-coded flying leads	0.324 mm <sup>2</sup> / AWG 22	3/9.84	<b>BMXFCW301</b>	0.820/ 1.808
				5/16.40	<b>BMXFCW501</b>	1.370/ 3.020
				10/32.81	<b>BMXFCW1001</b>	2.770/ 6.107
	2 x 20 wires (32 channels) (2)	One 40-way connector and two ends with color-coded flying leads	0.324 mm <sup>2</sup> / AWG 22	3/9.84	<b>BMXFCW303</b>	0.900/ 1.984
				5/16.40	<b>BMXFCW503</b>	1.490/ 3.285
				10/32.81	<b>BMXFCW1003</b>	2.960/ 6.526
Preassembled cordsets for Modicon Telefast ABE7 sub-bases	1 x 20 wires (16 channels)	One 40-way connector and one HE 10 connector	0.324 mm <sup>2</sup> / AWG 22	0.5/1.64	<b>BMXFCC051</b>	0.140/ 0.309
				1/3.28	<b>BMXFCC101</b>	0.195/ 0.430
				2/6.56	<b>BMXFCC201</b>	0.560/ 1.235
				3/9.84	<b>BMXFCC301</b>	0.840/ 1.852
				5/16.40	<b>BMXFCC501</b>	1.390/ 3.064
				10/32.81	<b>BMXFCC1001</b>	2.780/ 6.123
				0.5/1.64	<b>BMXFCC053</b>	0.210/ 0.463
				1/3.28	<b>BMXFCC103</b>	0.350/ 0.772
				2/6.56	<b>BMXFCC203</b>	0.630/ 1.389
				3/9.84	<b>BMXFCC303</b>	0.940/ 2.072
				5/16.40	<b>BMXFCC503</b>	1.530/ 3.373
				10/32.81	<b>BMXFCC1003</b>	3.000/ 6.614

(1) Typical consumption: See the power consumption table available on our website [www.schneider-electric.com](http://www.schneider-electric.com).

(2) 64-channel modules have 2 connectors and therefore require 2 connection cables.

# Modicon X80 I/O platform

## Analog I/O modules Input modules

### Applications

### Analog inputs



#### Type of input

Isolated low-level inputs, voltage, thermocouples, temperature probes, resistors

#### Type

Multirange

#### Range

Voltage

± 40 mV, ± 80 mV, ± 160 mV, ± 320 mV, ± 640 mV, ± 1.28 V

Current

–

Thermocouple  
Temperature probe  
Resistor

Thermocouples, type B, E, J, K, L, N, R, S, T, U  
2, 3 or 4-wire temperature probes, type Pt100, JPt100, Pt1000, JPt1000, Ni100, Ni1000  
(in accordance with DIN43760) and Cu 10  
2, 3 or 4-wire resistors, 400 Ω or 4000 Ω

#### Modularity

4 inputs                      8 inputs

#### Acquisition period

400 ms for the 4 inputs                      400 ms for the 8 inputs

#### Conversion time

–

#### Resolution

15 bits + sign

#### Isolation

Between channels

750 V  $\overline{\text{---}}$

Between channels and bus

1400 V  $\overline{\text{---}}$

Between channels and ground

750 V  $\overline{\text{---}}$

#### Connection

Directly to the module

Via 40-way connector                      Via two 40-way connectors

Via preassembled cordsets

Cordsets with one end with color-coded flying leads  
BMXFCW●01S (3 or 5 m/9.84 or 16.40 ft long)

#### Compatibility with Modicon Telefast ABE7 pre-wired system

Connection sub-base

4-channel sub-base for direct connection of 4 thermocouples plus connection and provision of cold junction compensation (see page 6/8)

Type of connection sub-base

ABE7CPA412

Type of preassembled cordsets

BMXFCA●●2  
(1.5, 3 or 5 m/4.92, 9.84 or 16.40 ft long)

#### References

**BMXART0414**                      **BMXART0814**

#### Pages

3/22

### Analog inputs



Isolated high-level inputs	Non-isolated high-level inputs	Isolated high-level inputs
----------------------------	--------------------------------	----------------------------

Voltage/current

± 10 V, 0...10 V, 0...5 V, 1..5 V, ± 5 V

0...20 mA, 4...20 mA, ± 20 mA

–

4 inputs                      8 inputs

Fast: 1 + (1 x no. of declared channels) ms  
Default: 5 ms for the 4 channels

Fast: 1 + (1 x no. of declared channels) ms  
Default: 9 ms for the 8 channels

–

16 bits                      15 bits + sign

300 V  $\overline{\text{---}}$                       –                      300 V  $\overline{\text{---}}$

1400 V  $\overline{\text{---}}$

1400 V  $\overline{\text{---}}$

Via 20-way removable terminal block (screw or spring-type) BMXFTB20●0                      Via 28-way removable terminal block (cage clamp-type) BMXFTB2800 or (spring-type) BMXFTB2820

Cordsets with one end with color-coded flying leads  
BMXFTW●01S (3 or 5 m/9.84 or 16.40 ft long)

Cordsets with one end with color-coded flying leads  
BMXFTW●08S (3 or 5 m/9.84 or 16.40 ft long)

4-channel sub-base for direct connection of 4 inputs, delivers and distributes 4 protected isolated power supplies (see page 6/8)

8-channel sub-base for direct connection of 8 current/voltage inputs (see page 6/8)

ABE7CPA410                      ABE7CPA02/03/31/31E                      ABE7CPA02/31/31E

BMXFCA●●0 (1.5, 3 or 5 m/4.92, 9.84 or 16.40 ft long)                      BMXFTA●●0 (1.5 or 3 m/4.92, 9.84 or 16.40 ft long)

**BMXAMI0410**                      **BMXAMI0800**                      **BMXAMI0810**

3/22

# Modicon X80 I/O platform

Analog I/O modules  
Output modules and mixed I/O modules

## Applications

## Analog outputs



<b>Type of I/O</b>	
<b>Type</b>	
<b>Range</b>	Voltage
	Current
<b>Modularity</b>	
<b>Acquisition period (inputs)</b>	
<b>Conversion time (outputs)</b>	
<b>Resolution</b>	Inputs
	Outputs
<b>Isolation</b>	
<b>Connection</b>	Directly to the module
	Via preassembled cordsets
<b>Compatibility with Modicon Telefast ABE7 pre-wired system</b>	Connection sub-base
	Type of connection sub-base
	Type of preassembled cordsets

Isolated high-level outputs	Isolated high-level outputs	Non-isolated high-level outputs
Voltage/current		Current
± 10 V		–
0–20 mA, 4–20 mA		
2 outputs	4 outputs	8 outputs
–		
≤ 1 ms		≤ 4 ms
–		–
15 bits + sign		–
Between channels: 750 V ∴		–
Between channels and bus: 1400 V ∴		
Between channels and ground: 1400 V ∴		
Via 20-way removable terminal block (screw or spring-type) BMXFTB20●0		
Cordsets with one end with color-coded flying leads BMXFTW●01S (3 or 5 m/9.84 or 16.40 ft long)		
4-channel sub-base for direct connection of 2/4 current/voltage outputs (see page 6/8)		8-channel sub-base for direct connection of 8 current/voltage inputs (see page 6/8)
ABE7CPA21		ABE7CPA02
BMXFCA●●0 (1.5, 3 or 5 m/4.92, 9.84 or 16.40 ft long)		BMXFTA●●2 (1.5 or 3 m/4.92, 9.84 or 16.40 ft long)

## References

<b>BMXAMO0210</b>	<b>BMXAMO0410</b>	<b>BMXAMO0802</b>
-------------------	-------------------	-------------------

## Pages

3/22

## Mixed analog I/O



<b>Type of I/O</b>	
<b>Type</b>	
Voltage/current	
Inputs: ± 10 V, 0...10 V, 0...5 V, 1..5 V Outputs: ± 10 V	
Inputs: 0–20 mA, 4–20 mA Outputs: 0–20 mA, 4–20 mA	
4 inputs and 2 outputs	
Fast: 1 + (1 x no. of declared channels) ms Default: 5 ms for the 4 channels	
≤ 1 ms	
14...12-bit in U range 12-bit in I range	
12-bit in U range 11-bit in I range	
Between groups of input or output channels: 750 V ∴	
Between channels and bus: 1400 V ∴	
Between channels and ground: 1400 V ∴	
Via 20-way removable terminal block (screw or spring-type) BMXFTB20●0	
BMXFTW●01S cordsets with one end with color-coded flying leads (3 or 5 m/9.84 or 16.40 ft long)	
–	
–	
–	

## References

**BMXAMM0600**  
3/22

### Presentation

The Modicon X80 I/O analog I/O module offer comprises:

- 5 analog input modules:
  - 2 modules with 4 and 8 isolated channels, low-level voltage, thermocouples, Pt, JPt, Ni, or Cu temperature probes and resistors, 15 bits + sign **BMXART0414/0814**
  - 1 module with 4 high-speed isolated analog channels, high-level voltage or current, 16 bits **BMXAMI0410**
  - 2 modules with 8 high-speed non-isolated analog channels, high-level voltage or current, 15 bits + sign **BMXAMI0800/0810**
- 3 analog output modules:
  - 1 module with 2 isolated analog channels, high-level voltage or current, 15 bits + sign **BMXAMO0210**
  - 1 module with 4 isolated analog channels, high-level voltage or current, 15 bits + sign **BMXAMO0410**
  - 1 module with 8 non-isolated analog channels, high-level current, 15 bits + sign **BMXAMO0802**
- 1 mixed analog I/O module with 4 input channels and 2 output channels (non-isolated), voltage or current, 12 to 14 bits according to type of channel and range **BMXAMM0600**

Analog I/O modules are equipped with a connector for a 20 or 28-way removable terminal block, except for **BMXART0414/0814** analog input modules for thermocouples/temperature probes, which are equipped with one or two 40-way connector(s).

All analog modules occupy a single slot in **BMEXBP●●●** or **BMXXBP●●●** racks. These modules can be installed in any slot in the rack, except the first two (PS and 00), which are reserved for the power supply module and the processor module respectively.

The power supply for the analog functions is supplied by the backplane bus (3.3 V and 24 V). Analog I/O modules are hot-swappable (see page 3/10).

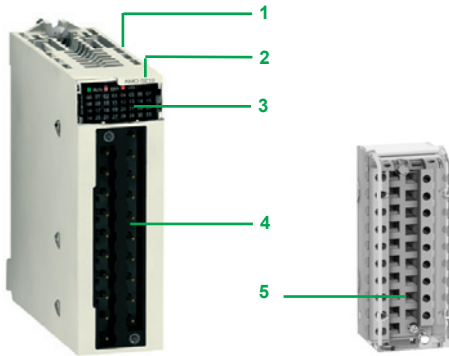

Module for connection via 20 or 28-way removable terminal block

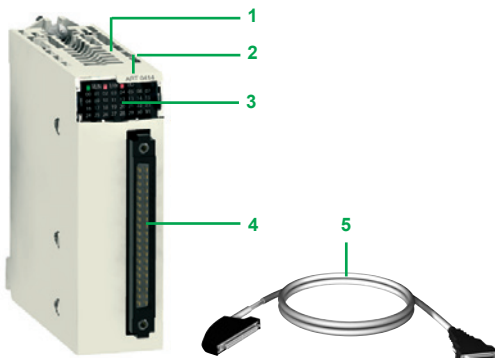

Module for connection for 40-way connector

### Description

**BMXAM●/ART** analog I/O modules are standard format (1 slot). They have a case, which provides IP 20 protection of the electronics, and are locked into position by a captive screw.

#### I/O modules connected via 20 or 28-way removable terminal block

**BMXAM●** analog I/O modules feature the following:

- 1 A rigid body providing support and protection for the electronic card
- 2 A module reference marking (a label is also visible on the right-hand side of the module)
- 3 A module and channel status display block
- 4 A connector taking the 20 or 28-way removable screw or spring-type terminal block for directly connecting the sensors or preactuators to the module

**To be ordered separately:**

- 5 A **BMXFTB20●0** or **BMXFTB28●0** 20 or 28-way removable terminal block (referencing label supplied with each I/O module) or pre-wired cables with:
  - A 20-way terminal block at one end and flying leads at the other (**BMXFTW●01S**)
  - A 28-way terminal block at one end and flying leads at the other (**BMXFTW●08S**)
  - A 20 or 28-way terminal block and a 25-way SUB-D connector (**BMXFCA●●0** or **BMXFCA●●2**), for connection to Modicon Telefast ABE7 sub-bases (see page 3/23).

#### I/O modules connected via 40-way connector

**BMXART** analog input modules have the following on the front panel:

- 1 A rigid body providing support and protection for the electronic card
- 2 A module reference marking (a label is also visible on the right-hand side of the module)
- 3 A module and channel status display block
- 4 One (or two) 40-way connector(s) for connecting the sensors

**To be ordered separately:**

- 5 Pre-wired cables with:
  - A 40-way connector at one end and flying leads at the other (**BMXFCW●01S**)
  - A 40-way connector and a 25-way SUB-D connector (**BMXFCA●●2**) for direct connection to the Modicon Telefast ABE7 sub-bases (see page 3/23)

**Must be ordered separately:**

- A shielding connection kit to help protect against electrostatic discharge, consisting of a metal bar and two sub-bases for mounting on the rack supporting the analog modules
- A set of **STBXSP3020** clamping rings for the shielding braids of analog signal cables



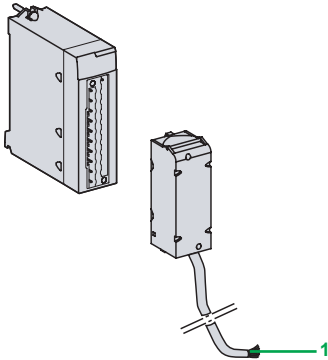

**BMXFTW●01S cordset**  
(with 20-way removable terminal block at one end and flying leads at the other)

3

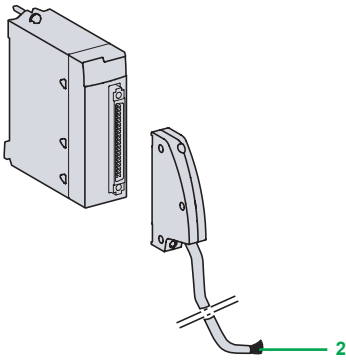

**BMXFCW●01S cordset**  
(with 40-way connector at one end and flying leads at the other)

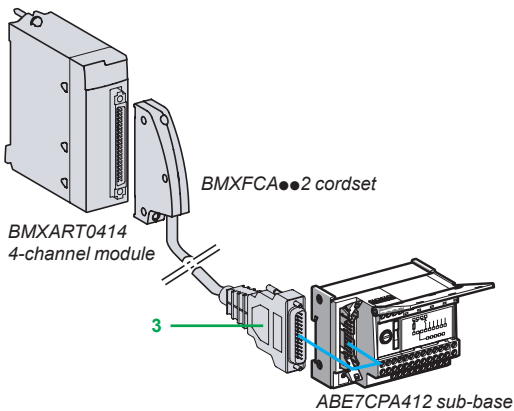

**BMXART0414**  
4-channel module

**BMXFCW●01S cordset**

**ABE7CPA412 sub-base**

### Connecting modules with removable terminal blocks

#### BMXAMI0410, BMXAMO, and BMXAMM modules with 20-way terminal block

The 20-way removable terminal blocks (**BMXFTB20●0**) are the same as those used for discrete I/O modules (screw clamp, cage clamp, or spring-type) (see page 3/9). One version of the removable terminal block is equipped with a 3 or 5 m/9.84 or 16.40 ft cordset with color-coded flying leads (**BMXFTW●01S**). These preassembled cordsets with reinforced shielding have color-coded flying leads at the other end **1**.

#### BMXAMI0800/0810 modules with 28-way terminal block

The 28-way removable terminal blocks are cage clamp-type (**BMXFTB2800**) or spring-type (**BMXFTB2820**). One version of the removable terminal block is equipped with a 3 or 5 m/9.84 or 16.40 ft cordset with color-coded flying leads (**BMXFTW●08S**). These preassembled cordsets with reinforced shielding have color-coded flying leads at the other end **1**.

### Connecting modules with 40-way connectors

#### BMXART0●14 modules with 40-way connectors

Two types of cordset are available:

- Preassembled cordsets with reinforced shielding (**BMXFCW●01S**) which have color-coded flying leads at the other end **2**. Available in 3 or 5 m/9.84 or 16.40 ft lengths, they enable easy direct wire-to-wire connection of the analog sensors via terminal blocks.
- Preassembled cordsets with reinforced shielding (**BMXFCA●02**) which have a 25-way SUB-D connector at the other end **3**. Available in 1.5, 3, or 5 m/4.92, 9.84, or 16.40 ft lengths, they enable direct connection to the Modicon Telefast **ABE7CPA412** sub-base (see below).

### Use with Modicon Telefast ABE7 sub-bases

Using the Modicon Telefast ABE7 pre-wired system makes it easier to install the modules since the inputs (or outputs) can be accessed via screw terminals. 7 special sub-bases are available:

#### Modicon Telefast ABE7CPA410 sub-base

The Modicon Telefast **ABE7CPA410** sub-base is mainly used in conjunction with the **BMXAMI0410** voltage/current analog 4-input module. This sub-base allows you to:

- Directly connect 4 sensors
- Remotely locate the input terminals in voltage mode
- Power the 4 to 20 mA conditioning units one channel at a time with a 24 V voltage, protected and limited to 25 mA, while maintaining isolation between channels
- Help protect the current impedance matching resistors integrated in the sub-base against overvoltages

Connection is via the **BMXFCW●01S** cordset (1.5, 3, or 5 m/4.92, 9.84, or 16.40 ft long).

#### Modicon Telefast ABE7CPA412 sub-base

The Modicon Telefast **ABE7CPA412** sub-base is specially designed as a wiring interface for the **BMXART0414** and **BMXART0814** thermocouple modules. This sub-base allows you to:

- Connect 4 thermocouple probes
- Provide external cold junction compensation with a temperature probe integrated in the sub-base
- Provide continuity of the shielding

The **BMXART0814** module requires two Modicon Telefast **ABE7CPA412** sub-bases. The connection with each sub-base is made via a **BMXFCW●01S** cordset (1.5, 3, or 5 m/4.92, 9.84, or 16.40 ft long).

#### Modicon Telefast ABE7CPA21 sub-base

The Modicon Telefast **ABE7CPA21** sub-base is compatible with the **BMXAMO0210** output module. This sub-base allows you to:

- Directly connect 2 current/voltage outputs
- Provide continuity of the shielding

Connection is via the **BMXFCW●01S** cordset **3** (1.5, 3, or 5 m/4.92, 9.84, or 16.40 ft long).

### Use with Modicon Telefast ABE7 sub-bases (continued)

#### Modicon Telefast ABE7CPA02 sub-base

The Modicon Telefast **ABE7CPA02** sub-base can be used in combination with:

- The **BMXAMI0800/0810** analog current input modules with 8 inputs
- The **BMXAMO0802** analog current output modules with 8 outputs

This sub-base allows you to:

- Connect the 8 analog inputs or outputs point-to-point
- Provide continuity of the shielding

The **BMXAMI0800/0810** modules are connected by means of the 1.5 or 3 m/4.92 or 9.84 ft long **BMXFTA●●0** cables.

The **BMXAMO0802** module is connected by means of the 1.5, 3, or 5 m/4.92, 9.84, or 16.40 ft long **BMXFTA●●2** cables.

#### Modicon Telefast ABE7CPA03 sub-base

The Modicon Telefast **ABE7CPA03** sub-base can be used in combination with the **BMXAMI0800** voltage/current analog 8-input module.

This sub-base allows you to:

- Directly connect 8 analog inputs
- Power the current inputs one channel at a time with a voltage of 24 V that is protected and limited to 25 mA
- Provide continuity of the shielding

The **BMXAMI0800** module is connected by means of the 1.5 or 3 m/4.92 or 9.84 ft long **BMXFTA●●0** cables.

#### Modicon Telefast ABE7CPA31/31E sub-bases

The Modicon Telefast **ABE7CPA31/31E** sub-bases can be used in combination with the **BMXAMI0800/0810** voltage/current analog 8-input modules.

These sub-bases allow you to:

- Directly connect 8 analog inputs
- Power the current inputs one channel at a time with 24 V converters
- Provide continuity of the shielding

The **BMXAMI0800/0810** modules are connected by means of the 1.5 or 3 m/4.92 or 9.84 ft long **BMXFTA●●0** cables.

### Complementary characteristics

#### BMXART0414/0814 analog input modules

The **BMXART0414/0814** modules are multirange input modules with 4 or 8 low-level isolated inputs (15 bits + sign) respectively.

Depending on the choice made during configuration, the modules offer, for each of the inputs, the following ranges:

- Temperature probe: Pt100, JPt100, Pt1000, JPt1000, Cu10, Ni100, or Ni1000 (in accordance with DIN43760), with open-circuit detection
- Thermocouple: B, E, J, K, L, N, R, S, T, or U with broken wire detection
- Resistor: 0...400 or 0...4000  $\Omega$ , 2, 3, or 4-wire
- Voltage:  $\pm 40$  mV,  $\pm 80$  mV,  $\pm 160$  mV,  $\pm 320$  mV,  $\pm 640$  mV,  $\pm 1.28$  V

#### BMXAMI0410 analog input modules

The **BMXAMI0410** module is a high-level analog input module with 4 isolated inputs (16 bits).

Used with sensors or transmitters, it performs monitoring, measurement, and process control functions for continuous processes.

The module offers the following ranges for each of the inputs depending on the choice made during configuration:

- Voltage  $\pm 10$  V,  $\pm 5$  V, 0...10 V, 0...5 V, and 1...5 V
- Current 0–20 mA, 4–20 mA, and  $\pm 20$  mA

#### BMXAMI0800/0810 analog input modules

**BMXAMI0800/0810** analog input modules are modules with 8 high-level isolated/non-isolated analog inputs (15 bits + sign).

The modules offer the following ranges for each of the inputs depending on the choice made during configuration:

- Voltage:  $\pm 10$  V, 0...10 V, 0...5 V, 1...5 V,  $\pm 5$  V
- Current: 0–20 mA and 4–20 mA



### Complementary characteristics (continued)

#### BMXAMO0210 analog output module

The **BMXAMO0210** module is a module with 2 high-level isolated outputs (15 bits + sign).  
The **BMXAMO0210** module offers the following ranges for each of the inputs depending on the choice made during configuration:

- Voltage:  $\pm 10$  V
- Current: 0–20 mA and 4–20 mA

#### BMXAMO0410/0802 analog output modules

The **BMXAMO0410/0802** analog output modules are modules with 4 or 8 high-level isolated/non-isolated analog outputs (16 bits/15 bits + sign).

The **BMXAMO0410** module offers the following ranges for each of the outputs depending on the choice made during configuration:

- Voltage:  $\pm 10$  V
- Current: 0–20 mA and 4–20 mA

The **BMXAMO0802** module offers the current ranges 0–20 mA and 4–20 mA.

#### BMXAMM0600 analog mixed I/O module

The **BMXAMM0600** mixed module is a non-isolated I/O module with 4 inputs (14/12 bits) and 2 outputs (12 bits).  
The module offers the following ranges for each of the inputs or outputs depending on the choice made during configuration:

- Voltage:  $\pm 10$  V, 0...10 V, 0...5 V, and 1...5 V
- Current: 0–20 mA and 4–20 mA

### References

#### Analog input modules (1)

Type of input	Input signal range	Resolution	Connection	No. of channels	Reference	Weight kg/lb
Isolated high-level inputs	$\pm 10$ V, 0...10 V, 0...5 V, 1...5 V, $\pm 5$ V, 0–20 mA, 4–20 mA, $\pm 20$ mA	16 bits	Removable terminal block, 20-way cage clamp, screw clamp, or spring-type	4 channels	<b>BMXAMI0410</b>	0.143/ 0.315
Non-isolated high-level inputs	$\pm 10$ V, 0...10 V, 0...5 V, 1...5 V, $\pm 5$ V, 0–20 mA	15 bits + sign	Removable terminal block, 28-way, cage clamp or spring-type	8 channels	<b>BMXAMI0800</b>	0.175/ 0.386
Isolated high-level inputs	$\pm 10$ V, 0...10 V, 0...5 V, 1...5 V, $\pm 5$ V, 0–20 mA	15 bits + sign	Removable terminal block, 28 way, cage clamp or spring-type	8 channels	<b>BMXAMI0810</b>	0.175/ 0.386
Isolated low-level inputs	Temperature probe, thermocouple, $\pm 40$ mV, $\pm 80$ mV, $\pm 160$ mV, $\pm 320$ mV, $\pm 640$ mV, $\pm 1.28$ V	15 bits + sign	40-way connector	4 channels	<b>BMXART0414</b>	0.135/ 0.298
				8 channels	<b>BMXART0814</b>	0.165/ 0.364



BMXAMO0210



BMXART0414

#### Analog output modules (1)

Type of outputs	Output signal range	Resolution	Connection	No. of channels	Reference	Weight kg/lb
Isolated high-level outputs	$\pm 10$ V, 0–20 mA, 4–20 mA	16 bits	Removable terminal block, 20-way, cage clamp, screw clamp, or spring-type	2 channels	<b>BMXAMO0210</b>	0.144/ 0.317
High-level outputs isolated	$\pm 10$ V, 0–20 mA, 4–20 mA, $\pm 20$ mA	15 bits + sign	Removable terminal block, 20-way, cage clamp, screw clamp, or spring-type	4 channels	<b>BMXAMO0410</b>	0.175/ 0.386
Non-isolated high-level inputs	0–20 mA, 4–20 mA	15 bits + sign	Removable terminal block, 20-way, cage clamp, screw clamp, or spring-type	8 channels	<b>BMXAMO0802</b>	0.175/ 0.386

#### Analog mixed I/O module (1)

Type of I/O	Signal range	Resolution	Connection	No. of channels	Reference	Weight kg/lb
Mixed I/O, non-isolated	$\pm 10$ V, 0...10 V, 0...5 V, 1...5 V, 0–20 mA, 4–20 mA	14 bits or 12 bits depending on the range	Removable terminal block, 20-way, cage clamp, screw clamp, or spring-type	Inputs: 4 channels Outputs: 2 channels	<b>BMXAMM0600</b>	0.155/ 0.342

(1) Typical consumption: See the power consumption table available on our website [www.schneider-electric.com](http://www.schneider-electric.com).

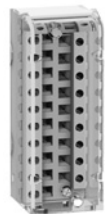

BMXFTB2000



BMXFTW01S



ABE7CPA41/21



BMXFCA000



BMXFCA002

## References (continued)

## Connection accessories for analog modules (1)

Description	For use with modules	Type, composition	Length	Reference	Weight kg/lb
20-way removable terminal blocks	BMXAMI0410 BMXAMO0210	Cage clamp	–	BMXFTB2000	0.093/ 0.205
	BMXAMO0410 BMXAMO0802 BMXAMM0600	Screw clamp	–	BMXFTB2010	0.075/ 0.165
		Spring	–	BMXFTB2020	0.060/ 0.132
28-way removable terminal block	BMXAMI0800 BMXAMI0810	Cage clamp	–	BMXFTB2800	0.111/ 0.245
		Spring	–	BMXFTB2820	0.080/ 0.176
Preassembled cordsets	BMXAMI0410 BMXAMO0210 BMXAMO0410 BMXAMO0802 BMXAMM0600	One 20-way terminal block (BMXFTB2020) and one end with color-coded flying leads	3 m/9.84 ft 5 m/16.40 ft	BMXFTW301S BMXFTW501S	0.470/ 1.036 0.700/ 1.543
	BMXAMI0800 BMXAMI0810	1 removable terminal block, 28-way, MX FTB 2820, and one end with color-coded flying leads	3 m/9.84 ft 5 m/16.40 ft	BMXFTW308S BMXFTW508S	0.435/ 0.959 0.750/ 1.653
	BMXART0414 BMXART0814	One 40-way connector and one end with color-coded flying leads	3 m/9.84 ft 5 m/16.40 ft	BMXFCW301S BMXFCW501S	0.480/ 1.058 0.710/ 1.565

## Modicon Telefast ABE7 pre-wired system

Description	For use with modules	Type, composition	Length or connection technology	Reference	Weight kg/lb
Modicon Telefast ABE7 sub-bases	BMXAMI0410	Distribution of isolated power supplies. Delivers 4 protected isolated power supplies for 4–20 mA inputs. Direct connection of 4 inputs	Screws	ABE7CPA410	0.180/ 0.397
	BMXART0414 BMXART0814 (2)	Connection and provision of cold-junction compensation for thermocouples Direct connection of 4 inputs	Screws	ABE7CPA412	0.180/ 0.397
	BMXAMO0210 BMXAMO0410	Direct connection of 2/4 outputs	Screws	ABE7CPA21	0.210/ 0.463
	BMXAMI0800 BMXAMI0810 BMXAMO0802	Point-to-point connection of 8 I/O	Screws	ABE7CPA02	0.317/ 0.699
	BMXAMI0800	Direct connection of 8 inputs. Delivers 8x 24 V $\pm$ power supplies limited to 25 mA to the 8 current inputs	Screws	ABE7CPA03	0.307/ 0.677
	BMXAMI0800 BMXAMI0810	Direct connection of 8 inputs Delivers 8x 24 V $\pm$ power supplies isolated and limited to 25 mA to the 8 current inputs	Screws Spring	ABE7CPA31 ABE7CPA31E	0.498/ 1.098 0.508/ 1.120
	Preassembled cordsets for Modicon Telefast ABE7 sub-bases	BMXAMI0410 BMXAMO0210 BMXAMO0410	One 20-way removable terminal block and one 25-way SUB-D connector for ABE7CPA410/CPA21 sub-base	1.5 m/4.92 ft 3 m/9.84 ft 5 m/16.40 ft	BMXFCA150 BMXFCA300 BMXFCA500
BMXART0414 BMXART0814 (2)		One 40-way connector and one 25-way SUB-D connector for ABE7CPA412 sub-base	1.5 m/4.92 ft 3 m/9.84 ft 5 m/16.40 ft	BMXFCA152 BMXFCA302 BMXFCA502	0.330/ 0.728 0.510/ 1.124 0.740/ 1.631
BMXAMI0800 BMXAMI0810		One 28-way removable terminal block and one 25-way SUB-D connector for sub-bases ABE7CPA02/03/31/31E	1.5 m/4.92 ft 3 m/9.84 ft	BMXFCA150 BMXFCA300	0.374/ 0.825 0.500/ 1.102
BMXAMO0802		One 20-way removable terminal block and one 25-way SUB-D connector for ABE7CPA02 sub-bases	1.5 m/4.92 ft 3 m/9.84 ft	BMXFCA152 BMXFCA302	0.374/ 0.825 0.500/ 1.102

(1) The shielding on the cordsets carrying the analog signals must always be connected to the BMXXSP000 shielding connection kit mounted under the rack holding the analog modules (see page 2/3).

(2) The BMXART0814 8-channel module requires two ABE7CPA412 sub-bases and two BMXFCA002 cordsets.

Applications

HART analog inputs



<b>Type of I/O</b>		Isolated analog inputs with HART
<b>Number of channels</b>		8
<b>Range</b>	Current	4-20 mA
<b>Maximum load impedance</b>		—
<b>Operating temperature</b>		0...60°C/32...140°F
<b>Compatible devices</b>		BMEP58●●●● processors, BMECRA31210 head module, BMEXBP●●00(H) Ethernet + X-bus backplanes
<b>Resolution</b>		15 bits + sign
<b>Isolation</b>	Between channels	1000 V ~ for 1 minute
	Between channels and bus	1400 V ~ for 1 minute
	Between channels and earth	1400 V ~ for 1 minute
<b>Connection</b>	Directly to the module	Via 20-way removable terminal blocks (screw or spring-type) BMXFTB20●0
<b>Compatibility with pre-wired ABE7</b>	Connection sub-base	8-channel sub-base for direct connection of 8 current/voltage inputs
	Type of connection sub-base	ABE7CPA02/03/31
	Type of preassembled cordsets	BMXFTA1522/3022 (1.5 or 3 m/4.92 or 9.84 ft long)
<b>Field device support</b>		2-wire/4-wire
<b>HART specification</b>	HART field device compliance	HART V5, V6, V7
	HART field device connection	Point to point
	HART I/O mapping	Yes

References

**BMEAHI0812**

Page

3/27

HART analog outputs



<b>Type of I/O</b>		Isolated analog outputs with HART
<b>Number of channels</b>		4
<b>Range</b>		4-20 mA
<b>Maximum load impedance</b>		600 Ω (0-20 mA)
<b>Operating temperature</b>		0...60°C/32...140°F
<b>Compatible devices</b>		BMEP58●●●● processors, BMECRA31210 head module, BMEXBP●●00(H) Ethernet + X-bus backplanes
<b>Resolution</b>		15 bits + sign
<b>Isolation</b>	Between channels	1000 V ~ for 1 minute
	Between channels and bus	1400 V ~ for 1 minute
	Between channels and earth	1400 V ~ for 1 minute
<b>Connection</b>	Directly to the module	Via 20-way removable terminal blocks (screw or spring-type) BMXFTB20●0
<b>Compatibility with pre-wired ABE7</b>	Connection sub-base	4-channel sub-base for direct connection of 2/4 current/voltage outputs
	Type of connection sub-base	ABE7CPA21
	Type of preassembled cordsets	BMXFCA150/300/500 (1.5, 3 or 5 m/4.92, 9.84 or 16.4 ft long)
<b>Field device support</b>		2-wire/4-wire
<b>HART specification</b>	HART field device compliance	HART V5, V6, V7
	HART field device connection	Point to point
	HART I/O mapping	Yes

**BMEAHO0412**

3/27

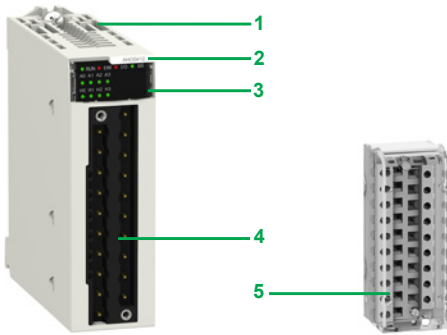

Module for connection via 20-way removable terminal block

3

### Presentation

**BMEAH●●12** HART analog I/O modules contain transceivers that master HART devices and information through the module. They can be managed by the AMS (Asset Management System) or by the automation platform CPU.

These modules require an Ethernet + X-bus backplane and can only be installed in the main local rack with the CPU or in RIO drops with a **BMECRA31210** performance EIO adapter module. They cannot be installed in expansion racks.

### Description

**BMEAH●●12** HART analog I/O modules are standard format (1 slot). They have a case, which provides IP 20 protection of the electronics, and are locked into position by a captive screw. They are connected via a 20-way removable terminal block.

**BMEAH●●12** HART analog I/O modules feature the following:

- 1 A rigid body providing support and protection for the electronic card
- 2 A module reference marking (a label is also visible on the right-hand side of the module)
- 3 A module and channel status display block
- 4 A connector taking the 20-way removable screw or spring-type terminal block for directly connecting the sensors or preactuators to the module

To be ordered separately:

- 5 A **BMXFTB20●0** 20-way removable terminal block (referencing label supplied with each I/O module) or pre-wired cables with:
  - A 20-way terminal block at one end and flying leads at the other (**BMXFTW●01S**)
  - A 20-way terminal block and a 25-way SUB-D connector (**BMXFCA●●0** or **BMXFTA●●22**), for connection to Modicon Telefast ABE 7 sub-bases

### Connecting modules using 20-way removable terminal blocks

The 20-way removable terminal blocks (**BMXFTB20●0**) are the same as those used for discrete I/O modules (screw clamp, cage clamp or spring-type) (see page 3/13).

One version of the removable terminal block is equipped with a 3 or 5 m/9.84 or 16.4 ft cordset with color-coded flying leads (**BMXFTW●01S**). These preassembled cordsets with reinforced shielding have color-coded flying leads at the other end.



**BMXFTW●01S**



**BMXFCA●●0**

### Use with Modicon Telefast ABE7 sub-bases

#### Modicon Telefast ABE7CPA21 sub-base

The Modicon Telefast **ABE7CPA21** sub-base is compatible with the **BMEAH00412** output module.

This sub-base allows you to:

- Directly connect two current/voltage outputs
- Ensure continuity of the shielding

Connection is via the **BMXFCA●●0** cordset (1.5, 3, or 5 m/4.92, 9.84, or 16.4 ft long).

#### Modicon Telefast ABE7CPA02 sub-base

The Modicon Telefast **ABE7CPA02** sub-base can be used with the **BMEAH10812** HART analog input module.

This sub-base allows you to:

- Connect the 8 analog inputs point-to-point
- Ensure continuity of the shielding

The **BMEAH10812** module is connected by means of the 1.5 or 3 m/4.92 or 9.84 ft long **BMXFTA1522/3022** cables.

**Use with Modicon Telefast ABE7 sub-bases (continued)**

**Modicon Telefast ABE7CPA03 sub-base**

The Modicon Telefast **ABE7CPA03** sub-base can be used with the **BMEAHI0812** HART analog input module.

This sub-base allows you to:

- Directly connect the 8 analog inputs
- Power the current inputs one channel at a time with a voltage of 24 V that is protected and limited to 25 mA
- Ensure continuity of the shielding

The **BMEAHI0812** module is connected by means of the 1.5 or 3 m/4.92 or 9.84 ft long **BMXFTA1522/3022** cables (1).

**Modicon Telefast ABE7CPA31 sub-base**

The Modicon Telefast **ABE7CPA31** sub-base can be used with the **BMEAHI0812** HART analog input module.

This sub-base allows you to:

- Directly connect the 8 analog inputs
- Power the current inputs one channel at a time with 24 V converters
- Ensure continuity of the shielding

The **BMEAHI0812** module is connected by means of the 1.5 or 3 m/4.92 or 9.84 ft long **BMXFTA1522/3022** cables.

**Additional characteristics**

**BMEAHI0812 HART analog input module**

The **BMEAHI0812** module is a module with 8 high-level isolated inputs (15 bits + sign).

The **BMEAHI0812** module offers the current range 4 - 20 mA for each of the inputs depending on the choice made during configuration.

**BMEAHO0412 HART analog output module**

The **BMEAHO0412** module is a module with 4 high-level isolated outputs (15 bits + sign).

The **BMEAHO0412** module offers the current range 4 - 20 mA for each of the inputs depending on the choice made during configuration.



BMEAHI0812

**References**

**HART analog input module**

Type of input	Input signal range	Resolution	Connection	No. of channels	Reference	Weight kg/lb
Isolated high-level inputs	4 - 20 mA	15 bits + sign	Removable terminal block, 20-way, cage clamp, screw clamp, or spring-type	8 channels	<b>BMEAHI0812</b>	0.233/0.514

**HART analog output module**

Type of input	Output signal range	Resolution	Connection	No. of channels	Reference	Weight kg/lb
Isolated high-level outputs	4 - 20 mA	15 bits + sign	Removable terminal block, 20-way, cage clamp, screw clamp, or spring-type	4 channels	<b>BMEAHO0412</b>	0.223/0.492

(1) The **BMEAHI0812** HART analog input module loses its isolation between channels when connected to the Modicon Telefast **ABE7CPA03** sub-base.

### Presentation

**BMXEHC0200** and **BMXEHC0800** counter modules for the Modicon X80 I/O platform are used to count the pulses generated by a sensor or to process the signals from an incremental encoder.

The two modules differ in their number of counter channels, maximum input frequencies, functions, and auxiliary input and output interfaces:

Counter module	No. of channels	Maximum frequency	Integrated functions	No. of physical inputs	No. of physical outputs
<b>BMXEHC0200</b>	2	60 KHz	Upcounting Downcounting Period meter Frequency meter Frequency generator Axis control	6	2
<b>BMXEHC0800</b>	8	10 KHz	Upcounting Downcounting Measurement	2	–

The sensors used on each channel can be:

- 2-wire 24 V proximity sensors
- 3-wire 24 V proximity sensors
- 10/30 V output signal incremental encoders with push-pull outputs

**BMXEHC0200/0800** counter modules can be used to meet the demands of applications such as:

- Alarm generation on empty unwinder status using the ratio
- Sorting small parts using the period meter
- Single electronic cam using the dynamic setting thresholds
- Speed control using the period meter

These standard format modules can be installed in any available slot of a Modicon X80 I/O PLC. They are hot-swappable.

In a Modicon X80 I/O PLC configuration, the number of **BMXEHC0200/0800** counter modules should be added to the number of application-specific modules (communication).

The function parameters are set by configuration using the Unity Pro software.

### Description

**BMXEHC0200/0800** counter modules are standard format. They occupy a single slot in **BM•XBP••••** racks. They come in a plastic case, which provides IP 20 protection of the electronics, and are locked into position by a captive screw.

#### BMXEHC0200 module, 2 channels, 60 KHz

The front panel of the **BMXEHC0200** counter module features:

- 1 Module and channel status display block
- 2 16-way connector for connecting the sensors of counter 0
- 3 16-way connector for connecting the sensors of counter 1
- 4 10-way connector for connecting:
  - Auxiliary outputs
  - Sensor power supplies

**To be ordered separately:**

- A **BMXXTSHSC20** kit containing two 16-pin connectors and one 10-pin connector
- A **BMXXSP••••00** shielding connection kit if the rack is not already equipped with one (see page 2/3)

#### BMXEHC0800 module, 8 channels, 10 KHz

The front panel of the **BMXEHC0800** counter module features:

- 1 Module and channel status display block
- 2 Connector taking the **BMXFTB20••0** 20-way removable terminal block 3 (same as that of I/O modules)

**To be ordered separately:**

- A 20-way removable terminal block 3 (cage clamp, screw clamp, or spring-type) **BMXFTB20••0**
- A **BMXXSP••••00** shielding connection kit if the rack is not already equipped with one (see page 2/3)

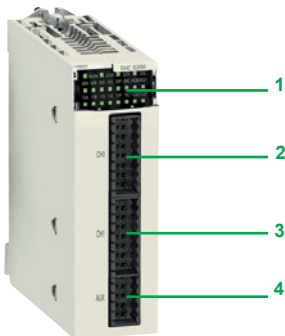

BMXEHC0200

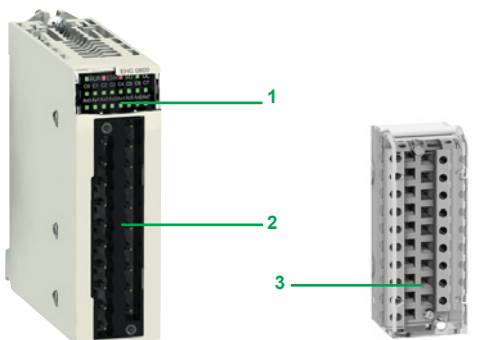

BMXEHC0800

BMXFTB20••0

### Operating modes for module BMXEHC0200

8 configurable modes	
Frequency meter	<p>This mode measures a frequency, speed, data rate, or an event stream. As standard, this mode measures the frequency received on the IN_A input. This frequency is expressed in Hz (number of pulses/second), with a precision of 1 Hz.</p> <p>The maximum frequency on the IN_A input is 60 kHz. The maximum cyclic ratio at 60 kHz is 60%.</p>
Event counting	<p>This mode is used to determine the number of events received. In this mode, the counter calculates the number of pulses applied to the IN_A input at time intervals defined by the user.</p> <p>The module counts the pulses applied to the IN_A input each time the pulse for this input lasts longer than 5 μs (without anti-bounce filter).</p>
Period measurement	<p>This mode is used to:</p> <ul style="list-style-type: none"> <li>■ Determine the duration of an event</li> <li>■ Determine the time between 2 events</li> <li>■ Time and measure the execution time of a process</li> </ul> <p>It measures the time elapsed during an event or between 2 events (IN_A input) according to a selectable time base of 1 μs, 100 μs, or 1 ms. The IN_SYNC input can be used to enable or stop a measurement. The module can carry out a maximum of 1 measurement every 5 ms. The shortest measurable pulse is 100 μs, even if the unit defined by the user is 1 μs. The maximum measurable duration is 4,294,967,295 units (unit to be defined).</p>
Ratio counting	<p>Ratio counting mode only uses the IN_A and IN_B inputs. There are 2 possible modes:</p> <ul style="list-style-type: none"> <li>■ Ratio 1: Used to divide 2 frequencies. This is intended for applications such as flowmeters, mixers, etc.</li> <li>■ Ratio 2: Used to subtract 2 frequencies. This is intended for the same applications, but for those requiring more precise regulation (more similar frequencies).</li> </ul> <p>Ratio 1 mode gives the results in thousandths for better accuracy (a display of 2000 corresponds to a value of 2) and ratio 2 mode gives the results in Hz.</p> <p>The maximum frequency that the module can measure on the IN_A and IN_B inputs is 60 kHz.</p>
Downcounting	<p>This mode is used to list a group of operations. In this mode, activating the synchronization function starts the counter which, starting from a user-defined preset value, decreases with each pulse applied to the IN_A input, until it reaches 0. This downcounting is made possible when the enable function has been activated. The counting register is thus updated at 1 ms intervals.</p> <p>One basic use of this mode is to signal, using an output, the end of a group of operations (when the counter reaches 0).</p> <p>The shortest pulse applied to the IN_SYNC input is 100 μs. The maximum frequency applied to the IN_SYNC input is 1 pulse every 5 ms. The maximum user-defined preset value is 4,294,967,295. The maximum count value is 4,294,967,295 units.</p>
Loop (modulo) counting	<p>This mode is used in packaging and labelling applications where actions are repeated on sets of moving objects:</p> <ul style="list-style-type: none"> <li>■ In upcounting, the counter increases until it reaches the user-defined "modulo - 1" value. On the next pulse, the counter is reset to 0 and upcounting restarts.</li> <li>■ In downcounting, the counter decreases until it reaches 0. On the next pulse, the counter is reset to the user-defined "modulo - 1" value. Downcounting can then restart.</li> </ul> <p>The maximum frequency applied to the IN_A and IN_B inputs is 60 kHz. The maximum frequency of the modulo event is 1 event every 5 ms. The maximum modulo value is 4,294,967,296 (possible by declaring 0 in the modulo adjust value).</p>
32-bit counter counting	<p>This mode is mainly used in axis following.</p> <p>The maximum frequency applied simultaneously to the IN_A and IN_B inputs is 60 kHz. The maximum frequency of the referencing event is 1 event every 5 ms. The counter value is between - 2,147,483,648 and + 2,147,483,647.</p>
Width modulation	<p>In this operating mode, the module uses an internal clock generator to supply a periodic signal on the module's O0 output. Only the O0 output is affected by this mode, as the O1 output is independent of it.</p> <p>The maximum output frequency is 4 kHz. As O0 is a source output, a load resistor is necessary for the O0 output signal to change to 0 at the correct frequency. The cyclic ratio adjustment range varies according to the frequency of the O0 output.</p>

### Operating modes for module BMXEHC0800

<b>5 configurable 16-bit modes</b>	Frequency meter	<p>This mode measures a frequency, speed, rate, or data stream control. As standard, this mode measures the frequency received on the IN A input. This frequency is expressed in Hz (number of pulses per second), with a precision of 1 Hz.</p> <p>The maximum frequency on the IN A input is 10 kHz. The maximum cyclic ratio at 10 kHz is 60%.</p>
	Event counting	<p>This mode is used to determine the number of events received. In this mode, the counter calculates the number of pulses applied to the IN_A input at time intervals defined by the user. As an option, it is possible to use the IN_AUX input during a period of time, provided that the enable bit has been configured.</p> <p>The module counts the pulses applied to the IN_A input each time the pulse for this input lasts longer than 50 μs (without anti-bounce filter). Pulses with less than 100 ms synchronization are lost.</p>
	Downcounting	<p>This mode is used to list a group of operations. In this mode, when counting is enabled (software validation via the valid_sync command), a rising or falling edge on the IN_AUX input causes a value, defined by the user, to be loaded in the counter. The latter decreases with each pulse applied to the IN_A input until it reaches the value 0. Downcounting is made possible when the force_enable command is high (software positioning).</p> <p>The smallest pulse applied to the IN_AUX input varies according to the selected filter level. The maximum frequency applied to the IN_AUX input is 1 pulse every 25 ms.</p>
	Loop (modulo) counting	<p>This mode is used in packaging and labelling applications where actions are repeated on sets of moving objects. The counter increases with each pulse applied to the IN_A input until it reaches the user-defined "modulo - 1" value. On the next pulse in the upcounting direction, the counter is reset to 0 and upcounting restarts.</p> <p>The maximum frequency applied to the IN_A input is 10 kHz. The smallest pulse applied to the IN_AUX input varies according to the selected filter level. The maximum frequency of the modulo event is 1 event every 25 ms. The maximum modulo value is 65,536 units.</p>
	Up/down counter	<p>This mode is used for an accumulation, upcounting, or downcounting operation on a single input. Each pulse applied to the IN_A input produces:</p> <ul style="list-style-type: none"> <li>■ Upcounting of pulses if the IN_AUX input is high</li> <li>■ Downcounting of pulses if the IN_AUX input is low</li> </ul> <p>The counter values vary between the limits - 65,536 and + 65,535. The maximum frequency applied to the IN_A input is 10 kHz. Pulses applied to the IN_A input after a change of direction are only upcounted or downcounted after a period corresponding to the delay for taking account of the state of the IN_AUX input due to the programmable filter level on this input.</p>
<b>One 32-bit mode</b>	32-bit counter counting	<p>32-bit counter counting mode is available for channels 0, 2, 4, and 6 (channels 1, 3, 5, and 7 are now inactive). It behaves in the same way as the up/down counting mode using up to 3 physical inputs. It enables simultaneous upcounting and downcounting.</p> <p>The counter values vary between the limits - 2,147,483,648 and + 2,147,483,647 (31 bits + sign). The maximum frequency applied to the IN_A and IN_B inputs is 10 kHz. The smallest pulse applied to the IN_AUX input is defined according to the filtering applied to this input. The maximum frequency of loading the preset value is 1 every 25 ms.</p>

3





BMXEHC0200



BMXEHC0800

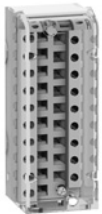

BMXFTB2000

### References

#### BMXEHC0200/0800 counter modules (1)

Description	No. of channels	Characteristics	Reference	Weight kg/lb
<b>Counter modules</b> for 24 V ---	2	60 kHz counting	<b>BMXEHC0200</b>	0.112/ 0.247
2 and 3-wire sensors and 10/30 V --- incremental encoders with push-pull outputs	8	10 kHz counting	<b>BMXEHC0800</b>	0.113/ 0.249

#### Connection accessories (2)

Description	Composition	Unit reference	Weight kg/lb
<b>Pack of connectors</b> for BMXEHC0200 module	Two 16-way connectors and one 10-way connector	<b>BMXXTSHSC20</b>	0.021/ 0.046
<b>20-way removable terminal blocks</b> for BMXEHC0800 module	Cage clamp	<b>BMXFTB2000</b>	0.093/ 0.205
	Screw clamp	<b>BMXFTB2010</b>	0.075/ 0.165
	Spring	<b>BMXFTB2020</b>	0.060/ 0.132

<b>Shielding connection kit</b> for BMXEHC0200/0800 modules	Comprising a metal bar and two support bases for mounting on rack modules	See page 2/3	—
---	---	--------------	---

(1) Typical consumption: See the power consumption table available on our website [www.schneider-electric.com](http://www.schneider-electric.com).

(2) The shielding on the cordsets carrying the counter signals must always be connected to the **BMXXSP0000** shielding connection kit mounted under the rack that holds the **BMXEHC0200** module (see page 2/3).

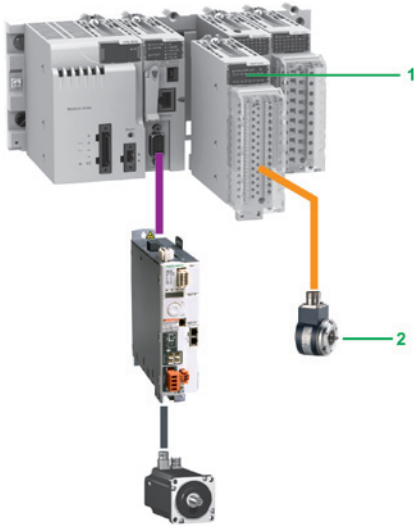

Modicon X80 I/O platform with Modicon M340 processor

3

### Presentation

The **BMXEAE0300** SSI encoder interface module **1** for the Modicon automation platform **(1)** is a 3-channel standard synchronous serial interface module designed for use with SSI absolute encoders **2**.

The **BMXEAE0300** module enables SSI encoder values to be processed on PAC platforms for applications requiring accurate and reliable position/angular control, such as:

- Hydro power, e.g. dam inlet gate position control
- Wind power, e.g. wind turbine blade pitch control
- Complex motion loop control, e.g. ship elevator, blast furnace, flame cutting, etc.

The **BMXEAE0300** module provides a migration path from Premium (with **TSXCTY2C** measurement and counter module) to the Modicon X80 I/O platform SSI solution to compete in the above market segments.

Like any other application-specific module, the **BMXEAE0300** module is installed in the rack slots (01 to 11). The number of modules is limited by the maximum number of application-specific channels, permitted according to the CPU type (consult our website [www.schneider-electric.com](http://www.schneider-electric.com)).

### Dam inlet gate control

Inlet gate control enables the water level in a dam to be monitored and controlled:

- The SSI encoder provides the PLC with accurate feedback of the gate position for precise monitoring of gate opening, adjustment, and positioning.
- The SSI interface converts the signals from the SSI encoders and transmits them to the CPU.

### Wind turbine blade pitch control

Pitch control is required for adjusting the angle of the wind turbine blades in relation to the wind direction and strength, in order to achieve optimum energy conversion efficiency.

- The SSI absolute encoder is frequently used to feedback the position of the blade due to its reliability and robustness.
- Typically, the position of each of the 3 blades are read by the SSI encoders and then transmitted to the CPU via the SSI interface for motion loop control. Sometimes, 3 additional SSI inputs act as backup. Therefore, this new offer is adequately sized for the channel density.

### Description

The **BMXEAE0300** SSI encoder interface module is standard format (1 slot). Its housing provides IP 20 protection of the electronics and it is locked in each slot (**01 to 11**) by a captive screw.

The front panel of the **BMXEAE0300** module features:

- 1** A rigid housing providing support and protection for the electronic card
- 2** The module reference marking (a label is also visible on the right-hand side of the module)
- 3** A display block indicating:
  - Module status, 4 LEDs:
    - RUN (green): module's operational status
    - ERR (red): internal fault detected in the module or a fault detected between the module and the rest of the configuration
    - I/O (red): external fault detected
    - DL (green): firmware download status
  - Status of the 3 SSI channels, 8 LEDs:
    - Sx (green): channel x input (x = 0, 1, or 2)
    - Qx (green): reflex output for channel x (x = 0, 1, or 2)
    - IO/1 (green): capture inputs for the 3 SSI channels
- 4** A connector for a 28-way terminal block, for connecting to a removable cage clamp or spring terminal block on sensors and preactuators

**To be ordered separately:**

- 5** A 28-way removable cage clamp terminal block **BMXFTB2800** or spring terminal block **BMXFTB2820**, supplied with a channel identification label
  - A shielding connection kit to help protect against electrostatic discharge, consisting of a metal bar and two sub-bases for mounting on the rack: **BMXXSP●●00** (reference dependent on the number of slots in the rack) (see page 2/3)
  - A set of clamping rings **STBXSP30●0** for the connection cable shielding braids (reference dependent on the cable diameter) (see page 2/3)

(1) Only for the Modicon automation platforms compatible with Modicon X80 I/O platform

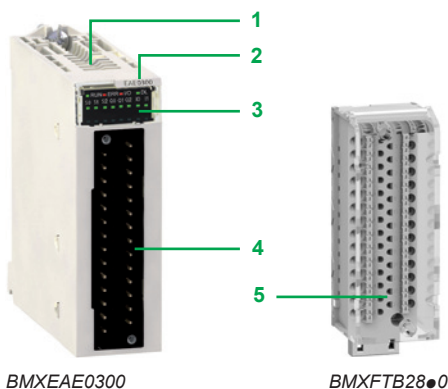

BMXEAE0300

BMXFTB2800

### Module specifications and functions

#### Specifications

The SSI module **BMXEAE0300** is a 3-channel, synchronous serial interface, absolute encoder interface for Modicon PLCs.

It supports:

- 3 channels of SSI inputs (DATA pair, CLK pair, 24 VDC field power supply to encoder)
- 1 reflex output for each SSI channel (Q)
- 2 capture inputs for the 3 SSI channels (CAP\_IN0, CAP\_IN1)
- 8 to 31 bits data width
- 4 ranks of baud rates (100 kHz, 200 kHz, 500 kHz, 1 MHz)
- capture and compare functions

#### Basic and optional functions

The following table presents the main functionalities of the **BMXEAE0300** module:

Function	Basic/optional	Description
Absolute SSI encoder value acquisition	Basic	The position values of the SSI channel are automatically read by the module within 1 ms, unless the channel is disabled.
Modulo	Optional for motion	The modulo function limits the dynamics of the position value within the power of 2. An event (if enabled) detects the modulo passing. The reflex output can also be asserted at the passing of modulo (if configured).
Reduction	Optional for motion	This function reduces the intrinsic resolution of the encoder by a value defined by the "reduction" parameter. This reduction is carried out by a shift in the bit field provided by the encoder.
Offset	Optional for motion	The correction function of the encoder offset systematically corrects the offset produced by the encoder at mechanical position "0". The user enters the absolute encoder offset parameter.
Capture	Optional for events	The two capture input registers (per channel) enable the PLC program to carry out a dynamic measurement function between two points. The capture action can be triggered by two capture inputs. The event will be triggered at each occurrence of capture.
Compare	Optional for events	Two independent comparators (per channel), with thresholds that can be modified by adjustment (explicit exchange), are able to generate an event or reflex output when the threshold is crossed.

#### Main features

- Supported by Unity Pro V6.0 (or higher).
- Supports absolute encoder 24 V model with standard SSI interface, including Telemecanique Sensors OsiSense SSI encoders. For further information, consult the website [www.tesensors.com](http://www.tesensors.com).
- Standards and approvals: CÉ, UL, CSA, C-Tick, GOST, etc.

#### References

##### SSI encoder interface module (1)

Description	Number of channels	Description per channel	Reference	Weight kg/lb
SSI encoder interface module	3 SSI channels	1 reflex output for each SSI channel	<b>BMXEAE0300</b>	0.138/
		2 capture inputs for the 3 SSI channels		0.304
		8 to 31 bits data width		
		4 ranks of baud rates: 100 kHz, 200 kHz, 500 kHz, 1 MHz		
		Capture and compare functions		

##### Cabling accessories

Description	Description, use	Reference	Weight kg/lb
28-way removable terminal block	Cage clamp	<b>BMXFTB2800</b>	0.111/ 0.245
	Spring	<b>BMXFTB2820</b>	0.080/ 0.176
Shielding connection kit for module BMXEAE0300 (2)	Comprising a metal bar and two support bases for mounting on rack	See page 2/3	–

(1) Typical consumption: See the power consumption table available on our website [www.schneider-electric.com](http://www.schneider-electric.com).  
 (2) The shielding on the cables carrying the power supply to the module, each SSI channel, the capture inputs and the reflex outputs (if any of them is wired) must always be connected to the **BMXXSP●●00** shielding connection kit mounted under the rack holding the **BMXEAE0300** module (see page 2/3).



BMXEAE0300



BMXFTB2800

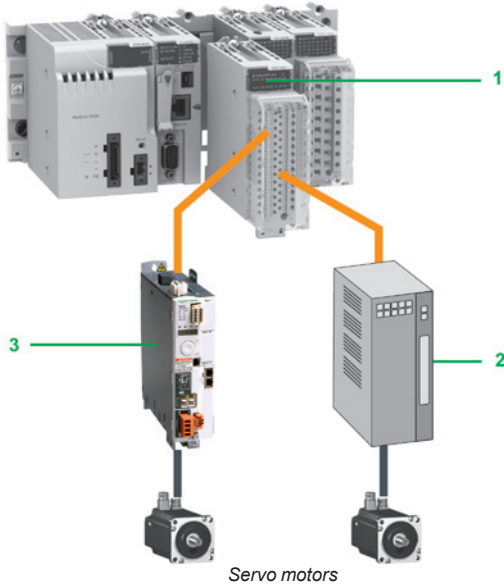

### Presentation

The **1 BMXMSP0200** motion control *pulse train output* (PTO) module for the Modicon X80 I/O platform is used for controlling third-party variable speed drives **2**, which have an integrated position loop and inputs that are compatible with open collector outputs.

The **BMXMSP0200** control module is also directly compatible with the Lexium 32C and 32M **3** servo drive ranges, which have an integrated pulse control interface.

The **BMXMSP0200** motion control PTO module has two independent PTO channels. Like any other application-specific module, it is installed in the rack slots (labelled **01** to **11**). The number of modules is limited by the maximum number of application-specific channels permitted according to the CPU type:

- Standard **BMXP341000**: Maximum of 20 application-specific channels (1)
- Performance **BMXP342000**: Maximum of 36 application-specific channels (1)
- **BMEP5810**: Maximum of 24 application-specific channels (1)
- **BMEP5820**: Maximum of 32 application-specific channels (1)
- **BMEP5830** and **BMEP5840**: Maximum of 64 application-specific channels (1)

### Description

The **BMXMSP0200** motion control module is standard format (1 slot). Its housing provides IP 20 protection of the electronics and it is locked in each slot (**01** to **11**) by a captive screw.

The front panel of the **BMXMSP0200** motion control module features:

- 4** A rigid body providing support and protection for the electronic card
- 5** A module reference marking (a label is also visible on the right-hand side of the module)
- 6** A display block indicating:
  - Module status, 4 LEDs (RUN, ERR, I/O and DL)
  - Status of the auxiliary inputs, 4 per channel
  - Status of the PTO outputs, 2 per channel
  - Status of the auxiliary outputs, 2 per channel
- 7** A connector for a 28-way terminal block, for connecting to a removable spring terminal block on sensors and preactuators

To be ordered separately:

- 8** A 28-way removable cage clamp terminal block **BMXFTB2800** or spring terminal block **BMXFTB2820**, supplied with a channel identification label
  - A shielding connection kit to help protect against electrostatic discharge, consisting of a metal bar and two sub-bases for mounting on the rack: **BMXXSP0000** (reference dependent on the number of slots in the rack) (see page 2/3)
  - A set of clamping rings **STBXSP3000** for the connection cable shielding braids (reference dependent on the cable diameter) (see page 2/3)

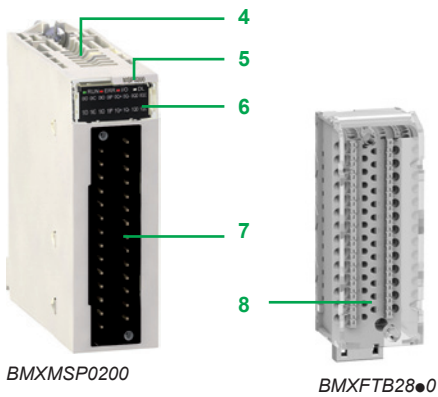

(1) Application-specific channels: **BMXEHC0200** (2-channel) and **BMXEHC0800** (8-channel) counter modules, **BMXMSP0200** (2-channel) motion control module, **BMXNOM0200** (2-channel) and **BMXNOR0200H** (1-channel) serial communication modules, **BMEAH10812** (8-channel) analog input module and **BMEAH00412** (4-channel) analog output module, **BMXEAE0300** (3-channel) SSI module and **BMXERT1604T** (16-channel) discrete input module.

### Operation

#### Block diagram of a BMXMSP0200 module channel

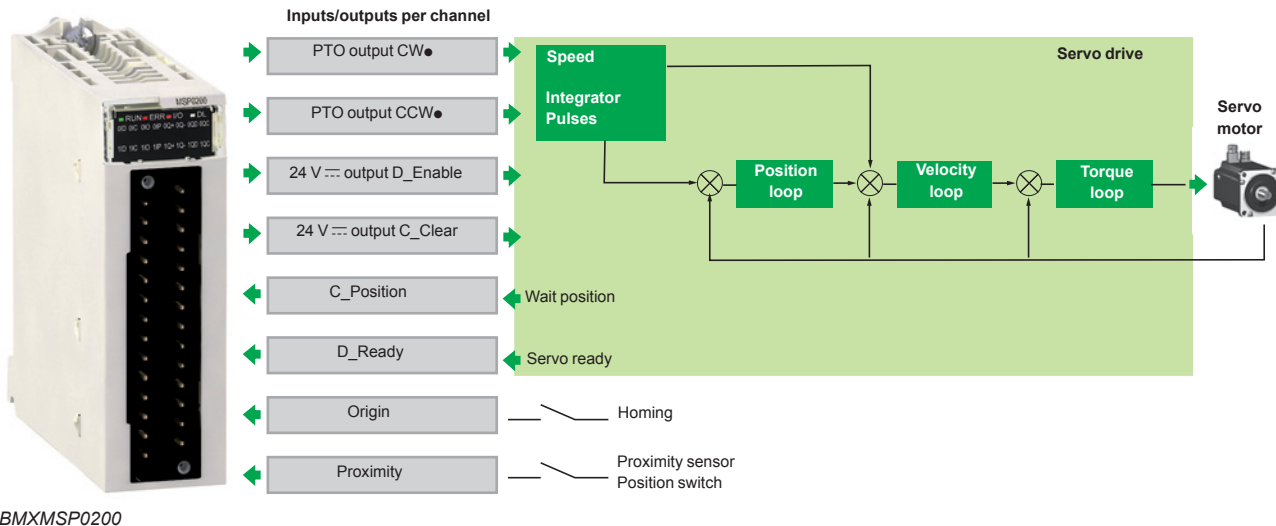

BMXMSP0200

3

### References

#### Motion control modules (1)

Description	Number of channels	Description per channel	Reference	Weight kg/lb
<b>PTO module</b> (PTO = Pulse Train Output)	2	2 x 200 kHz max. PTO outputs 2 x 24 V $\overline{\text{---}}$ /50 mA auxiliary outputs 4 x 24 V $\overline{\text{---}}$ auxiliary inputs	<b>BMXMSP0200</b>	0.145/ 0.320

#### Cabling accessories

Description	Description, use	Length	Reference	Weight kg/lb
<b>28-way removable terminal block</b>	Cage clamp	–	<b>BMXFTB2800</b>	0.111/ 0.245
	Spring	–	<b>BMXFTB2820</b>	0.080/ 0.176



BMXMSP0200



BMXFTB2800

<b>Connection cable</b> for daisy chain or pulse control (2)	From BMXMSP0200 (screw terminal block) module to Lexium 32C or 32M (RJ45 connector) (cable with flying leads at one end and an RJ45 connector at the other)	3 m/9.84 ft	<b>VW3M8223R30</b>	–
---	---	-------------	--------------------	---

<b>Shielding connection kit</b> for module BMXMSP0200	Comprising a metal bar and two support bases for mounting on rack	–	See page 2/3	–
--	---	---	--------------	---

(1) Typical consumption: See the power consumption table available on our website [www.schneider-electric.com](http://www.schneider-electric.com).

(2) The shielding on the cordsets carrying the motion control signals must always be connected to the **BMXXSP0000** shielding connection kit mounted under the rack holding the **BMXMSP0200** module (see page 2/3).

3

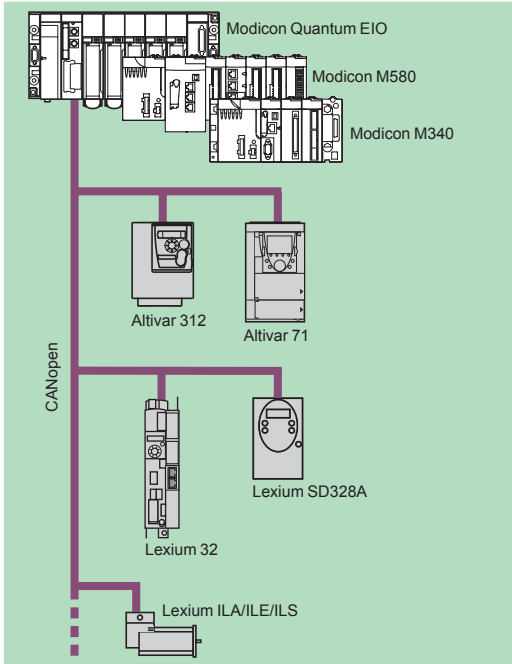

MFB: Motion control distributed over CANopen

### Presentation

MFB (*Motion Function Blocks*) is a library of function blocks integrated in Unity Pro used to set up motion control in the architectures of drives and servo drives on CANopen buses:

- Altivar 312: For asynchronous motors from 0.18 to 15 kW
- Altivar 71: For synchronous or asynchronous motors from 0.37 to 500 kW
- Lexium 32: For servo motors from 0.15 to 7 kW
- Lexium ILA/ILE/ILS: Integrated motor drives from 0.10 to 0.35 kW
- Lexium SD328A: For 3-phase stepper motors from 0.35 to 0.75 kW.

In compliance with PLCopen specifications, the MFB library allows both easy and flexible motion programming with Unity Pro, as well as axis diagnosis. In maintenance operations, drives can be replaced quickly thanks to drive parameter download blocks.

Setting up drives on the CANopen network is facilitated through *Motion Tree Manager* organization in the Unity Pro browser, making it easy for users to access the application drives.

### Applications

The features of the *Motion Function Blocks* library are particularly suitable for machines with independent axes. In the case of these modular/special machines, MFB function blocks are an ideal solution for controlling single axes. The following are typical applications for this type of architecture:

- Automatic storage/removal
- Material handling
- Palletizers/depalletizers
- Conveyors
- Packaging, simple label application
- Grouping/ungrouping
- Adjustment axes in flexible machines, etc.

### Functions

The table below lists the function blocks of the MFB library and the drives compatible with them. The prefix indicates the block family:

- MC: Function block defined by the Motion Function Blocks PLC Open standard
- TE: Function block specific to Schneider Electric products
- Lxm: Function block specific to Lexium servo drives



Type	Function	Function block	Altivar 312	Altivar 71	Lexium 32	Lexium ILA/ILE/ILS	Lexium SD328A
Management and motion	Read an internal parameter	MC_ReadParameter					
	Write an internal parameter	MC_WriteParameter					
	Read the current position	MC_ReadActualPosition					
	Read the instantaneous speed	MC_ReadActualVelocity					
	Acknowledge detected error messages	MC_Reset					
	Stop any active movement	MC_Stop					
	Axis coming to standstill	MC_Power					
	Movement to absolute position	MC_MoveAbsolute					
	Relative movement	MC_MoveRelative					
	Additional movement	MC_MoveAdditive					
	Homing	MC_Home					
	Movement at given speed	MC_MoveVelocity					
	Read diagnostic data	MC_ReadAxisError					
	Read servo drive status	MC_ReadStatus					
	Torque control	MC_TorqueControl					
	Read actual torque value	MC_ReadActualTorque					
Manual control	MC_Jog						
Save and restore parameters (FDR)	Read drive parameters and store in PLC memory	TE_UploadDriveParam					
	Write drive parameters from PLC memory	TE_DownloadDriveParam					
Advanced Lexium functions	Read a motion task	Lxm_UploadMTask					
	Write a motion task	Lxm_DownloadMTask					
	Start a motion task	Lxm_StartMTask			(1)		
	Set the reduction ratio, signed	Lxm_GearPosS			(1)		
System	Communication with the servo drive	TE_CAN_Handler					

Compatible

(1) The Lxm\_StartMTask and Lxm\_GearPosS function blocks are only compatible with the type Lexium 32 (LXM32M) servo drives.

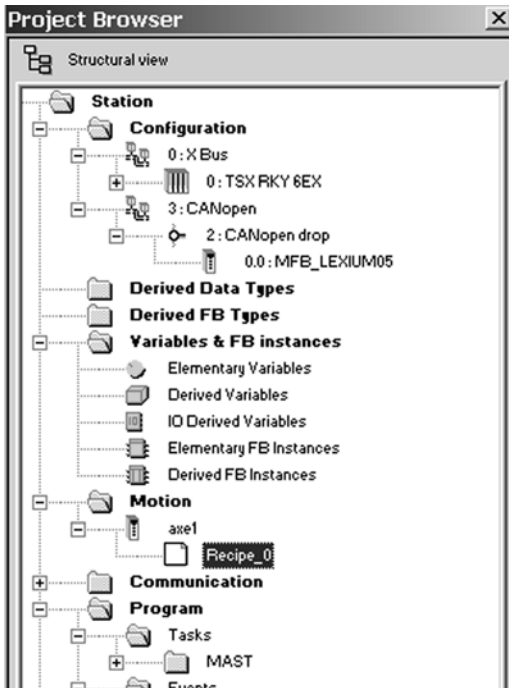

Motion Tree Manager integrated in the Unity Pro browser

### Motion Tree Manager

Motion Tree Manager is associated with Unity Pro's MFB library and integrated in its browser. It provides specific assistance for:

- Axis object management
- Axis variable definition
- Drive parameter management

Motion Tree Manager automatically creates links between the CANopen bus configuration and the MFB function block data using a limited amount of configuration data.

### General axis parameters

In this tab, the designer is prompted to define:

- The name of the axis that will identify it in the browser for the entire application
- The address of the drive on the CANopen bus

### Axis parameters

The drop-down lists in this tab are used to determine the exact type of drive: family, version.

### Variable names

This last tab is used to identify data structures:

- **Axis\_Reference**: Used by the function block instances for the axis in question
- **CAN\_Handler**: Used to manage communication with the drive via the CANopen network

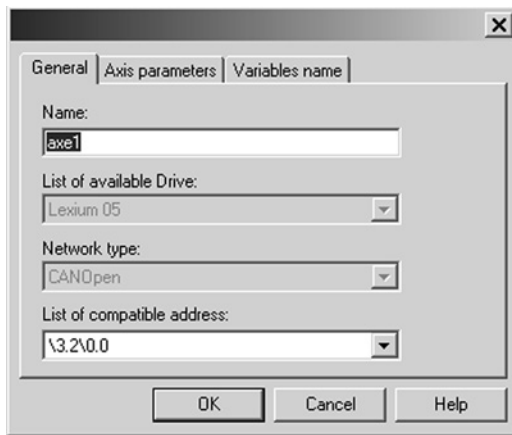

General parameters: Axis name and address

### Recipe definition

The "recipes" attached to the axis are the data structures containing the adjustment parameters of a given drive. This data is used when:

- Changing the drive with restoration of the context during "Faulty Device Replacement" (FDR) maintenance
- Changing the manufacturing program of the machine and calling up an appropriate set of parameters: servo control gains, limitations, etc. adapted to the weight and size of the moving parts
- Saving parameters in the initial values of the PLC application

### Programming, diagnostics, and maintenance

Communication between the PLC and drive is automatically set up by the system as soon as a TE\_CAN\_Handler instance is declared in the Unity Pro task with which the axis is associated. Movements are then programmed by sequencing function blocks from the library in the user's chosen Unity Pro editor (LD, ST, FBD).

The two function blocks, MC\_ReadStatus, and in some cases MC\_ReadAxisError, are useful for determining the overall status of the axis, as well as the code of the active detected errors.

The function blocks TE\_UploadDriveParam and TE\_DownloadDriveParam allow the application to save the drive parameters (recipe) and to then quickly reload them into another drive when it is necessary to change the original one.

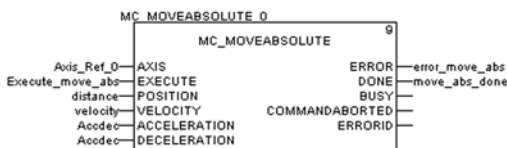

MFB: Programming a movement in absolute mode





---

## Drop adapters

- Modicon X80 CRA Ethernet drop adapters ..... page 4/2
- Modicon X80 NRP RIO drop optical repeaters ..... page 4/3
- Peripheral Remote I/O Adapter ..... page 4/4
- Time stamping system ..... page 4/6
- Modicon X80 performance EIO drop adapter ..... page 4/8

## Communication, integrated ports and modules

*Selection guide* ..... page 4/10

- RTU communication systems ..... page 4/12
  - Presentation ..... page 4/12
  - Description, functions ..... page 4/14
  - References ..... page 4/15
- BMXEIA0100 master module ..... page 4/16
  - Presentation, description ..... page 4/16
  - References ..... page 4/17
- Modbus and Character mode serial links ..... page 4/18
  - Presentation, description ..... page 4/18
  - Complementary characteristics, references ..... page 4/19
- PMXNOW0300 Wi-Fi access point ..... page 4/20
  - Presentation, characteristics ..... page 4/20
  - References ..... page 4/21
- PMESWT0100 weighing module ..... page 4/22
  - Presentation, description ..... page 4/22
  - References ..... page 4/23



# Modicon X80 I/O platform

## Modicon X80 CRA Ethernet drop adapters

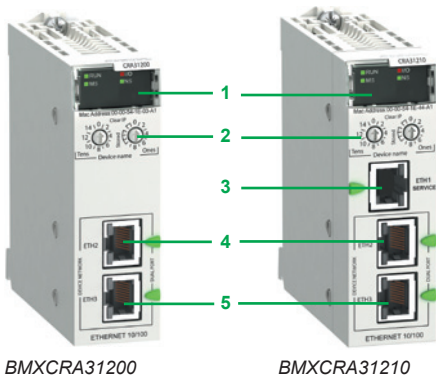

BMXCRA31200

BMXCRA31210

### Modicon X80 CRA Ethernet drop adapters (1)(2)

#### Presentation

A Quantum EIO architecture with Modicon X80 EIO drops requires the use of a dedicated CRA drop adapter in each Modicon X80 drop:

- “Standard” drop adapter BMXCRA31200 (capacity, see below)
- “Performance” drop adapter BMXCRA31210 (capacity, see below)

These drop adapters are connected by Ethernet cordsets fitted with RJ45 connectors. The dual Ethernet network connection port on each drop adapter allows *Daisy Chain Loop* connections using the RSTP protocol (*Rapid Spanning Tree Protocol*).

Each module uses one slot in the Modicon X80 rack.

The BMXCRA31210 adapter is also available in a conformal coating version for harsh environments.

#### Capacity of Quantum EIO architectures with Modicon X80 EIO

- 1 Quantum CPU drop that can have one primary rack and one secondary rack (3), equipped with a 140CPU6●●●● advanced CPU
- With 140CPU651●● standard CPUs and the 140CPU67160 HSBY CPU:
  - Up to 16 Modicon X80 EIO drops, limited to a maximum of 31 EIO drops (Quantum + Modicon X80)
- With the 140CPU65260 standard CPU and 140CPU6726● HSBY CPUs:
  - Up to 31 Modicon X80 EIO drops, limited to a maximum of 31 EIO drops (Ethernet Quantum and Modicon X80)
- Each Modicon X80 EIO drop can comprise one primary rack and one secondary rack (3)
- Distance:
  - 100 m/328.08 ft between stations (copper medium)
  - 2 km/1.24 mi between Modicon X80 drops, with BMXNRP0200 multimode optical fibre repeaters
  - 16 km/9.94 mi between Modicon X80 drops, with BMXNRP0201 multimode optical fibre repeaters

#### Capacity of Modicon X80 CRA drop adapters

Type of module	BMXCRA31200 “standard”	BMXCRA31210 “performance”
Primary racks per drop	Up to 2	Up to 2
SERVICE port	–	1
Discrete I/O modules	Up to 128	Up to 1024
Analog I/O modules	Up to 16	Up to 256
Expert modules supported:		
■ serial link	–	BMXNOM0200
■ time and date stamping at 1 ms	–	BMXERT1604T
■ counting	–	BMXEHC0200/0800
CCOTF function	–	Yes
Time and date stamping	–	10 ms

#### Description

- 1 Display block indicating the module status
- 2 Rotary switches for addressing EIO drops (00...159)
- 3 On BMXCRA31210 module: dedicated RJ45 SERVICE port for remote service tools such as a PC, an HMI terminal, or Ethernet DIO devices (identical to the SERVICE port on Quantum CRP/CRA modules, see page 2/6)
- 4 RJ45 DEVICE NETWORK port for connection to the Ethernet network
- 5 RJ45 DEVICE NETWORK port for connection to the Ethernet network

(1) For additional characteristics, see our website [www.schneider-electric.com](http://www.schneider-electric.com).

(2) Requires Unity Pro Extra Large software ≥ V7.0.

(3) Requires two BMXXBE1000 rack expansion modules (one in the primary rack and one in the secondary rack) and a BMXXBC●●●K extension cable (0.8, 2, or 28 m/2.62, 6.56, or 91.86 ft) for connecting these two modules. See page 2/8.

## Modicon X80 EIO drop optical repeaters (1)(2)

### Presentation

BMXNRP0200/0201 optical fibre repeaters are an alternative to the use of ConneXium managed dual ring switches (DRS), for optical fibre communications over long distances, in Ethernet I/O systems.

When inserted in Modicon X80 EIO drops, BMXNRP0200/0201 optical fibre repeaters make it possible to:

- Extend the total distance of the EIO network, when EIO drops are located in areas of the factory more than 100 m/328.08 ft away
- Enhance immunity to noise
- Resolve grounding incompatibilities, between sites with different grounding methods NRP repeaters can be installed on the primary ring or on secondary rings. These modules cannot however be used to connect secondary rings to the primary ring.

The BMXNRP0200 repeater for multimode optical fibre allows remote location up to 2 km/1.48 mi.

The BMXNRP0201 repeater or single mode optical fibre allows remote location up to 16 km/11.80 mi.

Depending on the configuration, the NRP repeater must be linked to the CRA adapter of the drop where it is installed, via one or two Ethernet Interlink cables.

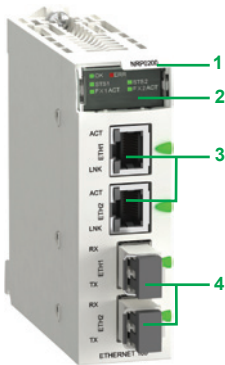

BMXNRP0200

### Description

- 1 Module reference
- 2 Display block indicating the module status
- 3 RJ45 Ethernet ports. Two LEDs LNK and ACT indicate the state of each port
- 4 Optical fibre ports with SFP transceiver for LC type connector

## References (1)

### Modicon X80 EIO drop optical repeaters (2)

Description	Optical fibre	Reference	Weight kg/lb
Modicon X80 EIO drop optical repeaters	multimode	<b>BMXNRP0200</b>	–
	single mode	<b>BMXNRP0201</b>	–

### Ethernet head and drop adapters (2)

Description	SERVICE port	Reference	Weight kg/lb
Modicon X80 EIO drop adapter Provide 1 module per Modicon X80 EIO drop	–	<b>BMXCRA31200</b>	–
	1	<b>BMXCRA31210</b>	–

(1) For additional characteristics, see our website [www.schneider-electric.com](http://www.schneider-electric.com).

(2) Requires Unity Pro Extra Large software ≥ V7.0, see our website [www.schneider-electric.com](http://www.schneider-electric.com).

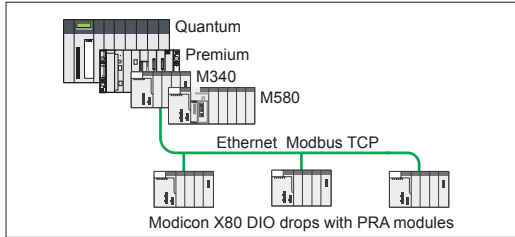

Modicon X80 DIO drops in a Quantum/Premium/M340/M580 I/O architecture using Ethernet Modbus TCP

### Presentation

The Peripheral Remote I/O Adapter (PRA) is specifically dedicated for Modicon X80 DIO drops in a Quantum/Premium/M340/M580 I/O architecture using Ethernet Modbus TCP.

The BMXPRA0100 module manages a remote X80 I/O rack on Ethernet Modbus TCP which includes:

- discrete I/O modules
- analog I/O modules

It communicates by I/O scanning with the master PAC (Quantum/ Premium/M340/ M580).

In case of a redundant Ethernet link, the use of a BMXNOE0100 Ethernet module is necessary.

### Principal characteristics

#### Primary racks per drop

Up to 4

#### Discrete I/O modules

Up to 1024

#### Analog I/O modules

Up to 256

#### Intern memory

Up to 448 kBits

#### Memory card capacity

Up to 96 kBits

#### Average consumption

95 mA

#### Dissipated power

2.3 W

#### Savable real time clock

Yes

### Description

- 1 Module reference
- 2 Display block indicating the module status
- 3 Protected memory card port
- 4 RJ45 Ethernet port

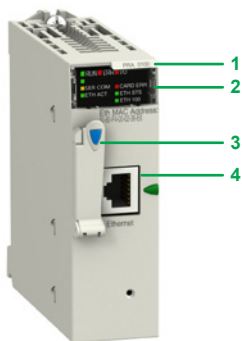



BMXPRA0100

Reference (1)		
Description	Reference	Weight kg/lb
Peripheral Remote I/O Adapter Provide 1 module per Ethernet Modbus TCP DIO drop	BMXPRA0100	–

(1) Requires Unity Pro software ≥ V4.1.



BMXERT1604T module

4

### Presentation

The time stamping system is a complete solution providing a SCADA with a sequence of events that are time-stamped at source, enabling the user to analyze the source of any abnormal behaviour in an automated system.

The SOE (sequence of events) is displayed in the alarms log or in the list of events for a client such as a SCADA.

Each event in the SOE is a change of value (transition) of a discrete I/O detected by a time stamping module.

### Advantages

Using the time stamping system has the following advantages:

- No PLC programming
- Direct communication between the time stamping modules and the client; if the time stamping modules are in a Quantum Ethernet I/O drop, the bandwidth of the PLC communication is not used
- Consistency of the I/O values between the process (time stamping modules) and the client
- Consistency is maintained irrespective of the operating mode
- No loss of events under normal operating conditions
- Management of Hot Standby configurations on the PLC and/or SCADA redundancy

### Composition of a time stamping architecture

#### BM●CRA312●0 module

This time stamping module can be at the source of any discrete I/O signal located in the drop with a resolution of 10 ms.

To help ensure no event is lost, all events are stored and kept in a buffer located in the product until OFS takes them.

Synchronization of the CRA module uses the NTP protocol.

#### BMXERT1604T module

This module has 16 discrete inputs which carry out the time stamping at source outputs with a resolution of 1 ms.

To help ensure no event is lost, all events are stored and kept in a buffer located in the product until OFS takes them.

This module can be placed either in an RIO drop, or in a local rack equipped with a BM●CRA31210 module.

The CRA module is synchronized via the DCF 77 or IRIG-B standards.

#### OFS V3.50

OFS V3.50 is used to access events stored in the various buffers in the architecture and to place them in the SCADA via the standard OPC DA protocol. For further information, consult our website [www.schneider-electric.com](http://www.schneider-electric.com).

#### Vijeo Citect V7.30

Vijeo Citect V7.30 receives events transmitted by OFS and displays them in the SOE or in the list of alarms.

Performance		
Performance	Event source module	Value
Between two identical source modules in the same rack	BMXERT1604T	1.6 < resolution < 3.3 ms
	BM●CRA31210	10 ms
Between two different inputs in the same source module	BMXERT1604T	1 ms
	BM●CRA31210	1 scan
Maximum number of events scanned	BMXERT1604T	400 events (1)
	BM●CRA31210	2048 events (1)
Maximum number of I/O and memory available	BMXERT1604T	16 discrete inputs on module 512 events in internal buffer
	BM●CRA31210	256 discrete I/O configured 4000 events in internal buffer
Maximum number of source modules in an Ethernet remote drop	BM●CRA31210	1 per drop
	BMXERT●●●●	9 per drop
Maximum number of event sources controlled	BMXERT●●●●	500 sources per second (1)

References			
Description	Input type	Reference	Weight kg/lb
Multifunction time stamping input module	16 discrete inputs	BMXERT1604T	—

(1) This maximum value is not an absolute value. It depends on the overall system dynamics (total number of scanned items and number of events generated by the system).



BMECRA31210

4

### Modicon X80 performance EIO adapter

#### Presentation

A M580 EIO architecture with Modicon X80 I/O drops requires the use of a dedicated adapter in each Modicon X80 drop.

The **BMECRA31210** adapter supports Ethernet and X-bus communications across the remote backplane.

This EIO adapter module supports several expert modules such as counting and weighing modules and CCOTF.

For Modicon X80 RIO drops on an Ethernet backplane, time stamping can be managed with a resolution of 10 ms when using a **BMECRA31210** performance EIO adapter.

Only one **BMECRA31210** module can be installed per Modicon X80 RIO drop.

This module can also support an expansion rack.

The **BMECRA31210** adapter is designed to be installed on an Ethernet backplane in the main remote rack. The adapter supports the Modicon X80 I/O and partner modules with both Ethernet and X-bus connections (1).

The keying pin on the rear side of the module helps ensure that the **BMECRA31210** adapter is not installed on unsupported backplanes.

These adapters are connected by Ethernet cordsets fitted with RJ45 connectors.

The dual Ethernet connection port on each adapter allows Daisy Chain Loop connections using the RSTP protocol (Rapid Spanning Tree Protocol).

The **BMECRA31210** adapter is also available in a “Conformal Coating” version for harsh environments.

### Capacity of the Modicon BMECRA31210 adapter

Primary racks per drop	Up to 2
SERVICE port	1
Discrete I/O modules	Up to 1024
Analog I/O module	Up to 256
Expert modules supported:	<ul style="list-style-type: none"> <li>■ serial link <b>BMXNOM0200</b></li> <li>■ time and date stamping at 1 ms <b>BMXERT1604T</b></li> <li>■ counting <b>BMXEHC0200/BMXEHC0800</b></li> <li>■ weighing <b>PMESWT0100</b></li> <li>■ HART integrated analog I/O modules <b>BMEAHI0812/BMEAHO0412</b></li> </ul>
CCOTF function	Yes
Time and date stamping	10 ms

(1) The module is also compatible with X-bus backplane (PV02 or later) via the connector on the rear left side. In this case it has the same functionalities as a **BMXCRA31210** “performance” Ethernet drop adapter.



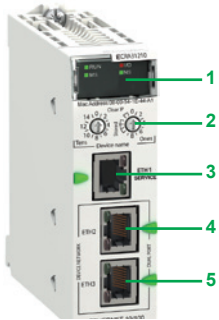

BMECRA31210

### Description

- 1 LED display block indicating the module status
- 2 Rotary switches for addressing EIO drops (00...159)
- 3 Dedicated RJ45 service port (ETH 1) for remote service tools such as a PC, an HMI terminal module, or Ethernet DIO devices
- 4 RJ45 device network port (ETH 2) for connection to the Ethernet network
- 5 RJ45 device network port (ETH 3) for connection to the Ethernet network

### References

#### Ethernet drop adapter

Description	SERVICE port	Reference	Weight kg/lb
<b>X80 EIO drop adapter</b> Provide one module per Modicon X80 EIO drop	1	<b>BMECRA31210</b>	-



### Presentation

RTU systems are designed to meet the needs of the water industry, the oil and gas sector, and other infrastructures, where remote monitoring and telecontrol are essential to the good management of sites and substations spread over a wide geographical area.

RTU protocols and Telemetry systems provide robust, reliable means of communication which are suitable for the process values, maintenance, and remote monitoring needs of infrastructures disseminated over a vast geographical area which may be difficult to access.

An RTU system consists of the following elements:

- A Telemetry Supervisor (SCADA) in a central control room
- A network infrastructure and a variety of suitable communication methods (LAN, WAN, modems, etc)
- A large number of RTU substations geographically distributed throughout the field

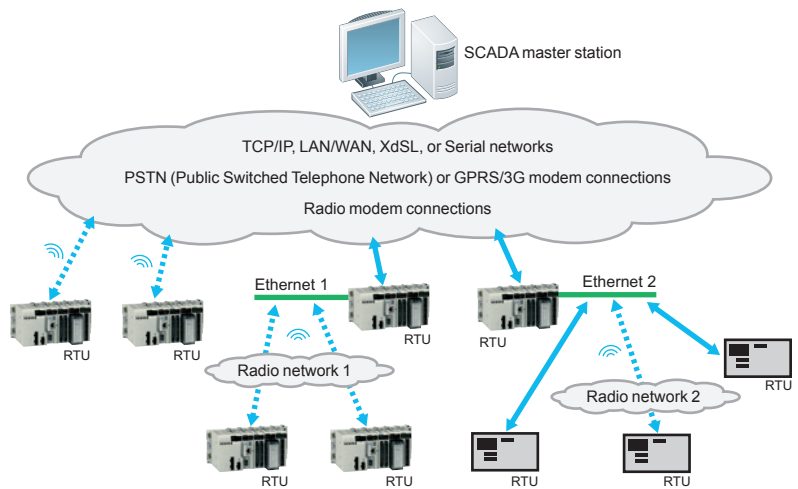

Example of an RTU system architecture

### Main functions

The main RTU system functions are as follows:

- Remote communications:
  - Between remote RTU sites (coordination, synchronization)
  - With the SCADA host system, controlling the central operator station (monitoring, alarm reports) and centralized databases (archiving of alarms or events)
  - With the on-call staff (alarm indication)
  - With the technical station (diagnostics, maintenance)
- Data acquisition, processing, and memorization:
  - Process data sampling using standard or dedicated sensors, validation
  - Exchange of data with other devices within the station, including controllers and operator consoles
  - Use of discrete or analog I/O, serial links, fieldbuses, and LANs
  - Event detection, time and date stamping, prioritization, and logging as required by the application
- Other functions:
  - IEC 1131-3 programmable control: forcing, access control, load sharing, servo control
  - Data logging
  - Alarm and report notification by e-mail/SMS
  - Web HMI: displaying the process, alarm handling, trend analysis, telecontrol

4

### Presentation (continued)

Currently, people working in the industrial Telemetry sectors use standard protocols for communication between control centres (SCADA) and RTU stations.

The most commonly used protocols are as follows:

- IEC 60870-5: IEC (International Electrotechnical Commission), in particular IEC 60870-5-101/104 (commonly known as IEC 101 or 104)
- DNP3: Distributed Network Protocol version 3

DNP3 is the predominant protocol in North America, Australia, and South Africa whereas, in certain European countries, the IEC protocol is required by the legislation. IEC is also commonly used in the Middle East.

The geographical distribution of these protocols is as follows:

- DNP3: North America, Australia, New Zealand, UK, Asia, South America, etc.
- IEC 60870-5: Europe, Middle East, Asia, South America, etc.

These protocols offer similar functions.

They are both particularly suited to “transient communications” (modem, radio) and data exchanges with limited bandwidth for the following reasons:

- They transfer data in a very robust and reliable manner between the SCADA system and the RTU devices
- They are essentially “event-triggered” protocols (exchanges on changes of state, exchanges of time and date stamped events).

They offer the following transmission modes:

- Interrogation via polling
- Data exchanges on changes of state (*RBE: Report By Exception*)
- Unsolicited messaging (a slave station can start an exchange of data with the master station)

Both protocols offer native data management and time and date stamped events:

- Time synchronization between the master station and auxiliary stations via protocol functions
- Time and date stamping of data and events
- Automatic transfer of time and date stamped events between the RTU stations and SCADA (control room)

### Presentation (continued)

The **BMXNOR0200H** communication module integrates the RTU (*Remote Terminal Unit*) functions and protocols in the Modicon X80 I/O platform for industrial Telemetry applications and other widely distributed infrastructures.

The **BMXNOR0200H** module can be used to connect an RTU X80 I/O PLC directly to a Telemetry supervisor or to other RTU stations, via the standard DNP3 protocols (subset level 3) or IEC 60870-5-101/104 with different connection methods: Ethernet TCP/IP, LAN, WAN, serial link, or modem connections (radio, PSTN, GSM, GPRS/3G, ADSL).

The **BMXNOR0200H** module is designed to operate in a harsh environment (conformal coating), in an extended temperature range (-25 to +70 °C/-13 to +158 °F).

### Functions

The **BMXNOR0200H** module offers the following functions:

- Upstream RTU communication to the SCADA (server or slave mode)
  - Downstream RTU communication to field devices (master mode)
  - RTU protocols: Time synchronization, exchanges of time and date stamped data via polling (on change of state and unsolicited), management of time and date stamped events
  - Application Data Logging with time and date stamping in the module Flash memory card
  - Event notifications via e-mail or SMS
  - Embedded Web server for setting the RTU protocol parameters, diagnostics, and monitoring
- 
- Communications on Ethernet port:
    - 10BASE-T/100BASE-TX physical interface
    - Modbus/TCP protocol (client and server)
    - Integrated RTU protocols for Ethernet communications: DNP3 IP (client or server) and IEC 60870-5-104 (over IP) (client or server)
    - Connection of ADSL external modem on the Ethernet port, via the PPPoE (*Point-to-Point Protocol over Ethernet*) protocol
    - Advanced Ethernet functions: NTP client, FTP client or server, HTTP server, SOAP/XML server, SNMP agent, SMTP agent
  - Communications on serial port:
    - Isolated RS232/RS485 point-to-point serial links
    - Integrated RTU protocols for serial and modem communications: IEC 60870-5-101 (master or slave) and DNP3 serial (master or slave)
    - Connection of external modems (radio, PSTN, GSM, GPRS/3G) via the PPP (*Point-to-Point Protocol*) protocol

### Description

The **BMXNOR0200H** module can be installed in either a standard or "ruggedized" configuration, equipped with a standard **BMXP34●●●●●/BMEP58●●●●●** or "ruggedized" **BMXP34●●●●●H/BMEP58●●●●●H** processor.

The front panel of the **BMXNOR0200H** module features:

- 1 A screw for locking the module in a slot in the rack
- 2 A display block with 8 LEDs, 4 of which relate to the serial and Ethernet communication ports
- 3 A slot for a Flash memory card (SD card), with protective cover
- 4 An RJ45 connector for the connection to the Ethernet network
- 5 An RJ45 connector for connection of the serial link or an external modem

**On the rear panel**, 2 rotary switches for selecting the IP address assignment method for the module.

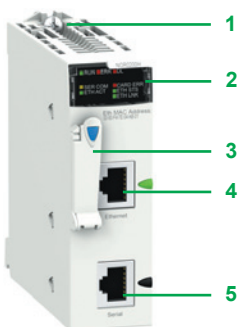



BMXNOR0200H

### References

Description	Communication port	Protocol	Reference	Weight kg/lb
RTU communication module (1)	Ethernet 10BASE- 100BASE-TX	<ul style="list-style-type: none"> <li>■ Modbus/TCP (client or server), Transparent Ready class C30</li> <li>■ DNP3 IP (client or server)</li> <li>■ IEC 60870-5-104 (over IP) (client or server)</li> </ul>	BMXNOR0200H (2)	0.205/ 0.452
		Serial, External modems <ul style="list-style-type: none"> <li>■ Isolated RS232/RS485 point-to-point serial links</li> <li>■ DNP3 serial (master or slave)</li> <li>■ IEC 60870-5-101 (master or slave)</li> </ul>		

### Spare parts

Description	Usage	Supplied with module	Reference	Weight kg/lb
128 MB Flash memory card supplied as standard with the module	Web pages, Storage of data logging files (CSV)	BMXNOR0200H	BMXRWS128MWF	0.002/ 0.004

(1) See ruggedized module characteristics, page 5/2.

(2) The Web Designer software is supplied on CD-ROM with the module. This software can be used to configure and download the embedded website and to configure advanced services: data logging, sending alarm notifications via SMS or e-mail. For further information, please consult our website [www.schneider-electric.com](http://www.schneider-electric.com).

# Modicon X80 I/O platform

BMXEIA0100 master module  
for AS-Interface cabling system

## Presentation

The **BMXEIA0100** master module for AS-Interface cabling system provides the AS-Interface system master function for the Modicon X80 I/O platform.

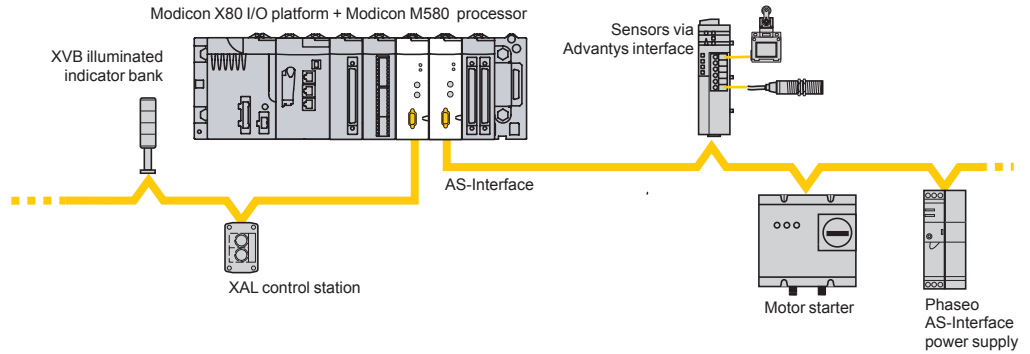

The AS-Interface cabling system consists of a master station (Modicon X80 I/O platform) and slave stations. The master supporting the AS-Interface profile interrogates the devices connected on the AS-Interface line one by one and stores the information (actuator/sensor status, device operating status) in the PLC memory. Communication on the AS-Interface line is managed totally transparently in relation to the application PLC program.

The **BMXEIA0100** master module supports the latest management profile for AS-Interface devices (*AS-Interface V3*), which is able to manage level V1, V2, and V3 AS-Interface slaves:

- Discrete slave devices (up to 62 devices of 4 inputs/4 outputs organized in 2 banks (A/B) of 31 addresses each)
- Analog devices (up to 31 devices (4 channels) in bank A)
- Safety interfaces (up to 31 devices in bank A)

An AS-Interface power supply is essential for powering the various devices on the line. Ideally it should be placed near stations that consume a great deal of energy. Please refer to the "Phaseo power supplies and transformers - AS-Interface range" catalog.

A Modicon M340 Performance configuration with a **BMXP3420●0/20●02** processor or a Modicon M580 configuration with a **BMEP58●●●●** processor can take 4 **BMXEIA0100** modules. A Standard configuration with **BMXP341000** processor can take 2 **BMXEIA0100** modules.

## Description

The **BMXEIA0100** AS-Interface master module is standard format (1 slot). Its housing provides IP 20 protection of the electronics and it is locked into each rack slot (01 .....11) by a captive screw.

The front panel of the **BMXEIA0100** AS-Interface master module features:

- 1 A rigid body providing support and protection for the electronic card
- 2 A module reference marking
- 3 A display block with 5 LEDs indicating the module operating modes:
  - RUN (green): Module running
  - ERR (red): Detected module fault
  - A/B (green): Displays the group of 31 slaves
  - I/O (red): Detected I/O fault on AS-Interface line
  - 32 LEDs for diagnostics of the AS-Interface line and each slave connected on the line depending on the A/B pushbutton selection (1)
- 4 2 LEDs marked ASI POWER and FAULT: AS-Interface external power supply present and AS-Interface line fault (see diagnostics on page 4/17)
- 5 Two pushbuttons marked A/B and MODE (see diagnostics on page 4/17)
- 6 A 3-way male SUB-D connector for the AS-Interface cable (female screw connector supplied)

(1) Depending on whether A or B is selected, this displays either the first 31 slaves (standard addressing) or the last 31 slaves (extended addressing).

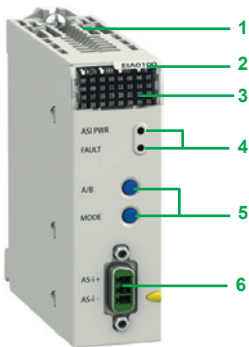

BMXEIA0100

# Modicon X80 I/O platform

BMXEIA0100 master module  
for AS-Interface cabling system

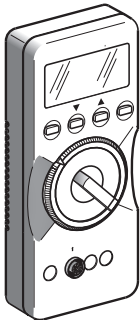
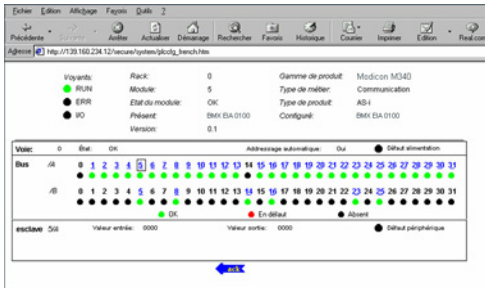

ASITERV2

## Diagnostics

### BMXEIA0100 module

The two LEDs **4** on the module front panel are used in conjunction with the two pushbuttons **5** for module diagnostics:

#### LEDs

**4** ASI PWR:  
AS-Interface  
power supply present

**4** FAULT: Detected  
AS-Interface line fault

#### Pushbuttons

**5** A/B: Selects the  
group of slaves on the  
display block **3**

**5** MODE: Module  
Offline/Online

The display block on the front panel of the **BMXEIA0100** master module can be used to perform simplified local diagnostics by displaying the slave devices present on the AS-Interface line.

Detailed diagnostics of each of the slave devices is also possible using:

- The **ASITERV2** adjustment terminal
- A web browser using the Rack Viewer function in the standard Web server on the Modicon X80 I/O platform. For further information, please consult our website [www.schneider-electric.com](http://www.schneider-electric.com).

## References

Description	Usage	Reference	Weight kg/lb
<b>AS-Interface master module</b> supplied with 3-way male SUB-D connector	M4 AS-Interface profile for level V1, V2, and V3 slaves	<b>BMXEIA0100</b>	0.340/ 0.750
<b>Adjustment terminal</b>	For addressing and diagnostics of AS-Interface level V1, V2, and V3 interfaces Powered by LR6 batteries	<b>ASITERV2</b>	1.000/ 2.205





### Presentation

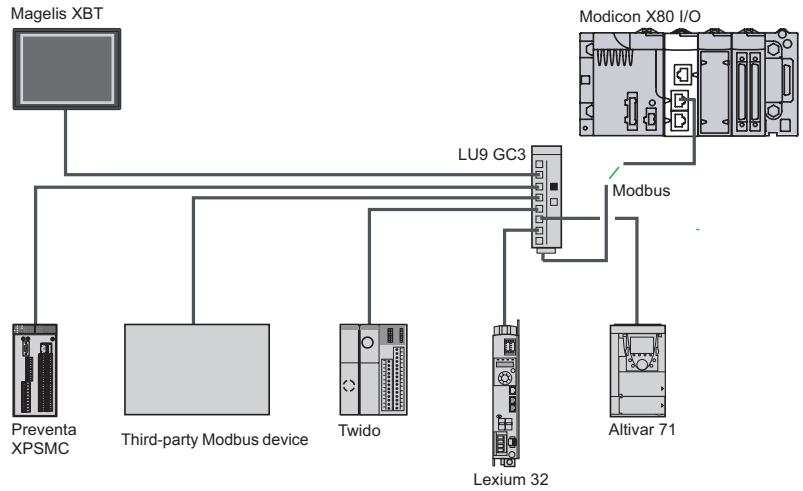

The Modbus serial link is used for master/slave architectures (it is necessary, however, to check that the Modbus services used by the application have been implemented on all relevant devices).

The bus consists of a master station and slave stations. Only the master station can initiate the exchange (direct communication between slave stations is not possible). Two exchange mechanisms are available:

- Question/response, where requests from the master are addressed to a given slave. The master then waits for the response from the slave that has been interrogated.
- Broadcasting, where the master broadcasts a message to all slave stations on the bus. The latter execute the order without transmitting a reply.
- It is necessary to use **BM●CRA31210** modules as drop adapters. On one drop it is possible to plug a maximum of two **BMXNOM0200** modules.

The following services are not available in the slave stations:

- Modbus slave
- Modem services

Although most processors have a serial link that can support modems, the **BMXNOM0200** 2-channel serial link module is particularly recommended for this type of use.

Its performance and numerous parameter-setting options make it ideal for any type of configuration, especially when using radio modems.

### Description

#### BMXNOM0200 serial link module

The front panel of the **BMXNOM0200** serial link module features:

- 1 A screw for locking the module in a slot in the rack
- 2 A display block with 4 LEDs:
  - RUN (green) and ERR (red): Module status
  - For each of the two channels: SER COM (green): Activity on the serial link (lit)/detected fault on a device present on the serial link (flashing)
- 3 Two RJ45 connectors (exclusive use) for connection of channel 0 (with black indicator):
  - 3a A connector for RS 232C connection, marked COM Port 0 RS232
  - 3b A connector for RS 485 connection, marked COM Port 0 RS485
- 4 An RJ45 connector for RS 485 connection of channel 1, marked COM Port 1 RS485, with black indicator

#### To be ordered separately:

RS 485 cordsets (see our "Modicon M580 automation platform" catalog available on our website [www.schneider-electric.com](http://www.schneider-electric.com)) or RS 232 cordsets for DCE terminal (see page 4/19).

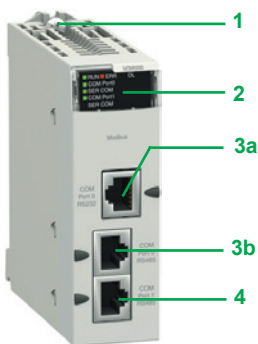

BMXNOM0200



BMXNOM0200

### Complementary characteristics

The following characteristics complement those indicated in the selection guide on page 4/11.

#### BMXNOM0200 module serial links

- Physical interface:
  - RS 232 port 0: RS 232 8-wire, non-isolated
  - RS 485 port 0 and port 1: RS 485 2-wire, isolated
- Frame:
  - Modbus: RTU/ASCII, full duplex in RS 232, half duplex in RS 485
  - Character mode: full duplex in RS 232, half duplex in RS 485
- Data rate:
  - RS 232 port 0: 0.3...115 Kbps (Modbus/Character mode)
  - RS 485 port 0 and port 1: 0.3...57.6 Kbps (Modbus/Character mode)
- Line polarization:
  - Modbus RS 485: automatic
  - RS 485 character mode: configurable with Unity Pro software
- Maximum length of a tap link in RS 485 2-wire:
  - 15 m/49.21 ft in a non-isolated link
  - 40 m/131.23 ft in an isolated link
- Expert mode (from version V1.2 of the module and version V5 of Unity Pro): used to configure the time out links individually from the application and thus adapt to the specific characteristics of certain modems.

### References (1)

#### Serial link module

Designation	Protocol	Physical layer	Reference	Weight kg/lb
<b>2-channel serial link module (2)</b>	Modbus master/slave RTU/ASCII, Character mode, GSM/GPRS modem	1 non-isolated RS 232 channel (Port 0) 2 isolated RS 485 channels (Port 0 and Port 1)	<b>BMXNOM0200</b>	0.230/ 0.507

#### Cordsets for RS 232 serial link (3)

Designation	Description	Length m/ft	Reference	Weight kg/lb
<b>Cordset for Data Terminal Equipment (DTE) (printer)</b>	Equipped with an RJ45 connector and a 9-way female SUB-D connector	3/ 9.84	<b>TCSMCN3M4F3C2</b>	0.150/ 0.331
<b>Cordset for Data Communication Equipment (DCE) (modem, etc.)</b>	Equipped with an RJ45 connector and a 9-way male SUB-D connector	4-wire (RX, TX, RTS, CTS) 3/ 9.84	<b>TCSMCN3M4M3S2</b>	0.150/ 0.331
		8-wire (excluding RI signal) 3/ 9.84	<b>TCSXCN3M4F3S4</b>	0.165/ 0.364

(1) Requires Unity Pro software ≥ V1.4.

(2) For the ruggedized version, **BMXNOM0200H**, see characteristics on page 5/8.

(3) RS 485 serial link connection (see our "Modicon M580 automation platform" catalog available on our website [www.schneider-electric.com](http://www.schneider-electric.com)).



PMXNOW0300 Wi-Fi access point

#### Presentation

The PMXNOW0300 Wi-Fi access point consists of a WLAN wireless connection combined with a 3-port 10/100 Ethernet switch.

This module is designed to be integrated in the Modicon X80 I/O platform Modicon processor (1). It retrieves the 24 V voltage from the backplane rack and occupies one slot in it. An Ethernet cable, supplied with the module, must be used to connect the Wi-Fi module to the processor or the communication module (BMXNO●●●●●).

This module offers the following functions:

- access point
- Ethernet bridge
- Wi-Fi repeater

The PMXNOW0300 is compatible with the majority of Ethernet-based protocols, including Modbus TCP, EtherNet/IP, etc.

It also allows Wi-Fi access to the associated Modicon processor from Vijeo Citect and Unity Pro software as well as exchange of data between automation platforms.

The PMXNOW0300 module can be removed and replaced while the rack is powered up. It is compatible with Vijeo Design' Air and Vijeo Design' Air Plus, allowing the HMI to be remotely located on a tablet or smartphone (2).

#### Main characteristics

##### Type of device

Wi-Fi access point, client and repeater

##### Wi-Fi standards

IEEE 802.11 a/b/g/h

##### Operating frequencies

2.4 GHz and 5 GHz

##### IP rating

IP 30

##### Mounting

On the rack

##### Number of radios

1

##### Nominal data rate

≤108 Mbps (Super AG mode, 54 Mbps in standard mode)

##### Antenna connections

1 x RP-SMA

##### Ethernet connections

3 x 10/100 BASE TX, MDI-MDIX

##### Wi-Fi connections

1 x WLAN interface

##### Range

Up to 300 m/984.25 ft in free field with the antenna supplied as standard and up to 5 km/3.11 mi with external antenna (frequency range and data rate dependent on antenna type)

##### Dimensions

97 x 32 x 104 mm/3.82 x 1.26 x 4.09 in.

##### Storage temperature

- 40 °C to + 80 °C/- 40 °F to + 176 °F

##### Humidity

Max. 95% (non-condensing)

##### Supply voltage

+ 24 V  $\overline{\text{DC}}$  from the Modicon X80 I/O platform rack

##### Consumption

3.5 W typical

(1) Only for processors compatible with the Modicon X80 I/O platform (see page 1/6).

(2) For more information, please consult our website [www.schneider-electric.com](http://www.schneider-electric.com).

# Modicon X80 I/O platform

## Wi-Fi network

### PMXNOW0300 Wi-Fi access point

#### References

##### Wi-Fi access points

Description	Number of radios	Data rate	IP rating	Reference	Weight
		Mbps			
<b>Wi-Fi 802.11a/b/g/h access point</b> with antenna and 50 cm/19.69 in. long Ethernet cable equipped with two RJ45 connectors, plus CD-ROM	1	≤108 (Super AG mode, 54 Mbps in standard mode)	IP 30	<b>PMXNOW0300 (1)</b>	0.205/ 0.452

Technology approved

by  



(1) To order this product, please consult our Customer Care Centre.

Technology approved

by  
**Schneider**  
Electric

PMESWT0100 Scaime partner  
weighing module

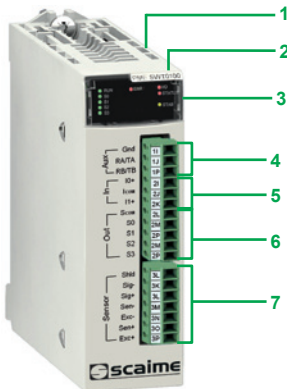
4



PMESWT0100

### Presentation

The **PMESWT0100** Scaime partner weighing module is integrated in a Modicon X80 I/O platform with an Ethernet + X-bus **BMEXBP●●00(H)** rack and a Modicon M580 **BMEP58●0●0** PLC or in a Modicon X80 RIO drop with an Ethernet + X-bus **BMEXBP●●00(H)** rack and a **BMECRA31210** adapter.

With this module it is possible to go beyond the scope of a simple weighing application.

It is suitable for static weighing applications such as silo level measurement and scale weighing and it also suits well for low speed dynamic weighing applications such as filling, dosing, and material transfer.

The Modicon X80 I/O platform can manage the whole weighing environment as well as the whole machine or industrial process associated with the weighing system. Indeed, weighing data is accessible by the PLC via implicit exchanges or explicit commands. Once the weighing signal is received, it is processed and transferred by the weighing module to the Modicon M580 PLC via the Ethernet backbone. This Ethernet weighing transmitter offline configuration, online calibration, monitoring, and weighing diagnostics are done by Unity Pro software via FDT/DTM. The Scaime partner weighing module has been developed to comply with the general standards and certifications of the Modicon X80 I/O platform. For more information, see page 8/2 or consult our website [www.schneider-electric.com](http://www.schneider-electric.com).

### Description

The **PMESWT0100** weighing module features the following:

- 1 A rigid body providing support and protection for the electronic card
- 2 A module reference marking (a label is also visible on the right-hand side of the module)
- 3 A module and channel status display block
- 4 Screw terminals for connecting an external HMI output
- 5 Screw terminals for connecting discrete reflex inputs
- 6 Screw terminals for connecting discrete reflex outputs
- 7 Screw terminals for connecting input load cells

### Main characteristics

#### Measurement input

1 weighing channel per module, comprising up to 8 load cells connected via junction box

#### Input load cell supply voltage

5 V  $\overline{\text{---}}$

#### Internal resolution

24 bit converter

#### User resolution

up to 1,000,000, factory-calibrated 500,000 at 2 mV/V

#### Internal measurement rate

6 to 400 measurements per second

#### External measurement rate

100 measurements per second

#### Discrete reflex outputs

#### Number of applications

4 positive logic outputs, 2 for dosing and 2 for threshold monitoring

#### Maximum voltage

55 V  $\overline{\text{---}}$

#### Nominal current

400 mA

#### Response time

2 ms discrimination

#### Discrete inputs

#### Number of applications

2 positive logic inputs, weighing functions

#### Low voltage range

0...3 V  $\overline{\text{---}}$

#### High voltage range

9...28 V  $\overline{\text{---}}$

#### High current

20 mA at 24 V  $\overline{\text{---}}$



PMESWT0100

### References

#### Weighing module

Description	Composition	Reference	Weight kg/lb
<b>Scaime partner weighing module</b> (1 weighing channel per module)	- Load cell input 100 measurements/s (for 1 to 8 load cells) - 4 discrete reflex outputs (for threshold monitoring and dosing) - 2 discrete inputs (for weighing functions) - 1 output for an external HMI	<b>PMESWT0100 (1)</b>	0.233/ 0.514

Technology approved by

(1) To order this product, please consult our Customer Care Centre.



---

## Treatment for severe environments

- Presentation..... page 5/2
- Harsh chemical environments..... page 5/2
- Extreme climatic environments..... page 5/2

## Ruggedized power supply modules

- References ..... page 5/3

## Ruggedized racks and rack expansion module

- References ..... page 5/4

## Ruggedized discrete I/O modules

- References ..... page 5/6

## Ruggedized analog I/O modules

- References ..... page 5/7

## Ruggedized communication modules and network gateway

- References ..... page 5/9

## Ruggedized application-specific modules

- References ..... page 5/11



# Modicon X80 I/O platform

## Treatment for harsh environments

### Ruggedized modules

#### Presentation

##### Protective treatment of Modicon X80 I/O platform

The Modicon X80 I/O platform complies with "TC" treatment requirements (Treatment for all Climates). They are designed as standard to operate in temperatures of 0 to + 60 °C/32 to 140 °F.

For installations in industrial production workshops or environments corresponding to "TH" (Treatment for Hot and humid environments), devices must be housed in enclosures providing at least IP 54 protection as specified by standard IEC/EN 60529, or an equivalent level of protection according to NEMA 250.

The Modicon X80 I/O platform offers **IP 20 degree of protection** (1). It can therefore be installed without an enclosure in reserved access areas that do not exceed **pollution level 2** (control room with no dust-producing machinery or activity). **Pollution level 2** does not take account of harsher environments, such as those where the air is polluted with dust, fumes, corrosive or radioactive particles, vapours or salts, moulds, insects, etc.

##### Treatment for harsh environments

If the Modicon X80 I/O platform has to be used in harsh environments or is required to start and operate in an extended temperature range, from **- 25 °C to + 70 °C/- 13 °F to 158 °F**, the "**ruggedized**" offer features industrially hardened processor and power supply modules, X-bus and Ethernet I/O modules and racks that have a protective coating on their circuit boards.

*Note: Capable of starting within an extended temperature range (from - 25 °C to + 70 °C/- 13 °F to 158 °F, a single-rack configuration is also able to operate at extremely low temperatures (to - 40 °C/- 40 °F) if placed in an appropriate enclosure. Please consult our Customer Care Center.*

This treatment increases the isolation capability of the circuit boards and their resistance to:

- Condensation
- Dusty atmospheres (conducting foreign particles)
- Chemical corrosion, in particular during use in sulphurous atmospheres (oil refinery, purification plant, etc.) or atmospheres containing halogens (chlorine, etc.)

This protection, combined with appropriate installation and maintenance, enables Modicon X80 I/O products to be used in the following environments:

##### ■ Harsh chemical environments:

- **IEC/EN 60721-3-3 class 3C3:**
  - 14 days; 25 °C/77 °F relative humidity 75%
  - Concentrations (mm<sup>3</sup>/m<sup>3</sup>): H<sub>2</sub>S: 2100/SO<sub>2</sub>: 1850/Cl<sub>2</sub>: 100
- **ISA S71.04 classes G1 to G3:**
  - 14 days; 25 °C/77 °F relative humidity 75%
  - Concentrations (mm<sup>3</sup>/m<sup>3</sup>): H<sub>2</sub>S: 50/SO<sub>2</sub>: 300/Cl<sub>2</sub>: 10/NO<sub>2</sub>: 1250
- **IEC/EN 60068-2-52 salt mist, Kb test severity level 2:**
  - 3 x 24-hour cycles
  - 5% NaCl
  - 40 °C/104 °F relative humidity 93%

##### ■ Extreme climatic environments:

- Temperatures from - 25 to + 70 °C/- 13 to 158 °F
- Relative humidity levels:
  - up to 93% from - 25 °C/- 13 °F to + 60 °C/140 °F
  - up to 95% from - 25 °C/- 13 °F to + 55 °C/131 °F
- Formation of ice
- Altitudes from 0 to 5000 m/0 to 16404 ft

Three modules are specifically designed for extended temperature ranges from - 25 to + 70 °C/- 13 to 158 °F (the product references include the suffix "T") :

- 125 V  $\overline{\text{---}}$  power supply module **BMXCPS3540T** (see page 2/11)
- 125 V  $\overline{\text{---}}$  discrete input module, 16 channels, **BMXDDI1604T** (see page 3/12)
- 125 V  $\overline{\text{---}}$  discrete relay output module, 8 channels, **BMXDRA0804T** (see page 3/12)

(1) Each slot in a **BM●XBP●●00** rack is equipped as standard with a protective cover that should only be removed when inserting a module. If any covers are subsequently misplaced, replacements can be ordered under reference **BMXXEM010** (sold in lots of 5).

## Composition

### References and characteristics

To order ruggedized modules and racks, see the reference pages 5/3 to 5/11 (the references of the ruggedized products available include the suffix "H").  
The standard separate parts (cordsets, cables, sub-bases, etc.) that are compatible with the ruggedized modules offer are listed in the reference pages (see pages 5/3 to 5/11).  
The majority of operating and electrical characteristics of ruggedized modules are identical to those of their equivalent standard versions. However, some characteristics are subject to either derating or limitation. Please consult our website [www.schneider-electric.com](http://www.schneider-electric.com).

## Ruggedized power supply modules

Each **BM●XBP●●00H** rack must be equipped with a power supply module. These modules are inserted in the first two slots of each rack (marked CPS).  
The available power values given below in **bold italic** correspond to operation at - 25 °C/- 13 °F and + 70 °C/158 °F (see temperature derating curves on our website [www.schneider-electric.com](http://www.schneider-electric.com)).  
The power required to supply each rack depends on the type and number of modules installed in the rack. It is therefore necessary to draw up a power consumption table for each rack in order to determine which is the most appropriate **BMXCPS●●●00H** power supply module for your requirements (consult our website [www.schneider-electric.com](http://www.schneider-electric.com)).

### Power supply modules (1)

Line supply	Available power (2)			Reference	Weight kg/lb
	3.3 V $\overline{\overline{\text{---}}}$ (3)	24 V $\overline{\overline{\text{---}}}$ rack (3)	24 V $\overline{\overline{\text{---}}}$ sensors (4)		
24...48 V $\overline{\overline{\text{---}}}$ isolated	15 W <b>11.3 W</b>	31.2 W <b>23.4 W</b>	–	<b>BMXCPS3020H</b>	0.340/ 0.750
100...240 V ~	15 W <b>11.3 W</b>	31.2 W <b>23.4 W</b>	21.6 W <b>16.2 W</b>	<b>BMXCPS3500H</b>	0.360/ 0.794

### Standard separate part

Description	Type	Composition	Reference	Weight kg/lb
Set of 2 removable connectors	Spring-type	One 5-way terminal block and one 2-way terminal block	<b>BMXXTSCPS20</b>	0.015/ 0.033

### Standard replacement part

Description	Type	Composition	Reference	Weight kg/lb
Set of 2 removable connectors	Cage clamp	One 5-way terminal block and one 2-way terminal block	<b>BMXXTSCPS10</b>	0.020/ 0.044

- (1) Includes a set of 2 cage clamp removable connectors **BMXXTSCPS10**.  
 (2) The total power consumed on each voltage (3.3 V  $\overline{\overline{\text{---}}}$  and 24 V  $\overline{\overline{\text{---}}}$ ) must not exceed the total power of the module. See the power consumption table on our website [www.schneider-electric.com](http://www.schneider-electric.com).  
 (3) 3.3 V  $\overline{\overline{\text{---}}}$  and 24 V  $\overline{\overline{\text{---}}}$  rack voltages for powering Modicon M340 and M580 PLC modules.  
 (4) 24 V  $\overline{\overline{\text{---}}}$  sensor voltage for powering the input sensors (voltage available via the 2-way removable connector on the front panel).



BMXCPS3020H



BMXCPS3500H

# Modicon X80 I/O platform

Dedicated parts for harsh environments  
Ruggedized racks and rack expansion module

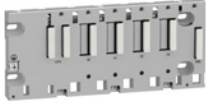

BMXXBP0400H

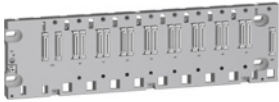

BMEXBP0800H



BMXXBE1000H

### Ruggedized racks

Description	Type of module to be inserted	No. of slots (1)	Power consumption (2)	Reference	Weight kg/lb
<b>Ruggedized X-bus racks</b>	BMXCPS power supply, BMXP34 or BMEP58 processor, I/O modules and application-specific (counter and communication) modules	4	1 W	<b>BMXXBP0400H</b>	0.630/ 1.389
		6	1.5 W	<b>BMXXBP0600H</b>	0.790/ 1.742
		8	2 W	<b>BMXXBP0800H</b>	0.950/ 2.094
		12	–	<b>BMXXBP1200H</b>	1.270/ 2.800
<b>Ruggedized Ethernet + X-bus racks</b>	BMXCPS power supply, BMEP58 processor, I/O modules and application-specific (counter and communication) modules	4	2.8 W	<b>BMEXBP0400H</b>	0.715/ 1.576
		8	3.9 W	<b>BMEXBP0800H</b>	1.070/ 2.359
		12	3.9 W	<b>BMEXBP1200H</b>	1.387/ 3.058

Description	Use	Reference	Weight kg/lb
<b>Ruggedized rack expansion module (3)</b>	Standard module to be installed in each rack (XBE slot) Used to daisy chain up to 4 racks	<b>BMXXBE1000H</b>	0.178/ 0.392

5



BMXXSP000 + BMXXSP3000

### Standard accessories for racks

Description	For use with	Sold in lots of	Reference	Weight kg/lb
<b>Shielding connection kits</b> comprising: - A metal bar - 2 support bases	BM●XBP0400H rack	–	<b>BMXXSP0400</b>	0.280/ 0.617
	BMXXBP0600H rack	–	<b>BMXXSP0600</b>	0.310/ 0.683
	BM●XBP0800H rack	–	<b>BMXXSP0800</b>	0.340/ 0.750
	BM●XBP1200H rack	–	<b>BMXXSP1200</b>	0.400/ 0.882
<b>Spring clamping rings</b>	Cables, cross-section 1.5...6 mm <sup>2</sup> /AWG 16...9	10	<b>STBXSP3010</b>	0.050/ 0.110
	Cables, cross-section 5...11 mm <sup>2</sup> /AWG 10...7	10	<b>STBXSP3020</b>	0.070/ 0.154
<b>Protective covers</b> (replacement parts)	Unoccupied slots on BM●XBP●●00H rack	5	<b>BMXXEM010</b>	0.005/ 0.011

(1) Number of slots taking the processor module, I/O modules and application-specific modules (excluding power supply module).

(2) Power consumption of anti-condensation resistor(s)

(3) Module and cordsets do not operate properly at temperatures lower than - 25 °C/- 13 °F.

# Modicon X80 I/O platform

## Dedicated parts for harsh environments

### Ruggedized racks and rack expansion module



Angled connector on extension cordsets

#### Standard cordsets and connection accessories

Description	Use	Composition	Type of connector	Length	Reference	Weight kg/lb
<b>X-bus extension cordsets</b> total length 30 m/ 98.425 ft max. (1)	Between two BMXXBE1000H rack expansion modules.	2 x 9-way SUB-D connectors	Angled	0.8 m/ 2.625 ft	<b>BMXXBC008K</b>	0.165/ 0.364
				1.5 m/ 4.921 ft	<b>BMXXBC015K</b>	0.250/ 0.551
				3 m/ 9.843 ft	<b>BMXXBC030K</b>	0.420/ 0.926
				5 m/ 16.404 ft	<b>BMXXBC050K</b>	0.650/ 1.433
				12 m/ 39.370 ft	<b>BMXXBC120K</b>	1.440/ 3.175
			Straight	1 m/ 3.281 ft	<b>TSXCBY010K</b>	0.160/ 0.353
				3 m/ 9.843 ft	<b>TSXCBY030K</b>	0.260/ 0.573
				5 m/ 16.404 ft	<b>TSXCBY050K</b>	0.360/ 0.794
				12 m/ 39.370 ft	<b>TSXCBY120K</b>	1.260/ 2.778
				18 m/ 59.055 ft	<b>TSXCBY180K</b>	1.860/ 4.101
28 m/ 91.864 ft	<b>TSXCBY280KT</b> (2)	2.860/ 6.305				
<b>Cable reel</b> (1)	Length of cable to be fitted with TSXCBYK9 connectors	Ends with flying leads, 2 line testers		100 m/ 328.084 ft	<b>TSXCBY1000</b>	12.320/ 27.161



TSXTLYEX

Description	Use	Composition	Sold in lots of	Reference	Weight kg/lb
<b>Line terminator</b>	Required on both BM●XBP●●●0H modules at each end of the daisy chain	2 x 9-way SUB-D connectors marked A/and/B	2	<b>TSXTLYEX</b>	0.050/ 0.110
<b>X-bus straight connectors</b>	For ends of TSXCBY1000 cables	2 x 9-way SUB-D straight connectors	2	<b>TSXCBYK9</b>	0.080/ 0.176
<b>Connector assembly kit</b>	Fitting TSXCBYK9 connectors	2 crimping pliers, 1 pen (3)	–	<b>TSXCBYACC10</b>	–

(1) Module and cordsets do not operate properly at temperatures **lower than - 25 °C/- 13 °F**.

(2) Cable supplied with a set of 2 TSXTVSY100 electrical transient suppressors.

(3) To fit the connectors on the cable, you also need a wire stripper, a pair of scissors and a digital ohmmeter.

# Modicon X80 I/O platform

Dedicated parts for harsh environments  
Ruggedized discrete I/O modules



BMXD1160H

References						
Ruggedized discrete input modules						
Type of current	Input voltage	Connection via (1)	IEC/EN 61131-2 conformity	No. of channels (common)	Reference	Weight kg/lb
DC	24 V (positive logic)	Screw or spring-type 20-way removable terminal block	Type 3	16 isolated inputs (1 x 16)	BMXDDI1602H	0.115/0.254
	24 V (negative logic)	Screw or spring-type 20-way removable terminal block	Non-IEC	16 isolated inputs (1 x 16)	BMXDAI1602H	0.115/0.254
	48 V (positive logic)	Screw or spring-type 20-way removable terminal block	Type 1	16 isolated inputs (1 x 16)	BMXDDI1603H	0.115/0.254
AC	24 V	Screw or spring-type 20-way removable terminal block	Type 1	16 isolated inputs (1 x 16)	BMXDAI1602H	0.115/0.254
	48 V	Screw or spring-type 20-way removable terminal block	Type 3	16 isolated inputs (1 x 16)	BMXDAI1603H	0.115/0.254
	100...120 V	Screw or spring-type 20-way removable terminal block	Type 3	16 isolated inputs (1 x 16)	BMXDAI1604H	0.115/0.254



BMXDDO162H BMXDRA0805H/1605H

Ruggedized discrete output modules						
Type of current	Output voltage	Connection via (1)	IEC/EN 61131-2 conformity	No. of channels (common)	Reference	Weight kg/lb
DC transistor	24 V/0.5 A (positive logic)	Screw or spring-type 20-way removable terminal block	Yes	16 protected outputs (1 x 16)	BMXDDO1602H	0.120/0.265
	24 V/0.5 A (negative logic)	Screw or spring-type 20-way removable terminal block	-	16 protected outputs (1 x 16)	BMXDDO1612H	0.120/0.265
AC triac	100...240	Screw or spring-type 20-way removable terminal block	-	16 outputs (4 x 4)	BMXDAO1605H	0.140/0.309
DC or AC relay	12...24 V DC/2 A	Screw or spring-type 20-way removable terminal block	Yes	8 non-protected outputs (without common)	BMXDRA0805H	0.145/0.320
	24...240 V AC/2 A		-			
	24 V DC/2 A, 240 V AC/2 A	Screw or spring-type 20-way removable terminal block	Yes	16 non-protected outputs (2 x 8)	BMXDRA1605H	0.150/0.331



BMXDDM1602H

Ruggedized mixed discrete I/O modules						
Number of I/O	Connection via (1)	No. of input channels (common)	No. of output channels (common)	IEC/EN 61131-2 conformity	Reference	Weight kg/lb
16	Screw or spring-type 20-way removable terminal block	8 (positive logic) (1 x 8)	8, transistor 24 V DC/0.5 A (1 x 8)	Inputs, type 3	BMXDDM16022H	0.115/0.254
			8, 24 V DC or 24...240 V AC relay (1 x 8)	Inputs, type 3	BMXDDM16025H	0.135/0.298

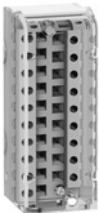

BMXF2000

Standard removable connection blocks				
Description	Use	Type	Reference	Weight kg/lb
20-way removable terminal blocks	For module with 20-way removable terminal block	Cage clamp	BMXF2000	0.093/0.205
		Screw clamp	BMXF2010	0.075/0.165
		Spring-type	BMXF2020	0.060/0.132

Standard preformed cordsets for I/O modules with removable terminal block				
Description	Composition	Length	Reference	Weight kg/lb
Preassembled cordsets with one end with flying leads	One 20-way spring-type removable terminal block (BMXF2020) One end with color-coded flying leads	3 m/ 9.843 ft	BMXF301	0.850/1.874
		5 m/ 16.404 ft	BMXF501	1.400/3.086
		10 m/ 32.808 ft	BMXF1001	2.780/6.129

(1) By connector, module supplied with cover(s)

# Modicon X80 I/O platform

## Dedicated parts for harsh environments

### Ruggedized analog I/O modules



BMXAMI0000H



BMXART0414H

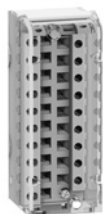

BMXFTB2000

#### References

##### Ruggedized analog input modules

Type of inputs	Input signal range	Resolution	Connection	No. of channels	Reference	Weight kg/lb
Isolated high-level inputs	$\pm 10$ V, 0...10 V, 0...5 V, 1...5 V, $\pm 5$ V, 0...20 mA, 4...20 mA, $\pm 20$ mA	16 bits	Via cage clamp, screw clamp or spring-type removable terminal block	4 high-speed channels	<b>BMXAMI0410H</b>	0.143/ 0.315
			Via cage clamp or spring-type removable terminal block	8 isolated high-speed channels	<b>BMXAMI0810H</b>	0.175/ 0.386
Isolated low-level inputs	Temperature probe, thermocouple, $\pm 40$ mV, $\pm 80$ mV, $\pm 160$ mV, $\pm 320$ mV, $\pm 640$ mV, $\pm 1.28$ V	15 bits + sign	40-way connector	4 channels	<b>BMXART0414H</b>	0.135/ 0.298
				8 channels	<b>BMXART0814H</b>	0.165/ 0.364

##### Ruggedized analog output module

Type of outputs	Output signal range	Resolution	Connection	No. of channels	Reference	Weight kg/lb
Isolated high-level outputs	$\pm 10$ V, 0...20 mA, 4...20 mA	16 bits	Via cage clamp, screw clamp or spring-type removable terminal block	2 channels	<b>BMXAMO0210H</b>	0.144/ 0.317
				4 channels	<b>BMXAMO0410H</b>	0.175/ 0.386

##### Ruggedized mixed analog I/O module

Type of outputs	Signal range	Resolution	Connection	No. of channels	Reference	Weight kg/lb
Mixed I/O, non-isolated	$\pm 10$ V, 0...10 V, 0...5 V, 1...5 V, 0...20 mA, 4...20 mA	14 bits or 12 bits depending on the range	Via cage clamp, screw clamp or spring-type removable terminal block	I: 4 channels Q: 2 channels	<b>BMXAMM0600H</b>	0.155/ 0.342



BMXFTW01S



ABE7CPA41



BMXFCA000



BMXFCA002

## References

### Standard connection accessories for analog modules (1)

Description	For use with modules	Type, composition	Length	Reference	Weight kg/lb
20-way removable terminal blocks	BMXAMI0410H	Cage clamp	–	<b>BMXFTB2000</b>	0.093/ 0.205
	BMXAMO0210H	Screw clamp	–	<b>BMXFTB2010</b>	0.075/ 0.165
	BMXAMM0600H		Spring-type	–	<b>BMXFTB2020</b>
Preassembled cordsets	BMXAMI0410H	One 20-way removable terminal block (BMXFTB2020)	3 m/ 9.843 ft	<b>BMXFTW301S</b>	0.470/ 1.036
	BMXAMO0210H		5 m/ 16.404 ft	<b>BMXFTW501S</b>	0.700/ 1.543
	BMXAMM0600H	One end with color-coded flying leads	3 m/ 9.843 ft	<b>BMXFCW301S</b>	0.480/ 1.058
	BMXART0414H		5 m/ 16.404 ft	<b>BMXFCW501S</b>	0.710/ 1.565

### Modicon Telefast ABE7 pre-wired system

Modicon Telefast ABE7 sub-bases	BMXAMI0410H	Distribution of isolated power supplies Delivers 4 protected isolated power supplies for 4...20 mA inputs Direct connection of 4 inputs	–	<b>ABE7CPA410</b>	0.180/ 0.397
	BMXART0414H BMXART0814H	Connection and provision of cold-junction compensation for thermocouples Direct connection of 4 inputs	–	<b>ABE7CPA412</b>	0.180/ 0.397
Preformed cordsets for Modicon Telefast ABE7CPA41	BMXAMI0410H	One 20-way removable terminal block and one 25-way SUB-D connector for ABE7CPA410/CPA21 sub-base	1.5 m/ 4.921 ft	<b>BMXFCA150</b>	0.320/ 0.705
	BMXAMO0210H		3 m/ 9.843 ft	<b>BMXFCA300</b>	0.500/ 1.102
			5 m/ 16.404 ft	<b>BMXFCA500</b>	0.730/ 1.609
	BMXART0414H	One 40-way connector and one 25-way SUB-D connector for ABE7CPA412 sub-base	1.5 m/ 4.921 ft	<b>BMXFCA152</b>	0.330/ 0.728
	BMXART0814H		3 m/ 9.843 ft	<b>BMXFCA302</b>	0.510/ 1.124
			5 m/ 16.404 ft	<b>BMXFCA502</b>	0.740/ 1.631

(1) The shielding on the cordsets carrying the analog signals must always be connected to the **BMXXSP0000** shielding connection kit mounted under the rack holding the analog modules (see page 2/3).

(2) The **BMXART0814H** 8-channel module requires two **ABE7CPA412** sub-bases and two **BMXFCA002** cordsets.



BMXNOE0100H/0110H



BMXNOM0200H



BMXNOR0200H

## Communication

### BMXNOE0100H/0110H ruggedized Ethernet communication modules

Description	Data rate	Transparent Ready Class	Reference	Weight kg/lb
Ethernet Modbus/TCP network modules	10/100 Mbps	B30	BMXNOE0100H	0.200/ 0.441
		C30	BMXNOE0110H	0.200/ 0.441

### BMXNOM0200H ruggedized serial link module

Description	Protocol	Physical layer	Reference	Weight kg/lb
Serial link module 2-channels	Modbus master/slave RTU/ASCII, Character mode, Modem GSM/GPRS	1 non-isolated RS 232 channel (SL0) 2 isolated RS 485 channels (SL0 and SL1)	BMXNOM0200H	0.230/ 0.507

### RTU BMXNOR0200H ruggedized communication module

Description	Protocols	Physical layer	Reference	Weight kg/lb
RTU communication module	Modbus TCP, IEC 60870-5-104 or DNP3 IP (client or server)	1 Ethernet port 10BASE-T/100BASE-TX	BMXNOR0200H	0.205/ 0.452
		1 non-isolated RS 232/485 serial link port		



# Modicon X80 I/O platform

Dedicated parts for harsh environments  
Ruggedized communication modules and network gateway



BMECRA31210



BMXCRA31210



TCSEGPA23F14FK

### Communication

#### “Conformal Coating” EIO drop adapters

Description	SERVICE port	Reference	Weight kg/lb
Modicon X80 EIO drop adapter for Ethernet + X-bus racks	1	BMECRA31210C	–
Modicon X80 EIO performance drop adapter	1	BMXCRA31210C	–

#### Ruggedized Profibus DP network gateway

Description	Protocols	Physical layer	Reference	Weight kg/lb
Profibus Remote Master (PRM) module	Modbus TCP	1 Ethernet switch, 2 ports 10BASE-T/ 100BASE-TX	TCSEGPA23F14FK	–
	Profibus DP V1 and Profibus PA (via gateway)	1 isolated RS 485 Profibus DP port		

#### Standard connection accessory

Designation	Description	RS 232 interface	Reference	Weight kg/lb
Cordset for DCE terminal (modem, etc.)	Equipped with 1 x RJ45 connector and 1 x 9-way male SUB-D connector Length 3 m/9.843 ft	Simplified 4-wire (RX, TX, RTS and CTS)	TCSMCN3M4M3S2	0.150/ 0.331
		Full 8-wire (except RI signal)	TCSXCN3M4F3S4	0.165/ 0.364

5



BMXEHC0200H



BMXEHC0800H

### Application-specific modules

#### BMXEHC0200H/0800H ruggedized counter modules

Description	No. of channels	Characteristics	Reference	Weight kg/lb
Counter modules for 24 V $\pm$ 2- and 3-wire sensors and 10/30 V $\pm$ incremental encoders with push-pull outputs	2	60 kHz counting	<b>BMXEHC0200H</b>	0.112 0.247
	8	10 kHz counting	<b>BMXEHC0800H</b>	0.113 0.249



BMXEAE0300H

#### BMXEAE0300H ruggedized SSI encoder interface module

Description	No. of channels	Characteristics	Reference	Weight kg/lb
SSI encoder interface module	3	8 to 31 bits data width 4 ranks of baud rates: 100 kHz, 200 kHz, 500 kHz, 1 MHz	<b>BMXEAE0300H</b>	0.138 0.304



BMXFTB20●0

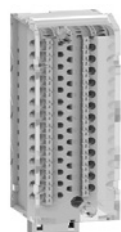

BMXFTB28●0

#### Standard connection accessories (1)

Description	Composition	Unit reference	Weight kg/lb
<b>Connector kit</b> for BMXEHC0200H module	Two 16-way connectors and one 10-way connector	<b>BMXXTSHSC20</b>	0.021/ 0.046
<b>20-way removable terminal blocks</b> for BMXEHC0800H module	Cage clamp	<b>BMXFTB2000</b>	0.093/ 0.205
	Screw clamp	<b>BMXFTB2010</b>	0.075/ 0.165
	Spring-type	<b>BMXFTB2020</b>	0.060/ 0.132
<b>28-way removable terminal blocks</b> for BMXEAE0300H module	Cage clamp	<b>BMXFTB2800</b>	0.111/ 0.245
	Spring-type	<b>BMXFTB2820</b>	0.080/ 0.176
<b>Shielding connection kits</b> for BMXEHC0200H/0800H and BMXEAE0300H modules	Comprising a metal bar and two support bases for mounting on rack	<b>See page 2/3</b>	–

(1) The shielding on the cordsets carrying the counter signals must always be connected to the **BMXXSP●●00** shielding connection kit mounted under the rack holding the **BMXEHC0200H** module (see page 2/3).



---

## Modicon Telefast ABE7 pre-wired system

- Modicon Telefast ABE7 selection guide* ..... page 6/2
- **Interface with Modicon X80 I/O modules** ..... page 6/8
- **References** ..... page 6/12
- Passive connection sub-bases ..... page 6/12
- Adaptor sub-bases with fixed relays and removable terminal blocks ..... page 6/14
- Input/output adaptor sub-bases for or with plug-in relays ..... page 6/15
- Output adaptor sub-bases for plug-in relays ..... page 6/16
- Plug-in relays ..... page 6/17
- Connection sub-bases for analog channels and application-specific channels ..... page 6/18
- Cabled connectors for Modicon Quantum I/O modules ..... page 6/19
- Accessories for connection sub-bases ..... page 6/20

# Connection interfaces

## Modicon Telefast ABE7 pre-wired system

### Discrete input and/or output sub-bases

Applications	Discrete inputs or outputs			
	Optimum "Economy"	Optimum "Miniature"	Universal	



Compatibility	TSX Micro, Modicon Premium, Modicon M340, Modicon M580		TSX Micro, Modicon Premium, Modicon Quantum, Modicon M340, Modicon M580	
Sub-base type	Passive connection sub-bases			
Equipped with relays	-			
Control voltage	24 V ~			
Output voltage	24 V ~			
Output current per channel	0.5 A			
Modularity	16	8 - 12 - 16		
No. of terminals per channel	1	1 to 3	1	2
Type of connection terminals	Signal	Signal, common (configurable as 24 V ~ or 0 V)	Signal	Signal, common (configurable as 24 V ~ or 0 V)
Connectors	20-way HE10 connector			
Terminal block	Removable No		No	
Terminal type	Screw			
Additional or optional* function	Low-cost version fitted with cable	Miniature sub-bases	Compact size *	Input type 2 * (1)
Type of device	ABE7H●●E●00	ABE7H16C●●	ABE7H●●R1● ABE7H●●R50	ABE7H●●R2● ABE7H●●S21
Page	6/12		6/13	

(1) For Modicon TSX Micro and Modicon Premium PLCs

Discrete inputs or outputs	Outputs for solid state and/or electromechanical relays	
	Optimum "Miniature"	Optimum and Universal



Compatibility	TSX Micro, Modicon Premium, Modicon Quantum, Modicon M340, Modicon M580		
Sub-base type	Passive connection sub-bases	Plug-in electromechanical or solid state relays	
Equipped with relays	-	Yes	
Control voltage	24 V ~		
Output voltage	24 V ~	24V ~ (solid state) 5... 24 V ~, 230 V ~ (electromechanical)	
Output current per channel	0.5 A	5 A (th)	
Modularity	16	16 8 passive inputs 8 relay outputs	
No. of terminals per channel	1	2	1
Type of connection terminals	Signal, 2 common connections between the inputs and the outputs	Signal, common, 2 common connections between the inputs and the outputs	1 N/O contact and common, 4 output channels 2 input connection points
Connectors	20-way HE10 connectors		
Terminal block	No		
Terminal type	Screw		
Additional or optional* function	Miniature sub-base Synergy with Tego Power and Micro PLC	Miniature sub-base - Common per group of 4 channels Synergy with Tego Power and Micro PLC	
Type of device	ABE7H16CM11	ABE7H16CM21	ABE7R16M111
Page	6/12	6/15	

## Connection interfaces

### Modicon Telefast ABE7 pre-wired system

#### Discrete input and output sub-bases

Applications	Discrete outputs			
	Optimum	Universal	Optimum	Universal

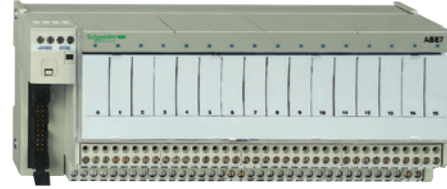

<b>Compatibility</b>	TSX Micro, Modicon Premium, Modicon Quantum, Modicon M340, Modicon M580					
<b>Relay sub-base</b>	Electromechanical, fixed		Electromechanical or solid state			
<b>Equipped with relays</b>	Yes		Yes	No	No	
<b>Control voltage</b>	24 V $\overline{\text{---}}$					
<b>Output voltage</b>	5 V... 30 V $\overline{\text{---}}$ 230 V $\sim$	5 V... 150 V $\overline{\text{---}}$ 230 V $\sim$	24 V $\overline{\text{---}}$ (solid state) 5 V... 24 V $\overline{\text{---}}$ , 230 V $\sim$ (E.M.)	5 V... 150 V $\overline{\text{---}}$ 230 V $\sim$		
<b>Output current per channel</b>	2 A (th)	3 A (th)	5 A (th)	2 A (solid state) 6 A (electromechanical)	0.5 to 10 A (dependent on relay)	
<b>Modularity</b>	8	8 - 16		16	8 or 16	
<b>No. of terminals per channel</b>	2	1	2	1	2 to 3	
<b>Type of connection terminals</b>	1 N/O contact and common Volt-free	1 N/O contact	1 N/O contact and common	1 N/O contact	Signal, Polarities	
<b>Connectors</b>	20-way HE 10 connector					
<b>Terminal block</b>	Removable	Yes	Yes	Yes	No	No
	Terminal type	Screw or spring			Screw	
<b>Additional or optional* function</b>	Miniature sub-base Latching relay	Volt-free or common per group of 8 channels		Miniature sub-bases Common per group of 4 channels	Isolator and fuse	
<b>Type of device</b>	ABE7R08S216●	ABE7R●S1●●	ABE7R●S2●●	ABE7R16T111	ABE7P16T111	ABE7P16T2●●● ABE7P08T3●●●
<b>Page</b>	6/14		6/15	6/16		

(1) For TSX Micro and Modicon Premium PLCs

Discrete outputs	Discrete inputs or outputs					
	Universal					

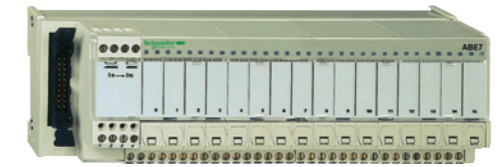

TSX Micro, Modicon Premium, Modicon Quantum, Modicon M340, Modicon M580						
Electromechanical, plug-in		Solid state, fixed		Solid state, fixed		Solid state, plug-in
Yes		Yes		Yes		No
24 V $\overline{\text{---}}$				From 24 V $\overline{\text{---}}$ to 230 V $\sim$		From 5 V TTL to 230 V $\sim$
5 V... 150 V $\overline{\text{---}}$ 230 V $\sim$		24 V $\overline{\text{---}}$				
5 A (th)	8 A (th)	0.5 to 2 A	125 mA	0.5 A	125 mA	12 mA
16						
2 to 3	2 to 6	2	3	2		
1 C/O contact or 1 N/O contact and common	1 C/O contact or 2 C/O contacts and common	Signal and 0 V		24 V $\overline{\text{---}}$ and 0 V signal	Signal can be isolated, Protected common	Signal Signal and common
20-way HE 10 connector						
No		Yes	No	No	Yes	No
Screw		Screw or spring		Screw		Screw or spring
Volt-free or common per group of: 8 channels		Fault signal 4 channels		Isolator and fuse (indicator)	3-wire proximity sensor	Isolator and fuse (indicator)
ABE7R16T2●●	ABE7R16T3●●	ABE7S●S2B●	ABE7H16F43	ABE7H16R3●	ABE7H16S43	ABE7S16E2●●E ABE7P16F31●
6/15		6/14	6/13		6/14	6/15

# Connection interfaces

## Modicon Telefast ABE7 pre-wired system

### Analog and application-specific sub-bases

**Applications** Analog signals and special functions



<b>Compatibility</b>	TSX Micro: □ TSX3722 □ TSXCTZ●A	Modicon Premium: □ TSXCTY●A □ TSXCAY●1	Modicon Premium: □ TSXASY800 □ TSXAEY1600 □ TSXA●Y800 Modicon X80 I/O: □ BMXAMI0800 □ BMXAMI0810 □ BMXAMO0802 Modicon Quantum: □ 140AVI03000 □ 140ACI03000 □ 140ACI04000 □ 140ACO13000	Modicon Premium: □ TSXASY410 □ TSXAEY420 Modicon X80 I/O: □ BMXAMO0210 □ BMXAMO0410 □ BMEAHO0412 Modicon Quantum: □ 140AVO02000 □ 140ACO2000	Modicon X80 I/O: □ BMXAMI0410 □ BMXAMI0410 □ BMXART0414 □ BMXART0814 Modicon Premium: □ TSXAEY1614
<b>Type of signal</b>	Counter inputs and analog I/O	Counter inputs Axis control Position control	Analog inputs Current/Voltage Pt 100	Analog outputs Current Voltage	Analog inputs
<b>Functions</b>	Passive connection, point-to-point with shield continuity			Connection of cold junction compensation or provision, distribution of isolated power supplies	
<b>Modularity</b>	1 counter channel or 8 analog inputs + 2 analog outputs		8 channels	4 channels	4 channels
<b>Control voltage</b>	24 V ---				–
<b>Output voltage</b>	24 V ---				–
<b>Output current per channel</b>	25 mA				–
<b>No. of terminals per channel</b>	2		2 or 4	2 or 4	2 or 4
<b>Connector type</b>	15-way SUB-D + 9-way SUB-D		25-way SUB-D		25-way SUB-D
<b>Terminal block</b>	Removable Terminal type	No Screw	No Screw	No Screw	No Screw
<b>Type of device</b>	ABE7CPA01	ABE7CPA02	ABE7CPA21	ABE7CPA412 ABE7CPA410	
<b>Page</b>	6/18				

**Applications** Analog signals and special functions



Modicon Premium: □ TSXAEY800 □ TSXAEY1600 Modicon Quantum: □ 140AVI03000 □ 140ACI03000 □ 140ACI04000	Modicon Premium: □ TSXAEY810 Modicon X80 I/O: □ BMXAMI0800 □ BMXAMI0810 □ BMEAHI0812 Modicon Quantum: □ 140AVI03000 □ 140ACI03000 □ 140ACI04000	Modicon Premium: □ TSXCAY●1, □ TSXCTY●A	Modicon Premium: □ TSXAEY1614	Modicon Premium: □ TSXPAY2●2
Analog inputs Current Voltage Pt 100	Isolated analog inputs	Counter inputs	Inputs for thermocouples	I/O
Distribution of sensor power supplies by limiter (25 mA)	Distribution of isolated sensor power supplies by converter	Acquisition of value from an absolute encoder	Connection of 16 thermocouples with cold junction compensation	Safety module (BG)
8 channels	8 channels	1 channel	16 channels	12 Emergency stops
24 V ---				
24 V ---				
25 mA				
2 or 4		–	2 or 4	1
25-way SUB-D	25-way SUB-D	15-way SUB-D	25-way SUB-D	50-way SUB-D
No Screw	No Screw or spring	No Screw	No Screw	No Screw
ABE7CPA03	ABE7CPA31●	ABE7CPA11	ABE7CPA12	ABE7CPA13
6/18				

# Connection interfaces

Modicon Telefast ABE7 pre-wired system  
 ABE7 interfaces with Modicon X80 I/O modules

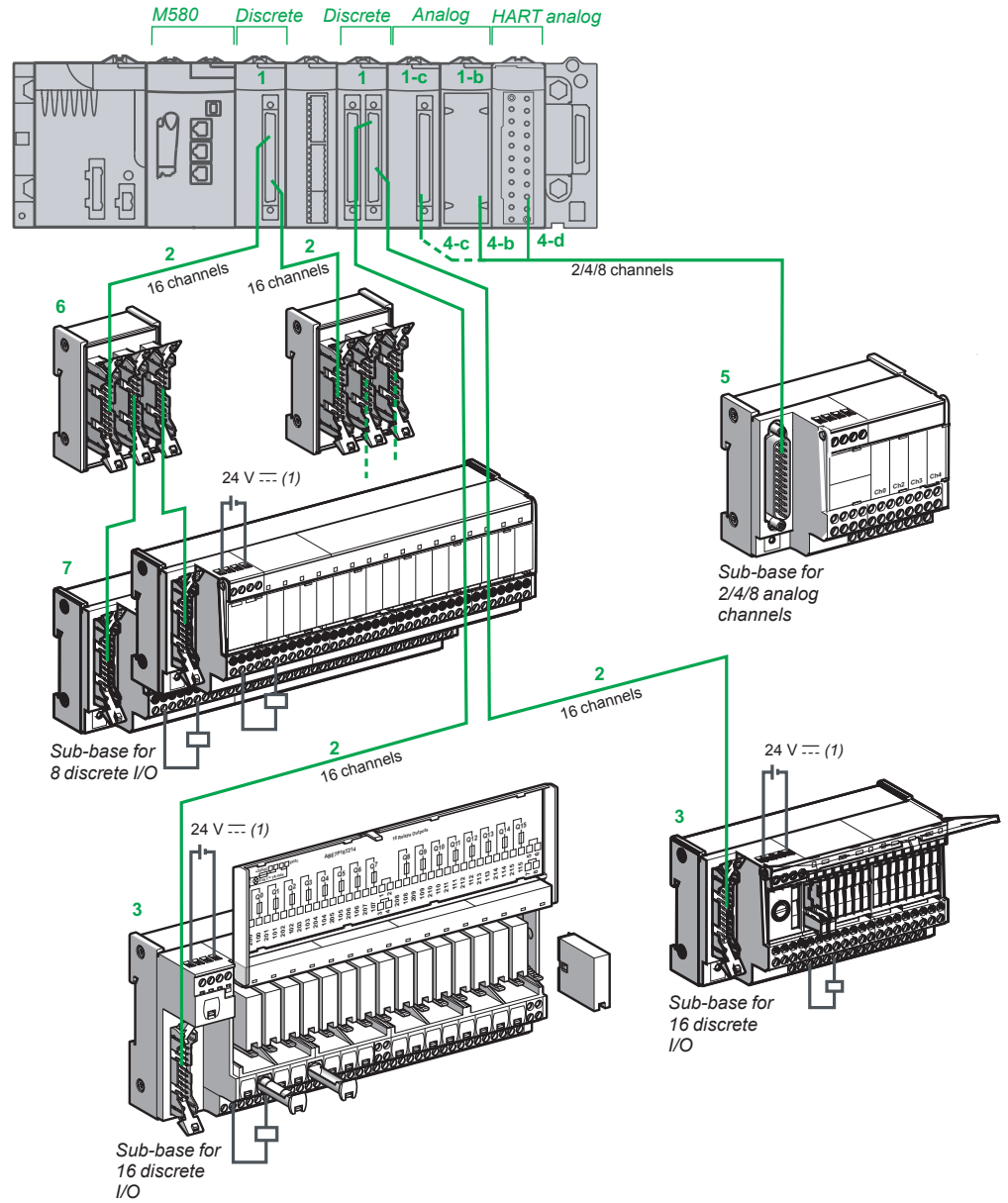

6

(1) Connection of the 24 V AC power supply is only possible using Modicon Telefast ABE7 sub-bases. The 0 V connections must be equipotential.



# Connection interfaces

## Modicon Telefast ABE7 pre-wired system

### ABE7 interfaces with Modicon X80 I/O modules

#### Presentation

##### I/O modules on the Modicon X80 platform

- 1 Discrete input modules (BMXDDI●●02K), discrete output modules (BMXDDO●●02K) and discrete mixed I/O modules (BMXDDM3202K) equipped with one or two 40-way FCN connectors. The modularity of each module (●●) is 32 or 64 channels.
  - 1-b Analog input or output modules:
    - Analog inputs: **BMXAMI0410** (4 channels), **BMXAMI0800** (4 channels) and **BMXAMI0810** (8 channels)
    - Analog outputs: **BMXAMO0210** (2 channels), **BMXAMO0410** (4 channels) and **BMXAMO0802** (8 channels)
  - 1-c Analog input modules **BMXART0414** (4 channels) and **BMXART0814** (8 channels)
  - 1-d HART analog I/O modules **BMEAHI0812** (8 channels) and **BMEAHO0412** (4 channels)
- 2 2 types of cordset are available depending on the type of discrete module connected to the sub-base (for combinations, see page 6/10). These cordsets are available in 0.5, 1, 2, 3, 5 or 10 m/1.640, 3.281, 6.562, 9.843, 16.404, 32.808 ft lengths:
  - **BMXFCC●●●1** cordsets with one 20-wire sheath (AWG 22) equipped with one 40-way FCN connector and one HE 10 moulded connector on the Telefast sub-base end
  - **BMXFCC●●●3** cordsets with two 20-wire sheaths (AWG 22) equipped with one common 40-way FCN connector on the module end and two HE 10 moulded connectors on the Telefast sub-base end
- 3 16-channel Modicon Telefast ABE7 Optimum or Universal passive connection sub-bases or adaptor sub-bases.
- 4 4 types of cordset are available depending on the type of analog module connected to the sub-base (for combinations, see page 6/11).
  - 4-b: Connection to analog module with 20-way or 28-way removable terminal block:
    - **BMXFCA●●●0** cordsets with a 20-way removable terminal block on the module end and a 25-way SUB-D connector on the Telefast sub-base end. Cordsets available in 1.5 or 3m/4.92 or 9.84 ft lengths.
    - **BMXFCA●●●2** cordsets with a 20-way removable terminal block on the module end and a 25-way SUB-D connector on the Telefast sub-base end. Cordsets available in 1.5 or 3m/4.92 or 9.84 ft lengths.
    - **BMXFCA●●●0** cordsets with a 28-way removable terminal block on the module end and a 25-way SUB-D connector on the Telefast sub-base end. Cordsets available in 1.5 or 3m/4.92 or 9.84 ft lengths.
  - 4-c: Connection to analog module with 40-way FCN connector:
    - **BMXFCA●●●2** cordsets with a 40-way FCN connector on the module end and a 25-way SUB-D connector on the Telefast sub-base end. Cordsets available in 1.5 or 3m/4.92 or 9.84 ft lengths.
  - 4-d: Connection to HART analog input module:
    - **BMXFCA1522/3022** cordsets with a 20-way removable terminal block on the module end and a 25-way SUB-D connector on the Telefast sub-base end. Cordsets available in 1.5 or 3m/4.92 or 9.84 ft lengths.
 For connection to HART analog output module:
    - **BMXFCA●●●0** (see description in section 4-b)
- 5 Modicon Telefast ABE7CPA analog and application-specific connection sub-bases (for combinations, see pages 6/11):
  - **ABE7CPA410** allows connection on a screw terminal block of 4 current/voltage inputs, with provision and distribution of 4 isolated power supplies for the current loop inputs
  - **ABE7CPA412** allows connection on a screw terminal block of 4 thermocouple inputs, with cold-junction compensation supplied for these inputs
  - **ABE7CPA21** allows connection on a screw terminal block of 4 current/voltage outputs
  - **ABE7CPA02** allows connection on a screw terminal block of 8 current/voltage I/O
  - **ABE7CPA03** allows connection on a screw terminal block of 8 inputs, with provision and distribution of the power supply (with limitation of each current loop) for the current/voltage outputs of the **BMXAMO0210** analog module
  - **ABE7CPA31**, **ABE7CPA31E** allows connection on a screw terminal block (ABE7CPA31) or a spring-type terminal block (ABE7CPA31E) of 8 inputs, with provision and distribution of the power supply (limited to 25 mA per input)
- 6 **ABE7ACC02** sub-base for splitting 16 into 2 x 8 channels, allowing connection of 8-channel sub-bases.
- 7 8-channel Modicon Telefast ABE7 Optimum or Universal passive connection sub-bases or adaptor sub-bases.

## Combinations of discrete inputs/outputs on the Modicon X80 platform with ABE7 sub-bases

(items 1...7), see Presentation on page 6/8

### Discrete I/O modules on the Modicon X80 platform

#### Reference for 24 V ∓ discrete I/O modules (item 1)

Inputs		Outputs		Inputs/outputs
2 x 16 I	4 x 16 I	2 x 16 Q	4 x 16 Q	1 x 16 I, 1 x 16 Q
BMXDDI3202K	BMXDDI6402K	BMXDDO3202K	BMXDDO6402K	BMXDDM3202K

#### Required cordsets

Preassembled cordsets (at both ends)	BMXFCC●●1, BMXFCC●●3 (item 2) (1)	Yes	Yes	Yes	Yes	No
	BMXFCC●●3 (item 2) (1)	No	No	No	No	Yes
	Quantities to be ordered	1	2	1	2	1

#### Passive connection sub-bases

Optimum 16 channels (item 3)	ABE7H34E●00 “economy” (2)					
	ABE7H16C●● “miniature”					
Universal 8 channels (item 7)	ABE7H08R●●	(3)	(3)	(3)	(3)	(3)
	ABE7H08S21	(3)	(3)	(3)	(3)	(3)
Universal 16 channels (item 3)	ABE7H16R1●●					
	ABE7H16R50●					
	ABE7H16R2●●					
	ABE7H16S21●					
	ABE7H16R3●●					
	ABE7H16R23					
	ABE7H16S43					
	ABE7H16F43					

#### Input adaptor sub-bases with solid state relays

Universal 16 channels (item 3)	ABE7S16E2●●●					
	Fixed solid state relays, removable terminal blocks					
	ABE7P16F31●					
	Plug-in solid state relays					

#### Output adaptor sub-bases with fixed relays, removable terminal blocks

Optimum & Universal 8 channels (item 7)	ABE7S08S2B●●			(3)	(3)	(3)
	Solid state relays					
	ABE7R08S111●, ABE7R08S21●●			(3)	(3)	(3)
	Electromechanical relays					
Optimum & Universal 16 channels (item 3)	ABE7S16S●B●●					
	Solid state relays					
	ABE7R16S111●, ABE7R16S210●, ABE7R16S212					
	Electromechanical relays					

#### Output adaptor sub-bases with plug-in relays

Universal 8 channels (item 7)	ABE7P08T330●			(3)	(3)	(3)
	Solid state relays					
Optimum & Universal 16 channels (item 3)	ABE7R16T●●●, ABE7R16M111					
	Electromechanical relays					
	ABE7P16T●●●					
	Solid state and/or electromechanical relays					

#### Sub-bases for analog I/O

4 channels (item 5)	ABE7CPA410					
	ABE7CPA412					
2 channels (item 5)	ABE7CPA21					
8 channels (item 5)	ABE7CPA02					
	ABE7CPA03					
	ABE7CPA31, ABE7CPA31E					

Compatible

Not compatible

(1) References for cordsets: to be completed, see page 3/13.

(2) ABE7H34E●00 “economy” sub-bases: the cordset is supplied.

(3) Via the splitter sub-base 6 ABE7ACC02 used to separate 16 channels into 2 x 8 channels

## Combinations of analog inputs/outputs on the Modicon X80 platform with ABE7 sub-bases

(items 1...7), see Presentation on page 6/8

		Analog I/O modules on the Modicon X80 platform									
		Reference for analog I/O modules (item 1-b, 1-c and 1-d)									
		Inputs						Outputs			
		4 I	4 I	2 x 4 I	8 I	8 I	8 I	2 Q	4 Q	8 Q	4 Q
		BMX AMI 0410	BMX ART 0414	BMX ART 0814	BMX AMI 0800	BMX AMI 0810	BME AHI 0812	BMX AMO 0210	BMX AMO 0410	BMX AMO 0802	BME AHO 0412
<b>Required cordsets</b>											
Preassembled cordsets (at both ends)	BMXFCA●●0 (item 4-b) (1)	Yes	No	No	No	No	No	Yes	Yes	No	Yes
	BMXFCA●●2 (item 4-c) (1)	No	Yes	Yes	No	No	No	No	No	No	No
	BMXFCA●●0 (item 4-c) (1)	No	No	No	Yes	Yes	No	No	Yes	No	No
	BMXFCA●●2 (item 4-c) (1)	No	No	No	No	No	No	No	No	Yes	No
	BMXFCA●●22 (item 4-d) (1)	No	No	No	No	No	Yes	No	No	No	No
Quantities to be ordered		1	1	2	1	1	1	1	1	1	1
<b>Passive connection sub-bases</b>											
Optimum 16 channels (item 3)	ABE7H16C●● “miniature”										
Universal 8 channels (item 7)	ABE7H08R●●										
	ABE7H08S21										
Universal 16 channels (item 3)	ABE7H16R1●●										
	ABE7H16R50●										
	ABE7H16R2●●										
	ABE7H16S21●										
	ABE7H16R3●										
	ABE7H16R23										
	ABE7H16S43										
ABE7H16F43											
<b>Input adaptor sub-bases with solid state relays</b>											
Universal 16 channels (item 3)	ABE7S16E2●●● Fixed solid state relays, removable terminal blocks										
	ABE7P16F31● Plug-in solid state relays										
<b>Output adaptor sub-bases with fixed relays, removable terminal blocks</b>											
Optimum & Universal 8 channels (item 7)	ABE7S08S2B●● Solid state relays										
	ABE7R08S111●, ABE7R08S21●● Electromechanical relays										
Optimum & Universal 16 channels (item 3)	ABE7S16S●B●● Solid state relays										
	ABE7R16S111●, ABE7R16S210●, ABE7R16S212 Electromechanical relays										
<b>Output adaptor sub-bases with plug-in relays</b>											
Universal 8 channels (item 7)	ABE7P08T330● Solid state relays										
Optimum & Universal 16 channels (item 3)	ABE7R16T●●●, ABE7R16M111 Electromechanical relays										
	ABE7P16T●●● Solid state and/or electromechanical relays										
<b>Sub-bases for analog I/O</b>											
4 channels (item 5)	ABE7CPA410										
	ABE7CPA412										
2 channels (item 5)	ABE7CPA21										
8 channels (item 5)	ABE7CPA02										
	ABE7CPA03										
	ABE7CPA31										
	ABE7CPA31E										

Compatible  
Not compatible

(1) References for cordsets: to be completed, see page 3/23.

# Connection interfaces

## Modicon Telefast ABE7 pre-wired system

### Passive connection sub-bases

#### Passive connection sub-bases for discrete signals

##### Optimum "Economy" sub-bases

Function	No. of channels	No. of terminals per channel on row number		For PLCs	Length of PLC connection cable	Type of connection	Reference	Weight kg lb
Input or output	16	1	2	Modicon TSX Micro Modicon Premium	1 m 3.281 ft.	Screw	<b>ABE7H20E100</b>	0.330 0.728
					2 m 6.562 ft.	Screw	<b>ABE7H20E200</b>	0.410 0.904
				3 m 9.843 ft.	Screw	<b>ABE7H20E300</b>	0.480 1.058	
				Siemens S7	1,5 m 4.921 ft.	Screw	<b>ABE7H32E150</b>	0.360 0.794
					3 m 9.843 ft.	Screw	<b>ABE7H32E300</b>	0.460 1.014



ABE7H20E●●●

##### Optimum "Miniature" sub-bases

Function	No. of channels	No. of terminals per channel on row number		LED per channel	Polarity distribution	Type of connection	Reference	Weight kg lb						
Input or output	16	1	1	No	No	Screw	<b>ABE7H16C10</b>	0.160 0.353						
								Yes	No	Screw	<b>ABE7H16C11</b>	0.160 0.353		
				2	2	Yes	0 or 24 V					Screw	<b>ABE7H16C21</b>	0.205 0.452
														3
				Input and output (1)	16	1	1	Yes	No	Screw	<b>ABE7H16CM11</b>	0.160 0.353		
2	2	Yes	0 or 24 V									Screw	<b>ABE7H16CM21</b>	0.200 0.441



ABE7H16C21



ABE7H16CM21

(1) 8 I + 8 Q: these products have 2 common connections which enable inputs and outputs to be connected to the same sub-base at the same time.

Passive connection sub-bases for discrete signals (continued)											
Universal sub-bases											
Function	No. of channels	No. of terminals per channel	No. of terminals on row channel number	LED per channel	Polarity distribution	Isolator (I) Fuse (F) per channel	Type of connection	Reference	Weight kg/lb		
Input or output	8	1	1	No	No	–	Screw	<b>ABE7H08R10</b>	0.187 0.412		
				Yes	No	–	Screw	<b>ABE7H08R11</b>	0.187 0.412		
		2	2	Yes	0 or 24 V	–	Screw	<b>ABE7H08R21</b>	0.218 0.481		
						I	Screw	<b>ABE7H08S21</b>	0.245 0.540		
			12	1	1	No	No	–	Screw	<b>ABE7H12R10</b>	0.274 0.604
						Yes	No	–	Screw	<b>ABE7H12R11</b>	0.274 0.604
	2	2	No	No	–	Screw	<b>ABE7H12R50</b>	0.196 0.432			
			Yes	0 or 24 V	–	Screw	<b>ABE7H12R20</b>	0.300 0.661			
		2	2	Yes	0 or 24 V	–	Screw	<b>ABE7H12R21</b>	0.300 0.661		
						I	Screw	<b>ABE7H12S21</b>	0.375 0.827		
			16	1	1	No	No	–	Screw	<b>ABE7H16R10</b>	0.274 0.604
						Yes	No	–	Screw	<b>ABE7H16R11</b>	0.274 0.604
2	2	No		No	–	Screw	<b>ABE7H16R50</b>	0.196 0.432			
		Yes		0 or 24 V	–	Screw	<b>ABE7H16R20</b>	0.300 0.661			
	2	2		Yes	0 or 24 V	–	Screw	<b>ABE7H16R21</b>	0.300 0.661		
						I	Screw	<b>ABE7H16S21</b>	0.375 0.827		
3	3	No	0 or 24 V	–	Screw	<b>ABE7H16R30</b>	0.346 0.763				
		Yes	0 or 24 V	–	Screw	<b>ABE7H16R31</b>	0.346 0.763				
Input type 2 (1)	16	2	2	Yes	0 or 24 V	–	Screw	<b>ABE7H16R23</b>	0.320 0.705		
Input	16	2	1	Yes	24 V	I, F (2)	Screw	<b>ABE7H16S43</b>	0.640 1.411		
Output	16	2	1	Yes	0 V	I, F (2)	Screw	<b>ABE7H16F43</b>	0.640 1.411		



ABE7H08R10

(1) For TSX Micro, Modicon Premium.

(2) With LED to indicate blown fuse.

# Connection interfaces

Modicon Telefast ABE7 pre-wired system  
Adaptor sub-bases with fixed relays and removable terminal blocks

## Adaptor sub-bases with fixed solid state relays, removable terminal blocks

Universal input sub-bases with solid state relays							
Number of channels	No. of terminals per channel	Isolation of PLC/ Operative part	Voltage	Type of connection	Reference	Weight kg/lb	
16	2	Yes	24 V $\overline{\text{---}}$	Screw	ABE7S16E2B1	0.370	0.816
				Spring	ABE7S16E2B1E	0.370	0.816
			48 V $\overline{\text{---}}$	Screw	ABE7S16E2E1	0.370	0.816
				Spring	ABE7S16E2E1E	0.370	0.816
			48 V $\sim$	Screw	ABE7S16E2E0	0.386	0.851
				Spring	ABE7S16E2E0E	0.386	0.851
			110 V $\sim$	Screw	ABE7S16E2F0	0.397	0.875
				Spring	ABE7S16E2F0E	0.397	0.875
230 V $\sim$	Screw	ABE7S16E2M0	0.407	0.897			
	Spring	ABE7S16E2M0E	0.407	0.897			



ABE7H16E2●●

Universal output sub-bases with solid state relays							
Number of channels	Isolation of PLC/ Operative part	Output voltage	Output current	Fault detection signal (1)	Type of connection	Reference	Weight kg/lb
16	No	24 V $\overline{\text{---}}$	0.5 A	Yes (2)	Screw	ABE7S16S2B0	0.405
					Spring	ABE7S16S2B0E	0.405
					Screw	ABE7S16S1B2	0.400
					Spring	ABE7S16S1B2E	0.400

Optimum and Universal output sub-bases with electromechanical relays							
Number of channels	Number of contacts	Output current	Polarity distribution/ operative part	Type of connection	Reference	Weight kg/lb	
8	1 N/O	2 A	Contact common per group of 4 channels	Screw	ABE7R08S111	0.252	0.556
				Spring	ABE7R08S111E	0.252	0.556
	Latching	2 A	Volt-free	Screw	ABE7R08S216	0.448	0.988
16	1 N/O	5 A	Volt-free	Screw	ABE7R08S210	0.448	0.988
				Spring	ABE7R08S210E	0.448	0.988
	1 N/O	2 A	Contact common per group of 8 channels	Screw	ABE7R16S111	0.405	0.893
				Spring	ABE7R16S111E	0.405	0.893
	1 N/O	5 A	Volt-free	Screw	ABE7R16S210	0.405	0.893
				Spring	ABE7R16S210E	0.405	0.893
Common per group of 8 channels on both poles	Screw	ABE7R16S212	0.400	0.882			

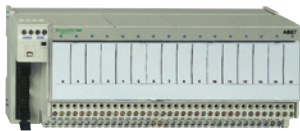

ABE7R08S216

(1) A fault on a sub-base output Qn will set PLC output Qn to safety mode, which will be detected by the PLC.  
(2) Can only be used with modules with protected outputs.

6

Adaptor sub-bases with plug-in relays							
Universal input sub-bases for solid state relays, supplied without relays							
Number of channels	No. of terminals per channel	For relay type	Isolation of PLC/Operative part	Input connection	Type of connection	Reference	Weight kg/lb
16	2	ABS7E ABR7 ABS7S33E	Yes	Volt-free	Screw	<b>ABE7P16F310</b>	0.850 1.874
					Polarity distribution	Screw	<b>ABE7P16F312</b>
Optimum and Universal output sub-bases, supplied with electromechanical relays (1)							
Number of channels	Relay width	Relay type supplied	Number and type of contacts	Polarity distribution/operative part	Reference	Weight kg/lb	
16	5 mm 0,197 in.	ABR7S11	1 N/O	Contact common per group of 4 channels	<b>ABE7R16T111</b>	0.600 1.323	
				Contact common per group of 4 output channels + 2 common input terminals	<b>ABE7R16M111</b> (2)	0.600 1.323	
	10 mm 0,394 in.	ABR7S21	1 N/O	Volt-free	<b>ABE7R16T210</b>	0.735 1.620	
				Common on both poles (3)	<b>ABE7R16T212</b>	0.730 1.609	
		ABR7S23	1 C/O	Volt-free	<b>ABE7R16T230</b>	0.775 1.709	
				Contact common (3)	<b>ABE7R16T231</b>	0.730 1.609	
	12 mm 0,472 in.	ABR7S33	1 C/O	Volt-free	<b>ABE7R16T330</b>	1.300 2.866	
				Common on both poles (4)	<b>ABE7R16T332</b>	1.200 2.646	
		ABR7S37	2 C/O	Volt-free	<b>ABE7R16T370</b>	1.300 2.866	



ABE7R16M111



ABE7R16T210

(1) The sub-bases are supplied as standard with electromechanical relays, all or part of which can be replaced by solid state relays of the same width (it is possible to combine these different technologies on a single sub-base).

(2) Two connection methods are available, enabling inputs and outputs to be connected to the same sub-base at the same time.

(3) Per group of 8 channels.

(4) Per group of 4 channels.

# Connection interfaces

## Modicon Telefast ABE7 pre-wired system

### Output adaptor sub-bases for plug-in relays

Output adaptor sub-bases for plug-in relays													
Optimum and Universal output sub-bases for solid state relays and/or electromechanical relays (1)													
No. of channels	Relay width	For relay type	Isolator per channel	Fuse per channel	Polarity distribution/operative part	Type of connection	Reference	Weight kg/lb					
16	5 mm 0.197 in.	ABR7S11 ABS7SC1B	No	No	Contact common per group of 4 channels	Screw	<b>ABE7P16T111</b>	0.550 1.213					
							10 mm 0.394 in.	ABR7S2● ABS7SA2●● ABS7SC2● ABE7ACC20	No	No	Volt-free	Screw	<b>ABE7P16T210</b> (2)
	<b>ABE7P16T230</b> (2)	0.655 1.444											
	Yes	Volt-free	Screw	<b>ABE7P16T214</b>	0.675 1.488								
	No	Common on both poles (3)	Screw	<b>ABE7P16T212</b>	0.615 1.356								
	Yes	Common on both poles (3)	Screw	<b>ABE7P16T215</b>	0.670 1.477								
8	12 mm 0.472 in.	ABR7S33 ABS7A3● ABS7SC3●● ABE7ACC21	No	No	Volt-free	Screw	<b>ABE7P08T330</b>	0.450 0.992					
							16	12 mm 0.472 in.	ABR7S33 ABS7A3● ABS7SC3●● ABE7ACC21	No	No	Volt-free	Screw
Common on both poles (4)	Screw	<b>ABE7P16T332</b>	0.900 1.984										
ABR7S33 ABS7SA3M ABS7SC3E ABE7ACC21	No	Yes	Volt-free	Screw	<b>ABE7P16T334</b>	0.900 1.984							
					Yes	Yes							

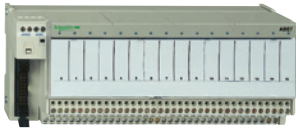

ABE7P16T210

(1) Not equipped with relays.  
 (2) With relay ABR7S21 for sub-base ABE7P16T210, with relay ABR7S23 for sub-base ABE7P16T230.  
 (3) Per group of 8 channels.  
 (4) Per group of 4 channels.





Plug-in solid state relays								
Relay width	Functions	Input circuit		Output circuit		Unit reference Order in lots of 4	Weight kg lb	
		Current	Nominal voltage	Current	Nominal voltage			
5 mm 0.197 in.	Output	---	24 V	2 A	24 V ---	ABS7SC1B	0.010 0.022	
10 mm 0.394 in.	Output	---	24 V	0.5 A	5...48 V ---	ABS7SC2E	0.016 0.035	
					24...240 V ~	ABS7SA2M	0.016 0.035	
12 mm 0.472 in.	Input	---	5 V TTL	–	24 V ---	ABS7EC3AL	0.014 0.031	
			24 V Type 2	–	24 V ---	ABS7EC3B2	0.014 0.031	
			48 V Type 2	–	24 V ---	ABS7EC3E2	0.014 0.031	
			50 Hz ~	48 V	–	24 V ---	ABS7EA3E5	0.014 0.031
			60 Hz ~	110...130 V	–	24 V ---	ABS7EA3F5	0.014 0.031
			50 Hz ~	230...240 V	–	24 V ---	ABS7EA3M5	0.014 0.031
			Output	---	24 V	2 A Self-protected	24 V ---	ABS7SC3BA
			1.5 A	5...48 V ---	ABS7SC3E	0.016 0.035		
			1.5 A	24...240 V ~	ABS7SA3M	0.016 0.035		



Plug-in electromechanical relays						
Relay width	Control voltage	Output current (1)	Number of contacts	Order in lots of	Unit reference	Weight kg lb
5 mm 0.197 in.	24 V ---	5 A (lth)	1 N/O	4	ABR7S11	0.005 0.011
10 mm 0.394 in.	24 V ---	5 A (lth)	1 N/O	4	ABR7S21	0.008 0.018
			1 C/O	4	ABR7S23	0.008 0.018
12 mm 0.472 in.	2 V ---	10 A (lth)	1 C/O	4	ABR7S33	0.017 0.037
		8 A (lth)	2 C/O	4	ABR7S37	0.017 0.037
		48 V ---	8 A (lth)	1 C/O	4	ABR7S33E

Accessory		
Description	Reference	Weight kg lb
Extractor for 5 mm (0.197 in.) miniature relay	ABE7ACC12	0.010 0.022

# Connection interfaces

## Modicon Telefast ABE7 pre-wired system

### Connection sub-bases for analog channels and application-specific channels



ABE7CPA01



ABE7CPA11



ABE7CPA21  
ABE7CPA410  
ABE7CPA412

#### Connection sub-bases for counter and analog channels

Functions	For platforms	Compatible modules	Type of connection on Telefast end	Type of connection	Reference	Weight kg lb
Analog and counter	TSX Micro	Analog and integrated counter TSX3722 TSXCTZ●A	15-way SUB-D	Screw	<b>ABE7CPA01</b>	0.300 0.661
Counter, axis control, position control	Modicon Premium	TSXCTY●A TSXCAY●1	15-way SUB-D	Screw	<b>ABE7CPA01</b>	0.300 0.661
Connection of absolute encoder with parallel output	Modicon Premium	TSXCTY●A TSXCAY●1	15-way SUB-D	Screw	<b>ABE7CPA11</b>	0.330 0.728
Distribution of 4 thermocouples	Modicon X80 I/O	BMXART0414 BMXART0814	25-way SUB-D	Screw	<b>ABE7CPA412</b>	0.180 0.397
Distribution of 16 thermocouples	Modicon Premium	TSXAEY1614	25-way SUB-D	Screw	<b>ABE7CPA12</b>	0.300 0.661
Passive distribution of 8 analog EIS channels on screw terminals, with shield continuity	Modicon Premium	TSXASY800 TSXAEY1600 TSXA●Y800	25-way SUB-D	Screw	<b>ABE7CPA02</b>	0.290 0.639
	Modicon X80 I/O	BMXAMI0800 BMXAMI0810 BMEAHI0812 BMXAMO0802				
	Modicon Quantum	140AVI03000 140ACI03000 140ACI04000 140ACO13000				
Provision and distribution of protected isolated power supplies for 4 analog input channels	Modicon M340	BMXAMI0410	25-way SUB-D	Screw	<b>ABE7CPA410</b>	0.180 0.397
Distribution of 4 analog output channels	Modicon Premium	TSXASY410 TSXAEY420	25-way SUB-D	Screw	<b>ABE7CPA21</b>	0.210 0.463
	Modicon X80 I/O	BMXAMO0210 BMXAMO0410 BMEAHO0412				
	Modicon Quantum	140AVO02000 140ACO02000				
Distribution and supply of 8 analog input channels with limitation of each current loop	Modicon Premium	TSXAEY800 TSXAEY1600	25-way SUB-D	Screw	<b>ABE7CPA03</b>	0.330 0.728
	Modicon Quantum	140AVI03000 140ACI03000 140ACI04000				
Distribution and supply of 8 analog input channels isolated from one another with 25 mA/ channel limitation	Modicon Premium	TSXAEY810	25-way SUB-D	Screw	<b>ABE7CPA31</b>	0.410 0.904
	Modicon X80 I/O	BMXAMI0800 BMXAMI0810 BMEAHI0812 (1)		Spring	<b>ABE7CPA31E</b>	0.410 0.904
	Modicon Quantum	140AVI03000 140ACI03000 140ACI04000				
Safety	Modicon Premium	TSXPAY2●2	25-way SUB-D	Screw	<b>ABE7CPA13</b>	0.290 0.639

(1) The BMEAHI0812 module is not compatible with the ABE7CPA31E connection sub-base.

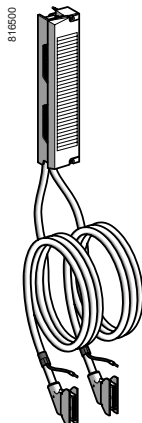

ABFM32H●●1

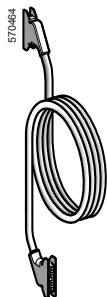

TSXCDP●03

## Cabled connectors for Modicon Quantum I/O modules

Type of signal	I/O modules	Type of connector	Gauge	Cross-section	Length		No. of channels	Reference	Weight
					AWG	mm <sup>2</sup>			
Inputs and relay outputs	Consult our website www.schneider-electric.com	2 x 20-way HE10	22	0.324	1.5	2 x 16	2	ABFM32H150	0.650
					4.921				1.433
0.5 A outputs	Consult our website www.schneider-electric.com	2 x 20-way HE10 + external power supply	22	0.324	1.5	2 x 16	2	ABFM32H151	0.650
					4.921				1.433
Inputs or outputs (96 channels)	140DDI36400 140DDO36400	2 x 20-way HE10	22	0.324	0.5	6 x 16	2	TSXCDP053	0.085
					1.640				0.187
					1	6 x 16			0.150
					3.281				0.331
					2	6 x 16			0.280
					6.562				0.617
Analog inputs	140AVI03000 140ACI03000 140ACI04000	1 x 25-way SUB-D	24	0.22	2	8	2	ABFM08S201	0.600
					6.562				1.323
		2 x 25-way SUB-D	24	0.22	2	16	2	ABFM16S201	0.620
									6.562
Analog outputs	140AVO02000 140ACO02000 140ACO13000	1 x 25-way SUB-D	24	0.22	2	4	2	ABFM04S200	0.450
					6.562				0.992
		1 x 25-way SUB-D	24	0.22	2	4	2	ABFM04S201	0.450
									6.562
1 x 25-way SUB-D	24	0.22	2	8	(1)	0.450			
6.562		0.992							

(1) For further information, please consult our Customer Care Center.

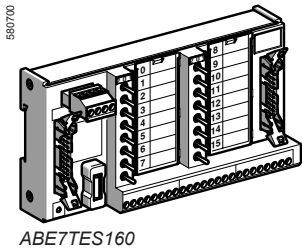
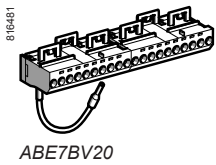
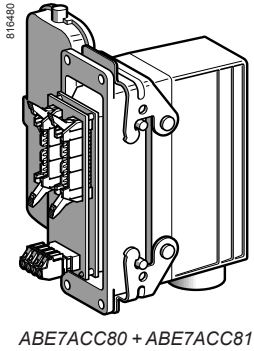
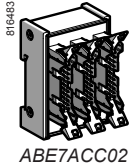

Accessories					
Description	No. of channels	Characteristics	Order in multiples of	Unit reference	Weight kg lb
Splitter sub-base	–	16 as 2 x 8 channels	1	ABE7ACC02	0.075 0.165
Redundant output sub-base	–	16 as 2 x 16 channels	1	ABE7ACC10	0.075 0.165
Redundant input sub-base	–	16 as 2 x 16 channels	1	ABE7ACC11	0.075 0.165
Plug-in continuity blocks	–	Width 12 mm (0.472 in.)	4	ABE7ACC21	0.010 0.022
Additional snap-on terminal blocks (shunted terminals)	8	10 screw terminals	5	ABE7BV10	0.030 0.066
	16	20 screw terminals	5	ABE7BV20	0.060 0.132
I/O simulator sub-base	16	For display, forcing, inhibition, continuity	1	ABE7TES160	0.350 0.772
Self-adhesive marker tag holder	–	For 6 characters	50	AR1SB3	0.001 0.002
Quick-blow fuses 5 x 20, 250 V, UL	–	0.125 A	10	ABE7FU012	0.010 0.022
	–	0.5 A	10	ABE7FU050	0.010 0.022
	–	1 A	10	ABE7FU100	0.010 0.022
	–	2 A	10	ABE7FU200	0.010 0.022
	–	4 A	10	ABE7FU400	0.010 0.022
–	6.3 A	10	ABE7FU630	0.010 0.022	

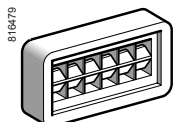

AR1SB3



ABEC08R02W

#### Commoning link accessories

Description	For common	Colour	Distance between cable ends	Reference	Weight kg lb
Commoning links Modularity 8 x 1 mm <sup>2</sup>	Coil	White	12 cm 4.724 in.	ABFC08R12W	0.020 0.044
			2 cm 0.787 in.	ABFC08R02W	0.010 0.022
	~	Red	12 cm 4.724 in.	ABFC08R12R	0.020 0.044
			2 cm 0.787 in.	ABFC08R02R	0.010 0.022
	---	Blue	12 cm 4.724 in.	ABFC08R12B	0.020 0.044
			2 cm 0.787 in.	ABFC08R02B	0.010 0.022



# 7 - Compatibility with OsiSense XU/XS

---

## Compatibility with sensors

- OsiSense XU photo-electric sensors ..... page 7/2
- OsiSense XS inductive proximity sensors ..... page 7/4

Photo-electric sensors				--- inputs, BMXDDI						
Type	Reference			1602	1603	1604T	3202K	6402K		
<b>General purpose</b>										
Design Ø 18	Metal	3 wire, PNP 24V	XUB0/1/2/4/5/9B●P●●●							
		3 wire, NPN 24V	XUB0/1/2/4/5/9B●N●●●							
	Plastic	3 wire, PNP 24V	XUB0/1/2/4/5/9A●P●●●							
		3 wire, NPN 24V	XUB0/1/2/4/5/9A●N●●●							
Design	Miniature	3 wire, PNP 24V	XUM0/2/5/9AP●●●●							
		3 wire, NPN 24V	XUM0/2/5/9AN●●●●							
	Compact 50x50	3 wire, PNP 24V	XUK1/2/5/8/9AP●●●							
		3 wire, NPN 24V	XUK1/2/5/8/9AN●●●							
		3 wire, programmable PNP/NPN DC	XUK0AK●●●							
		5 wire, programmable AC/DC	XUK0/1/2/5/8/9AR							
	Compact 92x71	3 wire, programmable PNP/NPN DC	XUX0/1/2/5/8/9AK							
		5 wire, programmable AC DC	XUX0/1/2/5/8/9AR							
	<b>Application</b>									
	Material handling	Optical fork	3 wire, PNP 24V	XUVR●●●●P●●						
3 wire, NPN 24V			XUVR●●●●N●●							
3 wire, PNP 24V			XUVA●●●●P●●							
3 wire, NPN 24V			XUVA●●●●N●●							
4 wire, PNP, or NPN 24V			XUYF●●●●●							
4 wire, PNP, or NPN 24V			XUVU06●●●							
4 wire, PNP, or NPN 24V			XUVK●●●							
3 wire, PNP 24V			XUVH●●●							
3 wire, NPN 24V			XUVJ●●●							
4 wire, PNP, or NPN 24V			XUVF●●●							
Packaging			Fiber	4 wire, PNP, or NPN 24V	XUYDCF●●●					
			Compact	4 wire, PNP, or NPN 24V	XUK●S●●●●					
	M 18, threaded	3 wire, PNP 24V	XU5M18U1D							
		Fiber	4 wire, PNP, or NPN 24V	XUYAFL●●●						
	M 18, threaded	3 wire, PNP 24V	XUBT●P●●●							
		3 wire, NPN 24V	XUBT●N●●●							
	Compact	4 wire, PNP, or NPN 24V	XUKT●●●							
		3 wire, PNP 24V	XUKC1N●●●							
		3 wire, NPN 24V	XUKC1P●●●							
		3 wire, PNP 24V	XURC3P●●●							
	M 18, threaded	3 wire, NPN 24V	XURC3N●●●							
		4 wire, PNP, or NPN 24V	XUMW●●●							
		3 wire, PNP 24V	XUB0SP●●●							
		3 wire, NPN 24V	XUB0SN●●●							
	M 8, threaded	3 wire, PNP 24V	XU●N18P●●●							
		3 wire, NPN 24V	XU●N18N●●●							
		3 wire, PNP 24V	XUAH●●●							
		3 wire, NPN 24V	XUAJ●●●							
	Miniature	3 wire, PNP 24V	XUYP●●●●P●●							
		3 wire, NPN 24V	XUYP●●●●N●●							
		3 wire, PNP 24V	XUM2/5/9BP●●●							
		3 wire, NPN 24V	XUM2/5/9BN●●●							
		3 wire, PNP 24V	XUY●●●929●●							
		3 wire, PNP 24V	XUY●●●929●●							
	Hoisting	M 18, threaded	3 wire, PNP 24V	XUBLBP●●●						
			3 wire, NPN 24V	XUBLBN●●●						
		Compact	2 wire 4...20 mA; 3 wire 0...10V	XUJK803538						
		M 18, threaded	2 wire 4...20 mA	XU5M18AB20D						
PNP, 2 wire 4...20 mA			XU2M18AB20D							
Compact		PNP, 2 wire 4...20 mA	XUYP●●●925							
		4 wire, PNP, or NPN 24V	XUYPS●●●							
Fiber		3 wire, PNP 24V	XUDA●P●●●							
		3 wire, NPN 24V	XUDA●N●●●							
		4 wire, PNP, or NPN 24V	XUYAF●●●							
Other formats		3 wire, programmable PNP/NPN DC	XUC2/8/9AK●●●							
		5 wire, programmable AC/DC	XUC2/8/9ARC●●●							
		3 wire, NPN 24V + analog	XUE●AA●●●							
		2 wire, AC	XULA●●●							
		5 wire, programmable AC/DC	XULM●●●							
		3 wire, programmable PNP/NPN DC	XUYB●●●S							
M 18, threaded		5 wire, programmable AC/DC	XUYB●●●R							
		2 wire, AC/DC	XU5/8/9M18MA●●●							

Compatible  
Incompatible





# Modicon X80 I/O platform

## Inputs and OsiSense XS inductive proximity sensors

Proximity sensors				--- inputs, BMXDDI				
Type			Reference	1602	1603	1604T	3202K	
<b>General purpose</b>								
Cylindrical, flush, standard sensing distance, short barrel	Ø 6.5 plain short	3 wire, PNP 24V	XS506B1P●●●					
		3 wire, NPN 24V	XS506B1N●●●					
		2 wire, DC 24V	XS506BSC●●●					
	M8, threaded short	3 wire, PNP 24V	XS508B1P●●●					
		3 wire, NPN 24V	XS508B1N●●●					
		2 wire, DC 24V	XS508BSC●●●					
	M12, threaded short	3 wire, PNP 24V	XS512B1P●●●					
		3 wire, NPN 24V	XS512B1N●●●					
		2 wire, DC 24V	XS512BSD/C●●●					
	M18, threaded short	3 wire, PNP 24V	XS518B1P●●●					
		3 wire, NPN 24V	XS518B1N●●●					
		2 wire, DC 24V	XS518BSD/C●●●					
M30, threaded short	3 wire, PNP 24V	XS530B1P●●●						
	3 wire, NPN 24V	XS530B1N●●●						
	2 wire, DC 24V	XS530BSD/C●●●						
Cylindrical, flush, standard sensing distance, long barrel	M8, threaded long	3 wire, PNP 24V-48V	XS508BLP●●●					
		3 wire, NPN 24V-48V	XS508BLN●●●					
		2 wire, DC 24V-48V	XS508B1D/C●●●					
	M12, threaded long	3 wire, PNP 24V-48V	XS512BLP●●●					
		3 wire, NPN 24V-48V	XS512BLN●●●					
		2 wire, DC 24V-48V	XS512B1D/C●●●					
	M18, threaded long	3 wire, PNP 24V-48V	XS518BLP●●●					
		3 wire, NPN 24V-48V	XS518BLN●●●					
		2 wire, DC 24V-48V	XS518B1D/C●●●					
	M30, threaded long	3 wire, PNP 24V-48V	XS530BLP●●●					
		3 wire, NPN 24V-48V	XS530BLN●●●					
		2 wire, DC 24V-48V	XS530B1D/C●●●					
M12, threaded long	2 wire, AC/DC	XS512B1M●●●						
	2 wire, AC/DC	XS518B1M●●●						
	2 wire, AC/DC	XS530B1M●●●						
Cylindrical, flush, extended sensing distance, short barrel	Ø 6,5 plain short	3 wire, PNP 24V	XS106B3P●●●					
		3 wire, NPN 24V	XS106B3N●●●					
		2 wire, DC 24V	XS606B3C●●●					
	M8, threaded short	3 wire, PNP 24V	XS108B3P●●●					
		3 wire, NPN 24V	XS108B3N●●●					
		2 wire, DC 24V	XS608B3C●●●					
	M12, threaded short	3 wire, PNP 24V	XS112B3P●●●					
		3 wire, NPN 24V	XS112B3N●●●					
		2 wire, DC 24V	XS612B3D●●●					
	M18, threaded short	3 wire, PNP 24V	XS118B3P●●●					
		3 wire, NPN 24V	XS118B3N●●●					
		2 wire, DC 24V	XS618B3D●●●					
M30, threaded short	3 wire, PNP 24V	XS130B3P●●●						
	3 wire, NPN 24V	XS130B3N●●●						
	2 wire, DC 24V	XS630B3D●●●						
Cylindrical, flush, extended sensing distance, long barrel	M8, threaded long	3 wire, PNP 24V-48V	XS608B1P●●●					
		3 wire, NPN 24V-48V	XS608B1N●●●					
		2 wire, DC 24V-48V	XS608B1D●●●					
	M12, threaded long	3 wire, PNP 24V-48V	XS612B1P●●●					
		3 wire, NPN 24V-48V	XS612B1N●●●					
		2 wire, DC 24V-48V	XS612B1D●●●					
	M18, threaded long	3 wire, PNP 24V-48V	XS618B1P●●●					
		3 wire, NPN 24V-48V	XS618B1N●●●					
		2 wire, DC 24V-48V	XS618B1D●●●					
	M30, threaded long	3 wire, PNP 24V-48V	XS630B1P●●●					
		3 wire, NPN 24V-48V	XS630B1N●●●					
		2 wire, DC 24V-48V	XS630B1D●●●					
M12, threaded long	2 wire, AC/DC	XS612B1M●●●						
M18, threaded long	2 wire, AC/DC	XS618B1M●●●						
M30, threaded long	2 wire, AC/DC	XS630B1M●●●						
Cylindrical, non flush, extended sensing distance, long barrel	M12, threaded long	3 wire, PNP 24V-48V	XS612B4P●●●					
		3 wire, NPN 24V-48V	XS612B4N●●●					
	M18, threaded long	3 wire, PNP 24V-48V	XS618B4P●●●					
		3 wire, NPN 24V-48V	XS618B4N●●●					
	M30, threaded long	3 wire, PNP 24V-48V	XS630B4P●●●					
		3 wire, NPN 24V-48V	XS630B4N●●●					
M12, threaded long	2 wire, AC/DC	XS612B4M●●●						
M18, threaded long	2 wire, AC/DC	XS618B4M●●●						
M30, threaded long	2 wire, AC/DC	XS630B4M●●●						

Compatible  
Incompatible



# Modicon X80 I/O platform

## Inputs and OsiSense XS inductive proximity sensors (continued)

Proximity sensors				--- inputs, BMXDDI					
Type			Reference	1602	1603	1604T	3202K		
<b>General purpose</b>									
Flat, flush mountable, standard sensing distance	Format J 8x22x8	3 wire, PNP 24V	XS7J1A1P●●●						
		3 wire, NPN 24V	XS7J1A1N●●●						
	Format F 15x22x8	2 wire, DC 24V	XS7J1A1D●●●						
		3 wire, PNP 24V	XS7F1A1P●●●						
		3 wire, NPN 24V	XS7F1A1N●●●						
	Format E 26x26x13	2 wire, DC 24V	XS7F1A1D●●●						
		3 wire, PNP 24V	XS7E1A1P●●●						
		3 wire, NPN 24V	XS7E1A1N●●●						
	Format C 40x40x15	2 wire, DC 24V	XS7E1A1D/C●●●						
		3 wire, PNP 24V	XS7C1A1P●●●						
		3 wire, NPN 24V	XS7C1A1N●●●						
	Format D 80x80x26	2 wire, DC 24V	XS7C1A1D/C●●●						
3 wire, PNP 24V		XS7D1A1P●●●							
3 wire, NPN 24V		XS7D1A1N●●●							
Format 40X40X70 and 40X40X117 Plastic, with turret head: 5 positions	NO + NC	2 wire, DC 24V	XS7D1A1D/C●●●						
		4 wire, PNP 24V-48V	XS7/XS8C2/C4A1/A4P●●●						
	NO/NC programmable	4 wire, NPN 24V-48V	XS7/XS8C2/C4A1/A4N●●●						
		2 wire, DC 24V-48V	XS7/XS8C2/C4A1/A4D●●●						
Flat, flush mountable, extended sensing distance	Format E 26x26x13	2 wire, AC/DC	XS7/XS8C2/C4A1/A4M●●●						
		3 wire, PNP 24V	XS8E1A1P●●●						
		3 wire, NPN 24V	XS8E1A1N●●●						
	Format C 40x40x15	2 wire, AC/DC	XS8E1A1M●●●						
		3 wire, PNP 24V	XS8C1A1P●●●						
		3 wire, NPN 24V	XS8C1A1N●●●						
	Format D 80x80x26	2 wire, AC/DC	XS8C1A1M●●●						
		3 wire, PNP 24V	XS8D1A1P●●●						
		3 wire, NPN 24V	XS8D1A1N●●●						
	Cylindrical multi-voltage	M12, threaded	2 wire, AC/DC	XS8D1A1M●●●					
			2 wire, AC/DC	XS1/2M12M●250					
			2 wire, AC/DC	XS1/2M18M●250					
Cylindrical Metal, 4 wire	Ø 6.5, plain	2 wire, AC/DC	XS1/2M30M●250						
		4 wire, PNP 24V	XS1L06PC410						
	M8, threaded	4 wire, NPN 24V	XS1L06NC410						
		4 wire, PNP 24V	XS1/2M08PC410●						
	M12, threaded	4 wire, NPN 24V	XS1/2M08NC410●						
		4 wire, PNP 24V	XS1/2N12PC410●						
	M18, threaded	4 wire, NPN 24V	XS1/2N12NC410●						
		4 wire, PNP 24V	XS1/2N18PC410●						
	M30, threaded	4 wire, NPN 24V	XS1/2N18NC410●						
		4 wire, PNP 24V	XS1/2N30PC410●						
	Cylindrical Metal, 4 wire PNP + NPN	M30, threaded	4 wire, NPN 24V	XS1/2N30NC410●					
			4 wire, PNP+NPN, prog. 24V	XS1/2/4M12KP340●					
4 wire, PNP+NPN, prog. 24V			XS1/2/4M18KP340●						
Cylindrical Plastic, non flush, standard sensing distance	M8, threaded	4 wire, PNP+NPN, prog. 24V	XS1/2/4M30KP340●						
		3 wire, PNP 24V	XS4P08P●340●						
		3 wire, PNP 24V-48V	XS4P08P●370●						
		3 wire, NPN 24V	XS4P08N●340●						
		3 wire, NPN 24V-48V	XS4P08N●370●						
		2 wire, AC/DC	XS4P08M●230●●●						
	M12, threaded	3 wire, PNP 24V	XS4P12P●340●						
		3 wire, PNP 24V-48V	XS4P12P●370●						
		3 wire, NPN 24V	XS4P12N●340●						
		3 wire, NPN 24V-48V	XS4P12N●370●						
		2 wire, AC/DC	XS4P12M●230●●●						
		3 wire, PNP 24V	XS4P18P●340●						
	M18, threaded	3 wire, PNP 24V-48V	XS4P18P●370●						
		3 wire, NPN 24V	XS4P18N●340●						
		3 wire, NPN 24V-48V	XS4P18N●370●						
		2 wire, AC/DC	XS4P18M●230●●●						
		3 wire, PNP 24V	XS4P30P●340●						
		3 wire, PNP 24V-48V	XS4P30P●370●						
	M30, threaded	3 wire, NPN 24V	XS4P30N●340●						
		3 wire, NPN 24V-48V	XS4P30N●370●						
		2 wire, AC/DC	XS4P30M●230●●●						

Compatible  
Incompatible



# Modicon X80 I/O platform

## Inputs and OsiSense XS inductive proximity sensors (continued)

Proximity sensors				--- inputs, BMXDDI				
Type			Reference	1602	1603	1604T	3202K	
<b>General purpose</b>								
Cylindrical basic flush or non flush, standard sensing distance, Plastic or Metal	Ø 6.5 plain	3 wire, PNP 24V	XS1/206BLP●●●					
		3 wire, NPN 24V	XS1/206BLN●●●					
	M8, threaded	3 wire, PNP 24V	XS1/208A/BLP●●●					
		3 wire, NPN 24V	XS1/208A/BLN●●●					
	M12, threaded	3 wire, PNP 24V	XS1/212A/BLP●●●					
		3 wire, NPN 24V	XS1/212A/BLN●●●					
	M18, threaded	3 wire, PNP 24V	XS1/218A/BLP●●●					
		3 wire, NPN 24V	XS1/218A/BLN●●●					
	M30, threaded	3 wire, PNP 24V	XS1/230A/BLP●●●					
		3 wire, NPN 24V	XS1/230A/BLN●●●					
Cylindrical, almost flush, extended sensing distance	M18, threaded	3 wire, PNP 24V	XS1N18P●349●					
		3 wire, NPN 24V	XS1N18N●349●					
	M30, threaded	3 wire, PNP 24V	XS1N30P●349●					
		3 wire, NPN 24V	XS1N30N●349●					
Cylindrical, miniature	Ø 4 plain	3 wire, PNP 24V	XS1L04P●31●●					
		3 wire, NPN 24V	XS1L04N●31●●					
	M5, threaded	3 wire, PNP 24V	XS1N05P●31●●					
		3 wire, NPN 24V	XS1N05N●31●●					
	Ø 6.5 plain	3 wire, PNP 24V	XS2L06P●340●					
		3 wire, NPN 24V	XS2L06N●340●					
<b>Application</b>								
Cylindrical, adjustable sensing distance	M12, threaded	3 wire, PNP 24V	XS612B2P●●●					
		3 wire, NPN 24V	XS612B2N●●●					
	M18, threaded	3 wire, PNP 24V	XS618B2P●●●					
		3 wire, NPN 24V	XS618B2N●●●					
	M30, threaded	3 wire, PNP 24V	XS630B2P●●●					
Rotation monitoring	M18, threaded	3 wire, PNP 24V-48V	XSAV11/2373					
		2 wire, AC/DC	XSAV11/2801					
	Format E 26x26x13	3 wire, PNP 24V	XS9●11RP●●●●					
	Format C 40x40x15	2 wire, AC/DC	XS9●11RM●●●●					
Analog output	M12, threaded	2 wire 4...20mA; 3 wire 0...10V	XS●12AB●●●●					
	M18, threaded	2 wire 4...20mA; 3 wire 0...10V	XS●18AB●●●●					
	M30, threaded	2 wire 4...20mA; 3 wire 0...10V	XS●30AB●●●●					
	Block format	2 wire 4...20mA; 3 wire 0...10V	XS9C2/C4A2A●●●●					
		2 wire 4...20mA; 3 wire 0...10V	XS9●111A●●●●					
Food and beverage	Cylindrical threaded Metal	3 wire, PNP 24V	XS2●●SAP●●●					
		3 wire, PNP 24V	XS908/12/18/30R/S●P●●●					
		3 wire, NPN 24V	XS2●●SAN●●●					
		2 wire, AC/DC	XS2●●SAMA●●●					
	Cylindrical threaded Plastic	3 wire, PNP 24V-48V	XS2●●AAP●●●					
		3 wire, NPN 24V	XS2●●AAN●●●					
		2 wire, AC/DC	XS2●●AAMA●●●					
			XS2●●AANA●●●					
Factor 1	Cylindrical threaded Metal	4 wire, PNP+NPN 24V	XS1M●●KPM40					
	Format C, 40 x 117 x 41	4 wire, PNP+NPN 24V	XS9C2/C4A●●●●					
	Cylindrical threaded Metal	3 wire, PNP 24V	XS1M18PAS●●					
Packaging	Format 12x26x40	3 wire, PNP 24V	XS7G12P●140					
		3 wire, NPN 24V	XS7G12N●140					
		4 wire, PNP 24V-48V	XS7G12P●440					
		4 wire, NPN 24V-48V	XS7G12N●440					
		2 wire, AC/DC	XS7G12M●230					
			XS7G12M●230					
Material handling	Format C 40x40x40	2 wire, DC 24V-48V	XS7T4DA●●●					
		4 wire, PNP 24V-48V	XS7T4PC●●●					
		4 wire, NPN 24V-48V	XS7T4NC●●●					
		2 wire, DC 24V-48V	XS7D1●●●●					
Welding	Cylindrical Metal	3 wire, PNP 24V	XS1M●●PAW●●					
		2 wire, DC 24V-48V	XSLC●●●					

Compatible  
Incompatible







---

## Technical appendices

- Standards, certifications and environmental conditions ..... page 8/2
- Certifications for automation products and EC regulations ..... page 8/6

### Standards and certifications

The Modicon X80 I/O platform has been developed to comply with the principal national and international standards concerning electronic equipment for industrial automation systems.

- Requirements specific to programmable controllers: functional characteristics, immunity, resistance, safety, etc.: **IEC/EN 61131-2**, UL and CSA standards for industry (**UL 508, CSA E61131-2**).
- Requirements specific to power utility automation systems: **IEC/EN 61850-3**.
- Merchant navy requirements of the major international organizations: unified in IACS (International Association of Classification Societies).
- Compliance with European Directives for CE marking:
  - Low Voltage: 2006/95/EC
  - Electromagnetic Compatibility: 2004/108/EC
- Ex areas:
  - For USA and Canada: Hazardous location class I, division 2, groups A,B,C and D
  - For other countries: CE ATEX (directive 94/9/EC) or IECEx in defined atmosphere Zone 2 (gas) and/or Zone 22 (dust).
  - Up-to-date information on which certifications have been obtained is available on our website.

### Characteristics

#### Service conditions and recommendations relating to the environment

		Modicon X80 I/O platform		Modicon X80 harsh I/O platform			
Temperature	Operation	°C	0...+ 60	- 25...+ 70			
	Storage	°C	- 40...+ 85	- 40...+ 85			
Relative humidity (without condensation)	Cyclical humidity	%	+ 5 ... + 95 up to 55°C	+ 5 ... + 95 up to 55°C			
	Continuous humidity	%	+ 5 ... + 93 up to 55°C	+ 5 ... + 93 up to 60°C			
Altitude	Operation	m	0...2000 (full specification: temperature and isolation) 2000 ... 5000 (temperature derating: 1°C/400 m, isolation lost: 150 V ÷/1000 m)				
Supply voltage	<b>Modicon X80 I/O power supply modules</b>						
			<b>BMXCPS2010</b>	<b>BMXCPS3020 BMXCPS3020H</b>	<b>BMXCPS3540T</b>	<b>BMXCPS2000</b>	<b>BMXCPS3500 BMXCPS3500H</b>
	Nominal voltage	V	24 ---	24...48 ---	125 ---	100...240 ~	100...240 ~
	Limit voltages	V	18...31.2 ---	18...62.4 ---	100...150 ---	85...264 ~	85...264 ~
	Nominal frequencies	Hz	–	–	–	50/60	50/60
	Limit frequencies	Hz	–	–	–	47/63	47/63

### Protective treatment of the Modicon X80 I/O platform

The Modicon X80 I/O platform meets the requirements of "TC" treatment (*Treatment for all Climates*).

For installations in industrial production workshops or environments corresponding to "TH" treatment (*treatment for hot and humid environments*), Modicon X80 I/O must be embedded in enclosures with minimum IP 54 protection.

The Modicon X80 I/O platform offers **protection to IP 20 level** and **protection against pins** (enclosed equipment) (1). They can therefore be installed without an enclosure in reserved-access areas which do not exceed **pollution level 2** (control room with no dust-producing machine or activity). Pollution level 2 does not take account of more severe environmental conditions: air pollution by dust, smoke, corrosive or radioactive particles, vapors or salts, attack by fungi, insects, etc.

(1) In cases where a position is not occupied by a module, a **BMXXEM010** protective cover must be installed.

(CE): tests required by European directives (CE) and based on IEC/EN 61131-2 standards.

Environment tests		
Name of test	Standards	Levels
<b>Immunity to LF interference (CE) (1)</b>		
Voltage and frequency variations	IEC/EN 61131-2; IEC/EN 61000-6-2; IEC 61000-4-11 IACS E10; IEC 61000-4-11	0.85...1.10 Un - 0.94...1.04 Fn; 4 steps t = 30 min 0.80 Un...0.90 Fn; 1.20 Un...1.10 Fn; t = 1.5 s/5 s
Direct voltage variations	IEC/EN 61131-2; IEC 61000-4-29; IACS E10 (PLC not connected to charging battery)	0.85...1.2 Un + ripple: 5% peak; 2 steps t = 30 min
Third Harmonic	IEC/EN 61131-2	H3 (10% Un), 0°/180°; 2 steps t = 5 min
Immunity to conducted low frequency (only IACS) IACS E10		For ~ : ■ H2...H15 (10% Un), H15...H100 (10%...1% Un), H100...H200 (1% Un) For --- : ■ H2...H200 (10% Un)
Voltage interruptions	IEC/EN 61131-2; IEC/EN 61000-6-2; IEC 61000-4-11; IEC 61000-4-29; IACS E10	Power supply immunity: ■ 1 ms for --- PS1/10 ms for ~ PS2 ■ Check operating mode for longer interruptions For IACS: ■ 30 s for ~ or ---
	IEC/EN 61131-2; IEC/EN 61000-6-2; IEC 61000-4-11	For ~ PS2: ■ 20% Un, t0: ½ period ■ 40% Un, cycle 10/12 ■ 70% Un, cycle 25/30 ■ 0% Un, cycle 250/300
Voltage shut-down and start-up	IEC/EN 61131-2	■ Un...0...Un; t = Un/60 s ■ Umin...0...Umin; t = Umin/5 s ■ Umin...0.9 Ud1...Umin; t = Umin/60 s
Magnetic field	IEC/EN 61131-2; IEC/TS 61000-6-5; IEC 61000-4-8 (for MV power stations: IEC 61850-3)	Power frequency: 50/60 Hz, 100 A/m continuous ...1000 A/m; t = 3 s; 3 axes
	IEC 61000-4-10 (for MV power stations: IEC 61850-3)	Oscillatory: 100 kHz...1 MHz, 100 A/m; t = 9 s; 3 axes
Conducted common mode disturbances range 0 Hz ...150 kHz	IEC 61000-4-16 (for MV power stations: IEC 61850-3)	For remote systems: ■ 50/60 Hz and ---, 300 V, t = 1 s ■ 50/60 Hz and ---, 30 V, t = 1 min ■ 5 Hz...150 kHz, sweep 3 V...30 V

Where:

- PS1 applies to PLC supplied by battery, PS2 applies to PLC energized from ~ or --- supplies
- Un: nominal voltage, Fn: nominal frequency, Ud1: detection level when powered

Name of test	Standards	Levels
<b>Immunity to LF interference (CE) (1)</b>		
Electrostatic discharges	IEC/EN 61131-2; IEC/EN 61000-6-2; IEC 61000-4-2; IACS E10	6 kV contact; 8 kV air; 6 kV indirect contact
Radiated radio frequency electromagnetic field	IEC/EN 61131-2; IEC/EN 61000-6-2; IEC 61000-4-3; IACS E10	15 V/m, 80 MHz ... 3 GHz Sinus amplitude modulated 80%, 1 kHz + internal clock frequencies
Electrical fast transient bursts	IEC/EN 61131-2; IEC/EN 61000-6-2; IEC 61000-4-4; IACS E10	For ~ or --- main supplies: ■ 2 kV in common mode/2 kV in wire mode For ~ or --- auxiliary supplies, ~ unshielded I/O: ■ 2 kV in common mode For analog, --- unshielded I/O, communication and shielded lines: ■ 1 kV in common mode
Surge	IEC/EN 61131-2; IEC/EN 61000-6-2; IEC 61000-4-5; IACS E10	For ~/--- main and auxiliary supplies, ~ unshielded I/O: ■ 2 kV in common mode/1 kV in differential mode For analog, --- unshielded I/O: ■ 0.5 kV in common mode/0.5 kV in differential mode For communication and shielded lines: ■ 1 kV in common mode
Conducted disturbances induced by radiated electromagnetic fields	IEC/EN 61131-2; IEC/EN 61000-6-2; IEC 61000-4-6; IACS E10	10 V; 0.15 MHz...80 MHz Sinus amplitude 80%, 1 kHz + spot frequencies
Damped oscillatory wave	IEC/EN 61131-2; IEC 61000-4-18; IACS E10	For ~/--- main supplies and ~ auxiliary supplies, ~ unshielded I/O: ■ 2.5 kV in common mode/1 kV in differential mode For --- auxiliary supplies, analog, --- unshielded I/O: ■ 1 kV in common mode/0.5 kV in differential mode For communication and shielded lines: ■ 0.5 kV in common mode

(1) Devices must be installed, wired and maintained in accordance with the instructions provided in the manual "Grounding and Electromagnetic Compatibility of PLC Systems".

(2) These tests are performed without an enclosure, with devices fixed on a metal grid and wired as per the recommendations in the manual "Grounding and Electromagnetic Compatibility of PLC systems".

(CE): tests required by European CE directives and based on IEC/EN 61131-2.

Environment tests (continued)		
Name of test	Standards	Levels
<b>Electromagnetic emissions (CE) (1)</b>		
Conducted emission	IEC/EN 61131-2; FCC part 15; IEC/EN 61000-6-4; CISPR 11 & 22, Class A, Group 1	150 kHz ... 500 kHz: quasi-peak 79 dB (µV/m); average 66 dB (µV/m) 500 kHz ... 30 MHz: quasi-peak 73 dB (µV/m); average 60 dB (µV/m)
	IACS E10	<ul style="list-style-type: none"> <li>■ ~ power (general power distribution zone): 10 kHz ... 150 kHz: quasi-peak 120...69 dB (µV/m); 150 kHz ... 0.5 MHz: quasi-peak 79 dB (µV/m) 0.5 MHz ... 30 MHz: quasi-peak 73 dB (µV/m)</li> <li>■ ~ power (bridge and deck zone for evaluation): 10 kHz ... 150 kHz: quasi-peak 96...50 dB (µV/m) 150 kHz ... 0.35 MHz: quasi-peak 60...50 dB (µV/m) 0.35 MHz ... 30 MHz: quasi-peak 50 dB (µV/m)</li> </ul>
Radiated emission	IEC/EN 61131-2; FCC part 15; IEC/EN 61000-6-4; CISPR 11 & 22, Class A, Group 1	30 MHz ... 230 MHz: quasi-peak 40 dB (µV/m) (at 10 m); 50 dB (µV/m) (at 3 m) 230 MHz ... 1 GHz: quasi-peak 47 dB (µV/m) (at 10 m); 57 dB (µV/m) (at 3 m)
	IACS E10	<ul style="list-style-type: none"> <li>■ For general power distribution zone 0.15 MHz ... 30 MHz: quasi-peak 80...50 dB (µV/m) (at 3 m) 30 MHz-100 MHz: quasi-peak 60...54 dB (µV/m) (at 3 m) 100 MHz - 2 GHz: quasi-peak 54 dB (µV/m) (at 3 m) 156 ... 165 MHz: quasi-peak 24 dB (µV/m) (at 3 m)</li> </ul>
<b>Name of test</b>		
<b>Standards</b>		
<b>Levels</b>		
<b>Immunity to climatic variations (1) (power on)</b>		
Dry heat	IEC 60068-2-2 (Bb & Bd)	60°C, t = 16 hrs [for ruggedized range: 70°C, t = 16 hrs] (2)
	IACS E10	60°C, t = 16 hrs + 70°C, t = 2 hrs [for ruggedized range: 70°C, t = 18 hrs] (2)
Cold	IEC 60068-2-1 (Ab & Ad) IACS E10	0°C ... -25°C, t = 16 hrs + power on at 0°C [for ruggedized range: power on at -25°C] (2)
Damp heat, steady state (continuous humidity)	IEC 60068-2-78 (Cab); IACS E10	55°C, 93% relative humidity, t = 96 hrs [for ruggedized range: 60°C] (2)
Damp heat, cyclic (cyclical humidity)	IEC 60068-2-30 (Db); IACS E10	55°C ... 25°C, 93...95% relative humidity, 2 cycles t = 12 hrs + 12 hrs
Change of temperature	IEC 60068-2-14 (Na & Nb)	0°C ... 60°C, 5 cycles t = 6 hrs + 6 hrs [for ruggedized range: -25 ... 70°C] (2)
<b>Name of test</b>		
<b>Standards</b>		
<b>Levels</b>		
<b>Withstand to climatic variations (1) (power off)</b>		
Dry heat	IEC/EN 61131-2; IEC 60068-2-2 (Bb & Bd) IEC/EN 60945	85°C, t = 96 hrs
Cold	IEC/EN 61131-2; IEC 60068-2-1 (Ab & Ad); IACS E10	-40°C, t = 96 hrs
Damp heat, cyclic (cyclical humidity)	IEC/EN 61131-2; IEC 60068-2-30 (Db)	55°C ... 25°C, 93...95% relative humidity, 2 cycles t = 12 hrs + 12 hrs
Change of temperature (thermal shocks)	IEC/EN 61131-2; IEC 60068-2-14 (Na & Nb)	-40°C ... 85°C, 5 cycles t = 3 hrs + 3 hrs

(1) Devices must be installed, wired and maintained in accordance with the instructions provided in the manual "Grounding and Electromagnetic Compatibility of PLC Systems".

(2) Refer also to the chapter "Treatment for severe environments".

(CE): tests required by European CE directives and based on IEC/EN 61131-2 standards.

Environment tests (continued)		
Name of test	Standards	Levels
<b>Immunity to mechanical constraints (1) (power on)</b>		
Sinusoidal vibrations	IEC/EN 61131-2; IEC 60068-2-6 (Fc)	Basic IEC/EN 61131-2: 5 Hz ... 150 Hz, ± 3.5 mm amplitude (5 Hz ... 8.4 Hz), 1 g (8.4 Hz ... 150 Hz) Specific profile: 5 Hz ... 150 Hz, ± 10.4 mm amplitude (5 Hz ... 8.4 Hz), 3 g (8.4 Hz ... 150 Hz) For basic and specific: endurance: 10 sweep cycles for each axis
	IACS E10	3 Hz ... 100 Hz, 1 mm amplitude (3 Hz ... 13.2 Hz), 0.7 g (13.2 Hz ... 100 Hz) Endurance at each resonance frequency: 90 min for each axis, amplification coefficient < 10
	IEC 60068-2-6	Seismic analysis: 3 Hz ... 35 Hz, 22.5 mm amplitude (3 Hz ... 8.1 Hz), 6 g (8.1 Hz ... 35 Hz)
Shocks	IEC/EN 61131-2; IEC 60068-2-27 (Ea)	30 g, 11 ms; 3 shocks/direction/axis (2) 25 g, 6 ms; 100 bumps/direction/axis (bumps) (3)
Free fall during operation	IEC/EN 61131-2; IEC 60068-2-32 (Ed Method 1)	1 m, 2 falls
Name of test	Standards	Levels
<b>Withstand to mechanical constraints (power off)</b>		
Random free fall with packaging	IEC/EN 61131-2; IEC 60068-2-32 (Method 1)	1 m, 5 falls
Flat free fall	IEC/EN 61131-2; IEC 60068-2-32 (Ed Method 1)	10 cm, 2 falls
Controlled free fall	IEC/EN 61131-2; IEC 60068-2-31 (Ec)	30° or 10 cm, 2 falls
Plugging/Unplugging	IEC/EN 61131-2	For modules and connectors: Operations: 50 for permanent connections, 500 for non-permanent connections
Name of test	Standards	Levels
<b>Equipment and personnel safety (1) (CE)</b>		
Dielectric strength and insulation resistance	IEC/EN 61131-2; IEC 61010-2-201; UL; CSA	Dielectric: 2 Un + 1000 V; t = 1 min Insulation: Un ≤ 50 V: 10 MΩ, 50 V ≤ Un ≤ 250 V : 100 MΩ
Continuity of earth	IEC/EN 61131-2; IEC 61010-2-201; UL; CSA	30A, R ≤ 0,1Ω; t = 2 min
Leakage current	UL; CSA	≤ 3.5 mA after disconnecting
Protection offered by enclosures	IEC/EN 61131-2; IEC 61010-2-201;	IP20 and protection against standardized pins
Impact withstand	IEC/EN 61131-2; IEC 61010-2-201; UL; CSA	Sphere of 500 g, fall from 1.30 m (energy 6.8 J minimum)
Stored energy injury risk	IEC/EN 61131-2; IEC 61010-2-201	Transient connection: 37% Un after 1 s Permanent connection: 37% Un after 10 s
Overload	IEC/EN 61131-2; IEC 61010-2-201; UL; CSA	50 cycles, Un, 1.5 In; t = 1 s ON + 9 s OFF
Endurance	IEC/EN 61131-2; IEC 61010-2-201; UL; CSA	In, Un; 12 cycles: t=100 ms ON + 100 ms OFF, 988 cycles : t = 1 s ON + 1 s OFF, 5000 cycles : t = 1 s ON + 9 s OFF
Temperature rise	IEC/EN 61131-2; UL; CSA; ATEX; IECEx	Ambient temperature 60°C [for ruggedized range: 70°C] (4)
Name of test	Standards	Levels
<b>Specific Environment (1)</b>		
Corrosion areas - gas, salt, dust	ISA S71.4	Mixed flowing gases: class G3, 25°C, 75% relative humidity, t = 14 days (4)
	IEC 60721-3-3	Mixed flowing gases: class 3C3, 25°C, 75% relative humidity, t = 14 days (4)
	IEC 60068-2-52	Salt spray: test Kb, severity 2 (4)

(1) Devices must be installed, wired and maintained in accordance with the instructions provided in the manual "Grounding and Electromagnetic Compatibility of PLC Systems".

(2) When using fast actuators (response time ≤ 5 ms) driven by relay outputs: 15 g, 11 ms; 3 shocks/direction/axis.

(3) When using fast actuators (response time ≤ 15 ms) driven by relay outputs: 15 g, 6 ms; 100 bumps/direction/axis.

(4) Refer also to the chapter "Treatment for severe environments".

(CE): tests required by European CE directives and based on IEC/EN 61131-2 standards.

# Technical appendices

## Automation product certifications

### EC regulations

Some countries require certain electrical components to undergo certification by law. This certification takes the form of a certificate of conformity to the relevant standards and is issued by the official body in question. Where applicable, certified devices must be labelled accordingly. Use of electrical equipment on board merchant vessels generally implies that it has gained prior approval (i.e. certification) by certain shipping classification societies.

Abbreviation	Certification body	Country
<b>CSA</b>	Canadian Standards Association	Canada
<b>RCM</b> (formerly C-Tick)	Australian Communications and Media Authority	Australia, New Zealand
<b>EAC</b> (formerly GOST)	Eurasian conformity	Russia and customs union
<b>UL</b>	Underwriters Laboratories	USA









  

Abbreviation	Classification authority	Country
<b>IACS</b>	International Association of Classification Societies	International
<b>ABS</b>	American Bureau of Shipping	USA
<b>BV</b>	Bureau Veritas	France
<b>DNV</b>	Det Norske Veritas	Norway
<b>GL</b>	Germanischer Lloyd	Germany
<b>LR</b>	Lloyd's Register	UK
<b>RINA</b>	Registro Italiano Navale	Italy
<b>RMRS</b>	Russian Maritime Register of Shipping	Russia
<b>RRR</b>	Russian River Register	Russia
<b>CCS</b>	China Classification Society	China

The tables below provide an overview of the situation as at 9th January 2014 in terms of which certifications (listed next to their respective bodies) have been granted or are pending for our automation products.

Up-to-date information on which certifications have been obtained by products bearing the Schneider Electric brand can be viewed on our website: [www.schneider-electric.com](http://www.schneider-electric.com)

### Product certifications

Certified Certification pending	Certifications							
	 UL USA	 CSA Canada	 RCM Australia	 EAC (9) Russia	Hazardous locations (1) Class I, div 2 USA, Canada	   (6)	  TÜV Rheinland	
Modicon OTB								
Modicon STB					FM	Zone 2 (2)(5)		
Modicon Telefast ABE 7								
ConneXium					(2)			
Magelis iPC/GTW		(3)		(2)	(3)	Zone 2/22 (2)		
Magelis XBT GT		(3)		(2)	(2) (3)	Zone 2/22 (2)(5)		
Magelis XBT GK		(3)			(3)			
Magelis XBT N/R/RT					CSA	Zone 2/22 (2)(5)		
Magelis HMI GTO		(3)		(2)	(3)	(2)		
Magelis HMI STO/STU		(3)		(2)	(2)(3)	(2)		
Modicon M340					CSA	Zone 2/22 (2)(8)		
Modicon M580								
Modicon X80 I/O					CSA	Zone 2/22 (2)(8)		
Modicon Momentum					FM			
Modicon Premium				(2)	CSA			
Modicon Quantum				(2)	CSA, FM (2)	Zone 2/22 (2)		
Modicon Quantum Safety				(2)	CSA	Zone 2/22 (2)	SIL 2, SIL 3 (7)	
Preventa XPSMF							SIL 3 (7)	
Modicon TSX Micro					CSA			
Phaseo	(3)							
Twido	(4)	(4)			CSA/UL (4)			

(1) Hazardous locations: According to ANSI/ISA 12.12.01, CSA 22.2 No. 213 and FM 3611, certified products are only approved for use in hazardous locations categorized as Class I, division 2, groups A, B, C and D, or in non-classified locations.

(2) Depends on product; please visit our website: [www.schneider-electric.com](http://www.schneider-electric.com).

(3) North American certification cULus (Canada and USA).

(4) Except for AS-Interface module TWD NOI 10M3, CE only.

(5) For zones not covered by this specification, Schneider Electric offers a solution as part of the CAPP (Collaborative Automation Partner Program). Please consult our Customer Care Centre.

(6) Refer to the instructions supplied with each ATEX and/or IECEx certified product.

(7) According to IEC 61508. Certified by TÜV Rheinland for integration into a safety function of up to SIL 2 or SIL 3.

(8) Can be used in gassy mines under certain conditions.











(9) Formerly GOST. GOST will be replaced by EAC after certificates are renewed.

# Technical appendices

## Automation product certifications

### EC regulations

#### Merchant navy certifications

Certified Certification pending	Shipping classification societies										
											
	ABS	BV	DNV	GL	KRS	LR	RINA	RMRS	RRR	PRS	CCS
	USA	France	Norway	Germany	Korea	Great Britain	Italy	Russia	Russia	Poland	China
Modicon OTB											
Modicon STB	(1) (2)	(2)	(2)	(2)		(2)	(2)				
Modicon Telefast ABE 7											
ConneXium											
Magelis iPC/GTW				Bridge (2)							
Magelis XBT GT	(2)	(2)	(2)	(2)		(2)	(2)	(2)	(2)		
Magelis XBT GK											
Magelis XBT N/R											
Magelis XBT RT											
Magelis HMI GTO											
Magelis HMI STO/STU		(2)	(2)								
Modicon M340								(2)	(2)		
Modicon M580											
Modicon X80 I/O								(2)	(2)		
Modicon Momentum											
Modicon Premium											
Modicon Quantum											
Modicon TSX Micro											
Phaseo											
Twido											

(1) Also covers US Navy requirements **ABS-NRV** part 4.

(2) Depends on product; please visit our website: [www.schneider-electric.com](http://www.schneider-electric.com).

#### EC regulations

##### European Directives

The open nature of the European markets assumes harmonization between the regulations set by the member states of the European Union. European Directives are texts whose aim is to remove restrictions on free circulation of goods and which must be applied within all European Union states.

Member states are obligated to incorporate each Directive into their national legislation, and to simultaneously withdraw any regulations that contradict it.

Directives - and particularly those of a technical nature with which we are concerned - merely set out the objectives to be fulfilled (referred to as "essential requirements"). Manufacturers are responsible for taking the necessary measures to establish that their products conform to the requirements of each Directive applicable to their equipment.

As a general rule, manufacturers certify compliance with the essential requirements of the Directive(s) that apply to their products by applying a CE mark. The CE mark is affixed to our products where applicable.

##### Significance of the CE mark

The CE mark on a product indicates the manufacturer's certification that the product conforms to the relevant European Directives; this is a prerequisite for placing a product which is subject to the requirements of one or more Directives on the market and allowing its free circulation within European Union countries. The CE mark is intended for use by those responsible for regulating national markets.

Where electrical equipment is concerned, conformity to standards indicates that the product is fit for use. Only a warranty by a well-known manufacturer can provide reassurance of a high level of quality.

As far as our products are concerned, one or more Directives are likely to apply in each case; in particular:

- The Low Voltage Directive (2006/95/EC)
- The Electromagnetic Compatibility Directive (2004/108/EC)
- The ATEX CE Directive (94/9/EC)

##### Hazardous substances

These products are compatible with:

- The WEEE Directive (2002/96/EC)
- The RoHS Directive ((2011/65/EU)
- The China RoHS Directive (Standard SJ/T 11363-2006)
- The REACH regulations Directive (EC 1907/2006)

**Note:** Documentation on sustainable development is available on our website [www.schneider-electric.com](http://www.schneider-electric.com) (product environmental profiles and instructions for use, ROHS and REACH directives).

##### End of life (WEEE)

End of life products containing electronic cards must be dealt with by specific treatment processes.

When products containing backup batteries are unusable or at end of life they must be collected and treated separately. Batteries do not contain a percentage by weight of heavy metals above the limit specified by European Directive 2006/66/EC.





---

## A dedicated services offer for your installed base

- Maintenance and support services ..... page 9/2
- Consultancy services..... page 9/3
- Modernization solutions ..... page 9/3
- Customization services ..... page 9/3

## Migration solutions

- TSX7 PLCs to Modicon X80 I/O platform..... page 9/4
  - Presentation ..... page 9/4
  - TSX7 module - X80 I/O platform compatibility ..... page 9/4
- Modicon Compact PLCs to Modicon X80 I/O platform..... page 9/6
  - Presentation ..... page 9/6
  - Compact module - X80 I/O platform compatibility ..... page 9/6

## Index

- Product reference index ..... page 9/10

# A dedicated services offer for your installed base

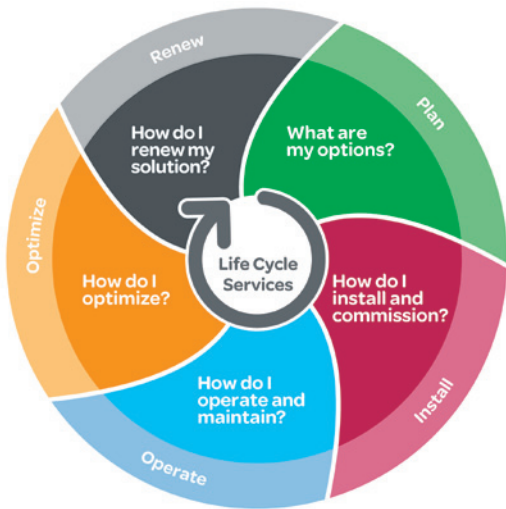

Schneider Electric, with its experts, products and dedicated tools, provides services such as system design, consultancy, maintenance contracts, modernisation of facilities or delivering projects.

The Schneider Electric services offer is structured around several key areas:

- Maintenance and support services:
  - A set of services to help maintain reliability and availability of automated control systems. These services may be the subject of a bespoke maintenance contract to meet your requirements more closely.
- Consultancy services:
  - Diagnostics of the installed base
- Modernization solutions:
  - Migration solutions including consultancy, expertise, tools and technical support to help ensure a smooth transition to newer technology while keeping the wiring and the encoding in most cases.

Customization services are also available to accommodate specific requirements. For more information, please consult the specific pages on our website [www.schneider-electric.com/automationservices](http://www.schneider-electric.com/automationservices)

## Maintenance and support services

### Spare parts, exchanges and repairs

*Everything you need to get equipment working again as quickly as possible*

Solutions to respond very quickly to requests for spare parts, exchanges and repairs to your installed automation equipment (automation platforms, Human Machine Interfaces, drives, distributed I/O):

- Spare parts management:
  - Identification of critical parts
  - Stock of spare parts: a Schneider Electric owned stock of spare parts, on your site or in one of our warehouses, with immediate availability on site or a contractually agreed delivery time if stored off site
  - Testing of spare parts stored on site
  - Automatic stock filling
- Repairs:
  - Broken down products are repaired in a network of worldwide repair centres. For each repaired product, our experts provide a detailed report.
- On-site repair:
  - Our experts' knowledge and expertise
  - Monitoring of specific repair procedures
  - Availability of our teams to respond 24/7
- Exchanges:
  - With standard replacements, receive a new or reconditioned product before the broken down product has even been sent back
  - Fast exchanges offer the option to receive the replacement product within 24 hours (in Europe)

### Preventive maintenance

*Improving and guaranteeing the long-term reliability and performance of your installations*

Schneider Electric's preventive maintenance expert assesses your site, the equipment to be managed and sets up a maintenance program to accommodate specific requirements. A list is provided of the tasks to be performed and their frequency, including site-specific tasks, describing how preventive maintenance is to be managed.

### Extended warranty

*An additional manufacturer warranty covering replacement or repair of the equipment*

The extended warranty offers the option to take out a 3-year warranty. The warranty period can vary according to the geographical area, consult your Customer Care Centre.

### Online support

*Access to dedicated experts*

Priority access to experts who can answer technical questions promptly concerning equipment and software both on sale and no longer commercially available.

### Software subscription

*Access to software upgrades and new features*

By subscribing to software updates, users are able to:

- Purchase licences
- Receive updates, upgrades, software migrations and transitions
- Download software from Schneider Electric's software library

## Consultancy services

### M2C (Maintenance and Modernization Consultancy)

*Professional tools and methods, proven experience of managing obsolescence and updating installed bases, to reduce downtimes and improve performance*

With our maintenance and modernization consultancy offer, Schneider Electric will help you check the state of your installed base by:

- Defining the scope and depth of the analysis in collaboration with you
- Collecting the technical data without shutting down production
- Analyzing and identifying avenues for improvement
- Producing a recommendation plan

Customer benefits:

- Learning about the components that make up the installed base and how up-to-date they are
- Better downtime anticipation
- Expert advice designed to improve performance

## Modernization solutions

### Migration to PlantStruxure

*Proven expertise, tools and methods to give you a clear vision of the improvement opportunities and guide you toward a successful modernization project*



To find out more about PlantStruxure architectures, please visit our website [www.schneider-electric.com/PlantStruxure](http://www.schneider-electric.com/PlantStruxure)

Schneider Electric offers a gradual program of modernization through a series of products, tools and services that allow you to upgrade to newer technology. There are several stages in this gradual modernization program:

- Partial program: replacement of an old component with a new one
- Staggered program: gradual incorporation of new offers in the system
- Total program: total renovation of the system

The table below lists our various migration offers:

### Wide range of migration offers

Solution		Change the CPU	Keep the I/O racks & wiring	Change the I/O racks & keep the wiring	Migrate your application	Manage your project	Execute your project
Platform (1)	TSX47 to TSX107	☑	☑	☑	☑	☑	☑
	April series 1000			☑	☑	☑	☑
	Modicon ●84, Compact	☑	☑	☑	☑	☑	☑
	April SMC				☑	☑	☑
	Merlin Gerin PB				☑	☑	☑
	AEG	☑	☑	☑	☑	☑	☑
	Symax	☑			☑	☑	☑
	Rockwell SLC500			☑	☑	☑	☑

☑

 Service available

*(1) Our migration service offer also includes SCADA, Human Machine Interfaces, drives, communication networks and distributed I/O.*

## Customization services

Schneider Electric is able to meet your specific requirements and provide you with adapted products:

- Protective coating for Human Machine Interfaces, automation platforms and distributed I/O modules for use in harsh environments
- Customized cable lengths to match your specific needs
- Customized front panels for Human Machine Interfaces

*Note: To check availability of services required, please contact our Customer Care Centre.*

#### Presentation

The quick wiring adapters comprise a set of connectors designed to simplify the replacement of legacy TSX7 PLCs by automation platforms integrating the Modicon X80 I/O platform, such as Modicon M340, M580, Quantum Ethernet RIO, etc. Replacement is carried out using the cabling of the existing installation. The adapters enable the I/O connectors of the TSX7 automation module in an existing installation to be matched to the equivalent I/O modules of the Modicon X80 I/O by using a corresponding pre-wired cable assembly.

Thirty-two references (four swing arm rack supports and twenty-eight quick wiring adapters) cover the main migration requirements between the TSX7 I/O modules and the Modicon X80 I/O platform and they conform to the specifications of the Modicon M340, M580 ranges.

#### Description of the solution

The electromechanical migration solution comprises a migration rack that includes a hinged door on which the Modicon X80 I/O backplane (8 or 12 slots), either for an M340 or either for an M580, is fixed, combined with a set of quick wiring adapters.

- The rear of the chassis replaces the TSX7 rack. It is designed to accommodate the adapters according to the modules present in the original TSX7 rack.
- The existing TSX7 wiring connector of the installation is mounted on the matching adapter attached to the rack support behind the hinged door. The other end of the adapter cable is connected to the corresponding I/O module of the Modicon X80 I/O platform.
- The M340 PLC or the M580 PLC is mounted at the front on the hinged door.
- The adapters transmit the same control signals to the installations without any changes to the wiring.

#### Advantages of the solution

This TSX7 PLC to the Modicon X80 I/O platform migration system offers the following advantages:

- Reduced production downtimes.
- Migration can be made during normal stoppage times (approximately 1 hour installation time per rack), as opposed to manual rewiring that requires a specific production stoppage. Backtracking is possible in the event of a detected problem.
- Cost savings due to use of existing wiring to sensors/actuators in the enclosures. Rewiring, tests, validation and update of wiring diagrams no longer required. This solution is therefore easier to implement.
- Choice of the range of M340 or M580 processors.

This migration solution is part of a complete set of TSX7 modernization solutions that comprise methods, dedicated solutions and tools. It can be implemented with the help of our experts so as to optimize suitability with the existing installation.

A correspondence table between TSX7 modules and the Modicon X80 I/O platform modules is shown on the next page. It lists only the possible compatibilities. However, TSX module terminal, modularity, common or power supply differences can be taken into account according to the setting up, installations and configurations. It is therefore recommended that compatibility conditions be checked with our Customer Care Center.

TSX7 module - X80 I/O platform compatibility					
Type of module	TSX7 modules		X80 I/O platform	Quick wiring adapters	
	Reference	Description	Reference	Description	Reference
Rack	TSXRKN8/RKS8	8-slot rack	BMEXBP0800	Support and 8-slot Ethernet rack	TSX7SWAEBP0800
	TSXRKN8/RKS8	8-slot rack	BMEXBP1200	Support and 12-slot Ethernet rack	TSX7SWAEBP1200
	TSXRKN8/RKS8	8-slot rack	BMXXBP0800	Support and 8-slot rack	TSX7SWAXBP0800
	TSXRKN8/RKS8	8-slot rack	BMXXBP1200	Support and 12-slot rack	TSX7SWAXBP1200
Discrete inputs	TSXDET802	8-point 24 VAC input	BMXDAI1602	Adapter, 40 cm/1.312 ft., between modules - TSXDET8●● - and BMXDAI16●● or BMXDDI16●●	DET08XXDXI160X
	TSXDET803	8-point 48 VAC input	BMXDAI1603		
	TSXDET812	8-point 24 VDC input	BMXDDI1602		
	TSXDET813	8-point 48 VDC input	BMXDDI1603		
	TSXDET814	8-point 130 VDC input	BMXDDI1604T		
	TSXDET824	8-point 110 VDC/115 VAC input	BMXDAI1604		
	TSXDET1603	16-point 48 VAC input	BMXDAI1603	Adapter, 40 cm/1.312 ft., between modules - TSXDET16●● - and BMXDAI16●● or BMXDDI16●●	DET16XXDXI160X
	TSXDET1604	16-point 110...120 VAC input	BMXDAI1604		
	TSXDET1612	16-point 24 VDC input	BMXDDI1602		
	TSXDET1613	16-point 48 VDC input	BMXDDI1603		
	TSXDET1633	16-point 48 VDC input	BMXDDI1603		
	TSXDET3232	32-point 24 VDC input	BMXDDI3202K	Adapter, 1 m/3.281 ft., between modules - TSXDET32●2 - and BMXDDI3202K	DET32X2DDI3202K
	TSXDET3242	32-point 24 VDC input	BMXDDI3202K		
TSXDET3252	32-point 24 VDC input	BMXDDI3202K			

# Modicon X80 I/O platform

## Migration solutions

### TSX7 PLCs to Modicon X80 I/O platform

TSX7 module - X80 I/O platform compatibility					
Type of module	TSX7 modules		X80 I/O platform	Quick wiring adapters	
	Reference	Description	Reference	Description	Reference
Discrete outputs	TSXDST835	8-point 24 VDC/24...240 VAC relay outputs	BMXDRA0805	Adapter, 40 cm/1.312 ft., between modules TSXDST835 (24 VDC/24...240 VAC/relay) and BMXDRA0805	DST835DRA0805
	TSXDST1612	16-point 24 VDC outputs	BMXDDO1612	Adapter, 40 cm/1.312 ft., between modules TSXDST1612 (24 VDC) and BMXDDO1612	DST1612DDO1612
	TSXDST1632	16-point 24 VDC outputs	BMXDDO1602	Adapter, 40 cm/1.312 ft., between modules TSXDST1632 (24 VDC) and BMXDDO1602	DST1632DDO1602
	TSXDST1632	16-point 24 VDC outputs	BMXDRA1605	Adapter, 40 cm/1.312 ft., between modules TSXDST1632 (24 VDC/relay) and BMXDRA1605	DST1632DRA1605
	TSXDST1633	16-point 24...240 VAC outputs	BMXDRA1605	Adapter, 40 cm/1.312 ft., between modules TSXDST1633 (24...240 VAC/relay) and BMXDRA1605	DST1633DRA1605
	TSXDST1634	16-point 48...130 VDC outputs	2 BMXDRA0804T modules	Adapter, 40 cm/1.312 ft., between 1 TSXDST1634 (125 VDC) module and 2 BMXDRA0804T modules	DST1634DRA0804T
	TSXDST1635	16-point 24...240 VAC outputs	BMXDAO1605	Adapter, 40 cm/1.312 ft., between modules TSXDST1635 (24...240 VAC/triac) and BMXDAO1605	DST1635DAO1605
	TSXDST1635	16-point 24...240 VAC outputs	BMXDRA1605	Adapter, 40 cm/1.312 ft., between modules TSXDST1635 (48...240 VAC/relais) and BMXDRA1605	DST1635DRA1605
	TSXDST1682	16-point 24 VDC outputs	BMXDDO1602	Adapter, 40 cm/1.312 ft., between modules TSXDST1682 (24 VDC) and BMXDDO1602	DST1682DDO1602
	TSXDST2472	24-point 24 VDC outputs	2 BMXDDO1602 modules	Adapter, 50 cm/1.640 ft., between 1 TSXDST2472 (24 VDC) module and 2 BMXDDO1602 modules	DST24X22DDO1602
	TSXDST2482	24-point 24 VDC outputs	2 BMXDDO1602 modules		
	TSXDST2472	24-point 24 VDC outputs	BMXDDO3202K	Adapter, 1 m/3.281 ft, between modules TSXDST2472 (24 VDC) and BMXDDO3202K	DST24X2DDO3202K
	TSXDST2482	24-point 24 VDC outputs	BMXDDO3202K		
	TSXDST3292	32-point 24 VDC outputs	BMXDDO3202K	Adapter, 1 m/3.281 ft, between modules TSXDST3292 (24 VDC) and BMXDDO3202K	DST3292DDO3202K
Analog Inputs	TSXAEM411	4-channel voltage/current inputs	BMXAMI0410	Adapter, 40 cm/1.312 ft, between modules TSXAEM411 and BMXAMI0410 (Current type)	AEM0411AMI0410C
	TSXAEM411	4-channel voltage/current inputs	BMXAMI0410	Adapter, 40 cm/1.312 ft, between modules TSXAEM411 and BMXAMI0410 (Voltage type)	AEM0411AMI0410V
	TSXAEM413	4-channel Pt100 inputs 3 or 4-wire	BMXART0414	Adapter, 40 cm/1.312 ft, between modules TSXAEM413 and BMXAMI0414 (RTD type)	AEM0413ART0414
	TSXAEM811	8-channel voltage/current inputs	BMXAMI0810	Adapter, 40 cm/1.312 ft, between modules TSXAEM811 and BMXAMI0810 (Current type)	AEM0811AMI0810C
	TSXAEM811	8-channel voltage/current inputs	BMXAMI0810	Adapter, 40 cm/1.312 ft, between modules TSXAEM811 and BMXAMI0810 (Voltage type)	AEM0811AMI0810V
	TSXAEM821	8-channel voltage/current inputs	BMXAMI0800	Adapter, 40 cm/1.312 ft, between modules TSXAEM821 and BMXAMI0800 (Current type)	AEM0821AMI0800C
	TSXAEM821	8-channel voltage/current inputs	BMXAMI0800	Adapter, 40 cm/1.312 ft, between modules TSXAEM821 and BMXAMI0800 (Voltage type)	AEM0821AMI0800V
	TSXAEM1601	16-channel inputs	2 BMXAMI0800 modules	Adapter, 50 cm/1.640 ft, between 1 TSXAEM1601 module and 2 BMXAMI0800 modules (Voltage type)	AEM1601AMI0800V
	TSXAEM1602	16-channel inputs	2 BMXAMI0800 modules	Adapter, 50 cm/1.640 ft, between 1 TSXAEM1602 module and 2 BMXAMI0800 (Current type) modules	AEM1602AMI0800C
	TSXASR200	2-channel voltage/current output	BMXAMO0210	Adapter, 50 cm/1.640 ft, between modules TSXASR200 and BMXAMO0210	ASR0200AMO0210
	2 TSXASR200 modules	2 x 2-channel voltage/current outputs	BMXAMO0410	Adapter, 50 cm/1.640 ft, between 2 TSXASR200 modules and 1 BMXAMO0410 module	2ASR0200AMO0410
	Analog outputs	TSXASR0401	4-channel voltage output	BMXAMO0410	Adapter, 40 cm/1.312 ft, between modules TSXASR0401 and BMXAMO0410
TSXASR0402		4-channel current output	BMXAMO0410		
TSXASR0403		4-channel current output	BMXAMO0410		
TSXAST200		2-channel voltage/current output	BMXAMO0210	Adapter, 40 cm/1.312 ft, between modules TSXAST200 and BMXAMO0210	AST0200AMO0210

## Presentation

The quick wiring adapters comprise a set of connectors designed to simplify the replacement of legacy Modicon Compact PLCs by automation platforms integrating the Modicon X80 I/O platform, such as Modicon M340, Quantum Ethernet RIO, etc.

The adapters enable the I/O field connectors of the Compact PLC in an existing installation to be matched to the equivalent I/O modules of the X80 I/O platform. Thirteen references provide the wiring translations between the I/O modules of Compact PLCs and those of the Modicon M340 platform and they fully meet the mechanical and environmental specifications of the Modicon M340 range.

## Quick wiring adapter features

The quick wiring adapters have the same look and feel as the standard I/O module connectors of the X80 I/O platform. The new connectors increase the depth and extend below the I/O module.

- The quick wiring adapters use the same mounting/retaining screws for attaching the adapter to the X80 I/O platform module.
- The sockets of the adapters accept 2 field wiring connectors of the Compact I/O module.
- A clear cover is sized to retain the wiring harness.
- The cover also has enough room for attaching the wiring label that was used on the Compact module.

## Compact module - X80 I/O platform compatibility

Type of module	Compact module		X80 I/O platform		Compact module - X80 I/O platform compatibility	Quick wiring adapter reference
	Reference	Description	Reference	Description		
Discrete input	AS-BDEO216	16-point 24 VDC input module	BMXDDI1602	16-point 24 VDC sink input	OK	990XSM00206
	AS-BDEP208	8-point 230 VAC input module	BMXDAI0805	8-point 200 to 240 VAC input	OK	990XSM00201
	AS-BDEP209	8-point 120 VAC input module	BMXDAI1604	16-point 110 VAC input	OK	990XSM00213
	AS-BDEP210	8-point 115 VAC input module	BMXDAI1604	16-point 110 VAC input	OK	990XSM00213
	AS-BDEP211	8-point 115 VAC input module	BMXDAI1604	16-point 110 VAC input	OK	None
	AS-BDEP214	16-point 12-60 VDC input module	BMXDDI1602 BMXDDI1603	16-point 24 VDC input 16-point 48 VDC input	For the 24 VDC module ensure that the input current threshold at switch on is compatible with the application. The input voltage threshold of BMXDDI1603 is 34 V compared with 12 V for AS-BDEP214. No replacement for 12 VDC and 60 VDC.	990XSM00206
	AS-BDEP215	16-point 5 VDC TTL input module	–	–	No exact replacement but can be replaced with HMI functionality.	None
	AS-BDEP216	16-point 24 VDC input module	BMXDDI1602	16-point 24 VDC sink input	OK	990XSM00206
	AS-BDEP217	16-point 24 VDC input module	BMXDAI1602	16-point 24 VDC sink input	OK but requires negative logic.	990XSM00201
	AS-BDEP218	16-point 115 VAC input module	BMXDAI1604	16-point 110 VAC input	OK	990XSM00201
	AS-BDEP220	16-point 24 VDC fast input module	–	–	The response time is a deciding factor when selecting replacement modules.	None
	AS-BDEP254	16-point 12-60 VDC input module	BMXDDI1602H BMXDDI1603H	16-point 24 VDC input 16-point 48 VDC input	For the 24 VDC module ensure that the input current threshold at switch on is compatible with the application. The input voltage threshold of BMXDDI1603 is 34 V compared with 12 V for AS-BDEP254. The temperature range for BMXDDI1603 is 0 to 60 °C compared with -40 °C to +70 °C for ASBDEP254. No replacement for 12 VDC and 60 VDC.	990XSM00206
	AS-BDEP254C	16-point 12-60 VDC input module, extended temp. + coating	BMXDDI1602H BMXDDI1603H	16-point 24 VDC input 16-point 48 VDC input	For the 24 VDC module ensure that the input current threshold at switch on is compatible with the application. The input voltage threshold of BMXDDI1603 is 34 V compared with 12 V for AS-BDEP254. The temperature range for BMXDDI1603 is 0 to 60 °C compared with -40 °C to +70 °C for ASBDEP254. No replacement for 12 VDC and 60 VDC.	990XSM00206
	AS-BDEP256	16-point 24 VDC input module	BMXDDI1602H	16-point 24 VDC sink input	The nominal temperature range of BMXDDI1602 is only 0 to +60 °C compared with -40 to +70 °C for AS-BDEP256.	990XSM00206
	AS-BDEP256C	16-point 24 VDC input module, extended temp. + coating	BMXDDI1602H	16-point 24 VDC sink input	The nominal temperature range of BMXDDI1602 is only 0 to +60 °C compared with -40 to +70 °C for AS-BDEP256C.	990XSM00206
AS-BDEP257	16 x 110 VDC inputs, extended temp.	BMXDDI1604T	16-point 125 VDC input	Nominal input voltage for BMXDDI1604T is 100 to 150 VDC compared with 55 to 170 VDC for AS-BDEP257. Response time for BMXDDI1604T is 9 ms compared with 6 ms for AS-BDEP257. Temperature range for BMXDAI1604T from -25 to +70 °C compared with -40 to +70 °C.	990XSM00206	
AS-BDEP257C	16-point 110 VDC input, extended temp. + coating	BMXDDI1604T	16-point 125 VDC input	Nominal input voltage for BMXDDI1604T is 100 to 150 VDC compared with 55 to 170 VDC for AS-BDEP257. Response time for BMXDDI1604T is 9 ms compared with 6 ms for AS-BDEP257. Temperature range for BMXDDI1604T from -25 to +70 °C compared with -40 to +70 °C. No conformal coating available.	990XSM00206	
AS-BDEP296	16 x 60 VDC inputs	–	–	No replacement	–	
AS-BDEP297	16 x 48 VDC inputs	BMXDDI1603	16-point 48 VDC input	OK	990XSM00206	

Green background with no comments indicates full functional equivalent between the X80 I/O platform module and the Compact module.

Green background with comments indicates full functional equivalent with differences notes. Check with your application.

Orange background indicates that, in most cases, the inputs of the X80 I/O platform fully replace those of the Compact module but differences are noted. For example, maximum current per point. Check with your application.

Red background indicates that there are no direct replacements but other solutions exist. Please consult Schneider Electric.

# Modicon X80 I/O platform

## Migration solutions

### Modicon Compact PLCs to Modicon X80 I/O platform

Compact module - X80 I/O platform compatibility						
Type of module	Compact module		X80 I/O platform		Compact module - X80 I/O platform compatibility	Quick wiring adapter reference
	Reference	Description	Reference	Description		
Discrete output	AS-BDAO216	16-point 24 VDC output module	BMXDDO1602	16-point 24 VDC output	OK, but with slightly slower response time. BMXDDO1602 response time of 1.2 ms compared with < 1 ms for AS-BDAO216.	990XSM00206
	AS-BDAP204	4-point relay (NO) module	BMXDRA0805	8-point relay outputs	OK, 4 relays on Compact, 8 on X80 I/O.	990XSM00203
	AS-BDAP204	4-point relay (NO) module	BMXDRA0804T	8-point 125 VDC output relay	OK, 4 relays on Compact, 8 on X80 I/O.	990XSM00203
	AS-BDAP208	8-point relay (NO) module	BMXDRA0805	8-point relay outputs	OK	990XSM00206
	AS-BDAP258	8-point relay (NO) module	BMXDRA0805H	8-point relay outputs	OK, but different extended temperatures.	990XSM00206
	AS-BDAP258C	8-point 24 VDC relay (NO) module, extended temp. + coating	BMXDRA0805H	8-point relay outputs	OK. Temperature between 0 and + 60 °C compared with - 40 to + 70 °C for BMXDRA0805H.	990XSM00206
	AS-BDAP209	8-point, 1 A, 120 VAC output module	BMXDAO1605	16-point 110 VAC to 230 VAC output	Lower current availability. BMXDAO1605 is limited to 600 mA compared with 1 A for AS-BDAP210. For AS-BDAP210, the nominal voltage goes down to 85 V compared with 100 V for BMXDAO1605.	990XSM00204
	AS-BDAP210	8-point, 24-230 VAC output module	BMXDAO1605	16-point 110 VAC to 230 VAC output	Lower current availability. BMXDAO1605 is limited to 600 mA compared with 1 A for AS-BDAP210. For AS-BDAP210, the nominal voltage goes down to 85 V compared with 100 V for BMXDAO1605.	990XSM00204
	AS-BDAP212	8-point 24 VDC input/4-point 2 A output	BMXDDM16025	8-point 24 VDC input + 8-point relay output	Compact: 2 groups of 2 outputs; X80 I/O: 1 group of 8. Consequently, different input isolation.	990XSM00205
	AS-BDAP252	8-point 24 VDC input/4-point 2 A output	BMXDDM16025H	8-point 24 VDC input + 8-point relay output	Compact: 2 groups of 2 outputs; X80 I/O: 1 group of 8. Consequently, different input isolation. Different extended temperatures.	990XSM00205
	AS-BDAP216	16-point 24 VDC output module	BMXDDO1602	16-point 24 VDC output	Compact: 2 groups of 8; X80 I/O: 1 group of 16. Consequently, different input isolation.	990XSM00206
	AS-BDAP256	16-point 24 VDC output module	BMXDDO1602H	16-point 24 VDC output	Compact: 2 groups of 8; X80 I/O: 1 group of 16. Consequently, different input isolation. Different extended temperatures.	990XSM00206
	AS-BDAP217	16-point 5-24 VDC output module	BMXDDO1612	16-point 24 VDC sink output	Slightly slower response time. BMXDDO1612 response time of 1.2 ms compared with < 1 ms for AS-BDAP217. Also, Compact: 2 groups of 8; X80 I/O: 1 group of 16.	990XSM00206
	AS-BDAP218	16-point 24-240 VAC output module	BMXDAO1605	16-point 110 VAC to 230 VAC module	Lower current availability. BMXDAO1605 is limited to 600 mA compared with 1 A for AS-BDAP210. For AS-BDAP210, the nominal voltage goes down to 24 V compared with 100 V for BMXDAO1605. If 24 V is required, select a different module.	990XSM00202
	AS-BDAP211	Combined press and stamp module, 120 VAC, inputs controlling the outputs	–	–	None	None
Discrete input/output	AS-BDAP220	8-point 24 VDC, 2 A, input/output module	BMXDDM16022	8-point 24 VDC input + 8-point 24 VDC output	BMXDDM16022 is limited to 0.625 A per channel compared with 2 A for AS-BDAP220. Also, the response time is 1.2 ms compared with < 1 ms for AS-BDAP220.	990XSM00207
	AS-BDAP250	8-point, 24 VDC, input/output module	BMXDDM16022H	8-point 24 VDC input + 8-point 24 VDC output	BMXDDM16022 is limited to 0.625 A per channel compared with 2 A for AS-BDAP220 and is not conformally coated. Also, the response time is 1.2 ms compared with < 1 ms for AS-BDAP220. BMXDDM16022 temperature range of 0 to + 60 °C compared with - 40 to + 70 °C for AS-BDAP250C.	990XSM00207
	AS-BDAP250C	8-point, 24 VDC, input/output module, extended temp. + coating	BMXDDM16022H	8-point 24 VDC input + 8-point 24 VDC output	BMXDDM16022 is limited to per channel compared with 2 A for AS-BDAP250. Also, the response time is 1.2 ms compared with < 1 ms for AS-BDAP220. DDM16022 temperature range of 0 to + 60 °C compared with - 40 to + 70 °C for AS-BDAP250C.	990XSM00207
	AS-BDAP212	8 inputs, 4 outputs, 24 VDC	BMXDDM16025	8-point 24 VDC input + 8-point relay output	Compact: 2 groups of 2 outputs; X80 I/O: 1 group of 8. Consequently, different input isolation.	990XSM00205
	AS-BDAP252	8 inputs, 4 outputs, 24 VDC	BMXDDM16025H	8-point 24 VDC input + 8-point relay output	BMXDDM16025 temperature range of 0 to + 60 °C compared with - 40 to + 70 °C. Compact: 2 groups of 2 outputs; X80 I/O: 1 group of 8. Consequently, different input isolation.	990XSM00205
	AS-BDAP252C	8 inputs, 4 outputs, 24 VDC, extended temp. + coating	BMXDDM16025H	8-point 24 VDC input + 8-point relay output	BMXDDM16025 temperature range of 0 to + 60 °C compared with - 40 to + 70 °C. Compact: 2 groups of 2 outputs; X80 I/O: 1 group of 8. Consequently, different input isolation.	990XSM00205
	AS-BDAP253	8 inputs, 4 outputs, 110 VDC	BMXDDM16025H	8-point 24 VDC input + 8-point relay output	1) Compact inputs: 110 VDC; X80 I/O: 24 VDC. 2) Compact: 2 groups of 2 outputs; X80 I/O: 1 group of 8. a) Different isolation b) 4 unused references	None
	AS-BDAP253C	8 inputs, 4 outputs, 110 VDC, extended temp. + coating	BMXDDM16025H	8-point 24 VDC input + 8-point relay output	1) Compact inputs: 110 VDC; X80 I/O: 24 VDC. 2) Compact: 2 groups of 2 outputs; X80 I/O: 1 group of 8. a) Different isolation b) 4 unused references	None
	AS-BDAP292	8 inputs, 4 outputs, 60 VDC	–	–	No exact replacement. Please consult Schneider Electric for a solution.	None

# Modicon X80 I/O platform

## Migration solutions

### Modicon Compact PLCs to Modicon X80 I/O platform

Compact module - X80 I/O platform compatibility						
Type of module	Compact module		X80 I/O platform		Compact module - X80 I/O platform compatibility	Quick wiring adapter reference
	Reference	Description	Reference	Description		
Analog input	AS-BADU204	4-channel $\pm 0.5$ V register, PT100, 11-bit	BMXART0414	4-channel TC/RTD, isolated, analog inputs	OK, but $\pm 0.5$ V missing. Also, X80 I/O has channel-to-channel and channel-to-bus isolation.	None
	AS-BADU205	4-channel register input	BMXAMI0410	4-channel, isolated, analog current/voltage input	OK, scaling differences.	990XSM00208
	AS-BADU205	4-channel register input	BMXAMM0600	4-channel, non-isolated, analog current/voltage input and 2-channel, non-isolated, 2-channel current/voltage output	OK, scaling differences.	990XSM00209
	AS-BADU206	4-channel, isolated, register input	BMXAMI0410	4-channel, isolated, analog current/voltage input	OK, but X80 I/O does not have $\pm 1$ V range.	990XSM00210
	AS-BADU206	4-channel, isolated, register input	BMXAMM0600	4-channel, non-isolated, analog current/voltage input and 2-channel, non-isolated, 2-channel current/voltage output	OK, but X80 I/O does not have $\pm 1$ V range. No isolation.	990XSM00211
	AS-BADU210	4-channel, isolated, analog voltage/current input	BMXAMI0410	4-channel, isolated, analog current/voltage input	OK, scaling differences. X80 I/O does not have all the corresponding voltage ranges.	990XSM00210
	AS-BADU210	4-channel, isolated, analog voltage/current input	BMXAMM0600	4-channel, non-isolated, analog current/voltage input and 2-channel, non-isolated, 2-channel current/voltage output	OK, scaling differences. X80 I/O does not have all the corresponding voltage ranges. No isolation.	990XSM00211
	AS-BADU211	8-channel analog input thermal module	BMXART0814	8-channel TC/RTD, isolated, analog inputs	OK, X80 I/O does not have 2, 5 or 10 V inputs nor 4-20 mA, $\pm 20$ mA, nor the 24 V external voltage.	None
	AS-BADU212	8-channel analog input thermal module	BMXART0814	8-channel TC/RTD, isolated, analog inputs	OK, X80 I/O does not have 2, 5 or 10 V inputs nor 4-20 mA, $\pm 20$ mA, nor the 24 V external voltage.	None
	AS-BADU214	4/8-channel multi-range Analog/Discrete inputs	BMXART0414	4-channel TC/RTD, isolated, analog inputs	X80 I/O has no 0 - 10 V, 1 - 5 V, 2 - 10 V voltage ranges nor loop capability.	None
	AS-BADU216	4/8-channel, isolated, thermocouple	BMXART0814	8-channel TC/RTD, isolated, analog inputs	OK	None
	AS-BADU254	4-channel register input	BMXAMI0410H	4-channel, isolated, analog current/voltage input	OK and X80 I/O has CAN/CAN and CAN/bus isolation whereas Compact has none. Different extended temperatures.	None
	AS-BADU254	4-channel register input	BMXAMM0600H	4-channel analog current/voltage input and 2-channel current/voltage output	OK, X80 I/O has 4 inputs and 2 outputs. Different extended temperatures.	None
	AS-BADU254C	4-channel register input, extended temp. + coating	BMXAMI0410H	4-channel, isolated, analog current/voltage input	OK and X80 I/O has CAN/CAN and CAN/bus isolation whereas Compact has none. Different extended temperatures.	None
	AS-BADU254C	4-channel register input, extended temp. + coating	BMXAMM0600H	4-channel analog current/voltage input and 2-channel current/voltage output	OK, X80 I/O has 4 inputs and 2 outputs. No isolation. Different extended temperatures.	None
	AS-BADU256	4-channel, isolated, register input	BMXAMI0410H	4-channel, isolated, analog current/voltage input	OK, but different extended temperatures.	None
	AS-BADU256	4-channel, isolated, register input	BMXAMM0600H	4-channel analog current/voltage input and 2-channel current/voltage output	OK, X80 I/O has 4 inputs and 2 outputs. No isolation. Different extended temperatures.	None
	AS-BADU256C	4-channel, isolated, register input, extended temp. + coating	BMXAMI0410H	4-channel, isolated, analog current/voltage input	OK, but different extended temperatures.	990XSM00210
	AS-BADU256C	4-channel, isolated, register input, extended temp. + coating	BMXAMM0600H	4-channel analog current/voltage input and 2-channel current/voltage output	OK, X80 I/O has 4 inputs and 2 outputs without isolation.	990XSM00211
	AS-BADU257	8-channel thermocouple	BMXART0814H	8-channel TC/RTD, isolated, analog inputs	OK, but different extended temperatures.	None
AS-BADU257C	8-channel thermocouple, extended temp. + coating	BMXART0814H	8-channel TC/RTD, isolated, analog inputs	OK, but different extended temperatures.	None	

Green background with no comments indicates full functional equivalent between the X80 I/O platform module and the Compact module.

Green background with comments indicates full functional equivalent with differences notes. Check with your application.

Orange background indicates that, in most cases, the inputs of the X80 I/O platform fully replace those of the Compact module but differences are noted. For example, maximum current per point. Check with your application.

Red background indicates that there are no direct replacements but other solutions exist. Please consult Schneider Electric.



Compact module - X80 I/O platform compatibility						
Type of module	Compact module		X80 I/O platform		Compact module - X80 I/O platform compatibility	Quick wiring adapter reference
	Reference	Description	Reference	Description		
Analog output	AS-BDAU202	2-point analog outputs, ± 10 V, ± 20 mA	BMXAMO0210	2-channel, isolated, analog current/voltage output	X80 I/O has no negative 20 mA capability.	990XSM00212
	AS-BDAU204	4-channel, opto-isolated, analog output	BMXAMO0210	2-channel, isolated, analog current/voltage output	X80 I/O does not support 0 to 1 V, 0 to 5 V, ± 1 V ranges. +- 5 V.	None
	AS-BDAU204	4-channel, opto-isolated, analog output	BMXAMO0410	4-channel, isolated, analog current/voltage output	X80 I/O does not support 0 to 1 V, 0 to 5 V, ± 1 V ranges. +- 5 V.	990XSM00214
	AS-BDAU208	8-channel register output	–	–	No 8-point analog output. Two modules need to be used.	None
	AS-BDAU252	2-point analog outputs, ± 10 V, ± 20 mA, extended temp.	BMXAMO0210H	2-channel, isolated, analog current/voltage output	X80 I/O has no negative 20 mA capability. Different extended temperatures.	990XSM00212
	AS-BDAU252C	2-point analog outputs, ± 10 V, ± 20 mA, extended temp. + coating	BMXAMO0210H	2-channel, isolated, analog current/voltage output	X80 I/O has no negative 20 mA capability. Different extended temperatures.	990XSM00212
Communication	AS-BBKF202	INTERBUS S slave	–	–	No replacement	None
	AS-BBKF201-16	16 word INTERBUS S Master	–	–	No replacement	None
	AS-BBKF201-64	64 word INTERBUS S Master	–	–	No replacement	None
Service communication	CM900	Auto interface	–	–	No replacement	None
	AS-BKOS260-24	24 word universal communication	–	–	Please consult Schneider Electric for assistance in finding the optimum solution. READ_VAR functionality could be a replacement solution.	None
	AS-BKOS260-64	64 word universal communication	–	–	Please consult Schneider Electric for assistance in finding the optimum solution. READ_VAR functionality could be a replacement solution.	None
	M7251	Programmable limit switch	–	–	No replacement, no movement	None
Motion	M7350	Resolver-decoder	–	–	No replacement, no movement	None
	AS-BMOT201	Axis motion control encoder module	–	–	Please consult Schneider Electric for assistance in finding the optimum solution.	None
Counter	AS-BMOT202	Axis motion control resolver encoder module	–	–	Please consult Schneider Electric for assistance in finding the optimum solution.	None
	AS-BFRQ204	4-point frequency module	BMXEHC0200	2-channel high speed counter	No 5 V input. Please consult Schneider Electric for the exact replacement.	None
CPU	AS-BFRQ254C	4-channel frequency module, extended temp. + coating	BMXEHC0200H	2-channel high speed counter	No 5 V input. Please consult Schneider Electric for the exact replacement.	None
	AS-BVIC200 VRC200	4 high speed pulse or 4 VRC inputs	–	–	Please consult Schneider Electric for assistance in finding the optimum solution.	None
	AS-BVIC205 CTR205	4 high speed pulse or 4 x 5 V TTL inputs	–	–	Please consult Schneider Electric for assistance in finding the optimum solution.	None
	AS-BVIC212 CTR212	4 high speed pulse or 12 VDC inputs	–	–	Please consult Schneider Electric for assistance in finding the optimum solution.	None
	AS-BVIC224 CTR224	4 high speed pulse or 24 VDC inputs	BMXEHC0800	8-channel high speed counter	Please consult Schneider Electric for assistance in finding the optimum solution.	None
	AS-BZAE201	High speed counter/positioner (2 relays)	BMXEHC0200	2-channel high speed counter	12 V counter OK, no relay outputs, no 5 V, no positioning.	None
	AS-BZAE204	4-channel high speed counter/positioner	BMXEHC0800	8-channel high speed counter	OK. No outputs.	None
	AS-B984-A145 up to E984-285	–	BMXP342020 + BMXCPS3020	–	Only 1 Modbus port on CPU 2-port NOM serial module available.	None
AS-P120000	105...240 VAC inputs, 24 VDC 1.0 A outputs	BMXCPS2000/ BMXCPS3500	–	–	None	

**Note:**

- Extended temperature modules for the X80 I/O platform are distinguished by having the suffix H added to the reference.
- The Modicon Compact range of PLCs had an extended temperature range of - 40 °C to + 70 °C. The extended temperature range of the X80 I/O platform is - 25 °C to + 70 °C. Derating the temperature may impose limits on some applications.
- As with any PLC migration, even an exact module to module replacement might not provide identical results (due to scan time, etc.).

<b>A</b>	ABE7H32E300	6/12	ABS7EA3E5	6/17	BMXDDI1602H	5/6	BMXFTA152	3/23	
ABE7ACC02	6/20	ABE7P08T330	6/16	ABS7EA3F5	6/17	BMXDDI1603	3/12	BMXFTA300	3/23
ABE7ACC10	6/20	ABE7P16F310	6/15	ABS7EA3M5	6/17	BMXDDI1603H	5/6	BMXFTA302	3/23
ABE7ACC11	6/20	ABE7P16F312	6/15	ABS7EC3AL	6/17	BMXDDI1604T	3/12	BMXFTB2000	3/13
ABE7ACC12	6/17	ABE7P16T111	6/16	ABS7EC3B2	6/17	BMXDDI3202K	3/12		3/23
ABE7ACC21	6/20	ABE7P16T210	6/16	ABS7EC3E2	6/17	BMXDDI6402K	3/12		3/31
ABE7BV10	6/20	ABE7P16T212	6/16	ABS7SA2M	6/17	BMXDDM3202K	3/13		5/6
ABE7BV20	6/20	ABE7P16T214	6/16	ABS7SA3M	6/17	BMXDDM16022	3/13		5/8
ABE7CPA01	6/18	ABE7P16T215	6/16	ABS7SC1B	6/17	BMXDDM16022H	5/6	BMXFTB2010	5/11
ABE7CPA02	3/23	ABE7P16T230	6/16	ABS7SC2E	6/17	BMXDDM16025	3/13		3/13
	6/18	ABE7P16T318	6/16	ABS7SC3BA	6/17	BMXDDM16025H	5/6		3/23
ABE7CPA03	3/23	ABE7P16T330	6/16	ABS7SC3E	6/17	BMXDDO1602	3/12		3/31
	6/18	ABE7P16T332	6/16	AR1SB3	6/20	BMXDDO1602H	5/6		5/6
ABE7CPA11	6/18	ABE7P16T334	6/16	ASITERV2	4/17	BMXDDO1612	3/12	BMXFTB2020	5/11
ABE7CPA12	6/18	ABE7R08S111	6/14			BMXDDO1612H	5/6		3/13
ABE7CPA13	6/18	ABE7R08S210	6/14	<b>B</b>		BMXDDO3202K	3/12		3/23
ABE7CPA21	3/23	ABE7R08S216	6/14	BMEAHI0812	3/27	BMXDDO6402K	3/12		3/31
	6/18	ABE7R16M111	6/15	BMEAHO0412	3/27	BMXDRA0804T	3/12		5/6
ABE7CPA31	3/23	ABE7R16S111	6/14	BMECRA31210	4/9	BMXDRA0805	3/12	BMXFTB2800	5/8
	6/18	ABE7R16S111E	6/14	BMECRA31210C	5/10	BMXDRA0805H	5/6		5/11
ABE7CPA31E	3/23	ABE7R16S210	6/14	BMEXPB0400	2/4	BMXDRA1605	3/12		3/23
	6/18	ABE7R16S210E	6/14	BMEXPB0400H	5/4	BMXDRA1605H	5/6	BMXFTB2820	3/33
ABE7CPA410	3/23	ABE7R16S212	6/14	BMEXPB0800	2/4	BMXEAE0300	3/33		3/35
	5/8	ABE7R16T111	6/15	BMEXPB0800H	5/4	BMXEAE0300H	5/11		5/11
	6/18	ABE7R16T210	6/15	BMEXPB1200	2/4	BMXEHC0200	3/31		3/35
ABE7CPA412	3/23	ABE7R16T212	6/15	BMEXPB1200H	5/4	BMXEHC0200H	5/11	BMXFTW301	5/11
	5/8	ABE7R16T230	6/15	BMXAMI0410	3/22	BMXEHC0800	3/31		3/13
	6/18	ABE7R16T231	6/15	BMXAMI0410H	5/7	BMXEHC0800H	5/11	BMXFTW301S	5/6
ABE7FU012	6/20	ABE7R16T330	6/15	BMXAMI0800	3/22	BMXEIA0100	4/17		3/23
ABE7FU050	6/20	ABE7R16T332	6/15	BMXAMI0810	3/22	BMXERT1604T	4/7	BMXFTW308S	3/23
ABE7FU100	6/20	ABE7R16T370	6/15	BMXAMI0810H	5/7	BMXFCA150	3/23	BMXFTW501	5/6
ABE7FU200	6/20	ABE7S16E2B1	6/14	BMXAMM0600	3/22		5/8	BMXFTW501S	3/23
ABE7FU400	6/20	ABE7S16E2B1E	6/14	BMXAMM0600H	5/7	BMXFCA152	3/23		5/8
ABE7FU630	6/20	ABE7S16E2E0	6/14	BMXAMO0210	3/22		5/8	BMXFTW508S	3/23
ABE7H08R10	6/13	ABE7S16E2E1	6/14	BMXAMO0210H	5/7	BMXFCA300	3/23	BMXFTW1001	3/13
ABE7H08R11	6/13	ABE7S16E2E0	6/14	BMXAMO0410	3/22		5/8		5/6
ABE7H08R21	6/13	ABE7S16E2F0	6/14	BMXAMO0410H	5/7	BMXFCA302	3/23	BMXMSP0200	3/35
ABE7H08S21	6/13	ABE7S16E2M0	6/14	BMXAMO0802	3/22		5/8	BMXNOE0100H	5/9
ABE7H12R10	6/13	ABE7S16E2M0E	6/14	BMXART0414	3/22	BMXFCA500	3/23	BMXNOE0110H	5/9
ABE7H12R11	6/13	ABE7S16S1B2	6/14	BMXART0414H	5/7		5/8	BMXNOM0200	4/19
ABE7H12R20	6/13	ABE7S16S2B0	6/14	BMXART0814	3/22	BMXFCA502	3/23	BMXNOM0200H	5/9
ABE7H12R21	6/13	ABE7S16S2B0E	6/14	BMXART0814H	5/7		5/8	BMXNOR0200H	4/15
ABE7H12R50	6/13	ABE7TES160	6/20	BMXCPS2000	2/11	BMXFCA502	3/23		5/9
ABE7H12S21	6/13	ABFC08R02B	6/21	BMXCPS2010	2/11	BMXFCA502	3/23	BMXNRP0200	4/3
ABE7H16C10	6/12	ABFC08R02R	6/21	BMXCPS3020	2/11	BMXFCC051	3/13	BMXNRP0201	4/3
ABE7H16C11	6/12	ABFC08R02W	6/21	BMXCPS3020H	5/3	BMXFCC101	3/13	BMXPRA0100	4/5
ABE7H16C21	6/12	ABFC08R12B	6/21	BMXCPS3500	2/11	BMXFCC103	3/13	BMXRWS128MWF	4/15
ABE7H16C31	6/12	ABFC08R12R	6/21	BMXCPS3500H	5/3	BMXFCC201	3/13	BMXXBC008K	2/8
ABE7H16CM11	6/12	ABFC08R12W	6/21	BMXCPS3540T	2/11	BMXFCC203	3/13		5/5
ABE7H16CM21	6/12	ABFM04S200	6/19	BMXCPS3540T	2/11	BMXFCC301	3/13	BMXXBC015K	2/8
ABE7H16F43	6/13	ABFM04S201	6/19	BMXCRA31200	4/3	BMXFCC303	3/13		5/5
ABE7H16R10	6/13	ABFM08S201	6/19	BMXCRA31210	4/3	BMXFCC501	3/13	BMXXBC030K	2/8
ABE7H16R11	6/13	ABFM08S201	6/19	BMXCRA31210C	5/10	BMXFCC503	3/13		5/5
ABE7H16R20	6/13	ABFM16S201	6/19	BMXDAI0805	3/12	BMXFCC1001	3/13	BMXXBC050K	2/8
ABE7H16R21	6/13	ABFM32H150	6/19	BMXDAI0814	3/12	BMXFCC1003	3/13		5/5
ABE7H16R23	6/13	ABFM32H151	6/19	BMXDAI1602	3/12	BMXFCC301	3/13	BMXXBC120K	2/8
ABE7H16R30	6/13	ABFM32H300	6/19	BMXDAI1602H	5/6	BMXFCC303	3/13		5/5
ABE7H16R31	6/13	ABFM32H301	6/19	BMXDAI1603	3/12	BMXFCC501	3/13	BMXXBE1000	2/8
ABE7H16R50	6/13	ABR7S11	6/17	BMXDAI1603H	5/6	BMXFCC503	3/13	BMXXBE1000H	5/4
ABE7H16S21	6/13	ABR7S21	6/17	BMXDAI1604	3/12	BMXFCC1001	3/13	BMXXBE2005	2/8
ABE7H16S43	6/13	ABR7S23	6/17	BMXDAI1604H	5/6	BMXFCC1001	3/13	BMXXBP0400	2/4
ABE7H20E100	6/12	ABR7S33	6/17	BMXDAO1605	3/12	BMXFCC1003	3/13	BMXXBP0400H	5/4
ABE7H20E200	6/12	ABR7S33E	6/17	BMXDAO1605H	5/6	BMXFCC1001	3/13	BMXXBP0600	2/4
ABE7H20E300	6/12	ABR7S37	6/17	BMXDDI1602	3/12	BMXFCC1003	3/13	BMXXBP0600H	5/4
ABE7H32E150	6/12					BMXFTA150	3/23	BMXXBP0800	2/4

<b>BMXXBP0800H</b>	5/4
<b>BMXXBP1200</b>	2/4
<b>BMXXBP1200H</b>	5/4
<b>BMXXEM010</b>	2/5 5/4
<b>BMXXSP0400</b>	2/5 5/4
<b>BMXXSP0600</b>	2/5 5/4
<b>BMXXSP0800</b>	2/5 5/4
<b>BMXXSP1200</b>	2/5 5/4
<b>BMXXTSCPS10</b>	2/11 5/3
<b>BMXXTSCPS20</b>	2/11 5/3
<b>BMXXTSHSC20</b>	3/31 5/11

**P**

<b>PMESWT0100</b>	4/23
<b>PMXNOW0300</b>	4/21

**S**

<b>STBXSP3010</b>	2/5 5/4
<b>STBXSP3020</b>	2/5 5/4

**T**

<b>TCSEGPA23F14FK</b>	5/10
<b>TCSMCN3M4F3C2</b>	4/19
<b>TCSMCN3M4M3S2</b>	4/19 5/10
<b>TCSXCN3M4F3S4</b>	4/19 5/10
<b>TSXCBY010K</b>	2/8 5/5
<b>TSXCBY030K</b>	2/8 5/5
<b>TSXCBY050K</b>	2/8 5/5
<b>TSXCBY120K</b>	2/8 5/5
<b>TSXCBY180K</b>	2/8 5/5
<b>TSXCBY280KT</b>	2/8 5/5
<b>TSXCBY1000</b>	2/8 5/5
<b>TSXCBYACC10</b>	2/9 5/5
<b>TSXCBYK9</b>	2/9 5/5
<b>TSXCDP053</b>	6/19
<b>TSXCDP103</b>	6/19
<b>TSXCDP203</b>	6/19
<b>TSXCDP303</b>	6/19
<b>TSXCDP503</b>	6/19
<b>TSXTLYEX</b>	2/9 5/5

**V**

<b>VW3M8223R30</b>	3/35
--------------------	------

PlantStruxure



## Schneider Electric Industries SAS

Head Office  
35, rue Joseph Monier  
F-92500 Rueil-Malmaison  
France

[www.schneider-electric.com/psx](http://www.schneider-electric.com/psx)

The information provided in this documentation contains general descriptions and/or technical characteristics of the performance of the products contained herein. This documentation is not intended as a substitute for and is not to be used for determining suitability or reliability of these products for specific user applications. It is the duty of any such user or integrator to perform the appropriate and complete risk analysis, evaluation and testing of the products with respect to the relevant specific application or use thereof. Neither Schneider Electric nor any of its affiliates or subsidiaries shall be responsible or liable for misuse of the information contained herein.

Design: Schneider Electric  
Photos: Schneider Electric

DIA6ED2131203EN