

EN - For pricing and availability in your local country please visit one of the below links:

DE - Informationen zu Preisen und Verfügbarkeit in Ihrem Land erhalten Sie über die unten aufgeführten Links:

FR - Pour connaître les tarifs et la disponibilité dans votre pays, cliquez sur l'un des liens suivants:

[TEFL006](#)

EN

This Datasheet is presented by
the manufacturer

DE

Dieses Datenblatt wird vom
Hersteller bereitgestellt

FR

Cette fiche technique est
présentée par le fabricant

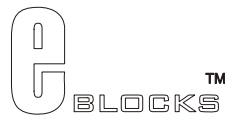

PICmicro® MCU Multiprogrammer EB006-00-6 Technical datasheet

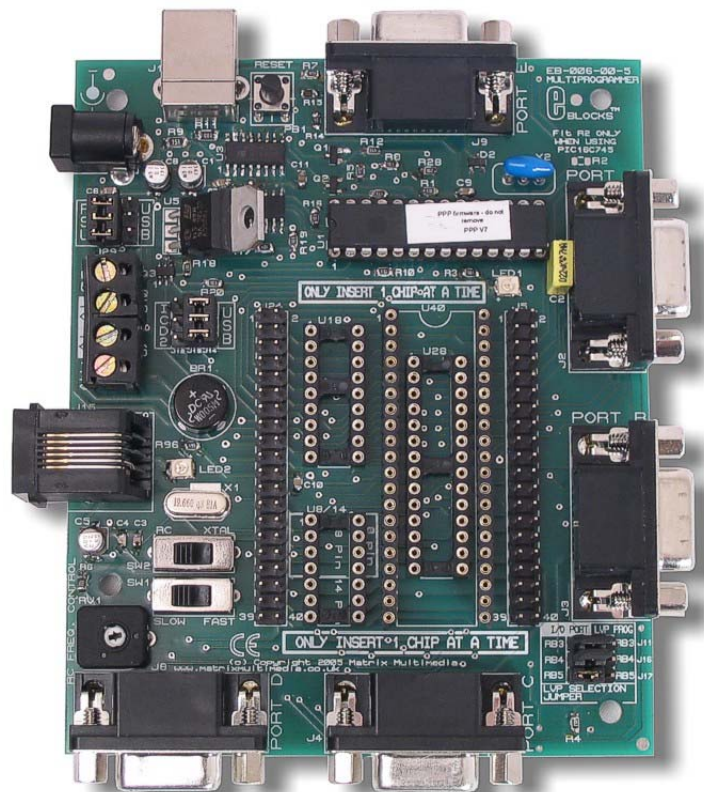

Contents

1.	About this document	2
2.	General information	3
3.	Board layout.....	5
4.	Testing this product	6
5.	Circuit description	9
6.	PICmicro microcontroller pin out details	11
7.	Bus connections	12

Appendix 1 Circuit Diagram

1. About this document

This document concerns the E-blocks PICmicro Multiprogrammer code EB006 version 6.

The order code for this product is EB006.

1. **Trademarks and copyright**

PIC and PICmicro are registered trademarks of Arizona Microchip Inc.
E-blocks is a trademark of Matrix Multimedia Limited.

2. **Other sources of information**

There are various other documents and sources that you may find useful:

Getting started with E-Blocks.pdf

This describes the E-blocks system and how it can be used to develop complete systems for learning electronics and for PICmicro programming.

PPP Help file

This describes the PPP software and its functionality. PPP software is used for transferring hex code to a PICmicro microcontroller.

C and assembly strategies

Not provided for this product.

3. **Disclaimer**

The information in this document is correct at the time of going to press. Matrix Multimedia reserves the right to change specifications from time to time. This product is for development purposes only and should not be used for any life-critical application.

4. **Technical support**

If you have any problems operating this product then please refer to the troubleshooting section of this document first. You will find the latest software updates, FAQs and other information on our web site: www.matrixmultimedia.com . If you still have problems please email us at: support@matrixmultimedia.co.uk.

2. General information

1. *Description*

This new PICmicro microcontroller programmer connects to your PC via USB to provide you with one of the world's lowest cost and most flexible PICmicro microcontroller programmers. This board can be used with Assembly, C or Flowcode programming utilities provided by Matrix Multimedia. The board will program most 8, 14, 18, 28 and 40 pin flash PICmicro microcontroller devices' using the flexible programming software provided – PPP - and provides 'clean' access to all I/O lines on the relevant PICmicro MCU devices.

2. *Features*

- E-blocks compatible
- Low cost
- Used as a programmer and as a development board
- Programs a wide range of PICmicro MCU devices
- Full suite of programming software available
- RC or Xtal operation
- 5 I/O ports
- In-Circuit Debugging via MPLAB® ICD2

3. *Change log*

New features for Version 6

- 1) Minor modifications to prevent breakdown of the 4052 chip when used with a power supply with excess ripple.

New features for Version 5

- 2) The board can now accept power supplies of either polarity – positive inner or positive outer.
- 3) The board is now compatible with a wider range of PICmicros for Low Voltage Programming which use B3, 4 or 5 for the LVP pin.
- 4) The USB control chip on board is now much faster and can program at the rate of 1k byte per second.
- 5) PPP has also been improved inline with these changes.

4. Block schematic

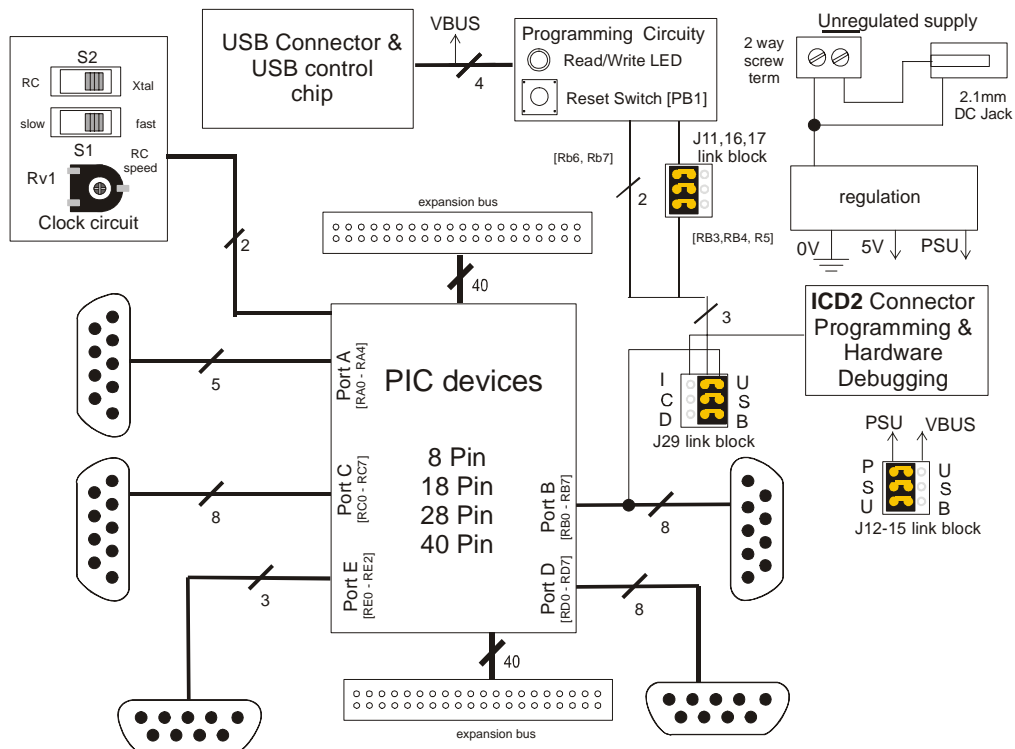

5. Supported devices

Currently PPP and the EB006 support the following devices:

PIC12F629, PIC12F675, PIC12F635, PIC12F683

PIC16F627A, PIC16F627, PIC16F628A, PIC16F628, PIC16F630, PIC16F648A, PIC16F676, PIC16F684, PIC16F688, PIC16F636, PIC16F716, PIC16F72, PIC16F737, PIC16F73, PIC16F747, PIC16F74, PIC16F767, PIC16F76, PIC16F777, PIC16F77, PIC16F818, PIC16F819, PIC16F83, PIC16F84A, PIC16F84, PIC16F870, PIC16F871, PIC16F872, PIC16F873A, PIC16F873, PIC16F874A, PIC16F874, PIC16F876A, PIC16F876, PIC16F877A, PIC16F877, PIC16F87, PIC16F88

PIC18F242, PIC18F248, PIC18F252, PIC18F258, PIC18F442, PIC18F448, PIC18F452, PIC18F458, PIC18F1220, PIC18F1320, PIC18F2220, PIC18F2320, PIC18F2331, PIC18F2410, PIC18F2420, PIC18F2431, PIC18F2439, PIC18F2455, PIC18F2510, PIC18F2515, PIC18F2520, PIC18F2525, PIC18F2539, PIC18F2550, PIC18F2585, PIC18F2586, PIC18F2610, PIC18F2620, PIC18F2680, PIC18F2681, PIC18F4220, PIC18F4320, PIC18F4331, PIC18F4410, PIC18F4420, PIC18F4431, PIC18F4439, PIC18F4455, PIC18F4510, PIC18F4515, PIC18F4520, PIC18F4525, PIC18F4539, PIC18F4550, PIC18F4585, PIC18F4586, PIC18F4610, PIC18F4620, PIC18F4680, PIC18F4681

3. Board layout

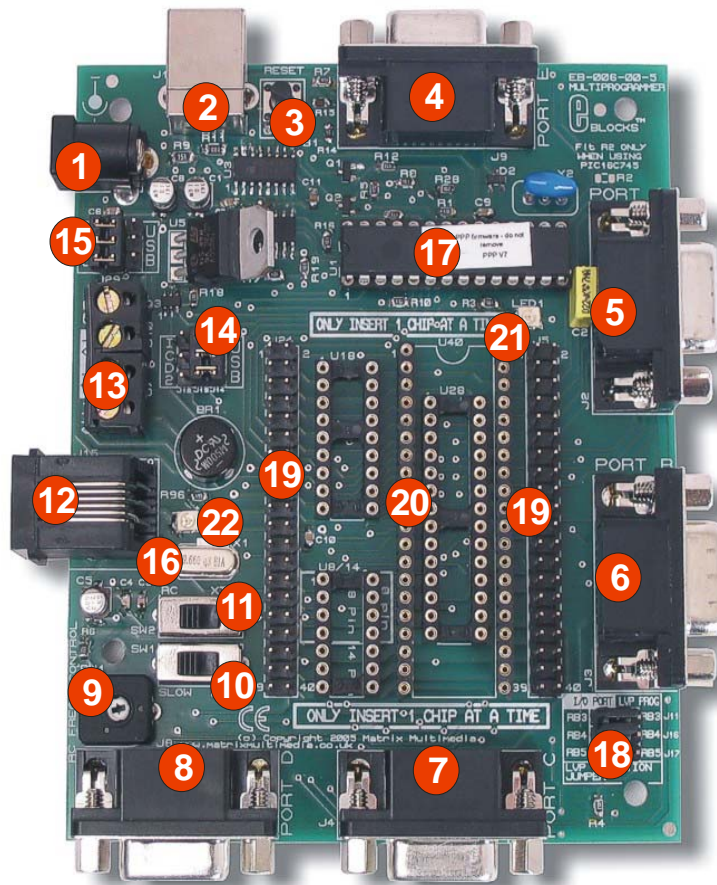

EB006-74-4.cdr

1. Power connector - either polarity
2. USB connector
3. Reset switch
4. Port E I/O
5. Port A I/O
6. Port B I/O
7. Port C I/O
8. Port D I/O
9. RC clock speed potentiometer
10. RC clock speed switch
11. Clock crystal / RC switch
12. ICD2 socket
13. Power screw terminals
14. USB/ICD2 programming selector
15. USB/ICD2 power selector
16. Removable crystal
17. USB control chip – do not remove
18. Low Voltage Program pin selector link block
19. Expansion connector – two off
20. Turned pin DIL sockets for 8, 14, 18, 28, 40 pin PICmicro devices
21. 'Ready to go' programming LED
22. Power LED

4. Testing this product

The following program will test the circuit. The test file can be downloaded from www.matrixmultimedia.com.

1. *Installing PPP*

To install run PPPv3.exe, which is located at <D>:\PPPv3\PPPv3.exe and follow the instructions provided. <D> refers to your CD drive.

By default PPPv3 is installed into:

C:\Program Files\Matrix Multimedia\Common\PPPv3\

There are four 'Features' that can be installed.

- PPP v3 core files - this is PPP v3 itself, and should be installed.
- Update ASM4PICs - This feature allows you to update ASM4PICs to use PPP v3.
- Update C4PICs - This feature allows you to update C4PICs to use PPP v3.
- Update FlowCode - This feature allows you to update FlowCode to use PPP v3.

The three updates will be automatically installed. Select the 'X' 'Do not install option' if you do not to update a feature.

If you need to update a product at a later date you can re-run the install and update that feature.

There is more help and information available on the CD provided at <D>:\PPPv3\readme.txt
<D> refers to your CD drive.

When you connect the Multiprogrammer to your computer, via the USB cable, the first time there will be installation routine for this 'new hardware'. This for most users will be a 'plug and play' routine where your computer will automatically recognize the hardware. During this routine you may get a message stating that the hardware has not been tested by Microsoft and may cause instability. Please ignore this message and click continue, the hardware and software have been thoroughly tried and tested.

Running on Windows 2000 / ME / XP

These programs allow 'plug and play' for your new hardware. Therefore when you first connect the Multiprogrammer to your computer you will receive a pop-up screen that indicates that there is new hardware connected to the computer. The program itself will deal with any installation of any drivers that it requires internally. Therefore you can use your Multiprogrammer immediately.

Running on Windows 98 (you will need the Windows 98 CD at hand)

When you connect the Multiprogrammer to the computer your Windows 98 program will run a 'New Hardware Wizard'. This procedure is straightforward and easy to understand. Follow the on-screen instructions. Once this has been completed the Multiprogrammer will be ready to use.

There is more detailed information and help on the CD provided at <D>:\eblocks\Installation Guide.doc

2. *Testing the board – with an external power supply*

- 1) Ensure power is supplied to the Multiprogrammer board
 1. USB cable required
 2. PSU cable required
- 2) Set Jumper J29 to 'PSU'
- 3) Set Jumper J12-14 to 'USB'
- 4) Set Jumpers J11, J16 and J17 to 'I/O PORT'
- 5) RC mode (SW2 towards the EDGE of the board)
- 6) FAST mode (SW1 towards the CENTRE of the board)

- 7) Insert EB-004 LED Board into Port B (and Port A if extra LED Board available)
- 8) Program the PIC16F88 with the test program RC_LVP.hex found in the directory <D>:\ E-Blocks\EB006 Multiprogrammer\RC_LVP.hex
- 9) Check the illumination of all LEDs
- 10) Note that LB3 will not illuminate due to the fact that the program sets the PICmicro into Low Voltage Programming mode

2. Testing the board – with a USB power supply

The following instructions explain the steps to test and use your PICmicro® Multiprogrammer Board in low voltage programming mode. Microchip® have enabled this feature in some devices however it has some adverse effects on the architecture of the PIC chips.

Follow these instructions to program a 16F88 PICmicro Microcontroller in Low Voltage Programming (LVP) mode.

Hardware Set-up

- 1) Set Jumper J29 to 'USB'
- 2) Set Jumper J12-14 to 'USB'
- 3) Set Jumper J11 to 'LVP PROG'
- 4) Set Jumpers J16 and J17 to 'I/O PORT'
- 5) Ensure power is supplied to the Multiprogrammer board via the USB cable being inserted into socket (J1) (no need for external power supply)

Software Set-up

- 1) Enter the configuration screen of PPP
- 2) Click on "Switch to expert config screen"
- 3) Select the target chip for your design.
- 4) The configure set-up should be as follows:

Oscillator Selection:	HS
Watchdog Timer:	Off
Power Up Timer:	Off
RA5/MCLR Pin Function Select:	MCLR
Brown Out Detect:	Off
Low Voltage Program:	Enabled
Data EE Read Protect:	Off
Flash Program Write Enable:	Write Protect Off
Background Debug:	Disabled
CCP1 Mux pin:	RBO
Code Protect:	Off
Fail-Safe Clock Monitor Enable:	Disabled
Internal External Switch Over Mode:	Disabled

- 5) **Ensure "Low Voltage Program" is ENABLED**
- 6) The only changes that might be required on your design are the "Oscillator Selection" (HS, XT and EXTRC) and the "Watchdog Timer" (generally off is best).
- 7) Once these have been set the board as stated the software is configured correctly
- 8) (See specific PICmicro® datasheet for more information regarding the configuration modes)
- 9) Click "ok" to return to programming section of PPP.
- 10) Send program to the chip

- 11) These instructions depend on the program that you are using. See relevant program (Flowcode, PPP etc.) help file for more information

Note

If the chip has been set to high voltage programming then the board will require a high voltage to re-enable the LVP. This must be done before attempting to program in LVP – however when shipped the chip is already configured in LVP.

3. Important information regarding LVP

When using LVP, bit 3 of Port B is not functional as it is part of the LVP programming architecture set by Microchip®. This should be noted as it may have an effect on the program that you write. For example the LCD Board (EB-005) using bit 3 and therefore will not operate as predicted – use the patch system on the LCD Board so that it uses a different pin. You will need to make the appropriate jumper selection on J11, 16 or 17 for Low Voltage Programming.

4. Trouble shooting for Low Voltage Programming

Due to the internal architecture of the Microchip® PICmicros a high voltage is needed to re-enable Low Voltage Programming (LVP) mode. The following instructions indicate how to tell if the chip is not in LVP mode and how to re-enable this feature.

Indicating if the PICmicro is in LVP mode or not

If LVP is disabled the programming software PPP will not be able to ID the on board PICmicro. A similar pop-up screen will appear: -



Then the PPP will indicate that the chip has not been erased. There is no point in continue to try to program the PICmicro.

Re-Enabling the LVP function

This requires the use of a +13.5V external power supply .

In order to re-enable the PICmicro must be erased. This erase function returns the PICmicro to the factory settings and thus LVP is enabled.

To Erase the PICmicro to enable LVP mode following these instructions: -

- 1) Remove all power supplies to the board
- 2) Remove USB cable from socket (J1)
- 3) Remove external power supply from socket (J6)
- 4) Place jumper J29 to 'PSU' (left-hand side)
- 5) Insert USB cable into socket (J1)
- 6) Insert +13.5V power supply via socket (J6)
- 7) In PPP click File -> Erase PICmicro
- 8) Note this cannot be done directly from FlowCode

The PICmicro will now be enabled for LVP.

5. Circuit description

The Multiprogrammer solution is made up of two parts: A circuit board that allows various slave PICmicro devices to be programmed, and the program to be executed 'seamlessly', and the Windows based programming utility 'PPP'.

1. Power Supply

The board is normally operated from a regulated DC supply of 13.5V. This allows full operation including programming.

The board can be operated in Low-voltage mode via solely the USB cable provided. However care must be taken, as there is only limited power that can be taken from a computers USB port. Also only certain chips can be reprogrammed in this Low-voltage mode, refer to the specific chip datasheet to determine if it has LVP function. The PIC16F88 provided with this board has been set-up to accept low-voltage programming (LVP), but some features are not available in this mode, such as I/O line B3. If this mode is disabled then the 13.5V regulated DC power supply must be used, **and only using this high-voltage programming can the low-voltage programming mode be re-enabled.** Please refer to the specific PIC datasheet regarding LVP function.

Please note that not all chips have the Low-Voltage Programming function and therefore these chips must be programmed using an external power supply as stated above.

The jumper link system, J29, allows the user to decide on the source of the power supply. If using a regulated 13.5V power supply the jumper should be positioned to the left hand side of the jumper system labelled 'PSU'. If using USB power place the jumper on the right hand side of the jumper system. The jumper should always be orientated so that the 3 links in the jumper block are always position horizontally – thus connecting the centre pins to either the left hand or right hand pins. LED2 indicates that power is supplied to the board from either the external power supply or the USB cable.

Please note that both USB and the PSU cables should be removed for the Multiprogrammer board BEFORE changing the position of this jumper.

When using the 13.5V regulated power supply the board will only supply up to 350mA. This is due to the thermal dynamics of the on board regulator. Therefore if more current is required a heat sink must be applied. The heat sink characteristics will determine the amount of power that can be dissipated and therefore will affect the amount of current available.

Please note that Matrix Multimedia HPPUS power supplies will supply UPTO 600mA.

Remember that other E-blocks will have to receive 5V by placing a connecting wire from the "+V Out" screw terminal of the Multiprogrammer to the "+V" screw terminal of each E-Block that requires a voltage.

2. Programming circuit

The Multiprogrammer connects to a personal computer via the USB socket. Any USB socket on the PC can be used. The host PIC16C745 microcontroller is used to communicate between the USB bus and the Multiprogrammer circuitry. The PIC16C745 is connected to a network of analogue switches formed by U3 and U4. These devices route 0V, 5V and V_{pp} to appropriate pins on the slave PICmicro devices as and when necessary.

The 'ready to go' indicator LED 1 connects to the host PIC16C745. The '745 has an on-board A/D converter that detects the level of the supply voltage. LED 1 is used to indicate that the host PIC16C745 is communicating with the PC and that the connection with the PC is valid.

3. DIL Sockets and I / O Ports

The slave PICmicro DIL sockets are wired in parallel (see table of connections below) and the ports are fed out to 5 D-type sockets grouped in ports. These signals are also available on a 40-way header (J5) for expansion purposes. Other important signals can be accessed via the other expansion header J24 (see table of connections below). Some ports are only partially complete – Port A has only 5 connections, and Port E has only 3 connections. This reflects the pin outs of the various PICmicro devices themselves. When using an 8-pin device it should be placed in the upper 8 pins of the 14-pin DIL socket. Please refer to device datasheets for availability of port outputs on each device.

NOTE

RA4 on many PICmicro devices has an open collector output. This means that you will most likely need a pull up resistor to be able to detect a change in status. Please see the datasheet on the device you are using for further details.

4. Reset Push Button

PB1 provides a reset by pulling the MCLR pin low. Note that the PIC16C745 will reset the slave PICmicro as part of the send routine so that you do not need to press this switch each time you send your program to the board.

5. Frequency Selection

The clock signal for this board can be either from the RC network or by the Crystal. SW2 dictates whether an RC circuit or a crystal circuit is used on the slave PICmicro device. SW1 dictates whether a fast or slow RC network is used and in this mode RV1 will allow you to vary the oscillator speed. By default the board is fitted with a 19.6608MHz crystal. The crystal fits into a small socket, which allows the crystal to be easily changed. For Matrix Multimedia courses a 3.2768MHz crystal is recommended. These frequencies are chosen as they divide down by PICmicro prescalers to give suitable frequencies for clock systems and for facilitating serial communication using standard baud rates.

6. In-Circuit Debugging

The Multiprogrammer board has a connection to allow the user to connect the Microchip® MPLAB® ICD2. This allows the user to run the software that is running on the actual hardware. The ICD2 allows the user to step through the actual program whilst it interacts with the hardware. Full information on the MPLAB® ICD2 can be found on the Microchip website at www.microchip.com

To use the In-Circuit Debugger, remove the power supply and the USB cable to the Multiprogrammer. Then place the 3-way jumper link associated with J11-13 to the left hand side of the 3 x 3 header pins. This is labelled 'ICD2'. Then simply connect the ICD2 cable into the Multiprogrammer via socket J15 and the user can then use the full functions of the MPLAB® ICD2 In-Circuit Debugger.

7. Low voltage programming

Many PICmicros have a low voltage programming mode where it is possible to program the device without the need for a 12V supply line. The difficulty here is that different families of PICmicro devices use different pins as the Low Voltage programming pin. B3 is predominantly used for this function but B4 and B5 are also used on some devices. These links are all in the left hand position when B3, 4, 5 are used as I/O lines. To program the PIC16F88 in LVP mode then J 11 should be in the right hand position and B3 will **not** be usable as an I/O line.

6. PICmicro microcontroller pin out details

Broadly speaking the ranges of PICmicro devices are designed to be upwards compatible: the pin functions on an 18-pin device are available on a 28-pin device and a 40-pin device. This can be seen from the following excerpt from the Microchip product selector card. The following diagram shows the pin out of the various PICmicro devices:

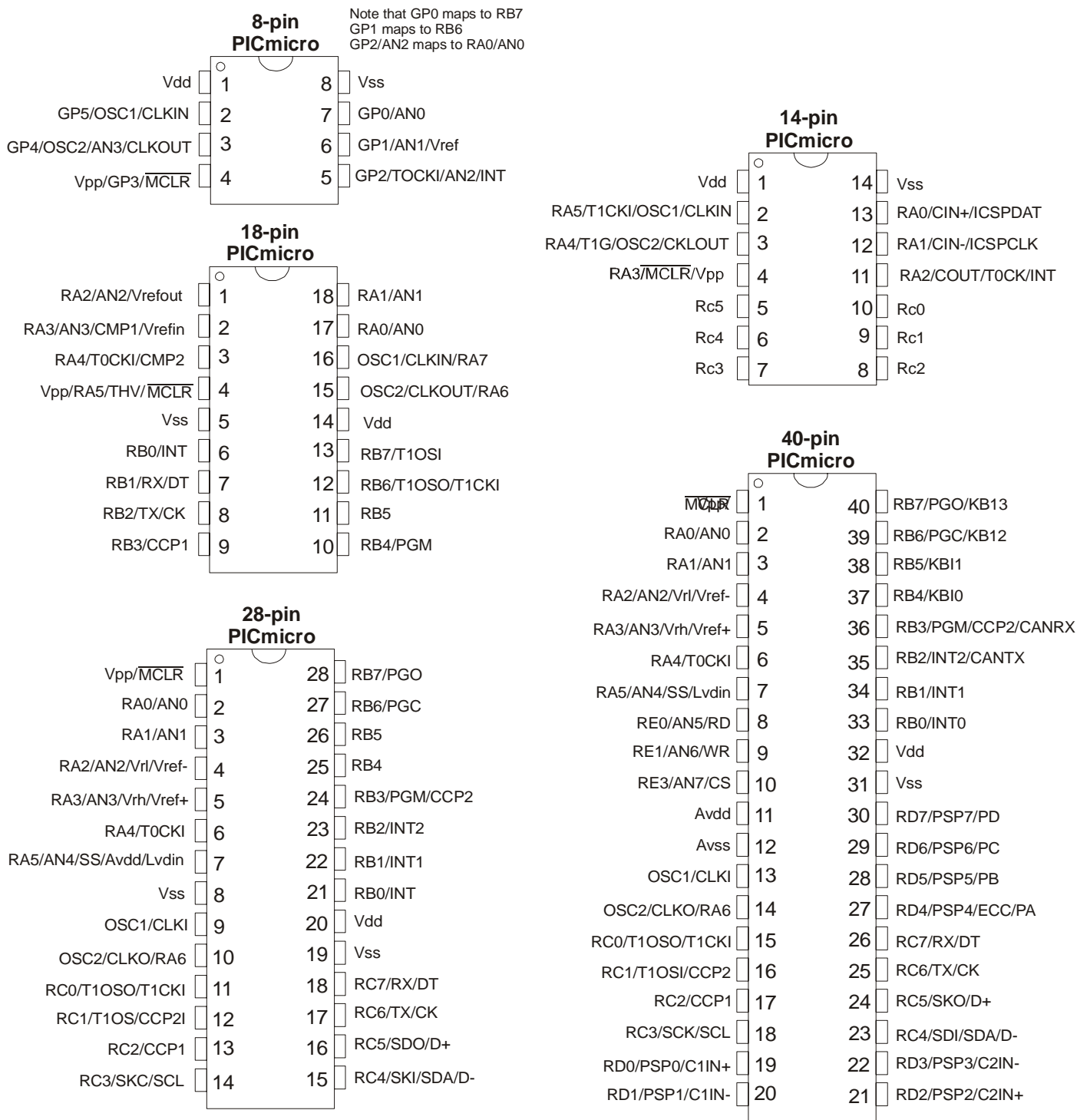

7. Bus connections

1. *Expansion bus*

The pin connections on the expansion bus exactly mirror the pin numbering on the 40-pin DIL socket. Note that the pin numbering on the IDC socket is slightly different to that on a DIL socket which results in the seemingly odd arrangement of pins on the IDC pin chart.

Pin Comparison Chart

Bus Name	PICmicro Pinout				
	18 Pin	8 Pin	14 Pin	28 Pin	40 Pin
Vpp/MCLR	4	4	4	1	1
Vdd	14	1	1	20	11 & 32
Vss	5	8	11	8 & 19	12 & 31
OCS1	16	2	2	9	13
OCS2	15	3	3	10	14
RA0/AN0	17			2	2
RA1/AN1	18			3	3
RA2	1			4	4
RA3/AN3	2			5	5
	3			6	6
RA5/AN4	4			7	7
RB0	6			21	33
RB1	7			22	34
RB2	8	5*	11*	23	35
RB3	9			24	36
RB4	10			25	37
RB5	11			26	38
RB6	12	6*	12*	27	39
RB7	13	7*	13*	28	40
RC0			10	11	15
RC1			9	12	16
RC2			8	13	17
RC3			7	14	18
RC4			6	15	23
RC5			5	16	24
RC6				17	25
RC7				18	26
RD0					19
RD1					20
RD2					21
RD3					22
RD4					27
RD5					28
RD6					29
RD7					30
RE0/AN5					8
RE1/AN6					9
RE2/AN7					10

For the 18, 28, and 40 pin devices the buses on devices are largely upwards compatible – pin connections on an 18-pin device appear on a 28-pin device and a 40-pin device, and pins on a 28-pin device appear on a 40-pin device. This allows the 18, 28, and 40 pin DIL sockets to be connected in parallel with the PICmicro bus structure intact.

* This parallel connection is not possible with 8 and 14 pin devices due to programming requirements which means that there are anomalies with the pin connections for the 8 and 14 pin devices as follows:

Multiprogrammer port line	Connection pin on 14 pin device	14 pin port line
RB2	5	RA2
RB6	6	RA1
RB7	7	RA0

Multiprogrammer port line	Connection pin on 8 pin device	8 pin port line
RB2	1	RA2
RB6	12	RA1
RB7	13	RA0

2. Connections on J5

Bus Name	40 Pin	IDC connector
Vpp/MCLR	1	1
VCCchip	11 & 32	18 & 21
GND	12 & 31	20 & 23
OCS1	13	25
OCS2	14	27
RA0/AN0	2	3
RA1/AN1	3	5
RA2	4	7
RA3/AN3	5	9
RA4/AN4	6	11
RA5	7	13
RB0	33	16
RB1	34	14
RB2	35	12
RB3	36	10
RB4	37	8
RB5	38	6
RB6	39	4
RB7	40	2
RC0	15	29
RC1	16	31
RC2	17	33
RC3	18	35
RC4	23	36
RC5	24	34
RC6	25	32
RC7	26	30
RD0	19	37
RD1	20	39
RD2	21	40
RD3	22	38
RD4	27	28
RD5	28	26
RD6	29	24
RD7	30	22
RE0/AN5	8	15
RE1/AN6	9	17
RE2/AN7	10	19

Note J5 is a set to copy the 40-way DIL socket

3. Connections on J24

Bus Name	IDC connector
Vpp/MCLR	1
VCCchip	21 & 22
VCC	29
VPPmain	19
VBUS	17
GND	23 & 24
OCS1	26
OCS2	28
RA0/AN0	4
RA1/AN1	6
RA2	8
RA3/AN3	10
RA4/AN4	12
RA5	14
RA6	25
RA7	27
RC0	30
RC1	32
RC2	34
RC3	36
RD0	38
RD1	40
RE0	16
RE1	18
RE2	20
PRB0	15
PRB1	13
PRB2	11
PRB3	9
PRB4	7
PRB5	5
PRB6	3
PRB7	1
PRA0	31
PRA1	33
BRB3	35
BRB6	37
BRB7	39

Appendix 1 – Circuit diagram

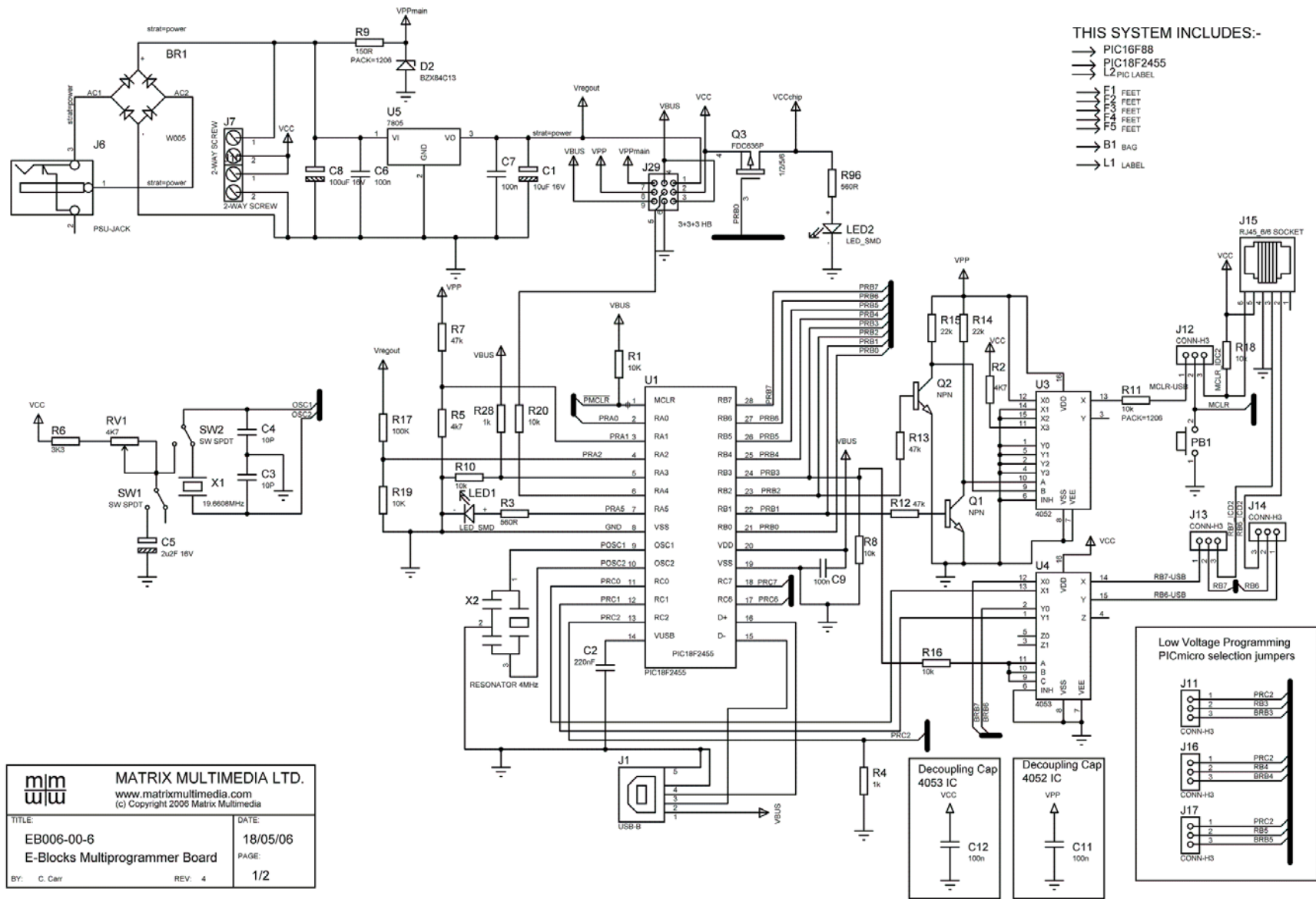

 MATRIX MULTIMEDIA LTD. www.matrixmultimedia.com (c) Copyright 2006 Matrix Multimedia	
TITLE: EB006-00-6 E-Blocks Multiprogrammer Board	DATE: 18/05/06 PAGE: 1/2
BY: C. Carr	REV: 4

Appendix 1 – Circuit diagram

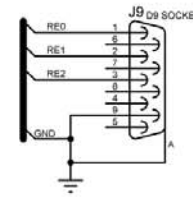
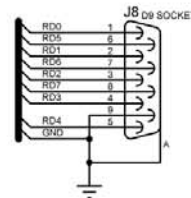
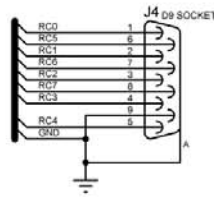
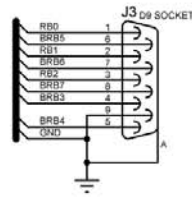
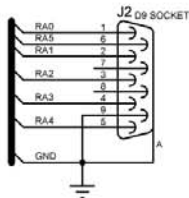
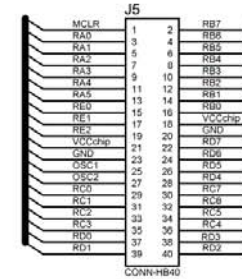
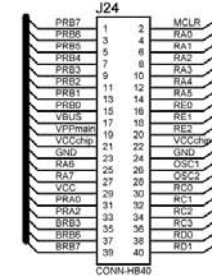
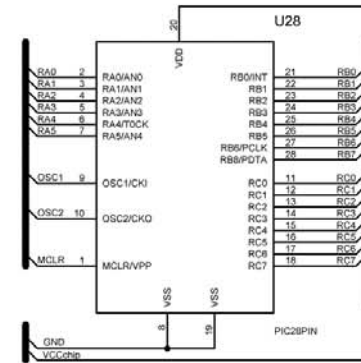
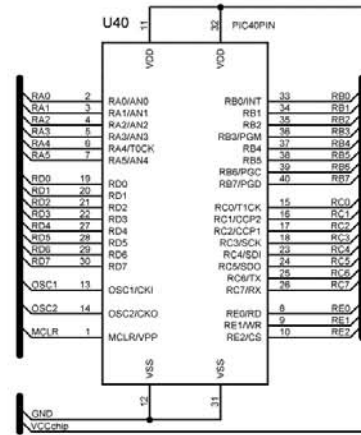
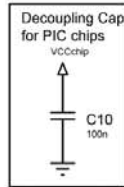
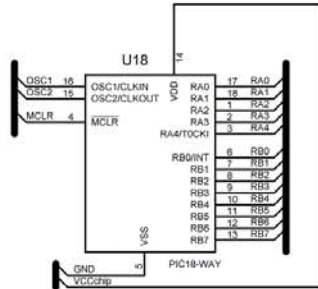
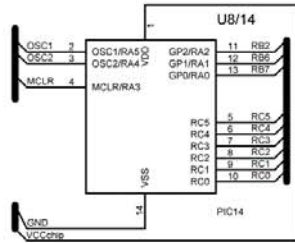

 MATRIX MULTIMEDIA LTD. www.matrixmultimedia.com (c) Copyright 2006 Matrix Multimedia	
TITLE: EB006-00-6 Multiprogrammer PICmicro & I/O	DATE: 18/05/06
BY: C. Carr	PAGE: 2/2

EN - For pricing and availability in your local country please visit one of the below links:

DE - Informationen zu Preisen und Verfügbarkeit in Ihrem Land erhalten Sie über die unten aufgeführten Links:

FR - Pour connaître les tarifs et la disponibilité dans votre pays, cliquez sur l'un des liens suivants:

[TEFL006](#)

EN

This Datasheet is presented by
the manufacturer

DE

Dieses Datenblatt wird vom
Hersteller bereitgestellt

FR

Cette fiche technique est
présentée par le fabricant