





















450



madera wood

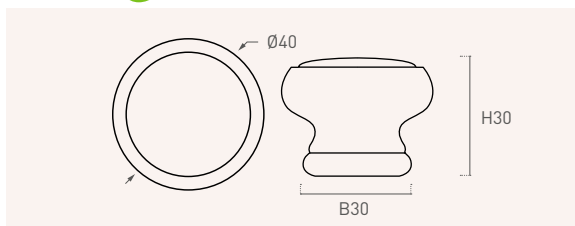

Color	Cod.	Ref.	Ø	H	B	📦
	<b>450DB100</b>	450-100.40.48	40	30	30	12
	<b>450DB101</b>	450-101.40.48	40	30	30	12
	<b>450DB102</b>	450-102.40.48	40	30	30	12
	<b>450DB103</b>	450-103.40.48	40	30	30	12
	<b>450DB104</b>	450-104.40.48	40	30	30	12

550

metal

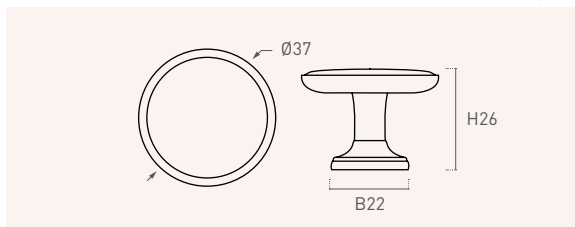

Color	Cod.	Ref.	Ø	H	B	📦
	<b>550PB100</b>	550-100.37.88	37	26	22	12
	<b>550PB101</b>	550-101.37.88	37	26	22	12
	<b>550PB102</b>	550-102.37.88	37	26	22	12
	<b>550PB103</b>	550-103.37.88	37	26	22	12
	<b>550PB104</b>	550-104.37.88	37	26	22	12

Color	Cod.	Ref.	Ø	H	B	📦
	<b>550NF100</b>	550-100.37.86	37	26	22	12
	<b>550NF101</b>	550-101.37.86	37	26	22	12
	<b>550NF102</b>	550-102.37.86	37	26	22	12
	<b>550NF103</b>	550-103.37.86	37	26	22	12
	<b>550NF104</b>	550-104.37.86	37	26	22	12
	<b>550NF106</b>	550-106.37.86	37	26	22	12
	<b>550NF107</b>	550-107.37.86	37	26	22	12
	<b>550NF108</b>	550-108.37.86	37	26	22	12





Color	Cod.	Ref.	Ø	H	B	📦
	<b>550BR103</b>	550-103.37.74	<b>37</b>	26	22	12
	<b>550BR102</b>	550-102.37.74	<b>37</b>	26	22	12
	<b>550BR107</b>	550-107.37.74	<b>37</b>	26	22	12
	<b>550BR108</b>	550-108.37.74	<b>37</b>	26	22	12

Color	Cod.	Ref.	Ø	H	B	📦
	<b>550PT100</b>	550-100.37.80	<b>37</b>	26	22	12
	<b>550PT101</b>	550-101.37.80	<b>37</b>	26	22	12
	<b>550PT102</b>	550-102.37.80	<b>37</b>	26	22	12
	<b>550PT103</b>	550-103.37.80	<b>37</b>	26	22	12
	<b>550PT104</b>	550-104.37.80	<b>37</b>	26	22	12
	<b>550PT106</b>	550-106.37.80	<b>37</b>	26	22	12
	<b>550PT107</b>	550-107.37.80	<b>37</b>	26	22	12
	<b>550PT108</b>	550-108.37.80	<b>37</b>	26	22	12



550

metal

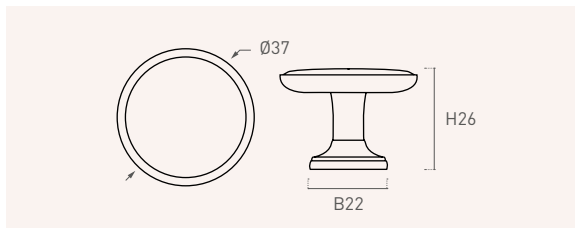

Color	Cod.	Ref.	Ø	H	B	☐
	<b>550BR120</b>	550-120.37.74	<b>37</b>	26	22	12
	<b>550BR121</b>	550-121.37.74	<b>37</b>	26	22	12
	<b>550BR122</b>	550-122.37.74	<b>37</b>	26	22	12
	<b>550BR123</b>	550-123.37.74	<b>37</b>	26	22	12
	<b>550BR124</b>	550-124.37.74	<b>37</b>	26	22	12
	<b>550PB120</b>	550-120.37.88	<b>37</b>	26	22	12
	<b>550PB121</b>	550-121.37.88	<b>37</b>	26	22	12
	<b>550NF120</b>	550-120.37.86	<b>37</b>	26	22	12
	<b>550NF121</b>	550-121.37.86	<b>37</b>	26	22	12

120

121

122

123

124





550

metal

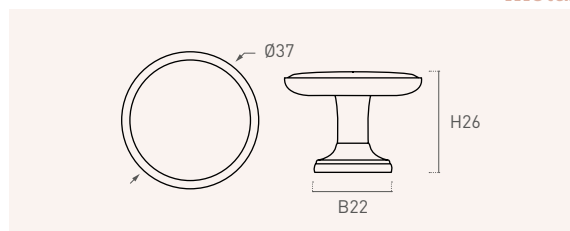

Color	Cod.	Ref.	Ø	H	B	
	<b>550PT120</b>	550-120.37.80	<b>37</b>	26	22	12
	<b>550PT121</b>	550-121.37.80	<b>37</b>	26	22	12
	<b>550PT122</b>	550-122.37.80	<b>37</b>	26	22	12
	<b>550PT123</b>	550-123.37.80	<b>37</b>	26	22	12
	<b>550PT124</b>	550-124.37.80	<b>37</b>	26	22	12







671MAPT



671VICM



671NECR

## 671P

zamak-piel sintética synthetic leather

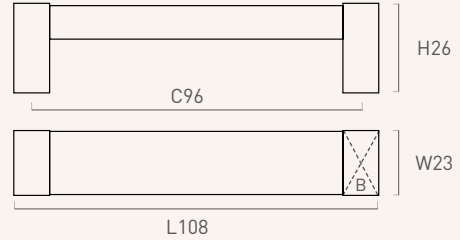

Color	Cod.	Ref.	C	L	W	H	B	
05	<b>671MAPT</b>	671PT.96.05	96	108	23	26	27x11	12
08	<b>671NECR</b>	671CR.96.08	96	108	23	26	27x11	12
21	<b>671VICM</b>	671CM.96.21	96	108	23	26	27x11	12

## 672P

zamak-piel sintética synthetic leather

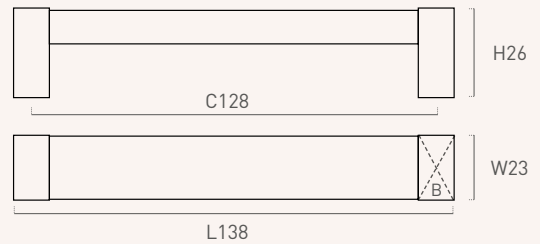

Color	Cod.	Ref.	C	L	W	H	B	
05	<b>672MAPT</b>	672PT.128.05	128	138	23	26	27x11	12
08	<b>672NECR</b>	672CR.128.08	128	138	23	26	27x11	12
21	<b>672VICM</b>	672CM.128.21	128	138	23	26	27x11	12



672VICM



672MAPT



672NECR



### 676P

zamak-piel sintética synthetic leather

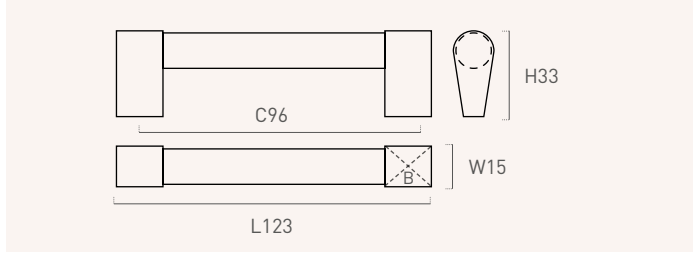

Color	Cod.	Ref.	C	L	W	H	B	
05	676MACM	676CM.96.05	96	123	15	33	10x18	12



### 677P

zamak-piel sintética synthetic leather

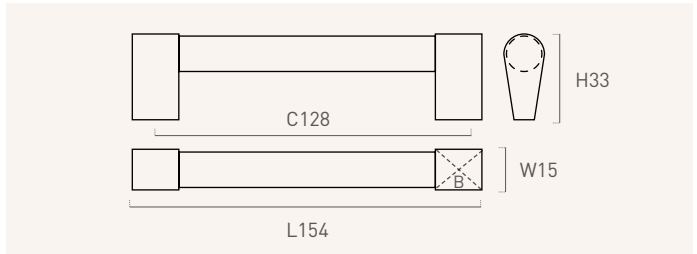

Color	Cod.	Ref.	C	L	W	H	B	
05	677MACM	677CM.128.05	128	154	15	33	10x18	12



1052NC2



1052NC1



1052NE3



1052BL3

### 1052

zamak-piel sintética synthetic leather

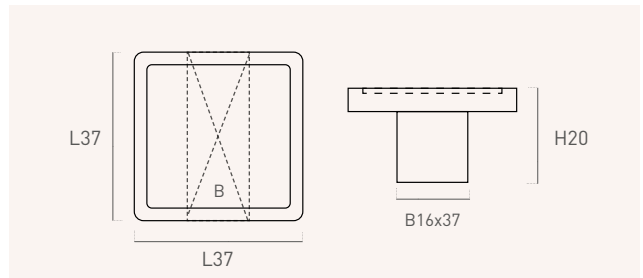



Color	Cod.	Ref.	L	W	H	B	
08	1052NC1	1052.38.NC1	37	37	20	16x37	12
05	1052NC2	1052.38.NC2	37	37	20	16x37	12
62	1052NE3	1052.38.NE3	37	37	20	16x37	12
62	1052BL3	1052.38.BL3	37	37	20	16x37	12

Vintage Watches

450  PEFC® PEFC/14-35-00303 madera wood

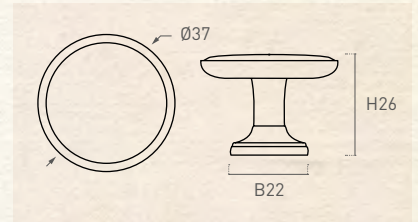
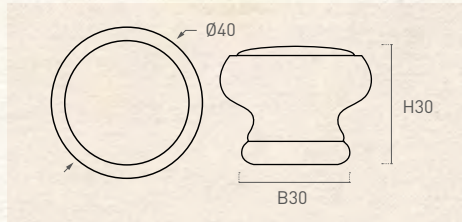
550 metal



Ø	H	B	
40	30	30	12

Ø	H	B	
37	26	22	12





## Vintage Watches



02



03



04



05



06



20



21



22



23



24



25





26



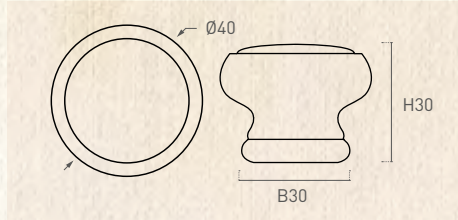

450  PEFC/14-35-00303 maderas wood

550 metal

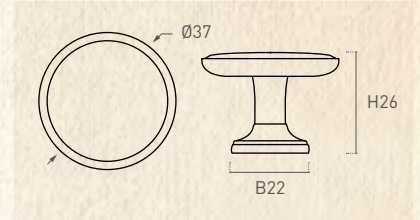

Ø	H	B	Icon
40	30	30	



Ø	H	B	Icon
37	26	22	



MODELO + ACABADO + N° DE MOTIVO = CÓDIGO DE PEDIDO (ver pág.14)  
MODEL + FINISH + N° DESIGN = ORDER CODE (see pag.14)



Nature



36



37



38



39



40



41



MODELO + ACABADO + Nº DE MOTIVO = CÓDIGO DE PEDIDO (ver pág.14)  
MODEL + FINISH + Nº DESIGN = ORDER CODE (see pag.14)



# Nature



57



58



59



60

450 PEFC/14-35-00303 maderas wood

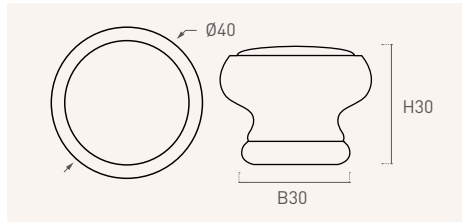

Ø	H	B	Icon
40	30	30	12

550 metal

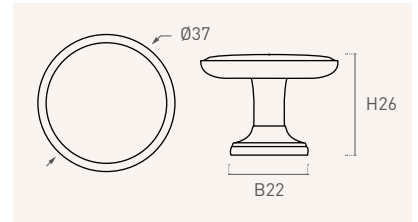

Ø	H	B	Icon
37	26	22	12



Le jardin



31



32



49



50



MODELO + ACABADO + Nº DE MOTIVO = CÓDIGO DE PEDIDO (ver pág.14)  
MODEL + FINISH + Nº DESIGN = ORDER CODE (see pag.14)



# Provence

450  PEFC/14-35-00303 madera wood

550 metal

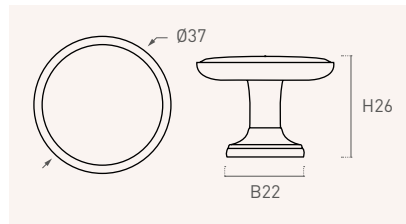
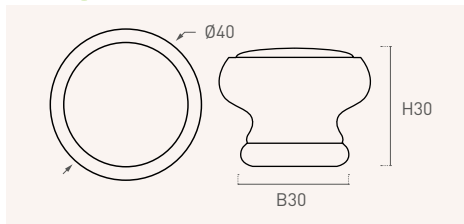

Ø	H	B	Icon
40	30	30	

Ø	H	B	Icon
37	26	22	



46



47



48





La Boheme



01



83



84



MODELO + ACABADO + N° DE MOTIVO = CÓDIGO DE PEDIDO (ver pág.14)  
MODEL + FINISH + N° DESIGN = ORDER CODE (see pag.14)



450  PEFC/14-35-00303 madera wood

550 metal

# La Boheme



51



52



53

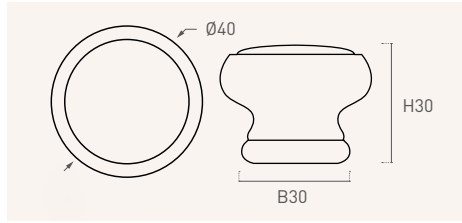

Ø	H	B	Icon
40	30	30	

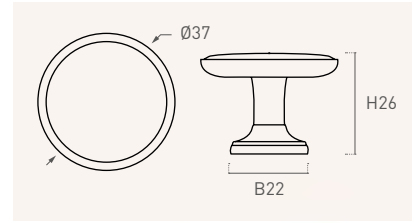

Ø	H	B	Icon
37	26	22	



# Kaleido



07



08



## The Old Crown



27



28



29



30



42



43



44



45



MODELO + ACABADO + N° DE MOTIVO = CÓDIGO DE PEDIDO (ver pág.14)  
MODEL + FINISH + N° DESIGN = ORDER CODE (see pag.14)



# The Crown

450 PEFC PEFC/14-35-00303 madera wood

550

metal



54



55



56

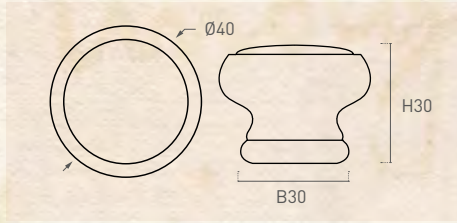

Ø	H	B	Icon
40	30	30	

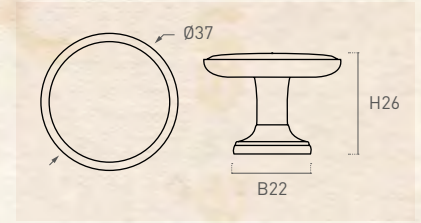

Ø	H	B	Icon
37	26	22	





Coffee Shop



61



62



63



64



65



MODELO + ACABADO + N° DE MOTIVO = CÓDIGO DE PEDIDO (ver pág.14)  
MODEL + FINISH + N° DESIGN = ORDER CODE (see pag.14)

450  PEFC/14-35-00303 madera wood

550 metal

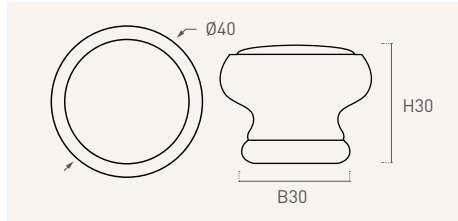

Ø	H	B	Icon
40	30	30	

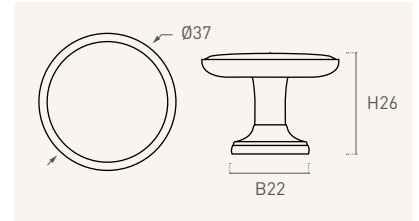

Ø	H	B	Icon
37	26	22	



## Fast food



10



12



85



American road



09



11



13



14



15



MODELO + ACABADO + N° DE MOTIVO = CÓDIGO DE PEDIDO (ver pág.14)  
MODEL + FINISH + N° DESIGN = ORDER CODE (see pag.14)



450  PEFC/14-35-00303 madera wood

550 metal

# Classic Bikes

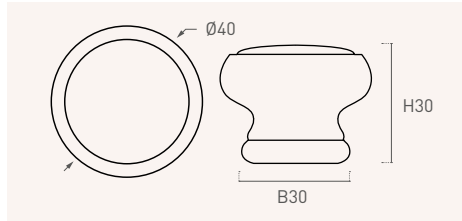

Ø	H	B	Icon
40	30	30	

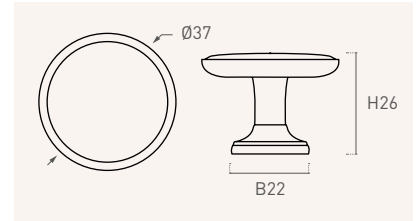

Ø	H	B	Icon
37	26	22	



33

34



35



# Old meters



80



81



82





Navigator



76



77



78



79



MODELO + ACABADO + Nº DE MOTIVO = CÓDIGO DE PEDIDO (ver pág.14)  
MODEL + FINISH + Nº DESIGN = ORDER CODE (see pag.14)



# Navigator



16



17



18



19

450 PEFC/14-35-00303 maderas wood

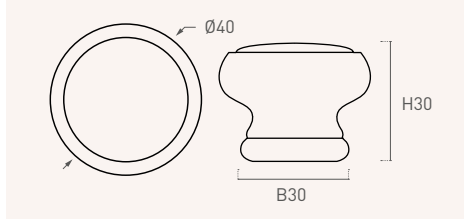

Ø	H	B	Icon
40	30	30	

550 metal

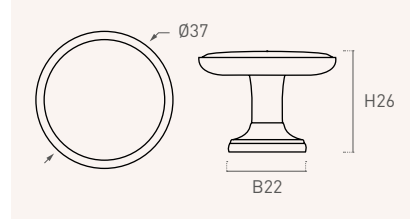

Ø	H	B	Icon
37	26	22	







Traveller



66



67



68



69



70



71



72



73



74



75



MODELO + ACABADO + N° DE MOTIVO = CÓDIGO DE PEDIDO (ver pág.14)  
 MODEL + FINISH + N° DESIGN = ORDER CODE (see pag.14)



450  PEFC/14-35-00303 madera wood

550

metal

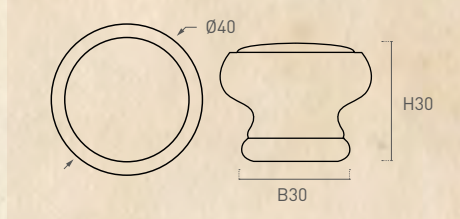

Ø	H	B	Icon
40	30	30	

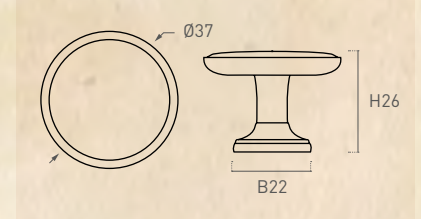

Ø	H	B	Icon
37	26	22	







451

madera wood

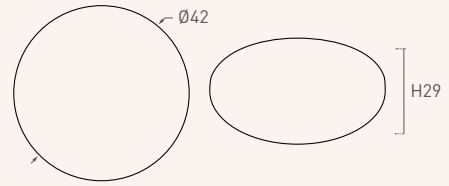

Color	Cod.	Ref.	Ø	H	
13	<b>451GR</b>	451.40.13	<b>42</b>	<b>29</b>	<b>12</b>



452

madera wood

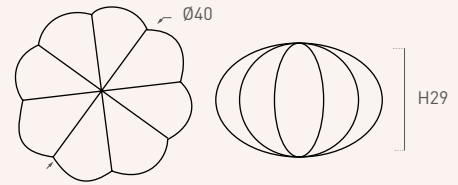

Color	Cod.	Ref.	Ø	H	
03	<b>452BL</b>	452.40.03	<b>40</b>	<b>29</b>	<b>12</b>



453

madera wood

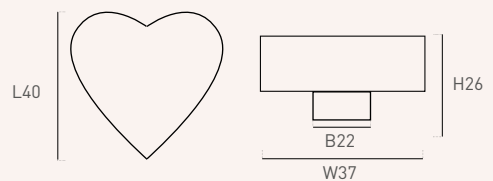

Color	Cod.	Ref.	L	W	H	B	
03	<b>453BL</b>	453.35.03	<b>40</b>	<b>37</b>	<b>26</b>	<b>22</b>	<b>12</b>
13	<b>453GR</b>	453.35.13	<b>40</b>	<b>37</b>	<b>26</b>	<b>22</b>	<b>12</b>

Surtido/ Assortment

<b>453SU</b>	453.35.35	<b>40</b>	<b>37</b>	<b>26</b>	<b>12</b>
--------------	-----------	-----------	-----------	-----------	-----------







454

madera wood

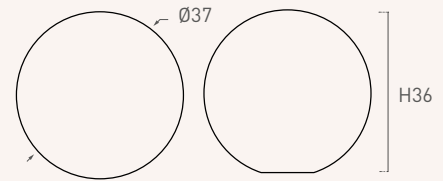

Color	Cod.	Ref.	Ø	H	⊠
<input type="radio"/> 03	<b>454BL</b>	454.35.03	37	36	12
<input type="radio"/> 13	<b>454GR</b>	454.35.13	37	36	12

Surtido/ Assortment

<b>454SU</b>	454.35.35	37	36	12
--------------	-----------	----	----	----



560

hierro iron

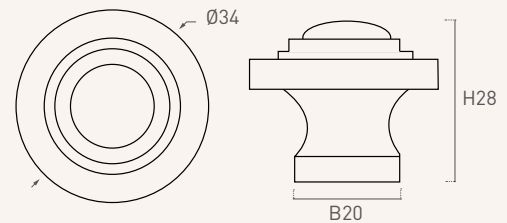

Color	Cod.	Ref.	Ø	H	B	⊠
<input type="radio"/> 03	<b>560BL</b>	560.34.03	34	28	20	12
<input type="radio"/> 05	<b>560MA</b>	560.34.05	34	28	20	12
<input type="radio"/> 21	<b>560BE</b>	560.34.21	34	28	20	12

Surtido/ Assortment

<b>560SU</b>	560.34.35	34	28	20	12
--------------	-----------	----	----	----	----



561

hierro iron

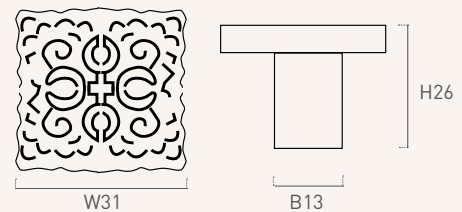

Color	Cod.	Ref.	W	H	B	⊠
<input type="radio"/> 03	<b>561BL</b>	561.32.03	31	26	13	12
<input type="radio"/> 05	<b>561MA</b>	561.32.05	31	26	13	12
<input type="radio"/> 21	<b>561BE</b>	561.32.21	31	26	13	12

Surtido/ Assortment

<b>561SU</b>	561.32.35	31	26	13	12
--------------	-----------	----	----	----	----



## 562

hierro iron

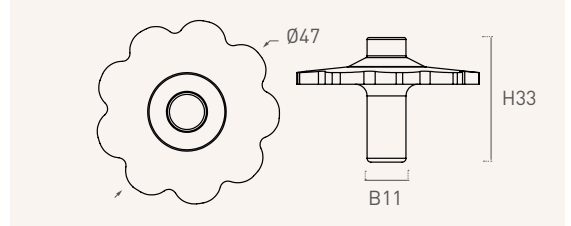

Color	Cod.	Ref.	Ø	H	B	☐
<input type="radio"/> 03	<b>562BL</b>	562.47.03	<b>47</b>	33	11	12
<input checked="" type="radio"/> 05	<b>562MA</b>	562.47.05	<b>47</b>	33	11	12
<input type="radio"/> 21	<b>562BE</b>	562.47.21	<b>47</b>	33	11	12

Surtido/ Assortment

<b>562SU</b>	562.47.35	<b>47</b>	33	11	12
--------------	-----------	-----------	----	----	----



## 563

hierro iron

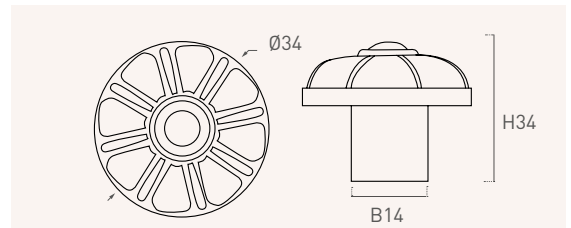

Color	Cod.	Ref.	Ø	H	B	☐
<input type="radio"/> 03	<b>563BL</b>	563.34.03	<b>34</b>	34	14	12
<input checked="" type="radio"/> 05	<b>563MA</b>	563.34.05	<b>34</b>	34	14	12
<input type="radio"/> 21	<b>563BE</b>	563.34.21	<b>34</b>	34	14	12

Surtido/ Assortment

<b>563SU</b>	563.34.35	<b>34</b>	34	14	12
--------------	-----------	-----------	----	----	----





564

hierro iron

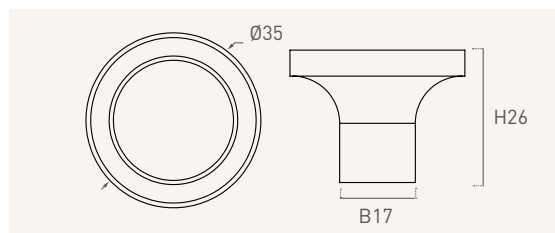

Color	Cod.	Ref.	Ø	H	B	📦
02	<b>564AZ</b>	564.35.02	35	26	17	12
03	<b>564BL</b>	564.35.03	35	26	17	12
04	<b>564MG</b>	564.35.04	35	26	17	12
07	<b>564NA</b>	564.35.07	35	26	17	12
10	<b>564RJ</b>	564.35.10	35	26	17	12
12	<b>564VE</b>	564.35.12	35	26	17	12

Surtido/ Assortment

<b>564SU</b>	564.35.35	35	26	17	24
--------------	-----------	----	----	----	----

598

metal

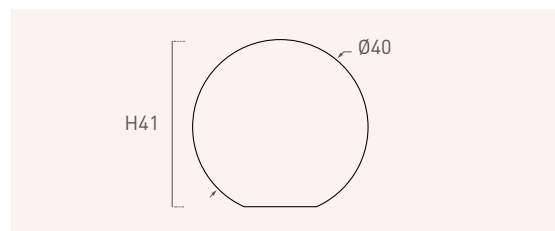

Color	Cod.	Ref.	Ø	H	📦
05	<b>598MA</b>	598.40.05	40	41	12









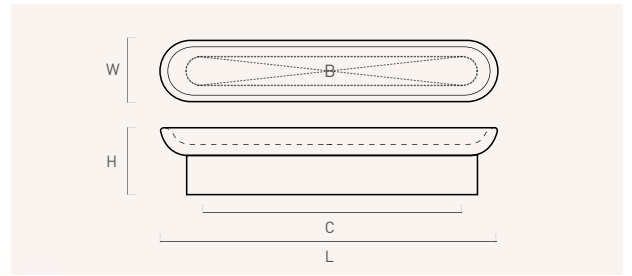

178

zamac







Color	Cod.	Ref.	C	L	W	H	B	
 99	<b>178LS3</b>	178.64.99	<b>64</b>	96	28	19	16x85	12
	<b>178LS4</b>	178.96.99	<b>96</b>	129	28	19	16x117	12
 100	<b>178CS3</b>	178.64.100	<b>64</b>	96	28	19	16x85	12
	<b>178CS4</b>	178.96.100	<b>96</b>	129	28	19	16x117	12
 102	<b>178AS3</b>	178.64.102	<b>64</b>	96	28	19	16x85	12
	<b>178AS4</b>	178.96.102	<b>96</b>	129	28	19	16x117	12

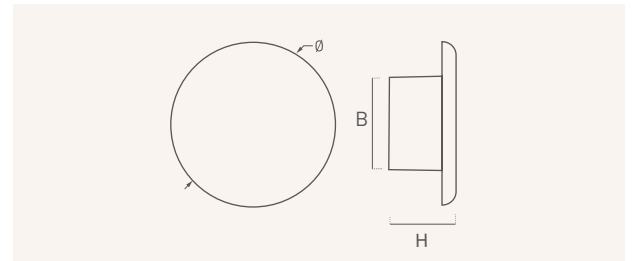

178

zamac



Color	Cod.	Ref.	Ø	H	B	
 31	<b>178LT1</b>	178.40.31	<b>40</b>	14	24	12
	<b>178LT2</b>	178.60.31	<b>60</b>	19	36	12
 99	<b>178LS1</b>	178.40.99	<b>40</b>	14	24	12
	<b>178LS2</b>	178.60.99	<b>60</b>	19	36	12
 100	<b>178CS1</b>	178.40.100	<b>40</b>	14	24	12
	<b>178CS2</b>	178.60.100	<b>60</b>	19	36	12
 102	<b>178AS1</b>	178.40.102	<b>40</b>	14	24	12
	<b>178AS2</b>	178.60.102	<b>60</b>	19	36	12



179

zamak

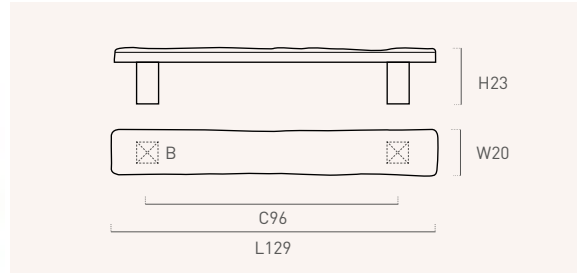

Color	Cod.	Ref.	C	L	W	H	B	
99	179LS3	179.96.99	96	129	20	23	10x10	12
100	179CS3	179.96.100	96	129	20	23	10x10	12

179

zamak

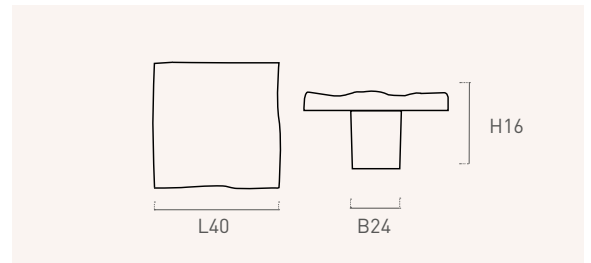

Color	Cod.	Ref.	L	W	H	B	
99	179LS1	179.40.99	40	40	16	24	12
100	179CS1	179.40.100	40	40	16	24	12





1065

latón brass

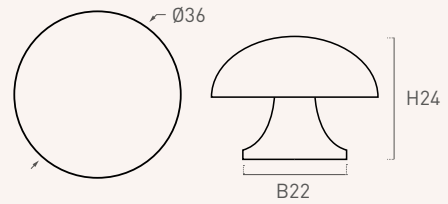

Color	Cod.	Ref.	Ø	H	B	Box
	<b>1065A</b>	1065A.37.70	<b>36</b>	24	22	12
	<b>1065B</b>	1065B.37.70	<b>36</b>	24	22	12
	<b>1065C</b>	1065C.37.70	<b>36</b>	24	22	12

Surtido/ Assortment

<b>1065SU</b>	1065.37.35	<b>36</b>	24	22	18
---------------	------------	-----------	----	----	----

121

cobre-latón cooper-brass

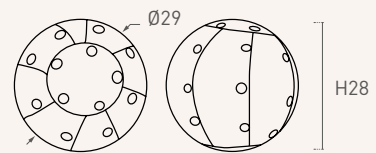

Color	Cod.	Ref.	Ø	H	Box
	<b>121A1</b>	121.29.81	<b>29</b>	28	12

559

glass - brass

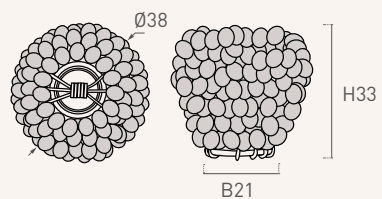

Color	Cod.	Ref.	Ø	H	B	Box
	<b>559CR</b>	559.38.26	<b>38</b>	33	21	12



# 1066

porcelana porcelain

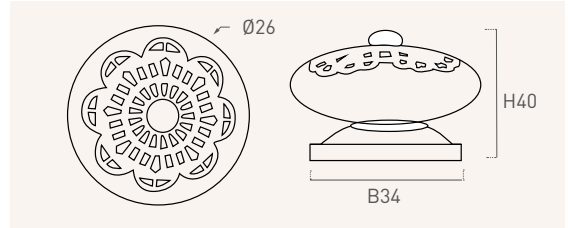

Color	Cod.	Ref.	Ø	H	B	☐
81	1066LT	1066.40.81	40	26	34	12
79	1066PT	1066.40.79	40	26	34	12

Surtido/ Assortment

1066SU	1066.40.35	40	26	34	12
--------	------------	----	----	----	----



# 1067

porcelana porcelain

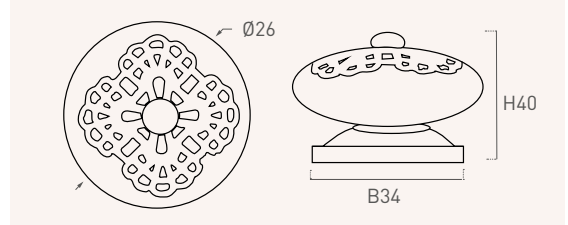

Color	Cod.	Ref.	Ø	H	B	☐
81	1067LT	1067.40.81	40	26	34	12
79	1067PT	1067.40.79	40	26	34	12

Surtido/ Assortment

1067SU	1067.40.35	40	26	34	12
--------	------------	----	----	----	----







1068

latón brass

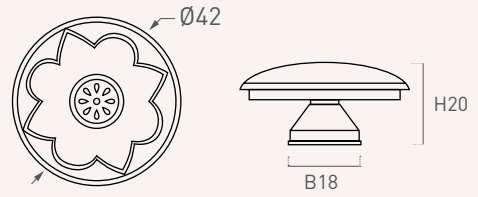

Color	Cod.	Ref.	Ø	H	B	⊞
81	1068LT	1068.42.81	42	20	18	12



1069

latón brass

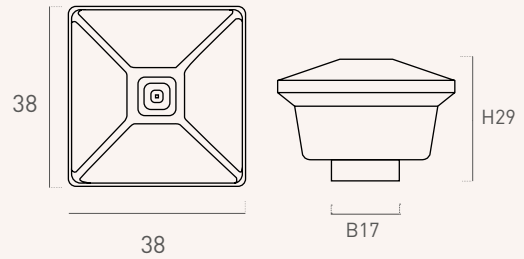

Color	Cod.	Ref.	W	H	B	⊞
81	1069LT	1069.38.81	38	29	17	12



1070

latón brass

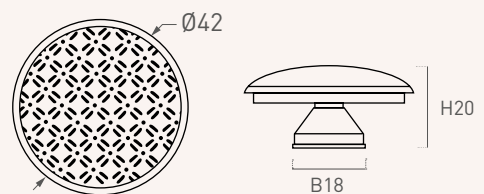

Color	Cod.	Ref.	Ø	H	B	⊞
81	1070LT	1070.42.81	42	20	18	12



1071

latón brass

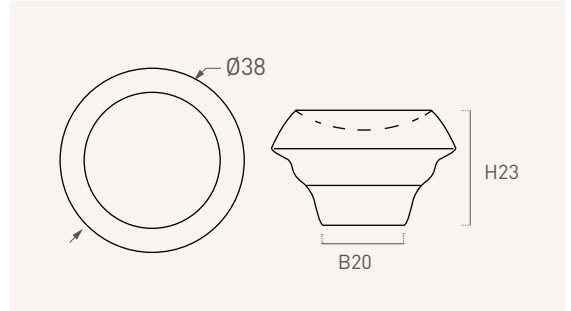

Color	Cod.	Ref.	Ø	H	B	📦
81	1071LT	1071.38.81	38	23	20	12



1072

latón brass

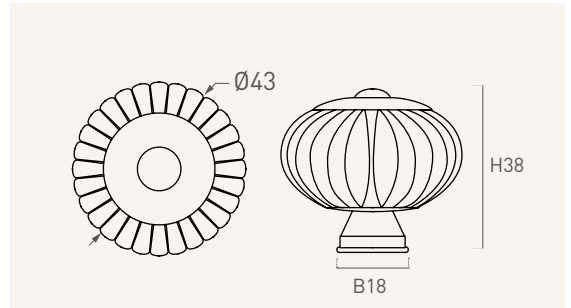

Color	Cod.	Ref.	Ø	H	B	📦
81	1072LT	1072.43.81	43	38	18	12













1073

latón-resina brass-resin

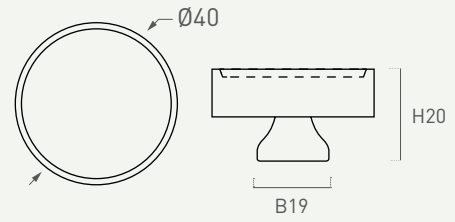

Color	Cod.	Ref.	Ø	H	B	Icon
46	1073LT	1073.40.46	40	20	19	12



1074

latón-resina brass-resin

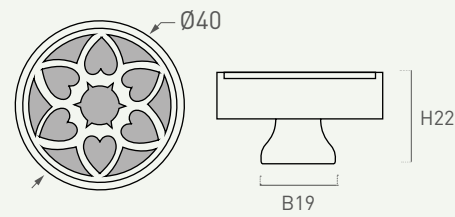

Color	Cod.	Ref.	Ø	H	B	Icon
08	1074LT	1074.40.08	40	22	19	12



1075

latón-madera brass-wood

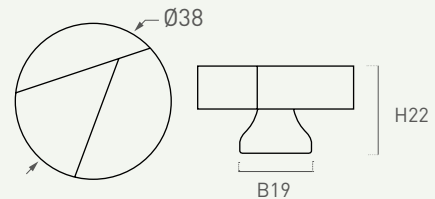

Color	Cod.	Ref.	Ø	H	B	Icon
61	1075MI	1075.38.61	38	22	19	12



1076

resina-madera resin-wood

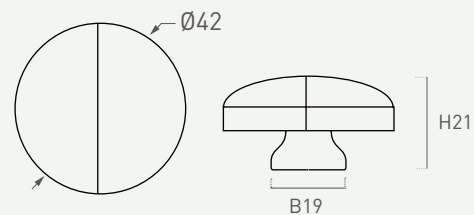

Color	Cod.	Ref.	Ø	H	B	Icon
43	1076HU	1076.42.43	42	21	19	12



1077

resina-madera resin-wood

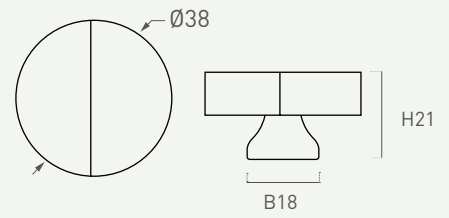

Color Cod. Ref. 

Ø	H	B
07	21	18

**1077NA** 1077.38.07 38 21 18 12



1078

resina resin

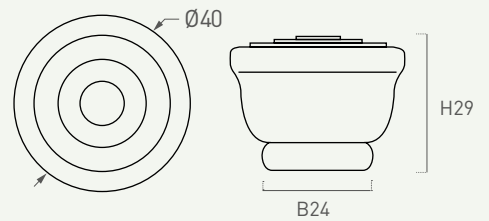

Color Cod. Ref. 

Ø	H	B
43	29	24

**1078HU** 1078.40.43 40 29 24 12



1079

resina resin

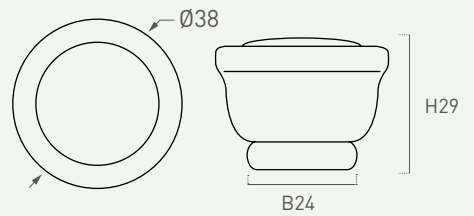

Color Cod. Ref. 

Ø	H	B
43	29	24

**1079HU** 1079.38.43 38 29 24 12







103

nácar nacre

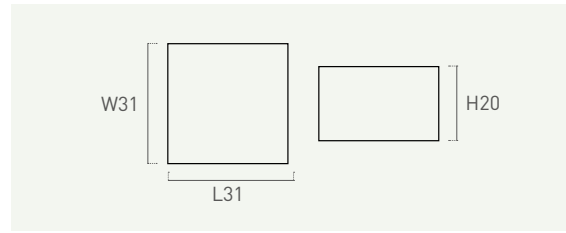

Color 46 Cod. **103B1** Ref. 103.29.46 L W H 31 31 20 12



107

hueso-madera bone-wood

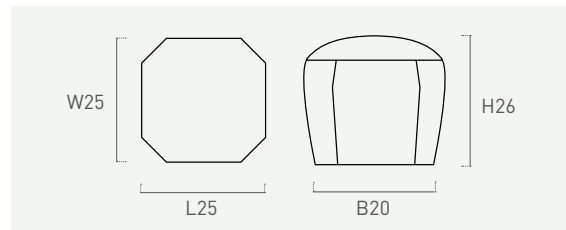

Color 43 Cod. **107A1** Ref. 107.28.43 L W H B 25 25 26 20 12



108

hueso-madera bone-wood

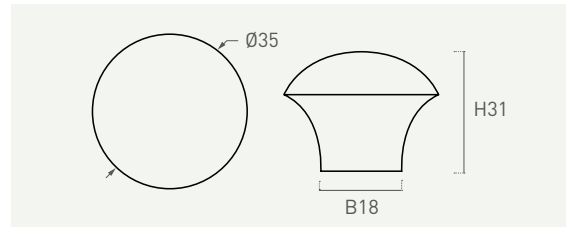

Color 43 Cod. **108A1** Ref. 108.32.43 Ø H B 35 31 18 12



109

hueso-madera bone-wood

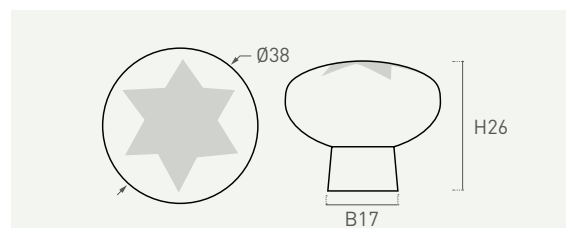

Color 43 Cod. **109A1** Ref. 109.35.43 Ø H B 38 26 17 12



147

hueso-madera bone-wood

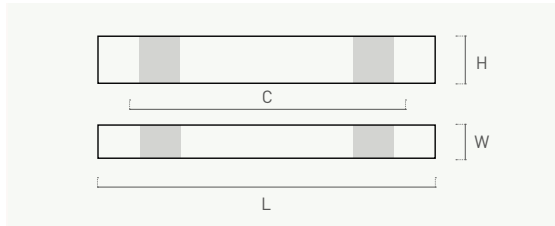

Color	Cod.	Ref.	C	L	W	H	
	<b>147A3</b>	147.40.43	<b>40</b>	46	11	15	12
43	<b>147A2</b>	147.64.43	<b>64</b>	100	13	17	12
	<b>147A1</b>	147.96.43	<b>96</b>	139	14	17	12



150

hueso bone

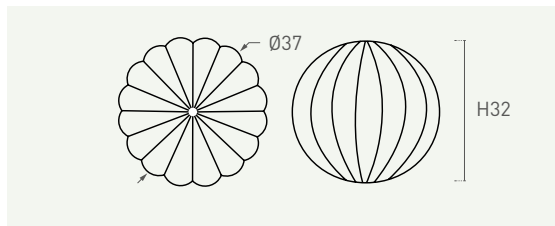

Color	Cod.	Ref.	Ø	H	
43	<b>150A1</b>	150.33.43	<b>37</b>	32	12



151

hueso bone

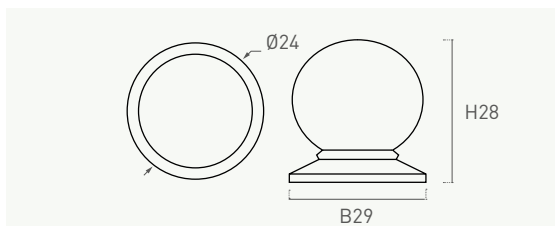

Color	Cod.	Ref.	Ø	H	B	
43	<b>151A1</b>	151.28.43	<b>24</b>	28	29	12





106

hueso bone

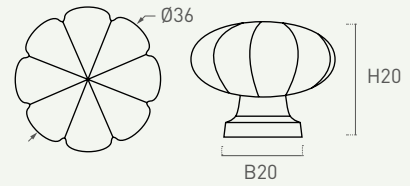

Color	Cod.	Ref.	Ø	H	B	Icon
43	<b>106A1</b>	106.36.43	<b>36</b>	26	20	12
47	<b>106A2</b>	106.36.47	<b>36</b>	26	20	12



148

hueso bone

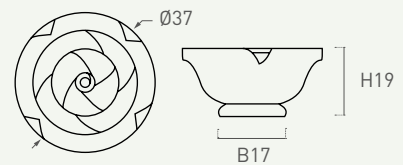

Color	Cod.	Ref.	Ø	H	B	Icon
43	<b>148A1</b>	148.37.43	<b>37</b>	19	17	12



118

hueso bone

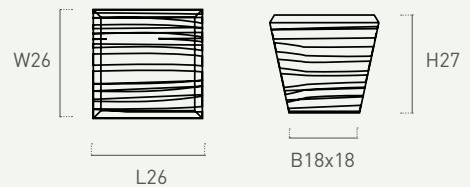

Color	Cod.	Ref.	L	W	H	B	Icon
43	<b>118B1</b>	107.26.43	<b>28</b>	28	27	18x18	12
65	<b>118B3</b>	107.26.65	<b>28</b>	28	27	18x18	12



137A1



137A3

137

nácar-hueso nacre-bone

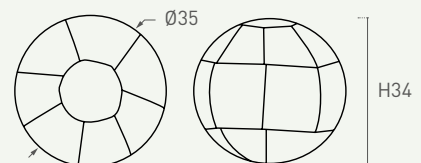

Color	Cod.	Ref.	Ø	H	Icon
43	<b>137A3</b>	137.33.43	<b>35</b>	34	12
46	<b>137A1</b>	137.33.46	<b>35</b>	34	12



124

nácar-coco nacre-coconut

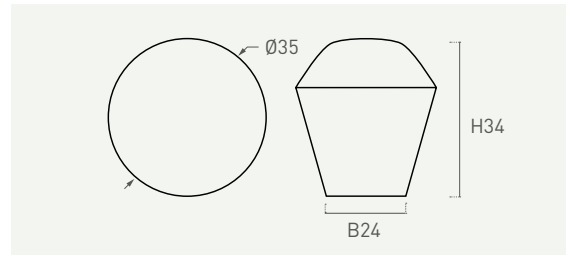

Color Cod. Ref. Ø H B

46 124A1 124.33.46 35 34 24 12



125

nácar-coco nacre-coconut

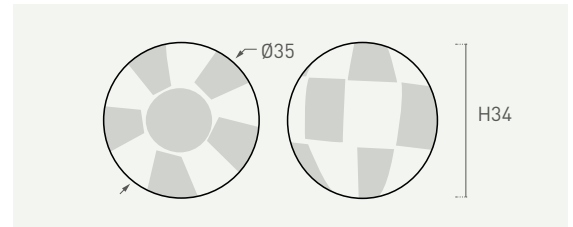

Color Cod. Ref. Ø H

46 125A1 125.35.46 35 34 12



144

nácar-resina nacre-resin

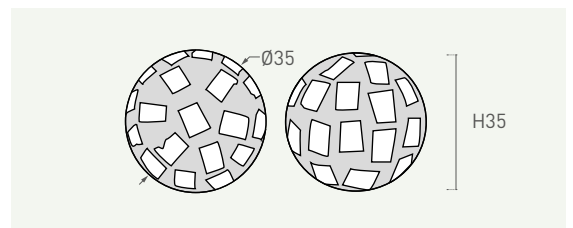

Color Cod. Ref. Ø H

46 144A1 144.33.46 35 35 12





404 PEFC/14-35-00303

madera wood

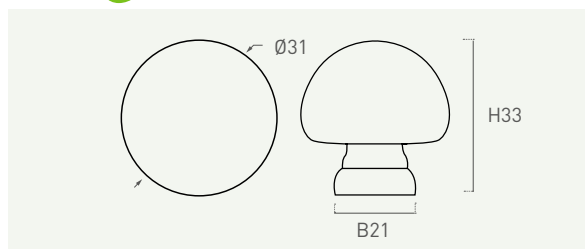

Color	Cod.	Ref.	Ø	H	B	
61	<b>404BC</b>	404.32.61	31	33	21	25
63	<b>404BD</b>	404.32.63	31	33	21	25

405 PEFC/14-35-00303

madera wood

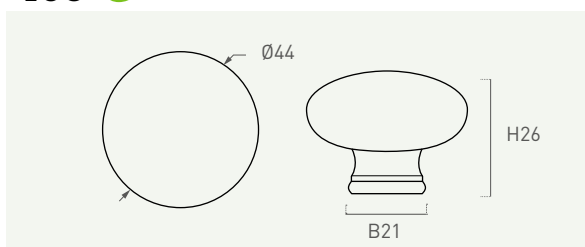

Color	Cod.	Ref.	Ø	H	B	
03	<b>405BL</b>	405.44.03	44	26	21	25
48	<b>405DB</b>	405.44.48	44	26	21	25
60	<b>405HC</b>	405.44.60	44	26	21	25
61	<b>405HM</b>	405.44.61	44	26	21	25
62	<b>405HN</b>	405.44.62	44	26	21	25
63	<b>405NG</b>	405.44.63	44	26	21	25

Surtido/ Assortment

<b>405SU</b>	<b>44</b>	<b>26</b>	<b>30</b>
--------------	-----------	-----------	-----------



406 PEFC/14-35-00303

madera wood

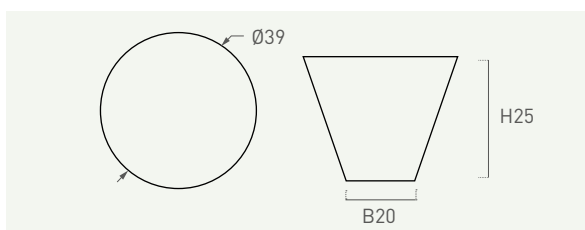

Color	Cod.	Ref.	Ø	H	B	
03	<b>406BL</b>	406.40.03	39	31	20	25
48	<b>406DB</b>	406.40.48	39	31	20	25
60	<b>406HC</b>	406.40.60	39	31	20	25
61	<b>406HM</b>	406.40.61	39	31	20	25
62	<b>406HN</b>	406.40.62	39	31	20	25
63	<b>406NG</b>	406.40.63	39	31	20	25



Surtido/ Assortment

<b>406SU</b>	<b>39</b>	<b>32</b>	<b>30</b>
--------------	-----------	-----------	-----------



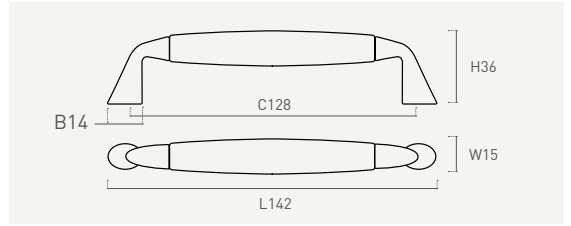



416  PEFC/14-35-00303 zamak-madera

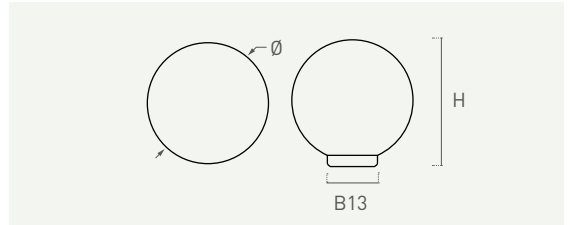

Color	Cod.	Ref.	C	L	W	H	B	
 61	<b>416AC</b>	416.128.61	<b>128</b>	142	15	36	14	12
 62	<b>416AB</b>	416.128.62	<b>128</b>	142	15	36	14	12
 63	<b>416AD</b>	416.128.63	<b>128</b>	142	15	36	14	12

400  PEFC/14-35-00303 madera wood



Color	Cod.	Ref.	Ø	H	B	
 60	<b>400DA</b>	400.25.60	<b>24</b>	25	13	25
	<b>400CA</b>	400.30.60	<b>29</b>	32	13	25
 61	<b>400DC</b>	400.25.61	<b>24</b>	25	13	25
	<b>400CC</b>	400.30.61	<b>29</b>	32	13	25
 62	<b>400DB</b>	400.25.62	<b>24</b>	25	13	25
	<b>400CB</b>	400.30.62	<b>29</b>	32	13	25
 63	<b>400DD</b>	400.25.63	<b>24</b>	25	13	25
	<b>400CD</b>	400.30.63	<b>29</b>	32	13	25



401  PEFC/14-35-00303 madera wood

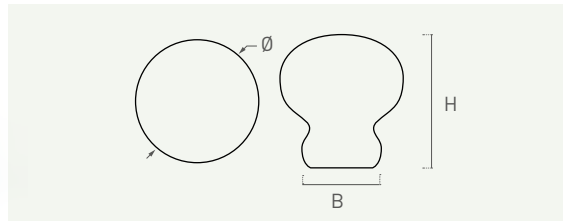

Color	Cod.	Ref.	Ø	H	B	
 60	<b>401CA</b>	401.30.60	<b>30</b>	31	24	25
	<b>401AA</b>	401.40.60	<b>39</b>	31	29	25
 61	<b>401CC</b>	401.30.61	<b>30</b>	31	24	25
	<b>401AC</b>	401.40.61	<b>39</b>	31	29	25
 62	<b>401CB</b>	401.30.62	<b>30</b>	31	24	25
	<b>401AB</b>	401.40.62	<b>39</b>	31	29	25







402 PEFC® PEFC/14-35-00303 madera wood

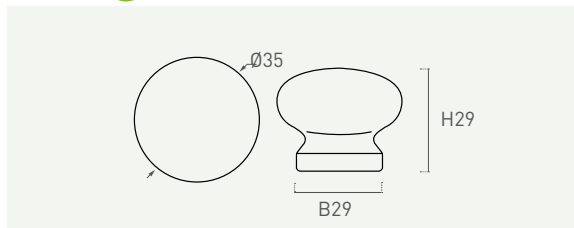

Color	Cod.	Ref.	Ø	H	B	
60	<b>402BG</b>	402.35.60	35	29	29	25
62	<b>402BH</b>	402.35.62	35	29	29	25



403 PEFC® PEFC/14-35-00303 madera wood

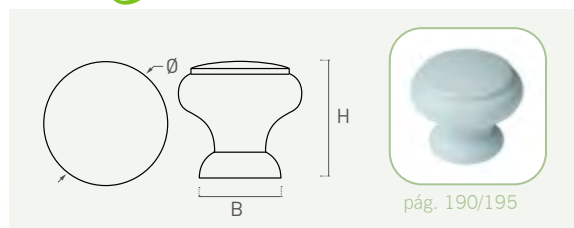

pág. 190/195

Color	Cod.	Ref.	Ø	H	B	
60	<b>403CA</b>	403.30.60	30	28	20	25
60	<b>403BA</b>	403.35.60	35	32	23	25
60	<b>403AA</b>	403.40.60	40	33	28	25
60	<b>403CC</b>	403.30.61	30	28	20	25
61	<b>403BC</b>	403.35.61	35	32	23	25
61	<b>403AC</b>	403.40.61	40	33	28	25
62	<b>403CB</b>	403.30.62	30	28	20	25
62	<b>403BB</b>	403.35.62	35	32	23	25
62	<b>403AB</b>	403.40.62	40	33	28	25
66	<b>403CE</b>	403.30.66	30	28	20	25
66	<b>403BE</b>	403.35.66	35	32	23	25
66	<b>403AE</b>	403.40.66	40	33	28	25
67	<b>403CF</b>	403.30.67	28	28	20	25
67	<b>403BF</b>	403.35.67	35	32	23	25
67	<b>403AF</b>	403.40.67	39	33	28	25

410 PEFC® PEFC/14-35-00303 madera wood

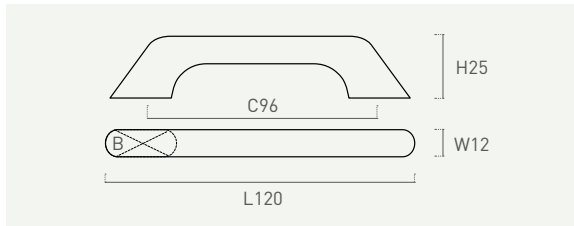

Color	Cod.	Ref.	C	L	W	H	B	
61	<b>410BC</b>	410.96.61	96	120	12	25	24x12	25
62	<b>410BB</b>	410.96.62	96	120	12	25	24x12	25



411

madera wood

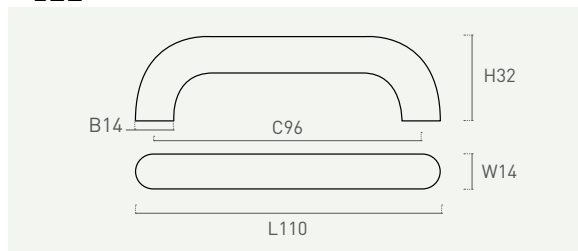

Color	Cod.	Ref.	C	L	W	H	B	
61	411BC	411.96.61	96	110	14	32	14	25
62	411BB	411.96.62	96	110	14	32	14	25

412

madera wood

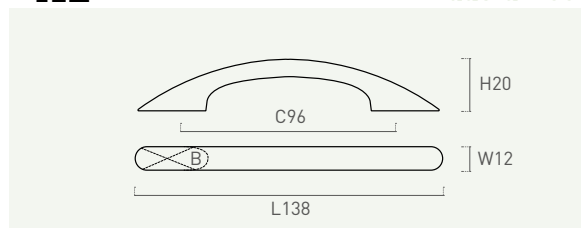

Color	Cod.	Ref.	C	L	W	H	B	
61	412BC	412.96.61	96	138	12	20	12x30	25
62	412BB	412.96.62	96	138	12	20	12x30	25
63	412BD	412.96.63	96	138	12	20	12x30	25
67	412BF	412.96.67	96	138	12	20	12x30	25



414

madera wood

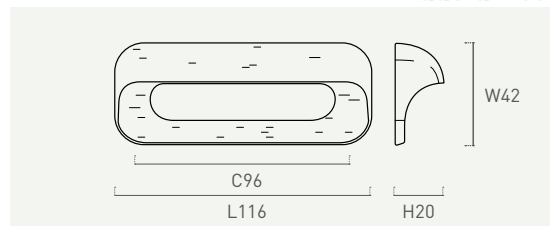

Color	Cod.	Ref.	C	L	W	H	
61	414BC	414.96.61	96	116	42	20	25
62	414BB	414.96.62	96	116	42	20	25













248

zamak

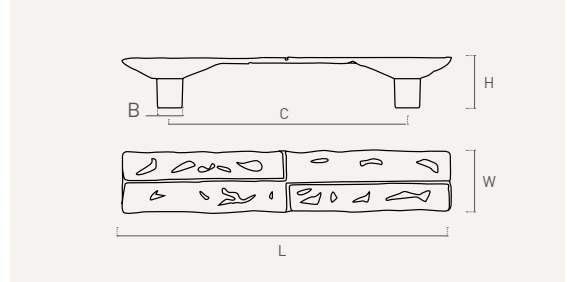

Color	Cod.	Ref.	C	L	W	H	B	
	<b>2484C</b>	248.64.73	64	94	23	19	10	12
	<b>2486C</b>	248.96.73	96	130	23	19	10	12
	<b>2484P</b>	248.64.80	64	94	23	19	10	12
	<b>2486P</b>	248.96.80	96	130	23	19	10	12



249

zamak

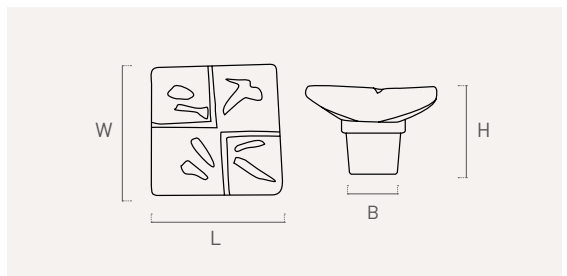

Color	Cod.	Ref.	L	W	H	B	
	<b>2492C</b>	249.20.73	20	20	17	8	12
	<b>2497C</b>	249.26.73	26	26	18	10	12
	<b>2493C</b>	249.33.73	33	33	18	13	12
	<b>2492P</b>	249.20.80	20	20	17	8	12
	<b>2497P</b>	249.26.80	26	26	18	10	12
	<b>2493P</b>	249.33.80	33	33	18	13	12



240

zamak

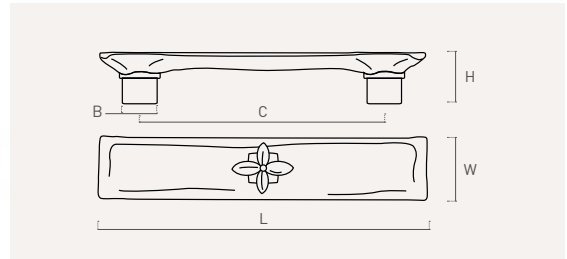

Color	Cod.	Ref.	C	L	W	B	H	
	<b>2404C</b>	240.64.73	64	94	24	10	19	12
	<b>2406C</b>	240.96.73	96	130	24	10	19	12
	<b>2404P</b>	240.64.80	64	94	24	10	19	12
	<b>2406P</b>	240.96.80	96	130	24	10	19	12



## 241

zamak

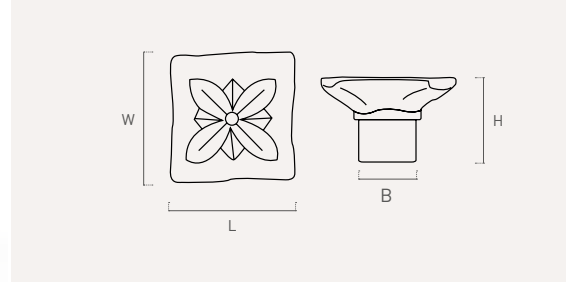

Color	Cod.	Ref.	L	W	H	B	📦
	<b>2412C</b>	241.20.73	<b>20</b>	20	17	8	12
73	<b>2417C</b>	241.26.73	<b>26</b>	26	18	10	12
	<b>2413C</b>	241.33.73	<b>33</b>	33	18	13	12
	<b>2412P</b>	241.20.80	<b>20</b>	20	17	8	12
80	<b>2417P</b>	241.26.80	<b>26</b>	26	18	10	12
	<b>2413P</b>	241.33.80	<b>33</b>	33	18	13	12



## 230

zamak

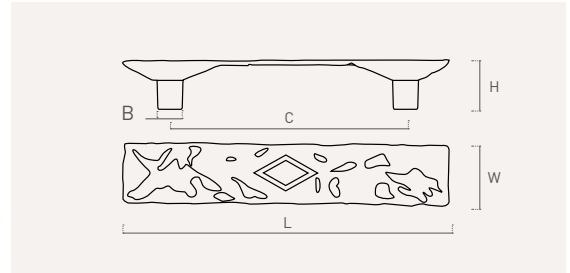

Color	Cod.	Ref.	C	L	W	H	B	📦
	<b>2304C</b>	230.64.73	<b>64</b>	94	23	19	10	12
73	<b>2306C</b>	230.96.73	<b>96</b>	130	23	19	10	12
	<b>2304P</b>	230.64.80	<b>64</b>	94	23	19	10	12
80	<b>2306P</b>	230.96.80	<b>96</b>	130	23	19	10	12

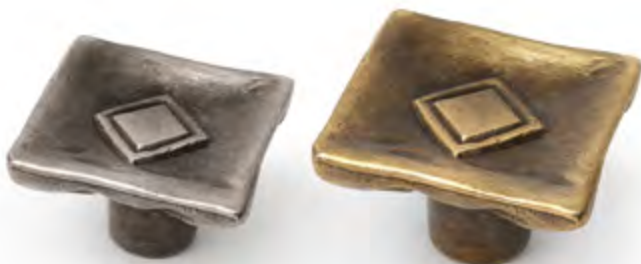

## 231

zamak

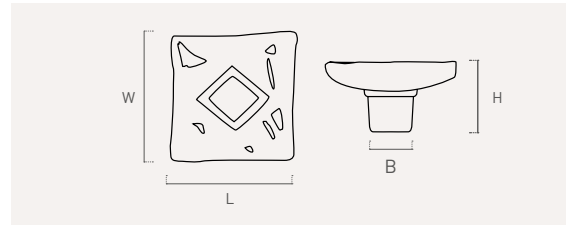

Color	Cod.	Ref.	L	W	H	B	📦
	<b>2312C</b>	231.20.73	<b>20</b>	20	17	8	12
73	<b>2317C</b>	231.26.73	<b>26</b>	26	18	10	12
	<b>2313C</b>	231.33.73	<b>33</b>	33	18	13	12
	<b>2312P</b>	231.20.80	<b>20</b>	20	17	8	12
80	<b>2317P</b>	231.26.80	<b>26</b>	26	18	10	12
	<b>2313P</b>	231.33.80	<b>33</b>	33	18	13	12





1081

hierro iron

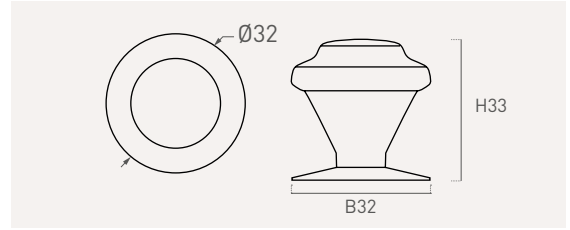

Color	Cod.	Ref.	Ø	H	B	
70	<b>1081BR</b>	1081.32.70	32	33	32	12
75	<b>1081NE</b>	1081.32.75	32	33	32	12



388

zamak zamak

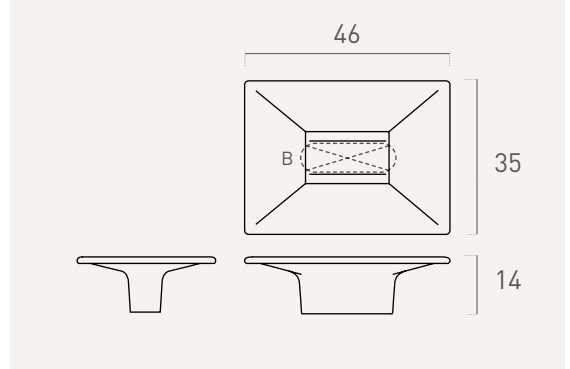

Color	Cod.	Ref.	L	W	H	B	
08	<b>388NE</b>	388.46.08	35	46	14	25x13	12
74	<b>388BR</b>	388.46.74	35	46	14	25x13	12





801

zamak zamak

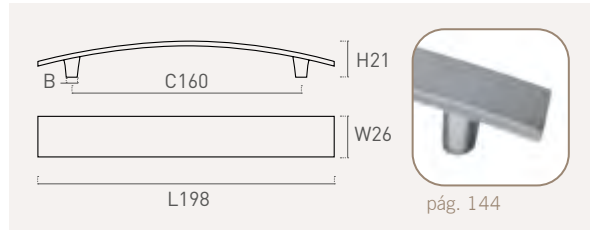

Color	Cod.	Ref.	C	L	W	H	B	
73	801015	801.160.73	160	198	26	21	12x8	12



809

zamak zamak

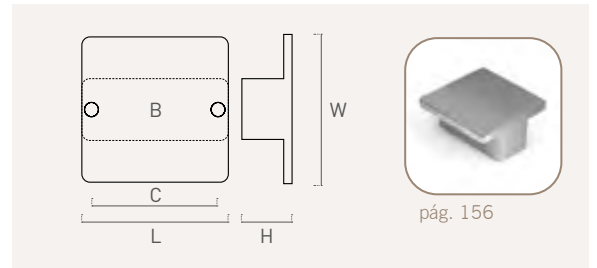

Color	Cod.	Ref.	C	L	W	H	B	
73	809215	809.32.73	32	50	50	24	22x50	12
	809815	809.38.73	-	38	38	21	11x37	12



897

zamak zamak

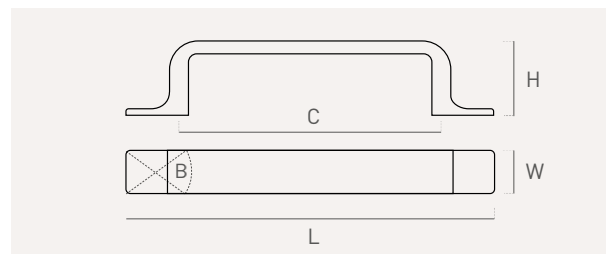





Color	Cod.	Ref.	C	L	W	H	B	
08	897622	897.96.08	96	130	15	29	15x21	12
08	897822	897.128.08	128	162	15	29	15x21	12



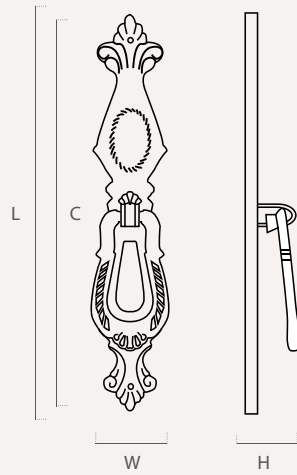





CON  
BOCALLAVE  
KEY HOLE 

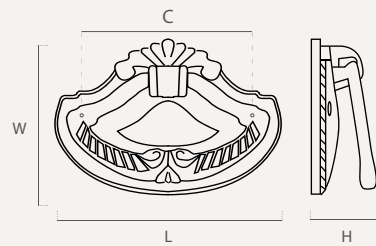

Color	Cod.	Ref.	C	L	W	H	
 74	<b>218A2</b>	218.122.74	101	<b>122</b>	26	16	12
	<b>218A1</b>	218.164.74	140	<b>164</b>	30	18	12
 87	<b>218ABB2</b>	218.122.87	101	<b>122</b>	26	16	12
	<b>218ABB1</b>	218.164.87	140	<b>164</b>	30	18	12
 74	<b>218A2B</b>	218B.122.74	101	<b>122</b>	26	16	12
	<b>218A1B</b>	218B.164.74	140	<b>164</b>	30	18	12







Color	Cod.	Ref.	L	W	H	C	
 31	<b>218LT2</b>	218.54.31	<b>53</b>	40	23	36	12
	<b>218LT1</b>	218.69.31	<b>68</b>	52	15	48	12
 74	<b>218B2</b>	218.54.74	<b>53</b>	40	23	36	12
	<b>218B1</b>	218.69.74	<b>68</b>	52	15	48	12
 87	<b>218BBB2</b>	218.54.87	<b>53</b>	40	23	36	12
	<b>218BBB1</b>	218.69.87	<b>68</b>	52	15	48	12

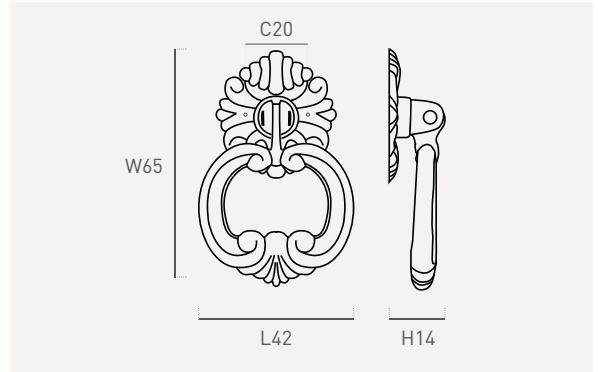

224

zamak



Color	Cod.	Ref.	L	W	H	C	∅
 31	<b>224LT1</b>	224.65.31	42	65	14	20	12
 74	<b>224C1</b>	224.65.74	42	65	14	20	12
 87	<b>224BB1</b>	224.65.87	42	65	14	20	12





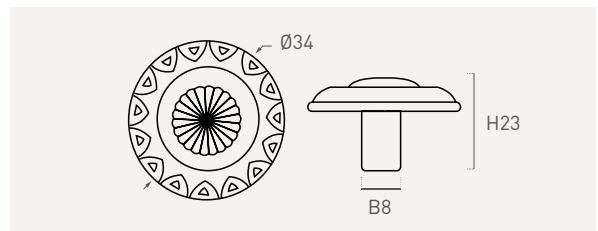

297

zamak



29731



Color	Cod.	Ref.	∅	H	B	∅
 31	<b>29731</b>	297.34.31	32	23	8	12
 74	<b>297BR1</b>	297.34.74	32	23	8	12
 80	<b>297PT1</b>	297.34.80	32	23	8	12
 86	<b>297NF1</b>	297.34.86	32	23	8	12
 87	<b>297BB1</b>	297.34.87	32	23	8	12
 88	<b>297PB1</b>	297.34.88	32	23	8	12



297BR1



297PT1



297NF1



297BB1



297PB1





299

zamak

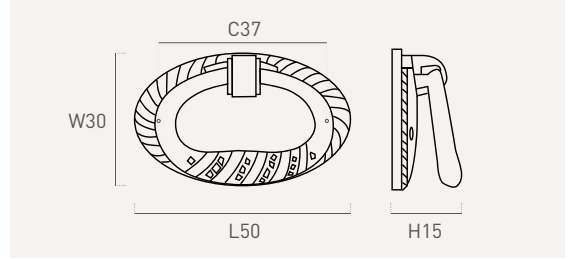



Color	Cod.	Ref.	L	W	H	C	
 87	<b>299BB1</b>	299.50.87	50	30	15	37	12

298

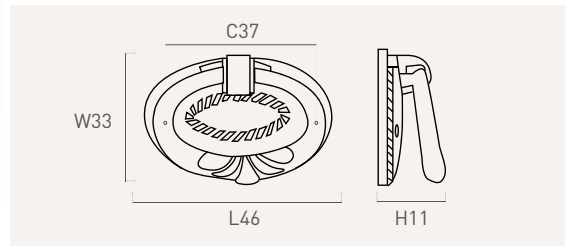
zamak



Color	Cod.	Ref.	L	W	H	C	
 31	<b>298LT1</b>	298.47.31	46	33	11	37	12
 87	<b>298BB1</b>	298.47.87	46	33	11	37	12
 88	<b>298PB1</b>	298.47.88	46	33	11	37	12



298BB1

298PB1





294

zamak

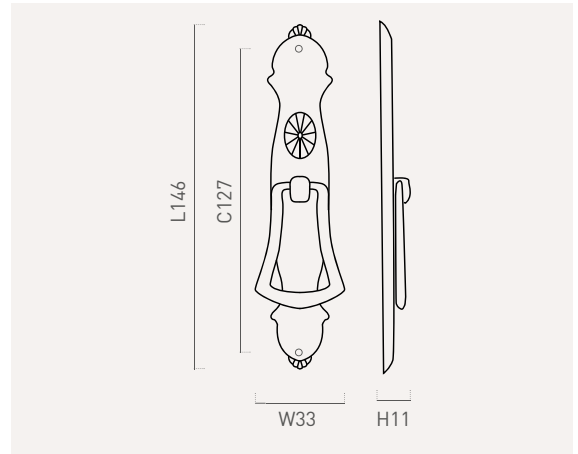

Color	Cod.	Ref.	C	W	L	H	📦
31	<b>294LT1</b>	294.145.31	127	33	146	11	12
74	<b>294BR1</b>	294.145.74	127	33	146	11	12
86	<b>294NF1</b>	294.145.86	127	33	146	11	12
98	<b>294CB1</b>	294.145.98	127	33	146	11	12



294

zamak

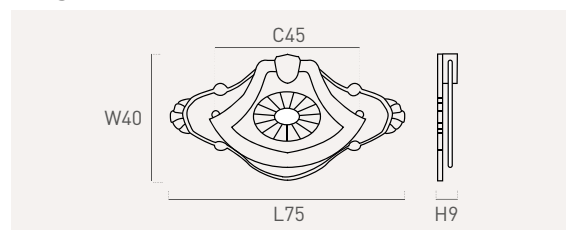

Color	Cod.	Ref.	L	W	C	H	📦
31	<b>294LT2</b>	294.75.31	75	40	45	9	12
74	<b>294BR2</b>	294.75.74	75	40	45	9	12
86	<b>294NF2</b>	294.75.86	75	40	45	9	12
98	<b>294CB2</b>	294.75.98	75	40	45	9	12



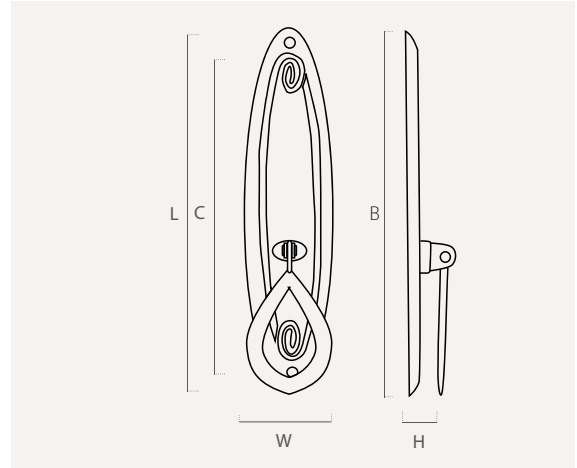

Color	Cod.	Ref.	C	L	B	W	H	
74	<b>295BR1</b>	295.143.74	<b>137</b>	152	148	29	15	12
74	<b>295BR2</b>	295.111.74	<b>93</b>	112	102	29	15	12
86	<b>295NF1</b>	295.143.86	<b>137</b>	152	148	29	15	12
86	<b>295NF2</b>	295.111.86	<b>93</b>	112	102	29	15	12
98	<b>295CB1</b>	295.143.98	<b>137</b>	152	148	29	15	12
98	<b>295CB2</b>	295.111.98	<b>93</b>	112	102	29	15	12

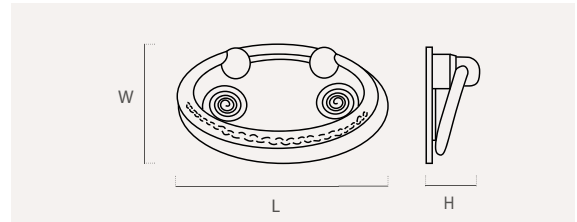

Color	Cod.	Ref.	L	W	H	
31	<b>295LT4</b>	295.56.31	<b>56</b>	33	14	12
31	<b>295LT3</b>	295.79.31	<b>79</b>	44	14	12
74	<b>295BR4</b>	295.56.74	<b>56</b>	33	14	12
74	<b>295BR3</b>	295.79.74	<b>79</b>	44	14	12
86	<b>295NF4</b>	295.56.86	<b>56</b>	33	14	12
86	<b>295NF3</b>	295.79.86	<b>79</b>	44	14	12
98	<b>295CB4</b>	295.56.98	<b>56</b>	33	14	12
98	<b>295CB3</b>	295.79.98	<b>79</b>	44	14	12



296

zamak

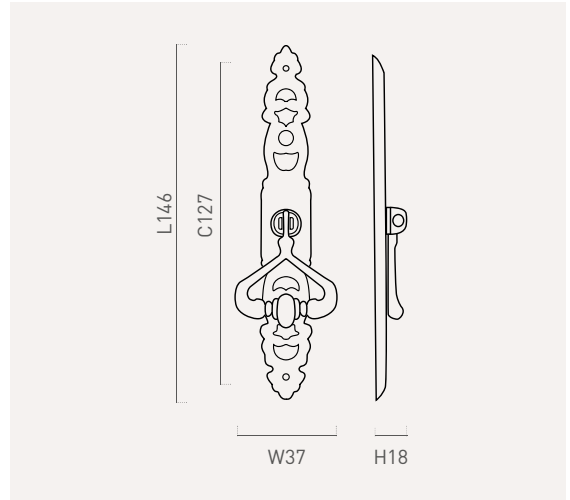

Color	Cod.	Ref.	C	L	W	H	
31	296LT3	296.135.31	116	132	37	18	12
74	296BR3	296.135.74	116	132	37	18	12
77	296NE3	296.135.77	116	132	37	18	12
86	296NF3	296.135.86	116	132	37	18	12

296

zamak

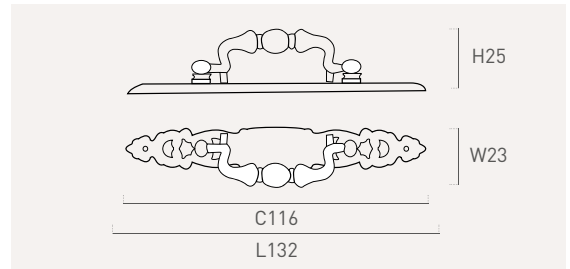

Color	Cod.	Ref.	C	L	W	H	
31	296LT4	296.132.31	116	132	23	25	12
74	296BR4	296.132.74	116	132	23	25	12
77	296NE4	296.132.77	116	132	23	25	12
86	296NF4	296.132.86	116	132	23	25	12

296

zamak

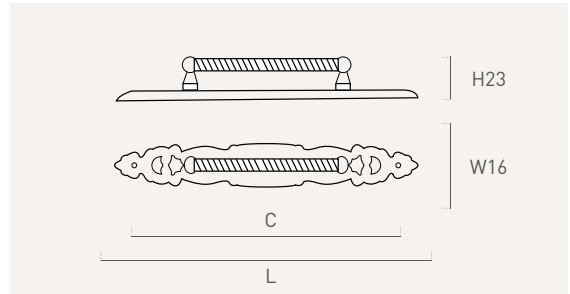

Color	Cod.	Ref.	C	L	W	H	
31	296LT2	296.133.31	116	132	16	23	12
74	296BR2	296.133.74	116	132	16	23	12
74	296BR1	296.185.74	168	185	16	23	12
77	296NE2	296.133.77	116	132	16	23	12
77	296NE1	296.185.77	168	185	16	23	12
86	296NF2	296.133.86	116	132	16	23	12
86	296NF1	296.185.86	168	185	16	23	12





347

zamak

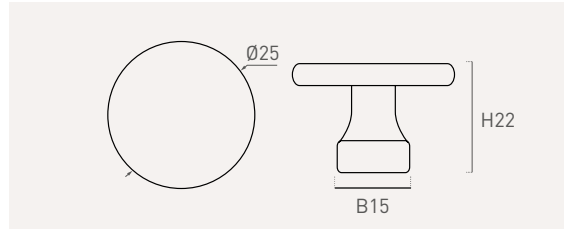

Color	Cod.	Ref.	Ø	H	B	☒
31	34731	347.25.31	25	22	15	12
74	347BR	347.25.74	25	22	15	12
77	347NE	347.25.77	25	22	15	12
80	347PT	347.25.80	25	22	15	12
98	347CB	347.25.98	25	22	15	12



175

zamak

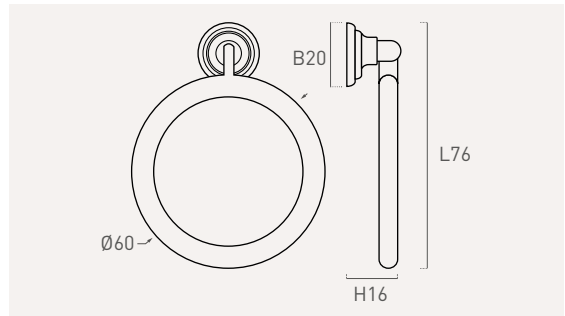

Color	Cod.	Ref.	Ø	L	H	B	☒
31	17531	175.60.31	60	76	16	20	12
74	175BR	175.60.74	60	76	16	20	12
77	175NE	175.60.77	60	76	16	20	12
80	175PT	175.60.80	60	76	16	20	12
98	175CB	175.60.98	60	76	16	20	12



176

zamak

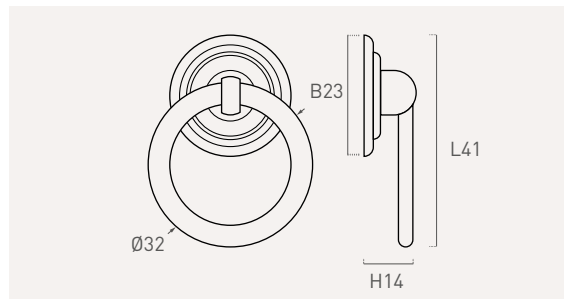

Color	Cod.	Ref.	Ø	L	H	B	☒
31	17631	176.32.31	32	41	14	23	12
74	176BR	176.32.74	32	41	14	23	12
77	176NE	176.32.77	32	41	14	23	12
80	176PT	176.32.80	32	41	14	23	12
98	176CB	176.32.98	32	41	14	23	12



177

zamak

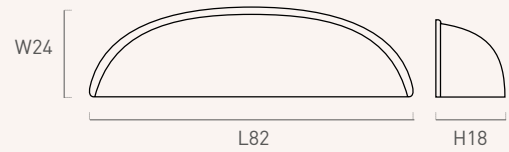

Color	Cod.	Ref.	C	L	W	H	☒
31	17731	177.64.31	64	82	24	18	12
74	177BR	177.64.74	64	82	24	18	12
77	177NE	177.64.77	64	82	24	18	12
80	177PT	177.64.80	64	82	24	18	12
98	177CB	177.64.98	64	82	24	18	12



227

zamak

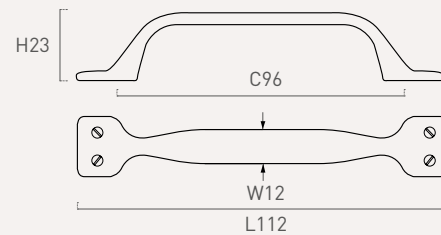

Color	Cod.	Ref.	C	L	W	H	☒
31	22731	227.96.31	96	127	12	23	12
74	227C1	227.96.74	96	127	12	23	12
77	227NE	227.96.77	96	127	12	23	12
80	227PT	227.96.80	96	127	12	23	12
98	227CB	227.96.98	96	127	12	23	12







220BBB1



220BPB1

220

zamak

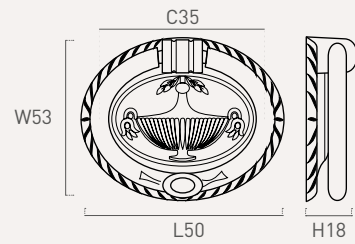

Color	Cod.	Ref.	L	W	H	C	☒
31	220LT1	220.50.31	50	43	18	35	12
74	220B1	220.50.74	50	43	18	35	12
87	220BBB1	220.50.87	50	43	18	35	12
88	220BPB1	220.50.88	50	43	18	35	12

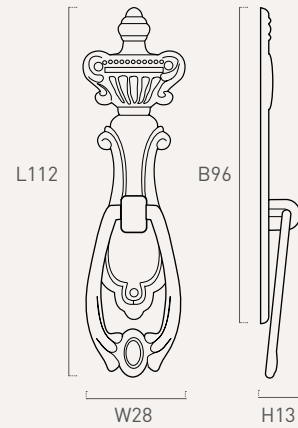

Color	Cod.	Ref.	L	W	H	B	☒
74	220A1	220.112.74	112	28	13	96	12

221

zamak

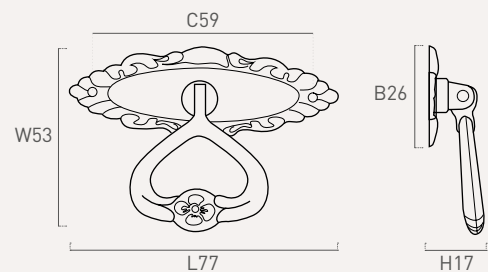

Color	Cod.	Ref.	L	W	H	B	C	☒
74	221C1	221.77.74	77	53	17	26	59	12



387

zamak

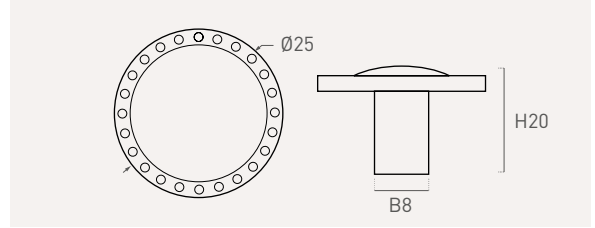

Color	Cod.	Ref.	Ø	H	B	📦
31	<b>38731</b>	387.25.31	25	20	8	12
74	<b>387BR</b>	387.25.74	25	20	8	12
80	<b>387PT</b>	387.25.80	25	20	8	12



226

zamak

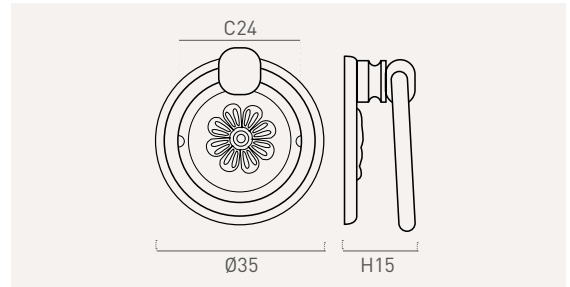

Color	Cod.	Ref.	Ø	H	C	📦
74	<b>226C1</b>	226.35.74	35	15	24	12



225

zamak

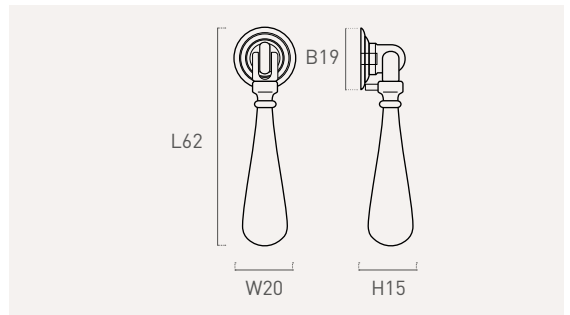

Color	Cod.	Ref.	L	W	H	B	📦
31	<b>22531</b>	225.62.31	62	20	15	19	12
74	<b>225C1</b>	225.62.74	62	20	15	19	12





05

zamak

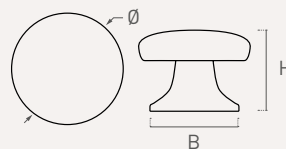

pág.115/174

Color	Cod.	Ref.	Ø	H	B	📦
31	<b>05731</b>	05.25.31	25	20	20	12
	<b>05331</b>	05.30.31	30	23	24	12
	<b>05831</b>	05.35.31	35	25	28	12
73	<b>05715</b>	05.25.73	25	20	20	12
	<b>05315</b>	05.30.73	30	23	24	12
	<b>05815</b>	05.35.73	35	25	28	12
74	<b>05718</b>	05.25.74	25	20	20	12
	<b>05318</b>	05.30.74	30	23	24	12
	<b>05818</b>	05.35.74	35	25	28	12



06

zamak

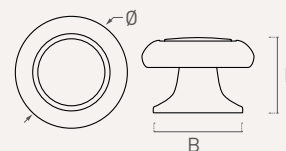

pág.175

Color	Cod.	Ref.	Ø	H	B	📦
31	<b>06731</b>	06.25.31	25	20	20	12
	<b>06331</b>	06.30.31	30	23	24	12
	<b>06831</b>	06.35.31	35	25	28	12
73	<b>06715</b>	06.25.73	25	20	20	12
	<b>06315</b>	06.30.73	30	23	24	12
	<b>06815</b>	06.35.73	35	25	28	12
74	<b>06718</b>	06.25.74	25	20	20	12
	<b>06318</b>	06.30.74	30	23	24	12
	<b>06818</b>	06.35.74	35	25	28	12



09

zamak

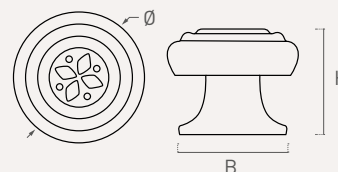

Color	Cod.	Ref.	Ø	H	B	📦
31	<b>09731</b>	09.25.31	25	20	20	12
	<b>09331</b>	09.30.31	30	23	24	12
	<b>09831</b>	09.35.31	35	25	28	12
72	<b>09706</b>	09.25.72	25	20	20	12
	<b>09306</b>	09.30.72	30	23	24	12
	<b>09806</b>	09.35.72	35	25	28	12
74	<b>09718</b>	09.25.74	25	20	20	12
	<b>09318</b>	09.30.74	30	23	24	12
	<b>09818</b>	09.35.74	35	25	28	12



# 10

zamak

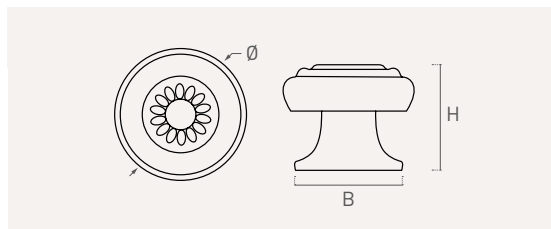

Color	Cod.	Ref.	Ø	H	B	📦
	<b>10731</b>	10.25.31	<b>25</b>	21	20	12
	<b>10331</b>	10.30.31	<b>30</b>	24	24	12
	<b>10831</b>	10.35.31	<b>35</b>	26	28	12
	<b>10718</b>	10.25.74	<b>25</b>	21	20	12
	<b>10318</b>	10.30.74	<b>30</b>	24	24	12
	<b>10818</b>	10.35.74	<b>35</b>	26	28	12



# 12

zamak

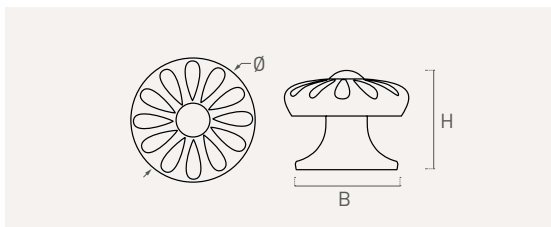

Color	Cod.	Ref.	Ø	H	B	📦
	<b>12731</b>	12.25.31	<b>25</b>	21	20	12
	<b>12331</b>	12.30.31	<b>30</b>	24	24	12
	<b>12831</b>	12.35.31	<b>35</b>	26	28	12
	<b>1 6</b>	12.25.72	<b>25</b>	21	20	12
	<b>12306</b>	12.30.72	<b>30</b>	24	24	12
	<b>12806</b>	12.35.72	<b>35</b>	26	28	12
	<b>12718</b>	12.25.74	<b>25</b>	21	20	12
	<b>12318</b>	12.30.74	<b>30</b>	24	24	12
	<b>12818</b>	12.35.74	<b>35</b>	26	28	12



mod.14

mod.18

# 14 - 18

zamak

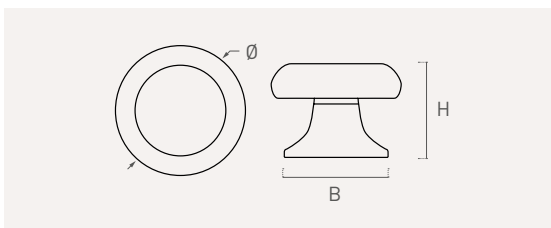

Color	Cod.	Ref.	Ø	H	B	📦
	<b>14715</b>	14.25.73	<b>25</b>	20	20	12
	<b>14315</b>	14.30.73	<b>30</b>	23	24	12
	<b>14815</b>	14.35.73	<b>35</b>	25	28	12
	<b>18726</b>	18.25.74	<b>25</b>	20	20	12
	<b>18326</b>	18.30.74	<b>30</b>	23	24	12
	<b>18826</b>	18.35.74	<b>35</b>	25	28	12





50 S

zamak

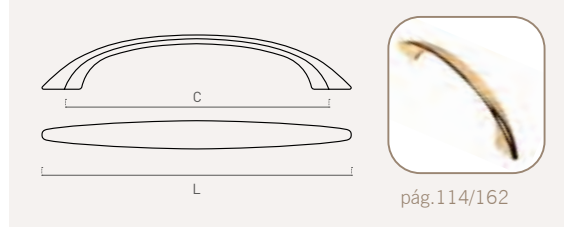

pág.114/162

Color	Cod.	Ref.	C	L	W	H	
31	50631	50.96.31	96	126	13	25	12
	50831	50.128.31	128	160	15	28	12
73	50615	50.96.73	96	126	13	25	12
	50815	50.128.73	128	160	15	28	12
74	50618	50.96.74	96	126	13	25	12
	50818	50.128.74	128	160	15	28	12



52

zamak

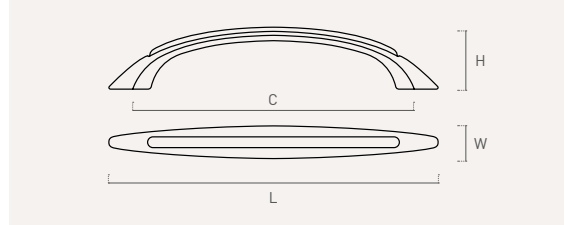

Color	Cod.	Ref.	C	L	W	H	
31	52631	52.96.31	96	126	13	27	12
	52831	52.128.31	128	160	15	30	12
72	52606	52.96.72	96	126	13	27	12
	52806	52.128.72	128	160	15	30	12
74	52618	52.96.74	96	126	13	27	12
	52818	52.128.74	128	160	15	30	12



55

zamak

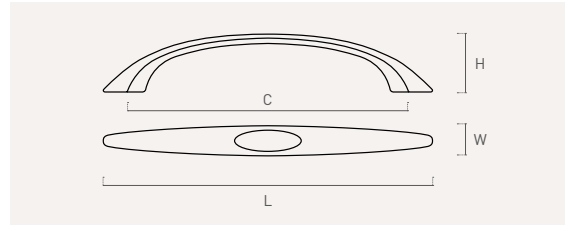

Color	Cod.	Ref.	C	L	W	H	
73	55615	55.96.73	96	126	13	25	12
	55815	55.128.73	128	160	15	28	12



56

zamak

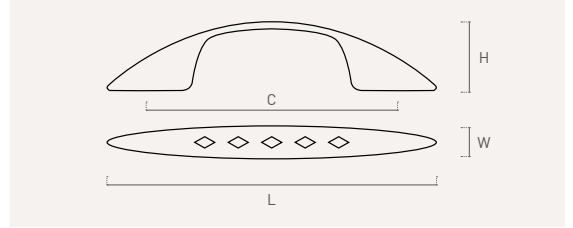

Color	Cod.	Ref.	C	L	W	H	
72	<b>56406</b>	56.64.72	<b>64</b>	102	10	22	12
74	<b>56418</b>	56.64.74	<b>64</b>	102	10	22	12



62

zamak

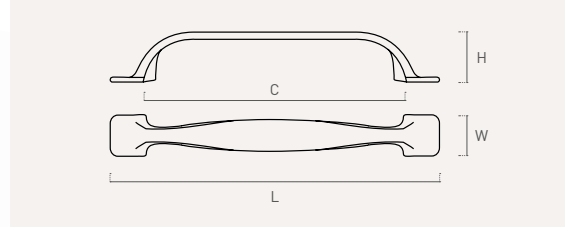

Color	Cod.	Ref.	C	L	W	H	
31	<b>62631</b>	62.96.73	<b>96</b>	127	18	24	12
	<b>62831</b>	62.128.73	<b>128</b>	165	20	24	12
73	<b>62615</b>	62.96.73	<b>96</b>	127	18	24	12
	<b>62815</b>	62.128.73	<b>128</b>	165	20	24	12
74	<b>62618</b>	62.96.74	<b>96</b>	127	18	24	12
	<b>62818</b>	62.128.74	<b>128</b>	165	20	24	12
80	<b>626PT</b>	62.96.80	<b>96</b>	127	18	24	12
98	<b>62620</b>	62.96.98	<b>96</b>	127	18	24	12
	<b>62820</b>	62.128.98	<b>128</b>	165	20	24	12



63

zamak

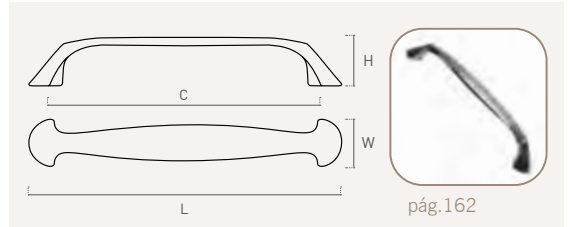

Color	Cod.	Ref.	C	L	W	H	
73	<b>63615</b>	63.96.73	<b>96</b>	118	14-18	23	12
	<b>63815</b>	63.128.73	<b>128</b>	150	16-20	25	12
74	<b>63618</b>	63.96.74	<b>96</b>	118	14-18	23	12
	<b>63818</b>	63.128.74	<b>128</b>	150	16-20	25	12





01

zamak

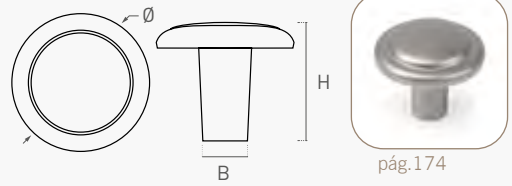

Color	Cod.	Ref.	Ø	H	B	📦
74	<b>01718</b>	01.25.74	<b>25</b>	22	9	12
	<b>01318</b>	01.30.74	<b>30</b>	20	8	12



211

zamak

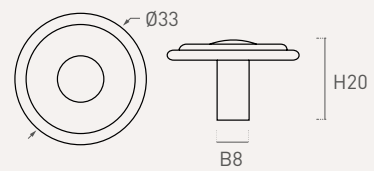

Color	Cod.	Ref.	Ø	H	B	📦
74	<b>211318</b>	211.33.74	<b>33</b>	20	8	12



213

zamak

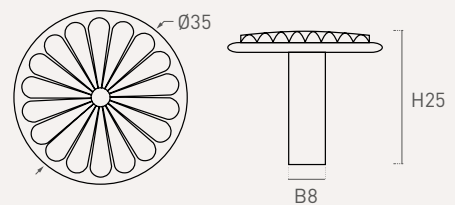

Color	Cod.	Ref.	Ø	H	B	📦
74	<b>213818</b>	213.35.74	<b>35</b>	25	8	12

## 215

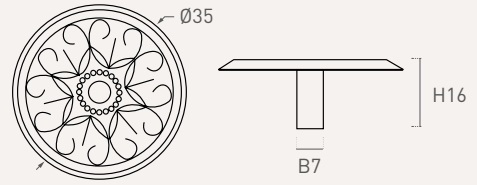

Color	Cod.	Ref.	Ø	H	B	Icon
74	215818	215.35.74	35	16	7	12

## 214

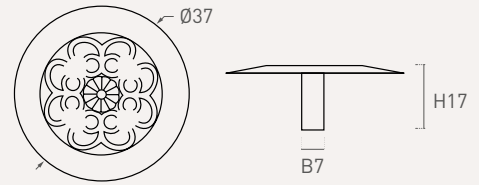

Color	Cod.	Ref.	Ø	H	B	Icon
74	214718	214.37.74	37	17	7	12







200

zamak

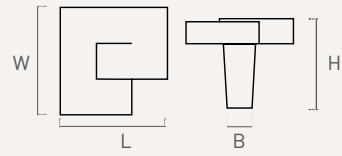

Color Cod. Ref. L W H B

74 200318 200.30.74 30 30 26 8 12

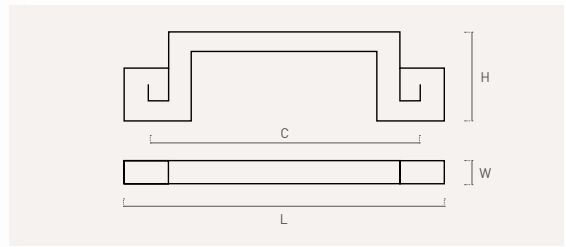

Color Cod. Ref. C L W H

74 200618 200.96.74 96 119 8 28 12



201

zamak

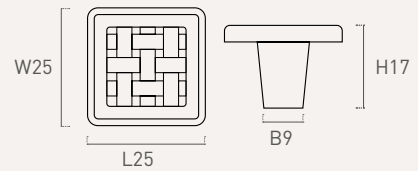

Color Cod. Ref. L W H B

74 201718 201.25.74 25 25 17 9 12

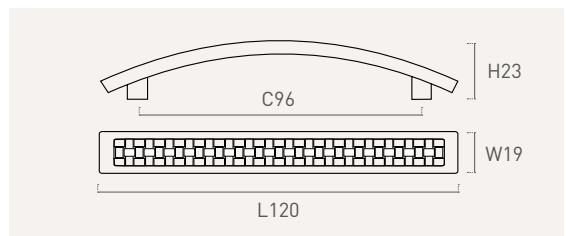

Color Cod. Ref. C L W H

74 201618 201.96.74 96 120 19 23 12



202

zamak

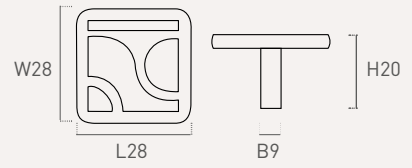

Color Cod. Ref. L W H B 

74 202718 202.25.74 28 28 20 9 12

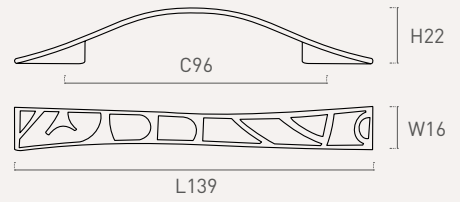



Color Cod. Ref. C L W H 

74 202618 202.96.74 96 139 16 22 12

205

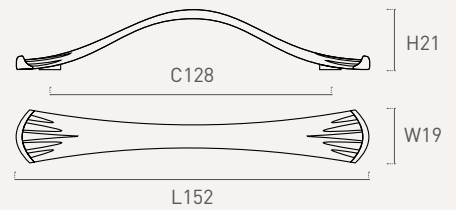
zamak



Color Cod. Ref. C L W H 

74 205818 205.128.74 128 152 19 21 12





75

zamak

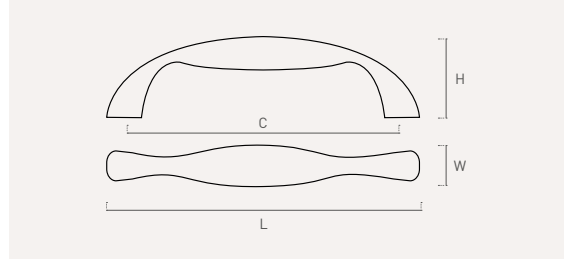

Color	Cod.	Ref.	C	L	W	H	
72	75615	75.96.72	96	112	15	30	12







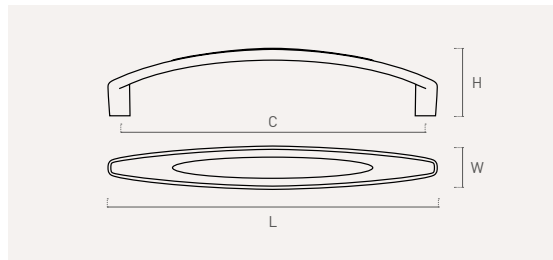

76

zamak



Color Cod. Ref. C L W H 

72 **76815** 76.128.72 **128** 137 18 29 12



77

zamak

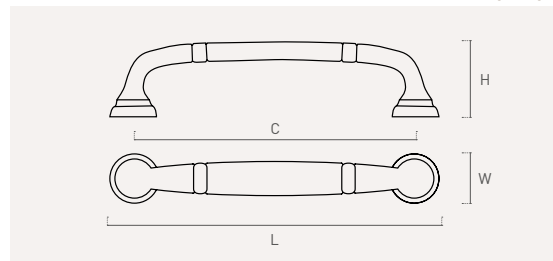

Color Cod. Ref. C L W H 

72 **77615** 77.96.72 **96** 113 15-16 25 12



217

zamak

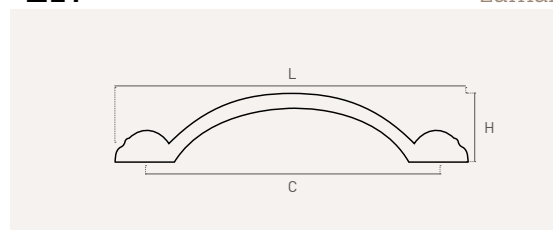

Color Cod. Ref. C L W H 

74 **217618** 217.96.74 **96** 110 18 21 12



280

zamak

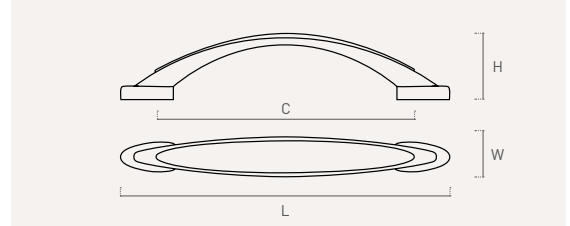



Color	Cod.	Ref.	C	L	W	H	
 70	<b>2804C</b>	280.64.70	64	88	13	21	12
	<b>2806C</b>	280.96.70	96	124	13	25	12

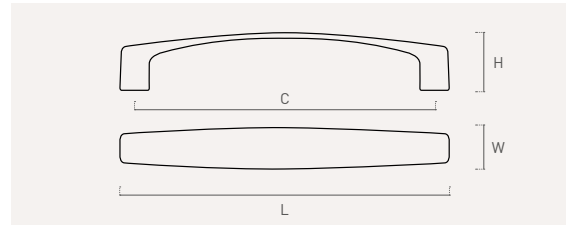

275

zamak



Color	Cod.	Ref.	C	L	W	H	
 73	<b>2754C</b>	275.64.73	64	75	13	18	12
	<b>2756C</b>	275.96.73	96	105	15	20	12



581

zamak

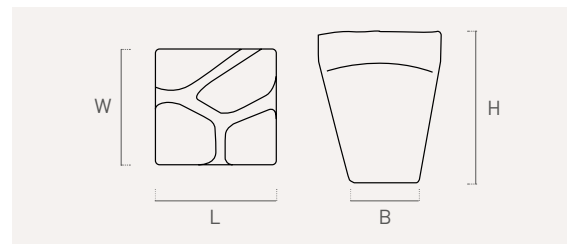

Color	Cod.	Ref.	L	W	H	B	
 73	<b>5819C</b>	581.18.73	18	18	23	10x10	12



582

zamak

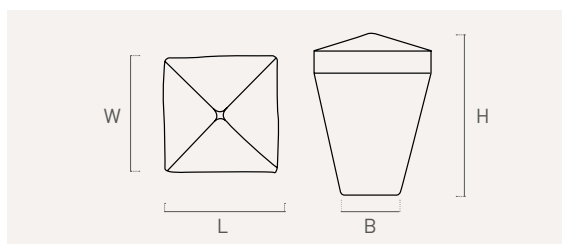

Color	Cod.	Ref.	L	W	H	B	
 73	<b>5829C</b>	582.18.73	18	18	24	10x10	12



583

zamak

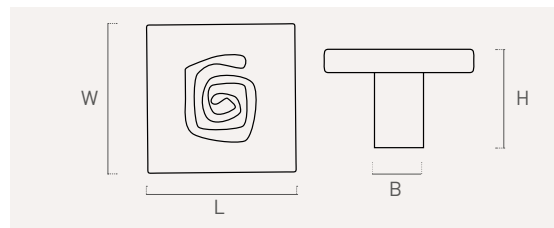

Color  Cod. Ref. 

L	W	H	B
---	---	---	---

73 **5837C** 583.25.73 **25 25 19 8 12**



584

zamak

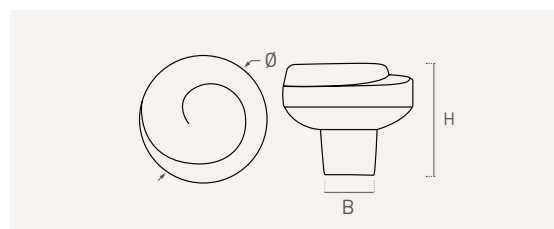

Color  Cod. Ref. 

Ø	H	B
---	---	---

73 **5843C** 584.30.73 **30 25 11 12**



585

zamak

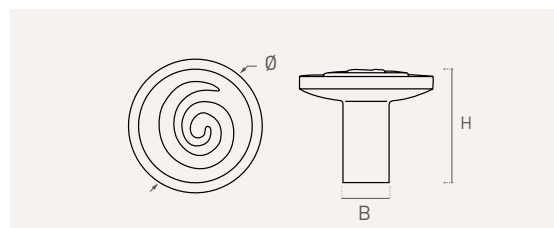

Color  Cod. Ref. 

Ø	H	B
---	---	---

73 **5853C** 585.33.73 **30 24 10 12**





### 217A

zamak

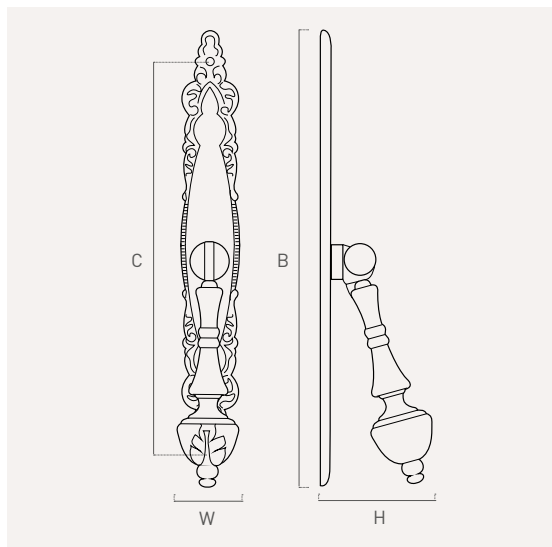

Color	Cod.	Ref.	B	W	H	C	Icon	
	<b>217A3</b>	217A.117.74	<b>107</b>	16	19	89	12	
74	<b>217A2</b>	217A.135.74	<b>134</b>	19	20	117	12	
	<b>217A1</b>	217A.165.74	<b>165</b>	22	32	138	12	
	<b>217A3B</b>	217AB.117.74	<b>107</b>	16	19	89	12	Icon
	<b>217A2B</b>	217AB.135.74	<b>134</b>	19	20	117	12	Icon
	<b>217A1B</b>	217AB.165.74	<b>165</b>	22	32	138	12	Icon

CON  
BOCALLAVE  
KEY HOLE



### 217B

zamak

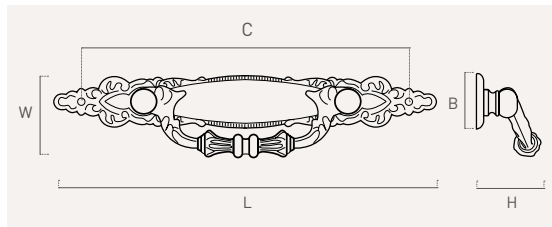

Color	Cod.	Ref.	L	W	H	B	C	Icon
	<b>217B2</b>	217B.117.74	<b>107</b>	24	20	16	89	12
74	<b>217B1</b>	217B.135.74	<b>135</b>	33	23	19	117	12



### 217C

zamak

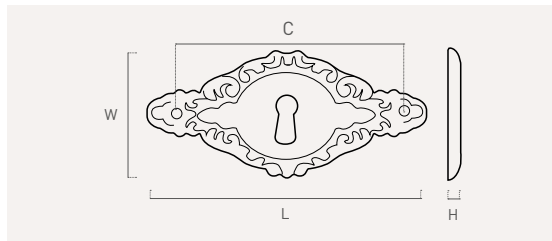

Color	Cod.	Ref.	L	W	H	C	Icon
74	<b>217C1</b>	217C.60.74	<b>60</b>	28	3	46	12





174A1

174A2

## 174

zamak

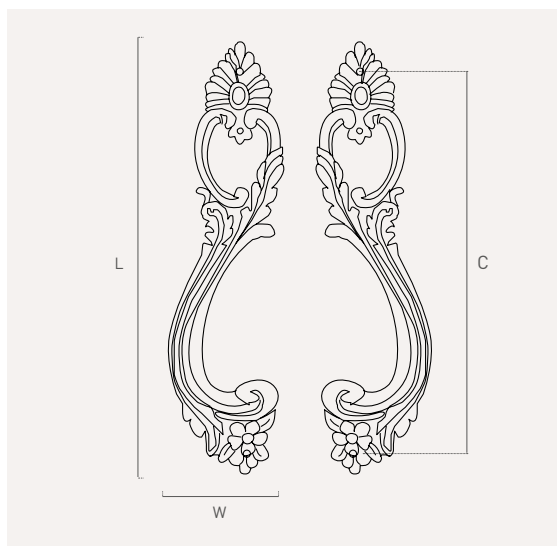

Color	Cod.	Ref.	L	W	H	H	
74	<b>174A1</b>	174L.152.74	<b>152</b>	40	20	131	12
	<b>174A2</b>	174R.152.74	<b>152</b>	40	20	131	12

## 219

zamak

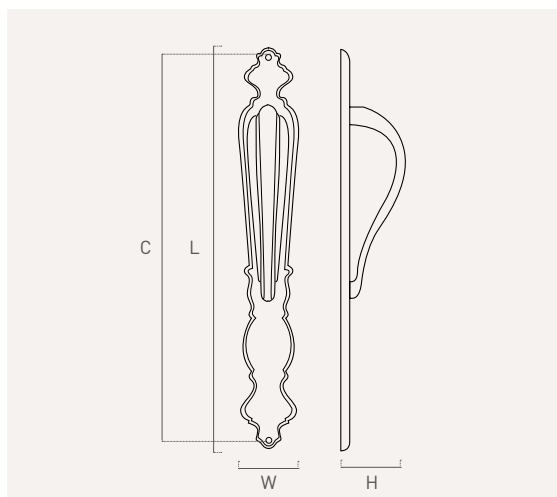

Color	Cod.	Ref.	L	W	H	C	
74	<b>219A2</b>	219.130.74	<b>130</b>	22	21	118	12
	<b>219A1</b>	219.178.74	<b>178</b>	28	24	165	12

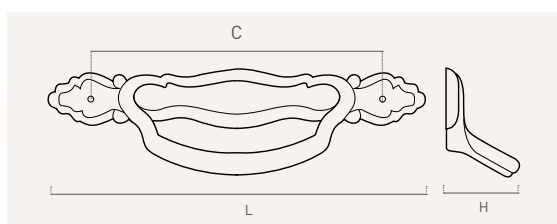

Color	Cod.	Ref.	L	W	H	C	
74	<b>219B1</b>	219.110.74	<b>110</b>	29	27	99	12



### 170A

zamak

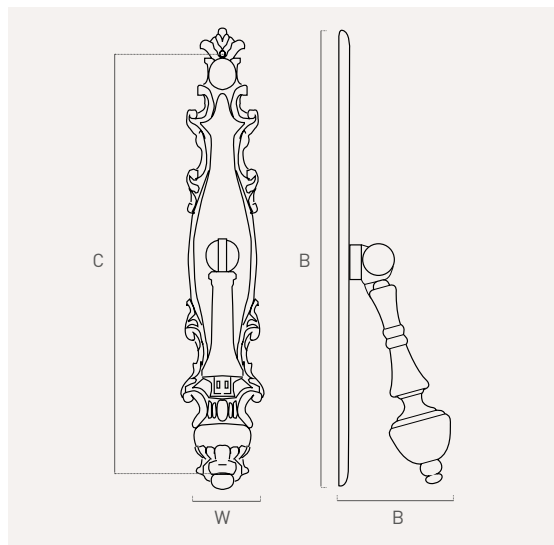

Color	Cod.	Ref.	B	W	H	C	
	<b>170A3</b>	170A.106.74	<b>106</b>	21	16	90	12
74	<b>170A2</b>	170A.132.74	<b>132</b>	24	23	109	12
	<b>170A1</b>	170A.166.74	<b>166</b>	26	29	147	12
	<b>170A2B</b>	170AB.132.74	<b>132</b>	24	23	109	12
	<b>170A1B</b>	170AB.166.74	<b>166</b>	26	29	147	12

CON  
BOCALLAVE  
KEY HOLE



### 170B

zamak

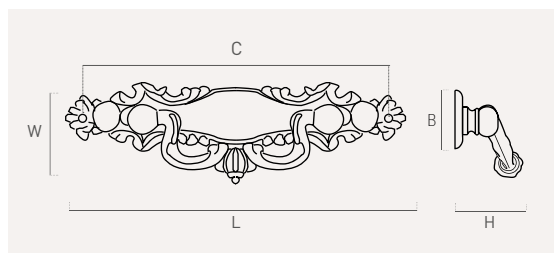

Color	Cod.	Ref.	B	W	H	C	
	<b>170B2</b>	170B.107.74	<b>107</b>	30	17	93	12
74	<b>170B1</b>	170B.131.74	<b>131</b>	33	22	112	12







# 171A

zamak

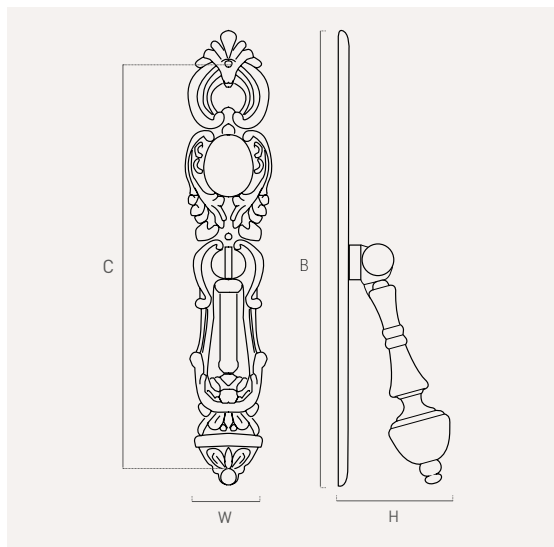

Color	Cod.	Ref.	B	W	H	C	☐
	<b>171A3</b>	171A.106.74	<b>106</b>	22	22	90	12
74	<b>171A2</b>	171A.131.74	<b>131</b>	24	24	110	12
	<b>171A1</b>	171A.175.74	<b>175</b>	29	26	154	12



# 171B

zamak

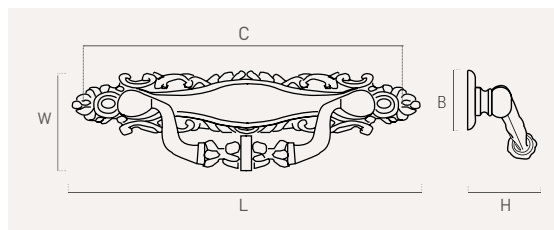

Color	Cod.	Ref.	B	W	H	C	☐
74	<b>171B2</b>	171B.103.74	<b>103</b>	37	22	90	12
	<b>171B1</b>	171B.120.74	<b>120</b>	41	22	101	12





172A

zamak

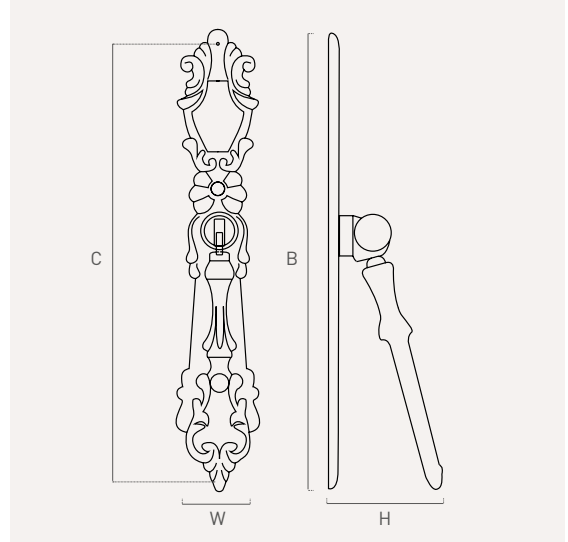

Color	Cod.	Ref.	B	W	H	C	
	<b>172A3</b>	172A.112.74	<b>105</b>	21	16	90	12
74	<b>172A2</b>	172A.127.74	<b>127</b>	23	17	110	12
	<b>172A1</b>	172A.178.74	<b>178</b>	30	35	150	12

172B

zamak

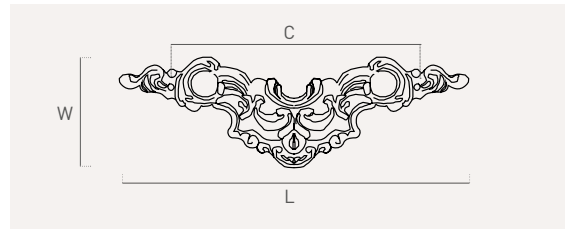

Color	Cod.	Ref.	L	W	H	C	
74	<b>172B2</b>	172B.105.74	<b>103</b>	27	19	85	12
	<b>172B1</b>	172B.125.74	<b>124</b>	40	20	85	12



172C

zamak

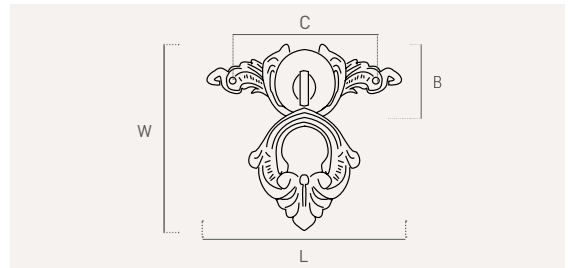

Color	Cod.	Ref.	L	W	H	B	C	
74	<b>172C1</b>	172C.69.74	<b>69</b>	56	29	25	50	12



172C

zamak

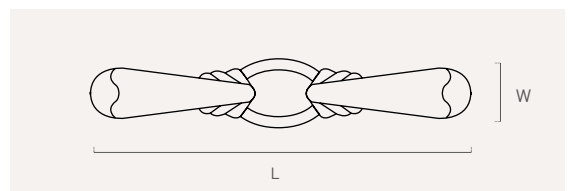

Color	Cod.	Ref.	L	W	H	
74	<b>172C2</b>	172C.64.74	<b>100</b>	21	22	12









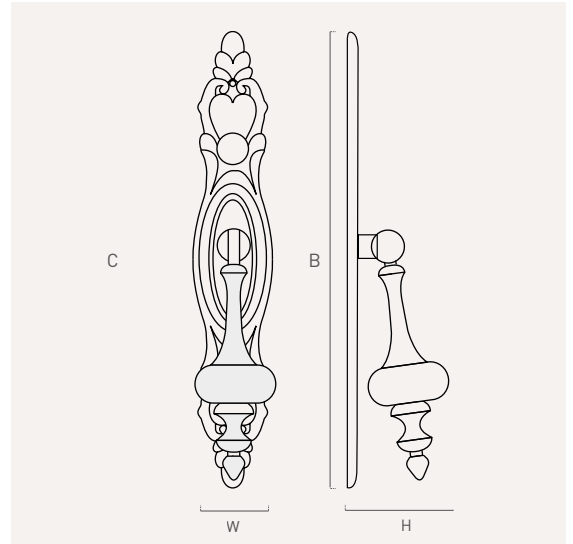

# 173A

zamak





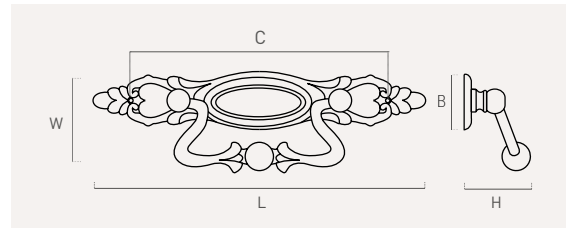

Color	Cod.	Ref.	B	W	H	C	📦
	<b>173BR1</b>	173.135.74	<b>107</b>	27	27	82	12
	<b>173BR2</b>	173.152.74	<b>130</b>	25	27	95	12
	<b>173BR3</b>	173.175.74	<b>167</b>	27	27	128	12
	<b>173PT1</b>	173.135.80	<b>107</b>	27	27	82	12
	<b>173PT2</b>	173.152.80	<b>130</b>	25	27	95	12
	<b>173PT3</b>	173.175.80	<b>167</b>	27	27	128	12

# 173B

zamak



Color	Cod.	Ref.	L	W	H	B	C	📦
	<b>173BR4</b>	173.107.74	<b>107</b>	38	18	28	82	12
	<b>173BR5</b>	173.130.74	<b>130</b>	34	18	24	96	12
	<b>173PT4</b>	173.107.80	<b>107</b>	38	18	28	82	12
	<b>173PT5</b>	173.130.80	<b>130</b>	34	18	24	96	12







209

zamak

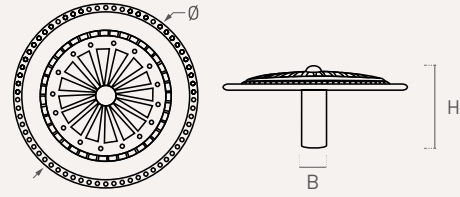

Color	Cod.	Ref.	Ø	H	B	
74	<b>209818</b>	209.44.74	<b>44</b>	26	8	12



209

zamak

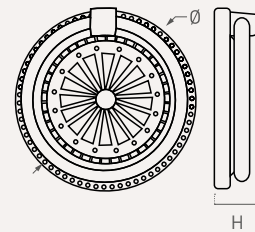

Color	Cod.	Ref.	Ø	H	
74	<b>209918</b>	209.45.74	<b>45</b>	11	12



206

zamak

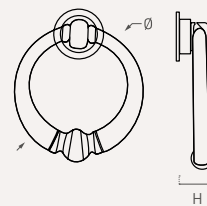

Color	Cod.	Ref.	Ø	H	
74	<b>206418</b>	206.40.74	<b>40</b>	14	12



206

zamak

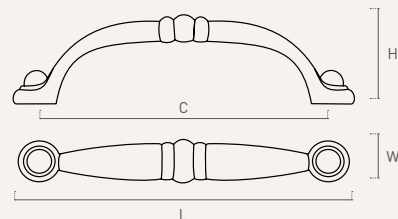



Color	Cod.	Ref.	C	L	W	H	
74	<b>206618</b>	206.96.74	<b>96</b>	110	14	29	12

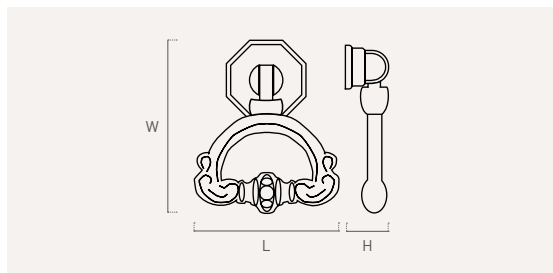

210

zamak





Color Cod. Ref. L W H  74 **210618** 210.36.74 36 40 14 12 

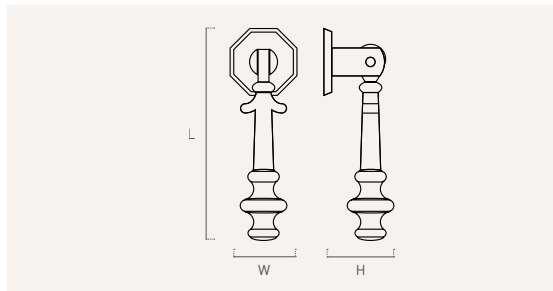

210

zamak





Color Cod. Ref. L W H  74 **210718** 210.67.74 67 22 23 12 

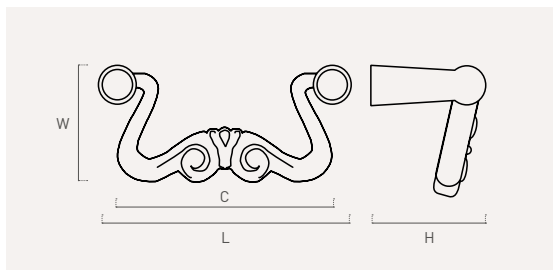

208

zamak





Color Cod. Ref. C L W H  74 **208418** 208.64.74 64 71 29 21 12 

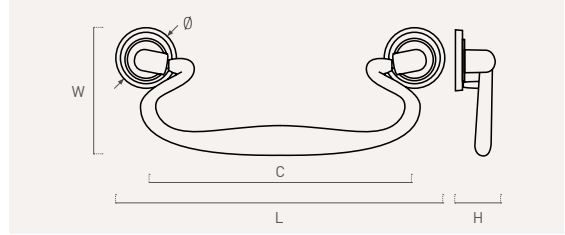

232

zamak



Color	Cod.	Ref.	C	L	W	H	Ø	
 73	<b>2324C</b>	232.64.73	64	81	34	13	22	12
	<b>2326C</b>	232.96.73	96	115	41	13	22	12
 80	<b>2326P</b>	232.96.80	96	115	41	13	22	12



233

zamak

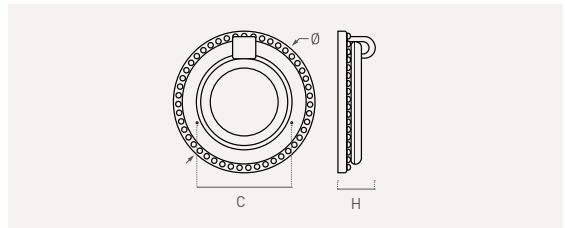



Color	Cod.	Ref.	Ø	H	C	
	<b>2333C</b>	233.30.73	30	9	19	12
 73	<b>2334C</b>	233.40.73	40	10	25	12
	<b>2335C</b>	233.50.73	50	11	32	12

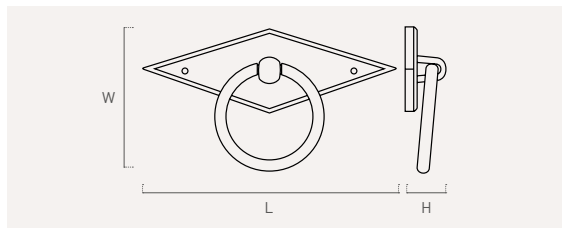

234

zamak



Color	Cod.	Ref.	L	W	H	
	<b>2348C</b>	234.48.73	48	40	14	12
 73	<b>2349C</b>	234.89.73	86	49	14	12







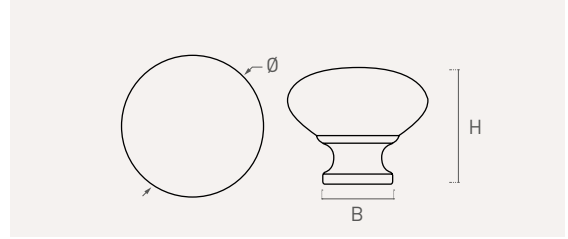

235

zamak



Color	Cod.	Ref.	Ø	H	B	
	<b>2352C</b>	235.20.73	<b>20</b>	17	10	12
	<b>2357C</b>	235.25.73	<b>25</b>	20	13	12
	<b>2353C</b>	235.30.73	<b>30</b>	24	15	12



247

zamak

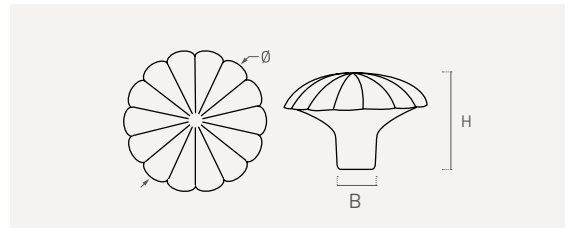

Color	Cod.	Ref.	Ø	H	B	
	<b>2477C</b>	247.25.73	<b>25</b>	19	9	12
	<b>2473C</b>	247.30.73	<b>30</b>	20	9	12





276

zamak

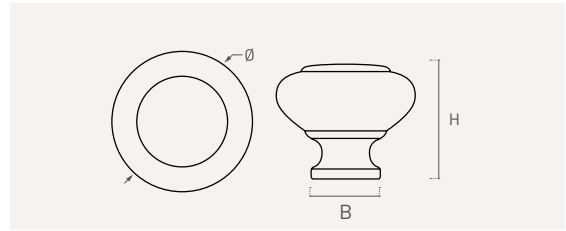

Color	Cod.	Ref.	Ø	H	B	
	<b>2767C</b>	276.25.73	25	20	12	12
	<b>2763C</b>	276.29.73	29	23	15	12



274

zamak

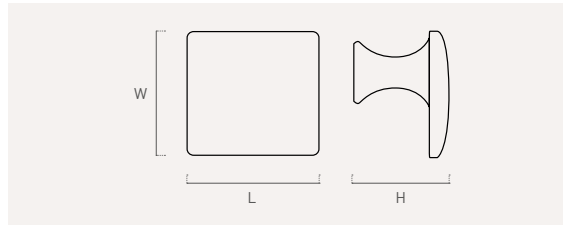

Color	Cod.	Ref.	L	W	H	
	<b>2742C</b>	274.20.73	20	18	14	12
	<b>2747C</b>	274.24.73	24	22	16	12



236

zamak

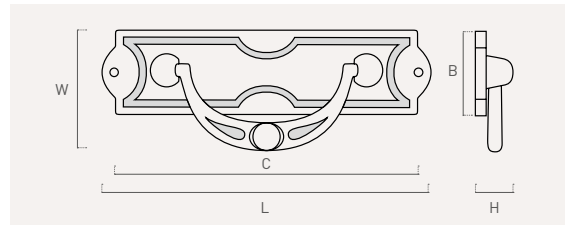

Color	Cod.	Ref.	C	L	W	H	B	
	<b>2366C</b>	236.76.73	68	76	30	13	25	12
	<b>2367C</b>	236.107.73	98	107	38	13	27	12
	<b>2366P</b>	236.76.80	68	76	30	13	25	12
	<b>2367P</b>	236.107.80	98	107	38	13	27	12



237

zamak

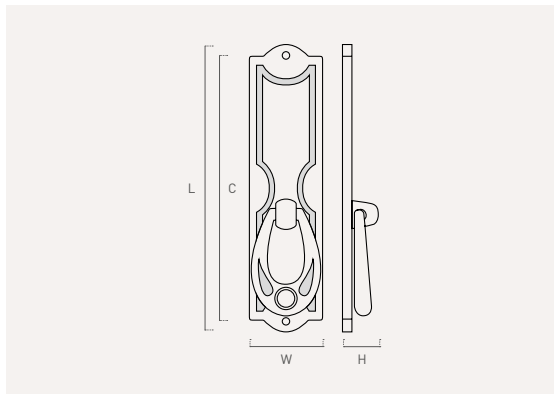

Color	Cod.	Ref.	C	L	W	H	📦
73	2377C	237.107.73	96	106	26	13	12
80	2377P	237.107.80	96	106	26	13	12



238

zamak

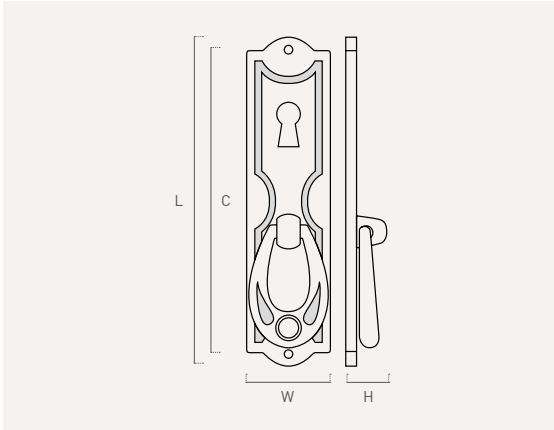

Color	Cod.	Ref.	C	L	W	H	📦
73	2387C	238.107.73	96	106	26	13	12
80	2387P	238.107.80	96	106	26	13	12



242

zamak

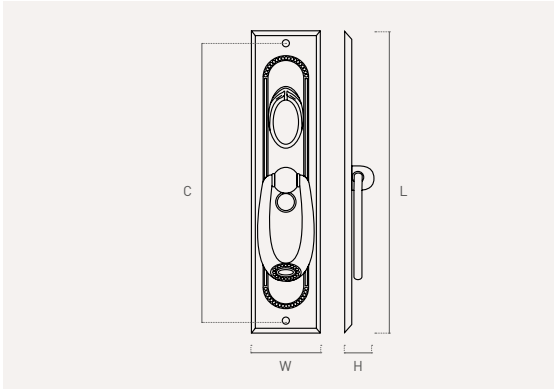

Color	Cod.	Ref.	L	W	H	C	📦
73	2420C	242.110.73	110	25	12	98	12





242 K

zamak

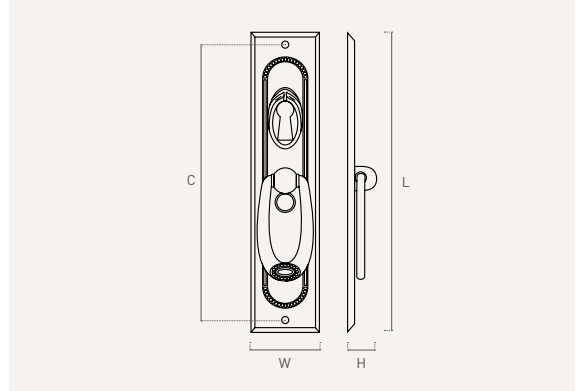

Color Cod. Ref. L W H C

73 **2421C** 242K.110.73 **110 25 12 98 12**



244

zamak

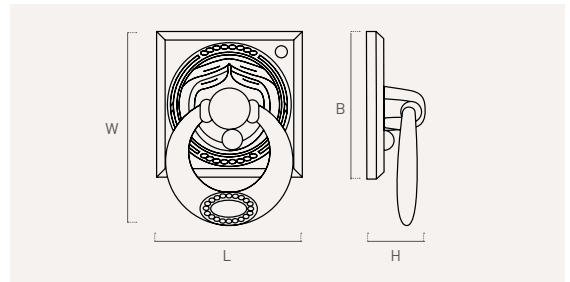

Color Cod. Ref. L W H B

73 **2442C** 244.30.73 **30 40 15 31 12**



245

zamak

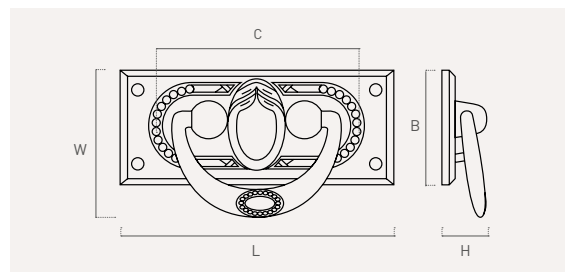

Color Cod. Ref. L W H B C

73 **2452C** 245.68.73 **68 38 12 12 55 12**  
**2453C** 245.97.73 **97 45 15 15 83 12**



255

zamak

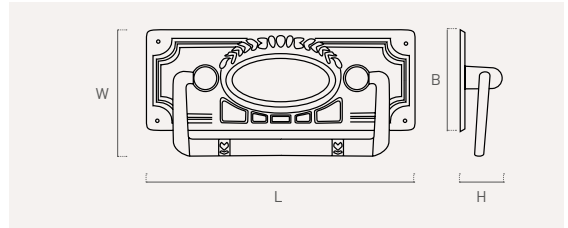

Color	Cod.	Ref.	L	W	H	B	📦
70	2550C	255.85.70	84	40	13	32	12



256

zamak

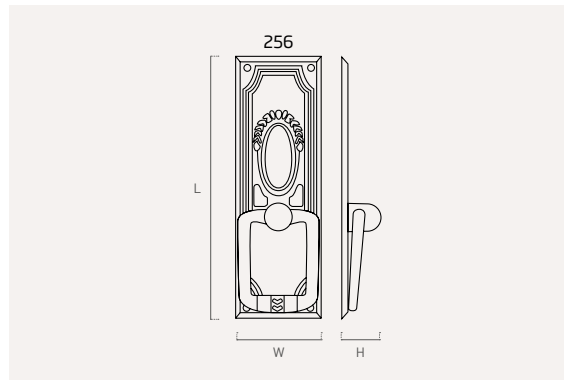

Color	Cod.	Ref.	L	W	H	📦
70	2560C	256.80.70	80	27	12	12



256K

zamak

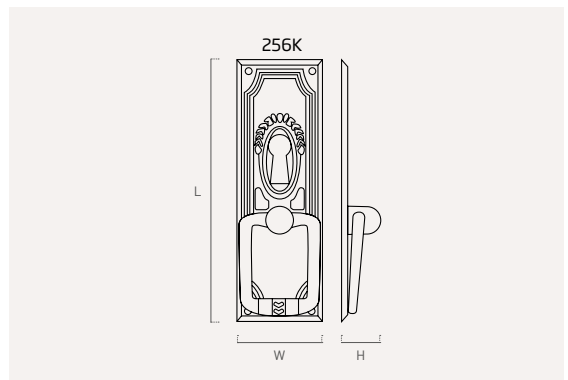

Color	Cod.	Ref.	L	W	H	📦
70	2561C	256K.80.70	80	27	12	12



257

zamak

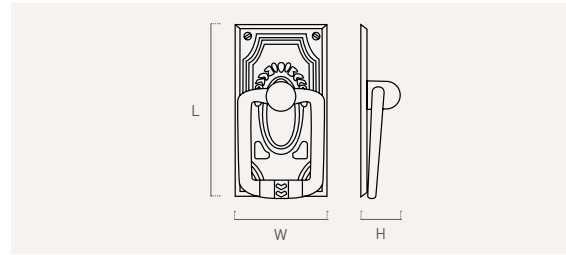

Color	Cod.	Ref.	L	W	H	
70	<b>2570C</b>	257.50.70	<b>50</b>	27	12	12



258

zamak

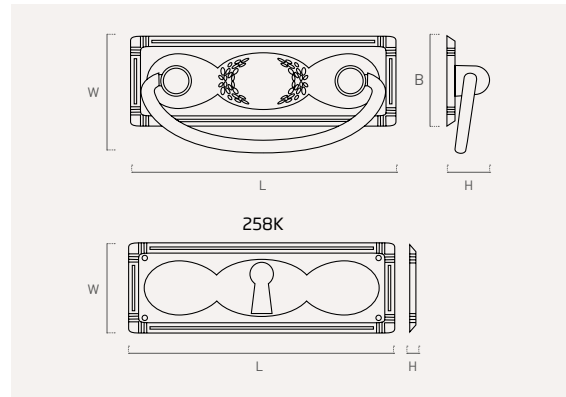

Color	Cod.	Ref.	L	W	H	B	
70	<b>2580C</b>	258.96.70	<b>96</b>	42	14	32	12
	<b>2581C</b>	258K.96.70	<b>96</b>	32	2	32	12



259

zamak

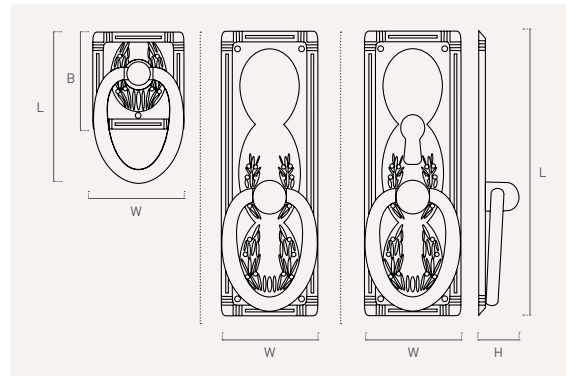

Color	Cod.	Ref.	L	W	H	B	
70	<b>2592C</b>	259.54.70	<b>54</b>	32	14	35	12
	<b>2590C</b>	259.96.70	<b>96</b>	32	14	96	12
	<b>2591C</b>	259K.96.70	<b>96</b>	32	14	96	12

CON  
BOCALLAVE  
KEY HOLE





260

zamak

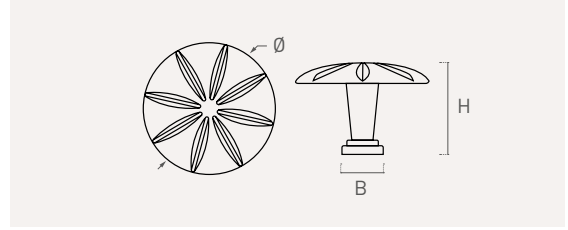

Color Cod. Ref.  $\emptyset$  H B

**2600C** 260.31.70 **31** 21 10 12



261

zamak

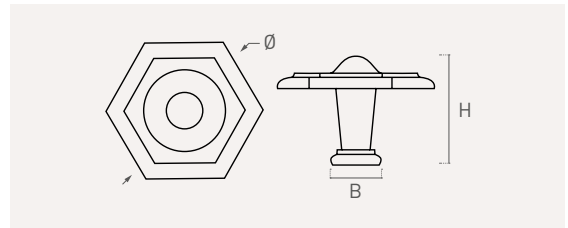

Color Cod. Ref.  $\emptyset$  H B

**2610C** 261.32.70 **32** 23 10 12



262

zamak

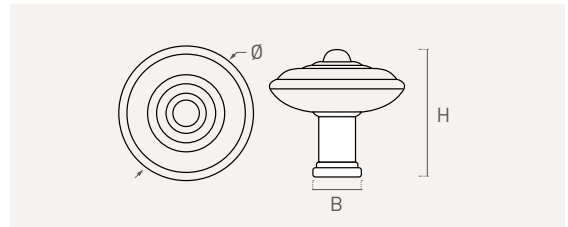

Color Cod. Ref.  $\emptyset$  H B

**2620C** 262.31.70 **31** 29 11 12



263

zamak

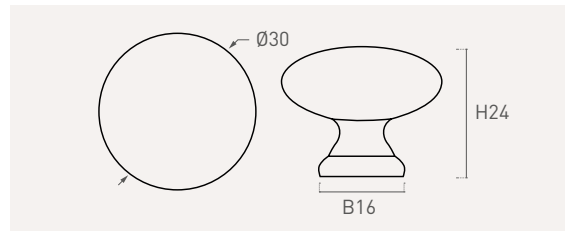

Color	Cod.	Ref.	Ø	H	B	Icon
70	<b>2630C</b>	263.30.70	30	24	16	12
77	<b>2630N</b>	263.30.77	30	24	16	12
80	<b>2630P</b>	263.30.80	30	24	16	12

264

zamak

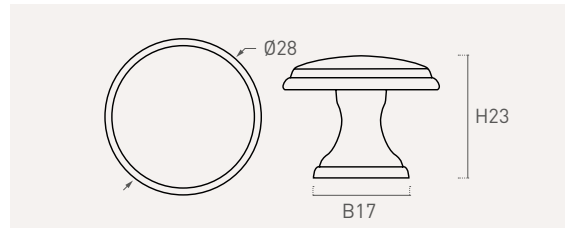

Color	Cod.	Ref.	Ø	H	B	Icon
70	<b>2640C</b>	264.29.70	28	23	17	12



265

zamak

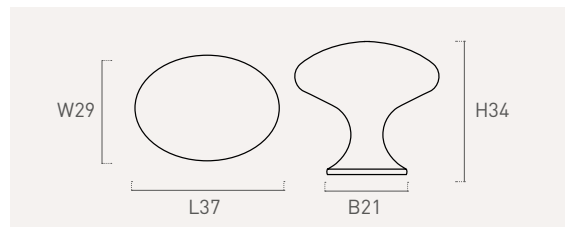

Color	Cod.	Ref.	L	W	H	B	Icon
70	<b>2650C</b>	265.37.70	37	29	34	21	12





266

zamak

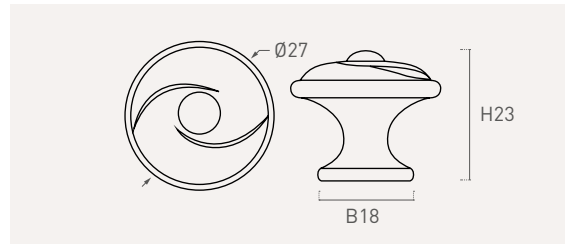

Color Cod. Ref.

70 **2660C** 266.27.70 **27** 23 18 12



267

zamak

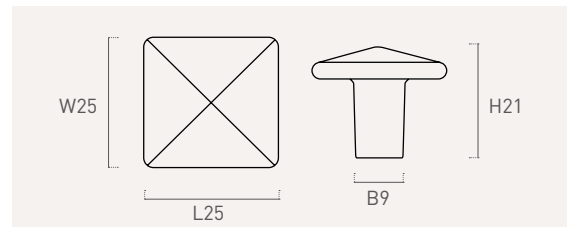

Color Cod. Ref.

70 **2670C** 267.25.70 **25** 25 21 9 12



268

zamak

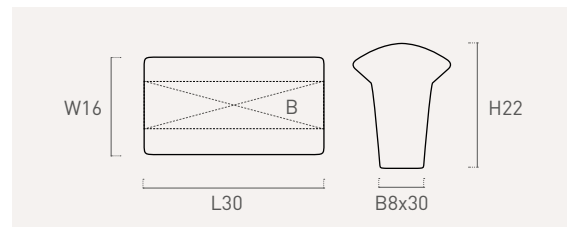

Color Cod. Ref.

70 **2680C** 268.30.70 **30** 16 22 8x30 12





269

zamak

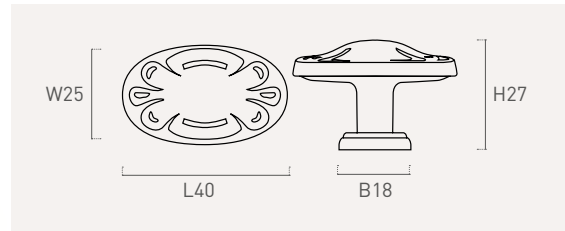

Color	Cod.	Ref.	L	W	H	B	Icon
70	<b>2690C</b>	269.40.70	40	25	27	18	12
80	<b>2690P</b>	269.40.80	40	25	27	18	12



289

zamak

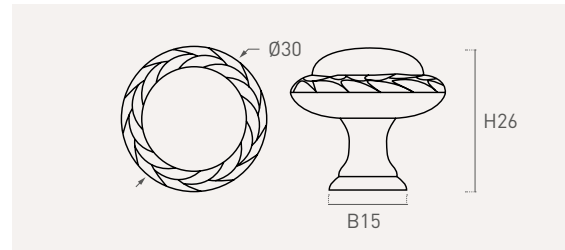

Color	Cod.	Ref.	Ø	B	H	Icon
70	<b>2893C</b>	289.30.70	30	15	26	12



290

zamak

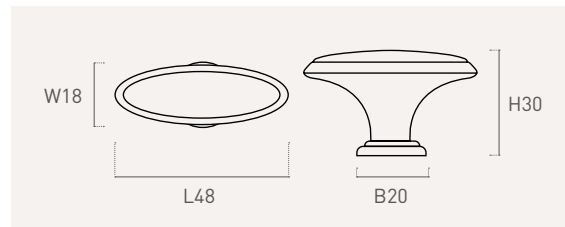

Color	Cod.	Ref.	L	W	H	B	Icon
70	<b>2905C</b>	290.48.70	48	18	30	20	12



277

zamak

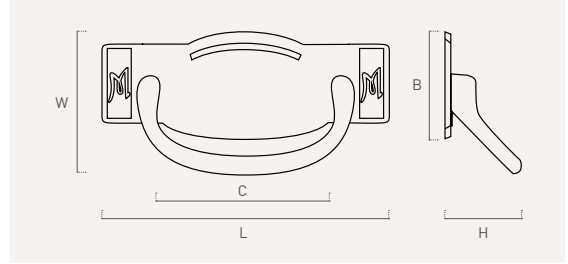

Color	Cod.	Ref.	C	L	W	H	B	
	<b>2772C</b>	277.32.70	32	64	32	23	28	12
	<b>2774C</b>	277.64.70	64	94	44	24	36	12



278

zamak

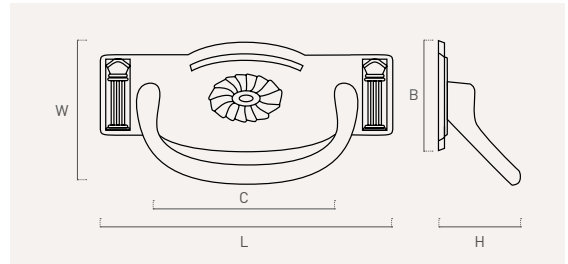

Color	Cod.	Ref.	C	L	W	H	B	
	<b>2782C</b>	278.32.70	32	64	32	15	28	12
	<b>2784C</b>	278.64.70	64	94	44	24	36	12



279

zamak

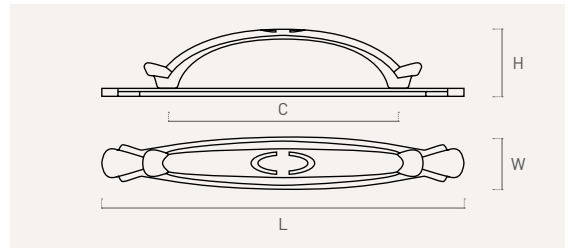

Color	Cod.	Ref.	C	L	W	H	
	<b>2794C</b>	279.64.70	64	101	20	24	12
	<b>2796C</b>	279.96.70	96	152	22	28	12



284

zamak

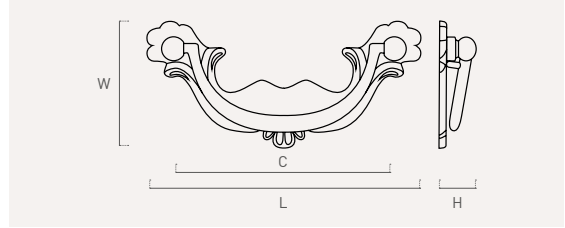

Color	Cod.	Ref.	C	L	W	H	☐
	<b>2844C</b>	284.75.70	<b>75</b>	99	44	13	12
	<b>2846C</b>	284.96.70	<b>96</b>	121	55	15	12



281

zamak

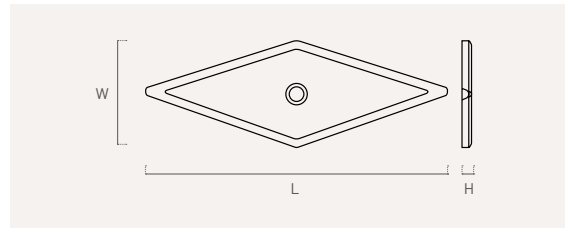

Color	Cod.	Ref.	L	W	H	☐
	<b>2813C</b>	281.73.70	<b>73</b>	25	4	12
	<b>2810C</b>	281.90.70	<b>90</b>	31	4	12



282

zamak

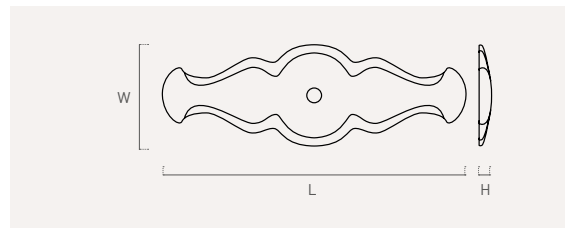

Color	Cod.	Ref.	L	W	H	☐
	<b>2820C</b>	282.92.70	<b>92</b>	30	3	12



288

zamak

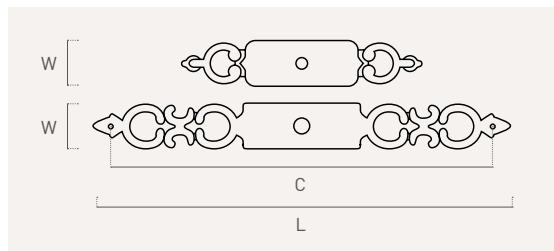

Color	Cod.	Ref.	L	W	H	C	
	<b>2888C</b>	288.87.70	<b>87</b>	16	2	-	12
	<b>2880C</b>	288.180.70	<b>180</b>	21	2	158	12

239

zamak

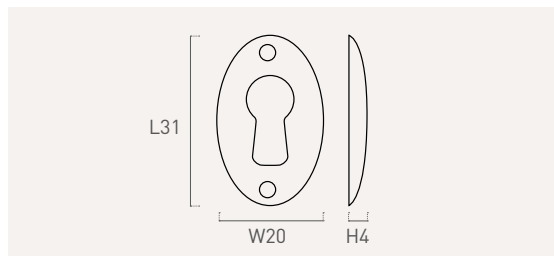

Color	Cod.	Ref.	L	W	H	
	<b>2393C</b>	239.30.73	<b>31</b>	20	4	12
	<b>2393P</b>	239.30.80	<b>31</b>	20	4	12

228

zamak

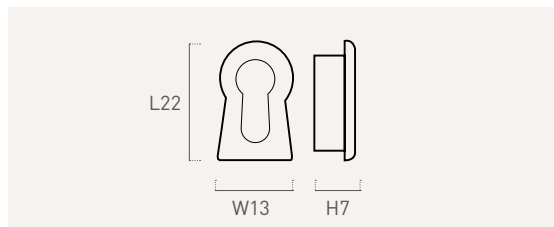

Color	Cod.	Ref.	L	W	H	
	<b>228C1</b>	228.22.74	<b>22</b>	13	7	12



223

zamak

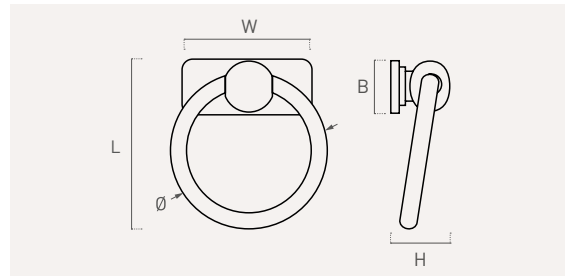

Color	Cod.	Ref.	Ø	L	W	H	B	📦
77	<b>2230N</b>	223.50.77	46	54	45	19	21	12



250

zamak

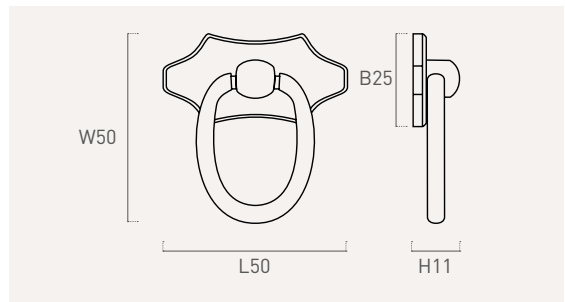

Color	Cod.	Ref.	L	W	H	B	📦
70	<b>2500C</b>	250.50.70	50	50	11	25	12
77	<b>2500N</b>	250.50.77	50	50	11	25	12



251

zamak

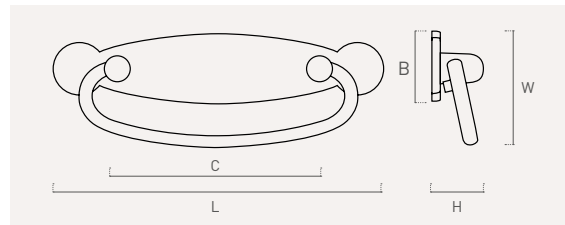

Color	Cod.	Ref.	C	L	W	H	B	📦
70	<b>2510C</b>	251.105.70	64	105	37	13	23	12
77	<b>2510N</b>	251.105.77	64	105	37	13	23	12



252

zamak

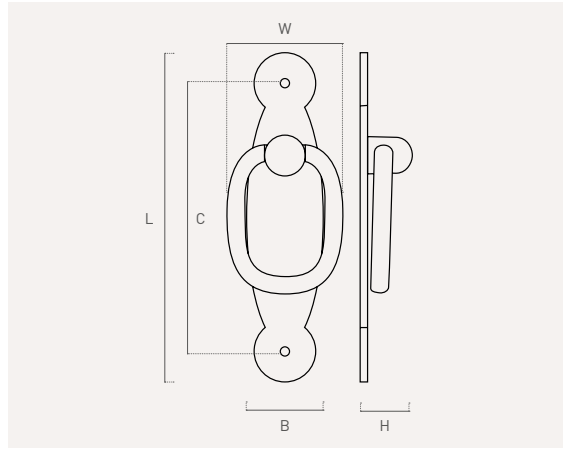

Color	Cod.	Ref.	C	L	W	H	B	☰
70	<b>2520C</b>	252.90.70	73	90	32	14	21	12
77	<b>2520N</b>	252.90.77	73	90	32	14	21	12



253

zamak

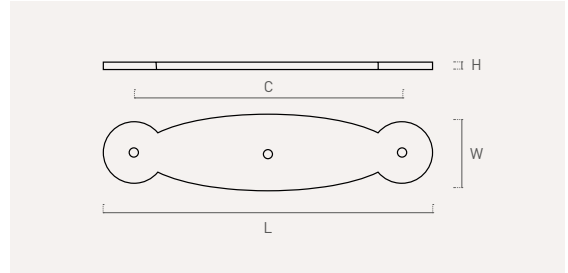

Color	Cod.	Ref.	C	L	W	H	☰
70	<b>2530C</b>	253.90.70	73	90	21	2	12
77	<b>2530N</b>	253.90.77	73	90	21	2	12

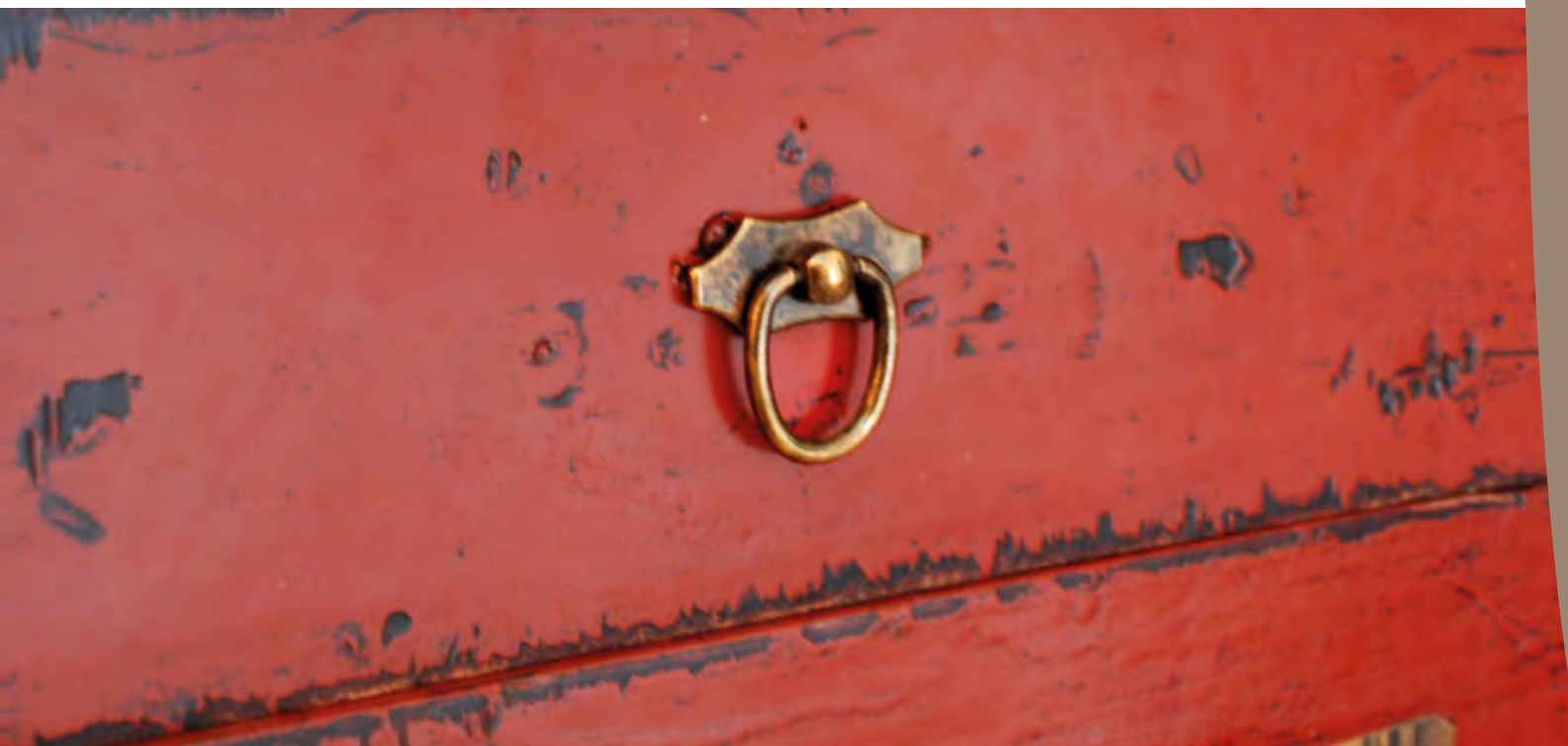





\*anilla redonda  
round ring

## 270

zamak

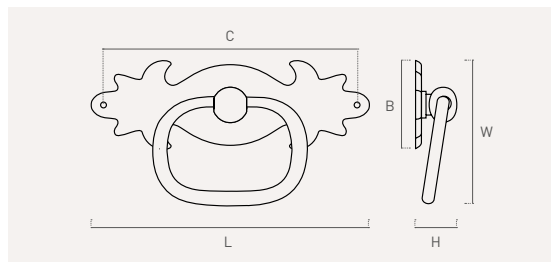

Color	Cod.	Ref.	L	W	C	H	B	
	<b>2700C</b>	270.115.70	115	53	103	14	34	12
	<b>2700N</b>	270.115.77	115	56	103	17	34	12
	<b>2700P</b>	270.115.80	115	53	103	14	34	12

## 271

zamak

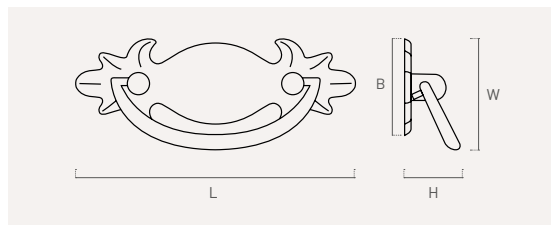

Color	Cod.	Ref.	L	W	H	B	
	<b>2710C</b>	271.115.70	115	45	13	34	12
	<b>2710N</b>	271.115.77	115	45	13	34	12
	<b>2710P</b>	271.115.80	115	45	13	34	12

## 272

zamak

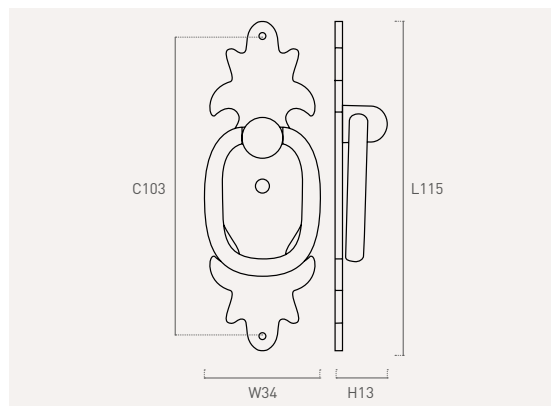



Color	Cod.	Ref.	L	W	H	C	
	<b>2720C</b>	272.115.70	115	34	13	103	12
	<b>2720N</b>	272.115.77	115	34	13	103	12
	<b>2720P</b>	272.115.80	115	34	13	103	12

273

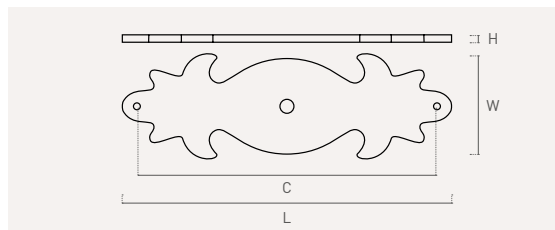
zamac



Color	Cod.	Ref.	L	W	H	C	
 70	<b>2730C</b>	273.115.70	115	34	2	103	12
 77	<b>2730N</b>	273.115.77	115	34	2	103	12
 80	<b>2730P</b>	273.115.80	115	34	2	103	12





02

zamak

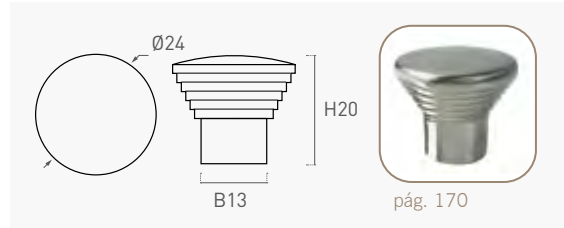

Color	Cod.	Ref.	Ø	H	B	
74	<b>02518</b>	02.23.74	<b>24</b>	<b>20</b>	<b>13</b>	<b>12</b>



21

zamak

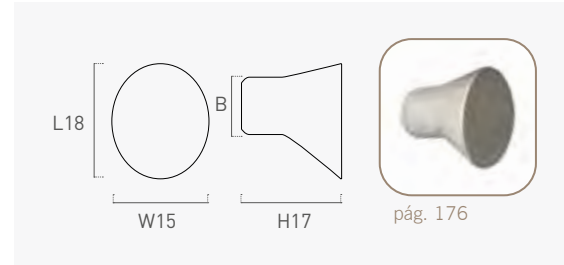

Color	Cod.	Ref.	L	W	H	B	
73	<b>21615</b>	21.18.73	<b>18</b>	<b>15</b>	<b>17</b>	<b>9</b>	<b>12</b>



36

zamak

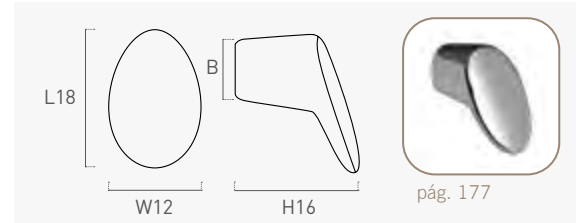

Color	Cod.	Ref.	L	W	H	B	
73	<b>36215</b>	36.20.73	<b>18</b>	<b>12</b>	<b>16</b>	<b>9</b>	<b>12</b>
96	<b>36203</b>	36.20.96	<b>18</b>	<b>12</b>	<b>16</b>	<b>9</b>	<b>12</b>





35

zamak

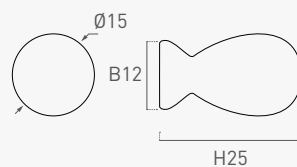

pág. 176

Color	Cod.	Ref.	Ø	H	B	📦
73	<b>35615</b>	35.15.73	15	25	12	12
74	<b>35618</b>	35.15.74	15	25	12	12
96	<b>35603</b>	35.15.96	15	25	12	12



25

zamak

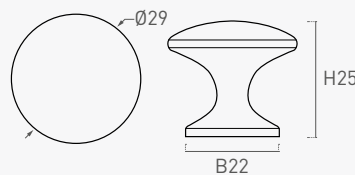

pág. 173

Color	Cod.	Ref.	Ø	H	B	📦
73	<b>25315</b>	25.30.73	29	25	22	12
96	<b>25303</b>	25.30.96	29	25	22	12



24

zamak

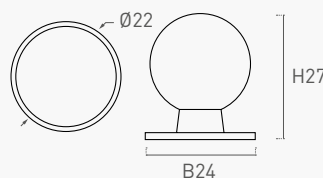

pág. 175

Color	Cod.	Ref.	Ø	H	B	📦
73	<b>24515</b>	24.23.73	22	27	24	12
96	<b>24503</b>	24.23.96	22	27	24	12

### 867

zamak

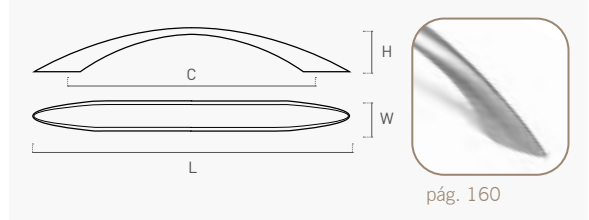

Color	Cod.	Ref.	C	L	W	H	☒
81	<b>867619</b>	867.96.81	<b>96</b>	124	11	23	12
	<b>867819</b>	867.128.81	<b>128</b>	163	14	24	12



### 50 S

zamak

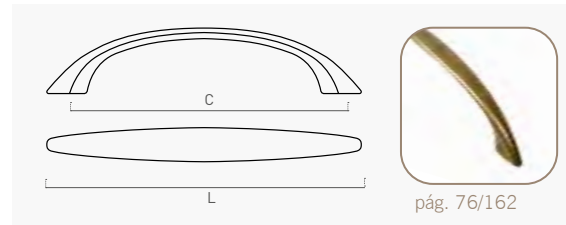

Color	Cod.	Ref.	C	L	W	H	☒
96	<b>50603</b>	50.96.96	<b>96</b>	126	13	25	12
	<b>50803</b>	50.128.96	<b>128</b>	160	15	28	12





868

zamak

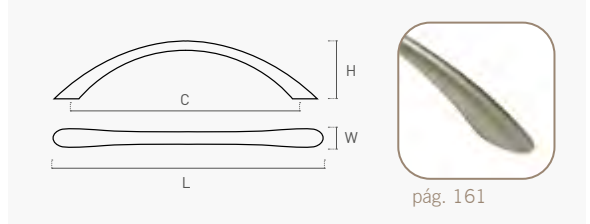



Color	Cod.	Ref.	C	L	W	H	
 81	<b>868619</b>	868.96.81	<b>96</b>	110	7	23,5	25
	<b>868819</b>	868.128.81	<b>128</b>	150	9	26	25

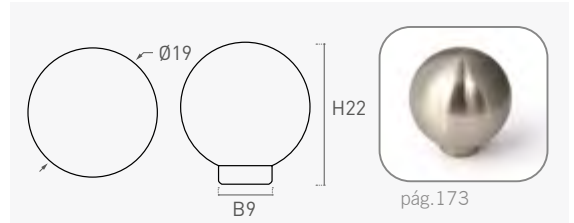

17

zamak



Color	Cod.	Ref.	Ø	H	B	
 81	<b>17219</b>	17.20.81	<b>19</b>	22	9	12



05

zamak

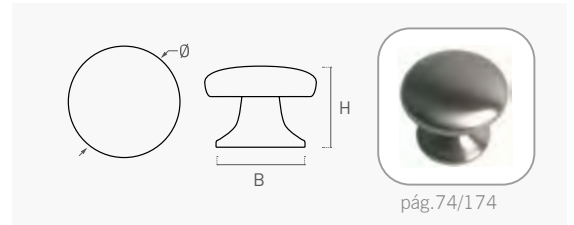

Color	Cod.	Ref.	Ø	H	B	
	<b>05703</b>	05.25.96	<b>25</b>	20	20	12
 96	<b>05303</b>	05.30.96	<b>30</b>	23	24	12
	<b>05803</b>	05.35.96	<b>35</b>	25	28	12





254

zamak

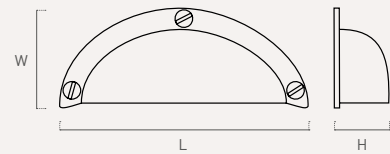

Color	Cod.	Ref.	C	L	W	H	
	<b>2542C</b>	254.32.70	32	78	30	17	12
	<b>2544C</b>	254.64.70	64	94	36	20	12



70

zamak

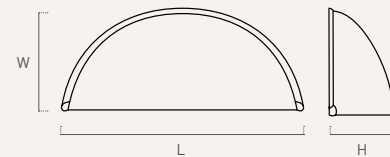

Color	Cod.	Ref.	C	L	W	H	
	<b>70431</b>	70.64.31	64	80	34	21	12
	<b>70418</b>	70.64.74	64	80	34	21	12
	<b>704PT</b>	70.64.80	64	80	34	21	12



72

zamak

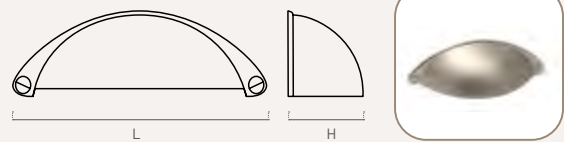

pág.163

Color	Cod.	Ref.	C	L	W	H	
	<b>72215</b>	72.32.73	32	75	27	20	12
	<b>72218</b>	72.32.74	32	75	27	20	12



71

zamak

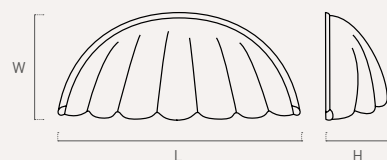

Color	Cod.	Ref.	C	L	W	H	
	<b>71231</b>	71.32.31	32	58	29	21	12
	<b>71431</b>	71.64.31	64	78	29	23	12
	<b>71206</b>	71.32.72	32	58	29	21	12
	<b>71406</b>	71.64.72	64	78	29	23	12
	<b>71218</b>	71.32.74	32	58	29	21	12
	<b>71418</b>	71.64.74	64	78	29	23	12



73

zamak

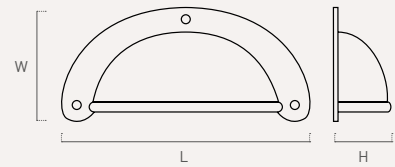

Color	Cod.	Ref.	L	W	H	Icon
73	<b>73218</b>	73.93.74	93	40	21	12



885

zamak

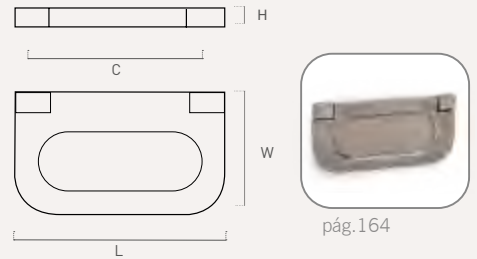

Color	Cod.	Ref.	C	L	W	H	Icon
74	<b>885418</b>	885.64.74	64	75	35	5	12



74

zamak

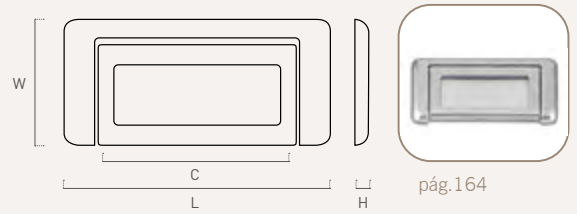

Color	Cod.	Ref.	L	W	H	C	Icon
81	<b>74219</b>	74.82.81	82	38	5	55	12



7334LT



7334CB



7334BR

7334

abs abs

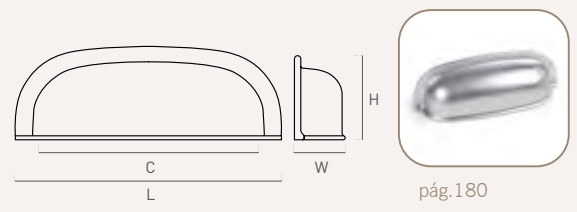

Color	Cod.	Ref.	C	L	W	H	Icon
31	<b>7334LT</b>	334.64.31	64	88	21	31	12
70	<b>7334BR</b>	7334.64.70	64	88	21	31	12
100	<b>7334CB</b>	7334.64.100	64	88	21	31	12



500

latón brass

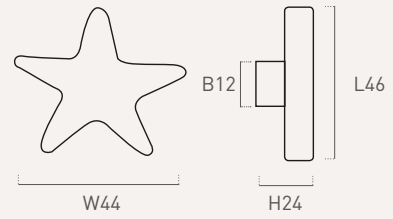

Color	Cod.	Ref.	L	W	H	B	
81	500L1	500.47.81	46	44	24	12	12



501

latón brass

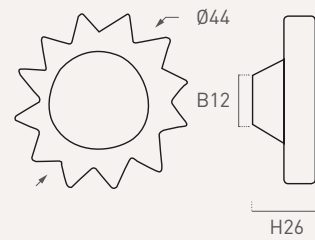

Color	Cod.	Ref.	Ø	H	B	
81	501L1	504.46.81	44	26	12	12



502

latón brass

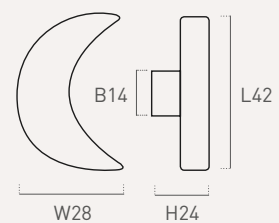

Color	Cod.	Ref.	L	W	H	B	
81	502L1	502.42.81	42	28	24	14	12





503

latón brass

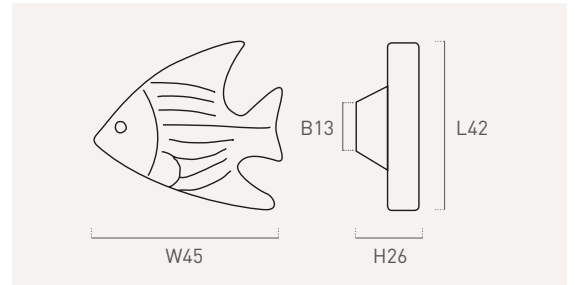

Color	Cod.	Ref.	L	W	H	B	☰
70	503L2	503.47.70	42	45	26	13	12



504

latón brass

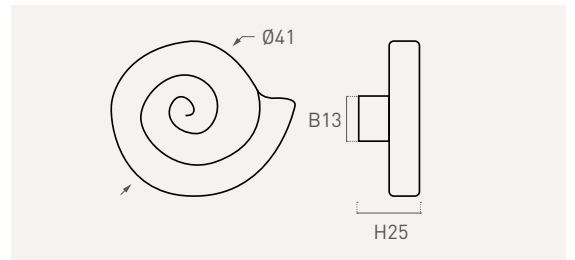

Color	Cod.	Ref.	Ø	H	B	☰
70	504L2	504.41.70	41	25	13	12



505

latón brass

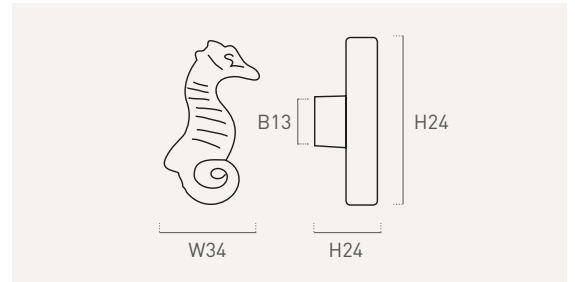

Color	Cod.	Ref.	L	W	H	B	☰
70	505L2	505.57.70	57	34	24	13	12



506

latón brass

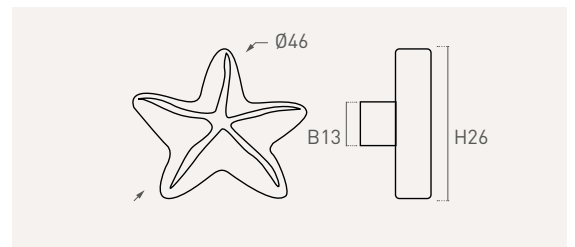

Color	Cod.	Ref.	Ø	H	B	☰
70	506L2	506.46.70	46	26	13	12









390

zamak **porcelana** porcelain

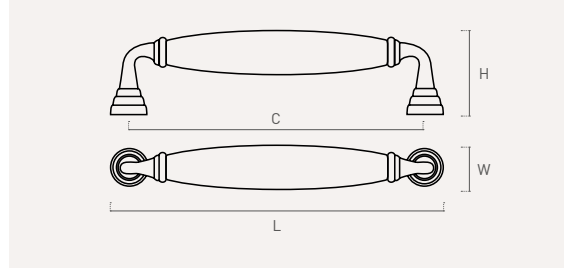

Color	Cod.	Ref.	C	L	W	H	
	<b>390B6</b>	390.96.24	<b>96</b>	112	20	35	12
	<b>390B8</b>	390.128.24	<b>128</b>	144	20	35	12



391

zamak **porcelana** porcelain

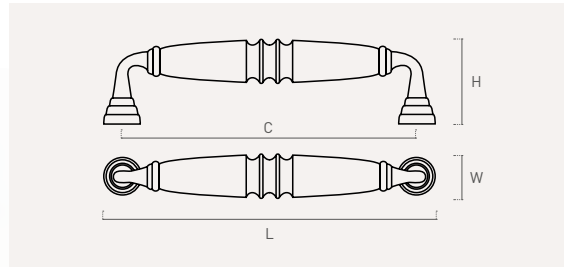

Color	Cod.	Ref.	C	L	W	H	
	<b>391B6</b>	391.96.24	<b>96</b>	112	16	33	12
	<b>391B8</b>	391.128.24	<b>128</b>	144	18	33	12



392

zamak **porcelana** porcelain

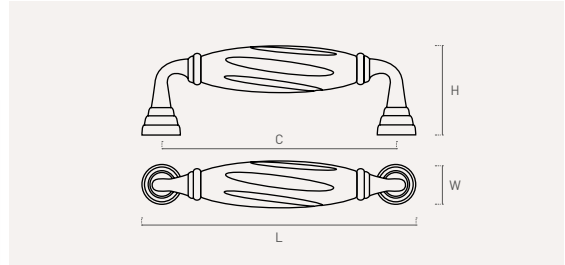



Color	Cod.	Ref.	C	L	W	H	
	<b>392B6</b>	392.96.24	<b>96</b>	112	19	35	12
	<b>392B8</b>	392.128.24	<b>128</b>	144	20	35	12

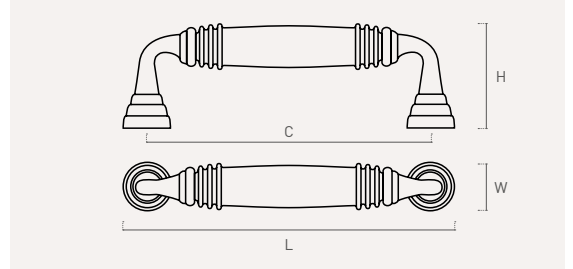

393

zamak **porcelana** porcelain



Color	Cod.	Ref.	C	L	W	H	
	<b>393B6</b>	393.96.24	<b>96</b>	112	16	32	12
	<b>393B8</b>	393.128.24	<b>128</b>	144	18	33	12





332

zamak **porcelana** porcelain

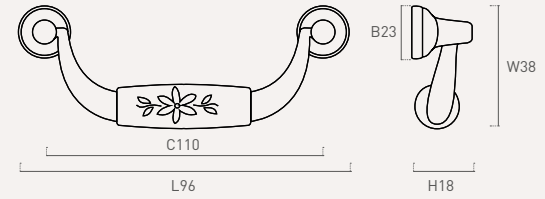

Color	Cod.	Ref.	C	L	W	B	H	
82	332H3	332.96.82	96	110	38	23	18	12
83	332H4	332.96.83	96	110	38	23	18	12



333

zamak **porcelana** porcelain

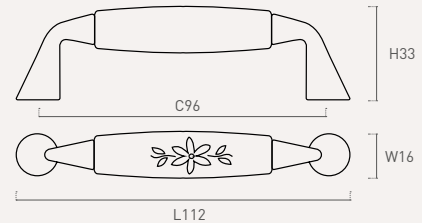

Color	Cod.	Ref.	C	L	W	H	
82	333H3	333.96.82	96	112	16	33	12
83	333H4	333.96.83	96	112	16	33	12



334

zamak **porcelana** porcelain

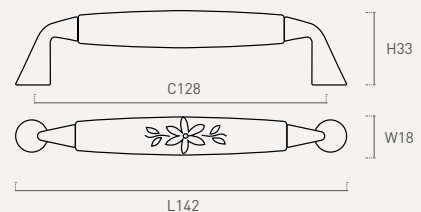

Color	Cod.	Ref.	C	L	W	H	
82	334H3	334.128.82	128	142	18	33	12
83	334H4	334.128.83	128	142	18	33	12





330

zamak **porcelana** porcelain

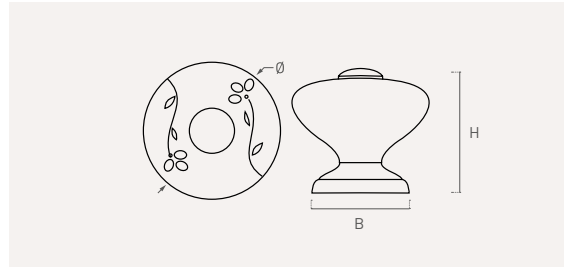

Color	Cod.	Ref.	Ø	H	B	
	<b>330H1</b>	330.35.24	<b>33</b>	30	25	12
	<b>330H3</b>	330.35.82	<b>33</b>	30	25	12
	<b>330H4</b>	330.35.83	<b>33</b>	30	25	12

331

zamak **porcelana** porcelain

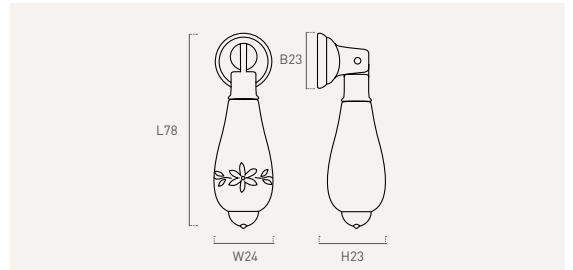

Color	Cod.	Ref.	L	W	B	H	
	<b>331H3</b>	331.65.82	<b>78</b>	24	23	23	12
	<b>331H4</b>	331.65.83	<b>78</b>	24	23	23	12

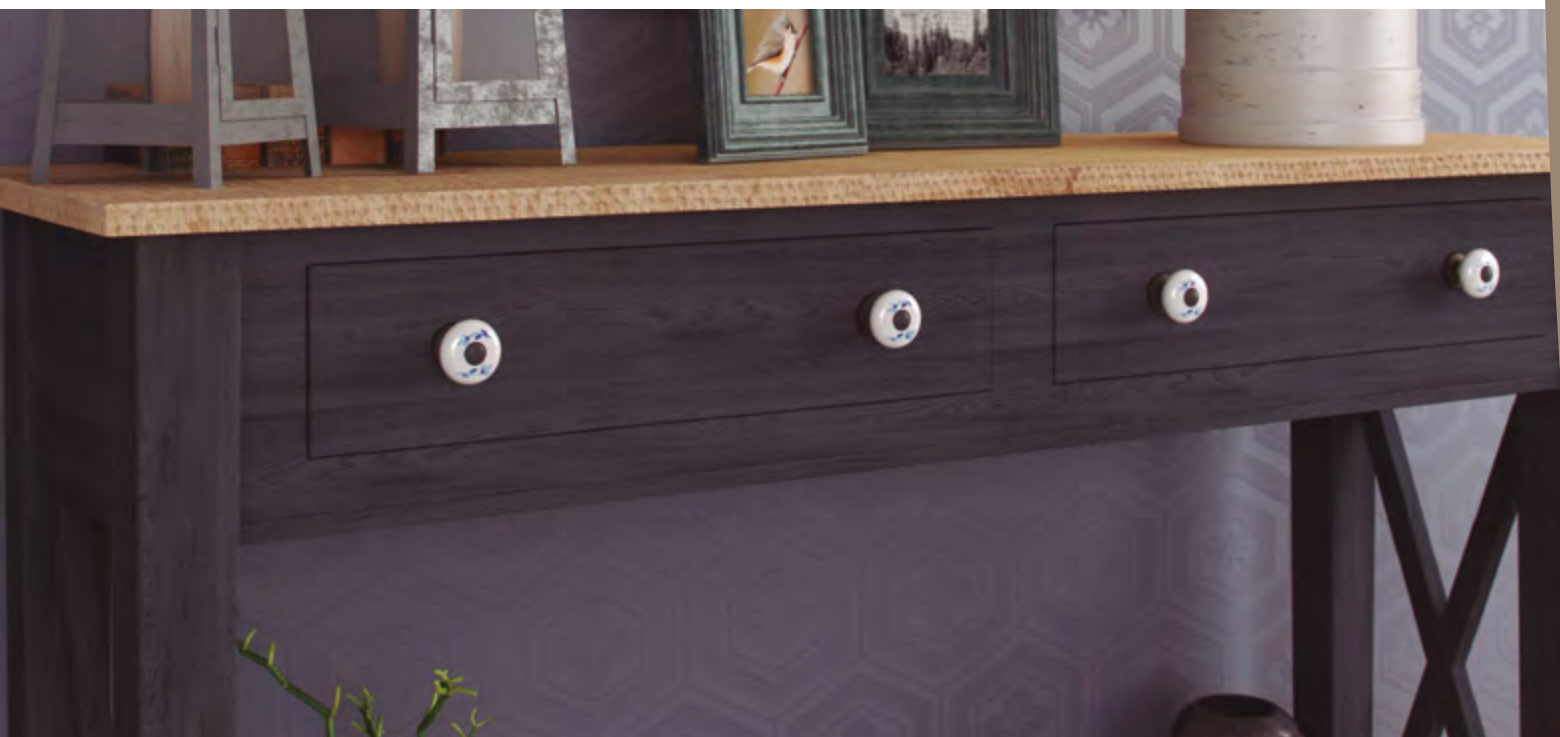

48

zamak porcelana porcelain

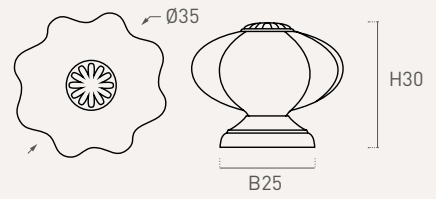

Color	Cod.	Ref.	Ø	H	B	☐
01	483J3	48.33.01	35	30	25	12
02	483J1	48.33.02	35	30	25	12
03	483J0	48.33.03	35	30	25	12
05	483J5	48.33.05	35	30	25	12
12	483J2	48.33.12	35	30	25	12
24	483H1	48.33.24	35	30	25	12

Surtido/ Assortment

483SU	48.33.35	33	30	25
-------	----------	----	----	----

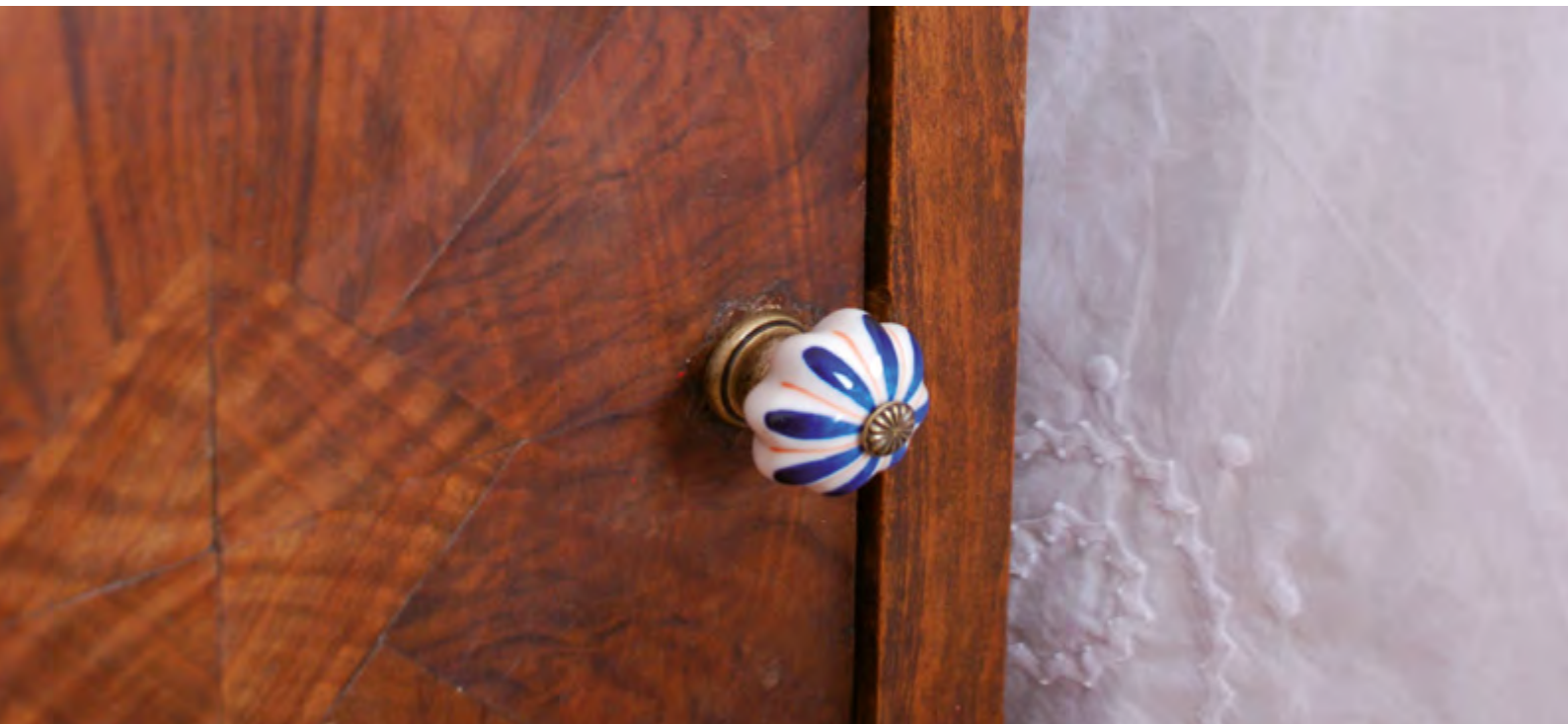



370A1



370A3



370AA1



370AA3

## 370

porcelana porcelain

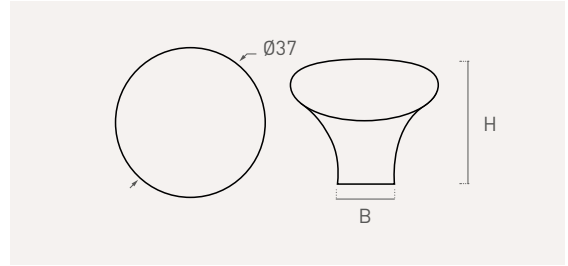

	Cod.	Ref.	Ø	H	B	📦
sin BASE without BASE	<b>370A1</b>	370A.32.24	<b>37</b>	26	20	12
	<b>370A3</b>	370C.32.34	<b>37</b>	26	20	12
con BASE with BASE	<b>370AA1</b>	370AA.32.24	<b>37</b>	31	15	12
	<b>370AA3</b>	370CC.32.34	<b>37</b>	31	15	12

## 371

zamac porcelana porcelain

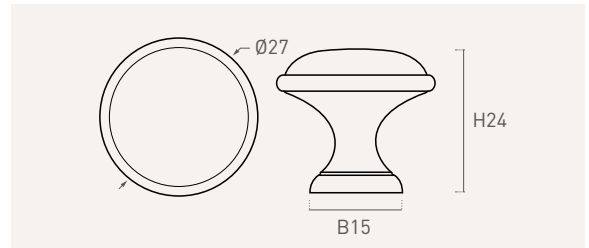

	Cod.	Ref.	Ø	H	B	📦
	<b>371A1</b>	371A.29.24	<b>27</b>	24	15	12
	<b>371A3</b>	371C.29.34	<b>27</b>	24	15	12



371A1



371A3





45

porcelana porcelain

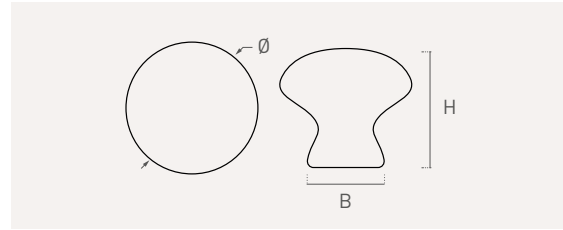

Color	Cod.	Ref.	Ø	H	B	
	<b>457M0</b>	45.29.03	<b>29</b>	25	15	12
	<b>453M0</b>	45.33.03	<b>33</b>	28	17	12
	<b>458M0</b>	45.39.03	<b>38</b>	29	19	12
	<b>457H1</b>	45.29.24	<b>29</b>	25	15	12
	<b>453H1</b>	45.33.24	<b>33</b>	28	17	12
	<b>458H1</b>	45.39.24	<b>38</b>	29	19	12



45R

porcelana porcelain

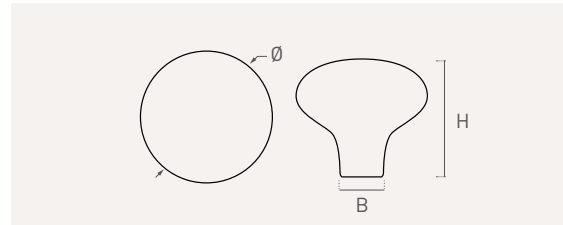

Color	Cod.	Ref.	Ø	H	B	
	<b>453R0</b>	45R.31.03	<b>31</b>	22	15	12
	<b>458R0</b>	45R.37.03	<b>37</b>	28	18	12
	<b>453R1</b>	45R.31.21	<b>31</b>	22	15	12
	<b>458R1</b>	45R.37.21	<b>37</b>	28	18	12



46

porcelana porcelain

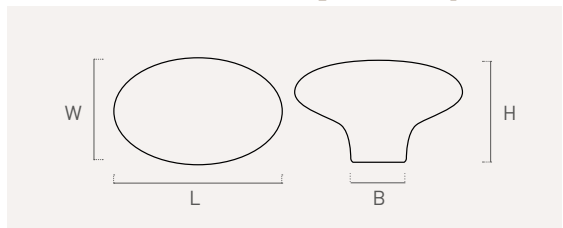

Color	Cod.	Ref.	L	W	H	B	
	<b>467P0</b>	46.32.03	<b>32</b>	24	21	16	12
	<b>463P0</b>	46.39.03	<b>41</b>	30	25	17	12
	<b>468P0</b>	46.48.03	<b>48</b>	36	30	17	12

47

porcelana porcelain

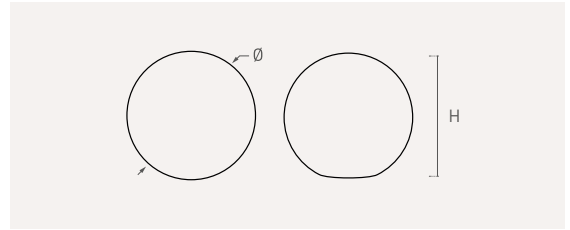

Color	Cod.	Ref.	Ø	H	12
	<b>477MO</b>	47.25.03	<b>26</b>	25	12
03	<b>473MO</b>	47.30.03	<b>32</b>	30	12
	<b>478MO</b>	47.35.03	<b>35</b>	33	12

1080

porcelana porcelain

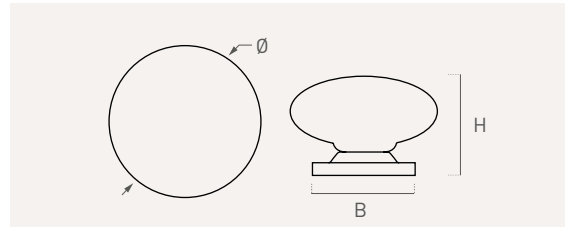

Color	Cod.	Ref.	Ø	H	B	12
71	<b>1080BL</b>	1080.38.71	<b>38</b>	25	30	12











1005

swarovski

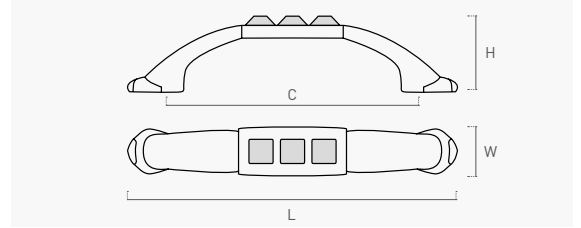

Color Cod. Ref. C L W H

**10056SW** 1005.96.80 **96** 131 19 29 4



1006

swarovski

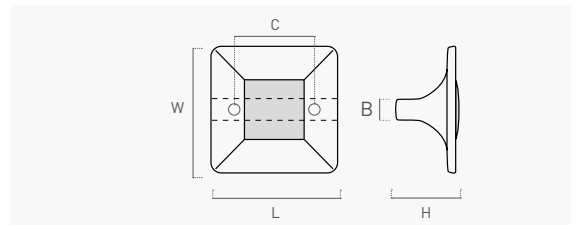

Color Cod. Ref. C L W B H

**10069SW** 1006.45.80 **32** 45 45 40x8 23 4

∅ H B



1007

swarovski

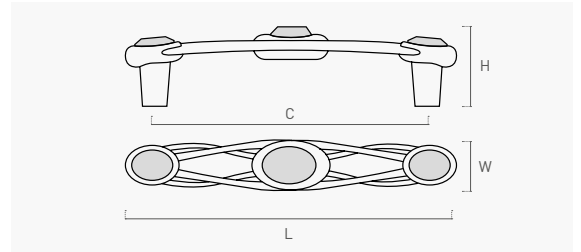

Color Cod. Ref. C L W H

**10076SW** 1007.96.80 **96** 116 18 28 4





1004

swarovski

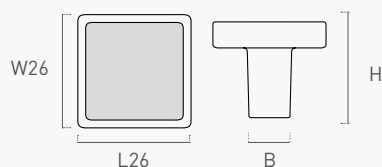

Color Cod. Ref. L W H B

80 **10047SW** 1004.26.80 **26** 26 24 10x10 4



1008

swarovski

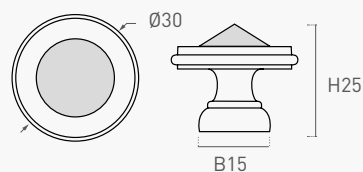

Color Cod. Ref. Ø H B

80 **10083SW** 1008.30.80 **30** 25 15 4



1009

swarovski

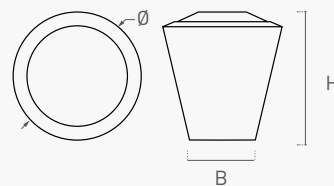

Color Cod. Ref. Ø H B

93 **10092SW** 1009.16.93 **16** 26 8 4

**10097SW** 1009.24.93 **24** 31 11 4

**10098SW** 1009.35.93 **35** 37 20 4



1031

zamak



Color Cod. Ref. C L W H B

**1031CR4** 1031.38.93 - 38 38 21 38x16 12

93 **1031CR3** 1031.32.93 **32** 50 50 24 50x22 12





**1031CR2** 1031.64.93 **64** 75 75 25 75x31 12



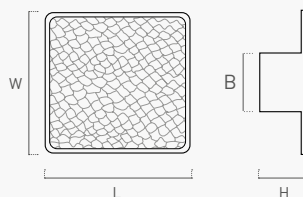





### 1027 zamak **piel sintética** synthetic leather

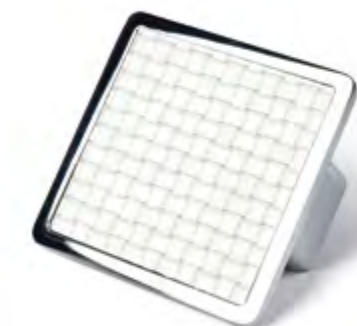
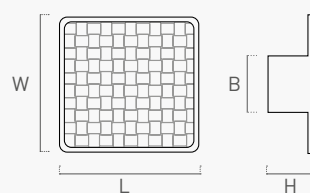

Color	Cod.	Ref.	C	L	W	H	B	
 03	<b>10272BL</b>	1027.32.03	<b>32</b>	50	50	24	50x22	12
	<b>10278BL</b>	1027.38.03	-	38	38	21	38x16	12
 05	<b>10272MA</b>	1027.32.05	<b>32</b>	50	50	24	50x22	12
	<b>10278MA</b>	1027.38.05	-	38	38	21	38x16	12
 08	<b>10272NE</b>	1027.32.08	<b>32</b>	50	50	24	50x22	12
	<b>10278NE</b>	1027.38.08	-	38	38	21	38x16	12
 21	<b>10272BE</b>	1027.32.21	<b>32</b>	50	50	24	50x22	12
	<b>10278BE</b>	1027.38.21	-	38	38	21	38x16	12

### 1028 zamak **piel sintética** synthetic leather



Color	Cod.	Ref.	C	L	W	H	B	
 03	<b>10282BL</b>	1028.32.03	<b>32</b>	50	50	24	50x22	12
	<b>10288BL</b>	1028.38.03	-	38	38	21	38x16	12
 08	<b>10282NE</b>	1028.32.08	<b>32</b>	50	50	24	50x22	12
	<b>10288NE</b>	1028.38.08	-	38	38	21	38x16	12



565

crystal

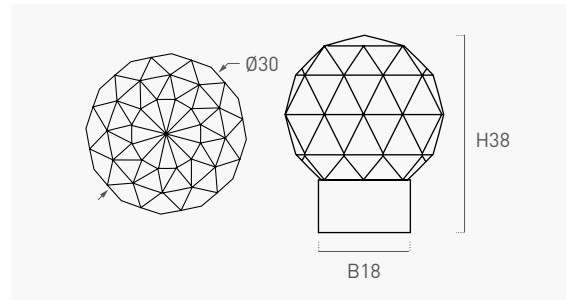

Color  93  93  
Cod. **565CR** Ref. 565.30.41  Ø  H  B  12



566

crystal

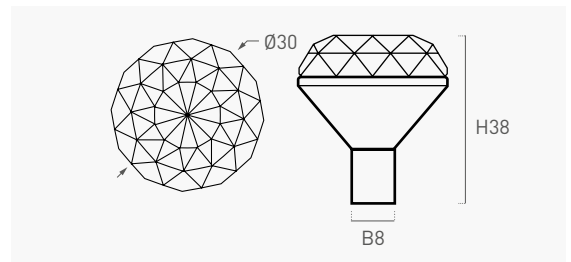

Color  93  93  
Cod. **566CR** Ref. 566.25.41  Ø  H  B  12



567

crystal

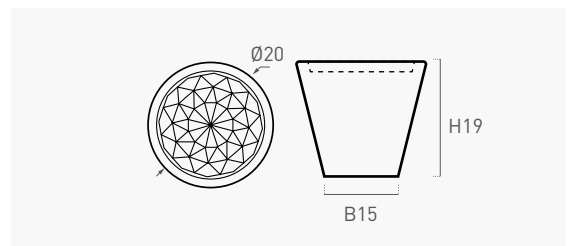

Color  93  93  
Cod. **567CR** Ref. 567.20.41  Ø  H  B  12









## 875

zamak

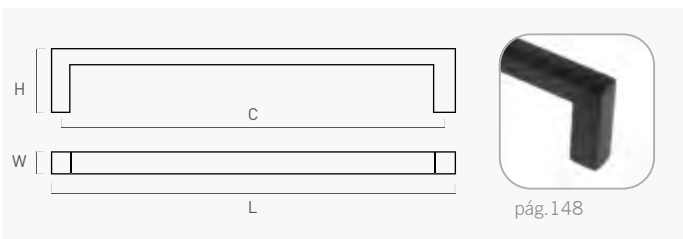

Color	Cod.	Ref.	C	L	W	H	
<input type="radio"/>	<b>875001</b>	875.160.93	<b>160</b>	168	8	27	12
<input type="radio"/>	<b>875201</b>	875.192.93	<b>192</b>	200	8	27	12
<input type="radio"/>	<b>875017</b>	875.160.94	<b>160</b>	168	8	27	12
<input type="radio"/>	<b>875217</b>	875.192.94	<b>192</b>	200	8	27	12
<input type="radio"/>	<b>875625</b>	875.96.101	<b>96</b>	105	8	26	12
<input type="radio"/>	<b>875825</b>	875.128.101	<b>128</b>	136	8	27	12
<input type="radio"/>	<b>875025</b>	875.160.101	<b>160</b>	168	8	27	12
<input type="radio"/>	<b>875225</b>	875.192.101	<b>192</b>	200	8	27	12
<input type="radio"/>	<b>875325</b>	875.320.101	<b>320</b>	328	8	27	12

## 893

zamak

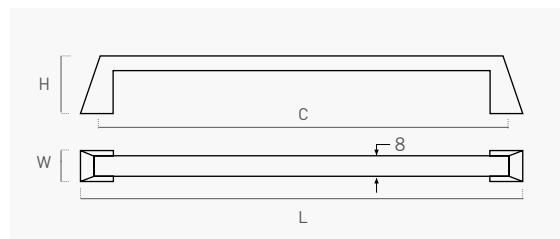

Color	Cod.	Ref.	C	L	W	H	
<input type="radio"/>	<b>893017</b>	893.160.94	<b>160</b>	172	12	22	12
<input type="radio"/>	<b>893625</b>	893.96.101	<b>96</b>	108	11	20	12
<input type="radio"/>	<b>893825</b>	893.128.101	<b>128</b>	140	12	22	12
<input type="radio"/>	<b>893025</b>	893.160.101	<b>160</b>	172	12	22	12



## 875

zamak

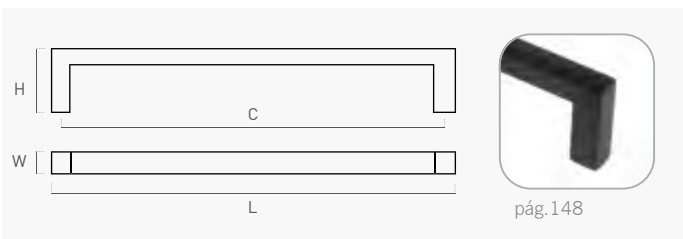

Color	Cod.	Ref.	C	L	W	H	
<input type="radio"/>	<b>875001</b>	875.160.93	<b>160</b>	168	8	27	12
<input type="radio"/>	<b>875201</b>	875.192.93	<b>192</b>	200	8	27	12
<input type="radio"/>	<b>875017</b>	875.160.94	<b>160</b>	168	8	27	12
<input type="radio"/>	<b>875217</b>	875.192.94	<b>192</b>	200	8	27	12
<input type="radio"/>	<b>875625</b>	875.96.101	<b>96</b>	105	8	26	12
<input type="radio"/>	<b>875825</b>	875.128.101	<b>128</b>	136	8	27	12
<input type="radio"/>	<b>875025</b>	875.160.101	<b>160</b>	168	8	27	12
<input type="radio"/>	<b>875225</b>	875.192.101	<b>192</b>	200	8	27	12
<input type="radio"/>	<b>875325</b>	875.320.101	<b>320</b>	328	8	27	12

## 893

zamak

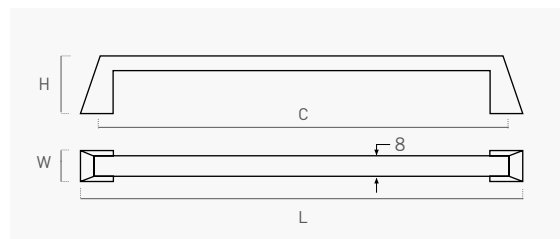

Color	Cod.	Ref.	C	L	W	H	
<input type="radio"/>	<b>893017</b>	893.160.94	<b>160</b>	172	12	22	12
<input type="radio"/>	<b>893625</b>	893.96.101	<b>96</b>	108	11	20	12
<input type="radio"/>	<b>893825</b>	893.128.101	<b>128</b>	140	12	22	12
<input type="radio"/>	<b>893025</b>	893.160.101	<b>160</b>	172	12	22	12





874

zamak

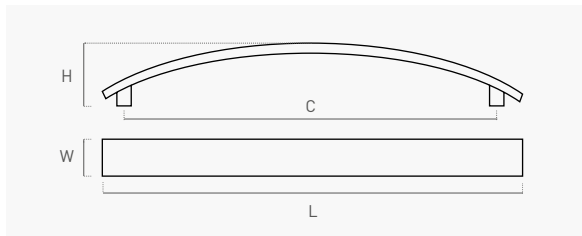

Color	Cod.	Ref.	C	L	W	H	
	<b>874625</b>	874.96.101	<b>96</b>	116	15	21	12
	<b>874825</b>	874.128.101	<b>128</b>	148	15	25	12
<input checked="" type="checkbox"/> 101	<b>874025</b>	874.160.101	<b>160</b>	178	15	25	12
	<b>874225</b>	874.192.101	<b>192</b>	204	15	25	12
	<b>874425</b>	874.224.101	<b>224</b>	244	15	25	12

894

zamak

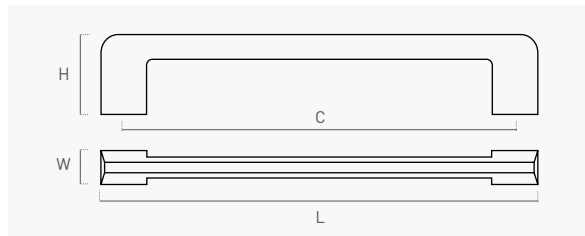

Color	Cod.	Ref.	C	L	W	H	
<input checked="" type="checkbox"/> 93	<b>894001</b>	894.160.93	<b>160</b>	174	15	32	12
<input checked="" type="checkbox"/> 94	<b>894017</b>	894.160.94	<b>160</b>	174	15	32	12
	<b>894825</b>	894.128.101	<b>128</b>	142	15	32	12
<input checked="" type="checkbox"/> 101	<b>894025</b>	894.160.101	<b>160</b>	174	15	32	12
	<b>894425</b>	894.224.101	<b>224</b>	238	15	32	12



889

zamak

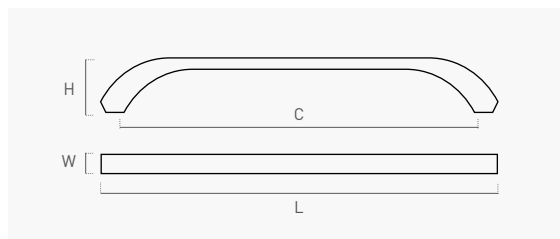

Color	Cod.	Ref.	C	L	W	H	
101	889025	889.160.101	160	174	12	22	12

877

zamak

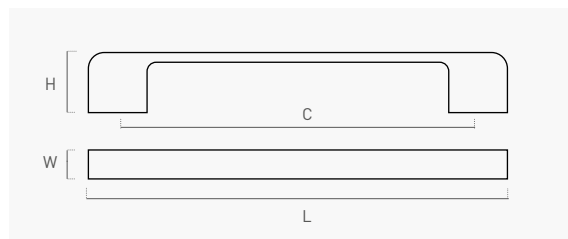

Color	Cod.	Ref.	C	L	W	H	
94	877017	877.160.94	160	170	11	25	12
	877217	877.192.94	192	200	11	25	12
	877025	877.160.101	160	170	11	25	12
101	877225	877.192.101	192	200	11	25	12
	877425	877.224.101	224	234	11	25	12



886

zamak

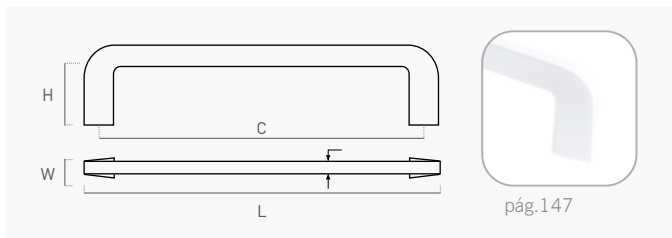

pág.147

Color	Cod.	Ref.	C	L	W	H	
93	<b>886001</b>	886.160.93	<b>160</b>	175	8	32	12
94	<b>886017</b>	886.160.94	<b>160</b>	175	8	32	12
	<b>886625</b>	886.96.101	<b>96</b>	110	8	32	12
	<b>886825</b>	886.128.101	<b>128</b>	142	8	32	12
101	<b>886025</b>	886.160.101	<b>160</b>	174	8	32	12
	<b>886225</b>	886.192.101	<b>192</b>	206	8	32	12
	<b>886525</b>	886.256.101	<b>256</b>	270	8	32	12

887

zamak

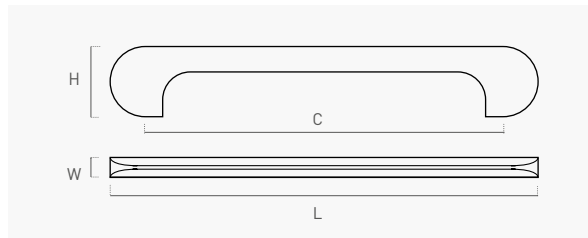

Color	Cod.	Ref.	C	L	W	H	
101	<b>887025</b>	887.160.101	<b>160</b>	195	9	30	12





876

zamak

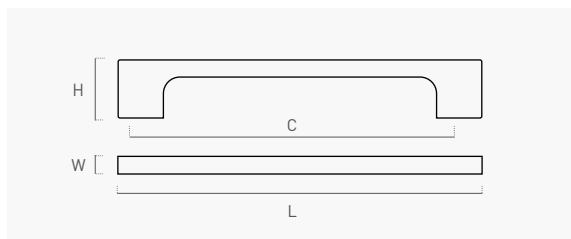

Color	Cod.	Ref.	C	L	W	H	
93	876001	876.160.93	160	180	7	25	12
	876017	876.160.94	160	180	7	25	12
94	876217	876.192.94	192	212	7	25	12
	876825	876.128.101	128	148	7	25	12
	876025	876.160.101	160	180	7	25	12
101	876225	876.192.101	192	212	7	25	12
	876425	876.224.101	224	244	7	25	12

891

zamak

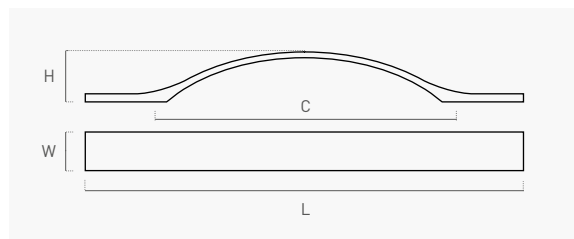

Color	Cod.	Ref.	C	L	W	H	
93	891801	891.128.93	128	193	17	22	12
101	891825	891.128.101	128	193	17	22	12



888

zamak

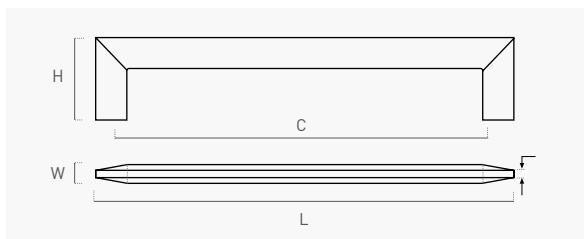

Color	Cod.	Ref.	C	L	W	H	
93	888001	888.160.93	160	180	8	34	12
101	888025	888.160.101	160	180	8	34	12

890

zamak

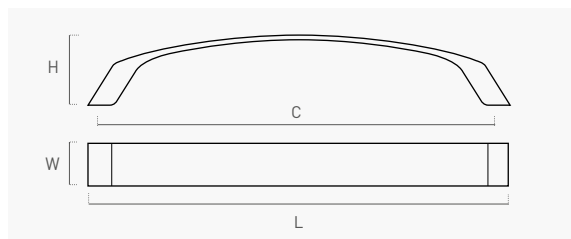

Color	Cod.	Ref.	C	L	W	H	
	890017	890.160.94	160	174	22	25	12
94	890217	890.192.94	192	206	22	25	12
	890825	890.128.101	128	142	22	25	12
101	890025	890.160.101	160	174	22	25	12
	890225	890.192.101	192	206	22	29	12



892

zamak

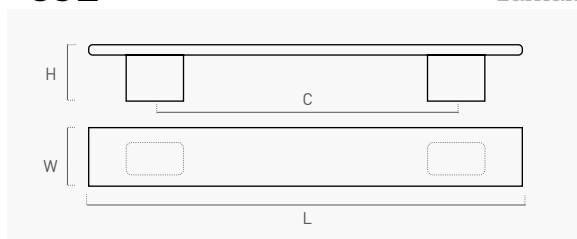

Color	Cod.	Ref.	C	L	W	H	
101	892025	892.160.101	160	200	27	26	12

801

zamak

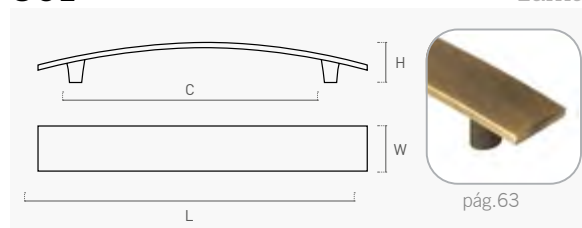

Color	Cod.	Ref.	C	L	W	H	B	
94	801017	801.160.94	160	198	26	21	12x8	12
95	801016	801.160.95	160	198	26	21	12x8	12





895

zamak

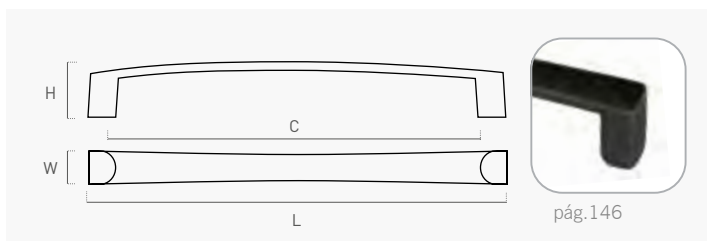

pág.146

Color	Cod.	Ref.	C	L	W	H	
	<b>895630</b>	895.96.75	<b>96</b>	108	14	22	12
	<b>895830</b>	895.128.75	<b>128</b>	140	14	22	12
	<b>895030</b>	895.160.75	<b>160</b>	172	14	22	12

896

zamak

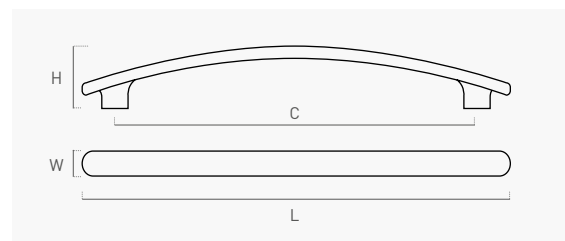

Color	Cod.	Ref.	C	L	W	H	
	<b>896830</b>	896.128.75	<b>128</b>	155	9	22	12
	<b>896030</b>	896.160.75	<b>160</b>	190	10	23	12
	<b>896230</b>	896.192.75	<b>192</b>	222	10	25	12



895

zamak

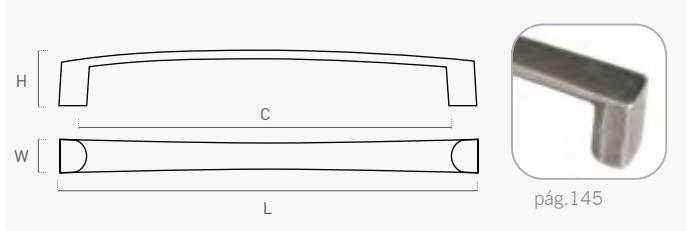

Color	Cod.	Ref.	C	L	W	H	
08	895022	895.160.08	160	172	14	22	12





886

zamac

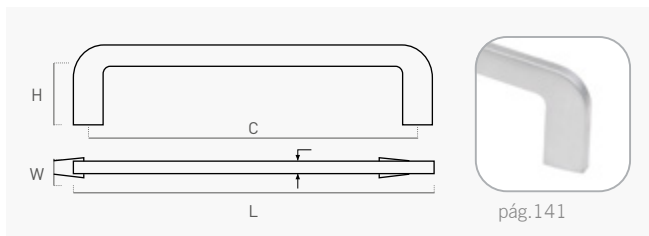

Color	Cod.	Ref.	C	L	W	H	
03	<b>886021</b>	886.160.03	<b>160</b>	175	8	32	12
	<b>886221</b>	886.192.03	<b>192</b>	206	8	32	12
	<b>886022</b>	886.160.08	<b>160</b>	175	8	32	12
08	<b>886222</b>	886.192.08	<b>192</b>	206	8	32	12





## 875

zamak

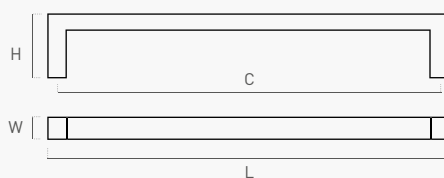

pág.138

Color	Cod.	Ref.	C	L	W	H	
	<b>875021</b>	875.160.03	<b>160</b>	168	8	27	12
	<b>875221</b>	875.192.03	<b>192</b>	200	8	27	12
	<b>875022</b>	875.160.08	<b>160</b>	168	8	27	12
	<b>875222</b>	875.192.08	<b>192</b>	200	8	27	12



## 857

aluminio aluminium

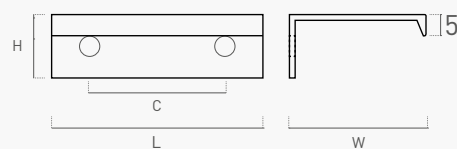

pág.154



Color	Cod.	Ref.	C	L	W	H	
	<b>857521</b>	857.32.03	<b>32</b>	50	32	15	12
	<b>857508</b>	857.32.08	<b>32</b>	50	32	15	12
	<b>857408</b>	857.64.08	<b>64</b>	88	32	15	12
	<b>857608</b>	857.96.08	<b>96</b>	116	32	15	12



nesu® Contemporary  
BLACK&WHITE

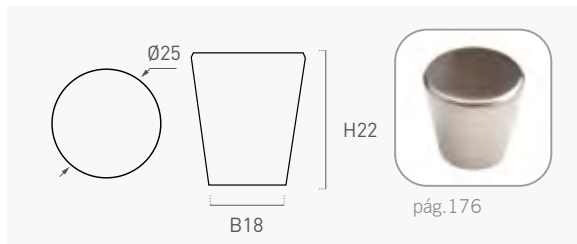

34

aluminium





Color	Cod.	Ref.	Ø	H	B	
 03	<b>34721</b>	34.25.03	<b>25</b>	22	18	12
 08	<b>34722</b>	34.25.08	<b>25</b>	22	18	12

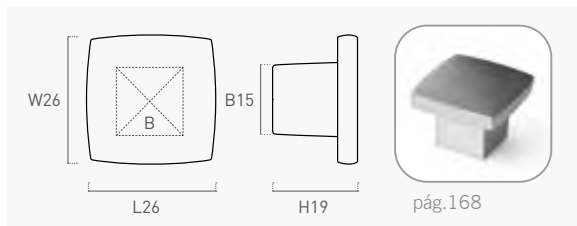

28

zamac



Color	Cod.	Ref.	L	W	H	B	
 03	<b>28721</b>	v.03	<b>26</b>	26	19	15x15	12
 08	<b>28722</b>	28.25.08	<b>26</b>	26	19	15x15	12





## 65G

acero inox stainless steel

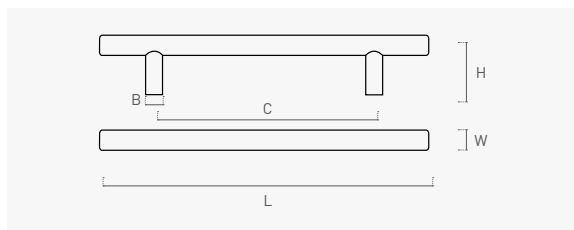

Color	Cod.	Ref.	C	L	W	H	B	
<input type="radio"/> 101	<b>65001G</b>	65G.96.101	<b>96</b>	146	10	32	8	12
<input type="radio"/> 101	<b>65002G</b>	65G.128.101	<b>128</b>	178	10	32	8	12
<input type="radio"/> 101	<b>65003G</b>	65G.160.101	<b>160</b>	210	10	32	8	12

AISI 304  95



## 65

Acero inox hueco hollow stainless steel

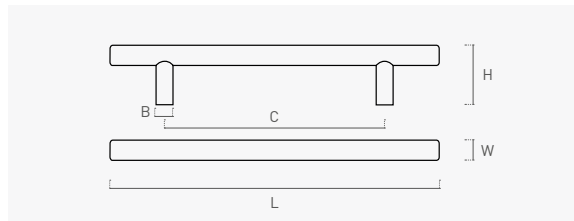

Color	Cod.	Ref.	C	L	W	H	B	
<input type="radio"/> 95	<b>65001</b>	65.96.95	<b>96</b>	146	12	36	8	12
<input type="radio"/> 95	<b>65002</b>	65.128.95	<b>128</b>	178	12	36	8	12
<input type="radio"/> 95	<b>65003</b>	65.160.95	<b>160</b>	210	12	36	8	12
<input type="radio"/> 95	<b>65004</b>	65.192.95	<b>192</b>	242	12	36	8	12
<input type="radio"/> 95	<b>65005</b>	65.224.95	<b>224</b>	274	12	36	8	12
<input type="radio"/> 95	<b>65006</b>	65.242.95	<b>242</b>	292	12	36	8	12
<input type="radio"/> 95	<b>65007</b>	65.292.95	<b>292</b>	342	12	36	8	5
<input type="radio"/> 95	<b>65008</b>	65.342.95	<b>342</b>	392	12	36	8	5
<input type="radio"/> 95	<b>65009</b>	65.392.95	<b>392</b>	442	12	36	8	5
<input type="radio"/> 95	<b>65010</b>	65.492.95	<b>492</b>	542	12	36	8	5
<input type="radio"/> 95	<b>65011</b>	65.592.95	<b>592</b>	642	12	36	8	5
<input type="radio"/> 95	<b>65012</b>	65.692.95	<b>692</b>	742	12	36	8	5
<input type="radio"/> 95	<b>65013</b>	65.792.95	<b>792</b>	842	12	36	8	5
<input type="radio"/> 08	<b>65001N</b>	65N.96.95	<b>96</b>	146	12	36	8	12
<input type="radio"/> 08	<b>65002N</b>	65N.128.95	<b>128</b>	178	12	36	8	12
<input type="radio"/> 08	<b>65003N</b>	65N.160.95	<b>160</b>	210	12	36	8	12
<input type="radio"/> 08	<b>65004N</b>	65N.192.95	<b>192</b>	242	12	36	8	12

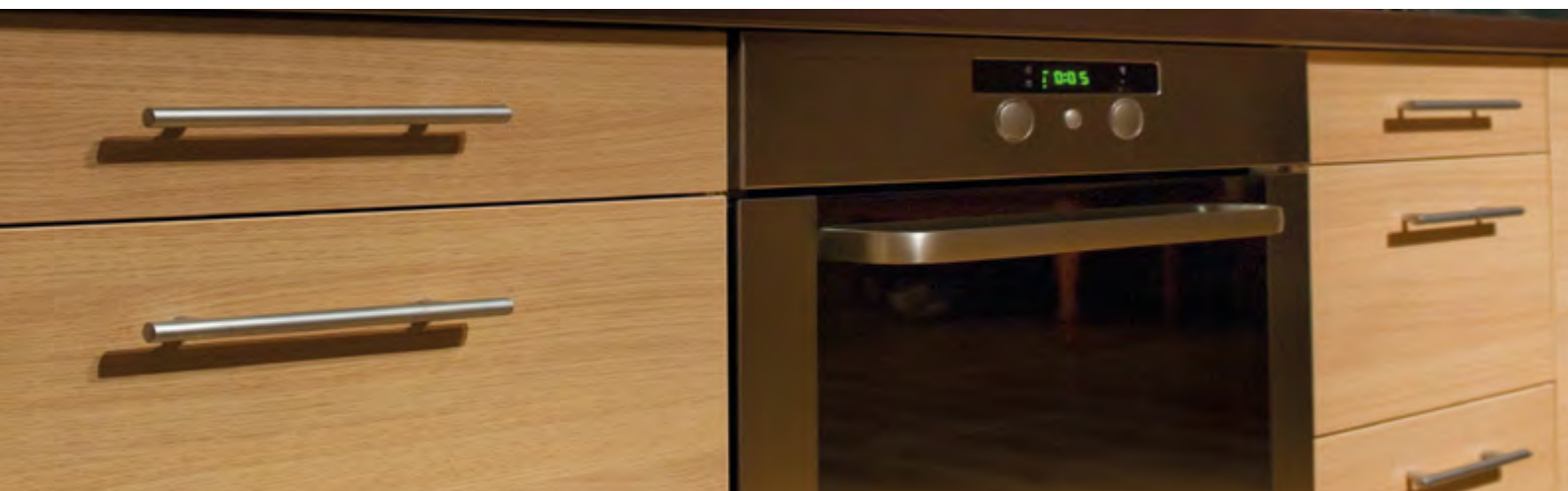



# nesu<sup>®</sup> Contemporary Inox

AISI 304



## 98 Acero inox hueco hollow stainless steel

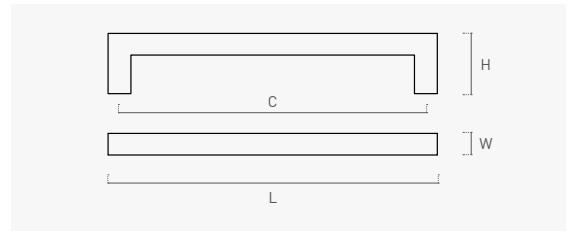

Color	Cod.	Ref.	C	L	W	H	
	<b>98001</b>	98.128.95	<b>128</b>	140	12	32	12
	<b>98002</b>	98.160.95	<b>160</b>	172	12	32	12
	<b>98003</b>	98.192.95	<b>192</b>	204	12	32	12
	<b>98004</b>	98.265.95	<b>256</b>	268	12	32	12
	<b>98005</b>	98.352.95	<b>352</b>	364	12	32	12

AISI 304



## 820 acero inox stainless steel

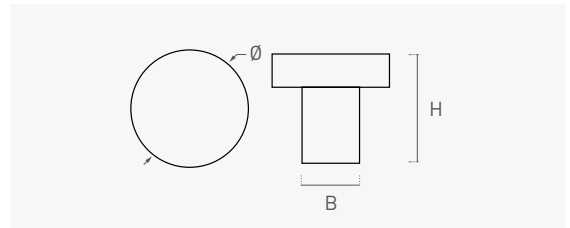

Color	Cod.	Ref.	Ø	H	B	
	<b>8207AI</b>	820.25.95	<b>25</b>	24	14	12
	<b>8203AI</b>	820.30.95	<b>30</b>	28	15	12

AISI 304



## 822 acero inox stainless steel

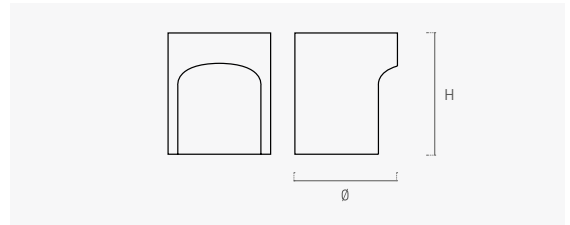

Color	Cod.	Ref.	Ø	H	
	<b>8222AI</b>	822.20.95	<b>20</b>	23	12
	<b>8227AI</b>	822.25.95	<b>25</b>	28	12

AISI 304



## 825 acero inox stainless steel

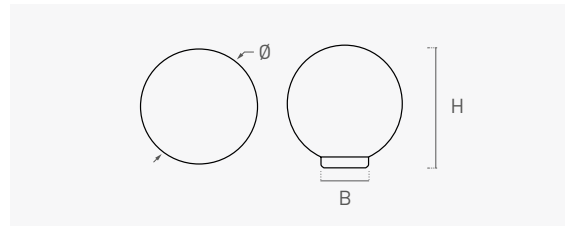

Color	Cod.	Ref.	Ø	H	B	
	<b>8257AI</b>	825.25.95	<b>25</b>	28	14	12
	<b>8253AI</b>	825.30.95	<b>30</b>	33	12	12



nesu<sup>®</sup> Contemporary  
Inox

AISI 304



826

acero inox stainless steel

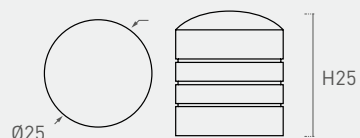

Color	Cod.	Ref.	Ø	H	Icon
95	8267AI	826.25.95	25	25	12

AISI 304



828

acero inox stainless steel

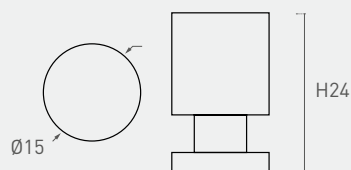

Color	Cod.	Ref.	Ø	H	Icon
95	8286AI	828.15.95	15	24	12

AISI 304



829

acero inox stainless steel

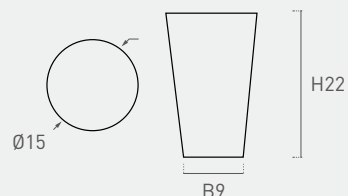

Color	Cod.	Ref.	Ø	H	B	Icon
95	8296AI	829.15.95	15	22	9	12

AISI 304



831

acero inox stainless steel

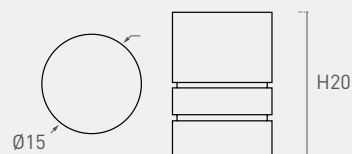

Color	Cod.	Ref.	Ø	H	Icon
95	8316AI	831.15.95	15	20	12





### 853

aluminio aluminium



Color	Cod.	Ref.	C	L	W	H	
	<b>853214</b>	853.32.91	<b>32</b>	44	14	18	12
	<b>853414</b>	853.64.91	<b>64</b>	88	14	18	12
91	<b>853614</b>	853.96.91	<b>96</b>	120	14	18	12
	<b>853814</b>	853.128.91	<b>128</b>	150	14	18	12
	<b>853014</b>	853.160.91	<b>160</b>	190	14	18	12

### 856

aluminio aluminium

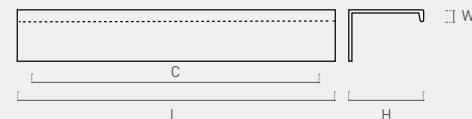

Color	Cod.	Ref.	C	L	W	H	
	<b>856114</b>	856.16.91	<b>16</b>	30	8	40	12
	<b>856414</b>	856.64.91	<b>64</b>	84	8	40	12
91	<b>856614</b>	856.96.91	<b>96</b>	116	8	40	12
	<b>856214</b>	856.2000.91	-	2000	8	40	12

### 857

aluminio aluminium

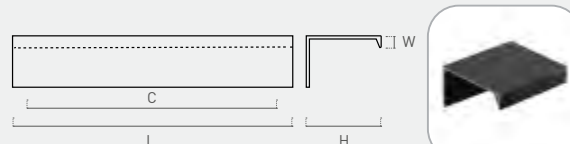

pág.148

Color	Cod.	Ref.	C	L	W	H	
	<b>857114</b>	857.16.91	<b>16</b>	30	5	32	12
	<b>857414</b>	857.64.91	<b>64</b>	84	5	32	12
91	<b>857614</b>	857.96.91	<b>96</b>	116	5	32	12
	<b>857214</b>	857.2000.91	-	2000	5	32	12



## 855

aluminio aluminium

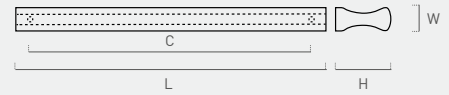

Color	Cod.	Ref.	C	L	W	H	
<input type="radio"/>	<b>855214</b>	855.32.91	<b>32</b>	44	9	17	12
<input type="radio"/>	<b>855414</b>	855.64.91	<b>64</b>	88	9	17	12
<input checked="" type="radio"/>	<b>855614</b>	855.96.91	<b>96</b>	120	9	17	12
<input type="radio"/>	<b>855814</b>	855.128.91	<b>128</b>	150	9	17	12



## 859

aluminio aluminium

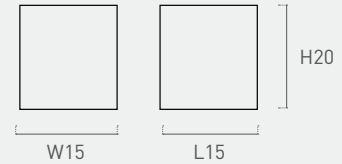

Color	Cod.	Ref.	L	W	H	
<input checked="" type="radio"/>	<b>859514</b>	859.15.91	<b>15</b>	15	20	25



## 861

aluminio aluminium

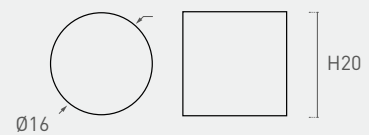

Color	Cod.	Ref.	Ø	H	
<input checked="" type="radio"/>	<b>861614</b>	861.16.91	<b>16</b>	20	25



## 862

aluminio aluminium

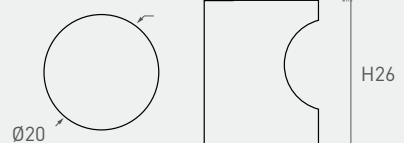

Color	Cod.	Ref.	Ø	H	
<input checked="" type="radio"/>	<b>862214</b>	862.20.91	<b>20</b>	26	12

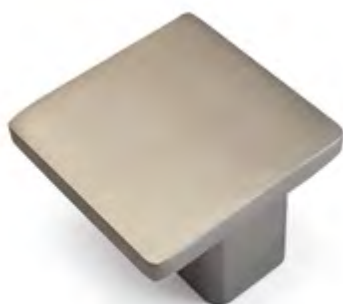
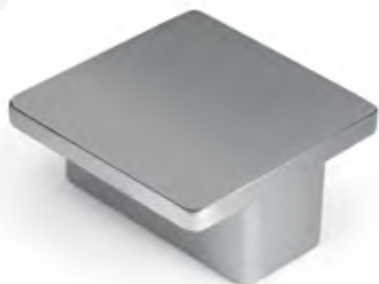

## 809

zamak

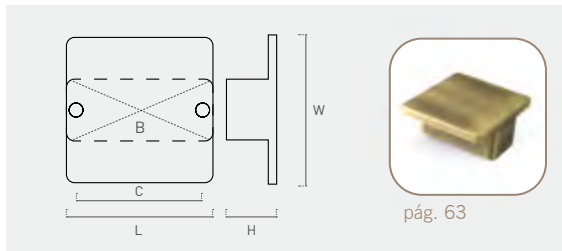

Color	Cod.	Ref.	C	L	W	H	B	
<input type="radio"/>	<b>809201</b>	809.32.93	<b>32</b>	50	50	24	50x22	12
<input checked="" type="radio"/>	<b>809801</b>	809.38.93	-	38	38	21	38x16	12
<input type="radio"/>	<b>809217</b>	809.32.94	<b>32</b>	50	50	24	50x22	12
<input checked="" type="radio"/>	<b>809817</b>	809.38.94	-	38	38	21	38x16	12
<input type="radio"/>	<b>809216</b>	809.32.95	<b>32</b>	50	50	24	50x22	12
<input checked="" type="radio"/>	<b>809816</b>	809.38.95	-	38	38	21	38x16	12
<input checked="" type="radio"/>	<b>809825</b>	809.38.101	-	38	38	24	38x16	12







90

zamak

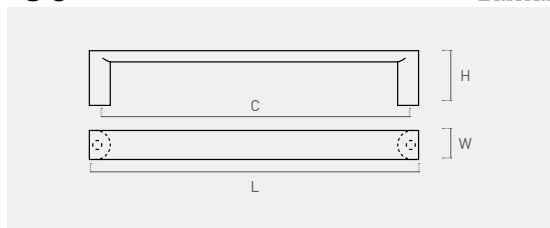

Color	Cod.	Ref.	C	L	W	H	
	<b>90616</b>	90.96.95	<b>96</b>	103	11	22	12
95	<b>90816</b>	90.128.95	<b>128</b>	135	12	24	12
	<b>90016</b>	90.160.95	<b>160</b>	167	13	24	12



95

zamak

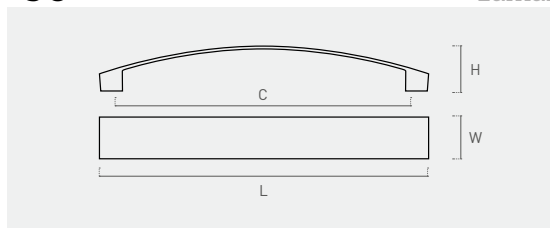

Color	Cod.	Ref.	C	L	W	H	
	<b>95016</b>	95.160.95	<b>160</b>	172	21	22	12
95	<b>95216</b>	95.224.95	<b>224</b>	236	22	20	12



79

zamak

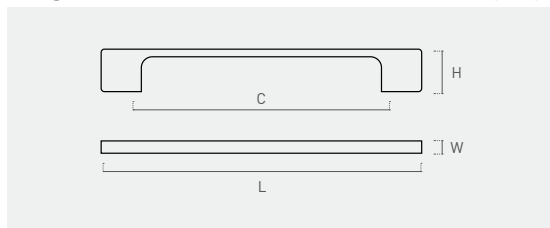

Color	Cod.	Ref.	C	L	W	H	
	<b>79617</b>	79.96.94	<b>96</b>	128	8	24	12
94	<b>79817</b>	79.128.94	<b>128</b>	154	8	25	12



91

zamak

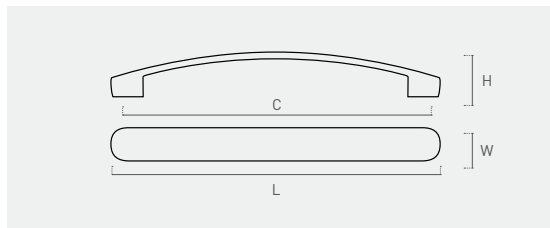

Color	Cod.	Ref.	C	L	W	H	
94	<b>91017</b>	91.160.94	<b>160</b>	180	19	24	12
95	<b>91016</b>	91.160.95	<b>160</b>	180	19	24	12



818

zamak

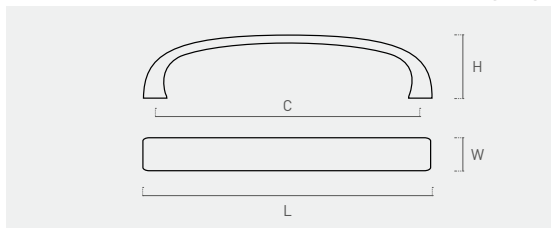

Color	Cod.	Ref.	C	L	W	H	
	<b>818417</b>	818.64.94	<b>64</b>	73	14	21	12
94	<b>818617</b>	818.96.94	<b>96</b>	105	16	21	12
	<b>818817</b>	818.128.94	<b>128</b>	138	18	21	12
	<b>818416</b>	818.64.95	<b>64</b>	72	14	22	12
95	<b>818616</b>	818.96.95	<b>96</b>	103	16	22	12
	<b>818816</b>	818.128.95	<b>128</b>	135	18	24	12



871

zamak

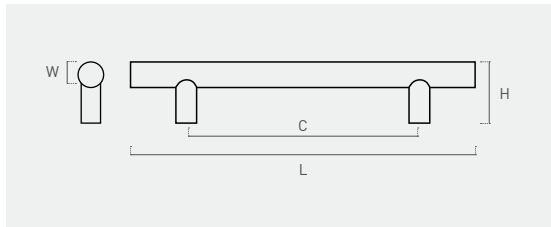

Color	Cod.	Ref.	C	L	W	H	
94	<b>871817</b>	871.128.94	<b>128</b>	188	Ø12	31	12





872

zamak

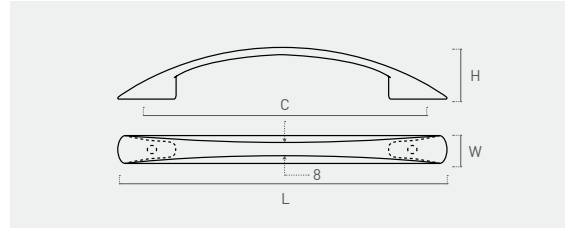

Color	Cod.	Ref.	C	L	W	H	
	<b>872617</b>	872.96.94	<b>96</b>	136	8-14	22	12
94	<b>872817</b>	872.128.94	<b>128</b>	171	8-14	22	12
	<b>872017</b>	872.160.94	<b>160</b>	200	8-14	24	12



99

zamak

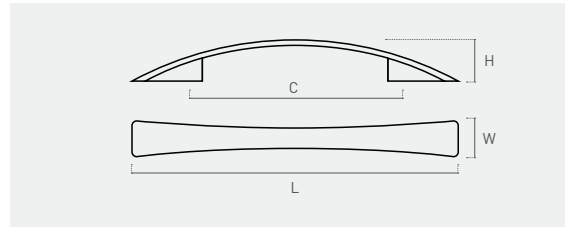

Color	Cod.	Ref.	C	L	W	H	
	<b>99617</b>	99.96.94	<b>96</b>	121	12-16	17	12
94	<b>99817</b>	99.128.94	<b>128</b>	157	13-19	25	12



57

zamak

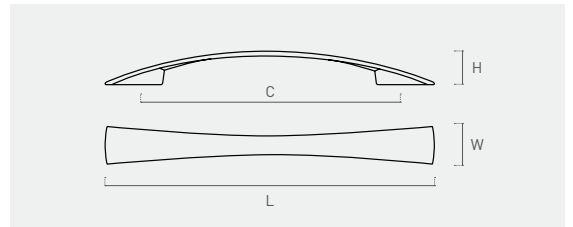

Color	Cod.	Ref.	C	L	W	H	
92	<b>57602</b>	57.96.92	<b>96</b>	151	8-18	22	12
	<b>57802</b>	57.96.92	<b>128</b>	184	8-18	21	12
93	<b>57601</b>	57.96.93	<b>96</b>	151	8-18	22	12
	<b>57801</b>	57.128.93	<b>128</b>	184	8-18	21	12
94	<b>57617</b>	57.96.94	<b>96</b>	151	8-18	22	12
	<b>57817</b>	57.128.94	<b>128</b>	184	10-21	21	12





### 873

zamak

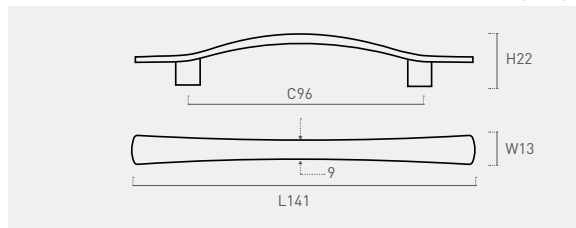

Color	Cod.	Ref.	C	L	W	H	📦
93	<b>873601</b>	873.96.93	96	141	13	22	12
94	<b>873617</b>	873.96.94	96	141	13	22	12
95	<b>873616</b>	873.96.95	96	141	13	22	12



### 84

zamak

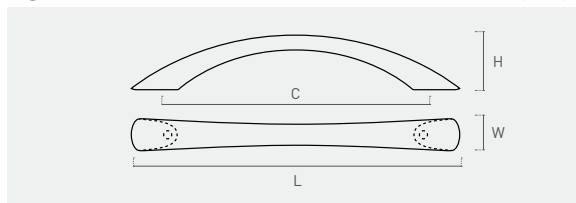

Color	Cod.	Ref.	C	L	W	H	📦
94	<b>84817</b>	84.128.94	128	164	10-17	29	12

### 867

zamak

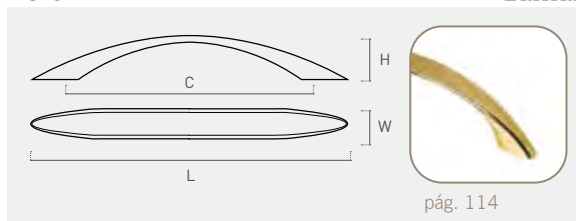

Color	Cod.	Ref.	C	L	W	H	📦
92	<b>867602</b>	867.96.92	96	124	11	23	12
	<b>867802</b>	867.128.92	128	163	14	24	12
93	<b>867601</b>	867.96.93	96	124	14	23	12
	<b>867801</b>	867.128.93	128	163	14	24	12
94	<b>867617</b>	867.96.94	96	124	14	23	12
	<b>867817</b>	867.128.94	128	163	14	24	12





868

zamak

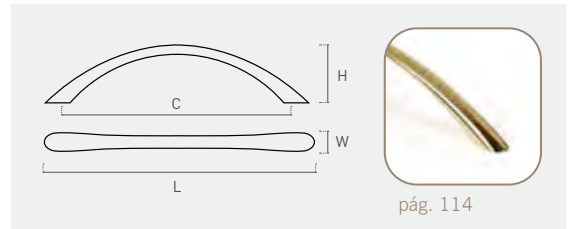

pág. 114

Color	Cod.	Ref.	C	L	W	H	
	<b>868602</b>	868.96.92	<b>96</b>	110	7	23,5	25
	<b>868802</b>	868.128.92	<b>128</b>	150	9	26	25
	<b>868601</b>	868.96.93	<b>96</b>	110	7	23,5	25
	<b>868801</b>	868.128.93	<b>128</b>	150	9	26	25
	<b>868617</b>	868.96.94	<b>96</b>	110	7	23,5	25
	<b>868817</b>	868.128.94	<b>128</b>	150	9	26	25



58

zamak

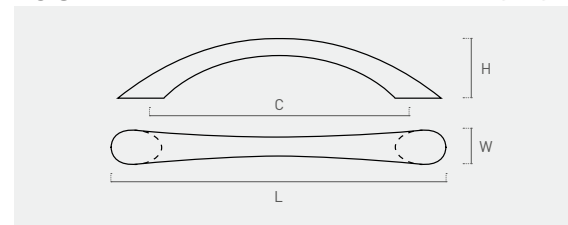

Color	Cod.	Ref.	C	L	W	H	
	<b>58602</b>	58.96.92	<b>96</b>	112	5-11	22	12
	<b>58802</b>	58.128.92	<b>128</b>	150	6-17	29	12
	<b>58601</b>	58.96.93	<b>96</b>	112	5-11	22	12
	<b>58801</b>	58.128.93	<b>128</b>	150	6-17	29	12
	<b>58617</b>	58.96.94	<b>96</b>	112	5-11	22	12
	<b>58817</b>	58.128.94	<b>128</b>	150	6-17	29	12



64

zamak

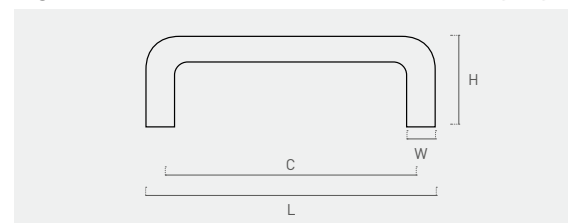

Color	Cod.	Ref.	C	L	W	H	
	<b>64402</b>	64.64.92	<b>64</b>	72	Ø8	28	12
	<b>64602</b>	64.96.92	<b>96</b>	104	Ø8	28	12
	<b>64401</b>	64.64.93	<b>64</b>	72	Ø8	28	12
	<b>64601</b>	64.96.93	<b>96</b>	104	Ø8	28	12



## 50 S

zamak

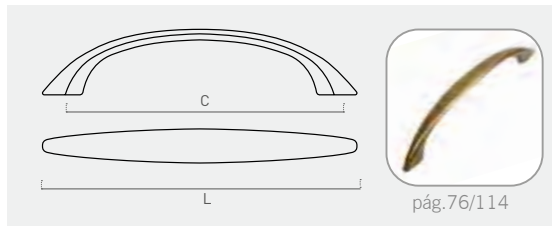

Color	Cod.	Ref.	C	L	W	H	Icon	
03	<b>50621</b>	50.96.03	<b>96</b>	126	13	25	12	
	<b>50821</b>	50.128.03	<b>128</b>	160	15	28	12	
95	<b>50616</b>	50.96.95	<b>96</b>	126	13	25	12	
	<b>50816</b>	50.128.95	<b>128</b>	160	15	28	12	

## 50 L

zamak

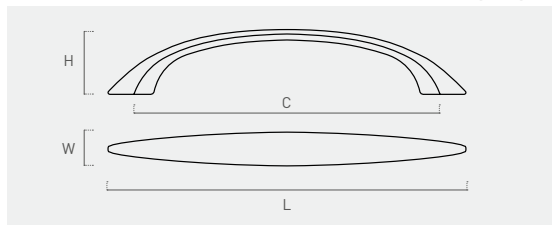

Color	Cod.	Ref.	C	L	W	H	Icon	
92	<b>50602</b>	50.96.92	<b>96</b>	134	14	22	12	
	<b>50802</b>	50.128.92	<b>128</b>	176	14	24	12	
93	<b>50601</b>	50.96.93	<b>96</b>	134	14	22	12	
	<b>50801</b>	50.128.93	<b>128</b>	176	14	24	12	
94	<b>50617</b>	50.96.94	<b>96</b>	134	14	22	12	
	<b>50817</b>	50.128.94	<b>128</b>	176	14	24	12	

## 63

zamak

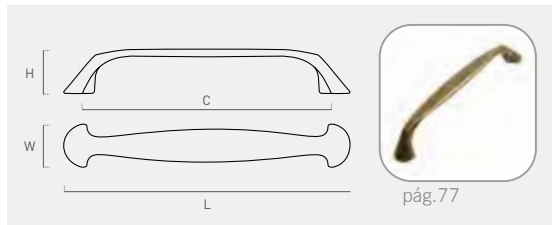

Color	Cod.	Ref.	C	L	W	H	Icon	
95	<b>63616</b>	63.96.95	<b>96</b>	118	14-18	25	12	
	<b>63816</b>	63.128.95	<b>128</b>	151	16-20	25	12	



60

zamak

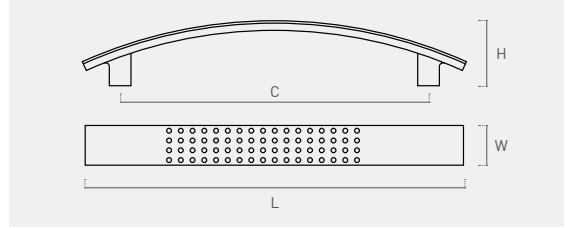

Color	Cod.	Ref.	C	L	W	H	
94	<b>60617</b>	60.96.94	<b>96</b>	125	17	27	12
	<b>60817</b>	60.128.94	<b>128</b>	158	17	27	12

61

zamak

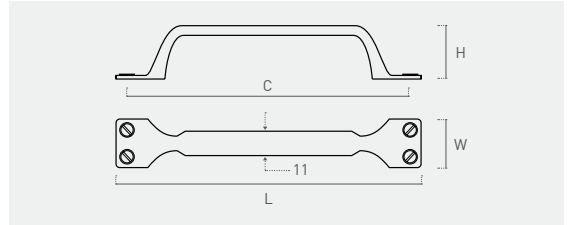

Color	Cod.	Ref.	C	L	W	H	
92	<b>61602</b>	61.96.92	<b>96</b>	127	20	24	12

72

zamak

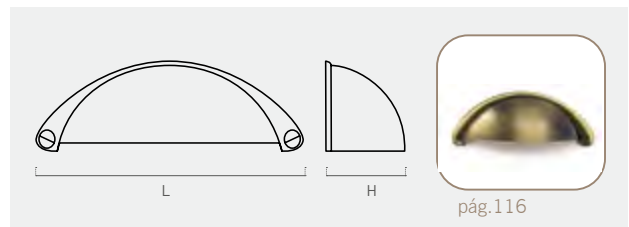

Color	Cod.	Ref.	C	L	W	H	
92	<b>72402</b>	72.64.92	<b>64</b>	89	30	22	12

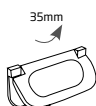

885

zamak

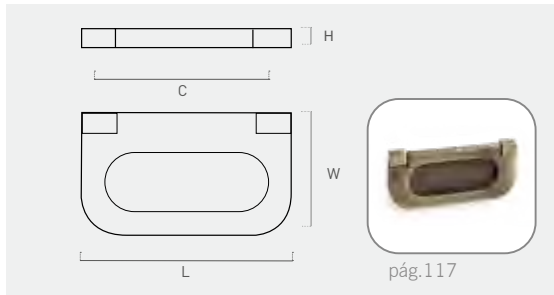

Color	Cod.	Ref.	C	L	W	H	
94	<b>885417</b>	885.64.94	64	75	35	5	12
95	<b>885416</b>	885.64.95	64	75	35	5	12

74

zamak

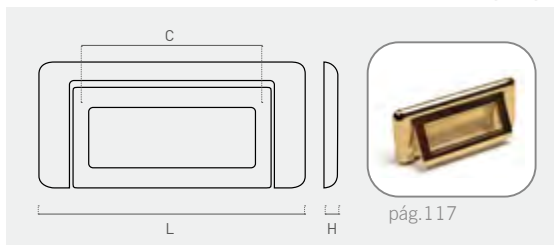

Color	Cod.	Ref.	L	W	C	H	
94	<b>74217</b>	74.82.94	82	38	55	5	12



863

zamak

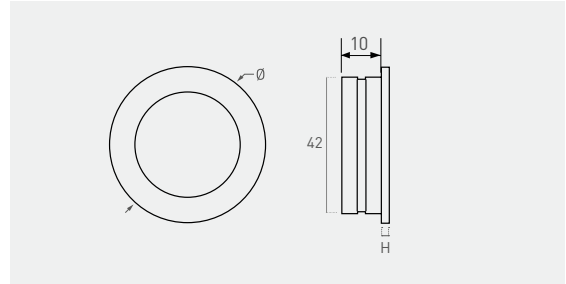

Color	Cod.	Ref.	Ø	H	
93	<b>863501</b>	863.50.93	50	2	12
94	<b>863517</b>	863.50.94	50	2	12
95	<b>863516</b>	863.50.95	50	2	12



866

zamak

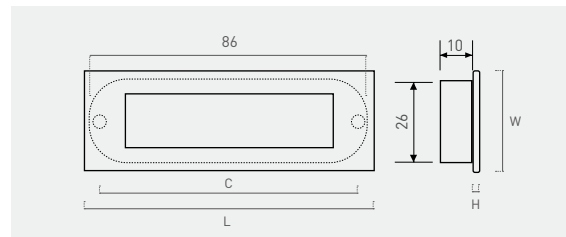

Color	Cod.	Ref.	C	L	W	H	
94	<b>866217</b>	866.92.94	76	92	32	2	12



816

zamak

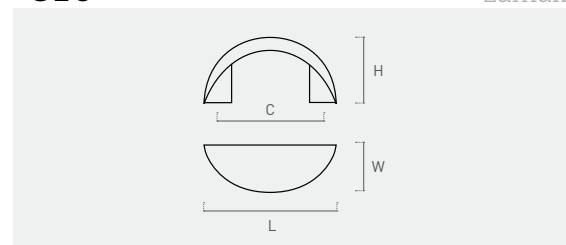

Color	Cod.	Ref.	C	L	W	H	
93	<b>816201</b>	816.32.93	32	40	17	20	12





880

zamak

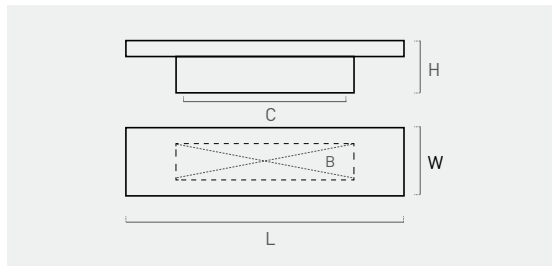

Color	Cod.	Ref.	C	L	W	B	H	
93	880201	880.32.93	32	70	20	10x43	17	12
94	880217	880.32.94	32	70	20	10x43	17	12
95	880216	880.32.95	32	70	20	10x43	17	12

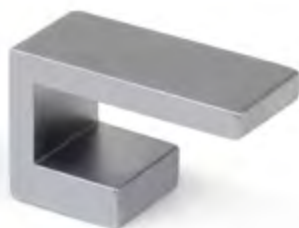

813

zamak

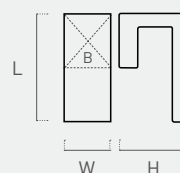

Color	Cod.	Ref.	L	W	B	H	
94	813417	813.40.94	40	18	18x20	25	12



815

zamak

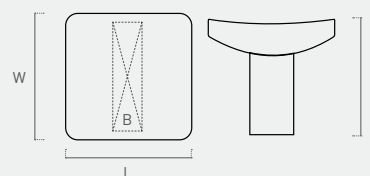

Color	Cod.	Ref.	L	W	B	H	
93	815501	815.32.93	32	32	24x9	22	12
94	815517	815.32.94	32	32	24x9	22	12
101	815525	815.32.101	32	32	24x9	22	12





26

zamak

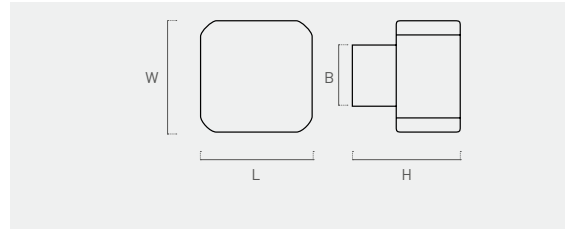

Color	Cod.	Ref.	L	W	B	H	
95	<b>26716</b>	26.25.95	<b>25</b>	<b>25</b>	<b>14</b>	<b>26</b>	<b>12</b>

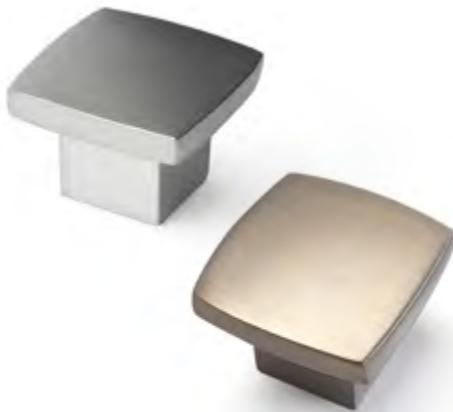

28

zamak

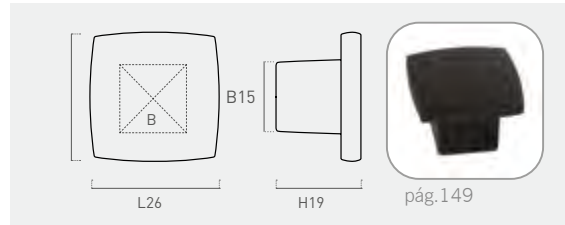

Color	Cod.	Ref.	L	W	B	H	
94	<b>28717</b>	28.25.94	<b>26</b>	<b>26</b>	<b>15x15</b>	<b>19</b>	<b>12</b>
95	<b>28716</b>	28.25.95	<b>26</b>	<b>26</b>	<b>15x15</b>	<b>19</b>	<b>12</b>
101	<b>28725</b>	28.25.101	<b>26</b>	<b>26</b>	<b>15x15</b>	<b>19</b>	<b>12</b>







29

zamak

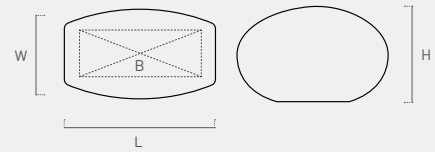

Color  95  94  93  92

Cod.	Ref.	L	W	B	H	Icon
<b>29316</b>	29.30.95	<b>30</b>	13	10x16	19	12



31

zamak

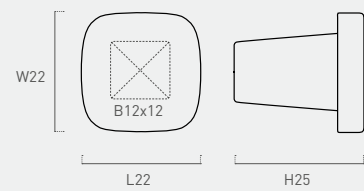

Color  95  94  93  92

Cod.	Ref.	L	W	B	H	Icon
<b>31217</b>	31.22.94	<b>22</b>	22	12x12	25	12
<b>31216</b>	31.22.95	<b>22</b>	22	12x12	25	12



03

zamak

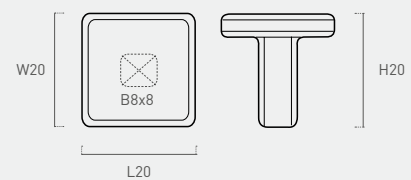

Color  92  93  94  95

Cod.	Ref.	L	W	B	H	Icon
<b>03202</b>	03.20.92	<b>20</b>	20	8x8	20	12
<b>03201</b>	03.20.93	<b>20</b>	20	8x8	20	12
<b>03217</b>	03.20.94	<b>20</b>	20	8x8	20	12



33

zamak

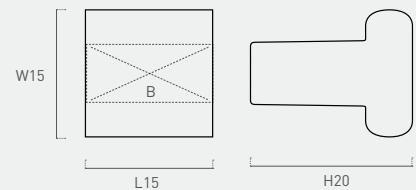

Color  95  94  93  92

Cod.	Ref.	L	W	B	H	Icon
<b>33517</b>	33.15.94	<b>15</b>	15	15x8	20	12
<b>33516</b>	33.15.95	<b>15</b>	15	15x8	20	12



20

zamak

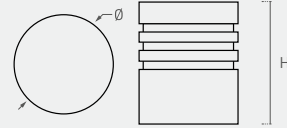

Color	Cod.	Ref.	Ø	H	
92	<b>20202</b>	20.20.92	<b>20</b>	22	12
93	<b>20201</b>	20.20.93	<b>20</b>	22	12

02

zamak

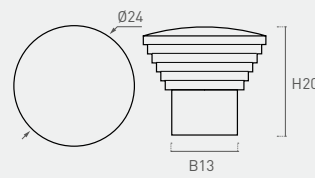

pág.112

Color	Cod.	Ref.	Ø	B	H	
94	<b>02517</b>	02.23.94	<b>24</b>	13	20	12
95	<b>02516</b>	02.23.95	<b>24</b>	13	20	12





30

zamak

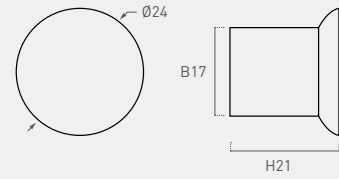

Color	Cod.	Ref.	Ø	B	H	
	<b>30717</b>	30.25.94	24	17	21	12
	<b>30716</b>	30.25.95	24	17	21	12



32

zamak

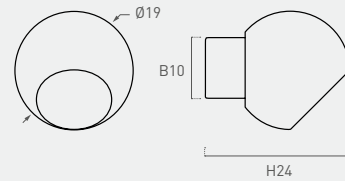

Color	Cod.	Ref.	Ø	B	H	
	<b>32217</b>	32.20.94	19	10	24	12
	<b>32216</b>	32.20.95	19	10	24	12



07

zamak

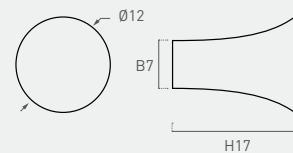

Color	Cod.	Ref.	Ø	B	H	
	<b>07202</b>	07.12.92	12	7	17	12
	<b>07201</b>	07.12.93	12	7	17	12
	<b>07217</b>	07.12.94	12	7	17	12

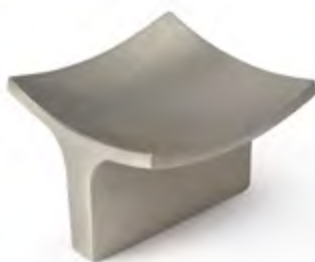

811

zamak

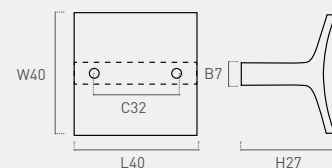

Color	Cod.	Ref.	C	L	W	B	H	
	<b>811416</b>	811.40.95	32	40	40	7	27	12





22

zamak

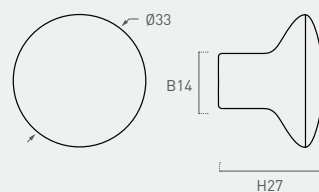

Color	Cod.	Ref.	Ø	B	H	
	<b>22817</b>	22.35.94	<b>33</b>	14	27	12



27

zamak

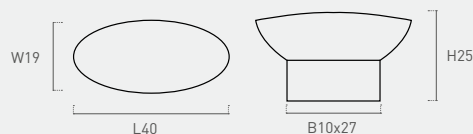

Color	Cod.	Ref.	L	W	B	H	
	<b>27416</b>	27.40.95	<b>40</b>	19	10x27	25	12
	<b>27417</b>	27.40.94	<b>40</b>	19	10x27	25	12



04

zamak

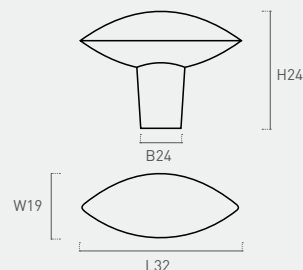

Color	Cod.	Ref.	L	W	B	H	
	<b>04601</b>	04.33.93	<b>32</b>	19	9	24	12
	<b>04617</b>	04.33.94	<b>32</b>	19	9	24	12



13

zamak

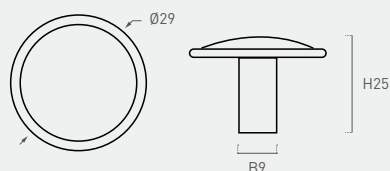

Color	Cod.	Ref.	Ø	B	H	
	<b>13302</b>	13.29.92	<b>29</b>	9	25	12
	<b>13301</b>	13.29.93	<b>29</b>	9	25	12
	<b>13317</b>	13.29.94	<b>29</b>	9	25	12



17

zamak

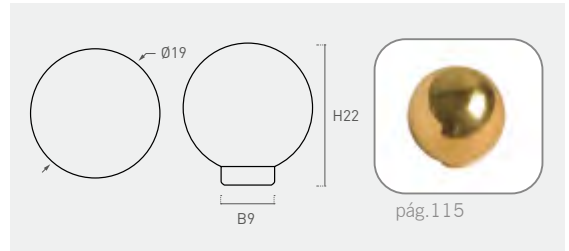

Color	Cod.	Ref.	Ø	H	B	Icon
95	<b>17216</b>	17.20.95	19	22	9	12



25

zamak

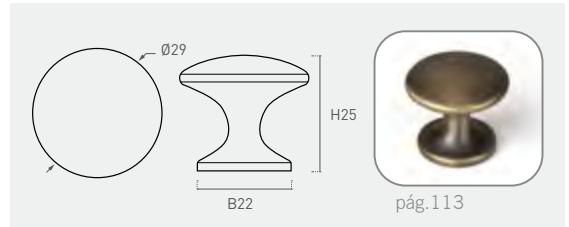

Color	Cod.	Ref.	Ø	H	B	Icon
94	<b>25317</b>	25.30.94	29	25	22	12
95	<b>25316</b>	25.30.95	29	25	22	12





01

zamak

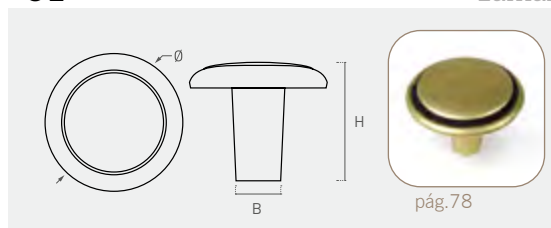

Color	Cod.	Ref.	Ø	H	B	Icon
92	<b>01702</b>	01.25.92	25	22	9	12
	<b>01302</b>	01.30.92	30	20	9	12
93	<b>01301</b>	01.30.93	30	20	8	12



92

05

zamak

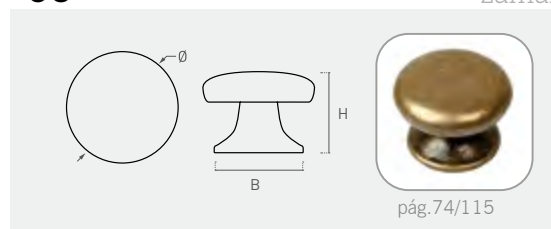

Color	Cod.	Ref.	Ø	H	B	Icon
	<b>05721</b>	05.25.03	25	20	20	12
03	<b>05321</b>	05.30.03	30	23	24	12
	<b>05821</b>	05.35.03	35	25	28	12
	<b>05702</b>	05.25.92	25	20	20	12
92	<b>05302</b>	05.30.92	30	23	24	12
	<b>05802</b>	05.35.92	35	25	28	12
	<b>05701</b>	05.25.93	25	20	20	12
93	<b>05301</b>	05.30.93	30	23	24	12
	<b>05801</b>	05.35.93	35	25	28	12
	<b>05717</b>	05.25.94	25	20	20	12
94	<b>05317</b>	05.30.94	30	23	24	12
	<b>05817</b>	05.35.94	35	25	28	12
	<b>05716</b>	05.25.95	25	20	20	12
95	<b>05316</b>	05.30.95	30	23	24	12
	<b>05816</b>	05.35.95	35	25	28	12



03

93

94



95





24

zamak

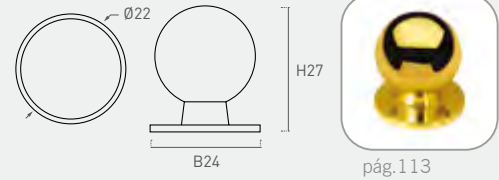

Color	Cod.	Ref.	Ø	H	B	Icon
94	<b>24517</b>	24.23.94	22	27	24	12
95	<b>24516</b>	24.23.95	22	27	24	12



06

zamak

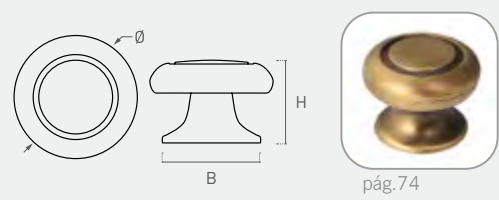

Color	Cod.	Ref.	Ø	H	B	Icon
	<b>06716</b>	06.25.95	25	20	20	12
95	<b>06316</b>	06.30.95	30	23	24	12
	<b>06816</b>	06.35.95	35	25	28	12



16

zamak

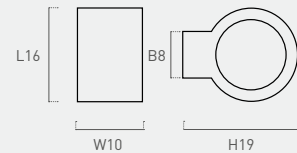

Color	Cod.	Ref.	L	W	B	H	Icon
93	<b>16601</b>	16.15.93	16	10	8	19	12



08

zamak

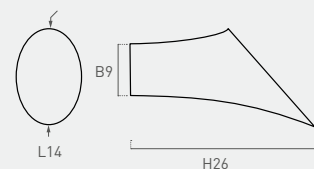

Color	Cod.	Ref.	L	B	H	Icon
93	<b>08601</b>	08.15.93	14	9	26	12
94	<b>08617</b>	08.15.94	14	9	26	12



15

zamak

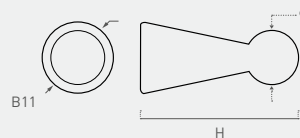

Color	Cod.	Ref.	Ø	B	H	📦
92	15202	15.11.92	9	11	25	12
93	15201	15.11.93	9	11	25	12
94	15217	15.11.94	9	11	25	12



21

zamak

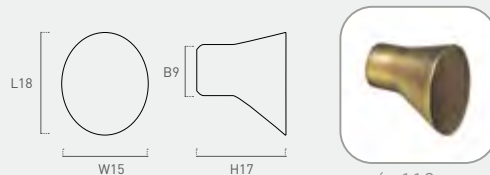

pág.112

Color	Cod.	Ref.	L	W	B	H	📦
08	21622	21.18.08	18	15	9	17	12
92	21602	21.18.92	18	15	9	17	12
94	21617	21.18.94	18	15	9	17	12



34

Aluminium

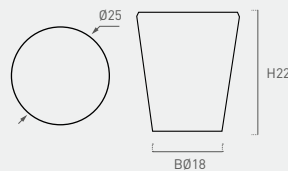

pág.149

Color	Cod.	Ref.	Ø	B	H	📦
91	34714	34.25.91	25	18	22	12
101	34725	34.25.101	25	18	22	12



35

zamak

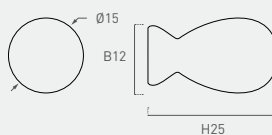

pág.113

Color	Cod.	Ref.	Ø	B	H	📦
92	35602	35.15.92	15	12	25	12
93	35601	35.15.93	15	12	25	12
94	35617	35.15.94	15	12	25	12



36

zamak

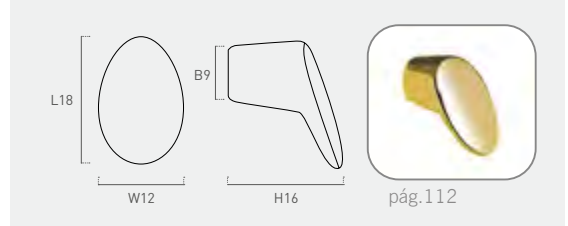

Color	Cod.	Ref.	L	W	B	H	☰
92	<b>36202</b>	36.20.92	18	12	9	16	12
93	<b>36201</b>	36.20.93	18	12	9	16	12
94	<b>36217</b>	36.20.94	18	12	9	16	12



37

zamak

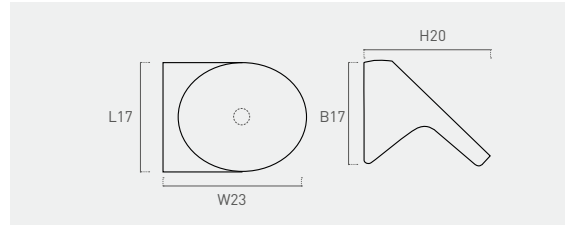

Color	Cod.	Ref.	L	W	B	H	☰
92	<b>37502</b>	37.23.92	17	23	17	20	12
93	<b>37501</b>	37.23.93	17	23	17	20	12







773

ABS

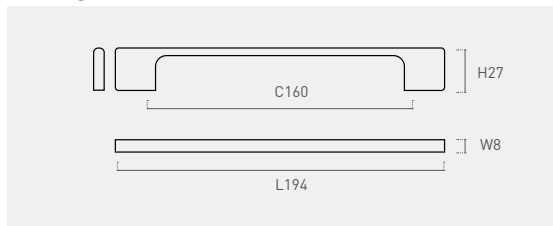

Color	Cod.	Ref.	C	L	W	H	📦
03	<b>7730BL</b>	773.160.03	160	194	8	27	12
08	<b>7730NE</b>	773.160.08	160	194	8	27	12
94	<b>7730CR</b>	773.160.94	160	194	8	27	12



774

ABS

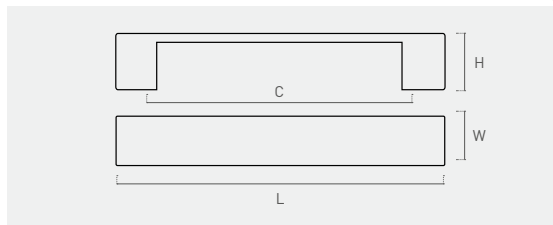

Color	Cod.	Ref.	C	L	W	H	📦
03	<b>7748BL</b>	774.128.03	128	145	21	25	12
	<b>7740BL</b>	774.160.03	160	192	25	27	12
08	<b>7748NE</b>	774.128.08	128	145	21	25	12
	<b>7740NE</b>	774.160.08	160	192	25	27	12
94	<b>7748CR</b>	774.128.94	128	145	21	25	12
	<b>7740CR</b>	774.160.94	160	192	25	27	12



788

ABS

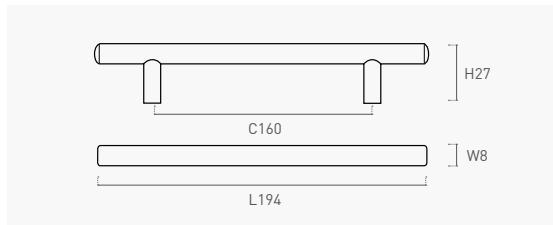

Color	Cod.	Ref.	C	L	W	H	📦
94	<b>788CR</b>	788.128.94	128	198	Ø11	29	12



787

ABS

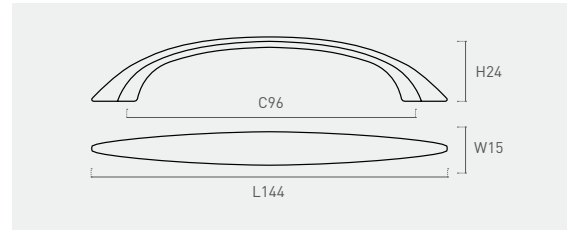

Color	Cod.	Ref.	C	L	W	H	📦
94	<b>7876CR</b>	787.96.94	<b>96</b>	144	15	24	12



786

ABS

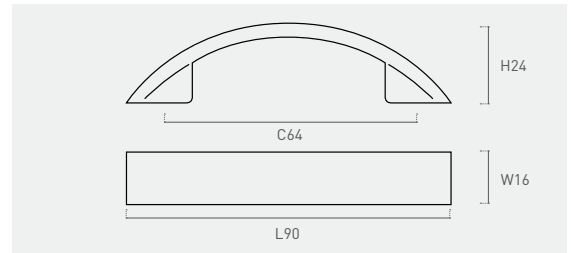

Color	Cod.	Ref.	C	L	W	H	📦
94	<b>7864CR</b>	786.64.94	<b>64</b>	90	16	24	12



770

ABS

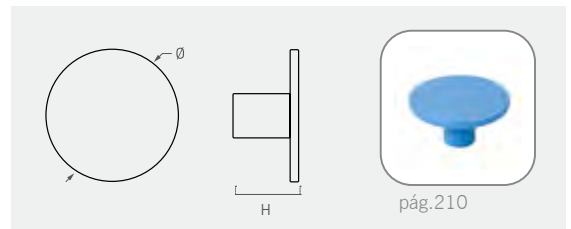

Color	Cod.	Ref.	Ø	H	📦
94	<b>7704CR</b>	770.40.94	<b>40</b>	23	12
	<b>770CR</b>	770.60.94	<b>61</b>	30	12



626

ABS

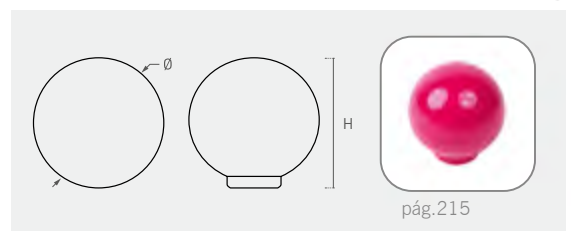

Color	Cod.	Ref.	Ø	H	📦
	<b>626CR</b>	626.24.94	<b>24</b>	25	25
94	<b>626CR1</b>	626.29.94	<b>28</b>	29	25
	<b>626CR2</b>	626.34.94	<b>34</b>	35	25



## 782

ABS

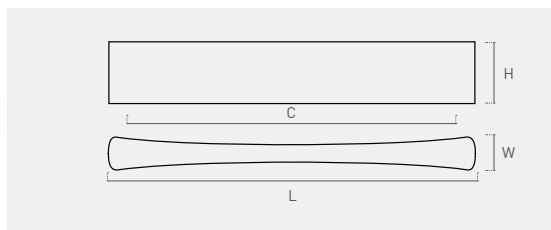

Color	Cod.	Ref.	C	L	W	H	94
	<b>7824CR</b>	782.64.94	<b>64</b>	78	7-11	18	12
	<b>7828CR</b>	782.128.94	<b>128</b>	155	7-11	18	12



## 784

ABS

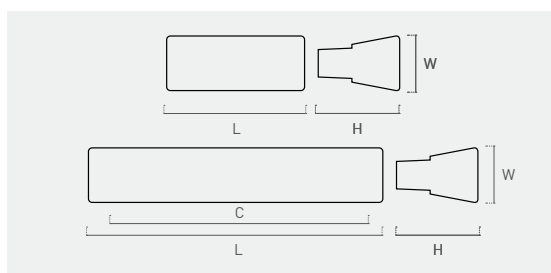

Color	Cod.	Ref.	C	L	W	H	94
	<b>7847CR</b>	784.25.94	-	25	13	18	12
	<b>7844CR</b>	784.64.94	<b>64</b>	78	13	18	12



## 785

ABS

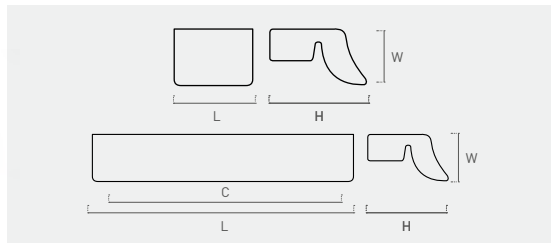

Color	Cod.	Ref.	C	L	W	H	94
	<b>7859CR</b>	785.18.94	-	18	13	22	12
	<b>7854CR</b>	785.64.94	<b>64</b>	96	13	22	12



7334PT



7334BL

7334CR

7334NE

## 7334

ABS

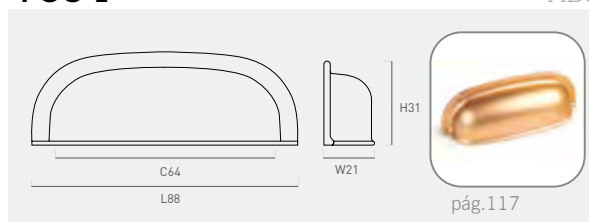

Color	Cod.	Ref.	C	L	W	H	94
<b>03</b>	<b>7334BL</b>	7334.64.03	<b>64</b>	88	21	31	12
<b>08</b>	<b>7334NE</b>	7334.64.08	<b>64</b>	88	21	31	12
<b>80</b>	<b>7334PT</b>	7334.64.80	<b>64</b>	88	21	31	12
<b>94</b>	<b>7334CR</b>	7334.64.94	<b>64</b>	88	21	31	12

# 790

ABS

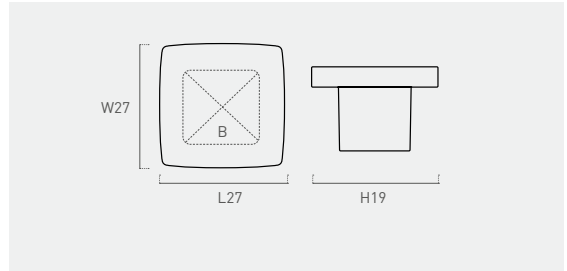

Color	Cod.	Ref.	L	W	B	H	
	<b>7905CR</b>	790.27.94	<b>27</b>	<b>27</b>	15x15	19	12

# 789

ABS

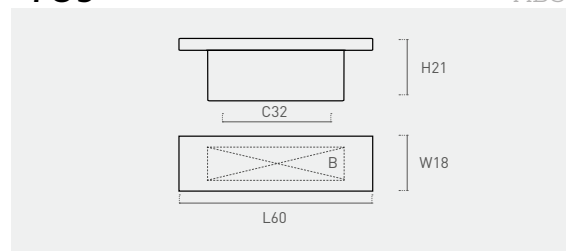

Color	Cod.	Ref.	C	L	W	B	H	
	<b>7892CR</b>	789.32.94	<b>32</b>	60	18	10x43	21	12

# 795

ABS

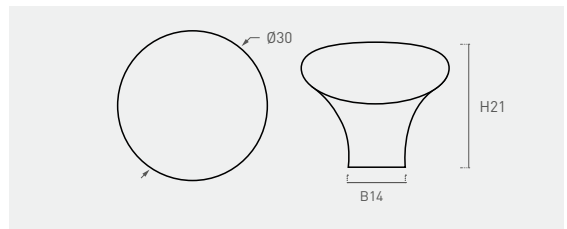

Color	Cod.	Ref.	Ø	B	H	
	<b>795BL</b>	795.30.03	<b>30</b>	14	21	25
	<b>795NE</b>	795.30.08	<b>30</b>	14	21	25
	<b>795GR</b>	795.30.13	<b>30</b>	14	21	25

# 783

ABS

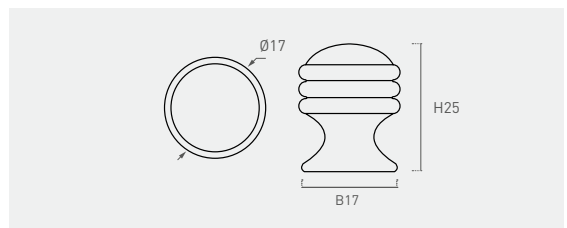

Color	Cod.	Ref.	Ø	H	
	<b>7837BL</b>	783.17.03	<b>17</b>	25	12
	<b>7837NE</b>	783.17.08	<b>17</b>	25	12
	<b>7837GR</b>	783.17.13	<b>17</b>	25	12
	<b>7837CR</b>	783.17.94	<b>17</b>	25	12



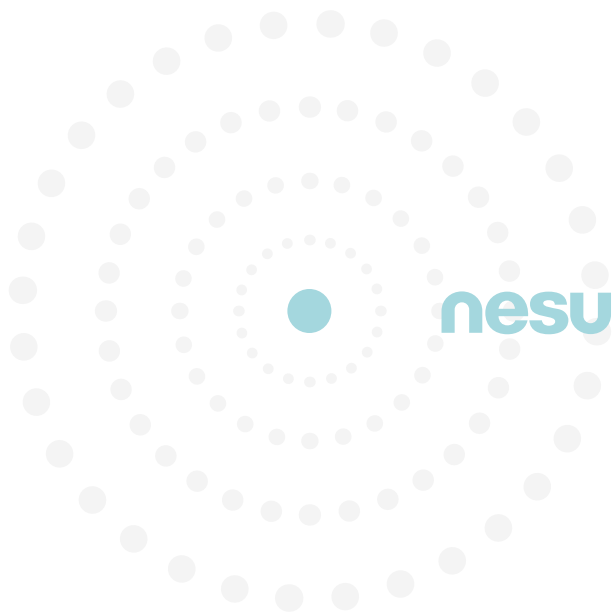







**nesu**® Baby, kids & teenage

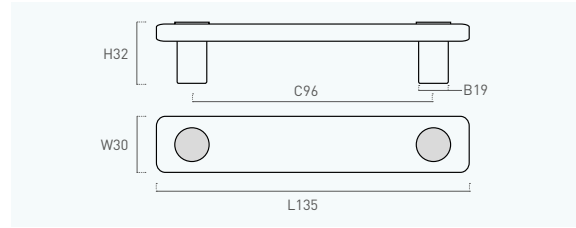



620S  PEFC® PEFC/14-35-00303 **madera wood**







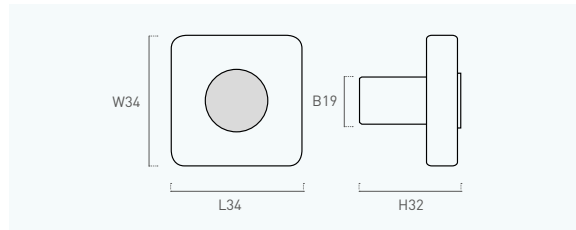

Color	Cod.	Ref.	C	L	W	H	B	⊞
 03	<b>620BLS</b>	620S.96.03	<b>96</b>	135	30	32	19	12
 11	<b>620RSS</b>	620S.96.11	<b>96</b>	135	30	32	19	12
 12	<b>620VES</b>	620S.96.12	<b>96</b>	135	30	32	19	12
 14	<b>620AZS</b>	620S.96.14	<b>96</b>	135	30	32	19	12
 21	<b>620ARS</b>	620S.96.21	<b>96</b>	135	30	32	19	12

Surtido/ Assortment

<b>620SUS</b>	620S.96.35	<b>96</b>	135	30	32	19	25
---------------	------------	-----------	-----	----	----	----	----

621S  PEFC® PEFC/14-35-00303 **madera wood**







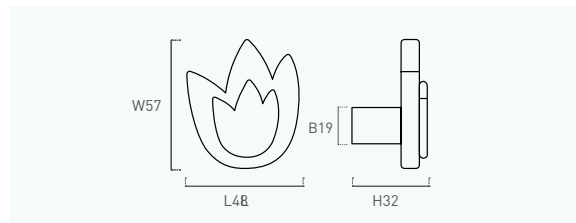

Color	Cod.	Ref.	L	W	B	H	⊞
 03	<b>621BLS</b>	621S.30.03	<b>34</b>	34	19	32	12
 11	<b>621RSS</b>	621S.30.11	<b>34</b>	34	19	32	12
 12	<b>621VES</b>	621S.30.12	<b>34</b>	34	19	32	12
 14	<b>621AZS</b>	621S.30.14	<b>34</b>	34	19	32	12
 21	<b>621ARS</b>	621S.30.21	<b>34</b>	34	19	32	12

Surtido/ Assortment

<b>621SUS</b>	621S.30.35	<b>34</b>	34	19	32	25
---------------	------------	-----------	----	----	----	----

665S  PEFC® PEFC/14-35-00303 **madera wood**



Color	Cod.	Ref.	L	W	B	H	⊞
 03	<b>665BLS</b>	665S.57.03	<b>48</b>	57	19	32	12
 11	<b>665RSS</b>	665S.57.11	<b>48</b>	57	19	32	12
 12	<b>665VES</b>	665S.57.12	<b>48</b>	57	19	32	12
 14	<b>665AZS</b>	665S.57.14	<b>48</b>	57	19	32	12
 21	<b>665ARS</b>	665S.57.21	<b>48</b>	57	19	32	12

Surtido/ Assortment

<b>665SUS</b>	665S.57.35	<b>48</b>	57	19	32	25
---------------	------------	-----------	----	----	----	----

666S  PEFC/14-35-00303

madera wood



Color	Cod.	Ref.	L	W	B	H	
03	<b>666BLS</b>	666S.54.03	56	48	15	32	12
11	<b>666RSS</b>	666S.54.11	56	48	15	32	12
12	<b>666VES</b>	666S.54.12	56	48	15	32	12
14	<b>666AZS</b>	666S.54.14	56	48	15	32	12
21	<b>666ARS</b>	666S.54.21	56	48	15	32	12

Surtido/ Assortment

<b>666SUS</b>	666S.54.35	56	48	15	32	25
---------------	------------	----	----	----	----	----

667S  PEFC/14-35-00303

madera wood

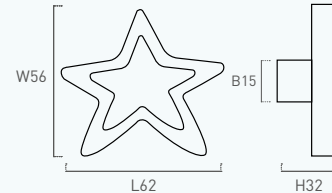

Color	Cod.	Ref.	L	W	B	H	
03	<b>667BLS</b>	667S.60.03	62	56	15	32	12
11	<b>667RSS</b>	667S.60.11	62	56	15	32	12
12	<b>667VES</b>	667S.60.12	62	56	15	32	12
14	<b>667AZS</b>	667S.60.14	62	56	15	32	12
21	<b>667ARS</b>	667S.60.21	62	56	15	32	12

Surtido/ Assortment

<b>667SUS</b>	667S.60.35	62	56	15	32	25
---------------	------------	----	----	----	----	----

698S  PEFC/14-35-00303

madera wood

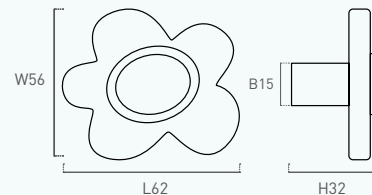







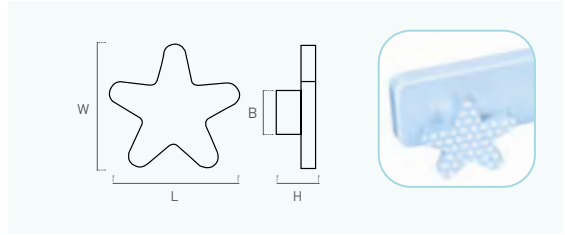

Color	Cod.	Ref.	L	W	B	H	
03	<b>698BLS</b>	698S.54.03	53	50	15	32	12
11	<b>698RSS</b>	698S.54.11	53	50	15	32	12
12	<b>698VES</b>	698S.54.12	53	50	15	32	12
14	<b>698AZS</b>	698S.54.14	53	50	15	32	12
21	<b>698ARS</b>	698S.54.21	53	50	15	32	12

Surtido/ Assortment

<b>698SUS</b>	698S.54.35	53	50	15	32	25
---------------	------------	----	----	----	----	----





Color	Cod.	Ref.	L	W	B	H	
	<b>440BL2</b>	440.67.03	<b>67</b>	65	18	29	12
	<b>440BL</b>	440.95.03	<b>92</b>	89	29	29	12
	<b>440RS2</b>	440.67.11	<b>67</b>	65	18	29	12
	<b>440RS</b>	440.95.11	<b>92</b>	89	29	29	12
	<b>440GR2</b>	440.67.13	<b>67</b>	65	18	29	12
	<b>440GR</b>	440.95.13	<b>92</b>	89	29	29	12
	<b>440AZ2</b>	440.67.14	<b>67</b>	65	18	29	12
	<b>440AZ</b>	440.95.14	<b>92</b>	89	29	29	12
	<b>440AR2</b>	440.67.27	<b>67</b>	65	18	29	12
	<b>440AR</b>	440.95.27	<b>92</b>	89	29	29	12
	<b>LM003C</b>	440.95.60	<b>92</b>	89	29	29	12



441



madera wood

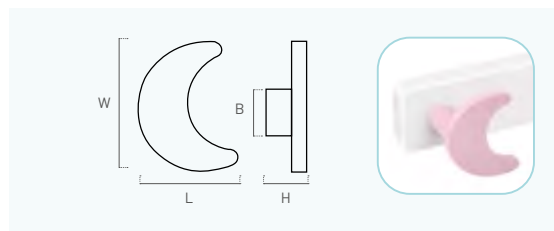

Color	Cod.	Ref.	L	W	B	H	
	<b>441BL2</b>	441.66.03	<b>49</b>	66	18	29	12
	<b>441BL</b>	441.95.03	<b>71</b>	97	29	29	12
	<b>441RS2</b>	441.66.11	<b>49</b>	66	18	29	12
	<b>441RS</b>	441.95.11	<b>71</b>	97	29	29	12
	<b>441GR2</b>	441.66.13	<b>49</b>	66	18	29	12
	<b>441GR</b>	441.95.13	<b>71</b>	97	29	29	12
	<b>441AZ2</b>	441.66.14	<b>49</b>	66	18	29	12
	<b>441AZ</b>	441.95.14	<b>71</b>	97	29	29	12
	<b>441AR2</b>	441.66.27	<b>49</b>	66	18	29	12
	<b>441AR</b>	441.95.27	<b>71</b>	97	29	29	12
	<b>LM005C</b>	441.95.60	<b>71</b>	97	29	29	12

442 - 442P



madera

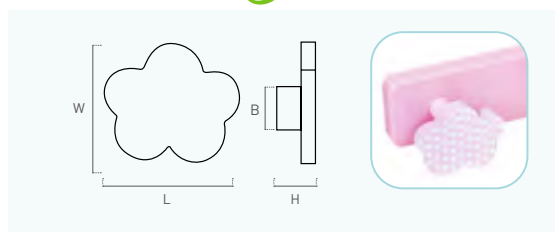

Color	Cod.	Ref.	L	W	B	H	
	<b>442BL2</b>	442.68.03	<b>68</b>	58	18	25	12
	<b>442BL</b>	442.95.03	<b>99</b>	85	29	28	12
	<b>442RS2</b>	442.68.11	<b>68</b>	58	18	25	12
	<b>442RS</b>	442.95.11	<b>99</b>	85	29	28	12
	<b>442GR2</b>	442.68.13	<b>68</b>	58	18	25	12
	<b>442GR</b>	442.95.13	<b>99</b>	85	29	28	12
	<b>442AZ2</b>	442.68.14	<b>68</b>	58	18	25	12
	<b>442AZ</b>	442.95.14	<b>99</b>	85	29	28	12
	<b>442AR2</b>	442.68.27	<b>68</b>	58	18	25	12
	<b>442AR</b>	442.95.27	<b>99</b>	85	29	28	12
	<b>LM007C</b>	442.95.60	<b>99</b>	85	29	28	12



	<b>442PR</b>	442P.95.11	<b>95</b>	92	29	28	12
--	--------------	------------	-----------	----	----	----	----

443



madera wood

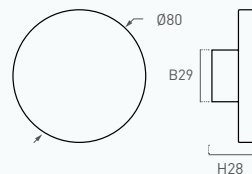

Color	Cod.	Ref.	Ø	B	H	
03	<b>443BL</b>	443.80.03	80	29	28	12
11	<b>443RS</b>	443.80.11	80	29	28	12
13	<b>443GR</b>	443.80.13	80	29	28	12
14	<b>443AZ</b>	443.80.14	80	29	28	12
27	<b>443AR</b>	443.80.27	80	29	28	12
60	<b>LM001C</b>	443.80.60	80	29	28	12

444



madera wood

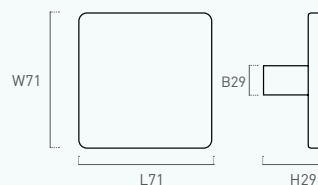

Color	Cod.	Ref.	L	W	H	B	
03	<b>444BL</b>	444.70.03	71	71	29	29	12
11	<b>444RS</b>	444.70.11	71	71	29	29	12
13	<b>444GR</b>	444.70.13	71	71	29	29	12
14	<b>444AZ</b>	444.70.14	71	71	29	29	12
27	<b>444AR</b>	444.70.27	71	71	29	29	12
60	<b>LM013C</b>	444.70.60	71	71	29	29	12

445



madera wood

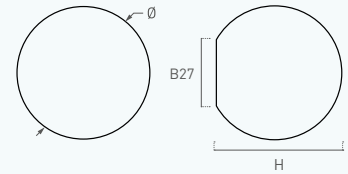

Color	Cod.	Ref.	Ø	B	H	
03	<b>445BL2</b>	445.40.03	40	27	37	12
	<b>445BL1</b>	445.50.03	50	27	47	12
11	<b>445RS2</b>	445.40.11	40	27	37	12
	<b>445RS1</b>	445.50.11	50	27	47	12
13	<b>445GR2</b>	445.40.13	40	27	37	12
	<b>445GR1</b>	445.50.13	50	27	47	12
14	<b>445AZ2</b>	445.40.14	40	27	37	12
	<b>445AZ1</b>	445.50.14	50	27	47	12
27	<b>445AR2</b>	445.40.27	40	27	37	12
	<b>445AR1</b>	445.50.27	50	27	47	12
60	<b>445CR2</b>	445.40.60	40	27	37	12
	<b>445CR1</b>	445.50.60	50	27	47	12

Surtido/ Assortment

	<b>445SB2</b>	445S1.40.35	40	27	37	25
	<b>445SB1</b>	445S1.50.35	50	27	47	25

446



madera wood

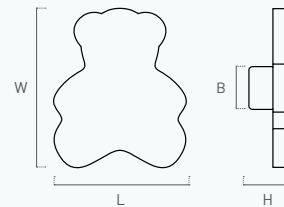

Color	Cod.	Ref.	L	W	B	H	
03	<b>446BL2</b>	446.63.03	53	63	18	29	12
	<b>446BL</b>	446.90.03	76	90	29	28	12
11	<b>446RS2</b>	446.63.11	53	63	18	29	12
	<b>446RS</b>	446.90.11	76	90	29	28	12
13	<b>446GR2</b>	446.63.13	53	63	18	29	12
	<b>446GR</b>	446.90.13	76	90	29	28	12
14	<b>446AZ2</b>	446.63.14	53	63	18	29	12
	<b>446AZ</b>	446.90.14	76	90	29	28	12
27	<b>446AR2</b>	446.63.27	53	63	18	29	12
	<b>446AR</b>	446.90.27	76	90	29	28	12
60	<b>446CR2</b>	446.63.60	53	63	18	29	12
	<b>446CR</b>	446.90.60	76	90	29	28	12



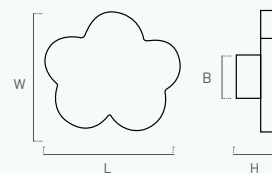

Color	Cod.	Ref.	L	W	B	H	📦
03	<b>442BLM2</b>	442M.68.03	68	58	18	29	12
	<b>442BLM</b>	442M.95.03	99	84	29	29	12
11	<b>442RSM2</b>	442M.68.11	68	58	18	29	12
	<b>442RSM</b>	442M.95.11	99	84	29	29	12
13	<b>442GRM2</b>	442M.68.13	68	58	18	29	12
	<b>442GRM</b>	442M.95.13	99	84	29	29	12
14	<b>442AZM2</b>	442M.68.14	68	58	18	29	12
	<b>442AZM</b>	442M.95.14	99	84	29	29	12
27	<b>442ARM2</b>	442M.68.27	68	58	18	29	12
	<b>442ARM</b>	442M.95.27	99	84	29	29	12
62	<b>442AN2</b>	442M.68.62	68	58	18	29	12
	<b>442AN</b>	442M.95.62	99	84	29	29	12

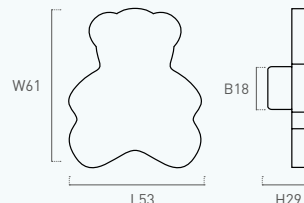

Color	Cod.	Ref.	L	W	B	H	📦
03	<b>446BLM2</b>	446M.63.03	53	61	18	29	12
11	<b>446RSM2</b>	446M.63.11	53	61	18	29	12
13	<b>446GRM2</b>	446M.63.13	53	61	18	29	12
14	<b>446AZM2</b>	446M.63.14	53	61	18	29	12
27	<b>446ARM2</b>	446M.63.27	53	61	18	29	12
62	<b>446AN2</b>	446M.63.62	53	61	18	29	12

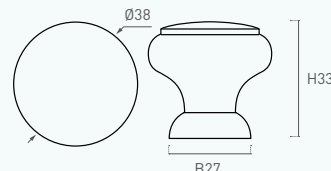

pág. 56/195

Color	Cod.	Ref.	Ø	B	H	📦
03	<b>403BL</b>	403.40.03	38	27	33	12
11	<b>403RS</b>	403.40.11	38	27	33	12
13	<b>403GR</b>	403.40.13	38	27	33	12
14	<b>403AZC</b>	403.40.14	38	27	33	12
27	<b>403AR</b>	403.40.27	38	27	33	12

Surtido/ Assortment

<b>403SB</b>	403S1.40.35	38	27	33	30
--------------	-------------	----	----	----	----



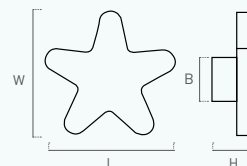

Color	Cod.	Ref.	L	W	B	H	
	<b>440BLM2</b>	440M.67.03	<b>67</b>	65	18	29	12
	<b>440BLM</b>	440M.95.03	<b>92</b>	88	29	29	12
	<b>440RSM2</b>	440M.67.11	<b>67</b>	65	18	29	12
	<b>440RSM</b>	440M.95.11	<b>92</b>	88	29	29	12
	<b>440GRM2</b>	440M.67.13	<b>67</b>	65	18	29	12
	<b>440GRM</b>	440M.95.13	<b>92</b>	88	29	29	12
	<b>440AZM2</b>	440M.67.14	<b>67</b>	65	18	29	12
	<b>440AZM</b>	440M.95.14	<b>92</b>	88	29	29	12
	<b>440ARM2</b>	440M.67.27	<b>67</b>	65	18	29	12
	<b>440ARM</b>	440M.95.27	<b>92</b>	88	29	29	12
	<b>440AN2</b>	440M.67.62	<b>67</b>	88	18	29	12
	<b>440AN</b>	440M.95.62	<b>92</b>	88	29	29	12

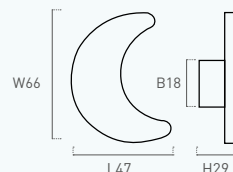

Color	Cod.	Ref.	L	W	B	H	
	<b>441BLM2</b>	441M.66.03	<b>47</b>	66	18	29	12
	<b>441RSM2</b>	441M.66.11	<b>47</b>	66	18	29	12
	<b>441GRM2</b>	441M.66.13	<b>47</b>	66	18	29	12
	<b>441AZM2</b>	441M.66.14	<b>47</b>	66	18	29	12
	<b>441ARM2</b>	441M.66.27	<b>47</b>	66	18	29	12
	<b>441AN2</b>	441M.66.62	<b>47</b>	66	18	29	12

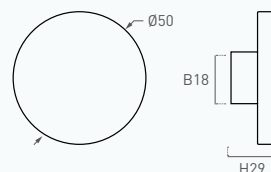

Color	Cod.	Ref.	Ø	B	H	
	<b>443BLM2</b>	443M.50.03	<b>50</b>	18	29	12
	<b>443RSM2</b>	443M.50.11	<b>50</b>	18	29	12
	<b>443GRM2</b>	443M.50.13	<b>50</b>	18	29	12
	<b>443AZM2</b>	443M.50.14	<b>50</b>	18	29	12
	<b>443ARM2</b>	443M.50.27	<b>50</b>	18	29	12
	<b>443AN2</b>	443M.50.62	<b>50</b>	18	29	12



732

ABS

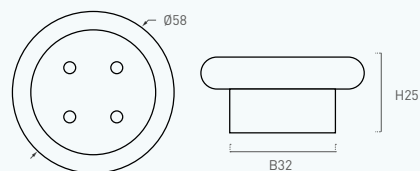

Color	Cod.	Ref.	Ø	B	H	
07	<b>732NA</b>	732.58.07	58	32	25	12
11	<b>732RS</b>	732.58.11	58	32	25	12
17	<b>732LI</b>	732.58.17	58	32	25	12
21	<b>732BE</b>	732.58.21	58	32	25	12

Surtido/ Assortment

<b>732SU</b>	732.58.35	58	32	25	24
--------------	-----------	----	----	----	----



688

ABS

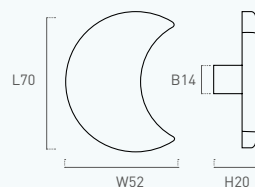

Color	Cod.	Ref.	L	W	B	H	
03	<b>688RS</b>	688.70.11	70	52	14	20	12
06	<b>688AZ</b>	688.70.14	70	52	14	20	12



689

ABS

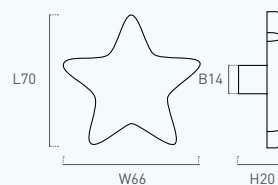

Color	Cod.	Ref.	L	W	B	H	
11	<b>689RS</b>	689.70.11	70	66	14	20	12
14	<b>689AZ</b>	689.70.14	70	66	14	20	12





725

ABS

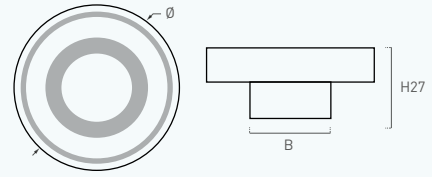

Color	Cod.	Ref.	Ø	B	H	Icon
	<b>7254NJ</b>	725.40.07	<b>43</b>	21	27	12
	<b>7258NJ</b>	725.80.07	<b>86</b>	28	27	12
	<b>7254RA</b>	725.40.10	<b>43</b>	21	27	12
	<b>7258RA</b>	725.80.10	<b>86</b>	28	27	12
	<b>7254MR</b>	725.40.11	<b>43</b>	21	27	12
	<b>7258MR</b>	725.80.11	<b>86</b>	28	27	12
	<b>7254VT</b>	725.40.12	<b>43</b>	21	27	12
	<b>7258VT</b>	725.80.12	<b>86</b>	28	27	12

Surtido/ Assortment

<b>7254SU</b>	725.40.35	<b>43</b>	21	27	24
<b>7258SU</b>	725.80.35	<b>86</b>	28	27	24



726

ABS

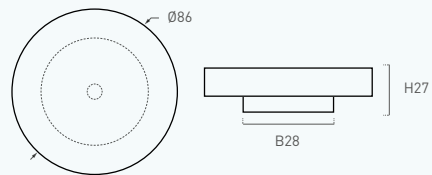

Color	Cod.	Ref.	Ø	B	H	Icon
	<b>726BL</b>	726.80.03	86	28	27	12
	<b>726MG</b>	726.80.04	86	28	27	12
	<b>726MO</b>	726.80.06	86	28	27	12
	<b>726NA</b>	726.80.07	86	28	27	12
	<b>726VE</b>	726.80.12	86	28	27	12

Surtido/ Assortment

<b>726SU</b>	726.80.35	86	28	27	25
--------------	-----------	----	----	----	----



450



madera tela  
wood fabric

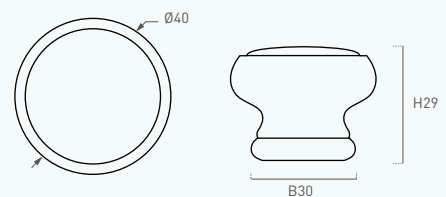

Color	Cod.	Ref.	Ø	B	H	Icon
	<b>450BL109</b>	450-109.40.10	<b>40</b>	30	29	12



## 666 - 666X metacrilato methacrylate

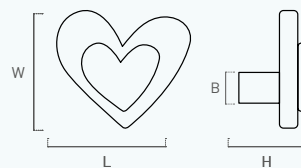

Color	Cod.	Ref.	L	W	B	H	
04	<b>666MG</b>	666.42.04	42	37	12	27	12
04	<b>666MGX</b>	666X.54.04	56	50	14	32	12



## 660 resina-nácar resin-nacre

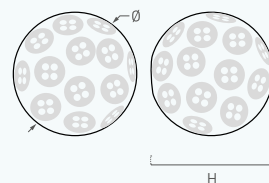

Color	Cod.	Ref.	Ø	H	
34	<b>660A1</b>	660.33.34	35	34	12
11	<b>660RS</b>	660.33.11	35	34	12
46	<b>660NC</b>	660.33.46	35	34	12
Surtido/ Assortment					
<b>660SUX</b>			660.33.35	35	34 12



## 403 PEFC<sup>®</sup> PEFC/14-35-00303 madera wood

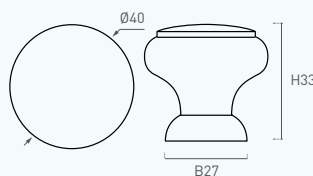

pág. 56/190

Color	Cod.	Ref.	Ø	B	H	
02	<b>403AZ</b>	403.40.02	38	33	27	12
07	<b>403NA</b>	403.40.07	38	33	27	12
10	<b>403BU</b>	403.40.10	38	33	27	12
12	<b>403VE</b>	403.40.12	38	33	27	12

Surtido/ Assortment

<b>403SC</b>	403S2.40.35	38	33	27	24
--------------	-------------	----	----	----	----



## 729

ABS

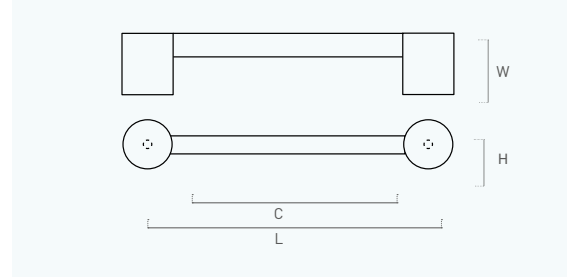

Color	Cod.	Ref.	C	L	W	H	
02	<b>729AZ</b>	729.128.02	<b>128</b>	152	31	24	12
03	<b>729BL</b>	729.128.03	<b>128</b>	152	31	24	12
04	<b>729MG</b>	729.128.04	<b>128</b>	152	31	24	12
06	<b>729MO</b>	729.128.06	<b>128</b>	152	31	24	12
07	<b>729NA</b>	729.128.07	<b>128</b>	152	31	24	12
09	<b>729VE</b>	729.128.09	<b>128</b>	152	31	24	12
11	<b>729RS</b>	729.128.11	<b>128</b>	152	31	24	12

Surtido/ Assortment

<b>729SU</b>	729.128.35	<b>128</b>	152	31	24	35
--------------	------------	------------	-----	----	----	----

## 731

ABS

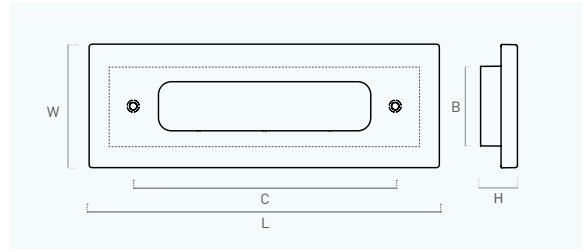

Color	Cod.	Ref.	C	L	W	B	H	
02	<b>731AZ</b>	731.128.02	<b>128</b>	170	60	40x150	18	12
03	<b>731BL</b>	731.128.03	<b>128</b>	170	60	40x150	18	12
04	<b>731MG</b>	731.128.04	<b>128</b>	170	60	40x150	18	12
06	<b>731MO</b>	731.128.06	<b>128</b>	170	60	40x150	18	12
07	<b>731NA</b>	731.128.07	<b>128</b>	170	60	40x150	18	12
09	<b>731VE</b>	731.128.09	<b>128</b>	170	60	40x150	18	12
11	<b>731RS</b>	731.128.11	<b>128</b>	170	60	40x150	18	12

Surtido/ Assortment

<b>731SU</b>	731.128.35	<b>128</b>	170	60	40x150	18	35
--------------	------------	------------	-----	----	--------	----	----





745

ABS

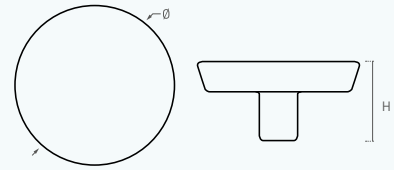
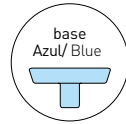

Cod.	Ref.	Ø	H	📦
745A1	745A1.50.14	50	24	12
745A2	745A2.50.14	50	24	12
745A3	745A3.50.14	50	24	12
745A4	745A4.50.14	50	24	12

Surtido/ Assortment

745SUA	745A.50.35	50	24	24
--------	------------	----	----	----



745A5	745A5.50.11	50	24	12
745A6	745A6.50.11	50	24	12
745A7	745A7.50.11	50	24	12
745A8	745A8.50.11	50	24	12

Surtido/ Assortment

745SUR	745R.50.35	50	24	24
--------	------------	----	----	----



**Perchas de ABS**  
Abs hooks

**740**

ABS

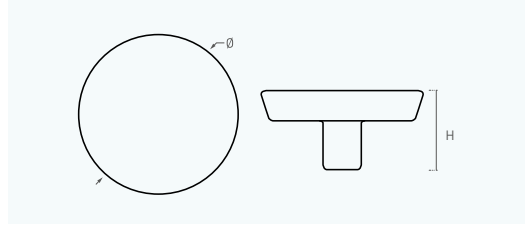
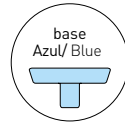

740A2

740A1



740A3



740A4

Cod.	Ref.	Ø	H	📦
740A1	740A1.50.14	50	24	12
740A2	740A2.50.14	50	24	12
740A3	740A3.50.14	50	24	12
740A4	740A4.50.14	50	24	12

Surtido/ Assortment

740SU	740.50.35	50	24	24
-------	-----------	----	----	----

**741**

ABS

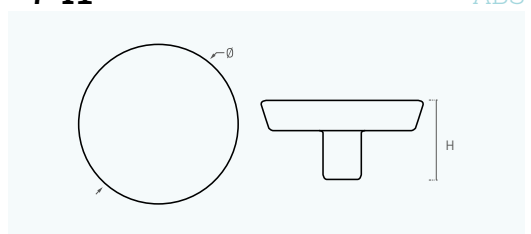
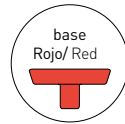

741A1



741A3



741A2



741A4

Cod.	Ref.	Ø	H	📦
741A1	741A1.50.02	50	24	12
741A2	741A2.50.02	50	24	12
741A3	741A3.50.02	50	24	12
741A4	741A4.50.02	50	24	12

Surtido/ Assortment

741SU	741.50.35	50	24	24
-------	-----------	----	----	----



742A2

742A1

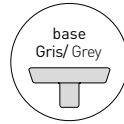

742

ABS

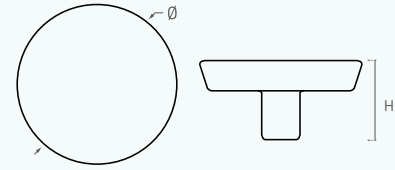

Cod.	Ref.	Ø	H	☐
<b>742A1</b>	742A1.50.11	<b>50</b>	24	12
<b>742A2</b>	742A2.50.11	<b>50</b>	24	12

Surtido/ Assortment

<b>742SU</b>	742.50.35	<b>50</b>	24	12
--------------	-----------	-----------	----	----



743A4

743A3

743A1

743A2



743

ABS

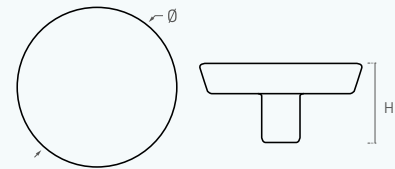

Cod.	Ref.	Ø	H	☐
<b>743A1</b>	743A1.50.36	<b>50</b>	24	12
<b>743A2</b>	743A2.50.11	<b>50</b>	24	12
<b>743A3</b>	743A3.50.04	<b>50</b>	24	12
<b>743A4</b>	743A4.50.36	<b>50</b>	24	12

Surtido/ Assortment

<b>743SU</b>	743.50.35	<b>50</b>	24	24
--------------	-----------	-----------	----	----



744A1

744A4

744A7

744A6

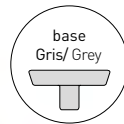

744

ABS

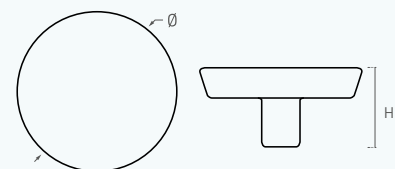

Cod.	Ref.	Ø	H	☐
<b>744A1</b>	744A1.50.04	<b>50</b>	24	12
<b>744A4</b>	744A4.50.11	<b>50</b>	24	12
<b>744A6</b>	744A6.50.14	<b>50</b>	24	12
<b>744A7</b>	744A7.50.07	<b>50</b>	24	12

Surtido/ Assortment

<b>744SU</b>	744.50.35	<b>50</b>	24	24
--------------	-----------	-----------	----	----



**Perchas de ABS**  
Abs hooks



746A2



746A1



**746**

ABS

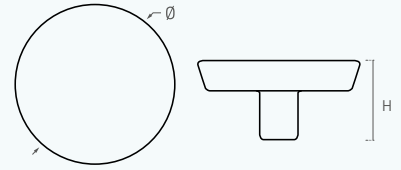

Cod.	Ref.	Ø	H	☒
<b>746A1</b>	746A1.50.11	<b>50</b>	24	12
<b>746A2</b>	746A2.50.11	<b>50</b>	24	12

Surtido/ Assortment

<b>746SU</b>	746.50.35	<b>50</b>	24	12
--------------	-----------	-----------	----	----

747A3



747A2



747A1



**747**

ABS

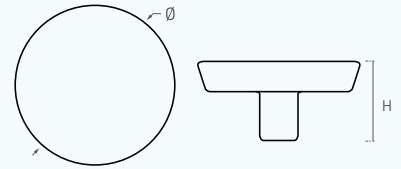

Cod.	Ref.	Ø	H	☒
<b>747A1</b>	747A1.50.11	<b>50</b>	24	12
<b>747A2</b>	747A2.50.11	<b>50</b>	24	12
<b>747A3</b>	747A3.50.11	<b>50</b>	24	12

Surtido/ Assortment

<b>747SU</b>	747.50.35	<b>50</b>	24	18
--------------	-----------	-----------	----	----

748A2



748A3



748A4



748A1

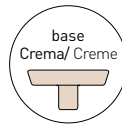

**748**

ABS

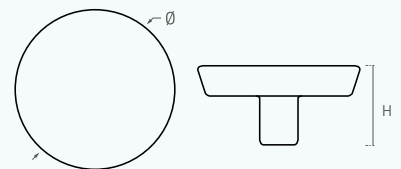

Cod.	Ref.	Ø	H	☒
<b>748A1</b>	748A1.50.34	<b>50</b>	24	12
<b>748A2</b>	748A2.50.34	<b>50</b>	24	12
<b>748A3</b>	748A3.50.34	<b>50</b>	24	12
<b>748A4</b>	748A4.50.34	<b>50</b>	24	12

Surtido/ Assortment

<b>748SU</b>	748.50.35	<b>50</b>	24	16
--------------	-----------	-----------	----	----





749A3



749A4

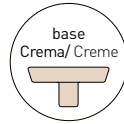

749A1



749A2

749

ABS

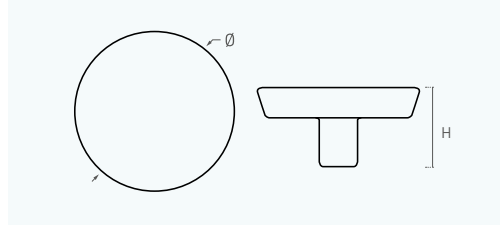

Cod.	Ref.	Ø	H	Icon
<b>749A1</b>	749A1.50.34	50	24	12
<b>749A2</b>	749A2.50.34	50	24	12
<b>749A3</b>	749A3.50.34	50	24	12
<b>749A4</b>	749A4.50.34	50	24	12

Surtido/ Assortment

<b>749SU</b>	749.50.35	50	24	16
--------------	-----------	----	----	----

750A2



750A1



750A3



750

ABS

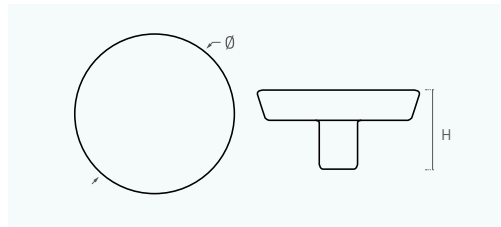

Cod.	Ref.	Ø	H	Icon
<b>750A1</b>	750A1.50.34	50	24	12
<b>750A2</b>	750A2.50.34	50	24	12
<b>750A3</b>	750A3.50.34	50	24	12

Surtido/ Assortment

<b>750SU</b>	750.50.35	50	24	18
--------------	-----------	----	----	----



753A2



753A1



753A3



753A4

753

ABS

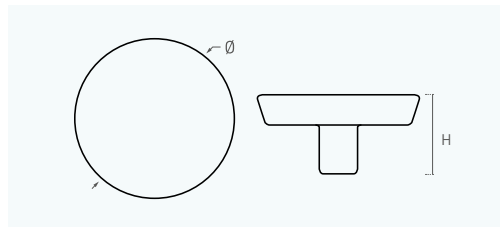

Cod.	Ref.	Ø	H	Icon
<b>753A1</b>	753A1.50.11	50	24	12
<b>753A2</b>	753A2.50.11	50	24	12
<b>753A3</b>	753A3.50.11	50	24	12
<b>753A4</b>	753A4.50.11	50	24	12

Surtido/ Assortment

<b>753SU</b>	753.50.35	50	24	16
--------------	-----------	----	----	----



**Perchas de ABS**  
Abs hooks

**751**

ABS

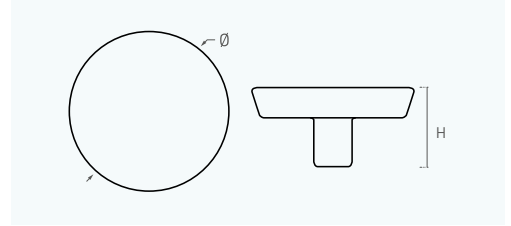
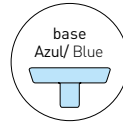

Cod.	Ref.	Ø	H	📦
<b>751A1</b>	751A1.50.14	<b>50</b>	24	12
<b>751A2</b>	751A2.50.14	<b>50</b>	24	12
<b>751A3</b>	751A3.50.14	<b>50</b>	24	12
<b>751A4</b>	751A4.50.14	<b>50</b>	24	12
<b>751A5</b>	751A5.50.14	<b>50</b>	24	12
<b>751A6</b>	751A6.50.14	<b>50</b>	24	12
<b>751A7</b>	751A7.50.14	<b>50</b>	24	12

Surtido/ Assortment

<b>751SU</b>	751.50.35	<b>50</b>	24	14
--------------	-----------	-----------	----	----



**754**

ABS

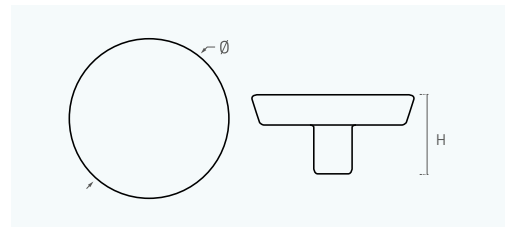

Cod.	Ref.	Ø	H	📦
<b>754A1</b>	754A1.50.12	<b>50</b>	24	12
<b>754A2</b>	754A2.50.07	<b>50</b>	24	12
<b>754A3</b>	754A3.50.10	<b>50</b>	24	12
<b>754A4</b>	754A4.50.36	<b>50</b>	24	12

Surtido/ Assortment

<b>754SU</b>	754.50.35	<b>50</b>	24	16
--------------	-----------	-----------	----	----





752A4



752A3



752A5



752A1



752A2

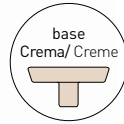

## 752

ABS

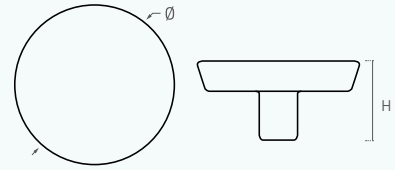

Cod.	Ref.	Ø	H	Icon
<b>752A1</b>	752A1.50.34	<b>50</b>	24	12
<b>752A2</b>	752A2.50.34	<b>50</b>	24	12
<b>752A3</b>	752A3.50.34	<b>50</b>	24	12
<b>752A4</b>	752A4.50.34	<b>50</b>	24	12
<b>752A5</b>	752A5.50.34	<b>50</b>	24	12

Surtido/ Assortment

<b>752SU</b>	752.50.35	<b>50</b>	24	15
--------------	-----------	-----------	----	----



756A5



756A2



756A3



756A4



756A1

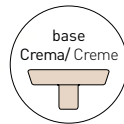

## 756

ABS

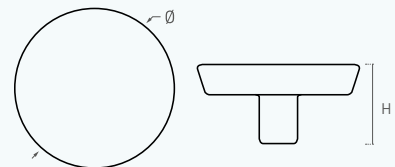

Cod.	Ref.	Ø	H	Icon
<b>756A1</b>	756A1.50.21	<b>50</b>	24	12
<b>756A2</b>	756A2.50.21	<b>50</b>	24	12
<b>756A3</b>	756A3.50.21	<b>50</b>	24	12
<b>756A4</b>	756A4.50.21	<b>50</b>	24	12
<b>756A5</b>	756A5.50.21	<b>50</b>	24	12

Surtido/ Assortment

<b>756SU</b>	756.50.35	<b>50</b>	24	15
--------------	-----------	-----------	----	----





**Perchas de ABS**  
Abs hooks



**755**

ABS

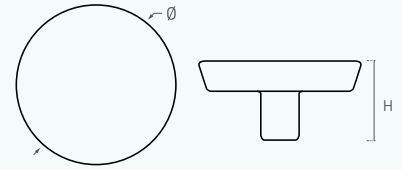

Cod.	Ref.	Ø	H	📦
<b>755A1</b>	755A1.50.34	<b>50</b>	24	12
<b>755A2</b>	755A2.50.34	<b>50</b>	24	12
<b>755A3</b>	755A3.50.34	<b>50</b>	24	12
<b>755A4</b>	755A4.50.34	<b>50</b>	24	12

Surtido/ Assortment

<b>755SU</b>	755.50.35	<b>50</b>	24	12
--------------	-----------	-----------	----	----

**757**

ABS

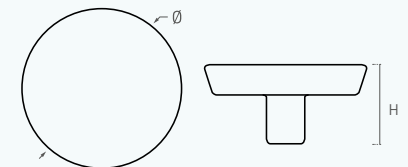
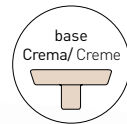

Cod.	Ref.	Ø	H	📦
<b>757A1</b>	757A1.50.34	<b>50</b>	24	12
<b>757A2</b>	757A2.50.34	<b>50</b>	24	12
<b>757A3</b>	757A3.50.34	<b>50</b>	24	12
<b>757A4</b>	757A4.50.34	<b>50</b>	24	12
<b>757A5</b>	757A5.50.34	<b>50</b>	24	12
<b>757A6</b>	757A6.50.34	<b>50</b>	24	12

Surtido/ Assortment

<b>757SU</b>	757.50.35	<b>50</b>	24	12
--------------	-----------	-----------	----	----



758

ABS

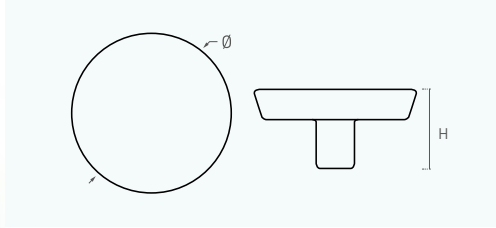

Cod.	Ref.	Ø	H	
<b>758A1</b>	758A1.50.10	<b>50</b>	24	12
<b>758A2</b>	758A2.50.24	<b>50</b>	24	12
<b>758A3</b>	758A3.50.11	<b>50</b>	24	12
<b>758A4</b>	758A4.50.01	<b>50</b>	24	12
<b>758A5</b>	758A5.50.12	<b>50</b>	24	12
<b>758A6</b>	758A6.50.11	<b>50</b>	24	12
<b>758A7</b>	758A7.50.12	<b>50</b>	24	12

Surtido/ Assortment

<b>758SU</b>	758.50.35	<b>50</b>	24	14
--------------	-----------	-----------	----	----

759

ABS

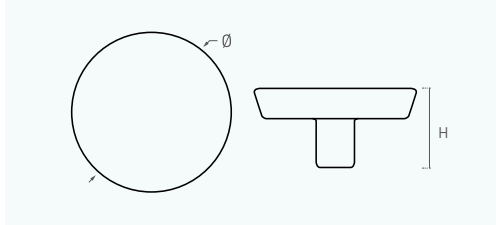

Cod.	Ref.	Ø	H	
<b>759A1</b>	759A1.50.01	<b>50</b>	24	12
<b>759A2</b>	759A2.50.02	<b>50</b>	24	12
<b>759A3</b>	759A3.50.04	<b>50</b>	24	12
<b>759A4</b>	759A4.50.07	<b>50</b>	24	12
<b>759A5</b>	759A5.50.16	<b>50</b>	24	12

Surtido/ Assortment

<b>759SU</b>	759.50.35	<b>50</b>	24	15
--------------	-----------	-----------	----	----



760A2



760A1



760A4



760A6



760A5



760A3

## 760

ABS

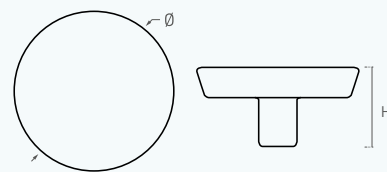

Cod.	Ref.	Ø	H	
<b>760A1</b>	760A1.50.34	<b>50</b>	24	12
<b>760A2</b>	760A2.50.34	<b>50</b>	24	12
<b>760A3</b>	760A3.50.34	<b>50</b>	24	12
<b>760A4</b>	760A4.50.34	<b>50</b>	24	12
<b>760A5</b>	760A5.50.34	<b>50</b>	24	12
<b>760A6</b>	760A6.50.34	<b>50</b>	24	12

Surtido/ Assortment

<b>760SU</b>	760.50.35	<b>50</b>	24	12
--------------	-----------	-----------	----	----



761A2



761A3



761A4



761A1



761A5



## 761

ABS

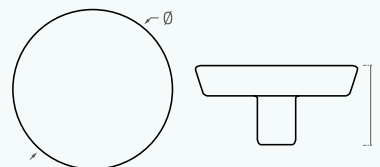

Cod.	Ref.	Ø	H	
<b>761A1</b>	761A1.50.06	<b>50</b>	24	12
<b>761A2</b>	761A2.50.06	<b>50</b>	24	12
<b>761A3</b>	761A3.50.12	<b>50</b>	24	12
<b>761A4</b>	761A4.50.06	<b>50</b>	24	12
<b>761A5</b>	761A5.50.21	<b>50</b>	24	12

Surtido/ Assortment

<b>761SU</b>	761.50.35	<b>50</b>	24	15
--------------	-----------	-----------	----	----



762A2



762A3



762A1



762A4

## 762

ABS

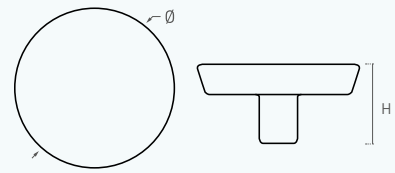

Cod.	Ref.	Ø	H	☐
<b>762A1</b>	762A1.50.36	<b>50</b>	24	12
<b>762A2</b>	762A2.50.36	<b>50</b>	24	12
<b>762A3</b>	762A3.50.36	<b>50</b>	24	12
<b>762A4</b>	762A4.50.36	<b>50</b>	24	12

Surtido/ Assortment

<b>762SU</b>	762.50.35	<b>50</b>	24	12
--------------	-----------	-----------	----	----



763A3



763A2



763A4



763A1

## 763

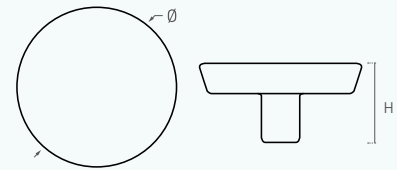

Cod.	Ref.	Ø	H	☐
<b>763A1</b>	763A1.50.36	<b>50</b>	24	12
<b>763A2</b>	763A2.50.36	<b>50</b>	24	12
<b>763A3</b>	763A3.50.36	<b>50</b>	24	12
<b>763A4</b>	763A4.50.36	<b>50</b>	24	12

Surtido/ Assortment

<b>763SU</b>	763.50.35	<b>50</b>	24	12
--------------	-----------	-----------	----	----



## 767

ABS

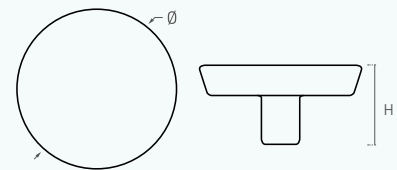

Cod.	Ref.	Ø	H	☐
<b>767A1</b>	767A1.50.03	<b>50</b>	24	12





## 764

ABS

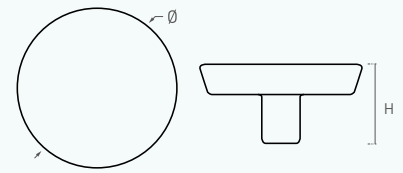

Cod.	Ref.	Ø	H	
<b>764A1</b>	764A1.50.06	<b>50</b>	24	12
<b>764A2</b>	764A2.50.14	<b>50</b>	24	12
<b>764A3</b>	764A3.50.02	<b>50</b>	24	12
<b>764A4</b>	764A4.50.12	<b>50</b>	24	12
<b>764A5</b>	764A5.50.06	<b>50</b>	24	12
<b>764A6</b>	764A6.50.14	<b>50</b>	24	12

Surtido/ Assortment

<b>764SU</b>	764.50.35	<b>50</b>	24	12
--------------	-----------	-----------	----	----



## 765

ABS

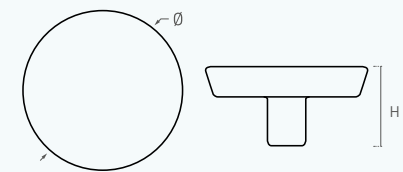

Cod.	Ref.	Ø	H	
<b>765A1</b>	765A1.50.21	<b>50</b>	24	12
<b>765A2</b>	765A2.50.04	<b>50</b>	24	12
<b>765A3</b>	765A3.50.02	<b>50</b>	24	12
<b>765A4</b>	765A4.50.21	<b>50</b>	24	12

Surtido/ Assortment

<b>765SU</b>	765.50.35	<b>50</b>	24	12
--------------	-----------	-----------	----	----



766A2



766A1

## 766

ABS

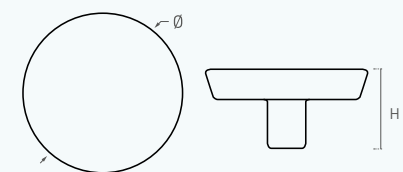

Cod.	Ref.	Ø	H	
<b>766A1</b>	766A1.50.03	<b>50</b>	24	12
<b>766A2</b>	766A2.50.07	<b>50</b>	24	12

Surtido/ Assortment

<b>766SU</b>	766.50.35	<b>50</b>	24	12
--------------	-----------	-----------	----	----





## 770

ABS

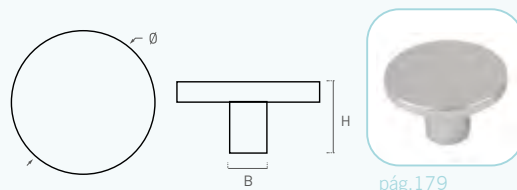

pág.179

Color	Cod.	Ref.	Ø	B	H	☐
02	7704AZ	770.40.02	40	15	23	12
	770AZ	770.60.02	61	20	30	12
03	7704BL	770.40.03	40	15	23	12
	770BL	770.60.03	61	20	30	12
04	7704MG	770.40.04	40	15	23	12
	770MG	770.60.04	61	20	30	12
06	7704MO	770.40.06	40	15	23	12
	770MO	770.60.06	61	20	30	12
07	7704NA	770.40.07	40	15	23	12
	770NA	770.60.07	61	20	30	12
09	7704VE	770.40.09	40	15	23	12
	770VE	770.60.09	61	20	30	12
11	7704RS	770.40.11	40	15	23	12
	770RS	770.60.11	61	20	30	12
94	7704CR	770.40.94	40	15	23	12
	770CR	770.60.94	61	20	30	12

## 771

ABS

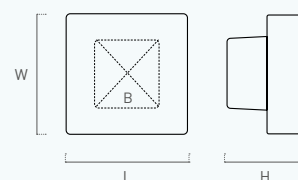

Color	Cod.	Ref.	L	W	B	H	☐
02	<b>771AZ</b>	771.30.02	<b>30</b>	30	18x18	20	12
03	<b>771BL</b>	771.30.03	<b>30</b>	30	18x18	20	12
04	<b>771MG</b>	771.30.04	<b>30</b>	30	18x18	20	12
06	<b>771MO</b>	771.30.06	<b>30</b>	30	18x18	20	12
07	<b>771NA</b>	771.30.07	<b>30</b>	30	18x18	20	12
09	<b>771VE</b>	771.30.09	<b>30</b>	30	18x18	20	12
94	<b>771CR</b>	771.30.94	<b>30</b>	30	18x18	20	12



## 772

ABS

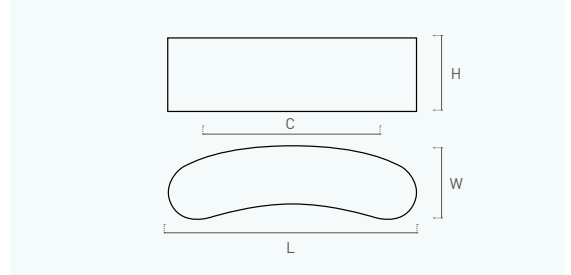

Color	Cod.	Ref.	C	L	W	H	
03	<b>772BL</b>	772.32.03	32	55	18	18	12
04	<b>772MG</b>	772.32.04	32	55	18	18	12
06	<b>772MO</b>	772.32.06	32	55	18	18	12
07	<b>772NA</b>	772.32.07	32	55	18	18	12
09	<b>772VE</b>	772.32.09	32	55	18	18	12
94	<b>772CR</b>	772.32.94	32	55	18	18	12

## 769

ABS

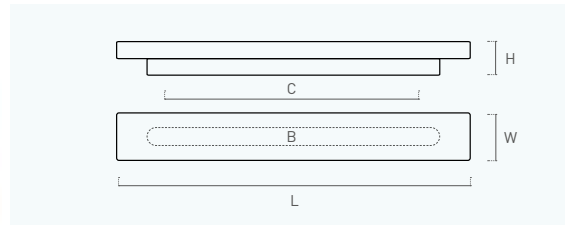

Color	Cod.	Ref.	C	L	W	B	H	
02	<b>769AZ</b>	769.128.02	128	198	40	9x170	21	12
03	<b>769BL</b>	769.128.03	128	198	40	9x170	21	12
04	<b>769MG</b>	769.128.04	128	198	40	9x170	21	12
06	<b>769MO</b>	769.128.06	128	198	40	9x170	21	12
07	<b>769NA</b>	769.128.07	128	198	40	9x170	21	12
09	<b>769VE</b>	769.128.09	128	198	40	9x170	21	12

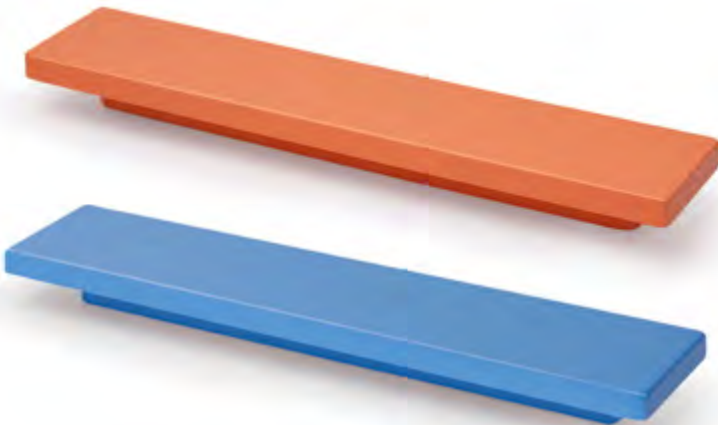



## 727

ABS

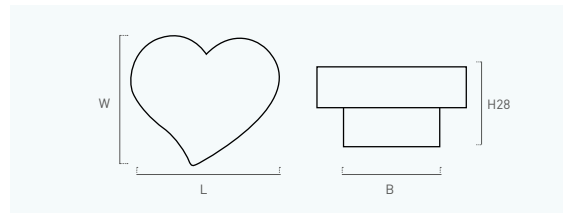

Color	Cod.	Ref.	L	W	B	H	
03	<b>7274BL</b>	727.47.03	48	44	20	28	12
	<b>7278BL</b>	727.88.03	88	77	28	28	12
04	<b>7274MG</b>	727.47.04	48	44	20	28	12
	<b>7278MG</b>	727.88.04	88	77	28	28	12
06	<b>7274MO</b>	727.47.06	48	44	20	28	12
	<b>7278MO</b>	727.88.06	88	77	28	28	12
11	<b>7274RS</b>	727.47.11	48	44	20	28	12
	<b>7278RS</b>	727.88.11	88	77	28	28	12
Surtido/ Assortment							
	<b>7274SU</b>	727.47.35	48	44	20	28	24
	<b>7278SU</b>	727.88.35	88	77	28	28	24

## 730

ABS

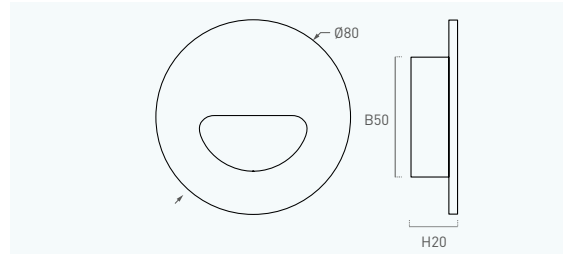

Color	Cod.	Ref.	C	Ø	B	H	
02	<b>730AZ</b>	730.32.02	32	80	50	20	12
03	<b>730BL</b>	730.32.03	32	80	50	20	12
04	<b>730MG</b>	730.32.04	32	80	50	20	12
06	<b>730MO</b>	730.32.06	32	80	50	20	12
07	<b>730NA</b>	730.32.07	32	80	50	20	12
09	<b>730VE</b>	730.32.09	32	80	50	20	12
11	<b>730RS</b>	730.32.11	32	80	50	20	12
Surtido/ Assortment							
	<b>730SU</b>	730.32.35	32	80	50	20	35



## 620

ABS

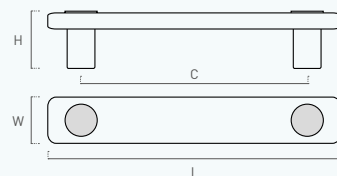

Color	Cod.	Ref.	C	L	W	H	
01	<b>620AM</b>	620.96.01	96	126	20	27	12
02	<b>620AZ</b>	620.96.02	96	126	20	27	12
04	<b>620MG</b>	620.96.04	96	126	20	27	12
07	<b>620NA</b>	620.96.07	96	126	20	27	12
10	<b>620RJ</b>	620.96.10	96	126	20	27	12
12	<b>620VE</b>	620.96.12	96	126	20	27	12
25	<b>620HI</b>	620.96.25	96	126	20	27	12

Surtido/ Assortment

<b>620SU</b>	620.96.35	96	126	20	27	35
--------------	-----------	----	-----	----	----	----

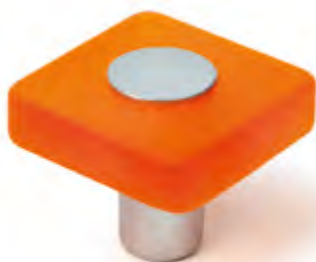

## 621

ABS

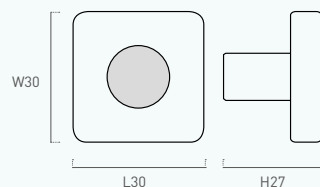

Color	Cod.	Ref.	L	W	H	
01	<b>621AM</b>	621.30.01	30	30	27	12
02	<b>621AZ</b>	621.30.02	30	30	27	12
04	<b>621MG</b>	621.30.04	30	30	27	12
07	<b>621NA</b>	621.30.07	30	30	27	12
10	<b>621RJ</b>	621.30.10	30	30	27	12
12	<b>621VE</b>	621.30.12	30	30	27	12
25	<b>621HI</b>	621.30.25	30	30	27	12

Surtido/ Assortment

<b>621SU</b>	621.30.35	30	30	27	35
--------------	-----------	----	----	----	----



## 622

ABS

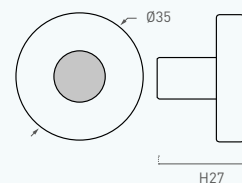

Color	Cod.	Ref.	Ø	H	
01	<b>622AM</b>	622.35.01	35	27	12
02	<b>622AZ</b>	622.35.02	35	27	12
04	<b>622MG</b>	622.35.04	35	27	12
07	<b>622NA</b>	622.35.07	35	27	12
10	<b>622RJ</b>	622.35.10	35	27	12
12	<b>622VE</b>	622.35.12	35	27	12
25	<b>622HI</b>	622.35.25	35	27	12

Surtido/ Assortment

<b>622SU</b>	622.35.35	35	27	30
--------------	-----------	----	----	----





608

resin ABS

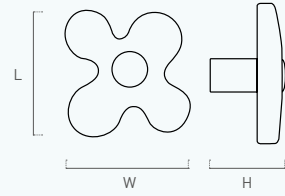

Color	Cod.	Ref.	L	W	H	☒
01	<b>608AM</b>	608.43.01	43	38	25	12
02	<b>608AZ</b>	608.43.02	43	38	25	12
04	<b>608MG</b>	608.43.04	43	38	25	12
06	<b>608MO</b>	608.43.06	43	38	25	12
07	<b>608NA</b>	608.43.07	43	38	25	12
09	<b>608PI</b>	608.43.09	43	38	25	12
25	<b>608HI</b>	608.43.25	43	38	25	12

Surtido/ Assortment

<b>608SU</b>	608.43.35	43	38	25	45
--------------	-----------	----	----	----	----



627

ABS

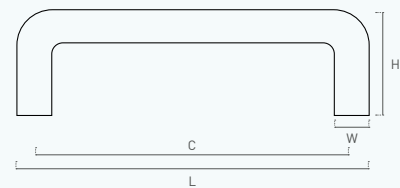

Color	Cod.	Ref.	C	L	W	H	☒
01	<b>627AM</b>	627.96.01	96	105	Ø10	35	25
02	<b>627AZM</b>	627.96.02	96	105	Ø10	35	25
03	<b>627BL</b>	627.96.03	96	105	Ø10	35	25
04	<b>627MG</b>	627.96.04	96	105	Ø10	35	25
06	<b>627MO</b>	627.96.06	96	105	Ø10	35	25
07	<b>627NA</b>	627.96.07	96	105	Ø10	35	25
08	<b>627NE</b>	627.96.08	96	105	Ø10	35	25
09	<b>627PI</b>	627.96.09	96	105	Ø10	35	25
10	<b>627RJ</b>	627.96.10	96	105	Ø10	35	25
11	<b>627RS</b>	627.96.11	96	105	Ø10	35	25
12	<b>627VE</b>	627.96.12	96	105	Ø10	35	25
13	<b>627GR</b>	627.96.13	96	105	Ø10	35	25
14	<b>627AZC</b>	627.96.14	96	105	Ø10	35	25
16	<b>627AZ</b>	627.96.16	96	105	Ø10	35	25

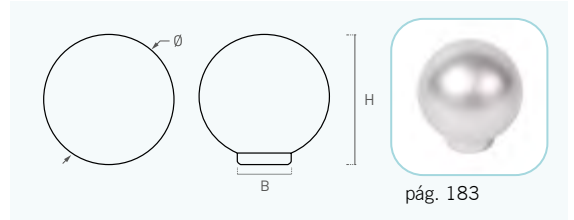

pág. 183



Color	Cod.	Ref.	Ø	H	H	H	
01	<b>626AM</b>	626.24.01	24	11	25	25	
02	<b>626AZM</b>	626.24.02	24	11	25	25	
03	<b>626BL</b>	626.24.03	24	11	25	25	
04	<b>626MG</b>	626.24.04	24	11	25	25	
06	<b>626MO</b>	626.24.06	24	11	25	25	
07	<b>626NA</b>	626.24.07	24	11	25	25	
08	<b>626NE</b>	626.24.08	24	11	25	25	
09	<b>626PI</b>	626.24.09	24	11	25	25	
10	<b>626RJ</b>	626.24.10	24	11	25	25	
11	<b>626RS</b>	626.24.11	24	11	25	25	
12	<b>626VE</b>	626.24.12	24	11	25	25	
13	<b>626GR</b>	626.24.13	24	11	25	25	
14	<b>626AZC</b>	626.24.14	24	11	25	25	
16	<b>626AZ</b>	626.24.16	24	11	25	25	

01	<b>626AM1</b>	626.29.01	28	13	29	25	
02	<b>626AZM1</b>	626.29.02	28	13	29	25	
03	<b>626BL1</b>	626.29.03	28	13	29	25	
04	<b>626MG1</b>	626.29.04	28	13	29	25	
06	<b>626MO1</b>	626.29.06	28	13	29	25	
07	<b>626NA1</b>	626.29.07	28	13	29	25	
08	<b>626NE1</b>	626.29.08	28	13	29	25	
09	<b>626PI1</b>	626.29.09	28	13	29	25	
10	<b>626RJ1</b>	626.29.10	28	13	29	25	
11	<b>626RS1</b>	626.29.11	28	13	29	25	
12	<b>626VE1</b>	626.29.12	28	13	29	25	
13	<b>626GR1</b>	626.29.13	28	13	29	25	
14	<b>626AZC1</b>	626.29.14	28	13	29	25	
16	<b>626AZ1</b>	626.29.16	28	13	29	25	











































































01	<b>626AM2</b>	626.34.01	34	16	35	25	
02	<b>626AZM2</b>	626.34.02	34	16	35	25	
03	<b>626BL2</b>	626.34.03	34	16	35	25	
04	<b>626MG2</b>	626.34.04	34	16	35	25	
06	<b>626MO2</b>	626.34.06	34	16	35	25	
07	<b>626NA2</b>	626.34.07	34	16	35	25	
08	<b>626NE2</b>	626.34.08	34	16	35	25	
09	<b>626PI2</b>	626.34.09	34	16	35	25	
10	<b>626RJ2</b>	626.34.10	34	16	35	25	
11	<b>626RS2</b>	626.34.11	34	16	35	25	
12	<b>626VE2</b>	626.34.12	34	16	35	25	
13	<b>626GR2</b>	626.34.13	34	16	35	25	
14	<b>626AZC2</b>	626.34.14	34	16	35	25	
16	<b>626AZ2</b>	626.34.16	34	16	35	25	

## 626X

Color	Cod.	Ref.	Ø	H	H	H	
02	<b>626AZX</b>	626X.29.02	28	29	25	25	
03	<b>626BLX</b>	626X.29.03	28	29	25	25	
04	<b>626MGX</b>	626X.29.04	28	29	25	25	
06	<b>626MOX</b>	626X.29.06	28	29	25	25	
07	<b>626NAX</b>	626X.29.07	28	29	25	25	
08	<b>626NEX</b>	626X.29.08	28	29	25	25	
09	<b>626PIX</b>	626X.29.09	28	29	25	25	



## Acabados/ Colour Chart/ Finitions/ Verarbeitung

 01	Amarillo/ Yellow/ Jaune/ Gelb	 61	Miel/ Honey/ Miel/ Honig
 02	Azul/Blue/ Bleu/ Blau	 62	Natural / Natural / Naturel / Natur
 03	Blanco/ White/ Blanc/ Weiss	 63	Nogal/ Walnut/ Noyer/ Nussbaum
 04	Magenta/ Magenta/ Magenta/ Magenta	 64	Teka/ Teak/ Teck/ Teak
 05	Marrón/ Brown/ Brun/ Braun	 65	Wengué/ Wenge/ Wenge/ Wenge
 06	Morado/ Purple/ Violet/ Violett	 66	Roble crudo/ Raw Oak/ Chêne brut/ Eiche Roh
 07	Naranja/ Orange/ Orange/ Orange	 67	Roble natural/ Natural Oak/ Chêne naturel/ Eiche Natur
 08	Negro/ Black/ Noir/ Schwarz	 68	Bambú/ Bamboo/ Bambou/ Bambus
 09	Pistacho/ Pistachio/ Pistache/ Pistazie	 69	Madera envejecida/ Antique wood / Bois vieux/ Altholz
 10	Rojo/ Red/ Rouge/ Rot	 70	Bronce viejo/ Antique Bronze/ Bronze Vieilli/ Alt Bronze
 11	Rosa/ Pink/ Rose/ Rosa	 71	Craquelé/ Cracked/ Craquelé/ Geknistert
 12	Verde/ Green/ Vert/ Grün	 72	Cuero Brillo /Bright Bronze/ Bronze brillant/ Glänzend Bronze
 13	Gris/ Grey/ Gris/ Grau	 73	Cuero Cepillado / Matt Bronze / Bronze mat / Matt Bronze
 14	Azul celeste/ Baby blue / Bleu bébé/ Baby-blau	 74	Cuero Viejo/ Antique Brass/ Vieux Laiton/ Alt Messing
 15	Amarillo pastel/ Yellow pastel/ Jaune pastel/ Pastelgelb	 75	Hierro envejecido/ Aged Iron/ Fer Vieilli/ Gealtert Eisen
 16	Azul oscuro/ Dark blue/ Bleu foncé/ Dunkelblau	 77	Negro Oxido / Oxide Black / Noir Oxydé / Oxid Schwarz
 17	Lila/ Lilac / Lilas/ Lila	 78	Plata / Silver/ Argent/ Silber
 20	Ámbar / Amber / Ambre / Bernstein gelb	 79	Plata Brillo/ Bright Silver/ Argent brillant/ Glänzend Silber
 21	Beige/ Beige /Beige/ Beige	 80	Plata Vieja/ Old Silver/ Argent vieilli/ Altsilber
 22	Cereza/ Cherry/ Cérise/ Kirsch	 81	Latón pulido/ Polished brass/ Laiton poli/ Poliertes messing
 23	Chocolate/ Chocolate/ Chocolat/ Schokolade	 82	Flor azul/ Blue flower /Fleur bleue/ Blaue Blume
 24	Crema/ Cream/ Crème/ Creme	 83	Flor marrón/ Brown flower/ Fleur marron/ Braune Blume
 25	Hielo/ Ice/ Glace/ Eis	 84	Aluminio pulido/ Polished aluminium/ Aluminium poli/ Poliertes aluminium
 26	Transparente/ Transparent/ Transparent/ Durchsichtig	 85	Hierro oxido/ Rusted metal/ Métal rouillé/ Rostig metall
 27	Arena/ Sand/ Sable/ Sand	 86	Oxido decape/ Washed rust/ Oxyde decape/ Geweisst Oxid
 31	Oro Inca / Inca Gold / Or Inca / Inca Gold	 87	Bronce pátina BL/ Patinated bronze/ Bronze patinée/ Bronze patiniert
 33	Estampado/ Printed/ Imprimé/ Bedruckt	 88	Plata pátina BL/ Patinated Silver/ Argent patinée/ Silber patiniert
 34	Fantasía / Fantasy / Fantasie / Phantasie	 90	Aluminio/ Aluminium/ Aluminium/ Aluminium
 35	Surtido/ Assortment/ Assortiment/ Sortiment	 91	Anodizado mate/ Matt anodized/ Anodisé/ Eloxiert matt
 36	Colores/ Colours/ Couleurs/ Farbe	 92	Niquel Mate / Matt Nickel / Nickel Mat / Matt Nickel
 37	Decorado flor/ Flower decor/ Décor fleur/ Blume-dekor	 93	Cromo Brillo/ Bright Chrome/ Chrome brillant/ Glänzend Chrom
 40	Coco/ Coconut/ Coco/ Kokos	 94	Cromo Mate/ Matt Chrome/ Chrome mat/ Matt Chrom
 41	Cristal/ Glass/ Verre/ Glas	 95	Niquel Cepillado / Brushed Nickel / Nickel Brossé / Gebürstetes Nickel
 42	Cuerno/ Horn/ Corne/ Horn	 96	Oro/ Gold/ Or/ Gold
 43	Hueso/ Bone/ Os/ Bein	 97	Niquel Negro/ Black Nickel/ Nickel noir/ Schwarz Nickel
 44	Marfil / Ivory / Ivoire/ Elfenbein	 98	Cobre Viejo/ Antique Copper/ Vieux Cuivre/ Alt Kupfer
 45	Mimbre / Wicker / Osier / Weidengeflecht	 99	Latón Satinado / Satin Brass / Laiton satiné / Satiniert Messing
 46	Nácar/ Mother of pearl/ Nacre/ Perlmutter	 100	Cobre Satinado / Satin Copper / Cuivre satiné / Satiniert Kupfer
 47	Hueso envejecido/ Antique Bone/ Os vieilli/ Gealtert Bein	 101	Inox Mate / Matt Brushed Nickel / Inox Mat / Matt Edelstahl
 48	Decapé/ White-washed/ Decapé/ Holz geweisst	 102	Acero Satinado/ Satin Steel/ Acier Satiné/ Satiniert Stahl
 59	Sapeli/ Sapeli/ Sapeli/ Sapeli	 691	Haya Vieja / Antique Beech / Hêtre vieilli / Alt-Buche
60	Crudo/ Raw/ Brut/ Roh	 692	Cerezo Viejo / Antique Cherry / Cerisier vieilli / Alt-Kirschbaum
		693	Nogal Viejo/ Antique Walnut/ Noyer vieilli/ Alt-Nussbaum

## Materials/ Materials/ Matériaux/ Materialien

**ABS** Abs/ Abs/ Abs/ Abs

**aluminium** Aluminio/ Aluminium/ Aluminium/ Aluminium

**bamboo** Bambú/ Bamboo/ Bambou/ Bambus

**brass** Latón/ Brass/ Laiton/ Messing

**bone** Hueso/ Bone/ Os/ Bein

**ceramic** Cerámica/ Ceramic/ Ceramique/ Keramik

**chrome iron** Hierro cromado/ Chromeplated iron/ Fer chromé/ Chromeisen

**coco** Coco/ Coconut/ Coco/ Kokos

**cooper** Cobre/ Copper/ Cuivre/ Kupfer

**enamel** Esmaltado/ Enamel/ Emaillé/ Email

**ethnic** Étnico/ Ethnic/ Ethnique/ Ethnisch

**forge** Forjado/ Forged/ Forgé/ Geschmiedet

**forged iron** Hierro forjado/ Forged Iron/ Fer forgé/ Geschmiedetes Eisen

**glass** Cristal/ Glass/ Verre/ Glas

**gum** Goma/ Rubber/ Caoutchouc/ Gummi

**horn** Cuerno/ Horn/ Corne/ Horn

**iron** Hierro/ Iron/ Fer/ Eisen

**leather** Cuero/ Leather/ Cuir/ Leder

**marble** Mármol/ Marble/ Marbre/ Marmor

**methacrylate** Methacrylato/ Methacrylate/ Methacrylate/ Methacrylate

**murano glass** Cristal de Murano/ Murano crystal/ Cristal de Murano/ Murano Kristall

**nacre** Nácar/ Mother-of-pearl/ Nacre/ Perlmutt

**pewter** Peltre/ Pewter/ Étain/ Zinn

**porcelain** Porcelana/ Porcelain/ Porselain/ Porzellan

**resin** Resina/ Resin/ Résine/ Harz

**rust iron** Hierro óxido/ Rusty Iron/ fer rouillé/ Ruststahl

**st. steel** Acero inoxidable/ St. Steel/ Acier Inox/ Edehlstahl

**Hollow st. steel** Acero Inoxidable hueco/ St. Steel - hollow/ Acier Inox - creux/ Edehlstahl - hohl

**swarovski** Swarovski/ Swarovski/ Swarovski/ Swarovski

**synthetic leather** Cuero sintético/ Synthetic leather/ Cuire synthétique/ Synthetisch Leder

**wood** Madera/ Wood/ Bois/ Holz

**zamak** Zamak/ Zamack/ Zamack/ Zamack