

# HP RACK & POWER SOLUTIONS

Notebook  
Edition 6

Businesses across the world rely on HP Qualified Options to complete their data centres. Boost the power, performance and reliability of your data centre with Rack & Power solutions.



# HP Rack & Power Solutions

## Notebook

Edition 6

### Table of contents:

HP Qualified Options .....	4
HP Rack & Power Solutions.....	5
Racks.....	6
Rack options.....	7
Cooling .....	8
Management – KVM solutions .....	9
KVM Interface Adapter .....	11
Rack Consoles .....	12
UPS solutions – Single-phase – Tower .....	13
UPS solutions – Single-phase – Rack .....	14
3-phase UPS solutions.....	15
PDU solutions.....	17
HP Intelligent PDU (iPDU).....	18
HP Monitored PDU .....	19
HP Modular PDU.....	20
Power cords .....	21
Power supplies.....	22
HP Factory Express Services .....	23

**Name:**

---

**Company:**

---

**Address 1:**

---

**Address 2:**

---

**Phone/Fax:**

---

**E-mail:**

---

# HP Qualified Options

## Completing your data centre and removing data centre boundaries

HP Qualified Options strengthen the foundation of your data centre with high-calibre products that are easy to maintain and tailored for ProLiant, Integrity and StorageWorks, giving you confidence in your whole infrastructure.

HP Qualified Options have passed our rigorous qualification processes. Experience dependable quality you can count on, and when you need it, use outstanding HP support services for your whole environment. When you purchase HP hardware, don't compromise on the quality of your options. With HP Qualified Options, you can be confident of your whole infrastructure.

### **Dependable quality**

Deliver greater business performance with fewer interruptions when you complete your infrastructure with HP options.

### **Simplified support**

Free up your valuable time when you have HP's high-calibre technical expertise, keeping your whole business in business.

### **Tailored for ProLiant/Integrity/StorageWorks**

Focus on growing your business and not maintaining IT when you optimise your infrastructure with HP options designed for servers and storage.

### **Energy maximisation**

Get more out of IT as you stretch the limits of your data centre's power and cooling capabilities.

### **Data centre adaptability**

Effortlessly manage changing energy demands as you grow IT to accelerate business performance.

### **Environmental transformation**

Gain IT flexibility and overcome tomorrow's data centre limitations today with innovative solutions built for your business's success.

[www.hp.com/go/qualifiedoptions](http://www.hp.com/go/qualifiedoptions)

**HP Rack & Power Solutions are part of the HP Qualified Options portfolio – read more on the next page.**



# HP Rack & Power Solutions

Completing your data centre and removing data centre boundaries



## HP Rack & Power Solutions are the foundation for your IT.

HP takes a holistic approach to power and cooling issues, from end to end (from chip to chiller). HP Rack & Power Solutions are part of HP's end-to-end solution, and are important if you want to increase energy-efficiency of your IT infrastructure.

HP has designed these solutions to ensure current and future integration with HP ProLiant, BladeSystem and Integrity servers, HP StorageWorks and HP Systems Insight Manager.

HP offers a one-stop shop for your ongoing physical infrastructure needs – from solutions to services.

**HP Qualified Options and HP Rack & Power Solutions** simplify product and vendor qualifications, procurement and customer support, and guarantee product compatibility as well. This all secures long-term scalability, energy efficiency and investment protection.

**Over 20 million servers sold worldwide – so turn to the one stop you've trusted so far.**

## HP Rack & Power Solutions are built on:

- **Rack and rack options** – to provide the base for a flexible, adaptive IT infrastructure
- **Power solutions** – to protect, distribute and monitor power
- **Access and monitoring solutions** – to harmonise the management of heterogeneous servers, storage and IT infrastructure
- **Cooling solutions** – to handle increased heat and increase cooling efficiency at rack and data centre level

## Synergy and integration is the difference

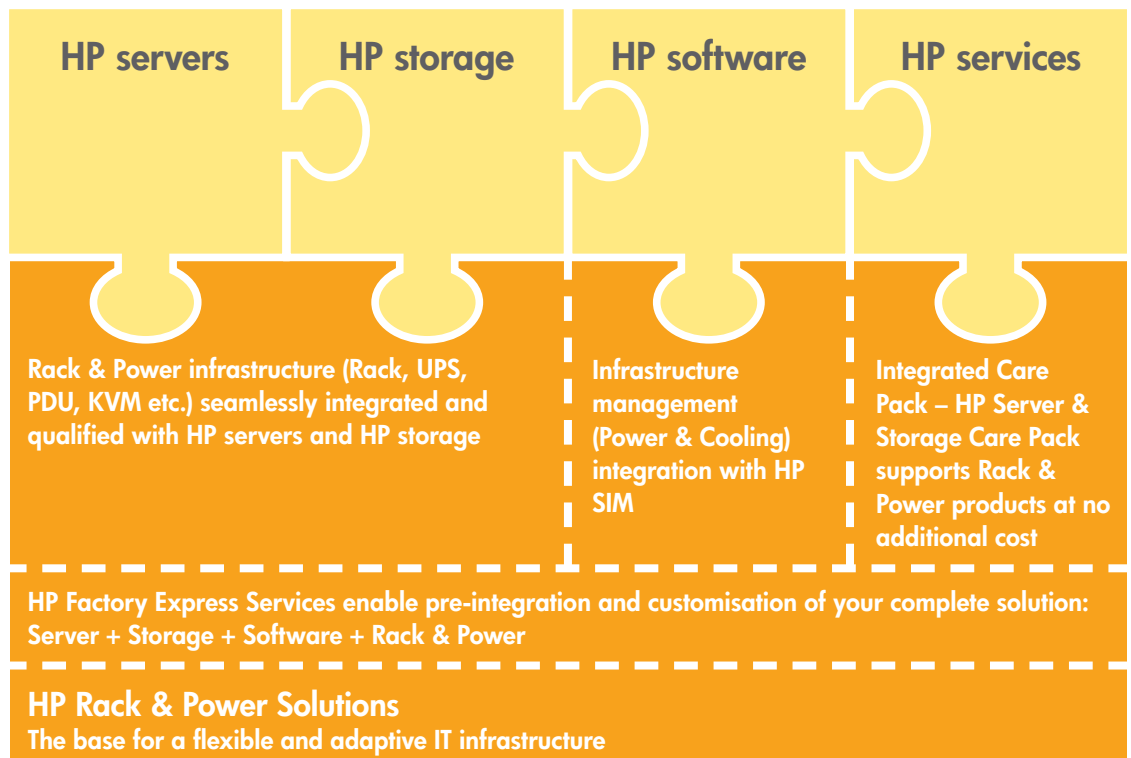

## HP racks

- **Industry standard** – outstanding quality and load capacity to protect your IT investment
- **Universal** – qualified with HP server and storage, EIA compliant to secure compatibility with HP server, storage and power solutions as well as third party equipment
- **Cool** – fully perforated doors and excellent cable management to maximise airflow
- **Flexible, with wide range of racks and rack options** – to meet your individual needs
- **Easy installation** – to deploy your IT easier and faster, and reduce costs
- **Fast IT deployment** – possible to ship racks preconfigured (ready to deploy) with shipping option “shock pallet” and HP Factory Express Rack Integration Service
- **Integrated Care Pack Support** – HP Server & Storage Care Pack support at no additional cost



10642 G2 10647 G2



10842 G2 10636 G2

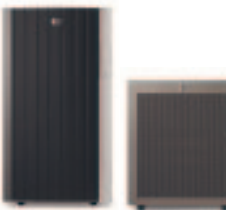

10622 G2 S10614



v142

### HP Universal Rack – HP Rack 10000 G2 Series

Model	Height	Dimensions (HxWxD)	Dynamic load	Static load	Part number	Shipped with	Shipping option
10622 G2	22U	1092 x 609.6 x 1008 mm (43 x 24 x 39.691 in)	474 kg (1045 lbs)	908 kg (2000 lbs)	AF021A	perforated front & rear door; side panel, stabiliser kit	Standard pallet
					AF022A		Shock pallet <sup>1</sup>
10636 G2	36U	1742.4 x 609.6 x 1008 mm (68.6 x 24 x 39.691 in)	690 kg (1520 lbs)	908 kg (2000 lbs)	AF011A	perforated front & rear door	Standard pallet
					AF012A		Shock pallet <sup>1</sup>
					AF014A	perforated front & rear door; rear extension (155 mm)	Shock pallet <sup>1</sup>
10642 G2	42U	1999.8 x 609.6 x 1008 mm (78.7 x 24 x 39.69 in)	908 kg (2000 lbs)	1360 kg (3000 lbs)	AF001A	perforated front & rear door	Standard pallet
					AF002A		Shock pallet <sup>1</sup>
			908 kg (2000 lbs)	1360 kg (3000 lbs)	AF030A	front & rear door, pre configured modified 42U rack <sup>2</sup>	Shock pallet <sup>1</sup>
					10642 G2 1200 mm deep	42U	1999.8 x 609.6 x 1200 mm (78.7 x 24 x 47.2 in)
			1133 kg (2500 lbs)	1360 kg (3000 lbs)	AF092A		Shock pallet <sup>1</sup>
10842 G2	42U wide	1999.8 x 800.1 x 1008 mm (78.7 x 31.5 x 39.69 in)	908 kg (2000 lbs)	908 kg (2000 lbs)	AF041A	perforated front & rear door	Standard pallet
					AF042A		Shock pallet <sup>1</sup>
10647 G2	47U	2285 x 609.6 x 1008 mm (89.96 x 24 x 39.69 in)	908 kg (2000 lbs)	1360 kg (3000 lbs)	AF031A	perforated front & rear door	Standard pallet
10647 G2 1200 mm deep	47U	2285 x 609.6 x 1200 mm (89.96 x 24 x 47.2 in)	1133 kg (2500 lbs)	1360 kg (3000 lbs)	AF097A	perforated front & rear door	Standard pallet
					AF094A		Shock pallet <sup>1</sup>

<sup>1</sup> It is mandatory to use a shock pallet when shipping racks with equipment installed.

<sup>2</sup> Modified and pre configured 10642 G2 rack for air duct solution (AF028A) which will be mounted at customer. Shipped including: special bottom and top panel, solid rear doors, air dams, side panels and rack rear extension.

### HP Rack 10000 Series G1

Model	Height	Dimensions (HxWxD)	Dynamic load	Static load	Part number	Shipped with	Shipping option
S10614	14U	724 x 600 x 1000 mm (23.62 x 23.62 x 39.37 in)	227 kg (500 lbs)	270 kg (600 lbs)	292302-B22	perforated front & rear door; side panel	Shock pallet*

\* It is mandatory to use a shock pallet when shipping racks with equipment installed.

### HP Rack 100 Series

Model	Height	Dimensions (HxWxD)	Dynamic load	Static load	Part number	Shipped with	Shipping option
v142	42U	2000 x 600 x 1070 mm	See note*	907 kg (2000 lbs)	AF046A	perforated front and rear door	Standard pallet

\* This rack is not certified to be shipped and moved within a data centre with equipment installed. This rack is not delivered on castors.



# Rack options

## HP rack options

- **Industry standard** – to secure compatibility and your investment protection
- **Thermal and cable management options** – to ensure correct airflow and cooling: filler/blanking panel, side panel kits, cable management kit, airflow optimisation kit and rack rear extension kit
- **Stabiliser and ballast kits** – increase rack stability and safety
- **Grounding kits** – optimise electrical grounding (mandatory)
- **Shelving, mounting and rail kits** – for maximum density and easy access
- **Rack options which complete the solution** – HP rack light kit, 2U universal locking drawer, etc.
- **Integrated Care Pack Support** – HP Server & Storage Care Pack support at no additional cost

### HP Rack Options

Part number	HP Rack Option – description	Compatible with HP rack series			
		10000 G1	10000 G2	MCS	other 19-inch racks
<b>Cable and thermal management</b>					
168233-B21	Cable-management D-rings Kit, 10 pack	•	•	•	• (incl. HP v142, 5642)
379820-B21	HP Rack Cable velcro (hoop and loop) strips/clips, 50 pack	•	•	•	• (incl. HP v142, 5642)
383982-B21	Rack Top Cable Tray 600 mm, 8 pack, for 600 mm wide 10000 series racks	•	•	•	HP v142
383983-B21	Rack Top Cable Tray 800 mm, for 10842 rack	10842			
383984-B21	Rack-to-Rack Adjustable Aisle Transfer, cable bridge, for 10000 series racks	•	•		HP v142
AF099A	Rack Cable Management Kit – one 1U and one 2U cable management bracket, 10 D-rings, 1 cross-over bracket, 20 Rack cable velcro stops/clips	•	•	•	• (incl. HP v142, 5642)
AF060A	36U Rack Rear Extension Kit (155 mm) – for HP rack 10636	36 U	36 U		
AF036A	42U (600 mm wide) Rack Rear Extension Kit (200 mm) – for HP rack 10642 G2 and HP MCS G1 & G2	•	42U/10642	•	
AF043A	47U (600 mm wide) Rack Rear Extension Kit (200 mm) – for HP rack 10647 G2	•	47U/10647	•	
257414-B21	Fan Kit 220V, 6 fans, mounted on top of the rack	All, beside 14U (not)	•		
AF070A	HP 10 pk, carbonite black, 1U Universal Filler Panel		•	•	• (incl. HP v142, 5642)
AF071A	HP 100 pk, carbonite black, 1U Universal Filler Panel	•	•	•	• (incl. HP v142, 5642)
AF090A	HP 10K G2 Series Rack Airflow Optimisation Kit	•	•		
AF028A	HP 10642 G2 Top Exhaust Extension Kit	•	•		
AF029A	HP 10642 G2 Top Exhaust Field Retrofit Kit	•	•		
AF030A	HP Modified 10642G2 Rack				
<b>Shelving, mounting, side panel &amp; grounding kits</b>					
234672-B21	100 kg Sliding Shelf – Graphite, has to be combined with the suitable Rack Stabiliser Kit	•	•	•	• (incl. HP v142, 5642)
253449-B21	Monitor/Utility Shelf – Graphite 1U fixed shelf that can be mounted at any height within 19"/HP Racks to place a monitor or another component. Width: 19"/482.6 mm, depth: 739.9 mm, load capacity: 68kg	•	•	•	• (incl. HP v142, 5642)
361591-B21	HP 2U Universal Locking Drawer – Graphite	•	•	•	• (incl. HP v142, 5642)
332558-B21	Depth Adjustable Fixed Rail Kit; max. 136 kg	•	•		• (incl. HP v142, 5642)
248929-B21	10000 Rack Series Baying Kit	•	•		
248931-B21	42U 9000 to 10000 Rack Series Offset Baying Kit	•	•		
AF048A	HP v142 Rack Baying Kit				HP v142
AF056A	10636 G2 (36U) Side Panels (set of two) (Graphite Metallic)		36 U		
AF054A	10642 G2 (42U) Side Panels (set of two) (Graphite Metallic)		42 U		
AF050A	Side Panel (47U) 10000 G2 series		47 U		
AF093A	10642 G2 (42U) 1200 deep Side Panels (set of two) (Graphite Metallic)		42U 1200 mm deep		
AF095A	10647 G2 (47U) 1200 deep Side Panels (set of two) (Graphite Metallic)		47U 1200 mm deep		
AF047A	Side Panel (42U) kit for HP v142 rack				v142 rack
AF019A	HP 10636 G2 Front Door ALL	36 U	36 U		
AF009A	HP 10642 G2 Front Door ALL	42U/10642	42U/10642		
AF074A	HP 10000 G2 Rack Grounding Kit	•	•	•	
AF040A	HP v142 Rack Grounding Kit				v142 rack
<b>Stabilisation &amp; Lighting</b>					
120672-B21	Ballast Kit	•	•		• (incl. HP v142, 5642)
AF062A	HP 10K G2 Stabiliser* Kit 600 mm, for 600 mm wide HP 10K G2 racks		•		
AF065A	HP 10K G2 Stabiliser* Kit 600 mm Heavy Duty V2, for 600 mm wide HP 10K G2 racks		•		
AF066A	Stabiliser* Kit 800 mm 10K G2 ALL		10842		
AF076A	HP Rack Tie Down Kit for 1000 mm deep 10K G2 racks		•		
AF075A	HP Rack Tie Down Kit for 1200 mm deep 10K G2 racks		•		
AF049A	HP v142 Rack Stabiliser* Kit				v142 rack
361589-B21	Rack Light Kit	•	•	•	v142 rack

\* An anti-tip stabiliser provides stability and support when equipment is installed, removed or accessed within the rack. Heavy-duty stabiliser kits should be used when a single racked component exceeds 90 kg

## HP Modular Cooling System (MCS) G2

- **Highly efficient closed coupled cooling system** – for high-density deployments
- **Cooling capacity: up to 35 kW**
  - in single-rack configuration/35 kW
  - in two-rack configuration (two HP MCS G2 42U racks at a time)/up to 17.5 kW per rack
- **Safe general design** – separation of cooling unit and IT rack – to prevent water contact with servers
- **Server/blade/storage deployments and access** – unaffected by design
- **Automatic door release** – for additional safety
- **Integrated remote management** – integration with HP SIM
- **Fast IT deployment** – possible to ship HP MCS and expansion rack preconfigured (ready to deploy) – shock pallet included



### HP Modular Cooling System (MCS) G2

Model	Product description	Part number
HP Modular Cooling System (MCS) G2	HP Modular Cooling System (MCS) G2, includes 10642 G2 rack, support for a 2nd rack (MCS G2 Expansion Rack), up to 35 kW cooling capacity (one rack config) or two times up to 17.5 kW (two rack config), 2750 CFM (~1800 m3/h) of chilled air, dimensions (H x W x D): 1999.8 x 909 x 1270 mm, delivered on shock pallet (CTO capable/ready for factory integration); Shipping info (shipped with): cooling rack + HP 10642 rack (42U) + sealed front and rear doors, rack front extension, side panel, automatic door opening release; shipped on shock pallet;	AF025A
HP Modular Cooling System (MCS) G2 10642 Expansion Rack	Expansion rack for HP Modular Cooling System (MCS) G2; includes special 42U HP 10642 G2 rack (sealed: front door, rear door, rack bottom plate), dimensions (H x W x D): 1999.8 x 609.6 x 1270 mm, delivered on shock pallet (CTO capable/ready for factory integration); Shipping info (shipped with): IT rack (42U, 10642) + sealed front and rear door, sealed bottom, rack front extension, side panel; shipped on shock pallet	AF026A
MCS G2 Flex Hose and Coupling Kit	The kit contains set of 1.0 inch diameter, Couplings and Parallel-to-Tapered adapter included to address regional differences. The Modular Cooling System Water Hook-up kit can be ordered ahead of the MCS G2 for site preparation purposes.	AF089A

### HP Care Packs for HP Modular Cooling System (MCS)

Model	Product description	Part number
Next Business Day On-Site Service, 5-Day x 9-Hour Coverage, 3 Years, Electronic	HP Care Pack for HP Modular Cooling System (MCS); standard warranty: 1 year	UE001E
4-Hour On-Site Service, 5-Day x 13-Hour Coverage, 3 Years, Electronic		UE002E
4-Hour On-Site Service, 7-Day x 24-Hour Coverage, 3 Years, Electronic		UE003E
6-Hour On-Site Service, 7-Day x 24-Hour Coverage, 3 Years, Electronic		UE004E
Hardware Installation for HP Modular Cooling System (MCS)	HP Care Pack for installation of servers and storage into the MCS (fixed price)	UE005E
Hardware Installation for HP Modular Cooling System (MCS) 10642 Expansion Rack	HP Care Pack for installation of servers and storage into the MCS expansion rack (fixed price)	U2871E
Model	Product description	Part number
Site Data Center Thermal Quick Assessment Service	Entry level Data Center Cooling assesment	HB691AE

# Management – KVM solutions

## Server management with HP KVMs

- **Improved management and efficiency** – to allow centralised management, convenient access and reduced costs
- **Multi-platform management from one console** – to fit perfectly into heterogeneous environments
- **Redundant access path for HP iLO and seamless integration with HP iLO** – to provide secure and redundant access
- **Lower costs** – through integrated Care Pack Support for HP KVM Switches with a ProLiant Server Care Pack
- **Integrated Care Pack Support** – HP Server & Storage Server Care Pack support at no additional cost

## HP KVM Switches

Four different model families by need

### KVM for desktop and small server room

- Entry level 4 port Desktop KVM switch with conventional KVM cabling (AF611A)

### KVM for Server Management

- Analogue KVM switch with local consoles (AF616A/AF617A)
- Analogue KVM switch with local consoles and Virtual Media (AF618A/AF619A)
- Digital KVM switch with local and remote access (KVM over IP) and Virtual Media (AF62xA)

See more details below and on next page.

### Model comparison: HP KVM with CAT5 cabling

Features	HP KVM Server Console Switch (AF616A, AF617A)	HP KVM Server Console Switch with Virtual Media (AF618A, AF619A)	HP KVM IP Console Switch with Virtual Media (AF620A, AF621A, AF622A)
Number of server ports/devices (with one unit)	8 or 16	16 or 32	8 or 16 or 32
Max. supported servers/devices	256 (cascaded)	up to 1024 (cascaded)	up to 1024 (cascaded)
LAN/WAN access	No	No	Yes (1 or 2 or 4 users)
Number of simultaneous users (local + remote via network)	2 (local)	2 (local)	2 (1l+1r) or 3 (1l+2r) or 5 (1l+4r)
Video resolution	up to 1280 x 1024	up to 1280 x 1024	up to 1280 x 1024
Improved cable management	Yes (CAT5e, up to 30 m)	Yes (CAT5e, up to 30 m)	Yes (CAT5e, up to 30 m)
SNMP – manageable through HP Systems Insight Manager (SIM)	No	No	Yes (1 IP address)
Multiple language support*	Yes	Yes	Yes
Multi-brand and multi-OS support	Yes	Yes	Yes
Supports different connections (PS/2, USB, Serial) for KVM	Yes – with PS/2, USB, Serial and BladeSystem Interface Adapters		
Supports Virtual Media (local)	No	Yes**	Yes**
Supports Virtual Media (remote)	No	No	Yes**
Built-in tiering (cascading) port	Yes	Yes	No
Seamless integration with iLO	Yes	Yes	Yes

\* Supports English, French, Italian, German, Spanish, Dutch and Japanese.

\*\* Yes – with PS/2 Interface Adapter with VM (via USB) support; USB Interface Adapter with VM support.

## Virtual Media

HP KVM Switches with Virtual Media support feature local virtual media for connecting USB media devices. With virtual media, you can transfer data that is stored on CDs, USB drives, USB external hard drives or any other media source between targets. This will make it possible to do software installations or updates from a remote location.





(An Interface adapter with virtual media support is required for this functionality)





# Management – KVM solutions

## KVM for Server Management

### Analogue KVM (local access)

	Model	Description	Part number
<b>Analogue HP KVM server console switches G2 (CAT5 based)</b>			
	HP 0x2x8 KVM SVR CNSL G2 SW	2 local user/8 ports; CAT5 cabling	AF616A
	HP 0x2x16 KVM SVR CNSL G2 SW	2 local user/16 ports; CAT5 cabling	AF617A
<b>Analogue HP KVM server console switches G2 (CAT5 based) – with USB Virtual Media* support</b>			
	HP 0x2x16 KVM Server Console Switch G2 with Virtual Media CAC Software	HP KVM Server Console Switch G2 with Virtual Media, CAC, 2 local users, 16 ports, local USB Virtual Media* support, CAT5 cabling	AF618A
	HP 0x2x32 KVM Server Console Switch G2 with Virtual Media CAC Software	HP KVM Server Console Switch G2 with Virtual Media, CAC, 2 local users, 32 ports, local USB Virtual Media* support, CAT5 cabling	AF619A

### Digital KVM (remote and local access)

	Model	Description	Part number
<b>Digital (over IP) HP KVM server console switches G2 (CAT5 based) – with USB Virtual Media* support</b>			
	HP 1x1Ex8 KVM IP Console Switch G2 with Virtual Media CAC Software	HP KVM IP Console Switch G2, with Virtual Media*, CAC, 1 remote user, 1 local user, 8 ports, local USB Virtual Media* and remote Virtual Media* support, integrated Active Directory support (LDAP), CAT5 cabling	AF620A
	HP 2x1Ex16 KVM IP Console Switch G2 with Virtual Media CAC Software	HP KVM IP Console Switch G2, with Virtual Media*, CAC, 2 remote users, 1 local user, 16 ports, local USB Virtual Media* and remote Virtual Media* support, integrated Active Directory support (LDAP), CAT5 cabling	AF621A
	HP 4x1Ex32 KVM IP Console Switch G2 with Virtual Media CAC Software	HP KVM IP Console Switch G2, with Virtual Media*, CAC, 4 remote users, 1 local user, 16 ports, local USB Virtual Media* and remote Virtual Media* support, integrated Active Directory support (LDAP), CAT5 cabling	AF622A

\* Virtual media support requires the use of Virtual Media Interface Adapters.

HP KVM Console Switches with Virtual Media are supporting up to two level tiering (cascading) and remote access (IP models)

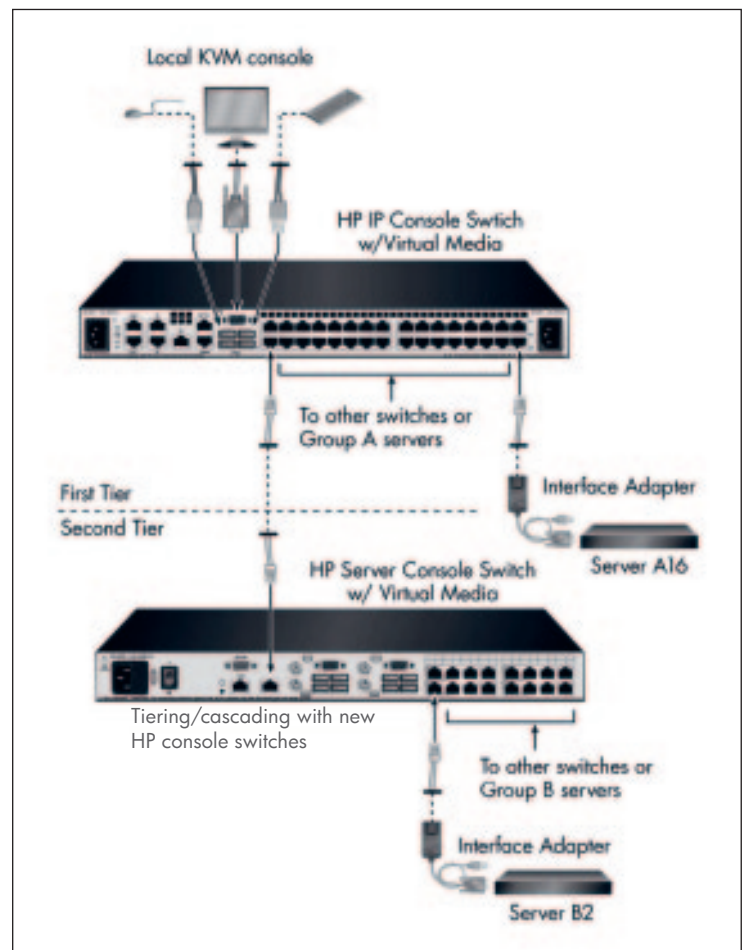

# KVM Interface Adapter

## HP KVM Interface Adapter and Cables

	Model	Description	Part number
<b>Universal components for CAT5 based HP KVM switches G2 with Virtual Media* and CAC support</b>			
	HP KVM Console USB Virtual Media CAC Interface Adapter	USB KVM IF adapter with Virtual Media support via USB and CAC support	AF623A
	HP KVM Console PS2/USB Virtual Media CAC Interface Adapter	USB KVM IF adapter with Virtual Media support via USB and CAC support**	AF624A
	HP KVM Console Serial/Power G2 Interface Adapter	Serial (Terminal)-RJ45/CAT5 G2, 1 pack, incl. Pwr supply	AF625A
<b>Universal components for CAT5 based HP KVM switches with Virtual Media* support</b>			
	PS/2 Virtual Media Interface Adapter, 1 pack	PS/2 KVM IF adapter with Virtual Media support via USB**	AF604A
	USB Virtual Media Interface Adapter, 1 pack	USB KVM IF adapter with Virtual Media support via USB	AF603A
<b>Universal components for CAT5 based HP KVM switches (no Virtual Media support; supports KVM only)</b>			
	HP KVM Interface Adapter PS/2-CAT5 Qty 8 WW	PS/2-RJ45/CAT5; 8 pack, <b>Note:</b> no Virtual Media support	262587-B21
	HP KVM Interface Adapter PS/2-CAT5 Qty 1 WW	PS/2-RJ45/CAT5; 1 pack, <b>Note:</b> no Virtual Media support	262588-B21
	HP KVM Interface Adapter USB-CAT5 Qty 1 WW	USB-RJ45/CAT5; 1 pack, <b>Note:</b> no Virtual Media support	336047-B21
	HP KVM Interface Adapter Serial-CAT5 Qty 1 WW	Serial (Terminal)-RJ45/CAT5, 1 pack, incl. Pwr supply, <b>Note:</b> VT100 terminal emulation	373035-B21
	HP BladeSystem CAT5 KVM Interface Adapter Qty 1 WW	HP BladeSystem p-Class, SUVI/CAT5 + 1USB, 1 pack, <b>Note:</b> supports HP BladeSystems p-Class products only, <b>Note:</b> no Virtual Media support	AF100A
	HP Blc KVM Interface Adapter	HP BladeSystem c-class, SUVI/CAT5 + 1USB, 1 pack, <b>Note:</b> supports HP BladeSystems c-Class products only	AF605A
<b>CAT5 UTP Cables for HP KVM Switches (CAT5 based) with &amp; without VM and for HP Serial Console Server</b>			
	CAT5e Cable 3ft, 4 pack	CAT5e Cable 0.9 metre, 4 pack	263474-B21
	CAT5e Cable 6ft, 8 pack	CAT5e Cable 1.8 metre, 8 pack	263474-B22
	CAT5e Cable 12ft, 8 pack	CAT5e Cable 3.7 metre, 8 pack	263474-B23
	CAT5e Cable 20ft, 4 pack	CAT5e Cable 6.1 metre, 4 pack	263474-B24
	CAT5e Cable 40ft, 1 pack	CAT5e Cable 12.2 metre, 1 pack	263474-B25

\* Virtual media support requires the use of Virtual Media Interface Adapters



\*\* Note: Requires PS/2 mouse and keyboard connections and one USB port on server.

## Workstation KVM switches

The HP Workstation KVM Switches provide the flexibility and performance for small environment to connect up to four computers and share USB peripherals like DVD-ROM burners, printers, and scanners. You can connect multiple workstations to a single keyboard, mouse, and monitor. Support for both USB and PS/2 devices. Flexible mounting allows the switch to work in table top or rack mount applications.



### The HP Workstation KVM switch can be used for:

- Managing up to 4 desktop or rack mount computers
- Sharing USB devices between up to 4 computers
- Front-end switch to other KVM switches (connect local user ports to the switch)
- Desktop migration projects

	Model	Description	Part number
<b>HP KVM switches with conventional KVM cabling</b>			
	HP PS2 Server Console Cable, 2 metre, 2-Pack	KVM Cable for HP 1x4 USB/PS2 KVM Switch, 6 foot, 2-Pack	AF612A
	HP USB Server Console Cable, 2 metre, 2-Pack	KVM Cable for HP 1x4 USB KVM Switch, 6 foot, 2-Pack	AF613A
	HP 1x4 Server Console Switch	1 user/4 ports; USB and PS2; 3 USB ports for additional devices; conventional KVM cabling; included: rack mount (rails), 2 x HP PS2 Server Console Cable (2 metre)	AF611A

# Rack Consoles

## Rack Console – TFT Monitors and keyboards

	Model	Description	Part number
	HP 1U Rackmount Keyboard with USB, with touch pad and USB pass through	1U rack keyboard with touch pad and front USB <ul style="list-style-type: none"> <li>• full size keyboard with Windows shortcut keys, different country specific keyboard layouts available</li> <li>• integrated touch pad</li> <li>• USB pass through (also on front available)</li> <li>• Tool-less universal rail kit included</li> </ul>	AG0xxA*
	HP TFT7600 G2 Rackmount Keyboard and Monitor (17" TFT), with touch pad, USB pass through, 1U	1U all-in-one rack console (monitor, keyboard, touch pad), new design <ul style="list-style-type: none"> <li>• 17,3" TFT display (WXGA+)</li> <li>• full size keyboard with Windows shortcut keys, different country specific keyboard layouts available</li> <li>• integrated touch pad</li> <li>• USB pass through (also on front available)</li> <li>• Tool-less universal rail kit included</li> </ul>	AZ8xxA*

Part number	HP Rack Option – description	Compatible with HP Racks and 19" racks			
		10000 G1	10000 G2	MCS	other 19" racks
<b>Rack TFT Monitors and Keyboards</b>					
AZ8xxA*	HP TFT7600 Rackmount Keyboard and Monitor, new design <ul style="list-style-type: none"> <li>• 1U all-in-one rack console (monitor, keyboard, touch pad)</li> <li>• 17,3" TFT display (WXGA+)</li> <li>• full size keyboard with Windows short cut keys, different country specific keyboard layouts available</li> <li>• integrated touch pad</li> <li>• USB pass through (also on front available)</li> </ul>	•	•	•	•
AZ871A	HP TFT7600 KVM Console UK Kit	•	•	•	•
AZ872A	HP TFT7600 KVM Console GR Kit	•	•	•	•
AZ873A	HP TFT7600 KVM Console FR Kit	•	•	•	•
AZ874A	HP TFT7600 KVM Console Itl Kit	•	•	•	•
AZ875A	HP TFT7600 KVM Console SP Kit	•	•	•	•
AZ876A	HP TFT7600 KVM Console Den Kit	•	•	•	•
AZ877A	HP TFT7600 KVM Console Nw Kit	•	•	•	•
AZ878A	HP TFT7600 KVM Console SE-FI Kit	•	•	•	•
AZ879A	HP TFT7600 KVM Console Swi Kit	•	•	•	•
AZ880A	HP TFT7600 KVM Console Port Kit	•	•	•	•
AZ881A	HP TFT7600 KVM Console Bel Kit	•	•	•	•
AZ883A	HP TFT7600 KVM Console Rus Kit	•	•	•	•
AZ884A	HP TFT7600 KVM Console Intl Kit	•	•	•	•
AG0xxA*	HP 1U Rackmount Keyboard with touch pad and USB	•	•	•	•
AG072A	1U Rackmount Keyboard with USB US	•	•	•	•
AG073A	1U Rackmount Keyboard with USB UK	•	•	•	•
AG074A	1U Rackmount Keyboard with USB GR	•	•	•	•
AG075A	1U Rackmount Keyboard with USB FR	•	•	•	•
AG076A	1U Rackmount Keyboard with USB IT	•	•	•	•
AG077A	1U Rackmount Keyboard with USB SP	•	•	•	•
AG078A	1U Rackmount Keyboard with USB DEN	•	•	•	•
AG079A	1U Rackmount Keyboard with USB NOR	•	•	•	•
AG080A	1U Rackmount Keyboard with USB SE/FI	•	•	•	•
AG081A	1U Rackmount Keyboard with USB SWI	•	•	•	•
AG082A	1U Rackmount Keyboard with USB PORT	•	•	•	•
AG083A	1U Rackmount Keyboard with USB BEL	•	•	•	•
AG084A	1U Rackmount Keyboard with USB JPN2	•	•	•	•
AG085A	1U Rackmount Keyboard with USB RUS	•	•	•	•
AG086A	1U Rackmount Keyboard with USB Intl	•	•	•	•





\* Refers to country-specific keyboard.

# UPS solutions – Single-phase – Tower

## HP Tower UPS

- **UPS capacity** – from 500 W to 3000 W (real power)
- **Enhanced Battery Management (EBM)** – significantly extend battery service life
- **60-day battery** – pre-failure warning and 3-year backup warranty
- **Extended Runtime Modules (ERMs)** – increase UPS backup time by need (optional)
- **Hot-swap battery modules** – provide highest availability
- **Integrated Care Pack Support** – HP Server & Storage Care Pack support of HP UPSs up to 12 kVA at no additional cost

### HP Tower UPS

Model	T750 G2 Intl	T1000 G3, Intl	T1500 G3, Intl	R/T3000 G2, Intl
				
<b>Part number</b>	AF447A	AF449A	AF451A	AF468A
<b>Replacement for/old model</b>	T750 Intl/ 378439-B31	T1000 G2, Intl/ AF405A	T1500 G2, Intl/ AF408A	R3000 Intl/AF414A R/T2200 G2 Intl/AF411A
<b>Form factor</b>	Tower	Tower	Tower	Tower/Rack/2U Tower to Rack conversion kit included
<b>Power output</b>	750 VA 500 W	1000 VA 670 W	1500 VA 950 W	3300 VA 3000 W
<b>Backup time at 80% load<sup>1</sup></b>	6 mins	6 mins	6 mins	7 mins <sup>2</sup>
<b>Load segments</b>	1	1	1	2
<b>Output connections (Intl model)</b>	4 x IEC 320 C13	6 x IEC 320 C13 (10A)		2x IEC 320 C19 (16A) 6x IEC 320 C13 (10A) + one extension bar (7 x C13)
<b>Input Power Cord</b>	Input connection: IEC 320 C13 Input power cord is not included; optional (country specific) power cord see "power cords"			Country specific power cord included
<b>Hot-swap batteries</b>	Yes	Yes	Yes	Yes
<b>Weight (kg)</b>	12.7	12.7	25	37
<b>Optional ERM/ ERM part number</b>	N/A	N/A	N/A	up to 2 ERM/AF455A
<b>Communication</b>	USB/serial; includes HP power-management software HP Power Protector			
<b>Communication option</b>	N/A			HP UPS Network Module (AF465A)
<b>Warranty</b>	3-year HP warranty (3-1-1), HP battery pre-failure warranty and integrated Care Pack Support with no additional costs <sup>3</sup>			

<sup>1</sup> Backup times are estimated for typical applications at recommended load level of 80%. Actual performance will depend on environment conditions, ambient temperature, battery age and other factors.



<sup>2</sup> Increased system uptime possible with optional Extended Runtime Modules (ERMs).

<sup>3</sup> HP Server and Storage Care Pack also supports HP UPSs up to 12 kVA at no additional cost.

# UPS Solutions – Single-phase – Rack

## HP Rack UPS – Single-phase

- **UPS capacity** – from 1000 W to 6500 W (real power)
- **Patented Enhanced Battery Management (EBM)** – doubles battery life time up to 6 years
- **60-day battery** – pre-failure warning and 3-year backup warranty
- **Extended Runtime Modules (ERMs)** – increase UPS backup time by need (optional)
- **Hot-swap battery modules** – provide highest availability
- **Integrated Care Pack Support** – HP Server & Storage Care Pack support of HP UPSs up to 12 kVA at no additional cost

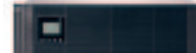
Model	R1500 G3, Intl	R/T3000 G2, Intl	R5000 Intl	R7000 Intl
				
<b>Part number</b>	AF471A	AF468A	AF461A	AF463A
<b>Form factor</b>	Rack/1U	Tower/Rack/2U; Tower to Rack conversion kit included;	Rack/3U	Rack/4U
<b>Power output (Watt)</b>	1000 W	3000 W	4500 W	6500 W
<b>Backup time at 80% load<sup>1</sup></b>	8 mins	7 mins	7 mins	7 mins
<b>Load segments</b>	2	2	2	2
<b>Output connections (Intl model)</b>	4x IEC 320 C13	2x IEC 320 C19 (16A) 6x IEC 320 C13 (10A) + one extension bar (7 x C13)	4x IEC320 C19 (16A); 4x IEC320 C13 (10A); 1x IEC309 (32A)	6x IEC320 C19 (16A); 2x IEC309 (32A); via included PDU sticks: 14x IEC320 C13 (10A); see footer <sup>3</sup>
<b>Input Power Cord</b>	not included; optional (country specific) power cord see “power cords”	country specific power cord included <sup>3</sup>	detached power cord with IEC320 309 (32A, one phase)	detached power cord with IEC320 309 (32A, one phase)
<b>Hot-swap batteries</b>	Yes	Yes	Yes	Yes
<b>Unit weight (kg)</b>	22.9	37	57	68
<b>Optional ERM/ERM part number</b>	N/A	up to 2 ERM/AF455A	up to 4 ERM/AF464A	up to 4 ERM/AF464A
<b>Communication</b>	Serial (RS-232/DB9), optional available: UPS Network Module (AF465A)	USB/serial; optional available: UPS Network Module (AF465A)	USB/serial/Ethernet; <b>Note:</b> UPS Network Module (AF465A) is included	
<b>Communication Software</b>	Includes Power Management software HP Power Protector			
<b>Warranty</b>	3-year HP warranty (3-1-1), HP battery pre-failure warranty and integrated Care Pack Support with no additional costs <sup>2</sup>			

<sup>1</sup> Backup times are estimated for typical applications at recommended load level of 80%. Actual performance will depend on environment conditions, ambient temperature, battery age and other factors. Increased system uptime possible with optional Extended Runtime Modules (ERMs).

<sup>2</sup> ProLiant server care pack supports connected HP UPS also – with no additional costs.

<sup>3</sup> HP R7000 UPS delivery includes: 2 Extension Bars (7 x C13 outlets each), these could be connected to the C19s on the UPS unit and provide up to 14 IEC320 C13 outputs. In addition: Two 10 Amp IEC to IEC jumper cords

### UPS Options

Model	Description	For which HP UPS	Part number
UPS ERM Module	UPS Expansion Runtime Module (extended battery) – extends backup time	availability depends on UPS model, see UPS table above	availability depends on UPS model, see UPS product tables
HP UPS Management Module	UPS management card with one ethernet port and five serial ports (RJ45); embedded management software with communication and management functions: <ul style="list-style-type: none"> <li>• allows direct communication to ethernet and up to five servers via serial connection</li> <li>• remote access</li> </ul>	HP UPS R1500 G2, R3000, R/T3000, R5000 and former “HP UPS XR models”; The HP UPS management module is included with R8000/3, R12000/3 and RP36000/3; further info see quick specs	AF401A
HP UPS Network Module	The HP UPS Management Module enables you to monitor and manage power environments through comprehensive control of HP UPSs. The HP UPS Management Module can support either a single UPS configuration or provides additional power protection with support for dual redundant UPS configuration for no-single-point-of-failure. The additional serial ports will provide greater power management control and flexible monitoring.	HP UPS R1500 G3, R/T3000 G2, R5000 and R7000 models. The HP UPS network module is included with R7000 UPS; further info see quick specs	AF465A

If you need help sizing your HP Rack and Power infrastructure solution (Rack, Rack options, UPS, PDU, KVM), please go to [www.hprackandpowersizer.com](http://www.hprackandpowersizer.com)

Or contact our experts at: [OBP.tech@hp.com](mailto:OBP.tech@hp.com) (for technical questions) or [OBP.SDS@hp.com](mailto:OBP.SDS@hp.com) (for solution design)



# 3-phase UPS solutions

## HP 3-phase UPS solutions – 3-phase UPS modules and Parallel UPS (preconfigured UPS Rack)

- **UPS modules** with 8 kVA and 12 kVA capacity
- **Parallel UPS with 36 kVA capacity** – scalable up to 60 kVA in a single 19-inch rack
- **High-density design**, lightweight, hot-swappable battery and electronics modules
- **Intelligent automated maintenance bypass** in each UPS module/chassis
- **Integrated Care Pack Support** for the single Rack UPS modules (R8000/3 and R12000/3) – HP Server & Storage Care Pack supports HP UPSs up to 12 kVA at no additional cost

### HP 3-phase UPS Modules (Rackmount)

Model	R8000/3 Intl	R12000/3 Intl
<b>Part number</b>	AF432A	AF430A
<b>Form factor</b>	Rack module/6U	Rack module/6U
<b>INput power</b> <b>INput connections</b> <b>(Intl model)</b>	400 V 3-phase 1 x IEC 309 16A (3-phase power)	400 V 3-phase 1 x IEC 309 32A (3-phase power)
<b>OUTput power rating/capacity</b>	8 kVA/8 kW; 400 V 3-phase	12 kVA/12 kW; 400 V 3-phase
<b>OUTput connections</b> <b>(Intl model)</b>	1 x IEC 309 16A (3-phase power)	2 x IEC 309 16A (3-phase power) = UPS output module (AF434A)
<b>Backup time at 80% load</b>	12 mins	6 mins
<b>Hot-swap electronic modules &amp; batteries</b>	Yes	Yes
<b>Weight (kg)</b>	140	140
<b>Optional ERM/ part number</b>	max. 4/AF434A	max. 4/AF434A
<b>Communication</b>	HP UPS Management module (AF401A) included; module with one ethernet port and five serial ports (RJ45)	
<b>Communication software</b>	Embedded HP Power Management software on HP UPS Management module (AF401A)	
<b>Warranty</b>	3-Year HP warranty (3-1-1), HP battery pre-failure warranty and integrated Care Pack Support at no additional cost	



### HP 3-phase Parallel UPS (preconfigured Rack & module)

Model	RP36000/3 Intl	RP12000/3 Intl
<b>Description</b>	Preconfigured parallel rack UPS Rack 42U with three UPS modules and power bar	Additional 12 kVA UPS module for RP36000/3 (to be added into the parallel rack UPS (RP36000/3))
<b>Part number</b>	AF439A	AF437A
<b>Form factor</b>	Rack 42U (HP 10000 Series G2, 10642)	Rack module/6U
<b>INput power</b> <b>INput connections</b> <b>(Intl model)</b>	400 V 3-phase Hard wire terminal	400 V 3-phase to power bus bar (on RP36000/3)
<b>OUTput power rating/capacity</b>	non-redundant: 36 kVA/36 kW n+1 redundant: 24 kVA/24 kW – expandable up to 60 kVA (n+1)	12 kVA/12 kW; 400 V 3-phase
<b>OUTput connections</b> <b>(Intl model)</b>	Hard wire terminal; Optional (add on): HP R12000/3 Intl UPS Output Module (AF441A)	Connector to power bus bar (on RP36000/3) or optional: UPS output module (AF441A)
<b>Backup time at 80% load</b>	12 mins	6 mins
<b>Hot-swap electronic modules &amp; batteries</b>	Yes	Yes
<b>Weight (kg)</b>	578	140
<b>Optional ERM/ part number</b>	AF434A	max. 4/AF434A
<b>Communication</b>	HP UPS Management module (AF401A) included; module with one ethernet port and five serial ports (RJ45)	
<b>Communication software</b>	Embedded HP Power Management software on HP UPS Management module (AF401A)	
<b>Warranty</b>	3-Year HP warranty (3-1-1), HP battery pre-failure warranty	



## 3-phase UPS solutions (cont.)

### Options – for HP 3-phase Rack and Parallel UPS

Model	Description	For which HP UPS	Part number
<b>HP R12000/3 Intl UPS Output Module</b>	Rackmount UPS Output Module, with 2 x IEC309 16A connectors (3-phase)	RP12000/3 (this module is included with R12000/3)	AF441A
<b>HP 3-phase UPS ERM Module</b>	UPS Expansion Runtime Module (extended battery) 3U extends backup time up to four (4) ERMs per UPS	R8000/3 R12000/3 RP36000/3 RP12000/3	AF434A
<b>HP 3-phase 16A Intl Mod PDU, Core unit</b>	Core unit only, input: 3-phase, IEC309 16A 4Pin, attached input cord, connects into 3-phase facility input or to a 3-phase UPS; Output: 6 x IEC320 C19 (single phase)	R8000/3 R12000/3	AF513A
<b>HP 11 kVA S1316 Monitored PDU (Intl)</b>	Single input, 3-phase, 16A, Intl Input: 1 x IEC309, 5Pin 16A Output: 39/36 C13 (10A) plus 3 C19 (16A)	R8000/3 R12000/3	AF508A
<b>HP 22 kVA S2316 Monitored PDU (Intl)</b>	Dual input, 3-phase, 16A, Intl Input: 2 x IEC309, 5Pin 16A Output: 78/72 (2 x 36) C13 (10A) plus 6 (2 x 3) C19	R12000/3 RP12000/3 and 36000/3 – with additional UPS output module (option)	AF507A

### Power cords/jumper cables

Model	Description	Part number
<b>HP 5' IEC309 516P Intl Jumper Cable</b>	Power cord – jumper cable IEC309 16A, 5Pin 1.65 m	460153-005
<b>HP 10' IEC309 516P Intl Jumper Cable</b>	Power cord – jumper cable IEC309 16A, 5Pin 3.3 m	460153-010
<b>HP 15' IEC309 516P Intl Jumper Cable</b>	Power cord – jumper cable IEC309 16A, 5Pin 4.95 m	460153-015

If you need help sizing your HP Rack and Power infrastructure solution (Rack, Rack options, UPS, PDU, KVM), please go to [www.hprackandpowersizer.com](http://www.hprackandpowersizer.com)

For more UPS options, information on HP power products and software downloads, please visit [www.hp.com/products/ups](http://www.hp.com/products/ups)

## HP is offering three different PDU families to meet different customer needs

### HP Intelligent PDU (iPDU) – New introduced End of 2010

- Key component of HP's Intelligent Power Discovery (IPD) solution – eliminate costly downtime caused by human errors in power wiring and PDU configurations
- Mountable in 1U or zero U locations to save valuable space in the rack and to offer proper cable management
- Monitor and control power outlets individually
- Measure and display the power consumption for every component in the rack with 99% accuracy
- Enable to manage and monitor power distribution from anywhere to prevent problems and speed response times
- Various models with different power inputs and capacities – see key features in comparison table below and on following pages

### HP Monitored PDU

See key features in comparison table below and on following pages

### HP Modular PDU

See key features in comparison table below and on following pages

## HP IPD Solution and PDU comparison

The PDU comparison (table below) helps to identify the best PDU solution and point out the difference to other PDUs on the market which stop at the power outlet control level. Key differentiators for HP's iPDU are all functions which are related to HP's Intelligent Power Discovery (IPD) solution.

Intelligent Power Discovery is the name for a solution which combines HP's highly efficient server power supplies, HP's intelligent power distribution units and HP's power management software. The HP IPD solution is designed to make it easy to add new servers to a data center and automatically adjust power allotment and includes remote power outlet control and power redundancy check. Using HP's software you can manage power allocation and find overheating servers and define policies to save energy and to increase availability. You can use HP's remote server management console iLO to manage practically all of your power requirements.

For more information, see next page and please visit [www.hp.com/go/IPD](http://www.hp.com/go/IPD)

### Model comparison: HP PDU

Feature	HP Intelligent PDU (iPDU)	HP Monitored PDU	HP Modular PDU
<b>Rack Mount</b>	1U or zero U locations	Vertical zero U in the back of the rack	1U or zero U locations
<b>Power Input</b>	Single and Three phase dependent on model	Single and Three phase dependent on model; dual power input models available	Single and Three phase dependent on model
<b>Multiple circuit breakers</b>	Yes	Yes	Yes
<b>Power Monitoring (at the rack)</b>	Yes, Monitoring display, 99% accuracy	Yes, Monitoring display	No
<b>Power Monitoring (remote)</b>	Yes (embedded SW and integration within HP SIM/Insight Control)	Yes, with optional Module (embedded SW and integration within HP SIM/Insight Control)	No
<b>Remote power outlet control (on/off switching)</b>	Yes	No	No
<b>Automatic power redundancy check</b>	Yes, as part of HP IPD solution	No	No
<b>Automatic power capping</b>	Yes, as part of HP IPD solution	No	No
<b>Automatic power re-deployment</b>	Yes, as part of HP IPD solution	No	No

# HP Intelligent PDU (iPDU)

HP iPDU is a key component of HPs Intelligent Power Discovery (IPD) – which includes automatic power redundancy control and integration with HP System Insight Manager and HP Insight Control. Key features:

- **Modular architecture** – based on PDU core unit with multiple circuit breaker, network connection and extension bars
- **Density optimised 1U/0U rackmount design** – including mounting brackets
- **Local and remote power monitoring** – local power monitoring display and remote power reporting
- **Remote power outlet control** – which could be set up automatically (based on events or/and thresholds)
- **Integrated Care Pack support** – HP Server & Storage Care Pack supports HP PDUs at no additional cost

Model	Description	Outlets (Output)	Part number
HP Intelligent Mod PDU 32a Intl Core	iPDU core unit, input: IEC 309 32A/IEC332P6, connects into facility input or HP UPS R5500; output: 6 x C19 (16A); includes the rack rear mount LED display unit. <b>Note:</b> iPDU core units could be combined with extension bars (AF528A, AF529A) by need;	6 x IEC 320 C19 (16A)	AF525A
HP Intelligent Mod PDU 3ph 16a Intl Core	iPDU core unit, input: 3-phase, IEC 309 16A 4 pin/IEC516P6, attached input cord, connects into 3-phase facility input or to a 3-phase UPS; output: 6 x C19 (16A); includes the rack rear mount LED display unit. <b>Note:</b> iPDU core units could be combined with extension bars (AF528A, AF529A) by need;	6 x IEC 320 C19 (16A)	AF526A
HP Intelligent Mod PDU 3ph 32a Intl Core	iPDU core unit, input: 3-phase, IEC 309 16A 4 pin/IEC532P6, attached input cord, connects into 3-phase facility input or to a 3-phase UPS; output: 6 x C19 (16A); includes the rack rear mount LED display unit. <b>Note:</b> iPDU core units could be combined with extension bars (AF528A, AF529A) by need;	6 x IEC 320 C19 (16A)	AF527A
HP 5xc13 PDU Extension Bars Kit	Two (kit) Standard Extension Bar, 5 x C13 outlets, power and UID LEDs; <b>Note:</b> Standard (non-intelligent) Extension Bars are monitored as a single load segment by the iPDU core unit and do not support Intelligent Power Discovery. <b>Note:</b> Extension Bars can be mixed on a PDU core to create custom configurations. Up to 6 extension bars may be added to each Intelligent PDU Core unit.	10 (2x5) IEC 320 C13 (10A)	AF528A
HP 5xc13 Intelligent PDU Ext Bars Kit	Two (kit) Intelligent Extension Bars, 5 x C13 outlets, individual monitoring and control; <b>Note:</b> Intelligent Extensions Bars have individually monitored outlets that are also individually switchable for power cycling attached equipment. Each individual C13 outlet has Power Line Communications to support Intelligent Power Discovery when connected to PLC enabled common slot power supplies. <b>Note:</b> Extension Bars can be mixed on a PDU core to create custom configurations. Up to 6 extension bars may be added to each Intelligent PDU Core unit.	10 (2x5) IEC 320 C13 (10A)	AF529A
HP Intelligent Mod PDU 32a Intl Kit	iPDU kit with core unit and four (4) intelligent extension bars, input: IEC 309 32A/IEC332P6, connects into facility input or HP UPS R5500; output on iPDU core: 6 x C19 (16A); output on extension bars: 20 (4 x 5) C13 (10A); includes the rack rear mount LED display unit.	20 (4x5) IEC 320 C13 (10A) 2 x IEC 320 C19 (16A)	AF534A

### HP Intelligent PDU (INTL/High Voltage) overview incl. PLC power cables & CS power supplies

Revision date: 8/2011

**Intelligent PDU 32A / 7,3 kVA – Core<sup>1</sup>; AF525A**  
6 x C19  
Input: IEC 309 32A

**Intelligent PDU 16A 3-phase / 11 kVA – Core<sup>1</sup>; AF526A**  
6 x C19  
Input: IEC 309 16A

**Intelligent PDU 32A 3-phase / 22 kVA – Core<sup>1</sup>; AF527A**  
6 x C19  
Input: IEC 309 32A

**Two iPDU intelligent extension bar kit AF529A**  
5 x C13 (per extension bar)  
individually monitored and switchable IEC C13 outlets with IEC connectors

**Two iPDU standard extension bar kit AF528A**  
5 x C13 (per extension bar)

**Power Line Communication (PLC) power cables**

- 82cm PLC power cable with data lines, single SG506A
- 82cm PLC power cable with data lines, 5 Pack SG507A
- 148cm PLC power cable with data lines, single SG508A
- 148cm PLC power cable with data lines, 5 Pack SG509A
- 198cm PLC power cable with data lines, single SG510A
- 198cm PLC power cable with data lines, 5 pack SG511A
- 330cm PLC power cable with data lines, single SG512A

**Common Slot (CS) Platinum Power Supplies with PLC connectors**

- HP 460W CS Platinum Power Supply Kit 593831-821
- HP 750W CS Platinum Power Supply Kit 593188-821
- HP 1200W CS Platinum Power Supply Kit 578322-821

**NOTE:** HP Common Slot Platinum Power Supplies use 94% efficient, PLC enabled power supplies and PLC power cables are required to enable Intelligent Power Discovery.

**NOTE:** All PLC Power cables use IEC C13 to IEC C14 "jumper cables" and designated by light blue IEC connectors. PLC power cables enable Intelligent Power Discovery communications between HP Common Slot Platinum Power Supplies and the HP Intelligent Extension Bars when used with the HP Intelligent PDU core.

Legend:  
 IEC309 – 1-phase<sup>2</sup>    IEC320-C19 / 16A    IEC320-C13 / 10A  
 IEC309 – 3-phase<sup>2</sup>    IEC320-C20 / 16A    IEC320-C14 / 10A

<sup>2</sup> Different connector sizes, dependent on 16A, 32A, 63A ...

For more information, please visit [www.hp.com/go/IPD](http://www.hp.com/go/IPD)



# HP Monitored PDU (with power monitoring)

- **Power input** – single and dual input models with 3-phase or single-phase power
- **Density-optimised OU rackmount design** (vertical in the back of the rack) – including mounting brackets
- **Local power** – monitoring display and optional remote power reporting
- **Unique colour-coded load identification** and circuit breaker per load segment
- **Mounting and cord retention brackets** – for rackmounting included
- **Integrated Care Pack support** – HP Server & Storage Care Pack supports HP PDUs at no additional cost



Model	Description	Outlets (Output)	Part number
HP 22 kVA S2316 Monitored PDU (Intl)	Dual input, 3-phase, 16A, Intl Input: 2x IEC 309, 5 pin 16A Height: 1524mm/~35U	78/72 (2x36) C13 (10A) plus 6 (2x3) C19	AF507A
HP 11 kVA S1316 Monitored PDU (Intl)	Single input, 3-phase, 16A, Intl Input: 1 x IEC 309, 5 pin 16A Height: 1524mm/~35U	39/36 C13 (10A) plus 3 C19 (16A)	AF508A
HP 14.7 kVA S2132 Monitored PDU (Intl)	Dual input, single-phase, 32A, Intl Input: 2 x IEC 309, 3 pin 32A Height: 1524mm/~35U	78/72 (2x36) C13 (10A) plus 6 (2x3) C19 (16A)	AF509A
HP 7.4 kVA S1132 Monitored PDU (Intl)	Single input, single-phase, 32A, Intl Input: 2 x IEC 309, 3 pin 32A Height: 1524mm/~35U	39/36 C13 (10A) plus 3 C19 (16A)	AF510A
HP 7.3 kVA S132 Monitored PDU (Intl)	Single input, single-phase, 32A, Intl Input: 1 x IEC 309, 3 pin 32A, flat enclosure Height: 733mm/~17U	27/24 C13 (10A) plus 3 C19 (16A)	AF915A
HP 22 kVA S1332 Monitored PDU (Intl)	Single input, 3-phase, 32A, Intl Input: 1 x IEC 309, 5 pin, 32A Height: 733mm/~17U	12 C19 (16A)	AF917A
HP PDU management module	Hot plug retrofit option for all HP monitored PDUs. Embedded software, remote power monitoring and PDU management via Ethernet.	Ethernet (RJ45), Serial (DB9)	AF400A
2 C13 PDU Extension bars	2 PDU extension bars with 7 receptacles (C13) Input: C20	14/ 2x7 C13 (10A)	AF500A
Fixed-cord extension bar kit	2 PDU extension bars with 7 fixed and short cables (33 cm) Input: C20	2 x 7 IEC320 C13	351655-B21

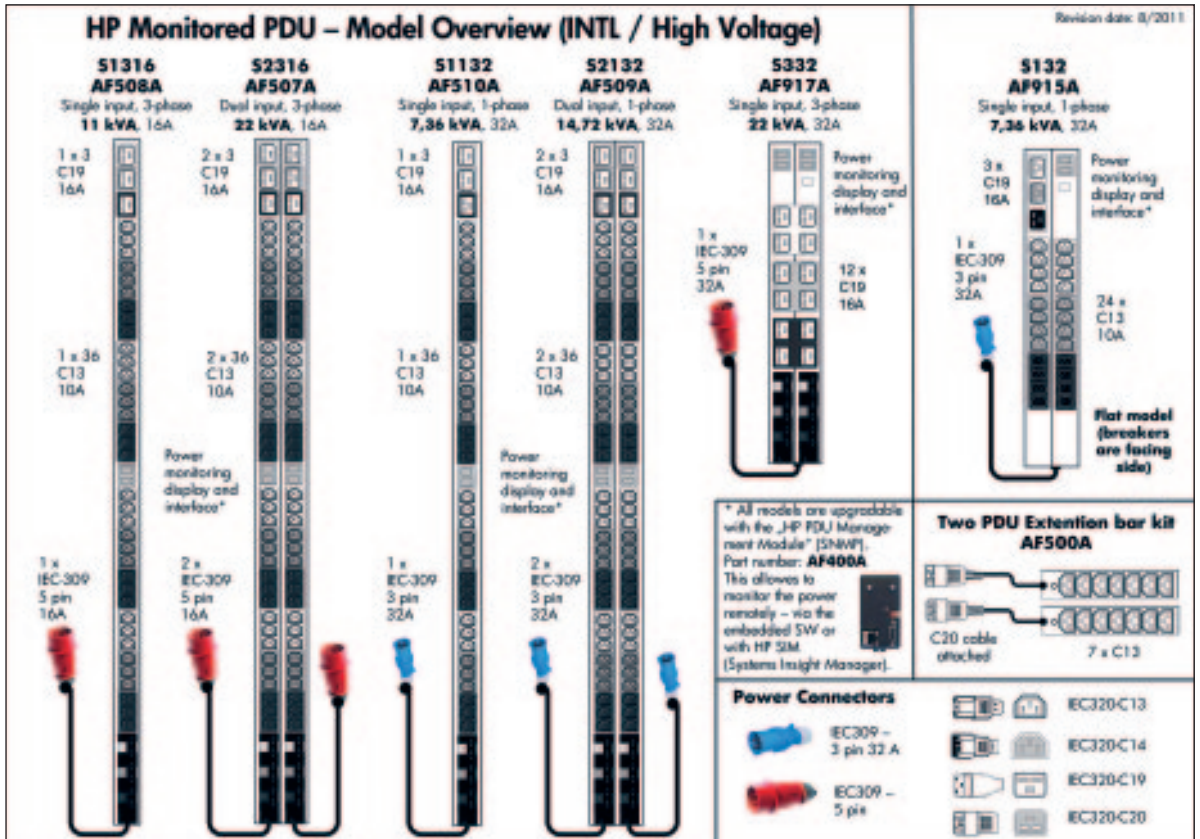



# HP Modular PDU

- **Modular architecture** – based on PDU core unit with multiple circuit breaker and extension bars
- **Density optimised 1U/OU rackmount design** – including mounting brackets
- **Power Input and capacity on demand** – various models with single phase and 3-phase power input
- **Integrated Care Pack support** – HP Server & Storage Care Pack supports HP PDUs at no additional cost



Model	Description	Outlets (Output/single phase)	Part number
<b>16A mPDU (worldwide)</b>	Core unit and 2 extension bars, input: IEC 309 C20, connects into facility input or high-voltage UPS R3000, R5500	14 (2x7) IEC 320 C13 (10A)	252663-B24
<b>32A mPDU (Intl)</b>	Core unit and 4 extension bars, input: IEC 309 32A, connects into facility input or HP UPS R5500	28 (4x7) IEC 320 C13 (10A)	252663-B31
<b>40A mPDU (worldwide)</b>	Core unit and 4 extension bars; can be hard wired directly into facility input or to a high-voltage UPS	28 (4x7) IEC 320 C13 (10A)	252663-B21
<b>40A mPDU (Intl)</b>	Core unit and 4 extension bars, input: IEC 309 63A, can be connected directly into facility input or to a high-voltage UPS	28 (4x7) IEC 320 C13 (10A)	252663-B32
<b>Core only 32A (Intl)</b>	Core unit only, input: IEC 309 32A, connects into facility input or R5500	4 x IEC 320 C19	252663-B33
<b>Core only 40A (Intl)</b>	Core unit only, input: IEC 309 63A 3 pin, attached input cord, connects into facility input or to a high-voltage UPS	4 x IEC 320 C19	252663-B34
<b>Core only, HP 3 Phase 16A Intl Mod PDU</b>	Modular PDU Core unit only, input: 3-phase, IEC 309 16A 4 pin, attached input cord, connects into 3-phase facility input or to a 3-phase UPS	6 x IEC 320 C19	AF513A
<b>Core only, HP 3 Phase 32A Intl Mod PDUs</b>	Modular PDU Core unit only, input: 3-phase, IEC 309 32A 4 pin, attached input cord, connects into 3-phase facility input or to a 3-phase UPS (hard wired output)	6 x IEC 320 C19	AF518A
<b>Fixed-cord extension bar kit</b>	2 PDU extension bars with 7 fixed and short cables (33cm) Input: C20	2 x 7 IEC320 C13	351655-B21
<b>2 C13 PDU extension bars</b>	2 PDU extension bars with 7 receptacles (C13) Input: C20	14; 2x7 C13 (10A)	AF500A
<b>3rd-party mPDU mounting kit</b>	3rd-party mPDU mounting kit (worldwide)		310777-B21

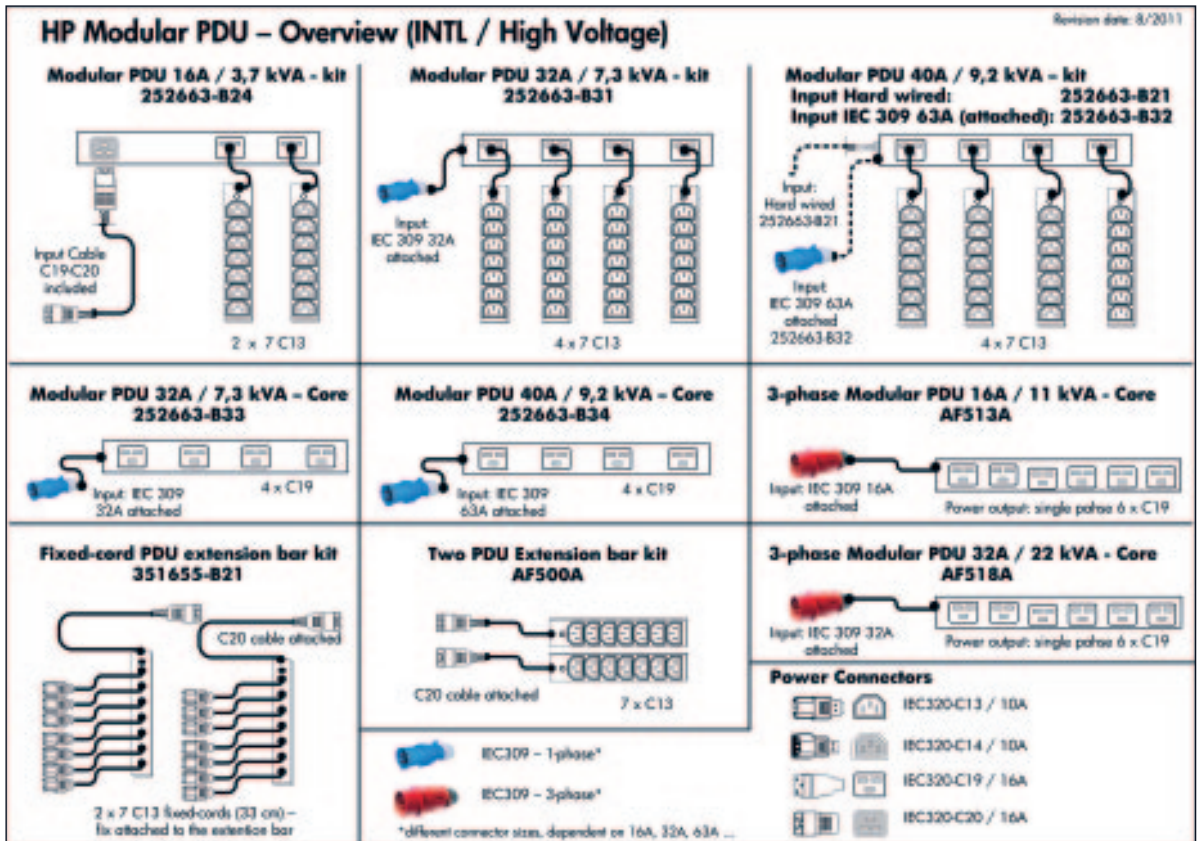

# Power cords

## Jumper cords (PDU to server, or UPS to server)

Model	Part number	Qty	Colour	County	Length (m)	Input	Output
CBL1xIECC13-C14 0.5 m WW ALL	142257-B28	1	black	WW	0,5	IEC C13	IEC C14
CBL1xIECC13-C14 1.37 m	142257-006	1	black	WW	1,37	IEC C13	IEC C14
CBL15xIECC13-C14 1.37 m	142257-007	15	black	WW	1,37	IEC C13	IEC C14
CBL1xIECC13-C14 2.5 m	142257-002	1	black	WW	2,5	IEC C13	IEC C14
CBL1xIECC13-C14 3.0 m	142257-003	1	black	WW	3	IEC C13	IEC C14
CBL1xIECC13-C14 3.6 m – right angled power cord	142257-003	1	black	WW	3,6	IEC C13	IEC C14
IEC320-C19 to IEC320-C14 Jumper (10A, IEC, 10ft/3.0 m)	313228-B21	1	black	WW	3	IEC C19	IEC C14
HP Rdnt 2 m,10A,C13-C14 Jumper Cord	AF573A	1	grey	WW	2	IEC C13	IEC C14
HP Rdnt 1.2 m 16A C19-C20 Jumper Cord	AF575A	1	grey	WW	1,2	IEC C19	IEC C20
HP Rdnt 2 m,16A,C19-C20 Jumper Cord	AF574A	1	grey	WW	2	IEC C19	IEC C20
HP Rdnt 2.5 m,16A,C19-C20 Jumper Cord	AF574A	1	grey	WW	2	IEC C19	IEC C20
HP Rdnt 4.5 m,16A,C19-C20 Jumper Cord	295633-B22	1	black	WW	2,5	IEC C19	IEC C20
CBL1xIECC19-C20 2.5 m	E7798A	1	black	WW	2,5	IEC C19	IEC C20
CBL1xIECC19-C20 4 m	E7804A	1	black	WW	4	IEC C19	IEC C20
CBL1xIECC19-Field Wired, 4.5 m	E7806A	1	black	WW	4,5	IEC C19	Field Wired

## Power cords for HP IPD solution

Model	Part number	Qty	Colour	County	Length (m)	Input	Output
82 cm PLC power cable with data lines, single	SG506A	1	black	WW	1	IEC C13 & PLC	IEC C14 & PLC
82 cm PLC power cable with data lines, 5 Pack	SG507A	5	black	WW	5	IEC C13 & PLC	IEC C14 & PLC
148 cm PLC power cable with data lines, single	SG508A	1	black	WW	1	IEC C13 & PLC	IEC C14 & PLC
148 cm PLC power cable with data lines, 5 pack	SG509A	5	black	WW	5	IEC C13 & PLC	IEC C14 & PLC
198 cm PLC power cable with data lines, single	SG510A	1	black	WW	1	IEC C13 & PLC	IEC C14 & PLC
198 cm PLC power cable with data lines, 5 pack	SG511A	5	black	WW	5	IEC C13 & PLC	IEC C14 & PLC
330 cm PLC power cable with data lines, single	SG512A	1	black	WW	1	IEC C13 & PLC	IEC C14 & PLC

Note: All PLC Power cables are IEC C13 to IEC C14 “jumper cables” and designated by bright blue IEC connectors. PLC power cables enable Intelligent Power Discovery communications between HP Common Slot Platinum Power Supplies and the HP Intelligent Extension Bars when used with the HP Intelligent PDU cores.

## Country specific power cords

Model	Part number	Qty	County	Length (m)	Input recept.	Output plug
Power Cord Kit, 1.83 m, 10A, C13-EURO	AF568A	1	Mainland Europe (Germany, France, ...)	1,83	IEC C13	IEC 83 C4 (CEE7-VII)/Schuko
Power Cord Kit, 1.83 m, 10A, C13-UK/HK/SINGAPORE	AF570A	1	UK	1,83	IEC C13	BS 1363/A
Power Cord Kit, 1.83 m, 10A, C13-SWISS	AF565A	1	Switzerland/Denmark	1,83	IEC C13	SEV 1011
Power Cord Kit, 1.83 m, 10A, C13-ITALY/CHILE	AF571A	1	Italy	1,83	IEC C13	CEI 23-50
Power Cord Kit, 1.83 m, 10A, C13-ISRAEL	AF564A	1	Israel	1,83	IEC C13	SI 32
Power Cord Kit, 1.83 m, 10A, C13-DANISH	AF566A	1	Denmark	1,83	IEC C13	DK 2-5A
Power Cord Kit, 2.5 m, 10A, C13-ISRAEL	AF583A	1	Israel	2,5	IEC C13	SI 32
Power Cord Kit, 2.5 m, 10A, C13-S.AFRICAN	AF567A	1	South Africa	2,5	IEC C13	SABS 164
Power Cord Kit, 2.5 m, 10A, C13-AUSTRALIAN	AF569A	1	Australia	2,5	IEC C13	
Power Cord Kit, 2.0 m, 10A, C13-JAPAN	AF572A	1	Japan	2	IEC C13	
Power Cord Kit, 3.6 m, 16A, C19-EURO	AF576A	1	Mainland Europe (Germany, France, ...)	3,6	IEC C19	IEC 83 C4 (CEE7-VII)/Schuko
Power Cord Kit, 3.6 m, 16A, C19-EURO	305340-021	25	Mainland Europe (Germany, France, ...)	3,6	IEC C19	IEC 83 C4 (CEE7-VII)/Schuko
Power Cord Kit, 3.6 m, 16A, IEC309	AF581A	1	Intl	3,6	IEC C19	IEC 306 16A single-phase
Power Cord Kit, 3.6 m, 16A, C19-UK/HK/SINGAPORE	305340-031	25	UK	3,6	IEC C19	BS 1363/A
Power Cord Kit, 3.6 m, 16A, C19-UK/HK/SINGAPORE	359615-031	1	UK	3,6	IEC C19	BS 1363/A
Power Cord Kit, 3.6 m, 16A, C19-SWISS	305340-081	25	Switzerland	3,6	IEC C19	SEV 1011
Power Cord Kit, 3.6 m, 16A, C19-ITALY/CHILE	AF580A	1	Italy	3,6	IEC C19	CEI 23-50
Power Cord Kit, 3.6 m, 16A, C19-ITALY/CHILE	305340-061	25	Italy	3,6	IEC C19	CEI 23-50
Power Cord Kit, 2.5 m, 16A, C19-ISRAEL	TBD	25	Israel	2,5	IEC C19	SI 32
Power Cord Kit, 3.6 m, 16A, C19-DANISH	305340-081	25	Denmark	3,6	IEC C19	DK 2-5A
Power Cord Kit, 3.6 m, 16A, C19-S.AFRICAN	AF579A	1	South Africa	3,6	IEC C19	SABS 164
Power Cord Kit, 3.6 m, 16A, C19-S.AFRICAN	305340-AR1	25	South Africa	3,6	IEC C19	SABS 164

For more information about power cords, please visit:

<http://h18004.www1.hp.com/products/servers/proliantstorage/power-protection/index.html>

<http://powercords.hp.com>

# Power Supplies

	Part number	Output	Max Power Efficiency	Power Efficiency Certification (80Plus, CSCI)	Supports Intelligent Power Discovery	Redundancy Supported	Supports HE Mode/ Load Balancing	Supports Dynamic Power Capping	Hot-Plug Power Supply	FCC Classification
<b>Non Common Slot Power Supplies</b>										
	HP 350W Factory Integrated Power Supply Kit	646146-B21	350W	80%						
	HP 400W Factory Integrated Power Supply Kit	515739-B21	400W	82%						
	HP 500W Factory Integrated Power Supply Kit	515915-B21	500W	90%	Gold					A
	HP 500W Factory Integrated Power Supply Kit with Backplane	537150-B21	500W	90%	Gold					A
	HP 500W Power Supply Kit	583437-B21	500W	90%	Gold					A
	HP 365W Redundant Power Supply Kit with Backplane	532092-B21	365W	89%		✓			✓	A
	HP 1100W Hot Plug Power Supply Kit	348114-B21	1100W	85%		✓			✓	B
	HP 750W Factory Integrated Power Supply Kit	515997-B21	750W	85%						
	HP 300W Power Supply Kit	445067-001	300W	80%						
	HP 460W Factory Integrated Power Supply Kit	500447-B21	460W	82%						
	HP 430W Factory Integrated Power Supply Kit	431652-B21	430W							
	HP 700W Hot Plug Power Supply Kit	411076-001	700W	85%		✓			✓	B
	HP 1000W Hot Plug Power Supply Kit	399771-001	1000W	85%		✓			✓	B
<b>Common Slot Power Supplies</b>										
	HP 1200W Common Slot Silver Hot Plug Power Supply Kit	437572-B21	1200W	90%	Silver		✓		✓	B
	HP 1200W Common Slot Silver Hot Plug Power Supply Kit	500172-B21	1200W	90%	Silver	✓	✓	✓	✓	B
	HP 460W Common Slot Gold Hot Plug Power Supply Kit	503296-B21	460W	92%	Gold	✓	✓	✓	✓	B
	HP 460W Common Slot Gold Hot Plug Power Supply Kit with Backplane	535684-B21	460W	92%	Gold	✓	✓	✓	✓	B
	HP 750W Common Slot Gold Hot Plug Power Supply Kit	512327-B21	750W	92%	Gold	✓	✓	✓	✓	B
	HP 750W Common Slot Gold Hot Plug Power Supply Kit with Backplane	535683-B21	750W	92%	Gold	✓	✓	✓	✓	B
	HP 460W Common Slot Platinum Hot Plug Power Supply Kit	593188-B21	460W	94%	Platinum	✓	✓	✓	✓	A
	HP 460W Common Slot Platinum Hot Plug Power Supply Kit with Backplane	605923-B21	460W	94%	Platinum	✓	✓	✓	✓	A
	HP 750W Common Slot Platinum Hot Plug Power Supply Kit	593831-B21	750W	94%	Platinum	✓	✓	✓	✓	A
	HP 1200W Common Slot Platinum Hot Plug Power Supply Kit	578322-B21	1200W	94%	Platinum	✓	✓	✓	✓	A
	HP 1200W Common Slot -48VDC Hot Plug Power Supply Kit	437573-B21	1200W	90%		✓			✓	
<b>Blade Power Supplies</b>										
	HP 2400W Gold Hot Plug Power Supply Kit	499243-B21	2400W	92%	Gold		✓	✓	✓	A
	HP 6X 2400W Gold Hot Plug Power Supply Kit	517521-B21	2400W	92%	Gold		✓	✓	✓	A
	HP 2400W Platinum Hot Plug Power Supply Kit	588603-B21	2400W	94%	Platinum		✓	✓	✓	A
	HP 6X 2400W Platinum Hot Plug Power Supply Kit	517521-B22	2400W	94%	Platinum		✓	✓	✓	A
	HP 2250W -48VDC Hot Plug Power Supply Kit	AH332A	2250W	90%		✓				

For more information about power supplies, please visit:

<http://h18004.www1.hp.com/products/servers/rackandpower/powersupplies/index.html>

## HP Factory Express Services

Customisation, integration and deployment services from the HP Factory to the data centre that save you time, money and resources

With HP Factory Express Services, you can:

- Collaborate with HP experts thereby freeing up your IT resources to deliver other strategic value for your business
- Choose how your solution is built, tested, integrated, shipped and deployed
- Receive ready-to-deploy solutions delivered consistently worldwide

HP Factory Express Services are a perfect fit for your Rack & Power solution since they enable pre-delivery customisation and integration, ensuring you receive a total solution that is ready to go.

### HP Factory Express System Customisation Services

Tell us how you want your system built, racked, labelled and cabled. HP offers:

- Custom system settings
- Hardware and rack integration
- Asset & RFID tagging and labelling
- Special packaging – and more!

### HP Factory Express Logistic Services

HP can create a custom delivery experience to accommodate your site constraints and project needs. HP offers:

- Delivery at your site directly to the data centre
- Special equipment to transport heavy racked items
- Unpacking and waste removal
- Non-working day/time delivery
- Consolidation of your orders ensuring one delivery

### HP Factory Express Software Image Management Services

By leveraging HP engineering to load and manage your software image at our factory, we can help reduce your installation time. HP offers:

- Image development and qualification
- Image loading
- Image recovery

### HP Factory Express Solution Services

For complex project rollout and end-to-end support for ease of implementation, HP offers additional value-added services:

- Project management
- Onsite setup and turn-on
- Engineering consultation, support and training



Top to bottom:

- Complete system documentation
- Rack integration up to cluster solutions across multiple racks
- Best-in-class cable management and airflow
- Almost ready to go, awaiting final packaging











# Synergy and integration is the difference

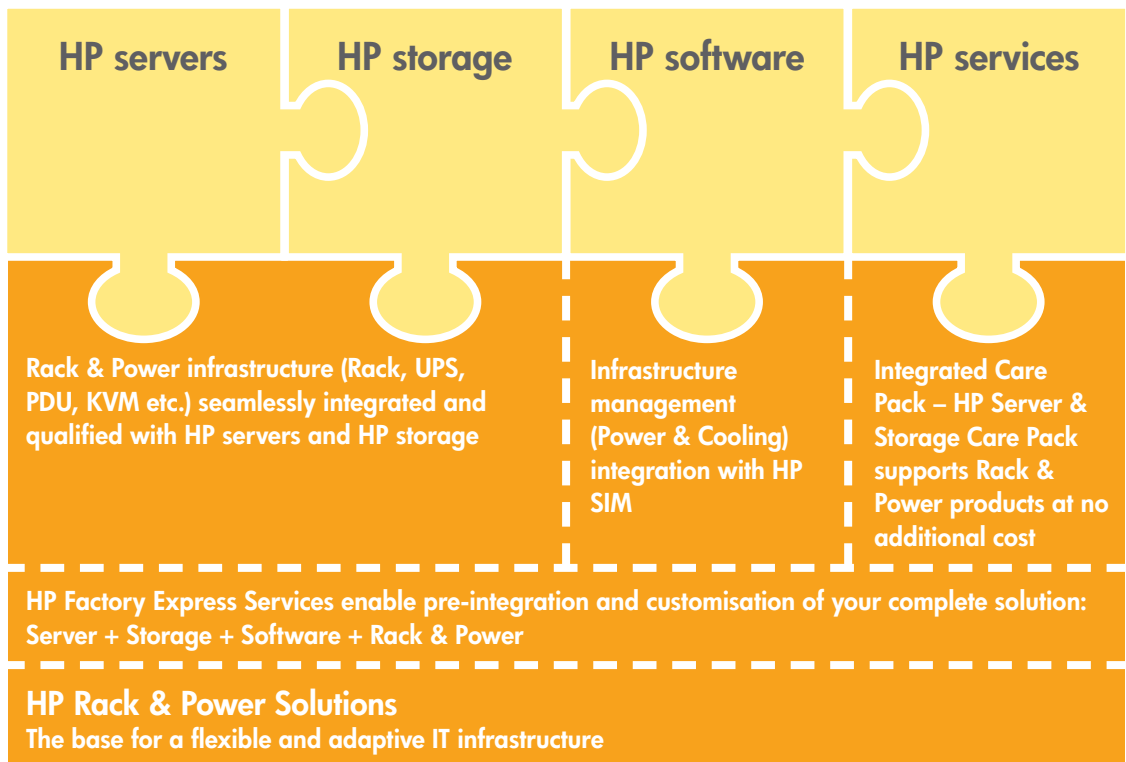

## Energy-efficient computing in the next-generation data centre

HP: Taking a holistic approach to power and cooling issues, from end to end – from Chip to Chiller.

HP Rack & Power Solutions are part of HP's end-to-end solution, and important if you want to create an energyefficient data centre.

### Made for HP, by HP

HP Rack & Power Solutions are qualified for seamless integration with HP ProLiant and Integrity servers, HP-UX based servers and HP storage offerings, as well as standards-based third-party solutions.

You can find out more by referring to the HP Rack & Power Solutions toolkit, or by visiting us online at: [www.hp.com/go/rackandpower](http://www.hp.com/go/rackandpower)  
[www.hp.com/eur/rackandpower](http://www.hp.com/eur/rackandpower)

For specific queries, please contact us at: [OBP.tech@hp.com](mailto:OBP.tech@hp.com) (for technical questions) or [OBP.SDS@hp.com](mailto:OBP.SDS@hp.com) (for solution design)

We give you a one-stop shop for your entire solution – simplifying product and vendor qualifications, procurement and customer support, and guaranteeing product compatibility.

### HP Rack & Power Solutions

- Racks and rack options – to provide the base for a flexible, adaptive IT infrastructure
- Power – to protect, distribute and monitor the power
- Access and monitoring – to harmonise the management of heterogeneous servers, storage and IT infrastructure
- Cooling – to handle the increased heat on the rack and data centre level



## Get connected

[www.hp.com/go/getconnected](http://www.hp.com/go/getconnected)

Get the insider view on tech trends, alerts, and HP solutions for better business outcomes

Share with colleagues

