



Despite its thin form, Caldera makes an undeniable impact in a contemporary space with its wisp of a profile and high light output.

Caldera's invisible light source brings a diffused glow to any space.

CALDERA 3046 / 4246

CANOPY POSITION

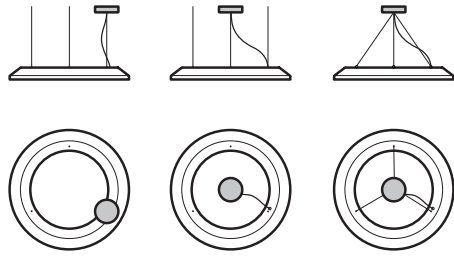

4246-XX
Canopy on mounting point (STD)

4246-XX RCC
Canopy centered with luminaire

4246-XX RCA
Canopy centered with luminaire

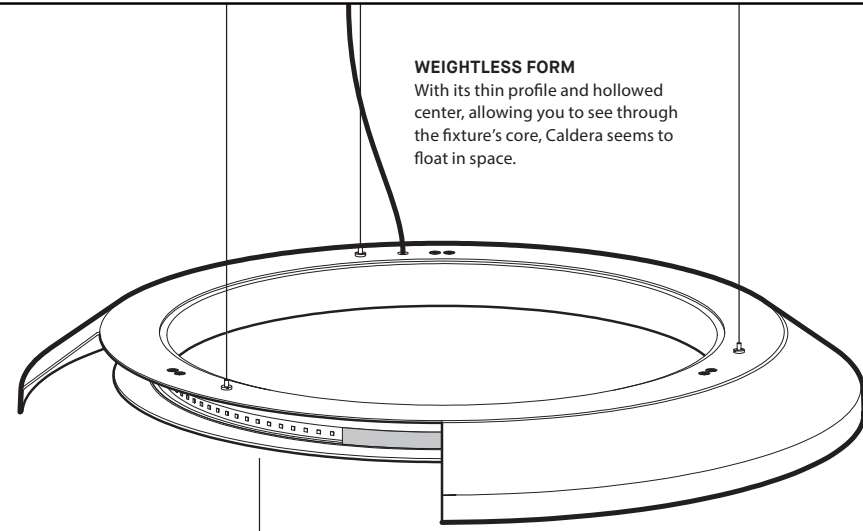

WEIGHTLESS FORM
With its thin profile and hollowed center, allowing you to see through the fixture's core, Caldera seems to float in space.

DISCREET ILLUMINATION
A thin lens wrapped around the LEDs helps create a softer illumination while retaining a high efficiency. The light source, hidden within the ring's cavity, is invisible from every angle allowing a minimal glare experience.

The conical shaped shade redirects light downwards to create an ambient illumination. Offered in two different diameters: 28" & 46".

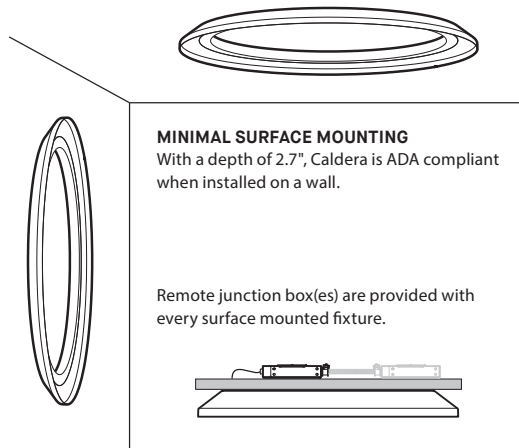

MINIMAL SURFACE MOUNTING
With a depth of 2.7", Caldera is ADA compliant when installed on a wall.

Remote junction box(es) are provided with every surface mounted fixture.

ADAPTABLE
Caldera is available in 2 surface mount options: installed on a rectangular cutout with no visible hardware or on an existing 4" hole with a cover plate (provided).

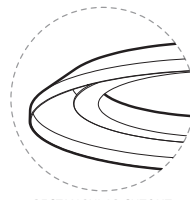

RECTANGULAR CUTOUT
Seamless, new installation



STANDARD 4" HOLE
Discreet plate, retrofit installation

PRODUCT SPECIFICATION	XX46-28					XX46-46		
	REG	HO	SHO	TW REG	TW HO	REG	HO	TW REG
PERFORMANCE								
SYSTEM WATTAGE	25.0 W	52.5 W	82.0 W	25.0 W	52.3 W	49.9 W	104.9 W	50.0 W
DELIVERED LUMENS (4000K)	1724.8 LM	3198.8 LM	4510 LM	1531.2 LM	2750 LM	3366 LM	6072 LM	2926 LM
EFFICACY	69 LM/W	61 LM/W	55 LM/W	61 LM/W	52 LM/W	67 LM/W	58 LM/W	58 LM/W
OTHER INFORMATION								
LUMINAIRE'S WEIGHT	10 LBS / 4.5 KG					16 LBS / 7.2KG		
L70 (LUMEN MAINTENANCE) REG/HO/SHO	60,000 HRS					60,000 HRS		
MAX. LUMINANCE OF NADIR	3316 CD/M ²					1782 CD/M ²		
LIGHT QUALITY	R9 > 50							

EFFICACY MULTIPLIERS

CRI	CCT	FACTOR	TW FACTOR
80+	5000K	-	0.93
80+	4000K	-	1.00
80+	3500K	-	0.99
80+	3000K	-	0.98
80+	2700K	-	0.91
90+	4000K	1.00	-
90+	3500K	0.96	-
90+	3000K	0.92	-
90+	2700K	0.87	-

LIGHT DISTRIBUTION

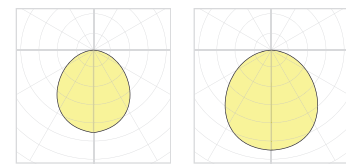

XX46-28

XX46-46



Visit our website for warranty terms and conditions.



A large wall is the perfect canvas for some lighting creativity with stylish wall-mounted Caldera rings in two sizes.



CALDERA 4246 PENDANT

PROJECT PROJÉT
SPEC TYPE
NOTES



FINISH FINI



BLKE

WHE

FAMILY FAMILLE

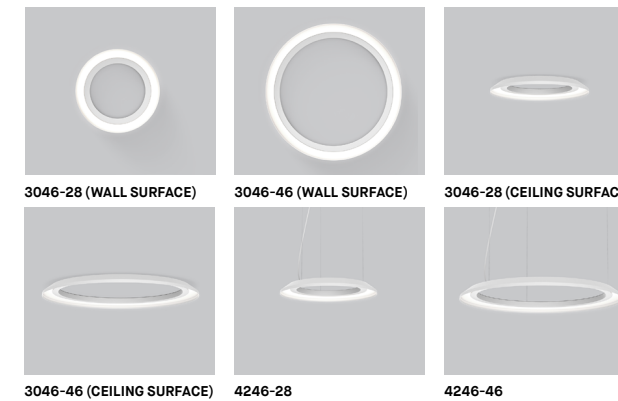

3046-28 (WALL SURFACE)

3046-46 (WALL SURFACE)

3046-28 (CEILING SURFACE)

3046-46 (CEILING SURFACE)

4246-28

4246-46

MOUNTING MONTAGE

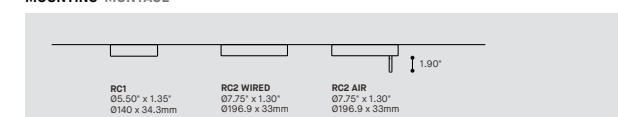

MOUNTING CABLE OPTION OPTION DE MONTAGE CÂBLE

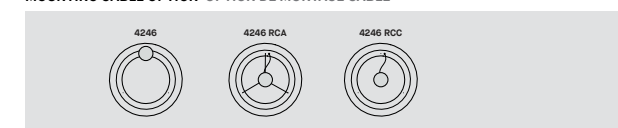

4246-28

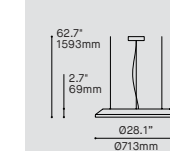

4246-46

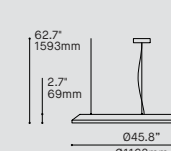

ORDERING SPECIFICATION	SPÉCIFICATION DE COMMANDE	CODE
MODEL MODÈLE		
4246-28	CALDERA 28"	
4246-46	CALDERA 46"	
LIGHT SOURCE SOURCE LUMINEUSE		
LED	REGULAR OUTPUT	
LED.HO	HIGH OUTPUT	
LED.SHO*	SUPER HIGH OUTPUT	
	* ONLY FOR 4246-28	
COLOR TEMPERATURE TEMPÉRATURE DE COULEUR		
27	2700K	
30	3000K	
35	3500K	
40*	4000K	
	* LONGER LEAD TIME MAY APPLY. PLEASE CONTACT YOUR EUREKA REPRESENTATIVE	
COLOR RENDERING INDEX (CRI) INDICE DE RENDU DE COULEUR (IRC)		90
90	90+ CRI	
VOLTAGE VOLTAGE		
120V	120 VOLT	
277V	277 VOLT	
CONTROL OPTION OPTION DE CONTRÔLE		
DV	0-10V DIMMING (120V-277V)	
DP	PHASE DIMMING (120V ONLY)	
NLTAIR2*	NLIGHT AIR CONTROL GEN 2	
NLIGHT*	NLIGHT WIRED CONTROL	
	* REQUIRES RC2 CANOPY	
	* EMERGENCY BATTERY NOT AVAILABLE WITH NLIGHT OPTIONS	
	REFER TO NLIGHT GUIDE AND INSTALLATION SHEET FOR ALL REQUIREMENTS	
EMERGENCY BATTERY BATTERIE D'URGENCE		
	EM DRIVER BOX INCLUDED, INSTALLED REMOTELY. SEE EM GUIDE FOR DETAILS.	
EMB*	EMERGENCY BATTERY FOR REMOTE BOX	
	* 3981E ACCESSORY IS REQUIRED FOR THIS OPTION	
CABLE CÂBLE		AC
AC	AIRCRAFT MOUNTING AND BLACK OR WHITE CABLE, FIELD ADJUSTABLE	
CABLE LENGTH LONGUEUR DE CÂBLE		
60	60" AIRCRAFT CABLE (STD LENGTH)	
**	CUSTOM AIRCRAFT CABLE LENGTH (PLEASE SPECIFY)	
	FOR OVERALL LENGTH PLEASE CONTACT YOUR EUREKA REPRESENTATIVE	
MOUNTING MONTAGE		
RC1	SCREWLESS CANOPY Ø5.50" X 1.35" (2473F)	
RC2	NLIGHT SCREWLESS CANOPY Ø7.75" X 1.30" (2474H)	
MOUNTING CABLE OPTION OPTION DE MONTAGE DE CÂBLE		
RCA	CENTERED ROUND CANOPY – AIRCRAFT CABLES ANGLED TO CENTER	
RCC	CENTERED ROUND CANOPY – STRAIGHT AIRCRAFT CABLES	
	IF NO OPTION IS SELECTED, AN OFF-CENTERED ROUND CANOPY WITH STRAIGHT AIRCRAFT CABLES IS STANDARD	
CANOPY FINISH FINI PAVILLON		
BLKE	BLACK FINE TEXTURE	
WHE	WHITE FINE TEXTURE	
POWER CORD FINISH FINI CÂBLE D'ALIMENTATION		
BLK	BLACK POWER CORD	
WH	WHITE POWER CORD	
EXTERIOR SHADE FINISH FINI ABAT-JOUR EXTÉRIEUR (A)		
BLKE	BLACK FINE TEXTURE	
WHE	WHITE FINE TEXTURE	
RAL*	PLEASE SPECIFY RAL CODE	
	* LONGER LEAD TIME MAY APPLY. PLEASE CONTACT YOUR EUREKA REPRESENTATIVE	
	(A) SHADE INTERIOR IS ALWAYS WHITE	
ACCESSORY EMERGENCY BATTERY ACCESSOIRE BATTERIE D'URGENCE		
3981EA	ELECTRICAL BOX FOR EMB EMERGENCY BATTERY	

PRODUCT CHARACTERISTICS CARACTÉRISTIQUES DU PRODUIT



CALDERA 4246 PENDANT TUNABLE WHITE

PROJECT PROJET
SPEC TYPE
NOTES



FINISH FINI



BLKE WHE

FAMILY FAMILLE



3046-28 (WALL SURFACE) 3046-46 (WALL SURFACE) 3046-28 (CEILING SURFACE)



3046-46 (CEILING SURFACE) 4246-28 4246-46

MOUNTING MONTAGE



MOUNTING CABLE OPTION OPTION DE MONTAGE CÂBLE

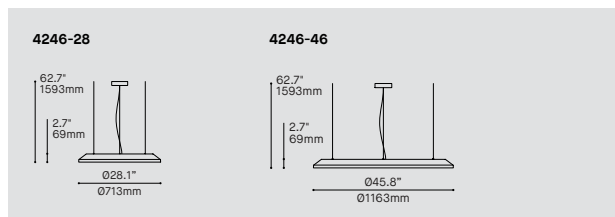

ORDERING SPECIFICATION	SPÉCIFICATION DE COMMANDE	CODE
MODEL MODÈLE		
4246-28	CALDERA 28"	
4246-46	CALDERA 46"	
LIGHT SOURCE SOURCE LUMINEUSE		LED
LED	REGULAR OUTPUT	
COLOR TEMPERATURE TEMPÉRATURE DE COULEUR		TW
TW*	TUNABLE WHITE (2700K TO 5000K) * LONGER LEAD TIME MAY APPLY, PLEASE CONTACT YOUR EUREKA REPRESENTATIVE	
COLOR RENDERING INDEX (CRI) INDICE DE RENDU DE COULEUR (IRC)		80
80	80+ CRI	
VOLTAGE VOLTAGE		
120V	120 VOLT	
277V	277 VOLT	
CONTROL OPTION OPTION DE CONTRÔLE		
DDV	DUAL 0-10V DIMMING	
NLT	NLIGHT NTUNE CONTROL	
CABLE CÂBLE		AC
AC	AIRCRAFT MOUNTING AND BLACK OR WHITE CABLE, FIELD ADJUSTABLE	
CABLE LENGTH LONGUEUR DE CÂBLE		
60	60" AIRCRAFT CABLE (STD LENGTH)	
**	CUSTOM AIRCRAFT CABLE LENGTH (PLEASE SPECIFY) FOR OVERALL LENGTH PLEASE CONTACT YOUR EUREKA REPRESENTATIVE	
MOUNTING MONTAGE		RC
RC	SCREWLESS CANOPY Ø9.42" X 1.88" (2475I)	
MOUNTING CABLE OPTION OPTION DE MONTAGE DE CÂBLE		
RCA	CENTERED ROUND CANOPY – AIRCRAFT CABLES ANGLED TO CENTER	
RCC	CENTERED ROUND CANOPY – STRAIGHT AIRCRAFT CABLES IF NO OPTION IS SELECTED, AN OFF-CENTERED ROUND CANOPY WITH STRAIGHT AIRCRAFT CABLES IS STANDARD	
CANOPY FINISH FINI PAVILLON		
BLKE	BLACK FINE TEXTURE	
WHE	WHITE FINE TEXTURE	
POWER CORD FINISH FINI CÂBLE D'ALIMENTATION		
BLK	BLACK POWER CORD	
WH	WHITE POWER CORD	
EXTERIOR SHADE FINISH FINI ABAT-JOUR EXTÉRIEUR (A)		
BLKE	BLACK FINE TEXTURE	
WHE	WHITE FINE TEXTURE	
RAL*	PLEASE SPECIFY RAL CODE * LONGER LEAD TIME MAY APPLY, PLEASE CONTACT YOUR EUREKA REPRESENTATIVE (A) SHADE INTERIOR IS ALWAYS WHITE	

PRODUCT CHARACTERISTICS CARACTÉRISTIQUES DU PRODUIT

BIM **DIM** **IES** **LED**

DESIGN:	A sleek and narrow profile with a large hollow center allows Caldera to harmonize gracefully with its surroundings, while its sharper and refined silhouette adds an elegant aesthetic touch to any space.
INSTALLATION:	The triple aircraft mounting allows an easy installation, adjustability, and levelling.
LIGHT SOURCE:	An enveloping halo of light with minimal glare emerges from the invisible light source, hidden within the central ring. Offered with phase, 0-10V dimming, as well as nLight integrated system. Emergency option also available.
SHADE:	An aluminium construction coated with a high-quality fine texture paint.
CONCEPTION:	Un profil étroit et épuré ainsi qu'un centre ouvert permettent à Caldera de s'harmoniser avec grâce à son environnement, alors que sa silhouette angulaire et raffinée ajoute une touche visuelle élégante à tout espace.
INSTALLATION:	Câbles de retenue en acier facilitant l'installation, l'ajustement et la mise à niveau.
SOURCE LUMINEUSE:	halo de lumière enveloppant et sans éblouissement émerge d'une source lumineuse dissimulée dans l'anneau central. Offert avec gradation de type phase ou 0-10V, ainsi que nLight. Batterie d'urgence disponible.
ABAT-JOUR:	Construction en aluminium, recouverte d'une peinture finement texturée de haute qualité.

CALDERA 3046

PROJECT PROJET
SPEC TYPE
NOTES

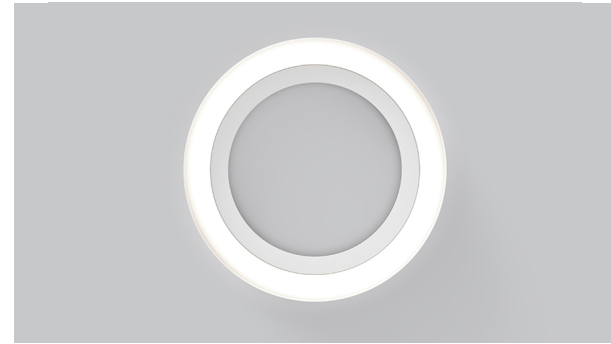

FINISH FINI



BLKE WHE

FAMILY FAMILLE

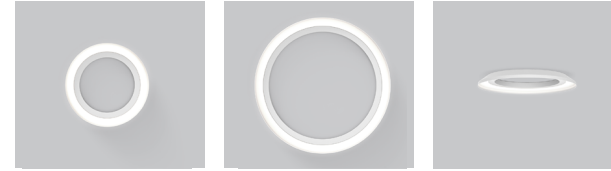

3046-28 (WALL SURFACE) 3046-46 (WALL SURFACE) 3046-28 (CEILING SURFACE)



3046-46 (CEILING SURFACE) 4246-28 4246-46

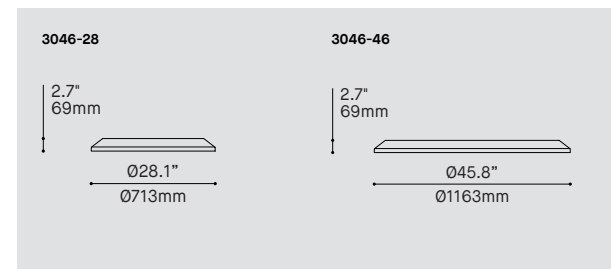

ORDERING SPECIFICATION	SPÉCIFICATION DE COMMANDE	CODE
MODEL MODÈLE		
3046-28	CALDERA 28"	
3046-46	CALDERA 46"	
LIGHT SOURCE SOURCE LUMINEUSE		
LED	REGULAR OUTPUT	
LED.HO	HIGH OUTPUT	
LED.SHO*	SUPER HIGH OUTPUT * ONLY FOR 3046-28	
COLOR TEMPERATURE TEMPÉRATURE DE COULEUR		
27	2700K	
30	3000K	
35	3500K	
40*	4000K * LONGER LEAD TIME MAY APPLY, PLEASE CONTACT YOUR EUREKA REPRESENTATIVE	
COLOR RENDERING INDEX (CRI) INDICE DE RENDU DE COULEUR (IRC)		90
90	90+ CRI	
VOLTAGE VOLTAGE		
120V	120 VOLT	
277V	277 VOLT	
CONTROL OPTION OPTION DE CONTRÔLE		
DV	0-10V DIMMING (120V-277V)	
DP	PHASE DIMMING (120V ONLY) LED DIMMING DRIVER IS STANDARD IN THIS PRODUCT, PLEASE SPECIFY YOUR DIMMING TYPE.	
EMERGENCY BATTERY BATTERIE D'URGENCE		
EMB*	EM DRIVER BOX INCLUDED, INSTALLED REMOTELY. SEE EM GUIDE FOR DETAILS. EMERGENCY BATTERY FOR REMOTE BOX * 3981E ACCESSORY IS REQUIRED FOR THIS OPTION	
MOUNTING MONTAGE		
SL*	SLIM RECTANGULAR MOUNTING HOLE (NO PLATE)	
RO**	COVER FOR EXISTING STANDARD 4" HOLE (D-SHAPED PLATE) * REFER TO INSTALLATION DOCUMENT FOR HOLE DIMENSIONS ** EXISTING JUNCTION BOX MUST BE REMOVED AND REPLACED WITH ONE PROVIDED	
EXTERIOR SHADE FINISH FINI ABAT-JOUR EXTÉRIEUR (A)		
BLKE	BLACK FINE TEXTURE	
WHE	WHITE FINE TEXTURE	
RAL*	PLEASE SPECIFY RAL CODE * LONGER LEAD TIME MAY APPLY, PLEASE CONTACT YOUR EUREKA REPRESENTATIVE (A) SHADE INTERIOR IS ALWAYS WHITE	
EMERGENCY BATTERY ACCESSORY ACCESSOIRE BATTERIE D'URGENCE		
3981EA	ELECTRICAL BOX FOR EMB EMERGENCY BATTERY	

PRODUCT CHARACTERISTICS CARACTÉRISTIQUES DU PRODUIT

ADA **BIM** **DIM** **EMB** **IES** **LED**

DESIGN:	A sleek and narrow profile with a large hollow center allows Caldera to harmonize gracefully with its surroundings, while its sharper and refined silhouette adds an elegant aesthetic touch to any space.
INSTALLATION:	Simple and discreet « twist & lock » installation system. Available with additional plate to cover existing standard junction box hole. (ADA compliant).
LIGHT SOURCE:	An enveloping halo of light with minimal glare emerges from the invisible light source, hidden within the central ring. Offered with phase, 0-10V dimming. Emergency option also available.
SHADE:	An aluminium construction coated with a high-quality fine texture paint.
CONCEPTION:	Un profil étroit et épuré ainsi qu'un centre ouvert permettent à Caldera de s'harmoniser avec grâce à son environnement, alors que sa silhouette angulaire et raffinée ajoute une touche visuelle élégante à tout espace.
INSTALLATION:	Installation avec système « twist & lock » simple et discret. Disponible avec plaque additionnelle pour couvrir trou de boîte de jonction standard. (Conforme à l'ADA).
SOURCE LUMINEUSE:	halo de lumière enveloppant et sans éblouissement émerge d'une source lumineuse dissimulée dans l'anneau central. Offert avec gradation de type phase ou 0-10V. Batterie d'urgence disponible.
ABAT-JOUR:	Construction en aluminium, recouverte d'une peinture finement texturée de haute qualité.

CALDERA 3046

PROJECT PROJÉT
SPEC TYPE
NOTES



FINISH FINI

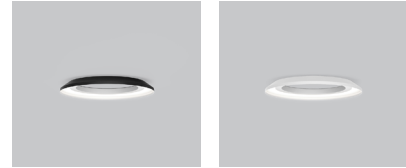

BLKE

WHE

FAMILY FAMILLE

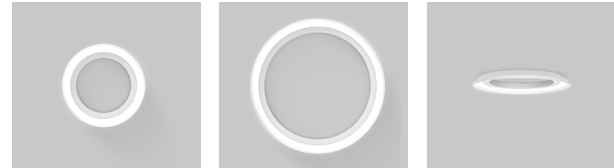

3046-28 (WALL SURFACE)

3046-46 (WALL SURFACE)

3046-28 (CEILING SURFACE)



3046-46 (CEILING SURFACE)

4246-28

4246-46

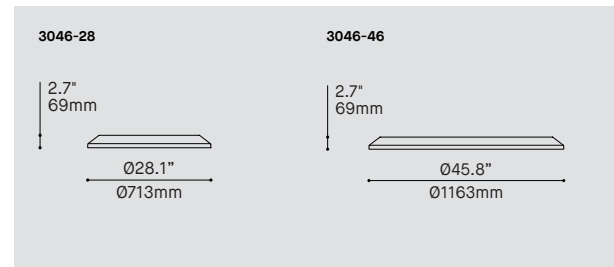

ORDERING SPECIFICATION	SPÉCIFICATION DE COMMANDE	CODE
MODEL MODÈLE		
3046-28	CALDERA 28"	
3046-46	CALDERA 46"	
LIGHT SOURCE SOURCE LUMINEUSE		
LED	REGULAR OUTPUT	
LED.HO	HIGH OUTPUT	
LED.SHO*	SUPER HIGH OUTPUT	
	* ONLY FOR 3046-28	
COLOR TEMPERATURE TEMPÉRATURE DE COULEUR		
27	2700K	
30	3000K	
35	3500K	
40*	4000K	
	* LONGER LEAD TIME MAY APPLY, PLEASE CONTACT YOUR EUREKA REPRESENTATIVE	
COLOR RENDERING INDEX (CRI) INDICE DE RENDU DE COULEUR (IRC)		90
90	90+ CRI	
VOLTAGE VOLTAGE		
120V	120 VOLT	
277V	277 VOLT	
CONTROL OPTION OPTION DE CONTRÔLE		
DV	0-10V DIMMING (120V-277V)	
DP	PHASE DIMMING (120V ONLY)	
	LED DIMMING DRIVER IS STANDARD IN THIS PRODUCT. PLEASE SPECIFY YOUR DIMMING TYPE.	
EMERGENCY BATTERY BATTERIE D'URGENCE		
EMB*	EM DRIVER BOX INCLUDED, INSTALLED REMOTELY. SEE EM GUIDE FOR DETAILS.	
	EMERGENCY BATTERY FOR REMOTE BOX	
	* 3981E ACCESSORY IS REQUIRED FOR THIS OPTION	
MOUNTING MONTAGE		
SL*	SLIM RECTANGULAR MOUNTING HOLE (NO PLATE)	
RO**	COVER FOR EXISTING STANDARD 4" HOLE (D-SHAPED PLATE)	
	* REFER TO INSTALLATION DOCUMENT FOR HOLE DIMENSIONS	
	** EXISTING JUNCTION BOX MUST BE REMOVED AND REPLACED WITH ONE PROVIDED	
EXTERIOR SHADE FINISH FINI ABAT-JOUR EXTÉRIEUR (A)		
BLKE	BLACK FINE TEXTURE	
WHE	WHITE FINE TEXTURE	
RAL*	PLEASE SPECIFY RAL CODE	
	* LONGER LEAD TIME MAY APPLY, PLEASE CONTACT YOUR EUREKA REPRESENTATIVE	
	(A) SHADE INTERIOR IS ALWAYS WHITE	
EMERGENCY BATTERY ACCESSORY ACCESSOIRE BATTERIE D'URGENCE		
3981EA	ELECTRICAL BOX FOR EMB EMERGENCY BATTERY	

PRODUCT CHARACTERISTICS CARACTÉRISTIQUES DU PRODUIT

BIM **DIM** **EMB** **IES** **LED**

DESIGN:	A sleek and narrow profile with a large hollow center allows Caldera to harmonize gracefully with its surroundings, while its sharper and refined silhouette adds an elegant aesthetic touch to any space.
INSTALLATION:	Simple and discreet « twist & lock » installation system. Available with additional plate to cover existing standard junction box hole. (ADA compliant).
LIGHT SOURCE:	An enveloping halo of light with minimal glare emerges from the invisible light source, hidden within the central ring. Offered with phase, 0-10V dimming. Emergency option also available.
SHADE:	An aluminium construction coated with a high-quality fine texture paint.
CONCEPTION:	Un profil étroit et épuré ainsi qu'un centre ouvert permettent à Caldera de s'harmoniser avec grâce à son environnement, alors que sa silhouette angulaire et raffinée ajoute une touche visuelle élégante à tout espace.
INSTALLATION:	Installation avec système « twist & lock » simple et discret. Disponible avec plaque additionnelle pour couvrir trou de boîte de jonction standard. (Conforme à l'ADA).
SOURCE LUMINEUSE:	halo de lumière enveloppant et sans éblouissement émerge d'une source lumineuse dissimulée dans l'anneau central. Offert avec gradation de type phase ou 0-10V. Batterie d'urgence disponible.
ABAT-JOUR:	Construction en aluminium, recouverte d'une peinture finement texturée de haute qualité.



At less than 3", Caldera's thin profile makes it ideal when impactful lighting is needed in low ceiling spaces.

PHOTOMETRIC REPORT

CALDERA 3046-28 / 4246-28

XX46-28-LED.REG

CCT (K): 4000
 Delivered Lumens (lm): 1724
 System wattage (W)*: 25.0
 Distribution: Direct
 Delivered Efficacy (lm/W): 69
 Photometric type: C

*System wattage include driver and LED module consumption

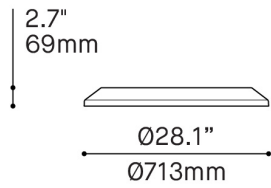
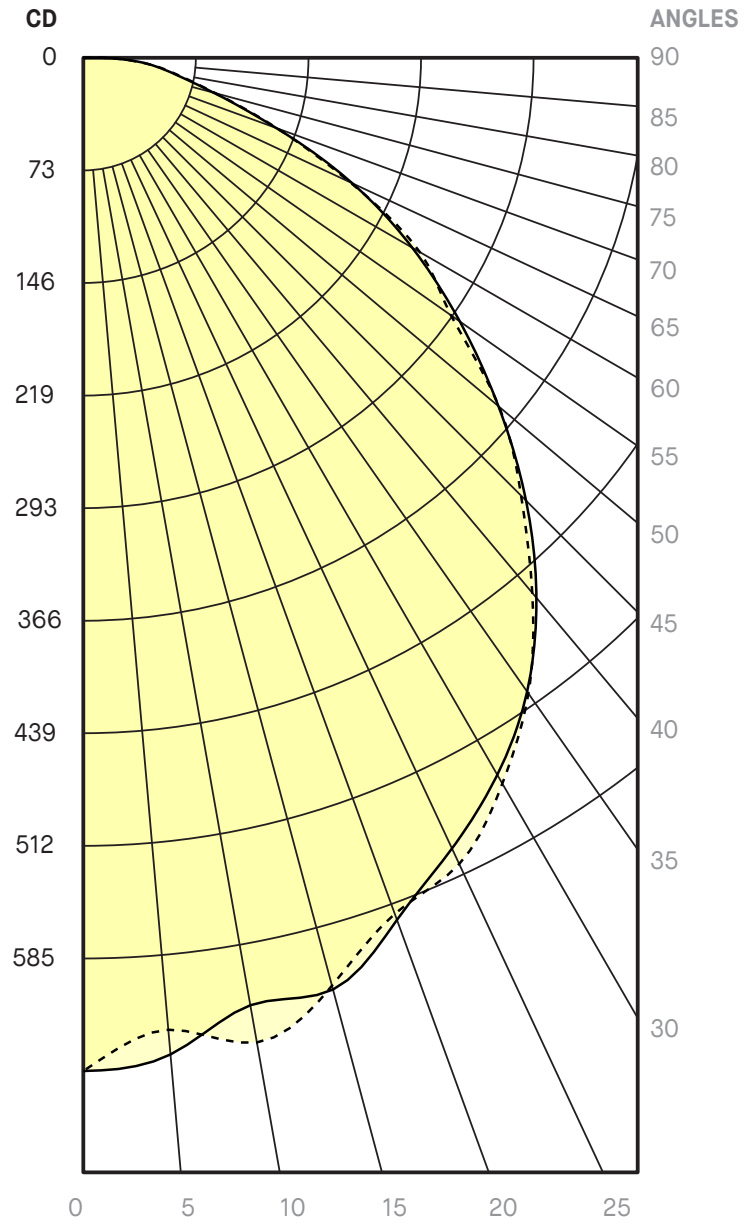

— 0 - 180
 - - - 90 - 270

PHOTOMETRIC REPORT

CALDERA 3046-28 / 4246-28

XX46-28-LED.HO

CCT (K): 4000
 Delivered Lumens (lm): 3199
 System wattage (W)*: 52.5
 Distribution: Direct
 Delivered Efficacy (lm/W): 61
 Photometric type: C

*System wattage include driver and LED module consumption

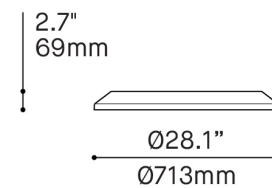
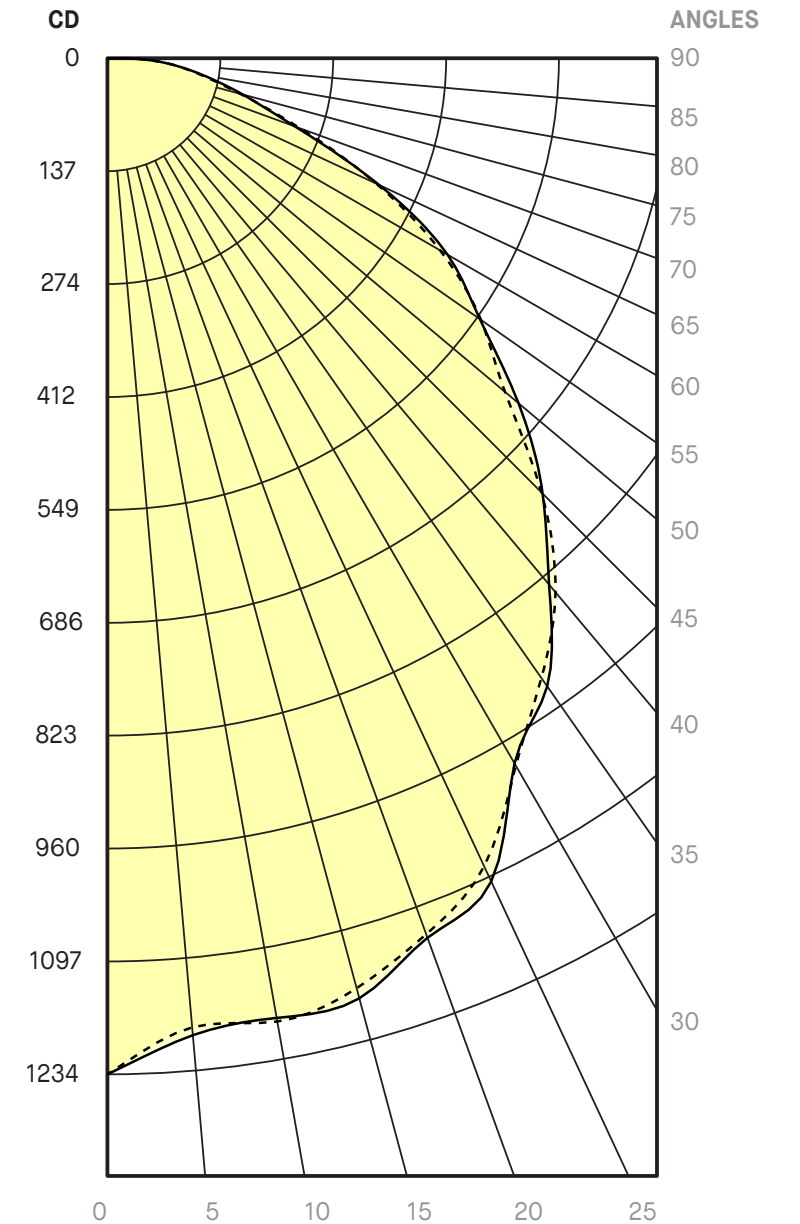

— 0 - 180
 - - - 90 - 270

PHOTOMETRIC REPORT

CALDERA 3046-28 / 4246-28

XX46-28-LED.SHO

CCT (K):	4000
Delivered Lumens (lm):	4510
System wattage (W)*:	82
Distribution:	Direct
Delivered Efficacy (lm/W):	55
Photometric type	C

*System wattage include driver and LED module consumption

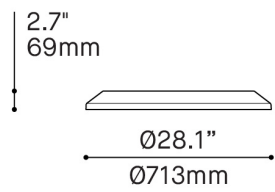
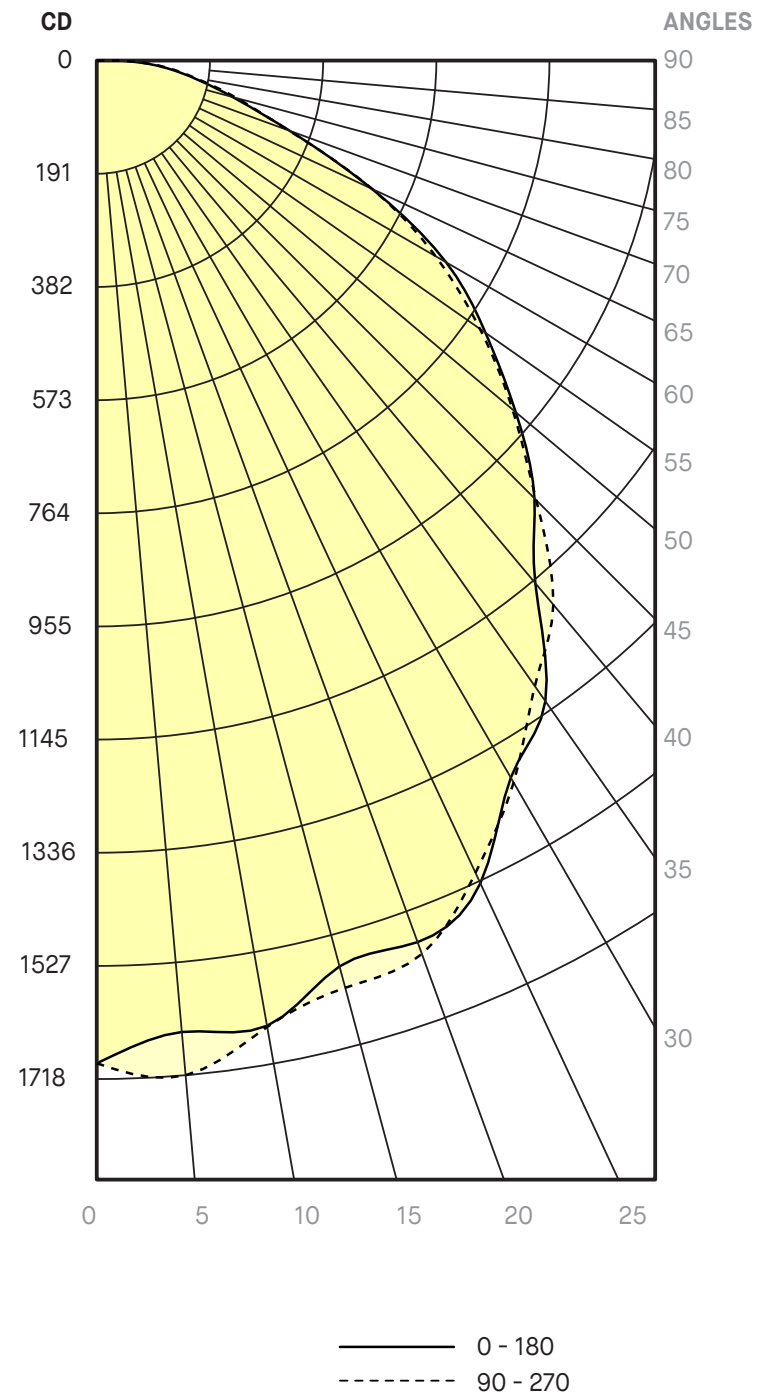

PHOTOMETRIC REPORT

CALDERA 3046-46 / 4246-46

XX46-46-LED.HO

CCT (K): 4000
 Delivered Lumens (lm): 6072
 System wattage (W)*: 104.9
 Distribution: Direct
 Delivered Efficacy (lm/W): 58
 Photometric type: C

*System wattage include driver and LED module consumption

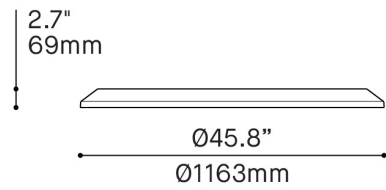
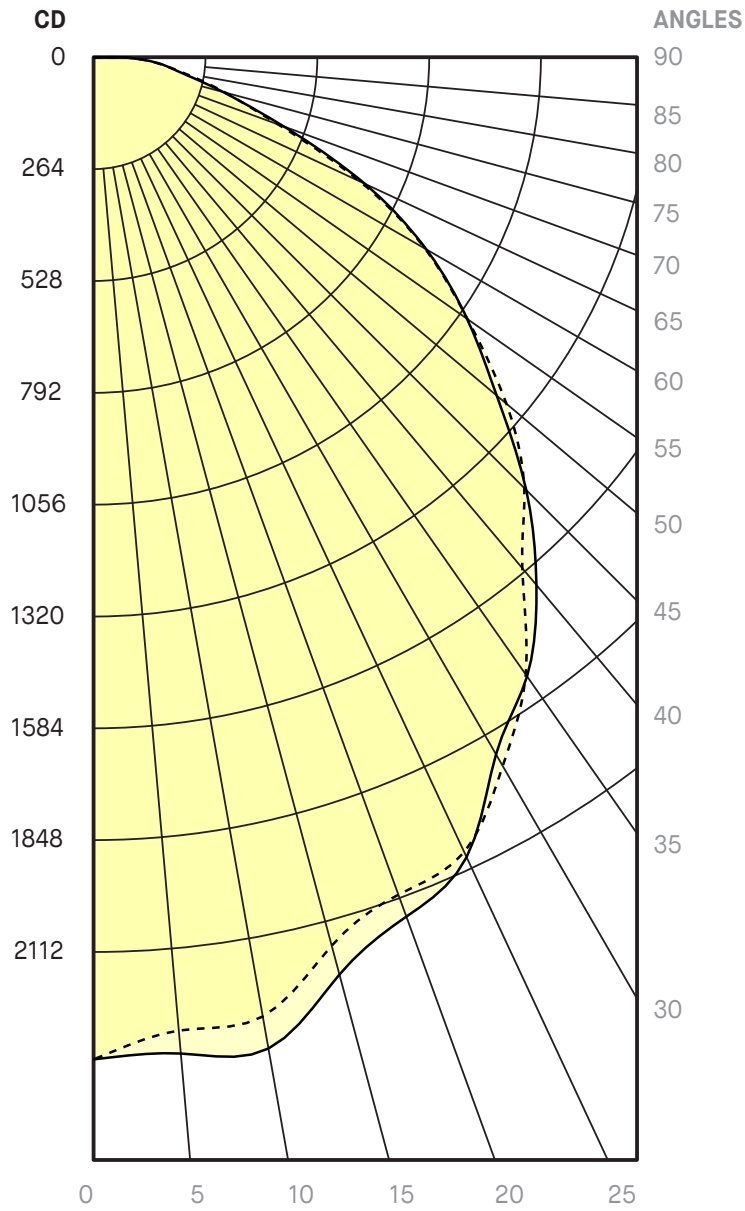

——— 0 - 180
 - - - - 90 - 270

PHOTOMETRIC REPORT

CALDERA 3046-46 / 4246-46

XX46-46-LED.REG

CCT (K): 4000
 Delivered Lumens (lm): 3366
 System wattage (W)*: 49.9
 Distribution: Direct
 Delivered Efficacy (lm/W): 67
 Photometric type: C

*System wattage include driver and LED module consumption

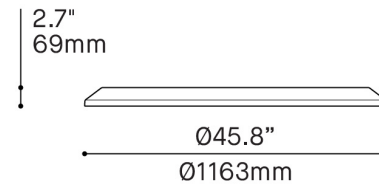
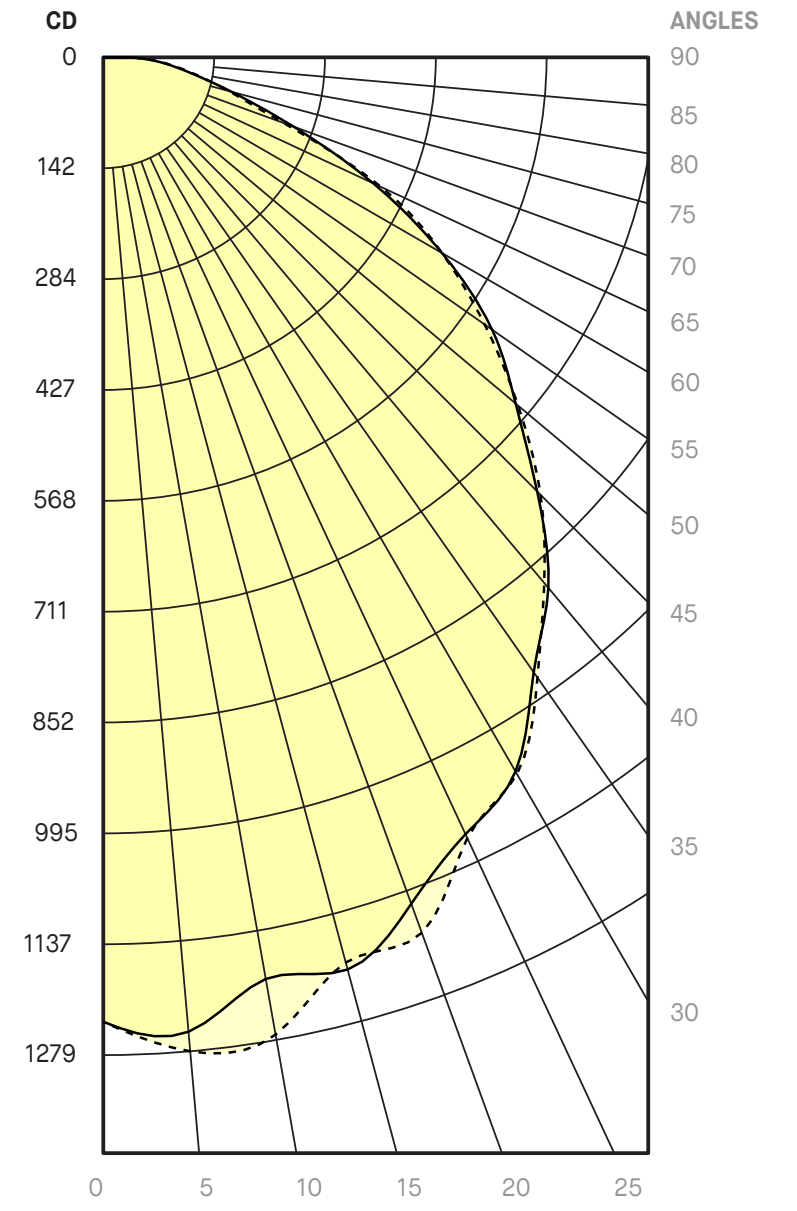

——— 0 - 180
 - - - - 90 - 270

