

MIG



Universal

T15	MIG2
T25	MIG4
T24	MIG6
T36	MIG8
T240w	MIG10
T501w	MIG14
TKITS	MIG18

Compatibles

BN 300	MIG20
BN 400	MIG21

Professional

Tx270	MIG26
Tx380	MIG28
Tx480	MIG32
Tx221w	MIG34
Tx421w	MIG38

Pulser

565P	MIG46
EPR 600	MIG50

NEW RANGE



NEWS: HOOK

Added high resistance metal hook, to facilitate storage and work speed.



NEWS: BUTTON

New button with greater contact surface and of comfortable and easy action.



NEWS: HANDLE

Completely redesigned handle, to guarantee the maximum ergonomics and comfort in the welding.

The best welding at your fingertips
TESLA



NEWS: BALL JOINT

New oversized ball joint design, greater rotation angle and mobility without bottlenecks.

TESLA MIG

UNIVERSAL



T 15

180 A

T 25

230 A

T 24

250 A

T 36

340 A

T 240w

300 A

T 501w

500 A

T 15



CODE	DESCRIPTION	PACK
1TS15102	TORCH ERGODANI TESLA ALUMINIUM TS-15 2MTS. EURO	1
1TS15103	TORCH ERGODANI TESLA TS-15 3MTS. EURO	1
1TS15104	TORCH ERGODANI TESLA TS-15 4MTS. EURO	1
1TS15105	TORCH ERGODANI TESLA TS-15 5MTS. EURO	1
1TS15106	TORCH ERGODANI TESLA TS-15 6MTS. EURO	1

POS.	CODE	DESCRIPTION	PACK
N1	11501	SWAN NECK EU-15	1
N1.1	1150101	SPRING NOZZLE RETAINER EU-15	10
N1.2	11502	CONTACT TIP HOLDER EU-15	10
N1.3	1150103	SWAN NECK INSULATOR EU-15	10
N1.4	19921	SWAN NECK HEXAGONAL EU-15	10
N1.5	19922	SWAN NECK LOCK CAP ERGODANI	10
N3	11504	STANDARD CONICAL NOZZL.ERGODANI EU-15-12MM. HD-1.5MM	5
N3	11504N	STANDARD CONICAL NOZZLE EU-15 - 12MM.	5
N4	11504SP	TAPERED NOZZLE EU-15 - 9.5MM.	5
N5	11504CL	CYLINDRICAL NOZZLE EU-15 - 16MM.	5
N6	11504BT	BOTTLE NECK NOZZLE EU-15 - 13MM.	5
N7	11504PT	SPOT NOZZLE EU-15 - 16MM.	5
N8	11504CV	NAIL NOZZLE EU-15 - 16MM.	5
M6	19915**	ERGODANI CONTACT TIP M/6*25 - *.* MM. CU.	25
M6	19915**C	ERGODANI CONTACT TIP CHROME M/6*25 - *.* MM. CU.	25
M6	19915**N	CONTACT TIP M/6*25 - *.* MM. CU.	25
E1	812 0801	TESLA HANDLE BLACK-BLUE GAS	1
E5	199TS01	BLUE SWITCH TESLA	5
G1	199SR02A	BLUE COATED LINER ERGODANI 0.6-0.8MM. 2.40MTS.	1
G1	199SR03A	BLUE COATED LINER ERGODANI 0.6-0.8MM. 3.40MTS.	1
G1	199SR04A	BLUE COATED LINER ERGODANI 0.6-0.8MM. 4.40MTS.	1
G1	199SR05A	BLUE COATED LINER ERGODANI 0.6-0.8MM. 5.40MTS.	1
G1	199SR02R	RED COATED LINER ERGODANI 1.0-1.2MM. 2.40MTS.	1
G1	199SR03R	RED COATED LINER ERGODANI 1.0-1.2MM. 3.40MTS.	1
G1	199SR04R	RED COATED LINER ERGODANI 1.0-1.2MM. 4.40MTS.	1
G1	199SR05R	RED COATED LINER ERGODANI 1.0-1.2MM. 5.40MTS.	1
G2	199SA102	ALUMINIUM WIRE LINER 0.8-1.0MM. 2MTS.	1
G2	199SA103	ALUMINIUM WIRE LINER 0.8-1.0MM. 3MTS.	1
G2	199SA104	ALUMINIUM WIRE LINER 0.8-1.0MM. 4MTS.	1
G2	199SA105	ALUMINIUM WIRE LINER 0.8-1.0MM. 5MTS.	1
G2	199SA202	ALUMINIUM WIRE LINER 1.2-1.6MM. 2MTS.	1
G2	199SA203	ALUMINIUM WIRE LINER 1.2-1.6MM. 3MTS.	1
G2	199SA204	ALUMINIUM WIRE LINER 1.2-1.6MM. 4MTS.	1
G2	199SA205	ALUMINIUM WIRE LINER 1.2-1.6MM. 5MTS.	1
G2.1	199SA88	LINER O-RING ALUWELD/ALUM.	10
G2.2	199SA77	COLLET LINER ALUWELD/ALUM.	10
G2.3	199SA1G	ALUMINIUM WIRE NECK-LINER 0.8-1.0MM.	2
G2.3	199SA2G	ALUMINIUM WIRE NECK-LINER 1.2-1.6MM.	2
G3	199SIN02	GRAY COATED BRONZE LINER ERGODANI INOX.1.0-1.2MM. 2.40M	1
G3	199SIN03	GRAY COATED BRONZE LINER ERGODANI INOX.1.0-1.2MM. 3.40M	1
G3	199SIN04	GRAY COATED BRONZE LINER ERGODANI INOX.1.0-1.2MM. 4.40M	1
G3	199SIN05	GRAY COATED BRONZE LINER ERGODANI INOX.1.0-1.2MM. 5.40M	1

T 15

Gas Cooled

180 Amp 60% CO₂
164 Amp 60% Ar + CO₂

Gas cooled torch with standard spare parts, reduced power model, very light and easy to handle.

Ideal for small reparations and general use. Perfect for 0,8 mm wire and small pieces.

Small diameter nozzle for difficult access welding.



811 1501

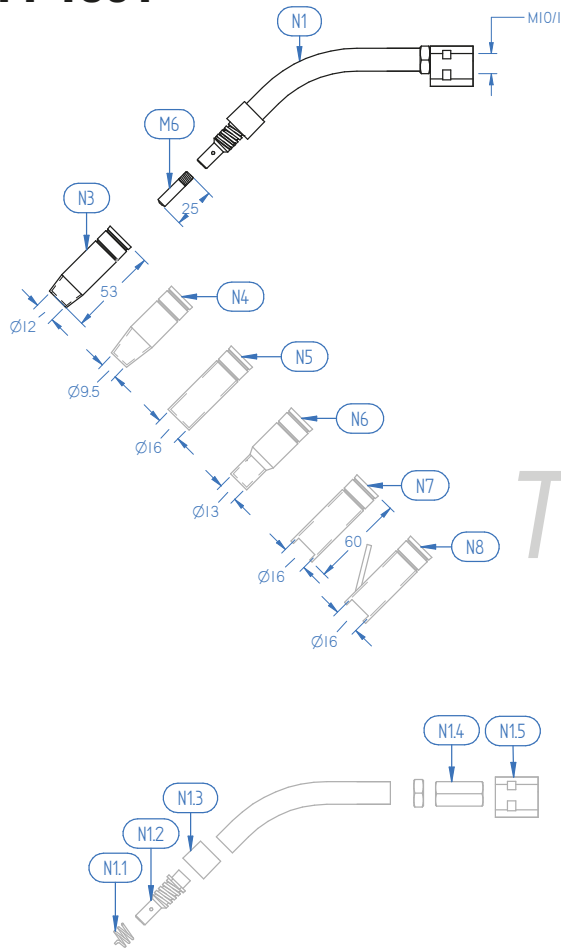

812 0801

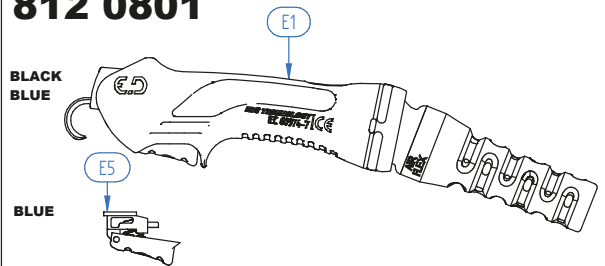

814 0107

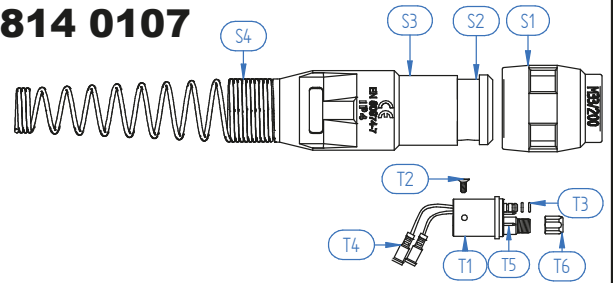

813 0102

813 0103

813 0104

813 0105

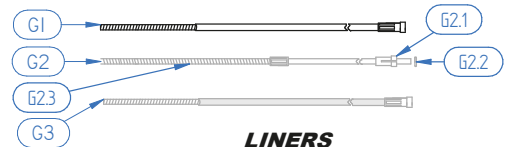
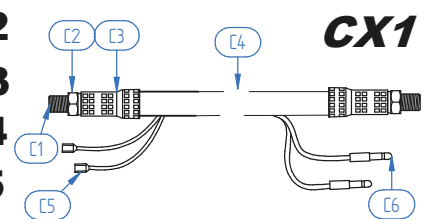

POS.	CODE	DESCRIPTION	PACK
C1	19923R	CABLE FITTING CX-1	10
C2	19920	LOCK NUT ERGODANI	10
C3	11505	CABLE COPPER SLEEVE CX-1	10
C4	115CX02	CABLE ASSEMBLY EU-15 2MTS.	1
C4	115CX03	CABLE ASSEMBLY EU-15 3MTS.	1
C4	115CX04	CABLE ASSEMBLY EU-15 4MTS.	1
C4	115CX05	CABLE ASSEMBLY EU-15 5MTS.	1
C5	199FT01	CABLE FRONT TERMINAL	25
C6	199FT02	CABLE REAR TERMINAL	25
S1	1000125	ADAPTOR NUT -BLACK CX	1
S2	100012401	CONNECTION SUPPORT TUBE CX	1
S3	100012402	REAR SPRING SUPPORT CX	1
S4	10001062	REAR SPRING CX	1
T1	199MZ	EURO CENTRAL CONNECTOR CX ERGODANI	1
T2	199MZ05	CENTRAL CONNECTOR SCREW	10
T3	199MZ03	CENTRAL CONNECTOR O-RING	10
T4	199FT03	CENTRAL CONNECTOR TERMINAL	25
T5	199MZ04	CENTRAL CONNECT.CONTACT PIN CX ERGODANI	2
T6	199MZ02	LINER FASTENER NUT ERGODANI	10





CODE	DESCRIPTION	PACK
1TS25102	TORCH ERGODANI TESLA ALUMINIUM TS-25 2MTS. EURO	1
1TS25103	TORCH ERGODANI TESLA TS-25 3MTS. EURO	1
1TS25104	TORCH ERGODANI TESLA TS-25 4MTS. EURO	1
1TS25105	TORCH ERGODANI TESLA TS-25 5MTS. EURO	1
125AC02	TORCH AUTOMATIC 45° CURVED EU-25 2MTS. EURO	1
125AC03	TORCH AUTOMATIC 45° CURVED EU-25 3MTS. EURO	1
125AC04	TORCH AUTOMATIC 45° CURVED EU-25 4MTS. EURO	1
125AR02	TORCH AUTOMATIC 0° STRAIGHT EU-25 2MTS. EURO	1
125AR03	TORCH AUTOMATIC 0° STRAIGHT EU-25 3MTS. EURO	1
125AR04	TORCH AUTOMATIC 0° STRAIGHT EU-25 4MTS. EURO	1

POS.	CODE	DESCRIPTION	PACK
N1	12501	SWAN NECK EU-25	1
N1.1	1250101	SPRING NOZZLE RETAINER EU-25	10
N2	12502	CONTACT TIP HOLDER EU-25 M/6*35MM.	10
N2.A	12502M8	CONTACT TIP HOLDER EU-25 M/8*35MM.	10
N4	12504	STANDARD CONICAL NOZZL.ERGODAN ERGODANI EU-25-15MM.	5
N4	12504N	STANDARD CONICAL NOZZLE EU-25 - 15MM.	5
N5	12504SP	TAPERED NOZZLE EU-25 - 13MM.	5
N6	12504SP1	PIPELINE NOZZLE EU-25 - 11.5MM.	5
N7	12504CL	CYLINDRICAL NOZZLE EU-25 - 18MM.	5
N8	12504BT	BOTTLE NECK NOZZLE EU-25 - 14.5MM.	5
N9	12504PT	SPOT NOZZLE EU-25 - 18MM.	5
N10	199EPAT	AUTOMATIC TORCHES HANDLE ERGODANI	1
N11	12501AC	45° CURVED AUTOMATIC SWAN NECK EU-25	1
N12	12501AR	0° STRAIGHT AUTOMATIC NECK EU-25	1
M6	199M6**	ERGODANI CONTACT TIP M/6*28 - *.* MM. CU.	25
M6	199M6**C	ERGODANI CONTACT TIP CHROME M/6*28 - *.* MM. CU.	25
M6	199M6**N	CONTACT TIP M/6*28 - *.* MM. CU.	25
M6	199M6**Z	ERGODANI CONTACT TIP M/6*28 - *.* MM. CU.CR.ZR.	25
M8	199CL**	ERGODANI CONTACT TIP CHROME M/8*28 - *.* MM. CU.	25
E1	812 0801	TESLA HANDLE BLACK-BLUE GAS	1
E5	199TS01	BLUE SWITCH TESLA	5
G1	199SR02A	BLUE COATED LINER ERGODANI 0.6-0.8MM. 2.40MTS.	1
G1	199SR03A	BLUE COATED LINER ERGODANI 0.6-0.8MM. 3.40MTS.	1
G1	199SR04A	BLUE COATED LINER ERGODANI 0.6-0.8MM. 4.40MTS.	1
G1	199SR05A	BLUE COATED LINER ERGODANI 0.6-0.8MM. 5.40MTS.	1
G1	199SR02R	RED COATED LINER ERGODANI 1.0-1.2MM. 2.40MTS.	1
G1	199SR03R	RED COATED LINER ERGODANI 1.0-1.2MM. 3.40MTS.	1
G1	199SR04R	RED COATED LINER ERGODANI 1.0-1.2MM. 4.40MTS.	1
G1	199SR05R	RED COATED LINER ERGODANI 1.0-1.2MM. 5.40MTS.	1
G1	199SR02M	YELLOW COATED LINER ERGODANI 1.6MM. 2.40MTS.	1
G1	199SR03M	YELLOW COATED LINER ERGODANI 1.6MM. 3.40MTS.	1
G1	199SR04M	YELLOW COATED LINER ERGODANI 1.6MM. 4.40MTS.	1
G1	199SR05M	YELLOW COATED LINER ERGODANI 1.6MM. 5.40MTS.	1
G2	199SA102	ALUMINIUM WIRE LINER 0.8-1.0MM. 2MTS.	1
G2	199SA103	ALUMINIUM WIRE LINER 0.8-1.0MM. 3MTS.	1
G2	199SA104	ALUMINIUM WIRE LINER 0.8-1.0MM. 4MTS.	1
G2	199SA105	ALUMINIUM WIRE LINER 0.8-1.0MM. 5MTS.	1
G2	199SA202	ALUMINIUM WIRE LINER 1.2-1.6MM. 2MTS.	1
G2	199SA203	ALUMINIUM WIRE LINER 1.2-1.6MM. 3MTS.	1
G2	199SA204	ALUMINIUM WIRE LINER 1.2-1.6MM. 4MTS.	1
G2	199SA205	ALUMINIUM WIRE LINER 1.2-1.6MM. 5MTS.	1

T25
Gas Cooled

230 Amp 60% CO₂
209 Amp 60% Ar + CO₂

Gas cooled torch with standard spare parts, medium amperage model. The most versatile with this type of spare parts!

Medium power for general use. Perfect for 0,8 and 1,0 mm wire, thin thickness, plucking of pieces and small seams.

Medium sized diameter nozzle, with multiple diameters of gas output.



SPARE PARTS KIT



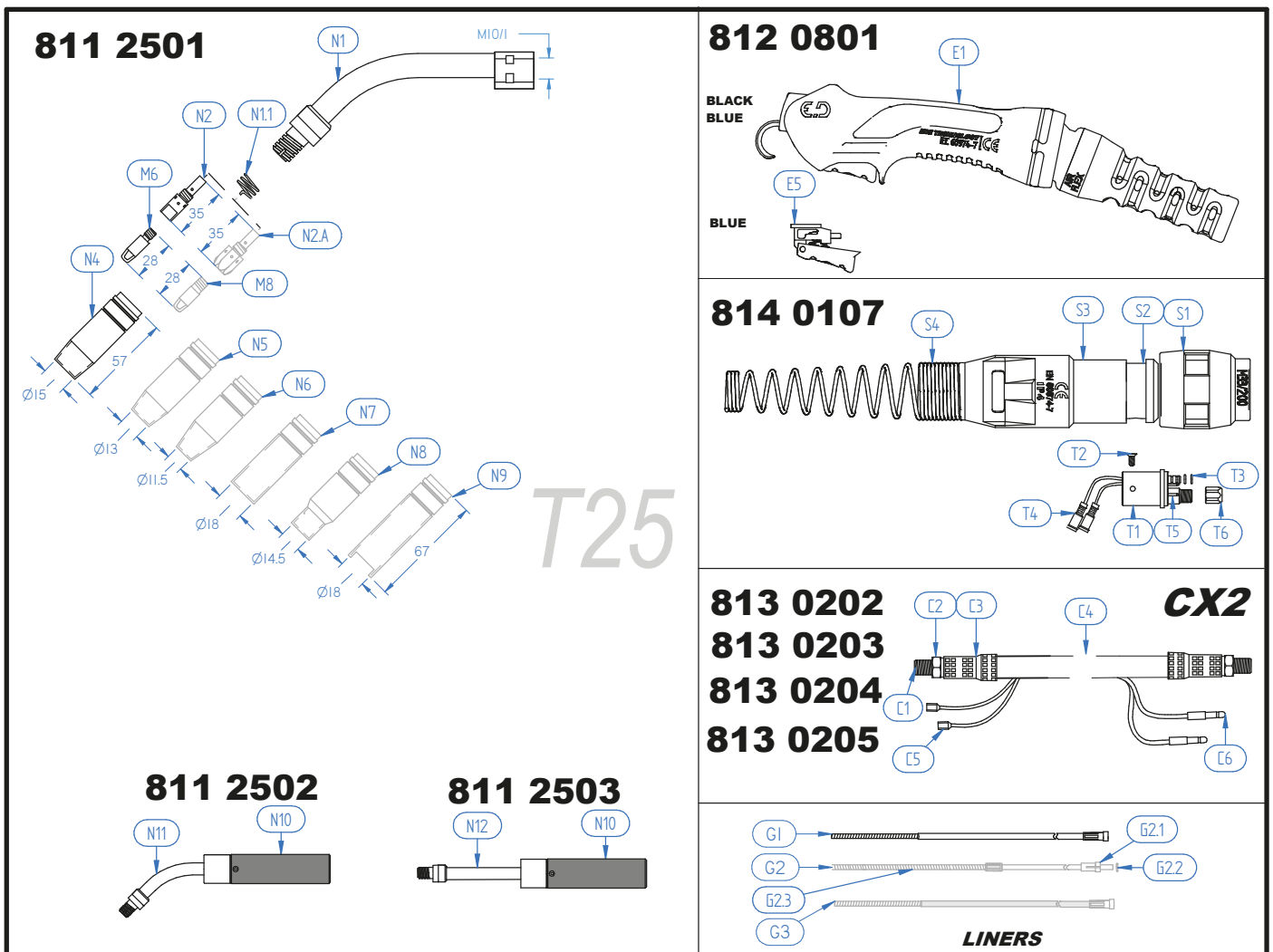

POS.	CODE	DESCRIPTION	PACK
G2.1	199SA88	COLLET LINER ALUWED/ALUM.	10
G2.2	199SA77	LINER O-RING ALUWED/ALUM.	10
G2.3	199SA1G	ALUMINIUM WIRE NECK-LINER 0.8-1.0MM.	2
G2.3	199SA2G	ALUMINIUM WIRE NECK-LINER 1.2-1.6MM.	2
G3	199SIN02	GRAY COATED BRONZE LINER ERGODANI INOX.1.0-1.2MM. 2.40M	1
G3	199SIN03	GRAY COATED BRONZE LINER ERGODANI INOX.1.0-1.2MM. 3.40M	1
G3	199SIN04	GRAY COATED BRONZE LINER ERGODANI INOX.1.0-1.2MM. 4.40M	1
G3	199SIN05	GRAY COATED BRONZE LINER ERGODANI INOX.1.0-1.2MM. 5.40M	1
C1	19923	CABLE FITTING CX-2/3/4	10
C2	19920	LOCK NUT ERGODANI	10
C3	12505	CABLE COPPER SLEEVE CX-2/3	10
C4	125CX02	CABLE ASSEMBLY EU-25 2MTS.	1
C4	125CX03	CABLE ASSEMBLY EU-25 3MTS.	1
C4	125CX04	CABLE ASSEMBLY EU-25 4MTS.	1
C4	125CX05	CABLE ASSEMBLY EU-25 5MTS.	1
C5	199FT01	CABLE FRONT TERMINAL	25
C6	199FT02	CABLE REAR TERMINAL	25
S1	1000125	ADAPTOR NUT -BLACK CX	1
S2	100012401	CONNECTION SUPPORT TUBE CX	1
S3	100012402	REAR SPRING SUPPORT CX	1
S4	10001062	REAR SPRING CX	1
T1	199MZ	EURO CENTRAL CONNECTOR CX ERGODANI CENTRAL	1
T2	199MZ05	CONNECTOR SCREW	10
T3	199MZ03	CENTRAL CONNECTOR O-RING	10
T4	199FT03	CENTRAL CONNECTOR TERMINAL	25
T5	199MZ04	CENTRAL CONNECT.CONTACT PIN CX ERGODANI	2
T6	199MZ02	LINER FASTENER NUT ERGODANI	10



**ALSO AVAILABLE
AUTOMATIC NECK.**





CODE	DESCRIPTION	PACK
1TS24102	TORCH ERGODANI TESLA ALUMINIUM TS-24 2MTS. EURO	1
1TS24103	TORCH ERGODANI TESLA TS-24 3MTS. EURO	1
1TS24104	TORCH ERGODANI TESLA TS-24 4MTS. EURO	1
1TS24105	TORCH ERGODANI TESLA TS-24 5MTS. EURO	1
124AC02	TORCH AUTOMATIC 45° CURVED EU-24 2MTS. EURO	1
124AC03	TORCH AUTOMATIC 45° CURVED EU-24 3MTS. EURO	1
124AC04	TORCH AUTOMATIC 45° CURVED EU-24 4MTS. EURO	1
124AR02	TORCH AUTOMATIC 0° STRAIGHT EU-24 2MTS. EURO	1
124AR03	TORCH AUTOMATIC 0° STRAIGHT EU-24 3MTS. EURO	1
124AR04	TORCH AUTOMATIC 0° STRAIGHT EU-24 4MTS. EURO	1

POS.	CODE	DESCRIPTION	PACK
N1	12401	SWAN NECK EU-24	1
N2	12402	GAS DIFFUSER WHITE EU-24/240W	10
N2.A	12402C	GAS DIFFUSER CERAMIC EU-24/240W	10
N3	12403	CONTACT TIP HOLDER EU-24/240W M/6*26MM.	10
N5	12404	STANDARD CONICAL NOZZLE EU-24/240W - 12.5MM.	5
N6	12404SP	TAPERED NOZZLE EU-24/240W - 10MM.	5
N7	12404CL	CYLINDRICAL NOZZLE EU-24/240W - 17MM.	5
N8	12404PT	SPOT NOZZLE EU-24/240W - 17MM.	5
N10	199EPAT	AUTOMATIC TORCHES HANDLE ERGODANI	1
N11	12401AC	45° CURVED AUTOMATIC SWAN NECK EU-24	1
N12	12401AR	0° STRAIGHT AUTOMATIC NECK EU-24	1
M6	199M6**	ERGODANI CONTACT TIP M/6*28 - *.* MM. CU.	25
M6	199M6**C	ERGODANI CONTACT TIP CHROME M/6*28 - *.* MM. CU.	25
M6	199M6**N	CONTACT TIP M/6*28 - *.* MM. CU.	25
M6	199M6**Z	ERGODANI CONTACT TIP M/6*28 - *.* MM. CU.CR.ZR.	25
E1	812 0801	TESLA HANDLE BLACK-BLUE GAS	1
E5	199TS01	BLUE SWITCH TESLA	5
G1	199SR02A	BLUE COATED LINER ERGODANI 0.6-0.8MM. 2.40MTS.	1
G1	199SR03A	BLUE COATED LINER ERGODANI 0.6-0.8MM. 3.40MTS.	1
G1	199SR04A	BLUE COATED LINER ERGODANI 0.6-0.8MM. 4.40MTS.	1
G1	199SR05A	BLUE COATED LINER ERGODANI 0.6-0.8MM. 5.40MTS.	1
G1	199SR02R	RED COATED LINER ERGODANI 1.0-1.2MM. 2.40MTS.	1
G1	199SR03R	RED COATED LINER ERGODANI 1.0-1.2MM. 3.40MTS.	1
G1	199SR04R	RED COATED LINER ERGODANI 1.0-1.2MM. 4.40MTS.	1
G1	199SR05R	RED COATED LINER ERGODANI 1.0-1.2MM. 5.40MTS.	1
G1	199SR02M	YELLOW COATED LINER ERGODANI 1.6MM. 2.40MTS.	1
G1	199SR03M	YELLOW COATED LINER ERGODANI 1.6MM. 3.40MTS.	1
G1	199SR04M	YELLOW COATED LINER ERGODANI 1.6MM. 4.40MTS.	1
G1	199SR05M	YELLOW COATED LINER ERGODANI 1.6MM. 5.40MTS.	1
G2	199SA102	ALUMINIUM WIRE LINER 0.8-1.0MM. 2MTS.	1
G2	199SA103	ALUMINIUM WIRE LINER 0.8-1.0MM. 3MTS.	1
G2	199SA104	ALUMINIUM WIRE LINER 0.8-1.0MM. 4MTS.	1
G2	199SA105	ALUMINIUM WIRE LINER 0.8-1.0MM. 5MTS.	1
G2	199SA202	ALUMINIUM WIRE LINER 1.2-1.6MM. 2MTS.	1
G2	199SA203	ALUMINIUM WIRE LINER 1.2-1.6MM. 3MTS.	1
G2	199SA204	ALUMINIUM WIRE LINER 1.2-1.6MM. 4MTS.	1
G2	199SA205	ALUMINIUM WIRE NECK-LINER 0.8-1.0MM.	1



250 Amp 60% CO₂
228 Amp 60% Ar + CO₂

Gas cooled torch with standard spare parts, medium intensity model with low weight and high power.

Medium amperage for general use. Perfect for 0,8 and 1,0 mm wire, thin-medium thicknesses, plucking of pieces and small seams.

Reduced diameter nozzle, increases its polyvalence and access, maintaining all its power.



811 2401

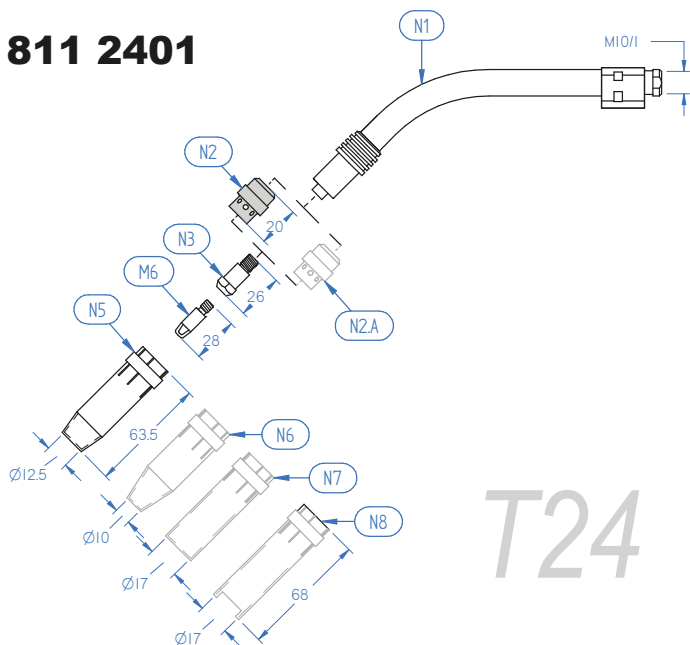

811 2402

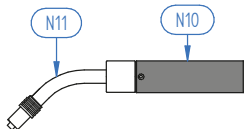

811 2403

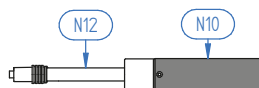

812 0801

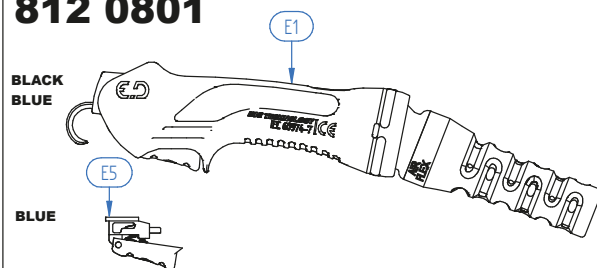

814 0107

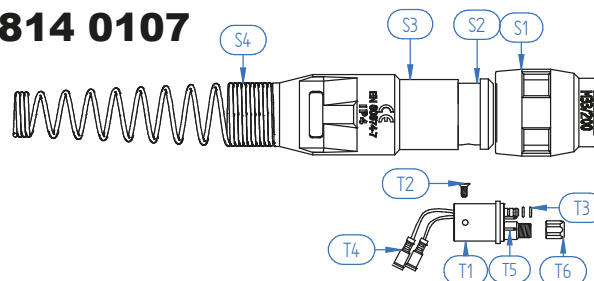

813 0302

813 0303

813 0304

813 0305

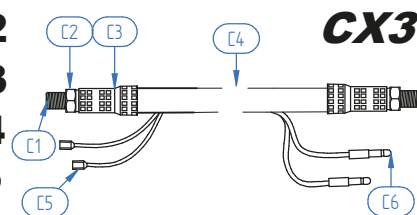

CX3

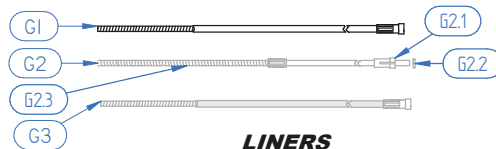

LINERS

POS.	CODE	DESCRIPTION	PACK
G2.1	199SA88	COLLET LINER ALUWED/ALUM.	10
G2.2	199SA77	LINER O-RING ALUWED/ALUM.	10
G2.3	199SA1G	ALUMINIUM WIRE NECK-LINER 0.8-1.0MM.	2
G2.3	199SA2G	ALUMINIUM WIRE NECK-LINER 1.2-1.6MM.	2
G3	199SIN02	GRAY COATED BRONZE LINER ERGODANI INOX.1.0-1.2MM. 2.40M	1
G3	199SIN03	GRAY COATED BRONZE LINER ERGODANI INOX.1.0-1.2MM. 3.40M	1
G3	199SIN04	GRAY COATED BRONZE LINER ERGODANI INOX.1.0-1.2MM. 4.40M	1
G3	199SIN05	GRAY COATED BRONZE LINER ERGODANI INOX.1.0-1.2MM. 5.40M	1
C1	19923	CABLE FITTING CX-2/3/4	10
C2	19920	LOCK NUT ERGODANI	10
C3	12505	CABLE COPPER SLEEVE CX-2/3	10
C4	124CX02	CABLE ASSEMBLY EU-24 2MTS.	1
C4	124CX03	CABLE ASSEMBLY EU-24 3MTS.	1
C4	124CX04	CABLE ASSEMBLY EU-24 4MTS.	1
C4	124CX05	CABLE ASSEMBLY EU-24 5MTS.	1
C5	199FT01	CABLE FRONT TERMINAL	25
C6	199FT02	CABLE REAR TERMINAL	25
S1	1000125	ADAPTOR NUT -BLACK CX	1
S2	100012401	CONNECTION SUPPORT TUBE CX	1
S3	100012402	REAR SPRING SUPPORT CX	1
S4	10001062	REAR SPRING CX	1
T1	199MZ	EURO CENTRAL CONNECTOR CX ERGODANI	1
T2	199MZ05	CENTRAL CONNECTOR SCREW	10
T3	199MZ03	CENTRAL CONNECTOR O-RING	10
T4	199FT03	CENTRAL CONNECTOR TERMINAL	25
T5	199MZ04	CENTRAL CONNECT.CONTACT PIN CX ERGODANI	2
T6	199MZ02	LINER FASTENER NUT ERGODANI	10



ALSO AVAILABLE
AUTOMATIC NECK.





CODE	DESCRIPTION	PACK
1TS36102	TORCH ERGODANI TESLA ALUMINIUM TS-36 2MTS. EURO	1
1TS36103	TORCH ERGODANI TESLA TS-36 3MTS. EURO	1
1TS36104	TORCH ERGODANI TESLA TS-36 4MTS. EURO	1
1TS36105	TORCH ERGODANI TESLA TS-36 5MTS. EURO	1
136AC02	TORCH AUTOMATIC 45° CURVED EU-36 2MTS. EURO	1
136AC03	TORCH AUTOMATIC 45° CURVED EU-36 3MTS. EURO	1
136AC04	TORCH AUTOMATIC 45° CURVED EU-36 4MTS. EURO	1
136AR02	TORCH AUTOMATIC 0° STRAIGHT EU-36 2MTS. EURO	1
136AR03	TORCH AUTOMATIC 0° STRAIGHT EU-36 3MTS. EURO	1
136AR04	TORCH AUTOMATIC 0° STRAIGHT EU-36 3MTS. EURO	1

POS.	CODE	DESCRIPTION	PACK
N1	13601	SWAN NECK EU-36	1
N2	13602	GAS DIFFUSER WHITE EU-36	10
N2.A	13602C	GAS DIFFUSER CERAMIC EU-36	10
N3	13603M8	CONTACT TIP HOLDER EU-36 M/8*28MM.	10
N3	13603M6	CONTACT TIP HOLDER EU-36 M/6*28MM.	10
N5	13604	STANDARD CONICAL NOZZL.ERGODAN ERGODANI EU-36-16MM HD(2.5MM)	5
N5	13604N	STANDARD CONICAL NOZZLE EU-36 - 16MM.	5
N6	13604SP	TAPERED NOZZLE EU-36 - 12MM.	5
N7	13604CL	CYLINDRICAL NOZZLE EU-36 - 19MM.	5
N8	13604BT	BOTTLE NECK NOZZLE EU-36 - 15MM.	5
N9	13604PT	SPOT NOZZLE EU-36 - 20MM.	5
N10	199EPAT	AUTOMATIC TORCHES HANDLE ERGODANI	1
N11	13601AC	45° CURVED AUTOMATIC SWAN NECK EU-36	1
N12	13601AR	0° STRAIGHT AUTOMATIC NECK EU-36	1
M6	199M6**	ERGODANI CONTACT TIP M/6*28 - **. MM. CU.	25
M6	199M6**C	ERGODANI CONTACT TIP CHROME M/6*28 - **. MM. CU.	25
M6	199M6**N	CONTACT TIP M/6*28 - **. MM. CU.	25
M6	199M6**Z	ERGODANI CONTACT TIP M/6*28 - **. MM. CU.	25
M8	199M8**	ERGODANI CONTACT TIP M/8*30 - **. MM. CU.	25
M8	199M8**A	ERGODANI CONTACT TIP M/8*30 - AL **. MM. CU.	25
M8	199M8**C	ERGODANI CONTACT TIP CHROME M/8*30 - **. MM. CU.	25
M8	199M8**N	CONTACT TIP M/8*30 - **. MM. CU.	25
M8	199M8**Z	ERGODANI CONTACT TIP M/8*30 - **. MM. CU.CR.ZR.	25
M8	199M8**ZN	CONTACT TIP M/8*30 - **. MM. CU.CR.ZR.	25
E1	812 0801	TESLA HANDLE BLACK-BLUE GAS	1
E5	199TS01	BLUE SWITCH TESLA	5
G1	199SR02A	BLUE COATED LINER ERGODANI 0.6-0.8MM. 2.40MTS.	1
G1	199SR03A	BLUE COATED LINER ERGODANI 0.6-0.8MM. 3.40MTS.	1
G1	199SR04A	BLUE COATED LINER ERGODANI 0.6-0.8MM. 4.40MTS.	1
G1	199SR05A	BLUE COATED LINER ERGODANI 0.6-0.8MM. 5.40MTS.	1
G1	199SR02R	RED COATED LINER ERGODANI 1.0-1.2MM. 2.40MTS.	1
G1	199SR03R	RED COATED LINER ERGODANI 1.0-1.2MM. 3.40MTS.	1
G1	199SR04R	RED COATED LINER ERGODANI 1.0-1.2MM. 4.40MTS.	1
G1	199SR05R	RED COATED LINER ERGODANI 1.0-1.2MM. 5.40MTS.	1
G1	199SR02M	YELLOW COATED LINER ERGODANI 1.6MM. 2.40MTS.	1
G1	199SR03M	YELLOW COATED LINER ERGODANI 1.6MM. 3.40MTS.	1
G1	199SR04M	YELLOW COATED LINER ERGODANI 1.6MM. 4.40MTS.	1
G1	199SR05M	YELLOW COATED LINER ERGODANI 1.6MM. 5.40MTS.	1
G1	199SR02V	GREEN COATED LINER ERGODANI 2.4MM. 2.40MTS.	1
G1	199SR03V	GREEN COATED LINER ERGODANI 2.4MM. 3.40MTS.	1
G1	199SR04V	GREEN COATED LINER ERGODANI 2.4MM. 4.40MTS.	1
G1	199SR05V	GREEN COATED LINER ERGODANI 2.4MM. 5.40MTS.	1
G2	199SA102	ALUMINIUM WIRE LINER 0.8-1.0MM. 2MTS.	1
G2	199SA103	ALUMINIUM WIRE LINER 0.8-1.0MM. 3MTS.	1
G2	199SA104	ALUMINIUM WIRE LINER 0.8-1.0MM. 4MTS.	1



Gas Cooled

340 Amp 60% CO₂
309 Amp 60% Ar + CO₂

The highest power air cooled standard torch.

Medium amperage for semiprofessional use. Perfect for 1,0 and 1,2 mm wire, plucking of pieces and medium-high thicknesses welding.

50 mm². section cable, 30% more than the actual standards. Thick nozzle. Multiple possibilities of gas outlet diameters.



SPARE PARTS KIT



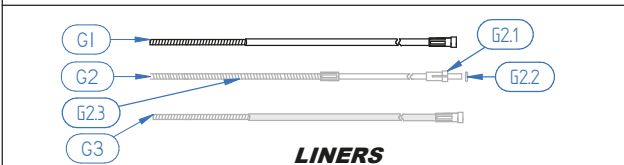
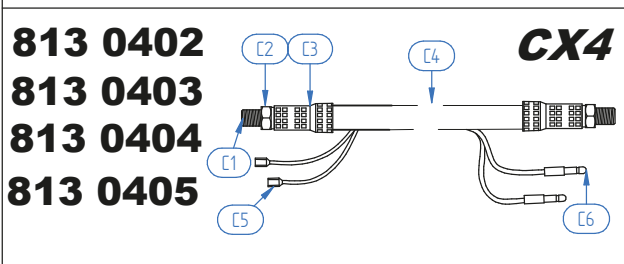
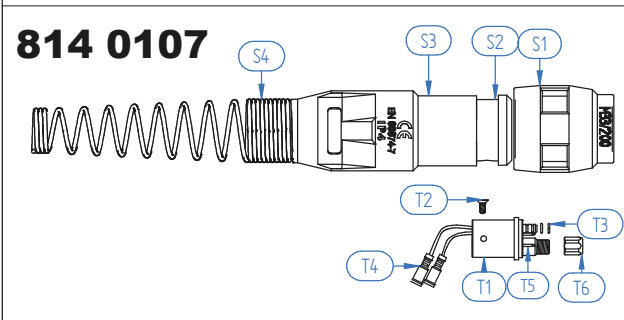
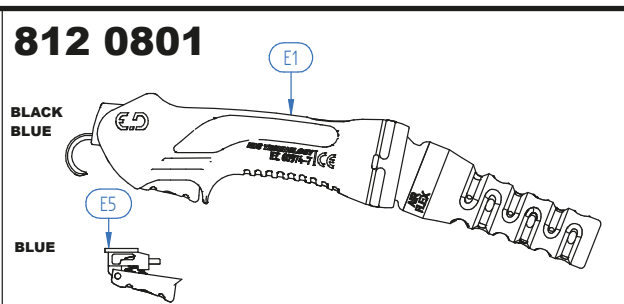
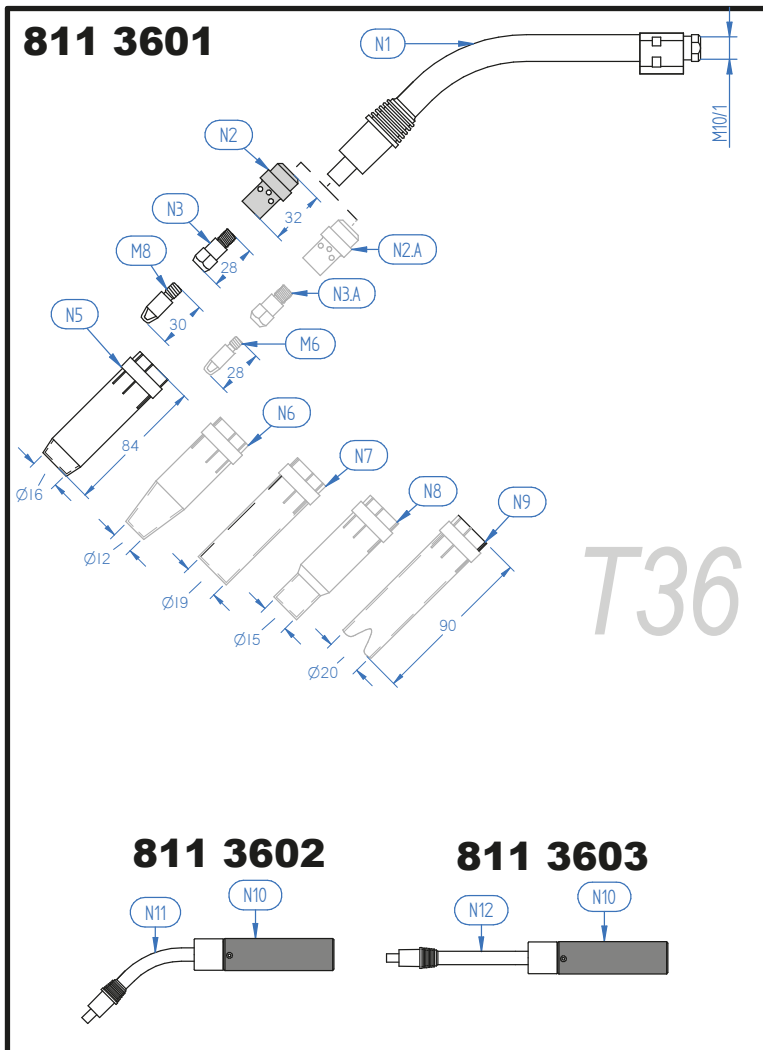

POS.	CODE	DESCRIPTION	PACK
G2	199SA105	ALUMINIUM WIRE LINER 0.8-1.0MM. 5MTS.	1
G2	199SA202	ALUMINIUM WIRE LINER 1.2-1.6MM. 2MTS.	1
G2	199SA203	ALUMINIUM WIRE LINER 1.2-1.6MM. 3MTS.	1
G2	199SA204	ALUMINIUM WIRE LINER 1.2-1.6MM. 4MTS.	1
G2	199SA205	ALUMINIUM WIRE LINER 1.2-1.6MM. 5MTS.	1
G2.1	199SA88	COLLET LINER ALUWED/ALUM.	10
G2.2	199SA77	LINER O-RING ALUWED/ALUM.	10
G2.3	199SA1G	ALUMINIUM WIRE NECK-LINER 0.8-1.0MM.	2
G2.3	199SA2G	ALUMINIUM WIRE NECK-LINER 1.2-1.6MM.	2
G3	199SIN02	GRAY COATED BRONZE LINER ERGODANI INOX.1.0-1.2MM. 2.40M	1
G3	199SIN03	GRAY COATED BRONZE LINER ERGODANI INOX.1.0-1.2MM. 3.40M	1
G3	199SIN04	GRAY COATED BRONZE LINER ERGODANI INOX.1.0-1.2MM. 4.40M	1
G3	199SIN05	GRAY COATED BRONZE LINER ERGODANI INOX.1.0-1.2MM. 5.40M	1
C1	19923	CABLE FITTING CX-2/3/4	10
C2	19920	LOCK NUT ERGODANI	10
C3.2	13605	CABLE COPPER SLEEVE CX-4	10
C4	136CX02	CABLE ASSEMBLY EU-24 2MTS.	1
C4	136CX03	CABLE ASSEMBLY EU-24 3MTS.	1
C4	136CX04	CABLE ASSEMBLY EU-24 4MTS.	1
C4	136CX05	CABLE ASSEMBLY EU-24 5MTS.	1
C5	199FT01	CABLE FRONT TERMINAL	25
C6	199FT02	CABLE REAR TERMINAL	25
S1	1000125	ADAPTOR NUT -BLACK CX	1
S2	100012401	CONNECTION SUPPORT TUBE CX	1
S3	100012402	REAR SPRING SUPPORT CX	1
S4	10001062	REAR SPRING CX	1
T1	199MZ	EURO CENTRAL CONNECTOR CX ERGODANI	1
T2	199MZ05	CENTRAL CONNECTOR SCREW	10
T3	199MZ03	CENTRAL CONNECTOR O-RING	10
T4	199FT03	CENTRAL CONNECTOR TERMINAL	25
T5	199MZ04	CENTRAL CONNECT.CONTACT PIN CX ERGODANI	2
T6	199MZ02	LINER FASTENER NUT ERGODANI	10



ALSO AVAILABLE
AUTOMATIC NECK.



ERGODANI

MIG 9

T 240w



CÓDIGO	DESCRIPCIÓN	PAQUETE
1TS02102	TORCH ERGODANI TESLA ALUMINIUM TS-240W 2MTS. EURO	1
1TS02103	TORCH ERGODANI TESLA TS-240W 3MTS. EURO	1
1TS02104	TORCH ERGODANI TESLA TS-240W 4MTS. EURO	1
1TS02105	TORCH ERGODANI TESLA TS-240W 5MTS. EURO	1
102AC01	TORCH AUTOMATIC 45° CURVED EU-240W 1.5MTS. EURO	1
102AC02	TORCH AUTOMATIC 45° CURVED EU-240W 2MTS. EURO	1
102AC03	TORCH AUTOMATIC 45° CURVED EU-240W 3MTS. EURO	1
102AR01	TORCH AUTOMATIC 0° STRAIGHT EU-240W 1.5MTS. EURO	1
102AR02	TORCH AUTOMATIC 0° STRAIGHT EU-240W 2MTS. EURO	1
102AR03	TORCH AUTOMATIC 0° STRAIGHT EU-240W 3MTS. EURO	1

POS.	CODE	DESCRIPTION	PACK
N1	10201	SWAN NECK EU-240W	1
N2	12402	GAS DIFFUSER WHITE EU-24/240W	10
N2.A	12402C	GAS DIFFUSER CERAMIC EU-24/240W	10
N3	12403	CONTACT TIP HOLDER EU-24/240W M/6*26MM.	10
N5	12404	STANDARD CONICAL NOZZLE EU-24/240W - 12.5MM.	5
N6	12404SP	TAPERED NOZZLE EU-24/240W - 10MM.	5
N7	12404CL	CYLINDRICAL NOZZLE EU-24/240W - 17MM.	5
N8	12404PT	SPOT NOZZLE EU-24/240W - 17MM.	5
N10	199EPAT	AUTOMATIC TORCHES HANDLE ERGODANI	1
N11	10201AC	45° CURVED AUTOMATIC SWAN NECK EU-240W	1
N12	10201AR	0° STRAIGHT AUTOMATIC NECK EU-240W	1
M6	199M6**	ERGODANI CONTACT TIP M/6*28 - ** MM. CU.	25
M6	199M6**C	ERGODANI CONTACT TIP CHROME M/6*28 - ** MM CU.	25
M6	199M6**N	CONTACT TIP M/6*28 - ** MM. CU.	25
M6	199M6**Z	ERGODANI CONTACT TIP M/6*28 - ** MM. CU.	25
E1	812 0802	TESLA HANDLE BLACK-BLUE LIQUID	1
E5	199TS01	BLUE SWITCH TESLA	5
G1	199SR02A	BLUE COATED LINER ERGODANI 0.6-0.8MM. 2.40MTS.	1
G1	199SR03A	BLUE COATED LINER ERGODANI 0.6-0.8MM. 3.40MTS.	1
G1	199SR04A	BLUE COATED LINER ERGODANI 0.6-0.8MM. 4.40MTS.	1
G1	199SR05A	BLUE COATED LINER ERGODANI 0.6-0.8MM. 5.40MTS.	1
G1	145SR02	NON COATED LINER ERGODANI 1.0-1.6MM. 2.5MTS.	1
G1	145SR03	NON COATED LINER ERGODANI 1.0-1.6MM. 3.5MTS.	1
G1	145SR04	NON COATED LINER ERGODANI 1.0-1.6MM. 4.5MTS.	1
G1	145SR05	NON COATED LINER ERGODANI 1.0-1.6MM. 5.5MTS.	1
G2	199SA102	ALUMINIUM WIRE LINER 0.8-1.0MM. 2MTS.	1
G2	199SA103	ALUMINIUM WIRE LINER 0.8-1.0MM. 3MTS.	1
G2	199SA104	ALUMINIUM WIRE LINER 0.8-1.0MM. 4MTS.	1
G2	199SA105	ALUMINIUM WIRE LINER 0.8-1.0MM. 5MTS.	1
G2	199SA202	ALUMINIUM WIRE LINER 1.2-1.6MM. 2MTS.	1
G2	199SA203	ALUMINIUM WIRE LINER 1.2-1.6MM. 3MTS.	1
G2	199SA204	ALUMINIUM WIRE LINER 1.2-1.6MM. 4MTS.	1
G2	199SA205	ALUMINIUM WIRE LINER 1.2-1.6MM. 5MTS.	1

T 240w

Liquid Cooled

300 Amp 100% CO₂
273 Amp 100% Ar + CO₂

Liquid cooled standard torch. Light, small and polyvalent. Extra power regarding the TS-24

Medium amperage for semiprofessional use. Perfect for 1,0 and 1,2 mm wire and complicated pieces, thanks to its easy management.

Small diameter nozzle, allows a big access range, with a magnificent relation power-weight.



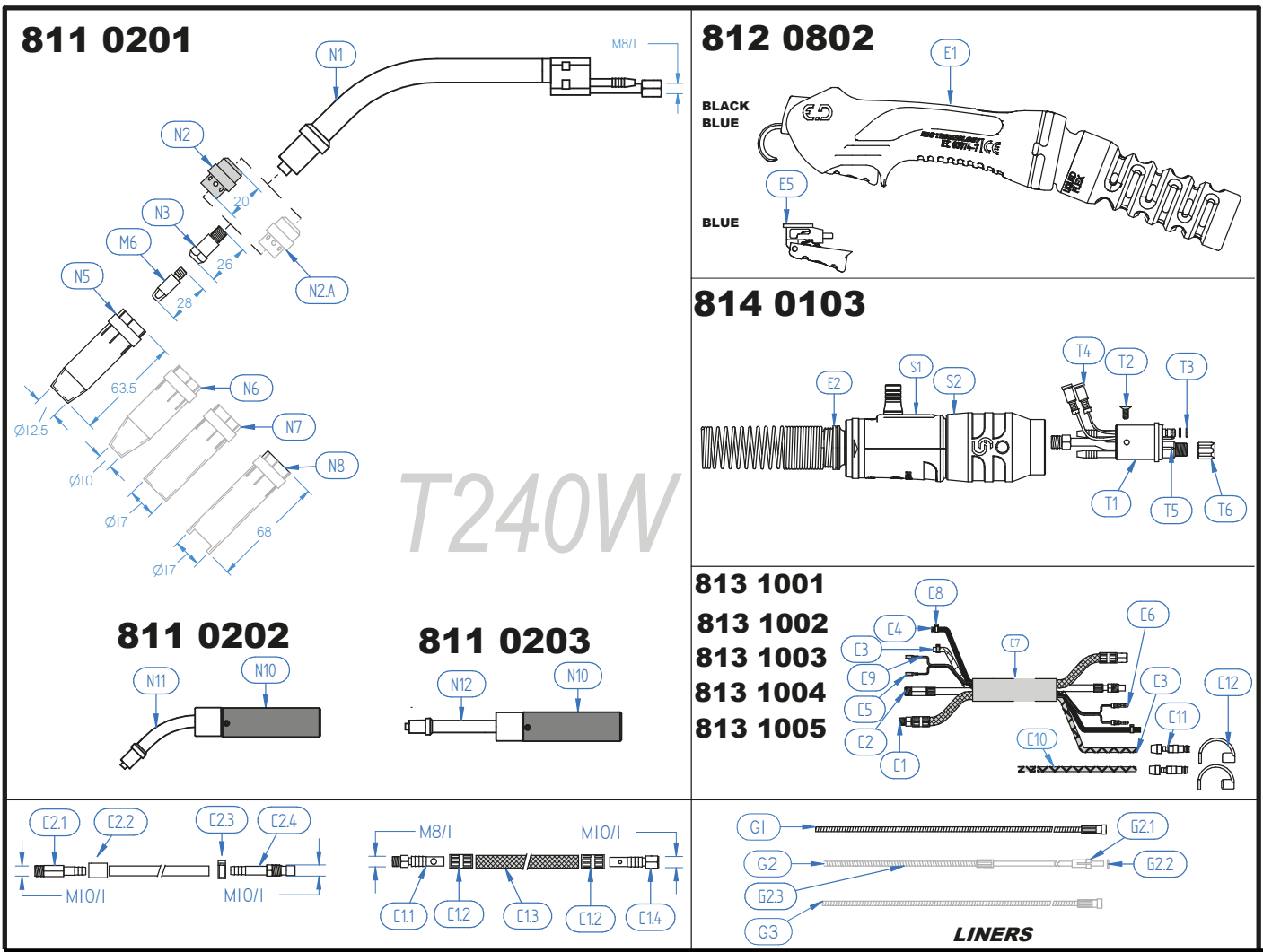

POS.	CODE	DESCRIPTION	PACK
G2.1	199SA88	COLLET LINER ALUWED/ALUM.	10
G2.2	199SA77	LINER O-RING ALUWED/ALUM.	10
G2.3	199SA1G	ALUMINIUM WIRE NECK-LINER 0.8-1.0MM.	2
G2.3	199SA2G	ALUMINIUM WIRE NECK-LINER 1.2-1.6MM.	2
G3	145SIN102	NON COATED BRONZE LINER INOX. 0.6-0.8MM. 2.5MTS.	1
G3	145SIN103	NON COATED BRONZE LINER INOX. 0.6-0.8MM. 3.5MTS.	1
G3	145SIN104	NON COATED BRONZE LINER INOX. 0.6-0.8MM. 4.5MTS.	1
G3	145SIN105	NON COATED BRONZE LINER INOX. 0.6-0.8MM. 5.5MTS.	1
G3	145SIN202	NON COATED BRONZE LINER INOX. 1.0-1.2MM. 2.5MTS.	1
G3	145SIN203	NON COATED BRONZE LINER INOX. 1.0-1.2MM. 3.5MTS.	1
G3	145SIN204	NON COATED BRONZE LINER INOX. 1.0-1.2MM. 4.5MTS.	1
G3	145SIN205	NON COATED BRONZE LINER INOX. 1.0-1.2MM. 5.5MTS.	1
G3	145SIN302	NON COATED BRONZE LINER INOX. 1.6MM. 2.5MTS.	1
G3	145SIN303	NON COATED BRONZE LINER INOX. 1.6MM. 3.5MTS.	1
G3	145SIN304	NON COATED BRONZE LINER INOX. 1.6MM. 4.5MTS.	1
G3	145SIN305	NON COATED BRONZE LINER INOX. 1.6MM. 5.5MTS.	1
C1	145CA01	POWER/WATER CABLE ERGODANI 1.5MTS.	1
C1	145CA02	POWER/WATER CABLE ERGODANI 2MTS.	1
C1	145CA03	POWER/WATER CABLE ERGODANI 3MTS.	1
C1	145CA04	POWER/WATER CABLE ERGODANI 4MTS.	1
C1	145CA05	POWER/WATER CABLE ERGODANI 5MTS.	1
C1.1	5450116	P/W FRONT CONNECTION ERGODANI (16MM2)	5
C1.2	145CA77	P/W SLEEVE ERGODANI (14ID.MM.)	10
C1.3	145CA91	P/W HOSE PVC BLACK 9*13MM.	100
C1.3	145CA93	P/W HOSE RUBBER RED ERGODANI 9*13MM.	20
C1.4	5450216	P/W REAR CONNECTION ERGODANI (16MM2)	5
C2	145CS01	LINER HOSE ERGODANI 1.5MTS.	1
C2	145CS02	LINER HOSE ERGODANI 2MTS.	1
C2	145CS03	LINER HOSE ERGODANI 3MTS.	1
C2	145CS04	LINER HOSE ERGODANI 4MTS.	1
C2	145CS05	LINER HOSE ERGODANI 5MTS.	1



**ALSO AVAILABLE
AUTOMATIC NECK.**



811 0201

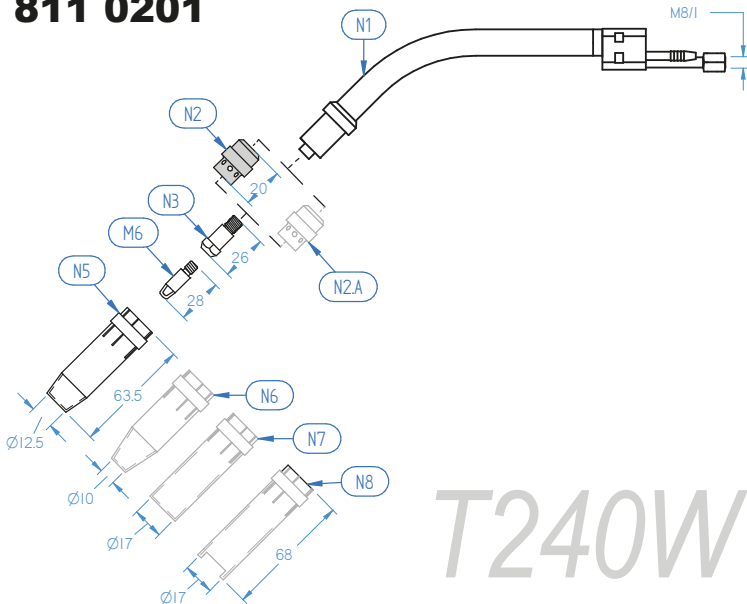

811 0202

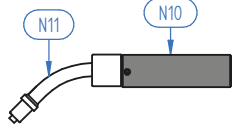

811 0203

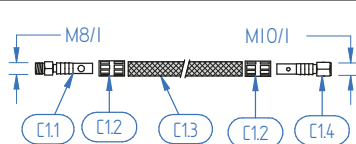
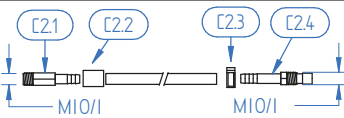
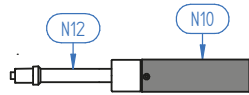

812 0802

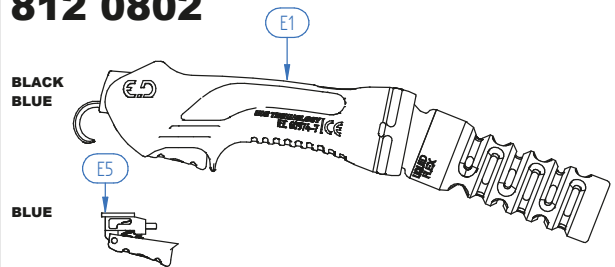

814 0103

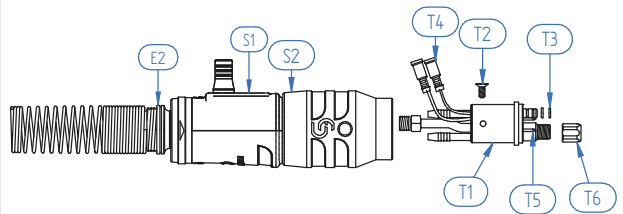

813 1001

813 1002

813 1003

813 1004

813 1005

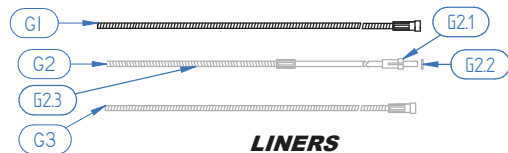
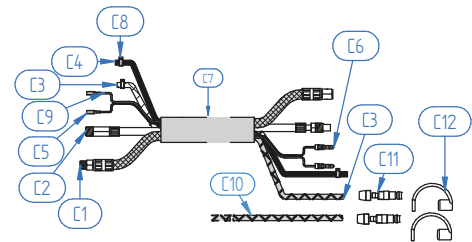

LINERS

POS.	CODE	DESCRIPTION	PACK
C2.1	145CS88D	L/H FRONT CONNECTION ERGODANI	5
C2.2	145CS77	L/H SLEEVE ERGODANI (10ID.MM.)	10
C2.3	145T105	HOSE CLAMP 10.5	10
C2.4	145CS88T	L/H REAR CONNECTION (2PCS) ERGODANI	5
C3	145TA99F	BRAIDED HOSE PVC BLUE 5*8MM.	100
C3	145TA	BRAIDED HOSE RUBBER BLUE 5*8MM.	20
C4	145TG99	BRAIDED HOSE PVC BLACK 5*8MM.	100
C4	145TN	BRAIDED HOSE RUBBER BLACK 5*8MM.	20
C4	145TG58	HOSE PVC BLACK 5*8MM.	200
C5	199FT01	CABLE FRONT TERMINAL	25
C6	199FT02	CABLE REAR TERMINAL	25
C7	4FN25	NEOPRENE COVER 25*28MM.	20
C8	145T090	HOSE CLAMP 09.0	10
C8	145T095	HOSE CLAMP 09.5	10
C9	145CB	SWITCH CABLE CW	100
C10	145TA99C	BRAIDED HOSE PVC RED 5*8MM.	100
C10	145TR	BRAIDED HOSE RUBBER RED 5*8MM.	20
C11	145TA88	PLUG NIPPLE HOSE 5*8MM.	10
C12	145TA88TA	BLUE COVER HOSE 5*8MM.	10
C12	145TA88TR	BRAIDED HOSE RUBBER RED 5*8MM.	10
S1	1EN924W	CONNECT SUPPORT W. BLACK RING EN-240W/501W/561PULSER	1
S2	1EX925	ADAPTOR NUT -BLACK EX-270/380 // CW	1
T1	145MZ	EURO CENTRAL CONNECTOR CW ERGODANI CENTRAL	1
T2	199MZ05	CONNECTOR SCREW	10
T3	199MZ03	P/W REAR CONNECTION ERGODANI (16MM2) CENTRAL	10
T4	199FT03	CONNECTOR TERMINAL	25
T5	145MZ04	CENTRAL CONNECT.PIN CW ERGODANI	2
T6	199MZ02	LINER FASTENER NUT ERGODANI	10



 **ERGODANI**[®]
Welding Technology Division

501w

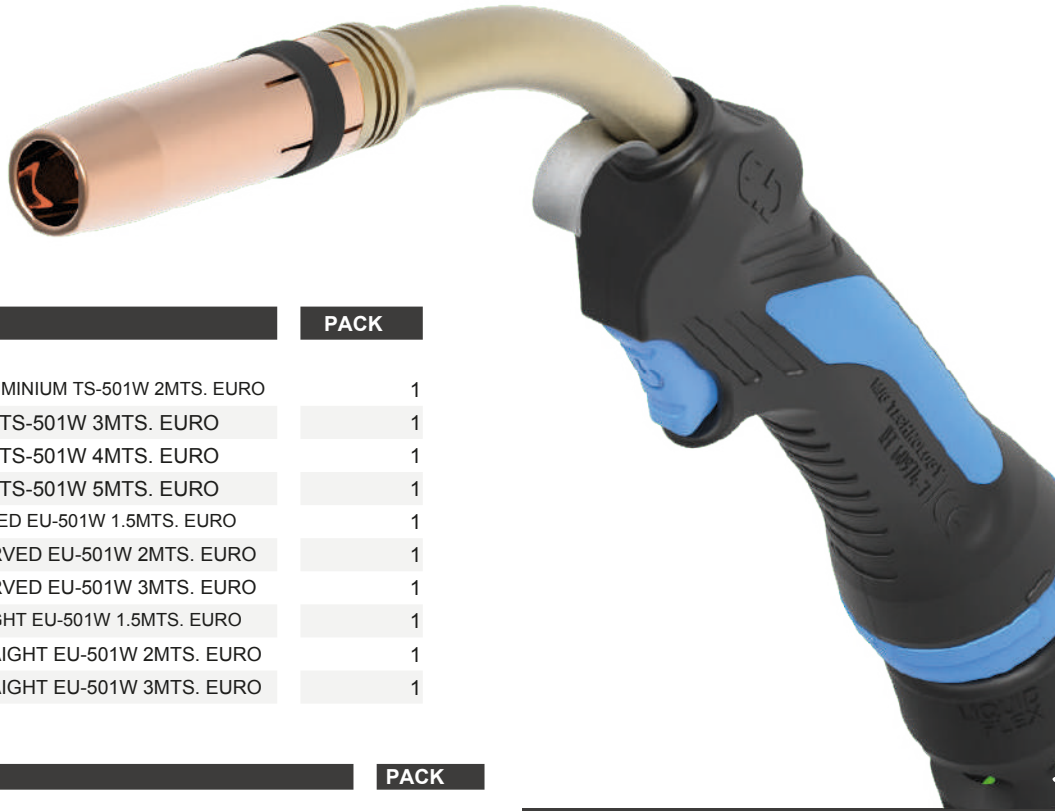

CODE	DESCRIPTION	PACK
1TS05102	TORCH ERGODANI TESLA ALUMINIUM TS-501W 2MTS. EURO	1
1TS05103	TORCH ERGODANI TESLA TS-501W 3MTS. EURO	1
1TS05104	TORCH ERGODANI TESLA TS-501W 4MTS. EURO	1
1TS05105	TORCH ERGODANI TESLA TS-501W 5MTS. EURO	1
105AC01	TORCH AUTOMATIC 45° CURVED EU-501W 1.5MTS. EURO	1
105AC02	TORCH AUTOMATIC 45° CURVED EU-501W 2MTS. EURO	1
105AC03	TORCH AUTOMATIC 45° CURVED EU-501W 3MTS. EURO	1
105AR01	TORCH AUTOMATIC 0° STRAIGHT EU-501W 1.5MTS. EURO	1
105AR02	TORCH AUTOMATIC 0° STRAIGHT EU-501W 2MTS. EURO	1
105AR03	TORCH AUTOMATIC 0° STRAIGHT EU-501W 3MTS. EURO	1

POS.	CODE	DESCRIPTION	PACK
N1	10501	SWAN NECK EU-501W	1
N1.1	14501	INSULATOR WASHER NECK EU-501W	10
N2	14503M8	CONTACT TIP HOLDER EU-501W M/8*25MM.	10
N2.A	14503M6	CONTACT TIP HOLDER EU-501W M/6*25MM.	10
N4	14502	DIFFUSER GAS WHITE EU-501W/561/565PULSER	10
N4.A	14502C	DIFFUSER GAS CERAMIC EU-501W/561/565PULSER	10
N5	14504	STANDARD CONICAL NOZZL.ERGODAN EU-501W/561/565PULSER - 16MM.	5
N5	14504N	STANDARD CONICAL NOZZLE EU-501W/561/565PULSER - 16MM.	5
N6	14504SP	TAPERED NOZZLE EU-501W/561/565PULSER - 14MM.	5
N7	14504CL	CYLINDRICAL NOZZLE EU-501W/561/565PULSER - 19MM.	5
N8	14504BT	BOTTLE NECK NOZZLE EU-501W/561/565PULSER - 15MM.	5
N9	14504PT	SPOT NOZZLE EU-501W/561/565PULSER - 20MM.	5
N10	199EPAT	AUTOMATIC TORCHES HANDLE ERGODANI	1
N11	10501AC	45° CURVED AUTOMATIC SWAN NECK EU-501W	1
N12	10501AR	0° STRAIGHT AUTOMATIC NECK EU-501W	1
M6	199M6**	ERGODANI CONTACT TIP M/6*28 - ** MM. CU. ERGODANI	25
M6	199M6**C	CONTACT TIP CHROME M/6*28 - **. MM CU. CONTACT TIP	25
M6	199M6**N	M/6*28 ** MM. CU.	25
M6	199M6**Z	ERGODANI CONTACT TIP M/6*28 - ** MM. CU.CR.ZR.	25
M8	199M8**	ERGODANI CONTACT TIP M/8*30 - ** MM. CU. ERGODANI	25
M8	199M8**A	CONTACT TIP M/8*30 - AL **. MM. CU. ERGODANI	25
M8	199M8**C	CONTACT TIP CHROME M/8*30 - **. MM. CU. CONTACT TIP	25
M8	199M8**N	M/8*30 - **. MM. CU.	25
M8	199M8**Z	ERGODANI CONTACT TIP M/8*30 - ** MM. CU.CR.ZR.	25
M8	199M8**ZN	CONTACT TIP M/8*30 - **. MM. CU.CR.ZR.	25
E1	812 0802	TESLA HANDLE BLACK-BLUE LIQUID	1
E5	199TS01	BLUE SWITCH TESLA	5
G1	199SR02A	BLUE COATED LINER ERGODANI 0.6-0.8MM. 2.40MTS.	1
G1	199SR03A	BLUE COATED LINER ERGODANI 0.6-0.8MM. 3.40MTS.	1
G1	199SR04A	BLUE COATED LINER ERGODANI 0.6-0.8MM. 4.40MTS.	1
G1	199SR05A	BLUE COATED LINER ERGODANI 0.6-0.8MM. 5.40MTS.	1
G1	145SR02	NON COATED LINER ERGODANI 1.0-1.6MM. 2.5MTS.	1
G1	145SR03	NON COATED LINER ERGODANI 1.0-1.6MM. 3.5MTS.	1
G1	145SR04	NON COATED LINER ERGODANI 1.0-1.6MM. 4.5MTS.	1
G1	145SR05	NON COATED LINER ERGODANI 1.0-1.6MM. 5.5MTS.	1
G1	199SR02V	GREEN COATED LINER ERGODANI 2.4MM. 2.40MTS.	1
G1	199SR03V	GREEN COATED LINER ERGODANI 2.4MM. 3.40MTS.	1
G1	199SR04V	GREEN COATED LINER ERGODANI 2.4MM. 4.40MTS.	1
G1	199SR05V	GREEN COATED LINER ERGODANI 2.4MM. 5.40MTS.	1

501w

Liquid Cooled

500 Amp 100% CO₂
455 Amp 100% Ar + CO₂

The most powerful, lightweight and polyvalent liquid cooled universal torch. Exceptional quality and finishes.

High amperage for professional welding. Perfect for 1,2 and 1,6 mm wire and pieces with big thicknesses where power is required.

Own neck manufacture and water stream cable. Oversized thickness nozzle.



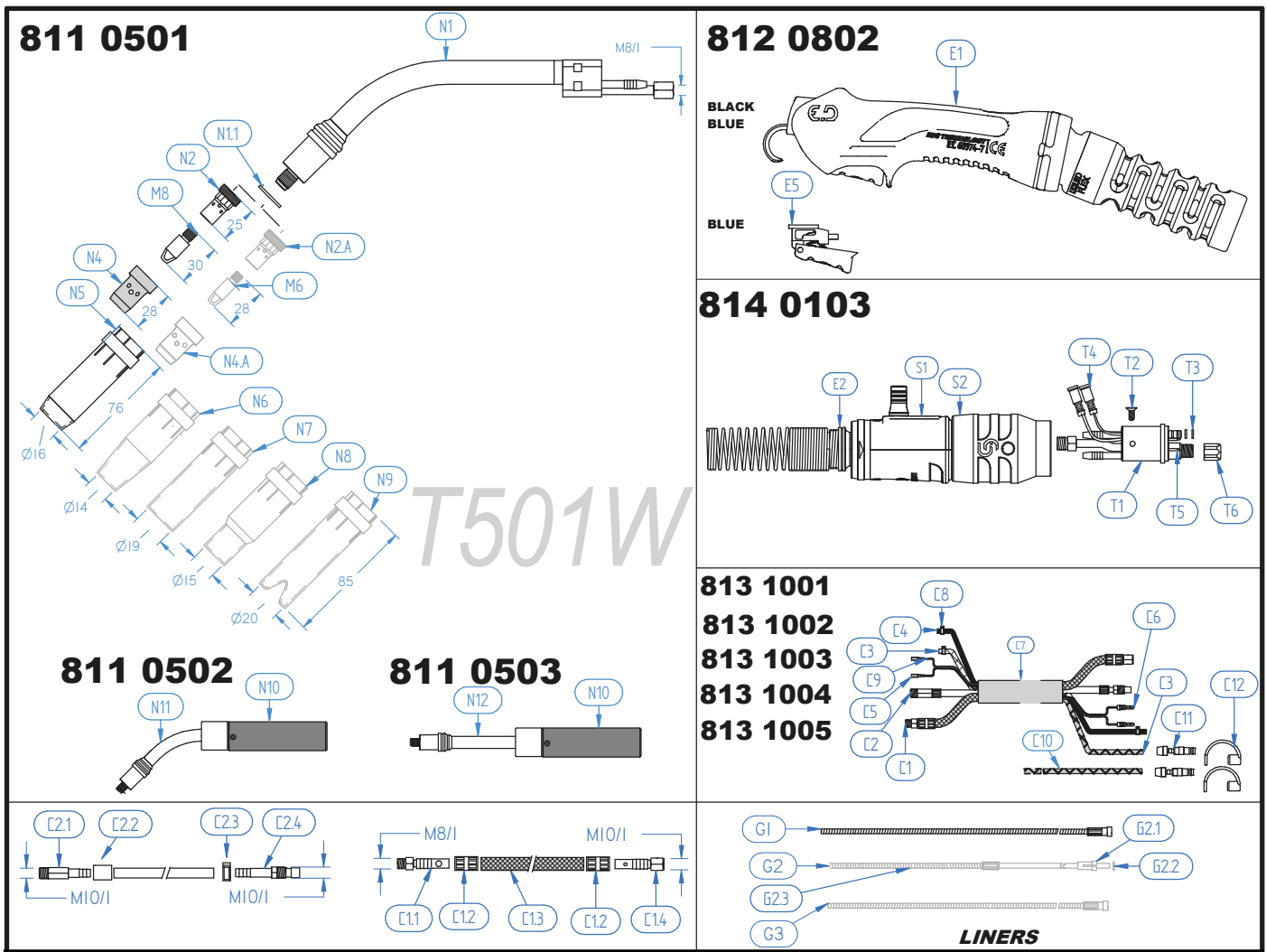

POS.	CODE	DESCRIPTION	PACK
G2	199SA102	ALUMINIUM WIRE LINER 0.8-1.0MM. 2MTS.	1
G2	199SA103	ALUMINIUM WIRE LINER 0.8-1.0MM. 3MTS.	1
G2	199SA104	ALUMINIUM WIRE LINER 0.8-1.0MM. 4MTS.	1
G2	199SA105	ALUMINIUM WIRE LINER 0.8-1.0MM. 5MTS.	1
G2	199SA202	ALUMINIUM WIRE LINER 1.2-1.6MM. 2MTS.	1
G2	199SA203	ALUMINIUM WIRE LINER 1.2-1.6MM. 3MTS.	1
G2	199SA204	ALUMINIUM WIRE LINER 1.2-1.6MM. 4MTS.	1
G2	199SA205	ALUMINIUM WIRE LINER 1.2-1.6MM. 5MTS.	1
G2.1	199SA88	COLLET LINER ALUWED/ALUM.	10
G2.2	199SA77	LINER O-RING ALUWED/ALUM.	10
G2.3	199SA1G	ALUMINIUM WIRE NECK-LINER 0.8-1.0MM.	2
G2.3	199SA2G	ALUMINIUM WIRE NECK-LINER 1.2-1.6MM.	2
G3	145SIN102	NON COATED BRONZE LINER INOX. 0.6-0.8MM. 2.5MTS.	1
G3	145SIN103	NON COATED BRONZE LINER INOX. 0.6-0.8MM. 3.5MTS.	1
G3	145SIN104	NON COATED BRONZE LINER INOX. 1.0-1.2MM. 4.5MTS.	1
G3	145SIN105	NON COATED BRONZE LINER INOX. 0.6-0.8MM. 5.5MTS.	1
G3	145SIN202	NON COATED BRONZE LINER INOX. 1.0-1.2MM. 2.5MTS.	1
G3	145SIN203	NON COATED BRONZE LINER INOX. 1.0-1.2MM. 3.5MTS.	1
G3	145SIN204	NON COATED BRONZE LINER INOX. 1.0-1.2MM. 4.5MTS.	1
G3	145SIN205	NON COATED BRONZE LINER INOX. 1.0-1.2MM. 5.5MTS.	1
G3	145SIN302	NON COATED BRONZE LINER INOX. 1.6MM. 2.5MTS.	1
G3	145SIN303	NON COATED BRONZE LINER INOX. 1.6MM. 3.5MTS.	1
G3	145SIN304	NON COATED BRONZE LINER INOX. 1.6MM. 4.5MTS.	1
G3	145SIN305	NON COATED BRONZE LINER INOX. 1.6MM. 5.5MTS.	1
C1	145CA01	POWER/WATER CABLE ERGODANI 1.5MTS.	1
C1	145CA02	POWER/WATER CABLE ERGODANI 2MTS.	1
C1	145CA03	POWER/WATER CABLE ERGODANI 3MTS.	1
C1	145CA04	POWER/WATER CABLE ERGODANI 4MTS.	1
C1	145CA05	POWER/WATER CABLE ERGODANI 5MTS.	1



**ALSO AVAILABLE
AUTOMATIC NECK.**



811 0501

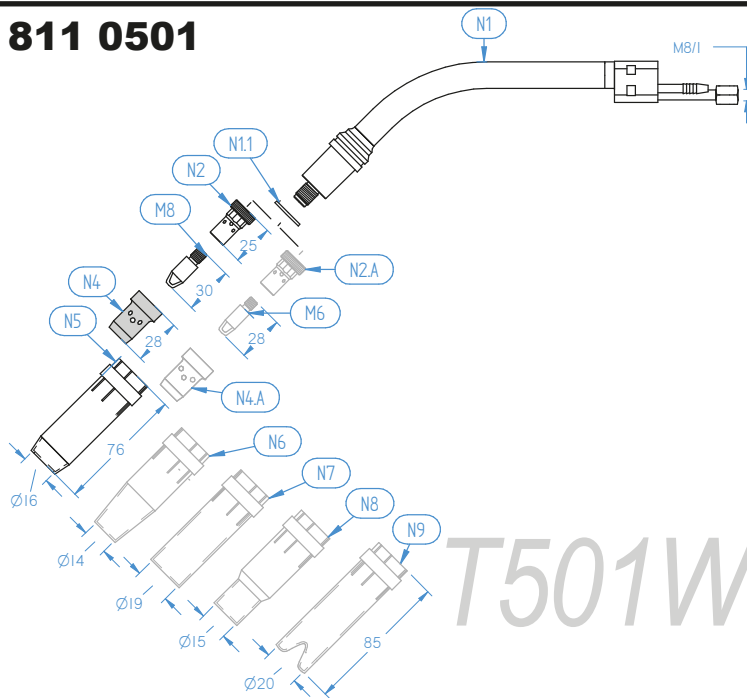

811 0502

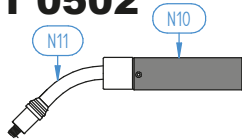

811 0503

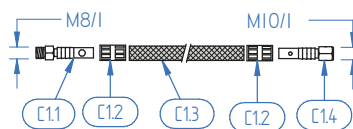
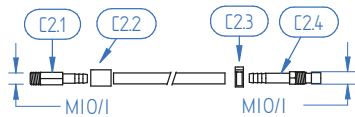
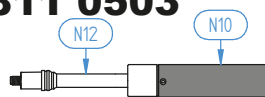

812 0802

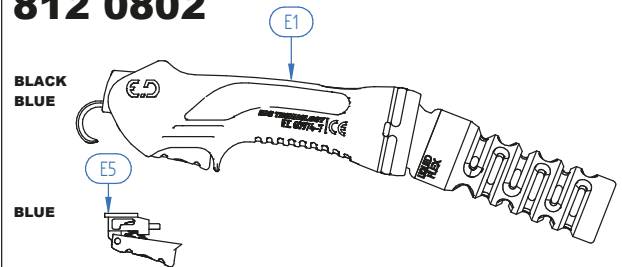

814 0103

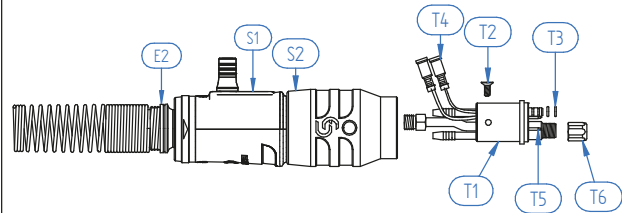

813 1001

813 1002

813 1003

813 1004

813 1005

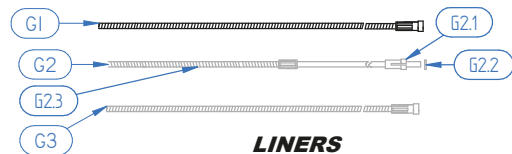
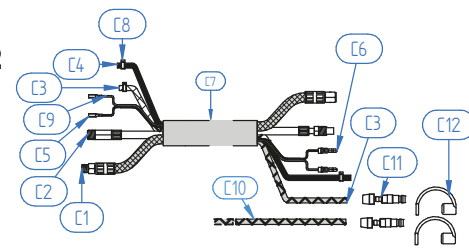

LINERS

POS.	CODE	DESCRIPTION	PACK
C1.1	5450116	P/W FRONT CONNECTION ERGODANI (16MM2)	5
C1.2	145CA77	P/W SLEEVE ERGODANI (14ID.MM.)	10
C1.3	145CA91	P/W HOSE PVC BLACK 9*13MM.	100
C1.3	145CA93	P/W HOSE RUBBER RED ERGODANI 9*13MM.	20
C1.4	5450216	P/W REAR CONNECTION ERGODANI (16MM2)	5
C2	145CS01	LINER HOSE ERGODANI 1.5MTS.	1
C2	145CS02	LINER HOSE ERGODANI 2MTS.	1
C2	145CS03	LINER HOSE ERGODANI 3MTS.	1
C2	145CS04	LINER HOSE ERGODANI 4MTS.	1
C2	145CS05	LINER HOSE ERGODANI 5MTS.	1
C2.1	145CS88D	L/H FRONT CONNECTION ERGODANI	5
C2.2	145CS77	L/H SLEEVE ERGODANI (10ID.MM.)	10
C2.3	145T105	HOSE CLAMP 10.5	10
C2.4	145CS88T	L/H REAR CONNECTION (2PCS) ERGODANI	5
C3	145TA99F	BRAIDED HOSE PVC BLUE 5*8MM.	100
C3	145TA	BRAIDED HOSE RUBBER BLUE 5*8MM.	20
C4	145TG99	BRAIDED HOSE PVC BLACK 5*8MM.	100
C4	145TN	BRAIDED HOSE RUBBER BLACK 5*8MM.	20
C4	145TG58	HOSE PVC BLACK 5*8MM.	200
C5	199FT01	CABLE FRONT TERMINAL	25
C6	199FT02	CABLE REAR TERMINAL	25
C7	4FN25	NEOPRENE COVER 25*28MM.	20
C8	145T090	HOSE CLAMP 09.0	10
C8	145T095	HOSE CLAMP 09.5	10
C9	145CB	SWITCH CABLE CW	100
C10	145TA99C	BRAIDED HOSE PVC RED 5*8MM.	100
C10	145TR	BRAIDED HOSE RUBBER RED 5*8MM.	20
C11	145TA88	PLUG NIPPLE HOSE 5*8MM.	10
C12	145TA88TA	BLUE COVER HOSE 5*8MM.	10
C12	145TA88TR	RED COVER HOSE 5*8MM.	10

POS.	CODE	DESCRIPTION	PACK
S1	1EN924W	CONNECT SUPPORT W. BLACK RING EN-240W/501W/561PULSER	1
S2	1EX925	ADAPTOR NUT -BLACK EX-270/380 // CW	1
T1	145MZ	EURO CENTRAL CONNECTOR CW ERGODANI	1
T2	199MZ05	CENTRAL CONNECTOR SCREW	10
T3	199MZ03	CENTRAL CONNECTOR O-RING	10
T4	199FT03	CENTRAL CONNECTOR TERMINAL	25
T5	145MZ04	CENTRAL CONNECT.CONTACT PIN CW ERGODANI	2
T6	199MZ02	LINER FASTENER NUT ERGODANI	10

SPECIAL NECKS

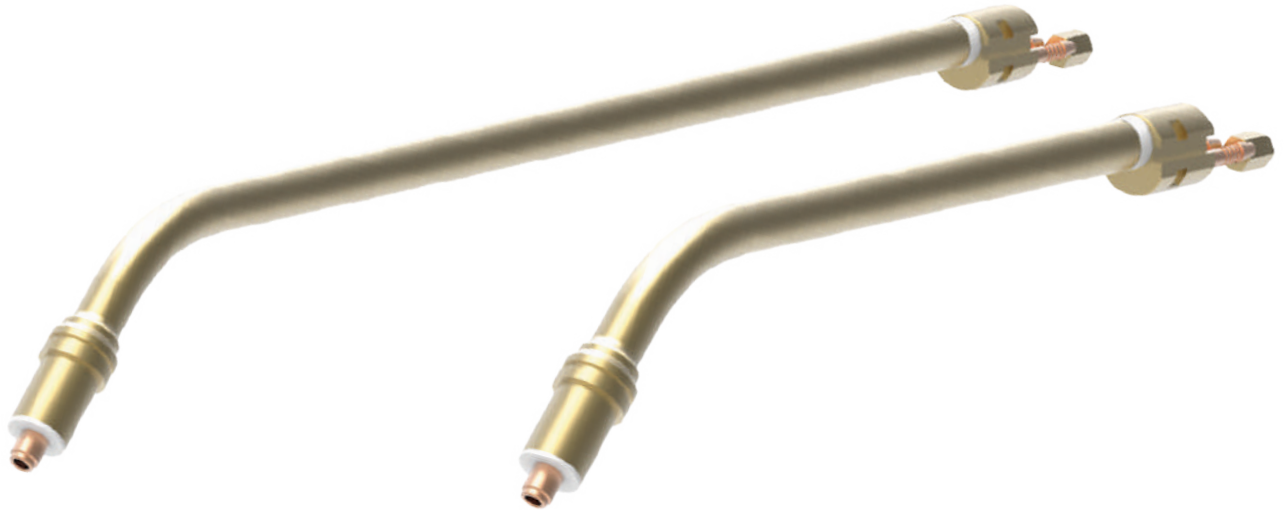

STANDAR 501

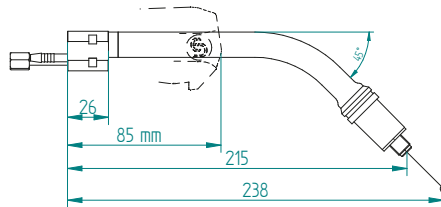

250 mm

CODE : 1050125

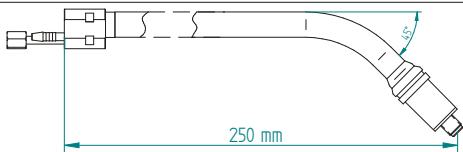

400mm

CODE : 1050140

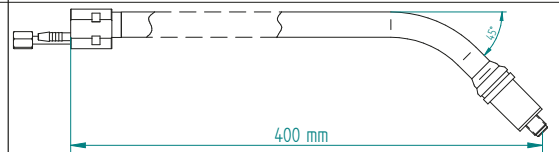

300 mm

CODE : 1050130

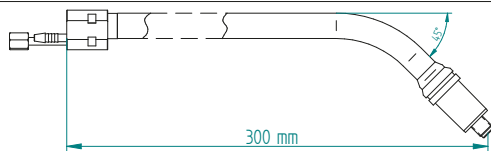

450 mm

CODE : 1050145

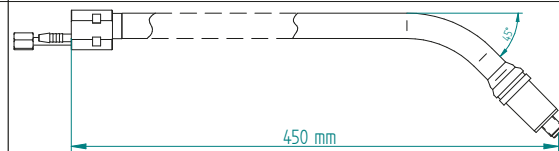

350 mm

CODE : 1050135

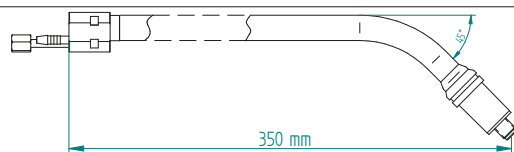

500 mm

CODE : 1050150

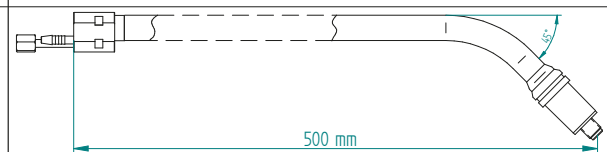

SPARE PARTS KIT



The kit includes all the needed spare parts for the torch T36.

It consists of nozzles (x2), contact tubes (x10), tube support (x5) and diffusers (x5).

There are kits for a wide range of torches (see page MIG 19).

CODE	DESCRIPTION	PACK
1EU15K2	TORCH KIT TS-15	1
1EU25K2	TORCH KIT TS-25	1
1EU24K2	TORCH KIT TS-24/240W	1
1EU36K2	TORCH KIT TS-36	1
1EU05K2	TORCH KIT TS-501W	1
1EU27K2	TORCH KIT TX-270/221W	1
1EU38K2	TORCH KIT TX-380/421W	1
1EU48K2	TORCH KIT TX-480	1
1EU57K2	TORCH KIT 565W PULSER	1
1EU60K2	TORCH KIT EPR-600	1

T15 MIG | Accessories Tesla MIG Torches



Tx270/221w MIG | Accessories Tesla MIG Torches



T25 MIG | Accessories Tesla MIG Torches

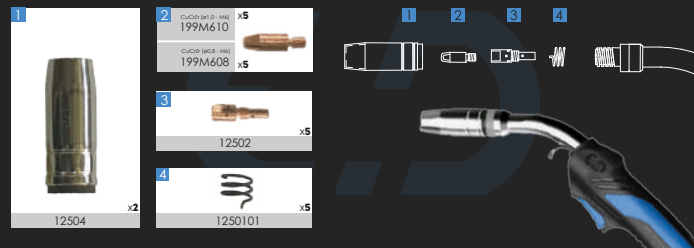

Tx380/421w MIG | Accessories Tesla MIG Torches



T24/240w MIG | Accessories Tesla MIG Torches

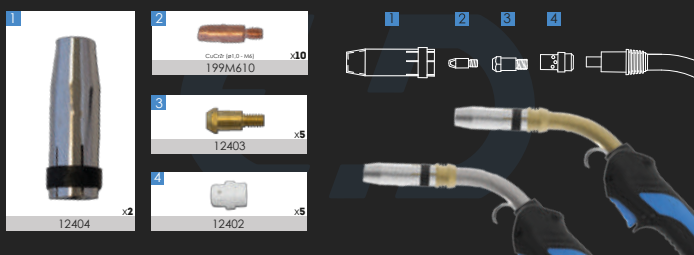

Tx480 MIG | Accessories Tesla MIG Torches

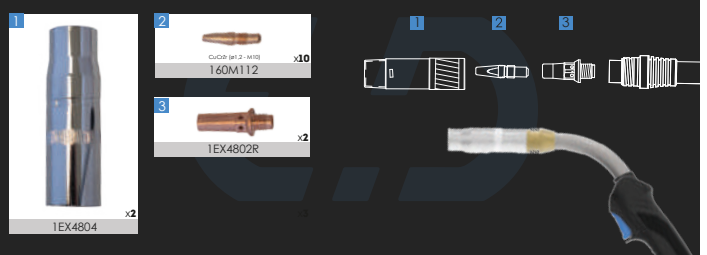

T36 MIG | Accessories Tesla MIG Torches



565 PULSER MIG | Accessories Tesla MIG Torches

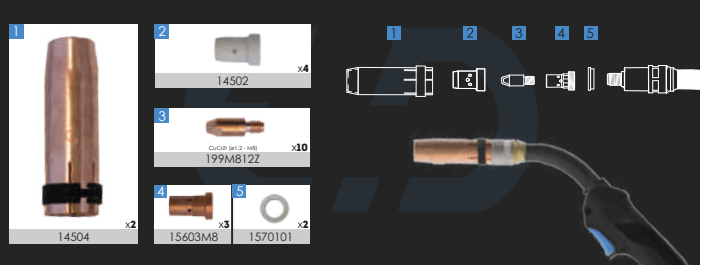

T501w MIG | Accessories Tesla MIG Torches

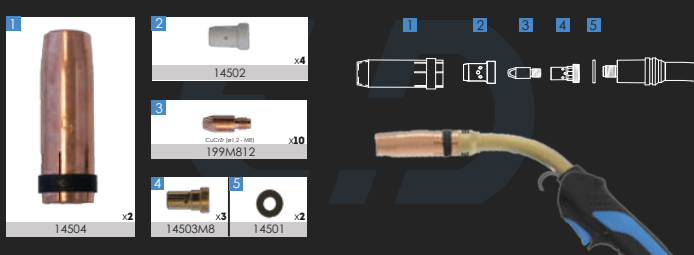

T600 EPR MIG | Accessories Tesla MIG Torches

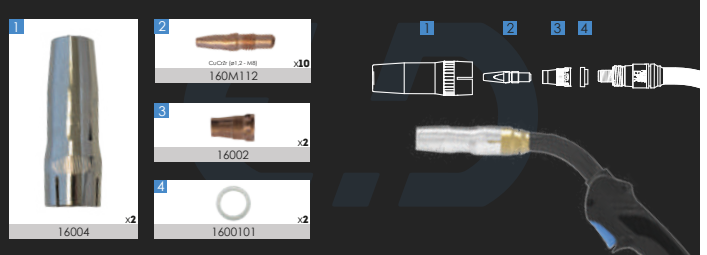

BN 300

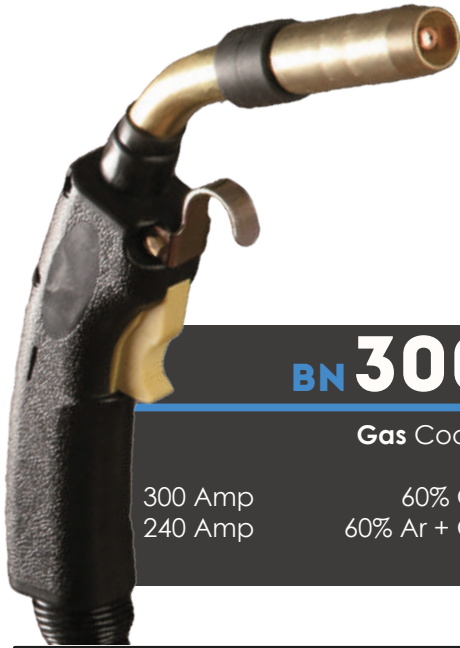

BN 300

Gas Cooled

300 Amp
240 Amp

60% CO₂
60% Ar + CO₂

POS.	CODE	DESCRIPTION	PACK
N6	1B4786	SWAN NECK BN-300	1
N2	1B4780	REAR INSULATING NECK BN-300/400	10
N7	1B4323	INSULATING NECK BN-300	10
N8	1B4335	CONTACT TIP HOLDER BN-300	5
N8.1	1B7126	CONTACT TIP HOLDER O-RING BN-300	10
N9	1B7488	SHORT CONTACT TIP BN-300 - 0.8MM. CU.	25
N9	1B7490	SHORT CONTACT TIP BN-300 - 1.2MM. CU.	25
N9	1B7491	SHORT CONTACT TIP BN-300 - 1.6MM. CU.	25
N9	1B7496	SHORT CONTACT TIP BN-300 - 1.0MM. CU.	25
N9	1B7498	SHORT CONTACT TIP BN-300 - 1.4MM. CU.	25
N12	1B4391	STANDARD NOZZLE BN-300 - 16MM.	5
N12	1B4393	COPPER STANDARD NOZZLE BN-300 - 16MM.	5
N13	1B4392	CONICAL NOZZLE BN-300 - 12.5MM.	5
N13	1B4394	COPPER CONICAL NOZZLE BN-300 - 12.5MM.	5
E1	1B1780006	BLACK HANDLE BN-300/400	1
E2	1B4238	HANDEL HOOK BN-300/400	1
E3	1B5662	SWITCH BN-300/400	5
G1	1B9SR03	BLACK COATED LINER BN-300/400 1.0-1.6MM. 3.65MTS.	1
G1	1B9SR04	BLACK COATED LINER BN-300/400 1.0-1.6MM. 4.65MTS.	1
G1	1B9SR05	BLACK COATED LINER BN-300/400 1.0-1.6MM. 5.65MTS.	1
C1	1B4213B	CABLE FITTING BN-300/400	5
C2	1B4305	CONE NUT BN-300/400	5
C3	145T200	HOSE CLAMP 20.0	10
C3.1	145T120	HOSE CLAMP 12.0	10
C3.2	13605	CABLE COPPER SLEEVE CX-4	10
C4	1B3CX03	CABLE ASSEMBLY BN-300 3MTS.	1
C4	1B3CX04	CABLE ASSEMBLY BN-300 4MTS.	1
C4	1B3CX05	CABLE ASSEMBLY BN-300 5MTS.	1
C4	199CX4	ERGODANI CONTACT TIP CHROME M/8*28 - 1.6MM. CU.	1
C5	1B2660001	CABLE FRONT TERMINAL BN-300/400	25
C6	199FT02	CABLE REAR TERMINAL	25
C7	1B923	CABLE FITTING BN-300/400 1/4G	10

811 3001

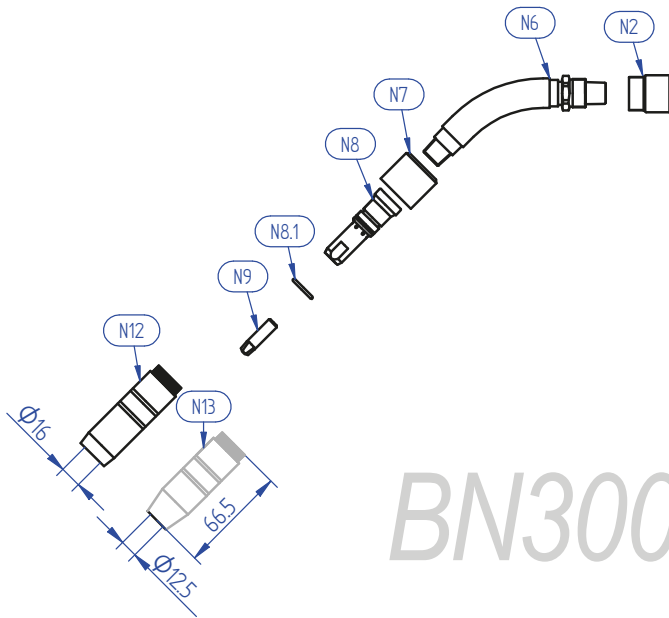

BN300

CODE	DESCRIPTION	PACK
1B3003	TORCH BN-300 3MTS. EURO	1
1B3004	TORCH BN-300 4MTS. EURO	1
1B3005	TORCH BN-300 5MTS. EURO	1

812 0701

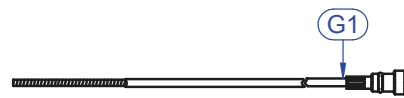
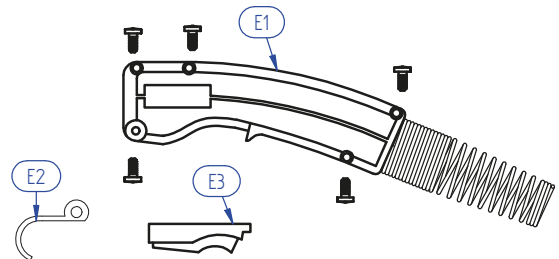

LINERS

BN 400

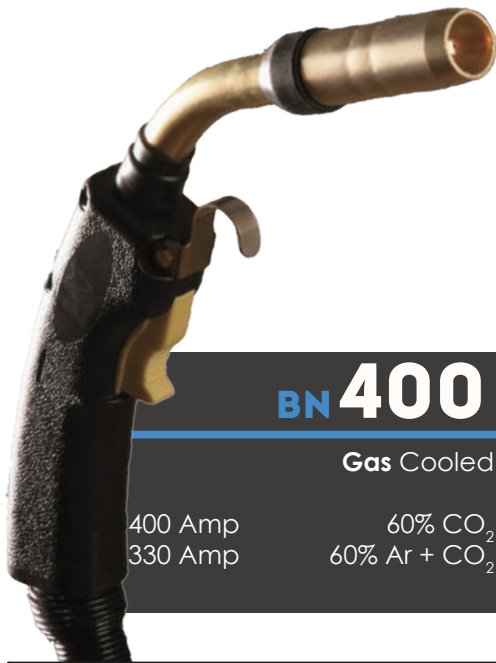

POS.	CODE	DESCRIPTION	PACK
N1	1B4790	SWAN NECK BN-400	1
N2	1B4780	REAR INSULATING NECK BN-300/400	10
N3	1B4423	INSULATING NECK BN-400	10
N4	1B4635	SHORT CONTACT TIP HOLDER BN-400	5
N4.1	1B7127	CONTACT TIP HOLDER O-RING BN-400	10
N4.2	1B4435	SHORT CONTACT TIP HOLDER BN-400	5
N5	1B1588	LONG CONTACT TIP BN-400 - 0.8MM. CU.	25
N5	1B1590	LONG CONTACT TIP BN-400 - 1.2MM. CU.	25
N5	1B1591	LONG CONTACT TIP BN-400 - 1.6MM. CU.	25
N5	1B1596	LONG CONTACT TIP BN-400 - 1.0MM. CU.	25
N5	1B1598	LONG CONTACT TIP BN-400 - 1.4MM. CU.	25
N9	1B7488	SHORT CONTACT TIP BN-300 - 0.8MM. CU.	25
N9	1B7490	SHORT CONTACT TIP BN-300 - 1.2MM. CU.	25
N9	1B7491	SHORT CONTACT TIP BN-300 - 1.6MM. CU.	25
N9	1B7496	SHORT CONTACT TIP BN-300 - 1.0MM. CU.	25
N9	1B7498	SHORT CONTACT TIP BN-300 - 1.4MM. CU.	25
N10	1B4491	STANDARD NOZZLE BN-400 - 19MM.	5
N10	1B4591	COPPER STANDARD NOZZLE BN-400 - 19MM.	5
N11	1B4492	CONICAL NOZZLE BN-400 - 14MM.	5
N11	1B4592	COPPER CONICAL NOZZLE BN-400 - 14MM.	5
E1	1B1780006	BLACK HANDLE BN-300/400	1
E2	1B4238	HANDEL HOOK BN-300/400	1
E3	1B5662	SWITCH BN-300/400	5
G1	1B9SR03	BLACK COATED LINER BN-300/400 1.0-1.6MM. 3.65MTS.	1
G1	1B9SR04	BLACK COATED LINER BN-300/400 1.0-1.6MM. 4.65MTS.	1
G1	1B9SR05	BLACK COATED LINER BN-300/400 1.0-1.6MM. 5.65MTS.	1
C1	1B4213B	CABLE FITTING BN-300/400	5
C2	1B4305	CONE NUT BN-300/400	5
C3	145T210	HOSE CLAMP 21.0	10
C3.1	145T120	HOSE CLAMP 12.0	10
C3.2	14005	CABLE COPPER SLEEVE CX-5	10
C4	1B4CX03	CABLE ASSEMBLY BN-400 3MTS.	1
C4	1B4CX04	CABLE ASSEMBLY BN-400 4MTS.	1
C4	1B4CX05	CABLE ASSEMBLY BN-400 5MTS.	1
C4	199CX5	ERGODANI CONTACT TIP CHROME M/8*28 - 1.6MM. CU.	1
C5	1B2660001	CABLE FRONT TERMINAL BN-300/400	25
C6	199FT02	CABLE REAR TERMINAL	25
C7	1B923	CABLE FITTING BN-300/400 1/4G	10

811 4001

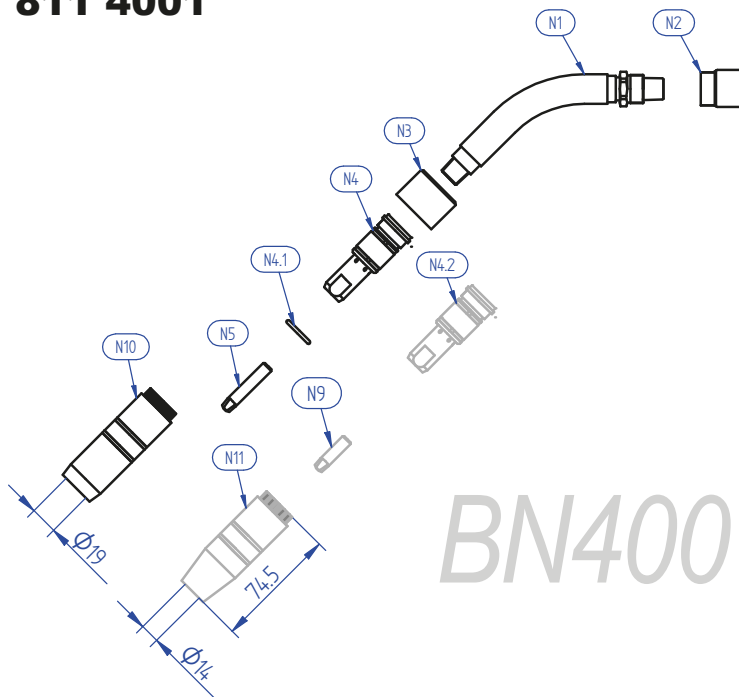

CODE	DESCRIPTION	PACK
------	-------------	------

1B4003	TORCH BN-400 3MTS. EURO	1
1B4004	TORCH BN-400 4MTS. EURO	1
1B4005	TORCH BN-400 5MTS. EURO	1

812 0701

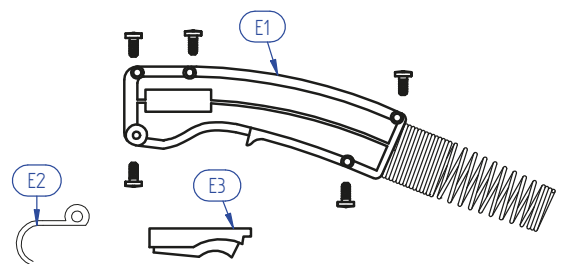

LINERS

NEW RANGE



THREADED NOZZLES WITH HARD CHROME BATH



Avoid the wear and increase the life service.

COPPER ISO CuCrZr CONTACT TIP HOLDERS



Gives greater refrigeration to the contact tip and fewer projection adherence.

"ALUWELD" SYSTEM



Revolutionary liner holder system, allow longer weld aluminum wire.

The best welding at your fingertips

TESLA

INTELLIGENT REGULATION MODELS



ERGODANI[®]
Welding Technology Division

TESLA MIG

PROFESSIONAL

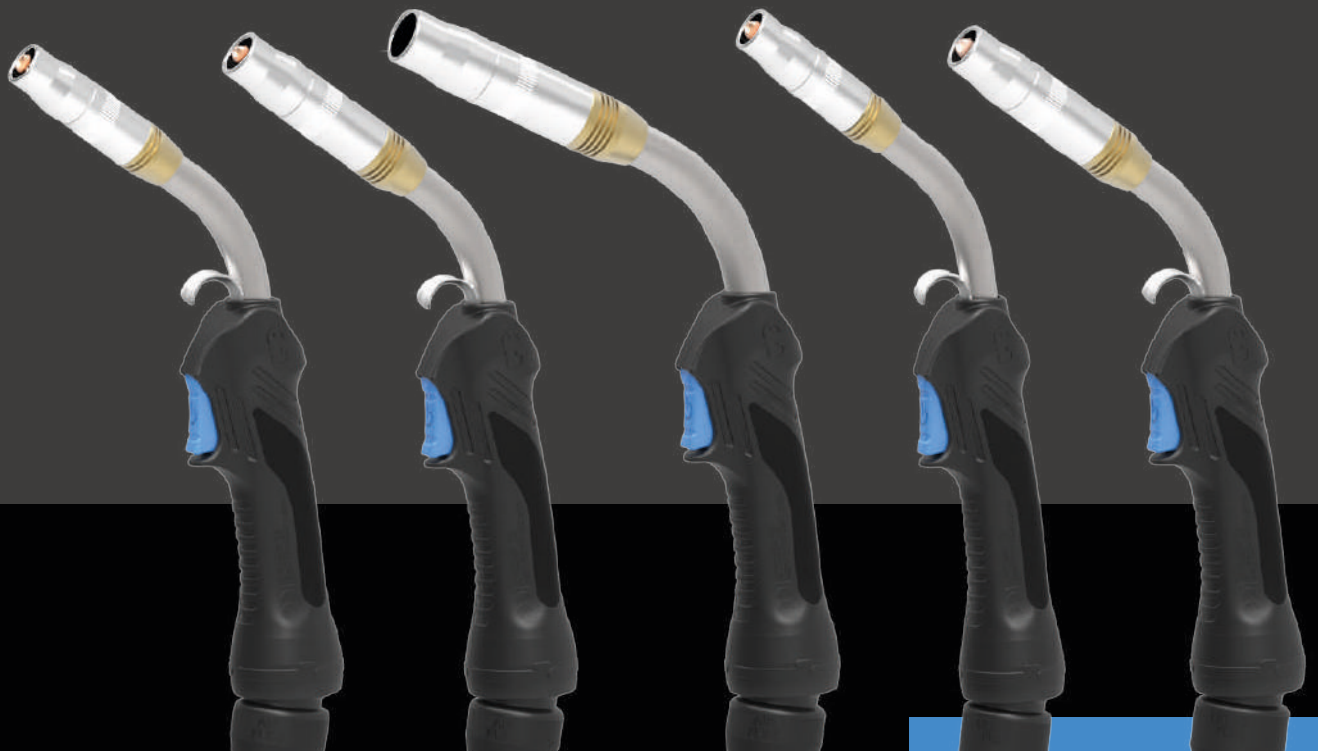

Tx 270

Tx 380

Tx 480

Tx 221W

Tx 421W

250 A

350 A

450 A

350 A

500 A



270



CODE	DESCRIPTION	PACK
1EX27103	TORCH ERGODANI TESLA EX-270 3MTS. EURO	1
1EX27104	TORCH ERGODANI TESLA TX-270 4MTS. EURO	1
1EX27105	TORCH ERGODANI TESLA EX-270 5MTS. EURO	1
1EX27203	TORCH ERGODANI ALUWELD EX-270 3MTS. EURO	1
1EX27204	TORCH ERGODANI ALUWELD EX-270 4MTS. EURO	1
1EX27205	TORCH ERGODANI ALUWELD EX-270 5MTS. EURO	1
1EX27AC02	TORCH AUTOMATIC 45° CURVED EX-270 2MTS. EURO	1
1EX27AC03	TORCH AUTOMATIC 45° CURVED EX-270 3MTS. EURO	1
1EX27AC04	TORCH AUTOMATIC 45° CURVED EX-270 4MTS. EURO	1
1EX27AR02	TORCH AUTOMATIC 0° STRAIGHT EX-270 2MTS. EURO	1
1EX27AR03	TORCH AUTOMATIC 0° STRAIGHT EX-270 3MTS. EURO	1
1EX27AR04	TORCH AUTOMATIC 0° STRAIGHT EX-270 4MTS. EURO	1

POS.	CODE	DESCRIPTION	PACK
N1	1EX2701	SWAN NECK EX-270	1
N1.1	1EX2702	CONTACT TIP HOLDER EX-270/221W M/9*34MM.	10
N1.2	1EX2702M8	CONTACT TIP HOLDER EX-270/221W M/8*34MM.	10
N3	1EX2704	STANDARD NOZZLE EX-270/221W - 15MM.	5
N3.1	1EX270402	CONICAL NOZZLE EX-270/221W - 13MM.	5
N8	1EX2701AC	45° CURVED AUTOMATIC SWAN NECK EX-270	1
N9	1EX2701AR	0° STRAIGHT AUTOMATIC NECK EX-270	1
N10	199EPAT	AUTOMATIC TORCHES HANDLE ERGODANI	1
M9	1EX9P08W	EX-SHORT CONTACT TIP M/9*30 - 0.8MM. CU.AG.	25
M9	1EX9P10W	EX-SHORT CONTACT TIP M/9*30 - 1.0MM. CU.AG.	25
M9	1EX9P12W	EX-SHORT CONTACT TIP M/9*30 - 1.2MM. CU.AG.	25
M9	1EX9P14W	EX-SHORT CONTACT TIP M/9*30 - 1.4MM. CU.AG.	25
M9	1EX9P16W	EX-SHORT CONTACT TIP M/9*30 - 1.6MM. CU.AG.	25
M9	1EX9P24W	EX-SHORT CONTACT TIP M/9*30 - 2.4MM. CU.AG.	25
M9	1EX9P08WA	EX-SHORT CONTACT TIP ALUWELD M/9*30 - 0.8MM. CU.AG.	25
M9	1EX9P10WA	EX-SHORT CONTACT TIP ALUWELD M/9*30 - 1.0MM. CU.AG.	25
M9	1EX9P12WA	EX-SHORT CONTACT TIP ALUWELD M/9*30 - 1.2MM. CU.AG.	25
M9	1EX9P16WA	EX-SHORT CONTACT TIP ALUWELD M/9*30 - 1.6MM. CU.AG.	25
M8	199CL08	ERGODANI CONTACT TIP CHROME M/8*28 - 0.8MM. CU.	25
M8	199CL10	ERGODANI CONTACT TIP CHROME M/8*28 - 1.0MM. CU.	25
M8	199CL12	ERGODANI CONTACT TIP CHROME M/8*28 - 1.2MM. CU.	25
M8	199CL14	ERGODANI CONTACT TIP CHROME M/8*28 - 1.4MM. CU.	25
M8	199CL16	ERGODANI CONTACT TIP CHROME M/8*28 - 1.6MM. CU.	25
E1	1EX9EP	PRO.TESLA HANDLE BLACK-BLACK GAS	1
E2	19906	SPRING & UNIVERSAL JOINT CX ERGODANI	2
E5	199TS01	BLUE TRIGGER TESLA	5
G1	199SR02A	BLUE COATED LINER ERGODANI 0.6-0.8MM. 2.40MTS.	1
G1	199SR03A	BLUE COATED LINER ERGODANI 0.6-0.8MM. 3.40MTS.	1
G1	199SR04A	BLUE COATED LINER ERGODANI 0.6-0.8MM. 4.40MTS.	1
G1	199SR05A	BLUE COATED LINER ERGODANI 0.6-0.8MM. 5.40MTS.	1
G1	199SR02R	RED COATED LINER ERGODANI 1.0-1.2MM. 2.40MTS.	1
G1	199SR03R	RED COATED LINER ERGODANI 1.0-1.2MM. 3.40MTS.	1
G1	199SR04R	RED COATED LINER ERGODANI 1.0-1.2MM. 4.40MTS.	1
G1	199SR05R	RED COATED LINER ERGODANI 1.0-1.2MM. 5.40MTS.	1
G1	199SR02M	YELLOW COATED LINER ERGODANI 1.6MM. 2.40MTS.	1
G1	199SR03M	YELLOW COATED LINER ERGODANI 1.6MM. 3.40MTS.	1
G1	199SR04M	YELLOW COATED LINER ERGODANI 1.6MM. 4.40MTS.	1
G1	199SR05M	YELLOW COATED LINER ERGODANI 1.6MM. 5.40MTS.	1
G1	199SR02V	GREEN COATED LINER ERGODANI 2.4MM. 2.40MTS.	1
G1	199SR03V	GREEN COATED LINER ERGODANI 2.4MM. 3.40MTS.	1
G1	199SR04V	GREEN COATED LINER ERGODANI 2.4MM. 4.40MTS.	1
G1	199SR05V	GREEN COATED LINER ERGODANI 2.4MM. 5.40MTS.	1

TX 270

Gas Cooled

250 Amp 60% CO₂
 225 Amp 60% Ar + CO₂

Torch developed for multi-purpose, medium intensity. Ideal for aluminum welding.

Torch designed for the professional welding industry and all spare parts are developed to be long-lasting.

The main features are the nozzles and over-sized M9 contact tips, and special insulation to withstand the high welding temperatures thus increasing the duration of the gun.



811 2701

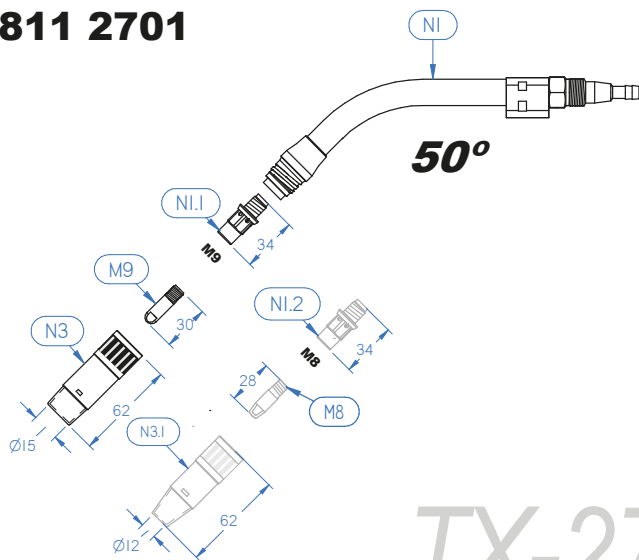

TX-270

811 2702

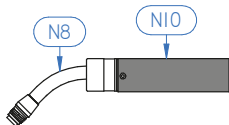

811 2703

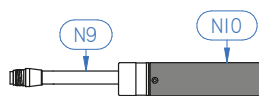

812 0901

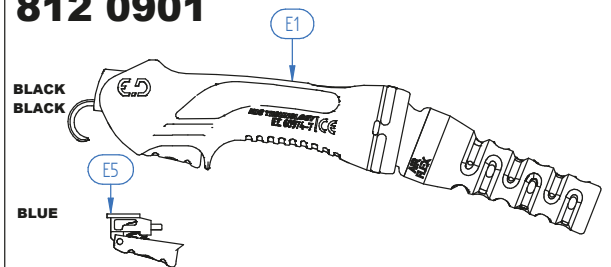

814 0107

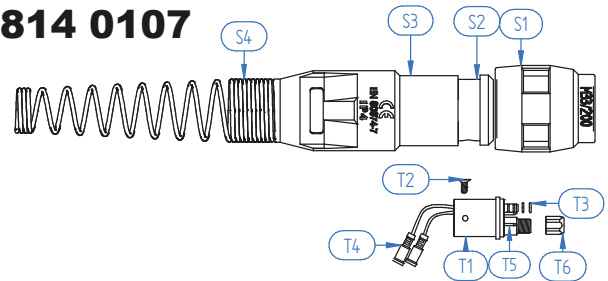

813 0312

813 0313

813 0314

813 0315

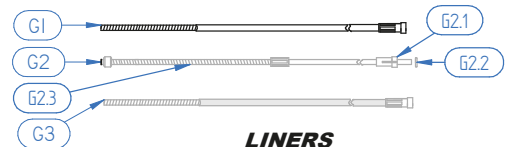
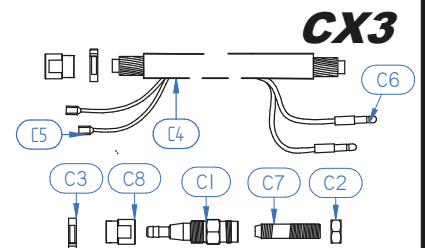

LINERS

POS.	CODE	DESCRIPTION	PACK
G2	199SA302	ALUWELD LINER ERGODANI 0.8-1.0MM. 2.50MTS.	1
G2	199SA303	ALUWELD LINER ERGODANI 0.8-1.0MM. 3.50MTS.	1
G2	199SA304	ALUWELD LINER ERGODANI 0.8-1.0MM. 4.50MTS.	1
G2	199SA305	ALUWELD LINER ERGODANI 0.8-1.0MM. 5.50MTS.	1
G2	199SA402	ALUWELD LINER ERGODANI 1.2-1.6MM. 2.50MTS.	1
G2	199SA403	ALUWELD LINER ERGODANI 1.2-1.6MM. 3.50MTS.	1
G2	199SA404	ALUWELD LINER ERGODANI 1.2-1.6MM. 4.50MTS.	1
G2	199SA405	ALUWELD LINER ERGODANI 1.2-1.6MM. 5.50MTS.	1
G2.1	199SA88	COLLET LINER ALUWED/ALUM.	10
G2.2	199SA77	LINER O-RING ALUWED/ALUM.	10
G2.3	199SA3G	ALUWELD NECK-LINER ERGODANI 0.8-1.0MM.	2
G2.3	199SA4G	ALUWELD NECK-LINER ERGODANI 1.2-1.6MM.	2
G3	199SIN02	GRAY COATED BRONZE LINER ERGODANI INOX.1.0-1.2MM. 2.40M	1
G3	199SIN03	GRAY COATED BRONZE LINER ERGODANI INOX.1.0-1.2MM. 3.40M	1
G3	199SIN04	GRAY COATED BRONZE LINER ERGODANI INOX.1.0-1.2MM. 4.40M	1
G3	199SIN05	GRAY COATED BRONZE LINER ERGODANI INOX.1.0-1.2MM. 5.40M	1
C1	1EX2723	CABLE FITTING EX-270	5
C2	19920	LOCK NUT ERGODANI	10
C3	145T185	HOSE CLAMP 18.5	10
C4	1EX27CX02	CABLE ASSEMBLY EX-270 2MTS.	1
C4	1EX27CX03	CABLE ASSEMBLY EX-270 3MTS.	1
C4	1EX27CX04	CABLE ASSEMBLY EX-270 4MTS.	1
C4	1EX27CX05	CABLE ASSEMBLY EX-270 5MTS.	1
C5	199FT01	CABLE FRONT TERMINAL	25
C6	199FT02	CABLE REAR TERMINAL	25
C7	1EX923	PIPE CONNECTION TO EURO EX-270/380	5
C8	1EX2720	CONE NUT EX-270	5
E2	19906	SPRING & UNIVERSAL JOINT CX ERGODANI	2
S1	1000125	ADAPTOR NUT -BLACK CX	1
S2	100012401	CONNECTION SUPPORT TUBE CX	1
T1	199MZ	EURO CENTRAL CONNECTOR CX ERGODANI	1
T2	199MZ05	CENTRAL CONNECTOR SCREW	10
T3	199MZ03	CENTRAL CONNECTOR O-RING	10
T4	199FT03	CENTRAL CONNECTOR TERMINAL	25
T5	199MZ04	CENTRAL CONNECT.CONTACT PIN CX ERGODANI	2
T6	199MZ02	LINER FASTENER NUT ERGODANI	10



ERGODANI

MIG 27

TX 380

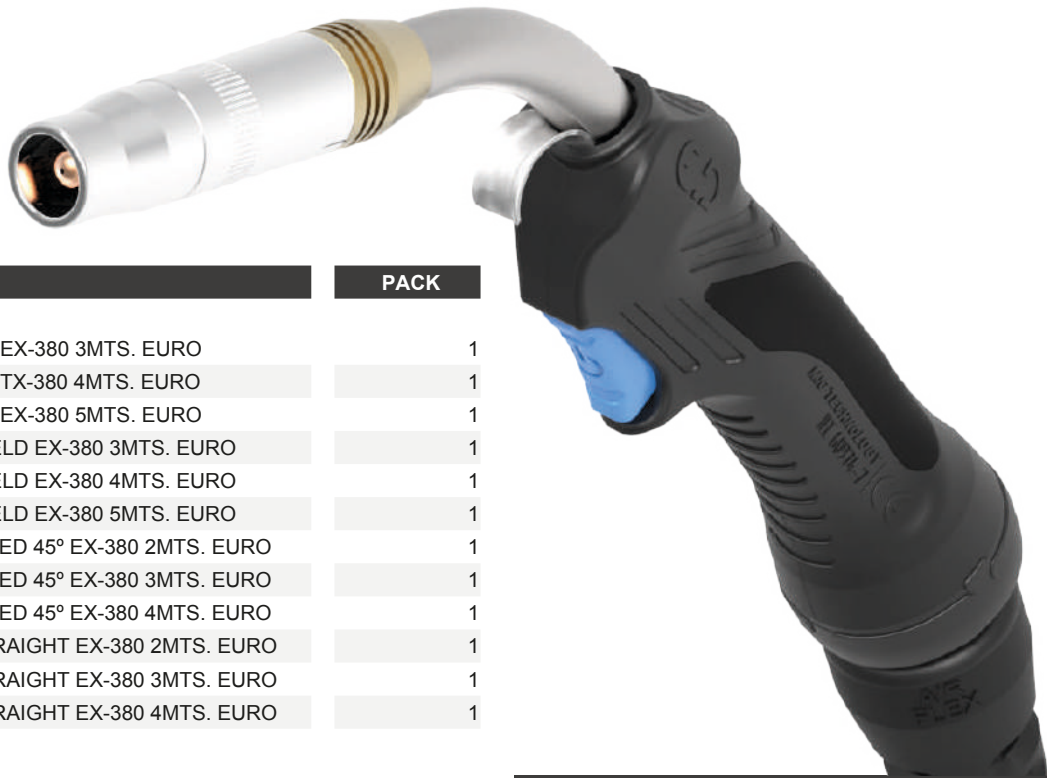

CODE	DESCRIPTION	PACK
1EX38103	TORCH ERGODANI TESLA EX-380 3MTS. EURO	1
1EX38104	TORCH ERGODANI TESLA TX-380 4MTS. EURO	1
1EX38105	TORCH ERGODANI TESLA EX-380 5MTS. EURO	1
1EX38203	TORCH ERGODANI ALUWELD EX-380 3MTS. EURO	1
1EX38204	TORCH ERGODANI ALUWELD EX-380 4MTS. EURO	1
1EX38205	TORCH ERGODANI ALUWELD EX-380 5MTS. EURO	1
1EX38AC02	TORCH AUTOMATIC CURVED 45° EX-380 2MTS. EURO	1
1EX38AC03	TORCH AUTOMATIC CURVED 45° EX-380 3MTS. EURO	1
1EX38AC04	TORCH AUTOMATIC CURVED 45° EX-380 4MTS. EURO	1
1EX38AR02	TORCH AUTOMATIC 0° STRAIGHT EX-380 2MTS. EURO	1
1EX38AR03	TORCH AUTOMATIC 0° STRAIGHT EX-380 3MTS. EURO	1
1EX38AR04	TORCH AUTOMATIC 0° STRAIGHT EX-380 4MTS. EURO	1

POS.	CODE	DESCRIPTION	PACK
N1	1EX3801	SWAN NECK EX-380	1
N1.1	1EX3802	CONTACT TIP HOLDER EX-380/421W M/9*38MM.	10
N1.2	1EX3802M8	CONTACT TIP HOLDER EX-380/421W M/8*38MM.	10
N3	1EX3804	STANDARD NOZZLE EX-380/421W - 16MM.	5
N3.1	1EX380402	CONICAL NOZZLE EX-380/421W - 13MM.	5
N8	1EX3801AC	45° CURVED AUTOMATIC SWAN NECK EX-380	1
N9	1EX3801AR	0° STRAIGHT AUTOMATIC NECK EX-380	1
N10	199EPAT	AUTOMATIC TORCHES HANDLE ERGODANI	1
M9	1EX9P08	EX-LONG CONTACT TIP M/9*34 - 0.8MM. CU.AG.	25
M9	1EX9P10	EX-LONG CONTACT TIP M/9*34 - 1.0MM. CU.AG.	25
M9	1EX9P12	EX-LONG CONTACT TIP M/9*34 - 1.2MM. CU.AG.	25
M9	1EX9P14	EX-LONG CONTACT TIP M/9*34 - 1.4MM. CU.AG.	25
M9	1EX9P16	EX-LONG CONTACT TIP M/9*34 - 1.6MM. CU.AG.	25
M9	1EX9P24	EX-LONG CONTACT TIP M/9*34 - 2.4MM. CU.AG.	25
M9	1EX9P08A	EX-LONG CONTACT TIP ALUWELD M/9*34 - 0.8MM. CU.AG.	25
M9	1EX9P10A	EX-LONG CONTACT TIP ALUWELD M/9*34 - 1.0MM. CU.AG.	25
M9	1EX9P12A	EX-LONG CONTACT TIP ALUWELD M/9*34 - 1.2MM. CU.AG.	25
M9	1EX9P16A	EX-LONG CONTACT TIP ALUWELD M/9*34 - 1.6MM. CU.AG.	25
M8	199M808	ERGODANI CONTACT TIP M/8*30 - 0.8MM. CU.	25
M8	199M810	ERGODANI CONTACT TIP M/8*30 - 1.0MM. CU.	25
M8	199M812	ERGODANI CONTACT TIP M/8*30 - 1.2MM. CU.	25
M8	199M814	ERGODANI CONTACT TIP M/8*30 - 1.4MM. CU.	25
M8	199M816	ERGODANI CONTACT TIP M/8*30 - 1.6MM. CU.	25
M8	199M818	ERGODANI CONTACT TIP M/8*30 - 1.8MM. CU.	25
M8	199M824	ERGODANI CONTACT TIP M/8*30 - 2.4MM. CU.	25
M8	199M808A	ERGODANI CONTACT TIP M/8*30 - AL0.8MM. CU.	25
M8	199M810A	ERGODANI CONTACT TIP M/8*30 - AL1.0MM. CU.	25
M8	199M812A	ERGODANI CONTACT TIP M/8*30 - AL1.2MM. CU.	25
M8	199M816A	ERGODANI CONTACT TIP M/8*30 - AL1.6MM. CU.	25
M8	199M808C	ERGODANI CONTACT TIP CHROME M/8*30 - 0.8MM. CU.	25
M8	199M810C	ERGODANI CONTACT TIP CHROME M/8*30 - 1.0MM. CU.	25
M8	199M812C	ERGODANI CONTACT TIP CHROME M/8*30 - 1.2MM. CU.	25
M8	199M814C	ERGODANI CONTACT TIP CHROME M/8*30 - 1.4MM. CU.	25
M8	199M816C	ERGODANI CONTACT TIP CHROME M/8*30 - 1.6MM. CU.	25

TX 380

Gas Cooled

350 Amp 60% CO₂
270 Amp 60% Ar + CO₂

Torch developed for medium to high intensity, gas cooled welding. Surpasses the universal torches in amperage and welding cycle duration.

The most versatile torch in the professional range.

Threaded nozzle, over-sized M9 contact tip and special insulation.



811 3801

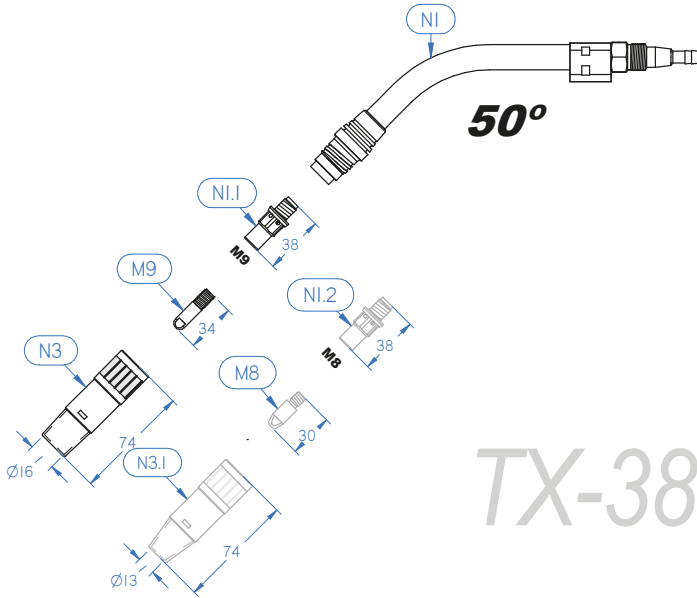

811 3802

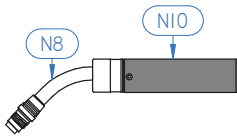

811 3803

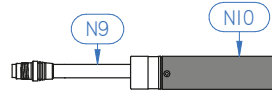

812 0901

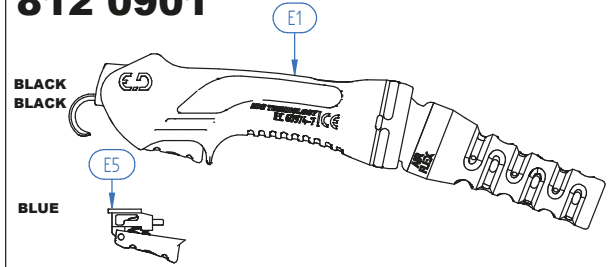

814 0107

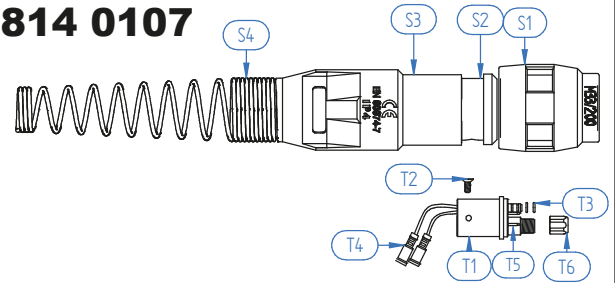

813 0412

813 0413

813 0414

813 0415

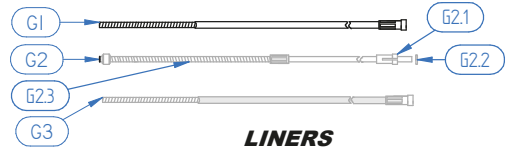
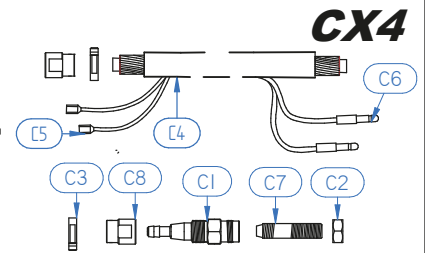

POS.	CODE	DESCRIPTION	PACK
M8	199M808N	CONTACT TIP M/8*30 - 0.8MM. CU.	25
M8	199M810N	CONTACT TIP M/8*30 - 1.0MM. CU.	25
M8	199M812N	CONTACT TIP M/8*30 - 1.2MM. CU.	25
M8	199M814N	CONTACT TIP M/8*30 - 1.4MM. CU.	25
M8	199M816N	CONTACT TIP M/8*30 - 1.6MM. CU.	25
M8	199M808Z	ERGODANI CONTACT TIP M/8*30 - 0.8MM. CU.CR.ZR.	25
M8	199M810Z	ERGODANI CONTACT TIP M/8*30 - 1.0MM. CU.CR.ZR.	25
M8	199M812Z	ERGODANI CONTACT TIP M/8*30 - 1.2MM. CU.CR.ZR.	25
M8	199M814Z	ERGODANI CONTACT TIP M/8*30 - 1.4MM. CU.CR.ZR.	25
M8	199M816Z	ERGODANI CONTACT TIP M/8*30 - 1.6MM. CU.CR.ZR.	25
M8	199M808ZN	CONTACT TIP M/8*30 - 0.8MM. CU.CR.ZR.	25
M8	199M810ZN	CONTACT TIP M/8*30 - 1.0MM. CU.CR.ZR.	25
M8	199M812ZN	CONTACT TIP M/8*30 - 1.2MM. CU.CR.ZR.	25
M8	199M814ZN	CONTACT TIP M/8*30 - 1.4MM. CU.CR.ZR.	25
M8	199M816ZN	CONTACT TIP M/8*30 - 1.6MM. CU.CR.ZR.	25
E1	1EX9EP	PRO.TESLA HANDLE BLACK-BLACK GAS	1
E2	19906	SPRING & UNIVERSAL JOINT CX ERGODANI BLUE	2
E5	199TS01	BLUE TRIGGER TESLA	5
G1	199SR02A	BLUE COATED LINER ERGODANI 0.6-0.8MM. 2.40MTS.	1
G1	199SR03A	BLUE COATED LINER ERGODANI 0.6-0.8MM. 3.40MTS.	1
G1	199SR04A	BLUE COATED LINER ERGODANI 0.6-0.8MM. 4.40MTS.	1
G1	199SR05A	BLUE COATED LINER ERGODANI 0.6-0.8MM. 5.40MTS.	1
G1	199SR02R	RED COATED LINER ERGODANI 1.0-1.2MM. 2.40MTS.	1
G1	199SR03R	RED COATED LINER ERGODANI 1.0-1.2MM. 3.40MTS.	1



811 3801

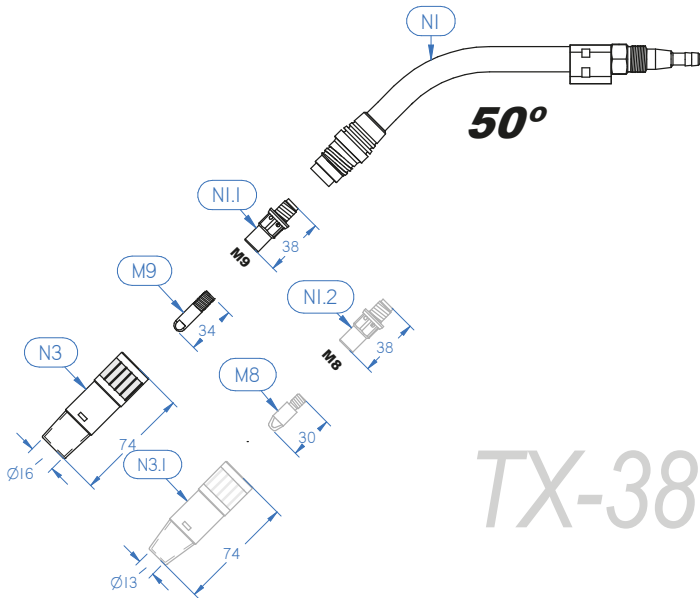

TX-380

811 3802

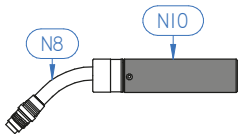

811 3803

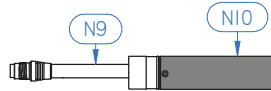

812 0901

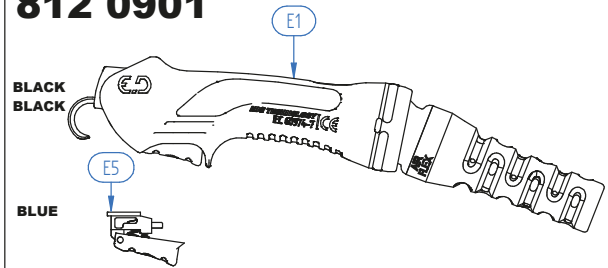

814 0107

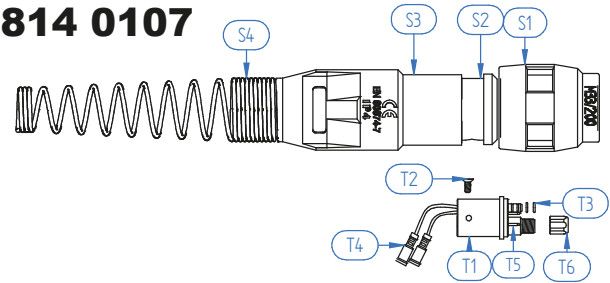

813 0412

813 0413

813 0414

813 0415

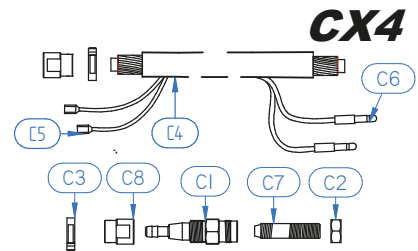

CX4

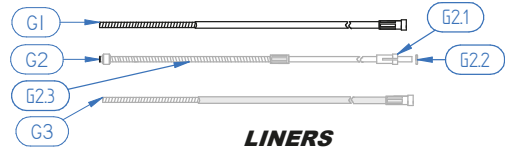

LINERS

POS.	CODE	DESCRIPTION	PACK
G1	199SR04R	RED COATED LINER ERGODANI 1.0-1.2MM. 4.40MTS.	1
G1	199SR05R	RED COATED LINER ERGODANI 1.0-1.2MM. 5.40MTS.	1
G1	199SR02M	YELLOW COATED LINER ERGODANI 1.6MM. 2.40MTS.	1
G1	199SR03M	YELLOW COATED LINER ERGODANI 1.6MM. 3.40MTS.	1
G1	199SR04M	YELLOW COATED LINER ERGODANI 1.6MM. 4.40MTS.	1
G1	199SR05M	YELLOW COATED LINER ERGODANI 1.6MM. 5.40MTS.	1
G1	199SR02V	GREEN COATED LINER ERGODANI 2.4MM. 2.40MTS.	1
G1	199SR03V	GREEN COATED LINER ERGODANI 2.4MM. 3.40MTS.	1
G1	199SR04V	GREEN COATED LINER ERGODANI 2.4MM. 4.40MTS.	1
G1	199SR05V	GREEN COATED LINER ERGODANI 2.4MM. 5.40MTS.	1
G2	199SA302	ALUWELD LINER ERGODANI 0.8-1.0MM. 2.50MTS.	1
G2	199SA303	ALUWELD LINER ERGODANI 0.8-1.0MM. 3.50MTS.	1
G2	199SA304	ALUWELD LINER ERGODANI 0.8-1.0MM. 4.50MTS.	1
G2	199SA305	ALUWELD LINER ERGODANI 0.8-1.0MM. 5.50MTS.	1
G2	199SA402	ALUWELD LINER ERGODANI 1.2-1.6MM. 2.50MTS.	1
G2	199SA403	ALUWELD LINER ERGODANI 1.2-1.6MM. 3.50MTS.	1
G2	199SA404	ALUWELD LINER ERGODANI 1.2-1.6MM. 4.50MTS.	1
G2	199SA405	ALUWELD LINER ERGODANI 1.2-1.6MM. 5.50MTS.	1
G2.1	199SA88	COLLET LINER ALUWED/ALUM.	10
G2.2	199SA77	LINER O-RING ALUWED/ALUM.	10
G2.3	199SA3G	ALUWELD NECK-LINER ERGODANI 0.8-1.0MM.	2
G2.3	199SA4G	ALUWELD NECK-LINER ERGODANI 1.2-1.6MM.	2
G3	199SIN02	GRAY COATED BRONZE LINER ERGODANI INOX.1.0-1.2MM. 2.40M	1
G3	199SIN03	GRAY COATED BRONZE LINER ERGODANI INOX.1.0-1.2MM. 3.40M	1
G3	199SIN04	GRAY COATED BRONZE LINER ERGODANI INOX.1.0-1.2MM. 4.40M	1
G3	199SIN05	GRAY COATED BRONZE LINER ERGODANI INOX.1.0-1.2MM. 5.40M	1
C1	1EX3823	CABLE FITTING EX-380	5
C2	19920	LOCK NUT ERGODANI	10
C3	145T200	HOSE CLAMP 20.0	10
C4	1EX38CX02	CABLE ASSEMBLY EX-380 2MTS.	1
C4	1EX38CX03	CABLE ASSEMBLY EX-380 3MTS.	1
C4	1EX38CX04	CABLE ASSEMBLY EX-380 4MTS.	1
C4	1EX38CX05	CABLE ASSEMBLY EX-380 5MTS.	1

POS.	CODE	DESCRIPTION	PACK
C5	199FT01	CABLE FRONT TERMINAL	25
C6	199FT02	CABLE REAR TERMINAL	25
C7	1EX923	PIPE CONNECTION TO EURO EX-270/380	5
C8	1EX3820	CONE NUT EX-380	5
E2	19906	SPRING & UNIVERSAL JOINT CX ERGODANI	2
S1	1EX924	ADAPTOR NUT -BLACK CX	1
S2	1EX925	CONNECTION SUPPORT TUBE CX	1
S3	100012402	REAR SPRING SUPPORT CX	1
S4	10001062	REAR SPRING CX	1
T1	199MZ	EURO CENTRAL CONNECTOR CX ERGODANI	1
T2	199MZ05	CENTRAL CONNECTOR SCREW	10
T3	199MZ03	CENTRAL CONNECTOR O-RING	10
T4	199FT03	CENTRAL CONNECTOR TERMINAL	25
T5	199MZ04	CENTRAL CONNECT.CONTACT PIN CX ERGODANI	2
T6	199MZ02	LINER FASTENER NUT ERGODANI	10



Tx 480



CODE	DESCRIPTION	PACK
1EX48103	TORCH ERGODANI TESLA EX-480 3MTS. EURO	1
1EX48104	TORCH ERGODANI TESLA TX-480 4MTS. EURO	1
1EX48105	TORCH ERGODANI TESLA EX-480 5MTS. EURO	1
1EX48AC02	TORCH AUTOMATIC 45° CURVED EX-480 2MTS. EURO	1
1EX48AC03	TORCH AUTOMATIC 45° CURVED EX-480 3MTS. EURO	1
1EX48AC04	TORCH AUTOMATIC 45° CURVED EX-480 4MTS. EURO	1
1EX48AR02	TORCH AUTOMATIC 0° STRAIGHT EX-380 2MTS. EURO	1
1EX48AR03	TORCH AUTOMATIC 0° STRAIGHT EX-380 3MTS. EURO	1
1EX48AR04	TORCH AUTOMATIC 0° STRAIGHT EX-380 4MTS. EURO	1

POS.	CODE	DESCRIPTION	PACK
N1	1EX4801	SWAN NECK EX-480	1
N1.2	1EX4802R	CONTACT TIP HOLDER EX-480 M/10*45MM.	10
N1.1	1EX4802	CONTACT TIP HOLDER EX-480 M/9*48MM.	10
N3	1EX4804	STANDARD NOZZLE EX-480 - 19MM.	5
N8	1EX4801AC	45° CURVED AUTOMATIC SWAN NECK EX-480	1
N9	1EX4801AR	0° STRAIGHT AUTOMATIC NECK EX-480	1
N10	199EPAT	AUTOMATIC TORCHES HANDLE ERGODANI	1
M10	160M108	EXR CONTACT TIP M/10*43 - 0.8MM. CU.CR.ZR.	10
M10	160M109	EXR CONTACT TIP M/10*43 - 0.9MM. CU.CR.ZR.	10
M10	160M110	EXR CONTACT TIP M/10*43 - 1.0MM. CU.CR.ZR.	10
M10	160M112	EXR CONTACT TIP M/10*43 - 1.2MM. CU.CR.ZR.	10
M10	160M114	EXR CONTACT TIP M/10*43 - 1.4MM. CU.CR.ZR.	10
M10	160M116	EXR CONTACT TIP M/10*43 - 1.6MM. CU.CR.ZR.	10
M10	160M124	EXR CONTACT TIP M/10*43 - 2.4MM. CU.CR.ZR.	10
M9	1EX9P08	EX-LONG CONTACT TIP M/9*34 - 0.8MM. CU.AG.	25
M9	1EX9P10	EX-LONG CONTACT TIP M/9*34 - 1.0MM. CU.AG.	25
M9	1EX9P12	EX-LONG CONTACT TIP M/9*34 - 1.2MM. CU.AG.	25
M9	1EX9P14	EX-LONG CONTACT TIP M/9*34 - 1.4MM. CU.AG.	25
M9	1EX9P16	EX-LONG CONTACT TIP M/9*34 - 1.6MM. CU.AG.	25
M9	1EX9P24	EX-LONG CONTACT TIP M/9*34 - 2.4MM. CU.AG.	25
M9	1EX9P08A	EX-LONG CONTACT TIP ALUWELD M/9*34 - 0.8MM. CU.AG.	25
M9	1EX9P10A	EX-LONG CONTACT TIP ALUWELD M/9*34 - 1.0MM. CU.AG.	25
M9	1EX9P12A	EX-LONG CONTACT TIP ALUWELD M/9*34 - 1.2MM. CU.AG.	25
M9	1EX9P16A	EX-LONG CONTACT TIP ALUWELD M/9*34 - 1.6MM. CU.AG.	25
E1	1EX48EP	PRO.TESLA HANDLE BLACK-BLACK GAS	1
E2	1EX4806	SPRING & UNIVERSAL JOIN CX5 EX-480	2
E5	199TS01	BLUE TRIGGER TESLA	5
G1	199SR02A	BLUE COATED LINER ERGODANI 0.6-0.8MM. 2.40MTS.	1
G1	199SR03A	BLUE COATED LINER ERGODANI 0.6-0.8MM. 3.40MTS.	1
G1	199SR04A	BLUE COATED LINER ERGODANI 0.6-0.8MM. 4.40MTS.	1
G1	199SR05A	BLUE COATED LINER ERGODANI 0.6-0.8MM. 5.40MTS.	1
G1	199SR02N	BLACK COATED LINER ERGODANI 1.0-1.6MM. 2.40MTS.	1
G1	199SR03N	BLACK COATED LINER ERGODANI 1.0-1.6MM. 3.40MTS.	1
G1	199SR04N	BLACK COATED LINER ERGODANI 1.0-1.6MM. 4.40MTS.	1
G1	199SR05N	BLACK COATED LINER ERGODANI 1.0-1.6MM. 5.40MTS.	1
G1	199SR02V	GREEN COATED LINER ERGODANI 2.4MM. 2.40MTS.	1
G1	199SR03V	GREEN COATED LINER ERGODANI 2.4MM. 3.40MTS.	1
G1	199SR04V	GREEN COATED LINER ERGODANI 2.4MM. 4.40MTS.	1
G1	199SR05V	GREEN COATED LINER ERGODANI 2.4MM. 5.40MTS.	1
G2	199SA102	ALUMINIUM WIRE LINER 0.8-1.0MM. 2MTS.	1
G2	199SA103	ALUMINIUM WIRE LINER 0.8-1.0MM. 3MTS.	1
G2	199SA104	ALUMINIUM WIRE LINER 0.8-1.0MM. 4MTS.	1
G2	199SA105	ALUMINIUM WIRE LINER 0.8-1.0MM. 5MTS.	1
G2	199SA202	ALUMINIUM WIRE LINER 1.2-1.6MM. 2MTS.	1
G2	199SA203	ALUMINIUM WIRE LINER 1.2-1.6MM. 3MTS.	1
G2	199SA204	ALUMINIUM WIRE LINER 1.2-1.6MM. 4MTS.	1
G2	199SA205	ALUMINIUM WIRE LINER 1.2-1.6MM. 5MTS.	1

Tx 480

Gas Cooled

450 Amp 60% CO₂
350 Amp 60% Ar + CO₂

The most powerful gas cooled torch in the Ergodani professional range. Brings greater resistance in high current welding with a balanced weight.

The gas cooled torch with highest cable section, ideal for automatism.

Threaded nozzle, over-sized M10 contact tip and special insulation.



811 4801

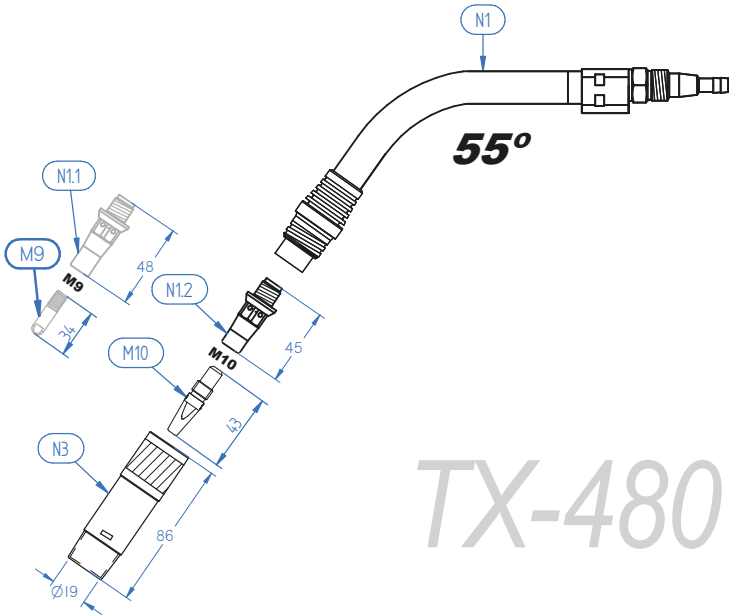

TX-480

811 4802

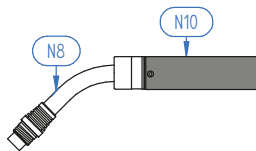

811 4803

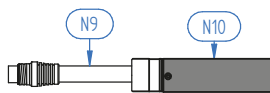

812 0901

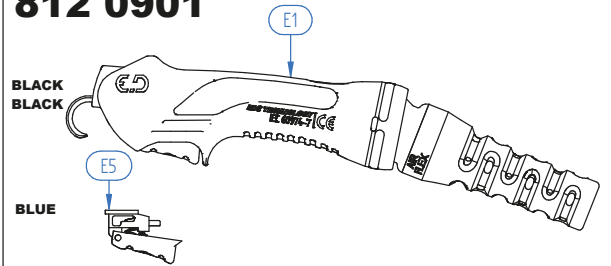

814 0107

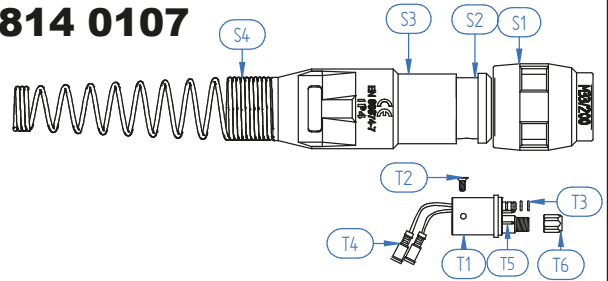

813 0512

813 0513

813 0514

813 0515

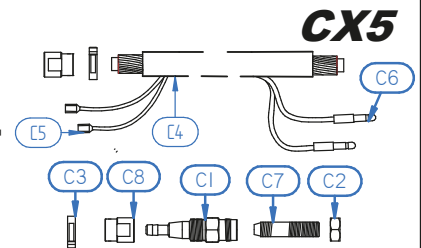

CX5

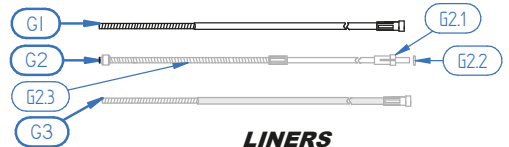

LINERS

POS.	CODE	DESCRIPTION	PACK
G2.1	199SA88	COLLET LINER ALUWED/ALUM.	10
G2.2	199SA77	LINER O-RING ALUWED/ALUM.	10
G2.3	199SA1G	ALUMINIUM WIRE NECK-LINER 0.8-1.0MM.	2
G2.3	199SA2G	ALUMINIUM WIRE NECK-LINER 1.2-1.6MM.	2
G3	199SIN02	GRAY COATED BRONZE LINER ERGODANI INOX.1.0-1.2MM. 2.40M	1
G3	199SIN03	GRAY COATED BRONZE LINER ERGODANI INOX.1.0-1.2MM. 3.40M	1
G3	199SIN04	GRAY COATED BRONZE LINER ERGODANI INOX.1.0-1.2MM. 4.40M	1
G3	199SIN05	GRAY COATED BRONZE LINER ERGODANI INOX.1.0-1.2MM. 5.40M	1
C1	1EX4823	CABLE FITTING EX-480	5
C2	1EX4820	CONE NUT EX-480	5
C3	145T210	HOSE CLAMP 21.0	10
C4	1EX48CX02	CABLE ASSEMBLY EX-480 2MTS.	1
C4	1EX48CX03	CABLE ASSEMBLY EX-480 3MTS.	1
C4	1EX48CX04	CABLE ASSEMBLY EX-480 4MTS.	1
C4	1EX48CX05	CABLE ASSEMBLY EX-480 5MTS.	1
C5	199FT01	CABLE FRONT TERMINAL	25
C6	199FT02	CABLE REAR TERMINAL	25
S1	1000125	ADAPTOR NUT BLACK CX	1
S2	100012401	CONNECTION SUPPORT TUBE CX	1
S3	100012402	REAR SPRING SUPPORT	1
S4	10001062	REAR SPRING.	1
T1	1EX48MZ	EURO CENTRAL CONNECTOR EX-480	1
T2	199MZ05	CENTRAL CONNECTOR SCREW	10
T3	199MZ03	CENTRAL CONNECTOR O-RING	10
T4	199FT03	CENTRAL CONNECTOR TERMINAL	25
T5	199MZ04	CENTRAL CONNECT.CONTACT PIN CX ERGODANI	2
T6	199MZ02	LINER FASTENER NUT ERGODANI	10



**ALSO AVAILABLE
AUTOMATIC NECK.**



TX 221w



CODE	DESCRIPTION	PACK
1EX22103	TORCH ERGODANI TESLA EX-221W 3MTS. EURO	1
1EX22104	TORCH ERGODANI TESLA TX-221W 4MTS. EURO	1
1EX22105	TORCH ERGODANI TESLA EX-221W 5MTS. EURO	1
1EX22203	TORCH ERGODANI ALUWELD EX-221W 3MTS. EURO	1
1EX22204	TORCH ERGODANI ALUWELD EX-221W 4MTS. EURO	1
1EX22205	TORCH ERGODANI ALUWELD EX-221W 5MTS. EURO	1
1EX22AC01	TORCH AUTOMATIC 45° CURVED EX-221W 1.5MTS. EURO	1
1EX22AC02	TORCH AUTOMATIC 45° CURVED EX-221W 2MTS. EURO	1
1EX22AC03	TORCH AUTOMATIC 45° CURVED EX-221W 3MTS. EURO	1
1EX22AR01	TORCH AUTOMATIC 0° STRAIGHT EX-221W 1.5MTS. EURO	1
1EX22AR02	TORCH AUTOMATIC 0° STRAIGHT EX-221W 2MTS. EURO	1
1EX22AR03	TORCH AUTOMATIC 0° STRAIGHT EX-221W 3MTS. EURO	1
1EID22103	TORCH ERGODANI TESLA EI-221W-D 3MTS. EURO	1
1EID22104	TORCH ERGODANI TESLA EI-221W-D 4MTS. EURO	1
1EID22105	TORCH ERGODANI TESLA EI-221W-D 5MTS. EURO	1
1EID22203	TORCH ERGODANI ALUWELD EI-221W-D 3MTS. EURO	1
1EID22204	TORCH ERGODANI ALUWELD EI-221W-D 4MTS. EURO	1
1EID22205	TORCH ERGODANI ALUWELD EI-221W-D 5MTS. EURO	1
1EII22103	TORCH ERGODANI TESLA EI-221W-I 3MTS. EURO	1
1EII22104	TORCH ERGODANI TESLA EI-221W-I 4MTS. EURO	1
1EII22105	TORCH ERGODANI TESLA EI-221W-I 5MTS. EURO	1
1EII22203	TORCH ERGODANI ALUWELD EI-221W-I 3MTS. EURO	1
1EII22204	TORCH ERGODANI ALUWELD EI-221W-I 4MTS. EURO	1
1EII22205	TORCH ERGODANI ALUWELD EI-221W-I 5MTS. EURO	1

TX 221w

Liquid Cooled

350 Amp 100% CO₂
330 Amp 100% Ar + CO₂

Liquid cooled torch designed for medium amperage versatile welding. Ideal for aluminum welding.

Small torch, easy to use with grip capable to reach difficult access places.

Threaded nozzle, over-sized M9 contact tip and special insulation.

POS.	CODE	DESCRIPTION	PACK
N1	1EX2201	SWAN NECK EX-221W	1
N1.1	1EX2702	CONTACT TIP HOLDER EX-270/221W M/9*34MM.	10
N1.2	1EX2702M8	CONTACT TIP HOLDER EX-270/221W M/8*34MM.	10
N3	1EX2704	STANDARD NOZZLE EX-270/221W - 15MM.	5
N3.1	1EX270402	CONICAL NOZZLE EX-270/221W - 13MM.	5
N8	1EX2201AC	45° CURVED AUTOMATIC SWAN NECK EX-221W	1
N9	1EX2201AR	0° STRAIGHT AUTOMATIC NECK EX-221W	1
N10	199EPAT	AUTOMATIC TORCHES HANDLE ERGODANI	1
M9	1EX9P08W	EX-SHORT CONTACT TIP M/9*30 - 0.8MM. CU.AG.	25
M9	1EX9P10W	EX-SHORT CONTACT TIP M/9*30 - 1.0MM. CU.AG.	25
M9	1EX9P12W	EX-SHORT CONTACT TIP M/9*30 - 1.2MM. CU.AG.	25
M9	1EX9P14W	EX-SHORT CONTACT TIP M/9*30 - 1.4MM. CU.AG.	25
M9	1EX9P16W	EX-SHORT CONTACT TIP M/9*30 - 1.6MM. CU.AG.	25
M9	1EX9P24W	EX-SHORT CONTACT TIP M/9*30 - 2.4MM. CU.AG.	25
M9	1EX9P08WA	EX-SHORT CONTACT TIP ALUWELD M/9*30 - 0.8MM. CU.AG.	25
M9	1EX9P10WA	EX-SHORT CONTACT TIP ALUWELD M/9*30 - 1.0MM. CU.AG.	25
M9	1EX9P12WA	EX-SHORT CONTACT TIP ALUWELD M/9*30 - 1.2MM. CU.AG.	25
M9	1EX9P16WA	EX-SHORT CONTACT TIP ALUWELD M/9*30 - 1.6MM. CU.AG.	25
M8	199CL08	ERGODANI CONTACT TIP CHROME M/8*28 - 0.8MM. CU.	25
M8	199CL10	ERGODANI CONTACT TIP CHROME M/8*28 - 1.0MM. CU.	25
M8	199CL12	ERGODANI CONTACT TIP CHROME M/8*28 - 1.2MM. CU.	25
M8	199CL14	ERGODANI CONTACT TIP CHROME M/8*28 - 1.4MM. CU.	25
M8	199CL16	ERGODANI CONTACT TIP CHROME M/8*28 - 1.6MM. CU.	25



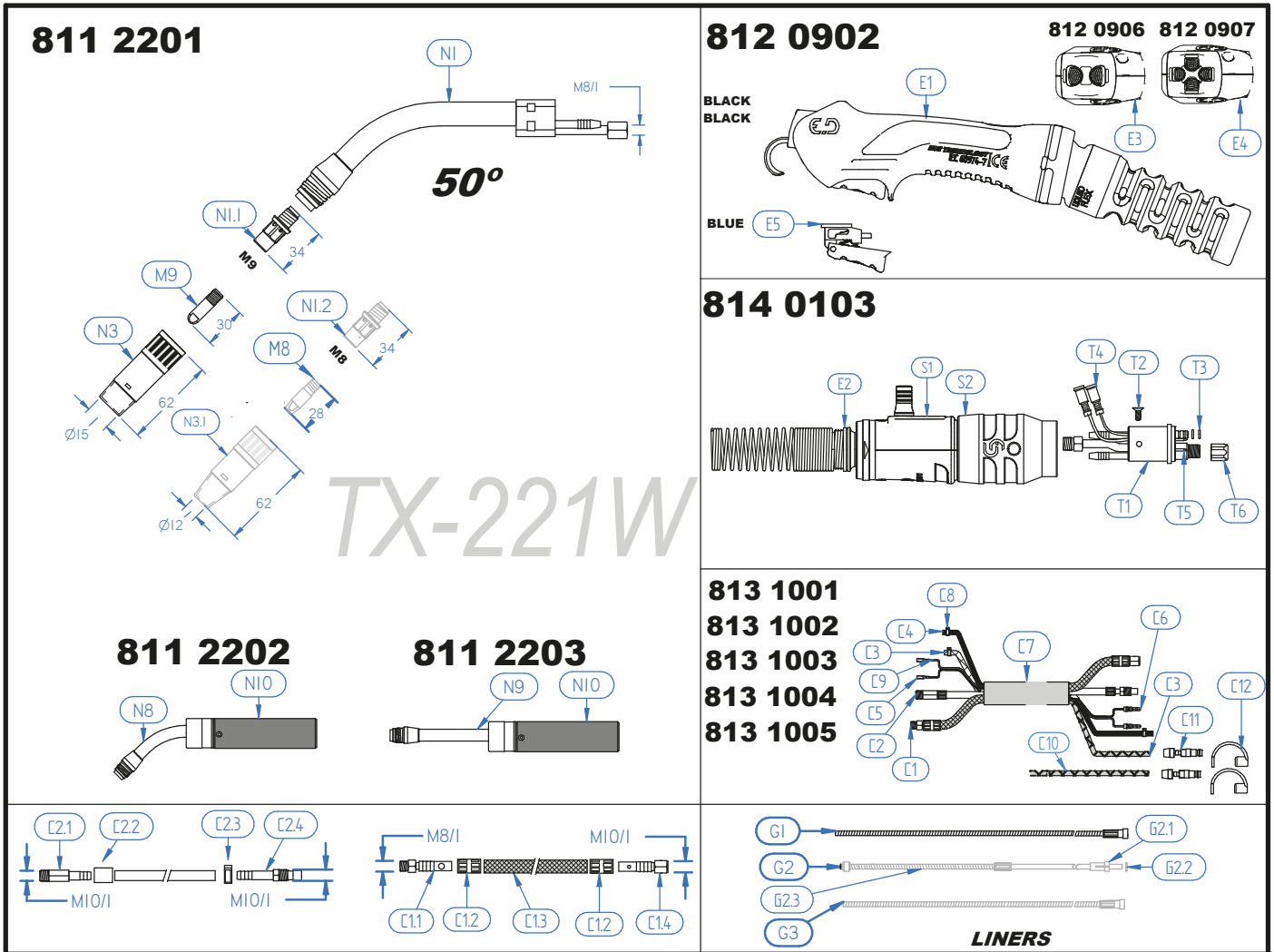

POS.	CODE	DESCRIPTION	PACK
E1	812 0902	PRO.TESLA HANDLE BLACK-BLACK LIQUID	1
E2	19906W	SPRING & UNIVERSAL JOINT CW ERGODANI	2
E5	199TS01	BLUE TRIGGER TESLA	5
E3	1EIP9EP	BLACK HANDLE W.ALUMINIUM RING ERGODANI EI-P	1
E3.1	1EIP9EP1	REGULATION CIRCUIT ERGODANI EI-P	1
E4	1EID9EP	BLACK HANDLE W.ALUMINIUM RING ERGODANI EI-D	1
E4.1	1EID9EP1	REGULATION CIRCUIT ERGODANI EI-D	1
(*)	1EII9EP	BLACK HANDLE W.ALUMINIUM RING ERGODANI EI-I	1
G1	199SR02A	BLUE COATED LINER ERGODANI 0.6-0.8MM. 2.40MTS.	1
G1	199SR03A	BLUE COATED LINER ERGODANI 0.6-0.8MM. 3.40MTS.	1
G1	199SR04A	BLUE COATED LINER ERGODANI 0.6-0.8MM. 4.40MTS.	1
G1	199SR05A	BLUE COATED LINER ERGODANI 0.6-0.8MM. 5.40MTS.	1
G1	145SR02	NON COATED LINER ERGODANI 1.0-1.6MM. 2.5MTS.	1
G1	145SR03	NON COATED LINER ERGODANI 1.0-1.6MM. 3.5MTS.	1
G1	145SR04	NON COATED LINER ERGODANI 1.0-1.6MM. 4.5MTS.	1
G1	145SR05	NON COATED LINER ERGODANI 1.0-1.6MM. 5.5MTS.	1
G1	199SR02V	GREEN COATED LINER ERGODANI 2.4MM. 2.40MTS.	1
G1	199SR03V	GREEN COATED LINER ERGODANI 2.4MM. 3.40MTS.	1
G1	199SR04V	GREEN COATED LINER ERGODANI 2.4MM. 4.40MTS.	1
G1	199SR05V	GREEN COATED LINER ERGODANI 2.4MM. 5.40MTS.	1
G2	199SA302	ALUWELD LINER ERGODANI 0.8-1.0MM. 2.50MTS.	1
G2	199SA303	ALUWELD LINER ERGODANI 0.8-1.0MM. 3.50MTS.	1
G2	199SA304	ALUWELD LINER ERGODANI 0.8-1.0MM. 4.50MTS.	1
G2	199SA305	ALUWELD LINER ERGODANI 0.8-1.0MM. 5.50MTS.	1
G2	199SA402	ALUWELD LINER ERGODANI 1.2-1.6MM. 2.50MTS.	1
G2	199SA403	ALUWELD LINER ERGODANI 1.2-1.6MM. 3.50MTS.	1
G2	199SA404	ALUWELD LINER ERGODANI 1.2-1.6MM. 4.50MTS.	1
G2	199SA405	ALUWELD LINER ERGODANI 1.2-1.6MM. 5.50MTS.	1
G2.1	199SA88	COLLET LINER ALUWED/ALUM.	10
G2.2	199SA77	LINER O-RING ALUWED/ALUM.	10
G2.3	199SA3G	ALUWELD NECK-LINER ERGODANI 0.8-1.0MM.	2
G2.3	199SA4G	ALUWELD NECK-LINER ERGODANI 1.2-1.6MM.	2



811 2201

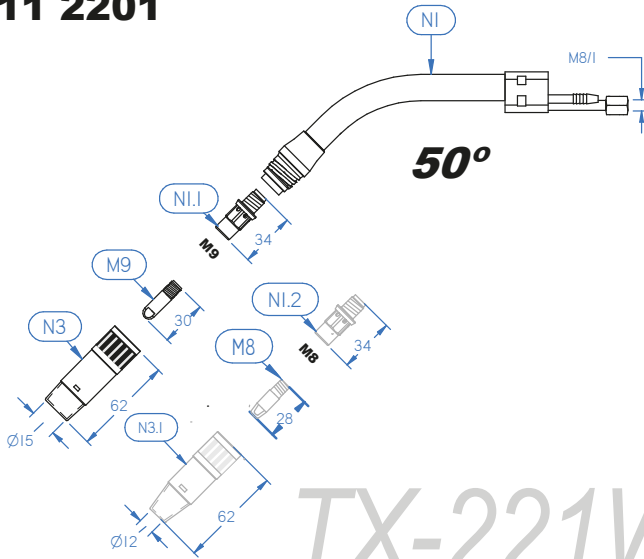

TX-221W

811 2202

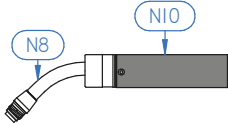

811 2203

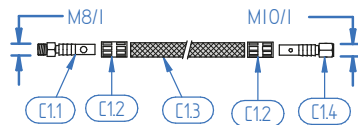
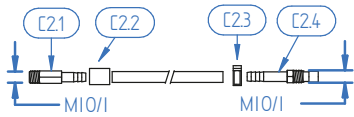
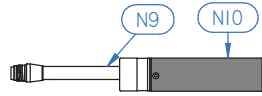

812 0902

812 0906 812 0907

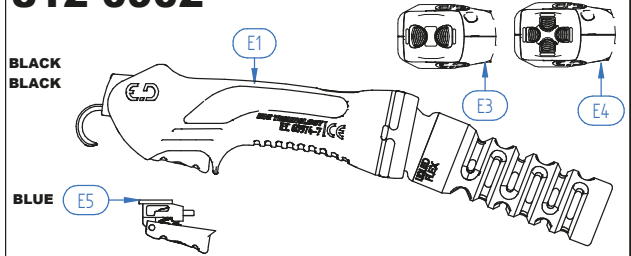

814 0103

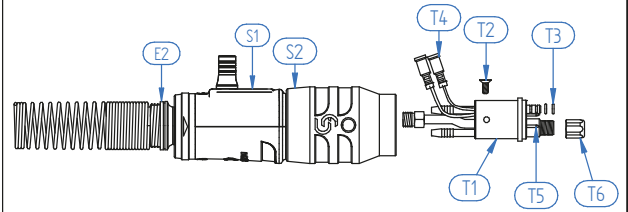

813 1001

813 1002

813 1003

813 1004

813 1005

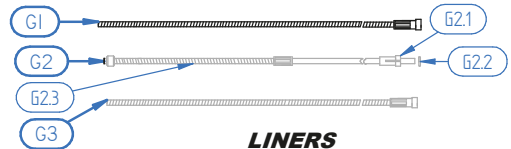
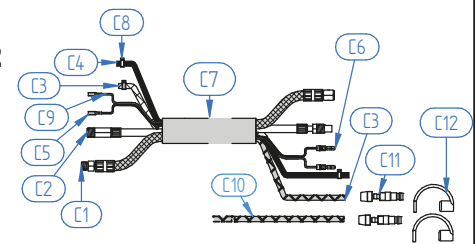

LINERS

POS.	CODE	DESCRIPTION	PACK
G3	145SIN102	NON COATED BRONZE LINER INOX. 0.6-0.8MM. 2.5MTS.	1
G3	145SIN103	NON COATED BRONZE LINER INOX. 0.6-0.8MM. 3.5MTS.	1
G3	145SIN104	NON COATED BRONZE LINER INOX. 0.6-0.8MM. 4.5MTS.	1
G3	145SIN105	NON COATED BRONZE LINER INOX. 0.6-0.8MM. 5.5MTS.	1
G3	145SIN202	NON COATED BRONZE LINER INOX. 1.0-1.2MM. 2.5MTS.	1
G3	145SIN203	NON COATED BRONZE LINER INOX. 1.0-1.2MM. 3.5MTS.	1
G3	145SIN204	NON COATED BRONZE LINER INOX. 1.0-1.2MM. 4.5MTS.	1
G3	145SIN205	NON COATED BRONZE LINER INOX. 1.0-1.2MM. 5.5MTS.	1
G3	145SIN302	NON COATED BRONZE LINER INOX. 1.6MM. 2.5MTS.	1
G3	145SIN303	NON COATED BRONZE LINER INOX. 1.6MM. 3.5MTS.	1
G3	145SIN304	NON COATED BRONZE LINER INOX. 1.6MM. 4.5MTS.	1
G3	145SIN305	NON COATED BRONZE LINER INOX. 1.6MM. 5.5MTS.	1
C1	145CA01	POWER/WATER CABLE ERGODANI 1.5MTS.	1
C1	145CA02	POWER/WATER CABLE ERGODANI 2MTS.	1
C1	145CA03	POWER/WATER CABLE ERGODANI 3MTS.	1
C1	145CA04	POWER/WATER CABLE ERGODANI 4MTS.	1
C1	145CA05	POWER/WATER CABLE ERGODANI 5MTS.	1
C1.1	5450116	P/W FRONT CONNECTION ERGODANI (16MM2)	5
C1.2	145CA77	P/W SLEEVE ERGODANI (14ID.MM.)	10
C1.3	145CA91	P/W HOSE PVC BLACK 9*13MM.	100
C1.3	145CA93	P/W HOSE RUBBER RED ERGODANI 9*13MM.	20
C1.4	5450216	P/W REAR CONNECTION ERGODANI (16MM2)	5
C2	145CS01	LINER HOSE ERGODANI 1.5MTS.	1
C2	145CS02	LINER HOSE ERGODANI 2MTS.	1
C2	145CS03	LINER HOSE ERGODANI 3MTS.	1
C2	145CS04	LINER HOSE ERGODANI 4MTS.	1
C2	145CS05	LINER HOSE ERGODANI 5MTS.	1
C2.1	145CS88D	L/H FRONT CONNECTION ERGODANI	5
C2.2	145CS77	L/H SLEEVE ERGODANI (10ID.MM.)	10
C2.3	145T105	HOSE CLAMP 10.5	10
C2.4	145CS88T	L/H REAR CONNECTION (2PCS) ERGODANI	5
C3	145TA99F	BRAIDED HOSE PVC BLUE 5*8MM.	100
C3	145TA	BRAIDED HOSE RUBBER BLUE 5*8MM.	20

POS.	CODE	DESCRIPTION	PACK
C4	145TG99	BRAIDED HOSE PVC BLACK 5*8MM.	100
C4	145TN	BRAIDED HOSE RUBBER BLACK 5*8MM.	20
C4	145TG58	HOSE PVC BLACK 5*8MM.	200
C5	199FT01	CABLE FRONT TERMINAL	25
C6	199FT02	CABLE REAR TERMINAL	25
C7	4FN25	NEOPRENE COVER 25*28MM.	20
C8	145T090	HOSE CLAMP 09.0	10
C8	145T095	HOSE CLAMP 09.5	10
C9	145CB	SWITCH CABLE CW	100
C10	145TA99C	BRAIDED HOSE PVC RED 5*8MM.	100
C10	145TR	BRAIDED HOSE RUBBER RED 5*8MM.	20
C11	145TA88	PLUG NIPPLE HOSE 5*8MM.	10
C12	145TA88TA	BLUE COVER HOSE 5*8MM.	10
C12	145TA88TR	RED COVER HOSE 5*8MM.	10
E2	19906W	SPRING & UNIVERSAL JOINT CW ERGODANI	2
S1	1EX924W	CONNECT SUPPORT WITH ALUM.RING EX-221W/421W/EPR-600	1
S2	1EX925	ADAPTOR NUT -BLACK EX-270/380 // CW	1
T1	145MZ	EURO CENTRAL CONNECTOR CW ERGODANI	1
T2	199MZ05	CENTRAL CONNECTOR SCREW	10
T3	199MZ03	CENTRAL CONNECTOR O-RING	10
T4	199FT03	CENTRAL CONNECTOR TERMINAL	25
T5	145MZ04	CENTRAL CONNECT.CONTACT PIN CW ERGODANI	2
T6	199MZ02	LINER FASTENER NUT ERGODANI	10



ERGODANI[®]
Welding Technology Division

ERGODANI

MIG 37

Tx 421w

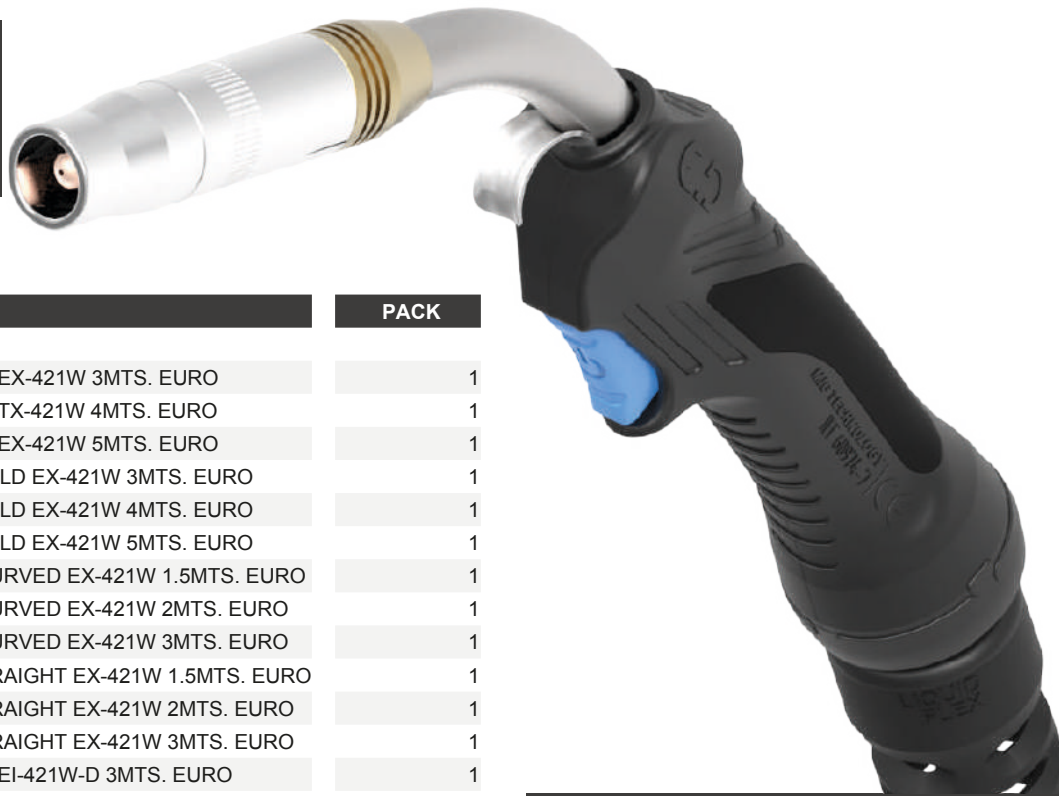

CODE	DESCRIPTION	PACK
1EX42103	TORCH ERGODANI TESLA EX-421W 3MTS. EURO	1
1EX42104	TORCH ERGODANI TESLA TX-421W 4MTS. EURO	1
1EX42105	TORCH ERGODANI TESLA EX-421W 5MTS. EURO	1
1EX42203	TORCH ERGODANI ALUWELD EX-421W 3MTS. EURO	1
1EX42204	TORCH ERGODANI ALUWELD EX-421W 4MTS. EURO	1
1EX42205	TORCH ERGODANI ALUWELD EX-421W 5MTS. EURO	1
1EX42AC01	TORCH AUTOMATIC 45° CURVED EX-421W 1.5MTS. EURO	1
1EX42AC02	TORCH AUTOMATIC 45° CURVED EX-421W 2MTS. EURO	1
1EX42AC03	TORCH AUTOMATIC 45° CURVED EX-421W 3MTS. EURO	1
1EX42AR01	TORCH AUTOMATIC 0° STRAIGHT EX-421W 1.5MTS. EURO	1
1EX42AR02	TORCH AUTOMATIC 0° STRAIGHT EX-421W 2MTS. EURO	1
1EX42AR03	TORCH AUTOMATIC 0° STRAIGHT EX-421W 3MTS. EURO	1
1EID42103	TORCH ERGODANI TESLA EI-421W-D 3MTS. EURO	1
1EID42104	TORCH ERGODANI TESLA EI-421W-D 4MTS. EURO	1
1EID42105	TORCH ERGODANI TESLA EI-421W-D 5MTS. EURO	1
1EID42203	TORCH ERGODANI ALUWELD EI-421W-D 3MTS. EURO	1
1EID42204	TORCH ERGODANI ALUWELD EI-421W-D 4MTS. EURO	1
1EID42205	TORCH ERGODANI ALUWELD EI-421W-D 5MTS. EURO	1
1EII42103	TORCH ERGODANI TESLA EI-421W-I 3MTS. EURO	1
1EII42104	TORCH ERGODANI TESLA EI-421W-I 4MTS. EURO	1
1EII42105	TORCH ERGODANI TESLA EI-421W-I 5MTS. EURO	1
1EII42203	TORCH ERGODANI ALUWELD EI-421W-I 3MTS. EURO	1
1EII42204	TORCH ERGODANI ALUWELD EI-421W-I 4MTS. EURO	1
1EII42205	TORCH ERGODANI ALUWELD EI-421W-I 5MTS. EURO	1

Tx 421w

Liquid Cooled

500 Amp 100% CO₂
450 Amp 100% Ar + CO₂

Liquid cooled torch designed for high amperage versatile welding, including pulsed arc welding. Thanks to the liquid cooled system it can reach more power than its gas cooled equivalent the Tesla Ex-380.

Torch for the professional sector with longer duration replacements.

Threaded nozzle, over-sized M9 contact tip or special insulation are only some of its advantages.



POS.	CODE	DESCRIPTION	PACK
N1	1EX4201	SWAN NECK EX-421W	1
N1.1	1EX3802	CONTACT TIP HOLDER EX-380/421W M/9*38MM.	10
N1.2	1EX3802M8	CONTACT TIP HOLDER EX-380/421W M/8*38MM.	10
N3	1EX3804	STANDARD NOZZLE EX-380/421W - 16MM.	5
N3.1	1EX380402	CONICAL NOZZLE EX-380/421W - 13MM.	5
N8	1EX4201AC	45° CURVED AUTOMATIC SWAN NECK EX-421W	1
N9	1EX4201AR	0° STRAIGHT AUTOMATIC NECK EX-421W	1
N10	199EPAT	AUTOMATIC TORCHES HANDLE ERGODANI	1
M9	1EX9P08	EX-LONG CONTACT TIP M/9*34 - 0.8MM. CU.AG.	25
M9	1EX9P10	EX-LONG CONTACT TIP M/9*34 - 1.0MM. CU.AG.	25
M9	1EX9P12	EX-LONG CONTACT TIP M/9*34 - 1.2MM. CU.AG.	25
M9	1EX9P14	EX-LONG CONTACT TIP M/9*34 - 1.4MM. CU.AG.	25
M9	1EX9P16	EX-LONG CONTACT TIP M/9*34 - 1.6MM. CU.AG.	25
M9	1EX9P24	EX-LONG CONTACT TIP M/9*34 - 2.4MM. CU.AG.	25
M9	1EX9P08A	EX-LONG CONTACT TIP ALUWELD M/9*34 - 0.8MM. CU.AG.	25
M9	1EX9P10A	EX-LONG CONTACT TIP ALUWELD M/9*34 - 1.0MM. CU.AG.	25
M9	1EX9P12A	EX-LONG CONTACT TIP ALUWELD M/9*34 - 1.2MM. CU.AG.	25
M9	1EX9P16A	EX-LONG CONTACT TIP ALUWELD M/9*34 - 1.6MM. CU.AG.	25

811 4201

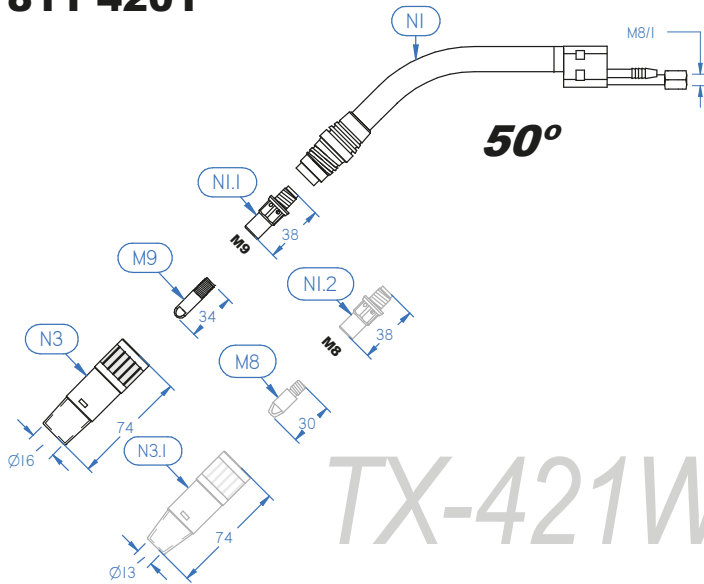

812 0902

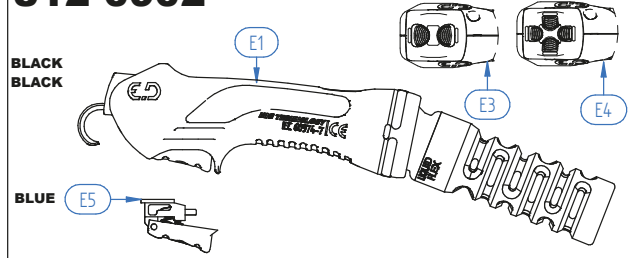

812 0906 812 0907

814 0103

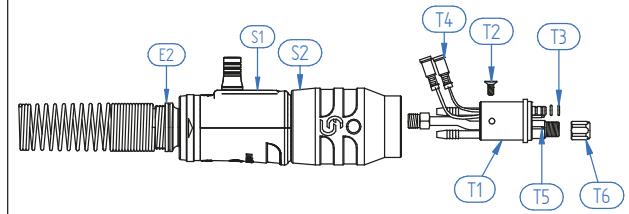

813 1001

813 1002

813 1003

813 1004

813 1005

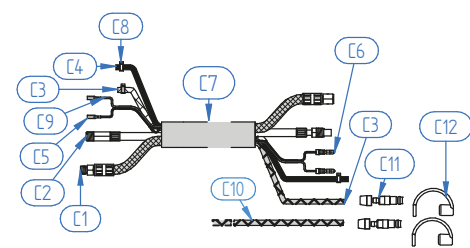

811 4202

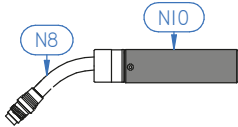

811 4203

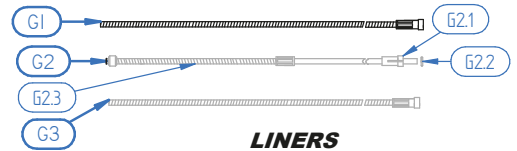
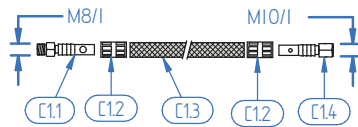
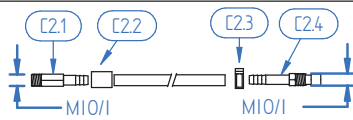
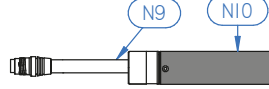

POS.	CODE	DESCRIPTION	PACK
M8	199M808	ERGODANI CONTACT TIP M/8*30 - 0.8MM. CU.	25
M8	199M810	ERGODANI CONTACT TIP M/8*30 - 1.0MM. CU.	25
M8	199M812	ERGODANI CONTACT TIP M/8*30 - 1.2MM. CU.	25
M8	199M814	ERGODANI CONTACT TIP M/8*30 - 1.4MM. CU.	25
M8	199M816	ERGODANI CONTACT TIP M/8*30 - 1.6MM. CU.	25
M8	199M818	ERGODANI CONTACT TIP M/8*30 - 1.8MM. CU.	25
M8	199M824	ERGODANI CONTACT TIP M/8*30 - 2.4MM. CU.	25
M8	199M808A	ERGODANI CONTACT TIP M/8*30 - AL0.8MM. CU.	25
M8	199M810A	ERGODANI CONTACT TIP M/8*30 - AL1.0MM. CU.	25
M8	199M812A	ERGODANI CONTACT TIP M/8*30 - AL1.2MM. CU.	25
M8	199M816A	ERGODANI CONTACT TIP M/8*30 - AL1.6MM. CU.	25
M8	199M808C	ERGODANI CONTACT TIP CHROME M/8*30 - 0.8MM. CU.	25
M8	199M810C	ERGODANI CONTACT TIP CHROME M/8*30 - 1.0MM. CU.	25
M8	199M812C	ERGODANI CONTACT TIP CHROME M/8*30 - 1.2MM. CU.	25
M8	199M814C	ERGODANI CONTACT TIP CHROME M/8*30 - 1.4MM. CU.	25
M8	199M816C	ERGODANI CONTACT TIP CHROME M/8*30 - 1.6MM. CU.	25
M8	199M808N	CONTACT TIP M/8*30 - 0.8MM. CU.	25
M8	199M810N	CONTACT TIP M/8*30 - 1.0MM. CU.	25
M8	199M812N	CONTACT TIP M/8*30 - 1.2MM. CU.	25
M8	199M814N	CONTACT TIP M/8*30 - 1.4MM. CU.	25
M8	199M816N	CONTACT TIP M/8*30 - 1.6MM. CU.	25
M8	199M808Z	ERGODANI CONTACT TIP M/8*30 - 0.8MM. CU.CR.ZR.	25
M8	199M810Z	ERGODANI CONTACT TIP M/8*30 - 1.0MM. CU.CR.ZR.	25
M8	199M812Z	ERGODANI CONTACT TIP M/8*30 - 1.2MM. CU.CR.ZR.	25
M8	199M814Z	ERGODANI CONTACT TIP M/8*30 - 1.4MM. CU.CR.ZR.	25
M8	199M816Z	ERGODANI CONTACT TIP M/8*30 - 1.6MM. CU.CR.ZR.	25
M8	199M808ZN	CONTACT TIP M/8*30 - 0.8MM. CU.CR.ZR.	25
M8	199M810ZN	CONTACT TIP M/8*30 - 1.0MM. CU.CR.ZR.	25
M8	199M812ZN	CONTACT TIP M/8*30 - 1.2MM. CU.CR.ZR.	25
M8	199M814ZN	CONTACT TIP M/8*30 - 1.4MM. CU.CR.ZR.	25
M8	199M816ZN	CONTACT TIP M/8*30 - 1.6MM. CU.CR.ZR.	25



811 4201

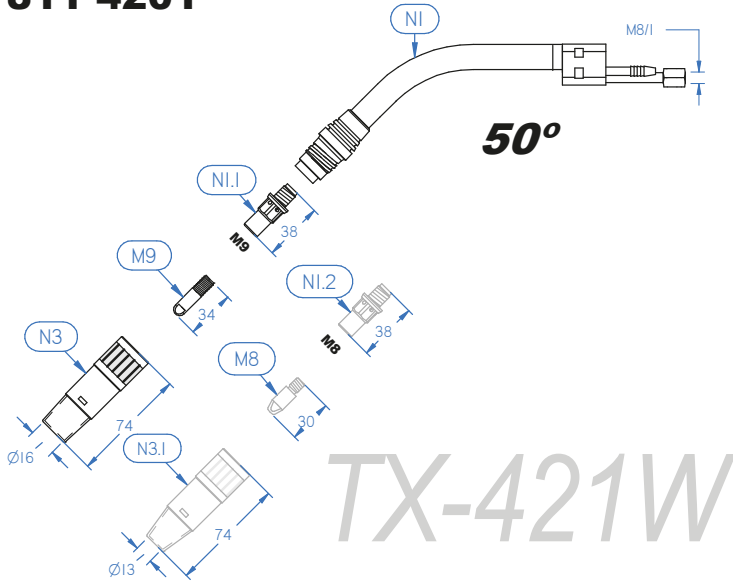

TX-421W

811 4202

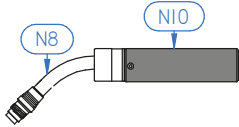

811 4203

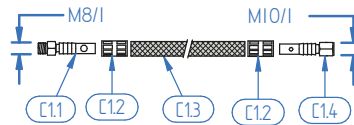
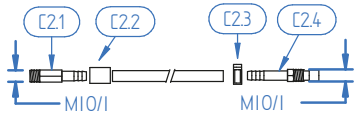
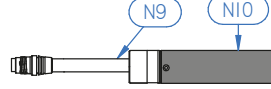

812 0902

812 0906 812 0907

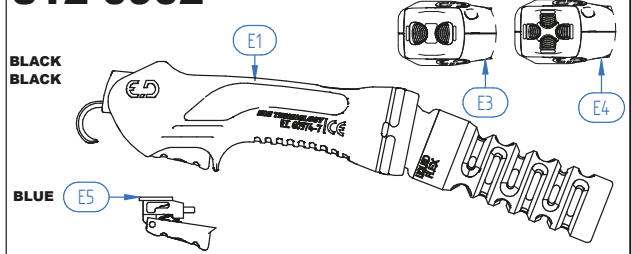

814 0103

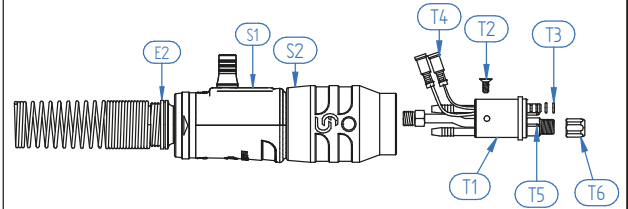

813 1001

813 1002

813 1003

813 1004

813 1005

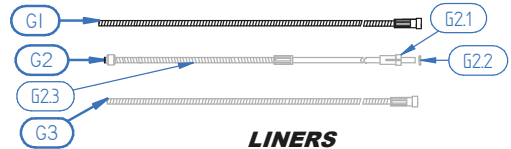
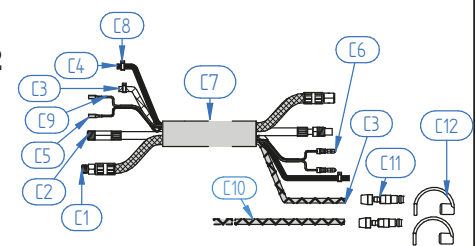

LINERS

POS.	CODE	DESCRIPTION	PACK
E1	1EX9EP	PRO.TESLA HANDLE NEGRO-NEGRO AGUA	1
E2	19906W	SPRING & UNIVERSAL JOINT CW ERGODANI	2
E5	199TS01	BLUE TRIGGER TESLA	5
E3	1EIP9EP	BLACK HANDLE W.ALUMINIUM RING ERGODANI EI-P	1
E3.1	1EIP9EP1	REGULATION CIRCUIT ERGODANI EI-P	1
E4	1EID9EP	BLACK HANDLE W.ALUMINIUM RING ERGODANI EI-D	1
E4.1	1EID9EP1	REGULATION CIRCUIT ERGODANI EI-D	1
(*)	1EII9EP	BLACK HANDLE W.ALUMINIUM RING ERGODANI EI-I	1
G1	199SR02A	BLUE COATED LINER ERGODANI 0.6-0.8MM. 2.40MTS.	1
G1	199SR03A	BLUE COATED LINER ERGODANI 0.6-0.8MM. 3.40MTS.	1
G1	199SR04A	BLUE COATED LINER ERGODANI 0.6-0.8MM. 4.40MTS.	1
G1	199SR05A	BLUE COATED LINER ERGODANI 0.6-0.8MM. 5.40MTS.	1
G1	145SR02	NON COATED LINER ERGODANI 1.0-1.6MM. 2.5MTS.	1
G1	145SR03	NON COATED LINER ERGODANI 1.0-1.6MM. 3.5MTS.	1
G1	145SR04	NON COATED LINER ERGODANI 1.0-1.6MM. 4.5MTS.	1
G1	145SR05	NON COATED LINER ERGODANI 1.0-1.6MM. 5.5MTS.	1
G1	199SR02V	GREEN COATED LINER ERGODANI 2.4MM. 2.40MTS.	1
G1	199SR03V	GREEN COATED LINER ERGODANI 2.4MM. 3.40MTS.	1
G1	199SR04V	GREEN COATED LINER ERGODANI 2.4MM. 4.40MTS.	1
G1	199SR05V	GREEN COATED LINER ERGODANI 2.4MM. 5.40MTS.	1
G2	199SA302	ALUWELD LINER ERGODANI 0.8-1.0MM. 2.50MTS.	1
G2	199SA303	ALUWELD LINER ERGODANI 0.8-1.0MM. 3.50MTS.	1
G2	199SA304	ALUWELD LINER ERGODANI 0.8-1.0MM. 4.50MTS.	1
G2	199SA305	ALUWELD LINER ERGODANI 0.8-1.0MM. 5.50MTS.	1
G2	199SA402	ALUWELD LINER ERGODANI 1.2-1.6MM. 2.50MTS.	1
G2	199SA403	ALUWELD LINER ERGODANI 1.2-1.6MM. 3.50MTS.	1
G2	199SA404	ALUWELD LINER ERGODANI 1.2-1.6MM. 4.50MTS.	1
G2	199SA405	ALUWELD LINER ERGODANI 1.2-1.6MM. 5.50MTS.	1
G2.1	199SA88	COLLET LINER ALUWED/ALUM.	10
G2.2	199SA77	LINER O-RING ALUWED/ALUM.	10
G2.3	199SA3G	ALUWELD NECK-LINER ERGODANI 0.8-1.0MM.	2
G2.3	199SA4G	ALUWELD NECK-LINER ERGODANI 1.2-1.6MM.	2

POS.	CODE	DESCRIPTION	PACK
G3	145SIN102	NON COATED BRONZE LINER INOX. 0.6-0.8MM. 2.5MTS.	1
G3	145SIN103	NON COATED BRONZE LINER INOX. 0.6-0.8MM. 3.5MTS.	1
G3	145SIN104	NON COATED BRONZE LINER INOX. 0.6-0.8MM. 4.5MTS.	1
G3	145SIN105	NON COATED BRONZE LINER INOX. 0.6-0.8MM. 5.5MTS.	1
G3	145SIN202	NON COATED BRONZE LINER INOX. 1.0-1.2MM. 2.5MTS.	1
G3	145SIN203	NON COATED BRONZE LINER INOX. 1.0-1.2MM. 3.5MTS.	1
G3	145SIN204	NON COATED BRONZE LINER INOX. 1.0-1.2MM. 4.5MTS.	1
G3	145SIN205	NON COATED BRONZE LINER INOX. 1.0-1.2MM. 5.5MTS.	1
G3	145SIN302	NON COATED BRONZE LINER INOX. 1.6MM. 2.5MTS.	1
G3	145SIN303	NON COATED BRONZE LINER INOX. 1.6MM. 3.5MTS.	1
G3	145SIN304	NON COATED BRONZE LINER INOX. 1.6MM. 4.5MTS.	1
G3	145SIN305	NON COATED BRONZE LINER INOX. 1.6MM. 5.5MTS.	1
C1	145CA01	POWER/WATER CABLE ERGODANI 1.5MTS.	1
C1	145CA02	POWER/WATER CABLE ERGODANI 2MTS.	1
C1	145CA03	POWER/WATER CABLE ERGODANI 3MTS.	1
C1	145CA04	POWER/WATER CABLE ERGODANI 4MTS.	1
C1	145CA05	POWER/WATER CABLE ERGODANI 5MTS.	1
C1.1	5450116	P/W FRONT CONNECTION ERGODANI (16MM2)	5
C1.2	145CA77	P/W SLEEVE ERGODANI (14ID.MM.)	10
C1.3	145CA91	P/W HOSE PVC BLACK 9*13MM.	100
C1.3	145CA93	P/W HOSE RUBBER RED ERGODANI 9*13MM.	20
C1.4	5450216	P/W REAR CONNECTION ERGODANI (16MM2)	5
C2	145CS01	LINER HOSE ERGODANI 1.5MTS.	1
C2	145CS02	LINER HOSE ERGODANI 2MTS.	1
C2	145CS03	LINER HOSE ERGODANI 3MTS.	1
C2	145CS04	LINER HOSE ERGODANI 4MTS.	1
C2	145CS05	LINER HOSE ERGODANI 5MTS.	1
C2.1	145CS88D	L/H FRONT CONNECTION ERGODANI	5
C2.2	145CS77	L/H SLEEVE ERGODANI (10ID.MM.)	10
C2.3	145T105	HOSE CLAMP 10.5	10
C2.4	145CS88T	L/H REAR CONNECTION (2PCS) ERGODANI	5
C3	145TA99F	BRAIDED HOSE PVC BLUE 5*8MM.	100
C3	145TA	BRAIDED HOSE RUBBER BLUE 5*8MM.	20
C4	145TG99	BRAIDED HOSE PVC BLACK 5*8MM.	100
C4	145TN	BRAIDED HOSE RUBBER BLACK 5*8MM.	20
C4	145TG58	HOSE PVC BLACK 5*8MM.	200
C5	199FT01	CABLE FRONT TERMINAL	25
C6	199FT02	CABLE REAR TERMINAL	25
C7	4FN25	NEOPRENE COVER 25*28MM.	20
C8	145T090	HOSE CLAMP 09.0	10
C8	145T095	HOSE CLAMP 09.5	10
C9	145CB	SWITCH CABLE CW	100
C10	145TA99C	BRAIDED HOSE PVC RED 5*8MM.	100
C10	145TR	BRAIDED HOSE RUBBER RED 5*8MM.	20
C11	145TA88	PLUG NIPPLE HOSE 5*8MM.	10
C12	145TA88TA	BLUE COVER HOSE 5*8MM.	10
C12	145TA88TR	RED COVER HOSE 5*8MM.	10
E2	19906W	SPRING & UNIVERSAL JOINT CW ERGODANI	2
S1	1EX924W	CONNECT SUPPORT WITH ALUM.RING EX-221W/421W/EPR-600	1
S2	1EX925	ADAPTOR NUT -BLACK EX-270/380 // CW	1
T1	145MZ	EURO CENTRAL CONNECTOR CW ERGODANI	1
T2	199MZ05	CENTRAL CONNECTOR SCREW	10
T3	199MZ03	CENTRAL CONNECTOR O-RING	10
T4	199FT03	CENTRAL CONNECTOR TERMINAL	25
T5	145MZ04	CENTRAL CONNECT.CONTACT PIN CW ERGODANI	2
T6	199MZ02	LINER FASTENER NUT ERGODANI	10

NEW RANGE



EUROPEAN QUALITY CONTACT TIPS



DOUBLE CIRCUIT TORCHES



Provides greater contact tip refrigeration and less spatter adherence.

PULSED ARC TORCHES



The correct choice for heavy duty welding operation, such as pulsed arc welding.

The best welding at your fingertips
TESLA



INTELLIGENT REGULATION MODELS



TESLA MIG

PULSER



565 PULSER

550 A

EPR 600

600 A

565 PULSER

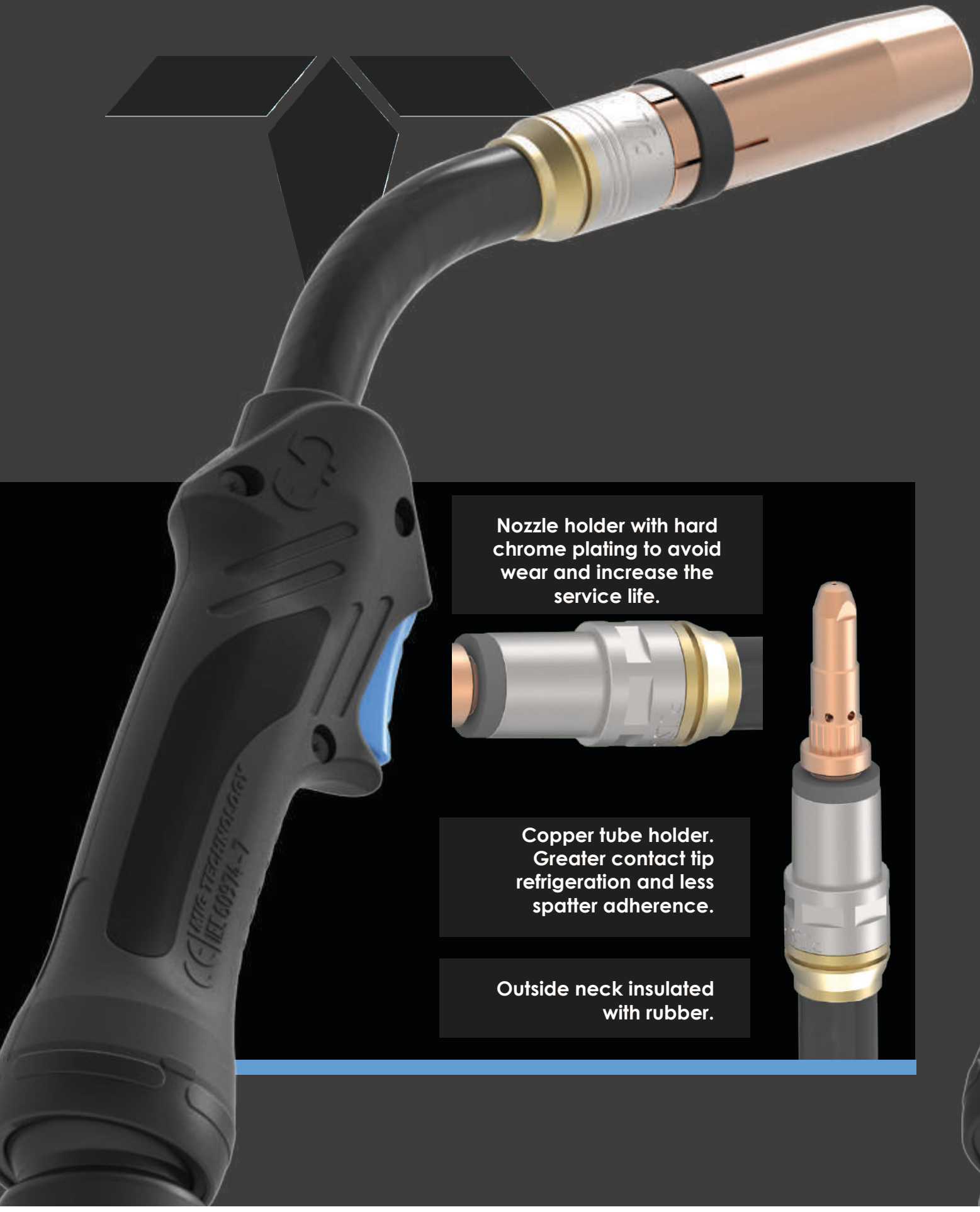

Nozzle holder with hard chrome plating to avoid wear and increase the service life.



Copper tube holder. Greater contact tip refrigeration and less spatter adherence.

Outside neck insulated with rubber.



EPR 600



Robotic spare parts.
M10 x 43mm tip.
Special alloy diffuser.
High conductivity. Tip
cooling system
"Cold pressure"

Insulated neck with rubber to avoid
short circuits.
Threaded nozzle with fin system
Increases the refrigeration
Liquid cooled nozzle holder,
exceptional nozzle and contact tip
lifetime.

565 P



CODE	DESCRIPTION	PACK
157TS102	TORCH ERGODANI LINER ALUMIN 565PULSER 2MTS. EURO	1
157TS103	TORCH ERGODANI TESLA 565PULSER 3MTS. EURO	1
157TS104	TORCH ERGODANI TESLA 565PULSER 4MTS. EURO	1
157TS105	TORCH ERGODANI TESLA 565PULSER 5MTS. EURO	1
157AC01	TORCH AUTOMATIC 45° CURVED 565PULSER 1.5MTS. EURO	1
157AC02	TORCH AUTOMATIC 45° CURVED 565PULSER 2MTS. EURO	1
157AC03	TORCH AUTOMATIC 45° CURVED 565PULSER 3MTS. EURO	1
157AR01	TORCH AUTOMATIC 0° STRAIGHT 565PULSER 1.5MTS. EURO	1
157AR02	TORCH AUTOMATIC 0° STRAIGHT 565PULSER 2MTS. EURO	1
157AR03	TORCH AUTOMATIC 0° STRAIGHT 565PULSER 3MTS. EURO	1
157EID103	TORCH ERGODANI TESLA EPR-565P-EID 3MTS. EURO	1
157EID104	TORCH ERGODANI TESLA EPR-565P-EID 4MTS. EURO	1
157EID105	TORCH ERGODANI TESLA EPR-565P-EID 5MTS. EURO	1
157EII103	TORCH ERGODANI TESLA EPR-600P-EII 3MTS. EURO	1
157EII104	TORCH ERGODANI TESLA EPR-565P-EII 4MTS. EURO	1
157EII105	TORCH ERGODANI TESLA EPR-565P-EII 5MTS. EURO	1

565 P

Liquid Cooled

550 Amp 100% CO₂
490 Amp 100% Ar + CO₂

Professional torch with the revolutionary PULSER cooled system. The evolution of the 561. With double refrigeration circuit. Special for machines with arc pulsed welding.

Improved standard spare parts, with greater tip and nozzle refrigeration. Longer lifetime and more powerful.

Special alloy diffuser: Polyvalence in soft wires like aluminum and CuSi alloys. Increases the refrigeration in the contact tip and reduces the dilatations. Improves the welding thread fluency.

POS.	CODE	DESCRIPTION	PACK
N1	15701	SWAN NECK 565PULSER	1
N1.1	1570101	INSULATOR WASHER NECK 565PULSER	10
N2	15603M8	CONTACT TIP HOLDER 561/565PULSER M/8*25MM.	10
N4	14502	DIFFUSER GAS WHITE EU-501W/561/565PULSER	10
N4.A	14502C	DIFFUSER GAS CERAMIC EU-501W/561/565PULSER	10
N5	14504	STANDARD CONICAL NOZZL.ERGODAN EU-501W/561/565PULSER - 16MM.	5
N5	14504N	STANDARD CONICAL NOZZLE EU-501W/561/565PULSER - 16MM.	5
N6	14504SP	TAPERED NOZZLE EU-501W/561/565PULSER - 14MM.	5
N7	14504CL	CYLINDRICAL NOZZLE EU-501W/561/565PULSER - 19MM.	5
N8	14504BT	BOTTLE NECK NOZZLE EU-501W/561/565PULSER - 15MM.	5
N9	14504PT	SPOT NOZZLE EU-501W/561/565PULSER - 20MM.	5
N10	199EPAT	AUTOMATIC TORCHES HANDLE ERGODANI	1
N11	15701AC	45° CURVED AUTOMATIC SWAN NECK 565PULSER	1
N12	15701AR	0° STRAIGHT AUTOMATIC NECK 565PULSER	1
M8	199M808Z	ERGODANI CONTACT TIP M/8*30 - 0.8MM. CU.CR.ZR.	25
M8	199M810Z	ERGODANI CONTACT TIP M/8*30 - 1.0MM. CU.CR.ZR.	25
M8	199M812Z	ERGODANI CONTACT TIP M/8*30 - 1.2MM. CU.CR.ZR.	25
M8	199M814Z	ERGODANI CONTACT TIP M/8*30 - 1.4MM. CU.CR.ZR.	25
M8	199M816Z	ERGODANI CONTACT TIP M/8*30 - 1.6MM. CU.CR.ZR.	25
M8	199M810X	XTRODE CONTACT TIP M/8*30 - 1.0MM. DSC	10
M8	199M812X	XTRODE CONTACT TIP M/8*30 - 1.2MM. DSC	10
M8	199M816X	XTRODE CONTACT TIP M/8*30 - 1.6MM. DSC	10
E1	812 0902	PRO.TESLA HANDLE NEGRO-NEGRO AGUA	1
E2	19906W	SPRING & UNIVERSAL JOINT CW ERGODANI	2
E3	812 0906	PRO.TESLA HANDLE NEGRO-NEGRO AGUA EI-D	1
E4	812 0907	PRO.TESLA HANDLE NEGRO-NEGRO AGUA EI-I	1
E5	199TS01	BLUE TRIGGER TESLA	5



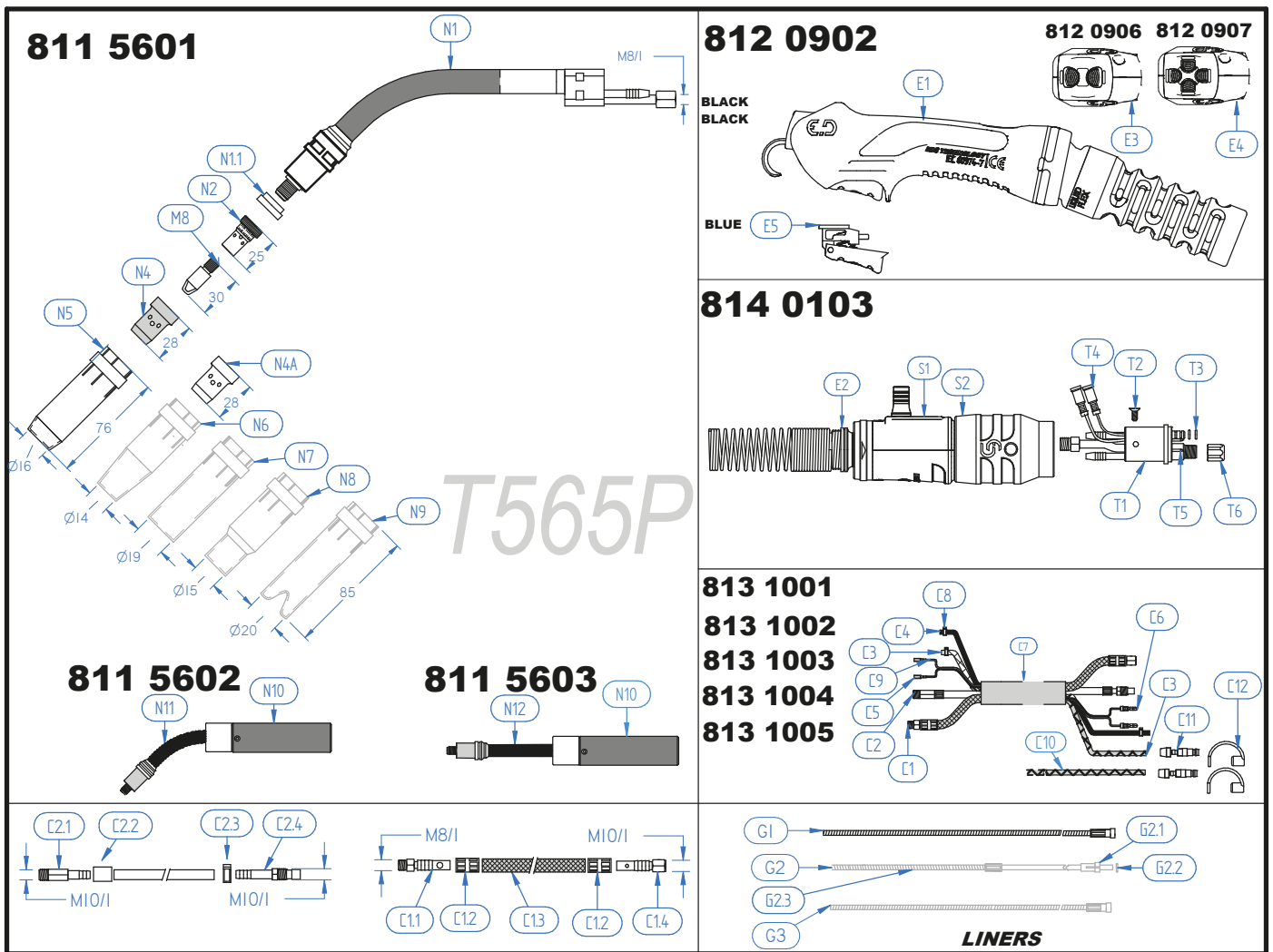

POS.	CODE	DESCRIPTION	PACK
G1	199SR02A	BLUE COATED LINER ERGODANI 0.6-0.8MM. 2.40MTS.	1
G1	199SR03A	BLUE COATED LINER ERGODANI 0.6-0.8MM. 3.40MTS.	1
G1	199SR04A	BLUE COATED LINER ERGODANI 0.6-0.8MM. 4.40MTS.	1
G1	199SR05A	BLUE COATED LINER ERGODANI 0.6-0.8MM. 5.40MTS.	1
G1	145SR02	NON COATED LINER ERGODANI 1.0-1.6MM. 2.5MTS.	1
G1	145SR03	NON COATED LINER ERGODANI 1.0-1.6MM. 3.5MTS.	1
G1	145SR04	NON COATED LINER ERGODANI 1.0-1.6MM. 4.5MTS.	1
G1	145SR05	NON COATED LINER ERGODANI 1.0-1.6MM. 5.5MTS.	1
G1	199SR02V	GREEN COATED LINER ERGODANI 2.4MM. 2.40MTS.	1
G1	199SR03V	GREEN COATED LINER ERGODANI 2.4MM. 3.40MTS.	1
G1	199SR04V	GREEN COATED LINER ERGODANI 2.4MM. 4.40MTS.	1
G1	199SR05V	GREEN COATED LINER ERGODANI 2.4MM. 5.40MTS.	1
G2	199SA102	ALUMINIUM WIRE LINER 0.8-1.0MM. 2MTS.	1
G2	199SA103	ALUMINIUM WIRE LINER 0.8-1.0MM. 3MTS.	1
G2	199SA104	ALUMINIUM WIRE LINER 0.8-1.0MM. 4MTS.	1
G2	199SA105	ALUMINIUM WIRE LINER 0.8-1.0MM. 5MTS.	1
G2	199SA202	ALUMINIUM WIRE LINER 1.2-1.6MM. 2MTS.	1
G2	199SA203	ALUMINIUM WIRE LINER 1.2-1.6MM. 3MTS.	1
G2	199SA204	ALUMINIUM WIRE LINER 1.2-1.6MM. 4MTS.	1
G2	199SA205	ALUMINIUM WIRE LINER 1.2-1.6MM. 5MTS.	1
G2.1	199SA88	COLLET LINER ALUWED/ALUM.	10
G2.2	199SA77	LINER O-RING ALUWED/ALUM.	10
G2.3	199SA1G	ALUMINIUM WIRE NECK-LINER 0.8-1.0MM.	2
G2.3	199SA2G	ALUMINIUM WIRE NECK-LINER 1.2-1.6MM.	2



**ALSO AVAILABLE
AUTOMATIC NECK.**



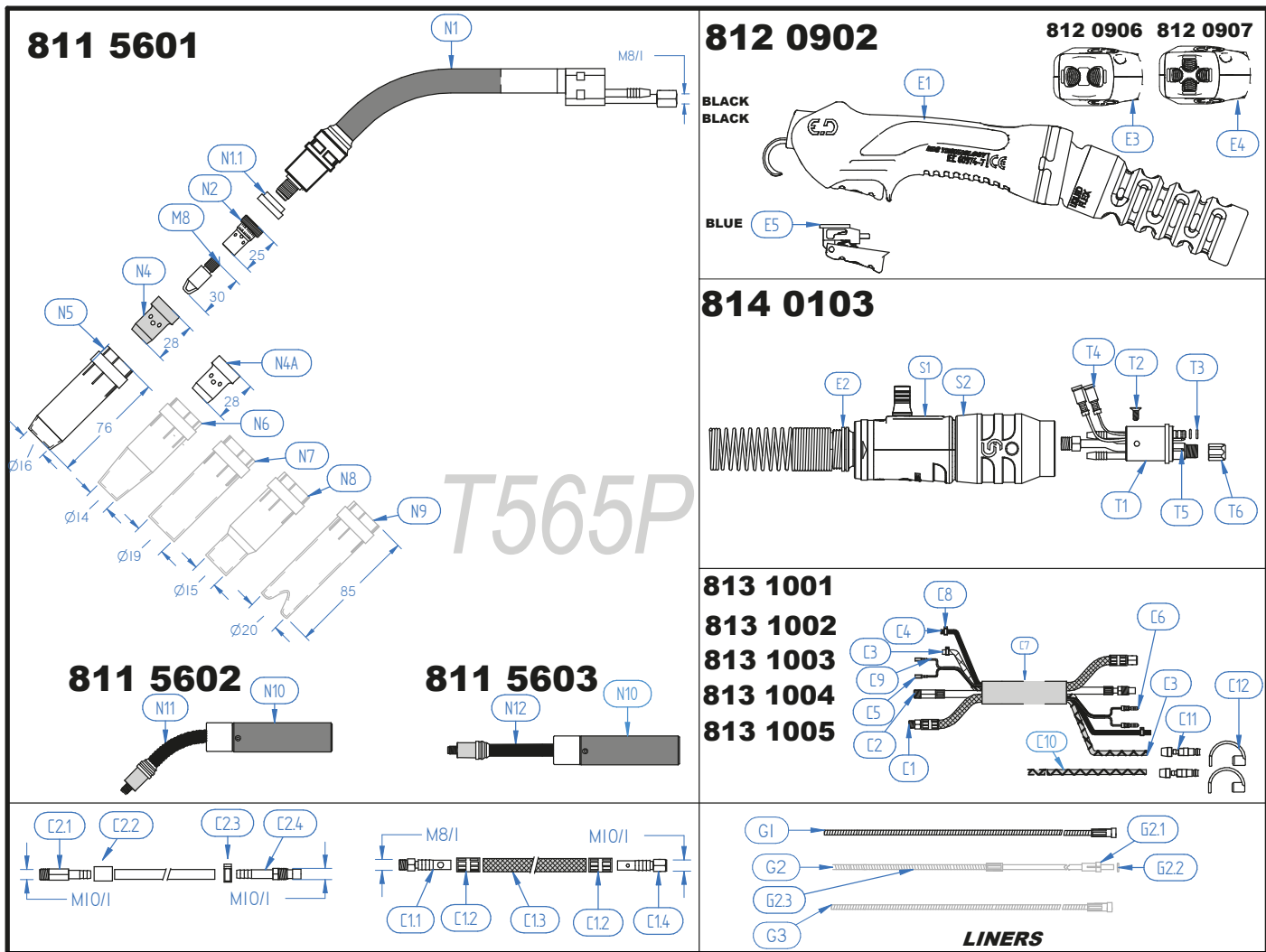

POS.	CODE	DESCRIPTION	PACK
G3	145SIN102	NON COATED BRONZE LINER INOX. 0.6-0.8MM. 2.5MTS.	1
G3	145SIN103	NON COATED BRONZE LINER INOX. 0.6-0.8MM. 3.5MTS.	1
G3	145SIN104	NON COATED BRONZE LINER INOX. 0.6-0.8MM. 4.5MTS.	1
G3	145SIN105	NON COATED BRONZE LINER INOX. 0.6-0.8MM. 5.5MTS.	1
G3	145SIN202	NON COATED BRONZE LINER INOX. 1.0-1.2MM. 2.5MTS.	1
G3	145SIN203	NON COATED BRONZE LINER INOX. 1.0-1.2MM. 3.5MTS.	1
G3	145SIN204	NON COATED BRONZE LINER INOX. 1.0-1.2MM. 4.5MTS.	1
G3	145SIN205	NON COATED BRONZE LINER INOX. 1.0-1.2MM. 5.5MTS.	1
G3	145SIN302	NON COATED BRONZE LINER INOX. 1.6MM. 2.5MTS.	1
G3	145SIN303	NON COATED BRONZE LINER INOX. 1.6MM. 3.5MTS.	1
G3	145SIN304	NON COATED BRONZE LINER INOX. 1.6MM. 4.5MTS.	1
G3	145SIN305	NON COATED BRONZE LINER INOX. 1.6MM. 5.5MTS.	1
C1	145CA01	POWER/WATER CABLE ERGODANI 1.5MTS.	1
C1	145CA02	POWER/WATER CABLE ERGODANI 2MTS.	1
C1	145CA03	POWER/WATER CABLE ERGODANI 3MTS.	1
C1	145CA04	POWER/WATER CABLE ERGODANI 4MTS.	1
C1	145CA05	POWER/WATER CABLE ERGODANI 5MTS.	1
C1.1	5450116	P/W FRONT CONNECTION ERGODANI (16MM2)	5
C1.2	145CA77	P/W SLEEVE ERGODANI (14ID.MM.)	10
C1.3	145CA91	P/W HOSE PVC BLACK 9*13MM.	100
C1.3	145CA93	P/W HOSE RUBBER RED ERGODANI 9*13MM.	20
C1.4	5450216	P/W REAR CONNECTION ERGODANI (16MM2)	5
C2	145CS01	POWER/WATER CABLE ERGODANI 1.5MTS.	1
C2	145CS02	POWER/WATER CABLE ERGODANI 2MTS.	1
C2	145CS03	POWER/WATER CABLE ERGODANI 3MTS.	1
C2	145CS04	POWER/WATER CABLE ERGODANI 4MTS.	1
C2	145CS05	POWER/WATER CABLE ERGODANI 5MTS.	1
C2.1	145CS88D	L/H FRONT CONNECTION ERGODANI	5
C2.2	145CS77	L/H SLEEVE ERGODANI (10ID.MM.)	10
C2.3	145T105	HOSE CLAMP 10.5	10
C2.4	145CS88T	L/H REAR CONNECTION (2PCS) ERGODANI	5

POS.	CODE	DESCRIPTION	PACK
C3	145TA99F	BRAIDED HOSE PVC BLUE 5*8MM.	100
C3	145TA	BRAIDED HOSE RUBBER BLUE 5*8MM.	20
C4	145TG99	BRAIDED HOSE PVC BLACK 5*8MM.	100
C4	145TN	BRAIDED HOSE RUBBER BLACK 5*8MM.	20
C4	145TG58	HOSE PVC BLACK 5*8MM.	200
C5	199FT01	CABLE FRONT TERMINAL	25
C6	199FT02	CABLE REAR TERMINAL	25
C7	4FN25	NEOPRENE COVER 25*28MM.	20
C8	145T090	HOSE CLAMP 09.0	10
C8	145T095	HOSE CLAMP 09.5	10
C9	145CB	SWITCH CABLE CW	100
C10	145TA99C	BRAIDED HOSE PVC RED 5*8MM.	100
C10	145TR	BRAIDED HOSE RUBBER RED 5*8MM.	20
C11	145TA88	PLUG NIPPLE HOSE 5*8MM.	10
C12	145TA88TA	BLUE COVER HOSE 5*8MM.	10
C12	145TA88TR	RED COVER HOSE 5*8MM.	10
E2	19906W	SPRING & UNIVERSAL JOINT CW ERGODANI	2
S1	1EN924W	CONNECT SUPPORT W. BLACK RING EN-240W/501W/561PULSER	1
S2	1EX925	ADAPTOR NUT -BLACK EX-270/380 // CW	1
T1	145MZ	EURO CENTRAL CONNECTOR CW ERGODANI	1
T2	199MZ05	CENTRAL CONNECTOR SCREW	10
T3	199MZ03	CENTRAL CONNECTOR O-RING	10
T4	199FT03	CENTRAL CONNECTOR TERMINAL	25
T5	145MZ04	CENTRAL CONNECT.CONTACT PIN CW ERGODANI	2
T6	199MZ02	LINER FASTENER NUT ERGODANI	10



ERGODANI[®]
Welding Technology Division

EPR 600



CODE	DESCRIPTION	PACK
160TS103	TORCH ERGODANI TESLA EPR-600P 3MTS. EURO	1
160TS104	TORCH ERGODANI TESLA EPR-600P 4MTS. EURO	1
160TS105	TORCH ERGODANI TESLA EPR-600P 5MTS. EURO	1
160AC01	TORCH AUTOMATIC 45° CURVED EPR-600P 1.5MTS. EURO	1
160AC02	TORCH AUTOMATIC 45° CURVED EPR-600P 2MTS. EURO	1
160AC03	TORCH AUTOMATIC 45° CURVED EPR-600P 3MTS. EURO	1
160AR01	TORCH AUTOMATIC 0° STRAIGHT EPR-600P 1.5MTS. EURO	1
160AR02	TORCH AUTOMATIC 0° STRAIGHT EPR-600P 2MTS. EURO	1
160AR03	TORCH AUTOMATIC 0° STRAIGHT EPR-600P 3MTS. EURO	1
160EID103	TORCH ERGODANI TESLA EPR-600P-EID 3MTS. EURO	1
160EID104	TORCH ERGODANI TESLA EPR-600P-EID 4MTS. EURO	1
160EID105	TORCH ERGODANI TESLA EPR-600P-EID 5MTS. EURO	1
160EII103	TORCH ERGODANI TESLA EPR-600P-EII 3MTS. EURO	1
160EII104	TORCH ERGODANI TESLA EPR-600P-EII 4MTS. EURO	1
160EII105	TORCH ERGODANI TESLA EPR-600P-EII 5MTS. EURO	1

POS.	CODE	DESCRIPTION	PACK
N1	16001	SWAN NECK EPR-600P	1
N2	1600101	INSULATOR WASHER NECK EPR-600	10
N3	16002	CONTACT TIP HOLDER EPR-600 M/10*26MM.	10
N4	16004	PIPELINE CONTACT TIP HOLDER EPR 600 M/8*34 MM.	10
N3.1	1600203	STANDARD NOZZLE EPR-600 - 16MM.	5
N10	199EPAT	AUTOMATIC TORCHES HANDLE ERGODANI	1
N11	16001AC	45° CURVED AUTOMATIC SWAN NECK EPR-600P 0°	1
N12	16001AR	STRAIGHT AUTOMATIC NECK EPR-600P	1
M10	160M108	EXR CONTACT TIP M/10*43 - 0.8MM. CU.CR.ZR. EXR	10
M10	160M109	CONTACT TIP M/10*43 - 0.9MM. CU.CR.ZR. EXR	10
M10	160M110	CONTACT TIP M/10*43 - 1.0MM. CU.CR.ZR. EXR	10
M10	160M112	CONTACT TIP M/10*43 - 1.2MM. CU.CR.ZR. EXR	10
M10	160M114	CONTACT TIP M/10*43 - 1.4MM. CU.CR.ZR. EXR	10
M10	160M116	CONTACT TIP M/10*43 - 1.6MM. CU.CR.ZR. EXR	10
M10	160M124	CONTACT TIP M/10*43 - 2.4MM. CU.CR.ZR.	10
M8	160M806	CONTACT TIP M/8*36 0.6 CU.	10
M8	160M808	CONTACT TIP M/8*36 0.8 CU.	10
M8	160M809	CONTACT TIP M/8*36 0.9 CU.	10
M8	160M810	CONTACT TIP M/8*36 1.0 CU.	10
M8	160M812	CONTACT TIP M/8*36 1.2 CU.	10
M8	160M814	CONTACT TIP M/8*36 1.4 CU.	10
M8	160M816	CONTACT TIP M/8*36 1.6 CU.	10
E1	812 0902	PRO.TESLA HANDLE NEGRO-NEGRO AGUA SPRING	1
E2	19906W	& UNIVERSAL JOINT CW ERGODANI	2
E3	812 0906	PRO.TESLA HANDLE NEGRO-NEGRO AGUA EI-D	1
E4	812 0907	PRO.TESLA HANDLE NEGRO-NEGRO AGUA EI-I BLUE	1
E5	199TS01	TRIGGER TESLA	5
G1	199SR02A	BLUE COATED LINER ERGODANI 0.6-0.8MM. 2.40MTS.	1
G1	199SR03A	BLUE COATED LINER ERGODANI 0.6-0.8MM. 3.40MTS.	1
G1	199SR04A	BLUE COATED LINER ERGODANI 0.6-0.8MM. 4.40MTS.	1
G1	199SR05A	BLUE COATED LINER ERGODANI 0.6-0.8MM. 5.40MTS.	1
G1	145SR02	NON COATED LINER ERGODANI 1.0-1.6MM. 2.5MTS.	1
G1	145SR03	NON COATED LINER ERGODANI 1.0-1.6MM. 3.5MTS.	1
G1	145SR04	NON COATED LINER ERGODANI 1.0-1.6MM. 4.5MTS.	1
G1	145SR05	NON COATED LINER ERGODANI 1.0-1.6MM. 5.5MTS.	1
G1	199SR02V	GREEN COATED LINER ERGODANI 2.4MM. 2.40MTS.	1
G1	199SR03V	GREEN COATED LINER ERGODANI 2.4MM. 3.40MTS.	1
G1	199SR04V	GREEN COATED LINER ERGODANI 2.4MM. 4.40MTS.	1
G1	199SR05V	GREEN COATED LINER ERGODANI 2.4MM. 5.40MTS.	1

EPR 600

Liquid Cooled

600 Amp

100% CO₂

525 Amp

100% Ar + CO₂

Double liquid cooled refrigeration circuit in the nozzle holder and contact tip.

This model uses replacements of torches intended for robotic welding where work cycles are of 24 hours. Applying this technology, we get a superior replacement duration and welding cycle than other torches.

Powerful cooling in the contact tip:

Polyvalence in both soft threads, aluminum and CuSi alloys. Improves the welding thread fluency.



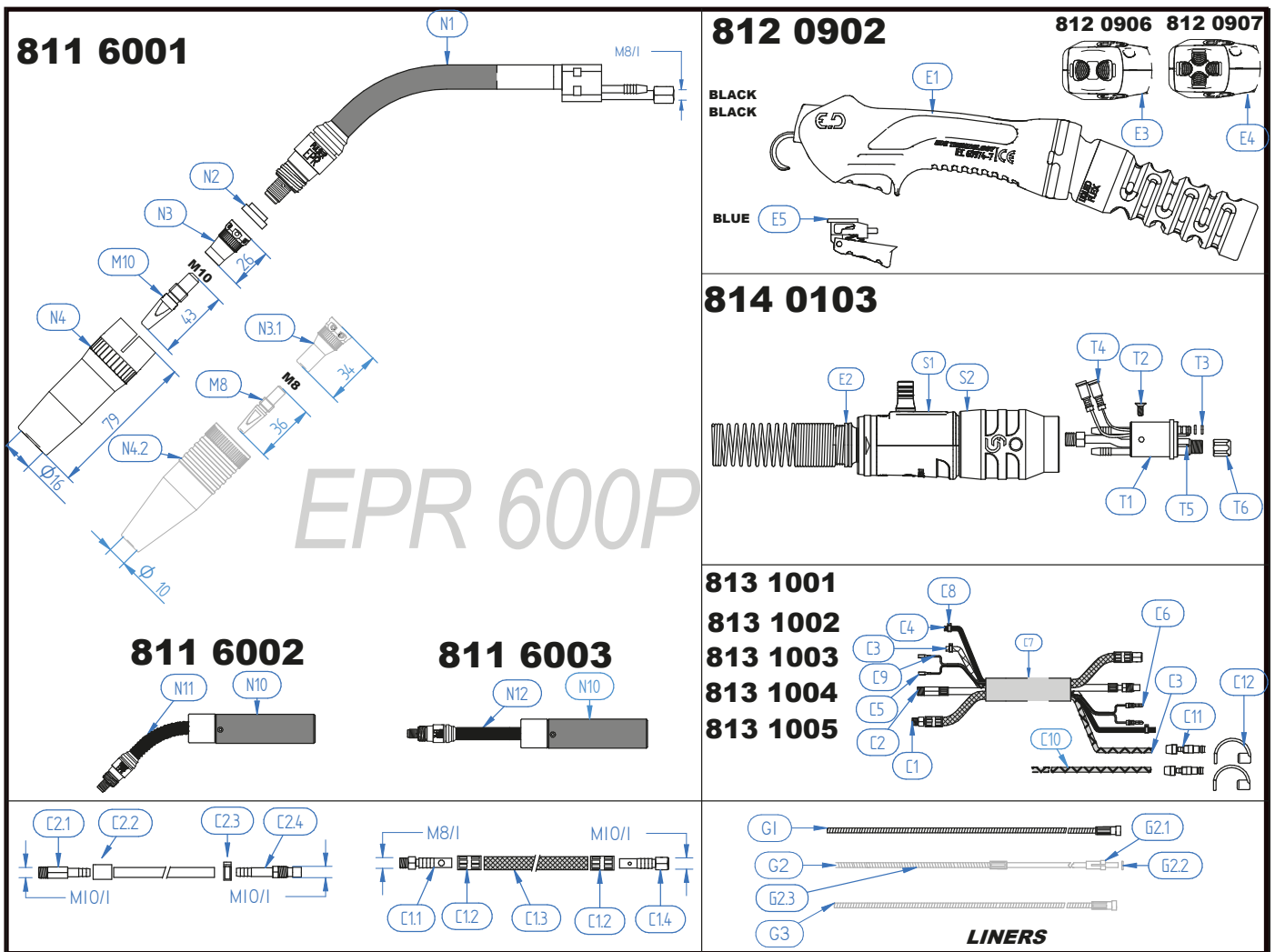

POS.	CODE	DESCRIPTION	PACK
G2	199SA102	ALUMINIUM WIRE LINER 0.8-1.0MM. 2MTS.	1
G2	199SA103	ALUMINIUM WIRE LINER 0.8-1.0MM. 3MTS.	1
G2	199SA104	ALUMINIUM WIRE LINER 0.8-1.0MM. 4MTS.	1
G2	199SA105	ALUMINIUM WIRE LINER 0.8-1.0MM. 5MTS.	1
G2	199SA202	ALUMINIUM WIRE LINER 1.2-1.6MM. 2MTS.	1
G2	199SA203	ALUMINIUM WIRE LINER 1.2-1.6MM. 3MTS.	1
G2	199SA204	ALUMINIUM WIRE LINER 1.2-1.6MM. 4MTS.	1
G2	199SA205	ALUMINIUM WIRE LINER 1.2-1.6MM. 5MTS.	1
G2.1	199SA88	COLLET LINER ALUWED/ALUM.	10
G2.2	199SA77	LINER O-RING ALUWED/ALUM.	10
G2.3	199SA1G	ALUMINIUM WIRE NECK-LINER 0.8-1.0MM.	2
G2.3	199SA2G	ALUMINIUM WIRE NECK-LINER 1.2-1.6MM.	2
G3	145SIN102	NON COATED BRONZE LINER INOX. 0.6-0.8MM. 2.5MTS.	1
G3	145SIN103	NON COATED BRONZE LINER INOX. 0.6-0.8MM. 3.5MTS.	1
G3	145SIN104	NON COATED BRONZE LINER INOX. 0.6-0.8MM. 4.5MTS.	1
G3	145SIN105	NON COATED BRONZE LINER INOX. 0.6-0.8MM. 5.5MTS.	1
G3	145SIN202	NON COATED BRONZE LINER INOX. 1.0-1.2MM. 2.5MTS.	1
G3	145SIN203	NON COATED BRONZE LINER INOX. 1.0-1.2MM. 3.5MTS.	1
G3	145SIN204	NON COATED BRONZE LINER INOX. 1.0-1.2MM. 4.5MTS.	1
G3	145SIN205	NON COATED BRONZE LINER INOX. 1.0-1.2MM. 5.5MTS.	1
G3	145SIN302	NON COATED BRONZE LINER INOX. 1.6MM. 2.5MTS.	1
G3	145SIN303	NON COATED BRONZE LINER INOX. 1.6MM. 3.5MTS.	1
G3	145SIN304	NON COATED BRONZE LINER INOX. 1.6MM. 4.5MTS.	1
G3	145SIN305	NON COATED BRONZE LINER INOX. 1.6MM. 5.5MTS.	1
C1	145CA01	POWER/WATER CABLE ERGODANI 1.5MTS.	1
C1	145CA02	POWER/WATER CABLE ERGODANI 2MTS.	1
C1	145CA03	POWER/WATER CABLE ERGODANI 3MTS.	1
C1	145CA04	POWER/WATER CABLE ERGODANI 4MTS.	1
C1	145CA05	POWER/WATER CABLE ERGODANI 5MTS.	1



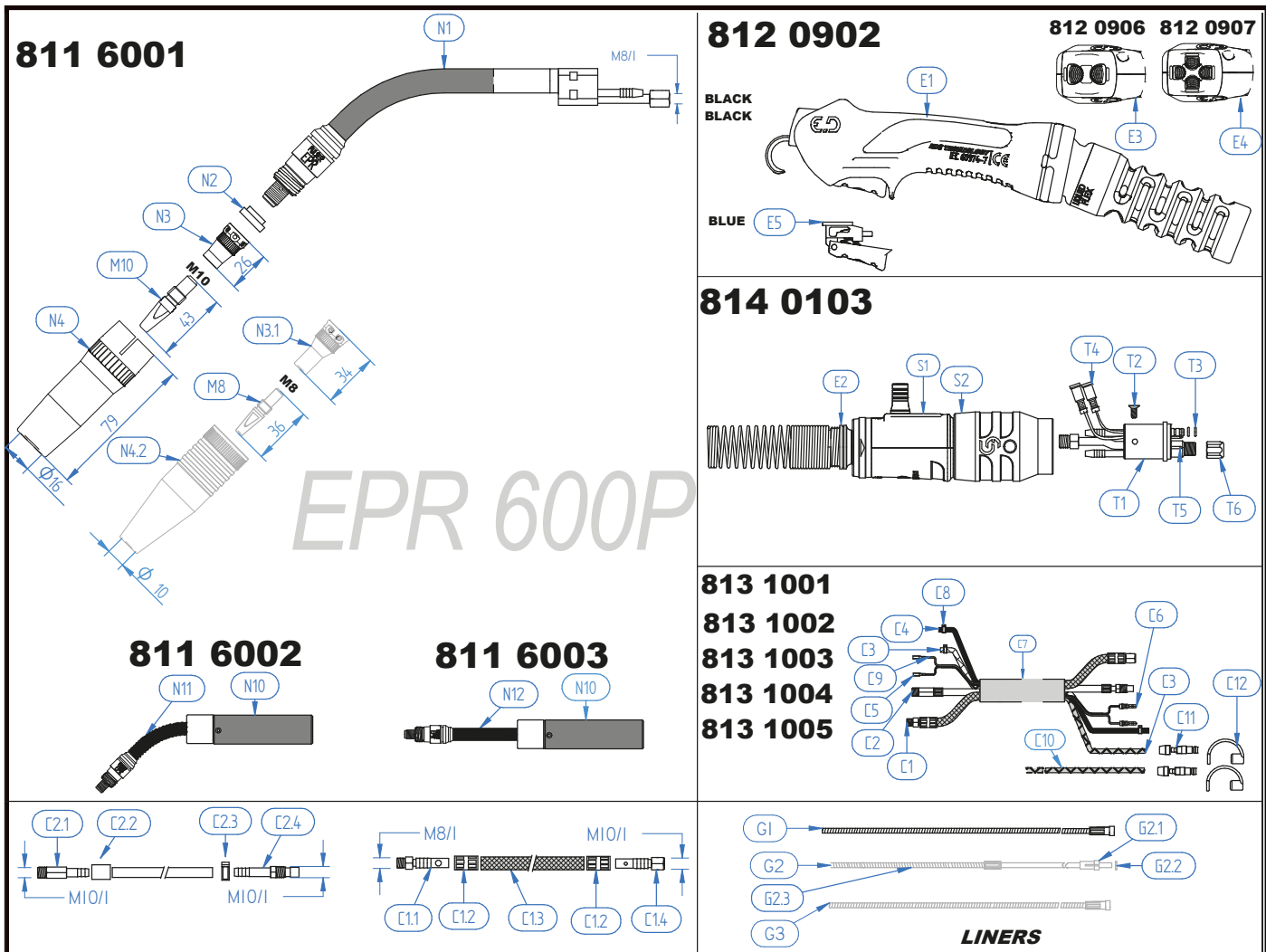

POS.	CODE	DESCRIPTION	PACK
C1.1	5450116	P/W FRONT CONNECTION ERGODANI (16MM2)	5
C1.2	145CA77	P/W SLEEVE ERGODANI (14ID.MM.)	10
C1.3	145CA91	P/W HOSE PVC BLACK 9*13MM.	100
C1.3	145CA93	P/W HOSE RUBBER RED ERGODANI 9*13MM.	20
C1.4	5450216	P/W REAR CONNECTION ERGODANI (16MM2)	5
C2	145CS01	LINER HOSE ERGODANI 1.5MTS.	1
C2	145CS02	LINER HOSE ERGODANI 2MTS.	1
C2	145CS03	LINER HOSE ERGODANI 3MTS.	1
C2	145CS04	LINER HOSE ERGODANI 4MTS.	1
C2	145CS05	LINER HOSE ERGODANI 5MTS.	1
C2.1	145CS88D	L/H FRONT CONNECTION ERGODANI	5
C2.2	145CS77	L/H SLEEVE ERGODANI (10ID.MM.)	10
C2.3	145T105	HOSE CLAMP 10.5	10
C2.4	145CS88T	L/H REAR CONNECTION (2PCS) ERGODANI	5
C3	145TA99F	BRAIDED HOSE PVC BLUE 5*8MM.	100
C3	145TA	BRAIDED HOSE RUBBER BLUE 5*8MM.	20
C4	145TG99	BRAIDED HOSE PVC BLACK 5*8MM.	100
C4	145TN	BRAIDED HOSE RUBBER BLACK 5*8MM.	20
C4	145TG58	HOSE PVC BLACK 5*8MM.	200
C5	199FT01	CABLE FRONT TERMINAL	25
C6	199FT02	CABLE REAR TERMINAL	25
C7	4FN25	NEOPRENE COVER 25*28MM.	20
C8	145T090	HOSE CLAMP 09.0	10
C8	145T095	HOSE CLAMP 09.5	10
C9	145CB	SWITCH CABLE CW	100
C10	145TA99C	BRAIDED HOSE PVC RED 5*8MM.	100
C10	145TR	BRAIDED HOSE RUBBER RED 5*8MM.	20
C11	145TA88	PLUG NIPPLE HOSE 5*8MM.	10
C12	145TA88TA	BLUE COVER HOSE 5*8MM.	10
C12	145TA88TR	RED COVER HOSE 5*8MM.	10

POS.	CODE	DESCRIPTION	PACK
E2	19906W	SPRING & UNIVERSAL JOINT CW ERGODANI	2
S1	1EX924W	CONNECT SUPPORT WITH ALUM.RING EX-221W/421W/EPR-600	1
S2	1EX925	ADAPTOR NUT -BLACK EX-270/380 // CW	1
T1	145MZ	EURO CENTRAL CONNECTOR CW ERGODANI	1
T2	199MZ05	CENTRAL CONNECTOR SCREW	10
T3	199MZ03	CENTRAL CONNECTOR O-RING	10
T4	199FT03	CENTRAL CONNECTOR TERMINAL	25
T5	145MZ04	CENTRAL CONNECT.CONTACT PIN CW ERGODANI	2
T6	199MZ02	LINER FASTENER NUT ERGODANI	10



ERGODANI[®]
Welding Technology Division

ERGODANI

MIG 53