

# MIG



## Universel

<b>T15</b>	<b>MIG2</b>
<b>T25</b>	<b>MIG4</b>
<b>T24</b>	<b>MIG6</b>
<b>T36</b>	<b>MIG8</b>
<b>T240w</b>	<b>MIG10</b>
<b>T501w</b>	<b>MIG14</b>
<b>TKITS</b>	<b>MIG18</b>

## Torches compatibles

<b>BN 300</b>	<b>MIG 20</b>
<b>BN 400</b>	<b>MIG 21</b>
<b>TKS</b>	<b>MIG 22</b>
<b>TCO</b>	<b>MIG 22</b>
<b>ESB</b>	<b>MIG 23</b>

## Professionnel

<b>Tx270</b>	<b>MIG26</b>
<b>Tx380</b>	<b>MIG 28</b>
<b>Tx480</b>	<b>MIG 32</b>
<b>Tx221w</b>	<b>MIG 34</b>
<b>Tx421w</b>	<b>MIG 38</b>

## Pulser

<b>565<sub>p</sub></b>	<b>MIG 46</b>
<b>EPR 600</b>	<b>MIG 50</b>
<b>EPR 650</b>	<b>MIG 54</b>

# NOUVELLE GAMME



## NOUVEAUTÉ : CROCHET



Crochet en métal ajouté, de grande résistance, pour faciliter le stockage et la rapidité de travail.

## NOUVEAUTÉ: GÂCHETTE



Nouvelle gâchette, avec une plus grande surface de contact et une action confortable et facile.

## NOUVEAUTÉ: POIGNÉE



Poignée entièrement redessinée, pour assurer une ergonomie et un confort maximum dans vos soudures

La meilleure soudure à portée de main  
TESLA

## NOUVEAUTÉ : ROTULE



Nouvelle conception de rotule surdimensionnée, plus grand angle de rotation et mobilité sans étranglement des tuyaux.

# TESLA MIG

UNIVERSELLE



T 15

180 A

T 25

230 A

T 24

250 A

T 36

340 A

T 240w

300 A

T 501w

500 A



COD.	DESCRIPTION	PACK
1TS15102	Torche Ergodani Gaine Alu Ts-15 2Mts. Euro	1
1TS15103	Torche Ergodani Ts-15 3Mts. Euro	1
1TS15104	Torche Ergodani Ts-15 4Mts. Euro	1
1TS15105	Torche Ergodani Ts-15 5Mts. Euro	1

POS.	COD.	DESCRIPTION	PACK
N1	11501	Col De Cygne Eu-15	1
N1.1	1150101	Ressort De Maintien De Buse Eu-15	10
N1.2	11502	Support Tube Contact Eu-15	10
N1.3	1150103	Isolant Col Eu-15	10
N1.4	19921	Ecrou Hexagonale Col Eu-15	10
N1.5	19922	Isolant Arriere Col Ergodani	10
N3	11504	Buse Conique Standard Ergodani Eu-15 - 12Mm.	5
N3	11504N	Buse Conique Standard Eu-15 - 12Mm.	5
N4	11504SP	Buse Tres Conique Eu-15 - 9.5Mm.	5
N5	11504CL	Buse Cylindrique Eu-15 - 16Mm.	5
N6	11504BT	Buse En Col Bouteille Eu-15 - 13Mm.	5
N7	11504PT	Buse Pour Pointage Eu-15 - 16Mm.	5
N8	11504CV	Buse A Clous Eu-15 - 16Mm.	5
M6	19915**	Tube Contact M/6*25 - 0.6Mm. Cu.	25
M6	19915**C	Tube Contact Chrome Ergodani M/6*25 - 0.8Mm. Cu.	25
M6	19915**N	Tube Contact M/6*25 - 0.6Mm. Cu.	25
E1	812 0801	Poignée Tesla Negro-Azul Aire	1
E5	199TS01	Gâchette Bleu Tesla	5
G1	199SR02A	Gaine Enveloppée Bleu Ergodani 0.6-0.8Mm. 2.40Mts.	1
G1	199SR03A	Gaine Enveloppée Bleu Ergodani 0.6-0.8Mm. 3.40Mts.	1
G1	199SR04A	Gaine Enveloppée Bleu Ergodani 0.6-0.8Mm. 4.40Mts.	1
G1	199SR05A	Gaine Enveloppée Bleu Ergodani 0.6-0.8Mm. 5.40Mts.	1
G1	199SR02R	Gaine Enveloppée Rouge Ergodani 1.0-1.2Mm. 2.40Mts.	1
G1	199SR03R	Gaine Enveloppée Rouge Ergodani 1.0-1.2Mm. 3.40Mts.	1
G1	199SR04R	Gaine Enveloppée Rouge Ergodani 1.0-1.2Mm. 4.40Mts.	1
G1	199SR05R	Gaine Enveloppée Rouge Ergodani 1.0-1.2Mm. 5.40Mts.	1
G2	199SA102	Gaine Pour Alu 0.8-1.0Mm. 2Mts.	1
G2	199SA103	Gaine Pour Alu 0.8-1.0Mm. 3Mts.	1
G2	199SA104	Gaine Pour Alu 0.8-1.0Mm. 4Mts.	1
G2	199SA105	Gaine Pour Alu 0.8-1.0Mm. 5Mts.	1
G2	199SA202	Gaine Pour Alu 1.2-1.6Mm. 2Mts.	1
G2	199SA203	Gaine Pour Alu 1.2-1.6Mm. 3Mts.	1
G2	199SA204	Gaine Pour Alu 1.2-1.6Mm. 4Mts.	1
G2	199SA205	Gaine Pour Alu 1.2-1.6Mm. 5Mts.	1
G2.1	199SA88	Collier Gaine Aluwed/Alum.	10
G2.2	199SA77	Joint Torique Gaine Aluwed/Alum.	10
G2.3	199SA1G	Embout Metal Gaine Por Alu 0.8-1.0Mm.	2
G2.3	199SA2G	Embout Metal Gaine Por Alu 1.2-1.6Mm.	2
G3	199SIN02	Gaine Bronze Enveloppée Gris Ergodani Inox.1.0-1.2Mm. 2.40M	1
G3	199SIN03	Gaine Bronze Enveloppée Gris Ergodani Inox.1.0-1.2Mm. 3.40M	1
G3	199SIN04	Gaine Bronze Enveloppée Gris Ergodani Inox.1.0-1.2Mm. 4.40M	1
G3	199SIN05	Gaine Bronze Enveloppée Gris Ergodani Inox.1.0-1.2Mm. 5.40M	1

Réfrigération par **Gaz**

180 Amp 60% CO<sub>2</sub>  
164 Amp 60% Ar + CO<sub>2</sub>

Torche de recharge standard, modèle à puissance réduite, très légère et facile à manipuler.

Idéal pour les petites réparations et l'utilisation générale. Parfait pour les fils de 0,8 mm et les petites pièces.

Buse de petit diamètre pour le soudage dans des endroits difficiles à atteindre.



# 811 1501

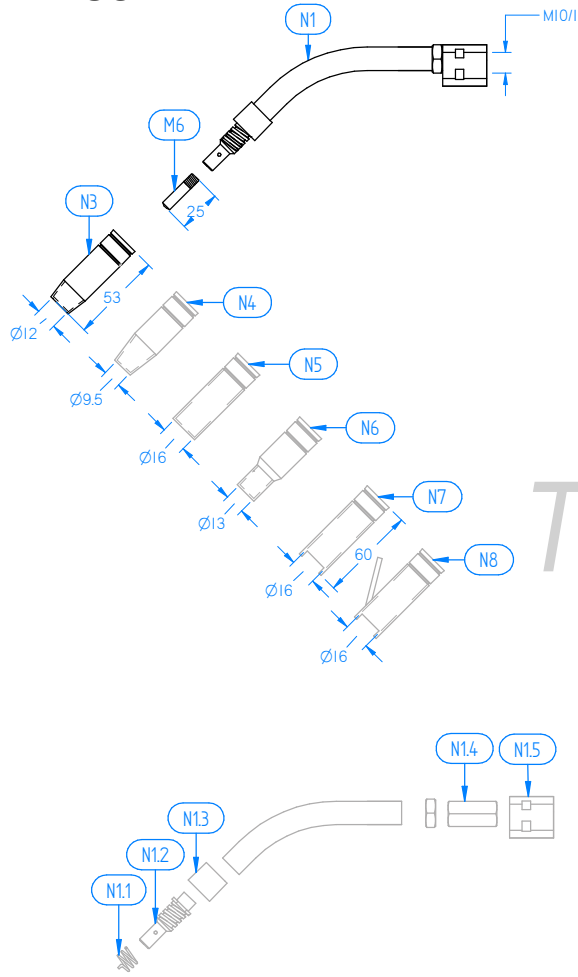

# 812 0801

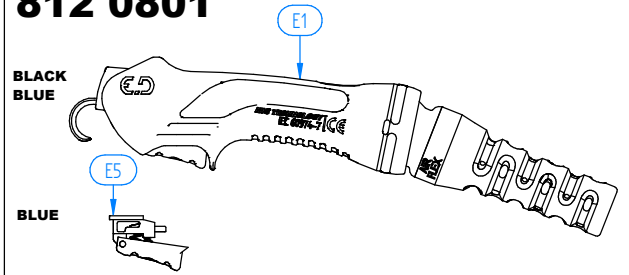

# 814 0107

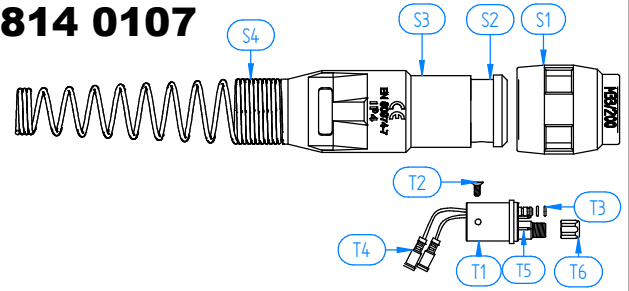

# 813 0102

# 813 0103

# 813 0104

# 813 0105

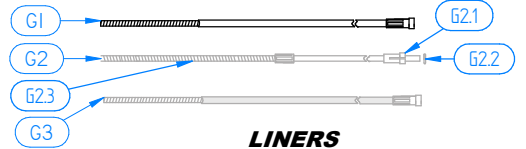
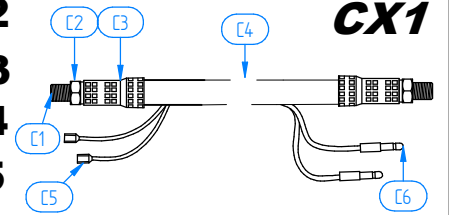

POS.	COD.	DESCRIPTION	PACK
C1	19923R	Pointe Cable Cx-1	10
C2	19920	Ecrou Cable Col De Cygne Ergodani	10
C3	11505	Coquille Pour Cable Cx-1	10
C4	115CX02	Cable Coaxial Eu-15 2Mts.	1
C4	115CX03	Cable Coaxial Eu-15 3Mts.	1
C4	115CX04	Cable Coaxial Eu-15 4Mts.	1
C4	115CX05	Cable Coaxial Eu-15 5Mts.	1
C5	199FT01	Connecteur Cable Elect. Av.	25
C6	199FT02	Connecteur Cable Elect. Ar.	25
S1	1000125	Ecrou Support Connexion Noir Cx	1
S2	100012401	Tuyau Support Connexion Cx	1
S3	100012402	Ressort Arriere Support Cx	1
S4	10001062	Ressort Arriere Cx	1
T1	199MZ	Connecteur Euro Cx Ergodani	1
T2	199MZ05	Vis Fixation Connecteur Euro	10
T3	199MZ03	Joint Torique Connecteur Euro	10
T4	199FT03	Connecteur Cable Elect. C.euro	25
T5	199MZ04	Plot Rect. Connecteur Euro Cx Ergodani	2
T6	199MZ02	Ecrou Du Connecteur Euro Ergodani	10





COD.	DESCRIPTION	PACK
1TS25102	Torche Ergodani Gaine Alu Ts-25 2Mts. Euro	1
1TS25103	Torche Ergodani Ts-25 3Mts. Euro	1
1TS25104	Torche Ergodani Ts-25 4Mts. Euro	1
1TS25105	Torche Ergodani Ts-25 5Mts. Euro	1
125AC02	Torche Auto Col Coudé 45° Eu-25 2Mts. Euro	1
125AC03	Torche Auto Col Coudé 45° Eu-25 3Mts. Euro	1
125AC04	Torche Auto Col Coudé 45° Eu-25 4Mts. Euro	1
125AR02	Torche Auto Col Droit 0° Eu-25 2Mts. Euro	1
125AR03	Torche Auto Col Droit 0° Eu-25 3Mts. Euro	1
125AR04	Torche Auto Col Droit 0° Eu-25 4Mts. Euro	1

POS.	COD.	DESCRIPTION	PACK
N1	12501	Col De Cygne Eu-25	1
N1.1	1250101	Ressort De Maintien De Buse Eu-25	10
N2	12502	Support Tube Contact Eu-25 M/6*35Mm.	10
N2.A	12502M8	Support Tube Contact Eu-25 M/8*35Mm.	10
N4	12504	Buse Conique Standard Ergodani Eu-25 - 15Mm.	5
N4	12504N	Buse Conique Standard Eu-25 - 15Mm.	5
N5	12504SP	Buse Tres Conique Eu-25 - 13Mm.	5
N6	12504SP1	Buse Effilé Eu-25 - 11.5Mm.	5
N7	12504CL	Buse Cylindrique Eu-25 - 18Mm.	5
N8	12504BT	Buse En Col Bouteille Eu-25 - 14.5Mm.	5
N9	12504PT	Buse Pour Pointage Eu-25 - 18Mm.	5
N10	199EPAT	Poignee Automatique Ergodani	1
N11	12501AC	Col Automatique Coudé 45° Eu-25	1
N12	12501AR	Col Automatique Droit 0° Eu-25	1
M6	199M6**	Tube Contact Ergodani M/6*28 - 0.6Mm. Cu.	25
M6	199M6**C	Tube Contact Chrome Ergodani M/6*28 - 0.8Mm. Cu.	25
M6	199M6**N	Tube Contact M/6*28 - 0.6Mm. Cu.	25
M6	199M6**Z	Tube Contact Ergodani M/6*28 - 0.8Mm. Cu.cr.zr.	25
M8	199CL**	Tube Contact Chrome Ergodani M/8*28 - 0.8Mm. Cu.	25
E1	812 0801	Poignée Tesla Negro-Azul Aire	1
E5	199TS01	Gâchette Bleu Tesla	5
G1	199SR02A	Gaine Enveloppée Bleu Ergodani 0.6-0.8Mm. 2.40Mts.	1
G1	199SR03A	Gaine Enveloppée Bleu Ergodani 0.6-0.8Mm. 3.40Mts.	1
G1	199SR04A	Gaine Enveloppée Bleu Ergodani 0.6-0.8Mm. 4.40Mts.	1
G1	199SR05A	Gaine Enveloppée Bleu Ergodani 0.6-0.8Mm. 5.40Mts.	1
G1	199SR02R	Gaine Enveloppée Rouge Ergodani 1.0-1.2Mm. 2.40Mts.	1
G1	199SR03R	Gaine Enveloppée Rouge Ergodani 1.0-1.2Mm. 3.40Mts.	1
G1	199SR04R	Gaine Enveloppée Rouge Ergodani 1.0-1.2Mm. 4.40Mts.	1
G1	199SR05R	Gaine Enveloppée Rouge Ergodani 1.0-1.2Mm. 5.40Mts.	1
G1	199SR02M	Gaine Enveloppée Jaune Ergodani 1.6Mm. 2.40Mts.	1
G1	199SR03M	Gaine Enveloppée Jaune Ergodani 1.6Mm. 3.40Mts.	1
G1	199SR04M	Gaine Enveloppée Jaune Ergodani 1.6Mm. 4.40Mts.	1
G1	199SR05M	Gaine Enveloppée Jaune Ergodani 1.6Mm. 5.40Mts.	1
G2	199SA102	Gaine Pour Alu 0.8-1.0Mm. 2Mts.	1
G2	199SA103	Gaine Pour Alu 0.8-1.0Mm. 3Mts.	1
G2	199SA104	Gaine Pour Alu 0.8-1.0Mm. 4Mts.	1
G2	199SA105	Gaine Pour Alu 0.8-1.0Mm. 5Mts.	1
G2	199SA202	Gaine Pour Alu 1.2-1.6Mm. 2Mts.	1
G2	199SA203	Gaine Pour Alu 1.2-1.6Mm. 3Mts.	1
G2	199SA204	Gaine Pour Alu 1.2-1.6Mm. 4Mts.	1
G2	199SA205	Gaine Pour Alu 1.2-1.6Mm. 5Mts.	1

## Réfrigération par Gaz

230 Amp 60% CO<sub>2</sub>  
209 Amp 60% Ar + CO<sub>2</sub>

Torche de remplacement standard, modèle d'intensité moyenne. La plus polyvalente avec ce type de recharge!

Ampérage moyen pour une utilisation générale Parfait pour les fils de 0,8 et 1,0 mm, les épaisseurs fines, le pointage des pièces et de petits cordons.

Buse de diamètre moyen, avec plusieurs diamètres de sortie de gaz.



## KIT CONSOMMABLES



## 811 2501

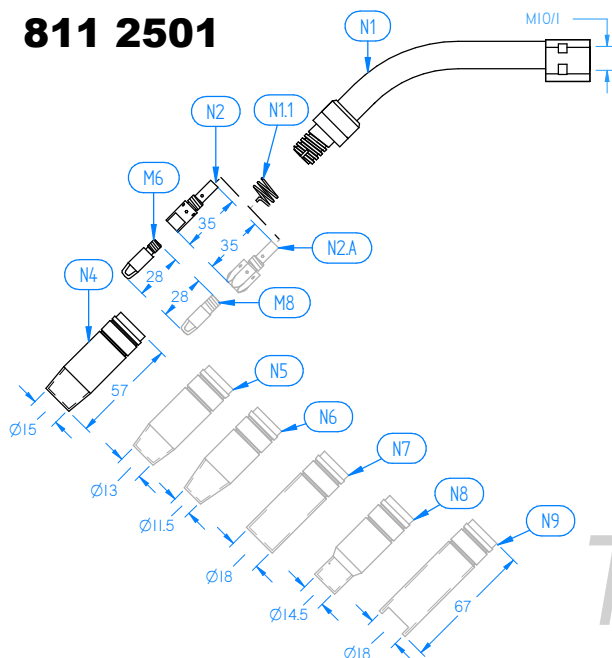

## 811 2502

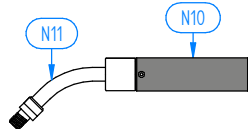

## 811 2503



T25

## 812 0801

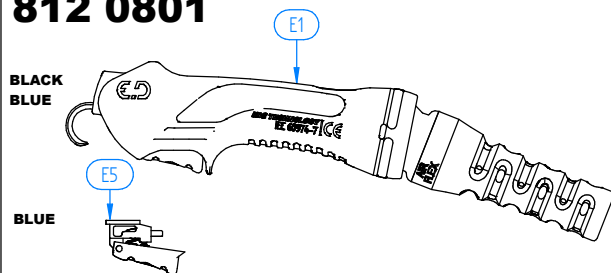

## 814 0107

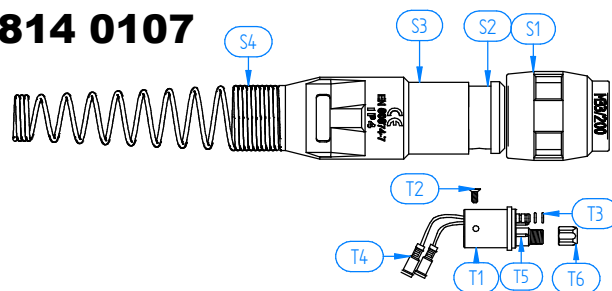

## 813 0202

## 813 0203

## 813 0204

## 813 0205

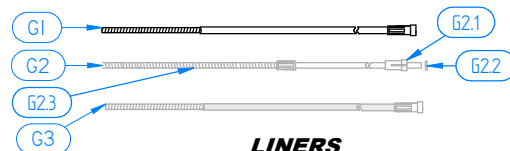
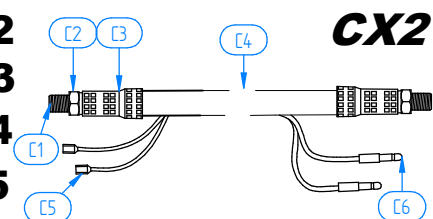

LINERS

POS.	COD.	DESCRIPTION	PACK
G2.1	199SA88	Collier Gaine Aluwed/Alum.	10
G2.2	199SA77	Joint Torique Gaine Aluwed/Alum.	10
G2.3	199SA1G	Embout Metal Gaine Por Alu 0.8-1.0Mm.	2
G2.3	199SA2G	Embout Metal Gaine Por Alu 1.2-1.6Mm.	2
G3	199SIN02	Gaine Bronze Enveloppée Gris Ergodani Inox.1.0-1.2Mm. 2.40M	1
G3	199SIN03	Gaine Bronze Enveloppée Gris Ergodani Inox.1.0-1.2Mm. 3.40M	1
G3	199SIN04	Gaine Bronze Enveloppée Gris Ergodani Inox.1.0-1.2Mm. 4.40M	1
G3	199SIN05	Gaine Bronze Enveloppée Gris Ergodani Inox.1.0-1.2Mm. 5.40M	1
C1	19923	Pointe Cable Cx-2/3/4	10
C2	19920	Ecrou Cable Col De Cygne Ergodani	10
C3	12505	Coquille Pour Cable Cx-2/3	10
C4	125CX02	Cable Coaxial Eu-25 2Mts.	1
C4	125CX03	Cable Coaxial Eu-25 3Mts.	1
C4	125CX04	Cable Coaxial Eu-25 4Mts.	1
C4	125CX05	Cable Coaxial Eu-25 5Mts.	1
C5	199FT01	Connecteur Cable Elect. Av.	25
C6	199FT02	Connecteur Cable Elect. Ar.	25
S1	1000125	Ecrou Support Connexion Noir Cx	1
S2	100012401	Tuyau Support Connexion Cx	1
S3	100012402	Ressort Arriere Support Cx	1
S4	10001062	Ressort Arriere Cx	1
T1	199MZ	Connecteur Euro Cx Ergodani	1
T2	199MZ05	Vis Fixation Connecteur Euro	10
T3	199MZ03	Joint Torique Connecteur Euro	10
T4	199FT03	Connecteur Cable Elect. C.euro	25
T5	199MZ04	Plot Rect. Connecteur Euro Cx Ergodani	2
T6	199MZ02	Ecrou Du Connecteur Euro Ergodani	10



DISPONIBLE EN COL  
AUTOMATIQUE





COD.	DESCRIPTION	PACK
1TS24102	Torche Ergodani Gaine Alu Ts-24 2Mts. Euro	1
1TS24103	Torche Ergodani Ts-24 3Mts. Euro	1
1TS24104	Torche Ergodani Ts-24 4Mts. Euro	1
1TS24105	Torche Ergodani Ts-24 5Mts. Euro	1
124AC02	Torche Auto Col Coudé 45° Eu-24 2Mts. Euro	1
124AC03	Torche Auto Col Coudé 45° Eu-24 3Mts. Euro	1
124AC04	Torche Auto Col Coudé 45° Eu-24 4Mts. Euro	1
124AR02	Torche Auto Col Droit 0° Eu-24 2Mts. Euro	1
124AR03	Torche Auto Col Droit 0° Eu-24 3Mts. Euro	1
124AR04	Torche Auto Col Droit 0° Eu-24 4Mts. Euro	1

POS.	COD.	DESCRIPTION	PACK
N1	12401	Col De Cygne Eu-24	1
N2	12402	Diffuseur Gaz Blanc Eu-24/240W	10
N2.A	12402C	Diffuseur Gaz Ceramique Eu-24/240W	10
N3	12403	Support Tube Contact Eu-24/240W M/6*26Mm.	10
N5	12404	Buse Conique Standard Eu-24/240W - 12.5Mm.	5
N6	12404SP	Buse Tres Conique Eu-24/240W - 10Mm.	5
N7	12404CL	Buse Cylindrique Eu-24/240W - 17Mm.	5
N8	12404PT	Buse Pour Pointage Eu-24/240W - 17Mm.	5
N10	199EPAT	Poignee Automatique Ergodani	1
N11	12401AC	Col Automatique Coudé 45° Eu-24	1
N12	12401AR	Col Automatique Droit 0° Eu-24	1
M6	199M6**	Tube Contact Ergodani M/6*28 - 0.6Mm. Cu.	25
M6	199M6**C	Tube Contact Chrome Ergodani M/6*28 - 0.8Mm. Cu.	25
M6	199M6**N	Tube Contact M/6*28 - 0.6Mm. Cu.	25
M6	199M6**Z	Tube Contact Ergodani M/6*28 - 0.8Mm. Cu.cr.zr.	25
E1	812 0801	Poignée Tesla Negro-Azul Aire	1
E5	199TS01	Gâchette Bleu Tesla	5
G1	199SR02A	Gaine Enveloppée Bleu Ergodani 0.6-0.8Mm. 2.40Mts.	1
G1	199SR03A	Gaine Enveloppée Bleu Ergodani 0.6-0.8Mm. 3.40Mts.	1
G1	199SR04A	Gaine Enveloppée Bleu Ergodani 0.6-0.8Mm. 4.40Mts.	1
G1	199SR05A	Gaine Enveloppée Bleu Ergodani 0.6-0.8Mm. 5.40Mts.	1
G1	199SR02R	Gaine Enveloppée Rouge Ergodani 1.0-1.2Mm. 2.40Mts.	1
G1	199SR03R	Gaine Enveloppée Rouge Ergodani 1.0-1.2Mm. 3.40Mts.	1
G1	199SR04R	Gaine Enveloppée Rouge Ergodani 1.0-1.2Mm. 4.40Mts.	1
G1	199SR05R	Gaine Enveloppée Rouge Ergodani 1.0-1.2Mm. 5.40Mts.	1
G1	199SR02M	Gaine Enveloppée Jaune Ergodani 1.6Mm. 2.40Mts.	1
G1	199SR03M	Gaine Enveloppée Jaune Ergodani 1.6Mm. 3.40Mts.	1
G1	199SR04M	Gaine Enveloppée Jaune Ergodani 1.6Mm. 4.40Mts.	1
G1	199SR05M	Gaine Enveloppée Jaune Ergodani 1.6Mm. 5.40Mts.	1
G2	199SA102	Gaine Pour Alu 0.8-1.0Mm. 2Mts.	1
G2	199SA103	Gaine Pour Alu 0.8-1.0Mm. 3Mts.	1
G2	199SA104	Gaine Pour Alu 0.8-1.0Mm. 4Mts.	1
G2	199SA105	Gaine Pour Alu 0.8-1.0Mm. 5Mts.	1
G2	199SA202	Gaine Pour Alu 1.2-1.6Mm. 2Mts.	1
G2	199SA203	Gaine Pour Alu 1.2-1.6Mm. 3Mts.	1
G2	199SA204	Gaine Pour Alu 1.2-1.6Mm. 4Mts.	1
G2	199SA205	Gaine Pour Alu 1.2-1.6Mm. 5Mts.	1

## Réfrigération par Gaz

250 Amp 60% CO<sub>2</sub>  
228 Amp 60% Ar + CO<sub>2</sub>

Torche de remplacement standard, modèle de moyenne intensité avec un faible poids et une puissance élevée.

Ampérage moyen pour une utilisation générale Parfait pour les fils de 0,8 et 1,2 mm, épaisseurs minces - moyenne, pointage de pièces et de petits cordons

Buse de diamètre réduit, augmente sa polyvalence et son accès, en maintenant toute sa puissance.





# 811 2401

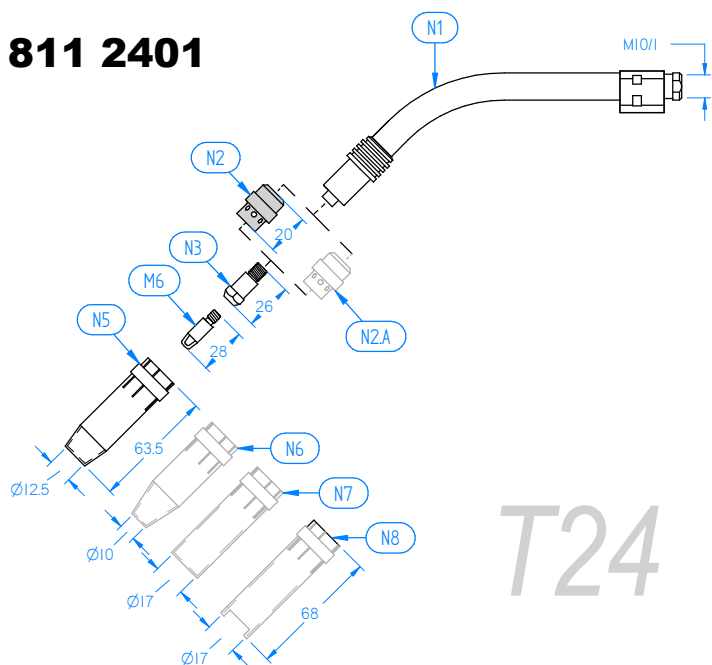

T24

# 811 2402

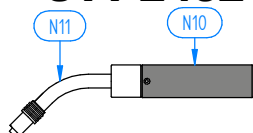

# 811 2403

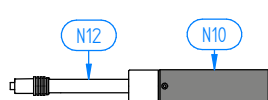

# 812 0801

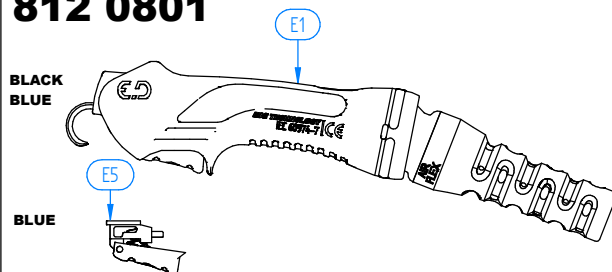

# 814 0107

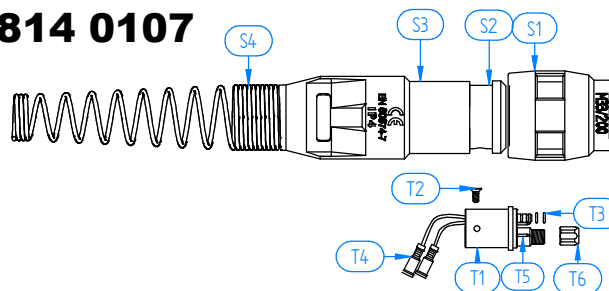

# 813 0302

# 813 0303

# 813 0304

# 813 0305

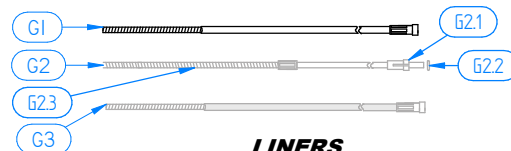
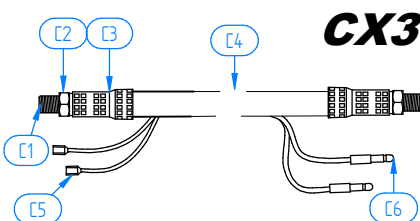

LINERS

POS.	COD.	DESCRIPTION	PACK
G2.1	199SA88	Collier Gaine Aluwed/Alum.	10
G2.2	199SA77	Joint Torique Gaine Aluwed/Alum.	10
G2.3	199SA1G	Embout Metal Gaine Por Alu 0.8-1.0Mm.	2
G2.3	199SA2G	Embout Metal Gaine Por Alu 1.2-1.6Mm.	2
G3	199SIN02	Gaine Bronze Enveloppée Gris Ergodani Inox.1.0-1.2Mm. 2.40M	1
G3	199SIN03	Gaine Bronze Enveloppée Gris Ergodani Inox.1.0-1.2Mm. 3.40M	1
G3	199SIN04	Gaine Bronze Enveloppée Gris Ergodani Inox.1.0-1.2Mm. 4.40M	1
G3	199SIN05	Gaine Bronze Enveloppée Gris Ergodani Inox.1.0-1.2Mm. 5.40M	1
C1	19923	Pointe Cable Cx-2/3/4	10
C2	19920	Ecrou Cable Col De Cygne Ergodani	10
C3	12505	Coquille Pour Cable Cx-2/3	10
C4	124CX02	Cable Coaxial Eu-24 2Mts.	1
C4	124CX03	Cable Coaxial Eu-24 3Mts.	1
C4	124CX04	Cable Coaxial Eu-24 4Mts.	1
C4	124CX05	Cable Coaxial Eu-24 5Mts.	1
C5	199FT01	Connecteur Cable Elect. Av.	25
C6	199FT02	Connecteur Cable Elect. Ar.	25
S1	1000125	Ecrou Support Connexion Noir Cx	1
S2	100012401	Tuyau Support Connexion Cx	1
S3	100012402	Ressort Arriere Support Cx	1
S4	10001062	Ressort Arriere Cx	1
T1	199MZ	Connecteur Euro Cx Ergodani	1
T2	199MZ05	Vis Fixation Connecteur Euro	10
T3	199MZ03	Joint Torique Connecteur Euro	10
T4	199FT03	Connecteur Cable Elect. C.euro	25
T5	199MZ04	Plot Rect. Connecteur Euro Cx Ergodani	2
T6	199MZ02	Ecrou Du Connecteur Euro Ergodani	10



DISPONIBLE EN COL  
AUTOMATIQUE



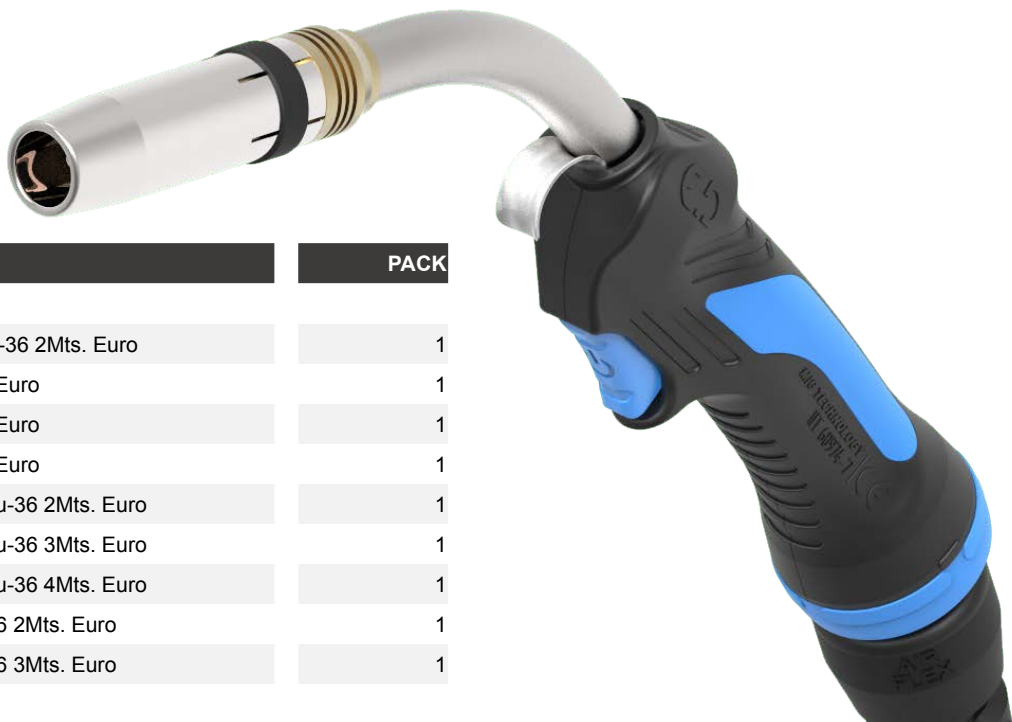

COD.	DESCRIPTION	PACK
1TS36102	Torche Ergodani Gaine Alu Ts-36 2Mts. Euro	1
1TS36103	Torche Ergodani Ts-36 3Mts. Euro	1
1TS36104	Torche Ergodani Ts-36 4Mts. Euro	1
1TS36105	Torche Ergodani Ts-36 5Mts. Euro	1
136AC02	Torche Auto Col Coudé 45° Eu-36 2Mts. Euro	1
136AC03	Torche Auto Col Coudé 45° Eu-36 3Mts. Euro	1
136AC04	Torche Auto Col Coudé 45° Eu-36 4Mts. Euro	1
136AR02	Torche Auto Col Droit 0° Eu-36 2Mts. Euro	1
136AR03	Torche Auto Col Droit 0° Eu-36 3Mts. Euro	1

POS.	COD.	DESCRIPTION	PACK
N1	13601	Col De Cygne Eu-36	1
N2	13602	Diffuseur Gaz Blanc Eu-36	10
N2.A	13602C	Diffuseur Gaz Ceramique Eu-36	10
N3	13603M8	Support Tube Contact Eu-36 M/8*28Mm.	10
N3	13603M6	Support Tube Contact Eu-36 M/6*28Mm.	10
N5	13604	Buse Conique Standard Ergodani Eu-36 - 16Mm.	5
N5	13604N	Buse Conique Standard Eu-36 - 16Mm.	5
N6	13604SP	Buse Tres Conique Eu-36 - 12Mm.	5
N7	13604CL	Buse Cylindrique Eu-36 - 19Mm.	5
N8	13604BT	Buse En Col Bouteille Eu-36 - 15Mm.	5
N9	13604PT	Buse Pour Pointage Eu-36 - 20Mm.	5
N10	199EPAT	Poignee Automatique Ergodani	1
N11	13601AC	Col Automatique Coudé 45° Eu-36	1
N12	13601AR	Col Automatique Droit 0° Eu-36	1
M6	199M6**	Tube Contact Ergodani M/6*28 - 0.6Mm. Cu.	25
M6	199M6**C	Tube Contact Chrome Ergodani M/6*28 - 0.8Mm. Cu.	25
M6	199M6**N	Tube Contact M/6*28 - 0.6Mm. Cu.	25
M6	199M6**Z	Tube Contact Ergodani M/6*28 - 0.8Mm. Cu.cr.zr.	25
M8	199M8**	Tube Contact Ergodani M/8*30 - 0.8Mm. Cu.	25
M8	199M8**A	Tube Contact Ergodani M/8*30 - Al0.8mm. Cu.	25
M8	199M8**C	Tube Contact Chrome Ergodani M/8*30 - 0.8Mm. Cu.	25
M8	199M8**N	Tube Contact M/8*30 - 0.8Mm. Cu.	25
M8	199M8**Z	Tube Contact Ergodani M/8*30 - 0.8Mm. Cu.cr.zr.	25
M8	199M8**ZN	Tube Contact M/8*30 - 0.8Mm. Cu.cr.zr.	25
E1	812 0801	Poignée Tesla Negro-Azul Aire	1
E5	199TS01	Gâchette Bleu Tesla	5
G1	199SR02A	Gaine Enveloppée Bleu Ergodani 0.6-0.8Mm. 2.40Mts.	1
G1	199SR03A	Gaine Enveloppée Bleu Ergodani 0.6-0.8Mm. 3.40Mts.	1
G1	199SR04A	Gaine Enveloppée Bleu Ergodani 0.6-0.8Mm. 4.40Mts.	1
G1	199SR05A	Gaine Enveloppée Bleu Ergodani 0.6-0.8Mm. 5.40Mts.	1
G1	199SR02R	Gaine Enveloppée Rouge Ergodani 1.0-1.2Mm. 2.40Mts.	1
G1	199SR03R	Gaine Enveloppée Rouge Ergodani 1.0-1.2Mm. 3.40Mts.	1
G1	199SR04R	Gaine Enveloppée Rouge Ergodani 1.0-1.2Mm. 4.40Mts.	1
G1	199SR05R	Gaine Enveloppée Rouge Ergodani 1.0-1.2Mm. 5.40Mts.	1
G1	199SR02M	Gaine Enveloppée Jaune Ergodani 1.6Mm. 2.40Mts.	1
G1	199SR03M	Gaine Enveloppée Jaune Ergodani 1.6Mm. 3.40Mts.	1
G1	199SR04M	Gaine Enveloppée Jaune Ergodani 1.6Mm. 4.40Mts.	1
G1	199SR05M	Gaine Enveloppée Jaune Ergodani 1.6Mm. 5.40Mts.	1
G1	199SR02V	Gaine Enveloppée Vert Ergodani 2.4Mm. 2.40Mts.	1
G1	199SR03V	Gaine Enveloppée Vert Ergodani 2.4Mm. 3.40Mts.	1
G1	199SR04V	Gaine Enveloppée Vert Ergodani 2.4Mm. 4.40Mts.	1
G1	199SR05V	Gaine Enveloppée Vert Ergodani 2.4Mm. 5.40Mts.	1
G2	199SA102	Gaine Pour Alu 0.8-1.0Mm. 2Mts.	1
G2	199SA103	Gaine Pour Alu 0.8-1.0Mm. 3Mts.	1

## Réfrigération par Gaz

340 Amp 60% CO<sub>2</sub>  
309 Amp 60% Ar + CO<sub>2</sub>

La torche et son consommable standard de plus grande puissance refroidie par le gaz.

Ampérage moyen pour un usage semi-professionnel. Parfait pour les fils de 1,0 et 1,2 mm, le pointage de pièces et le soudage d'épaisseur moyenne à élevée.

50mm de section de câble, 30% de plus que les normes actuelles. Buse de grande épaisseur. Possibilités multiples dans les diamètres de sortie de gaz.



## KIT DE REPUESTOS



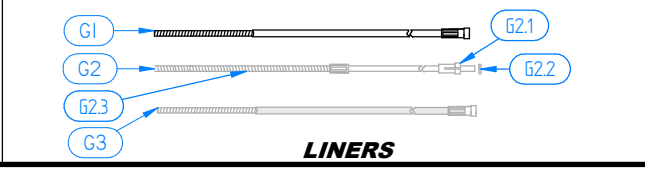
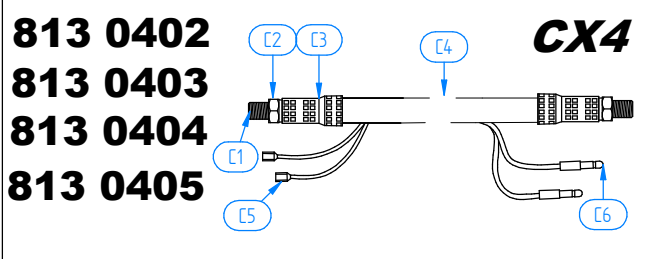
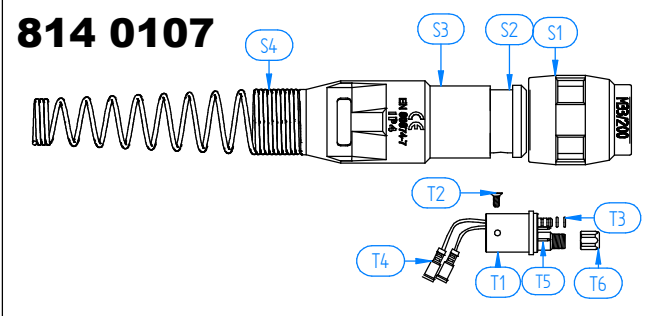
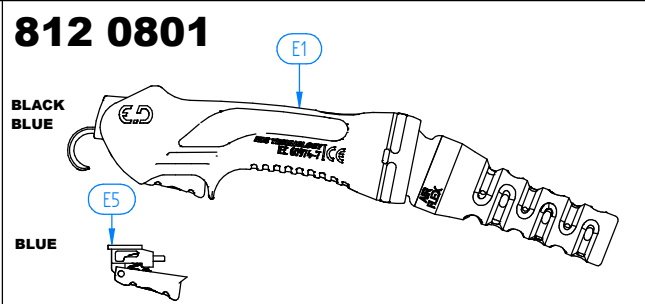
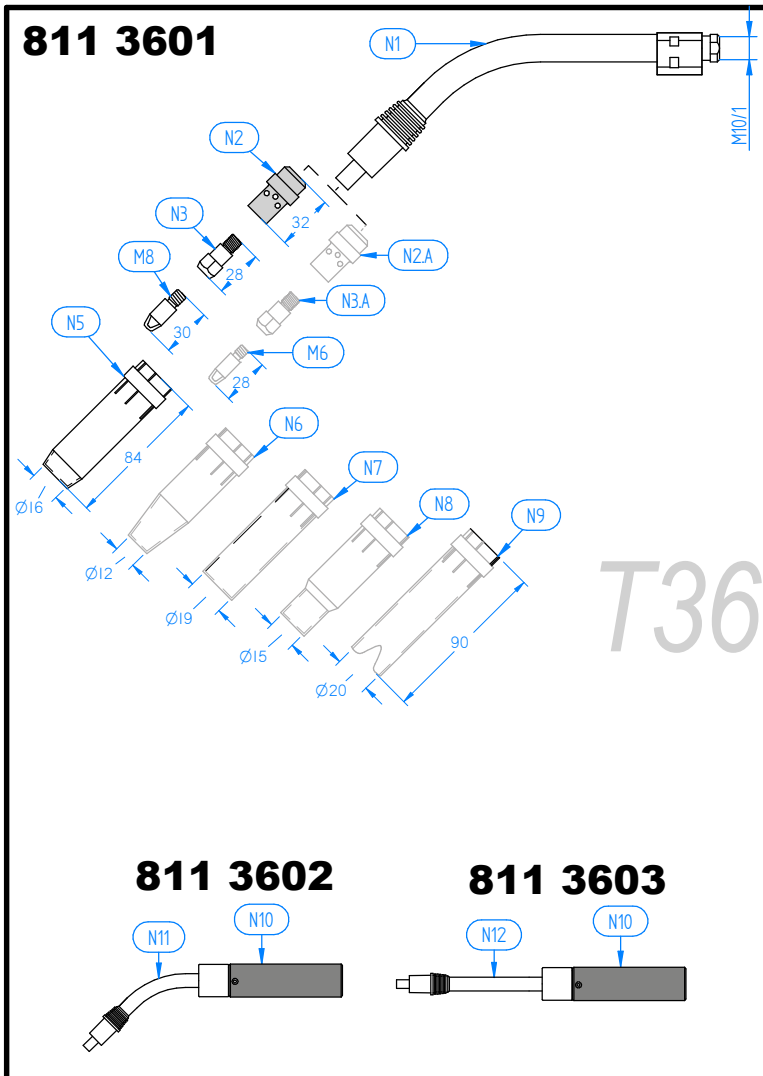

POS.	COD.	DESCRIPTION	PACK
G2	199SA104	Gainé Pour Alu 0.8-1.0Mm. 4Mts.	1
G2	199SA105	Gainé Pour Alu 0.8-1.0Mm. 5Mts.	1
G2	199SA202	Gainé Pour Alu 1.2-1.6Mm. 2Mts.	1
G2	199SA203	Gainé Pour Alu 1.2-1.6Mm. 3Mts.	1
G2	199SA204	Gainé Pour Alu 1.2-1.6Mm. 4Mts.	1
G2	199SA205	Gainé Pour Alu 1.2-1.6Mm. 5Mts.	1
G2.1	199SA88	Collier Gainé Aluwed/Alum.	10
G2.2	199SA77	Joint Torique Gainé Aluwed/Alum.	10
G2.3	199SA1G	Embout Metal Gainé Por Alu 0.8-1.0Mm.	2
G2.3	199SA2G	Embout Metal Gainé Por Alu 1.2-1.6Mm.	2
G3	199SIN02	Gainé Bronze Enveloppée Gris Ergodani Inox.1.0-1.2Mm. 2.40M	1
G3	199SIN03	Gainé Bronze Enveloppée Gris Ergodani Inox.1.0-1.2Mm. 3.40M	1
G3	199SIN04	Gainé Bronze Enveloppée Gris Ergodani Inox.1.0-1.2Mm. 4.40M	1
G3	199SIN05	Gainé Bronze Enveloppée Gris Ergodani Inox.1.0-1.2Mm. 5.40M	1
C1	19923	Pointe Cable Cx-2/3/4	10
C2	19920	Ecrou Cable Col De Cygne Ergodani	10
C3.2	13605	Coquille Pour Cable Cx-4	10
C4	136CX02	Cable Coaxial Eu-36 2Mts.	1
C4	136CX03	Cable Coaxial Eu-36 3Mts.	1
C4	136CX04	Cable Coaxial Eu-36 4Mts.	1
C4	136CX05	Cable Coaxial Eu-36 5Mts.	1
C5	199FT01	Connecteur Cable Elect. Av.	25
C6	199FT02	Connecteur Cable Elect. Ar.	25
S1	1000125	Ecrou Support Connexion Noir Cx	1
S2	100012401	Tuyau Support Connexion Cx	1
S3	100012402	Ressort Arriere Support Cx	1
S4	10001062	Ressort Arriere Cx	1
T1	199MZ	Connecteur Euro Cx Ergodani	1
T2	199MZ05	Vis Fixation Connecteur Euro	10
T3	199MZ03	Joint Torique Connecteur Euro	10
T4	199FT03	Connecteur Cable Elect. C.euro	25
T5	199MZ04	Plot Rect. Connecteur Euro Cx Ergodani	2
T6	199MZ02	Ecrou Du Connecteur Euro Ergodani	10



# T 240w



COD.	DESCRIPTION	PACK
1TS02102	Torche Ergodani Gaine Alu Ts-240W 2Mts. Euro	1
1TS02103	Torche Ergodani Ts-240W 3Mts. Euro	1
1TS02104	Torche Ergodani Ts-240W 4Mts. Euro	1
1TS02105	Torche Ergodani Ts-240W 5Mts. Euro	1
102AC01	Torche Auto Col Coudé 45° Eu-240W 1.5Mts. Euro	1
102AC02	Torche Auto Col Coudé 45° Eu-240W 2Mts. Euro	1
102AC03	Torche Auto Col Coudé 45° Eu-240W 3Mts. Euro	1
102AR01	Torche Auto Col Droit 0° Eu-240W 1.5Mts. Euro	1
102AR02	Torche Auto Col Droit 0° Eu-240W 2Mts. Euro	1
102AR03	Torche Auto Col Droit 0° Eu-240W 3Mts. Euro	1

POS.	COD.	DESCRIPTION	PACK
N1	10201	Col De Cygne Eu-240W	1
N2	12402	Diffuseur Gaz Blanc Eu-24/240W	10
N2.A	12402C	Diffuseur Gaz Ceramique Eu-24/240W	10
N3	12403	Support Tube Contact Eu-24/240W M/6*26Mm.	10
N5	12404	Buse Conique Standard Eu-24/240W - 12.5Mm.	5
N6	12404SP	Buse Tres Conique Eu-24/240W - 10Mm.	5
N7	12404CL	Buse Cylindrique Eu-24/240W - 17Mm.	5
N8	12404PT	Buse Pour Pointage Eu-24/240W - 17Mm.	5
N10	199EPAT	Poignee Automatique Ergodani	1
N11	10201AC	Col Automatique Coudé 45° Eu-240W	1
N12	10201AR	Col Automatique Droit 0° Eu-240W	1

M6	199M6**	Tube Contact Ergodani M/6*28 - 0.6Mm. Cu.	25
M6	199M6**C	Tube Contact Chrome Ergodani M/6*28 - 0.8Mm. Cu.	25
M6	199M6**N	Tube Contact M/6*28 - 0.6Mm. Cu.	25
M6	199M6**Z	Tube Contact Ergodani M/6*28 - 0.8Mm. Cu.cr.zr.	25

E1	812 0802	Poignée Tesla Negro-Azul Agua	1
E5	199TS01	Gâchette Bleu Tesla	5

G1	199SR02A	Gaine Enveloppée Bleu Ergodani 0.6-0.8Mm. 2.40Mts.	1
G1	199SR03A	Gaine Enveloppée Bleu Ergodani 0.6-0.8Mm. 3.40Mts.	1
G1	199SR04A	Gaine Enveloppée Bleu Ergodani 0.6-0.8Mm. 4.40Mts.	1
G1	199SR05A	Gaine Enveloppée Bleu Ergodani 0.6-0.8Mm. 5.40Mts.	1
G1	145SR02	Gaine Denudee Ergodani 1.0-1.6Mm. 2.5Mts.	1
G1	145SR03	Gaine Denudee Ergodani 1.0-1.6Mm. 3.5Mts.	1
G1	145SR04	Gaine Denudee Ergodani 1.0-1.6Mm. 4.5Mts.	1
G1	145SR05	Gaine Denudee Ergodani 1.0-1.6Mm. 5.5Mts.	1
G2	199SA102	Gaine Pour Alu 0.8-1.0Mm. 2Mts.	1
G2	199SA103	Gaine Pour Alu 0.8-1.0Mm. 3Mts.	1
G2	199SA104	Gaine Pour Alu 0.8-1.0Mm. 4Mts.	1
G2	199SA105	Gaine Pour Alu 0.8-1.0Mm. 5Mts.	1
G2	199SA202	Gaine Pour Alu 1.2-1.6Mm. 2Mts.	1
G2	199SA203	Gaine Pour Alu 1.2-1.6Mm. 3Mts.	1
G2	199SA204	Gaine Pour Alu 1.2-1.6Mm. 4Mts.	1
G2	199SA205	Gaine Pour Alu 1.2-1.6Mm. 5Mts.	1
G2.1	199SA88	Collier Gaine Aluwed/Alum.	10
G2.2	199SA77	Joint Torique Gaine Aluwed/Alum.	10
G2.3	199SA1G	Embout Metal Gaine Por Alu 0.8-1.0Mm.	2
G2.3	199SA3G	Embout Metal Gaine Aluweld Ergodani 0.8-1.0Mm.	2

## T 240w

### Refroidissement par Liquide

300 Amp 100% CO<sub>2</sub>  
273 Amp 100% Ar + CO<sub>2</sub>

Torche et consommable standard réfrigérées par liquide. Légère, petite et polyvalente. Puissance supplémentaire par rapport au T 24

Ampérage moyen pour un usage semi-professionnel. Parfait pour les fils de 1,0 et 1,2 mm et les pièces compliquées, grâce à sa manipulation facile.

Buse de petit diamètre; Il permet un large éventail d'accès, avec un magnifique rapport puissance / poids.



# 811 0201

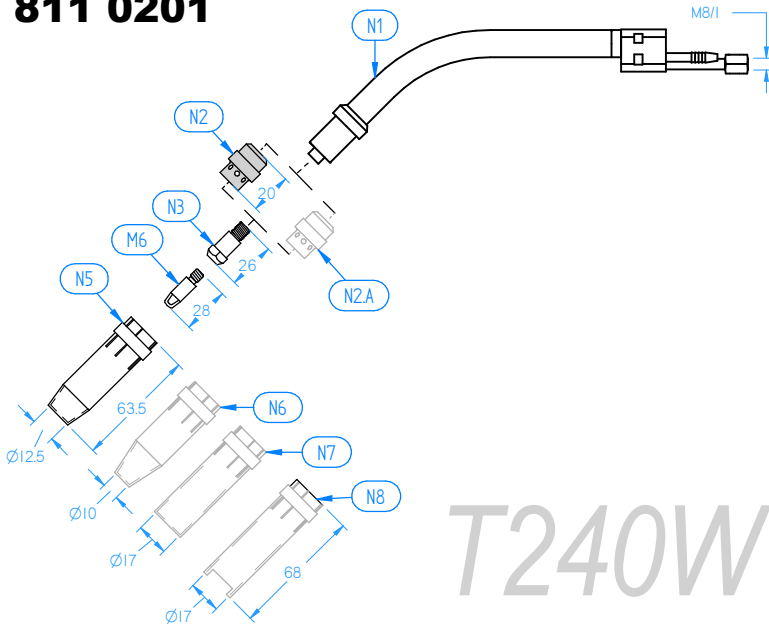

T240W

# 811 0202

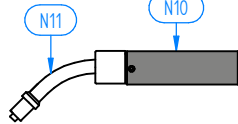

# 811 0203

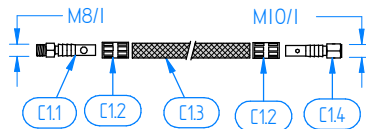
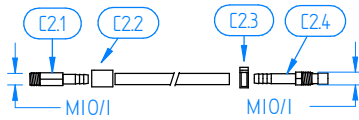
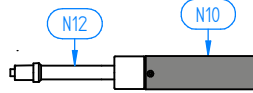

# 812 0802

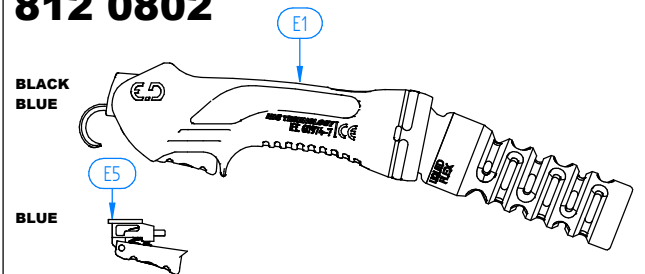

# 814 0103

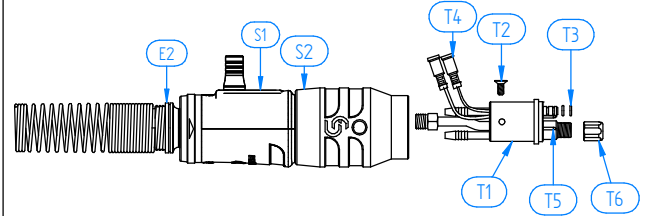

# 813 1001

# 813 1002

# 813 1003

# 813 1004

# 813 1005

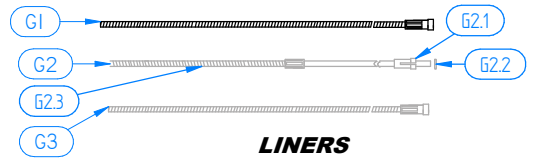
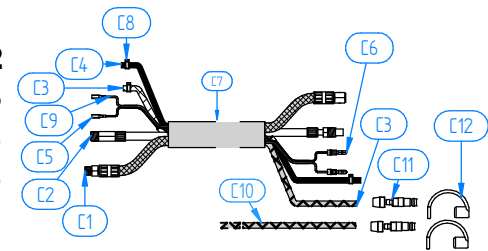

LINERS

POS.	COD.	DESCRIPTION	PACK
G3	145SIN102	Gainé Denudee Bronze Inox. 0.6-0.8Mm. 2.5Mts.	1
G3	145SIN103	Gainé Denudee Bronze Inox. 0.6-0.8Mm. 3.5Mts.	1
G3	145SIN104	Gainé Denudee Bronze Inox. 0.6-0.8Mm. 4.5Mts.	1
G3	145SIN105	Gainé Denudee Bronze Inox. 0.6-0.8Mm. 5.5Mts.	1
G3	145SIN202	Gainé Denudee Bronze Inox. 1.0-1.2Mm. 2.5Mts.	1
G3	145SIN203	Gainé Denudee Bronze Inox. 1.0-1.2Mm. 3.5Mts.	1
G3	145SIN204	Gainé Denudee Bronze Inox. 1.0-1.2Mm. 4.5Mts.	1
G3	145SIN205	Gainé Denudee Bronze Inox. 1.0-1.2Mm. 5.5Mts.	1
G3	145SIN302	Gainé Denudee Bronze Inox. 1.6Mm. 2.5Mts.	1
G3	145SIN303	Gainé Denudee Bronze Inox. 1.6Mm. 3.5Mts.	1
G3	145SIN304	Gainé Denudee Bronze Inox. 1.6Mm. 4.5Mts.	1
G3	145SIN305	Gainé Denudee Bronze Inox. 1.6Mm. 5.5Mts.	1
C1	145CA01	Cable Eau/Courant Ergodani 1.5Mts.	1
C1	145CA02	Cable Eau/Courant Ergodani 2Mts.	1
C1	145CA03	Cable Eau/Courant Ergodani 3Mts.	1
C1	145CA04	Cable Eau/Courant Ergodani 4Mts.	1
C1	145CA05	Cable Eau/Courant Ergodani 5Mts.	1
C1.1	5450116	Connexion Avant E/C Ergodani (16Mm2)	5
C1.2	145CA77	Collier E/C Ergodani (14Id.mm.)	10
C1.3	145CA91	Tuyau E/C Noir/Pvc 9*13Mm.	100
C1.3	145CA93	Tuyau E/C Rouge/Caoutch Ergodani 9*13Mm.	20
C1.4	5450216	Connexion Arriere E/C Ergodani (16Mm2)	5
C2	145CS01	Tube Conducteur Gainé Ergodani 1.5Mts.	1
C2	145CS02	Tube Conducteur Gainé Ergodani 2Mts.	1
C2	145CS03	Tube Conducteur Gainé Ergodani 3Mts.	1
C2	145CS04	Tube Conducteur Gainé Ergodani 4Mts.	1
C2	145CS05	Tube Conducteur Gainé Ergodani 5Mts.	1



DISPONIBLE EN COL  
AUTOMATIQUE



# 811 0201

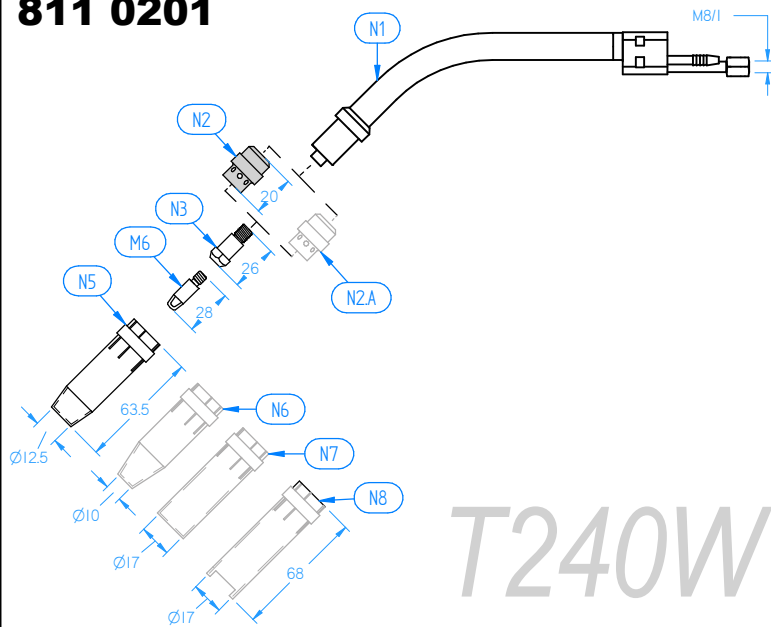

# 811 0202

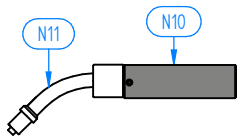

# 811 0203

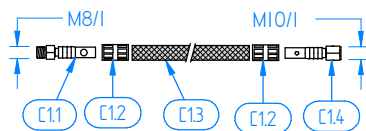
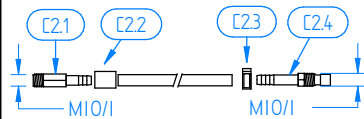
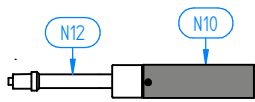

# 812 0802

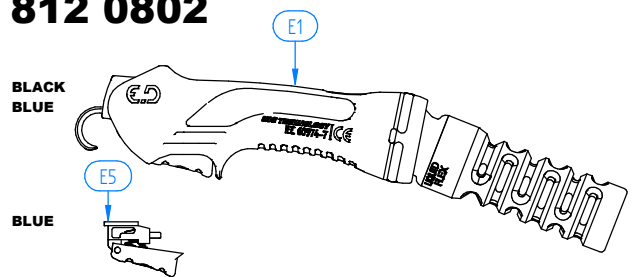

# 814 0103

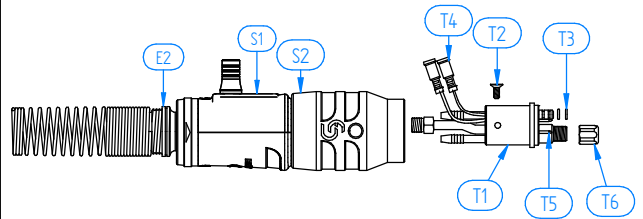

# 813 1001

# 813 1002

# 813 1003

# 813 1004

# 813 1005

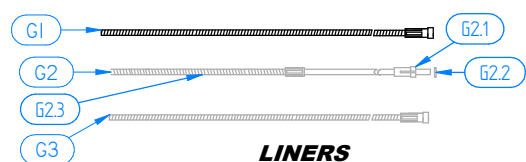
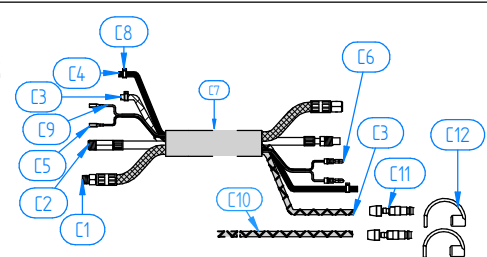

**LINERS**

POS.	COD.	DESCRIPTION	PACK
C2.1	145CS88D	Connexion Avant C/G Ergodani	5
C2.2	145CS77	Collier C/G Ergodani (10ld.mm.)	10
C2.3	145T105	Collier A Oreille 10.5	10
C2.4	145CS88T	Ensemble Connexion Arriere C/G Ergodani	5
C3	145TA99F	Tuyau Renforcé Bleu/Pvc 5*8Mm.	100
C3	145TA	Tuyau Renforcé Bleu/Caoutch 5*8Mm.	20
C4	145TG99	Tuyau Renforcé Noir/Pvc 5*8Mm.	100
C4	145TN	Tuyau Renforcé Noir/Caoutch 5*8Mm.	20
C4	145TG58	Tuyau Noir/Pvc 5*8Mm.	200
C5	199FT01	Connecteur Cable Elect. Av.	25
C6	199FT02	Connecteur Cable Elect. Ar.	25
C7	4FN25	Housse Exterieur Neoprene 25*28Mm.	20
C8	145T090	Collier A Oreille 09.0	10
C8	145T095	Collier A Oreille 09.5	10
C9	145CB	Cable De Commande Cw	100
C10	145TA99C	Tuyau Renforcé Rouge/Pvc 5*8Mm.	100
C10	145TR	Tuyau Renforcé Rouge/Caoutch 5*8Mm.	20
C11	145TA88	Raccord Rapide Male Tuyau 5*8Mm.	10
C12	145TA88TA	Bouchon Bleu Tuyau 5*8Mm.	10
C12	145TA88TR	Bouchon Rouge Tuyau 5*8Mm.	10
S1	1EN924W	Support Connect. Bouchon Noir En-240W/501W/561Pulser	1
S2	1EX925	Ecrou Support Connexion Noir Ex-270/380 // Cw	1
T1	145MZ	Connecteur Euro Cw Ergodani	1
T2	199MZ05	Vis Fixation Connecteur Euro	10
T3	199MZ03	Joint Torique Connecteur Euro	10
T4	199FT03	Connecteur Cable Elect. C.euro	25
T5	145MZ04	Plot Rect. Connecteur Euro Cw Ergodani	2
T6	199MZ02	Ecrou Du Connecteur Euro Ergodani	10



 **ERGODANI**<sup>®</sup>  
*Welding Technology Division*

# 501w



COD.	DESCRIPTION	PACK
1TS05102	TORCHE ERGODANI GAINÉ ALU TS-501W 2MTS. EURO	1
1TS05103	TORCHE ERGODANI TS-501W 3MTS. EURO	1
1TS05104	TORCHE ERGODANI TS-501W 4MTS. EURO	1
1TS05105	TORCHE ERGODANI TS-501W 5MTS. EURO	1
105AC01	TORCHE AUTO COL COUDÉ 45° EU-501W 1.5MTS. EURO	1
105AC02	TORCHE AUTO COL COUDÉ 45° EU-501W 2MTS. EURO	1
105AC03	TORCHE AUTO COL COUDÉ 45° EU-501W 3MTS. EURO	1
105AR01	TORCHE AUTO COL DROIT 0° EU-501W 1.5MTS. EURO	1
105AR02	TORCHE AUTO COL DROIT 0° EU-501W 2MTS. EURO	1
105AR03	TORCHE AUTO COL DROIT 0° EU-501W 3MTS. EURO	1

POS.	COD.	DESCRIPTION	PACK
N1	10501	Col De Cygne Eu-501W	1
N1.1	14501	Rondelle Isolante Col Eu-501W	10
N2	14503M8	Support Tube Contact Eu-501W M/8*25Mm.	10
N2.A	14503M6	Support Tube Contact Eu-501W M/6*25Mm.	10
N4	14502	Diffuseur Gaz Blanc Eu-501W/561Pulser	10
N4.A	14502C	Diffuseur Gaz Ceramique Eu-501W/561Pulser	10
N5	14504	Buse Conique Standard Ergodani Eu-501W/561Pulser - 16Mm.	5
N5	14504N	Buse Conique Standard Eu-501W/561Pulser - 16Mm.	5
N6	14504SP	Buse Tres Conique Eu-501W/561Pulser - 14Mm.	5
N7	14504CL	Buse Cylindrique Eu-501W/561Pulser - 19Mm.	5
N8	14504BT	Buse En Col Bouteille Eu-501W/561Pulser - 15Mm.	5
N9	14504PT	Buse A Pointage Eu-501W/561Pulser - 20Mm.	5
N10	199EPAT	Poignée Automatique Ergodani	1
N11	10501AC	Col Automatique Coudé 45° Eu-501W	1
N12	10501AR	Col Automatique Droit 0° Eu-501W	1
M6	199M6**	Tube Contact Ergodani M/6*28 - 0.6Mm. Cu.	25
M6	199M6**C	Tube Contact Chrome Ergodani M/6*28 - 0.8Mm. Cu.	25
M6	199M6**N	Tube Contact M/6*28 - 0.6Mm. Cu.	25
M6	199M6**Z	Tube Contact Ergodani M/6*28 - 0.8Mm. Cu.cr.zr.	25
M8	199M8**	Tube Contact Ergodani M/8*30 - 0.8Mm. Cu.	25
M8	199M8**A	Tube Contact Ergodani M/8*30 - Al0.8mm. Cu.	25
M8	199M8**C	Tube Contact Chrome Ergodani M/8*30 - 0.8Mm. Cu.	25
M8	199M8**N	Tube Contact M/8*30 - 0.8Mm. Cu.	25
M8	199M8**Z	Tube Contact Ergodani M/8*30 - 0.8Mm. Cu.cr.zr.	25
M8	199M8**ZN	Tube Contact M/8*30 - 0.8Mm. Cu.cr.zr.	25
E1	812 0802	Poignée Tesla Negro-Azul Agua	1
E5	199TS01	Gâchette Bleu Tesla	5
G1	199SR02A	Gaine Enveloppée Bleu Ergodani 0.6-0.8Mm. 2.40Mts.	1
G1	199SR03A	Gaine Enveloppée Bleu Ergodani 0.6-0.8Mm. 3.40Mts.	1
G1	199SR04A	Gaine Enveloppée Bleu Ergodani 0.6-0.8Mm. 4.40Mts.	1
G1	199SR05A	Gaine Enveloppée Bleu Ergodani 0.6-0.8Mm. 5.40Mts.	1
G1	145SR02	Gaine Denudee Ergodani 1.0-1.6Mm. 2.5Mts.	1
G1	145SR03	Gaine Denudee Ergodani 1.0-1.6Mm. 3.5Mts.	1
G1	145SR04	Gaine Denudee Ergodani 1.0-1.6Mm. 4.5Mts.	1
G1	145SR05	Gaine Denudee Ergodani 1.0-1.6Mm. 5.5Mts.	1
G1	199SR02V	Gaine Enveloppée Vert Ergodani 2.4Mm. 2.40Mts.	1
G1	199SR03V	Gaine Enveloppée Vert Ergodani 2.4Mm. 3.40Mts.	1
G1	199SR04V	Gaine Enveloppée Vert Ergodani 2.4Mm. 4.40Mts.	1
G1	199SR05V	Gaine Enveloppée Vert Ergodani 2.4Mm. 5.40Mts.	1

## 501w

### Refroidissement par Liquide

500 Amp 100% CO<sub>2</sub>  
455 Amp 100% Ar + CO<sub>2</sub>

Une des torches universelles, refroidie par liquide, plus puissante. Légère et polyvalente Qualité et finitions exceptionnelles.

Ampérage élevé pour le soudage professionnel. Parfait pour les fils de 1,2 et 1,6 mm et les pièces de grande épaisseur où la puissance est requise.

Propre fabrication du col et de câble. Buse épaisse surdimensionnée.





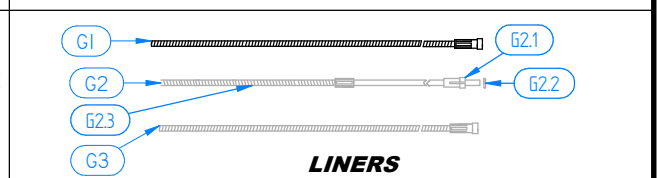
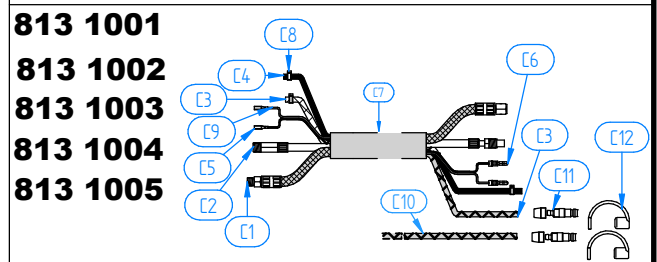
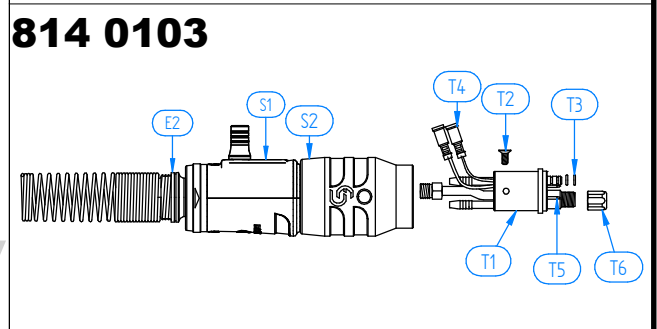
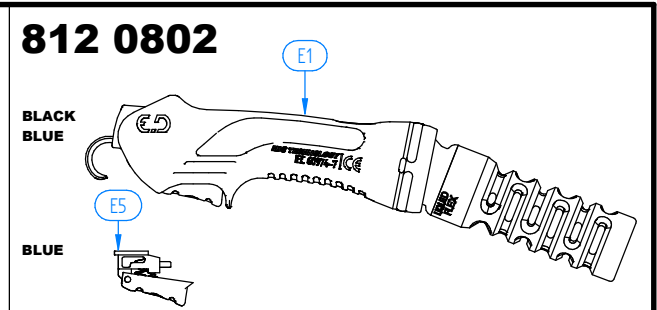
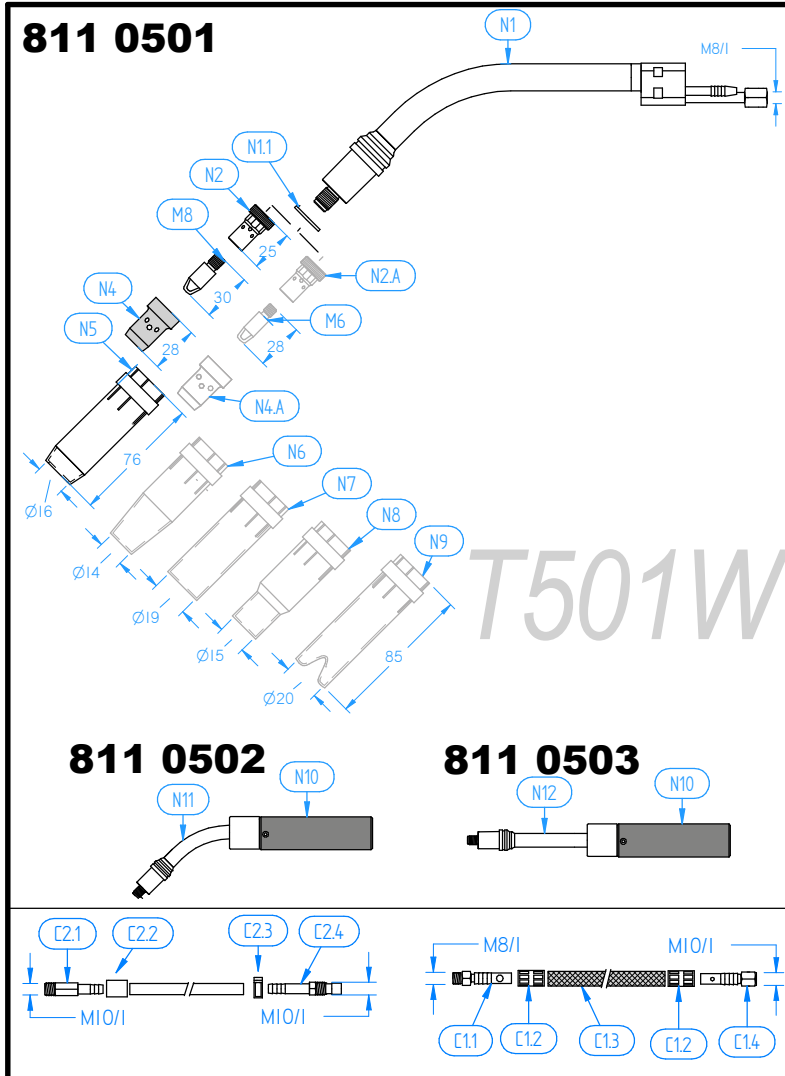

POS.	COD.	DESCRIPTION	PACK
G2	199SA102	Gaine Pour Alu 0.8-1.0Mm. 2Mts.	1
G2	199SA103	Gaine Pour Alu 0.8-1.0Mm. 3Mts.	1
G2	199SA104	Gaine Pour Alu 0.8-1.0Mm. 4Mts.	1
G2	199SA105	Gaine Pour Alu 0.8-1.0Mm. 5Mts.	1
G2	199SA202	Gaine Pour Alu 1.2-1.6Mm. 2Mts.	1
G2	199SA203	Gaine Pour Alu 1.2-1.6Mm. 3Mts.	1
G2	199SA204	Gaine Pour Alu 1.2-1.6Mm. 4Mts.	1
G2	199SA205	Gaine Pour Alu 1.2-1.6Mm. 5Mts.	1
G2.1	199SA88	Collier Gaine Aluwed/Alum.	10
G2.2	199SA77	Joint Torique Gaine Aluwed/Alum.	10
G2.3	199SA1G	Embout Metal Gaine Por Alu 0.8-1.0Mm.	2
G2.3	199SA2G	Embout Metal Gaine Por Alu 1.2-1.6Mm.	2
G3	145SIN102	Gaine Denudee Bronze Inox. 0.6-0.8Mm. 2.5Mts.	1
G3	145SIN103	Gaine Denudee Bronze Inox. 0.6-0.8Mm. 3.5Mts.	1
G3	145SIN104	Gaine Denudee Bronze Inox. 0.6-0.8Mm. 4.5Mts.	1
G3	145SIN105	Gaine Denudee Bronze Inox. 0.6-0.8Mm. 5.5Mts.	1
G3	145SIN202	Gaine Denudee Bronze Inox. 1.0-1.2Mm. 2.5Mts.	1
G3	145SIN203	Gaine Denudee Bronze Inox. 1.0-1.2Mm. 3.5Mts.	1
G3	145SIN204	Gaine Denudee Bronze Inox. 1.0-1.2Mm. 4.5Mts.	1
G3	145SIN205	Gaine Denudee Bronze Inox. 1.0-1.2Mm. 5.5Mts.	1
G3	145SIN302	Gaine Denudee Bronze Inox. 1.6Mm. 2.5Mts.	1
G3	145SIN303	Gaine Denudee Bronze Inox. 1.6Mm. 3.5Mts.	1
G3	145SIN304	Gaine Denudee Bronze Inox. 1.6Mm. 4.5Mts.	1
G3	145SIN305	Gaine Denudee Bronze Inox. 1.6Mm. 5.5Mts.	1
C1	145CA01	Cable Eau/Courant Ergodani 1.5Mts.	1
C1	145CA02	Cable Eau/Courant Ergodani 2Mts.	1
C1	145CA03	Cable Eau/Courant Ergodani 3Mts.	1
C1	145CA04	Cable Eau/Courant Ergodani 4Mts.	1
C1	145CA05	Cable Eau/Courant Ergodani 5Mts.	1





POS.	COD.	DESCRIPTION	PACK
S1	1EN924W	Support Connect. Bouchon Noir En-240W/501W/561Pulser	1
S2	1EX925	Ecrou Support Connexion Noir Ex-270/380 // Cw	1
T1	145MZ	Connecteur Euro Cw Ergodani	1
T2	199MZ05	Vis Fixation Connecteur Euro	10
T3	199MZ03	Joint Torique Connecteur Euro	10
T4	199FT03	Connecteur Cable Elect. C.euro	25
T5	145MZ04	Plot Rect. Connecteur Euro Cw Ergodani	2
T6	199MZ02	Ecrou Du Connecteur Euro Ergodani	10

## COLLIERS SPÉCIAUX

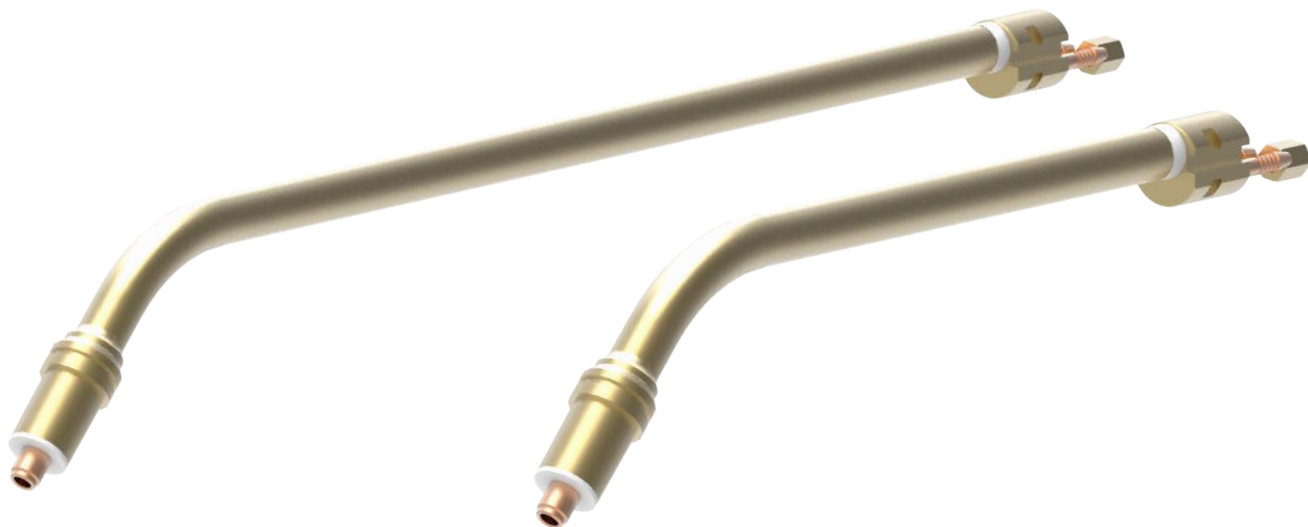

**STANDAR 501**

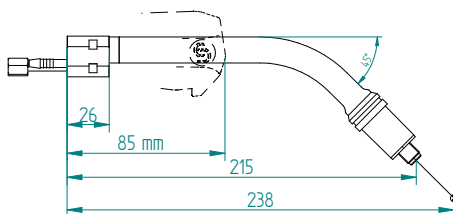

250 mm

CODE : 1050125

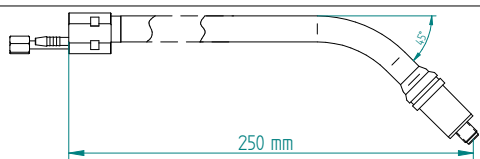

250 mm

400mm

CODE : 1050140

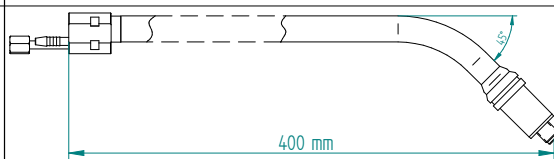

400 mm

300 mm

CODE : 1050130

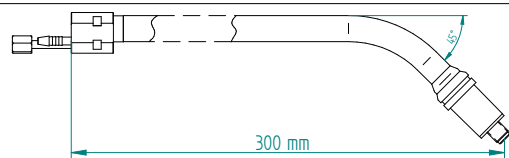

300 mm

450 mm

CODE : 1050145

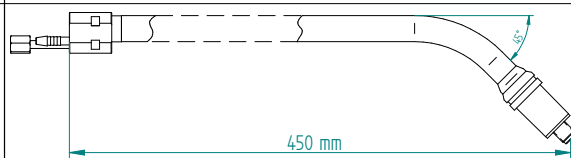

450 mm

350 mm

CODE : 1050135

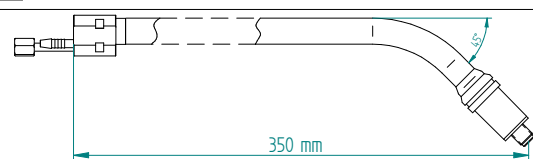

350 mm

500 mm

CODE : 1050150

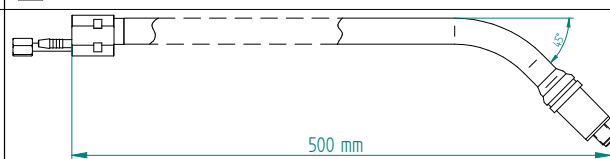

500 mm

# KIT ACCESSOIRES



Le kit comprend toutes les pièces de rechange nécessaires pour la torche T 36. Il se compose de buses (x2), de tubes contact (x10), de support-tubes (x5) et de diffuseurs (x5)

COD.	DESCRIPTION	PACK
1EU15K2	KIT DE TORCHE Ts-15	1
1EU25K2	KIT DE TORCHE Ts-25	1
1EU24K2	KIT DE TORCHE Ts-24/240w	1
1EU36K2	KIT DE TORCHE Ts-36	1
1EU05K2	KIT DE TORCHE Ts-501w	1
1EU27K2	KIT DE TORCHE Tx-270/221w	1
1EU38K2	KIT DE TORCHE Tx-380/421w	1
1EU48K2	KIT DE TORCHE Tx-480	1
1EU57K2	KIT DE TORCHE 565w PULSER	1
1EU60K2	KIT DE TORCHE EPR 600	1

## 15 MIG | Accessories Tesla MIG Torches



## x270/221w MIG | Accessories Tesla MIG Torches

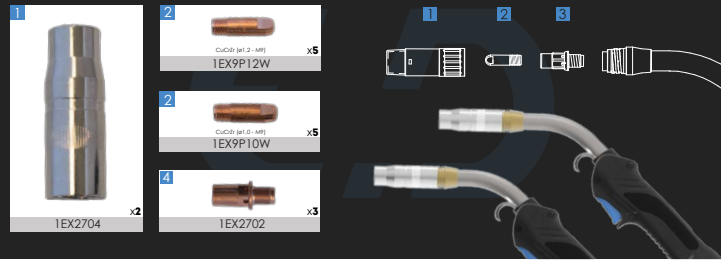

## 25 MIG | Accessories Tesla MIG Torches

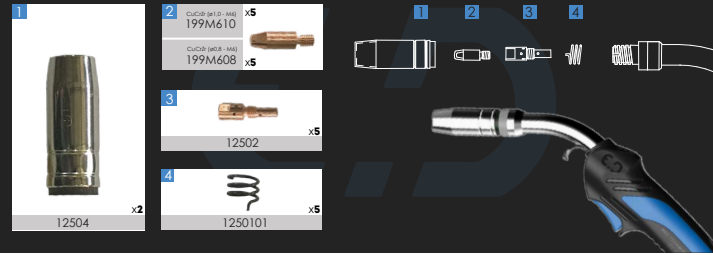

## x380/421w MIG | Accessories Tesla MIG Torches

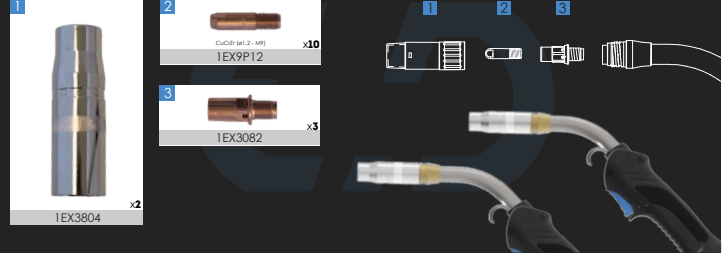

## 24/240w MIG | Accessories Tesla MIG Torches

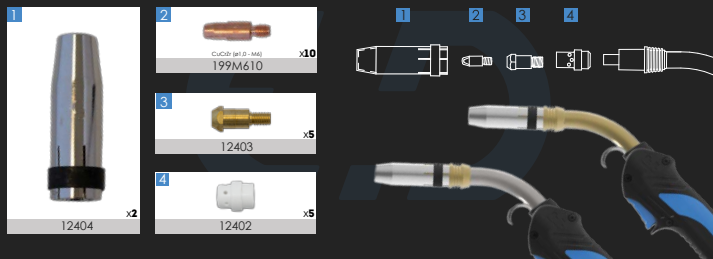

## x480 MIG | Accessories Tesla MIG Torches

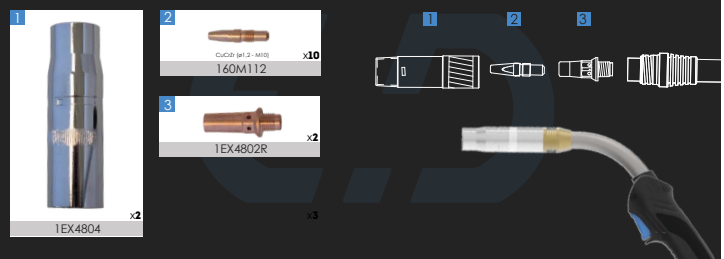

## 36 MIG | Accessories Tesla MIG Torches



## 565 PULSER MIG | Accessories Tesla MIG Torches

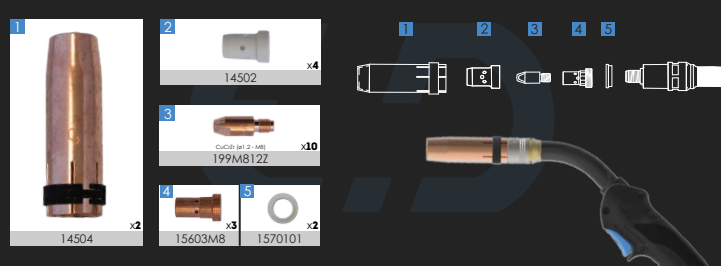

## 501w MIG | Accessories Tesla MIG Torches

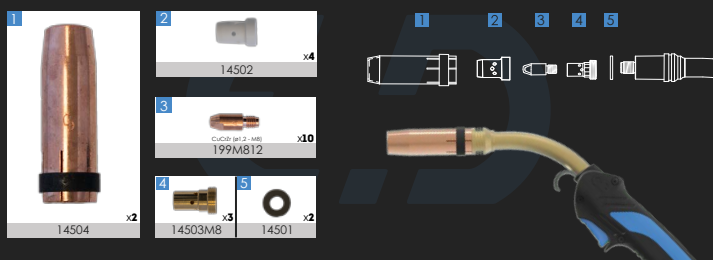

## 600 EPR MIG | Accessories Tesla MIG Torches

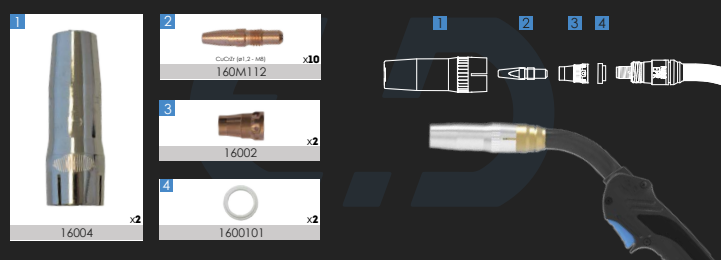

# BN 300

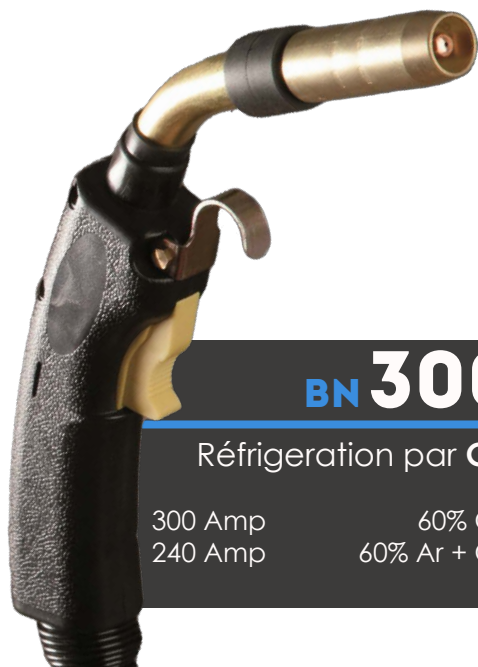

**BN 300**

Réfrigération par **Gaz**

300 Amp  
240 Amp

60% CO<sub>2</sub>  
60% Ar + CO<sub>2</sub>

POS.	COD.	DESCRIPTION	PACK
N6	1B4786	Col De Cygne Bn-300	1
N2	1B4780	Isolant Col Arriere Bn-300/400	10
N7	1B4323	Collier Isolant Col Bn-300	10
N8	1B4335	Support Tube Contact Bn-300	5
N8.1	1B7126	Joint Toriq.support Tube Cont. Bn-300	10
N9	1B7488	Tube Contact Court Bn-300 - 0.8Mm. Cu.	25
N9	1B7490	Tube Contact Court Bn-300 - 1.2Mm. Cu.	25
N9	1B7491	Tube Contact Court Bn-300 - 1.6Mm. Cu.	25
N9	1B7496	Tube Contact Court Bn-300 - 1.0Mm. Cu.	25
N9	1B7498	Tube Contact Court Bn-300 - 1.4Mm. Cu.	25
N12	1B4391	Buse Standard Bn-300 - 16Mm.	5
N12	1B4393	Buse Standard Cuivre Bn-300 - 16Mm.	5
N13	1B4392	Buse Conique Bn-300 - 12.5Mm.	5
N13	1B4394	Buse Conique Cuivre Bn-300 - 12.5Mm.	5
E1	1B1780006	Poignee Noir Bn-300/400	1
E2	1B4238	Crochet Poignee Bn-300/400	1
E3	1B5662	Gâchette Bn-300/400	5
G1	1B9SR03	Gaine Enveloppée Noir Bn-300/400 1.0-1.6Mm. 3.65Mts.	1
G1	1B9SR04	Gaine Enveloppée Noir Bn-300/400 1.0-1.6Mm. 4.65Mts.	1
G1	1B9SR05	Gaine Enveloppée Noir Bn-300/400 1.0-1.6Mm. 5.65Mts.	1
C1	1B4213B	Pointe Cable Bn-300/400	5
C2	1B4305	Ecrou Anneau Cable Bn-300/400	5
C3	145T200	Collier A Oreille 20.0	10
C3.1	145T120	Collier A Oreille 12.0	10
C3.2	13605	Coquille Pour Cable Cx-4	10
C4	1B3CX03	Cable Coaxial Bn-300 3Mts.	1
C4	1B3CX04	Cable Coaxial Bn-300 4Mts.	1
C4	1B3CX05	Cable Coaxial Bn-300 5Mts.	1
C4	199CX4	Cable Cx-4 50Mm2. *Mts.	1
C5	1B2660001	Terminal Avant Cable Bn-300/400	25
C6	199FT02	Connecteur Cable Elect. Ar.	25
C7	1B923	Pointe Cable Bn-300/400 1/4G	10

## 811 3001

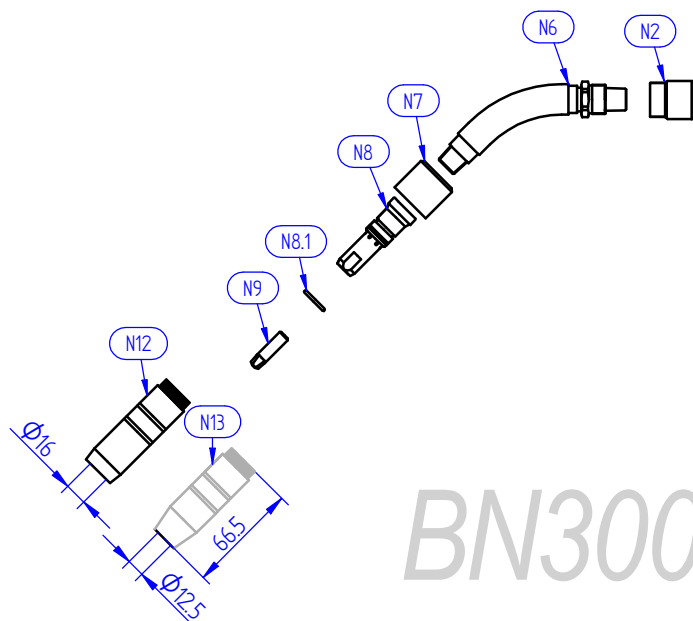

**BN300**

COD.	DESCRIPTION	PACK
1B3003	Torche Bn-300 3Mts. Euro	1
1B3004	Torche Bn-300 4Mts. Euro	1
1B3005	Torche Bn-300 5Mts. Euro	1

## 812 0701

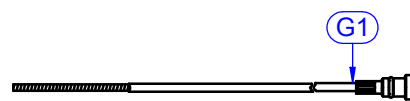
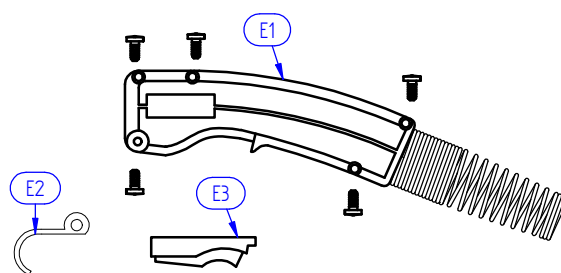

**LINERS**

# BN 400



POS.	COD.	DESCRIPTION	PACK
N1	1B4790	Col De Cygne Bn-400	1
N2	1B4780	Isolant Col Arriere Bn-300/400	10
N3	1B4423	Collier Isolant Col Bn-400	10
N4	1B4635	Support Tube Contact Bn-400	5
N4.1	1B7127	Joint Toriq.support Tube Cont. Bn-400	10
N4.2	1B4435	Support Tube Contact Court Bn-400	5
N5	1B1588	Tube Contact Long Bn-400 - 0.8Mm. Cu.	25
N5	1B1590	Tube Contact Long Bn-400 - 1.2Mm. Cu.	25
N5	1B1591	Tube Contact Long Bn-400 - 1.6Mm. Cu.	25
N5	1B1596	Tube Contact Long Bn-400 - 1.0Mm. Cu.	25
N5	1B1598	Tube Contact Long Bn-400 - 1.4Mm. Cu.	25
N9	1B7488	Tube Contact Court Bn-300 - 0.8Mm. Cu.	25
N9	1B7490	Tube Contact Court Bn-300 - 1.2Mm. Cu.	25
N9	1B7491	Tube Contact Court Bn-300 - 1.6Mm. Cu.	25
N9	1B7496	Tube Contact Court Bn-300 - 1.0Mm. Cu.	25
N9	1B7498	Tube Contact Court Bn-300 - 1.4Mm. Cu.	25
N10	1B4491	Buse Standard Bn-400 - 19Mm.	5
N10	1B4591	Buse Standard Cuivre Bn-400 - 19Mm.	5
N11	1B4492	Buse Conique Bn-400 - 14Mm.	5
N11	1B4592	Buse Conique Cuivre Bn-400 - 14Mm.	5
E1	1B1780006	Poignee Noir Bn-300/400	1
E2	1B4238	Crochet Poignee Bn-300/400	1
E3	1B5662	Gâchette Bn-300/400	5
G1	1B9SR03	Gaine Enveloppée Noir Bn-300/400 1.0-1.6Mm. 3.65Mts.	1
G1	1B9SR04	Gaine Enveloppée Noir Bn-300/400 1.0-1.6Mm. 4.65Mts.	1
G1	1B9SR05	Gaine Enveloppée Noir Bn-300/400 1.0-1.6Mm. 5.65Mts.	1
C1	1B4213B	Pointe Cable Bn-300/400	5
C2	1B4305	Ecrou Anneau Cable Bn-300/400	5
C3	145T210	Collier A Oreille 21.0	10
C3.1	145T120	Collier A Oreille 12.0	10
C3.2	14005	Collier Cable Cx-5	10
C4	1B4CX03	Cable Coaxial Bn-400 3Mts.	1
C4	1B4CX04	Cable Coaxial Bn-400 4Mts.	1
C4	1B4CX05	Cable Coaxial Bn-400 5Mts.	1
C4	199CX5	Cable Cx-5 60Mm2. *Mts.	1
C5	1B2660001	Terminal Avant Cable Bn-300/400	25
C6	199FT02	Connecteur Cable Elect. Ar.	25
C7	1B923	Pointe Cable Bn-300/400 1/4G	10

## 811 4001

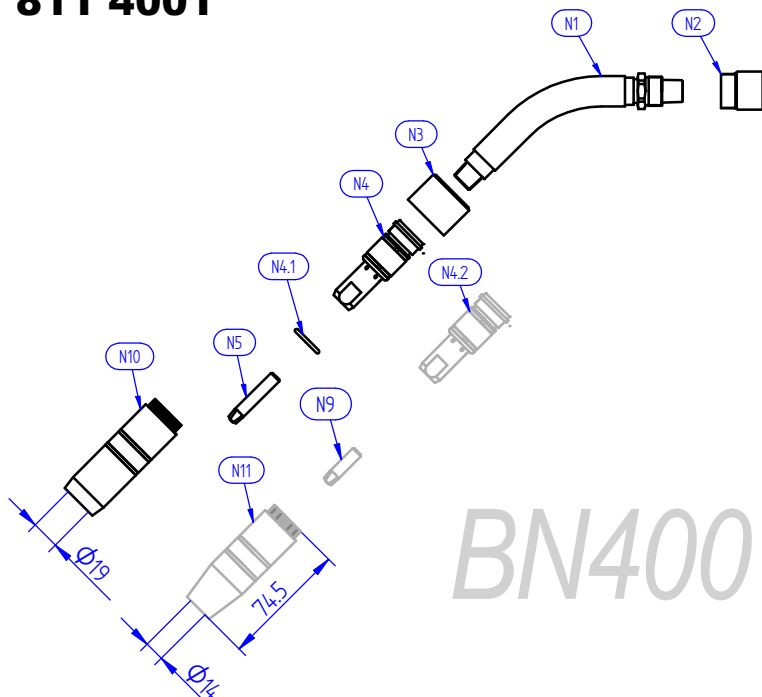

COD.	DESCRIPTION	PACK
1B4003	TORCHE BN-400 3MTS. EURO	1
1B4004	TORCHE BN-400 4MTS. EURO	1
1B4005	TORCHE BN-400 5MTS. EURO	1

## 812 0701

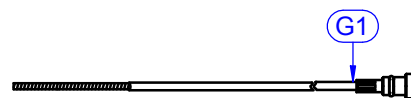
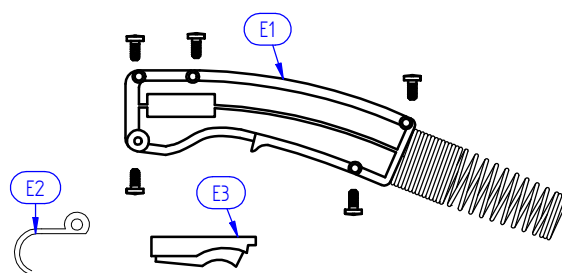

### LINERS

# TORCHES COMPATIBLES



## TYPE FRONIUS <sup>1</sup>

Modèle Rodacta 5000

POS.	COD.	DESCRIPTION	PACK
1	1FR5000104	Torche Fronius Fr. 4Mts.	1
2	1F4200015128	Buse Conique Frn R-5000 D.17/25*79	5
3	1F4200012970	Isolant Buse Fr.	10
4	1F4201001007	Isolant Diffuseur R-5000 D.20.8*28.5	10
5	1F4200011576	Tube Contact Frn M10*40Mm.Ø0'8mm.cucrzt(Fecrni)	10
5	1F4200011577	Tube Contact Frn M10*40Mm.Ø1'0mm.cucrzt(Fecrni)	10
5	1F4200011578	Tube Contact Frn M10*40Mm.Ø1'2mm.cucrzt(Fecrni)	10
6	1F4200015122	Support Tube Contact R-5000 M10/Sw 13*32	10
7	1F4201001016	Isolant Col R-5000 D.21*10	10



## TYPE TREGASKIS <sup>1</sup>

Modèle Tregaskis 400 Amp.

POS.	COD.	DESCRIPTION	PACK
1	1TR104	Torche Tregaskis Tr. 4Mts.	1
2	1TR04	Buse Conique Tregaskis D.19 Mm.	5
3	199TR10	Tube Contact Tregaskisn Od.6.3*34 Ø1'0mm	10
3	199TR12	Tube Contact Tregaskisn Od.6.3*34 Ø1'2mm	10
4	1TR03	Support Tube Contact Tregaskis Tr.	5



## TYPE ESAB <sup>1</sup>

Modèle PSF 315



POS.	COD.	DESCRIPTION	PACK
1	1ES400104	Torche Esaab Sf. 4Mts.	1
2	1ES04	Buse Conique Esaab D.17 Mm.	5
3	1ES040	Isolant Buse Esaab Sf.	5
4	199ES10	Tube Contact Esaab M8*37 Ø1'0mm Cu-E	10
4	199ES12	Tube Contact Esaab M8*37 Ø1'2mm Cu-E	10
5	1ES03	Diffuseur Gaz Esaab Sf.	10

1. Ergoweld S.L n'a aucune affiliation avec les marques mentionnées dans ces pages.  
Les références de nom et de modèle sont citées simplement à des fins d'identification.

Il est indiqué que ce sont des pièces non originales fabriquées par des tiers. L'utilisation de la marque appartient uniquement à ses propriétaires.

# NOUVELLE GAMME



## BUSES FILETÉES AVEC BAIN DE CHROME DUR



Ils empêchent l'usure ils augmentent la durée de vie utile.

## SUPPORT TUBE CONTACT EN CUIVRE ISO CrCuZr

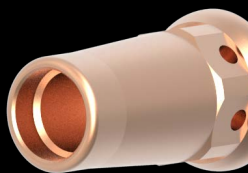

Fournit un plus grand refroidissement de la pointe de contact et moins d'adhérence des projections.

## SYSTÈME "ALUWELD"



Système de maintien de gaine révolutionnaire, permettant de souder avec des fils d'aluminium plus longs.

La meilleure soudure à portée de main  
TESLA



## MODÈLES DE RÉGULATION INTELLIGENTE

**ERGODANI**<sup>®</sup>  
Welding Technology Division

# TESLA MIG

PROFESSIONNELLE

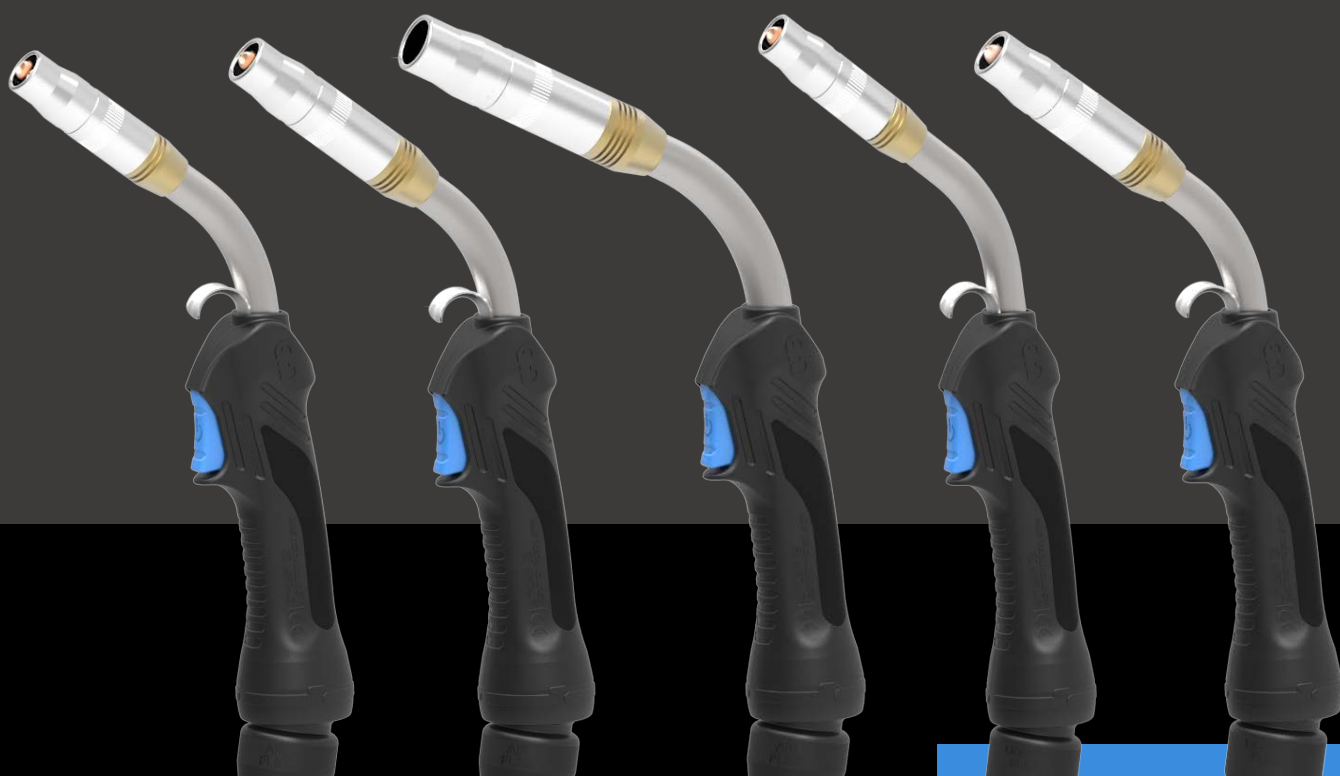

**Tx 270**

250 A

**Tx 380**

350 A

**Tx 480**

450 A

**Tx 221W**

350 A

**Tx 421W**

500 A

# Ex 270



COD.	DESCRIPTION	PACK
1EX27103	Torche Ergodani Tesla Ex-270 3Mts. Euro	1
1EX27104	Torche Ergodani Tesla Ex-270 4Mts. Euro	1
1EX27105	Torche Ergodani Tesla Ex-270 5Mts. Euro	1
1EX27203	Torche Ergodani Aluweld Ex-270 3Mts. Euro	1
1EX27204	Torche Ergodani Aluweld Ex-270 4Mts. Euro	1
1EX27205	Torche Ergodani Aluweld Ex-270 5Mts. Euro	1
1EX27AC02	Torche Automat. Col Coudé 45° Ex-270 2Mts. Euro	1
1EX27AC03	Torche Automat. Col Coudé 45° Ex-270 3Mts. Euro	1
1EX27AC04	Torche Automat. Col Coudé 45° Ex-270 4Mts. Euro	1
1EX27AR02	Torche Automat. Col Droit 0° Ex-270 2Mts. Euro	1
1EX27AR03	Torche Automat. Col Droit 0° Ex-270 3Mts. Euro	1
1EX27AR04	Torche Automat. Col Droit 0° Ex-270 4Mts. Euro	1

POS.	COD.	DESCRIPTION	PACK
N1	1EX2701	Col De Cygne Principal Ex-270	1
N1.1	1EX2702	Diffuseur Support Tube Contact Ex-270/221W M/9*34Mm.	10
N1.2	1EX2702M8	Diffuseur Support Tube Contact Ex-270/221W M/8*34Mm.	10
N3	1EX2704	Buse Standard Ex-270/221W - 15Mm.	5
N3.1	1EX270402	Buse Conique Ex-270/221W - 13Mm.	5
N8	1EX2701AC	Col Automatique Coudé 45° Ex-270	1
N9	1EX2701AR	Col Automatique Droit 0° Ex-270	1
N10	199EPAT	Poignee Automatique Ergodani	1
M9	1EX9P08W	Tube Contact Ex-Court M/9*30 - 0.8Mm. Cu.ag.	25
M9	1EX9P10W	Tube Contact Ex-Court M/9*30 - 1.0Mm. Cu.ag.	25
M9	1EX9P12W	Tube Contact Ex-Court M/9*30 - 1.2Mm. Cu.ag.	25
M9	1EX9P14W	Tube Contact Ex-Court M/9*30 - 1.4Mm. Cu.ag.	25
M9	1EX9P16W	Tube Contact Ex-Court M/9*30 - 1.6Mm. Cu.ag.	25
M9	1EX9P24W	Tube Contact Ex-Court M/9*30 - 2.4Mm. Cu.ag.	25
M9	1EX9P08WA	Tube Contact Ex-Court Aluweld M/9*30 - 0.8Mm. Cu.ag.	25
M9	1EX9P10WA	Tube Contact Ex-Court Aluweld M/9*30 - 1.0Mm. Cu.ag.	25
M9	1EX9P12WA	Tube Contact Ex-Court Aluweld M/9*30 - 1.2Mm. Cu.ag.	25
M9	1EX9P16WA	Tube Contact Ex-Court Aluweld M/9*30 - 1.6Mm. Cu.ag.	25
M8	199CL08	Tube Contact Chrome Ergodani M/8*28 - 0.8Mm. Cu.	25
M8	199CL10	Tube Contact Chrome Ergodani M/8*28 - 1.0Mm. Cu.	25
M8	199CL12	Tube Contact Chrome Ergodani M/8*28 - 1.2Mm. Cu.	25
M8	199CL14	Tube Contact Chrome Ergodani M/8*28 - 1.4Mm. Cu.	25
M8	199CL16	Tube Contact Chrome Ergodani M/8*28 - 1.6Mm. Cu.	25
E1	812 0901	Poignee Noir Bouchon Aluminium Ex	1
E2	19906	Ressort & Rotule Cx Ergodani	2
E5	199EP01	Gâchette Bleu Ergodani	5
G1	199SR02A	Gaine Enveloppée Bleu Ergodani 0.6-0.8Mm. 2.40Mts.	1
G1	199SR03A	Gaine Enveloppée Bleu Ergodani 0.6-0.8Mm. 3.40Mts.	1
G1	199SR04A	Gaine Enveloppée Bleu Ergodani 0.6-0.8Mm. 4.40Mts.	1
G1	199SR05A	Gaine Enveloppée Bleu Ergodani 0.6-0.8Mm. 5.40Mts.	1
G1	199SR02R	Gaine Enveloppée Rouge Ergodani 1.0-1.2Mm. 2.40Mts.	1
G1	199SR03R	Gaine Enveloppée Rouge Ergodani 1.0-1.2Mm. 3.40Mts.	1
G1	199SR04R	Gaine Enveloppée Rouge Ergodani 1.0-1.2Mm. 4.40Mts.	1
G1	199SR05R	Gaine Enveloppée Rouge Ergodani 1.0-1.2Mm. 5.40Mts.	1
G1	199SR02M	Gaine Enveloppée Jaune Ergodani 1.6Mm. 2.40Mts.	1
G1	199SR03M	Gaine Enveloppée Jaune Ergodani 1.6Mm. 3.40Mts.	1
G1	199SR04M	Gaine Enveloppée Jaune Ergodani 1.6Mm. 4.40Mts.	1
G1	199SR05M	Gaine Enveloppée Jaune Ergodani 1.6Mm. 5.40Mts.	1
G1	199SR02V	Gaine Enveloppée Vert Ergodani 2.4Mm. 2.40Mts.	1
G1	199SR03V	Gaine Enveloppée Vert Ergodani 2.4Mm. 3.40Mts.	1
G1	199SR04V	Gaine Enveloppée Vert Ergodani 2.4Mm. 4.40Mts.	1
G1	199SR05V	Gaine Enveloppée Vert Ergodani 2.4Mm. 5.40Mts.	1

## Ex 270

Réfrigération par Gaz

250 Amp 60% CO<sub>2</sub>  
225 Amp 60% Ar + CO<sub>2</sub>

Torche conçue pour les soudures polyvalentes de moyenne intensité. Idéal pour souder l'aluminium.

Torche pour le secteur professionnel, avec une durée de consommable plus long.

Buse filetée, tube contact surdimensionné de M9 et isolation spéciale.



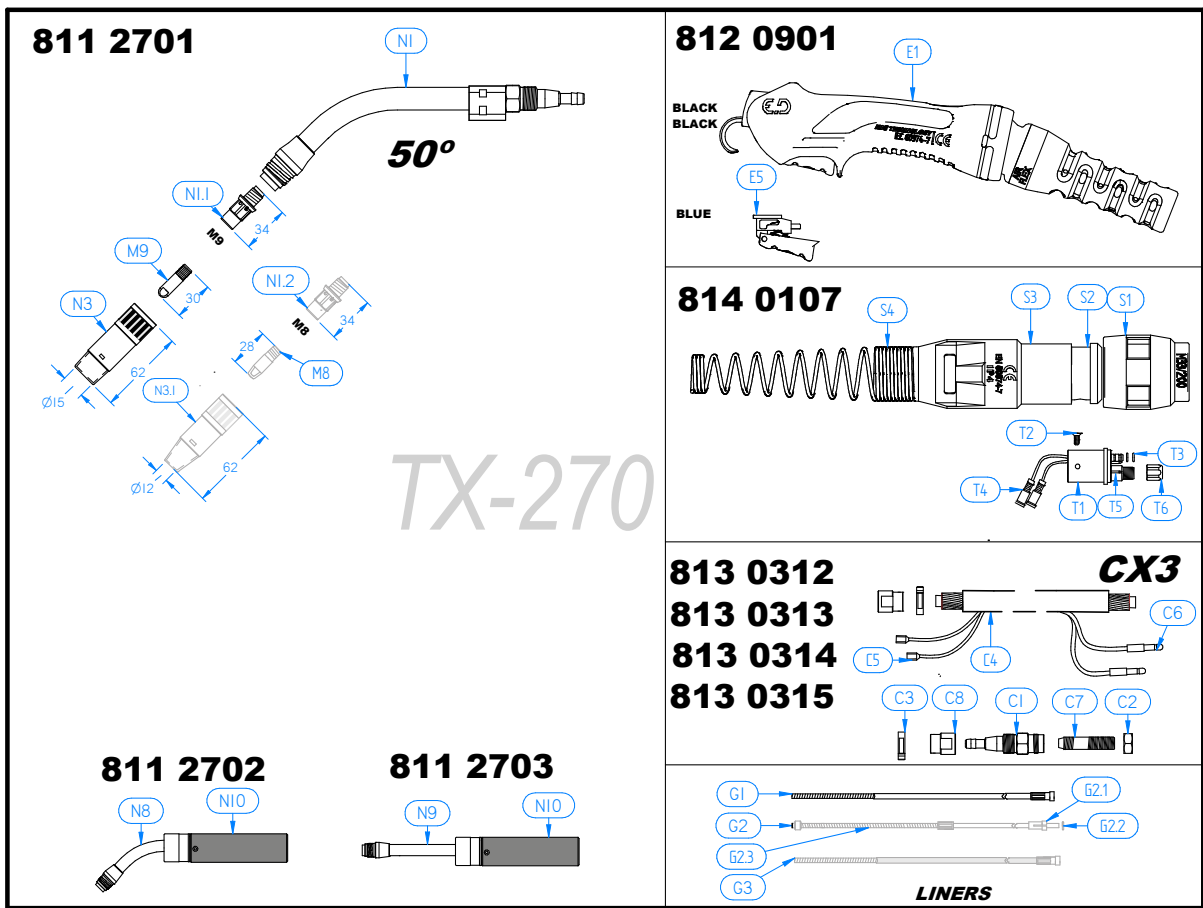

POS.	COD.	DESCRIPTION	PACK
G2	199SA302	Gaine Aluweld Ergodani 0.8-1.0Mm. 2.50Mts.	1
G2	199SA303	Gaine Aluweld Ergodani 0.8-1.0Mm. 3.50Mts.	1
G2	199SA304	Gaine Aluweld Ergodani 0.8-1.0Mm. 4.50Mts.	1
G2	199SA305	Gaine Aluweld Ergodani 0.8-1.0Mm. 5.50Mts.	1
G2	199SA402	Gaine Aluweld Ergodani 1.2-1.6Mm. 2.50Mts.	1
G2	199SA403	Gaine Aluweld Ergodani 1.2-1.6Mm. 3.50Mts.	1
G2	199SA404	Gaine Aluweld Ergodani 1.2-1.6Mm. 4.50Mts.	1
G2	199SA405	Gaine Aluweld Ergodani 1.2-1.6Mm. 5.50Mts.	1
G2.1	199SA88	Collier Gaine Aluwed/Alum.	10
G2.2	199SA77	Joint Torique Gaine Aluwed/Alum.	10
G2.3	199SA3G	Embout Metal Gaine Aluweld Ergodani 0.8-1.0Mm.	2
G2.3	199SA4G	Embout Metal Gaine Aluweld Ergodani 1.2-1.6Mm.	2
G3	199SIN02	Gaine Bronze Enveloppée Gris Ergodani Inox.1.0-1.2Mm. 2.40M	1
G3	199SIN03	Gaine Bronze Enveloppée Gris Ergodani Inox.1.0-1.2Mm. 3.40M	1
G3	199SIN04	Gaine Bronze Enveloppée Gris Ergodani Inox.1.0-1.2Mm. 4.40M	1
G3	199SIN05	Gaine Bronze Enveloppée Gris Ergodani Inox.1.0-1.2Mm. 5.40M	1
C1	1EX2723	Pointe Cable Ex-270	5
C2	19920	Ecrou Cable Col De Cygne Ergodani	10
C3	145T185	Collier A Oreille 18.5	10
C4	1EX27CX02	Cable Coaxial Ex-270 2Mts.	1
C4	1EX27CX03	Cable Coaxial Ex-270 3Mts.	1
C4	1EX27CX04	Cable Coaxial Ex-270 4Mts.	1
C4	1EX27CX05	Cable Coaxial Ex-270 5Mts.	1
C5	199FT01	Connecteur Cable Elect. Av.	25
C6	199FT02	Connecteur Cable Elect. Ar.	25
C7	1EX923	Conduit Connexion Euro Ex-270/380	5
C8	1EX2720	Ecrou Collier Cable Ex-270	5
E2	19906	Ressort & Rotule Cx Ergodani	2
S1	1000125	Ecrou Support Connexion Noir Cx	1
S2	100012401	Tuyau Support Connexion Cx	1
S3	100012402	Ressort Arriere Support Cx	1
S4	10001062	Ressort Arriere Cx	1
T1	199MZ	Connecteur Euro Cx Ergodani	1
T2	199MZ05	Vis Fixation Connecteur Euro	10
T3	199MZ03	Joint Torique Connecteur Euro	10
T4	199FT03	Connecteur Cable Elect. C.euro	25
T5	199MZ04	Plot Rect. Connecteur Euro Cx Ergodani	2
T6	199MZ02	Ecrou Du Connecteur Euro Ergodani	10
H9	199MZ03	Joint Torique Connecteur Euro	10
T4	199FT03	Connecteur Cable Elect. C.euro	25
T5	199MZ04	Plot Rect. Connecteur Euro Cx Ergodani	2
C4	199MZ02	Ecrou Du Connecteur Euro Ergodani	10



# Tx 380



COD.	DESCRIPTION	PACK
1EX38103	Torche Ergodani Tesla Ex-380 3Mts. Euro	1
1EX38104	Torche Ergodani Tesla Ex-380 4Mts. Euro	1
1EX38105	Torche Ergodani Tesla Ex-380 5Mts. Euro	1
1EX38203	Torche Ergodani Aluweld Ex-380 3Mts. Euro	1
1EX38204	Torche Ergodani Aluweld Ex-380 4Mts. Euro	1
1EX38205	Torche Ergodani Aluweld Ex-380 5Mts. Euro	1
1EX38AC02	Torche Automat. Col Coudé 45° Ex-380 2Mts. Euro	1
1EX38AC03	Torche Automat. Col Coudé 45° Ex-380 3Mts. Euro	1
1EX38AC04	Torche Automat. Col Coudé 45° Ex-380 4Mts. Euro	1
1EX38AR02	Torche Automat. Col Droit 0° Ex-380 2Mts. Euro	1
1EX38AR03	Torche Automat. Col Droit 0° Ex-380 3Mts. Euro	1
1EX38AR04	Torche Automat. Col Droit 0° Ex-380 4Mts. Euro	1

POS.	COD.	DESCRIPTION	PACK
N1	1EX3801	Col De Cygne Principal Ex-380	1
N1.1	1EX3802	Diffuseur Support Tube Contact Ex-380/421W M/9*38Mm.	10
N1.2	1EX3802M8	Diffuseur Support Tube Contact Ex-380/421W M/8*38Mm.	10
N3	1EX3804	Buse Standard Ex-380/421W - 16Mm.	5
N3.1	1EX380402	Buse Conique Ex-380/421W - 13Mm.	5
N8	1EX3801AC	Col Automatique Coudé 45° Ex-380	1
N9	1EX3801AR	Col Automatique Droit 0° Ex-380	1
N10	199EPAT	Poignee Automatique Ergodani	1
M9	1EX9P08	Tube Contact Ex-Long M/9*34 - 0.8Mm. Cu.ag.	25
M9	1EX9P10	Tube Contact Ex-Long M/9*34 - 1.0Mm. Cu.ag.	25
M9	1EX9P12	Tube Contact Ex-Long M/9*34 - 1.2Mm. Cu.ag.	25
M9	1EX9P14	Tube Contact Ex-Long M/9*34 - 1.4Mm. Cu.ag.	25
M9	1EX9P16	Tube Contact Ex-Long M/9*34 - 1.6Mm. Cu.ag.	25
M9	1EX9P24	Tube Contact Ex-Long M/9*34 - 2.4Mm. Cu.ag.	25
M9	1EX9P08A	Tube Contact Ex-Long Aluweld M/9*34 - 0.8Mm. Cu.ag.	25
M9	1EX9P10A	Tube Contact Ex-Long Aluweld M/9*34 - 1.0Mm. Cu.ag.	25
M9	1EX9P12A	Tube Contact Ex-Long Aluweld M/9*34 - 1.2Mm. Cu.ag.	25
M9	1EX9P16A	Tube Contact Ex-Long Aluweld M/9*34 - 1.6Mm. Cu.ag.	25
M8	199M808	Tube Contact Ergodani M/8*30 - 0.8Mm. Cu.	25
M8	199M810	Tube Contact Ergodani M/8*30 - 1.0Mm. Cu.	25
M8	199M812	Tube Contact Ergodani M/8*30 - 1.2Mm. Cu.	25
M8	199M814	Tube Contact Ergodani M/8*30 - 1.4Mm. Cu.	25
M8	199M816	Tube Contact Ergodani M/8*30 - 1.6Mm. Cu.	25
M8	199M818	Tube Contact Ergodani M/8*30 - 1.8Mm. Cu.	25
M8	199M824	Tube Contact Ergodani M/8*30 - 2.4Mm. Cu.	25
M8	199M808A	Tube Contact Ergodani M/8*30 - A10.8mm. Cu.	25
M8	199M810A	Tube Contact Ergodani M/8*30 - A11.0mm. Cu.	25
M8	199M812A	Tube Contact Ergodani M/8*30 - A11.2mm. Cu.	25
M8	199M816A	Tube Contact Ergodani M/8*30 - A11.6mm. Cu.	25
M8	199M808C	Tube Contact Chrome Ergodani M/8*30 - 0.8Mm. Cu.	25
M8	199M810C	Tube Contact Chrome Ergodani M/8*30 - 1.0Mm. Cu.	25
M8	199M812C	Tube Contact Chrome Ergodani M/8*30 - 1.2Mm. Cu.	25
M8	199M814C	Tube Contact Chrome Ergodani M/8*30 - 1.4Mm. Cu.	25
M8	199M816C	Tube Contact Chrome Ergodani M/8*30 - 1.6Mm. Cu.	25

## Tx 380

Réfrigération par Gaz

350 Amp 60% CO<sub>2</sub>  
270 Amp 60% Ar + CO<sub>2</sub>

Torche conçue pour des soudures polyvalentes d'intensité moyenne à élevée. Avantages en intensité et durée du cycle de soudure.

Torche la plus polyvalente de la gamme professionnelle.

Buse filetée, tube contact surdimensionné de M9 et isolation spéciale.



## 811 3801

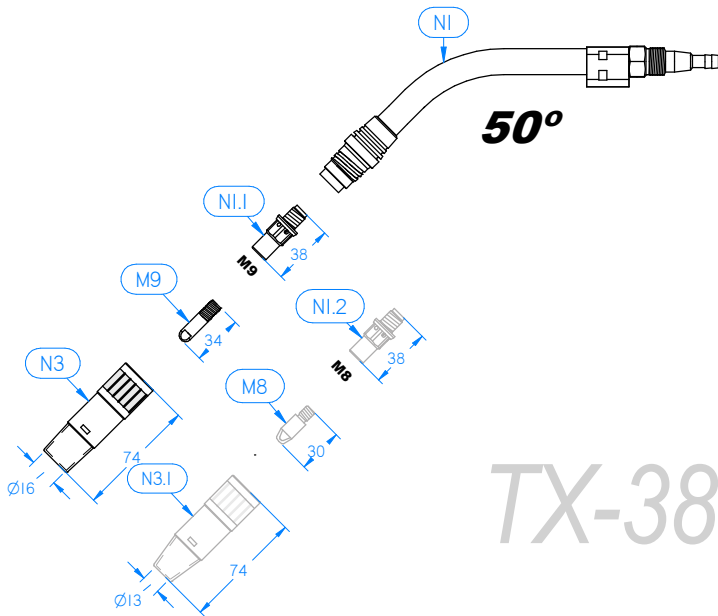

TX-380

## 811 3802

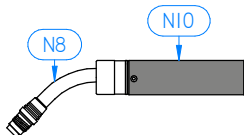

## 811 3803

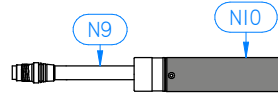

## 812 0901

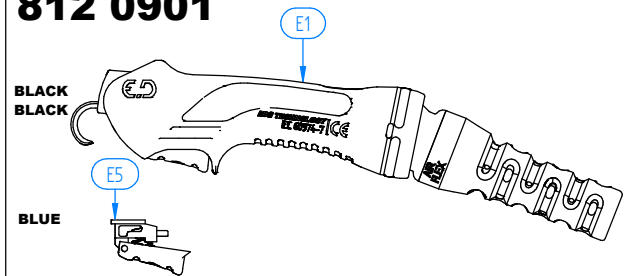

## 814 0107

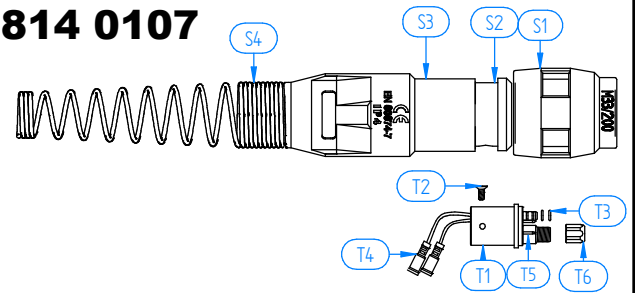

## 813 0412

## 813 0413

## 813 0414

## 813 0415

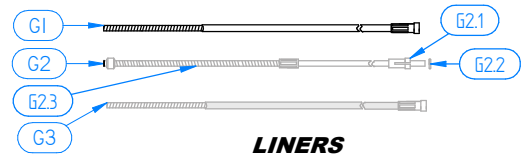
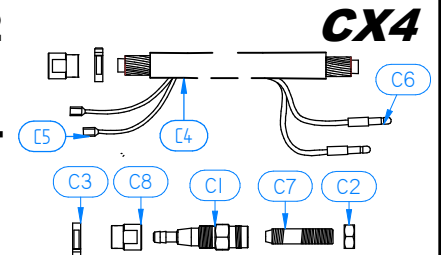

LINERS

POS.	COD.	DESCRIPTION	PACK
M8	199M808N	Tube Contact M/8*30 - 0.8Mm. Cu.	25
M8	199M810N	Tube Contact M/8*30 - 1.0Mm. Cu.	25
M8	199M812N	Tube Contact M/8*30 - 1.2Mm. Cu.	25
M8	199M814N	Tube Contact M/8*30 - 1.4Mm. Cu.	25
M8	199M816N	Tube Contact M/8*30 - 1.6Mm. Cu.	25
M8	199M808Z	Tube Contact Ergodani M/8*30 - 0.8Mm. Cu.cr.zr.	25
M8	199M810Z	Tube Contact Ergodani M/8*30 - 1.0Mm. Cu.cr.zr.	25
M8	199M812Z	Tube Contact Ergodani M/8*30 - 1.2Mm. Cu.cr.zr.	25
M8	199M814Z	Tube Contact Ergodani M/8*30 - 1.4Mm. Cu.cr.zr.	25
M8	199M816Z	Tube Contact Ergodani M/8*30 - 1.6Mm. Cu.cr.zr.	25
M8	199M808ZN	Tube Contact M/8*30 - 0.8Mm. Cu.cr.zr.	25
M8	199M810ZN	Tube Contact M/8*30 - 1.0Mm. Cu.cr.zr.	25
M8	199M812ZN	Tube Contact M/8*30 - 1.2Mm. Cu.cr.zr.	25
M8	199M814ZN	Tube Contact M/8*30 - 1.4Mm. Cu.cr.zr.	25
M8	199M816ZN	Tube Contact M/8*30 - 1.6Mm. Cu.cr.zr.	25
E1	812 0901	Poignée Noir Bouchon Aluminium Ex	1
E2	19906	Ressort & Rotule Cx Ergodani	2
E5	199EP01	Gâchette Bleu Ergodani	5
G1	199SR02A	Gaine Enveloppée Bleu Ergodani 0.6-0.8Mm. 2.40Mts.	1
G1	199SR03A	Gaine Enveloppée Bleu Ergodani 0.6-0.8Mm. 3.40Mts.	1
G1	199SR04A	Gaine Enveloppée Bleu Ergodani 0.6-0.8Mm. 4.40Mts.	1
G1	199SR05A	Gaine Enveloppée Bleu Ergodani 0.6-0.8Mm. 5.40Mts.	1
G1	199SR02R	Gaine Enveloppée Rouge Ergodani 1.0-1.2Mm. 2.40Mts.	1
G1	199SR03R	Gaine Enveloppée Rouge Ergodani 1.0-1.2Mm. 3.40Mts.	1



# 811 3801

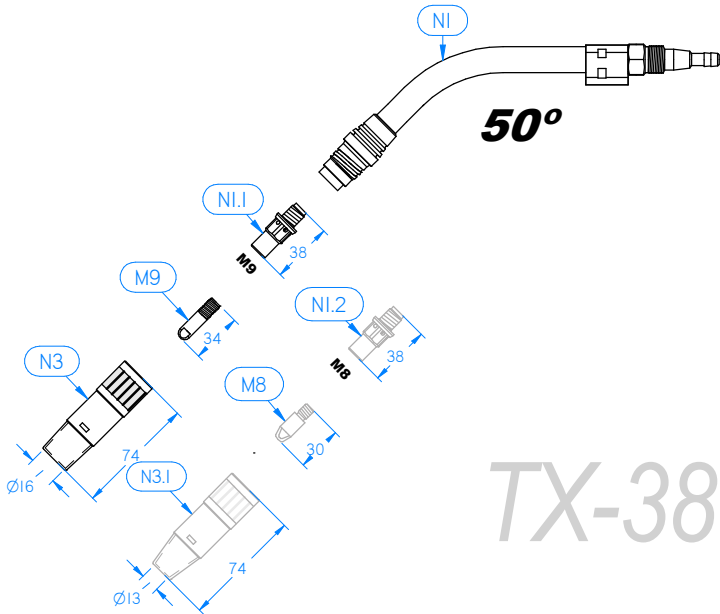

TX-380

# 811 3802

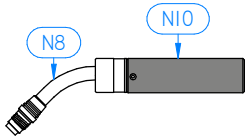

# 811 3803

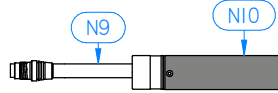

# 812 0901

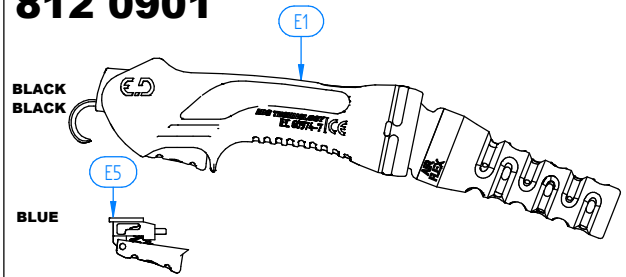

# 814 0107

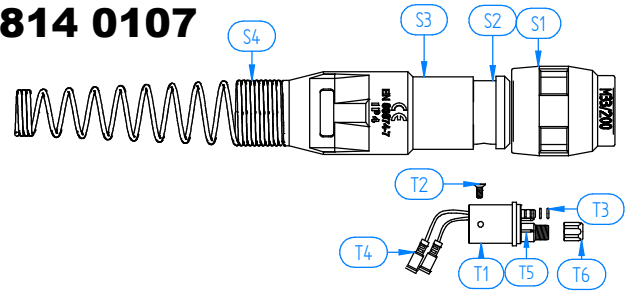

# 813 0412

# 813 0413

# 813 0414

# 813 0415

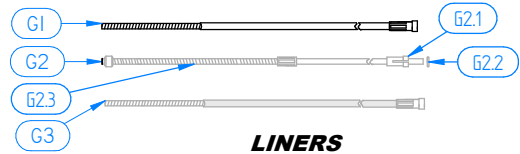
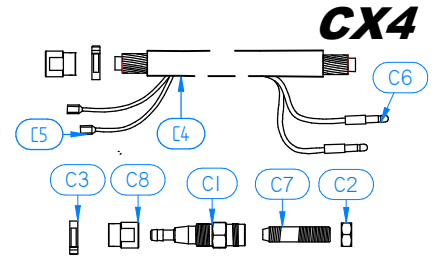

LINERS

POS.	COD.	DESCRIPTION	PACK
G1	199SR04R	Gaine Enveloppée Rouge Ergodani 1.0-1.2Mm. 4.40Mts.	1
G1	199SR05R	Gaine Enveloppée Rouge Ergodani 1.0-1.2Mm. 5.40Mts.	1
G1	199SR02M	Gaine Enveloppée Jaune Ergodani 1.6Mm. 2.40Mts.	1
G1	199SR03M	Gaine Enveloppée Jaune Ergodani 1.6Mm. 3.40Mts.	1
G1	199SR04M	Gaine Enveloppée Jaune Ergodani 1.6Mm. 4.40Mts.	1
G1	199SR05M	Gaine Enveloppée Jaune Ergodani 1.6Mm. 5.40Mts.	1
G1	199SR02V	Gaine Enveloppée Vert Ergodani 2.4Mm. 2.40Mts.	1
G1	199SR03V	Gaine Enveloppée Vert Ergodani 2.4Mm. 3.40Mts.	1
G1	199SR04V	Gaine Enveloppée Vert Ergodani 2.4Mm. 4.40Mts.	1
G1	199SR05V	Gaine Enveloppée Vert Ergodani 2.4Mm. 5.40Mts.	1
G2	199SA302	Gaine Aluweld Ergodani 0.8-1.0Mm. 2.50Mts.	1
G2	199SA303	Gaine Aluweld Ergodani 0.8-1.0Mm. 3.50Mts.	1
G2	199SA304	Gaine Aluweld Ergodani 0.8-1.0Mm. 4.50Mts.	1
G2	199SA305	Gaine Aluweld Ergodani 0.8-1.0Mm. 5.50Mts.	1
G2	199SA402	Gaine Aluweld Ergodani 1.2-1.6Mm. 2.50Mts.	1
G2	199SA403	Gaine Aluweld Ergodani 1.2-1.6Mm. 3.50Mts.	1
G2	199SA404	Gaine Aluweld Ergodani 1.2-1.6Mm. 4.50Mts.	1
G2	199SA405	Gaine Aluweld Ergodani 1.2-1.6Mm. 5.50Mts.	1
G2.1	199SA88	Collier Gaine Aluweld/Alum.	10
G2.2	199SA77	Joint Torique Gaine Aluweld/Alum.	10
G2.3	199SA3G	Embout Metal Gaine Aluweld Ergodani 0.8-1.0Mm.	2
G2.3	199SA4G	Embout Metal Gaine Aluweld Ergodani 1.2-1.6Mm.	2
G3	199SIN02	Gaine Bronze Enveloppée Gris Ergodani Inox.1.0-1.2Mm. 2.40M	1
G3	199SIN03	Gaine Bronze Enveloppée Gris Ergodani Inox.1.0-1.2Mm. 3.40M	1
G3	199SIN04	Gaine Bronze Enveloppée Gris Ergodani Inox.1.0-1.2Mm. 4.40M	1
G3	199SIN05	Gaine Bronze Enveloppée Gris Ergodani Inox.1.0-1.2Mm. 5.40M	1
C1	1EX3823	Pointe Cable Ex-380	5
C2	19920	Ecrou Cable Col De Cygne Ergodani	10
C3	145T200	Collier A Oreille 20.0	10
C4	1EX38CX02	Cable Coaxial Ex-380 2Mts.	1
C4	1EX38CX03	Cable Coaxial Ex-380 3Mts.	1
C4	1EX38CX04	Cable Coaxial Ex-380 4Mts.	1
C4	1EX38CX05	Cable Coaxial Ex-380 5Mts.	1



POS.	COD.	DESCRIPTION	PACK
C5	199FT01	Connecteur Cable Elect. Av.	25
C6	199FT02	Connecteur Cable Elect. Ar.	25
C7	1EX923	Conduit Connexion Euro Ex-270/380	5
C8	1EX3820	Ecrou Collier Cable Ex-380	5
E2	19906	Ressort & Rotule Cx Ergodani	2
S1	1000125	Ecrou Support Connexion Noir Cx	1
S2	100012401	Tuyau Support Connexion Cx	1
S3	100012402	Ressort Arriere Support Cx	1
S4	10001062	Ressort Arriere Cx	1
T1	199MZ	Connecteur Euro Cx Ergodani	1
T2	199MZ05	Vis Fixation Connecteur Euro	10
T3	199MZ03	Joint Torique Connecteur Euro	10
T4	199FT03	Connecteur Cable Elect. C.euro	25
T5	199MZ04	Plot Rect. Connecteur Euro Cx Ergodani	2
T6	199MZ02	Ecrou Du Connecteur Euro Ergodani	10
H9	199MZ03	Joint Torique Connecteur Euro	10
C4	199MZ02	Ecrou Du Connecteur Euro Ergodani	10



**ERGODANI**<sup>®</sup>  
Welding Technology Division

# Tx 480



COD.	DESCRIPTION	PACK
1EX48103	Torche Ergodani Tesla Ex-480 3Mts. Euro	1
1EX48104	Torche Ergodani Tesla Ex-480 4Mts. Euro	1
1EX48105	Torche Ergodani Tesla Ex-480 5Mts. Euro	1
1EX48AC02	Torche Automat. Col Coudé 45° Ex-480 2Mts. Euro	1
1EX48AC03	Torche Automat. Col Coudé 45° Ex-480 3Mts. Euro	1
1EX48AC04	Torche Automat. Col Coudé 45° Ex-480 4Mts. Euro	1
1EX48AR02	Torche Automat. Col Droit 0° Ex-480 2Mts. Euro	1
1EX48AR03	Torche Automat. Col Droit 0° Ex-480 3Mts. Euro	1
1EX48AR04	Torche Automat. Col Droit 0° Ex-480 4Mts. Euro	1

POS.	COD.	DESCRIPTION	PACK
N1	1EX4801	Col De Cygne Principal Ex-480	1
N1.2	1EX4802R	Diffuseur Support Tube Contact Ex-480 M/10*45Mm.	10
N1.1	1EX4802	Diffuseur Support Tube Contact Ex-480 M/9*48Mm.	10
N3	1EX4804	Buse Standard Ex-480 - 19Mm.	5
N8	1EX4801AC	Col Automatique Coudé 45° Ex-480	1
N9	1EX4801AR	Col Automatique Droit 0° Ex-480	1
N10	199EPAT	Poignee Automatique Ergodani	1
M10	160M108	Tube Contact Exr M/10*43 - 0.8Mm. Cu.cr.zr.	10
M10	160M109	Tube Contact Exr M/10*43 - 0.9Mm. Cu.cr.zr.	10
M10	160M110	Tube Contact Exr M/10*43 - 1.0Mm. Cu.cr.zr.	10
M10	160M112	Tube Contact Exr M/10*43 - 1.2Mm. Cu.cr.zr.	10
M10	160M114	Tube Contact Exr M/10*43 - 1.4Mm. Cu.cr.zr.	10
M10	160M116	Tube Contact Exr M/10*43 - 1.6Mm. Cu.cr.zr.	10
M10	160M124	Tube Contact Exr M/10*43 - 2.4Mm. Cu.cr.zr.	10
M9	1EX9P08	Tube Contact Ex-Long M/9*34 - 0.8Mm. Cu.ag.	25
M9	1EX9P10	Tube Contact Ex-Long M/9*34 - 1.0Mm. Cu.ag.	25
M9	1EX9P12	Tube Contact Ex-Long M/9*34 - 1.2Mm. Cu.ag.	25
M9	1EX9P14	Tube Contact Ex-Long M/9*34 - 1.4Mm. Cu.ag.	25
M9	1EX9P16	Tube Contact Ex-Long M/9*34 - 1.6Mm. Cu.ag.	25
M9	1EX9P24	Tube Contact Ex-Long M/9*34 - 2.4Mm. Cu.ag.	25
M9	1EX9P08A	Tube Contact Ex-Long Aluweld M/9*34 - 0.8Mm. Cu.ag.	25
M9	1EX9P10A	Tube Contact Ex-Long Aluweld M/9*34 - 1.0Mm. Cu.ag.	25
M9	1EX9P12A	Tube Contact Ex-Long Aluweld M/9*34 - 1.2Mm. Cu.ag.	25
M9	1EX9P16A	Tube Contact Ex-Long Aluweld M/9*34 - 1.6Mm. Cu.ag.	25
E1	812 0901	Poignee Noir Bouchon Noir Ex-480	1
E2	1EX4806	Ressort & Rotule Cx5 Ex-480	2
E5	199EP01	Gâchette Bleu Ergodani	5
G1	199SR02A	Gaine Enveloppée Bleu Ergodani 0.6-0.8Mm. 2.40Mts.	1
G1	199SR03A	Gaine Enveloppée Bleu Ergodani 0.6-0.8Mm. 3.40Mts.	1
G1	199SR04A	Gaine Enveloppée Bleu Ergodani 0.6-0.8Mm. 4.40Mts.	1
G1	199SR05A	Gaine Enveloppée Bleu Ergodani 0.6-0.8Mm. 5.40Mts.	1
G1	199SR02N	Gaine Enveloppée Noir Ergodani 1.0-1.6Mm. 2.40Mts.	1
G1	199SR03N	Gaine Enveloppée Noir Ergodani 1.0-1.6Mm. 3.40Mts.	1
G1	199SR04N	Gaine Enveloppée Noir Ergodani 1.0-1.6Mm. 4.40Mts.	1
G1	199SR05N	Gaine Enveloppée Noir Ergodani 1.0-1.6Mm. 5.40Mts.	1
G1	199SR02V	Gaine Enveloppée Vert Ergodani 2.4Mm. 2.40Mts.	1
G1	199SR03V	Gaine Enveloppée Vert Ergodani 2.4Mm. 3.40Mts.	1
G1	199SR04V	Gaine Enveloppée Vert Ergodani 2.4Mm. 4.40Mts.	1
G1	199SR05V	Gaine Enveloppée Vert Ergodani 2.4Mm. 5.40Mts.	1
G2	199SA102	Gaine Pour Alu 0.8-1.0Mm. 2Mts.	1
G2	199SA103	Gaine Pour Alu 0.8-1.0Mm. 3Mts.	1
G2	199SA104	Gaine Pour Alu 0.8-1.0Mm. 4Mts.	1
G2	199SA105	Gaine Pour Alu 0.8-1.0Mm. 5Mts.	1
G2	199SA202	Gaine Pour Alu 1.2-1.6Mm. 2Mts.	1
G2	199SA203	Gaine Pour Alu 1.2-1.6Mm. 3Mts.	1
G2	199SA204	Gaine Pour Alu 1.2-1.6Mm. 4Mts.	1

## Tx 480

Réfrigération par Gaz

450 Amp 60% CO<sub>2</sub>  
350 Amp 60% Ar + CO<sub>2</sub>

La torche refroidie au gaz la plus puissante de la gamme professionnelle ED Ergodani. Il fournit une plus grande résistance dans le soudage à haute intensité avec un poids équilibré.

La torche de refroidissement à gaz avec la plus grande section de câble, idéale pour l'automatisation.

Buse filetée, tube contact surdimensionné de M10 et isolation spéciale.



## 811 4801

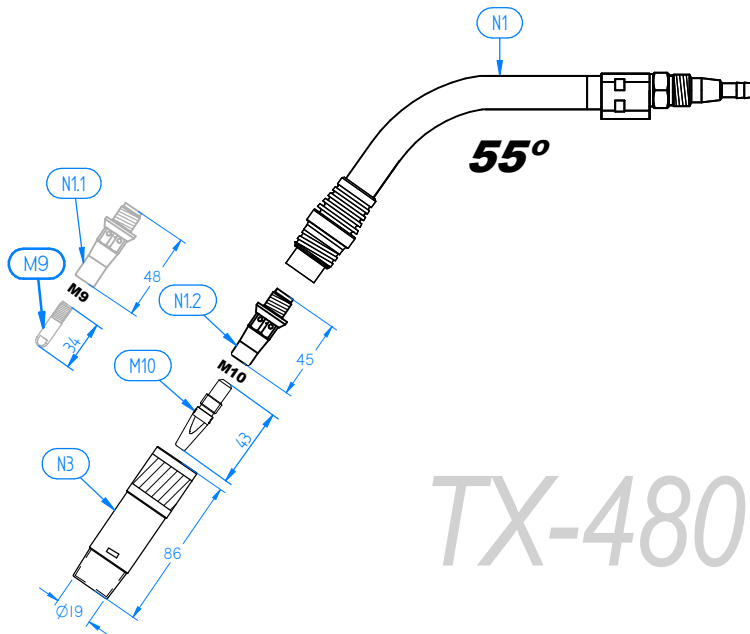

TX-480

## 811 4802

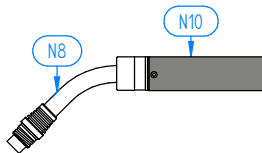

## 811 4803

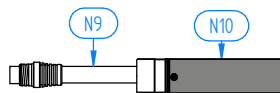

## 812 0901

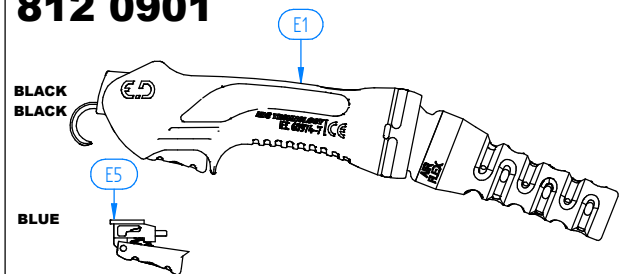

## 814 0107

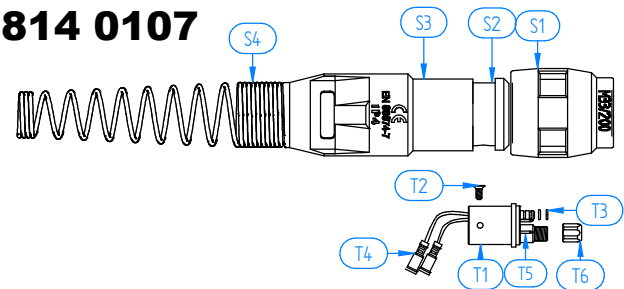

## 813 0512

## 813 0513

## 813 0514

## 813 0515

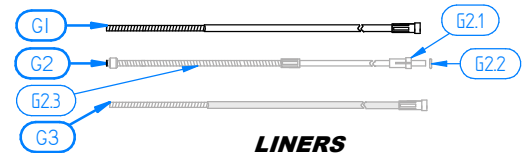
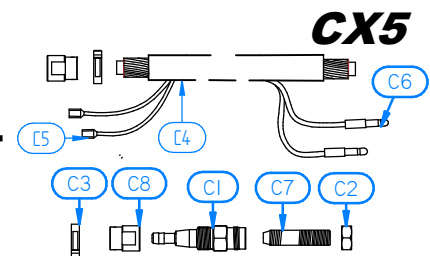

LINERS

POS.	COD.	DESCRIPTION	PACK
G2.1	199SA88	Collier Gaine Aluved/Alum.	10
G2.2	199SA77	Joint Torique Gaine Aluved/Alum.	10
G2.3	199SA1G	Embout Metal Gaine Por Alu 0.8-1.0Mm.	2
G2.3	199SA2G	Embout Metal Gaine Por Alu 1.2-1.6Mm.	2
G3	199SIN02	Gaine Bronze Enveloppée Gris Ergodani Inox.1.0-1.2Mm. 2.40M	1
G3	199SIN03	Gaine Bronze Enveloppée Gris Ergodani Inox.1.0-1.2Mm. 3.40M	1
G3	199SIN04	Gaine Bronze Enveloppée Gris Ergodani Inox.1.0-1.2Mm. 4.40M	1
G3	199SIN05	Gaine Bronze Enveloppée Gris Ergodani Inox.1.0-1.2Mm. 5.40M	1
C1	1EX4823	Pointe Cable Ex-480	5
C2	1EX4820	Ecrou Collier Cable Ex-480	5
C3	145T210	Collier A Oreille 21.0	10
C4	1EX48CX02	Cable Coaxial Ex-480 2Mts.	1
C4	1EX48CX03	Cable Coaxial Ex-480 3Mts.	1
C4	1EX48CX04	Cable Coaxial Ex-480 4Mts.	1
C4	1EX48CX05	Cable Coaxial Ex-480 5Mts.	1
C5	199FT01	Connecteur Cable Elect. Av.	25
C6	199FT02	Connecteur Cable Elect. Ar.	25
S1	1000125	Ecrou Support Connexion Noir Cx	1
S2	100012401	Tuyau Support Connexion Cx	1
S3	100012402	Ressort Arriere Support Cx	1
S4	10001062	Ressort Arriere Cx	1
T1	199MZ	Connecteur Euro Cx Ergodani	1
T2	199MZ05	Vis Fixation Connecteur Euro	10
T3	199MZ03	Joint Torique Connecteur Euro	10
T4	199FT03	Connecteur Cable Elect. C.euro	25
T5	199MZ04	Plot Rect. Connecteur Euro Cx Ergodani	2
T6	199MZ02	Ecrou Du Connecteur Euro Ergodani	10
H9	199MZ03	Joint Torique Connecteur Euro	10
T4	199FT03	Connecteur Cable Elect. C.euro	25
T5	199MZ04	Plot Rect. Connecteur Euro Cx Ergodani	2
C4	199MZ02	Ecrou Du Connecteur Euro Ergodani	10



DISPONIBLE EN COL  
AUTOMATIQUE



ERGODANI

MIG 33

# Ex 221w

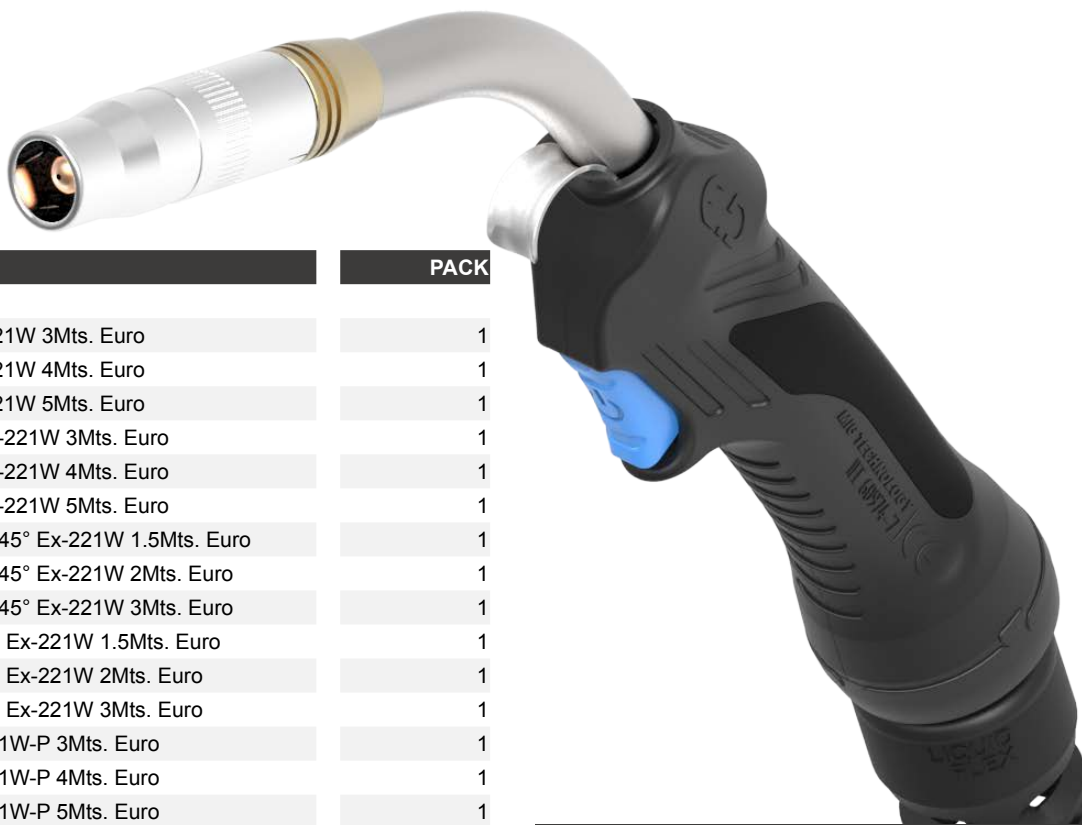

COD.	DESCRIPTION	PACK
1EX22103	Torche Ergodani Tesla Ex-221W 3Mts. Euro	1
1EX22104	Torche Ergodani Tesla Ex-221W 4Mts. Euro	1
1EX22105	Torche Ergodani Tesla Ex-221W 5Mts. Euro	1
1EX22203	Torche Ergodani Aluweld Ex-221W 3Mts. Euro	1
1EX22204	Torche Ergodani Aluweld Ex-221W 4Mts. Euro	1
1EX22205	Torche Ergodani Aluweld Ex-221W 5Mts. Euro	1
1EX22AC01	Torche Automat. Col Coudé 45° Ex-221W 1.5Mts. Euro	1
1EX22AC02	Torche Automat. Col Coudé 45° Ex-221W 2Mts. Euro	1
1EX22AC03	Torche Automat. Col Coudé 45° Ex-221W 3Mts. Euro	1
1EX22AR01	Torche Automat. Col Droit 0° Ex-221W 1.5Mts. Euro	1
1EX22AR02	Torche Automat. Col Droit 0° Ex-221W 2Mts. Euro	1
1EX22AR03	Torche Automat. Col Droit 0° Ex-221W 3Mts. Euro	1
1EIP22103	Torche Ergodani Tesla Ei-221W-P 3Mts. Euro	1
1EIP22104	Torche Ergodani Tesla Ei-221W-P 4Mts. Euro	1
1EIP22105	Torche Ergodani Tesla Ei-221W-P 5Mts. Euro	1
1EIP22203	Torche Ergodani Aluweld Ei-221W-P 3Mts. Euro	1
1EIP22204	Torche Ergodani Aluweld Ei-221W-P 4Mts. Euro	1
1EIP22205	Torche Ergodani Aluweld Ei-221W-P 5Mts. Euro	1
1EID22103	Torche Ergodani Tesla Ei-221W-D 3Mts. Euro	1
1EID22104	Torche Ergodani Tesla Ei-221W-D 4Mts. Euro	1
1EID22105	Torche Ergodani Tesla Ei-221W-D 5Mts. Euro	1
1EID22203	Torche Ergodani Aluweld Ei-221W-D 3Mts. Euro	1
1EID22204	Torche Ergodani Aluweld Ei-221W-D 4Mts. Euro	1
1EID22205	Torche Ergodani Aluweld Ei-221W-D 5Mts. Euro	1
1EII22103	Torche Ergodani Tesla Ei-221W-I 3Mts. Euro	1
1EII22104	Torche Ergodani Tesla Ei-221W-I 4Mts. Euro	1
1EII22105	Torche Ergodani Tesla Ei-221W-I 5Mts. Euro	1
1EII22203	Torche Ergodani Aluweld Ei-221W-I 3Mts. Euro	1
1EII22204	Torche Ergodani Aluweld Ei-221W-I 4Mts. Euro	1
1EII22205	Torche Ergodani Aluweld Ei-221W-I 5Mts. Euro	1

POS.	COD.	DESCRIPTION	PACK
N1	1EX2201	Col De Cygne Principal Ex-221W	1
N1.1	1EX2702	Diffuseur Support Tube Contact Ex-270/221W M/9*34Mm.	10
N1.2	1EX2702M8	Diffuseur Support Tube Contact Ex-270/221W M/8*34Mm.	10
N3	1EX2704	Buse Standard Ex-270/221W - 15Mm.	5
N3.1	1EX270402	Buse Conique Ex-270/221W - 13Mm.	5
N8	1EX2201AC	Col Automatique Coudé 45° Ex-221W	1
N9	1EX2201AR	Col Automatique Droit 0° Ex-221W	1
N10	199EPAT	Poignee Automatique Ergodani	1
M9	1EX9P08W	Tube Contact Ex-Court M/9*30 - 0.8Mm. Cu.ag.	25
M9	1EX9P10W	Tube Contact Ex-Court M/9*30 - 1.0Mm. Cu.ag.	25
M9	1EX9P12W	Tube Contact Ex-Court M/9*30 - 1.2Mm. Cu.ag.	25
M9	1EX9P14W	Tube Contact Ex-Court M/9*30 - 1.4Mm. Cu.ag.	25
M9	1EX9P16W	Tube Contact Ex-Court M/9*30 - 1.6Mm. Cu.ag.	25
M9	1EX9P24W	Tube Contact Ex-Court M/9*30 - 2.4Mm. Cu.ag.	25
M9	1EX9P08WA	Tube Contact Ex-Court Aluweld M/9*30 - 0.8Mm. Cu.ag.	25
M9	1EX9P10WA	Tube Contact Ex-Court Aluweld M/9*30 - 1.0Mm. Cu.ag.	25
M9	1EX9P12WA	Tube Contact Ex-Court Aluweld M/9*30 - 1.2Mm. Cu.ag.	25
M9	1EX9P16WA	Tube Contact Ex-Court Aluweld M/9*30 - 1.6Mm. Cu.ag.	25
M8	199CL08	Tube Contact Chrome Ergodani M/8*28 - 0.8Mm. Cu.	25
M8	199CL10	Tube Contact Chrome Ergodani M/8*28 - 1.0Mm. Cu.	25
M8	199CL12	Tube Contact Chrome Ergodani M/8*28 - 1.2Mm. Cu.	25
M8	199CL14	Tube Contact Chrome Ergodani M/8*28 - 1.4Mm. Cu.	25
M8	199CL16	Tube Contact Chrome Ergodani M/8*28 - 1.6Mm. Cu.	25

## Ex 221w

Refroidissement par **Liquide**

350 Amp 100% CO<sub>2</sub>  
330 Amp 100% Ar + CO<sub>2</sub>

Buse filetée, tube contact surdimensionné de M10 et isolation spéciale.

Petite torche avec facilité d'utilisation et prise en main capable d'atteindre les endroits difficiles d'accès.

Buse filetée, tube contact surdimensionné de M9 et isolation spéciale.



# 811 2201

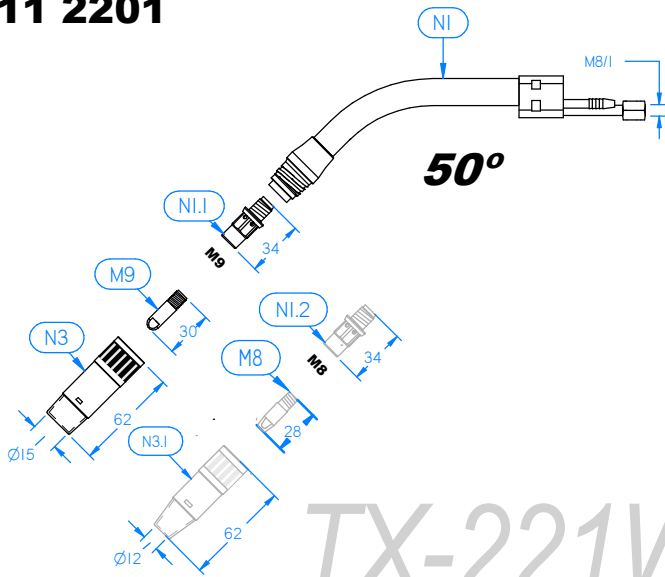

# 811 2202

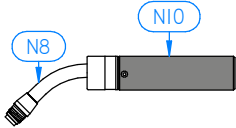

# 811 2203

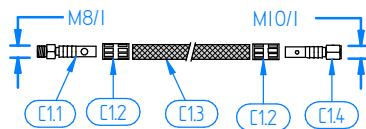
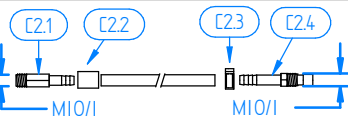
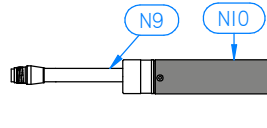

# 812 0902

BLACK  
BLACK

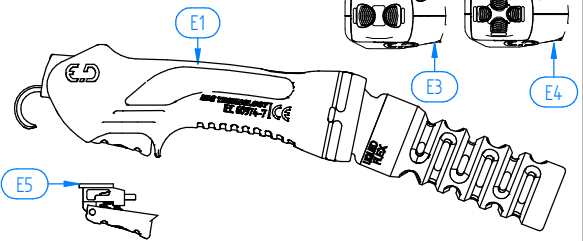

# 812 0906 812 0907

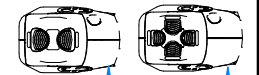

# 814 0103

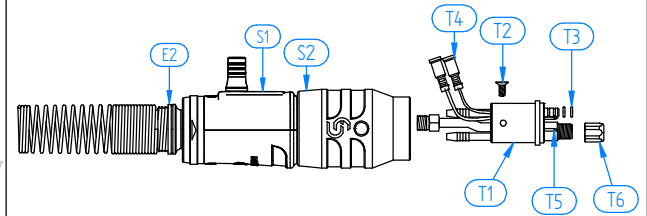

# 813 1001

# 813 1002

# 813 1003

# 813 1004

# 813 1005

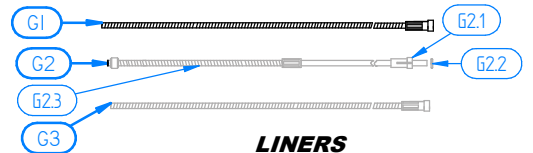
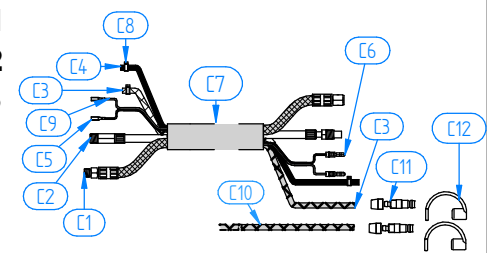

POS.	COD.	DESCRIPTION	PACK
E1	812 0902	Poignee Noir Bouchon Aluminium Ex	1
E2	19906W	Ressort & Rotule Cw Ergodani	2
E5	199EP01	Gâchette Bleu Ergodani	5
E3	1EIP9EP	Poignee Noir Bouchon Aluminium Ergodani Ei-P	1
E3.1	1EIP9EP1	Platine De Régulation Ergodani Ei-P	1
E4	1EID9EP	Poignee Noir Bouchon Aluminium Ergodani Ei-D	1
E4.1	1EID9EP1	Platine De Régulation Ergodani Ei-D	1
(*)	1EII9EP	Poignee Noir Bouchon Aluminium Ergodani Ei-I	1
G1	199SR02A	Gaine Enveloppée Bleu Ergodani 0.6-0.8Mm. 2.40Mts.	1
G1	199SR03A	Gaine Enveloppée Bleu Ergodani 0.6-0.8Mm. 3.40Mts.	1
G1	199SR04A	Gaine Enveloppée Bleu Ergodani 0.6-0.8Mm. 4.40Mts.	1
G1	199SR05A	Gaine Enveloppée Bleu Ergodani 0.6-0.8Mm. 5.40Mts.	1
G1	145SR02	Gaine Denudee Ergodani 1.0-1.6Mm. 2.5Mts.	1
G1	145SR03	Gaine Denudee Ergodani 1.0-1.6Mm. 3.5Mts.	1
G1	145SR04	Gaine Denudee Ergodani 1.0-1.6Mm. 4.5Mts.	1
G1	145SR05	Gaine Denudee Ergodani 1.0-1.6Mm. 5.5Mts.	1
G1	199SR02V	Gaine Enveloppée Vert Ergodani 2.4Mm. 2.40Mts.	1
G1	199SR03V	Gaine Enveloppée Vert Ergodani 2.4Mm. 3.40Mts.	1
G1	199SR04V	Gaine Enveloppée Vert Ergodani 2.4Mm. 4.40Mts.	1
G1	199SR05V	Gaine Enveloppée Vert Ergodani 2.4Mm. 5.40Mts.	1
G2	199SA302	Gaine Aluweld Ergodani 0.8-1.0Mm. 2.50Mts.	1
G2	199SA303	Gaine Aluweld Ergodani 0.8-1.0Mm. 3.50Mts.	1
G2	199SA304	Gaine Aluweld Ergodani 0.8-1.0Mm. 4.50Mts.	1
G2	199SA305	Gaine Aluweld Ergodani 0.8-1.0Mm. 5.50Mts.	1
G2	199SA402	Gaine Aluweld Ergodani 1.2-1.6Mm. 2.50Mts.	1
G2	199SA403	Gaine Aluweld Ergodani 1.2-1.6Mm. 3.50Mts.	1
G2	199SA404	Gaine Aluweld Ergodani 1.2-1.6Mm. 4.50Mts.	1
G2	199SA405	Gaine Aluweld Ergodani 1.2-1.6Mm. 5.50Mts.	1
G2.1	199SA88	Collier Gaine Aluweld/Alum.	10
G2.2	199SA77	Joint Torique Gaine Aluweld/Alum.	10
G2.3	199SA3G	Embout Metal Gaine Aluweld Ergodani 0.8-1.0Mm.	2
G2.3	199SA4G	Embout Metal Gaine Aluweld Ergodani 1.2-1.6Mm.	2



# 811 2201

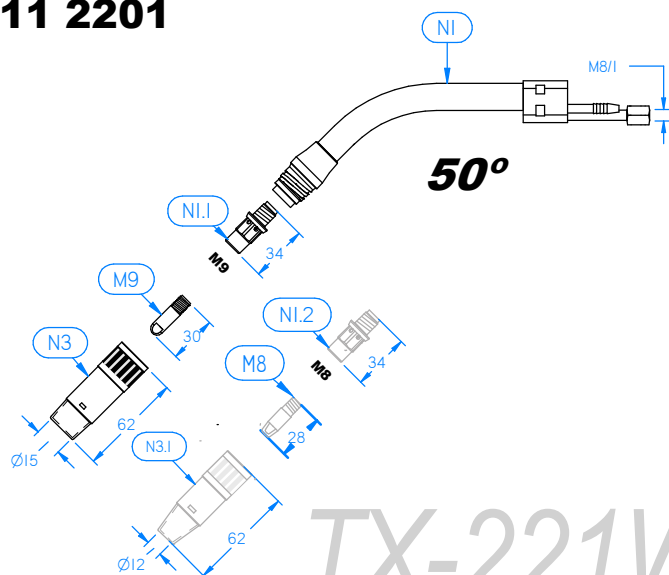

# 811 2202

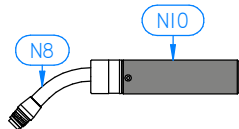

# 811 2203

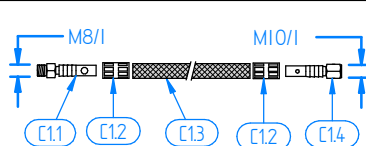
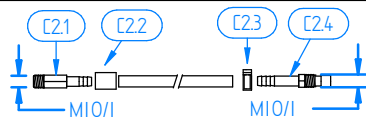
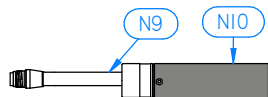

# 812 0902

812 0906 812 0907

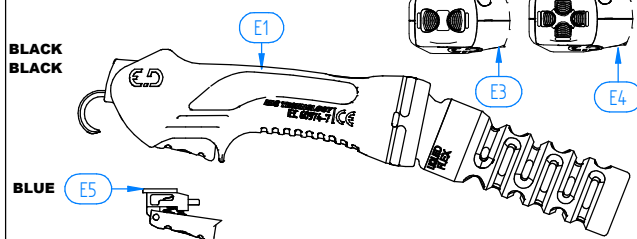

# 814 0103

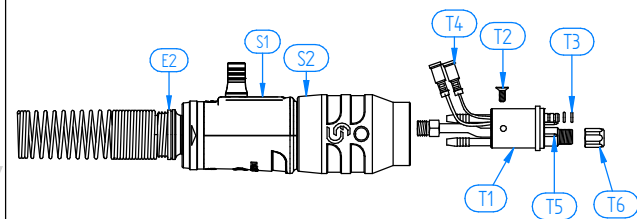

# 813 1001

# 813 1002

# 813 1003

# 813 1004

# 813 1005

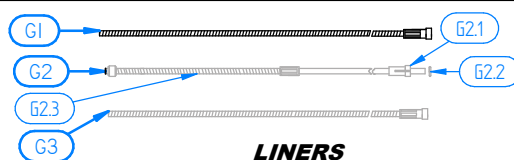
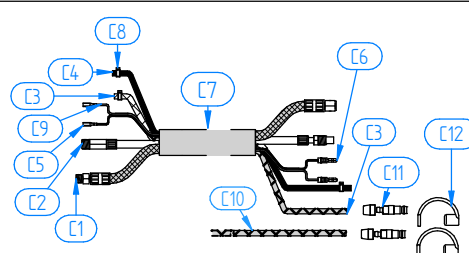

POS.	COD.	DESCRIPTION	PACK
G3	145SIN102	Gainé Denudee Bronze Inox. 0.6-0.8Mm. 2.5Mts.	1
G3	145SIN103	Gainé Denudee Bronze Inox. 0.6-0.8Mm. 3.5Mts.	1
G3	145SIN104	Gainé Denudee Bronze Inox. 0.6-0.8Mm. 4.5Mts.	1
G3	145SIN105	Gainé Denudee Bronze Inox. 0.6-0.8Mm. 5.5Mts.	1
G3	145SIN202	Gainé Denudee Bronze Inox. 1.0-1.2Mm. 2.5Mts.	1
G3	145SIN203	Gainé Denudee Bronze Inox. 1.0-1.2Mm. 3.5Mts.	1
G3	145SIN204	Gainé Denudee Bronze Inox. 1.0-1.2Mm. 4.5Mts.	1
G3	145SIN205	Gainé Denudee Bronze Inox. 1.0-1.2Mm. 5.5Mts.	1
G3	145SIN302	Gainé Denudee Bronze Inox. 1.6Mm. 2.5Mts.	1
G3	145SIN303	Gainé Denudee Bronze Inox. 1.6Mm. 3.5Mts.	1
G3	145SIN304	Gainé Denudee Bronze Inox. 1.6Mm. 4.5Mts.	1
G3	145SIN305	Gainé Denudee Bronze Inox. 1.6Mm. 5.5Mts.	1
C1	145CA01	Cable Eau/Courant Ergodani 1.5Mts.	1
C1	145CA02	Cable Eau/Courant Ergodani 2Mts.	1
C1	145CA03	Cable Eau/Courant Ergodani 3Mts.	1
C1	145CA04	Cable Eau/Courant Ergodani 4Mts.	1
C1	145CA05	Cable Eau/Courant Ergodani 5Mts.	1
C1.1	5450116	Connexion Avant E/C Ergodani (16Mm2)	5
C1.2	145CA77	Collier E/C Ergodani (14ld.mm.)	10
C1.3	145CA91	Tuyau E/C Noir/Pvc 9*13Mm.	100
C1.3	145CA93	Tuyau E/C Rouge/Caoutch Ergodani 9*13Mm.	20
C1.4	5450216	Connexion Arriere E/C Ergodani (16Mm2)	5
C2	145CS01	Tube Conducteur Gainé Ergodani 1.5Mts.	1
C2	145CS02	Tube Conducteur Gainé Ergodani 2Mts.	1
C2	145CS03	Tube Conducteur Gainé Ergodani 3Mts.	1
C2	145CS04	Tube Conducteur Gainé Ergodani 4Mts.	1
C2	145CS05	Tube Conducteur Gainé Ergodani 5Mts.	1
C2.1	145CS88D	Connexion Avant C/G Ergodani	5
C2.2	145CS77	Collier C/G Ergodani (10ld.mm.)	10
C2.3	145T105	Collier A Oreille 10.5	10
C2.4	145CS88T	Ensemble Connexion Arriere C/G Ergodani	5
C3	145TA99F	Tuyau Renforcé Bleu/Pvc 5*8Mm.	100
C3	145TA	Tuyau Renforcé Bleu/Caoutch 5*8Mm.	20

POS.	COD.	DESCRIPTION	PACK
C4	145TG99	Tuyau Renforcé Noir/Pvc 5*8Mm.	100
C4	145TN	Tuyau Renforcé Noir/Caoutch 5*8Mm.	20
C4	145TG58	Tuyau Noir/Pvc 5*8Mm.	200
C5	199FT01	Connecteur Cable Elect. Av.	25
C6	199FT02	Connecteur Cable Elect. Ar.	25
C7	4FN25	Housse Exterieur Neoprene 25*28Mm.	20
C8	145T090	Collier A Oreille 09.0	10
C8	145T095	Collier A Oreille 09.5	10
C9	145CB	Cable De Commande Cw	100
C10	145TA99C	Tuyau Renforcé Rouge/Pvc 5*8Mm.	100
C10	145TR	Tuyau Renforcé Rouge/Caoutch 5*8Mm.	20
C11	145TA88	Raccord Rapide Male Tuyau 5*8Mm.	10
C9	145TA88TA	Bouchon Bleu Tuyau 5*8Mm.	10
C9	145TA88TR	Bouchon Rouge Tuyau 5*8Mm.	10
E2	19906W	Ressort & Rotule Cw Ergodani	2
S1	1EX924W	Support Connexion Bouchon Alum Ex-221W/421W/Epr-600	1
S2	1EX925	Ecrou Support Connexion Noir Ex-270/380 // Cw	1
T1	145MZ	Connecteur Euro Cw Ergodani	1
T2	199MZ05	Vis Fixation Connecteur Euro	10
H9	199MZ03	Joint Torique Connecteur Euro	10
T4	199FT03	Connecteur Cable Elect. C.euro	25
T5	145MZ04	Plot Rect. Connecteur Euro Cw Ergodani	2
C4	199MZ02	Ecrou Du Connecteur Euro Ergodani	10



**ERGODANI**<sup>®</sup>  
Welding Technology Division

# Tx 421w



COD.	DESCRIPTION	PACK
1EX42103	Torche Ergodani Tesla Ex-421W 3Mts. Euro	1
1EX42104	Torche Ergodani Tesla Ex-421W 4Mts. Euro	1
1EX42105	Torche Ergodani Tesla Ex-421W 5Mts. Euro	1
1EX42203	Torche Ergodani Aluweld Ex-421W 3Mts. Euro	1
1EX42204	Torche Ergodani Aluweld Ex-421W 4Mts. Euro	1
1EX42205	Torche Ergodani Aluweld Ex-421W 5Mts. Euro	1
1EX42AC01	Torche Automat. Col Coudé 45° Ex-421W 1.5Mts. Euro	1
1EX42AC02	Torche Automat. Col Coudé 45° Ex-421W 2Mts. Euro	1
1EX42AC03	Torche Automat. Col Coudé 45° Ex-421W 3Mts. Euro	1
1EX42AR01	Torche Automat. Col Droit 0° Ex-421W 1.5Mts. Euro	1
1EX42AR02	Torche Automat. Col Droit 0° Ex-421W 2Mts. Euro	1
1EX42AR03	Torche Automat. Col Droit 0° Ex-421W 3Mts. Euro	1
1EIP42103	Torche Ergodani Tesla Ei-421W-P 3Mts. Euro	1
1EIP42104	Torche Ergodani Tesla Ei-421W-P 4Mts. Euro	1
1EIP42105	Torche Ergodani Tesla Ei-421W-P 5Mts. Euro	1
1EIP42203	Torche Ergodani Aluweld Ei-421W-P 3Mts. Euro	1
1EIP42204	Torche Ergodani Aluweld Ei-421W-P 4Mts. Euro	1
1EIP42205	Torche Ergodani Aluweld Ei-421W-P 5Mts. Euro	1
1EID42103	Torche Ergodani Tesla Ei-421W-D 3Mts. Euro	1
1EID42104	Torche Ergodani Tesla Ei-421W-D 4Mts. Euro	1
1EID42105	Torche Ergodani Tesla Ei-421W-D 5Mts. Euro	1
1EID42203	Torche Ergodani Aluweld Ei-421W-D 3Mts. Euro	1
1EID42204	Torche Ergodani Aluweld Ei-421W-D 4Mts. Euro	1
1EID42205	Torche Ergodani Aluweld Ei-421W-D 5Mts. Euro	1
1EII42103	Torche Ergodani Tesla Ei-421W-I 3Mts. Euro	1
1EII42104	Torche Ergodani Tesla Ei-421W-I 4Mts. Euro	1
1EII42105	Torche Ergodani Tesla Ei-421W-I 5Mts. Euro	1
1EII42203	Torche Ergodani Aluweld Ei-421W-I 3Mts. Euro	1
1EII42204	Torche Ergodani Aluweld Ei-421W-I 4Mts. Euro	1
1EII42205	Torche Ergodani Aluweld Ei-421W-I 5Mts. Euro	1

POS.	COD.	DESCRIPTION	PACK
N1	1EX4201	Col De Cygne Principal Ex-421W	1
N1.1	1EX3802	Diffuseur Support Tube Contact Ex-380/421W M/9*38Mm.	10
N1.2	1EX3802M8	Diffuseur Support Tube Contact Ex-380/421W M/8*38Mm.	10
N3	1EX3804	Buse Standard Ex-380/421W - 16Mm.	5
N3.1	1EX380402	Buse Conique Ex-380/421W - 13Mm.	5
N8	1EX4201AC	Col Automatique Coudé 45° Ex-421W	1
N9	1EX4201AR	Col Automatique Droit 0° Ex-421W	1
N10	199EPAT	Poignee Automatique Ergodani	1
M9	1EX9P08	Tube Contact Ex-Long M/9*34 - 0.8Mm. Cu.ag.	25
M9	1EX9P10	Tube Contact Ex-Long M/9*34 - 1.0Mm. Cu.ag.	25
M9	1EX9P12	Tube Contact Ex-Long M/9*34 - 1.2Mm. Cu.ag.	25
M9	1EX9P14	Tube Contact Ex-Long M/9*34 - 1.4Mm. Cu.ag.	25
M9	1EX9P16	Tube Contact Ex-Long M/9*34 - 1.6Mm. Cu.ag.	25
M9	1EX9P24	Tube Contact Ex-Long M/9*34 - 2.4Mm. Cu.ag.	25
M9	1EX9P08A	Tube Contact Ex-Long Aluweld M/9*34 - 0.8Mm. Cu.ag.	25
M9	1EX9P10A	Tube Contact Ex-Long Aluweld M/9*34 - 1.0Mm. Cu.ag.	25
M9	1EX9P12A	Tube Contact Ex-Long Aluweld M/9*34 - 1.2Mm. Cu.ag.	25
M9	1EX9P16A	Tube Contact Ex-Long Aluweld M/9*34 - 1.6Mm. Cu.ag.	25

## Tx 421w

### Refroidissement par Liquide

500 Amp 100% CO<sub>2</sub>  
450 Amp 100% Ar + CO<sub>2</sub>

Conçu pour les soudures polyvalentes de fortes intensités et d'arcs pulsés. Grâce au refroidissement par liquide, il fournit plus d'intensité que son équivalent gazeux, le Tx 380.

Torche pour le secteur professionnel, avec une durée de consommable plus long.

La buse filetée, le tube contact surdimensionné de M9 ou un isolateur spécial ne sont que quelques-uns de ses avantages.





# 811 4201

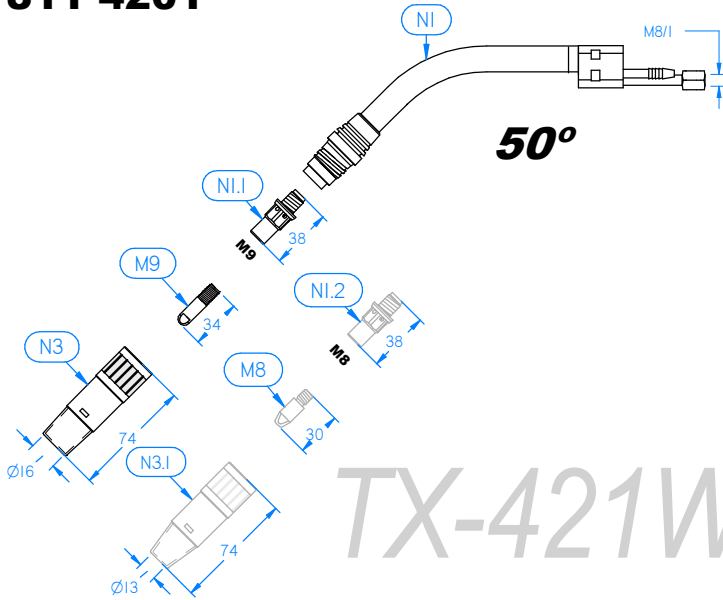

# 811 4202

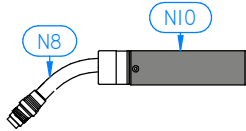

# 811 4203

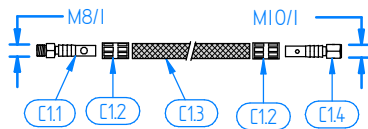
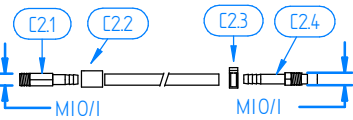
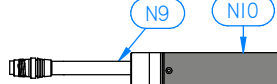

# 812 0902

812 0906 812 0907

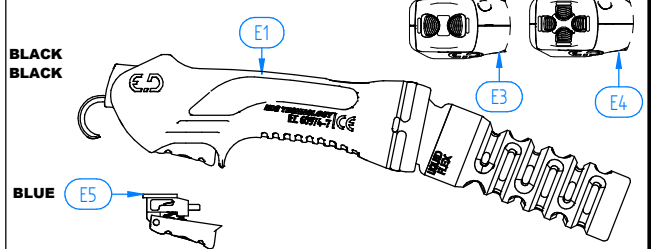

# 814 0103

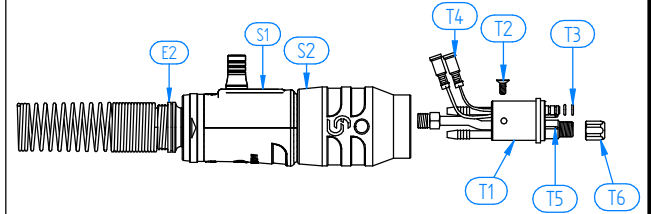

# 813 1001

# 813 1002

# 813 1003

# 813 1004

# 813 1005

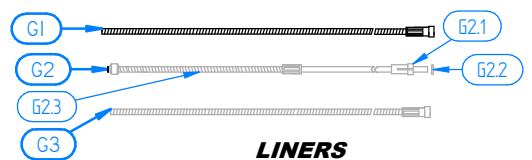
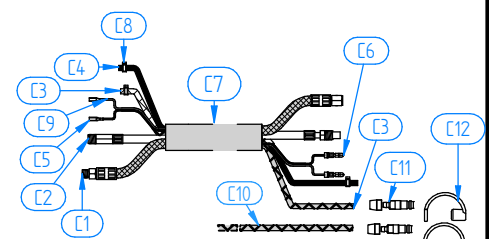

POS.	COD.	DESCRIPTION	PACK
M8	199M808	Tube Contact Ergodani M/8*30 - 0.8Mm. Cu.	25
M8	199M810	Tube Contact Ergodani M/8*30 - 1.0Mm. Cu.	25
M8	199M812	Tube Contact Ergodani M/8*30 - 1.2Mm. Cu.	25
M8	199M814	Tube Contact Ergodani M/8*30 - 1.4Mm. Cu.	25
M8	199M816	Tube Contact Ergodani M/8*30 - 1.6Mm. Cu.	25
M8	199M818	Tube Contact Ergodani M/8*30 - 1.8Mm. Cu.	25
M8	199M824	Tube Contact Ergodani M/8*30 - 2.4Mm. Cu.	25
M8	199M808A	Tube Contact Ergodani M/8*30 - Al0.8mm. Cu.	25
M8	199M810A	Tube Contact Ergodani M/8*30 - Al1.0mm. Cu.	25
M8	199M812A	Tube Contact Ergodani M/8*30 - Al1.2mm. Cu.	25
M8	199M816A	Tube Contact Ergodani M/8*30 - Al1.6mm. Cu.	25
M8	199M808C	Tube Contact Chrome Ergodani M/8*30 - 0.8Mm. Cu.	25
M8	199M810C	Tube Contact Chrome Ergodani M/8*30 - 1.0Mm. Cu.	25
M8	199M812C	Tube Contact Chrome Ergodani M/8*30 - 1.2Mm. Cu.	25
M8	199M814C	Tube Contact Chrome Ergodani M/8*30 - 1.4Mm. Cu.	25
M8	199M816C	Tube Contact Chrome Ergodani M/8*30 - 1.6Mm. Cu.	25
M8	199M808N	Tube Contact M/8*30 - 0.8Mm. Cu.	25
M8	199M810N	Tube Contact M/8*30 - 1.0Mm. Cu.	25
M8	199M812N	Tube Contact M/8*30 - 1.2Mm. Cu.	25
M8	199M814N	Tube Contact M/8*30 - 1.4Mm. Cu.	25
M8	199M816N	Tube Contact M/8*30 - 1.6Mm. Cu.	25
M8	199M808Z	Tube Contact Ergodani M/8*30 - 0.8Mm. Cu.cr.zr.	25
M8	199M810Z	Tube Contact Ergodani M/8*30 - 1.0Mm. Cu.cr.zr.	25
M8	199M812Z	Tube Contact Ergodani M/8*30 - 1.2Mm. Cu.cr.zr.	25
M8	199M814Z	Tube Contact Ergodani M/8*30 - 1.4Mm. Cu.cr.zr.	25
M8	199M816Z	Tube Contact Ergodani M/8*30 - 1.6Mm. Cu.cr.zr.	25
M8	199M808ZN	Tube Contact M/8*30 - 0.8Mm. Cu.cr.zr.	25
M8	199M810ZN	Tube Contact M/8*30 - 1.0Mm. Cu.cr.zr.	25
M8	199M812ZN	Tube Contact M/8*30 - 1.2Mm. Cu.cr.zr.	25
M8	199M814ZN	Tube Contact M/8*30 - 1.4Mm. Cu.cr.zr.	25
M8	199M816ZN	Tube Contact M/8*30 - 1.6Mm. Cu.cr.zr.	25



# 811 4201

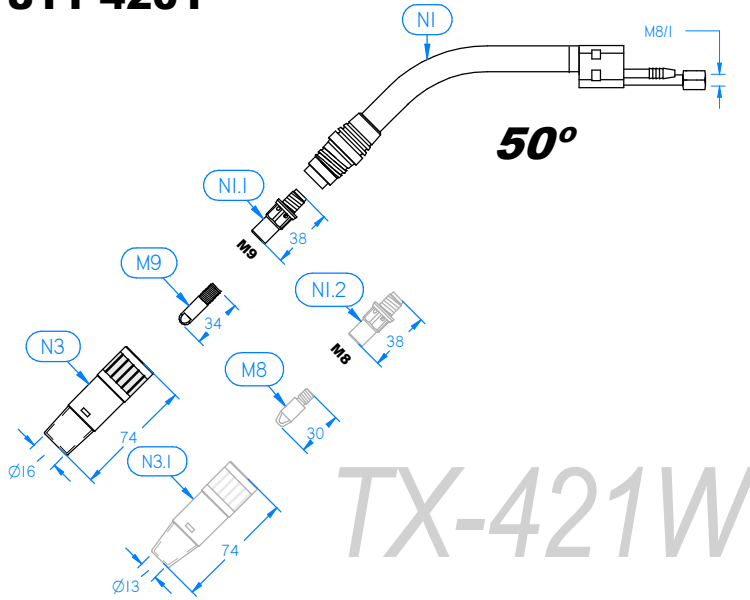

TX-421W

# 811 4202

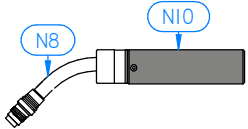

# 811 4203

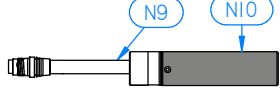

# 812 0902

812 0906 812 0907

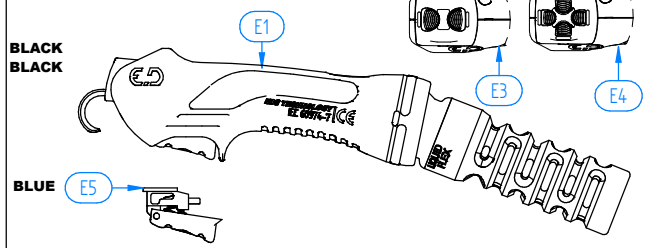

# 814 0103

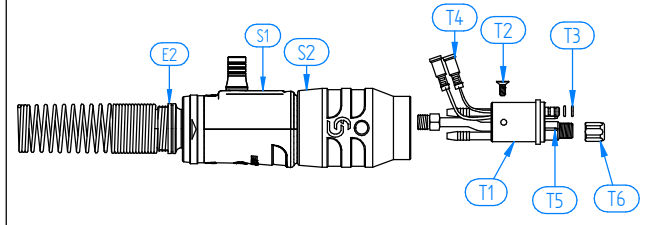

# 813 1001

# 813 1002

# 813 1003

# 813 1004

# 813 1005

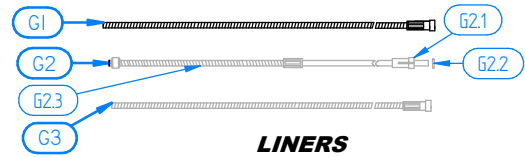
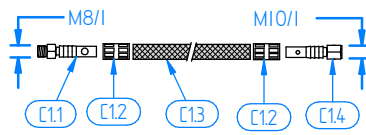
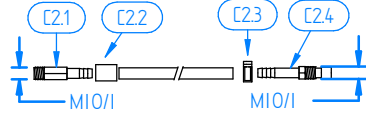
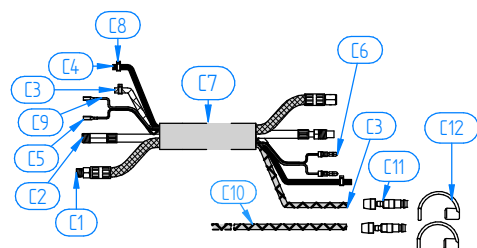

POS.	COD.	DESCRIPTION	PACK
E1	812 0902	Poignee Noir Bouchon Aluminium Ex	1
E2	19906W	Ressort & Rotule Cw Ergodani	2
E5	199EP01	Gâchette Bleu Ergodani	5
E3	1EIP9EP	Poignee Noir Bouchon Aluminium Ergodani Ei-P	1
E3.1	1EIP9EP1	Platine De Régulation Ergodani Ei-P	1
E4	1EID9EP	Poignee Noir Bouchon Aluminium Ergodani Ei-D	1
E4.1	1EID9EP1	Platine De Régulation Ergodani Ei-D	1
(*)	1EII9EP	Poignee Noir Bouchon Aluminium Ergodani Ei-I	1
G1	199SR02A	Gaine Enveloppée Bleu Ergodani 0.6-0.8Mm. 2.40Mts.	1
G1	199SR03A	Gaine Enveloppée Bleu Ergodani 0.6-0.8Mm. 3.40Mts.	1
G1	199SR04A	Gaine Enveloppée Bleu Ergodani 0.6-0.8Mm. 4.40Mts.	1
G1	199SR05A	Gaine Enveloppée Bleu Ergodani 0.6-0.8Mm. 5.40Mts.	1
G1	145SR02	Gaine Denudee Ergodani 1.0-1.6Mm. 2.5Mts.	1
G1	145SR03	Gaine Denudee Ergodani 1.0-1.6Mm. 3.5Mts.	1
G1	145SR04	Gaine Denudee Ergodani 1.0-1.6Mm. 4.5Mts.	1
G1	145SR05	Gaine Denudee Ergodani 1.0-1.6Mm. 5.5Mts.	1
G1	199SR02V	Gaine Enveloppée Vert Ergodani 2.4Mm. 2.40Mts.	1
G1	199SR03V	Gaine Enveloppée Vert Ergodani 2.4Mm. 3.40Mts.	1
G1	199SR04V	Gaine Enveloppée Vert Ergodani 2.4Mm. 4.40Mts.	1
G1	199SR05V	Gaine Enveloppée Vert Ergodani 2.4Mm. 5.40Mts.	1
G2	199SA302	Gaine Aluweld Ergodani 0.8-1.0Mm. 2.50Mts.	1
G2	199SA303	Gaine Aluweld Ergodani 0.8-1.0Mm. 3.50Mts.	1
G2	199SA304	Gaine Aluweld Ergodani 0.8-1.0Mm. 4.50Mts.	1
G2	199SA305	Gaine Aluweld Ergodani 0.8-1.0Mm. 5.50Mts.	1
G2	199SA402	Gaine Aluweld Ergodani 1.2-1.6Mm. 2.50Mts.	1
G2	199SA403	Gaine Aluweld Ergodani 1.2-1.6Mm. 3.50Mts.	1
G2	199SA404	Gaine Aluweld Ergodani 1.2-1.6Mm. 4.50Mts.	1
G2	199SA405	Gaine Aluweld Ergodani 1.2-1.6Mm. 5.50Mts.	1
G2.1	199SA88	Collier Gaine Aluweld/Alum.	10
G2.2	199SA77	Joint Torique Gaine Aluweld/Alum.	10
G2.3	199SA3G	Embout Metal Gaine Aluweld Ergodani 0.8-1.0Mm.	2
G2.3	199SA4G	Embout Metal Gaine Aluweld Ergodani 1.2-1.6Mm.	2

POS.	COD.	DESCRIPTION	PACK
G3	145SIN102	Gaine Denudee Bronze Inox. 0.6-0.8Mm. 2.5Mts.	1
G3	145SIN103	Gaine Denudee Bronze Inox. 0.6-0.8Mm. 3.5Mts.	1
G3	145SIN104	Gaine Denudee Bronze Inox. 0.6-0.8Mm. 4.5Mts.	1
G3	145SIN105	Gaine Denudee Bronze Inox. 0.6-0.8Mm. 5.5Mts.	1
G3	145SIN202	Gaine Denudee Bronze Inox. 1.0-1.2Mm. 2.5Mts.	1
G3	145SIN203	Gaine Denudee Bronze Inox. 1.0-1.2Mm. 3.5Mts.	1
G3	145SIN204	Gaine Denudee Bronze Inox. 1.0-1.2Mm. 4.5Mts.	1
G3	145SIN205	Gaine Denudee Bronze Inox. 1.0-1.2Mm. 5.5Mts.	1
G3	145SIN302	Gaine Denudee Bronze Inox. 1.6Mm. 2.5Mts.	1
G3	145SIN303	Gaine Denudee Bronze Inox. 1.6Mm. 3.5Mts.	1
G3	145SIN304	Gaine Denudee Bronze Inox. 1.6Mm. 4.5Mts.	1
G3	145SIN305	Gaine Denudee Bronze Inox. 1.6Mm. 5.5Mts.	1
C1	145CA01	Cable Eau/Courant Ergodani 1.5Mts.	1
C1	145CA02	Cable Eau/Courant Ergodani 2Mts.	1
C1	145CA03	Cable Eau/Courant Ergodani 3Mts.	1
C1	145CA04	Cable Eau/Courant Ergodani 4Mts.	1
C1	145CA05	Cable Eau/Courant Ergodani 5Mts.	1
C1.1	5450116	Connexion Avant E/C Ergodani (16Mm2)	5
C1.2	145CA77	Collier E/C Ergodani (14ld.mm.)	10
C1.3	145CA91	Tuyau E/C Noir/Pvc 9*13Mm.	100
C1.3	145CA93	Tuyau E/C Rouge/Caoutch Ergodani 9*13Mm.	20
C1.4	5450216	Connexion Arriere E/C Ergodani (16Mm2)	5
C2	145CS01	Tube Conducteur Gaine Ergodani 1.5Mts.	1
C2	145CS02	Tube Conducteur Gaine Ergodani 2Mts.	1
C2	145CS03	Tube Conducteur Gaine Ergodani 3Mts.	1
C2	145CS04	Tube Conducteur Gaine Ergodani 4Mts.	1
C2	145CS05	Tube Conducteur Gaine Ergodani 5Mts.	1
C2.1	145CS88D	Connexion Avant C/G Ergodani	5
C2.2	145CS77	Collier C/G Ergodani (10ld.mm.)	10
C2.3	145T105	Collier A Oreille 10.5	10
C2.4	145CS88T	Ensemble Connexion Arriere C/G Ergodani	5
C3	145TA99F	Tuyau Renforcé Bleu/Pvc 5*8Mm.	100
C3	145TA	Tuyau Renforcé Bleu/Caoutch 5*8Mm.	20
C4	145TG99	Tuyau Renforcé Noir/Pvc 5*8Mm.	100
C4	145TN	Tuyau Renforcé Noir/Caoutch 5*8Mm.	20
C4	145TG58	Tuyau Noir/Pvc 5*8Mm.	200
C5	199FT01	Connecteur Cable Elect. Av.	25
C6	199FT02	Connecteur Cable Elect. Ar.	25
C7	4FN25	Housse Exterieur Neoprene 25*28Mm.	20
C8	145T090	Collier A Oreille 09.0	10
C8	145T095	Collier A Oreille 09.5	10
C9	145CB	Cable De Commande Cw	100
C10	145TA99C	Tuyau Renforcé Rouge/Pvc 5*8Mm.	100
C10	145TR	Tuyau Renforcé Rouge/Caoutch 5*8Mm.	20
C11	145TA88	Raccord Rapide Male Tuyau 5*8Mm.	10
C9	145TA88TA	Bouchon Bleu Tuyau 5*8Mm.	10
C9	145TA88TR	Bouchon Rouge Tuyau 5*8Mm.	10
E2	19906W	Ressort & Rotule Cw Ergodani	2
S1	1EX924W	Support Connexion Bouchon Alum Ex-221W/421W/Epr-600	1
S2	1EX925	Ecrou Support Connexion Noir Ex-270/380 // Cw	1
T1	145MZ	Connecteur Euro Cw Ergodani	1
T2	199MZ05	Vis Fixation Connecteur Euro	10
H9	199MZ03	Joint Torique Connecteur Euro	10
T4	199FT03	Connecteur Cable Elect. C.euro	25
T5	145MZ04	Plot Rect. Connecteur Euro Cw Ergodani	2
C4	199MZ02	Ecrou Du Connecteur Euro Ergodani	10

# NOUVELLE GAMME



## TUBES CONTACT DE QUALITÉ EUROPÉENNE

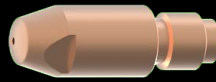

## TORCHES DOUBLE CIRCUIT



Fournit un plus grand refroidissement de la pointe de contact et moins d'adhérence des projections

## TORCHES ARC PULSÉ



Système de maintien de gaine révolutionnaire, permettant de souder des fils d'aluminium plus longs.

La meilleure soudure à portée de main  
TESLA

## MODÈLES RÉGULATION INTELLIGENTE

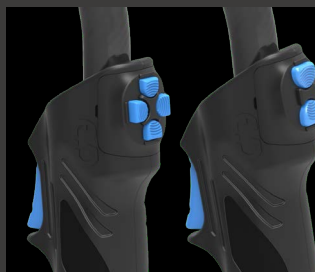

# TESLA MIG

PULSER



**565 PULSER**

550 A

**EPR 600**

600 A

# 565 PULSER

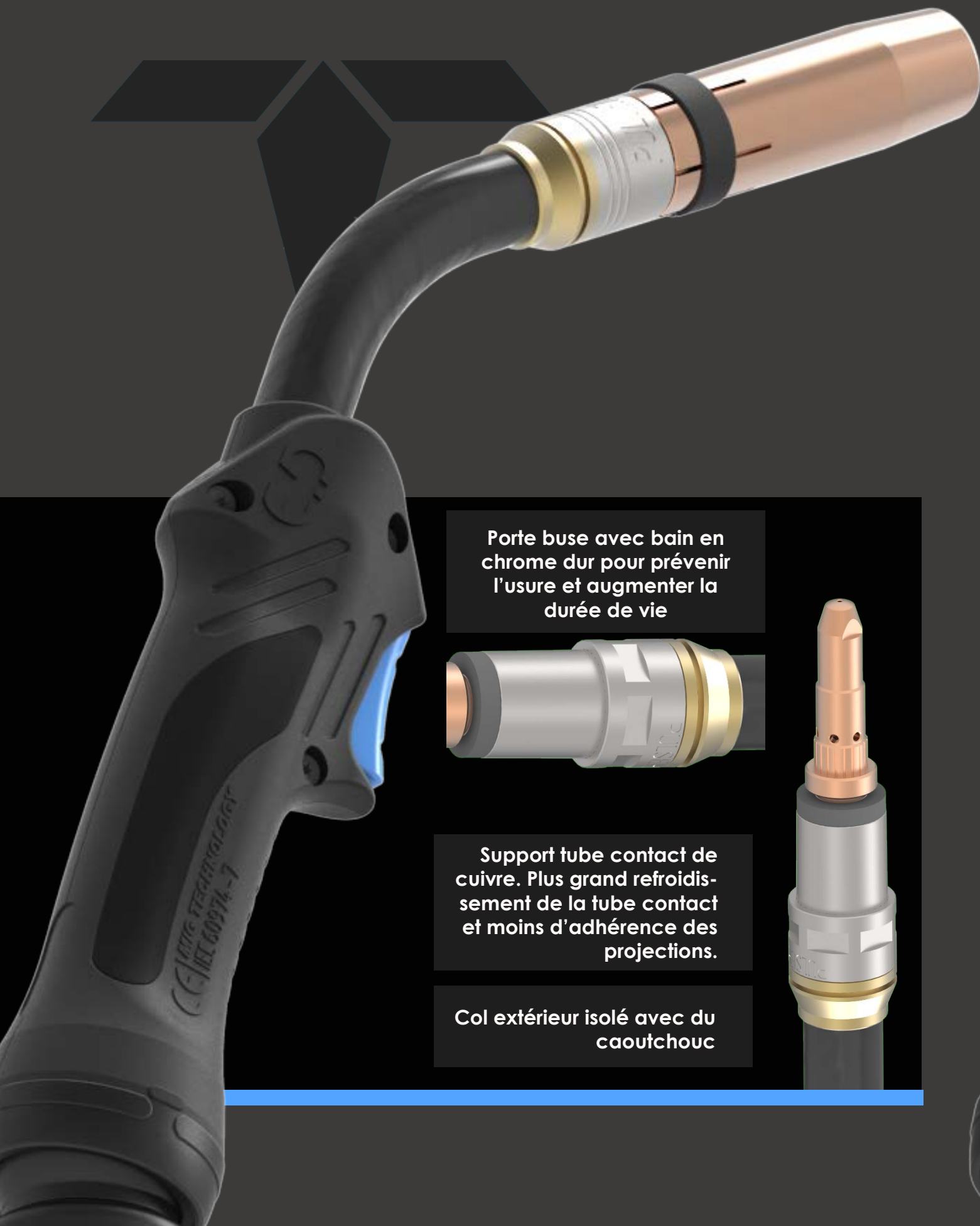

Porte buse avec bain en chrome dur pour prévenir l'usure et augmenter la durée de vie

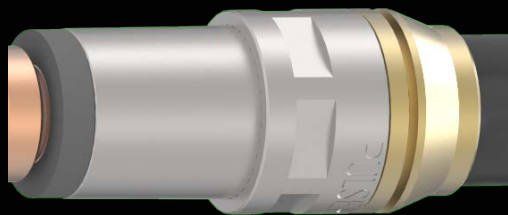

Support tube contact de cuivre. Plus grand refroidissement de la tube contact et moins d'adhérence des projections.

Col extérieur isolé avec du caoutchouc

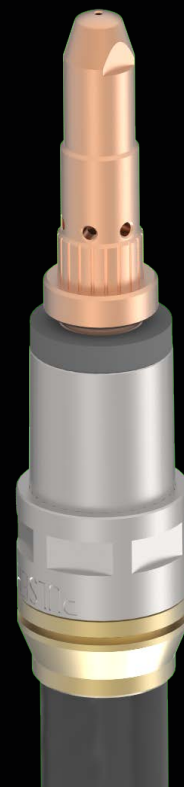

# EPR 600



Consommable robot.  
Tube contact M10 x 43 mm  
Diffuseur en alliage spécial à  
haute conductivité.  
Système de refroidissement du  
tube contact "Cold pressure"

Col isolé avec du caoutchouc  
pour éviter les courts-circuits.  
Buse filetée avec système  
d'ailettes.  
Augmenter la réfrigération  
Porte-buse réfrigéré.

# 565 P



CÓDIGO	DESCRIPCIÓN	PAQUETE
157TS102	Antorcha Ergodani Sirga Alum 565P 2Mts. Euro	1
157TS103	Antorcha Ergodani Tesla 565P 3Mts. Euro	1
157TS104	Antorcha Ergodani Tesla 565P 4Mts. Euro	1
157TS105	Antorcha Ergodani Tesla 565P 5Mts. Euro	1
157AC01	Antorcha Automatica Curva 45° 565P 1.5Mts. Euro	1
157AC02	Antorcha Automatica Curva 45° 565P 2Mts. Euro	1
157AC03	Antorcha Automatica Curva 45° 565P 3Mts. Euro	1
157AR01	Antorcha Automatica Recta 0° 565P 1.5Mts. Euro	1
157AR02	Antorcha Automatica Recta 0° 565P 2Mts. Euro	1
157AR03	Antorcha Automatica Recta 0° 565P 3Mts. Euro	1
157EID103	Antorcha Ergodani Tesla Epr-565P-Eid 3Mts. Euro	1
157EID104	Antorcha Ergodani Tesla Epr-565P-Eid 4Mts. Euro	1
157EID105	Antorcha Ergodani Tesla Epr-565P-Eid 5Mts. Euro	1
157EII103	Antorcha Ergodani Tesla Epr-600P-Eii 3Mts. Euro	1
157EII104	Antorcha Ergodani Tesla Epr-565P-Eii 4Mts. Euro	1
157EII105	Antorcha Ergodani Tesla Epr-565P-Eii 5Mts. Euro	1

## 565 P

### Refroidissement par **Liquide**

550 Amp    100% CO<sub>2</sub>  
 490 Amp    100% Ar + CO<sub>2</sub>

Torche professionnelle avec le système de refroidissement révolutionnaire PULSER. L'évolution de 561. Avec double circuit de refroidissement. Spécial pour les machines à soudage à l'arc pulsé.

Consommable standard amélioré, avec un meilleur refroidissement du tube contact et de la buse. Durée de vie et puissance supérieures.

**Diffuseur en alliage spécial:**  
 Polyvalence en fils tendres, alliages d'aluminium et CuSi. Augmente le refroidissement à l'extrémité du contact et réduit la dilatation Améliore la fluidité du fil de soudage.

POS.	CÓDIGO	DESCRIPCIÓN	PAQUETE
N1	15701	Cuello Principal 565Pulser	1
N1.1	1570101	Anillo Aislante Cuello 565Pulser	10
N2	15603M8	Portatubo 561/565Pulser M/8*25Mm.	10
N4	14502	Difusor Gas Blanco Eu-501W/561/565Pulser	10
N4.A	14502C	Difusor Gas Ceramico Eu-501W/561/565Pulser	10
N5	14504	Tobera Conica Estandar Ergodan Eu-501W/565Pulser - 16Mm.	5
N5	14504N	Tobera Conica Estandar Eu-501W/561/565Pulser - 16Mm.	5
N6	14504SP	Tobera Superconica Eu-501W/561/565Pulser - 14Mm.	5
N7	14504CL	Tobera Cilindrica Eu-501W/561/565Pulser - 19Mm.	5
N8	14504BT	Tobera Cuello Botella Eu-501W/561/565Pulser - 15Mm.	5
N9	14504PT	Tobera Puntos Eu-501W/561/565Pulser - 20Mm.	5
N10	199EPAT	Empuñadura Automatica Ergodani	1
N11	15701AC	Cuello Automatico Curvo 45° 565Pulser	1
N12	15701AR	Cuello Automatico Recto 0° 565Pulser	1
M8	199M808Z	Punta Contacto Ergodani M/8*30 - 0.8Mm. Cu.cr.zr.	25
M8	199M810Z	Punta Contacto Ergodani M/8*30 - 1.0Mm. Cu.cr.zr.	25
M8	199M812Z	Punta Contacto Ergodani M/8*30 - 1.2Mm. Cu.cr.zr.	25
M8	199M814Z	Punta Contacto Ergodani M/8*30 - 1.4Mm. Cu.cr.zr.	25
M8	199M816Z	Punta Contacto Ergodani M/8*30 - 1.6Mm. Cu.cr.zr.	25
M8	199M810X	Punta Contacto Xtrode M/8*30 - 1.0Mm. Dsc	10
M8	199M812X	Punta Contacto Xtrode M/8*30 - 1.2Mm. Dsc	10
M8	199M816X	Punta Contacto Xtrode M/8*30 - 1.6Mm. Dsc	10
E1	812 0902	Empuñadura Tesla Pro. Negro-Negro Agua	1
E2	19906W	Muelle + Rotula Cw Ergodani	2
E3	812 0906	Empuñadura Tesla Pro. Negro-Negro Agua Ei-D	1
E4	812 0907	Empuñadura Tesla Pro. Negro-Negro Agua Ei-I	1
E5	199EP01	Pulsador Azul Ergodani	5





# 811 5601

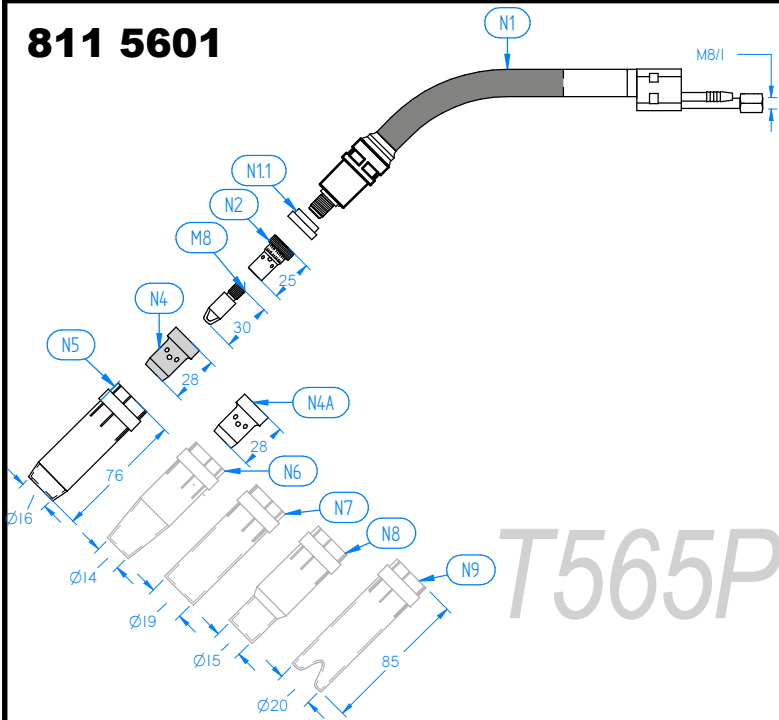

# 811 5602

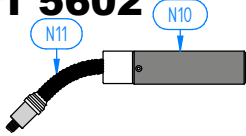

# 811 5603

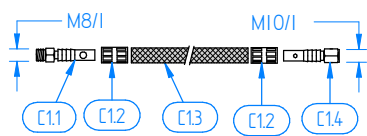
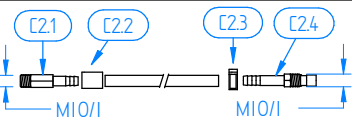
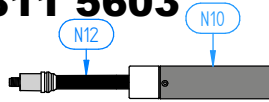

# 812 0902

BLACK  
BLACK

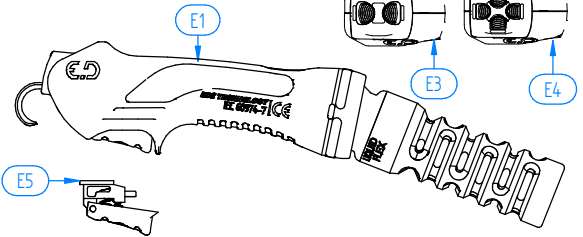

# 812 0906 812 0907

# 814 0103

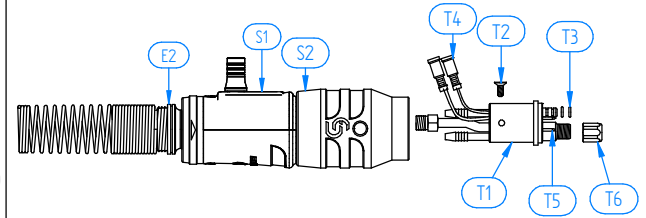

# 813 1001

# 813 1002

# 813 1003

# 813 1004

# 813 1005

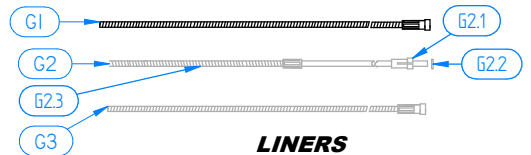
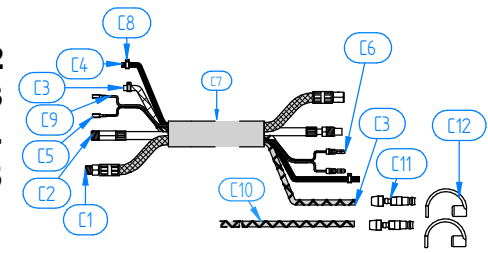

POS.	CÓDIGO	DESCRIPCIÓN	PAQUETE
G1	199SR02A	Sirga Forrada Azul Ergodani 0.6-0.8Mm. 2.40Mts.	1
G1	199SR03A	Sirga Forrada Azul Ergodani 0.6-0.8Mm. 3.40Mts.	1
G1	199SR04A	Sirga Forrada Azul Ergodani 0.6-0.8Mm. 4.40Mts.	1
G1	199SR05A	Sirga Forrada Azul Ergodani 0.6-0.8Mm. 5.40Mts.	1
G1	145SR02	Sirga Desnuda Ergodani 1.0-1.6Mm. 2.5Mts.	1
G1	145SR03	Sirga Desnuda Ergodani 1.0-1.6Mm. 3.5Mts.	1
G1	145SR04	Sirga Desnuda Ergodani 1.0-1.6Mm. 4.5Mts.	1
G1	145SR05	Sirga Desnuda Ergodani 1.0-1.6Mm. 5.5Mts.	1
G1	199SR02V	Sirga Forrada Verde Ergodani 2.4Mm. 2.40Mts.	1
G1	199SR03V	Sirga Forrada Verde Ergodani 2.4Mm. 3.40Mts.	1
G1	199SR04V	Sirga Forrada Verde Ergodani 2.4Mm. 4.40Mts.	1
G1	199SR05V	Sirga Forrada Verde Ergodani 2.4Mm. 5.40Mts.	1
G2	199SA102	Sirga Hilo Aluminio 0.8-1.0Mm. 2Mts.	1
G2	199SA103	Sirga Hilo Aluminio 0.8-1.0Mm. 3Mts.	1
G2	199SA104	Sirga Hilo Aluminio 0.8-1.0Mm. 4Mts.	1
G2	199SA105	Sirga Hilo Aluminio 0.8-1.0Mm. 5Mts.	1
G2	199SA202	Sirga Hilo Aluminio 1.2-1.6Mm. 2Mts.	1
G2	199SA203	Sirga Hilo Aluminio 1.2-1.6Mm. 3Mts.	1
G2	199SA204	Sirga Hilo Aluminio 1.2-1.6Mm. 4Mts.	1
G2	199SA205	Sirga Hilo Aluminio 1.2-1.6Mm. 5Mts.	1
G2.1	199SA88	Casquillo Sirga Aluwed/Alum.	10
G2.2	199SA77	Junta Torica Sirga Aluwed/Alum.	10
G2.3	199SA1G	Gusanillo Sirga Hilo Aluminio 0.8-1.0Mm.	2
G2.3	199SA2G	Gusanillo Sirga Hilo Aluminio 1.2-1.6Mm.	2



# 811 5601

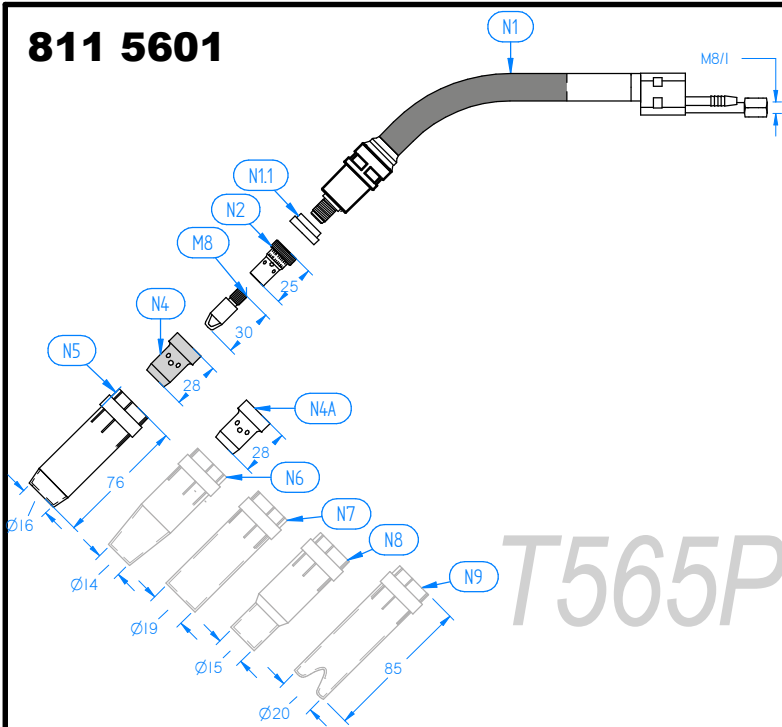

# 811 5602

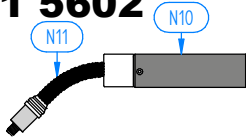

# 811 5603

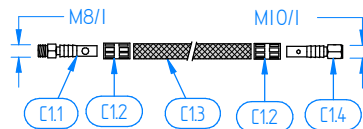
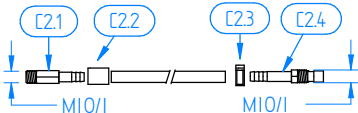
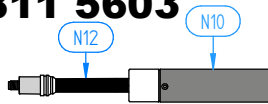

# 812 0902

812 0906 812 0907

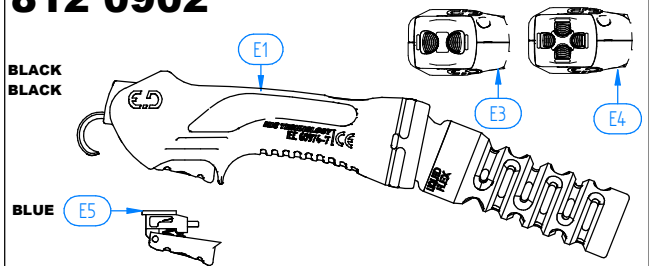

# 814 0103

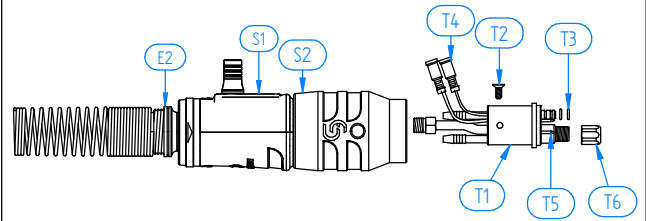

# 813 1001

# 813 1002

# 813 1003

# 813 1004

# 813 1005

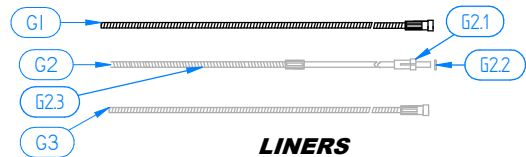
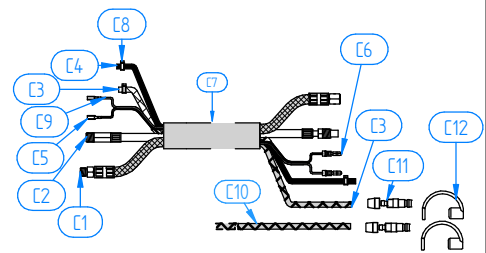

LINERS

POS.	CÓDIGO	DESCRIPCIÓN	PAQUETE
G3	145SIN102	Sirga Bronce Desnuda Inox. 0.6-0.8Mm. 2.5Mts.	1
G3	145SIN103	Sirga Bronce Desnuda Inox. 0.6-0.8Mm. 3.5Mts.	1
G3	145SIN104	Sirga Bronce Desnuda Inox. 0.6-0.8Mm. 4.5Mts.	1
G3	145SIN105	Sirga Bronce Desnuda Inox. 0.6-0.8Mm. 5.5Mts.	1
G3	145SIN202	Sirga Bronce Desnuda Inox. 1.0-1.2Mm. 2.5Mts.	1
G3	145SIN203	Sirga Bronce Desnuda Inox. 1.0-1.2Mm. 3.5Mts.	1
G3	145SIN204	Sirga Bronce Desnuda Inox. 1.0-1.2Mm. 4.5Mts.	1
G3	145SIN205	Sirga Bronce Desnuda Inox. 1.0-1.2Mm. 5.5Mts.	1
G3	145SIN302	Sirga Bronce Desnuda Inox. 1.6Mm. 2.5Mts.	1
G3	145SIN303	Sirga Bronce Desnuda Inox. 1.6Mm. 3.5Mts.	1
G3	145SIN304	Sirga Bronce Desnuda Inox. 1.6Mm. 4.5Mts.	1
G3	145SIN305	Sirga Bronce Desnuda Inox. 1.6Mm. 5.5Mts.	1
C1	145CA01	Cable Corriente Agua Ergodani 1.5Mts.	1
C1	145CA02	Cable Corriente Agua Ergodani 2Mts.	1
C1	145CA03	Cable Corriente Agua Ergodani 3Mts.	1
C1	145CA04	Cable Corriente Agua Ergodani 4Mts.	1
C1	145CA05	Cable Corriente Agua Ergodani 5Mts.	1
C1.1	5450116	Conexion C/A Delantera Ergodani (16Mm2)	5
C1.2	145CA77	Campana Apriete C/A Ergodani (14ld.mm.)	10
C1.3	145CA91	Tubo Exterior C/A Pvc Negro 9*13Mm.	100
C1.3	145CA93	Tubo Exterior C/A Goma Rojo Ergodani 9*13Mm.	20
C1.4	5450216	Conexion C/A Trasera Ergodani (16Mm2)	5
C2	145CS01	Tubo Conductor Sirga Ergodani 1.5Mts.	1
C2	145CS02	Tubo Conductor Sirga Ergodani 2Mts.	1
C2	145CS03	Tubo Conductor Sirga Ergodani 3Mts.	1
C2	145CS04	Tubo Conductor Sirga Ergodani 4Mts.	1
C2	145CS05	Tubo Conductor Sirga Ergodani 5Mts.	1
C2.1	145CS88D	Conexion C/S Delantera Ergodani	5
C2.2	145CS77	Campana Apriete C/S Ergodani (10ld.mm.)	10
C2.3	145T105	Abrazadera Oreja 10.5	10
C2.4	145CS88T	Conexion C/S Trasera (2Pcs) Ergodani	5

POS.	CÓDIGO	DESCRIPCIÓN	PAQUETE
C3	145TA99F	Tubo Reforzado Pvc Azul 5*8Mm.	100
C3	145TA	Tubo Reforzado Goma Azul 5*8Mm.	20
C4	145TG99	Tubo Reforzado Pvc Negro 5*8Mm.	100
C4	145TN	Tubo Reforzado Goma Negro 5*8Mm.	20
C4	145TG58	Tubo Pvc Negro 5*8Mm.	200
C5	199FT01	Faston Delantero Cable	25
C6	199FT02	Faston Trasero Cable	25
C7	4FN25	Funda Neopreno Textil 25*28Mm.	20
C8	145T090	Abrazadera Oreja 09.0	10
C8	145T095	Abrazadera Oreja 09.5	10
C9	145CB	Cable Maniobra Cw	100
C10	145TA99C	Tubo Reforzado Pvc Rojo 5*8Mm.	100
C10	145TR	Tubo Reforzado Goma Rojo 5*8Mm.	20
C11	145TA88	Enchufe Rapido Tubo 5*8Mm.	10
C12	145TA88TA	Tapon Azul Tubo 5*8Mm.	10
C12	145TA88TR	Tapon Rojo Tubo 5*8Mm.	10
E2	19906W	Muelle + Rotula Cw Ergodani	2
S1	1EN924W	Soport.conex. Negro Tapon Negr En-240W/501W/561Pulser	1
S2	1EX925	Tuerca Insertada Negra Ex-270/380 // Cw	1
T1	145MZ	Cuerpo Conexion Euro Cw Ergodani	1
T2	199MZ05	Tornillo Cuerpo Conexion	10
T3	199MZ03	Junta Torica Cuerpo Conexion	10
T4	199FT03	Faston Cuerpo Conexion	25
T5	145MZ04	Aguja Cuerpo Conexion Cw Ergodani	2
T6	199MZ02	Tuerca Sujeccion Sirga Ergodani	10



  
 Welding Technology Division

# EPR 600



CÓDIGO	DESCRIPCIÓN	PAQUETE
160TS103	Antorcha Ergodani Tesla Epr-600P 3Mts. Euro	1
160TS104	Antorcha Ergodani Tesla Epr-600P 4Mts. Euro	1
160TS105	Antorcha Ergodani Tesla Epr-600P 5Mts. Euro	1
160AC01	Antorcha Automatica Curva 45° Epr-600P 1.5Mts. Euro	1
160AC02	Antorcha Automatica Curva 45° Epr-600P 2Mts. Euro	1
160AC03	Antorcha Automatica Curva 45° Epr-600P 3Mts. Euro	1
160AR01	Antorcha Automatica Recta 0° Epr-600P 1.5Mts. Euro	1
160AR02	Antorcha Automatica Recta 0° Epr-600P 2Mts. Euro	1
160AR03	Antorcha Automatica Recta 0° Epr-600P 3Mts. Euro	1
160EID103	Antorcha Ergodani Tesla Epr-600P-Eid 3Mts. Euro	1
160EID104	Antorcha Ergodani Tesla Epr-600P-Eid 4Mts. Euro	1
160EID105	Antorcha Ergodani Tesla Epr-600P-Eid 5Mts. Euro	1
160EII103	Antorcha Ergodani Tesla Epr-600P-Eii 3Mts. Euro	1
160EII104	Antorcha Ergodani Tesla Epr-600P-Eii 4Mts. Euro	1
160EII105	Antorcha Ergodani Tesla Epr-600P-Eii 5Mts. Euro	1

POS.	CÓDIGO	DESCRIPCIÓN	PAQUETE
N1	16001	Cuello Principal Epr-600P	1
N2	1600101	Anillo Aislante Cuello Epr-600	10
N3	16002	Difusor Portatubo Epr-600 M/10*26Mm.	10
N4	16004	Tobera Estandar Epr-600 - 16Mm.	5
N10	199EPAT	Empuñadura Automatica Ergodani	1
N11	16001AC	Cuello Automatico Curvo 45° Epr-600P	1
N12	16001AR	Cuello Automatico Recto 0° Epr-600P	1
M10	160M108	Punta Contacto Exr M/10*43 - 0.8Mm. Cu.cr.zr.	10
M10	160M109	Punta Contacto Exr M/10*43 - 0.9Mm. Cu.cr.zr.	10
M10	160M110	Punta Contacto Exr M/10*43 - 1.0Mm. Cu.cr.zr.	10
M10	160M112	Punta Contacto Exr M/10*43 - 1.2Mm. Cu.cr.zr.	10
M10	160M114	Punta Contacto Exr M/10*43 - 1.4Mm. Cu.cr.zr.	10
M10	160M116	Punta Contacto Exr M/10*43 - 1.6Mm. Cu.cr.zr.	10
M10	160M124	Punta Contacto Exr M/10*43 - 2.4Mm. Cu.cr.zr.	10
E1	812 0902	Empuñadura Tesla Pro. Negro-Negro Agua	1
E2	19906W	Muelle + Rotula Cw Ergodani	2
E3	812 0906	Empuñadura Tesla Pro. Negro-Negro Agua Ei-D	1
E4	812 0907	Empuñadura Tesla Pro. Negro-Negro Agua Ei-I	1
E5	199EP01	Pulsador Azul Ergodani	5
G1	199SR02A	Sirga Forrada Azul Ergodani 0.6-0.8Mm. 2.40Mts.	1
G1	199SR03A	Sirga Forrada Azul Ergodani 0.6-0.8Mm. 3.40Mts.	1
G1	199SR04A	Sirga Forrada Azul Ergodani 0.6-0.8Mm. 4.40Mts.	1
G1	199SR05A	Sirga Forrada Azul Ergodani 0.6-0.8Mm. 5.40Mts.	1
G1	145SR02	Sirga Desnuda Ergodani 1.0-1.6Mm. 2.5Mts.	1
G1	145SR03	Sirga Desnuda Ergodani 1.0-1.6Mm. 3.5Mts.	1
G1	145SR04	Sirga Desnuda Ergodani 1.0-1.6Mm. 4.5Mts.	1
G1	145SR05	Sirga Desnuda Ergodani 1.0-1.6Mm. 5.5Mts.	1
G1	199SR02V	Sirga Forrada Verde Ergodani 2.4Mm. 2.40Mts.	1
G1	199SR03V	Sirga Forrada Verde Ergodani 2.4Mm. 3.40Mts.	1
G1	199SR04V	Sirga Forrada Verde Ergodani 2.4Mm. 4.40Mts.	1
G1	199SR05V	Sirga Forrada Verde Ergodani 2.4Mm. 5.40Mts.	1

## EPR 600

Refroidissement par **Liquide**

600 Amp

100% CO<sub>2</sub>

525 Amp

100% Ar + CO<sub>2</sub>

Torche avec double circuit de refroidissement dans le porte-buse et le tube contact.

Ce modèle utilise du consommable destiné aux torches de soudages robotisés où les cycles de travail sont de 24 heures. En appliquant cette technologie, nous obtenons une durée de vie des composants des pièces de rechange et un cycle de soudage plus longs que d'autres torches satandards.

**Refroidissement puissant au tube contact:**

Polyvalence dans les fils tendres, les alliages d'aluminium et CuSi. Améliore la fluidité du fil de soudure.



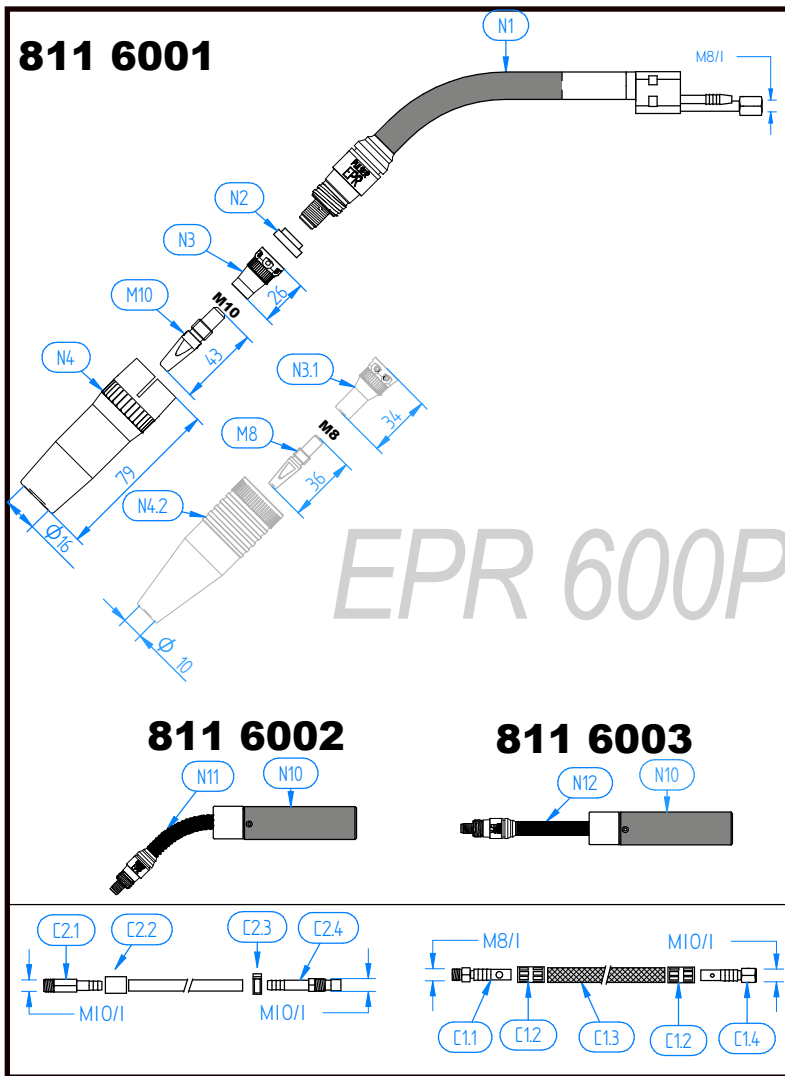

EPR 600P

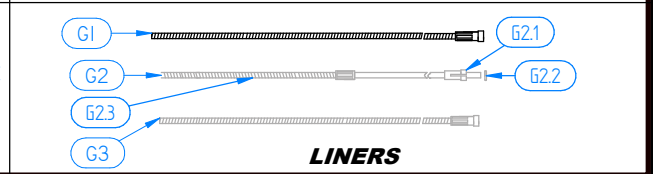
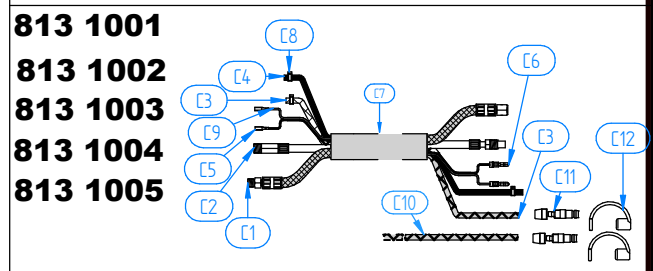
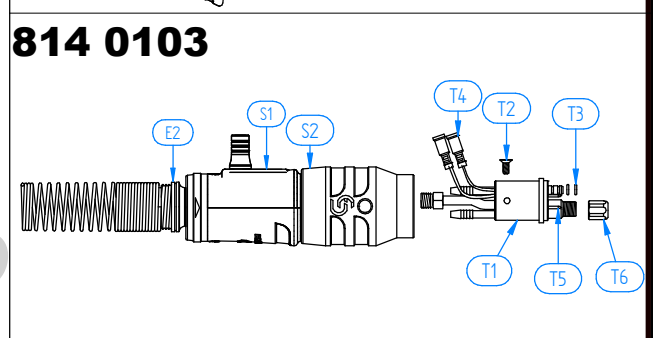
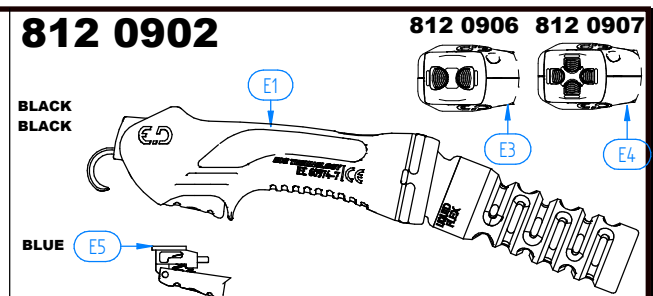

POS.	CÓDIGO	DESCRIPCIÓN	PAQUETE
G2	199SA102	Sirga Hilo Aluminio 0.8-1.0Mm. 2Mts.	1
G2	199SA103	Sirga Hilo Aluminio 0.8-1.0Mm. 3Mts.	1
G2	199SA104	Sirga Hilo Aluminio 0.8-1.0Mm. 4Mts.	1
G2	199SA105	Sirga Hilo Aluminio 0.8-1.0Mm. 5Mts.	1
G2	199SA202	Sirga Hilo Aluminio 1.2-1.6Mm. 2Mts.	1
G2	199SA203	Sirga Hilo Aluminio 1.2-1.6Mm. 3Mts.	1
G2	199SA204	Sirga Hilo Aluminio 1.2-1.6Mm. 4Mts.	1
G2	199SA205	Sirga Hilo Aluminio 1.2-1.6Mm. 5Mts.	1
G2.1	199SA88	Casquillo Sirga Aluwed/Alum.	10
G2.2	199SA77	Junta Torica Sirga Aluwed/Alum.	10
G2.3	199SA1G	Gusanillo Sirga Hilo Aluminio 0.8-1.0Mm.	2
G2.3	199SA2G	Gusanillo Sirga Hilo Aluminio 1.2-1.6Mm.	2
G3	145SIN102	Sirga Bronce Desnuda Inox. 0.6-0.8Mm. 2.5Mts.	1
G3	145SIN103	Sirga Bronce Desnuda Inox. 0.6-0.8Mm. 3.5Mts.	1
G3	145SIN104	Sirga Bronce Desnuda Inox. 0.6-0.8Mm. 4.5Mts.	1
G3	145SIN105	Sirga Bronce Desnuda Inox. 0.6-0.8Mm. 5.5Mts.	1
G3	145SIN202	Sirga Bronce Desnuda Inox. 1.0-1.2Mm. 2.5Mts.	1
G3	145SIN203	Sirga Bronce Desnuda Inox. 1.0-1.2Mm. 3.5Mts.	1
G3	145SIN204	Sirga Bronce Desnuda Inox. 1.0-1.2Mm. 4.5Mts.	1
G3	145SIN205	Sirga Bronce Desnuda Inox. 1.0-1.2Mm. 5.5Mts.	1
G3	145SIN302	Sirga Bronce Desnuda Inox. 1.6Mm. 2.5Mts.	1
G3	145SIN303	Sirga Bronce Desnuda Inox. 1.6Mm. 3.5Mts.	1
G3	145SIN304	Sirga Bronce Desnuda Inox. 1.6Mm. 4.5Mts.	1
G3	145SIN305	Sirga Bronce Desnuda Inox. 1.6Mm. 5.5Mts.	1
C1	145CA01	Cable Corriente Agua Ergodani 1.5Mts.	1
C1	145CA02	Cable Corriente Agua Ergodani 2Mts.	1
C1	145CA03	Cable Corriente Agua Ergodani 3Mts.	1
C1	145CA04	Cable Corriente Agua Ergodani 4Mts.	1
C1	145CA05	Cable Corriente Agua Ergodani 5Mts.	1



DISPONIBLE EN COL  
AUTOMATIQUE



ERGODANI

MIG51

# 811 6001

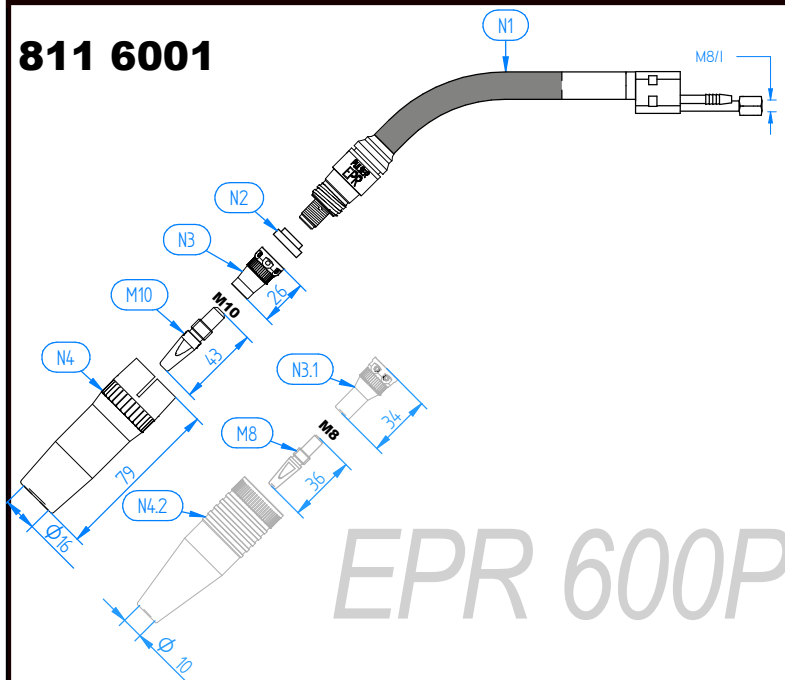

EPR 600P

# 811 6002

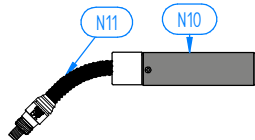

# 811 6003

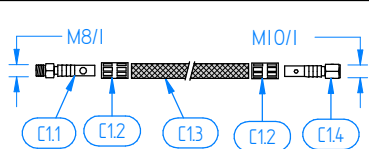
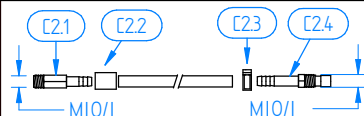
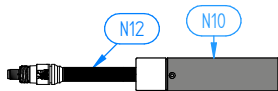

# 812 0902

812 0906 812 0907

BLACK  
BLACK

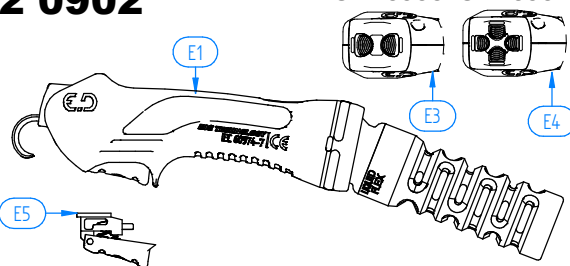

# 814 0103

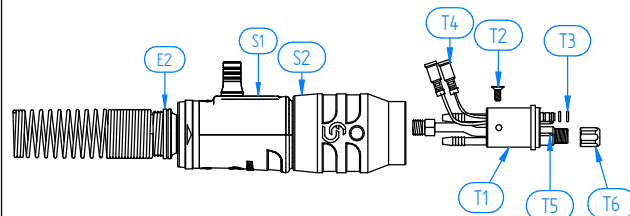

# 813 1001

# 813 1002

# 813 1003

# 813 1004

# 813 1005

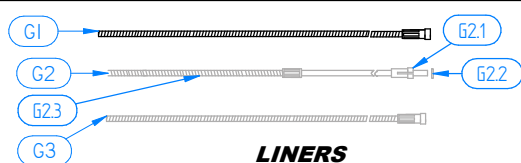
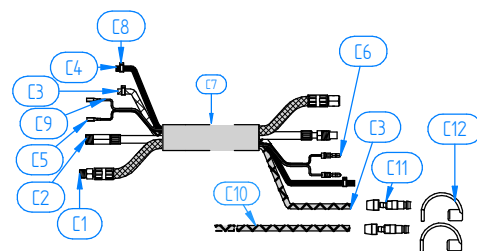

LINERS

POS.	CÓDIGO	DESCRIPCIÓN	PAQUETE
C1.1	5450116	Conexion C/A Delantera Ergodani (16Mm2)	5
C1.2	145CA77	Campana Apriete C/A Ergodani (14ld.mm.)	10
C1.3	145CA91	Tubo Exterior C/A Pvc Negro 9*13Mm.	100
C1.3	145CA93	Tubo Exterior C/A Goma Rojo Ergodani 9*13Mm.	20
C1.4	5450216	Conexion C/A Trasera Ergodani (16Mm2)	5
C2	145CS01	Tubo Conductor Sirga Ergodani 1.5Mts.	1
C2	145CS02	Tubo Conductor Sirga Ergodani 2Mts.	1
C2	145CS03	Tubo Conductor Sirga Ergodani 3Mts.	1
C2	145CS04	Tubo Conductor Sirga Ergodani 4Mts.	1
C2	145CS05	Tubo Conductor Sirga Ergodani 5Mts.	1
C2.1	145CS88D	Conexion C/S Delantera Ergodani	5
C2.2	145CS77	Campana Apriete C/S Ergodani (10ld.mm.)	10
C2.3	145T105	Abrazadera Oreja 10.5	10
C2.4	145CS88T	Conexion C/S Trasera (2Pcs) Ergodani	5
C3	145TA99F	Tubo Reforzado Pvc Azul 5*8Mm.	100
C3	145TA	Tubo Reforzado Goma Azul 5*8Mm.	20
C4	145TG99	Tubo Reforzado Pvc Negro 5*8Mm.	100
C4	145TN	Tubo Reforzado Goma Negro 5*8Mm.	20
C4	145TG58	Tubo Pvc Negro 5*8Mm.	200
C5	199FT01	Faston Delantero Cable	25
C6	199FT02	Faston Trasero Cable	25
C7	4FN25	Funda Neopreno Textil 25*28Mm.	20
C8	145T090	Abrazadera Oreja 09.0	10
C8	145T095	Abrazadera Oreja 09.5	10
C9	145CB	Cable Maniobra Cw	100
C10	145TA99C	Tubo Reforzado Pvc Rojo 5*8Mm.	100
C10	145TR	Tubo Reforzado Goma Rojo 5*8Mm.	20
C11	145TA88	Enchufe Rapido Tubo 5*8Mm.	10
C12	145TA88TA	Tapon Azul Tubo 5*8Mm.	10
C12	145TA88TR	Tapon Rojo Tubo 5*8Mm.	10

POS.	CÓDIGO	DESCRIPCIÓN	PAQUETE
E2	19906W	Muelle + Rotula Cw Ergodani	2
S1	1EX924W	Soport.conex. Negro Tapon Alum Ex-221W/421W/Epr-600	1
S2	1EX925	Tuerca Insertada Negra Ex-270/380 // Cw	1
T1	145MZ	Cuerpo Conexion Euro Cw Ergodani	1
T2	199MZ05	Tornillo Cuerpo Conexion	10
T3	199MZ03	Junta Torica Cuerpo Conexion	10
T4	199FT03	Faston Cuerpo Conexion	25
T5	145MZ04	Aguja Cuerpo Conexion Cw Ergodani	2
T6	199MZ02	Tuerca Sujecion Sirga Ergodani	10



**ERGODANI**<sup>®</sup>  
Welding Technology Division

**ERGODANI**

MIG 53