



Catalogue 2023

Download now...



...and get Mobile!

Do you already know our app?

Use our App to get all new information about our products. Did you know you can also register your products by scanning them with the Eppendorf App? This is your quick and easy way to get exclusive benefits like a 10 % discount on your next purchase or extended warranty.* With every registration you collect up to 100 epPoints®.*

Here are some more highlights you will find in our app:

- > Scan and collect your epPoints® quickly and easily
- > Calculate the amount of crude oil/polypropylene that has been saved through the innovative design of your new epT.I.P.S.® or ep Dualfilter T.I.P.S.® disposable racks.



Download the Eppendorf App! We wish you a lot of fun!

www.eppendorf.com/app

*Please check the website for participating countries and products.

Dear reader,

... we take responsibility.

Eppendorf has been dealing with the issue of sustainability for a long time. For us, this means taking responsibility for our actions not only today, but also for tomorrow. But what exactly does that mean?

We in the catalog team are making our contribution to sustainability. Did you know that the Eppendorf catalog has been produced climate-neutrally since 2019? This means that we planted 233 trees to create the printed catalog last year. Paper is a valuable raw material. By making further information available to you online via QR codes, we are able to save paper. In addition, we attach great importance to the use of certified paper, which further improves the carbon footprint of the Eppendorf catalog.

To find out how we at Eppendorf live and implement the issue of sustainability as an integral part of our corporate strategy every day, turn to pages 8 - 11.

And, of course, there are also new products that we would like to present to you. We are particularly excited about the new generation of Eppendorf Tubes, which are made from certified polypropylene based on renewable raw materials. Read all the details on page 120 and let yourself be surprised.

As you can see, we have already achieved a great deal, but we continue to work every day to implement the mission of our founding fathers, namely to improve human living conditions. **For our generation and for the generations to come.**

Your Eppendorf catalog team

Feedback

Do you have feedback?
Contact our catalog team!

catalog@eppendorf.com

We look forward to hearing from you!



Online Shop

Further information on our product portfolio, service offerings and current sales promotions can be found on our website. Visit and order at

www.eppendorf.com/eshop



Follow us on    

Welcome!

As a leading life science company, we at Eppendorf develop, produce and distribute multiple systems for use in laboratories world-wide. Our product range includes pipettes, centrifuges, mixers or freezers and much more. In addition, we provide a broad selection of high-quality consumables. Digital laboratory management solutions for complete laboratory processes round out our portfolio of customized services and product solutions for you.

Have fun browsing and discovering!

Introduction

New Highlights 2023	6 - 7
Sustainability	8 - 11
Pharma	12 - 13
OEM	14 - 17



Digital Lab Management

18 - 21



Pipetting

22 - 47, 70

Tips

48 - 75

Automated Pipetting

76 - 95

Temperature Control and Mixing

96 - 105



Tubes and Plates

106 - 133



Centrifuges and Rotors

134 - 219



PCR

220-235

Bioprocessing

298-311



Freezer

236-257



Service Products

312 - 334

Micromanipulation

258-271

EU-IVD Products

335 - 348

CO₂ Incubators

272-281



Lab Shakers

282-297

Index

Different mains voltage versions	349
Your local contact	358
Legal notices, trademarks, patent and design attributions	358

New Highlights 2023



epT.I.P.S.® Sterile Reloads

Experience the Magic! Less Plastic! Less Waste!

The new epT.I.P.S.® Reload System for pre-sterilized pipette tips like epT.I.P.S.® Biopur®, ep Dualfilter T.I.P.S.® PCR clean/Sterile and ep Dualfilter T.I.P.S.® SealMax® Biopur® support you to save significantly plastic raw material and reduce the waste in your lab. They are completely compatible with the new epT.I.P.S.® Box 2.0.

See page
48



See page
116

Eppendorf Conical Tubes 25 mL

This special format will be completed with variants of Eppendorf Protein LoBind® and Eppendorf DNA LoBind® to minimize sample loss and in Amber for UV-light sensitive samples. These new tubes will be available with either SnapTec® cap or screw cap.

Eppendorf Tubes® BioBased

Get to know the New Eppendorf Tubes BioBased

Since oil-based plastic vessels have replaced glass vessels, they have become irreplaceable in laboratories around the world, providing quality standards needed in increasingly demanding research. This is the growing challenge for laboratories in respect to sustainability.

Thus, Eppendorf focuses on finding alternative, more environmentally friendly raw materials and succeeded. The next generation of Eppendorf Tubes is manufactured of certified polypropylene based on renewable raw materials. The new Eppendorf Tubes BioBased are available with screw caps in volumes 5 mL, 15 mL, 25 mL and 50 mL.

Find all further information on certifications and order numbers in this catalog.



See page
120



Centrifuge 5427 R

To protect our planet for future generations, it is important to switch to much more environmentally friendly, »green« cooling agents – hydrocarbons. These natural coolants have a Global Warming Potential similar to CO₂. To support this matter in the laboratory environment, Eppendorf now offers Centrifuge 5427 R with hydrocarbon cooling – the first centrifuge in our portfolio with a natural refrigerant – to protect your samples, and the planet.

Our newest centrifuge model does not only support you on your way to a greener lab. It is also the perfect solution for labs in need of high-throughput solutions for 1.5 – 2 mL tubes or with a multiplicity of different molecular biology applications or – all combined in a centrifuge with the highest throughput/ footprint-ratio within the Eppendorf microcentrifuge range.

See page
147

Eppendorf twin.tec® Trace PCR Plates

Discover our most advanced PCR plate: Eppendorf twin.tec® Trace! These PCR plates have improved ergonomics and traceability without sacrificing the superior twin.tec quality you know and trust! The additional features offer a perfect choice for high-throughput applications, automated workflows, and standardized processes. With laser-engraved lot number and expiration date on every single plate, twin.tec Trace supports workflows with high compliance demands. In addition, a new innovative optical guiding grid allows quick orientation on the plate and simplifies your manual and semi-automated liquid handling steps.



See page
223

Sustainability

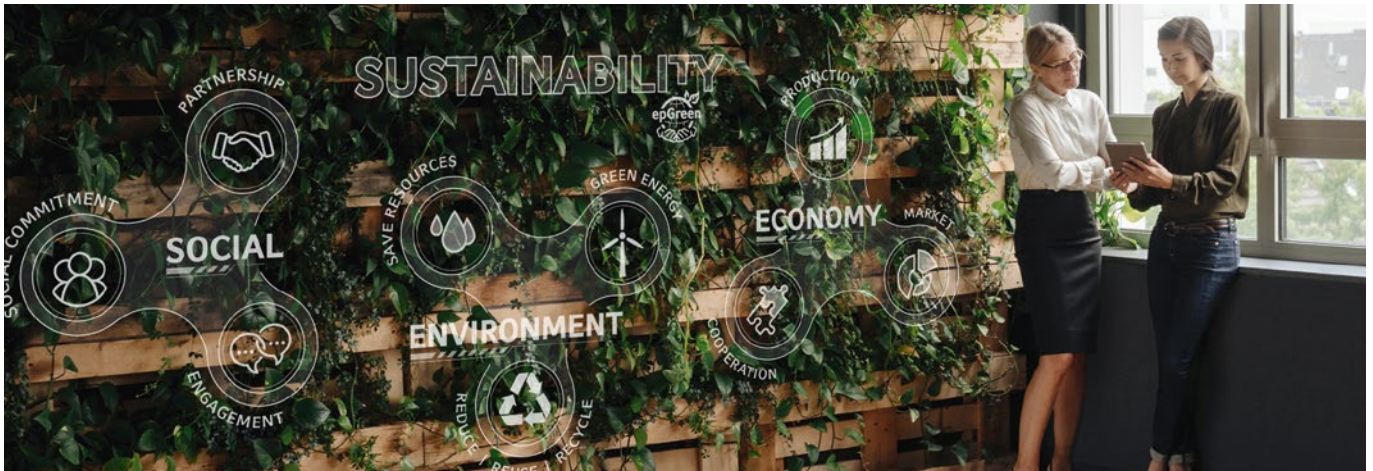

Our commitment to people and the environment

To achieve sustainable success, we consider not only financial but also environmental and social aspects in our business activities and strive to harmonize these three dimensions. Sustainability has always been an integral part of our company:

Our products are becoming ever more sustainable and help ensure that research can be carried out optimally all over the world. We are continuously working on protecting the environment and are aware of our significant responsibility as an employer towards our employees.

Our commitment to society manifests itself in many ways and is closely linked to our core competencies. Compliance with laws and regulations is more than a matter of course for us.

Sustainability Vision

A Systematic Approach to Sustainability

Our mission "to improve human living conditions" requires us to positively transform the Eppendorf Group to operate safely within the planetary boundaries and respecting humanity: We shall become Carbon-Zero, minimize the use of natural resources, and improve human well-being throughout our value chain. This vision is part of our strategic approach to take responsibility and contribute to a sustainable development.

Stakeholder-, Impact- and Success-oriented

For years now, Eppendorf has taken its corporate responsibility very seriously. In order to systematically integrate environmental and social aspects even more strongly into the Group's activities, Eppendorf has set itself a clear strategic framework.

Our Management Team is committed to ensure successful implementation, each member of the Board of Management has assumed responsibility for a guiding theme. Overall responsibility for strategy and governance is taken by Co-CEO Eva van Pelt.

Mid of 2022, we published our first sustainability report compliant to GRI standards.

Please find more details:

www.eppendorf.com/sustainability-report

The basis of the strategic framework is a combination of integrating different perspectives on 20 responsibility topics relevant for Eppendorf: The dialog with various stakeholders, a data-based determination of our environmental and social footprint using an impact analysis and a success-oriented assessment.

Sustainability along the entire value chain

For Eppendorf, corporate responsibility does not begin with its own incoming goods, nor does it end at the sales table. Instead, the focus is on the entire value chain. Thus, the strategic framework includes many topics in the areas of climate change, natural resources, social compliance, human well-being, digitalization, and society - and this from the raw material supplier to the customer.



Get all information about Sustainability at Eppendorf!

www.eppendorf.com/sustainability

Sustainability in the Lab Concerns Us All

Sustainability is becoming more and more important in public life. Wherever we interact in our personal area, there is a growing number of sustainability topics. The same holds true for our interaction with you, our customers in the labs worldwide. Whereas just a few years ago the topic of sustainability was mainly driven by dedicated employees in academic institutes and research-based companies, there has been a noticeable change for some time now. Purchasing departments as well as procurements systems request information. We see a growing interest in Eppendorf and our approach to sustainability.

Retrospect

In 2010, our centrifuge team started a green sustainability project. We found that a new centrifuge provided a far higher energy saving than expected. We were proud of the results. But the concept came too early: Energy efficiency in the laboratory was not yet the focus at that time.

Meanwhile, more and more customers expect sustainability facts about our products.

How Far can We Go? Safety First

The use of new, innovative technologies can optimize both resource consumption during production and power consumption during use. Even small improvements optimize the longevity of devices and thus contribute to greater sustainability.

Despite all needs for improved sustainability, there is a special situation in the lab: The safety of the employees, combined with safety for the samples, is the focus, embraced by sustainable progress.

The safety of valuable samples is always our top priority. For example, the set temperature for centrifuging sensitive RNA samples must be maintained accurately throughout the process to ensure data reliability and reproducibility.



Beyond Green

The green idea may be the most familiar one, but in fact sustainability encompasses many environmental, social, and economic factors.

At Eppendorf, we consider the entire supply chain and define our impact on sustainability in areas such as climate change and the use of natural resources, social compliance and human well-being, as well as with regard to data security and our role as responsible citizens in society.

This consideration begins before the product; it encompasses Eppendorf as an employer as well as a customer vis-à-vis our suppliers. Thus, our own Code of Conduct sets the bar. Our social behavior includes treating each other with respect, paying heed to the intellectual property of others, sticking to facts, and making ourselves reliable partners for our counterparts. These expectations are clearly defined and subject to continuous improvement and learning.

Ergonomics - It's About You!

Workflows in today's laboratories are becoming ever more condensed, and the strain of laboratory work is constantly increasing – making the ergonomics of laboratory devices and the entire work environment more and more important.

Personal health status or corporate sickness levels of employees due to back bone trouble or hand/wrist load – everyone tries to reduce the stress.

Ergonomics goes far beyond the "ergonomically designed chair". At the beginning of the 1970s, Eppendorf began optimizing the ergonomics of its laboratory equipment. In 2003, we launched the PhysioCare Concept®, which was focused on liquid handling devices such as our pipettes. Today, the PhysioCare Concept® implemented in all Eppendorf products supports the well-being of our users.



Sustainability

Biological sourcing for Laboratory Consumables?

Do materials manufactured with renewable feedstocks offer the same quality, purity, sterility, and process reliability criteria as the high quality products you have been using?

At Eppendorf, we have found just such a source material and are using it for a new product line of Eppendorf Tubes®. This premium polyolefin* product offers the same material performance as our virgin polyolefins* guaranteed in all existing consumables quality certificates from Eppendorf.

It is made of renewably-sourced feedstocks derived solely from vegetable oil production as well as oil waste and residues - for instance, used cooking oil. Find all variants of Eppendorf Tubes® BioBased on page 118.

*Polyolefins is a collective term for polymers produced by polymerization from olefins such as ethylene, propylene, 1-butene or isobutene, such as polyethylene and polypropylene. They are saturated hydrocarbons, which represent the largest group of plastics in terms of volume.

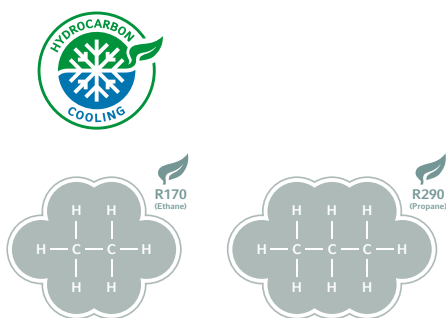

Remember 2008? Hydrocarbons - Green Cooling of the Future

As one of the very first advocates of green gases at -86 °C, Eppendorf now has more than nearly 15 years of experience with hydrocarbons in R&D, production, logistics, and service in the field. In 2008, the Premium U570h ULT freezer was one of the very first commercially available ULT freezers driven by green cooling liquids.

Replacement of the HFC based cooling liquids for refrigerated instruments is needed as global warming needs to be slowed down. The preferred hydrocarbons are also known as green or natural gases. The two major representatives are propane and ethane (known as R290 and R170).

Due to this goal, we at Eppendorf clearly plan to replace all classic cooling in our portfolio within the next years. This is not limited to freezers but also includes the refrigerated centrifuges and refrigerated shakers.

The new Centrifuge 5427 R with green cooling is the first step. Discover more (page 143)

Trust in Others: Independent Validation

As Eppendorf, we respect external test procedures and external independent test results of our products. Besides external test house checks for e.g. the ULT freezers, we ask for independent validation by third party organizations like ENERGY STAR®, My Green Lab® or ISCC PLUS (International Sustainability & Carbon Certification).

Eppendorf collaborates with My Green Lab®, an international NGO that validates and certifies lab products with "ACT - The Environmental Impact Factor Label" since 2017.

We are proud of a growing number of ACT validated and certified Eppendorf products, e.g. different tips, tubes, ULT freezers, pipettes, and more to come.

ISCC PLUS (International Sustainability & Carbon Certification) is a globally leading certification system, which offers solutions to address sustainability requirements for all feedstocks and markets. ISCC principals aim at the implementation of highest sustainability requirements. Thus traceability throughout the supply chain enables each player to source sustainable products from any certificate holder.

Eppendorf Polymere GmbH, situated in Oldenburg/Schleswig-Holstein, is ISCC PLUS certified and complies with the requirements of the certification system of ISCC PLUS.

US	
Eppendorf Conical Tubes 25 mL with SnapTec® Cap, sterile	
Oldenburg, Germany SKU 30118421	
Environmental Impact Scale 1 ← → 10 Decreasing Environmental Impact	
Manufacturing	
Manufacturing Impact Reduction	1.0
Renewable Energy Use	Yes
Responsible Chemical Management	1.0
Shipping Impact	8.7
Product Content	10.0
Packaging Content	1.0
User Impact	
Energy Consumption (kWh/day)	N/A
Water Consumption (gallons/day)	N/A
Product Lifetime	5.0
End of Life	
Packaging	4.2
Product	7.0



100% Renewable Energy for Assembly

Stepwise, our production facilities have been changed to power supply from renewable sources. Since 2021, we can proudly announce that nearly all products within the Eppendorf factories are assembled by 100% renewable power. But the product assembly is just one part of the energy story – the usage of lab instruments also requires energy. Did you already check the power origin in your lab?

Limit Your Power Bill

Electricity is also required for usage of lab instruments. ULT freezers are top of mind, they need to combine efficient cooling with energy savings. Get reliable -80 °C while minimizing energy consumption. Eppendorf ULT freezers like the CryoCube® F570h keep -80 °C with 7.4 KWh / day. Spend some time on easy maintenance of your freezer like de-icing or cleaning of the heat exchanger grid for less energy consumption and a longer lifetime. You can reduce the power consumption of your Eppendorf centrifuge by features like programmed pre-cooling, automatic eco-shut off of the compressor, or light rotors. Fast PCR cycler can also save energy by design. Check the Eppendorf Mastercycler® nexus.

What Comes After the End?

Despite good ideas, lab waste still cannot be recycled efficiently, e.g., due to regulatory requirements for biological, chemical, or radioactive hazards.

Disposal of packaging

The packaging of the products contains different materials. This includes mainly cardboard, plastic covers or bags, and some foam parts. Recycling of materials becomes more and more important. Our packaging cardboard material already consists of a high ratio of recycling material of 70 to almost 100%. Please support the global sustainability initiative of recycling valuable raw material by also collecting the packaging material and disposing of it in the appropriate collection containers at your organization. We suggest you to contact your local waste hauler or facility management team to understand the available recycling options for your organization.

Disposal of instruments

Our instruments last for many years, but if they need to be replaced, we kindly ask you to fulfill local requirements for disposal of these instruments. We strongly recommend a certified local recycling partner with experience in instruments from the lab. Keeping it “local” reduces the impact of transportation, and the „certified” aspect is recommended due to the safe and sustainable removal of all parts.

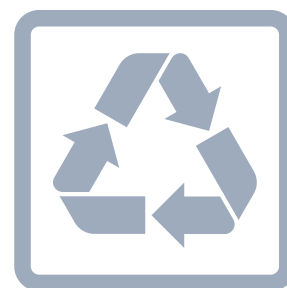

Sustainability: Our On-Going Journey

Science is based on facts. Statements such as “Our product is more sustainable compared to others” are questioned by researchers in many ways. Analyzing and improving sustainability issues requires knowledge and intensive work. None of the sustainability challenges can be solved quickly or easily. But they all require manufacturers and customers to listen to each other and work together.

This work is never over, but an on-going journey in which we communicate in constant dialogue with our stakeholders. We are researching new technologies, alternative materials and concepts. Each of these changes has the potential to contribute to progress in sustainability.



Get all information about Sustainability at Eppendorf!

www.eppendorf.com/sustainability

Pharma

Reach your 100% - Your Partner for Biopharma Research

Pharma research comes with considerable costs and lengthy processes. Reducing both and accelerating time to market is crucial for staying competitive. As a reliable partner at your side, we use all our experience, competence, and industry insights to effectively guide you through every step, from development to debut. We know and value the immense amount of work done in laboratories around the world,

which is why we offer a wide product and service portfolio that enables concentrated, relaxed work tailored to your specific needs. Whether it's monoclonal antibody drug discovery or vaccine research, we help you to find the solutions you need to stay ahead in the market. Let's work together to make our world a better place.

Faster workflows

You need to rely on products and services that ensure maximum efficiency at every step. Our products are designed with faster workflows in mind to accelerate time-to-market and create a lasting competitive advantage. Eppendorf high-quality solutions are all engineered around the functionality and intuitive performance necessary to speed up workflows, and accelerate the desired results.



Streamlined processes

In optimal pharma research and development environments, every step and function is effortlessly connected to the others. With our process-improving aspects like advanced equipment, intuitive features, and reliable process monitoring, we help you to streamline your processes; for more productivity across the board, so that researchers can focus on what matters.

Reliable results

You want reliable results with the required accuracy and reproducibility you need for your assurance. Our high-quality products and service portfolio ensure that. For 75 years, Eppendorf has stood for high quality, reliability and robust performance. We are committed to continuously drive pharmaceutical innovation and best-equip all those finding tomorrow's breakthroughs.



Compliance with requirements

When it comes to aspects such as documentation, quality management, sustainability, calibration or qualification, you want a reliable partner on your side. We embed compliance requirements and quality assurance into products and services. Whether it is complying with standards or providing licenses and documentation. Only then can you get the peace of mind required to keep making a difference.



Get all information about Pharma at Eppendorf!

www.eppendorf.com/pharma



Monoclonal Antibody Drug Discovery - Excellence at Every Step

Monoclonal antibodies have become increasingly popular within the biopharmaceutical market. Today, their production is more sought-after than ever. Our solutions streamline workflows while reducing procedural steps and costs. No matter if it's providing optimal

centrifugation for fast, reliable results, ultra-low freezers for cold storage, high-performance shakers, or bioreactors to optimize cell growth and antibody generation, our portfolio keeps efficient drug discovery on track.

Monoclonal Antibody Drug Discovery Workflow

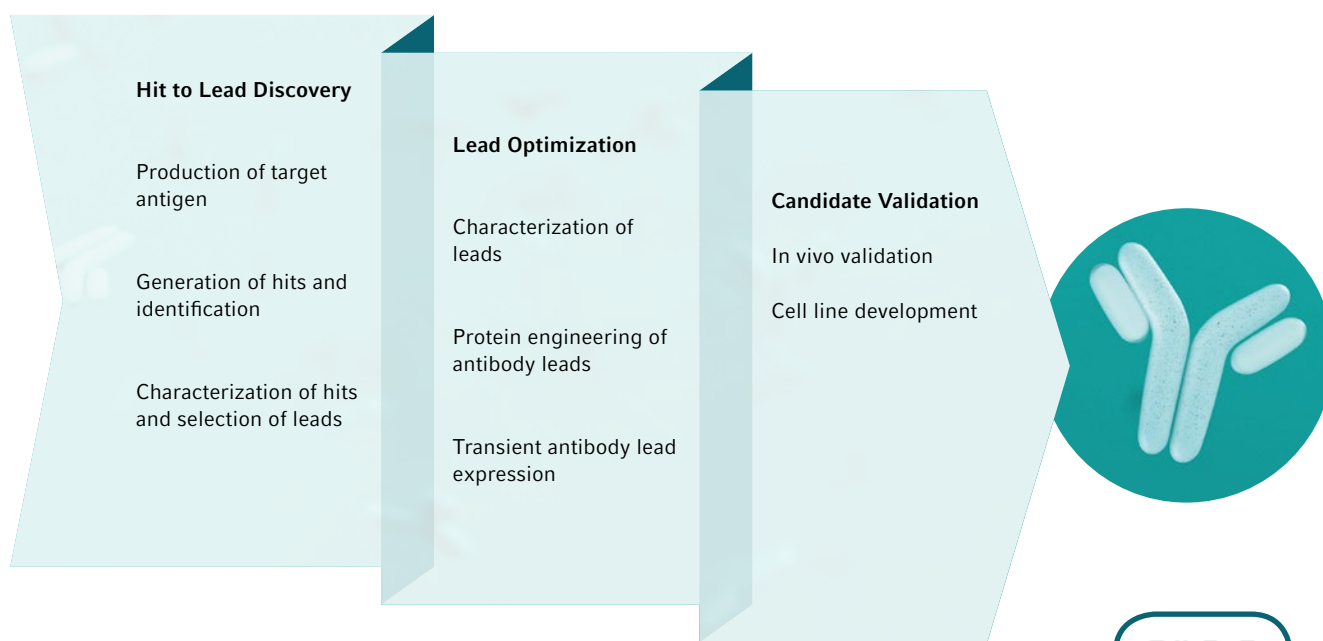

OEM

Trust Our Expertise



With Eppendorf OEM as your partner, you can take advantage of decades of competence and experience in developing and manufacturing high-tech laboratory products with premium quality.

Find an OEM product or component that perfectly fits your requirements and applicational needs and start partnering with us today.

Searching for a manufacturer capable of producing your OEM solution in a high volume?

- > Production scalability at high volumes can be achieved through our proprietary precision molding technologies
- > Automated quality checks measure coaxiality and residual volume of tips as well as 100% in-line filter inspection
- > Manufacturing sites in Germany and the US secure delivery on-time, worldwide
- > Fully automated manufacturing facilities ensure a low level of contamination
- > In-house development and manufacturing of injection tools results in high quality production with extremely low failure rates



Planning your OEM project?

Please contact us at
oem@eppendorf.com



Contact our OEM experts

Do you want to know more about how we can support you with OEM solutions?



Get all information about the Eppendorf OEM portfolio!
www.eppendorf.com/oem-portfolio

Your Benefits when Partnering with Eppendorf OEM



Fast time to market



High scalability



Variety of in-house capabilities

With you every step

We know it can be a struggle to integrate custom design diagnostic components. But it doesn't have to be that way. If you are looking for precision engineering, understanding and expertise – you've come to the right place.

With Eppendorf OEM, you'll benefit from our decades of experience in the manufacture of premium-quality components as well as our deep scientific domain understanding.



Quality down to the tips

Using only the purest raw materials and performing quality and functional checks throughout the entire production process, Eppendorf OEM products always come with premium quality.

Since our production is fully automated, contamination is reduced as far as possible.

ISO-certified for your confidence

Eppendorf is certified according to worldwide recognized and accepted ISO 9001, 13485 and 14001 standards.

This gives you the confidence that all processes in product design, manufacturing and marketing are defined and monitored in order to ensure consistent products and services.

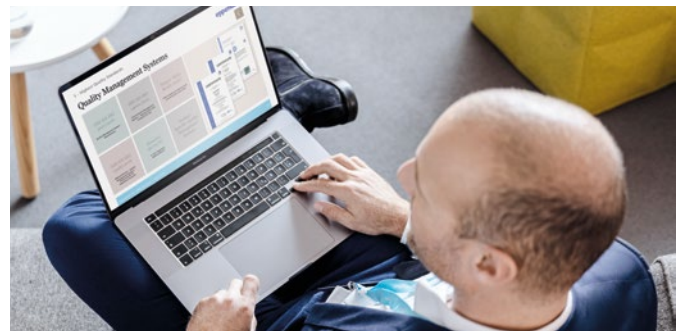

Your OEM Solution

Eppendorf is recognized as a global leader for its high quality standards, innovative technologies and cutting-edge developments. Take advantage of our competence and decades of experience in developing OEM partnerships and manufacturing high-tech laboratory products. All our products are manufactured to premium quality standards as we have our own production facilities.

Eppendorf OEM is covering the full lifecycle as an expert partner from concept and design to production, logistics and beyond. Our services include:

Requirements & specification

- > Analysis of requirements and specification definition
- > Central project management & complete documentation
- > Agile development

Product management

- > Product lifecycle management
- > On-market support – manufacturing, regulatory and change management
- > End of life product support

Infrastructure

- > Worldwide distribution centers
- > Manufacturing on multiple continents
- > Global regulatory & quality management systems

Design & prototyping

- > Material development
- > Polymer chemistry
- > Electronics design
- > Pilot runs for manufacturing
- > 3D printing & in-house tool making

Packaging

- > Packaging design
- > Transport studies
- > Sterile packaging

Performance test

- > Development of test systems
- > Documentation
- > Quality assurance

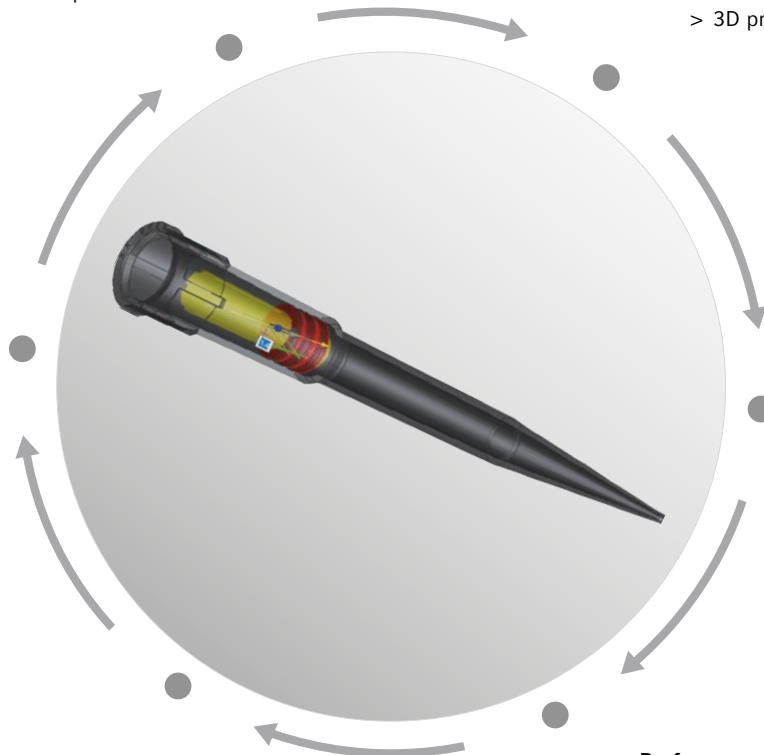

Customized Consumables



Eppendorf offers a broad range of consumables including a broad diversity of plates, tubes and tips. Whether you choose one of our standard products with a specific packaging or you prefer a customization, for example, a specific surface treatment, please contact us. We will support you with an optimized solution.

Customized tips for automation

Countless liquid handling workstations in the world work with Eppendorf conductive or non-conductive tips, benefitting from our high quality standards. Eppendorf tips for automation can cover a broad range of tasks in all major life science applications. Upon request, Eppendorf tips can also be equipped to comply with specific requirements.



Customized plates

Eppendorf offers a wide variety of plates: PCR, MTP and DWP. Plates can be customized, even to include specific barcoding using our automated barcode system. Plates can be provided in a number of customizable configurations: from labels, to 1D/2D barcodes to customer specific packaging.

Whether you choose one of our standard products with a specific packaging or you need a customization, please contact us.

Customized Instruments

Eppendorf offers you a choice from a variety of instrument configurations; covering your requirements for versatility, throughput, and speed (e.g. our *epMotion*[®] workstation). Request your customized solution today.



Watch our video about customized OEM consumables

www.eppendorf.com/oem-video

Digital Lab Management



Be prepared for tomorrow and ready for today

Streamlined processes and operations are crucial for a successful laboratory. Once considered a vision, digitalization of the lab is becoming reality thanks to the advent of innovative digital lab solutions that aim to increase productivity when handling routine tasks in your lab.

And when it comes to digitalization, connectivity is key.

There are numerous ways to optimize and improve your laboratory processes through digitalization.

General lab tasks such as device monitoring, maintenance planning or experiment documentation are more efficiently solved in the form of software platforms.

Explore Eppendorf Digital Lab Solutions and make the switch to Digital Laboratory Management Solutions.

Overall Digital Lab Management with VisioNize® Lab Suite

One platform designed to empower you to focus on your next scientific breakthrough. VisioNize Lab Suite (VNLS) enables overall digital lab management including remote device monitoring, notifications, maintenance planning, device documentation as well as experiment management options to improve sample safety, boost your lab's efficiency, enhance reproducibility as well as conformity with increasing compliance pressures. This gives you time to focus on what is important, your research!



Explore the gains of a digital,
connected lab in our White Paper
www.eppendorf.com/whitepaper-lab-digitalization

Why to switch to VisioNize Lab Suite



Evolve your maintenance routine and realize optimal device performance.

- > Setting of recurring tasks for devices or groups of devices
- > User defined reminders for upcoming tasks
- > Logging the completion of all tasks in the software
- > Booking of instruments in your lab

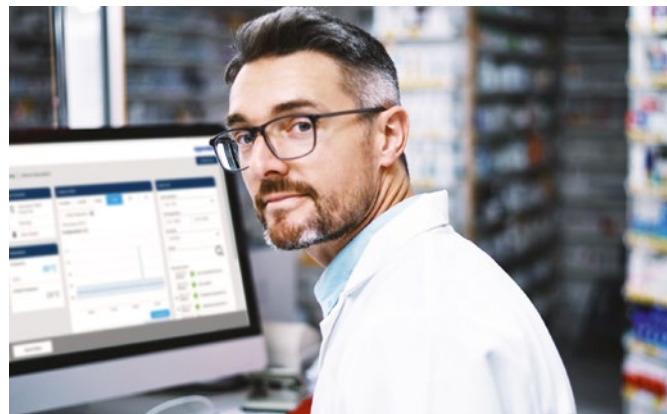

Streamline your internal audits and eliminate your paper-based documentation.

- > Quickly create reports for devices including:
 - > Time, date and user details
 - > Maintenance history
 - > Events, alarms, notifications acknowledgement
 - > Device trend data
- > Benefit from detailed audit logs with device performance data, such as parameters, user interventions & setpoint changes

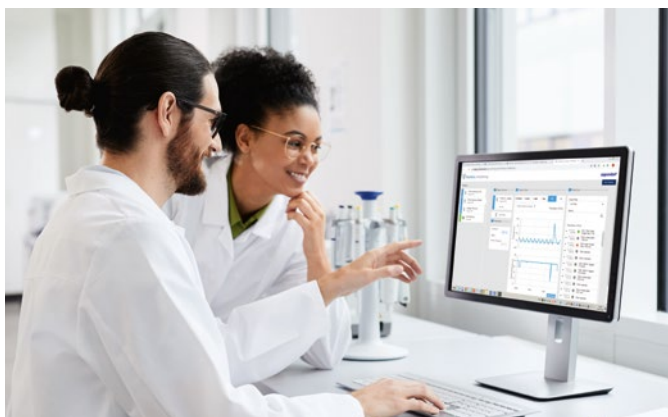

Facilitate reproducibility and time-savings with one solution for all your experiments. Eliminate human error through guided execution and benefit from automated high-quality documentation.

- > Automatically generated documentation available after experimentation completion
- > Create and manage protocols and workflows more easily
- > Plan experiments and assign them to the team members
- > Execute experiments with full guidance and structured, automated data capture



Know that your samples are secure and be on the safe side with precise decision making.

- > User defined notifications of alarms, events and more
- > Real-time device data on your computer, tablet or smartphone
- > User defined alarm escalation scheme & acknowledgement for absent team member or assets with high value samples



Digital Lab Management

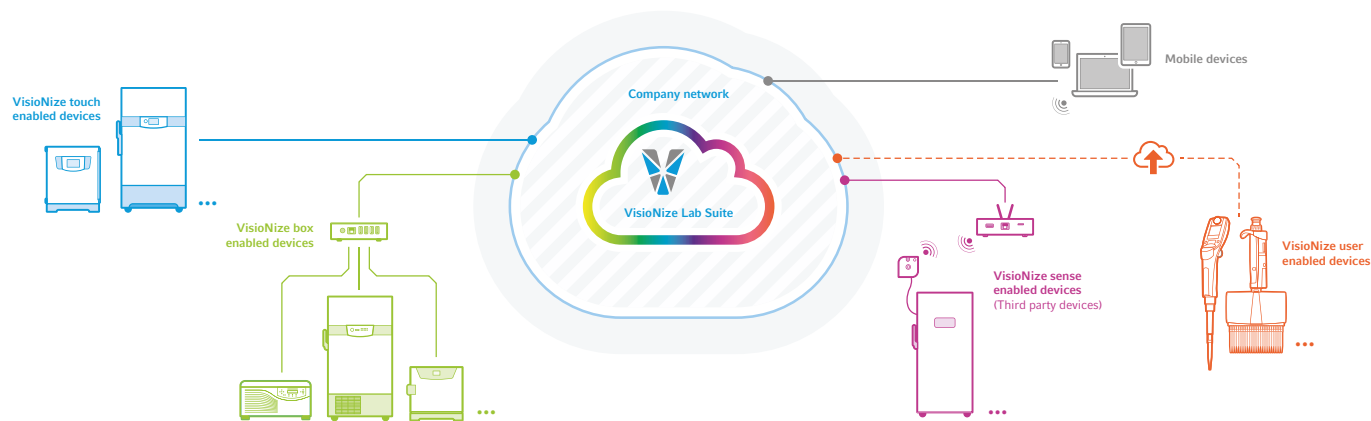

VisioNize Lab Suite provides a universal laboratory digitization solution for monitoring instruments from pipettes to freezers regardless of their manufacturer and minimizes unintended instrument downtime.

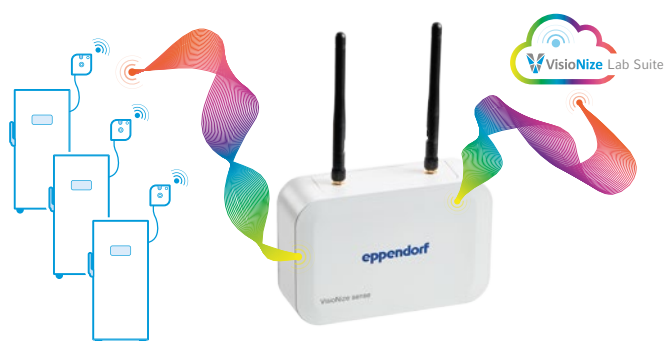

Enable connectivity for remote device monitoring

VisioNize sense is an all-in-one sensor system that works with VisioNize Lab Suite and other platforms, e.g. eLabInventory, to monitor the real-time status of devices and therefore protect integrity of samples. The system can capture, record and transfer even the smallest changes of your environmental conditions and can be used to monitor your lab rooms, CO₂ incubators, fridges or freezers from any supplier.

It includes an environmental monitoring sensor that measures ambient temperature, humidity, pressure & light, and a PT-100 extension that can measure temperature of any device (including ULT freezers) within the range of +60 to -90 °C.

Ordering information

Description	Order no.
VisioNize® sense gateway router , routes the collected parameter data to VisioNize® Lab Suite	ESS1000001
VisioNize® sense environmental monitoring sensors , a wireless, rechargeable multi-sensor unit (ambient temperature, humidity, pressure & light)	ESS1000002
VisioNize® sense external temperature sensor , PT-100 extension that can measure temperature of any device (including ULT Freezers) within the range of +60 to -90 °C.	ESS1000003
VisioNize® sense monitoring kit , all-in-one package including temperature sensor, environmental monitoring sensors and gateway router.	ESS1000004





All-in-one Electronic Lab Notebook and Sample Management with eLabNext®

Struggling with a paper-based documentation system? Or constantly lost in samples? Explore the eLabNext® solutions for your laboratory.

More than just an ELN

eLabJournal® offers an intuitive and flexible solution to document experimental information in your lab. This all-in-one Electronic Lab Notebook also includes modules for sample tracking and experiment documentation.

The software is suitable for any lab ranging from small academic laboratories and start-up companies to large academic institutes and globally operating companies.

- > Fully customizable to fit your workflow
- > Collaborative access to any data
- > Secure & compliant

Flexible sample management for laboratories

eLabInventory offers an intuitive and flexible solution for inventory management in laboratories. This highly customizable software organizes any sample type in the lab and can be fully configured to work in your unique environment. It is available standalone or integrated into eLabJournal.

- > Visualize your inventory storage
- > Organize & optimize your lab
- > Maintain a full audit trail for every sample

eLabJournal

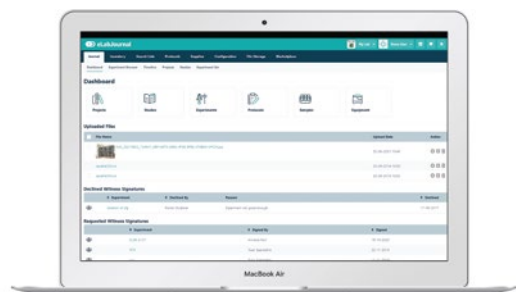

eLabInventory

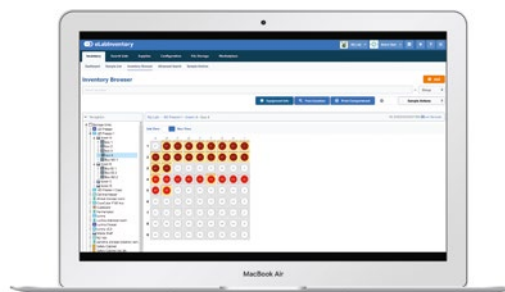

Learn more about
eLabJournal key features
www.elabnext.com/products/elabjournal



Learn more about
how to organize your lab
www.elabnext.com/products/elabinventory

Pipetting

Eppendorf – Your Expert Partner for Liquid Handling



As the first company to launch a microliter pipette, we at Eppendorf have over 60 years' experience in precise manual and automatic pipetting & dispensing to transfer the smallest quantities of liquids. Today, liquid handling systems from Eppendorf are used wherever accuracy, precision, and absolute reliability are important.

To make your lab work more efficient, ergonomic and less cumbersome, we offer a wide portfolio ranging from award-winning mechanical single- and multi-channel pipettes over (connected) electronic pipettes and dispensers to fully automated pipetting robots. Rest assured that you'll find the right liquid handling solution with Eppendorf.

How to Select the Right Liquid Handling System

Selecting the right pipette or dispenser can be the key to success in your work. It can boost your efficiency and throughput and ensure reliable results for different use cases. Here is a quick introduction to the basics:

Air-Cushion Principle

Air-cushion pipettes are most commonly used in labs around the world and ideal for liquids with physical properties similar to water. In this instrument type, the piston is separated from the liquid sample by a small air cushion. Temperature or humidity changes, as well as the physical properties of different liquids can affect the performance of air-cushion instruments. To reduce these risks however, Eppendorf air-cushion pipettes work with extra small air cushions and may be adjusted temporarily to different liquid types.

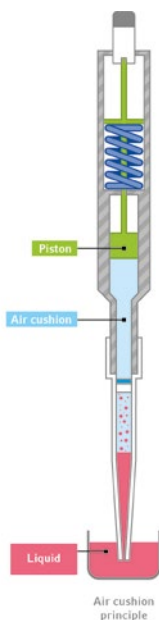

Positive Displacement Principle

In positive displacement systems, the piston is part of the tip and in direct contact with the liquid. There is no air cushion that may be affected by liquid sample properties. These tools are therefore ideal for liquids with varying viscosity, volatility, surface tension or density as well as hot or cold liquids. The disposable tips with integrated pistons also prevent contamination and help to keep user and instrument safe when working with hazardous liquids.

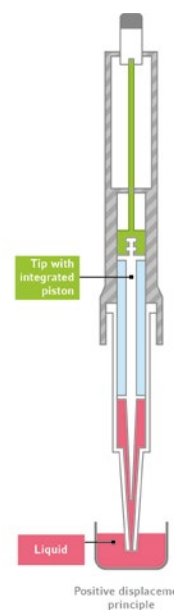

Not sure which Liquid Handling system to choose?

Check out our selection guide
www.eppendorf.com/LH-Selection





When Should You Use an Electronic Instrument?

The most important general benefits of using an electronic instrument are: better ergonomics by requiring almost no operating forces, a higher precision and reproducibility and an additional efficiency gain due to various operating modes (such as e.g. pipetting and dispensing with only one tool). Furthermore, electronic instruments are the basis for digital lab solutions supporting scientists with choosing settings for different liquid types, collaborating across the lab or documenting steps.

When Should You Think About an Automated Solution?

Automated liquid handling systems such as the *epMotion*[®] family are ideal to take over routine and repetitive pipetting tasks that are commonly found in many molecular biological applications. They are ideally suited whenever complex processes need to be standardized, help to reduce the risk of manual pipetting errors, increase reproducibility and free up your valuable time for other tasks.

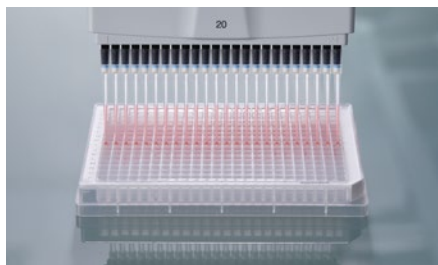

Eppendorf Pipettes and Pipette Tips: An Unbeatable Combination

The mere fact that a tip fits onto a pipette cone is no guarantee for the performance of a liquid handling system, which comprises of the components instrument and tip. Eppendorf micropipettes and pipette tips are designed to work in perfect unison and to ensure a maximum of precision and accuracy. With our wide portfolio of variants and sizes as well as certified purity grades, our pipette tips offering is tailored to various requirements in today's labs.

Learn more at page 48



Ensure Consistent Results with our Maintenance, Calibration & Adjustment Services

Pipettes and dispensers are precision instruments with moving parts subject to normal wear and tear that may lead to imprecision over time. Therefore, regular maintenance and calibration are fundamental to the precision and accuracy of your instruments. We provide sincere, reliable services to help you maintain premium performance, and maximum safety of our instruments and your applications.

Learn more at page 318

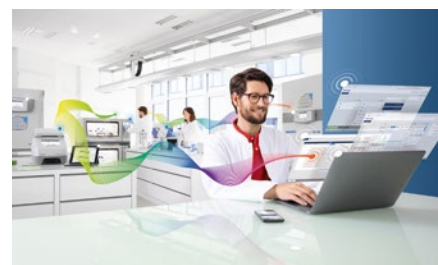

Your Transition to the Lab of the Future – with Eppendorf

Digital solutions can make everyday lab work even safer and more efficient for you. Keep track of your instruments & samples and plan your next pipette calibration with our digital lab solutions or evolve your electronic pipettes with the Pipette Manager to work faster, more accurate and in collaboration with your fellow researchers.

Learn more at page 18

Do you already know everything there is about pipetting?
Download our comprehensive guidebook and improve your pipetting skills even more!
www.eppendorf.com/download-pipetting-guide



Our Portfolio – Your Choice



Model	Eppendorf Research® plus	Eppendorf Reference® 2	Eppendorf Xplorer®/ Eppendorf Xplorer® plus
Page(s)	36	39	42
Product type	Pipette	Pipette	Pipette
Operating mode	mechanical	mechanical	electronic
Adjustable cone spacing	no	no	no
Pipetting type	Air cushion system	Air cushion system	Air cushion system
Positioning	The ultra-light mechanical pipette with low operating forces for effortless pipetting	Outstanding reliability in robustness and results	Efficient, fast and precise pipetting with untiring battery power
Application	Pipetting of aqueous liquids, two-button operation	Pipetting of aqueous liquids, single-button operation	Pipetting of aqueous liquids
Volume range	0.1 µL – 10 mL	0.1 µL – 10 mL	0.5 µL – 10 mL
Available options	1-channel 8-channel 12-channel 16-channel 24-channel	1-channel 8-channel 12-channel	1-channel 8-channel 12-channel 16-channel 24-channel
Autoclavable	yes	yes	yes (lower part)
Consumables	universal tips, epT.I.P.S.®, epT.I.P.S.® 384	universal tips, epT.I.P.S.®	universal tips, epT.I.P.S.®, epT.I.P.S.® 384
Purity grades of consumables	> Eppendorf Quality > PCR clean and sterile > Biopur® > Forensic DNA Grade	> Eppendorf Quality > PCR clean and sterile > Biopur® > Forensic DNA Grade	> Eppendorf Quality > PCR clean and sterile > Biopur® > Forensic DNA Grade
Compatible with Pipette Manager	no	no	yes



**Eppendorf Research® plus Move It®/
Eppendorf Xplorer® plus Move It®**

32
Pipette
mechanical/electronic
yes
Air cushion system
Double your pipetting performance: fast and secure multiple sample transfer between different formats made easy
Pipetting of aqueous liquids
1 – 1,200 µL
4-channel
6-channel
8-channel
12-channel
yes/yes (lower part)
universal tips, epT.I.P.S.®, epT.I.P.S.® 384
> Eppendorf Quality
> PCR clean and sterile
> Biopur®
> Forensic DNA Grade
yes (Xplorer plus variants only)

Varipette 4720

70
Pipette
mechanical
no
Positive displacement system
Fault tolerant pipetting of large volumes, independent of external effects
Contamination-free pipetting of aqueous, viscous and volatile liquids
1 – 10 mL
1-channel
no
Eppendorf Varitips®
> Eppendorf Quality
no

Multipette® M4

66
Dispenser
mechanical
no
Positive displacement system
Speed up long dispensing series with low outside fault effects
Contamination-free dispensing (up to 100 steps per tip filling) of aqueous solutions and challenging liquids (e.g. viscous, volatile, dense...)
1 µL – 10 mL
1-channel
no
Combitips® advanced, ViscoTip®
> Eppendorf Quality
> PCR clean
> Biopur®
> Forensic DNA Grade
no

Multipette® E3/Multipette® E3x

67
Dispenser
electronic
no
Positive displacement system
Save time and accelerate long dispensing series, with highest volume flexibility and lowest outside fault effects
Contamination-free motor-driven dispensing (up to 100 steps per tip filling) of aqueous solutions and challenging liquids (e.g. viscous, volatile, dense...)
1 µL – 50 mL
1-channel
no
Combitips® advanced, ViscoTip®
> Eppendorf Quality
> PCR clean
> Biopur®
> Forensic DNA Grade
no

Our Portfolio – Your Choice

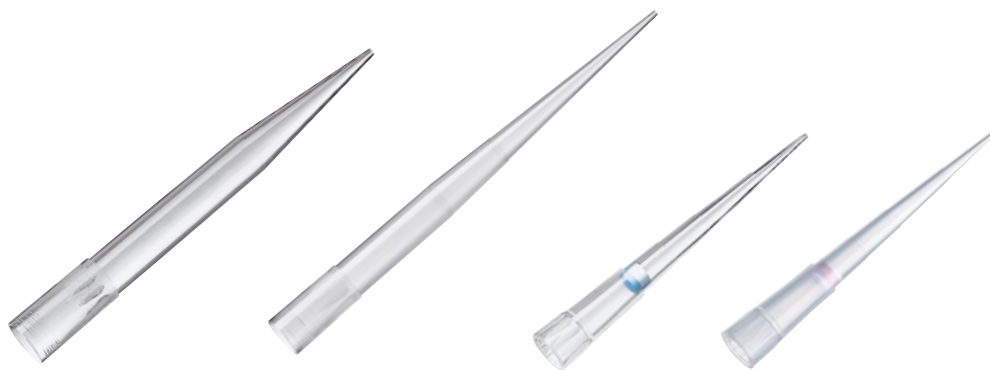

Model	epT.I.P.S.®	epT.I.P.S.® Long	ep Dualfilter T.I.P.S.®	ep Dualfilter T.I.P.S.® SealMax®
Page(s)	52	55	54	54
Applications	<ul style="list-style-type: none"> > Pipetting liquids > Dispensing liquids > Mixing liquids > Filling plates and reaction vessels > For applications with 384-well microplates, we recommend using 16- or 24-channel pipettes and epT.I.P.S.® 384 		<ul style="list-style-type: none"> > DNA applications (e.g. PCR) > RNA applications (e.g. gene expression analysis) > Protein applications (e.g. antibody research) > Cell culture applications (e.g. media) > Applications with radio actives > For applications with 384-well microplates, we recommend using 16- or 24-channel pipettes and ep Dualfilter T.I.P.S.® 384 	

¹⁾ An aerosol is a colloid of fine solid particles or liquid droplets, in air or another gas.



Model	Combitips® advanced	ViscoTip®
Page(s)	68	68
Applications	<ul style="list-style-type: none"> > Positive displacement principle (comparable to a syringe) > High-precision dispensing regardless of the physical properties of the liquid (like e.g. viscosity, volatility, density or temperature) > Prevents aerosol contamination with hermetically sealed piston for secure dispensing > Provides protection from radioactive and toxic substances > Quick dispensing of long series with precise, repeated dispensing of identical volumes (with Multipipette® hand dispensers) 	<ul style="list-style-type: none"> > Positive displacement principle (comparable to a syringe) > For highly viscous liquids such as glycerol 99.5 %, Tween®, oils, creams, shampoos or honey > Quick dispensing of long series with precise, repeated dispensing of identical volumes (with Multipipette hand dispensers)





epT.I.P.S.® 384

ep Dualfilter T.I.P.S.® 384

53

- > Biochemical assays
- > Cell based assays
- > Immunoassays
- > Storage of biological samples or chemical compounds
- > Nucleic acid based methods
- > Amplification
- > Loading of agarose gels
- > Purification
- > Quantification
- > Sequencing

53

- > DNA applications (e.g. PCR)
- > RNA applications (e.g. gene expression analysis)
- > Protein applications (e.g. antibody research)
- > Cell culture applications (e.g. media)
- > Applications with radioactives
- > All applications which use aerosol¹⁹ binding liquids

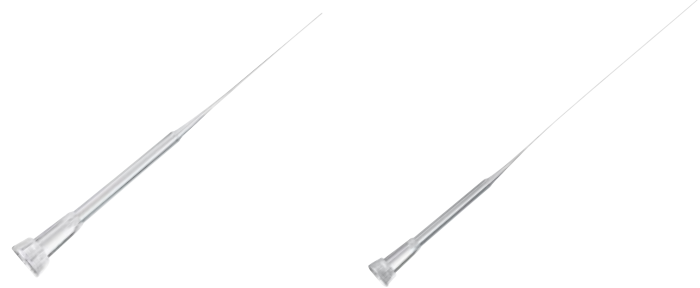

GELoader®

Microloader

52

- > Gel electrophoresis
- > Loading of samples onto polyacrylamide gels
- > Handling of smallest volumes

52

- > Pipette tip for back-filling of Femtotips® and other microcapillaries



Eppendorf Varitips®

70

- > Pipetting aqueous solutions
- > Extraction of liquids from deep receptacles
- > Transfer of organic liquids (alcohols, org. acids etc.)
- > Transfer of solvents with high vapor pressure (e.g. diethyl ether)
- > Transfer of liquids with high density
- > Transfer of viscous liquids



Eppendorf Serological Pipets

75

- > Transfer of liquids
- > Mixing suspensions
- > Combining reagents and chemical solutions
- > Transferring cells for empirical analysis or expansion
- > Layering reagents for creating higher density gradients

Our Portfolio – Your Choice



Model	Varispenser® 2/Varispenser® 2x	Eppendorf Top Buret
Page(s)	72	71
Product type	Bottle-top dispenser	Bottle-top burette
Operating mode	Mechanical	Mechanical
Pipetting type	Positive displacement system	Positive displacement system
Positioning	Safe and easy dispensing of liquid aliquots from supply bottles	Continuous and pulse-free manual titration
Application	Single stroke dispensing of lyes, acids, bases, aqueous liquids or solvents	Titration of aqueous liquids
Volume range	0.2 – 100 mL	0.1 – 999.9 mL
Available options	1-channel	1-channel
Autoclavable	yes	no
Consumables	–	–
Purity grades of consumables	–	–





Easypet® 3
74
Pipette controller
Electronic
Air cushion system
Overall ergonomic concept with speed control for stress-free pipetting
Pipetting of aqueous liquids with serological and volumetric pipettes
0.1 – 100 mL
1-channel
yes (pipette adapter and aspirating cone)
Eppendorf Serological Pipets & other serological pipettes
> Sterile, pyrogen-, DNase-, RNase-, human and bacterial DNA-free. Non-cytotoxic.

Pipet Helper®
75
Pipette controller
Mechanical
Air cushion system
The robust and intuitive design makes it a perfect entry-level instrument
Pipetting of aqueous liquids with serological and volumetric pipettes
0.1 – 100 mL
1-channel
yes
Eppendorf Serological Pipets & other serological pipettes
> Sterile, pyrogen-, DNase-, RNase-, human and bacterial DNA-free. Non-cytotoxic.



Experience the quality and convenience you have trusted in for decades with Eppendorf serological pipettes!

Designed to work in perfect harmony with your Easypet 3 or Pipet Helper, Eppendorf completes its portfolio in liquid handling with this serological pipette. For ease and flexibility, our serological pipettes can also be used with any other standard pipette controller.

Rely on precise graduations overlaid on ultra-clear pipette material for quick and easy volume readings from 0.1 mL to 50 mL. Enjoy the freedom of individually wrapped pipettes packaged in a robust dispenser box to ensure consistent premium quality.

See page 75.

Connected Electronic Pipettes



Evolve your electronic pipette with the Eppendorf Pipette Manager

Put connected electronic pipettes to use for faster operation, increased reproducibility and digital documentation of every step. The Eppendorf Pipette Manager is a standalone touch server that reacts in real-time with Eppendorf Xplorer®, Eppendorf Xplorer plus and Xplorer plus Move It® connected pipettes via WiFi technology.

What connectivity can do for you:

- > Transmit settings and other parameters quickly to connected electronic pipettes and start pipetting right away
- > Get guidance from the software-embedded Liquid Manager when working with liquids of different viscosity, volatility or foam building liquids
- > Choose from predefined Eppendorf liquid types (e.g. Acetone) or create your own
- > Manage your pipette fleet more effectively within your working group and enhance collaboration (e.g. through sharing created liquid types)
- > Document your pipetting activities to increase repeatability and support comprehensive documentation

The Pipette Manager will continue to evolve to include numerous updates and additions.



Learn more
about the Pipette
Manager:

[www.eppendorf.com/
pipette-manager](http://www.eppendorf.com/pipette-manager)



Pipette Manager

External touch server to enable communication with connected electronic pipettes as standalone systems.



Convert your Eppendorf Xplorer, Eppendorf Xplorer plus or Eppendorf Xplorer plus Move It pipette into a connected device.

Connect tablets (Android® & iOS®) to work in parallel.

Apart from the operation via the Pipette Manager, users can connect tablets allowing access to the software and its features.



The embedded software is based on the VisioNize touch interface concept that has been extensively tested by customers to reduce learning and adjustment time. It is used across different Eppendorf instruments, like the CryoCube® F740hi ULT freezer or the Mastercycler® X50.

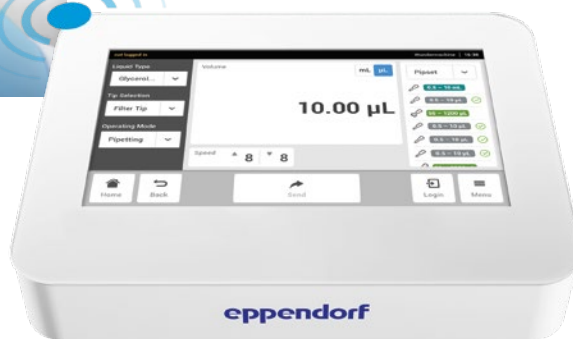

Ordering information

Description	Order no.
Pipette Manager , an external touch server enabling the communication with connected electronic pipettes.	1004 000 001
Eppendorf Xplorer® connect , WiFi module to connect pipette to the Pipette Manager	4861 000 970

These products are not available in all markets.

Please check with your local sales organization, if the Pipette Manager has been released for sales in your country.

Get Ready For Move It®

Move It doubles your pipetting performance

Do you frequently transfer samples between different vessel formats, such as between tubes and plates, and strive for more efficient and safe solutions? The adjustable tip spacing pipette Move It® accelerates and simplifies synchronous pipetting of a series of samples. A unique design without tubing connections results in increased precision and durability as well as autoclavability, increasing user and sample safety.



Product features

- > 4-, 6-, 8- and 12-channel air-cushion pipettes with variable volume and adjustable tip spacing option
- > Available as mechanical (Research plus) and electronic (Xplorer plus) adjustable tip spacing multi-channel pipette
- > For plates (384-, 96-, 48-, 24- and 12-well), tubes (1.5 and 2.0 mL), agarose gels and more

Applications

- > ELISA
- > Cell culture
- > Cell-based assays
- > (Real time) PCR
- > Mouse genotyping
- > Blood analysis
- > FACS analysis
- > Media transfer
- > Dilution series
- > Screening

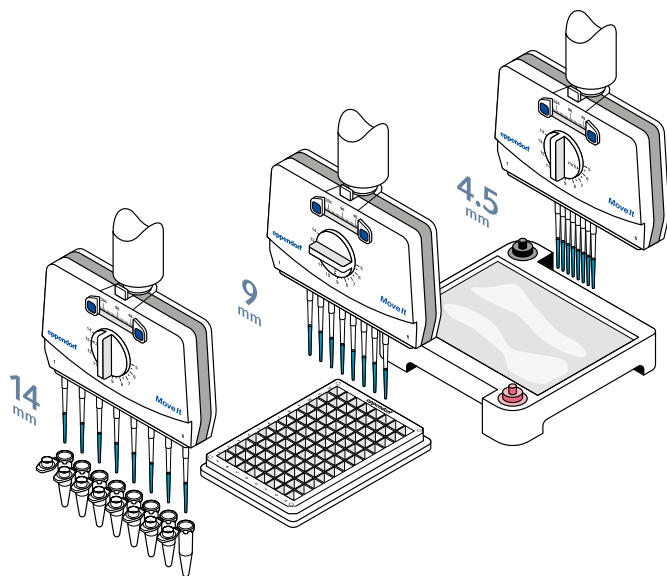

Multiple sample transfer between different formats becomes fast and secure with Move It

Instead of pipetting many times, move 4 – 12 samples simultaneously. Reduce throughput time while increasing your performance.

More about
Move It®

Please use the QR Code.

www.eppendorf.com/move-it



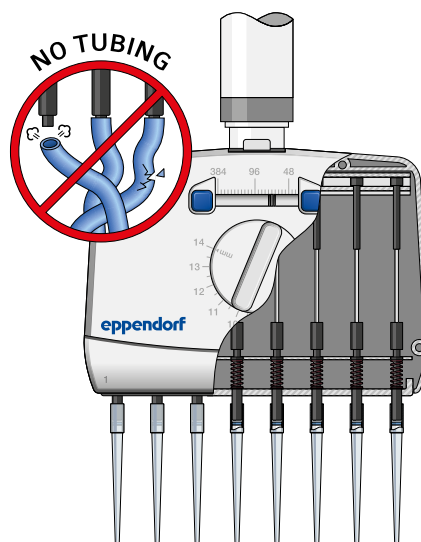
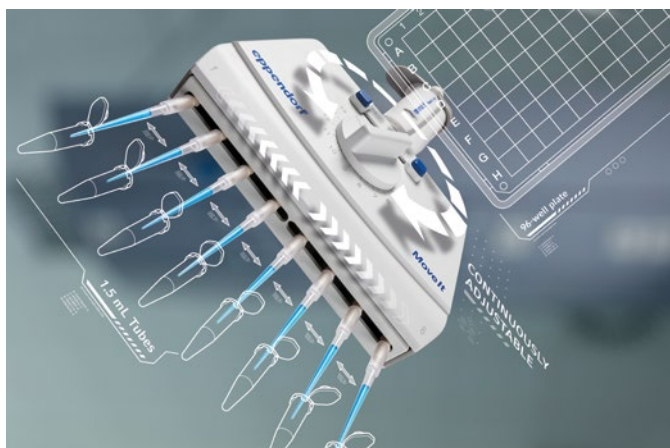

Increase your
384-well plate
efficiency



www.eppendorf.com/ready-set-pipette

Move It pipettes work without any tubing connections. Your benefits: fewer moving parts and a smaller air cushion increase durability and precision. Furthermore, the unique design makes autoclaving possible.¹⁾

¹⁾ Research plus variants fully, Xplorer plus lower part only.

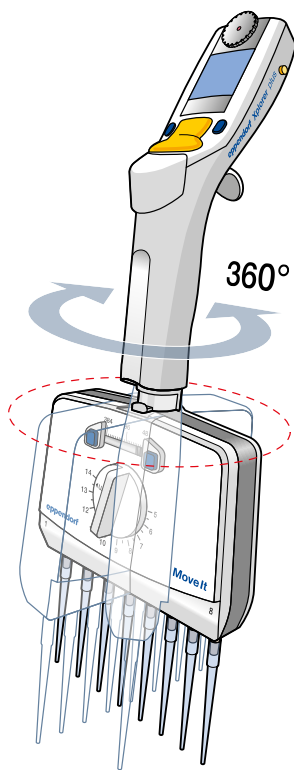

The pipette head may be rotated by 360°. Work ergonomically and benefit from perfect readability of the display at any pipetting angle.

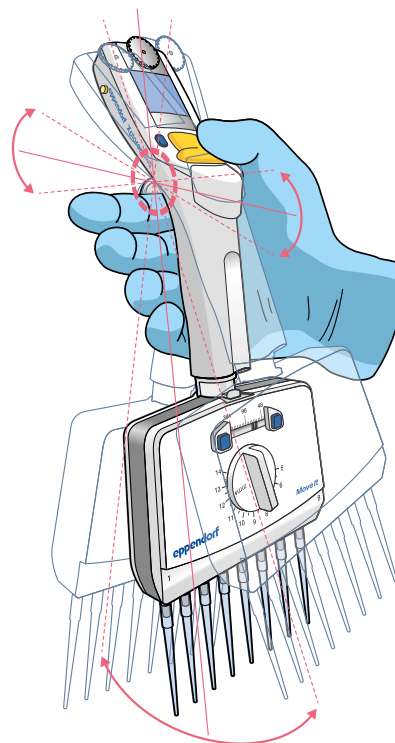

Move It pipettes are extremely well-balanced to minimize hand and body fatigue. Experience the difference!

Pipetting



Move It® - Adjustable Multi-channel Pipettes

Eppendorf Research® plus and Eppendorf Xplorer® plus

Move It selection guide

Find the right choice for your application. Select the source and destination formats according to your application and see which version suits your application best.

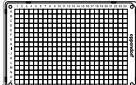
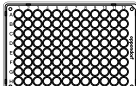
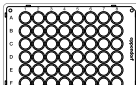
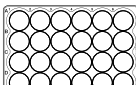
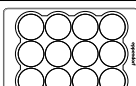
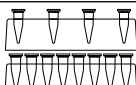
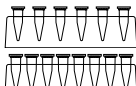
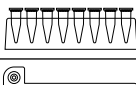

Vessel Type	Type of tips	epT.I.P.S.®			epT.I.P.S.® 384	
	Electronic/Mechanical	Xplorer plus/Research plus	Xplorer plus/Research plus	Xplorer plus/Research plus	Xplorer plus/Research plus	Xplorer plus/Research plus
	Number of channels	4	6	8	8	12
	Volume	300 µL/1,200 µL	300 µL/1,200 µL	300 µL/1,200 µL	20 µL/100 µL	20 µL/100 µL
	Adj. Cone Spacing (mm)	9-33 mm	9-20 mm	9-14 mm	4.5-14 mm	4.5-9 mm
	384 Wells (Tip distance 4.5 mm)	-	-	-	■	■
	96 Wells (Tip distance 9 mm)	■	■	■	■	■
	48 Wells (Tip distance 13 mm)	■	■	■	■	-
	24 Wells (Tip distance 19 mm)	■	■	-	-	-
	12 Wells (Tip distance 26 mm)	■	-	-	-	-
	1.5/2.0/5.0 mL Tube (Tip distance min. - max.: 9 mm - 33 mm)	■	-	-	-	-
	1.5/2.0/5.0 mL Tube (Tip distance min. - max.: 9 mm - 20 mm)	-	■	-	-	-
	1.5/2.0 mL Tube (Tip distance 14, 18, 20 mm)	-	-	■	■	-
	Agarose gel	■ ¹⁾	■ ¹⁾	■ ¹⁾	■	■

¹⁾ Limited suitability due to volume and size of tips.



You have the choice

Mechanical Research plus pipettes are the workhorses for each lab. The Xplorer plus electronic pipettes with highest variety of functions are the ideal instrument if you need intuitively and precisely adjustable parameters, reproducible and accurate results while experiencing fatigue-free pipetting.

Move It®, mechanical multi-channel pipettes, adjustable cone distance

Ordering information		Order no.
Description		
Eppendorf Research® plus Move It® , 4-channel, 9 mm cone distance, variable, incl. epT.I.P.S.® Box 2.0		
30 – 300 µL, orange	■	3125 000 150
Eppendorf Research® plus Move It® , 4-channel, 9 mm cone distance, variable		
120 – 1,200 µL, dark green	■	3125 000 184
Eppendorf Research® plus Move It® , 6-channel, 9 mm cone distance, variable, incl. epT.I.P.S.® Box 2.0		
30 – 300 µL, orange	■	3125 000 168
Eppendorf Research® plus Move It® , 6-channel, 9 mm cone distance, variable		
120 – 1,200 µL, dark green	■	3125 000 192
Eppendorf Research® plus Move It® , 8-channel, 4.5 mm cone distance, variable, incl. epT.I.P.S.® Box 2.0		
1 – 20 µL, light pink	■	3125 000 117
5 – 100 µL, light yellow	■	3125 000 133
Eppendorf Research® plus Move It® , 8-channel, 9 mm cone distance, variable, incl. epT.I.P.S.® Box 2.0		
30 – 300 µL, orange	■	3125 000 176
Eppendorf Research® plus Move It® , 8-channel, 9 mm cone distance, variable		
120 – 1,200 µL, dark green	■	3125 000 206
Eppendorf Research® plus Move It® , 12-channel, 4.5 mm cone distance, variable, incl. epT.I.P.S.® Box 2.0		
1 – 20 µL, light pink	■	3125 000 125
5 – 100 µL, light yellow	■	3125 000 141

Move It®, electronic multi-channel pipettes, adjustable cone distance

Ordering information		Order no.
Description		
Eppendorf Xplorer® plus Move It® , 4-channel, 9 mm cone distance, variable		
15 – 300 µL, orange	■	4861 000 816
50 – 1,200 µL, green	■	4861 000 833
Eppendorf Xplorer® plus Move It® , 6-channel, 9 mm cone distance, variable		
15 – 300 µL, orange	■	4861 000 817
50 – 1,200 µL, green	■	4861 000 834
Eppendorf Xplorer® plus Move It® , 8-channel, 4.5 mm cone distance, variable		
1 – 20 µL, light pink	■	4861 000 781
5 – 100 µL, light yellow	■	4861 000 794
Eppendorf Xplorer® plus Move It® , 8-channel, 9 mm cone distance, variable		
15 – 300 µL, orange	■	4861 000 818
50 – 1,200 µL, green	■	4861 000 835
Eppendorf Xplorer® plus Move It® , 12-channel, 4.5 mm cone distance, variable		
1 – 20 µL, light pink	■	4861 000 782
5 – 100 µL, light yellow	■	4861 000 795

Pipetting

Eppendorf Research[®] plus

The ultra-light pipette for effortless pipetting

The Eppendorf Research plus mechanical pipette is the result of over 60 years of experience in liquid handling and is one of the most commonly used pipettes in the world. Thanks to the pioneering Eppendorf PhysioCare Concept[®], the Research plus is highly ergonomic and protects your health in the laboratory. It features very low weight and operation forces, is extremely reliable, fully autoclavable and easy to use.

With a variety of options available, including single-channel pipettes with fixed or variable volume, multi-channel pipette options with 8-, 12-, 16- or 24-channels, and our Research plus Move It[®] adjustable tip spacing micropipettes (see page 32), we are confident that we can offer the right choice for your application.



Product features

- > Mechanical air-cushion pipette for accurate, easy & ergonomic pipetting of aqueous solutions
- > Feel the difference in weight and pipetting forces: this ultra-light pipette is designed according to the Eppendorf PhysioCare Concept[®] principles
- > Enjoy minimal tip attachment forces due to a spring-loaded tip cone (available for all pipettes up to 1 mL) that reduces stress without sacrificing tip tightness

Applications

- > Forward pipetting
- > Reverse pipetting
- > Removal of supernatants
- > Sample mixing
- > Phase extraction
- > Filling of plates, gels, and reaction vessels



A joy for your eyes - 4-digit volume display on Eppendorf Research[®] plus mechanical pipettes.

Ordering information

Description	Order no.
Eppendorf Research[®] plus, 1-channel, fixed	
10 µL, medium gray	3124 000 016
10 µL, yellow	3124 000 024
20 µL, light gray	3124 000 032
20 µL, yellow	3124 000 040
25 µL, yellow	3124 000 059
50 µL, yellow	3124 000 067
100 µL, yellow	3124 000 075
200 µL, yellow	3124 000 083
200 µL, blue	3124 000 091
250 µL, blue	3124 000 105
500 µL, blue	3124 000 113
1,000 µL, blue	3124 000 121

Learn more about the Research plus:

www.eppendorf.com/researchplus



Ordering information

Description	Order no.
Eppendorf Research® plus , 1-channel, variable, incl. epT.I.P.S.® Box	
0.1 – 2.5 µL, dark gray	3123 000 012
0.5 – 10 µL, medium gray	3123 000 020
2 – 20 µL, light gray	3123 000 098
2 – 20 µL, yellow	3123 000 039
10 – 100 µL, yellow	3123 000 047
20 – 200 µL, yellow	3123 000 055
30 – 300 µL, orange	3123 000 101
100 – 1,000 µL, blue	3123 000 063
Eppendorf Research® plus , 1-channel, variable, incl. epT.I.P.S.® sample bag	
0.25 – 2.5 mL, red	3123 000 144
0.5 – 5 mL, violet	3123 000 071
1 – 10 mL, turquoise	3123 000 080

Ordering information

Description	Order no.
Eppendorf Research® plus , 8-channel, variable, incl. epT.I.P.S.® Box	
0.5 – 10 µL, medium gray	3125 000 010
10 – 100 µL, yellow	3125 000 036
30 – 300 µL, orange	3125 000 052
Eppendorf Research® plus , 8-channel, variable	
120 – 1,200 µL, dark green	3125 000 214

Ordering information

Description	Order no.
Eppendorf Research® plus , 12-channel, variable, incl. epT.I.P.S.® Box	
0.5 – 10 µL, medium gray	3125 000 028
10 – 100 µL, yellow	3125 000 044
30 – 300 µL, orange	3125 000 060
Eppendorf Research® plus , 12-channel, variable	
120 – 1,200 µL, dark green	3125 000 222

Ordering information

Description	Order no.
Eppendorf Research® plus	
16-channel, variable, incl. epT.I.P.S.® Box, 1 – 20 µL, light pink	3125 000 079
16-channel, variable, incl. epT.I.P.S.® Box, 5 – 100 µL, light yellow	3125 000 095

Ordering information

Description	Order no.
Eppendorf Research® plus	
24-channel, variable, incl. epT.I.P.S.® Box, 1 – 20 µL, light pink	3125 000 087
24-channel, variable, incl. epT.I.P.S.® Box, 5 – 100 µL, light yellow	3125 000 109

Pipetting

Eppendorf Research® plus Multi-packs



Ordering information

Description

Eppendorf Research® plus, 3-pack, 1-channel, variable, incl. 3x epT.I.P.S.® Box 2.0 and ballpoint pen

Option 1: 0.5 – 10 µL, 10 – 100 µL, 100 – 1,000 µL

Option 2: 2 – 20 µL yellow, 20 – 200 µL, 100 – 1,000 µL

Eppendorf Research® plus, 3-pack, 1-channel, variable, incl. 1x epT.I.P.S.® Box 2.0, 2x epT.I.P.S. sample bags and ballpoint pen

Option 3: 100 – 1,000 µL, 0.5 – 5 mL, 1 – 10 mL

Eppendorf Research® plus, 6-pack, 1-channel, incl. 6x epT.I.P.S.® Box 2.0 and ballpoint pen

0.1 – 2.5 µL, 0.5 – 10 µL, 2 – 20 µL (yellow), 10 – 100 µL, 20 – 200 µL, 100 – 1,000 µL

Order no.

3123 000 900

3123 000 918

3123 000 926

3123 000 942

Accessories

Accessories

Description

Reagent reservoir Tip-Tub, autoclavable reservoir for the aspiration of liquids with multi-channel pipettes, 1 set = 10 reservoirs and 10 lids

Grease for pipettes, incl. lint-free applicators, to relubricate the piston or cylinder in pipette lower parts

Protection filter, 2.5 mL, for Eppendorf Research® plus, Reference® 2 and Xplorer® (plus), 10 filters with 1 filter sleeve, for 2.5 mL pipettes, color code: red

Protection filter, 5 mL, for Eppendorf Research® plus, Reference® 2 and Xplorer® (plus), 10 filters with 1 filter sleeve, for 5 mL pipettes, color code: violet

Protection filter, 10 mL, for Eppendorf Research® plus, Reference® 2 and Xplorer® (plus), 10 filters with 1 filter sleeve, for 10 mL pipettes, color code: turquoise

Safety plug tools, for Eppendorf Research® plus, to change the factory adjustment, 5 pcs.

Adjustment tool, for Eppendorf Research® plus and Reference® 2, to change factory or temporary adjustment

Multi-channel tool, for cutting the O-rings on tip cones of multi-channel pipettes, for 5 – 100 µL or 15 – 300 µL pipettes

Adjustment seal ADJ, for Eppendorf Research® plus, red, 5 pcs.

Pipette wrench 2 mL – 10 mL, to open multi-channel pipette lower parts up to 10 mL

Multi-channel tool, for cutting the O-rings on tip cones of multi-channel pipettes, for 50 – 1,200 µL pipettes

Unlocking tool, to open multi-channel lower parts of 1,200 µL pipettes

Locking ring for single-channel pipettes, to prevent spring action in single-channel pipettes, for pipettes from 2.5 µL – 1,000 µL

Locking clip for 8-channel pipettes, to prevent spring action in multi-channel pipettes, 2 pieces

Locking clip for 12-channel pipettes, to prevent spring action in multi-channel pipettes, 3 pieces

O-ring, red, for multi-channel pipette lower parts, 5 – 100 µL, 15 – 300 µL (1 set = 24 pcs)

O-ring, red, for multi-channel pipette lower parts, 50 – 1,200 µL (1 set = 24 pcs)

Lower part with PTFE coating (higher chemical resistance)

for Eppendorf Research® plus, single-channel, 5 mL, color code: violet

for Eppendorf Research® plus, single-channel, 1,000 µL, color code: blue

for Eppendorf Research® plus, single-channel, 10 mL, color code: turquoise

Order no.

0030 058 607

0013 022 153

4920 622 009

4920 623 005

4920 624 001

3120 639 004

3120 633 006

3122 610 003

3120 636 005

3120 634 002

4860 736 000

4861 605 006

3120 635 009

3122 612 006

3122 613 002

3122 611 000

4860 716 009

3120 642 005

3120 641 009

3120 646 000

Eppendorf Reference[®] 2

A premium pipette that delivers extraordinary precision and accuracy

Choose the Eppendorf Reference 2 mechanical pipette with ergonomic single-button operation and benefit from its high precision and accuracy with reduced operating efforts. Its smooth surface and full autoclavability guarantee efficient decontamination - making it the ideal companion when working under sterile conditions. Available as a single-channel pipette in fixed or variable volume, and as 8- and 12-channel pipettes - all with time-saving single-button operation. Once you have experienced this unique operating philosophy you will not want to change back!



Product features

- > Mechanical air-cushion pipette with outstanding precision and accuracy - operated with one button
- > With its innovative one-button operation, the Reference 2 allows fast and ergonomic handling with reduced operating efforts and active aerosol reduction. A clear haptic feedback helps to avoid accidental tip ejection
- > 4-digit display with magnifying window for quick and secure volume setting and identification (clearly visible from every angle), incl. volume lock



User-friendly temporary adjustment

For liquids other than aqueous solutions. Recommended settings are provided in the manual and you can easily and quickly reset to the manufacturer settings.



Exquisite stainless steel upper part

Equips the Reference 2 with outstanding robustness at potential impact sites. It includes quick volume setting and a secure volume lock.

Learn more about
the Reference 2:

[www.eppendorf.com/
reference2](http://www.eppendorf.com/reference2)



Pipetting

Eppendorf Reference® 2

Ordering information		Order no.
Description		
Eppendorf Reference® 2, 1-channel, fixed		
1 µL, dark gray	■	4925 000 014
2 µL, dark gray	■	4925 000 022
5 µL, medium gray	■	4925 000 030
10 µL, medium gray	■	4925 000 049
10 µL, yellow	■	4925 000 057
20 µL, light gray	■	4925 000 065
20 µL, yellow	■	4925 000 073
25 µL, yellow	■	4925 000 081
50 µL, yellow	■	4925 000 090
100 µL, yellow	■	4925 000 103
200 µL, yellow	■	4925 000 111
200 µL, blue	■	4925 000 120
250 µL, blue	■	4925 000 138
500 µL, blue	■	4925 000 146
1,000 µL, blue	■	4925 000 154
2 mL, red	■	4925 000 162
2.5 mL, red	■	4925 000 170

Ordering information		Order no.
Description		
Eppendorf Reference® 2, 1-channel, variable, incl. epT.I.P.S.® Box		
0.1 – 2.5 µL, dark gray	■	4924 000 010
0.5 – 10 µL, medium gray	■	4924 000 029
2 – 20 µL, light gray	■	4924 000 037
2 – 20 µL, yellow	■	4924 000 045
10 – 100 µL, yellow	■	4924 000 053
20 – 200 µL, yellow	■	4924 000 061
30 – 300 µL, orange	■	4924 000 070
100 – 1,000 µL, blue	■	4924 000 088
Eppendorf Reference® 2, 1-channel, variable, incl. epT.I.P.S.® sample bag		
0.25 – 2.5 mL, red	■	4924 000 096
0.5 – 5 mL, violet	■	4924 000 100
1 – 10 mL, turquoise	■	4924 000 118

Ordering information		Order no.
Description		
Eppendorf Reference® 2, 8-channel, variable, incl. epT.I.P.S.® Box		
0.5 – 10 µL, medium gray	■	4926 000 018
10 – 100 µL, yellow	■	4926 000 034
30 – 300 µL, orange	■	4926 000 050
Eppendorf Reference® 2, 12-channel, variable, incl. epT.I.P.S.® Box		
0.5 – 10 µL, medium gray	■	4926 000 026
10 – 100 µL, yellow	■	4926 000 042
30 – 300 µL, orange	■	4926 000 069

Eppendorf Reference® 2 Multi-packs



Ordering information

Description	Order no.
Eppendorf Reference® 2, 3-pack , 1-channel, variable, incl. 3x epT.I.P.S.® Box 2.0 and ballpoint pen	
Option 1: 0.5 – 10 µL, 10 – 100 µL, 100 – 1,000 µL	4924 000 908
Option 2: 2 – 20 µL yellow, 20 – 200 µL, 100 – 1,000 µL	4924 000 916
Eppendorf Reference® 2, 3-pack , 1-channel, variable, incl. 1x epT.I.P.S.® Box 2.0, 2x epT.I.P.S. sample bags and ballpoint pen	
Option 3: 100 – 1,000 µL, 0.5 – 5 mL, 1 – 10 mL	4924 000 924
Eppendorf Reference® 2, 6-pack , 1-channel, incl. 6x epT.I.P.S.® Box 2.0 and ballpoint pen	
0.1 – 2.5 µL, 0.5 – 10 µL, 2 – 20 µL (yellow), 10 – 100 µL, 20 – 200 µL, 100 – 1,000 µL	4924 000 940

Accessories

Description	Order no.
Reagent reservoir Tip-Tub , autoclavable reservoir for the aspiration of liquids with multi-channel pipettes, 1 set = 10 reservoirs and 10 lids	0030 058 607
Grease for pipettes , incl. lint-free applicators, to relubricate the piston or cylinder in pipette lower parts	0013 022 153
Protection filter , 2.5 mL, for Eppendorf Research® plus, Reference® 2 and Xplorer® (plus), 10 filters with 1 filter sleeve, for 2.5 mL pipettes, color code: red	4920 622 009
Protection filter , 5 mL, for Eppendorf Research® plus, Reference® 2 and Xplorer® (plus), 10 filters with 1 filter sleeve, for 5 mL pipettes, color code: violet	4920 623 005
Protection filter , 10 mL, for Eppendorf Research® plus, Reference® 2 and Xplorer® (plus), 10 filters with 1 filter sleeve, for 10 mL pipettes, color code: turquoise	4920 624 001
Adjustment tool , for Eppendorf Research® plus and Reference® 2, to change factory or temporary adjustment	3120 633 006
Adjustment seal ADJ, red , for Eppendorf Reference® 2, incl. pin for removing the inserted seal, 1 set = 5 pieces	4920 626 004
Multi-channel tool , for cutting the O-rings on tip cones of multi-channel pipettes, for 5 – 100 µL or 15 – 300 µL pipettes	3122 610 003
Pipette wrench 2 mL – 10 mL , to open multi-channel pipette lower parts up to 10 mL	3120 634 002
O-ring , red, for multi-channel pipette lower parts, 5 – 100 µL, 15 – 300 µL (1 set = 24 pcs)	3122 611 000
Locking ring for single-channel pipettes , to prevent spring action in single-channel pipettes, for pipettes from 2.5 µL – 1,000 µL	3120 635 009
Lower part with PTFE coating (higher chemical resistance)	
for Eppendorf Reference® 2, single-channel, 1,000 µL, color code: blue	4920 627 000
for Eppendorf Reference® 2, fixed, single-channel, 2 mL, color code: red	4921 610 004
for Eppendorf Reference® 2, single-channel, 2.5 mL, color code: red	4920 629 003
for Eppendorf Reference® 2, single-channel, 5 mL, color code: violet	4920 633 000
for Eppendorf Reference® 2, single-channel, 10 mL, color code: turquoise	4920 636 000

Eppendorf Xplorer®/Eppendorf Xplorer® plus

Simple, fast and precise with untiring battery power – You deserve it!

People who give 100 % every day deserve the best tools and the best laboratory equipment. The Eppendorf Xplorer and Xplorer plus electronic pipettes are single-, 8-, 12-, 16- and 24-channel pipettes designed to aspirate and dispense liquid volumes from 0.5 µL to 10 mL, while eliminating many of the potential error risks associated with manual pipetting. With the Eppendorf Xplorer/Xplorer plus electronic pipette, your work achieves a new level of simplicity, precision and reproducibility. Also available as Move It® adjustable tip spacing multi-channel pipette (see page 32).



Product features

- > Electronic air-cushion pipette reaching new levels of simplicity, precision and reproducibility
- > Intuitive handling via multi-function rocker with »up is up« (aspiration) and »down is down« (dispensing) logic and selection dial for quick and easy mode selection
- > Self-explanatory color display without submenus and with ergonomic angle for optimal readability in every position

Applications

- > Automated pipetting of liquids (**Pip**) for forward pipetting
- > Manual pipetting (**Man**) for volume determination
- > Pipetting and mixing (**P/M**) for automated mixing of samples
- > Dispensing (**Dis**) for manual filling of plates, gels, and reaction vessels
- > Automatic dispensing (**Ads**) for automated filling of plates, gels, and reaction vessels
- > Multi aspiration (**Spc**): Pooling supernatants from different vessels¹⁾
- > Sequential dispensing and pipetting (**Spc**) for user-defined volume steps¹⁾
- > Reverse pipetting (**Spc**) for non-aqueous solutions¹⁾
- > Diluting (**Spc**) for preparation of dilution series¹⁾
- > Fix volume (**Fix**): Save up to 10 volumes for ease of operation¹⁾



¹⁾ Xplorer plus only





Learn more about
the Xplorer:





[www.eppendorf.com/
xplorer](http://www.eppendorf.com/xplorer)



Eppendorf Xplorer®

Ordering information		Order no.
Description		
Eppendorf Xplorer® , 1-channel, variable		
0.5 – 10 µL, medium gray		4861 000 015
1 – 20 µL, light gray		4861 000 017
5 – 100 µL, yellow		4861 000 023
10 – 200 µL, yellow		4861 000 027
15 – 300 µL, orange		4861 000 031
50 – 1,000 µL, blue		4861 000 040
0.1 – 2.5 mL, red		4861 000 044
0.2 – 5 mL, violet		4861 000 058
0.5 – 10 mL, turquoise		4861 000 066









Ordering information		Order no.
Description		
Eppendorf Xplorer® , 8-channel, variable		
0.5 – 10 µL, medium gray		4861 000 104
5 – 100 µL, yellow		4861 000 120
15 – 300 µL, orange		4861 000 147
50 – 1,200 µL, green		4861 000 163

Ordering information		Order no.
Description		
Eppendorf Xplorer® , 12-channel, variable		
0.5 – 10 µL, medium gray		4861 000 112
5 – 100 µL, yellow		4861 000 139
15 – 300 µL, orange		4861 000 155
50 – 1,200 µL, green		4861 000 171





Pipetting

Eppendorf Xplorer® plus





Ordering information

Description		Order no.
Eppendorf Xplorer® plus, 1-channel, variable		
0.5 – 10 µL, medium gray		4861 000 708
1 – 20 µL, light gray		4861 000 710
5 – 100 µL, yellow		4861 000 716
10 – 200 µL, yellow		4861 000 720
15 – 300 µL, orange		4861 000 724
50 – 1,000 µL, blue		4861 000 732
0.1 – 2.5 mL, red		4861 000 736
0.2 – 5 mL, violet		4861 000 740
0.5 – 10 mL, turquoise		4861 000 759

Ordering information

Description		Order no.
Eppendorf Xplorer® plus, 8-channel, variable		
0.5 – 10 µL, medium gray		4861 000 767
5 – 100 µL, yellow		4861 000 783
15 – 300 µL, orange		4861 000 805
50 – 1,200 µL, green		4861 000 821

Ordering information

Description		Order no.
Eppendorf Xplorer® plus, 12-channel, variable		
0.5 – 10 µL, medium gray		4861 000 775
5 – 100 µL, yellow		4861 000 791
15 – 300 µL, orange		4861 000 813
50 – 1,200 µL, green		4861 000 830

Eppendorf Xplorer® plus

Ordering information		Order no.
Description		
Eppendorf Xplorer® plus , 16-channel, variable		
1 – 20 µL, light pink	■	4861 000 778
5 – 100 µL, light yellow	■	4861 000 792

Ordering information		Order no.
Description		
Eppendorf Xplorer® plus , 24-channel, variable		
1 – 20 µL, light pink	■	4861 000 779
5 – 100 µL, light yellow	■	4861 000 793

Accessories		Order no.
Description		
Lithium polymer rechargeable battery , for Eppendorf Xplorer® pipette family		
		4861 601 000
Lithium polymer rechargeable battery (small) , for Eppendorf Xplorer® connect		
		4861 618 000
Power supply with power plug adapters , for Eppendorf pipettes, multi-dispenser and charger stand, 100 – 240 VAC / 5 VDC		
		4986 603 005
Reagent reservoir Tip-Tub , autoclavable reservoir for the aspiration of liquids with multi-channel pipettes, 1 set = 10 reservoirs and 10 lids		
		0030 058 607
Grease for pipettes , incl. lint-free applicators, to relubricate the piston or cylinder in pipette lower parts		
		0013 022 153
Multi-channel tool , for cutting the O-rings on tip cones of multi-channel pipettes, for 5 – 100 µL or 15 – 300 µL pipettes		
		3122 610 003
Multi-channel tool , for cutting the O-rings on tip cones of multi-channel pipettes, for 50 – 1,200 µL pipettes		
		4860 736 000
O-ring , red, for multi-channel pipette lower parts, 5 – 100 µL, 15 – 300 µL (1 set = 24 pcs)		
		3122 611 000
O-ring , red, for multi-channel pipette lower parts, 50 – 1,200 µL (1 set = 24 pcs)		
		4860 716 009
Pipette wrench 2 mL – 10 mL , to open multi-channel pipette lower parts up to 10 mL		
		3120 634 002
Unlocking tool , to open multi-channel lower parts of 1,200 µL pipettes		
		4861 605 006
Locking ring for single-channel pipettes , to prevent spring action in single-channel pipettes, for pipettes from 2.5 µL – 1,000 µL		
		3120 635 009
Locking clip for 8-channel pipettes , to prevent spring action in multi-channel pipettes, 2 pieces		
		3122 612 006
Locking clip for 12-channel pipettes , to prevent spring action in multi-channel pipettes, 3 pieces		
		3122 613 002

Eppendorf Pipette Holder System

Well within reach: the Eppendorf Pipette Holder System helps you to organize your lab

Save valuable bench space with the Eppendorf Pipette Holder System! With space for up to six single- or multi-channel pipettes, you can easily store all of your Eppendorf pipettes and multi-dispensers within easy reach. Our flexible carousels, stands and wall mount devices fit all current Eppendorf manual liquid handling instruments as well as most of their predecessors.



- > Pipette Carousel 2: Rotatable holder with completely new design for all mechanical pipettes
- > Charger Carousel 2: Carousel with intelligent charging electronics, increased capacity for up to six instruments (charges four instruments at a time and all six in turn) and magnetic power connector for fast and easy connection



- > With Charger Stand 2, the Eppendorf Xplorer/Xplorer plus or Multipipette® E3/E3x is always fully charged and ready for use. Pipette Stand 2 carries one Multipipette M4.
- > Large rubber feet protect stands and carousels from liquids spilled on lab bench
- > Charger Stand 2 with cord wrap functionality for more convenience



reddot design award

- > Place your pipette and Multipipette where you need them: Mounted to a wall, on the shelf above your bench or inside a biological safety cabinet.
- > Pictograms on all holders for clear assignment in the lab
- > Pipette holders are downwards compatible for Eppendorf Research and Reference pipettes

Ordering information

Description	Order no.
Pipette Carousel 2 , with holders for 6 Eppendorf Research®, Eppendorf Research® plus, Eppendorf Reference®, Eppendorf Reference® 2 or Biomaster®, additional pipette holders are optionally available	3116 000 015
Charger Carousel 2 , with charger shells for 6 Eppendorf Xplorer®/Xplorer® plus, mains/power adapter included, additional charger shells and pipette holders are optionally available	3116 000 023
Charger Stand 2 , for one Eppendorf Xplorer®/Xplorer® plus	3116 000 031
Charger Stand 2 , for one Multipipette® E3/E3x or Multipipette® stream/Xstream, operated with mains/power adapter supplied with Multipipette® E3/E3x or Multipipette® stream/Xstream	3116 000 040
Pipette Stand 2 , for one Multipipette® M4, without charging functionality, additional pipette holders are optionally available	3116 000 058
Pipette Holder 2 , for one Eppendorf Research®, Eppendorf Research® plus, Eppendorf Reference®, Eppendorf Reference® 2 or Biomaster®, for Pipette Carousel 2 and Charger Carousel 2 or wall mounting, sticky tape included	3116 000 112
Pipette Holder 2 , for one Eppendorf Xplorer®/Xplorer® plus, for Pipette Carousel 2 or wall mounting, sticky tape included, without charging functionality	3116 000 120
Pipette Holder 2 , for one Multipipette® E3/E3x or Multipipette® stream/Xstream, for Pipette Carousel 2 or wall mounting, sticky tape included, without charging functionality	3116 000 139
Pipette Holder 2 , for one Multipipette® M4, for Pipette Carousel 2 and Charger Carousel 2 or wall mounting, sticky tape included	3116 000 147
Charger Shell 2 , for one Eppendorf Xplorer®/Xplorer® plus, for Charger Carousel 2 (with charging functionality)	3116 602 007
Charger Shell 2 , for one Multipipette® E3/E3x or Multipipette® stream/Xstream, for Charger Carousel 2 (with charging functionality)	3116 603 003

Tips

The Perfect Fit – Eppendorf Pipette Tips

With respect to material, fit, design and operating forces, our pipette tips set standards. The close environment of each sample should be adapted to its specific quality and purity needs. This can involve a specific purity level or the absence of certain substances, but also stability, reliability of quality standard or geometry. The epT.I.P.S.[®] pipette tips from Eppendorf are designed to cover all of the specific needs of your samples.

Our epT.I.P.S. – Eppendorf Totally Integrated Pipetting System – have been developed to work in perfect combination with our pipettes. This results in reduced tip attachment and ejection forces while maintaining a complete seal between tip and pipette. Additionally, the universal nose cone design allows the tips to be used with pipettes from other manufacturers.

In the Eppendorf owned production facilities in the north of Germany, we can maintain the highest standards in the selection and processing of plastic materials. Ideal wetting properties, high transparency, and special certified purity levels are the visible expression of this production philosophy. Every tip is manufactured to match specifically to its respective Eppendorf pipettes, thus ensuring the maximum precision and reliability you have come to expect and to rely on.

How to reduce laboratory waste volume by choosing the right packaging format. Depending on their purity grade, epT.I.P.S. pipette tips and ep Dualfilter T.I.P.S. filter pipette tips are available in a number of different packaging formats.

It is precisely the different forms of packaging that generate large proportions of laboratory waste. This can be remedied by optimizing the packaging with regard to the type of use, but also by reducing the amount of manufacturing material required.

Our challenge in developing the new epT.I.P.S. packaging design. For special applications that require a high degree of integrity and purity, there is no alternative to the disposable packaging form. But our disposable racks also had potential for plastic savings. We were able to save up to 30 % polypropylene (PP) in the production of the epT.I.P.S. and ep Dualfilter T.I.P.S. Racks for pre-sterilized pipette tips. Additionally we redesigned the well-known epT.I.P.S. box – now epT.I.P.S. Box 2.0 – and at the same time optimized it for use with the new innovative Sterile Reload variants. Where possible this new form of packaging is the more sustainable and plastic-saving alternative to disposable racks while maintaining sterility and purity. In this case, an additional about 50 % polypropylene (PP) is saved and at the same time the waste weight generated in the laboratory is reduced by about 30%.

Depending on their purity grade, epT.I.P.S. pipette tips from Eppendorf are available in a number of different packaging formats:



epT.I.P.S.[®] Reloads

- > Reduced waste as compared with disposable racks
- > The refill trays can be autoclaved up to 121 °C, in packaging and without foil, for subsequent use
- > The refill system, depending on tip size, is packaged as either dual-sided or in stack form

epT.I.P.S.[®] Sterile Reloads

- > Less waste – reduce your waste volume up to 30 % compared to disposable racks
- > Less raw material – reduced CO₂ by up to 54 % less raw material compared to disposable racks
- > Certified Sterility – premium quality packaging with TwinLid[®] technology for safe, easy use and avoidance of contamination

Get all the details of our pipette tips portfolio!
Explore the eshop and get an overview!

www.eppendorf.com/tips





epT.I.P.S.® Box 2.0/epT.I.P.S.® Set

- > Contamination-free transfer of trays to stable working box
- > System optimized for use with multi-channel pipettes
- > Color-coded trays for simple identification of tips and pipette



epT.I.P.S.® Racks

- > Eppendorf Biopur® pipette tips in disposable Racks offer the highest biological purity grade
- > Ensured PCR clean, sterile, pyrogen-, ATP- and DNA-free
- > All pre-sterilized epT.I.P.S. and ep Dualfilter T.I.P.S. variants are available in Racks

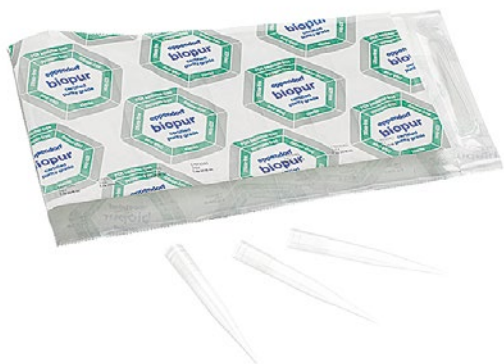

epT.I.P.S.® Singles

- > Eppendorf Biopur® pipette tip, individually wrapped
- > Ensured PCR clean, sterile, pyrogen-, ATP- and DNA-free
- > For use in pharmaceutical and food industry, molecular biology and cell technology



epT.I.P.S.® Standard

- > Original, high-quality Eppendorf pipette tips packaged in resealable bags
- > Available in sizes from 10 μ L to 10 mL in Eppendorf Quality purity grade
- > epT.I.P.S. Standard 200 μ L, 300 μ L and 1,000 μ L tips are also available color-coded yellow and blue

Learn more about Eppendorf
pipette tip quality
www.eppendorf.com/tip-quality



Which epT.I.P.S.® pipette tips fit
to my Eppendorf pipette?
www.eppendorf.com/tip-combination



Tips

Eppendorf Purity Grades for Tips

epT.I.P.S.[®], ep Dualfilter T.I.P.S.[®] and Combitips[®] advanced stand for highest quality and purity

The high precision and accuracy of pipette tips and Combitips is ensured by precise molding. Each lot of pipette tips and Combitips is subject to gravimetric measurement during final testing. Low wetting ensures reliable volume readings and minimal adhesion.

Pipette tips and Combitips cylinders are made of PP (polypropylene). A relatively inert plastic characterized by low wettability as well as high dimensional and mechanical stability across a wide temperature range. For the Combitips advanced pistons, PE (polyethylene) is used. This is due to the fact that ideal running properties between two parts can only be achieved by using two different types of plastic. Our tips are available in a variety of purity grades (See purity grades table on page 51).

Pure Quality at Eppendorf

Please use the QR Code.

www.eppendorf.com/purity



eppendorf

Eppendorf Certificate

Certificate of Purity – PCR clean

This package contains a high quality consumable manufactured under the PCR clean Eppendorf Purity Standard.

The Eppendorf PCR clean consumables are produced in a class 6 (according to VDI 2083) and a class 100,000 (according to U.S. Fed. Stand. 209 D) clean room environment.

For this product Eppendorf certifies the following [*]:

- Free of detectable
 - Human DNA
 - DNase
 - RNase
 - PCR inhibitors

Quality control and subsequent certification is done by an independent laboratory (accredited by DAKKS). Lot-specific certificates are available on request or on the internet at www.eppendorf.com/certificates.

The certification comprises the following tests:

Human DNA Contamination Test

A PCR master mix is prepared using the QuantiTect[®] Sybr[®] Green PCR Kit (Qiagen[®]) and primer for the detection of human DNA. The primers amplify a 294 bp fragment present in more than 1x10⁶ copies per human cell. The master mix (15 µl) is added to 5 positive control vessels containing known amounts of human DNA (32, 16, 8, 4 and 2 µg in 10 µl H₂O) plus a negative control (10 µl DNA-free H₂O).

15 samples are rinsed one after another with DNA-free water. 10 µl of this solution is added to 15 µl master mix. PCR is done for 30 cycles.

The emittance of Sybr Green-induced fluorescence is detected in samples and controls. For the samples to pass certification, no fluorescence must be found corresponding to the negative control.

DNase Test

15 samples are rinsed one after another with DNA-free water. 17 µl of these solutions are mixed with 3 µl DNase-buffer containing 100 bp DNA-ladder in a DNase-free tube. A positive control is spiked with DNase, a negative control contains DNA-free water. All tubes are incubated for 24 h at 37 °C.

Page 1 of 2

www.eppendorf.com

LADR GmbH MVZ Bremen
Bereich Lebensmittel- und Umweltanalytik
Friedrich-Karl-Str. 22, D-28205 Bremen

ISO 17025 accredited by
DAKKS
Deutsche Akkreditierungsstelle
D-PL 13288-03-03

Test Report

– Eppendorf PCR clean & sterile –

ep Dualfilter T.I.P.S.[®] 2 - 200 µL

16x 20 Eppendorf Tips
PCR clean / sterile

Order no.: 0030 078.591
Superior AG
22881 Hamburg - Germany
Email: superior@eppendorf.com

Lot: L2020488
2027-03-28
STERILE

Order no.: 0030078591
Distributor in North America by
Eppendorf North America, Inc. USA
Email: info@eppendorf.com

Customer: Eppendorf AG, Barkhausenweg 1, D-22330 Hamburg
Date of sample receipt / examination: 07.02.22
Testing of the above described lot showed conformity within the limits of detection.

Date of release: 08.03.22
Registration number: ep 2207 538
Dipl.-Biol. Thomas Weigel (Head)

The test results refer exclusively to the items tested as arrived. The test report must not be copied partially without the approval of LADR GmbH.

page 1 of 1

LADR GmbH MVZ Bremen, Bereich Lebensmittel- und Umweltanalytik | Friedrich-Karl-Str. 22 | D-28205 Bremen | Germany
Phone: +49 421 4307-500 | Fax: +49 421 4307-199 | info@laborbiologie@laborzentrum-bremen.de | www.laborzentrum-bremen.de

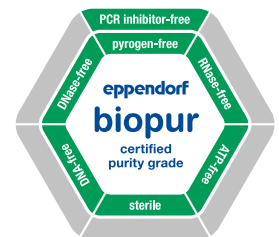
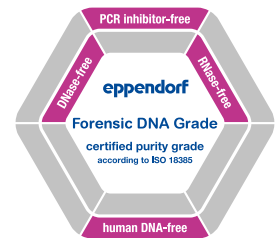
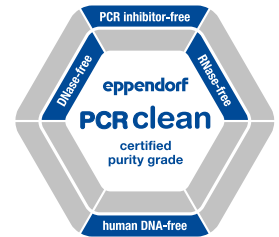

Pure quality

With the strictest control criteria, internally and externally monitored, we ensure the consistent high quality of our products – from lot to lot. Our consumables are available in a variety of purity qualities. Eppendorf Quality as well as more advanced purity grades:

“Sterile, Protein-free, PCR clean, Eppendorf Forensic DNA Grade, and Biopur®”. In addition to our internal process controls and general quality certificates, lot-specific certificates are provided by an external accredited laboratory for the Sterile, Protein-free, PCR clean, Eppendorf Forensic DNA Grade, and Biopur purity grades. This allows us to consistently meet our customer’s high demands when it comes to purity (www.eppendorf.com/purity). As a special service, we make the inspection certificate for each delivered lot available online (www.eppendorf.com/certificates).



Purity grades

Eppendorf purity grades for tips	Eppendorf Quality	Eppendorf sterile	Eppendorf PCR clean	Eppendorf sterile and PCR clean	Eppendorf Forensic DNA Grade ⁴⁾	Biopur®
Continuous quality control for the following relevant criteria:						
Function, tightness, precision	■	■	■	■	■	■
Low wetting	■	■	■	■	■	■
High chemical resistance	■	■	■	■	■	■
High thermal resistance	■	■	■	■	■	■
High resistance to centrifugation forces ¹⁾	■	■	■	■	■	■
High transparency	■	■	■	■	■	■
Precisely shaped	■	■	■	■	■	■
Lot-specific certified²⁾ for the following purity criteria:						
Pyrogen-free ⁵⁾ (endotoxin-free)		■		■		■
Sterile (Ph.Eur./USP)		■		■		■
DNA-free ⁵⁾ (Human DNA)			■	■	■	■
DNA-free ⁵⁾ (Bacteria DNA)						■
DNase-free ⁵⁾			■	■	■	■
RNase-free ⁵⁾			■	■	■	■
PCR-inhibitor-free ⁵⁾			■	■	■	■
ATP-free ⁵⁾						■
Eppendorf tips						
epT.I.P.S.® Standard, Box and Set	■					
epT.I.P.S.® Reloads	■		■			
epT.I.P.S.® Racks		■ ³⁾				■
epT.I.P.S.® Singles						■
epT.I.P.S.® 384 Reload and Set	■		■			
ep Dualfilter T.I.P.S.®				■	■	
ep Dualfilter T.I.P.S.® 384 Rack				■		
ep Dualfilter T.I.P.S.® SealMax®				■		
ep Dualfilter T.I.P.S.® LoRetention®				■		
Combitips advanced®	■	■ ³⁾	■		■	■
ViscoTip®	■					
epT.I.P.S.® LoRetention®	■		■			
epT.I.P.S.® Motion	■	■				
epT.I.P.S.® Motion filtertips		■	■	■		

¹⁾ For accurate details regarding resistance to centrifugation, please refer to the respective product pages. ²⁾ Lot-specific certificate can be downloaded from www.eppendorf.com/certificates. ³⁾ Only available in North America. ⁴⁾ According to ISO 18385. ⁵⁾ Testing showed conformity within the detection limits

epT.I.P.S.[®]

Description

epT.I.P.S. PipetteTips – Eppendorf Totally Integrated Pipetting System – the perfect combination with Eppendorf pipettes, resulting in reduced-force tip attachment and ejection with complete sealing.



Product features

- > epT.I.P.S. pipette tips can be used universally, including pipette models from other manufacturers
- > Available in purity grades of: Eppendorf Quality, PCR clean, Biopur[®]
- > Disposable Racks in slim new epT.I.P.S. design, reclosable, optimized for safe stackability, in sterility packaging compliant to DIN EN ISO 11607 - 1 and 2 and DIN EN 868-2 to 10

Applications

- > Pipetting liquids
- > Dispensing liquids
- > Mixing liquids
- > Filling plates and reaction vessels
- > Filling gels for electrophoresis
- > Phase extraction and removal of supernatants
- > For applications in 384-microplate format we recommend using 16- or 24-channel pipettes together with epT.I.P.S. 384

GEloader[®]

- > Special tip for gel electrophoresis, loading of polyacrylamide gels
- > Flexible long and narrow tips for handling of smallest volumes
- > GEloader tips and rack autoclavable



Microloader

- > Extremely long, fine and flexible tip for filling of microcapillaries for microinjection and where additional reach is needed
- > Microloader tips and rack autoclavable
- > Highest precision and accuracy when used with Eppendorf pipettes for 0.5 to 10 μ L (gray control button)

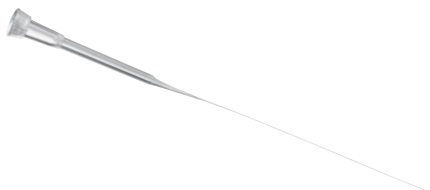

epT.I.P.S.[®] 384

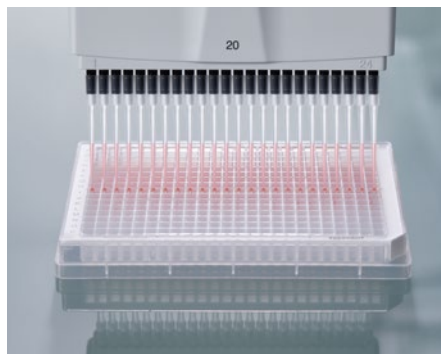

epT.I.P.S. 384 pipette tips with innovative SOFTattach technology for 16- and 24-channel as well as adjustable tip spacing pipettes

epT.I.P.S. 384 micropipette tips with the innovative SOFTattach technology are optimized for use with Eppendorf Research[®] plus and Xplorer[®] plus 16- and 24-channel pipettes, as well as 20 µL and 100 µL Move It[®] adjustable tip spacing pipettes. Process 384-well plates manually with the highest level of tip tightness and alignment but extremely low operating forces.

Product features

- > epT.I.P.S. 384 pipette tips build a system together with the Research plus and Xplorer plus 16- and 24-channel pipettes as well as 20 µL and 100 µL Move It adjustable tip spacing pipettes for utmost safety and reliability
- > Designed for a cone distance of 4.5 mm
- > Innovative SOFTattach technology allows for reliable tip fit and tightness



The elastic forming grooves

As soon as the tips are attached, they adapt perfectly to the shape of the tip cone. This SOFTattach technology allows the user to achieve perfect tip tightness and safety.

ep Dualfilter T.I.P.S.[®] 384

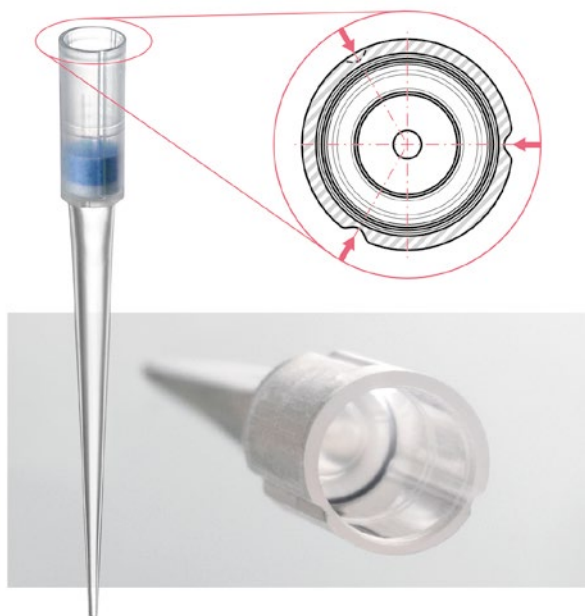

Description

ep Dualfilter T.I.P.S. 384 with the innovative SOFTattach technology are optimally coordinated to the Eppendorf 16- and 24-channel pipettes Research plus and Xplorer plus, as well as 20 µL and 100 µL Move It adjustable tip spacing pipettes. Process 384-well plates manually with highest level of filter pipette tip tightness and coaxiality but extraordinary low operating forces.

Product features

- > ep Dualfilter T.I.P.S. 384 pipette tips build a system together with the Research plus and Xplorer plus 16- and 24-channel pipettes as well as 20 µL and 100 µL Move It adjustable tip spacing pipettes for utmost safety and reliability
- > Innovative SOFTattach technology allows for reliable tip fit and tightness while operating forces are reduced to a minimum
- > Fill a whole 384-well plate without loosening pipette tips

An extraordinary tip alignment

All tips are perfectly aligned, making it easy and safe to transfer up to 24 samples simultaneously to the 384-well plate.



ep Dualfilter T.I.P.S.[®]



Description

ep Dualfilter T.I.P.S. Filter Tips - The ultimate protection of pipette and sample against unintentional and unnoticed contamination by aerosols, drops and splashes.

Product features

- > Dual protection against aerosols¹⁾ and biomolecules
- > Dual protection for pipette and sample
- > Free of PCR inhibitor additives

The unmistakable blue and white filter layers are made of flexible, hydrophobic material to fit perfectly in the tip cone and retain practically 100 % of all aerosols¹⁾ and biomolecules. This unique filtering effect is achieved using various well-defined pore sizes in the two filter layers.

¹⁾ An aerosol is a colloid of fine solid particles or liquid droplets, in air or another gas.

ep Dualfilter T.I.P.S.[®] SealMax[®]

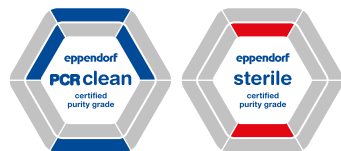

Description

ep Dualfilter T.I.P.S. SealMax Self-Sealing Filter Tips - The combination of the well known unique two-phase filter protection of sample and pipette with an innovative liquid and moisture barrier.

Product features

- > Reliable protection from liquids, aerosols¹⁾ and biomolecules
- > Certificate of filter efficiency of class ISO 25 E in accordance with DIN EN ISO 29463-5 available here
- > No PCR inhibiting additives

¹⁾ An aerosol is a colloid of fine solid particles or liquid droplets, in air or another gas.

epT.I.P.S.[®] LoRetention[®]



The “Pearl Effect” – a comparison of the amount of residual liquid when pipetting solutions that contain detergents:

1. Significant loss of sample using standard tips
2. Maximized recovery with epT.I.P.S. LoRetention



epT.I.P.S.[®] Long

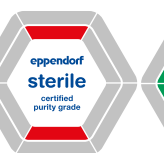

Description

The “Pearl Effect” - Maximum recovery and reproducibility with epT.I.P.S. LoRetention and ep Dualfilter T.I.P.S. LoRetention - No sample loss, reduced costs, improved results.

Product features

- > Ultrahomogenous surface for maximized reproducibility
- > Ultrahydrophobic surface for minimal sample loss
- > Significantly reduced foam formation during pipetting

epT.I.P.S. LoRetention pipette tips will be relaunched in 2023. The new order numbers will be available soon.

**epT.I.P.S.[®]
LoRetention[®]
pipette tips new
order numbers**

[www.eppendorf.com/
LoRetention](http://www.eppendorf.com/LoRetention)



Description

epT.I.P.S. PipetteTips – Eppendorf Totally Integrated Pipetting System - the perfect combination with Eppendorf pipettes, resulting in reduced-force tip attachment and ejection with complete sealing.

Product features

- > Slim design of the extra long epT.I.P.S. and ep Dualfilter T.I.P.S. pipette tips
- > Always obtain high-quality results when pipetting from and into Eppendorf Tubes[®] 5.0 mL, conical tubes, cell culture flasks, deep wells and other deep vessels
- > The risk of touching the walls of deep vessels is minimized and cross-contamination is prevented







**Watch this
video!**

[www.eppendorf.com/
eptips-video](http://www.eppendorf.com/eptips-video)



Tips



Volume range/epT.I.P.S.®	Standard/Bulk	Reloads	Reloads	Box
dark gray	1,000 tips (2 bags × 500 tips)	960 tips (10 trays × 96 tips)	960 tips (10 trays × 96 tips)	1 reusable box × 96 tips
0.1 – 10 µL, 34 mm	0030 000 811	0030 073 371	0030 073 754	0030 076 125
				
medium gray	1,000 tips (2 bags × 500 tips)	960 tips (10 trays × 96 tips)	960 tips (10 trays × 96 tips)	1 reusable box × 96 tips
0.1 – 20 µL, 40 mm	0030 000 838	0030 073 398	0030 073 770	0030 076 133
				
light gray	1,000 tips (2 bags × 500 tips)	960 tips (10 trays × 96 tips)	960 tips (10 trays × 96 tips)	1 reusable box × 96 tips
0.5 – 20 µL L, 46 mm	0030 000 854	0030 073 410	0030 073 797	0030 076 141
				
yellow	1,000 tips (2 bags × 500 tips)	960 tips (10 trays × 96 tips)	960 tips (10 trays × 96 tips)	1 reusable box × 96 tips
2 – 200 µL, 53 mm	0030 000 889	0030 073 436	0030 073 819	0030 076 150
	0030 000 870 yellow tips			
orange	1,000 tips (2 bags × 500 tips)	960 tips (10 trays × 96 tips)	960 tips (10 trays × 96 tips)	1 reusable box × 96 tips
20 – 300 µL, 55 mm	0030 000 900 0030 000 897 yellow tips	0030 073 452	0030 073 835	0030 076 168
				
blue	1,000 tips (2 bags × 500 tips)	960 tips (10 trays × 96 tips)	960 tips (10 trays × 96 tips)	1 reusable box × 96 tips
50 – 1,000 µL, 71 mm	0030 000 927 0030 000 919 blue tips	0030 073 479	0030 073 851	0030 076 176
				
green	1,000 tips (4 bags × 250 tips)	960 tips (10 trays × 96 tips)	960 tips (10 trays × 96 tips)	1 reusable box × 96 tips
50 – 1,250 µL, 76 mm	0030 000 935	0030 073 495	0030 073 878	0030 076 184
				



Set	Singles	Racks	Reloads
480 tips (5 trays × 96 tips), 1 reusable box 0030 076 290			
480 tips (5 trays × 96 tips), 1 reusable box 0030 076 303	100 tips, individually packed 0030 010 027	480 tips (5 racks × 96 tips) 0030 075 226	480 tips (5 trays × 96 tips) 0030 075 420
480 tips (5 trays × 96 tips), 1 reusable box 0030 076 311			
480 tips (5 trays × 96 tips), 1 reusable box 0030 076 320	100 tips, individually packed 0030 010 043	480 tips (5 racks × 96 tips) 0030 075 234	480 tips (5 trays × 96 tips) 0030 075 439
480 tips (5 trays × 96 tips), 1 reusable box 0030 076 338		480 tips (5 racks × 96 tips) 0030 075 242	480 tips (5 trays × 96 tips) 0030 075 447
480 tips (5 trays × 96 tips), 1 reusable box 0030 076 346	100 tips, individually packed 0030 010 060	480 tips (5 racks × 96 tips) 0030 075 250	480 tips (5 trays × 96 tips) 0030 075 455
480 tips (5 trays × 96 tips), 1 reusable box 0030 076 354		480 tips (5 racks × 96 tips) 0030 075 269	480 tips (5 trays × 96 tips) 0030 075 463

Tips



Volume range/epT.I.P.S.®

Standard/Bulk

Reloads

Reloads

■ dark green

1,000 tips (4 bags × 250 tips)

960 tips (10 trays × 96 tips)

960 tips (10 trays × 96 tips)

50 – 1,250 µL L, 103 mm

0030 000 730

0030 073 630

0030 073 649



■ red

500 tips (5 bags × 100 tips)

480 tips (10 trays × 48 tips)

480 tips (10 trays × 48 tips)

0.25 – 2.5 mL, 115 mm

0030 000 951

0030 073 517

0030 073 894



■ violet

500 tips (5 bags × 100 tips)

0.1 – 5 mL, 120 mm

0030 000 978



■ violet

300 tips (3 bags × 100 tips)

0.2 – 5 mL L, 175 mm

0030 000 650



■ turquoise

200 tips (2 bags × 100 tips)

0.5 – 10 mL, 165 mm

0030 000 765



■ turquoise

200 tips (2 bags × 100 tips)

0.5 – 10 mL L, 243 mm

0030 000 781

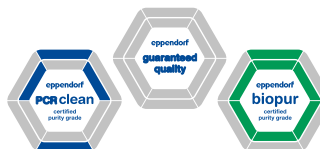

(Image reduced size)

**Box**

1 reusable box × 96 tips
0030 076 192

Set

240 tips (5 trays × 48 tips),
1 reusable box
0030 076 362

Racks

480 tips (5 racks × 96 tips)
0030 075 277 Biopur®

Reloads

480 tips (5 trays × 96 tips)
0030 075 471

1 reusable box × 48 tips
0030 076 206

240 tips (5 trays × 48 tips),
1 reusable box
0030 076 362

240 tips (5 racks × 48 tips)
0030 075 285 Biopur®

1 reusable box × 24 tips
0030 076 214

120 tips (5 racks × 24 tips)
0030 075 293 sterile
0030 071 638 Eppendorf Quality
0030 071 662 PCR clean















120 tips (5 racks × 24 tips)
0030 075 307 Biopur®
0030 071 646 Eppendorf Quality

120 tips (5 racks × 24 tips)
0030 075 315 Biopur®
0030 071 654 Eppendorf Quality

Tips

Volume range/
ep Dualfilter T.I.P.S.[®]/
ep Dualfilter T.I.P.S.[®] SealMax[®]



	Racks		Reloads	
dark gray	960 tips (10 racks × 96 tips)		960 tips (10 racks × 96 tips)	
0.1 μL – S, 34 mm	0030 078 500	0030 078 691 SealMax	0030 081 021	0030 081 226 SealMax
				
medium gray	960 tips (10 racks × 96 tips)		960 tips (10 racks × 96 tips)	
0.1 – 10 μL M, 40 mm	0030 078 519	0030 078 810	0030 081 030	
				
light gray	960 tips (10 racks × 96 tips)		960 tips (10 racks × 96 tips)	
0.5 – 20 μL L, 46 mm	0030 078 527	0030 078 705 SealMax	0030 081 048	0030 081 234 SealMax
				
yellow	960 tips (10 racks × 96 tips)		960 tips (10 racks × 96 tips)	
2 – 20 μL, 53 mm	0030 078 535	0030 078 829	0030 081 056	
				
yellow	960 tips (10 racks × 96 tips)		960 tips (10 racks × 96 tips)	
2 – 100 μL, 53 mm	0030 078 543	0030 078 713 SealMax	0030 081 064	0030 081 242 SealMax
				
yellow	960 tips (10 racks × 96 tips)		960 tips (10 racks × 96 tips)	
2 – 200 μL, 55 mm	0030 078 551	0030 078 721 SealMax	0030 078 837	0030 081 072
				0030 081 250 SealMax
orange	960 tips (10 racks × 96 tips)		960 tips (10 racks × 96 tips)	
20 – 300 μL, 55 mm	0030 078 560	0030 078 730 SealMax	0030 081 080	0030 081 269 SealMax
				
blue	960 tips (10 racks × 96 tips)		960 tips (10 racks × 96 tips)	
50 – 1,000 μL, 76 mm	0030 078 578	0030 078 748 SealMax	0030 078 845	0030 081 099
				0030 081 277 SealMax
dark green	480 tips (5 racks × 96 tips)		480 tips (5 racks × 96 tips)	
50 – 1,250 μL L, 103 mm	0030 078 594		0030 081 102	
				



Volume range/
ep Dualfilter T.I.P.S.®

■ red

0.25 – 2.5 mL, 115 mm



Racks

240 tips (5 racks × 48 tips)

0030 078 586

■ violet

0.1 – 5 mL, 120 mm



120 tips (5 racks × 24 tips)

0030 078 616

■ violet

0.2 – 5 mL L, 175 mm



120 tips (5 racks × 24 tips)

0030 078 624

■ turquoise

0.5 – 10 mL L, 243 mm



100 tips, individually packed

0030 077 598

(Image reduced size)

Special Tips



Volume range/ pipette tip

■ light gray

0.5 – 20 µL, 62 mm



GELoader®

192 tips (2 racks × 96 tips)

0030 001 222

■ light gray

0.5 – 20 µL, 100 mm



Microloader

192 pcs. (2 racks × 96 pcs.)



5242 956 003

Tips



Special Tips

Tips for 384-Well Microplates

Volume range/epT.I.P.S.® 384	Reloads	Reloads	Set
light pink 0.1 – 20 µL, 42 mm 	3,840 tips (10 trays × 384 tips) 0030 076 001	3,840 tips (10 trays × 384 tips) 0030 076 044	1,920 tips (5 trays × 384 tips), 1 reusable box 0030 076 273
light yellow 5 – 100 µL, 53 mm 	3,840 tips (10 trays × 384 tips) 0030 076 010	3,840 tips (10 trays × 384 tips) 0030 076 052	1,920 tips (5 trays × 384 tips), 1 reusable box 0030 076 281

Combination of pipette tips and pipettes

	0.1 – 10 µL, dark gray	0.1 – 10 µL, M, medium gray	0.1 – 20 µL, medium gray	0.5 – 20 µL, L, light gray	0.1 – 20 µL, light pink	5 – 100 µL, light yellow	2 – 20 µL, yellow	2 – 100 µL, yellow	2 – 200 µL, yellow
epT.I.P.S.®	■		■	■	■				■
epT.I.P.S.® LoRetention®	■			■					■
ep Dualfilter T.I.P.S.®	■	■		■	■	■	■	■	■
ep Dualfilter T.I.P.S.® LoRetention®	■			■				■	
ep Dualfilter T.I.P.S.® SealMax®	■			■				■	■
Fixed volume, single-channel pipettes									
10 µL	■ ●	■	■	●					
20 µL	■		●	■					
10 µL	■						■	■	■
20 µL	■						■	■	■
25 µL/50 µL/100 µL	■							■	■
200 µL	■								■
200 µL/250 µL/500 µL/1,000 µL	■								■
Variable volume, single-, 8- and 12-channel pipettes									
0.1 – 2.5 µL	■ ■	●	●						
0.5 – 10 µL	■ ●	■	■	●					
2 – 20 µL	■ ◆	◆	●	■					
2 – 20 µL	■						■	■	■
10 – 100 µL	■						◆	■	■
20 – 200 µL	■						◆	◆	■
30 – 300 µL	■						◆	◆	◆
100 – 1,000 µL	■								
120 – 1,200 µL	■								
0.25 – 2.5 mL	■								
0.5 – 5 mL	■								
1 – 10 mL	■								
Variable volume, 16- and 24-channel pipettes									
1 – 20 µL	■				■				
5 – 100 µL	■					■			
Move It®, variable volume, 4-, 6-, 8- and 12-channel pipettes									
1 – 20 µL	■				■				
5 – 100 µL	■					■			
30 – 300 µL	■						◆	◆	◆
120 – 1,200 µL	■								

■ Test tip (other tips may require adjustment) ● Full volume range ◆ Limited volume range



Volume range/ep Dualfilter T.I.P.S.® 384

Racks

■ light pink

0.1 – 20 µL, 42 mm



3,840 tips (10 racks × 384 tips)

0030 078 853

3,840 tips (10 rack × 384 tips)

0030 081 005

■ light yellow

5 – 100 µL, 53 mm



3,840 tips (10 racks × 384 tips)

0030 078 861

3,840 tips (10 rack × 384 tips)

0030 081 013

20 – 300 µL, orange	50 – 1,000 µL, blue	50 – 1,250 µL, green	50 – 1,250 µL, L, dark green	0.25 – 2.5 mL, red	0.1 – 5 mL, violet	0.2 – 5 mL L, violet	0.5 – 10 mL, turquoise	0.5 – 10 mL L, turquoise	GEloader®/ Microloader 0.5-20 µL
■	■	■	■	■	■	■	■	■	■
■	■		■	■	■	■	■	■	
■	■								
■	■								
									●
●									●
●									
●									
●									
	■	●	●						
									●
									●
●									
●									
●									
■									
	■	●	●						
	◆	●	■						
				■					
					■	●			
							■	●	
■									
	◆	●	■						

Tips

	0.1 – 10 µL, dark gray	0.1 – 10 µL M, medium gray	0.1 – 20 µL, medium gray	0.5 – 20 µL L, light gray	2 – 20 µL, yellow	2 – 100 µL, yellow	2 – 200 µL, yellow	20 – 300 µL, orange
Eppendorf Reference® 2								
epT.I.P.S.®	■		■	■			■	■
epT.I.P.S.® LoRetention®	■			■			■	
ep Dualfilter T.I.P.S.®	■	■		■	■	■	■	■
ep Dualfilter T.I.P.S.® LoRetention®	■			■		■	■	■
ep Dualfilter T.I.P.S.® SealMax®	■			■		■	■	■
Fixed volume, single-channel pipettes								
1 µL/2 µL	■	●	●					
5 µL/10 µL	■	■	■	●				
20 µL	■		●	■				
10 µL	■				■	■	■	●
20 µL	■				■	■	■	●
25 µL/50 µL/100 µL	■					■	■	●
200 µL	■						■	●
200 µL/250 µL/500 µL/1,000 µL	■							●
2 mL/2.5 mL	■							
Variable volume, single-, 8- and 12-channel pipettes								
0.1 – 2.5 µL	■	●	●					
0.5 – 10 µL	■	■	■	●				
2 – 20 µL	■	◆	●	■				
2 – 20 µL	■				◆	◆	■	●
10 – 100 µL	■				◆	■	■	●
20 – 200 µL	■				■	■	■	●
30 – 300 µL	■				◆	◆	◆	■
100 – 1,000 µL	■							
0.25 – 2.5 mL	■							
0.5 – 5 mL	■							
1 – 10 mL	■							

■ Test tip (other tips may require adjustment) ● Full volume range ◆ Limited volume range

	0.1 – 10 µL, dark gray	0.1 – 10 µL M, medium gray	0.1 – 20 µL, medium gray	0.5 – 20 µL L, light gray	0.1 – 20 µL, light pink	5 – 100 µL, light yellow	2 – 20 µL, yellow	2 – 100 µL, yellow	2 – 200 µL, yellow
Eppendorf Xplorer®/									
Eppendorf Xplorer® plus/									
Eppendorf Xplorer® plus Move It®									
epT.I.P.S.®	■		■	■	■				■
epT.I.P.S.® LoRetention®	■			■					■
ep Dualfilter T.I.P.S.®	■	■		■	■	■	■	■	■
ep Dualfilter T.I.P.S.® LoRetention®	■			■				■	
ep Dualfilter T.I.P.S.® SealMax®	■			■				■	■
Variable volume, single-, 8- and 12-channel pipettes									
0.5 – 10 µL	■	■	■	●					
1 – 20 µL	■	◆	●	■					
5 – 100 µL	■						◆	■	■
10 – 200 µL	■						◆	◆	■
15 – 300 µL	■						◆	◆	◆
50 – 1,000 µL	■								
50 – 1,200 µL	■								
0.1 – 2.5 mL	■								
0.2 – 5 mL	■								
0.5 – 10 mL	■								
Variable volume, 16- and 24-channel pipettes									
1 – 20 µL	■				■				
5 – 100 µL	■					■			
Move It®, variable volume, 4-, 6-, 8- and 12-channel pipettes									
1 – 20 µL	■				■				
5 – 100 µL	■					■			
15 – 300 µL	■						◆	◆	◆
50 – 1,200 µL	■								

■ Test tip (other tips may require adjustment) ● Full volume range ◆ Limited volume range

Multipette® M4



Aspirate liquid once and dispense up to 100 times without tip refill

Say goodbye to tedious, long serial pipetting tasks! The Multipette M4 pipette from Eppendorf is ideal for repetitive dispensing of volumes in long series without the need for repeated liquid aspiration. In combination with Combitips® advanced dispenser tips, even viscous or volatile liquids that are difficult to pipette are no problem for the Multipette. With hermetically sealed tips, the system also offers a high level of safety for handling of infectious, toxic or radioactive liquids.

Product features

- > Mechanical positive displacement multi-dispenser: fill the tip once and dispense up to 100 times without a refill
- > Automatic Combitips® advanced recognition eliminates time consuming volume calculations
- > Easy-to-read display guarantees stress-free and intuitive operation with a digital display of the dispensing volume

Applications

- > Repetitive dispensing of volumes in long series such as tube or plate filling, aliquoting reagents and kit usage
- > Safe dispensing of toxic, radioactive and other hazardous liquids
- > Precise and accurate dispensing of viscous solutions (e.g. glycerol) or liquids with high vapor pressure (e.g. ethanol)

Combitips®
advanced/
Multipette® M4
technical data

[www.eppendorf.com/
MultipetteM4_data](http://www.eppendorf.com/MultipetteM4_data)



Ordering information

Description	Order no.
Multipette® M4 , 1-channel, incl. 1x Combitips® advanced 2.5 mL (green) tip and holder for Eppendorf Pipette Holder System or wall mounting, 1 µL – 10 mL	4982 000 012
Multipette® M4 Starter Kit , 1-channel, incl. Combitips® advanced Rack, Combitips® advanced assortment pack (1 tip of each size) and holder for Eppendorf Pipette Holder System or wall mounting, 1 µL – 10 mL	4982 000 314
Pipette Holder 2 , for one Multipette® M4, for Pipette Carousel 2 and Charger Carousel 2 or wall mounting, sticky tape included	3116 000 147
Battery CR2032 , for Multipette® M4, 1 piece	4980 215 003

Multipette® E3/Multipette® E3x



Precise, safe, versatile and a dream to use over a long pipetting day!

These electronic dispensers combine easy handling during dispensing with a broad range of features! The Multipette E3x dispenser offers additional high-end applications, such as titration and aspirating of supernatants or sequential dilutions. In combination with the Combitips® advanced pipette tips, it is an essential lab tool for all kind of liquid handling.

Product features

- > Electronic positive displacement dispenser with several functions e.g. for dilution series, titration, automatic dispensing into microplates and vessel series
- > Automatic Combitips® advanced pipette tip recognition: Eliminates time-consuming volume calculations, avoiding incorrect dispensing volumes
- > Ergonomic one-button tip ejector: For one-handed operation and contact-free Combitips® advanced pipette tip ejection

Applications

- > Dispensing (**Dis**) or Automatic dispensing (**Ads***) for repetitive (*automated) dispensing of set volumes in long series such as tube or plate filling, aliquoting reagents and kit usage
- > Pipetting (**Pip**) for refilling of liquids
- > Sequential dispensing (**Seq**) to create dilution series¹⁾
- > Aspiration (**Asp**) for pooling of supernatants from different vessels¹⁾
- > Aspirate and dispensing (**A/D**) for pooling and volume determination with subsequent dispensing¹⁾
- > Titration (**Ttr**) for controlled dropwise dispensing and concentration determination¹⁾

¹⁾ Multipette® E3x only

Combitips®
advanced/
Multipette® E3
technical data

[www.eppendorf.com/
MultipetteE3_data](http://www.eppendorf.com/MultipetteE3_data)



Ordering information

Description	Order no.
Multipette® E3 , 1-channel, incl. charging cable and Combitips® advanced assortment pack (1 tip of each size), 1 µL – 50 mL	4987 000 010
Multipette® E3 bundle with charger stand , 1-channel, incl. charging cable, Charger Stand 2 and Combitips® advanced assortment pack (1 tip of each size), 1 µL – 50 mL	4987 000 371
Multipette® E3x , 1-channel, incl. charging cable and Combitips® advanced assortment pack (1 tip of each size), 1 µL – 50 mL	4987 000 029
Multipette® E3x bundle with charger stand , 1-channel, incl. charging cable, Charger Stand 2 and Combitips® advanced assortment pack (1 tip of each size), 1 µL – 50 mL	4987 000 380
Pipette Holder 2 , for one Multipette® E3/E3x or Multipette® stream/Xstream, for Pipette Carousel 2 or wall mounting, sticky tape included, without charging functionality	3116 000 139
Lithium ion rechargeable battery , for Multipette® E3/E3x and Multipette (X)stream	4986 602 009
Power supply with power plug adapters , for Eppendorf pipettes, multi-dispenser and charger stand, 100 – 240 VAC / 5 VDC	4986 603 005

Combitips® advanced



Description

Optimize your workflows involving plates or large series of other vessels with Combitips advanced dispenser tips and accurately and precisely pipette both viscous and volatile liquids. These positive displacement pipette tips are your consumable of choice for all Multipipette® multi-dispenser pipettes from Eppendorf and offer a variety of advantages in comparison to their predecessor Combitips plus. Available in nine volume sizes (0.1 mL – 50 mL), Combitips advanced have a maximum range of dispensing volumes with increments as low as 100 nanoliters depending on the Multipipette model used.

Product features

- > Combitips® advanced tips are the ideal consumable choice for all Multipipette® multi-dispenser pipettes from Eppendorf
- > The 9 volume sizes (0.1 mL – 50 mL) offer a maximum range of dispensing volumes with increments as low as 100 nanoliters depending on the Combitips® advanced used
- > Elongated Combitips® advanced in volumes 2.5 mL, 5.0 mL and 10 mL make it possible to reach the bottom of the most common laboratory vessels

Applications

- > Positive displacement principle (comparable to a syringe)
- > High-precision dispensing regardless of the physical properties of the liquid (like e.g. viscosity, volatility, density or temperature)
- > Prevents aerosol contamination with hermetically sealed piston for secure dispensing
- > Provides protection from radioactive and toxic substances
- > Quick dispensing of long series with precise, repeated dispensing of identical volumes (with Multipipette hand dispensers)

ViscoTip®



Easily master the highest viscosity liquids with your Multipipette® from Eppendorf!

The latest member of the Combitips® advanced dispenser tip family, ViscoTip positive displacement tips, are specifically designed and optimized for handling high viscosity liquids up to 14,000 mPa*s such as glycerol 99.5 %, Tween®, oils, creams, shampoos, nail polish - even honey. So, if you need to dispense high viscosity liquids and you want to do it with ease, turn to ViscoTip.

Product features

- > Specialized for liquids with a dynamic viscosity from 200 mPa*s to 14,000 mPa*s
- > For dispensing volumes from 100 µL to 10 mL in increments of 10 µL
- > Make life easier for your instrument: The new design of the tip means significantly lower operation forces are used, thus it speeds up work and reduces energy consumption

Applications

- > Positive displacement principle (comparable to a syringe)
- > For highly viscous liquids such as glycerol 99.5 %, Tween®, oils, creams, shampoos or honey
- > Quick dispensing of long series with precise, repeated dispensing of identical volumes (with Multipipette hand dispensers)



Ordering information

Combitips® advanced	Color code	Eppendorf Quality 100 pcs. (4 bags × 25 pcs.)	PCR clean 100 pcs. (4 reclosable bags × 25 pcs.)	Biopur® 100 pcs., individually blister- wrapped	Forensic DNA Grade 100 pcs., individually blister-wrapped
0.1 mL	□ white	0030 089 405	0030 089 766	0030 089 618	
0.2 mL	□ light blue	0030 089 413	0030 089 774	0030 089 626	
0.5 mL	□ violet	0030 089 421	0030 089 782	0030 089 634	
1.0 mL	□ yellow	0030 089 430	0030 089 790	0030 089 642	0030 089 855
2.5 mL	□ green	0030 089 448	0030 089 804	0030 089 650	0030 089 863
5.0 mL	□ blue	0030 089 456	0030 089 812	0030 089 669	0030 089 871
10 mL	□ orange	0030 089 464	0030 089 820	0030 089 677	
25 mL ¹⁾	□ red	0030 089 472	0030 089 839	0030 089 685	
50 mL ¹⁾	□ light gray	0030 089 480	0030 089 847	0030 089 693	
ViscoTip®					
10 mL	□ orange	0030 089 502			
Accessories					
Adapter advanced					
25 mL, autoclavable, 1 piece	□ red	0030 089 715			
25 mL, autoclavable, 7 pcs., individually wrapped	□ red			0030 089 731	
50 mL, autoclavable, 1 piece	□ light gray	0030 089 723			
50 mL, autoclavable, 7 pcs., individually wrapped	□ light gray			0030 089 740	
Combitips® advanced Rack, for 8 Combitips® advanced (0.1 – 10 mL), Eppendorf Quality, 1 piece		0030 089 758			
Combitips® advanced Assortment Pack, contains one Combitips® advanced sample of each size and Adapter advanced 25 and 50 mL, Eppendorf Quality		0030 089 936			

¹⁾ 4 boxes of 25 pcs. each. Each box containing one adapter.

Pipetting

Varipette® 4720

**The large volume pipette for large bottles or tall, narrow vessels**

Handle challenging liquid handling tasks with ease! The Varipette® 4720 is a large volume, positive displacement pipette that is optimized for lab work with viscous or volatile liquids. Ideal to safely aspirate liquids from large bottles or tall, narrow vessels when using the Eppendorf Varitips® S system (figures 2 & 3) or from beakers using the Varitips® P pipette tips (figure 1).

Product features

- > Mechanical positive displacement pipette designed for precise pipetting of liquids with high vapor pressure or viscosity
- > Volume range: 1 mL to 10 mL, adjustable in 10 µL increments for accurate volume setting via 4-digit volume display
- > Fast pipetting and convenient operation due to unique one-hand operation. Liquid automatically aspirates and dispenses by simply pressing the operating lever

Applications

- > Safe and precise pipetting of aqueous, viscous and volatile liquids

Combination	Volume range	Volume	Rel. systematic error ¹⁾	Abs. systematic error ¹⁾	Rel. random error ¹⁾	Abs. random error ¹⁾
Varipette 4720 and Varitips S system	2.5 – 10 mL	2.5 mL	±1.0 %	0.025 mL	±0.2 %	0.005 mL
		5 mL	±0.4 %	0.02 mL	±0.2 %	0.01 mL
		10 mL	±0.3 %	0.03 mL	±0.2 %	0.02 mL
Varipette 4720 and Varitips P	1 – 10 mL	1 mL	±0.6 %	0.006 mL	±0.2 %	0.002 mL
		5 mL	±0.5 %	0.025 mL	±0.1 %	0.005 mL
		10 mL	±0.3 %	0.03 mL	±0.1 %	0.01 mL

¹⁾ The error data, according to EN ISO 8655, only apply if original Eppendorf tips are used. Technical specifications are subject to change. Errors and omissions excepted.

Ordering information

Description	Order no.
Varipette® 4720, 1-channel, 1 – 10 mL (continuous volume selection)	4720 000 011
Eppendorf Varitips® P, to remove liquid from smaller vessels, 100 pcs.	0030 048 130
Eppendorf Varitips® S Starter Kit, to remove liquid from narrow-necked vessels and measuring flasks, consisting of 100 Maxitips, 10 dispensing parts, 10 valves	0030 050 525
Eppendorf Varitips® S, graduated, 200 pcs.	0030 050 568
Eppendorf Varitips® S valve, 100 pcs.	0030 050 541
Eppendorf Varitips® S dispensing part, 30 pcs.	0030 050 533
Wall mount for Varipette® 4720 & Multipipette® plus, with adhesive surface	4981 203 009

Eppendorf Top Buret



Continuous and pulse-free manual titration

The innovative Eppendorf Top Buret sets new standards in manual liquid titration. Its pulse-free dispensing technique means that exact volumes can be dispensed continuously, making titration simple, safe and precise. And with a user-friendly display and simple control features, this extremely sturdy digital bottle-top burette is really easy to use.

Product features

- > Bottle-top burette with continuous, pulse-free dispensing technology for manual titration
- > Digital display ranging from 0.01 mL to 999.9 mL, dosing rates: Model M: 2.5 mL per turn, Model H: 5 mL per turn
- > Recirculation valve with valve lever

Ordering information

Description	Order no.
Eppendorf Top Buret M , manual bottle-top buret with discharge valve, telescopic aspiration tube and variable discharge tube, 2.5 mL per turn, digital display ranging from 0.01 – 999.9 mL, for 45 mm bottle thread, incl. 3 PP adapters for 40/38/32 mm threads, 2 micro batteries 1.5 V, certificate of conformity	4965 000 017
Eppendorf Top Buret H , manual bottle-top buret with discharge valve, telescopic aspiration tube and variable discharge tube, 5 mL per turn, digital display ranging from 0.01 – 999.9 mL, for 45 mm bottle thread, incl. 3 PP adapters for 40/38/32 mm threads, 2 micro batteries 1.5 V, certificate of conformity	4965 000 025

Accessories

Description	Order no.
Drying tube , for Eppendorf Top Buret, without drying agent	4960 851 000
Telescopic aspirating tube , for Eppendorf Top Buret, for 2.5 mL, 5 mL, 10 mL, 25 mL, 50 mL, 100 mL	4960 805 009
Batteries (2 pcs.) , for Eppendorf Top Buret, LR03/AAA, 1.5 V	4965 625 009
Bottle thread adapter , PP, from GL 32 to GL 25	4960 800 040
Bottle thread adapter , PP, from GL 32 to GL 27	4960 800 139
Bottle thread adapter , PP, from GL 32 to GL/S 28	4960 800 058
Bottle thread adapter , PP, from GL 45 to GL 32	4960 800 120
Bottle thread adapter , PP, from GL 45 to GL 38	4960 800 155
Bottle thread adapter , PP, from GL 45 to S 40	4960 800 147
Bottle thread adapter , PP, from GL 32 to NS 19/26	4960 800 082
Bottle thread adapter , PP, from GL 32 to NS 24/29	4960 800 090
Bottle thread adapter , PP, from GL 32 to NS 29/32	4960 800 104

Varispenser® 2/Varispenser® 2x



Safe and easy dispensing of liquids from bottles without compromise

Need a bottle-top dispenser for aggressive solutions such as acids, solutions or bases? The Eppendorf bottle-top dispensers Varispenser 2 and Varispenser 2x allow you to safely dispense liquids from a wide range of bottles without reagent waste and are ideal for conveniently dispensing aliquots from large supply bottles. Chemically resistant and autoclavable, their tight seal provides protection against caustic media.

Product features

- > Bottle-top dispenser with standard GL 45 thread for most common bottle threads in all sizes
- > Safety valve balls in discharge valve prevent leakage when discharge tube is not mounted
- > Air vent cap can be unscrewed for easy assembly of drying tube

Applications

- > Liquid dispensing directly from supply bottles or other big laboratory vessels containing aqueous liquids, lyes, acids, bases or solvents

Learn more in
our White Paper

Please use the QR Code.

www.eppendorf.com/WP_Varispenser



Varispenser® 2/
Varispenser® 2x
technical data

[www.eppendorf.com/
Varispenser-data](http://www.eppendorf.com/Varispenser-data)



Ordering information	
Description	Order no.
Varispenser® 2 , 1-channel, bottle-top dispenser with telescopic intake tube (length 125 – 240 mm)	
0.2 – 2 mL, incl. adapters GL 25, GL 28/S 28, GL 32, GL 38, S 40	4966 000 010
0.5 – 5 mL, incl. adapters GL 25, GL 28/S 28, GL 32, GL 38, S 40	4966 000 029
1 – 10 mL, incl. adapters GL 25, GL 28/S 28, GL 32, GL 38, S 40	4966 000 037
Varispenser® 2 , 1-channel, bottle-top dispenser with telescopic intake tube (length 170 – 330 mm)	
2.5 – 25 mL, incl. adapters GL 32, GL 38, S 40	4966 000 045
5 – 50 mL, incl. adapters GL 32, GL 38, S 40	4966 000 053
10 – 100 mL, incl. adapters GL 32, GL 38, S 40	4966 000 061
Varispenser® 2x , 1-channel, bottle top dispenser with recirculation valve and telescopic intake tube (length 125 – 240 mm)	
0.2 – 2 mL, incl. adapters GL 25, GL 28/S 28, GL 32, GL 38, S 40	4967 000 014
0.5 – 5 mL, incl. adapters GL 25, GL 28/S 28, GL 32, GL 38, S 40	4967 000 022
1 – 10 mL, incl. adapters GL 25, GL 28/S 28, GL 32, GL 38, S 40	4967 000 030
Varispenser® 2x , 1-channel, bottle top dispenser with recirculation valve and telescopic intake tube (length 170 – 330 mm)	
2.5 – 25 mL, incl. adapters GL 32, GL 38, S 40	4967 000 049
5 – 50 mL, incl. adapters GL 32, GL 38, S 40	4967 000 057
10 – 100 mL, incl. adapters GL 32, GL 38, S 40	4967 000 065

Accessories	
Description	Order no.
Drying tube , for Varispenser® 2/2x, without filling, including sealing washer (PFTE)	4966 509 002
Ventilation screw , for microfilters with Luer connector, PP, with PTFE sealing washer	4966 511 007
Ventilation screw , for Varispenser® 2/2x, PP	4966 601 006
Discharge tube , for Varispenser® 2/2x, spiraled, for 2 mL, 5 mL, 10 mL	4966 501 001
Discharge tube , for Varispenser® 2/2x, spiraled, for 25 mL, 50 mL, 100 mL	4966 502 008
Telescopic aspirating tube , FEP; for Varispenser® 2/2x, 70 mm – 140 mm, for 2 mL, 5 mL, 10 mL	4966 503 004
Telescopic aspirating tube , FEP; for Varispenser® 2/2x, 125 mm – 240 mm, for 2 mL, 5 mL, 10 mL	4966 504 000
Telescopic aspirating tube , FEP; for Varispenser® 2/2x, 195 mm – 350 mm, for 2 mL, 5 mL, 10 mL	4966 505 007
Telescopic aspirating tube , FEP; for Varispenser® 2/2x, 250 mm – 480 mm, for 2 mL, 5 mL, 10 mL	4966 506 003
Telescopic aspirating tube , FEP; for Varispenser® 2/2x, 250 mm – 480 mm, for 25 mL, 50 mL, 100 mL	4966 508 006
Telescopic aspirating tube , FEP; for Varispenser® 2/2x, 170 mm – 330 mm, for 25 mL, 50 mL, 100 mL	4966 507 000
Bottle thread adapter , PP, from GL 32 to GL 25	4960 800 040
Bottle thread adapter , PP, from GL 32 to GL 27	4960 800 139
Bottle thread adapter , PP, from GL 32 to GL/S 28	4960 800 058
Bottle thread adapter , PP, from GL 45 to GL 32	4960 800 120
Bottle thread adapter , PP, from GL 45 to GL 38	4960 800 155
Bottle thread adapter , PP, from GL 45 to S 40	4960 800 147
Bottle thread adapter , ETFE, from GL 32 to GL 25	4966 614 000
Bottle thread adapter , ETFE, from GL 32 to GL/S 28	4960 835 005
Bottle thread adapter , ETFE, from GL 45 to GL 32	4966 615 007
Bottle thread adapter , ETFE, from GL 45 to GL 38	4960 839 000
Bottle thread adapter , PTFE, from GL 45 to S 40	4960 834 009
Thread adapter , for jerrycan 5 L, ETFE, from 45 mm to 17/8" thread	4960 832 006

Pipetting

Easypet® 3

**Experience total control with the Easypet 3**

Looking to simplify your manual liquid handling tasks in cell culture and other applications? The Easypet 3 electronic pipette controller from Eppendorf gives you precision and complete speed control, making it ideal for serial dispensing and resuspending bacterial or cell pellets. Easypet 3 can be used with all types of serological and volumetric pipettes from volumes of 0.1 – 100 mL.

Product features

- > Electronic pipette controller designed for use with serological and volumetric pipettes
- > Intuitive and convenient speed adjustment simply done with the tips of your fingers
- > Lightweight, well-balanced and ergonomic design that allows for fatigue-free pipetting

Applications

- > Liquid handling with serological and volumetric pipettes from 0.1 – 100 mL
- > Serial dispensing of aliquots of different volumes
- > Resuspension of bacteria or cell pellets
- > Aspiration of cell layer from e.g. Ficoll® gradient

Technical specifications

Model	Easypet® 3
Weight	160 g
Rechargeable battery	
Capacity	1,100 mAh/3.7 V
Charging time	~3 h
Type	Lithium polymer
Channel type	1-channel
Number of dispensings	~2,000 (with a 25 mL pipette)
Operation	Electronic
Pipetting type	Air cushion system
Mains/power supply	
Input	100 V – 240 V AC ± 10 %, 50 Hz – 60 Hz, 0.5 A
Output	5 V DC, 1.0 A

Ordering information

Description	Order no.
Easypet® 3 , 1-channel, incl. mains/power supply device, wall mounting device, shelf stand, 2 membrane filters 0.45 µm, 0.1 – 100 mL	4430 000 018
Membrane filter , for Easypet® 3, 0.2 µm, sterile, 5 pcs.	4430 606 005
Membrane filter , for Easypet® 3, 0.45 µm, sterile, 5 pcs.	4421 601 009
Lithium polymer rechargeable battery , for Easypet® 3	4430 605 009

Pipet Helper®



The mechanical pipette aid that allows inexperienced users to work like experts!

Make liquid handling tasks easier than ever with the Pipet Helper mechanical pipette aid from Eppendorf. Streamline lab applications such as assay preparation, petrochemical sample transfer, and preparing buffers for chromatography and fluids for fermentation. Ensuring high-precision manual aspiration and dispensing of liquids, the Pipet Helper is perfect also for less experienced users.

Product features

- > Lightweight mechanical pipette controller with reduced operating force
- > Easy maintenance and cleaning due to easy disassembly, few parts and fully autoclavable
- > Comfortable working because of the good balance and pleasing material

Ordering information

Description	Order no.
Pipet Helper®, 1-channel, 0.1 – 100 mL	4423 000 010
Membrane filter, for Pipet Helper®, 3 µm, non-sterile, 10 pieces	4423 601 014

Eppendorf Serological Pipets



Designed to work in perfect harmony with your Easypet® 3 or Pipet Helper®

Eppendorf Serological Pipets are single-use serological pipettes made of ultraclear plastic. They are designed to aspirate and dispense liquids using mechanical or electronic pipette controllers such as the Pipet Helper or Easypet 3.

Product features

- > Clear and precise graduations for easy volume determination
- > Color-coding for easy identification of pipet sizes
- > Subunits with dispenser option to keep stored products safe

Ordering information

Description	Color code	Volume	Order no.
Eppendorf Serological Pipets , sterile, free of detectable pyrogens, DNA, RNase and DNase. Non-cytotoxic			
sterile, pyrogen-, DNase-, RNase-, human and bacterial DNA-free. Non-cytotoxic, 800 pcs. (4 × 200 pcs.), individually blister-wrapped	yellow	1 mL	0030 127 692
sterile, pyrogen-, DNase-, RNase-, human and bacterial DNA-free. Non-cytotoxic, 600 pcs. (4 × 150 pcs.), individually blister-wrapped	green	2 mL	0030 127 706
sterile, pyrogen-, DNase-, RNase-, human and bacterial DNA-free. Non-cytotoxic, 400 pcs. (4 × 100 pcs.), individually blister-wrapped	blue	5 mL	0030 127 714
sterile, pyrogen-, DNase-, RNase-, human and bacterial DNA-free. Non-cytotoxic, 400 pcs. (4 × 100 pcs.), individually blister-wrapped	orange	10 mL	0030 127 722
sterile, pyrogen-, DNase-, RNase-, human and bacterial DNA-free. Non-cytotoxic, 200 pcs. (4 × 50 pcs.), individually blister-wrapped	red	25 mL	0030 127 730
sterile, pyrogen-, DNase-, RNase-, human and bacterial DNA-free. Non-cytotoxic, 160 pcs. (4 × 40 pcs.), individually blister-wrapped	violet	50 mL	0030 127 749

Automated Pipetting



Automated pipetting represents a natural progression in biological sample processing and gives superior accuracy and reproducibility compared to manual pipetting. It simplifies the process of liquid handling for academic research as well as industrial applications.

The *epMotion*® line of automated liquid handling systems from Eppendorf offer pipetting solutions for low, medium, and high-throughput workflows that can dramatically increase the consistency of your liquid handling tasks.

At Eppendorf, we also provide a wide range of consumables and accessories to extend the versatility and scalability of our *epMotion* workstations, ensuring that our automated liquid handling systems meet the specific needs of your laboratory.

Automated pipetting workstations

Increase the accuracy and precision of your pipetting with our *epMotion* family of robotic liquid handlers for low, medium, and high-throughput molecular biology applications. Our liquid handling robots can save you time and increase the reproducibility of your results.

Molecular biology methods and genomic workflows are our application focus. We offer easy-to-use, but powerful automated solutions for PCR and qPCR, nucleic acid purification, and Next Generation Sequencing (NGS) library preparation.

Why lab
automation?



[www.eppendorf.com/
choose-a-robot](http://www.eppendorf.com/choose-a-robot)

Automate your
NGS workflow!



[www.eppendorf.com/
ngsmadeeasy/](http://www.eppendorf.com/ngsmadeeasy/)

Get all information about the Eppendorf automation portfolio!

Explore the eshop and get an overview!

www.eppendorf.com/automation-portfolio



Automated pipetting consumables & accessories

Ensure your workflow is as efficient as possible with our epT.I.P.S.® Motion range of pipetting supplies, designed for use with epMotion workstations. All our liquid handling consumables are available in a range of purity grades and are manufactured under strict compliance with ISO regulations.

Optimize your liquid handling workflow with accessories designed for use with epMotion workstations. These accessories extend the functions of our liquid handling robots and enable you to automate more of your protocol for consistent sample processing.



Download the automation brochure here
www.eppendorf.com/Friends-Life-brochure



Our Portfolio – Your Choice



Model	epMotion® 96/epMotion® 96xl with 2-position slider	epMotion® 5070
Page(s)	84	85
Dimensions (W x D x H)	22.9 x 45.7 x 53.3 cm / 9 x 18 x 21 in	65 x 48 x 63 cm / 26 x 19 x 25 in
Weight w/o accessories	19 kg / 42 lb/20 kg / 44 lb	45 kg / 99.2 lb
Max. power consumption	175 W	150 W
Power supply	100 – 240 V ±10 %, 50 – 60 Hz ±5 %	100 – 240 V ±10 %, 50 – 60 Hz ±5 %
Optical confocal infrared detector	Mechanical sensor for tip size verification	Contact-free recognition of fill level, inserted tools, labware, tip types and quantities
SLAS/ANSI positions	1/2	4
Volume range	0.5 – 300 µL/5 – 1,000 µL	0.2 µL – 1 mL
Random measurement error (X, Y, Z)		±0.1 mm
Systematic measurement error		±0.3 mm
Dispensing tool ¹⁾²⁾		
Random measurement error (1 µL)		≤3 %
Systematic measurement error (1 µL)		±5 %
Random measurement error (50 µL)		≤0.4 %
Systematic measurement error (50 µL)		±1.2 %
Random measurement error (1,000 µL)		≤0.15 %
Systematic measurement error (1,000 µL)		±0.7 %
Pipetting type	Air cushion system	Air cushion system
Gripper option	no	no
Thermal module		
Thermal module available?	no	no
Cooling rate	–	–
Heating rate	–	–
ThermoMixer upgrade option	no	no
Eppendorf ThermoMixer®		
Max. load	–	–
Mixing period	–	–
Speed	–	–
Temperature range	–	–
Magnetic separation	no	no
Vacuum separation	no	no
Automatic tool exchange	–	2 tools
UV/HEPA option	no	no

¹⁾ in pipetting mode, free jet, without pre-wetting, with distilled water, at 20 °C²⁾ See Eppendorf Application Note 168 for typical pipetting performance



epMotion® 5070 PCR solution

85
65 × 48 × 63 cm / 26 × 19 × 25 in
45 kg / 99.2 lb
150 W
100 – 240 V ±10 %, 50 – 60 Hz ±5 %
Contact-free recognition of fill level, inserted tools, labware, tip types and quantities
4
0.2 µL – 1 mL
±0.1 mm
±0.3 mm
≤3 %
±5 %
≤0.4 %
±1.2 %
≤0.15 %
±0.7 %
Air cushion system
no
no
–
–
no
–
–
–
no
no
2 tools
no

epMotion® 5073I

85
65 × 61 × 67 cm / 26 × 24 × 27 in
50 kg / 110.2 lb
600 W
100 – 240 V ±10 %, 50 – 60 Hz ±5 %
Contact-free recognition of fill level, inserted tools, labware, tip types and quantities
6
0.2 µL – 1 mL
±0.1 mm
±0.3 mm
≤3 %
±5 %
≤0.4 %
±1.2 %
≤0.15 %
±0.7 %
Air cushion system
yes
max. 1
4 °C/min
9 °C/min
no
–
–
–
with magnet plate and gripper
no
3 tools and gripper
yes

epMotion® 5073t

86
65 × 61 × 77 cm / 26 × 24 × 30 in
57 kg / 125.6 lb
600 W
100 – 240 V ±10 %, 50 – 60 Hz ±5 %
Contact-free recognition of fill level, inserted tools, labware, tip types and quantities
0.2 µL – 1 mL
±0.3 mm
≤3 %
±5 %
≤0.4 %
±1.2 %
≤0.15 %
±0.7 %
Air cushion system
yes
no
–
–
included
1,000 g
5 s – 120 min
300 – 2,000 rpm
15 °C below RT to 95 °C
with magnet plate and gripper
no
3 tools and gripper
yes

Our Portfolio – Your Choice



Model	epMotion® 5075i	epMotion® 5075v
Page(s)	86	87
Dimensions (W × D × H)	107 × 61 × 67 cm / 43 × 24 × 27 in	107 × 61 × 67 cm / 43 × 24 × 27 in
Weight w/o accessories	85 kg / 187.4 lb	86 kg / 189.6 lb
Max. power consumption	700 W	700 W
Power supply	100 – 240 V ±10 %, 50 – 60 Hz ±5 %	100 – 240 V ±10 %, 50 – 60 Hz ±5 %
Optical confocal infrared detector	Contact-free recognition of fill level, inserted tools, labware, tip types and quantities	Contact-free recognition of fill level, inserted tools, labware, tip types and quantities
SLAS/ANSI positions	15	12
Volume range	0.2 µL – 1 mL	0.2 µL – 1 mL
Random measurement error (X, Y, Z)	±0.1 mm	±0.1 mm
Systematic measurement error	±0.3 mm	±0.3 mm
Dispensing tool ¹⁾²⁾		
Random measurement error (1 µL)	≤3 %	≤3 %
Systematic measurement error (1 µL)	±5 %	±5 %
Random measurement error (50 µL)	≤0.4 %	≤0.4 %
Systematic measurement error (50 µL)	±1.2 %	±1.2 %
Random measurement error (1,000 µL)	≤0.15 %	≤0.15 %
Systematic measurement error (1,000 µL)	±0.7 %	±0.7 %
Pipetting type	Air cushion system	Air cushion system
Gripper option	yes	included
Thermal module		
Thermal module available?	max. 3	max. 3
Cooling rate	4 °C/min	4 °C/min
Heating rate	9 °C/min	9 °C/min
ThermoMixer upgrade option	yes	yes
Vacuum unit		
Vacuum max. output	–	35 NL/min
Magnetic separation	with magnet plate and gripper	with magnet plate and gripper
Vacuum separation	no	yes
Automatic tool exchange	4 tools and gripper	4 tools and gripper
UV/HEPA option	yes	yes

¹⁾ in pipetting mode, free jet, without pre-wetting, with distilled water, at 20 °C²⁾ See Eppendorf Application Note 168 for typical pipetting performance



**epMotion® 5075vt**

87
107 × 61 × 67 cm / 43 × 24 × 27 in
90 kg / 198.4 lb
700 W
100 – 240 V ±10 %, 50 – 60 Hz ±5 %
Contact-free recognition of fill level, inserted tools, labware, tip types and quantities
12
0.2 µL – 1 mL
±0.1 mm
±0.3 mm
≤3 %
±5 %
≤0.4 %
±1.2 %
≤0.15 %
±0.7 %
Air cushion system
included
max. 2
4 °C/min
9 °C/min
included
35 NL/min
with magnet plate and gripper
yes
4 tools and gripper
yes

epMotion® 5075t

87
107 × 61 × 67 cm / 43 × 24 × 27 in
87 kg / 191.8 lb
700 W
100 – 240 V ±10 %, 50 – 60 Hz ±5 %
Contact-free recognition of fill level, inserted tools, labware, tip types and quantities
14.5
0.2 µL – 1 mL
±0.1 mm
±0.3 mm
≤3 %
±5 %
≤0.4 %
±1.2 %
≤0.15 %
±0.7 %
Air cushion system
yes
max. 2
4 °C/min
9 °C/min
included
–
with magnet plate and gripper
no
4 tools and gripper
yes

epMotion® 5075t NGS solution

88
107 × 61 × 77 cm / 43 × 24 × 30 in
87 kg / 191.8 lb
700 W
100 – 240 V ±10 %, 50 – 60 Hz ±5 %
Contact-free recognition of fill level, inserted tools, labware, tip types and quantities
14.5
0.2 µL – 1 mL
±0.1 mm
±0.3 mm
≤3 %
±5 %
≤0.4 %
±1.2 %
≤0.15 %
±0.7 %
Air cushion system
yes
max. 2
4 °C/min
9 °C/min
included
–
with magnet plate and gripper
no
4 tools and gripper
yes

Automated Pipetting

epMotion® 5073t NGS Solution

Description

The epMotion 5073t NGS solution contains everything you need to begin automated NGS library preparation of up to 24 samples. It combines automated liquid handling and unique software features with all of the accessories and high-quality consumables needed for reliable low-to-medium-throughput NGS library preparation. By automating NGS library preparation with epMotion 5073t, you increase reproducibility and reduce pipetting errors and, in turn, improve your experimental data.

Easily operate liquid handling tasks via the MultiCon Desktop PC equipped with Windows 10. The intuitive software interface allows for fast and flexible method implementation and an integrated Eppendorf ThermoMixer® allows for upstream nucleic acid purification. Purification to save you valuable time for other laboratory task and data analysis.



Product features

- > Up to 24 samples for NGS library preparation with minimal user intervention
- > Three dispensing tools eliminate interruptions during NGS library preparation
- > TipHolder 73 and Gripper Tower allow the use of 5 x 96 tips on just two ANSI/SLAS positions

Applications

- > Sample or reagent transfer
- > Mixing and tempering
- > Assay set-up
- > Nucleic acid extraction
- > Dilution series, cherry picking and normalization
- > NGS library preparation



Your compact NGS solution!

Please use the QR Code.
www.eppendorf.com/ngscompact



Handling beads in NGS.

Please use the QR Code.
www.eppendorf.com/stay-informed-beads



Ordering information

Description

epMotion® 5073t NGS solution, MultiCon PC, 3 tools, gripper, plus NGS specific accessories and consumables, waste bags and holder, 100 – 240 V ±10 %/50 – 60 Hz ±5 % (EU/AU/CN/GB/US), 0.2 µL – 1 mL

Order no.

5073 000 978

epMotion® 96 and 96xl



Description

The Eppendorf *epMotion 96* is a semi-automated, 96-well multi-channel pipette for fast and precise parallel microplate processing. It is an easy to use bench top liquid handling robot for high precision pipetting in 96 and 384 well plates. Without changes to the system, a large volume range of 0.5 µL to 300 µL is available for convenient use over a range of applications. Its ergonomic design and intuitive handling makes the *epMotion 96* a great tool for anyone in the lab who needs fast and precise liquid handling in 96 format.

Product features

- > 0.5 to 300 µL or 5 to 1,000 µL with one system
- > Electronic pipetting with synchronous 96 channel piston movement for better precision and reproducibility of results
- > Auto-detect function for tip size

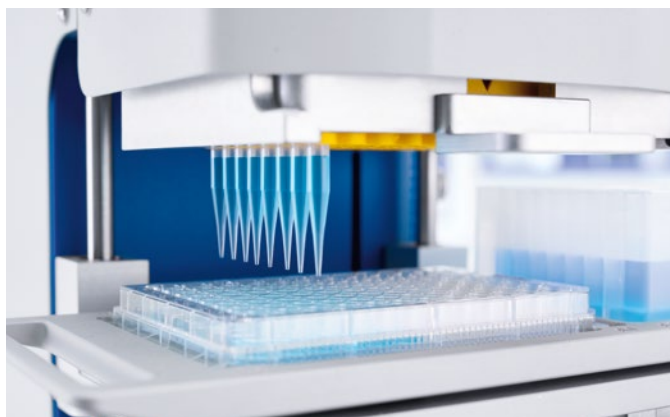

**epMotion 96
in motion!**

[www.eppendorf.com/
epM96-in-motion](http://www.eppendorf.com/epM96-in-motion)



Ordering information

Description

epMotion® 96, 96-channel, semi-automated electronic pipette for parallel 96 channel microplate processing, 100 – 240 V ±10 %/50 – 60 Hz ±5 % (GB), 0.5 – 300 µL

epMotion® 96 with 2-position slider, 96-channel, with 2-position slider, semi-automated electronic pipette for parallel 96 channel microplate processing, 100 – 240 V ±10 %/50 – 60 Hz ±5 % (GB), 0.5 – 300 µL

epMotion® 96xl, 96-channel, semi-automated electronic pipette for parallel 96 channel microplate processing, 100 – 240 V ±10 %/50 – 60 Hz ±5 % (GB), 5 – 1,000 µL

epMotion® 96xl with 2-position slider, 96-channel, semi-automated electronic pipette for parallel 96 channel microplate processing, 100 – 240 V ±10 %/50 – 60 Hz ±5 % (GB), 5 – 1,000 µL

Order no.

5069 000 020

5069 000 128

5069 000 225

5069 000 322

epMotion® 5070/5070 PCR Solution



Description

The innovative epMotion 5070 is the most compact solution for accurate and reproducible automated pipetting of the epMotion family. With four worktable positions, it is a perfect match for routine applications. The 5070 PCR solution comes ready equipped with all accessories for hassle-free PCR and qPCR set up. Don't wait to achieve reproducible automated pipetting results.

Product features

- > 4 ANSI/SLAS worktable and unlimited virtual positions
- > Maximum pipetting accuracy from 0.2 to 1,000 µL
- > Calibrated 1-channel and 8-channel pipetting tools

Ordering information

Description	Order no.
epMotion® 5070 MultiCon, completely contained housing, system incl. MultiCon, epBlue software, keyboard, mouse, waste box, 100 – 240 V ±10 %/50 – 60 Hz ±5 % (GB), 0.2 µL – 1 mL	5070 007 012
epMotion® 5070 MultiCon PCR solution, includes MultiCon PC, dispensing tool (TS 50), PCR specific accessories, 100 – 240 V ±10 %/50 – 60 Hz ±5 % (EU/AU/CN/GB/US), 0.2 µL – 1 mL	5070 000 948

epMotion® 5073I



Description

Why spend valuable time on challenging liquid handling procedures when you can achieve fast, accurate and reproducible PCR setup with the epMotion 5073I automated liquid handler? Perfect for medium-throughput setup for PCR, real-time PCR (qPCR), DNA/RNA normalization, cherry picking, dilution series and reformatting, the epMotion 5073I helps you perform pipetting tasks with ease and greater efficiency.

Product features

- > 6 ANSI/SLAS microplate positions
- > Software assistants for simple, step-by-step application programming
- > Optical sensor ¹⁾ for detecting liquids, labware, tips

¹⁾ US patent 6,819,437 B2

Ordering information

Description	Order no.
epMotion® 5073I MultiCon, completely contained housing system incl. MultiCon, epBlue software, keyboard, mouse, waste box, 100 – 240 V ±10 %/50 – 60 Hz ±5 % (GB), 0.2 µL – 1 mL	5073 007 412

Automated Pipetting

epMotion[®] 5073t**Description**

The *epMotion* 5073t automated liquid handling system allows you to perform fast and efficient nucleic acid purification (NAP) of 1 to 24 samples. It is also ideal for automating more complex, time-consuming liquid handling tasks such as DNA/RNA extraction. Save time and improve the reproducibility of your results with the *epMotion* 5073t!

Product features

- > 6 ANSI/SLAS microplate positions
- > Intuitive, drag and drop based software
- > Optical sensor ¹⁾ for detecting liquids, labware, tips

¹⁾ US patent 6,819,437 B2

Ordering information

Description	Order no.
<i>epMotion</i> [®] 5073t, completely contained housing, system incl. MultiCon, Eppendorf ThermoMixer [®] , epBlue software, keyboard, mouse, waste bags and holder, 100 – 240 V ±10 %/50 – 60 Hz ±5 % (EU/AU/CN/GB/US), 0.2 µL – 1 mL	5073 000 345

epMotion[®] 5075I**Description**

Don't stress yourself by doing complex pipetting tasks when you can perform fast, accurate and reproducible PCR plate setup with the *epMotion* 5075I automated liquid handler. The *epMotion* 5075I offers 15 worktable positions and is well suited for high-throughput preparation of plates for PCR or real-time PCR (qPCR), DNA/RNA normalization, cherry picking, dilution series, reformatting and immunoassays. Say goodbye to tedious pipetting steps!

Product features

- > 15 ANSI/SLAS worktable positions
- > Maximum pipetting accuracy from 0.2 to 1,000 µL
- > Automatic exchange of all tools (gripper, 1-channel and 8-channel)

Ordering information

Description	Order no.
<i>epMotion</i> [®] 5075I, basic device incl. epBlue software, mouse, waste box, 100 – 240 V ±10 %/50 – 60 Hz ±5 %, 0.2 µL – 1 mL	5075 000 301

epMotion® 5075t



Description

The epMotion 5075t automated liquid handling system allows you to perform high-throughput nucleic acid purification (NAP) using magnetic bead separation with speed and efficiency. It is also ideal for automating more complex, time-consuming liquid handling tasks such as DNA/RNA extraction, NGS library preparation and ELISA. Save time and improve the reproducibility of your results with the epMotion 5075t!

Product features

- > Same as 5075i, plus
- > Integrated Eppendorf ThermoMixer with ²⁰Mix-Control technology
- > Temperature control range 15 °C below RT to 95 °C

Ordering information

Description	Order no.
epMotion® 5075t, basic device incl. Eppendorf ThermoMixer®, epBlue software, mouse, waste box, 100 – 240 V ±10 %/50 – 60 Hz ±5 %, 0.2 µL – 1 mL	5075 000 302

epMotion® 5075v/5075vt



Description

Complex applications, such as nucleic acid purification or solid phase extraction, should not tie you to the workbench. With integrated vacuum filtration and a combined mixing and temperature control (only for 5075vt) in one system, the epMotion 5075v and epMotion 5075vt allow true walk-away automation of complex purification or extraction protocols. Increase your lab productivity and free up time for other tasks!

Product features

- > Same as 5075i
- > 12 SLAS/ANSI deck positions, including ThermoMixer (for 5075vt)
- > Integrated vacuum pump – silent operation, no tubing, wiring, or reservoirs to maintain

Ordering information

Description	Order no.
epMotion® 5075v, basic device incl. vacuum system, gripper, vac frame 2, vac frame holder, epBlue software, mouse, waste box, 100 – 240 V ±10 %/50 – 60 Hz ±5 %, 0.2 µL – 1 mL	5075 000 303
epMotion® 5075vt, basic device incl. vacuum system, gripper, vac frame 2, vac frame holder, Eppendorf ThermoMixer®, epBlue software, mouse, waste box, 100 – 240 V ±10 %/50 – 60 Hz ±5 %, 0.2 µL – 1 mL	5075 000 304

Automated Pipetting

epMotion® 5075t NGS Solution

**Description**

Automating library preparation for NGS eliminates the risk of pipetting errors, provides reproducible results and increases your lab productivity. The epMotion 5075t NGS solution provides everything you need for reliable, accurate and precise automated library prep as well as maximum NGS kit flexibility. Ideal for high-throughput and complex NGS workflows, the epMotion 5075t NGS delivers reproducible results at speed and makes labor-intensive workflows a thing of the past.

Product features

- > Same as 5075t, plus
- > Industry-proven, large library of manufacturer and customer qualified NGS methods enables sequencing results comparable or better to those from manual preparation
- > Intelligent Tool Selection automatically decides which tools (single or 8-channel) to use for fastest run time – ideal when sample numbers change frequently or are not a multiple-of-8

epMotion 5075
in motion!

Please use the QR Code.

eppendorf.com/epM5075-in-motion

**Ordering information**

Description	Order no.
epMotion® 5075t NGS solution, package with completely contained housing, MultiCon PC, Enhanced feature set 1, C2 thermal module, dispensing tools, plus NGS specific accessories, plus NGS specific consumables to start automated library preparation, 100 – 240 V ±10 %/50 – 60 Hz ±5 % (EU/AU/CN/GB/US), 0.2 µL – 1 mL	5075 000 962
epMotion® 5075tc NGS solution, package with CleanCap, MultiCon PC, Enhanced feature set 1, C2 thermal module, dispensing tools, plus NGS specific accessories, waste bag holder, plus NGS specific consumables to start automated library preparation, 100 – 240 V ±10 %/50 – 60 Hz ±5 % (EU/AU/CN/GB/US), 0.2 µL – 1 mL	5075 000 963

epT.I.P.S.[®] Motion as Reload System



Description

Eppendorf Totally Integrated Pipetting System for Automation

The epT.I.P.S. Motion have been developed to work in perfect combination with our epMotion platform. In combination with a TipHolder accessory the Reload trays offer a more environmentally friendly option.

Ordering information

Description	Order no.
epT.I.P.S.[®] Motion as Reload System, without filter	
Eppendorf Quality, 10 µL, 2,304 tips (24 trays × 96 tips)	0030 014 545
Eppendorf Quality, 50 µL, 2,304 tips (24 trays × 96 tips)	0030 014 421
Eppendorf Quality, 300 µL, 2,304 tips (24 trays × 96 tips)	0030 014 464
Eppendorf Quality, 1,000 µL, 2,304 tips (24 trays × 96 tips)	0030 014 502
epT.I.P.S.[®] Motion as Reload System, with filter	
PCR clean, 10 µL, 2,304 tips (24 trays × 96 tips)	0030 014 553
PCR clean, 50 µL, 2,304 tips (24 trays × 96 tips)	0030 014 430
PCR clean, 300 µL, 2,304 tips (24 trays × 96 tips)	0030 014 472
PCR clean, 1,000 µL, 2,304 tips (24 trays × 96 tips)	0030 014 510
PCR clean and sterile, 10 µL, 2,304 tips (24 trays × 96 tips)	0030 014 561
PCR clean and sterile, 50 µL, 2,304 tips (24 trays × 96 tips)	0030 014 529
PCR clean and sterile, 300 µL, 2,304 tips (24 trays × 96 tips)	0030 014 537
PCR clean and sterile, 1,000 µL, 2,304 tips (24 trays × 96 tips)	0030 014 570
TipHolder, for epT.I.P.S.[®] Motion Reloads	5075 751 399
Clip for epT.I.P.S.[®] Motion Reloads	5075 751 070
Box for epT.I.P.S.[®] Motion 1,000 µL Reload	0030 014 677
Box for epT.I.P.S.[®] Motion 10/50/300 µL Reload	0030 014 669

epT.I.P.S.[®] Motion Pipette Tips



Description

Eppendorf Totally Integrated Pipetting System for Automation

For routine pipetting with excellent precision it is important to have a perfect system of tips and automate. The epT.I.P.S. Motion have been developed to work in perfect combination with our epMotion platform.

Ordering information

Description	Order no.
epT.I.P.S.[®] Motion Pipette Tips, without filter	
sterile, 10 µL, 960 tips (10 racks × 96 tips)	0030 015 185
sterile, 50 µL, 960 tips (10 racks × 96 tips)	0030 015 207
sterile, 300 µL, 960 tips (10 racks × 96 tips)	0030 015 223
sterile, 1,000 µL, 960 tips (10 racks × 96 tips)	0030 015 240
Eppendorf Quality, 10 µL, 960 tips (10 racks × 96 tips)	0030 014 383
Eppendorf Quality, 50 µL, 960 tips (10 racks × 96 tips)	0030 014 405
Eppendorf Quality, 300 µL, 960 tips (10 racks × 96 tips)	0030 014 448
Eppendorf Quality, 1,000 µL, 960 tips (10 racks × 96 tips)	0030 014 480
epT.I.P.S.[®] Motion pipette tips, with filter	
PCR clean and sterile, 10 µL, 960 tips (10 racks × 96 tips)	0030 015 193
PCR clean and sterile, 50 µL, 960 tips (10 racks × 96 tips)	0030 015 215
PCR clean and sterile, 300 µL, 960 tips (10 racks × 96 tips)	0030 015 231
PCR clean and sterile, 1,000 µL, 960 tips (10 racks × 96 tips)	0030 015 258
PCR clean, 10 µL, 960 tips (10 racks × 96 tips)	0030 014 391
PCR clean, 50 µL, 960 tips (10 racks × 96 tips)	0030 014 413
PCR clean, 300 µL, 960 tips (10 racks × 96 tips)	0030 014 456
PCR clean, 1,000 µL, 960 tips (10 racks × 96 tips)	0030 014 499
epT.I.P.S.[®] Motion as SafeRack tips, without filter	
Eppendorf Quality, 50 µL, 960 tips (10 racks × 96 tips)	0030 014 600
Eppendorf Quality, 300 µL, 960 tips (10 racks × 96 tips)	0030 014 626
Eppendorf Quality, 1,000 µL, 960 tips (10 racks × 96 tips)	0030 014 642
epT.I.P.S.[®] Motion as SafeRack tips, with filter	
PCR clean, 50 µL, 960 tips (10 racks × 96 tips)	0030 014 618
PCR clean, 300 µL, 960 tips (10 racks × 96 tips)	0030 014 634
PCR clean, 1,000 µL, 960 tips (10 racks × 96 tips)	0030 014 650

Automated Pipetting

Software

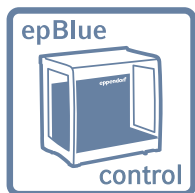

epBlue epMotion® PC software

- > Graphical user interface
- > Main menu with direct access to the most important functions
- > 3D view of workstation and run simulation



epBlue ID software

- > Visual tracking of the scan procedure
- > Automatic checking of the worktable
- > Scanning of individual reaction vessels and microplates

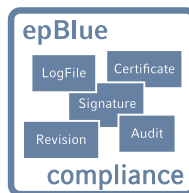

epBlue GxP software

- > Complete electronic documentation
- > Access control and user level management
- > Audit trail and log file



Device Hardware Upgrades and Software

Ordering information

Description	Order no.
Thermal module , thermal module for heating or cooling (0 – 110 °C) thermo adaptors, thermoblock and thermoracks	5075 757 001
Work surface adapter , for raising the epMotion® worktable by 5.5 cm, 4 feet	5070 752 001
Device Hardware Upgrades and Software , Upgrade set to MultiCon, changes existing epMotion EasyCon to PC controller. Includes PC, keyboard, mouse, epBlue SW, PCR & Prep assistant, cables	5075 000 725
CleanCap upgrade set , UV lamp and HEPA filter system for decontamination and pipetting under clean air conditions, for upgrading an epMotion 5073 (SN>7000) with epBlue version >40.7, optionally available	5073 001 333
epBlue ID barcode and tracking software incl. manual barcode scanner , modular expansion of epBlue for barcode support. Incl. manual barcode reader with stand. Compatible with epBlue version 40.1 and higher	5075 002 701
epBlue GxP software , for use in supporting process environments (according to GLP, GMP, 21 CFR part 11), as configuration option or for pre-installed epMotion® MultiCon versions with epBlue version 40.1 to 40.7, with epBlue GxP software, corresponding firmware, certificates	5075 002 728
epMotion® Editor 40 , software CD ROM with instructions, used to create, edit and simulate application on a PC, compatible with epBlue version >40.x	5075 014 220
epMotion® Editor 40 , additional software license	5075 014 300
Enhanced Feature Set 1 , license for epBlue additional features: Calculated no. of samples; Automatic tool selection; Start at command; Email notification, requires service visit and epBlue >40.6	5075 000 964
Enhanced Feature Set 2 , license for epBlue feature: Normalization, requires Service visit and epBlue 40.8 or higher	5075 000 981
Modification kit TMX for 5075I , to modify a 5075I with Eppendorf ThermoMixer® to a 5075t (for units SN>4000)	5075 000 630
Extension plate 5075I to TMX and VAC , to be ordered with 5075 000.620 and 5075 000.630 (for units SN>4000)	5075 000 640
Expansion board , for supporting the cleanbench work surface	5070 751 005
Waste bin UV-shield 45 mm , adapter to install at waste position. Allows using UV light by an increased waste capacity. Waste bag holder not included.	5075 751 976
Waste bin UV-shield 100 mm, incl. adapter , adapter to install at waste position. Allows the use of UV light through increased waste capacity in an epMotion with a raised worktable (5.5 cm, work surface adapters included). Waste bag holder not included.	5075 751 992

Dispensing Tools



Description

The dispensing tools for the ep*Motion* liquid handling workstations are precision instruments for pipetting and dispensing of a variety of different liquids. They are available as single channel as well as multichannel tools, and they cover the volume range between 0.2 and 1,000 μL .

Product features

- > Highest accuracy from 200 nL to 1,000 μL
- > For various types of liquids
- > 1- and 8-channel dispensing tools

Ordering information

Description	Order no.
Holder for 6 dispensing tools	5075 774 003
Gripper , incl. holder, for transporting plates on the worktable and automatic operation of the vacuum manifold, additionally order Gripper Tower 5075 751 895 for 5073 with SN > 6000	5282 000 018
TS 10 single channel dispensing tool , 1-channel, 0.2 – 10 μL	5280 000 100
TS 50 single-channel dispensing tool , 1-channel, 1.0 – 50 μL	5280 000 010
TS 300 single-channel dispensing tool , 1-channel, 20 – 300 μL	5280 000 037
TS 1000 single-channel dispensing tool , 1-channel, 40 – 1,000 μL	5280 000 053
TM 10-8 eight-channel dispensing tool , 8-channel, 0.2 – 10 μL	5280 000 304
TM 50-8 eight-channel dispensing tool , 8-channel, 1.0 – 50 μL	5280 000 215
TM 300-8 eight-channel dispensing tool , 8-channel, 20 – 300 μL	5280 000 231
TM 1000-8 eight-channel dispensing tool , 8-channel, 40 – 1,000 μL	5280 000 258
Holder for gripper	5075 759 004

ep*Motion*[®] 96 Accessories



Description

The accessories for the ep*Motion* 96 and ep*Motion* 96xl increase the capacity for plates and reservoirs. Optional tip trays and adapter allow 384 well plates to be handled with ease.

Ordering information

Description	Order no.
Loading frame for ep<i>Motion</i>[®] 96	5069 072 005
Adapter 384-well plate for ep<i>Motion</i>[®] 96	5069 073 001
Upgrade set 2-position slider for ep<i>Motion</i>[®] 96	5069 074 008
O-ring tool set , with separator, blade, hook, mounting cone, mounting cylinder	5069 858 505
Modification kit for 2-position slider (4.5 mm increments) , including constant-force spring, shielding plates (ep <i>Motion</i> 96 and 96xl), screws, guiding aid and holding devices (ep <i>Motion</i> 96 as of serial number 2008, all ep <i>Motion</i> 96xl)	5069 878 506

epMotion® ReservoirRacks and Modules



Description

The Eppendorf Reservoirs are the perfect vessels for a 10 to 400 mL liquid range, and permit the use of single channel and multichannel dispensing tools. The tapered shape of the reservoirs allows utilization of the entire liquid volume with minimal residue. Moreover, the reservoirs may be temperature-controlled inside the racks to allow cooling or warming of liquids.

Our Reservoir Racks hold reaction vessels of different sizes, and allow tempering in order to protect valuable samples or carry out reactions directly inside the Reservoir Rack.

Ordering information

Description	Order no.
ReservoirRack , for presenting 10 mL, 30 mL and 100 mL reagent reservoirs. Up to 7 reservoirs or Reservoir Rack modules can be presented.	5075 754 002
Adapter sleeves , to retrofit the 1.5/2.0 mL thermoracks for use with 0.5 mL vessels, 25 pcs.	5075 772 000
Gripper Tower , enables positioning epT.I.P.S.® Motion Reload trays in the parking position of the gripper and holds the gripper when it is not in use; only for use with epMotion® 5073 as of serial number 6000	5075 751 895
Tip Tool , tool for exclusively transferring epT.I.P.S.® Motion from racks and trays to the ReservoirRack modules for tips, incl. wall mount for safe storage of the tool	5285 000 000
Reservoir Rack Module NGS , for use with epMotion® ReservoirRacks, for distributing samples and reagents for NGS-specific applications, space for 20 x ILMN tubes, 4 x Eppendorf Tubes® 5.0 mL, 4 x Eppendorf Tubes 1.5 mL	5075 751 917
Reservoir Rack Module PCR , for use with epMotion® ReservoirRacks, for distributing samples and reagents for PCR, space for 48 x PCR tubes 0.2 mL incl. 2 x strip adapters 0.2 mL, (alternatively, space sufficient for 16 index tubes and up to 32 x PCR tubes 0.2 mL), 12 x Eppendorf Tubes 1.5/2.0 mL, 1 x tube 5.0 mL	5075 751 933
Reservoir Rack Module Tips , for use with epMotion® ReservoirRacks, for providing up to 16 epT.I.P.S.® Motion per module and up to 7 modules per ReservoirRack (112 tips in total), set consisting of 7 modules	5075 751 950
TipHolder , for epT.I.P.S.® Motion Reloads	5075 751 399
TipHolder 73 , enables positioning epT.I.P.S.® Motion Reload trays above a rack of epT.I.P.S.® Motion and thus doubles the tip capacity in an ANSI/SLAS position, reusable and autoclavable, epBlue 40.7 or higher required	5075 751 879
ReservoirRack Module TC , for use in epMotion® ReservoirRacks, temperable, 8 x PCR tubes 0.2 mL	5075 799 049
ReservoirRack Module TC , for use in epMotion® ReservoirRacks, temperable, 4 x Safe-Lock tubes 0.5/1.5/2.0 mL	5075 799 081
ReservoirRack Module TC , for use in epMotion® ReservoirRacks, temperable, 4 x Eppendorf Tubes® 5.0 mL	5075 799 340
ReservoirRack Module TC , for use in epMotion® ReservoirRacks, temperable, 4 x reaction vessels Ø 12 mm	5075 799 103
ReservoirRack Module TC , for use in epMotion® ReservoirRacks, temperable, 4 x reaction vessels Ø 16 mm	5075 799 120
ReservoirRack Module TC , for use in epMotion® ReservoirRacks, temperable, 4 x reaction vessels Ø 17 mm	5075 799 162
ReservoirRack Module TC , for use in epMotion® ReservoirRacks, temperable, 2 x reaction vessels Ø 29 mm	5075 799 189
ReservoirRack Module TC , for use in epMotion® ReservoirRacks, temperable, 1 x reservoir 10 mL	5075 799 421
ReservoirRack Module TC , for use in epMotion® ReservoirRacks, temperable, 1 x reservoir 30 mL	5075 799 146
ReservoirRack Module TC , for use in epMotion® ReservoirRacks, temperable, 1 x reservoir 100 mL	5075 799 260
epMotion® reservoir 10 mL , small-volume container for reagent presentation on the epMotion®, can only be inserted with the Reservoir Rack; production batch testing, certified, 10 mL, PCR clean, 10 x 5 reservoirs in the bag, polypropylene (PP)	0030 126 521
epMotion® reservoir 30 mL , large-volume container for reagent presentation on the epMotion®, can only be inserted with the Reservoir Rack; production batch testing, certified, 30 mL, PCR clean, 10 x 5 reservoirs in the bag, polypropylene (PP)	0030 126 505
epMotion® reservoir 100 mL , large-volume container for reagent presentation on the epMotion®, can only be inserted with the Reservoir Rack; production batch testing, certified, 100 mL, PCR clean, 10 x 5 reservoirs in the bag, polypropylene (PP)	0030 126 513
epMotion® reservoir 400 mL , large-volume container for reagent presentation on the epMotion®; production batch testing, certified, 400 mL, PCR clean, 400 mL, 10 reservoirs, PCR clean, autoclavable, polypropylene, polypropylene (PP)	5075 751 364
epMotion® reservoir 195 mL , low dead volume reservoir, single well with 96 cavities, PCR clean, 4 x 5 reservoirs, 195 mL, polypropylene (PP)	0030 126 556

epMotion® Thermoracks and Plate Accessories



Description

The Thermoracks, Thermoblocks and Thermoadapters comprise versatile options for the cooling or warming of reaction vessels and plates of different formats. The gripper for plates and racks allows automated transport and stacking on the deck. A 96 well magnet adapter for applications using magnetic beads is also available, and it enables fully automated extraction and purification protocols and/or NGS library preparation using a diverse range of kits.

Ordering information

Description	Order no.
Thermorack CB , for up to 384 × 0.1 mL strip tubes in the Qiagen® Rotor-Gene®	5075 767 031
Eppendorf Magnum FLX® Magnet Adapter , universal ring magnet plate for rapid magnetic bead separation. Supports most 96-well plates (standard, PCR, deepwell)	5075 751 836
Thermorack Rotor/Tubes , for temperature controlled pipetting of Qiagen® Rotor-Disc® 72/100 and 20 tubes 1.5/2.0 mL	5075 751 526
Thermoblock PCR 96 OC , for temperature control and safe piercing of sealed, semi-skirted PCR plates with orientation control	5075 751 666
Thermoadapter for PCR , for temperature control of PCR plates, 96 wells, skirted	5075 787 008
Thermoadapter for PCR , for temperature control of PCR plates, 384 wells, skirted	5075 788 004
Thermoadapter Frosty , combination of height adapter and PCR-Cooler, for cooling skirted PCR plates	5075 789 000
Lid for Thermorack Rotor/Tubes , with adapter for placing the lid on the epMotion® worktable	5075 751 640
Thermoblock DWP 2000 , for 2 mL Eppendorf Deepwell Plates 96/2000	5075 751 330
Thermoadapter DWP 96 , for Deepwell Plates 96/1000	5075 751 054
Thermoadapter LC Sample , for MagNA Pure LC sample cartridge	5075 751 305
Thermorack , for 24 Safe-Lock tubes, temperable, 0.5/1.5/2.0 mL	5075 769 000
Thermorack , for 24 Safe-Lock tubes, temperable, 1.5/2.0 mL	5075 771 004
Thermorack TMX , for 24 Safe-Lock micro test tubes, 0.5 mL/1.5 mL/2.0 mL	5075 751 160
Thermorack TMX , for 24 Safe-Lock tubes, temperable, 1.5/2.0 mL	5075 751 186
Thermorack , for 24 Cryo tubes	5075 777 055
Thermoblock for PCR , for temperature control of 96 vessels 0.2 mL or one PCR plate 96 wells	5075 766 000
Thermoblock for PCR , for temperature control of PCR plate 384 wells	5075 767 007
Thermoadapter for Microplate 96/V/U , for holding and temperature control of Eppendorf Microplates with V or U bottom	5075 751 577

Automated Pipetting

epMotion® Tube Racks, Adapters and Vacuum Modules

**Description**

Tube racks are specially designed for the respective dimensions of the reaction vessels, and they thus provide optimal support for plastic as well as glass vessels.

Ordering information

Description	Order no.
PrepRack for 24 Eppendorf Safe-Lock Tubes 2 mL , for nucleic acid preparation	5073 751 006
Rack for single test tubes , for presenting Eppendorf reaction vessels, glass or plastic tubes, not temperable	
Ø 17 mm × 100 mm max. length	5075 761 009
Ø 17 mm × 60 mm max. length	5075 775 000
Ø 16 mm × 100 mm max. length	5075 760 002
Ø 16 mm × 60 mm max. length	5075 776 006
Ø 15 mm × 100 mm max. length	5075 792 028
Ø 15 mm × 60 mm max. length	5075 792 044
Ø 14 mm × 100 mm max. length	5075 792 001
Ø 14 mm × 60 mm max. length	5075 792 060
Ø 13 mm × 100 mm max. length	5075 762 005
Ø 13 mm × 60 mm max. length	5075 792 087
Ø 12 mm × 100 mm max. length	5075 763 001
Ø 12 mm × 60 mm max. length	5075 792 109
Rack , for 24 HPLC tubes, Ø 12 mm × 40 mm max. length	5075 792 125
Rack , for 96 screw cap tubes, 1.5/2.0 mL	5075 791 005
Rack for 24 tubes , for 24 Safe-Lock tubes, no tempering	
0.5/1.5/2.0 mL	5075 751 453
1.5/2.0 mL	5075 751 275
Vac holder , adapter for Vac Frame	5075 778 009
Vacuum lid , lid for vacuum unit	5075 779 005
Silicone mat for Vac Lid	5075 793 008
Vac Frame 1 , 16 mm height, recommended for filter plates from 5Prime, Invitex	5075 784 009
Vac Frame 2 , 26 mm height, recommended for filter plates from MACHERY NAGEL®, Promega® or Qiagen®	5075 785 005
Anticontamination plate adapter , for vacuum processes with foaming solutions in multiwell plates, set of 10	5075 794 004
Vac Thermo lid	5075 796 007
Collection plate adapter MN , type for VAC station	5075 785 064
Elution plate adapter , for processing micro tubes in racks	5075 785 030
Rack Smart , for holding one tube rack of SmartCycler® reaction tubes	5075 790 009
Rack LC 20 µL/100 µL , for up to 96 × 20 µL or 100 µL LightCycler capillaries for use with Centrifuge 5804/5804 R or 5810/5810 R and other devices, set of 2	5075 795 000
Adapter for Covaris Rack 12 × 8 Strips , for E-series rack 12 place 8 microTUBEStrip V2 from Covaris PN 500444	5075 751 801
Rack ILMN tubes , Rack for single tubes, 40 × Ø 8.4 mm and 12 × Ø 11.2 mm, transportable, autoclavable	5075 751 747

epMotion® Waste Disposal Accessories



Description

During the pipetting of liquids, waste, both liquid and solid, is generated. Solid waste mainly consists of pipette tips and reaction vessels. In order to dispose both types of waste correctly, we offer variable options. For collecting solid waste we offer bags or boxes, and for collecting liquid waste a specialized reservoir.

In order to use waste bags of larger capacity inside an epMotion Workstation, it will be necessary to elevate the Workstation slightly by using a work surface adapter (5070 752.001).

Ordering information

Description	Order no.
Waste bag holder , for epMotion® 5070/5073/5075 waste position	5075 753 103
Waste container with ring , for holding used pipette tips	5075 753 006
Liquid Waste Tub 400 mL , to mount in waste bag holder and waste container of epMotion®, with lid, autoclavable, working volume 400 mL	5075 751 720
Waste bags bio-hazardous waste , for epMotion® 5070/5073/5075 waste position, up to 7 L volume, ideal for disposing of biologically hazardous waste, autoclavable, PP material, thickness 50 µm, transparent, 50 bags	5075 751 763
Waste bags , for epMotion® 5070/5073/5075 waste position, up to 7 L volume, ideal for disposing of non hazardous waste, autoclavable, PP material, thickness 50 µm, transparent, 50 bags	5075 751 780

epMotion® Height Adapters



Description

Adjusting the height of vessels is necessary when optimizing protocols and workflows. Our various height adapters enable users to level lab ware on the worktable for faster sample processing.

Ordering information

Description	Order no.
epMotion® height adapter , for leveling labware, enables faster plate processing	
85 mm	5075 751 003
55 mm	5075 752 000
40 mm, for pipette tips	5075 755 009

Temperature Control and Mixing



Every lab needs to heat, cool, and mix samples. Nucleic acid or protein purification and analysis, cell and tissue research or expression profiling – all of these applications require a thermal mixer.

An accurate temperature might be the first thing that comes to your mind when thinking about a thermal mixer. For us, temperature accuracy is a must, and we test each device separately after production to certify its performance.

The mixing performance is guaranteed by our proven ^{2D}Mix-Control, ensuring even small volumes are mixed efficiently. If you are only looking for efficient mixing without temperature control, the MixMate® is your 3-in-1 choice – a vortex, plate, and tube mixer all in one package.

Additionally, your thermal mixer must be reliable, robust, easy-to-handle, and versatile. We enhance your vessel flexibility with 15 different Eppendorf SmartBlock thermoblocks – from 0.1 mL tubes or plates up to 50 mL Eppendorf conical tubes. Each SmartBlock can be easily attached with only one hand to the Eppendorf ThermoMixer® C, or Eppendorf ThermoStat C, and is individually certified for temperature accuracy. If you need enhanced capacity and a second incubation temperature for 1.5 mL tubes, we offer the SmartExtender – perform your heat-shock transformation in one device.



Get all information about the Eppendorf mixer portfolio!
Explore the eshop and get an overview!
www.eppendorf.com/mixer-portfolio



When working with cell lines, our Eppendorf SmartBlock cryo thaw offers a special program for smooth thawing of cell culture vials, and reagents: convenient, capable of handling multiple vials at once, reduced contamination, and reproducible.

Your samples can be protected from evaporation and condensation at the tube lid when using the ThermoTop®, which heats the sample from above. Your reaction happens where you want it – down in the tube.

Easy programming is a necessity. To increase your efficiency, each device has preprogrammed keys with the ideal parameters for efficient mixing of vessels, like a PCR plate, as well as preprogrammed temperature keys, like 37 °C or 95 °C.

We care about you and your safety, so we designed all of our devices with an isolating layer on the block that protects you from burning your fingers. All surfaces are smooth without edges and easy to clean and disinfect.



Use the Eppendorf ThermoMixer® C for heating, cooling and mixing of your samples. Multiple Eppendorf SmartBlocks enlarge your vessel flexibility from 384-well plates to 50 mL tubes.

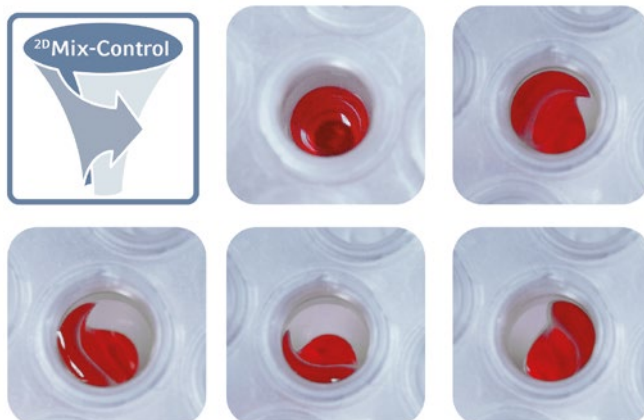

The 2^D Mix-control ensures efficient mixing of even small volumes by a broad orbital movement.

Versatility of ThermoMixer

Please use the QR Code.

www.eppendorf.com/mixer-versatility



Download the mixer brochure for detailed information

www.eppendorf.com/mixer-brochure



Our Portfolio – Your Choice



Model	Eppendorf ThermoMixer® C	Eppendorf ThermoStat C	Eppendorf ThermoMixer® F0.5
Page(s)	100	101	102
Timer	5 sec to 99:30 h, continuous	5 s to 99:30 h, continuous	–
Mixing and vortexing radius	1.5 mm	–	1.5 mm
Mixing orbit	3 mm	–	3 mm
Mixing frequency	300 – 3,000 rpm ¹⁾	–	300 – 2,000 rpm
Max. speed	3,000 rpm ¹⁾	–	2,000 rpm
Temperature settings	1 °C / 100 °C	–10 °C/110 °C (110 °C when using the SmartBlocks 12 mm or cryo)	1 °C / 100 °C
Temperature range	Min: 15 °C ¹⁾ below RT, max: 100 °C	Min: 30 °C ¹⁾ below RT, max: 110 °C (110 °C when using the 12 mm and cryo SmartBlocks)	Min: 4 °C above RT, max: 100 °C
Temperature accuracy	Max. ±0.5 °C at 20 – 45 °C	Max. ±0.5 °C at 20 – 45 °C ¹⁾	Max. ±0.5 °C at 20 – 45 °C
Interfaces	USB interface	USB interface	USB interface
Dimensions (W × D × H)	20.6 × 30.4 × 13.6 cm / 8.1 × 12.0 × 5.4 in	20.6 × 30.4 × 13.6 cm / 8.1 × 11.9 × 5.3 in	20.6 × 30.4 × 16.3 cm / 8.1 × 1.9 × 6.4 in
Weight w/o accessories	6.3 kg / 13.9 lb	4.3 kg / 9.7 lb	6.2 kg / 13.6 lb
Power supply	100 – 130 V/220 – 240 V, 50 – 60 Hz	100 – 130 V/220 – 240 V, 50 – 60 Hz	100 – 130 V/220 – 240 V, 50 – 60 Hz
Max. power consumption	200 W	200 W	200 W
Application	<ul style="list-style-type: none"> > Heating > Cooling > Mixing > all SmartBlocks can be adapted 	<ul style="list-style-type: none"> > Heating > Cooling > all SmartBlocks can be adapted 	<ul style="list-style-type: none"> > Heating > Mixing > only suitable for 0.5 mL tubes

¹⁾ depending on SmartBlock used



eppendorf.com/eshop

Get all information about the Eppendorf mixer portfolio!
Explore the eshop and get an overview!

www.eppendorf.com/mixer-portfolio



Eppendorf ThermoMixer® F1.5

102
–
1.5 mm
3 mm
300 – 1,500 rpm
1,500 rpm
1 °C / 100 °C
Min: 4 °C above RT, max: 100 °C
Max. ±0.5 °C at 20 – 45 °C
USB interface
20.6 × 30.4 × 17.0 cm / 8.1 × 11.9 × 6.7 in
6.3 kg / 13.9 lb
100 – 130 V/220 – 240 V, 50 – 60 Hz
200 W
> Heating
> Mixing
> only suitable for 1.5 mL tubes

Eppendorf ThermoMixer® F2.0

102
–
1.5 mm
3 mm
300 – 1,500 rpm
1,500 rpm
1 °C / 100 °C
Min: 4 °C above RT, max: 100 °C
Max. ±0.5 °C at 20 – 45 °C
USB interface
20.6 × 30.4 × 17.0 cm / 8.1 × 11.9 × 6.7 in
6.3 kg / 13.9 lb
100 – 130 V/220 – 240 V, 50 – 60 Hz
200 W
> Heating
> Mixing
> only suitable for 2 mL tubes

Eppendorf ThermoMixer® FP

102
–
1.5 mm
3 mm
300 – 2,000 rpm
2,000 rpm
1 °C / 100 °C
Min: 4 °C above RT, max: 100 °C
Max. ±0.5 °C at 20 – 45 °C
USB interface
20.6 × 30.4 × 16.4 cm / 8.1 × 11.9 × 6.4 in
6.1 kg / 13.4 lb
100 – 130 V/220 – 240 V, 50 – 60 Hz
200 W
> Heating
> Mixing
> only suitable for plates

MixMate®

103
15 s – 99:30 h, continuous
1.5 mm
3 mm
300 – 3,000 rpm
3,000 rpm
–
–
–
17.0 × 23.0 × 13.0 cm / 6.7 × 9.1 × 5.1 in
4.2 kg / 9.2 lb
110 – 120 V/220 – 240 V, 50 – 60 Hz
40 W
> Mixing
> Vortexing

Eppendorf ThermoMixer® C



Description

Eppendorf ThermoMixer C is for heating, cooling, and mixing almost any of your lab vessels. Efficient mixing of your samples is executed by ^{2D}Mix technology.

Product features

- > Mixing, heating, and cooling in one instrument for high flexibility
- > All common vessels and plate formats from 5 µL to 50 mL by different Eppendorf SmartBlocks for standard applications
- > Ideal for cell thawing when using Eppendorf SmartBlock cryo thaw

More about ThermoMixer C

Please use the QR Code.

www.eppendorf.com/ThermomixerC



	Plate type	96-well plates	384-well plates
Mixing of different buffers			
Buffer with detergent	PCR	30 s 1,800 rpm	30 s 2,800 rpm
Buffer without detergent	PCR	1 min 2,000 rpm	30 s 3,000 rpm
Buffer with high salt concentration	DWP	5 s 1,400 rpm	30 s 2,000 rpm
Buffer with DMSO	MTP	5 s 1,100 rpm	5 s 2,000 rpm
Mixing of viscous solutions			
Genomic-DNA	PCR	30 s 2,000 rpm	1 min 3,000 rpm
Resuspension of pellets			
Bacteria cell pellets	DWP	30 s 2,000 rpm	2 min 2,000 rpm

Eppendorf ThermoMixer C provides enough mixing power to handle challenging mixing tasks. Most samples are efficiently mixed less than a minute independent of vessel geometry or sample properties. For more informations see AppNote 130.

Ordering information

Description

Eppendorf ThermoMixer® C, basic device without thermoblock, 220 – 240 V/50 – 60 Hz (GB)

Order no.

5382 000 031

✂ Ordering information for other voltage options begins on page 349

50 µL sample mixing with 1,800 rpm

Competitor 1 min



Suboptimal sample mixing

Eppendorf ^{2D}Mix-Control 1 min (MixMate®)



Reliable sample mixing

Eppendorf ^{2D}Mix-Control 1 min (Eppendorf ThermoMixer®)



Reliable sample mixing

Eppendorf ThermoStat C



Get more
information

Please use the QR Code.
www.eppendorf.com/ThermostatC



The ideal device to accurately set and maintain temperatures:
The Eppendorf ThermoStat C is for heating and cooling almost any of your lab vessels. For additional condensation prevention of small volumes we recommend the Eppendorf ThermoTop (optional), a heated lid with condens.protect technology.

Product features

- > Heating and active cooling in all common vessel and plate formats from 5 μ L to 50 mL for high flexibility
- > Broad range of Eppendorf SmartBlocks enables high vessel flexibility
- > Excellent temperature accuracy for safe sample handling

Ordering information

Description	Order no.
Eppendorf ThermoStat C, basic device without thermoblock, 220 – 240 V/50 – 60 Hz (GB)	5383 000 035
ThermoTop®, with condens.protect technology	5308 000 003
SmartExtender, 1.5 mL	5322 000 008

✎ Ordering information for other voltage options begins on page 349

Eppendorf ThermoMixer® F



Product features

- > Heating and mixing in 0.5/1.5/2.0 mL reaction vessels (F0.5/F1.5/F2.0) or plates (FP)
- > Up to 1,500 rpm (F1.5/F2.0) or 2,000 rpm (F0.5/FP) for efficient sample mixing
- > Outstanding ^{2D}Mix-Control technology results in excellent mixing performance

Check out more



Please use the QR Code.

www.eppendorf.com/ThermomixerF

Doing a lot of routine mixing and heating?

These products are the perfect choice for mixing and heating established routine applications. The Eppendorf ThermoMixer F0.5/F1.5/F2.0 and FP have a fixed block for 0.5/1.5/2.0 mL tubes and plates, respectively. Reliable prevention of condensate formation in small vessels can be achieved with the heated lid Eppendorf ThermoTop (optional).

Ordering information

Description	Order no.
Eppendorf ThermoMixer® FP, with thermoblock for microplates and deepwell plates, including lid, 220 – 240 V/50 – 60 Hz (GB)	5385 000 032
Eppendorf ThermoMixer® F0.5, with thermoblock for 24 reaction vessels 0.5 mL, 200 – 240 V/50 – 60 Hz (GB)	5386 000 036
Eppendorf ThermoMixer® F1.5, with thermoblock for 24 reaction vessels 1.5 mL, 220 – 240 V/50 – 60 Hz (GB)	5384 000 039
Eppendorf ThermoMixer® F2.0, with thermoblock for 24 reaction vessels 2.0 mL, 220 – 240 V/50 – 60 Hz (GB)	5387 000 030

✎ Ordering information for other voltage options begins on page 349

MixMate®



Straight mixing required? The 3-in-1 mixer for plates, tubes, and vortex mixing. This high speed instrument provides complete mixing of your samples in seconds. Remarkable ^{2D}Mix-Control enables optimized mixing with anti-spill technology.

Product features

- > High-speed mixer (up to 3,000 rpm) for fast and efficient mixing of small volumes in all common vessel formats up to 50 mL
- > ^{2D}Mix-Control technology (planar mixing orbit without vertical movement) for controlled mixing and reproducible results in seconds
- > Anti-spill technology for controlled mixing movements without lid wetting and cross-contamination

Get more information

Please use the QR Code.

www.eppendorf.com/Mixmate



	Plate type	96-well plates	384-well plates
Mixing of different buffers			
Buffer with detergent	PCR	15 s 1,800 rpm	45 s 2,800 rpm
Buffer without detergent	PCR	30 s 2,100 rpm	30 s 3,000 rpm
Buffer with high salt concentration	DWP	5 s 1,400 rpm	1 min 2,000 rpm
Buffer with DMSO	MTP	5 s 1,100 rpm	5 s 2,200 rpm
Mixing of viscous solutions			
Genomic-DNA	PCR	30 s 2,000 rpm	45 s 3,000 rpm
Resuspension of pellets			
Bacteria cell pellets	DWP	30 s 2,000 rpm	3 min 2,000 rpm

MixMate provides enough mixing power to handle the most challenging mixing tasks. Most samples are efficiently mixed within less than a minute independent of vessel geometry or sample properties. For more information see AppNote 130.

Ordering information

Description	Order no.
MixMate®, basic device without tube holders, 230 V/50 – 60 Hz (GB)	5353 000 537
Tube Holder 0.5 mL, for 24 × 0.5 mL reaction vessels	5353 040 121
Tube Holder 1.5/2.0 mL, for 24 × 1.5 mL or 2.0 mL reaction vessels	5353 040 130
Tube Holder 5/15 mL, for 8 × 5/15 mL conical tubes	5353 040 148
Tube Holder 25/50 mL, for 4 × 25/50 mL conical tubes	5353 040 156
Tube Holder PCR 96, for 96 × 0.2 mL PCR tubes, PCR strips or 1 × 96-well PCR plate, semi-skirted or unskirted	5353 040 113

✂ Ordering information for other voltage options begins on page 349

Temperature Control and Mixing

ThermoTop®

Having non-regular enzymatic results after temperature incubation?

The ThermoTop with condens.protect technology heated lid avoids condensation on tube lid and tube wall. It is compatible with Eppendorf ThermoMixer C/ Eppendorf ThermoStat C with SmartBlock plates and lab vessels up to 2 mL and Eppendorf ThermoMixer F 0.5/F1.5/F2.0/FP.



Product features

- > Efficient and reliable of condensation prevention for safe sample heating
- > Get stable reaction conditions for optimal enzymatic performance within your samples
- > Wireless connection with automatic recognition and operation for user-friendly handling

Ordering information

Description	Order no.
ThermoTop®, with condens.protect technology	5308 000 003

SmartExtender

Do you need a second temperature or more space for incubation steps?

The Eppendorf SmartExtender offers a comfortable incubation tool which can easily be used as an add-on to your existing SmartBlocks and the Eppendorf ThermoMixer® C/F as well as Eppendorf ThermoStat C.



Product features

- > Independent temperature set-up for parallel application
- > Up to 12 × 1.5 mL vessels
- > Temperature range from 3 °C above room temperature to 110 °C

Ordering information

Description	Order no.
SmartExtender, 1.5 mL	5322 000 008

IsoTherm-System®

The IsoTherm-System is the ideal system for safely cooling your samples in 0.5mL or 1.5 mL/2.0 mL tube formats at -21°C or 0°C throughout your entire lab workflow.



Ordering information

Description	Order no.
IsoTherm-System® starter set , includes IsoSafe, IsoRack, 0 °C IsoPack and -21 °C IsoPack for 1.5/2.0 mL tubes	3880 001 018
IsoPack and IsoRack set , includes one IsoPack and one IsoRack for 1.5/2.0 mL vessels, 0 °C	3880 001 166
for 1.5/2.0 mL vessels, -21 °C	3880 001 174

Eppendorf SmartBlock

Interchangeable in just seconds.

These individually sensor-controlled SmartBlocks are your solution for maintaining accurate, uniform temperatures. The flexible thermoblocks are compatible with common lab vessels to support a broad range of applications - for use with Eppendorf ThermoMixer® C (heating/ cooling and mixing) and Eppendorf ThermoStat C (heating/ cooling).



Eppendorf SmartBlocks for the following reaction vessels:

- A. 24 lab vessels up to 12 mm in diameter
- B. 8 × 15 mL conical tubes
- C. 4 × 50 mL conical tubes
- D. Eppendorf Deepwell Plates 96/500 μ L
- E. Eppendorf Deepwell Plates 96/1000 μ L
- F. 24 × cryo tubes
- G. 8 × Eppendorf Tubes® 5.0 mL
- H. Lid for Eppendorf SmartBlock plates, PCR 96, PCR 384, DWP, 0.5 mL, 1.5 mL and 2.0 mL
- I. 384-well PCR plates
- J. 96-well PCR plates
- K. 24 × 0.5 mL vessels
- L. 24 × 1.5 mL vessels
- M. 24 × 2.0 mL vessels
- N. MTPs and Deepwell Plates
- O. 4 × 25 mL adapter for SmartBlock 50 mL

Product features

- > Optimized block design supports optimal temperature transfer to your sample to achieve excellent results
- > Eppendorf SmartBlock-specific calibration by integrated sensor technology maximizes temperature accuracy and homogeneity
- > Every Eppendorf SmartBlock is individually inspected in production for temperature accuracy and includes a serial-number specific certificate for documentation purpose

SmartBlocks can only be used with ThermoMixer C and ThermoStat C

Get more details

Please use the QR Code.

www.eppendorf.com/Smartblock



Ordering information

Description	Order no.
Eppendorf SmartBlock cryo thaw , thermoblock for 24 cryo tubes, 1.5 mL – 2 mL, max. external diameter 12.7 mm, flat base. Replaces order no. 5367000025.	5318 000 001
Eppendorf SmartBlock 0.5 mL , thermoblock for 24 reaction vessels 0.5 mL, incl. Transfer Rack 0.5 mL	5361 000 031
Eppendorf SmartBlock 1.5 mL , thermoblock for 24 reaction vessels 1.5 mL, incl. Transfer Rack 1.5/2.0 mL	5360 000 038
Eppendorf SmartBlock 2.0 mL , thermoblock for 24 reaction vessels 2.0 mL, incl. Transfer Rack 1.5/2.0 mL	5362 000 035
Eppendorf SmartBlock 5 mL , thermoblock for 8 Eppendorf Tubes® 5.0 mL, 8 × 5.0 mL reaction vessels	5309 000 007
Eppendorf SmartBlock 15 mL , thermoblock for 8 conical tubes 15 mL	5366 000 021
Adapter 25 mL for Eppendorf SmartBlock 50 mL , Set consisting of 4 adapters and removal tool	5365 000 109
Eppendorf SmartBlock 50 mL , thermoblock for 4 conical tubes 50 mL	5365 000 028
Eppendorf SmartBlock 12 mm , thermoblock for 24 reaction vessels, diameter up to 12 mm, height 35 mm – 76 mm	5364 000 024
Eppendorf SmartBlock PCR 96 , thermoblock for PCR plates 96, incl. lid	5306 000 006
Eppendorf SmartBlock PCR 384 , thermoblock for PCR plates 384, incl. lid	5307 000 000
Eppendorf SmartBlock DWP 500 , thermoblock for Eppendorf Deepwell Plates 96/500 μ L, incl. lid	5316 000 004
Eppendorf SmartBlock DWP 1000 , thermoblock for Eppendorf Deepwell Plate 96/1,000 μ L, incl. lid	5310 000 002
Eppendorf SmartBlock plates , thermoblock for microplates and Deepwell Plates, incl. lid	5363 000 039
Lid , for Eppendorf ThermoMixer® F0.5/F1.5/F2.0 and FP, for Eppendorf SmartBlock 0.5 – 2.0 mL, plates, PCR 96, PCR 384, and DWP	5363 000 233
Transfer Rack 0.5 mL , for Eppendorf SmartBlock 0.5 mL	3880 000 305
Transfer Rack 1.5/2.0 mL , for Eppendorf SmartBlock 1.5 mL and Eppendorf SmartBlock 2.0 mL	3880 000 151

Tubes and Plates

Protect Your Sample



Eppendorf Tubes®

- > Made of high quality, virgin polypropylene (PP), free of biocides, plasticizers and latex
- > Produced with optimized, highly polished molds without the use of slip agents like oleamide, erucamide, stearamide
- > Produced with dyes free of organic additives and heavy metals (applies for screw caps and Amber variants)
- > Designed and manufactured under ISO 13485 and ISO 9001 certified Quality Management System
- > Full traceability is provided for each product back to material lot

Disposable plasticware is used routinely in most life science laboratories. To achieve the highest level of reliability and consistency for your experiments, Eppendorf has optimized source materials and processes for the production of Eppendorf Tubes® to minimize the risk of interference. The effects from chemical substances such as slip agents, plasticizers or biocides leaching out of plastic consumables are still frequently underestimated in the majority of life science applications.

However, increasing scientific evidence shows that this heterogeneous group of chemicals may significantly affect experiments and pose a likely source of error in various assay systems. They slow down evaporation, skew absorbance readings and lead to erroneous DNA quantification. Some of these slip agents have also been shown to negatively affect the outcome of biological tests like enzyme activity or receptor-binding assays.



Effective light protection in amber tubes

Numerous types of light-sensitive reagents and samples are often used in the laboratory routine. Once exposed to light, their quality, longevity or activity may rapidly decrease and therefore adversely affect subsequent assays and experiments. To avoid these issues, light-sensitive reagents and samples must be handled and stored in a manner that protects them from direct light exposure. Amber-colored laboratory plastic tubes reduce or completely block light transmission, and thus allow safe storage and handling of light-sensitive samples.

Light protection meets transparency

While providing good sample protection against high-energy light in the short wavelength UV/VIS spectrum, amber tubes often come with a major drawback: They are opaque and therefore do not allow for a clear view of the sample. Designed specifically for eppendorf conical tubes from 5 mL to 50 mL, our amber material has an optimized degree of transparency to allow for full visibility of the sample, offering full control over pipette tip insertion depth and providing a clear advantage in sample handling and contamination prevention.

Get all information about the Eppendorf tubes portfolio!

Download the brochure!

www.eppendorf.com/tubes_brochure



Quality Starts Here



High Quality for your Application Needs
Eppendorf Plates® are produced, handled, stored, and delivered according to our premium quality and purity standards – that is what our customers call the Eppendorf Quality. Our plates are manufactured from carefully selected and purest raw materials that comply with international criteria for maximum purity.

Fully automated production in clean room conditions removes any human interaction and possible contamination. With the particularly strict control criteria, internally and externally monitored, we guarantee the superior consistency of our products and your results.



www.eppendorf.com/appnote382

DNA LoBind® – Recover your nucleic acids

When dealing with low concentrations of nucleic acids, any sample loss could make downstream steps difficult. For example, in workflows including preparation and setup of PCR applications, loss of DNA on vessel surfaces can affect the performance of individual processing steps and can lead to misinterpretation of results. DNA LoBind Tubes and Plates maximize sample recovery of nucleic acids by significantly reducing sample-to-surface binding. They represent the ideal solution for preparing and storing samples containing low amounts of DNA. To minimize the risk of sample loss, the DNA LoBind properties are achieved without surface coating.

Applications

- > Preparation or storage of DNA and RNA samples
- > Forensic trace analysis
- > Preparing dilution series in quantitative qPCR
- > Sample preparation in next-generation sequencing
- > Creation of genomic or oligonucleotide libraries

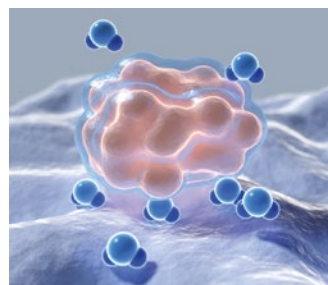

www.eppendorf.com/appnote404

Protein LoBind® – Get the most out of your applications

Protein preparation and storage represent critical steps in a wide range of laboratory applications. Unspecific adsorption of up to 90% of protein molecules or peptides to the polymer surface of the inner walls of tubes can significantly contribute to sample loss within 24 hours and artificially affect experimental results. Eppendorf Protein LoBind Tubes and Plates are specifically designed for use in applications where protein concentrations tend to be small and sample recovery is vital for assay results. A special, two-component polymer mix creates a hydrophilic surface that guarantees optimal recovery rates of valuable samples.

Applications

- > Preparation or storage of protein, peptide or antibody samples
- > Storage of virus stock solutions
- > Sample preparation in toxicology
- > Storage of cell suspensions
- > Enzymatic assays

Get all information about the Eppendorf plates portfolio!
Download the brochure!

www.eppendorf.com/plates_brochure



Our Portfolio – Your Choice



Model	Tube 3810X	Safe-Lock Tube 0.5 mL	Safe-Lock Tube 1.5 mL	Safe-Lock Tube 2.0 mL
Page(s)	114	113	113	113
Volume	1.5 mL	0.5 mL	1.5 mL	2.0 mL
Bottom shape	conical	conical	conical	round
Max. RCF	30,000 × g	30,000 × g	30,000 × g	25,000 × g
Eppendorf Quality				
Max. RCF PCR clean	30,000 × g	30,000 × g	30,000 × g	25,000 × g
Max. RCF Biopur®	–	22,000 × g	22,000 × g	22,000 × g
Max. RCF sterile	–	–	–	–
Max. RCF Forensic DNA Grade	–	22,000 × g	22,000 × g	22,000 × g
Light protection	no	yes	yes	yes

¹⁾ Test conditions: Rotor FA-45-6-30 in Eppendorf Centrifuge 5810 R (using a suitable centrifuge adapter for 15 mL tube), sample: saline solution (density: 1.0 g/mL), controlled centrifugation temp.: 25 °C, centrifugation time: 90 min



Model	Protein LoBind® Tubes/ DNA LoBind®, 0.5 mL	Protein LoBind® Tubes/ DNA LoBind®, 1.5 mL	Protein LoBind® Tubes/ DNA LoBind®, 2.0 mL
Page(s)	122/123	122/123	122/123
Bottom shape	conical	conical	conical
Max. RCF PCR clean	18,000 × g/ 30,000 × g	18,000 × g/ 30,000 × g	18,000 × g/ 25,000 × g

¹⁾ Test conditions: Rotor FA-45-6-30 in Eppendorf Centrifuge 5810 R (using a suitable centrifuge adapter for 15 mL tube), sample: saline solution (density: 1.0 g/mL), controlled centrifugation temp.: 25 °C, centrifugation time: 90 min





Eppendorf Tubes® 5.0 mL	Eppendorf Conical Tubes 15 mL	25 mL SnapTec® cap/ 25 mL screw cap	Eppendorf Conical Tubes 50 mL	Eppendorf Conical Tubes SnapTec® 50
114	118	116	118	119
5.0 mL	15 mL	25 mL	50 mL	45 mL
conical	conical	conical	conical	conical
25,000 × g	-	17,000 × g	-	17,000 × g
25,000 × g	-	17,000 × g	-	17,000 × g
25,000 × g	-	-	-	-
25,000 × g	19,500 × g ¹⁾	17,000 × g	19,500 × g ¹⁾	17,000 × g
25,000 × g	19,500 × g ¹⁾	-	19,500 × g ¹⁾	17,000 × g
yes	yes	yes	yes	no



Protein LoBind® Tubes/ DNA LoBind®, 5.0 mL	Protein LoBind® Tubes/ DNA LoBind®, 15 mL, conical tubes	Protein LoBind® Tubes/ DNA LoBind®, 25 mL, conical tubes	Protein LoBind® Tubes/ DNA LoBind®, 50 mL, conical tubes
122/123	122/123	122/123	122/123
conical	conical	conical	conical
25,000 × g/ 25,000 × g	19,500 × g	14000 × g ¹⁾ / 17,000 × g	19,500 × g

Our Portfolio – Your Choice



Microplates

Model	MTP 96/F	MTP 96/U	MTP 96/V
Page(s)	124	124	124
Number of wells	96 wells	96 wells	96 wells
Total volume per well	400 μ L	360 μ L	350 μ L
Working volume	50 – 350 μ L	20 – 320 μ L	20 – 320 μ L
Material	polypropylene (PP)	polypropylene (PP)	polypropylene (PP)
Bottom shape	F bottom	U bottom	V bottom
Dimensions (W x D x H)	127.8 x 85.5 x 14.4 mm	127.8 x 85.5 x 14.4 mm	127.8 x 85.5 x 14.4 mm
Max. RCF	6,000 x g	6,000 x g	6,000 x g



Deepwell Plates

Model	DWP 96/500	DWP 96/1000	DWP 96/2000	DWP 384/200
Page(s)	126	126	126	126
Number of wells	96 wells	96 wells	96 wells	384 wells
Total volume per well	700 μ L	1,200 μ L	2,400 μ L	240 μ L
Working volume	30 – 550 μ L	30 – 1,000 μ L	50 – 2,000 μ L	20 – 225 μ L
Material	polypropylene (PP)	polypropylene (PP)	polypropylene (PP)	polypropylene (PP)
Bottom shape	conical	conical	conical	conical
Dimensions (W x D x H)	127.8 x 85.5 x 27.1 mm	127.8 x 85.5 x 44.1 mm	127.8 x 85.5 x 44.1 mm	127.8 x 85.5 x 25.1 mm
Max. RCF	6,000 x g	6,000 x g	6,000 x g	6,000 x g



Tubes and Plates

Eppendorf Purity Grades for Tubes and Plates

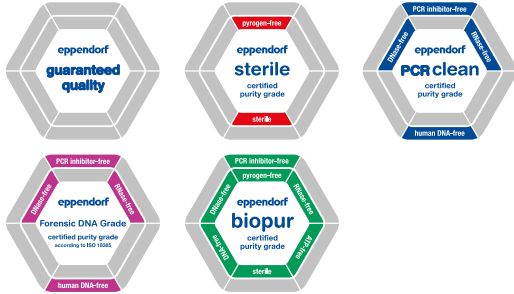

Pure Quality at Eppendorf

Please use the QR Code.

www.eppendorf.com/purity



Eppendorf sample handling consumables stand for highest quality and purity

Our tubes and plates are available in a variety of purity grades (see table below). The purity grades “sterile”, “PCR clean”, “Biopur®” and “Forensic DNA Grade” are certified by an ISO 17025 accredited external lab. As a special service, we make the lot-specific certificates available online (www.eppendorf.com/certificates).

Purity grades

Eppendorf purity grades for tubes and plates

	Eppendorf Quality	Eppendorf sterile	Eppendorf PCR clean	Eppendorf Forensic DNA Grade ⁵⁾	Eppendorf Biopur®
Continuous quality control for the following relevant criteria:					
Function, tightness, precision	■	■	■	■	■
Low wetting	■	■	■	■	■
High chemical resistance	■	■	■	■	■
High thermal resistance	■	■	■	■	■
High resistance to centrifugation forces ¹⁾	■	■	■	■	■
High transparency	■	■	■	■	■
Precisely shaped	■	■	■	■	■
Lot-specific certificates²⁾ for the following purity criteria:					
Pyrogen-free ⁶⁾ (endotoxin-free)		■			■
Sterile (Ph.Eur./USP)		■			■
DNA-free ⁶⁾ (Human DNA)			■	■	■
DNA-free ⁶⁾ (Bacteria DNA)					■
DNase-free ⁶⁾			■	■	■
RNase-free ⁶⁾			■	■	■
PCR-inhibitor-free ⁶⁾			■	■	■
ATP-free ⁶⁾					■
Eppendorf Tubes®					
Safe-Lock Tubes	■		■	■	■ ³⁾
Flex-Tubes®/ 3810X	■		■		
Eppendorf Tubes® 5.0 mL	■	■	■	■	■ ³⁾
Eppendorf Conical Tubes 25 mL	■	■ ⁴⁾	■		
Eppendorf Conical Tubes 15 mL and 50 mL		■ ⁴⁾		■ ³⁾	
DNA and Protein LoBind Tubes			■		
PCR Tubes (PCR and real-time PCR)			■	■	
Cap Strips (PCR and real-time PCR)			■	■	
Eppendorf Plates® and accessories					
Deepwell Plates and Microplates		■	■		
Protein LoBind Deepwell Plates			■		
DNA LoBind Deepwell Plates			■		
Eppendorf twin.tec® PCR Plates (PCR and real-time PCR)			■		■
Eppendorf twin.tec® PCR Plates				■ ³⁾	■
Heat Sealing Film and Foil			■		
PCR Storage Films and Foils			■		
Plate Lid		■	■		

¹⁾ For accurate details regarding resistance to centrifugation, please refer to the respective product pages. ²⁾ Lot-specific certificate can be downloaded from www.eppendorf.com/certificates. ³⁾ Individually packaged. ⁴⁾ Eppendorf sterile, RNase free, DNase free, DNA free. Testing showed conformity within the detection limits (human and bacteria DNA) ⁵⁾ According to ISO 18385. ⁶⁾ Testing showed conformity within the detection limits

Eppendorf Safe-Lock Tubes



Unrivaled for Decades

Eppendorf Safe-Lock Tubes are the result of 50 years of continuous improvement and development. The hinged Eppendorf Safe-Lock lid provides outstanding protection against unintentional opening during incubation and storage. Trust in the original Eppendorf Safe-Lock Tubes, because your samples deserve nothing but the best.

Product features

- > Hinged Eppendorf Safe-Lock lid prevents unintentional lid opening during incubation and storage
- > g-Safe®: Depending on Safe-Lock Tube variant (see manual) exceptional centrifugation stability up to 30,000 × g prevents sample loss due to tube breakage and provides extra safety when working with hazardous samples
- > Manufactured without the use of slip agents, plasticizers, and biocides – substances that have been shown to leach from plastic consumables into the sample and negatively affect bio-assay results

Ordering information

Description	Order no.
Eppendorf Safe-Lock Tubes, 0.5 mL	
Eppendorf Quality, colorless, 500 tubes. Replaces order no. 0030121503.	0030 121 023
Eppendorf Quality, yellow, 500 tubes	0030 121 112
Eppendorf Quality, red, 500 tubes	0030 121 120
Eppendorf Quality, blue, 500 tubes	0030 121 139
Eppendorf Quality, green, 500 tubes	0030 121 147
Eppendorf Quality, assorted colors (per 100), 500 tubes	0030 121 708
PCR clean, amber (light protection), 500 tubes	0030 121 155
PCR clean, colorless, 500 tubes	0030 123 301
Biopur®, colorless, 50 tubes, individually packed	0030 121 570
Forensic DNA Grade, colorless, 500 tubes (10 bags × 50 tubes)	0030 123 603
Eppendorf Safe-Lock Tubes, 1.5 mL	
Eppendorf Quality, colorless, 1,000 tubes. Replaces order no. 0030121872.	0030 120 086
Eppendorf Quality, yellow, 1,000 tubes	0030 120 159
Eppendorf Quality, red, 1,000 tubes	0030 120 167
Eppendorf Quality, blue, 1,000 tubes	0030 120 175
Eppendorf Quality, green, 1,000 tubes	0030 120 183
Eppendorf Quality, assorted colors (per 200), 1,000 tubes	0030 121 694
PCR clean, amber (light protection), 1,000 tubes	0030 120 191
PCR clean, colorless, 1,000 tubes	0030 123 328
Biopur®, colorless, 100 tubes, individually packed	0030 121 589
Forensic DNA Grade, colorless, 500 tubes (10 bags × 50 tubes)	0030 123 611
Eppendorf Safe-Lock Tubes, 2.0 mL	
Eppendorf Quality, colorless, 1,000 tubes. Replaces order no. 0030121880.	0030 120 094
Eppendorf Quality, yellow, 1,000 tubes	0030 120 205
Eppendorf Quality, red, 1,000 tubes	0030 120 213
Eppendorf Quality, blue, 1,000 tubes	0030 120 221
Eppendorf Quality, green, 1,000 tubes	0030 120 230
Eppendorf Quality, assorted colors (per 200), 1,000 tubes	0030 121 686
PCR clean, amber (light protection), 1,000 tubes	0030 120 248
PCR clean, colorless, 1,000 tubes	0030 123 344
Biopur®, colorless, 100 tubes, individually packed	0030 121 597
Forensic DNA Grade, colorless, 500 tubes (10 bags × 50 tubes)	0030 123 620
Storage Box 8 × 8 , freezer box, for 64 tubes 1 – 2 mL, 3 pcs., height 53 mm, 2 in, polypropylene, for freezing to -86 °C, autoclavable, with lid and alphanumeric code	0030 140 524
Eppendorf Tube Rack , 36 positions, for 1.5 mL and 2.0 mL tubes, polypropylene, numbered positions, autoclavable, 2 pcs.	0030 119 819

Eppendorf Tubes® 3810X



The Original

The easy-open, easy-close design of the Eppendorf Tubes® 3810X provides convenient, ergonomic, and reliable one-handed operation. Whether sample preparation, centrifugation or storage – the Eppendorf Tubes® 3810X fit perfectly into your workflows!

Product features

- > Tube lid is easy to open and close for ergonomic operation
- > Polypropylene provides high resistance to chemicals, mechanical stress, and temperature extremes
- > g-Safe®: Exceptional centrifugation stability up to 30,000 × g prevents sample loss due to tube breakage and provides extra safety when working with hazardous samples

Ordering information

Description	Order no.
Eppendorf Tubes® 3810X , 1.5 mL, g-safe® centrifugation stability	
Eppendorf Quality, colorless, 1,000 pcs.	0030 125 150
Eppendorf Quality, yellow, 1,000 pcs.	0030 125 207
Eppendorf Quality, red, 1,000 pcs.	0030 125 193
Eppendorf Quality, blue, 1,000 pcs.	0030 125 177
Eppendorf Quality, green, 1,000 pcs.	0030 125 185
PCR clean, colorless, 1,000 pcs.	0030 125 215
Storage Box 8 × 8 , freezer box, for 64 tubes 1 – 2 mL, 3 pcs., height 53 mm, 2 in, polypropylene, for freezing to -86 °C, autoclavable, with lid and alphanumeric code	0030 140 524
Eppendorf Tube Rack , 36 positions, for 1.5 mL and 2.0 mL tubes, polypropylene, numbered positions, autoclavable, 2 pcs.	0030 119 819

Eppendorf Tubes® 5.0 mL



The Missing Link!

Eppendorf Tubes 5.0 mL. This product represents the perfect option for working with medium-sized sample volumes. It fills the gap between existing tube formats and enables the simple and safe processing of sample volumes up to 5.0 mL.

Product features

- > Ergonomic operation: Snap cap - simple, practical and ergonomic singlehand operation. Screw cap - flattened and grooved sides provide optimal grip and user-friendly handling
- > Broad operating temperature range: Screw cap tubes: -86 °C – 100 °C. Snap cap tubes: -86 °C – 80 °C (when using the clip ≤ 100 °C)
- > Material: Exceptionally high-quality, transparent polypropylene, free of plasticizers, biocides or mold release agents, for reliable test results

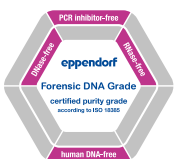
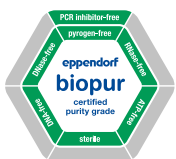
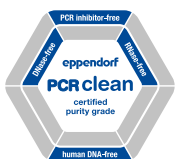

www.eppendorf.com/5mL



Light Protection as well as Transparency

The amber colored Eppendorf Tubes® 5.0 mL with screw cap combine effective protection of your sensitive samples from energy-rich light in the lower wavelength range with a high degree of transparency. You get full control on the insertion depths of pipette tips - often a source of contamination when handling solutions in intransparent tube formats.

Ordering information

Description	Order no.
Eppendorf Tubes® 5.0 mL with snap cap, 5.0 mL	
Eppendorf Quality, colorless, 200 tubes (2 bags × 100 tubes)	0030 119 401
PCR clean, colorless, 200 tubes (2 bags × 100 tubes)	0030 119 460
Biopur®, colorless, 50 tubes, individually wrapped	0030 119 479
Forensic DNA Grade, colorless, 200 tubes (4 bags × 50 tubes)	0030 119 606
sterile, colorless, 200 tubes (10 bags × 20 tubes)	0030 119 487
PCR clean, amber (light protection), 200 tubes (2 bags × 100 tubes)	0030 119 452
Eppendorf Tubes® 5.0 mL with screw cap, 5.0 mL	
Eppendorf Quality, colorless, 200 tubes (2 bags × 100 tubes). Replaces order no. 0030119517.	0030 122 305
PCR clean, colorless, 200 tubes (2 bags × 100 tubes)	0030 122 313
sterile, pyrogen-, DNase-, RNase-, human and bacterial DNA-free, colorless, 200 tubes (2 bags × 100 tubes)	0030 122 321
Forensic DNA Grade, colorless, 200 tubes (2 bags × 100 tubes)	0030 122 402
PCR clean, amber (light protection), 200 tubes (2 bags × 100 tubes)	0030 122 330
Eppendorf Tubes® 5.0 mL with snap cap starter pack, 5.0 mL, 400 tubes (2 packages with 2 bags of 100 each), 2 racks (with 12 locations each), white, 8 universal adapters for rotors with bore holes for 15 mL conical tubes, PCR clean, colorless	0030 119 380
Eppendorf Tubes® 5.0 mL with screw cap, starter pack, 5.0 mL, 400 tubes (2 packages with 2 bags of 100 each), 2 racks (with 12 locations each), white, 8 universal adapters for rotors with bore holes for 15 mL conical tubes, PCR clean, colorless	0030 122 364

Ordering information for DNA and Protein LoBind Tubes can be found on page 122/123.

Ordering information

Description	Order no.
Eppendorf Tubes® 5.0 mL – System Accessories, 5.0 mL	
Tube Clip for Eppendorf Tubes® 5.0 mL, 5.0 mL, Eppendorf Quality, 10 pcs.	0030 119 509
Eppendorf Tube Rack, 12 positions, for 5.0 mL and 15 mL tubes, polypropylene, numbered positions, autoclavable, 2 pcs.	0030 119 827
Storage Box 5 × 5, freezer box, for 25 tubes 5 mL, 4 pcs., height 64 mm, 2.5 in, polypropylene, for freezing to -86 °C, autoclavable, with lid and alphanumeric code	0030 140 532
Storage Box 5 × 5, freezer box, for 25 tubes 5 mL screw cap, 2 pcs., height 76 mm, 3 in, polypropylene, for freezing to -86 °C, autoclavable, with lid and alphanumeric code	0030 140 613
Rotor FA-45-12-17, aerosol-tight, incl. rotor lid, aluminum	5409 700 006
Rotor FA-45-16-17, aerosol-tight, incl. rotor lid, for 16 × Eppendorf Tubes® 5.0 mL	5427 750 002
Rotor FA-45-20-17, incl. rotor lid, for 20 Eppendorf Tubes® 5.0 mL	5820 765 003
Adapter, for 14 Eppendorf Tubes® 5.0 mL, for Rotor S-4-104, Rotor S-4x1000 round buckets and Rotor S-4x750, 2 pcs.	5825 739 000
Adapter, for 1 Eppendorf Tubes® 5.0 mL, 17 mm × 60 mm, for 100 mL round bucket in Rotor A-4-38, 2 pcs.	5702 733 008
Adapter, for 1 Eppendorf Tubes® 5.0 mL, for Rotor F-35-6-30, large rotor bore, 2 pcs.	5427 747 001
Adapter, for 1 Eppendorf Tubes® 5.0 mL, for Rotor F-34-6-38, 2 pcs.	5804 777 000
Adapter, for 1 Eppendorf Tubes® 5.0 mL, for Rotor F-35-6-30, small rotor bore, 2 pcs.	5427 746 005
Adapter, for 1 Eppendorf Tubes® 5.0 mL with snap cap, for Rotor FA-45-6-30 and FA-6x50, 2 pcs.	5820 730 005
Universal adapter, for 1 Eppendorf Tubes® 5.0 mL, for rotors for conical 15 mL tubes, 8 pcs.	5820 732 008
Adapter, for 8 Eppendorf Tubes® 5.0 mL, for Rotor S-4-72, 2 pcs.	5804 793 005
Exchangeable thermoblocks, for 8 × Eppendorf Tubes® 5.0 mL	5309 000 333
Eppendorf SmartBlock 5 mL, thermoblock for 8 Eppendorf Tubes® 5.0 mL, 8 × 5.0 mL reaction vessels	5309 000 007
ReservoirRack Module TC, for use in epMotion® ReservoirRacks, temperable, 4 × Eppendorf Tubes® 5.0 mL	5075 799 340

Eppendorf Conical Tubes 25 mL



The Next Level – Eppendorf Conical Tubes 25 mL!

This member of the big Eppendorf Tube Family fills the gap between the volumes of traditional conical tubes of 15 mL and 50 mL. Optimized height and outstanding quality make these conical tubes ideally suited for cell biology tasks such as for pooling media from T75 flasks, bacteria culture in midi prep size or overlapping applications like buffer preparation, storage and transport.

Also available in Amber for UV-light sensitive samples and in DNA LoBind and Protein LoBind.

Product features

- > Reduced height gives easy sample access even with low-volume pipettes and tips – reduces risk of cross-contamination between pipette and tube
- > Single-handed opening and closing through SnapTec® cap version for fast liquid extraction and addition
- > Centrifugation stability up to 17,000 x g¹⁾ for both tube variants - SnapTec® cap and screw cap

¹⁾ Please note the Instructions For Use for details (www.eppendorf.com/manuals): "Eppendorf Conical Tubes 25 mL, snap cap" and "Eppendorf Conical Tubes 15, 25 and 50 mL"

Applications

- > Cell culture applications, optimal for pooling, e.g. pooling media from 3 x T75 flasks (25 mL)
- > Sample preparation in microbiology and molecular biology labs, e.g. bacteria culture in midi prep size, cloning, DNA extraction when working with a relatively high amount of biological starting material (in botany)
- > Storage and transport of samples and solutions up to 25 mL
- > Preparation of master mixes and buffers

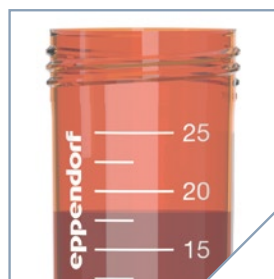
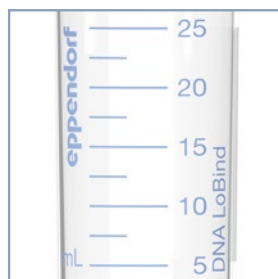

Please use the QR Code to get more Informations

www.eppendorf.com/conicals





Improved sample processing

Greater diameter and lower height than 15 mL conical tubes enable better sample access and faster resuspension of pellets after centrifugation.



Single-handed operation

Supports optimized and faster handling of sample solutions, especially in multi-step protocols.

A Full System of Components



Centrifugation

Centrifuges with rotors for 50 mL conical tubes, e.g. 59xx series and 58xx series: Two adapter variants for snap cap (order no.: 5820 733 004) and screw cap (order no.: 5820 734 000) 25 mL tubes enable usage in 50 mL rotors and buckets.



Sample Storage

Single Tube Stand:

Ideally suited for weighing samples on the balance and for handling individual samples. The viewing slit enables observation of the filling level at any time. (order no.: 0030 119 860)



Heating and Mixing

Eppendorf ThermoMixer® C and Eppendorf ThermoStat C:

Adapter for 25 mL tubes ensures compatibility with Eppendorf SmartBlock 50 mL. (order no.: 5365 000 109)



Tube Rack 25 mL:

Eppendorf Racks for 50 mL conical tubes can be used with the new 25 mL tubes. (order no.: 0030 119 835)



MixMate:

Tube Holder 25/50 mL, for 4 × 25/50 mL conical tubes. (order no.: 5353 040 156)



Storage box made of polypropylene:

Lower height allows space-saving storage for up to 9 × 25 mL tubes in 3.5 inches Eppendorf Storage Boxes. (order no.: 0030 140 729)

Ordering information

Description	Order no.
Eppendorf Conical Tubes 25 mL with SnapTec® cap, 25 mL	
sterile, pyrogen-, DNase-, RNase-, human and bacterial DNA-free, amber (light protection), 150 tubes (6 bags × 25 tubes)	0030 118 430
Eppendorf Quality, colorless, 200 tubes (5 bags × 40 tubes)	0030 118 405
PCR clean, colorless, 200 tubes (5 bags × 40 tubes)	0030 118 413
sterile, pyrogen-, DNase-, RNase-, human and bacterial DNA-free, colorless, 150 tubes (6 bags × 25 tubes)	0030 118 421
Eppendorf Conical Tubes 25 mL with SnapTec® cap, 25 mL, Starter Pack, 4 Single Tube Stands, 6 adapters for rotors with bore for 50 mL conical tubes	
PCR clean, colorless, 200 tubes (5 bags × 40 tubes)	0030 118 502
Eppendorf Conical Tubes 25 mL with screw cap, 25 mL	
sterile, pyrogen-, DNase-, RNase-, human and bacterial DNA-free, amber (light protection), 200 tubes (8 bags × 25 tubes)	0030 122 445
Eppendorf Quality, colorless, 200 tubes (4 bags × 50 tubes)	0030 122 410
PCR clean, colorless, 200 tubes (4 bags × 50 tubes)	0030 122 429
sterile, pyrogen-, DNase-, RNase-, human and bacterial DNA-free, colorless, 200 tubes (8 bags × 25 tubes)	0030 122 437
Eppendorf Conical Tubes 25 mL with screw cap, 25 mL, Starter Pack, 4 Single Tube Stands, 6 adapters for rotors with bore for 50 mL conical tubes	
PCR clean, colorless, 200 tubes (4 bags × 50 tubes)	0030 122 500

Ordering information for DNA and Protein LoBind Tubes can be found on page 122/123.

Eppendorf Conical Tubes 15 mL and 50 mL

Conical Competence

The Eppendorf Conical Tubes 15 and 50 mL meet the highest demands of diverse laboratory applications. The excellent quality and specifications make them ideally suited for cell biology applications as well as for sample preparation protocols in microbiology and molecular biology laboratories. The new Eppendorf Conical Tubes SnapTec® 50 allow easy one-handed sample handling.

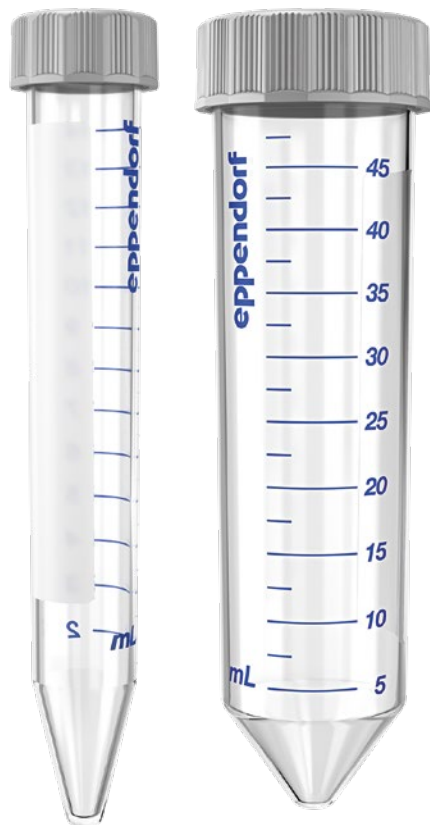

Product features

- > Premium USP class 6 raw material and no use of slip agents, plasticizers, and biocides during manufacturing ensure highest sample integrity, high g-Safe® centrifugation stability, and optimal sample and pellet visibility
- > Cap with flattened and grooved sides supports a user-friendly ergonomic handling, enables a stable upright positioning, and minimizes contamination risk
- > **New!** Eppendorf Conical Tubes SnapTec® 50 for fast opening and closing in routine multistep protocols

Applications

- > Convenient and safe cell culture applications
- > Sample preparation in microbiology and molecular biology labs
- > Storage of samples and solutions with larger volumes
- > Preparation of mastermixes and buffers



Whether centrifugation, mixing, or other applications, the Eppendorf Conical Tubes 15 and 50 mL suit your needs.



Light protection as well as transparency - two benefits in one tube.

Ordering information

Description	Order no.
Eppendorf Conical Tubes, 15 mL	
sterile, pyrogen-, DNase-, RNase-, human and bacterial DNA-free, colorless, 500 tubes (10 bags × 50 tubes)	0030 122 151
sterile, pyrogen-, DNase-, RNase-, human and bacterial DNA-free, amber (light protection), 200 tubes (4 bags × 50 tubes)	0030 122 194
Forensic DNA Grade, colorless, 100 tubes, individually wrapped	0030 122 259
sterile, pyrogen-, DNase-, RNase-, human and bacterial DNA-free, colorless, 500 tubes (20 racks × 25 tubes)	0030 122 160
Eppendorf Conical Tubes, 50 mL	
sterile, pyrogen-, DNase-, RNase-, human and bacterial DNA-free, colorless, 500 tubes (20 bags × 25 tubes)	0030 122 178
sterile, pyrogen-, DNase-, RNase-, human and bacterial DNA-free, amber (light protection), 200 tubes (8 bags × 25 tubes)	0030 122 224
Forensic DNA Grade, colorless, 48 tubes, individually wrapped	0030 122 267
sterile, pyrogen-, DNase-, RNase-, human and bacterial DNA-free, colorless, 300 tubes (12 racks × 25 tubes)	0030 122 186

Eppendorf Conical Tubes SnapTec® 50

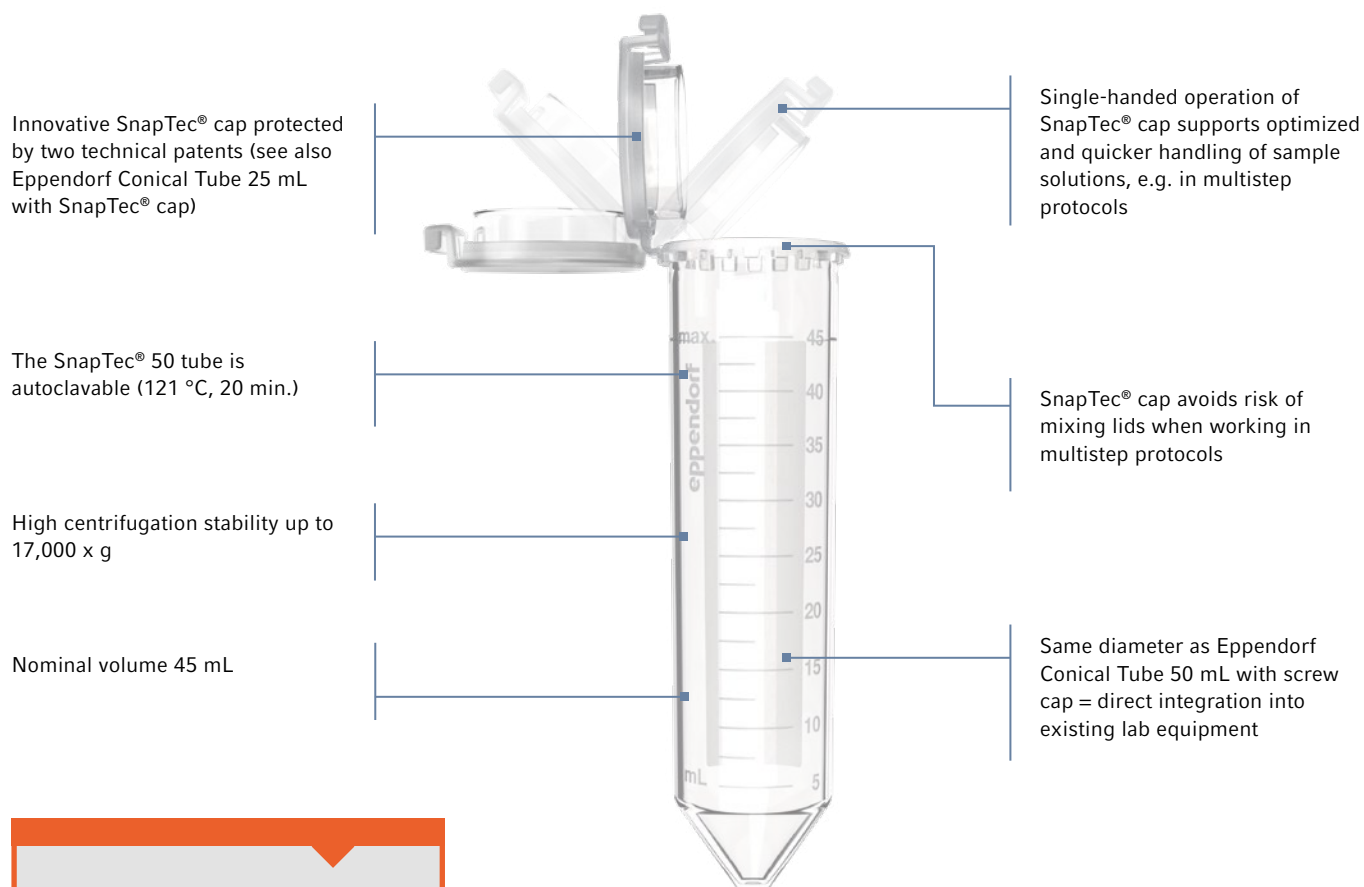

Please use the QR Code to get more Informations



www.eppendorf.com/SnapTec50



Ordering information

Description

Eppendorf Conical Tubes SnapTec® 50, 45 mL

Eppendorf Quality, colorless, 240 tubes (8 bags × 30 tubes)

PCR clean, colorless, 240 tubes (8 bags × 30 tubes)

sterile, pyrogen-, DNase-, RNase-, human and bacterial DNA-free, colorless, 200 tubes (10 bags × 20 tubes)

Eppendorf Tube Rack, 12 positions, for 5.0 mL and 15 mL tubes, polypropylene, numbered positions, autoclavable, 2 pcs.

Eppendorf Tube Rack, 12 positions, 6 for 5.0 mL and 15 mL tubes and 6 for 25 mL and 50 mL tubes, polypropylene, numbered positions, autoclavable, 2 pcs.

Storage Box 5 × 5, freezer box, for 25 tubes 15 mL, 2 pcs., height 127 mm, 5 in, polypropylene, for freezing to -86 °C, autoclavable, with lid and alphanumeric code

Storage Box 3 × 3, freezer box, for 9 tubes 50 mL and 4 tubes 15 mL, 2 pcs., height 127 mm, 5 in, polypropylene, for freezing to -86 °C, autoclavable, with lid and alphanumeric code

Order no.

0030 118 650

0030 118 669

0030 118 677

0030 119 827

0030 119 835

0030 140 583

0030 140 591

Ordering information for DNA and Protein LoBind Tubes can be found on page 122/123.

Your local distributor: www.eppendorf.com/contact

Eppendorf UK Limited · Gateway 1000 · Whittle Way · Stevenage SG1 2FP · United Kingdom · sales@eppendorf.co.uk · www.eppendorf.co.uk · www.eppendorf.com/eshop

Eppendorf Tubes® BioBased

2nd Generation Feedstock, 1st Class Consumables

Minimal carbon footprint! No compromise on quality! The Eppendorf Tubes® BioBased meet the highest demands of diverse laboratory applications and convince by their sustainability which is achieved by producing these tubes from renewable feedstock of the second generation. General Quality Certificates on compliance with standards and general Eppendorf quality requirements,

product-specific and lot-specific purity certificates as well as ACT Certificates attest the well-known premium product quality customers can expect from Eppendorf Tubes. The sustainability factor of Eppendorf Tubes® BioBased will clearly be visible with continuous use in your laboratory carbon footprint. Eppendorf Tubes® BioBased are available with screw caps in volumes from 5.0 mL to 50 mL.



Product features

- > Premium biobased polypropylene - produced from recycled feedstock in second generation - in this case derived solely from waste and residue streams e.g. from vegetable oil production and used cooking oil
- > ISCC PLUS (International Sustainability & Carbon Certification) to enable traceability along the entire supply chain
- > ACT (Accountability, Consistency, and Transparency) Certification - the independent validation provided by My Green Lab®
- > Lot-specific purity certificates from an independent laboratory can be downloaded from Eppendorf website
- > General Quality Certificates on compliance with standards and general Eppendorf quality requirements
- > Premium USP class 6 raw material and no use of slip agents, plasticizers, and biocides during manufacturing ensure highest sample integrity

Applications

- > Convenient and safe cell culture applications
- > Sample preparation in microbiology and molecular biology labs
- > Storage of samples and solutions with larger volumes
- > Preparation of mastermixes and buffers

Download Brochure

"2nd Generation Feedstock,
1st Class Consumables"

www.eppendorf.com/BioBased_brochure



About Bio-based Polymer Used for Eppendorf Tubes® BioBased



To increase the sustainable properties of plastic used for the production of lab consumables, we must make and use plastics more sustainably using recycled and renewable feedstocks.

- > In this specific bio-based polymer production, fossil raw material is saved by replacing it with sustainable raw material produced from bio-based waste and residues (2nd generation renewable feedstock)
- > The raw materials used to produce the renewable feedstock can be backtraced to the first collection points and the origin of the renewable raw materials from carefully selected suppliers committed to sustainability is assured
- > The final polymers are sustainability certified by "ISCC PLUS" - the reliable global leading certification scheme for manufacturers producing bio-based polymers and their further processing



How to Identify Eppendorf Tubes® BioBased

Packaging

- > Tubes are packed in resealable bags
- > For better identification on explanatory additional label is placed under the product label

These tubes¹⁾ are made with 90 % biobased plastic. The plastic can be traced back to biological waste material which is attributed to these tubes via the ISCC mass balance approach.

By choosing these tubes, our customers help to significantly reduce the amount of fossil resources required for their production.

¹⁾ The screw caps are actual fossil-based material. The material switch will be made to BioBased in 2023.



Ordering information

Description	Order no.
Eppendorf Tubes® BioBased	
15 mL, screw cap, sterile, pyrogen-, DNase-, RNase-, human and bacterial DNA-free, colorless, 500 tubes (10 bags × 50 tubes)	0030 122 526
25 mL, screw cap, sterile, pyrogen-, DNase-, RNase-, human and bacterial DNA-free, colorless, 200 tubes (8 bags × 25 tubes)	0030 122 534
50 mL, screw cap, sterile, pyrogen-, DNase-, RNase-, human and bacterial DNA-free, colorless, 500 tubes (20 bags × 25 tubes)	0030 122 542
5.0 mL, screw cap, sterile, pyrogen-, DNase-, RNase-, human and bacterial DNA-free, colorless, 200 tubes (2 bags × 100 tubes)	0030 122 518

Protein LoBind® Tubes

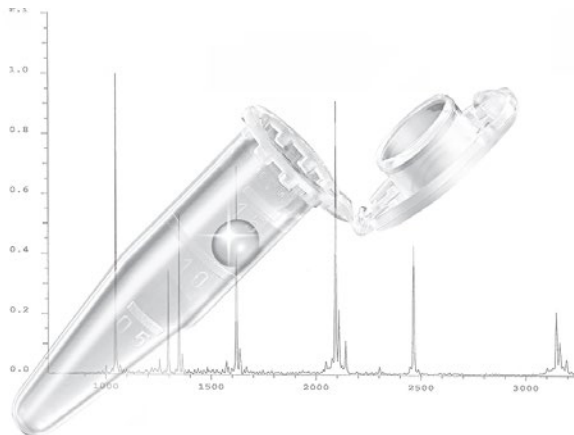
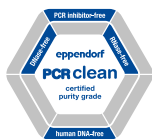

Optimal Sample Recovery!

Eppendorf Protein LoBind Tubes are specifically designed for use in proteomics or other fields of protein research, where protein concentration tends to be very small and sample recovery is vital for assay results. Significantly more protein can be recovered for downstream analyses, and enzymes remain active.

Product features

- > Eppendorf LoBind material ensures optimized sample recovery for improved assay results
- > Free of surface coating (e.g., silicone) to minimize the risk of sample interference
- > Lot-certified PCR clean purity grade: free of human DNA, DNase, RNase and PCR inhibitors

Ordering information

	Description	Order no.
New	Protein LoBind® Tubes , Protein LoBind®, 25 mL, with SnapTec® cap, PCR clean, colorless, 200 tubes (5 bags × 40 tubes)	0030 108 531
New	Protein LoBind® Tubes , Protein LoBind®, 25 mL, with screw cap, PCR clean, colorless, 200 tubes (4 bags × 50 tubes)	0030 122 283
	Protein LoBind® Tubes , Protein LoBind®, 0.5 mL, PCR clean, colorless, 100 tubes (2 bags × 50 tubes)	0030 108 094
	Protein LoBind® Tubes , Protein LoBind®, 1.5 mL, PCR clean, colorless, 100 tubes (2 bags × 50 tubes)	0030 108 116
	Protein LoBind® Tubes , Protein LoBind®, 2.0 mL, PCR clean, colorless, 100 tubes (2 bags × 50 tubes)	0030 108 132
	Protein LoBind® Tubes , Protein LoBind®, 5.0 mL, with snap cap, PCR clean, colorless, 100 tubes (2 bags × 50 tubes)	0030 108 302
	Protein LoBind® Tubes , Protein LoBind®, 5.0 mL, with screw cap, PCR clean, colorless, 200 tubes (2 bags × 100 tubes)	0030 122 356
	Protein LoBind® Tubes , Protein LoBind®, 15 mL, conical tube, PCR clean, colorless, 200 tubes (4 bags × 50 tubes)	0030 122 216
	Protein LoBind® Tubes , Protein LoBind®, 50 mL, conical tube, PCR clean, colorless, 200 tubes (8 bags × 25 tubes)	0030 122 240

SafeCode Tubes



How often do you find samples difficult to identify on your lab bench?

Discover our solution

Please use the QR Code.

www.eppendorf.com/safecode



DNA LoBind® Tubes

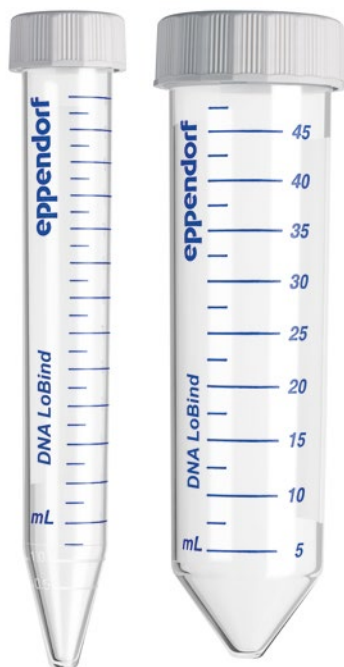

Improved Reproducibility!

DNA LoBind Tubes maximize sample recovery of nucleic acids by significantly reducing sample-to-surface binding. The ideal solution for sample preparation and long-term storage of your precious samples!

Product features

- > Eppendorf LoBind material ensures optimized sample recovery for improved assay results
- > Free of surface coating (e.g., silicone) to minimize the risk of sample interference
- > Lot-certified PCR clean purity grade: free of human DNA, DNase, RNase and PCR inhibitors

Ordering information

	Description	Order no.
New	DNA LoBind® Tubes , DNA LoBind®, 25 mL, conical tubes, PCR clean, colorless, 200 tubes (5 bags × 40 tubes)	0030 108 523
New	DNA LoBind® Tubes , DNA LoBind®, 25 mL, with screw cap, PCR clean, colorless, 200 tubes (4 bags × 50 tubes)	0030 122 275
	DNA LoBind® Tubes , DNA LoBind®, 0.5 mL, PCR clean, colorless, 1 bag × 500 tubes	0030 108 400
	DNA LoBind® Tubes , DNA LoBind®, 1.5 mL, PCR clean, colorless, 1 bag × 500 tubes	0030 108 418
	DNA LoBind® Tubes , DNA LoBind®, 2.0 mL, PCR clean, colorless, 1 bag × 500 tubes	0030 108 426
	DNA LoBind® Tubes , DNA LoBind®, 0.5 mL, PCR clean, colorless, 250 tubes (5 bags × 50 tubes)	0030 108 035
	DNA LoBind® Tubes , DNA LoBind®, 1.5 mL, PCR clean, colorless, 250 tubes (5 bags × 50 tubes)	0030 108 051
	DNA LoBind® Tubes , DNA LoBind®, 2.0 mL, PCR clean, colorless, 250 tubes (5 bags × 50 tubes)	0030 108 078
	DNA LoBind® Tubes , DNA LoBind®, 5.0 mL, with snap cap, PCR clean, colorless, 200 tubes (4 bags × 50 tubes)	0030 108 310
	DNA LoBind® Tubes , DNA LoBind®, 5.0 mL, with screw cap, PCR clean, colorless, 200 tubes (2 bags × 100 tubes)	0030 122 348
	DNA LoBind® Tubes , DNA LoBind®, 15 mL, conical tubes, PCR clean, colorless, 200 tubes (4 bags × 50 tubes)	0030 122 208
	DNA LoBind® Tubes , DNA LoBind®, 50 mL, conical tubes, PCR clean, colorless, 200 tubes (8 bags × 25 tubes)	0030 122 232

Eppendorf Microplates

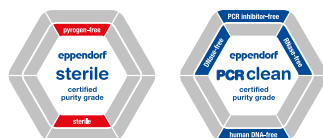





Get More!

Experience a new dimension of transparency - the Eppendorf Microplates! It has never been this easy and reliable to pipette, control and recover samples with a polypropylene microplate. We offer a wide variety of plates which are highly robust making it easy to find the optimal solution for your application needs. Also available as barcoded versions.

Product features

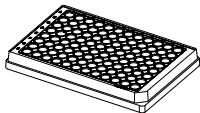
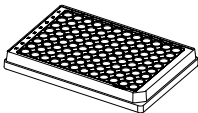
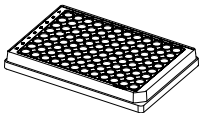
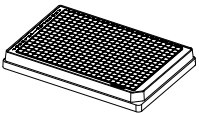
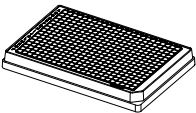
- > g-Safe®: exceptional centrifugation stability up to 6,000 × g
- > OptiTrack® Matrix: up to 30 % faster sample identification and fewer pipetting errors via high-contrast alphanumeric labeling
- > RecoverMax® well design: Optimized well geometry for minimal remaining volume and excellent mixing properties

Technical specifications

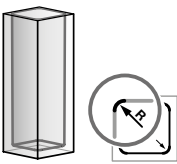
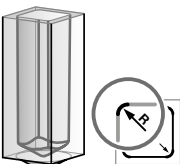
					
Description	Microplate 96/F	Microplate 96/U	Microplate 96/V	Microplate 384/F	Microplate 384/V-PP
Number of wells	96 wells	96 wells	96 wells	384 wells	384 wells
Working volume	50 – 350 µL	20 – 320 µL	20 – 320 µL	10 – 120 µL	5 – 120 µL
Total volume per well	400 µL	360 µL	350 µL	150 µL	140 µL
					
Bottom shape	F bottom	U bottom	V bottom	F bottom	conical

Ordering information

Description	Order no.
Microplate 96/F , wells clear, RecoverMax® well design	
PCR clean, white, 80 plates (5 bags × 16 plates)	0030 601 106
sterile, white, 80 plates (5 bags × 16 plates)	0030 602 102
Microplate 96/U , wells clear, RecoverMax® well design	
PCR clean, white, 80 plates (5 bags × 16 plates)	0030 601 203
sterile, white, 80 plates (5 bags × 16 plates)	0030 602 200
Microplate 96/V , wells clear, RecoverMax® well design	
PCR clean, white, 80 plates (5 bags × 16 plates)	0030 601 300
sterile, white, 80 plates (5 bags × 16 plates)	0030 602 307
Microplate 384/F , wells clear, RecoverMax® well design	
PCR clean, white, 80 plates (5 bags × 16 plates)	0030 621 107
sterile, white, 80 plates (5 bags × 16 plates)	0030 622 103
Microplate 384/V , wells clear, RecoverMax® well design	
PCR clean, white, 80 plates (5 bags × 16 plates)	0030 621 301
sterile, white, 80 plates (5 bags × 16 plates)	0030 622 308

Eppendorf Assay/Reader Microplates

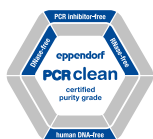

Unique Clarity!

Elevate the sensitivity of your assays with the Eppendorf Assay/Reader Plates to a higher level! The plates offer an excellent signal-to-noise ratio, resulting in an extremely low detection limit. Whether fluorescence or chemiluminescence - select the optimal plate for your assay! Solid plates are suitable for top-reading plates readers. Clear plates and black/clear plates can be used with top- and bottom-reading plates readers.

Product features

- > Black Eppendorf Microplates offer an excellent signal-to-noise ratio – for clear signals even with low-concentration samples
- > White Eppendorf Microplates are optimized for highest sensitivity in the detection of luminescence signals by maximizing reflection
- > Solid black and white assay plates are made of polypropylene resulting in high resistance to chemicals, mechanical stress, and temperature extremes

Ordering information

Description	Order no.
Microplate 96/F , wells white	
PCR clean, gray, 80 plates (5 bags × 16 plates)	0030 601 475
Microplate 96/U , wells white	
PCR clean, gray, 80 plates (5 bags × 16 plates)	0030 601 572
Microplate 96/V , wells white	
PCR clean, gray, 80 plates (5 bags × 16 plates)	0030 601 670
Microplate 384/V , wells white	
PCR clean, gray, 80 plates (5 bags × 16 plates)	0030 621 670
Microplate 96/F , wells black	
PCR clean, white, 80 plates (5 bags × 16 plates)	0030 601 700
Microplate 96/U , wells black	
PCR clean, white, 80 plates (5 bags × 16 plates)	0030 601 807
Microplate 96/V , wells black	
PCR clean, white, 80 plates (5 bags × 16 plates)	0030 601 904
Microplate 384/V , wells black	
PCR clean, white, 80 plates (5 bags × 16 plates)	0030 621 905

Eppendorf Deepwell Plates



Precision and Accuracy!

Eppendorf Deepwell Plates 96 and 384 are high performance plates fulfilling highest requirements of all manual and automated applications. They combine innovative features, like the OptiTrack® matrix, with thoroughgoing quality for which Eppendorf consumables are globally known as a premium standard. Also available as barcoded versions.

Product features

- > OptiTrack® matrix: up to 30 % faster sample identification and fewer pipetting errors via high-contrast alphanumeric labeling
- > RecoverMax® well design: Optimized well geometry for maximum sample recovery and excellent mixing properties
- > g-Safe®: exceptional centrifugation stability up to 6,000 x g for faster protocols and improved sample quality

Ordering information

Description	Order no.
Deepwell Plate 96/500 µL , wells clear, 500 µL	
PCR clean, white, 40 plates (5 bags × 8 plates)	0030 501 101
PCR clean, yellow, 40 plates (5 bags × 8 plates)	0030 501 110
PCR clean, green, 40 plates (5 bags × 8 plates)	0030 501 136
PCR clean, blue, 40 plates (5 bags × 8 plates)	0030 501 144
PCR clean, white, 120 plates (10 bags × 12 plates)	0030 505 107
sterile, white, 40 plates (5 bags × 8 plates)	0030 502 108
sterile, yellow, 40 plates (5 bags × 8 plates)	0030 502 116
sterile, green, 40 plates (5 bags × 8 plates)	0030 502 132
sterile, blue, 40 plates (5 bags × 8 plates)	0030 502 140
sterile, white, 120 plates (10 bags × 12 plates)	0030 506 103
Deepwell Plate 96/1000 µL , wells clear, 1,000 µL	
PCR clean, white, 20 plates (5 bags × 4 plates)	0030 501 209
PCR clean, yellow, 20 plates (5 bags × 4 plates)	0030 501 217
PCR clean, green, 20 plates (5 bags × 4 plates)	0030 501 233
PCR clean, blue, 20 plates (5 bags × 4 plates)	0030 501 241
PCR clean, white, 80 plates (10 bags × 8 plates)	0030 505 204
sterile, white, 20 plates (5 bags × 4 plates)	0030 502 205
sterile, yellow, 20 plates (5 bags × 4 plates)	0030 502 213
sterile, green, 20 plates (5 bags × 4 plates)	0030 502 230
sterile, blue, 20 plates (5 bags × 4 plates)	0030 502 248
sterile, white, 80 plates (10 bags × 8 plates)	0030 506 200
Deepwell Plate 96/2000 µL , wells clear, 2,000 µL	
PCR clean, white, 20 plates (5 bags × 4 plates)	0030 501 306
PCR clean, yellow, 20 plates (5 bags × 4 plates)	0030 501 314
PCR clean, green, 20 plates (5 bags × 4 plates)	0030 501 330
PCR clean, blue, 20 plates (5 bags × 4 plates)	0030 501 349
PCR clean, white, 80 plates (10 bags × 8 plates)	0030 505 301
sterile, white, 20 plates (5 bags × 4 plates)	0030 502 302
sterile, yellow, 20 plates (5 bags × 4 plates)	0030 502 310
sterile, green, 20 plates (5 bags × 4 plates)	0030 502 337
sterile, blue, 20 plates (5 bags × 4 plates)	0030 502 345
sterile, white, 80 plates (10 bags × 8 plates)	0030 506 308
Deepwell Plate 384/200 µL , wells clear, 200 µL	
PCR clean, white, 40 plates (5 bags × 8 plates)	0030 521 102
sterile, white, 40 plates (5 bags × 8 plates)	0030 522 109
PCR clean, white, 120 plates (10 bags × 12 plates)	0030 525 108
sterile, white, 120 plates (10 bags × 12 plates)	0030 526 104

Protein LoBind® Plates

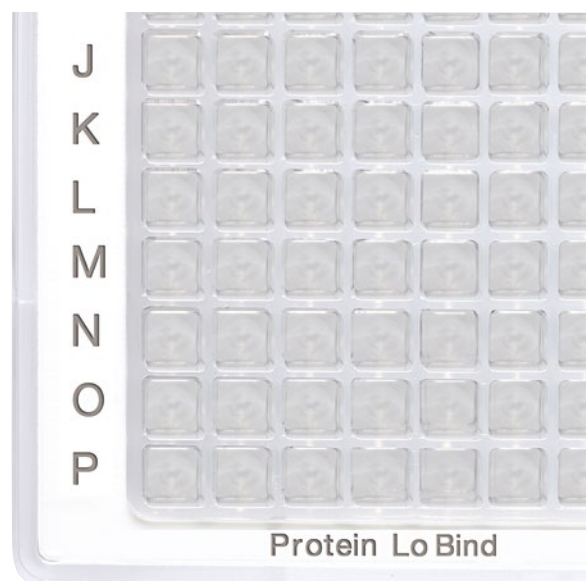

Optimal Sample Recovery!

Eppendorf Protein LoBind Plates are specifically designed for use in proteomics or other fields of protein research, where protein concentration tend to be very small and sample recovery is vital for assay results. Significantly more protein can be recovered for downstream analysis and enzymes remain active. Also available as barcoded versions.

Product features

- > Eppendorf LoBind material ensures excellent sample recovery for improved assay results
- > Free of surface coating (e.g., silicone) to minimize the risk of sample interference
- > Lot-certified PCR clean purity grade: free of human DNA, DNase, RNase and PCR inhibitors

Ordering information

Description	Order no.
Deepwell Plate 96/500 μL , Protein LoBind®, wells colorless, 500 μ L	
PCR clean, white, 40 plates (5 bags \times 8 plates)	0030 504 100
PCR clean, yellow, 40 plates (5 bags \times 8 plates)	0030 504 119
PCR clean, white, 120 plates (10 bags \times 12 plates)	0030 508 106
Deepwell Plate 96/1000 μL , Protein LoBind®, wells colorless, 1,000 μ L	
PCR clean, white, 20 plates (5 bags \times 4 plates)	0030 504 208
PCR clean, yellow, 20 plates (5 bags \times 4 plates)	0030 504 216
PCR clean, white, 80 plates (10 bags \times 8 plates)	0030 508 203
Deepwell Plate 96/2000 μL , Protein LoBind®, wells colorless, 2,000 μ L	
PCR clean, white, 20 plates (5 bags \times 4 plates)	0030 504 305
Deepwell Plate 384/200μL , Protein LoBind®, wells colorless, 200 μ L	
PCR clean, white, 40 plates (5 bags \times 8 plates)	0030 524 101
PCR clean, white, 120 plates (10 bags \times 12 plates)	0030 528 107
Microplate 384/V-PP , Protein LoBind®, wells clear, 140 μ L	
PCR clean, white, 80 plates (5 bags \times 16 plates)	0030 624 300
PCR clean, white, 240 plates (10 bags \times 24 plates)	0030 628 306

Tubes and Plates

DNA LoBind® Plates

**Improved Reproducibility!**

DNA LoBind Plates maximize sample recovery of nucleic acids by significantly reducing sample-to-surface binding. The ideal solution for sample preparation and long-term storage of your precious samples! Also available as barcoded versions.

Product features

- > Eppendorf LoBind material ensures optimized sample recovery for improved assay results
- > Free of surface coating (e.g. silicone) to minimize the risk of sample interference
- > Lot-certified PCR clean purity grade: free of human DNA, DNase, RNase and PCR inhibitors

How it works



Please use the QR Code.

www.eppendorf.com/purity-video

Ordering information

Description	Order no.
Deepwell Plate 96/500µL , DNA LoBind®, wells clear, 500 µL, LoBind®	
PCR clean, white, 40 plates (5 bags × 8 plates)	0030 503 104
PCR clean, blue, 40 plates (5 bags × 8 plates)	0030 503 147
PCR clean, white, 120 plates (10 bags × 12 plates)	0030 507 100
Deepwell Plate 96/1000µL , DNA LoBind®, wells clear, 1,000 µL, LoBind®	
PCR clean, white, 20 plates (5 bags × 4 plates)	0030 503 201
PCR clean, blue, 20 plates (5 bags × 4 plates)	0030 503 244
PCR clean, white, 80 plates (10 bags × 8 plates)	0030 507 207
Deepwell Plate 384/200µL , DNA LoBind®, wells clear, 200 µL, LoBind®	
PCR clean, white, 40 plates (5 bags × 8 plates)	0030 523 105
PCR clean, white, 120 plates (10 bags × 12 plates)	0030 527 100
Microplate 96/V-PP , DNA LoBind®, wells clear, 350 µL, LoBind®	
PCR clean, white, 80 plates (5 bags × 16 plates)	0030 603 303
Microplate 384/V-PP , DNA LoBind®, wells clear, 140 µL, LoBind®	
PCR clean, white, 80 plates (5 bags × 16 plates)	0030 623 304
PCR clean, white, 240 plates (10 bags × 24 plates)	0030 627 300

Plate Accessories

Sealing options for Sample Preparation and Storage

- > Sealing Mats are reusable and can be autoclave. Sealing mats are suitable for short-term storage
- > Heat Sealing Film and Foil for continuous locking with the best evaporation protection
- > Foil products are made of aluminum, can be pierced, and protect light-sensitive samples



Ordering information

Description	Order no.
Eppendorf Storage Film , self-adhesive, PCR clean, 100 pcs. (2 bags × 50 pcs.)	0030 127 870
Eppendorf Storage Foil , self-adhesive, PCR clean, 100 pcs.	0030 127 889
Eppendorf Sealing Mat , for DWP 96/2000, PCR clean, 50 pcs. (5 bags × 10 pcs.)	0030 127 960
Eppendorf Sealing Mat , for DWP 96/1000 and DWP 96/500, PCR clean, 50 pcs. (5 bags × 10 pcs.)	0030 127 978
Eppendorf Plates® Lid , for MTP and DWP, PCR clean, 80 pcs. (5 bags × 16 pcs.)	0030 131 517
Eppendorf Plates® Lid , for MTP and DWP, sterile, 80 pcs. (5 bags × 16 pcs.)	0030 131 525
Eppendorf Heat Sealing Film , PCR clean, 100 pcs.	0030 127 838
Eppendorf Heat Sealing Foil , PCR clean, 100 pcs.	0030 127 854

Eppendorf Tube and Cuvette Racks

- > Made from high quality polypropylene (PP):
 - > Ensuring dimensional stability across a broad temperature range (-86° C to 121° C)
 - > Providing chemical resistance
- > The racks are UV-light resistant
- > Six different formats always offer the optimal choice for all common tubes and cuvettes



Ordering information

Description	Order no.
Eppendorf Tube Rack , 48 positions, for 0.5 mL tubes, polypropylene, numbered positions, autoclavable, 2 pcs.	0030 119 800
Eppendorf Tube Rack , 12 positions, for 5.0 mL and 15 mL tubes, polypropylene, numbered positions, autoclavable, 2 pcs.	0030 119 827
Eppendorf Tube Rack , 12 positions, 6 for 5.0 mL and 15 mL tubes and 6 for 25 mL and 50 mL tubes, polypropylene, numbered positions, autoclavable, 2 pcs.	0030 119 835
Eppendorf Cuvette Rack , 30 positions, for glass and plastic cuvettes, polypropylene, numbered positions, autoclavable, 2 pcs.	0030 119 851
Eppendorf Tube Rack , 36 positions, for cryogenic tubes, polypropylene, numbered positions, autoclavable, 2 pcs.	0030 119 843
Eppendorf Tube Rack , 36 positions, for 1.5 mL and 2.0 mL tubes, polypropylene, numbered positions, autoclavable, 2 pcs.	0030 119 819

Tubes and Plates

Tubes and Cuvettes Accessories

Micropestle

- > Two sides for optimal fit in 1.5 mL and 2.0 mL vessels
- > Autoclavable (121 °C, 20 min)



Ordering information

Description	Order no.
Micropestle , for resuspending pellets in 1.5/2.0 mL vessels, 10 pcs.	0030 120 973

Eppendorf Storage Boxes

- > Made of polypropylene (PP) for high stability in freezing applications and smooth opening and closing
- > For freezing to -86 °C
- > High-contrast permanent alphanumeric marking of each location through laser labeling enables easy sample identification and minimizes risk of sample mix-up



Ordering information

Description	Order no.
Storage Box 10 × 10 , freezer box, for 100 cryogenic tubes w. int. thread, 3 pcs., height 53 mm, 2 in, polypropylene, for freezing to -86 °C, autoclavable, with lid and alphanumeric code	0030 140 508
Storage Box 9 × 9 , freezer box, for 81 screw cap (cryog.) tubes 1 – 2 mL, 3 pcs., height 53 mm, 2 in, polypropylene, for freezing to -86 °C, autoclavable, with lid and alphanumeric code	0030 140 516
Storage Box 9 × 9 , freezer box, for 81 screw cap (cryog.) tubes 3 mL, 2 pcs., height 76 mm, 3 in, polypropylene, for freezing to -86 °C, autoclavable, with lid and alphanumeric code	0030 140 540
Storage Box 9 × 9 , freezer box, for 81 screw cap (cryog.) tubes 4 – 5 mL, 2 pcs., height 102 mm, 4 in, polypropylene, for freezing to -86 °C, autoclavable, with lid and alphanumeric code	0030 140 567
Storage Box 8 × 8 , freezer box, for 64 tubes 1 – 2 mL, 3 pcs., height 53 mm, 2 in, polypropylene, for freezing to -86 °C, autoclavable, with lid and alphanumeric code	0030 140 524
Storage Box 5 × 5 , freezer box, for 25 tubes 5 mL, 4 pcs., height 64 mm, 2.5 in, polypropylene, for freezing to -86 °C, autoclavable, with lid and alphanumeric code	0030 140 532
Storage Box 5 × 5 , freezer box, for 25 tubes 5 mL screw cap, 2 pcs., height 76 mm, 3 in, polypropylene, for freezing to -86 °C, autoclavable, with lid and alphanumeric code	0030 140 613
Storage Box 5 × 5 , freezer box, for 25 tubes 15 mL, 2 pcs., height 127 mm, 5 in, polypropylene, for freezing to -86 °C, autoclavable, with lid and alphanumeric code	0030 140 583
Storage Box 3 × 3 , freezer box, for 9 tubes 25 mL, 2 pcs., height 89 mm, 3.5 in, polypropylene, for freezing to -86 °C, autoclavable, with lid and alphanumeric code	0030 140 729
Storage Box 3 × 3 , freezer box, for 9 tubes 50 mL and 4 tubes 15 mL, 2 pcs., height 127 mm, 5 in, polypropylene, for freezing to -86 °C, autoclavable, with lid and alphanumeric code	0030 140 591

Our Portfolio – Your Choice

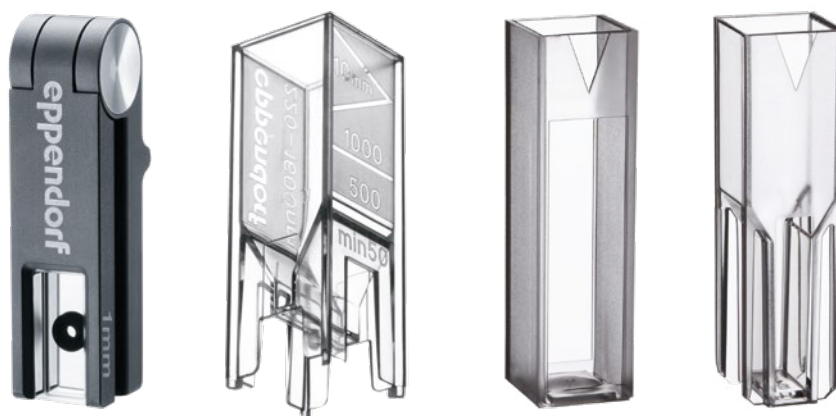

Model	Eppendorf μCuvette® G1.0	Eppendorf UVette®	Macro Vis Cuvette	Semi-micro Vis Cuvette
Page(s)	132	132	133	133
dsDNA concentration range (UV 260 nm)	25 ng/μL – 1,500 ng/μL	2.5 ng/μL – 750 ng/μL	1 pg/μL 1,000 pg/μL (Pico Green Assay)	1 pg/μL 1,000 pg/μL (Pico Green Assay)
BSA concentration range (UV 280 nm)	758 ng/μL – 45,450 ng/μL	76 ng/μL – 22,725 ng/μL	0.01 ng/μL – 0.01 μg/μL (NanoOrange Assay)	0.01 ng/μL – 0.01 μg/μL (NanoOrange Assay)
Colorimetric protein assays	yes	yes	yes	yes
OD 600 methods	no	yes	yes	yes
Fluorescence measurements	yes	yes	yes	yes
UV transparency	>180 nm	>220 nm	–	–
Light transmission	180 nm – 2,000 nm	220 nm – 1,600 nm	300 nm – 900 nm	300 nm – 900 nm
Material	quartz glass (with hydrophobic coating)	UV-transparent plastic	PMMA	PMMA
Dimensions (W × D × H)	12.5 × 12.5 × 48 mm	12.5 × 12.5 × 36 mm / 0.49 × 0.49 × 1.42 in	12.5 × 12.5 × 45 mm	12.5 × 12.5 × 45 mm
Temperature control	no	no	yes	no
Minimum filling volume				
in Eppendorf photometers	1.5 μL	50 μL	1,000 μL	400 μL
in devices of other manufacturers	–	50 μL	2,500 μL	1,500 μL
Maximum filling volume	10 μL	2,000 μL	4,500 μL	3,000 μL
Sample light path length	1 mm	2 mm and 10 mm	10 mm	10 mm
Cuvette blank	≤0.05 A at 260 nm	≤0.5 A at 260 nm	–	–
Height of light source	8.5 mm	8.5 mm ¹⁾	all common cell heights	all common cell heights
Use in Eppendorf BioPhotometer®	yes	yes	yes	yes
Use in Eppendorf BioSpectrometer®	yes	yes	yes	yes
Use in devices of other manufacturers	no	yes (adapters available)	yes	yes

¹⁾ adapters available for height adjustment

Get all information about the Eppendorf detection portfolio!
Explore the eshop and get an overview!

www.eppendorf.com/detection



Eppendorf μ Cuvette[®] G1.0

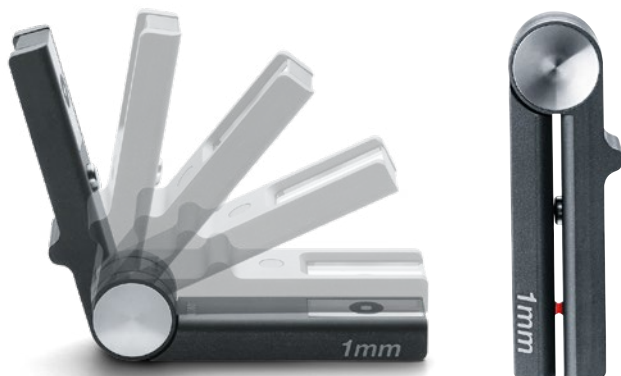

One droplet is the limit?

The μ Cuvette G1.0 is in your range: Only 1.5 μ L of a sample is needed. The optical path length of only 1 mm enables a light path that is 10x shorter than the light path on standard cuvettes: Measure high nucleic acid and protein concentrations.

Product features

- > Microvolume measuring cell for measuring 1.5 – 10 μ L sample volumes
- > Concentration determination of nucleic acids and proteins, amongst other target analytes
- > Measurement of highly concentrated samples without prior dilution

Ordering information

Description	Order no.
Eppendorf μ Cuvette [®] G1.0, Microvolume measuring cell for Eppendorf BioPhotometer [®] and BioSpectrometer [®]	6138 000 018

Eppendorf UVette[®]



Working with very low amount of samples?

The UVette is a disposable UV/Vis cuvette with a light transmission of 220 nm to 1,600 nm for spectrophotometer and photometers. As an example of Eppendorf's expertise in the production of high quality consumables, the UVette offers superb purity, convenience and precision for photometric analysis. The unique shape of the UVette combines two optical light path lengths to offer greater flexibility.

Product features

- > Suitable for measuring small volumes ($\geq 50 \mu$ L)
- > UV and Vis measurements from 220 nm to 1,600 nm
- > UV transparent plastic, free of fluoropolymers and other halogenated hydrocarbons

Ordering information

Description	Order no.
UVette [®] 220 nm – 1,600 nm, original Eppendorf plastic cuvette, individually packed, (including RNase-free, DNase-free) and protein-free, PCR clean, 50 – 2,000 μ L, 80 pcs.	0030 106 300
UVette [®] starter set, 80 UVettes and 1 universal adapter for light path height 15 mm, convertible to 8.5 mm, 50 – 2,000 μ L	4099 100 007
UVette [®] routine pack 220 nm – 1,600 nm, reclosable box, Eppendorf Quality, 50 – 2,000 μ L, 200 pcs.	0030 106 318
Adapter for UVette [®] , for photometer/spectrophotometer with light path height	
8.5 mm	4099 001 009
10 mm	4099 002 005
15 mm	4099 003 001
20 mm	4099 005 004
Eppendorf Cuvette Rack, 30 positions, for glass and plastic cuvettes, polypropylene, numbered positions, autoclavable, 2 pcs.	0030 119 851

Eppendorf Vis Cuvettes



Optimal Clarity!

The Eppendorf Vis Cuvettes are disposable cuvettes made of clear plastic with a light transmission of 300 nm to 900 nm. These cuvettes are perfect for applications outside of the UV range, such as colorimetric protein assays (Bradford, Lowry, etc.), determining of the optical density of bacterial cultures (OD600 methods), and kinetic and fluorescence measurements.

Product features

- > Two different cuvette sizes (semi-micro and macro) for a wide variety of volumes and applications
- > Disposable cuvettes made of clear plastic with a light transmission of 300 nm to 900 nm

Ordering information

Description	Order no.
Eppendorf macro Vis Cuvette , plastic cuvette for measurements in the Vis range, max. filling volume 4,500 μL 1,000 cuvettes (10 boxes \times 100 cuvettes)	0030 079 345
Eppendorf semi-micro Vis Cuvette , plastic cuvette for measurements in the Vis range max. filling volume 3,000 μL	0030 079 353
Eppendorf Cuvette Rack , 30 positions, for glass and plastic cuvettes, polypropylene, numbered positions, autoclavable, 2 pcs.	0030 119 851



Centrifuges and Rotors

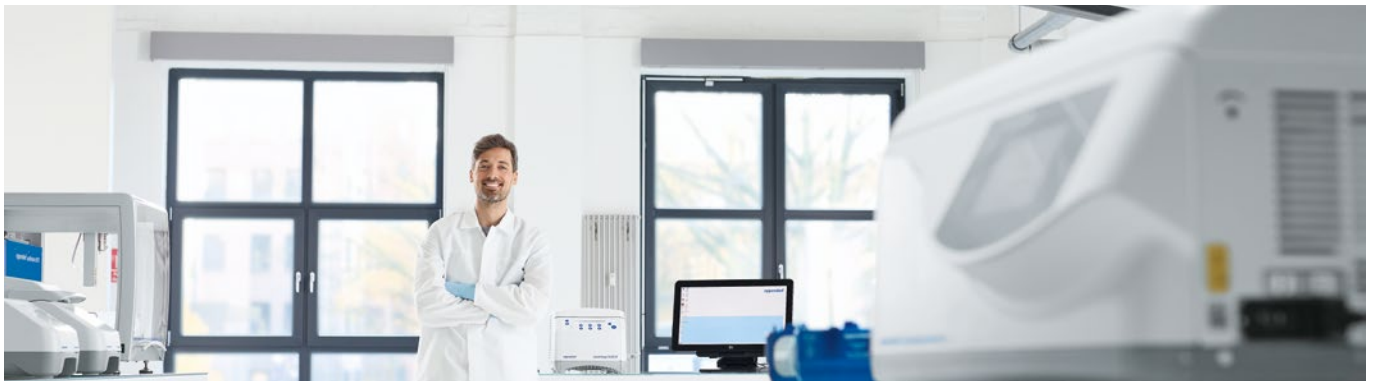

We introduced our very first centrifuge in 1964 as an integral part of the Eppendorf Microliter System, and revolutionized life science research practices worldwide. To this day, the Eppendorf name remains synonymous with creative design, innovative technology and reliable performance that stand the test of time.

The Eppendorf approach to product development is about listening to our customers' needs, understanding daily laboratory routines and anticipating future trends. The result is a comprehensive line of centrifuges that fulfill the demands for a wide range of applications. Our goal is to provide you with a product solution that not only leaves you thoroughly satisfied but that is also comfortable and easy to use. That is why Eppendorf centrifuges are designed to go beyond speed and capacity to offer you unparalleled ergonomic operation and superior temperature management. With this sound foundation and our extensive experience, Eppendorf is proud to serve you as your expert partner in centrifugation.

Our Centrifuge Portfolio – Your Centrifuge Solution

From your personal 12-place microcentrifuge to compact and super-versatile benchtop centrifuges to high-speed floorstanding and ultracentrifuges, our united portfolio offers comprehensive solutions for all your separation applications in the areas of molecular biology, biochemistry, cell biology and material science.

Microcentrifuges



General purpose centrifuges



Multipurpose centrifuges



Whether you wish to spin just a few tubes at a time or you require extra versatility for volumes up to four liters or high-throughput of tubes and plates, the Eppendorf benchtop centrifuge portfolio offers solutions for your daily separation tasks.

Looking to process more than four liters per run? Do you need increased speeds up to 110,000 x g? In either case, you will find our high-speed floorstanding centrifuges are your best choice. For super-speed applications requiring up to 1,050,000 x g, our range of innovative and user-friendly ultracentrifuges provide the perfect solution.

High-speed centrifuges



Ultracentrifuges



Your challenges are multidimensional – so are our offerings

In your daily research work, you will encounter a variety of challenges. That's why we continuously work to understand your unique issues and provide you with tailored solutions to suit your needs, so you can spend more time focusing on your research. Our solutions go beyond the centrifuge itself to provide everything you need to ensure the best performance and best results every day.

CENTRIFUGES

Our high-quality devices offer innovative features to optimize your experience and your results.

SUSTAINABILITY

Sustainable production, energy-saving operation and an innovative cooling system are just some of the ways Eppendorf supports the environment.

SERVICE

Enjoy peace-of-mind and maximize your uptime with your choice of epServices.

ROTORS & ADAPTERS

A great variety of accessories ensure application flexibility – for your separation tasks of today and tomorrow.

CONSUMABLES

Protect your valuable samples by using only the best consumables tailored to your needs in format, size and purity grades.

DIGITAL PRODUCTS

Get everything you need for a connected and paper-free lab of the future.



With Eppendorf at your side, you can be sure to have the best equipment as well as the best team to support you. From our trusted sales representatives to our dedicated applications and technical support teams to our highly skilled service technicians – you will always find a helping hand when you need it.

Learn more about the Eppendorf centrifuge portfolio!
Explore the eshop and get an overview!
www.eppendorf.com/centrifugation



Our Portfolio – Your Choice



Model	MiniSpin®/MiniSpin® plus	5418 R	5420
Positioning	Space-saving 12-place mini-centrifuge for quick spin downs even in the smallest workstation, non-refrigerated	Compact refrigerated 18-place microcentrifuge for temperature sensitive samples	Small footprint 24-place microcentrifuge for molecular biology routine applications, non-refrigerated
Page(s)	142	143	144
Max. capacity	12 × 1.5/2.0 mL	18 × 1.5/2.0 mL	24 × 1.5/2.0 mL
Max. RCF	12,100 × g/14,100 × g	16,873 × g	21,300 × g
Max. speed	13,400 rpm/14,500 rpm	14,000 rpm	15,060 rpm
Rotors available	2	1	2
Temperature control range		0 °C to +40 °C	
Dimensions (W × D × H)	22.5 × 23.0 × 13.0 cm / 8.86 × 9.06 × 5.12 in	30 × 46 × 25 cm / 11.7 × 18.23 × 9.8 in	24 × 35 × 22 cm / 9.4 × 13.8 × 8.7 in
Weight w/o accessories	3.7 kg / 8.16 lb/4.1 kg / 9 lb	22 kg / 48.5 lb	13 kg / 28.7 lb
Max. power consumption	70 W/85 W	320 W	290 W
Noise level	< 49 dB(A)/<52 dB(A)	< 57 dB(A)	< 56 dB(A)
Height (with open lid)	25 cm / 9.8 in	52 cm / 20 in	44 cm
Display	LCD	large LCD	large, brightly lit LCD
Tube/plate/bottle capacity			
1.5/2.0 mL Eppendorf Tubes®	12	18	24
Eppendorf Tubes® 5.0 mL	–	–	–
8-place PCR strips	2	–	4
15 mL conical tubes	–	–	–
25 mL conical tubes	–	–	–
50 mL conical tubes	–	–	–
13 mm round-bottom and blood collection tubes	–	–	–
16 mm round-bottom and blood collection tubes	–	–	–
17.5 mm round-bottom and blood collection tubes	–	–	–
PCR plates/MTP	–	–	–
Deepwell plates (DWP)	–	–	–



**5425 / 5425 R**

Whisper quiet 24-place standard microcentrifuge with outstanding feature set for broad range of applications, refrigerated for temperature-sensitive samples or non-refrigerated

145

10 × 5.0 mL

21,300 × g

15,060 rpm

6

-10 °C to +40 °C

24 × 39 × 24 cm / 9.5 × 15.4 × 9.5 in /

29 × 48 × 26 cm / 11.42 × 18.9 × 10.24 in

15.6 kg / 34.4 lb / 21.0 kg / 46.3 lb

280 W / 360 W

average of 45 dB(A) in the first 12 minutes and < 51 dB(A) thereafter with Rotor FA-24x2 / < 54 dB(A) for all other rotors

48 cm / 18.8 in / 50.8 cm / 20.0 in

large, brightly lit LCD

24

10

12

-

-

-

-

-

1 (divisible)

-

5427 R

High-throughput 48-place microcentrifuge, refrigerated (green cooling liquid (R290)) for temperature sensitive samples

147

48 × 1.5/2.0 mL

25,001 × g

16,220 rpm

9

-11 °C to 40 °C

31.9 × 54.0 × 25.4 cm / 12.6 × 21.3 × 10 in

30 kg / 66.1 lb

495 W

< 56 dB(A)

56 cm / 21.9 in

large, brightly lit LCD

48

12

6

-

-

-

-

-

-

-

5430 / 5430 R

Crossover microcentrifuge with high versatility and 12 rotor options including rotor for 15/50 mL conical tubes, 30-place high-speed rotor and swing-bucket rotor for MTPs or DWPs, refrigerated for temperature sensitive samples or non-refrigerated

149

48 × 1.5/2.0 mL, 6 × 50 mL, 2 × MTP

30,130 × g

17,500 rpm

12

-11 °C to 40 °C

34 × 42 × 25 cm / 11.2 × 16.3 × 9.8 in /

38 × 64 × 29 cm / 15 × 25.2 × 11.7 in

29 kg / 63.9 lb / 56 kg / 123.5 lb

475 W / 1,050 W

< 58 dB(A) with Rotor F-45-30-11 / < 54 dB(A) with Rotor F-45-30-11

56 cm / 21.8 in / 63 cm / 24.8 in

large, brightly lit LCD

48

16

8

6

6

6

12

12

2

2

Our Portfolio – Your Choice



Model	5702 / 5702 R / 5702 RH	5804 / 5804 R
Positioning	General purpose centrifuge with medium capacity for low speed cell culture applications, refrigerated for temperature sensitive samples, active heating and cooling to improve cell viability or non-refrigerated	High speed multipurpose centrifuge with medium capacity, refrigerated for temperature sensitive samples or non-refrigerated
Page(s)	152	156
Max. capacity	4 × 100 mL	4 × 250 mL/2 × 5 MTP
Max. RCF	3,000 × g	20,913 × g
Max. speed	4,400 rpm	14,000 rpm
Temperature control range	-9 °C to 40 °C / -9 °C to 42 °C	-9 °C to 40 °C
Dimensions (W × D × H)	32 × 40 × 24 cm / 12.6 × 15.6 × 9.6 in / 38 × 58 × 27 cm / 15 × 22.9 × 10.6 in / 38 × 58 × 27 cm / 15 × 22.9 × 10.6 in	46.6 × 55.0 × 33.7 cm / 18.4 × 21.7 × 13.3 in / 63.4 × 55.0 × 34.2 cm / 25.0 × 21.7 × 13.5 in
Footprint (dimensions w/o front panel, WxD)	32 × 40 cm / 12.6 × 15.6 in / 38 × 58 cm / 15 × 22.9 in	47 × 50 cm / 18.4 × 21.7 in / 64 × 50 cm / 25 × 21.7 in
Weight w/o accessories	19 kg / 41.9 lb / 35 kg / 77.1 lb / 35 kg / 77.1 lb	55 kg / 121.3 lb / 80 kg / 176.4 lb
Max. power consumption	200 W / 380 W / 380 W	900 W / 1,650 W
Noise level	< 52 dB(A) with Rotor A-4-38 / <46 dB(A) with Rotor A-4-38 / <46 dB(A) with Rotor A-4-38	< 62 dB(A) / < 58 dB(A)
Height (with open lid)	53 cm / 20.7 in / 60 cm / 23.4 in / 60 cm / 23.4 in	74 cm / 29 in
Display	LCD	large, brightly lit LCD
Tube/plate/bottle capacity		
1.5/2.0 mL Eppendorf Tubes®	24	104
Eppendorf Tubes® 5.0 mL	4	32
8-place PCR strips	–	6
15 mL conical tubes	20	40
25 mL conical tubes	4	16
50 mL conical tubes	4	16
13 mm round-bottom and blood collection tubes	40	56
16 mm round-bottom and blood collection tubes	16	52
17.5 mm round-bottom and blood collection tubes	24	48
180 – 250 mL bottles (flat)	–	4
500 mL Corning®	–	–
750 mL bottles	–	–
1,000 mL Eppendorf bottles	–	–
1,000 mL standard bottles	–	–
PCR plates/MTP	–	10
Deepwell plates (DWP)	–	4



**5810 / 5810 R**

Compact multipurpose centrifuge with medium capacity, refrigerated for temperature sensitive samples or non-refrigerated

156

4 x 750 mL/4 x 4 MTP

20,913 x g

14,000 rpm

-9 °C to 40 °C

53.5 x 60.8 x 34.5 cm / 21.1 x 23.9 x 13.6 in /

70.0 x 60.8 x 34.5 cm / 27.6 x 23.9 x 13.6 in

54 x 54 cm / 21.1 x 21.1 in /

70 x 54 cm / 27.6 x 21.1 in

68 kg / 149.9 lb / 99 kg / 218.3 lb

900 W / 1,650 W

<70 dB(A) / <56 dB(A)

80 cm / 31.5 in

large, brightly lit LCD

200

56

6

56

32

28

100

80

80

4

4

4

-

-

16

4

5910 Ri

Super versatile multipurpose centrifuge with an intuitive touch screen user interface and high capacity for a broad range of consumables, refrigerated for temperature sensitive samples

176

68 x 15 mL/36 x 50 mL/4 x 1000 mL/ 4 x 5 MTP

22,132 x g

14,000 rpm

-11 °C to 40 °C

72 x 68 x 37 cm / 28.3 x 25.9 x 14.5 in

72 x 62 cm / 28.3 x 24.4 in

109 kg / 240.3 lb

1,650 W

<59 dB(A) with Rotor FA-6x50

85 cm / 33.5 in

VisioNize® touch interface

200

68

-

68

36

36

120

104

84

6

4

4

4

-

20

8

5920 R

High-throughput multipurpose centrifuge with very high capacity, refrigerated for temperature sensitive samples

176

4 x 1,000 mL/4 x 7 MTP

21,194 x g

13,700 rpm

-11 °C to 40 °C

74 x 71 x 40 cm / 29.2 x 27.8 x 15.9 in

74 x 67 cm / 29.2 x 26.4 in

139 kg / 286.6 lb

1,650 W

<55 dB(A)

94 cm / 37 in

large, brightly lit LCD

368

108

-

108

52

52

196

148

80

8

4

4

-

4

28

8

Our Portfolio – Your Choice



Model	CR22N	CR30NX
Description	High-speed floorstanding centrifuge with high capacity, ideal for harvesting of biomass in up to 6 L per run. Refrigerated for temperature sensitive samples.	2-in-1 high-speed floorstanding centrifuge with vacuum function, suitable for applications with super-speed requirements up to 110,000 x g and large volumes. Refrigerated for temperature sensitive samples.
Page(s)	208	212
Capacity¹⁾	up to 4 x 1.5 Liter	up to 4 x 1.5 Liter and continuous flow (>10 L)
Max. RCF	58,700 x g	110,000 x g
Max. speed	22,000 rpm	30,000 rpm
Temperature control range	-20 to 40°C	-20 to 40°C
Dimensions (WxDxH)	70 x 76 x 91.5 cm/ 27.5 x 30 x 36 in	70.8 x 89.2 x 86.6 cm/ 27.8 x 35.1 x 34 in
Height (with open lid)	151 cm/59.4 in	150 cm/59 in
Footprint (WxD)	70 x 76 cm/ 27.5 x 30 in	70.8 x 89.2 cm/ 27.8 x 35.1 in
Weight (w/o accessories)	260 kg/ 573.2 lbs	310 kg/ 683.4 lbs
Data Export	Yes	Yes
Noise level (max.)	≤ 64 dB(A)	≤ 56 dB(A)
Display	5.7 inch color touch-sensitive LCD panel	6.5 inch color touch-sensitive LCD panel
Numer of programs	30	1,000
Tracking of Rotor Usage	By serial number	By serial number
User Managment	yes	yes
Data Export	yes	yes
Vacuum function	no	yes

¹⁾ Refers to the nominal volume. The maximum filling volume may depend on the application, rotor and speed. Please consult with your sales representative for further details.



CP100NX/ CP90NX/ CP80NX

Ultracentrifuge with a broad rotor portfolio. Three versions with shared functionality but different speed offerings are available to match your personal speed requirements.

216

up to 6 x 230 mL

803,000 x g/ 700,000 x g/ 615,000 x g

100,000 rpm/ 90,000 rpm/ 80,000 rpm

0 to 40°C

79 x 69 x 89 cm/ 31.1 x 27.1 x 35 in

88 cm/35 in

79 x 89 cm/ 31.1 x 35.0 in

390 kg/ 860 lbs

Yes

≤ 51 dB(A)

6.5 inch color touch-sensitive LCD panel

1,000

Rotor life management

yes

yes

yes

CS150FNX

Floorstanding micro-ultracentrifuge with speeds of up to 1,050,000 x g in a very compact design.

218

up to 6 x 30 mL

1,050,000 x g

150,000 rpm

0 to 40°C

44 x 52 x 91 cm/ 17.3 x 20.5 x 35.8 in

91 cm/35.8 in

44 x 52 cm/ 17.3 x 20.5 in

105 kg/ 231 lbs

Yes

≤ 45 dB(A)

6.5 inch color touch-sensitive LCD panel

20

By serial number

yes

yes

yes

CS150NX

Benchtop micro-ultracentrifuge with speeds of up to 1,050,000 x g, offering a flexible placement within the lab with standard electricity requirements and its compact design.

218

up to 6 x 30 mL

1,050,000 x g

150,000 rpm

0 to 40°C

59 x 58.2 x 40.8 cm/ 23.2 x 22.9 x 16 in

40.8 cm/16 in

59 x 58.2 cm/ 23.2 x 22.9 lbs

97 kg/ 214 lbs

Yes

≤ 45 dB(A)

6.5 inch color touch-sensitive LCD panel

20

By serial number

yes

yes

yes

Centrifuges and Rotors

MiniSpin®/MiniSpin® plus

**Description**

MiniSpin® and MiniSpin® plus are entry-level mini centrifuges that are powerful, easy-to-use and small enough to allow individual workstations to be equipped with a portable centrifuge.

Product features

- > Rotor capacity: 12 × 1.5/2.0 mL vessels, 2 × 8-tube PCR strips
- > Max. speed: 14,100 × g (14,500 rpm)
- > Extremely compact footprint

Special features for MiniSpin plus

- > Automatic rpm/rcf conversion
- > Extended time to 99 min or continuous centrifugation

www.eppendorf.com/minispin

**Rotor F-45-12-11**

- > for 12 × 1.5/2.0 mL tubes

**Rotor F-55-16-5 PCR**

- > for 2 × PCR strips

Ordering information

Description	Order no.
Centrifuge MiniSpin®, keypad, non-refrigerated, with Rotor F-45-12-11, 230 V/50 – 60 Hz (GB)	5452 000 060
Centrifuge MiniSpin® plus, keypad, non-refrigerated, with Rotor F-45-12-11, 230 V/50 – 60 Hz (GB)	5453 000 060
Rotor F-45-12-11, angle 45°, 12 places, max. tube diameter 11 mm, incl. rotor lid and rotor nut, MiniSpin®/MiniSpin® plus	5452 720 008
Rotor F-55-16-5 PCR, angle 55°, 16 places, max. tube diameter 5 mm, incl. rotor lid (aluminum), MiniSpin®/MiniSpin® plus	5452 727 007
Adapter, for 1 PCR tube (0.2 mL, max. Ø 6 mm), for all 1.5/2.0 mL rotors, 6 pcs.	5425 715 005
Adapter, for 1 micro test tube (0.4 mL, max. Ø 6 mm), for all 1.5/2.0 mL rotors, 6 pcs.	5425 717 008
Adapter, for 1 sample tube (0.5 mL, max. Ø 8 mm) or 1 Microtainer® (0.6 mL, max. Ø 8 mm), for all 1.5/2.0 mL rotors, 6 pcs.	5425 716 001

✎ Ordering information for other voltage options begins on page 349

Centrifuge 5418 R



Description

Centrifuge 5418 R is an 18-place microcentrifuge that is specifically designed for low to medium capacity in 1.5/2.0 mL tubes and Microtainer®. The speed of up to 16,873 × g allows for standard molecular biology applications.

Product features

- > Max. rotor capacity: 18 × 1.5/2.0 mL vessels
- > Max. speed: 16,873 × g (14,000 rpm)
- > Small footprint and low access height of 23 cm



Adapter for BD Microtainer® and 0.5 mL tubes

- > The adapter can be used with every Eppendorf rotor for 1.5/2.0 mL tubes

www.eppendorf.com/centrifuge5418R



Rotor FA-45-18-11

- > for 18 × 1.5/2.0 mL tubes, comes standard with unique Eppendorf QuickLock® aerosol-tight lid for fast and reliable locking



Adapter for 0.2 mL PCR Tubes

- > Ideal to spin down PCR Tubes after reaction setup. Adapter fits in any Eppendorf 1.5/2.0 mL rotor

Ordering information

Description	Order no.
Centrifuge 5418 R , rotary knobs, refrigerated, with Rotor FA-45-18-11 and rotor lid, 230 V/50 – 60 Hz (GB)	5401 000 060
Rotor FA-45-18-11 , aerosol-tight, 45° angle, 18 places, max. tube Ø 11 mm, incl. rotor lid (aluminum)	5418 707 005
Adapter , for 1 PCR tube (0.2 mL, max. Ø 6 mm), for all 1.5/2.0 mL rotors, 6 pcs.	5425 715 005
Adapter , for 1 sample tube (0.5 mL, max. Ø 8 mm) or 1 Microtainer® (0.6 mL, max. Ø 8 mm), for all 1.5/2.0 mL rotors, 6 pcs.	5425 716 001
Adapter , for 1 micro test tube (0.4 mL, max. Ø 6 mm), for all 1.5/2.0 mL rotors, 6 pcs.	5425 717 008

✓ Ordering information for other voltage options begins on page 349

Centrifuge 5420



Description

Centrifuge 5420 supports your nucleic acid purification and gel-extraction workflows. This centrifuge offers 24-place capacity in an aerosol-tight rotor and speeds up to $21,300 \times g$ in a small footprint.

Product features

- > Standard rotor for up to 24 x 1.5 and 2.0 mL tubes
- > Rotor option for up to 32 x 0.2 mL PCR tubes or 4 x 8-place PCR strips
- > Adapters for 0.2, 0.4 and 0.5 mL tubes as well as 0.6 mL BD Microtainer®



www.eppendorf.com/centrifuge5420



Rotor FA-24x2

- > Max. speed: $21,300 \times g$ (15,060 rpm)
- > Max. capacity: 24 x 1.5/2.0 mL tubes
- > Aerosol-tight



Rotor F-32x0.2-PCR

- > Max. speed: $18,257 \times g$ (15,060 rpm)
- > Max capacity: 4 x PCR strips or 32 x PCR tubes (0.2 mL)

Ordering information

Description	Order no.
Centrifuge 5420, keypad, non-refrigerated, without rotor, 230 V/50 – 60 Hz (GB)	5420 000 369
Centrifuge 5420, keypad, non-refrigerated, with aerosol-tight Rotor FA-24x2, 230 V/50 – 60 Hz (GB)	5420 000 164
Rotor F-32x0.2-PCR, incl. rotor lid, for 32 x 0.2 mL PCR tubes or 4 x 8 PCR tube strips, for 5420	5495 404 007
Rotor FA-24x2, aerosol-tight, incl. rotor lid, aerosol-tight, for 24 x 1.5/2.0 mL tubes, for 5420	5495 400 001
Adapter, for 1 PCR tube (0.2 mL, max. Ø 6 mm), for all 1.5/2.0 mL rotors, 6 pcs.	5425 715 005
Adapter, for 1 sample tube (0.5 mL, max. Ø 8 mm) or 1 Microtainer® (0.6 mL, max. Ø 8 mm), for all 1.5/2.0 mL rotors, 6 pcs.	5425 716 001
Adapter, for 1 micro test tube (0.4 mL, max. Ø 6 mm), for all 1.5/2.0 mL rotors, 6 pcs.	5425 717 008

✎ Ordering information for other voltage options begins on page 349

Centrifuge 5425/5425 R



www.eppendorf.com/centrifuge5425/5425R

Description

Eppendorf microcentrifuges 5425 and 5425 R are true laboratory standards. These whisper quiet 24-place microcentrifuges offer an outstanding set of features for a broad range of molecular and cell biology applications in Eppendorf and PCR tubes from 0.2 to 5 mL. The refrigerated Centrifuge 5425 R provides precise temperature control for processing temperature-sensitive samples with its advanced cooling system.

Product features

- > Aerosol-tight Eppendorf QuickLock® lids for simple and safe handling
- > Outstanding software features (e.g. adjustable acceleration and braking ramps, 3 program buttons (only Centrifuge 5425), short function without continuous pressing of the key)
- > Extended rotor program (e.g. 5.0 mL rotor, swing-bucket rotor for PCR strips)

Main Features



Enhanced convenience

- > One push short-spin key – no need to hold key all the while



Improved ergonomics

- > Eppendorf QuickLock® rotors for ergonomic lid locking
- > Closes with only a 1/4 turn and takes repetitive stress of your wrist



Increased versatility

- > Swing-bucket rotor for divisible plates to speed up your PCR/qPCR setup
- > 10-place 5.0 mL rotor for screw cap and snap lid tubes

Ordering information

Description	Order no.
Centrifuge 5425, keypad, non-refrigerated, without rotor, 230 V/50 – 60 Hz (GB)	5405 000 360
Centrifuge 5425, rotary knobs, non-refrigerated, without rotor, 230 V/50 – 60 Hz (GB)	5405 000 760
Centrifuge 5425, keypad, non-refrigerated, with Rotor FA-24x2, 230 V/50 – 60 Hz (GB)	5405 000 166
Centrifuge 5425, rotary knobs, non-refrigerated, with Rotor FA-24x2, 230 V/50 – 60 Hz (GB)	5405 000 565
Centrifuge 5425, rotary knobs, non-refrigerated, Molecular Biology Solution, with Rotor FA-18x2-Kit, 230 V/50 – 60 Hz (GB)	5405 000 182
Centrifuge 5425 R, keypad, refrigerated, without rotor, 230 V/50 – 60 Hz (GB)	5406 000 364
Centrifuge 5425 R, rotary knobs, refrigerated, without rotor, 230 V/50 – 60 Hz (GB)	5406 000 763
Centrifuge 5425 R, keypad, refrigerated, with Rotor FA-24x2, 230 V/50 – 60 Hz (GB)	5406 000 160
Centrifuge 5425 R, rotary knobs, refrigerated, with Rotor FA-24x2, 230 V/50 – 60 Hz (GB)	5406 000 569

✎ Ordering information for other voltage options begins on page 349

Your local distributor: www.eppendorf.com/contact

Eppendorf UK Limited · Gateway 1000 · Whittle Way · Stevenage SG1 2FP · United Kingdom · sales@eppendorf.co.uk · www.eppendorf.co.uk · www.eppendorf.com/eshop

Centrifuges and Rotors

Rotors for Centrifuge 5425/5425R

**Rotors FA-24x2**

- > Max. speed: 21,300 × g (15,060 rpm)
- > Max. capacity: 24 × 1.5/2.0 mL tubes
- > Aerosol-tight with Eppendorf QuickLock® lid

**Rotor FA-24x2-PTFE**

- > Max. speed: 21,300 × g (15,060 rpm)
- > Max. capacity: 24 × 1.5/2.0 mL tubes
- > Aerosol-tight with Eppendorf QuickLock® lid
- > PTFE coating for increased chemical resistance

**Rotor FA-10x5**

- > Max. speed: 21,300 × g (15,060 rpm)
- > Max capacity: 10 × Eppendorf Tubes® 5.0 mL
- > Aerosol-tight with Eppendorf QuickLock® lid

**Rotor FA-18x2 Kit**

- > Max. speed: 18,565 × g (15,060 rpm)
- > Rotor with higher edge for safe centrifugation of up to 18 spin columns
- > Aerosol-tight with Eppendorf QuickLock® lid

**Rotor F-32x0.2-PCR**

- > Max. speed: 18,134 × g (15,060 rpm)
- > for 4 × PCR strips or 32 × PCR tubes (0.2 mL)

**Rotor 96x0.2-PCR**

- > Max. speed: 3,217 × g (6,000 rpm)
- > Unique swing bucket rotor for 12 × 8 PCR strips 0.1/0.2 mL or 4 × 1/4 twin.tec® PCR plate 96, unskirted divisible or 96 × PCR tubes 0.2 mL

Ordering information

Description	Order no.
Rotor FA-24x2 , aerosol-tight, incl. rotor lid, for 24 × 1.5/2.0 mL tubes	5495 500 006
Rotor FA-24x2-PTFE , aerosol-tight, incl. rotor lid, PTFE coated, for 24 × 1.5/2.0 mL tubes	5495 503 005
Rotor FA-10x5 , aerosol-tight, incl. rotor lid, for 10 × 5.0 mL tubes (snap and screw cap)	5495 505 008
Rotor FA-18x2-Kit , aerosol-tight, incl. rotor lid, for 18 × 1.5/2.0 mL tubes or spin columns	5495 508 007
Rotor F-32x0.2-PCR , incl. rotor lid, for 32 × 0.2 mL PCR tubes or 4 × 8 PCR strips	5495 510 001
Rotor S-96x0.2-PCR , for 96 × 0.2 mL PCR tubes or 12 × 8 PCR strips, incl. buckets	5495 512 004
Adapter , for 1 PCR tube (0.2 mL, max. Ø 6 mm), for all 1.5/2.0 mL rotors, 6 pcs.	5425 715 005
Adapter , for 1 sample tube (0.5 mL, max. Ø 8 mm) or 1 Microtainer® (0.6 mL, max. Ø 8 mm), for all 1.5/2.0 mL rotors, 6 pcs.	5425 716 001
Adapter , for 1 vessel 1.5 – 2.0 mL, for all 5.0 mL rotors, 4 pcs.	5820 768 002
Adapter , for 1 cryo tube, for all 5.0 mL rotors, 4 pcs.	5820 769 009
Adapter , for 1 HPLC tube, for all 5.0 mL rotors, 4 pcs.	5820 770 007
Adapter , for 1 micro test tube (0.4 mL, max. Ø 6 mm), for all 1.5/2.0 mL rotors, 6 pcs.	5425 717 008

Centrifuge 5427 R

New



Description

Eppendorf Centrifuge 5427 R is a high-speed, refrigerated microcentrifuge for high-throughput research. It doubles your tube capacity compared to a standard 24-place microcentrifuge thanks to its 48-place double-row rotor, while contributing to a more sustainable lab environment with its natural refrigerant.

Product features

- > Cooled with natural refrigerant (R290) to protect your samples - and the planet
- > Rotor capacity: 48 × 1.5/2.0 mL, 12 × 5.0 mL; Eppendorf QuickLock® rotor allows for fast and ergonomic lid locking
- > Max. speed: 25,001 × g (16,220 rpm)



www.eppendorf.com/centrifuge5427R

Ordering information

Description	Order no.
Centrifuge 5427 R, rotary knobs, refrigerated, without rotor, 230 V/50 – 60 Hz (GB)	*
Centrifuge 5427 R, rotary knobs, refrigerated, with Rotor FA-45-30-11, 230 V/50 – 60 Hz (GB)	*
Centrifuge 5427 R, rotary knobs, refrigerated, with Rotor FA-45-48-11, 230 V/50 – 60 Hz (GB)	*

* To find the correct order number for your country, please have a look on page 349 and forward, or please check our local website or contact your local sales representative. www.eppendorf.com/distributors



Rotor S-24-11-AT

- > Max. speed: 16,049 × g (12,700 rpm)
- > Swing-bucket rotor for 24 × 1.5/2.0 mL tubes
- > Aerosol-tight with Eppendorf QuickLock® lid



Rotor FA-45-12-17

- > Max. speed: 20,598 × g (14,000 rpm)
- > Max capacity: 12 × Eppendorf Tubes® 5.0 mL
- > Aerosol-tight with Eppendorf QuickLock® lid



Rotor F-45-48-5-PCR

- > Max. speed: 11,710 × g (10,500 rpm)
- > PCR strip rotor for up to 48 × 0.2 mL PCR tubes

Rotor options continued on next page.

Centrifuges and Rotors

Rotors for Centrifuge 5427 R

**Rotor F-45-48-11**

- > Max. speed: 18,213 × g (12,700 rpm)
- > Max. capacity: 48 × 1.5/2.0 mL tubes

**Rotor FA-45-48-11**

- > Max. speed: 18,213 × g (12,700 rpm)
- > Max. capacity: 48 × 1.5/2.0 mL tubes
- > Aerosol-tight with Eppendorf QuickLock® lid

**Rotor FA-45-30-11**

- > Max. speed: 20,817 × g (14,000 rpm)
- > Max. capacity: 30 × 1.5/2.0 mL tubes
- > Aerosol-tight with Eppendorf QuickLock® lid

**Rotor F-45-30-11**

- > Max. speed: 20,817 × g (14,000 rpm)
- > Max. capacity: 30 × 1.5/2.0 mL tubes

**Rotor FA-45-24-11**

- > Max. speed: 25,001 × g (16,220 rpm)
- > Max. capacity: 24 × 1.5/2.0 mL tubes
- > Aerosol-tight with Eppendorf QuickLock® lid

**Rotor FA-45-24-11-Kit**

- > Max. speed: 19,090 × g (13,200 rpm)
- > Rotor with higher rim for safe centrifugation of up to 24 spin columns
- > Aerosol-tight with Eppendorf QuickLock® lid

Ordering information

Description	Order no.
Rotor FA-45-48-11 , aerosol-tight, incl. rotor lid, for 5427R	5409 710 001
Rotor F-45-48-11 , incl. rotor lid, aluminum	5409 712 004
Rotor FA-45-30-11 , aerosol-tight, incl. rotor lid, aluminum	5409 706 004
Rotor F-45-30-11 , incl. rotor lid, aluminum	5409 708 007
Rotor FA-45-24-11 , aerosol-tight, incl. rotor lid, aluminum	5409 702 009
Rotor FA-45-24-11-Kit , aerosol-tight, incl. rotor lid, aluminum	5409 704 001
Rotor S-24-11-AT , aerosol-tight, stainless steel	5409 715 003
Rotor F-45-48-5-PCR , aluminum	5409 714 007
Rotor FA-45-12-17 , aerosol-tight, incl. rotor lid, aluminum	5409 700 006
Adapter , for 1 PCR tube (0.2 mL, max. Ø 6 mm), for all 1.5/2.0 mL rotors, 6 pcs.	5425 715 005
Adapter , for 1 sample tube (0.5 mL, max. Ø 8 mm) or 1 Microtainer® (0.6 mL, max. Ø 8 mm), for all 1.5/2.0 mL rotors, 6 pcs.	5425 716 001
Adapter , for 1 vessel 1.5 – 2.0 mL, for all 5.0 mL rotors, 4 pcs.	5820 768 002
Adapter , for 1 cryo tube, for all 5.0 mL rotors, 4 pcs.	5820 769 009
Adapter , for 1 HPLC tube, for all 5.0 mL rotors, 4 pcs.	5820 770 007
Adapter , for 1 micro test tube (0.4 mL, max. Ø 6 mm), for all 1.5/2.0 mL rotors, 6 pcs.	5425 717 008

Centrifuge 5430/5430 R



Description

Combine the best of both worlds with Centrifuge 5430 and 5430 R. These high-speed centrifuges have the small footprint of a microcentrifuge and the versatility of a multipurpose centrifuge.

Product features

- > Max. rotor capacity: 48 × 1.5/2.0 mL, 6 × 50 mL, 2 × MTP
- > Max. speed: 30,130 × g (17,500 rpm)
- > Remarkable versatility with 12 different rotors



www.eppendorf.com/centrifuge5430

Ordering information

Description	Order no.
Centrifuge 5430, keypad, non-refrigerated, without rotor, 230 V/50 – 60 Hz (GB)	5427 000 060
Centrifuge 5430, rotary knobs, non-refrigerated, without rotor, 230 V/50 – 60 Hz (GB)	5427 000 660
Centrifuge 5430, keypad, non-refrigerated, with Rotor FA-45-30-11 incl. rotor lid, 230 V/50 – 60 Hz (GB)	5427 000 260
Centrifuge 5430, rotary knobs, non-refrigerated, with Rotor FA-45-30-11 incl. rotor lid, 230 V/50 – 60 Hz (GB)	5427 000 465
Centrifuge 5430, rotary knobs, non-refrigerated, Low-Throughput Plate Solution, with Rotor A-2-MTP, 230 V/50 – 60 Hz (GB)	5427 000 186
Centrifuge 5430 R, keypad, refrigerated, without rotor, 230 V/50 – 60 Hz (GB)	5428 000 255
Centrifuge 5430 R, rotary knobs, refrigerated, without rotor, 230 V/50 – 60 Hz (GB)	5428 000 655
Centrifuge 5430 R, keypad, refrigerated, with Rotor FA-45-30-11 incl. rotor lid, 230 V/50 – 60 Hz (GB)	5428 000 060
Centrifuge 5430 R, rotary knobs, refrigerated, with Rotor FA-45-30-11 incl. rotor lid, 230 V/50 – 60 Hz (GB)	5428 000 460

✂ Ordering information for other voltage options begins on page 349

Rotors for Centrifuge 5430/5430 R



Rotor FA-45-48-11

- > Max. speed: 18,210 × g (12,700 rpm)
- > Max. capacity: 48 × 1.5/2.0 mL tubes
- > Aerosol-tight for safe centrifugation of hazardous samples



Rotor F-45-48-11

- > Max. speed: 18,210 × g (12,700 rpm)
- > Max. capacity: 48 × 1.5/2.0 mL tubes



Rotor S-24-11-AT

- > Max. speed: 16,049 × g (12,700 rpm)
- > Swing-bucket rotor for 24 × 1.5/2.0 mL tubes
- > Aerosol-tight with Eppendorf QuickLock® lid

Centrifuges and Rotors

Rotors for Centrifuge 5430/5430 R

**Rotor FA-45-16-17**

- > Max. speed: 21,191 × g (14,200 rpm)
- > Max. capacity: 16 × Eppendorf Tubes® 5.0 mL¹⁾
- > Aerosol-tight for safe centrifugation of hazardous samples

¹⁾ Snap cap - reduced capacity for 5 mL screw cap tubes

**Rotor FA-45-30-11**

- > Max. speed: 25,000 × g (15,350 rpm)
- > Max. capacity: 30 × 1.5/2.0 mL tubes
- > Aerosol-tight for safe centrifugation of hazardous samples

**Rotor FA-45-24-11-Kit**

- > Max. speed: 19,090 × g (13,200 rpm)
- > Rotor with higher rim for safe centrifugation of up to 24 spin columns
- > Aerosol-tight for safe centrifugation of hazardous samples

**Rotor F-45-30-11**

- > Max. speed: 20,817 × g (14,000 rpm)
- > Max. capacity: 30 × 1.5/2.0 mL tubes
- > PTFE coating for increased chemical resistance

**Rotor FA-45-24-11-HS**

- > Max. speed: 30,130 × g (17,500 rpm)
- > Max. capacity: 24 × 1.5/2.0 mL tubes
- > Extremely fast separation results
- > Aerosol-tight for safe centrifugation of hazardous samples
- > PTFE coating for increased chemical resistance

**Rotor F-35-6-30**

- > Max. speed: 7,745 × g (7,830 rpm)
- > Rotor for 6 × 15/50 mL conical or 12 × Vacutainer® tubes

**Rotor A-2-MTP**

- > Max. speed: 2,204 × g (4,680 rpm)
- > 2-place swing-bucket rotor for MTP, PCR and Deepwell Plates (max. 0.5 mL)
- > Windshield design for quiet operation

**Rotor F-45-64-5-PCR**

- > Max. speed: 13,543 × g (11,800 rpm)
- > PCR strip rotor for up to 64 × 0.2 mL PCR tubes

**Rotor F-45-18-17-Cryo**

- > Max. speed: 8,324 × g (8,900 rpm)
- > 18-place rotor for Cryo tubes

Ordering information

Description	Order no.
Rotor FA-45-16-17 , aerosol-tight, incl. rotor lid, for 16 × Eppendorf Tubes® 5.0 mL	5427 750 002
Adapter , for 1 PCR tube (0.2 mL, max. Ø 6 mm), for all 1.5/2.0 mL rotors, 6 pcs.	5425 715 005
Adapter , for 1 sample tube (0.5 mL, max. Ø 8 mm) or 1 Microtainer® (0.6 mL, max. Ø 8 mm), for all 1.5/2.0 mL rotors, 6 pcs.	5425 716 001
Rotor FA-45-48-11 , aerosol-tight, incl. rotor lid, for 5430/5430R	5427 754 008
Rotor F-45-48-11 , incl. rotor lid	5427 755 004
Rotor S-24-11-AT , aerosol-tight, incl. rotor lid, stainless steel	5427 757 007
Rotor FA-45-30-11 , aerosol-tight, incl. rotor lid, for 5430/5430R	5427 753 001
Rotor FA-45-24-11-Kit , aerosol-tight, incl. rotor lid	5427 752 005
Rotor F-45-30-11 , incl. rotor lid, PTFE coated	5427 712 003
Rotor FA-45-24-11-HS , aerosol-tight, incl. rotor lid, PTFE coated	5427 710 000
Rotor F-35-6-30 , incl. rotor lid, with 6 adapters each for 15 mL/50 mL conical tubes	5427 716 009
Rotor A-2-MTP , incl. wind shield and rotor lid, with 2 buckets	5427 700 005
Rotor F-45-64-5-PCR , incl. rotor lid and adapters	5427 714 006
Rotor F-45-18-17-Cryo , incl. rotor lid and cryovial adapters	5427 705 007
Adapter , for 1 cryo tubes (max. Ø 13 mm) or sealable centrifugation tubes (Ø 12.2 mm), max. length 50 mm, for Rotor F-45-18-17-Cryo, 6 pcs.	5702 752 002
Adapter , for 1 vessel 1.5 – 2.0 mL, for all 5.0 mL rotors, 4 pcs.	5820 768 002
Adapter , for 1 cryo tube, for all 5.0 mL rotors, 4 pcs.	5820 769 009
Adapter , for 1 HPLC tube, for all 5.0 mL rotors, 4 pcs.	5820 770 007
Adapter , for 1 micro test tube (0.4 mL, max. Ø 6 mm), for all 1.5/2.0 mL rotors, 6 pcs.	5425 717 008
Adapter , for 1 HPLC vessel 1.5 mL, for Rotor F-45-18-17-Cryo, 18 pcs.	5427 708 006

Adapter options for Rotor F-35-6-30

Adapter	Rotor capacity ³⁾	Max. tube dimensions Ø x L	Max. RCF	For bore hole	Order no. ⁴⁾
13 mm round	12	13 × 65 – 89 mm	6,443 × g	small	5427 740 007
			6,100 × g	large	5427 742 000
13 mm round	12	13 × 90 – 110 mm	7,471 × g	small	5427 741 003
			7,129 × g	large	5427 743 006
16 mm round	12	16 × 75 – 105 mm	7,005 × g	small	5427 732 004
			7,005 × g	large	5427 734 007
17 mm round	12	17 × 90 – 125 mm	7,745 × g	small	5427 735 003
			7,403 × g	large	5427 738 002
Eppendorf Tubes® 5.0 mL		17.5 × 80 mm	6,237 × g	small	5427 746 005
			7,129 × g	large	5427 747 001
15 mL conical	6	17.5 × 100 – 125 mm	7,540 × g	small	5427 726 004
30 mL round	6	26 × 92 – 112 mm	7,087 × g	large	5427 736 000
50 mL round	6	29 × 95 – 125 mm	7,581 × g	large	5427 737 006
50 mL conical	6 ^{1) 2)}	29.5 × 100 – 125 mm	7,197 × g	large	5427 727 000
Centriprep®	6	29.5 × 100 – 125 mm	7,567 × g	large	5427 723 005

¹⁾ Three sets of 2 included with Rotor F-35-6-30. ²⁾ Adapter accommodates skirted 50 mL conical tubes. ³⁾ Please perform a manual test to determine the actual loading capacity. ⁴⁾ Set of 2

Centrifuges and Rotors

Centrifuge 5702/5702 R/5702 RH









www.eppendorf.com/centrifuge5702

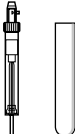
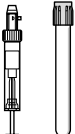
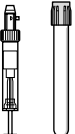

Ordering information

Description	Order no.
Centrifuge 5702 , rotary knobs, non-refrigerated, without rotor, 230 V/50 – 60 Hz (GB)	5702 000 065
Centrifuge 5702 , rotary knobs, non-refrigerated, with Rotor A-4-38 incl. adapters for 15/50 mL conical tubes, 2 sets of 2 adapters, 230 V/50 – 60 Hz (GB)	5702 000 365
Centrifuge 5702 R , rotary knobs, refrigerated, without rotor, 230 V/50 – 60 Hz (GB)	5703 000 060
Centrifuge 5702 R , rotary knobs, refrigerated, with Rotor A-4-38 incl. adapters for 13/16 mm blood collection tubes, 2 sets of 2 adapters, 230 V/50 – 60 Hz (GB)	5703 000 360
Centrifuge 5702 R , rotary knobs, refrigerated, with Rotor A-4-38 incl. adapters for 15/50 mL conical tubes, 2 sets of 2 adapters, 230 V/50 – 60 Hz (GB)	5703 000 460
Centrifuge 5702 RH , rotary knobs, refrigerated/heated, without rotor, 230 V/50 – 60 Hz (GB)	5704 000 060
Centrifuge 5702 , rotary knobs, non-refrigerated, with Rotor A-4-38 incl. adapters for round-bottom tubes 4 – 10 mL and adapters for round-bottom tubes 2.6 – 7 mL, 2 sets of 2 adapters, 230 V/50 – 60 Hz (EU)	5702 000 515

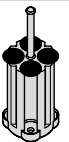
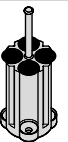
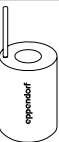
						
Adapters for Rotor A-4-38 with round buckets						
Tube Volume	1.5 – 2.0 mL	1 – 1.4 mL	2 – 7 mL	2.6 – 7 mL	4 – 10 mL	Eppendorf Tubes® 5.0 mL
Max. tube diameter	11 mm	8.5 mm	12.5 mm	13.5 mm	16 mm	17 mm
Max. vessel height	43 mm	100 mm	100 mm	100 mm	100 mm	60 mm
Max. vessel height for use with cap/lid¹⁾	43 mm	100 mm	100 mm	100 mm	100 mm	60 mm
Adapter						
Number of vessels per adapter/rotor	4/16	5/20	5/20	4/16	4/16	1/4
Bottom shape	round	flat	flat	flat	flat	flat
Centrifugation radius	134 mm	132 mm	132 mm	132 mm	132 mm	136 mm
Max. RCF	2,900 × g	2,850 × g	2,850 × g	2,850 × g	2,850 × g	2,943 × g
Packing	2 pcs.	2 pcs.	2 pcs.	2 pcs.	2 pcs.	2 pcs.
Order no.	5702 745 006	5702 736 007	5702 737 003	5702 719 005	5702 735 000	5702 733 008

¹⁾ Exceeding the maximum tube length may reduce the loading capacity of the rotor. Please perform a manual swing-out test before starting the centrifuge run to make sure the tubes do not hit the rotor yoke.

²⁾ Please order adapter for 25 mL conical tubes screw cap 5820 734 000.³⁾ Please order adapter for 25 mL conical tubes snap cap 5820 733 004.

Description

Are you looking to improve your work environment? The 5702 family of low-speed centrifuges are quiet in operation, compact in design and provide six different rotor options to accommodate any type of tube and requirement for low to mid-throughput applications in immunology research and cell culture.











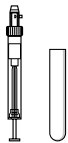

Rotor A-4-38 with round buckets

- > Maximum speed: 3,000 × g (4,400 rpm)
- > Standard rotor for centrifugation of blood collection tubes or 15/50 mL conical tubes
- > Round buckets for vessels with 1.5 – 100 mL

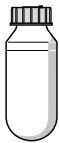
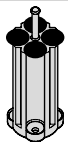
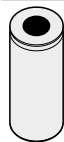
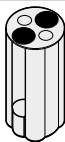
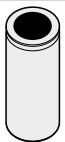
Ordering information

Description	Order no.
Rotor A-4-38 with round buckets , 8 positions, max. Ø 38 mm, incl. 4 round buckets 100 mL	5702 720 003
16 x 125 mm bucket , for 16 x 125 mm round bottom tubes, non aerosol-tight, for rotor A-4-38, 4 pcs.	5702 764 000
Rotor A-4-38 , 8 positions, max. Ø 38 mm, without buckets	5702 740 004
Round bucket 100 mL , for Rotor A-4-38, 4 pcs.	5702 722 006
Caps for 100 mL round buckets , aerosol-tight, 2 pcs.	5702 721 000

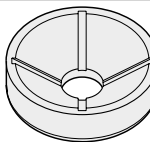











							
9 – 15 mL	15 mL conical	15 mL conical	25 mL	25 mL screw cap ²⁾	25 mL snap cap ³⁾	50 mL screw cap	85/100 mL
17.5 mm	17.2 mm	17.2 mm	39 mm	30 mm	30 mm	30 mm	38 mm
100 mm	121 mm	121 mm		78.5 mm	83 mm	115 mm	106 mm
100 mm	120 mm	–		78.5 mm	83 mm	115 mm	106 mm
							
4/16	1/4	2/8	1/4	1/4	1/4	1/4	1/4
round	conical	conical	conical		conical		round
130 mm	137 mm	137 mm		97 mm	107 mm	135 mm	135 mm
2,800 × g	3,000 × g	3,000 × g		2,100 × g	2,316 × g	2,900 × g	2,900 × g
2 pcs.	2 pcs.	2 pcs.	2 pcs.		2 pcs.		2 pcs.
5702 724 009	5702 732 001	5702 723 002	5702 717 002		5702 734 004		5702 718 009

Centrifuges and Rotors

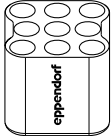
Rotors for Centrifuge 5702/5702 R/5702 RH

**Rotor A-4-38 with rectangular buckets**

- > Maximum speed: 2,750 × g (4,400 rpm)
- > Rectangular buckets for vessels with 5 – 25 mL

						
Adapters for Rotor A-4-38 with rectangular buckets						
Tube Volume	round-bottom tubes	5 – 7 mL	9 mL	15 mL	25 mL	20 mL
Max. tube diameter	12 mm	13 mm	14.5 mm	17.5 mm	25 mm	22 mm
Max. vessel height	75 mm	100 mm	100 mm	100 mm	100 mm	100 mm
Adapter						
Number of vessels per adapter/rotor	9/36	10/40	8/32	6/24	2/8	4/16
Bottom shape	round	flat	flat	flat	flat	flat
Centrifugation radius	119 mm	127 mm	127 mm	127 mm	127 mm	127 mm
Max. RCF	2,577 × g	2,750 × g	2,750 × g	2,750 × g	2,750 × g	2,750 × g
Packing	2 pcs.	2 pcs.	2 pcs.	2 pcs.	2 pcs.	2 pcs.
Order no.	5702 763 004	5702 710 008	5702 711 004	5702 712 000	5702 716 006	5702 713 007

Ordering information

Description	Order no.
Rotor A-4-38 , 8 positions, max. Ø 38 mm, without buckets	5702 740 004
Rectangular bucket 90 mL , for Rotor A-4-38, 4 pcs.	5702 709 000

**Rotor A-8-17**

- > Maximum speed: 2,800 × g (4,400 rpm)
- > Low capacity rotor for centrifugation of 15 mL conical tubes or 15 mL glass tubes¹⁾
- > Adapters for 15 mL conical tubes and rubber mat inserts for glass tubes optionally available

¹⁾ Max. vessel height: 120 mm

**Rotor F-35-30-17**

- > Maximum speed: 2,750 × g (4,400 rpm)
- > High capacity rotor for 20 × 15 mL conical tubes or 30 × 15 mL glass tubes
- > Inserts for 15 mL conical tubes and rubber mats for use with glass tubes are included

**Rotor F-45-24-11**

- > Maximum speed: 1,770 × g (4,400 rpm)
- > Fixed-angle rotor for 24 × 1.5/2.0 mL tubes
- > Quiet centrifugation even without rotor lid
- > Adapters optionally available for:
 - 0.2 mL PCR tubes (5425 715 005)
 - 0.4 mL centrifuge tubes (5425 717 008)
 - 0.5 mL micro test tubes and BD Microtainer® tubes (5425 716 001)
- > Rotor and adapters are autoclavable (121 °C, 20 min)

**Rotor F-45-18-17-Cryo**

- > Maximum speed: 1,970 × g (4,400 rpm)
- > Quiet centrifugation even without rotor lid
- > Centrifugation of 1 – 2 mL cryo container (max. 13 mm Ø, use with adapter) and tubes with screw cap (max. 17 mm Ø, no adapter required)
- > Rotor and adapters are autoclavable (121 °C, 20 min)

Ordering information

Description	Order no.
Rotor A-8-17 , 8 × 15 mL, without adapter, without rubber mats	5702 700 002
Rotor F-35-30-17 , incl. 30 steel sleeves for 15 mL vessels, with 20 adapters for conical tubes and 30 rubber mats	5702 704 008
Rotor F-35-30-17 , incl. 10 steel sleeves for 15 mL vessels, with 10 adapters for conical tubes and 10 rubber mats	5702 705 004
Rotor F-45-24-11 , 45° angle, 24 places, max. Ø 11 mm, without lid	5702 746 002
Rotor F-45-18-17-Cryo , without rotor lid, without adapters	5702 747 009
Adapter , for 1 PCR tube (0.2 mL, max. Ø 6 mm), for all 1.5/2.0 mL rotors, 6 pcs.	5425 715 005
Adapter , for 1 sample tube (0.5 mL, max. Ø 8 mm) or 1 Microtainer® (0.6 mL, max. Ø 8 mm), for all 1.5/2.0 mL rotors, 6 pcs.	5425 716 001
Adapter , for 1 cryo tubes (max. Ø 13 mm) or sealable centrifugation tubes (Ø 12.2 mm), max. length 50 mm, for Rotor F-45-18-17-Cryo, 6 pcs.	5702 752 002
Adapter , for 1 micro test tube (0.4 mL, max. Ø 6 mm), for all 1.5/2.0 mL rotors, 6 pcs.	5425 717 008
Adapter , for 1 HPLC vessel 1.5 mL, for Rotor F-45-18-17-Cryo, 18 pcs.	5427 708 006

Centrifuges and Rotors

Centrifuge 5804/5804 R and 5810/5810 R



Centrifuge Packages 58xx Family

**Description**

Whether you need a refrigerated or non-refrigerated centrifuge for low or medium throughput applications, one of these packages will definitely suit your requirements.

Cell Culture Centrifuge packages include

- > Centrifuge 5804/5804 R or 5810/5810 R
- > Swing-bucket rotor incl. buckets
- > Four adapters for 15 mL conical tubes (two sets of 2)
- > Four adapters for 50 mL conical tubes (two sets of 2)

Centrifuge packages for round-bottom tubes include

- > Centrifuge 5810/5810 R
- > Swing-bucket rotor S-4-104 incl. buckets
- > Four adapters for 13 mm (5/7 mL) round bottom tubes (two sets of 2)
- > Four adapters for 16 mm (10 mL) round bottom tubes (two sets of 2)

Eppendorf Conical Tubes 15 mL, 25 mL and 50 mL

The Eppendorf Conical Tubes are the optimal solution for sample preparation protocols in microbiology and molecular biology laboratories. Safe design and easy handling ensure best sample processing.

Premium USP class 6 raw material ensures

- > Highest sample integrity
- > High g-Safe® centrifugation stability
- > Optimal sample and pellet visibility

For more information go to chapter "tubes and plates" on page 106.

Ordering information

Description	Order no.
Centrifuge 5804 , keypad, non-refrigerated, without rotor, 230 V/50 – 60 Hz (GB)	5804 000 060
Centrifuge 5804 R , keypad, refrigerated, without rotor, 230 V/50 – 60 Hz (GB)	5805 000 060
Centrifuge 5810 , keypad, non-refrigerated, without rotor, 230 V/50 – 60 Hz (GB)	5810 000 060
Centrifuge 5810 R , keypad, refrigerated, without rotor, 230 V/50 – 60 Hz (GB)	5811 000 065

✎ Ordering information for other voltage options begins on page 349

Number of vessels per adapter/rotor

Centrifuge Packages 58xx Family	15 mL conical	50 mL conical
5702/5702 R	2/8	1/4
5804/5804 R + Rotor A-4-44	4/16	1/4
5804/5804 R + Rotor S-4-72	8/32	4/16
5810/5810 R + Rotor A-4-62	9/36	4/16
5810/5810 R + Rotor A-4-81	12/48	5/20
5810/5810 R + Rotor S-4-104	14/56	7/28
	13 mm	16 mm
5810/5810 R + S-4-104	23/92	20/80

Ordering information

Description	Conical tubes	Order no.
Centrifuge 5804 , keypad, non-refrigerated, with Rotor A-4-44 incl. adapters for 15/50 mL conical tubes, 230 V/50 – 60 Hz (GB)	16 × 15 mL/4 × 50 mL	5804 000 360
Centrifuge 5804 R , keypad, refrigerated, with Rotor A-4-44 incl. adapters for 15/50 mL conical tubes, 230 V/50 – 60 Hz (GB)	16 × 15 mL/4 × 50 mL	5805 000 365
Centrifuge 5804 , keypad, non-refrigerated, with Rotor S-4-72 incl. adapters for 15/50 mL conical tubes, 230 V/50 – 60 Hz (GB)	32 × 15 mL/16 × 50 mL	5804 000 565
Centrifuge 5804 R , keypad, refrigerated, with Rotor S-4-72 incl. adapters for 15/50 mL conical tubes, 230 V/50 – 60 Hz (GB)	32 × 15 mL/16 × 50 mL	5805 000 665
Centrifuge 5810 , keypad, non-refrigerated, with Rotor A-4-62 incl. adapters for 15/50 mL conical tubes, 230 V/50 – 60 Hz (GB)	36 × 15 mL/16 × 50 mL	5810 000 365
Centrifuge 5810 R , keypad, refrigerated, with Rotor A-4-62 incl. adapters for 15/50 mL conical tubes, 230 V/50 – 60 Hz (GB)	36 × 15 mL/16 × 50 mL	5811 000 360
Centrifuge 5810 , keypad, non-refrigerated, with Rotor A-4-81 incl. adapters for 15/50 mL conical tubes, 230 V/50 – 60 Hz (GB)	48 × 15 mL/20 × 50 mL	5810 000 460
Centrifuge 5810 R , keypad, refrigerated, with Rotor A-4-81 incl. adapters for 15/50 mL conical tubes, 230 V/50 – 60 Hz (GB)	48 × 15 mL/20 × 50 mL	5811 000 465
Centrifuge 5810 , keypad, non-refrigerated, Classic Cell Culture Solution, with Rotor S-4-104 including 4 adapters for 5/15 mL tubes and 4 adapters for 50 mL conical tubes, 230 V/50 – 60 Hz (GB)	56 × 15 mL/28 × 50 mL	5810 000 560
Centrifuge 5810 R , keypad, refrigerated, with Rotor S-4-104 incl. adapters for 15/50 mL conical tubes, 230 V/50 – 60 Hz (GB)	56 × 15 mL/28 × 50 mL	5811 000 660
Centrifuge 5810 , keypad, non-refrigerated, with Rotor S-4-104 incl. adapters for 13/16 mm round-bottom tubes, 230 V/50 – 60 Hz (GB)	56 × 15 mL/28 × 50 mL 92 × 13 mm/80 × 16 mm	5810 000 665
Centrifuge 5810 R , keypad, refrigerated, with Rotor S-4-104 incl. adapters for 13/16 mm round-bottom tubes, 230 V/50 – 60 Hz (GB)	56 × 15 mL/28 × 50 mL 92 × 13 mm/80 × 16 mm	5811 000 865

✎ Ordering information for other voltage options begins on page 349

Centrifuges and Rotors

Overview of Swing-Bucket Rotors Centrifuge 58xx Family



Model	Rotor S-4-104	Rotor A-4-81	Rotor A-4-62
Max. capacity 5804/5804 R	4 × 750 mL	4 × 500 mL	4 × 250 mL
5810/5810 R	■	■	■
Description	Medium capacity swing-bucket rotor for blood, bacteria, cell culture and plate centrifugation	Medium capacity swing-bucket rotor for blood, bacteria, cell culture and plate centrifugation	Economic swing-bucket rotor for blood, bacteria, cell culture and plate centrifugation
Aerosol-tightness tubes/plates	yes/yes	yes/no	yes/no
Max. RCF	3,214 × g	3,220 × g	3,220 × g
Max. speed	3,900 rpm	4,000 rpm	4,000 rpm
Eppendorf Tubes® 5.0 mL and 15 mL conical	56	48	36
25 mL snap cap tubes	24	20	12
25 mL screw cap tubes	28	20	12
50 mL conical tubes	28	20/28 ¹⁾	16
13 mm round-bottom and blood collection tubes	92	100	60
16 mm round-bottom and blood collection tubes	80	64	48
1.5/2.0 mL micro tube	200	80	64
PCR plates/MTP	16	16	16
Deepwell plates (DWP)	4	4	4

¹⁾ Maximum capacity with dedicated bucket/adaptor. ²⁾ Maximum capacity with dedicated 50 mL bucket.

Overview of Fixed-Angle Rotors Centrifuge 58xx Family



Model	Rotor F-34-6-38	Rotor FA-45-6-30
Max. capacity 5804/5804 R	6 × 85 mL	6 × 50 mL
5810/5810 R	■	■
Description	High-speed rotor suitable for molecular applications in tubes up to 85 mL	Aerosol-tight high-speed rotor for safe centrifugation of hazardous samples
Aerosol-tightness	no	yes
Max. RCF	18,514 × g	20,133 × g
Max. speed	12,000 rpm	12,100 rpm
1.5/2.0 mL micro tube	24	–
Eppendorf Tubes® 5.0 mL and 15 mL conical	6	6
50 mL conical tubes	6	6
25 mL conical tubes	6 ¹⁾²⁾	6 ²⁾³⁾
85 mL Oakridge tubes	6	–

¹⁾ Screw cap tubes only. ²⁾ Please order adapter for 25 mL conical tubes screw cap 5820 734 000. ³⁾ Please order adapter for 25 mL conical tubes snap cap 5820 733 004.

Centrifuges and Rotors

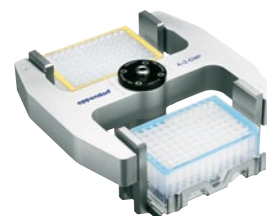

Rotor S-4-72	Rotor A-4-44	Rotor A-2-DWP-AT	Rotor A-2-DWP
4 × 250 mL	4 × 100 mL	2 × 4 MTP, 2 × 1 DWP	2 × 4 MTP, 2 × 2 DWP
■	■	■	■
Economic swing-bucket rotor for blood, bacteria, cell culture centrifugation	High-speed swing-bucket rotor for platelet poor plasma, blood, bacteria and cell culture	Aerosol-tight deepwell plate rotor for safe centrifugation of hazardous samples.	Economic deepwell plate rotor
no/-	yes/-	-/yes	-/no
3,234 × g	4,500 × g	3,486 × g	2,250 × g
4,200 rpm	5,000 rpm	4,500 rpm	3,700 rpm
32	16	-	-
16	4	-	-
16	4	-	-
16	4/8 ²⁾	-	-
56	36	-	-
52	28	-	-
104	48	48	48
-	-	8	8
-	-	2	4



Rotor FA-45-20-17	Rotor FA-45-48-11	Rotor F-45-30-11/Rotor FA-45-30-11
20 × 5.0 mL	48 × 1.5/2.0 mL	30 × 1.5/2.0 mL
■	■	■
■	■	■
Aerosol-tight applications in Eppendorf Tubes® 5.0 mL	Aerosol-tight microcentrifuge tube rotor for safe centrifugation of hazardous samples	Microcentrifuge tube rotor
yes	yes	no/yes
20,913 × g	19,083 × g	20,817 × g
13,100 rpm	13,000 rpm	14,000 rpm
20	48	30
20/-	-	-
-	-	-
-	-	-
-	-	-

Centrifuges and Rotors

Rotors for Centrifuge 58xx Family



Model	Rotor F-35-48-17 ¹⁾	Rotor T-60-11	Rotor F-45-48-PCR
Max. capacity		60 × 1.5/2.0 mL	6 × 5/8 PCR strips (48 × 0.2 mL)
5804/5804 R	■	■	■
5810/5810 R	■	■	■
Aerosol-tightness	no	no	no
Max. RCF	5,005 × g	16,435 × g	15,294 × g
Max. speed	5,500 rpm	14,000 rpm	12,000 rpm
1.5/2.0 mL micro tube	–	60	–
Eppendorf Tubes® 5.0 mL and 15 mL conical	-/40	–	–

¹⁾ Please note that a software upgrade will be necessary for older centrifuges when using this rotor. Please contact your local Eppendorf organization or dealer for further information.

Ordering information

Description	Order no.
Rotor FA-45-20-17, incl. rotor lid, for 20 Eppendorf Tubes® 5.0 mL	5820 765 003
Adapter, for 1 vessel 1.5 – 2.0 mL, for all 5.0 mL rotors, 4 pcs.	5820 768 002
Adapter, for 1 cryo tube, for all 5.0 mL rotors, 4 pcs.	5820 769 009
Adapter, for 1 HPLC tube, for all 5.0 mL rotors, 4 pcs.	5820 770 007
Rotor FA-45-48-11, aerosol-tight, incl. rotor lid, for 48 × 1.5/2.0 mL tubes	5820 760 001
Rotor F-45-30-11, incl. rotor lid, for 30 × 1.5/2.0 mL reaction vessels	5804 715 004
Rotor FA-45-30-11, aerosol-tight, incl. rotor lid, for 30 × 1.5/2.0 mL reaction vessels	5804 726 006

Ordering information

Description	Order no.
Rotor F-35-48-17, for 24 × 15 mL conical tubes, incl. 24 steel sleeves and adapters	5820 771 003
Rotor F-35-48-17, for 40 × 15 mL conical tubes, incl. 48 steel sleeves and adapters	5820 772 000
Rotor T-60-11, incl. rotor lid, for 1.5/2.0 mL tubes, without adapter	5804 730 003
Adapter, for 10 reaction vessels 1.5/2.0 mL, for Rotor T-60-11, 6 pcs.	5804 731 000
Adapter, for 20 reaction vessels 0.4 mL, for Rotor T-60-11, 6 pcs.	5804 732 006
Rotor F-45-48-PCR, for 6 × 8, 6 × 5 PCR tube strips, 48 × 0.2 mL individual PCR tubes	5804 735 005

**Rotor A-2-DWP**

- > For use in Centrifuge 5804/5804 R and 5810/5810 R
- > Max. speed: 2,250 x g (3,700 rpm)
- > Rotor can handle up to
 - 2 x 4 MTP
 - 2 x 4 Cell culture plates
 - 2 x 2 DWP
 - 2 x 1 Filtration plate kits

**Rotor A-2-DWP-AT**

- > For use in Centrifuge 5810/5810 R only¹⁾
- > Max. speed: 3,486 x g (4,500 rpm)
- > Rotor can handle up to
 - 2 x 4 MTP
 - 2 x 1 DWP
 - 2 x 1 Filtration plate kits
 - 2 x 2 Cell culture plates

¹⁾ Please note that a software upgrade may be necessary for older centrifuges when using Rotor A-2-DWP-AT. Please contact your local Eppendorf organization or dealer for further information.

Ordering information

Description	Order no.
Rotor A-2-DWP , for Deepwell plates, incl. 2 buckets	5804 740 009
Rotor A-2-DWP-AT , incl. 2 buckets, 2 aerosol-tight caps and 2 plate carriers	5820 710 004

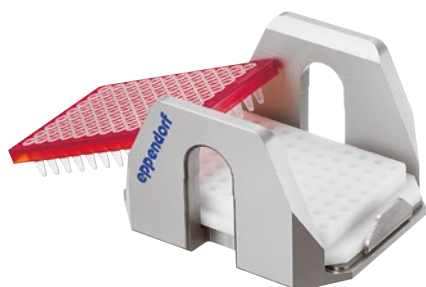
**PCR plate adapter**

- > Adapter is designed to support thin-walled PCR plate wells during centrifugation
- > Available for 96-well and 384-well PCR plates
- > Can be used in all Eppendorf plate rotors

**Cell culture flask adapter**

- > Adapter to spin down cell cultures directly in a cell culture flask
- > Suitable for 25 cm² and selective 75 cm² flasks (please ask for details)
- > Can be used in Eppendorf plate rotor A-4-81-MTP/Flex

**IsoRack adapter**

- > IsoRack adapters to support 0.5 mL and 1.5/2.0 mL IsoRacks during centrifugation
- > Can be used in Eppendorf plate rotors A-2-DWP and A-4-81-MTP/Flex

Ordering information

Description	Order no.
Adapter , for 1 cell culture flask, for Rotors A-4-81-MTP/Flex	5825 719 000
Adapter , for 1 PCR plate (96 wells), for 96-well PCR plates, used in A-4-81-MTP/Flex, A-4-62-MTP, A-2-DWP-AT and A-2-DWP, 2 pcs.	5825 711 009
Adapter , for 1 PCR plate (384 wells), for 384-well PCR plates, used in A-4-81-MTP/Flex, A-4-62-MTP, A-2-DWP-AT and A-2-DWP, 2 pcs.	5825 713 001
IsoRack adapter , for 24 vessels in the IsoRack 0.5 mL, for Rotor A-4-81 (MTP), for 24 x 0.5 mL tubes in the IsoRack, 2 pcs.	5825 708 008
IsoRack adapter , for 24 vessels in the IsoRack 1.5/2.0 mL, for Rotor A-4-81 (MTP), for Rotor A-2-DWP-AT, for 24 x 1.5/2.0 mL tubes in the IsoRack, 2 pcs.	5825 709 004
CombiSlide Adapter , for 12 slides Combi Slide, for Rotors A-2-MTP and A-4-81 (MTP), 2 pcs.	5825 706 005





Rotors for Centrifuge 5810 and 5810 R



Rotor S-4-104

- > Medium capacity swing-bucket rotor with max. speed $3,214 \times g$ ($3,900 \text{ rpm}$)¹⁾
- > Broad range of adapters enables high versatility for tubes and bottles from 0.2 mL to 750 mL and plates
- > Aerodynamic round bucket design for up to 36 % energy savings compared to Rotor A-4-81

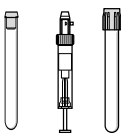
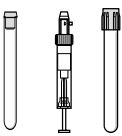
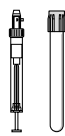

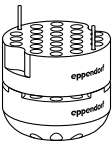
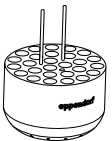
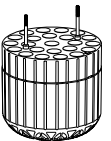
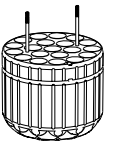
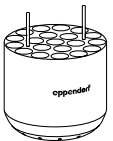
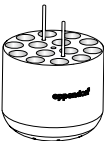
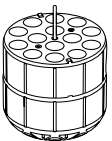









¹⁾Please note that a software upgrade may be necessary for older centrifuges when using this rotor. Please contact your local Eppendorf organization or dealer for further information.

							
Adapters for Rotor S-4-104							
Tube Volume	1.5/2.0 mL	12 x 75 mm, 5 mL FACS	2.6 – 8 mL	5.5 – 12 mL	9 mL	14 mL	Eppendorf Tubes® 5.0 mL and 15 mL conical
Max. tube diameter	11 mm	12 mm	13 mm	16 mm	17.5 mm	17.5 mm	17 mm
Max. vessel height	39 mm	115 mm	115 mm	119 mm	111 mm	117 mm	125 mm
Max. vessel height for use with cap/lid¹⁾	39 mm	108 mm	108 mm	114 mm	106 mm	112 mm	121 mm
Adapter							
Number of vessels per adapter/rotor	50/200	27/108	23/92	20/80	20/80	14/56	14/56
Bottom shape	flat	round	round	round	round	round	conical
Centrifugation radius	188 mm	183 mm	179 mm	180 mm	179 mm	185 mm	188 mm
Max. RCF	$3,197 \times g$	$3,112 \times g$	$3,044 \times g$	$3,061 \times g$	$3,044 \times g$	$3,146 \times g$	$3,197 \times g$
Packing	2 pcs.	2 pcs.	2 pcs.	2 pcs.	2 pcs.	2 pcs.	2 pcs.
Order no.	5825 740 009	5825 747 003	5825 738 004	5825 736 001	5825 743 008	5825 748 000	5825 734 009

¹⁾ Exceeding the maximum tube length may reduce the loading capacity of the rotor. Please perform a manual swing-out test before starting the centrifuge run to make sure the tubes do not hit the rotor yoke.
²⁾ Please order adapter for 25 mL conical tubes snap cap 5820 733 004. ³⁾ Please order adapter for 25 mL conical tubes screw cap 5820 734 000. ⁴⁾ Please note that these conical bottles need to be used together with a conical form insert provided by the manufacturer. ⁵⁾ 225 mL conical bottles from BD®/Corning® and 250 mL conical bottles from Nunc® for Rotor S-4-104 and S-4x750.

Ordering information

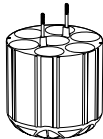
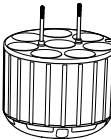
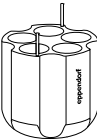
Description	Order no.
Rotor S-4-104	
incl. 4 x 750 mL round buckets	5820 740 000
aerosol-tight capable, incl. 4 plate buckets	5820 754 001
without buckets	5820 755 008
Inlay for microfluidic card , for Rotor S-4-104, 4 pcs.	5820 751 002
Plate carrier , Rotoren S-4-104, S-4x750, 2 pcs.	5820 756 004
Plate bucket , for Rotor S-4-104, aerosol-tight capable, incl. plate carrier, 2 pcs.	5820 744 006
Plate bucket , for Rotor S-4-104, aerosol-tight capable, incl. plate carrier, 4 pcs.	5820 743 000
Plate bucket (open) , for Rotor S-4-104, incl. plate carrier, 4 pcs.	5820 757 000
Round bucket 750 mL , for Rotor S-4-104, 2 pcs.	5820 742 003
Round bucket 750 mL , for Rotor S-4-104, aerosol-tight capable, 4 pcs.	5820 741 007
Caps , rotors S-4-104, S-4x750, plate bucket, aerosol-tight, 2 pcs.	5820 748 001
Caps for 750 mL/1000 mL , for rotors S-4-104, S-4x750, S-4x1000, aerosol-tight, 2 pcs.	5820 747 005
Wide-neck bottle 750 mL , for Rotors S-4-104, S-4x750, S-4x1000, 2 pcs.	5820 708 000

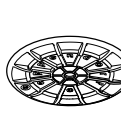
									
25 mL snap cap ²⁾	25 mL screw cap ³⁾	50 mL screw cap	45 mL snap cap	30 mL	50 mL conical, skirted	250 mL flat, 175 – 225/250 mL conical ⁴⁾⁵⁾	500 mL Corning®	750 mL	
30 mm	30 mm	30 mm	30 mm	25 mm	30 mm	62 mm	96 mm	102 mm	
83 mm	78.5 mm	122 mm	122 mm		120 mm	145 mm	147 mm	140 mm	
83 mm	78.5 mm	116 mm	116 mm		116 mm	125 mm	-	-	
									
6/24	7/28	7/28	6/24	8/32	5/20	1/4	1/4	1/4	
	conical			flat	conical, skirted	flat	conical	flat	
161 mm	151 mm	187 mm	187 mm		178 mm	183 mm	187 mm	185 mm	
2,737 x g	2,567 x g	3,180 x g	3,180 x g		3,027 x g	3,112 x g	3,180 x g	3,146 x g	
2 pcs.	2 pcs.	2 pcs.	2 pcs.	2 pcs.	2 pcs.	2 pcs.	2 pcs.	2 pcs.	
	5825 733 002			5825 755 006	5825 732 006	5825 741 005	5825 745 000	5825 744 004	





Centrifuges and Rotors

Rotors for Centrifuge 5810 and 5810 R

**Rotor A-4-81**

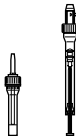
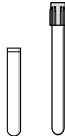
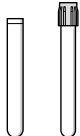
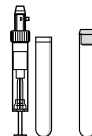
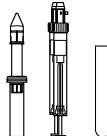
- > Swing-bucket rotor with max. speed 3,220 × g (4,000 rpm)
- > Rotor A-4-81 accommodates tubes and bottles from 0.2 mL to 500 mL as well as plates
- > Aerosol-tight caps¹⁾ for safe centrifugation of hazardous samples optionally available

¹⁾ Aerosol-tightness tested by Public Health England, Porton Down, UK.

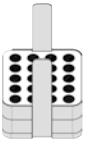
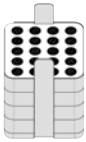
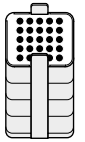
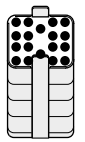
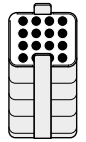
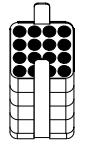
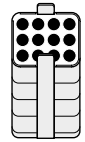
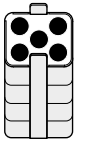











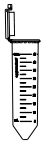
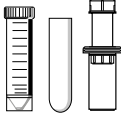

									
Adapters for Rotor A-4-81									
Tube Volume	1.5/2.0 mL	1.2 – 5 mL	2.6 – 5 mL	2.6 – 7 mL	3 – 15 mL	7 – 17 mL	Eppendorf Tubes® 5.0 mL and 15 mL conical tubes	25 mL snap cap	25 mL screw cap
Max. tube diameter	11 mm	11 mm	13 mm	13 mm	16 mm	17.5 mm	17 mm	30 mm	30 mm
Max. vessel height	43 mm	108 mm	108 mm	108 mm	108 mm	118 mm	121 mm	83 mm	78.5 mm
Max. vessel height for use with cap/lid¹⁾	43 mm	108 mm	107 mm	108 mm	108 mm	118 mm	121 mm	116 mm	78.5 mm
Adapter									
Number of vessels per adapter/rotor	20/80	20/80	25/100	18/72	16/64	16/64	12/48	5/20	5/20
Bottom shape	flat	flat	flat with rubber mat	flat with rubber mat	flat with rubber mat	flat with rubber mat	conical	conical	conical
Centrifugation radius	165 mm	168 mm	168 mm	168 mm	168 mm	168 mm	173 mm	158 mm	148 mm
Max. RCF	2,950 × g	3,000 × g	3,000 × g	3,000 × g	3,000 × g	3,000 × g	3,100 × g	2,826 × g	2,647 × g
Packing	2 pcs.	2 pcs.	2 pcs.	2 pcs.	2 pcs.	2 pcs.	2 pcs.	2 pcs.	2 pcs.
Order no.	5810 745 004	5810 746 000	5810 720 001	5810 747 007	5810 748 003	5810 721 008	5810 722 004	5810 723 000	

¹⁾ Exceeding the maximum tube length may reduce the loading capacity of the rotor. Please perform a manual swing-out test before starting the centrifuge run to make sure the tubes do not hit the rotor yoke.

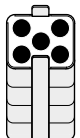
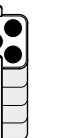
²⁾ Please order adapter for 25 mL conical tubes snap cap 5820 733 004. ³⁾ Please order adapter for 25 mL conical tubes screw cap 5820 734 000. ⁴⁾ Please order adapter for 50 mL conical tubes skirted 5804 737 008. ⁵⁾ Please note that these conical bottles need to be used together with a conical form insert provided by the manufacturer.

Ordering information

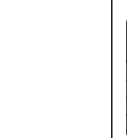
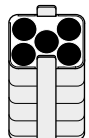
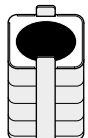
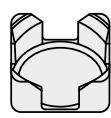
Description	Order no.
Rotor A-4-81 , for 500 mL rectangular buckets or MTP/Flex buckets, incl. 4 x 500 mL rectangular buckets	5810 718 007
Rotor A-4-81 , without buckets	5810 743 001
Rotor A-4-81-MTP/Flex , Swing-bucket rotor, incl. 4 MTP/Flex buckets	5810 725 003
Bucket for 7 x 50 mL conical tubes , for Rotor A-4-81, 4 pcs.	5825 730 003
Rectangular bucket 500 mL , for Rotor A-4-81, 4 pcs.	5810 730 007
Cap , aerosol-tight, for 500 mL rectangular bucket, 2 pcs.	5810 724 007
Wide-neck bottle 500 mL , for Rotors A-4-81, S-4x500, rectangular, 2 pcs.	5820 707 003
Wide-neck bottle 400 mL , for Rotors A-4-81, S-4x500, 400 mL, lid blue, 2 pcs.	5810 729 009
MTP/Flex buckets , for Rotors A-4-81, S-4x500, for use with IsoRack and cell culture flask adapters as well as MTP and DWP, 2 pcs.	5810 742 005
MTP/Flex buckets , for Rotors A-4-81, S-4x500, for use with IsoRack and cell culture flask adapters as well as MTP and DWP, 4 pcs.	5810 741 009

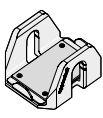
										
50 mL screw cap	45 mL snap cap	25 mL snap cap ²⁾	25 mL screw cap ³⁾	50 mL screw cap	45 mL snap cap	30 – 50 mL round- bottom/50 mL conical, skirted ⁴⁾	180 – 250 mL flat/ 175 – 225 mL conical ⁵⁾	400 mL	500 mL	MTP, DWP, PCR plates
30 mm	30 mm	30 mm	30 mm	30 mm	30 mm	30 mm	62 mm	133 mm	83 mm	–
122 mm	122 mm	83 mm	78.5 mm	122 mm	122 mm	121 mm	133 mm	133 mm	134 mm	60 mm
116 mm	116 mm	–	–	–	–	–	–	–	134 mm	–
										
5/20	5/20	7/28	7/28	7/28	7/28	5/20	1/4	1/4	–/4	4/16 (MTP) 1/4 (DWP)
conical	conical	conical	conical	conical	conical	flat with rubber mat	flat with rubber mat	flat, rubber	flat	flat with rubber mat
173 mm	173 mm	155 mm	145 mm	180 mm	180 mm	173 mm	173 mm	180 mm	180 mm	163 mm
3,100 x g	3,100 x g	2,772 x g	2,593 x g	3,220 x g	3,220 x g	3,100 x g	3,100 x g	3,220 x g	3,220 x g	2 900 x g
2 pcs.			4 pcs.			2 pcs.	2 pcs.	2 pcs.		2 pcs.
5810 723 000			5825 730 003			5810 739 004	5825 722 000	5810 728 002	–	5810 742 005





Rotors for Centrifuge 5810 and 5810 R

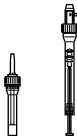
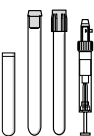
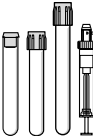
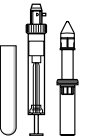

Rotor A-4-62

- > Swing-bucket rotor with max. speed 3,220 × g (4,000 rpm)
- > Rotor A-4-62 accommodates tubes and bottles from 0.2 mL to 250 mL as well as plates
- > Aerosol-tight caps¹⁾ for safe centrifugation of hazardous samples optionally available

¹⁾ Aerosol-tightness tested by Public Health England, Porton Down, UK.

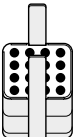
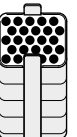
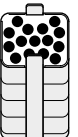
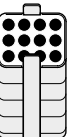
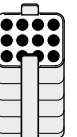
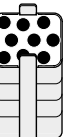
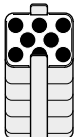
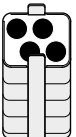











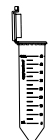

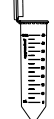
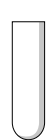

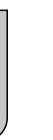
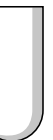



								
Adapters for Rotor A-4-62								
Tube Volume	1.5 – 2.0 mL	1.2 – 5 mL	2.6 – 7 mL	3 – 15 mL	7 – 17 mL	Eppendorf Tubes® 5.0 mL and 15 mL conical	7 – 18 mL	18 – 25 mL
Max. tube diameter	11 mm	11 mm	13 mm	16 mm	17.5 mm	17 mm	20 mm	26 mm
Max. vessel height	43 mm	123 mm	121 mm	121 mm	118 mm	127 mm	126 mm	119 mm
Max. vessel height for use with cap/lid¹⁾	43 mm	115 mm	118 mm	116 mm	114 mm	121 mm	119 mm	116 mm
Adapter								
Number of vessels per adapter/rotor	16/64	25/100	15/60	12/48	12/48	9/36	8/32	4/16
Bottom shape	flat	flat with rubber mat	flat with rubber mat	flat with rubber mat	flat with rubber mat	conical	flat with rubber mat	flat with rubber mat
Centrifugation radius	171 mm	173 mm	173 mm	173 mm	173 mm	178 mm	173 mm	173 mm
Max. RCF	3,000 × g	3,050 × g	3,050 × g	3,050 × g	3,050 × g	3,150 × g	3,050 × g	3,050 × g
Packing	2 pcs.	2 pcs.	2 pcs.	2 pcs.	2 pcs.	2 pcs.	2 pcs.	2 pcs.
Order no.	5810 751 004	5810 750 008	5810 752 000	5810 753 007	5810 754 003	5810 755 000	5810 756 006	5810 757 002

¹⁾ Exceeding the maximum tube length may reduce the loading capacity of the rotor. Please perform a manual swing-out test before starting the centrifuge run to make sure the tubes do not hit the rotor yoke.

²⁾ Please order adapter for 50 mL conical tubes skirted 5804 737 008.

Ordering information

Description	Order no.
Rotor A-4-62 , incl. 4 × 250 mL rectangular buckets	5810 709 008
Rotor A-4-62-MTP , with 4 MTP buckets	5810 711 002
MTP bucket for Rotor A-4-62 , for 4 MTP or 1 DWP, 4 pcs.	5810 702 003
Caps , for rectangular bucket 250 mL, aerosol-tight, 2 pcs.	5810 710 006
Rectangular bucket 250 mL , for Rotor A-4-62, 4 pieces	5810 716 004

											
25 mL snap cap	25 mL screw cap	50 mL screw cap	45 mL snap cap	50 mL screw cap	45 mL snap cap	30 – 50 mL round-bottom/ 50 mL conical, skirted ²⁾	50 – 75 mL	80 – 120 mL	200 – 250 mL flat/ 175 – 225 mL conical		MTP, DWP, PCR plates
30 mm	30 mm	30 mm	30 mm	30 mm	30 mm	30 mm	35 mm	45 mm	62 mm		–
83 mm	78.5 mm	122 mm	119 mm	122 mm	122 mm	115 mm	122 mm	138 mm	136 mm		53 mm
83 mm	78.5 mm	116 mm	116 mm	–	–	–	118 mm	125 mm	127 mm		–
											
3/12	3/12	3/12	3/12	4/16	4/16	4/16	2/8	1/4	1/4	1/4	4/16 (MTP) 1/4 (DWP)
conical	conical	conical	conical	flat with conical inlay	flat with conical inlay	flat with rubber mat	flat with rubber mat	flat with rubber mat	flat with rubber mat	flat with rubber mat	flat with rubber mat
151 mm	141 mm	178 mm	173 mm	173 mm	173 mm	173 mm	173 mm	173 mm	180 mm	180 mm	154 mm
2,701 × g	2,522 × g	3,150 × g	3,050 × g	3,050 × g	3,050 × g	3,050 × g	3,050 × g	3,050 × g	3,220 × g	3,220 × g	2 750 × g
2 pcs.	2 pcs.	2 pcs.	2 pcs.	2 pcs.	2 pcs.	2 pcs.	2 pcs.	2 pcs.	2 pcs.	2 pcs.	4 pcs.
5810 758 009				5810 763 002		5810 759 005	5810 760 003	5810 761 000	5810 770 009		5810 702 003





Rotors for Centrifuge 58xx Family



Rotor S-4-72

- > Medium capacity swing-bucket rotor with speeds up to $3,234 \times g$ ($4,200 \text{ rpm}$)¹⁾
- > Broad range of adapters available to handle all common tube formats from 0.2 mL to 250 mL
- > Aerodynamic round bucket design for up to 48 % energy savings compared to Rotor A-4-62

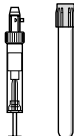
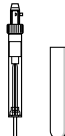
¹⁾ Please note that a software upgrade may be necessary for older centrifuges when using this rotor. Please contact your local Eppendorf organization or dealer for further information.

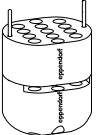
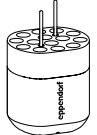
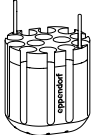
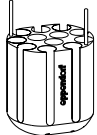
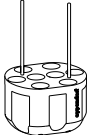







					
Adapters for Rotor S-4-72					
Tube Volume	1.5/2.0 mL	2.6 – 8 mL	5.5 – 12 mL	9 mL	Eppendorf Tubes® 5.0 mL
Max. tube diameter	11 mm	13 mm	16 mm	17.5 mm	17 mm
Max. vessel height	43 mm	115 mm	112 mm	113 mm	60 mm
Adapter					
Number of vessels per adapter/rotor	26/104	14/56	13/52	12/48	8/32 ¹⁾
Bottom shape	flat	round	round	round	conical
Centrifugation radius	159 mm	159 mm	157 mm	158 mm	163 mm
Max. RCF	$3,136 \times g$	$3,136 \times g$	$3,096 \times g$	$3,116 \times g$	$3,215 \times g$
Packing	2 pcs.	2 pcs.	2 pcs.	2 pcs.	2 pcs.
Order no.	5804 794 001	5804 789 008	5804 791 002	5804 792 009	5804 793 005

¹⁾ For Eppendorf Tubes® 5.0 mL with screw cap the capacity is limited to 6 tubes per adapter.²⁾ Please order adapter for 25 mL conical tubes snap cap 5820 733 004.³⁾ Please order adapter for 25 mL conical tubes screw cap 5820 734 000.⁴⁾ Please note that these conical bottles need to be used together with a conical form insert provided by the manufacturer.

Centrifuges and Rotors

Ordering information

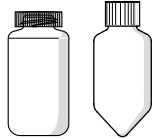
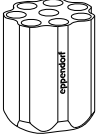
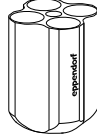
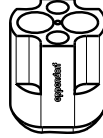
Description	Order no.
Rotor S-4-72, incl. 4 × 250 mL round buckets	5804 746 007

						
15 mL conical	25 mL snap cap ²⁾	25 mL screw cap ³⁾	50 mL screw cap	45 mL snap cap	50 mL conical, skirted	250 mL flat/175 mL Falcon ^{®4)}
17 mm	30 mm	30 mm	30 mm	30 mm	30 mm	62 mm
120 mm	83 mm	78.5 mm	120 mm	83 mm	120 mm	130 mm
						
8/32	4/16	4/16	4/16	4/16	2/8	1/4
conical			conical		conical	flat
164 mm	137 mm	128 mm	164 mm	137 mm	153 mm	160 mm
3,234 × g	2,701 × g	2,524 × g	3,234 × g	2,701 × g	2,602 × g	3,155 × g
2 pcs.			2 pcs.		2 pcs.	2 pcs.
5804 783 000			5804 784 006		5804 785 002	5804 787 005









Rotors for Centrifuge 58xx Family

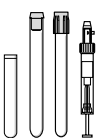
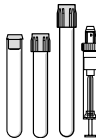
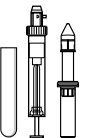

Rotor A-4-44

- > High-speed swing-bucket rotor for applications up to 4,500 × g (5,000 rpm)
- > Rotor A-4-44 accommodates tubes from 0.2 mL to 100 mL
- > Aerosol-tight caps¹⁾ for safe centrifugation of hazardous samples optionally available

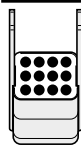
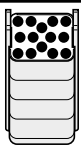
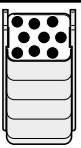
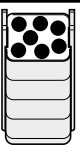
¹⁾ Aerosol-tightness tested by Public Health England, Porton Down, UK.

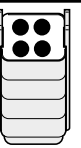
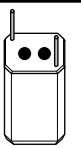
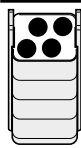
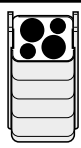











									
Adapters for Rotor A-4-44									
Tube Volume	1.5 – 2.0 mL	1.2 – 5 mL	2.6 – 7 mL	3 – 15 mL	7 – 17 mL	Eppendorf Tubes® 5.0 mL and 15 mL conical	15 mL conical	7 – 18 mL	18 – 30 mL
Max. tube diameter	11 mm	11 mm	13 mm	16 mm	17.5 mm	17 mm	17 mm	20 mm	26 mm
Max. vessel height	43 mm	105 mm	108 mm	108 mm	110 mm	121 mm	121 mm	107 mm	110 mm
Max. vessel height for use with cap/lid¹⁾	43 mm	102 mm	106 mm	106 mm	106 mm	–	121 mm	104 mm	100 mm
Adapter									
Number of vessels per adapter/rotor	12/48	14/56	9/36	7/28	6/24	4/16	2/8	4/16	2/8
Bottom shape	flat	flat with rubber mat	flat with rubber mat	flat with rubber mat	flat with rubber mat	conical	conical	flat with rubber mat	flat with rubber mat
Centrifugation radius	148 mm	150 mm	150 mm	150 mm	150 mm	155 mm	157 mm	150 mm	150 mm
Max. RCF	4,100 × g	4,200 × g	4,200 × g	4,200 × g	4,200 × g	4,332 × g	4,388 × g	4,200 × g	4,200 × g
Packing	2 pcs.	2 pcs.	2 pcs.	2 pcs.	2 pcs.	2 pcs.	2 pcs.	2 pcs.	2 pcs.
Order no.	5804 751 000	5804 750 004	5804 752 007	5804 753 003	5804 754 000	5804 755 006	5804 717 007	5804 756 002	5804 757 009

¹⁾ Exceeding the maximum tube length may reduce the loading capacity of the rotor. Please perform a manual swing-out test before starting the centrifuge run to make sure the tubes do not hit the rotor yoke.

²⁾ Please order adapter for 25 mL conical tubes snap cap 5820 733 004. ³⁾ Please order adapter for 25 mL conical tubes screw cap 5820 734 000.

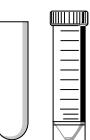
Ordering information

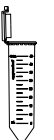
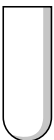
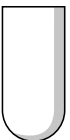
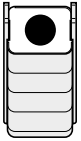
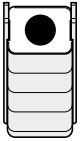
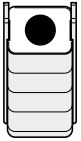
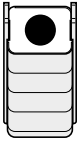
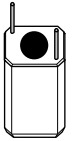
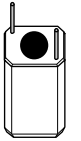
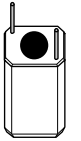
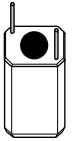
Description	Order no.
Rotor A-4-44 , incl. 4 × 100 mL rectangular buckets	5804 709 004
Bucket for 2 × 50 mL conical tubes , for Rotor A-4-44, 4 pcs.	5804 706 005
Rotor A-4-44 , incl. 4 buckets for 2 × 50 mL conical tubes	5804 719 000
Rectangular bucket 100 mL , for Rotor A-4-44, 4 pcs.	5804 741 005
Caps , for 100 mL rectangular bucket, aerosol-tight, 2 pcs.	5804 712 005
Adapter Insert , insert for 50 mL conical tubes with skirted bottom, 8 pcs.	5804 737 008

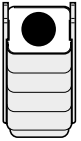
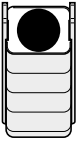
												
25 mL snap cap	25 mL screw cap	50 mL screw cap	45 mL snap cap	25 mL snap cap ²⁾	25 mL screw cap ³⁾	50 mL screw cap	45 mL snap cap	30 – 50 mL round-bottom/50 mL conical, skirted	50 mL screw cap	45 mL snap cap	50 – 75 mL	80 – 100 mL
30 mm	30 mm	30 mm	30 mm	30 mm	30 mm	30 mm	30 mm	30 mm	–	–	35 mm	45 mm
83 mm	78.5 mm	122 mm	122 mm	83 mm	78.5 mm	122 mm	122 mm	122 mm	120 mm	120 mm	119 mm	114 mm
83 mm	78.5 mm	–	–	83 mm	78.5 mm	119 mm	119 mm	108 mm	–	–	108 mm	100 mm
												
1/4	1/4	1/4	1/4	1/4	1/4	1/4	1/4	1/4	–/8	–/8	1/4	1/4
conical				conical				flat with rubber mat	flat with conical inlay		flat with rubber mat	flat with rubber mat
124 mm	114 mm	155 mm	155 mm	126 mm	116 mm	157 mm	157 mm	150 mm	161 mm		150 mm	150 mm
3,465 × g	3,186 × g	4,332 × g	4,332 × g	3,521 × g	3,242 × g	4,388 × g	4,388 × g	4,200 × g	4,500 × g		4,200 × g	4,200 × g
2 pcs.				2 pcs.				2 pcs.	4 pcs.		2 pcs.	2 pcs.
5804 758 005				5804 718 003				5804 759 001	5804 706 005		5804 760 000	5804 761 006









Rotors for Centrifuge 58xx Family



Rotor F-34-6-38

- > For molecular applications in tubes from 0.2 mL to 85 mL
- > Max. speed: 18,514 × g (12,000 rpm) in Centrifuge 5810 R or 15,557 × g (11,000 rpm) in Centrifuge 5804/5804 R/5810¹⁾
- > Low rotor weight (3.2 kg) for easy handling

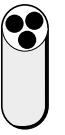
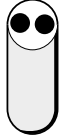













¹⁾ Rotors F-34-6-38 and FA-45-6-30 maintain 4 °C at 11,000 rpm

					
Adapters for Rotor F-34-6-38					
Tube Volume	1.5 – 2.0 mL	2 – 5 mL (13x75 mm)	4 – 7 mL (13x100 mm)	7 – 15 mL	Eppendorf Tubes® 5.0 mL
Max. tube diameter	11 mm	13 mm	13 mm	16 mm	17 mm
Max. vessel height for use with cap/lid	43 mm	80 mm	107 mm	112 mm	–
Adapter					
Number of vessels per adapter/rotor	4/24	3/18	3/18	2/12	1/6
Bottom shape	round	flat	flat	round	conical
Centrifugation radius	113 mm	106 mm	114 mm	112 mm	105 mm
Max. RCF at 12.100 rpm (5810 R)	18,200 × g	17,065 × g	18,353 × g	18,000 × g	17,187 × g
Max. RCF at 11.000 rpm (5804, 5804 R, 5810)	15,300 × g	14,339 × g	15,422 × g	15,150 × g	14,204 × g
Packing	2 pcs.	2 pcs.	2 pcs.	2 pcs.	2 pcs.
Order no.	5804 770 005	5804 738 004	5804 739 000	5804 771 001	5804 777 000

¹⁾ Please order adapter for 25 mL conical tubes screw cap 5820 734 000.

Ordering information

Description	Order no.
Rotor F-34-6-38 , for 6 × 85 mL tubes, incl. rotor lid	5804 727 002
Rotor lid , for F-34-6-38, for Centrifuge 58xx	5804 727 509

							
15 mL conical	15 – 18 mL	30 mL	25 mL screw cap ¹⁾	50 mL screw cap	45 mL snap cap	50 mL	85 mL
17 mm	18 mm	26 mm	30 mm	30 mm	30 mm	29 mm	38 mm
123 mm	123 mm	123 mm	78.5 mm	117 mm		123 mm	121 mm
							
1/6	1/6	1/6	1/4	1/6	1/4	1/6	-/6
conical	round	round	conical	conical	conical	round	round
107 mm	109 mm	110 mm	87 mm	108 mm	108 mm	112 mm	115 mm
17,200 × g	17,550 × g	17,700 × g	14,241 × g	17,400 × g	17,400 × g	18,014 × g	18,500 × g
14,450 × g	14,750 × g	14,900 × g	14,070 × g	14,600 × g	14,600 × g	15,157 × g	15,550 × g
2 pcs.	2 pcs.	2 pcs.		2 pcs.		2 pcs.	
5804 776 003	5804 772 008	5804 773 004		5804 775 007		5804 774 000	-

Rotors for Centrifuge 58xx Family



Rotor FA-45-6-30

- > High-speed rotor for applications in tubes from 5 – 50 mL¹⁾
- > Max. speed 20,133 × g (12,100 rpm) in Centrifuge 5810 R or 16,639 × g (11,000 rpm) in Centrifuge 5804/5804 R/5810²⁾
- > Eppendorf QuickLock® rotor lid for fast lid locking

¹⁾ Please note that a software upgrade may be necessary for older centrifuges when using this rotor. Please contact your local Eppendorf organization or dealer for further information.

²⁾ Rotors F-34-6-38 and FA-45-6-30 maintain 4 °C at 11,000 rpm

Ordering information

Description	Order no.
Rotor FA-45-6-30, aerosol-tight, incl. rotor lid, for 6 × 15/50 mL conical tubes	5820 715 006

Adapters for Rotor FA-45-6-30					
Tube Volume	2.6 – 5 mL	4 – 8 mL	5.5 – 10 mL	7.5 – 12 mL	Eppendorf Tubes® 5.0 mL
Max. tube diameter	13 mm	13 mm	16 mm	16 mm	17 mm
Max. vessel height for use with cap/lid	–	119 mm	–	119 mm	–
Adapter					
Number of vessels per adapter/rotor	1/6	1/6	1/6	1/6	1/6 ¹⁾
Bottom shape	round	round	round	round	conical
Centrifugation radius	120 mm	120 mm	120 mm	120 mm	121 mm
Max. RCF at 12.100 rpm (5810 R)	19,642 × g	19,642 × g	19,642 × g	19,642 × g	19,806 × g
Max. RCF at 11.000 rpm (5804, 5804 R, 5810)	16,233 × g	16,233 × g	16,233 × g	16,233 × g	16,369 × g
Packing	2 pcs.	2 pcs.	2 pcs.	2 pcs.	2 pcs.
Order no.	5820 726 008	5820 725 001	5820 728 000	5820 727 004	5820 730 005













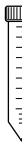

¹⁾ Eppendorf Tubes® 5.0 mL with screw cap will not fit in this adapter.

Eppendorf Conical Tubes

Whether you use them for centrifugation, mixing, or other applications – the Eppendorf Conical Tubes 15 mL, 25 mL and 50 mL will perfectly fit into your workflows. They represent the next step in Eppendorf's comprehensive system solutions in liquid, sample and cell handling.

More information: www.ependorf.com/conicals



							
7 – 17 mL	15 mL	16 mL	30 mL	25 mL snap cap	25 mL screw cap	50 mL screw cap	45 mL snap cap
17.5 mm	17 mm	18 mm	26 mm	30 mm	30 mm	30 mm	30 mm
122 mm	121 mm	107 mm	104 mm	83 mm	78.5 mm	127 mm	127 mm
							
1/6	1/6	1/6	1/6	1/6	1/6	-/6	-/6
round	conical	round	round	conical	conical	conical	conical
120 mm	120 mm	120 mm	105 mm	104 mm	97 mm	123 mm	123 mm
19,642 × g	19,642 × g	19,642 × g	17,187 × g	17,023 × g	15,616 × g	19,500 × g	20,133 × g
16,233 × g	16,223 × g	16,223 × g	14,204 × g	14,069 × g	13,122 × g	16,639 × g	16,639 × g
2 pcs.	2 pcs.	2 pcs.	2 pcs.	6 pcs.	6 pcs.	-	-
5820 729 007	5820 717 009	5820 720 000	5820 721 006	5820 733 004	5820 734 000	-	-

Centrifuges and Rotors

Centrifuge 5910 Ri

**Description**

The refrigerated Centrifuge 5910 Ri combines high capacity and performance in a compact and ergonomic footprint. It comes with an intuitive touchscreen user interface and an advanced temperature management system.

Product features

- > Large 7-inch VisioNize® touch interface for super-fast parameter settings via unique favorites function
- > User management with multiple authorization levels and documentation features supporting GLP/GxP requirements
- > Swing-bucket rotors and adapters for tubes and bottles from 0.2 mL to 1,000 mL as well as all types of MTP, PCR or Deepwell Plates

Ordering information**Description**

Centrifuge 5910 Ri, touch interface, refrigerated, without rotor, 230 V/50 – 60 Hz (GB)

Order no.

5943 000 061



www.eppendorf.com/centrifuge5910Ri

Centrifuge 5920 R

**Description**

Centrifuge 5920 R is a large benchtop refrigerated centrifuge with exceptional performance and high capacity, making it a superior choice for high-throughput applications.

Product features

- > Swing-bucket rotors and adapters accommodate tubes and bottles from 0.2 mL to 1,000 mL
- > Plate rotor options for centrifugation of all types of MTP, PCR or Deepwell Plates
- > Fixed-angle rotors for high-speed molecular biology applications in tubes from 0.2 mL to 50 mL

Ordering information**Description**

Centrifuge 5920 R, keypad, refrigerated, without rotor, 230 V/50 – 60 Hz (GB)

Order no.

5948 000 060



www.eppendorf.com/centrifuge5920R

Product Name	Centrifuge 5910 Ri	Centrifuge 5920 R
1,000 mL Eppendorf bottles	4	–
1,000 mL standard bottles	–	4
750 mL bottles	4	4
180 – 250 mL bottles (flat)	6	8
50 mL conical tubes	36	52
25 mL conical tubes	36	52
5 mL and 15 mL conical tubes	68	108
1.5/2.0 mL Eppendorf Tubes®	200	368
BD Vacutainer® CPT™ (16 mm × 125 mm/8 mL)	28	80
16 mm round-bottom and blood collection tubes	104	148
13 mm round-bottom and blood collection tubes	120	196
PCR plates/MTP	20	28
Universal adapters for conical tubes, plates and bottles	■	■
Dual use of plates and tubes in one rotor bucket	■	■
Plate rotor options for MTP, PCR or DWP	■	■
Fixed-angle rotors for high-speed applications	■	■

Centrifuge Packages 5910 Ri

Ordering information	
Description	Order no.
Centrifuge 5910 Ri, touch interface, refrigerated, High Speed Solution, with Rotor FA-6x50, 230 V/50 – 60 Hz (GB)	5943 000 157
Centrifuge 5910 Ri, touch interface, refrigerated, with Rotor S-4x750, incl. round buckets and adapters for 5 mL/15 mL/50 mL conical tubes, 230 V/50 – 60 Hz (GB)	5943 000 561
Centrifuge 5910 Ri, touch interface, refrigerated, with Rotor S-4xUniversal, incl. universal buckets and adapters for 5 mL/15 mL/50 mL conical tubes and plates, 230 V/50 – 60 Hz (GB)	5943 000 361
Centrifuge 5910 Ri, touch interface, refrigerated, Big Volume Harvesting Solution, with Rotor S-4xUniversal, incl. universal buckets and 1 L adapters (4x), Eppendorf 1 L bottles (4x), 230 V/50 – 60 Hz (GB)	5943 000 181
Centrifuge 5910 Ri, touch interface, refrigerated, Versatility Solution, with Rotor S-4xUniversal, incl. universal buckets and adapters for 5 mL/15 mL/50 mL conical tubes, 175 – 250 mL bottles and plates, 230 V/50 – 60 Hz (GB)	5943 000 266
Centrifuge 5910 Ri, touch interface, refrigerated, with Rotor S-4xUniversal, incl. universal buckets, adapters for 5 mL/15 mL/50 mL conical tubes, 175 – 250 mL bottles and plates, adapters for 1000 mL bottles incl. 4 x 1000 mL bottles, 230 V/50 – 60 Hz (GB)	5943 000 912

✎ Ordering information for other voltage options begins on page 349

Centrifuge Packages 5920 R

Ordering information	
Description	Order no.
Centrifuge 5920 R, keypad, refrigerated, with Rotor S-4xUniversal-Large, incl. universal buckets and adapters for 5 mL/15 mL/25 mL/50 mL conical tubes and plates, 230 V/50 – 60 Hz (GB)	5948 000 961
Centrifuge 5920 R, keypad, refrigerated, with Rotor S-4xUniversal-Large, incl. universal buckets and adapters for round-bottom tubes with diameter 13/16 mm, 230 V/50 – 60 Hz (GB)	5948 000 860
Centrifuge 5920 R, keypad, refrigerated, with Rotor S-4x1000, incl. high-capacity buckets and adapters for 15 mL/50 mL conical tubes, 230 V/50 – 60 Hz (GB)	5948 000 260
Centrifuge 5920 R, keypad, refrigerated, with Rotor S-4x1000, incl. plate/tube buckets and adapters for 15 mL/50 mL conical tubes, 230 V/50 – 60 Hz (GB)	5948 000 460
Centrifuge 5920 R, keypad, refrigerated, High-Throughput Screening Solution, with Rotor S-4x1000, incl. plate/tube bucket and plate carrier, 230 V/50 – 60 Hz (GB)	5948 000 182
Centrifuge 5920 R, keypad, refrigerated, with Rotor S-4x1000, incl. round buckets and adapters for 15 mL/50 mL conical tubes, 230 V/50 – 60 Hz (GB)	5948 000 365

✎ Ordering information for other voltage options begins on page 349

Centrifuges and Rotors

Overview of Swing-Bucket Rotors Centrifuge 59xx Family



Model	Rotor S-4xUniversal-Large	Rotor S-4x1000 high-capacity buckets	Rotor S-4x1000 plate/tube buckets	Rotor S-4x1000 round buckets
Description	Extra high capacity	Extra high capacity	High capacity	Medium capacity, compatible with standard 1 Liter bottle
5910 Ri				
5920 R	■	■	■	■
Universal bucket	yes	no	no	no
Aerosol-tightness	yes	no	yes	yes
Max. capacity	4 × 750 mL	8 × 250 mL	40 × 50 mL	4 × 1,000 mL
Max. RCF	4,402 × g	3,153 × g	3,076 × g	3,428 × g
Max. speed	4,250 rpm	3,700 rpm	3,700 rpm	3,700 rpm
1.5/2.0 mL micro tube	368			200
Eppendorf Tubes® 5.0 mL and 15 mL conical	96	108	88	56
50 mL conical tubes	40	52	40	28
25 mL snap cap tubes	40	48	36	24
25 mL screw cap tubes	40	52	40	28
13 mm round-bottom and blood collection tubes	196	196	140	92
16 mm round-bottom and blood collection tubes	148	144	132	80
750 mL bottles	4			4
1,000 mL Eppendorf bottles				
1,000 mL standard bottles				4
PCR plates/MTP	20	24	28	
Deepwell plates (DWP)	8	8	8	



400 mL



500 mL



750 mL



400 mL



1,000 mL

Eppendorf bottles for Centrifuge 5910 Ri and Centrifuge 5920 R

Bottle Manufacturer	Volume	Order no.	Size Diameter x Height	Bottom shape	Material	S-4x Universal-Large	AT ¹⁾	S-4x1000 Round Bucket	AT ¹⁾
Eppendorf	400 mL	5810 729 009	80 x 133 mm	flat	PP				
Eppendorf	500 mL	5820 707 003	83 x 134 mm	flat	PP				
Eppendorf	750 mL	5820 708 000	102 x 133 mm	flat	PP	■	■	■	■
Eppendorf	400 mL	5910 707 002	81 x 117 mm	flat	PP				
Eppendorf	1,000 mL	5910 770 006	118 x 133.1 mm	flat	PP				

¹⁾ Aerosol tight cap possible.

Centrifuges and Rotors



Rotor S-4xUniversal	Rotor S-4x750 with round buckets	Rotor S-4x500	Rotor S-4x400
High capacity and versatility, compatible with Eppendorf 1 Liter bottle	Medium capacity, high speed	Medium capacity	Low capacity, high speed
■	■	■	■
yes	no	no	no
yes	yes	yes	yes
4 × 1,000 mL	4 × 750 mL	4 × 500 mL	4 × 400 mL
4,347 × g	4,800 × g	3,220 × g	5,263 × g
4,500 rpm	4,700 rpm	4,000 rpm	5,100 rpm
68	200	96	104
36	56	48	28
36	28	20	16
36	24	20	16
36	28	20	16
120	92	100	60
104	80	64	44
4	4		
4			
20	16	16	
4	4	4	

Eppendorf bottles for Centrifuge 5910 Ri and Centrifuge 5920 R

S-4x750	AT ¹⁾	S-4xUniversal	AT ¹⁾	S-4x500	AT ¹⁾	S-4x400	AT ¹⁾
				■			
				■	■		
■	■	■					
						■	■
		■	■				

Centrifuges and Rotors

Rotors for Centrifuge 5910 Ri

**Rotor S-4xUniversal**

- > High capacity swing-bucket rotor with max. speed 4,347 × g (4,500 rpm)
- > Broad range of adapters enables high versatility for tubes and flasks from 4 mL to 1,000 mL and plates
- > Universal bucket design accommodates both plates and tubes

Ordering information

Description	Order no.
Rotor S-4xUniversal , incl. universal buckets	5895 200 001
Universal buckets , for Rotor S-4xUniversal, 2 pcs.	5895 202 004
Universal buckets , for Rotor S-4xUniversal, 4 pcs.	5895 203 000
Caps , for Rotor S-4xUniversal, aerosol-tight, 2 pcs.	5910 750 005
Wide-neck bottle 1,000 mL , for Rotor S-4xUniversal, 2 pcs.	5910 770 006
Wide-neck bottle 750 mL , for Rotors S-4-104, S-4x750, S-4x1000, 2 pcs.	5820 708 000

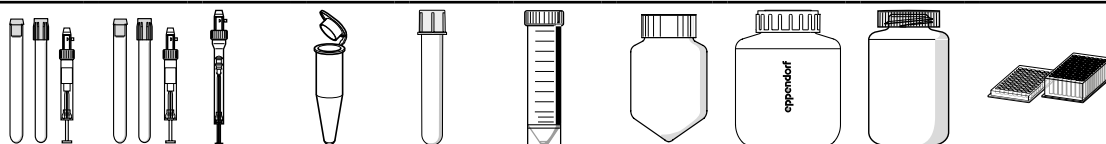
**Adapters for Rotor S-4xUniversal**

Tube Volume	4 mL – 8 mL	7.5 mL – 12 mL	9 mL	1.5 - 2 mL	12 × 75 mm, 5 mL FACS	50 mL conical, skirted	500 mL Corning®	750 mL	1,000 mL	MTP, DWP, PCR plates
Max. tube diameter	13 mm	16 mm	17.5 mm	11 mm	12 mm	31 mm	96 mm	102 mm	118 mm	–
Max. vessel height	119 mm	120 mm	120 mm		112 mm	124 mm	148 mm	139 mm	133 mm	80 mm
Max. vessel height for use with cap/lid¹⁾	117 mm	118 mm	118 mm	43 mm	107 mm	121 mm	–	135 mm	133 mm	66 mm
Adapter										
Number of vessels per adapter/rotor	30/120	26/104	21/84	46/184	46/184	7/28	1/4	1/4	1/4	5/20
Bottom shape	round	round	round	flat	round	flat	conical	flat	flat	flat
Centrifugation radius	190 mm	195 mm	188 mm	187 mm	189 mm	185 mm	187 mm	188 mm	188 mm	170 mm
Max. RCF	4,302 × g	4,415 × g	4,256 × g	4,233 × g	4,279 × g	4,188 × g	4,234 × g	4,256 × g	4,256 × g	3,849 × g
Order no.	5910 755 007	5910 754 000	5910 762 003	5910 763 000	5910 758 006	5910 764 006	5910 760 000	5910 757 000	5910 756 003	5910 753 004

¹⁾ Please perform a manual test to determine the actual loading capacity.²⁾ Aerosol-tight caps compatible with MTP, DWP 96 500 µl, DWP 384 200 µl. Aerosol-tight caps not compatible with DWP 96 1,000 µl and 2,000 µl.³⁾ Please order adapter for 25 mL conical tubes snap cap 5820 733 004.⁴⁾ When used with aerosol-tight caps the max. capacity is reduced to 20 × 50 mL (5 × 50 mL per adapter).⁵⁾ Please order adapter for 25 mL conical tubes screw cap 5820 734 000.⁶⁾ Please note that these conical bottles need to be used together with a conical form insert provided by the manufacturer.

Universal Adapters for Rotor S-4xUniversal

Rotor S-4xUniversal brings outstanding versatility to those customers who need to spin a variety of vessels and plates.

Three innovative universal adapters accommodate a selection of tubes, plates and bottles:

- > Adapter 1: 5.0 mL and 15 mL conical tubes, MTP/DWP
- > Adapter 2: 25 mL and 50 mL conical tubes, MTP
- > Adapter 3: 25 mL and 50 mL conical tubes, 250 mL bottles, MTP

For customers who need either stacking capability, higher speed or aerosol-tight centrifugation of certain plate formats, a separate plate carrier is available.

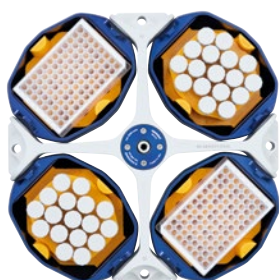

Universal adapter 1
Setup for deepwell plates and
Eppendorf Tubes® 5.0/15 mL.



Universal adapter 2
Setup for microplates and 25/50 mL
conical tubes.



Universal adapter 3
Setup for 25/50 mL conical tubes, 250 mL
bottles and microplates.

Eppendorf Tubes® 5.0 mL	15 mL conical	MTP, DWP	25 mL snap cap ³⁾	25 mL screw cap ⁵⁾	50 mL screw cap	Microplate 96/384 wells	25 mL snap cap ³⁾	25 mL screw cap ⁵⁾	50 mL screw cap	45 mL snap cap	Microplate 96/384 wells	250 mL flat, 175 - 225 mL conical ⁶⁾
17 mm	17 mm	–	30 mm	30 mm	30 mm	–	30 mm	30 mm	30 mm	30 mm	–	62 mm
124 mm	124 mm	64 mm	83 mm	78.5 mm	116 ⁴⁾ mm	16 mm	83 mm	78.5 mm	124 mm	133 mm	16 mm	146 mm
122 mm	122 mm	²⁾	83 ⁴⁾ mm	78.5 ⁴⁾ mm	116 ⁴⁾ mm	–	83 mm	78.5 mm	121 mm	133 mm	–	139 mm
17/68	17/68	1/4	9/36	9/36	9/36	1/4	7/28	7/28	7/28	7/28	1/4	1/4
conical	conical	flat	conical	conical	conical	flat	conical	conical	conical	conical	flat	flat
191 mm	191 mm	143 mm	107 mm	156 mm	192 mm	115 mm	107 mm	155 mm	191 mm	188 mm	115 mm	187 mm
4,324 × g	4,324 × g	3,237 × g	3,758 × g	3,531 × g	4,347 × g	2,604 × g	3,735 × g	3,509 × g	4,324 × g	4,256 × g	2,604 × g	4,234 × g
5910 752 008				5910 769 008					5910 751 001			



Rotors for Centrifuge 5910 Ri



Rotor S-4x500

- > Medium capacity swing-bucket rotor with max. speed $3,220 \times g$ (4,000 rpm)
- > Rotor S-4x500 accommodates tubes and bottles from 0.2 mL to 500 mL as well as plates
- > Aerosol-tight caps for safe centrifugation of hazardous samples optionally available¹⁾

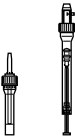
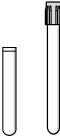
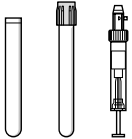
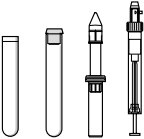
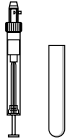
¹⁾ Aerosol-tightness tested by Public Health England, Porton Down, UK.

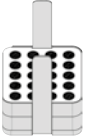
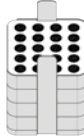
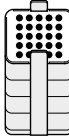
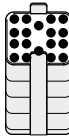
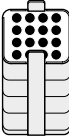
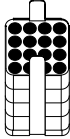
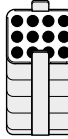
							
Adapters for Rotor S-4x500							
Tube Volume	1.5/2.0 mL	1.2 – 5 mL	2.6 – 5 mL	2.6 – 7 mL	3 – 15 mL	7 – 17 mL	Eppendorf Tubes® 5.0 mL and 15 mL conical tubes
Max. tube diameter	11 mm	11 mm	13 mm	13 mm	16 mm	17.5 mm	17 mm
Max. vessel height	43 mm	108 mm	108 mm	108 mm	108 mm	118 mm	121 mm
Max. vessel height for use with cap/lid¹⁾	43 mm	108 mm	107 mm	108 mm	108 mm	118 mm	121 mm
Adapter							
Number of vessels per adapter/rotor	20/80	20/80	25/100	18/72	16/64	16/64	12/48
Bottom shape	flat	flat	flat with rubber mat	flat with rubber mat	flat with rubber mat	flat with rubber mat	conical
Centrifugation radius	165 mm	168 mm	168 mm	168 mm	168 mm	168 mm	173 mm
Max. RCF	$2,950 \times g$	$3,000 \times g$	$3,000 \times g$	$3,000 \times g$	$3,000 \times g$	$3,000 \times g$	$3,100 \times g$
Packing	2 pcs.	2 pcs.	2 pcs.	2 pcs.	2 pcs.	2 pcs.	2 pcs.
Order no.	5810 745 004	5810 746 000	5810 720 001	5810 747 007	5810 748 003	5810 721 008	5810 722 004

¹⁾ Please perform a manual test to determine the actual loading capacity.²⁾ Please order adapter for 50 mL conical tubes skirted 5804 737 008 or 022654373 for U.S. and Canada.³⁾ Please note that these conical bottles need to be used together with a conical form insert provided by the manufacturer.



Ordering information

Description	Order no.
Rotor S-4x500 , for 500 mL rectangular buckets or MTP/Flex buckets	
incl. 4 x 500 mL rectangular buckets	5895 170 005
without buckets	5895 171 001
Rectangular bucket 500 mL , for Rotor A-4-81, 4 pcs.	5810 730 007
Cap , aerosol-tight, for 500 mL rectangular bucket, 2 pcs.	5810 724 007
Wide-neck bottle 500 mL , for Rotors A-4-81, S-4x500, rectangular, 2 pcs.	5820 707 003
Wide-neck bottle 400 mL , for Rotors A-4-81, S-4x500, 400 mL, lid blue, 2 pcs.	5810 729 009
MTP/Flex buckets , for Rotors A-4-81, S-4x500, for use with IsoRack and cell culture flask adapters as well as MTP and DWP, 2 pcs.	5810 742 005
MTP/Flex buckets , for Rotors A-4-81, S-4x500, for use with IsoRack and cell culture flask adapters as well as MTP and DWP, 4 pcs.	5810 741 009

25 mL snap cap	25 mL screw cap	50 mL screw cap	45 mL snap cap	30 – 50 mL round-bottom/50 mL conical, skirted ²⁾	180 – 250 mL flat/ 175 – 225 mL conical ³⁾	400 mL	500 mL	MTP, DWP, PCR plates
30 mm	30 mm	30 mm	30 mm	30 mm	62 mm	133 mm	83 mm	–
83 mm	78.5 mm	122 mm	122 mm	121 mm	133 mm	–	134 mm	60 mm
83 mm	78.5 mm	116 mm	116 mm	–	–	–	134	–
5/20	5/20	5/20	5/20	5/20	1/4	1/4	–/4	4/16 (MTP) 1/4 (DWP)
conical	conical	conical	conical	flat with rubber mat	flat with rubber mat	flat, rubber	flat	flat with rubber mat
158 mm	148 mm	173 mm	173 mm	173 mm	173 mm	180 mm	180 mm	163 mm
2,826 × g	2,647 × g	3,100 × g	3,100 × g	3,100 × g	3,100 × g	3,220 × g	3,220 × g	2 900 × g
	2 pcs.			2 pcs.	2 pcs.	2 pcs.		2 pcs.
	5810 723 000			5810 739 004	5825 722 000	5810 728 002	–	5810 742 005

Rotors for Centrifuge 5910 Ri



Rotor S-4x400

- > High-speed medium capacity swing-bucket rotor with max. speed 5,263 × g (5,100 rpm)
- > Broad range of adapters enables high versatility for tubes and bottles from 0.2 mL to 400 mL
- > Aerosol-tight QuickLock caps for safe centrifugation of hazardous samples optionally available¹⁾

¹⁾ Aerosol-tightness tested by Public Health England, Porton Down, UK.













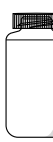

Adapters for Rotor S-4x400						
Tube Volume	1.5 mL/2.0 mL	12 mm × 75 mm	4 mL – 8 mL	7.5 mL – 12 mL	9 mL	Eppendorf Tubes® 5.0 mL and 15 mL conical
Max. tube diameter	11 mm	12 mm	13 mm	16 mm	17.5 mm	17 mm
Max. vessel height	39 mm	118 mm	119 mm	122 mm	122 mm	133 mm
Max. vessel height for use with cap/lid¹⁾	–	112 mm	105 mm	115 mm	115 mm	126 mm
Adapter						
Number of vessels per adapter/rotor	26/104	17/68	15/60	11/44	8/32	7/28
Bottom shape	open	round	round	round	round	conical
Centrifugation radius	177 mm	172 mm	171 mm	173 mm	173 mm	180 mm
Max. RCF	5,147 × g	5,002 × g	4,818 × g	4,874 × g	4,874 × g	5,071 × g
Packing	2 pcs.	2 pcs.	2 pcs.	2 pcs.	2 pcs.	2 pcs.
Order no.	5910 708 009	5910 711 000	5910 703 007	5910 704 003	5910 709 005	5910 702 000

¹⁾ Please perform a manual test to determine the actual loading capacity.²⁾ Please order adapter for 25 mL conical tubes snap cap 5820 733 004.³⁾ Please order adapter for 25 mL conical tubes screw cap 5820 734 000.⁴⁾ Please note that these conical bottles need to be used together with a conical form insert provided by the manufacturer.

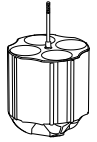

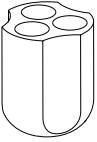
Ordering information

Description	Order no.
Rotor S-4x400 , incl. 400 mL round bucket	5895 180 000
Caps , for Rotor S-4x400, aerosol-tight, 2 pcs.	5910 700 008
Wide-neck bottle 400 mL , for Rotor S-4x400, 2 pcs.	5910 707 002

							
25 mL snap cap ²⁾	25 mL screw cap ³⁾	50 mL screw cap	45 mL snap cap	50 mL skirted, Centriprep and Oak Ridge 30 mL	175 mL conical (Becton Dickinson®, Nalgene® ⁴⁾), 250 mL flat	175 – 225 mL conical	400 mL
30 mm	30 mm	30 mm	30 mm	30 mm	62 mm	62 mm	81 mm
83 mm	78.5 mm	125 mm	125 mm	122 mm	138 mm	143 mm	117 mm
83 mm	78.5 mm	117 mm	117 mm	121 mm	129 mm	137 mm	117 mm
							
4/16	4/16	4/16	4/16	3/12	1/4	1/4	1/4
conical	conical	conical	conical	skirted	flat	conical	flat
152 mm	142 mm	179 mm	179 mm	170 mm	174 mm	181 mm	173 mm
4,420 × g	4,129 × g	5,043 × g	5,043 × g	4,943 × g	5,060 × g	5,263 × g	5,030 × g
	2 pcs.			2 pcs.	2 pcs.	2 pcs.	2 pcs.
	5910 701 004			5910 712 006	5910 705 000	5910 714 009	5910 706 006









Rotors for Centrifuge 5910 Ri/5920 R

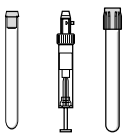
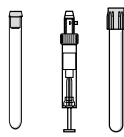
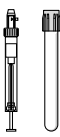

Rotor S-4x750 with round buckets

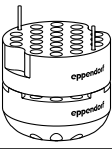
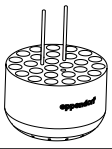
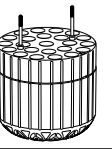
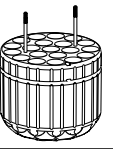
- > Medium capacity swing-bucket rotor with max. speed $4,800 \times g$ ($4,700 \text{ rpm}$)¹⁾
- > Broad range of adapters enables high versatility for tubes and flasks from 0.2 mL to 750 mL and plates
- > Mixed loading with 2 plate buckets and 2 round tube buckets allows for increased versatility

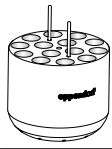
¹⁾ For 100 V device, max. speed $4,031 \times g$ / $4,300 \text{ rpm}$













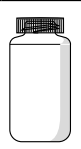
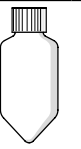

							
Adapters for Rotor S-4x750							
Tube Volume	1.5/2.0 mL	12 x 75 mm, 5 mL FACS	2.6 – 8 mL	5.5 – 12 mL	9 mL	14 mL	Eppendorf Tubes® 5.0 mL and 15 mL conical
Max. tube diameter	11 mm	12 mm	13 mm	16 mm	17.5 mm	17.5 mm	17 mm
Max. vessel height	39 mm	120 mm	121 mm	125 mm	117 mm	106 mm	125 mm
Max. vessel height for use with cap/lid¹⁾	39 mm	113 mm	113 mm	120 mm	112 mm	106 mm	120 mm
Adapter							
Number of vessels per adapter/rotor	50/200	27/108	23/92	20/80	20/80	14/56	14/56
Bottom shape	flat	round	round	round	round	round	conical
Centrifugation radius	194 mm	186 mm	185 mm	186 mm	185 mm	185 mm	188 mm
Max. RCF	$4,791 \times g$	$4,594 \times g$	$4,569 \times g$	$4,594 \times g$	$4,569 \times g$	$4,569 \times g$	$4,643 \times g$
Packing	2 pcs.	2 pcs.	2 pcs.	2 pcs.	2 pcs.	2 pcs.	2 pcs.
Order no.	5825 740 009	5825 747 003	5825 738 004	5825 736 001	5825 743 008	5825 748 000	5825 734 009

¹⁾ Exceeding the maximum tube length may reduce the loading capacity of the rotor. Please perform a manual swing-out test before starting the centrifuge run to make sure the tubes do not hit the rotor yoke.

²⁾ Please order adapter for 25 mL conical tubes snap cap 5820 733 004. ³⁾ Please order adapter for 25 mL conical tubes screw cap 5820 734 000. ⁴⁾ Please note that these conical bottles need to be used together with a conical form insert provided by the manufacturer. ⁵⁾ 225 mL conical bottles from BD[®]/Corning[®] and 250 mL conical bottles from Nunc[®] for Rotor S-4-104 and S-4x750.

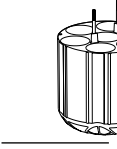
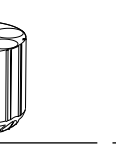
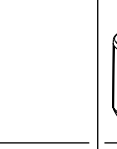
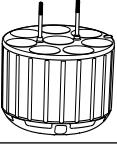
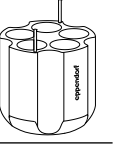
Ordering information

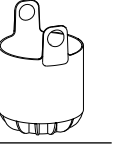
Description	Order no.
Rotor S-4x750 , aerosol-tight, without buckets	5895 121 004
Rotor S-4x750 , aerosol-tight, incl. round buckets	5895 120 008
Plate bucket , for Rotor S-4x750, aerosol-tight capable, incl. plate carrier, 2 pcs.	5895 125 000
Round bucket , for Rotor S-4x750, 2 pcs.	5895 123 007
Round bucket , for Rotor S-4x750, 4 pcs.	5895 122 000
Plate bucket , for Rotor S-4x750, aerosol-tight capable, incl. plate carrier, 4 pcs.	5895 124 003
Caps , rotors S-4-104, S-4x750, plate bucket, aerosol-tight, 2 pcs.	5820 748 001
Caps for 750 mL/1000 mL , for rotors S-4-104, S-4x750, S-4x1000, aerosol-tight, 2 pcs.	5820 747 005
Wide-neck bottle 750 mL , for Rotors S-4-104, S-4x750, S-4x1000, 2 pcs.	5820 708 000

										
25 mL snap cap ²⁾	25 mL screw cap ³⁾	50 mL screw cap	45 mL snap cap	30 mL	50 mL conical, skirted	250 mL flat, 175 – 225/ 250 mL conical ⁴⁾ ⁵⁾	500 mL Corning®	750 mL	MTP, DWP, PCR plates	
30 mm	30 mm	30 mm	30 mm	25 mm	30 mm	62 mm	96 mm	102 mm	–	
83 mm	78.5 mm	122 mm	122 mm	119 mm	122 mm	145 mm	147 mm	150 mm	64 mm	
83 mm	78.5 mm	116 mm	116 mm	114 mm	116 mm	125 mm	–	150 mm	47 mm	
										
6/24	7/28	7/28	6/24	8/32	5/20	1/4	1/4	1/4	4/16 (MTP) 1/4 (DWP)	
conical	conical	conical	conical	flat	conical, skirted	flat	conical	flat	–	
167 mm	157 mm	187 mm	187 mm	181 mm	177 mm	183 mm	186 mm	185 mm	161 mm	
4,124 × g	3,877 × g	4,618 × g	4,618 × g	4,470 × g	4,371 × g	4,519 × g	4,594 × g	4,569 × g	3,976 × g	
2 pcs.	2 pcs.	2 pcs.	2 pcs.	2 pcs.	2 pcs.	2 pcs.	2 pcs.	2 pcs.	2 pcs.	
	5825 733 002			5825 755 006	5825 732 006	5825 741 005	5825 745 000	5825 744 004	5895 125 000	

Centrifuges and Rotors

Rotors for Centrifuge 5920 R

**Rotor S-4xUniversal-Large**









- > Extra high capacity swing-bucket rotor with max. speed 4,402 × g (4,250 rpm)
- > Broad range of adapters enables high versatility for tubes and flasks from 0.2 mL to 750 mL and plates
- > Universal bucket design accommodates both plates and tubes

Adapters for Rotor S-4xUniversal-Large										
Tube Volume	Eppendorf Tubes® 5.0 mL	15 mL conical	MTP, DWP	1.5/2.0 mL	5 mL FACS	25 mL snap cap ¹⁾	25 mL screw cap ²⁾	50 mL screw cap	45 mL snap cap	Microplate 96/384 wells
Max. tube diameter	17 mm	17 mm	-	11 mm	12 mm	30 mm	30 mm	30 mm	30 mm	-
Max. vessel height	131 mm	131 mm	45 mm	39 mm	113 mm	131 mm	131 mm	131 mm	131 mm	45 mm
Max. vessel height for use with cap/lid	123 mm	123 mm	45 mm	39 mm	82 mm	125 mm	125 mm	125 mm	125 mm	45 mm
Adapter										
Number of vessels per adapter/rotor	24/96	24/96	2 MTP, 1 DWP	92/368	51/204	10/40	10/40	10/40	10/40	2 MTP, 1 DWP
Bottom shape	conical	conical	skirted	flat	round	conical	conical	conical	conical	skirted
Centrifugation radius	218 mm	218 mm	160 mm	205 mm	205 mm	189 mm	179 mm	213 mm	213 mm	153 mm
Max. RCF	4,402 × g	4,402 × g	3,231 × g	4,140 × g	4,140 × g	3,816 × g	3,614 × g	4,301 × g		3,090 × g
Packing	2 pcs.	2 pcs.	2 pcs.	2 pcs.	2 pcs.	2 pcs.	2 pcs.	2 pcs.	2 pcs.	2 pcs.
Order no.	5920 757 008			5920 747 002	5920 742 000	5920 756 001				

¹⁾ Please order adapter for 25 mL conical tubes snap cap 5820 733 004. ²⁾ Please order adapter for 25 mL conical tubes screw cap 5820 734 000. ³⁾ Please note that these conical bottles need to be used together with a conical form insert provided by the manufacturer.

Centrifuges and Rotors

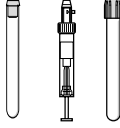
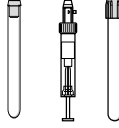

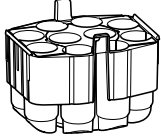
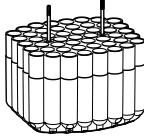
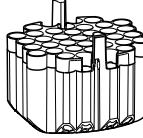
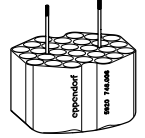
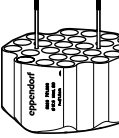



									
25 mL snap cap ¹⁾	25 mL screw cap ²⁾	50 mL screw cap	45 mL snap cap	Microplate 96/384 Wells	250 mL flat, 175-225 mL conical ³⁾	2.6 – 8 mL	5.5 – 12 mL	9 mL	14 mL
30 mm	30 mm	30 mm	30 mm	-	62 mm	13 mm	16 mm	17.5 mm	17.5 mm
131 mm	131 mm	131 mm	131 mm	18 mm	133 mm	110 mm	110 mm	136 mm	123 mm
125 mm	125 mm	125 mm	125 mm	-	126 mm	107 mm	106 mm	130 mm	120 mm
									
10/40	10/40	10/40	10/40	1 MTP	1/4	49/196	37/148	28/112	24/96
conical	conical	conical	conical	skirted	flat	round	round	round	round
107 mm	155 mm	213 mm	213 mm	134 mm	207 mm	205 mm	204 mm	209 mm	210 mm
3,735 × g	3,509 × g	4,301 × g		2,706 × g	4,180 × g	4,140 × g	4,120 × g	4,221 × g	4,240 × g
		2 pcs.				2 pcs.	2 pcs.	2 pcs.	2 pcs.
		5920 755 005				5920 739 000	5920 738 003	5920 746 006	5920 751 000

Centrifuges and Rotors

Rotors for Centrifuge 5920 R

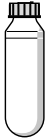

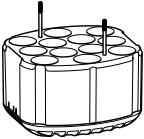
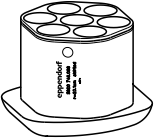
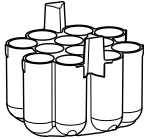
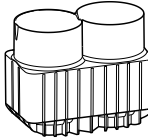
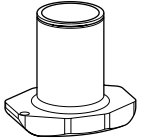





					
Adapters for Rotor S-4xUniversal-Large					
Tube Volume	30 mL	50 mL conical, skirted	50 mL Nalgene® Oak Ridge	250 mL flat, 175 – 225 mL conical ¹⁾	250 mL conical (Corning®, Nunc®)
Max. tube diameter	25 mm	30 mm	29 mm	62 mm	62 mm
Max. vessel height	117 mm	141 mm	132 mm	133 mm	171 mm
Max. vessel height for use with cap/lid	108 mm	121 mm	121 mm	126 mm	144 mm
Adapter					
Number of vessels per adapter/rotor	12/48	7/28	12/48	2/8	1/4
Bottom shape	flat	conical, skirted	round	flat	conical
Centrifugation radius	194 mm	197 mm	206 mm	203 mm	208 mm
Max. RCF	3,918 × g	3,978 × g	4,160 × g	4,099 × g	4,200 × g
Packing	2 pcs.	2 pcs.	2 pcs.	2 pcs.	2 pcs.
Order no.	5920 743 007	5920 748 009	5920 753 002	5920 740 008	5920 750 003

¹⁾ Please note that these conical bottles need to be used together with a conical form insert provided by the manufacturer.

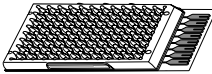

Ordering information

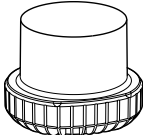
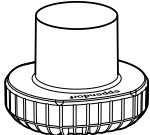
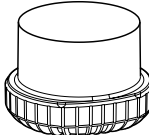
Description	Order no.
Rotor S-4xUniversal-Large , incl. universal buckets	5895 190 006
Buckets , for Rotor S-4xUniversal-Large, 4 pcs.	5895 192 009
Caps , Rotor S-4xUniversal-Large, universal buckets, aerosol-tight, 2 pcs.	5920 752 006



				
500 mL conical Corning®	500 mL flat Nalgene®	750 mL	Micro Fluidic Cards	MTP, DWP, PCR plates
96 mm	69.5 mm	102 mm	–	–
160 mm	168 mm	166 mm	153 mm	116 mm
148 mm	143 mm	143 mm	–	110 mm
				
1/4	1/4	1/4	3/12	5/20 (MTP) 2/8 (DWP)
conical	flat	flat	flat	flat
208 mm	206 mm	202 mm	200 mm	196 mm
4,200 × g	4,160 × g	4,079 × g	4,039 × g	3,938 × g
2 pcs.	2 pcs.	2 pcs.	2 pcs.	2 pcs.
5920 744 003	5920 745 000	5920 741 004	5920 749 005	5920 737 007

Rotors for Centrifuge 5920 R

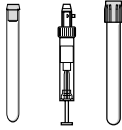
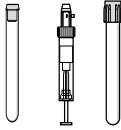

Rotor S-4x1000 high-capacity buckets

- > Extra high capacity swing-bucket rotor with max. speed $3,153 \times g$ (3,700 rpm)
- > Bucket accommodates both plates and tubes
- > Buckets and adapters are autoclavable

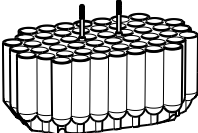
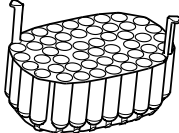
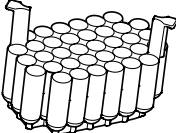
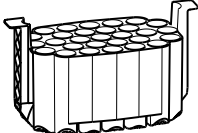









				
Adapters for Rotor S-4x1000 high-capacity buckets				
Tube Volume	5 mL FACS	2.6 – 8 mL	5.5 – 12 mL	9 mL
Max. tube diameter	12 mm	13 mm	16 mm	17.5 mm
Max. vessel height	108 mm	107 mm	107 mm	129 mm
Adapter				
Number of vessels per adapter/rotor	52/208	49/196	36/144	29/116
Bottom shape	round	round	round	round
Centrifugation radius	204 mm	204 mm	199 mm	204 mm
Max. RCF	$3,122 \times g$	$3,122 \times g$	$3,046 \times g$	$3,122 \times g$
Packing	2 pcs.	2 pcs.	2 pcs.	2 pcs.
Order no.	5920 724 002	5920 718 002	5920 720 007	5920 722 000

¹⁾ Please order adapter for 25 mL conical tubes snap cap 5820 733 004. ²⁾ Please order adapter for 25 mL conical tubes screw cap 5820 734 000. ³⁾ Please note that these conical bottles need to be used together with a conical form insert provided by the manufacturer.

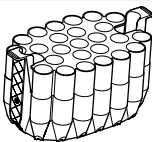

Ordering information

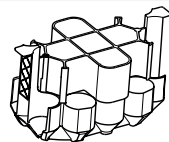
Description	Order no.
Rotor S-4x1000 , incl. high-capacity buckets	5895 118 003
High-Capacity bucket , Rotor S-4x1000, 2 pcs.	5895 107 001
High-Capacity bucket , for Rotor S-4x1000, 4 pcs.	5895 106 005

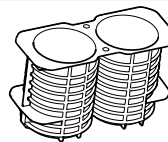
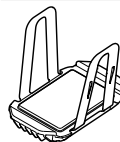
					
Eppendorf Tubes® 5.0 mL and 15 mL conical	25 mL snap cap ¹⁾	25 mL screw cap ²⁾	50 mL screw cap	250 mL flat, 175 – 225 mL conical ³⁾ and Nunc® 250 mL conical	MTP, DWP, PCR plates
17 mm	30 mm	30 mm	30 mm	62 mm	–
121 mm	83 mm	78.5 mm	116 mm	148 mm	88 mm
					
27/108	12/48	13/52	13/52	2/8	6/24 (MTP) 2/8 (DWP)
conical	conical	conical	conical	flat	flat
205 mm	179 mm	169 mm	206 mm	200 mm	185 mm
3,138 × g	2,739 × g	2,586 × g	3,153 × g	3,061 × g	2,832 × g
2 pcs.	2 pcs.	2 pcs.	2 pcs.	2 pcs.	2 pcs.
5920 716 000		5920 715 003		5920 717 006	5920 729 004

Rotors for Centrifuge 5920 R



Rotor S-4x1000 plate/tube buckets

- > High capacity swing-bucket rotor with max. speed $3,076 \times g$ (3,700 rpm)
- > Bucket accommodates both plates and tubes
- > Aerosol-tight QuickLock caps for safe centrifugation of hazardous samples optionally available¹⁾

¹⁾ Aerosol-tightness tested by Public Health England, Porton Down, UK.

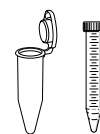
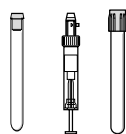
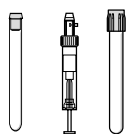

Adapters for Rotor S-4x1000 plate/tube buckets

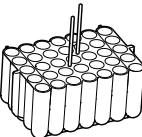
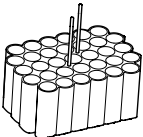
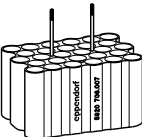
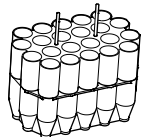
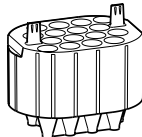
Tube Volume	2.6 – 8 mL	5.5 – 12 mL	9 mL	Eppendorf Tubes® 5.0 mL and 15 mL conical	Eppendorf Tubes® 5.0 mL and 15 mL conical
Max. tube diameter	13 mm	16 mm	17.5 mm	17 mm	17 mm
Max. vessel height	109 mm	109 mm	109 mm	121 mm	123 mm
Max. vessel height for use with cap/lid ¹⁾	108 mm	108 mm	109 mm	–	121 mm
Adapter					
Number of vessels per adapter/rotor	35/140	33/132	28/112	22/88	16/64
Bottom shape	round	round	round	conical	conical
Centrifugation radius	201 mm	200 mm	200 mm	201 mm	201 mm
Max. RCF	$3,076 \times g$	$3,061 \times g$	$3,061 \times g$	$3,076 \times g$	$3,076 \times g$
Packing	2 pcs.	2 pcs.	2 pcs.	2 pcs.	2 pcs.
Order no.	5920 706 004	5920 707 000	5920 708 007	5920 710 001	5920 712 004

¹⁾ Please perform a manual test to determine the actual loading capacity.²⁾ Please order adapter for 25 mL conical tubes screw cap 5820 734 000.³⁾ Please order adapter for 25 mL conical tubes snap cap 5820 733 004.



Ordering information

Description	Order no.
Rotor S-4x1000 , aerosol-tight, incl. plate/tube buckets	5895 117 007
Caps , Rotor S-4x1000: plate/tube bucket; Rotor S-4x750: plate bucket, aerosol-tight, 2 pcs.	5895 111 009
Plate carrier , for Rotor S-4x1000 with plate/tube buckets, 2 pcs.	5920 705 008
Plate/tube bucket , for Rotor S-4x1000, 4 pcs.	5895 104 002
Plate/tube bucket , for Rotor S-4x1000, 2 pcs.	5895 105 009







25 ml screw cap ²⁾	25 ml snap cap ³⁾	50 mL screw cap	45 mL snap cap	25 mL screw cap ²⁾	25 mL snap cap ³⁾	45 mL snap cap	50 mL screw cap	MTP, DWP, PCR plates
30 mm	30 mm	30 mm	30 mm	30 mm	30 mm	30 mm	30 mm	–
78.5 mm	83 mm	121 mm		78.5 mm	83 mm	121 mm	121 mm	104 mm
–	–	–		78.5 mm	83 mm	121 mm	121 mm	91 mm
10/40	9/36	10/40	9/36	7/28	6/24	6/24	7/28	7/28(MTP) 2/8(DWP)
conical	conical	conical	conical	conical	conical	conical	conical	flat
165 mm	175 mm	201 mm		166 mm	107 mm	201 mm	201 mm	198 mm
2,525 × g	2,678 × g	3,076 × g		2,540 × g	2,693 × g	3,076 × g	3,076 × g	3,030 × g
	2 pcs.				2 pcs.			2 pcs.
	5920 709 003				5920 711 008			5920 705 008

Rotors for Centrifuge 5920 R

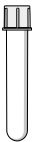
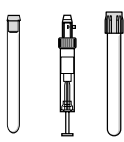
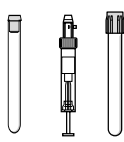
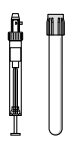

Rotor S-4x1000 round buckets

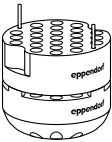
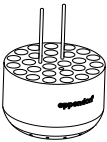
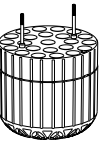

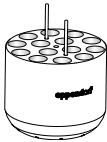
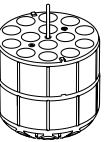













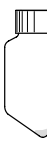



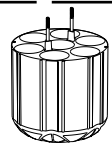
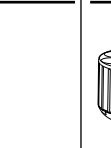
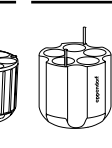

- > Medium capacity swing-bucket rotor with max. speed 3,428 × g (3,700 rpm)
- > Broad range of adapters enables high versatility for tubes and flasks from 0.2 mL to 1,000 mL
- > Mixed loading with 2 plate buckets and 2 round tube buckets allows for increased versatility

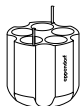
								
Adapters for Rotor S-4x1000 round buckets								
Tube Volume	1.5/2.0 mL	12 × 75 mm, 5 mL FACS	2.6 – 8 mL	5.5 – 12 mL	9 mL	14 mL	Eppendorf Tubes® 5.0 mL and 15 mL conical	25 mL snap cap ²⁾
Max. tube diameter	11 mm	12 mm	13 mm	16 mm	17.5 mm	17.5 mm	17 mm	30 mm
Max. vessel height	39 mm	115 mm	121 mm	140 mm	117 mm	117 mm	161 mm	83 mm
Max. vessel height for use with cap/lid¹⁾	39 mm	108 mm	113 mm	140 mm	112 mm	112 mm	150 mm	83 mm
Adapter								
Number of vessels per adapter/rotor	50/200	27/108	23/92	20/80	20/80	14/56	14/56	6/24
Bottom shape	flat	round	round	round	round	round	conical	conical
Centrifugation radius	219 mm	211 mm	210 mm	211 mm	210 mm	210 mm	224 mm	107 mm
Max. RCF	3,352 × g	3,229 × g	3,214 × g	3,229 × g	3,214 × g	3,214 × g	3,428 × g	2,005 × g
Packing	2 pcs.	2 pcs.	2 pcs.	2 pcs.	2 pcs.	2 pcs.	2 pcs.	2 pcs.
Order no.	5825 740 009	5825 747 003	5825 738 004	5825 736 001	5825 743 008	5825 748 000	5825 734 009	

¹⁾ Exceeding the maximum tube length may reduce the loading capacity of the rotor. Please perform a manual swing-out test before starting the centrifuge run to make sure the tubes do not hit the rotor yoke.
²⁾ Please order adapter for 25 mL conical tubes snap cap 5820 733 004.³⁾ Please order adapter for 25 mL conical tubes screw cap 5820 734 000.⁴⁾ Please note that these conical bottles need to be used together with a conical form insert provided by the manufacturer.⁵⁾ 225 mL conical bottles from BD®/Corning® and 250 mL conical bottles from Nunc® for Rotor S-4-104 and S-4x750.

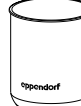
Ordering information

Description	Order no.
Round bucket, for Rotor S-4x1000, 2 pcs.	5895 103 006
Round bucket, for Rotor S-4x1000, 4 pcs.	5895 102 000
Rotor S-4x1000 round buckets, aerosol-tight, incl. 4 × 1,000 mL round buckets	5895 100 007
Caps for 750 mL/1000 mL, for rotors S-4-104, S-4x750, S-4x1000, aerosol-tight, 2 pcs.	5820 747 005
Wide-neck bottle 750 mL, for Rotors S-4-104, S-4x750, S-4x1000, 2 pcs.	5820 708 000

												
25 mL screw cap ³⁾	50 mL screw cap	45 mL snap cap	30 mL	50 mL conical, skirted	250 mL flat, 175 – 225/250 mL conical ⁴⁾⁵⁾	500 mL Corning®	500 mL Nalgene®	600 mL TPP	750 mL	1 Liter Nalgene®	MTP, DWP, PCR plates	
30 mm	30 mm	30 mm	25 mm	30 mm	62 mm	96 mm	69.5 mm	98 mm	102 mm	98 mm	–	
78.5 mm	156 mm	156 mm	144 mm	151 mm	176 mm	167 mm	183 mm	181 mm	150 mm	196 mm	104 mm	
78.5 mm	150 mm	150 mm	139 mm	147 mm	156 mm	167 mm	183 mm	181 mm	150 mm	–	91 mm	
												
7/28	7/28	6/24	8/32	5/20	1/4	1/4	1/4	1/4	1/4	1/4	7/28 (MTP) 2/8 (DWP)	
conical	conical	conical	flat	conical, skirted	flat	conical	flat	conical	flat	flat	flat	
121 mm	223 mm	223 mm	212 mm	209 mm	214 mm	218 mm	221 mm	224 mm	216 mm	218 mm	198 mm	
1,852 × g	3,413 × g	3,413 × g	3,245 × g	3,199 × g	3,275 × g	3,336 × g	3,382 × g	3,428 × g	3,306 × g	3,336 × g	3,030 × g	
2 pcs.	2 pcs.	2 pcs.	2 pcs.	2 pcs.	2 pcs.	2 pcs.	2 pcs.	2 pcs.	2 pcs.	2 pcs.	2 pcs.	
5825 733 002			5825	5825	5825 741 005	5825 745 000	5920 703 005	5920 701 002	5825 744 004	5920 700 006	5895 105 009	

Overview of Fixed-Angle Rotors Centrifuge 59xx Family



Model	Rotor FA-6x250	Rotor FA-6x50	Rotor FA-20x5
Description	Processing of cells in higher volumes at high speed	Molecular biology applications in tubes up to 50 mL	Applications in Eppendorf Tubes® 5.0 mL
5910 Ri	■	■	■
5920 R	■	■	■
Aerosol-tightness	yes	yes	yes
Max. capacity	6 × 250 mL	6 × 50 mL	20 × 5 mL
Max. RCF	15,054 × g	20,130 × g	20,913 × g
Max. speed	10,100 rpm	12,100 rpm	13,100 rpm
1.5/2.0 mL micro tube		6	20
Eppendorf Tubes® 5.0 mL and 15 mL conical	24	6	20/0
25 mL conical tubes	6 ¹⁾²⁾	6 ³⁾⁴⁾	
50 mL conical tubes	6	6	
85 mL Oakridge tubes	6		
250 mL conical tubes	6		

¹⁾ Screw cap tubes only. ²⁾ Please order adapter for 25 mL conical tubes screw cap 5820 734 000. ³⁾ Please order adapter for 25 mL conical tubes screw cap 5820 734 000. ⁴⁾ Please order adapter for 25 mL conical tubes snap cap 5820 733 004.

Advanced Rotor Design



Cross section of Rotor FA-6x50 (6 × 50 mL conical) showing the light-weight design. All metal not needed for safety or performance is hollowed out to reduce weight and improve handling.

Low rotor weight

Eppendorf's fixed-angle rotors are among the lightest in the industry to improve handling and operational safety. Light-weight rotors cause less wear and tear on the motor and allow for faster acceleration and braking times.

**Rotor FA-48x2**

Aerosol-tight microcentrifuge tube rotor

■
■
yes
48 × 2 mL
21,194 × g (5920 R) / 22,132 × g (5910 Ri)
13,700 rpm (5920 R) / 14,000 rpm (5910 Ri)
48

Rotor FA-30x2

Aerosol-tight microcentrifuge tube rotor for safe centrifugation of hazardous samples

■
-
yes
30 × 2 mL
20,984 × g
13,700 rpm
30

Rotor F-48x15

High-capacity fixed-angle rotor for 15 mL conical and glass tubes

■
-
40 × 15 mL
5,005 × g
5,500 rpm
0/40

Eppendorf QuickLock® lids for ergonomic lid locking

Our aerosol-tight QuickLock rotors close with only ¼ of a turn. This not only saves you time during every day use, it also takes repetitive stress off your wrist.

Superior temperature control

Aluminum, with its high heat conductivity, allows fast pre-cooling and accurate temperature control in refrigerated centrifuges.

**Perfect fit with Eppendorf Conical Tubes 15 mL and 50 mL**

The Eppendorf Conical Tubes are characterized by an outstanding centrifugation stability of up to 19,500 × g¹⁾. This makes them suited for a broad range of applications.

¹⁾ Test conditions: Rotor FA-45-6-30 in Eppendorf Centrifuge 5810 R (using a suitable centrifuge adapter for 15 mL tube), sample: Saline solution (density: 1.0 g/mL), controlled centrifugation temp.: 25 °C, centrifugation time: 90 min (SnapTec® tube: 17,000 × g max.)

Centrifuges and Rotors

Rotors for Centrifuge 5910 Ri/5920 R





**Rotor FA-6x250**

- > Fixed-angle rotor for up to 6 x 250 mL bottles¹⁾
- > Ideal for the pelleting of microorganisms and mammalian cells
- > 12 different adapters for broad range of additional applications

¹⁾ To run this rotor, a software update is required for earlier centrifuges (5910 R & 5920 R). Please contact your local Eppendorf organization or dealer for further information.

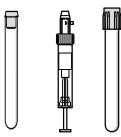
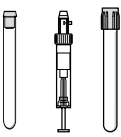
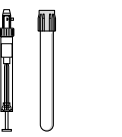
Ordering information

Description	Order no.
Rotor FA-6x250, aerosol-tight, for 6 x 250 mL bottles incl. Eppendorf QuickLock® rotor lid	5895 175 007

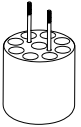
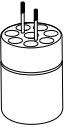
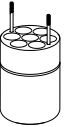
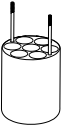
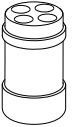
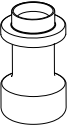
								
Adapters for Rotor FA-6x250								
Tube Volume	5 mL	2.6 – 8.0 mL	5.5 – 12.0 mL	9 mL	Eppendorf Tubes® 5.0 mL and 15 mL	25 mL screw cap ²⁾	50 mL screw cap	45 mL snap cap
Max. tube diameter	12 mm	13 mm	16 mm	17.5 mm	17 mm	30 mm	30 mm	30 mm
Max. vessel height for use with cap/lid¹⁾	114 mm	114 mm	115 mm	112 mm	122 mm	78.5 mm	125 mm	125 mm
Adapter								
Number of vessels per adapter/rotor	9/54	8/48	7/42	7/42	4/24	1/6	1/6	1/6
Bottom shape	round	round	round	round	conical	conical	conical	conical
Centrifugation radius	126 mm	125 mm	125 mm	126 mm	120 mm	95 mm	110 mm	110 mm
Max. RCF	14,370 × g	14,256 × g	14,256 × g	14,370 × g	13,686 × g	10,834 × g	12,545 × g	12,545 × g
Packing	2 pcs.	2 pcs.	2 pcs.	2 pcs.	2 pcs.	2 pcs.		
Order no.	5920 765 000	5920 763 008	5920 762 001	5920 764 004	5920 761 005	5920 760 009		

¹⁾ Please perform a manual test to determine the actual loading capacity. ²⁾ Please order adapter for 25 mL conical tubes screw cap 5820 734 000. ³⁾ 175 mL conical bottles from BD/Corning® (352076). Please note that these conical bottles need to be used together with a conical form insert provided by the bottle manufacturer. ⁴⁾ 250 mL flat bottom bottles from Nalgene® (3127-0250, 3122-0250, 3120-0250) and Corning® (431841, 431842). When used with wide lid 250 mL flat bottom bottle from Nalgene® (3140-0250) max. capacity is reduced to 4 x 250 mL.

Centrifuges and Rotors



50 mL	10 mL	16 mL	30 mL	50 mL	85 mL	175 mL ³⁾	250 mL ⁴⁾
30 mm	17 mm	18 mm	26 mm	29 mm	38 mm	62 mm	62 mm
125 mm	115 mm	115 mm	116 mm	125 mm	118 mm	118 mm	135 mm
						—	—
1/6	7/42	7/42	3/18	1/6	1/6	1/6	1/6
conical, skirted	round	round	round	round	round	conical	flat
108 mm	126 mm	126 mm	125 mm	111 mm	113 mm	132 mm	132 mm
12,317 × g	14,370 × g	14,370 × g	14,256 × g	12,659 × g	12,887 × g	15,054 × g	15,054 × g
2 pcs.	2 pcs.	2 pcs.	2 pcs.	2 pcs.	2 pcs.	—	—
5920 766 007	5920 769 006	5920 770 004	5920 767 003	5920 771 000	5920 768 000	Conical form insert required ³⁾	No adapter required ⁴⁾

Rotors for Centrifuge 5910 Ri/5920 R











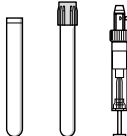
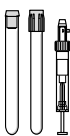

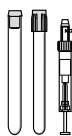
Rotor FA-6x50

- > High-speed rotor for applications in tubes from 5 – 50 mL
- > Max. speed 20,130 × g (12,100 rpm)
- > Eppendorf QuickLock® rotor lid for fast lid locking

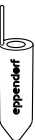
Ordering information

Description	Order no.
Rotor FA-6x50, aerosol-tight, incl. rotor lid, 6 × 50 mL conical tubes	5895 150 004

						
Adapters for Rotor FA-6x50						
Tube Volume	2.6 – 5 mL	4 – 8 mL	5.5 – 10 mL	7.5 – 12 mL	Eppendorf Tubes® 5.0 mL	7 – 17 mL
Max. tube diameter	13 mm	13 mm	16 mm	16 mm	17 mm	17.5 mm
Max. vessel height for use with cap/lid	119 mm	119 mm	119 mm	119 mm	121 mm	112 mm
Adapter						
Number of vessels per adapter/rotor	1/6	1/6	1/6	1/6	1/6 ¹⁾	1/6
Bottom shape	round	round	round	round	conical	round
Centrifugation radius	120 mm	120 mm	120 mm	120 mm	121 mm	120 mm
Max. RCF	19,642 × g	19,642 × g	19,642 × g	19,642 × g	19,806 × g	19,642 × g
Packing	2 pcs.	2 pcs.	2 pcs.	2 pcs.	2 pcs.	2 pcs.
Order no.	5820 726 008	5820 725 001	5820 728 000	5820 727 004	5820 730 005	5820 729 007











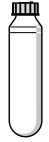

¹⁾ Eppendorf Tubes® 5.0 mL with screw cap will not fit in this adapter.

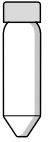
Eppendorf Tubes® BioBased

- > Tubes are made from 90 % renewable-based feedstock plus 10 % fossil-based feedstock
- > ACT labeled – Environmental Impact Factor Certification
- > “Certified ISCC PLUS Manufacturer”
(International Sustainability & Carbon Certification)
- > General Quality Certificates / Compliance with Standards,
lot-specific certificates available
- > Eppendorf Tubes® in 5.0 mL, 15 mL, 25 mL and 50 mL in Sterile
(sterile, pyrogen-free, DNase- / RNase-free, DNA (human and bacterial) free)

Find more information on page 120



							
15 mL	16 mL	30 mL	25 mL snap cap	25 mL screw cap	35 mL	50 mL screw cap	45 mL snap cap
17 mm	18 mm	26 mm	30 mm	30 mm	29 mm	30 mm	30 mm
121 mm	107 mm	104 mm	83 mm	78.5 mm	113 mm	116 mm	118 mm
						—	—
1/6	1/6	1/6	1/6	1/6	1/6	—/6	—/6
conical	round	round	conical	conical	conical	conical	conical
120 mm	120 mm	105 mm	104 mm	97 mm	112 mm	123 mm	123 mm
19,642 × g	19,642 × g	17,187 × g	17,023 × g	15,877 × g	18,333 × g	20,133 × g	20,133 × g
2 pcs.	2 pcs.	2 pcs.	6 pcs.	6 pcs.	2 pcs.	—	—
5820 717 009	5820 720 000	5820 721 006	5820 733 004	5820 734 000	5820 722 002	—	—

Centrifuges and Rotors

Rotors for Centrifuge 5910 Ri/5920 R

**Rotor FA-20x5**

- > 20 places for Eppendorf Tubes® 5.0 mL¹⁾
- > Max. speed: 20,913 × g (13,100 rpm)
- > Aerosol-tight²⁾ Eppendorf QuickLock® rotor lid

¹⁾ For Eppendorf Tubes® 5.0 mL with screw cap the capacity is limited to 10 tubes.

²⁾ Aerosol-tightness tested by Public Health England, Porton Down, UK.

Ordering information

Description	Order no.
Rotor FA-20x5 , aerosol-tight, for 20 Eppendorf Tubes® 5.0 mL, incl. Eppendorf QuickLock® rotor lid	5895 130 003
Adapter , for 1 vessel 1.5 – 2.0 mL, for all 5.0 mL rotors, 4 pcs.	5820 768 002
Adapter , for 1 cryo tube, for all 5.0 mL rotors, 4 pcs.	5820 769 009
Adapter , for 1 HPLC tube, for all 5.0 mL rotors, 4 pcs.	5820 770 007

**Rotor FA-48x2**

- > 48 places for 1.5/2.0 mL tubes
- > Max. speed: 21,194 × g/13,700 rpm (5920 R) / 22,132 × g / 14,000 rpm (5910 Ri)
- > Eppendorf QuickLock® rotor lid for fast lid locking

Ordering information

Description	Order no.
Adapter , for 1 PCR tube (0.2 mL, max. Ø 6 mm), for all 1.5/2.0 mL rotors, 6 pcs.	5425 715 005
Adapter , for 1 sample tube (0.5 mL, max. Ø 8 mm) or 1 Microtainer® (0.6 mL, max. Ø 8 mm), for all 1.5/2.0 mL rotors, 6 pcs.	5425 716 001
Rotor FA-48x2 , 48 × 1.5/2 mL tubes, incl. aerosol-tight Eppendorf QuickLock® rotor lid	5895 135 005
Adapter , for 1 micro test tube (0.4 mL, max. Ø 6 mm), for all 1.5/2.0 mL rotors, 6 pcs.	5425 717 008

**Rotor F-48x15**

- > High-capacity fixed-angle rotor for 15 mL conical and glass tubes
- > Maximum speed: 5,005 × g (5,500 rpm)
- > Form inserts for 15 mL conical tubes

Ordering information

Description	Order no.
Rotor F-48x15 , for 40 × 15 mL conical tubes, incl. 48 steel sleeves and adapters	5895 160 000

Rotors for Centrifuge 5910 Ri



Rotor FA-30x2

- > 30 places for 1.5/2.0 mL tubes
- > Max. speed: 20,984 × g (max. 13,700 rpm)
- > Eppendorf QuickLock® rotor lid for fast lid locking

Ordering information

Description	Order no.
Rotor FA-30x2, incl. aerosol-tight Eppendorf QuickLock® rotor lid	5895 155 006

Mobile Tables



Description

Is space a limited resource in your lab or are you looking for an ergonomic location for your Eppendorf tabletop centrifuge? The new Eppendorf Mobile Tables save precious benchtop space and provide the freedom and flexibility to use your Centrifuge 5804/5804 R, 5810/5810 R, 5910 Ri or 5920 R wherever you need it.

Product features

- > Designed for Centrifuge 5804/5804 R, 5810/5810 R, 5910 R/5910 Ri, 5920 R
- > Save precious benchtop space
- > Sturdy design for safe centrifugation

Ordering information

Description	Order no.
Mobile table for under bench storage (low design) , fits under standard 90 cm lab bench with centrifuge lid closed for Centrifuge 5804/5804 R, 5810/5810 R, 5910 R, 5910 Ri and 5920 R	5921 000 010
Mobile table for ergonomic loading and unloading (high design) , fits in any empty floor space for Centrifuge 5804/5804 R, 5810/5810 R, 5910 R, 5910 Ri and 5920 R	5921 000 012

Centrifuges and Rotors

Concentrator plus

**Description**

With its advanced heating technology, the Eppendorf Concentrator plus facilitates fast and efficient, gentle vacuum concentration of DNA, RNA, nucleotides, proteins and other liquid or wet samples. Its new coated lid provides superior chemical resistance against many acids and organic solvents.

Product features

- > Comes in 3 system configurations
- > Extremely quiet operation <50 dB(A)
- > Chemical-resistant, maintenance-free PTFE diaphragm pump eliminates the need for changing pump oil

Technical specifications

Model	Concentrator plus basic	Concentrator plus system	Concentrator plus system w/port
Vacuum		20 hPa (20 mbar)	20 hPa (20 mbar)
Sample capacity	max. 144 vessels/2 microplates	max. 144 vessels/2 microplates	max. 144 vessels/2 microplates
Fixed speed	1,400 rpm	1,400 rpm	1,400 rpm
Tube volume	0.2 – 50 mL	0.2 – 50 mL	0.2 – 50 mL
Port to connect external devices to vacuum pump	no	no	yes
Max. power consumption	150 W	350 W	350 W
Dimensions (W × D × H)	33 × 37 × 23 cm / 12.6 × 14.5 × 9.1 in	33 × 58 × 29 cm / 12.6 × 20.9 × 11.7 in	33 × 58 × 29 cm / 12.6 × 20.9 × 11.7 in
Weight w/o accessories	16.5 kg / 37.5 lb	31.5 kg / 68.3 lb	31.5 kg / 68.3 lb

Ordering information

Description	Order no.
Concentrator plus basic device , w/o pump, with Rotor F-45-48-11 230 V/50 – 60 Hz (GB)	5305 000 169
Concentrator plus complete system , with integrated diaphragm vacuum pump with Rotor F-45-48-11, 230 V/50 – 60 Hz (GB)	5305 000 363
without rotor, 230 V/50 – 60 Hz (GB)	5305 000 568
Concentrator plus complete system , with integrated diaphragm vacuum pump, with connection, e.g., for a gel dryer without rotor, 230 V/50 – 60 Hz (GB)	5305 000 762
Adapter , for 1 PCR tube (0.2 mL, max. Ø 6 mm), for all 1.5/2.0 mL rotors, 6 pcs.	5425 715 005
Adapter , for 1 sample tube (0.5 mL, max. Ø 8 mm) or 1 Microtainer® (0.6 mL, max. Ø 8 mm), for all 1.5/2.0 mL rotors, 6 pcs.	5425 716 001
CombiSlide Adapter , for 12 slides Combi Slide, for Rotors A-2-MTP and A-4-81 (MTP), 2 pcs.	5825 706 005
Adapter , for 1 PCR tube 0.2 mL, for Rotor F-45-72-8, 6 pcs.	5425 723 008
Rotor spacer , required for stacking rotors F-45-72-8 and F-45-48-11	5301 316 005
Frame for work tray , for Rotor A-2-VC, 5 pcs.	0030 124 243
Adapter , for 1 micro test tube (0.4 mL, max. Ø 6 mm), for all 1.5/2.0 mL rotors, 6 pcs.	5425 717 008

✓ Ordering information for other voltage options begins on page 349

Rotors for Concentrator plus



Rotor F-45-48-11

- > Rotor for 48 × 1.5/2.0 mL microcentrifuge tubes
- > A spacer enables additional stacking (double capacity)



Rotor F-35-6-30

- > Rotor for 6 × 50 mL conical tubes
- > Rotor for 6 × 15 mL conical tubes
- > Also accommodates for 6 × 25 mL conical tubes



Rotor A-2-VC



- > For use with MTP, PCR and Deepwell Plates up to 27 mm high
- > A work tray with frame is available for PCR test plates and microplates without frames
- > Rotor can be autoclaved for 20 min. at 121°C



Rotor F-45-22-17

- > Max. load: 22 × 5.0 mL
- > Tube Options: Snap caps and screw caps
- > Tube diameter: 17 mm

Ordering information

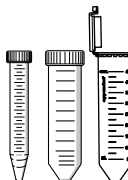
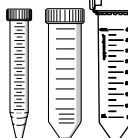
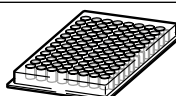
	Description	Max. tube dimensions Ø x L	Sample capacity	Order no.
	Rotor F-45-72-8	8 × 31 mm ¹⁾	72 × 0.5 mL	5490 034 007
	Rotor F-45-70-11	11 × 41/47 mm	70 × 1.5 mL, 70 × 2.0 mL	5490 032 004
	Rotor F-45-48-11	11 × 41/47 mm ¹⁾	48 × 1.5 mL / 2.0 mL	5490 030 001
	Rotor F-45-22-17	17 × 59.4 – 67.4 mm	22 × 5.0 mL	5490 048 008
	Rotor F-40-36-12	12 × 32 mm	36 × 1.5 mL	5490 040 007
	Rotor F-45-36-15	15 × 45 – 48 mm ²⁾	36 × 3.0/5.0 mL	5490 035 003
	Rotor F-45-16-20	20 × 42 – 55 mm ²⁾	16 × 6.5/10 mL	5490 043 006
	Rotor F-40-18-19	19 × 66 mm	18 × 10 mL	5490 037 006
	Rotor F-45-12-31	31 × 55 mm	12 × 20 mL	5490 044 002
	Rotor F-35-8-24	24 × 86 – 105 mm ²⁾	8 × 25 mL	5490 039 009
	Rotor F-45-24-12	12 × 67 – 100 mm ^{2) 3)}	24 × 5 – 7 mL	5490 036 000
	Rotor F-50-8-16	16 × 105 – 120 mm ²⁾	8 × 8 – 12 mL	5490 041 003
	Rotor F-50-8-18	18 × 105 – 128 mm ²⁾	8 × 10 – 18 mL	5490 042 000
	Rotor F-45-8-17	17 × 116 – 123 mm ²⁾	8 × 15 mL conical tubes	5490 038 002
	Rotor F-35-6-30	17 × 116 – 123 mm or 30 × 116 – 123 mm ²⁾	6 × 15 mL conical tubes or 6 × 50 mL conical tubes	5490 047 001
	Rotor A-2-VC	128 × 86 × 27 mm	2 × MTP or skirted PCR plates 2 × Deepwell plates (DWP) (max. height = 27 mm)	5490 045 009

¹⁾ Rotor is stackable for double capacity using spacer 5301 316.005. ²⁾ Min./max. tube length. ³⁾ Tube length = 75 mm: max capacity 24 tubes, tube length > 75 mm: max capacity 12 tubes.

High-speed Centrifuge CR22N



Whether your work requires harvesting of biomass in volumes of up to 6 L per run, pelleting of cells, subcellular organelles or larger viruses, or extraction, precipitation, concentration and purification of nucleic acids in up to 50 mL tubes, the Centrifuge CR22N is the optimal solution to support your everyday centrifugation tasks.

- > Speeds of up to 58,700 x g (fixed-angle) or 11,500 x g (swing-bucket) support applications in genomics, cell biology and proteomics
- > Unique 1.5 L triangular bottle for easy and time efficient harvesting of cells, yeast and bacterial cultures (up to 15,100 x g)
- > Large touchscreen interface for fast and easy operation
- > User management and documentation function supports labs working in a GLP/GxP environment
- > Self-locking rotor system for increased safety and convenience

Ordering information

Description	Order no.
High-Speed Centrifuge CR22N, refrigerated, 230 V/50/60 Hz (no plug), 30 A	5721 220 012
CR22N Harvesting Bundle (4 x 1.5 L), refrigerated, High-Speed Centrifuge CR22N incl. rotor R9A2 and 4 x 1.5 L triangular bottles, 230 V/50/60 Hz (no plug), 30 A	5721 261 412

Unique 1.5 L Triangular Bottle – Spinning Made Easy



Gain great flexibility and save precious time with our innovative triangular bottles:

- > No minimum filling level. Spin samples between 0 – 1.5 L without worrying about bottle stability
- > Reduces handling steps during the separation process such as balancing, supernatant harvesting, pellet recovery and cleaning of bottles after the run

Ordering information

Description	Order no.
Rotor R9A2 , fixed-angle rotor, incl. 4 x 1.5 L triangular bottles, for Centrifuge CR22N	5721 221 014
Rotor R9A2 , fixed-angle rotor, incl. 4 x 1.5 L triangular bottles, for Centrifuge CR30NX	5721 302 115

Centrifuges and Rotors

Rotors for Centrifuge CR22N

Product Name	Max. capacity	Max. speed	Max. RCF
fixed-angle rotor			
Rotor R10A3	6 x 500 mL	10,000 rpm	18,800 × g
Rotor R10A5	6 x 500 mL	10,000 rpm	18,900 × g
Rotor R12A3	6 x 250 mL	12,000 rpm	23,800 × g
Rotor R12A6	4 x 500 mL	12,000 rpm	22,500 × g
Rotor R13A	6 x 250 mL	13,000 rpm	26,400 × g
Rotor R14A	4 x 250 mL	14,000 rpm	30,240 × g
Rotor R15A	10 x 50 mL	15,000 rpm	32,300 × g
Rotor R18A	8 x 50 mL	18,000 rpm	42,200 × g
Rotor R20A2	8 x 50 mL	20,000 rpm	48,000 × g
Rotor R21A2	6 x 30 mL	21,000 rpm	50,000 × g
Rotor R22A4	30 x 2 mL	22,000 rpm	55,200 × g
Rotor R22A6	12 x 10 mL	22,000 rpm	55,100 × g
Rotor R27A	8 x 50 mL	22,000 rpm	58,700 × g
Rotor R9A	4 x 1,000 mL	9,000 rpm	15,300 × g
Rotor R9A2	4 x 1,500 mL	8,500 rpm	15,100 × g
horizontal rotor			
Rotor R10H	NA	10,000 rpm	13,000 × g
soil dehydration rotor			
Rotor R11D2	4 x 110 mL	11,000 rpm	15,800 × g
swing-bucket rotor			
Rotor R3S	4 x 500 mL	3,000 rpm	1,940 × g
Rotor R4SS	40 x 15 mL	4,000 rpm	2,900 × g
Rotor R5S4	NA	4,700 rpm	3,100 × g
Rotor R8S	4 x 50 mL	8,000 rpm	11,500 × g

The maximum capacity refers to the nominal volume. The maximum filling volume may depend on the application, rotor and speed. Please consult with your sales representative for further details.

Separation example	Included tube	Order no.
For harvesting of bacteria, cells or yeast for e.g. recombinant protein purification or cell compartment purification in 6 x 500 mL bottles.	6 x 500PA Bottle	5721 221 013
For harvesting of bacteria, cells or yeast for e.g. recombinant protein purification or cell compartment purification in 6 x 500 mL Nalgene® bottles.		5721 221 012
For harvesting of bacteria, cells or yeast for e.g. recombinant protein or cell compartment purification in 6 x 250 mL bottles.	6 x 250PP Bottle	5721 221 011
For harvesting of bacteria, cells or yeast for e.g. recombinant protein purification or cell compartment purification in 4 x 500 mL Nalgene® bottles.	4 x 500PA Bottle	5721 221 010
For harvesting of bacteria, cells or yeast and removing cellular debris for e.g. recombinant protein or cell compartment purification in 6 x 250 mL bottles.	6 x 250PP Bottle	5721 221 009
For harvesting of bacteria, cells or yeast and removing cellular debris for e.g. recombinant protein or cell compartment purification in 4 x 250 mL bottles.	4 x 250PP Bottle	5721 221 008
For removing cellular debris or differential pelleting of subcellular organelles/compartments in conical tubes with 10 x 50 mL.	100 x 50TC Tube	5721 221 007
For fast removal of cellular debris or differential pelleting of subcellular organelles/compartments in conical tubes with 8 x 50 mL.	100 x 50TC Tube	5721 221 006
For differential pelleting of subcellular organelles/compartments in tubes with 8 x 50 mL.	8 x 50PA Tube	5721 302 106
For differential pelleting of subcellular organelles/compartments or larger virus particles in tubes with 6 x 30 mL.	6 x 30PA Bottle	5721 221 004
For pelleting of subcellular organelles/compartments or larger virus particles. For high throughput of small volumes with 30 x 2 mL tubes.		5721 221 003
For pelleting of subcellular organelles/compartments or larger virus particles in tubes with 12 x 10 mL.	12 x 10PA Bottle	5721 221 002
For pelleting of subcellular organelles/compartments or larger virus particles in tubes with 8 x 50 mL.	8 x 50PP Bottle	5721 202 101
For harvesting of bacteria, cells or yeast for e.g. recombinant protein or antibody purification in bottles with 4 x 1 L.	4 x 1000PP Bottle (WM)	5721 221 015
For harvesting of bacteria, cells or yeast for e.g. recombinant protein or antibody purification in easy to handle bottles with 4 x 1.5 L.	4 x 1500PP Bottle (WM)	5721 221 014
For plate centrifugation for e.g. PCR or cell-free protein synthesis with up to 12 x 96 plates.		5721 227 000
For liquid separation from soil or other solid organic material.		5721 228 000
For serum isolation or harvesting of bacteria or cells. For mid volumes with up to 4 x 500 mL bottles.		5721 224 003
For serum isolation, protein concentration in columns or harvesting of bacteria or cells in round bottom tubes with 40 x 15 mL.		5721 264 002
For plate centrifugation for e.g. ELISA or PCR in up to 12 x 96 plates.		5721 224 001
For strong pelleting of bacteria, yeast or cells for e.g. recombinant protein purification in conical tubes with 4 x 50 mL.		5721 202 400

Centrifuges and Rotors

High-speed Centrifuge CR30NX

With high speeds up to 110,000 x g, this centrifuge reaches g-forces that cross into the range of ultracentrifugation, making it the optimal solution for laboratories with a broad application range. From harvesting of biomass via continuous flow to separation steps of small particles such as viruses, organelles, extracellular vesicles or nanoparticles, the outstanding versatility and performance of Centrifuge CR30NX covers them all.

- > 2-in-1 model: suitable for centrifugation steps with super-speed requirements (with vacuum function)
- > Unique 1.5 L triangular bottle for easy and time efficient harvesting of cell, yeast and bacterial cultures (up to 15,100 x g)
- > Immediate rotor recognition and self-locking rotor system for highest level of user safety
- > Large touchscreen interface for fast and easy operation
- > User management and documentation functions support labs working in a GLP/GxP environment



Ordering information

Description	Order no.
High-Speed Centrifuge CR30NX, refrigerated, 230 V/50/60 Hz (no plug), 30 A, 1-phase	5721 300 012
CR30NX Harvesting Bundle (4 x 1.5 L), refrigerated, High Speed Centrifuge CR30NX incl. rotor R9A2 and 4 x 1.5 L triangular bottles, 230 V/50/60 Hz (no plug), 30 A, 1-phase	5721 351 512

Super-Speed Rotors – No Switching Needed



Choose from two rotors with max. speed of 110,000 x g:

- > Top-loading swing-bucket rotor for high-speed density gradient applications (e.g. rate zonal or Isopycnic centrifugation)
- > Fixed-angle rotor for cell fractionation (e.g. Virus-, viral particle or exosome pelleting)
- > With the self-locking rotor system and the immediate rotor recognition, you can toggle between applications in just a few minutes

Ordering information

Description	Order no.
Rotor R30AT , fixed-angle rotor, Super-Speed Pelleting Kit 8 x 50 mL for Centrifuge CR30NX, incl. 8 x 50PP bottle	5721 302 101
Rotor R25ST , swing-bucket rotor, Super-Speed Pelleting Kit 6 x 40 mL for Centrifuge CR30NX, incl. 50 x 40PA tube	5721 302 400

Learn more about
our high-speed
centrifuges

[www.eppendorf.com/
high-speed](http://www.eppendorf.com/high-speed)



Centrifuges and Rotors

Rotors for Centrifuge CR30NX

Product Name	Max. capacity	Max. speed	Max. RCF
continuous flow rotor			
Rotor R10C2	3,200 mL	10,000 rpm	14,290 × g
Rotor R18C2	1 x 1000 mL	18,000 rpm	35,100 × g
fixed-angle rotor			
Rotor R10A3	6 x 500 mL	10,000 rpm	18,800 × g
Rotor R10A5	6 x 500 mL	10,000 rpm	18,900 × g
Rotor R16A2	10 x 50 mL	16,000 rpm	36,100 × g
Rotor R16A3	6 x 250 mL	16,000 rpm	40,100 × g
Rotor R17A	14 x 50 mL	17,000 rpm	40,900 × g
Rotor R19A	6 x 80 mL	19,000 rpm	45,600 × g
Rotor R19A2	8 x 50 mL	19,000 rpm	50,000 × g
Rotor R20A2	8 x 50 mL	20,000 rpm	48,000 × g
Rotor R21A2	6 x 30 mL	21,000 rpm	50,000 × g
Rotor R22A4	30 x 2 mL	22,000 rpm	55,200 × g
Rotor R22A6	12 x 10 mL	22,000 rpm	55,100 × g
Rotor R27A	8 x 50 mL	27,000 rpm	88,400 × g
Rotor R30AT	8 x 50 mL	30,000 rpm	110,000 × g
Rotor R7A	6 x 1,000 mL	7,000 rpm	11,100 × g
Rotor R9A	4 x 1,000 mL	9,000 rpm	15,300 × g
Rotor R9A2	4 x 1,500 mL	8,500 rpm	15,100 × g
horizontal rotor			
Rotor R10H	NA	10,000 rpm	13,000 × g
soil dehydration rotor			
Rotor R11D2	4 x 100 mL	11,000 rpm	15,800 × g
swing-bucket rotor			
Rotor R25ST	6 x 40 mL	25,000 rpm	110,000 × g
Rotor R4SS	40 x 15 mL	4,000 rpm	2,900 × g
Rotor R5S4	NA	4,700 rpm	3,100 × g

The maximum capacity refers to the nominal volume. The maximum filling volume may depend on the application, rotor and speed. Please consult with your sales representative for further details.

Centrifuges and Rotors

Separation example	Included tube	Order no.
For continuous flow harvesting of bacteria, cells or yeast for e.g. recombinant protein or antibody purification in very large volumes of >10 L.		5721 352 601
For continuous flow harvesting of bacteria, cells or yeast for e.g. recombinant protein or antibody purification in very large volumes of >10 L.		5721 302 600
For harvesting of bacteria, cells or yeast for e.g. recombinant protein purification or cell compartment purification in 6 x 500 mL bottles.	6 x 500PA bottle	5721 302 112
For harvesting of bacteria, cells or yeast for e.g. recombinant protein purification or cell compartment purification in 6 x 500 mL Nalgene® bottles.		5721 302 113
For removing cellular debris or differential pelleting of subcellular organelles/compartments and easy handling in conical tubes with 10 x 50 mL.	100 x 15TC Tube and 100 x 50TC tube	5721 302 110
For fast harvesting of bacteria, cells or yeast and removing cellular debris for e.g. recombinant protein or cell compartment purification in 6 x 250 mL bottles.	6 x 250PP bottle	5721 302 111
For fast removal of cellular debris or differential pelleting of subcellular organelles/compartments in tubes with 14 x 50 mL.	14 x 50PA tube with M-PP lid	5721 302 109
For fast removal of cellular debris or differential pelleting of subcellular organelles/compartments in tubes with 6 x 80 mL.	6 x 80PA bottle	5721 302 108
For differential pelleting of subcellular organelles/compartments or larger virus particles in conical tubes with 8 x 50 mL.	100 x 50TC tube	5721 302 107
For differential pelleting of subcellular organelles/compartments in tubes with 8 x 50 mL.	8 x 50PA tube and M-PP lids	5721 221 005
For differential pelleting of subcellular organelles/compartments or larger virus particles in tubes with 6 x 30 mL.	6 x 30PA bottle	5721 302 105
For pelleting of subcellular organelles/compartments or larger virus particles. For high throughput with 30 x 2 mL tubes.		5721 302 104
For pelleting of subcellular organelles/compartments or larger virus particles in tubes with 12 x 10 mL.	12 x 10PA bottle	5721 302 103
For pelleting of subcellular organelles/compartments or larger virus particles in tubes with 8 x 50 mL.	8 x 50PP bottle	5721 302 102
For pelleting and separation of small viruses, subcellular particles and vesicles in tubes with 8 x 50 mL.	8 x 50PP bottle	5721 302 101
For harvesting of bacteria, cells or yeast for e.g. recombinant protein or antibody purification in bottles in 6 x 1 L bottles.	6 x 1000PP bottle	5721 352 100
For harvesting of bacteria, cells or yeast for e.g. recombinant protein or antibody purification in bottles in 4 x 1 L bottles.	4 x 1000PP bottle	5721 302 114
For harvesting of bacteria, cells or yeast for e.g. recombinant protein or antibody purification in easy to handle bottles with 4 x 1.5 L.	4 x 1500PP bottle	5721 302 115
For plate centrifugation for e.g. PCR or cell-free protein synthesis with up to 12 x 96 MTP.		5721 302 700
For liquid separation from soil or other solid organic material.		5721 302 800
For pelleting or density gradient separation of subcellular organelles/compartments or virus particles in tubes with 6 x 40 mL.	50 x 40PA tube	5721 302 400
For serum isolation, protein concentration in columns or harvesting of bacteria or cells in round bottom tubes with 40 x 15 mL.		5721 352 402
For plate centrifugation for e.g. ELISA or PCR in up to 12 x 96 plates.		5721 302 401

Centrifuges and Rotors

Ultracentrifuges - CP-NX Series

The CP-NX Centrifuge Series, the flagship of our ultracentrifuge portfolio, has been designed to make ultracentrifugation as safe and convenient as possible. With speeds of up to 803,000 x g (100,000 rpm), it is the optimal solution for nucleic acid, vesicle, organelle and virus isolation, as well as protein and nano-particle purification, just to name a few.

The centrifuge series consists of three models: Centrifuge CP100NX, CP90NX and CP80NX¹⁾, all of which share the same great range of user-friendly and innovative features along with a comprehensive rotor portfolio, making them your indispensable companion for all high- to ultra-speed applications.

The Automatic Rotor Life Management System (RLM) significantly increases the lifetime of the rotors by automatically tracking the exact run times on the internal rotor memory, making handwritten rotor logs a thing of the past. The self-locking rotor system eliminates the need to manually tighten the rotor, enabling quick and easy rotor exchange within seconds. The non-contact imbalance sensor ensures safe operation, while the possibility to balance samples by eye (up to 5 mm)²⁾ eliminates time-consuming sample balancing via scale.

The large touch display stands out with its intuitive, multilingual operation, offering three-level user management and documentation of runs. The additional option to pre-program up to 1,000 programs supports multi-user labs as well as laboratories working in GxP/GLP compliance.



¹⁾ The CP-NX models are available with max. speeds of 100,000 rpm (CP100NX)/90,000 rpm (CP90NX)/80,000 rpm (CP80NX), respectively. ²⁾ Except rotor P21A2

Product Name	Max. capacity	Max. speed	Max. RCF
fixed-angle rotor			
Rotor P21A2	6 x 230 mL	21,000 rpm	71,000 x g
Rotor P45AT	6 x 94 mL	45,000 rpm	235,000 x g
Rotor P50A3	24 x 1.5 mL	50,000 rpm	252,000 x g
Rotor P50AT2	12 x 40 mL	50,000 rpm	303,000 x g
Rotor P70AT	8 x 40 mL	70,000 rpm	505,000 x g
Rotor P70AT2	12 x 12 mL	70,000 rpm	452,000 x g
Rotor P80AT	8 x 12 mL	80,000 rpm	615,000 x g
Rotor P90AT	8 x 12 mL	90,000 rpm	700,000 x g
Rotor P100AT2	8 x 6.5 mL	100,000 rpm	803,000 x g
swing-bucket rotor			
Rotor P28S	6 x 40 mL	28,000 rpm	141,000 x g
Rotor P32ST	6 x 40 mL	32,000 rpm	180,000 x g
Rotor P40ST	6 x 13 mL	40,000 rpm	284,000 x g
Rotor P55ST2	6 x 5 mL	55,000 rpm	366,000 x g
vertical rotor			
Rotor P100VT	8 x 5 mL	100,000 rpm	700,000 x g

The maximum capacity refers to the nominal volume. The maximum filling volume may depend on the application, rotor and speed. Please consult with your sales representative for further details.

Centrifuges and Rotors

Ordering information

Description	Order no.
Centrifuge CP100NX, refrigerated, touch interface, 230 V/50/60 Hz (no plug), 16 A	5720 110 012
Centrifuge CP90NX, refrigerated, touch interface, 230 V/50/60 Hz (no plug), 16 A	5720 109 012
Centrifuge CP80NX, refrigerated, touch interface, 230 V/50/60 Hz (no plug), 16 A	5720 108 012

Learn more about
our ultracentrifuge
solutions



[www.eppendorf.com/
ultracentrifuge](http://www.eppendorf.com/ultracentrifuge)

K-factor	Included tube	Order no.
486	6 x 230PA bottle	5720 211 205
130		5720 211 109
33	300 x 1.5ml Micro Tube (C)	5720 211 108
70		5720 211 107
44		5720 211 105
36		5720 211 104
27		5720 211 103
25		5720 211 102
18		5720 211 101
252	100 x 40PA tube	5720 214 005
198	100 x 40PA tube	5720 214 003
139	100 x 13PA tube	5720 214 002
50	100 x 5PA tube	5720 214 001
6		5720 213 001

Centrifuges and Rotors

Micro-Ultracentrifuges - CS150FNX and CS150NX

With extraordinarily high speeds of up to 1,050,000 x g (150,000 rpm), plus fast acceleration and deceleration ramps and a broad range of rotors, our micro-ultracentrifuges ensure speedy separation of samples such as nucleic acids, proteins, cell organelles, viruses and nanoparticles in volumes between 0.2 - 30 mL.

Depending on the space available, you can choose between a floorstanding model (CS150FNX) with a very compact footprint or a benchtop model (CS150NX) with standard power requirements for flexible placement within the laboratory. Both devices have a low noise level of <45 dB(A), ensuring a stress-free work environment, even when working directly next to the device.

Additional features include a Rotor Management and the self-locking rotor system, which enables quick and easy rotor exchange within seconds. The innovative, non-contact imbalance sensor ensures safe operation, while the possibility to balance samples by eye (up to 5 mm)¹⁾ eliminates time-consuming sample balancing via scale.

The large touch display makes operation easy, while providing enhanced security and compliance with user-based access control and documentation of runs. The ability to pre-program up to 20 programs supports multi-user labs as well as laboratories working in GxP/GLP compliance.



¹⁾ Except rotor S140AT, S110AT, S80AT3, S50A

Product Name	Max. capacity	Max. speed	Max. RCF
fixed-angle rotor			
Rotor S50A	6 x 30 mL	50,000 rpm	210,000 x g
Rotor S55A2	12 x 1.5 mL	55,000 rpm	201,000 x g
Rotor S58A	8 x 13.5 mL	58,000 rpm	289,000 x g
Rotor S70AT	20 x 0.5 mL	70,000 rpm	307,000 x g
Rotor S80AT2	30 x 0.5 mL	80,000 rpm	304,000 x g
Rotor S80AT3	8 x 6 mL	80,000 rpm	415,000 x g
Rotor S100AT3	20 x 0.23 mL	100,000 rpm	436,000 x g
Rotor S100AT4	6 x 4 mL	100,000 rpm	541,000 x g
Rotor S110AT	8 x 5 mL	110,000 rpm	691,000 x g
Rotor S120AT2	10 x 2 mL	120,000 rpm	650,000 x g
Rotor S120AT3	14 x 0.5 mL	120,000 rpm	650,000 x g
Rotor S140AT	10 x 2 mL	140,000 rpm	1,050,000 x g
Rotor S150AT	8 x 2 mL	150,000 rpm	901,000 x g
neo-angle rotor			
Rotor S100NT	8 x 4 mL	100,000 rpm	479,000 x g
Rotor S120NT	8 x 2 mL	120,000 rpm	586,000 x g
Rotor S140NT	8 x 2 mL	140,000 rpm	752,000 x g
swing-bucket rotor			
Rotor S50ST	4 x 7 mL	50,000 rpm	253,000 x g
Rotor S52ST	4 x 5 mL	52,000 rpm	276,000 x g
Rotor S55S	4 x 2.2 mL	55,000 rpm	259,000 x g
vertical rotor			
Rotor S120VT	8 x 2 mL	120,000 rpm	501,000 x g

The maximum capacity refers to the nominal volume. The maximum filling volume may depend on the application, rotor and speed. Please consult with your sales representative for further details.

Ordering information

Description	Order no.
Centrifuge CS150FNX, refrigerated, floorstanding, touch interface, 230 V/50/60 Hz (EU), 8 A	5720 121 511
Centrifuge CS150NX, refrigerated, benchtop, touch interface, 230 V/50/60 Hz (EU), 8 A	5720 131 511

K-factor	Included tube	Order no.
61	20 x 25PC TW tube	5720 221 012
40	300 x 1.5mL Micro Tube (C)	5720 221 011
50	20 x 10PC TW tube	5720 221 010
31	100 x 0.5PC tube	5720 221 009
17	100 x 0.5PC tube	5720 221 007
23	100 x 6PC TW tube	5720 221 008
7	100 x 0.23PC tube	5720 221 005
16	100 x 3PC tube	5720 221 006
15	100 x 4PC tube	5720 221 004
8	100 x 1PC tube	5720 221 002
8	100 x 0.5PC tube	5720 221 003
5	100 x 1PC tube	5720 221 001
6	100 x 1PC tube	5720 221 000
12	100 x 4PA Seal tube	5720 222 002
9	100 x 2PA Seal tube	5720 222 001
6	100 x 2PA Seal tube	5720 222 000
77	50 x 7PA tube	5720 224 002
79	100 x 5PA tube	5720 224 001
44	100 x 2.2PA tube	5720 224 000
8	100 x 2PA Seal tube	5720 223 000

PCR



Whether your application involves genome editing, NGS library preparation, cloning, or virus detection, a PCR thermocycler is required. Traditional end-point PCR is utilized in virtually every molecular biology laboratory where the need for optimal performance, and fast, reproducible results is crucial.

Key features of a high-quality thermocycler include durability, versatility, speed and throughput. When choosing a cycler based on such characteristics, it is additionally important to think about the block material and configuration. Choose from multiple block configurations utilizing either a silver block with good heat conducting properties for increased speed or traditional aluminum blocks with 96 or 384 wells. We also offer the Mastercycler® nexus X2 with a dual block for running PCR reactions in parallel.

Depending on your lab's needs, you require different vessel types and a cycler that is compatible with both tube and plate formats. Our Mastercycler® X50 and Mastercycler® nexus utilize flexlid® technology that guarantees optimal pressure for a tight seal of your sample plates or tubes in the block to eliminate evaporation.

For added flexibility and efficiency, the 2D-Gradient of the Mastercycler® X50 enables you to optimize the annealing and denaturation temperature. This enables optimization of specificity and yield by testing 96 temperature combinations in only one PCR run. If you need support for further optimization of your PCR protocols, we have articles that explain the technological background of cycler technology and different ways to improve your PCR.



Connect multiple thermocyclers to increase capacity.

Optimize your PCR set-up

Please use the QR Code.

www.eppendorf.com/PCR-productivity



Get all information about the Eppendorf PCR portfolio!

Explore the eshop and get an overview!

www.eppendorf.com/PCR-portfolio

For high throughput or expanding labs, we also offer eco units that can be connected to one main cycler. The Mastercycler X50 can control up to 9 eco units directly. For even more throughput you may connect up to 50 eco unit devices and conveniently control them via the CycleManager X50 software or one main Mastercycler X50. With Mastercycler nexus and nexus X2 you can connect up to 3 cyclers to increase productivity. Become a digital, connected lab and monitor multiple lab devices with VisioNize®. The touchscreen interface of Mastercycler X50 enables using VisioNize for your digital future. You can manage users, audits and runs easily from the device, a PC or smartphone and tablet.

We also offer distinguished service plans to ensure preventive maintenance of your thermal cycler assessing factors such as temperature block homogeneity. You may also use the temperature verification system TVS-T6 to check the block temperature of your cyclers yourself for minimal device downtime and regular temperature verification.



Raise your throughput and run two separate PCRs at the same time

CycleManager X50 software

Please use the QR Code.

www.eppendorf.com/cyclemanager-software



Mastercycler nexus X2 - two thermal cycler in one device

Download the Mastercycler® family brochure
www.eppendorf.com/PCR-brochure



PCR

PCR consumables



Eppendorf twin.tec® plates are available in different colors.

The Eppendorf twin.tec® PCR plate combines extremely thin-walled polypropylene wells for optimal heat transfer to the sample with robust polycarbonate frames for high rigidity. With raised well rims, twin.tec plates enable highly effective sealing to reduce the risk of cross-contamination.

The heart of our PCR consumables is the Eppendorf twin.tec® PCR plate. It is available in a 96-well or 384-well format. All of the 96-well plates are offered in three different frame variants: unskirted and, skirted to perfectly fit your instruments. The plates are

also available in standard or LoBind® quality and additional variations such as low profile to suit multiple applications. We also supply a range of PCR tubes, films, foils, tube strips, and cap strips.

All PCR consumables are made of high-purity plastics and are 'PCR clean'. This means they are batch-tested and certified by an independent laboratory to be free of a range of common PCR contaminants, including DNA, DNase, RNase, and PCR inhibitors. Products that are labeled 'forensic DNA grade' fulfill the requirements for ISO 18385.

The special design and manufacturing process results in high precision products. Every single plate is a high-performance component in your workflow offering superior reproducibility.

The plate portfolio also includes plates for real-time PCR with white wells and individually wrapped microbiology plates. Those plates are specially designed for these methods and research areas, helping you to achieve the best possible results.

All Eppendorf Plates are available with customized barcodes.



Different frame formats of Eppendorf twin.tec® plates: unskirted (top), semi-skirted (middle) and skirted (bottom).



Eppendorf twin.tec[®] Trace PCR Plates



With their laser-engraved lot and expiration date, twin.tec Trace PCR plates are ideally suited for your complex studies, automated high-throughput applications and regulated workflows. They support traceability and documentation for your next audit.

In addition to their high-throughput and compliance features, these microtiter plates come with a laser-engraved optical guiding grid and OptiTrack[®] matrix that ensure quick well-orientation when you are pipetting manually.

Available in transparent and 2 fresh colors twin.tec Trace plates are ready to deliver maximum performance and reliability for your most demanding workflows!

All Eppendorf twin.tec Trace plates are 'PCR clean', having been batch-tested and certified by an independent and accredited laboratory to be free of a range of common PCR contaminants, including DNA, RNA, DNase, RNase, and PCR inhibitors. With these microplates you'll have maximum confidence in your results.

Product features

- > Laser-engraved lot number and expiration date on each single plate to improve traceability in your laboratory processes
- > Unique laser-engraved optical guiding grid and OptiTrack[®] matrix for quick orientation when pipetting manually
- > One-piece design: combining a polycarbonate frame and polypropylene wells for optimum performance

Get all information about twin.tec Trace
www.eppendorf.com/twintec-Trace



Our Portfolio – Your Choice



Model	MC X50s	MC X50a	MC X50i
Page(s)	226	226	227
Dimensions (W × D × H)	27.5 × 43 × 33 cm / 10.8 × 16.9 × 13 in	27.5 × 43 × 33 cm / 10.8 × 16.9 × 13 in	27.5 × 43 × 33 cm / 10.8 × 16.9 × 13 in
2D-Gradient block	over 12 columns/over 8 rows	over 12 columns/over 8 rows	over 12 columns/over 8 rows
Gradient block	–	–	–
Heating rate	10 °C/s	5 °C/s	10 °C/s
Cooling rate	5 °C/s	2.3 °C/s	5 °C/s
Interfaces	Ethernet, USB	Ethernet, USB	Ethernet, USB
Lid descent	flexlid® technology with TSP	flexlid® technology with TSP	flexlid® technology with TSP
Lid temperature range	37 – 110 °C	37 – 110 °C	37 – 110 °C
Sample capacity	96-well plate or 0.1/0.2 mL tubes	96-well plate or 0.1/0.2 mL tubes	96-well plate or 0.1/0.2 mL tubes
Gradient temperature control range	30 – 99 °C	30 – 99 °C	30 – 99 °C
Temperature control range of the block	4 – 99 °C	4 – 99 °C	4 – 99 °C
Thermoblock	Silver	Aluminum	Silver
Remote Device Monitoring and Notifications (VisioNize®)	VisioNize® touch enabled	VisioNize® touch enabled	VisioNize® touch enabled

¹⁾ measured at the block

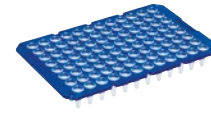
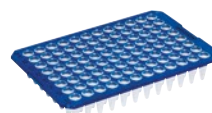

Model	Eppendorf twin.tec® PCR Plate 96 skirted	Eppendorf twin.tec® PCR Plate 96 semi-skirted	Eppendorf twin.tec® PCR Plate 96 unskirted	Eppendorf twin.tec® PCR Plate 96 unskirted, divisible
Page(s)	230	230	230	230
Number of wells	96 wells	96 wells	96 wells	96 wells
Total volume per well	150 µL	250 µL	150 or 250 µL	150 or 250 µL
OptiTrack® frame color	colorless yellow green blue red	colorless yellow green blue red	colorless blue	colorless blue

Get all information about the Eppendorf PCR portfolio!
Explore the eshop and get an overview!

www.eppendorf.com/PCR-portfolio



eppendorf.com/eshop



MC nexus gradient	MC nexus	MC nexus GX2
228	228	229
25 x 41.2 x 32.1 cm / 9.8 x 16.2 x 12.6 in	25 x 41.2 x 32.1 cm / 9.8 x 16.2 x 12.6 in	25 x 41.2 x 33 cm / 9.8 x 16.2 x 13 in
–	–	–
Over 12 rows (0.2 mL)	–	Over 8 rows (0.2 mL)
3 °C/s ¹⁾	3 °C/s ¹⁾	3 °C/s ¹⁾
2 °C/s ¹⁾	2 °C/s ¹⁾	2 °C/s ¹⁾
CAN_in/CAN_out, Ethernet, USB	CAN_in/CAN_out, Ethernet, USB	CAN_in/CAN_out, Ethernet, USB
flexlid® technology, with TSP	flexlid® technology, with TSP	flexlid® technology, with TSP
37 – 110 °C	37 – 110 °C	37 – 110 °C
96 x 0.2 mL PCR tubes, 1 PCR plate (96 wells) or up to 38 x 0.5 mL Eppendorf PCR tubes	96 x 0.2 mL PCR tubes, 1 PCR plate (96 wells) or up to 38 x 0.5 mL Eppendorf PCR tubes	64/32 x 0.2 mL PCR tubes or up to 24/10 x 0.5 mL PCR tubes
30 – 99 °C	–	30 – 99 °C
4 – 99 °C	4 – 99 °C	4 – 99 °C
Aluminum	Aluminum	Aluminum
VisioNize® box enabled	VisioNize® box enabled	VisioNize® box enabled



Eppendorf twin.tec® PCR Plate 384	Eppendorf twin.tec® PCR Plate LoBind®		Eppendorf twin.tec® PCR Plate, Forensic DNA Grade		Eppendorf twin.tec® 96 real-time PCR Plate
230	231		230		232
384 wells	96 wells	384 wells	96 wells	384 wells	96 wells
45 µL	150 or 250 µL	45 µL	45, 150 or 250 µL		150 or 250 µL
colorless	colorless	colorless	colorless	colorless	white
yellow	yellow				blue
green	green				
blue	blue				
red	red				

Mastercycler® X50

Description

The Mastercycler® X50 elegantly combines speed, flexibility, and ease of use. With its intuitive touch screen offering precise fingertip control, the MC X50 thermocycler enables easy PCR optimization in advanced molecular biology research and dependable standardization in routine PCR applications. It is also perfectly fitted for NGS.



Product features

- > Heating rate: up to 10 °C/s
- > Wide selection of blocks from a fast silver block to 384 well block
- > VisioNize touchscreen interface

Applications

- > Fast PCR
- > PCR optimization
- > Standard PCR
- > Incubation
- > Cycle sequencing

Learn more



Please use the QR Code.

www.eppendorf.com/Mastercycler-X50

Ordering information

Description	Order no.
Mastercycler® X50s, 110 – 230 V/50 – 60 Hz (GB), silver block, 96-well or 0.1/0.2 mL tubes, with touchscreen interface	6311 000 045
Mastercycler® X50a, 110 – 230 V/50 – 60 Hz (GB), aluminium block, 96-well or 0.1/0.2 mL tubes, with touchscreen interface	6313 000 042
Mastercycler® X50h, 110 – 230 V/50 – 60 Hz (GB), aluminium block, 384-well, high pressure lid, with touchscreen interface	6316 000 043

✎ Ordering information for other voltage options begins on page 349

Mastercycler® X50, eco unit



Description

Mastercycler® X50 eco units combine the speed and performance of the master device with the option to be connected to each other. Up to 9 units can be controlled by one master device, while up to 50 eco units can be conveniently controlled with the CycleManager X50 software, even if they are placed in multiple laboratories.

Product features

- > Heating rate: up to 10 °C/s
- > Cooling rate: 5 °C/s
- > Control up to 50 units from one PC

Applications

- > Fast PCR
- > PCR optimization
- > Standard PCR
- > Incubation
- > Cycle sequencing

Ordering information

Description	Order no.
Mastercycler® X50i, 110 – 230 V/50 – 60 Hz (GB), silver block, 96-well or 0.1/0.2 mL tubes, eco unit	6301 000 047
Mastercycler® X50i, 110 – 230 V/50 – 60 Hz (GB), aluminium block, 96-well or 0.1/0.2 mL tubes, eco unit	6303 000 044
Mastercycler® X50t, 110 – 230 V/50 – 60 Hz (GB), aluminium block, 384-well, high pressure lid, eco unit	6306 000 045

✎ Ordering information for other voltage options begins on page 349

CycleManager X50 Software



Simple, Central, Smart ...
Mastercycler X50
 with CycleManager X50 Software

50x

Description

Maximize your PCR efficiency. CycleManager X50 enables you to increase your throughput by managing up to fifty Mastercycler X50 eco units simultaneously. Now there's no need for repetitive copying of PCR documentation and parameters, time-consuming searches for an available cycler, or checking the status of your runs on multiple cyclers. Address this bottleneck in your workflow and get full PCR control with CycleManager X50 software.

Ordering information

Description	Order no.
CycleManager X50 Software	6349 000 014

Mastercycler® nexus

Description

The versatile Mastercycler® nexus enables you to select the PCR consumables that best fit your assay. The nexus PCR cycler can accommodate 96-well PCR plates, 0.2 mL PCR tubes, 0.2 mL PCR tube strips, and 0.5 mL PCR tubes. With less than 40 dB[a] noise emission, the nexus is whisper quiet, while also being energy efficient.



Product features

- > Intuitive graphic programming
- > Small footprint
- > Universal block for ultimate flexibility

Applications

- > Standard PCR
- > Fast PCR
- > PCR optimization

Discover our
Cycler

Please use the QR Code.

www.eppendorf.com/Mastercycler-nexus



Ordering information

Description	Order no.
Mastercycler® nexus gradient, 230 V/50 – 60 Hz (GB)	6331 000 041
Mastercycler® nexus, 230 V/50 – 60 Hz (GB)	6333 000 049
Mastercycler® nexus gradient eco, 230 V/50 – 60 Hz (GB)	6334 000 042
Mastercycler® nexus eco, 230 V/50 – 60 Hz (GB)	6332 000 045
CAN bus connecting cable, 150 cm	5341 611 000
CAN bus cable, connecting cable between 2 thermomodules, 50 cm	5341 612 006

✂ Ordering information for other voltage options begins on page 349

Mastercycler® nexus X2

Description

The Mastercycler® nexus X2 is Eppendorf's solution for busy PCR labs. Two totally independent protocols can be run on the nexus X2 in parallel so two users can start their PCR reactions whenever it fits their schedule. With less than 40 dB[a] noise emission, the nexus X2 PCR cyclers are whisper quiet and also very energy efficient.



Product features

- > Asymmetrically divided block for running different assays in parallel, one 32-well and one 64-well block
- > Intuitive graphic programming
- > Universal block for strips, 0.1 mL, 0.2 mL and 0.5 mL PCR tubes and fits for divisible PCR plates

Applications

- > Standard PCR
- > PCR optimization

Enlarge your capacity

Please use the QR Code.

www.eppendorf.com/Mastercycler-nexus-x2



Ordering information

Description	Order no.
Mastercycler® nexus GX2, 230 V/50 – 60 Hz (GB)	6336 000 040
Mastercycler® nexus GX2e, 230 V/50 – 60 Hz (GB)	6338 000 047
Mastercycler® nexus X2, 230 V/50 – 60 Hz (GB)	6337 000 043
Mastercycler® nexus X2e, 230 V/50 – 60 Hz (GB)	6339 000 040

✎ Ordering information for other voltage options begins on page 349

PCR Consumables and Sealing



New

Eppendorf twin.tec® PCR Plates

Choose Eppendorf twin.tec® PCR plates for confidence in every PCR assay. twin.tec® plates offer purity, rigidity, color, and other simple, smart features can make your daily life a lot easier. The rigid polycarbonate frame works well in automation and high-throughput processes, and the different colors mean you can quickly organize the different steps of your workflow.

All plates also available as barcoded version.

Ordering information

Description	Order no.
Eppendorf twin.tec® Trace PCR Plate 96, skirted, 150 µL	
PCR clean, colorless, 25 plates	0030 129 768
PCR clean, crystal blue, 25 plates	0030 129 776
PCR clean, fuchsia, 25 plates	0030 129 784
Eppendorf twin.tec® PCR Plate 96, skirted, 150 µL	
PCR clean, colorless, 25 plates	0030 128 648
PCR clean, yellow, 25 plates	0030 128 656
PCR clean, green, 25 plates	0030 128 664
PCR clean, blue, 25 plates	0030 128 672
PCR clean, red, 25 plates	0030 128 680
Forensic DNA Grade, colorless, 10 plates, individually wrapped	0030 129 601
Eppendorf twin.tec® PCR Plate 96, semi-skirted, 250 µL	
PCR clean, colorless, 25 plates	0030 128 575
PCR clean, yellow, 25 plates	0030 128 583
PCR clean, green, 25 plates	0030 128 591
PCR clean, blue, 25 plates	0030 128 605
PCR clean, red, 25 plates	0030 128 613
Forensic DNA Grade, colorless, 10 plates, individually wrapped	0030 129 610
Eppendorf twin.tec® PCR Plate 96, low profile, unskirted, 150 µL	
PCR clean, colorless, 20 plates	0030 133 307
PCR clean, blue, 20 plates	0030 133 331
Eppendorf twin.tec® PCR Plate 96, unskirted, 250 µL	
PCR clean, colorless, 20 plates	0030 133 366
PCR clean, blue, 20 plates	0030 133 390
Eppendorf twin.tec® PCR Plate 96, divisible, unskirted, divisible, 150 µL	
PCR clean, colorless, 20 plates	0030 133 358
PCR clean, blue, 20 plates	0030 133 382
Eppendorf twin.tec® PCR Plate 96, divisible, unskirted, divisible, 250 µL	
PCR clean, colorless, 20 plates	0030 133 374
PCR clean, blue, 20 plates	0030 133 404
Eppendorf twin.tec® microbiology PCR Plate 96, skirted, 150 µL	
PCR clean, colorless, 10 plates	0030 129 300
PCR clean, blue, 10 plates	0030 129 318
Eppendorf twin.tec® microbiology PCR Plate 96, semi-skirted, 250 µL	
PCR clean, colorless, 10 plates	0030 129 326
PCR clean, blue, 10 plates	0030 129 334
Eppendorf twin.tec® microbiology PCR Plate 384, skirted, 45 µL	
PCR clean, colorless, 10 plates	0030 129 342
PCR clean, blue, 10 plates	0030 129 350
Eppendorf twin.tec® PCR Plate 384, skirted, 45 µL	
PCR clean, colorless, 25 plates	0030 128 508
PCR clean, yellow, 25 plates	0030 128 516
PCR clean, green, 25 plates	0030 128 524
PCR clean, blue, 25 plates	0030 128 532
PCR clean, red, 25 plates	0030 128 540
Forensic DNA Grade, colorless, 10 plates, individually wrapped	0030 129 628

Ordering information

Description	Order no.
Eppendorf twin.tec® PCR Plate 96 , skirted, 150 µL	
PCR clean, colorless, 300 plates	0030 128 770
PCR clean, green, 300 plates	0030 128 796
PCR clean, yellow, 300 plates	0030 128 788
PCR clean, blue, 300 plates	0030 128 842
PCR clean, red, 300 plates	0030 128 850
Eppendorf twin.tec® PCR Plate 96 , semi-skirted, 250 µL	
PCR clean, colorless, 300 plates	0030 128 869
Eppendorf twin.tec® PCR Plate 384 , 40 µL	
PCR clean, colorless, 300 plates	0030 128 931
PCR clean, yellow, 300 plates	0030 128 940
PCR clean, green, 300 plates	0030 128 958
PCR clean, blue, 300 plates	0030 128 966
PCR clean, red, 300 plates	0030 128 974

**Eppendorf twin.tec® PCR Plates LoBind®**

Get the most out of your PCR. Eppendorf's twin.tec® PCR plates LoBind® are specially designed to maximize the yield of your target molecules. LoBind wells are made of polypropylene, with low DNA binding properties, leading to reduced loss of target molecules and higher yields in PCR and other molecular assays.

Ordering information

Description	Order no.
Eppendorf twin.tec® PCR Plate 96 LoBind® , semi-skirted, 250 µL	
PCR clean, colorless, 25 plates	0030 129 504
Eppendorf twin.tec® PCR Plate 96 LoBind® , skirted, 150 µL	
PCR clean, colorless, 25 plates	0030 129 512
PCR clean, red, 25 plates	0030 129 598
PCR clean, blue, 25 plates	0030 129 580
PCR clean, yellow, 25 plates	0030 129 679
PCR clean, green, 25 plates	0030 129 660
Eppendorf twin.tec® PCR Plate 96 LoBind® , skirted	
PCR clean, yellow, 300 plates	0030 129 563
PCR clean, orange, 300 plates	0030 129 571
PCR clean, green, 300 plates	0030 129 555
Eppendorf twin.tec® PCR plate 384 LoBind® , skirted, 45 µL	
PCR clean, colorless, 25 plates	0030 129 547

Learn more about
LoBind® technology

[www.eppendorf.com/
howitworks-lobind](http://www.eppendorf.com/howitworks-lobind)



PCR Consumables and Sealing



Eppendorf twin.tec® *real-time* PCR Plates

The white wells of Eppendorf's twin.tec® real-time PCR plates increase the reflection of fluorescent light in real-time PCR (qPCR) and other fluorescence assays. The increased fluorescence from these specialized qPCR plates improves the sensitivity of your assays, while also improving reproducibility and consistency of your results.

Ordering information

Description	Order no.
Eppendorf twin.tec® 96 <i>real-time</i> PCR Plate, skirted, 150 µL	
PCR clean, blue, wells white, 25 plates	0030 132 505
PCR clean, white, wells white, 25 plates	0030 132 513
Eppendorf twin.tec® 96 <i>real-time</i> PCR Plate, semi-skirted, 250 µL	
PCR clean, blue, wells white, 25 plates	0030 132 530
PCR clean, white, wells white, 25 plates	0030 132 548
Eppendorf twin.tec® 96 <i>real-time</i> PCR Plate, unskirted, low profile, 150 µL	
PCR clean, white, wells white, 20 plates	0030 132 700
PCR clean, blue, wells white, 20 plates	0030 132 718
Eppendorf twin.tec® 96 <i>real-time</i> PCR Plate, skirted, 150 µL	
Forensic DNA Grade, white, wells white, 10 plates, individually wrapped	0030 129 636
Eppendorf twin.tec® 96 <i>real-time</i> PCR Plate, semi-skirted, 250 µL	
Forensic DNA Grade, white, wells white, 10 plates, individually wrapped	0030 129 644

PCR Consumables and Sealing



Eppendorf PCR Tubes

Since 1963, when Eppendorf invented the microcentrifuge tube, Eppendorf tubes have proven to be reliable companions in a scientist's daily work. Eppendorf PCR tubes are easy to open and provide tight sealing to prevent evaporation in PCR. With their thin, consistent wall thickness and smooth wall surface, they also ensure efficient heat transfer to the sample, speeding up your PCR.

Ordering information

Description	Order no.
Eppendorf PCR Tube Strips, 0.1 mL	
PCR clean, without lids (10 × 12 strips)	0030 124 804
PCR clean, with Cap Strips, domed (10 × 12 strips)	0030 124 812
PCR clean, with Cap Strips, flat (10 × 12 strips)	0030 124 820
Eppendorf PCR Tubes, 0.2 mL	
PCR clean, colorless, 1,000 pcs.	0030 124 332
Forensic DNA Grade, colorless, 500 pcs. (5 bags × 100 pcs.)	0030 124 707
PCR clean, 8-tube strips, 120 pcs. (960 tubes)	0030 124 359
Eppendorf PCR Tubes, 0.5 mL, PCR clean, with hinged lid, clear, 500 pcs.	0030 124 537

Eppendorf Fast PCR Tube Strips

The Eppendorf Fast PCR Tube Strips are made of polyethylene to transfer heat faster than tubes made of traditional plastics. These PCR strips with caps are particularly suited to fast PCR, for example using fast PCR reagent kits or cyclers with high heating and cooling rates, such as the Mastercycler® X50 family.

Ordering information

Description	Order no.
Eppendorf Fast PCR Tube Strips	
0.1 mL, without lids, PCR clean, 120 pcs. (10 × 12 pcs.)	0030 124 901
0.1 mL, with cap strips, flat, PCR clean, 120 pcs. (10 × 12 pcs.)	0030 124 910
0.1 mL, with cap strips, domed, PCR clean, 120 pcs. (10 × 12 pcs.)	0030 124 928

PCR cap strips

Eppendorf Cap Strips provide easy and rapid sealing of Eppendorf twin.tec® PCR plates, PCR tubes and other standard multiwell plates. Each strip has eight PCR caps for use on 0.1 mL and 0.2 mL wells.

PCR Cap Strips can also be used in real-time PCR (qPCR) assays. In this case it is recommended to use flat capped strips or Masterclear® strips for maximal transparency. If you encounter evaporation and sample loss, domed caps can be used to provide a tighter seal when using a heated lid. Eppendorf Cap Strips can be sterilized by autoclaving for 20 minutes at 121 °C.

Ordering information

Description	Order no.
Cap Strips, 8-strips, domed, 120 pcs. (10 bags × 12 pcs.)	0030 124 839
Cap Strips, 8-strips, flat, 120 pcs. (10 × 12 pcs.)	0030 124 847
real-time PCR Tube Strips, without caps, 120 pcs. (10 × 12 pcs.)	0030 132 882
Masterclear® Cap Strips and real-time PCR Tube Strips, 120 pcs. (10 × 12 pcs.)	0030 132 890
Masterclear® Cap Strip, 120 pcs. (10 × 12 pcs.)	0030 132 874

PCR Consumables and Sealing



PCR-Cooler

Say goodbye to unstable racks and ice buckets at your bench. The PCR racks are ideal for safe sample transport and storage while the PCR-Cooler is perfect for keeping your samples cold throughout your PCR setup without using ice. Suitable for 0.2 mL and 0.5 mL PCR tubes and for 96-well PCR plates.

Ordering information

Description	Order no.
PCR-Cooler 0.2 mL Starter Set, 1 pink, 1 blue	3881 000 015
PCR-Cooler 0.2 mL, Pink	3881 000 023
PCR-Cooler 0.2 mL, Blue	3881 000 031



PCR-Rack

Handling several PCR tubes or tube strips can be cumbersome. Eppendorf PCR racks are a great help when dealing with numerous 0.1, 0.2, and 0.5 mL tubes and strips. The racks are stackable, can be stored down to -90°C and can be autoclaved.

Ordering information

Description	Order no.
PCR-Rack, assorted colors, 10 pcs.	0030 124 545



PCR Films and Foils provide effective and tight sealing for plates.

Eppendorf PCR films and foils provide effective and airtight sealing for plates to help protect PCR samples during thermal cycling and storage. PCR plate seals offer excellent chemical resistance and have been tested for resistance to a variety of common laboratory substances. Specialized seals with optimal optical properties are available to help minimize signal loss in qPCR.

Ordering information

Description	Order no.
Eppendorf Heat Sealing Film, PCR clean, 100 pcs.	0030 127 838
Eppendorf Heat Sealing Foil, PCR clean, 100 pcs.	0030 127 854
Eppendorf PCR Film, self-adhesive, PCR clean, 100 pcs.	0030 127 781
Eppendorf PCR Foil, self-adhesive, PCR clean, 100 pcs.	0030 127 790
Masterclear® real-time PCR Film, self-adhesive, PCR clean, 100 pcs.	0030 132 947

HeatSealer



Description

To obtain reliable assay results, PCR plates need to be sealed tightly in a reproducible manner – and the same is true for maintaining sample integrity during storage. The HeatSealers S100 and S200 are user friendly instruments for reliable plate sealing of different plate formats. In combination with our range of adapters, Eppendorf HeatSealers enable you to seal almost any plate.

Ordering information

Description	Order no.
HeatSealer S100, incl. PCR Plate Adapter, 100 – 230 V/50 – 60 Hz (GB)	5391 000 036
HeatSealer S200, incl. PCR Plate Adapter, 100 – 230 V/50 – 60 Hz (GB)	5392 000 030
Plate Adapter low profile, for HeatSealer S100	5391 070 018
Plate Adapter high profile, for HeatSealer S100	5391 070 034
96-well-PCR Plate Adapter, for HeatSealer S100	5391 070 026
Plate Adapter high profile, for HeatSealer S200	5392 070 011
Plate Adapter low profile, for HeatSealer S200	5392 070 020
96-well Plate Adapter, for HeatSealer S200	5392 070 038
Eppendorf Heat Sealing Film, PCR clean, 100 pcs.	0030 127 838
Eppendorf Heat Sealing Foil, PCR clean, 100 pcs.	0030 127 854

✎ Ordering information for other voltage options begins on page 349

Freezer

Cold Storage – Protect what Matters



How Much Effort Did You Spend on Your Sample?

Did you ever calculate the value within your freezer? All the hours, days, weeks, and months spent on your samples? More than 50,000 samples fit into a large, standard ULT (also known as ultra-low temperature freezer, -80°C). The value of every single sample differs – from simple buffers to high-value clones, expensive enzymes, or very rare sample material. When predominantly storing

high-value samples which are a result of months of work – a single freezer can easily reach a value equal to hundreds of thousands of Euros or dollars. Your ULT freezer is not just a storage room for samples. This instrument is your assurance for long-term scientific success, securing your work.

Confidence in Quality

Eppendorf has a long-standing history of innovation and quality, and our freezer manufacturing process is no exception. Each Eppendorf ULT freezer is thoroughly inspected to meet our rigorous quality guidelines. The final inspection takes more than 24h and is based on manual and visual technical checks. This process is documented by an individual certificate of quality, completed with serial number, provided as standard for your documentation.

As your expert partner for reliable, high-quality, and efficient storage solutions, Eppendorf finely engineers each freezer with care, using only the highest quality materials to ensure a long lasting freezer that offers peace of mind and security. Performance data are based on external test runs of 3 units.

Eppendorf freezers are designed to offer a long-term value over the lifetime of its ownership. You can entrust your valuable samples to our ULT freezers, and you can trust your investment in high quality, reliable, and efficient storage solutions from Eppendorf.



Get all information about the Eppendorf freezer portfolio!
Explore the eshop and get an overview!
www.eppendorf.com/freezer-portfolio



Our Part for Sustainability

- > ENERGY STAR® and ACT® label (My Green Lab®) partner
- > 100% renewable power usage in our production facility
- > Production based on high European social and environmental standards
- > Environmentally-friendly insulation with green foam, vacuum insulation panels („h“-version), and insulated inner doors for energy efficiency
- > Green cooling liquids (Hydrocarbons: R170/ R290) with very low global warming potential (GWP) — to comply with the European F-Gas regulation and US SNAP regulations
- > Over a decade of experience at Eppendorf with green hydrocarbon-based cooling liquids for -80 °C applications in R&D, production, logistics, and service in the field
- > Low energy consumption combined with efficient cooling performance and long freezer lifespan that you can rely on



Digitalization of Cold Storage



Remember Your Last 2 a.m. Wake-up Call?

VisioNize® Lab Suite is your central software solution for effective monitoring and maintenance management to prevent sample storage emergencies. Benefit from 24/7 notification & monitoring for your ULT freezers and high-value stored samples



Independent Temperature Measurement Required?

With VisioNize sense, you can connect non-Eppendorf devices to VisioNize Lab Suite or utilize the sensor system as a second source of validation for monitoring the temperature in your freezer.



Lost in Samples? Stay Organized!

Over many years, you collect and handle many samples – samples of high value. Keep track of your samples with eLabNext, the sample management software

Digitalization at Eppendorf
www.eppendorf.com/digitalabsolutions



Explore the digital freezer rack configurator
<https://econfig.bio-itech.de/>



Our Portfolio – Your Choice



Model	CryoCube® F740hi, 3 c./ CryoCube® F740hi, 5 c.	CryoCube® F740hiw, 3 c./ CryoCube® F740hiw, 5 c.	CryoCube® F740h, 3c./ CryoCube® F740h, 5c.
Insulation	vacuum insulation paneling / polyurethane foam	vacuum insulation paneling / polyurethane foam	vacuum insulation paneling / polyurethane foam
Wall Thickness¹⁾	type B	type B	type B
Capacity	740 L (26.1 ft ³)	740 L (26.1 ft ³)	740 L (26.1 ft ³)
No. of internal doors	3	3	3
No. of compartments	3/5	3/5	3/5
Max. racks per freezer	18/30	18/30	18/30
Box capacity per rack			
53 mm (2 in) tall boxes	32/16	32/16	32/16
76 mm (3 in) tall boxes	20/8	20/8	20/8
102 mm (4 in) tall boxes	16/8	16/8	16/8
Box capacity per freezer			
53 mm (2 in) tall boxes	576/528	576/528	576/528
76 mm (3 in) tall boxes	360/288	360/288	360/288
102 mm (4 in) tall boxes	288/264	288/264	288/264
Sample capacity			
53 mm (2 in) samples	57,600/52,800	57,600/52,800	57,600/52,800
Dimensions (W × D × H)²⁾³⁾⁴⁾	111 × 98.0 × 197.3 cm / 43.7 × 38.6 × 77.7 in	111 × 98.0 × 197.3 cm / 43.7 × 38.6 × 77.7 in	111 × 91.3 × 197.3 cm / 43.7 × 36 × 77.7 in
Dimensions internal (W × D × H)	86.5 × 62.1 × 139 cm / 34.1 × 24.5 × 54.7 in	86.5 × 62.1 × 139 cm / 34.1 × 24.5 × 54.7 in	86.5 × 62.1 × 139 cm / 34.1 × 24.5 × 54.7 in
Weight w/o accessories	315 kg / 694 lb/333 kg / 734 lb	320 kg / 705 lb/328 kg / 723 lb	308 kg / 679 lb/317 kg / 699 lb
Shipping weight	364 kg / 787 lb/382 kg / 806 lb	369 kg / 787 lb/377 kg / 806 lb	357 kg / 787 lb/366 kg / 806 lb
Pull-down time to -80 °C⁵⁾	4 h 10 min	4 h 10 min	4 h 10 min
Noise level	41.3 dB	41.3 dB	47.8 dB
Power supply	100 – 230 V, 50/60 Hz	100 – 230 V, 50/60 Hz	100 – 230 V, 50/60 Hz
Average Daily Consumption (115 V)	11.6 kWh/day	11.7 kWh/day	13 kWh/day
Average Daily Consumption (208 V)	10.5 kWh/day	10.6 kWh/day	11.8 kWh/day
Average Daily Consumption (230 V)	10.5 kWh/day	10.6 kWh/day	11.8 kWh/day
Interior (shelves + chamber)	Stainless steel	Stainless steel	Stainless steel
Password protection of parameters	yes	yes	yes
Extras	Automatic vent port	Automatic vent port	Automatic vent port
Cooling liquid	R290 / R170	R290 / R170	R290 / R170
Remote Device Monitoring and Notifications (VisioNize®)	VisioNize® touch enabled	VisioNize® touch enabled	VisioNize® box enabled

¹⁾ Type A: 130 mm (foam), Type B: 80 mm (foam + VIP), Type C: 130 mm (foam + VIP)²⁾ Optional CO₂/LN₂ backup systems add 8.65 cm/3.5 in to height.³⁾ To allow for handles and hinges, add 80 mm to width of upright freezers and 110 mm to the depth of chest freezers.⁴⁾ Door open adds up to 15 cm.⁵⁾ Empty freezer with shelves fitted, upright freezers only, pull down from 20 – 22 °C ambient conditions.



**CryoCube® F570h**

vacuum insulation paneling / polyurethane foam

type C

570 L (20.1 ft³)

5

5

25

16

8

8

400

200

200

40,000

110.3 × 89.8 × 195.0 cm /

43.4 × 35.4 × 76.8 in

76.5 × 57.5 × 126.5 cm /

30.1 × 22.6 × 49.8 in

341 kg / 752 lb

388 kg / 855 lb

3 h 30 min

57.7 dBA

230 V, 115 V

7.1 kWh/day

7.4 kWh/day

Stainless steel

yes

Automatic vent port

R290 / R170

VisioNize® box enabled

CryoCube® F570hw

vacuum insulation paneling / polyurethane foam

type C

570 L (20.1 ft³)

5

5

25

16

8

8

400

200

200

40,000

110.3 × 89.8 × 195.0 cm /

43.4 × 35.4 × 76.8 in

76.5 × 57.5 × 126.5 cm /

30.1 × 22.6 × 49.8 in

341 kg / 752 lb

388 kg / 855 lb

3 h 45 min

56.0 dBA

230 V

8.0 kWh/day

Stainless steel

yes

Automatic vent port

R290 / R170

VisioNize® box enabled

CryoCube® F570n

polyurethane foam

type A

570 L (20.1 ft³)

5

5

25

16

8

8

400

200

200

40,000

110.3 × 89.8 × 195.0 cm /

43.4 × 35.4 × 76.8 in

76.5 × 57.5 × 126.5 cm /

30.1 × 22.6 × 49.8 in

281 kg / 619 lb

328 kg / 723 lb

3 h 50 min

57.5 dB

230 V, 208 V, 115 V

8.8 kWh/day

8.5 kWh/day

8.3 kWh/day

Stainless steel

yes

Automatic vent port

R290 / R170

VisioNize® box enabled

Our Portfolio – Your Choice



Model	Innova® U535	CryoCube® F440h
Insulation	vacuum insulation paneling / polyurethane foam	vacuum insulation paneling / polyurethane foam
Wall Thickness¹⁾	type B	type C
Capacity	535 L (18.9 ft ³)	440 L (15.5 ft ³)
No. of internal doors	3	5
No. of compartments	3	5
Max. racks per freezer	12	20
Box capacity per rack		
53 mm (2 in) tall boxes	28	16
76 mm (3 in) tall boxes	20	8
102 mm (4 in) tall boxes	12	8
Box capacity per freezer		
53 mm (2 in) tall boxes	336	320
76 mm (3 in) tall boxes	240	160
102 mm (4 in) tall boxes	144	160
Sample capacity		
53 mm (2 in) samples	33,600	32,000
Dimensions (W x D x H)²⁾³⁾⁴⁾	80 x 86.7 x 195 cm / 31.5 x 34.1 x 76.8 in	95.5 x 89.8 x 195.0 cm / 37.6 x 35.4 x 76.8 in
Dimensions internal (W x D x H)	64 x 61.5 x 136.5 cm / 25.2 x 24.2 x 53.7 in	61.6 x 57.5 x 126.5 cm / 24.3 x 22.6 x 49.8 in
Weight w/o accessories	250 kg / 551 lb	286 kg / 631 lb
Shipping weight	296 kg / 653 lb	327 kg / 721 lb
Pull-down time to -80 °C⁵⁾	4 h	3 h 20 min
Noise level	56 dBA	51.5 dBA
Power supply	230 V, 208 V, 115 V	230 V, 115 V
Average Daily Consumption (115 V)	13.2 kWh/day	6.5 kWh/day
Average Daily Consumption (208 V)	13.2 kWh/day	
Average Daily Consumption (230 V)	13.2 kWh/day	6.8 kWh/day
Interior (shelves + chamber)	Stainless steel	Stainless steel
Password protection of parameters	yes	yes
Extras	–	Automatic vent port
Cooling liquid	R404A / R508B	R290 / R170
Remote Device Monitoring and Notifications (VisioNize®)	VisioNize® box enabled	VisioNize® box enabled

¹⁾ Type A: 130 mm (foam), Type B: 80 mm (foam + VIP), Type C: 130 mm (foam + VIP)²⁾ Optional CO₂/LN₂ backup systems add 8.65 cm/3.5 in to height.³⁾ To allow for handles and hinges, add 80 mm to width of upright freezers and 110 mm to the depth of chest freezers.⁴⁾ Door open adds up to 15 cm.⁵⁾ Empty freezer with shelves fitted, upright freezers only, pull down from 20 – 22 °C ambient conditions.



**CryoCube® F440n**

polyurethane foam

type A

440 L (15.5 ft³)

5

5

20

16

8

8

320

160

160

32,000

95.5 × 89.8 × 195.0 cm / 37.6 × 35.4 × 76.8 in

61.6 × 57.5 × 126.5 cm / 24.3 × 22.6 × 49.8 in

267 kg / 589 lb

308 kg / 679 lb

3 h 35 min

51.5 dBA

230 V, 208 V, 115 V

8.5 kWh/day

7.9 kWh/day

8.3 kWh/day

Stainless steel

yes

Automatic vent port

R290 / R170

VisioNize® box enabled

CryoCube® F101h

vacuum insulation paneling / polyurethane foam

type B

101 L (3.6 ft³)

2

2

6

10

6

4

60

36

24

6,000

See online

48 × 33 × 64 cm / 18.9 × 13 × 25.2 in

See online

See online

See online

See online

230 V, 115 V

See online

Stainless steel

yes

Stackable, fits below bench

R290 / R170

VisioNize® box enabled

CryoCube® FC660h

vacuum insulation paneling / polyurethane foam

type C

660 L (23.3 ft³)

40

13

9

7

520

360

280

52,000

207 × 94.5 × 109 cm / 81.5 × 37.2 × 42.9 in

147 × 59 × 76 cm / 57.9 × 23.2 × 29.9 in

304 kg / 670 lb

379 kg / 836 lb

2 h 50 min

58.3 dBA

230 V, 208 V

Stainless steel

yes

30 mm thick inner lids for temp uniformity

R290 / R170 (208 V: R404A/ R508B)

VisioNize® box enabled

CryoCube® F440 Series



Zero compromise

How often do you open your ULT freezer door each day? For how long? What are the crucial factors for maintaining a steady -80 °C? It's best practice to open and close your freezer as quickly as possible when accessing samples. However, locating and removing the correct sample can take time. The more time it takes, the more the temperature of your frozen samples increases as they are exposed to the warm air flow.

The efficient and reliable compressor systems of CryoCube F440 series ULT freezers ensure sample protection by guaranteeing fast recovery and pull-down back to -80 °C.

The CryoCube F440h freezer is based on foam insulation enforced by vacuum insulation panels whereas the CryoCube F440n is based on foam insulation.



For daily usage

- > Space for up to 320 boxes (1.5 mL) for your daily sample storage, combined with efficient pull-down and recovery times back to -80 °C
- > Green cooling (hydrocarbon-based) and low power consumption of 6.8 KWh/ day for high levels of sustainability
- > Technical data based on external test house evaluation for independent validation

Download the
Eppendorf freezer
family brochure

[www.eppendorf.com/
freezer-brochure](http://www.eppendorf.com/freezer-brochure)





Easy opening of your freezer requested? Following the PhysioCare Concept®, the CryoCube® ULT freezers have an ergonomic door handle for convenient opening and closing



Filter cleaning needed for your ULT freezer? Simple filter replacement - just open the filter cover and insert a clean filter



Cleaning your ULT freezer? The inner insulated doors of the CryoCube® freezer can easily be removed to quickly clean and maintain your ULT freezer



Reliable temperature measurement within your ULT freezer requested? All CryoCube® freezers have an integrated probe which is located in the middle compartment for a reliable temperature measurement



Doubled safety for the samples? The built-in temperature probe can be supported by the independent temperature measurement system of VisioNize sense



Cleaning needed? The CryoCube® F440 ULT freezer is equipped with 5 compartments and a stainless steel chamber for easy cleaning

CryoCube® F740 Series



Design the Freezer Around the Sample

The CryoCube® F740 freezer series is the smartest member of the Eppendorf ULT Freezer family. Combining the high-quality tradition of our previous freezers with an increased capacity, the CryoCube F740 series is designed to store more of your samples

securely while maintaining optimal energy usage. Fast pull-down and recovery time back to -80°C increase sample safety. The integration of the PhysioCare Concept® during development means that the CryoCube F740 is easier and more comfortable to use, supports an ergonomic workspace, and enables an optimal workflow in the lab.

Smart Control

Worried about the safety of your high value samples stored in your -80 °C ULT freezer? With the Eppendorf ULT monitoring concept available on CryoCube F740hi/ hiw models, you can check the freezer performance whenever you want. All temperature data and all events are stored in the VisioNize touch interface.

- > On-board data storage to keep track of freezer data
- > Connect to VisioNize Lab Suite for 24/7 monitoring and notification (option)
- > Easily adjust parameters using device touchscreen, even while wearing gloves
- > Receive alert notifications to address issues quickly
- > Electronic lock system with user management for controlled access and higher sample safety

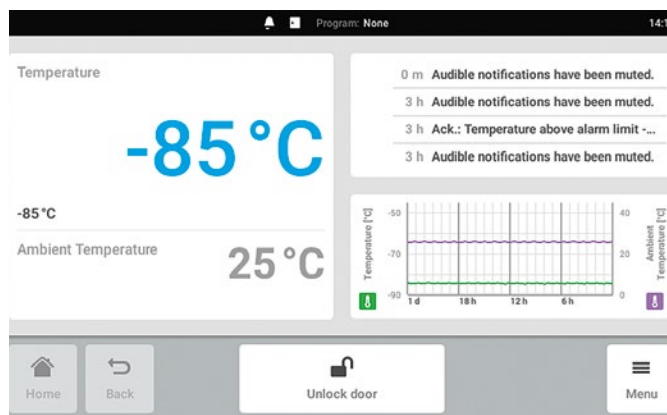

Easy overview required? Quickly review important parameters on the home screen of the ULT freezer

Discover VisioNize
Lab Suite

Please use the QR Code.
www.eppendorf.com/visionize





Take your pick: 3-compartment or 5-compartment options available (CryoCube® F740 series only)



If you are in a hurry: Automatic vent port enables fast sample access without door vacuum locking (CryoCube® F440/ 570/ 740 series)



Keep it tight: Compact, flat, and flexible outer door seal for optimal insulation of the CryoCube® ULT freezer

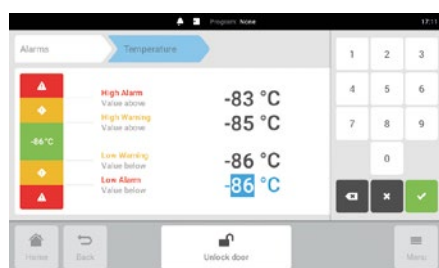

Tailored alarm settings needed? The alarm system of the CryoCube® F740hi freezer can be easily adapted to your needs



Double protection: Gaskets at outer door as well as at inner door (CryoCube® F740 series + Innova® series)



Easy access to filter?: Just flip down the cover of CryoCube® F740 series
Silence requested?: Filter position reduces noise level of CryoCube F740 series



Discover the
Eppendorf freezer
portfolio

[www.eppendorf.com/
freezer-portfolio](http://www.eppendorf.com/freezer-portfolio)



Freezer

Eppendorf ULT Upright Freezers

Ordering information	
Description	Order no.
CryoCube® F740h , 740 L, classic interface, VIP, green cooling liquids, air cooling, handle left side, 3 shelves, 230 V/50 Hz (GB)	F740340012
CryoCube® F740h , 740 L, classic interface, VIP, green cooling liquids, air cooling, handle right side, 3 shelves, 230 V/50 Hz (GB)	F740340022
CryoCube® F740h , 740 L, classic interface, VIP, green cooling liquids, air cooling, handle left side, 5 shelves, 230 V/50 Hz (GB)	F740340032
CryoCube® F740h , 740 L, classic interface, VIP, green cooling liquids, air cooling, handle right side, 5 shelves, 230 V/50 Hz (GB)	F740340042
CryoCube® F740hi , 740 L, touchscreen interface, VIP, green cooling liquids, air cooling, handle left side, 3 shelves, 230 V/50 Hz (GB)	F740320012
CryoCube® F740hi , 740 L, touchscreen interface, VIP, green cooling liquids, air cooling, handle right side, 3 shelves, 230 V/50 Hz (GB)	F740320022
CryoCube® F740hi , 740 L, touchscreen interface, VIP, green cooling liquids, air cooling, handle left side, 5 shelves, 230 V/50 Hz (GB)	F740320032
CryoCube® F740hi , 740 L, touchscreen interface, VIP, green cooling liquids, air cooling, handle right side, 5 shelves, 230 V/50 Hz (GB)	F740320042
CryoCube® F740hiw , 740 L, touchscreen interface, VIP, green cooling liquids, water cooling, handle left side, 3 shelves, 230 V/50 Hz (GB)	F740320112
CryoCube® F740hiw , 740 L, touchscreen interface, VIP, green cooling liquids, water cooling, handle left side, 5 shelves, 230 V/50 Hz (GB)	F740320132
CryoCube® F570n , 570 L, classic interface, green cooling liquids, air cooling, handle left side, 5 shelves, 230 V/50 Hz (EU/GB)	F571300031
CryoCube® F570h , 570 L, classic interface, VIP, green cooling liquids, air cooling, handle left side, 5 shelves, 230 V/50 Hz (EU/GB)	F571340031
CryoCube® F570hw , 570 L, classic interface, VIP, green cooling liquids, water cooling, handle left side, 5 shelves, 230 V/50 Hz (EU/GB)	F571340131
CryoCube® F440h , 440 L, classic interface, VIP, green cooling liquids, air cooling, handle left side, 5 shelves, 230 V/50 Hz (EU/GB)	F440340031
CryoCube® F440n , 440 L, classic interface, green cooling liquids, air cooling, handle left side, 5 shelves, 230 V/50 Hz (EU/GB)	F440300031
Innova® U360 , 360 L, classic interface, classic cooling liquids, air cooling, handle left side, 3 shelves, 230 V/50 Hz (EU/GB)	U9425-0001
CryoCube® F101h , 101 L, classic interface, VIP, green cooling liquids, air cooling, handle right side, 2 shelves, 230 V/50 Hz (EU/GB)	F101340061

✎ Ordering information for other voltage options begins on page 349

➤ For racks please check page 248

Eppendorf ULT Chest Freezers

Ordering information	
Description	Order no.
CryoCube® FC660h , 660 L, classic interface, VIP, green cooling liquids, air cooling, 230 V/50 Hz (EU/GB)	F660320001

✎ Ordering information for other voltage options begins on page 349

➤ For racks please check page 248

Freezer Accessories



CO₂ and LN₂ Back-up System

- > Equipped with a battery back-up to temporarily protect the contents of your freezer in case of power or system failure
- > Available in either liquid CO₂ and LN₂. Liquid CO₂ can maintain temperatures between -50 °C and -70 °C, where as LN₂ can go down to -80 °C
- > Both systems can be factory installed with your freezer order or retrofitted on existing models

CO₂ and LN₂ Back-up System for Innova® U101, U360, U535, U725/ -G, C585, C760, CryoCube® F101h and F740 series

Description	Order no.
CO ₂ back-up system, 100 V/50 – 60 Hz (JP)	F652999005
CO ₂ back-up system, 120 – 220 V/60 Hz, Innova® and Green 'G', ('narrow')	U9043-0002
LN ₂ back-up system, 100 V/50 – 60 Hz (JP), Innova® Green 'G' / F740, LN ₂ Backup	F652999006
LN ₂ back-up system, 115 – 220 V/60 Hz, Innova® and Green 'G', ('narrow')	U9044-0002
CO ₂ back-up system, 230 V/50 Hz, Innova®, Green 'G', and CryoCube® 740 series, ('narrow')	U9043-0004
LN ₂ back-up system, 230 V/50 Hz, Innova®, Green 'G', and CryoCube® 740 series, ('narrow')	U9044-0004

CO₂ and LN₂ Back-up Systems for CryoCube® F440/ F570/ FC660 series, Premium U410, HEF® U410

Description	Order no.
CO ₂ back-up system, 120 – 220 V/60 Hz, CryoCube® F440/ F570/ FC660 series, Premium, and HEF®	U9043-0006
LN ₂ back-up system, 120 – 220 V/60 Hz, CryoCube® F440/F570/FC660 series, Premium, and HEF®	U9044-0006
CO ₂ back-up system, 230 V/50 Hz, CryoCube® F440/F570/FC660 series, Premium, and HEF®	U9043-0008
LN ₂ back-up system, 230 V/50 Hz, CryoCube® F440/ F570/FC660 series, Premium, and HEF®	U9044-0008



Chart Recorder

- > Can be factory installed with your freezer order or retrofitted on location
- > Selectable temperature range (0 to -50 °C and -50 to -100 °C) and rotation speed

Ordering information

Description	Order no.
Chart Recorder (Type I)	P0625-2100
Chart Recorder pens (Type I), 3 pcs.	K0660-0051
Chart Recorder paper (Type I), 0 to -50 °C, 60 pcs.	P0625-2111
Chart Recorder paper (Type I), -50 to -100 °C, 60 pcs.	P0625-2110

Freezer

Freezer Racks

Drawer or side access?

When using racks with drawers, only the drawer with the freezer boxes of interest is pulled out. All other boxes stay in the cold inner area of the ULT freezer. Eppendorf drawers are optimized for smooth movement at -80 °C for ergonomic handling.

When using side access racks, most of the storage boxes have to be pulled out of the cold inner area of the ULT freezer to access the samples. Racks for chest freezers can be equipped with locking rods to secure freezer boxes when pulling out the rack tower.



Stainless steel tower rack for Eppendorf Innova® ULT chest freezers without locking pin: 2.0 in boxes



Rack with locking rod for Eppendorf Innova® ULT chest freezer



Drawer rack for Eppendorf ULT freezer



Side access rack for Eppendorf ULT freezer

Pick your material

Standard freezer racks are available in either stainless steel or aluminum, each with its own benefits.

Stainless steel:

- > Stable/robust for longevity and higher capacity
- > Fits freezer boxes up to 136 mm × 136 mm for high flexibility regarding boxes
- > Special design of drawer racks for optimized cooling conditions and improved sample safety

Aluminum:

- > For freezer boxes up to 133 mm × 133 mm
- > Non-corrosive anodized aluminum for long-term use

3-compartment or 5-compartment?

The ULT freezer with 3 compartments/ shelves (e.g. Innova® U535) has higher compartments compared to the 5-compartment ULT freezer (e.g. CryoCube® F570 series). Racks of a 5-compartment freezer do fit into a 3-compartment freezer but not vice versa. To get the maximum capacity out of your ULT freezer, the CryoCube F740 series (3-compartment) can be equipped with "3-compartment MAX" racks. These racks only fit into the CryoCube F740 series 3-compartment instruments.

Stainless steel racks

Ordering information

Description	Order no.
Freezer Rack: Innova® U101, CryoCube® F101h	
2 in/53 mm, drawer, stainless steel	6001 062 210
2.5 in/64 mm, drawer, stainless steel	6001 062 910
3 in/76 mm, drawer, stainless steel	6001 062 310
4 in/102 mm, drawer, stainless steel	6001 062 410
5 in/127 mm, drawer, stainless steel	6001 062 510
2 in/53 mm, side access, stainless steel	6001 061 210
2.5 in/64 mm, side access, stainless steel	6001 061 910
3 in/76 mm, side access, stainless steel	6001 061 310
4 in/102 mm, side access, stainless steel	6001 061 410
5 in/127 mm, side access, stainless steel	6001 061 510
Freezer Rack: CryoCube® F740 series (3-compartment, Standard), Innova® U360, U535	
2 in/53 mm, drawer, stainless steel	6001 012 210
2.5 in/64 mm, drawer, stainless steel	6001 012 910
3 in/76 mm, drawer, stainless steel	6001 012 310
4 in/102 mm, drawer, stainless steel	6001 012 410
5 in/127 mm, drawer, stainless steel	6001 012 510
2 in/53 mm, side access, stainless steel	6001 011 210
2.5 in/64 mm, side access, stainless steel	6001 011 910
3 in/76 mm, side access, stainless steel	6001 011 310
4 in/102 mm, side access, stainless steel	6001 011 410
5 in/127 mm, side access, stainless steel	6001 011 510
DWP (53 mm), side access, stainless steel	6001 011 110
Freezer Rack: CryoCube® F440/ F570 series, CryoCube® F740 series (5-compartment, compartment 1-4), Premium U410, HEF® U410	
2 in/53 mm, drawer, stainless steel	6001 022 210
2.5 in/64 mm, drawer, stainless steel	6001 022 910
3 in/76 mm, drawer, stainless steel	6001 022 310
4 in/102 mm, drawer, stainless steel	6001 022 410
2 in/53 mm, side access, stainless steel	6001 021 210
2.5 in/64 mm, side access, stainless steel	6001 021 910
3 in/76 mm, side access, stainless steel	6001 021 310
4 in/102 mm, side access, stainless steel	6001 021 410
DWP (53 mm), side access, stainless steel	6001 021 110
Freezer Rack: CryoCube® F740 series (5-compartment, MAX for 5th comp.)	
2 in/53 mm, side access, stainless steel	6001 081 210
2.5 in/64 mm, side access, stainless steel	6001 081 910
3 in/76 mm, side access, stainless steel	6001 081 310
4 in/102 mm, side access, stainless steel	6001 081 410
5 in/127 mm, side access, stainless steel	6001 081 510
DWP (53 mm), side access, stainless steel	6001 081 110
2 in/53 mm, drawer, stainless steel	6001 082 210
2.5 in/64 mm, drawer, stainless steel	6001 082 910
3 in/76 mm, drawer, stainless steel	6001 082 310
4 in/102 mm, drawer, stainless steel	6001 082 410
5 in/127 mm, drawer, stainless steel	6001 082 510

Freezer

Freezer Racks

Please check the rack brochure for easy rack selection or use the rack configuration tool:

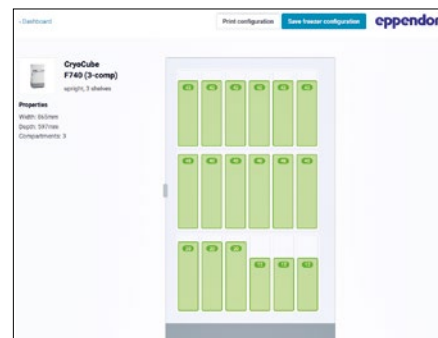
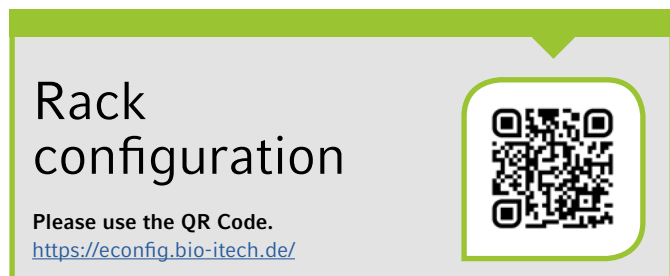

Ordering information

Description	Order no.
Freezer Rack: CryoCube® F740 series (3-compartment, MAX)	
2 in/53 mm, side access, stainless steel	6001 071 210
2.5 in/64 mm, side access, stainless steel	6001 071 910
3 in/76 mm, side access, stainless steel	6001 071 310
4 in/102 mm, side access, stainless steel	6001 071 410
5 in/127 mm, side access, stainless steel	6001 071 510
DWP (53 mm), side access, stainless steel	6001 071 110
2 in/53 mm, drawer, stainless steel	6001 072 210
2.5 in/64 mm, drawer, stainless steel	6001 072 910
3 in/76 mm, drawer, stainless steel	6001 072 310
4 in/102 mm, drawer, stainless steel	6001 072 410
5 in/127 mm, drawer, stainless steel	6001 072 510

Freezer Rack: CryoCube® F740 series (3-compartment, Standard)

➤ see page 249 at Innova table

Chest freezer racks

Ordering information

Description	Order no.
Freezer Rack: Innova® C580, C760	
2 in/53 mm, side access, stainless steel	6001 040 210
Freezer Rack: Innova® C580, C760, CryoCube® FC660 series	
2.5 in/64 mm, side access, stainless steel	6001 000 910
3 in/76 mm, side access, stainless steel	6001 000 310
4 in/102 mm, side access, stainless steel	6001 000 410
5 in/127 mm, side access, stainless steel	6001 000 510
Freezer Rack: Innova® C580, C760	
DWP (53 mm), side access, stainless steel	6001 040 110
MTP, side access, stainless steel	6001 040 010
locking rod, 2 in/53 mm, side access, stainless steel	6001 040 211
Freezer Rack: Innova® C580, C760, CryoCube® FC660 series	
locking rod, 2.5 in/64 mm, side access, stainless steel	6001 000 911
locking rod, 3 in/76 mm, side access, stainless steel	6001 000 311
locking rod, 4 in/102 mm, side access, stainless steel	6001 000 411
Freezer Rack: Innova® C580, C760	
locking rod, DWP (53 mm), side access, stainless steel	6001 040 111
locking rod, MTP, side access, stainless steel	6001 040 011

Ordering information

Description	Order no.
Freezer Rack: CryoCube® FC660 series	
2 in/53 mm, side access, stainless steel	6001 050 210
Freezer Rack: Innova® C580, C760, CryoCube® FC660 series	
2.5 in/64 mm, side access, stainless steel	6001 000 910
3 in/76 mm, side access, stainless steel	6001 000 310
4 in/102 mm, side access, stainless steel	6001 000 410
5 in/127 mm, side access, stainless steel	6001 000 510
Freezer Rack: CryoCube® FC660 series	
DWP (53 mm), side access, stainless steel	6001 050 110
MTP, side access, stainless steel	6001 050 010
locking rod, 2 in/53 mm, side access, stainless steel	6001 050 211
Freezer Rack: Innova® C580, C760, CryoCube® FC660 series	
locking rod, 2.5 in/64 mm, side access, stainless steel	6001 000 911
locking rod, 3 in/76 mm, side access, stainless steel	6001 000 311
locking rod, 4 in/102 mm, side access, stainless steel	6001 000 411
Freezer Rack: CryoCube® FC660 series	
locking rod, DWP (53 mm), side access, stainless steel	6001 050 111
locking rod, MTP, side access, stainless steel	6001 050 011

Aluminum racks**Ordering information**

Description	Order no.
Upright freezer rack: Innova® U101, CryoCube® F101h	
10 boxes per rack, 2 in/53 mm, drawer, aluminum	K0641-3003
6 boxes per rack, 3 in/76 mm, drawer, aluminum	K0641-3004
4 boxes per rack, 4 in/102 mm, drawer, aluminum	K0641-3005
Chest freezer rack: Innova® C585, C760, CryoCube® FC660 series	
13 boxes per rack, 2 in/53 mm, side access, aluminum	K0641-1690
9 boxes per rack, 3 in/76 mm, side access, aluminum	K0641-1700
6 boxes per rack, 4 in/102 mm, side access, aluminum	K0641-1750
Upright freezer rack: CryoCube® F740 series (3-compartment), Innova® U360, U535	
28 boxes per rack, 2 in/53 mm, drawer, aluminum	K0641-3000
20 boxes per rack, 3 in/76 mm, drawer, aluminum	K0641-3001
12 boxes per rack, 4 in/102 mm, drawer, aluminum	K0641-3002
Upright freezer rack: U410 series, CryoCube® F440/ F570 series, CryoCube® F740 series (5-compartment)	
16 boxes per rack, 2 in/53 mm, drawer, aluminum	K0641-1900
12 boxes per rack, 3 in/76 mm, drawer, aluminum	K0641-1890
8 boxes per rack, 4 in/102 mm, drawer, aluminum	K0641-1880

K0641-1890, optimal for cardboard boxes of lower height

Eppendorf Storage Boxes



In need of resilient options for long-term storage?

The Eppendorf Storage Boxes are a durable system solution for sample storage. The outer footprint dimensions (133 mm) are compatible with common freezer rack systems. The different inner grids provide a perfect fit for all typical tube formats: cryogenic tubes, microcentrifuge tubes, conical tubes (5 mL, 15 mL, 25 mL, and 50 mL), and other laboratory vessels. This space-saving approach helps to optimize your storage and archiving of samples.



Product features

- > Made of polypropylene (PP) for high stability in freezing applications and smooth opening and closing
- > For freezing to -86 °C
- > High-contrast permanent alphanumeric marking of each location through laser labeling enables easy sample identification and minimizes risk of sample mix-up

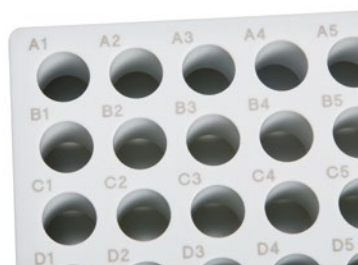

Ordering information

Description	Order no.
Storage Box 10 × 10 , freezer box, for 100 cryogenic tubes w. int. thread, 3 pcs., height 53 mm, 2 in, polypropylene, for freezing to -86 °C, autoclavable, with lid and alphanumeric code	0030 140 508
Storage Box 9 × 9 , freezer box, for 81 screw cap (cryog.) tubes 1 – 2 mL, 3 pcs., height 53 mm, 2 in, polypropylene, for freezing to -86 °C, autoclavable, with lid and alphanumeric code	0030 140 516
Storage Box 9 × 9 , freezer box, for 81 screw cap (cryog.) tubes 3 mL, 2 pcs., height 76 mm, 3 in, polypropylene, for freezing to -86 °C, autoclavable, with lid and alphanumeric code	0030 140 540
Storage Box 9 × 9 , freezer box, for 81 screw cap (cryog.) tubes 4 – 5 mL, 2 pcs., height 102 mm, 4 in, polypropylene, for freezing to -86 °C, autoclavable, with lid and alphanumeric code	0030 140 567
Storage Box 8 × 8 , freezer box, for 64 tubes 1 – 2 mL, 3 pcs., height 53 mm, 2 in, polypropylene, for freezing to -86 °C, autoclavable, with lid and alphanumeric code	0030 140 524
Storage Box 5 × 5 , freezer box, for 25 tubes 5 mL, 4 pcs., height 64 mm, 2.5 in, polypropylene, for freezing to -86 °C, autoclavable, with lid and alphanumeric code	0030 140 532
Storage Box 5 × 5 , freezer box, for 25 tubes 5 mL screw cap, 2 pcs., height 76 mm, 3 in, polypropylene, for freezing to -86 °C, autoclavable, with lid and alphanumeric code	0030 140 613
Storage Box 5 × 5 , freezer box, for 25 tubes 15 mL, 2 pcs., height 127 mm, 5 in, polypropylene, for freezing to -86 °C, autoclavable, with lid and alphanumeric code	0030 140 583
Storage Box 3 × 3 , freezer box, for 9 tubes 25 mL, 2 pcs., height 89 mm, 3.5 in, polypropylene, for freezing to -86 °C, autoclavable, with lid and alphanumeric code	0030 140 729
Storage Box 3 × 3 , freezer box, for 9 tubes 50 mL and 4 tubes 15 mL, 2 pcs., height 127 mm, 5 in, polypropylene, for freezing to -86 °C, autoclavable, with lid and alphanumeric code	0030 140 591

Freezer Boxes and Dividers

Looking for basic freezer boxes for storage?

Water-resistant cardboard boxes are a cost-effective solution to safely organize and store your samples at -80°C. The freezer boxes fit into both models of ULT freezers, upright as well as chest lab freezers.

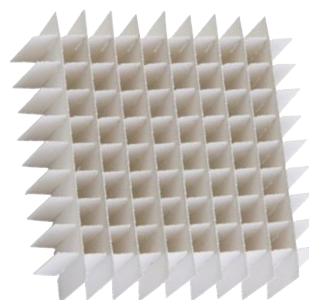
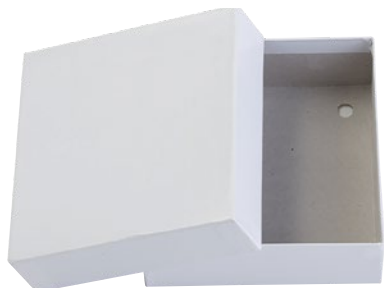

Freezer Cardboard Storage Boxes

- > White cardboard box with water resistant coating, designed to withstand ultra-low temperature
- > Available in 53 mm (2 in), 76 mm (3 in), and 102 mm (4 in) tall boxes
- > Compatible with box dividers 7 × 7 to 10 × 10 (dividers sold separately)

Freezer Boxes Dividers

- > Available in 7 × 7, 8 × 8, 9 × 9 and 10 × 10 configurations
- > Compatible with freezer cardboard storage boxes (sold separately)

Ordering information

Description	Order no.
Freezer Boxes Dividers	
7 × 7, 17.4 mm max. tube diameter, holds 49 tubes	D49
8 × 8, 15 mm max. tube diameter, holds 64 tubes	D64
9 × 9, 13 mm max. tube diameter, holds 81 tubes	D81
10 × 10, 11.8 mm max. tube diameter, holds 100 tubes	D100
Freezer Cardboard Storage Boxes, white	
53 mm tall	B50-SQ
76 mm tall	B75-SQ
102 mm tall	B95-SQ

Freezer

Eppendorf SafeCode System

Safe sample identification needed?

Every stored sample vessel must be labeled for clear identification. Yet, you always find samples in your freezer with an illegible or lost label. Clear labeling is recommended to make reading as easy and as reliable as possible for everyone. Printed labels on vessels in plain writing are the minimum condition for safe reading. Barcodes or 2D datamatrix codes are one step further towards a fast and safe sample

identification. Vessels with up to a 3-level coding in different formats enable you to improve your processes.

Smart labeling of your high-value samples is crucial for safe identification and ultimately for reliable results. For added security, manage your coded samples with sample management software like eLabNext.

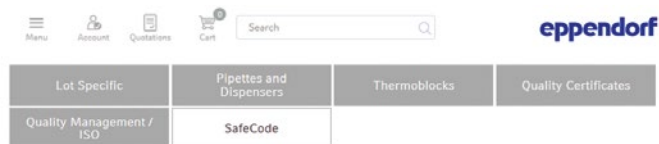

How can I get the ID-specific information for my SafeCode consumables?

Depending on the ID of the Eppendorf SafeCode consumable product, we provide further information like volume, lot numbers, certificates of quality, as well as further documents for your process documentation.

- > Start your process by scanning the SafeCode datamatrix code. Without a dedicated scanner, read the clear coding on the vial
- > Paste the captured code(s) into the box below
- > Receive all ID-specific information and further documents

A package of your dedicated files can be downloaded for documentation purposes.

If you have any further questions you may contact certificates@eppendorf.de



Documentation required?

For certification purposes, more and more users need to document every piece of information. Vials are a major part of the workflow within the lab. Therefore, further information about Eppendorf consumables with SafeCode are available via the Eppendorf website. Based on the individual vial or tube code you can get:

- > Lot number
- > Order number
- > Certificates

The information can be exported manually into local databases or automatically transferred to the sample management software Eppendorf eLabInventory or eLabJournal® (software add-on).

eLabInventory

Start your
30-day free-trial:

Please use the QR Code.

www.elabnext.com/eppendorf



Eppendorf CryoStorage Vials



Scanning labels of 20 vials in a row?

The SafeCode system for Eppendorf CryoStorage Vials is based on a 3-level coding to enable safe sample identification. Up to 96 pre-labeled vials are pre-racked and pre-capped for convenient usage.



Product features

- > 3-level coding for safe sample identification
- > ECC 200 error correction function enables safe code reading with up to 30 % damaged codes
- > Temperature range: -196 °C (gas phase of LN₂) to +121 °C

Ordering information

Description	Order no.
Eppendorf CryoStorage Vial , 0.5 mL, free of DNase, RNase, human DNA, endotoxin; external thread, pre-capped gray, with 2D SafeCode (DataMatrix/ECC200), linear and human readable code, 960 vials (10 racks × 96 vials), individually packed racks	0030 079 400
Eppendorf CryoStorage Vial , 1.0 mL, free of DNase, RNase, human DNA, endotoxin; external thread, pre-capped gray, with 2D SafeCode (DataMatrix/ECC200), linear and human readable code, 960 vials (10 racks × 96 vials), individually packed racks	0030 079 418
Eppendorf CryoStorage Vial , 1.5 mL, free of DNase, RNase, human DNA, endotoxin; external thread, pre-capped gray, with 2D SafeCode (DataMatrix/ECC200), linear and human readable code, 480 vials (10 racks × 48 vials), individually packed racks	0030 079 426
Eppendorf CryoStorage Vial , 2.0 mL, free of DNase, RNase, human DNA, endotoxin; external thread, pre-capped gray, with 2D SafeCode (DataMatrix/ECC200), linear and human readable code, 480 vials (10 racks × 48 vials), individually packed racks	0030 079 434
Eppendorf CryoStorage Vial , 4.0 mL, free of DNase, RNase, human DNA, endotoxin; external thread, pre-capped gray, with 2D SafeCode (DataMatrix/ECC200), linear and human readable code, 480 vials (10 racks × 48 vials), individually packed racks	0030 079 442
Eppendorf CryoStorage Vial , sterile, 0.5 mL, free of DNase, RNase, human DNA, endotoxin; external thread, pre-capped gray, with 2D SafeCode (DataMatrix/ECC200), linear and human readable code, 960 vials (10 racks × 96 vials), individually packed racks	0030 079 450
Eppendorf CryoStorage Vial , sterile, 1.0 mL, free of DNase, RNase, human DNA, endotoxin; external thread, pre-capped gray, with 2D SafeCode (DataMatrix/ECC200), linear and human readable code, 960 vials (10 racks × 96 vials), individually packed racks	0030 079 469
Eppendorf CryoStorage Vial , sterile, 1.5 mL, free of DNase, RNase, human DNA, endotoxin; external thread, pre-capped gray, with 2D SafeCode (DataMatrix/ECC200), linear and human readable code, 480 vials (10 racks × 48 vials), individually packed racks	0030 079 477
Eppendorf CryoStorage Vial , sterile, 2.0 mL, free of DNase, RNase, human DNA, endotoxin; external thread, pre-capped gray, with 2D SafeCode (DataMatrix/ECC200), linear and human readable code, 480 vials (10 racks × 48 vials), individually packed racks	0030 079 485
Eppendorf CryoStorage Vial , sterile, 4.0 mL, free of DNase, RNase, human DNA, endotoxin; external thread, pre-capped gray, with 2D SafeCode (DataMatrix/ECC200), linear and human readable code, 480 vials (10 racks × 48 vials), individually packed racks	0030 079 493

Freezer

SafeCode Tubes

How often do you puzzle about tube labels while working at the bench?

A clean and stable label on the side or top of the vessel can make scientific life so much easier. Eppendorf microtubes and conical tubes are available with SafeCode - a well-designed barcoding system. Take advantage of the pre-labeled and durable 2-level coding of the SafeCode system (datamatrix code and clear coding) to enable

safe sample identification. The safe sample ID is supported by online information about the dedicated consumable.

These tubes are available in volumes from 5 mL to 50.0 mL for a broad range of applications at the bench. These sets of vessels expand your safe sample management solution from the existing SafeCode CryoStorage Vials at -80 °C storage for complete security in your daily work at the bench.



Product features

- > 2-level coding for safe sample identification
- > ECC 200 error correction function enables safe code reading with up to 30 % damaged codes
- > Temperature range: -86 °C to +121 °C

Safe sample identification needed? Eppendorf SafeCode provides reliable sample IDs for safe identification

Ordering information

Description	Order no.
Eppendorf Conical Tubes , 15 mL, 2D SafeCode, sterile, pyrogen-, DNase-, RNase-, human and bacterial DNA-free, colorless, 500 tubes (10 bags × 50 tubes)	0030 113 489
Eppendorf Conical Tubes , 50 mL, 2D SafeCode, sterile, pyrogen-, DNase-, RNase-, human and bacterial DNA-free, colorless, 500 tubes (20 bags × 25 tubes)	0030 113 497
Eppendorf Tubes® 5.0 mL with screw cap , 5 mL, 2D SafeCode, sterile, pyrogen-, DNase-, RNase-, human and bacterial DNA-free, 200 tubes (2 bags × 100 tubes)	0030 113 500

Eppendorf RackScan



Scanning more than one sample at a time?

The Eppendorf RackScan provides you a number of solutions to scan samples tubes with datamatrix (2D) codes. The Eppendorf RackScan b scans data from the bottom of the vessels. The instrument can also be equipped with the „s“ accessory to read side-labeled barcodes.

Data can be exported in different formats for downstream software applications.

Product features

- > Camera based instrument resulting in rapid imaging and decoding
- > Comfortable and easy plug-in system
- > Small footprint, ideal for benchtop (and integration)

Ordering information

Description	Order no.
Eppendorf RackScan s , code scanner for side reading of SBS racks and cryostorage boxes, accessory for the RackScan product family, /50 – 60 Hz	6002 000 014
Eppendorf RackScan b , scanner (bottom reading) for 2D-coded tubes in SBS racks and cryostorage boxes, incl. software RackScan Analyzer, 100 – 240 V \pm 10 %/50 – 60 Hz (GB)	6002 000 111

Micromanipulation

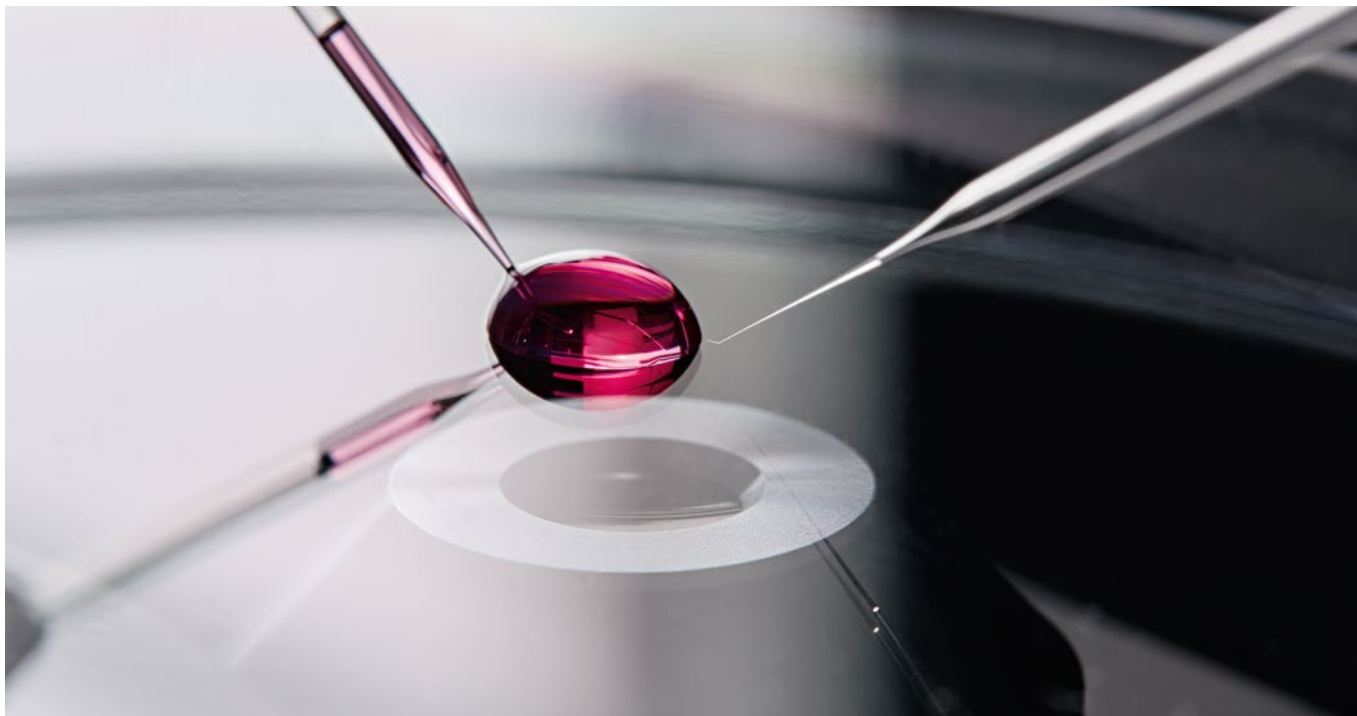

Micromanipulation is ideally suited to address a wide range of experimental questions in the field of life sciences. In many instances, physical manipulation exposes cells to less trauma than other methods, like chemical transfection, thus contributing to the quality of your results.

With almost 40 years of cell manipulation expertise, Eppendorf is your expert partner for micromanipulation and microinjection in the life sciences. As a systems provider for a diverse range of applications, we can support you with a customized solution for your cell manipulation requirements.

Eppendorf offers a wide range of micromanipulation workstations for specific application profiles. Our cell manipulation systems are compatible with common instruments produced by the major microscope manufacturers, thus providing the flexibility to fit your micromanipulation system to the microscope of your choice.

Successful micromanipulation of cells requires precision, reliability, and fast sample processing. Our motivation is to consistently provide you with the best possible tools for your life science experiments - for cell manipulation and beyond.



[eppendorf.com/eshop](https://www.eppendorf.com/eshop)

Get all information about the Eppendorf micromanipulation portfolio!
Explore the eshop and get an overview!

www.eppendorf.com/cellmanipulation-portfolio



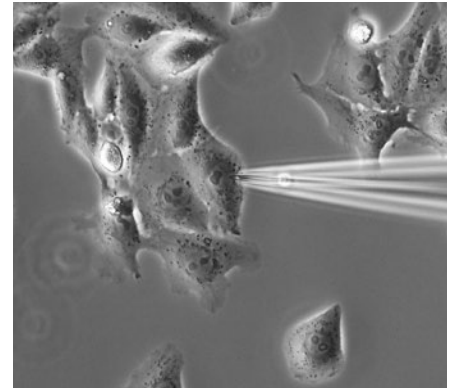
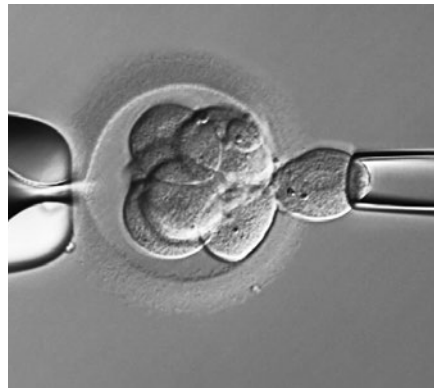

Microinjection into oocytes, embryos and small organisms

- > Production of genetically modified animals using pronuclear and cytoplasmic injection (e.g. CRISPR & TALEN)
- > Applications in animal assisted reproduction (e.g. mouse ICSI)
- > Serial injection into fish embryos (e.g. Zebrafish, Medaka)
- > Injection into *C. elegans*, other worms, insects, etc.

Cell transfer or biopsies

- > Stem cell transfer
- > Nuclear transfer
- > Transplantation of cells
- > Removal of individual cells from cell assemblies, e.g. biopsies
- > Single cell picking

Other application examples

- > Semi-automatic microinjection into adherent cells
- > Injection into 3D cell culture or organoids
- > Positioning and selection of microparticles
- > Microdissection of chromosomes, etc.
- > Automatic dispensing of cell suspensions or solutions



CellTram[®] 4r Air/Oil

Description

Working with the CellTram 4r Air and CellTram 4r Oil is like taking a breath of fresh air. Our new manual microinjectors have been designed with special emphasis on excellent ergonomics, ease of use and highest precision. They cover a wide range of research applications and suit all personal working techniques.



1. Pneumatic system for oil-free manipulation and injection of cells (CellTram 4r Air)
2. Piston position scale enables setting of air volume and injection characteristics according to individual needs (CellTram 4r Air)
3. Improved oil-filling system for quick and clean re-filling (CellTram 4r Oil)
4. Coarse and fine drive for precise and intuitive sample control
5. Improved rotary knob design for better handling and easier cleaning
6. Capillary holder 4 with markings for easier positioning
7. New grip head 4 system for simple capillary change and higher user safety
8. Position indicators and marking for in/out to reduce risk of user errors
9. Stable, nonslip base plate
10. Highly reliable performance with minimal maintenance



CellTram 4r Air: Pressure responsiveness for various applications can be adjusted by different piston positions

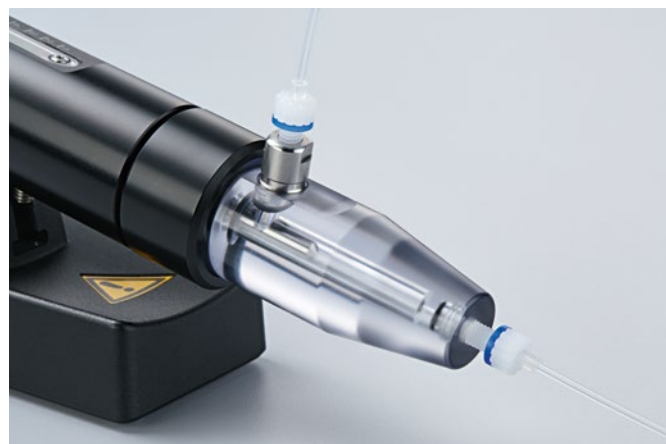

CellTram 4r Oil: The new oil-filling system helps avoid oil-spilling and facilitates the filling process

Applications

- > ICSI of mouse and large mammals (e.g., equine, porcine...)
- > Holding of sensitive oocytes, embryos or small organisms
- > Piezo-assisted micromanipulation in combination with the Eppendorf PiezoXpert®
- > Transfer of cells or organelles (e.g., ES cell or iPS cell transfer into blastocysts or morulae)
- > Enucleation/nuclear transfer
- > (Xeno)transplantations
- > Removal of cells (e.g., for polar body biopsy, blastomere biopsy or trophectoderm biopsy)
- > Manual microinjection and dispensing of aqueous solutions
- > Single cell picking

Technical specifications

Model	CellTram 4r Air	CellTram 4r Oil
Cylinder volume	10 mL	1,000 µL
Max. pressure	3,000 hPa	20,000 hPa
Min. adjustable volume	< 100 nL	< 1.5 nL
Pressure generation	Cylinder/piston system, air-filled	Cylinder/piston system, oil-filled
Volume change per revolution	60 µL/600 µL (fine/ coarse rotary knob)	1 µL/10 µL (fine/ coarse rotary knob)

Ordering information

Description	Order no.
CellTram® 4r Air, manual pneumatic microinjector, with gears 1:1 and 1:10, for holding and injection	5196 000 013
CellTram® 4r Oil, manual hydraulic microinjector, with gears 1:1 and 1:10, for holding and injection	5196 000 030
Filling and Cleaning set, for CellTram® 4 Oil and CellTram® Oil/vario, incl. filling tube, Luer lock adapter, 2 syringes	5196 088 000
Injection tube Air, white ring mark, I.D. 0.5 mm, length 1.3 m	5196 061 004
Injection tube Oil, blue ring mark, I.D. 1.0 mm, length 1.3 m	5196 089 006
Capillary holder 4, incl. 1x Grip head set 4 size 0 (for microcapillaries with outer diameter 1.0 – 1.1 mm)	5196 081 005
Capillary holder 4 slim shape, for flat angle injections, for microcapillaries with outer diameter 1.0 mm	5196 062 000
O-ring set 4, incl. 10 o-rings large, 10 o-rings small, 2 distance sleeves, o-ring removal tool for grip head set 4	5196 086 007
Grip head set 4 size 0, 1 pc, for microcapillaries with outer diameter 1.0 to 1.1 mm	5196 082 001
Grip head set 4 size 1, 1 pc, for microcapillaries with outer diameter 1.2 to 1.3 mm	5196 083 008
Grip head set 4 size 2, 1 pc, for microcapillaries with outer diameter 1.4 to 1.5 mm	5196 084 004
Grip head set 4 size 3, 1 pc, for microcapillaries with outer diameter 0.7 to 0.9 mm	5196 085 000

TransferMan® 4r



The injection angle can be adjusted from 0° to 90°. This ensures highest flexibility for various applications.

Description

Successful cell manipulation requires precision and fast sample processing. Eppendorf's new flagship micromanipulator, the TransferMan® 4r, is designed to ensure optimal results for any of your micromanipulation requirements. Together with our complete portfolio of cell manipulation products, it forms an ideal system to fully support your cell manipulation applications.

Applications

- > Micromanipulation of oocytes and early embryos
- > ES and iPS cell transfer
- > Nuclear transfer
- > Pronuclear and cytoplasmic injection (e.g., CRISPR/Cas, TALEN)
- > Selection of individual cells (e.g., biopsies, single cell picking)
- > Positioning and selection of microparticles
- > Microdissection of chromosomes, etc.

Product features

- > Unique DualSpeed™ joystick for precise and instantaneous movement control
- > Maximum stability ensures vibration-free work
- > One Joystick for all 3 axes (X, Y, Z) movements and in axial direction (X/Z)

Ordering information

Description

TransferMan® 4r, micromanipulator with DualSpeed™ joystick for direct and dynamic movement control, 100 – 240 V/50 – 60 Hz (GB), For research use only.

Order no.

5193 000 039

✂ Ordering information for other voltage options begins on page 349

Select the right adapter for your microscope on page 264

InjectMan® 4

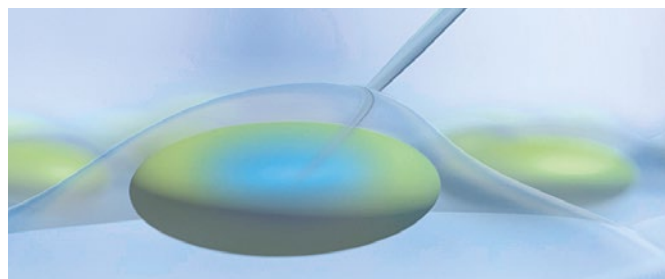

Electronic coupling with the FemtoJet® 4 - for fast, serial (>20 cells/min) and minimally invasive (axial direction) injections

Description

Minimal lesion hole size for high cell survival rates are key in your DNA/RNA, protein or fluorescent dye microinjection experiment? Or you want to speed up your serial adherent cell injections to ~20-30 cells/min? The InjectMan® 4 electronically coupled with the FemtoJet® 4i/x supports you with easy (semi-automatic) microinjections into adherent cells, smaller organisms (e.g. zebrafish) and embryos in the early stages of development.

Applications

- > Semi-automatic microinjection into adherent cells
- > Serial microinjection into fish larvae, frog eggs, insect embryos, etc.
- > Injection into living plant cells, *C. elegans* and other roundworms and flatworms
- > Automatic dispensing of cell suspensions or solutions
- > Stable, drift-free positioning, e.g. for electrophysiology techniques

See the video:
Adherent cell
injection



[www.eppendorf.com/
microinjection-video](http://www.eppendorf.com/microinjection-video)

Product features

- > Maximum stability ensures drift-free work
- > Electronic coupling to FemtoJet microinjectors for fast serial semi-automatic injections with highest reproducibility
- > Selection and programming of advanced functions (e.g. axial movement, step injection)

Ordering information

Description	Order no.
InjectMan® 4 , micromanipulator with dynamic movement control, 100 – 240 V/50 – 60 Hz (GB)	5192 000 035

✂ Ordering information for other voltage options begins on page 349

Select the right adapter for your microscope on page 264

InjectMan® 4 and TransferMan® 4r Accessories

Description	Order no.
Positioning aid , for universal capillary holder, capillary holder 4, 2 pcs.	5192 072 001
Spare parts kit , 1 slider (complete), 2 machine screws M2.5x6 (swivel joint), 2 set screws (angle head), 2 compression springs (knurled screw angle head)	5192 071 005
Headstage holder , for preamplifier	5192 073 008
Foot control , for FemtoJet® 4i/4x	5252 070 020
Connection cable , for connecting TransferMan® 4r/InjectMan® 4 to FemtoJet® 4i/4x	5192 082 007
Y-cable FJ4 , Y-cable for connecting FemtoJet® 4i/4x with a PC and TransferMan® 4r or InjectMan® 4	5192 080 004
Y-cable PX , Y-cable for connecting PiezoXpert® or a PC with TransferMan® 4r or InjectMan® 4 and FemtoJet® 4i/4x	5192 081 000

Microscope Adapters for Micromanipulation Systems

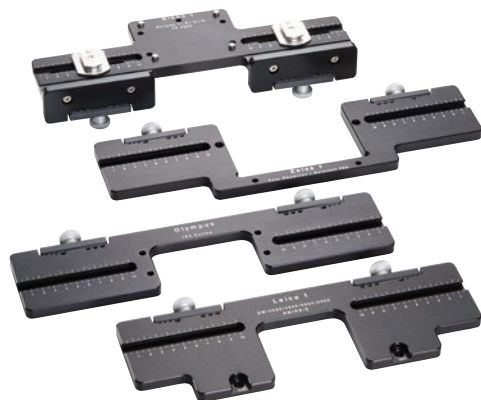

Microscope adapters

Eppendorf microscope adapters enable the simple installation of the TransferMan® 4r or InjectMan® 4 on all conventional inverted microscopes manufactured by Leica®, Nikon®, Olympus® and Zeiss®



Universal stand

The Universal stand can be used for mounting the TransferMan 4 and InjectMan 4 micromanipulators on upright microscopes and stereo microscopes independent of the microscope tripod used. With its magnetic foot the Universal stand can be firmly fixed to any ferromagnetic base (plate or table).

Find all available adapters here

www.eppendorf.com/microscope-adapter



Ordering information

Description	Order no.
Adapter Leica® 1 , for Eppendorf micromanipulation systems, for Leica® DMI8, DMI3000 B, 3000 M, 4000 B, 5000 B, 5000 M, 6000 B, DM IRB E, HC and DM IRE 2 microscopes	5192 301 000
Adapter Leica® 2 , for Eppendorf micromanipulation systems, for Leica® DM IL LED and HC microscopes	5192 302 007
Adapter Nikon® 1 , for Eppendorf micromanipulation systems, for Nikon® Eclipse® Diaphot 200, 300 and Eclipse® Ti-E, Ti-U, Ti-S, TE200, TE300, TE2000 microscopes	5192 316 008
Adapter Nikon® 2 , for Eppendorf micromanipulation systems, for Nikon® Eclipse® Ts2R microscope	5192 317 004
Adapter Nikon® 3 , for Eppendorf micromanipulation systems, for Nikon® Eclipse Ti2-E/-A/-U microscopes	5192 318 000
Adapter Olympus® 1 , for Eppendorf micromanipulation systems, for Olympus® IX50, IX51, IX70, IX71, IX80 and IX81 microscopes	5192 306 002
Adapter Olympus® 2 , for Eppendorf micromanipulation systems, for microscopes of Olympus® IX3 series (IX53, IX73, IX83) with standard illumination column	5192 307 009
Adapter Olympus® 3 , for Eppendorf micromanipulation systems, for microscopes of Olympus® IX3 series (IX53, IX73, IX83) with special illumination column IX2-ILL30	5192 308 005
Adapter Zeiss® 1 , for Eppendorf micromanipulation systems, for Zeiss® Axiovert® 200, Axio Observer A1, D1, Z1 and Axio Observer 3, 5 and 7 microscopes	5192 311 006
Adapter Zeiss® 2 , for Eppendorf micromanipulation systems, for Zeiss® Axio Vert.A1 microscope	5192 312 002
Universal stand , for mounting Eppendorf micromanipulators on upright microscopes and stereo microscopes independent of the microscope tripod used	5192 325 007
Adapter bridge , for mounting the TransferMan® 4 and InjectMan® 4 on the microscope adapters of the predecessors TransferMan NK2, InjectMan NI2 and PatchMan NP2.	5192 321 001

Antivibration Pad



Description

Do you (still) worry about capillary vibrations and cell safety? Antivibration tables offer good protection from external vibrations. However, if you are looking for cost-efficient basic, low-maintenance, or additional vibration protection, Antivibration Pads from Eppendorf are a solid choice. They are easy to install under the base of the microscope to protect your microscope and its components from external oscillations and vibrations.

Product features

- > Easy to install as a stand-alone or as an addition to your antivibration table
- > Five models available optimized for different weights below individual microscope basis
- > No gas supply or maintenance required

Ordering information

Description	Order no.
Antivibration Pad XS , weight range 4.5 – 6.0 kg	5181 301 009
Antivibration Pad S , weight range 6.0 – 8.0 kg	5181 303 001
Antivibration Pad M , weight range 8.0 – 10.0 kg	5181 305 004
Antivibration Pad L , weight range 10.0 – 12.5 kg	5181 307 007
Antivibration Pad XL , weight range 12.5 – 16.5 kg	5181 309 000

- i** It is decisive to take into account the total weight of your microscope, including the mounted accessories, and the load distribution of the individual contact points.

Download the flyer:
Antivibration Pads

[www.eppendorf.com/
flyer-antivibration-pad](http://www.eppendorf.com/flyer-antivibration-pad)



Micromanipulation

PiezoXpert®



Description

Many cells require additional assistance for successful microinjection. Piezo-assisted injection methods such as Piezo-ICSI can significantly increase productivity and enhance yields for a variety of micromanipulation applications. The Eppendorf PiezoXpert® ensures gentle and effective penetration of the cell membrane, thereby improving the outcome of your cell manipulation experiments.

Applications

- > Piezo-ICSI (Intracytoplasmic Sperm Injection) in mouse, equine, porcine etc.
- > Transfer of embryonic or induced pluripotent stem cells into blastocysts or morulae
- > Enucleation/nuclear transfer
- > Blastomere biopsy from mouse embryos
- > Biopsy of equine embryos for Preimplantation Genetic Testing
- > RNA/DNA injection into fertilized oocytes of mammals

Product features

- > Fast and simple sample processing due to intuitive operation
- > Reproducible parameter setting
- > Program keys to save your experimental parameters

Ordering information

Description	Order no.
PiezoXpert® , for piezo-assisted micromanipulation, incl. actuator 2, foot control and spacer plate and grip head 4 size 0, 100 – 240 V/50 – 60 Hz (GB)	5194 000 032
Piezo Drill Tip ES , for piezo-assisted mouse ES cell transfer (for research use only), 25 ° tip angle, 15 µm inner diameter, 6 mm flange, sterile, 25 pcs.	5195 000 095
Piezo Drill Tip ICSI , for piezo-assisted mouse ICSI (for research use only), 25 ° tip angle, 6 µm inner diameter, 6 mm flange, sterile, 25 pcs.	5195 000 087
Actuator 2 , for piezo-assisted micromanipulation, as accessory for the PiezoXpert®	5194 075 156
Grip head set 4 size 0 , 1 pc, for microcapillaries with outer diameter 1.0 to 1.1 mm	5196 082 001
Grip head set 4 size 1 , 1 pc, for microcapillaries with outer diameter 1.2 to 1.3 mm	5196 083 008
Grip head set 4 size 2 , 1 pc, for microcapillaries with outer diameter 1.4 to 1.5 mm	5196 084 004
Grip head set 4 size 3 , 1 pc, for microcapillaries with outer diameter 0.7 to 0.9 mm	5196 085 000
Tube adapter , pack of 2, for connecting tubes with an outer diameter of 2 mm or 3 mm with the capillary holder and the capillary holder 4	5194 075 407

✎ Ordering information for other voltage options begins on page 349

Download the
Piezoxpert flyer



[www.eppendorf.com/
piezoxpert-flyer](http://www.eppendorf.com/piezoxpert-flyer)

FemtoJet[®] 4i and FemtoJet[®] 4x



Typical Injection Volume	FemtoJet 4i	FemtoJet 4x		
Cell nucleus of adherent cells				
Cytoplasm of adherent cells				
Pronucleus of fertilized mouse oocytes				
<i>Caenorhabditis elegans</i>				
Fish embryos in early development phases				
<i>Xenopus laevis</i> oocytes				
Volume (liter, logarithm, measurement unit)	10 ⁻¹⁵	10 ⁻¹²	10 ⁻⁹	10 ⁻⁶
Unit	femtoliter	picoliter	nanoliter	microliter

Description

Eppendorf's electronic microinjectors FemtoJet 4i and FemtoJet 4x with their simple operation menu and a range of functionalities are perfectly suited for injecting small to intermediate volumes. Both the FemtoJet 4i and FemtoJet 4x, form the perfect system with Eppendorf micromanipulators, yet they integrate just as easily with non-Eppendorf micromanipulation systems. The electronic connection between FemtoJet 4i or 4x and TransferMan 4r or InjectMan 4 guarantees simple, rapid and reproducible microinjections into cells.

	FemtoJet 4i	FemtoJet 4x
Application - Volume range	Serial injections of small to intermediate volumes (femtoliters – 100 pL) for research purposes.	Injection of volumes 100 pL – 1 µL and more and/or longer series at higher, continuous pressures ("heavy duty" device)
Application	Reproducible and serial microinjection into adherent cells when combined with the InjectMan 4 or InjectMan NI 2 micromanipulator Pronuclear or cytoplasmic injection of RNA/DNA solutions into fertilized oocytes of mammals, when combined with the TransferMan 4r micromanipulator	Microinjection into small organisms and embryos in the early stages of development (e.g., <i>Drosophila melanogaster</i> , Zebrafish, etc.)
Pressure supply	Integrated compressor	External pressure supply (not included)
Semi-automatic serial injections	Electronic connection to Eppendorf micromanipulators	

Ordering information

Description	Order no.
FemtoJet[®] 4i , programmable microinjector with integrated pressure supply, 100 – 240 V ±10 %/50 – 60 Hz (GB), including foot control, GB	5252 000 030
FemtoJet[®] 4x , programmable microinjector with external pressure supply (not included), 100 – 240 V ±10 %/50 – 60 Hz (GB), including foot control	5253 000 033
Capillary holder 4 , incl. 1x Grip head set 4 size 0 (for microcapillaries with outer diameter 1.0 – 1.1 mm)	5196 081 005
Capillary holder 4 slim shape , for flat angle injections, for microcapillaries with outer diameter 1.0 mm	5196 062 000
Injection tube , for universal capillary holder and capillary holder 4, 2 m	5252 070 054
O-ring set 4 , incl. 10 o-rings large, 10 o-rings small, 2 distance sleeves, o-ring removal tool for grip head set 4	5196 086 007
Hand control , for triggering inject function	5252 070 011
Grip head set 4 size 0 , 1 pc, for microcapillaries with outer diameter 1.0 to 1.1 mm	5196 082 001
Grip head set 4 size 1 , 1 pc, for microcapillaries with outer diameter 1.2 to 1.3 mm	5196 083 008
Grip head set 4 size 2 , 1 pc, for microcapillaries with outer diameter 1.4 to 1.5 mm	5196 084 004
Grip head set 4 size 3 , 1 pc, for microcapillaries with outer diameter 0.7 to 0.9 mm	5196 085 000
Grip head set 4 (slim shape) , for Capillary holder 4 slim shape incl. 6 O-rings and 2 distance sleeves, for capillaries with outer diameter 1.0 mm	5196 063 007
Y-cable FJ4 , Y-cable for connecting FemtoJet [®] 4i/4x with a PC and TransferMan [®] 4r or InjectMan [®] 4	5192 080 004
Y-cable PX , Y-cable for connecting PiezoXpert [®] or a PC with TransferMan [®] 4r or InjectMan [®] 4 and FemtoJet [®] 4i/4x	5192 081 000

✂ Ordering information for other voltage options begins on page 349

Micromanipulation

Eppendorf Microcapillaries

Category	Application	Description	Outer diameter	Inner diameter	Tip angle
Cell transfer capillaries	Sperm transfer into oocytes	TransferTip® RP (ICSI)		4 µm	35 °
Cell transfer capillaries	Sperm transfer into oocytes	TransferTip® R (ICSI)		4 µm	35 °
Cell transfer capillaries	Sperm transfer into oocytes	TransferTip® F (ICSI)		4 µm	35 °
Cell transfer capillaries	Transfer of ES cells into mouse blastocyst or morula	TransferTip® (ES)		15 µm	20 °
Holding capillaries	For holding oocytes, blastocysts, etc.	VacuTip I	100 µm	15 µm	35 °
Holding capillaries	For holding oocytes, blastocysts, etc.	VacuTip II	110 µm	60 µm	25 °
Capillaries for Piezo-assisted cell transfer	Piezo-assisted transfer of sperms into mammalian oocytes	Piezo Drill Tip ICSI		6 µm	25 °
Capillaries for Piezo-assisted cell transfer	Piezo-assisted transfer of embryonic stem cells into blastocysts	Piezo Drill Tip ES		15 µm	25 °
Biopsy tips	Laser-assisted biopsy of cells and organelles	Biopsy Tip I		19 µm	35 °
Biopsy tips	Laser-assisted biopsy of cells and organelles	Biopsy Tip II		20 µm	15 °
Microinjection capillaries	Injection into adherent cells, near-surface injection into oocytes, early stage embryos and smaller organisms	Femtotips®		0.5 µm	0 °
Microinjection capillaries	Injection into adherent cells, deep injection into mammalian oocytes, early stage embryos (e.g. Zebrafish) and smaller organisms	Femtotip II		0.5 µm	0 °
Filling capillaries	Pipette tip for back-filling of Femtotips® and other microcapillaries	Microloader			

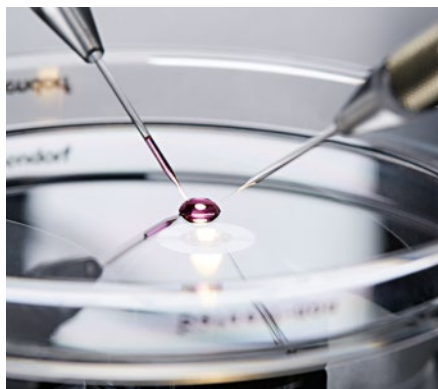

Flange length	Cytotoxicity tested?	Sterile?	Product features	Packing	Order no.
0.5 mm	yes	yes	Fine tapered and rigid tip flange for optimal cell penetration Heat-formed spike eases penetration	25 pcs.	5195 000 010
1 mm	yes	yes	Rigid tip flange for successful penetration Heat-formed spike eases penetration	25 pcs.	5195 000 028
0.4 mm	yes	yes	Fine tapered and flexible tip flange for minimal cell trauma Heat-formed spike eases penetration	25 pcs.	5195 000 001
1 mm		yes	Rigid flange Heat-formed spike eases penetration	25 pcs.	5195 000 079
1 mm	yes	yes	Smooth, rounded tip end for gentle holding	25 pcs.	5195 000 036
0.5 mm	yes	yes	Smooth rounded tip end for gentle holding	25 pcs.	5195 000 044
6 mm		yes	Non-polished, blunt tip end for optimal piezo pulse force transfer and minimal trauma	25 pcs.	5195 000 087
6 mm		yes	Non-polished, blunt tip end for optimal piezo pulse force transfer and minimal trauma	25 pcs.	5195 000 095
1.9 mm	yes	yes	Rounded tip end to minimize oolemma trauma	25 pcs.	5195 000 052
0.5 mm	yes	yes	Rounded tip end to minimize oolemma trauma	25 pcs.	5195 000 060
		yes	Screw-in thread for quick assembly into FemtoJet capillary holder 100 % individual testing of every Femtotip using a flow parameter	20 pcs.	5242 952 008
		yes	Screw-in thread for quick assembly into FemtoJet capillary holder 100 % individual testing of every Femtotip using a flow parameter	20 pcs.	5242 957 000
			Extremely long, fine and flexible tip, tips and rack autoclavable Highest precision and accuracy when used with Eppendorf pipettes for 0.5 to 10 μ L (gray control button)	192 pcs. (2 racks x 96 pcs.)	5242 956 003

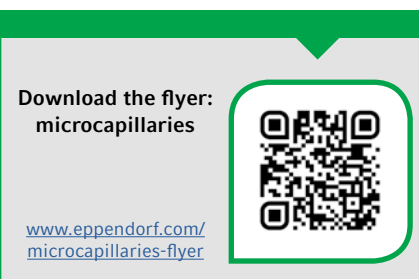
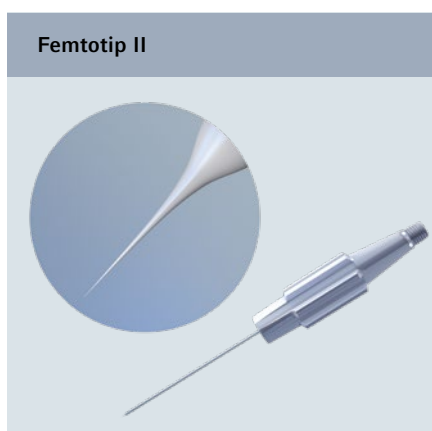
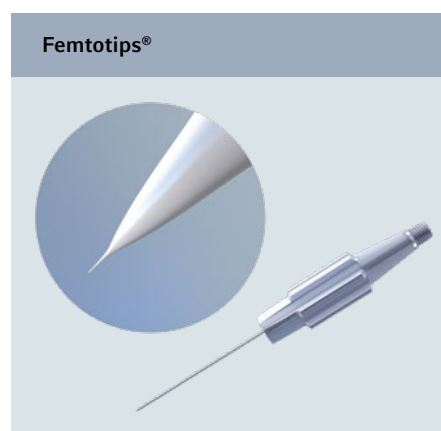

Workstations for Microinjection and Micromanipulation

Setup Requirements Microcapillaries

Required devices	Microinjection adherent cells	Microinjection non-mammalian embryos / small organisms	DNA/CRISPR injection zygotes / GMO production
Universal stand		1 adapter or stand	
Microscope adapter	1		1
Micromanipulators			
TransferMan® 4r			2
InjectMan® 4	1	1	
Microinjectors			
FemtoJet® 4i	1		1
FemtoJet® 4x		1	
CellTram® 4r Air			1
CellTram® 4r Oil			
Accessories			
PiezoXpert®			
Antivibration Pads	3 to 4	3 to 4	3 to 4
Microcapillaries¹⁾			
Femtotips®			
Femtotip II	1	1	1
VacuTip I			1
VacuTip II			
TransferTip® R (ICSI)			
TransferTip® (ES)			
Piezo Drill Tip ES			
Piezo Drill Tip ICSI			
Microloader	1	1	1
Additional			
Eppendorf Research® plus pipette 0.5 – 10 µL	1	1	1



Workstation for microinjection into small organisms



Workstation for adherent cell injection

Stem Cell Transfer / GMO production	Nuclear Transfer / Cloning	Animal ICSI	Order no.
			5192 325 007
1	1	1	see page 264
2	2	2	5193 000 039
			5192 000 035
			5252 000 030
			5253 000 033
	1		5196 000 013
1 Air / 1 Oil or 2 Air	1	1 Air / 1 Oil or 2 Air	5196 000 030
1 optional	1	1 optional	5194 000 032
3 to 4	3 to 4	3 to 4	see page 265
			5242 952 008
			5242 957 000
1	1	1	5195 000 036
			5195 000 044
		1	5195 000 028
1			5195 000 079
1 optional	1	1 optional	5195 000 095
		1	5195 000 087
			5242 956 003
			see page 36



Workstation for DNA/CRISPR injection zygotes / GMO production



Workstation for stem cell transfer, nuclear transfer or animal ICSI

CO₂ Incubators



CO₂ incubators, service products, and digital lab management from Eppendorf



The CO₂ incubator is the home of your cells and a key device in every cell culture lab. Therefore, it is crucial that a CO₂ incubator provides **optimized and stable growth conditions** to ensure a high degree of reproducibility for your culturing results – even for sensitive cells. Fast atmosphere recovery rates after door openings without setpoint overshoot, uniformity of the atmosphere inside the CO₂ incubator chamber, and protection from vibrations and air turbulence are important features to consider and are all parts of the Eppendorf CO₂ incubator lineup. Eppendorf also offers various CO₂ incubator service products like IQ/OQ or preventive maintenance. These services are conducted by experienced Eppendorf service technicians to help you to **continuously achieve reproducible results and prepare for internal or external audits**. Furthermore, **comprehensive and centralized documentation** of incubation conditions (e.g. alarms and events), as well as **management of a device fleet** (e.g. customizable tasks or service reminders) are provided by our VisioNize® Lab Suite for a growing number of devices from Eppendorf.

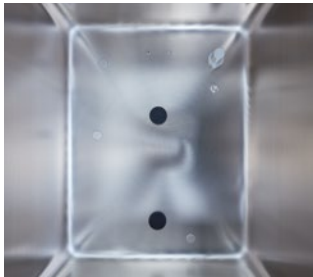

In addition to optimized growth conditions, a CO₂ incubator must provide a **high degree of contamination protection and should be as easy to clean**. Eppendorf CO₂ incubators have a fanless incubator design that leaves no space for contaminants to hide and omits the need for internal fan-associated HEPA-filters. Fast and easy cleaning are ensured by a deep-drawn, seamless incubator chamber, few internal parts that are disassembled and quickly cleaned, and integrated high temperature disinfection (HTD). Furthermore, options for additional protection like copper interior or segmented inner doors are available for selected CO₂ incubators.



Often underestimated, running costs of CO₂ incubators can add significantly to a cell culture lab's total expenses. Main factors include, for example, costs for regular replacement of internal parts like fan-associated HEPA-filters, costs related to gas consumption (incl. gas costs, labor costs for replacing cylinders, CO₂ incubator downtime during changes etc.), costs for lost lab space due to low usable space vs. footprint ratio, or costs for insufficient future flexibility. Eppendorf CO₂ incubators support cell culture labs to **reduce the running costs** and to **achieve corporate carbon footprint reduction goals**.

Get all information about the Eppendorf CO₂ incubator portfolio!
Explore the eshop and get an overview!
www.eppendorf.com/CO2-incubators-portfolio





CO₂ Incubator Service

Qualification, regular maintenance, and calibration of your CO₂ incubator are key to ensure reproducible results and easy audits at any time. Our trained Eppendorf service technicians will help you to continuously achieve this with preventive maintenance, IQ/OQ or extended warranty.



Smart cultivation with VisioNize® Lab Suite

Are you interested in monitoring your lab devices and receiving notifications e.g., for device alarms? A digital, connected lab offers even more.

VisioNize Lab Suite offers everything you need as a lab manager or scientist to get started to digitally manage your lab for increased sample security, compliance needs and maintenance management. Gain access to a modular range of digital services and choose what works for your lab.



Inside Cell Culture Newsletter

You are experienced in cell culture and want to keep expanding your knowledge? Are you looking for resources to improve your trainings? Then our "Inside Cell Culture" Newsletter is just perfect for you.

- > Tips and tricks to improve your daily work
- > Free videos, downloads, posters and more
- > Access to advanced educational webinars
- > Teaching support resources
- > Upcoming events and trainings

Discover your
service options



[www.eppendorf.com/
epservices](http://www.eppendorf.com/epservices)

Discover VisioNize®
Lab Suite



[www.eppendorf.com/
visionize](http://www.eppendorf.com/visionize)

Sign up now



[www.eppendorf.com/
icc](http://www.eppendorf.com/icc)

Our Portfolio – Your Choice



Model	CellXpert® C170i
Positioning	Large (170 L) CO ₂ incubator with many options for demanding cell culture applications (e.g. copper interior or field upgradeable O ₂ control)
Page(s)	276
Capacity	170 L
Dimensions (W × D × H)	71.8 × 71.5 × 90.0 cm / 28.3 × 28.1 × 35.4 in
Dimensions internal (W × D × H)	53.9 × 44.5 × 69.2 cm / 21.2 × 17.5 × 27.2 in
Weight w/o accessories	113 kg / 249 lb
Benchtop (B), Under Bench (U), Floor (F) or Stackable (S)	B, U, F, S (x2)
Display	color touch screen
High temperature disinfection (HTD)	180 °C
Sealed inner glass doors	yes
Segmented door options	4/8 segments (factory & in-field upgradeable)
Temperature range	Ambient +4 °C to 50 °C
Temperature control increment	±0.1 °C
Temperature stability at 37 °C	±0.1 °C
Temperature uniformity	±0.3 °C
Temperature accuracy	±0.3 °C
CO₂ range	0.1 – 20 %
CO₂ control increment	±0.1 %
CO₂ stability at 5 % CO₂	±0.1 %
CO₂ uniformity	±0.1 %
O₂ control	1 – 20 % optional (upgradeable in-field later)
Number of shelves (standard/max)	4/8
Copper options	chamber, water tray, shelves
Access port	2
On-board data logging	yes
Data export interface	USB, Ethernet, VisioNize®
Water/Humidity monitoring	optional
BMS relay	yes
Remote Device Monitoring and Notifications (VisioNize®)	VisioNize® touch enabled

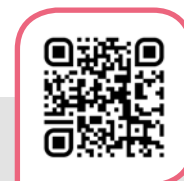



CellXpert® C170

Basic version of the C170i

279

170 L

71.8 × 71.5 × 90.0 cm / 28.3 × 28.1 × 35.4 in

53.9 × 44.5 × 69.2 cm / 21.2 × 17.5 × 27.2 in

113 kg / 249 lb

B, U, F, S (x2)

softkey operated LCD display

140 °C

yes

4- (factory-installed)/8-segments (in-field upgrade)

Ambient +4 °C to 50 °C

±0.1 °C

±0.1 °C

±0.3 °C

±0.3 °C

0.1 – 20 %

±0.1 %

±0.1 %

±0.1 %

–

3 (4 with 4-segmented door)/8

water tray, shelves

2

no

Ethernet

–

yes

VisioNize® box enabled

New Brunswick S41i

Large (170 L) CO₂ incubator shaker with integrated high temperature disinfection

280

170 L

87.5 × 73 × 85 cm / 34.4 × 28.7 × 33.5 in

69.1 × 44.4 × 53.8 cm / 27.2 × 17.5 × 21.2 in

154 kg / 340 lb

U, F, S (x2)

touchscreen interface

120 °C

yes

–

Ambient +4 °C to 50 °C

±0.1 °C

±0.1 °C

±0.25 °C at 37 °C (in flask media)

±0.2 °C

0.2 – 20 %

±0.1 %

±0.2 %

±0.1 %

–

1/2

–

1

data display (no data log or export)

Ethernet

–

yes

VisioNize® box enabled

CellXpert® C170i

Description

Cell culture incubator CellXpert® – Culture of Tomorrow

Are you looking for a 170 L cell culture incubator that is easy to clean and delivers optimized growth conditions, even for your sensitive cells? The GMP/GLP-compatible CellXpert C170i is more than just that. It also helps to reduce the running costs of your lab significantly and it provides flexibility for different future lab setups and applications – with many in-field upgradeable options.



Product features

- > **Easy cleaning and disinfection:** Seamless chamber, easy disassembling in 40 s
- > **Effective contamination protection:** 180 °C High temperature disinfection (HTD) with protocol, no internal fan-associated HEPA filters necessary
- > **Uniform temperature:** Innovative heating concept with multiple temperature sensors at various locations - verified at 27 spots inside the incubator (German DIN 12880)

See the Video:
Easy cleaning

[www.eppendorf.com/
Video-Contamination-
Prevention](http://www.eppendorf.com/Video-Contamination-Prevention)





Full control and easy documentation with the intuitive user interface.



The removable water tray is easy to clean and refill.

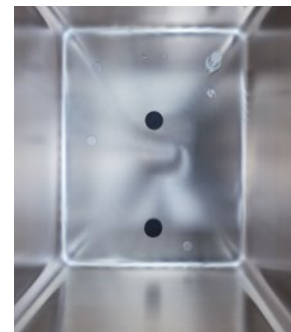

There is no place for contaminants to hide in the seamless chamber.

	C170i	C170
Display	VisioNize® touch interface, onboard data log	Standard display
High temperature disinfection	180 °C standard (protocol downloadable)	140 °C standard
O₂ control (optional)	1-20 % (upgradeable in-field later)	-
In-field upgradeable options	<ul style="list-style-type: none"> > O₂ control > 4/8-segmented inner door > humidity monitoring > water level monitoring > door handle position 	<ul style="list-style-type: none"> > 4/8-segmented inner door > door handle position
Inner door latch	magnetic, dual way	magnetic, single way
VisioNize® Lab Suite	touch enabled	box enabled
VisioNize® device management software including: User management, Performance charts, HTD-wizard, Customized tasks, Remote monitoring, Notifications	standard	optional
USB port	2 (front)	no

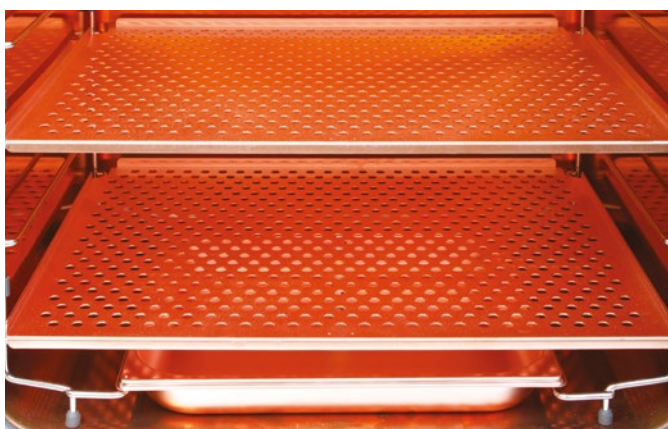

White Paper:
Save costs with the CellXpert



www.eppendorf.com/cut-costs

CO₂ Incubators

Ordering information

Segmented door options	Door handle	O ₂ control	Water/Humidity monitoring	Copper package	Order no.
1 segment	right	–	no	no	6731 000 012
1 segment	right	–	no	yes	6731 000 512
1 segment	right	–	humidity monitoring	no	6731 000 112
1 segment	right	–	water-level monitoring	no	6731 000 212
1 segment	right	–	water and humidity monitoring package	no	6731 000 312
1 segment	right	1 – 20 %	no	no	6731 001 012
1 segment	right	1 – 20 %	water and humidity monitoring package	yes	6731 001 812
1 segment	right	1 – 20 %	no	yes	6731 001 512
1 segment	left	–	no	no	6731 000 022
1 segment	left	1 – 20 %	no	yes	6731 001 522
1 segment	left	–	no	yes	6731 000 522
1 segment	left	–	humidity monitoring	no	6731 000 122
1 segment	left	–	water-level monitoring	no	6731 000 222
1 segment	left	–	water and humidity monitoring package	no	6731 000 322
1 segment	left	1 – 20 %	no	no	6731 001 022
1 segment	left	1 – 20 %	water and humidity monitoring package	yes	6731 001 822
4 segments	right	–	no	no	6731 000 042
4 segments	right	–	water and humidity monitoring package	no	6731 000 342
4 segments	right	–	water and humidity monitoring package	yes	6731 000 842
4 segments	right	1 – 20 %	no	no	6731 001 042
4 segments	right	1 – 20 %	water and humidity monitoring package	no	6731 001 342
4 segments	left	–	no	no	6731 000 052
4 segments	left	–	water and humidity monitoring package	no	6731 000 352
4 segments	left	–	water and humidity monitoring package	yes	6731 000 852
4 segments	left	1 – 20 %	water and humidity monitoring package	no	6731 001 352
4 segments	left	1 – 20 %	no	no	6731 001 052
8 segments	right	1 – 20 %	no	no	6731 001 082
8 segments	left	1 – 20 %	no	no	6731 001 092

✎ Ordering information for other voltage options begins on page 331

CellXpert® C170/C170i shelves, water trays and stacking stand

Description	Order no.
Door lock, for CellXpert® C170i CO ₂ incubators, retrofittable, no service required	6731 070 166
Stacking stand, lower frame, with castors	6731 070 093
Stacking stand, upper frame	6731 070 085
Universal stacking stand, upper frame, CellXpert with other 170 L CO ₂ incubators	6731 070 158
Set of copper water tray and 4 copper shelves for 170 L incubators	6731 080 013
Copper water tray, for 170 L incubators	P0628-6260
Copper shelves, for 170 L incubators, 2 pcs.	6710 859 106
Shelves, for 170 L incubators, 2 pcs.	6710 859 009
Shelf, for 170 L CO ₂ incubators, stainless steel, 1 piece	6731 070 123
Shelf rack for 8 shelves, for 170 L incubators	P0628-6390
Water tray, for 170 L incubators	P0628-6140

CellXpert® C170

Description

The C170 is the basic version of the C170i. It comes with the same uniform atmosphere, fast recovery, cleanability, high usable space but for example with a simpler user interface and less in-field upgradeable options. Use the flyer "C170i vs. C170" to find the right device for your needs.



The CellXpert C170i and C170 are stackable with CO₂ incubators of Thermo Scientific®, PHCbi (former Panasonic) and more with the Universal Stacking Kit

Product features

- > **Easy cleaning:** Seamless chamber, easy disassembly in 40 s
- > **Effective contamination protection:** 140 °C High temperature disinfection (HTD), no internal fan-associated HEPA-filters necessary
- > **Temperature uniformity:** Innovative heating concept with multiple independent temperature sensors – verified at 27 spots inside the incubator according to German DIN 12880 norm

C170i or C170?
Find the right
CellXpert for your
needs.



[www.eppendorf.com/
C170i_C170](http://www.eppendorf.com/C170i_C170)

Ordering information

Description	Order no.
CellXpert® C170, non-segmented inner door, handle right side, 220 – 240 V/50 – 60 Hz (GB)	6734 000 012
CellXpert® C170, inner door with 4 door segments, handle right side, 220 – 240 V/50 – 60 Hz (GB)	6734 000 042

✎ Ordering information for other voltage options begins on page 331

For Accessories see page 281

CO₂ Incubators

New Brunswick S41i

Description

Are you looking for a CO₂ incubator shaker with integrated high temperature disinfection (120 °C) and significantly reduced gas consumption? Make cleaning easy and change CO₂ cylinders less often with the fanless and stackable New Brunswick S41i.



Product features

- > Experimental flexibility: Perforated shelf allows for static incubation at the same time as shaking
- > Stable, uniform and vibration-free shaking: robust Innova triple eccentric drive
- > Saves gas and provides an optimal growing atmosphere: Smart gas control (0.2 - 20% CO₂)

Applications

- > Culturing of suspension cells requiring gentle agitation
- > Protein expression
- > Adherent cells such as stem cells that require both incubation and periodic gentle shaking

Download flyer

Incubator Shaker Evolution
[www.eppendorf.com/
 flyer-incubator-shaker-evolution](http://www.eppendorf.com/flyer-incubator-shaker-evolution)



Ordering information

Description	Order no.
New Brunswick S41i , 170 L, CO ₂ incubator shaker with inner shelf and touch screen control, stackable up to 2-fold, 1 (2. optional) shelves, 230 V/50 – 60 Hz (GB), orbit 2.5 cm (1 in), UK	S41I230012
Universal platform for New Brunswick S41i , 36 × 61 cm (14 × 24 in), compatible with sticky pads: 5 necessary to cover platform (sold separately, order no: M1250-9700, cutting required), anodized aluminum	M1334-9920
Interchangeable platform for New Brunswick S41i , 36 × 61 cm (14 × 24 in)	
125 mL Erlenmeyer flask dedicated platform, comes complete with 32 clamps installed	M1334-9921
250 mL Erlenmeyer flask dedicated platform, comes complete with 24 clamps installed	M1334-9922
500 mL Erlenmeyer flask dedicated platform, comes complete with 15 clamps installed	M1334-9923
1 L Erlenmeyer flask dedicated platform, comes complete with 11 clamps installed	M1334-9924
2 L Erlenmeyer flask dedicated platform, comes complete with 6 clamps installed	M1334-9925
2.8 L Erlenmeyer flask dedicated platform, comes complete with 3 clamps installed	M1334-9926
4 L Erlenmeyer flask dedicated platform, comes complete with 3 clamps installed	M1334-9927
Stacking kit , allows up to 2 each New Brunswick S41i shakers to be stacked one on top of the other	P0628-6502
Additional shelf for New Brunswick S41i , perforated, can easily be added for static cell culture of adherent cells	P0628-6181
Sticky pad , 20 × 20 cm (8 × 8 in), Compatible platform or adapter kit necessary	M1250-9700

✎ Ordering information for other voltage options begins on page 331

Additional CO₂ Incubators Accessories



For stacking kits see individual CO₂ incubator pages.

White paper:
Guide to copper in
CO₂ incubators



[www.eppendorf.com/
copper-CO2-incubators](http://www.eppendorf.com/copper-CO2-incubators)

Ordering information

Description	Order no.
HEPA filter 25 mm	P0628-5060
In-line gas filter, 2 pcs.	6710 070 251
Automatic gas cylinder CO ₂ changeover unit	P0628-5000
Temperature probe, 100 mm tip for gas analyzer	P0628-7880
Temperature probe, 5 mm tip for gas analyzer	P0628-7881

Lab Shakers



Incubated lab shakers

If the growth atmosphere needs to be controlled (e.g. temperature and photosynthetic light) and medium or high throughput is needed, an incubated lab shaker is necessary. Usually, incubated lab shakers are grouped based on any of the following criteria:

Temperature control:

- > Cooling for a minimum of 4 °C
- > Heating for a maximum of 80 °C

- > Speed range (25 – 500 rpm)
- > Position in the lab (Benchtop, under bench or stackable floor models)
- > Stackability (2- or 3-fold)
- > Capacity and throughput: Vessel type, size and capacity
- > Mode of loading (front vs. top loading)
- > CO₂ control
- > Photosynthetic light

Lab Shaker Service

Qualification, regular maintenance, and calibration of your lab shaker are key to ensure reproducible results and easy audits at any time. Our trained Eppendorf service technicians will help you to continuously achieve this with preventive maintenance, IQ/OQ or extended warranty.

Smart shaking with VisioNize® Lab Suite

Are you interested in monitoring your lab shakers and other devices? What about receiving notifications e.g., for device alarms? A digital, connected lab offers even more.

VisioNize Lab Suite offers everything you need as a lab manager or scientist to get started to digitally manage your lab for increased sample security, compliance needs and maintenance management. Gain access to a modular range of digital services and choose what works for your lab.

Discover your service options
www.eppendorf.com/epservices



Discover VisioNize® Lab Suite
www.eppendorf.com/visionize



Lab Shaker Accessories

Eppendorf offers a wide range of accessories for lab shakers to provide full flexibility for your processes.

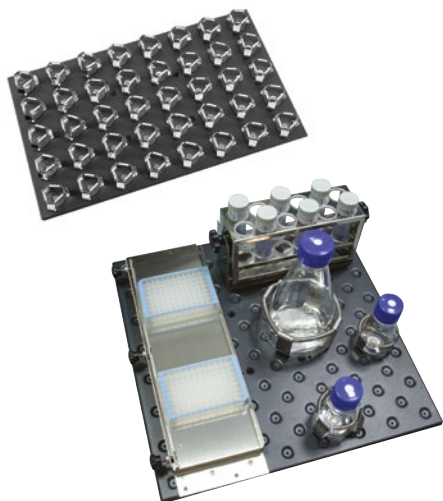

Lab shaker platforms

Different lab shaker platforms are available to provide you with the right balance between vessel capacity, vessel type flexibility, handling speed, and regarding necessary shaking speeds:

- > Dedicated platforms
- > Universal platforms
- > Sticky pad platforms

Universal platforms are the best choice when a high degree of vessel type flexibility is needed, e.g. to mix different vessel types and sizes. These platforms come with multiple screwing holes that allow virtually any combination of lab shaker clamps and other

accessories. Dedicated platforms are used when just one flask size will be used and high capacity is needed. Dedicated platforms come complete with clamps installed. Adhesive mats called sticky pad can be used as an alternative to clamps for flat bottom vessels. Sticky pads are re-usable and require an anodized aluminum platform for best performance. Thus, sticky pads are compatible with universal platforms of New Brunswick S41i and Innova® S44i. All other shakers require a sticky pad adapter kit for universal platforms or a dedicated sticky pad platform.



Flask clamps for lab shakers

Eppendorf flask clamps for lab shakers are made of a single piece stainless-steel construction (not spot welded or riveted) for added strength and safety. All flask clamps come with coiled wire springs for added safety and stability at higher shaking speeds. Flask clamps for 2-, 2.8-, 4- and 6 L and higher volumes come with an extra girdle for added security and noise reduction.

- Available clamps for lab shakers:
- > Erlenmeyer flask clamps (10 mL – 6 L)
 - > 2.8 L Fernbach flask clamps
 - > 500 mL and 1 L media bottles
 - > 450 mL or 600 mL TPP bioreactors
 - > 2 L Lauber Thomson flask clamps



Test tube racks and microplate racks for lab shakers

Eppendorf offers 18 different racks for various test tubes with diameters between 8 – 30 mm. Racks come with an adjustable angle (to optimize media oxygenation), tube height-support, and are made of stainless-steel with specialized inserts. These inserts help to retain tubes and prevent them from spinning in the shaker rack.

Two different racks for microplates are available: for stacks (three deep-well plates or nine standard plates) or single layers (five plates). In addition, universal lab shaker platforms are also compatible with microplate screening systems like the Duetz System.

Get all information about the Eppendorf lab shaker portfolio!
Explore the eshop and get an overview!

www.eppendorf.com/shakers-portfolio



Our Portfolio – Your Choice



Model	Innova® S44i	Innova® 44/44R	Innova® 43/43R
Page(s)	286	288	289
Positioning	Most advanced stackable (2-3x) incubator shaker with highest capacity in our portfolio	Stackable (2-3x) incubator shaker with high vessel capacity	Top-loading incubator shaker with large capacity for easy handling flasks with volume up to 6 L
Capacity	extra large	large	large
Platform size (cm/in)	76 × 62 cm (30 × 24 in)	76 × 46 cm (30 × 18 in)	76 × 46 cm (30 × 18 in)
Max. vessel volume (without static shelf, depending on flask format)	5 L	5 L	6 L
Application-related features			
Bacteria, Yeast, Fungi, Insect cells	yes	yes	yes
Algae/plant cells	yes (LED-light, tunable intensity to simulate day/night-cycles)	yes (fluorescent bulbs, no intensity modulation)	yes (fluorescent bulbs, no intensity modulation)
Mammalian cells (CO ₂ control and humidification)	no	no	no
Parallel static cultivation	yes (static shelf optional)	no	no
Orbit	2.5/5.1 cm (1/2 in)	2.5/5.1 cm (1/2 in)	2.5/5.1 cm (1/2 in)
Temperature range	Incubated: 5 °C above ambient to 80 °C; Refrigerated: 20 °C below ambient (min. 4 °C) to 80 °C.	Incubated: 5 °C above ambient to 80 °C; Refrigerated: 20 °C below ambient (min. 4 °C) to 80 °C (max. 70 °C with PS-light, 60 °C with rH-monitoring).	Incubated: 5 °C above ambient to 80 °C; Refrigerated: 20 °C below ambient (min. 4 °C) to 80 °C (max. 70 °C with PS-light, 60 °C with rH-monitoring).
Speed range	2.5 cm orbit: 20 – 400 rpm, 5.1 cm orbit: 20 – 300 rpm	25 – 400 rpm with 2.5 cm orbit; 25 – 300 rpm with 5.1 cm orbit or 2 stacked units; 25 – 250 rpm with 3 stacked units	25 – 500 rpm with 2.5 cm orbit; 25 – 300 rpm with 5.1 cm orbit
Lab position and stackability			
Lab position	floor	floor	floor (console-style)
Stackability	up to 3-fold	up to 3-fold	non-stackable
Handling, ergonomics, programmability			
Door opening	glide up	glide up	console style
Platform type	slide out	slide out	fixed
Programming steps / storable programs	unlimited/unlimited	15/4	15/4
Drive mechanism	Eppendorf X-Drive	triple-eccentric counterbalanced drive	triple-eccentric counterbalanced drive
Dimensions (W × D × H)	118.2 × 86.9 × 63 cm / 46.5 × 34.2 × 24.8 in	134.9 × 84.3 × 66 cm / 53.1 × 33.2 × 26 in	115.6 × 81.3 × 103.1 cm / 45.5 × 20 × 40.6 in





Innova® 42/42R 290	Innova® 40/40R 292	New Brunswick S41i 280
Space-saving, stackable (2x) incubator shaker with high versatility	Benchtop orbital shaker with compact design and capacity for flasks with a volume up to 3 L	Large (170 L) CO ₂ incubator shaker with integrated high temperature disinfection
medium	medium	medium
46 x 46 cm (18 x 18 in)	46 x 46 cm (18 x 18 in)	36 x 61 cm (14 x 24 in)
6 L	3 L	4 L
yes	yes	no
yes (fluorescent bulbs, no intensity modulation)	no	no
no	no	yes
yes (one static shelf included, culture drawer for Agar plates optional)	no	yes (static shelf included)
1.9/2.5 cm (0.75/1 in)	1.9/2.5 cm (0.75/1 in)	2.5 cm (1 in)
Incubated: 5 °C above ambient to 80 °C; Refrigerated: 20 °C below ambient (min. 4 °C) to 80 °C (max. 70 °C with PS-light, 60 °C with rH-monitoring).	Incubated: 5 °C above ambient to 80 °C; Refrigerated: 15 °C below ambient (min. 4 °C) to 80 °C.	Ambient +4 °C to 50 °C
25 – 400 rpm; 25 – 300 rpm when using flasks > 500 mL in stacked devices	25 up to 500 rpm (depending on load)	25 – 400 rpm (25 – 250 rpm for bottom unit if stacked)
floor, under/on bench up to 2-fold	benchtop non-stackable	floor, under bench up to 2-fold
opening to front fixed 15/4	top opening hood fixed 15/4	opening to front fixed –
triple-eccentric counterbalanced drive	triple-eccentric counterbalanced drive	triple-eccentric counterbalanced drive
63.5 x 74.5 x 81.8 cm / 25 x 29.3 x 32.8 in	55.9 x 76.2 x 61 cm / 22 x 30 x 24 in	87.5 x 73 x 85 cm / 34.4 x 28.7 x 33.5 in

Innova[®] S44i



Description

Do you need a stackable incubator shaker for the highest plasmid or protein yields in a small footprint to quickly reach your ambitious targets? The latest and most advanced incubator shaker from Eppendorf, the Innova S44i, can fit up to twice as many flasks as other shakers in the market and is ready to reliably support current high-yield expression protocols at high speeds, 24/7.

Product features

- > **For higher plasmid or protein quantities:** Up to twice as many flasks as other shakers (e.g. 15x/13x 2.5 L UltraYield™ or 39/36x 1 L Erlenmeyer flasks on dedicated/universal platform); 2x/3x stackable
- > **Ready for high-speed expression protocols:** Up to 400 rpm (orbit 25 mm/1 in) in all devices of a triple stack
- > **True control with touch interface:** All setpoints and current values are visible at a glance; Restrict access to change settings with user management

Applications

- > Grow bacteria, yeast, fungus, photosynthetic organisms
- > Plasmid DNA production and protein expression
- > Process optimization and media development
- > Media screening and optimization
- > Seed cultures for bioprocess scale-up
- > Biofuel research
- > Food quality testing

See the video:
Innova[®] S44i
fully loaded



[www.eppendorf.com/
s44i-fully-loaded](http://www.eppendorf.com/s44i-fully-loaded)



Eppendorf X-Drive: The five eccentric mounting points for the shaker platform are precisely engineered to ensure long-lasting, repeatable performance for years to come. The four shafts in the corners and Balance Master Technology support precise vibration-free shaking on every point of the platform, including the periphery.



Glide up door: saves lab space and makes cleaning easier



All parameter at a glance



The Innova S44i is also available with a photosynthetic LED light bank for the growth of algae or plant cells.

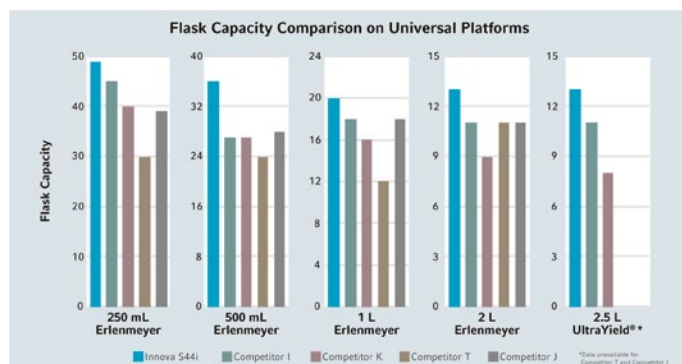

Compare your Innova® S44i now

www.eppendorf.com/s44i-comparison

Ordering information

Description

Innova® S44i, non-refrigerated, stackable up to 3-fold, 230 V/50/60 Hz (GB), orbit 2.5 cm (1 in)

Order no.

S44I300002

Innova® S44i, refrigerated, stackable up to 3-fold, 230 V/50/60 Hz (GB), orbit 2.5 cm (1 in)

S44I310002

Innova® S44i, refrigerated, stackable up to 3-fold, 230 V/50 – 60 Hz (GB), orbit 2.5 cm (1 in), photosynthetic LED light bank

S44I311002

Innova® S44i, non-refrigerated, stackable up to 3-fold, 230 V/50/60 Hz (GB), orbit 5.1 cm (2 in)

S44I320002

Innova® S44i, refrigerated, stackable up to 3-fold, 230 V/50/60 Hz (GB), orbit 5.1 cm (2 in)

S44I330002

Innova® S44i, refrigerated, stackable up to 3-fold, 230 V/50 – 60 Hz (GB), orbit 5.1 cm (2 in), photosynthetic LED light bank

S44I331002

Positioning base, 10.16 cm (4 in), Innova® S44i

S44I041001

Positioning base, 30.48 cm (12 in), Innova® S44i

S44I041002

Stacking kit, for double stack of Innova® S44i

S44I041005

Stacking kit, for Innova® S44i to Innova® 44/44R

S44I041006

Stacking kit, for triple stack Innova® S44i

S44I041003

Static incubation shelf, Innova® S44i

S44I042001

Darkening window shade, removable, Innova® S44i

S44I042002

Universal platform for Innova® S44i, 76 × 62 cm (30 × 24 in), compatible with sticky pads: 9 necessary to cover platform (sold separately, order no: M1250-9700, cutting required), anodized aluminum

S44I040001

125 mL Erlenmeyer flask dedicated platform, 86 clamps

S44I040002

250 mL Erlenmeyer flask dedicated platform, 53 clamps

S44I040003

500 mL Erlenmeyer flask dedicated platform, 39 clamps

S44I040004

2 L Lauber Thomson flask dedicated platform, 15 clamps, aluminum, for 2 L narrow neck Erlenmeyer, Thomson, or Corning flasks (DIN-ISO 1773) bottom diameter ~166 mm

S44I040010

1 L Erlenmeyer flask dedicated platform, 23 clamps

S44I040005

2 L Erlenmeyer flask dedicated platform, 15 clamps, aluminum, for 2 L wide neck Erlenmeyer flasks (DIN-ISO 24450), bottom diameter ~153 mm

S44I040006

✎ Ordering information for other voltage options begins on page 349

Lab Shakers

New Brunswick Innova® 44/44R

**Description**

Are you looking for a reliable high-capacity stackable incubator shaker? The Innova 44/44R is one of our most popular shakers – its capacity for flasks up to 5 L in volume, the space-saving glide up door, multistep programming, the reliable Innova triple-eccentric drive, and the cost saving potential make it a smart choice.

Product features

- > **Applicational flexibility:** Accommodates flasks up to 5 L, sticky pad platform for flat bottom vessels, orbits 25 or 51 mm (1 or 2 in), optional: photosynthetic light bank and humidity monitoring
- > **Saves money and lab space:** No internal HEPA-filter that must be replaced annually for optimal performance, 2x/3x stackable in a small footprint
- > **Reliable 24/7 with high loads:** Innova triple eccentric counterbalanced drive (three weight-supporting shafts; please do not confuse with “triple counterbalanced” drives that usually come with only one weight support), max. load 26 kg / 57 lb (solid weight test)

Ordering information

Description	Order no.
New Brunswick Innova® 44	
stackable up to 3-fold, 230 V/50/60 Hz (EU/CN), orbit 2.5 cm (1 in)	M1282-0002
stackable up to 3-fold, 230 V/50/60 Hz (EU/CN), orbit 5.1 cm (2 in)	M1282-0012
New Brunswick Innova® 44R	
refrigerated, stackable up to 3-fold, 230 V/50/60 Hz (EU/CN), orbit 2.5 cm (1 in)	M1282-0006
refrigerated, stackable up to 3-fold, 230 V/50/60 Hz (EU/CN), orbit 5.1 cm (2 in)	M1282-0016
Stacking kit , for stacking one additional 44 or 44R (3 × Innova® 44/44R can be placed in a single stack)	M1282-0500
Remote alarm option , for Innova® 44/44, Innova® 43/43, Innova® 42/42 or Innova® 40/40	M1320-8029
Universal platform for Innova® 44/44R , 76 × 46 cm (30 × 18 in), not interchangeable with other 76 × 46 cm platforms	M1282-9904
Aluminum platform for Innova® 44/44R , 76 × 46 cm (30 × 18 in), not interchangeable with other 76 × 46 cm platforms	
125 mL Erlenmeyer flask dedicated platform	M1282-9905
250 mL Erlenmeyer flask dedicated platform	M1282-9906
500 mL Erlenmeyer flask dedicated platform	M1282-9907
1 L Erlenmeyer flask dedicated platform	M1282-9908
2 L Erlenmeyer flask dedicated platform for Innova® 44 , 76 × 46 cm (30 × 18 in), 12 clamps, aluminum, for 2 L wide neck Erlenmeyer flasks (DIN-ISO 24450), bottom diameter ~153 mm. For 2 L narrow neck Erlenmeyer, Thomson, or Corning flasks (DIN-ISO 1773) bottom diameter ~166 mm, please refer to universal platform and clamps M1190-9004	M1282-9909
Sticky pad platform for Innova® 44(R) , 76 × 46 cm (30 × 18 in), 7 sticky pads necessary to cover platform (sold separately, order no: M1250-9700, cutting required), anodized aluminum	M1282-9913
Heavy duty 0.95 cm-thick aluminum plate platform for Innova® 44/44R only , 76 × 46 cm (30 × 18 in), not interchangeable with other 76 × 46 cm platforms. Heavy-duty platforms are recommended for shaking full loads of flasks, 1 L and larger, containing more than 20 % volume or with baffles.	
Heavy duty universal platform	M1282-9915
1 L Erlenmeyer flask dedicated platform, heavy duty	M1282-9925
2 L Erlenmeyer flask dedicated platform, heavy duty, for 2 L wide neck Erlenmeyer flasks (DIN-ISO 24450)	M1282-9926
Positioning bases , increases the height of the shaker for easier access, mandatory for stacked shakers	
for Innova® 44/44R, 10.2 cm, short	M1282-0600
for Innova® 44/44R, 30.5 cm, medium	M1282-0800
for Innova® 44/44R, 40.6 cm, tall	M1282-0700
12-port gassing manifold , for Innova® 44R - contact Eppendorf for installation options	M1282-0291
Humidity monitor , for Innova® 44R - contact Eppendorf for installation options	M1282-5011
UV germicidal light , for Innova® 44R - contact Eppendorf for installation options	M1282-9921
Photosynthetic light bank , for Innova® 44R - contact Eppendorf for installation options	M1282-9922

✎ Ordering information for other voltage options begins on page 349

New Brunswick Innova® 43/43R



Description

Are you looking for a large-capacity console incubator shaker for easy handling of large shake flasks? Have a look at the Innova 43 which offers peace of mind 24/7 with the famous heavy-duty Innova triple eccentric drive. It also reduces running costs significantly as there is no internal HEPA-filter that requires yearly replacement for optimal performance.

Product features

- > **Applicational flexibility:** Accommodates flasks up to 6 L, sticky pad platform for flat bottom vessels, orbits 25 or 51 mm (1 or 2 in), optional: photosynthetic light bank and humidity monitoring
- > **Saves money:** No internal HEPA-filter that must be replaced annually for optimal performance
- > **Reliable 24/7 with high loads:** Proven and tested Innova triple eccentric counterbalanced drive (three weight-supporting shafts)

Ordering information

Description	Order no.
New Brunswick Innova® 43	
non-stackable, 230 V/50/60 Hz (CN/EU), orbit 2.5 cm (1 in)	M1320-0002
non-stackable, 230 V/50/60 Hz (CN/EU), orbit 5.1 cm (2 in)	M1320-0012
New Brunswick Innova® 43R	
refrigerated, non-stackable, 230 V/50/60 Hz (CN/EU), orbit 2.5 cm (1 in)	M1320-0006
refrigerated, non-stackable, 230 V/50/60 Hz (CN/EU), orbit 5.1 cm (2 in)	M1320-0016
Remote alarm option , for Innova® 44/44, Innova® 43/43, Innova® 42/42 or Innova® 40/40	M1320-8029
Platforms for Innova® 2300/43/43R, Excella® E10/E25/E25R , 76 × 46 cm (30 × 18 in), aluminum, Universal platform	M1250-9920
Platform for Innova® 2300/43/43R, Excella® E10/E25/E25R , 76 × 46 cm (30 × 18 in), aluminum	
125 mL Erlenmeyer flask dedicated platform	M1191-9909
250 mL Erlenmeyer flask dedicated platform	M1191-9910
500 mL Erlenmeyer flask dedicated platform	M1191-9911
1 L Erlenmeyer flask dedicated platform	AG-1
2 L Erlenmeyer flask dedicated platform, for 2 L wide neck Erlenmeyer flasks (DIN-ISO 24450), bottom diameter ~153 mm. For 2 L narrow neck Erlenmeyer, Thomson, or Corning flasks (DIN-ISO 1773) bottom diameter ~166 mm please refer to universal platform and clamps M1190-9004.	AG-2
Sticky pad platform for Innova® 43(R)/2300 , 76 × 46 cm (30 × 18 in), 7 sticky pads necessary to cover platform (sold separately, order no: M1250-9700, cutting required), anodized aluminum	M1250-9904
Utility tray with non-skid rubber surface for Innova® 2300 , usable as a stand-alone – no other platform required	AG-00
12-port gassing manifold , permits direct gassing into flasks	M1320-0500
Humidity monitor , for use with spill pan as water reservoir, for Innova® 43/43R	M1320-0600
UV germicidal light , in the airflow path outside the chamber reduces the bio-burden of circulated air, Innova® 43R only	M1320-0400
Photosynthetic light bank , for Innova® 43R only	M1320-0300

✎ Ordering information for other voltage options begins on page 349

New Brunswick Innova® 42/42R



Description

Are you looking for a highly-versatile stackable incubator shaker that comes with Innova reliability? The Innova 42/42R is one of our most popular shakers because of its cleanability, variety of options (like a static cultivation shelf, a culture drawer to protect Agar plates from evaporation, UV germicidal or photosynthetic light), and flexibility of positioning in the lab.

Product features

- > **High capacity in a small footprint:** for example, 4x 5 L or 2x 6 L flasks on universal platform; device footprint 4731 cm² /733 in² (63.5 cm/25 in width, 74.5 cm/29.3 in depth)
- > **Ergonomical and safe interface handling:** Top mounted controls and display make bending down unnecessary during handling, avoids accidental parameter changes, and can be reached easily even in a double stack
- > **Easy to clean:** Spill diverter and drainable built-in spill pan with rounded corners protect the drive from accidental spills (can be used as a water reservoir to reduce sample evaporation); airflow UV-germicidal light optional

Ordering information	
Description	Order no.
New Brunswick Innova® 42	
stackable up to 2-fold, 230 V/50/60 Hz (CN/EU), orbit 1.9 cm (0.75 in)	M1335-0002
stackable up to 2-fold, 230 V/50/60 Hz (CN/EU), orbit 2.5 cm (1 in)	M1335-0012
New Brunswick Innova® 42R	
refrigerated, stackable up to 2-fold, 230 V/50/60 Hz (CN/EU), orbit 1.9 cm (0.75 in)	M1335-0006
refrigerated, stackable up to 2-fold, 230 V/50/60 Hz (CN/EU), orbit 2.5 cm (1 in)	M1335-0016
Stacking kit , for stacking Innova® 42/42R units	M1335-0800
Stacking kit , for stacking Innova® 4200/4230 units on top of Innova® 42/42R shakers	M1335-0810
Remote alarm option , for Innova® 44/44, Innova® 43/43, Innova® 42/42 or Innova® 40/40	M1320-8029
Additional perforated shelf and brackets , for Innova® 42/42R	M1335-0080
Platforms for Innova® 2100/40/40R/42/42R, Excella® E24/E24R , 46 × 46 cm (18 × 18 in), phenolic resin (unless otherwise stated)	
Universal platform, aluminum	M1250-9902
125 mL Erlenmeyer flask dedicated platform	M1194-9904
250 mL Erlenmeyer flask dedicated platform	M1194-9905
500 mL Erlenmeyer flask dedicated platform	M1194-9906
1 L Erlenmeyer flask dedicated platform	M1194-9907
2 L Erlenmeyer flask dedicated platform, for 2 L wide neck Erlenmeyer flasks (DIN-ISO 24450), bottom diameter ~153 mm. For 2 L narrow neck Erlenmeyer, Thomson, or Corning flasks (DIN-ISO 1773) bottom diameter ~166 mm refer to universal platform and clamps M1190-9004.	M1194-9908
Sticky pad platform for Innova® 40(R)/42(R)/2100, Excella® E24(R) , 46 × 46 cm (18 × 18 in), 4 sticky pads necessary to cover platform (sold separately, order no: M1250-9700), anodized aluminum	M1250-9903
Quick-change platform kit , enables platform attachment without tools, for Innova® 2100/4000/4080/4230	M1192-9901
Culture drawer , (height adjustable) prevents plates from drying	M1335-0501
Utility carrier , holds racks and vessels between x2 rubber-cushioned cross bars, for Innova® 2100/Innova® 40 /Innova® 42/Excella® 24	M1194-9909
Rod kit , for utility carrier (one additional rod), of Innova 40/42/2100 and Excella 24 lab shakers	M1194-9923
Utility tray with non-skid rubber surface for Innova® 2100, 40, 42 , usable as a stand-alone – no other platform required	M1194-9910
Drip pan , to catch accidental spills, for universal platform M1250-9902	M1250-9906
Photosynthetic light bank , programmable, Innova® 42R only - contact Eppendorf for installation options	M1335-0300
UV germicidal light , programmable, Innova® 42R only - contact Eppendorf for installation options	M1335-0400
Humidity monitor , for Innova® 42/42R - contact Eppendorf for installation options	M1335-0500
12-port gassing manifold , for Innova® 42/42R - contact Eppendorf for installation options	M1335-0600

✎ Ordering information for other voltage options begins on page 349

New Brunswick Innova® 40/40R



Description

Do you need a compact benchtop orbital shaker that offers high visibility and quick access to flasks with a volume of up to 3 L? The Innova 40/40R is an easy-to-program orbital shaker that comes with the famous Innova triple eccentric drive to provide 24/7 reliable operation for decades.

Product features

- > Triple-eccentric counterbalanced drive in cast iron housing provides vibration and trouble-free operation for years
- > Compact benchtop model – fits easily on the bench and holds flasks up to 3 L
- > Clear cover allows easy viewing of the cultures and lifts easily to access all samples

Ordering information	
Description	Order no.
New Brunswick Innova® 40	
non-stackable, 230 V/50/60 Hz (CN/EU), orbit 1.9 cm (0.75 in)	M1299-0082
non-stackable, 230 V/50/60 Hz (CN/EU), orbit 2.5 cm (1 in)	M1299-0092
New Brunswick Innova® 40R	
refrigerated, non-stackable, 230 V/50/60 Hz (CN/EU), orbit 1.9 cm (0.75 in)	M1299-0086
refrigerated, non-stackable, 230 V/50/60 Hz (CN/EU), orbit 2.5 cm (1 in)	M1299-0096
Remote alarm option , for Innova® 44/44, Innova® 43/43, Innova® 42/42 or Innova® 40/40	M1320-8029
Platforms for Innova® 2100/40/40R/42/42R, Excella® E24/E24R, 46 × 46 cm (18 × 18 in), phenolic resin (unless otherwise stated)	
Universal platform, aluminum	M1250-9902
125 mL Erlenmeyer flask dedicated platform	M1194-9904
250 mL Erlenmeyer flask dedicated platform	M1194-9905
500 mL Erlenmeyer flask dedicated platform	M1194-9906
1 L Erlenmeyer flask dedicated platform	M1194-9907
2 L Erlenmeyer flask dedicated platform, for 2 L wide neck Erlenmeyer flasks (DIN-ISO 24450), bottom diameter ~153 mm. For 2 L narrow neck Erlenmeyer, Thomson, or Corning flasks (DIN-ISO 1773) bottom diameter ~166 mm refer to universal platform and clamps M1190-9004.	M1194-9908
Sticky pad platform for Innova® 40(R)/42(R)/2100, Excella® E24(R) , 46 × 46 cm (18 × 18 in), 4 sticky pads necessary to cover platform (sold separately, order no: M1250-9700), anodized aluminum	M1250-9903
Quick-change platform kit , enables platform attachment without tools, for Innova® 2100/4000/4080/4230	M1192-9901
Utility carrier , holds racks and vessels between x2 rubber-cushioned cross bars, for Innova® 2100/Innova® 40 /Innova® 42/Excella® 24	M1194-9909
Rod kit , for utility carrier (one additional rod), of Innova 40/42/2100 and Excella 24 lab shakers	M1194-9923
Utility tray with non-skid rubber surface for Innova® 2100, 40, 42 , usable as a stand-alone – no other platform required	M1194-9910
Drip pan , to catch accidental spills, for universal platform M1250-9902	M1250-9906

✎ Ordering information for other voltage options begins on page 349

Lab Shakers

Shakers Accessories

Accessories	Order no.
Description	
Test tube rack, small, 30 × 8 × 12.9 cm	
diameter 8 – 11 mm, 48 tubes	M1289-0001
diameter 12 – 15 mm, 34 tubes	M1289-0002
diameter 15 – 18 mm, 24 tubes	M1289-0003
diameter 18 – 21 mm, 18 tubes	M1289-0004
diameter 22 – 26 mm, 13 tubes	M1289-0005
diameter 26 – 30 mm, 12 tubes	M1289-0006
Test tube rack, medium, 36 × 8 × 12.9 cm	
diameter 8 – 11 mm, 60 tubes	M1289-0010
diameter 12 – 15 mm, 44 tubes	M1289-0020
diameter 15 – 18 mm, 31 tubes	M1289-0030
diameter 18 – 21 mm, 23 tubes	M1289-0040
diameter 22 – 26 mm, 16 tubes	M1289-0050
diameter 26 – 30 mm, 16 tubes	M1289-0060
Test tube rack, large, 45 × 8 × 12.9 cm	
diameter 8 – 11 mm, 80 tubes	M1289-0100
diameter 12 – 15 mm, 60 tubes	M1289-0200
diameter 15 – 18 mm, 42 tubes	M1289-0300
diameter 18 – 21 mm, 30 tubes	M1289-0400
diameter 22 – 26 mm, 22 tubes	M1289-0500
diameter 26 – 30 mm, 20 tubes	M1289-0600
Clamp, for 1 L media bottles	ACSB-1000S
Clamp, for 500 mL media bottles and TPP Bioreactors 450 mL or 600 mL	ACSB-500S
Angled test tube rack holder, for user-supplied test tube racks and microplates	TTR-210
Angled Test Tube Rack Spacer Bar, for use with TTR-210	
to accommodate test tubes racks that are less than 13 mm (5 in) wide	TTR-215
Microplate rack, single layer, for single layer of five plates	TTR-221
Microplate rack, stack, stack three deepwell or nine standard plates	M1289-0700
Sticky tape, 23 m × 3.8 cm (75 feet × 1.5 in) roll	M1250-9600
Sticky pad, 20 × 20 cm (8 × 8 in), Compatible platform or adapter kit necessary	M1250-9700
Drip pan, to catch accidental spills, for use with universal platform M1250-9920	M1250-9921
Drip pan, to catch accidental spills, for universal platform M1250-9902	M1250-9906

8 – 11 mm: fits e.g. Eppendorf tubes 1.5 mL, 15 – 18 mm: fits e.g. 15 mL Conicals, 26 – 30 mm: fits e.g. 50 mL Conicals

Find the right lab shaker accessory

Shaker Accessory Guide

www.eppendorf.com/shaker-accessory-guide



Test tube racks

Shakers Accessories

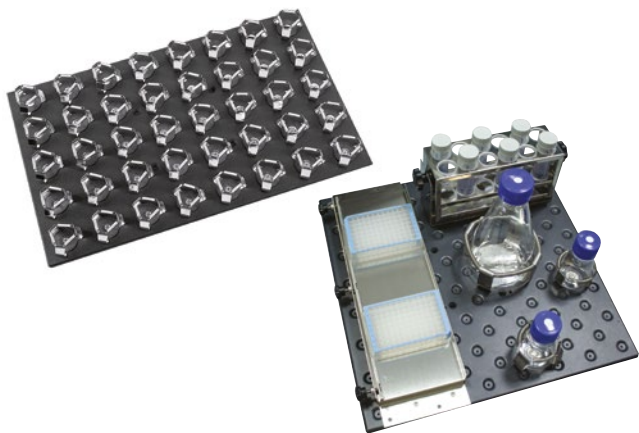

Various platform types



Lab shaker clamps

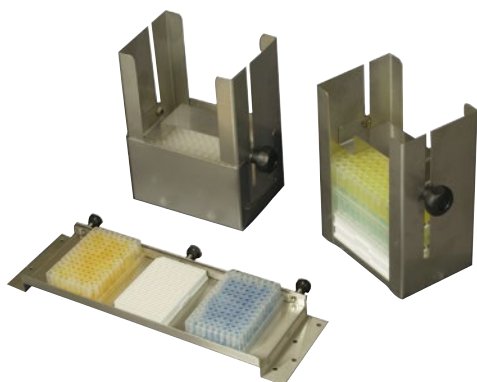

Microplate racks



Sticky pad



Utility carrier



Utility Tray

Lab Shakers

Universal Platforms for Incubated Shakers

Universal Platforms and Clamps for Incubated Shakers				
	Innova® S44i	Innova® 44/44R	Innova® 43/43R	Innova® 42/42R
Order no. universal platform	S44I040001	M1282-9904	M1250-9920	M1250-9902
	Clamps	Clamps	Clamps	Clamps
10 mL Erlenmeyer flasks	238	187	183	109
25 mL Erlenmeyer flasks	238	96	92	64
50 mL Erlenmeyer flasks	130	96	92	45
125 mL Erlenmeyer flasks	81	39	39	24
250 mL Erlenmeyer flasks	48	31	30	19
500 mL Erlenmeyer flasks	36	24	24	14
1 L Erlenmeyer flasks	20	14	12	8
2 L Erlenmeyer flasks*	14 ¹⁾	11	11	6
3 L Erlenmeyer flasks	9 ¹⁾	6	6	4
4 L Erlenmeyer flasks	8 ¹⁾	6	6	4
5 L Erlenmeyer flasks	6 ¹⁾	6 ²⁾	6 ²⁾	4 ³⁾
6 L Erlenmeyer flasks			4 ²⁾	2 ³⁾
2 L Lauber Thomson*	13	11	11	6
2.8 L Fernbach flasks	8	6	6	4
500 mL media bottle flasks	30	24	24	14
1 L media bottle flasks	20	13	13	8
Microplate rack, single layer	4	4	4	2
Microplate rack, stack	20	16	16	8
Test tube rack, small, 30 × 8 × 12.9 cm	12	9	9	5
Test tube rack, medium, 36 × 8 × 12.9 cm	10	8	8	4
Test tube rack, large, 45 × 8 × 12.9 cm	7	6	6	4
Platform size (cm/in)	76 × 62 cm (30 × 24 in)	76 × 46 cm (30 × 18 in)	76 × 46 cm (30 × 18 in)	46 × 46 cm (18 × 18 in)

* Note to 2 L clamps: ACE-2000S fits 2 L wide neck Erlenmeyer flasks (DIN-ISO 24450), max. bottom diameter ~158 mm. For 2 L narrow neck Erlenmeyer (DIN-ISO 1773), Thomson, or Corning flasks with max. bottom diameter of 166 mm refer to clamp M1190-9005 (Clamp, for 2 L Thomson flasks).

¹⁾ S44i: Maximum flask capacity limited to 1 L with installed shelf (removable), distance platform to ceiling ~43.7 cm, platform to shelf ~27 cm, platform to photosynthetic light bank ~40.6 cm.²⁾ Innova 43/44: Maximum flask size limited to 4 L with installed photosynthetic light bank. I44: Distance platform to ceiling ~46 cm, platform to photosynthetic light bank ~40 cm. I43: Distance platform to ceiling ~48 cm.³⁾ Innova 42: Maximum flask size limited to 4 L with installed drawer, shelf or photosynthetic light bank (shelf and drawer removable, shelf adjustable in height). Distance platform to ceiling: ~47.7 cm, platform to drawer ~35.3 cm, platform to shelf (in position 5 from top) ~36.8 cm.⁴⁾ New Brunswick S41i: Max. flask size with shelf in lower position limited to 250 mL Erlenmeyer or 500 mL Thomson Optimum Growth. Max. flask size without shelves 3 L and 5 L Corning and 5 L Thomson Optimum Growth. No fit of standard 5 L Erlenmeyer flasks (nn/wn). Platform to ceiling: ~40 cm, platform to lower shelf: ~18.5 cm, platform to upper shelf ~27.5 cm

Dedicated Platforms and Clamps for Incubated Shakers						
	Innova® S44i		Innova® 44/44R		Innova® 43/43R	
	Clamps	Order no.	Clamps	Order no.	Clamps	Order no.
125 mL Erlenmeyer flasks	86	S44I040002	60	M1282-9905	60	M1191-9909
250 mL Erlenmeyer flasks	53	S44I040003	40	M1282-9906	40	M1191-9910
500 mL Erlenmeyer flasks	39	S44I040004	24	M1282-9907	24	M1191-9911
1 L Erlenmeyer flasks	23	S44I040005	15	M1282-9908	15	AG-1
2 L Erlenmeyer flasks*	15	S44I040006	12	M1282-9909	12	AG-2
2 L Lauber Thomson*	15	S44I040010				
Sticky pad platform**		Not required ¹⁾		M1282-9913		M1250-9904
Platform size (cm/in)	76 × 62 cm (30 × 24 in)		76 × 46 cm (30 × 18 in)		76 × 46 cm (30 × 18 in)	

* Note to 2 L clamps: For 2 L wide neck Erlenmeyer flasks (DIN-ISO 24450), max. bottom diameter ~158 mm refer to 2 L Erlenmeyer flask platforms. For 2 L narrow neck Erlenmeyer (DIN-ISO 1773), Thomson, or Corning flasks with max. bottom diameter of 166 mm refer to 2 L Lauber Thomson platforms.

** Sticky pads to be ordered separately see page 280

¹⁾ The universal platform of the Innova S44i and the New Brunswick S41 are designed to be compatible with sticky pads directly.

Lab Shaker Clamps

Innova® 40/40R M1250-9902		New Brunswick S41i M1334-9920	
Clamps		Clamps	
109		110	
64		60	
45		60	
24		23	
19		18	
14		15 ⁴⁾	
8		10 ⁴⁾	
6		6 ⁴⁾	
4		3 ⁴⁾	
		3 ⁴⁾	
6		6 ⁴⁾	
4		3 ⁴⁾	
14		15 ⁴⁾	
8		8 ⁴⁾	
2			
8			
5		6	
4		3	
4		3	
46 × 46 cm (18 × 18 in)		46 × 46 cm (18 × 18 in)	

Clamps		Clamps	
Dimensions (W × H)		Order no.	
31 × 26 mm		ACE-10S	
23 × 22 mm		M1190-9004	
51 × 26 mm		M1190-9000	
68 × 37 mm		M1190-9001	
91 × 47 mm		M1190-9002	
102 × 48 mm		M1190-9003	
130 × 64 mm		ACE-1000S	
158 × 72 mm		ACE-2000S	
189 × 112 mm		ACE-3000S	
210 × 99 mm		ACE-4000S	
222 × 145 mm		ACE-5000S	
244 × 100 mm		ACE-6000S	
165 × 112 mm		M1190-9005	
203 × 73 mm		ACFE-2800S	
92 × 108 mm		ACSB-500S	
108 × 150 mm		ACSB-1000S	
		TTR-221	
		M1289-0700	
		see page 280	
		see page 280	
		see page 280	

Innova® 42/42R		Innova® 40/40R		New Brunswick S41i		Clamps	
Clamps	Order no.	Clamps	Order no.	Clamps	Order no.	Dimensions (W × H)	
34	M1194-9904	34	M1194-9904	32	M1334-9921	68 × 37 mm	
25	M1194-9905	25	M1194-9905	24	M1334-9922	91 × 47 mm	
16	M1194-9906	16	M1194-9906	15	M1334-9923	102 × 48 mm	
9	M1194-9907	9	M1194-9907	11	M1334-9924	130 × 64 mm	
5	M1194-9908	5	M1194-9908	6	M1334-9925	158 × 72 mm	
						165 × 112 mm	
	M1250-9903		M1250-9903		Not required ¹⁾		
46 × 46 cm (18 × 18 in)		46 × 46 cm (18 × 18 in)		36 × 61 cm (14 × 24 in)			

Bioprocessing

»Heal, fuel, and feed the World.«

Stephen Sherwin

Bioprocess engineers develop and produce a multitude of products and ingredients available today.

Their applications are diverse, and the products can be found in pharmaceutical, chemical, and nutrition industries. Within those branches, promising new bioprocess approaches, such as cell and gene therapies or stem cell-derived novel food, start gaining momentum and open the door towards a new tomorrow. Stephen Sherwin, former chairman of BIO association put it aptly: "Heal, fuel, and feed the world". Our Eppendorf bioprocess solutions are successfully used in a broad range of industries ranging from applied

research to industrial production. By exploiting the strong synergies in bioreactor technology and polymer manufacturing, Eppendorf has emerged as a global player and valuable resource to its customers. With our equipment, training programs, and application services, we support scientists in resolving cultivation bottlenecks from bioprocess development through production. In that way and in line with our corporate mission, we contribute to the efforts of our customers worldwide to improve human living conditions.

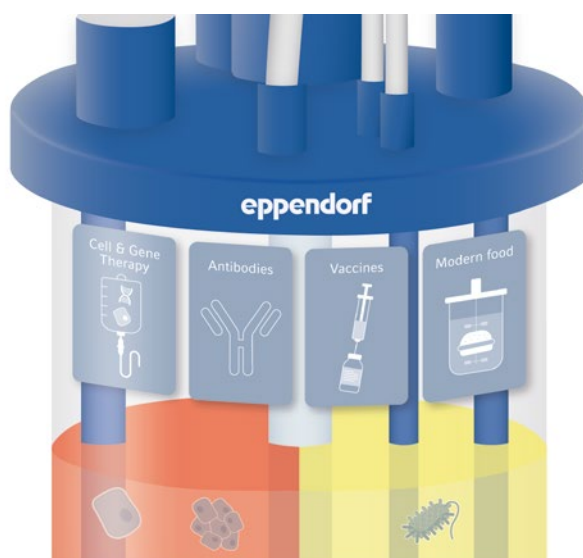

Vaccines

Driven by events such as the COVID-19 pandemic and other governmental vaccination programs, there is a rising demand for development of new vaccines. Eppendorf bioprocess equipment helps companies in setting up flexible processes to balance costs and shorten time-to-market. Besides standard impellers, Eppendorf offers specialty impellers which can facilitate perfusion processes: for example, our packed bed impeller. It uses Fibra-Cel® Disks as a solid support material for growth of adherent mammalian, animal, and insect cells, when secreted proteins are desired.

Antibodies/Hormones

Improved cultivation techniques such as perfusion and new possibilities in data handling and automation enhance the development of antibodies, therapeutic proteins, and active ingredients.

Eppendorf offers one of the most scalable and comprehensive single-use portfolios for cell culture applications on the market, for seamless process scale-up from R&D labs to pilot and manufacturing facilities.



Learn more about vaccines
www.eppendorf.com/vaccines



Learn more about antibodies
www.eppendorf.com/antibodies



From small scale to pilot/production, Eppendorf can provide the bioprocess solution you need.



The SciVario® twin provides full flexibility. With changes in the type of cells or process, the system can easily be adapted to your needs, now and in the future.



The BioFlo® 720 provides a powerful controller with advanced options for pilot/production scale Single-Use processes. Scale Up Assist and Auto Calibrate of DO sensors make it also easy to use!

From Cell and Gene Therapy to Cultured Meat

Currently, we are entering an age where not only cell products but also the cell itself is the product of interest. Cell and gene therapies can facilitate treating diseases like cancer, for example by modulated immune cells or viral vectors that adjust immune responses accordingly. In the same line, stem cell-based technologies are promising approaches for drug discovery and therapy. Moreover, new advances within the stem cell field revolutionize how we will cultivate meat in the future. Our bioprocess solutions enable the controlled cultivation of induced pluripotent stem cells (iPSCs), mesenchymal stem cells (MSCs) and others to help establishing optimal and reproducible conditions for your process development.

Find this and more research examples at www.eppendorf.com/stem-cell-bioprocessing

Academic Customers

No matter on which research area you are focusing on: We understand that universities and other publicly funded institutes are facing special challenges, such as frequently changing staff and often limited budgets. With flexible hardware and intuitive software tools, Eppendorf bioprocess systems support the various stages of discovery – from understanding a metabolic pathway to developing a commercially viable bioprocess. Specialists from Eppendorf will recommend equipment that meets the user's needs and budget.



Download the bioprocess family brochure
www.eppendorf.com/bioprocess-brochure

Our Portfolio – Your Choice



Model	DASbox® Mini Bioreactor System	DASGIP® Parallel Bioreactor Systems
Page	306	306
Working volume range ¹⁾	60 – 250 mL	0.2 – 1.8 L
Single-use vessels available	■	■
Glass vessels, autoclavable	■	■
Stainless-steel vessels, SIP		
Interchangeable vessels	■	■
Bacteria/yeasts/fungi	■	■
Plant cells/algae	■	■
Mammalian/animal cells	■	■
Stem cells	■	■
Insect cells	■	■
Number of parallel units	Up to 24	Up to 16
Controller ²⁾	PC	PC
BioCommand®		
DASware®	■	■
Gas mixing options	4 gas (air, N ₂ , O ₂ , CO ₂)	4 gas (air, N ₂ , O ₂ , CO ₂)
Gas flow control ²⁾	TMFC	R or TMFC
Exhaust analysis	■	■
Optical density measurement	■	■
Validation		

¹⁾ Realized using multiple vessel sizes ²⁾ Gas Flow Controllers: R = Rotameter, TMFC = Thermal Mass Flow Controller





SciVario® twin	BioFlo® 120	BioFlo® 320
304	307	307
0.2 – 40 L	0.4 – 40 L	0.4 – 40 L
■	■	■
■	■	■
■	■	■
■	■	■
Optional	■	■
■	■	■
Optional	■	■
Optional	■	■
2	■	Up to 8
Touchscreen	Touchscreen	Touchscreen
■	■	■
■	■	■
4 gas (air, N ₂ , O ₂ , CO ₂)	4 gas (air, N ₂ , O ₂ , CO ₂)	4 gas (air, N ₂ , O ₂ , CO ₂)
TMFC	R or TMFC	TMFC
■	■	■
■	■	■
■	■	■

Our Portfolio – Your Choice



Model	BioFlo® 510	CelliGen® 510
Page	308	308
Working volume ranges ¹⁾	10.75 – 32 L	10.75 – 32 L
Single-use vessels available		
Glass vessels, autoclavable		
Stainless-steel vessels, SIP	■	■
Interchangeable vessels		
Bacteria/yeasts/fungi	■	
Plant cells/algae	■	■
Mammalian/animal cells		■
Stem cells		■
Insect cells	■	■
Number of parallel units		
Controller ²⁾	Touchscreen	Touchscreen
BioCommand®	■	■
DASware®		
Gas mixing options	4-gas (air, N ₂ , O ₂ , CO ₂)	4-gas (air, N ₂ , O ₂ , CO ₂)
Gas flow control ²⁾	TMFC	TMFC
Exhaust analysis	■	■
Optical density measurement		
Validation	■	■

¹⁾ Realized using multiple vessel sizes ²⁾ Gas Flow Controllers: TMFC = Thermal Mass Flow Controller



SciVario® twin



Description

The SciVario twin is a next-generation bioprocess controller that evolves together with you. In a fast-changing field like the modern biotechnology, working with a system that supports your needs now – and in the future – is indispensable. With an intuitive user-interface and highly innovative hardware and software it enables flexibility for process optimization and a readiness for the digital age.

Applications

- > Research and development in cell culture and microbiology
- > Lab scale fermentation of aerobic and anaerobic bacteria, yeasts and other or filamentous fungi
- > Cultivation of mammalian and human cell lines
- > Media optimization
- > Clone and cell line screening, strain characterization

Product features

- > Customizable and flexible thanks to the innovative bay-drawer concept for further extension and reconfiguration
- > Integrated digital sensor technology (Mettler Toledo ISM® and Hamilton ARC®), supporting analog sensors for pH and DO and optical DO sensors
- > Optional PreSens® optical DO sensor technology for BioBLU Single-Use Bioreactors

SciVario® twin

- 0.2 – 3.8 L working volume (autoclavable)**
- 0.25 – 40 L working volume (single-use)**



- > Variable speed pumps for accurate liquid addition and operation in batch and fed-batch mode
- > Wide range TMFC to allow for individual mixing of air, N₂, O₂, and CO₂ to headspace and/or submerged aeration



- > Parallel operation of two glass and/or BioBLU Single-Use Bioreactors, in any combination of bioreactor types, that can be run independently or in parallel
- > Suitable for cell culture and microbial fermentation



- > Compact design, 16-40 cm of benchspace needed per bioreactor
- > Cable management guides for a clean and tidy setup



- > VisioNize® touch: intuitive and exciting new user interface supporting efficient and intelligent process control
- > Compatible with DASware® control software

SciVario twin Video

Please use the QR Code.

www.eppendorf.com/SciVario-twin-video



SciVario twin Brochure

Please use the QR Code.

www.eppendorf.com/One-for-All-brochure



DASbox® Mini Bioreactor System



DASbox® Mini Bioreactor System
 60 – 250 mL working volume (autoclavable)
 65 – 250 mL working volume (single-use)

[www.eppendorf.com/
DASbox](http://www.eppendorf.com/DASbox)

Product features

- > 4-fold parallel system expandable to up to 24 vessels
- > Suitable for glass and/or BioBLU Single-Use Bioreactors, that can be used in any combination
- > Bioreactors can be run independently or in parallel
- > Suitable for cell culture and microbial fermentation
- > Compact mini bioreactor system: requires only 7 cm (3 inches) bench space per bioreactor
- > Optimal tool for DoE and scale down approaches
- > Agitation control supporting overhead-driven Rushton, marine-type or pitched blade impellers
- > Innovative liquid-free temperature control system needs no cooling agent supply and supports independent temperature control for each bioreactor
- > Accurate monitoring and control of pH, DO, and level
- > Variable speed pumps for accurate liquid addition and operation in batch, fed-batch, continuous, and cyclic perfusion mode
- > Four mass flow controllers per bioreactor allow for individual mixing of air, N₂, O₂, and CO₂ to headspace and/or submerged aeration
- > Novel liquid-free Peltier exhaust condenser with easy to handle slide in – slide out activation and deactivation
- > DASware® control software for advanced process control
- > Compatible with DASware Software Suite for interconnectivity and bioprocess information management

DASGIP® Parallel Bioreactor Systems



DASGIP® Parallel Bioreactor Systems
 200 mL – 1.8 L working volume (autoclavable)
 250 mL – 1.25 L working volume (single-use)

[www.eppendorf.com/
DASGIP-Parallel](http://www.eppendorf.com/DASGIP-Parallel)

Product features

- > Parallel operation of up to 16 glass or single-use bioreactors
- > DASGIP Bioblock for advanced and user-friendly temperature control
- > Suitable for cell culture and microbial fermentation
- > Modular design of control units allows for flexible system configurations that meet the demands of specific applications
- > Control of agitation, pH, level, and DO (including customizable cascade modes) in each bioreactor
- > Variable speed pumps for accurate liquid addition and operation in batch, fed-batch, continuous, and cyclic perfusion mode
- > Optical absorbance measurement for online calculation of e.g. OD₆₀₀ or cell dry weight
- > TMFC individual gas mixing of air, N₂, O₂ and CO₂
- > Online calculation of OTR, CTR and RQ
- > DASware control software for advanced process control
- > Compatible with DASware Software Suite for interconnectivity and bioprocess information management

BioFlo® 120



BioFlo® 120
0.4 – 10.5 L working volume (autoclavable),
0.4 – 40 L working volume (single-use)

[www.eppendorf.com/
BioFlo-120](http://www.eppendorf.com/BioFlo-120)

Product features

- > Flexible software platform for universal control of both microbial and cell culture applications
- > Auto Culture modes offer process control at the touch of a button
- > Compatible with BioBLU® Single-Use Bioreactors for fermentation and cell culture applications
- > Precise temperature control provided through interchangeable heat-blanketed or water-jacketed vessels
- > High precision thermal mass flow controller (TMFC) for automatic gas flow control
- > Automatic gas mix for four independent sparge gas supplies
- > Available analog input/output connection for direct integration of accessories (i.e. scales, variable-speed pumps, etc.)
- > Integrated Mettler Toledo® Intelligent Sensor Management (ISM) platform
- > Compatible with DASware Software Suite or BioCommand for bioprocess information management

BioFlo® 320



BioFlo® 320
0.6 - 10.5 L working volume (autoclavable),
0.4 - 40 L working volume (single-use)

[www.eppendorf.com/
BioFlo-320](http://www.eppendorf.com/BioFlo-320)

Product features

- > Interchangeable autoclavable and BioBLU Single-Use Bioreactors
- > Integrated Mettler Toledo Intelligent Sensor Management (ISM) platform
- > Control up to eight systems from a single user interface
- > Universal control for both microbial and cell culture applications
- > Field-upgradable TMFC drawers for sparge and overlay gas
- > Enhanced software package with new cascade and time profile features
- > Built-in optical pH sensing technology for use with the BioBLU Single-Use Bioreactors
- > DeltaV™ compatibility available through DeltaV Discovery and DeltaV ProPlus PAS
- > Up to six integrated pumps capable of operating in variable-speed mode
- > Eight independently controlled process gas supplies
- > Validation packages available for GMP regulated processes
- > Compatible with DASware Software Suite or BioCommand for bioprocess information management

BioFlo®/CelliGen 510



BioFlo® 510 and CelliGen 510
Bench- and pilot-scale SIP fermentor and
bioreactor
10.75 – 32 L working volume

[www.eppendorf.com/
BioFlo-510](http://www.eppendorf.com/BioFlo-510)

Product features

- > SIP bench and pilot scale reactors designed to meet the needs of R&D through production
- > Modular design allows for complete system flexibility
- > Add or remove components pre- or post-delivery
- > Multiple impeller and gas flow options
- > Integrated skid design with mobile table option to simplify transport
- > Features intuitive RPC control software and touchscreen interface
- > Integrated load cell for online vessel volume monitoring
- > Fully automated SIP sequence for sterilization
- > Flush mounted vessel ports for enhanced vessel design and drainability
- > Validation packages available
- > 7 additional analog input/output connections for local integration of ancillary equipment
- > ASME-rated pressure vessel

BioFlo® 610



BioFlo® 610
Pilot Scale SIP Fermentor
16 – 100 L Working Volume

Product features

- > Pilot production system without the traditional cost or footprint
- > Modular design allows for complete system flexibility
- > Add or remove components pre- or post-delivery
- > Multiple impeller and gas flow options
- > Integrated mobile skid simplifies transport
- > Features intuitive RPC control software and touchscreen interface
- > Integrated load cell for online vessel volume monitoring
- > Fully automated SIP sequence for sterilization
- > Flush mounted vessel ports for enhanced vessel design and drainability
- > Validation packages available
- > 7 additional analog input/output connections for local integration of ancillary equipment
- > ASME-rated pressure vessel

BioFlo® Pro



[www.eppendorf.com/
BioFlo-Pro](http://www.eppendorf.com/BioFlo-Pro)



BioFlo® Pro
Large-scale SIP fermentor
45 – 2,400 L working volume

Product features

- > Large scale pilot/production system
- > Modular design with over a hundred options allows for high level of customization pre and post delivery
- > Multiple impeller and gas flow options
- > NEMA-4 (IP65) rated control cabinet with industry-standard Allen Bradley® PLC
- > Open piping skid allows for easy accessibility
- > Fully automated SIP sequence for sterilization
- > Clean-in-Place (CIP) options available for vessel and piping
- > Flush mounted vessel ports for enhanced vessel design and drainability
- > Validation packages available
- > ASME-rated pressure vessel

BioFlo® 720



[www.eppendorf.com/
BioFlo-720](http://www.eppendorf.com/BioFlo-720)

BioFlo® 720
Pilot- and Large-scale Single-Use bioreactor
50 – 2,000 L Working Volume

Product features

- > Compatible with Thermo Scientific™ HyPerforma™ 5:1 bioreactors from 50 L to 2,000 L
- > High performance Mass Flow Controllers capable of up to 500:1 turn-down allowing multiple vessel sizes to be run from the same controller
- > Suitable for analog & digital sensors (Mettler-Toledo® ISM and Hamilton® ARC)
- > Available with dual sparge, overlay and CO₂ stripping options
- > Field-upgradeable options for future expansion of the system
- > Documentation packages available to help qualify the system for use in cGMP environments¹⁾
- > Intuitive software tools such as Auto Calibrate and Auto Inflate reduce preparation time, maximizing system efficiency
- > Integrated Scale Up Assist software simplifies the workflow and calculations necessary to scale up and scale down
- > Flexible choices for SUBs and Bioprocess Containers (BPCs)
- > Mobile enclosure with a small footprint (0.7 m²/7.55 sq ft) fitting through a standard lab door
- > Watson-Marlow peristaltic pumps for flow rates in a range of 1.2 mL/min - 3.3 L/min

¹⁾ BioFlo 720 is not a medical device as defined by the Food and Drug Administration or other regulatory authorities.

BioBLU® Single-Use Bioreactors – Dependability through Proven Design

Single-use simplicity

With renowned polymer expertise, Eppendorf is proud to offer the largest portfolio of rigid walled stirred-tank single-use bioreactors – in small and bench scale, to be operated with parallel DASbox Mini Bioreactor System, DASGIP Parallel Bioreactor Systems, SciVario twin or BioFlo bench-scale systems.



BioBLU c Single-Use Bioreactors for cell culture applications

Single-use solutions for small and bench scale cell culture applications. A full portfolio of vessels covers a working volume range of 100 mL – 40 L, offering unmatched scalability. The single-layer polymer design mitigates issues related to leachables and extractables.



BioBLU 5p Single-Use Bioreactor with packed bed

For the cultivation of adherent cells and for perfusion processes we offer the BioBLU 5p packed-bed bioreactor. It utilizes the proprietary Eppendorf packed-bed impeller design and is pre-loaded with Fibracel® disks. Providing a shear-free environment, it is a premium choice in a wide variety of applications, including the production of secreted products and stem cell culture.



BioBLU f Single-Use Bioreactors for microbial applications

Single-use solutions for small and bench scale fermentation applications, covering a working volume range of 65 mL – 3.75 L. Fermentation processes have high mass transfer and heat removal requirements. Proven stirred-tank design, powerful overhead drives featuring Rushton-type impellers, and effective cooling make it possible for the BioBLU f Bioreactors to achieve these demands.

Want to know more about BioBLU Single-Use Bioreactors?

If you want to know more about our Single-Use bioreactor offering, follow the links to the cell culture or microbiology vessels below and find the brochures, application notes, and publications.

Learn more about
BioBLU c Single-Use
Bioreactors

[www.eppendorf.com/
BioBLU_c](http://www.eppendorf.com/BioBLU_c)



Learn more about
BioBLU f Single-Use
Bioreactors

[www.eppendorf.com/
BioBLU_f](http://www.eppendorf.com/BioBLU_f)



Eppendorf Bioprocess Software – Much More Than Just Bioprocess Control

Eppendorf offers BioCommand and DASware control Supervisory Control and Data Acquisition (SCADA) software packages for advanced bioprocess control. The comprehensive DASware software suite provides next-generation bioprocess management.

DASware software suite

Next-generation bioprocess management

A suite of smart and flexible software solutions to accelerate bioprocess development, with DASware control for parallel bioprocess control. The DASware licences enable interconnectivity of bioreactors with external lab-devices, Design of Experiments (DoE), and integration into process control systems.



DASware control

> Advanced process monitoring, control, and data logging - for parallel cultivation with individual control of each bioreactor

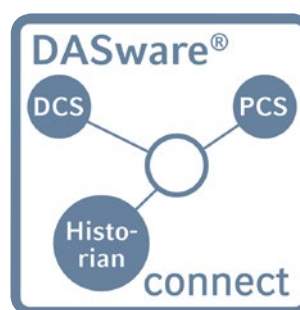

DASware connect

> Integration into process control systems and legacy corporate historians facilitating company-wide access to all relevant bioprocess data



DASware design

> Applies the Design of Experiments (DoE) concept via a full factorial DoE builder or by importing DoE designs from third-party DoE tools

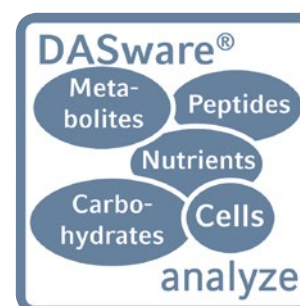

DASware analyze

> Seamless integration of external lab devices to the bioreactor allows for process automation and feedback control loops



BioCommand software

> The ability to monitor, control, and log data from your fermentation and cell culture processes. Three distinct packages provide the tools needed for research, optimization, and if needed, the security and audit trails to support your regulatory requirements.

Service Products



Supporting You for Over 75 Years

Eppendorf Services

Eppendorf began in 1945 as a medical instrument repair workshop on the grounds of the University Hospital Eppendorf in Hamburg, Germany. Today, more than 500 factory-trained and certified service specialists across the world provide in-house or on-site service solutions, ensuring the uptime you need and can rely on, increasing your peace of mind in terms of complying to regulatory requirements, and the quality and safety of your results.

Application and Training Services

Keep pace with new trends, methods and technologies by receiving training and application support from our global team of scientific product and application specialists. Acquire basic knowledge, or develop more advanced skills needed for your workflows and routine maintenance within scientific research, healthcare and industry.

Our dedicated Applications and Technical Service teams are here to support you!

Get all information about the Eppendorf epServices portfolio!
www.eppendorf.com/epServices



Your Needs - Our Solutions

From service agreements to on-demand services - You choose the best suit your uptime requirements and budgetary needs, while meeting national and international compliance to corresponding norms and regulations.

We take care of your equipment during their full life cycle of your lab, while you can fully concentrate on achieving the reliable results you are looking for with your research and routine lab work.



Pipette Service Done Right

Since we released the first piston stroke pipette in 1961, we continue to manufacture and service pipettes with a passion for improving user results. Our highly qualified technicians go through an intensive training and must pass rigorous exams to become certified before servicing pipettes. We maintain over 5000 pipette manufacturer specifications and conform to the manufacturer standard when their specifications are tighter than ISO 8655 standards, if requested. In our major markets, ISO 17025 accredited calibration processes are available. As your liquid handling expert partner, we can help you meet your regulatory needs.

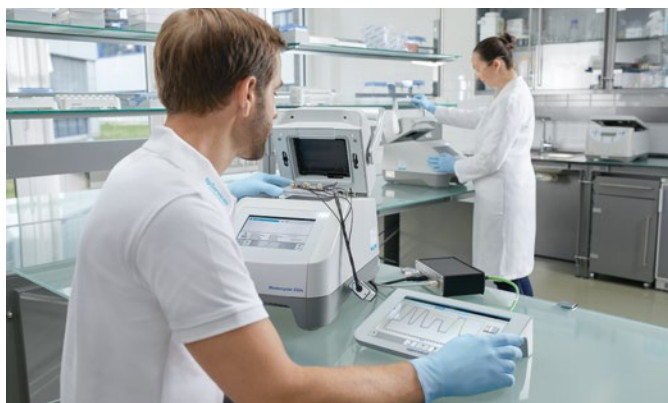

Your Instruments - Our Services

How much effort does it cost you to take good care of your lab instruments to ensure valuable uptime, and prove that they are delivering reproducible results? For your peace of mind, we offer a comprehensive service portfolio, so you can be assured of reliable and optimal working equipment in compliance with regulatory requirements. Trust in Eppendorf as your service partner.

Service Agreements

Extended Warranty Agreements



Installation
Service



Qualification
Service



Preventive
Maintenance



Calibration /
Verification



Repair
Service



Application
Support



Training /
Webinar

Knowledge Base

Various Application Notes, Short Protocols, FAQs, and videos are available on our website.



Exceeding your expectations
Download instrument brochure here!
www.eppendorf.com/epServices-instrument



Pipette service done right
Download pipette brochure here!
www.eppendorf.com/epServices-pipette

Service Products

Simplify Your Service Processes

We accompany you every step of the way - from the installation and maintenance of your lab instrument or software to the support for your quality and regulatory audits.

Choose from the following service options:

- > Service agreements from cost-efficient to all-inclusive care packages for an easy service process
- > On-demand service solutions for individual service needs

Our Service Agreements - Your Advantages

With our basket of Service Agreement solutions we take the load off your shoulders by simplifying your ordering and budgeting process for various services saving you costs by:

- > Assuring continuous productivity
- > Maintenance for a long service life
- > Including repair costs - fully or partially
- > Discounting on additional services

Benefit from assured premium performance for your peace of mind!



Eppendorf Service Agreements



Services Agreement	AdvancedCare	PremiumCare
Full preventive maintenance	For assured instrument reliability and uptime 1/year	For assured instrument reliability, uptime and financial plannability 1/year
Software update (during annual maintenance, if applicable)	■	■
Priority support ¹⁾	■	■
Parts, labor, travel on repairs	20 % discount	included
Discount on additional services (e.g. IQ/OQ)	10 %	10 %

¹⁾ Subject to local business conditions, and based on a "best effort" practise. For more information please contact your local service organization.



Extended Warranty Agreements

For your peace of mind, we offer Extended Warranty agreements covering all repair costs and optional maintenance after the standard warranty period.

Services Agreement	Extended Warranty Purchased one time within the standard warranty period. Valid for one year following the standard warranty period.	Extended Warranty plus Purchased within the standard warranty period. Valid following the standard warranty period.
Full preventive maintenance	–	1/year
Software update (during annual maintenance, if applicable)	–	■
Priority support ¹⁾	■	■
Parts, labor, travel included on repairs	■	■
Discount on additional services (e.g. IQ/OQ)	–	10 %

¹⁾ Subject to local business conditions, and based on a "best effort" practise. For more information please contact your local service organization.



Service Products



Installation Service

The installation of your Eppendorf instrument and software will be performed by our manufacturer trained and experienced service technicians. They will support you with the correct instrument settings in your environment, and will provide the initial operational instructions.



Qualification Services

Installation Qualification and Operational Qualification Services GxP compliant

Are you working in a regulated environment? We now offer specifically created and revised Installation Qualification and Operational Qualification services including GxP compliant documentation. These documents support the complex GxP standards and regulations reducing your administrative

workload, and provide you with qualified assurance that your instrument is installed and is operating in accordance with manufacturers' specifications.

Be prepared for your internal and external audits with our GxP supporting documentation!

Installation Qualification & Operational Qualification Services	IQ/OQ GxP	OQ GxP
Check of delivery status, and installation environment	■	
Installation incl. configuration and functional checks	■	
Detailed IQ report	■	
Test of alarm functions	■	■
Verification of instrument parameters (e.g. temperature, speed)	■	■
Detailed OQ report	■	■
Handling of deviation list	■	■
Signed approval by customer and service technician	■	■



Maintenance Services

Preventive Maintenance Services

How much do you rely on keeping your instrument in good working order? Our professional cleaning and maintenance services are aimed at the prevention of unexpected downtimes and failures by early detection of problems. Keeping your instrument in perfect working order will not only extend their service life, but also increase your productivity.

Services include:

- > Cleaning (external and internal)
- > Maintenance
- > Exchange of wear and tear parts
- > Comprehensive functional check
- > Software updates
- > Evaluation of stored data
- > Documentation
- > Dated service sticker to confirm Eppendorf Service

Ensure reliability and save your resources!



Calibration Services

Calibration and Verification Services

Assuring the precision and accuracy of your instrument is maintained according to specifications is your first step to reliable results.

Eppendorf offers calibration, verification and adjustment services for:

- > epMotion® 5073/5075 (temperature, speed)
- > Centrifuges (time, speed, temperature)
- > Thermocycler (temperature)
- > Biological Shaker (speed, temperature)
- > CO₂ Incubator (temperature, CO₂, O₂, rH)
- > ULT Freezer (temperature)
- > Photometry (wavelength, temperature i.a.)
- > Temperature control- & Mixing instruments (i.a. temperature)



Repair Service

For the most productive long life and highest uptime of your Eppendorf instrument, we can provide complete and thorough technical support. Our qualified service staff

ensure timely and accurate resolutions are provided with professional guidance and care worldwide. For any technical support please contact your local service organization.



Application Support

You can expect the highest standards of support for your products and applications from Eppendorf. Our highly trained

scientific support staff is available in all time zones to assist you with any questions concerning our products.



Training & Webinar

The Eppendorf Training Center has been providing high-quality webinars and training courses since 1997 at various locations and in several languages. Contents are constantly being updated to always include the latest insights into the scientific fields. We work with small groups to ensure optimal attention and sufficient hands-on time for our participants.



Download your
decontamination
form to return
goods:

[www.eppendorf.com/
decontamination](http://www.eppendorf.com/decontamination)



Pipette Calibration Service



Preventive Maintenance, Calibration and Adjustment Services

Pipettes are precision instruments with parts subject to normal wear and tear leading to imprecision over the time. Therefore, regular maintenance and calibration are fundamental to their precision and accuracy. Calibration services performed by highly trained and certified Eppendorf Calibration Service Technicians build the foundation of your reliable and reproducible results with your downstream applications.

Our newly, clearly designed calibration service portfolio includes a thorough check of the pipette internally and externally, ensuring that wearable parts like O-rings are replaced in a timely manner.

We offer a range of transparent and modular service options

- > We maintain every pipette's conformity according to ISO 8655
- > ISO 17025 accredited certification in 19 countries



Take a break,
watch this video!

Please use the QR Code.

www.eppendorf.com/pipette-video



Pipette Calibration Services Ordering Information

Service	Calibration measurements "As Is"	Calibration measurements "As Left"	Decontamination from the outside ²⁾	Checking, cleaning, lubricating ³⁾ before calibration
ISO 8655 without Preventive Maintenance	10 per test volume ¹⁾		included	
ISO 8655 including Preventive Maintenance		10 per test volume ¹⁾	included	included
3x4 without Preventive Maintenance	4 per test volume ¹⁾		included	
3x4 including Preventive Maintenance		4 per test volume ¹⁾	included	included

¹⁾ 10%, 50% and 100% of nominal volumes for variable volume instruments. ²⁾ Pipettes and dispensers and package equipment need to be decontaminated before sending in. Download decontamination form at www.eppendorf.com/epServices. ³⁾ Internal parts

Pipette Calibration Service Packages Ordering Information

Service	Calibration measurements "As Is"	Calibration measurements "As Left"	Outside decontamination ²⁾ , checking, cleaning, lubrication ⁴⁾	ISO 17025 Accreditation calibration certificate
ISO 8655 Verified	4 per test volume ¹⁾	10 per test volume ¹⁾	included	
ISO 17025 including Preventive Maintenance		10 per test volume ¹⁾	included	included
ISO 17025 Advanced	4 per test volume ¹⁾	10 per test volume ¹⁾	included	included ³⁾
ISO 17025 Professional	10 per test volume ¹⁾	10 per test volume ¹⁾	included	included

¹⁾ 10%, 50% and 100% of nominal volumes for variable volume instruments. ²⁾ Pipettes and dispensers and package equipment need to be decontaminated before sending in. Download decontamination form at www.eppendorf.com/epServices. ³⁾ ISO 17025 accreditation calibration certificate is included in the second calibration after the maintenance. ⁴⁾ Internal parts

ISO 8655

ISO 8655 lays out the standard criteria by which a pipette should be calibrated and what error limits should be used at each volume. ISO 8655 criteria includes measurements at 3 volumes, 10 measurements at each volume, and controls for room environment.

Manufacturer Standard

In addition to ISO 8655 specifications, many manufacturers make pipettes that work within a tighter set of error limits than required by ISO 8655. It is important to calibrate using manufacturer error limits to ensure the pipette works according to manufacturer specifications.

ISO 17025

The ISO 17025 accreditation ensures the high level of competence and compliance with strict quality rules. ISO 17025 criteria include a traceability chain for measurement equipment, measurement uncertainty values, and approved quality standards.

We ensure our stringent and validated procedures are followed to the highest standards possible, for Eppendorf and other brand pipettes.

Description of Additional Services	Order no.
Labor Charge, 15 min. of repair services, time unit of one technician	0082 000 210
ISO 17025 Calibration Certificate ²⁾	0082 000 211
Advanced Documentation, Excel file for calibration information on all pipettes/dispensers per order ¹⁾²⁾	0082 000 212
On-site calibration services in your own laboratory ²⁾	please inquire

¹⁾ ISO 17025 accreditation calibration certificate is included in the second calibration after the maintenance. ²⁾ This service may be available in your country. Please contact your local Eppendorf service organization

Single Channel Pipette/ Dispenser	8-Channel Pipette	12-Channel Pipette	16-Channel Pipette	24-Channel Pipette
0082 000 140	0082 000 161	0082 000 162	0082 000 181	0082 000 182
0082 000 142	0082 000 165	0082 000 166	0082 000 185	0082 000 186
0082 000 139	0082 000 159	0082 000 160	0082 000 179	0082 000 180
0082 000 141	0082 000 163	0082 000 164	0082 000 183	0082 000 184

Single Channel Pipette/ Dispenser	8-Channel Pipette	12-Channel Pipette	16-Channel Pipette	24-Channel Pipette
0082 000 234	0082 000 235	0082 000 236	0082 000 237	0082 000 238
0082 000 143	0082 000 167	0082 000 168	0082 000 187	0082 000 188
0082 000 227	0082 000 228	0082 000 229	0082 000 230	0082 000 231
0082 000 220	0082 000 221	0082 000 222	0082 000 223	0082 000 224

Service Products

epMotion® 96 Service



epMotion 96 Service

The Eppendorf epMotion 96 is a semi-automated electronic pipette system for fast and precise parallel 96-channel microplate processing. The reliability of the electronic parallel pipetting system movement is the prerequisite for high precision and reproducibility of the results across the whole 96- or 384- well plate. Maintaining and verifying your system's accuracy and precision on a regular basis is highly recommended to make sure your system still dispenses according to the specification.

Preventive Maintenance services include:

- > Cleaning and lubrication of dispensing head
- > Checking and exchanging of 96 O-rings from cones
- > Software/firmware update if applicable
- > Leak Test (50 µL + 300 µL)
- > Calibration according to ISO 23783
- > Service check list
- > Dated service sticker to confirm Eppendorf Service
- > Calibration Report

Qualification services include:

- > Checking of
 - > delivery status, and environment
 - > installation incl. configuration and functions
- > Testing of alarm functions
- > Verification of instrument parameters (e.g. volume)
- > Detailed IQ/OQ report
- > Handling of deviation list/management
- > Signed approval by customer and service technician

96 x confidence by verified performance!

epMotion® Service



epMotion Service

epMotion and its dispensing tools are precision instruments. As such, they should be regularly maintained and calibrated to ensure continuing high accuracy, precision and reproducibility.

Preventive Maintenance services include:

- > Cleaning (external and internal)
- > Maintenance, instrument calibration software update
- > Exchange of CAN bus cables/O-rings of dispensing tools
- > Comprehensive functional check
- > Evaluation of stored data
- > Service check list
- > Dated service sticker to confirm Eppendorf Service

Qualification services include:

- > Checking of
 - > delivery status, and environment
 - > installation incl. configuration and functions
- > Testing of alarm functions
- > Verification of instrument parameters (e.g. temperature, vacuum, speed, volume)
- > Detailed IQ/OQ report
- > Handling of deviation list/management
- > Signed approval by customer and service technician

Calibration services for dispensing tools

How do you know that your experimental data are correct? Your first step to reliable results is to ensure your dispensing tools are calibrated according to ISO 23783, assuring the:

- > Accuracy and precision of the dispensing tool
- > Reproducibility of the dispensed volumes
- > Optimization of sample yields

Keep your process in *motion* with regular maintenance and calibration services!

epMotion® Application Implementation



Automated Pipetting – Difficult Application?

Are you having trouble with a protocol or are not sure how to optimize your automated application? We are happy to advise and assist you with your application. Eppendorf offers various application support services for epMotion users with low to high throughput experiments. Our network of highly skilled and extensively trained In-Field Automation Specialists are available for comprehensive application training and support after installation of your epMotion as well as during the setup of your own advanced methods.

Application Implementation

Eppendorf will provide the on-site support to program your epMotion methods for a single application as well as optimize all liquid classes needed for the application to the best of the instrument's capability. An initial in-house feasibility test is performed. Upon completion of the method on the customer's epMotion, the application will be approved by the user. Optimization to the maximum level of performance!

For your next level of performance!

Your advantages

- > Well trained Application Specialist will get you started with your methods in less time than without professional help
- > Approved reliability of your programmed method
- > Shortening your protocol setup times and reducing your personnel costs
- > Reducing waste of valuable samples
- > Improving productivity with optimized utilization of the deck capacities and the operation of the system

All systems go -
At all times
Download epMotion
brochure here!

[www.eppendorf.com/
epServices-epMotion](http://www.eppendorf.com/epServices-epMotion)



Centrifuge Service



Centrifuge Service

Regular service of centrifuges and rotors in either an operational or a disassembled state ensures a safe working environment. Functional inspections assure that all manufacturer specifications are met.

Preventive Maintenance services include:

- > Cleaning of external and internal parts
- > Checking of
 - > stability, housing, lid latch, display and keypad
 - > temperature sensors and speed sensor
 - > rotor and imbalance detection
- > Software update, if required
- > System test run
- > Evaluation of stored data
- > Service check list
- > Dated service sticker to confirm Eppendorf Service

Relax while your samples are spinning safely!

Qualification services include:

- > Checking of
 - > delivery status, and environment
 - > installation incl. configuration and functions
- > Testing of alarm functions
- > Verification of instrument parameters (temperature, speed)
- > Detailed IQ/OQ report
- > Handling of deviation list/management
- > Signed approval by customer and service technician

Rotor Assurance Plans

Rotors and buckets are subject to normal wear and tear during regular operation. Microscopic cracks can be detected early during a qualified inspection, which will allow the rotor to be exchanged before serious damage has occurred. If none or very few surface changes are identified, the rotor can be used according to instructions.

Take a break,
watch this video!

Please use the QR Code.

www.eppendorf.com/centrifuge-video



Himac High-Speed Floorstanding and Ultracentrifuges Service



Himac High-Speed Floorstanding and Ultracentrifuges Service

Your Himac centrifuges are now supported by Eppendorf. Our qualified staff ensures timely and accurate solutions are provided with professional guidance and care. Maintain and qualify your laboratory instruments on a regular basis with our service agreement options and on-demand services for many years of productive and reliable operation. See page 140 for more detailed information.

Preventive Maintenance services include:

- > Cleaning of external and internal parts
- > Checking of
 - > stability, housing, lid latch, display and keypad
 - > temperature sensors and speed sensor
 - > rotor and imbalance detection
- > Software update, if required
- > System test run
- > Service check list
- > Dated service sticker to confirm Eppendorf Service

Qualification services include:

- > Checking of
 - > delivery status, and environment
 - > installation incl. configuration and functions
- > Testing of alarm functions
- > Verification of instrument parameters (temperature, speed)
- > Detailed IQ/OQ report
- > Handling of deviation list/management
- > Signed approval by customer and service technician

Save time by ensuring uptime and reproducible results!

Find our Himac
service flyer



www.eppendorf.com/epService-centrifuges

Owner of a Himac
centrifuge?



Register now:

www.eppendorf.com/productregistration

Mastercycler® Service



Mastercycler Service

Your cycler should be regularly maintained, and followed by a temperature verification. The exact adherence to defined temperatures is crucial for reproducible results.

Preventive Maintenance services include:

- > Cleaning of external and internal parts
- > Checking of
 - > housing, accessories and internal parts
 - > electrical connection (incl. mains power)
 - > LED, display and keyboard, touchscreen
 - > USB-interface
 - > thermoblock
 - > heated lid
 - > fan(s)
- > Software update if required
- > Verification of temperature
- > Evaluation of stored data
- > Service check list
- > Dated service sticker to confirm Eppendorf Service

Qualification services include:

- > Checking of
 - > delivery status, and environment
 - > installation incl. configuration and functions
- > Testing of alarm functions
- > Verification of instrument parameters (e.g. temperature)
- > Detailed IQ/OQ report
- > Handling of deviation list/management
- > Signed approval by customer and service technician

Temperature verification services

Temperature verification of selected well positions and adjustment of the cycler block temperature if necessary is highly recommended to assure instrument consistency and accuracy. The temperature verification from Eppendorf is a very accurate and precise method, meeting all documentation and detection requirements in the lab.

Keep operating – with absolute confidence

Temperature Control and Mixing Service



Temperature Control and Mixing Service

Slight deviations in temperature and mixing frequency of your samples can affect their reaction conditions leading to non-reproducible results. To guarantee you the precise function of the instrument we offer manufacturer designed maintenance and qualification services.

Preventive Maintenance services include:

- > Cleaning of housing, accessories, internal parts
- > Checking of
 - > housing, plate holder, accessories, internal parts
 - > electrical connection
- > Function checking of
 - > LED, display and keyboard
 - > vortex sensor
 - > overload protection
 - > detection of ThermoTop, SmartBlock, thermoblock
 - > mixing, heating, cooling, vortexing
 - > fans
- > Evaluation of stored data
- > Service check list
- > Dated service sticker to confirm Eppendorf Service

Qualification services include:

- > Checking of
 - > delivery status, and environment
 - > installation incl. configuration and functions
- > Testing of alarm functions
- > Verification of instrument parameters (e.g. heating, cooling, mixing, vortexing, timer)
- > Detailed IQ/OQ report
- > Handling of deviation list/management
- > Signed approval by customer and service technician

Temperature Verification

Temperature verification of selected well positions is highly recommended to assure instrument consistency and accuracy.

Care for your samples with our mix of services!

ULT Freezer Service



ULT Freezer Service

Reliable and efficient performance can be expected for years of smooth operation from any of our ULT Freezers. Our services are designed to check, validate, and promote reliable freezer performance according to specifications.

Preventive Maintenance services include:

- > Cleaning and inspection of air filter, heated vent/condenser
- > Checking of
 - > environment, electrical supply and fittings
 - > CO₂ /LN₂ backup system
 - > independent temperature monitoring system
 - > compressor operating temperature
 - > condition and function of inner door/lids, cooling fan
 - > motor, bearings, blades, insulation, accessible cooling
 - > circuit pipes, and accessible electrical wiring
- > Operation of
 - > freezer lid gas strut (chest freezer)
 - > display and function keys
 - > chamber temperature sensors and alarm
 - > RS232/RS485 communication port
- > Alignment of door handle/sealing of outer door (upright freezer)
- > Verification and adjustment of operating parameters
- > Service check list
- > Dated service sticker to confirm Eppendorf Service

Qualification services include:

- > Checking of
 - > delivery status, and environment
 - > installation incl. configuration and functions
- > Testing of alarm functions
- > Verification of instrument parameters (e.g. temperature)
- > Basic IQ/OQ report

Protect your priceless samples!

**How to protect
precious samples
in your Eppendorf
ULT freezer:**



[www.eppendorf.com/
epServices-freezer-video](http://www.eppendorf.com/epServices-freezer-video)

ULT Freezer Service

Multi-Temperature Mapping for Ultra-Low Temperature Upright Freezer

Regular verification with the help of an external, calibrated multi-channel temperature verification system inside your ULT freezer provides you with security of reliable long-term sample storage.

Our factory-trained and certified service technician will perform an on-site temperature mapping study including a full report stating:

- > Minimum, maximum and average temperature of each location
- > Full log of raw data of each measurement
- > Temperature profile graphic for duration of measuring period
- > All relevant calibration certificates

Norms, standards and best practices such as ISPE-Controlled Temperature Chamber Mapping and Monitoring, IEC 60068 - Environmental testing, or Vaisala – 5 Rules of Sensor Placement in Validation/Mapping Applications recommend a temperature mapping of 9 or 15 probes after installation, and subsequently every two years, or when changes are made to the system.

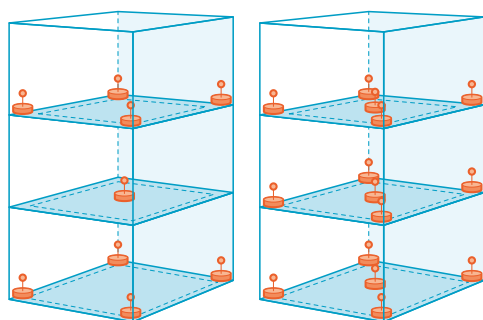

A probe holder system (9 and 15 probes) is used to ensure comparable results between different measurements and units

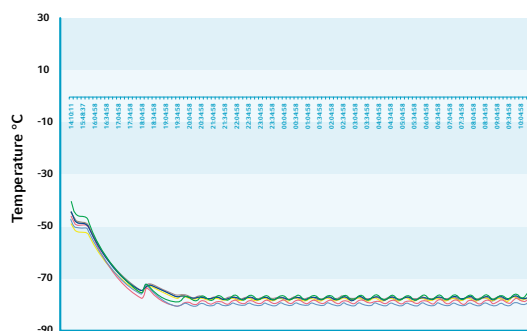

Example of a Multi-Temperature Mapping with 9 probes inside an ULT upright freezer

Your advantages

- > 24 hours, 365 days a year reliable storage for temperature-sensitive samples
- > Comparable annual temperature distribution results in one or multiple freezers
- > Audit proof documentation

This service is only available in selected countries. Please contact your local Eppendorf service organization for further information.

**Poster maintenance
ULT freezer**



[www.eppendorf.com/
epServices-freezer-poster](http://www.eppendorf.com/epServices-freezer-poster)

CO₂ Incubator Service



CO₂ Incubator Service

CO₂ incubators feature complex, dynamic control systems to maintain user-defined culturing parameters for optimized cell growth and proliferation. To ensure reproducible results and to protect your precious cultures from undesirable variables, we check and validate your incubator performance.

Preventive Maintenance services include:

- > Checking of
 - > installation environment
 - > electrical/gas supply and fittings
 - > door seals and door hinges
 - > all chamber gas, temperature, humidity sensors
 - > security of incubator shelf and racking systems
 - > sensor covers
 - > humidity trays
 - > wiring system, PCB's, display, and controller
- > Testing of alarm functions
- > Replace in-line gas filter(s) and auto-zero filter
- > Validation/adjustment of operating parameters within specifications
- > Service check list
- > Dated service sticker to confirm Eppendorf Service

Qualification service include:

- > Checking of
 - > delivery status, and environment
 - > installation incl. configuration and functions
- > Testing of alarm functions
- > Verification of instrument parameters (e.g. temperature, CO₂, speed, alarm)
- > Basic IQ/OQ report

For CellXpert®:

- > Detailed IQ/OQ report
- > Handling of deviation list/management
- > Signed approval by customer and service technician

Our service culture for peace of mind!

S41i Incubator Shaker Service



S41i Incubator Shaker Service

The versatility of the S41i Incubator Shaker supports simultaneous culture of adherent and suspension cultures. The smallest deviations in the culturing environment can result in undesirable outcomes. To ensure reproducible results and to protect your precious cultures from undesirable variables, we offer a range of maintenance and qualification services.

Preventive Maintenance services include

- > Checking of
 - > electrical/gas supply and fittings
 - > chamber CO₂, temperature sensors
 - > security of shaker platform(s) and flask holders
 - > security of incubator shelf and racking systems
 - > humidity trays
 - > shaker drive belt
 - > platform support boot seals
- > Replace
 - > in-line CO₂ filter and auto-zero filter
- > Validation/adjustment of operating parameters within specifications
- > Service check list
- > Dated service sticker to confirm Eppendorf Service

Qualification services include:

- > Checking of
 - > delivery status, and environment
 - > installation incl. configuration and functions
- > Testing of alarm functions
- > Verification of instrument parameters (e.g. temperature, CO₂, speed, alarm)
- > Basic IQ/OQ report

Achieve reliable culturing results with optimized performance of incubating and shaking systems!

How to clean your incubator:



www.eppendorf.com/epServices-incubator

Biological Shaker Service



Biological Shaker Service

Biological shakers are required to be in continuous use for years. Small and short term variations in shaker operation can influence culturing outcomes, with negative effects on yields and/or cell expression. Ensure consistent, reliable shaker performance with our shaker services.

Preventive Maintenance services include:

- > Cleaning of condenser
- > Lubricate non-sealed shaker bearings, as appropriate
- > Checking of
 - > installation environment
 - > electrical/gas supply and fittings
 - > any door/lid open sensors
 - > security of doors/lids, handles, door struts and hinges
 - > security of shaker mechanism
 - > shaker drive motor, and circulation fan
 - > shaker drive belt; adjust belt tension as necessary
- > Validation/adjustment of operating parameters within specifications
- > Service check list
- > Dated service sticker to confirm Eppendorf Service

Qualification services include:

- > Checking of
 - > delivery status, and environment
 - > installation incl. configuration and functions
- > Testing of alarm functions
- > Verification of instrument parameters (e.g. rpm, temperature, alarms)
- > Detailed IQ/OQ report
- > Handling of deviation list/management
- > Signed approval by customer and service technician

Care for your shaker – optimize your cultures!

Photometry Service



Photometry Service

To optimize photometric and fluorometric precision, accuracy, and linearity, your instrument should be routinely checked and adjusted by a qualified Eppendorf Service Technician.

Preventive Maintenance services include:

- > Cleaning of housing and cuvette shaft
- > Checking of
 - > housing (incl. stability) and cuvette shaft
 - > internal parts, light path, keyboard, display
 - > printer output and USB port
- > Software update
- > Setting number of flashes
- > dsDNA Test - 260 nm (Biophotometer plus)
- > Self Test (Biospectrometer/Biophotometer D30)
- > Photometer Test (wavelength systematic error/precision and photometric accuracy/fluorescence)
- > Temperature verification/adjustment
- > Evaluation of stored data
- > Service check list
- > Dated service sticker to confirm Eppendorf Service

Qualification services include:

- > Checking of
 - > delivery status, and environment
 - > installation incl. configuration and functions
- > Testing of alarm functions
- > Verification of instrument parameters (e.g. wavelength, temperature)
- > Detailed IQ/OQ report

Stay tuned to the right wavelength!

Photometer Test

You are also able to verify photometric and wavelength accuracy and the respective precision using the Secondary UV-VIS Filter Set. In the event your instrument does not conform to specifications, you must have it checked and properly adjusted by a trained service technician. The filter sets themselves must be inspected every two years as their spectral properties can change over time. Your filter set must be tested, maintained and certified directly by the manufacturer at Eppendorf's plant.

Check how to clean
and maintain your
Eppendorf μ Cuvette



[www.eppendorf.com/
epServices-Cuvette](http://www.eppendorf.com/epServices-Cuvette)

Cell Manipulation Service



Cell Manipulation Service

Our entire application and service team demonstrates a passion for helping you achieve success with your cell manipulation work. We will ensure that your instruments are in good working condition by professional maintenance and qualification service including the exchange of parts due to wear and tear.

Preventive Maintenance services include:

- > Cleaning of housing, internal assemblies
- > Checking of
 - > stability
 - > keyboard, display
 - > leak-tightness (CellTram®/FemtoJet®)
 - > contacts (Electroporator)
- > Exchange of oil (CellTram® Oil/vario)
- > Software upgrade
- > Testing of motor module (Micromanipulator)
- > Testing of system
- > Analysis of error statistics
- > Service check list
- > Dated service sticker to confirm Eppendorf service

Qualification services include:

- > Checking of
 - > delivery status, and environment
 - > installation incl. configuration and functions
- > Testing of alarm functions
- > Verification of instrument parameters (e.g. motor)
- > Basic IQ/OQ report

Getting to the heart of your cells with precise and accurate instruments and services from Eppendorf!

Service Products

Service Agreements and Qualification Services Ordering Information

Ordering Information	AdvancedCare Agreement	PremiumCare Agreement	IQ/OQ GxP	OQ GxP	1 Year Extended Warranty ¹⁾	1 Year Extended Warranty plus ²⁾
	Assured instrument reliability and uptime	Full coverage for instrument reliability and uptime	Qualification services for the regulated environment	Re-Qualification services for the regulated environment	Parts, labor and travel cost are covered in case of a repair	Full coverage for repair, including maintenance for reliability
epMotion® 5070	0082 030 105	0082 030 107	0082 030 030	0082 030 040	0082 030 100	0082 030 102
epMotion® 5073	0082 030 106	0082 030 108	0082 030 031	0082 030 041	0082 030 101	0082 030 103
epMotion® 5075	0082 030 073	0082 030 075	0082 030 032	0082 030 042	0082 030 069	0082 030 071
epMotion® 96	0082 030 074	0082 030 076	0082 030 036	0082 030 016	0082 030 070	0082 030 072
Microcentrifuge w/o refrigeration	0082 020 325	0082 020 320	0082 020 300	0082 020 305	0082 020 340	0082 020 345
Microcentrifuge with refrigeration	0082 020 326	0082 020 321	0082 020 301	0082 020 306	0082 020 341	0082 020 346
Multipurpose centrifuge w/o refrigeration	0082 020 327	0082 020 322	0082 020 302	0082 020 307	0082 020 342	0082 020 347
Multipurpose centrifuge with refrigeration	0082 020 328	0082 020 323	0082 020 303	0082 020 308	0082 020 343	0082 020 348
Himac High-Speed Floorstanding Centrifuge	0082 029 327	0082 029 321	0082 029 221	0082 029 227	0082 029 341	0082 029 347
Himac Ultracentrifuge	0082 029 326	0082 029 320	0082 029 220	0082 029 226	0082 029 340	0082 029 346
Vacuom Concentrator	0082 020 329	0082 020 324	0082 020 012 ³⁾	0082 020 011 ³⁾	0082 020 344	0082 020 349
Mastercycler® pro, nexus, X50	0082 040 325	0082 040 320	0082 040 300	0082 040 301	0082 040 340	0082 040 345
ULT Freezer	0082 070 325	0082 070 320	0082 070 009 ³⁾	0082 070 008 ³⁾	0082 070 340	0082 070 345
CO₂ Incubator	0082 060 325	0082 060 320	0082 060 009 ³⁾	0082 060 008 ³⁾	0082 060 340	0082 060 345
CellXpert®	0082 060 325	0082 060 320	0082 060 302	0082 060 303	0082 060 340	0082 060 345
Incubator Shaker S41i	0082 050 325	0082 050 320	0082 050 300	0082 050 301	0082 050 340	0082 050 345
Shaker - open air	0082 080 325	0082 080 320	0082 080 300	0082 080 305	0082 080 340	0082 080 345
Shaker - heating	0082 080 326	0082 080 321	0082 080 301	0082 080 306	0082 080 341	0082 080 346
Shaker - heating & cooling	0082 080 327	0082 080 322	0082 080 302	0082 080 307	0082 080 342	0082 080 347
Shaker - S44i	0082 080 329	0082 080 324	0082 080 304	0082 080 309	0082 080 344	0082 080 349
Eppendorf BioPhotometer®	0082 110 325	0082 110 320	0082 110 300	0082 110 302	0082 110 340	0082 110 345
Eppendorf BioSpectrometer®	0082 110 326	0082 110 321	0082 110 301	0082 110 303	0082 110 341	0082 110 346
Temperature control & mixing instruments⁴⁾	0082 100 325	0082 100 320	0082 100 300	0082 100 301	0082 100 340	0082 100 345
Electroporator	0082 010 325	0082 010 320	0082 010 300	0082 010 302	0082 010 340	0082 010 345
Microinjector/-manipulator	0082 010 326	0082 010 321	0082 010 301	0082 010 303	0082 010 341	0082 010 346

¹⁾ Purchased once within the standard warranty period. Valid for one year following the standard warranty period. ²⁾ Purchased within the standard warranty period. Valid following the standard warranty period.

³⁾ Non GxP compliant. ⁴⁾ Eppendorf ThermoMixer®/Eppendorf ThermoStat, MixMate®

Further Services

epMotion® and Other Services Ordering Information	Order no.
1-channel dispensing tool calibration - 10 measurements per test volume (min, mid, max)	0050 600 255
8-channel dispensing tool calibration - 10 measurements per test volume (min, mid, max)	0050 600 259
1-channel dispensing tool calibration - 4 measurements per test volume (min, mid, max)	0082 030 077
8-channel dispensing tool calibration - 4 measurements per test volume (min, mid, max)	0082 030 078
UV lamp exchange	5073 920 070

Info: Our service offers may differ by country. Please contact your local service representative for more information.

Instrument Installation and Maintenance Services Ordering Information	Installation Services	Preventive Maintenance	Device Check
epMotion® 5070	0082 030 081	0082 030 010	N/A
epMotion® 5073	0082 030 111	0082 030 011	N/A
epMotion® 5075	0082 030 141	0082 030 012	N/A
epMotion® 96	0082 030 171	0082 030 002	N/A
Microcentrifuge w/o refrigeration	0082 020 101	0082 020 260	0082 020 270
Microcentrifuge w/o refrigeration	0082 020 101	0082 020 260	0082 020 270
Microcentrifuge with refrigeration	0082 020 131	0082 020 261	0082 020 271
Multipurpose Centrifuge w/o refrigeration	0082 020 161	0082 020 262	0082 020 272
Multipurpose Centrifuge with refrigeration	0082 020 191	0082 020 263	0082 020 273
Himac High-Speed Floorstanding Centrifuge	0082 029 211	0082 029 251	N/A
Himac Ultracentrifuge	0082 029 210	0082 029 250	N/A
Vacuum Concentrator	0082 020 212	0082 020 265	0082 020 275
Mastercycler® MX50, pro, nexus	0082 040 131	0082 040 260	N/A
ULT Freezer	0082 070 071	0082 070 260	0082 070 270
CO ₂ Incubator	0082 060 071	0082 060 260	0082 060 270
S41i Incubator Shaker	0082 050 021	0082 050 260	0082 050 270
Open Air Shaker	0082 080 091	0082 080 260	0082 080 270
Shaker with Heating	0082 080 121	0082 080 261	0082 080 271
Shaker with Heating/Cooling	0082 080 151	0082 080 262	0082 080 272
Shaker S44i	0082 080 231	0082 080 264	0082 080 274
Eppendorf BioPhotometer®	0082 110 081	0082 110 260	N/A
Eppendorf BioSpectrometer®	0082 110 111	0082 110 261	N/A
Temperature control & mixing instruments ¹⁾	0082 100 061	0082 100 260	N/A
Electroporators	0082 010 081	0082 010 260	N/A
Microinjectors/Micromanipulators	0082 010 111	0082 010 261	N/A
VisioNize®	0082 160 001		

¹⁾ Eppendorf ThermoMixer®/Eppendorf ThermoStat, MixMate®

Info: Our service offers may differ by country. Please contact your local service representative for more information.

Rotor Inspection Services for Microcentrifuges and Multipurpose Centrifuges Ordering Information		
Fixed-angle rotors		5424 860 109
Swing-bucket rotors		5810 860 113
Temperature Verification Services Ordering Information		
Eppendorf ThermoMixer®/Eppendorf ThermoStat/MixMate®		0082 100 025
Eppendorf ThermoMixer®/Eppendorf ThermoStat/MixMate® - ISO 17025		0082 100 026
Eppendorf ThermoMixer®/Eppendorf ThermoStat/MixMate® - multi-channel		0082 100 023
Eppendorf ThermoMixer®/Eppendorf ThermoStat/MixMate® - multi-channel - ISO 17025		0082 100 024
Mastercycler® - sequential		6321 897 000
Mastercycler® - ISO 17025 - sequential		0082 040 027
Mastercycler® - parallel		6321 897 507
Eppendorf BioSpectrometer® kinetic		6136 005 004
Other Verification Services Ordering Information		
Eppendorf PiezoXpert® Actuator Verification		5194 075 016
Photometer Test for Eppendorf BioPhotometer®		6132 005 026
Photometer Test for Eppendorf BioSpectrometer®		6135 005 027
Photometer Test for Eppendorf BioSpectrometer® fluorescence		6137 005 008

Bioprocess Service



Bioprocess Performance Plans

Bioprocess systems include several sophisticated technologies. Peak performance requires smooth interplay of the subsystems and fully functioning consumable parts. Regular maintenance by qualified engineers helps to ensure reliable operation, while deferring it can cause unreliable results, expensive repairs, and prolonged downtime. Eppendorf Bioprocess Performance Plans help you to maintain the optimal performance of your equipment over years of frequent use.

**Download the
bioprocess catalog**

[www.eppendorf.com/
catalog](http://www.eppendorf.com/catalog)

You will find details and ordering information for all Bioprocess Performance Plans in the Bioprocess Catalog 2022/2023!



EU-IVD Centrifuges



Are the tools in your lab compliant to the IVD legislation? Do they need to be?

To support regulatory compliance, Eppendorf offers two versions of our benchtop centrifuges:

An EU-IVD compliant, CE marked version for diagnostic applications (according to the EU In Vitro Diagnostic Regulation (IVDR) 2017/746), and a General Lab Product version for research applications.

Choosing the right version for your laboratory is easy

If your lab work is predominantly a clinical or diagnostic application EU-IVD compliant products can add peace of mind to support your documentation and accreditation requirements. Eppendorf has taken all measures needed to make sure the EU-IVD compliant documentation is fulfilled and furthermore CE certificates are provided.

If your lab work is rather research oriented, no matter if it is basic research or teaching or all the way up to pharmacological research and development, the General Lab Product version is the right choice. It comes with a large variety of research application examples and testimonials.

Quality promise of Eppendorf

Both versions follow the same extremely high quality standards at Eppendorf. We are not making any compromises in precision, accuracy, robustness, safety and ergonomics. By giving you, our customer, the choice, we spare you the effort of validating a "research product" for clinical purposes or the inconvenience of using a "clinical product" for research and having application examples from an unrelated field only. We want you to concentrate on your work, for the better of mankind, and enable you to take care of necessary EU-IVD compliant documentation.

Learn more about
the Eppendorf
centrifuge portfolio!



[www.eppendorf.com/
IVDCentrifugation](http://www.eppendorf.com/IVDCentrifugation)

MiniSpin®/MiniSpin® plus



CE*

* The MiniSpin®/MiniSpin® plus is a non-automatic centrifuge for the separation of liquid substance mixtures from the human body and is specifically intended to be used as an accessory together with an in vitro diagnostic device and to enable its use according to its intended purpose. This product complies with the requirements of the EU In Vitro Diagnostics Regulation (IVDR) 2017/746.

Ordering information

Description	Order no.
Centrifuge MiniSpin® (EU-IVD) , keypad, non-refrigerated, with Rotor F-45-12-11, 230 V/50 – 60 Hz (GB)	5452 000 069
Centrifuge MiniSpin® plus (EU-IVD) , keypad, non-refrigerated, with Rotor F-45-12-11, 230 V/50 – 60 Hz (GB)	5453 000 062
Rotor F-45-12-11 , angle 45°, 12 places, max. tube diameter 11 mm, incl. rotor lid and rotor nut, MiniSpin®/MiniSpin® plus	5452 720 008
Rotor F-55-16-5 PCR , angle 55°, 16 places, max. tube diameter 5 mm, incl. rotor lid (aluminum), MiniSpin®/MiniSpin® plus	5452 727 007
Adapter , for 1 PCR tube (0.2 mL, max. Ø 6 mm), for all 1.5/2.0 mL rotors, 6 pcs.	5425 715 005
Adapter , for 1 sample tube (0.5 mL, max. Ø 8 mm) or 1 Microtainer® (0.6 mL, max. Ø 8 mm), for all 1.5/2.0 mL rotors, 6 pcs.	5425 716 001
Adapter , for 1 micro test tube (0.4 mL, max. Ø 6 mm), for all 1.5/2.0 mL rotors, 6 pcs.	5425 717 008

✎ Ordering information for other voltage options begins on page 349

Centrifuge 5418 R



CE*

* The Centrifuge 5418 R is a non-automatic centrifuge for the separation of liquid substance mixtures from the human body and is specifically intended to be used as an accessory together with an in vitro diagnostic device and to enable its use according to its intended purpose. This product complies with the requirements of the EU In Vitro Diagnostics Regulation (IVDR) 2017/746.

Ordering information

Description	Order no.
Centrifuge 5418 R (EU-IVD) , rotary knobs, refrigerated, with Rotor FA-45-18-11 and rotor lid, 230 V/50 – 60 Hz (GB)	5401 000 064
Adapter , for 1 PCR tube (0.2 mL, max. Ø 6 mm), for all 1.5/2.0 mL rotors, 6 pcs.	5425 715 005
Adapter , for 1 sample tube (0.5 mL, max. Ø 8 mm) or 1 Microtainer® (0.6 mL, max. Ø 8 mm), for all 1.5/2.0 mL rotors, 6 pcs.	5425 716 001
Adapter , for 1 micro test tube (0.4 mL, max. Ø 6 mm), for all 1.5/2.0 mL rotors, 6 pcs.	5425 717 008

✎ Ordering information for other voltage options begins on page 349

Centrifuge 5420



CE*

* The Centrifuge 5420 is a non-automatic centrifuge for the separation of liquid substance mixtures from the human body and is specifically intended to be used as an accessory together with an in vitro diagnostic device and to enable its use according to its intended purpose. This product complies with the requirements of the EU In Vitro Diagnostics Regulation (IVDR) 2017/746.

Ordering information

Description	Order no.
Centrifuge 5420 (EU-IVD) , keypad, non-refrigerated, without rotor, 230 V/50 – 60 Hz (GB)	5420 000 261
Centrifuge 5420 (EU-IVD) , keypad, non-refrigerated, with aerosol-tight Rotor FA-24x2, 230 V/50 – 60 Hz (GB)	5420 000 067

✎ Ordering information for other voltage options begins on page 349

Centrifuge 5425/5425 R



* The Centrifuge 5425/5425 R is a non-automatic centrifuge for the separation of liquid substance mixtures from the human body and is specifically intended to be used as an accessory together with an in vitro diagnostic device and to enable its use according to its intended purpose. This product complies with the requirements of the EU In Vitro Diagnostics Regulation (IVDR) 2017/746.

Ordering information

Description	Order no.
Centrifuge 5425 (EU-IVD) , keypad, non-refrigerated, without rotor, 230 V/50 – 60 Hz (GB)	5405 000 263
Centrifuge 5425 (EU-IVD) , rotary knobs, non-refrigerated, without rotor, 230 V/50 – 60 Hz (GB)	5405 000 662
Centrifuge 5425 (EU-IVD) , keypad, non-refrigerated, with Rotor FA-24x2, 230 V/50 – 60 Hz (GB)	5405 000 069
Centrifuge 5425 (EU-IVD) , rotary knobs, non-refrigerated, with Rotor FA-24x2, 230 V/50 – 60 Hz (GB)	5405 000 468
Centrifuge 5425 R (EU-IVD) , keypad, refrigerated, without rotor, 230 V/50 – 60 Hz (GB)	5406 000 267
Centrifuge 5425 R (EU-IVD) , rotary knobs, refrigerated, without rotor, 230 V/50 – 60 Hz (GB)	5406 000 666
Centrifuge 5425 R (EU-IVD) , keypad, refrigerated, with Rotor FA-24x2, 230 V/50 – 60 Hz (GB)	5406 000 062
Centrifuge 5425 R (EU-IVD) , rotary knobs, refrigerated, with Rotor FA-24x2, 230 V/50 – 60 Hz (GB)	5406 000 461

✓ Ordering information for other voltage options begins on page 349

Centrifuge 5427 R

New



CE*



* The Centrifuge 5427 R is a non-automatic centrifuge for the separation of liquid substance mixtures from the human body and is specifically intended to be used as an accessory together with an in vitro diagnostic device and to enable its use according to its intended purpose. This product complies with the requirements of the EU In Vitro Diagnostics Regulation (IVDR) 2017/746.

Ordering information

Description	Order no.
Centrifuge 5427 R, rotary knobs, refrigerated, without rotor, 230 V/50 – 60 Hz (GB)	*
Centrifuge 5427 R, rotary knobs, refrigerated, with Rotor FA-45-30-11, 230 V/50 – 60 Hz (GB)	*
Centrifuge 5427 R, rotary knobs, refrigerated, with Rotor FA-45-48-11, 230 V/50 – 60 Hz (GB)	*

* To find the correct order number for your country, please have a look on page 349 and forward, or please check our local website or contact your local sales representative. www.eppendorf.com/distributors

Centrifuge 5430/5430 R



* The Centrifuge 5430/5430 R is a non-automatic centrifuge for the separation of liquid substance mixtures from the human body and is specifically intended to be used as an accessory together with an in vitro diagnostic device and to enable its use according to its intended purpose. This product complies with the requirements of the EU In Vitro Diagnostics Regulation (IVDR) 2017/746.

Ordering information

Description	Order no.
Centrifuge 5430 (EU-IVD) , keypad, non-refrigerated, without rotor, 230 V/50 – 60 Hz (GB)	5427 000 062
Centrifuge 5430 (EU-IVD) , rotary knobs, non-refrigerated, without rotor, 230 V/50 – 60 Hz (GB)	5427 000 666
Centrifuge 5430 (EU-IVD) , keypad, non-refrigerated, with Rotor FA-45-30-11 incl. rotor lid, 230 V/50 – 60 Hz (GB)	5427 000 267
Centrifuge 5430 (EU-IVD) , rotary knobs, non-refrigerated, with Rotor FA-45-30-11 incl. rotor lid, 230 V/50 – 60 Hz (GB)	5427 000 461
Centrifuge 5430 R (EU-IVD) , keypad, refrigerated, without rotor, 230 V/50 – 60 Hz (GB)	5428 000 260
Centrifuge 5430 R (EU-IVD) , rotary knobs, refrigerated, without rotor, 230 V/50 – 60 Hz (GB)	5428 000 660
Centrifuge 5430 R (EU-IVD) , keypad, refrigerated, with Rotor FA-45-30-11 incl. rotor lid, 230 V/50 – 60 Hz (GB)	5428 000 066
Centrifuge 5430 R (EU-IVD) , rotary knobs, refrigerated, with Rotor FA-45-30-11 incl. rotor lid, 230 V/50 – 60 Hz (GB)	5428 000 465

✓ Ordering information for other voltage options begins on page 349

Centrifuge 5702/5702 R/5702 RH



* The Centrifuge 5702/5702 R/5702 RH is a non-automatic centrifuge for the separation of liquid substance mixtures from the human body and is specifically intended to be used as an accessory together with an in vitro diagnostic device and to enable its use according to its intended purpose. This product complies with the requirements of the EU In Vitro Diagnostics Regulation (IVDR) 2017/746.

Ordering information

Description	Order no.
Centrifuge 5702 (EU-IVD) , rotary knobs, non-refrigerated, without rotor, 230 V/50 – 60 Hz (GB)	5702 000 060
Centrifuge 5702 (EU-IVD) , rotary knobs, non-refrigerated, with Rotor A-4-38 incl. adapters for 15/50 mL conical tubes, 2 sets of 2 adapters, 230 V/50 – 60 Hz (GB)	5702 000 361
Centrifuge 5702 R (EU-IVD) , rotary knobs, refrigerated, without rotor, 230 V/50 – 60 Hz (GB)	5703 000 063
Centrifuge 5702 R (EU-IVD) , rotary knobs, refrigerated, with Rotor A-4-38 incl. adapters for 13/16 mm blood collection tubes, 2 sets of 2 adapters, 230 V/50 – 60 Hz (GB)	5703 000 365
Centrifuge 5702 R (EU-IVD) , rotary knobs, refrigerated, with Rotor A-4-38 incl. adapters for 15/50 mL conical tubes, 2 sets of 2 adapters, 230 V/50 – 60 Hz (GB)	5703 000 462
Centrifuge 5702 RH (EU-IVD) , rotary knobs, refrigerated/heated, without rotor, 230 V/50 – 60 Hz (GB)	5704 000 067
Centrifuge 5702 (EU-IVD) , rotary knobs, non-refrigerated, with Rotor A-4-38 incl. adapters for round-bottom tubes 4 – 10 mL and adapters for round-bottom tubes 2.6 – 7 mL, 2 sets of 2 adapters, 230 V/50 – 60 Hz (GB)	5702 000 558

✎ Ordering information for other voltage options begins on page 349

Centrifuges and Rotors

Centrifuge 5804/5804 R and 5810/5810 R



* The Centrifuge 5804/5804 R and 5810/5810 R is a non-automatic centrifuge for the separation of liquid substance mixtures from the human body and is specifically intended to be used as an accessory together with an in vitro diagnostic device and to enable its use according to its intended purpose. This product complies with the requirements of the EU In Vitro Diagnostics Regulation (IVDR) 2017/746.

Ordering information

Description	Order no.
Centrifuge 5804 (EU-IVD) , keypad, non-refrigerated, without rotor, 230 V/50 – 60 Hz (GB)	5804 000 064
Centrifuge 5804 R (EU-IVD) , keypad, refrigerated, without rotor, 230 V/50 – 60 Hz (GB)	5805 000 068
Centrifuge 5810 (EU-IVD) , keypad, non-refrigerated, without rotor, 230 V/50 – 60 Hz (GB)	5810 000 068
Centrifuge 5810 R (EU-IVD) , keypad, refrigerated, without rotor, 230 V/50 – 60 Hz (GB)	5811 000 061

✎ Ordering information for other voltage options begins on page 349

Centrifuge Packages 58xx Family

Ordering information

Description	Conical tubes	Order no.
Centrifuge 5804 (EU-IVD) , keypad, non-refrigerated, with Rotor A-4-44 incl. adapters for 15/50 mL conical tubes, 230 V/50 – 60 Hz (GB)	16 × 15 mL/4 × 50 mL	5804 000 366
Centrifuge 5804 R (EU-IVD) , keypad, refrigerated, with Rotor A-4-44 incl. adapters for 15/50 mL conical tubes, 230 V/50 – 60 Hz (GB)	16 × 15 mL/4 × 50 mL	5805 000 360
Centrifuge 5804 (EU-IVD) , keypad, non-refrigerated, with Rotor S-4-72 incl. adapters for 15/50 mL conical tubes, 230 V/50 – 60 Hz (GB)	32 × 15 mL/16 × 50 mL	5804 000 560
Centrifuge 5804 R (EU-IVD) , keypad, refrigerated, with Rotor S-4-72 incl. adapters for 15/50 mL conical tubes, 230 V/50 – 60 Hz (GB)	32 × 15 mL/16 × 50 mL	5805 000 661
Centrifuge 5810 (EU-IVD) , keypad, non-refrigerated, with Rotor A-4-62 incl. adapters for 15/50 mL conical tubes, 230 V/50 – 60 Hz (GB)	36 × 15 mL/16 × 50 mL	5810 000 360
Centrifuge 5810 R (EU-IVD) , keypad, refrigerated, with Rotor A-4-62 incl. adapters for 15/50 mL conical tubes, 230 V/50 – 60 Hz (GB)	36 × 15 mL/16 × 50 mL	5811 000 363
Centrifuge 5810 (EU-IVD) , keypad, non-refrigerated, with Rotor A-4-81 incl. adapters for 15/50 mL conical tubes, 230 V/50 – 60 Hz (GB)	48 × 15 mL/20 × 50 mL	5810 000 467
Centrifuge 5810 R (EU-IVD) , keypad, refrigerated, with Rotor A-4-81 incl. adapters for 15/50 mL conical tubes, 230 V/50 – 60 Hz (GB)	48 × 15 mL/20 × 50 mL	5811 000 460
Centrifuge 5810 (EU-IVD) , keypad, non-refrigerated, with Rotor S-4-104 incl. adapters for 15/50 mL conical tubes, 230 V/50 – 60 Hz (GB)	56 × 15 mL/28 × 50 mL	5810 000 564
Centrifuge 5810 R (EU-IVD) , keypad, refrigerated, with Rotor S-4-104 incl. adapters for 15/50 mL conical tubes, 230 V/50 – 60 Hz (GB)	56 × 15 mL/28 × 50 mL	5811 000 665
Centrifuge 5810 (EU-IVD) , keypad, non-refrigerated, with Rotor S-4-104 incl. adapters for 13/16 mm round-bottom tubes, 230 V/50 – 60 Hz (GB)	56 × 15 mL/28 × 50 mL 92 × 13 mm/80 × 16 mm	5810 000 661
Centrifuge 5810 R (EU-IVD) , keypad, refrigerated, with Rotor S-4-104 incl. adapters for 13/16 mm round-bottom tubes, 230 V/50 – 60 Hz (GB)	56 × 15 mL/28 × 50 mL 92 × 13 mm/80 × 16 mm	5811 000 860

✎ Ordering information for other voltage options begins on page 349

Centrifuge 5910 Ri



CE*

* The Centrifuge 5910 Ri is a non-automatic centrifuge for the separation of liquid substance mixtures from the human body and is specifically intended to be used as an accessory together with an in vitro diagnostic device and to enable its use according to its intended purpose. This product complies with the requirements of the EU In Vitro Diagnostics Regulation (IVDR) 2017/746.

Ordering information

Description	Order no.
Centrifuge 5910 Ri (EU-IVD) , touch interface, refrigerated, without rotor, 230 V/50 – 60 Hz (GB)	5943 000 068

✎ Ordering information for other voltage options begins on page 349

Centrifuge Packages 5910 Ri

Ordering information

Description	Conical tubes	Order no.
Centrifuge 5910 Ri (EU-IVD) , touch interface, refrigerated, with Rotor S-4x750, incl. round buckets and adapters for 5 mL/15 mL/50 mL conical tubes, 230 V/50 – 60 Hz (GB)	56 × 15 mL/28 × 50 mL	5943 000 564
Centrifuge 5910 Ri (EU-IVD) , touch interface, refrigerated, with Rotor S-4xUniversal, incl. universal buckets and adapters for 5 mL/15 mL/50 mL conical tubes and plates, 230 V/50 – 60 Hz (GB)	68 × 15 mL/36 × 50 mL	5943 000 368
Centrifuge 5910 Ri (EU-IVD) , touch interface, refrigerated, with Rotor S-4xUniversal, incl. universal buckets and adapters for 5 mL/15 mL/50 mL conical tubes, 175 – 250 mL bottles and plates, 230 V/50 – 60 Hz (GB)	68 × 15 mL/28 × 50 mL	5943 000 262

✎ Ordering information for other voltage options begins on page 349

Centrifuges and Rotors

Centrifuge 5920 R



As awarded by The Chicago Athenaeum: Museum of Architecture and Design.



CE*

* The Centrifuge 5920 R is a non-automatic centrifuge for the separation of liquid substance mixtures from the human body and is specifically intended to be used as an accessory together with an in vitro diagnostic device and to enable its use according to its intended purpose. This product complies with the requirements of the EU In Vitro Diagnostics Regulation (IVDR) 2017/746.

Ordering information

Description	Order no.
Centrifuge 5920 R (EU-IVD) , keypad, refrigerated, without rotor, 230 V/50 – 60 Hz (GB)	5948 000 069

Ordering information for other voltage options begins on page 349

Centrifuge Packages 5920 R

Ordering information

Description	Conical tubes	Order no.
Centrifuge 5920 R (EU-IVD) , keypad, refrigerated, with Rotor S-4x1000, incl. high-capacity buckets and adapters for 15 mL/50 mL conical tubes, 230 V/50 – 60 Hz (GB)	108 × 15 mL/52 × 50 mL	5948 000 263
Centrifuge 5920 R (EU-IVD) , keypad, refrigerated, with Rotor S-4xUniversal-Large, incl. universal buckets and adapters for 5 mL/15 mL/25 mL/50 mL conical tubes and plates, 230 V/50 – 60 Hz (GB)	96 × 15 mL/40 × 50 mL	5948 000 965
Centrifuge 5920 R (EU-IVD) , keypad, refrigerated, with Rotor S-4x1000, incl. plate/tube buckets and adapters for 15 mL/50 mL conical tubes, 230 V/50 – 60 Hz (GB)	88 × 15 mL/40 × 50 mL	5948 000 468
Centrifuge 5920 R (EU-IVD) , keypad, refrigerated, with Rotor S-4x1000, incl. round buckets and adapters for 15 mL/50 mL conical tubes, 230 V/50 – 60 Hz (GB)	56 × 15 mL/28 × 50 mL	5948 000 360
Centrifuge 5920 R (EU-IVD) , keypad, refrigerated, with Rotor S-4xUniversal-Large, incl. universal buckets and adapters for round-bottom tubes with diameter 13/16 mm, 230 V/50 – 60 Hz (GB)	108 × 15 mL/52 × 50 mL 196 × 13 mm/148 × 16 mm	5948 000 867

Ordering information for other voltage options begins on page 349

IVF-Micromanipulation

TransferMan® 4m

Description

Your precious cells deserve the best possible micromanipulation. With its unprecedented movement control and optimized operation concept, the TransferMan® 4m minimizes exposure of your IVF sample to stress or trauma. In this manner, it embodies Eppendorf's ambition to live up to the highest standards of performance and precision.



Product features

- > Unique DualSpeed joystick for both precise and fast movements
- > Designed with PhysioCare Concept® for enhanced ergonomics and less pain
- > Y-off function for precise and less traumatic injection movement in X-direction

Applications

- > Micromanipulation of oocytes or embryos of the early developmental stages (e.g. ICSI, hatching, etc.)
- > PGT-related biopsies (e.g. trophoctoderm biopsy)



* The TransferMan® 4m has been designed and manufactured to assist in the positioning of micro tools (e.g., microcapillaries or micro glass pipettes) under the microscope, during the performance of assisted reproductive technologies (ART) such as intracytoplasmic sperm injection (ICSI), or the collection of genetic material for the purpose of genetic preimplantation testing (PGT).

Higher fertilization/blastocyst rates

- > Less traumatic injections by minimized lesion holes with Y motor off function (100% movement in x-direction only)
- > Real-time feeling, direct mode for precise and dynamic mode for fast movements - with the unique DualSpeed joystick

Increased workflow-speed

- > Fast capillary exchange and re-positioning without re-focusing within a few seconds by home function, swivel joint and reproducible positioning of the capillary inside the holder (no exchange of the capillary holder)
- > Fast automatic switch between stored capillary positions in and above the medium droplet
- > Adjustable speed control of the joystick to fit the needs of training centers and high-throughput clinics

Reduced work-related stress and pain - PhysioCare Concept®:

- > The hand can rest relaxed on the panel without accidental activation of buttons
- > "One joystick"-concept omits the need to switch between several control elements
- > Easy training of beginners with intuitive "one-joystick"-concept
- > Programmable Z-axis limit to prevent capillary breakage

TransferMan® 4m



Workstation for intracytoplasmic sperm injection (ICSI).
TransferMan 4m mounted on Olympus IX73



Smooth Operator – The Eppendorf system speeds up workflow with high cell survival rates

Technical specifications	
Model	TransferMan 4m
Power supply	100 – 240 V, 50 – 60 Hz
Motor module set	
Max. traveling distance	≥20 mm in X, Y, Z and X/Z direction
Weight (complete)	2.15 kg
Stepper motor	X-, Y-, Z-module
Single module (X, Y, Z)	
Step size	< 20 nm (computational resolution)
Speed	0 – 10,000 µm/s
Mechanical adjustability	>80 mm
Dimensions	129 × 51 × 36 mm
Weight	570 g
Swivel joint	
Direction of rotation	-45° to +90°
Capillary exchange	Direction of rotation: forward
Sample replacement	Direction of rotation: backward
Angle head	
Operating angle	0° – 90°
Control board	
Control	joystick (proportional and dynamic kinetics)
Speed modes	coarse, fine, x-fine
Speed control	Proportional and dynamic kinetics
Dimensions (W x H x D)	205 × 288 × 152 mm
Weight	1.8 kg

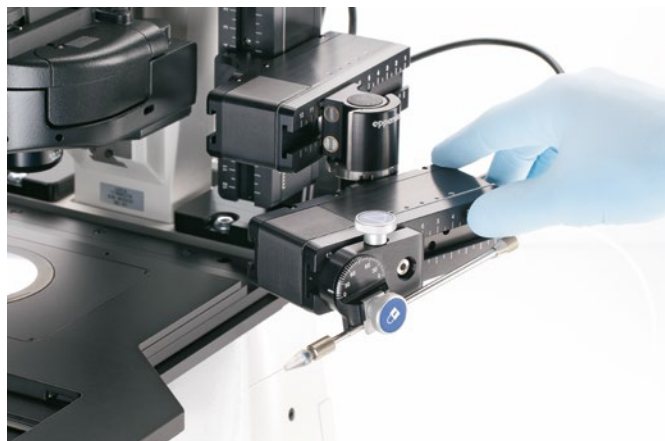

A fast capillary exchange within a few seconds is ensured via home function, swivel joint and a reproducible positioning of the capillary inside the holder.

Ordering information

Description

TransferMan® 4m, micromanipulator with DualSpeed™ joystick for direct and dynamic movement control, 100 – 240 V/50 – 60 Hz (GB), The TransferMan® 4m has been designed and manufactured to assist in the positioning of micro tools (e.g., microcapillaries or micro glass pipettes) under the microscope, during the performance of assisted reproductive technologies (ART) such as intracytoplasmic sperm injection (ICSI), or the collection of genetic material for the purpose of genetic preimplantation testing (PGT).

Order no.

5191 000 031

CellTram[®] 4m Air/Oil

Description

Working with the CellTram 4m Air and CellTram 4m Oil is like taking a breath of fresh air. Our new manual microinjectors have been designed with special emphasis on excellent ergonomics, ease of use and highest precision. They are optimized for use in assisted reproductive technology and suit all personal working techniques.



CE*

* The CellTram[®] 4m Air/Oil has been designed and manufactured to support the injection and aspiration of cells or cell components during the performance of assisted reproductive technologies (ART) such as intracytoplasmic sperm injection (ICSI), or the collection of genetic material for the purpose of genetic preimplantation testing (PGT), using micro tools (e.g., microcapillaries or micro glass pipettes).

Product features

- > Non-hydraulic system for oil-free manipulation but also injection of cells (CellTram 4m Air)
- > Piston position scale enables setting of air volume and injection characteristics according to individual needs (CellTram 4m Air)
- > Improved oil-filling system for minimal interruption of the workflow (CellTram 4m Oil)

Applications

- > Intracytoplasmic sperm injection (ICSI)
- > Gentle holding of cells or embryos (e.g., oocytes or blastocysts)
- > Uptake and microinjection of small cells (e.g., sperm)
- > Transfer of suspension cells or organelles
- > Removal of cells (e.g., for embryo biopsies)

CellTram[®] 4m Air/Oil



CellTram 4m Air: Pressure responsiveness for various applications can be adjusted by different piston positions



CellTram 4m Oil: The new oil-filling system helps avoid oil-spilling and facilitates the filling process

Technical specifications

Technical specifications	CellTram 4m Air	CellTram 4m Oil
Model	CellTram 4m Air	CellTram 4m Oil
Cylinder volume	10 mL	1,000 µL
Max. pressure	3,000 hPa	20,000 hPa
Min. adjustable volume	< 100 nL	< 1.5 nL
Pressure generation	Cylinder/piston system, air-filled	Cylinder/piston system, oil-filled
Volume change per revolution	60 µL/600 µL	1 µL/10 µL

Ordering information

Description	Order no.
CellTram[®] 4m Air , manual pneumatic microinjector, with gears 1:1 and 1:10, for holding and injection, The CellTram [®] 4m Air has been designed and manufactured to support the injection and aspiration of cells or cell components during the performance of assisted reproductive technologies (ART) such as intracytoplasmic sperm injection (ICSI), or the collection of genetic material for the purpose of genetic preimplantation testing (PGT), using micro tools (e.g., microcapillaries or micro glass pipettes).	5196 000 021
CellTram[®] 4m Oil , manual hydraulic microinjector, with gears 1:1 and 1:10, for holding and injection, The CellTram [®] 4m Oil has been designed and manufactured to support the injection and aspiration of cells or cell components during the performance of assisted reproductive technologies (ART) such as intracytoplasmic sperm injection (ICSI), or the collection of genetic material for the purpose of genetic preimplantation testing (PGT), using micro tools (e.g., microcapillaries or micro glass pipettes).	5196 000 048
Filling and Cleaning set , for CellTram [®] 4 Oil and CellTram [®] Oil/vario, incl. filling tube, Luer lock adapter, 2 syringes	5196 088 000
Injection tube Air , white ring mark, I.D. 0.5 mm, length 1.3 m	5196 061 004
Injection tube Oil , blue ring mark, I.D. 1.0 mm, length 1.3 m	5196 089 006
Capillary holder 4 , incl. 1x Grip head set 4 size 0 (for microcapillaries with outer diameter 1.0 – 1.1 mm)	5196 081 005
O-ring set 4 , incl. 10 o-rings large, 10 o-rings small, 2 distance sleeves, o-ring removal tool for grip head set 4	5196 086 007
Grip head set 4 size 0 , 1 pc, for microcapillaries with outer diameter 1.0 to 1.1 mm	5196 082 001
Grip head set 4 size 1 , 1 pc, for microcapillaries with outer diameter 1.2 to 1.3 mm	5196 083 008
Grip head set 4 size 2 , 1 pc, for microcapillaries with outer diameter 1.4 to 1.5 mm	5196 084 004
Grip head set 4 size 3 , 1 pc, for microcapillaries with outer diameter 0.7 to 0.9 mm	5196 085 000

Order Numbers for Different Mains Voltage Versions



The following products are available in the listed mains voltage versions. For mains voltage versions for which no separate order number is listed, the valid order numbers are also those listed in the first column or in

the product description. The versions marked n.a. are not available. Order-related production is marked with *

Automated Pipetting

Power supply	Europe	UK/HKG	Australia	China	Japan	Argentina	ROW
epMotion® 96	5069 000 012	5069 000 020	5069 000 039	5069 000 047	5069 000 004	5069 000 055	5069 000 004
epMotion® 96 with 2-position slider	5069 000 110	5069 000 128	5069 000 136	5069 000 144	5069 000 101	5069 000 152	5069 000 101
epMotion® 96xl	5069 000 217	5069 000 225	5069 000 233	5069 000 241	5069 000 209	5069 000 250	5069 000 209
epMotion® 96xl with 2-position slider	5069 000 314	5069 000 322	5069 000 330	5069 000 349	5069 000 306	5069 000 357	5069 000 306
epMotion® 5070 MultiCon	5070 000 282	5070 007 012	5070 007 013	5070 007 014	5070 007 011	5070 007 015	5070 007 011
epMotion® 5070 MultiCon PCR solution	5070 000 948	5070 000 948	5070 000 948	5070 000 948	5070 000 948	5070 000 948	5070 000 948
epMotion® 5073l	5073 000 590	5073 007 412	5073 007 413	5073 007 414	5073 007 411	5073 007 415	5073 007 411
epMotion® 5073t	5073 000 345	5073 000 345	5073 000 345	5073 000 345	5073 000 345	5073 000 345	5073 000 345
epMotion® 5073t NGS solution	5073 000 978	5073 000 978	5073 000 978	5073 000 978	5073 000 978	5073 000 978	5073 000 978
epMotion® 5075l	5075 000 301	5075 000 301	5075 000 301	5075 000 301	5075 000 301	5075 000 301	5075 000 301
epMotion® 5075t	5075 000 302	5075 000 302	5075 000 302	5075 000 302	5075 000 302	5075 000 302	5075 000 302
epMotion® 5075t NGS solution	5075 000 962	5075 000 962	5075 000 962	5075 000 962	5075 000 962	5075 000 962	5075 000 962
epMotion® 5075tc NGS solution	5075 000 963	5075 000 963	5075 000 963	5075 000 963	5075 000 963	5075 000 963	5075 000 963
epMotion® 5075v	5075 000 303	5075 000 303	5075 000 303	5075 000 303	5075 000 303	5075 000 303	5075 000 303
epMotion® 5075vt	5075 000 304	5075 000 304	5075 000 304	5075 000 304	5075 000 304	5075 000 304	5075 000 304

Temperature Control and Mixing

Power supply	Europe	UK/HKG	Australia	China	Japan	Argentina	ROW
Eppendorf ThermoMixer® C, basic device without thermoblock	5382 000 015	5382 000 031	5382 000 066	5382 000 074	5382 000 023	5382 000 082	5382 000 023
Eppendorf ThermoMixer® F0.5, with thermoblock for 24 reaction vessels 0.5 mL	5386 000 010	5386 000 036	5386 000 060	5386 000 079	5386 000 028	5386 000 087	5386 000 028
Eppendorf ThermoMixer® F1.5, with thermoblock for 24 reaction vessels 1.5 mL	5384 000 012	5384 000 039	5384 000 063	5384 000 071	5384 000 020	5384 000 080	5384 000 020
Eppendorf ThermoMixer® F2.0, with thermoblock for 24 reaction vessels 2.0 mL	5387 000 013	5387 000 030	5387 000 064	5387 000 072	5387 000 021	5387 000 080	5387 000 021
Eppendorf ThermoMixer® FP, with thermoblock for Microplates and Deepwell Plates, including lid	5385 000 016	5385 000 032	5385 000 067	5385 000 075	5385 000 024	5385 000 083	5385 000 024
Eppendorf ThermoStat C, basic device without thermoblock	5383 000 019	5383 000 035	5383 000 060	5383 000 078	5383 000 027	5383 000 086	5383 000 027
MixMate®, basic device without tube holders	5353 000 510	5353 000 537	5353 000 545	5353 000 553	n.a.	n.a.	5353 000 022

Centrifuges and Rotors - General Lab Products

Power supply	Europe	UK/HKG	Australia	China	Japan	Argentina	ROW
Centrifuge MiniSpin® plus, non-refrigerated, with Rotor F-45-12-11	5453 000 015	5452 000 060	5453 000 089		5453 000 038	5453 000 054	n.a.
Centrifuge MiniSpin®, non-refrigerated, with Rotor F-45-12-11	5452 000 010	5453 000 060	5452 000 085		5452 000 034	5452 000 050	5452 000 816
Centrifuge 5418 R, refrigerated, with Rotor FA-45-18-11 and rotor lid	5401 000 010	5401 000 060	5401 000 080		5401 000 030	5401 000 056	5401 000 021
Centrifuge 5420, keypad, non-refrigerated, without rotor	5420 000 318	5420 000 369	5420 000 288	5420 000 296	5420 000 237	5420 000 253	5420 000 229
Centrifuge 5420, keypad, non-refrigerated, with aerosol-tight Rotor FA-24x2	5420 000 113	5420 000 164	5420 000 083	5420 000 091	5420 000 032	5420 000 059	5420 000 024
Centrifuge 5425, keypad, non-refrigerated, without rotor	5405 000 310	5405 000 360	5405 000 280		n.a.	5405 000 255	5405 000 220
Centrifuge 5425, rotary knobs, non-refrigerated, without rotor	5405 000 719	5405 000 760	5405 000 689		5405 000 638	5405 000 654	5405 000 620
Centrifuge 5425, keypad, non-refrigerated, with Rotor FA-24x2	5405 000 115	5405 000 166	5405 000 085		n.a.	5405 000 050	5405 000 026
Centrifuge 5425, rotary knobs, non-refrigerated, with Rotor FA-24x2	5405 000 514	5405 000 565	5405 000 484		5405 000 433	5405 000 450	5405 000 425
Centrifuge 5425, rotary knobs, non-refrigerated, Molecular Biology Solution, with Rotor FA-18x2-Kit	5405 000 174	5405 000 182	5405 000 190		5405 000 239		n.a.
Centrifuge 5425 R, keypad, refrigerated, without rotor	5406 000 313	5406 000 364	5406 000 283		5406 000 631	5406 000 259	5406 000 224
Centrifuge 5425 R, rotary knobs, refrigerated, without rotor	5406 000 712	5406 000 763	5406 000 682		n.a.	5406 000 658	5406 000 623
Centrifuge 5425 R, keypad, refrigerated, with Rotor FA-24x2	5406 000 119	5406 000 160	5406 000 089		5406 000 437	5406 000 054	5406 000 020
Centrifuge 5425 R, rotary knobs, refrigerated, with Rotor FA-24x2	5406 000 518	5406 000 569	5406 000 488		n.a.	5406 000 453	5406 000 429
Centrifuge 5427 R, rotary knobs, refrigerated, without rotor	5429 000 010				5429 000 037		5429 000 027
Centrifuge 5427 R, rotary knobs, refrigerated, with Rotor FA-45-30-11	5429 000 310				5429 000 333		5429 000 327
Centrifuge 5427 R, rotary knobs, refrigerated, with Rotor FA-45-48-11	5429 000 210				5429 000 233		5429 000 227
Centrifuge 5430, keypad, non-refrigerated, without rotor	5427 000 015	5427 000 060	5427 000 089		5427 000 038	5427 000 054	5427 000 020
Centrifuge 5430, rotary knobs, non-refrigerated, without rotor	5427 000 610	5427 000 660	5427 000 682		5427 000 631	5427 000 658	5427 000 623
Centrifuge 5430, keypad, non-refrigerated, with Rotor FA-45-30-11 incl. rotor lid	5427 000 210	5427 000 260	5427 000 283		5427 000 232	5427 000 259	5427 000 224
Centrifuge 5430, rotary knobs, non-refrigerated, with Rotor FA-45-30-11 incl. rotor lid	5427 000 415	5427 000 465	5427 000 488		5427 000 437	5427 000 453	5427 000 429
Centrifuge 5430, rotary knobs, non-refrigerated, Low-Throughput Plate Solution, with Rotor A-2-MTP	5427 000 178	5427 000 186	5427 000 194		5427 000 275		
Centrifuge 5430 R, keypad, refrigerated, without rotor	5428 000 205	5428 000 255	5428 000 287		5428 000 236	5428 000 252	5428 000 228
Centrifuge 5430 R, rotary knobs, refrigerated, without rotor	5428 000 610	5428 000 655	5428 000 686		5428 000 635	5428 000 651	5428 000 627
Centrifuge 5430 R, keypad, refrigerated, with Rotor FA-45-30-11 incl. rotor lid	5428 000 010	5428 000 060	5428 000 082		5428 000 031	5428 000 058	5428 000 023
Centrifuge 5430 R, rotary knobs, refrigerated, with Rotor FA-45-30-11 incl. rotor lid	5428 000 410	5428 000 460	5428 000 481		5428 000 430	5428 000 457	5428 000 422
Centrifuge 5702, rotary knobs, non-refrigerated, without rotor	5702 000 010	5702 000 065	5702 000 086		5702 000 043	5702 000 051	5702 000 817
Centrifuge 5702, rotary knobs, with Rotor A-4-38 incl. adapters for 15/50 mL conical tubes, 2 sets of 2 adapters	5702 000 320	5702 000 365	5702 000 388		n.a.	5702 000 353	5702 000 345
Centrifuge 5702 R, rotary knobs, refrigerated, without rotor	5703 000 010	5703 000 060	5703 000 080		5703 000 039	5703 000 055	5703 000 047
Centrifuge 5702 R, rotary knobs, refrigerated, with Rotor A-4-38 incl. adapters for 13/16 mm blood collection tubes, 2 sets of 2 adapters	5703 000 320	5703 000 360	5703 000 381		n.a.	5703 000 357	5703 000 349
Centrifuge 5702 R, rotary knobs, refrigerated, with Rotor A-4-38 incl. adapters for 15/50 mL conical tubes, 2 sets of 2 adapters	5703 000 425	5703 000 460	5703 000 489		n.a.	5703 000 454	5703 000 470
Centrifuge 5702 RH, rotary knobs, refrigerated/heated, without rotor	5704 000 010	5704 000 060	5704 000 083		5704 000 032	5704 000 059	5704 000 040
Centrifuge 5702, rotary knobs, non-refrigerated, with Rotor A-4-38 incl. adapters for round-bottom tubes 4 – 10 mL and adapters for round-bottom tubes 2.6 – 7 mL, 2 sets of 2 adapters	5702 000 515		5702 000 566		5702 000 590	5702 000 540	5702 000 582

Centrifuges and Rotors - General Lab Products

Power supply	Europe	UK/HKG	Australia	China	Japan	Argentina	ROW
Centrifuge 5804, keypad, without rotor	5804 000 010	5804 000 060	5804 000 080		5804 000 048	5804 000 056	5804 000 170
Centrifuge 5804 R, keypad, refrigerated, without rotor	5805 000 010	5805 000 060	5805 000 084		*	5805 000 050	*
Centrifuge 5804, keypad, with Rotor A-4-44 incl. adapters for 15/50 mL conical tubes	5804 000 320	5804 000 360	5804 000 382		*	5804 000 358	5804 000 374
Centrifuge 5804, keypad, with Rotor S-4-72 incl. adapters for 15/50 mL conical tubes	5804 000 520	5804 000 565	5804 000 587		*	5804 000 552	5804 000 544
Centrifuge 5804 R, keypad, refrigerated, with Rotor A-4-44 incl. adapters for 15/50 mL conical tubes	5805 000 320	5805 000 365	5805 000 386		*	5805 000 351	5805 000 378
Centrifuge 5804 R, keypad, refrigerated, with Rotor S-4-72 incl. adapters for 15/50 mL conical tubes	5805 000 620	5805 000 665	5805 000 688		*	5805 000 653	5805 000 645
Centrifuge 5810, keypad, non-refrigerated, without rotor	5810 000 010	5810 000 060	5810 000 084		*	5810 000 050	5805 000 181
Centrifuge 5810 R, keypad, refrigerated, without rotor	5811 000 015	5811 000 065	5811 000 088		*	5811 000 053	5811 000 231
Centrifuge 5810 R, keypad, refrigerated, with Rotor A-4-62 incl. adapters for 15/50 mL conical tubes	5811 000 325	5811 000 360	5811 000 380		*	5811 000 355	5811 000 371
Centrifuge 5810, keypad, non-refrigerated, with Rotor A-4-81 incl. adapters for 15/50 mL conical tubes	5810 000 420	5810 000 460	5810 000 483		*	5810 000 459	5810 000 475
Centrifuge 5810 R, keypad, refrigerated, with Rotor A-4-81 incl. adapters for 15/50 mL conical tubes	5811 000 420	5811 000 465	5811 000 487		*	5811 000 452	5811 000 479
Centrifuge 5810, keypad, non-refrigerated, Classic Cell Culture Solution, with Rotor S-4-104 including 4 adapters for 5/15 mL tubes and 4 adapters for 50 mL conical tubes	5810 000 525	5810 000 560	5810 000 580		*	5810 000 556	5810 000 548
Centrifuge 5810 R, keypad, refrigerated, with Rotor S-4-104 incl. adapters for 15/50 mL conical tubes	5811 000 620	5811 000 660	5811 000 681		*	5811 000 657	5811 000 649
Centrifuge 5810, keypad, non-refrigerated, with Rotor S-4-104 incl. adapters for 13/16 mm round-bottom tubes	5810 000 620	5810 000 665	5810 000 688		*	5810 000 653	5810 000 670
Centrifuge 5810 R, keypad, refrigerated, with Rotor S-4-104 incl. adapters for 13/16 mm round-bottom tubes	5811 000 820	5811 000 865	5811 000 886		*	5811 000 851	5811 000 843
Centrifuge 5810, keypad, non-refrigerated, with Rotor A-4-62 incl. adapters for 15/50 mL conical tubes	5810 000 320	5810 000 365	5810 000 386		*	5810 000 351	5810 000 378
Centrifuge 5910 Ri, refrigerated, without rotor	5943 000 011	5943 000 061	5943 000 084	5943 000 092	5943 000 033	5943 000 058	5943 000 025
Centrifuge 5910 Ri, refrigerated, with Rotor FA-6x50	5943 000 149	5943 000 157	5943 000 165				
Centrifuge 5910 Ri, refrigerated, with Rotor S-4x750, incl. round buckets and adapters for 5 mL/15 mL/50 mL conical tubes	5943 000 516	5943 000 561	5943 000 581		5943 000 538	5943 000 554	5943 000 521
Centrifuge 5910 Ri, refrigerated, with Rotor S-4xUniversal, incl. universal buckets and adapters for 5 mL/15 mL/50 mL conical tubes and plates	5943 000 316	5943 000 361	5943 000 386		5943 000 335	5943 000 351	5943 000 327
Centrifuge 5910 Ri, refrigerated, with Rotor S-4xUniversal, incl. universal buckets and adapters for 5 mL/15 mL/50 mL conical tubes, 175 – 250 mL bottles and plates	5943 000 216	5943 000 266	5943 000 289		5943 000 238	5943 000 254	5943 000 228
Centrifuge 5910 Ri, refrigerated, with Rotor S-4xUniversal, incl. universal buckets, adapters for 175 - 250 mL and 1000 mL bottles and 1000 mL bottles	5943 000 173	5943 000 181	5943 000 198				
Centrifuge 5910 Ri, refrigerated, with Rotor S-4xUniversal, incl. universal buckets, adapters for 5 mL/15 mL/50 mL conical tubes and plates, adapters for 1000 mL bottles and 1000 mL bottles	5943 000 904	5943 000 912	5943 000 921		5943 000 947		
Centrifuge 5920 R, refrigerated, without rotor	5948 000 010	5948 000 060	5948 000 085	5948 000 093	5948 000 026	5948 000 050	5948 000 026
Centrifuge 5920 R, refrigerated, with Rotor S-4xUniversal-Large	5948 000 910	5948 000 960	5948 000 980			5948 000 956	5948 000 921
Centrifuge 5920 R, keypad, refrigerated, with Rotor S-4xUniversal-Large, incl. universal buckets and adapters for 5 mL/15 mL/25 mL/50 mL conical tubes and plates	5948 000 911	5948 000 961	5948 000 981			5948 000 957	5948 000 922
Centrifuge 5920 R, keypad, refrigerated, with Rotor S-4xUniversal-Large, incl. universal buckets and adapters for round-bottom tubes with diameter 13/16 mm	5948 000 810	5948 000 860	5948 000 883			5948 000 859	5948 000 824
Centrifuge 5920 R, keypad, refrigerated, with Rotor S-4x1000, incl. high-capacity buckets and adapters for 15 mL/50 mL conical tubes	5948 000 210	5948 000 260	5948 000 280		5948 000 220	5948 000 255	5948 000 220
Centrifuge 5920 R, keypad, refrigerated, with Rotor S-4x1000, incl. plate/tube buckets and adapters for 15 mL/50 mL conical tubes	5948 000 410	5948 000 460	5948 000 484		5948 000 425	5948 000 450	5948 000 425
Centrifuge 5920 R, keypad, refrigerated, with Rotor S-4x1000, incl. round buckets and adapters for 15 mL/50 mL conical tubes	5948 000 315	5948 000 365	5948 000 387		5948 000 328	5948 000 352	5948 000 328
Centrifuge 5920 R, keypad, refrigerated, High-Throughput Screening Solution, with Rotor S-4x1000, incl. plate/tube bucket and plate carrier	5948 000 174	5948 000 182	5948 000 190				

Centrifuges and Rotors - General Lab Products

Power supply	Europe	UK/HKG	Australia	China	Japan	Argentina	ROW
Concentrator plus basic device, w/o pump, with Rotor F-45-48-11	5305 000 100	5305 000 169	5305 000 185		5305 000 142	5305 000 150	5305 000 177
Concentrator plus complete system, with integrated diaphragm vacuum pump, with Rotor F-45-48-11	5305 000 304	5305 000 363	5305 000 380		5305 000 347	5305 000 355	5305 000 371
Concentrator plus complete system, with integrated diaphragm vacuum pump, without rotor	5305 000 509	5305 000 568	5305 000 584		5305 000 541	5305 000 550	5305 000 576
Concentrator plus complete system, with integrated diaphragm vacuum pump, with connection, e.g., for a gel dryer, without rotor	5305 000 703	5305 000 762	5305 000 589		5305 000 746	5305 000 754	5305 000 770

Power supply	230V Variant, no plug*	208V Variant, NEMA 6-30P plug	220V Variant, no plug*	200V Variant, no plug*
Example regions and countries	EU and India	USA	Australia, New Zealand, SEA, China	Japan
High-Speed Centrifuge CR22N	5721 220 012	5721 220 013	5721 220 011	5721 220 000
CR22N Harvesting Bundle (4 x 1.5 L), refrigerated, High-Speed Centrifuge CR22N incl. rotor R9A2 and 4 x 1.5 L triangular bottles	5721 261 412	5721 261 413	5721 261 411	-
High-Speed Centrifuge CR30NX, refrigerated	5721 300 012	5721 300 013	5721 300 011	5721 300 010
CR30NX Harvesting Bundle (4 x 1.5 L), refrigerated, High-Speed Centrifuge CR30NX incl. rotor R9A2 and 4 x 1.5 L triangular bottles	5721 351 512	5721 351 513	5721 351 511	-
Centrifuge CP100NX, refrigerated, touch interface	5720 110 012	5720 110 013	5720 110 011	5720 110 010
Centrifuge CP90NX, refrigerated, touch interface	5720 109 012	5720 109 013	5720 109 011	5720 109 010
Centrifuge CP80NX, refrigerated, touch interface	5720 108 012	5720 108 013	5720 108 011	5720 100 810

Power supply	230V Variant*	120V Variant, NEMA 5-15 plug	220V Variant*	100V Variant*
Example regions and countries	EU and India	USA	Australia, New Zealand, SEA, China	Japan
Centrifuge CS150FNX, refrigerated, floorstanding, touch interface	5720 121 511	5720 121 513	5720 121 501	5720 121 500
Centrifuge CS150NX, refrigerated, benchtop, touch interface	5720 131 511	5720 131 513	5720 131 501	5720 131 500

* Inquire with our service experts to install your fitting plug

PCR

Power supply	Europe	UK/HKG	Australia	China	Japan	Argentina	ROW
Mastercycler® nexus	6333 000 014	6333 000 049	6333 000 065	6333 000 073	6333 000 030	6333 000 081	6333 000 030
Mastercycler® nexus eco	6332 000 010	6332 000 045	6332 000 061	6332 000 070	6332 000 037	6332 000 088	6332 000 037
Mastercycler® nexus gradient	6331 000 017	6331 000 041	6331 000 068	6331 000 076	6331 000 033	6331 000 084	6331 000 033
Mastercycler® nexus gradient eco	6334 000 018	6334 000 042	6334 000 069	6334 000 077	6334 000 026	6334 000 085	6334 000 026
Mastercycler® nexus flat	6335 000 011	6335 000 046	6335 000 062	6335 000 070	6335 000 038	6335 000 089	6335 000 038
Mastercycler® nexus flat eco	6330 000 013	6330 000 048	6330 000 064	6330 000 072	6330 000 021	6330 000 080	6330 000 021
Mastercycler® nexus GSX1	6345 000 010	6345 000 044	6345 000 060	6345 000 079	6345 000 028	6345 000 087	6345 000 028
Mastercycler® nexus GSX1e	6347 000 017	6347 000 041	6347 000 068	6347 000 076	6347 000 025	6347 000 084	6347 000 025
Mastercycler® nexus SX1e	6348 000 010	6348 000 045	6348 000 061	6348 000 070	6348 000 029	6348 000 088	6348 000 029
Mastercycler® nexus SX1	6346 000 013	6346 000 048	6346 000 064	6346 000 072	6346 000 021	6346 000 080	6346 000 021
Mastercycler® nexus GX2	6336 000 015	6336 000 040	6336 000 066	6336 000 074	n.a.	6336 000 082	6336 000 023
Mastercycler® nexus GX2e	6338 000 012	6338 000 047	6338 000 063	6338 000 071	n.a.	6338 000 080	6338 000 020
Mastercycler® nexus X2	6337 000 019	6337 000 043	6337 000 060	6337 000 078	6337 000 027	6337 000 086	n.a.
Mastercycler® nexus X2e	6339 000 016	6339 000 040	6339 000 067	6339 000 075	n.a.	6339 000 083	6339 000 024
Mastercycler® X50s	6311 000 010	6311 000 045	6311 000 061	6311 000 070	n.a.	6311 000 088	n.a.
Mastercycler® X50a	6313 000 018	6313 000 042	6313 000 069	6313 000 077	n.a.	6313 000 085	n.a.
Mastercycler® X50p	6315 000 015	6315 000 040	6315 000 066	6315 000 074	n.a.	n.a.	n.a.
Mastercycler® X50h	6316 000 019	6316 000 043	6316 000 060	6316 000 078	n.a.	6316 000 086	n.a.
Mastercycler® X50i	6301 000 012	6301 000 047	6301 000 063	6301 000 071	n.a.	6301 000 080	n.a.
Mastercycler® X50l	6303 000 010	6303 000 044	6303 000 060	6303 000 079	n.a.	6303 000 087	n.a.
Mastercycler® X50r	6305 000 017	6305 000 041	6305 000 068	6305 000 076	n.a.	6305 000 084	n.a.
Mastercycler® X50t	6306 000 010	6306 000 045	6306 000 061	6306 000 070	n.a.	6306 000 088	n.a.
HeatSealer S100, incl. PCR Plate Adapter	5391 000 001	5391 000 036	5391 000 044	5391 000 060	n.a.	5391 000 079	5391 000 010
HeatSealer S200, incl. PCR Plate Adapter	5392 000 005	5392 000 030	5392 000 048	5392 000 064	n.a.	5392 000 072	5392 000 013

Freezers

Power supply	Europe/UK	Australia	China	115 V, 60 Hz	USA	Japan
CryoCube® F570n, 570 L, classic interface, green cooling liquids, air cooling, handle left side, 5 shelves	F571300031	F571300033	F571300034	F571200035	F571400035	
CryoCube® F570h, 570 L, classic interface, VIP, green cooling liquids, air cooling, handle left side, 5 shelves	F571340031	F571340033	F571340034	F571240035		
CryoCube® F570hw, 570 L, classic interface, VIP, green cooling liquids, water cooling, handle left side, 5 shelves	F571340131	F571340133	F571340134			
Innova® U535, 535 L, classic interface, VIP, classic cooling liquids, air cooling, handle left side, 3 shelves	U9430-0001	U535310003	U535310004	U9430-0000	U9430-0002	
CryoCube® F440h, 440 L, classic interface, VIP, green cooling liquids, air cooling, handle left side, 5 shelves	F440340031	F440340033	F440340034	F440240035		
CryoCube® F440n, 440 L, classic interface, green cooling liquids, air cooling, handle left side, 5 shelves	F440300031	F440300033	F440300034	F440200035	F440400035	
Innova® U360, ULT freezer, with LED interface, classic cooling liquids, and air-cooling	U9425-0001	U360310003	U360310004	U9425-0000		
Innova® C760, ULT chest freezer, with LED interface, classic cooling liquids, and air-cooling	U9410-0001	C760310003	C760310004		U9410-0002	
CryoCube® FC660, ULT chest freezer, with LED interface, classic cooling liquids, and air-cooling	F660300001	F660300003	F660300004		F660400005	
Innova® C585, ULT chest freezer, with LED interface, classic cooling liquids, and air-cooling	U9400-0001	C585310003		U9400-0000	U9400-0002	
CryoCube® FC660h, ULT chest freezer, with LED interface, green cooling liquids, and air-cooling	F660320001	F660320003	F660320004		F660420005 ¹⁾	
CO ₂ back-up system, for Innova® U101, U360, U535, U725/ -G, C585, C760, CryoCube® F101h and F740 series	U9043-0004			U9043-0002		F652999005
LN ₂ back-up system, for Innova® U101, U360, U535, U725/ -G, C585, C760, CryoCube® F101h and F740 series	U9044-0004			U9044-0002		F652999006
CO ₂ back-up system, for CryoCube® F440/ F570/ FC660 series, Premium U410, HEF® U410	U9043-0008			U9043-0006		
LN ₂ back-up system, for CryoCube® F440/ F570/ FC660 series, Premium U410, HEF® U410	U9044-0008			U9044-0006		
Innova® U101, ULT freezer, with LED interface, classic cooling liquids, and air-cooling				U9420-0000		

¹⁾ classic cooling in USA

Power supply	Europe	UK/HKG	Australia	China	USA	Japan
CryoCube® F101h, 101 L, classic interface, VIP, green cooling liquids, air cooling, handle right side, 2 shelves	F101340061	F101240062	F101240063	F101240064	F101240065	-
CryoCube® F740h, 3 c., 740 L, ULT freezer, with LED interface, green cooling liquids, and air-cooling, handle left side, 3 shelves	F740340011	F740340012	F740340013	F740340014	F740540015	F740040016
CryoCube® F740h, 3 c., 740 L, ULT freezer, with LED interface, green cooling liquids, and air-cooling, handle right side, 3 shelves	F740340021	F740340022	F740340023	F740340024	F740540025	F740040026
CryoCube® F740h, 5 c., 740 L, ULT freezer, with LED interface, green cooling liquids, and air-cooling, handle left side, 5 shelves	F740340031	F740340032	F740340033	F740340034	F740540035	F740400036
CryoCube® F740h, 5 c., 740 L, ULT freezer, with LED interface, green cooling liquids, and air-cooling, handle right side, 5 shelves	F740340041	F740340042	F740340043	F740340044	F740540045	F740040046
CryoCube® F740hi, 5 c., 740 L, ULT freezer, with touchscreen interface, green cooling liquids, and air-cooling, handle left side, 5 shelves	F740320031	F740320032	F740320033	F740320034	F740520035	F740020036
CryoCube® F740hi, 5 c., 740 L, ULT freezer, with touchscreen interface, green cooling liquids, and air-cooling, handle right side, 5 shelves	F740320041	F740320042	F740320043	F740320044	F740520045	F740020046
CryoCube® F740hi, 3 c., 740 L, ULT freezer, with touchscreen interface, green cooling liquids, and air-cooling, handle left side, 3 shelves	F740320011	F740320012	F740320013	F740320014	F740520015	F740020016
CryoCube® F740hi, 3 c., 740 L, ULT freezer, with touchscreen interface, green cooling liquids, and air-cooling, handle right side, 3 shelves	F740320021	F740320022	F740320023	F740320024	F740520025	F740020026
CryoCube® F740hiw, 5 c., 740 L, ULT freezer, with touchscreen interface, green cooling liquids, and water-cooling, handle left side, 5 shelves	F740320131	F740320132	F740320133	F740320134	F74052013	F740020136
CryoCube® F740hiw, 3 c., 740 L, ULT freezer, with touchscreen interface, green cooling liquids, and water-cooling, handle left side, 3 shelves	F740320111	F740320112	F740320113	F740320114	F740520115	F740020116

CO₂ Incubators

CellXpert® C170i Ordering Information

Device Options					Order no				
Door Segments	Door Handle	O ₂ Control	Humidity Monitor/ Water Level Sensor	Copper	230 V, 50/60 Hz	230 V, 50/60 Hz	230 V, 50/60 Hz	230 V, 50/60 Hz	100–120 V, 50/60 Hz
					European	UK/HKG	Australia	China	USA/Japan
1	Right				6731 000 011*	6731 000 012*	6731 000 013*	6731 000 014*	6731 010 015*
1	Right			Yes	6731 000 511	6731 000 512	6731 000 513	6731 000 514	6731 010 515
1	Right		Humidity monitor		6731 000 111*	6731 000 112*	6731 000 113*	6731 000 114*	6731 010 115*
1	Right		Water level sensor		6731 000 211*	6731 000 212*	6731 000 213*	6731 000 214*	6731 010 215*
1	Right		Both		6731 000 311*	6731 000 312*	6731 000 313*	6731 000 314*	6731 010 315*
1	Right	1–20%			6731 001 011*	6731 001 012*	6731 001 013*	6731 001 014*	6731 011 015*
1	Right	1–20%		Yes	6731 001 511	6731 001 512	6731 001 513	6731 001 514	6731 001 515
1	Right	1–20%	Both	Yes	6731 001 811	6731 001 812	6731 001 813	6731 001 814	6731 011 815
1	Left				6731 000 021*	6731 000 022*	6731 000 023*	6731 000 024*	6731 010 025*
1	Left			Yes	6731 000 521	6731 000 522	6731 000 523	6731 000 524	6731 010 525
1	Left		Humidity monitor		6731 000 121	6731 000 122	6731 000 123	6731 000 124	6731 010 125
1	Left		Water level sensor		6731 000 221	6731 000 222	6731 000 223	6731 000 224	6731 010 225
1	Left		Both		6731 000 321	6731 000 322	6731 000 323	6731 000 324	6731 010 325
1	Left	1–20%			6731 001 021*	6731 001 022*	6731 001 023*	6731 001 024*	6731 011 025*
1	Left	1–20%		Yes	6731 001 521	6731 001 522	6731 001 523	6731 001 524	6731 001 525
1	Left	1–20%	Both	Yes	6731 001 821	6731 001 822	6731 001 823	6731 001 824	6731 011 825
4	Right				6731 000 041*	6731 000 042*	6731 000 043*	6731 000 044*	6731 010 045*
4	Right		Both		6731 000 341	6731 000 342	6731 000 343	6731 000 344	6731 010 345
4	Right		Both	Yes	6731 000 841	6731 000 842	6731 000 843	6731 000 844	6731 010 845
4	Right	1–20%			6731 001 041*	6731 001 042*	6731 001 043*	6731 001 044*	6731 011 045*
4	Right	1–20%	Both		6731 001 341	6731 001 342	6731 001 343	6731 001 344	6731 011 345
4	Left				6731 000 051	6731 000 052	6731 000 053	6731 000 054	6731 010 055
4	Left		Both		6731 000 351	6731 000 352	6731 000 353	6731 000 354	6731 010 355
4	Left		Both	Yes	6731 000 851	6731 000 852	6731 000 853	6731 000 854	6731 010 855
4	Left	1–20%	Both		6731 001 351	6731 001 352	6731 001 353	6731 001 354	6731 011 355
4	Left	1–20%			6731 001 051	6731 001 052	6731 001 053	6731 001 054	6731 011 055
8	Right	1–20%			6731 001 081*	6731 001 082*	6731 001 083*	6731 001 084*	6731 011 085*
8	Left	1–20%			6731 001 091	6731 001 092	6731 001 093	6731 001 094	6731 011 095

* Stock article; all others are built-to-order

CellXpert® C170 Ordering Information

Device Options	Order no				
	230 V, 50/60 Hz	230 V, 50/60 Hz	230 V, 50/60 Hz	230 V, 50/60 Hz	100–120 V, 150/60 Hz
Door Handle	European	UK/HKG	Australia	China	USA/Japan
CellXpert® C170, non-segmented inner door, handle right side	6734 000 011	6734 000 012	6734 000 013	6734 000 014	6734 010 015
CellXpert® C170, inner door with 4 door segments, handle right side	6734 000 041	6734 000 042	6734 000 043	6734 000 044	6734 010 045

Power supply

	Europe	UK/HKG	Australia	China	ROW
New Brunswick S41i	S411230011	S411230012	S411230013	S411230014	S411120010

Lab Shakers

Power supply	230 V, 50 Hz	120 V, 60 Hz	100 V, 60 Hz	100 V, 50 Hz
New Brunswick Innova® 40, 1.9 cm (3/4 in)	M1299-0082	M1299-0080	M1299-0081	M1299-0083
New Brunswick Innova® 40, 2.5 cm (1 in)	M1299-0092	M1299-0090	M1299-0091	M1299-0093
New Brunswick Innova® 40R, 1.9 cm (3/4 in)	M1299-0086	M1299-0084	M1299-0085	M1299-0087
New Brunswick Innova® 40R, 2.5 cm (1 in)	M1299-0096	M1299-0094	M1299-0095	M1299-0097
New Brunswick Innova® 42, 1.9 cm (3/4 in)	M1335-0002	M1335-0000	M1335-0001	M1335-0003
New Brunswick Innova® 42, 2.5 cm (1 in)	M1335-0012	M1335-0010	M1335-0011	M1335-0013
New Brunswick Innova® 42R, 1.9 cm (3/4 in)	M1335-0006	M1335-0004	M1335-0005	M1335-0007
New Brunswick Innova® 42R, 2.5 cm (1 in)	M1335-0016	M1335-0014	M1335-0015	M1335-0017
New Brunswick Innova® 43, 2.5 cm (1 in)	M1320-0002	M1320-0000	M1320-0001	M1320-0003
New Brunswick Innova® 43, 5.1 cm (2 in)	M1320-0012	M1320-0010	M1320-0011	M1320-0013
New Brunswick Innova® 43R, 2.5 cm (1 in)	M1320-0006	M1320-0004	M1320-0005	M1320-0007
New Brunswick Innova® 43R, 5.1 cm (2 in)	M1320-0016	M1320-0014	M1320-0015	M1320-0017
New Brunswick Innova® 44, 2.5 cm (1 in)	M1282-0002	M1282-0000	M1282-0001	M1282-0003
New Brunswick Innova® 44, 5.1 cm (2 in)	M1282-0012	M1282-0010	M1282-0011	M1282-0013
New Brunswick Innova® 44R, 2.5 cm (1 in)	M1282-0006	M1282-0004	M1282-0005	M1282-0007
New Brunswick Innova® 44R, 5.1 cm (2 in)	M1282-0016	M1282-0014	M1282-0015	M1282-0017

Power supply	Europe	UK/HKG	Australia	China	Japan	Argentina	Brazil	ROW
Innova® S44i, 2.5 cm (1 in) orbit, orbit 2.5 cm (1 in), incubated	S44I300001	S44I300002	S44I300003	S44I300004	S44I000006	S44I300008	S44I300009	S44I200005
Innova® S44i, 2.5 cm (1 in) orbit, orbit 2.5 cm (1 in), refrigerated	S44I310001	S44I310002	S44I310003	S44I310004	S44I010006	S44I310008	S44I310009	S44I210005
Innova® S44i, 2.5 cm (1 in) orbit, orbit 2.5 cm (1 in), refrigerated, photosynthetic LED light bank	S44I311001	S44I311002	S44I311003	S44I311004		S44I311008	S44I311009	S44I211005
Innova® S44i, 5.1 cm (2 in) orbit, orbit 5.1 cm (2 in), incubated	S44I320001	S44I320002	S44I320003	S44I320004	S44I020006	S44I320008	S44I320009	S44I220005
Innova® S44i, 5.1 cm (2 in) orbit, orbit 5.1 cm (2 in), refrigerated	S44I330001	S44I330002	S44I330003	S44I330004	S44I030006	S44I330008	S44I330009	S44I230005
Innova® S44i, 5.1 cm (2 in) orbit, orbit 5.1 cm (2 in), refrigerated, photosynthetic LED light bank	S44I331001	S44I331002	S44I331003	S44I331004		S44I331008	S44I331009	S44I231005

Centrifuges and Rotors - EU-IVD Products

Power supply	Europe	UK	China ¹⁾
Centrifuge MiniSpin® plus, non-refrigerated, with Rotor F-45-12-11	5453 000 011	5452 000 069	5452 000 093
Centrifuge MiniSpin®, non-refrigerated, with Rotor F-45-12-11	5452 000 018	5453 000 062	5453 000 097
Centrifuge 5418 R, refrigerated, with Rotor FA-45-18-11 and rotor lid	5401 000 013	5401 000 064	5401 000 099
Centrifuge 5420, keypad, non-refrigerated, without rotor	5420 000 210	5420 000 261	5420 000 296
Centrifuge 5420, keypad, non-refrigerated, with aerosol-tight Rotor FA-24x2	5420 000 016	5420 000 067	5420 000 091
Centrifuge 5425, keypad, refrigerated, without rotor	5405 000 212	5405 000 263	5405 000 298
Centrifuge 5425, rotary knobs, refrigerated, without rotor	5405 000 611	5405 000 662	5405 000 697
Centrifuge 5425, keypad, refrigerated, with Rotor FA-24x2	5405 000 018	5405 000 069	5405 000 093
Centrifuge 5425, rotary knobs, refrigerated, with Rotor FA-24x2	5405 000 417	5405 000 468	5405 000 492
Centrifuge 5425, rotary knobs, non-refrigerated, Molecular Biology Solution, with Rotor FA-18x2-Kit	5405 000 158		
Centrifuge 5425 R, keypad, non-refrigerated, without rotor	5406 000 216	5406 000 267	5406 000 291
Centrifuge 5425 R, rotary knobs, non-refrigerated, without rotor	5406 000 615	5406 000 666	5406 000 690
Centrifuge 5425 R, keypad, non-refrigerated, with Rotor FA-24x2	5406 000 011	5406 000 062	5406 000 097
Centrifuge 5425 R, rotary knobs, non-refrigerated, with Rotor FA-24x2	5406 000 410	5406 000 461	5406 000 496
Centrifuge 5427R, rotary knobs, refrigerated, without rotor	5429 000 015	5429 000 065	5429 000 097
Centrifuge 5427R, rotary knobs, refrigerated, with Rotor FA-45-30-11	5429 000 315	5429 000 365	5429 000 397
Centrifuge 5427R, rotary knobs, refrigerated, with Rotor FA-45-48-11	5429 000 215	5429 000 265	5429 000 297
Centrifuge 5430 R, keypad, refrigerated, with Rotor FA-45-30-11 incl. rotor lid	5428 000 015	5428 000 066	5428 000 090
Centrifuge 5430 R, rotary knobs, refrigerated, with Rotor FA-45-30-11 incl. rotor lid	5428 000 414	5428 000 465	5428 000 490
Centrifuge 5430 R, keypad, refrigerated, without rotor	5428 000 210	5428 000 260	5428 000 295
Centrifuge 5430 R, rotary knobs, refrigerated, without rotor	5428 000 619	5428 000 660	5428 000 694
Centrifuge 5430, keypad, non-refrigerated, with Rotor FA-45-30-11 incl. rotor lid	5427 000 216	5427 000 267	5427 000 291
Centrifuge 5430, rotary knobs, non-refrigerated, with Rotor FA-45-30-11 incl. rotor lid	5427 000 410	5427 000 461	5427 000 496
Centrifuge 5430, keypad, without rotor	5427 000 011	5427 000 062	5427 000 097
Centrifuge 5430, rotary knobs, non-refrigerated, without rotor	5427 000 615	5427 000 666	5427 000 690
Centrifuge 5702, rotary knobs, with Rotor A-4-38 incl. adapters for 15/50 mL conical tubes, 2 sets of 2 adapters	5702 000 329	5702 000 361	5702 000 396
Centrifuge 5702 R, rotary knobs, refrigerated, with Rotor A-4-38 incl. adapters for 15/50 mL conical tubes, 2 sets of 2 adapters	5703 000 420	5703 000 462	5703 000 497
Centrifuge 5702 R, rotary knobs, refrigerated, with Rotor A-4-38 incl. adapters for 13/16 mm blood collection tubes, 2 sets of 2 adapters	5703 000 322	5703 000 365	5703 000 390
Centrifuge 5702 R, rotary knobs, refrigerated, without rotor	5703 000 012	5703 000 063	5703 000 098
Centrifuge 5702 RH, rotary knobs, refrigerated/heated, without rotor	5704 000 016	5704 000 067	5704 000 091
Centrifuge 5702, rotary knobs, without rotor	5702 000 019	5702 000 060	5702 000 094
Centrifuge 5702, rotary knobs, non-refrigerated, with Rotor A-4-38 incl. adapters for round-bottom tubes 4 – 10 mL and adapters for round-bottom tubes 2.6 – 7 mL, 2 sets of 2 adapters	5702 000 510	5702 000 558	5702 000 574
Centrifuge 5804, keypad, non-refrigerated, with Rotor A-4-44 incl. adapters for 15/50 mL conical tubes	5804 000 323	5804 000 366	5804 000 390
Centrifuge 5804, keypad, non-refrigerated, with Rotor S-4-72 incl. adapters for 15/50 mL conical tubes	5804 000 528	5804 000 560	5804 000 595
Centrifuge 5804 R, keypad, refrigerated, with Rotor A-4-44 incl. adapters for 15/50 mL conical tubes	5805 000 327	5805 000 360	5805 000 394
Centrifuge 5804 R, keypad, refrigerated, with Rotor S-4-72 incl. adapters for 15/50 mL conical tubes	5805 000 629	5805 000 661	5805 000 696
Centrifuge 5804 R, keypad, refrigerated, without rotor	5805 000 017	5805 000 068	5805 000 092
Centrifuge 5804, keypad, non-refrigerated, without rotor	5804 000 013	5804 000 064	5804 000 099
Centrifuge 5810, keypad, non-refrigerated, with Rotor A-4-62 incl. adapters for 15/50 mL conical tubes	5810 000 327	5810 000 360	5810 000 394
Centrifuge 5810, keypad, non-refrigerated, with Rotor A-4-81 incl. adapters for 15/50 mL conical tubes	5810 000 424	5810 000 467	5810 000 491
Centrifuge 5810, keypad, non-refrigerated, with Rotor S-4-104 incl. adapters for 15/50 mL conical tubes	5810 000 521	5810 000 564	5810 000 599
Centrifuge 5810, keypad, non-refrigerated, with Rotor S-4-104 incl. adapters for 13/16 mm round-bottom tubes	5810 000 629	5810 000 661	5810 000 696
Centrifuge 5810 R, keypad, refrigerated, with Rotor A-4-62 incl. adapters for 15/50 mL conical tubes	5811 000 320	5811 000 363	5811 000 398
Centrifuge 5810 R, keypad, refrigerated, with Rotor A-4-81 incl. adapters for 15/50 mL conical tubes	5811 000 428	5811 000 460	5811 000 495
Centrifuge 5810 R, keypad, refrigerated, with Rotor S-4-104 incl. adapters for 15/50 mL conical tubes	5811 000 622	5811 000 665	5811 000 690
Centrifuge 5810 R, keypad, refrigerated, with Rotor S-4-104 incl. adapters for 13/16 mm round-bottom tubes	5811 000 827	5811 000 860	5811 000 894
Centrifuge 5810 R, keypad, refrigerated, without rotor	5811 000 010	5811 000 061	5811 000 096
Centrifuge 5810, keypad, non-refrigerated, without rotor	5810 000 017	5810 000 068	5810 000 092
Centrifuge 5910 Ri, refrigerated, without rotor	5943 000 017	5943 000 068	5943 000 092
Centrifuge 5910 Ri, refrigerated, with Rotor S-4x750, incl. round buckets and adapters for 5 mL/15 mL/50 mL conical tubes	5943 000 511	5943 000 564	5943 000 599
Centrifuge 5910 Ri, refrigerated, with Rotor S-4xUniversal, incl. universal buckets and adapters for 5 mL/15 mL/50 mL conical tubes and plates	5943 000 319	5943 000 368	5943 000 394
Centrifuge 5910 Ri, refrigerated, with Rotor S-4xUniversal, incl. universal buckets and adapters for 5 mL/15 mL/50 mL conical tubes, 175 – 250 mL bottles and plates	5943 000 211	5943 000 262	5943 000 297
Centrifuge 5920 R, keypad, refrigerated, without rotor	5948 000 018	5948 000 069	5948 000 093
Centrifuge 5920 R, keypad, refrigerated, with Rotor S-4x1000, incl. high-capacity buckets and adapters for 15 mL/50 mL conical tubes	5948 000 212	5948 000 263	5948 000 298
Centrifuge 5920 R, keypad, refrigerated, with Rotor S-4x1000, incl. round buckets and adapters for 15 mL/50 mL conical tubes	5948 000 310	5948 000 360	5948 000 395
Centrifuge 5920 R, keypad, refrigerated, with Rotor S-4x1000, incl. plate/tube buckets and adapters for 15 mL/50 mL conical tubes	5948 000 417	5948 000 468	5948 000 492
Centrifuge 5920 R, keypad, refrigerated, with Rotor S-4xUniversal-Large, incl. universal buckets and adapters for round-bottom tubes with diameter 13/16 mm	5948 000 816	5948 000 867	5948 000 891
Centrifuge 5920 R, keypad, refrigerated, with Rotor S-4xUniversal-Large, incl. universal buckets and adapters for 5 mL/15 mL/25 mL/50 mL conical tubes and plates	5948 000 914	5948 000 965	5948 000 998

¹⁾ Listed articles (except for Centrifuge 5920 R) registered as medical devices class 1 in China.

More Information for You:

Our distributors



Your local contact

www.eppendorf.com/distributors/

Legal notices, trademarks, patent and design attributions



Trademarks of third parties may appear on this catalogue when referring to their products or services. All trademarks are the property of their respective owners. The trademark name representations and listed owners can be found here:

www.eppendorf.com/trademarks

Contact: General Enquiries 01438 735 888



Eppendorf UK Limited
Gateway 1000 · Whittle Way
Arlington Business Park
Stevenage · SG1 2FP
Phone.: +44 (0)1438 735 888
Fax: +44 (0)1438 735 889



www.eppendorf.co.uk
sales@eppendorf.co.uk



Eppendorf Online Shop
www.eppendorf.com/eshop

Application Support



UK Application Hotline:
+44 (0) 1438 735 880
support@eppendorf.com

North America:
+1 800 645 3050, menu option 2
techserv@eppendorf.com

Asia Pacific Africa:
+603 8023 6869
support_asiapacific@eppendorf.com

Eppendorf Bioprocessing-Catalogue. More info at www.eppendorf.com/catalog



Your local distributor: www.eppendorf.com/contact
Eppendorf UK Limited · Stevenage SG1 2FP · United Kingdom
sales@eppendorf.co.uk · www.eppendorf.co.uk