

We are in the process of ensuring this document is accessible to all audiences. If you need assistance accessing this document, or any materials on the EPA East Palestine, Ohio emergency response webpages, please contact the Region 5 Public Information Officer on-call [r5\\_eastpalestine@epa.gov](mailto:r5_eastpalestine@epa.gov)



Norfolk Southern Railway Company

# Characterization Work Plan for Derailment-Area Soil

**East Palestine Train Derailment Site  
East Palestine, Ohio**

September 7, 2023  
V 3.6

Characterization Work Plan for Derailment-Area Soil  
September 7, 2023  
V 3.6

# Characterization Work Plan for Derailment- Area Soil

**East Palestine Train Derailment  
Columbiana County, Ohio**

September 7, 2023

**Prepared By:**

Arcadis U.S., Inc.  
7575 Huntington Park Drive, Suite 130  
Columbus  
Ohio 43235  
Phone: 614 985 9100  
Fax: 614 985 9170

**Prepared For:**

Mr. Daniel Hunt  
Regional Manager Environmental Remediation  
Norfolk Southern Railway Company

**Our Ref:**

30169714



## Version Control

Revision No.	Date Issued	Description
1.0	March 6, 2023	Initial submittal
2.0	May 5, 2023	Updated plan incorporating revised sampling design and parameter list
2.1	May 10, 2023	Further revised sampling design and parameter list
3	June 13, 2023	Current submittal, revised sampling design and parameter list
3.1	July 12, 2023	Updated to address EU draft comments dated 6/23/23 and subsequent discussions
3.2	July 18, 2023	Updated to address EU draft comments dated 7/15/23
3.3	July 23, 2023	Updated to address modifications from the USEPA on 7/20/23
3.4	August 11, 2023	Updated to address non-substantive changes from V3.3.
3.5	August 29, 2023	Updated to reflect changes to analytical program identified during QAPP finalization.
3.6	September 7, 2023	Updated to address modifications from the USEPA on 9/4/2023

## Contents

<b>1</b>	<b>Introduction</b> .....	<b>1</b>
<b>2</b>	<b>Purpose and Scope</b> .....	<b>2</b>
<b>3</b>	<b>Interim Conceptual Site Model</b> .....	<b>3</b>
<b>3.1</b>	<b>Categorization of Areas</b> .....	<b>3</b>
<b>3.2</b>	<b>Sequence and Timing of Activities</b> .....	<b>6</b>
<b>4</b>	<b>Sample Design</b> .....	<b>8</b>
<b>4.1</b>	<b>ISM Design for Categories 1 through 3</b> .....	<b>8</b>
<b>4.2</b>	<b>Discrete Sampling Method Design for Categories 1 through 3</b> .....	<b>9</b>
<b>4.3</b>	<b>Subsurface Conveyance Features</b> .....	<b>11</b>
<b>4.4</b>	<b>Vapor Intrusion Assessment</b> .....	<b>13</b>
<b>4.5</b>	<b>Other Sampling</b> .....	<b>14</b>
<b>5</b>	<b>Sampling Procedures</b> .....	<b>15</b>
<b>5.1</b>	<b>Surface Soil and Sediment Sampling Procedures</b> .....	<b>15</b>
<b>5.2</b>	<b>ISM Replicate Sampling</b> .....	<b>17</b>
<b>5.3</b>	<b>Subsurface Soil Sampling Procedure</b> .....	<b>18</b>
<b>5.4</b>	<b>Building Vapor Sampling Procedures</b> .....	<b>19</b>
<b>5.4.1</b>	<b>Ambient Air Sampling Procedures</b> .....	<b>19</b>
<b>5.4.2</b>	<b>Indoor Air Sampling Procedures</b> .....	<b>20</b>
<b>5.4.3</b>	<b>Sub-Slab Vapor Port Installation and Sampling Plan</b> .....	<b>20</b>
<b>5.4.3.1</b>	<b>Leak Testing</b> .....	<b>21</b>
<b>5.5</b>	<b>Sample Nomenclature</b> .....	<b>21</b>
<b>5.6</b>	<b>Sample Summary</b> .....	<b>22</b>
<b>6</b>	<b>Laboratory Analysis and QA/QC</b> .....	<b>24</b>
<b>6.1</b>	<b>Analytical Parameters and Screening Levels</b> .....	<b>24</b>
<b>6.1.1</b>	<b>Soil Screening Levels</b> .....	<b>24</b>
<b>6.1.2</b>	<b>Soil Vapor and Indoor Air Screening Levels</b> .....	<b>25</b>
<b>6.1.3</b>	<b>Sediment Screening Levels</b> .....	<b>25</b>
<b>6.2</b>	<b>QA/QC Samples and Validation</b> .....	<b>25</b>
<b>7</b>	<b>Data Review and Evaluation</b> .....	<b>27</b>
<b>7.1</b>	<b>Review of Category 1A Data</b> .....	<b>27</b>
<b>7.2</b>	<b>Review Process for ISM Sample Results</b> .....	<b>28</b>

7.2.1	Replicate Sample Evaluation.....	28
7.2.2	Sample Result Evaluation.....	28
7.3	Review Process for Discrete VOC samples.....	30
7.4	Subsurface Conveyance Sample Data Review.....	31
7.5	Soil Gas and Indoor Air Sample Data Review .....	32
8	Reporting.....	33
9	References .....	34

## Tables

Table 1. Conceptual Site Model Summary Table

Table 2. Schedule Predecessors

Table 3. Soil Sampling Plan

Table 4. Proposed Soil Screening Levels

Table 5. Proposed Sediment Screening Levels

Table 6. Commercial Vapor Intrusion Screening Level (VISL) Calculations

## Figures

Figure 1. Site Working Area

Figure 2. Surface Water Flow

Figure 3. Car Scrapping 3

Figure 4. Car Scrapping 4

Figure 5. Ditch East of Car Scrapping 4

Figure 6. South Ditch East of Pleasant

Figure 7. South Ditch West of Pleasant

Figure 8. North Ditch West of Pleasant

Figure 9. PA Waste Staging

Figure 10. Park Drive

Figure 11. Bacon Ave and Upper Level Park

Figure 12. Wastewater 1 and Wastewater 2

Figure 13. Car Scrapping 2

- Figure 14. Car Scrapping 1**
- Figure 15. Tank Farm 1**
- Figure 16. Upland of the Main Line East**
- Figure 17. Upland of North Ditch**
- Figure 18. Tank Farm 2**
- Figure 19. Tank Farm 3**
- Figure 20. Tank Farm 5**
- Figure 21. Tank Farm 6**
- Figure 22. Waste Staging**
- Figure 23. Wetland Phase 1**
- Figure 24. Underground Features**
- Figure 25. Standby Tank Area 1**
- Figure 26: Standby Tank Area 2**
- Figure 27: WWTP Effluent Tanks**
- Figure 28. Sample Evaluation Decision Logic**

## **Exhibits**

<b>Exhibit 1. VSP Model Summary.....</b>	<b>10</b>
<b>Exhibit 2a. Example VSP Output for a Narrow DU .....</b>	<b>10</b>
<b>Exhibit 2b. Example of Manually placed samples in a Narrow DU .....</b>	<b>10</b>
<b>Exhibit 3. Subsurface Feature Sample Locations Concept – Plan View.....</b>	<b>12</b>
<b>Exhibit 4. Subsurface Feature Sample Locations Concept – Cross Section View A .....</b>	<b>12</b>
<b>Exhibit 5. Subsurface Feature Sample Locations Concept – Cross Section View B .....</b>	<b>13</b>
<b>Exhibit 6. DU Replicate Summary .....</b>	<b>18</b>
<b>Exhibit 7. VISL Calculator Inputs .....</b>	<b>25</b>
<b>Exhibit 8. DU Delineation Concept.....</b>	<b>29</b>

## Attachments

**Attachment 1. Decision Unit Sample Points**

**Attachment 2. Technical Guidance Instructions**

# 1 Introduction

This Characterization Work Plan for Derailment-Area Soil (Plan) was developed on behalf of Norfolk Southern Railway Company (NSRC) by Arcadis US, Inc. (Arcadis) in response to the derailment in East Palestine, Ohio (Site), and pursuant to the United States Environmental Protection Agency (USEPA) February 21, 2023 Unilateral Administrative Order for Removal Actions (UAO), effective February 27, 2023. This Plan outlines the objectives and procedures for characterization activities related to the derailment conducted relative to soil in the vicinity of the derailment and is intended to satisfy the requirements for submittals relative to these media in Paragraphs 36 and 38 of the UAO.

As part of a larger group of plans collectively making up the project Removal Work Plan, the work described in this Plan will be conducted in accordance with the Quality Assurance Project Plan, Health and Safety Plan, and other overall documents that provide procedures for sample collection, identification, and analysis. Media-specific sampling and analysis procedures are presented below to support the scope of work discussed herein.

"Unified Command" in this Plan refers to the incident management structure established by USEPA under the UAO and the Incident Command System. The Unified Command team includes USEPA incident managers as well as representatives from state and federal agencies such as the Ohio Environmental Protection Agency (Ohio EPA) and the Pennsylvania Department of Environmental Protection. As described in this Plan, Unified Command will work collaboratively to review characterization and remediation decisions.

## 2 Purpose and Scope

The purpose of this Plan is to identify and guide implementation efforts to delineate the extent of contamination for surface and subsurface soils, identify areas that may be potential long-term sources of groundwater contamination, identify potential preferential pathways, and assess potential vapor intrusion issues. Short-term characterization and removal of soil in the NSRC right-of-way and some adjacent areas, including the burn pit areas, north and south ditch areas, and car scrapping areas, are addressed under a separate plan (i.e., Appendix D - the Main Line Interim Soil Removal Work Plan). Additional data collection is proposed beyond what was required under Appendix D to meet the requirements the UAO, including what is proposed in this Plan.

Initial removal of surficial soil during the process of closing of some of the operational areas will take place under the direction of on-site operational personnel; however, for those areas where contaminants of concern exceed the screening levels, additional review of these areas will be conducted to evaluate the need to address future removal/remedial action under a separate plan.

The sampling activities described herein are intended to evaluate the following questions for the areas shown on **Figures 1a** and **1b**:

- Does sufficient data exist to inform the refinement of a Conceptual Site Model (CSM), and future development of a risk assessment and/or remedial action approach, where necessary?
- Are there areas or decision units where the data show that all constituents analyzed are below screening levels and therefore require no further action?
- If a decision unit or samples within a decision unit exceed screening levels for a given area, do the data suggest that further delineation is required prior to removal/remediation?
- Do conditions in or near preferential pathways that are known or suspected of carrying derailment materials, such as storm sewers, pose a potential risk to indoor air?
- Do subsurface conveyances act as a conduit for horizontal and vertical distribution of contaminants in soil?

Additional soil sampling may be proposed in consultation with the USEPA, as necessary, based on the results of the sampling proposed in this Plan. Implementation of this Plan will be completed by NSRC, its consultants, and/or contractors.

## 3 Interim Conceptual Site Model

Soil sampling conducted under this Plan will focus on areas near the derailment location where equipment, materials, and debris were handled as part of the overall emergency response with evaluation of the data driving the need to investigate beyond these boundaries. As part of ongoing response activities, these areas may undergo temporary site restoration to return them to original conditions. An understanding of the use of these areas, aided by extensive aerial photography of the Site, and the physical features have been used to develop the sampling design.

### 3.1 Categorization of Areas

In order to support expedient characterization of these areas, a categorical framework is proposed to group areas with similar characteristics together and allow use of a consistent characterization approach across each category. The similar characteristics are based on the understanding of the release of hazardous materials and their deposition following the derailment and subsequent response activities. Note that for this document the “Site Working Area”, as shown on **Figures 1a** and **1b** and subsequent figures (**Figures 2** through **27**), includes the categories defined below and extends to the property boundaries in which site activities are occurring (if a commercial property) or the next property outside of working limits (if a residential property). Exceptions to this approach include the following:

- The limits of the work areas in Pennsylvania extend 25 feet beyond the investigation areas, including around the PA Waste Staging Area.
- Along the eastern and southern boundary of Tank Farms 3, 5, and 6 where the Bogner property areas abut the Tank Farms, the work areas do not extend to the property boundary.

Section 7 addresses the areas that are not specifically identified in the categories described below; but are included in the Site Working Area.

Refer to **Figures 1** and **1b** for the defined extents of each specific investigation category discussed below. **Figure 2** is provided as a reference to the known surface water flow pathways prior to the derailment to clarify what ditches and site features were present before the derailment and response activities. A more detailed description of the CSM for each of the investigation categories and areas is included in **Table 1**, I which includes information associated with topographic flow, land use, and specifics relative to the materials handled in these areas. These categories include:

**Category 1A:** These areas are represented by Main Line 1, Main Line 2, the centerline (i.e., area between Main Lines 1 and 2), the North Ditch east of Pleasant Avenue, and Pleasant Avenue; were likely impacted by the derailment; and excavation was required as part of Appendix D – Main Line Interim Soil Removal Plan. Samples have been collected at the base of the excavation for confirmation that the primary constituents as part of that plan were less than the screening levels. These areas have or are being backfilled and restored. To inform the need for additional future sampling in Category 1A areas, the following will be reviewed:

- Category 1A samples that were analyzed under the Appendix D work plan will be re-reported from the laboratory for the volatile organic compound (VOC) and semi volatile organic compound (SVOC) analytes associated with this Plan (**Section 6**).



- The data collected from the adjacent Category 1 areas, along with the confirmation samples from the Category 1A areas, will be reviewed to inform the need for additional future sampling.

Refer to **Section 7** for further discussion.

**Category 1:** These areas are likely impacted by the derailment and removal action is required. In each of these areas initial removal of impacted soil will occur in accordance with the Appendix D – Main Line Interim Soil Removal Plan or at the direction of on-site operational personnel. Characteristics of Category 1 areas include:

- Locations of potential product releases including areas of direct contact between soil and hazardous material rail cars during wrecking and scrapping operations:
  - Car Scrapping 3 (also known as North Car Scrapping Area), modified to include:
    - Burn Pits 1 and 2
    - Appendix D areas that could not be excavated during track and ditch work as a result of health and safety concerns including: CON-10-CSA3, CON-12-CSA3, CON-14-CSA3, CON-16-CSA3, CON-18-CSA3, CON-20-CSA3, CON-22-CSA3
    - Additional Appendix D areas that were located between burn pits, essentially the North Ditch between the burn pits (CON-01-CSA3, CON-02-CSA3, CON-03-CSA3, CON-04-CSA3, CON-05-CSA3, CON-06-CSA3, CON-07-CSA3, CON-08-CSA3, CON-09-CSA3, CON-11-CSA3, CON-13-CSA3, CON-15-CSA3, CON-17-CSA3, CON-19-CSA3, CON-21-CSA3)
  - Car Scrapping 4 (also known as South Car Scrapping Area)
- Locations that may have conveyed product releases or firefighting water:
  - South Ditch (east and west of Pleasant)
  - Ditch east of Car Scrapping 4
  - North Ditch west of Pleasant Avenue

**Category 2:** These areas may have been impacted by the derailment and immediate response or areas that handled waste containers. Characteristics of these areas include:

- Potential impacts in these areas may have been subject to transport mechanisms rather than direct release from rail cars.
- Impacts in these areas may be predominantly in surface soils, except where noted.
- Areas where removal efforts occurred associated with Sulphur Run and Leslie Run:
  - Park Drive 1 - Potential incidental releases during removal in Sulphur Run; noting that the area has already been scraped
  - Park Drive 3 - Waste storage and equipment storage during water removal efforts in Leslie Run
  - Bacon Ave – Waste storage during removal efforts
  - Upper Level Park – Waste storage during removal efforts
- Areas where potential drippage/containment leakage occurred including:
  - Wastewater 1 where temporary drum storage and decontamination efforts associated with the sentinel well program occurred
  - Car Scrapping 1 (former HEPACO command post) and 2 (currently the South Ditch Basin and Tank Farm 4 areas) where rail car scrapping activities for non-hazardous materials cars occurred

## Characterization Work Plan for Derailment – Area Soil

September 7, 2023

V 3.6

- Tank Farms 2, 3, 5, and 6 where temporary storage of frac tanks or roll-off boxes have been handled
- Tank Farm 1 where temporary storage of frac tanks or roll-off boxes have been handled. Work in this area is being deferred as a result of the use of this area for the temporary wastewater treatment system (i.e., 1 million-gallon tanks and treatment equipment)
- Subsurface features (such as drainage piping) conveyed liquid materials released as a result of the derailment from the derailment area. May also include subsurface utilities with coarse backfill that may have conveyed liquids. A number of these features within the Category 1A and 1 areas have been removed during Appendix D activities. Additional investigation will be conducted to assess the location of subsurface conveyance features and their condition in order to assess the potential for soil impacts adjacent to these features. Known sources are identified below:
  - CeramFab stormwater system, including the portion removed adjacent to Car Scrapping 4
  - South Ditch East of Pleasant terracotta piping that was part of the railroad drainage system and may have had other businesses tied into it
  - Strohecker building and parking lot where several drains are known to be tied together and product was found evident during the initial responses
  - Upland North Ditch terracotta piping that was part of the railroad drainage system
- Areas topographically higher in elevation relative to adjacent North Ditch removal efforts:
  - Upland North Ditch represents an area that is upland of the portion of the North Ditch excavation completed as part of Appendix D.
  - Upland Main Line East is an area that prior to the derailment didn't convey water except as it was part of the railroad drainage system. This area is divided into sections where a topographic divide is located.
- The waste staging area is used for stockpiling of soils, loadout, and washing of trucks. Although the area is lined, after waste piles are removed, sampling will be conducted to confirm that surface impacts are not present.
- The wetland area northeast of the derailment.

**Category 3:** These areas may have been impacted by the derailment, but the degree of impact is uncertain and may be lower than Categories 1, 1A, and 2. Characteristics include:

- Areas used for the placement of aeration equipment in support of the Sulphur Run and Leslie Run responses:
  - Park Drive 2 and 4 areas were used only for aeration equipment
  - Wastewater 2 was used for aeration equipment
- Other areas where limited impacts from the derailment activities are likely to be present:
  - Standby Tank Areas 1 and 2
  - Wastewater Treatment Plant Effluent Tanks.

In areas surrounding the Category 1 and 1A areas, where buildings are present, there is a potential for vapor intrusion. The mapping of subsurface conveyances (Section 4.3), the sidewall sampling from Category 1 excavations, and response activities will inform where vapor intrusion may be a potential issue for evaluation. The two known areas with a potential for vapor intrusion include the CeramFab building and the Strohecker building, both south of the tracks, topographically downgradient from the release area, and adjacent to the South Ditch which conveyed free product. Brave Industries and Advanced Ceramics, north of the tracks will also be evaluated for vapor intrusion. Additional soil vapor/indoor air investigation areas may be identified during implementation of

this Plan. Refer to Section 4.3 and 4.4 for the evaluation process associated with identification of potential subsurface conveyances as well as the locating of the appropriate samples for soil vapor/indoor air investigation.

**Category 4:** These areas are not currently defined on any figure. However, if potential impacts from the derailment and response activities are discovered in an area not included in this Plan, then a delineation area will be created to address the discovery. The extent of sampling and list of COCs to be included in the newly defined area will be determined collaboratively with USEPA and Ohio EPA.

## 3.2 Sequence and Timing of Activities

The sequence in which areas are assessed will be guided by access constraints and overall site planning. For example, sampling may initially focus on both readily accessible Category 1 areas (such as Car Scrapping 3) following soil removal activities, as well as readily accessible Category 3 areas (such as Park Drive 2), with the goal of identifying remaining impacts and reducing the overall operational footprint of the response and remediation work. The schedule for assessment of individual areas will be proposed by NSRC and reviewed during periodic (e.g., weekly or twice-weekly) meetings with agency partners.

Throughout soil sampling work discussed in the sections below, NSRC will conduct air quality monitoring in accordance with the existing Air Sampling and Analysis Plan developed for the Site. Active engineering controls (i.e., controls beyond monitoring) are not expected to be required; however, dust suppression equipment will be on hand for use, if needed.

The general workflow for activities conducted under this plan, regardless of category, is expected to be:

- Operational personnel identify an area as “ready for assessment” under this Plan after operational activities have concluded, stockpiled/stored waste has been removed, and material has been demobilized from that area. For Category 1 areas, this would also correspond with completion of soil removal and sampling under the Appendix D - Main Line Interim Soil Removal Work Plan. Refer to **Table 2** for the events that are required to “ready” an area for assessment under this Plan.
- Sampling will be conducted in the area to be assessed consistent with the approach in **Sections 4 and 5**. If the Decision Unit (DU) is the first of its category assessed, or otherwise identified for replicate sampling, then replicate samples will be collected at that DU.
- Laboratory analytical results will be received, validated, and reviewed. Replicate sample evaluation will be based on validated data and reviewed to evaluate heterogeneity. If the relative standard deviation (RSD) for replicate samples is acceptable, evaluation will proceed to the next steps. If the RSD between replicates is greater than 30% for a given constituent, a qualitative evaluation will be conducted in parallel with the quantitative RSD evaluation. If RSD is over 30%, measures to improve data quality within that DU will be evaluated. Additional increments may be collected or DUs may be subdivided, in consultation with USEPA and Ohio EPA.
- Results will be evaluated relative to decision statements presented in **Section 2** and screening levels presented in **Section 6**.
- DUs with concentrations at or below screening levels will be identified as appropriate to return to unrestricted use. DUs with concentrations above screening levels will be further evaluated through additional delineation, removal or other remedial action.

Characterization Work Plan for Derailment – Area Soil

September 7, 2023

V 3.6

- If a DU exceeds screening levels and delineation is not established by other sampling activities, such as sampling results from adjacent DUs, delineation along DU boundaries will be conducted and additional subsurface sampling will be conducted. These activities are discussed further in **Section 7**.
- Subsurface soil sampling around utilities and potential preferential pathways, along with sub-slab and indoor air sampling, will be conducted concurrently with the soil sampling work identified in this Plan.

## 4 Sample Design

A combination of Incremental Sampling Methodology (ISM) and discrete sampling will be utilized for the initial delineation of soil impacts. Aside from sampling associated with subsurface flow conveyance sampling, soil samples will be collected from depths of 0 to 1 foot below ground surface. Surface samples should be free of the upper root zone from surface growth and should be representative of the materials within the upper foot of soil. Where the area to be sampled was reconstructed for the areas use (i.e., tank farms), the samples will be collected below the materials that were brought in for the operations, such that samples are representative of the materials at the surface upon decommissioning an area. For example, in Tank Farm 3, the samples will be collected below any area that is scraped of operational stone that was placed for tank use. In Tank Farms 4 and 6, for example, the composite mats, liner, and geotextile will be removed before sampling will occur. These are examples of each area as it is known at this time and how these areas will be decommissioned. Other areas may also require similar consideration, such as ditch reconstruction areas and areas covered with asphalt.

**Table 3** provides a summary of the DUs, the number of aliquots for samples by ISM for non-volatile compounds, and the number of samples for VOC analysis.

### 4.1 ISM Design for Categories 1 through 3

ISM is a sampling protocol that is intended to reduce data variability and increase sample representativeness of the media to be evaluated. ISM sample design will be completed in accordance with the Interstate Technology and Regulatory Council (ITRC) document Incremental Sampling Methodology (ITRC 2020). ISM sampling will consist of the following steps:

1. Define DUs
2. Determine Incremental Sample Points within DUs
3. Collect Aliquots from each Incremental Sample Point
4. Laboratory processing of the sample.

The DUs have been defined using the categories presented above in conjunction with the ITRC document considering the overall extent of the areas and the degree of variability expected from area to area, based on knowledge of area use during immediate and subsequent response activities. Specifically, where an area has been split into separate DUs, the primary goal was to split out areas where support activities occurred (e.g., parking, material storage, trucking) and to then focus the DUs on areas with the potential for contaminated media to have been in contact with surface soils. A maximum size of 0.5 acre was targeted, though a few areas are over that size. Through regulatory discussion, the maximum DU size of 0.5 acres for Category 1, 2, and 3 areas was agreed to be appropriate.

The overall approach used for sampling will be to collect composite samples within each DU for non-VOC constituents of concern (COCs). In general, a sample spacing that allows for a minimum of 30 approximately equal-distant sample locations will be used for each DU. One aliquot of soil will be collected from each increment location. The aliquots will be collected into sampling jars and provided to the laboratory for compositing in accordance with ISM. Processing will be conducted at the laboratory in a more controlled environment than the field offers. The Eurofins Lancaster, Pennsylvania and Cleveland, Ohio laboratories, both of which have extensive experience in ISM sample handling and procedures, will conduct sample processing

and analysis.

## 4.2 Discrete Sampling Method Design for Categories 1 through 3

Due to the challenges of obtaining reporting limits below the screening levels when compositing VOCs with the required preservation, discrete soil samples for VOC analysis will be collected. The basis for the sampling design for discrete sample locations is based on the CSM presented above in conjunction with the support of the Visual Sample Plan (VSP) software tool. VSP is a software tool developed at the Pacific Northwest National Laboratory under contract with the United States Department of Energy for selecting the appropriate number and location of environmental samples so that the results of statistical tests performed on the data generated from the sampling have the required confidence for decision making (Matzke, et al. 2014).

The VSP tool was used to evaluate the appropriate spacing of sample points that would be necessary to identify a potential “hot spot” within the area sampled. VOC sampling will be based on the DUs that were defined for the ISM sampling. The sampling goal of locating a “hot spot” in VSP was used for a DU and defining at least a 90% chance of detecting a circular “hot spot” with a varying size. An example of the analysis ran is included here for review. Since a majority of the contaminants that are being evaluated were liquids originating from the derailment, a circular “hot spot” was chosen as the “hot spot” geometry. The VSP model was used as follows:

- Data without false negatives were evaluated.
- The total area to sample was set as the size of the DU (for example 0.5 acre or 21,780 square feet)
- The parameter to solve for was the number of samples required to detect a “hot spot” of a specified size.
- The confidence level of 90% was set per discussions with the regulatory working group.
- A square grid was chosen to align with the grids to be used for the ISM.
- The radius of the hot spot was varied to evaluate the sensitivity of the calculation and to bracket the 30 samples per 0.5-acre DU size (per the ISM sampling).
- The results show that for a “hot spot” of 15 feet in radius over a 0.5-acre DU, 31 samples on a 27-foot spacing would be appropriate to have a 90% chance of detecting the hot spot.
- The sampling frequency inside DUs is designed such that spacing between grid centers is no greater than 27 feet.
- To co-locate ISM and VOC sample points, the number of ISM aliquots will be increased in the DUs that are larger than 0.5 acres, resulting in some ISM samples being made of more than 30 increments.

Exhibit 1. VSP Model Summary

Radius of Hot Spot	Number of Samples	Maximum Spacing of Samples
10	68	18
15	31	27
20	17	36
25	11	45

In order to evaluate the number of samples per DU, the VSP model was run for each of the DUs that were 0.5 acres or less using the “the size of hot spot that can be detected with a fixed number of samples”, with the total number of samples of 30 and a 90% chance of detecting the specified hot spot, with the DU surface area.

**Table 3** provides the model output for each DU.

For DUs that were greater than 0.5 acres, the VSP model was run with the “probability of detecting a hot spot of a specified size with a fixed number of samples”, with the “grid spacing” set for square with a length of grid size of 27 feet and a radius of 15 feet. The output for these larger DUs confirmed that the probability of detecting a hotspot remained equal to or greater than 90%.

**Table 3** includes the number of samples for each DU and **Attachment 1** provides the maps with the sampling points shown.

Several DUs were of such a narrow shape that the output from the model, which uses grids, would result in samples being spaced unconventionally, as in Exhibits 2a and 2b below. As such, samples in these DUs were placed manually, as shown below for example with observance of the 30-sample minimum and a maximum spacing of 27 feet between samples in a DU.

Exhibit 2a. Example VSP Output for a Narrow DU

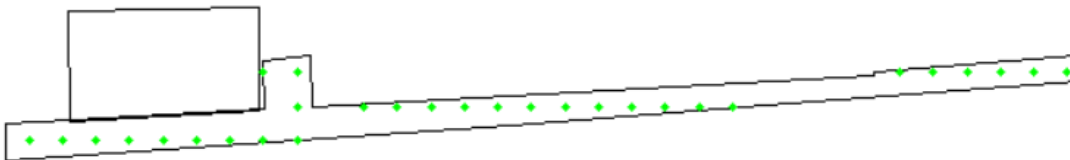
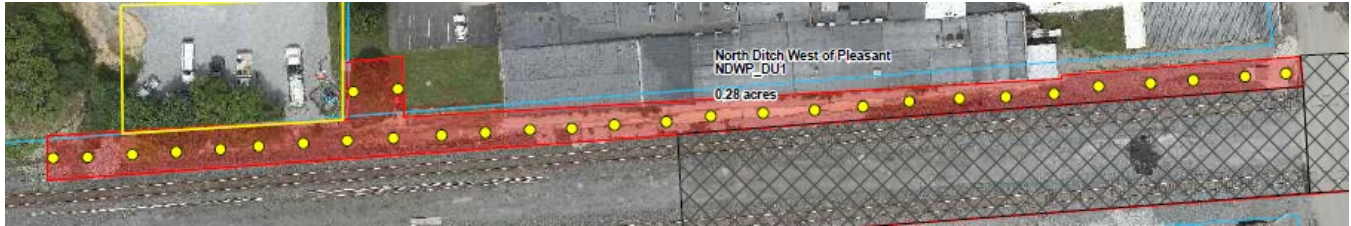


Exhibit 2b. Example of Manually placed samples in a Narrow DU



## 4.3 Subsurface Conveyance Features

The objective of the subsurface sampling is to assess if subsurface conveyance pathways released derailment-related liquids to the surrounding soils.

- The areas of subsurface conveyance from the Category 1A/1 will be mapped to understand the potential flow paths of derailment-related liquids. Where conveyances were removed during Appendix D work, the sampling will occur below the bottom of the Appendix D excavation depth along the alignment of the former conveyance (which may be estimated if survey of these pipes has not been captured).
- If possible, remotely operated cameras with closed-circuit television (CCTV) will be used to inspect remaining subsurface features to assess its direction, connections, and competence.
- Ground penetrating radar (GPR) will be conducted in areas surrounding known piping networks to help identify other potential pipe connections that are not visible from the surface. GPR will also be used based on site reconnaissance to identify other shallow utilities that might be backfilled with a more porous medium as a bedding material.
- Historic and current information that is found available will be used to help assist in piping identification.
- Surveys of pipe inverts (bottom of pipe) will be conducted, if accessible, to verify direction of flow.
- Review meetings will be held with EPA and OEPA to discuss the findings of the reconnaissance and mapping work prior to collecting samples. However, the process of sampling will generally be conducted as noted in the following sub-bullets.
  - At features known or suspected of carrying derailment-related materials (including piping that was left in place at the edges of Appendix D based excavations (crock area in Car Scraping 4 area, for instance))
  - At locations where CCTV demonstrates potential failures or CCTV information cannot be collected
  - At locations where a utility backfill is suspected of carrying derailment-related materials.
- Subsurface soil sample locations will be advanced in the inner sampling transect per the exhibits below and as identified in review meetings for analysis of the constituents identified in Section 6.
- NSRC may opt to collect the subsurface soil samples from the outer sampling transect per the exhibits below and held by the laboratory pending analysis of the inner transect samples. The outer samples would be collected, preserved via freezing, and subject to a maximum hold time of 14 days prior to analysis. Inner transect samples may be expedited to support analysis within this hold time. Alternately, NSRC may return to the second transect (and deeper depths if warranted) for separate sample collection at a later date.



- If the inner sample exceeds the screening level, the outer sample will be analyzed for the constituents that exceeded the screening level.
- If the inner sample is below the screening levels, the outer sample will not be analyzed.

Exhibit 3. Subsurface Feature Sample Locations Concept – Plan View

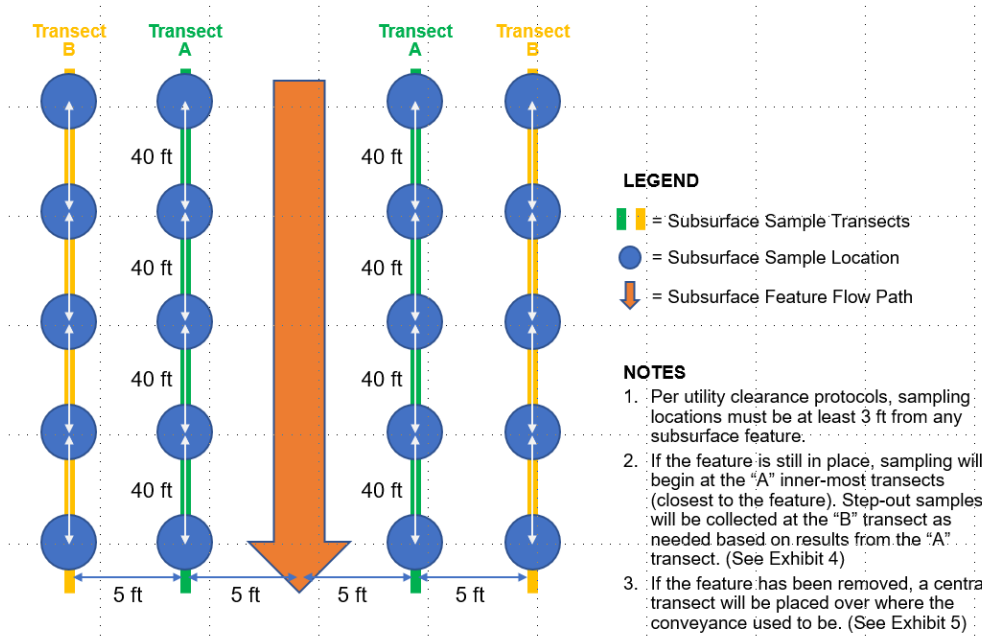
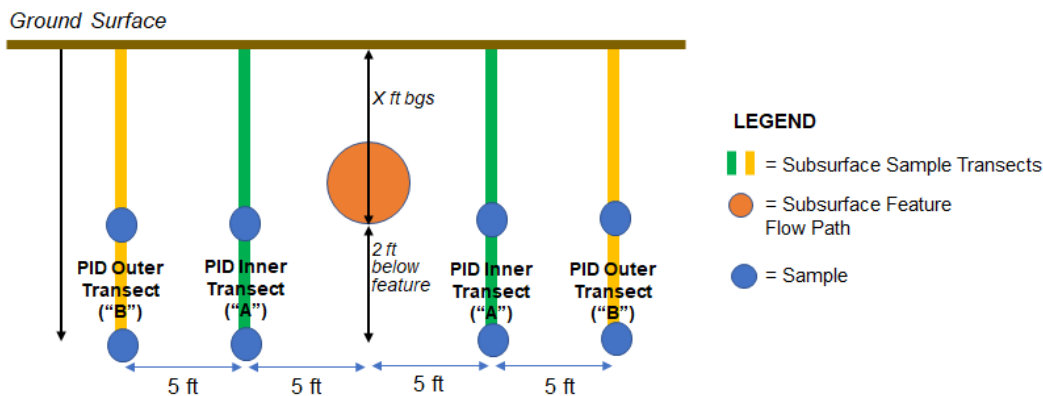
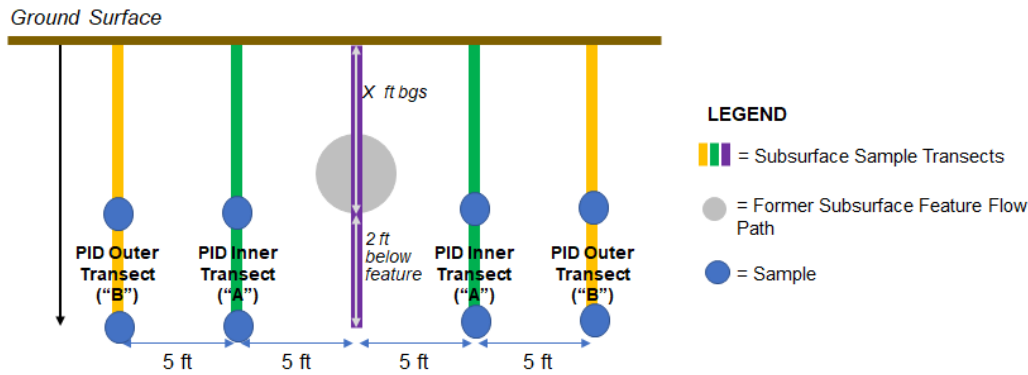


Exhibit 4. Subsurface Feature Sample Locations Concept – Cross Section View A



- NOTES**
1. Example: If the bottom of the feature is at 3 ft bgs the first sample will be taken at that depth. Additional deeper or wider samples will be collected as noted in text and in Figure 28.
  2. Per utility clearance protocols, sampling locations must be at least 3 ft from any subsurface feature.

Exhibit 5. Subsurface Feature Sample Locations Concept – Cross Section View B



**NOTES**

1. Example: If the bottom of the feature is at 3 ft bgs the first sample will be taken at that depth. Additional deeper or wider samples will be collected as noted in text and in Figure 28.
2. Per utility clearance protocols, sampling locations must be at least 3 ft from any subsurface feature.
3. If the subsurface feature is removed, sample locations will be established along a central transect (shown in purple on the exhibit) below the location of the feature.

## 4.4 Vapor Intrusion Assessment

Based on reported odors in the Strohecker and CeramFab buildings, ambient air, indoor air, and sub-slab vapor sampling will be conducted under this Plan for these buildings. Sampling will also be conducted at Brave Industries and US Stoneware, north of the mainlines. If through the subsurface conveyance work additional vapor intrusion evaluation needs are identified, additional buildings may be addressed through a similar process following discussion with the regulatory stakeholders. The following tasks will be completed:

- Perform a site visit and building inspection to review the available building drawings, figures, maps, and floor plans to determine foundation type, heating and cooling systems, floor plan layout, potential preferential pathways, building materials, sub-surface features.
- Reconnaissance of the buildings to determine appropriate placement of paired indoor air and sub-slab vapor sample locations including, but not limited to, the presence of floor cracks, joints, and drains, and potential materials that might influence indoor air samples.
- Evaluate potential odor contributions from outdoor ambient air by collecting outdoor ambient air samples from each cardinal direction around the buildings.
- Collect indoor air samples concurrently with outdoor ambient air samples to determine potential outdoor ambient air contributions and potential sub-slab contributions to indoor air in the buildings.
- Collect sub-slab vapor samples concurrently with indoor air sample collection in the buildings to determine potential sub-surface concentration for contribution to indoor air.

The proposed number of indoor air and sub-slab vapor ports will be discussed with the working group upon the completion of the building evaluation with notes and figures that detail the findings. These locations will be

influenced based on the size of the buildings and reconnaissance of the buildings. Prior to installation, utility locating activities will be completed to identify buried utilities in the vicinity of each proposed sub-slab vapor port. The final location of the sub-slab vapor ports may be adjusted based on observations made in the field. Sampling is contingent on access to the buildings by the property owners.

## 4.5 Other Sampling

**Section 7** provides the methodology for determining if areas outside of the Category 1, 1A, 2, and 3 require sampling. Should that analysis identify additional areas for sampling, including areas requiring delineation at DU boundaries, the samples will be collected as discrete samples following the procedures described in **Section 5.1**, similar to the VOC discrete sampling.

## 5 Sampling Procedures

Procedures for the collection, handling, and identification of samples collected under this Plan are presented below and summarized in the Technical Guidance Instructions (TGIs; **Attachment 2**). Included in these TGIs is a field guide for per- and polyfluoroalkyl substances (PFAS) sampling, which provides specific precautions to minimize cross-contamination and potential interferences when samples are being collected for PFAS analysis.

In some cases, soil sampling may be completed from the base of an excavation or surface scrape. If the depth of the excavation extends into a perched water bearing zone, efforts will be made to minimize water entering the excavation (e.g., a temporary dewatering system may be used). Where practicable, water will be removed prior to collection of soil samples. If water removal is not practicable, soil sampling will not be completed, and potential impacts to groundwater, if any, will be evaluated under a separate plan (i.e., Appendix I – Groundwater Characterization Work Plan).

Additional sampling may be directed by UC, and USEPA and/or Ohio EPA may collect split or co-located samples as part of the efforts described below. Logistics and data review procedures will be adjusted as needed to support such efforts.

### 5.1 Surface Soil and Sediment Sampling Procedures

Once the DUs have been field-located and the appropriate grids for VOC sampling have been identified, aliquots and discrete samples will be collected from the DU using hand coring devices as described below. A sampling location will be identified randomly by field personnel within approximately 13 feet of each sample location (i.e., each point or dot) shown on the maps in Attachment 1, while remaining within the DU boundary. ISM increments/aliquots and VOC discrete samples will be collected from the top one foot (see previous note in **Section 4** concerning what constitutes surface) of soil at each identified sampling location. In the event that clear visual indications of impact (such as stained soil) are observed, additional sampling locations for both ISM increment collection and discrete VOC sample collection will be added within a DU based on field judgment.

Sediment sampling procedures are included in the TGIs within **Attachment 2** which address generally dry conditions that allow access by foot. Should conditions require the use of a boat for access, additional planning will be conducted and TGIs or procedures will be added to planning documents. Sediment sampling results will be evaluated similarly to soil sampling results for the purposes of this Plan and compared to screening levels within **Section 6**.

Field personnel will wear new nitrile gloves at each sample location and will be required to wear additional personal protective equipment (PPE), as necessary, for the safe implementation of the soil sampling.

Sample locations will be identified using stakes, flagging, or other appropriate means, and will be noted in a field tablet/computer and/or soil sampling logs/logbook. Sample points will be located by surveying with the use of a global positioning system (GPS).

The following sample collection and handling steps will be followed at each location:

1. Identify the location targeted for sampling using field GPS equipment and sampling grids established by Geographic Information System (GIS software) and/or on-site surveyors.
2. Record sample identification (ID) and sample date, time, and location on the field form.

3. When sampling under fill material placed during response activities, the fill layer above the target sample depth will be removed by shovel, hammer drill, hand auger, or similar, when practical. If removal of fill materials is not feasible, DPT or sonic drilling technology may be utilized to reach the required depth.
4. Soil will be collected with a small core sampler (about ¾" to 1") to the extent practicable. If preferred small-diameter tooling is ineffective at allowing the collection of the sample within the elevations/depth/zones necessary or if soil composition does not allow for small core collection, the tooling will be changed out to include a larger diameter core sampler (hand auger, slide hammer, or DPT core) in the field. When larger diameter coring equipment is needed, samples will be split longitudinally, if the sample allows, for sample volume separation, providing split samples to USEPA when requested or for use with multiple analyses. Field teams will use a stainless-steel spade, spoon, scoop, hand auger, step sampler, or slide hammer. The sample collection method and the coring device used for sample collection will be consistent throughout a given decision unit. If adjustments to the coring approach are proposed within a DU due to site-specific soil conditions, the subsequent sample points within the remaining DU area will be split off to form a sub-DU and it will become a new DU. The same sample collection methodology will be used to complete the sub-DU sampling. Sample points will be added to each sub-DU to equal 30 sample aliquots in each DU. This means that if a DU was split into two sub-DUs, 30 aliquots are to be collected from each sub-DU. As an alternative, previously sampled locations within the original DU can be resampled by the new methodology. This approach affects ISM samples, and not VOC samples.
5. If soil is being collected for volatile analysis:
  - a. Immediately upon collecting the soil, the soil selected for volatile analysis will be containerized using Terra Core® samplers (or equivalent). The remaining soil in the core will not be submitted for laboratory analysis.
  - a. Once volatile samples are containerized, soil will be photographed for post-processing descriptions of color/staining, general texture, recovery, and other characteristics. Photos of the samples will include a view of an identifying label with the sample ID, date, and time. The photo will also include a view of a tape measure/ruler for scale. Characterize and record each soil sampling interval with regard to soil type, color, staining, odors, and moisture content.
  - b. Decontaminate equipment between boring locations within a DU using an Alconox™ (or similar product) solution, scrub brush, and triple-rinse using organic-free water such as distilled water.
6. If soil is being collected for other than volatile analysis:
  - a. Aliquots for ISM sampling will be collected with a small core sampler (about ¾" to 1") for the entire interval and placed into the jar for selected analysis. If multiple analysis is required, where smaller tooling is feasible, one small-diameter core will be advanced per analysis so that the entirety of the interval can be submitted to the lab. If preferred smaller-core tooling is ineffective, soil samples will be collected and sub-sampled per bullet 4.
  - b. Prior to containerization, samples will be photographed for post-processing descriptions of color/staining, general texture, recovery, and other characteristics. Photos of the samples will include a view of an identifying label with the sample ID, date, and time. The photo will also include a view of a tape measure/ruler for scale. Characterize and record each soil sampling interval with regard to soil type, color, staining, odors, and moisture content
  - c. Following soil description, the soil sample will be containerized in laboratory supplied, methodology compliant laboratory bottles/jars.

- d. Decontaminate equipment between DUs using an Alconox™ (or similar product) solution, scrub brush, and triple- rinse using organic-free water such as distilled water. Additional decontamination procedures for PFAS sample collection are outlined in the attached PFAS sampling TGI.
7. Fill out sample container labels and chain-of-custody form.
8. Place the sample containers in coolers with bagged ice.

Consistent methods will be used for collection of each increment throughout a DU. See #4 above for proposed changes in collection methodology.

In cases where larger-diameter soil cores or higher-volume soil samples are collected, sub-sampling may be necessary to collect ISM increments that maintain a practical overall ISM sample size and minimize potential biases that could be introduced when some increments contain more soil mass than others. This subsampling will be conducted through core wedge sampling, with sections of soil samples (or cores) divided lengthwise into multiple fractions using a steel spatula or straightedge, with each fraction representing the target vertical interval of soil. For non-cohesive soil, the soil sample will be similarly divided on a clean working surface. One fraction corresponding to the target sample mass will be selected for collection as an ISM increment. Sub-sample size for a given DU will be selected to target a total ISM sample mass (across all increments) of approximately 1 to 2 kilograms per DU, with each increment of equal mass.

For ISM sampling, compositing and processing of sampling will be conducted at the laboratory after receipt of sample aliquots. The Eurofins Lancaster, Pennsylvania laboratory, which has extensive experience in ISM sample handling and procedures, will conduct sample processing and analysis. This processing will follow the procedures in the laboratory work instructions included in **Attachment 2**.

ISM samples for SVOCs and dioxins/furans will be air-dried overnight on metal sample preparation trays and then manually disaggregated. ISM samples for PFAS analysis will not be dried.

The resulting soil samples will then be prepared for extraction and analysis pursuant to the analytical methods to be performed. The subsampling process is described in detail in laboratory procedures included in **Attachment 2**.

## 5.2 ISM Replicate Sampling

To evaluate field and laboratory precision, independent replicates will be collected in triplicate from 15% of the DUs, with replicates also representing different sampling methodologies. Replicates will be discussed in weekly data review meetings. The increments will consist of a primary (“A”), first replicate (“B”) and second replicate (“C”) sample locations. The first and second replicate sample will be located a minimum of 5 feet from the primary replicate in random directions. With the three replicates, the 15% of DUs selected to be sampled in triplicate will have three ISM samples submitted for laboratory analysis. Each replicate will be collected in its entirety, after which field equipment will be decontaminated before the next replicate set is collected (i.e., all 30 increments for the primary ISM sample will be collected, equipment will be decontaminated, all 30 increments for the duplicate ISM sample will be collected, etc.).

A review of the replicates will be conducted to determine the RSD between the replicates. A RSD equal or less than 30% will be considered confirmation that variability within the DU and sampling process is sufficiently low to

support decision-making, and a single ISM sample will be adequately representative of the DU. A RSD of greater than 30% will require further evaluation including a parallel qualitative evaluation, to determine if an action is necessary to improve the precision of the DU characterization either through reducing the DU size or increasing the number of increments.

In order to assess the overall precision of the sampling design provided in this Plan, the majority of the replicates will be collected during the first DUs completed for each category with additional replicates to be completed mid-way through the work. In addition, for the DUs over 0.5-acre, replicates will be collected. If the RSD from the initial DUs sampled is over 30%, the sampling design will be discussed with agency stakeholders and refined.

*Exhibit 6. DU Replicate Summary*

Category	DUs per Category	Number of DUs requiring replicates
Category 1	17	3
Category 2	56	9
Category 3	13	2
<b>TOTAL</b>	<b>86</b>	<b>14</b>

**Note:** Five current DUs have areas greater than 0.5 acre and therefore require replicates based on their area. If practical, these DUs will be assessed at or near the start of sampling, so that the DU will serve as the required replicate for its category. If access considerations require these DUs to be assessed later in the process, replicates will initially be collected at smaller DUs, and additional replicates will be collected at these DUs later in the process.

### 5.3 Subsurface Soil Sampling Procedure

Per the sample design outlined above, DPT or sonic drilling will be utilized to advance sample collection cores to at least 2 feet below the bottom of a subsurface conveyance feature. The locations will be continuously cored and logged using DPT or sonic drilling methods.

Soil samples will be collected in laboratory-supplied and pre-preserved containers for the specified testing methods (described below). Field personnel will wear new nitrile gloves at each sample location and will be required to wear additional PPE, as necessary, for the safe implementation of the soil sampling.

Sample locations will be identified using stakes, flagging, or other appropriate means, and will be noted in a field tablet/computer and/or soil sampling logs/logbook. Sample points will be located by surveying with the use of a GPS.

The following sample collection and handling steps will be followed at each location:

1. Identify the location targeted for sampling using field GPS equipment and sampling grids established by GIS software and/or on-site surveyors.
2. Record sample ID and sample date, time, and location on the field form.
3. Use a new, disposable sample liner to collect soil sample at the required depth interval.
4. Immediately upon collecting the soil, the sample for volatile analysis will be containerized using Terra Core® samplers (or equivalent) and the remainder of the sample will be bagged for screening with a PID.

5. Following volatile sample collection, characterize and record each soil sampling interval with regard to soil type, color, staining, odors, and moisture content. The logging procedures will follow Ohio EPA, Division of Environmental Response and Revitalization (DERR), Field Standard Operating Procedure (FSOP 2.1.5). Soils will be field screened using a Photo Ionization Detector (PID) as per Ohio EPA, DERR, FSOP 3.1.1. The FSOPs are included in **Attachment 2**. Logging of lithology and PID screening data will be entered into a field tablet/computer and/or soil sampling logs/logbook.
6. Photograph samples for descriptions of color/staining, general texture, recovery, and other characteristics. Photos of the samples will include a view of an identifying label with the sample ID, date, and time. The photo will also include a view of a tape measure/ruler for scale.
7. The remaining soil in the core will be collected into a laboratory-provided jar(s) for non-volatile analysis.
8. Fill out sample container labels and chain-of-custody form.
9. Place the sample containers in coolers with bagged ice.
10. For non-disposable equipment, decontaminate equipment between samples using an Alconox™ (or similar product) solution, scrub brush, and triple-rinse using organic-free water such as distilled water. Additional decontamination procedures for PFAS sample collection are outlined in the attached PFAS Sampling TGI.

## 5.4 Building Vapor Sampling Procedures

The TGIs conform to the USEPA, Office of Solid Waste and Emergency Response (OSWER) Technical Guide for Assessing and Mitigating the Vapor Intrusion Pathway from Subsurface Vapor Sources to Indoor Air (USEPA 2015) and the Ohio EPA Sample Collection and Evaluation of Vapor Intrusion to Indoor Air for Remedial Response, Resource Conservation and Recovery Act and Voluntary Action Programs (VI Guidance; Ohio EPA 2020).

Arcadis proposes to collect sub-slab vapor samples from sub-slab vapor ports and analyze the samples utilizing USEPA Method TO-15 and sorbent methods OSHA PV2011 and PV2026 for acrylate compounds.

### 5.4.1 Ambient Air Sampling Procedures

Ambient air samples will be collected outdoors concurrently with indoor air samples to evaluate potential background contaminant sources from outside the buildings. For each building, four ambient air samples will be collected, one in each cardinal direction. The ambient air samples will be placed to minimize potential contamination from extraneous sources. The ambient air samples will be positioned away from wind shields such as trees or bushes and at least 15 feet away from any buildings. Meteorological data (i.e., temperature, precipitation, humidity, barometric pressure, and wind speed/direction) will be collected before and during sampling activities. The following procedures will be used to collect the samples:

- TO-15: Samples will be collected in 6-liter, polished, stainless-steel canisters with calibrated flow controllers that are cleaned and certified by the laboratory. The canisters will utilize flow controllers calibrated for an 8-hour (11.5 milliliters per minute [mL/min]) sample collection to access the worker exposure scenario. During the collection process, the sample canister will be securely positioned at breathing height (approximately 5 feet above the ground). A final canister vacuum on the flow controller between 2 and 10 inches of mercury will signify that sample collection is complete. At the completion of sampling, the canister will be closed and the flow controller removed. The canisters will be gauged with an independent gauge and the final vacuum recorded. The canister will then be closed and sealed with a brass Swagelok® cap.



- Sorbent Tube Method: Samples will be collected in glass tubes packed with sorbent and a pump over an approximate 8-hour sample collection. Clean sorbent tubes will be obtained from the laboratory and calibrated pumps will be rented.

## 5.4.2 Indoor Air Sampling Procedures

Indoor air samples will be collected under normal building conditions (i.e., during operating air conditioning/heating conditions). During the collection process, the indoor air canister will be securely positioned at the breathing zone level. Collection of the indoor air sample will follow the same methodology as described for ambient air samples but will commence approximately 1-2 hours after the ambient air samples. A duplicate indoor air sample will be placed next to the parent indoor air sample and connected using a duplicate tee. The following procedures will be used to collect the samples:

- TO:15: Indoor air samples will be collected using 6-liter, polished, stainless-steel canisters with calibrated flow controllers that are cleaned and certified by the laboratory. The canisters will utilize flow controllers calibrated for an 8-hour (11.5 mL/min) sample collection to access the worker exposure scenario. A final canister vacuum on the flow controller between 2 and 10 inches of mercury will signify that sample collection is complete. At the completion of sampling, the canister will be closed and the flow controller removed. The canisters will be gauged with an independent gauge and the final vacuum recorded. The canister will then be closed and sealed with a brass Swagelok® cap.
- Sorbent Tube Method: Samples will be collected with sorbent media and a pump over an approximate 8-hour sample collection. Clean sorbent tubes will be obtained from the laboratory and calibrated pumps will be rented. A DryCal® calibrator will be utilized in the field to determine that the appropriate calibration and flow rate has been achieved.

## 5.4.3 Sub-Slab Vapor Port Installation and Sampling Plan

The sub-slab vapor ports will be placed in unobtrusive locations within the buildings to minimize operational disturbance. The sub-slab vapor ports will be set flush to the upper surface of the concrete floor and will “float” in the slab to enable collection of vapors from the sub-slab material in direct contact with the slab or from a pocket of air directly beneath the slab created by sub-slab material subsidence. New stainless steel VAPOR PINS® will be utilized. The VAPOR PIN® will be preassembled for each location prior to drilling through the floor to minimize exposure time of the sub-slab soils to ambient conditions. At this time, the paired sub-slab vapor sample locations adjacent to indoor air sample locations are proposed throughout the buildings with final locations determined during the reconnaissance. A duplicate sub-slab vapor sample will be connected to the parent sample using a duplicate tee, with the exception of sorbent tube sampling, which will be done back-to-back.

To install a sub-slab vapor port, a rotary hammer drill will be used to drill a 1.5-inch, outer-diameter hole approximately 2 inches into the floor. The inside of the 1.5-inch, outer-diameter hole will be cleaned with a damp towel and then a 0.625-inch, outer-diameter hole will be drilled through the remainder of the concrete. Once through the concrete, the drill will be allowed to penetrate an additional 2 to 3 inches into the sub-slab material. The inner-diameter hole will be cleaned with a bottle brush and the outer-diameter hole will be cleaned once more with a damp towel. The VAPOR PIN® will be pressed into the concrete slab and sealed with the supplied non-VOC silicone sleeve. A protective cap will be placed on the end of the VAPOR PIN® and finished with a stainless-steel thread-on flush-mount cover.

Once the sub-slab vapor port is installed, it will be allowed to equilibrate for a minimum of 2 hours prior to sampling. The following procedures will be used to collect the samples concurrent with the indoor air sampling:

- TO-15: The sub-slab vapor ports will be sampled using 6-liter, polished, stainless-steel canisters with calibrated flow controllers that are cleaned and certified by the laboratory. The canisters will utilize flow controllers calibrated for an 8-hour sample collection, consistent with the indoor air samples).
- Sorbent Tube Method: Samples will be collected with sorbent media using a pump. The acrylate sub-slab samples will be collected over an 8-hour period.
- Clean tubes and will be obtained from the laboratory. Calibrated sampling pumps will be rented.

After sub-slab vapor samples are collected, a Landtec GEM™ 5000 Gas Analyzer or equivalent will be connected to the sub-slab port to screen sub-surface vapors for fixed gases (i.e., oxygen, carbon dioxide, and methane). If methane concentrations are detected greater than 5% by volume in the sub-slab vapor sample, the sample(s) will be shipped in an approved Department of Transportation secondary container via ground method.

Meteorological data (i.e., temperature, precipitation, humidity, barometric pressure, and wind speed/direction) will be collected before and during sampling activities.

These sub-slab vapor ports will remain in place after the initial sampling for use in future sampling events, if necessary. After all sampling events have been completed, the sub-slab vapor ports will be removed, the holes will be patched and returned to a similar surface (e.g., concrete or epoxy).

Sampling will be conducted over approximately 4 quarters to represent seasonal variations with two samples representing a heating season.

#### **5.4.3.1 Leak Testing**

Atmospheric dilution can occur in sub-slab vapor ports if drawn from the surface into the sub-slab port. To determine if atmospheric dilution is occurring a leak test will be performed on the sub-slab sampling locations prior to sampling. Leak testing verifies the integrity of the sample collection system and demonstrates that representative samples are being collected.

Leak testing will be accomplished by connecting the sample tubing to the VAPOR PIN® and pouring enough distilled water into the sub-slab port annulus to immerse the base of the VAPOR PIN® and the tubing connection at the top of the VAPOR PIN®. A measuring tape will be used to monitor the water level during purging. One to three volumes of air will be purged from the sub-slab port into a Tedlar bag. If water is lost to the sub-slab during purging, sampling will be stopped, the water will be removed from the annulus, and the VAPOR PIN® will be repositioned to stop the leakage. The leak test will be performed again as described above. If water is not lost during the leak test, sample collection will be initiated.

A “leak down” test will also be performed to test the integrity of the valves and fittings for the sub-slab vapor port. After connecting the canister to the sample tubing, the canister will be opened and allowed to sit for 1 minute while the valve on the tubing is closed. The vacuum gauge will be monitored to determine if vacuum is lost.

## **5.5 Sample Nomenclature**

Soil samples or increments will be identified using the following nomenclature:

- Prefix representing the decision units associated with the sample, based on the attached figures
- Grid cell associated with the sample
- Sampling interval in feet below ground surface (i.e., 0-1')
- Sample date in YYYYMMDD
  - Example: CS2-DU1-###-G-(0-1')/20230330
  - CS2 – Prefix used to indicate area (e.g., Car Scrapping Area 2)
  - DU1 – DU associated with the sample (e.g., Decision Unit 1)
  - G – designation as ISM increment aliquot (A, B, or C) or discrete (G) sample
    - For the ISM increment aliquots: primary (“A”), first replicate (“B”) and second replicate (“C”)
  - A11 – Represents associated grid or increment number (for discrete samples or ISM increments)
  - (0-1') – Indicates depth interval the soil sample was collected from the ground surface in feet (will not be used for ISM sampling)
  - 20230330 – Indicates sample collection date of March 30, 2023 in this example.

Vapor intrusion/indoor/ambient air samples will be identified using the above nomenclature with the following modifications for building and location identification:

- Grid cell will be the building first three characters:
  - STR (Strohecker), CER (Ceramfab), ADV (Advanced Ceramics), BRA (Brave Industries).
  - Followed by SS (subslab), IA (indoor air), AM (ambient air)
  - Example: STR-IA/20230906

Field duplicate samples will be identified utilizing the following nomenclature:

- SSFD prefix (for Soil Sample Field Duplicate) or VIFD prefix (for VI Field Duplicate)
- Sample Date follows the SSFD prefix in YYYYMMDD:
  - Example: SSFD/20230301.

## 5.6 Sample Summary

Based on the information presented above and the DUs defined in the subsequent section, **Table 3** presents a summary of the number of aliquots and samples that are projected initially for the soil investigation. Note that this table does not identify the subsurface sampling surrounding underground structures as those are more specifically dependent on the subsurface investigation that is proposed in **Section 4.3**, which is defined to verify some of the initial investigations and reconnaissance that has been initiated since the response began.

Characterization Work Plan for Derailment – Area Soil  
September 7, 2023  
V 3.6

## 6 Laboratory Analysis and QA/QC

### 6.1 Analytical Parameters and Screening Levels

The list of chemicals of concern to inform delineation of the extent of contamination for the derailment site, as required by the UAO, represents what was on the train and spilled, what subsequently has been detected in soil, and what poses human health toxicity concerns. Degradation products and combustion products associated with chemicals released were also considered. COCs identified for analysis in soil and sediment samples are presented in **Tables 4** and **5**, respectively.

A subset of this list, focused on VOC compounds that meet the definition of volatility per the USEPA Vapor Intrusion Screening Level (VISL) Calculator and have available inhalation-based toxicity data, have been identified for soil vapor and air sample analysis. These COCs are presented in **Table 6**. Based on their physical properties and the CSM, dioxin/furan, and PFAS compounds are not expected to present a significant vapor-phase migration or indoor inhalation risk and are therefore not included as analytes for vapor samples.

#### 6.1.1 Soil Screening Levels

Screening levels were calculated on a site-specific basis using the USEPA Regional Screening Level (RSL) calculator, with inputs consistent with those used to calculate benzene and vinyl chloride screening levels for version 4.2 of the Main Line Interim Soil Removal Work Plan (Appendix D to the overall Removal Work Plan prepared under the UAO).

Screening levels reflecting the soil-leaching-to-groundwater pathway were determined using the USEPA RSL calculator to achieve MCLs (when available) or an acceptable risk range of a hazard index of 1 and an excess lifetime cancer risk of  $10^{-6}$  (if MCLs were not available) in groundwater. The current CSM based site-specific input parameters for hydraulic gradient, hydraulic conductivity, aquifer thickness, source length, infiltration rate, and groundwater temperature were incorporated into the calculator. The other input parameters were default input parameters provided within the RSL calculator. The calculator developed a site-specific dilution attenuation factor (DAF) of 5.2. The calculator used the site-specific DAF in conjunction with default chemical properties specific to each compound to determine a soil screening level to protect groundwater. The DAF or other site-specific input parameters may be updated if additional site-specific information is collected that revises the input parameters.

Screening levels reflecting the soil-leaching-to-groundwater pathway were combined with default screening levels from the USEPA RSL tables for residential soil, also reflecting a hazard index of 1 and an excess lifetime cancer risk of  $10^{-6}$  (**Table 4**).

For evaluation of dioxin and furan compounds, a toxicity equivalent (TEQ) for dioxin and furan mixtures will be calculated for each sample by the laboratory, and the aggregate TEQ will be compared to screening levels for 2,3,7,8-tetrachlorodibenzo-p-dioxin (2,3,7,8-TCDD) to evaluate whether a given sample exceeds screening levels.

**Tables 1** and **3** describe the locations at which each category of constituents will be analyzed. The proposed constituents for each area exclude constituent groups that are unlikely to be present at that location as a result of the derailment, considering subsequent response and remediation activities. Dioxins will not be analyzed in samples that are collected below areas where excavations have already been conducted as part of Appendix D or at subsurface soil samples. PFAS will not be analyzed in samples collected away from the original PFAS

containing firefighting foam use area. Dioxins will be analyzed at 25% of the locations for Category 2 and 3 surface samples.

### 6.1.2 Soil Vapor and Indoor Air Screening Levels

Screening levels for soil vapor and air samples are provided in **Table 6**. These screening levels were calculated using the USEPA VISL calculator and the following inputs, except as noted on **Table 6**:

*Exhibit 7. VISL Calculator Inputs*

Variable	Value
Exposure Scenario	Commercial
Temperature for Groundwater Vapor Concentration °C	15
THQ (target hazard quotient) unitless	1
TR (target risk) unitless	0.000001
AT <sub>com</sub> (averaging time - composite worker) days	365
EF <sub>com</sub> (exposure frequency - composite worker) days per year	250
ED <sub>com</sub> (exposure duration - composite worker) year	25
ET <sub>com</sub> (exposure time - composite worker) hours	8
LT (lifetime) year	70
AF <sub>gw</sub> (Attenuation Factor Groundwater) unitless	0.001
AF <sub>ss</sub> (Attenuation Factor Sub-Slab) unitless	0.03

### 6.1.3 Sediment Screening Levels

Sediment sample results from Wetland DU will be evaluated relative to those in **Table 5**, as well as the ecological sediment screening values developed under Appendix H (with the exception of 2-ethylhexyl acrylate, methyl acrylate and n-butyl acrylate which were added after the approval of Appendix H) and presented in **Table 5**.

## 6.2 QA/QC Samples and Validation

For soil sampling activities, equipment blanks (consisting of rinsate from sampling equipment), field blanks (consisting of laboratory-supplied deionized/reagent water transferred directly to sample containers in the field), field duplicates (for discrete grab samples only), and matrix spike/matrix spike duplicates will be collected and

Characterization Work Plan for Derailment – Area Soil

September 7, 2023

V 3.6

analyzed at a 5% (i.e., 1 per 20) frequency. Trip blanks will be transmitted with samples to the laboratory with each cooler or container containing VOC samples.

For soil gas and air samples, duplicates will be collected at a 5% (1 per 20) frequency.

Level 2 and 4 laboratory packages will be requested from the laboratory to include summaries of sample, batch, and instrumental quality control results in addition to all raw data that allows full traceability and recalculation of sample results. A Stage IV data validation will be completed on a subset of sample results (e.g., 10 to 20% of total results) upon completion of the laboratory analysis. The remainder of sample results will be validated using Stage II data validation procedures. Data validation will be Stage 2A and 10% Stage 3 with limited recalculations. The laboratory will provide Scribe-ready electronic data deliverables. Data will be compiled in electronic data deliverables and uploaded, in validated form, to the project database maintained by Environmental Standards, Inc.

Data management will be conducted in accordance with the March 12, 2023, Site Directive #2: Data Management/Communication and the Environmental Analytical Data Management Plan prepared by Environmental Standards, Inc (March 31, 2023).

## 7 Data Review and Evaluation

Data collected as part of this Plan, soil data that was collected post-excavation of Category 1 or 1A areas, soil data collected under the Phase I Residential Commercial Agricultural Sampling Plan, and additional data collection plans under development will be used to inform further development of the CSM. Depending on the sequencing of data collection under this Plan relative to the decommissioning of waste areas or the current operational areas and the installation of monitoring wells and sampling of other media, the CSM will be developed in phases and is expected to be an iterative process. Nonetheless, it is expected that through incremental stages, the CSM development will help to further inform site decisions such as:

- Identification of potentially complete current and future exposure pathways
- Refinement of risk-based screening levels
- Development of remedial actions, where appropriate, to address risks associated with exposure and/or the removal of future threats to human health and environment.

Five distinct categories of sampling results will be generated under this Plan:

1. Sampling data sets generated through re-reporting of previously collected samples for Category 1A areas
2. ISM sampling results for DUs (including triplicate results)
3. Discrete sampling results for VOCs from the same DUs
4. Grab sampling results from discrete samples collected as part of assessment of subsurface preferential pathways
5. Sub-slab soil vapor, ambient air, and indoor air sampling data.

Overall, the data obtained in this plan will be incorporated in to an updated CSM. The evaluation processes for each area are described in the following sections and in the flow chart provided as **Figure 28** with the overall goal to obtain delineation both horizontally and vertically. Should soil sample exceedances extend to the water table, additional evaluation of groundwater conditions will be necessary, which may lead to review of existing groundwater analytical data or the installation of additional monitoring wells. If additional wells are required, the procedures identified in the approved Appendix I: Groundwater Characterization Work Plan will be used for installation and sampling. Following this evaluation process, the evaluation will be summarized and the next steps for an area [e.g., a Category or DU(s)] will be provided in summary reports as detailed in Section 8.

### 7.1 Review of Category 1A Data

Category 1A samples that were analyzed under the Appendix D work plan will be re-reported from the laboratory for the VOC and SVOC analytes associated with this Plan. This reporting activity will generate soil data for the full list of VOCs and SVOCs described in **Table 4** at a large number of sample locations within the main line right-of-way and adjacent areas, where samples were generally spaced at 25- to 50-foot intervals throughout the study areas. Data will be re-reported for the uppermost sample remaining in place at each sampling location.

The data collected from the adjacent Category 1 areas, along with the confirmation samples from the Category 1A areas, will be used to inform the need for additional future sampling in the Category 1A. Samples will be



compared to soil screening levels presented in **Table 4** to identify areas that may require additional delineation. Delineation may be provided by other samples in Category 1A areas, neighboring DUs, or data collected under other work plans (e.g., Appendix I - Groundwater Characterization Work Plan). This evaluation may indicate that additional delineation activities are warranted based on data within or adjacent to Category 1A areas, which would be conducted under an addendum or revision to this Plan.

## 7.2 Review Process for ISM Sample Results

ISM soil sample results will be reviewed in two sequential steps: first, where replicate samples (i.e., triplicates) are collected from within a DU, the variability among those replicates will be compared to targets for data quality. If targets are met, this step will support the conclusion that results from the DU, and others in its category, are appropriate representations of the areas included in the DU and are suitable for comparison to screening levels and further use of the data in decision making. Note that replicate sampling will only be conducted at a sub-set of DUs near the beginning of the sampling process and once mid sampling at one DU. This step will not be conducted for all DUs.

Second, the sample results will be compared to screening levels to assess whether additional delineation is needed and to identify locations in which impacts from the derailment may be present. Both of these processes are outlined in the following sections.

### 7.2.1 Replicate Sample Evaluation

Variability and heterogeneity within DUs will be evaluated through the collection of replicate samples, as described in **Section 5**. Replicates will be identified for collection from at least one DU from each category and will be collected from DUs early in the sampling process. Replicate samples will be collected from one of the first three DUs of each category for which sampling is begun and preferably from the first DU sampled from each category.

Replicate sample results will be compared for each DU, and a RSD for three replicates will be calculated for each COC. An RSD of less than 30% between each of the three replicate samples will be considered acceptable. If the RSD between replicates is greater than 30% for a given constituent, that DU will be identified as not meeting data quality objectives for that constituent. The DU will then be evaluated for actions to improve data quality, which may be either: (1) collection of additional increments from within the DU, or (2) division of the DU into multiple smaller DUs. If replicate data evaluation indicates that data quality objectives for repeatability across replicate samples are met, evaluation will proceed to the next step.

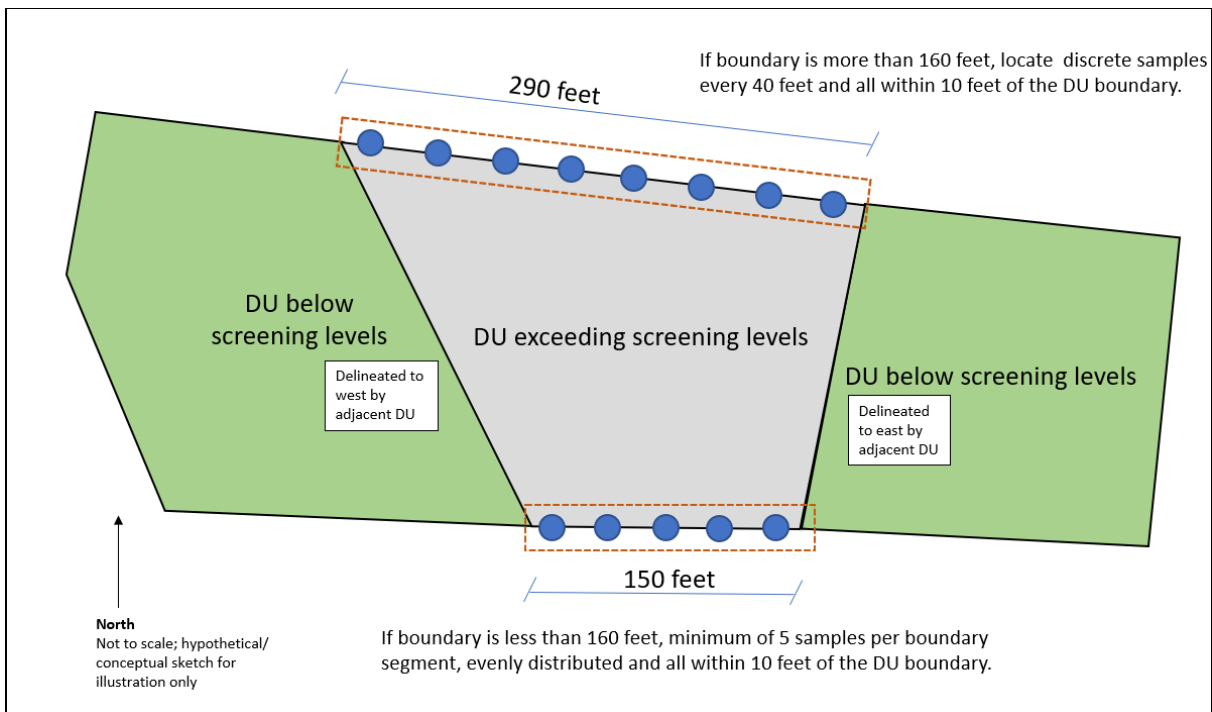
### 7.2.2 Sample Result Evaluation

Assuming acceptance of triplicate data and following receipt of the validated data for an individual work area (**Figures 1a** and **1b**), the results for the samples from each DU will be reviewed against the screening levels presented herein. For DUs where triplicate samples were collected, the arithmetic mean of the three triplicates will be calculated for each constituent and will be considered as the sampling result for that DU, similar to results for a single ISM sample from other DUs. This approach is described in Section 6.2.1.2 of the ITRC ISM guidance (ITRC 2020). Non-detect results will be treated as equal to one-half of the method detection limit for calculation of mean and RSD.

If validated results for any of the samples show concentrations above the screening levels for a given constituent, then that constituent in the DU from which that sample was obtained will be identified as requiring additional delineation including the following, in the order in which these are presented:

- Completion of ISM sampling in surrounding or adjacent DUs, if one is already identified, to evaluate lateral delineation of the COC(s).
- Step out sampling to be conducted using one of the methods below; as collaboratively discussed with USEPA and Ohio EPA prior to determination on which methodology should apply in the specific condition:
  - Completion of a targeted discrete sampling effort to establish lateral delineation at a DU boundary. These efforts would be intended to assess whether elevated concentrations of a COC exist at a specific portion of the DU perimeter. Discrete sampling along portions of a DU perimeter would be based on a sampling spacing at 40-linear-foot intervals, consistent with the spacing used for assessment of preferential pathways, with all samples collected within 10 feet of the DU boundary. The COCs to be analyzed in these samples will be analyzed for the full list of compounds in the group containing the COC requiring delineation and may include constituents up to the full COC list used in the initial sampling of the DU. A minimum of five discrete samples would be used for delineation in the event that the relevant portion of the DU boundary is less than 160 feet long. A conceptual sketch is provided below to illustrate this concept.

Exhibit 8. DU Delineation Concept



Evaluation of these discrete samples will be used as a focused assessment of whether impacts in the DU extend beyond the boundary of interest. The overall ISM sample result will still be considered representative

of overall soil conditions within the DU. This additional discrete sampling would be for delineation purposes only.

Completion of additional discrete sampling outside of the existing DU boundaries. These efforts would be intended to delineate elevated concentrations of COCs laterally through a step-out approach, potentially using iterative sample collection or iterative sample analysis. The general density and layout of samples would be based on the concepts described above for delineation via discrete samples at the perimeter of a DU (i.e., one sample per 40 linear feet along the boundary requiring delineation). The scope of such an effort would be developed collaboratively with USEPA and Ohio EPA and submitted for review as part of an addendum or revision to this work plan.

- Definition of an additional DU outside of the previous DU, with samples collected similarly to the original DU. Note that sample spacing may be different based on decisions made during the collaborative discussions with USEPA and Ohio EPA.

In addition, the evaluation of the vertical transport potential of the (COCs), and, if necessary, completion of subsurface sampling for vertical delineation through collection of ISM increments at a greater depth. The recommendation for additional subsurface sampling should be made after discussions with USEPA and Ohio EPA reviewing data already collected, continued refinement of the CSM that includes the data collected through other subsurface sampling activities, such as preferential pathway assessment under this Plan or monitoring well installation under the Groundwater Characterization Plan (Appendix I to the Removal Work Plan) which may also provide sufficient data to establish vertical delineation. Should subsurface sampling and vertical delineation be necessary, sampling for dioxin/furan constituents is not anticipated due to their low mobility in soil and the surficial nature of their potential deposition during the derailment.

Multiple DU areas will be evaluated to observe trends in data relative to adjacent areas sampled such that a determination of delineation can be made which will inform the need to sample areas not defined by categories but included within the Site Working Area (**Section 2** and **Figures 1a** and **1b**).

## 7.3 Review Process for Discrete VOC samples

Discrete VOC grab sample results will be evaluated on an individual basis to assess whether a specific sampling location requires additional assessment relative to a specific pathway (e.g., soil-leaching-to-groundwater or vapor intrusion).

As noted in **Figure 28**, VOC sample results will be compared to the screening levels and if exceedances are noted, the surrounding VOC sample results will be reviewed to evaluate if horizontal delineation has been achieved. Where adjacent samples are not present or also suggest data is above the screening levels, the data will be reviewed with the USEPA and Ohio EPA to evaluate the location for additional samples.

**Subsurface soil sampling.** Where surface soil data exceed the screening level, additional delineation will be conducted, or removal of impacted soil will occur in accordance with the Appendix D – Main Line Interim Soil Removal Plan. If additional delineation is conducted, soil samples will not be collected at or below the field-interpreted water table as part of this Plan. Soil samples will be collected for analysis at 2-foot intervals vertically for analysis of the VOC(s) exceeding screening levels. A vertical profile of VOC concentrations will be compiled for each boring and combined with other hydrogeologic data (e.g., soil descriptions, geotechnical data, and

groundwater monitoring data) to evaluate whether VOC impacts are vertically delineated and whether the soil-leaching-to-groundwater pathway is potentially complete and is of concern for this DU.

**Groundwater quality assessment.** If soil-to-groundwater screening levels are exceeded at a given sampling location, additional soil sampling will be completed at that location to establish vertical delineation above the saturated zone. Should soil sample exceedances extend to the water table, an evaluation of the potential for observed soil conditions to result in groundwater screening level exceedances will be conducted. This evaluation would be presented to USEPA and Ohio EPA personnel for review and comment and will be performed after conclusion of sampling within a DU, using a multiple-lines-of-evidence approach. Lines of evidence that would support a conclusion that the soil-to-groundwater pathway is incomplete would include:

- Multiple rounds of groundwater sampling results at or downgradient of the sampling location in question that show dissolved-phase impacts below screening levels;
- Partitioning/modeling calculations, such as the SSL equations, using site-specific data where available, that show that dissolved-phase concentrations would not exceed screening levels;
- Evaluation through comparison to other soil sampling locations with similar COC concentrations in soil and available dissolved-phase groundwater data;
- Analysis of samples for SPLP testing or similar leaching procedures.

If existing groundwater and hydrogeologic data are not sufficient to support evaluation of the soil-leaching-to-groundwater pathway, in consultation with USEPA and Ohio EPA, the installation of additional monitoring wells will be evaluated. If additional wells are required, the procedures identified in the approved Appendix I: Groundwater Characterization Work Plan will be used for installation and sampling.

Note that as part of or concurrent with data evaluation, updates to site-specific data that may affect the calculation of screening levels may be completed. These updates may include collection of site-specific hydraulic conductivity data and geotechnical data. Further, the CSM will also be in the process of being updated as groundwater data, etc. are received and additional data are collected under other plans. The evaluation framework will be adjusted to incorporate updates to screening levels that are agreed upon during future work.

## 7.4 Subsurface Conveyance Sample Data Review

Data collected during characterization of subsurface features and potential preferential pathways will be compared to the screening levels described in this Plan, reflecting both residential soil RSLs and site-specific soil-leaching-to-groundwater RSLs, consistent with the comparison conducted for other samples mentioned in earlier sections. A discrete, point-by-point approach will be used in evaluation of data. No averaging or mean estimation is anticipated during the first stage of evaluation.

Locations exceeding screening levels will be identified for delineation if they are not otherwise delineated by samples in exterior transects (i.e., further away from the preferential pathway or in an outer line of samples) or by work in surrounding DUs. Delineation procedures for these locations will include samples at the 5 foot step out transect (unless buildings are encountered or other supporting analytical data is present) as well as 2 feet below (unless groundwater is encountered) such that horizontal and vertical delineation is obtained where exceedances were noted.

If soil samples associated with a preferential pathway exceed screening levels but soil in the surrounding area is part of an overall DU that also exceeds screening levels for the same COCs, delineation specific to that preferential pathway will not be required. Data specific to the assessment of the preferential pathway will be incorporated into the CSM and used in future assessments of potential risk. Delineation for the area will be conducted at a DU level as described in **Sections 7.2** and **7.3**.

## 7.5 Soil Gas and Indoor Air Sample Data Review

Where ambient air, indoor air, and sub-slab soil gas samples are collected, the data will be compared to site-specific VISL values provided in **Table 6**. The sub-slab soil gas will be evaluated in context with the indoor air and the ambient air sample results to assess if derailment-related COCs are present. Sub-slab soil vapor concentrations will be compared to the screening levels presented for near-slab soil gas, and indoor and ambient air values will be compared to the screening levels presented for indoor air.

The following framework will be used to evaluate these results:

- If screening level exceedances are present in sub-slab soil vapor, but not in indoor air, a receptor evaluation will be completed to assess whether further sampling is warranted and characterize the risk of future potential exposures.
- If screening level exceedances are present in indoor air, but not in sub-slab soil vapor, additional evaluation of preferential pathways and background sources (both inside and outside) will be conducted. This condition may indicate that preferential pathways are contributing to potential indoor air concerns.
- If screening level exceedances are present in both sub-slab soil vapor and indoor air, additional assessment of potential risks and pathways will be discussed during routine calls with the agencies to evaluate the need to address future removal/remedial action under a separate plan.

The sampling will be conducted for 4 periods to represent seasonal variations, with at least two collected during the indoor heating season. The need for additional sampling and/or future removal/remedial action will be discussed with the agencies as data become available.

## 8 Reporting

During the investigation process, an updated schedule will be established to inform the USEPA and Ohio EPA of the data collection progress. As analytical data begins to be received and validated the calls will add discussion of analytical results, the RSD calculations, and review of the need for additional sampling. Similar to current grid clearance under Appendix D, where data review indicates that a DU can be considered delineated, these areas will be formally noted as such with a request for clearance from further soil sampling. Interim reports will be submitted that document the sampling results at the conclusion of each area or group of areas that are near one another. Once delineation is complete across all areas, a final report will be prepared referencing the clearance discussions, providing maps depicting the delineation work and providing summary tables of analytical data, along with laboratory reports.

The data, as it is collected, will be incorporated into the CSM being developed across multiple media for the site. An updated discussion of the CSM will be presented in the final report discussed above.

## 9 References

- ITRC. 2020. Incremental Sampling Methodology (ISM) Update. <https://ism-2.itrcweb.org/>. October.
- Matzke, B.D.; J.E. Wilson; L.L. Newburn; S.T. Dowson; J.E. Hathaway; L.H. Segó; L.M. Bramer; B.A. Pulsipher. 2014. Visual Sample Plan Version 7.0 User's Guide. PNNL-23211. March.
- Ohio EPA. 2020. Sample Collection and Evaluation of Vapor Intrusion to Indoor Air for Remedial Response, for Resource Conservation and Recovery Act and Voluntary Action Programs. <https://epa.ohio.gov/static/Portals/30/vap/docs/VI+guidance+Final+3-6-2020.pdf>. March.
- USEPA. 2015. Technical Guide for Assessing and Mitigating the Vapor Intrusion Pathway from Subsurface Vapor Sources to Indoor Air. Office of Solid Waste and Emergency Response. OSWER Publication 9200.2-154. <https://www.epa.gov/sites/default/files/2015-09/documents/oswer-vapor-intrusion-technical-guide-final.pdf>. June.

# Tables



**Table 1**  
**Conceptual Site Model Summary Table**  
**Derailment-Area Soil Characterization Work Plan**  
**East Palestine Train Derailment Site**  
**East Palestine, Ohio**

Area	Description and History	Known Features	Investigation Questions <sup>3</sup>	Analytes for Sampling
<b>CATEGORY 1 Areas likely impacted by the derailment and removal action is required. Initial removal of impacted soil will occur along with the Appendix D – Main Line Interim Soil Removal Plan or at the direction of on-site operational personnel</b>				
<b>Car Scrapping 3 (Figure 3)</b>	Area was used for car scrapping following the derailment. Area has been expanded to include the excavated outline of the Burn Pits along the area between the burn pits. Northern side of area was used for waste soil stockpiling.  Zoning: Industrial and Other Industrial (unoccupied)	North of tracks. Topography falls south to the tracks and west to Brave Industries. The north is bound by a ditch that runs between the Area and a pond. The ditch is now dry but previously conveyed water from the wetlands to the east into the North Ditch.  Perched groundwater is known present with a thickness of approximately 2-3 feet above the till based on one soil boring in the area.	Post excavation: Do residual materials remain in soils below the initial investigation because of the car scrapping activities and burn pit?  Refer to Underground Features in Category 2 for additional investigation.	Post Excavation: VOC SVOC PFAS No dioxins/furans - surficial as soil has been or will be removed under Appendix D work. <sup>1</sup>
<b>Car Scrapping 4 (Figure 4)</b>	Area was used for car scrapping following the derailment. Use during the source removal included waste storage pending transport, truck washing, truck covering, material staging, and support zones.  Zoning: Industrial and Open	South of tracks. Surface flow prior to derailment appeared to be northward toward the track and west toward the CeramFab building. A water drainage feature referred to as the "crock" exists in the southwestern portion of this area.  During the waste storage period, a ditch was constructed on the western boundary near the CeramFab building in a location where a buried corrugated steel pipe and catch basins conveyed water to the South Ditch. The catch basin system in CeramFab also conveyed roof drainage, basement sump drainage, and parking area drainage south of CeramFab building.  Perched groundwater is known present with a thickness that varies from east to west.	Post excavation: Do residual materials remain in soils below the initial investigation because of the car scrapping/waste storage activities?  Refer to Underground Features in Category 2 for additional investigation.	Post Excavation: VOC SVOC PFAS No dioxins/furans - surficial soil has been or will be removed under Appendix D work. <sup>1</sup>
<b>Ditch East of Car Scrapping 4 (Figure 5)</b>	Firefighting water and released commodities collected in portions of this ditch during the initial response. Zoning: NS ROW	Immediately south of tracks. Surface flow is into the ditch, with the ditch flowing to the west.	Post excavation: Do residual materials remain in soils because of activities?	Post Excavation: VOC SVOC PFAS No dioxins/furans - surficial soil has been or will be removed under Appendix D work. <sup>1</sup>
<b>South Ditch (east of Pleasant) (Figure 6)</b>	Area conveyed flow of materials during the derailment. Following the derailment, the ditch may also have carried contact stormwater and perched groundwater.  Zoning: NS Right-Of-Way (ROW), Industrial Warehouse, Other Industrial Structures, and Medium Manufacturing and Assembly	Immediately south of tracks. Topography falls from surrounding areas into the South Ditch, with the ditch flowing to the west.  Some known piping north of the CeramFab building that may have conveyed roof drainage into the ditch. Current piping installed to temporarily transport "crock" water to the wastewater treatment plant (WWTP) also flows through this ditch.	Post excavation: Do residual materials remain in soils below the initial investigation because of the activities?  Refer to Underground Features in Category 2 for additional investigation.	Post Excavation: VOC SVOC PFAS No dioxins/furans-surficial soil has been or will be removed under Appendix D work. <sup>1</sup>
<b>South Ditch (west of Pleasant) (Figure 7)</b>	Area conveyed flow of materials during the derailment. Following the derailment, the ditch may also have carried contact stormwater and perched groundwater.  Zoning: NS ROW, Light Manufacturing and Assembly	Immediately south of tracks. Surface flow is into the ditch, with the ditch flowing to the west. Flow into the ditch from surrounding properties.  Former terracotta pipe north of the Strohecker building was exposed during the initial work, then buried again due to lack of trench stability.	Post excavation: Do residual materials remain in soils below the initial investigation because of the activities?  Refer to Underground Features in Category 2 for additional investigation.	Post Excavation: VOC SVOC PFAS No dioxins/furans-surficial soil has been or will be removed under Appendix D work. <sup>1</sup>
<b>North Ditch (west of Pleasant) (Figure 8)</b>	Area conveyed flow of materials during the derailment. Following the derailment, the flow into the ditch from the pond north of Car Scrapping Area 3 was rerouted away from the ditch.  During Appendix D work, a non-aqueous phase liquid (NAPL) was found present on the north wall of the excavation that appears unrelated to derailment impacts. Sidewall samples from 6 of the 7 grids west of the Pleasant Crossing in the North Ditch excavation did not clear for backfill. These grids were ultimately excavated, cleared, and a layer of stabilized sand was installed on the north sidewall to isolate the NAPL from the ditch.  Currently the area west of Standby Area 1 includes a sump that is used to pump water if the ditch in the area floods.  Pre-Order this area had surface material scrapped and stockpiled to the west (included in area). Analytical samples are available for informational purposes for this area.  Zoning: NS ROW, Foundries and Heavy Manufacturing, Industrial	Immediately north of tracks west of Pleasant.  Prior to derailment this area conveyed water from a watershed to the east and north of the derailment area, including but not limited to the fields north of Brave Industries, the wetlands east of the derailment area, and the fire suppression pond north of Car Scrapping Area 3.  Topography falls into the ditch with the ditch flowing to the west. The ditch is currently dammed at the western end, and a temporary sump has been constructed to contain and pump stormwater, if necessary.	Post excavation: Do residual materials remain in soils below the initial investigation because of the activities?  Refer to Underground Features in Category 2 for additional investigation.	Post Excavation: VOC SVOC PFAS No dioxins/furans-surficial soil has been or will be removed under Appendix D work. <sup>1</sup>

**Table 1**  
**Conceptual Site Model Summary Table**  
**Derailment-Area Soil Characterization Work Plan**  
**East Palestine Train Derailment Site**  
**East Palestine, Ohio**

Area	Description and History	Features	Investigation Questions	Analytes for Sampling
<b>CATEGORY 2: These areas may have been impacted by the derailment and immediate response</b>				
<b>PA Waste Staging Area (Figure 9)</b>	For an approximate 4-day period temporary storage tanks were placed in this area and fluids were transferred between vacuum trucks and these tanks. The Ohio Environmental Protection Agency (Ohio EPA) noted a sheen on fluids on the ground during a routine inspection.  Zoning: Highway Commercial H-C	Area is generally flat and is adjacent to a surface water body to the east.	Are there impacts remaining from waste staging operations?	VOC SVOC No PFAS <sup>2</sup> Dioxins/furans at 25% of DUs (throughout category 2 areas not previously excavated)
<b>Park Dr. 1 (Figure 10)</b>	Area was used as a staging and operational area during the initial response. Derailment-related impacts are expected to be surficial and derived from incidental releases during removal activities in Sulphur Run.  This area has already been scraped, where possible.  Zoning: Municipal	Topography falls toward Sulphur Run (west) and Sulphur Run/Leslie Run confluence (south) throughout the area.	Are there impacts remaining from Sulphur Run operational activities?	VOC SVOC No PFAS <sup>2</sup> No dioxins/furans-surficial soil has been removed under previous work. <sup>1</sup>
<b>Park Dr. 3 (Figure 10)</b>	Area was used for equipment and waste storage during a short period associated with water removal from Leslie Run.  Zoning: Municipal	Former gravel area adjacent to the park and Leslie Run. Topography falls north towards the confluence of Sulphur Run and Leslie Run and also to the east.	Do residual materials remain in soils (or below fill that was brought in during restoration) as a result of the activities?	VOC SVOC No PFAS <sup>2</sup> Dioxins/furans at 25% of DUs (throughout category 2 areas not previously excavated)
<b>Bacon Avenue (Figure 11)</b>	Area was used for storage of sorbent material with roll offs from Leslie Run activities.  Zoning: Municipal	Parking area adjacent to a playground and ball field. Topography falls toward the north toward Leslie Run.	Do residual materials remain in soils as a result of activities?	VOC SVOC Dioxins/furans at 25% of DUs (throughout category 2 areas not previously excavated)
<b>Upper Level Park (Figure 11)</b>	Area was used for storage of 10 roll offs, 2 vacuum boxes and 1 storage tank along both sides of the road.  Zoning: Municipal	Park fields access road.	Do residual materials remain in soils as a result of activities?	VOC SVOC Dioxins/furans at 25% of DUs (throughout category 2 areas not previously excavated)
<b>Wastewater 1 (Figure 12)</b>	Area was used as a support zone for sentinel wells and other activities including decontamination and temporary drum storage.  Zoning: Municipal	Adjacent to residential properties. Topography falls to the east toward Wastewater 2 and Leslie Run.	Do residual materials remain in the soils as a result of the activities.	VOC SVOC No PFAS <sup>2</sup> Dioxins/furans at 25% of DUs (throughout category 2 areas not previously excavated)
<b>Car Scrapping 2 (Figure 13)</b>	Area was used for rail car scrapping. No haz-mat cars were scrapped in this area, though benzene cars were temporarily staged in this area and were transported off site whole. A temporary soil waste pile was located in the northwestern portion of this area. Derailment-related impacts are expected to be minimal and derived from car wrecking and scrapping operations.  Zoning: Medium Manufacturing and Assembly	Topography falls toward the east and toward the South Ditch. Some of the flow may be transferred onto the CeramFab property stormwater drainage catch basins.	Do residual materials remain in soils as a result of the activities?	VOC SVOC No PFAS <sup>2</sup> Dioxins/furans at 25% of DUs (throughout category 2 areas not previously excavated)
<b>Car Scrapping 1 (Figure 14)</b>	Area was used for rail car scrapping. No haz-mat cars were scrapped in this area. Derailment-related impacts are expected to be minimal and derived from car wrecking and scrapping operations.  Zoning: Light Manufacturing and Assembly	Topography falls from the east off the adjacent road onto the site and then northward to the South Ditch.	Do residual materials remain in soils as a result of the activities?	VOC SVOC No PFAS <sup>2</sup> Dioxins/furans at 25% of DUs (throughout category 2 areas not previously excavated)
<b>Tank Farm 1 (Figure 15)</b>	Area was used for mobile storage container staging. Derailment-related impacts were observed at the southern boundary of this area during the initial response. The area is currently used for two 1-million-gallon storage tanks, a water treatment facility, and is fully lined for secondary containment.  Zoning: Industrial and Industrial Warehouse	Prior to work in this area the flat zone outside of the existing building fell to the southeast, southwest, and south. Following the derailment, the North Ditch was dammed, and water ponded in the southern portion of the area. Prior to building the water treatment facility, the area was scraped with impacted soils removed, as evidenced by the high concentrations observed in waste characterization samples from soils stored in roll-off boxes. The land was brought up to the grade of the original building area [(approx. 1,032 feet above mean sea level (AMSL))] with stone and leveled to support the tank-based systems that are installed as water treatment influent tanks. The grade of the water surface in the dammed ditch was approximately 1,023 feet AMSL.	Due to the water treatment facility activities in this area and the secondary containment lining, no soil sampling is currently proposed for this area. Following completion of water treatment, this area will be assessed.  Following water treatment facility cessation and demolition, sampling as part of this plan can be completed below the fill material that makes up the area based on historic topography.	Assessment deferred until water treatment operations cease.  VOC SVOC No PFAS <sup>2</sup> No dioxins/furans-surficial soil has been removed under previous work. <sup>1</sup>

**Table 1**  
**Conceptual Site Model Summary Table**  
**Derailment-Area Soil Characterization Work Plan**  
**East Palestine Train Derailment Site**  
**East Palestine, Ohio**

Area	Description and History	Features	Investigation Questions	Analytes for Sampling
<b>CATEGORY 2: These areas may have been impacted by the derailment and immediate response</b>				
<b>Upland of Main Line East (Figure 16)</b>	This area may have conveyed firefighting water away from the derailment area, over the ground surface, toward the east. The area extends east and upgradient of the Burn Pits that are being addressed under the Appendix D plan.  Zoning: NS ROW and Other Industrial Structures	Topography before the incident fell from the track area and from the north, with runoff from precipitation flowing into a shallow swale. Flow within the ditch is west and east with the flow direction being split at a topographic high point.  This area includes the eastern terminus of the terracotta pipe that extended west to North Ditch. The entirety of the pipe has been excavated and the eastern terminus was discovered to be plugged with concrete. Two 25'x25' grids were/will be sampled in this area under Appendix D.	Did derailment-related impacts reach the easterly flow path in the ditch to convey impacts to the wetland inlet?  Terracotta pipe addressed in the Underground Features Area - Category 2.	VOC SVOC PFAS Dioxins/furans at 25% of DUs (throughout category 2 areas not previously excavated)
<b>Upland of North Ditch (Figure 17)</b>	This area, south/adjacent to the Brave Industries building, is at a slightly higher elevation than the North Ditch (which is handled under Appendix D removal activities). Surface water did not reach this elevation during the initial response.  Zoning: NS owned & Industrial Warehouse	Linear feature. Topography falls from the north, with surface runoff, Brave Industries roof drains, and basement sumps flowing into the ditch. Flow within the ditch is to the west.	Are there impacts in this area as a result of runoff and/or tracking of equipment from nearby site activities?	VOC SVOC No PFAS – this area is topographically higher than the North Ditch and outside of water flow paths during response activities <sup>2</sup> Dioxins/furans at 25% of DUs (throughout category 2 areas not previously excavated)
<b>Tank Farm 2 (Figure 18)</b>	Area was used as a mobile storage container staging area. Derailment related impacts are expected to be surficial and derived from incidental releases from the transfer operations. Ground surface in this area is mostly asphalt.  Zoning: Industrial Warehouse	Topography flows from the east and north from this area, potentially impeded by buildings and loading docks with ultimate flow into the vegetated area and Upland North Ditch.	Are there impacts remaining from mobile storage container staging and waste management operations?	VOC SVOC No PFAS <sup>2</sup> Dioxins/furans at 25% of DUs (throughout category 2 areas not previously excavated)  NOTE: sampling will be conducted under the asphalt
<b>Tank Farm 3 (Figure 19)</b>	Area was used as a mobile storage container staging area. Derailment related impacts are expected to be surficial and derived from incidental releases from the transfer operations. Ditch areas at entrance and between Tank Farms 3 and 5 are included.  Zoning: Industrial (undeveloped)	Topography falls to the north and east, where a vegetated area with a ditch separates Tank Farm 3 from 5. Tank Farm 3 was not lined prior to use. The ditch flows north to Taggart Rd. then west. Water within the ditch is currently being bypassed into a pond to the southeast of Tank Farm 6.	Following termination of activities in this area, are there impacts remaining from mobile storage container staging and waste management operations?	VOC SVOC No PFAS <sup>2</sup> Dioxins/furans at 25% of DUs (throughout category 2 areas not previously excavated)  NOTE: sampling will be conducted after the areas is scraped, and therefore representative of conditions post demobilization.
<b>Tank Farm 5 (Figure 20)</b>	Area was used as a mobile storage container staging area. Derailment related impacts are expected to be surficial and derived from incidental releases from the transfer operations. Egress from the tank farm is included.  Zoning: Light Manufacturing and Assembly (undeveloped)	Topography falls toward the west where a vegetated area with a ditch separates Tank Farm 3 from 5. The ditch flows north to Taggart Rd. then west. Water within the ditch is currently being bypassed into a pond to the southeast of Tank Farm 6.  Property to the south is a business that manages coke and coal products.  Tank Farm 5 is fully lined with HDPE with composite mats at the surface, except for the entrance from Taggart Rd and the exit to the south road traveling west.	Following termination of activities in this area, are there impacts remaining from mobile storage container staging and waste management operations?	VOC SVOC No PFAS <sup>2</sup> Dioxins/furans at 25% of DUs (throughout category 2 areas not previously excavated)  NOTE: sampling will be conducted after the surficial material (e.g., mats, liner, geotextile, and potentially material below the geotextile) is removed, and therefore representative of conditions post demobilization.
<b>Tank Farm 6 (Figure 21)</b>	Area was used as a mobile storage container staging area. Derailment related impacts are expected to be surficial and derived from incidental releases from the transfer operations. Egress from the tank farm is included.  Zoning: Light Manufacturing and Assembly and Residential (undeveloped)	Topography falls toward the east where a pond/wetland is located. Property to the south is a business that manages coke and coal products. This area is fully lined with HDPE, with the exception of the entrance from Taggart Rd.	Following termination of activities in this area, are there impacts remaining from mobile storage container staging and waste management operations?	VOC SVOC No PFAS <sup>2</sup> Dioxins/furans at 25% of DUs (throughout category 2 areas not previously excavated)  NOTE: sampling will be conducted after the surficial material (e.g., mats, liner, geotextile, and potentially material below the geotextile) is removed, and therefore representative of conditions post demobilization.
<b>Waste Staging (Figure 22)</b>	Area was used for waste soil operations. Derailment-related impacts are expected to be minimal and derived from staging, loading, and shipping.  Zoning: Open (undeveloped)	Perched water may be present in this area as evidenced by the crock area. Surface flow is generally to the west and northwest (to South Ditch and Taggart Street).  Area is adjacent to firefighting activities leading to the possibility of PFAS presence in soils. Given the amount of waste that has been processed, should any residues have been present from fires, dioxins may be present.	Following waste removals in Category 1 areas and load out of waste materials, are impacts present due to truck loading and/or waste staging?  Are subsurface impacts present due to releases from the derailment, firefighting operations, or derailment emergency response activities?	VOC SVOC PFAS Dioxins/furans at 25% of DUs (throughout category 2 areas not previously excavated)



**Table 1**  
**Conceptual Site Model Summary Table**  
**Derailment-Area Soil Characterization Work Plan**  
**East Palestine Train Derailment Site**  
**East Palestine, Ohio**

Area	Description and History	Features	Investigation Questions	Analytes for Sampling
<b>CATEGORY 2: These areas may have been impacted by the derailment and immediate response</b>				
<b>Wetland Phase 1 (Figure 23)</b>	<p>Infrared imagery from Ohio state police helicopter reportedly showed warm area in wetland during response. Ohio EPA requested assessment of this area as a result. Initial approach is to assess surface soil near wetland boundary for signs of impact. May be appropriate to integrate with sediment sampling work plan.</p> <p>Zoning: Industrial</p>	<p>Potential flow from derailment site to the northeast overland to wetland. Wetland also connects under tracks near state line to south ditch. Wetland area is part of a general topographic high near the state line and a hydrologic divide (i.e., eastern end of the East Palestine valley area).</p>	<p>Are there indications of unacceptable risks to human health or ecological receptors in the wetland area?</p> <p>Is further investigation of the wetland area warranted?</p>	<p>VOC  SVOC  No PFAS<sup>2</sup>  Dioxins/furans</p>
<b>Underground Features (Figure 24)</b>	<p>Underground features have been identified as part of response activities and potential unknown subsurface features may be present. Known features are summarized herein.</p> <p>CeramFab: Surface drainage from the south of CeramFab (coming off Taggart Street and parking lot) is conveyed to catch basins and through below grade stormwater piping to the South Ditch (through the Car Scrapping 2 area). A foundation sump on the eastern end of the building conveyed water out of the eastern wall of CeramFab and into a stormwater pipe that flowed around the north side of CeramFab and into South Ditch. Roof drains also are connected to this system.</p> <p>Car Scrapping 4: A portion of the CeramFab catch basin and conveyance system was removed and replaced with a ditch to help manage perched water from the Car Scrapping 4 area.</p> <p>South Ditch East of Pleasant: Conveyances that lie to the north and south of CeramFab converge at a manhole on the eastern extent of this area. The water conveyed through these conveyances drain into South Ditch. The western terminus of this area is a clay pipe that flows under Pleasant Drive.</p> <p>Strohecker parking lot south of Strohecker has catch basins that outflow into a ditch which flows into Sulphur Run. Additional site features include roof drains. There are reports of a dry well and other connections to the catch basin system from nearby residential properties and East Taggart Street stormwater. Derailment-related impacts were observed coming from the parking lot outfall during the initial response.</p> <p>Upland North Ditch Terracotta Pipe: A pipe that appeared to be a drain-tile for the railroad right of way/ditch.</p>	<p>Other Areas: Areas that generally originate from the Category 1 areas or areas with reported building odors will be the initial focus of the investigation. Where known; they are summarized below.</p> <p>CeramFab: Closed RCRA site where welded finish steel products and metal plating occurs. Flow from the parking lot piping is believed to be to the north and west based on catch basin monitoring during the early response. Surface soil is not expected to be impacted on this property.</p> <p>Car Scrapping 4: Includes the portion of the removed CeramFab catch basin system and abuts to the CeramFab building. The "crock" in this area has been piped to a ditch east of CeramFab which drains to the South Ditch. Before response efforts the crock was piped to the CeramFab piping network.</p> <p>South Ditch East of Pleasant: The existing piping in this area is to be removed as part of the South Ditch removal.</p> <p>The northern portion of the roof drains to the northern end of the building and flow to the ground surface of South Ditch. Foundation drains flow from the north side of the building into the South Ditch terracotta pipe. In the crawlspace of the building there is reportedly a dry well. A former ditch that was south of the building was filled in and storm drains were installed in the South parking lot. An open pipe exists in the crawl space in the structure and the facility has connected this pipe to a blower.</p> <p>Upland North Ditch Terracotta Pipe: Terracotta drainage pipe that ran parallel and north of Main Line 2. The eastern extent of the pipe is unknown and the western extent of the pipe is estimated to be proximal to the eastern extent of North Ditch.</p>	<p>Other: Are there additional unknown potential subsurface features that could have conveyed impacted fluids to other areas?</p> <p>CeramFab known network: Is the condition of this piping essentially intact such that if product or impacted water was encountered it was contained?</p> <p>Car Scrapping 4: Do the conveyances from this area have the potential to have impacted other areas?</p> <p>South Ditch East of Pleasant: Do the conveyances or utilities from this area have the potential to have impacted other areas, including any vapor in buildings?</p> <p>Strohecker: Do the utilities in this area have the potential to be contributing to vapors within the building. Do the subsurface conveyances have the potential to have impacted the subsurface where product was known to be flowing in them?</p> <p>Upland North Ditch: Did the pipe impact soils in the area?</p>	<p>VOC  SVOC  PFAS  No dioxins/furans, as this work targets subsurface features and subsurface transport of dioxins/furans in soil is expected to be minimal, if any.</p> <p>Vapor Intrusion sampling will be performed in areas where the subsurface sampling, surface sampling, and conveyance piping evaluation indicate VI sampling is appropriate.</p>
<b>CATEGORY 3: These areas may have been impacted by the derailment, but the degree of impact is uncertain and is likely lower than other areas</b>				
<b>Park Dr. 2 (Figure 10)</b>	<p>Area was used for pumps to support the aeration of Sulphur Run and Leslie Run.</p> <p>Some surficial scraping was performed in this area for interim restoration after the cessation of aeration operations.</p> <p>Zoning: Residential; one dwelling</p>	<p>Property is in the northwest corner of the confluence of Leslie and Sulphur Run. Topography falls to the east and south. Operations were generally along the eastern edge of the property.</p>	<p>Are there impacts remaining from equipment use in this area?</p>	<p>VOC  SVOC  No PFAS<sup>2</sup>  Dioxins/furans at 25% of DUs (throughout category 3 areas)</p>
<b>Park Dr. 4 (Figure 10)</b>	<p>Area was used for equipment to respond to the surface water impacts including waste storage (Park Dr. 3) and locations of pumps (Park Dr. 4) for aeration equipment.</p> <p>Some surficial scraping was performed in this area for interim restoration after the cessation of aeration operations.</p> <p>Zoning: Residential; one dwelling</p>	<p>Topography falls toward the south to Leslie Run.</p>	<p>Are there impacts remaining from aeration and equipment storage?</p>	<p>VOC  SVOC  No PFAS<sup>2</sup>  Dioxins/furans at 25% of DUs (throughout category 3 areas)</p>

**Table 1**  
**Conceptual Site Model Summary Table**  
**Derailment-Area Soil Characterization Work Plan**  
**East Palestine Train Derailment Site**  
**East Palestine, Ohio**

Area	Description and History	Features	Investigation Questions	Analytes for Sampling
<b>CATEGORY 3: These areas may have been impacted by the derailment, but the degree of impact is uncertain and is likely lower than other areas</b>				
<b>Wastewater 2 (Figure 12)</b>	Area was used for pumps to support the aeration of Sulphur Run and Leslie Run.  Zoning: Municipal	Topography falls to Leslie Run. Leslie Run makes up the northern and eastern boundary of the area. The East Palestine water plant and wastewater plant also occupy this property. The Wastewater 1 area is topographically upgradient across a paved road.	Are there impacts remaining from equipment use in this area?	VOC SVOC No PFAS <sup>2</sup> Dioxins/furans at 25% of DUs (throughout category 3 areas)
<b>Standby Tank Area 1 (Figure 25)</b>	Area was used as a mobile storage container staging area. Impacted water was pumped from North Ditch (upstream of the earthen berm) and into the mobile storage container. Derailment related impacts are expected to be surficial and derived from incidental releases from the transfer operations.  Zoning: Industrial (undeveloped)	Topography falls from the surrounding area into North Ditch.	Following the termination of the standby sump use, are there impacts remaining from operations in the truck and pump area from waste management operations?	VOC SVOC No PFAS <sup>2</sup> Dioxin <sup>3</sup> Dioxins/furans at 25% of DUs (throughout category 3 areas)
<b>Standby Tank Area 2 (Figure 26)</b>	Area is used as a mobile storage container staging and boom operational area. Derailment related impacts are expected to be surficial and derived from incidental releases from transfer operations and/or boom removal and deployment operations.  Zoning: Residential (undeveloped)	Topography falls to the north and west, directly into Sulphur Run.	Are there impacts remaining from mobile storage container staging and waste management operations?	VOC SVOC No PFAS <sup>2</sup> Dioxins/furans
<b>WWTP Effluent Tanks (Figure 27)</b>	Effluent tanks for the WWTP installed for the response. Should the Contained-In Determination be accepted; this area will be a non-hazardous waste storage area that will hold only treated water prior to disposal.  Zoning: Industrial	Area was generally flat and has been further leveled to allow for the tank placement.	Are there impacts resulting from use of this area?  Following water treatment facility cessation and demolition, sampling as part of this plan can be completed below the fill material that makes up the area based on historic topography.	Assessment deferred until water treatment operations cease.  VOC SVOC No PFAS <sup>2</sup> Dioxins/furans at 25% of DUs (throughout category 3 areas)

**Notes:**

1. The soil surface present at the time of the derailment and initial response has been, or will be, removed to a depth of at least 1 foot as part of remediation activities under Appendix D or other operational activities. Analyses for dioxins and furans are not included in these areas because significant movement of any dioxin and furan constituents in the soil column after deposition is not expected.
2. PFAS sampling is not planned in this area because it is outside of the immediate derailment and response area where firefighting activities took place.
3. Where warranted and as discussed in the document text, subsurface samples may also be collected.

**Table 2**  
**Schedule Predecessors**  
**Characterization Work Plan for Derailment-Area Soil**  
**East Palestine Train Derailment Site**  
**East Palestine, Ohio**



Area of Concern	Current Activity	Immediate Predecessor
<b>CATEGORY 1 AREAS</b>		
Car Scrapping 3	Appendix D	Piping; Appendix D
Car Scrapping 4	planning for Appendix D	Final stockpile removals; Appendix D
Ditch East of Car Scrapping 4	Appendix D	Removal of track crossing; Appendix D
South Ditch (east of Pleasant Dr)	No activity	Appendix D; Modify the perched water management. (Crock and MH3 water)
South Ditch (west of Pleasant Dr)	No activity	Appendix D; decisions on final grades
North Ditch West of Pleasant	Completion of stone placement for structural support	NOTE: sampling areas will be limited to non-wet areas and also to areas without concrete
<b>CATEGORY 2 AREAS</b>		
PA Waste Staging Area	Available	--
Park Drive 1	Available	--
Park Drive 3	Available	--
Bacon Avenue	Available	--
Upper Level Park	Available	--
Wastewater 1	Available	--
Car Scrapping 2	Available	Temporary removal of the pumping system above grade components to facilitate sampling.
Car Scrapping 1	Operations area	Completion of sheet piling; material storage area
Tank Farm 1	Operations area	Removal of treatment system; no further water management
Upland of the Main Line East	Operations area	Appendix D access for Car Scrapping 3
Upland of North Ditch	Available	--
Tank Farm 2	Operations area	CID complete; water trucking can cease
Tank Farm 3	Operations area	Demobilization of contractors SPSI and Hepaco; completion of equipment and roll off decontamination; completion of work in Tank Farm 5
Tank Farm 5	Operations area	Frac tank cleaning and demobilization; completion of work in Tank Farm 3
Tank Farm 6	Operations area	Confirmation no further need for remote waste management
Waste Staging	Operations area	Appendix D complete; no further loose waste management
Wetland Phase I	Available	--
<b>CATEGORY 3 AREAS</b>		
Park Drive 2	Available	--
Park Drive 4	Available	--
Waste Water 2	Available	--
Standby Tank Area 1	Operations area	Bypass pumping complete
Standby Tank Area 2	Operations area	South Ditch restoration for surface water flow/roof drains
Wastewater Treatment Plant Effluent Tanks	Operations area	Removal of treatment system; no further water management

Table 3  
Soil Sampling Plan  
Characterization Work Plan for Derailment-Area Soil  
East Palestine Train Derailment Site  
East Palestine, Ohio



Area of Concern	Estimated Surface Area (sf)	Land Ownership and Use <sup>2</sup>	ISM Based Surface <sup>5</sup> Samples (30 aliquots per DU)				DU Size (sf)	Number of Surface <sup>5</sup> Samples				Conveyance Features Sampling <sup>3</sup>			
			Maximum DU Size (sf)	Minimum Number of DUs @ 1 per 0.5 acre	Proposed Number of DUs	DU Name: Purpose		VOC	SVOC	Dioxin <sup>7</sup>	PFAS	VOC	SVOC	Dioxin	PFAS
<b>CATEGORY 1 AREAS</b>															
Car Scrapping 3	83,000	67-00402.000 Gotthardt David Other Industrial Structures (unoccupied) 67-00403.000 Gotthardt David Industrial (unoccupied)	21,780	3.8	4	CS3_DU1 Car Scrapping	19,786	30	4	0	4	TBD			
						CS3_DU2 Car Scrapping	16,263	30							
						<b>CS3_DU3 Car Scrapping</b>	<b>27,763</b>	<b>36</b>							
						CS3_DU4 Appendix D	13,540	30							
Car Scrapping 4	95,000	67-00079.000 Leake Willard Open Code (unoccupied) & 68-00029.000 Leake Willard 300 Industrial (unoccupied)	21,780	4.4	5	CS4_DU1 Lower elevation and fluid management	16,909	32	5	0	5	TBD			
						CS4_DU2 Car scrapping area	13,059	30							
						CS4_DU3 Car scrapping area	16,909	30							
						<b>CS4_DU4 Car scrapping/waste management</b>	<b>29,602</b>	<b>38</b>							
CS4_DU5 Car scrapping area	16,687	30													
Ditch East of Car Scrapping 4	9,000	No Parcel Number: NS ROW	9,000	1.0	1	DECS4_DU1 Ditch	9,694	30	1	0	1	TBD			
South Ditch (east of Pleasant Dr)	47,000	No Parcel Number: NS ROW & 68-00066.000 Strohecker Properties LLC Industrial Warehouse & 68-04139.000, 68-04138.001 Strohecker Properties LLC Other Industrial Structures & 68-00070.000 Yonggong LLC Medium Manufacturing and Assembly	21,780	2.2	3	SDEP_DU1 Tank storage	9,694	30	3	0	3	TBD			
						SDEP_DU2 Construction ditch	17,506	30							
						SDEP_DU3 Level ground	19,696	30							
South Ditch (west of Pleasant Dr)	50,000	No Parcel Number: NS ROW &68-00427.000 Strohecker Properties LLC Light Manufacturing and Assembly	21,780	2.3	3	SDWP_DU1 Surface activity	8,610	30	3	0	3	TBD			
						SDWP_DU2 Temporary sumps and pumping	15,779	30							
						<b>SDWP_DU3 Surface activity</b>	<b>25,106</b>	<b>33</b>							
North Ditch West of Pleasant	13,000	No Parcel Number: NS ROW & 68-00156.000 ER Advanced Ceramics Inc. Foundries & Heavy Manufacturing & 68-00157.000 ER Advanced Ceramics Inc. Industrial	13,000	1.0	1	NDWP_DU1 Ditch area	12,970	30	1	0	1	TBD			
<b>CATEGORY 2 AREAS</b>															
PA Waste Staging Area	13,000	581000119002 Nulco Highway Commercial H-C	13,000	1.0	1	PAWS_DU1 Waste staging	12,721	30	1	0	0	NA	NA	NA	NA
Park Drive 1	8,000	68-50030.000 City of East Palestine Municipality	8,000	1.0	1	PKDR1_DU1 Boom management	7,921	30	1	0	0	NA	NA	NA	NA
Park Drive 3	12,000	68-50040.000 City of East Palestine Municipalities	12,000	1.0	1	PKDR3_DU1 Waste storage	11,760	30	1	1	0	NA	NA	NA	NA
Bacon Avenue	10,000	68-50040.000 City of East Palestine Municipalities	10,000	1.0	1	BA_DU1 Rolloff	9,498	30	1	0	0	NA	NA	NA	NA
Upper Level Park	18,000	68-50040.000 City of East Palestine Municipalities	18,000	1.0	1	ULP_DU1 Waste storage	16,117	30	1	0	0	NA	NA	NA	NA
Wastewater 1	16,000	68-04194.003, 68-04194.002 City of East Palestine Municipalities (unoccupied)	16,000	1.0	1	WW1_DU1 Waste storage	16,117	30	1	1	0	NA	NA	NA	NA
Car Scrapping 2	43,000	68-00070.000 Yonggong LLC Medium Manufacturing and Assembly	21,780	2.0	3	CS2_DU1 Benzene car storage	4,971	30	3	1	0	NA	NA	NA	NA
						CS2_DU2 Waste pile/storage	16,405	30							
						CS2_DU3 Car scrapping	21,568	30							
Car Scrapping 1	35,000	68-00427.000 Strohecker Properties LLC Light Manufacturing and Assembly	21,780	1.6	3	CS1_DU1 Support and surface scrapings	7,214	30	3	2	0	NA	NA	NA	NA
						CS1_DU2 Transport and Strohecker access	12,052	30							
						CS1_DU3 Car scrapping	15,382	30							
Tank Farm 1 <sup>1</sup>	58,000	68-00154.000 Hammer John Industrial (unoccupied) & 68-00581.000 Columbiana Sanitation Industry LLC Industrial Warehouse & 68-00326.000 Gotthardt David Industrial Warehouse	21,780	2.7	4	TF1_DU1 Former dammed ditch	11,469	30	4	0	0	NA	NA	NA	NA
						TF1_DU2 Secondary containment	21,610	30							
						TF1_DU3 Water offloading	16,056	30							
						TF1_DU4 WWTP equipment in containment	9,159	30							

Notes on Page 3.

Table 3  
Soil Sampling Plan  
Characterization Work Plan for Derailment-Area Soil  
East Palestine Train Derailment Site  
East Palestine, Ohio

Area of Concern	Estimated Surface Area (sf)	Land Ownership and Use <sup>2</sup>	ISM Based Surface <sup>5</sup> Samples (30 aliquots per DU)				DU Size (sf)	Number of Surface <sup>5</sup> Samples				Conveyance Features Sampling <sup>3</sup>			
			Maximum DU Size (sf)	Minimum Number of DUs @ 1 per 0.5 acre	Proposed Number of DUs	DU Name: Purpose		VOC	SVOC	Dioxin <sup>7</sup>	PFAS	VOC	SVOC	Dioxin	PFAS
<b>CATEGORY 2 AREAS (continued)</b>															
Upland of the Main Line East	33,000	No Parcel #-Norfolk Southern & 67-00402.000 Gotthardt David Other Industrial Structures (unoccupied)	21,780	1.5	2	UMLE_DU1 Eastern end of upland of ditch UMLE_DU2 Western end of upland of ditch	11,913 21,027	30 30	2	1	2	TBD			
Upland of North Ditch	28,000	No parcel Norfolk Southern & 68-01720.000 & 68-00326.000 Gotthardt David Industrial Whse. 0-5% office (parking/transport and storage) & 68-00154.000 Hamner John Industrial (drive/unoccupied)	21,780	1.3	2	UND_DU1 Western end of upland ditch UND_DU2 Eastern end of upland ditch	15,723 12,375	30 30	2	1	0	NA	NA	NA	NA
Tank Farm 2	50,000	68-01720.000 Gotthardt David Industrial Whse. 0-5% office (parking/transport and storage) & 68-00326.000 & 68-00327.000 Gotthardt David 350 Industrial Whse. 0-5% office (parking/transport and storage)	21,780	2.3	3	TF2_DU1 Support traffic TF2_DU2 Waste storage TF2:DU3 Waste storage	6,077 21,907 21,704	30 30 30	3	1	0	NA	NA	NA	NA
Tank Farm 3	181,000	67-00274.000 Bogner Industrial (unoccupied) 67-00275.000 Bogner Light Mfg & Assembly 0-20% off (unoccupied)	21,780	8	9	TF3_DU1 Upgradient area/not storage TF3_DU2 Downgradient and limited storage TF3_DU3 Majority waste storage TF3_DU4 Majority waste storage TF3_DU5 Entire area used for waste storage TF3_DU6 Entire area used for waste storage TF3_DU7 Ditch and pumping TF3_DU8 Downgradient of storage TF3_DU9 Downgradient of storage	21,834 19,471 21,424 21,745 21,907 20,734 11,216 21,220 21,569	30 30 30 30 30 30 30 30 31	9	2	0	NA	NA	NA	NA
Tank Farm 5	144,000	67-00275.000 Bogner Light Mfg & Assembly 0-20% off (unoccupied)	21,780	6.6	8	TF5_DU1 Support traffic TF5_DU2 Waste storage TF5_DU3 Waste storage TF5_DU4 Waste storage TF5_DU5 Waste storage TF5_DU6 Waste storage TF5_DU7 Waste storage TF5_DU8 Egress	12,812 21,665 20,099 20,929 19,128 18,692 17,957 12,772	30 30 30 30 30 30 30 30	8	2	0	NA	NA	NA	NA
Tank Farm 6	116,000	67-00275.000 Bogner Light Mfg & Assembly 0-20% off (unoccupied) & 67-00273.000 500 Residential (unoccupied)	21,780	5.3	6	TF6_DU1 Waste storage TF6_DU2 Waste storage TF6_DU3 Waste storage TF6_DU4 Waste storage TF6_DU5 Waste storage TF6_DU6 Waste storage	21,468 19,590 19,111 21,330 17,894 18,852	30 30 30 30 30 30	6	2	0	NA	NA	NA	NA
Waste Staging	179,000	67-00079.000 Leake Willard Open Code (unoccupied)	21,780	8.2	8	<b>WS_DU1 Support zone</b> WS_DU2 Waste management WS_DU3 Waste management WS_DU4 Waste management WS_DU5 Truck cover and support WS_DU6 Waste management WS_DU7 Ingress/egress WS_DU8 Storage and truck cover	<b>32,791</b> 21,835 21,869 21,986 21,873 21,758 15,578 21,963	<b>42</b> 30 30 30 30 30 30 30	8	2	8	NA	NA	NA	NA
Wetland Phase I	17,000	67-00402.000 Gotthardt David Other Industrial Structures (unoccupied) 67-00403.000 Gotthardt David Industrial (unoccupied)	17,000	1.0	1	WP1_DU1	16,782	30	1	1	0	NA	NA	NA	NA

Notes on Page 3.



**Table 3**  
**Soil Sampling Plan**  
**Characterization Work Plan for Derailment-Area Soil**  
**East Palestine Train Derailment Site**  
**East Palestine, Ohio**



Area of Concern	Estimated Surface Area (sf)	Land Ownership and Use <sup>2</sup>	ISM Based Surface <sup>5</sup> Samples (30 aliquots per DU)				DU Size (sf)	Number of Surface <sup>5</sup> Samples				Conveyance Features Sampling <sup>3</sup>			
			Maximum DU Size (sf)	Minimum Number of DUs @ 1 per 0.5 acre	Proposed Number of DUs	DU Name: Purpose		VOC	SVOC	Dioxin <sup>7</sup>	PFAS	VOC	SVOC	Dioxin	PFAS
<b>CATEGORY 2 AREAS (continued)</b>															
Underground Structures	NA	68-00070.000 Yonggong LLC Medium Manufacturing and Assembly additional as noted	NA	NA	NA	NA	NA	NA	NA	NA	NA	NA	TBD		
<i>Total Cat 1 and 2</i>	<i>1,258,000</i>			<i>61</i>	<i>72</i>			<i>2,192</i>	<i>72</i>	<i>17</i>	<i>27</i>				
<b>CATEGORY 3 AREAS</b>															
Park Drive 2	20,000	38-00088.000 Leak Willard 510 One Family Dwelling & 68-50030.000 City of East Palestine 640 Municipalities (unoccupied)	20,000	1.0	2	PKDR2_DU1 Operational Area	6,492	30	2	1	0	NA	NA	NA	NA
						PKDR2_DU2 Support Area	12,999	30							
Park Drive 4	7,000	68-04194.003, 68-04194.002 City of East Palestine 640 Municipalities (unoccupied)	7,000	1.0	1	PKDR4_DU1 Aeration	7,534	30	1	1	0				
Waste Water 2	84,000	68-04194.002 East Palestine City 660 Park District (Town WWTP)	21,780	3.9	5	<b>WW2_DU1 Aeration operations and downgradient</b>	<b>26,114</b>	<b>41</b>	5	1	0	NA	NA	NA	NA
						WW2_DU2 Support traffic	18,062	30							
						WW2_DU3 Support/low impact	9,120	30							
						WW2_DU4 Support/low impact	11,182	30							
						WW2_DU5 Support area downgradient from WW1	19,143	30							
Standby Tank Area 1	7,000	68-00157.000 ER Advanced Ceramics Inc. Industrial (unoccupied)	7,000	1.0	1	SB1_DU1 Emergency Pump Around	7,405	30	1	0	0	NA	NA	NA	NA
Standby Tank Area 2	8,000	68-01583.000 Strohecker Properties LLC Residential (unoccupied)	8,000	1.0	1	SB2_DU1	7,841	30	1	1	0	NA	NA	NA	NA
Wastewater Treatment Plant Effluent Tanks <sup>1</sup>	57,000	68-01712.000 Gotthardt David 300 Industrial (unoccupied)	21,780	2.6	3	WWET_DU1	18,731	30	3	0	0	NA	NA	NA	NA
						WWET_DU2	19,166	30							
						WWET_DU3	18,731	30							
<i>Total Cat 3</i>	<i>183,000</i>			<i>10</i>	<i>13</i>			<i>401</i>	<i>13</i>	<i>4</i>	<i>0</i>				
<b>TOTAL</b>	<b>1,441,000</b>		<b>Total DUs</b>		<b>85</b>										
			<b>single aliquots<sup>6</sup></b>		<b>2,593</b>			<b>2,593</b>	<b>85</b>	<b>21</b>	<b>27</b>				

**Notes:**

Bold and italics = Size of DU is greater than 0.5 acre.

DU = Decision Unit

NA = not analyzed

PFAS = Per- and polyfluoroalkyl substances

sf = square feet

SVOC = semi volatile organic compounds

TBD = to be determined

VOC = volatile organic compounds

1 = Tank Farm 1 and Wastewater Treatment Plant Effluent Tanks are currently the WWTP for derailment activities. Work to be deferred for investigation until decommissioning.

2 = Source: Columbiana County GIS

3 = Areas identified with potential subsurface conveyances emanating from source areas will be accessed for subsurface utilities; the actual parameter counts have not been determined at this time. Those noted as TBD are areas where subsurface piping is known and could have contributed to conveyance of fluids.

4 = ISM method for non VOC compounds (SVOC, dioxin-where collected, PFAS-where collected)

5 = Surface sample does not always reflect current ground surface; for example in Category 1 areas that may be backfilled after Appendix D work or areas where the current surface being potentially exposed is being removed/scraped prior to sampling.

6 = Does not include replicates that will be performed at in at least 1 decision unit per Category at the beginning of the sampling process, and at least once toward the middle of the sampling process, and at a total of 15 percent.

7 = Dioxin and furan sampling will be conducted at approximately 25 percent of DUs where previous excavation has not been conducted (category 2 and 3); this proportion reflects findings from the residential/commercial/agricultural soil sampling effort that elevated concentrations of dioxins and furans (above the screening level of 4.8 ppt TEQ) are not uniformly present around the derailment area and do not follow a discernible spatial pattern overall. Data supporting this evaluation include results from sampling locations SS-01\_R\_K11-5, SS-01\_R\_K11-6, SS-01\_R\_K11-8, and SS-01\_R\_K12-5, which all exhibited dioxin/furan concentrations between 10 and 100 ng/kg TEQ, consistent with values at or below typical background levels for soil. Generally the sample locations are spread through the larger DUs while spreading them out to all areas of the site rather than focusing them into the larger sampling areas that are comprised of a larger number of DUs that are at or above 0.5 acres.

**Table 4**  
**Proposed Soil Screening Levels,**  
**Characterization Work Plan for Derailment-Area Soil**  
**East Palestine Train Derailment Site**  
**East Palestine, Ohio**

Parameter	CAS	RSL for the Protection of Groundwater	Residential Soil RSL	Units
<b>VOCs and SVOCs (8260/8270)</b>				
1,1-Biphenyl	92-52-4	0.045	47	mg/kg
1,2,4-Trimethylbenzene	95-63-6	0.42	300	mg/kg
1-Methylnaphthalene	90-12-0	0.031	17.6	mg/kg
2-Butanone (methyl ethyl ketone)	78-93-3	6.1	27000	mg/kg
2-Ethylhexyl acrylate	103-11-7	2.8	NA	mg/kg
2-Methylnaphthalene	91-57-6	0.96	240	mg/kg
Acenaphthene	83-32-9	28.5	3600	mg/kg
Acenaphthylene	208-96-8	28.5	3600	mg/kg
Anthracene	120-12-7	302	18000	mg/kg
Benz[a]anthracene	56-55-3	0.055	1.13	mg/kg
Benzaldehyde	100-52-7	0.022	174	mg/kg
Benzene	71-43-2	0.0131	1.16	mg/kg
Benzo[a]pyrene	50-32-8	1.22	0.115	mg/kg
Benzo[b]fluoranthene	205-99-2	1.6	1.15	mg/kg
Benzo[g,h,i]perylene	191-24-2	67.6	1800	mg/kg
Benzo[k]fluoranthene	207-08-9	15	11.5	mg/kg
Chrysene	218-01-9	47	115	mg/kg
Cyclohexane	110-82-7	55.2	6500	mg/kg
Dibenz[a,h]anthracene	53-70-3	0.49	0.115	mg/kg
Dibenzofuran	132-64-9	0.76	78	mg/kg
Ethylbenzene	100-41-4	4	5.78	mg/kg
Ethylene glycol monobutyl ether	111-76-2	2.12	6300	mg/kg
Fluoranthene	206-44-0	463	2400	mg/kg
Fluorene	86-73-7	28	2400	mg/kg
Indeno[1,2,3-cd]pyrene	193-39-5	5.1	1.15	mg/kg
Isopropylbenzene (cumene)	98-82-8	3.8	1900	mg/kg
Methyl Acrylate	96-33-3	0.046	150	mg/kg
Naphthalene	91-20-3	0.002	2.01	mg/kg
n-Butyl acrylate	141-32-2	0.9	NA	mg/kg
Phenanthrene	85-01-8	67.6	1800	mg/kg
Propylene glycol <sup>1</sup>	57-55-6	421	1300000	mg/kg
Pyrene	129-00-0	67.6	1800	mg/kg
Toluene	108-88-3	3.6	4900	mg/kg
Vinyl chloride	75-01-4	0.0034	0.059	mg/kg
<b>o-Xylene</b>	<b>95-47-6</b>	<b>0.983</b>	<b>640</b>	<b>mg/kg</b>
<b>m- &amp; p-Xylene</b>	<b>179601-23-1</b>	<b>0.969</b>	<b>550*</b>	<b>mg/kg</b>
<b>Dioxins and Furans</b>				
2,3,7,8-tetrachlorodibenzo-p-dioxin (2,3,7,8-TCDD)	1746-01-6	7.8	4.8	ng/kg
2,3,4,6,7,8-hexachlorodibenzofuran	60851-34-5	**	**	ng/kg
2,3,4,7,8-pentachlorodibenzofuran	57117-31-4	**	**	ng/kg
2,3,7,8-tetrachlorodibenzofuran	51207-31-9	**	**	ng/kg
1,2,3,4,6,7,8,9-octachlorodibenzofuran	39001-02-0	**	**	ng/kg
1,2,3,4,6,7,8,9-octachlorodibenzo-p-dioxin	3268-87-9	**	**	ng/kg
1,2,3,4,6,7,8-heptachlorodibenzofuran	67562-39-4	**	**	ng/kg
1,2,3,4,6,7,8-heptachlorodibenzo-p-dioxin	35822-46-9	**	**	ng/kg
1,2,3,4,7,8,9-heptachlorodibenzofuran	55673-89-7	**	**	ng/kg
1,2,3,4,7,8-hexachlorodibenzofuran	70648-26-9	**	**	ng/kg
1,2,3,4,7,8-hexachlorodibenzo-p-dioxin	39227-28-6	**	**	ng/kg
1,2,3,6,7,8-hexachlorodibenzofuran	57117-44-9	**	**	ng/kg
1,2,3,6,7,8-hexachlorodibenzo-p-dioxin	57653-85-7	**	**	ng/kg
1,2,3,7,8,9-hexachlorodibenzofuran	72918-21-9	**	**	ng/kg

Notes on Page 2.

**Table 4**  
**Proposed Soil Screening Levels,**  
**Characterization Work Plan for Derailment-Area Soil**  
**East Palestine Train Derailment Site**  
**East Palestine, Ohio**

Parameter	CAS	RSL for the Protection of Groundwater	Residential Direct Contact RSL	Units
<b>Dioxins and Furans (continued)</b>				
1,2,3,7,8,9-hexachlorodibenzo-p-dioxin	19408-74-3	**	**	ng/kg
1,2,3,7,8-pentachlorodibenzofuran	57117-41-6	*	**	ng/kg
1,2,3,7,8-pentachlorodibenzo-p-dioxin	40321-76-4	**	**	ng/kg
<b>PFAS</b>				
HFPO-DA (Hexafluoropropylene oxide dimer acid)	13252-13-6	NA	0.23	mg/kg
PFBA (Perfluoro-n-butanoic acid)	375-22-4	0.0338	78	mg/kg
PFBS (Perfluorobutanesulfonic acid)	375-73-5	0.0101	19	mg/kg
PFHxS (Perfluoro-n-hexanoic acid)	307-24-4	0.0124	32	mg/kg
PFHxS (Perfluorohexanesulfonic acid)	355-46-4	0.000870	1.3	mg/kg
PFNA (Perfluorononanoic acid)	375-95-1	0.00130	0.19	mg/kg
PFOA (Perfluorooctanoic acid)	335-67-1	0.00470	0.19	mg/kg
PFOS (Perfluorooctanesulfonic acid)	1763-23-1	0.00160	0.13	mg/kg

**Notes:**

\* = m- & p- xylene are unresolvable by the lab due to similar elution times and will be reported as a grouped m- & p-xylene by the lab, with a conservative RSL of 550 mg/kg which is the lower RSL of the two compounds.

\*\* = Dioxin and furan compounds will be evaluated using a toxicity equivalent (TEQ) approach, with the calculated TEQ across the compounds listed compared to the screening level presented for 2,3,7,8-TCDD.

mg/kg = milligrams per kilogram

ng/kg = nanograms per kilogram

PFAS = per- and poly-fluoroalkyl substances

RSL = Regional Screening Level

SVOCs = semivolatile organic compounds

VOCs = volatile organic compounds

1. Propylene glycol will be analyzed by SW-846 method 8015.

RSLs include site-specific values for the soil-leaching-to-groundwater pathway and the default screening levels from the USEPA RSL tables for residential soil, both reflecting a hazard index of 1 and an excess lifetime cancer risk of 10<sup>-6</sup>.

Published soil-to-groundwater and residential soil RSLs are not published for acenaphthylene, benzo(g,h,i)perylene, and phenanthrene. Proposed RSLs for acenaphthylene are based on acenaphthene as a surrogate compound; proposed RSLs for benzo(g,h,i)perylene and phenanthrene are based on pyrene as a surrogate compound.

NA: Not available

**Table 5**  
**Proposed Sediment Screening Levels,**  
**Characterization Work Plan for Derailment-Area Soil**  
**East Palestine Train Derailment Site**  
**East Palestine, Ohio**

Parameter	CAS	Selected Screening Benchmark (µg/kg)	Source
1,2,4-Trimethylbenzene	95-63-6	97	R4
1-Methylnaphthalene	90-12-0	141	R4
2-Butanone	78-93-3	7604	R4
2-Butoxyethanol	111-76-2	NV	NV
2-Ethylhexyl acrylate	103-11-7	53	Wash
2-Hexanone <sup>1</sup>	591-78-6	45	R4
2,4-Dinitrophenol <sup>1</sup>	51-28-5	223	R4
2,6-Dinitrotoluene <sup>1</sup>	606-20-2	296	R4
2-Methylnaphthalene	91-57-6	20.2	R4/R6
2-Nitrophenol <sup>1</sup>	88-75-5	168	R4
3&4-Methylphenol <sup>1</sup>	15831-10-4	NV	
4-Nitrophenol <sup>1</sup>	100-02-7	153	R4
4,6-Dinitro-2-Methylphenol <sup>1</sup>	534-52-1	1477	R4
Acenaphthene	83-32-9	6.7	R4/CCME/R6/R5/R3/NJ
Acenaphthylene	208-96-8	5.87	R4/CCME/R6/R5/R3/NJ
Acetone <sup>1</sup>	67-64-1	65	R4
Anthracene	120-12-7	27	ORNL
Benzene	71-43-2	10	R4/LANL
Benz[a]anthracene	56-55-3	31.7	CCME
Benzo[a]pyrene	50-32-8	31.9	CCME
Benzo[b]fluoranthene	205-99-2	27.2	R3
Benzo[g,h,i]perylene	191-24-2	170	R4/R5/R3/LANL/NJ
Benzoic acid <sup>1</sup>	65-85-0	19	R4
Benzo[k]fluoranthene	207-08-9	27.2	ARCS TEC
Benzyl Alcohol <sup>1</sup>	100-51-6	3.7	R4
n-Butyl Acrylate	141-32-2	159	Wash
Carbon Disulfide <sup>1</sup>	75-15-0	7.8	R4
Chrysene	218-01-9	57.1	CCME
Diethylene Glycol <sup>1</sup>	111-46-6	NV	
Ethylbenzene	100-41-4	175	R5
Ethylene Glycol <sup>1</sup>	107-21-1	42389	R4
Fluoranthene	206-44-0	64.23	ARCS TEC
Fluorene	86-73-7	19	NOAA
Indeno[1,2,3-cd]pyrene	193-39-5	17	R3
Isophorone <sup>1</sup>	78-59-1	876	R4
Methyl Acrylate <sup>1</sup>	96-33-3	3	Wash
Methyl Isobutyl Ketone <sup>1</sup>	108-10-1	73	R4
Naphthalene	91-20-3	32.75	ARCS TEC
Nitrobenzene <sup>1</sup>	98-95-3	407	R4
Phenanthrene	85-01-8	41.9	CCME
Phenol	108-95-2	175	R4

Notes on Page 2.

**Table 5**  
**Proposed Sediment Screening Levels,**  
**Characterization Work Plan for Derailment-Area Soil**  
**East Palestine Train Derailment Site**  
**East Palestine, Ohio**

Parameter	CAS	Selected Screening Benchmark (µg/kg)	Source
Pyrene	129-00-0	53	CCME
Styrene <sup>1</sup>	100-42-5	126	R4
Toluene	108-88-3	10	LANL
Vinyl Chloride	75-01-4	140	LANL
m- & p-Xylenes	179601-23-1	4.6	R6
o-Xylene	95-47-6	103	R4

**Note:**

µg/kg = micrograms per kilogram

1 - Screening level provided by the USEPA; however, constituent is not included in planned analysis.

NV: No value

**REFERENCES:**

ARCS TEC, ARCS PEC = Buchman, M.F. 1999. NOAA Screening Quick Reference Tables, NOAA HAZMAT Report 99-1, Seattle, WA, Coastal Protection and Restoration Division, National Oceanic and Atmospheric Administration, 12 pp.

CCMER = Canadian Council of Ministers of the Environment Sediment Quality guidelines, <https://ccme.ca/en/resources#>

EPA Region 3 = U.S. EPA Region III BTAG Freshwater Screening Benchmarks. <https://www.epa.gov/risk/biological-technical-assistance-group-btag-screening-values>

EPA Region 5 = U.S. EPA Region 5, RCRA. 2003. Ecological Screening Levels. July 17, 2003. <https://archive.epa.gov/region5/waste/cars/web/pdf/ecological-screening-levels-200308.pdf>

EPA Region 6 = Texas Commission on Environmental Quality. Ecological Risk Assessments. Ecological Risk Assessment Resources. 2022 TCEQ Ecological Screening Benchmarks. <https://www.tceq.texas.gov/remediation/eco>

FDEP ERL, FDEP LEL = MacDonald, D. D., et al. (2003). Development and Evaluation of Numerical Sediment Quality Assessment Guidelines for Florida Inland Waters. Technical Report, Prepared for Florida Department of Environmental Protection.

LANL = LANL (Los Alamos National Laboratory). (2022). ECORISK Database (Release 4.3), Los Alamos National Laboratory, Los Alamos, New Mexico. Developed by Newport News Nuclear BWXT-Los Alamos, LLC (N3B).

NJ LEL = NJDEP (2009). NJDEP Ecological Screening Criteria. <https://www.nj.gov/dep/srp/guidance/ecoscreening/>

NYSDEC = NYSDEC (2014). Screening and Assessment of Contaminated Sediment, New York State Department of Environmental Conservation. Division of Fish, Wildlife and Marine Resources, Bureau of Habitat: 99.

ORNL 1997 = Jones et al. 1997. Toxicological benchmarks for screening contaminants of potential concern for effects on sediment-associated biota. ES/ER/TM-95/R4

OSWER ECOTOX = U.S. EPA (1996). Ecotox Thresholds. Washington, D.C., U. S. EPA, Office of Solid Waste and Emergency Response.

OSWER SQB = U.S. EPA. 1996. Eco Update: EcoTox Thresholds. Office of Solid Waste and Emergency Response, Publication 9345.0-12FSI, EPA 540/F-95/038 PB95-963324, January 1996.

**Table 5  
Proposed Sediment Screening Levels,  
Characterization Work Plan for Derailment-Area Soil  
East Palestine Train Derailment Site  
East Palestine, Ohio**

Parameter	CAS	Selected Screening Benchmark (µg/kg)	Source
-----------	-----	--------------------------------------	--------

R4 ESV = U.S. EPA Region 4 (2018). Region 4 Ecological Risk Assessment Supplemental Guidance. Interim Draft. [https://www.epa.gov/sites/default/files/2018-03/documents/era\\_regional\\_supplemental\\_guidance\\_report-march-2018\\_update.pdf](https://www.epa.gov/sites/default/files/2018-03/documents/era_regional_supplemental_guidance_report-march-2018_update.pdf)

Wash = Values referenced by USEPA as from the Washington State Sediment Management Standard

**Table 6**  
**Commercial Vapor Intrusion Screening Level (VISL) Calculations**  
**Characterization Work Plan for Derailment-Area Soil**  
**East Palestine Train Derailment Site**  
**East Palestine, Ohio**

Chemical	CAS Number	Does the chemical meet the definition for volatility? (HLC>1E-5 or VP>1)	Does the chemical have inhalation toxicity data? (IUR and/or RfC)	Is Chemical Sufficiently Volatile and Toxic to Pose Inhalation Risk Via Vapor Intrusion from Soil Source? ( $C_{vp} > C_{i,a}, Target?$ )	Is Chemical Sufficiently Volatile and Toxic to Pose Inhalation Risk Via Vapor Intrusion from Groundwater Source?	Target Indoor Air Concentration (TCR=1E-06 or THQ=1) $MIN(C_{i,a,c}, C_{i,a,nc})$ ( $\mu\text{g}/\text{m}^3$ )	Target Sub-Slab and Near-source Soil Gas Concentration (TCR=1E-06 or THQ=1) $C_{sg,Target}$ ( $\mu\text{g}/\text{m}^3$ )
Benzene	71-43-2	Yes	Yes	Yes	Yes	1.57E+00	5.24E+01
Cumene	98-82-8	Yes	Yes	Yes	Yes	1.75E+03	5.84E+04
Cyclohexane	110-82-7	Yes	Yes	Yes	Yes	2.63E+04	8.76E+05
Ethylbenzene	100-41-4	Yes	Yes	Yes	Yes	4.91E+00	1.64E+02
Methyl Ethyl Ketone (2-Butanone)	78-93-3	Yes	Yes	Yes	Yes	2.19E+04	7.30E+05
Naphthalene	91-20-3	Yes	Yes	Yes	Yes	3.61E-01	1.20E+01
Toluene	108-88-3	Yes	Yes	Yes	Yes	2.19E+04	7.30E+05
Trimethylbenzene, 1,2,4-	95-63-6	Yes	Yes	Yes	Yes	2.63E+02	8.76E+03
Vinyl Chloride	75-01-4	Yes	Yes	Yes	Yes	2.79E+00	9.29E+01
Xylene, o-	95-47-6	Yes	Yes	Yes	Yes	4.38E+02	1.46E+04
Xylene, m- & p-*	179601-23-1	Yes	Yes	Yes	Yes	4.38E+02	1.46E+04
N-butyl acrylate**	141-32-2	Yes	No	--	--	2.60E+01	8.67E+02
2-ethylhexyl acrylate**	103-11-7	Yes	No	--	--	1.28E+02	4.27E+03

**Notes:**

$\mu\text{g}/\text{m}^3$  = micrograms per cubic meter.

Calculations based on a target excess lifetime cancer risk of  $10^{-6}$  and a target hazard quotient of 1.

\* m- & p- xylene are unresolvable by the lab due to similar elution times and will be reported as a grouped m- & p-xylene.

\*\* Screening levels provided by USEPA from ATSDR; with a chronic inhalation screening level and chronic subslab/soil gas screening levels provided in units of ppb. Values were converted to  $\mu\text{g}/\text{m}^3$  using the molecular weights of 128.17 for n-butyl acrylate and 184.28 for 2-ethylhexyl acrylate.

# Figures



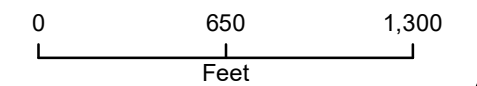


Note:  
Site Working Area includes a buffer  
of 25 feet off of the PA State Line  
and areas to be investigated

Note:  
Site Working Area does not extend  
to property limits in the south and  
east of the tank farms due to the  
current site use in this area by  
Bogner as property owner

**Legend**

- Site Working Area
- Sampling Decision Units**
- Category 1
- Category 2
- Category 3
- Deferred Work
- Cleared and Restored Under Appendix D
- Property Boundary Lines
- County/State Boundary



Map Date: 7/10/2023

Drone imagery incident area date: 07/09/2023  
Drone imagery offsite dates: 05/14/2023



NORFOLK SOUTHERN  
EAST PALESTINE, OHIO

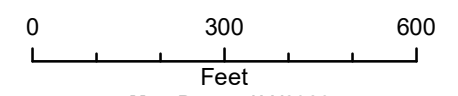
**SITE WORKING AREA**







- Legend**
- Site Working Area
  - Decision Unit Areas/Boundaries**
  - Category 1
  - Category 2
  - Category 3
  - Category 4
  - Cleared and Restored Under Appendix D
  - Property Boundary Lines
  - Stormwater Conveyance
  - Trench
  - Perennial stream
  - Intermittent stream
  - Ditch
  - Drain Tile
  - Culvert
  - County/State Boundary
  - Existing Wastewater Collection System**
  - Piping and Flow Direction
  - Wetland Areas**
  - PEM: Palustrine Emergent Wetland
  - PSS: Palustrine Scrub-Shrub Wetland
  - PFO: Palustrine Forested Wetland



Map Date: 7/11/2023  
 Imagery from ESRI World Imagery  
 (Pre Derailment)



NORFOLK SOUTHERN  
 EAST PALESTINE, OHIO

**SURFACE WATER FLOW**



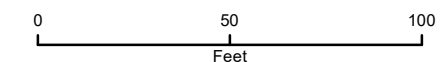
Document Path: T:\ENW\NorfolkSouthern\EastPalestine\_Feb\_2023\Project\_Peater\_Layers\MS\_EastPalestine\_F2\_SurfaceWaterFlow.mxd





**Legend**

- Category 1
- Category 2
- Category 3
- Deferred Work
- Cleared and Restored Under Appendix D
- Property Boundary Lines
- Stormwater Catch Basin Removed
- County/State Boundary
- Study Area
- Terracotta Drain Pipe (Inferred Location)
- Burn Pits
- Confirmation Sampling Grids
- DU Samples



Map Date: 7/11/2023

Drone imagery main incident area dates: 07/10/21  
 Drone imagery main offsite area dates: 05/14/2023



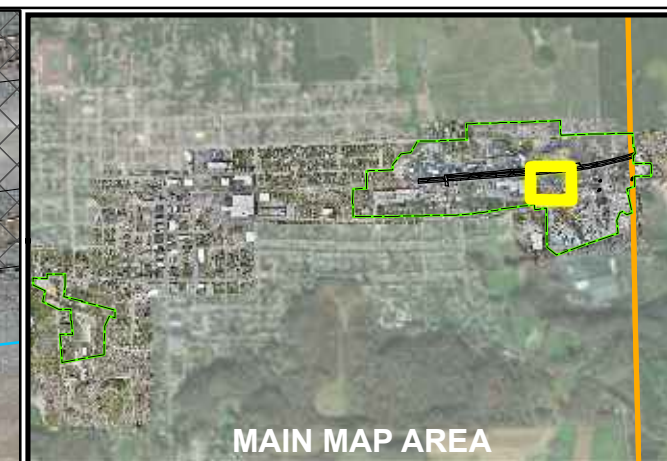
NORFOLK SOUTHERN  
 EAST PALESTINE, OHIO

**CAR SCRAPPING 3**



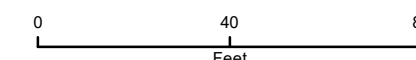
FIGURE  
**3**





**Legend**

- Category 1
- Category 2
- Category 3
- Deferred Work
- Cleared and Restored Under Appendix D
- Property Boundry Lines
- Stormwater Catch Basin
- Stormwater Catch Basin Removed
- Stormwater Conveyance
- County/State Boundary
- Study Area
- DU Samples



**Map Date: 7/11/2023**  
 Drone imagery main incident area dates: 07/10/21  
 Drone imagery main offsite area dates: 05/14/2023

NORFOLK SOUTHERN  
 EAST PALESTINE, OHIO

**CAR SCRAPPING 4**



FIGURE  
**4**

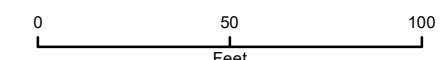
Document Path: T:\EN\NofolkSouthern\EastPalestine\_Feb5\_2023\Project\_Peasr\_Layouts\MS\_East\_Palestine\_F2\_dipage\_Site\_Working\_Areas.mxd





**Legend**

- Category 1
- Category 2
- Category 3
- Deferred Work
- Cleared and Restored Under Appendix D
- Property Boundary Lines
- County/State Boundary
- Study Area
- DU Samples



**Map Date: 7/11/2023**

Drone imagery main incident area dates: 07/10/21  
 Drone imagery main offsite area dates: 05/14/2023



NORFOLK SOUTHERN  
 EAST PALESTINE, OHIO

**DITCH EAST OF CAR SCRAPPING 4**



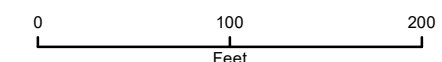
FIGURE  
**5**





**Legend**

- Category 1
- Category 2
- Category 3
- Deferred Work
- Cleared and Restored Under Appendix D
- Property Boundary Lines
- Stormwater Catch Basin
- Stormwater Catch Basin Removed
- Stormwater Conveyance
- County/State Boundary
- Study Area
- DU Samples



Map Date: 7/11/2023

Drone imagery main incident area dates: 07/10/21  
 Drone imagery main offsite area dates: 05/14/2023



NORFOLK SOUTHERN  
 EAST PALESTINE, OHIO

**SOUTH DITCH EAST OF PLEASANT**



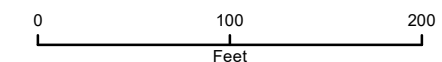
FIGURE  
**6**





**Legend**

- Category 1
- Category 2
- Category 3
- Deferred Work
- Cleared and Restored Under Appendix D
- Property Boundary Lines
- County/State Boundary
- Study Area
- DU Samples



**Map Date: 7/11/2023**  
 Drone imagery main incident area dates: 07/10/21  
 Drone imagery main offsite area dates: 05/14/2023

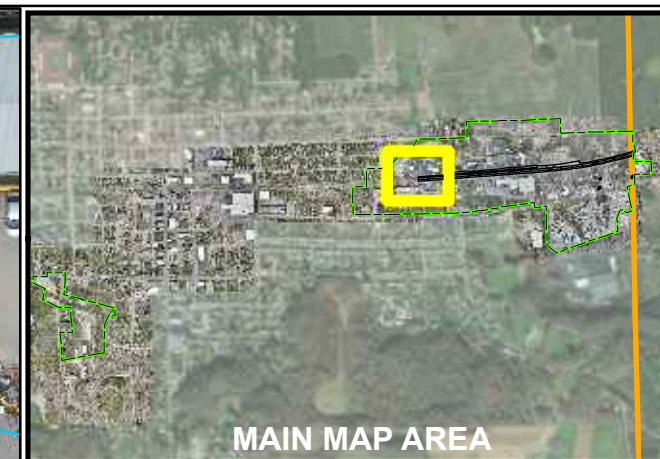
NORFOLK SOUTHERN  
 EAST PALESTINE, OHIO

**SOUTH DITCH WEST OF PLEASANT**



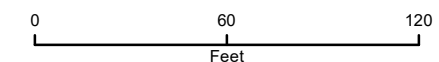
FIGURE  
**7**





**Legend**

- Category 1
- Category 2
- Category 3
- Deferred Work
- Cleared and Restored Under Appendix D
- Property Boundary Lines
- County/State Boundary
- Study Area
- DU Samples



Map Date: 7/11/2023

Drone imagery main incident area dates: 07/10/21  
 Drone imagery main offsite area dates: 05/14/2023



NORFOLK SOUTHERN  
 EAST PALESTINE, OHIO

**NORTH DITCH WEST OF PLEASANT**



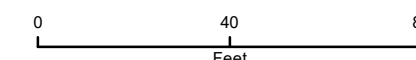
FIGURE  
**8**





**Legend**

- Category 1
- Category 2
- Category 3
- Deferred Work
- Property Boundary Lines
- County/State Boundary
- Study Area
- DU Samples



**Map Date: 7/11/2023**

Drone imagery main incident area dates: 07/10/21  
 Drone imagery main offsite area dates: 05/14/2023



NORFOLK SOUTHERN  
 EAST PALESTINE, OHIO

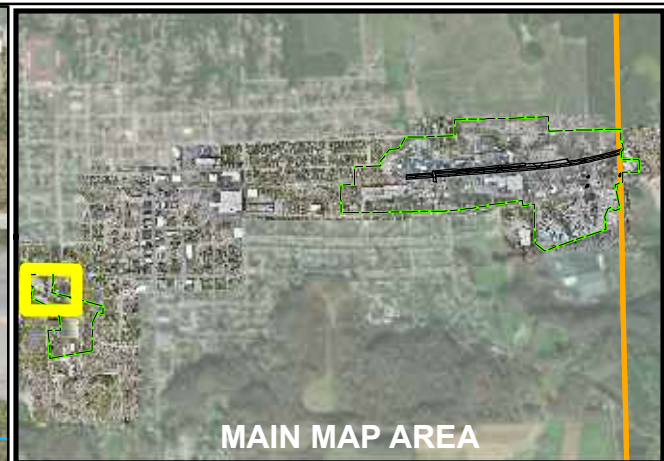
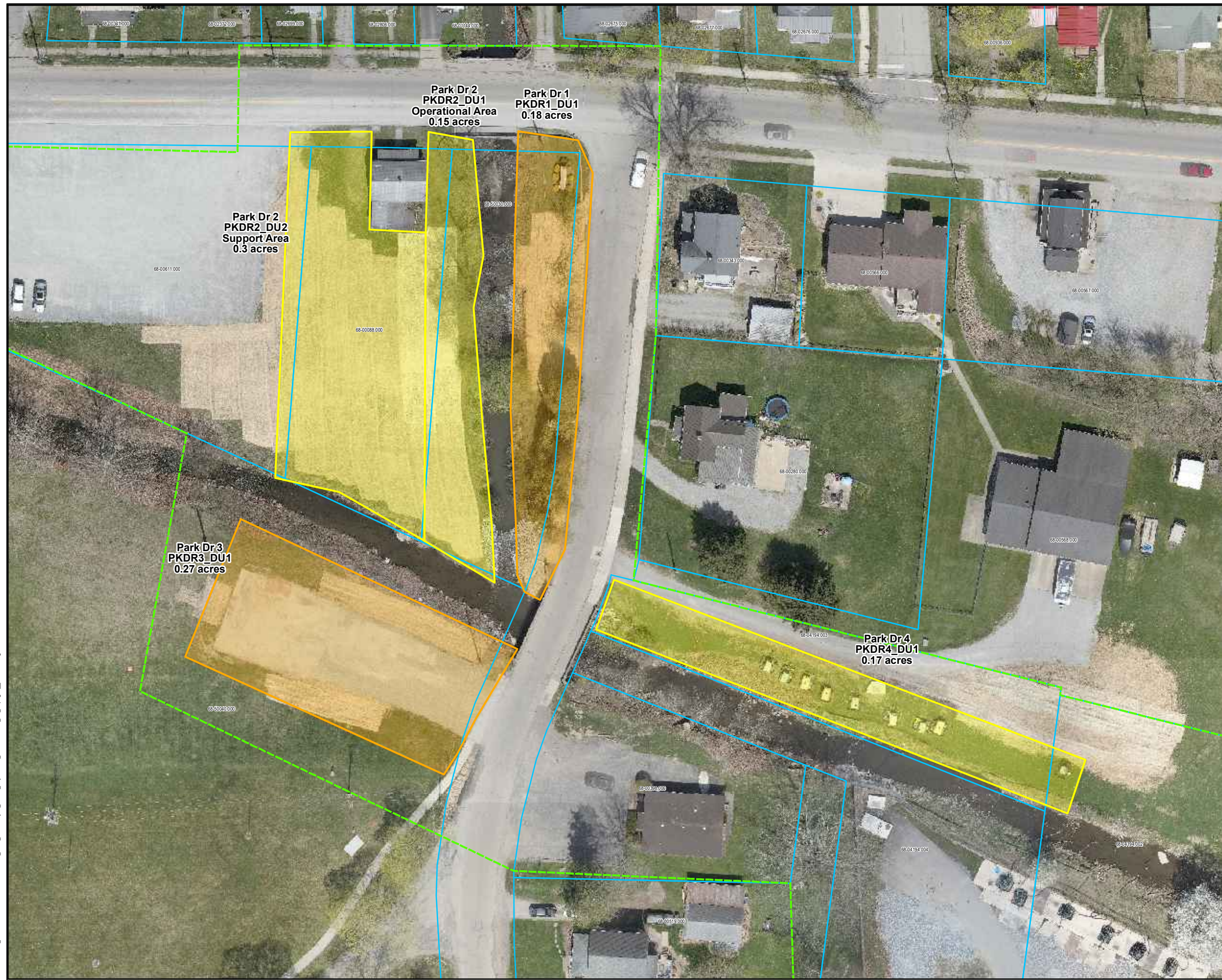
**PA WASTE STAGING**



FIGURE

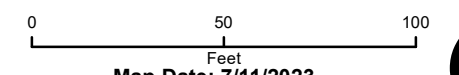
**9**





**Legend**

- Category 1
- Category 2
- Category 3
- Deferred Work
- Property Boundry Lines
- County/State Boundary
- Study Area
- DU Samples



**Map Date: 7/11/2023**  
 Drone imagery main incident area dates: 07/10/21  
 Drone imagery main offsite area dates: 05/14/2023

NORFOLK SOUTHERN  
 EAST PALESTINE, OHIO

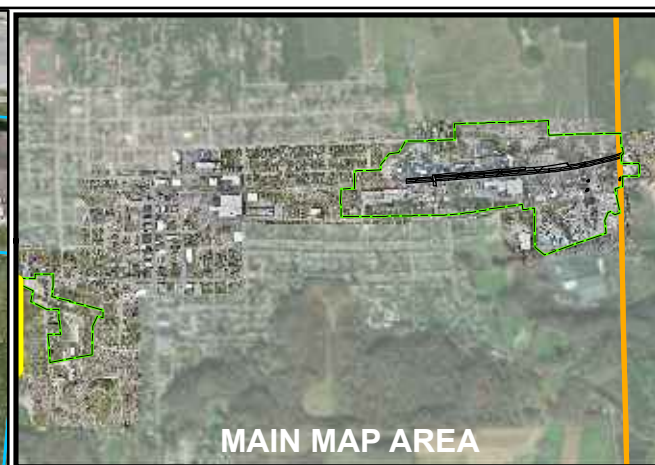
**PARK DR**



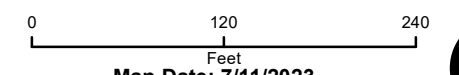
FIGURE  
**10**



Document Path: T:\EN\NoforSouthernEastPalestine\_Feb5\_2023\Project\_Peasr\_Layouts\NS\_East Palestine\_F2\_clippage\_Site Working Areas.mxd



- Legend**
- Category 1
  - Category 2
  - Category 3
  - Deferred Work
  - Property Boundry Lines
  - County/State Boundary
  - Study Area
  - DU Samples



**Map Date: 7/11/2023**  
 Drone imagery main incident area dates: 07/10/21  
 Drone imagery main offsite area dates: 05/14/2023

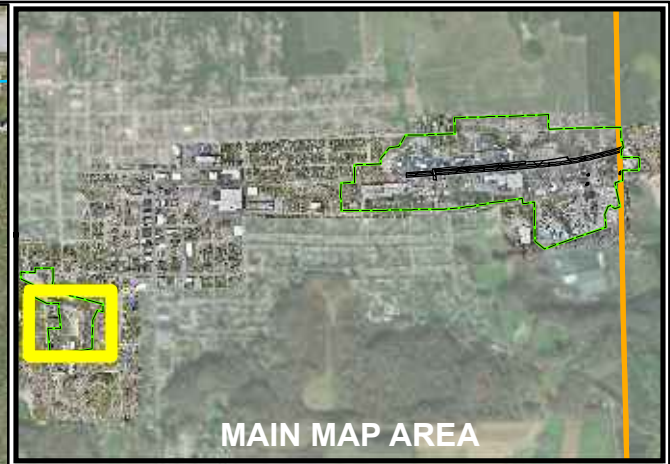
NORFOLK SOUTHERN  
 EAST PALESTINE, OHIO

**BACON AVE**



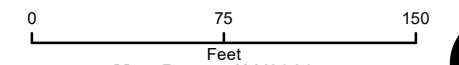
FIGURE  
**11**





**Legend**

- Category 1
- Category 2
- Category 3
- Deferred Work
- Property Boundry Lines
- County/State Boundary
- Study Area
- DU Samples



**Map Date: 7/11/2023**  
 Drone imagery main incident area dates: 07/10/21  
 Drone imagery main offsite area dates: 05/14/2023

NORFOLK SOUTHERN  
 EAST PALESTINE, OHIO

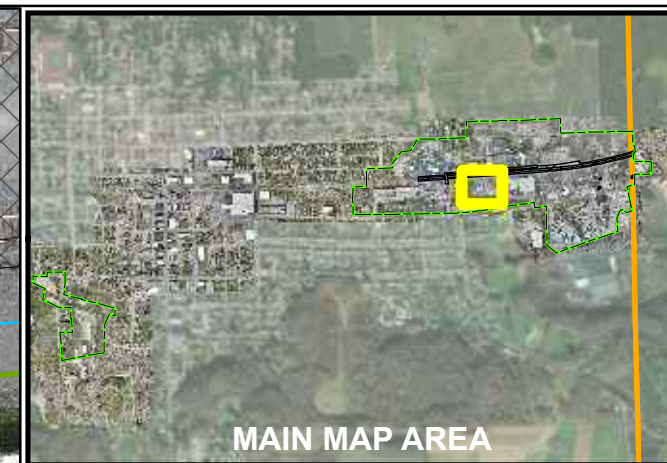
**WASTEWATER 1 AND WASTEWATER 2**



FIGURE

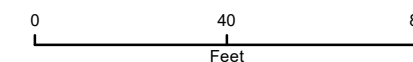
12





**Legend**

- Category 1
- Category 2
- Category 3
- Deferred Work
- Cleared and Restored Under Appendix D
- Property Boundary Lines
- Stormwater Catch Basin
- Stormwater Conveyance
- County/State Boundary
- Study Area
- DU Samples



Map Date: 7/11/2023

Drone imagery main incident area dates: 07/10/21  
 Drone imagery main offsite area dates: 05/14/2023

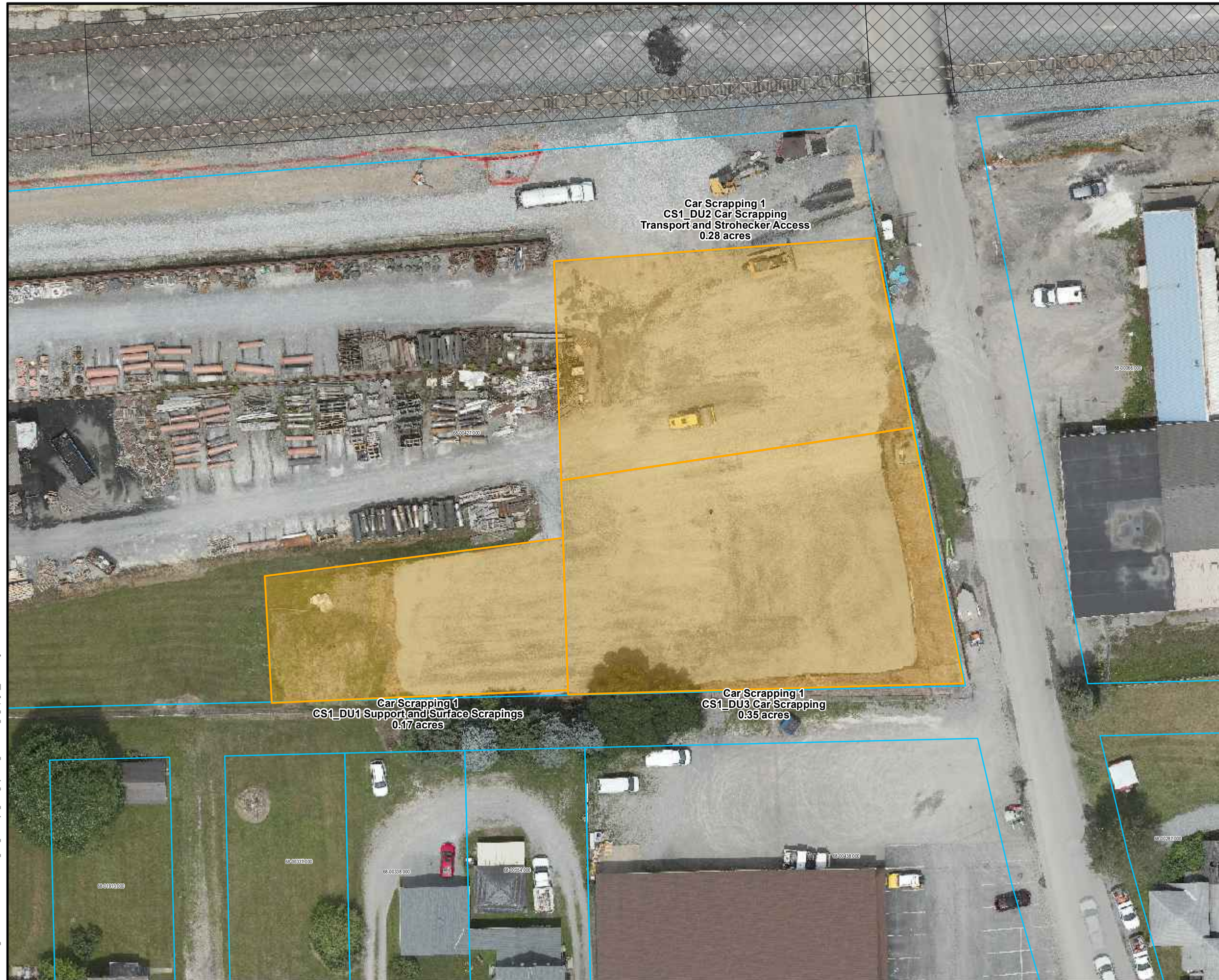


NORFOLK SOUTHERN  
 EAST PALESTINE, OHIO

**CAR SCRAPPING 2**



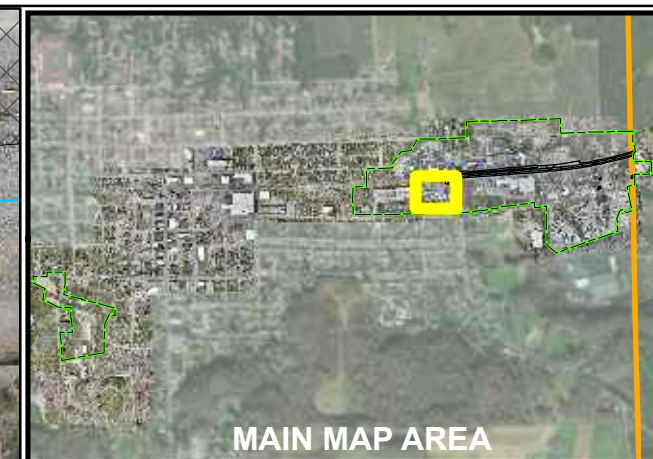




Car Scrapping 1  
 CS1\_DU2 Car Scrapping  
 Transport and Strohecker Access  
 0.28 acres

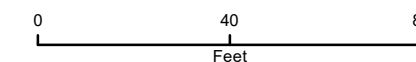
Car Scrapping 1  
 CS1\_DU1 Support and Surface Scrapings  
 0.17 acres

Car Scrapping 1  
 CS1\_DU3 Car Scrapping  
 0.35 acres



**Legend**

- Category 1
- Category 2
- Category 3
- Deferred Work
- Cleared and Restored Under Appendix D
- Property Boundary Lines
- County/State Boundary
- Study Area
- DU Samples



Map Date: 7/11/2023

Drone imagery main incident area dates: 07/10/21  
 Drone imagery main offsite area dates: 05/14/2023



NORFOLK SOUTHERN  
 EAST PALESTINE, OHIO

**CAR SCRAPPING 1**



FIGURE

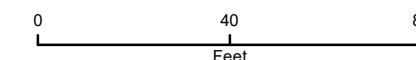
**14**





**Legend**

- Category 1
  - Category 2
  - Category 3
  - Deferred Work
  - Cleared and Restored Under Appendix D
  - Property Boundary Lines
  - County/State Boundary
  - Study Area
  - DU Samples
- Note:  
Refer to Figure 22 for Effluent Tanks



Map Date: 7/11/2023

Drone imagery main incident area dates: 07/10/21  
Drone imagery main offsite area dates: 05/14/2023

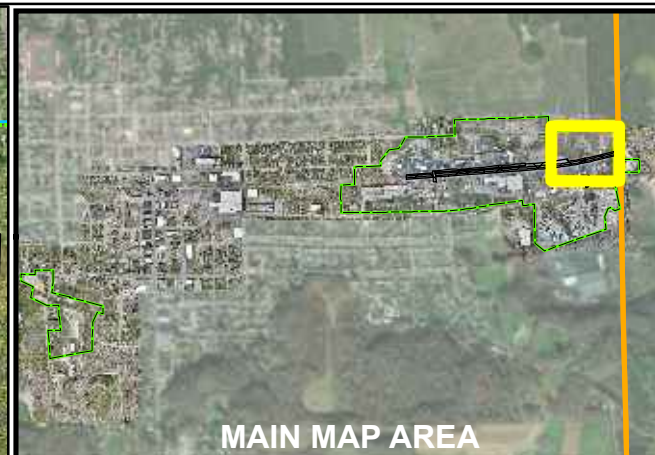


NORFOLK SOUTHERN  
EAST PALESTINE, OHIO

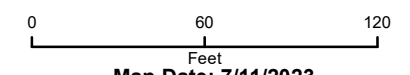
**TANK FARM 1**







- Legend**
- Category 1
  - Category 2
  - Category 3
  - Deferred Work
  - Cleared and Restored Under Appendix D
  - Property Boundary Lines
  - County/State Boundary
  - Study Area
  - DU Samples



**Map Date: 7/11/2023**

Drone imagery main incident area dates: 07/10/21  
 Drone imagery main offsite area dates: 05/14/2023



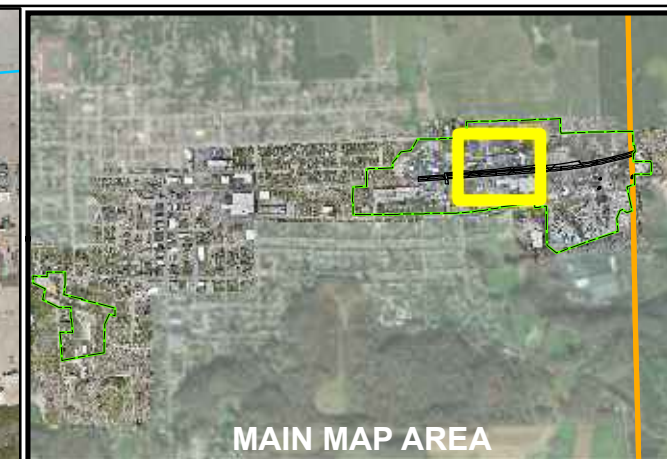
NORFOLK SOUTHERN  
 EAST PALESTINE, OHIO

**UPLAND OF THE MAIN LINE EAST**



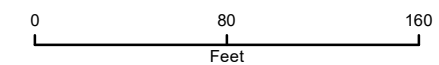
Document Path: T:\EN\NoforSouthernEastPalestine\_Feb\_2023\Project\_Peasie\_Layouts\NS\_East\_Palestine\_F2\_clippage\_Site Working Areas.mxd





**Legend**

- Category 1
- Category 2
- Category 3
- Deferred Work
- Cleared and Restored Under Appendix D
- Property Boundary Lines
- Stormwater Catch Basin
- Stormwater Catch Basin Removed
- Stormwater Conveyance
- County/State Boundary
- Study Area
- DU Samples



**Map Date: 7/11/2023**  
 Drone imagery main incident area dates: 07/10/21  
 Drone imagery main offsite area dates: 05/14/2023

NORFOLK SOUTHERN  
 EAST PALESTINE, OHIO

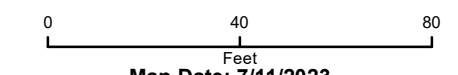
**UPLAND OF NORTH DITCH**







- Legend**
- Category 1
  - Category 2
  - Category 3
  - Deferred Work
  - Property Boundry Lines
  - County/State Boundary
  - Study Area
  - DU Samples



**Map Date: 7/11/2023**  
 Drone imagery main incident area dates: 07/10/21  
 Drone imagery main offsite area dates: 05/14/2023



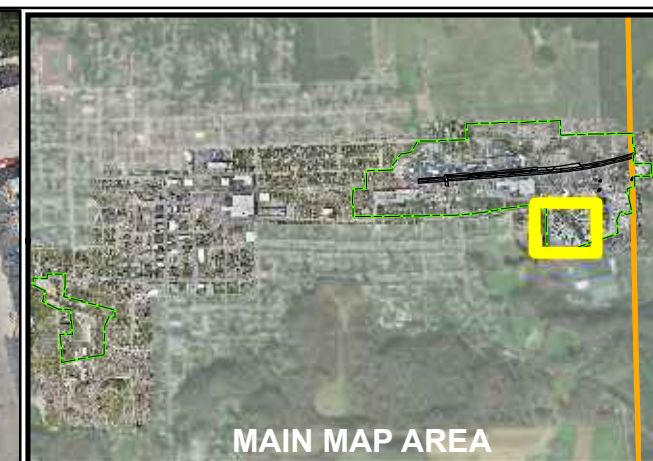
NORFOLK SOUTHERN  
 EAST PALESTINE, OHIO

**TANK FARM 2**



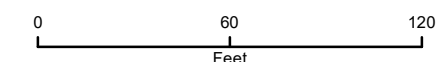
Document Path: T:\ENW\of NorfolkSouthern\EastPalestine\_Fab5\_2023\Project\_Peasie\_Layouts\Fab5\_2023\Project\_Peasie\_F2\_clippage\_Site Working Areas.mxd





**Legend**

- Category 1
- Category 2
- Category 3
- Deferred Work
- Property Boundry Lines
- County/State Boundary
- Study Area
- DU Samples



Map Date: 7/11/2023

Drone imagery main incident area dates: 07/10/21  
 Drone imagery main offsite area dates: 05/14/2023

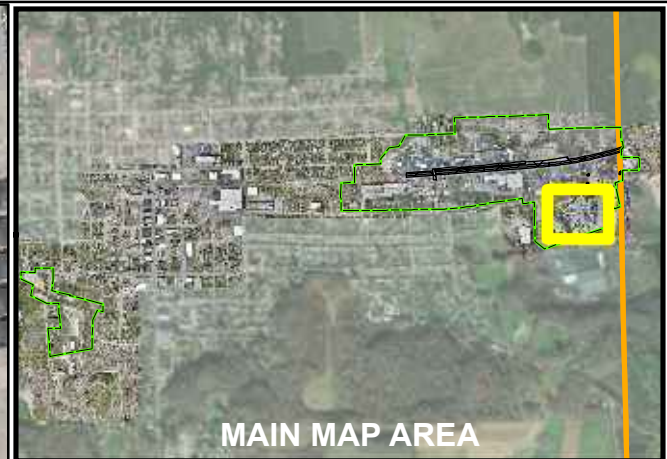


NORFOLK SOUTHERN  
 EAST PALESTINE, OHIO

**TANK FARM 3**

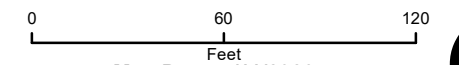






**Legend**

- Category 1
- Category 2
- Category 3
- Deferred Work
- Property Boundry Lines
- County/State Boundary
- Study Area
- DU Samples



**Map Date: 7/11/2023**

Drone imagery main incident area dates: 07/10/21  
 Drone imagery main offsite area dates: 05/14/2023



NORFOLK SOUTHERN  
 EAST PALESTINE, OHIO

**TANK FARM 5**



FIGURE

**20**





- Legend**
- Category 1
  - Category 2
  - Category 3
  - Deferred Work
  - Property Boundry Lines
  - County/State Boundary
  - Study Area
  - DU Samples

0 60 120  
Feet  
Map Date: 7/11/2023  
Drone imagery main incident area dates: 07/10/21  
Drone imagery main offsite area dates: 05/14/2023

NORFOLK SOUTHERN  
EAST PALESTINE, OHIO

**TANK FARM 6**



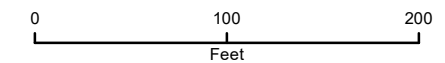
Document Path: T:\EN\NorfolkSouthern\EastPalestine\_Fac6\_2023\Project\_Peasie\_Layouts\NS\_East\_Palestine\_F2\_clippage\_Site\_Working\_Areas.mxd





**Legend**

- Category 1
- Category 2
- Category 3
- Deferred Work
- Cleared and Restored Under Appendix D
- Property Boundary Lines
- Stormwater Catch Basin
- Stormwater Catch Basin Removed
- Stormwater Conveyance
- County/State Boundary
- Study Area
- DU Samples



**Map Date: 7/11/2023**  
 Drone imagery main incident area dates: 07/10/21  
 Drone imagery main offsite area dates: 05/14/2023

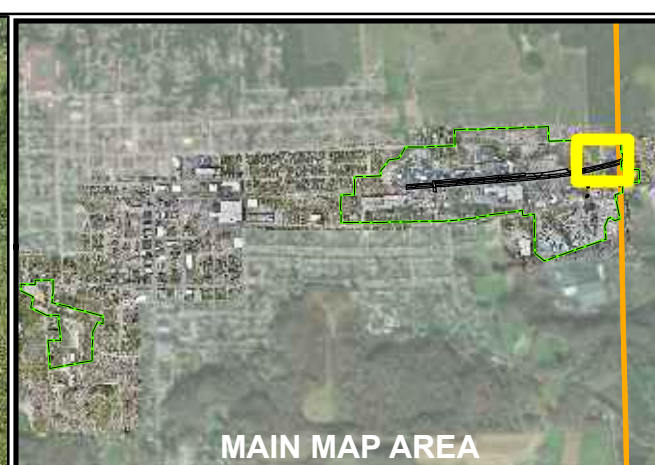
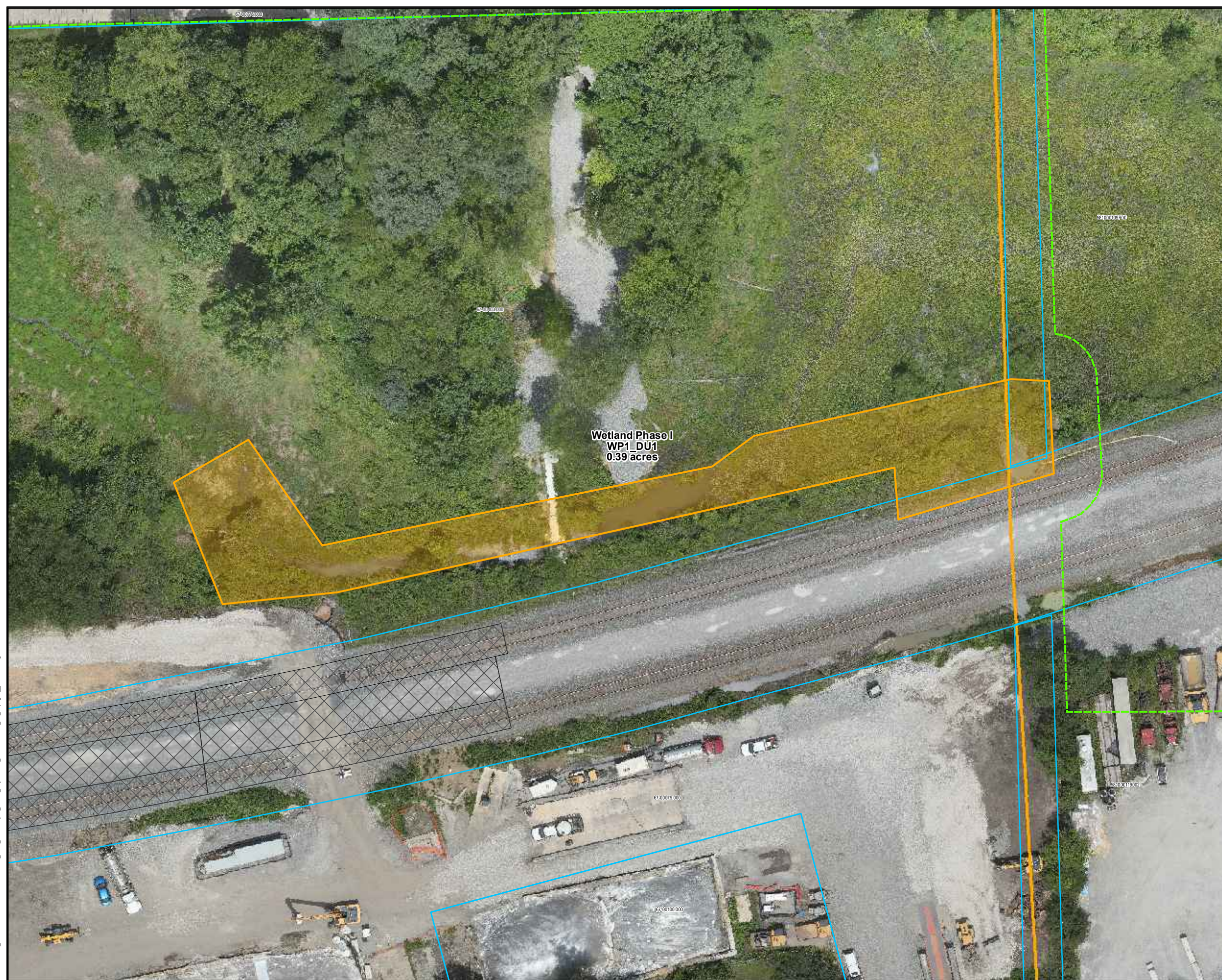
NORFOLK SOUTHERN  
 EAST PALESTINE, OHIO

**WASTE STAGING**

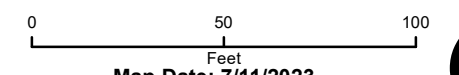




Document Path: T:\EN\NorfolkSouthern\EastPalestine\_Feb5\_2023\Project\_Peair\_Layouts\MS\_EastPalestine\_F2\_clippage\_Site Working Areas.mxd



- Legend**
- Category 1
  - Category 2
  - Category 3
  - Deferred Work
  - Cleared and Restored Under Appendix D
  - Property Boundary Lines
  - County/State Boundary
  - Study Area
  - DU Samples



Map Date: 7/11/2023

Drone imagery main incident area dates: 07/10/21  
Drone imagery main offsite area dates: 05/14/2023



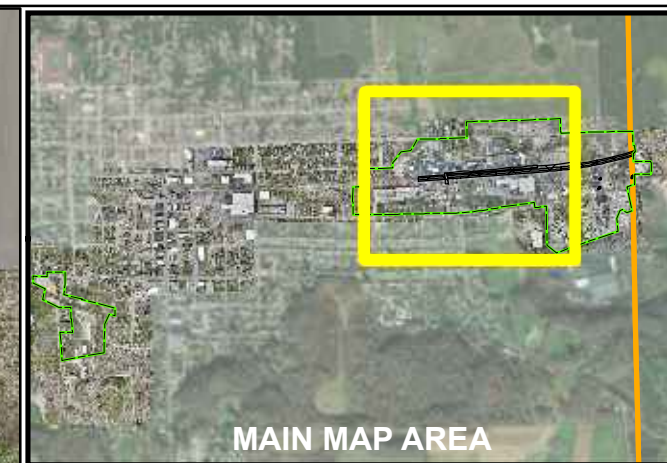
NORFOLK SOUTHERN  
EAST PALESTINE, OHIO

**WETLAND PHASE I**



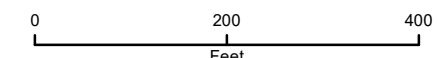
FIGURE  
**23**





**Legend**

- Category 1
- Category 2
- Category 3
- Deferred Work
- Cleared and Restored Under Appendix D
- Property Boundary Lines
- Stormwater Catch Basin
- Stormwater Catch Basin Removed
- Catch Basin
- Roof Drains
- Dry Well
- Stormwater Conveyance
- Catch Basin Drain Line
- Drain-4 inch PVC
- RR Ditch Drain Piping
- Culvert
- County/State Boundary
- Study Area
- Existing Wastewater Collection System**
- Piping and Flow Direction
- Terracotta Drain Pipe (Inferred Location)
- DU Samples



Map Date: 7/11/2023

Drone imagery main incident area dates: 07/10/21  
 Drone imagery main offsite area dates: 05/14/2023



NORFOLK SOUTHERN  
 EAST PALESTINE, OHIO

**UNDERGROUND FEATURES**

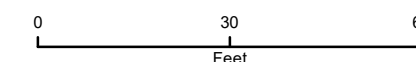






**Legend**

- Category 1
- Category 2
- Category 3
- Deferred Work
- Property Boundry Lines
- County/State Boundary
- Study Area
- DU Samples



Map Date: 7/11/2023

Drone imagery main incident area dates: 07/10/21  
 Drone imagery main offsite area dates: 05/14/2023



NORFOLK SOUTHERN  
 EAST PALESTINE, OHIO

**STANDBY TANK AREA 1**



FIGURE  
**25**

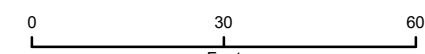




**Legend**

- Category 1
- Category 2
- Category 3
- Deferred Work
- Property Boundry Lines
- County/State Boundary
- Study Area
- DU Samples

Standby Tank Area 2  
SB2\_DU1  
0.18 acres



Map Date: 7/11/2023

Drone imagery main incident area dates: 07/10/21  
Drone imagery main offsite area dates: 05/14/2023



NORFOLK SOUTHERN  
EAST PALESTINE, OHIO

**STANDBY TANK AREA 2**

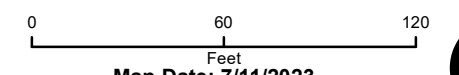


FIGURE  
**26**





- Legend**
- Category 1
  - Category 2
  - Category 3
  - Deferred Work
  - Property Boundry Lines
- Note:  
Refer to Figure 14 for WWTP
- County/State Boundary
  - Study Area
  - DU Samples



**Map Date: 7/11/2023**  
 Drone imagery main incident area dates: 07/10/21  
 Drone imagery main offsite area dates: 05/14/2023



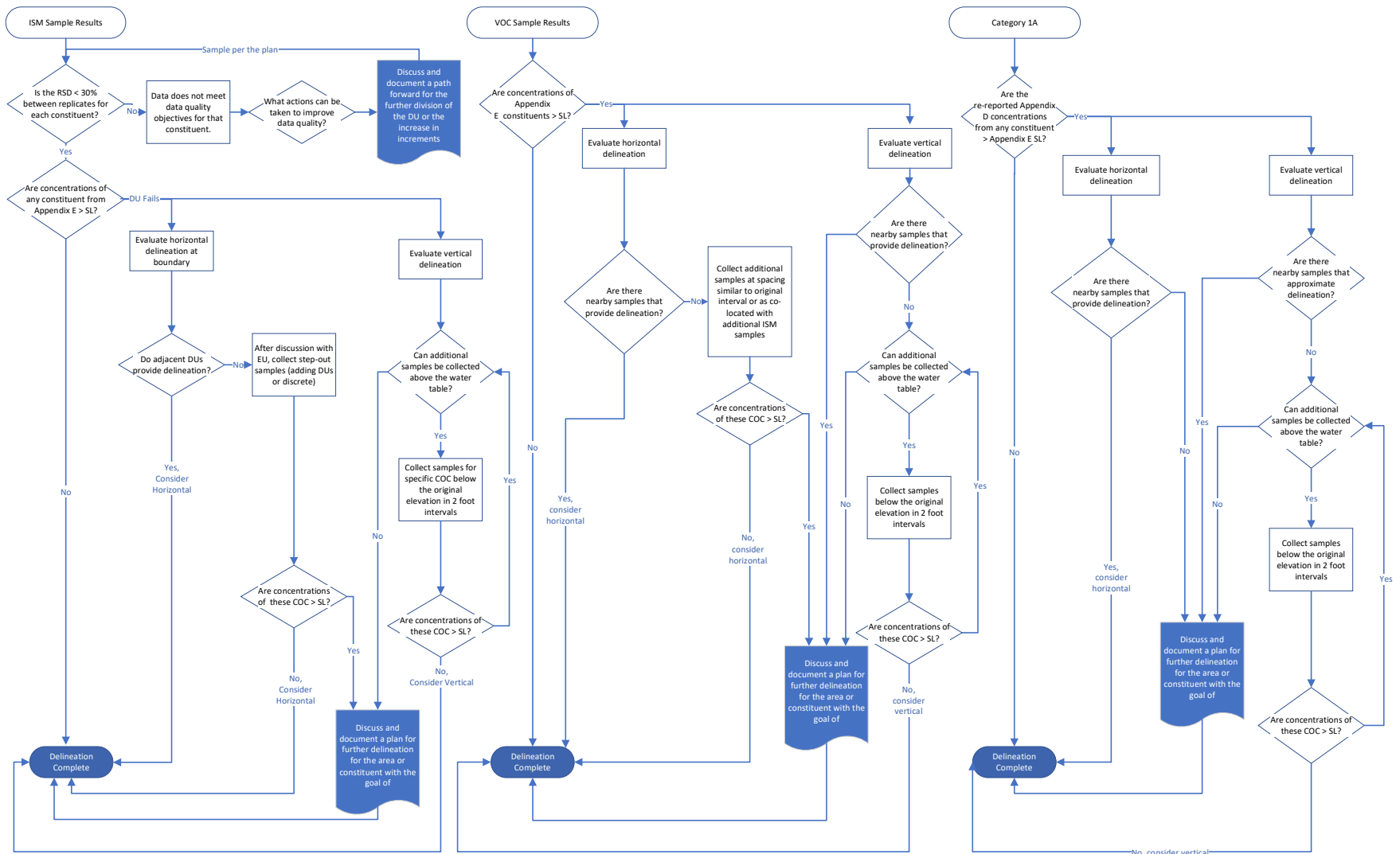
NORFOLK SOUTHERN  
 EAST PALESTINE, OHIO

**WWTP EFFLUENT TANKS**



Document Path: T:\ENW\NorfolkSouthern\EastPalestine\_Feb5\_2023\Project\_Peace\_Layouts\NS\_East Palestine\_F2\_clippage\_Site Working Areas.mxd





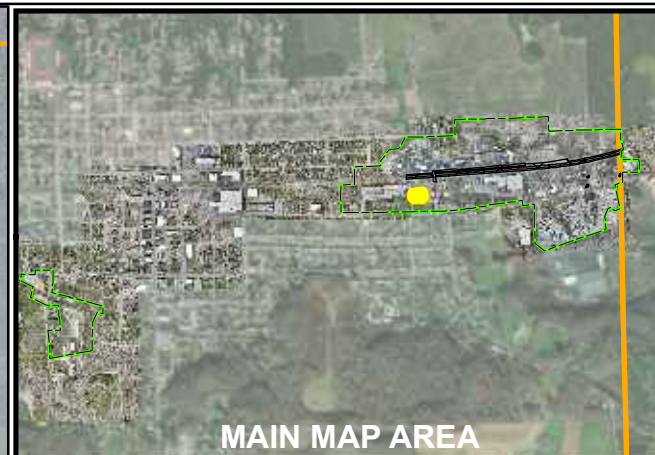
NORFOLK SOUTHERN  
EAST PALESTINE, OHIO

### SAMPLE EVALUATION DECISION LOGIC

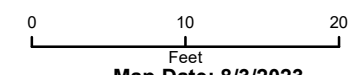
# Attachment 1

## Decision Unit Sample Points





- Legend**
- Property Boundry Lines
  - County/State Boundary
  - Study Area
  - Category 2



Map Date: 8/3/2023



Drone imagery main incident area dates: 08/02/2023

NORFOLK SOUTHERN  
EAST PALESTINE, OHIO

CS1\_DU1

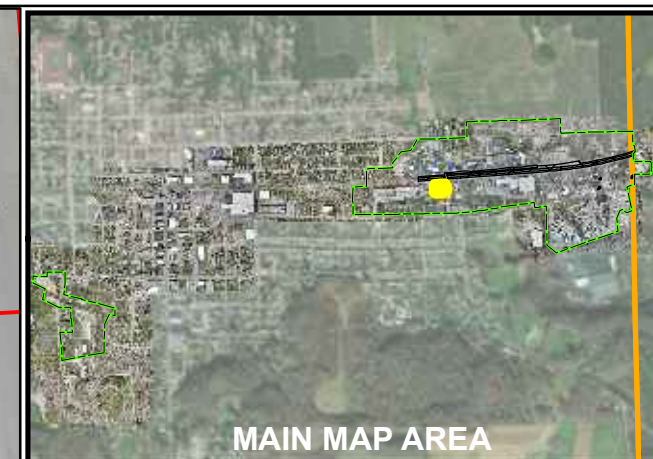


FIGURE  
1





Document Path: T:\EN\NORFOLKSouthernEastPalestine\_Feb5\_2023\MXD\Appendix\_ENS\_East Palestine\_F2\_ddpages\_Site Working Areas\_Sampling Map Set.mxd

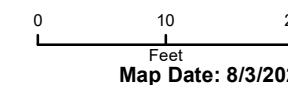


Document Path: T:\EN\NorfolkSouthern\EastPalestine\_Feb5\_2023\MXD\Appendix\_ENS\_EastPalestine\_F2\_ddpages\_SiteWorkingAreas\_SamplingMap\_Sri.mxd



**Legend**

-  Property Boundary Lines
-  County/State Boundary
-  Study Area
-  Category 2



Drone imagery main incident area dates: 08/02/2023

NORFOLK SOUTHERN  
EAST PALESTINE, OHIO

CS1\_DU2



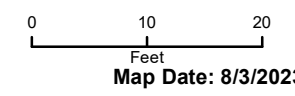
FIGURE  
2



Document Path: T:\EN\NorfolkSouthern\EastPalestine\_Feb5\_2023\MXD\Appendix\_ENS\_EastPalestine\_F2\_ddpages\_SiteWorkingAreas\_SamplingMap\_Sri.mxd



- Legend**
- Property Boundary Lines
  - County/State Boundary
  - Study Area
  - Category 2



Drone imagery main incident area dates: 08/02/2023

NORFOLK SOUTHERN  
EAST PALESTINE, OHIO

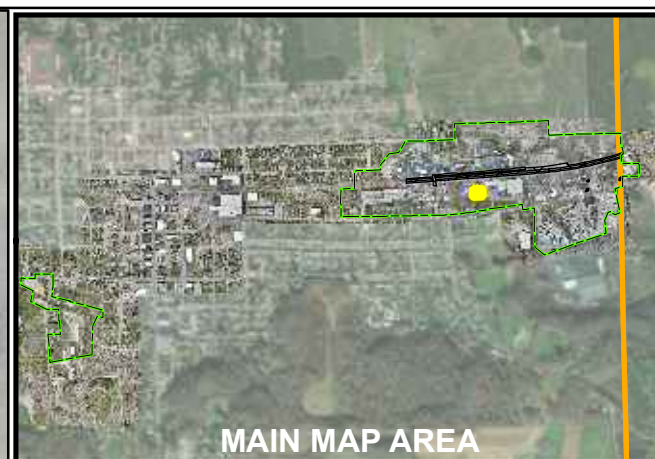
CS1\_DU3



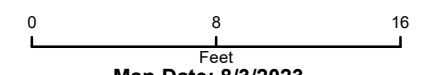
FIGURE  
3



Document Path: T:\EN\NORFOLKSouthernEastPalestine\_Feb5\_2023\MXD\Appendix\_E\_NS\_EastPalestine\_F2\_ddpages\_SiteWorkingAreas\_SamplingMap\_Sri.mxd



- Legend**
- Property Boundry Lines
  - County/State Boundary
  - Study Area
  - Category 2



Map Date: 8/3/2023



Drone imagery main incident area dates: 08/02/2023

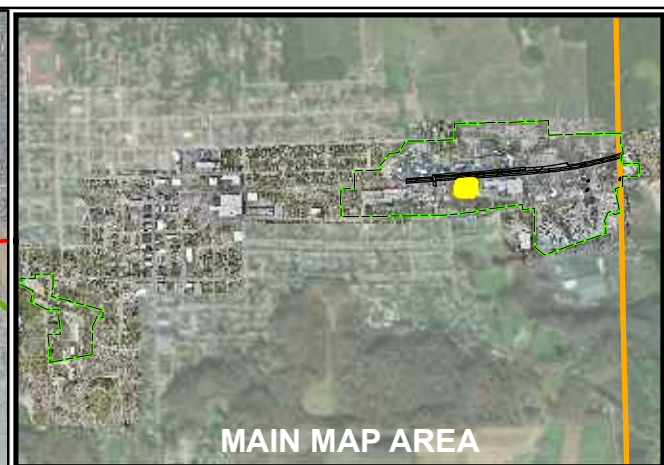
NORFOLK SOUTHERN  
EAST PALESTINE, OHIO

CS2\_DU1



FIGURE  
4





- Legend**
- Property Boundry Lines
  - Stormwater Conveyance
  - County/State Boundary
  - Study Area
  - Category 2

0 10 20  
Feet  
Map Date: 8/3/2023



Drone imagery main incident area dates: 08/02/2023

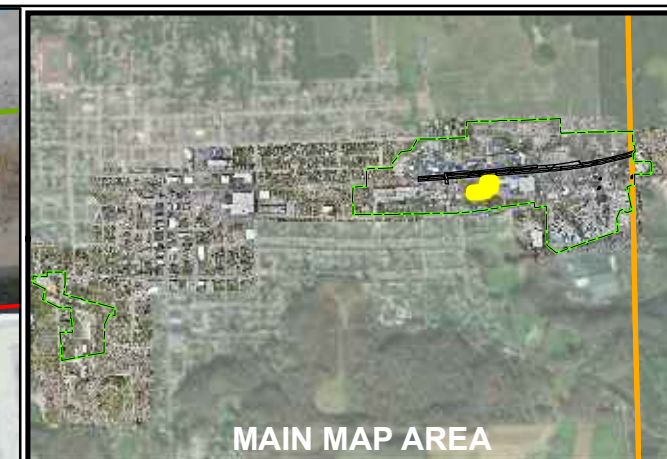
NORFOLK SOUTHERN  
EAST PALESTINE, OHIO

CS2\_DU2










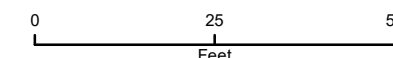
FIGURE  
5





**Legend**

-  Cleared and Restored Under Appendix D
-  Property Boundary Lines
-  Stormwater Catch Basin
-  Stormwater Conveyance
-  County/State Boundary
-  Study Area
-  Category 2



Map Date: 8/3/2023

Drone imagery main incident area dates: 08/02/2023



NORFOLK SOUTHERN  
EAST PALESTINE, OHIO

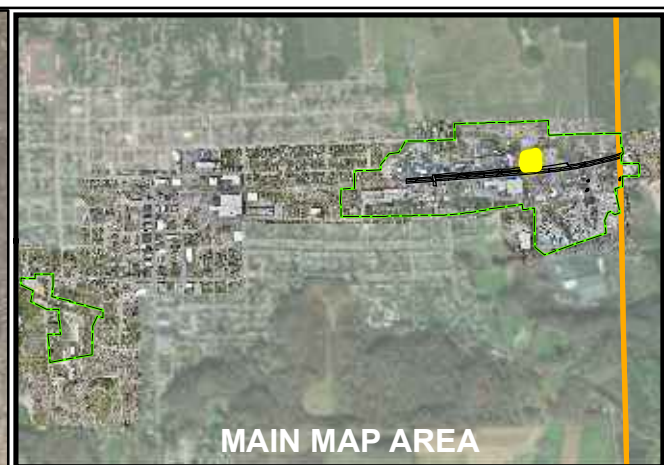
CS2\_DU3



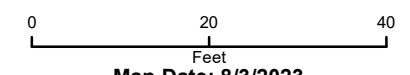
FIGURE  
6



Document Path: T:\EN\NorfolkSouthern\EastPalestine\_Feb5\_2023\MXD\Appendix\_E\_NS\_EastPalestine\_F2\_ddpages\_Site Working Areas\_Sampling Map\_Sri.mxd



- Legend**
- Cleared and Restored Under Appendix D
  - Property Boundary Lines
  - County/State Boundary
  - Study Area
  - Piezometer Locations
  - Category 1



Map Date: 8/3/2023



Drone imagery main incident area dates: 08/02/2023

NORFOLK SOUTHERN  
EAST PALESTINE, OHIO

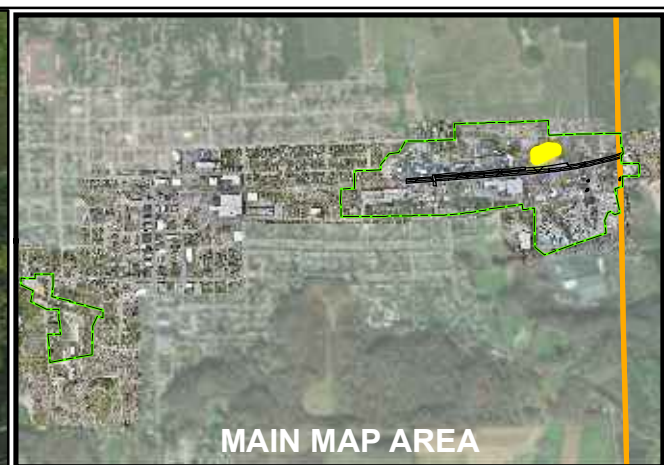
CS3\_DU1








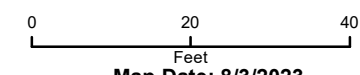
FIGURE  
7



Document Path: T:\EN\NorfolkSouthern\EastPalestine\_Feb5\_2023\MXD\Appendix\_E\_NS\_EastPalestine\_F2\_ddpages\_Site Working Areas\_Sampling Map\_Sri.mxd



- Legend**
-  Property Boundary Lines
  -  County/State Boundary
  -  Study Area
  -  Piezometer Locations
  -  Category 1



Map Date: 8/3/2023

Drone imagery main incident area dates: 08/02/2023



NORFOLK SOUTHERN  
EAST PALESTINE, OHIO

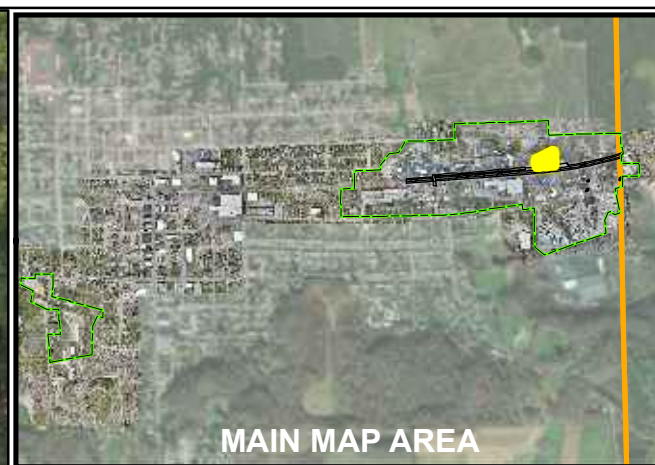
CS3\_DU2









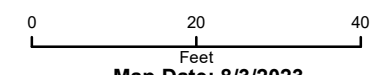
FIGURE  
8



Document Path: T:\EN\NorfolkSouthern\EastPalestine\_Feb5\_2023\MXD\Appendix\_E\_NS\_East Palestine\_F2\_ddpages\_Site Working Areas\_Sampling Map\_Sri.mxd



- Legend**
-  Cleared and Restored Under Appendix D
  -  Property Boundry Lines
  -  County/State Boundary
  -  Study Area
  -  Piezometer Locations
  -  Category 1



Map Date: 8/3/2023



Drone imagery main incident area dates: 08/02/2023

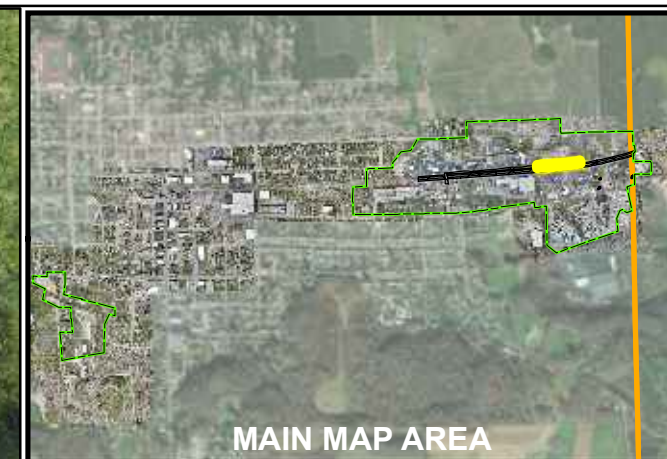
NORFOLK SOUTHERN  
EAST PALESTINE, OHIO

CS3\_DU3











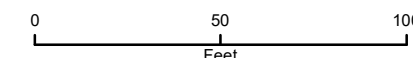
FIGURE  
9





**Legend**

-  Cleared and Restored Under Appendix D
-  Property Boundary Lines
-  Stormwater Catch Basin Removed
-  Stormwater Conveyance
-  County/State Boundary
-  Study Area
-  Piezometer Locations
-  Category 1



Map Date: 8/3/2023



Drone imagery main incident area dates: 08/02/2023

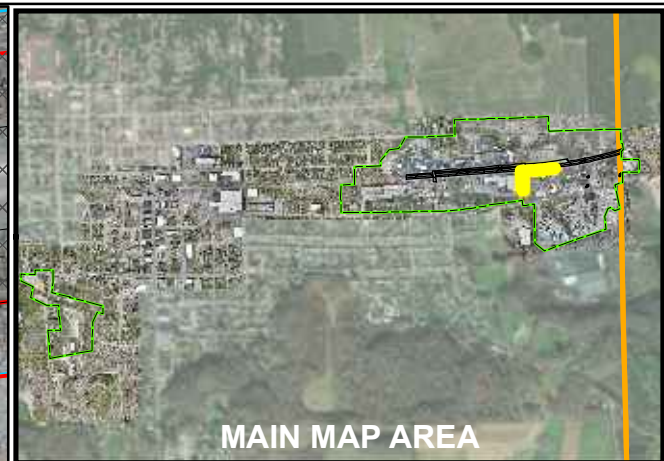
NORFOLK SOUTHERN  
EAST PALESTINE, OHIO

CS3\_DU4

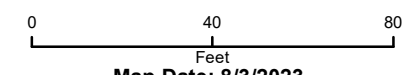


FIGURE  
10





- Legend**
- Cleared and Restored Under Appendix D
  - Property Boundary Lines
  - Stormwater Catch Basin
  - Stormwater Catch Basin Removed
  - Stormwater Conveyance
  - County/State Boundary
  - Study Area
  - Piezometer Locations
  - Category 1



Map Date: 8/3/2023



Drone imagery main incident area dates: 08/02/2023

NORFOLK SOUTHERN  
EAST PALESTINE, OHIO

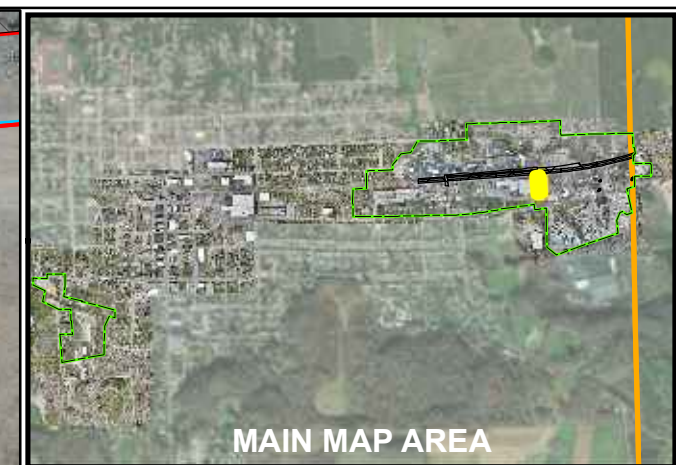
CS4\_DU1



FIGURE  
11

Document Path: T:\EN\NORFOLKSouthern\EastPalestine\_Feb5\_2023\MXD\Appendix\_E\_NS\_EastPalestine\_F2\_ddpages\_SiteWorkingAreas\_SamplingMap\_Sri.mxd





- Legend**
- Cleared and Restored Under Appendix D
  - Property Boundary Lines
  - Stormwater Catch Basin
  - Stormwater Catch Basin Removed
  - Stormwater Conveyance
  - County/State Boundary
  - Study Area
  - Piezometer Locations
  - Category 1

0 25 50  
Feet  
Map Date: 8/3/2023  
Drone imagery main incident area dates: 08/02/2023



NORFOLK SOUTHERN  
EAST PALESTINE, OHIO

CS4\_DU2

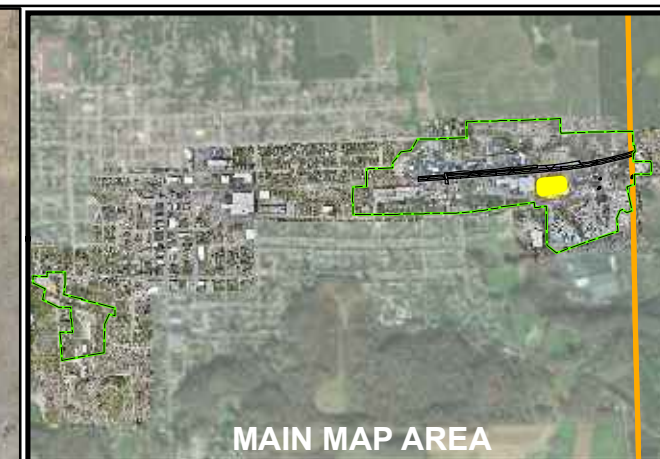


FIGURE  
12







Document Path: T:\EN\NORfolkSouthernEastPalestine\_Fab5\_2023\MXD\Appendix\_E\_NS\_East Palestine\_F2\_ddpages\_Site Working Areas\_Sampling Map\_Sri.mxd

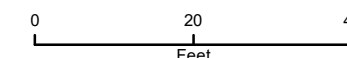


Document Path: T:\EN\NORFOLKSouthernEastPalestine\_Feb5\_2023\MXD\Appendix\_E\_NS\_EastPalestine\_F2\_ddpages\_SiteWorkingAreas\_SamplingMap\_Sri.mxd



**Legend**

-  Property Boundary Lines
-  Stormwater Catch Basin Removed
-  County/State Boundary
-  Study Area
-  Piezometer Locations
-  Category 1



Map Date: 8/3/2023



Drone imagery main incident area dates: 08/02/2023

NORFOLK SOUTHERN  
EAST PALESTINE, OHIO

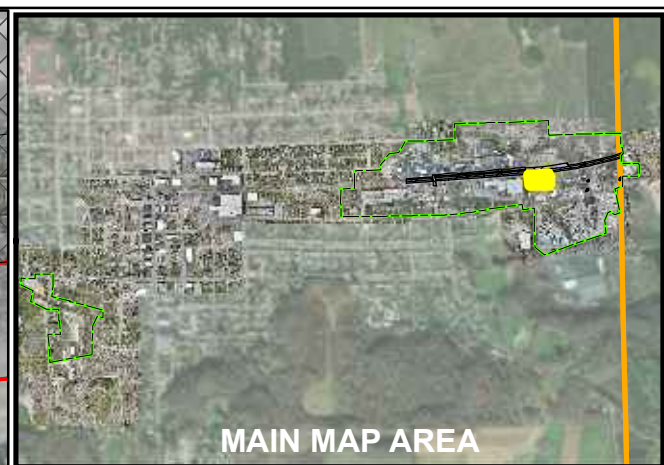
CS4\_DU3



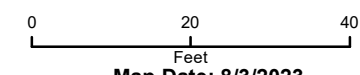
FIGURE  
13



Document Path: T:\EN\NorfolkSouthern\East Palestine\_Feb5\_2023\MXD\Appendix\_E\_NS\_East Palestine\_F2\_ddpages\_Site Working Areas\_Sampling Map\_Sri.mxd



- Legend**
- Cleared and Restored Under Appendix D
  - Property Boundry Lines
  - Stormwater Catch Basin Removed
  - County/State Boundary
  - Study Area
  - Piezometer Locations
  - Category 1



Map Date: 8/3/2023

Drone imagery main incident area dates: 08/02/2023



NORFOLK SOUTHERN  
EAST PALESTINE, OHIO

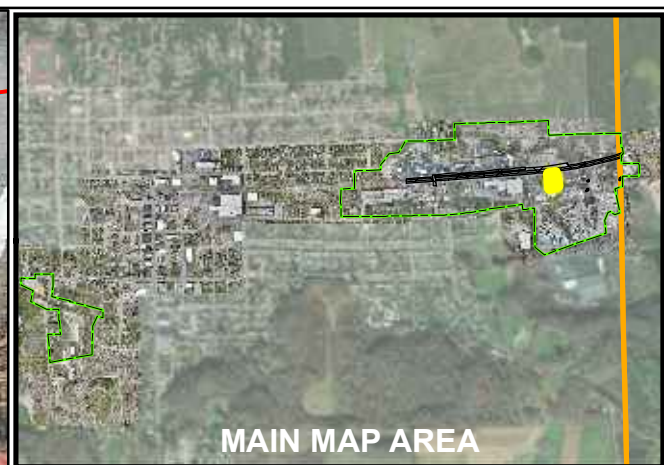
CS4\_DU4



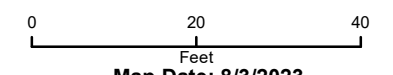
FIGURE  
**14**



Document Path: T:\EN\NORFOLKSouthernEastPalestine\_Feb5\_2023\MXD\Appendix\_E\_NS\_EastPalestine\_F2\_ddpages\_SiteWorkingAreas\_SamplingMap\_Sri.mxd



- Legend**
- Cleared and Restored Under Appendix D
  - Property Boundry Lines
  - County/State Boundary
  - Study Area
  - Piezometer Locations
  - Category 1



Map Date: 8/3/2023



Drone imagery main incident area dates: 08/02/2023

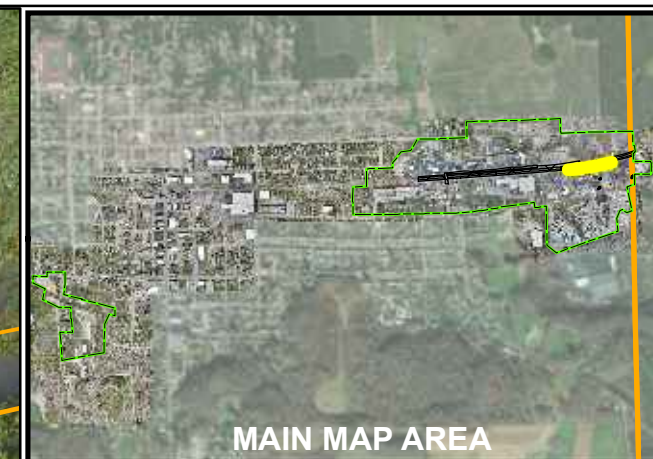
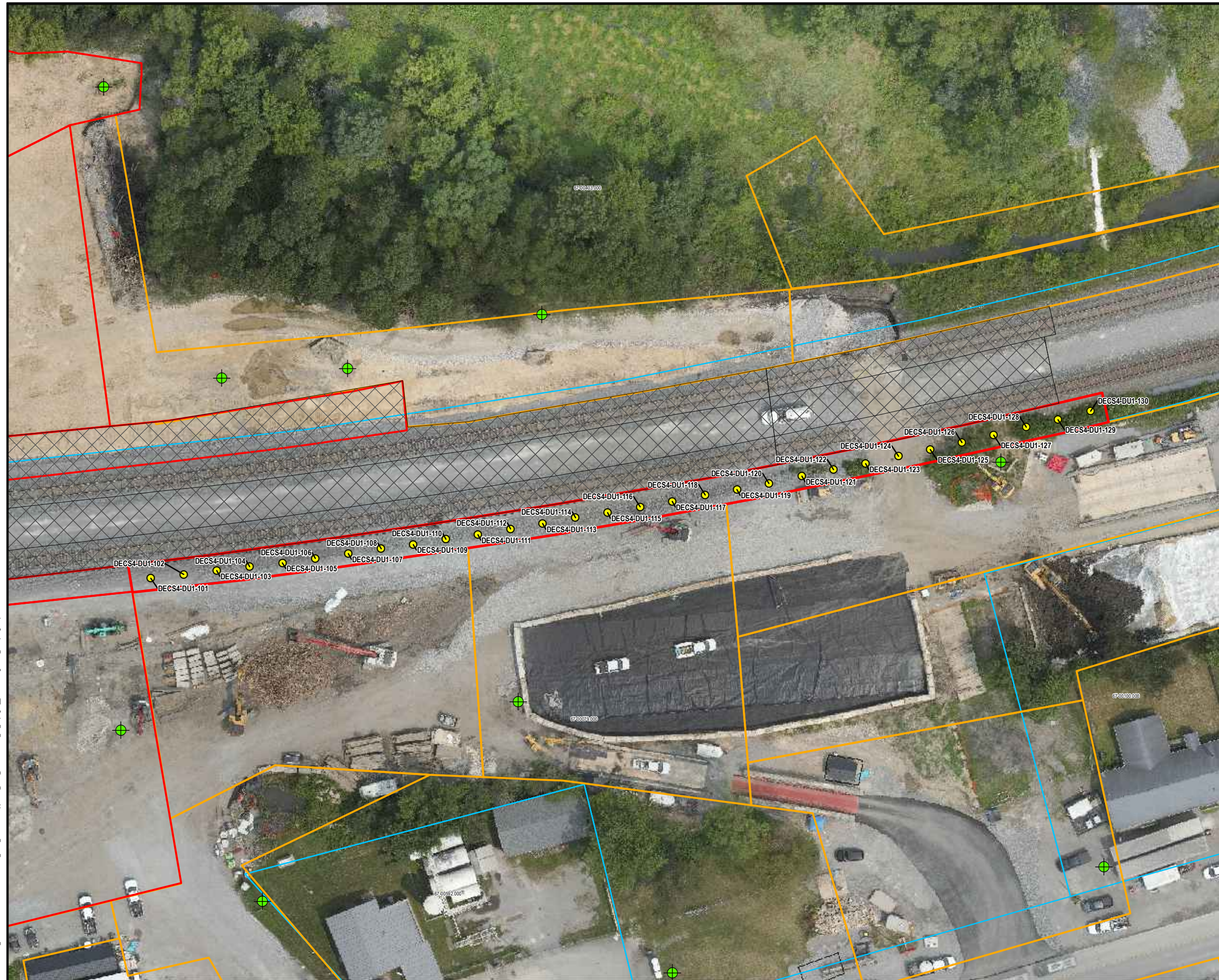
NORFOLK SOUTHERN  
EAST PALESTINE, OHIO

CS4\_DU5









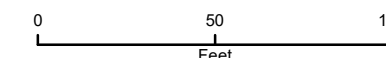
FIGURE  
15





**Legend**

-  Cleared and Restored Under Appendix D
-  Property Boundary Lines
-  County/State Boundary
-  Study Area
-  Piezometer Locations
-  Category 1



Map Date: 8/3/2023



Drone imagery main incident area dates: 08/02/2023

NORFOLK SOUTHERN  
EAST PALESTINE, OHIO

DECS4\_DU1



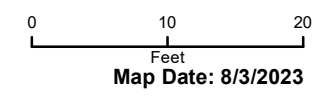
FIGURE

16





- Legend**
- Property Boundary Lines
  - County/State Boundary
  - Study Area
  - Category 2



Drone imagery main incident area dates: 08/02/2023

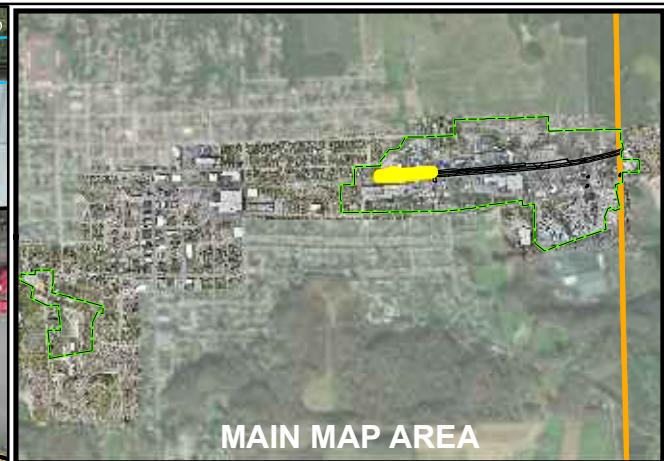
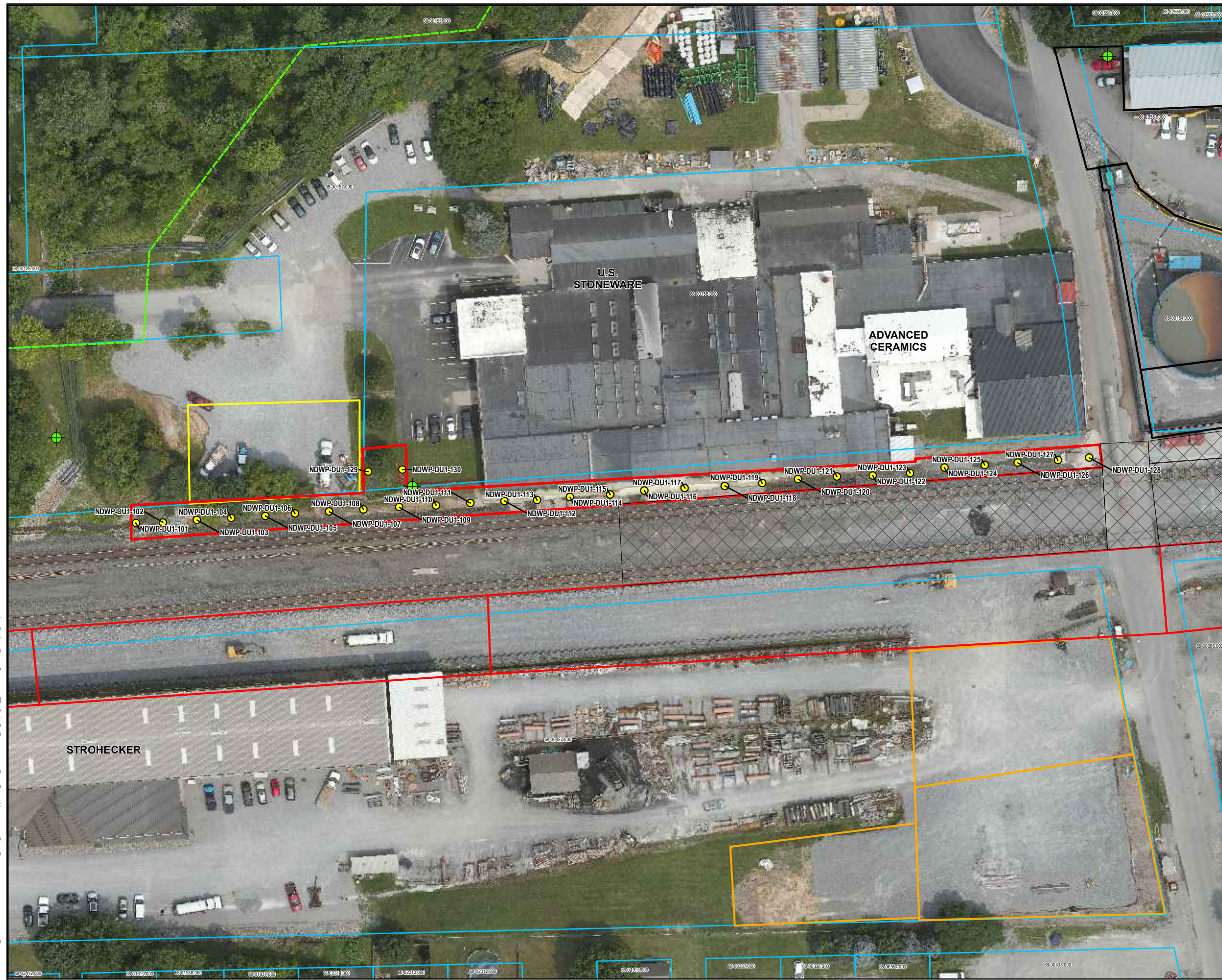
NORFOLK SOUTHERN  
EAST PALESTINE, OHIO

PAWS\_DU1

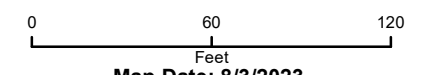


FIGURE  
17





- Legend**
- Cleared and Restored Under Appendix D
  - Property Boundary Lines
  - County/State Boundary
  - Study Area
  - Piezometer Locations
  - Category 1



Map Date: 8/3/2023



Drone imagery main incident area dates: 08/02/2023

NORFOLK SOUTHERN  
EAST PALESTINE, OHIO

NDWP\_DU1



FIGURE  
18





Document Path: T:\EN\NORFOLKSouthernEastPalestine\_Feb5\_2023\MXD\Appendix\_E\_NS\_East Palestine\_F2\_ddpages\_Site Working Areas\_Sampling Map\_Sri.mxd

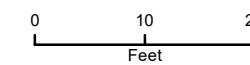


Document Path: T:\EN\NorfolkSouthern\EastPalestine\_Feb5\_2023\MXD\Appendix\_ENS\_EastPalestine\_F2\_ddpages\_SiteWorkingAreas\_SamplingMap\_Sri.mxd



**Legend**

-  Property Boundary Lines
-  County/State Boundary
-  Study Area
-  Category 1



Map Date: 8/3/2023



Drone imagery main incident area dates: 08/02/2023

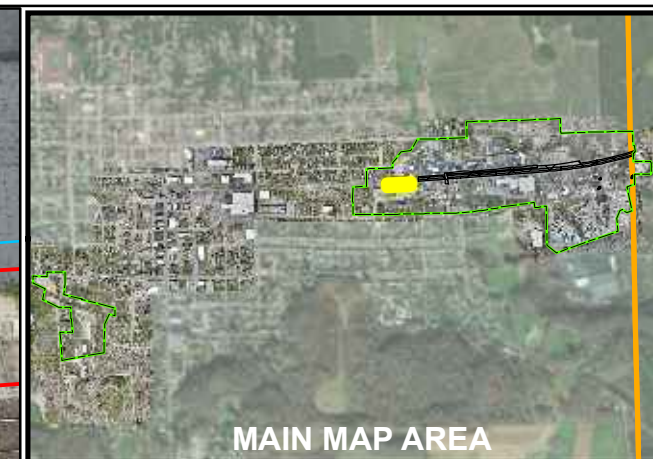
NORFOLK SOUTHERN  
EAST PALESTINE, OHIO

SDWP\_DU1



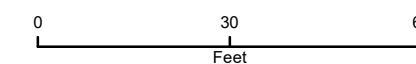
FIGURE  
19





**Legend**

- Property Boundary Lines
- County/State Boundary
- Study Area
- Piezometer Locations
- Category 1



Map Date: 8/3/2023



Drone imagery main incident area dates: 08/02/2023

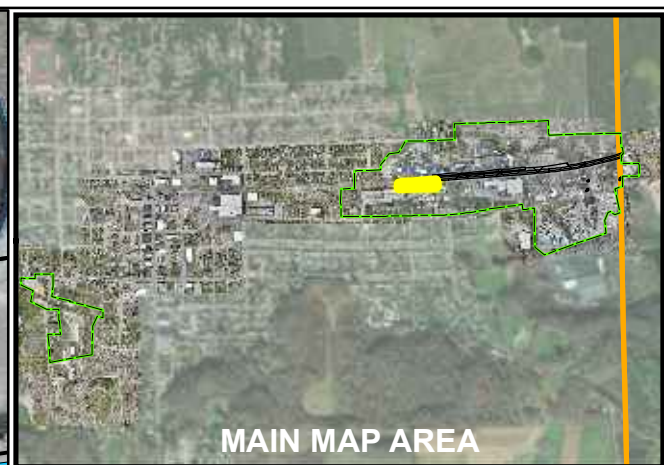
NORFOLK SOUTHERN  
EAST PALESTINE, OHIO

SDWP\_DU2



FIGURE  
20





- Legend**
- Cleared and Restored Under Appendix D
  - Property Boundary Lines
  - County/State Boundary
  - Study Area
  - Piezometer Locations
  - Category 1

0 40 80  
Feet

Map Date: 8/3/2023



Drone imagery main incident area dates: 08/02/2023

NORFOLK SOUTHERN  
EAST PALESTINE, OHIO

SDWP\_DU3



FIGURE  
21

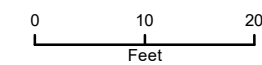
Document Path: T:\EN\NORfolkSouthern\East Palestine\_Feb5\_2023\MXD\Appendix\_E\_NS\_East Palestine\_F2\_ddpages\_Site Working Areas\_Sampling Map\_Sri.mxd





**Legend**

- Cleared and Restored Under Appendix D
- Property Boundary Lines
- County/State Boundary
- Study Area
- Category 1



Map Date: 8/3/2023

Drone imagery main incident area dates: 08/02/2023



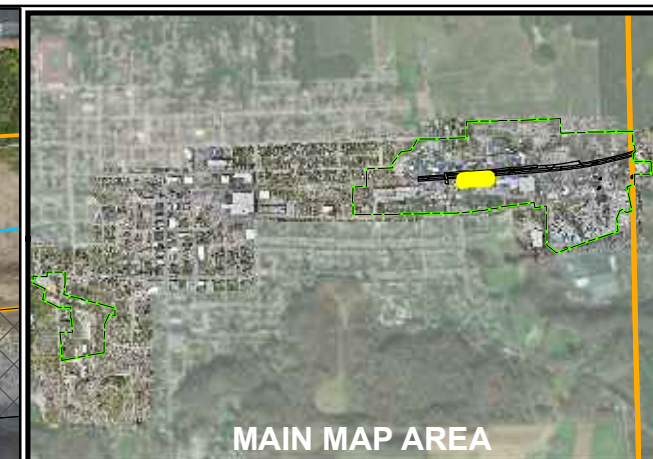
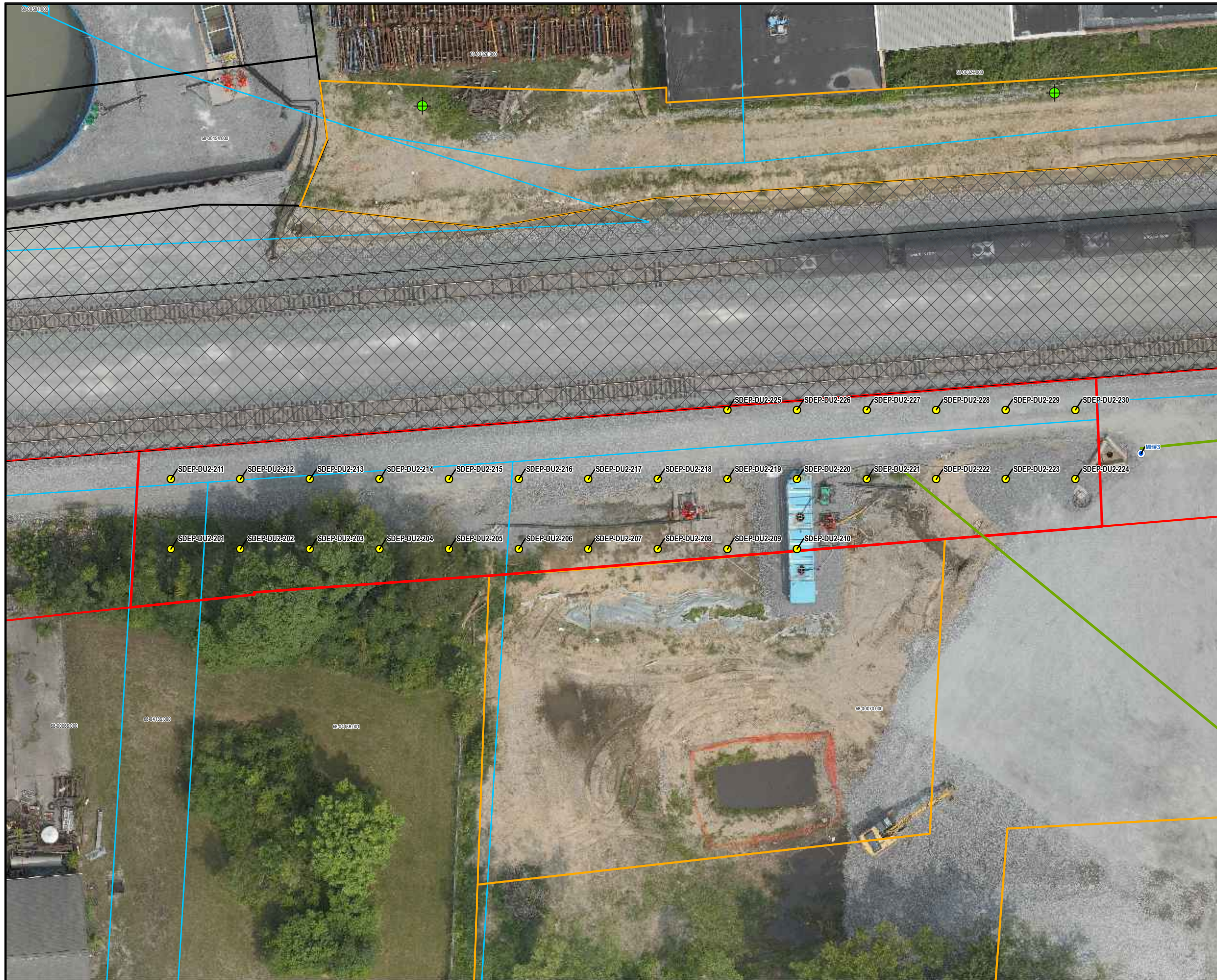
NORFOLK SOUTHERN  
EAST PALESTINE, OHIO

SDEP\_DU1











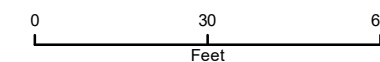
FIGURE  
22





**Legend**

-  Cleared and Restored Under Appendix D
-  Property Boundry Lines
-  Stormwater Catch Basin
-  Stormwater Conveyance
-  County/State Boundary
-  Study Area
-  Piezometer Locations
-  Category 1



Map Date: 8/3/2023



Drone imagery main incident area dates: 08/02/2023

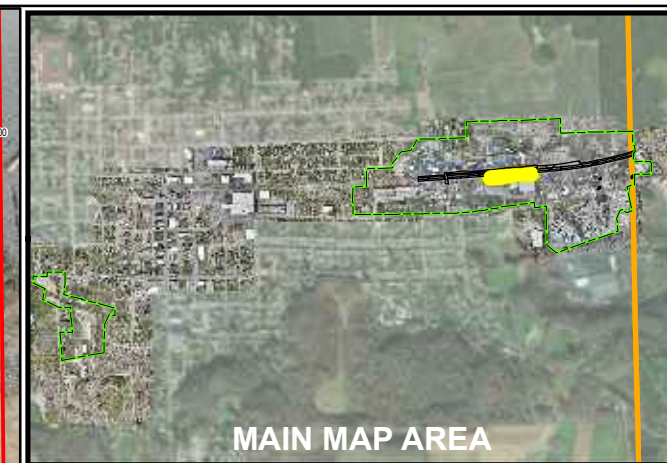
NORFOLK SOUTHERN  
EAST PALESTINE, OHIO

SDEP\_DU2




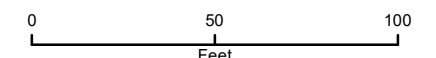
FIGURE  
**23**





**Legend**

-  Cleared and Restored Under Appendix D
-  Property Boundary Lines
-  Stormwater Catch Basin
-  Stormwater Catch Basin Removed
-  Stormwater Conveyance
-  County/State Boundary
-  Study Area
-  Piezometer Locations
-  Category 1



Map Date: 8/3/2023

Drone imagery main incident area dates: 08/02/2023



NORFOLK SOUTHERN  
EAST PALESTINE, OHIO

SDEP\_DU3









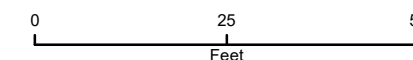
FIGURE  
24





**Legend**

-  Cleared and Restored Under Appendix D
-  Property Boundry Lines
-  County/State Boundary
-  Study Area
-  Piezometer Locations
-  Category 4



Map Date: 8/3/2023



Drone imagery main incident area dates: 08/02/2023

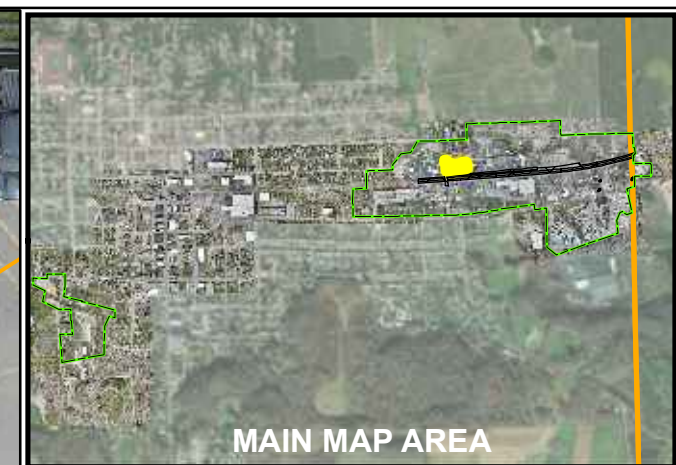
NORFOLK SOUTHERN  
EAST PALESTINE, OHIO

TF1\_DU1

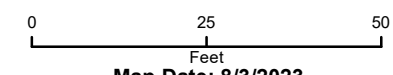


FIGURE  
25





- Legend**
- Cleared and Restored Under Appendix D
  - Property Boundary Lines
  - County/State Boundary
  - Study Area
  - Piezometer Locations
  - Category 4



Map Date: 8/3/2023



Drone imagery main incident area dates: 08/02/2023

NORFOLK SOUTHERN  
EAST PALESTINE, OHIO

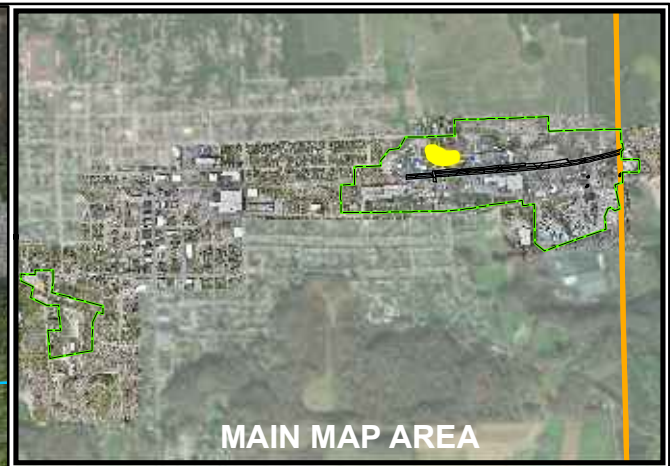
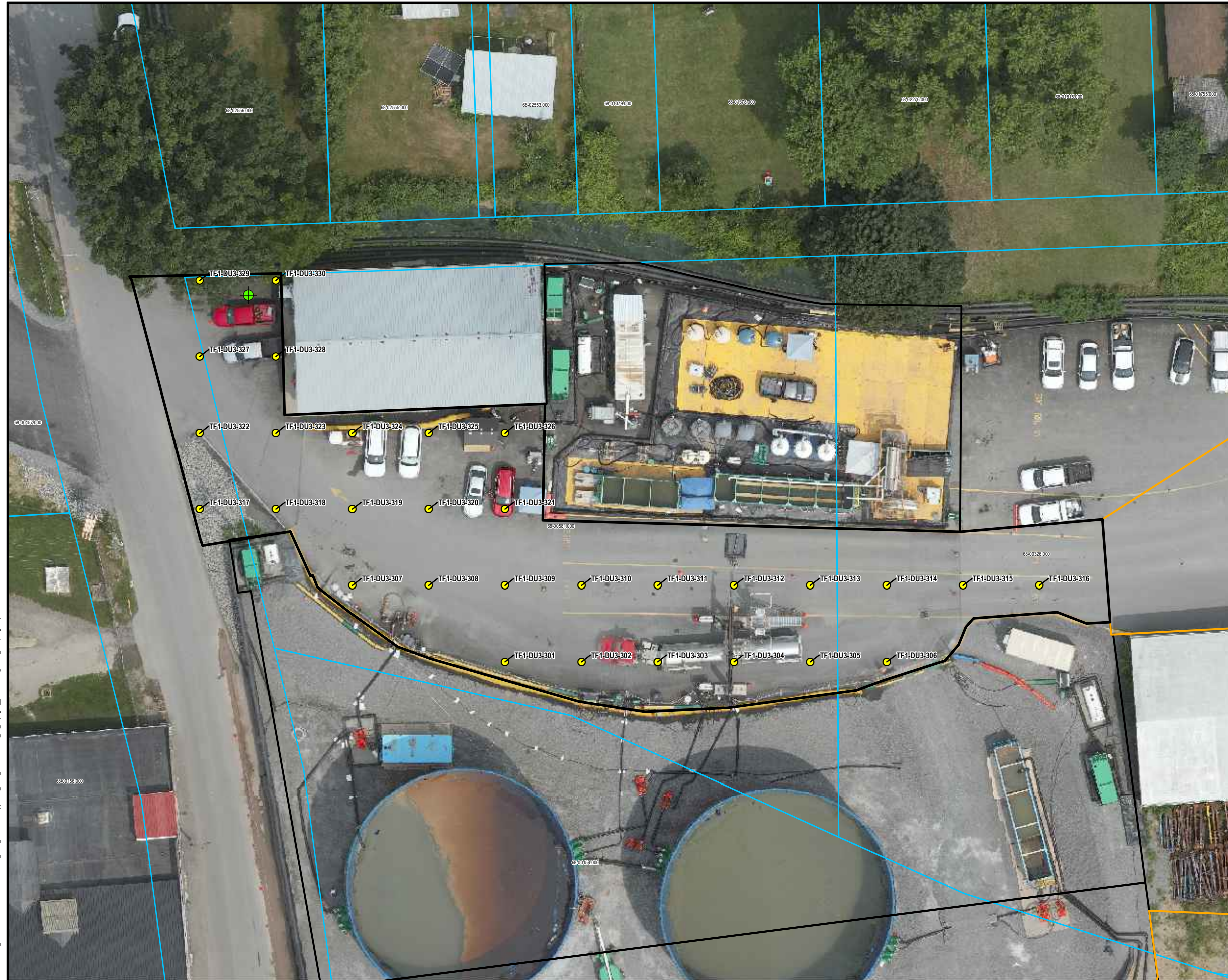
TF1\_DU2



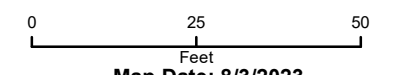
FIGURE  
26

Document Path: T:\EN\NORfolkSouthern\EastPalestine\_Feb5\_2023\MXD\Appendix\_E\_NS\_EastPalestine\_F2\_dpages\_Site Working Areas\_Sampling Map\_Sri.mxd





- Legend**
- Property Boundary Lines
  - County/State Boundary
  - Study Area
  - + Piezometer Locations
  - Category 4



Map Date: 8/3/2023



Drone imagery main incident area dates: 08/02/2023

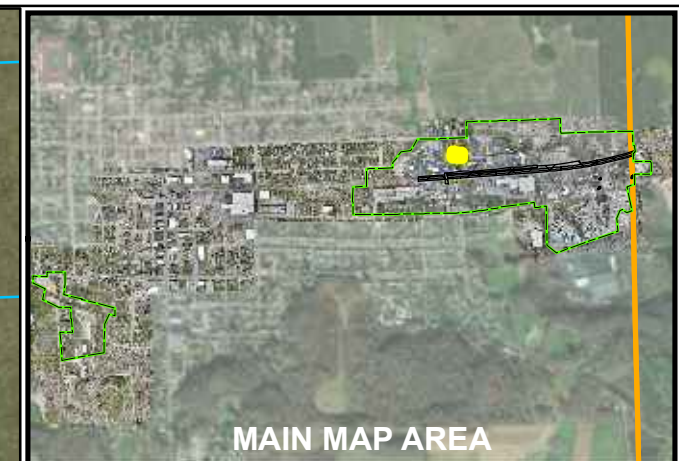
NORFOLK SOUTHERN  
EAST PALESTINE, OHIO

TF1\_DU3



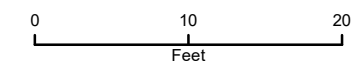
FIGURE  
27





**Legend**

- Property Boundary Lines
- County/State Boundary
- Study Area
- Category 4



Map Date: 8/3/2023



Drone imagery main incident area dates: 08/02/2023

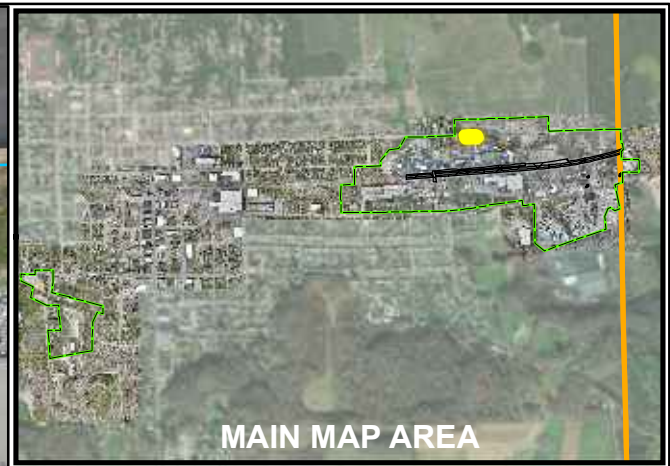
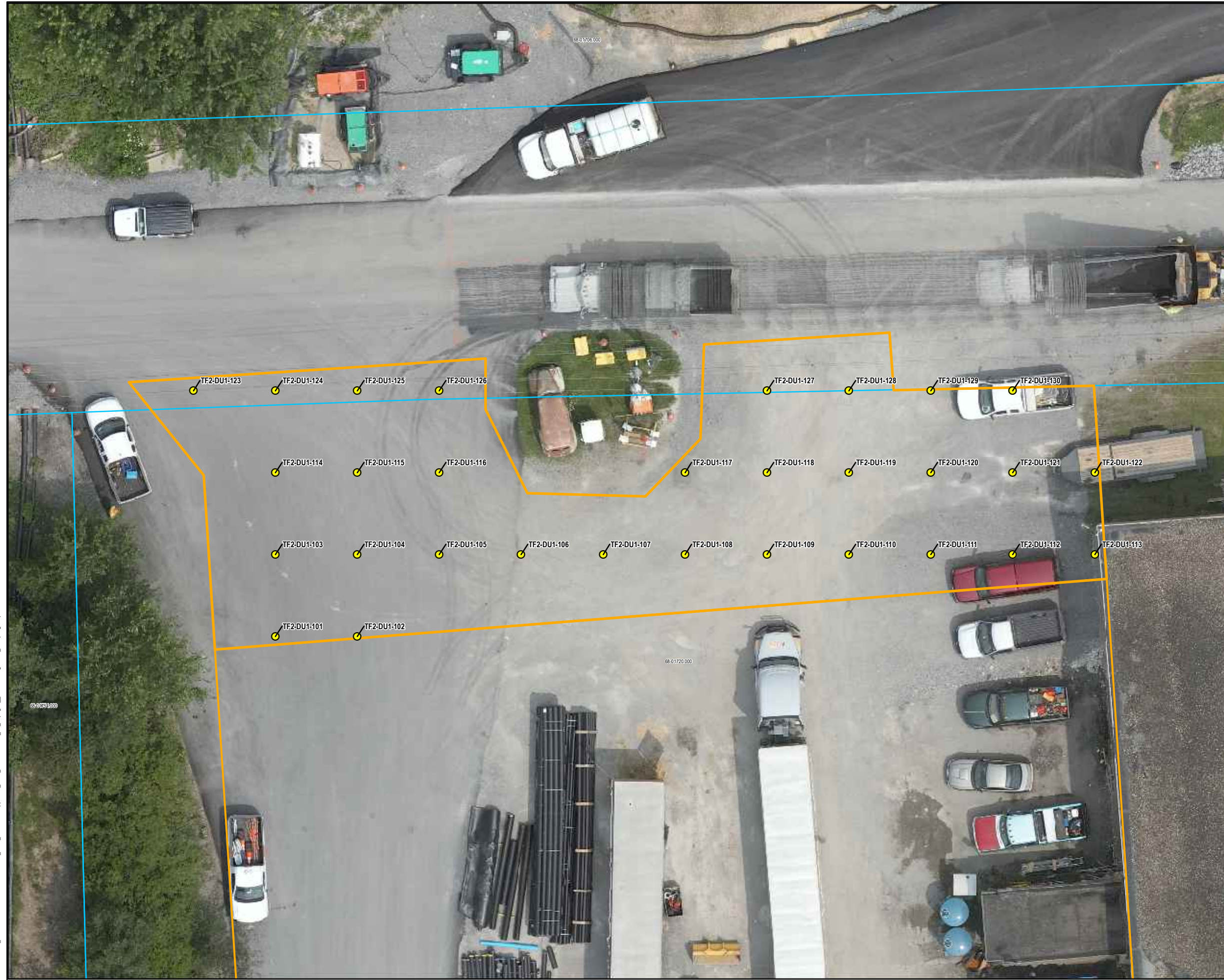
NORFOLK SOUTHERN  
EAST PALESTINE, OHIO

TF1\_DU4

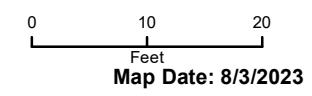


FIGURE  
28





- Legend**
- Property Boundary Lines
  - County/State Boundary
  - Study Area
  - Category 2



Drone imagery main incident area dates: 08/02/2023

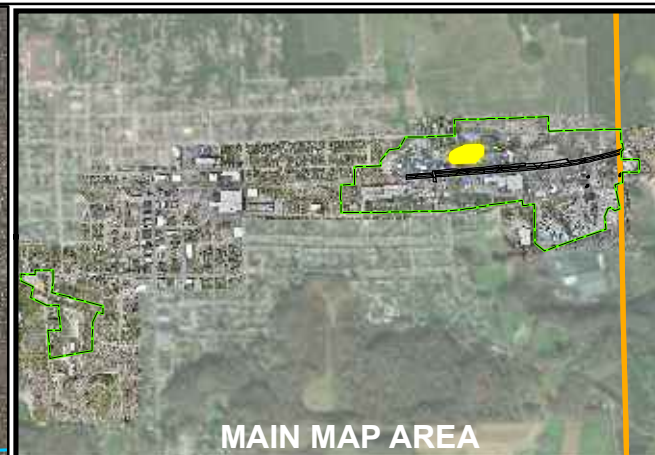
NORFOLK SOUTHERN  
EAST PALESTINE, OHIO

TF2\_DU1

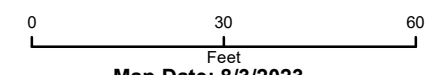


FIGURE  
29





- Legend**
- Property Boundary Lines
  - County/State Boundary
  - Study Area
  - + Piezometer Locations
  - Category 2



Map Date: 8/3/2023



Drone imagery main incident area dates: 08/02/2023

NORFOLK SOUTHERN  
EAST PALESTINE, OHIO

TF2\_DU2



FIGURE  
**30**

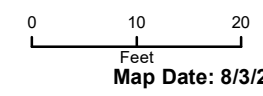
Document Path: T:\EN\NORfolkSouthern\EastPalestine\_Feb5\_2023\MXD\Appendix\_ENS\_East Palestine\_F2\_ddpages\_Site Working Areas\_Sampling Map Set.mxd



Document Path: T:\EN\NORFOLKSouthernEastPalestine\_Feb2\_2023\MXD\Appendix\_ENS\_EastPalestine\_F2\_ddpages\_SiteWorkingAreas\_SamplingMap\_Sri.mxd



- Legend**
- Property Boundary Lines
  - County/State Boundary
  - Study Area
  - Category 2



Map Date: 8/3/2023

Drone imagery main incident area dates: 08/02/2023



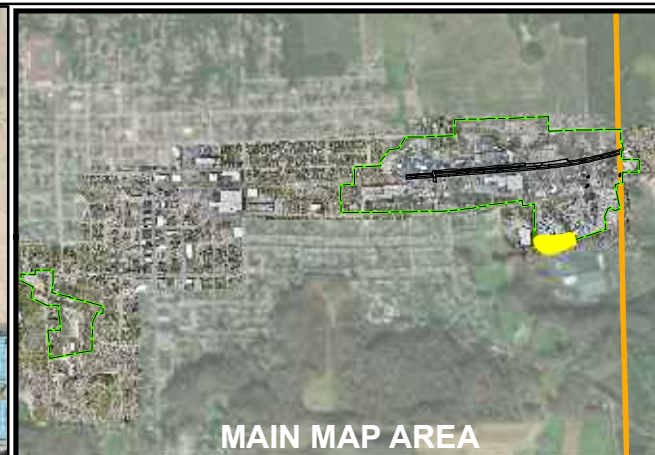
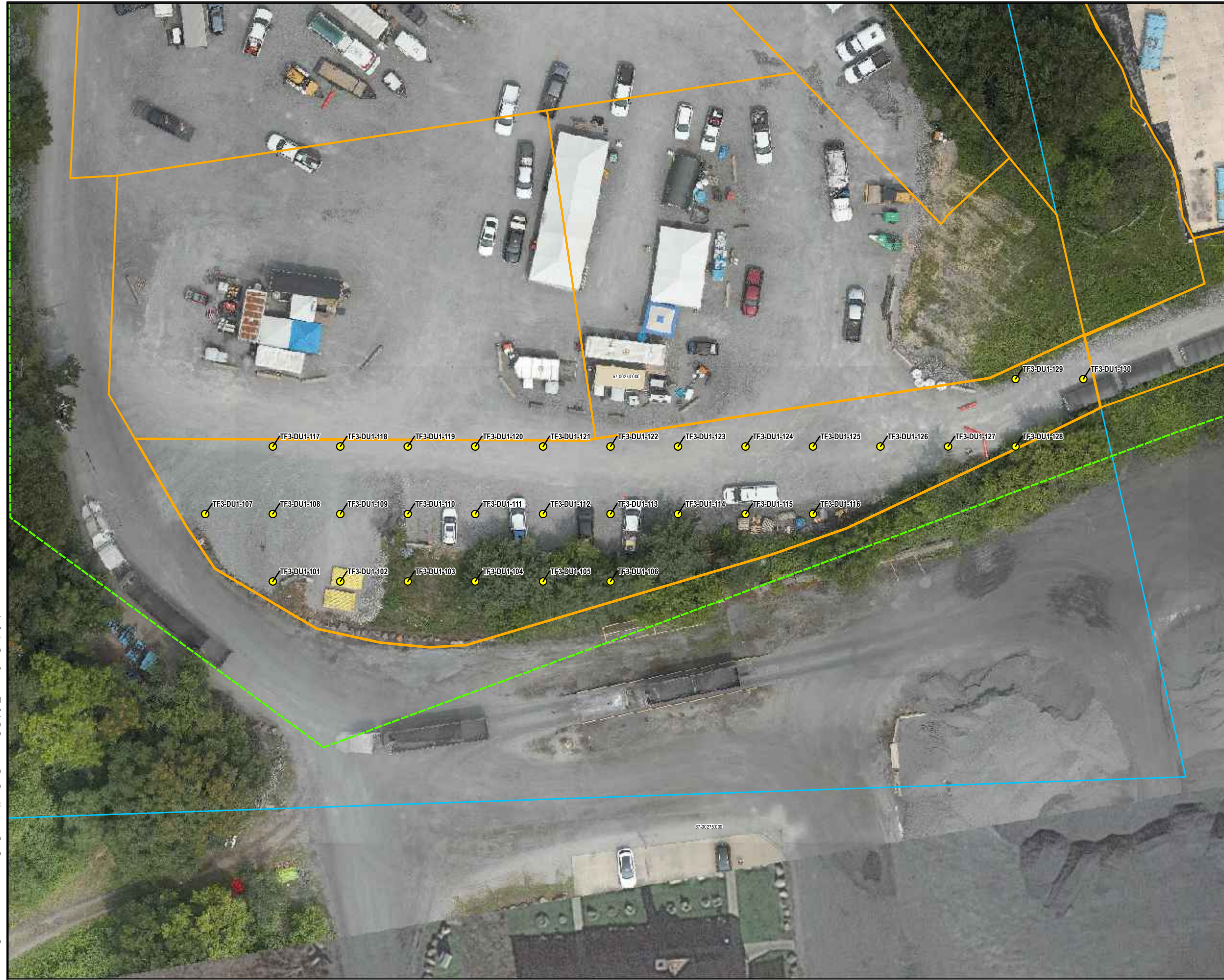
NORFOLK SOUTHERN  
EAST PALESTINE, OHIO

TF2\_DU3

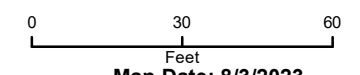


FIGURE  
31





- Legend**
- Property Boundry Lines
  - County/State Boundary
  - Study Area
  - Category 2



Map Date: 8/3/2023



Drone imagery main incident area dates: 08/02/2023

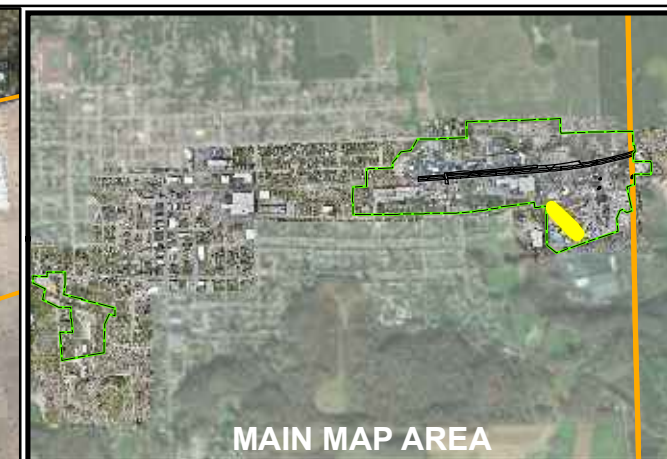
NORFOLK SOUTHERN  
EAST PALESTINE, OHIO

TF3\_DU1



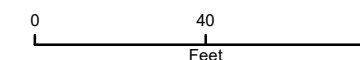
FIGURE  
32





**Legend**

- Property Boundary Lines
- County/State Boundary
- Study Area
- Category 2



Map Date: 8/3/2023



Drone imagery main incident area dates: 08/02/2023

NORFOLK SOUTHERN  
EAST PALESTINE, OHIO

TF3\_DU2

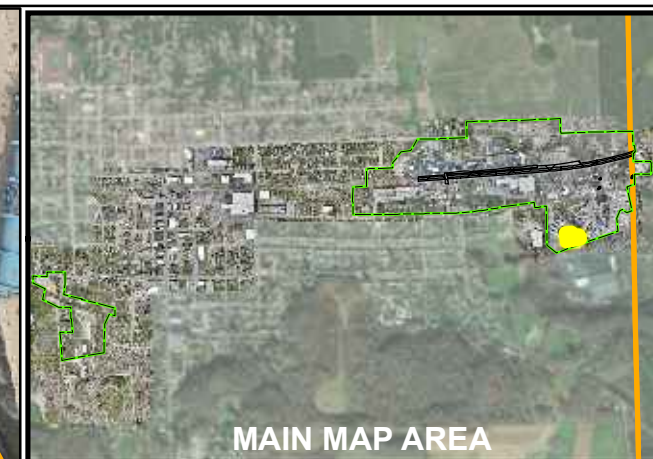
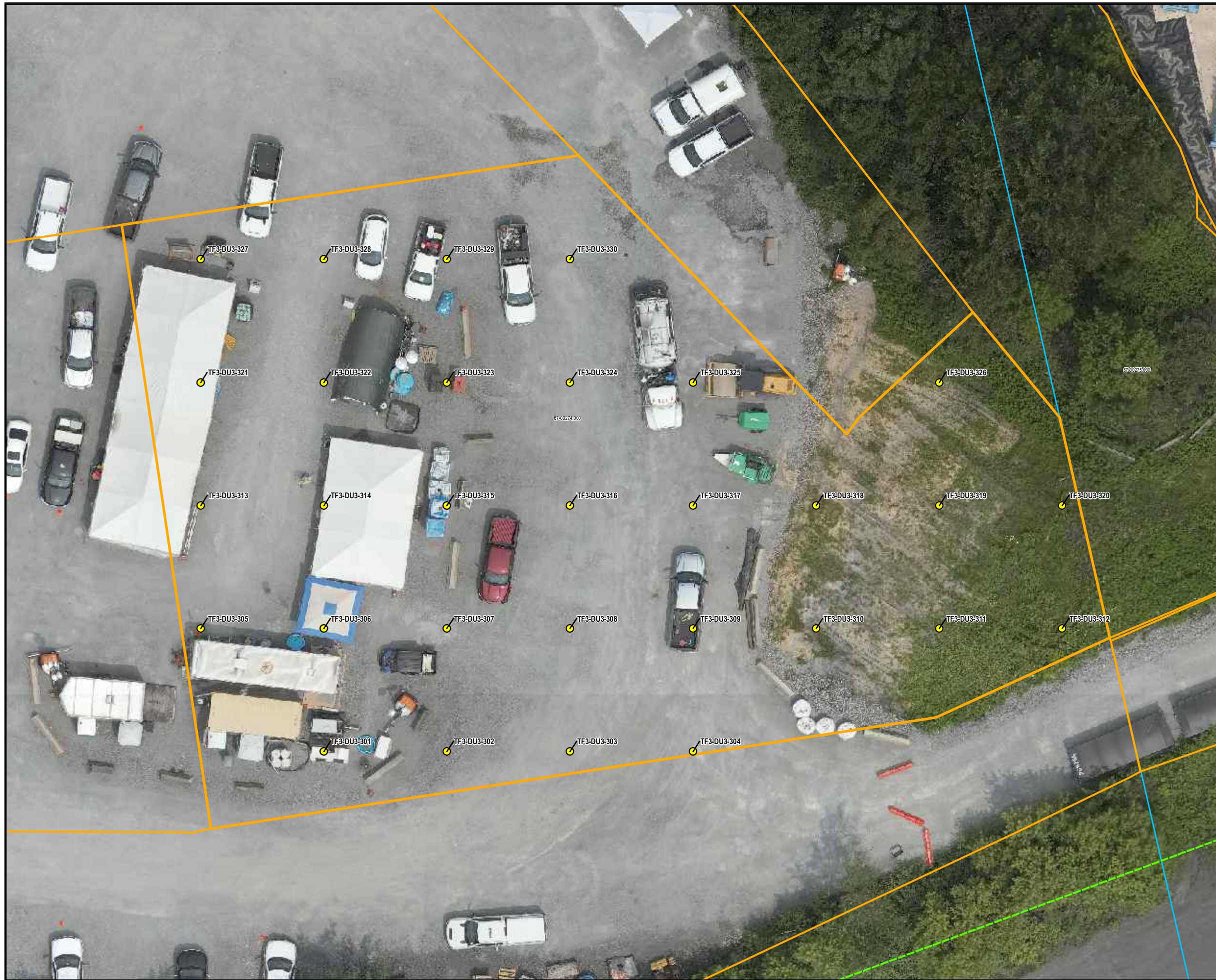


FIGURE

33

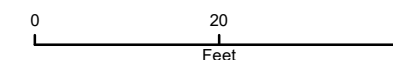


Document Path: T:\EN\NORFOLKSouthernEastPalestine\_Feb5\_2023\MXD\Appendix\_E\_NS\_EastPalestine\_F2\_ddpages\_Site Working Areas\_Sampling Map Set.mxd



**Legend**

- Property Boundry Lines
- County/State Boundary
- Study Area
- Category 2



Map Date: 8/3/2023



Drone imagery main incident area dates: 08/02/2023

NORFOLK SOUTHERN  
EAST PALESTINE, OHIO

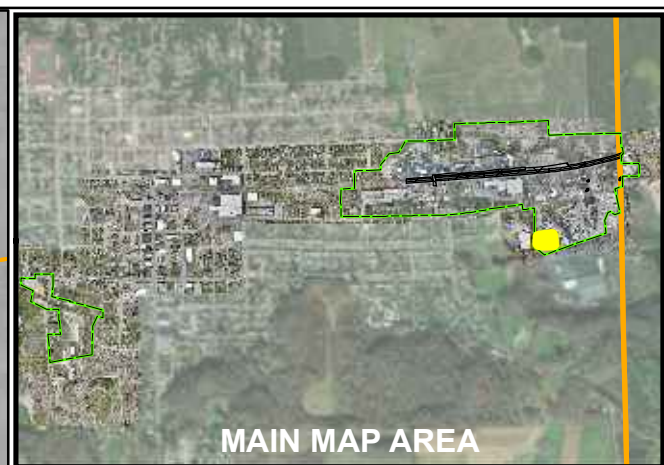
TF3\_DU3



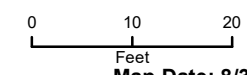
FIGURE  
34



Document Path: T:\EN\NorfolkSouthern\EastPalestine\_Feb5\_2023\MXD\Appendix\_E\_NS\_EastPalestine\_F2\_ddpages\_SiteWorkingAreas\_SamplingMap\_Sri.mxd



- Legend**
- Property Boundry Lines
  - County/State Boundary
  - Study Area
  - Category 2



Map Date: 8/3/2023



Drone imagery main incident area dates: 08/02/2023

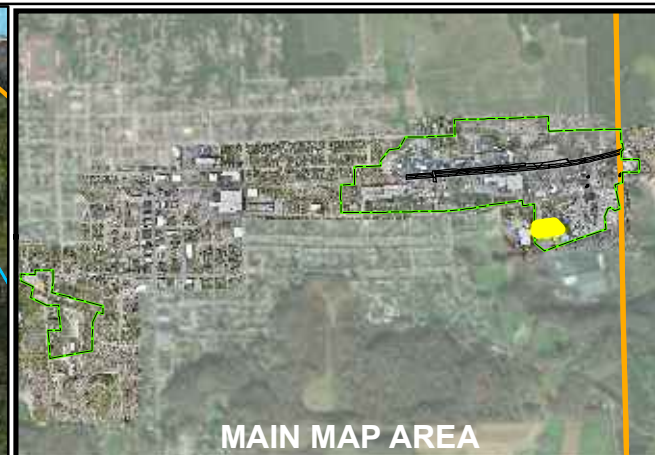
NORFOLK SOUTHERN  
EAST PALESTINE, OHIO

TF3\_DU4



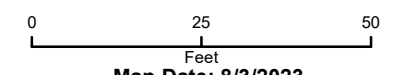
FIGURE  
35





- Legend**
- Property Boundary Lines
  - County/State Boundary
  - Study Area
  - Category 2

End of Impervious Surface



Map Date: 8/3/2023



Drone imagery main incident area dates: 08/02/2023

NORFOLK SOUTHERN  
EAST PALESTINE, OHIO

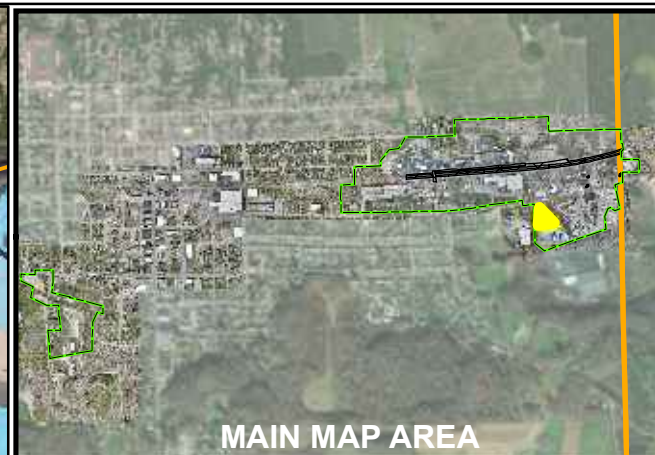
TF3\_DU5



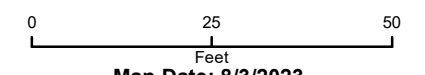
FIGURE  
36

Document Path: T:\EN\NorfolkSouthern\EastPalestine\_Feb5\_2023\MXD\Appendix\_ENS\_EastPalestine\_F2\_ddpages\_SiteWorkingAreas\_SamplingMap\_Sr1.mxd





- Legend**
- Property Boundry Lines
  - County/State Boundary
  - Study Area
  - Category 2



Map Date: 8/3/2023



Drone imagery main incident area dates: 08/02/2023

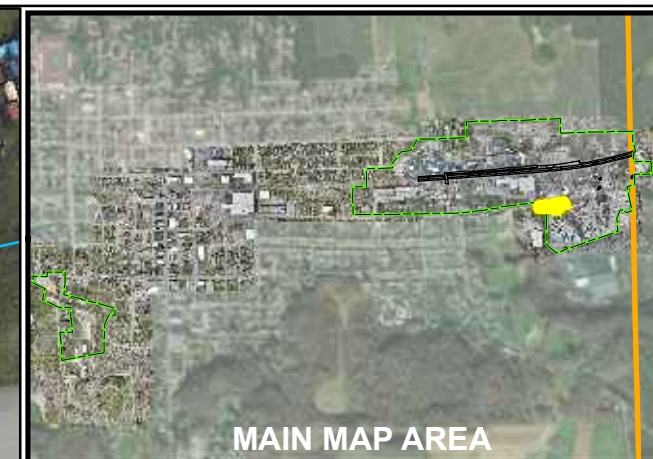
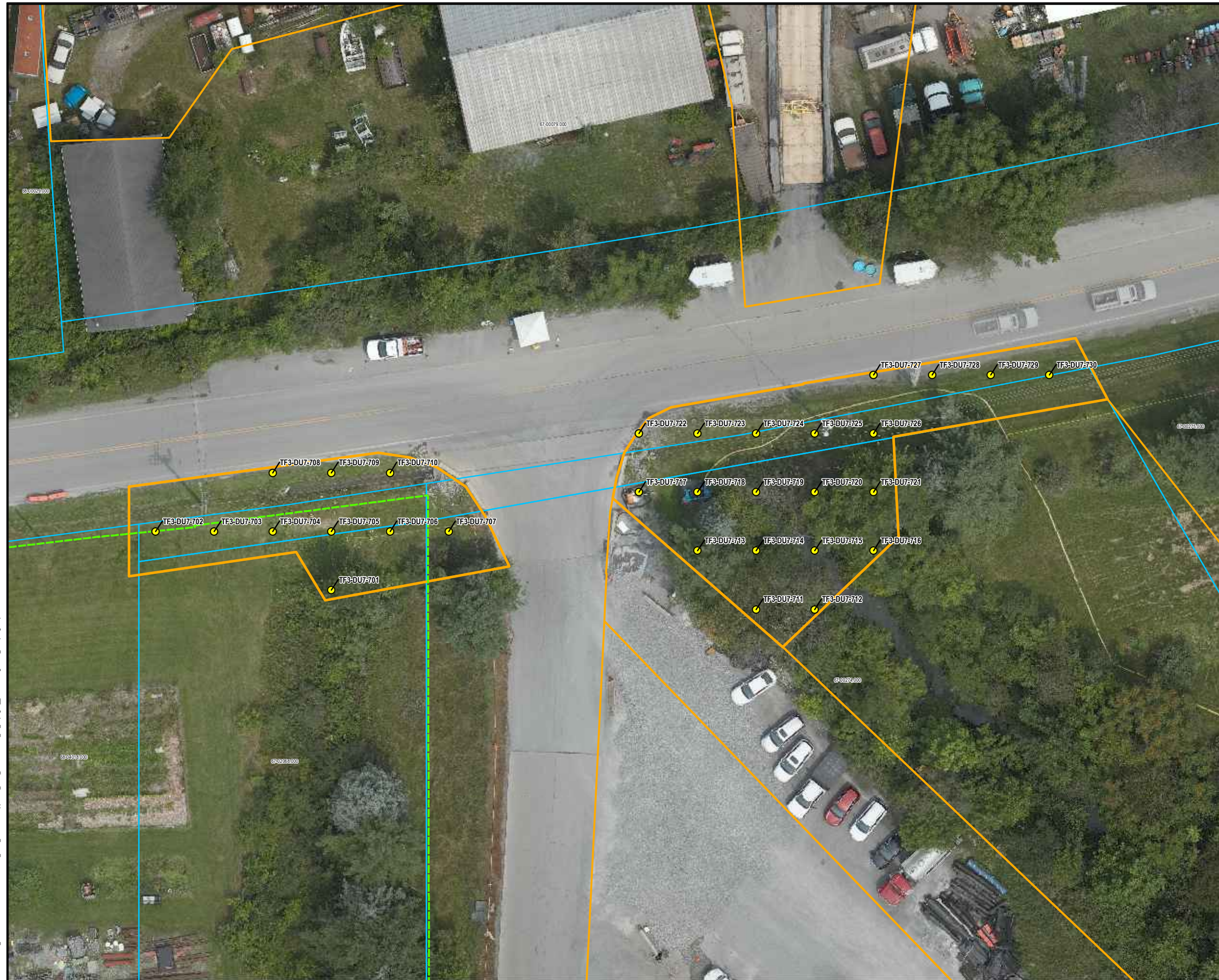
NORFOLK SOUTHERN  
EAST PALESTINE, OHIO

TF3\_DU6



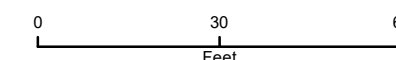
FIGURE  
37





**Legend**

- Property Boundary Lines
- County/State Boundary
- Study Area
- Category 2



Map Date: 8/3/2023



Drone imagery main incident area dates: 08/02/2023

NORFOLK SOUTHERN  
EAST PALESTINE, OHIO

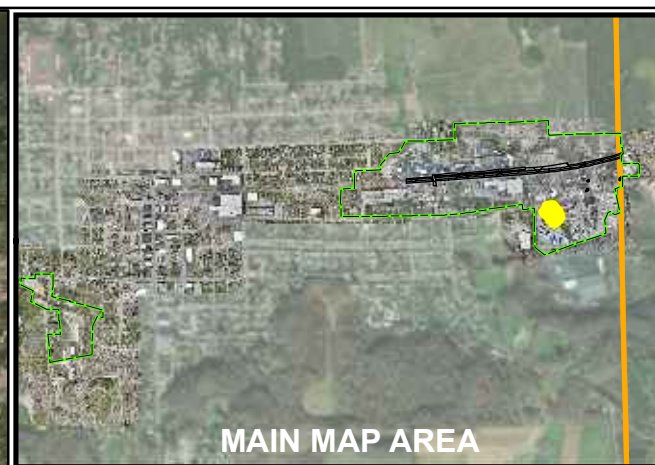
TF3\_DU7



FIGURE  
38

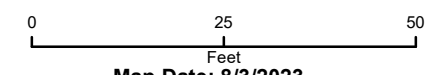


Document Path: T:\ENW\NorfolkSouthern\East Palestine\_Feb5\_2023\MXD\Appendix\_ENS\_East Palestine\_F2\_ddpages\_Site Working Areas\_Sampling Map Set.mxd



**Legend**

- Property Boundry Lines
- County/State Boundary
- Study Area
- Category 2



Map Date: 8/3/2023



Drone imagery main incident area dates: 08/02/2023

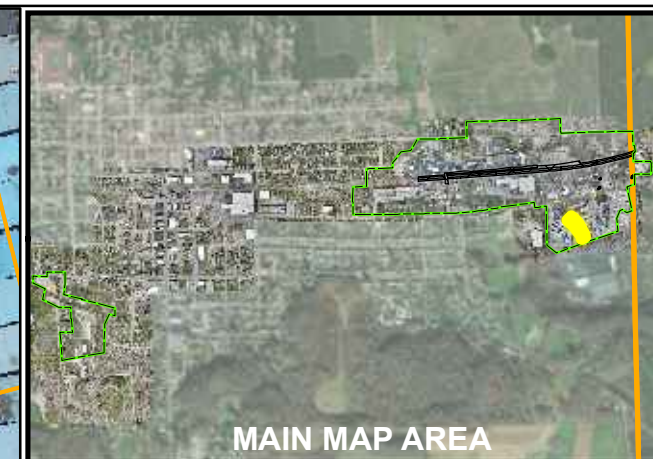
NORFOLK SOUTHERN  
EAST PALESTINE, OHIO

TF3\_DU8



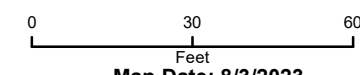
FIGURE  
**39**





**Legend**

- Property Boundry Lines
- County/State Boundary
- Study Area
- Category 2



Map Date: 8/3/2023



Drone imagery main incident area dates: 08/02/2023

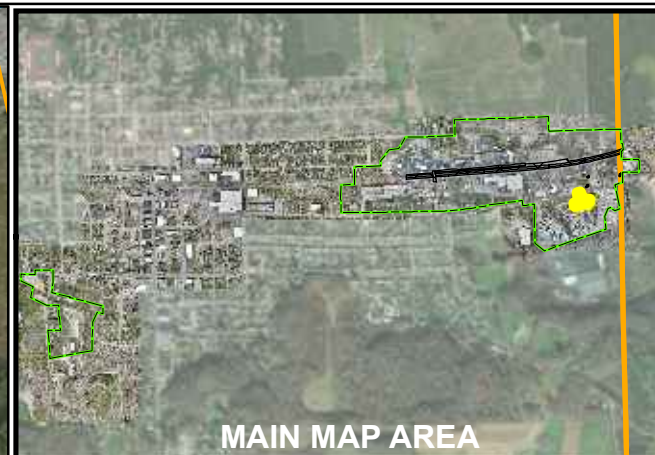
NORFOLK SOUTHERN  
EAST PALESTINE, OHIO

TF3\_DU9

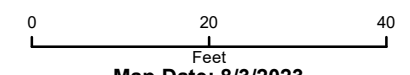


FIGURE  
**40**





- Legend**
- Property Boundry Lines
  - County/State Boundary
  - Study Area
  - Category 2



Map Date: 8/3/2023



Drone imagery main incident area dates: 08/02/2023

NORFOLK SOUTHERN  
EAST PALESTINE, OHIO

TF5\_DU1



FIGURE  
41

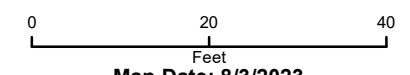
Document Path: T:\EN\NorfolkSouthern\East Palestine\_Feb5\_2023\MXD\Appendix\_ENS\_East Palestine\_F2\_ddpages\_Site Working Areas\_Sampling Map Set.mxd



Document Path: T:\EN\NORFOLKSouthernEastPalestine\_Feb5\_2023\MXD\Appendix\_ENS\_EastPalestine\_F2\_ddpages\_SiteWorkingAreas\_SamplingMap\_Sri.mxd



- Legend**
- Property Boundary Lines
  - County/State Boundary
  - Study Area
  - Category 2



Map Date: 8/3/2023



Drone imagery main incident area dates: 08/02/2023

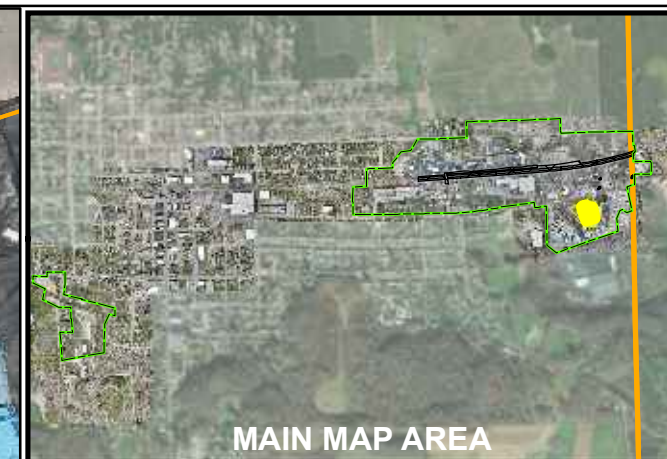
NORFOLK SOUTHERN  
EAST PALESTINE, OHIO

TF5\_DU2



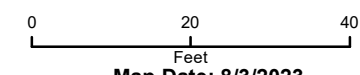
FIGURE  
42





**Legend**

- Property Boundary Lines
- County/State Boundary
- Study Area
- Category 2



Map Date: 8/3/2023



Drone imagery main incident area dates: 08/02/2023

NORFOLK SOUTHERN  
EAST PALESTINE, OHIO

TF5\_DU3

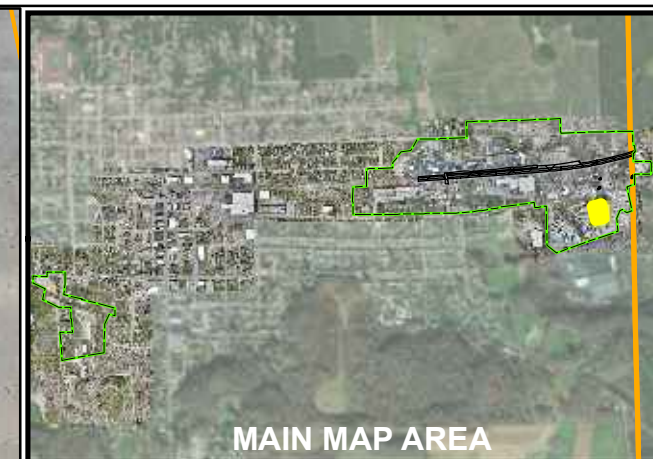


FIGURE  
**43**

Document Path: T:\EN\NofolkSouthern\EastPalestine\_Feb5\_2023\MXD\Appendix\_ENS\_EastPalestine\_F2\_ddpages\_Site Working Areas\_Sampling Map\_Sri.mxd

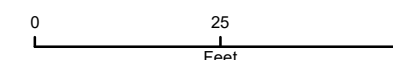
3/2/2023





**Legend**

- Property Boundary Lines
- County/State Boundary
- Study Area
- Category 2



Map Date: 8/3/2023



Drone imagery main incident area dates: 08/02/2023

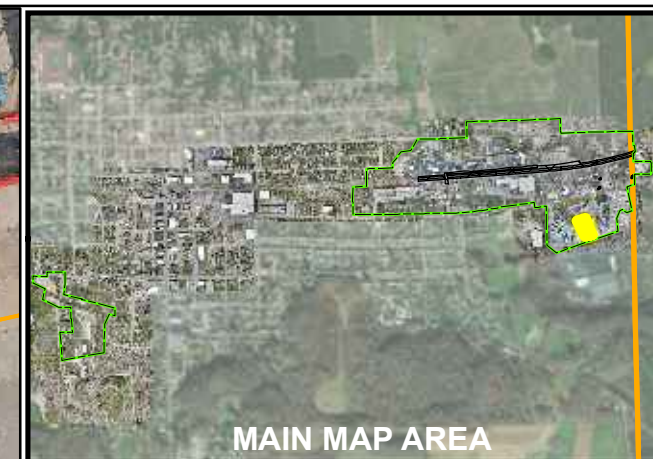
NORFOLK SOUTHERN  
EAST PALESTINE, OHIO

TF5\_DU4



FIGURE  
44





**Legend**

- Property Boundry Lines
- County/State Boundary
- Study Area
- Category 2



Map Date: 8/3/2023



Drone imagery main incident area dates: 08/02/2023

NORFOLK SOUTHERN  
EAST PALESTINE, OHIO

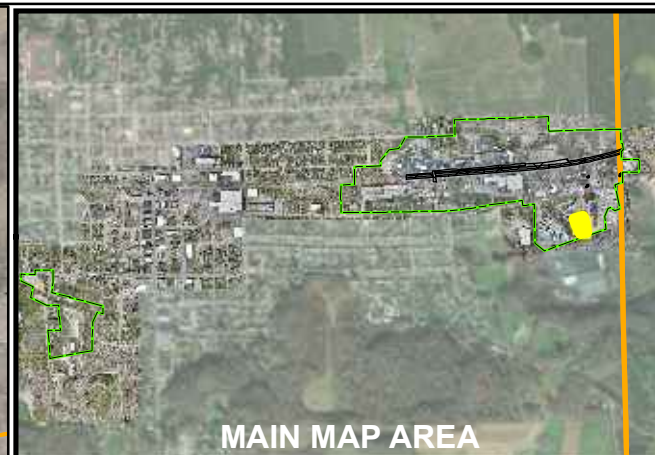
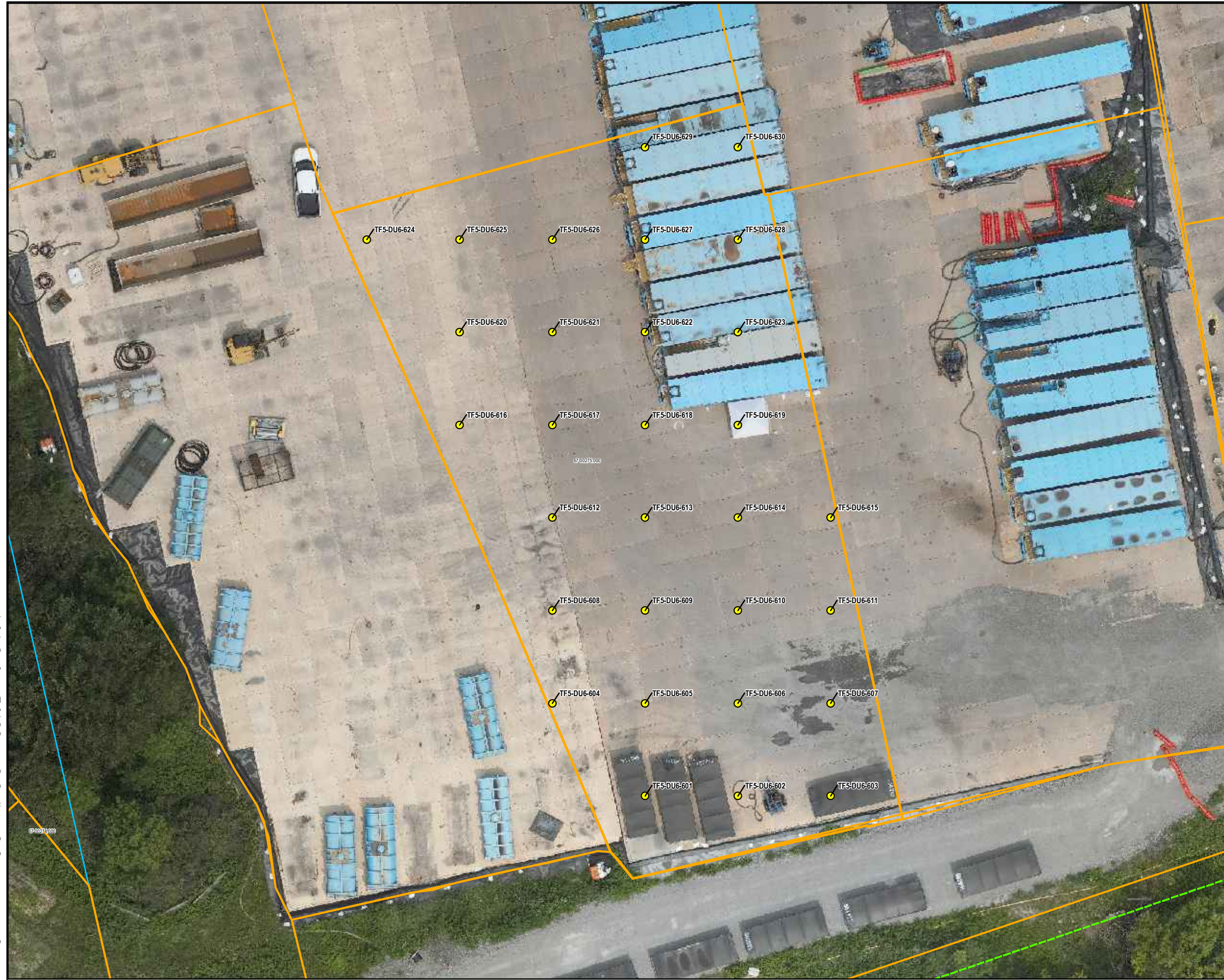
TF5\_DU5



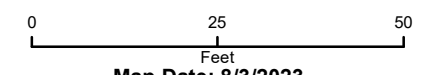
FIGURE  
45

Document Path: T:\EN\NORFOLKSouthern\EastPalestine\_Feb5\_2023\MXD\Appendix\_ENS\_EastPalestine\_F2\_ddpages\_SiteWorkingAreas\_SamplingMap\_Sri.mxd





- Legend**
- Property Boundry Lines
  - County/State Boundary
  - Study Area
  - Category 2



Map Date: 8/3/2023



Drone imagery main incident area dates: 08/02/2023

NORFOLK SOUTHERN  
EAST PALESTINE, OHIO

TF5\_DU6



FIGURE  
46

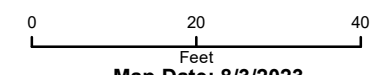
Document Path: T:\EN\NORFOLKSouthernEastPalestine\_Feb5\_2023\MXD\Appendix\_ENS\_East Palestine\_F2\_ddpages\_Site Working Areas\_Sampling Map Set.mxd



Document Path: T:\ENW\NorfolkSouthern\EastPalestine\_Feb5\_2023\MXD\Appendix\_ENS\_EastPalestine\_F2\_ddpages\_Site Working Areas\_Sampling Map\_Sri.mxd



- Legend**
- Property Boundry Lines
  - County/State Boundary
  - Study Area
  - Category 2



Map Date: 8/3/2023



Drone imagery main incident area dates: 08/02/2023

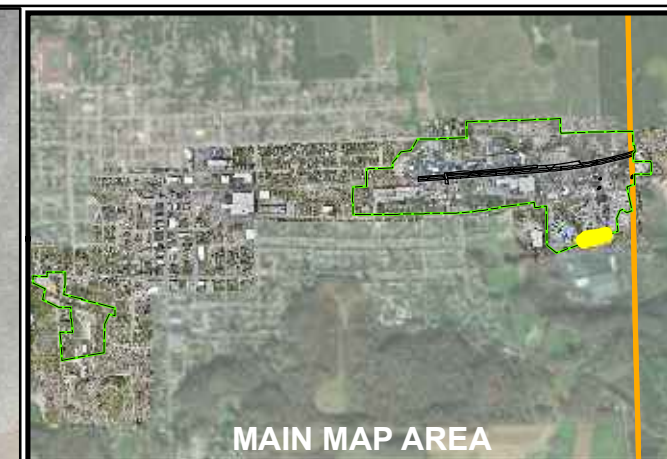
NORFOLK SOUTHERN  
EAST PALESTINE, OHIO

TF5\_DU7



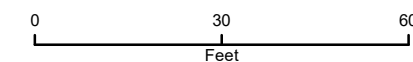
FIGURE  
47





**Legend**

- Property Boundary Lines
- County/State Boundary
- Study Area
- Category 2



Map Date: 8/3/2023



Drone imagery main incident area dates: 08/02/2023

NORFOLK SOUTHERN  
EAST PALESTINE, OHIO

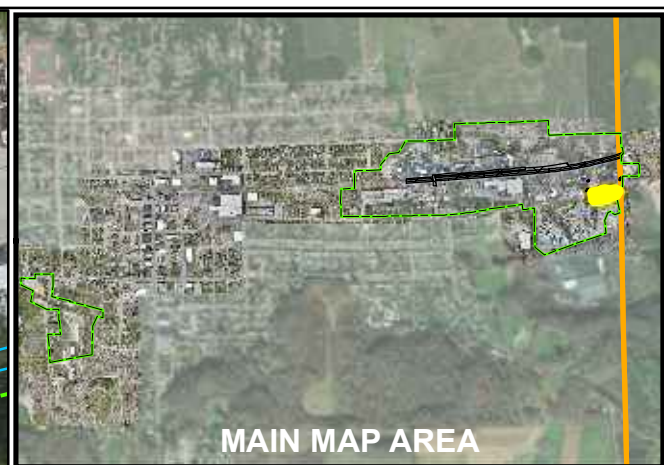
TF5\_DU8



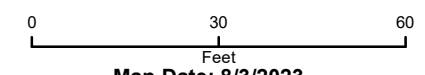
FIGURE  
48



Document Path: T:\EN\NorfolkSouthern\East Palestine\_Feb5\_2023\MXD\Appendix\_ENS\_East Palestine\_F2\_ddpages\_Site Working Areas\_Sampling Map Set.mxd



- Legend**
- Property Boundary Lines
  - County/State Boundary
  - Study Area
  - + Piezometer Locations
  - Category 2



Map Date: 8/3/2023



Drone imagery main incident area dates: 08/02/2023

NORFOLK SOUTHERN  
EAST PALESTINE, OHIO

TF6\_DU1

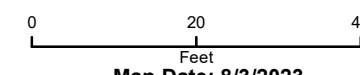


FIGURE  
49





- Legend**
- Property Boundary Lines
  - County/State Boundary
  - Study Area
  - Category 2



Map Date: 8/3/2023



Drone imagery main incident area dates: 08/02/2023

NORFOLK SOUTHERN  
EAST PALESTINE, OHIO

TF6\_DU2



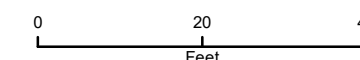
FIGURE  
50





**Legend**

- Property Boundary Lines
- County/State Boundary
- Study Area
- Category 2



Map Date: 8/3/2023



Drone imagery main incident area dates: 08/02/2023

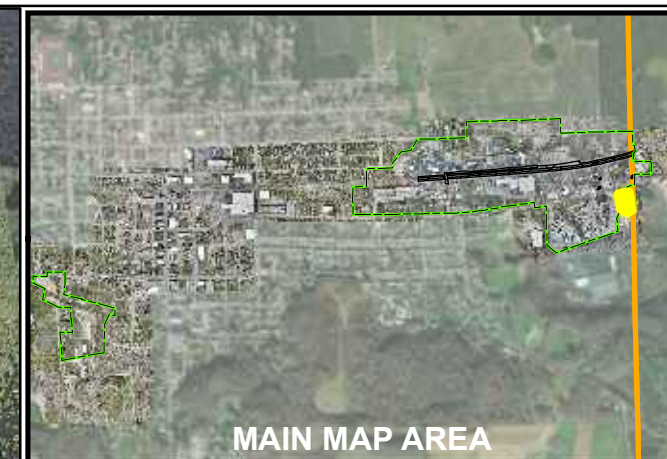
NORFOLK SOUTHERN  
EAST PALESTINE, OHIO

TF6\_DU3



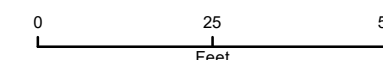
FIGURE  
51





**Legend**

- Property Boundry Lines
- County/State Boundary
- Study Area
- Category 2



Map Date: 8/3/2023



Drone imagery main incident area dates: 08/02/2023

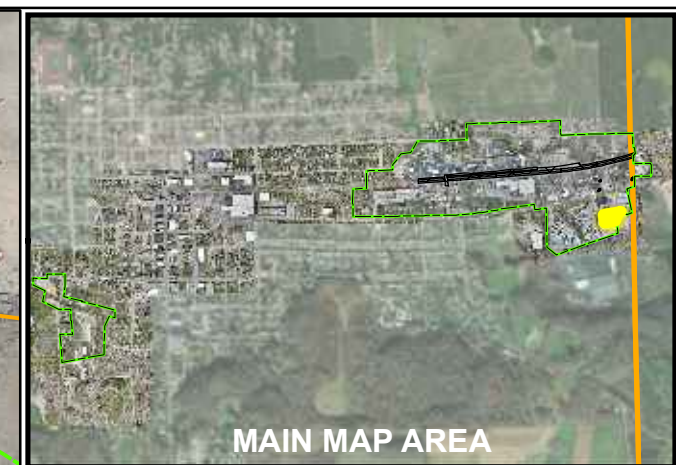
NORFOLK SOUTHERN  
EAST PALESTINE, OHIO

TF6\_DU4



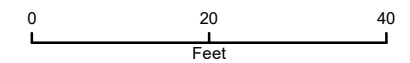
FIGURE  
52





**Legend**

- Property Boundry Lines
- County/State Boundary
- Study Area
- Category 2



Map Date: 8/3/2023



Drone imagery main incident area dates: 08/02/2023

NORFOLK SOUTHERN  
EAST PALESTINE, OHIO

TF6\_DU5



FIGURE

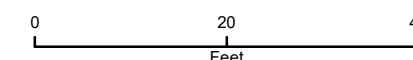
53





**Legend**

- Property Boundry Lines
- County/State Boundary
- Study Area
- Category 2



Map Date: 8/3/2023



Drone imagery main incident area dates: 08/02/2023

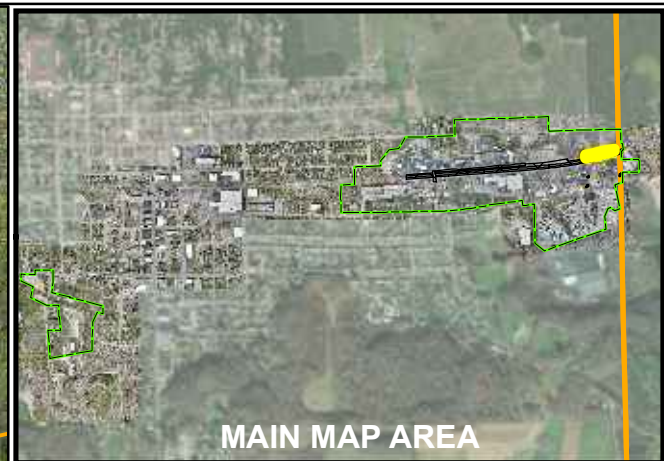
NORFOLK SOUTHERN  
EAST PALESTINE, OHIO

TF6\_DU6

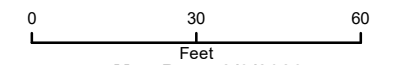


FIGURE  
54





- Legend**
- Cleared and Restored Under Appendix D
  - Property Boundary Lines
  - County/State Boundary
  - Study Area
  - Piezometer Locations
  - Category 2



Map Date: 8/3/2023



Drone imagery main incident area dates: 08/02/2023

NORFOLK SOUTHERN  
EAST PALESTINE, OHIO

UMLE\_DU1



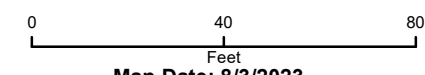
FIGURE  
55

Document Path: T:\EN\NORFOLKSouthernEastPalestine\_Feb2\_2023\MXD\Appendix\_E\_NS\_East Palestine\_F2\_ddpages\_Site Working Areas\_Sampling Map\_Sri.mxd





- Legend**
- Cleared and Restored Under Appendix D
  - Property Boundary Lines
  - County/State Boundary
  - Study Area
  - Piezometer Locations
  - Category 2



Map Date: 8/3/2023



Drone imagery main incident area dates: 08/02/2023

NORFOLK SOUTHERN  
EAST PALESTINE, OHIO

UMLE\_DU2











FIGURE  
56

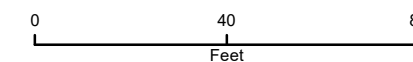
Document Path: T:\EN\NORfolkSouthern\EastPalestine\_Feb2\_2023\MXD\Appendix\_E\_NS\_East Palestine\_F2\_ddpages\_Site Working Areas\_Sampling Map\_Sri.mxd





**Legend**

-  Cleared and Restored Under Appendix D
-  Property Boundry Lines
-  Stormwater Catch Basin
-  Stormwater Conveyance
-  County/State Boundary
-  Study Area
-  Piezometer Locations
-  Category 2



Map Date: 8/3/2023



Drone imagery main incident area dates: 08/02/2023

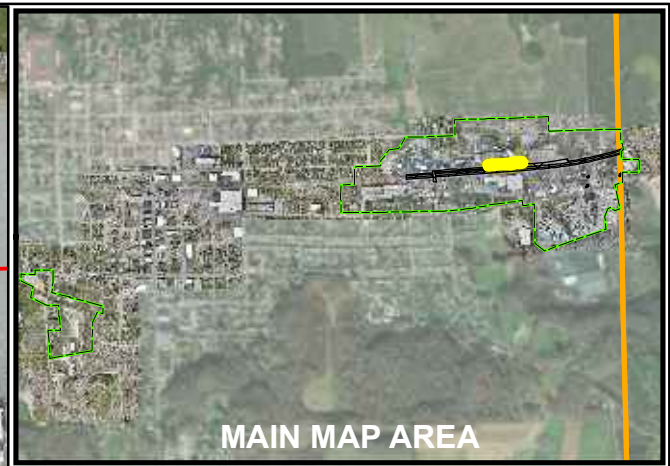
NORFOLK SOUTHERN  
EAST PALESTINE, OHIO

UND\_DU1

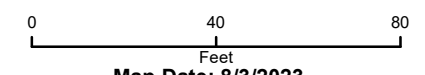


FIGURE  
57





- Legend**
- Cleared and Restored Under Appendix D
  - Property Boundary Lines
  - Stormwater Catch Basin Removed
  - Stormwater Conveyance
  - County/State Boundary
  - Study Area
  - Piezometer Locations
  - Category 2



Map Date: 8/3/2023



Drone imagery main incident area dates: 08/02/2023

NORFOLK SOUTHERN  
EAST PALESTINE, OHIO

UND\_DU2

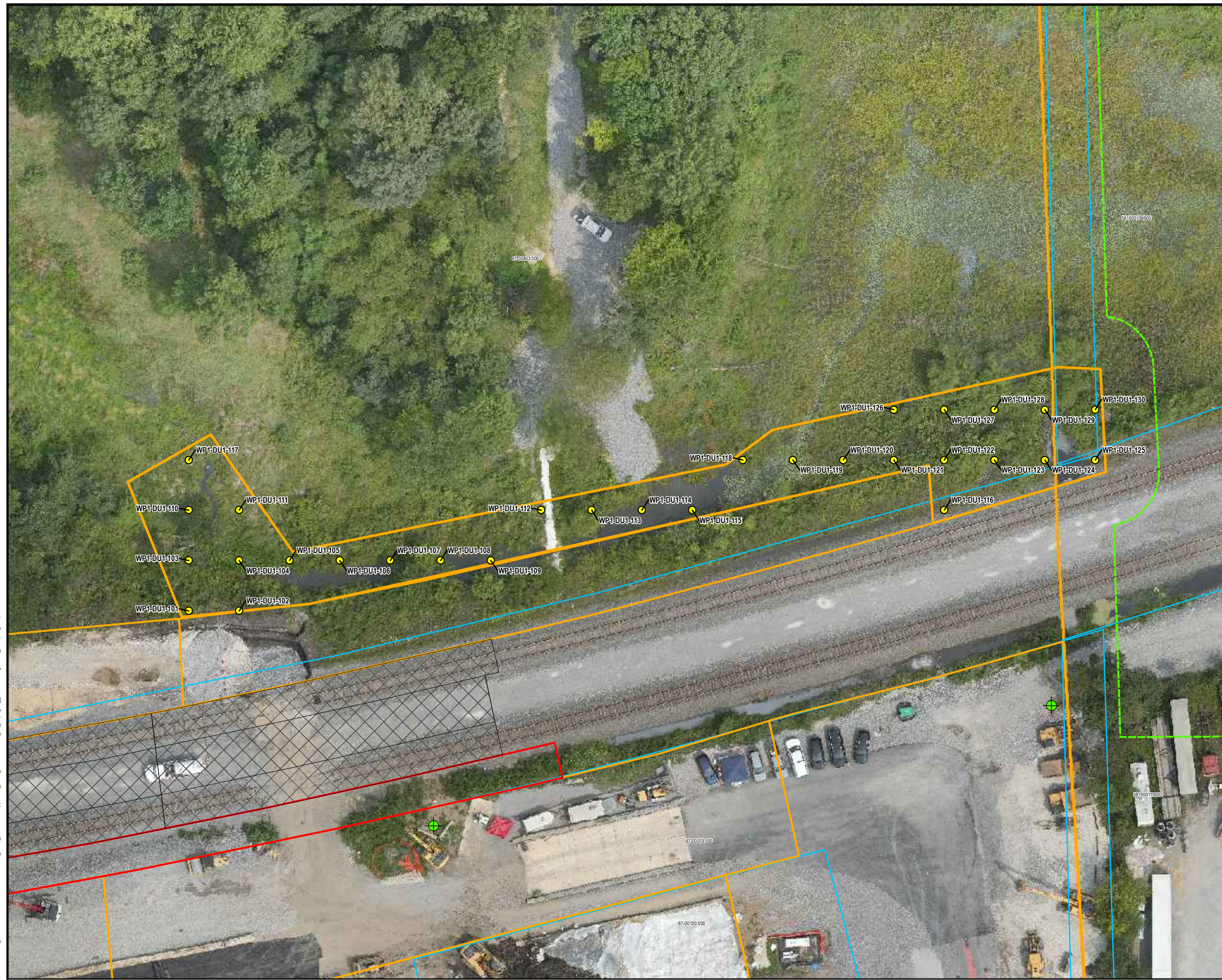


FIGURE  
58

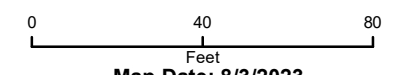
Document Path: T:\EN\NORfolkSouthern\East Palestine\_Fab5\_2023\MXD\Appendix\_E\_NS\_East Palestine\_F2\_ddpages\_Site Working Areas\_Sampling Map\_Sri.mxd



Document Path: T:\EN\NorfolkSouthern\East Palestine\_Feb\_2023\MXD\Appendix\_E\_NS\_East Palestine\_F2\_ddpages\_Site Working Areas\_Sampling Map\_Sri.mxd



- Legend**
- Cleared and Restored Under Appendix D
  - Property Boundary Lines
  - County/State Boundary
  - Study Area
  - Piezometer Locations
  - Category 2



Map Date: 8/3/2023



Drone imagery main incident area dates: 08/02/2023

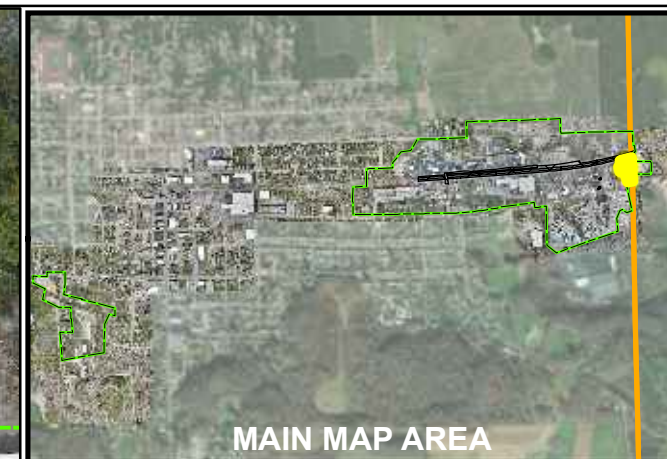
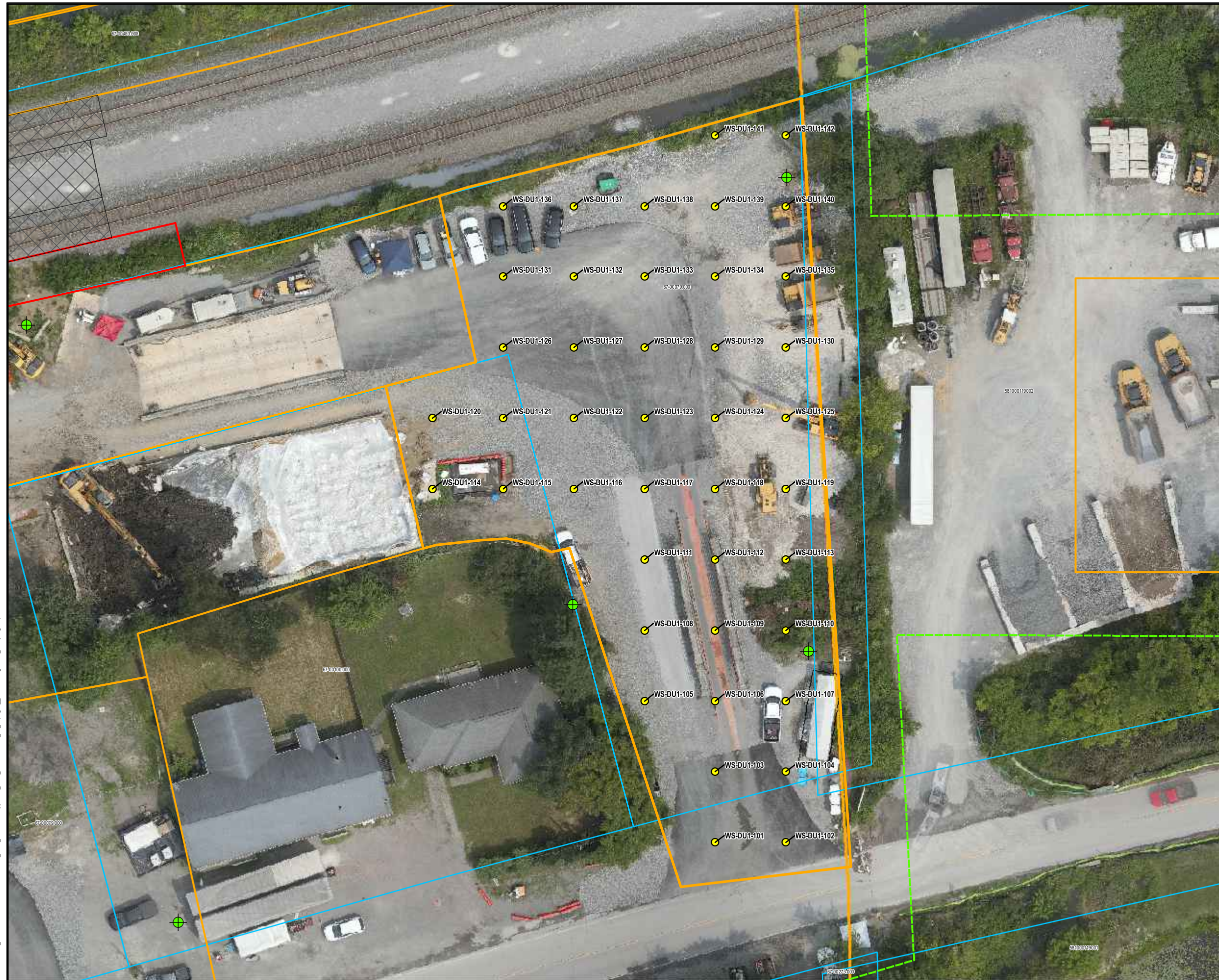
NORFOLK SOUTHERN  
EAST PALESTINE, OHIO

WP1\_DU1



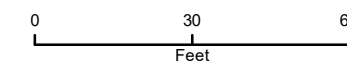
FIGURE  
**59**





**Legend**

- Cleared and Restored Under Appendix D
- Property Boundary Lines
- County/State Boundary
- Study Area
- Piezometer Locations
- Category 2



Map Date: 8/3/2023



Drone imagery main incident area dates: 08/02/2023

NORFOLK SOUTHERN  
EAST PALESTINE, OHIO

WS\_DU1



FIGURE  
60

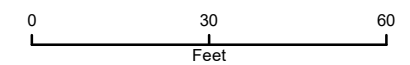


Document Path: T:\EN\NorfolkSouthern\EastPalestine\_Feb2\_2023\MXD\Appendix\_E\_NS\_EastPalestine\_F2\_ddpages\_SiteWorkingAreas\_SamplingMap\_Sri.mxd



**Legend**

- Cleared and Restored Under Appendix D
- Property Boundary Lines
- County/State Boundary
- Study Area
- Piezometer Locations
- Category 2



Map Date: 8/3/2023



Drone imagery main incident area dates: 08/02/2023

NORFOLK SOUTHERN  
EAST PALESTINE, OHIO

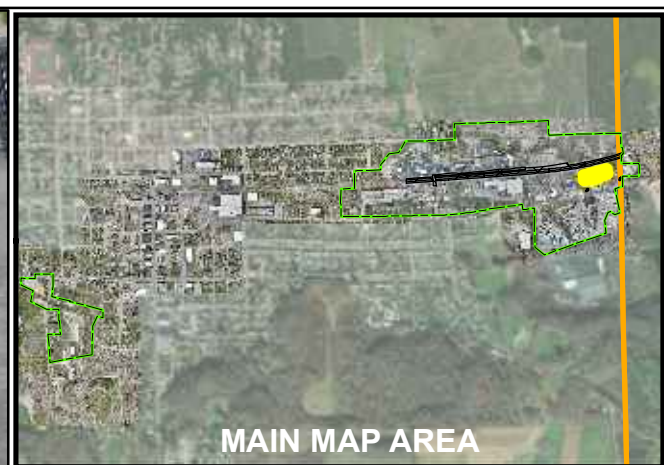
WS\_DU2









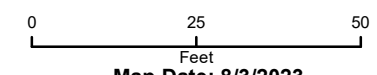
FIGURE  
61



Document Path: T:\EN\NORFOLKSouthernEastPalestine\_Feb5\_2023\MXD\Appendix\_E\_NS\_East Palestine\_F2\_ddpages\_Site Working Areas\_Sampling Map\_Sri.mxd



- Legend**
-  Cleared and Restored Under Appendix D
  -  Property Boundry Lines
  -  County/State Boundary
  -  Study Area
  -  Piezometer Locations
  -  Category 2



Map Date: 8/3/2023



Drone imagery main incident area dates: 08/02/2023

NORFOLK SOUTHERN  
EAST PALESTINE, OHIO

WS\_DU3









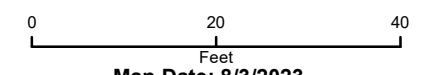
FIGURE  
62



Document Path: T:\EN\NorfolkSouthern\EastPalestine\_Feb5\_2023\MXD\Appendix\_E\_NS\_East Palestine\_F2\_ddpages\_Site Working Areas\_Sampling Map\_Sri.mxd



- Legend**
-  Cleared and Restored Under Appendix D
  -  Property Boundary Lines
  -  County/State Boundary
  -  Study Area
  -  Piezometer Locations
  -  Category 2



Map Date: 8/3/2023



Drone imagery main incident area dates: 08/02/2023

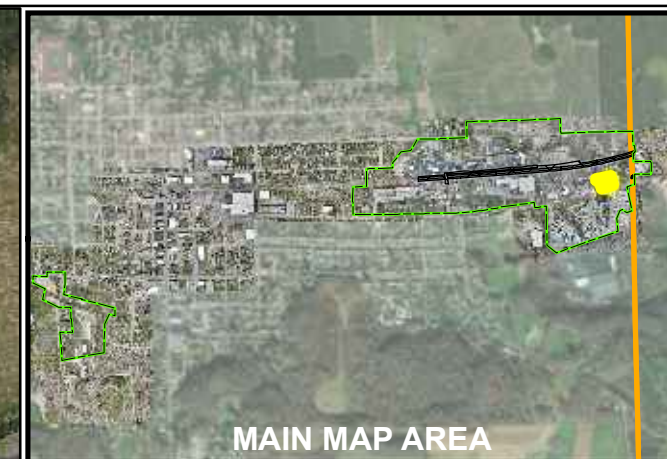
NORFOLK SOUTHERN  
EAST PALESTINE, OHIO

WS\_DU4








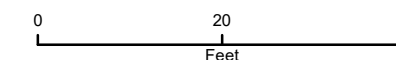
FIGURE  
**63**





**Legend**

-  Property Boundary Lines
-  County/State Boundary
-  Study Area
-  Piezometer Locations
-  Category 2



Map Date: 8/3/2023



Drone imagery main incident area dates: 08/02/2023

NORFOLK SOUTHERN  
EAST PALESTINE, OHIO

WS\_DU5



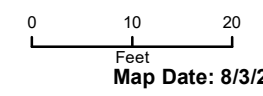
FIGURE  
64



Document Path: T:\EN\NORFOLKSouthernEastPalestine\_Feb5\_2023\MXD\Appendix\_E\_NS\_EastPalestine\_F2\_ddpages\_SiteWorkingAreas\_SamplingMap\_Sri.mxd



- Legend**
- Cleared and Restored Under Appendix D
  - Property Boundary Lines
  - County/State Boundary
  - Study Area
  - Piezometer Locations
  - Category 2



Map Date: 8/3/2023

Drone imagery main incident area dates: 08/02/2023



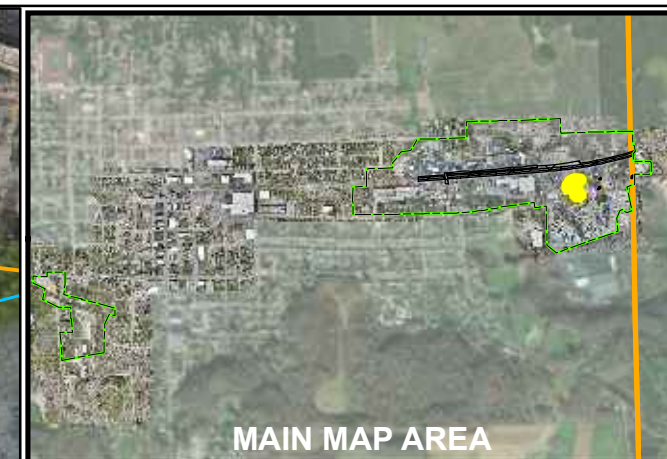
NORFOLK SOUTHERN  
EAST PALESTINE, OHIO

WS\_DU6



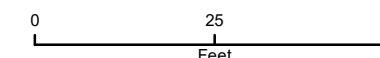
FIGURE  
65





**Legend**

- Property Boundary Lines
- County/State Boundary
- Study Area
- ⊕ Piezometer Locations
- Category 2



Map Date: 8/3/2023



Drone imagery main incident area dates: 08/02/2023

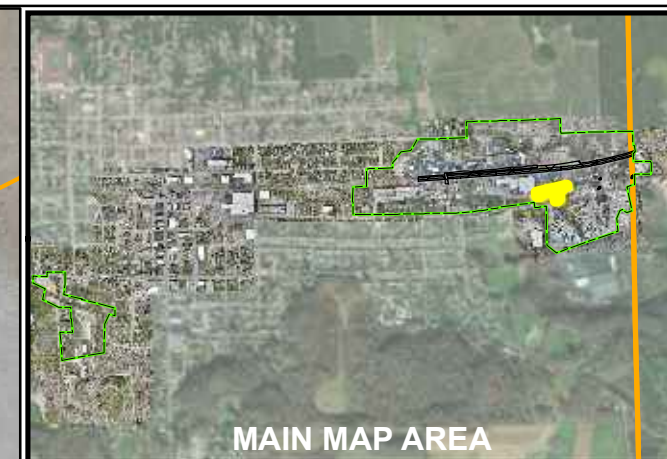
NORFOLK SOUTHERN  
EAST PALESTINE, OHIO

WS\_DU7



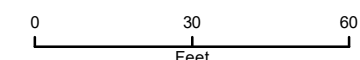
FIGURE  
66





**Legend**

- Property Boundry Lines
- Stormwater Catch Basin
- Stormwater Catch Basin Removed
- Stormwater Conveyance
- County/State Boundary
- Study Area
- ⊕ Piezometer Locations
- Category 2



Map Date: 8/3/2023



Drone imagery main incident area dates: 08/02/2023

NORFOLK SOUTHERN  
EAST PALESTINE, OHIO

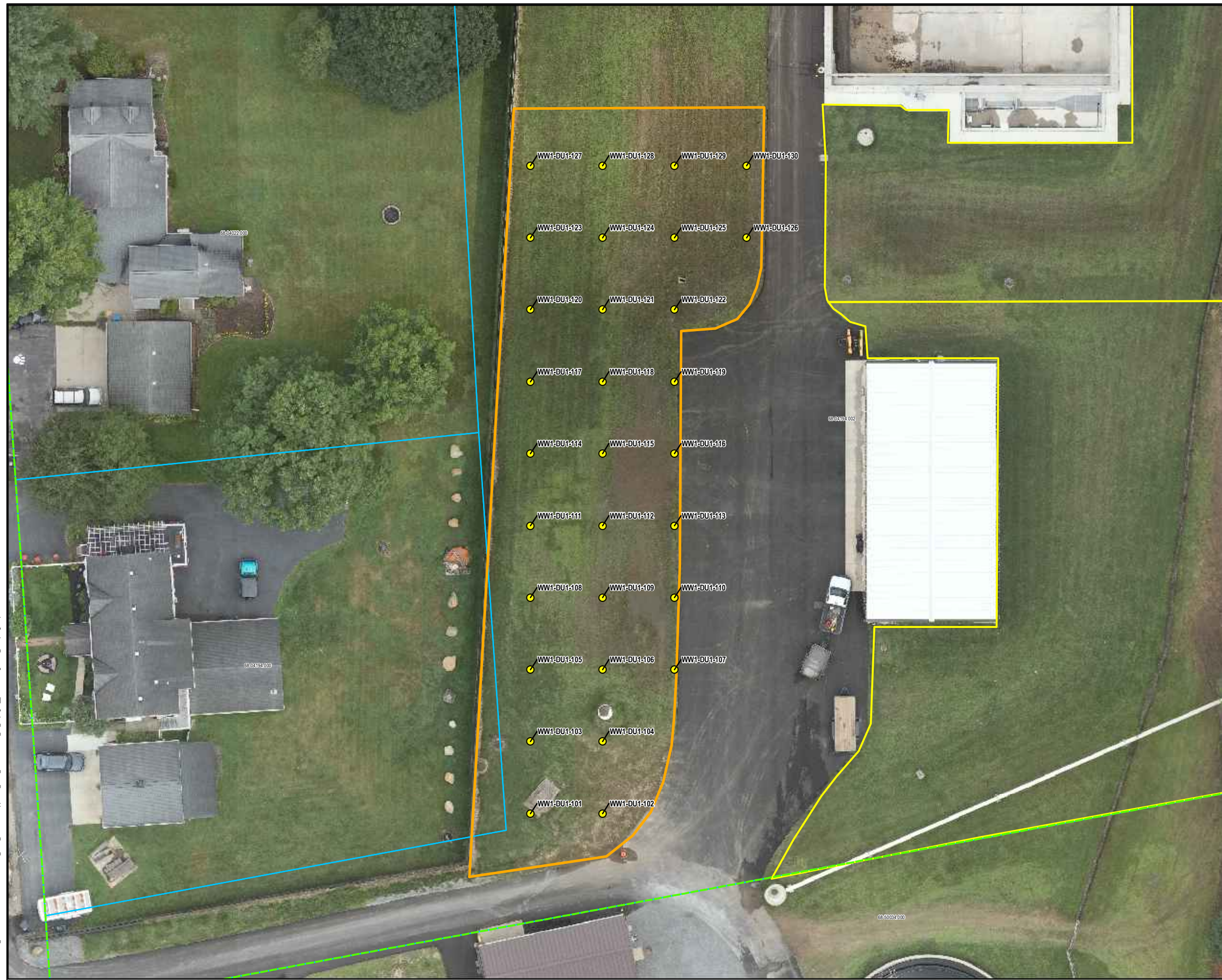
WS\_DU8



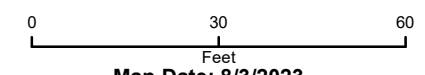
FIGURE  
67



Document Path: T:\ENW\NorfolkSouthern\East Palestine\_Feb5\_2023\MXD\Appendix\_E\_NS\_East Palestine\_F2\_ddpages\_Site Working Areas\_Sampling Map Set.mxd



- Legend**
- Property Boundry Lines
  - County/State Boundary
  - Study Area
  - Category 2



Map Date: 8/3/2023



Drone imagery main incident area dates: 08/02/2023

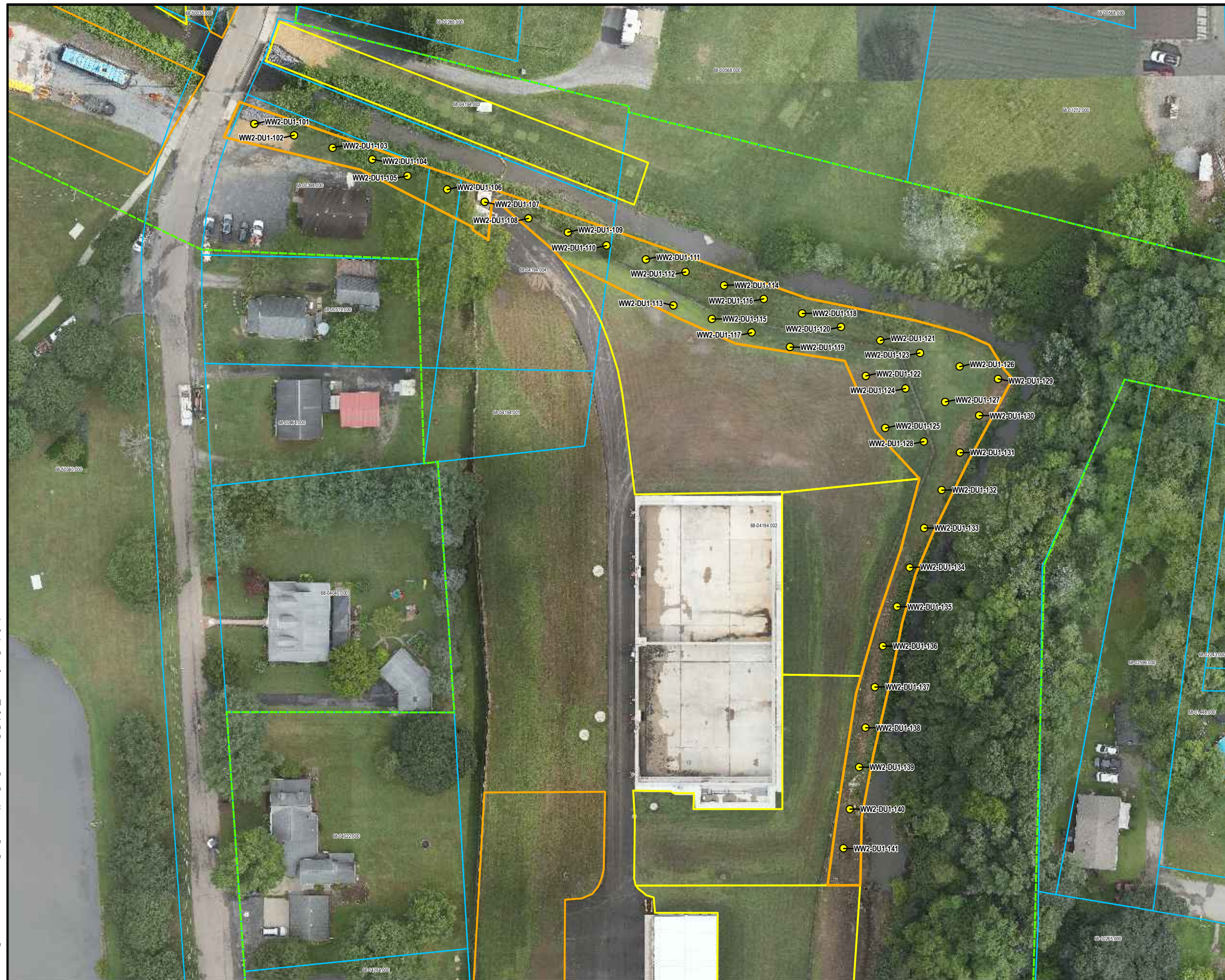
NORFOLK SOUTHERN  
EAST PALESTINE, OHIO

WW1\_DU1

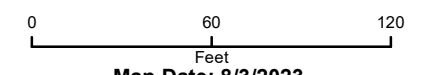


FIGURE  
**68**





- Legend**
- Property Boundary Lines
  - County/State Boundary
  - Study Area
  - Category 2



Map Date: 8/3/2023



Drone imagery main incident area dates: 08/02/2023

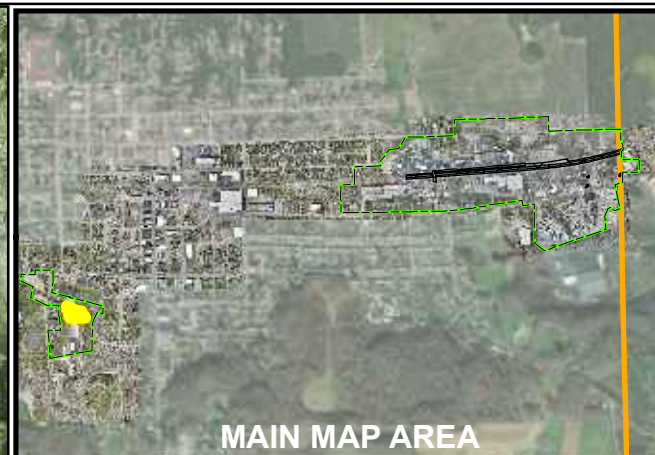
NORFOLK SOUTHERN  
EAST PALESTINE, OHIO

WW2\_DU1

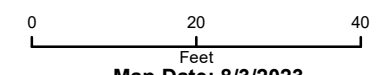


FIGURE  
**69**





- Legend**
- Property Boundary Lines
  - County/State Boundary
  - Study Area
  - Category 3



Map Date: 8/3/2023



Drone imagery main incident area dates: 08/02/2023

NORFOLK SOUTHERN  
EAST PALESTINE, OHIO

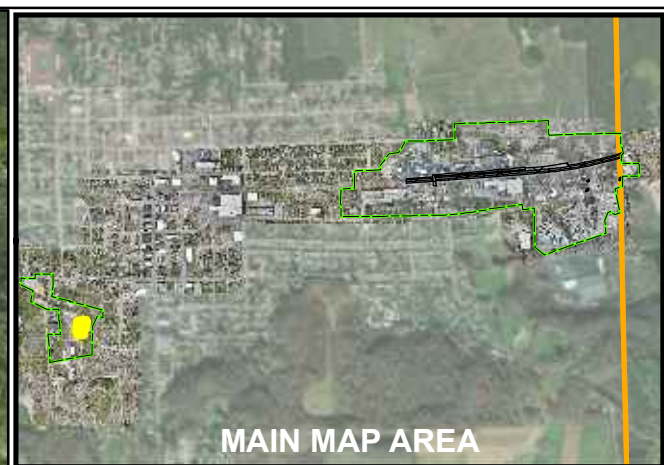
WW2\_DU2



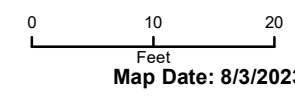
FIGURE  
70



Document Path: T:\EN\NorfolkSouthern\EastPalestine\_Feb5\_2023\MXD\Appendix\_E\_NS\_EastPalestine\_F2\_ddpages\_Site Working Areas\_Sampling Map\_Sri.mxd



- Legend**
- Property Boundary Lines
  - County/State Boundary
  - Study Area
  - Category 3



Drone imagery main incident area dates: 08/02/2023

NORFOLK SOUTHERN  
EAST PALESTINE, OHIO

WW2\_DU3



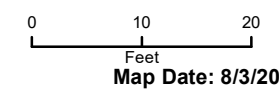
FIGURE  
71



Document Path: T:\ENW\NorfolkSouthern\East Palestine\_Feb5\_2023\MXD\Appendix\_ENS\_East Palestine\_F2\_ddpages\_Site Working Areas\_Sampling Map\_Sri.mxd



- Legend**
- Property Boundary Lines
  - County/State Boundary
  - Study Area
  - Category 3



Drone imagery main incident area dates: 08/02/2023

NORFOLK SOUTHERN  
EAST PALESTINE, OHIO

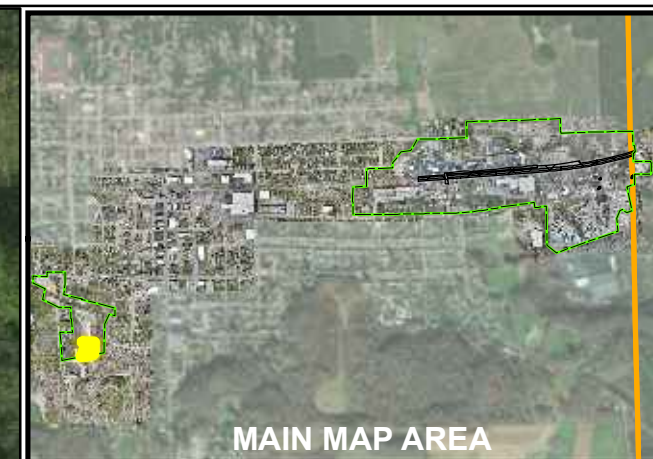
WW2\_DU4



FIGURE  
72

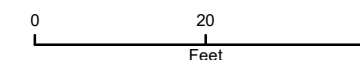


Document Path: T:\EN\NorfolkSouthern\EastPalestine\_Feb5\_2023\MXD\Appendix\_ENS\_EastPalestine\_F2\_ddpages\_SiteWorkingAreas\_SamplingMap\_Sri.mxd



**Legend**

- Property Boundry Lines
- County/State Boundary
- Study Area
- Category 3



Map Date: 8/3/2023



Drone imagery main incident area dates: 08/02/2023

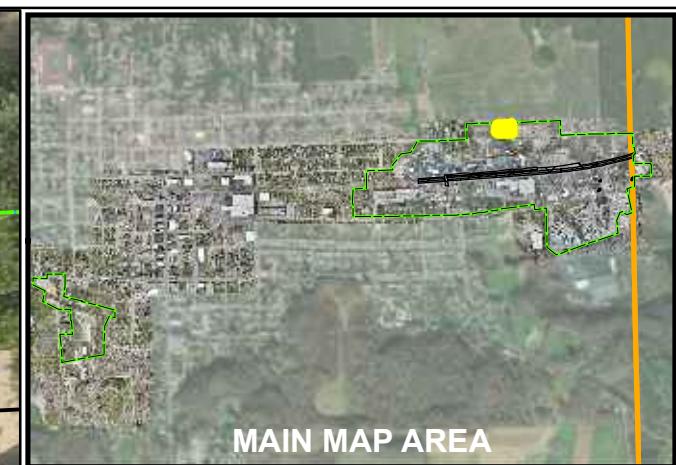
NORFOLK SOUTHERN  
EAST PALESTINE, OHIO

WW2\_DU5



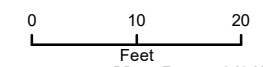
FIGURE  
73





**Legend**

- Property Boundary Lines
- County/State Boundary
- Study Area
- Category 4



Map Date: 8/3/2023

Drone imagery main incident area dates: 08/02/2023



NORFOLK SOUTHERN  
EAST PALESTINE, OHIO

WWET\_DU1



FIGURE  
74

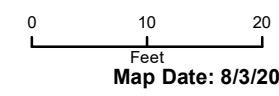


Document Path: T:\EN\NORFOLKSouthernEastPalestine\_Feb5\_2023\MXD\Appendix\_E\_NS\_East Palestine\_F2\_ddpages\_Site Working Areas\_Sampling Map\_Sri.mxd



**Legend**

- Property Boundary Lines
- County/State Boundary
- Study Area
- Category 4



Drone imagery main incident area dates: 08/02/2023

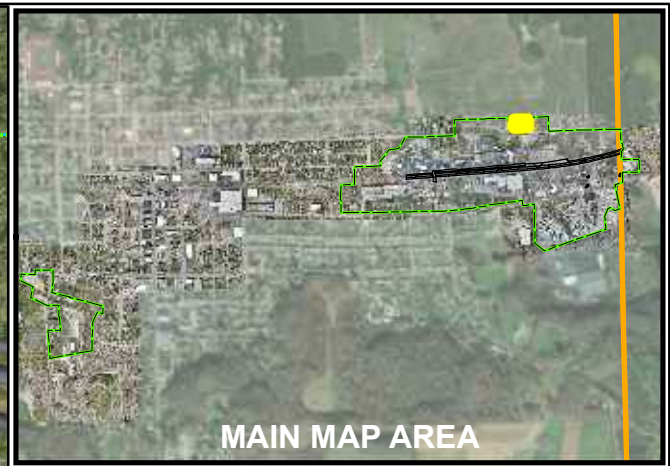
NORFOLK SOUTHERN  
EAST PALESTINE, OHIO

WWET\_DU2

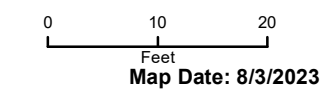


FIGURE  
75





- Legend**
- Property Boundary Lines
  - County/State Boundary
  - Study Area
  - Category 4



Drone imagery main incident area dates: 08/02/2023

NORFOLK SOUTHERN  
EAST PALESTINE, OHIO

WWET\_DU3

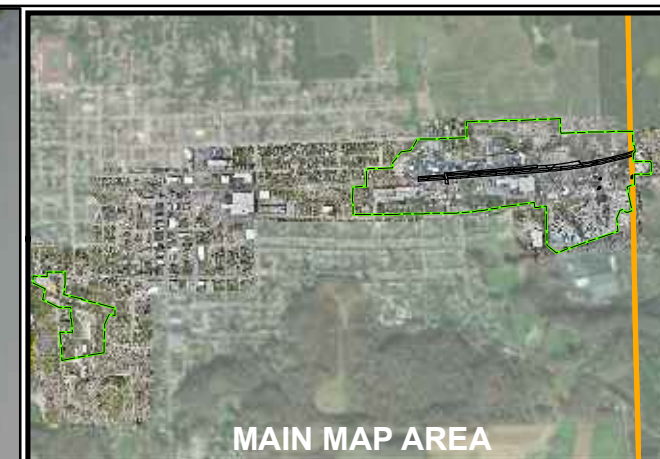


FIGURE  
76





Document Path: T:\EN\NORFOLKSouthernEastPalestine\_Feb5\_2023\MXD\Appendix\_ENS\_EastPalestine\_F2\_dpages\_SiteWorkingAreas\_SamplingMap\_Sri.mxd

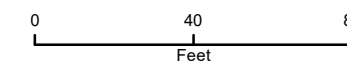


Document Path: T:\EN\NORFOLKSouthernEastPalestine\_Feb2\_2023\MXD\Appendix\_ENS\_EastPalestine\_F2\_ddpages\_SiteWorkingAreas\_SamplingMap\_Sri.mxd



**Legend**

-  Property Boundry Lines
-  County/State Boundary
-  Study Area
-  Category 2



Map Date: 8/3/2023



Drone imagery main incident area dates: 08/02/2023

NORFOLK SOUTHERN  
EAST PALESTINE, OHIO

ULP\_DU1



FIGURE

77

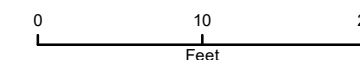


Document Path: T:\EN\NORFOLKSouthern\EastPalestine\_Feb5\_2023\MXD\Appendix\_E\_NS\_EastPalestine\_F2\_ddpages\_SiteWorkingAreas\_SamplingMap\_Sri.mxd



**Legend**

- Property Boundry Lines
- County/State Boundary
- Study Area
- Category 3



Map Date: 8/3/2023



Drone imagery main incident area dates: 08/02/2023

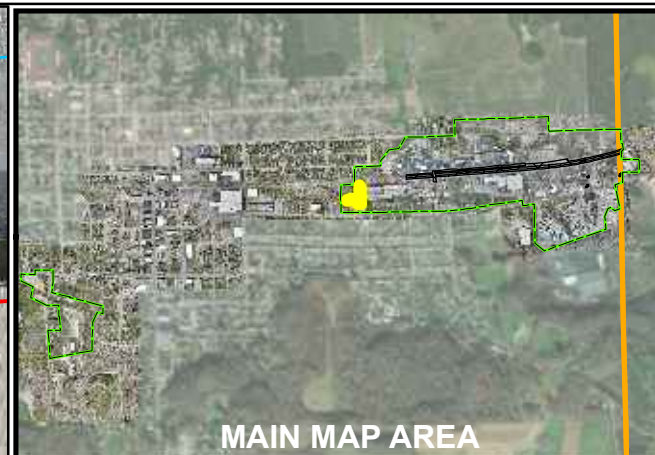
NORFOLK SOUTHERN  
EAST PALESTINE, OHIO

SB1\_DU1

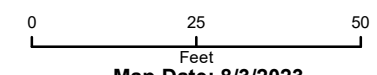


FIGURE  
78





- Legend**
- Property Boundary Lines
  - County/State Boundary
  - Study Area
  - Category 3



Map Date: 8/3/2023



Drone imagery main incident area dates: 08/02/2023

NORFOLK SOUTHERN  
EAST PALESTINE, OHIO

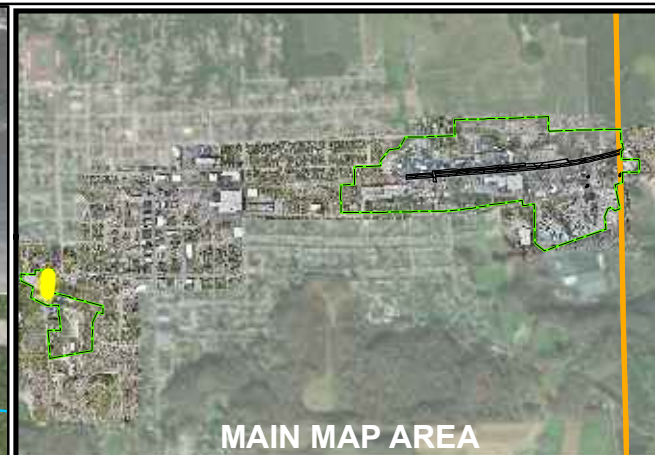
SB2\_DU1



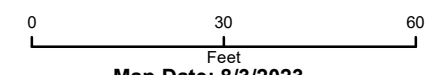
FIGURE  
79

Document Path: T:\EN\NORFOLKSouthernEastPalestine\_Feb2\_2023\MXD\Appendix\_E\_NS\_East Palestine\_F2\_ddpages\_Site Working Areas\_Sampling Map Set.mxd





- Legend**
- Property Boundary Lines
  - County/State Boundary
  - Study Area
  - Category 2



Map Date: 8/3/2023



Drone imagery main incident area dates: 08/02/2023

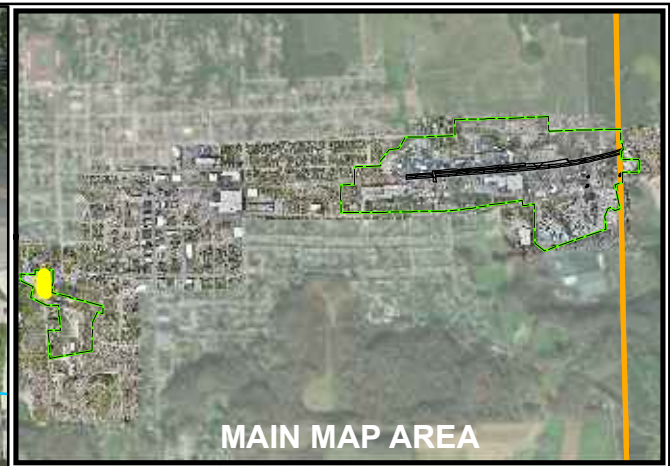
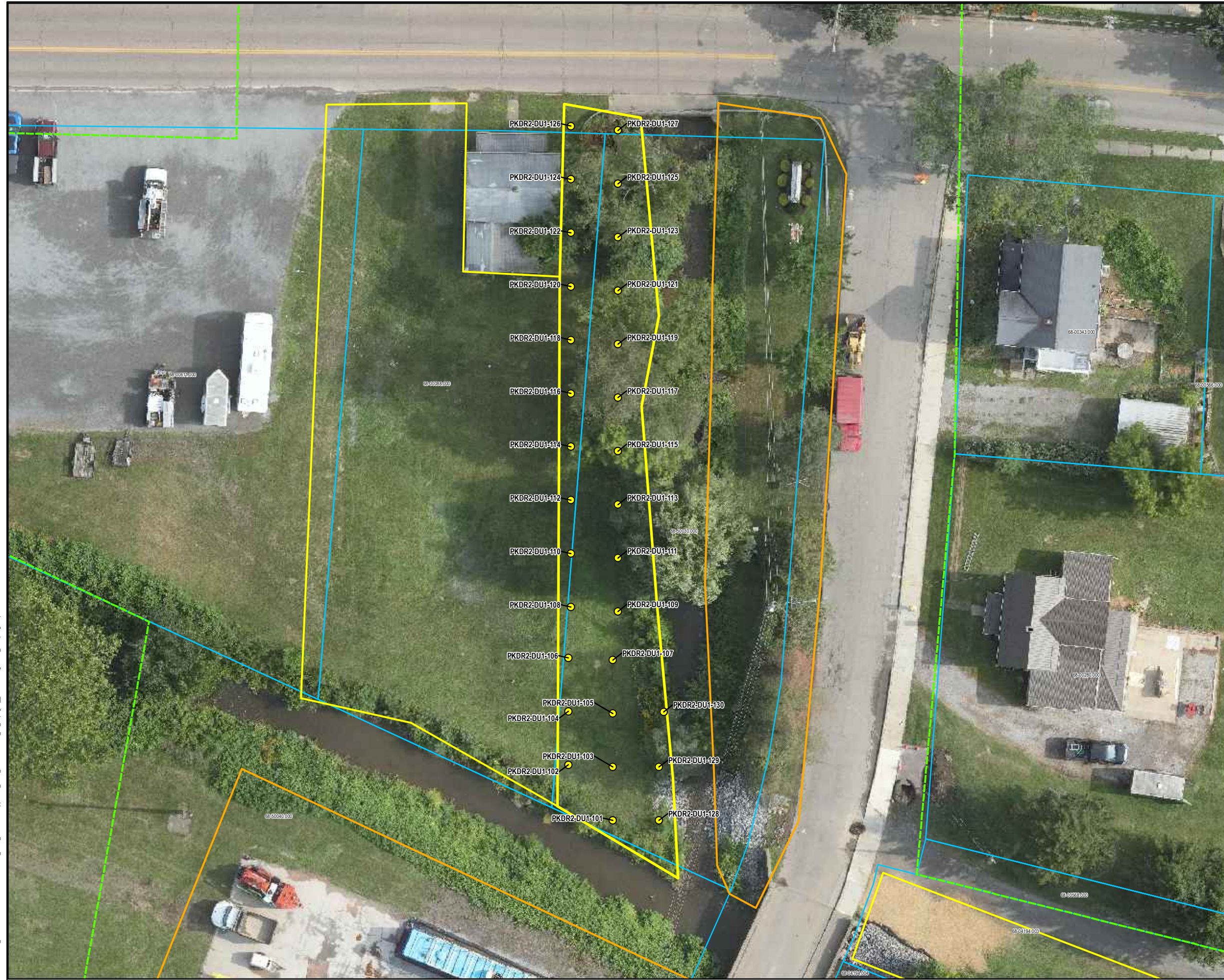
NORFOLK SOUTHERN  
EAST PALESTINE, OHIO

PKDR1\_DU1

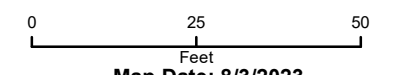


FIGURE  
80





- Legend**
- Property Boundary Lines
  - County/State Boundary
  - Study Area
  - Category 3



Map Date: 8/3/2023



Drone imagery main incident area dates: 08/02/2023

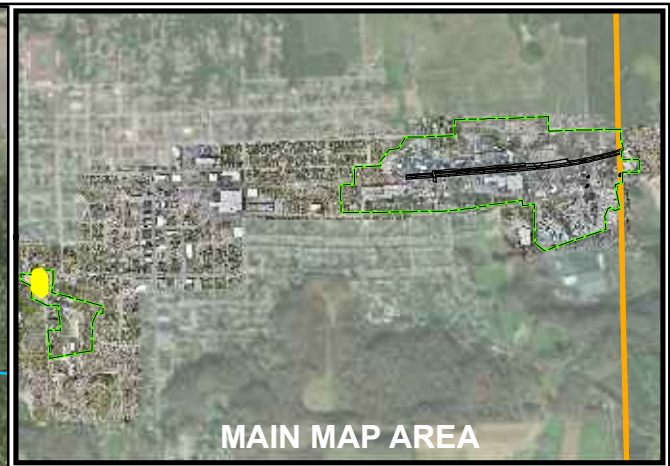
NORFOLK SOUTHERN  
EAST PALESTINE, OHIO

PKDR2\_DU1

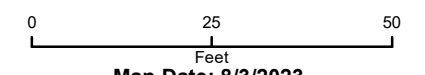


FIGURE  
81





- Legend**
- Property Boundry Lines
  - County/State Boundary
  - Study Area
  - Category 3



Map Date: 8/3/2023



Drone imagery main incident area dates: 08/02/2023

NORFOLK SOUTHERN  
EAST PALESTINE, OHIO

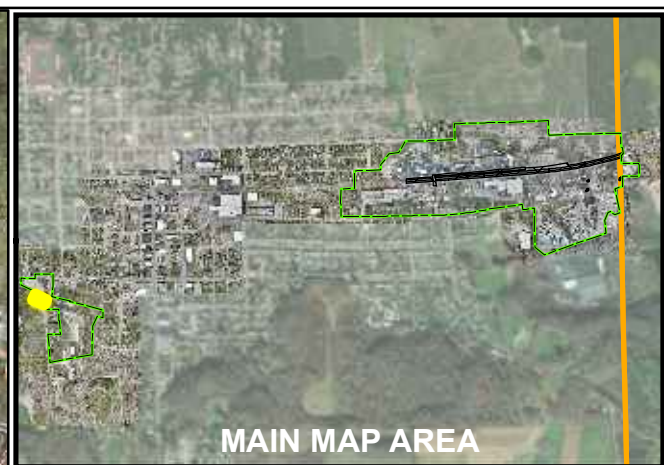
PKDR2\_DU2



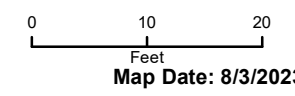
FIGURE  
82



Document Path: T:\EN\NORFOLKSouthern\EastPalestine\_Feb5\_2023\MXD\Appendix\_E\_NS\_EastPalestine\_F2\_ddpages\_SiteWorkingAreas\_SamplingMap\_Sri.mxd



- Legend**
- Property Boundary Lines
  - County/State Boundary
  - Study Area
  - Category 2



Drone imagery main incident area dates: 08/02/2023

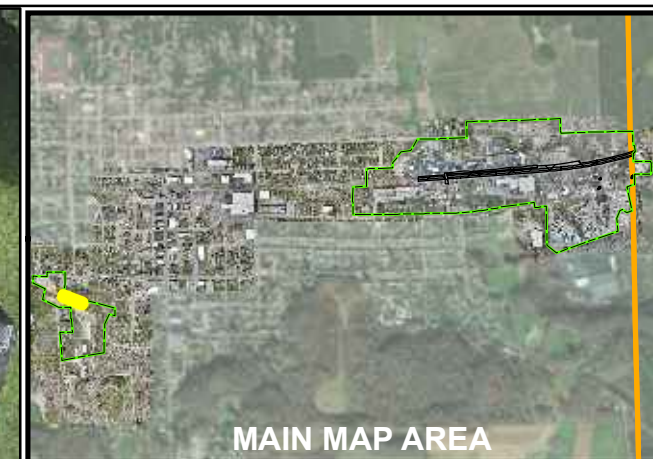
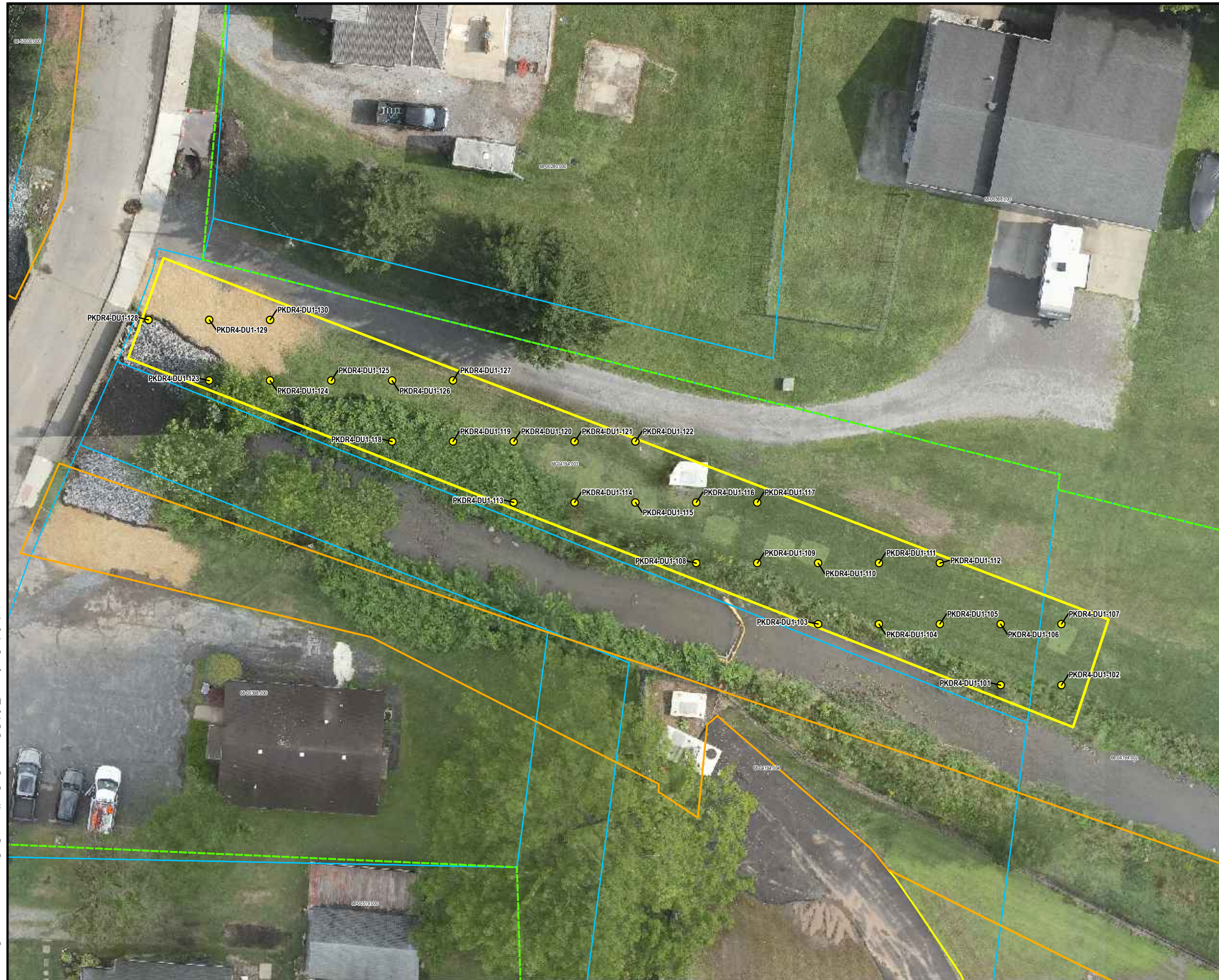
NORFOLK SOUTHERN  
EAST PALESTINE, OHIO

PKDR3\_DU1



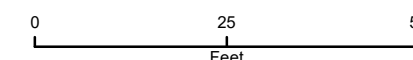
FIGURE  
83





**Legend**

- Property Boundary Lines
- County/State Boundary
- Study Area
- Category 3



Map Date: 8/3/2023



Drone imagery main incident area dates: 08/02/2023

NORFOLK SOUTHERN  
EAST PALESTINE, OHIO

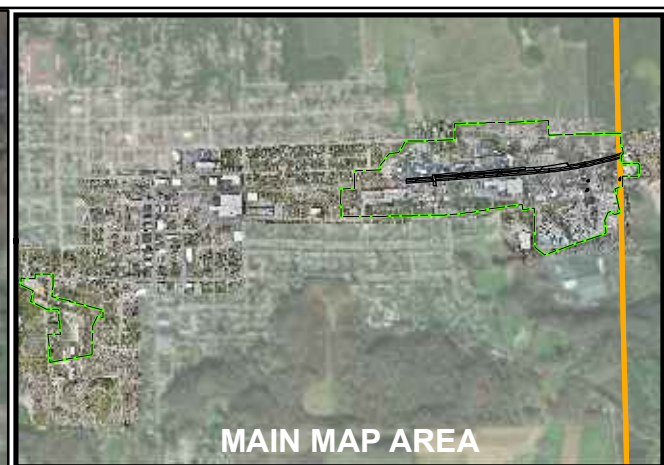
PKDR4\_DU1



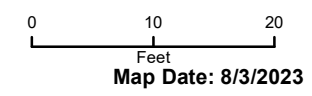
FIGURE  
84



Document Path: T:\EN\NORFOLKSouthern\EastPalestine\_Feb5\_2023\MXD\Appendix\_ENS\_EastPalestine\_F2\_ddpages\_SiteWorkingAreas\_SamplingMap\_Sri.mxd



- Legend**
- Property Boundary Lines
  - County/State Boundary
  - Study Area
  - Category 2



Drone imagery main incident area dates: 08/02/2023

NORFOLK SOUTHERN  
EAST PALESTINE, OHIO

BA\_DU1



FIGURE  
85



# Attachment 2

## Technical Guidance Instructions



# **ATTACHMENT 2**

## **Technical Guidance Documents**

**Associated with Worksheet 21-A and**

**Worksheet 21-B**





# ATTACHMENT 2

## Technical Guidance Documents

### Associated with Worksheet 21-A

TGI - Soil Description

TGI - Soil Drilling and Sample Collection

TGI - Groundwater and Soil Sampling Equipment Decontamination

TGI - Investigation-derived Waste Handling and Storage

TGI - Sample Chain of Custody

SOP#1 - Sediment Characterization via Probing and Sampling

SOP#2 - Bank Soil Sampling

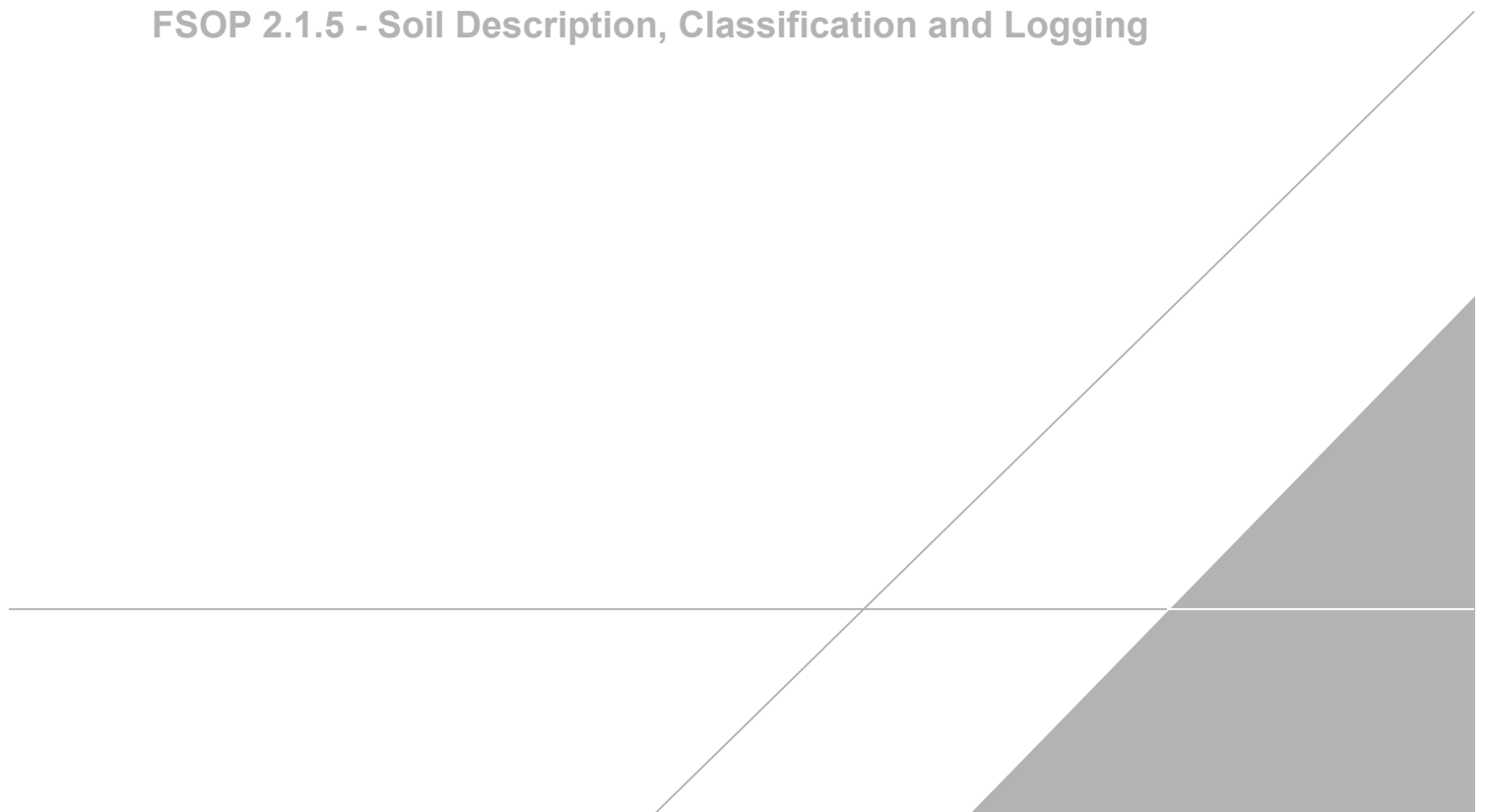
TGI - Per- and Polyfluoroalkyl Substances (PFAS) Field Sampling Guide

QP 3.07 - Calibration and Control of Measuring and Test Equipment

ARC HSFS019 Utility Location and Clearance

FSOP 3.1.1 - Photoionization Detector

FSOP 2.1.5 - Soil Description, Classification and Logging





# TGI – Soil Description

Rev: 4

Rev Date: June 14, 2022



## Version Control

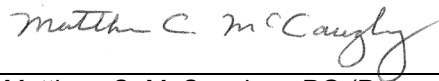
Issue	Revision No.	Date Issued	Page No.	Description	Reviewed By
	0	May 20, 2008	17	Original SOP	Joe Quinnan Joel Hunt
	1	September 2016	15	Updated to TGI	Nick Welty Patrick Curry
	2	February 16, 2018	15	Updated descriptions, attachments and references in text	Nick Welty Patrick Curry
	3	April 15, 2022		Minor description edits, intro of grain-size K analysis, revised boring log template	Matt McCaughey Patrick Curry
	4	June 14, 2022		<p>Updated date on cover page and header.</p> <p>Updated revision number from 3 to 4.</p> <p>Updated reference throughout document from ASTM D2488-06 to ASTM D-2488.17 .</p> <p>Change “25% silt and clay; 15% pebbles” to “20% silt and 20% clay” on page 10 of 23.</p> <p>Updates made to Section 8.2.1 Changed reference to Appendix B to Appendix A</p>	



## Approval Signatures

Prepared by:

6/14/2022




Matthew C. McCaughey, PG (Preparer)

Date

Reviewed by:

6/14/2022



Patrick Curry, PG (Subject Matter Expert)

Date



## 1 Introduction

This Arcadis Technical Guidance Instruction (TGI) describes proper soil description procedures based on visual inspection and testing of soil cores and samples. This document has been developed to emphasize field observation and documentation of details required to:

- Make hydrostratigraphic interpretations guided by depositional environment/geologic settings
- Provide information needed to understand the distribution of constituents of concern; properly design wells, piezometers, and/or additional field investigations; and develop appropriate remedial strategies.

## 2 Intended Use and Responsibilities

This document describes general and/or specific procedures, methods, actions, steps, and considerations to be used and observed by Arcadis staff when performing work, tasks, or actions under the scope and relevancy of this document. This document may describe expectations, requirements, guidance, recommendations, and/or instructions pertinent to the service, work task, or activity it covers.

It is the responsibility of the Arcadis Certified Project Manager (CPM) to provide this document to the persons conducting services that fall under the scope and purpose of this procedure, instruction, and/or guidance. The Arcadis CPM will also ensure that the persons conducting the work falling under this document are appropriately trained and familiar with its content. The persons conducting the work under this document are required to meet the minimum competency requirements outlined herein, and inquire to the CPM regarding any questions, misunderstanding, or discrepancy related to the work under this document.

This document is not considered to be all inclusive nor does it apply to all projects. It is the CPM's responsibility to determine the proper scope and personnel required for each project. There may be project- and/or client- and/or state-specific requirements that may be more or less stringent than what is described herein. The CPM is responsible for informing Arcadis and/or Subcontractor personnel of omissions and/or deviations from this document that may be required for the project. In turn, project staff are required to inform the CPM if or when there is a deviation or omission from work performed as compared to what is described herein.

In following this document to execute the scope of work for a project, it may be necessary for staff to make professional judgment decisions to meet the project's scope of work based upon site conditions, staffing expertise, regulation-specific requirements, health and safety concerns, etc. Staff are required to consult with the CPM when or if a deviation or omission from this document is required that has not already been previously approved by the CPM. Upon approval by the CPM, the staff can perform the deviation or omission as confirmed by the CPM.

## 3 Scope and Application

This TGI should be followed for unconsolidated material unless there is an established client-required specific procedure or regulatory-required specific procedure. In cases where there is a required specific procedure, it should be followed and should be referenced and/or provided as an appendix to reports that include soil classifications and/or boring logs. When following a required non-Arcadis procedure, additional information required by this TGI should be included in field notes with client approval.



This TGI incorporates elements from various standard systems such as ASTM D-2488-17, Unified Soil Classification System, Burmister and Udden Wentworth. However, none of these standard systems focus specifically on contaminant hydrogeology and remedial design. Therefore, although each of these systems contain valuable guidance and information related to correct descriptions, strict application of these systems can omit information critical to our clients and the projects that we perform.

This TGI includes the following attachments:

- **Attachment A** – Field Soil Description Guide
- **Attachment B** – Particle Size System Comparison
- **Attachment C** – Description of Logging Terms
- **Attachment D** – Blank Boring Log
- **Attachment E** – Completed Boring Log

This TGI does not address details of health and safety; drilling method selection; boring log preparation; sample collection; or laboratory analysis. Refer to other Arcadis procedure, guidance, and instructional documents, the project work plans including the quality assurance project plan, sampling plan, and health and safety plan (HASP), as appropriate.

## 4 Personnel Qualifications

Soil descriptions should only be performed by Arcadis personnel or authorized sub-contractors with a degree in geology or a geology-related discipline. Field personnel will complete training on the Arcadis soil description TGI in the office and/or in the field under the guidance of an experienced field geologist with at least 2 years of prior experience applying the Arcadis soil description method.

## 5 Equipment List

The following equipment should be taken to the field to facilitate soil descriptions:

- Field book, field forms or digital devices to record soil descriptions
- Field book for supplemental notes
- This TGI for Soil Descriptions and any project-specific procedure, guidance, and/or instructional documents (if required)
- Field card showing Wentworth scale
- Munsell® soil color chart
- Tape measure divided into tenths of a foot
- Stainless steel knife or spatula
- Hand lens
- Water squirt bottle
- 4-ounce glass jars with lids (for collecting soil core samples)
- Personal protective equipment (PPE), as required by the HASP
- Digital camera



- Folding table

## 6 Cautions

Drilling and drilling-related hazards including subsurface utilities are discussed in other procedure documents and site-specific HASPs and are not discussed herein.

Soil samples may contain hazardous substances that can result in exposure to persons describing soils. Routes for exposure may include dermal contact, inhalation and ingestion. Refer to the project specific HASP for guidance in these situations.

## 7 Health and Safety Considerations

Field activities associated with soil sampling and description will be performed in accordance with a site-specific HASP, a copy of which will be present on site during such activities. Know what hazardous substances may be present in the soil and understand their hazards. Always avoid the temptation to touch soils with bare hands, detect odors by placing soils close to your nose, or tasting soils.

## 8 Procedure

### 8.1 General Procedures

- Select the appropriate sampling method to obtain representative samples in accordance with the selected sub-surface exploration method, e.g., split-spoon or Shelby sample for hollow-stem drilling, acetate sleeves for direct push, bagged core for sonic drilling, etc.
- Proceed with field activities in required sequence. Although completion of soil descriptions is often not the first activity after opening sampler, identification of stratigraphic changes is often necessary to select appropriate intervals for field screening and/or selection of laboratory samples.
- Set up boring log field sheet.
  - Determine the proper units of measure. Drillers in both the US and Canada generally work in feet due to equipment specifications. Field geologists typically record drilling depths, core recovery, and sample intervals in feet and grain size in millimeters
  - Use the Arcadis standard boring log form (**Attachment D**). *Note that as of April 2022, several digital logging applications are available through the FieldNow™ program and the Fulcrum app. A future revision of this TGI, likely in early 2023, will emphasize digital logging methods and field boring log forms will no longer be acceptable. FieldNow is discussed further in Section 10.*
  - The boring log template includes a graphic log of the primary soil texture to support quick visual evaluation of grain size. The purpose of the graphic log is to quickly assess relative soil permeability. Note, for poorly sorted soils (e.g., glacial till), the principal component may not correlate to permeability of the sample. In this case, the geologist should use best judgement to graph overall soil type consistent with relative soil permeability. For example, for a dense sand/silt/clay till, the graphic log would reflect the silt/clay, rather than sand.



- Record depths along the left-hand side at a standard scale to aid in the use of this tool.
- Examine each soil core (this is different than examining each sample selected for laboratory analysis) and record the soil conditions in accordance with guidelines provided in Section 8.2.
- At the end of the boring, record the amount of drilling fluid used (if applicable) and the total depth logged.
- At a minimum, a written or digital boring log should be prepared with the following information:
  - Describe type of surface material (asphalt, grass, topsoil, gravel, etc.)
  - Describe the type of fill or non-native soils and estimated depth to native soils
  - Record sample intervals (soil cores, environmental and/or geotechnical samples)
  - Describe soil conditions in accordance with this TGI
  - Record moisture content and estimated depth to water table or saturated zone
  - Record the total depth and document why drilling was stopped (refusal, target depth achieved, etc.)

## 8.2 Soil Description Procedures

The standard soil description order is presented below.

- Depth
- PRIMARY TEXTURE
- Principal and Minor Components with Descriptors
  - % Modifiers and grain size fraction
  - Angularity for coarse sand and larger particles
  - Consistency or Density
  - Plasticity for silt and clay
  - Dilatancy for silt and silt-sand mixtures
- Sorting
- Moisture Content
- Color
- Notes

**Depth.** To measure and record the depth below ground surface (bgs) of top and bottom of each stratum, the following information should be recorded.

- Measured depth to the top and bottom of sampled interval. Use starting depth of sample based upon measured tool length information and the length of sample interval.
- Length of sample recovered, not including slough (material that has fallen into hole from previous interval), expressed as fraction with length of recovered sample as numerator over length of sampled interval as denominator (e.g., 36/60 for 36 inches recovered from 5-ft [60-inch] sampling interval).
- Thickness of each stratum measured sequentially from the top of recovery to the bottom of recovery.
- Any observations of sample condition or drilling activity that would help identify whether there was loss from the top of the sampling interval, loss from the bottom of the sampling interval, or compression of the sampling interval. Examples: 14/24, gravel in nose of spoon; or 36/60 bottom 12 inches of core empty.



**Determination of Components.** Obtain a representative sample of soil from a single stratum. If multiple strata are present in a single sample interval, each stratum should be described separately. More specifically, if the sample is from a 2-foot-long split-spoon where strata of coarse sand, fine sand and clay are present, then the resultant description should be of the three individual strata unless a combined description can clearly describe the interbedded nature of the three strata. Example: SAND, fine; with interbedded lenses of Silt and Clay, ranging between 1 and 3 inches thick.

Identify principal component and express volume estimates for minor components on logs using the following standard modifiers.

Modifier	Percent of Total Sample (by volume)
and	36 – 50
some	21 - 35
little	10 - 20
trace	<10

Determination of components is based on using the Udden-Wentworth particle size classification (see below) and measurement of the average grain size diameter. Each size class differs from the next larger class by a constant ratio of ½. Due to visual limitations, the finer classifications of Wentworth’s scale cannot be distinguished in the field and the subgroups are not included. Visual determinations in the field should be made carefully by comparing the sample to the Soil Description Field Guide (**Attachment A**) that shows Udden-Wentworth scale or by measuring with a ruler.

The following table summarized the modified Udden-Wentworth Scale for grain size classification. Note that gravel is a size category encompassing the granule, pebble, cobble, and boulder size classes.

Udden-Wentworth Scale (Modified by Arcadis, 2008)				
Size Category	Size Class	Millimeters	Inches	Standard Sieve #
Gravel (Cobble)	Boulder	256 – 4096	10.08+	
	Large cobble	128 - 256	5.04 -10.08	
	Small cobble	64 - 128	2.52 – 5.04	
Gravel (Pebble)	Very large pebble	32 – 64	0.16 - 2.52	
	Large pebble	16 – 32	0.63 – 1.26	
	Medium pebble	8 – 16	0.31 – 0.63	
	Small pebble	4 – 8	0.16 – 0.31	No. 5 +
	Granule	2 – 4	0.08 – 0.16	No.5 – No.10



Sand	Very coarse sand	1 -2	0.04 – 0.08	No.10 – No.18
	Coarse sand	½ - 1	0.02 – 0.04	No.18 - No.35
	Medium sand	¼ - ½	0.01 – 0.02	No.35 - No.60
	Fine sand	1/8 -¼	0.005 – 0.1	No.60 - No.120
	Very fine sand	1/16 – 1/8	0.002 – 0.005	No. 120 – No. 230
Fines	Silt (subgroups not included)	1/256 – 1/16	0.0002 – 0.002	Not applicable (analyze by pipette or hydrometer)
	Clay (subgroups not included)	1/2048 – 1/256	0.00002 – 0.0002	

Identify components as follows. Remove particles greater than very large pebbles (64-mm diameter) from the soil sample. Record the volume estimate of the greater than very large pebbles. Examine the sample fraction of very large pebbles and smaller particles and estimate the volume percentage of the pebbles, granules, sand, silt and clay. Use the jar method, visual method, and/or wash method (Appendix X4 of ASTM D2488) to estimate the volume percentages of each category.

Sieve and hydrometer grain-size analysis can be used to vet the visual description, as well as used to estimate hydraulic conductivity. Lab or field sieve analysis is advisable to characterize the variability and facies trends within each hydrostratigraphic unit. It is recommended that sieve-hydrometer analysis be performed on representative samples from each soil type to estimate the fraction of each grain size category using ASTM D422 Standard Test Method for Particle-Size Analysis of Soils. If desired sieve sizes can be specified to follow the Udden-Wentworth classification (U.S. Standard sieve sizes 6; 12; 20; 40; 70; 140; and 270) to retain pebbles; granules; very coarse sand; coarse sand; medium sand; fine sand; and very fine sand, respectively.

Several empirical formulas provide a reliable means of estimating hydraulic conductivity (K) from grain-size distribution data, provided that the formation does not contain abundant fines that result in cohesive or plastic behavior or include cobble-sized grains (Payne et al. 2008). Grain-size analysis can help bracket the permeability of hydrostratigraphic units (HSUs) and identify order-of-magnitude spatial variations in K. Arcadis has completed modifications to the Excel-based program HydroGeoSieveXL (Devlin 2015) to process sieve data quickly and estimate K. The tool calculates estimated K values from grain-size data using 15 different empirical formulas. A decision matrix then selects which of the formulas is relevant for the soil type and calculates an average K.

**Principal Component.** The principal component is the size fraction or range of size fractions containing the majority of the volume. Examples: the principal component in a sample that contained 55% small to medium pebbles would be “PEBBLES, small to medium”; or the principal component in a sample that was 20% fine sand, 30% medium sand and 25% coarse sand would be “SAND, fine to coarse” or for a sample that was 40% silt and 45% clay the principal component would be “CLAY and SILT”.

The boring log form (**Appendix D**) includes a graphic log to visually illustrate a relative estimate of soil permeability. To use the graphic log, place an ‘X’ or shade the appropriate column for the primary soil texture. If the soils have a high percentage of a secondary soil texture (i.e., when the ‘and’ modifier is used), it’s acceptable to mark off the appropriate column for the secondary soil texture in this instance. However, care should be used to avoid marking off the columns for other minor soil textures because doing so will make it difficult to determine the relative soil permeability of the poorly sorted soils.



As noted above, for poorly sorted soils such as glacial till, the principal component may not correlate to permeability of the sample. In this case, the geologist should use best judgement to graph overall soil type consistent with relative soil permeability.

**Minor Component(s).** The minor component(s) are the size fraction(s) containing less than 50% volume. Example: the identified components are estimated to be 60% medium sand to granules, 20% silt and 20% clay – there are two identified minor components: silt and clay.

Include a standard modifier to indicate percentage of minor components (see particle size table) and the same descriptors that would be used for a principal component. An example of minor constituents with modifiers include: some silt and clay, low plasticity; little medium to large pebbles, sub-round.

### 8.2.1 Secondary Descriptors

The following are the descriptors used outside of the principal and minor components. Note that plasticity should be provided as a descriptor for clay and clay mixtures. Dilatancy should be provided for silt and silt mixtures. Angularity should be provided as a descriptor for pebbles and coarse sand.

**Angularity.** Describe the angularity for coarse sand and larger particles in accordance with the table below (ASTM D-2488-17). Figures showing examples of angularity are available in ASTM D2488-17 and the Arcadis Soil Description Field Guide (**Appendix A**).

Description	Criteria
Angular	Particles have sharp edges and relatively plane sides with unpolished surfaces
Sub-Angular	Particles are like angular description but have rounded edges
Sub-Rounded	Particles have nearly plane sides but have well-rounded corners and edges
Rounded	Particles have smoothly curved sides and no edges.

**Plasticity.** Describe the plasticity for silt and clay based on observations made during the following test method (ASTM D-2488-17).

- As in the dilatancy test (described below), select enough material to mold into a ball about ½ inch (12 mm) in diameter. Mold the material, adding water, if necessary, until it has a soft, but not sticky, consistency.
- Shape the test specimen into an elongated pat and roll by hand on a smooth surface or between the palms into a thread about 1/8 inch (3 mm) in diameter. If the sample is too wet to roll easily, it should be spread into a thin layer and allowed to lose some water by evaporation. Fold the sample threads and reroll repeatedly until the thread crumbles at a diameter of about 1/8 inch. The thread will crumble when the soil is near the plastic limit.



Description	Criteria
Non-plastic	A 1/8-inch (3 mm) thread cannot be rolled at any water content.
Low	The thread can barely be rolled, and the lump cannot be formed when drier than the plastic limit.
Medium	The thread is easy to roll and not much time is required to reach the plastic limit. The thread cannot be rerolled after reaching the plastic limit. The lump crumbles when drier than the plastic limit.
High	It takes considerable time rolling and kneading to reach the plastic limit. The thread can be rolled several times after reaching the plastic limit. The lump can be formed without crumbling when drier than the plastic limit.

**Dilatancy.** Describe the dilatancy for silt and silt-sand mixtures using the following field test method (ASTM D-2488-17).

- From the specimen, select enough material to mold into a ball about ½ inch (12 mm) in diameter. Mold the material adding water, if necessary, until it has a soft, but not sticky, consistency.
- Smooth the ball in the palm of one hand with a small spatula.
- Shake horizontally, striking the side of the hand vigorously with the other hand several times.
- Note the reaction of water appearing on the surface of the soil.
- Squeeze the sample by closing the hand or pinching the soil between the fingers, and note the reaction as none, slow, or rapid in accordance with the table below. The reaction is the speed with which water appears while shaking and disappears while squeezing.

Description	Criteria
None	No visible change in the specimen
Slow	Water appears slowly on the surface of the specimen during shaking and does not disappear or disappears slowly upon squeezing
Rapid	Water appears quickly on the surface of the specimen during shaking and disappears quickly upon squeezing

Note that silt and silt-sand mixtures will be non-plastic and display dilatancy. Clay mixtures will have some degree of plasticity but do not typically react to dilatancy testing. Therefore, the tests outlined above can be used to differentiate between silt-dominated and clay-dominated soils.

**Sorting.** Sorting is the opposite of grading, which is a commonly used term in the USCS or ASTM methods to describe the uniformity of the particle size distribution in a sample. Well-sorted samples are poorly graded and poorly sorted samples are well graded. Arcadis prefers the use of sorting for particle size distributions and grading to describe particle size distribution trends in the vertical profile of a sample or hydrostratigraphic unit because of



the relationship between sorting and the energy of the depositional process. For soils with sand-sized or larger particles, sorting should be determined as follows:

Description	Criteria
Well Sorted	the range of particle sizes is limited (e.g., the sample is comprised of predominantly one or two grain sizes)
Poorly Sorted	A wide range of particle sizes are present

You can also use sieve analysis to estimate sorting from a sedimentological perspective; sorting is the statistical equivalent of standard deviation. Smaller standard deviations correspond to higher degree of sorting (see Remediation Hydraulics, 2008).

**Consistency or Density.** This can be determined by standard penetration test (SPT) blow counts (ASTM D-1586) obtained when using hollow-stem auger drilling methods and a split spoon sampling device. Otherwise, some field tests are available as outlined below. When drilling with hollow-stem augers and split-spoon sampling, the SPT blow counts and N-value is used to estimate density. The N-value is the blows per foot for the 6” to 18” interval. For example, for a 24-inch split spoon soil core, the recorded blows per 6-inch interval are: 4/6/9/22. Since the second interval is 6” to 12”, the third interval is 12” to 18”, the N value is 6+9, or 15. Fifty blow counts for less than 6 inches is considered refusal. In recent years, more common drilling methods include rotary-sonic or direct push. When blow counts are not available, density is determined using a thumb test. Note however, the thumb test only applies to fine-grained soils.

**Fine-grained soil – Consistency**

Description	Criteria	Blow Counts (6-12 to 12-18-inch split spoon interval)
Very soft	Easily penetrated several inches by thumb	N-value < 2
Soft	Easily penetrated one inch by thumb	N-value 2-4
Medium Stiff	Indented about ½ inch with much effort	N-value 5-8
Stiff	Indented with ¼ inch with great effort	N-value 9-15
Very Stiff	Readily indented by thumbnail	N-value 16-30
Hard	Indented by thumbnail with difficulty	N-value > than 30



**Coarse-grained soil – Density**

Description	Criteria	Blow Counts (6-12 to 12-18-inch split spoon interval)
Very loose	Density classification of coarse-grained soils is only required when blow counts from standard penetration tests are performed during hollow-stem auger drilling	N-value 1- 4
Loose		N-value 5-10
Medium dense		N-value 11-30
Dense		N-value 31- 50
Very dense		N-value >50

**Moisture Content.** Moisture content should be described for each soil sample in accordance with the table below (percentages should not be used unless determined in the laboratory). *Note that some drilling methods (e.g., sonic) can compress and dry out the sample during drilling. Therefore, it can be difficult to determine if a sample is saturated, or merely moist. In this case, care should be taken to try and determine a static water level within the borehole by measuring depth to water through the drill casing, if possible.*

Description	Criteria
Dry	Absence of moisture, dry to touch, dusty
Moist	Damp but no visible water
Wet	Visibly free water

**Color.** Color should be described using simple basic terminology and modifiers based on the Munsell system. Munsell alpha-numeric codes are required for all samples. If the sample contains layers or patches of varying colors this should be noted, and all representative colors should be described. The colors should be described for moist samples. If the sample is dry, it should be wetted prior to comparing the sample to the Munsell chart.

**Notes.** Additional comments should be made where observed and should be presented as notes with reference to a specific depth interval(s) to which they apply. Some of the significant information that may be observed includes the following.

- Odor - You should not make an effort to smell samples by placing near your nose since this can result in unnecessary exposure to hazardous materials. However, odors should be noted if they are detected during the normal sampling procedures. Odors should be based upon descriptors such as those used in NIOSH “Pocket Guide to Chemical Hazards”, e.g., “pungent” or “sweet” and should not indicate specific chemicals such as “phenol-like” odor or “BTEX” odor.
- Structure
- Bedding planes (laminated, banded, geologic contacts).
- Presence of roots, root holes, organic material, man-made materials, minerals, etc.
- Mineralogy



- Cementation
- NAPL presence/characteristics, including sheen (based on client-specific guidance).
- Reaction with HCl - typically only used for special soil conditions, such as caliche environments.
- Origin, if known (Lacustrine; Fill; etc.).

## 8.3 Example of Soil Descriptions

The standard generic description order is presented below.

- Depth
- PRIMARY TEXTURE
- Principal and Minor Components with Descriptors
  - % Modifiers and grain size fraction
  - Angularity for coarse sand and larger particles
  - Consistency or Density
  - Plasticity for silt and clay
  - Dilatancy for silt and silt-sand mixtures
- Sorting
- Moisture Content
- Color
- Notes





**10-15 feet CLAY, trace silt, trace small to very large pebbles, subround to subangular up to 2" diameter; medium to high plasticity, stiff, moist, dark grayish brown (10YR 4/2). NOTE: Lacustrine; laminated 0.1 to 0.2" thick, laminations brownish yellow (10YR 4/3).**



**10 -15 feet SAND, medium to very coarse, little granules to medium pebbles, subround to subangular, trace silt; poorly sorted, wet, grayish brown (10YR5/2).**

Unlike the first example where a density of cohesive soils could be estimated, this rotary-sonic sand and pebble sample was disturbed during drilling (due to vibrations in a loose sand and pebble matrix) so no density description could be provided. Neither sample had noticeable odor so odor comments were not included.

## 9 Waste Management

Project-specific requirements should be identified and followed. The following procedures, or similar waste management procedures are generally required.

Water generated during cleaning procedures will be collected and contained onsite in appropriate containers for future analysis and appropriate disposal. PPE (such as gloves, disposable clothing, and other disposable equipment) resulting from personnel cleaning procedures and soil sampling/handling activities will be placed in plastic bags. These bags will be transferred into appropriately labeled 55-gallon drums or a covered roll-off box for appropriate disposal.

Soil materials will be placed in sealed 55-gallon steel drums or covered roll-off boxes and stored in a secured area. Once full, the material will be analyzed to determine the appropriate disposal method.



## 10 Data Recording and Management

### 10.1 Digital Data Collection Process Overview

Digital data collection is the Arcadis standard using available FieldNow® applications that enable real-time, paperless data collection, entry, and automated reporting. Paper forms should only be used as backup to FieldNow® digital data collection and/or as necessary to collect data not captured by available FieldNow® applications. The Field Now® digital form applications follow a standardized approach, correlate to most TGIs and are available to all projects accessible with a PC or capable mobile device. Once the digital forms are saved within FieldNow®, the data is instantly available for review on a web interface. This facilitates review by project management team members and SMEs enabling error or anomalous data detection for correction while the staff are still in the field. Continual improvements of FieldNow® applications are ongoing, and revisions are made as necessary in response to feedback from users and subject matter experts.

### 10.2 Digital Data Collection Tools for Soil Descriptions

Arcadis is transitioning from the use of paper forms to a digital soil description logging process using web-based FieldNow applications accessible on field tablets and smart phones. Company-wide roll out of a FieldNow application for soil descriptions is targeted by the end of 2022.

Paper forms are included in Revision 3 (April 2022) of this Soil Description TGI. Specifically, a blank boring log and completed boring log are provided in **Attachment D** and **Attachment E**. Additional guidance and examples of the digital data collection tools for soil descriptions will be provided in the next revision to this TGI.

### 10.3 Additional Guidance

The general logging scheme for soil descriptions is described in this document. Depending on project data quality objectives, specific soil description parameters that are not applicable to project goals may be omitted at the project manager's discretion. In any case, use of consistent procedures is required.

Completed logs and/or logbook will be maintained in the task/project field records file. Digital photographs of typical soil types observed at the site and any unusual features should be obtained whenever possible. Photographs should include a ruler or common object for scale. Photo location, depth and orientation must be recorded in the daily log or logbook and a label showing this information in the photo is useful.

For projects involving soil logging and soil sampling, the soil sample should be recorded on the Arcadis boring log form and the field logbook based on Data Quality Objectives for the task/project.

## 11 Quality Assurance

Soil descriptions should be completed only by appropriately trained personnel. Descriptions should be reviewed by an experienced field geologist for content, format and consistency. Edited boring logs should be reviewed by the original author to assure that content has not changed.



## 12 References

- ASTM D-1586, Test Method for Penetration Test and Split-Barrel Sampling of Soils.
- ASTM D-2488-17, Standard Practice for Description and Identification of Soils (Visual-Manual Procedure)
- ASTM D422, 63rd Edition, 1972 - Standard Test Method for Particle-Size Analysis of Soils.
- Devlin, J.F. 2015. HydroGeoSieve XL: an Excel-based tool to estimate hydraulic conductivity from grain-size analysis. Hydrogeology Journal, DOI 10.1007/s10040-015-1255-0.
- Folk, Robert L. 1980. Petrology of Sedimentary Rocks, p. 1-48.
- Payne, F. C., Quinnan, J. A., & Potter, S. T. 2008. Remediation Hydraulics. Boca Raton: FL: CRC Press.
- United States Bureau of Reclamation. Engineering Geology Field Manual. United States Department of Interior, Bureau of Reclamation. <http://www.usbr.gov/pmts/geology/fieldmap.htm>.
- Munsell® Color Chart – available from Forestry Suppliers, Inc.- Item 77341 “Munsell® Color Soil Color Charts. Field Gauge Card that Shows Udden-Wentworth scale – available from Forestry Suppliers, Inc. – Item 77332 “Sand Grain Sizing Folder.”
- NIOSH Pocket Guide to Chemical Hazards.



# Attachment A

## Soil Field Reference Guide

*The purpose of this attachment is to present a field reference guide for use during soil logging. Field staff are encouraged to bring a laminated copy of this reference guide into the job site.*





FINE-GRAINED SOILS	
Description	Criteria
<b>Descriptor - Plasticity</b>	
Nonplastic	A 1/8-inch (3 mm) thread cannot be rolled at any water content.
Low	The thread can barely be rolled, and the lump cannot be formed when drier than the plastic limit.
Medium	The thread is easy to roll and not much time is required to reach the plastic limit. The thread cannot be re-rolled after reaching the plastic limit. The lump crumbles when drier than the plastic limit.
High	It takes considerable time rolling and kneading to reach the plastic limit. The thread can be rolled several times after reaching the plastic limit. The lump can be formed without crumbling when drier than the plastic limit.
<b>Descriptor - Dilatancy</b>	
No Dilatancy	No visible change when shaken or squeezed.
Slow	Water appears slowly on the surface of soil during shaking and does not disappear or disappears slowly when squeezed.
Rapid	Water appears quickly on surface of soil during shaking and disappears quickly when squeezed.
Minor Components with Descriptors	
<b>Moisture</b>	
Dry	Absence of moisture, dry to touch, dusty.
Moist	Damp but no visible water.
Wet	Visible free water; soil is usually below the water table. (Saturated)
<b>Consistency</b>	
Very soft	N-value < 2 or easily penetrated several inches by thumb.
Soft	N-value 2-4 or easily penetrated 1 inch by thumb.
Medium stiff	N-value 5-8 or indented about 1/2 inch by thumb with great effort.
Stiff	N-value 9-15 or indented about 1/4 inch by thumb with great effort.
Very stiff	N-value 16-30 or readily indented by thumb nail.
Hard	N-value > than 30 or indented by thumbnail with difficulty.
Color using Munsell	
Geologic Origin (if known)	
Other	

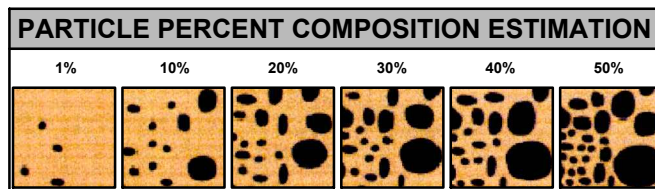
DESCRIPTION ORDER
<p>Depth Interval PRIMARY TEXTURE (e.g., SAND) Principal and Minor Components with Descriptors:</p> <ul style="list-style-type: none"> <li>• % Modifiers and grain size fraction</li> <li>• Angularity coarse sand and larger</li> <li>• Consistency or Density</li> <li>• Plasticity for silt and clay</li> <li>• Dilatancy for silt and silt-sand</li> </ul> <p>Sorting for granular sediments Moisture Content Color Other NOTES</p>

MINOR COMPONENTS % MODIFIERS	
Modifier	Percent of Total Sample (by volume)
and	36 - 50
some	21 - 35
little	10 - 20
trace	<10

FOR COARSE-GRAINED SOILS	
Description	Criteria
<b>Descriptor - Angularity</b>	
Angular	Particles have sharp edges and relatively planar sides with unpolished surfaces.
Subangular	Particles are similar to angular but have rounded edges.
Subround	Particles have nearly planar sides but have well-rounded corners and edges.
Round	Particles have smoothly curved sides and no edges.

UDDEN-WENTWORTH SCALE			
Fraction	Sieve Size	Grain Size	Approximate Scale
Boulder		256 - 4096 mm	Larger than volleyball
Large Cobble		128 - 256 mm	Softball to volleyball
Small Cobble		64 - 128 mm	Pool ball to softball
Very Large Pebble		32 - 64 mm	Pinball to pool ball
Large Pebble		16 - 32 mm	Dime size to pinball
Medium Pebble		8 - 16 mm	Pencil eraser to dime size
Small Pebble	No. 5+	4 - 8 mm	Pea size to pencil eraser
Granule	No. 10 - 5	2 - 4 mm	Rock salt to pea size
Very Coarse Sand	No. 18 - 10	1 - 2 mm	See field gauge card
Coarse Sand	No. 35 - 18	0.5 - 1 mm	See field gauge card
Medium Sand	No. 60 - 35	0.25 - 0.5 mm	See field gauge card
Fine Sand	No. 120 - 60	0.125 - 0.25 mm	See field gauge card
Very Fine Sand	No. 230 - 120	0.0625 - 0.125 mm	See field gauge card
Silt and Clay. See SOP for description of fines	Not Applicable	<0.0625 mm	Analyze by pipette or hydrometer

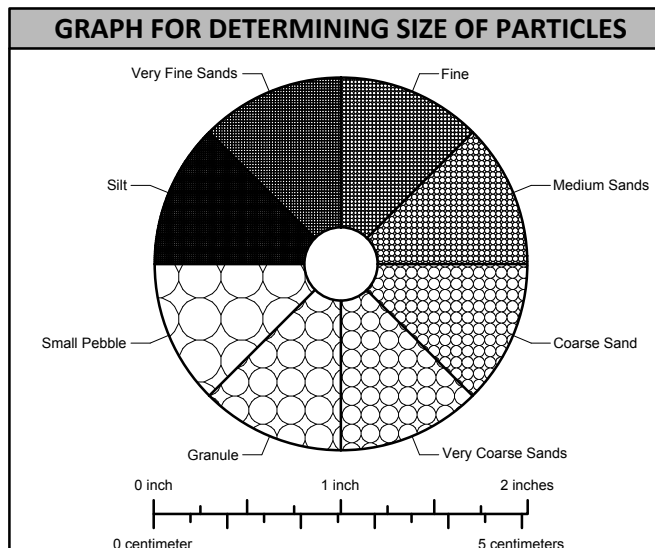
Minor Components with Descriptors	
<b>Sorting</b> Cu= d60/d10	
Well Sorted	Near uniform grain-size distribution Cu= 1 to 3.
Poorly Sorted	Wide range of grain size Cu= 4 to 6.
<b>Moisture</b>	
Dry	Absence of moisture, dry to touch, dusty.
Moist	Damp but no visible water.
Wet	Visible free water; soil is usually below the water table. (Saturated)
<b>Density</b>	
Very loose	N-value 1 - 4
Loose	N-value 5 - 10
Medium Dense	N-value 11 - 30
Dense	N-value 31 - 50
Very dense	N-value >50



Color using Munsell	
Geologic Origin (if known)	
Other	
Cementation	
Weak Cementation	Crumbles or breaks with handling or little finger pressure.
Moderate Cementation	Crumbles or breaks with considerable finger pressure.
Strong Cementation	Will not crumble with finger pressure.
Reaction with Dilute HCl Solution (10%)	
No Reaction	No visible reaction.
Weak Reaction	Some reaction, with bubbles forming slowly.
Strong Reaction	Violent reaction, with bubbles forming immediately.

**EXAMPLE OF SOIL DESCRIPTION AND PHOTO**

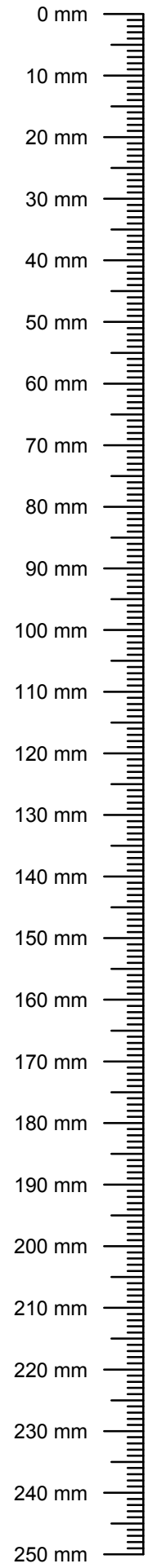
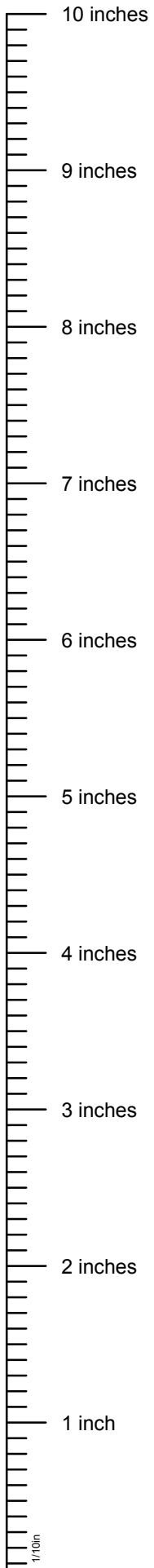
10-15 feet CLAY, trace silt, trace small to very large pebbles, subround to subangular up to 2" diameter; medium to high plasticity, stiff, moist, dark grayish brown (10YR 4/2). NOTE: Lacustrine; laminated 0.1 to 0.2" thick, laminations brownish yellow (10YR 4/3).



**EXAMPLE OF SOIL DESCRIPTION AND PHOTO**

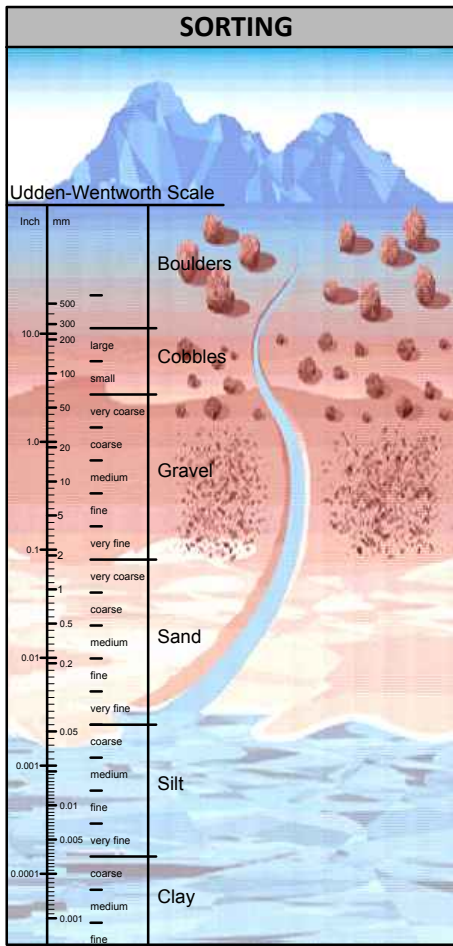
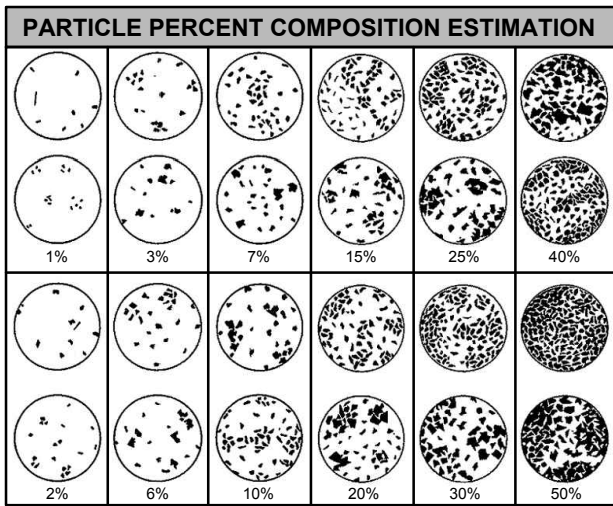
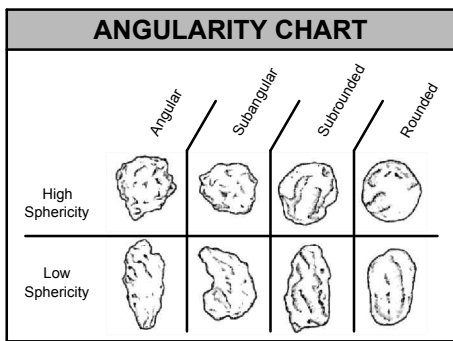
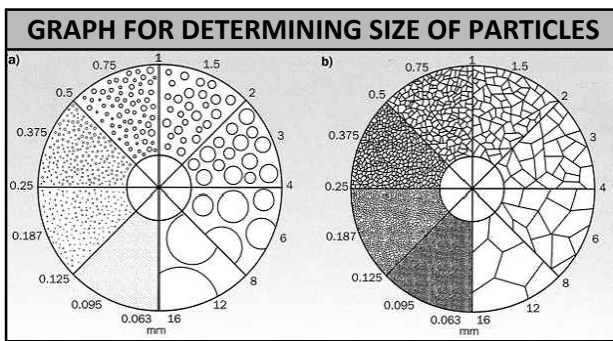
10 - 15 feet SAND, medium to very coarse, little granules to medium pebbles, subround to subangular, trace silt; poorly sorted, wet, grayish brown (10YR 5/2).





VARIATIONS IN SOIL STRATIGRAPHY	
Term	Thickness of Configuration
Parting	0 - to 1/16-inch thickness.
Seam	1/16 - to 1/2-inch thickness.
Layer	1/2 - to 12-inch thickness.
Stratum	> 12-inch thickness.
Pocket	Small erratic deposit, usually less than 1 foot in size.
Varved Clay	Alternating seams or layers of sand, silt, and clay (laminated).
Occasional	≤ 1 foot thick.
Frequent	> 1 foot thick.

SOIL STRUCTURE DESCRIPTIONS	
Term	Description
Homogeneous	Same color and appearance throughout.
Laminated	Alternating layers < 1/4 inch thick.
Stratified	Alternating layers ≥ 1/4 inch thick.
Lensed	Inclusions of small pockets of different materials, such as lenses of sand scattered through a mass of clay; note thickness.
Blocky	Cohesive soil can be broken down into small angular lumps, which resist further breakdown.
Fissured	Breaks along definite planes of fracture with little resistance to fracturing.
Slickensided	Fracture planes appear to be polished or glossy, sometimes striated.



SETTLING TABLE (SILT/CLAY)							
Diameter of Particle (mm)	<0.625	<0.031	<0.016	<0.008	<0.004	<0.002	<0.0005
Depth of Withdrawal (cm)	10	10	10	10	5	5	3
Time of Withdrawal	hr:min:sec	hr:min:sec	hr:min:sec	hr:min:sec	hr:min:sec	hr:min:sec	hr:min:sec
Temperature (Celsius)							
20	00:00:29	00:01:55	00:07:40	00:30:40	00:61:19	04:05:00	37:21:00
21	00:00:28	00:01:52	00:07:29	00:29:58	00:59:50	04:00:00	
22	00:00:27	00:01:50	00:07:18	00:29:13	00:58:22	03:54:00	
23	00:00:27	00:01:47	00:07:08	00:28:34	00:57:05	03:48:00	
24	00:00:26	00:01:45	00:06:58	00:27:52	00:55:41	03:43:00	33:56:00
25	00:00:25	00:01:42	00:06:48	00:27:14	00:54:25	03:38:00	
26	00:00:25	00:01:40	00:06:39	00:26:38	00:53:12	03:33:00	
27	00:00:24	00:01:38	00:06:31	00:26:02	00:52:02	03:28:00	
28	00:00:24	00:01:35	00:06:22	00:25:28	00:50:52	03:24:00	31:00:00
29	00:00:23	00:01:33	00:06:13	00:24:53	00:49:42	03:10:00	
30	00:00:23	00:01:31	00:06:06	00:24:22	00:48:42	03:05:00	



# Attachment B

## Particle Size System Comparison

*The purpose of this attachment is to illustrate how the Udden-Wentworth particle sizes and descriptive terms compares to other particle size systems.*

*When in the field, it is a customary practice to compare current soil descriptions to historical soil boring logs for reference purposes. When reviewing boring logs prepared by others, field staff should first note the particle size system used and recognize these particle size systems may differ. This will avoid confusion when cross referencing between historical and new boring logs and when reviewing existing geologic cross-sections.*

*For example, a well-sorted sand with grain sizes ranging from 1 to 2 mm should be classified as a very coarse sand by the Udden-Wentworth system. As shown in this attachment, the same particle size would be classified as a medium sand by the United Soil Classification System. The later system has fewer particle size grades and in general, is less descriptive than the Udden-Wentworth system.*



## PARTICLE SIZE SYSTEM COMPARISON

System Name	Used By	Grain size distribution in millimeters (mm)													
Udden-Wentworth	Remediation Geologists and Engineers			V. Fine	Fine	Medium	Coarse	V. Coarse	Granule	Pebbles				Cobbles	
		CLAY	SILT	SAND				GRAVEL						Small	Large
		0.039	0.065	0.125	0.25	0.5	1	2	4	8	16	32	64	128	256
			1/16	1/8	1/4	1/2									
United Soil Classification System	Geotechnical Engineers			Fine			Medium	Coarse	Fine		Coarse				
		CLAY	SILT	SAND				GRAVEL				COBBLE			
		0.074			0.42		2	4.75		19		75		300	
U.S. Dept. of Agriculture	Soil Scientists			V. Fine	Fine	Medium	Coarse	V. Coarse	GRAVEL						
		CLAY	SILT	SAND				GRAVEL							
		0.002	0.05	0.10	0.25	0.5	1	2						75	

**Remediation Hydraulics 2008, page 195): The Udden-Wentworth scale is preferred "...because the geometric progression of grain-size diameter also reflects relationships that are important when considering the erosion and deposition of sediments during the depositional process. The correlation between increasing grain size and degree of sorting and permeability is the most important, as permeability structure is responsible for the mobile and immobile porosity within aquifer systems. "**



# Attachment C

## Description of Soil Logging Terms

*The purpose of this attachment is to concisely define the soil logging terms used when filling out boring logs. During report preparation, project staff could use this sheet as an index placed in front of the completed boring logs. Also, it can serve as a supplemental reference sheet during field activities.*



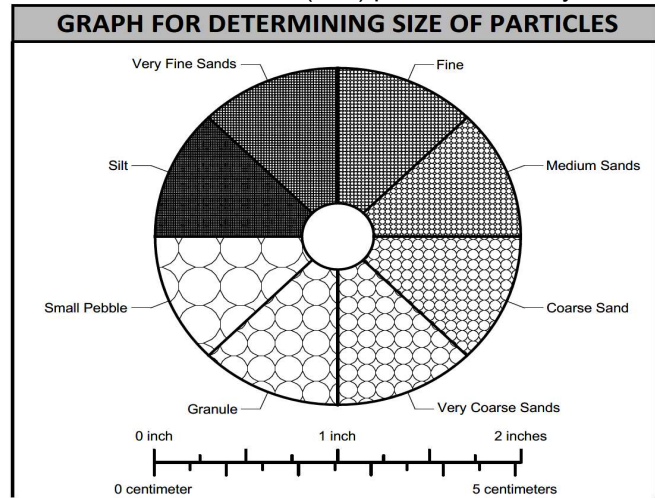
# Description of Logging Terms



Note: Soil descriptions based on Arcadis Technical Guidance and Instructions (TGI) procedures. Key terms defined below.

## Udden Wentworth Soil Sizes

Boulder	> 256 mm
Large Cobble	128 to 256 mm
Small Cobble	64 to 128 mm
Very Large Pebble	32 to 64 mm
Large Pebble	16 to 32 mm
Medium Pebble	8 to 16 mm
Small Pebble	4 to 8 mm
Granule	2 to 4 mm
Very Coarse Sand	1 to 2 mm
Coarse Sand	0.5 to 1 mm
Medium Sand	0.25 to 0.5 mm
Fine Sand	0.125 to 0.25 mm
Very Fine Sand	0.062 to 0.12 mm
Silt/Clay	<0.065 mm



## Primary Texture (e.g. CLAY, SILT, SAND, GRANULE, PEAT, MUCK, FILL, etc.)

List particle size with the highest percentage per sample interval (e.g. SAND)

Always CAPITALIZE the primary texture

Follow primary texture with a comma followed by grain-size descriptors, etc.

## Minor Texture

And	(36 to 50%)
Some	(21 to 35%)
Little	(10 to 20%)
Trace	(>10%)

## Angularity

Angular	Sharp edges
Sub-Angular	Rounded edges
Sub-Rounded	Well-rounded
Rounded	Smooth curved edges

## Sand Density (Blow Counts/ft)

Very Loose	0-4
Loose	5-10
Medium Dense	11-30
Dense	31-50
Very Dense	<50

## Silt/Clay Consistency (Blow Counts/ft)

Very Soft	0-2,	thumb easily penetrates several inches
Soft	3-4,	thumb easily penetrates one inch
Medium Stiff	5-8,	thumb indents 0.5 in. with much effort
Stiff	9-15,	thumb indents 0.25 in. with great effort
Very Stiff	16-30,	thumbnail is readily intended

## Sorting

Well Sorted	1 to 3 Particle Sizes
Poorly Sorted	4+ Particle Sizes

## Moisture Content

Dry	Dry to touch
Moist	No visible water
Wet	Visible free water

## Plasticity (for silts and clays)

Non-Plastic	3 mm thread can not be rolled
Low Plasticity	3 mm thread can barely be rolled
Medium Plasticity	3 mm thread can easily and quickly rolled, but not rerolled
High Plasticity	3 mm thread can be rolled slowly, but can be rerolled

## Dilatancy (for silts and silt-sand mixtures)

None	No visible change in the specimen
Slow	Water appears slowly during shaking / disappears slowly or not at all upon squeezing
Rapid	Water appears quickly during shaking / disappears quickly upon squeezing

## Example Description

**10 -15 feet SAND, medium to very coarse, little granules to medium pebbles, subround to subangular, trace silt; poorly sorted, wet, grayish brown (10YR5/2).**



# Attachment D

## Blank Boring Log

*The purpose of this attachment is to present a blank field form for use during soil logging. A digital version (Microsoft Excel) of this field form is available from the authors (upon request). If project specific modifications to this boring log template are warranted, please contact the Site Investigation Community of Practice leader for further assistance.*



# BORING LOG



**Boring ID:** \_\_\_\_\_ **Project Name:** \_\_\_\_\_ **Page:** \_\_\_\_\_ / \_\_\_\_\_  
**Permit ID:** \_\_\_\_\_ **Date Started:** \_\_\_\_\_ **Ground Elevation:** \_\_\_\_\_  
**Site Address:** \_\_\_\_\_ **Date Completed:** \_\_\_\_\_ **Vertical Datum:** \_\_\_\_\_  
**City, State:** \_\_\_\_\_ **Total Depth:** \_\_\_\_\_ **Northing:** \_\_\_\_\_  
**Drilling Co:** \_\_\_\_\_ **Depth to Water:** \_\_\_\_\_ **Easting:** \_\_\_\_\_  
**Driller:** \_\_\_\_\_ **Hole Diameter:** \_\_\_\_\_ **Horizontal Datum:** \_\_\_\_\_  
**Drilling Method:** \_\_\_\_\_ **Core Device:** \_\_\_\_\_ **Prepared by:** \_\_\_\_\_  
**Boring Status:** \_\_\_\_\_ **Drilling Fluid:** \_\_\_\_\_ **Reviewed by:** \_\_\_\_\_

Drilling Information				Graphical Log for Primary Texture							Soil Description (Udden-Wentworth System)	Field Notes
Drilling Depth (ft bgs)	Core Interval (ft)	Core Recovery (inches)	Vapor Reading (ppm)	Fines		Sand			Gravel		Depth Interval (ft), PRIMARY TEXTURE, Principal and Minor Components with Descriptors (% modifiers and grain size fraction, angularity for coarse sand and larger, consistency/density, plasticity for silt and clay, dilatancy for silt/silt-sand); Sorting, Moisture Content, Color. NOTES: <i>Texture Modifiers: Trace (&lt;10%), Little (10 to 20%), Some (21 to 35%), And (36 to 50%)</i>	Driller's Observations, Geologic Formation, Field Screening Results, Sample Interval etc.
				clay	silt	very fine	fine	medium	coarse	very coarse		



# BORING LOG



Boring ID: \_\_\_\_\_ Project Name: \_\_\_\_\_ Page: \_\_\_\_\_ / \_\_\_\_\_

Drilling Information				Graphical Log for Primary Texture							Soil Description (Udden-Wentworth System)	Field Notes		
Drilling Depth (ft bgs)	Core Interval (ft)	Core Recovery (inches)	Vapor Reading (ppm)	Fines		Sand				Gravel			Depth Interval (ft), PRIMARY TEXTURE, Principal and Minor Components with Descriptors (% modifiers and grain size fraction, angularity for coarse sand and larger, consistency/density, plasticity for silt and clay, dilatancy for silt/silt-sand); Sorting, Moisture Content, Color. NOTES: <i>Texture Modifiers: Trace (&lt;10%), Little (10 to 20%), Some (21 to 35%), And (36 to 50%)</i>	Driller's Observations, Geologic Formation, Field Screening Results, Sample Interval etc.
				clay	silt	very fine	fine	medium	coarse	very coarse	granule	pebble		



# Attachment E

## Completed Boring Log

*The purpose of this attachment is to provide an example of a completed boring log for reference purposes to field staff. The example provided is for a soil boring completed outside the waste mass of a closed municipal landfill near Baltimore, Maryland. The objective of the drilling program was to determine the depth to groundwater to determine the appropriate depth interval to install a soil gas monitoring well and groundwater monitoring well across the first water-bearing zone. The site geology consists of unconsolidated sediments of the Mid-Atlantic Coastal Plain, specifically the Upper Patapsco formation. These sediments were deposited in a moderate gradient fluvial environment during the Cretaceous period. The landfill was constructed into a regional clay confining unit.*



# BORING LOG



<b>Boring ID:</b>	<u>MW-08</u>	<b>Project Name:</b>	<u>Acme Landfill</u>	<b>Page:</b>	<u>1 / 1</u>
<b>Permit ID:</b>	<u>MD-PG-100</u>	<b>Date Started:</b>	<u>7/18/2018</u>	<b>Ground Elevation:</b>	<u>50.5 ft</u>
<b>Site Address:</b>	<u>100 Landfill Road</u>	<b>Date Completed:</b>	<u>7/18/2018</u>	<b>Vertical Datum:</b>	<u>NAVD 88, feet</u>
<b>City, State:</b>	<u>Baltimore, Maryland</u>	<b>Total Depth:</b>	<u>35 ft below ground</u>	<b>Northing:</b>	<u>123456.79</u>
<b>Drilling Co:</b>	<u>Earth Matters</u>	<b>Depth to Water:</b>	<u>19 ft below ground</u>	<b>Easting:</b>	<u>123456.79</u>
<b>Driller:</b>	<u>Rod E. Piper</u>	<b>Hole Diameter:</b>	<u>2-inch</u>	<b>Horizontal Datum:</b>	<u>NAD 83 feet, MD State</u>
<b>Drilling Method:</b>	<u>Direct-push/hollow-stem</u>	<b>Core Device:</b>	<u>5-foot macrocore sampler</u>	<b>Prepared by:</b>	<u>Sandy Pebbles</u>
<b>Boring Status:</b>	<u>completed as well</u>	<b>Drilling Fluid:</b>	<u>none</u>	<b>Reviewed by:</b>	<u>Clay Brown</u>

Drilling Information				Graphical Log for Primary Texture								Soil Description (Udden-Wentworth System)	Field Notes			
Drilling Depth (ft bgs)	Core Interval (ft)	Core Recovery (inches)	VOC Vapor Reading (ppm)	Fines		Sand				Gravel				Depth Interval (ft), PRIMARY TEXTURE, Principal and Minor Components with Descriptors (% modifiers and grain size fraction, angularity for coarse sand and larger, consistency/density, plasticity for silt and clay, dilatancy for silt/silt-sand); Sorting, Moisture Content, Color. NOTES: <i>Texture Modifiers: Trace (&lt;10%), Little (10 to 20%), Some (21 to 35%), And (36 to 50%)</i>	Driller's Observations, Geologic Formation, Field Screening Results, Sample Interval etc.	
				clay	silt	very fine	fine	medium	coarse	very coarse	granule	pebble	cobble			boulder
0 to 1	0-5	43.2/60	< 1											0-0.5 ft, topsoil with organics	Grass covered area	
1 to 2			< 1			X								0.5-5 ft, SAND, fine, trace silt, trace pebble, round; poorly sorted, moist, yellowish brown (7.5 YR 5/8). NOTE: some cementation, does not react with HCl	continuous macro-core logging	
2 to 3			< 1			X										
3 to 4			< 1			X										cemented sand @3.6-4 ft
4 to 5			< 1			X										
5 to 6	5-10	40.8/60	< 1			X	X	X						5-10 ft, SAND, fine to coarse, round to subround; well sorted, moist, light to strong brown (7.5 YR 6/4 to 7.5 YR 5/6).		
6 to 7			< 1			X	X	X								
7 to 8			< 1			X	X	X								
8 to 9			< 1			X	X	X								
9 to 10			< 1			X	X	X								
10 to 11	10-15	36/60	< 1			X	X	X						10-12.5 ft, same as above with trace silt		
11 to 12			< 1			X	X	X								
12 to 13			< 1			X	X	X								
13 to 14			< 1			X	X	X							12.5 to 15 ft, same as above, color change to pink (7.5 YR 7/3) and reddish yellow (7.5YR 6/8)	
14 to 15			< 1			X	X	X								
15 to 16	15-20	55.2/60	< 1				X	X						15-18.9 ft, SAND, coarse to very coarse, round to subround; well sorted, moist, strong brown (7.5YR 5/6) to reddish yellow (7.5YR 6/6)		
16 to 17			< 1				X	X								
17 to 18			< 1			X	X									
18 to 19	20-25	36/60	< 1	X	X	X								18.9-22.7 ft, SAND, very fine to fine, and SILT, coarse to very coarse, poorly sorted, wet, light gray (7.5YR 7/1)	water table encountered @ 18.9 ft	
19 to 20			< 1	X	X	X										
20 to 21			< 1	X	X	X										
21 to 22			< 1	X	X	X										
21 to 23			< 1	X	X	X										
23 to 24	25-30	30/60	< 1	X	X									22.7-25 ft, CLAY and SILT, high plasticity, soft to stiff at 25 ft, dry to moist, light gray (2/5YR 7/1) w/ red mottling (2.5YR 4/6)	Middle Patapsco Confining Unit	
24 to 25			< 1	X	X											
25 to 26			< 1	X	X											
26 to 27			< 1	X	X											
27 to 28			< 1	X	X											
28 to 29	30-35 ft	60/60	< 1	X	X									25-31.1 ft, CLAY and SILT, high plasticity, stiff; dry to moist, light gray (2/5YR 7/1) with red mottling (2.5YR 4/6)		
29 to 30			< 1	X	X											
30 to 31			< 1	X	X											
31 to 32			< 1	X												
32 to 33			< 1	X												
33 to 34	< 1	X											31.1-35 ft, SILT, low plasticity, high dilatancy; wet, gray (7.5YR 7/1)	End of direct-push boring @ 35 ft		
34 to 35	< 1	X														



Arcadis U.S., Inc.  
630 Plaza Drive, Suite 200  
Highlands Ranch  
Colorado 80129  
Phone: 720 344 3500  
Fax: 720 344 3535  
[www.arcadis.com](http://www.arcadis.com)



# TGI – Soil Drilling and Sample Collection

Rev: #2

Rev Date: April 8, 2022



## Version Control

Issue	Revision No.	Date Issued	Page No.	Description	Reviewed By
	0	October 11, 2018	All	Updated and re-written as a TGI	Marc Killingstad
	1	May 12, 2020	None	Review – no changes necessary	Marc Killingstad
	2	April 8, 2022	All	Updated to new format and minor content (e.g., PFAS)	Chris Shepherd/Marc Killingstad



## Approval Signatures

Prepared by:

4/8/2022

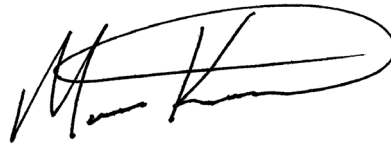
---

Chris Shepherd (Preparer)

---

Date

Reviewed by:



4/8/2022

---

Marc Killingstad (Subject Matter Expert)

---

Date



## 1 Introduction

This document describes general and/or specific procedures, methods, actions, steps, and considerations to be used and observed by Arcadis staff when performing work, tasks, or actions under the scope and relevancy of this document. This document may describe expectations, requirements, guidance, recommendations, and/or instructions pertinent to the service, work task, or activity it covers.

It is the responsibility of the Arcadis Certified Project Manager (CPM) to provide this document to the persons conducting services that fall under the scope and purpose of this procedure, instruction, and/or guidance. The Arcadis CPM will also ensure that the persons conducting the work falling under this document are appropriately trained and familiar with its content. The persons conducting the work under this document are required to meet the minimum competency requirements outlined herein, and inquire to the CPM regarding any questions, misunderstanding, or discrepancy related to the work under this document.

This document is not considered to be all inclusive nor does it apply to any and all projects. It is the CPM's responsibility to determine the proper scope and personnel required for each project. There may be project- and/or client- and/or state-specific requirements that may be more or less stringent than what is described herein. The CPM is responsible for informing Arcadis and/or Subcontractor personnel of omissions and/or deviations from this document that may be required for the project. In turn, project staff are required to inform the CPM if or when there is a deviation or omission from work performed as compared to what is described herein.

In following this document to execute the scope of work for a project, it may be necessary for staff to make professional judgment decisions to meet the project's scope of work based upon site conditions, staffing expertise, state-specific requirements, health and safety concerns, etc. Staff are required to consult with the CPM when or if a deviation or omission from this document is required that has not already been previously approved by the CPM. Upon approval by the CPM, the staff can perform the deviation or omission as confirmed by the CPM. All deviations or omissions should be documented.

## 2 Intended Use and Responsibilities

This document describes general and/or specific procedures, methods, actions, steps, and considerations to be used and observed by Arcadis staff when performing work, tasks, or actions under the scope and relevancy of this document. This document may describe expectations, requirements, guidance, recommendations, and/or instructions pertinent to the service, work task, or activity it covers.

It is the responsibility of the Arcadis Certified Project Manager (CPM) to provide this document to the persons conducting services that fall under the scope and purpose of this procedure, instruction, and/or guidance. The Arcadis CPM will also ensure that the persons conducting the work falling under this document are appropriately trained and familiar with its content. The persons conducting the work under this document are required to meet the minimum competency requirements outlined herein, and inquire to the CPM regarding any questions, misunderstanding, or discrepancy related to the work under this document.

This document is not considered to be all inclusive nor does it apply to all projects. It is the CPM's responsibility to determine the proper scope and personnel required for each project. There may be project- and/or client- and/or state-specific requirements that may be more or less stringent than what is described herein. The CPM is responsible for informing Arcadis and/or Subcontractor personnel of omissions and/or deviations from this document that may be required for the project. In turn, project staff are required to inform the CPM if or when there is a deviation or omission from work performed as compared to what is described herein.



In following this document to execute the scope of work for a project, it may be necessary for staff to make professional judgment decisions to meet the project's scope of work based upon site conditions, staffing expertise, regulation-specific requirements, health and safety concerns, etc. Staff are required to consult with the CPM when or if a deviation or omission from this document is required that has not already been previously approved by the CPM. Upon approval by the CPM, the staff can perform the deviation or omission as confirmed by the CPM.

### 3 Scope and Application

This Technical Guidance Instruction (TGI) describes general drilling procedures and the methods to be used to field screen and collect soil samples for laboratory analysis in unconsolidated or weakly consolidated sediments. For soil description procedures, please refer to the *TGI - Soil Description*. For monitoring well installation in granular aquifers, please refer to the *TGI - Monitoring Well Installation*. For per- and polyfluoroalkyl substances (PFASs) drilling and soil sampling procedures, please refer to: *TGI – PFAS-Specific Drilling and Monitoring Well Installation*, *TGI – Per- and Polyfluoroalkyl Substances (PFAS) Field Sampling Guide*, and *TGI – Equipment and Reagent Blank Sample Collection for PFAS Analysis*.

Overburden (unconsolidated sediments) drilling is commonly performed using the hollow-stem auger drilling method. Other drilling methods suitable for overburden drilling, which are sometimes necessary due to site-specific geologic conditions, include: direct-push, drive-and-wash, spun casing, rotasonic, dual-rotary (Barber Rig), and fluid/mud rotary with core barrel or roller bit. Direct-push techniques (e.g., Geoprobe or cone penetrometer) and hand tools may also be used. Drilling within consolidated materials such as fractured rock is commonly performed using water-rotary (coring or tri-cone roller bit), air rotary or rotasonic methods. For guidance when drilling in consolidated materials (i.e., bedrock), please refer to *the TGI – Bedrock Core Collection and Description*.

The drilling method to be used at a given site will be selected based on site-specific consideration of anticipated drilling depths, targeted chemicals, site or regional geologic knowledge, types of sampling to be conducted, required sample quality and volume, and cost.

Field screening of soil samples is commonly performed using a photoionization detector (PID) and/or a flame ionization detector (FID). These instruments are used to measure relative concentrations of volatile organic compounds (VOCs) for the selection of samples for further laboratory or field analysis. Field screening for dense non-aqueous phase liquids (DNAPL) may be performed using hydrophobic dye (Oil Red O or Sudan IV), which is pertinent at chlorinated solvent sites.

Collection of soil samples for laboratory analysis may be performed using a variety of techniques including grab samples, undisturbed cores, and composite or homogenized samples. Samples may require homogenization across a given depth interval, or several discrete grabs (usually five) may be combined into a composite sample. Samples for VOC analysis will not be homogenized or composited and are collected as discrete grab samples.

No oils or grease will be used on equipment introduced into the boring (e.g., drill rod, casing, or sampling tools). Some lubricants (e.g., vegetable oil-based lubricants) may be acceptable, if the constituents won't interfere with the analyses.

### 4 Personnel Qualifications

Arcadis field personnel will have completed or are in the process of completing site-specific training as well as having current health and safety training as required by Arcadis, client, or state/federal regulations, such as 40-hour HAZWOPER training and/or OSHA HAZWOPER site supervisor training. Arcadis personnel will also have current training as identified in the site-specific Health and Safety Plan (HASP) which may include first aid,



cardiopulmonary resuscitation (CPR), Blood Borne Pathogens (BBP) as needed. The HASP will also identify any access control requirements.

Prior to mobilizing to the field, Arcadis field personnel will review and be thoroughly familiar with relevant site-specific documents including but not limited to the task-specific work plan or field implementation plan (FIP), Quality Assurance Project Plan (QAPP), HASP, historical information, and other relevant site documents.

Arcadis field personnel will be knowledgeable in the relevant processes, procedures, and TGIs and possess the demonstrated required skills and experience necessary to successfully complete the desired field work. Personnel responsible for overseeing drilling operations will have at least 16 hours of prior training overseeing drilling activities with an experienced geologist, environmental scientist, or engineer with at least 2 years of prior experience.

Arcadis personnel directing, supervising, or leading soil sampling activities will have a minimum of 1 year of previous environmental soil sampling experience. Field employees with less than 6 months of experience will be accompanied by a supervisor (as described above) to ensure that proper sample collection techniques are employed.

Additionally, the Arcadis field team will review and be thoroughly familiar with documentation provided by equipment manufacturers and become familiar with the operation of (i.e., hands-on experience) all equipment that will be used in the field prior to mobilization.

## 5 Equipment List

The following materials will be available, as required, during soil boring drilling, field screening, and sampling activities:

- Site-specific HASP and health and safety documents identified in the HASP
- FIP/work plan that includes site map with proposed boring locations, field sampling plan (with corresponding depths, sample analyses, sample volume required, and sample holding time), and previous boring logs (as available)
- Appropriate personal protective equipment (PPE), as specified in the HASP
- Including but not limited to disposable chemical resistant gloves and Level D PPE
- Traffic cones, delineators, and caution tape as appropriate for securing the work area as specified in the Traffic Safety Plan (TSP)
- Photoionization detector (PID), flame ionization detector (FID) or other air/soil screening equipment, as needed, in accordance with the HASP or workplan
- Sampling equipment:
- Drilling equipment required by *ASTM D1586*, when performing split-spoon sampling including clean sample sleeves
- Disposable plastic liners, when drilling with direct-push equipment
- Stainless steel hand auger and stainless-steel spade if using manual methods
- Appropriate soil sampling equipment (e.g., stainless steel spatulas/spoons/bowls, knife)
- Sealable plastic bags (e.g., Ziploc®)



- Air-tight sample containers and 8-oz. glass Mason jars or driller's jars
- Aluminum foil
- Appropriate sample blanks (trip blank supplied by the laboratory), as specified in the FSP
- Soil sample containers and labels (supplied by the laboratory) appropriate for the analytical method(s) with preservative, as needed (parameter-specific)
- Sample labels
- Indelible ink pens
- Engineer's ruler or survey rod
- Plastic sheeting (e.g., Weatherall Visqueen)
- Appropriate transport containers (coolers) with ice and appropriate labeling, packing, and shipping materials
- Decontamination equipment (buckets, distilled or deionized water, cleansers appropriate for removing expected chemicals of concern, paper towels) in accordance with the *TGI for Groundwater and Soil Sampling Equipment Decontamination*
- Forms/notes:
  - Tablet with digital forms, etc., if appropriate
  - Appropriate soil boring log (**Attachment 1**)
  - Chain-of-custody forms
  - Field notebook
  - Digital camera (or smart phone with camera)
- Drums or other containers appropriate for soil and decontamination water, as specified by the site investigation-derived waste (IDW) management plan, and appropriate drum labels

## 6 Cautions

Prior to beginning field work, underground utilities in the vicinity of the drilling areas will be delineated by the drilling contractor or an independent underground utility locator service in accordance with the work plan, client requirements, and Arcadis guidance. See appropriate guidance for proper utility clearance protocol. Work will be performed in accordance with the Arcadis *Utility Location and Clearance Health and Safety Standard* and the *Utilities and Structures Checklist* will be completed before beginning any intrusive work.

Prior to beginning field work, the project technical team will ensure that all field logistics (e.g., access issues, health and safety issues, communication network, schedules, etc.) and task objectives are clearly understood by all team members. An internal call with the project technical team to review the FIP/work plan scope and objectives is strongly recommended prior to mobilization to ensure that the field work will be effectively and efficiently executed.

Some regulatory agencies have specific requirements regarding borehole abandonment and grout mixtures. Determine whether the oversight agency has any such requirements prior to finalizing the



drilling plan.

If DNAPL is known or expected to exist at the site, refer to the project specific documents (e.g., DNAPL Contingency Plan) for additional details regarding drilling to reduce the potential for inadvertent DNAPL remobilization.

Similarly, if light non-aqueous phase liquid (LNAPL) is known or expected to be present as “perched” layers above the water table, refer to the DNAPL Contingency Plan. Follow the general provisions and concepts in the DNAPL contingency plan during drilling above the water table at known or expected LNAPL sites.

Avoid using drilling fluids or materials that could impact groundwater or soil quality, or could be incompatible with the subsurface conditions. Water used for drilling, decontamination of drilling/sampling equipment, or grouting boreholes upon completion will be of a quality acceptable for project objectives. Testing of water supply will be considered.

Specifications of materials used for backfilling the borehole will be obtained, reviewed and approved to meet project quality objectives. Bentonite is not recommended where DNAPL is likely to be present or in groundwater with high salinity. In these situations, neat cement grout is preferred.

Store and/or stage empty and full sample containers and coolers out of direct sunlight. Sample container threads should be wiped down with a clean, nonabrasive material (e.g., paper towels) to better ensure the sample container is properly sealed. Be careful not to over-tighten lids with Teflon® liners or septa. Over-tightening can impair the integrity of the seal and can cause the glass to shatter and create a risk for hand injuries.

*NOTE: Field logs and some forms are considered to be legal documents. All field logs and forms will therefore be filled out in indelible ink. Do not use permanent marker or felt-tipped pens for labels on sample container or sample coolers. Permanent markers could introduce volatile constituents into the samples.*

*NOTE: An Arcadis employee that is appropriately trained at the correct level of internal hazardous materials/DOT (Department of Transportation) shipping must complete an Arcadis shipping determination to address applicable DOT and IATA (International Air Transport Association) shipping requirements. Review the applicable Arcadis procedures and guidance instructions for sample packaging and labeling. Prior to using air transportation, confirm air shipment is acceptable under DOT and IATA regulations.*

## 7 Health and Safety Considerations

The HASP will be followed, as appropriate, to ensure the safety of field personnel. Review all site-specific and procedural hazards as they are provided in the HASP, and review Job Safety Analysis (JSA) documents in the field each day prior to beginning work.

Prior to drilling, utility clearance must be performed (see Section 5). Appropriate personal protective equipment (PPE) will be worn at all times in line with the task and the site-specific HASP.

Working outside at sites with suspected contamination may expose field personnel to hazardous materials such as contaminated groundwater or NAPL (e.g., oil). Other potential hazards include biological hazards (e.g., stinging insects, ticks in long grass/weeds, etc.), and potentially the use of sharp cutting tools (scissors, knife). Only use non-toxic peppermint oil spray for stinging insect nests. Review client-specific health and safety requirements, which may preclude the use of fixed/folding-blade knives



and use appropriate hand protection.

If thunder or lightning is present, discontinue drilling and sampling until 30 minutes have passed after the last occurrence of thunder or lightning.

## 8 Procedure

The procedures for drilling and the methods to be used to field screen and collect soil samples for laboratory analysis are presented below:

### 8.1 Drilling Procedures

#### 8.1.1 Hollow-Stem Auger, Drive-and-Wash, Spun Casing, Fluid/Mud Rotary, Rotasonic, and Dual-Rotary Drilling Methods

1. Find/identify boring location, establish work zone, and set up sampling equipment decontamination area.
  - a. Verify utilities were cleared (see Section 5) and use soft dig technique to clear borehole, if applicable
  - b. Clean sampling equipment in accordance with the FIP/work plan prior to drilling
2. Advance boring to target depth:
  - a. Collect soil samples at appropriate interval as specified in the FIP/work plan (or equivalent) using the appropriate tooling (e.g., split-barrel sampler) and sample containers
    - i. Split-barrel or drive-ahead samples are obtained during drilling
    - ii. A common sampling method that produces high-quality soil samples with relatively little soil disturbance is described in *ASTM D1586 – Standard Test Method for Standard Penetration Test (SPT) and Split-Barrel Sampling of Soils* (ASTM D1586).
  - b. Always change disposable gloves before handling the sampling equipment
  - c. Collect, document, and store samples for laboratory analysis as specified in the FIP/work plan (or equivalent; see below for additional details on sample collection procedures)
  - d. Field screen samples as specified in the FIP/work plan (or equivalent; see below for additional details on field screening procedures)
  - e. Rotasonic drilling produces soil cores that, for the most part, are relatively undisturbed, but note that when drilling in consolidated or finer-grained sediment the vibratory action during core barrel advancement may create secondary fractures or breaks. The core is retrieved by vibrating the soil/rock into a separate core bag, typically in 5-foot or 10-foot increments. The soil cores may consolidate or expand during retrieval, depending on soils, etc.
  - f. Dual-rotary removes cuttings by compressed air or water/mud and allow only a



- general assessment of geology unless separate coring tools and techniques are used
- g. Decontaminate equipment between samples in accordance with the FIP/work plan (or equivalent)
3. Describe each soil sample as outlined in the appropriate project records (refer to the description procedures outlined in the *TGI - Soil Description*)
- a. Record descriptions on the soil boring log (**Attachment 1**) and/or field notebook
  - b. When possible, photo document the samples (e.g., soil cores, split-barrels)
  - c. During soil boring advancement, document all drilling events in field notebook, including blow counts (i.e., the number of blows from a soil sampling drive weight [140 pounds] required to drive the split-barrel sampler in 6-inch increments) and work stoppages
  - d. Blow counts will not be available if rotasonic, dual-rotary, or direct-push methods are used; however, if standard penetration testing is required during rotasonic drilling, an automatic drop hammer may be used in conjunction with the method to switch from core barrel advancement to standard penetration testing
  - e. If soils are screened with a PID/FID or another instrument, document the measurement in accordance with the work plan
4. The drilling contractor will be responsible for obtaining accurate and representative samples, informing the supervising Arcadis geologist of changes in drilling pressure, drilling penetration rates, and keeping a separate general log of soils encountered, including blow counts
- a. The term “samples” means soil materials from particular depth intervals, whether or not portions of these materials are submitted for laboratory analyses
  - b. Records will also be kept of occurrences of premature refusal due to boulders, construction materials that may have been used as fill, etc.
  - c. Where a boring cannot be advanced to the desired depth, the boring will be abandoned, and an additional boring will be advanced at an adjacent location to obtain the required sample in accordance with the work plan
  - d. Where it is desirable to avoid leaving vertical connections between depth intervals (e.g., if DNAPL or perched LNAPL are known or expected to exist at the site), the borehole will be sealed using cement and/or bentonite (see **Section 5** above)
  - e. Multiple refusals may lead to a decision by the supervising geologist to abandon that sampling location

### 8.1.2 Direct-Push Method

The direct-push drilling method may also be used to complete soil borings. Examples of this technique include Geoprobe®, Diedrich Environmental Soil Probe (ESP) System, or AMS PowerProbe.

Environmental probe systems typically use a hydraulically operated percussion hammer.

Depending on the equipment used, the hammer delivers 140- to 350-foot pounds of energy with each blow. The hammer provides the force needed to penetrate very stiff to medium dense soil formations. The hammer simultaneously advances an outer steel casing that contains a dual tube liner for sampling soil



(dual tube sampling system).

The outside diameter (OD) of the outer casing ranges from 2.25 to 6 inches and the OD of the inner sampling tube diameter ranges from 1.4 to 4.5 inches. The outer casing isolates overlying soil and permits the unit to continue to probe at depth. The dual tube sampling system provides a borehole that may be tremie-grouted from the bottom up. Alternatively, a single rod system may be used that does not provide a cased boring and which limits tremie-grouting from the bottom up.

Direct-push drilling can generally achieve target depths 100 feet or less depending on the site geology. The known or expected site conditions (e.g., presence of NAPL) will be evaluated when selecting the type of direct-push sampling system to be employed.

1. Find/identify boring location, establish work zone, and set up sampling equipment decontamination area
  - a. Verify utilities were cleared (see Section 5) and use soft dig technique to clear borehole, if applicable
  - b. Clean sampling equipment in accordance with the FIP/work plan prior to drilling
2. Advance soil boring to target depth.
  - a. Collect soil samples at appropriate interval as specified in the FIP/work plan (or equivalent) using clean/disposable sampling equipment (plastic liners)
  - b. Always change disposable gloves before handling the sampling equipment
  - c. Collect, document, and store samples for laboratory analysis as specified in the FIP/work plan (or equivalent; see below for additional details on sample collection procedures)
  - d. Field screen samples as specified in the FIP/work plan (or equivalent; see below for additional details on field screening procedures)
3. Decontaminate equipment between samples in accordance with the FIP/work plan (or equivalent)
4. Describe samples in accordance with the procedures outlined in **Step 3** under ***Hollow-Stem Auger, Drive-and-Wash, Spun Casing, Fluid/Mud Rotary, Rotasonic, and Dual-Rotary Drilling Methods*** above (refer to the description procedures outlined in the *TGI - Soil Description*)

### 8.1.3 Manual Methods

Manual methods may also be used to complete shallow soil borings. Examples of this technique include using a spade, spoon, scoop, hand auger, or slide hammer. Manual methods are typically used to collect surface soil samples (0 to 6 inches) or to complete soil borings/collect soil samples from a depth of 5 feet or less.

1. Find/identify boring location, establish work zone, and set up sampling equipment decontamination area
2. Clear the ground surface of brush, root mat, grass, leaves, or other debris
3. Use a spade, spoon, scoop, hand auger, or slide hammer to collect a sample of the required depth interval
4. Use an engineer's ruler or survey rod to verify that the sample is collected to the correct depth and



record the top and bottom depths from the ground surface

5. To collect samples below the surface interval, remove the surface interval first; then collect the deeper interval
  - a. To prevent the hole from collapsing, it may be necessary to remove a wider section from the surface or use cut polyvinyl chloride (PVC) pipe to maintain the opening
  - b. Collect soil samples at appropriate interval as specified in the FIP/work plan (or equivalent) and transfer to the appropriate, laboratory-supplied container
  - c. Collect, document, and store samples for laboratory analysis as specified in the FIP/work plan (or equivalent; see below for additional details on sample collection procedures)
  - d. Field screen samples as specified in the FIP/work plan (or equivalent; see below for additional details on field screening procedures)
6. Decontaminate equipment between samples in accordance with the FIP/work plan (or equivalent)
7. Describe samples in accordance with the procedures outlined in **Step 3** under ***Hollow-Stem Auger, Drive-and-Wash, Spun Casing, Fluid/Mud Rotary, Rotasonic, and Dual-Rotary Drilling Methods*** above (refer to the description procedures outlined in the *TGI - Soil Description*)

## 8.2 Field Screening Procedures

### 8.2.1 PID and FID Screening

Soils are typically field screened with a PID or FID for a relative measure of the total VOCs at sites where VOCs are known or suspected to exist. PIDs and FIDs require calibration in accordance with the work plan(s) and manufacturer's specifications and PIDs should be calibrated based on the target chemicals. The PID employs an ultraviolet lamp to measure VOCs and the ionization energy (IE) of the site constituents need to be considered when selecting the type of lamp (e.g., 10.6 eV, 11.7 eV) that will be used. In general, any compound with an IE lower than that of the lamp photons can be measured. The FID has a wide linear range and responds to almost all VOCs.

Field screening is performed using one (or both) of the following two methods:

1. Upon opening the sampler, the soil is split open and the PID or FID probe is placed in the opening and covered with a clean, gloved hand. Such readings will be obtained at several locations along the length of the sample.
2. A portion of the collected soil is placed in a jar, which is covered with aluminum foil, sealed, and allowed to warm to room temperature (see below). After warming, the cover is removed, the foil is pierced with the PID or FID probe, and a reading is obtained.

Prior to usage, the PID or FID must be calibrated according to the manufacturer's specifications at a minimum frequency of once per day prior to collecting PID or FID readings. The PID will be calibrated to a benzene-related compound (isobutylene) or other appropriate gas, while the FID will be calibrated to methane. The time, date, and calibration procedure must be clearly documented in the field notebook and/or the calibration form.

If at any time the PID or FID results appear erratic or inconsistent with field observations, then the instrument will be recalibrated.



If calibration is difficult to achieve, then the PID's lamp will be checked for dirt or moisture and cleaned, or technical assistance will be required. Maintenance and calibration records will be kept as part of the field quality assurance program.

Initial PID readings will be recorded on the soil boring log (**Attachment 1**) and/or in the field notes. The soil sample will be separated from the slough material (if any) by using disposable gloves and a pre-cleaned stainless-steel spoon or tool.

For the second method, a representative portion of the sample will be placed in a pre-cleaned air-tight container (as quickly as possible to avoid loss of VOCs), filling the container half full to allow for the accumulation of vapors above the soil. An aluminum foil seal will be placed between the glass and cap and the cap will be screwed on tightly. Unless the screening will be performed immediately after the sample is placed in the container, the sample containers will be stored in a cooler chilled to approximately 4°C until screening can be performed.

The headspace of the container will be measured using a PID or FID as follows:

1. Samples will be taken to a warm workspace and allowed to equilibrate to room temperature for at least one hour.
2. Prior to measuring the soil vapor headspace concentration, the container will be shaken.
3. The headspace of the sample will then be measured directly from the container by piercing the aluminum foil seal with the probe of the PID or FID and measuring the relative concentration of VOCs in the headspace of the soil sample. The initial (peak) reading must be recorded.

## 8.2.2 NAPL Screening

To screen for the potential presence of non-aqueous phase liquid (NAPL) in soil, drilling procedures must allow for high-quality porous media samples to be taken. Split-barrel samplers or direct-push samplers will be collected continuously ahead of the auger, drill casing/rods, or probe rods. Upon opening each split-barrel sampler or direct-push plastic liner sleeve, the soil will immediately be evaluated for the presence of visible NAPL and odors. If suspected NAPL is immediately visible in the sample, its depth will be noted.

Additionally, the soil will be screened for the presence of organic vapors using a PID or FID, in accordance with the work plan, if applicable. During screening, the soil will be split open using a clean spatula or knife and the PID or FID probe will be placed in the opening and covered with a clean, gloved hand (**Method 1** above). Such readings will be obtained along the entire length of the sample. Alternatively, **Method 2** for PID/FID screening (outlined above) may also be performed. If the PID or FID examination reveals the presence of organic vapors above 100 parts per million (ppm), the sample will undergo further detailed evaluation for visible NAPL.

The assessment for NAPL will include the following tests/observations:

- Evaluation for Visible NAPL Sheen or Free-Phase NAPL in Soil Sampler
  - NAPL sheen will be a colorful iridescent appearance on the soil sample
  - NAPL may also appear as droplets or continuous accumulations of liquid with a color typically ranging from yellow to brown to black, depending on the type of NAPL
  - Creosote DNAPL (associated with wood-treating sites) and coal tar DNAPL (associated with manufactured gas plant [MGP] sites) are typically black and have a characteristic, pungent odor
  - Pure chlorinated solvents may be colorless in the absence of hydrophobic dye. Solvents mixed



with oils may appear brown

- Particular care will be taken to fully describe any sheens observed, staining, discoloration, droplets (blebs), or NAPL saturation
- Soil-Water Pan Test
  - A portion of the selected soil interval with the highest PID or FID reading above 100 ppm will be placed in a disposable polyethylene dish along with a small volume of potable or distilled water
  - The dish will be gently tilted back and forth to mix the soil and water, and the surface of the water will be viewed in natural light to observe the development of a sheen, if any
  - A small quantity of Oil Red O or Sudan IV hydrophobic dye powder should be added in accordance with the work plan, and the soil and dye will be manually mixed for approximately 30 to 60 seconds and smeared in the dish to create a paste-like consistency
  - A positive test result will be indicated by a sheen on the surface of the water and/or a bright red color imparted to the soil following mixing with dye
- Soil-Water Shake Test
  - A small quantity of soil (up to 15 cc) will be placed in a clear, colorless, jar containing an equal volume of potable or distilled water (40-mL vials are well suited to this purpose, but not required)
  - After the soil settles into the water, the surface of the water will be evaluated for a visible sheen under natural light
  - The jar will be closed and gently shaken for approximately 10 to 20 seconds
  - Again, the surface of the water will be evaluated for a visible sheen or a temporary layer of foam
  - A small quantity (approximately 0.5 to 1 cc) of Oil Red O or Sudan IV powder will be placed in the jar in accordance with the work plan
  - The sheen layer, if present, will be evaluated for a reaction to the dye (change to bright red color)
  - The jar will be closed and gently shaken for approximately 10 to 20 seconds
  - The contents in the closed jar will be examined under natural light for visible bright red dyed liquid inside the jar



- A positive test result will be indicated by the presence of a visible sheen or foam on the surface of water, a reaction between the dye and the sheen layer upon first addition of the dye powder, a bright red coating on the inside of the vial (particularly above the water line), or red-dyed droplets within the soil

NOTE: *If NAPL is obviously present upon opening the soil sampler or evaluating the soil sample within the split-spoon sampler or direct-push liner sleeve, it is not necessary to perform a soil-water pan test or soil-water shake test. In addition, it is not necessary to perform both a soil-water pan test and a soil-water shake test; either test method is acceptable. The pan test may be preferred in some circumstances because the presence of a sheen may be easier to see on a wider surface. Further, these tests will only be performed if specified in the work plan(s).*

NOTE: *When using hydrophobic dye in the tests above, color will be assessed outdoors under natural light during the period between sunrise and sunset, regardless of the degree of cloud cover. The hydrophobic dye Safety Data Sheets (SDS) will be incorporated into the HASP and reviewed prior to use and the dyes will be carefully handled and disposed in accordance with regulations, if applicable.*

### 8.3 Soil Sample Collection for Laboratory Procedures

If not specifically identified in the FIP/work plan, soil samples will be selected for laboratory analysis based on:

1. Their position in relation to identified source areas
2. The visual presence of source residues (e.g., NAPL or staining)
3. The relative levels of total VOCs based on field screening measurements
4. The judgment of the field coordinator
5. Moisture content or relative position with regard to apparent groundwater table/saturation

Samples designated for laboratory analysis will be placed in the appropriate containers.

*Sample containers for VOC analysis will be filled first immediately following soil core retrieval to reduce loss of VOCs.*

If samples will be collected for other analyses, a sufficient amount of the remaining soil will then be homogenized as described below and sample containers will be filled for other parameters.

VOC samples will be collected as discrete samples using a small diameter core sampler (e.g., En Core® Sampler, Terra Core™ Sampler).

The En Core® Sampler is a disposable volumetric sampling device that collects, stores and delivers soil samples without in-field chemical preservation. The En Core® Sampler requires the use of a reusable T-handle.

The Terra Core™ Sampler is a one-time use transfer tool, designed to collect soil samples and transfer them to the appropriate containers for in-field chemical preservation (e.g., methanol).

The small diameter core samplers will be used according to the manufacturer's instructions (e.g., En Novative Technologies). Some regulatory agencies have specific requirements regarding VOC sample



collection. Determine whether the oversight agency has specific requirements prior to commencing sampling and collect samples at appropriate interval as specified in the FIP/work plan (or equivalent). Samples may require homogenization across a given depth interval, or several discrete grabs (usually five) may be combined into a composite sample.

*NOTE: Samples for VOC and PFAS analysis will NOT be homogenized or composited and will be collected as discrete samples as described above.*

The procedure for mixing samples is provided below.

1. Mix the materials in a stainless steel (or appropriate non-reactive material) bowl using a stainless-steel spoon (or disposable equivalents)
  - a. When dealing with large sample quantities, use disposable plastic sheeting and a shovel or trowel
  - b. *NOTE: When preparing samples for metals analyses, do not use disposable aluminum (or metal tools or trays other than stainless steel), as it may influence the analytical results*
2. Flatten the pile by pressing the top without further mixing
3. Divide the circular pile by into four equal quarters by dividing out two diameters at right angles
4. Mix each quarter individually using appropriate non-reactive bowls, spoons and/or sheeting
5. Mix two quarters (as described above) to form halves, then mix the two halves to form a composite or homogenized sample
6. Place composite or homogenized sample into specified containers
7. Remaining material will be disposed of in accordance with project requirements and applicable regulations
8. Sample containers will be labeled with sample identification number, date, and time of collection and placed on ice in a cooler (target 4° Celsius)
9. Samples selected for laboratory analysis will be documented (chain-of-custody forms), handled, packed, and shipped in accordance with the procedures outlined in the FIP/work plan (or equivalent).

## 8.4 Soil Boring Abandonment

All soil borings need to be abandoned in accordance with ***TGI for Monitoring Well and Soil Boring Decommissioning***. See Attachment E of the TGI for specifics.

## 9 Waste Management

Investigative-Derived Waste (IDW) generated during drilling activities, including soil and excess drilling fluids (if used), and decontamination liquids, will be stored on site in appropriately labeled containers and disposed of properly. Disposable materials will be stored and disposed of separately. Containers must be labeled at the time of collection and will include date, location(s), site name, city, state, and description of matrix contained (e.g., soil, PPE). Waste will be managed in accordance with the ***TGI – Investigation-Derived Waste Handling and Storage***, the procedures identified in the FIP/work plan or QAPP as well as



state-, federal- or client-specific requirements. Be certain that waste containers are properly labeled and documented in the field log.

## 10 Data Recording and Management

Digital data collection is the Arcadis standard using available FieldNow® applications that enable real-time, paperless data collection, entry, and automated reporting. Paper forms should only be used as backup to FieldNow® digital data collection and/or as necessary to collect data not captured by available FieldNow® applications. The Field Now® digital form applications follow a standardized approach, correlate to most TGIs and are available to all projects accessible with a PC or capable mobile device. Once the digital forms are saved within FieldNow®, the data is instantly available for review on a web interface. This facilitates review by project management team members and SMEs enabling error or anomalous data detection for correction while the staff are still in the field. Continual improvements of FieldNow® applications are ongoing, and revisions are made as necessary in response to feedback from users and subject matter experts.

Management of the original documents from the field will be completed in accordance with the site- specific QAPP.

In general, drilling activities will be documented on appropriate field/log forms as well as in a proper field notebook. All field data will be recorded digitally or with indelible ink. Field forms, logs/notes (including daily field and calibration logs), digital records, and chain-of-custody records will be maintained by the field team lead. Any deviations or omissions from this TGI should be documented.

Initial field logs and chain-of-custody records will be transmitted to the Arcadis CPM and Technical Lead at the end of each day unless otherwise directed by the CPM. The field teamleader retains copies of the field documentation.

Additionally, all documents (and photographs) will be scanned and electronically filed in the appropriate project directory for easy access. Pertinent information will include personnel present on site, times of arrival and departure, significant weather conditions, timing of drilling activities, soil descriptions, soil boring information, and quantities of materials used.

In addition, the locations of soil borings will be documented photographically and in a site sketch. If appropriate, a measuring wheel or engineer's tape will be used to determine approximate distances between important site features.

Records generated as a result of this TGI will be controlled and maintained in the project record files in accordance with project requirements.

## 11 Quality Assurance

Quality assurance procedures shall be conducted in accordance with the Arcadis Quality Management System or the site-specific QAPP.

All drilling equipment and associated tools (including augers, drill rods, sampling equipment, wrenches, and any other equipment or tools) that may have come in contact with soil will be cleaned in accordance with the procedures outlined in the appropriate TGI.



Field-derived quality assurance blanks will be collected as specified in the FIP/work plan and/or site- specific QAPP, depending on the project quality objectives. Typically, field rinse blanks (equipment blanks) will be collected when non-dedicated equipment (e.g., split-spoon sampler, stainless steel spoon) is used during soil sampling. Field rinse blanks will be used to confirm that decontamination procedures are sufficient and samples are representative of site conditions. Trip blanks for VOCs, which aid in the detection of contaminants from other media, sources, or the container itself, will be kept with the coolers and the sample containers throughout the sampling activities and during transport to the laboratory.

Operate all monitoring instrumentation in accordance with manufacturer’s instructions and calibration procedures. Calibrate instruments at the beginning of each day and verify the calibration at the end of each day. Record all calibration activities in the field notebook.

## 12 References

ASTM D1586 - *Standard Test Method for Standard Penetration Test (SPT) and Split-Barrel Sampling of Soils*. ASTM International. West Conshohocken, Pennsylvania.

## 13 Attachments

Attachment 1. Soil Boring Log Form



# Attachment 1

## Soil Boring Log Form



# BORING LOG



<b>Boring ID:</b>	_____	<b>Project Name:</b>	_____	<b>Page:</b>	_____
<b>Permit ID:</b>	_____	<b>Date Started:</b>	_____	<b>Ground Elevation:</b>	_____
<b>Site Address:</b>	_____	<b>Date Completed:</b>	_____	<b>Vertical Datum:</b>	_____
<b>City, State:</b>	_____	<b>Total Depth:</b>	_____	<b>Northing:</b>	_____
<b>Drilling Co:</b>	_____	<b>Depth to Water:</b>	_____	<b>Easting:</b>	_____
<b>Driller:</b>	_____	<b>Hole Diameter:</b>	_____	<b>Horizontal Datum:</b>	_____
<b>Drilling Method:</b>	_____	<b>Core Device:</b>	_____	<b>Prepared by:</b>	_____
<b>Boring Status:</b>	_____	<b>Drilling Fluid:</b>	_____	<b>Reviewed by:</b>	_____

Drilling Information				Primary Texture							Soil Description (Udden-Wentworth System)	Field Notes		
Drilling Depth (ft bgs)	Core Interval (ft)	Core Recovery (inches)	PID Reading (ppm)	Fines		Sand				Gravel			Depth interval (ft), Moisture, PRIMARY TEXTURE, Modifier/Minor Texture, Sorting, Angularity, Consistency, Plasticity, Color - Only Record Sand Density with Standard Penetration Tests Minor Texture Modifiers: Trace (<10%), Little (10 to 20%), Some (21 to 35%), And (36 to 50%)	Driller's Observations, Particle Size Percentages, Geologic Formation, Field Screening Results, Sample Interval etc.
				clay	silt	very fine	fine	medium	coarse	very coarse	granule	pebble		



# BORING LOG

Boring ID: \_\_\_\_\_ Project Name: \_\_\_\_\_ Page: /

Drilling Information				Primary Texture									Soil Description (Udden-Wentworth System)	Field Notes	
Drilling Depth (ft bgs)	Core Interval (ft)	Core Recovery (inches)	PID Reading (ppm)	Fines		Sand				Gravel			Depth interval (ft), Moisture, PRIMARY TEXTURE, Modifier/Minor Texture, Sorting, Angularity, Consistency, Plasticity, Color - Only Record Sand Density with Standard Penetration Tests Minor Texture Modifiers: Trace (<10%), Little (10 to 20%), Some (21 to 35%), And (36 to 50%)	Driller's Observations, Particle Size Percentages, Geologic Formation, Field Screening Results, Sample Interval etc.	
				clay	silt	very fine	fine	medium	coarse	very coarse	granule	pebble			cobble



# BORING LOG



Boring ID: \_\_\_\_\_ Project Name: \_\_\_\_\_ Page: 1 / \_\_\_\_\_

Drilling Information				Primary Texture								Soil Description (Udden-Wentworth System)	Field Notes	
Drilling Depth (ft bgs)	Core Interval (ft)	Core Recovery (inches)	PID Reading (ppm)	Fines		Sand				Gravel				
				clay	silt	very fine	fine	medium	coarse	very coarse	granule	pebble	cobble	boulder



Arcadis U.S., Inc.  
630 Plaza Drive, Suite 200  
Highlands Ranch  
Colorado 80129  
Phone: 720 344 3500  
Fax: 720 344 3535  
[www.arcadis.com](http://www.arcadis.com)



# TGI – Groundwater and Soil Sampling Equipment Decontamination

Rev: 2

Rev Date: June 14, 2022



## Version Control

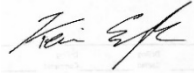
Issue	Revision No.	Date Issued	Page No.	Description	Reviewed By
	0	February 23, 2017	All	Conversion from SOP to TGI	Cassandra McCloud / Pete Frederick
	1	May 8, 2020	4, 5	Added note regarding use of Liquinox and 1,4-Dioxane	Marc Killingstad
	2	June 14, 2022	All	Conversion to new TGI format and minor edits.	Kevin Engle / Marc Killingstad



## Approval Signatures

Prepared by:

6/14/2022



\_\_\_\_\_  
Name (Preparer)

\_\_\_\_\_  
Date

Reviewed by:

6/14/2022



\_\_\_\_\_  
Marc Killingstad (Subject Matter Expert)

\_\_\_\_\_  
Date



## 1 Introduction

This document is intended to provide guidance to staff performing decontamination procedures at project sites. The content in this document describes the intended use, scope and application, personnel qualifications, equipment, cautions, health and safety considerations, procedures, waste management, data recording and management, and quality assurance of decontamination procedures.

## 2 Intended Use and Responsibilities

This document describes general and/or specific procedures, methods, actions, steps, and considerations to be used and observed by Arcadis staff when performing work, tasks, or actions under the scope and relevancy of this document. This document may describe expectations, requirements, guidance, recommendations, and/or instructions pertinent to the service, work task, or activity it covers.

It is the responsibility of the Arcadis Certified Project Manager (CPM) to provide this document to the persons conducting services that fall under the scope and purpose of this procedure, instruction, and/or guidance. The Arcadis CPM will also ensure that the persons conducting the work falling under this document are appropriately trained and familiar with its content. The persons conducting the work under this document are required to meet the minimum competency requirements outlined herein, and inquire to the CPM regarding any questions, misunderstanding, or discrepancy related to the work under this document.

This document is not considered to be all inclusive nor does it apply to all projects. It is the CPM's responsibility to determine the proper scope and personnel required for each project. There may be project- and/or client- and/or state-specific requirements that may be more or less stringent than what is described herein. The CPM is responsible for informing Arcadis and/or Subcontractor personnel of omissions and/or deviations from this document that may be required for the project. In turn, project staff are required to inform the CPM if or when there is a deviation or omission from work performed as compared to what is described herein.

In following this document to execute the scope of work for a project, it may be necessary for staff to make professional judgment decisions to meet the project's scope of work based upon site conditions, staffing expertise, regulation-specific requirements, health and safety concerns, etc. Staff are required to consult with the CPM when or if a deviation or omission from this document is required that has not already been previously approved by the CPM. Upon approval by the CPM, the staff can perform the deviation or omission as confirmed by the CPM.

## 3 Scope and Application

Decontamination is performed on sampling equipment prior to sample collection to ensure that the sampling equipment that contacts a sample, or monitoring equipment that is brought into contact with environmental media to be sampled, is free from analytes of interest and/or constituents that could interfere with laboratory analysis for analytes of interest. Sampling equipment must be appropriately cleaned prior to use for sampling or coming into contact with environmental media to be sampled and following completion of the sampling event prior to shipment or storage. The effectiveness of the decontamination procedure should be verified by collecting and analyzing equipment blank samples.



The sampling equipment cleaning procedures described herein includes pre-field, in the field, and post-field cleaning of sampling equipment which may be conducted at an established equipment decontamination area (EDA) on site, as appropriate and necessary. Sampling equipment that may require decontamination at a given site include soil sampling tools; groundwater, sediment, and surface-water sampling devices; water testing instruments; down-hole instruments; and other activity-specific sampling equipment. Non-disposable equipment will be cleaned before collecting each sample, between each sample collected, and prior to placing sampling equipment in protective cases, or containers for transport. Cleaning procedures for sampling equipment should be monitored by collecting equipment blank samples as required in project work plans, field sampling plans, quality assurance project plans (QAPP), or other pertinent project documents. Dedicated and/or single-use (i.e., not to be re-used) sampling equipment will not require decontamination.

## 4 Personnel Qualifications

Arcadis field sampling personnel will have completed or are in the process of completing site-specific training as well as having current health and safety training as required by Arcadis, client, or regulations, such as 40-hour hazardous waste operations and emergency response (HAZWOPER) training and/or Occupational Safety and Health Administration (OSHA) HAZWOPER site supervisor training. Arcadis personnel will also have current training as specified in the Health and Safety Plan (HASP) which may include first aid, cardiopulmonary resuscitation (CPR), Blood Borne Pathogens (BBP) as needed. In addition, Arcadis field sampling personnel will be knowledgeable in the relevant processes, procedures, and Technical Guidance Instructions (TGIs) and possess the demonstrated required skills and experience necessary to successfully complete the desired field work. The project HASP and other documents will identify other training requirements or access control requirements.

## 5 Equipment List

The equipment required for equipment decontamination is presented below. Note that certain contaminants may require specific materials be used that are not captured in this list. Always review project and contaminant specific TGIs or work plans to ensure proper equipment is utilized. Note for per- and polyfluoroalkyl substances (PFAS) see *TGI – Per- and Polyfluoroalkyl Substances (PFAS) Field Sampling Guide*.

- Health and safety equipment, including appropriate personal protective equipment (PPE), as required in the site HASP
- Deionized water that meets the analytical criteria for deionized water with no detectable constituents above the reporting limits for the methods to be used and analytes being analyzed for. Deionized water is used for inorganics, and organic-free water for volatile organic compounds (VOCs), semi-volatile organic compounds (SVOCs), pesticides, etc.
- Non-phosphate detergent such as Alconox® or, if sampling for phosphorus or phosphorus-containing compounds, Liquinox (or equivalent). NOTE: Liquinox has shown to provide false positives for 1,4-Dioxane and should not be used at sites where that may be a constituent of concern (COC).
- Tap water
- Rinsate collection plastic containers



- Department of Transportation (DOT)-approved waste shipping container(s), as specified in the work plan, field sampling plan, or regulatory requirements if decontamination waste is to be shipped for disposal
- Brushes
- Large heavy-duty garbage bags
- Spray bottles
- (Optional) – Isopropyl alcohol (free of ketones) or methanol. These can be wipes or diluted with water (usually 1part isopropyl/methanol to 10 parts water) if a spray is needed.
- Airtight, sealable plastic baggies, such as Ziploc®-type
- Plastic sheeting

## 6 Cautions

Rinse equipment thoroughly and allow the equipment to dry before re-use or storage to prevent introducing solvent into sample medium. If manual drying of equipment is required, use clean lint-free material to wipe the equipment dry. Ensure all rinse materials do not adversely affect sample collection efficiency or analytical results.

Store decontaminated equipment in a clean, dry environment. Do not store near combustion engine exhausts. Properly containerize equipment to ensure cross-contamination doesn't happen from other uncontaminated surfaces or equipment.

If equipment is damaged to the extent that decontamination is uncertain due to cracks, gouges, crevices, or dents, the equipment should not be used and should be discarded or submitted for repair prior to use for sample collection.

A proper shipping determination regarding hazardous materials will be performed by a DOT-trained individual for cleaning materials shipped by Arcadis.

Caution should be exercised to avoid contact with the pump casing and water in the container while the pump is running (do not use metal drums or garbage cans) to avoid electric shock.

## 7 Health and Safety Considerations

Review the safety data sheets (SDS) for the cleaning agents and materials used in decontamination. If solvent is used during decontamination, use appropriate PPE and work in a well-ventilated area and stand upwind while applying solvent to equipment. Apply solvent in a manner that minimizes potential for exposure to workers and bystanders. Follow health and safety procedures outlined in the HASP.

## 8 Procedure

A designated area will be established to clean sampling equipment in the field prior to and following sample collection. Equipment cleaning areas will be set up within or adjacent to the specific work area, but not at a location that expose equipment to contamination (i.e., exposed to combustion engine exhaust). Detergent solutions will be prepared in clean containers for use in equipment decontamination. Decontaminated equipment



will be handled by workers wearing clean gloves, properly changed to prevent cross-contamination. The procedures detailed in this section provide an overview of common decontamination techniques. Additional steps may be required based on the type of contaminant present or client/site requirements.

### **Cleaning Sampling Equipment**

1. Wash the equipment/pump with potable water.
2. Wash with detergent solution (Alconox®, Liquinox® or equivalent) to remove all visible particulate matter and any residual oils or grease. NOTE: Liquinox® has shown to provide false positives for 1,4-Dioxane and will not be used at sites where that may be a COC.
3. If equipment is very dirty, precleaning gross debris with a brush and tap water may be necessary.
4. If non-aqueous phase liquids are present, the use of isopropyl alcohol (free of ketones) or methanol is recommended. Cloth wipes or diluted solution can be used to remove the non-aqueous phase liquids that are hard to remove with detergent solution in step 2. Consult with project manager if non-aqueous phase liquids are present onsite and design an appropriate decontamination procedure that includes step 4.
5. Rinse with deionized water.

### **Decontaminating Submersible Pumps**

Submersible pumps may be used during well development, groundwater sampling, or other investigative activities. The pumps must be cleaned and flushed before and between uses. This cleaning process will consist of an external detergent solution wash and tap water rinse, a flush of detergent solution through the pump, followed by a flush of potable water through the pump. Flushing will be accomplished by using an appropriate container filled with detergent solution and another container filled with potable water. The pump will be flushed with deionized water as the last step prior to use. The pump will run long enough to effectively flush the pump housing and hose (unless new, disposable hose is used). Disconnect the pump from the power source before handling. The pump and hose will be placed on or in clean polyethylene sheeting to avoid contact with the ground surface.

## **9 Waste Management**

Equipment decontamination rinsate will be managed in conjunction with all other waste produced during the field sampling effort. Waste management procedures are outlined in the work plan or Waste Management Plan (WMP).

## **10 Data Recording and Management**

Digital data collection is the Arcadis standard using available FieldNow® applications that enable real-time, paperless data collection, entry, and automated reporting. Paper forms should only be used as backup to FieldNow® digital data collection and/or as necessary to collect data not captured by available FieldNow® applications. The Field Now® digital form applications follow a standardized approach, correlate to most TGIs and are available to all projects accessible with a PC or capable mobile device. Once the digital forms are saved within FieldNow®, the data is instantly available for review on a web interface. This facilitates review by project management team members and SMEs enabling error or anomalous data detection for correction while the staff



are still in the field. Continual improvements of FieldNow® applications are ongoing, and revisions are made as necessary in response to feedback from users and subject matter experts.

Equipment cleaning and decontamination will be noted during project documentation. Information will include the type of equipment cleaned, the decontamination location, specific procedures utilized, solvents and/or cleaning agents used, source of water, and deviations or omissions from this TGI.

Unusual field conditions should be noted if there is potential to impact the efficacy of the decontamination or subsequent sample collection.

An inventory of the solvents brought on site and used and removed from the site will be maintained in the project documentation. Records will be maintained for solvents used in decontamination, including lot number and expiration date.

Containers with decontamination fluids will be labeled.

## 11 Quality Assurance

Equipment blanks should be collected to verify that the decontamination procedures are effective in minimizing potential for cross contamination. The equipment blank is prepared by pouring deionized water (or organic-free water, for organic analyses) over the clean and dry tools and collecting the water into appropriate sample containers. Equipment blanks should be analyzed for the same set of parameters that are performed on the field samples collected with the equipment that was cleaned as specified in the sampling and analysis plan. Equipment blanks are collected per equipment set, which represents all the tools needed to collect a specific sample.

## 12 References

USEPA Region 9 - Field Sampling Guidance #1230, Sampling Equipment Decontamination.

USEPA Region 1 - Low Stress (low flow) Purging and Sampling Procedure for the Collection of Groundwater Samples from Monitoring Wells.



Arcadis U.S., Inc.  
630 Plaza Drive, Suite 200  
Highlands Ranch  
Colorado 80129  
Phone: 720 344 3500  
Fax: 720 344 3535  
[www.arcadis.com](http://www.arcadis.com)



# TGI - INVESTIGATION-DERIVED WASTE HANDLING AND STORAGE

Rev #: 1

Rev Date: May 15, 2020





## VERSION CONTROL

Revision No	Revision Date	Page No(s)	Description	Reviewed by
0	February 23, 2017	ALL	Conversion from SOP to TGI	Ryan Mattson / Peter Frederick
1	May 15, 2020	ALL	Updated to reflect regulatory changes	



## APPROVAL SIGNATURES

Prepared by:



---

Derrick Maurer

02/23/2017

---

Date:

Technical Expert Reviewed by:



---

Ryan Mattson (Technical Expert)

05/15/2020

---

Date:



## 1 INTRODUCTION

This document describes general and/or specific procedures, methods, actions, steps, and considerations to be used and observed by Arcadis staff when performing work, tasks, or actions under the scope and relevancy of this document. This document may describe expectations, requirements, guidance, recommendations, and/or instructions pertinent to the service, work task, or activity it covers.

It is the responsibility of the Arcadis Certified Project Manager (CPM) to provide this document to the persons conducting services that fall under the scope and purpose of this procedure, instruction, and/or guidance. The Arcadis CPM will also ensure that the persons conducting the work falling under this document are appropriately trained and familiar with its content. The persons conducting the work under this document are required to meet the minimum competency requirements outlined herein, and inquire to the CPM regarding any questions, misunderstanding, or discrepancy related to the work under this document.

This document is not considered to be all inclusive nor does it apply to any and all projects. It is the CPM's responsibility to determine the proper scope and personnel required for each project. There may be project- and/or client- and/or state-specific requirements that may be more or less stringent than what is described herein. The CPM is responsible for informing Arcadis and/or Subcontractor personnel of omissions and/or deviations from this document that may be required for the project. In turn, project staff are required to inform the CPM if or when there is a deviation or omission from work performed as compared to what is described herein.

In following this document to execute the scope of work for a project, it may be necessary for staff to make professional judgment decisions to meet the project's scope of work based upon site conditions, staffing expertise, state-specific requirements, health and safety concerns, etc. Staff are required to consult with the CPM when or if a deviation or omission from this document is required that has not already been previously approved by the CPM. Upon approval by the CPM, the staff can perform the deviation or omission as confirmed by the CPM.

## 2 SCOPE AND APPLICATION

The objective of this Technical Guidance Instruction (TGI) is to describe the procedures to manage investigation-derived wastes (IDW), both hazardous and nonhazardous, generated during site activities, which may include, but are not limited to: drilling, trenching/excavation, construction, demolition, monitoring well sampling, soil sampling, decontamination and remediation. For the purposes of this TGI, IDW is considered to be discarded materials which are defined as solid waste by United States Environmental Protection Agency (EPA) standard 40 CFR § 261.2 (which may include liquids, solids, or sludges). IDW may include soil, groundwater, drilling fluids, decontamination liquids, as well as contaminated personal protective equipment (PPE), sorbent materials, construction and demolition debris, and disposable sampling materials. Hazardous or uncharacterized IDW will be collected and staged at the point of generation. Quantities small enough to be containerized in 55-gallon drums will be taken to a designated temporary onsite storage area (discussed in further detail under Drum Storage) pending characterization and disposal. IDW materials will be characterized using process knowledge and appropriate laboratory analyses to determine the waste classification and evaluate proper safe handling and disposal methods.



This TGI describes the necessary equipment, field procedures, materials, regulatory references, and documentation procedures necessary for proper handling and storage of IDW up to the time it is properly transported from the project site and disposed. The procedures included in this TGI for handling and temporary storage of IDW are based on the EPA's guidance document *Guide to Management of Investigation Derived Wastes* (USEPA, 1992). IDW is assumed to be contaminated with the site constituents of concern (COCs) until analytical evidence indicates otherwise. IDW will be managed to ensure the protection of human health and the environment and will comply with all applicable or relevant and appropriate requirements (ARAR). Although not comprehensive, the following laws and regulations on Hazardous Waste Management should be considered as potential ARAR. It is the Arcadis Certified Project Manager (CPM) and/or designated Technical Expert to determine which laws and regulations, at all levels of government, are applicable to each project site and activity falling under this TGI.

#### Federal Laws and Regulations

- Resource Conservation and Recovery Act (RCRA) 42 USC § 6901-6987.
- Federal Hazardous Waste Regulations 40 CFR § 260-265

Department of Transportation (DOT) Hazardous Materials Transportation 49 CFR

Occupational Safety and Health Administration (OSHA) Regulations 29 CFR

#### State Laws and Regulations

- To be determined based on location of site and location of treatment, storage, and/or disposal facility (TSDF) to be utilized.

Regional, County, Municipal, and Local Regulations

- To be determined based on location of site and location of treatment, storage, and/or disposal facility (TSDF) to be utilized.

#### **Initial Storage**

Pending characterization, IDW will be temporarily stored appropriately within each area of contamination (AOC). Under RCRA, "storage" is defined as the "holding of hazardous waste for a temporary period, at the end of which the hazardous waste is treated, disposed of, or stored elsewhere" (40 CFR § 260.10). The onsite waste staging area will be in a secure and controlled area. Uncharacterized wastes are considered potentially hazardous wastes and must be stored in DOT approved packaging. Liquid wastes must be stored in DOT approved closed head drums or other approved containers (e.g., portable tank containers) that are compatible with the type of material stored therein. Solid materials must be stored in DOT approved open head drums where practicable. Larger quantities of solid IDW can be containerized in bulk containers (such as in a roll-off box). Soil from large excavation projects may be managed in stockpiles with within the AOC and does not need to be containerized until exiting the AOC.

#### **Characterization**

Waste characterization can either be based on generator knowledge, such as using historical process knowledge and safety data sheets (SDS), or can be based upon characterization sampling analytical results. IDW typically is not characterized using SDS as it is a mixture of aged chemicals and environmental media. Historical process knowledge should be used to determine if the IDW is a listed hazardous waste (40 CFR § 261.31-33). If the IDW is not a listed hazardous waste, waste



characterization can be completed by laboratory analysis of representative samples of the IDW. The laboratory used for waste characterization analysis must have the appropriate state and federal accreditations and may be required to be pre-approved by the Client. IDW will be classified as RCRA hazardous or non-regulated under RCRA based on the waste characterization determination.

If IDW is characterized as RCRA hazardous waste, RCRA and DOT requirements must be followed for packaging, labeling, transporting, storing, and record keeping as described in 40 CFR § 262 and 49 CFR § 171-178. Waste material classified as RCRA nonhazardous may be handled and disposed of as nonhazardous waste in accordance with applicable federal, state, and local regulations.

### **Storage Time Limitations**

Containerized hazardous wastes can be temporarily stored for a maximum of 90 calendar days from the accumulation start date for a large quantity generator or a maximum of 180 calendar days from the accumulation start date for a small quantity generator. Wastes classified as nonhazardous may be handled and disposed of as nonhazardous waste and are not subject to storage time limitations.

This TGI may be modified by the CPM and/or Technical Expert for a specific project or client program, as required, dependent upon client requirements, site conditions, equipment limitations, or limitations imposed by the procedure. The resulting procedure employed to execute the work will be documented in the project work plans or reports. If changes to the sampling procedures are required due to unanticipated field conditions, the changes will be discussed with the CPM and/or Technical Expert as soon as practicable, and if approved to be performed, be documented.

## **3 PERSONNEL QUALIFICATIONS**

Arcadis field sampling personnel will have current regulatory- and Arcadis-required health and safety training including 40-hour HAZWOPER training, site supervisor training, site-specific training, first aid, and cardiopulmonary resuscitation (CPR), as needed. Personnel handling and packaging hazardous waste and performing hazardous waste characterizations must have RCRA hazardous waste management training per 40 CFR § 264.16. Additional state-specific hazardous waste management training is required in certain states (i.e., California).

Although not common practice, in certain situations Arcadis personnel may sign waste profiles and/or waste manifests on a case by case basis for clients, provided the appropriate agreement is in place between Arcadis and the client documenting that Arcadis is not the generator, but is acting as an authorized representative of the generator. Arcadis personnel who sign waste profiles and/or waste manifests will have both current RCRA hazardous waste management training per 40 CFR § 264.16 and current DOT hazardous materials transportation training per 49 CFR § 172.704. Arcadis field personnel will also comply with client-specific training. In addition, Arcadis field sampling personnel will be knowledgeable in the relevant processes, procedures, and Technical Guidance Instructions (TGIs) and possess the demonstrated required skills and experience necessary to successfully complete the desired field work. The project health and safety plan (HASP) and other documents will identify other training requirements or access control requirements.



## 4 EQUIPMENT LIST

The Following Materials, as required, will be available for IDW handling and Storage:

- Appropriate personal protective equipment as specified in the Site Health and Safety Plan (HASP)
- DOT approved containers
- Hammer
- Leather gloves
- Drum dolly
- Appropriate drum labels (outdoor waterproof self-adhesive)
- Portable tank container
- Appropriate labeling, packing, chain-of-custody forms, and shipping materials as determined by the CPM and/or Technical Expert.
- Indelible ink and/or permanent marking pens
- Plastic sheeting
- Appropriate sample containers, labels, and forms
- Stainless-steel bucket auger
- Stainless steel spatula or knife
- Stainless steel hand spade
- Stainless steel scoop
- Digital camera
- Field logbook

## 5 CAUTIONS

Filled drums can be very heavy, become unbalanced, or spill its contents. Therefore, use appropriate moving techniques and equipment for safe handling. Similar media (e.g. soils with other soils; or liquids with other liquids) will be stored in the same drums to aid in sample analysis and disposal. Drum lids must be secured to prevent rainwater from entering the drums and leakage during movement. Drums containing solid material may not contain any free liquids. Waste containers stored for extended periods of time may be subject to deterioration. Drum Over Packs may be used as secondary containment. All drums must be visually inspected for condition to ensure that they are in good condition without visible evidence of rusting, holes, breakage, etc., to prevent potential leakage and facilitate subsequent disposal. All drum lids must be verified as having a properly functioning secured lid prior to use.

## 6 HEALTH AND SAFETY CONSIDERATIONS

As determined by the site's known and suspected hazards, appropriate PPE must be worn by all field personnel within the designated work area. Exposure air monitoring may be required during certain field activities as required in the Site Health and Safety Plan. If soil excavation in areas with potentially hazardous contaminants is possible, contingency plans will be developed to address the potential for encountering gross contamination or non-aqueous phase liquids. All excavation activities shall be in compliance with OSHA standard 29 CFR 1926.651 Excavations, and any other applicable regulations.



Arcadis field personnel and subcontractors will be trained in and perform their work in compliance with all applicable federal, state, and local health and safety regulations as well as Arcadis' HASP and applicable Client health and safety requirements.

## 7 PROCEDURE

Specific waste temporary storage and handling procedures to be used are dependent upon the type of generated waste, including type of media (e.g. soils or free liquids) and constituents of concern. For this reason, IDW can be stored in a secure location onsite in separate 55-gallon storage drums, where solids can be stockpiled onsite (if nonhazardous) and purge water may be stored in portable tank containers. Waste materials such as broken sample bottles or equipment containers and wrappings will be stored in 55-gallon drums unless they were not in contact with sample media.

### Management of IDW

Minimization of IDW should be considered by the project team during all phases of the project. Site managers may want to consider techniques such as replacing solvent based cleaners with aqueous-based cleaners for decontamination of equipment, reuse of equipment (where it can be properly decontaminated), limitation of traffic between exclusion and support zones, and drilling methods and sampling techniques that minimize the generation of waste. Alternative drilling and subsurface sampling methods may include the use of small diameter boreholes, as well as borehole testing methods such as a core penetrometer or direct push technique instead of coring.

### Drum Storage

Drums containing hazardous waste will be stored in accordance with the requirements of 40 CFR 265 Subpart I (for containers) and 265 Subpart DD (for containment buildings). All 55-gallon drums will be stored at a secure, centralized onsite location that is readily accessible for vehicular pick-up. Drums confirmed as, or assumed to contain hazardous waste will be stored over an impervious surface provided with secondary spill containment. The storage location will, for drums containing liquid, have a containment system that can contain at least the larger of 10% of the aggregate volume of staged materials or 100% of the volume of the largest container. Drums will be closed during storage and be in good condition in accordance with the Guide to Management of Investigation-Derived Wastes (USEPA, 1992).

### Hazardous Waste Determination

Waste material must be characterized to determine if it meets any of the federal definitions of hazardous waste as required by 40 CFR § 262.11. If the waste does not meet any of the federal definitions, it must then be established if any state-specific or local-specific hazardous waste criteria exist/apply.

### Generator Status

Once hazardous waste determination has been made, the generator status will be determined. Large quantity generators (LQG) are generators who generate more than 1,000 kilograms of hazardous waste in a calendar month. Small quantity generators (SQG) of hazardous waste are generators who generate greater than 100 kilograms but less than 1,000 kilograms of hazardous waste in a calendar month. Very small quantity generators (VSQG) are generators who generate less than 100 kilograms of hazardous



waste per month. Please note that a generator status may change from month to month and that a notice of this change is usually required by the generator's state agency.

### **Accumulation Time for Hazardous Waste**

A LQG may accumulate hazardous waste on site for 90 calendar days or less without a permit and without having interim status, provided that such accumulation is in compliance with requirements in 40 CFR § 262.17. A SQG may accumulate hazardous waste on site for 180 calendar days or less without a permit or without having interim status, subject to the requirements of 40 CFR § 262.16. VSQG requirements are found in 40 CFR § 262.14. NOTE: The federal VSQG and SQG provisions may not be recognized by some states (e.g., California and Rhode Island). State-specific and local-specific regulations must be reviewed and understood prior to the generation of hazardous waste.

**Satellite Accumulation of Hazardous Waste** Satellite accumulation (SAA) will mean the accumulation of as much as fifty-five (55) gallons of hazardous waste, or the accumulation of as much as one quart of acutely hazardous waste, in containers at or near any point of generation where the waste initially accumulates, which is under the control of the operator of the process generating the waste, without a permit or interim status and without complying with the requirements of 40 CFR § 262.15 and without any storage time limit, provided that the generator complies with 40 CFR § 262.15.

Once more than 55 gallons of hazardous waste accumulates in SAA, the generator has three days to move this waste into storage.

Storage recommendations for hazardous waste include:

- Ignitable or reactive hazardous wastes must be >50 feet from the property line per 40 CFR § 265.176 (LQG generators only).
- Hazardous waste should be stored on a concrete slab (asphalt is acceptable if there are no free liquids in the waste).
- Drainage must be directed away from the accumulation area.
- Area must be properly vented.
- Area must be secure.

### **Drum/Container Labeling**

Drums will be labeled on both the side and lid of the drum using a permanent marking pen. Old drum labels must be removed to the extent possible, descriptions crossed out should any information remain, and new labels affixed on top of the old labels. Other containers used to store various types of waste (e.g., polyethylene tanks, roll-off boxes, end-dump trailers, etc.) will be labeled with an appropriate "Waste Container" or "Testing in Progress" label pending characterization. Drums and containers will be labeled as follows:

- Appropriate waste characterization label (Pending Analysis, Hazardous, or Nonhazardous)
- Waste generator's name (e.g., client name)
- Project Name
- Name and telephone number of Arcadis project manager
- Composition of contents (e.g., used oil, acetone 40%, toluene 60%)
- Media (e.g., solid, liquid)
- Accumulation start date



- Drum number of total drums as reconciled with the Drum Inventory maintained in the field log book.

IDW containers will remain closed except when adding or removing waste. Immediately upon beginning to place waste into the drum/container, a "Waste Container" or "Pending Analysis" label will be filled out to include the information specified above, and affixed to the container. Once the contents of the container are identified as either non-hazardous or hazardous, the following additional labels will be applied.

- Containers with waste determined to be non-hazardous will be labeled with a green and white "Nonhazardous Waste" label over the "Waste Container" label.
- Containers with waste determined to be hazardous will be stored in an onsite storage area and will be labeled with the "Hazardous Waste" label and affixed over the "Waste Container" label.

The ACCUMULATION DATE for the hazardous waste is the date the waste is first placed in the container and is the same date as the date on the "Waste Container" label. DOT hazardous class labels must be applied to all hazardous waste containers for shipment offsite to an approved disposal or recycling facility. In addition, a DOT proper shipping name will be included on the hazardous waste label. The transporter should be equipped with the appropriate DOT placards. However, placarding or offering placards to the initial transporter is the responsibility of the generator per 40 CFR § 262.33.

### **Inspections and Documentation**

All IDW will be documented as generated on a Drum Inventory Log maintained in the field log book. The Drum Inventory will record the generation date, type, quantity, matrix and origin (e.g., Boring-1, Test Pit 3, etc.) of materials in every drum, as well as a unique identification number for each drum. The drum inventory will be used during drum pickup to assist with labeling of drums. The drum storage area and any other areas of temporarily staged waste, such as soil/debris piles, will be inspected weekly. The weekly inspections will be recorded in the field notebook or on a Weekly Inspection Log. Digital photographs will be taken upon the initial generation and drumming/staging of waste, and final labeling after characterization to document compliance with labeling and storage protocols, and condition of the container. Evidence of damage, tampering or other discrepancy should be documented photographically.

### **Emergency Response and Notifications**

Specific procedures for responding to site emergencies will be detailed in the HASP. If the generator is designated as a LQG, a Contingency Plan will need to be prepared to include emergency response and notification procedures per 40 CFR § 265 Subpart D. In the event of a fire, explosion, or other release which could threaten human health outside of the site or when Client or Arcadis has knowledge of a spill that has reached surface water, Client or Arcadis must immediately notify the National Response Center (800-424-8802) in accordance with 40 CFR § 262.265. Other notifications to state and/or other local regulatory agencies may also be necessary.

### **Drilling Soil Cuttings and Muds**

Soil cuttings are solid to semi-solid soils generated during trenching activities, subsurface soil sampling, or installation of monitoring wells. Depending on the drilling method, drilling fluids known as "muds" may be used to remove soil cuttings. Drilling fluids flushed from the borehole must be directed into a settling section of a mud pit. This allows reuse of the decanted fluids after removal of the settled sediments. Soil cuttings will be labeled and stored in 55-gallon drums with bolt-sealed lids.



### **Excavated Solids**

Excavated solids may include, but are not limited to: soil, fill, and construction and demolition debris. Prior to permitted treatment or offsite disposal, potentially hazardous excavated solids may be temporarily stockpiled onsite as long as the stockpile remains in the same AOC from where it was excavated. Potentially hazardous excavated solids removed from the AOC must be immediately containerized in labeled drums or closable top roll-offs lined with 9-mil polyvinyl chloride (PVC) sheeting and are subject to LQG storage time limits. Nonhazardous excavated solids can be stockpiled either inside or outside of the AOC, do not have to be containerized and are not subject to hazardous waste regulations. Potentially hazardous excavated solids must not be mixed with nonhazardous excavated solids. All classes of excavated solid stockpiles should be maintained in a secure area onsite. At a minimum, the floor of the stockpile area will be covered with a 20-mil high density polyethylene liner that is supported by a foundation or at least a 60-mil high density polyethylene liner that is not supported by a foundation. The excavated material will not contain free liquids. The owner/operator will provide controls for windblown dispersion, run-on control, and precipitation runoff. The run-on control system will prevent flow onto the active portion of the pile during peak discharge from at least a 25-year storm and the run-off management system will collect and control at least the water volume resulting from a 24-hour, 25-year storm (USEPA, 1992). Additionally, the stockpile area will be inspected on a weekly basis and after storm events. Individual states may require that the stockpile be inspected/certified by a licensed professional engineer. Stockpiled material will be covered with a 6-mil polyvinyl chloride (PVC) liner or sprayed dust control product. The stockpile cover will be secured in place with appropriate material (concrete blocks, weights, etc.) to prevent the movement of the cover.

### **Decontamination Solutions**

Decontamination solutions are generated during the decontamination of personal protective equipment and sampling equipment. Decontamination solutions may range from detergents, organic solvents and acids used to decontaminate small field sampling equipment to steam cleaning rinsate used to wash heavy field equipment. These solutions are to be labeled and stored in closed head drums compatible with the decontamination solution. Decontamination procedures, including personnel and field sampling equipment, must comply with applicable Arcadis procedural documents.

### **Disposable Equipment**

Disposable equipment includes personal protective equipment (e.g., tyvek coveralls, gloves, booties and APR cartridges) and disposable sampling equipment such as trowels or disposable bailers. If the media sampled exhibits hazardous characteristics per results of waste characterization sampling, contaminated disposable equipment will also be disposed of as a hazardous waste. If compatible with the original IDW waste stream (i.e., the IDW is a solid and the disposal equipment is a solid), the disposable equipment can be combined with the IDW. If these materials are not compatible (i.e., the IDW is a liquid and the disposal equipment is a solid), the disposable equipment will be stored onsite in separate labeled 55-gallon drums. Uncontaminated or decontaminated disposable equipment can be considered nonhazardous waste.

### **Purge Water**

Purge water includes groundwater generated during well development, groundwater sampling, or aquifer testing. The volume of groundwater generated will dictate the appropriate storage procedure. Monitoring



well development and groundwater sampling may generate three well volumes of groundwater or more. This volume will be stored in labeled 55-gallon drums. Aquifer tests may generate significantly greater volumes of groundwater depending on the well yield and the duration of the test. Therefore, large-volume portable polyethylene tanks will be considered for temporary storage pending groundwater-waste characterization.

### **Purged Water Storage Tank Decontamination and Removal**

The following procedures will be used for inspection, cleaning, and offsite removal of storage tanks used for temporary storage of purge water. These procedures are intended to be used for rented portable tanks such as Baker Tanks or Rain for Rent containers. Storage tanks will be made of inert plastic materials. The major steps for preparing a rented tank for return to a vendor include characterizing the purge water, disposing of the purge water, decontaminating the tank, final tank inspection, and mobilization. Decontamination and inspection procedures are described in further detail below.

- **Tank Cleaning:** Most vendors require that tanks be free of any visible sediment and water before returning, a professional cleaning service may be required. Each specific vendor should be consulted concerning specific requirements for returning tanks.
- **Tank Inspection:** After emptying the tank, purged water storage tanks should be inspected for debris, chemical staining, and physical damage. The vendors require that tanks be returned in the original condition (i.e., free of sediment, staining and no physical damage).

## **8 WASTE MANAGEMENT**

### **Soil/Solids Characterization**

Waste characterization will be conducted in accordance with waste hauler, waste handling facility, and local/state/federal requirements. In general, RCRA hazardous wastes are those solid wastes determined by a Toxicity Characteristic Leaching Procedure (TCLP) test or to contain levels of certain toxic metals, pesticides, or other organic chemicals above specific applicable regulatory agency thresholds. If the one or more of 40 toxic compounds listed in Table I of 40 CFR § 261.24 are detected in the sample at levels above the maximum unregulated concentrations, the waste must be characterized as a toxic hazardous waste. Wastes can also be considered “listed” hazardous waste depending on site-specific processes.

Composite soil samples will be collected at a frequency of one sample per 250 cubic yard basis for stockpiled soil or one per 55-gallon drum per different waste stream for containerized. A four-point composite sample will be collected per 250 cubic yards of stockpiled material and for each drum waste stream. Sample and composite frequencies may be adjusted in accordance with the waste handling facility’s requirements and may be reduced for large volumes of waste with consistent properties. Waste characterization samples will be considered valid for consistent waste streams for a period of 1 year. Waste characterization samples may be analyzed for the TCLP volatile organic compounds (VOCs), TCLP semi-volatile organic compounds (SVOCs), TCLP RCRA metals, and polychlorinated biphenyls (PCBs), as well as reactivity and flammability (flashpoint). Additional samples may be collected and analyzed by the laboratory on a contingency basis. Site-specific constituents of concern including pesticides may require additional sampling. Please note that state- or local-specific regulations may require a different or additional sampling approaches.



### **Wastewater Characterization**

Waste characterization will be conducted in accordance with the requirements of the waste hauler, waste handling facility, and local/state/federal governments. In general, purge water should be analyzed by methods appropriate for the known contaminants, if any, that have been historically detected in the monitoring wells. Samples will be collected and analyzed in accordance with the requirements of the waste disposal facility. Wastewater characterization samples may be analyzed for TCLP volatile organic compounds (VOCs), TCLP semi-volatile organic compounds (SVOCs), TCLP RCRA metals, and polychlorinated biphenyls, as well as corrosivity (pH), reactivity and flammability (flashpoint). Additional samples may be collected and analyzed by the laboratory on a contingency basis. Site-specific constituents of concern including pesticides may require additional sampling. Please note that state- and/or local-specific regulations may require different or additional sampling approaches.

### **Sample Handling and Shipping**

All samples will be appropriately labeled, packed, and shipped, and the chain-of-custody will be filled out in accordance with current Arcadis sample chain of custody, handling, packing, and shipping procedures and guidance instructions.

It should be noted that additional training is required for packaging and shipping of hazardous and/or dangerous materials. Please refer to the current Arcadis training requirements related to handling and shipping of samples, shipping determinations, and hazardous materials.

### **Preparing Waste Shipment Documentation (Hazardous and Nonhazardous)**

Waste profiles will be prepared by the Arcadis CPM and forwarded, along with laboratory analytical data to the Client for approval/signature. The Client will then return the profile to Arcadis who will then forward to the waste removal contractor for preparation of a manifest. The manifest will be reviewed by Arcadis prior to forwarding to the Client for approval. Upon approval of the manifest, the Client will return the original signed manifest directly to the waste contractor or to the Arcadis CPM for forwarding to the waste contractor. Arcadis personnel may sign waste profiles and/or waste manifests on a case by case basis for clients, provided the appropriate agreement is in place between Arcadis and the client documenting that Arcadis is not the generator, but is acting as an authorized representative of the generator.

Final drum labeling and pickup will be supervised by an Arcadis representative who is trained and experienced with applicable waste labeling procedures. The Arcadis representative will have a copy of the drum inventory maintained in the field book and will reconcile the drum inventory with the profile numbers on the labels and on the manifest. Different profile numbers will be generated for different matrices or materials in the drums. For example, the profile number for drill cuttings will be different than the profile number for purge water. When there are multiple profiles it is critical that the proper label, with the profile number appropriate to a specific material be affixed to the proper drums. A copy of the Arcadis drum inventory will be provided to the waste transporter during drum pickup and to the facility receiving the waste.



## **9 DATA RECORDING AND MANAGEMENT**

Waste characterization sample handling, packing, and shipping procedures will be documented in accordance with relevant Arcadis procedures and guidance instructions as well as applicable client and/or project requirements, such as a Quality Assurance Project Plan or Sampling and Analysis Plan. Copies of the chain-of-custody forms will be maintained in the project file. Arcadis should photograph or maintain a copy of any hazardous waste manifest signed on behalf of Client in the corresponding office DOT record file.

## **10 QUALITY ASSURANCE**

The CPM or APM will review all field documentation once per week for errors or omissions as compared to applicable project requirements including but not limited to: the proposal/scope of work, QAPP, SAP, HASP, etc. Deficiencies will be noted, tracked, and resolved. Upon correction, they will be noted for project documentation.

## **11 REFERENCES**

United States Environmental Protection Agency (USEPA). 1992. Guide to Management of Investigation-Derived Wastes. Office of Remedial and Emergency Response. Hazardous Site Control Division. January 1992.







# TGI – Sample Chain of Custody

Rev: 3

Rev Date: March 28, 2022



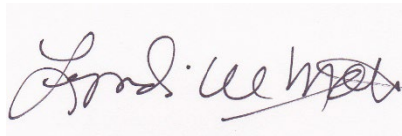
## Version Control

Issue	Revision No.	Date Issued	Page No.	Description	Reviewed By
	0	April 19, 2017	All	Re-write to COC only	Richard Murphy
	1	May 23, 2017	4,7,9	Add: Guidance on use of previous version of TGI. Add: Info on COCs for multiple shipping containers Modify: Move letter i. to letter m. and change to “when appropriate”	Peter Frederick
	2	April 29, 2020	4, 11	Remove obsolete link	Lyndi Mott
	3	December 28, 2022	All	Updated Arcadis format Added to 6c. Collection time between COC and container must match. Added to 6o. Add name of overnight courier when relinquishing samples. Updated reference documents and added internet links.	Lyndi Mott



## Approval Signatures

Prepared by:



3/28/2022

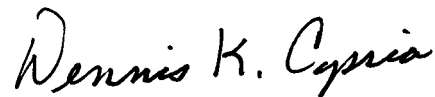
---

Lyndi Mott (Preparer)

---

Date

Reviewed by:



3/28/2022

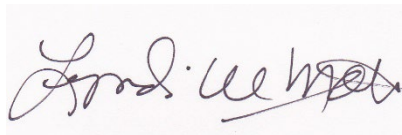
---

Dennis Capria (Chain of Custody Reviewer)

---

Date

Reviewed by:



12/22/2021

---

Lyndi Mott (Subject Matter Expert)

---

Date



## 1 Introduction

This Technical Guidance Instruction (TGI) provides the procedure for Arcadis field personnel for required documentation during the collection of environmental field samples and transfer of custody to a laboratory. It provides direction for completion of the Chain of Custody form that must accompany collected field samples for analysis by a laboratory.

## 2 Intended Use and Responsibilities

This document describes general and/or specific procedures, methods, actions, steps, and considerations to be used and observed by Arcadis staff when performing work, tasks, or actions under the scope and relevancy of this document. This document may describe expectations, requirements, guidance, recommendations, and/or instructions pertinent to the service, work task, or activity it covers.

It is the responsibility of the Arcadis Certified Project Manager (CPM) to provide this document to the persons conducting services that fall under the scope and purpose of this procedure, instruction, and/or guidance. The Arcadis CPM will also ensure that the persons conducting the work falling under this document are appropriately trained and familiar with its content. The persons conducting the work under this document are required to meet the minimum competency requirements outlined herein, and inquire to the CPM regarding any questions, misunderstanding, or discrepancy related to the work under this document.

This document is not considered to be all inclusive nor does it apply to all projects. It is the CPM's responsibility to determine the proper scope and personnel required for each project. There may be project- and/or client- and/or state-specific requirements that may be more or less stringent than what is described herein. The CPM is responsible for informing Arcadis and/or Subcontractor personnel of omissions and/or deviations from this document that may be required for the project. In turn, project staff are required to inform the CPM if or when there is a deviation or omission from work performed as compared to what is described herein.

In following this document to execute the scope of work for a project, it may be necessary for staff to make professional judgment decisions to meet the project's scope of work based upon site conditions, staffing expertise, regulation-specific requirements, health and safety concerns, etc. Staff are required to consult with the CPM when or if a deviation or omission from this document is required that has not already been previously approved by the CPM. Upon approval by the CPM, the staff can perform the deviation or omission as confirmed by the CPM.

## 3 Scope and Application

This TGI describes the general Chain of Custody (COC) procedures and guidance instructions for samples collected from project sites that are relinquished from Arcadis' possession.

COC is defined as the maintenance of an unbroken record of possession of an item from the time of its collection through some analytical or testing procedure. COC is typically documented by a written record of the collection, possession, and handling of samples collected from a project location. Each sample will be tracked by a documented record that efficiently documents the individuals who were responsible for the sample during each successive transfer of that sample to various recipients beyond Arcadis' possession. This information can be used to legally establish the integrity of the samples and therefore the analytical results derived from the samples. This



information can be used in addition to other records and documentation regarding the samples, such as field forms, field logs, and photographs.

A sample is considered under custody if:

- It is in your possession; or
- It is in your view, after being in your possession; or
- It was in your possession and then you then locked it up to prevent tampering; or
- It is in a designated secure area.

Continued use of previous version of TGI:

Although not recommended, Arcadis program-, project-, and client-teams may be able to use the previous version of this TGI provided that it meets all of the quality expectations of Arcadis and client and meets applicable regulatory requirements. It is up to the program, project, and/or client-team leader to determine whether it is appropriate to adopt the current TGI or to continue using the previous version.

However, all new work not associated with the previous version of this TGI must be performed with the current version of the TGI.

When adopting this new TGI, users of the previous versions must be aware that specific handling, packing, and shipping procedures and guidance has been removed and that those should be addressed within program or project plans (e.g., Quality Assurance Project Plans (QAPP), Work Plans, Sampling and Analysis Plans (SAPs), etc.) or in a more detailed TGI specific to that sampling activity, whether related to media, constituent/analyte, client, state, etc.

In addition, adopting this new TGI will require users to refer to the Arcadis Department of Transportation (DOT) Safety Program for procedures and guidance on the determination and handling, packing, and shipping of samples that are or may be considered hazardous materials.

## 4 Personnel Qualifications

Arcadis personnel performing work under the purview of this TGI will have received appropriate training and have field experience regarding the collection of samples from project locations. Arcadis personnel will have all other applicable and appropriate training relevant to the sampling work and project site.

## 5 Equipment List

The following list provides materials that may be required for each COC. Project reporting and documentation requirements must be reviewed with the CPM prior to execution of work. Additional materials, tools, equipment, etc. may be required, and project staff are required to verify with the CPM and/or Technical Expert what specific equipment is required to complete the COC.

- Indelible ink pen (preferably either black or blue ink);
- COC form (**Appendix A**) from either Arcadis, laboratory receiving and analyzing the samples, or other applicable and appropriate entity for the work performed;
- When appropriate, such as for litigation or expert testimony work, custody seals or tape.



## 6 Cautions

One way in which the law tries to ensure the integrity of evidence is by requiring proof of the chain of custody by the party who is seeking to introduce a particular piece of evidence.

A proper chain of custody requires three types of affirmations: (1) affirmation that a sample is what it purports to be (for example, soil collected from a specified location and depth); (2) affirmation of continuous possession by each individual who has had possession of the sample from the time it is collected until the time it is analyzed or held by a laboratory; and (3) affirmation by each person who has had possession that sample remained in substantially the same condition and not contaminated or affected by outside influences from the moment one person took possession until the moment that person released the evidence into the custody of another (for example, affirmation that the sample was stored in a secure location where no one but the person in custody had access to it).

Proving chain of custody is necessary to "lay a foundation" for the samples in question, by showing the absence of alteration, substitution, or change of condition.

Ensure that appropriate sample containers with applicable preservatives, coolers, and packing material are planned for and provided at the site at the time of sample collection.

Understand the offsite transfer requirements of the samples for the facility at which samples are collected.

If overnight courier service is required schedule pick-up or know where the drop-off service center is located and the hours of operation.

**An Arcadis employee appropriately trained at the correct level of internal hazardous materials/DOT)shipping must complete an Arcadis shipping determination to address applicable DOT and International Air Transport Association (IATA) shipping requirements.** Review the applicable Arcadis procedures and guidance instructions for sample packaging, and labeling. Prior to using air transportation, confirm air shipment is acceptable under DOT and IATA regulations.

The person relinquishing possession of the samples or other member of the project team should contact the final recipient of the samples to confirm receipt and review any special provisions on the COC or questions that they may have.

## 7 Health and Safety Considerations

Follow the health and safety procedures outlined in the project/site Health and Safety Plan (HASP) as well as other applicable H&S requirements, such as:

- Arcadis Hazardous Material/DOT handling, packaging, and shipping training
- Project site-specific H&S training
- Client-specific H&S training
- Constituent-specific H&S training
- Media-specific H&S training



## 8 Procedure

Collected samples must be uniquely identified, and properly documented, containerized, labeled with unique identifier, possessed in a secure manner during remainder of sampling event, packaged, and shipped to recipient laboratory.

### Sample Identification

The method of sample identification depends on the type of measurement or analyses performed. In some cases, in-situ measurements of existing conditions and/or sample location must be made during sample collection.

These data will be recorded directly on field forms, logbooks, or other project record data sheets used to permanently retain this information for the project file. Examples of location identification information includes: latitude/longitudinal measurements, compass directions, well number, building number, floor number, room name, or proximity to a site feature unique to the site. Examples of in-situ measurements are pH, temperature, conductivity, flow measurement, or physical condition of the media being sampled. Physical samples collected are identified by a unique identifying number or code on a sample tag or label. These physical samples are removed from the sample location and transported to a laboratory for analyses.

In some cases, before samples are placed into individual containers and labeled as individual samples, samples may be separated into portions depending upon the analytical methods and required duplicate or triplicate analyses to be performed.

When completing a COC for samples, personnel must complete the following:

1. Written COCs must be completed with indelible ink (preferably either black or blue colored ink).
2. Written COCs must be completed using legible printed writing, and not cursive writing.
3. All entry fields on the COC form must be completed. If information is not applicable for a specific entry field, personnel will either put "N/A" or use a strike-out line or dash like "-----" to indicate no applicable information is needed for that field.
4. Use of quotation marks or lines/down arrows to represent repetitive/duplicative text in similar fields.
5. Regardless of the type or specific COC form, the following pertinent information must be provided on the COC form:
  - a. Arcadis project number
  - b. Arcadis project name
  - c. Project location, including street address, city, state, building number, providing as much detail as appropriate
  - d. Recipient laboratory contact and sample receiving shipping location information
  - e. Entities'/persons' contact information for who will be receiving analytical results
  - f. Name of sampler, i.e., person collecting sample and relinquishing possession of samples to the next entity in the chain of custody
  - g. Date of sample collection
  - h. If appropriate for the sample media, contaminant/constituent of concern, or analytical method, document time of sample collection using standard military time
  - i. Sample analytical method(s)



- j. Turnaround time required for analyses and/or reporting
- k. Instructions to laboratory regarding handling, timing, analyses, etc. as applicable and appropriate.
- l. Printed name and signature of the individual person who collected the samples and relinquishing possession of the samples
- m. If appropriate or when documentation of the specific sample collection method will influence how the laboratory handles, prepares, or analyzes the samples, document the sample collection methodology used for collecting the samples (e.g., ASTM D5755)

6. The following additional specific information will be entered on the COC form, regardless of what type of COC is being used:

- a. Unique Sample Identifier – The sample identifier (ID) must be unique to the individual sample it is applied to. The information in which the sample ID conveys is determined by the CPM, Technical Expert, and/or other project team members in advance of sample collection so that sample identification is consistently applied for the project. The sample nomenclature may be dictated by a specific client, program, or project database and require unique identification for each sample collected for the project. Consult with the CPM and/or Technical Expert for additional information regarding sample identification.

The sample ID could convey specific information regarding the sample to aid personnel in recognizing what the sample represents, or they may be arbitrary so as to facilitate the anonymity of the sample location, media, constituent of concern, project site, etc.

Examples of unique identifiers include:

- 1. Well locations, grid points, or soil boring identification numbers (e.g., MW-3, X-20, SB-30). When the depth interval is included, the complete sample ID would be “SB-30 (0.5-1.0) where the depth interval is in feet. Please note it is very important that the use of hyphens in sample names and depth units (i.e., feet or inches) remain consistent for all samples entered on the chain of custody form. DO NOT use the apostrophe or quotes in the sample ID.
  - 2. Sample names may also use the abbreviations “FB,” “TB,” “FD” and “DUP” as prefixes or suffixes to indicate that the sample is a field blank, trip blank, or field duplicate, respectively.
- b. List the date of sample collection. All indicated dates must be formatted using either mm/dd/yy (e.g., 03/07/09) or mm/dd/yyyy (e.g., 03/07/2009).
  - c. List the local time that the sample was collected. The time value should be presented using military format. For example, 3:15 P.M. should be entered as 15:15. The time listed on the COC form must match the sample collection time on the sample container(s).
  - d. Samples should be indicated to be either “Grab” or “Composite”. Grab samples are collected from only one unique location at one specific point in time.
  - e. Composite samples are a group of individual samples that are combined for analysis in their totality. Composite samples need to be documented if they are either collected from a number of different locations over a broader area to be representative of the entire area being sampled, or if they are representative of a single location over an extended period of time.



- f. If used, preservatives for the individual sample will be noted.
  - g. The requested analytical method(s) that the samples are being analyzed for must be indicated. As much detail, as necessary, should be presented to allow the analytical laboratory to properly analyze the samples. For example, polychlorinated biphenyl (PCB) analyses may be represented by entering “EPA Method 8082 – PCBs” or “EPA PLM 600-R93-116.” In cases where multiple analytical methods and/or analytical parameters are required for an individual sample, each method should be indicated for the sample (e.g., EPA 8082/8260/8270 or EPA PLM/400-point count).
  - h. If there are project-specific sample analytes to be reported, they should be specifically listed for each individual sample (e.g., 40 CFR 264 Appendix IX).
  - i. The total number of containers for each analytical method requested should be documented. This information may be included under the parameter or as a total for the sample.
  - j. When necessary, note which samples should be used for site specific matrix spikes in the Remarks or Comments field.
  - k. Indicate special project-specific requirements pertinent to the handling, shipping, or analyses. These requirements may be on a per sample basis such as “extract and hold sample until notified,” or may be used to inform the laboratory of special reporting requirements for the entire sample delivery group (SDG).
  - l. Indicate turnaround time (TAT) required for samples on COC. If individual samples have differing TATs, the different TATs for each sample or groups of samples must be clearly indicated.
  - m. Provide contact name and phone number in the event that problems are encountered when samples are received at the laboratory. The person relinquishing possession of the samples or other member of the project team should contact the final recipient of the samples to confirm receipt and review any special provisions on the COC or questions that they may have.
  - n. If available, attach the Laboratory Task Order or Work Authorization forms.
  - o. The “Relinquished By” field must contain the signature of the Arcadis person who relinquished custody of the samples to the next entity in the chain of custody, which may be another person, the shipping courier, or the analytical laboratory. If a courier, enter the shipping courier in the “Received by” such as FedEx. The date/time relinquished should be when the person signs the COC and seals the cooler or shipping container for pick-up by the shipping courier.
  - p. Dates and times must be indicated using the following format:
    - 1) Date: either mm/dd/yy e.g., 01/01/17 OR mm/dd/yyyy e.g., 01/01/2017
    - 2) Time: use military format, e.g., 9:30 a.m. is 0930 and 9:30 p.m. is 2130
  - q. The “Received By” section is signed by sample courier or laboratory representative who received the samples from the sampler. The laboratory will sign upon laboratory receipt from the overnight courier service.
7. When more than one page of the COC form is required to complete the total number of samples, use as many sheets as necessary to accurately and clearly, document the samples and information. Some COCs may have a standard first page/cover page, and subsequent pages may not contain all the detailed fields as



the first page/cover page. Ensure that any subsequent pages convey all of the necessary and pertinent information for each individual sample as required in this procedure document.

8. Pages of the COC must retain a page count of the total number of pages; e.g., Page 1 of 3, Page 2 of 3, Page 3 of 3.
9. Upon completing the COC forms, forward the original signed COC with the sample package. Ensure that the original COC form is secured with the sample package so that it remains with the physical samples for the duration of transport and handling to its final destination and ensure that the COC form will not be become damaged or rendered unreadable due to sample breakage/leakage if stored inside the sample shipping container or outside influences if COC is stored in an outside plastic pouch to the container.
10. If you've collected enough samples that would require more than one container to ship them all to the same laboratory or location, then each separate/individual container that contains any number of samples must have a separate COC representing only those samples contained within that specific container. For example, if you have 3 total shipping containers for all of your samples, you must have a total of 3 separate, individual COCs for each of the 3 containers representing only those samples in their representative container. Thus, every container holding samples must have its own, individual COC.
11. If electronic chain of custody (eCOC) forms are utilized, ensure that the requirements of this procedure and guidance instructions are followed to the extent possible. Verify that proper signature and COC procedures are maintained with the CPM and/or Technical Expert when using eCOC.

## 9 Waste Management

Not Applicable.

## 10 Data Recording and Management

The original signed COC shall be submitted with the samples. Copies of COC records will be transmitted to the CPM or designee at the end of each day unless otherwise directed by the CPM. The sampling team leader retains copies of the chain of custody forms for filing in the project file. Record retention shall be in accordance with client- and project-specific requirements and Arcadis policies, the most stringent will apply.

The option to use the Electronic Chain of Custody (eCOC) form in conjunction with the appropriate sample application(s) may be available through the FieldNow® program but is currently limited to a select list of approved analytical laboratories. Use of the eCOC application is intended to reduce common transcription errors both by field staff and laboratory staff on a conventional handwritten paper COC. Once the eCOC form is completed and approved on the field tablet by field staff, a PDF version of the form is automatically emailed to each assigned team member. In addition, a dedicated or mobile printer is recommended for printing a hard copy of the completed eCOC to be included in each sample cooler to meet laboratory requirements.

## 11 Quality Assurance

COC forms will be legibly completed in accordance with this procedure and guidance instruction document, as well as other applicable and appropriate project documents such as SAP, Quality QAPP, Work Plan, or other project guidance documents.



COC records will be reviewed by the CPM or their appropriate designee for completeness and accuracy to the applicable requirements. Non-conformances will be noted and corrected in a timely manner on the copies retained by Arcadis as well as contacting the ultimate receiving entity for correction to the originally signed COC in their possession.

## 12 References

Arcadis Transportation Safety Program requirements, procedures, and guidance instructions.

EPA Samplers' Guide – Contract Laboratory Program Guidance for Field Samplers, EPA document EPA-540-R014-013 October 2014 [https://www.epa.gov/sites/default/files/2015-03/documents/samplers\\_guide.pdf](https://www.epa.gov/sites/default/files/2015-03/documents/samplers_guide.pdf).

EPA Region III – Sample Submission Procedures for the Office of Analytical Services and Quality Assurance (OASQA) Laboratory Branch revision 14.0 October 18, 2018, <https://www.epa.gov/sites/default/files/2018-12/documents/sample-submission-procedures-rev14.pdf>.

EPA Region IV Science and Ecosystem Support Division Operating Procedure for Sample and Evidence Management May 25, 2016, <https://www.epa.gov/sites/default/files/2015-06/documents/Sample-and-Evidence-Management.pdf>.



## Attachment A

### Chain of Custody and Laboratory Analysis Request Form



		ID# <input style="width: 80px;" type="text"/>	<b>CHAIN OF CUSTODY &amp; LABORATORY ANALYSIS REQUEST FORM</b>										Lab Work Order # <input style="width: 150px;" type="text"/>
		Page ____ of ____											
<b>Send Results to:</b>	Contact & Company Name:	Telephone:	Preservative									<b>Keys</b> <b>Preservation Key:</b> A. H <sub>2</sub> SO <sub>4</sub> B. HCL C. HNO <sub>3</sub> D. NaOH E. None F. Other: _____ G. Other: _____ H. Other: _____  <b>Containment Information Key</b> 1. 40 ml Vial 2. 1 L Amber 3. 250 ml Plastic 4. 500 ml Plastic 5. Encore 6. 2 oz. Glass 7. 4 oz. Glass 8. 8 oz. Glass 9. Other: _____ 10. Other: _____  <b>Matrix Key:</b> SO - Soil W - Water T - Tissue SE - Sediment SL - Sludge  A - Air NL - NAPL/Oil SW - Sample Wipe Other: _____	
	Address:	Fax:	Filtered (✓)										
	City State Zip	E-mail Address:	# of Containers										
Project Name/Location (City, State):		Project #:	Container Information										
Sampler's Printed Name:		Sampler's Signature		<b>PARAMETER ANALYSIS &amp; METHOD</b>									
<b>SAMPLE ID</b>	<b>Collection</b>		<b>Type (✓)</b>		<b>Matrix</b>								<b>REMARKS</b>
	Date	Time	Comp	Grab									
Special Instructions/Comments												<input type="checkbox"/> Special QA/QC Instructions (✓)	
<b>Laboratory Information and Receipt</b>			<b>Relinquished By</b>		<b>Received By</b>		<b>Relinquished By</b>		<b>Laboratory Received By</b>				
Last Name:		Cooler Custody Seal (✓)		Printed Name:		Printed Name:		Printed Name:		Printed Name:			
		<input type="checkbox"/> Intact <input type="checkbox"/> Not Intact		Signature:		Signature:		Signature:		Signature:			
<input type="checkbox"/> Cooler packed with ice (✓)		Sample Receipt		Firm:		Firm:		Firm:		Firm:			
Specify Turnaround Requirements:		Condition/Cooler Temp: _____		Date/Time:		Date/Time:		Date/Time:		Date/Time:			
Shipping Tracking #:													

SOP – Sample Chain of Custody Rev1\_May 23, 2017



Arcadis U.S., Inc.  
630 Plaza Drive, Suite 200  
Highlands Ranch  
Colorado 80129  
Phone: 720 344 3500  
Fax: 720 344 3535  
[www.arcadis.com](http://www.arcadis.com)



# Standard Operating Procedure #1: Sediment Characterization via Probing and Sampling

Rev: 0

Rev Date: April 2023



## 1 Introduction

This Standard Operating Procedure (SOP) describes the general methods and procedures to characterize the stream via probing and sediment collection. This SOP may change depending upon field conditions, equipment limitations, or limitations imposed by the procedure. Substantive modification to this SOP will be approved in advance by the Certified Project Manager (CPM), as well as a Technical Expert.

## 2 Intended Use and Responsibilities

This document describes general and/or specific procedures, methods, actions, steps, and considerations to be used and observed by Arcadis staff when performing work, tasks, or actions under the scope and relevancy of this document.

It is the responsibility of the Arcadis CPM to provide this document to the persons conducting services that fall under the scope and purpose of this procedure, instruction, and/or guidance. The Arcadis CPM will also ensure that the persons conducting the work falling under this document are appropriately trained and familiar with its content. The persons conducting the work under this document are required to meet the minimum competency requirements outlined herein, and inquire to the CPM regarding any questions, misunderstanding, or discrepancy related to the work under this document.

In following this document to execute the scope of work for a project, it may be necessary for staff to make professional judgment decisions to meet the project's scope of work based upon site conditions, staffing expertise, regulation-specific requirements, health and safety concerns, etc. Staff are required to consult with the CPM when or if a deviation or omission from this document is required that has not already been previously approved by the CPM. Upon approval by the CPM, the staff can perform the deviation or omission as confirmed by the CPM.

## 3 Related Documents

- Sediment Characterization Work Plan
- Removal Work Plan
- Quality Assurance Project Plan (QAPP)
- Health and Safety Plan (HASP)

## 4 Description of the Procedure

### 4.1 Pre-Collection

ARCADIS field personnel will be versed in the relevant SOPs and will possess the skills and experience necessary to successfully complete the desired field work. Staff assigned the responsibility of collecting cores, samples, and probing information will be provided with the following information:

- Work documents;



- Site maps;
- Collecting and processing procedures; and
- Special instructions (if any).

## 4.2 Equipment List

The following equipment list contains materials that may be needed in carrying out the procedures contained in this SOP. Not all equipment listed below may be necessary for a specific activity. Additional equipment may be required, pending field conditions.

- Personal protective equipment (as required by the HASP)
- Real-Time Kinematic (RTK) survey equipment
- Appropriate sample containers, labels, and forms
- Chest waders/personal floatation device
- Decontamination supplies
- Surveyor's rod
- Calibrated probe rod ( $\frac{5}{8}$ -inch outside-diameter metal pipe with maximum graduations of tenths of feet)
- Shovel
- Trowel
- Post-hole digger
- Steel sampling barrel (fitted with a clear PVC liner), slide hammer, and/or use of a jackhammer attachment
- Six-foot rule
- Plastic sealable bags
- Trash bags
- Indelible ink markers
- Digital camera
- Appropriate transport containers and packing, labeling, and shipping materials (coolers) with ice
- Field notebook

## 4.3 Field Notes

Field notes will be recorded during probing and/or sediment sampling activities, and at a minimum, will include the following:

- Names of field crew and oversight personnel if present;
- General weather conditions;



- Date, time, and sampling locations;
- Total water depth, probing depth, and material descriptions; and
- Any general observations.

Field crews will primarily record field information in a field notebook.

## 4.4 Stream Bed Probing Procedures

Probing efforts will be performed either as a stand-alone effort or in combination with sediment collection efforts. The following procedures describe the probing efforts.

1. Don personal protective equipment (as required by the HASP).
2. Locate the target location using RTK surveying techniques and identify the proposed probing location in the field notebook.
3. Measure the total depth of the water column using a surveyor's rod to the nearest 0.1 foot and record. Record the water surface elevation.
4. Lower the calibrated probing rod through the water column slowly to the stream bed surface.
5. Advance the rod vertically through the stream bottom materials to refusal using reasonable human force (e.g., arm strength and body weight). The depth of refusal will be interpreted as the interface between soft material (e.g., cap material or sediment) and rock or stiff bottom. Record depth, type, and presence of debris or obstructions.
6. Estimate the material thickness and type of material present. The thickness will be determined based on the water depth and the depth of refusal (i.e., depth of refusal minus water depth). The type of material present will be determined by feel of the probe rod as it advances (e.g., soft material, sand, clay, gravel, rock).

## 4.5 Sediment Collection Procedures

Sediment sampling efforts will be performed in combination with probing as described in Section 4.4. If probing indicates little to no sediment present, expand the probing efforts to an area around the sampling target location (approximately 5-10 feet in any direction) in an effort to identify a location with recoverable sediment. If no sediment can be identified based on probing efforts due to large cobbles, boulders, or bedrock, abandon the location and document probing attempts. The following procedures describe the sediment sampling efforts.

1. Don personal protective equipment (as required by the HASP).
2. Locate the target sample location using RTK surveying techniques and identify the proposed sample location in the field notebook.
3. Identify the proposed sample location in the field notebook, including other appropriate information collected during sampling activities.
4. Conduct steps outlined in Section 4.4. Based on the probing efforts and sediment type present, determine the appropriate sampling equipment – a decontaminated stainless-steel trowel, post-hole digger, steel sampling barrel with slide hammer/jackhammer.



5. Lower the sampling equipment until it just reaches the stream bottom. Advance the selected sampler into the stream bottom to the depth targeted in the plan or refusal.
6. Record the depth penetration or recovered material.
7. Slowly pull the sampling equipment from the stream bed and secure material as needed before it breaks the water surface.
8. Observe the sediment surface during sampling for evidence of impacts; record observations on the field form.
9. Photograph the sample location and general area to document habitat conditions. Record any observations or illustrations to document data not requested but deemed important including major landmarks or features of the channel morphology or orientation, vegetative zones, etc.
10. Document the appearance and recovery of the sample to confirm acceptability of the sample; target finer-grained material (such as sand) for sampling.
11. Photograph the sample. Describe sediment sample according to color, texture and grain size and document other observations such as type of organic material present, odor, sheen, staining, etc. and document.
12. Prepare the core and or process samples for submittal to the laboratory. As appropriate, sediment samples will be collected in laboratory supplied and pre-preserved containers for the specified testing method. Collect ample volume of sediment for the proposed analysis. Fill containers intended for volatile analysis with sediment sample as soon as possible and prior to homogenization.in accordance with the QAPP. Homogenize the sample and fill bottleware intended for non-VOC analysis in accordance with the QAPP.
13. Label sample containers in accordance with the procedures presented in the work plan.
14. Once the sample is collected in the appropriate container(s), place on ice in a cooler.
15. Thoroughly decontaminate reusable sampling equipment between each sample using Alconox® or similar product and triple rinse utilizing distilled water. Repeat the above procedures until all samples are collected.
16. Fill out the chain of custody form and handle, pack, and ship the samples in accordance with the procedures described in the QAPP.

## 5 Waste Management

Investigative-derived waste generated during the sampling activities and disposable equipment will be transported for offsite disposal in accordance with the site-specific Waste Management Plan.

## 6 Data Recording and Management

All sample and location measurements and observations will be maintained in a field notebook or log. Upon project completion, field notebooks will be forwarded to the Project Manager for storage in the project files.

## 7 Quality Assurance

Samplers will forward copies of field notes and chains of custody to the CPM for quality assurance checks during project implementation at a frequency determined by the CPM.



Field duplicates and other quality assurance samples (e.g., rinse blanks, trip blanks) will be collected at the frequency presented in the QAPP. Sample quality will be achieved by complying with the procedures outlined in this SOP and by following site-specific plans. Cross-contamination will be prevented by following the protocols described in the QAPP or SOP for Field Equipment Decontamination. Field activities will be supervised by appropriate experienced field supervisors. Additional quality assurance information is presented in the project-specific QAPP.

**- END OF PROCEDURE**



Arcadis U.S., Inc.  
One Lincoln Center, 110 West Fayette Street, Suite 300  
Syracuse  
New York 13202  
Phone: 315 446 9120  
Fax: 315 449 0017  
[www.arcadis.com](http://www.arcadis.com)



# Standard Operating Procedure #2: Bank Soil Sampling

Rev: 0

Rev Date: April 2023



## 1 Introduction

This Standard Operating Procedure (SOP) describes the general methods and procedures to collect bank soil. This SOP may change depending upon field conditions, equipment limitations, or limitations imposed by the procedure. Substantive modification to this SOP will be approved in advance by the Certified Project Manager (CPM), as well as a Technical Expert.

## 2 Intended Use and Responsibilities

This document describes general and/or specific procedures, methods, actions, steps, and considerations to be used and observed by Arcadis staff when performing work, tasks, or actions under the scope and relevancy of this document.

It is the responsibility of the Arcadis CPM to provide this document to the persons conducting services that fall under the scope and purpose of this procedure, instruction, and/or guidance. The Arcadis CPM will also ensure that the persons conducting the work falling under this document are appropriately trained and familiar with its content. The persons conducting the work under this document are required to meet the minimum competency requirements outlined herein, and inquire to the CPM regarding any questions, misunderstanding, or discrepancy related to the work under this document.

In following this document to execute the scope of work for a project, it may be necessary for staff to make professional judgment decisions to meet the project's scope of work based upon site conditions, staffing expertise, regulation-specific requirements, health and safety concerns, etc. Staff are required to consult with the CPM when or if a deviation or omission from this document is required that has not already been previously approved by the CPM. Upon approval by the CPM, the staff can perform the deviation or omission as confirmed by the CPM.

## 3 Related Documents

- Sediment Characterization Work Plan
- Removal Work Plan
- Quality Assurance Project Plan (QAPP)
- Health and Safety Plan (HASP)

## 4 Description of the Procedure

### 4.1 Pre-Collection

ARCADIS field personnel will be versed in the relevant SOPs and will possess the skills and experience necessary to successfully complete the desired field work. Staff assigned the responsibility of collecting samples will be provided with the following information:

- Work documents;



- Site maps;
- Collecting and processing procedures; and
- Special instructions (if any).

## 4.2 Equipment List

The following equipment list contains materials that may be needed in carrying out the procedures contained in this SOP. Not all equipment listed below may be necessary for a specific activity. Additional equipment may be required, pending field conditions.

- Personal protective equipment (as required by the HASP)
- Real-Time Kinematic (RTK) survey equipment
- Appropriate sample containers, labels, and forms
- Chest waders/personal floatation device
- Decontamination supplies
- Macrocore® sampler;
- Slide hammer;
- Aluminum or stainless spade, spoon, scoop, or hand auger;
- Six-foot rule
- Plastic sealable bags
- Trash bags
- Indelible ink markers
- Digital camera
- Appropriate transport containers and packing, labeling, and shipping materials (coolers) with ice
- Field notebook

## 4.3 Field Notes

Field notes will be recorded during sampling, and at a minimum, will include the following:

- Names of field crew and oversight personnel if present;
- General weather conditions;
- Date, time, and sampling locations;
- Total water depth, probing depth, and material descriptions; and
- Any general observations.

Field crews will primarily record field information in a field notebook.



## 4.4 Bank Soil Sampling Procedures

The following procedures describe the bank soil sampling efforts. If soil cannot be collected due to large cobbles, boulders, bedrock or other obstructions, the sample location will be relocated to an adjacent location and a note made in the field notebook about the refusal and location.

1. Don personal protective equipment (as required by the HASP).
2. Locate the target sample location using RTK surveying techniques.
3. Identify the proposed sample location in the field notebook, including other appropriate information collected during sampling activities.
4. Clear the ground surface of brush, root mat, grass, leaves, or other debris.
5. Determine the appropriate sampling equipment – spade, spoon, scoop, hand auger, or Macrocore (see steps below) to collect a sample of the required depth.
6. Observe the soil surface during sampling for evidence of impacts; record observations on the field form.
7. Photograph the sample location and general area to document habitat conditions. Record any observations or illustrations to document data not requested but deemed important including major landmarks or features of the banks, orientation, vegetative zones, etc.
8. Document the appearance and recovery of the sample to confirm acceptability of the sample.
9. Photograph the sample.
10. Collect ample volume of soil for the proposed analysis.
11. Use a ruler to verify that the sample is collected to the correct depth and record the top and bottom depths from the ground surface.
12. Describe sample according to color, texture and grain size and document other observations such as type of organic material present, odor, sheen, staining, etc. and document.
13. Backfill sample holes to grade with native material or with clean builder's sand or other suitable material.
14. Prepare the core and or process samples for submittal to the laboratory. As appropriate, sediment samples will be collected in laboratory supplied and pre-preserved containers for the specified testing method. Collect ample volume of sediment for the proposed analysis. Fill containers intended for volatile analysis with sediment sample as soon as possible and prior to homogenization.in accordance with the QAPP. Homogenize the sample and fill bottleware intended for non-VOC analysis in accordance with the QAPP.
15. Label sample containers in accordance with the procedures presented in the work plan.
16. Once the sample is collected in the appropriate container(s), place on ice in a cooler.
17. Thoroughly decontaminate reusable sampling equipment between each sample using Alconox® or similar product and triple rinse utilizing distilled water. Repeat the above procedures until all samples are collected..
18. Fill out the chain of custody form and handle, pack, and ship the samples in accordance with the procedures described in the QAPP.



As an alternate sampling method for those collection locations where deeper soil sampling is necessary (i.e., beyond surficial soil) or if collection with a scoop is not possible, steps 5 will be replaced with A through I for collection using manual coring techniques.

- A. At the designated sampling locations, soil samples will be collected manually using a Macrocore® sampler advanced with a slide hammer. The Macrocore® sampler consists of an outer steel barrel with an inner acetate liner that will be replaced for each new sample. The sampler will be advanced to the required sampling depth.
- B. If the sample depth is not reached due to refusal or encountered debris, up to 3 attempts will be made with the Macrocore® sampler in the general area. Then a hand auger will be utilized as a last option to meet the sample depths.
- C. Once the acetate liner is extracted from the sampler, use a ruler to verify that the sample recovery depth is sufficient. Recollect the sample if poor sample recovery (less than 80%) is encountered. Record field collection information.
- D. Label the core tube with the appropriate sample nomenclature, date, time of collection, soil penetration, and recovery.
- E. Soil cores will be kept upright and transported to a processing area for documentation, segmentation and sample collection.
- F. Acetate soil liners will be split open utilizing a safety cutter on a core processing table.
- G. A ruler will be used to verify that the sample recovery depth matches the noted field collection recovery. If any discrepancies due to voids or settlement are encountered, the sample will be recollected.

Samples will be sectioned and placed into disposable aluminum pans for homogenization using disposable wooden tongue depressors. In situations where compression of soil is evident (recover less than 100% but greater than 80%) within the acetate liner, the processor will make a professional judgment as to the interval within the liner as it relates to the in-situ interval and this will be documented.

## 5 Waste Management

Investigative-derived waste generated during the sampling activities and disposable equipment will be transported for offsite disposal in accordance with the site-specific Waste Management Plan.

## 6 Data Recording and Management

All sample and location measurements and observations will be maintained in a field notebook or log. Upon project completion, field notebooks will be forwarded to the Project Manager for storage in the project files.

## 7 Quality Assurance

Samplers will forward copies of field notes and chains of custody to the CPM for quality assurance checks during project implementation at a frequency determined by the CPM.



Field duplicates and other quality assurance samples (e.g., rinse blanks, trip blanks) will be collected at the frequency presented in the QAPP. Sample quality will be achieved by complying with the procedures outlined in this SOP and by following site-specific plans. Cross-contamination will be prevented by following the protocols described in the QAPP or SOP for Field Equipment Decontamination. Field activities will be supervised by appropriate experienced field supervisors. Additional quality assurance information is presented in the project-specific QAPP.

**- END OF PROCEDURE -**



Arcadis U.S., Inc.  
One Lincoln Center, 110 West Fayette Street, Suite 300  
Syracuse  
New York 13202  
Phone: 315 446 9120  
Fax: 315 449 0017  
[www.arcadis.com](http://www.arcadis.com)



# TGI – Per- and Polyfluoroalkyl Substances (PFAS) Field Sampling Guide

Rev: 10

Rev Date: January 26, 2022



## Version Control

Issue	Revision No.	Date Issued	Page No.	Description	Reviewed By
	0	April 27, 2017	All	Initial Release	Erica Kalve Erika Houtz Sue Tauro
	1	June 19, 2018	1 through 4 and 17	Updated Information on Sampling Materials	Erica Kalve Erika Houtz
	2	October 15, 2018	6 to 16	Minor updates on laboratory elements, updates to decontamination procedures, and clarification on equipment and reagent blank collection	Erika Houtz Erica Kalve
	3	December 17, 2018	4, 6, 17	Removed Sharpies from acceptable field writing implements; Changed language in Section 3.2 and Section 10.5 to provide stricter guidance for DoD projects.	Erika Houtz, Erica Kalve
	4	March 26, 2019	4,5	Removed Citranox from acceptable Decon solutions in Table 1a, added all fluoropolymer containing materials to prohibited items in Table 1b. Made a correction that Liquinox contains trace levels of 1,4 Dioxane, not Alconox.	Erika Houtz
	5	October 16, 2020	14	Added Air Force preference to sample surface water at surface for Air Force investigations.	Erika Houtz



6	March 23, 2021	4, 5, 7, 12, 13, 14, 15, 16, 17	Made clarifications that fine/ultra-fine point Sharpies are allowed. Referenced 2018 MDEQ sampling guidance. Made updates to 'After Sample Collection' in Section 7.	Kevin Engle
7	April 18, 2021	All	Changed title from Poly- and Perfluoroalkyl Substances to <b>“Per- and Polyfluoroalkyl Substances”</b> and changed PFASs to PFAS.	Rosario Varrella, Erika Houtz
8	May 4, 2021	12, 13, 15, 16	Clarified that sample containers should have an HDPE lined screw cap and that LDPE plastic sheeting should be used.	Kevin Engle, Erika Houtz
9	October 20, 2021	Note that numbers have shifted one page forward relative to prior versions. 5, 7, 9-12, 15, 16, 18-25.	Specific acceptable sunscreen and insect repellent brands were added to Table 1. Clarified language regarding footwear and H&S trainings. Laboratories section and Section 10.5 was updated to reflect new laboratory names and an updated version of the QSM. Sections 5 and 6 were updated to provide clearer language on health and safety protocols for sunscreen, insect repellent, and rain events. Added language to specify decontamination of reusable equipment prior to initial use in Section 7.1. Section 8 on Waste Management was updated to state that	Kevin Engle, Erika Houtz



waste storage and disposal should be determined in the site specific workplan. Section 9 was updated to include Rite in the Rain® notebooks as approved for PFAS sampling. Changed the term “sample port” to “sample location” when describing where to place plastic sheeting. Section 10.1 was updated to indicate an equipment blank can be collected for unvetted hazard controls that contact a sample. References were updated to include the newer version of the DoD QSM, MDEQ Sampling Guidance, and California State Water Board PFAS Sampling Guidance.

10	January 26, 2022	Various, Section 7	<p>TGI formatted to comply with new QMS TGI template and Arcadis brand compliance.</p> <p>Indicated to avoid use of anti-fog spray on safety glasses due to possible presence of PFAS.</p>
----	------------------	--------------------	--



## Approval Signatures

Prepared by:

1/26/2022



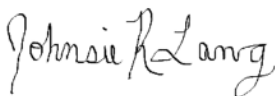
---

Kevin Engle, PG Geologist (Preparer)

---

Date

Reviewed by:



1/26/2022

---

Johnnie Lang, PhD (Subject Matter Expert)

---

Date



## 1 Introduction

This document is intended to provide guidance to field staff sampling for Per- and Polyfluoroalkyl Substances (PFAS). The content in this document describes the intended use, scope and application, personnel qualifications, equipment, cautions, health and safety considerations, procedures, waste management, data recording and management, and quality assurance of PFAS sampling.

## 2 Intended Use and Responsibilities

This document describes general and/or specific procedures, methods, actions, steps, and considerations to be used and observed by Arcadis staff when performing work, tasks, or actions under the scope and relevancy of this document. This document may describe expectations, requirements, guidance, recommendations, and/or instructions pertinent to the service, work task, or activity it covers.

It is the responsibility of the Arcadis Certified Project Manager (CPM) to provide this document to the persons conducting services that fall under the scope and purpose of this procedure, instruction, and/or guidance. The Arcadis CPM will also ensure that the persons conducting the work falling under this document are appropriately trained and familiar with its content. The persons conducting the work under this document are required to meet the minimum competency requirements outlined herein, and inquire to the CPM regarding any questions, misunderstanding, or discrepancy related to the work under this document.

This document is not considered to be all inclusive nor does it apply to all projects. It is the CPM's responsibility to determine the proper scope and personnel required for each project. There may be project- and/or client- and/or state-specific requirements that may be more or less stringent than what is described herein. The CPM is responsible for informing Arcadis and/or Subcontractor personnel of omissions and/or deviations from this document that may be required for the project. In turn, project staff are required to inform the CPM if or when there is a deviation or omission from work performed as compared to what is described herein.

In following this document to execute the scope of work for a project, it may be necessary for staff to make professional judgment decisions to meet the project's scope of work based upon site conditions, staffing expertise, regulation-specific requirements, health and safety concerns, etc. Staff are required to consult with the CPM when or if a deviation or omission from this document is required that has not already been previously approved by the CPM. Upon approval by the CPM, the staff can perform the deviation or omission as confirmed by the CPM.

## 3 Scope and Application

The purpose of this Technical Guidance Instructions (TGI) is to provide guidance on field sampling to be used for **Per- and Polyfluoroalkyl Substances** (PFAS). This protocol was adapted from various sources including Arcadis Australia, Transport Canada, and the U.S Army Corp of Engineers (USACE) Omaha. In general, sampling techniques used for PFAS site characterization are consistent with conventional sampling techniques used in the environmental industry, but special consideration is made regarding PFAS-containing materials and cross-contamination potential. **Table 1a** provides a summary of materials that have been approved for site investigation; this list is expected to grow longer as industry experience increases. **Table 1b** provides a summary of field equipment and materials that have available testing information and/or industry knowledge regarding



PFAS cross-contamination potential, and it is recommended that these materials be prohibited for sample collection; for materials that are suspected of containing PFAS and/or to retain PFAS, these recommendations are considered preliminary and subject to change. Further discussion of approved and prohibited materials is found throughout this document.

**Table 1a: Summary of Acceptable Sampling Equipment and Materials for PFAS Site Investigations**

Sampling Materials	Additional Considerations	References
<b>Water Sampling Materials</b>		
High density polyethylene (HDPE) or silicone tubing materials	--	DER 2016; USACE 2016; NHDES 2016; MassDEP 2017
HDPE HydraSleeves™	Low density polyethylene (LDPE) HydraSleeves™ are not recommended	USACE 2016; MassDEP 2017
<b>Drilling and Soil Sampling Materials</b>		
PFAS-free drilling fluids	--	DER 2016
PFAS-free makeup water	Confirm PFAS-free water source via laboratory analysis prior to investigation	--
Acetate liners	For use in soil sampling	USACE 2016
<b>Sample Containers and Storage</b>		
HDPE sample containers with HDPE lined lids for soil and water samples	Laboratory should provide; whole bottle analysis of aqueous samples combined with a solvent rinse of bottle is recommended	DER 2016, MassDEP 2017
Ice contained in plastic (polyethylene) bags (double bagged)	--	DER 2016; USACE 2016; NHDES 2016; MassDEP 2017
<b>Field Documentation</b>		
Ball point pens	--	MassDEP 2017
Standard paper and paper labels	--	DER 2016; USACE 2016; NHDES 2016; MassDEP 2017
Fine/Ultra-Fine point Sharpies®	Larger point Sharpies® should be avoided.	MDEQ 2018
<b>Decontamination</b>		
Water-only decontamination	Confirm PFAS-free water source via laboratory analysis prior to investigation	DER 2016



Sampling Materials	Additional Considerations	References
Alconox® or Liquinox® followed by deionized water or PFAS-free water rinse	Liquinox® known to contain trace levels of 1,4-dioxane	NHDES 2016; USACE 2016; MassDEP 2017
Methanol, isopropanol, or acetone	Special health and safety precautions are necessary	UNEP 2015; USACE 2016
<b><i>Sun and Biological Protection</i></b>		
OFF Deep Woods, Sawyer Permethrin	Apply >10 m away from sampling area	MDEQ 2018
Banana Boat, Coppertone, Neutrogena, Meijer, and L'Oreal Sunscreens	Apply >10 m away from sampling area	MDEQ 2018

Note: This list is considered preliminary and additional materials may be added as additional information becomes available. Project teams are expected to follow a methodical evaluation process of materials to be used and confirm acceptance prior to implementation of field activities.

**Table 1b: Summary of Sampling Equipment and Materials Not Recommended for PFAS Site Investigations.**

Sampling Materials	Known PFAS-Containing Materials	Suspected PFAS-Containing Materials	Materials with Potential to Retain PFAS	References
<b><i>Water Sampling Materials</i></b>				
Teflon®, PTFE-containing or other fluoropolymer coated or containing field equipment (e.g., tubing, bailers, liners, tape, plumbing paste, pump parts)	x			DER 2016; USACE 2016; NHDES 2016; MassDEP 2017
Passive diffusion bags			x	MassDEP 2017
LDPE HydraSleeves™			x	USACE 2016; MassDEP 2017
Water particle filters			x	MassDEP 2017
<b><i>Drilling and Soil Sampling Materials</i></b>				
Aluminum foil			x	DER 2016; USACE 2016; NHDES 2016; MassDEP 2017
Drilling fluid containing PFAS	x	x		DER 2016
<b><i>Sample Containers and Storage</i></b>				
Glass sample containers with lined lids			x	DER 2016; USACE 2016; NHDES 2016; MassDEP 2017



Sampling Materials	Known PFAS-Containing Materials	Suspected PFAS-Containing Materials	Materials with Potential to Retain PFAS	References
LDPE containers and lined lids			x	USACE 2016
Teflon® or PTFE- lined lids on containers (e.g., sample containers, rinsate water storage containers)	x			DER 2016; USACE 2016; NHDES 2016; MassDEP 2017
Reusable chemical or gel ice packs (e.g., BlueIce®)		x		DER 2016; USACE 2016; NHDES 2016; MassDEP 2017
<b>Field Documentation</b>				
Self-sticking notes and similar office products (e.g., 3M Post-it-notes)		x		DER 2016; USACE 2016; NHDES 2016; MassDEP 2017
Waterproof paper, notebooks, and labels	x			DER 2016, MassDEP 2017
Markers		x		NHDES 2016
<b>Decontamination</b>				
[Some] detergents and decontamination solutions (e.g., Decon 90® Decontamination Solution)	x	x		DER 2016; NHDES 2016; MassDEP 2017

**Note:** For materials that are suspected of containing PFAS, or have the potential to retain PFAS, project specific considerations may provide adequate justification for use during the field event. For example, further evaluation may be conducted in the form of pre-field equipment blank sample analysis.

Given the extremely low detection limits associated with PFAS analysis and the many potential sources of trace levels of PFAS, field personnel are advised to err on the side of caution by strictly following these protocols, frequently replacing nitrile gloves, and rinsing field equipment to help mitigate the potential for false detections of PFAS. A summary of other specific items related to field sampling for PFAS are discussed in the sections below.

This TGI applies to all Arcadis and subcontractor personnel involved in field sampling for PFAS.

## 4 Personnel Qualifications

### 4.1 Sampling Personnel

Field personnel must have current health and safety training, including 40-hour HAZWOPER training, up to date 8-hour refresher, site supervisor training, and site-specific training, as needed. In addition, field personnel will be versed in the other relevant SOPs (e.g., low flow sampling) and will possess the skills and experience necessary



to successfully complete the desired field work. The site Health and Safety Plan (HASP) and other documents will identify any other training requirements such as site-specific safety training or access control requirements.

## 4.2 Laboratories

These laboratories are example laboratories that could be used to analyze environmental media for PFAS, pending project approval:

- United States: Pace, SGS, Vista, ALS, and Eurofins
- Canada: AXYS-SGS and Bureau Veritas

Other laboratories may be used if they are appropriately accredited for PFAS analysis according to any project requirements. It is recommended that a laboratory is Environmental Laboratory Accreditation Program (ELAP)-accredited for PFAS analysis in accordance with the Department of Defense (DoD) Quality Systems Manual (QSM) 5.3 Table B-15 or any subsequent updates. **For all data collection efforts at DoD sites, PFAS data must be obtained using a method that is DoD ELAP-accredited under QSM 5.3 or later.**

## 5 Equipment List

The following equipment and materials must be available for sampling:

- Site plan of sampling locations, relevant work plan (or equivalent), and this TGI;
- Appropriate health and safety equipment, as specified in the site HASP;
- Dedicated plastic sheeting (preferably high-density polyethylene [HDPE]) or other clean surface to prevent sample contact with the ground;
- Conductivity/temperature/pH meter;
- Dissolved oxygen meter, oxidation reduction potential meter, and turbidity meter;
- Depth to water meter;
- If using low-flow groundwater sampling techniques, peristaltic pump (groundwater sampling)/bladder pump (with PFAS free bladder/ HDPE bladder), flow through cell, and accompanying HDPE and silicone tubing;
- Hydrasleeves™, if using Hydrasleeves™ for groundwater sampling;
- Metal trowel for soil samples; specialized soil/sediment sampling equipment as required;
- Brushes for scrubbing sampling equipment;
- Pens, pencils, and/or fine/ultra-fine point Sharpies® for writing;
- Clipboards, field binders, and field note pages that are not waterproof;
- Labeled sample bottles:
  - Water: HDPE bottles fitted with polypropylene screw cap only; some types of PFAS samples (primarily drinking water) may require preservative, which will be indicated by the laboratory conducting the analysis. The laboratory will specify the sample bottle volume.



- Soil and sediment: HDPE bottles fitted with polypropylene screw cap only; no preservatives. The laboratory will specify the sample bottle volume.
- If high concentrations of PFAS related to class B firefighting foams are expected, bring additional small vials to conduct field-based shaker tests for foaming;
- Ziploc® bags to hold ice and samples;
- Bottles containing “PFAS-free” water used for reagent blanks;
- Labeled, thoroughly decontaminated coolers for samples with ice; Blue ice is not permitted;
- Deionized or distilled water for initial decontamination rinsing;
- “PFAS-free” water provided by the laboratory for final decontamination rinsing;
- Methanol, isopropanol, or acetone if able to be brought safely to field site; especially important for decontamination during soil sampling;
- Alconox or Liquinox®;
- Packing and shipping materials;
- Groundwater and/or Sampling Log; and
- Chain-of-Custody (COC) Forms.

## 6 Cautions

### 6.1 Food Packaging

Some food packaging may be treated with PFAS-containing chemicals to prevent permeation of oil and water in the food outside of the packaging. To avoid potential food packaging-related PFAS contact:

- Do not bring any food outside of the field vehicles onsite and eat snacks and meals offsite.
- Wash hands after eating.
- Remove any field garments or outer layers prior to eating. Do not put them back on until done eating and hands are washed.

### 6.2 Field Gear

#### 6.2.1 Clothing

Many types of clothing are treated with PFAS for stain and water resistance, in particular outdoor performance wear under brand names such as Gore-Tex®. To avoid potential clothing-related PFAS contact:

- Do not wear any outdoor performance wear that is water or stain resistant, or appears to be. Err on the side of caution.



- Wear pre-laundered (multiple washings, i.e., 6+) clothing that is not stain resistant or waterproof (unless made from the materials listed in Section 5.3.1).
- Natural fabrics such as cotton are preferred. Synthetic fabrics may also be acceptable if there is no indication on the label that the fabric is water and stain resistant.
- Most importantly, avoid contacting your clothing with sampling equipment, bottles, and samples.

## 6.2.2 Personal Protective Equipment

### Safety Footwear

Some safety footwear has been treated to provide a degree of waterproofing and increased durability and may represent a source of trace PFAS. If at all possible, Gore-Tex footwear should not be worn and safety footwear without waterproofing should be worn; footwear that provides adequate safety from physical hazards is required and takes precedence over potential PFAS concerns. To avoid any PFAS cross contamination to samples from footwear:

- Do not contact your footwear with equipment, bottles, or samples in any way.
- Do not allow gloves used for sampling to come in contact with safety footwear.

### Nitrile Gloves

Wear disposable nitrile gloves at all times. Don a new pair of nitrile gloves **before** the following activities at each sample location:

- Decontamination of re-usable sampling equipment;
- Contact with sample bottles or “PFAS-free” water bottles;
- Insertion of anything into the sample ports (e.g., HDPE tubing); and
- Handling of any quality assurance/quality control (QA/QC) samples including field blanks and equipment blanks.

Don a new pair of nitrile gloves **after** the following activities:

- Handling of any non-dedicated sampling equipment;
- Contact with contaminated surfaces; or
- When judged necessary by field personnel.

## 6.3 Personal Hygiene

- Shower at night.
- Do not use personal care products after showering such as lotions, makeup, and perfumes, UNLESS medically necessary.
- Use sunscreen and insect repellent as necessary for health and safety, i.e., if sampling is to occur outdoors in direct sunlight and/or if insect hazards may be present. Specific products that are acceptable for PFAS



sampling are listed in Table 1 and in Section 6.1. Apply sunscreen and insect repellent prior to initiating field sampling. If sunscreen and/or repellent need to be reapplied, ensure a safe distance away from the sampling locations and equipment (i.e., more than 10 meters (m) away). Wash hands after application and don new gloves following hand washing.

## 6.4 Visitors

Visitors to the site are asked to remain at least 10 m from sampling areas.

# 7 Health and Safety Considerations

## 7.1 Biological and Environmental Hazard Controls

### 7.1.1 Sunscreens and Insect Repellents

When site conditions warrant, insect repellent and sunscreen should be applied. Some insect repellents and sunscreen have been approved for PFAS sampling by individual states. According to Michigan Department of Environmental Quality (MDEQ; now known as Michigan Department of Environment, Great Lakes, and Energy [EGLE]), the products below are allowable (MDEQ 2018). Note that California State Water Quality Control Board's PFAS sampling guidance refers to MDEQ/EGLE's allowable list of sunscreens and insect repellents (California State Water Quality Control Board 2020).

#### Insect Repellents

- OFF Deep Woods
- Sawyer Permethrin

#### Sunscreen

- Banana Boat Sport Performance Sunscreen Lotion Broad Spectrum SPF 30
- Meijer Sunscreen Lotion Broad Spectrum SPF 30
- Neutrogena Ultra-Sheer Dry-Touch Sunscreen Broad Spectrum SPF 30
- Banana Boat for Men Triple Defense Continuous Spray Sunscreen SPF 30
- Banana Boat Sport Performance Coolzone Broad Spectrum SPF 30
- Banana Boat Sport Performance Sunscreen Lotion Broad Spectrum SPF 30
- Banana Boat Sport Performance Sunscreen Stick SPF 50
- Coppertone Sunscreen Lotion Ultra Guard Broad Spectrum SPF 50
- Coppertone Sport High-Performance AccuSpray Sunscreen SPF 30
- Coppertone Sunscreen Stick Kids SPF 55
- L'Oréal Silky Sheer Face Lotion 50+
- Meijer Clear Zinc Sunscreen Lotion Broad Spectrum SPF 15, 30 and 50
- Meijer Wet Skin Kids Sunscreen Continuous Spray Broad Spectrum SPF 70
- Neutrogena Beach Defense Water + Sun Barrier Lotion SPF 70
- Neutrogena Beach Defense Water + Sun Barrier Spray Broad Spectrum SPF 30
- Neutrogena Pure & Free Baby Sunscreen Broad Spectrum SPF 60+



Please plan for sampling events and purchase these products ahead of time. For any sunscreens and bug sprays, including those listed above, always follow these instructions for application:

- Insect repellents and sunscreen should be applied away from the work area prior to initiating sampling.
- When re-applying, stay at least 10 m away from the sampling locations and equipment.
- Wash hands after application and don new nitrile gloves.

### 7.1.2 Rain Event

Special care should be taken when rain is falling at the project site:

- Field sampling during extreme rainfall should be avoided if possible. If sampling needs to take place during a rain event (or other extreme weather condition), ensure the rain gear or other safety clothing is appropriate. For example, rain gear made from the following materials is allowable: polyurethane, PVC, wax coated fabrics, rubber/neoprene, uncoated Tyvek® (MDEQ 2018).
- If project timelines are tight, consider the use of a gazebo tent that can be erected over the top of the monitoring well to provide shelter from the rain. The canopy material is possibly a PFAS-treated surface and should be managed as such; therefore, wear gloves when moving the tent, change them immediately after moving the tent, and avoid further contact with the tent until all sampling activities have been finished and the team is ready to move on to the next site.

### 7.1.3 Other H&S Considerations

- ***If an unapproved or potentially suspect hazard control is needed for health and safety, apply or keep that control away from the samples, document its use in field notes, and, if it does contact a sample, take an equipment blank with that material.***
- The ability to safely access the surface water sampling locations must be verified before sampling.
- Field activities must be performed in accordance with the site HASP, a copy of which will be present onsite during such activities.
- Safety hazards associated with sampling surface water include fast-moving water, deep water, and steep slopes close to sampling sites. Use extreme caution when approaching sampling sites.
- If thunder or lightning is present, discontinue sampling and take cover until 30 minutes have passed after the last occurrence of thunder or lightning.
- Use caution when removing well caps as well may be under pressure, cap can dislodge forcefully and cause injury.
- Avoid the use of anti-fog sprays on glasses, which may contain PFAS. It's recommended to instead purchase pre-treated anti-fog safety glasses.



## 8 Procedure

### 8.1 Field Equipment Cleaning

Reusable field sampling equipment will require cleaning before initial use and between uses. For groundwater sampling, between uses, decontaminate the flow-through cell and any non-dedicated equipment (i.e., interface probe of depth to water meter) that comes into contact with well water. Trowels and other materials used to sample soil samples will also require decontamination, although dedicated, single use equipment such as liners should be used where possible.

After donning a new pair of nitrile gloves:

- Rinse sampling equipment with Alconox or Liquinox® cleaning solution; Scrub equipment with a plastic brush if needed;
- Rinse two times with distilled water or deionized water;
- Rinse one time with “PFAS-free” water or once with methanol/isopropanol/acetone, if it is available, and once with “PFAS-free” water; organic solvents are especially useful for decontaminating soil sampling equipment. If organic cleaning solvents cannot be brought to site, scrub equipment a second time after a single distilled or deionized water rinse, then rinse two times with distilled or deionized water and once with “PFAS-free” water (i.e., two scrubbing and four water rinsings total).
- Collect all rinsate in a sealed pail for disposal. Do not reuse decontamination solutions between sampling locations.

### 8.2 Borehole/Monitoring Well Development

If a drill rig is being used to drill for soil cores or to install monitoring wells, wear clean nitrile gloves before collecting each continuous soil sample. Additional requirements include the following:

- Verify in writing with the manufacturer that single-use liners used to collect each sample are made of a material that does not contain PFAS;
- Collect soil samples in laboratory-supplied HDPE bottles.
- Store the sample bottles in coolers and keep at a temperature of 0 to 6°C until transported to the laboratory.

#### 8.2.1 Well Condition Survey/ Water Level Monitoring

Using equipment that has been thoroughly decontaminated according to the procedures in Section 7.1, conduct the well condition surveys and water level monitoring:

- Conduct monitoring well inspections and record water levels.
- Use an interface probe to evaluate presence/absence of non-aqueous phase liquid (NAPL).
- Measure the depth to water from the top of the polyvinyl chloride (PVC) riser and the total depth of the well.
- Record information in the field notes.



## 8.2.2 Monitoring Well Development and Purging

Follow these requirements for monitoring well development and purging:

- Do not use Teflon™ tubing for purging or sample collection. HDPE tubing is acceptable.
- Do not re-use materials between wells. Upon completion of use, remove all disposable materials (such as HDPE and/or silicone tubing) and place in heavy duty garbage bags for disposal.
- During development of the well, create sufficient energy to agitate the water column and create flow reversals in the well screen, filter pack and formation to loosen fine-grained materials and draw them into the well. The pumping or bailing action should then draw all drilling fluids and fine-grained material out of the borehole and adjacent formation and then out of the well. Review the Arcadis Monitoring Well Development guidance (Arcadis 2010) for more detailed information.
- Follow the low-flow purge and sampling techniques per the U.S. Protection Agency's (EPA's) guidance document titled *Low Stress (Low Flow) purging and Sampling Procedure for the Collection of Ground Water Samples from Monitoring Wells* (2010) and ASTM's standard titled *Standard Practice for Low-Flow Purging and Sampling for Wells and Devices Used for Ground-Water Quality Investigations* (2002). Also available for review is the Arcadis Low-Flow Groundwater Purging and Sampling Procedures for Monitoring Wells (Arcadis 2011).
- To purge the well, if using HDPE tubing and a peristaltic pump, insert the end of the tubing to the approximate depth of the midpoint of the screened section of the monitoring wells. Measure the length of HDPE tubing to be inserted into each monitoring well and pre-cut it to approximate lengths (such as the previously measured arm span of a field technician) to avoid contact with any materials other than the monitoring well and peristaltic pump. Flow rates should be as low as can be reasonably achieved. Collect and appropriately dispose of purge water.
- Silicone tubing should direct the purge water through a flow-through cell for field parameter measurements of pH, conductivity, temperature, dissolved oxygen, and turbidity. Calibrate the instrument in the field prior to use. Decontaminate the instrument and flow-through cell at each monitoring well location before purging.
- Record field parameters in intervals (generally of 3-minute duration) to ensure purge water has cycled through the flow-through cell. Sample the wells after field parameter measurements indicate stabilization, which allows collection of representative formation water (generally acceptable standards are three consecutive pH readings to within  $\pm 0.1$  units, and three consecutive conductivity, temperature and dissolved oxygen measurements to within 3%). Turbidity must be monitored, but does not need to be used as a stabilization indicator of purge completion. Record field parameter measurements at each well. Drawdown should be monitored throughout the purge.
- If wells are suspected to be dewatering throughout the purge (i.e., reduced flow rate/difficulty pumping water or bubbles begin to come through the flow through cell), turn off the pump and allow the water level to recover for ½ hour, followed by sample collection. Document these activities in the field notes.



## 8.3 Sample Collection

Different laboratories may supply sample collection bottles of varying sizes depending on the type of media to be sampled.

### 8.3.1 Sample Containers

- Collect samples in HDPE bottles fitted with a HDPE lined (no Teflon™) screw cap.
- Complete bottle labels after the caps have been placed back on each bottle.
- Do not use glass bottles due to potential loss of analyte through adsorption. This is particularly important for aqueous samples.
- Review with analytical lab the sample size, sample container, etc. depending upon the type of PFAS analysis that is being requested.

### 8.3.2 Soil Sampling

#### Before Sample Collection

- Place LDPE plastic sheeting adjacent to the sample location for use as a clean work area, if conditions allow. Otherwise, prevent sampling equipment from contacting the ground or other surface that could compromise sample integrity.
- Trowels or drilling equipment that will come into contact with a sample should be decontaminated prior to sample collection, preferably with methanol/isopropanol/acetone;
- Don a new set of nitrile gloves. Do not use gloved hands to subsequently handle papers, pens, clothes, etc., before collecting samples.
- Use the HDPE bottles that are supplied by the laboratory. Make sure that the caps remain on the bottle until immediately prior to sample collection.

#### During Sample Collection

- Collect soil samples using a clean stainless-steel trowel or with single-use PFAS-free liners;
- Place soil samples in labeled HDPE bottles supplied by the laboratory.
- Note the time on the sample label.
- Collect any necessary duplicates/co-located samples and matrix spikes – verify with laboratory whether they need to be collected in separate sample bottles.
- Collect any necessary equipment blanks. The best timing to collect equipment blanks is immediately after the collection of a sample likely to contain high concentrations of PFAS, after the sampling equipment has been appropriately decontaminated.
- Collect any necessary field reagent blanks. This sample should be collected after field staff return from an offsite break (e.g., lunch) to capture any potential cross-contamination from field personnel.



### After Sample Collection

- Place each sample bottle in two sealed Ziploc® bags. Another brand of LDPE bag is acceptable.
- Record the label information and time of sampling in the field notes.
- Place soil sample bottles in coolers that are durable in transportation and keep the temperature between 0 and 6°C until transported to the laboratory. Do not use blue ice.

## 8.3.3 Groundwater Sampling

### Before Sample Collection

- Place LDPE plastic sheeting adjacent to the sample location for use as a clean work area, if conditions allow. Otherwise, prevent sampling equipment from contacting the ground or other surface that could compromise sample integrity.
- Don a new set of nitrile gloves. Do not use gloved hands to subsequently handle papers, pens, clothes, etc., before collecting samples.
- Use the labeled HDPE bottles that are supplied by the laboratory. Make sure that the caps remain on the bottle until immediately prior to sample collection.
- Measure depth to water and field parameters. Turbidity and the physical appearance of the purged water should be noted on the Groundwater Sampling Log.

### During Sample Collection

- Start groundwater sample collection upon stabilization of field parameters.
- If low-flow groundwater sampling techniques are being used, disconnect the silicone tubing from the flow-through cell, enabling collection of groundwater samples without passing through the cell.
- Hydrasleeves are also considered acceptable for sampling of PFAS in groundwater – consult the project manager to determine which technique should be used. In general, low flow sampling is preferable.
- Collect groundwater samples (to the neck of the bottle, some headspace is acceptable) from the dedicated sampling ports at the center of the well screen. While collecting the sample, make sure the bottle cap remains in the other hand of the sampler, until replaced on the bottle.
- To mitigate cross contamination, collect groundwater samples in a pre-determined order from least impacted to greater impacted based on previous analytical data or knowledge about past activities at the site. If no analytical data are available, samples are to be collected in the following order:
  1. First sample the upgradient well(s).
  2. Next, sample the well located furthest downgradient of the interpreted or known source.
  3. The remaining wells should be progressively sampled in order from downgradient to upgradient, such that the wells closest to the interpreted or known source are sampled last.
- NOTE: If high concentrations of PFAS related to class B firefighting foams are expected in a groundwater sample, conduct a Shaker test by collecting and shaking a small portion of the sample (~10 to 25 mL) on site in a small disposable vial. If foaming is noted within the sample, document the foaming when samples are



submitted for analysis; the 'shaker test' vial can then be disposed. This shaker test provides information about how each of the samples should be handled analytically.

- After collecting the sample, tightly screw on the polypropylene cap (snug, but not too tight). This will minimize leaking or cross contamination of the sample. Most PFAS, including all analytes measured by USEPA Method 537, are not volatile at environmental pH.
- Note the time on the sample label.
- Collect any necessary duplicates and matrix spikes. As the laboratory should be analyzing the entire aqueous sample rather than sub-sampling, separate bottles will be required for these samples.
- Collect any necessary equipment blanks. The best timing to collect equipment blanks is immediately after the collection of a sample likely to contain high concentrations of PFAS, after the sampling equipment has been appropriately decontaminated.
- Collect any necessary field reagent blanks. This sample should be collected after field staff return from an offsite break (e.g., lunch) to capture any potential cross-contamination from field personnel.
- Do not rinse PFAS sample bottles during sampling. Do not filter samples.

#### After Sample Collection

- Place each sample bottle in two sealed Ziploc® bags. Another brand of LDPE bag is acceptable.
- Record the label information and time of sampling in the field notes and COC. Note 'shake test' results if appropriate.
- Place groundwater samples in coolers that are durable in transportation and keep the temperature between 0 and 6°C until transported to the laboratory. **Do not use blue ice. Store PFAS samples in a separate cooler from other types of samples.**

Treat all disposable sampling materials as single use and dispose of them appropriately after sampling at each monitoring well.

### 8.3.4 Sediment Sampling

#### Before Sample Collection

- Place LDPE plastic sheeting adjacent to the sample location for use as a clean work area, if conditions allow. Otherwise, prevent sampling equipment from contacting the ground or other surface that could compromise sample integrity.
- Don a new set of nitrile gloves. Do not use gloved hands to subsequently handle papers, pens, clothes, etc., before collecting samples.
- Use the HDPE bottles that are supplied by the laboratory. Make sure that the caps remain on the bottle until immediately prior to sample collection.

#### During Sample Collection

- Where surface water samples and sediment samples are collected at the same location, collect surface water samples first to minimize siltation.



- Collect sediment samples either manually using a stainless-steel trowel or using a petite ponar grab sampler, depending on field conditions at each sampling location during sampling program.
- Collect sediment samples from the upper 10 cm of sediment.
- For a sample to be acceptable overlying, low turbidity water must be present.
- Decant the overlying water and use a stainless-steel trowel to collect only the upper 5 centimeters (cm) of sediment.
- Collect sediment samples directly into laboratory-supplied bottles that are suitable in both material and size.
- Do not overfill the sample bottle.
- Make sure that the sample does not contain vegetation, that the sediment is undisturbed, and that the sampler shows no signs of winnowing or leaking.
- Make sure bottle caps remain in the gloved hand of the sampler until sampling is complete and caps are replaced on the bottle.
- Note the time on the sample label.
- Collect any necessary duplicates and matrix spikes.
- Collect any necessary equipment blanks. The best timing to collect equipment blanks is immediately after the collection of a sample likely to contain high concentrations of PFAS, after the sampling equipment has been appropriately decontaminated.
- Collect any necessary field reagent blanks. This sample should be collected after field staff return from an offsite break (e.g., lunch) to capture any potential cross-contamination from field personnel.

#### **After Sample Collection**

- Place each sample bottle in two sealed Ziploc® bags. Another brand of LDPE bag is acceptable.
- Record the label information and time of sampling in the field notes.
- Place samples in coolers that are durable in transportation and keep the temperature between 0 and 6°C until transported to the laboratory. **Do not use blue ice. Store PFAS samples in a separate cooler from other types of samples.**
- Measure surface water pH, conductivity, temperature, and total dissolved solids (TDS) at each location **after** both surface water and sediment sampling is completed.

### **8.3.5 Surface Water Sampling**

#### **Before Sample Collection**

- Place LDPE plastic sheeting adjacent to the sample location for use as a clean work area, if conditions allow. Otherwise, prevent sampling equipment from contacting the ground or other surface that could compromise sample integrity.
- Don a new set of nitrile gloves. Do not use gloved hands to subsequently handle papers, pens, clothes, etc., before collecting samples.



- Use the HDPE bottles that are supplied by the laboratory. Make sure that the caps remain on the bottle until immediately prior to sample collection.

### **During Sample Collection**

- Avoid sampling the surface, in general.
- However, for Air Force investigations, collect samples from the water surface.
- Where surface water samples and sediment samples are collected at the same location, collect surface water samples first to minimize siltation.
- Collect surface water samples directly into laboratory-supplied bottles; wide-mouth bottles may be preferable to narrow mouth bottles for ease of surface water collection.
- Make sure bottle caps remain in the gloved hand of the sampler until sampling is complete and caps are replaced on the bottle.
- Note the time on the sample bottle.
- Collect any necessary duplicates and matrix spikes. As the laboratory should be analyzing the entire aqueous sample rather than sub-sampling, separate bottles will be required for these samples.
- Collect any necessary equipment blanks. The best timing to collect equipment blanks is immediately after the collection of a sample likely to contain high concentrations of PFAS, after the sampling equipment has been appropriately decontaminated.
- Collect any necessary field reagent blanks. This sample should be collected after field staff return from an offsite break (e.g., lunch) to capture any potential cross-contamination from field personnel.

### **After Sample Collection**

- Place each sample bottle in two sealed Ziploc® bags. Another brand of LDPE bag is acceptable.
- Record the label information and time of sampling in the field notes.
- Place samples in coolers that are durable in transportation and keep the temperature between 0 and 6°C until transported to the laboratory. **Do not use blue ice. Store PFAS samples in a separate cooler from other types of samples.**
- Measure surface water pH, conductivity, temperature, and TDS at each location **after** both surface water and sediment sampling.

## **8.4 Shipping**

- If samples cannot be shipped the same day as collected, arrange an appropriate means of keeping the samples cool overnight and maintain the temperature between 0 and 10°C for the first 48 hours after collection, and then between 0 and 6°C thereafter.
- Store samples in appropriate transport bottles (coolers) with ice (Ziploc® bags for use as ice containers) with appropriate labeling. **Do not use blue ice. Store PFAS samples in a separate cooler from other types of samples.**



- Complete the appropriate procedures for COC, handling, packing, and shipping.
- Fill out and check COC Forms against the labels on the sample bottles progressively after each sample is collected.
- Place all disposable sampling materials (such as plastic sheeting, and health and safety equipment) in appropriate containers.
- Ship samples via courier service with priority overnight delivery. Tracking numbers for all shipments should be provided and recorded after they have been sent out to ensure their timely delivery.
- Do not ship samples via Fed Ex for Saturday delivery.

## 9 Waste Management

All rinsate should be collected in a sealed pail for disposal. Drill cuttings and purge water will be managed as specified in the Field Sampling Plan (FSP) or Work Plan, and according to state and/or federal requirements. PPE and decontaminated fluids will be contained separately and staged at the sampling location. Containers must be labeled at the time of collection. Labels will include date, location(s), site name, city, state, and description of matrix contained (e.g., soil, groundwater, PPE). General guidelines for investigation derived waste (IDW) handling and storage are set forth in a separate IDW guidance document (Arcadis 2009).

Typical waste characterization procedures include collection of a composite sample of the drill cutting material and a composite sample of the purge water for laboratory analysis. Samples are typically analyzed for disposal toxicity characteristic leaching procedure (TCLP) analysis for metals and VOCs. For PFAS, a simple leach test with neutral pH water may be more indicative of actual risk. Additionally, generators of waste are required to include analysis of other constituents that are reasonably believed to be present including (in this case) PFAS.

Waste storage and final waste disposition should be determined in the site specific workplan.

## 10 Data Recording and Management

Digital data collection is the Arcadis standard using available FieldNow® applications that enable real-time, paperless data collection, entry, and automated reporting. Paper forms should only be used as backup to FieldNow® digital data collection and/or as necessary to collect data not captured by available FieldNow® applications. The Field Now® digital form applications follow a standardized approach, correlate to most TGIs and are available to all projects accessible with a PC or capable mobile device. Once the digital forms are saved within FieldNow®, the data is instantly available for review on a web interface. This facilitates review by project management team members and SMEs enabling error or anomalous data detection for correction while the staff are still in the field. Continual improvements of FieldNow® applications are ongoing, and revisions are made as necessary in response to feedback from users and subject matter experts.

If digital data collection isn't possible, waterproof field books should be avoided for field notes. Instead, field notes on loose paper on Masonite, plastic, or aluminum clip boards is preferred. Please note that newer Rite in the Rain® notebooks are approved for PFAS sampling. Other requirements for field notes include:

- Pens, pencils, and fine/ultra-fine point Sharpies® may be used.
- Keep field notes and writing implements away from samples and sampling materials.
- One person should conduct sampling while another records field notes.



- Do not write on sampling bottles unless they are closed.

## 10.1 Other Project Documentation

- Complete groundwater and/or soil sampling logs.
- Make sure COC Forms are properly completed. Verify which PFAS analytes (e.g., just PFOS and PFOA, some or all of the 537 list, etc.) are required for analysis and note on the COC.

## 11 Quality Assurance

Refer to quality control requirements for the project to ensure that appropriate quality assurance and quality control (QA/QC) samples are collected. When collecting QA/QC samples, the same guidelines apply as when collecting regular samples – specifically that:

- Samples should be collected in laboratory-supplied HDPE bottles;
- Bottle caps must remain in the hand of the sampler until replaced on the bottle;
- Labels must be completed after the caps have been placed back on each bottle; and
- Samples must be stored in appropriate transport bottles (coolers) with ice (Ziploc® bags for use as ice containers) with appropriate labeling. **Do not use blue ice. Store PFAS samples in a separate cooler from other types of samples.**

### 11.1 Equipment Blanks (if relevant)

QA/QC sampling typically includes daily collection of equipment blanks using the laboratory-supplied “PFAS-free” water. For peristaltic pump tubing, laboratory supplied “PFAS-free” water should be poured into a clean HDPE sample bottle and then pumped through new HDPE tubing using the peristaltic pump (with new silicone tubing). The best timing to collect equipment blanks is immediately after the collection of a sample likely to contain high concentrations of PFAS, after the sampling equipment has been appropriately decontaminated. Note that an equipment blank can also be collected if an unapproved or potentially suspect hazard control is needed for health and safety and it contacts a sample, i.e., that material would be exposed to PFAS free water then the water would be collected in a separate sample container.

### 11.2 Field Duplicates

QA/QC sampling typically includes the collection of one field duplicate for every 10 or 20 samples collected. Each duplicate sample will be collected immediately after the initial sample of which it is a duplicate into a separate laboratory-provided sample bottle. Do not indicate to the laboratory which sample the duplicate replicates, i.e., it should be given a blind reference on the COC and sample name such as “duplicate”.

### 11.3 Field Reagent Blanks

QA/QC sampling for PFAS typically includes the submission of one laboratory supplied field reagent blank per day. The field reagent blank sample is brought to the site in a laboratory-supplied sample bottle. Field staff



transfer the laboratory-supplied reagent blank to an empty sample bottle. This sample should be collected after field staff return from an offsite break (e.g., lunch) to capture any potential cross-contamination from field personnel and should be placed in the same cooler as the other PFAS samples.

## 11.4 Matrix Spikes (optional in some cases)

QA/QC sampling includes submitting a sample to be used as a matrix spike if the project requires it. If a separate sample bottle is required, an additional sample will be collected immediately after the initial sample of which it is a duplicate into a separate laboratory-supplied sample bottle.

## 11.5 Laboratory Analytical QA/QC

- Arcadis recommends that any request for PFAS analysis in groundwater or soil should be conducted by an ELAP-accredited method compliant with QSM 5.3 Table B-15. Requirements laid out in Table B-15 strictly govern acceptable laboratory data quality for PFAS analysis in environmental samples. **For all data collection efforts at DoD sites, PFAS data must be obtained using a method that is DoD ELAP-accredited under QSM 5.3 or later.**
- Laboratory QA/QC should consist of one laboratory blank and one laboratory control sample (or blank spike) per batch of samples, and additional QA/QCs as indicated by the laboratory QA/QC procedures.
- Isotope dilution should be used for quantification with isotope-labeled surrogate standards, as available, according to the guidelines of QSM 5.3 Table B-15. The USEPA has two drinking water methods (USEPA Method 537.1 and USEPA Method 533). Method 537.1 does not allow for isotope dilution but USEPA Method 533 requires isotope dilution.
- For drinking water, groundwater, and surface water samples, laboratories must extract the entire sample and include a solvent rinse of the bottle for analysis. Aqueous samples should generally not be sub-sampled prior to analysis, unless they are high concentration and require serial dilution (US DoD 2017).
- Soil samples should be analyzed in their entirety or thoroughly homogenized before extraction and analysis.
- As part of the internal QA/QC of laboratory results, relative percent difference (RPD) should be calculated between samples and corresponding field or laboratory duplicates. The laboratory quality assurance portion of the laboratory certificates should be reviewed to verify that all calculations/recoveries were within acceptable limits as established by the laboratory method and guidelines in Table B-15 of QSM 5.3 or later (USDoD 2019).

## 12 References

Arcadis Australia. 2017. Soil and Concrete Sampling for PFAS. April.

Arcadis. 2010. Monitoring Well Development, Rev. #2.2. March 22.

Arcadis. 2009. Investigation-Derived Waste Handling and Storage, Rev. #2. March 6.

Arcadis. 2011. Low-Flow Groundwater Purging and Sampling Procedures for Monitoring Wells, Rev. #4. February 2.



- ASTM. 2002. ASTM D6771-02 - Standard Practice for Low-Flow Purging and Sampling for Wells and Devices Used for Ground-Water Quality Investigations (Withdrawn 2011). Available at: <https://www.astm.org/Standards/D6771.htm>.
- California State Water Quality Control Board. 2020. Per- and Polyfluoroalkyl Substances (PFAS) Sampling Guidelines for Non-Drinking Water. September. [https://www.waterboards.ca.gov/pfas/docs/sept\\_2020\\_pfas\\_sampling\\_guidelines.pdf](https://www.waterboards.ca.gov/pfas/docs/sept_2020_pfas_sampling_guidelines.pdf)
- Department of Environment Regulation (DER). Government of Western Australia. 2016. Interim Guideline on the Assessment and Management of Perfluoroalkyl and Polyfluoroalkyl Substances (PFAS). Contaminated Sites Guidelines. February.
- Michigan Department of Environmental Quality (MDEQ). 2018. General PFAS Sampling Guidance. October. [https://www.michigan.gov/documents/pfasresponse/General\\_PFAS\\_Sampling\\_Guidance\\_634597\\_7.pdf](https://www.michigan.gov/documents/pfasresponse/General_PFAS_Sampling_Guidance_634597_7.pdf)
- Massachusetts Department of Environmental Protection (MassDEP). 2017. DRAFT Fact Sheet, Guidance on Sampling and Analysis for PFAS at Disposal Sites Regulated under the Massachusetts Contingency Plan. January.
- New Hampshire Department of Environmental Services (NHDES). 2016. Perfluorinated Compound (PFC) Sample Collection Guidance. November.
- United Nations Environment Programme (UNEP). 2015. PFAS analysis in water for the Global Monitoring Plan of the Stockholm Convention, Set-up and guidelines for monitoring. Jana Weiss, Jacob de Boer, Urs Berger, Derek Muir, Ting Ruan, Alejandra Torre, Foppe Smedes, Branislav Vrana, Fabrice Clavient, and Heidelore Fiedler. Division of Technology, Industry and Economics. Geneva. April.
- United States Army Corps of Engineers (USACE). 2016. DRAFT – Standard Operating Procedure 047: Per/Poly Fluorinated Alkyl Substances (PFAS) Field Sampling. Revision: 1. March.
- U.S. Army Corps of Engineers – Omaha District. 2016. Chemistry Requirements – PFAS.
- U.S. Department of Defense (DoD). 2019. Consolidated Quality Systems Manual (QSM) for Environmental Laboratories, Version 5.3. In conjunction with the U.S. Department of Energy. May.
- U.S. Environmental Protection Agency. 2009. USEPA Method 537: Determination of Selected Perfluorinated Alkyl Acids in Drinking Water by Solid Phase Extraction and Liquid Chromatography/Tandem Mass Spectrometry (LC/MS/MS), version 1.1, September. National Exposure Research Laboratory, Office of Research and Development.
- U.S. Environmental Protection Agency. 2010. Low Stress (Low Flow) purging and Sampling Procedure for the Collection of Ground Water Samples from Monitoring Wells. Available at: <https://www.epa.gov/quality/low-stress-low-flow-purging-and-sampling-procedure-collection-groundwater-samples-monitoring>.
- Transport Canada. February 2016, Per-and Polyfluorinated Alkyl Substances (PFAS) Field Sampling Guidance.



Arcadis U.S., Inc.  
630 Plaza Drive, Suite 200  
Highlands Ranch  
Colorado 80129  
Phone: 720 344 3500  
Fax: 720 344 3535  
[www.arcadis.com](http://www.arcadis.com)



# QP 3.07 – Calibration and Control of Measuring and Test Equipment

Rev: 1

Rev Date: October 20, 2021





## Version Control

Issue	Revision No.	Date Issued	Page No.	Description	Reviewed By
	0	November 8, 2016	All	QP Issued	QMS
	1	October 20, 2021	All	Updated for QMS Relaunch October 12, 2021	Thomas Darby



## Approval Signatures

Prepared by:	Thomas Darby	10/20/2021
	_____	_____
	Name (Preparer)	Date
Quality Reviewer:		10/20/2021
	_____	_____
	Thomas Darby (Quality Reviewer)	Date
QMS Approver:		10/20/2021
	_____	_____
	David Gerber (QMS Approver)	Date



## STATEMENT OF POLICY:

The Arcadis Environment Business Line (ENV) uses measuring and test equipment in the course of its activities. Equipment used by ENV and their subcontractors must be in the condition required for the performance of specified activities. A procedure for performing and documenting calibration and for the preventive maintenance of measuring and test equipment will be followed to provide necessary controls.

### 1 Purpose

The objective of this Quality Procedure (QP) is to provide a standard procedure for the calibration and control of measuring and test equipment, including establishing the correct equipment type, range, accuracy, and precision to meet data collection needs. Equipment must be uniquely identified, calibrated against recognized standards that are clearly identified and documented, and maintained to provide reliable performance and to meet ENV quality requirements.

### 2 Responsibilities

**Certified Project Manager** – responsible for implementation of this procedure.

**Field Supervisor** – is responsible for field equipment and for communicating calibration and maintenance procedures for equipment used by ENV staff. Similar requirements for field equipment calibration and maintenance should also be communicated to subcontractors using field equipment. Subcontractors are responsible for following those requirements and are subject to performance audits.

**Quality Consultant** – is responsible for providing quality assurance and quality control guidance to the CPM in implementing this procedure.

**Quality Reviewer** – is responsible for final review of this Quality Procedure (QP). Quality Reviewers may be a Quality Consultant, QMS Document Owner, Technical Solution Leader, Community of Practice Leader, or other qualified subject matter expert (SME).

**Project Team Members** – project team members are responsible for verifying calibration status prior to using the equipment, and for operating equipment by approved procedures, documenting information, and reporting equipment malfunctions.

### 3 Terms and Conditions

**Accuracy** – a qualitative evaluation of the agreement between an individual value (or the central tendency of a set of values) and the correct value or the accepted reference value.

**Calibration** – the process of evaluating and standardizing an instrument by determining the deviation from a known standard.

**Measuring and Test Equipment** – devices or systems used to calibrate, measure, gauge, test, or inspect in order to acquire data.



**Precision** – a qualitative evaluation of measurement data used to describe the dispersion of a set of numbers with respect to its central tendency.

## 4 Related Documents

Not Applicable.

## 5 Description of the Procedure

Measuring and test equipment will be controlled by a calibration and preventive maintenance program. Instruments that measure a quantity or whose performance must meet stated criteria will be subject to calibration. Calibration of equipment may be performed internally using reference equipment and standards, or externally by agencies or manufacturers. Two types of calibration are presented in this procedure:

- Operational calibration, which is routinely performed as part of instrument usage.
- Periodic calibration, which is performed at prescribed intervals for equipment such as water-level indicators, pressure recording devices, and thermometers. In general, equipment that can be calibrated periodically is relatively stable in performance.

Preventive maintenance is an organized and documented program of equipment cleaning, lubricating, reconditioning, adjusting, and/or testing intended to maintain proper performance, prevent equipment from failing during use, and maintain reliability.

### 1. Calibration Procedures

Documented procedures must be used for calibrating measuring and test equipment and reference equipment. Procedures such as those published by ASTM International (formerly known as the American Society for Testing and Materials), U.S. Environmental Protection Agency (USEPA), or procedures provided by manufacturers will be used whenever possible.

Where pre-established procedures are not available, procedures will be developed. Factors such as the type of equipment, stability characteristics of the equipment, required accuracy and precision, and the effect of error on the quantities measured must be considered. Calibration procedures must include:

- Type of equipment to be calibrated
- Reference equipment and standards to be used
- Calibration method and specific procedure
- Acceptance tolerances
- Frequency of calibration
- Data recording form.

### 2. Equipment Identification

Measuring and test equipment owned by Arcadis must be uniquely identified using the manufacturer's serial number, a calibration system identification number, or an inventory control tag number. This identification must be attached to the equipment. In addition to the identification number, equipment requiring periodic calibration must bear a label indicating when the next calibration is due. Equipment that is rented or leased for the purposes of measuring and testing must also be uniquely identified.



Personnel are responsible for verifying calibration status from due date labels or instrument records prior to using the equipment. Measuring and test equipment that is not properly calibrated must not be used.

### **3. Calibration Frequency**

Measuring and test equipment and reference equipment will be calibrated at prescribed intervals and/or as part of operational use. The calibration frequency will depend on the type of equipment, inherent stability, manufacturer's recommendations, intended use, effect of error on the measurement process, and experience. Calibration frequencies may be defined in project-specific plans or in calibration procedures. The CPM or Field Supervisor is responsible for specifying the procedures to be followed to meet project data quality objectives.

Scheduled periodic calibration may not be performed for infrequently used equipment; such equipment will be calibrated on an "as needed" basis prior to use, and then at the required frequencies for the duration of its use.

Field equipment will require an operational check per the applicable procedure and or the equipment manual prior to use, and then again at the end of the working day. Pre-use calibration should be completed under conditions of anticipated use (e.g., temperature, humidity, and atmospheric pressure) if these parameters may influence results.

### **4. Reference Equipment and Standards**

Whenever possible, equipment must be calibrated using reference equipment (i.e., physical standards) and chemical and radioactive standards having known relationships to nationally recognized standards (e.g., National Institute of Standards and Technology [NIST]) or accepted values of natural physical constants. If national standards or constants do not exist, the basis for the calibration must be documented.

Physical standards may include calibration weights, certified thermometers, standard measurement tapes, gauge blocks, and reference gauges. These are generally used for periodic calibrations. Physical standards must be used only for calibration.

Chemical and radioactive standards may include reagents, solvents, and gases. These may be Standard Reference Materials (SRM) provided by NIST or USEPA, or they may be vendor-certified materials traceable to NIST or USEPA SRMs. Chemical and radioactive standards will primarily be used for operational calibrations.

The date of receipt and expiration date must be clearly labeled on the container of each standard. If calibration standards are transferred to additional containers, these containers must be labeled with the name of the standard, the lot number, and the shelf life. Calibration standards that exceed shelf life must not be used and must be discarded.

If equipment is sent to the manufacturer or calibration laboratory for calibration, adequate documentation must be maintained to establish the calibration method, reference standard source, or traceability to recognized standards.

### **5. Calibration Failure**

Equipment failing calibration or becoming inoperable during use will be removed from service and segregated to prevent inadvertent use or tagged to indicate it is out of service. The equipment must be repaired and properly recalibrated; equipment that cannot be repaired will be replaced.

The results of activities involving equipment that has failed recalibration will be evaluated by the CPM. If the results are adversely affected, the findings of the evaluation will be documented, and appropriate personnel will be notified.



Periodic calibration of measuring and test equipment does not replace the user's responsibility for verifying proper function of equipment. If an equipment malfunction is suspected, the device must be tagged or removed from service, and recalibrated. If it fails recalibration, it must be repaired or replaced.

## 6. Documentation of Calibration

Records must be maintained for each piece of calibrated measuring and test equipment and each piece of reference equipment. The records must indicate that established calibration procedures have been followed, and that the accuracy of reference chemical and radioactive standards has been verified.

Records for periodically calibrated equipment must include the following minimum information:

- Type and identification number of equipment
- Calibration frequency and acceptance tolerances
- Calibration dates
- Name of individual and organization performing the calibration
- Reference equipment and/or standards used for calibration
- Calibration data
- Certificates or statements of calibration provided by manufacturers and external organizations
- Documentation of calibration acceptance or failure, and of repair of failed equipment.

For equipment requiring calibration, information should be maintained in a project or equipment database regarding the calibration and maintenance history for that equipment. Equipment that does not have a calibration sticker or that has an expired calibration sticker should be tagged inoperable and sent for calibration. The equipment information file should contain periodic calibration files, as well as equipment calibration and maintenance records, calibration data forms, and/or certification of calibration provided by manufacturers or external organizations and notice of equipment calibration failure.

Measuring and test equipment used for field investigations will typically be calibrated as part of operational use. For this equipment, records of the calibrations or checks will be documented as part of the test data (e.g., in the field notebook or on a Field Activity Log). Equipment-specific forms may also be developed. These records should include information similar to that required for periodically calibrated equipment. Documentation related to malfunctioning equipment or equipment that fails calibration should also be included in the individual equipment file.

Calibration files for equipment requiring periodic calibration should be sent with equipment that is transferred to allow a continuously updated record to be maintained. Recalibration of sensitive equipment should be performed following the transfer.

When measuring and test equipment is rented or leased, procurement documents must specify that a current certificate of calibration must accompany the equipment. This certificate must be maintained with the project documentation calibration records.

## 7. Operational Checks

Certain equipment may require periodic operability tests or checks to verify that operating systems are within the allowed range. These tests are in addition to formal calibration. Like calibrations, these tests will be performed at specified frequencies, or as part of operational use using reference equipment and standards.



If an instrument fails an operability test, and corrective action cannot bring the instrument into tolerance, it must be removed from service and segregated to prevent inadvertent use or tagged to indicate it is out of service.

Such equipment will be repaired and/or recalibrated.

Operability tests will generally be performed in conjunction with data acquisition. Information recorded must include:

- Type and identification number of equipment (e.g., model and serial numbers)
- Test date
- Name of individual and organization performing the test
- Reference equipment and standards used
- Test data
- Documentation of acceptance or failure.

Documentation may be in the field notebook or on a Field Activity Log.

## 8. Preventive Maintenance

Preventive maintenance is an organized program of equipment cleaning, lubricating, reconditioning, adjusting, and/or testing intended to maintain proper performance, prevent equipment from failing during use, and maintain reliability. Specific maintenance details may be supplied in project-specific plans. A typical preventive maintenance program includes:

- A listing of the equipment that is included in the program
- The frequency of maintenance (manufacturer's recommendations or previous experience with the equipment)
- Service contracts
- Identification of spare parts
- Items to be checked and specific protocols to be followed
- Documentation of maintenance.

Maintenance records of measuring and test equipment must be maintained at the location that is the host for the equipment. Documentation of subcontractor and Arcadis equipment that is used for an individual project will be included in the project files. Records for multi-project equipment will be maintained by the location that controls the equipment.


Measuring and test equipment must be controlled through the use of sign-out/sign-in records or other suitable method. Equipment that is returned from field use must be free of contamination, packaged in a manner suitable for storage, and returned to its designated area. Support personnel should be notified of performance problems with equipment.[Click to enter text]

**- END OF PROCEDURE -**



Arcadis U.S., Inc.  
630 Plaza Drive, Suite 200  
Highlands Ranch  
Colorado 80129  
Phone: 720 344 3500  
Fax: 720 344 3535  
[www.arcadis.com](http://www.arcadis.com)



<u>Implementation Date</u> 13 December 2006	<u>ARCADIS HS Standard Name</u> Utility Location and Clearance	 <b>ARCADIS</b> Design & Consultancy for natural and built assets
<u>Revision Date</u> 13 May 2020	<u>ARCADIS HS Standard No.</u> ARC HSFS019	<u>Revision Number</u> 17

## QUICK SHEET

### Applicability

This HSS assigns responsibilities and expectations for proper utility location and clearance by both Arcadis employees and Arcadis subcontractors at project sites

### Need to Know

PMs are responsible for ensuring the requirements of this HSS are followed. Project personnel are responsible for understanding the HSS and Supplemental document, having the minimum 1 year of required training in order to clear sites, understand and apply the requirement for a minimum three reliable lines of evidence for each point of work, know and understand the Arcadis 30-in tolerance Zone requirements.

**If and when any line of evidence reveals planned subsurface work will occur within the Arcadis 30-inch Tolerance Zone of known/marked/located/observed utilities or structures, the project team must Stop Work and contact Corporate H&S for a review of steps the team has taken to prevent injury or incident involving the conflict.**

Additional details addressing hazards, risk factors, and safe work practices are discussed in the HSS Supplemental document Sections:

1. Best Practices for Project Managers (or Their Delegates) Concerning Utility Clearance.
2. Best Practices for Field Personnel Concerning Utility Clearance.
3. Use and Limitations of Common Underground Locating Technologies and Clearance Methods.
4. Best Practices for State One Call Notification Process and Mark Outs.
5. Emergency Action Plan Guidelines for Utility Strikes.
6. Utility Location Procedures for Aquatic Work Activities.


Arcadis field personnel involved with any strike incidents including contact with a structural feature, subsurface, submerged, and/or aboveground utilities must immediately STOP WORK and contact the Project Manager to discuss the incident. If there are life threatening injuries, or the incident presents a risk to public safety (e.g. natural gas leak, downed live electrical line, flooding, or an unstable building) first call 911 or the available emergency services number for the client site or area and then call the Project Manager. The incident must be reported to Corporate Health and Safety immediately and no later than 24 hours after gaining knowledge of the incident. Compliant notification within 24 hrs. requires an acknowledgement of the notification by Corporate H&S.

The Arcadis standard client and subcontractor contracts contain required terms and conditions defining responsibility for utility clearance and the allocation of risk associated with an impacted utility.

### Training

Field staff must complete a minimum of one year of utility clearance-related experience before accepting responsibility for any utility clearance tasks. This experience requires mentorship by a currently trained and experienced Arcadis employee for the processes of; completing DigSafe 811 notifications, developing a working understanding of the types of utilities present at project sites, developing a working understanding of the various reliable lines of evidence, and




<u>Implementation Date</u> 13 December 2006	<u>ARCADIS HS Standard Name</u> Utility Location and Clearance	 <b>ARCADIS</b> <small>Design &amp; Consultancy for natural and built assets</small>
<u>Revision Date</u> 13 May 2020	<u>ARCADIS HS Standard No.</u> ARC HSFS019	<u>Revision Number</u> 17

participating in on-site training led by another Arcadis employee with detailed knowledge and experience in identifying utilities and structures.

**Permits or Forms Required**

The Utility Location HSS and associated supplements will be reviewed, and the Utility and Structures Checklist will be prepared during project planning to document and record the location and clearance process for the Site.



<u>Implementation Date</u> 13 December 2006	<u>ARCADIS HS Standard Name</u> Utility Location and Clearance	 <b>ARCADIS</b> <small>Design &amp; Consultancy for natural and built assets</small>
<u>Revision Date</u> 13 May 2020	<u>ARCADIS HS Standard No.</u> ARC HSFS019	<u>Revision Number</u> 17

## 1. POLICY

It is the practice of Arcadis and its affiliated companies to implement appropriate, reasonable, and practical standards within acceptable and customary industry practices to promote the health and safety of its employees and avoid and mitigate exposure of risk in the performance of their work. In furtherance of this policy, Arcadis promotes and encourages compliance by all employees with this policy and standards relating to work in the vicinity of subsurface, submerged, or aboveground utilities.

## 2. PURPOSE AND SCOPE

### 2.1 Purpose

Arcadis is committed to providing a healthy and safe work environment for our employees, subcontractors, clients, and visitors. To this end, this health and safety standard (HSS) establishes general safety standards and best practices associated with the identification, management and avoidance of subsurface, submerged, and aboveground structures and utilities on project sites.

### 2.2 Scope

This HSS assigns responsibilities and expectations for proper utility location and clearance by both Arcadis employees and Arcadis subcontractors at project sites.

## 3. DEFINITIONS

Definitions related to Utility Location and Clearance can be found in [Exhibit 1](#). Acronyms and Abbreviations are found in [Exhibit 2](#).

## 4. RESPONSIBILITIES


Project staff involved in subsurface and aboveground work activities are expected to read, understand and comply with this HSS and the ARC HSFS-019 Supplements, specifically ARC HSFS-019 Supplement Sections 2 and 3, make the required DigSafe notification(s), and complete the appropriate checklists during the on-site utility and structures locate and clearance process.

### 4.1 Project Managers

For every project site having the potential to come into contact with utilities, Project Managers (PMs) are responsible for the requirements of this HSS in that:

- The requirements of this HSS are followed.
- Local regulations governing utility clearance are followed. This includes ensuring local and/or state laws defining activities or depth of intrusive work/excavation requiring utility clearance are reviewed as they vary by location. For further information, refer to the



<u>Implementation Date</u> 13 December 2006	<u>ARCADIS HS Standard Name</u> Utility Location and Clearance	
<u>Revision Date</u> 13 May 2020	<u>ARCADIS HS Standard No.</u> ARC HSFS019	<u>Revision Number</u> 17

Common Ground Alliance One Call State Law Directory  
<https://commongroundalliance.com/map>).


- Efforts are made to work with the client, project site representatives, public utility companies, and subcontractors to identify the nature of any utilities and to determine control processes that need to be implemented by Arcadis and the subcontractors to prevent damage to these utilities and to properly manage the effects in the event there is utility damage.
- In jurisdictions where the actual contractor performing the subsurface intrusive work is required to perform utility clearance notifications (811, State One Call, etc.) **and** Arcadis is also self-performing the work, Arcadis will complete the clearance notifications and include the ticket number on the Utility Clearance Checklist. Refer to ARC HSFS-019 Supplement Section 4 for Best Practices for State One Call procedures.
- Utility clearance activities are only delegated to a Task Manager or other individual meeting the requirements of Section 4.2 below, as appropriate. However, even if the Project Manager delegates certain responsibilities, the Project Manager maintains primary responsibility for the completion of utility clearance. For additional information on Project Manager responsibilities and best practices, refer to ARC HSFS-019 Supplement 1.
- Prior to beginning subsurface work, Project Managers or designee must review the [Utility and Structures Checklist](#) with staff and Arcadis subcontractors (including subs of subs). The Project Manager or designee review must be documented on the Utility and Structures Checklist prior to starting subsurface intrusive work

#### 4.2 Field Personnel Responsibilities

Arcadis field personnel conducting work on a project site having the potential to come into contact with utilities have the responsibility to:

- Read, understand, and follow this HSS and ARC HSFS-019 Supplement document.
- Complete a minimum of one year of utility clearance-related experience before accepting responsibility for any utility clearance tasks. This experience requires mentorship for notifying DigSafe 811, developing a working understanding of the types of utilities present at project sites, developing a working understanding of the various reliable lines of evidence, and participating in on-site training led by another Arcadis employee with detailed knowledge and experience in identifying utilities and structures.
- Request and review the 811 DigSafe notification(s) in place for the appropriate work area(s).
- Prior to beginning any subsurface intrusive work (i.e., any work or activity that breaks the plane of the ground surface), excavation work involving heavy and mechanized equipment, or operating high clearance equipment at the Site, the [Utility and Structures Checklist](#) must be completed and signed by the staff member completing or overseeing the clearance. Confirm that the Utility and Structures Checklist was reviewed by the Project Manager or designee as discussed in Section 4.1 above. Review the Utility and Structures Checklist daily prior to starting subsurface intrusive activities to ensure all



<u>Implementation Date</u> 13 December 2006	<u>ARCADIS HS Standard Name</u> Utility Location and Clearance	 <b>ARCADIS</b> <small>Design &amp; Consultancy for natural and built assets</small>
<u>Revision Date</u> 13 May 2020	<u>ARCADIS HS Standard No.</u> ARC HSFS019	<u>Revision Number</u> 17

utilities are identified and markings are present. A copy of the completed Utility and Structures Checklist will remain on-site during all subsurface intrusive work.

- Use their STOP WORK Authority to eliminate any reasonable concern if utilities cannot be reasonably located and contact the Project Manager to review the STOP WORK situation and confirm the direction of action before proceeding with the work.
- Check that Arcadis subcontractors conduct their own reasonable independent utility clearance efforts as required by state and local laws and the Arcadis subcontractor agreement.
- Be on-site and provide oversight during utility location and clearance activities and any active subsurface intrusive work or activities involving subcontractor under contract to Arcadis.
- If a utility is damaged and repaired during the course of the field event, Arcadis field staff must provide oversight and document that the repair was tested to ensure the repaired utility is competent and complete to prevent further damage to the site when the damaged utility is re-activated.

#### 4.3 Corporate Health & Safety

Corporate H&S is responsible for keeping this HSS up to date with regulatory requirements and best work practices.

Corporate H&S will, as requested, provide guidance to employees and their supervisors engaged in work involving utility location and clearance on the risks and measures prevention utility strikes, including how to recognize the presence of utilities whether overhead, underground, or submerged and how to mark and protect them from damage.


#### 4.4 Arcadis Subcontractor Responsibilities

According to the Arcadis standard subcontract terms and conditions, subcontractors agree to take responsibility for any damages resulting from a utility impact caused by their work. Therefore, Arcadis subcontractors are expected to take reasonable time and diligence to conduct their own independent utility clearance using reasonable standards and processes. Subcontractors have the responsibility to stop their work if utility concerns are identified and will report those concerns to the Arcadis employee overseeing their work activities. Arcadis staff should reinforce these responsibilities with subcontractors during job safety briefings.

In jurisdictions where the actual contractor performing the subsurface intrusive work is required to perform utility clearance notifications (811, State One Call, etc.), the contractor will perform the clearance notification and will provide evidence of the notification to Arcadis (ticket or ticket number, etc.). Refer to ARC HSFS-019 Supplement Section 4 for Best Practices for State One Call procedures.

- If overhead utilities are present in areas where heavy equipment will be operated, ensure adequate clearance is provided. For heavy equipment with extendable or telescoping (e.g., excavators, dump trucks, extendable lift trucks) equipment, evaluate whether the use of a spotter is necessary prior to operating heavy equipment when in proximity to the overhead utility.



<u>Implementation Date</u> 13 December 2006	<u>ARCADIS HS Standard Name</u> Utility Location and Clearance	 <b>ARCADIS</b> <small>Design &amp; Consultancy for natural and built assets</small>
<u>Revision Date</u> 13 May 2020	<u>ARCADIS HS Standard No.</u> ARC HSFS019	<u>Revision Number</u> 17

- Consider signage and/or other forms of identification to ensure aboveground and overhead utilities that need to be protected during Arcadis work are effectively addressed.
- If a utility is struck and requires repair, the repair must be tested prior to restoring the utility to full service.

## 5. PROCEDURE

### 5.1 General Safe Work Practices

Arcadis staff will follow these general safe work practices when working around utilities. Procedures to be followed during utility and structures location and clearance activities are outlined in the following sections of the Utility Location and Clearance Supplemental document:


7. Best Practices for Project Managers (or Their Delegates) Concerning Utility Clearance.
8. Best Practices for Field Personnel Concerning Utility Clearance.
9. Use and Limitations of Common Underground Locating Technologies and Clearance Methods.
10. Best Practices for State One Call Notification Process and Mark Outs.
11. Emergency Action Plan Guidelines for Utility Strikes.
12. Utility Location Procedures for Aquatic Work Activities.

### 5.2 Lines of Evidence

When locating utilities and structures three (3) reliable “lines of evidence” must be established to help determine where a subsurface utility may be located. A line of evidence may be a scaled site drawing showing where a utility is located, it could be information obtained verbally from owners or employees who meet the definition of a “knowledgeable person” regarding utility and structural features, it could be established using any number of non-intrusive geophysical methods including but not limited to; ground penetrating radar (GPR), electromagnetic survey (EM), radio-frequency methods (RF), or it could involve probing for or exposing the utility by soft dig technologies (AKA “daylighting” or “potholing”) using air knife, Hydroknife and/or soil vacuum. Some lines of evidence will identify utility locations with a high degree of certainty (e.g., direct connect radio-frequency technique, daylighting, or potholing, sonde tracing, etc.). Other lines of evidence will identify utilities with less certainty (e.g., GPR, historical reports, old design drawings, etc.).

Effective utility locate practices must use multiple lines of evidence until there is a high degree of certainty that the various underground utility services have been adequately located. A minimum of three (3) reliable lines of evidence are required for an appropriate utility clearance as defined in this HSS. All reliable lines of evidence used during the utility clearance procedure will be recorded on the [Utility and Structures Checklist](#) or equivalent client-provided checklist or ground disturbance permit. If three (3) reliable lines of evidence have not established certainty regarding the location of a utility, STOP WORK and do not proceed until the certainty has improved, the work has been modified to resolve the lack of certainty. Additional reliable lines of evidence must be utilized until the presence or absence of the underground utility can be established. During work activities, if a line of evidence is lost or not apparent (e.g., paint markings have faded), STOP WORK, and re-establish the line of evidence prior to resuming subsurface intrusive work.



<u>Implementation Date</u> 13 December 2006	<u>ARCADIS HS Standard Name</u> Utility Location and Clearance	 <b>ARCADIS</b> Design & Consultancy for natural and built assets
<u>Revision Date</u> 13 May 2020	<u>ARCADIS HS Standard No.</u> ARC HSFS019	<u>Revision Number</u> 17


Generally, the following example reliable lines of evidence may be used to meet the minimum three lines utility clearance requirement:

1. Contacting the State One Call or equivalent service (Nationwide “811”) in advance of intrusive work is **REQUIRED BY LAW**. Contacting the State One Call or equivalent service (Nationwide “811”) is an acceptable reliable line of evidence when working within or adjacent to the public right of way or easement. Note that the State One Call can provide valuable information regarding locations and types of utilities entering a privately owned property.

**Note:** When conducting work on private property or in areas not served by State One Call or equivalent service, teams are to evaluate using a reputable private utility locating company to locate and mark the utilities. **Use of a reputable private utility locator is encouraged for all projects with subsurface or submerged utilities.** When working with a private utility location subcontractor, it is best practice to pre-plan clearance areas, review the necessary clearance equipment needed based on the types of utilities anticipated to be present, and the re-clearing/confirmation of any public utility location markings (State One Call or equivalent service Nationwide “811”).

2. Use detailed, scaled site utility plans, preferably in the form of an “as-built” or “record” drawing, to identify and/or confirm utility locations. Document request and/or receipt of utility drawings from the property owner/client on the Utilities and Structures Checklist.
3. Interview(s) with knowledgeable site or client personnel. The following questions should be asked during the interview and answers documented on the [Utility and Structures Checklist](#)
  - Employees(s) Name and Affiliation(s) with the site.
  - Types of utilities, including utility composition and location of utilities on-site.
  - Depths of known utilities; and
  - Any other pertinent information regarding utilities on the site.
4. Conduct a detailed visual site inspection of areas around all planned subsurface intrusive work points or areas to identify and/or confirm utility locations. The area needed to conduct a thorough site inspection can vary significantly depending on the number and type of utilities present, notably gravity-fed utilities such as sewers. Sewer network manhole spacing can often include 100-foot distances or greater between manholes. For underground utilities, conduct an inspection for structures that tend to indicate the presence and general location of such utilities, including, but not limited to manholes, vaults, valve covers, valve markers, telephone pedestals, transformer housings, fire hydrants, fire suppression post indicator valves (PIVs), spigots, sprinkler heads, air relief valves, backflow preventers, meters, vent lines, downspouts going into the subsurface, power poles with wiring going into the subsurface and line markers, stakes, and monuments. Saw cut lines and concrete/asphalt repairs often yield valuable information regarding utility locations.



<u>Implementation Date</u> 13 December 2006	<u>ARCADIS HS Standard Name</u> Utility Location and Clearance	 <b>ARCADIS</b> <small>Design &amp; Consultancy for natural and built assets</small>
<u>Revision Date</u> 13 May 2020	<u>ARCADIS HS Standard No.</u> ARC HSFS019	<u>Revision Number</u> 17

Always discuss the presence of utilities with the site owner, operator, facility representative and/or occupant to identify any potential utilities that might not be readily identified by non-intrusive geophysical clearing methods. Situations where non-intrusive clearance methods may not be effective include:

- Depths > 5 ft. below ground surface (BGS).
- Small diameter or certain utility construction materials (e.g. plastics).
- Multiple layers of surface cover e.g. reinforced concrete, multiple layers of historical roadbed.
- Soil conditions such as dense soils or shallow groundwater table.

A discussion of use and limitations associated with common utility location and clearance geophysical methods is provided in ARC HSFS-019 Supplement Section 3.

Standard operating procedures for utility location in submerged settings are presented in ARC HSFS-019 Supplement Section 6.

The lines of evidence will be recorded on the [Utility and Structures Checklist](#) or equivalent client-provided checklist or permit.


**Note:** If a line of evidence is lost, not apparent, no longer applicable or utility location markings are removed/worn/unclear, or area of previous clearance is not confirmed, STOP WORK and re-establish the line(s) of evidence prior to resuming subsurface intrusive work. **Each location of subsurface intrusive work must have a minimum of 3 reliable lines of evidence.** All lines of evidence used during the utility clearance procedure will be recorded on the Utility and Structures Checklist or equivalent client-provided checklist or permit. The Utility Structures and Checklist is valid for 15 business days from the date of completion. Prior to the end of the 15 day period the checklist detailing the utilities which have been located and marked must be reviewed to verify no new utilities have been identified but are unmarked and, utilities which have been located and marked continue to be clearly marked. Update the checklist with the date of the review and reviewer name to “re-set” the 15-day period. A copy of the completed Utility and Structures Checklist will remain onsite while work involving or in the vicinity of utilities is conducted.

**Caution: If and when any line of evidence reveals planned subsurface work will occur within the Arcadis 30-inch Tolerance Zone of known/located/observed utilities, the project team must Stop Work and contact Corporate H&S for a review of the steps the team has taken to prevent injury or incident involving the utility conflict.**









### 5.3 Color Codes Used for Utility Markings

The following colors are used for marking utilities. Some government agencies or large industrial facilities may use additional colors not provided below. Arcadis policy is to assume any paint marking or pin flag color not provided below is a subsurface utility marking until proven otherwise.



<u>Implementation Date</u> 13 December 2006	<u>ARCADIS HS Standard Name</u> Utility Location and Clearance	 <b>ARCADIS</b> Design & Consultancy for natural and built assets
<u>Revision Date</u> 13 May 2020	<u>ARCADIS HS Standard No.</u> ARC HSFS019	<u>Revision Number</u> 17

If utilities or subsurface anomalies are identified but the utility type or anomalies are not classified, it is recommended the color pink (Temporary Survey Marking) be used to mark the location pending confirmation. Once the type of utility is established, the pink marks will be repainted/remarked to represent the correct type of utility.

COLOR	Utility Line
WHITE 	Proposed Excavation
PINK 	Temporary Survey Markings
RED 	Electrical Power Lines, Cables, Conduit and Lighting Cables
YELLOW 	Gas, Oil, Steam, Petroleum or Gaseous Materials
ORANGE 	Communication, Alarm or Signal Lines, Cables or Conduit
BLUE 	Potable Water
PURPLE 	Reclaimed Water, Irrigation and Slurry Lines
GREEN 	Sewer and Drain Lines

APWA and ANSI standard Z-53.1

#### 5.4 Locating Technologies


There are several types of locating technologies that can be used to identify and locate utilities in the subsurface. Project teams need to work closely with private utility locators (PUL) in order to best match locating technology with site conditions. To provide the best results, all possible locating technologies should be available for use and implementation at the project location. Any potential interferences should also be discussed up front and then at the project site during utility location activities. Potential interferences could be soil moisture, soil type, standing water on concrete/asphalt, rebar, fencing, and metal structures that are in the subsurface. Employees overseeing locating technology activities should have an understanding of device operation and limitations. For further information, refer to ARC HSFS-019 Supplement Section 3, Use and Limitations of Common Utility Location Technologies and Clearance Methods.

#### 5.5 Clearance Methods

In some cases, proposed subsurface intrusive locations may be pre-cleared using other intrusive methods. Determine the clearance or soft dig method based on-site conditions and utilize the least invasive method possible. The number of subsurface intrusive locations and soil type should be taken into consideration. The following clearance methods are listed from least invasive to most invasive:

1. Vacuum Extraction/Potholing (air or water-based)
2. Air knifing
3. Hydro knifing
4. Probing
5. Hand augering
6. Hand digging
7. Posthole digging



<u>Implementation Date</u> 13 December 2006	<u>ARCADIS HS Standard Name</u> Utility Location and Clearance	 <b>ARCADIS</b> <small>Design &amp; Consultancy for natural and built assets</small>
<u>Revision Date</u> 13 May 2020	<u>ARCADIS HS Standard No.</u> ARC HSFS019	<u>Revision Number</u> 17

“Single-Point” clearance involves clearing the intrusive location to 110% of the proposed subsurface intrusive area or the diameter plus 2 inches of the largest piece of tooling used in the subsurface (e.g. clear the borehole to 10-in. when setting wells using 8-in. hollow stem auger tooling), or whichever is greater.

“Three-Point” clearance involves clearing the utility using a triangular pattern placed around the proposed borehole location and in a configuration such as to not allow utilities to pass undetected between the clearance boreholes. In some cases, it is more practical to advance three individual slot trenches which connect at each end making a “clearance triangle” instead of advancing multiple boreholes side-by-side. Using the Three-Point clearance triangle trenching method allows for teams to inspect larger areas for potential utilities. The teams can advance trenches along each side of the proposed work area extending down to a target depth based on suspected depth of utilities at the Site. Each method of clearance will be documented on the [Utility and Structures Checklist](#).

Manual clearing methods, such as shoveling, using pickaxes, digging bars (AKA “Spud bars” and other hand tools, should be avoided completely or only used when absolutely necessary and used with caution. Excessive downward force, prying or use in poor/obstructed visibility conditions is prohibited as these tools are known to be capable of damaging utilities.

Surface cover (e.g., asphalt) removal methods that pose excessive downward force, such as jackhammering, must be used with extreme caution. Methods that only cut the surface cover (coring or saw cutting) present less risk due to the absence of the blunt downward force, which could cause collateral damage to shallow subsurface utilities by unintentionally pushing buried debris into the utility. Note that certain utilities are often present at the concrete or pavement/soil interface or encased within the concrete or pavement and are easily damaged during concrete coring or pavement removal. Always work slowly, methodically, and frequently STOP WORK to evaluate conditions during these work activities.


For borings and excavations, if the utility is known to be at depths where hand clearing is not feasible or creates additional safety concerns, no work will be performed within the Arcadis 30-inch Tolerance Zone vertically or horizontally of the utility unless manual clearing of the utility is performed under the oversight of an Excavation Competent Person as defined in ARC HSFS005 HSS Arcadis Excavation and Trenching.

#### 5.5.1 Temporary Backfilling of Pre-Cleared Boreholes

In some cases, it may be necessary to temporarily backfill a pre-cleared / daylighted location until the remaining subsurface activities are performed. At these locations where subsurface intrusive work does not immediately follow pre-clearance, it is important to properly backfill and mark the pre-cleared location in order to protect the utility integrity and maintain the location. In general, wooden stakes, survey flags, whisker markers, paint marking, or other surface markings alone are inadequate because these markings can be easily removed, damaged, or otherwise lost creating uncertainty for the pre-cleared location. Although the specific steps for backfilling a pre-cleared location will depend on site-specific conditions, use the following steps to prevent loss of the pre-cleared location:

- Backfill a pre-cleared location with clean sand or other granular material that is recognizably different from the surrounding subsurface native material. Native soil should not be used to backfill a pre-cleared location that may require further subsurface work.



<u>Implementation Date</u> 13 December 2006	<u>ARCADIS HS Standard Name</u> Utility Location and Clearance	 <b>ARCADIS</b> <small>Design &amp; Consultancy for natural and built assets</small>
<u>Revision Date</u> 13 May 2020	<u>ARCADIS HS Standard No.</u> ARC HSFS019	<u>Revision Number</u> 17

- Backfill the top 2 feet of a pre-cleared location with dyed sand or gravel to facilitate re-location.
- Place wooden stakes or delineators to mark locations as an additional measure, if practical.
- In the event that the pre-cleared borehole is located on asphalt or concrete and an asphalt cold patch is required, use white paint to mark the intrusive location over the asphalt cold patch.
- In some instances, such as projects potentially affected by unexploded ordinance (UXO), the pre-cleared borehole may require that a PVC pipe of matching diameter be inserted into the pre-cleared borehole, filled with clean sand and affixed with a matching cap. Project teams are to discuss client specific utility location and marking requirements with the project manager prior to conducting work.
- Always use a physical subsurface marker such as described above to identify the pre-cleared borehole location. Don't rely solely on field measurements or GPS coordinates as the only means for locating pre-cleared locations.
- If a utility or anomaly/obstruction is encountered during the pre-clearing process, backfill the hole with the native soil and mark the location with a pink-painted X and/or NO.

In the event that a previously pre-cleared location cannot be located, the location must be re-cleared prior to performing subsurface intrusive work


### **5.6 Clearance for Working in Vicinity of Subsurface Utilities – The Arcadis Utility Tolerance Zone**

Prior to the start of subsurface intrusive activities (i.e., excavating / test pitting, drilling, installing grounding rods, manual soil sampling etc.), all utilities must be located, and steps taken to avoid unintentionally contacting or damaging subsurface utilities. See exemptions for subsurface intrusive work in [Exhibit 1](#) (Definitions). Field Teams are not to proceed with subsurface work involving utilities located within 30 inches of a line marking as measured radially (e.g. 360 degrees) from the outermost point of the marked utility. If only the centerline of the utility or utility bank is marked, but the utility width or diameter is known or suspected, the diameter of the utility or utility bank ([Exhibit 1](#)) must be incorporated into the Arcadis 30-inch Tolerance Zone, see Figure 1 located in [Exhibit 2](#) for further instructions and an illustration of the Arcadis 30-in. Tolerance Zone.

If and when any line of evidence reveals planned subsurface work will occur within the Arcadis 30-inch Tolerance Zone of known/located/observed utilities or structures, the project team must Stop Work and contact Corporate H&S for a review of steps the team has taken to prevent injury or incident involving the conflict.

If subsurface work using heavy or mechanized equipment must take place within the Arcadis 30-inch Tolerance Zone of the marked utility, the utility must be exposed (daylighted) using soft dig clearance methods prior to starting subsurface intrusive activities as described in Section 5.5 of this HSS.



<u>Implementation Date</u> 13 December 2006	<u>ARCADIS HS Standard Name</u> Utility Location and Clearance	 <b>ARCADIS</b> <small>Design &amp; Consultancy for natural and built assets</small>
<u>Revision Date</u> 13 May 2020	<u>ARCADIS HS Standard No.</u> ARC HSFS019	<u>Revision Number</u> 17

**Note: No heavy or mechanized equipment is permitted to be used within the Arcadis 30-inch Tolerance Zone for the purpose of daylighting the utility.**

Once the utility in conflict has been daylighted, and heavy or mechanized equipment use is planned within the Arcadis 30-inch Tolerance Zone of the utility, such work must receive pre-approval by Corporate H&S to review steps the team has taken to assess and mitigate the risk associated with the planned work. Additional excavation safety procedures may have to be developed as part of the Corporate H&S approval to proceed. It should be noted that any disturbance within 30 inches of the marked utility, or disruption of the surrounding bedding materials could affect the integrity of the utility.

For horizontal borings, to avoid striking a utility, damage from vibration, damage by pressure of the advancing boring, do not drill within 30 inches in all directions (3-Dimensional cylinder) of a line marking. Make sure to factor the diameter of the line or utility bank when calculating the extent of the 30-inch Tolerance Zone. When crossing a utility during horizontal drilling, it is recommended that the utility be exposed 30 inches in a 360°-direction. When exposing utilities for horizontal borings, the utility must be exposed (potholed) by soft dig/clearance methods. This recommendation applies even if the operating contractor has technology that places the location to within a few inches. Make sure to factor the diameter of the utility when determining the 30-inch Tolerance Zone. If subsurface work must take place within the 30-inch Tolerance Zone of the line marking, the utility must be exposed (potholed) by soft dig/clearance methods prior to starting subsurface intrusive work (see Section 5.5 for options); no mechanized equipment is permitted for the exposing of the utility. Once the utility has been exposed, if mechanized equipment is planned for use within the 30-inch Tolerance Zone of the utility, such activity must receive pre-approval by Corporate H&S, as necessary, to mitigate or accept the risk associated with the planned work. Additional excavation safety procedures may have to be developed as part of the approval to proceed. It should be noted that any disturbance within the 30 inches or disruption of the bedding materials could affect the integrity of the utility.


Additional cautions for horizontal borings include gravity-fed utilities, such as sewers and storm drains. The depth of these utilities will change (sometimes significantly) as they run across the project site. Project teams need to obtain sewer utility depths in the work area(s) and determine the depth of the sewer at the location where the boring will actually intersect with the sewer line by collecting sewer pipe invert elevations from identified manholes and interpolating those depths to the area of the subsurface intrusive work.

During well installations and well abandonment via mechanical equipment, the Arcadis 30-inch Tolerance Zone rule applies in an outward direction extending from the outermost edge of the largest diameter auger or greatest width tool used for installation and abandonment (e.g. “over drilling”). In cases where wells have been previously installed and the 30-inch rule has not been followed, work proposed using heavy or mechanized equipment falling within the Arcadis 30-inch Tolerance Zone requires approval from Corporate H&S. For more information, see Figure 1 in [Exhibit 2](#) for further instructions.

**5.6.1 Aboveground Activities causing Subsurface Disturbance in the Vicinity of Underground Utilities**

Aboveground work-related activities can cause damage to shallow underground utilities or structures. Asses the intended travel paths, mobilization, staging, and operation of heavy equipment and take steps to ensure shallow utilities are not damaged. If heavy equipment must cross over shallow utilities, the team is responsible for confirming the utilities will be protected.

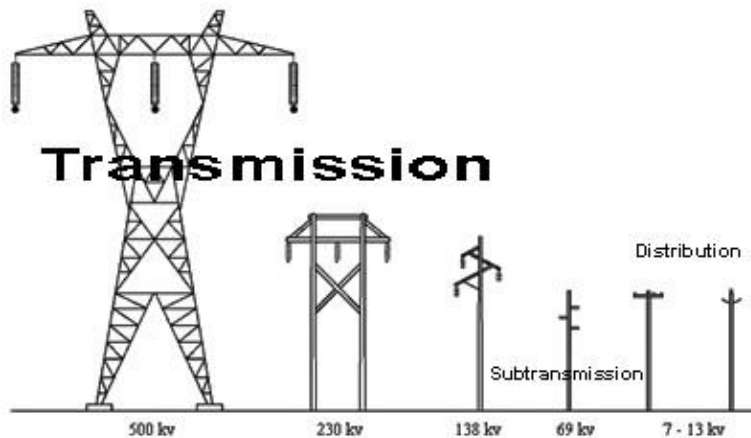


<u>Implementation Date</u> 13 December 2006	<u>ARCADIS HS Standard Name</u> Utility Location and Clearance	 <b>ARCADIS</b> Design & Consultancy for natural and built assets
<u>Revision Date</u> 13 May 2020	<u>ARCADIS HS Standard No.</u> ARC HSFS019	<u>Revision Number</u> 17

Other subsurface disturbances may lead to damage such as removing trees/tree stumps, shrubs, or dense vegetation as roots may be entangled with underground piping or structures. For more information, see ARC HSFS-019 Supplement Section 2\_Best Practices for Field Personnel Concerning Utility Clearance.

### 5.7 Acceptable Clearance for Working in Vicinity of Overhead Power Lines and Other Overhead Lines and Structures

No work will be performed by Arcadis or our subcontractor near overhead power lines where any Unqualified Person or equipment is within the limits specified below, unless the power line has been properly covered or de-energized by the owner or operator of the power line, or a qualified electrical subcontractor. Qualified Person approach distances are defined in Exhibit 5A and 5B of [ARC HSFS0006 Electrical Safety Standard](#). Illustrations of general types of overhead utility conveyances are provided in [Exhibit 3](#) - Overhead Power Utility Illustrations




[OSHA Electric Power etool](#) illustration

Power Line Voltage Phase to phase (kV)	Minimum Safe Clearance (feet)
50 or below	10
Above 50 to 200	15
Above 200 to 350	20
Above 350 to 500	25
Above 500 to 750	35
Above 750 to 1,000	45

ANSI standard B30.5-1994, 5-3.4.5



<u>Implementation Date</u> 13 December 2006	<u>ARCADIS HS Standard Name</u> Utility Location and Clearance	 <b>ARCADIS</b> <small>Design &amp; Consultancy for natural and built assets</small>
<u>Revision Date</u> 13 May 2020	<u>ARCADIS HS Standard No.</u> ARC HSFS019	<u>Revision Number</u> 17

### 5.7.1 Reducing Vehicle and Mechanical Equipment Clearance Requirements

Any vehicle or mechanical equipment capable of having parts of its structure elevated near energized overhead lines shall be operated so that a minimum clearance of 10 feet (305 centimeters [cm]) is maintained. If the voltage is greater than 50 kilovolts (kV), the clearance shall be increased 4 inches (10 cm) for every 10 kV over that voltage. However, under any of the following conditions, the clearance may be reduced:

- If the vehicle is in transit with its structure lowered, the clearance may be reduced to 4 feet (122 cm).
- If insulating barriers or “power line shields” rated for the voltage of the line being guarded are installed to prevent contact with the lines, and the barriers are not a part of, or an attachment to, the vehicle or its raised structure, the clearance may be reduced to a distance within the designed working dimensions of the insulating barrier.
- If the equipment is an aerial lift that is insulated for the voltage involved and if the work is performed by a qualified person, the clearance (between the uninsulated portion of the aerial lift and the power line) may be reduced to the distance given in [OSHA 1910.333\(c\)\(3\)\(ii\)\(C\) Table S-5](#). Reference information from OSHA 1910.333 Table S-5 and NFPA 70E Table 130.4(C)(a) for alternating-current systems and 130.4(C)(b) for the distances associated with direct-current voltage systems is included as Exhibit 5 of ARC HSFS0006 Electrical Safety Standard.

Employees standing on the ground may not contact the vehicle or mechanical equipment or any of its attachments unless:

- The employee is using protective equipment rated for the voltage; or
- The equipment is located so that no uninsulated part of its structure (that portion of the structure that provides a conductive path to employees on the ground) can come closer to the line than permitted in this section of this HSS.


If any vehicle or mechanical equipment capable of having parts of its structure elevated near energized overhead lines is intentionally grounded, employees working on the ground near the point of grounding may not stand at the grounding location whenever there is a possibility of overhead line contact. Additional precautions, such as the use of barricades or insulation, shall be taken to protect employees from hazardous ground potentials, depending on earth resistivity and fault currents, which can develop within the first few feet or more outward from the grounding point.

When a machine is in contact with an overhead power line, do not allow anyone to come near or touch the machine. Stay away from the machine and summon outside assistance.

### 5.7.2 Acceptable Clearance for Working in Vicinity of Non-Electrical Overhead Utilities and Structures

Arcadis field personnel will identify non-electrical overhead utilities and structures and where possible, work is not be conducted within the 30-inch Tolerance Zone of these overhead utilities



<u>Implementation Date</u> 13 December 2006	<u>ARCADIS HS Standard Name</u> Utility Location and Clearance	 <small>Design &amp; Consultancy for natural and built assets</small>
<u>Revision Date</u> 13 May 2020	<u>ARCADIS HS Standard No.</u> ARC HSFS019	<u>Revision Number</u> 17

and structures. It is recommended that if work will be completed in the vicinity of non-electric overhead utilities, the overhead utilities should be labeled with warning signs, protective barricades, and/or flags. Non-electrical overhead utilities and structures may include, but is not limited to, pipe chases, water lines, ceilings in buildings, etc. Arcadis field personnel will notify its site workers (employees, subcontractors, vendors, etc.) of known overhead utilities and structures during the tailgate safety meeting. See [Exhibit 2](#) for additional details.

### 5.8 Reporting Utility Incidents

Arcadis field personnel involved with any strike incidents including contact with a structural feature, subsurface, submerged, and/or aboveground utilities must immediately STOP WORK and contact the Project Manager to discuss the incident. If there are life threatening injuries, or the incident presents a risk to public safety (e.g. natural gas leak, downed live electrical line, flooding, or an unstable building) first call 911 or the available emergency services number for the client site or area and then call the Project Manager. The incident must be reported to Corporate Health and Safety immediately and no later than 24 hours after gaining knowledge of the incident. Compliant notification within 24 hrs. requires an acknowledgement of the notification by Corporate H&S. Team must provide critical details of the incident when notifying Corporate H&S such as; 3<sup>rd</sup> party involvement, any injuries, known extent of damage and estimate of potential repair cost, service interruption, and client reporting requirements. The project team and field staff will use the Arcadis [Utility Line Strike Investigation Form](#) to record initial details of the incident as part of the notification process.

Selected utility strike incidents may also utilize a conference call with operations management to review findings and lessons learned. The Business Line H&S Director will make the determination concerning the need to have the incident investigation review call and will arrange the call, if deemed necessary.

### 5.9 Relationship of this HSS to the Project Specific HASP


With the exception of the Utility and Structures Checklist, this HSS and the supplement documents, are not required to be printed and attached to project HASPs. Project teams have discretion to include such supplements as a BMP or reference guide when developing a project HASP. During project health and safety planning, this HSS will be reviewed and applicable clearance technologies and methods will be documented on the [Utility and Structures Checklist](#).

Additionally, emergency response procedures specific to utility strikes should be addressed. See ARC HSFS-019 Supplement Section 5 which provides general guidelines for emergency response to utility strikes. Applicable information may be attached to the HASP or the Utility and Structures Checklist to facilitate communication of response expectations.

### 5.10 Required Contract Terms and Conditions

The Arcadis standard client and subcontractor contracts contain required terms and conditions defining responsibility for utility clearance and the allocation of risk associated with an impacted utility. These terms and conditions have prescribed language concerning subsurface work that is presented in Arcadis client contracts and the Arcadis subcontractor contracts, which can be found on the [ANA Intranet Legal webpage](#). If such provisions cannot be agreed upon, the reasons are documented and other risk-management actions should be identified, such as limits of liability, add additional physical investigations, additional lines of evidence or utility location, assignment



<u>Implementation Date</u> 13 December 2006	<u>ARCADIS HS Standard Name</u> Utility Location and Clearance	 <b>ARCADIS</b> <small>Design &amp; Consultancy for natural and built assets</small>
<u>Revision Date</u> 13 May 2020	<u>ARCADIS HS Standard No.</u> ARC HSFS019	<u>Revision Number</u> 17

of risk to subcontractors, etc. In addition, any changes to these terms and conditions require approval by Legal Services.

## 6. TRAINING


Employees responsible for coordinating or conducting utility clearance activities will be familiar with the requirements of this HSS and the supplemental documents. Arcadis in-house 8-hour Hazardous Waste Operations and Emergency Response (HAZWOPER) refresher may provide awareness-level training regarding this utility location and clearance HSS.

Field staff must complete a minimum of one year of utility clearance-related experience before accepting responsibility for any utility clearance tasks. This experience requires mentorship by a currently trained and experienced Arcadis employee for the processes of; completing DigSafe 811 notifications, developing a working understanding of the types of utilities present at project sites, developing a working understanding of the various reliable lines of evidence, and participating in on-site training led by another Arcadis employee with detailed knowledge and experience in identifying utilities and structures.

## 7. REFERENCES

- Occupational Safety and Health Administration (OSHA) 29 CFR Subpart P, Excavations, 1926.651, Specific Excavation Requirements.
- Common Ground Alliance State Law Directory - <https://commongroundalliance.com/map>
- Arcadis Utilities and Structures Checklist:
  - Excel Version - [Utility and Structures Checklist](#)
  - PDF Version - [Utility and Structures Checklist](#)
- Arcadis [Utility Line Strike Investigation Form](#)
- The [Arcadis ARC HSFS-019 Supplement Documents](#) include the following Sections:
  - Section 1 - Best Practices for Project Managers (or Their Delegates) Concerning Utility Clearance
  - Section 2 - Best Practices for Field Personnel Concerning Utility Clearance
  - Section 3 - Use and Limitations Associated with Location Technologies and Common Utility Clearance Methods
  - Section 4 - Best Practices for State One Call Procedures and Notifications
  - Section 5 - Emergency Action Plan guidelines for Utility Strikes
  - Section 6 - Utility Location SOP for Aquatic Work Activities
- [Figure 1](#) – 30-Inch Tolerance Zone
- Arcadis H&S Standard [ARC HSCS005 Excavation and Trenching](#)



<u>Implementation Date</u> 13 December 2006	<u>ARCADIS HS Standard Name</u> Utility Location and Clearance	 <b>ARCADIS</b> Design & Consultancy for natural and built assets
<u>Revision Date</u> 13 May 2020	<u>ARCADIS HS Standard No.</u> ARC HSFS019	<u>Revision Number</u> 17

- Arcadis H&S Standard [ARC HSFS0006 Electrical Safety Standard](#)

## 8. RECORDS

### 8.1 Utility Clearance Records

All records (maps, checklists, and documentation of communications) used to determine the location of utilities should be retained and kept in the project file.

## 9. APPROVALS AND HISTORY OF CHANGE


Approved by Julie Santaniello, CSP – Corporate H&S Manager of Technical Programs



### History of Change


Revision Date	Revision Number	Standard Developed/Reviewed by or Revised By	Reason for change
13 December 2006	01	Mike Thomas/Pat Vollertsen	Original document
26 March 2007	02	Mike Thomas/Pat Vollertsen	Put in new company format
15 May 2007	03	Mike Thomas/Pat Vollertsen	Added nation-wide 811 number
6 September 2007	04	Mike Thomas/Pat Vollertsen	Changing over to new template format
22 February 2008	05	Mija Coppola	Changing over to new template format
13 January 2009	06	Mija Coppola	Define lines of evidence
4 October 2010	07	Sam Moyers/Mija Coppola	Reformatting and addition of utility clearance information
13 February 2012	08	Sam Moyers/Mija Coppola	Modified link information for utility strike reporting, clarified local/state requirements in section 4.1 and 4.3



<u>Implementation Date</u> 13 December 2006	<u>ARCADIS HS Standard Name</u> Utility Location and Clearance	 <b>ARCADIS</b> <small>Design &amp; Consultancy for natural and built assets</small>
<u>Revision Date</u> 13 May 2020	<u>ARCADIS HS Standard No.</u> ARC HSFS019	<u>Revision Number</u> 17


<b>Revision Date</b>	<b>Revision Number</b>	<b>Standard Developed/Reviewed by or Revised By</b>	<b>Reason for change</b>
28 January 2013	09	Tony Tremblay	Utility and Structures Checklist revised; hyperlink updated
12 February 2013	10	Amanda Tine/Tony Tremblay	Clarified clearance boundaries for Unqualified staff in Section 5.7 and added information about vehicles and equipment being used near power lines in Section 5.7.1
15 March 2013	11	Kurt Merkle, Rebecca Lindeman / Tony Tremblay	Added additional text to HSS for recent lessons learned, added section 5.4 (Locating Technologies) and 5.5 (Clearance Methodologies), added additional details to section 5.6 when working in close proximity to subsurface utilities, and added Supplement 6 - Utility Location SOP for Aquatic Work Activities.
07 July 2013	12	Andrew McDonald/ Tony Tremblay	Removed <a href="#">HSFS-019 Supplement 1</a> , Utility Definitions. Added hyperlink for One Call and State Law Directory. Segregated evidence of sewer or storm drains in USC list. Removed Sam Moyers and added Andrew McDonald as author.
26 September 2014	13	Andrew McDonald/Tony Tremblay	Added Exhibit 1. Definitions and 30-inch tolerance zone. Clarified use of 811 or state one call as a reliable line of evidence. Added best practice to cover backfilling of pre-cleared boreholes. Updated USC list to cover soft dig termination depths and PM review.
23 February 2015	14	Tony Tremblay	Page number correction



<u>Implementation Date</u> 13 December 2006	<u>ARCADIS HS Standard Name</u> Utility Location and Clearance	 <b>ARCADIS</b> <small>Design &amp; Consultancy for natural and built assets</small>
<u>Revision Date</u> 13 May 2020	<u>ARCADIS HS Standard No.</u> ARC HSFS019	<u>Revision Number</u> 17


<b>Revision Date</b>	<b>Revision Number</b>	<b>Standard Developed/Reviewed by or Revised By</b>	<b>Reason for change</b>
10 May 2016	15	Denis Balcer/Sharon Lingle/Alec MacAdam/Andrew McDonald/Tony Tremblay/Julie Santaniello	ES and Section 4.2 - define subsurface intrusive work; clarify employees providing oversight of utility contractors, Arcadis requirements of operating and interpreting results of utility clearance equipment, and utility clearance before all subsurface intrusive work. Sections 1 and 5.8- changed submarine to submerged. Section 4.1 – added contacting public utility companies to help clear utilities. Section 4.2 – Clarified requirement to complete one year of utility clearance-related experience. Section 4.2 and 4.3 - Added discussion on aboveground activities causing subsurface disturbances. Added responsibility to clear overhead utilities when heavy equipment will be used and to evaluate use of a spotter. Added that repairs to damaged utilities need to be verified as competent and complete. Section 5.2 – Clarified reliable lines of evidence for each subsurface intrusive work point and degrees of certainty. Added all work within 30-inch Tolerance Zone needs Corp H&S preapproval. Section 5.6 and Exhibit 1- Clarify subsurface intrusive work and activity and exemptions for subsurface intrusive work. Section 5.6.1 – Add requirement to evaluate aboveground activities that may lead to subsurface disturbances that may cause damage to shallow underground utilities or structures.



<u>Implementation Date</u> 13 December 2006	<u>ARCADIS HS Standard Name</u> Utility Location and Clearance	 <b>ARCADIS</b> <small>Design &amp; Consultancy for natural and built assets</small>
<u>Revision Date</u> 13 May 2020	<u>ARCADIS HS Standard No.</u> ARC HSFS019	<u>Revision Number</u> 17

<b>Revision Date</b>	<b>Revision Number</b>	<b>Standard Developed/Reviewed by or Revised By</b>	<b>Reason for change</b>
10 May 2016	15	Denis Balcer/Sharon Lingle/Alec MacAdam/Andrew McDonald/Tony Tremblay/Julie Santaniello	<p>Section 5.7.2 – added non-electric overhead utilities and structures other than power lines need to be identified and marked if working in that area. Section 9 – Changed reviewer from Tony Tremblay to Julie Santaniello. Exhibit 1 – added definitions of Utility Strike, Daylighting, Potholing, Subsurface Intrusive Work, Subsurface Intrusive Activities, and Utility Bank.</p> <p>HSS and Supplements placed on new Arcadis headers. Updated Supplement revision numbers to be consistent with HSS. Supplement 2 revised. Utility Clearance and Structures Checklist and Utility Strike Investigation Form revised.</p>
17 March 2017	16	Alec MacAdam/Julie Santaniello	Hyperlink updates; minor formatting; Utility Clearance and Structures Checklist revised.
13 May 2020	17	Alec MacAdam/Denis Balcer/Greg Mason/Julie Santaniello	Updated HSS format. Combined HSS Supplements, revised HSS sections, revised the Utility & Structures Checklist, added Exhibit 2 - Acronyms and Abbreviations.



<u>Implementation Date</u> 13 December 2006	<u>ARCADIS HS Standard Name</u> Utility Location and Clearance	 <b>ARCADIS</b> <small>Design &amp; Consultancy for natural and built assets</small>
<u>Revision Date</u> 13 May 2020	<u>ARCADIS HS Standard No.</u> ARC HSFS019	<u>Revision Number</u> 17

### EXHIBIT 1 - Definitions

**Aboveground Utilities** - For the purpose of this procedure, aboveground utilities include, but are not limited to: any aboveground line, pipe, conduit, system, or facility used for producing, storing, conveying, transmitting or distributing communication or telecommunications signals, electricity, gas, liquid, petroleum and petroleum products, coal slurry, hazardous liquids or gases, water under pressure, steam, sanitary sewage, storm water, or other materials, liquids, or gases.

**Daylighting** – exposing underground utilities or structures through soft dig technology/clearance prior to completing subsurface intrusive activities.

**e.g.** - Exempli gratia. Latin for “for the sake of example.” Use it to introduce one or more examples.

**Excavation** - Any man-made cut, cavity, trench, or depression, in an earth surface formed by earth removal into which a person can bodily enter.

**I.e.** - I.e. is the abbreviation for “id est” and means “in other words” or “in essence”.

**Kilovolt (kV)** - One kilovolt is equal to 1,000 volts (v), which are the potential difference that would move one ampere of current against one ohm of resistance. The kilovolt is a multiple of the volt, which is the SI derived unit for voltage.

**Overhead Utilities and Structures** – Overhead water lines, overhead pipe chases, ceilings in buildings.

**Potholing** – exposing underground utilities or structures through soft dig technology/clearance prior to completing subsurface intrusive activities.

**Subsurface Intrusive Activities** – For the purposes of this procedure, subsurface intrusive activities include, but are not limited to excavations, vertical drilling, installing grounding rod, soil sampling, etc.,


**Subsurface Intrusive Work** – Is any work or activity that breaks the plane of the ground surface. Exemptions include soil sampling using a non-conductive sampling tool to a depth of 6 inches below ground surface (bgs), placement of survey flagging to a depth of 6 inches bgs, and placement of non-conductive survey stake(s) to a depth of 6 inches bgs).

**Subsurface Utilities** - For the purposes of this procedure, subsurface utilities include, but are not limited to: any underground line, pipe, conduit, system, or facility used for producing, storing, conveying, transmitting or distributing communication or telecommunications signals, electricity, gas, liquid, petroleum and petroleum products, coal slurry, hazardous liquids or gases, water under pressure, steam, storm water, or sanitary sewage; underground storage tanks; tunnels and cisterns; and septic tanks and lines.

**Utility Bank** – a structure containing two or more conduits. A conduit is a single enclosure containing one or more facilities.


**Utility Strike** – An unplanned contact of a utility (i.e., overhead utilities, buildings, structures, aboveground utilities, underground utilities. or submerged utilities) during the course of work that results in; damage requiring repairs, making a report to the utility owner, or requiring further assessment to evaluate the potential for damage.



<u>Implementation Date</u> 13 December 2006	<u>ARCADIS HS Standard Name</u> Utility Location and Clearance	 <b>ARCADIS</b> <small>Design &amp; Consultancy for natural and built assets</small>
<u>Revision Date</u> 13 May 2020	<u>ARCADIS HS Standard No.</u> ARC HSFS019	<u>Revision Number</u> 17

**Utility Tolerance Zone** – The area within 30 inches measured radially (e.g. extending in all directions) from the outside diameter of a located/marked utility in which special care is to be taken. If the centerline of the utility is marked, the diameter of the utility or utility bank/trench must be incorporated into the 30 inches. This area must be hand cleared with non-mechanized equipment. Once the utility has been exposed, if mechanized equipment is planned for use within the Arcadis 30-inch Tolerance Zone of the utility, such activity must receive pre-approval by Corporate H&S, to mitigate or accept the risk associated with the planned work. See Figure 1 – 30-inch Tolerance Zone.




<u>Implementation Date</u> 13 December 2006	<u>ARCADIS HS Standard Name</u> Utility Location and Clearance	 <b>ARCADIS</b> <small>Design &amp; Consultancy for natural and built assets</small>
<u>Revision Date</u> 13 May 2020	<u>ARCADIS HS Standard No.</u> ARC HSFS019	<u>Revision Number</u> 17

### Exhibit 2 – Acronyms and Abbreviations


ANA	Arcadis North America
Arcadis	Arcadis U.S. Inc.
ARC	Arcadis
APM	Associate Project Manager
APL	Acoustic Pipe Location
AKA	Also Known As
BGS	Below Ground Surface
cm	Centimeter
EM	Electromagnetic
ft.	Feet
GPR	Ground Penetrating Radar
HS	Health and Safety
H&S	Health and Safety
HSS	Health and Safety Standard
HAZWOPER	Hazardous Waste Operations and Emergency Response
HSFS	Health and Safety Field Safety
HSCS	Health and Safety Construction Safety
https	Hypertext transfer protocol secure
in.	Inch
kV	Kilovolt
m	Meter
NFPA	National Fire Protection Association
OSHA	Occupational Safety and Health Administration
PIV	Post Indicator Valve
PUL	Private Utility Locator
PM	Project Manager
RF	Radio Frequency



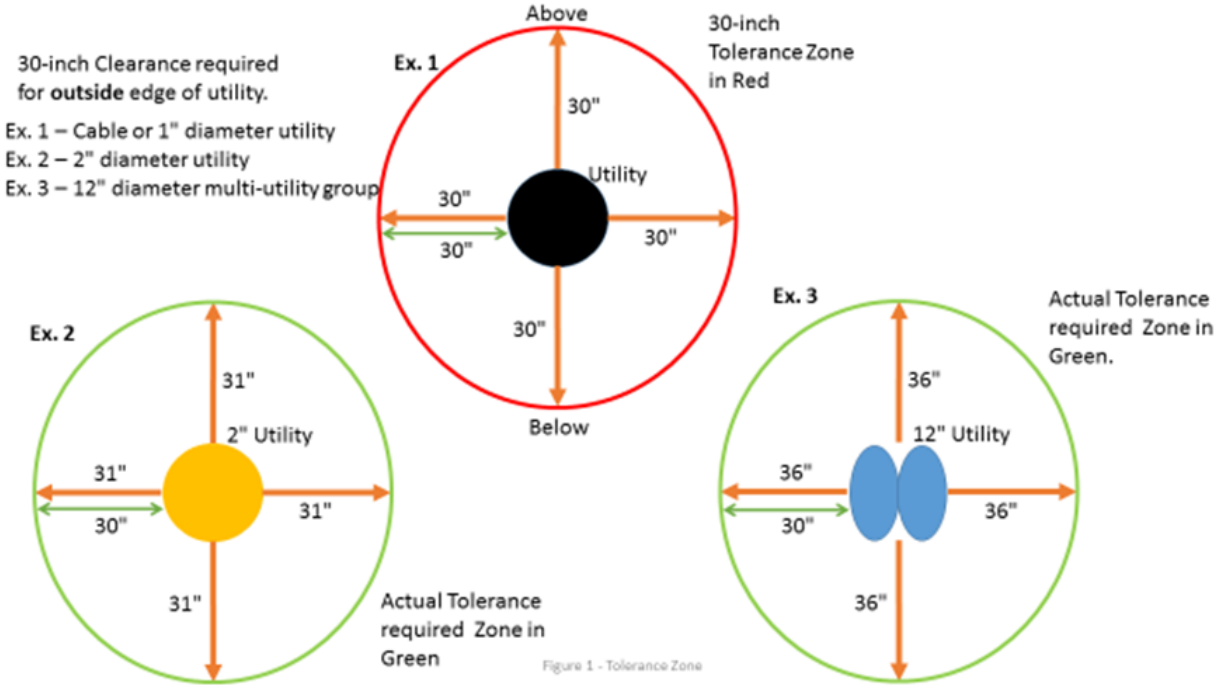
<u>Implementation Date</u> 13 December 2006	<u>ARCADIS HS Standard Name</u> Utility Location and Clearance	 <b>ARCADIS</b> <small>Design &amp; Consultancy for natural and built assets</small>
<u>Revision Date</u> 13 May 2020	<u>ARCADIS HS Standard No.</u> ARC HSFS019	<u>Revision Number</u> 17

- RFD      Radio Frequency Detection
- SOP      Standard Operating Procedure
- TM        Task Manager
- TZ        Tolerance Zone
- UXO      Unexploded Ordinance




<u>Implementation Date</u> 13 December 2006	<u>ARCADIS HS Standard Name</u> Utility Location and Clearance	 <b>ARCADIS</b> Design & Consultancy for natural and built assets
<u>Revision Date</u> 13 May 2020	<u>ARCADIS HS Standard No.</u> ARC HSFS019	<u>Revision Number</u> 17

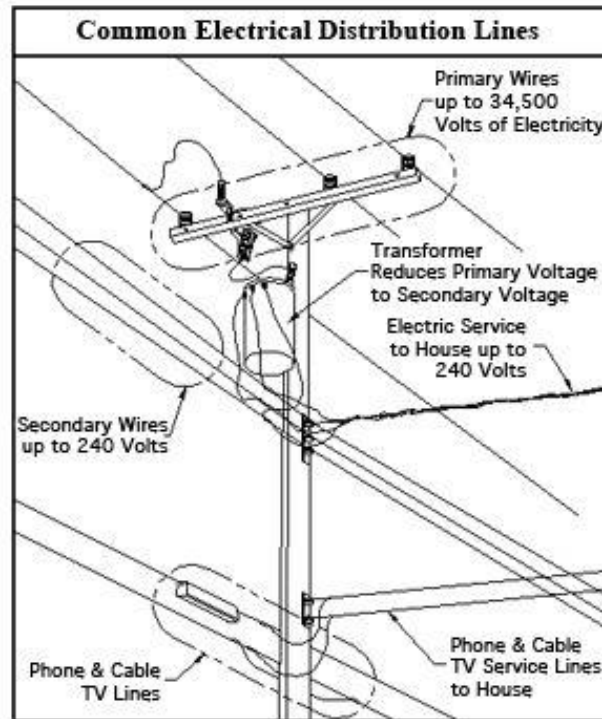
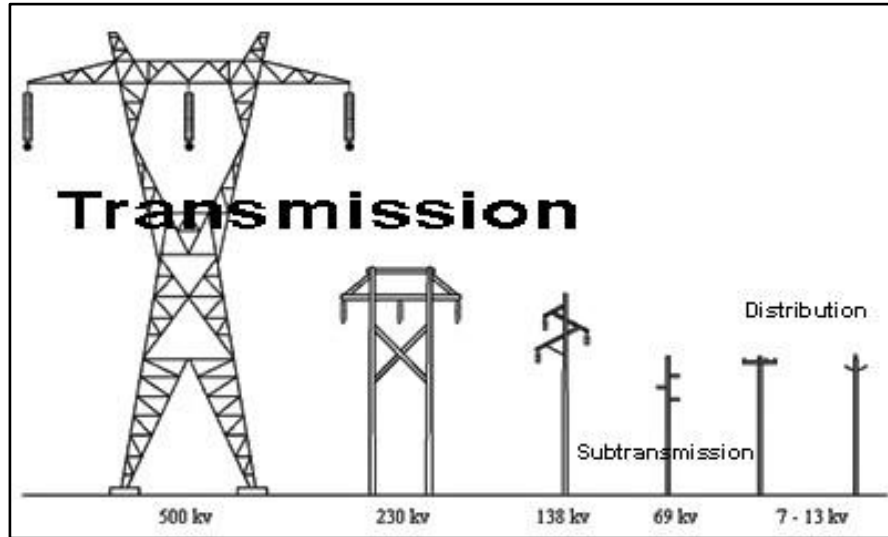
**Exhibit 2 Figure 1 – Arcadis Tolerance Zone Illustration**





<u>Implementation Date</u> 13 December 2006	<u>ARCADIS HS Standard Name</u> Utility Location and Clearance	 <b>ARCADIS</b> <small>Design &amp; Consultancy for natural and built assets</small>
<u>Revision Date</u> 13 May 2020	<u>ARCADIS HS Standard No.</u> ARC HSFS019	<u>Revision Number</u> 17

**Exhibit 3 – Overhead Power Utility Illustrations**



## **Photoionization Detector**

### **FSOP 3.1.1 (January 27, 2021)**

## **Ohio EPA Division of Environmental Response and Revitalization**

### **1.0 Scope and Applicability**

The photoionization detector (PID) is a portable instrument used to detect the real-time presence and relative concentration of certain ionizable compounds in gaseous or vapor states. This instrument is typically used for both health and safety monitoring of the work area breathing zone and for the screening of environmental samples. Other uses may include screening of soil gas probes or leak detection (e.g., tanks, vessels, process lines). Consult FSOP 1.1, Initial Site Entry and FSOP 2.1.4, Sample Headspace Screening prior to using a PID for health and safety monitoring or sample headspace screening procedures, respectively.

### **2.0 Definitions**

Not applicable

### **3.0 Health and Safety Considerations**

**3.1** Hazardous vapors or explosive gases may be present in concentrations requiring use of personal protective equipment (PPE) such as respiratory protection (Table 1, FSOP 1.1, Initial Site Entry) when work area breathing zone air conditions need to be monitored. Only personnel cleared to wear respiratory protection can enter the work area breathing zone if respiratory protection is required.

**3.2** Prior to use in potentially flammable atmospheres, consult the instrument manual to determine if the PID is intrinsically safe.

**3.3** PIDs only measure the relative concentration of molecules in gases or vapors that are ionizable (*i.e.*, those with an ionization potential (IP) less than that of the ionization energy (IE) of the instrument's ultraviolet lamp). Refer to paragraph 3.3 below for additional information. PIDs may not detect the presence of toxic or explosive gases or vapors with relatively high IPs, including carbon monoxide, chlorine, hydrogen, hydrogen cyanide, hydrogen sulfide or methane. PIDs do not detect or measure the concentration of atmospheric oxygen or the presence of explosive atmospheres. Be sure to use the correct instrument(s) for health and safety monitoring. (Refer to FSOP 1.1, Initial Site Entry.)

**3.4** Many instruments are equipped with audio and visual alarms that may be set at threshold limits for the gas or condition of concern. Default alarm levels are generally set by the manufacturer but should be set in accordance with the specified limits in the site-specific health and safety plan.

### **4.0 Procedure Cautions**

**4.1** The user should be familiar with the operation of the instrument being used. Consult the instrument manual for operating and calibration instructions specific to the instrument prior to use.



- 4.2 PID readings are not compound-specific. The instrument must be calibrated using a relatively non-toxic gas such as isobutylene and zeroed to a known clean or background air source. Readings are relative to the calibrant gas, and although the instruments display “ppm” or parts per million readings, the readings are actually ppm-calibration gas equivalents. The PID’s display concentration may be lower or higher than the actual concentration. There are correction factors that can be applied if the compound detected is known and the calibration gas is known.
- 4.3 PIDs only detect molecules that can be ionized. PIDs are equipped with ultraviolet lamps of different IEs, typically 9.8 electron volts (eV), 10.2 eV, 10.6 eV, and 11.7 eV. The IE of the lamp must be higher than the ionization potential (IP) of the compound(s) being screened. Consult the instrument manual or other reference for the ionization potential of the constituent(s) to be monitored to determine the proper lamp (or if a PID is appropriate for the proposed monitoring task).
- 4.4 PID performance may be adversely affected by temperature fluctuations, and PID readings are significantly affected by the presence of water vapor and methane due to their high IEs (> 12 eV). If using a PID in extremely wet or cold conditions, store the instrument in a relatively warm, dry location such as the front seat of a field vehicle with the heater running. A flame ionization detector may be better suited for use in these conditions and generally is preferred in situations where large temperature fluctuations, very moist or humid conditions or high methane concentrations are anticipated. Elevated methane concentrations may be encountered in subsurface areas at or adjacent to solid waste landfill disposal units.
- 4.5 Excessively dusty environments may overwhelm a PID inlet filter and reduce performance by fouling the ionization chamber or lamp. Filters should be inspected and changed after use in excessively dusty environments, and the lamp or ionization chamber should be cleaned if the instrument begins exhibiting a weak response to calibration gas.
- 4.6 If used for sample headspace screening, never allow the instrument probe to draw in liquid or solid material from a sample container, which may damage the instrument.
- 4.7 PIDs should be calibrated before each use and at any time the proper performance of the instrument appears to be questionable.
- 4.8 Always use a regulator with an appropriate flow rate to calibrate a PID. Information on calibration and regulator flow rate should be included in the operator’s manual.
- 4.9 Never use a source of highly concentrated organic vapors to check whether a PID is responding properly (e.g., never insert a PID probe into the fill port of a vehicle fuel tank, as doing so could damage the instrument).

- 4.10 Take care when using a PID to screen atmospheres with highly concentrated organic vapors (e.g., opening of a drum containing solvent- or petroleum-contaminated soil). Screening in this manner may contaminate the instrument's lamp or filter to the point that the PID must be serviced or removed from the area of elevated vapor concentrations until it can equilibrate or may otherwise damage the instrument.
- 4.11 PIDs should be cleaned, inspected, and internally calibrated annually by a service center authorized by the instrument manufacturer.
- 4.12 Always transport the instrument in a protective case or secure the instrument during transport.

## 5.0 Personnel Qualifications

Ohio EPA personnel working at sites that fall under the scope of OSHA's hazardous waste operations and emergency response standard (29 CFR 1910.120) must meet the training requirements described in that standard.

## 6.0 Equipment and Supplies

- 6.1 Calibrant gas (e.g., isobutylene)
- 6.2 Regulator for calibrant gas cylinder
- 6.3 Clean containers such as sealable plastic bags or jars with foil or film covers (if using for headspace screening)
- 6.4 Field logbook, field log sheets, or appropriate field form
- 6.5 Pens or markers
- 6.6 PPE appropriate for site-specific work activities
- 6.7 Inert tubing with "tee" connector
- 6.8 Instrument with operation manual
- 6.9 Protective case for instrument transport
- 6.10 Tedlar® bag
- 6.11 Calibration log sheet

## 7.0 Procedures

- 7.1 Consult the instrument manual for both general procedures and instrument-specific operating functions prior to using the instrument.
- 7.2 Make sure instrument is fully charged before use. Bring a backup battery if necessary.
- 7.3 Turn the instrument on and allow it to warm up. Some instruments will give a "ready" prompt in the instrument display when ready for use. Make sure pump is running and lamp is on. Check for warnings on instrument display during warm up. Check alarm levels to be sure they are consistent with site specific health and safety plan.



- 7.4 Calibrate the instrument according to the manufacturer's instructions with a relatively non-toxic span gas (e.g., isobutylene) before each use.
- 7.4.1 Calibrate the instrument directly from the cylinder using a flow regulator of appropriate flow rate (equal to or slightly higher than the pump capacity) or a pressure demand regulator. Use a piece of tubing to connect the regulator to the instrument probe. If the regulator flow rate is significantly higher than the pump flow, then install a "tee" fitting in the tubing to bleed of excess calibrant gas.
- 7.4.2 For an alternate calibration method, fill a clean Tedlar® bag with the calibrant gas by first connecting the cylinder to the bag with the regulator and tubing and allowing the bag to inflate after opening the valve on the bag. Next, close the valve on the bag, attach the instrument probe to the bag with a length of tubing and open the bag valve when ready to calibrate.
- 7.4.3 Record calibration data, including operator name, location, instrument make and model, date, time, calibration gas type, and result on the calibration log sheet.
- 7.5 Zero the instrument with a clean air source such as a cylinder of certified clean air, or to ambient (background or off-site) air, and ensure that the instrument is zeroed or recording background readings before use.
- 7.6 Use the instrument for health and safety monitoring or headspace screening in accordance with the site-specific health and safety plan and FSOP 1.1, Initial Site Entry and/or site-specific work plan and FSOP 2.1.4, Sample Headspace Screening as appropriate.
- 7.7 Observe and record the instrument readings as appropriate.

## 8.0 Data and Records Management

Refer to FSOP 1.3, Field Documentation.

## 9.0 Quality Assurance and Quality Control

Not applicable

## 10.0 Attachments

None

## 11.0 References

FSOP 1.1, Initial Site Entry

FSOP 1.3, Field Documentation

FSOP 2.1.4, Sample Headspace Screening



# **Soil Description, Classification and Logging**

## **FSOP 2.1.5 (June 30, 2020)**

### **Ohio EPA Division of Environmental Response and Revitalization**

#### **1.0 Scope and Applicability**

- 1.1 This procedure describes standard practices and recommendations used by the Division of Environmental Response and Revitalization (DERR) for field soil description, classification and logging.
- 1.2 This FSOP is not intended to replace the education or experience of Ohio EPA staff members who have degrees in geology, hydrogeology, soil science, geotechnical engineering, or similar fields. This FSOP should be used in conjunction with professional judgment.
- 1.3 For the purposes of this FSOP, “soil” includes natural deposits or natural fill materials consisting primarily of granular or cohesive mineral particles derived from sedimentary deposition or the weathering of bedrock. In addition, soil may contain minor amounts of natural organic debris or minor amounts of inorganic or organic waste materials. Soil may be unconsolidated or consolidated but is never cemented or lithified.
- 1.4 As discussed in this FSOP, soil description is a method of documenting the observed physical properties of soil for scientific or engineering purposes. Soil properties that are important for evaluating the behavior and fate of contaminants at waste sites include, but are not necessarily limited to the following:
  - texture (also referred to as grain-size or particle size distribution)
  - plasticity characteristics
  - color
  - moisture content
  - sedimentary structures
  - anthropogenic influence: the presence of fill materials, waste materials, hazardous substances, or petroleum

The soil properties and soil property criteria described in the FSOP are based on ASTM D2488-09a, Standard Practice for Description and Identification of Soils (Visual-Manual Procedure). ASTM D2488 is also recommended by the Ohio EPA Division of Drinking and Ground Water (DDAGW) Technical Guidance Manual for Ground Water Investigations (TGM), Chapter 3, Characterization of Site Hydrogeology, for soil description and classification for hydrogeologic investigations.

- 1.5 Soil classification is a method of systematically categorizing soil into groups with similar physical properties based on field description or laboratory testing. For environmental site assessment and engineering purposes, a soil classification system provides a uniform description of the physical properties of soil. U.S. EPA

(April 1999) recommends the use of the following soil classification systems for environmental investigations at hazardous waste sites:

- 1.5.1 The Unified Soil Classification System (USCS) as described by ASTM D2488-09a, Standard Practice for Description and Identification of Soils (Visual-Manual Procedure)
- 1.5.2 The United States Department of Agriculture (USDA) Soil Textural Triangle, USDA Natural Resources Conservation Service Soil Survey Manual, Chapter 3, Examination and Description of Soils (Figure 3-16)

Project data quality objectives (DQOs) should determine whether the USCS or USDA systems (or both) are used.

- 1.6 Soil description and classification should be performed: 1) during the collection of soil samples for laboratory analysis; 2) during the installation of borings, monitoring wells or soil gas/vapor probes; or 3) whenever characterization of subsurface geologic conditions is needed to meet site assessment project or data quality objectives.

Describing and classifying soil samples in an accurate and consistent manner:

- is critical for understanding site geology and hydrogeology
  - helps to ensure proper location and construction of monitoring wells and soil gas probes
  - facilitates the selection of samples for laboratory analysis and the subsequent evaluation of contaminant distribution and migration
  - may provide an understanding of contaminant migration pathways
  - determines the thickness of cover materials or depth of wastes or contaminated soil layers
  - provides a means of correlating soil types with geophysical surveys
- 1.7 Logging the description and classification of soil samples includes the continuous recording of drilling and sampling, field monitoring, and well or probe construction data. A field logging form (example attached) is recommended for logging soils collected with direct-push or rotary drilling rigs or excavating equipment. The form may also be designed to record ground water data and serve as a monitoring well or soil gas probe construction diagram.

## **2.0 Definitions**

Refer to the attached list (Soil Descriptive Terminology).



### 3.0 Health and Safety Considerations

- 3.1 Wear appropriate personal protective equipment (PPE) when working in the vicinity of drilling rigs or other types of mechanical equipment used for soil sampling, in accordance with the site-specific health and safety plan. At a minimum, PPE should include protective eyewear, footwear, and hearing protection. In addition, a hard hat is required when working in the vicinity of drilling rigs and the use of canvas coveralls or similar protective clothing is recommended.
- 3.2 Use heavy protective gloves to help prevent hand injuries when opening and handling split-spoon samplers, core barrels, or plastic soil core liners.
- 3.3 Wear chemical-resistant gloves when handling soil samples to avoid direct contact with chemical contaminants. Always thoroughly wash your hands after completing soil logging activities.
- 3.4 If free product or splash hazards are a concern during drilling or sampling, use of a chemically resistant suit (e.g., Saranex® or coated Tyvek®) is recommended.
- 3.5 If drilling and soil sampling activities cause dusty conditions, respiratory protection may be necessary to provide protection from dust-inhalation hazards. Work should be stopped to assess site conditions. Work requiring respiratory protection may only be performed by staff certified to wear respiratory protection. Depending on site-specific conditions and chemicals of concern, monitoring with a particulate meter and/or other air monitoring instruments as appropriate. For action levels, refer to Table 1 of FSOP 1.1, Initial Site Entry.
- 3.6 Conduct air monitoring in accordance with the site-specific health and safety plan. For action levels, refer to Table 1 of FSOP 1.1, Initial Site Entry.
- 3.7 Dress appropriately for anticipated weather conditions, and always have ample drinking water available when working in hot weather. Insect repellent may be needed for protection from ticks, mosquitoes, and other biting insects in heavily wooded areas.

### 4.0 Procedure Cautions

- 4.1 For logging soil borings or excavations greater than six feet deep, a field logging form (example attached) is preferred. Logging soil borings using a field logbook or log sheets may be difficult due to the volume of information that typically needs to be recorded.
- 4.2 Use a level of detail for soil descriptions that is consistent with the site-specific work plan and project DQOs.

- 4.3 If the driller is collecting soil samples so quickly that logging is difficult, direct the driller to slow down or stop. Soil cores should be processed (*i.e.*, logged, screened, and sampled) as soon as possible after being retrieved from the ground.
- 4.4 When recording soil descriptions, use a consistent format such as that recommended in paragraph 7.9. Doing so makes logging easier, improves the readability of the field log, and facilitates subsequent data entry in the office.
- 4.5 Do not indiscriminately apply soil classification systems. Project DQOs will determine whether the USCS, USDA classification system, or both systems should be used for a project. Additionally, DQOs may indicate how soil classification should be applied at a site with respect to boring locations and depth of investigation.
- 4.6 An accurate location of each boring should be included on the logging form (or field notebook). The location could include a narrative description of the boring location with reference to site features, a schematic and/or GPS coordinates.

## 5.0 Personnel Qualifications

Ohio EPA personnel working at sites that fall under the scope of OSHA's hazardous waste operations and emergency response standard (29 CFR 1910.120) must meet the training requirements described in that standard. In addition, personnel who log soil borings should have a background in geology, hydrogeology, soil science or geotechnical engineering, or should have received training in soil classification, description and logging from a qualified individual.

## 6.0 Equipment and Supplies

- 6.1 Field logging form (example attached)
- 6.2 Field logbook or log sheets (*recommended for use as an alternative to a logging form only if soil logging activities are limited to borings or excavations less than six feet deep*).
- 6.3 Engineering ruler or measuring tape with 0.1 foot increments for measuring soil cores
- 6.4 Stainless steel spatula or knife for examining and sampling soil core
- 6.5 Field guide for soil classification/description or soil texturing, a geotechnical (sand) gauge, and/or Munsell Soil Color chart (optional)
- 6.6 Hand lens (optional, helps identify waste materials)
- 6.7 Magnet (optional, helps identify waste materials)



## 7.0 Procedures

- 7.1 Before drilling begins record project information, boring identification and location, the date, and drilling and sampling method(s) on the soil logging field form.
- 7.2 Be sure that the driller identifies the top of each core sample.
- 7.3 If any of the soil in the sampler appears to be caved or sloughed material from the open boring overlying the sampled interval, remove it from the sampler. Do not log it as part of the sampled interval or submit it for laboratory analysis. If in doubt based on sample appearance, consult with the driller regarding the stability of the borehole, i.e., is it collapsing or heaving between sample intervals?
- 7.4 Using the ruler or tape, measure the length of the soil core recovered from each sampled interval (excluding any caved/sloughed material if present). Record the sampler type and the sampled interval recovery to the nearest 0.1 foot on the soil logging field form. Do not record a recovery that is greater than the length of soil core actually recovered. For example, if a core sampler pushed from 8.0 to 10.0 ft recovers only 1.5 ft of soil core, record the recovery as 1.5 ft (or 8.0 to 9.5 ft) and not 2.0 ft (or 8.0-10.0 ft).
- 7.5 Discuss possible reasons for core loss with the driller, as well as the driller's insight on likely soil or fill materials encountered based on the behavior of the drilling and sampling equipment.
- 7.6 Split or scrape any soil core consisting of cohesive soils (silts or clays) using a stainless steel knife or spatula.
- 7.7 Quickly examine the soil core and evaluate the following properties (preliminary evaluation) to select samples for field screening and/or analytical sampling:
  - Soil texture (*i.e.*, is it mostly gravel, sand, silt, or clay?) and changes in texture within the core sample
  - Moisture content
  - The presence of waste materials, potentially hazardous substances, or petroleum (*the hand lens and/or magnet may be helpful*)
- 7.8 As required, collect soil samples for field screening and laboratory analysis based on project DQOs and preliminary core examination (paragraph 7.5). Assign each screening or laboratory sample an identification number). Record the sample identification and depth interval to the nearest 0.1 foot on the soil logging form.
- 7.9 Record a description of the soil core. The soil properties included in the description will depend on project DQOs; however, a soil description should generally include the following information:

- 7.9.1 **Soil color:** the following colors (with Munsell Soil Color Chart numbers for reference only) are recommended for soil description:

Brown Shades	Munsell #	Gray Shades	Munsell #
Brownish yellow	10YR 6/6	Grayish brown	2.5Y 5/2
Light brown	10YR 7/4	Light gray	2.5Y 7/1
Reddish brown	5YR 5/4	Gray	2.5Y 5/1
Brown	10YR 4/3	Greenish gray	GLE Y1 5/1
Dark yellowish brown	10YR 4/6	Olive gray	5Y 4/2
Dark brown	10YR 3/3	Dark gray	2.5Y 4/1

If the soil exhibits a primary color and one or more secondary colors, describe the soil color as “mottled” or “with mottling”, e.g., “gray with brownish yellow mottling” or “mottled light brown, dark yellowish brown, and light gray”.

- 7.9.2 **Soil classification:** follow the attached Unified Soil Classification System Field Guidance to classify soils according to the USCS or the attached Estimating Soil Texture By Feel (Presley and Thien, September 2008) to classify soils according to the USDA System.

- 7.9.3 **Moisture content:** ASTM D2488-09a recommends describing soil moisture content as follows:

- **Dry** – absence of moisture, dry and dusty to the touch
- **Moist** – damp but no visible water
- **Wet** – visible free water, usually soil is below the water table

The terms “**slightly moist**” (intermediate between dry and moist) and “**very moist**” (intermediate between moist and wet) may also be used.

- 7.9.4 **Plasticity characteristics** (for silts and clays only): describe the soil **plasticity**. If possible, also include descriptions for **consistency**, **dilatancy**, and/or **toughness** (refer to Soil Descriptive Terminology, attached). The dry strength test is generally too time-consuming to be performed.

- 7.9.5 **Sedimentary structures:** describe soil sedimentary structures (refer to Soil Descriptive Terminology)

- 7.9.6 **Anthropogenic influence:** determine if the soil is native or fill material, and describe the presence of waste materials (construction/demolition debris, solid waste, industrial wastes), hazardous substances, or petroleum (*the hand lens and magnet may be helpful*)



- 7.10 The following soil properties may also be included in soil descriptions at the discretion of the soil logger:
- 7.10.1 Secondary grain size percentages as recommended by ASTM D2488-09a:
    - Trace – particles are present but estimated to be less than 5%
    - Few – 5% to 10%
    - Little – 15% to 25 %
    - Some – 30% to 45%
    - Mostly – 50% to 100%
  - 7.10.2 Depositional environment (*Note: this is a geologic interpretation based on soil texture and sedimentary structures which should be made by a geologist or hydrogeologist.*)
  - 7.10.3 Oxidation, leaching and/or degree of weathering
  - 7.10.4 Other properties described in ASTM D2488-09a
- 7.11 The following soil description format is suggested: *consistency – color – soil classification: moisture content, plasticity characteristics, sedimentary structures, anthropogenic influence, other*
- Examples:
- *firm gray lean clay with dark yellowish brown mottling: moist, medium toughness and plasticity, massive structure, solvent odor*
  - *brownish yellow loam: dry to slightly moist, low plasticity, vertical fractures with iron oxide staining, broken glass and demolition debris (concrete, brick and wood fragments)*
  - *dark brown sand: wet, stratified, trace fine gravel*
  - *soft gray lean clay with silt: moist to very moist, low to medium plasticity, no dilatancy to slow dilatancy, varved, lacustrine (lake) deposit*
- Regardless of the specific soil description format, a consistent format should be utilized for borings on the same site/property or installed for the same project.
- 7.12 In addition to soil descriptions, record field information associated with boring installation, soil sampling or well or probe installation on the soil logging form. Such information may include, but is not limited to the following:
- Field screening data
  - Laboratory sample identification numbers for soil and ground water samples
  - Ground water levels

- Relevant information recorded by the driller, e.g., changes in penetration resistance
  - Monitoring well screen placement and sand pack thickness
  - GPS coordinates and/or other boring location data
- 7.13 Properly dispose of IDW in accordance with FSOP 1.7, Investigation-Derived Wastes.
- 7.14 In addition to completing a field logging form for each soil boring, an Ohio Department of Natural Resources (ODNR) Well Log and Drilling Report Form may need to be filed with the ODNR Division of Soil and Water Resources. Refer to FSOP 1.8, ODNR Well Construction Logs & Well Sealing Reports.

## **8.0 Data and Records Management**

Please refer to FSOP 1.3, Field Documentation.

## **9.0 Quality Control and Quality Assurance**

Draft soil boring logs should be peer-reviewed by an Ohio EPA staff member with a degree in geology, hydrogeology, soil science, geotechnical engineering, or similar field experience before being finalized.

## **10.0 Attachments**

Logging Field Form (example)

Soil Descriptive Terminology

Unified Soil Classification System Field Guidance

Presley, D. and Thien, S., September 2008, Estimating Soil Texture By Feel, Kansas State University

## **11.0 References**

ASTM D 2488-09a, Standard Practice for Description and Identification of Soils (Visual-Manual Procedure)

FSOP 1.1, Initial Site Entry

FSOP 1.3, Field Documentation

FSOP 1.7, Investigation Derived Waste

FSOP 1.8, ODNR Well Construction Logs & Well Sealing Reports



Ohio EPA Division of Drinking and Ground Waters, April 2015, Technical Guidance Manual for Ground Water Investigations: Chapter 3, Characterization of Site Hydrogeology

Munsell Soil Color Chart

USDA Natural Resources Conservation Service, October 1993, Soil Survey Manual: Chapter 3, Examination and Description of Soils

U.S. EPA (D.S. Burden and J.L. Sims), April 1999, Ground Water Issue, Fundamentals of Soil Science as Applicable to the Management of Hazardous Wastes: EPA/540/S-98/500

# ATTACHMENT 2

## Technical Guidance Documents

### Associated with Worksheet 21-B

TGI - Groundwater and Soil Sampling Equipment Decontamination

TGI - Investigation-derived Waste Handling and Storage

TGI - Sample Chain of Custody

QP 3.07 - Calibration and Control of Measuring and Test Equipment

TGI - Indoor or Ambient Air Sampling and Analysis Via USEPA Method TO-15

TGI - Sub-Slab Soil Gas Sampling Point Installation using Vapor PIN Approach

TGI - Sub-Slab Vapor and Soil Vapor Sampling Using Whole Air Canisters

TGI - Building Surveying Prior to Vapor Intrusion Indoor Air Sampling

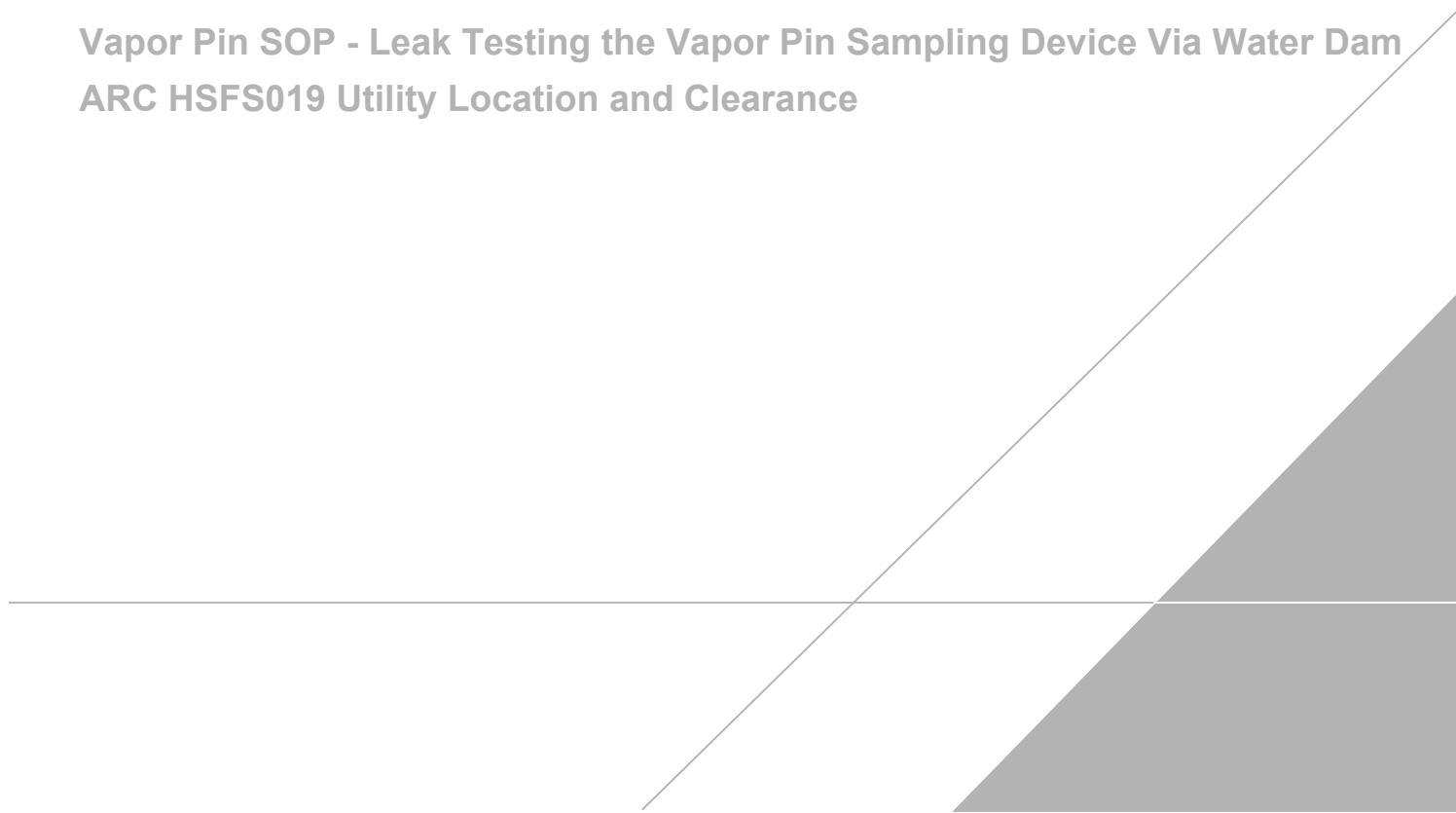
Ohio EPA Indoor Air Building Survey and Sampling Form

TGI - Decontamination of Components for Vapor Intrusion Sampling

TGI - Soil Vapor Sampling and Analysis using Sorbent Tubes for USEPA  
Method TO-17

Vapor Pin SOP - Leak Testing the Vapor Pin Sampling Device Via Water Dam

ARC HSFS019 Utility Location and Clearance





# TGI – Groundwater and Soil Sampling Equipment Decontamination

Rev: 2

Rev Date: June 14, 2022

## Version Control

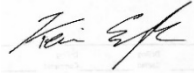
Issue	Revision No.	Date Issued	Page No.	Description	Reviewed By
	0	February 23, 2017	All	Conversion from SOP to TGI	Cassandra McCloud / Pete Frederick
	1	May 8, 2020	4, 5	Added note regarding use of Liquinox and 1,4-Dioxane	Marc Killingstad
	2	June 14, 2022	All	Conversion to new TGI format and minor edits.	Kevin Engle / Marc Killingstad



## Approval Signatures

Prepared by:

6/14/2022



\_\_\_\_\_  
Name (Preparer)

\_\_\_\_\_  
Date

Reviewed by:

6/14/2022



\_\_\_\_\_  
Marc Killingstad (Subject Matter Expert)

\_\_\_\_\_  
Date

## 1 Introduction

This document is intended to provide guidance to staff performing decontamination procedures at project sites. The content in this document describes the intended use, scope and application, personnel qualifications, equipment, cautions, health and safety considerations, procedures, waste management, data recording and management, and quality assurance of decontamination procedures.

## 2 Intended Use and Responsibilities

This document describes general and/or specific procedures, methods, actions, steps, and considerations to be used and observed by Arcadis staff when performing work, tasks, or actions under the scope and relevancy of this document. This document may describe expectations, requirements, guidance, recommendations, and/or instructions pertinent to the service, work task, or activity it covers.

It is the responsibility of the Arcadis Certified Project Manager (CPM) to provide this document to the persons conducting services that fall under the scope and purpose of this procedure, instruction, and/or guidance. The Arcadis CPM will also ensure that the persons conducting the work falling under this document are appropriately trained and familiar with its content. The persons conducting the work under this document are required to meet the minimum competency requirements outlined herein, and inquire to the CPM regarding any questions, misunderstanding, or discrepancy related to the work under this document.

This document is not considered to be all inclusive nor does it apply to all projects. It is the CPM's responsibility to determine the proper scope and personnel required for each project. There may be project- and/or client- and/or state-specific requirements that may be more or less stringent than what is described herein. The CPM is responsible for informing Arcadis and/or Subcontractor personnel of omissions and/or deviations from this document that may be required for the project. In turn, project staff are required to inform the CPM if or when there is a deviation or omission from work performed as compared to what is described herein.

In following this document to execute the scope of work for a project, it may be necessary for staff to make professional judgment decisions to meet the project's scope of work based upon site conditions, staffing expertise, regulation-specific requirements, health and safety concerns, etc. Staff are required to consult with the CPM when or if a deviation or omission from this document is required that has not already been previously approved by the CPM. Upon approval by the CPM, the staff can perform the deviation or omission as confirmed by the CPM.

## 3 Scope and Application

Decontamination is performed on sampling equipment prior to sample collection to ensure that the sampling equipment that contacts a sample, or monitoring equipment that is brought into contact with environmental media to be sampled, is free from analytes of interest and/or constituents that could interfere with laboratory analysis for analytes of interest. Sampling equipment must be appropriately cleaned prior to use for sampling or coming into contact with environmental media to be sampled and following completion of the sampling event prior to shipment or storage. The effectiveness of the decontamination procedure should be verified by collecting and analyzing equipment blank samples.



The sampling equipment cleaning procedures described herein includes pre-field, in the field, and post-field cleaning of sampling equipment which may be conducted at an established equipment decontamination area (EDA) on site, as appropriate and necessary. Sampling equipment that may require decontamination at a given site include soil sampling tools; groundwater, sediment, and surface-water sampling devices; water testing instruments; down-hole instruments; and other activity-specific sampling equipment. Non-disposable equipment will be cleaned before collecting each sample, between each sample collected, and prior to placing sampling equipment in protective cases, or containers for transport. Cleaning procedures for sampling equipment should be monitored by collecting equipment blank samples as required in project work plans, field sampling plans, quality assurance project plans (QAPP), or other pertinent project documents. Dedicated and/or single-use (i.e., not to be re-used) sampling equipment will not require decontamination.

## 4 Personnel Qualifications

Arcadis field sampling personnel will have completed or are in the process of completing site-specific training as well as having current health and safety training as required by Arcadis, client, or regulations, such as 40-hour hazardous waste operations and emergency response (HAZWOPER) training and/or Occupational Safety and Health Administration (OSHA) HAZWOPER site supervisor training. Arcadis personnel will also have current training as specified in the Health and Safety Plan (HASP) which may include first aid, cardiopulmonary resuscitation (CPR), Blood Borne Pathogens (BBP) as needed. In addition, Arcadis field sampling personnel will be knowledgeable in the relevant processes, procedures, and Technical Guidance Instructions (TGIs) and possess the demonstrated required skills and experience necessary to successfully complete the desired field work. The project HASP and other documents will identify other training requirements or access control requirements.

## 5 Equipment List

The equipment required for equipment decontamination is presented below. Note that certain contaminants may require specific materials be used that are not captured in this list. Always review project and contaminant specific TGIs or work plans to ensure proper equipment is utilized. Note for per- and polyfluoroalkyl substances (PFAS) see *TGI – Per- and Polyfluoroalkyl Substances (PFAS) Field Sampling Guide*.

- Health and safety equipment, including appropriate personal protective equipment (PPE), as required in the site HASP
- Deionized water that meets the analytical criteria for deionized water with no detectable constituents above the reporting limits for the methods to be used and analytes being analyzed for. Deionized water is used for inorganics, and organic-free water for volatile organic compounds (VOCs), semi-volatile organic compounds (SVOCs), pesticides, etc.
- Non-phosphate detergent such as Alconox® or, if sampling for phosphorus or phosphorus-containing compounds, Liquinox (or equivalent). NOTE: Liquinox has shown to provide false positives for 1,4-Dioxane and should not be used at sites where that may be a constituent of concern (COC).
- Tap water
- Rinsate collection plastic containers

- Department of Transportation (DOT)-approved waste shipping container(s), as specified in the work plan, field sampling plan, or regulatory requirements if decontamination waste is to be shipped for disposal
- Brushes
- Large heavy-duty garbage bags
- Spray bottles
- (Optional) – Isopropyl alcohol (free of ketones) or methanol. These can be wipes or diluted with water (usually 1part isopropyl/methanol to 10 parts water) if a spray is needed.
- Airtight, sealable plastic baggies, such as Ziploc®-type
- Plastic sheeting

## 6 Cautions

Rinse equipment thoroughly and allow the equipment to dry before re-use or storage to prevent introducing solvent into sample medium. If manual drying of equipment is required, use clean lint-free material to wipe the equipment dry. Ensure all rinse materials do not adversely affect sample collection efficiency or analytical results.

Store decontaminated equipment in a clean, dry environment. Do not store near combustion engine exhausts. Properly containerize equipment to ensure cross-contamination doesn't happen from other uncontaminated surfaces or equipment.

If equipment is damaged to the extent that decontamination is uncertain due to cracks, gouges, crevices, or dents, the equipment should not be used and should be discarded or submitted for repair prior to use for sample collection.

A proper shipping determination regarding hazardous materials will be performed by a DOT-trained individual for cleaning materials shipped by Arcadis.

Caution should be exercised to avoid contact with the pump casing and water in the container while the pump is running (do not use metal drums or garbage cans) to avoid electric shock.

## 7 Health and Safety Considerations

Review the safety data sheets (SDS) for the cleaning agents and materials used in decontamination. If solvent is used during decontamination, use appropriate PPE and work in a well-ventilated area and stand upwind while applying solvent to equipment. Apply solvent in a manner that minimizes potential for exposure to workers and bystanders. Follow health and safety procedures outlined in the HASP.

## 8 Procedure

A designated area will be established to clean sampling equipment in the field prior to and following sample collection. Equipment cleaning areas will be set up within or adjacent to the specific work area, but not at a location that expose equipment to contamination (i.e., exposed to combustion engine exhaust). Detergent solutions will be prepared in clean containers for use in equipment decontamination. Decontaminated equipment



will be handled by workers wearing clean gloves, properly changed to prevent cross-contamination. The procedures detailed in this section provide an overview of common decontamination techniques. Additional steps may be required based on the type of contaminant present or client/site requirements.

### **Cleaning Sampling Equipment**

1. Wash the equipment/pump with potable water.
2. Wash with detergent solution (Alconox®, Liquinox® or equivalent) to remove all visible particulate matter and any residual oils or grease. NOTE: Liquinox® has shown to provide false positives for 1,4-Dioxane and will not be used at sites where that may be a COC.
3. If equipment is very dirty, precleaning gross debris with a brush and tap water may be necessary.
4. If non-aqueous phase liquids are present, the use of isopropyl alcohol (free of ketones) or methanol is recommended. Cloth wipes or diluted solution can be used to remove the non-aqueous phase liquids that are hard to remove with detergent solution in step 2. Consult with project manager if non-aqueous phase liquids are present onsite and design an appropriate decontamination procedure that includes step 4.
5. Rinse with deionized water.

### **Decontaminating Submersible Pumps**

Submersible pumps may be used during well development, groundwater sampling, or other investigative activities. The pumps must be cleaned and flushed before and between uses. This cleaning process will consist of an external detergent solution wash and tap water rinse, a flush of detergent solution through the pump, followed by a flush of potable water through the pump. Flushing will be accomplished by using an appropriate container filled with detergent solution and another container filled with potable water. The pump will be flushed with deionized water as the last step prior to use. The pump will run long enough to effectively flush the pump housing and hose (unless new, disposable hose is used). Disconnect the pump from the power source before handling. The pump and hose will be placed on or in clean polyethylene sheeting to avoid contact with the ground surface.

## **9 Waste Management**

Equipment decontamination rinsate will be managed in conjunction with all other waste produced during the field sampling effort. Waste management procedures are outlined in the work plan or Waste Management Plan (WMP).

## **10 Data Recording and Management**

Digital data collection is the Arcadis standard using available FieldNow® applications that enable real-time, paperless data collection, entry, and automated reporting. Paper forms should only be used as backup to FieldNow® digital data collection and/or as necessary to collect data not captured by available FieldNow® applications. The Field Now® digital form applications follow a standardized approach, correlate to most TGIs and are available to all projects accessible with a PC or capable mobile device. Once the digital forms are saved within FieldNow®, the data is instantly available for review on a web interface. This facilitates review by project management team members and SMEs enabling error or anomalous data detection for correction while the staff

are still in the field. Continual improvements of FieldNow® applications are ongoing, and revisions are made as necessary in response to feedback from users and subject matter experts.

Equipment cleaning and decontamination will be noted during project documentation. Information will include the type of equipment cleaned, the decontamination location, specific procedures utilized, solvents and/or cleaning agents used, source of water, and deviations or omissions from this TGI.

Unusual field conditions should be noted if there is potential to impact the efficacy of the decontamination or subsequent sample collection.

An inventory of the solvents brought on site and used and removed from the site will be maintained in the project documentation. Records will be maintained for solvents used in decontamination, including lot number and expiration date.

Containers with decontamination fluids will be labeled.

## 11 Quality Assurance

Equipment blanks should be collected to verify that the decontamination procedures are effective in minimizing potential for cross contamination. The equipment blank is prepared by pouring deionized water (or organic-free water, for organic analyses) over the clean and dry tools and collecting the water into appropriate sample containers. Equipment blanks should be analyzed for the same set of parameters that are performed on the field samples collected with the equipment that was cleaned as specified in the sampling and analysis plan. Equipment blanks are collected per equipment set, which represents all the tools needed to collect a specific sample.

## 12 References

USEPA Region 9 - Field Sampling Guidance #1230, Sampling Equipment Decontamination.

USEPA Region 1 - Low Stress (low flow) Purging and Sampling Procedure for the Collection of Groundwater Samples from Monitoring Wells.



Arcadis U.S., Inc.  
630 Plaza Drive, Suite 200  
Highlands Ranch  
Colorado 80129  
Phone: 720 344 3500  
Fax: 720 344 3535  
[www.arcadis.com](http://www.arcadis.com)

# TGI - INVESTIGATION-DERIVED WASTE HANDLING AND STORAGE

Rev #: 1

Rev Date: May 15, 2020





## VERSION CONTROL

Revision No	Revision Date	Page No(s)	Description	Reviewed by
0	February 23, 2017	ALL	Conversion from SOP to TGI	Ryan Mattson / Peter Frederick
1	May 15, 2020	ALL	Updated to reflect regulatory changes	

## APPROVAL SIGNATURES

Prepared by:



---

Derrick Maurer

02/23/2017

---

Date:

Technical Expert Reviewed by:



---

Ryan Mattson (Technical Expert)

05/15/2020

---

Date:



## 1 INTRODUCTION

This document describes general and/or specific procedures, methods, actions, steps, and considerations to be used and observed by Arcadis staff when performing work, tasks, or actions under the scope and relevancy of this document. This document may describe expectations, requirements, guidance, recommendations, and/or instructions pertinent to the service, work task, or activity it covers.

It is the responsibility of the Arcadis Certified Project Manager (CPM) to provide this document to the persons conducting services that fall under the scope and purpose of this procedure, instruction, and/or guidance. The Arcadis CPM will also ensure that the persons conducting the work falling under this document are appropriately trained and familiar with its content. The persons conducting the work under this document are required to meet the minimum competency requirements outlined herein, and inquire to the CPM regarding any questions, misunderstanding, or discrepancy related to the work under this document.

This document is not considered to be all inclusive nor does it apply to any and all projects. It is the CPM's responsibility to determine the proper scope and personnel required for each project. There may be project- and/or client- and/or state-specific requirements that may be more or less stringent than what is described herein. The CPM is responsible for informing Arcadis and/or Subcontractor personnel of omissions and/or deviations from this document that may be required for the project. In turn, project staff are required to inform the CPM if or when there is a deviation or omission from work performed as compared to what is described herein.

In following this document to execute the scope of work for a project, it may be necessary for staff to make professional judgment decisions to meet the project's scope of work based upon site conditions, staffing expertise, state-specific requirements, health and safety concerns, etc. Staff are required to consult with the CPM when or if a deviation or omission from this document is required that has not already been previously approved by the CPM. Upon approval by the CPM, the staff can perform the deviation or omission as confirmed by the CPM.

## 2 SCOPE AND APPLICATION

The objective of this Technical Guidance Instruction (TGI) is to describe the procedures to manage investigation-derived wastes (IDW), both hazardous and nonhazardous, generated during site activities, which may include, but are not limited to: drilling, trenching/excavation, construction, demolition, monitoring well sampling, soil sampling, decontamination and remediation. For the purposes of this TGI, IDW is considered to be discarded materials which are defined as solid waste by United States Environmental Protection Agency (EPA) standard 40 CFR § 261.2 (which may include liquids, solids, or sludges). IDW may include soil, groundwater, drilling fluids, decontamination liquids, as well as contaminated personal protective equipment (PPE), sorbent materials, construction and demolition debris, and disposable sampling materials. Hazardous or uncharacterized IDW will be collected and staged at the point of generation. Quantities small enough to be containerized in 55-gallon drums will be taken to a designated temporary onsite storage area (discussed in further detail under Drum Storage) pending characterization and disposal. IDW materials will be characterized using process knowledge and appropriate laboratory analyses to determine the waste classification and evaluate proper safe handling and disposal methods.

This TGI describes the necessary equipment, field procedures, materials, regulatory references, and documentation procedures necessary for proper handling and storage of IDW up to the time it is properly transported from the project site and disposed. The procedures included in this TGI for handling and temporary storage of IDW are based on the EPA's guidance document *Guide to Management of Investigation Derived Wastes* (USEPA, 1992). IDW is assumed to be contaminated with the site constituents of concern (COCs) until analytical evidence indicates otherwise. IDW will be managed to ensure the protection of human health and the environment and will comply with all applicable or relevant and appropriate requirements (ARAR). Although not comprehensive, the following laws and regulations on Hazardous Waste Management should be considered as potential ARAR. It is the Arcadis Certified Project Manager (CPM) and/or designated Technical Expert to determine which laws and regulations, at all levels of government, are applicable to each project site and activity falling under this TGI.

#### Federal Laws and Regulations

- Resource Conservation and Recovery Act (RCRA) 42 USC § 6901-6987.
- Federal Hazardous Waste Regulations 40 CFR § 260-265

Department of Transportation (DOT) Hazardous Materials Transportation 49 CFR

Occupational Safety and Health Administration (OSHA) Regulations 29 CFR

#### State Laws and Regulations

- To be determined based on location of site and location of treatment, storage, and/or disposal facility (TSDF) to be utilized.

Regional, County, Municipal, and Local Regulations

- To be determined based on location of site and location of treatment, storage, and/or disposal facility (TSDF) to be utilized.

#### **Initial Storage**

Pending characterization, IDW will be temporarily stored appropriately within each area of contamination (AOC). Under RCRA, "storage" is defined as the "holding of hazardous waste for a temporary period, at the end of which the hazardous waste is treated, disposed of, or stored elsewhere" (40 CFR § 260.10). The onsite waste staging area will be in a secure and controlled area. Uncharacterized wastes are considered potentially hazardous wastes and must be stored in DOT approved packaging. Liquid wastes must be stored in DOT approved closed head drums or other approved containers (e.g., portable tank containers) that are compatible with the type of material stored therein. Solid materials must be stored in DOT approved open head drums where practicable. Larger quantities of solid IDW can be containerized in bulk containers (such as in a roll-off box). Soil from large excavation projects may be managed in stockpiles with within the AOC and does not need to be containerized until exiting the AOC.

#### **Characterization**

Waste characterization can either be based on generator knowledge, such as using historical process knowledge and safety data sheets (SDS), or can be based upon characterization sampling analytical results. IDW typically is not characterized using SDS as it is a mixture of aged chemicals and environmental media. Historical process knowledge should be used to determine if the IDW is a listed hazardous waste (40 CFR § 261.31-33). If the IDW is not a listed hazardous waste, waste



characterization can be completed by laboratory analysis of representative samples of the IDW. The laboratory used for waste characterization analysis must have the appropriate state and federal accreditations and may be required to be pre-approved by the Client. IDW will be classified as RCRA hazardous or non-regulated under RCRA based on the waste characterization determination.

If IDW is characterized as RCRA hazardous waste, RCRA and DOT requirements must be followed for packaging, labeling, transporting, storing, and record keeping as described in 40 CFR § 262 and 49 CFR § 171-178. Waste material classified as RCRA nonhazardous may be handled and disposed of as nonhazardous waste in accordance with applicable federal, state, and local regulations.

### **Storage Time Limitations**

Containerized hazardous wastes can be temporarily stored for a maximum of 90 calendar days from the accumulation start date for a large quantity generator or a maximum of 180 calendar days from the accumulation start date for a small quantity generator. Wastes classified as nonhazardous may be handled and disposed of as nonhazardous waste and are not subject to storage time limitations.

This is TGI may be modified by the CPM and/or Technical Expert for a specific project or client program, as required, dependent upon client requirements, site conditions, equipment limitations, or limitations imposed by the procedure. The resulting procedure employed to execute the work will be documented in the project work plans or reports. If changes to the sampling procedures are required due to unanticipated field conditions, the changes will be discussed with the CPM and/or Technical Expert as soon as practicable, and if approved to be performed, be documented.

## **3 PERSONNEL QUALIFICATIONS**

Arcadis field sampling personnel will have current regulatory- and Arcadis-required health and safety training including 40-hour HAZWOPER training, site supervisor training, site-specific training, first aid, and cardiopulmonary resuscitation (CPR), as needed. Personnel handling and packaging hazardous waste and performing hazardous waste characterizations must have RCRA hazardous waste management training per 40 CFR § 264.16. Additional state-specific hazardous waste management training is required in certain states (i.e., California).

Although not common practice, in certain situations Arcadis personnel may sign waste profiles and/or waste manifests on a case by case basis for clients, provided the appropriate agreement is in place between Arcadis and the client documenting that Arcadis is not the generator, but is acting as an authorized representative of the generator. Arcadis personnel who sign waste profiles and/or waste manifests will have both current RCRA hazardous waste management training per 40 CFR § 264.16 and current DOT hazardous materials transportation training per 49 CFR § 172.704. Arcadis field personnel will also comply with client-specific training. In addition, Arcadis field sampling personnel will be knowledgeable in the relevant processes, procedures, and Technical Guidance Instructions (TGIs) and possess the demonstrated required skills and experience necessary to successfully complete the desired field work. The project health and safety plan (HASP) and other documents will identify other training requirements or access control requirements.

## 4 EQUIPMENT LIST

The Following Materials, as required, will be available for IDW handling and Storage:

- Appropriate personal protective equipment as specified in the Site Health and Safety Plan (HASP)
- DOT approved containers
- Hammer
- Leather gloves
- Drum dolly
- Appropriate drum labels (outdoor waterproof self-adhesive)
- Portable tank container
- Appropriate labeling, packing, chain-of-custody forms, and shipping materials as determined by the CPM and/or Technical Expert.
- Indelible ink and/or permanent marking pens
- Plastic sheeting
- Appropriate sample containers, labels, and forms
- Stainless-steel bucket auger
- Stainless steel spatula or knife
- Stainless steel hand spade
- Stainless steel scoop
- Digital camera
- Field logbook

## 5 CAUTIONS

Filled drums can be very heavy, become unbalanced, or spill its contents. Therefore, use appropriate moving techniques and equipment for safe handling. Similar media (e.g. soils with other soils; or liquids with other liquids) will be stored in the same drums to aid in sample analysis and disposal. Drum lids must be secured to prevent rainwater from entering the drums and leakage during movement. Drums containing solid material may not contain any free liquids. Waste containers stored for extended periods of time may be subject to deterioration. Drum Over Packs may be used as secondary containment. All drums must be visually inspected for condition to ensure that they are in good condition without visible evidence of rusting, holes, breakage, etc., to prevent potential leakage and facilitate subsequent disposal. All drum lids must be verified as having a properly functioning secured lid prior to use.

## 6 HEALTH AND SAFETY CONSIDERATIONS

As determined by the site's known and suspected hazards, appropriate PPE must be worn by all field personnel within the designated work area. Exposure air monitoring may be required during certain field activities as required in the Site Health and Safety Plan. If soil excavation in areas with potentially hazardous contaminants is possible, contingency plans will be developed to address the potential for encountering gross contamination or non-aqueous phase liquids. All excavation activities shall be in compliance with OSHA standard 29 CFR 1926.651 Excavations, and any other applicable regulations.



Arcadis field personnel and subcontractors will be trained in and perform their work in compliance with all applicable federal, state, and local health and safety regulations as well as Arcadis' HASP and applicable Client health and safety requirements.

## 7 PROCEDURE

Specific waste temporary storage and handling procedures to be used are dependent upon the type of generated waste, including type of media (e.g. soils or free liquids) and constituents of concern. For this reason, IDW can be stored in a secure location onsite in separate 55-gallon storage drums, where solids can be stockpiled onsite (if nonhazardous) and purge water may be stored in portable tank containers. Waste materials such as broken sample bottles or equipment containers and wrappings will be stored in 55-gallon drums unless they were not in contact with sample media.

### Management of IDW

Minimization of IDW should be considered by the project team during all phases of the project. Site managers may want to consider techniques such as replacing solvent based cleaners with aqueous-based cleaners for decontamination of equipment, reuse of equipment (where it can be properly decontaminated), limitation of traffic between exclusion and support zones, and drilling methods and sampling techniques that minimize the generation of waste. Alternative drilling and subsurface sampling methods may include the use of small diameter boreholes, as well as borehole testing methods such as a core penetrometer or direct push technique instead of coring.

### Drum Storage

Drums containing hazardous waste will be stored in accordance with the requirements of 40 CFR 265 Subpart I (for containers) and 265 Subpart DD (for containment buildings). All 55-gallon drums will be stored at a secure, centralized onsite location that is readily accessible for vehicular pick-up. Drums confirmed as, or assumed to contain hazardous waste will be stored over an impervious surface provided with secondary spill containment. The storage location will, for drums containing liquid, have a containment system that can contain at least the larger of 10% of the aggregate volume of staged materials or 100% of the volume of the largest container. Drums will be closed during storage and be in good condition in accordance with the Guide to Management of Investigation-Derived Wastes (USEPA, 1992).

### Hazardous Waste Determination

Waste material must be characterized to determine if it meets any of the federal definitions of hazardous waste as required by 40 CFR § 262.11. If the waste does not meet any of the federal definitions, it must then be established if any state-specific or local-specific hazardous waste criteria exist/apply.

### Generator Status

Once hazardous waste determination has been made, the generator status will be determined. Large quantity generators (LQG) are generators who generate more than 1,000 kilograms of hazardous waste in a calendar month. Small quantity generators (SQG) of hazardous waste are generators who generate greater than 100 kilograms but less than 1,000 kilograms of hazardous waste in a calendar month. Very small quantity generators (VSQG) are generators who generate less than 100 kilograms of hazardous

waste per month. Please note that a generator status may change from month to month and that a notice of this change is usually required by the generator's state agency.

### **Accumulation Time for Hazardous Waste**

A LQG may accumulate hazardous waste on site for 90 calendar days or less without a permit and without having interim status, provided that such accumulation is in compliance with requirements in 40 CFR § 262.17. A SQG may accumulate hazardous waste on site for 180 calendar days or less without a permit or without having interim status, subject to the requirements of 40 CFR § 262.16. VSQG requirements are found in 40 CFR § 262.14. NOTE: The federal VSQG and SQG provisions may not be recognized by some states (e.g., California and Rhode Island). State-specific and local-specific regulations must be reviewed and understood prior to the generation of hazardous waste.

**Satellite Accumulation of Hazardous Waste** Satellite accumulation (SAA) will mean the accumulation of as much as fifty-five (55) gallons of hazardous waste, or the accumulation of as much as one quart of acutely hazardous waste, in containers at or near any point of generation where the waste initially accumulates, which is under the control of the operator of the process generating the waste, without a permit or interim status and without complying with the requirements of 40 CFR § 262.15 and without any storage time limit, provided that the generator complies with 40 CFR § 262.15.

Once more than 55 gallons of hazardous waste accumulates in SAA, the generator has three days to move this waste into storage.

Storage recommendations for hazardous waste include:

- Ignitable or reactive hazardous wastes must be >50 feet from the property line per 40 CFR § 265.176 (LQG generators only).
- Hazardous waste should be stored on a concrete slab (asphalt is acceptable if there are no free liquids in the waste).
- Drainage must be directed away from the accumulation area.
- Area must be properly vented.
- Area must be secure.

### **Drum/Container Labeling**

Drums will be labeled on both the side and lid of the drum using a permanent marking pen. Old drum labels must be removed to the extent possible, descriptions crossed out should any information remain, and new labels affixed on top of the old labels. Other containers used to store various types of waste (e.g., polyethylene tanks, roll-off boxes, end-dump trailers, etc.) will be labeled with an appropriate "Waste Container" or "Testing in Progress" label pending characterization. Drums and containers will be labeled as follows:

- Appropriate waste characterization label (Pending Analysis, Hazardous, or Nonhazardous)
- Waste generator's name (e.g., client name)
- Project Name
- Name and telephone number of Arcadis project manager
- Composition of contents (e.g., used oil, acetone 40%, toluene 60%)
- Media (e.g., solid, liquid)
- Accumulation start date



- Drum number of total drums as reconciled with the Drum Inventory maintained in the field log book.

IDW containers will remain closed except when adding or removing waste. Immediately upon beginning to place waste into the drum/container, a "Waste Container" or "Pending Analysis" label will be filled out to include the information specified above, and affixed to the container. Once the contents of the container are identified as either non-hazardous or hazardous, the following additional labels will be applied.

- Containers with waste determined to be non-hazardous will be labeled with a green and white "Nonhazardous Waste" label over the "Waste Container" label.
- Containers with waste determined to be hazardous will be stored in an onsite storage area and will be labeled with the "Hazardous Waste" label and affixed over the "Waste Container" label.

The ACCUMULATION DATE for the hazardous waste is the date the waste is first placed in the container and is the same date as the date on the "Waste Container" label. DOT hazardous class labels must be applied to all hazardous waste containers for shipment offsite to an approved disposal or recycling facility. In addition, a DOT proper shipping name will be included on the hazardous waste label. The transporter should be equipped with the appropriate DOT placards. However, placarding or offering placards to the initial transporter is the responsibility of the generator per 40 CFR § 262.33.

### **Inspections and Documentation**

All IDW will be documented as generated on a Drum Inventory Log maintained in the field log book. The Drum Inventory will record the generation date, type, quantity, matrix and origin (e.g., Boring-1, Test Pit 3, etc.) of materials in every drum, as well as a unique identification number for each drum. The drum inventory will be used during drum pickup to assist with labeling of drums. The drum storage area and any other areas of temporarily staged waste, such as soil/debris piles, will be inspected weekly. The weekly inspections will be recorded in the field notebook or on a Weekly Inspection Log. Digital photographs will be taken upon the initial generation and drumming/staging of waste, and final labeling after characterization to document compliance with labeling and storage protocols, and condition of the container. Evidence of damage, tampering or other discrepancy should be documented photographically.

### **Emergency Response and Notifications**

Specific procedures for responding to site emergencies will be detailed in the HASP. If the generator is designated as a LQG, a Contingency Plan will need to be prepared to include emergency response and notification procedures per 40 CFR § 265 Subpart D. In the event of a fire, explosion, or other release which could threaten human health outside of the site or when Client or Arcadis has knowledge of a spill that has reached surface water, Client or Arcadis must immediately notify the National Response Center (800-424-8802) in accordance with 40 CFR § 262.265. Other notifications to state and/or other local regulatory agencies may also be necessary.

### **Drilling Soil Cuttings and Muds**

Soil cuttings are solid to semi-solid soils generated during trenching activities, subsurface soil sampling, or installation of monitoring wells. Depending on the drilling method, drilling fluids known as "muds" may be used to remove soil cuttings. Drilling fluids flushed from the borehole must be directed into a settling section of a mud pit. This allows reuse of the decanted fluids after removal of the settled sediments. Soil cuttings will be labeled and stored in 55-gallon drums with bolt-sealed lids.

### **Excavated Solids**

Excavated solids may include, but are not limited to: soil, fill, and construction and demolition debris. Prior to permitted treatment or offsite disposal, potentially hazardous excavated solids may be temporarily stockpiled onsite as long as the stockpile remains in the same AOC from where it was excavated. Potentially hazardous excavated solids removed from the AOC must be immediately containerized in labeled drums or closable top roll-offs lined with 9-mil polyvinyl chloride (PVC) sheeting and are subject to LQG storage time limits. Nonhazardous excavated solids can be stockpiled either inside or outside of the AOC, do not have to be containerized and are not subject to hazardous waste regulations. Potentially hazardous excavated solids must not be mixed with nonhazardous excavated solids. All classes of excavated solid stockpiles should be maintained in a secure area onsite. At a minimum, the floor of the stockpile area will be covered with a 20-mil high density polyethylene liner that is supported by a foundation or at least a 60-mil high density polyethylene liner that is not supported by a foundation. The excavated material will not contain free liquids. The owner/operator will provide controls for windblown dispersion, run-on control, and precipitation runoff. The run-on control system will prevent flow onto the active portion of the pile during peak discharge from at least a 25-year storm and the run-off management system will collect and control at least the water volume resulting from a 24-hour, 25-year storm (USEPA, 1992). Additionally, the stockpile area will be inspected on a weekly basis and after storm events. Individual states may require that the stockpile be inspected/certified by a licensed professional engineer. Stockpiled material will be covered with a 6-mil polyvinyl chloride (PVC) liner or sprayed dust control product. The stockpile cover will be secured in place with appropriate material (concrete blocks, weights, etc.) to prevent the movement of the cover.

### **Decontamination Solutions**

Decontamination solutions are generated during the decontamination of personal protective equipment and sampling equipment. Decontamination solutions may range from detergents, organic solvents and acids used to decontaminate small field sampling equipment to steam cleaning rinsate used to wash heavy field equipment. These solutions are to be labeled and stored in closed head drums compatible with the decontamination solution. Decontamination procedures, including personnel and field sampling equipment, must comply with applicable Arcadis procedural documents.

### **Disposable Equipment**

Disposable equipment includes personal protective equipment (e.g., tyvek coveralls, gloves, booties and APR cartridges) and disposable sampling equipment such as trowels or disposable bailers. If the media sampled exhibits hazardous characteristics per results of waste characterization sampling, contaminated disposable equipment will also be disposed of as a hazardous waste. If compatible with the original IDW waste stream (i.e., the IDW is a solid and the disposal equipment is a solid), the disposable equipment can be combined with the IDW. If these materials are not compatible (i.e., the IDW is a liquid and the disposal equipment is a solid), the disposable equipment will be stored onsite in separate labeled 55-gallon drums. Uncontaminated or decontaminated disposable equipment can be considered nonhazardous waste.

### **Purge Water**

Purge water includes groundwater generated during well development, groundwater sampling, or aquifer testing. The volume of groundwater generated will dictate the appropriate storage procedure. Monitoring



well development and groundwater sampling may generate three well volumes of groundwater or more. This volume will be stored in labeled 55-gallon drums. Aquifer tests may generate significantly greater volumes of groundwater depending on the well yield and the duration of the test. Therefore, large-volume portable polyethylene tanks will be considered for temporary storage pending groundwater-waste characterization.

### **Purged Water Storage Tank Decontamination and Removal**

The following procedures will be used for inspection, cleaning, and offsite removal of storage tanks used for temporary storage of purge water. These procedures are intended to be used for rented portable tanks such as Baker Tanks or Rain for Rent containers. Storage tanks will be made of inert plastic materials. The major steps for preparing a rented tank for return to a vendor include characterizing the purge water, disposing of the purge water, decontaminating the tank, final tank inspection, and mobilization. Decontamination and inspection procedures are described in further detail below.

- **Tank Cleaning:** Most vendors require that tanks be free of any visible sediment and water before returning, a professional cleaning service may be required. Each specific vendor should be consulted concerning specific requirements for returning tanks.
- **Tank Inspection:** After emptying the tank, purged water storage tanks should be inspected for debris, chemical staining, and physical damage. The vendors require that tanks be returned in the original condition (i.e., free of sediment, staining and no physical damage).

## **8 WASTE MANAGEMENT**

### **Soil/Solids Characterization**

Waste characterization will be conducted in accordance with waste hauler, waste handling facility, and local/state/federal requirements. In general, RCRA hazardous wastes are those solid wastes determined by a Toxicity Characteristic Leaching Procedure (TCLP) test or to contain levels of certain toxic metals, pesticides, or other organic chemicals above specific applicable regulatory agency thresholds. If the one or more of 40 toxic compounds listed in Table I of 40 CFR § 261.24 are detected in the sample at levels above the maximum unregulated concentrations, the waste must be characterized as a toxic hazardous waste. Wastes can also be considered “listed” hazardous waste depending on site-specific processes.

Composite soil samples will be collected at a frequency of one sample per 250 cubic yard basis for stockpiled soil or one per 55-gallon drum per different waste stream for containerized. A four-point composite sample will be collected per 250 cubic yards of stockpiled material and for each drum waste stream. Sample and composite frequencies may be adjusted in accordance with the waste handling facility’s requirements and may be reduced for large volumes of waste with consistent properties. Waste characterization samples will be considered valid for consistent waste streams for a period of 1 year. Waste characterization samples may be analyzed for the TCLP volatile organic compounds (VOCs), TCLP semi-volatile organic compounds (SVOCs), TCLP RCRA metals, and polychlorinated biphenyls (PCBs), as well as reactivity and flammability (flashpoint). Additional samples may be collected and analyzed by the laboratory on a contingency basis. Site-specific constituents of concern including pesticides may require additional sampling. Please note that state- or local-specific regulations may require a different or additional sampling approaches.

### **Wastewater Characterization**

Waste characterization will be conducted in accordance with the requirements of the waste hauler, waste handling facility, and local/state/federal governments. In general, purge water should be analyzed by methods appropriate for the known contaminants, if any, that have been historically detected in the monitoring wells. Samples will be collected and analyzed in accordance with the requirements of the waste disposal facility. Wastewater characterization samples may be analyzed for TCLP volatile organic compounds (VOCs), TCLP semi-volatile organic compounds (SVOCs), TCLP RCRA metals, and polychlorinated biphenyls, as well as corrosivity (pH), reactivity and flammability (flashpoint). Additional samples may be collected and analyzed by the laboratory on a contingency basis. Site-specific constituents of concern including pesticides may require additional sampling. Please note that state- and/or local-specific regulations may require different or additional sampling approaches.

### **Sample Handling and Shipping**

All samples will be appropriately labeled, packed, and shipped, and the chain-of-custody will be filled out in accordance with current Arcadis sample chain of custody, handling, packing, and shipping procedures and guidance instructions.

It should be noted that additional training is required for packaging and shipping of hazardous and/or dangerous materials. Please refer to the current Arcadis training requirements related to handling and shipping of samples, shipping determinations, and hazardous materials.

### **Preparing Waste Shipment Documentation (Hazardous and Nonhazardous)**

Waste profiles will be prepared by the Arcadis CPM and forwarded, along with laboratory analytical data to the Client for approval/signature. The Client will then return the profile to Arcadis who will then forward to the waste removal contractor for preparation of a manifest. The manifest will be reviewed by Arcadis prior to forwarding to the Client for approval. Upon approval of the manifest, the Client will return the original signed manifest directly to the waste contractor or to the Arcadis CPM for forwarding to the waste contractor. Arcadis personnel may sign waste profiles and/or waste manifests on a case by case basis for clients, provided the appropriate agreement is in place between Arcadis and the client documenting that Arcadis is not the generator, but is acting as an authorized representative of the generator.

Final drum labeling and pickup will be supervised by an Arcadis representative who is trained and experienced with applicable waste labeling procedures. The Arcadis representative will have a copy of the drum inventory maintained in the field book and will reconcile the drum inventory with the profile numbers on the labels and on the manifest. Different profile numbers will be generated for different matrices or materials in the drums. For example, the profile number for drill cuttings will be different than the profile number for purge water. When there are multiple profiles it is critical that the proper label, with the profile number appropriate to a specific material be affixed to the proper drums. A copy of the Arcadis drum inventory will be provided to the waste transporter during drum pickup and to the facility receiving the waste.



## **9 DATA RECORDING AND MANAGEMENT**

Waste characterization sample handling, packing, and shipping procedures will be documented in accordance with relevant Arcadis procedures and guidance instructions as well as applicable client and/or project requirements, such as a Quality Assurance Project Plan or Sampling and Analysis Plan. Copies of the chain-of-custody forms will be maintained in the project file. Arcadis should photograph or maintain a copy of any hazardous waste manifest signed on behalf of Client in the corresponding office DOT record file.

## **10 QUALITY ASSURANCE**

The CPM or APM will review all field documentation once per week for errors or omissions as compared to applicable project requirements including but not limited to: the proposal/scope of work, QAPP, SAP, HASP, etc. Deficiencies will be noted, tracked, and resolved. Upon correction, they will be noted for project documentation.

## **11 REFERENCES**

United States Environmental Protection Agency (USEPA). 1992. Guide to Management of Investigation-Derived Wastes. Office of Remedial and Emergency Response. Hazardous Site Control Division. January 1992.

# **TGI – Sample Chain of Custody**

Rev: 3

Rev Date: March 28, 2022

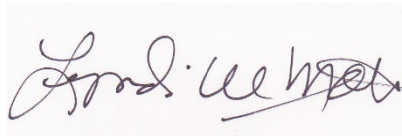


## Version Control

Issue	Revision No.	Date Issued	Page No.	Description	Reviewed By
	0	April 19, 2017	All	Re-write to COC only	Richard Murphy
	1	May 23, 2017	4,7,9	Add: Guidance on use of previous version of TGI. Add: Info on COCs for multiple shipping containers Modify: Move letter i. to letter m. and change to “when appropriate”	Peter Frederick
	2	April 29, 2020	4, 11	Remove obsolete link	Lyndi Mott
	3	December 28, 2022	All	Updated Arcadis format Added to 6c. Collection time between COC and container must match. Added to 6o. Add name of overnight courier when relinquishing samples. Updated reference documents and added internet links.	Lyndi Mott

## Approval Signatures

Prepared by:



3/28/2022

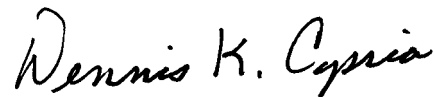
---

Lyndi Mott (Preparer)

---

Date

Reviewed by:



3/28/2022

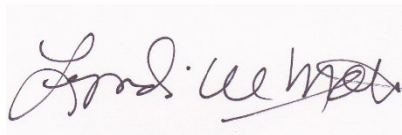
---

Dennis Capria (Chain of Custody Reviewer)

---

Date

Reviewed by:



12/22/2021

---

Lyndi Mott (Subject Matter Expert)

---

Date



## 1 Introduction

This Technical Guidance Instruction (TGI) provides the procedure for Arcadis field personnel for required documentation during the collection of environmental field samples and transfer of custody to a laboratory. It provides direction for completion of the Chain of Custody form that must accompany collected field samples for analysis by a laboratory.

## 2 Intended Use and Responsibilities

This document describes general and/or specific procedures, methods, actions, steps, and considerations to be used and observed by Arcadis staff when performing work, tasks, or actions under the scope and relevancy of this document. This document may describe expectations, requirements, guidance, recommendations, and/or instructions pertinent to the service, work task, or activity it covers.

It is the responsibility of the Arcadis Certified Project Manager (CPM) to provide this document to the persons conducting services that fall under the scope and purpose of this procedure, instruction, and/or guidance. The Arcadis CPM will also ensure that the persons conducting the work falling under this document are appropriately trained and familiar with its content. The persons conducting the work under this document are required to meet the minimum competency requirements outlined herein, and inquire to the CPM regarding any questions, misunderstanding, or discrepancy related to the work under this document.

This document is not considered to be all inclusive nor does it apply to all projects. It is the CPM's responsibility to determine the proper scope and personnel required for each project. There may be project- and/or client- and/or state-specific requirements that may be more or less stringent than what is described herein. The CPM is responsible for informing Arcadis and/or Subcontractor personnel of omissions and/or deviations from this document that may be required for the project. In turn, project staff are required to inform the CPM if or when there is a deviation or omission from work performed as compared to what is described herein.

In following this document to execute the scope of work for a project, it may be necessary for staff to make professional judgment decisions to meet the project's scope of work based upon site conditions, staffing expertise, regulation-specific requirements, health and safety concerns, etc. Staff are required to consult with the CPM when or if a deviation or omission from this document is required that has not already been previously approved by the CPM. Upon approval by the CPM, the staff can perform the deviation or omission as confirmed by the CPM.

## 3 Scope and Application

This TGI describes the general Chain of Custody (COC) procedures and guidance instructions for samples collected from project sites that are relinquished from Arcadis' possession.

COC is defined as the maintenance of an unbroken record of possession of an item from the time of its collection through some analytical or testing procedure. COC is typically documented by a written record of the collection, possession, and handling of samples collected from a project location. Each sample will be tracked by a documented record that efficiently documents the individuals who were responsible for the sample during each successive transfer of that sample to various recipients beyond Arcadis' possession. This information can be used to legally establish the integrity of the samples and therefore the analytical results derived from the samples. This

information can be used in addition to other records and documentation regarding the samples, such as field forms, field logs, and photographs.

A sample is considered under custody if:

- It is in your possession; or
- It is in your view, after being in your possession; or
- It was in your possession and then you then locked it up to prevent tampering; or
- It is in a designated secure area.

Continued use of previous version of TGI:

Although not recommended, Arcadis program-, project-, and client-teams may be able to use the previous version of this TGI provided that it meets all of the quality expectations of Arcadis and client and meets applicable regulatory requirements. It is up to the program, project, and/or client-team leader to determine whether it is appropriate to adopt the current TGI or to continue using the previous version.

However, all new work not associated with the previous version of this TGI must be performed with the current version of the TGI.

When adopting this new TGI, users of the previous versions must be aware that specific handling, packing, and shipping procedures and guidance has been removed and that those should be addressed within program or project plans (e.g., Quality Assurance Project Plans (QAPP), Work Plans, Sampling and Analysis Plans (SAPs), etc.) or in a more detailed TGI specific to that sampling activity, whether related to media, constituent/analyte, client, state, etc.

In addition, adopting this new TGI will require users to refer to the Arcadis Department of Transportation (DOT) Safety Program for procedures and guidance on the determination and handling, packing, and shipping of samples that are or may be considered hazardous materials.

## 4 Personnel Qualifications

Arcadis personnel performing work under the purview of this TGI will have received appropriate training and have field experience regarding the collection of samples from project locations. Arcadis personnel will have all other applicable and appropriate training relevant to the sampling work and project site.

## 5 Equipment List

The following list provides materials that may be required for each COC. Project reporting and documentation requirements must be reviewed with the CPM prior to execution of work. Additional materials, tools, equipment, etc. may be required, and project staff are required to verify with the CPM and/or Technical Expert what specific equipment is required to complete the COC.

- Indelible ink pen (preferably either black or blue ink);
- COC form (**Appendix A**) from either Arcadis, laboratory receiving and analyzing the samples, or other applicable and appropriate entity for the work performed;
- When appropriate, such as for litigation or expert testimony work, custody seals or tape.



## 6 Cautions

One way in which the law tries to ensure the integrity of evidence is by requiring proof of the chain of custody by the party who is seeking to introduce a particular piece of evidence.

A proper chain of custody requires three types of affirmations: (1) affirmation that a sample is what it purports to be (for example, soil collected from a specified location and depth); (2) affirmation of continuous possession by each individual who has had possession of the sample from the time it is collected until the time it is analyzed or held by a laboratory; and (3) affirmation by each person who has had possession that sample remained in substantially the same condition and not contaminated or affected by outside influences from the moment one person took possession until the moment that person released the evidence into the custody of another (for example, affirmation that the sample was stored in a secure location where no one but the person in custody had access to it).

Proving chain of custody is necessary to "lay a foundation" for the samples in question, by showing the absence of alteration, substitution, or change of condition.

Ensure that appropriate sample containers with applicable preservatives, coolers, and packing material are planned for and provided at the site at the time of sample collection.

Understand the offsite transfer requirements of the samples for the facility at which samples are collected.

If overnight courier service is required schedule pick-up or know where the drop-off service center is located and the hours of operation.

**An Arcadis employee appropriately trained at the correct level of internal hazardous materials/DOT)shipping must complete an Arcadis shipping determination to address applicable DOT and International Air Transport Association (IATA) shipping requirements.** Review the applicable Arcadis procedures and guidance instructions for sample packaging, and labeling. Prior to using air transportation, confirm air shipment is acceptable under DOT and IATA regulations.

The person relinquishing possession of the samples or other member of the project team should contact the final recipient of the samples to confirm receipt and review any special provisions on the COC or questions that they may have.

## 7 Health and Safety Considerations

Follow the health and safety procedures outlined in the project/site Health and Safety Plan (HASP) as well as other applicable H&S requirements, such as:

- Arcadis Hazardous Material/DOT handling, packaging, and shipping training
- Project site-specific H&S training
- Client-specific H&S training
- Constituent-specific H&S training
- Media-specific H&S training

## 8 Procedure

Collected samples must be uniquely identified, and properly documented, containerized, labeled with unique identifier, possessed in a secure manner during remainder of sampling event, packaged, and shipped to recipient laboratory.

### Sample Identification

The method of sample identification depends on the type of measurement or analyses performed. In some cases, in-situ measurements of existing conditions and/or sample location must be made during sample collection.

These data will be recorded directly on field forms, logbooks, or other project record data sheets used to permanently retain this information for the project file. Examples of location identification information includes: latitude/longitudinal measurements, compass directions, well number, building number, floor number, room name, or proximity to a site feature unique to the site. Examples of in-situ measurements are pH, temperature, conductivity, flow measurement, or physical condition of the media being sampled. Physical samples collected are identified by a unique identifying number or code on a sample tag or label. These physical samples are removed from the sample location and transported to a laboratory for analyses.

In some cases, before samples are placed into individual containers and labeled as individual samples, samples may be separated into portions depending upon the analytical methods and required duplicate or triplicate analyses to be performed.

When completing a COC for samples, personnel must complete the following:

1. Written COCs must be completed with indelible ink (preferably either black or blue colored ink).
2. Written COCs must be completed using legible printed writing, and not cursive writing.
3. All entry fields on the COC form must be completed. If information is not applicable for a specific entry field, personnel will either put "N/A" or use a strike-out line or dash like "-----" to indicate no applicable information is needed for that field.
4. Use of quotation marks or lines/down arrows to represent repetitive/duplicative text in similar fields.
5. Regardless of the type or specific COC form, the following pertinent information must be provided on the COC form:
  - a. Arcadis project number
  - b. Arcadis project name
  - c. Project location, including street address, city, state, building number, providing as much detail as appropriate
  - d. Recipient laboratory contact and sample receiving shipping location information
  - e. Entities'/persons' contact information for who will be receiving analytical results
  - f. Name of sampler, i.e., person collecting sample and relinquishing possession of samples to the next entity in the chain of custody
  - g. Date of sample collection
  - h. If appropriate for the sample media, contaminant/constituent of concern, or analytical method, document time of sample collection using standard military time
  - i. Sample analytical method(s)



- j. Turnaround time required for analyses and/or reporting
- k. Instructions to laboratory regarding handling, timing, analyses, etc. as applicable and appropriate.
- l. Printed name and signature of the individual person who collected the samples and relinquishing possession of the samples
- m. If appropriate or when documentation of the specific sample collection method will influence how the laboratory handles, prepares, or analyzes the samples, document the sample collection methodology used for collecting the samples (e.g., ASTM D5755)

6. The following additional specific information will be entered on the COC form, regardless of what type of COC is being used:

- a. Unique Sample Identifier – The sample identifier (ID) must be unique to the individual sample it is applied to. The information in which the sample ID conveys is determined by the CPM, Technical Expert, and/or other project team members in advance of sample collection so that sample identification is consistently applied for the project. The sample nomenclature may be dictated by a specific client, program, or project database and require unique identification for each sample collected for the project. Consult with the CPM and/or Technical Expert for additional information regarding sample identification.

The sample ID could convey specific information regarding the sample to aid personnel in recognizing what the sample represents, or they may be arbitrary so as to facilitate the anonymity of the sample location, media, constituent of concern, project site, etc.

Examples of unique identifiers include:

- 1. Well locations, grid points, or soil boring identification numbers (e.g., MW-3, X-20, SB-30). When the depth interval is included, the complete sample ID would be “SB-30 (0.5-1.0) where the depth interval is in feet. Please note it is very important that the use of hyphens in sample names and depth units (i.e., feet or inches) remain consistent for all samples entered on the chain of custody form. DO NOT use the apostrophe or quotes in the sample ID.
  - 2. Sample names may also use the abbreviations “FB,” “TB,” “FD” and “DUP” as prefixes or suffixes to indicate that the sample is a field blank, trip blank, or field duplicate, respectively.
- b. List the date of sample collection. All indicated dates must be formatted using either mm/dd/yy (e.g., 03/07/09) or mm/dd/yyyy (e.g., 03/07/2009).
  - c. List the local time that the sample was collected. The time value should be presented using military format. For example, 3:15 P.M. should be entered as 15:15. The time listed on the COC form must match the sample collection time on the sample container(s).
  - d. Samples should be indicated to be either “Grab” or “Composite”. Grab samples are collected from only one unique location at one specific point in time.
  - e. Composite samples are a group of individual samples that are combined for analysis in their totality. Composite samples need to be documented if they are either collected from a number of different locations over a broader area to be representative of the entire area being sampled, or if they are representative of a single location over an extended period of time.

- f. If used, preservatives for the individual sample will be noted.
  - g. The requested analytical method(s) that the samples are being analyzed for must be indicated. As much detail, as necessary, should be presented to allow the analytical laboratory to properly analyze the samples. For example, polychlorinated biphenyl (PCB) analyses may be represented by entering “EPA Method 8082 – PCBs” or “EPA PLM 600-R93-116.” In cases where multiple analytical methods and/or analytical parameters are required for an individual sample, each method should be indicated for the sample (e.g., EPA 8082/8260/8270 or EPA PLM/400-point count).
  - h. If there are project-specific sample analytes to be reported, they should be specifically listed for each individual sample (e.g., 40 CFR 264 Appendix IX).
  - i. The total number of containers for each analytical method requested should be documented. This information may be included under the parameter or as a total for the sample.
  - j. When necessary, note which samples should be used for site specific matrix spikes in the Remarks or Comments field.
  - k. Indicate special project-specific requirements pertinent to the handling, shipping, or analyses. These requirements may be on a per sample basis such as “extract and hold sample until notified,” or may be used to inform the laboratory of special reporting requirements for the entire sample delivery group (SDG).
  - l. Indicate turnaround time (TAT) required for samples on COC. If individual samples have differing TATs, the different TATs for each sample or groups of samples must be clearly indicated.
  - m. Provide contact name and phone number in the event that problems are encountered when samples are received at the laboratory. The person relinquishing possession of the samples or other member of the project team should contact the final recipient of the samples to confirm receipt and review any special provisions on the COC or questions that they may have.
  - n. If available, attach the Laboratory Task Order or Work Authorization forms.
  - o. The “Relinquished By” field must contain the signature of the Arcadis person who relinquished custody of the samples to the next entity in the chain of custody, which may be another person, the shipping courier, or the analytical laboratory. If a courier, enter the shipping courier in the “Received by” such as FedEx. The date/time relinquished should be when the person signs the COC and seals the cooler or shipping container for pick-up by the shipping courier.
  - p. Dates and times must be indicated using the following format:
    - 1) Date: either mm/dd/yy e.g., 01/01/17 OR mm/dd/yyyy e.g., 01/01/2017
    - 2) Time: use military format, e.g., 9:30 a.m. is 0930 and 9:30 p.m. is 2130
  - q. The “Received By” section is signed by sample courier or laboratory representative who received the samples from the sampler. The laboratory will sign upon laboratory receipt from the overnight courier service.
7. When more than one page of the COC form is required to complete the total number of samples, use as many sheets as necessary to accurately and clearly, document the samples and information. Some COCs may have a standard first page/cover page, and subsequent pages may not contain all the detailed fields as



the first page/cover page. Ensure that any subsequent pages convey all of the necessary and pertinent information for each individual sample as required in this procedure document.

8. Pages of the COC must retain a page count of the total number of pages; e.g., Page 1 of 3, Page 2 of 3, Page 3 of 3.
9. Upon completing the COC forms, forward the original signed COC with the sample package. Ensure that the original COC form is secured with the sample package so that it remains with the physical samples for the duration of transport and handling to its final destination and ensure that the COC form will not be become damaged or rendered unreadable due to sample breakage/leakage if stored inside the sample shipping container or outside influences if COC is stored in an outside plastic pouch to the container.
10. If you've collected enough samples that would require more than one container to ship them all to the same laboratory or location, then each separate/individual container that contains any number of samples must have a separate COC representing only those samples contained within that specific container. For example, if you have 3 total shipping containers for all of your samples, you must have a total of 3 separate, individual COCs for each of the 3 containers representing only those samples in their representative container. Thus, every container holding samples must have its own, individual COC.
11. If electronic chain of custody (eCOC) forms are utilized, ensure that the requirements of this procedure and guidance instructions are followed to the extent possible. Verify that proper signature and COC procedures are maintained with the CPM and/or Technical Expert when using eCOC.

## 9 Waste Management

Not Applicable.

## 10 Data Recording and Management

The original signed COC shall be submitted with the samples. Copies of COC records will be transmitted to the CPM or designee at the end of each day unless otherwise directed by the CPM. The sampling team leader retains copies of the chain of custody forms for filing in the project file. Record retention shall be in accordance with client- and project-specific requirements and Arcadis policies, the most stringent will apply.

The option to use the Electronic Chain of Custody (eCOC) form in conjunction with the appropriate sample application(s) may be available through the FieldNow® program but is currently limited to a select list of approved analytical laboratories. Use of the eCOC application is intended to reduce common transcription errors both by field staff and laboratory staff on a conventional handwritten paper COC. Once the eCOC form is completed and approved on the field tablet by field staff, a PDF version of the form is automatically emailed to each assigned team member. In addition, a dedicated or mobile printer is recommended for printing a hard copy of the completed eCOC to be included in each sample cooler to meet laboratory requirements.

## 11 Quality Assurance

COC forms will be legibly completed in accordance with this procedure and guidance instruction document, as well as other applicable and appropriate project documents such as SAP, Quality QAPP, Work Plan, or other project guidance documents.

COC records will be reviewed by the CPM or their appropriate designee for completeness and accuracy to the applicable requirements. Non-conformances will be noted and corrected in a timely manner on the copies retained by Arcadis as well as contacting the ultimate receiving entity for correction to the originally signed COC in their possession.

## 12 References

Arcadis Transportation Safety Program requirements, procedures, and guidance instructions.

EPA Samplers' Guide – Contract Laboratory Program Guidance for Field Samplers, EPA document EPA-540-R014-013 October 2014 [https://www.epa.gov/sites/default/files/2015-03/documents/samplers\\_guide.pdf](https://www.epa.gov/sites/default/files/2015-03/documents/samplers_guide.pdf).

EPA Region III – Sample Submission Procedures for the Office of Analytical Services and Quality Assurance (OASQA) Laboratory Branch revision 14.0 October 18, 2018, <https://www.epa.gov/sites/default/files/2018-12/documents/sample-submission-procedures-rev14.pdf>.

EPA Region IV Science and Ecosystem Support Division Operating Procedure for Sample and Evidence Management May 25, 2016, <https://www.epa.gov/sites/default/files/2015-06/documents/Sample-and-Evidence-Management.pdf>.



## Attachment A

### Chain of Custody and Laboratory Analysis Request Form

		ID# <input style="width: 80px; height: 20px;" type="text"/>	<b>CHAIN OF CUSTODY &amp; LABORATORY ANALYSIS REQUEST FORM</b>										Page ____ of ____	Lab Work Order # <input style="width: 100px; height: 20px;" type="text"/>	
Send Results to:	Contact & Company Name:	Telephone:	Preservative											<b>Keys</b> <b>Preservation Key:</b> A. H <sub>2</sub> SO <sub>4</sub> B. HCL C. HNO <sub>3</sub> D. NaOH E. None F. Other: _____ G. Other: _____ H. Other: _____  <b>Containment Information Key</b> 1. 40 ml Vial 2. 1 L Amber 3. 250 ml Plastic 4. 500 ml Plastic 5. Encore 6. 2 oz. Glass 7. 4 oz. Glass 8. 8 oz. Glass 9. Other: _____ 10. Other: _____  <b>Matrix Key:</b> SO - Soil W - Water T - Tissue SE - Sediment SL - Sludge  A - Air NL - NAPL/Oil SW - Sample Wipe Other: _____	
	Address:	Fax:	Filtered (✓)												
	City State Zip	E-mail Address:	# of Containers												
Project Name/Location (City, State):		Project #:	Container Information												
Sampler's Printed Name:		Sampler's Signature		<b>PARAMETER ANALYSIS &amp; METHOD</b>											
<b>SAMPLE ID</b>	<b>Collection</b>		<b>Type (✓)</b>		<b>Matrix</b>										<b>REMARKS</b>
	Date	Time	Comp	Grab											
Special Instructions/Comments													<input type="checkbox"/> Special QA/QC Instructions (✓)		
<b>Laboratory Information and Receipt</b>			<b>Relinquished By</b>		<b>Received By</b>		<b>Relinquished By</b>		<b>Laboratory Received By</b>						
Last Name:		Cooler Custody Seal (✓)		Printed Name:		Printed Name:		Printed Name:		Printed Name:					
		<input type="checkbox"/> Intact <input type="checkbox"/> Not Intact		Signature:		Signature:		Signature:		Signature:					
<input type="checkbox"/> Cooler packed with ice (✓)				Firm:		Firm:		Firm:		Firm:					
Specify Turnaround Requirements:		Sample Receipt		Date/Time:		Date/Time:		Date/Time:		Date/Time:					
Shipping Tracking #:		Condition/Cooler Temp: _____													

SOP – Sample Chain of Custody Rev1\_May 23, 2017



Arcadis U.S., Inc.  
630 Plaza Drive, Suite 200  
Highlands Ranch  
Colorado 80129  
Phone: 720 344 3500  
Fax: 720 344 3535  
[www.arcadis.com](http://www.arcadis.com)

# QP 3.07 – Calibration and Control of Measuring and Test Equipment

Rev: 1



Rev Date: October 20, 2021



## Version Control

Issue	Revision No.	Date Issued	Page No.	Description	Reviewed By
	0	November 8, 2016	All	QP Issued	QMS
	1	October 20, 2021	All	Updated for QMS Relaunch October 12, 2021	Thomas Darby

## Approval Signatures

Prepared by:	Thomas Darby	10/20/2021
	_____	_____
	Name (Preparer)	Date
Quality Reviewer:		10/20/2021
	_____	_____
	Thomas Darby (Quality Reviewer)	Date
QMS Approver:		10/20/2021
	_____	_____
	David Gerber (QMS Approver)	Date



## STATEMENT OF POLICY:

The Arcadis Environment Business Line (ENV) uses measuring and test equipment in the course of its activities. Equipment used by ENV and their subcontractors must be in the condition required for the performance of specified activities. A procedure for performing and documenting calibration and for the preventive maintenance of measuring and test equipment will be followed to provide necessary controls.

### 1 Purpose

The objective of this Quality Procedure (QP) is to provide a standard procedure for the calibration and control of measuring and test equipment, including establishing the correct equipment type, range, accuracy, and precision to meet data collection needs. Equipment must be uniquely identified, calibrated against recognized standards that are clearly identified and documented, and maintained to provide reliable performance and to meet ENV quality requirements.

### 2 Responsibilities

**Certified Project Manager** – responsible for implementation of this procedure.

**Field Supervisor** – is responsible for field equipment and for communicating calibration and maintenance procedures for equipment used by ENV staff. Similar requirements for field equipment calibration and maintenance should also be communicated to subcontractors using field equipment. Subcontractors are responsible for following those requirements and are subject to performance audits.

**Quality Consultant** – is responsible for providing quality assurance and quality control guidance to the CPM in implementing this procedure.

**Quality Reviewer** – is responsible for final review of this Quality Procedure (QP). Quality Reviewers may be a Quality Consultant, QMS Document Owner, Technical Solution Leader, Community of Practice Leader, or other qualified subject matter expert (SME).

**Project Team Members** – project team members are responsible for verifying calibration status prior to using the equipment, and for operating equipment by approved procedures, documenting information, and reporting equipment malfunctions.

### 3 Terms and Conditions

**Accuracy** – a qualitative evaluation of the agreement between an individual value (or the central tendency of a set of values) and the correct value or the accepted reference value.

**Calibration** – the process of evaluating and standardizing an instrument by determining the deviation from a known standard.

**Measuring and Test Equipment** – devices or systems used to calibrate, measure, gauge, test, or inspect in order to acquire data.

**Precision** – a qualitative evaluation of measurement data used to describe the dispersion of a set of numbers with respect to its central tendency.

## 4 Related Documents

Not Applicable.

## 5 Description of the Procedure

Measuring and test equipment will be controlled by a calibration and preventive maintenance program. Instruments that measure a quantity or whose performance must meet stated criteria will be subject to calibration. Calibration of equipment may be performed internally using reference equipment and standards, or externally by agencies or manufacturers. Two types of calibration are presented in this procedure:

- Operational calibration, which is routinely performed as part of instrument usage.
- Periodic calibration, which is performed at prescribed intervals for equipment such as water-level indicators, pressure recording devices, and thermometers. In general, equipment that can be calibrated periodically is relatively stable in performance.

Preventive maintenance is an organized and documented program of equipment cleaning, lubricating, reconditioning, adjusting, and/or testing intended to maintain proper performance, prevent equipment from failing during use, and maintain reliability.

### 1. Calibration Procedures

Documented procedures must be used for calibrating measuring and test equipment and reference equipment. Procedures such as those published by ASTM International (formerly known as the American Society for Testing and Materials), U.S. Environmental Protection Agency (USEPA), or procedures provided by manufacturers will be used whenever possible.

Where pre-established procedures are not available, procedures will be developed. Factors such as the type of equipment, stability characteristics of the equipment, required accuracy and precision, and the effect of error on the quantities measured must be considered. Calibration procedures must include:

- Type of equipment to be calibrated
- Reference equipment and standards to be used
- Calibration method and specific procedure
- Acceptance tolerances
- Frequency of calibration
- Data recording form.

### 2. Equipment Identification

Measuring and test equipment owned by Arcadis must be uniquely identified using the manufacturer's serial number, a calibration system identification number, or an inventory control tag number. This identification must be attached to the equipment. In addition to the identification number, equipment requiring periodic calibration must bear a label indicating when the next calibration is due. Equipment that is rented or leased for the purposes of measuring and testing must also be uniquely identified.



Personnel are responsible for verifying calibration status from due date labels or instrument records prior to using the equipment. Measuring and test equipment that is not properly calibrated must not be used.

### **3. Calibration Frequency**

Measuring and test equipment and reference equipment will be calibrated at prescribed intervals and/or as part of operational use. The calibration frequency will depend on the type of equipment, inherent stability, manufacturer's recommendations, intended use, effect of error on the measurement process, and experience. Calibration frequencies may be defined in project-specific plans or in calibration procedures. The CPM or Field Supervisor is responsible for specifying the procedures to be followed to meet project data quality objectives.

Scheduled periodic calibration may not be performed for infrequently used equipment; such equipment will be calibrated on an "as needed" basis prior to use, and then at the required frequencies for the duration of its use.

Field equipment will require an operational check per the applicable procedure and or the equipment manual prior to use, and then again at the end of the working day. Pre-use calibration should be completed under conditions of anticipated use (e.g., temperature, humidity, and atmospheric pressure) if these parameters may influence results.

### **4. Reference Equipment and Standards**

Whenever possible, equipment must be calibrated using reference equipment (i.e., physical standards) and chemical and radioactive standards having known relationships to nationally recognized standards (e.g., National Institute of Standards and Technology [NIST]) or accepted values of natural physical constants. If national standards or constants do not exist, the basis for the calibration must be documented.

Physical standards may include calibration weights, certified thermometers, standard measurement tapes, gauge blocks, and reference gauges. These are generally used for periodic calibrations. Physical standards must be used only for calibration.

Chemical and radioactive standards may include reagents, solvents, and gases. These may be Standard Reference Materials (SRM) provided by NIST or USEPA, or they may be vendor-certified materials traceable to NIST or USEPA SRMs. Chemical and radioactive standards will primarily be used for operational calibrations.

The date of receipt and expiration date must be clearly labeled on the container of each standard. If calibration standards are transferred to additional containers, these containers must be labeled with the name of the standard, the lot number, and the shelf life. Calibration standards that exceed shelf life must not be used and must be discarded.

If equipment is sent to the manufacturer or calibration laboratory for calibration, adequate documentation must be maintained to establish the calibration method, reference standard source, or traceability to recognized standards.

### **5. Calibration Failure**

Equipment failing calibration or becoming inoperable during use will be removed from service and segregated to prevent inadvertent use or tagged to indicate it is out of service. The equipment must be repaired and properly recalibrated; equipment that cannot be repaired will be replaced.

The results of activities involving equipment that has failed recalibration will be evaluated by the CPM. If the results are adversely affected, the findings of the evaluation will be documented, and appropriate personnel will be notified.

Periodic calibration of measuring and test equipment does not replace the user's responsibility for verifying proper function of equipment. If an equipment malfunction is suspected, the device must be tagged or removed from service, and recalibrated. If it fails recalibration, it must be repaired or replaced.

## 6. Documentation of Calibration

Records must be maintained for each piece of calibrated measuring and test equipment and each piece of reference equipment. The records must indicate that established calibration procedures have been followed, and that the accuracy of reference chemical and radioactive standards has been verified.

Records for periodically calibrated equipment must include the following minimum information:

- Type and identification number of equipment
- Calibration frequency and acceptance tolerances
- Calibration dates
- Name of individual and organization performing the calibration
- Reference equipment and/or standards used for calibration
- Calibration data
- Certificates or statements of calibration provided by manufacturers and external organizations
- Documentation of calibration acceptance or failure, and of repair of failed equipment.

For equipment requiring calibration, information should be maintained in a project or equipment database regarding the calibration and maintenance history for that equipment. Equipment that does not have a calibration sticker or that has an expired calibration sticker should be tagged inoperable and sent for calibration. The equipment information file should contain periodic calibration files, as well as equipment calibration and maintenance records, calibration data forms, and/or certification of calibration provided by manufacturers or external organizations and notice of equipment calibration failure.

Measuring and test equipment used for field investigations will typically be calibrated as part of operational use. For this equipment, records of the calibrations or checks will be documented as part of the test data (e.g., in the field notebook or on a Field Activity Log). Equipment-specific forms may also be developed. These records should include information similar to that required for periodically calibrated equipment. Documentation related to malfunctioning equipment or equipment that fails calibration should also be included in the individual equipment file.

Calibration files for equipment requiring periodic calibration should be sent with equipment that is transferred to allow a continuously updated record to be maintained. Recalibration of sensitive equipment should be performed following the transfer.

When measuring and test equipment is rented or leased, procurement documents must specify that a current certificate of calibration must accompany the equipment. This certificate must be maintained with the project documentation calibration records.

## 7. Operational Checks

Certain equipment may require periodic operability tests or checks to verify that operating systems are within the allowed range. These tests are in addition to formal calibration. Like calibrations, these tests will be performed at specified frequencies, or as part of operational use using reference equipment and standards.



If an instrument fails an operability test, and corrective action cannot bring the instrument into tolerance, it must be removed from service and segregated to prevent inadvertent use or tagged to indicate it is out of service.

Such equipment will be repaired and/or recalibrated.

Operability tests will generally be performed in conjunction with data acquisition. Information recorded must include:

- Type and identification number of equipment (e.g., model and serial numbers)
- Test date
- Name of individual and organization performing the test
- Reference equipment and standards used
- Test data
- Documentation of acceptance or failure.

Documentation may be in the field notebook or on a Field Activity Log.

## 8. Preventive Maintenance

Preventive maintenance is an organized program of equipment cleaning, lubricating, reconditioning, adjusting, and/or testing intended to maintain proper performance, prevent equipment from failing during use, and maintain reliability. Specific maintenance details may be supplied in project-specific plans. A typical preventive maintenance program includes:

- A listing of the equipment that is included in the program
- The frequency of maintenance (manufacturer's recommendations or previous experience with the equipment)
- Service contracts
- Identification of spare parts
- Items to be checked and specific protocols to be followed
- Documentation of maintenance.

Maintenance records of measuring and test equipment must be maintained at the location that is the host for the equipment. Documentation of subcontractor and Arcadis equipment that is used for an individual project will be included in the project files. Records for multi-project equipment will be maintained by the location that controls the equipment.

Measuring and test equipment must be controlled through the use of sign-out/sign-in records or other suitable method. Equipment that is returned from field use must be free of contamination, packaged in a manner suitable for storage, and returned to its designated area. Support personnel should be notified of performance problems with equipment.[Click to enter text]

**- END OF PROCEDURE -**

Arcadis U.S., Inc.  
630 Plaza Drive, Suite 200  
Highlands Ranch  
Colorado 80129  
Phone: 720 344 3500  
Fax: 720 344 3535  
[www.arcadis.com](http://www.arcadis.com)



# TGI - Indoor or Ambient Air Sampling and Analysis Via USEPA Method TO-15

Rev: 3

Rev Date: August 22, 2023

## Version Control

Issue	Revision No.	Date Issued	Page No.	Description	Reviewed By
	1	August 19, 2016	All	Update Rev 0	Margaret Bartee Mitch Wacksman
	2	December 30, 2021	All	Updated Rev 1 and for QMS Relaunch	Sarah Jonker Robert Uppencamp
	3	August 22, 2023	All	Updated Rev 2	Megan Hamilton



## Approval Signatures

Prepared by:

8/22/2023



---

Sarah Jonker (Subject Matter Expert)

---

Date

Reviewed by:

8/22/2023



---

Megan Hamilton (Subject Matter Expert)

---

Date

## 1 Introduction

This document describes specific procedures and considerations to be used by Arcadis staff to collect indoor air or ambient air samples in passivated stainless-steel canisters (e.g., SUMMA®) for the analysis of volatile organic compounds (VOCs) using United States Environmental Protection Agency (USEPA) Compendium Method TO-15 (TO-15).

## 2 Intended Use and Responsibilities

This document describes general and/or specific procedures, methods, actions, steps, and considerations to be used and observed by Arcadis staff when performing work, tasks, or actions under the scope and relevancy of this document. This document may describe expectations, requirements, guidance, recommendations, and/or instructions pertinent to the service, work task, or activity it covers.

It is the responsibility of the Arcadis Certified Project Manager (CPM) to provide this document to the persons conducting services that fall under the scope and purpose of this procedure, instruction, and/or guidance. The Arcadis CPM will also ensure that the persons conducting the work falling under this document are appropriately trained and familiar with its content. The persons conducting the work under this document are required to meet the minimum competency requirements outlined herein, and inquire to the CPM regarding any questions, misunderstanding, or discrepancy related to the work under this document.

This document is not considered to be all inclusive nor does it apply to all projects. It is the CPM's responsibility to determine the proper scope and personnel required for each project. There may be project- and/or client- and/or state-specific requirements that may be more or less stringent than what is described herein. The CPM is responsible for informing Arcadis and/or Subcontractor personnel of omissions and/or deviations from this document that may be required for the project. In turn, project staff are required to inform the CPM if or when there is a deviation or omission from work performed as compared to what is described herein.

In following this document to execute the scope of work for a project, it may be necessary for staff to make professional judgment decisions to meet the project's scope of work based upon site conditions, staffing expertise, regulation-specific requirements, health and safety concerns, etc. Staff are required to consult with the CPM when or if a deviation or omission from this document is required that has not already been previously approved by the CPM. Upon approval by the CPM, the staff can perform the deviation or omission as confirmed by the CPM.

## 3 Scope and Application

This Technical Guidance Instruction (TGI) document describes the methods and procedures for collecting indoor air or ambient air samples with passivated stainless-steel canisters (e.g., SUMMA®) and the subsequent analysis of volatile organic compounds (VOCs) using USEPA TO-15.

## 4 Personnel Qualifications

Arcadis field sampling personnel will have current health and safety training, including 40-hour HAZWOPER training, site supervisor training, site-specific training, first aid, and cardiopulmonary resuscitation (CPR), as



needed. Arcadis field sampling personnel will be competent in the relevant procedures and possess the required skills and experience necessary to successfully collect indoor air and ambient air samples and the desired field work. Arcadis personnel responsible for directing indoor air and/or ambient air sample collection activities must have previous indoor air sampling experience and be able to complete the field work without direct supervision.

## 5 Equipment List

The equipment required for indoor air and ambient air collection is presented below:

- 6-liter, stainless steel passivated canisters (e.g., SUMMA®). Request one canister for each sampling location, plus duplicate canisters per project-specific requirements. If feasible, order extra canisters at a rate of 10 to 20% of the total number of sampling canisters (including duplicates).
- Flow controllers with in-line particulate filters and vacuum gauges. Flow controllers are pre-calibrated by the laboratory to the sampling duration [typically 8-hours in commercial/industrial settings and 24-hours in residential settings] specified by the project team). Vacuum gauges are also generally supplied by the laboratory. Flow controllers can be connected to the canister via 9/16-inch compression fittings or quick-connect fittings.
- Open-end wrench. Typical canister caps require 9/16-inch wrenches.
- Chain-of-custody (COC) form.
- Sample collection log (attached) or the Fulcrum Application: FieldNow® – TO-15 Indoor/Outdoor Air Collection Log Version 2.0 (Tier 1).
- Box, chair, tripod, or similar to hold canister above the ground surface at approximate breathing height (3-5 feet).
- Hand-held weather meter (optional).
- Nitrile gloves
- Camera (if photography is permitted at sampling locations).
- Chain and padlock or bike lock (for securing ambient air canisters).
- Zip ties
- Independent digital gauge (optional).
- Outdoor Air Sampling Tag noting: “Environmental Testing – Do Not Disturb”

For abnormal situations (i.e., sumps, crawlspaces with no access, where canisters must be hidden, etc.), Teflon tubing may be used to collect an air sample. In these situations, ¼-inch Swagelok fittings (including nut, front sleeve, and back sleeve) or other methods may be appropriate to affix tubing to canister. Teflon tubing may be connected to various lengths of electrical fish rods with zip ties (do not use tape) to direct the end of the tubing into a crawlspace or other area.

## 6 Cautions

Care must be taken to minimize the potential for introducing interferences during the sampling event. As such, keep canisters away from heavy pedestrian traffic areas (e.g., main entranceways, walkways), if possible. Sampling personnel should not handle hazardous substances (such as gasoline), permanent marking pens (sharpies), wear/apply fragrances, use hand sanitizer, or smoke cigarettes before and/or during the sampling event.

Specify sample collection duration with the laboratory when ordering equipment and confirm with the laboratory upon equipment receipt. Sample integrity can be compromised if sample collection is extended to the point that the canister reaches atmospheric pressure. Sample integrity is maintained if sample collection is terminated prior to the target sample duration and a measurable vacuum (e.g., 5 inches Hg) remains in the canister when sample collection is terminated. In extreme cold temperature, it is suggested the final measurable vacuum remains higher (e.g., 10 inches of Hg) to account for pressure loss. Digital gauges are recommended.

## 7 Health and Safety Considerations

All sampling personnel should review the appropriate health and safety plan (HASP) and job safety analysis (JSA) prior to beginning work to be aware of all potential hazards associated with the job site and the specific task.

## 8 Procedure

### Preparation of Passivated Canister and Collection of Sample

1. Record the following information on the sampling form (use a hand-held weather meter, contact the local airport or other suitable information source [e.g., [weatherunderground.com](http://weatherunderground.com)] to obtain the following information):
  - Ambient temperature
  - Barometric pressure
  - Wind speed
  - Relative humidity
  - Significant recent precipitation
  - Snow/ice cover
1. For indoor air sampling, note whether the heating, ventilation, and air conditioning (HVAC) system is operational and record settings.
2. For outdoor air sampling, canisters should be initiated at least 30 minutes prior to initiating the first indoor air sample and should be placed upwind of the structure(s) being sampled.
2. Attach an outdoor air tag to each outdoor air canister using a zip tie as applicable. Outdoor air tags are usually only required for off-site locations where disturbance of the canister may occur. The outdoor air tag should include the words, "Environmental Testing – Do Not Disturb". If possible, place the outdoor air canister(s) in areas with less foot traffic.
3. Choose the sampling location in accordance with the project sampling plan. If a breathing zone sample is required, place the canister on a box, chair, tripod, or other similar stand to locate the canister orifice 3 to 5 feet above the ground or floor surface. The canister may be affixed to wall/ceiling support with nylon rope or placed on a stable surface. In general, areas near windows, doors, air supply vents, and/or other potential sources of "drafts" shall be avoided.
4. Record canister serial number and flow controller number on the sampling log or FieldNow® application and COC form. Assign sample identification (ID) and record on canister ID tag on the sample collection log or FieldNow® application and COC form.
5. Remove the brass dust cap from the canister with the wrench. Attach the independent gauge provided by the laboratory or a digital gauge to the canister. For compression fittings tighten with fingers first, then gently with



the wrench (roughly a quarter turn). Use caution not to over tighten fittings. For quick-connect fittings simply attach the gauge to the canister. Open the canister and record the initial vacuum on the sampling log or FieldNow® application and COC form. Close the canister and remove the gauge. The initial pressure reading should be evaluated with respect to project-specific and regulatory jurisdictional requirements. If the initial pressure registers less than -25 inches of Hg, then the canister is not appropriate for use, and another canister should be used. Note: confirm specific project jurisdiction regulatory requirements for initial pressure.

6. Attach the flow controller and integrated vacuum gauge to the canister with the wrench. Tighten with fingers first, then gently with the wrench (roughly a quarter turn). Use caution not to over tighten fittings. Some laboratories ship the canister and flow controller pre-assembled. Confirm that connections are appropriately tight. For quick-connect fittings simply attach to the canister. Caution – some quick-connect canisters do not have valves and begin sampling as soon as the flow controller is attached.
7. Open the canister valve to initiate sample collection. Record the date and local time (24-hour basis) of valve opening on the sample collection log and COC form. Collection of duplicate samples will include collecting two samples side by side at the same time or by using a duplicate tee. Duplicate tees can be requested from the laboratory and made from Teflon tubing and Swagelok fittings.
8. Check the initial canister pressure using the vacuum gauge. Ensure the initial pressure on the flow controller vacuum gauge matches the pressure from the independent gauge, note difference in the canister on the sample log.
9. Photograph the canister and surrounding area within the FieldNow® application; if photography is permitted at sampling locations. Also photograph the sample tag.
3. If feasible, check the canister approximately half-way through the sample duration and note progress on sample logs.

### **Termination of Sample Collection**

1. Arrive at the sampling location at least 1 to 2 hours prior to the end of the sampling interval (e.g., 6 hours following sample initiation for an 8-hour sampling duration).
2. The appropriate canister pressure for termination of sampling is between -2 and -10 inches of Hg with the optimal ending pressure of -5 inches of Hg. Leaving some vacuum in the canister provides a way to ensure that the sample was collected over the appropriate duration and to evaluate whether the canister leaks before it reaches the laboratory. Stop collecting the sample by turning the valve on the canister when the canister pressure reaches approximately -5 inches of Hg and when the desired sample time has elapsed. If the canister pressure is outside of the appropriate range at the end of the sampling duration, consult with the project manager before ending the sample.
3. Record the final canister pressure. Record the date and local time (24-hour basis) of valve closing on the sample collection log or FieldNow® application and COC form.
4. Remove the flow controller from the canister. Connect the independent gauge to confirm the final canister pressure using the procedure as described above. Re-install brass cap on canister fitting and tighten with the wrench.
5. Package the canister and flow controller in accordance with Department of Transportation regulations available on the Transportation Health and Safety's Team Site on the Source for return shipment to the laboratory. The canister does not require preservation with ice or refrigeration during shipment.
6. Complete the forms and sample labels provided by the laboratory as directed (e.g., affix card with string).

7. Complete the COC form; copy, photograph, or scan a version for the project file (if possible); and place the form in the shipping container. Close the shipping container and affix the custody seal to the container closure. Transmit canisters via courier delivery service (e.g., Federal Express or UPS) to laboratory for analysis.

## 9 Waste Management

No specific waste management procedures are required.

## 10 Data Recording and Management

Digital data collection is the Arcadis standard using available FieldNow® applications that enable real-time, paperless data collection, entry, and automated reporting. Paper forms should only be used as backup to FieldNow® digital data collection and/or as necessary to collect data not captured by available FieldNow® applications. The Field Now® digital form applications follow a standardized approach, correlate to most TGIs and are available to all projects accessible with a PC or capable mobile device. Once the digital forms are saved within FieldNow®, the data is instantly available for review on a web interface. This facilitates review by project management team members and SMEs enabling error or anomalous data detection for correction while the staff are still in the field. Continual improvements of FieldNow® applications are ongoing, and revisions are made as necessary in response to feedback from users and subject matter experts.

Notes and pictures taken during the sampling process that cannot be collected using the FieldNow® application will be compiled and uploaded to the project specific folder on SharePoint and/or Collaboration Hub.

## 11 Quality Assurance

Conduct quality assurance as required by the project-specific work plan and/or Quality Assurance Project Plan (QAPP). Additionally:

4. Canisters should be pre-cleaned by an accredited laboratory and individually certified clean.
5. Communicate with laboratory to insure that project-specific reporting limits and deliverables are met.
6. If tubing is used during sampling activities, the tubing should be Teflon or Teflon-lined tubing.
7. All fittings should be stainless-steel.
8. Ambient (outdoor) air sample(s) should be collected each day of the indoor air sampling event to evaluate background VOC concentrations.

## 12 References

Not Applicable



Arcadis U.S., Inc.  
55 Monument Circle, Suite 300B  
Indianapolis  
Indiana 46204  
Phone: 317 231 6500  
Fax: 317 231 6514  
[www.arcadis.com](http://www.arcadis.com)





# **TGI - Sub-Slab Soil Gas Sampling Point Installation Using Vapor PIN™ Approach**

Rev: 2

Rev Date: December 30, 2021

## Version Control

Issue	Revision No.	Date Issued	Page No.	Description	Reviewed By
	1	July 20, 2017	All	Original/Rev 1	Dawn Cacia Mitch Wacksman
	2	December 30, 2021	All	Rev 2 for QMS Library / Updates	Robert Uppencamp



## Approval Signatures

Prepared by:



7/20/2017

---

Dawn Cacia (Preparer)

---

Date

Reviewed by:



12/30/2021

---

Robert Uppencamp (Subject Matter Expert)

---

Date

## 1 Introduction

This Technical Guidance Instruction (TGI) provides the methods and procedures for installing sub-slab vapor ports using the Vapor Pin™ approach.

## 2 Intended Use and Responsibilities

This document describes general and/or specific procedures, methods, actions, steps, and considerations to be used and observed by Arcadis staff when performing work, tasks, or actions under the scope and relevancy of this document. This document may describe expectations, requirements, guidance, recommendations, and/or instructions pertinent to the service, work task, or activity it covers.

It is the responsibility of the Arcadis Certified Project Manager (CPM) to provide this document to the persons conducting services that fall under the scope and purpose of this procedure, instruction, and/or guidance. The Arcadis CPM will also ensure that the persons conducting the work falling under this document are appropriately trained and familiar with its content. The persons conducting the work under this document are required to meet the minimum competency requirements outlined herein, and inquire to the CPM regarding any questions, misunderstanding, or discrepancy related to the work under this document.

This document is not considered to be all inclusive nor does it apply to all projects. It is the CPM's responsibility to determine the proper scope and personnel required for each project. There may be project- and/or client- and/or state-specific requirements that may be more or less stringent than what is described herein. The CPM is responsible for informing Arcadis and/or Subcontractor personnel of omissions and/or deviations from this document that may be required for the project. In turn, project staff are required to inform the CPM if or when there is a deviation or omission from work performed as compared to what is described herein.

In following this document to execute the scope of work for a project, it may be necessary for staff to make professional judgment decisions to meet the project's scope of work based upon site conditions, staffing expertise, regulation-specific requirements, health and safety concerns, etc. Staff are required to consult with the CPM when or if a deviation or omission from this document is required that has not already been previously approved by the CPM. Upon approval by the CPM, the staff can perform the deviation or omission as confirmed by the CPM.

## 3 Scope and Application

This document describes the procedures for installing permanent sub-slab sampling probes using the Vapor Pin™ approach. These sample probes can then be used for the collection of sub-slab soil gas samples, for vacuum readings, or other uses. When not in use, the probes can be sealed in place without having to abandon the point.

The following sections list the necessary materials, equipment, and detailed instructions for installing sub-slab sampling points using the Vapor Pin™ approach.

## 4 Personnel Qualifications

Arcadis field sampling personnel will have current health and safety training, including 40-hour HAZWOPER training, site supervisor training, site-specific training, first-aid, and cardiopulmonary resuscitation (CPR), as



needed. Arcadis field sampling personnel will be well versed in the relevant standard operating procedures (SOPs), technical guidance instructions (TGIs) and possess the required skills and experience necessary to successfully complete the desired field work. Arcadis personnel responsible for leading sub-slab soil gas sampling point installation activities must have previous sub-slab soil gas sampling point installation experience.

## 5 Equipment List

- Appropriate personal protective equipment (PPE), as required by the site-specific Health and Safety Plan (HASP) and the job safety analysis (JSA)
- Electric hammer drill (big – e.g., Bosch, Hilti, etc.)
- 5/8-inch and 1 ½-inch concrete drill bits for impact drill (drill bit length contingent on slab thickness)
- 2-inch concrete coring drill bit (for stainless steel flush mount cover installation)
- Contractor Cox Colvin Vapor Pin™ Kit that includes:
  - Decontaminated Stainless Steel Vapor Pin™ with barbed fitting (0.5-inch outside diameter at end, 0.8125-inch diameter at middle, 3.5-inch in length)
  - Vapor Pin™ sleeves
  - Vapor Pin™ rubber protective caps
  - Secure, steel flush mount covers or plastic flush mount cover
  - Spanner screwdriver
  - Stainless steel drilling guide
  - Installation/Extraction tool
  - Bottle brush
  - Vapor Pin™ SOP
- Photoionization detector (PID) with appropriate eV lamp for site related contaminants of concern (COCs)
- Dead blow hammer
- Pliers
- Whisk broom and dustpan or shop vacuum with clean fine-particle filter
- Spray bottle with distilled water
- Paper towels
- Nitrile gloves
- Work gloves
- Knee pads
- Ground fault circuit interrupter (GFCI)
- Extension cords capable of amperage required for hammer drill
- Plastic sheeting
- Field notebook and/or FieldNow® application

## 6 Cautions

The following cautions and field tips should be reviewed and considered prior to installing or collecting a sub-slab soil gas sample.

- When drilling sample collection holes, be mindful of utilities that may be in the area. Always complete utility location, identification and marking before installing sub-slab ports as required by the Arcadis Utility Location Policy and Procedure. Be aware that public utility locator organizations frequently do not provide location information within buildings so alternative lines of evidence must be used. If the driller is concerned about a particular location, consult the project manager about moving it to another location. Do not hesitate to use Stop Work Authority; if something doesn't seem right stop and remedy the situation.
- Use of Vapor Pins™ and drill bit length will be based on the thickness of the slab encountered. Every effort will be made to establish the thickness of the slab during the preliminary investigation activities, such as interviews with site personnel, review of construction drawings, building walk through and utility clearance process. If slab is determined to be too thin for Vapor Pins™ – install a standard port using the permanent probe approach consistent with the corresponding TGI.
- Sampling personnel should not handle hazardous substances (such as gasoline), permanent marking pens (sharpies), use hand sanitizer, wear/apply fragrances, or smoke cigarettes/cigars before and/or during the installation event.
- Only a clean decontaminated hammer drill and drill bits should be used for installation. A hammer drill dedicated to VI work is preferred. Be extra cautious if using rental equipment.
- Field personnel will properly seal the sub-slab soil gas sampling point at the slab surface to prevent leaks of atmosphere into the sub-slab soil gas sampling point during purging and sampling. Permanent ports will be fit snug into the predrilled hole by ensuring that the silicone sleeve is fitted properly around the Vapor Pin™ before installation and expands sufficiently inside the hole during installation. A protective cap will be installed on the end of the barb fitting. If this is not done properly, the integrity of the sample port may be compromised.
- If possible, have equipment shipped two to three days before the scheduled start of the installation event so that all materials can be checked. Order replacements if needed.

## 7 Health and Safety Considerations

All sampling personnel should review the appropriate HASP and JSA prior to beginning work to be aware of all potential hazards associated with the job site and the specific task. Field sampling must be carefully performed to minimize the potential for injury and the spread of hazardous substances. For sub-slab soil gas sampling point installation, drilling with an electric concrete impact drill should be done only by personnel with prior experience using such a piece of equipment or directly supervised by an experienced person and with the appropriate health and safety measures in place as presented in the JSA. It is possible to encounter high concentrations of VOCs in sub-slab soil gas, so the amount of time the borehole remains open should be minimized. For the same reason, when installing sub-slab soil gas sampling points in spaces with minimal dilution potential, such as closets, it is advisable to provide local ventilation. Finally, sub-slab soil gas sampling point installation should be completed at least 24 hours in advance or after any indoor air sampling to avoid cross contamination of the indoor air samples.

Proper procedures should be used to eliminate exposure to silica dust when drilling through concrete and asbestos containing materials such as floor tile, etc.



## 8 Procedure

Permanent sub-slab soil gas sampling points are installed using a hammer drill and manual placement of the Vapor Pin™ probe. After a dry fit, the vapor probe is inserted into the hole and installed using a dead blow hammer to tap the installation/extraction tool over the Vapor Pin™ to protect the barb fitting. The vapor probe is equipped with a rubber protective cap that is used to close the sampling port when not in use. A figure presenting a properly installed Vapor Pin™ is below:



*Figure 1 - Cross-section of properly installed Vapor Pin™ (Cox-Colvin Vapor Pin™ Installation SOP [2016])*

The Vapor Pin™ and tubing will be purged prior to collecting the soil gas sample. Detailed installation methods are as follows:

1. Complete the procedure in the Arcadis Utility Location and Clearance Standard prior to drilling activities.
2. Remove, only to the extent necessary, any covering on top of the slab (e.g., carpet) if present.
3. Lay down plastic sheeting to keep the work area clean. Check to make sure shop vacuum is working properly and fine concrete particles will not pass through filter.
4. Advance the 1½-inch drill bit approximately 1.75 inches into the slab (Please note that if the stainless-steel flush mount is being used, advance the 2-inch drill bit approximately 1/8 inch into the slab first before using the 1½-inch drill bit). This hole is drilled deep enough to permit the top of the Vapor Pin™ to be set flush with the slab when the Vapor Pin™ is inserted into the 5/8-inch hole drilled under Step 7, below. Careful not to advance too far into the slab. This will cause the threaded portion of the Vapor Pin™ to be set too deeply to engage with stainless-steel cover. Clean up cuttings with shop vacuum, bottle brush, and dust pan.
5. Drill a 5/8-inch-diameter hole into the concrete slab using the hammer drill. Do not fully penetrate the slab at this time. Stop drilling approximately 1-inch short of penetrating the slab.
6. Use the shop vacuum, bottle brush and dust broom to clean up the work area and material that may have fallen into and around the drill hole.

7. Advance the 5/8-inch drill bit the remaining thickness of the slab and approximately 3 inches into the sub-slab material to create an open cavity. Record any observations from the drill cuttings, if possible, regarding approximate soil type(s), presence of soil moisture/water, and presence or absence of a plastic sub-slab sheet. Record PID readings.
8. Use the bottle brush, dust broom and dust pan to clean material around and within the hole. Do not use the shop vacuum to clean up the drill hole after the full thickness of the slab has been penetrated.
9. Using a Vapor Pin™ without the silicone sleeve fitted, test fit the components so that the proper depth of the 1½-inch hole provides enough space for the Vapor Pin™. Adjust so that the Vapor Pin™ will lie flush with the slab surface and does not create a tripping hazard.
10. Re-drill the 5/8-inch hole to ensure it remains clear. This can also be accomplished using a piece of steel rod, sample tubing or a piece of heavy wire (e.g., coat hanger).
11. Assemble the Vapor Pin™ for installation by fitting the silicone sleeve over the lower end of the pin.
12. Place the lower end of Vapor Pin™ assembly into the drilled hole. Place the small hole located in the handle of the installation/extraction tool over the Vapor Pin™ to protect the barb fitting, and tap the Vapor Pin™ into place using a dead blow hammer. Make sure the installation/extraction tool is aligned with the Vapor Pin™ to avoid damaging the barb fitting. Place the rubber protective cap over the Vapor Pin™ barb so that it covers the first barb. Do not push the cap down so that it is flush as this will make it very difficult to remove when preparing to sample.
13. For flush mount installations, cover the Vapor Pin™ with a flush mount cover, using either the plastic cover or by threading the stainless-steel secure cover onto the Vapor Pin™. Replace the surface covering (e.g., carpet) if warranted. Sample collection location should be returned to pre-sampling conditions to the extent feasible given the presence of a permanent probe.
14. All permanent sub-slab soil gas sampling points should be allowed to equilibrate for a minimum of 24 hours before proceeding to sample collection.

## 9 Waste Management

Silica dust generated from drilling through concrete must be captured and disposed of properly. If drilling through known or potential asbestos containing materials (e.g., floor tile, linoleum, etc.), discuss with the project manager and VI lead for proper management and disposal of dust and cuttings.

## 10 Data Recording and Management

Digital data collection is the Arcadis standard using available FieldNow® applications that enable real-time, paperless data collection, entry, and automated reporting. Paper forms should only be used as backup to FieldNow® digital data collection and/or as necessary to collect data not captured by available FieldNow® applications. The Field Now® digital form applications follow a standardized approach, correlate to most TGIs and are available to all projects accessible with a PC or capable mobile device. Once the digital forms are saved within FieldNow®, the data is instantly available for review on a web interface. This facilitates review by project management team members and SMEs enabling error or anomalous data detection for correction while the staff are still in the field. Continual improvements of FieldNow® applications are ongoing, and revisions are made as necessary in response to feedback from users and subject matter experts.



## 11 Quality Assurance

Conduct quality assurance as required by the project-specific work plan and/or Quality Assurance Project Plan (QAPP).

## 12 References

Cox-Colvin & Associates, Inc. 2016. Standard Operating Procedure Installation and Extraction of the Vapor Pin™. <http://vaporpin.coxcolvin.com/wp-content/uploads/2016/09/Vapor-Pin-SOP-09-2016-Web.pdf>

Arcadis U.S., Inc.  
630 Plaza Drive, Suite 200  
Highlands Ranch  
Colorado 80129  
Phone: 720 344 3500  
Fax: 720 344 3535  
[www.arcadis.com](http://www.arcadis.com)



# TGI - Sub-Slab Vapor and Soil Vapor Sampling Using Whole Air Canisters

Rev: 2

Rev Date: August 4, 2023


## Version Control

Issue	Revision No.	Date Issued	Page No.	Description	Reviewed By
1	1	9/18/2016	All	Updated Rev0	Mitch Wacksman
2	2	8/4/2023	All	Updated Rev1	Sarah Jonker Christina Weaver Robert Uppencamp



## Approval Signatures

Prepared by:



8/4/2023

---

Sarah Jonker (Preparer)

---

Date

Reviewed by:



8/4/2023

---

Robert Uppencamp (Subject Matter Expert)

---

Date

## 1 Introduction

This Technical Guidance Instruction (TGI) provides the methods and procedures for collecting whole air samples via USEPA Method TO-15 for sub-slab vapor or exterior soil vapor using whole air stainless-steel canisters.

## 2 Intended Use and Responsibilities

This document describes general and/or specific procedures, methods, actions, steps, and considerations to be used and observed by Arcadis staff when performing work, tasks, or actions under the scope and relevancy of this document. This document may describe expectations, requirements, guidance, recommendations, and/or instructions pertinent to the service, work task, or activity it covers.

It is the responsibility of the Arcadis Certified Project Manager (CPM) to provide this document to the persons conducting services that fall under the scope and purpose of this procedure, instruction, and/or guidance. The Arcadis CPM will also ensure that the persons conducting the work falling under this document are appropriately trained and familiar with its content. The persons conducting the work under this document are required to meet the minimum competency requirements outlined herein, and inquire to the CPM regarding any questions, misunderstanding, or discrepancy related to the work under this document.

This document is not considered to be all inclusive nor does it apply to all projects. It is the CPM's responsibility to determine the proper scope and personnel required for each project. There may be project- and/or client- and/or state-specific requirements that may be more or less stringent than what is described herein. The CPM is responsible for informing Arcadis and/or Subcontractor personnel of omissions and/or deviations from this document that may be required for the project. In turn, project staff are required to inform the CPM if or when there is a deviation or omission from work performed as compared to what is described herein.

In following this document to execute the scope of work for a project, it may be necessary for staff to make professional judgment decisions to meet the project's scope of work based upon site conditions, staffing expertise, regulation-specific requirements, health and safety concerns, etc. Staff are required to consult with the CPM when or if a deviation or omission from this document is required that has not already been previously approved by the CPM. Upon approval by the CPM, the staff can perform the deviation or omission as confirmed by the CPM.

## 3 Scope and Application

This Technical Guidance Instruction (TGI) has been updated to reflect United States Environmental Protection Agency (USEPA) criteria (USEPA 2015) and best practices.

This document describes the procedures for collecting exterior soil vapor or sub-slab soil vapor (herein referred to as "soil vapor") samples using whole air stainless-steel canisters for the analysis of volatile organic compounds (VOCs) by USEPA Method TO-15 (TO-15). This document assumes a sample port (either sub-slab port or exterior soil vapor probe) has already been installed. This document covers the above ground assembly and sampling methods.

Separate TGIs are available in the TGI library for the installation of sub-slab ports and exterior soil vapor probes. Sampling is typically able to commence a minimum of 2 hours after installation of a sub-slab port (VaporPin®) and



a minimum of 24 hours after installation of a soil vapor probe. Confirm equilibration times with the project's regulatory jurisdiction.

Method TO-15 typically uses a 1-liter, 3-liter, or 6-liter stainless-steel canisters to collect a whole air sample. The whole air sample is then analyzed for VOCs using a quadrupole or ion-trap gas chromatograph/mass spectrometer (GS/MS) system to provide typical compound detection limits of 0.5 parts per billion volume (ppbv).

The following sections list the necessary equipment, materials, and detailed instructions for collecting soil vapor samples for VOC analysis.

## 4 Personnel Qualifications

Arcadis field sampling personnel will have current health and safety training, including 40-hour HAZWOPER training, site supervisor training, Department of Transportation (DOT)/International Air Transport Association HazMat #1, site-specific training, first-aid, and cardiopulmonary resuscitation (CPR), as needed. Arcadis field sampling personnel will be well versed in the relevant technical guidance instructions (TGIs) and possess the required skills and experience necessary to successfully complete the desired field work. Arcadis personnel responsible for leading soil vapor sample collection activities must have previous soil vapor sampling experience.

## 5 Equipment List

The equipment required for soil vapor sample collection is presented below. All stainless-steel supplies must be cleaned/decontaminated prior to use.

### 5.1 Laboratory

- 1, 3, or 6-liter whole air stainless-steel canisters. Order either batch certified canisters or individually certified canisters as required by the project. Order one extra whole air stainless-steel canister per 20 samples to account for a potential loss of vacuum malfunction in shipping, if feasible. A 1-liter whole air stainless-steel canister is typical for soil vapor sampling and will achieve most reporting limit requirements. Confirm the applicable screening levels for the project will be met by the laboratory reporting limits.
- Flow controllers must be ordered for each whole air stainless-steel canister ordered. Flow controllers will come with in-line particulate filters and vacuum gauges. Flow controllers are pre-calibrated to specified sample duration (e.g., 5, 10, or 30 minutes) or flow rate (e.g., between 80-200 milliliters per minute [mL/min]). Confirm with the laboratory that the flow controller comes with a particulate filter and vacuum gauge.
- Order a stainless-steel duplicate tee as needed. Projects typically require 1 duplicate per 10 samples or 20 samples. Confirm the project QA/QC requirements.

### 5.2 Supplies

Soil vapor probes are typically completed with all sample assembly components permanently connected and contained within the manway vault. Purging materials and sampling media are required.

Supplies to build one sub-slab port assembly are listed below. Clean/decontaminate all stainless-steel supplies prior to use. Tubing and ferrules cannot be reused. Stainless-steel supplies should be Swagelok® & Parker A-Lok

compatible compression fittings. Supplies can be purchased at companies such as Swagelok® [www.swagelok.com](http://www.swagelok.com), McMaster Carr [www.mcmaster.com](http://www.mcmaster.com), or ESP Supply [www.shop-esp.com](http://www.shop-esp.com).

Two sub-slab sample assembly types are detailed in Section 8. Materials to build each type of sample assembly are listed below.

#### Sub-Slab Port Assembly for Vapor Pin™ with Barb Fitting using the Sample Configuration with Purge Isolation

- 1: 1/4-inch stainless-steel valve with compression fittings.
- 6: 1/4-inch stainless-steel compression nuts.
- 6: 1/4-inch stainless-steel front and back compression ferrules.
- 1: 1/4-inch stainless steel union tee. Some labs have flow controllers with a purge port and valve built in. Confirm with the lab flow controller setup (request a diagram or photo). A Luer-Lok™ 3-way valve can be used at the tee fitting as well.
- 36-inches: 1/4-inch outer diameter (OD) Teflon®, Teflon® lined, or Nylaflow tubing.
- 8-inches: 1/4-inch inner diameter (ID) silicone tubing.
- 60-mL syringe equipped with a three-way Luer-Lok™ valve. Alternately, a low-flow air pump may be used.
- 1-liter Tedlar® bag.

#### Sub-Slab Port Assembly for Vapor Pin™ with Barb Fitting using Separate Purge and Sample Configuration

- 1: 1/4-inch stainless-steel ball with compression fittings.
- 3: 1/4-inch stainless-steel compression nuts.
- 3: 1/4-inch stainless-steel front and back compression ferrules.
- 24-inches: 1/4-inch OD Teflon®, Teflon® lined, or Nylaflow tubing.
- 8-inches: 1/4-inch ID silicone tubing.
- 60-mL syringe equipped with a three-way Luer-Lok™ valve. Alternately, a low-flow air pump may be used.
- 1-liter Tedlar® bag.

## 5.3 Rental Equipment

Appropriate equipment and materials for quality assurance testing are detailed in the respective quality assurance TGIs (i.e., helium leak testing, water dam testing, methane testing).

- Nitrile gloves.
- Low-flow air pump with time-elapse clock (GilAir or equivalent) capable of a flow rate between  $100 \leq \text{to} \leq 200$  mL/min for purging. This may require a low-flow module. Alternately, a 60-mL syringe with a three-way Luer-Lok™ valve may be used.
- Air pump calibration instrument such as a DryCal® Defender (or equivalent), as needed.
- Photoionization detector (PID) with calibration kit, as needed.
- Multi-gas monitor (LANDTEC® GEM™ 2000 PLUS/5000 or similar) capable of detecting percentage of carbon Dioxide, methane, and oxygen with calibration kit, as needed.
- Portable weather meter, as needed. Alternately, weather applications or weather websites can be used.



## 5.4 Personal Gear and Documents

- Appropriate-sized open-end wrench (typically 9/16-inch and 1/4-inch, #14 spanner for Vapor Pins®).
- 1/4-inch adjustable wrench.
- Channel locking plier with 1.5-inch or larger opening (helium tank manifold and 2-way valves).
- Non-VOC containing modelling clay to mitigate leaks.
- Chain-of-custody (COC) form(s).
- Sample collection log or current Soil Vapor Sampling FieldNow® TO-15 application.
- Work gloves.
- Field notebook or current Soil Vapor Sampling FieldNow® TO-15 application.

## 6 Cautions

The following cautions and field tips should be reviewed and considered prior to installing or collecting a soil vapor sample.

- Sampling personnel should not handle hazardous substances (such as gasoline), permanent marking pens (sharpies), wear/apply fragrances including sunscreens, hand sanitizer, or alcohol-based cleaning products. Do not smoke cigarettes/cigars before and/or during the sampling event.
- Ensure the flow controller is pre-calibrated to the proper sample collection duration (confirm with laboratory). Sample integrity can be compromised if sample collection is extended to the point that the canister reaches atmospheric pressure. Sample integrity is maintained if sample collection is terminated prior to the target duration and a measurable vacuum (e.g., 2 to 10 inches of mercury [in. Hg]) remains in the canister when sample collection is terminated.
- The integrity of the sample train and sample port will be tested in accordance with the project specific requirements. These procedures are contained in their own TGI documents and include helium leak testing, water dam testing, and methane testing.
- It is important to record the canister vacuum, start and stop times, and sample identification on a proper field sampling form or current Soil Vapor Sampling FieldNow® TO-15 application. You should observe and record the time/ vacuum at the start, and then again one or two minutes after starting the sample collection. It is a good practice to lightly tap the vacuum gauge with your finger before reading it to make sure the needle is not stuck. If the canister is filling as expected, the sampling rate should match the rate of the flow controller set point. If available utilize an independent analog or digital gauge to verify vacuum; may be laboratory provided. Consult your project manager, risk assessor, or air sampling expert by phone if the canister does not appear to be working properly due to insufficient or rapid pressure changes.
- When sampling, carefully consider elevation. If your site is over 2,000 feet above sea level, or the difference in elevation between your site and your lab is more than 2,000 feet, then pressure effects will be significant. If you take samples at a higher elevation, they will contain less air for a given ending vacuum reading. High elevation samples analyzed at low elevation will result in more dilution at the lab, which could affect reporting limits. Conversely, low elevation samples received by a laboratory at high elevation may appear to not have much vacuum left in them. [http://www.uigi.com/Atmos\\_pressure.html](http://www.uigi.com/Atmos_pressure.html).

- If possible, have equipment shipped two to three days before the scheduled start of the sampling event so that all materials can be checked. Check the vacuum in each canister as soon as they arrive. If the initial vacuum registers less than -25 inches of Hg, then the canister is not appropriate for use and another canister should be used. The initial vacuum required varies by jurisdiction; confirm with the project regulatory authority. If an analog or digital gauge is available when conducting inventory, ensure the vacuum is similar to the laboratory recorded vacuum on the sample tag. Order replacements, if needed.
- Requesting extra canisters and flow controllers from the laboratory should also be considered to ensure that you have enough equipment on site in case of an equipment failure, especially at remote sites.
- When taking field measurement readings of the soil vapor conditions, it is best practice to collect reading from a Tedlar® bag instead of directly from sample port. This is due to field instruments having a flow rate of greater than 200 ml/min, which can cause partitioning of contaminants during sampling. In addition, for health and safety reasons, when there are elevated concentrations of site contaminants it is best not to purge into the sampler's breathing zone.
- Considering laying out a new trash bag or tarp on the ground next to the sample port to prevent sampling equipment from touching potentially impacted ground (i.e., asphalt parking lot with car oil stains).

## 7 Health and Safety Considerations

All sampling personnel should review the appropriate health and safety plan (HASP) and job safety analysis (JSA) prior to beginning work to be aware of all potential hazards associated with the job site and the specific task. Field sampling must be carefully performed to minimize the potential for injury and the spread of hazardous substances.

Soil vapor sampling is often done on the ground with workers on their knees. Low stools, knee pads, or a large pad can be used under the entire sample area (i.e., a large, folded box). This will protect the worker's knees. Ensure proper hand protection is worn while working with hand tools during sample train assembly. The metal-on-metal fittings often create small metal splinters when cross-threaded. Always use gloves when handling the canisters, fittings, valves, etc. Do not blow the metal splinters off towards other workers. Use outer nitrile gloves when handling all sample train components to prevent potential cross contamination.

## 8 Procedure

### 8.1 Sample Train Assembly

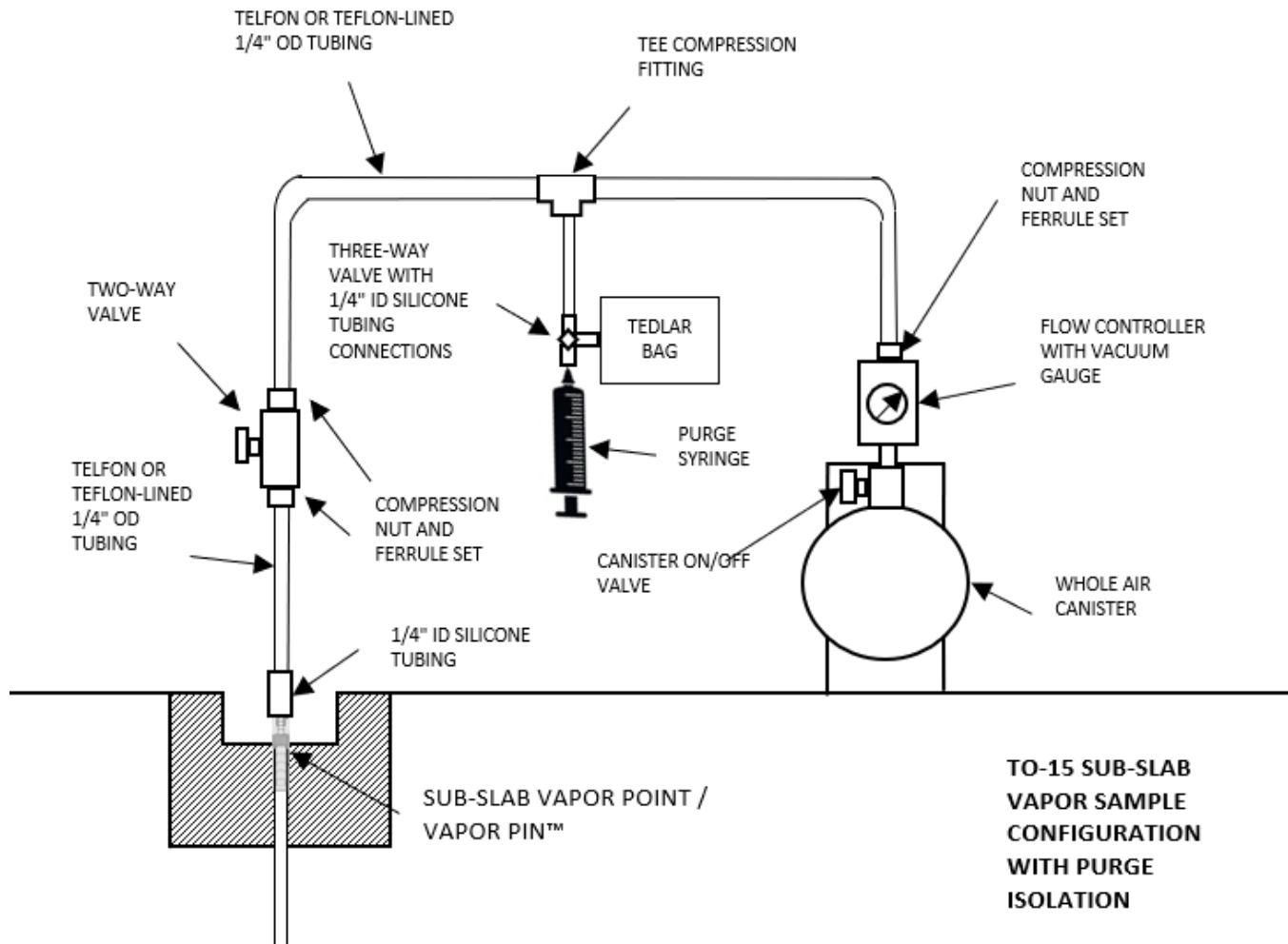
The following procedures should be used to collect a soil vapor sample using a whole air stainless-steel canister. These methods can be used for both soil vapor probe samples and interior sub-slab soil vapor samples collected from both permanent and temporary sample point installations. Two configurations of the sample train are acceptable in most jurisdictions; confirm with the project regulatory authority.



Sub-Slab Port Assembly for Vapor Pin™ with Barb Fitting using the Sample Configuration with Purge Isolation

1. Pre-assemble the sample train for each sub-slab port to be sampled (Vapor Pin® with barb fitting). Cut three ~10-inch pieces of 1/4- inch OD Teflon®, Teflon® lined, or Nylaflow tubing and 1 ~6-inch piece of the same tubing.
2. Connect one piece of the 10-inch tubing to the two opposite sides of the stainless-steel tee with compression nuts and ferrule sets. Install a compression nut and ferrule set to the other side of each tubing piece.
3. Remove the cap from the canister and connecting the flow controller with in-line particulate filter and vacuum gauge. The flow controller attaches directly to the canister and the pre-set rate dictates the sample duration. The laboratory may have connected the canister and flow controller prior to shipping. Attach the canister and flow controller assembly to the tubing from one side of the stainless-steel tee.
4. Unless the flow controller manifold came with a purge port and valve, one will need to be added. Cut a short length (~6-inches) of 1/4- inch OD Teflon®, Teflon® lined, or Nylaflow tubing. Connect to the open end of the tee fitting using a compression nut and ferrule set. This tee adds a leg to the sample train that will be used to purge “dead” air from the sample train.
5. Connect the purge syringe with three-way valve and/or air pump to the free end tubing from the tee using a length short piece of 1/4-inch ID silicon tubing.
6. Attach a two-way compression valve to the remaining free end of the tee tubing. Cut another 6-inch piece of 1/4-inch OD Teflon tubing and connect to the other side of the two-way valve with a compression nut and ferrule set. The two-way valve will be immediately adjacent to the sample point in the train assembly. This valve is used to isolate the sample train from the sample point prior to sampling in order to test the sample train’s integrity. See Section 8.3 for purging details.
7. When collecting duplicate or other quality assurance/quality control (QA/QC) samples as required by applicable regulations and guidance, couple two canisters using a stainless-steel compression duplicate sample tee-fitting supplied by the laboratory. Attach flow controller with in-line particulate filter and vacuum gauge to duplicate sample tee.
8. Attach the terminal end of the two-way compression valve to the sample port as appropriate. This may be done using the options below:
  - a. Use a section of silicon tube to connect the Teflon sample tubing to the barbed fitting of a Vapor Pin® port.
  - b. Use Swagelok® or equivalent compression fittings to connect Teflon tubing to the sample port. Teflon tape should never be used on Swagelok® or equivalent compression fittings.

A schematic of the first suggested sample train setup isolating the purge line is illustrated below:



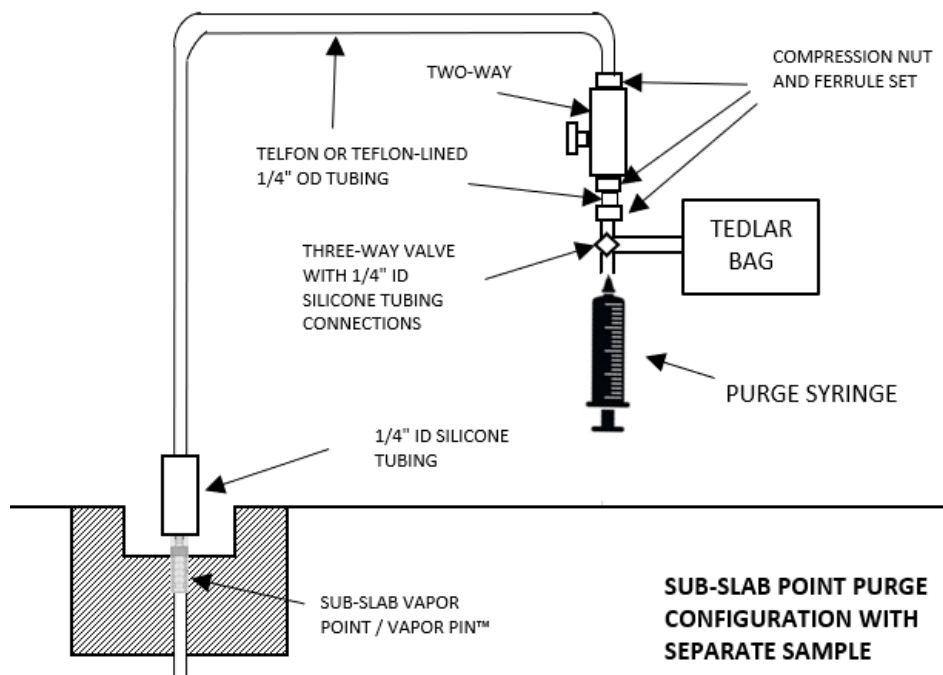
Sub-Slab Port Assembly for Vapor Pin™ with Barb Fitting using Separate Purge and Sample Configuration

1. Pre-assemble the sample train for each sub-slab port to be sampled (Vapor Pin® with barb fitting). Cut an approximate 18-inch length and a 1-inch length of Teflon or Teflon-lined 1/4-inch OD tubing. Cut a 2-inch piece of 1/4-inch ID silicone tubing. Connect the silicone tubing to one end of the 18-inch length of tubing. Connect a stainless-steel two-way valve with compression fittings to the other side of the Teflon tubing. Connect the 1-inch piece of Teflon tubing to the other side of the two-way valve. Connect a compression nut and ferrule set to the other end of the 1-inch piece of Teflon tubing for the connection to the canister. This sample train is found within the well vault at permanent soil vapor probes.
2. Assemble the sample train by removing the cap from the canister and connecting the flow controller with in-line particulate filter and vacuum gauge. The flow controller attaches directly to the canister and the pre-set rate dictates the sample duration. The laboratory may have connected the canister and flow controller prior to shipping.

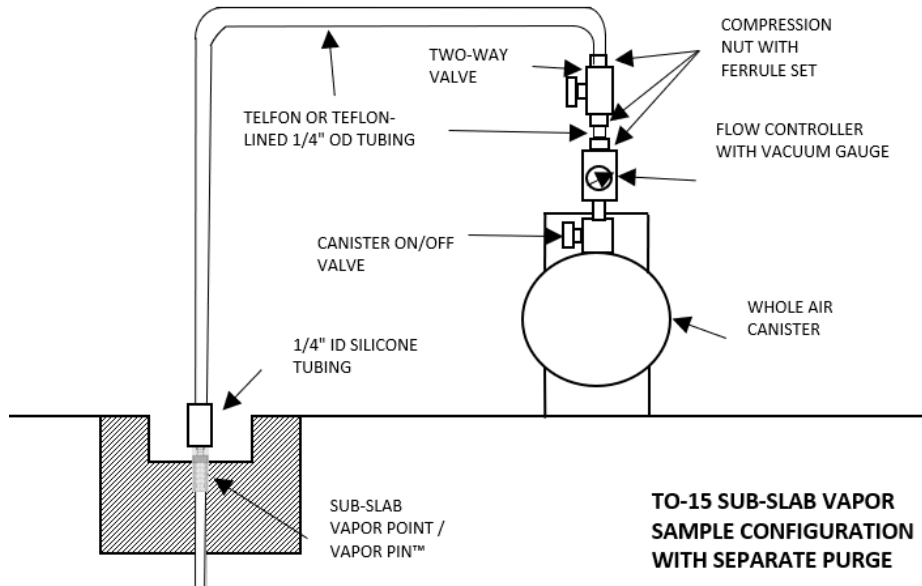


- At sub-slab ports, connect the silicone end of the sample train to the barb fitting of the Vapor Pin®. For both sub-slab ports and soil vapor wells, connect a three-way valve to a syringe using the Lok-Lur tip. Connect one end of the sample train to the three-way valve with a 1-inch piece of silicone tubing and the last end to a Tedlar bag with a 1-inch piece of silicone tubing. A personal air pump capable of 200 milliliters per minute (mL/min) can be substituted for the syringe. See Section 8.3 for purging details.

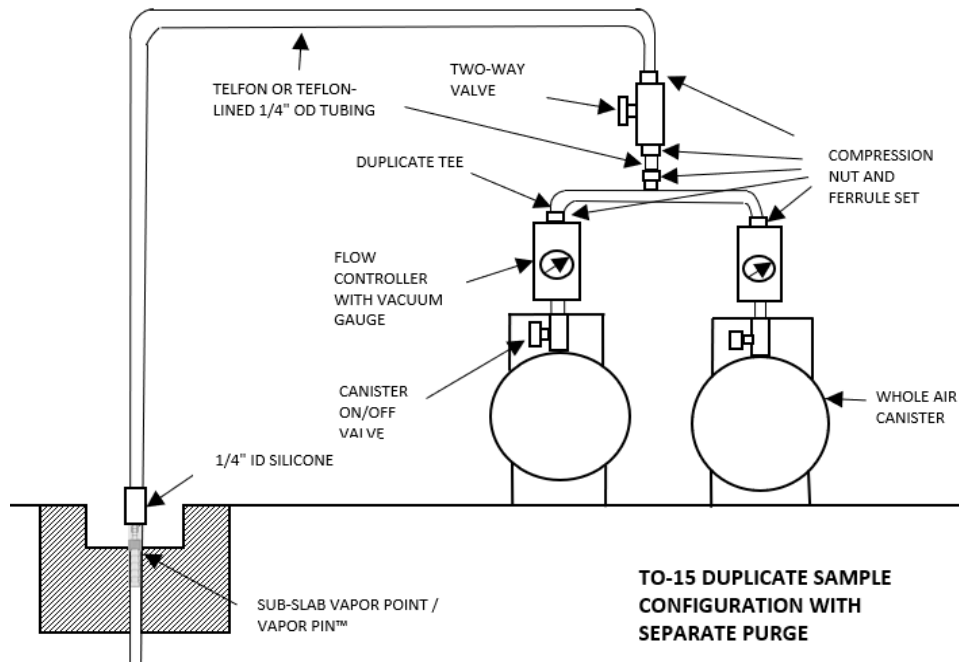
**A schematic of the suggested second type of sample train setup is illustrated below:**



- Once purging is complete, close the two-way valve, then disconnect the silicon tubing next to the two-way compression valve from the sample assembly. Connect the canister and flow controller using the installed compression nut.



- When collecting duplicate or other quality assurance/quality control (QA/QC) samples as required by applicable regulations and guidance, couple two canisters using stainless-steel duplicate sample T-fitting supplied by the laboratory. Attach flow controller with in-line particulate filter and vacuum gauge to duplicate sample tee-fitting as illustrated below.





## 8.2 Sample Documentation

Record weather information at the beginning of each day of the sampling event at a minimum. If appropriate record weather information during the middle and end of each day of the sampling event. Use the weather function in the current Soil Vapor Sampling FieldNow® TO-15 application. If using a field sampling form contact the local airport or other suitable information source (e.g., [weatherunderground.com](http://weatherunderground.com), or [NOAA](http://NOAA)) to obtain the following information:

- wind speed and direction;
- ambient temperature;
- barometric pressure; and
- relative humidity.

Record information on sample label tags on canister, on field sample log/current Soil Vapor Sampling FieldNow® TO-15 application, and COC. This includes:

- canister number;
- flow controller number;
- sample ID;
- time: start/end;
- initial vacuum in canister; and
- final vacuum in canister once sampling is complete.

Take a photograph of the canister, completed canister tag, and surrounding area.

## 8.3 Sample Collection

At sub-slab ports, connect the sample train to the sub-slab port barb fitting with 1/4-inch ID silicone tubing. The two-way compression valve should be closed. Soil vapor probes are typically completed with all sample train components permanently connected and contained within the manway vault.

When calculating the purge volume for exterior soil gas probes, the void space of the sand pack around the probe tip and the void space of the dry bentonite in the annular space should not be included in the calculated purge volume purged immediately prior to sampling. The void space of the sand pack and dry bentonite is purged directly after installation.

### 8.3.1 Shut-in Test and 3-Volume Purge

#### Sample Train Purge Isolation Setup with Syringe

1. Perform a shut-in test or leak-down-test with the two-way compression valve closed to the sample port. Open the three-way valve to the syringe and pull a vacuum. Quickly close the three-way valve and record the pressure indicated on the gauge.
2. Open the canister valve but do not open the two-way valve on the sample assembly.

- Record the vacuum indicated on the gauge connected to the canister. Observe the vacuum gauge for at least two minutes. If there are no leaks in the system, this vacuum should be held exactly (estimate the decimal place – i.e., 29.1 inches of Hg). Tap the gauge and wait to see if pressure drops on the gauge.
- If vacuum holds, document values and proceed with purge by opening the two-way sample assembly valve. If not, attempt to rectify the situation by tightening fittings and restart shut-in test.
- Purge approximately three volumes of air from the sample port and tubing using the syringe or personal air pump capable of <200 mL/min into the Tedlar® bag using a flow rate <200 mL/min. Purge volume is calculated using the equation:

$$\text{Purge volume} = 3 \times \pi \times \text{inner radius of tubing} \times \text{length of tubing}$$

- Purge air will be collected into a Tedlar® bag so VOCs are not released into interior spaces or the sampler's breathing zone. Perform quality control method tests such as helium leak testing, water dam testing, or field screening for VOCs concurrently per the project-specific work plan.
- Close the three-way valve to the syringe to isolate this leg of the sample train.

#### **Sample Train Separate Purge/Sample Setup with Canister**

- Connect the three-way valve, syringe, and Tedlar bag to the sample train. Open the two-way compression valve and purge approximately three volumes of air from the sample port and tubing using the syringe or personal air pump capable of <200 mL/min into the Tedlar® bag using a flow rate <200 mL/min. Purge volume is calculated using the equation above.
- Close the two-way compression valve and disconnect the syringe purge setup.
- Connect the canister and flow controller to the sample train. Perform a shut-in test or leak-down-test by opening the canister valve but do not open the two-way valve on the sample assembly.
- Record the vacuum indicated on the gauge connected to the canister. Observe the vacuum gauge for at least two minutes. If there are no leaks in the system, this vacuum should be held exactly (estimate the decimal place – i.e., 29.5 inches of Hg).
- If vacuum holds, document values and proceed with sampling by opening the two-way sample assembly valve. If not, attempt to rectify the situation by tightening fittings and restart shut-in test.

### **8.3.2 Sampling**

- Open the canister valve to initiate sample collection. Record the start time and the initial canister vacuum on the sample log or FieldNow® application. If the initial vacuum registers less than -25 inches of Hg (-27 inches of Hg in Michigan), then the canister is not appropriate for use and another canister should be used. The initial vacuum required varies by jurisdiction; confirm with the project regulatory authority.
- Check the canister approximately halfway through the sample duration and note progress on sample logs or FieldNow® application. If the vacuum decreases greater than a rate of 200 mL/min or the vacuum stops decreasing during sample collection contact the project team.

### **8.3.3 Termination of Sample Collection**

- Sampling a 1-liter canister will take approximately 5 to 10 minutes, so do not leave it unattended or get distracted.



2. Record the final vacuum on the sample collection log or FieldNow® app. Stop collecting the sample by closing the canister valve then the sample train valve. The canister should have a minimum amount of vacuum (approximately 5 inches of Hg or slightly greater). Check with the project team on final pressure requirements as these vary by region.
3. Record the date and local time (24-hour basis) of valve closing on the canister tag, sample collection log or FieldNow® application and COC form.
4. Disconnect sample tubing from the sample port; collect post sample fixed gas readings if required; and replace any coverings or abandon as appropriate to mitigate tripping hazards.
5. Remove the flow controller from the canister, re-install the brass plug on the canister fitting, and tighten with the appropriate wrench. If the canister and flow controller were shipped pre-assembled from the laboratory do not disassemble; simply re-install the brass plug on the flow controller fitting.
6. Verify the appropriate forms and sample labels are filled out appropriately as directed by the laboratory (e.g., affix card with a string).
7. Package the canister and flow controller per DOT regulations for return shipment to the laboratory. These regulations can be found at the [Transportation Safety Program's Team Site](#) on the Source. The canister does not require preservation with ice or refrigeration during shipment. Refer to TGI – Soil Gas Methane Monitoring for Shipping Determination of Soil Gas Samples if sampling in an area with unknown or known methane conditions. A shipping determination form is required for shipment of any type of samples prior to field mobilization.
8. Complete and verify the COC form and place the requisite copies in a shipping container. Close the shipping container and affix a custody seal to the container closure. Ship the container to the laboratory via overnight carrier (e.g., Federal Express) or sign COC over to courier. Consult with the project team on appropriate shipping speeds and shipment insurance.

## 9 Waste Management

No specific waste management procedures are required.

## 10 Data Recording and Management

Digital data collection is the Arcadis standard using available FieldNow® applications that enable real-time, paperless data collection, entry, and automated reporting. Paper forms should only be used as backup to FieldNow® digital data collection and/or as necessary to collect data not captured by available FieldNow® applications. The Field Now® digital form applications follow a standardized approach, correlate to most TGIs and are available to all projects accessible with a PC or capable mobile device. Once the digital forms are saved within FieldNow®, the data is instantly available for review on a web interface. This facilitates review by project management team members and SMEs enabling error or anomalous data detection for correction while the staff are still in the field. Continual improvements of FieldNow® applications are ongoing, and revisions are made as necessary in response to feedback from users and subject matter experts.

## 11 Quality Assurance

Quality assurance and quality control (QA/QC) will be conducted following project requirements.

### 11.1 Duplicate Samples

Duplicate samples should be collected in the field as a quality assurance step per project requirements. Generally, one duplicate is taken per 10 or per 20 samples analyzed, but project specific requirements should take precedence. A duplicate tee is required when collecting soil vapor duplicate samples.

### 11.2 Equipment Blank

Equipment blank samples may be collected in the field as a quality assurance step in order to verify and evaluate the effectiveness of decontamination procedures for new, recycled, or reused materials (i.e., syringes, Swagelok® fittings, 1/4-inch tubing) per project requirements. Generally, one equipment blank sample is taken per 20 sample locations, but project specific requirements should take precedence. Equipment blank sampling steps detailed below:

1. Connect reused and/or decontaminated sample supplies to a nitrogen-filled passivated stainless-steel canister and have in line with a 1-liter canister. Open the valves to begin sampling.
2. Record the final vacuum. Stop collecting the sample by closing the canister valves. The canister should have a minimum amount of vacuum (approximately 5 inches of Hg or slightly greater).
3. Record the date and local time (24-hour basis) of valve closing on the sample collection log on the sample collection log or FieldNow® app and COC form.

## 12 References

- DiGiulio et. al. 2003. Draft Standard Operating Procedure (SOP) for Installation of Sub-Slab Vapor Probes and Sampling Using EPA TO-15 to Support Vapor Intrusion Investigations.  
<http://www.cdphe.state.co.us/hm/indoorair.pdf>.
- DiGiulio et. al. 2006. Assessment of Vapor intrusion in Homes Near the Raymark Superfund Site Using Basement and Sub-Slab Air Samples. USEPA. EPA/600/R-05/147.
- USEPA. 1999a. Compendium Method TO-15. Determination of Volatile Organic Compounds (VOCs) In Air Collected In Specially-Prepared Canisters And Analyzed by Gas Chromatography/Mass Spectrometry (GC/MS). Center for Environmental Research Information. Office of Research and Development. January.
- USEPA. 2015. Assessing and Mitigating the Vapor Intrusion Pathway from Subsurface Vapor Sources to Indoor Air. OSWER Publication 9200.2-154. June.
- New York State Department of Health (NYSDOH). 2005. DRAFT “Guidance for Evaluating Soil Vapor Intrusion in the State of New York” February 23, 2005.



Arcadis U.S., Inc.  
630 Plaza Drive, Suite 200  
Highlands Ranch  
Colorado 80129  
Phone: 720 344 3500  
Fax: 720 344 3535  
[www.arcadis.com](http://www.arcadis.com)





# **TGI – Building Surveying Prior to Vapor Intrusion Indoor Air Sampling**

Rev: 3

Rev Date: August 22, 2023

## Version Control

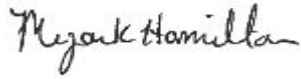
Issue	Revision No.	Date Issued	Page No.	Description	Reviewed By
	1	August 19, 2016	All	Update Rev 0	Margaret Bartee Mitch Wacksman
	2	December 22, 2021	All	Updated Rev 1 and for QMS Relaunch	Megan Hamilton Robert Uppencamp
	3	August 22, 2023	All	Updated Rev 2	Megan Hamilton



## Approval Signatures

Prepared by:

8/22/2023



---

Megan Hamilton (Subject Matter Expert)

---

Date

Reviewed by:

8/22/2023



---

Sarah Jonker (Subject Matter Expert)

---

Date

## 1 Introduction

This document describes specific procedures and considerations to be used and observed by Arcadis staff when conducting a building survey prior to indoor air sampling.

## 2 Intended Use and Responsibilities

This document describes general and/or specific procedures, methods, actions, steps, and considerations to be used and observed by Arcadis staff when performing work, tasks, or actions under the scope and relevancy of this document. This document may describe expectations, requirements, guidance, recommendations, and/or instructions pertinent to the service, work task, or activity it covers.

It is the responsibility of the Arcadis Certified Project Manager (CPM) to provide this document to the persons conducting services that fall under the scope and purpose of this procedure, instruction, and/or guidance. The Arcadis CPM will also ensure that the persons conducting the work falling under this document are appropriately trained and familiar with its content. The persons conducting the work under this document are required to meet the minimum competency requirements outlined herein, and inquire to the CPM regarding any questions, misunderstanding, or discrepancy related to the work under this document.

This document is not considered to be all inclusive nor does it apply to all projects. It is the CPM's responsibility to determine the proper scope and personnel required for each project. There may be project- and/or client- and/or state-specific requirements that may be more or less stringent than what is described herein. The CPM is responsible for informing Arcadis and/or Subcontractor personnel of omissions and/or deviations from this document that may be required for the project. In turn, project staff are required to inform the CPM if or when there is a deviation or omission from work performed as compared to what is described herein.

In following this document to execute the scope of work for a project, it may be necessary for staff to make professional judgment decisions to meet the project's scope of work based upon site conditions, staffing expertise, regulation-specific requirements, health and safety concerns, etc. Staff are required to consult with the CPM when or if a deviation or omission from this document is required that has not already been previously approved by the CPM. Upon approval by the CPM, the staff can perform the deviation or omission as confirmed by the CPM.

## 3 Scope and Application

This Technical Guidance Instruction (TGI) document describes the procedures to conduct a building survey prior to collecting indoor air samples for the purpose of assessing the potential vapor intrusion pathway.

## 4 Personnel Qualifications

Arcadis field sampling personnel will have current health and safety training, including 40-hour HAZWOPER training, site supervisor training, site-specific training, first aid, and cardiopulmonary resuscitation (CPR), as needed. Arcadis field sampling personnel will be competent in the relevant procedures and possess the required skills and experience necessary to successfully complete a thorough building survey and the desired field work. Arcadis personnel responsible for directing indoor air and/or ambient air sample collection activities, including



building surveying, must have previous indoor air sampling experience and be able to complete the field work without direct supervision.

## 5 Equipment List

The equipment required for conducting a building survey is presented below:

- Building survey form specific to state or region (if required) or Fulcrum FieldNow® Indoor Air Building Survey Form (Tier 1). Examples can be obtained from the survey form repository located on the Vapor Intrusion Teams SharePoint Site or by asking the project manager. If the building survey form does not include sufficient space for documenting the chemical product inventory, bring additional pages to complete the chemical product inventory.
- Photoionization detector (PID) capable of readings in the parts per billion by volume (ppbv) range (e.g., ppbRae)
- Nitrile gloves
- Camera
- Flashlight

## 6 Cautions and Health and Safety Considerations

All survey personnel should review the appropriate health and safety plan (HASP) and job safety analysis (JSA) prior to beginning work to be aware of all potential hazards associated with the job site and the specific task. Building surveys should always be completed by a team of two Arcadis personnel.

## 7 Procedure

Using the appropriate building survey form or FieldNow® application, document site information; building construction, usage, and layout; and chemical products present in the building prior to conducting indoor air sampling. The building survey form should be jurisdiction-specific (various states and regions require specific forms) or the Fulcrum FieldNow® Indoor Air Building Survey Form (Tier 1 or state specific).

- Complete the portions of the form to provide site and property information. This information may be completed in advance of the building survey.
- If property contact is available, review building construction, layout, usage, and occupancy information with property contact. If no property contact is available, complete these portions of the form based on observations during the building survey.
- Document observed products or materials that may potentially produce or emit volatile organic compounds (VOCs) on the building survey form, or if sufficient space is unavailable, on separate pages. Record brand name, product name, and product identification number; take a reading with the PID to evaluate potential off-gassing; and take a photograph of each product or material documented. Use nitrile gloves, as needed, to handle chemical products. If the building is owned and/or occupied by a commercial/industrial occupant, ask

the property contact whether a copy of the chemical product inventory could be provided for confirmatory purposes.

- Items or materials that contain contaminants of concern and/or exhibit elevated PID readings shall be considered probable sources of VOCs. Request approval of the owner or occupant to have these items removed to a structure not attached to the target structure at least 48 hours prior to sampling, if possible.
- Note the building's current condition, particularly the floor slab. Pay attention for any penetrations or perforations in the floor that could act as preferential pathways and note these on the building sketch. These include floor cracks, floor drains, utility penetrations, and sumps.
- Complete all sections of the building survey form or FieldNow® application. Record not applicable (NA) in fields where appropriate rather than leaving blank.
- Set a date and time with the owner or occupant to return to conduct sampling.

## 8 Waste Management

No specific waste management procedures are required.

## 9 Data Recording and Management

Digital data collection is the Arcadis standard using available FieldNow® applications that enable real-time, paperless data collection, entry, and automated reporting. Paper forms should only be used as backup to FieldNow® digital data collection and/or as necessary to collect data not captured by available FieldNow® applications. The Field Now® digital form applications follow a standardized approach, correlate to most TGIs and are available to all projects accessible with a PC or capable mobile device. Once the digital forms are saved within FieldNow®, the data is instantly available for review on a web interface. This facilitates review by project management team members and SMEs enabling error or anomalous data detection for correction while the staff are still in the field. Continual improvements of FieldNow® applications are ongoing, and revisions are made as necessary in response to feedback from users and subject matter experts.

Notes and pictures taken during the initial building survey that cannot be collected using the FieldNow application will be compiled and uploaded to the project specific folder on SharePoint and/or Collaboration Hub.

## 10 Quality Assurance

Conduct quality assurance as required by the project-specific work plan and/or Quality Assurance Project Plan (QAPP).



Arcadis U.S., Inc.  
55 Monument Circle, Suite 300B  
Indianapolis  
Indiana 46204  
Phone: 317 231 6500  
Fax: 317 231 6514  
[www.arcadis.com](http://www.arcadis.com)



# INDOOR AIR BUILDING SURVEY and SAMPLING FORM

Preparer's name: \_\_\_\_\_ Date: \_\_\_\_\_

Preparer's affiliation: \_\_\_\_\_ Phone #: \_\_\_\_\_

Site Name: \_\_\_\_\_ Case #: \_\_\_\_\_

## Part I - Occupants

Building Address: \_\_\_\_\_

Property Contact: \_\_\_\_\_ Owner / Renter / other: \_\_\_\_\_

Contact's Phone: home ( ) \_\_\_\_\_ work ( ) \_\_\_\_\_ cell ( ) \_\_\_\_\_

# of Building occupants: Children under age 13 \_\_\_\_\_ Children age 13-18 \_\_\_\_\_ Adults \_\_\_\_\_

## Part II – Building Characteristics

Building type: residential / multi-family residential / office / strip mall / commercial / industrial

Describe building: \_\_\_\_\_ Year constructed: \_\_\_\_\_

Sensitive population: day care / nursing home / hospital / school / other (specify): \_\_\_\_\_

Number of floors below grade: \_\_\_\_\_ (full basement / crawl space / slab on grade)

Number of floors at or above grade: \_\_\_\_\_

Depth of basement below grade surface: \_\_\_\_\_ ft. Basement size: \_\_\_\_\_ ft<sup>2</sup>

Basement floor construction: concrete / dirt / floating / stone / other (specify): \_\_\_\_\_

Foundation walls: poured concrete / cinder blocks / stone / other (specify) \_\_\_\_\_

Basement sump present? *Yes / No* Sump pump? *Yes / No* Water in sump? *Yes / No*

Type of heating system (circle all that apply):

- |                        |                     |                 |                    |
|------------------------|---------------------|-----------------|--------------------|
| hot air circulation    | hot air radiation   | wood            | steam radiation    |
| heat pump              | hot water radiation | kerosene heater | electric baseboard |
| other (specify): _____ |                     |                 |                    |

Type of ventilation system (circle all that apply):



central air conditioning  
conditioning units  
other (specify): \_\_\_\_\_

mechanical fans  
kitchen range hood fan

bathroom ventilation fans individual air  
outside air intake

Type of fuel utilized (circle all that apply):

Natural gas / electric / fuel oil / wood / coal / solar / kerosene

Are the basement walls or floor sealed with waterproof paint or epoxy coatings?

Yes / No

Is there a whole house fan?

Yes / No

Septic system?

Yes / Yes (but not used) / No

Irrigation/private well?

Yes / Yes (but not used) / No

Type of ground cover outside of building: grass / concrete / asphalt / other (specify) \_\_\_\_\_

Existing subsurface depressurization (radon) system in place?

Yes / No

active / passive

Sub-slab vapor/moisture barrier in place?

Yes / No

Type of barrier: \_\_\_\_\_

### Part III - Outside Contaminant Sources

Potential contaminated site (1000-ft. radius): \_\_\_\_\_

Other stationary sources nearby (gas stations, emission stacks, etc.): \_\_\_\_\_

Heavy vehicular traffic nearby (or other mobile sources): \_\_\_\_\_

### Part IV – Indoor Contaminant Sources

Identify all potential indoor sources found in the building (including attached garages), the location of the source (floor and room), and whether the item was removed from the building 48 hours prior to indoor air sampling event. Any ventilation implemented after removal of the items should be completed at least 24 hours prior to the commencement of the indoor air sampling event.

Potential Sources	Location(s)	Removed (Yes / No / NA)
Gasoline storage cans		
Gas-powered equipment		
Kerosene storage cans		
Paints / thinners / strippers		
Cleaning solvents		
Oven cleaners		
Carpet / upholstery cleaners		
Other house cleaning products		
Moth balls		
Polishes / waxes		
Insecticides		
Furniture / floor polish		
Nail polish / polish remover		
Hairspray		
Cologne / perfume		
Air fresheners		
Fuel tank (inside building)		NA

Wood stove or fireplace		NA
New furniture / upholstery		
New carpeting / flooring		NA
Hobbies - glues, paints, etc.		

Part V – Miscellaneous Items

Do any occupants of the building smoke? *Yes / No* How often? \_\_\_\_\_

Last time someone smoked in the building? \_\_\_\_\_ hours / days ago

Does the building have an attached garage directly connected to living space? *Yes / No*

If so, is a car usually parked in the garage? *Yes / No*

Are gas-powered equipment or cans of gasoline/fuels stored in the garage? *Yes / No*

Do the occupants of the building have their clothes dry cleaned? *Yes / No*

If yes, how often? weekly / monthly / 3-4 times a year

Do any of the occupants use solvents in work? *Yes / No*

If yes, what types of solvents are used? \_\_\_\_\_

If yes, are their clothes washed at work? *Yes / No*

Have any pesticides/herbicides been applied around the building or in the yard? *Yes / No*

If so, when and which chemicals? \_\_\_\_\_

Has there ever been a fire in the building? *Yes / No* If yes, when? \_\_\_\_\_

Has painting or staining been done in the building in the last 6 months? *Yes / No*

If yes, when \_\_\_\_\_ and where? \_\_\_\_\_

Has there been any remodeling done (flooring/carpeting) in the building in the last 6 months? *Yes / No*

If yes, when \_\_\_\_\_ and where? \_\_\_\_\_

Part VI – Sampling Information

Sample Technician: \_\_\_\_\_ Phone number: ( ) \_\_\_\_\_ - \_\_\_\_\_

Sample Source: Indoor Air / Sub-Slab / Soil Gas

Sampler Type: Tedlar bag / Sorbent / Stainless Steel Canister / Other (specify): \_\_\_\_\_

Analytical Method: TO-15 / TO-17 / other: \_\_\_\_\_ Cert. Laboratory: \_\_\_\_\_

Sample locations (floor, room):

Field ID # \_\_\_\_\_ - \_\_\_\_\_ Field ID # \_\_\_\_\_ - \_\_\_\_\_



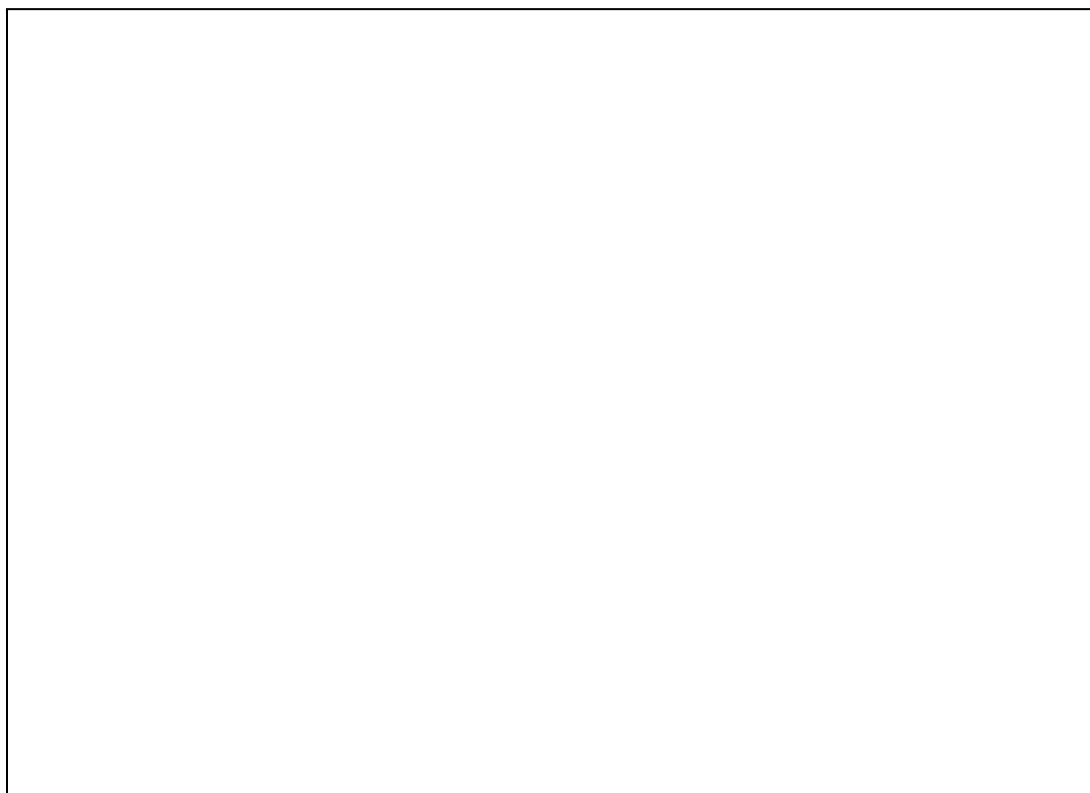
Field ID # \_\_\_\_\_ - \_\_\_\_\_      Field ID # \_\_\_\_\_ - \_\_\_\_\_

Were "Instructions for Occupants" followed?      *Yes / No*

If not, describe modifications: \_\_\_\_\_

**Additional Comments:**

*Provide Drawing of Sample Location(s) in Building*



Part VII - Meteorological Conditions

Was there significant precipitation within 12 hours prior to (or during) the sampling event?      *Yes / No*

Describe the general weather conditions: \_\_\_\_\_

\_\_\_\_\_

Part VIII – General Observations

Provide any information that may be pertinent to the sampling event and may assist in the data interpretation process.

\_\_\_\_\_

\_\_\_\_\_

\_\_\_\_\_

(NJDEP 1997; NHDES 1998; VDOH 1993; MassDEP 2002; NYSDOH 2005; CalEPA 2005; Ohio EPA 2015)



# TGI - Decontamination of Components for Vapor Intrusion Sampling

Rev: 1

Rev Date: December 13, 2021

## Version Control

Issue	Revision No.	Date Issued	Page No.	Description	Reviewed By
	0	November 13, 2020	All	Development of TGI	Megan Hamilton
	1	December 13, 2021	All	Updated for QMS Relaunch	Megan Hamilton



## Approval Signatures

Prepared by:



12/13/2021

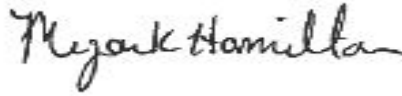
---

Sarah Jonker (Preparer)

---

Date

Reviewed by:



12/13/2021

---

Megan Hamilton (Subject Matter Expert)

---

Date

## 1 Introduction

This document describes specific decontamination procedures and considerations to be used and observed by Arcadis staff when performing vapor intrusion sampling activities.

## 2 Intended Use and Responsibilities

This document describes general and/or specific procedures, methods, actions, steps, and considerations to be used and observed by Arcadis staff when performing work, tasks, or actions under the scope and relevancy of this document. This document may describe expectations, requirements, guidance, recommendations, and/or instructions pertinent to the service, work task, or activity it covers.

It is the responsibility of the Arcadis Certified Project Manager (CPM) to provide this document to the persons conducting services that fall under the scope and purpose of this procedure, instruction, and/or guidance. The Arcadis CPM will also ensure that the persons conducting the work falling under this document are appropriately trained and familiar with its content. The persons conducting the work under this document are required to meet the minimum competency requirements outlined herein, and inquire to the CPM regarding any questions, misunderstanding, or discrepancy related to the work under this document.

This document is not considered to be all inclusive nor does it apply to all projects. It is the CPM's responsibility to determine the proper scope and personnel required for each project. There may be project- and/or client- and/or state-specific requirements that may be more or less stringent than what is described herein. The CPM is responsible for informing Arcadis and/or Subcontractor personnel of omissions and/or deviations from this document that may be required for the project. In turn, project staff are required to inform the CPM if or when there is a deviation or omission from work performed as compared to what is described herein.

In following this document to execute the scope of work for a project, it may be necessary for staff to make professional judgment decisions to meet the project's scope of work based upon site conditions, staffing expertise, regulation-specific requirements, health and safety concerns, etc. Staff are required to consult with the CPM when or if a deviation or omission from this document is required that has not already been previously approved by the CPM. Upon approval by the CPM, the staff can perform the deviation or omission as confirmed by the CPM.

## 3 Scope and Application

This Technical Guidance Instruction (TGI) document describes the procedures to decontaminate components used during the installation and sampling of soil vapor monitoring locations (sub-slab and exterior soil gas probes).

## 4 Personnel Qualifications

Arcadis field sampling personnel will have current health and safety training, including 40-hour HAZWOPER training, site-specific training, first aid, and cardiopulmonary resuscitation (CPR), as needed. Arcadis field sampling personnel will be competent in the relevant procedures and possess the required skills and experience necessary to successfully complete the desired decontamination procedures and field work.



## 5 Equipment List

Precautions regarding cross-contamination should be strongly considered. Laboratory reporting limits for soil vapor samples are in the parts-per billion (ppb) and equipment contamination could affect overall data quality. Decontamination of components should be completed using only confirmed clean or new equipment.

Specific components required for decontamination may vary depending on project scope of work and objectives for the site. Relevant components to decontaminate are listed below.

Sampling Components	Installation Components
Stainless-steel valves, nuts, caps, ferrules	Hammer drill bits
Stainless-steel Vapor Pins including extensions	Hand auger
Stainless-steel vapor screens (exterior soil gas)	Drill rig tooling

Reusable drill rig tooling and equipment decontamination procedures are provided in other associated TGIs. Arcadis recommends following approved procedures for the decontamination of drilling subcontractor equipment.

The equipment required to complete decontamination of the above components is listed below:

- Stainless-Steel Bowl or Bucket for Drill Bits
- Personal Protective Equipment including Nitrile Gloves and Safety Glasses
- Paper Towels
- Brushes – bottle brush or toothbrush, wire brush
- Distilled Water
- Trisodium Phosphate (TSP), Alconox, Liquinox or equivalent (TSP preferred, especially when sampling for 1,4-dioxane)

Sampling components should be decontaminated prior to mobilization to the site.

## 6 Cautions and Health and Safety Considerations

Take safety precautions as with handling any heavy-duty cleaner using nitrile gloves and safety glasses throughout the decontamination process.

## 7 Procedure

Decontamination procedures should be completed prior to arrival at the project site and will vary dependent upon the application as detailed below.

- Place supplies (valves, nuts, caps, ferrules, tees, vapor pins, vapor pin extensions, and/or vapor screens) into the stainless-steel bowl or plastic bucket for drill bits.
  - Used components need to be completely broken down (tubing and ferrules cannot be reused).

- Valves should be in the open position.
- Pour a mixture of distilled water and TSP (or equivalent) into the bowl completely covering all components. Follow the TSP (or equivalent) mixing instructions.
- Mix applicable components and soapy mixture.
- Use the toothbrush or bottle brush to clean components.
- Drain the soapy mixture from the stainless-steel bowl into a bucket or sanitary sewer, leaving the components.
- Rinse components in distilled water and completely empty the rinsate into a bucket or sanitary sewer. Repeat the rinsing process two additional times or continue rinsing until soapy mixture is not visible.
- Shake water from components and place on clean, dry paper towels.
- Allow all components to completely dry by using paper towels, a fan, air dry, or a combination of these prior to assembly/use.

Hammer drill bits used during the installation of sub-slab ports need to be decontaminated prior to use at each new installation location in the field and is outlined below:

- Create a solution of TSP cleaner (or equivalent) and distilled water in a clean spray bottle.
- Prepare another spray bottle with clean distilled water for rinsing.
- Remove any soil clinging to hammer drill bits with a wire brush.
- Place the drill bit into a clean, new, 5-gallon bucket.
- Spray the drill bit with the cleaning solution over enough paper towels to absorb the water and capture the solution into the bucket.
- Thoroughly clean the drill bit with a scrub brush.
- Repeat process with cleaning solution.
- Rinse by spraying the drill bit with clean distilled water and capture the rinse water in the bucket.
- Wipe drill bit down with paper towels.
- Repeat rinsing process.
- Completely dry drill bits with clean paper towels.

## 8 Waste Management

Used cleaning solution water and rinsate water utilized for decontaminating sampling components can be disposed directly into the sanitary sewer. Used cleaning solution water and rinsate water utilized for decontaminating installation components should be containerized and disposed of in accordance with project specifications.

## 9 Data Recording and Management

Digital data collection is the Arcadis standard using available FieldNow® applications that enable real-time, paperless data collection, entry, and automated reporting. Paper forms should only be used as backup to FieldNow® digital data collection and/or as necessary to collect data not captured by available FieldNow® applications. The Field Now® digital form applications follow a standardized approach, correlate to most TGIs and are available to all projects accessible with a PC or capable mobile device. Once the digital forms are saved within FieldNow®, the data is instantly available for review on a web interface. This facilitates review by project



management team members and SMEs enabling error or anomalous data detection for correction while the staff are still in the field. Continual improvements of FieldNow® applications are ongoing, and revisions are made as necessary in response to feedback from users and subject matter experts.

Arcadis U.S., Inc.  
150 W. Market St., Suite 728  
Indianapolis  
Indiana 46204  
Phone: 317 231 6500  
Fax: 317 231 6514  
[www.arcadis.com](http://www.arcadis.com)



# TGI – Soil Vapor Sampling and Analysis using Sorbent Tubes for USEPA Method TO- 17

Rev: 4

Rev Date: January 5, 2022

Note: This TGI is included to cover the use of sorbent tubes under the scope of the Work Plan to collect the acrylate compounds, despite the use of OSHA methods PV2011 and PV2026 in place of TO-17.

## Version Control

Issue	Revision No.	Date Issued	Page No.	Description	Reviewed By
1	0	June 17, 2016	All	Initial Procedure	Mitch Wacksman
2	1	May 31, 2017	All	Update to TGI and new template	Peter Frederick and Mitch Wacksman
3	2	October 9, 2018	All	Review, minor updates	Peter Frederick and Eric Cathcart
4	3	May 12, 2020	All	Review	Eric Epple
5	4	January 5, 2022	All	Review and update to new template, overall procedure updates	Everett Rubin Eric Epple Sarah Jonker Megan Hamilton Robert Uppencamp



## Approval Signatures

Prepared by:



1/5/2021

---

Everett Rubin (Preparer)

---

Date

Reviewed by:



1/5/2021

---

Eric Epple (Subject Matter Expert)

---

Date

## 1 Introduction

This Technical Guidance Instruction (TGI) describes the procedures to collect subsurface soil vapor samples from sub-slab ports and soil vapor probes for the analysis of volatile organic compounds (VOCs) including volatile polyaromatic hydrocarbons (PAHs) using sorbent tubes. These samples will be collected and analyzed in accordance with United States Environmental Protection Agency (USEPA) Compendium Method TO-17 (TO-17).

## 2 Intended Use and Responsibilities

This document describes general and/or specific procedures, methods, actions, steps, and considerations to be used and observed by Arcadis staff when performing work, tasks, or actions under the scope and relevancy of this document. This document may describe expectations, requirements, guidance, recommendations, and/or instructions pertinent to the service, work task, or activity it covers.

It is the responsibility of the Arcadis Certified Project Manager (CPM) to provide this document to the persons conducting services that fall under the scope and purpose of this procedure, instruction, and/or guidance. The Arcadis CPM will also ensure that the persons conducting the work falling under this document are appropriately trained and familiar with its content. The persons conducting the work under this document are required to meet the minimum competency requirements outlined herein, and inquire to the CPM regarding any questions, misunderstanding, or discrepancy related to the work under this document.

This document is not considered to be all inclusive nor does it apply to all projects. It is the CPM's responsibility to determine the proper scope and personnel required for each project. There may be project- and/or client- and/or state-specific requirements that may be more or less stringent than what is described herein. The CPM is responsible for informing Arcadis and/or Subcontractor personnel of omissions and/or deviations from this document that may be required for the project. In turn, project staff are required to inform the CPM if or when there is a deviation or omission from work performed as compared to what is described herein.

In following this document to execute the scope of work for a project, it may be necessary for staff to make professional judgment decisions to meet the project's scope of work based upon site conditions, staffing expertise, regulation-specific requirements, health and safety concerns, etc. Staff are required to consult with the CPM when or if a deviation or omission from this document is required that has not already been previously approved by the CPM. Upon approval by the CPM, the staff can perform the deviation or omission as confirmed by the CPM.

## 3 Scope and Application

USEPA Method TO-17 uses a glass or stainless-steel tube packed with a sorbent material to collect a VOC vapor sample. Sorbents of often increasing strength and composition are packed within the tube. The specific sorbent material packed within each tube is selected based on the target compounds, sample volumes, and desired reporting limits. A measured volume of soil vapor is passed through the tube during sample collection.

Following sample collection, the sorbent tube is sent to the laboratory where the sampling media is analyzed for the target compounds.

Section 4 below lists the necessary equipment and Section 7 provides detailed instructions for the collection of soil vapor samples using sorbent tubes.



Soil vapor samples can be collected from sub-slab vapor probes or soil-vapor probes. Refer to the appropriate Technical Guidance Instruction (TGI) from the Arcadis Procedure Library for a description of sub-slab port and soil vapor probe construction methods.

## 4 Personnel Qualifications

Arcadis field sampling personnel will have current Arcadis required and client-specific health and safety training, including 40-hour HAZWOPER training, site supervisor training, site-specific training, first-aid, and cardiopulmonary resuscitation (CPR), as needed. Arcadis field sampling personnel will be well versed in relevant Quality Procedures and TGIs and possess the required skills and experience necessary to successfully complete the desired field work. Arcadis personnel responsible for leading soil vapor sample collection activities must have previous soil vapor sampling experience.

## 5 Equipment List

The equipment required for collecting soil vapor samples for analysis using USEPA Method TO-17 sorbent tubes is presented below:

- Appropriate personal protective equipment (PPE) as presented in the site-specific health and safety plan (HASP) and the job safety analysis (JSA);
- Sorbent tubes pre-packed by the laboratory with the desired sorbent. Specific sorbents will be recommended by the laboratory considering the target compound list and the necessary reporting limits;
- One decontaminated stainless-steel or comparable two-way ball or needle valve with compression fittings (Swagelok® or equivalent) per sample;
- 1/4-inch outer diameter (OD) tubing (Teflon®, Teflon-lined polyethylene or Nylon [aka Nylaflo]) (referred to throughout as “tubing”);
- Stainless steel or comparable Swagelok® or equivalent compression fittings for 1/4-inch OD tubing;
- One Stainless steel duplicate “T” fitting (if duplicate sample collection is necessary);
- 60 milliliter (mL) plastic syringe (equipped with 3-way valve if employing a tracer gas leak test);
- Integrity testing supplies (depending on site conditions could employ a helium leak test or a water dam test. Arcadis procedures for both can be found in the appropriate TGI within the Quality Management System);
- Appropriate-sized open-end wrench (typically 9/16-inch, 1/2-inch, and 3/4-inch);
- Tubing cutter;
- Chain of Custody (COC) form;
- Sample collection log;
- Cooler;
- Gel ice (e.g., blue ice); and

- Field notebook or the Fulcrum Application: FieldNow® - Soil Vapor Collection Log (TO-17 Soil Gas) Version 2.0 (Tier 1).

## 6 Cautions

The following cautions and field tips should be reviewed and considered prior to collecting soil vapor samples:

- Sampling personnel will not handle hazardous substances (such as gasoline), permanent marking pens (sharpies), wear/apply fragrances, apply volatizing hand sanitizer, or smoke cigarettes/cigars before and/or during the sampling event.
- Care will be taken to ensure that the appropriate sorbent is used in the sorbent tube preparation. Sorbent should be selected in consultation with the analytical laboratory and in consideration of the target compound list, the necessary reporting limits, and the expected range of concentrations in field samples. The expected range of concentrations in field samples may be estimated from previous site data, release history and professional judgment informed by the conceptual site model.
- Sample volumes for sorbent tubes should be determined well in advance of field work in consultation with the laboratory.
- A Shipping Determination must be performed, by Department of Transportation-trained Arcadis personnel, for all environmental samples that are to be shipped, as well as some types of environmental equipment/supplies that are to be shipped.
- At the sampling location, keep the tubes in their storage and transportation container to equilibrate with ambient temperature prior to attaching to the sample train.
- Ensure the sample train is set up so that the flow across the sorbent tube is in the proper direction. Appropriate flow direction is often indicated via engraving or decal arrow on the sorbent tube itself per laboratory instructions.
- Keep the sorbent tube oriented vertically (perpendicular with ground surface) while sampling, if feasible. Sorbent tubes perform best when oriented vertically as intended.
- Always use clean nitrile gloves when handling sampling tubes.
- Wrap capped tubes individually in uncoated aluminum foil (often laboratory provided). Use clean, sealable glass jars or metal cans containing a small packet of activated charcoal or activated charcoal/silica gel for storage and transportation of multiple tubes. This activated charcoal is not analyzed but serves as a protection for the analytical sorbent tube. Store the multi-tube storage container in a cooler at 4°C.
- Keep the sample tubes inside the storage container during transportation and only remove them at the monitoring location after the tubes have reached ambient temperature.
- Do not overtighten the caps on the sorbent tubes. Use only a quarter turn past finger tight. Tubes cannot be analyzed if caps are overtightened, and the fitting becomes crimped.
- The purge flow rate should be consistent with the sample collection rate as determined in consultation with the laboratory prior to field activities. Record the measured flow rate during sample collection.



- If possible, have equipment shipped two or three days before the sampling date to allow ample time for materials and equipment to be received, inventoried, checked, and order replacements, if needed.
- Requesting extra sorbent tubes from the laboratory should also be considered to ensure that you have enough sampling media and equipment on site in case of an equipment failure.
- Shallow exterior soil-gas sampling normally should not proceed within 3 days following a significant rain event (1/2-inch of rainfall or more).

## 7 Health and Safety Considerations

All sampling personnel will review the appropriate HASP and JSAs prior to beginning work to be aware of potential hazards associated with the job site and the specific task. Field sampling equipment must be carefully handled to minimize the potential for injury and the spread of hazardous substances.

## 8 Procedure

### Sample Volume Calculation

Identify the necessary final reporting limit for the target compound(s) in accordance with the project quality assurance plan and/or in consultation with the data end user.

1. Identify the necessary method reporting limit(s). The laboratory will be helpful in providing this information as it is typically specific to the sensitivity of the instrumentation.
2. The minimum sampling volume is the volume of soil vapor sample that must be drawn through the sorbent in order to achieve the desired final reporting limit. Calculate the minimum sampling volume using the following equation:

$$\textit{Minimum Sampling Volume (L)} = \frac{\textit{Final Reporting Limit (\mu g)}}{\textit{Action Level (\mu g/m}^3)} \times \frac{1,000 L}{m^3}$$

Where:

L = liters

μg = microgram

m = meter

Note: purging and sampling flow rates should not exceed 200 milliliters per minute (mL/min).

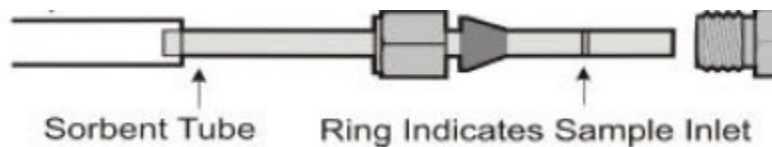
### Soil Vapor Sampling

1. Record the following information in the field notebook or FieldNow® application, if appropriate (contact the local airport or other suitable information source [e.g., site-specific measurements, weatherunderground.com] to obtain the information):
  - a. wind speed and direction;
  - b. ambient temperature;

- c. barometric pressure; and
  - d. relative humidity.
2. Remove soil vapor probe cap or plug and connect sample train tubing to the installation. Note, if collecting sorbent tube sample media with canister sampling from the same location, the sorbent media sample should be collected first, followed by the canister. Be aware that there may be regional requirements (e.g., California) to collect the samples concurrently. In this case, sorbent tubes can be connected downstream of the purge valve on the sample train for sample collection.
  3. Attach a length of tubing to the other end of the two-way valve.
  4. Connect the 60mL purge syringe to the tubing using a short piece of silicon tubing.
  5. Complete gaseous tracer (helium) leak testing or water dam testing per the appropriate TGI. Arcadis procedures for leak testing can be found in the appropriate TGI within the Quality Management System.

#### Sorbent Tube Sample Collection

1. Record in the field notebook or FieldNow® application and COC form the tube number on the sorbent tube.
2. Close two-way valve and remove purge syringe and associated silicon tubing from sample train.
3. Attach sorbent tube to Swagelok valve using laboratory provided fitting or to the terminal end of tubing with proper orientation per figure below:



4. Ensure the two-way valve is closed at this time. Attempt to pull a small volume from the sample train system using the purge syringe to conduct shut-in test. If all fittings are airtight the syringe plunger should try to return to its original position. If the vacuum is lost adjust fittings as needed and repeat process. Note: Sample media should be replaced if shut-in test fails.
5. Begin sampling by slowly pulling air through the tubing with the syringe (use a separate syringe than the one used for purging). Oriented sample tube vertically while sampling, if feasible. Use a stopwatch to ensure the flow rate is less than 200 mL/min (flow rates may vary depending on state-specific regulatory guidance). Record in the field notebook or and the field sample log the time sampling began and the approximate flow rate from each of the samples.

#### Termination of Sample Collection

1. Close the two-way valve after the pre-set volume of air has been drawn through the sorbent tube.
2. Record the stop time.
3. Remove sorbent tube from sample train and replace compression caps on both ends of the tube. **Do not overtighten the caps.** Use only a quarter turn past finger tight.
4. Record in the field logbook or FieldNow® application, the sample collection log, and on the COC.



5. Package the tubes according to laboratory protocol on gel ice and ship to the laboratory for analysis.

## 9 Waste Management

The waste materials generated during sampling activities should be minimal. PPE, such as gloves and other disposable equipment (e.g., tubing), will be collected by field personnel for proper disposal.

## 10 Data Recording and Management

Digital data collection is the Arcadis standard using available FieldNow® applications that enable real-time, paperless data collection, entry, and automated reporting. Paper forms should only be used as backup to FieldNow® digital data collection and/or as necessary to collect data not captured by available FieldNow® applications. The Field Now® digital form applications follow a standardized approach, correlate to most TGIs and are available to all projects accessible with a PC or capable mobile device. Once the digital forms are saved within FieldNow®, the data is instantly available for review on a web interface. This facilitates review by project management team members and SMEs enabling error or anomalous data detection for correction while the staff are still in the field. Continual improvements of FieldNow® applications are ongoing, and revisions are made as necessary in response to feedback from users and subject matter experts.

## 11 Quality Assurance

Duplicate samples should be collected in the field as a quality assurance step. Generally, duplicates are taken of 10% of samples, but project specific requirements should take precedence. Duplicate soil vapor samples should be collected sequentially, with the parent sample being collected first and the duplicate second from the same sample location.

Field blanks should be collected at a frequency of once per day. Field blank collection consists of removing the compression caps on both ends of a selected sorbent tube exposing the media to the sampling environment and immediately replacing the caps. Field blanks should be submitted for analysis for quality assurance purposes.

Quality assurance planning for Method TO-17 should take careful note of the method requirement for distributed volume pairs. Although in some circumstances this requirement may be waived, this does constitute a deviation from the method as written. It is wise to discuss this decision with clients and/or regulators before sampling.

Soil vapor sample analysis will be performed using USEPA TO-17 methodology for a site-specific constituent list defined in the work plan. Constituent lists and reporting limits must be discussed with the laboratory prior to mobilizing for sampling. Quality assurance parameters should be confirmed with the laboratory prior to sampling. Field quality assurance parameters should be defined in the site-specific work plan.

## 12 References

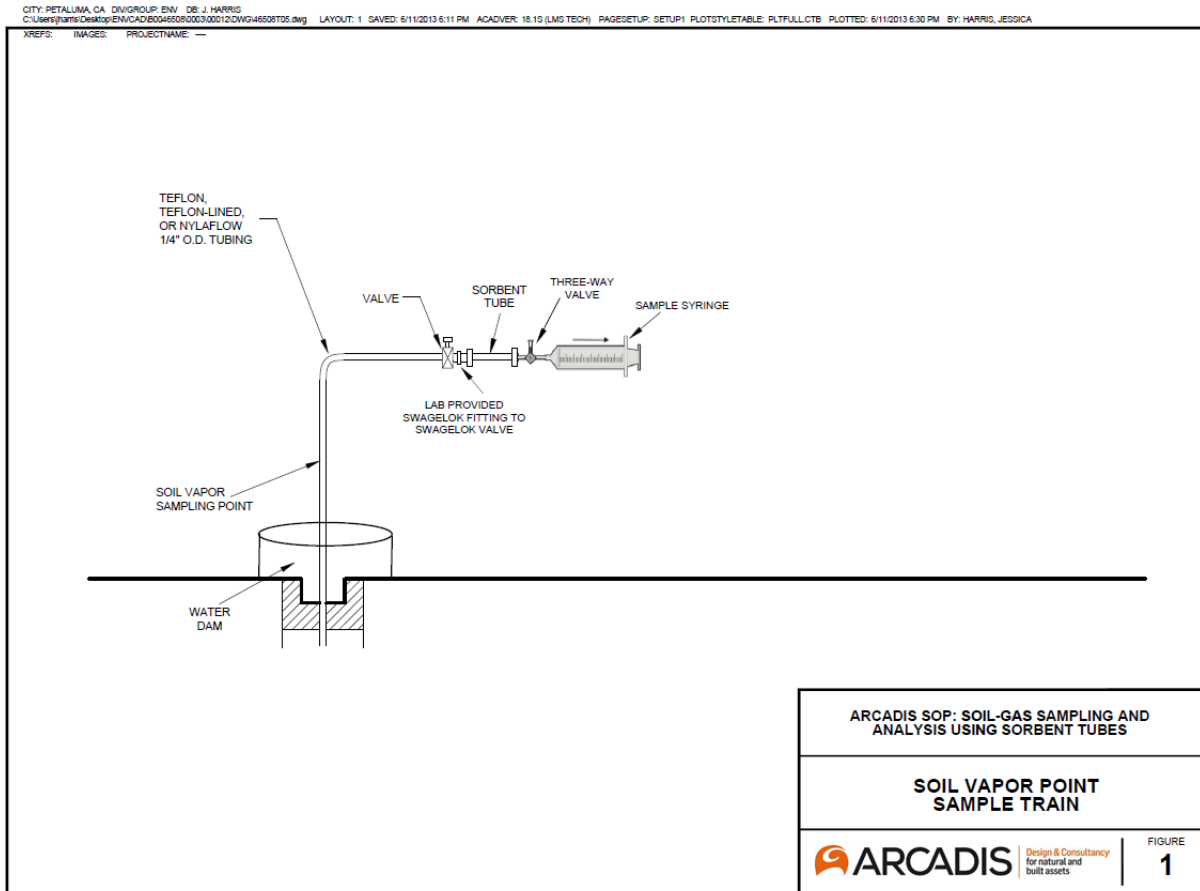
United States Environmental Protection Agency (USEPA) Method TO-17 - Compendium of Methods for the Determination of Toxic Organic Compounds in Ambient Air, Second Edition, *Compendium Method TO-17 Determination of Volatile Organic Compounds in Ambient Air Using Active Sampling Onto Sorbent Tubes*

New York State Department of Health (NYSDOH). 2005. DRAFT “Guidance for Evaluating Soil Vapor Intrusion in the State of New York” February 23, 2005.

Eurofins AirToxics Ltd. “Sorbent & Solution Sampling Guide.”



**FIGURE 1**  
**SOIL VAPOR POINT SAMPLE TRAIN**



Arcadis U.S., Inc.  
630 Plaza Drive, Suite 200  
Highlands Ranch  
Colorado 80129  
Phone: 720 344 3500  
Fax: 720 344 3535  
[www.arcadis.com](http://www.arcadis.com)





# Vapor Pin®

## Standard Operating Procedure

### Leak Testing the Vapor Pin® Sampling Device Via Water Dam

#### Scope & Purpose

##### Scope

The operating procedure describes the methodology to test a Vapor Pin® Sampling Device or equivalent sub-slab sampling device for leakage of indoor air.

##### Purpose

The purpose of this procedure is to assess the potential for indoor air to leak past the Vapor Pin® Sampling Device.

#### Equipment Needed

- Water Dam
- Distilled water
- VOC free modeling clay or equivalent
- Vapor Pin® Sampling Device and associated sample tubing


#### Procedure

1. Drill a 5/8-inch (16mm) hole in the concrete slab and install the Vapor Pin® Sampling Device as per the Standard Operating Procedure (SOP).
2. Clean the slab within a 2-inch radius of the Vapor Pin® Sampling Device to remove dust. Avoid wetting the concrete or wait until the concrete is dry before proceeding and avoid cleaning with VOC-containing substances. A whisk broom or shop vacuum is recommended. Remaining dust can be picked up with a piece of scrap modeling clay.
3. Roll a 1-inch diameter ball of modeling clay between your palms to form a “snake” approximately 7 inches long and press it against the end of the water dam. Push the water dam gently against the slab to form a seal with the concrete.
4. Attach the sample tubing to the top of the Vapor Pin® Sampling Device and pour enough distilled water into the water dam to immerse the base of the Vapor Pin® and the tubing connection at the top of the Vapor Pin® Sampling Device.
5. Purge the sample point as required by the data quality objectives. Concrete will absorb some of the water, which is normal; however, if water is lost to the sub-slab, stop, remove the water from the water dam, and reposition the Vapor Pin® Sampling Device to stop the leakage. Reseat the leak test equipment, if needed.
6. If the Vapor Pin® Sampling Device is installed in the flush-mount configuration, the larger hole can be filled with water in place of the water dam modeling clay.

**Figure 1.** Water dam used for leak detection






<u>Implementation Date</u> 13 December 2006	<u>ARCADIS HS Standard Name</u> Utility Location and Clearance	 <b>ARCADIS</b> Design & Consultancy for natural and built assets
<u>Revision Date</u> 13 May 2020	<u>ARCADIS HS Standard No.</u> ARC HSFS019	<u>Revision Number</u> 17


## Table of Contents

<b>QUICK SHEET</b>	<b>3</b>
<b>1. POLICY</b>	<b>5</b>
<b>2. PURPOSE AND SCOPE</b>	<b>5</b>
2.1 Purpose	5
2.2 Scope	5
<b>3. DEFINITIONS</b>	<b>5</b>
<b>4. RESPONSIBILITIES</b>	<b>5</b>
4.1 Project Managers	5
4.2 Field Personnel Responsibilities	6
4.3 Corporate Health & Safety	7
4.4 Arcadis Subcontractor Responsibilities	7
<b>5. PROCEDURE</b>	<b>8</b>
5.1 General Safe Work Practices	8
5.2 Lines of Evidence	8
5.3 Color Codes Used for Utility Markings	10
5.4 Locating Technologies	11
5.5 Clearance Methods	11
5.5.1 Temporary Backfilling of Pre-Cleared Boreholes	12
5.6 Clearance for Working in Vicinity of Subsurface Utilities – The Arcadis Utility Tolerance Zone	13
5.6.1 Aboveground Activities causing Subsurface Disturbance in the Vicinity of Underground Utilities	14
5.7 Acceptable Clearance for Working in Vicinity of Overhead Power Lines and Other Overhead Lines and Structures	15
5.7.1 Reducing Vehicle and Mechanical Equipment Clearance Requirements	16
5.7.2 Acceptable Clearance for Working in Vicinity of Non-Electrical Overhead Utilities and Structures	16
5.8 Reporting Utility Incidents	17
5.9 Relationship of this HSS to the Project Specific HASP	17

<u>Implementation Date</u> 13 December 2006	<u>ARCADIS HS Standard Name</u> Utility Location and Clearance	 <b>ARCADIS</b> Design & Consultancy for natural and built assets
<u>Revision Date</u> 13 May 2020	<u>ARCADIS HS Standard No.</u> ARC HSFS019	<u>Revision Number</u> 17

5.10	Required Contract Terms and Conditions	17
<b>6.</b>	<b>TRAINING</b>	<b>18</b>
<b>7.</b>	<b>REFERENCES</b>	<b>18</b>
<b>8.</b>	<b>RECORDS</b>	<b>19</b>
8.1	Utility Clearance Records	19
<b>9.</b>	<b>APPROVALS AND HISTORY OF CHANGE</b>	<b>19</b>
	<b>EXHIBIT 1 - DEFINITIONS</b>	<b>E-1</b>
	<b>Exhibit 2 – Acronyms and Abbreviations</b>	<b>E-3</b>
	<b>Exhibit 2 Figure 1 – Arcadis Tolerance Zone Illustration</b>	<b>E-5</b>
	<b>Exhibit 3 – Overhead Power Utility Illustrations</b>	<b>E-6</b>



<u>Implementation Date</u> 13 December 2006	<u>ARCADIS HS Standard Name</u> Utility Location and Clearance	 <b>ARCADIS</b> <small>Design &amp; Consultancy for natural and built assets</small>
<u>Revision Date</u> 13 May 2020	<u>ARCADIS HS Standard No.</u> ARC HSFS019	<u>Revision Number</u> 17

## QUICK SHEET

### Applicability

This HSS assigns responsibilities and expectations for proper utility location and clearance by both Arcadis employees and Arcadis subcontractors at project sites

### Need to Know

PMs are responsible for ensuring the requirements of this HSS are followed. Project personnel are responsible for understanding the HSS and Supplemental document, having the minimum 1 year of required training in order to clear sites, understand and apply the requirement for a minimum three reliable lines of evidence for each point of work, know and understand the Arcadis 30-in tolerance Zone requirements.

**If and when any line of evidence reveals planned subsurface work will occur within the Arcadis 30-inch Tolerance Zone of known/marked/located/observed utilities or structures, the project team must Stop Work and contact Corporate H&S for a review of steps the team has taken to prevent injury or incident involving the conflict.**

Additional details addressing hazards, risk factors, and safe work practices are discussed in the HSS Supplemental document Sections:


1. Best Practices for Project Managers (or Their Delegates) Concerning Utility Clearance.
2. Best Practices for Field Personnel Concerning Utility Clearance.
3. Use and Limitations of Common Underground Locating Technologies and Clearance Methods.
4. Best Practices for State One Call Notification Process and Mark Outs.
5. Emergency Action Plan Guidelines for Utility Strikes.
6. Utility Location Procedures for Aquatic Work Activities.

Arcadis field personnel involved with any strike incidents including contact with a structural feature, subsurface, submerged, and/or aboveground utilities must immediately STOP WORK and contact the Project Manager to discuss the incident. If there are life threatening injuries, or the incident presents a risk to public safety (e.g. natural gas leak, downed live electrical line, flooding, or an unstable building) first call 911 or the available emergency services number for the client site or area and then call the Project Manager. The incident must be reported to Corporate Health and Safety immediately and no later than 24 hours after gaining knowledge of the incident. Compliant notification within 24 hrs. requires an acknowledgement of the notification by Corporate H&S.

The Arcadis standard client and subcontractor contracts contain required terms and conditions defining responsibility for utility clearance and the allocation of risk associated with an impacted utility.

### Training

Field staff must complete a minimum of one year of utility clearance-related experience before accepting responsibility for any utility clearance tasks. This experience requires mentorship by a currently trained and experienced Arcadis employee for the processes of; completing DigSafe 811 notifications, developing a working understanding of the types of utilities present at project sites, developing a working understanding of the various reliable lines of evidence, and


<u>Implementation Date</u> 13 December 2006	<u>ARCADIS HS Standard Name</u> Utility Location and Clearance	 <b>ARCADIS</b> <small>Design &amp; Consultancy for natural and built assets</small>
<u>Revision Date</u> 13 May 2020	<u>ARCADIS HS Standard No.</u> ARC HSFS019	<u>Revision Number</u> 17

participating in on-site training led by another Arcadis employee with detailed knowledge and experience in identifying utilities and structures.

**Permits or Forms Required**

The Utility Location HSS and associated supplements will be reviewed, and the Utility and Structures Checklist will be prepared during project planning to document and record the location and clearance process for the Site.



<u>Implementation Date</u> 13 December 2006	<u>ARCADIS HS Standard Name</u> Utility Location and Clearance	 <b>ARCADIS</b> <small>Design &amp; Consultancy for natural and built assets</small>
<u>Revision Date</u> 13 May 2020	<u>ARCADIS HS Standard No.</u> ARC HSFS019	<u>Revision Number</u> 17

## 1. POLICY

It is the practice of Arcadis and its affiliated companies to implement appropriate, reasonable, and practical standards within acceptable and customary industry practices to promote the health and safety of its employees and avoid and mitigate exposure of risk in the performance of their work. In furtherance of this policy, Arcadis promotes and encourages compliance by all employees with this policy and standards relating to work in the vicinity of subsurface, submerged, or aboveground utilities.

## 2. PURPOSE AND SCOPE

### 2.1 Purpose

Arcadis is committed to providing a healthy and safe work environment for our employees, subcontractors, clients, and visitors. To this end, this health and safety standard (HSS) establishes general safety standards and best practices associated with the identification, management and avoidance of subsurface, submerged, and aboveground structures and utilities on project sites.

### 2.2 Scope

This HSS assigns responsibilities and expectations for proper utility location and clearance by both Arcadis employees and Arcadis subcontractors at project sites.

## 3. DEFINITIONS

Definitions related to Utility Location and Clearance can be found in [Exhibit 1](#). Acronyms and Abbreviations are found in [Exhibit 2](#).


## 4. RESPONSIBILITIES

Project staff involved in subsurface and aboveground work activities are expected to read, understand and comply with this HSS and the ARC HSFS-019 Supplements, specifically ARC HSFS-019 Supplement Sections 2 and 3, make the required DigSafe notification(s), and complete the appropriate checklists during the on-site utility and structures locate and clearance process.

### 4.1 Project Managers

For every project site having the potential to come into contact with utilities, Project Managers (PMs) are responsible for the requirements of this HSS in that:

- The requirements of this HSS are followed.
- Local regulations governing utility clearance are followed. This includes ensuring local and/or state laws defining activities or depth of intrusive work/excavation requiring utility clearance are reviewed as they vary by location. For further information, refer to the

<u>Implementation Date</u> 13 December 2006	<u>ARCADIS HS Standard Name</u> Utility Location and Clearance	
<u>Revision Date</u> 13 May 2020	<u>ARCADIS HS Standard No.</u> ARC HSFS019	<u>Revision Number</u> 17

Common Ground Alliance One Call State Law Directory  
<https://commongroundalliance.com/map>).


- Efforts are made to work with the client, project site representatives, public utility companies, and subcontractors to identify the nature of any utilities and to determine control processes that need to be implemented by Arcadis and the subcontractors to prevent damage to these utilities and to properly manage the effects in the event there is utility damage.
- In jurisdictions where the actual contractor performing the subsurface intrusive work is required to perform utility clearance notifications (811, State One Call, etc.) **and** Arcadis is also self-performing the work, Arcadis will complete the clearance notifications and include the ticket number on the Utility Clearance Checklist. Refer to ARC HSFS-019 Supplement Section 4 for Best Practices for State One Call procedures.
- Utility clearance activities are only delegated to a Task Manager or other individual meeting the requirements of Section 4.2 below, as appropriate. However, even if the Project Manager delegates certain responsibilities, the Project Manager maintains primary responsibility for the completion of utility clearance. For additional information on Project Manager responsibilities and best practices, refer to ARC HSFS-019 Supplement 1.
- Prior to beginning subsurface work, Project Managers or designee must review the [Utility and Structures Checklist](#) with staff and Arcadis subcontractors (including subs of subs). The Project Manager or designee review must be documented on the Utility and Structures Checklist prior to starting subsurface intrusive work

#### 4.2 Field Personnel Responsibilities

Arcadis field personnel conducting work on a project site having the potential to come into contact with utilities have the responsibility to:

- Read, understand, and follow this HSS and ARC HSFS-019 Supplement document.
- Complete a minimum of one year of utility clearance-related experience before accepting responsibility for any utility clearance tasks. This experience requires mentorship for notifying DigSafe 811, developing a working understanding of the types of utilities present at project sites, developing a working understanding of the various reliable lines of evidence, and participating in on-site training led by another Arcadis employee with detailed knowledge and experience in identifying utilities and structures.
- Request and review the 811 DigSafe notification(s) in place for the appropriate work area(s).
- Prior to beginning any subsurface intrusive work (i.e., any work or activity that breaks the plane of the ground surface), excavation work involving heavy and mechanized equipment, or operating high clearance equipment at the Site, the [Utility and Structures Checklist](#) must be completed and signed by the staff member completing or overseeing the clearance. Confirm that the Utility and Structures Checklist was reviewed by the Project Manager or designee as discussed in Section 4.1 above. Review the Utility and Structures Checklist daily prior to starting subsurface intrusive activities to ensure all



<u>Implementation Date</u> 13 December 2006	<u>ARCADIS HS Standard Name</u> Utility Location and Clearance	
<u>Revision Date</u> 13 May 2020	<u>ARCADIS HS Standard No.</u> ARC HSFS019	<u>Revision Number</u> 17

utilities are identified and markings are present. A copy of the completed Utility and Structures Checklist will remain on-site during all subsurface intrusive work.

- Use their STOP WORK Authority to eliminate any reasonable concern if utilities cannot be reasonably located and contact the Project Manager to review the STOP WORK situation and confirm the direction of action before proceeding with the work.
- Check that Arcadis subcontractors conduct their own reasonable independent utility clearance efforts as required by state and local laws and the Arcadis subcontractor agreement.
- Be on-site and provide oversight during utility location and clearance activities and any active subsurface intrusive work or activities involving subcontractor under contract to Arcadis.
- If a utility is damaged and repaired during the course of the field event, Arcadis field staff must provide oversight and document that the repair was tested to ensure the repaired utility is competent and complete to prevent further damage to the site when the damaged utility is re-activated.

### 4.3 Corporate Health & Safety

Corporate H&S is responsible for keeping this HSS up to date with regulatory requirements and best work practices.


Corporate H&S will, as requested, provide guidance to employees and their supervisors engaged in work involving utility location and clearance on the risks and measures prevention utility strikes, including how to recognize the presence of utilities whether overhead, underground, or submerged and how to mark and protect them from damage.

### 4.4 Arcadis Subcontractor Responsibilities

According to the Arcadis standard subcontract terms and conditions, subcontractors agree to take responsibility for any damages resulting from a utility impact caused by their work. Therefore, Arcadis subcontractors are expected to take reasonable time and diligence to conduct their own independent utility clearance using reasonable standards and processes. Subcontractors have the responsibility to stop their work if utility concerns are identified and will report those concerns to the Arcadis employee overseeing their work activities. Arcadis staff should reinforce these responsibilities with subcontractors during job safety briefings.

In jurisdictions where the actual contractor performing the subsurface intrusive work is required to perform utility clearance notifications (811, State One Call, etc.), the contractor will perform the clearance notification and will provide evidence of the notification to Arcadis (ticket or ticket number, etc.). Refer to ARC HSFS-019 Supplement Section 4 for Best Practices for State One Call procedures.

- If overhead utilities are present in areas where heavy equipment will be operated, ensure adequate clearance is provided. For heavy equipment with extendable or telescoping (e.g., excavators, dump trucks, extendable lift trucks) equipment, evaluate whether the use of a spotter is necessary prior to operating heavy equipment when in proximity to the overhead utility.

<u>Implementation Date</u> 13 December 2006	<u>ARCADIS HS Standard Name</u> Utility Location and Clearance	 <b>ARCADIS</b> <small>Design &amp; Consultancy for natural and built assets</small>
<u>Revision Date</u> 13 May 2020	<u>ARCADIS HS Standard No.</u> ARC HSFS019	<u>Revision Number</u> 17

- Consider signage and/or other forms of identification to ensure aboveground and overhead utilities that need to be protected during Arcadis work are effectively addressed.
- If a utility is struck and requires repair, the repair must be tested prior to restoring the utility to full service.

## 5. PROCEDURE

### 5.1 General Safe Work Practices

Arcadis staff will follow these general safe work practices when working around utilities. Procedures to be followed during utility and structures location and clearance activities are outlined in the following sections of the Utility Location and Clearance Supplemental document:


7. Best Practices for Project Managers (or Their Delegates) Concerning Utility Clearance.
8. Best Practices for Field Personnel Concerning Utility Clearance.
9. Use and Limitations of Common Underground Locating Technologies and Clearance Methods.
10. Best Practices for State One Call Notification Process and Mark Outs.
11. Emergency Action Plan Guidelines for Utility Strikes.
12. Utility Location Procedures for Aquatic Work Activities.

### 5.2 Lines of Evidence

When locating utilities and structures three (3) reliable “lines of evidence” must be established to help determine where a subsurface utility may be located. A line of evidence may be a scaled site drawing showing where a utility is located, it could be information obtained verbally from owners or employees who meet the definition of a “knowledgeable person” regarding utility and structural features, it could be established using any number of non-intrusive geophysical methods including but not limited to; ground penetrating radar (GPR), electromagnetic survey (EM), radio-frequency methods (RF), or it could involve probing for or exposing the utility by soft dig technologies (AKA “daylighting” or “potholing”) using air knife, Hydroknife and/or soil vacuum. Some lines of evidence will identify utility locations with a high degree of certainty (e.g., direct connect radio-frequency technique, daylighting, or potholing, sonde tracing, etc.). Other lines of evidence will identify utilities with less certainty (e.g., GPR, historical reports, old design drawings, etc.).

Effective utility locate practices must use multiple lines of evidence until there is a high degree of certainty that the various underground utility services have been adequately located. A minimum of three (3) reliable lines of evidence are required for an appropriate utility clearance as defined in this HSS. All reliable lines of evidence used during the utility clearance procedure will be recorded on the [Utility and Structures Checklist](#) or equivalent client-provided checklist or ground disturbance permit. If three (3) reliable lines of evidence have not established certainty regarding the location of a utility, STOP WORK and do not proceed until the certainty has improved, the work has been modified to resolve the lack of certainty. Additional reliable lines of evidence must be utilized until the presence or absence of the underground utility can be established. During work activities, if a line of evidence is lost or not apparent (e.g., paint markings have faded), STOP WORK, and re-establish the line of evidence prior to resuming subsurface intrusive work.




<u>Implementation Date</u> 13 December 2006	<u>ARCADIS HS Standard Name</u> Utility Location and Clearance	 <b>ARCADIS</b> Design & Consultancy for natural and built assets
<u>Revision Date</u> 13 May 2020	<u>ARCADIS HS Standard No.</u> ARC HSFS019	<u>Revision Number</u> 17

Generally, the following example reliable lines of evidence may be used to meet the minimum three lines utility clearance requirement:

1. Contacting the State One Call or equivalent service (Nationwide “811”) in advance of intrusive work is **REQUIRED BY LAW**. Contacting the State One Call or equivalent service (Nationwide “811”) is an acceptable reliable line of evidence when working within or adjacent to the public right of way or easement. Note that the State One Call can provide valuable information regarding locations and types of utilities entering a privately owned property.

**Note:** When conducting work on private property or in areas not served by State One Call or equivalent service, teams are to evaluate using a reputable private utility locating company to locate and mark the utilities. **Use of a reputable private utility locator is encouraged for all projects with subsurface or submerged utilities.** When working with a private utility location subcontractor, it is best practice to pre-plan clearance areas, review the necessary clearance equipment needed based on the types of utilities anticipated to be present, and the re-clearing/confirmation of any public utility location markings (State One Call or equivalent service Nationwide “811”).

2. Use detailed, scaled site utility plans, preferably in the form of an “as-built” or “record” drawing, to identify and/or confirm utility locations. Document request and/or receipt of utility drawings from the property owner/client on the Utilities and Structures Checklist.
3. Interview(s) with knowledgeable site or client personnel. The following questions should be asked during the interview and answers documented on the [Utility and Structures Checklist](#)
  - Employees(s) Name and Affiliation(s) with the site.
  - Types of utilities, including utility composition and location of utilities on-site.
  - Depths of known utilities; and
  - Any other pertinent information regarding utilities on the site.
4. Conduct a detailed visual site inspection of areas around all planned subsurface intrusive work points or areas to identify and/or confirm utility locations. The area needed to conduct a thorough site inspection can vary significantly depending on the number and type of utilities present, notably gravity-fed utilities such as sewers. Sewer network manhole spacing can often include 100-foot distances or greater between manholes. For underground utilities, conduct an inspection for structures that tend to indicate the presence and general location of such utilities, including, but not limited to manholes, vaults, valve covers, valve markers, telephone pedestals, transformer housings, fire hydrants, fire suppression post indicator valves (PIVs), spigots, sprinkler heads, air relief valves, backflow preventers, meters, vent lines, downspouts going into the subsurface, power poles with wiring going into the subsurface and line markers, stakes, and monuments. Saw cut lines and concrete/asphalt repairs often yield valuable information regarding utility locations.

<u>Implementation Date</u> 13 December 2006	<u>ARCADIS HS Standard Name</u> Utility Location and Clearance	 <b>ARCADIS</b> <small>Design &amp; Consultancy for natural and built assets</small>
<u>Revision Date</u> 13 May 2020	<u>ARCADIS HS Standard No.</u> ARC HSFS019	<u>Revision Number</u> 17

Always discuss the presence of utilities with the site owner, operator, facility representative and/or occupant to identify any potential utilities that might not be readily identified by non-intrusive geophysical clearing methods. Situations where non-intrusive clearance methods may not be effective include:

- Depths > 5 ft. below ground surface (BGS).
- Small diameter or certain utility construction materials (e.g. plastics).
- Multiple layers of surface cover e.g. reinforced concrete, multiple layers of historical roadbed.
- Soil conditions such as dense soils or shallow groundwater table.

A discussion of use and limitations associated with common utility location and clearance geophysical methods is provided in ARC HSFS-019 Supplement Section 3.

Standard operating procedures for utility location in submerged settings are presented in ARC HSFS-019 Supplement Section 6.

The lines of evidence will be recorded on the [Utility and Structures Checklist](#) or equivalent client-provided checklist or permit.


**Note:** If a line of evidence is lost, not apparent, no longer applicable or utility location markings are removed/worn/unclear, or area of previous clearance is not confirmed, STOP WORK and re-establish the line(s) of evidence prior to resuming subsurface intrusive work. **Each location of subsurface intrusive work must have a minimum of 3 reliable lines of evidence.** All lines of evidence used during the utility clearance procedure will be recorded on the Utility and Structures Checklist or equivalent client-provided checklist or permit. The Utility Structures and Checklist is valid for 15 business days from the date of completion. Prior to the end of the 15 day period the checklist detailing the utilities which have been located and marked must be reviewed to verify no new utilities have been identified but are unmarked and, utilities which have been located and marked continue to be clearly marked. Update the checklist with the date of the review and reviewer name to “re-set” the 15-day period. A copy of the completed Utility and Structures Checklist will remain onsite while work involving or in the vicinity of utilities is conducted.

**Caution: If and when any line of evidence reveals planned subsurface work will occur within the Arcadis 30-inch Tolerance Zone of known/marked/located/observed utilities, the project team must Stop Work and contact Corporate H&S for a review of the steps the team has taken to prevent injury or incident involving the utility conflict.**









### 5.3 Color Codes Used for Utility Markings

The following colors are used for marking utilities. Some government agencies or large industrial facilities may use additional colors not provided below. Arcadis policy is to assume any paint marking or pin flag color not provided below is a subsurface utility marking until proven otherwise.



<u>Implementation Date</u> 13 December 2006	<u>ARCADIS HS Standard Name</u> Utility Location and Clearance	 <b>ARCADIS</b> Design & Consultancy for natural and built assets
<u>Revision Date</u> 13 May 2020	<u>ARCADIS HS Standard No.</u> ARC HSFS019	<u>Revision Number</u> 17

If utilities or subsurface anomalies are identified but the utility type or anomalies are not classified, it is recommended the color pink (Temporary Survey Marking) be used to mark the location pending confirmation. Once the type of utility is established, the pink marks will be repainted/remarked to represent the correct type of utility.

COLOR	Utility Line
WHITE 	Proposed Excavation
PINK 	Temporary Survey Markings
RED 	Electrical Power Lines, Cables, Conduit and Lighting Cables
YELLOW 	Gas, Oil, Steam, Petroleum or Gaseous Materials
ORANGE 	Communication, Alarm or Signal Lines, Cables or Conduit
BLUE 	Potable Water
PURPLE 	Reclaimed Water, Irrigation and Slurry Lines
GREEN 	Sewer and Drain Lines

APWA and ANSI standard Z-53.1


#### 5.4 Locating Technologies

There are several types of locating technologies that can be used to identify and locate utilities in the subsurface. Project teams need to work closely with private utility locators (PUL) in order to best match locating technology with site conditions. To provide the best results, all possible locating technologies should be available for use and implementation at the project location. Any potential interferences should also be discussed up front and then at the project site during utility location activities. Potential interferences could be soil moisture, soil type, standing water on concrete/asphalt, rebar, fencing, and metal structures that are in the subsurface. Employees overseeing locating technology activities should have an understanding of device operation and limitations. For further information, refer to ARC HSFS-019 Supplement Section 3, Use and Limitations of Common Utility Location Technologies and Clearance Methods.

#### 5.5 Clearance Methods

In some cases, proposed subsurface intrusive locations may be pre-cleared using other intrusive methods. Determine the clearance or soft dig method based on-site conditions and utilize the least invasive method possible. The number of subsurface intrusive locations and soil type should be taken into consideration. The following clearance methods are listed from least invasive to most invasive:

1. Vacuum Extraction/Potholing (air or water-based)
2. Air knifing
3. Hydro knifing
4. Probing
5. Hand augering
6. Hand digging
7. Posthole digging

<u>Implementation Date</u> 13 December 2006	<u>ARCADIS HS Standard Name</u> Utility Location and Clearance	 <b>ARCADIS</b> <small>Design &amp; Consultancy for natural and built assets</small>
<u>Revision Date</u> 13 May 2020	<u>ARCADIS HS Standard No.</u> ARC HSFS019	<u>Revision Number</u> 17

“Single-Point” clearance involves clearing the intrusive location to 110% of the proposed subsurface intrusive area or the diameter plus 2 inches of the largest piece of tooling used in the subsurface (e.g. clear the borehole to 10-in. when setting wells using 8-in. hollow stem auger tooling), or whichever is greater.

“Three-Point” clearance involves clearing the utility using a triangular pattern placed around the proposed borehole location and in a configuration such as to not allow utilities to pass undetected between the clearance boreholes. In some cases, it is more practical to advance three individual slot trenches which connect at each end making a “clearance triangle” instead of advancing multiple boreholes side-by-side. Using the Three-Point clearance triangle trenching method allows for teams to inspect larger areas for potential utilities. The teams can advance trenches along each side of the proposed work area extending down to a target depth based on suspected depth of utilities at the Site. Each method of clearance will be documented on the [Utility and Structures Checklist](#).

Manual clearing methods, such as shoveling, using pickaxes, digging bars (AKA “Spud bars” and other hand tools, should be avoided completely or only used when absolutely necessary and used with caution. Excessive downward force, prying or use in poor/obstructed visibility conditions is prohibited as these tools are known to be capable of damaging utilities.

Surface cover (e.g., asphalt) removal methods that pose excessive downward force, such as jackhammering, must be used with extreme caution. Methods that only cut the surface cover (coring or saw cutting) present less risk due to the absence of the blunt downward force, which could cause collateral damage to shallow subsurface utilities by unintentionally pushing buried debris into the utility. Note that certain utilities are often present at the concrete or pavement/soil interface or encased within the concrete or pavement and are easily damaged during concrete coring or pavement removal. Always work slowly, methodically, and frequently STOP WORK to evaluate conditions during these work activities.


For borings and excavations, if the utility is known to be at depths where hand clearing is not feasible or creates additional safety concerns, no work will be performed within the Arcadis 30-inch Tolerance Zone vertically or horizontally of the utility unless manual clearing of the utility is performed under the oversight of an Excavation Competent Person as defined in ARC HSFS005 HSS Arcadis Excavation and Trenching.

#### 5.5.1 Temporary Backfilling of Pre-Cleared Boreholes

In some cases, it may be necessary to temporarily backfill a pre-cleared / daylighted location until the remaining subsurface activities are performed. At these locations where subsurface intrusive work does not immediately follow pre-clearance, it is important to properly backfill and mark the pre-cleared location in order to protect the utility integrity and maintain the location. In general, wooden stakes, survey flags, whisker markers, paint marking, or other surface markings alone are inadequate because these markings can be easily removed, damaged, or otherwise lost creating uncertainty for the pre-cleared location. Although the specific steps for backfilling a pre-cleared location will depend on site-specific conditions, use the following steps to prevent loss of the pre-cleared location:

- Backfill a pre-cleared location with clean sand or other granular material that is recognizably different from the surrounding subsurface native material. Native soil should not be used to backfill a pre-cleared location that may require further subsurface work.



<u>Implementation Date</u> 13 December 2006	<u>ARCADIS HS Standard Name</u> Utility Location and Clearance	 <b>ARCADIS</b> <small>Design &amp; Consultancy for natural and built assets</small>
<u>Revision Date</u> 13 May 2020	<u>ARCADIS HS Standard No.</u> ARC HSFS019	<u>Revision Number</u> 17

- Backfill the top 2 feet of a pre-cleared location with dyed sand or gravel to facilitate re-location.
- Place wooden stakes or delineators to mark locations as an additional measure, if practical.
- In the event that the pre-cleared borehole is located on asphalt or concrete and an asphalt cold patch is required, use white paint to mark the intrusive location over the asphalt cold patch.
- In some instances, such as projects potentially affected by unexploded ordinance (UXO), the pre-cleared borehole may require that a PVC pipe of matching diameter be inserted into the pre-cleared borehole, filled with clean sand and affixed with a matching cap. Project teams are to discuss client specific utility location and marking requirements with the project manager prior to conducting work.
- Always use a physical subsurface marker such as described above to identify the pre-cleared borehole location. Don't rely solely on field measurements or GPS coordinates as the only means for locating pre-cleared locations.
- If a utility or anomaly/obstruction is encountered during the pre-clearing process, backfill the hole with the native soil and mark the location with a pink-painted X and/or NO.


In the event that a previously pre-cleared location cannot be located, the location must be re-cleared prior to performing subsurface intrusive work

### **5.6 Clearance for Working in Vicinity of Subsurface Utilities – The Arcadis Utility Tolerance Zone**

Prior to the start of subsurface intrusive activities (i.e., excavating / test pitting, drilling, installing grounding rods, manual soil sampling etc.), all utilities must be located, and steps taken to avoid unintentionally contacting or damaging subsurface utilities. See exemptions for subsurface intrusive work in [Exhibit 1](#) (Definitions). Field Teams are not to proceed with subsurface work involving utilities located within 30 inches of a line marking as measured radially (e.g. 360 degrees) from the outermost point of the marked utility. If only the centerline of the utility or utility bank is marked, but the utility width or diameter is known or suspected, the diameter of the utility or utility bank ([Exhibit 1](#)) must be incorporated into the Arcadis 30-inch Tolerance Zone, see Figure 1 located in [Exhibit 2](#) for further instructions and an illustration of the Arcadis 30-in. Tolerance Zone.

If and when any line of evidence reveals planned subsurface work will occur within the Arcadis 30-inch Tolerance Zone of known/marked/located/observed utilities or structures, the project team must Stop Work and contact Corporate H&S for a review of steps the team has taken to prevent injury or incident involving the conflict.

If subsurface work using heavy or mechanized equipment must take place within the Arcadis 30-inch Tolerance Zone of the marked utility, the utility must be exposed (daylighted) using soft dig clearance methods prior to starting subsurface intrusive activities as described in Section 5.5 of this HSS.

<u>Implementation Date</u> 13 December 2006	<u>ARCADIS HS Standard Name</u> Utility Location and Clearance	 <b>ARCADIS</b> <small>Design &amp; Consultancy for natural and built assets</small>
<u>Revision Date</u> 13 May 2020	<u>ARCADIS HS Standard No.</u> ARC HSFS019	<u>Revision Number</u> 17

**Note: No heavy or mechanized equipment is permitted to be used within the Arcadis 30-inch Tolerance Zone for the purpose of daylighting the utility.**

Once the utility in conflict has been daylighted, and heavy or mechanized equipment use is planned within the Arcadis 30-inch Tolerance Zone of the utility, such work must receive pre-approval by Corporate H&S to review steps the team has taken to assess and mitigate the risk associated with the planned work. Additional excavation safety procedures may have to be developed as part of the Corporate H&S approval to proceed. It should be noted that any disturbance within 30 inches of the marked utility, or disruption of the surrounding bedding materials could affect the integrity of the utility.

For horizontal borings, to avoid striking a utility, damage from vibration, damage by pressure of the advancing boring, do not drill within 30 inches in all directions (3-Dimensional cylinder) of a line marking. Make sure to factor the diameter of the line or utility bank when calculating the extent of the 30-inch Tolerance Zone. When crossing a utility during horizontal drilling, it is recommended that the utility be exposed 30 inches in a 360°-direction. When exposing utilities for horizontal borings, the utility must be exposed (potholed) by soft dig/clearance methods. This recommendation applies even if the operating contractor has technology that places the location to within a few inches. Make sure to factor the diameter of the utility when determining the 30-inch Tolerance Zone. If subsurface work must take place within the 30-inch Tolerance Zone of the line marking, the utility must be exposed (potholed) by soft dig/clearance methods prior to starting subsurface intrusive work (see Section 5.5 for options); no mechanized equipment is permitted for the exposing of the utility. Once the utility has been exposed, if mechanized equipment is planned for use within the 30-inch Tolerance Zone of the utility, such activity must receive pre-approval by Corporate H&S, as necessary, to mitigate or accept the risk associated with the planned work. Additional excavation safety procedures may have to be developed as part of the approval to proceed. It should be noted that any disturbance within the 30 inches or disruption of the bedding materials could affect the integrity of the utility.


Additional cautions for horizontal borings include gravity-fed utilities, such as sewers and storm drains. The depth of these utilities will change (sometimes significantly) as they run across the project site. Project teams need to obtain sewer utility depths in the work area(s) and determine the depth of the sewer at the location where the boring will actually intersect with the sewer line by collecting sewer pipe invert elevations from identified manholes and interpolating those depths to the area of the subsurface intrusive work.

During well installations and well abandonment via mechanical equipment, the Arcadis 30-inch Tolerance Zone rule applies in an outward direction extending from the outermost edge of the largest diameter auger or greatest width tool used for installation and abandonment (e.g. “over drilling”). In cases where wells have been previously installed and the 30-inch rule has not been followed, work proposed using heavy or mechanized equipment falling within the Arcadis 30-inch Tolerance Zone requires approval from Corporate H&S. For more information, see Figure 1 in [Exhibit 2](#) for further instructions.

**5.6.1 Aboveground Activities causing Subsurface Disturbance in the Vicinity of Underground Utilities**

Aboveground work-related activities can cause damage to shallow underground utilities or structures. Asses the intended travel paths, mobilization, staging, and operation of heavy equipment and take steps to ensure shallow utilities are not damaged. If heavy equipment must cross over shallow utilities, the team is responsible for confirming the utilities will be protected.

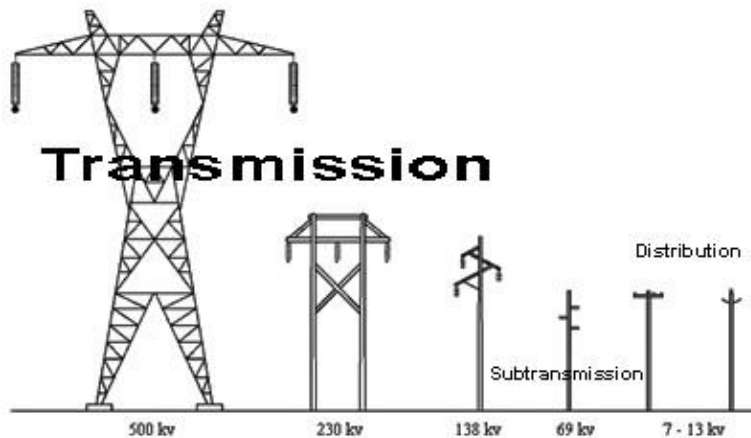


<u>Implementation Date</u> 13 December 2006	<u>ARCADIS HS Standard Name</u> Utility Location and Clearance	 <b>ARCADIS</b> Design & Consultancy for natural and built assets
<u>Revision Date</u> 13 May 2020	<u>ARCADIS HS Standard No.</u> ARC HSFS019	<u>Revision Number</u> 17

Other subsurface disturbances may lead to damage such as removing trees/tree stumps, shrubs, or dense vegetation as roots may be entangled with underground piping or structures. For more information, see ARC HSFS-019 Supplement Section 2\_Best Practices for Field Personnel Concerning Utility Clearance.

### 5.7 Acceptable Clearance for Working in Vicinity of Overhead Power Lines and Other Overhead Lines and Structures


No work will be performed by Arcadis or our subcontractor near overhead power lines where any Unqualified Person or equipment is within the limits specified below, unless the power line has been properly covered or de-energized by the owner or operator of the power line, or a qualified electrical subcontractor. Qualified Person approach distances are defined in Exhibit 5A and 5B of [ARC HSFS0006 Electrical Safety Standard](#). Illustrations of general types of overhead utility conveyances are provided in [Exhibit 3](#) - Overhead Power Utility Illustrations



[OSHA Electric Power etool](#) illustration

Power Line Voltage Phase to phase (kV)	Minimum Safe Clearance (feet)
50 or below	10
Above 50 to 200	15
Above 200 to 350	20
Above 350 to 500	25
Above 500 to 750	35
Above 750 to 1,000	45

ANSI standard B30.5-1994, 5-3.4.5

<u>Implementation Date</u> 13 December 2006	<u>ARCADIS HS Standard Name</u> Utility Location and Clearance	 <b>ARCADIS</b> <small>Design &amp; Consultancy for natural and built assets</small>
<u>Revision Date</u> 13 May 2020	<u>ARCADIS HS Standard No.</u> ARC HSFS019	<u>Revision Number</u> 17

### 5.7.1 Reducing Vehicle and Mechanical Equipment Clearance Requirements

Any vehicle or mechanical equipment capable of having parts of its structure elevated near energized overhead lines shall be operated so that a minimum clearance of 10 feet (305 centimeters [cm]) is maintained. If the voltage is greater than 50 kilovolts (kV), the clearance shall be increased 4 inches (10 cm) for every 10 kV over that voltage. However, under any of the following conditions, the clearance may be reduced:

- If the vehicle is in transit with its structure lowered, the clearance may be reduced to 4 feet (122 cm).
- If insulating barriers or “power line shields” rated for the voltage of the line being guarded are installed to prevent contact with the lines, and the barriers are not a part of, or an attachment to, the vehicle or its raised structure, the clearance may be reduced to a distance within the designed working dimensions of the insulating barrier.
- If the equipment is an aerial lift that is insulated for the voltage involved and if the work is performed by a qualified person, the clearance (between the uninsulated portion of the aerial lift and the power line) may be reduced to the distance given in [OSHA 1910.333\(c\)\(3\)\(ii\)\(C\) Table S-5](#). Reference information from OSHA 1910.333 Table S-5 and NFPA 70E Table 130.4(C)(a) for alternating-current systems and 130.4(C)(b) for the distances associated with direct-current voltage systems is included as Exhibit 5 of ARC HSFS0006 Electrical Safety Standard.

Employees standing on the ground may not contact the vehicle or mechanical equipment or any of its attachments unless:

- The employee is using protective equipment rated for the voltage; or
- The equipment is located so that no uninsulated part of its structure (that portion of the structure that provides a conductive path to employees on the ground) can come closer to the line than permitted in this section of this HSS.


If any vehicle or mechanical equipment capable of having parts of its structure elevated near energized overhead lines is intentionally grounded, employees working on the ground near the point of grounding may not stand at the grounding location whenever there is a possibility of overhead line contact. Additional precautions, such as the use of barricades or insulation, shall be taken to protect employees from hazardous ground potentials, depending on earth resistivity and fault currents, which can develop within the first few feet or more outward from the grounding point.

When a machine is in contact with an overhead power line, do not allow anyone to come near or touch the machine. Stay away from the machine and summon outside assistance.

### 5.7.2 Acceptable Clearance for Working in Vicinity of Non-Electrical Overhead Utilities and Structures

Arcadis field personnel will identify non-electrical overhead utilities and structures and where possible, work is not be conducted within the 30-inch Tolerance Zone of these overhead utilities



<u>Implementation Date</u> 13 December 2006	<u>ARCADIS HS Standard Name</u> Utility Location and Clearance	 <b>ARCADIS</b> <small>Design &amp; Consultancy for natural and built assets</small>
<u>Revision Date</u> 13 May 2020	<u>ARCADIS HS Standard No.</u> ARC HSFS019	<u>Revision Number</u> 17

and structures. It is recommended that if work will be completed in the vicinity of non-electric overhead utilities, the overhead utilities should be labeled with warning signs, protective barricades, and/or flags. Non-electrical overhead utilities and structures may include, but is not limited to, pipe chases, water lines, ceilings in buildings, etc. Arcadis field personnel will notify its site workers (employees, subcontractors, vendors, etc.) of known overhead utilities and structures during the tailgate safety meeting. See [Exhibit 2](#) for additional details.

### 5.8 Reporting Utility Incidents

Arcadis field personnel involved with any strike incidents including contact with a structural feature, subsurface, submerged, and/or aboveground utilities must immediately STOP WORK and contact the Project Manager to discuss the incident. If there are life threatening injuries, or the incident presents a risk to public safety (e.g. natural gas leak, downed live electrical line, flooding, or an unstable building) first call 911 or the available emergency services number for the client site or area and then call the Project Manager. The incident must be reported to Corporate Health and Safety immediately and no later than 24 hours after gaining knowledge of the incident. Compliant notification within 24 hrs. requires an acknowledgement of the notification by Corporate H&S. Team must provide critical details of the incident when notifying Corporate H&S such as; 3<sup>rd</sup> party involvement, any injuries, known extent of damage and estimate of potential repair cost, service interruption, and client reporting requirements. The project team and field staff will use the Arcadis [Utility Line Strike Investigation Form](#) to record initial details of the incident as part of the notification process.

Selected utility strike incidents may also utilize a conference call with operations management to review findings and lessons learned. The Business Line H&S Director will make the determination concerning the need to have the incident investigation review call and will arrange the call, if deemed necessary.


### 5.9 Relationship of this HSS to the Project Specific HASP

With the exception of the Utility and Structures Checklist, this HSS and the supplement documents, are not required to be printed and attached to project HASPs. Project teams have discretion to include such supplements as a BMP or reference guide when developing a project HASP. During project health and safety planning, this HSS will be reviewed and applicable clearance technologies and methods will be documented on the [Utility and Structures Checklist](#).

Additionally, emergency response procedures specific to utility strikes should be addressed. See ARC HSFS-019 Supplement Section 5 which provides general guidelines for emergency response to utility strikes. Applicable information may be attached to the HASP or the Utility and Structures Checklist to facilitate communication of response expectations.

### 5.10 Required Contract Terms and Conditions

The Arcadis standard client and subcontractor contracts contain required terms and conditions defining responsibility for utility clearance and the allocation of risk associated with an impacted utility. These terms and conditions have prescribed language concerning subsurface work that is presented in Arcadis client contracts and the Arcadis subcontractor contracts, which can be found on the [ANA Intranet Legal webpage](#). If such provisions cannot be agreed upon, the reasons are documented and other risk-management actions should be identified, such as limits of liability, add additional physical investigations, additional lines of evidence or utility location, assignment

<u>Implementation Date</u> 13 December 2006	<u>ARCADIS HS Standard Name</u> Utility Location and Clearance	 <b>ARCADIS</b> <small>Design &amp; Consultancy for natural and built assets</small>
<u>Revision Date</u> 13 May 2020	<u>ARCADIS HS Standard No.</u> ARC HSFS019	<u>Revision Number</u> 17

of risk to subcontractors, etc. In addition, any changes to these terms and conditions require approval by Legal Services.

## 6. TRAINING


Employees responsible for coordinating or conducting utility clearance activities will be familiar with the requirements of this HSS and the supplemental documents. Arcadis in-house 8-hour Hazardous Waste Operations and Emergency Response (HAZWOPER) refresher may provide awareness-level training regarding this utility location and clearance HSS.

Field staff must complete a minimum of one year of utility clearance-related experience before accepting responsibility for any utility clearance tasks. This experience requires mentorship by a currently trained and experienced Arcadis employee for the processes of; completing DigSafe 811 notifications, developing a working understanding of the types of utilities present at project sites, developing a working understanding of the various reliable lines of evidence, and participating in on-site training led by another Arcadis employee with detailed knowledge and experience in identifying utilities and structures.

## 7. REFERENCES

- Occupational Safety and Health Administration (OSHA) 29 CFR Subpart P, Excavations, 1926.651, Specific Excavation Requirements.
- Common Ground Alliance State Law Directory - <https://commongroundalliance.com/map>
- Arcadis Utilities and Structures Checklist:
  - Excel Version - [Utility and Structures Checklist](#)
  - PDF Version - [Utility and Structures Checklist](#)
- Arcadis [Utility Line Strike Investigation Form](#)
- The [Arcadis ARC HSFS-019 Supplement Documents](#) include the following Sections:
  - Section 1 - Best Practices for Project Managers (or Their Delegates) Concerning Utility Clearance
  - Section 2 - Best Practices for Field Personnel Concerning Utility Clearance
  - Section 3 - Use and Limitations Associated with Location Technologies and Common Utility Clearance Methods
  - Section 4 - Best Practices for State One Call Procedures and Notifications
  - Section 5 - Emergency Action Plan guidelines for Utility Strikes
  - Section 6 - Utility Location SOP for Aquatic Work Activities
- [Figure 1](#) – 30-Inch Tolerance Zone
- Arcadis H&S Standard [ARC HSCS005 Excavation and Trenching](#)



<u>Implementation Date</u> 13 December 2006	<u>ARCADIS HS Standard Name</u> Utility Location and Clearance	 <b>ARCADIS</b> Design & Consultancy for natural and built assets
<u>Revision Date</u> 13 May 2020	<u>ARCADIS HS Standard No.</u> ARC HSFS019	<u>Revision Number</u> 17

- Arcadis H&S Standard [ARC HSFS0006 Electrical Safety Standard](#)

## 8. RECORDS

### 8.1 Utility Clearance Records

All records (maps, checklists, and documentation of communications) used to determine the location of utilities should be retained and kept in the project file.


## 9. APPROVALS AND HISTORY OF CHANGE

Approved by Julie Santaniello, CSP – Corporate H&S Manager of Technical Programs




### History of Change

Revision Date	Revision Number	Standard Developed/Reviewed by or Revised By	Reason for change
13 December 2006	01	Mike Thomas/Pat Vollertsen	Original document
26 March 2007	02	Mike Thomas/Pat Vollertsen	Put in new company format
15 May 2007	03	Mike Thomas/Pat Vollertsen	Added nation-wide 811 number
6 September 2007	04	Mike Thomas/Pat Vollertsen	Changing over to new template format
22 February 2008	05	Mija Coppola	Changing over to new template format
13 January 2009	06	Mija Coppola	Define lines of evidence
4 October 2010	07	Sam Moyers/Mija Coppola	Reformatting and addition of utility clearance information
13 February 2012	08	Sam Moyers/Mija Coppola	Modified link information for utility strike reporting, clarified local/state requirements in section 4.1 and 4.3


<u>Implementation Date</u> 13 December 2006	<u>ARCADIS HS Standard Name</u> Utility Location and Clearance	 <b>ARCADIS</b> <small>Design &amp; Consultancy for natural and built assets</small>
<u>Revision Date</u> 13 May 2020	<u>ARCADIS HS Standard No.</u> ARC HSFS019	<u>Revision Number</u> 17

<b>Revision Date</b>	<b>Revision Number</b>	<b>Standard Developed/Reviewed by or Revised By</b>	<b>Reason for change</b>
28 January 2013	09	Tony Tremblay	Utility and Structures Checklist revised; hyperlink updated
12 February 2013	10	Amanda Tine/Tony Tremblay	Clarified clearance boundaries for Unqualified staff in Section 5.7 and added information about vehicles and equipment being used near power lines in Section 5.7.1
15 March 2013	11	Kurt Merkle, Rebecca Lindeman / Tony Tremblay	Added additional text to HSS for recent lessons learned, added section 5.4 (Locating Technologies) and 5.5 (Clearance Methodologies), added additional details to section 5.6 when working in close proximity to subsurface utilities, and added Supplement 6 - Utility Location SOP for Aquatic Work Activities.
07 July 2013	12	Andrew McDonald/ Tony Tremblay	Removed <a href="#">HSFS-019 Supplement 1</a> , Utility Definitions. Added hyperlink for One Call and State Law Directory. Segregated evidence of sewer or storm drains in USC list. Removed Sam Moyers and added Andrew McDonald as author.
26 September 2014	13	Andrew McDonald/Tony Tremblay	Added Exhibit 1. Definitions and 30-inch tolerance zone. Clarified use of 811 or state one call as a reliable line of evidence. Added best practice to cover backfilling of pre-cleared boreholes. Updated USC list to cover soft dig termination depths and PM review.
23 February 2015	14	Tony Tremblay	Page number correction




<u>Implementation Date</u> 13 December 2006	<u>ARCADIS HS Standard Name</u> Utility Location and Clearance	 <b>ARCADIS</b> <small>Design &amp; Consultancy for natural and built assets</small>
<u>Revision Date</u> 13 May 2020	<u>ARCADIS HS Standard No.</u> ARC HSFS019	<u>Revision Number</u> 17

<b>Revision Date</b>	<b>Revision Number</b>	<b>Standard Developed/Reviewed by or Revised By</b>	<b>Reason for change</b>
10 May 2016	15	Denis Balcer/Sharon Lingle/Alec MacAdam/Andrew McDonald/Tony Tremblay/Julie Santaniello	ES and Section 4.2 - define subsurface intrusive work; clarify employees providing oversight of utility contractors, Arcadis requirements of operating and interpreting results of utility clearance equipment, and utility clearance before all subsurface intrusive work. Sections 1 and 5.8- changed submarine to submerged. Section 4.1 – added contacting public utility companies to help clear utilities. Section 4.2 – Clarified requirement to complete one year of utility clearance-related experience. Section 4.2 and 4.3 - Added discussion on aboveground activities causing subsurface disturbances. Added responsibility to clear overhead utilities when heavy equipment will be used and to evaluate use of a spotter. Added that repairs to damaged utilities need to be verified as competent and complete. Section 5.2 – Clarified reliable lines of evidence for each subsurface intrusive work point and degrees of certainty. Added all work within 30-inch Tolerance Zone needs Corp H&S preapproval. Section 5.6 and Exhibit 1- Clarify subsurface intrusive work and activity and exemptions for subsurface intrusive work. Section 5.6.1 – Add requirement to evaluate aboveground activities that may lead to subsurface disturbances that may cause damage to shallow underground utilities or structures.

<u>Implementation Date</u> 13 December 2006	<u>ARCADIS HS Standard Name</u> Utility Location and Clearance	 <b>ARCADIS</b> Design & Consultancy for natural and built assets
<u>Revision Date</u> 13 May 2020	<u>ARCADIS HS Standard No.</u> ARC HSFS019	<u>Revision Number</u> 17

<b>Revision Date</b>	<b>Revision Number</b>	<b>Standard Developed/Reviewed by or Revised By</b>	<b>Reason for change</b>
10 May 2016	15	Denis Balcer/Sharon Lingle/Alec MacAdam/Andrew McDonald/Tony Tremblay/Julie Santaniello	<p>Section 5.7.2 – added non-electric overhead utilities and structures other than power lines need to be identified and marked if working in that area. Section 9 – Changed reviewer from Tony Tremblay to Julie Santaniello. Exhibit 1 – added definitions of Utility Strike, Daylighting, Potholing, Subsurface Intrusive Work, Subsurface Intrusive Activities, and Utility Bank.</p> <p>HSS and Supplements placed on new Arcadis headers. Updated Supplement revision numbers to be consistent with HSS. Supplement 2 revised. Utility Clearance and Structures Checklist and Utility Strike Investigation Form revised.</p>
17 March 2017	16	Alec MacAdam/Julie Santaniello	Hyperlink updates; minor formatting; Utility Clearance and Structures Checklist revised.
13 May 2020	17	Alec MacAdam/Denis Balcer/Greg Mason/Julie Santaniello	Updated HSS format. Combined HSS Supplements, revised HSS sections, revised the Utility & Structures Checklist, added Exhibit 2 - Acronyms and Abbreviations.



<u>Implementation Date</u> 13 December 2006	<u>ARCADIS HS Standard Name</u> Utility Location and Clearance	 <small>Design &amp; Consultancy for natural and built assets</small>
<u>Revision Date</u> 13 May 2020	<u>ARCADIS HS Standard No.</u> ARC HSFS019	<u>Revision Number</u> 17

### EXHIBIT 1 - Definitions

**Aboveground Utilities** - For the purpose of this procedure, aboveground utilities include, but are not limited to: any aboveground line, pipe, conduit, system, or facility used for producing, storing, conveying, transmitting or distributing communication or telecommunications signals, electricity, gas, liquid, petroleum and petroleum products, coal slurry, hazardous liquids or gases, water under pressure, steam, sanitary sewage, storm water, or other materials, liquids, or gases.

**Daylighting** – exposing underground utilities or structures through soft dig technology/clearance prior to completing subsurface intrusive activities.

**e.g.** - Exempli gratia. Latin for “for the sake of example.” Use it to introduce one or more examples.

**Excavation** - Any man-made cut, cavity, trench, or depression, in an earth surface formed by earth removal into which a person can bodily enter.

**I.e.** - I.e. is the abbreviation for “id est” and means “in other words” or “in essence”.

**Kilovolt (kV)** - One kilovolt is equal to 1,000 volts (v), which are the potential difference that would move one ampere of current against one ohm of resistance. The kilovolt is a multiple of the volt, which is the SI derived unit for voltage.

**Overhead Utilities and Structures** – Overhead water lines, overhead pipe chases, ceilings in buildings.

**Potholing** – exposing underground utilities or structures through soft dig technology/clearance prior to completing subsurface intrusive activities.


**Subsurface Intrusive Activities** – For the purposes of this procedure, subsurface intrusive activities include, but are not limited to excavations, vertical drilling, installing grounding rod, soil sampling, etc.,

**Subsurface Intrusive Work** – Is any work or activity that breaks the plane of the ground surface. Exemptions include soil sampling using a non-conductive sampling tool to a depth of 6 inches below ground surface (bgs), placement of survey flagging to a depth of 6 inches bgs, and placement of non-conductive survey stake(s) to a depth of 6 inches bgs).

**Subsurface Utilities** - For the purposes of this procedure, subsurface utilities include, but are not limited to: any underground line, pipe, conduit, system, or facility used for producing, storing, conveying, transmitting or distributing communication or telecommunications signals, electricity, gas, liquid, petroleum and petroleum products, coal slurry, hazardous liquids or gases, water under pressure, steam, storm water, or sanitary sewage; underground storage tanks; tunnels and cisterns; and septic tanks and lines.


**Utility Bank** – a structure containing two or more conduits. A conduit is a single enclosure containing one or more facilities.

**Utility Strike** – An unplanned contact of a utility (i.e., overhead utilities, buildings, structures, aboveground utilities, underground utilities. or submerged utilities) during the course of work that results in; damage requiring repairs, making a report to the utility owner, or requiring further assessment to evaluate the potential for damage.

<u>Implementation Date</u> 13 December 2006	<u>ARCADIS HS Standard Name</u> Utility Location and Clearance	 <b>ARCADIS</b> <small>Design &amp; Consultancy for natural and built assets</small>
<u>Revision Date</u> 13 May 2020	<u>ARCADIS HS Standard No.</u> ARC HSFS019	<u>Revision Number</u> 17


**Utility Tolerance Zone** – The area within 30 inches measured radially (e.g. extending in all directions) from the outside diameter of a located/marked utility in which special care is to be taken. If the centerline of the utility is marked, the diameter of the utility or utility bank/trench must be incorporated into the 30 inches. This area must be hand cleared with non-mechanized equipment. Once the utility has been exposed, if mechanized equipment is planned for use within the Arcadis 30-inch Tolerance Zone of the utility, such activity must receive pre-approval by Corporate H&S, to mitigate or accept the risk associated with the planned work. See Figure 1 – 30-inch Tolerance Zone.



<u>Implementation Date</u> 13 December 2006	<u>ARCADIS HS Standard Name</u> Utility Location and Clearance	 <b>ARCADIS</b> <small>Design &amp; Consultancy for natural and built assets</small>
<u>Revision Date</u> 13 May 2020	<u>ARCADIS HS Standard No.</u> ARC HSFS019	<u>Revision Number</u> 17


### Exhibit 2 – Acronyms and Abbreviations

ANA	Arcadis North America
Arcadis	Arcadis U.S. Inc.
ARC	Arcadis
APM	Associate Project Manager
APL	Acoustic Pipe Location
AKA	Also Known As
BGS	Below Ground Surface
cm	Centimeter
EM	Electromagnetic
ft.	Feet
GPR	Ground Penetrating Radar
HS	Health and Safety
H&S	Health and Safety
HSS	Health and Safety Standard
HAZWOPER	Hazardous Waste Operations and Emergency Response
HSFS	Health and Safety Field Safety
HSCS	Health and Safety Construction Safety
https	Hypertext transfer protocol secure
in.	Inch
kV	Kilovolt
m	Meter
NFPA	National Fire Protection Association
OSHA	Occupational Safety and Health Administration
PIV	Post Indicator Valve
PUL	Private Utility Locator
PM	Project Manager
RF	Radio Frequency

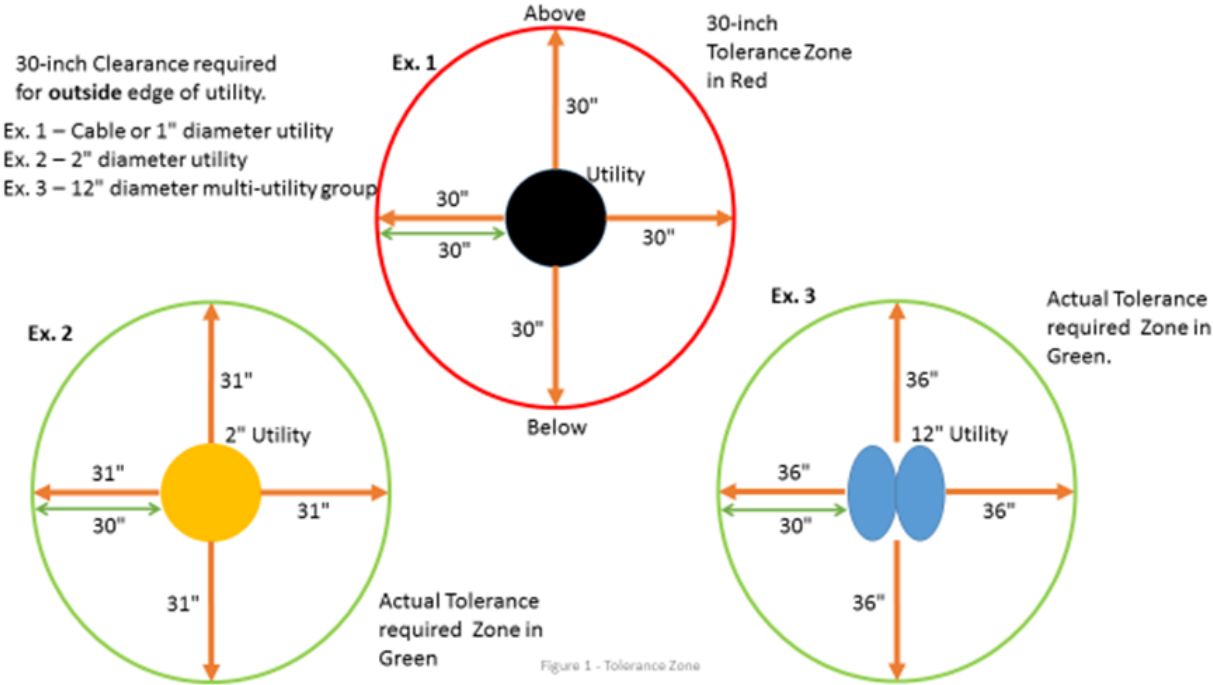
<u>Implementation Date</u> 13 December 2006	<u>ARCADIS HS Standard Name</u> Utility Location and Clearance	 <b>ARCADIS</b> <small>Design &amp; Consultancy for natural and built assets</small>
<u>Revision Date</u> 13 May 2020	<u>ARCADIS HS Standard No.</u> ARC HSFS019	<u>Revision Number</u> 17


- RFD      Radio Frequency Detection
- SOP      Standard Operating Procedure
- TM        Task Manager
- TZ        Tolerance Zone
- UXO      Unexploded Ordinance



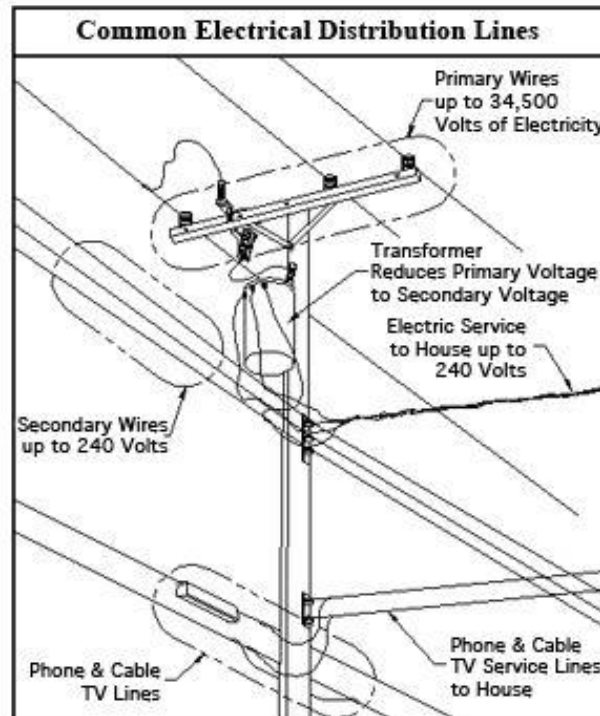
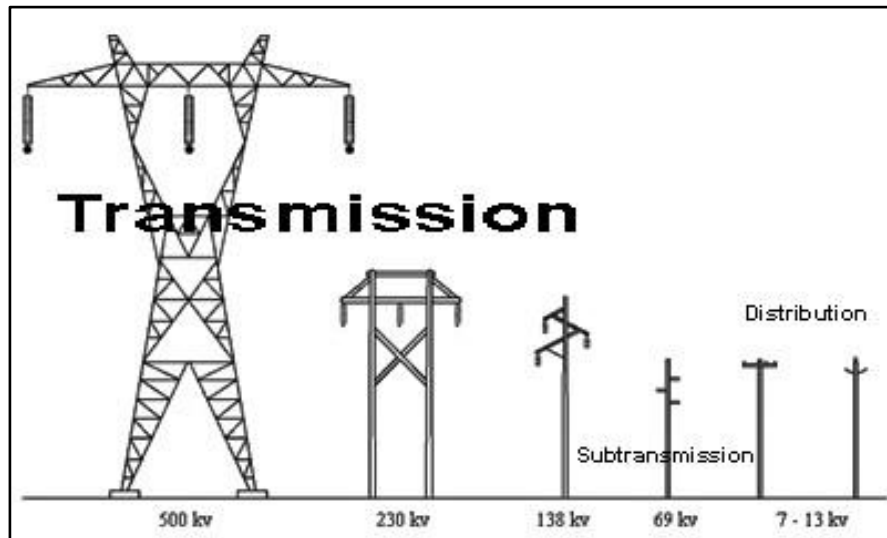
<u>Implementation Date</u> 13 December 2006	<u>ARCADIS HS Standard Name</u> Utility Location and Clearance	 <b>ARCADIS</b> <small>Design &amp; Consultancy for natural and built assets</small>
<u>Revision Date</u> 13 May 2020	<u>ARCADIS HS Standard No.</u> ARC HSFS019	<u>Revision Number</u> 17

**Exhibit 2 Figure 1 – Arcadis Tolerance Zone Illustration**



<u>Implementation Date</u> 13 December 2006	<u>ARCADIS HS Standard Name</u> Utility Location and Clearance	 <b>ARCADIS</b> <small>Design &amp; Consultancy for natural and built assets</small>
<u>Revision Date</u> 13 May 2020	<u>ARCADIS HS Standard No.</u> ARC HSFS019	<u>Revision Number</u> 17

**Exhibit 3 – Overhead Power Utility Illustrations**







# STANDARD OPERATING PROCEDURES

SOP: ERT-PROC-2008-20

PAGE: 1 of 26

REV: 1.1

EFFECTIVE DATE: 10/19/20

## GENERAL AIR MONITORING AND SAMPLING GUIDELINES

---

### CONTENTS

#### DISCLAIMERS

1.0 SCOPE AND APPLICATION

2.0 METHOD SUMMARY

3.0 SAMPLE PRESERVATION, CONTAINERS, HANDLING, AND STORAGE

4.0 INTERFERENCES AND POTENTIAL PROBLEMS

5.0 EQUIPMENT/APPARATUS

5.1 Direct Reading Instruments (Air Monitoring Instruments)

5.2 Air Sampling Equipment and Media/Devices

5.3 Tools/Material and Equipment List

6.0 REAGENTS

7.0 PROCEDURES

7.1 Air Monitoring Design

7.1.1 Initial Surveys

7.1.2 Off-Site Monitoring

7.2 Air Sampling Design

7.2.1 Air Sampling Strategy

7.2.2 Sampling Objectives

7.2.3 Location and Number of Individual Sampling Points

7.2.4 Time, Duration and Frequency of Sampling Events

7.2.5 Meteorological and Physical/Chemical Considerations

8.0 CALCULATIONS

9.0 QUALITY ASSURANCE/QUALITY CONTROL

9.1 QA/QC Samples

9.2 Sample Documentation

10.0 DATA VALIDATION

11.0 HEALTH AND SAFETY

12.0 REFERENCES

13.0 APPENDICES

A - Portable Screening Devices and Specialized Analytical Instruments



# STANDARD OPERATING PROCEDURES

SOP: ERT-PROC-2008-20

PAGE: 2 of 26

REV: 1.1

EFFECTIVE DATE: 10/19/20

## GENERAL AIR MONITORING AND SAMPLING GUIDELINES

---

B - Air Sampling Equipment and Media/Devices





## STANDARD OPERATING PROCEDURES

SOP: ERT-PROC-2008-20

PAGE: 3 of 26

REV: 1.1

EFFECTIVE DATE: 10/19/20

### GENERAL AIR MONITORING AND SAMPLING GUIDELINES

---

*The policies and procedures established in this document are intended solely for the guidance of OLEM employees of the U.S. Environmental Protection Agency (EPA). They are not intended and cannot be relied upon to create any rights, substantive or procedural, enforceable by any party in litigation with the United States. EPA reserves the right to act at variance with these policies and procedures, and to change them at any time without public notice. EPA strongly encourages all readers to verify the validity of the information contained in this document by consulting the most recent Code of Federal Regulations (CFR) and updated guidance documents.*

*Mention of trade names or commercial products does not constitute U.S. Environmental Protection Agency (U.S. EPA) endorsement or recommendation for use.*



# STANDARD OPERATING PROCEDURES

SOP: ERT-PROC-2008-20

PAGE: 4 of 26

REV: 1.1

EFFECTIVE DATE: 10/19/20

## GENERAL AIR MONITORING AND SAMPLING GUIDELINES

---

### 1.0 SCOPE AND APPLICATION

This Standard Operating Procedure (SOP) provides guidance in developing and implementing sampling plans to assess the impact of hazardous chemicals on ambient or indoor air. It presents a standard approach to air sampling and monitoring and identifies equipment requirements. It is not within the scope of this SOP to provide a generic air sampling plan. Experience, objectives, site characteristics, and chemical characteristics will dictate sampling strategy.

Air monitoring or sampling involves measuring the air impact at selected locations during specific time periods. These measurements can be used to document actual air impacts during specific time intervals (i.e., during cleanup operations) or to extrapolate the potential "worst case" concentrations at that and similar locations over a longer time period than was sampled.

This SOP addresses issues associated with air monitoring or sampling, and discusses the typical monitoring instruments, air sampling kits, and approach to air sampling and monitoring.

A Quality Assurance Project Plan (QAPP) in Uniform Federal Policy (UFP) format describing the project objectives must be prepared prior to deploying for a sampling event. The sampler needs to ensure that the methods used are adequate to satisfy the data quality objectives listed in the QAPP for a particular site.

The procedures in this SOP may be varied or changed as required, dependent on site conditions, equipment limitations or other procedural limitations. In all instances, the procedures employed must be documented on a Field Change Form and attached to the QAPP. These changes must be documented in the final deliverable.

### 2.0 METHOD SUMMARY

*Air monitoring* is defined as the use of direct-reading instruments and other screening or monitoring equipment and techniques that provide instantaneous (real-time) data on the levels of airborne contaminants. There are numerous types of monitors for real-time air measurements. Examples of some widely used air monitoring equipment are hand-held photoionization detectors (PID), flame ionization detectors (FID), oxygen/combustible gas detectors, and toxic chemical sensors. These instruments are both manufactured individually and combined into multi-gas monitors.

*Air sampling* is defined as those sampling and analytical techniques that require either off- or on-site laboratory analysis, and therefore, do not provide immediate results. Typically, air sampling occurs after use of real-time air monitoring equipment has narrowed the number of possible contaminants and has provided some qualitative measurement of contaminant concentration. Air sampling techniques are used to more accurately detect, identify and quantify specific chemical compounds relative to the majority of air monitoring technologies.

Some typical situations where air monitoring and/or sampling provides useful data include the following: emergency responses, site assessments, and removal activities. Each of these activities has a related air monitoring/sampling objective that is used to determine the potential hazards to workers and/or the community.

- Emergency Response

Emergency responses are immediate responses to a release or threatened release of hazardous substances presenting an imminent danger to public health, welfare, or the environment (i.e., chemical spills, fires, or chemical process failures resulting in an uncontrolled release of hazardous substances). Generally





# STANDARD OPERATING PROCEDURES

SOP: ERT-PROC-2008-20

PAGE: 5 of 26

REV: 1.1

EFFECTIVE DATE: 10/19/20

## GENERAL AIR MONITORING AND SAMPLING GUIDELINES

---

these situations require rapid on-site investigation and response. A major part of this investigation consists of assessing the air impact of these releases.

- Removal Site Assessment

Removal site assessments (referred to as site assessments) are defined as any of several activities undertaken to determine the extent of contamination at a site and which help to formulate the appropriate response to a release or threatened release of hazardous substances. These activities may include a site inspection, multimedia sampling, and other data collection.

- Removal Actions

Removal actions clean up or remove hazardous substances released into the environment. Removal actions include any activity conducted to abate, prevent, minimize, stabilize, or eliminate a threat to public health or welfare, or to the environment.

Personal risk from airborne contaminants can be determined by comparing the results of on-site monitoring and sampling to health-based action levels such as the American Conference of Governmental Industrial Hygienists (ACGIH) Threshold Limit Values (TLVs), the Occupational Safety and Health Administration (OSHA) Permissible Exposure Limits (PELs) and Acute Exposure Guideline Levels (AEGs). Residential risk can be determined by comparing the results of off-site monitoring or sampling to health-based action levels such as those developed by the Agency for Toxic Substance and Disease Registry (ATSDR) or the EPA Risk-Based Regional Screening Levels (RSLs).

The extent to which valid inferences can be drawn from air monitoring/sampling depends on the degree to which the monitoring/sampling effort conforms to the objectives of the event. Meeting the project's objectives requires thorough planning of the monitoring/sampling activities, and implementation of the most appropriate monitoring/sampling and analytical procedures. These issues will be discussed in this SOP.

### 3.0 SAMPLE PRESERVATION, CONTAINERS, HANDLING, AND STORAGE

Preservation, containers, handling and storage for air samples are discussed in the specific SOPs for the technique selected. In addition, the analytical method (i.e., EPA, National Institute for Occupational Safety and Health [NIOSH], and OSHA Methods) may be consulted for storage temperature, holding times and packaging requirements. After sample collection, the sampling media (e.g., cassettes or tubes) are immediately sealed. The samples are then placed into suitable containers (e.g., whirl-paks, re-sealable bags, or culture tubes) that are placed into a shipping container.

Bubble wrap or another suitable material will be used when packing air samples for shipment. Vermiculite is not to be used due to potential asbestos content. Additional information may be found in Environmental Response Team (ERT) SOP, *Sample Packing and Shipment*.

### 4.0 INTERFERENCES AND POTENTIAL PROBLEMS

Upwind sources can contribute to sample concentrations. Natural sources, such as biological waste, can produce hydrogen sulfide and methane that may contribute to the overall contaminant level. Extraneous anthropogenic contaminants (e.g., burning of fossil fuels; emissions from vehicular traffic, especially diesel; volatile compounds from petrochemical facilities; and effluvia from smoke stacks) may also contribute to the overall contaminant level. Air sampling stations, therefore, should be strategically placed to identify contributing sources.



# STANDARD OPERATING PROCEDURES

SOP: ERT-PROC-2008-20

PAGE: 6 of 26

REV: 1.1

EFFECTIVE DATE: 10/19/20

## GENERAL AIR MONITORING AND SAMPLING GUIDELINES

---

Photoreactivity or reaction of the parameters with non-related compounds of concern may occur resulting in a positive or negative bias to the analytical results. Some sorbent media/samples should not be exposed to light during or after sampling due to photochemical effects (e.g., polycyclic aromatic hydrocarbons [PAHs]). Always refer to the analytical method or SOP for interferences, potential problems, and any special sample preservation requirements.

Various environmental factors, including humidity, temperature and pressure, also impact the air sampling methodology, collection efficiency and detection limit. Since the determination of air contaminants is specifically dependent on the collection parameters and efficiencies, the collection procedure is an integral part of the analytical method.

Detection limits (DLs) and reporting limits (RLs) depend on the contaminants being investigated and the particular site situation. It is important to know why the data are needed and how the data will be used. Care should be taken to ensure the DLs and/or RLs are adequate for the intended use of the final data.

Some equipment may be sensitive to humidity and temperature extremes.

### 5.0 EQUIPMENT/APPARATUS

#### 5.1 Direct Reading Instruments (Air Monitoring Instruments)

There are two general types of direct reading instruments: portable screening devices and specialized analytical instruments. Generally, all these techniques involve acquiring, for a specific location or area, continuous or sequential direct air concentrations in either a real-time or semi-real-time mode. The document, "Guide to Portable Instruments for Assessing Airborne Pollutants Arising from Hazardous Waste Sites" (OIML 1991), provides additional information about air sampling and monitoring. The hazard levels for airborne contaminants vary. See the ACGIH TLVs and the OSHA PELs for safe working levels. Common screening devices are described in Appendix A.

In years past older instruments were not capable of acquiring simultaneous concentration readings at multiple locations. USEPA-ERT has developed the VIPER wireless sensor communication system utilizing commercially available hardware in conjunction with standard air monitoring instrumentation. The VIPER system allows data from multiple instruments and multiple types of instrumentation to be collected and displayed in a common platform in near real-time.

VIPER is a wireless network-based communications system designed to enable real time transmission of data from field sensors to a local computer, remote computer, or enterprise server and provide data management, analysis, and visualization enhanced by ERT custom software. Additional information is available to epa.gov employees on the EPA On-Scene Coordinator (OSC) Response website located at [https://response.epa.gov/site/site\\_profile.aspx?site\\_id=5033](https://response.epa.gov/site/site_profile.aspx?site_id=5033) or by contacting [ERTSupport@epa.gov](mailto:ERTSupport@epa.gov).

#### 5.2 Air Sampling Equipment and Media/Devices

The following sources of analytical methods are used for most environmental air sampling applications: *Manual of Analytical Methods* (NIOSH 2016), *American Society for Testing and Materials (ASTM) Methods*, *U.S. EPA Compendium of Methods for the Determination of Toxic Organic Compounds in Ambient Air* (U.S. EPA 1999), and *OSHA Methods* (OSHA 1990, 1991).





# STANDARD OPERATING PROCEDURES

SOP: ERT-PROC-2008-20

PAGE: 7 of 26

REV: 1.1

EFFECTIVE DATE: 10/19/20

## GENERAL AIR MONITORING AND SAMPLING GUIDELINES

---

Additional air sampling references include *Industrial Hygiene and Toxicology, Fourth Edition* (Patty 1994) and *Air Sampling Instruments for Evaluation of Atmospheric Contaminants* (ACGIH 2001). These methods typically specify equipment requirements for sampling. Since air sampling is such a diverse technology, no single method or reference is best for all applications. Common sampling equipment and media/devices are described in Appendix B.

### 5.3 Tools/Material and Equipment List

In addition to equipment and materials identified in Appendices A and B, the following equipment and materials may be required to conduct air sampling and monitoring at hazardous waste sites:

- Site logbook
- Clipboard
- Chain of custody records
- Custody seals
- Air sampling worksheets
- Air monitoring worksheets
- Sample labels
- Small screwdriver set
- Aluminum foil
- Extension cords
- Glass tube cracker
- Multiple plug outlet
- Whirl-pak™ bags or culture tubes
- Teflon tape
- Calibration devices
- Tygon and/or Teflon tubing
- Surgical gloves
- Lint-free gloves
- Ice
- Sample container
- Camera
- Scribe Printer with paper

Use the following additional equipment when decontaminating glassware or air sampling equipment on site:

- Protective equipment (i.e., gloves, splash goggles, etc.)
  - Paper towels
  - Five-gallon buckets
  - Scrub brushes and bottle brushes

### 6.0 REAGENTS

Impinger sampling involves using reagents contained in a glass vial to absorb contaminants of concern (for example, NIOSH Method 3500 for formaldehyde uses 1 percent [%] sodium bisulfite solution). Impinger solutions vary and are method-dependent.

Reagents such as acetone and hexane are required to decontaminate glassware and some air sampling



# STANDARD OPERATING PROCEDURES

SOP: ERT-PROC-2008-20

PAGE: 8 of 26

REV: 1.1

EFFECTIVE DATE: 10/19/20

## GENERAL AIR MONITORING AND SAMPLING GUIDELINES

---

equipment. Decontamination solutions are specified in ERT SOP, *Sampling Equipment Decontamination*.

### 7.0 PROCEDURES

#### 7.1 Air Monitoring Design

##### 7.1.1 Initial Surveys

In general, the initial survey is considered to be a relatively rapid screening process for collecting preliminary data at hazardous waste sites. However, initial surveys may require many hours to complete and may consist of more than one entry.

Some information is generally known about the site; therefore, real-time instrumentation for specific compounds (i.e., detector tubes and electrochemical sensors) can be used to identify hot spots. Sufficient data should be obtained with real-time instruments during the initial entry to screen the site for various contaminants. When warranted, intrinsically safe or explosion-proof instruments should be used. An instrument capable of a broad-spectrum measurement of volatile organic compounds (VOCs) is also typically used during this survey. These gross measurements may be used on a preliminary basis to (1) determine levels of personal protection, (2) establish site work zones, and (3) map candidate areas for more thorough qualitative and quantitative studies involving air sampling.

In some situations, the information obtained may be sufficient to preclude additional monitoring. Materials detected during the initial survey may call for a more comprehensive evaluation of hazards and analyses for specific compounds. Since site activities and weather conditions change, a continuous program to monitor the ambient atmosphere must be established.

##### 7.1.2 Off-Site Monitoring

Typically, perimeter monitoring with the same instruments employed for on-site monitoring is utilized to determine site boundaries. Because air is a dynamic matrix, physical boundaries like property lines and fences do not necessarily delineate the site boundary or area influenced by a release. Whenever possible, atmospheric hazards in the areas adjacent to the on-site zone should be monitored with direct-reading instruments. Monitoring at the fenceline or at varying locations off site provides useful information regarding pollutant migration. Three to four locations downwind of the source (i.e., plume) at breathing-zone height can provide a basic fingerprint of the plume. Negative instrument readings off site should not be interpreted as the complete absence of airborne toxic substances; rather, they should be considered another piece of information to assist in the preliminary evaluation. The interpretation of negative readings is instrument dependent. The lack of instrument readings off site should not be interpreted as the complete absence of all airborne toxic substances; rather, it is possible that the particular compound or class of compounds to which the monitoring instrument responds is not present or that the concentration of the compound(s) is below the instrument's DL.

#### 7.2 Air Sampling Design

##### 7.2.1 Air Sampling Strategy





# STANDARD OPERATING PROCEDURES

SOP: ERT-PROC-2008-20

PAGE: 9 of 26

REV: 1.1

EFFECTIVE DATE: 10/19/20

## GENERAL AIR MONITORING AND SAMPLING GUIDELINES

---

The goal of air sampling is to accurately assess the impact of a contaminant source(s) on ambient air quality. This impact is expressed in terms of overall average and/or maximum air concentrations for the time period of concern and may be affected by the transport and release of pollutants from both on- and off-site sources. The location of these sources must be taken into account as they impact the selection of sampling locations. Unlike soil and groundwater concentrations, air concentrations at points of interest can easily vary by orders of magnitude over the period of concern. This variability plays a major role in designing an air sampling strategy.

Downwind air concentration is determined by the amount of material being released from the site into the air (the emission rate) and by the degree that the contamination is diluted as it is transported. Local meteorology and topography govern downwind dilution. Contaminant emission rates can also be heavily influenced by on-site meteorology and on-site activities. All of these concerns must be incorporated into an air sampling strategy.

A sampling strategy can be simple or complex, depending on the sampling program objectives. Programs involving characterization of the pollutant contribution from a single point source tend to be simple, whereas sampling programs investigating fate and transport characteristics of components from diverse sources require a more complex sampling strategy. In addition, resource constraints may affect the complexity of the sampling design.

An optimal sampling strategy accounts for the following site parameters:

- Location of stationary as well as mobile sources
- Analytes of concern
- Analytical RL to be achieved
- Rate of release and transport of pollutants from sources
- Availability of space and utilities for operating sampling equipment
- Meteorological monitoring data
- Meteorological conditions in which sampling is to be conducted

The sampling strategy typically requires that the concentration of contaminants at the source or area of concern as well as background contributions be quantified. It is important to establish background levels of contaminants in order to develop a reference point from which to evaluate the source data. Field blanks and lot blanks, as well as various other types of quality assurance/quality control (QA/QC) samples, can be utilized to determine other sources. The impact of extraneous sources on sampling results can frequently be accounted for by placing samplers upwind, downwind and crosswind from the subject source. The analytical data from these different sampling locations may be compared to determine statistical differences.

### 7.2.2 Sampling Objectives

The objectives of the sampling must be determined prior to developing the QAPP. Does the sampling strategy verify adequate levels of protection for on-site personnel, or address potential off-site impacts associated with the site or with site activities? In addition, the assumptions associated with the sampling program must be defined. These assumptions include whether the sampling is to take place under "typical," "worst case", or "one-time" conditions. If the conditions present at the time of sampling are different from those



# STANDARD OPERATING PROCEDURES

SOP: ERT-PROC-2008-20

PAGE: 10 of 26

REV: 1.1

EFFECTIVE DATE: 10/19/20

## GENERAL AIR MONITORING AND SAMPLING GUIDELINES

---

assumed during the development of the sampling plan, the quality of the data collected may be affected. The following definitions have been established:

- Typical: routine daily sampling or routine scheduled sampling at pre-established locations.
- Worst case: sampling conducted during meteorological and/or site conditions that have the greatest potential to result in elevated ambient concentrations.
- One-time: only one chance is given to collect a sample without regard to time or conditions. Qualitative data acquired under these conditions are usually applicable only to the time period during which the data were collected and may not provide accurate information to be used in estimating the magnitude of an air impact during other periods or over a long time interval.

The sampling objectives also dictate the DLs or RLs. Sampling methods for airborne contaminants will depend upon the nature and state (solid, liquid or gas) of the contaminant. Gases and vapors may be collected in aqueous media or adsorbents, in molecular sieves, or in suitable containers. Particulates and aerosols are collected by filters or impactors. The volume of sample to be collected is dependent upon an estimate of the contaminant concentration in the air, the sensitivity of the analytical method, and the standard or desired DL or RL. A sufficient amount of sample must be collected to achieve the desired DL without interference from other contaminants. Most importantly, the selected method must be able to detect the target compound(s).

### 7.2.3 Location and Number of Individual Sampling Points

Choose the number and location of sampling points according to the variability, or sensitivity, of the sampling and analytical methods being utilized, the variability of contaminant concentrations over time at the site, the level of precision required, and cost limitations. In addition, determine the number of locations and placement of samplers by considering the nature of the response, local terrain, meteorological conditions, location of the site (with respect to other conflicting background sources), size of the site, and the number, size, and relative proximity of separate on-site emission sources and upwind sources. The following are several considerations for sampler placement:

- Location of potential on-site emission sources, as identified from the review of site background information or from preliminary on-site inspections.
- Location of potential off-site emission sources upwind of the sampling location(s). Review local wind patterns to determine the location of off-site sources relative to wind direction.
- Topographic features that affect the dispersion and transport of airborne toxic constituents. Avoid natural obstructions when choosing air sampling station locations, and account for channelization around those obstructions.
- Large water bodies, which affect atmospheric stability and the dispersion of air contaminants.





# STANDARD OPERATING PROCEDURES

SOP: ERT-PROC-2008-20

PAGE: 11 of 26

REV: 1.1

EFFECTIVE DATE: 10/19/20

## GENERAL AIR MONITORING AND SAMPLING GUIDELINES

---

- Roadways (dirt or paved), which may generate dust that could mask site contaminants.
- Vegetation, such as trees and shrubs, which stabilizes soil and retards subsurface contaminants from becoming airborne. It also affects air flow and scrubs some contaminants from the air. Sometimes thick vegetation can make an otherwise ideal air monitoring location inaccessible.

Consider the duration of sampling activities when choosing the location and number of samples to be collected. For example, if the sampling period is limited to a few hours, one or two upwind and several downwind samples may be adequate, especially around major emission sources.

A short-term monitoring program ranges from several days to a few weeks and generally includes gathering data for site assessments, removal actions, and source determination data (for further modeling). Activities involved in a short-term sampling strategy must make the most of the limited possibilities for data collection. Consider moving upwind/downwind locations daily based on National Oceanic and Atmospheric Administration (NOAA) weather forecasts. Weather monitoring becomes critical where complex terrain and local meteorological effects frequently change wind direction. A number of alternatives can often fulfill the same objective.

Prevailing winds running the length of a valley usually require a minimum number of sampler locations; however, a complex valley may require more sampler locations to account for the wide variety of winds. At sites located on hillsides, wind will move down a valley and produce an upward fetch at the same time. Sampling locations may have to surround the site to measure the wind's impact.

Off-site sources may affect on-site monitoring. In this case, on-site meteorological data, concurrent with sampling data, is essential to interpreting the acquired data, and additional upwind sampling sites may be needed to fully characterize ambient background contaminant levels. Multiple off-site sources may require several monitoring locations, but if the sources are at a sufficient distance, only one monitoring location is needed.

Topography and weather are not the only factors to consider when selecting a sampling location; the sampling sites must be secure from vandals and mishap. Secure all sampling locations to the best extent possible in order to maintain chain of custody, and to prevent tampering with samples or loss of sampling units. High-volume sampling methods often require the use of 110 volt alternating current (VAC) electric power. When portable generators are used, the power quality may affect sampler operation. In addition, be aware that the generators themselves could be a potential pollution source if their placement is not carefully considered (i.e., use of a gas generator when collecting VOC samples).

### 7.2.4 Time, Duration and Frequency of Sampling Events

After choosing appropriate sampling or monitoring locations, determine the sampling frequency and the number of samples to be collected. The time of day, duration and frequency of sampling events is governed by:

- The effects of site activities and meteorology on emission rates
- The diurnal effect of the meteorology on downwind dispersion



# STANDARD OPERATING PROCEDURES

SOP: ERT-PROC-2008-20

PAGE: 12 of 26

REV: 1.1

EFFECTIVE DATE: 10/19/20

## GENERAL AIR MONITORING AND SAMPLING GUIDELINES

---

- The time period(s) of concern as defined by the objective
- The variability in the impact from other non-site-related sources
- Cost and other logistical considerations

The duration of the removal action and the number of hours per day that site work is conducted determine the time, duration, and frequency of samples. Short-term sampling programs may require daily sampling, while long-term programs may require 24-hour sampling every sixth or twelfth day. If the site will be undergoing removal activities 24 hours a day, continuous air monitoring or sampling may be warranted. However, if the site activities will be conducted for only eight hours a day and there are no emissions likely to occur during the remaining 16 hours, sampling would be appropriate prior to the start of daily activities, continuing during operations, and end at the conclusion of the daily activities. An off-peak sample collection can ensure that emissions are not persisting after the conclusion of daily cleanup activities. For some sites, emissions are still a factor several hours after daily site activities have been completed. Because of the typically decreased downwind dispersion in the evening, higher downwind concentrations than were present during daytime site activities may be detected. For sites where this is possible, the sampling duration needs to be lengthened accordingly.

Sampling duration and flow rate dictate the volume of air collected, and to a major degree, the RL. The analytical method selected will provide a reference to flow rate and volume. Flow rates are limited to the capacity of the pumps being employed and the contact time required by the collection media.

The duration or period of air sampling is commonly divided into two categories: (1) samples collected over a brief time period are referred to as "instantaneous" or "grab" samples that are usually collected in less than five minutes; and (2) average or integrated samples are collected over a significantly longer period of time. Integrated samples provide an average concentration over the entire sampling period. Integrated samples are not suited to determining cyclical releases of contaminants because periodic or cyclical events are averaged out by the proportionally long sampling duration.

### 7.2.5 Meteorological and Physical/Chemical Considerations

A meteorological monitoring program is an integral part of site monitoring activities. Meteorological data, which define local terrain impacts on air flow paths, are needed to interpret air concentration data. Meteorological data may be available from an existing station located near the site (i.e., at a local airport), otherwise a station should be set up at the site. These data will document the degree that samples actually were downwind and verify whether other worst-case assumptions were met. Meteorological parameters to be monitored are, at a minimum, wind speed, and wind direction. The remaining parameters primarily affect the amount of a contaminant available in the air.

- Wind Speed

When the contaminant of concern is a particulate, wind speed is critical in determining whether the particulate will become airborne, the quantity of the particulate that becomes airborne, and the distance the particulate will travel from the source. Wind speed also contributes to the volatilization of contaminants from liquid sources.





# STANDARD OPERATING PROCEDURES

SOP: ERT-PROC-2008-20

PAGE: 13 of 26

REV: 1.1

EFFECTIVE DATE: 10/19/20

## GENERAL AIR MONITORING AND SAMPLING GUIDELINES

---

- Wind Direction

Wind direction significantly influences the path of airborne contaminants. In addition, variations in wind direction increase the dispersion of pollutants from a given source.

- Temperature

Higher temperatures increase the rate of volatilization of organic and some inorganic compounds and affect the initial rise of gaseous or vapor contaminants. Therefore, worst-case emission of volatiles and semi-volatiles will likely occur at the hottest time of day, or on the hottest day of the site activities.

- Humidity

High humidity affects water-soluble chemicals and particulates. Humid conditions may dictate the sampling media used to collect the air sample or limit the volume of air sampled and thereby increase the detection limit.

- Atmospheric Pressure

Migration of landfill gases through the landfill surface and through surrounding soils is governed by changes in atmospheric pressure. In addition, atmospheric pressure will influence upward migration of gaseous contaminants from shallow aquifers into the basements or first floors of overlying structures.

In many cases, the transport and dispersion of air pollutants is complicated by local meteorology. Normal diurnal variations (i.e., temperature inversions) affect dispersion of airborne contaminants. Terrain features can enhance or create air inversions and can also influence the path and speed of air flow, complicating transport and dispersion patterns.

The chemical characteristics of a contaminant (i.e., molecular weight, physical state, vapor pressure, aerodynamic size, temperature, reactive compounds, and photodegradation) affect its behavior and can influence the method used to sample and analyze it.

### 8.0 CALCULATIONS

Volume is obtained by multiplying the sample time in minutes by the average flow rate. Sample volume should be indicated on the chain of custody record. Adjustments for temperature and pressure differences may be required.

Results are provided in parts per million (ppm), parts per billion (ppb), milligrams per cubic meter ( $\text{mg}/\text{m}^3$ ) or micrograms per cubic meter ( $\mu\text{g}/\text{m}^3$ ).

Refer to the analytical method or regulatory guidelines for other applicable calculations.

### 9.0 QUALITY ASSURANCE/QUALITY CONTROL

Specific QA/QC activities that apply to the implementation of these procedures will be listed in the QAPP



# STANDARD OPERATING PROCEDURES

SOP: ERT-PROC-2008-20

PAGE: 14 of 26

REV: 1.1

EFFECTIVE DATE: 10/19/20

## GENERAL AIR MONITORING AND SAMPLING GUIDELINES

---

prepared for the applicable sampling event. The following general QA procedures will also apply:

1. All data must be documented on approved field data sheets, in a site logbook, and/or recorded electronically.
2. All instrumentation must be operated in accordance with operation instructions as supplied by the manufacturer, unless otherwise specified in the QAPP. Equipment checkout must be performed prior to operation and must be documented.
3. Records must be maintained, documenting the training of the operators that use instrumentation and equipment for the collection of environmental information.

### 9.1 QA/QC Samples

QA/QC samples provide information on the variability and usability of environmental sample results. Various QA/QC samples may be collected to detect error or potential sources of sample bias. QA/QC samples are submitted with the field samples for analysis to aid in identifying the origin of field and/or analytical discrepancies. Following the QA/QC sample analysis, a determination can be made as to how the analytical results should be used. Collocated samples, background samples, field blanks, trip blanks and lot blanks are the most commonly collected QA/QC field samples. Performance evaluation (PE) samples and blank spikes provide additional measures of data QA/QC control. QA/QC results may suggest the need for modifying sample collection, preparation, handling, or analytical procedures if the resultant data do not meet site-specific QA or data quality objectives. Refer to ERT SOP, *Quality Assurance/Quality Control Samples*, for further details, and suggested frequencies for submittal of QA/QC samples.

### 9.2 Sample Documentation

All sample and monitoring activities should be documented legibly in ink. Any corrections or revisions should be made by lining through the incorrect entry and by initialing the error. All samples must be recorded on an Air Sampling Worksheet or logbook. A chain of custody record must be maintained from the time a sample is taken to the final deposition of the sample. Custody seals demonstrate that a sample container has not been opened or tampered with during transport or storage of samples. Enter all pertinent data into Scribe and print a COC record from Scribe. Refer to ERT SOP, *Sample Documentation*, for further information.

## 10.0 DATA VALIDATION

Data verification (completeness checks) must be conducted to ensure that all data inputs are present for ensuring the availability of sufficient information. These data are essential to providing an accurate and complete final deliverable. The ERT contractor's Task Leader (TL) is responsible for completing the UFP-QAPP verification checklist for each project. The data generated will be reviewed and processed by the TL prior to distribution.

Results for QA/QC samples should be evaluated for contamination. This information should be utilized to qualify the environmental sample results accordingly with data quality objectives.





# STANDARD OPERATING PROCEDURES

SOP: ERT-PROC-2008-20

PAGE: 15 of 26

REV: 1.1

EFFECTIVE DATE: 10/19/20

## GENERAL AIR MONITORING AND SAMPLING GUIDELINES

---

### 11.0 HEALTH AND SAFETY

Based on OSHA requirements, a site-specific health and safety plan (HASP) must be prepared for response operations under the Hazardous Waste Operations and Emergency Response (HAZWOPER) standard, [29 CFR 1910.120](#). Field personnel working for EPA's ERT should consult the Emergency Responder Health and Safety Manual currently located at [https://response.epa.gov/\\_HealthSafetyManual/manual-index.htm](https://response.epa.gov/_HealthSafetyManual/manual-index.htm) for the development of the HASP, required personal protective equipment (PPE) and respiratory protection.

The majority of physical precautions involved in air sampling are related to the contaminant sampled. Attention should be given when sampling in potentially explosive, flammable or acidic atmospheres. On rare occasions, the collection media may be hazardous; for example, in the instance where an acidic or basic solution is utilized in an impinger.

### 12.0 REFERENCES

ACGIH. 2001. *Air Sampling Instruments for Evaluation of Atmospheric Contaminants, Ninth Edition*, 2001, American Conference of Governmental Industrial Hygienists, Cincinnati, OH.

ASTM. 2020. *Standard Terminology Relating to Sampling and Analysis of Atmospheres, D1356-20*.

Driscoll, Jack, 2013. "Monitoring of Soil Gas Extraction and Soil Gas by PID and FID Analyzers," Continuous Soil Gas Measurements: Worst Case Risk Parameters, STP 1570, Lorne G. Everett and Mark L. Kram, Eds., pp. 141–156, available online at [www.astm.org](http://www.astm.org)

NIOSH 2016. *NIOSH Manual of Analytical Methods*, Fifth Edition, [Online];Centers for Disease Control and Prevention. The National Institute for Occupational Safety and Health: Atlanta, GA. <https://www.cdc.gov/niosh/nmam/> (accessed May 5, 2020)

OIML. 1991. *Guide to Portable Instruments for Assessing Airborne Pollutants Arising from Hazardous Wastes*, International Organization of Legal Metrology (OIML) U.S. National Working Group (NWG) for OIML, American Conference of Governmental Industrial Hygienists, Cincinnati, OH.

OSHA. 1991. *Analytical Methods Manual, Second Edition. Part 1, Organic Substances*, January 1990. *Part 2, Inorganic Substances* August 1991.

Patty, F.A. 1994. *Industrial Hygiene and Toxicology, Fourth Edition*, John Wiley and Sons, Inc., New York, NY.

U.S. EPA. 1992. *Air Superfund National Technical Guidance Series. Volume I. Application of Air Pathway Analyses for Superfund Activities (Revised)*, November 1992. EPA/450/1-89/001a.

U.S. EPA. 1990. *Air Superfund National Technical Guidance Series. Volume II. Estimation of Baseline Air Emissions at Superfund Sites*, August 1990. EPA/450/1-89/002a.

U.S. EPA. 1989. *Air Superfund National Technical Guidance Series. Volume III. Estimations of Air Emissions from Cleanup Activities at Superfund Sites*. EPA/450/1-89/003.

U.S. EPA. 1989. *Air Superfund National Technical Guidance Series. Volume IV. Procedures for Dispersion Air Modeling and Air Monitoring for Superfund Air Pathway Analysis*. EPA/450/1-89/004.



# STANDARD OPERATING PROCEDURES

SOP: ERT-PROC-2008-20

PAGE: 16 of 26

REV: 1.1

EFFECTIVE DATE: 10/19/20

## GENERAL AIR MONITORING AND SAMPLING GUIDELINES

---

U.S. EPA. 1999. *Compendium of Methods for the Determination of Toxic Organic Compounds in Ambient Air – Second Edition, January 1999*. EPA/625/R-96/010b.

U.S. EPA. Winberry, W.T. *Supplement to U.S. EPA/600/4-84/041: Compendium of Methods for the Determination of Toxic Organic Compounds in Ambient Air*. EPA/600/4-87/006.

U.S. EPA. 1992. *Removal Program Representative Sampling Guidance, Volume 2: Air*, Environmental Response Branch, Emergency Response Division, Office of Emergency and Remedial Response, Office of Solid Waste and Emergency Response, U.S. Environmental Protection Agency, April 1992, Interim Final.

### 13.0 APPENDICES

A – Portable Screening Devices and Specialized Analytical Instruments

B - Air Sampling Equipment and Media/Devices





# STANDARD OPERATING PROCEDURES

SOP: ERT-PROC-2008-20

PAGE: 17 of 26

REV: 1.1

EFFECTIVE DATE: 10/19/20

## GENERAL AIR MONITORING AND SAMPLING GUIDELINES

---

### APPENDIX A

Portable Screening Devices and Specialized Analytical Instruments

SOP: ERT-PROC-2008-20

October 2020



# STANDARD OPERATING PROCEDURES

SOP: ERT-PROC-2008-20

PAGE: 18 of 26

REV: 1.1

EFFECTIVE DATE: 10/19/20

## GENERAL AIR MONITORING AND SAMPLING GUIDELINES

---

### PORTABLE SCREENING DEVICES

The following represent typical examples of air monitoring technologies. These monitoring devices may exist as a stand-alone instrument utilizing a single technology or may be combined into a multi-gas meter.

- Total Hydrocarbon Analyzers

Total hydrocarbon analyzers used to detect a variety of VOCs at hazardous waste sites principally employ either a PID or an FID. Compounds are ionized by a flame or an ultraviolet lamp. PIDs depend on the ionization potential of the compounds of interest. PIDs are sensitive to aromatic and olefinic (unsaturated) compounds such as benzene, toluene, styrene, xylenes, and acetylene. Greater selectivity is possible by using low-voltage lamps (i.e. fewer compounds will be detected). The ionization potential of individual compounds can be found in the NIOSH Pocket Guide to Chemical Hazards or from the specific instrument manufacturer. These instruments are not compound-specific and are typically used as screening instruments. FIDs are sensitive to volatile organic vapor compounds such as methane, propanol, benzene and toluene, but FIDs respond poorly to organic compounds lacking hydrocarbon characteristics.

Examples of instruments included under this grouping include the TVA 1000 & TVA 2020 (FID and PID), and AreaRAE/AreaRAE Pro/MultiRAE Pro (PID as part of multi-gas meter).

- Oxygen and Combustible Gas Indicators

Combustible Gas Indicators (CGIs) provide efficient and reliable methods to test for potentially explosive atmospheres. CGI meters measure the concentration of a flammable vapor or gas in air and present these measurements as a percentage of the lower explosive limit (LEL). The measurements are temperature-dependent. The properties of the calibration gas determines sensitivity. LELs for individual compounds can be found in the NIOSH Pocket Guide to Chemical Hazards or from the specific instrument manufacturer. If readings approach or exceed 10% of the LEL, extreme caution should be exercised in continuing the investigation. If readings approach or exceed 25% LEL, personnel should be withdrawn immediately.

CGIs typically house an electrochemical sensor to determine the oxygen concentration in ambient air. Normally, air contains approximately 20.9% oxygen by volume. Oxygen measurements are of particular importance for work in enclosed spaces, low-lying areas, or in the vicinity of accidents that have produced heavier-than-air vapors that could displace ambient air. The meters are calibrated for sea level and may indicate a false negative (i.e., oxygen [O<sub>2</sub>] content) at higher altitudes. Since the air has been displaced by other substances, these oxygen-deficient areas are also prime locations for taking additional organic vapor and combustible gas measurements. Oxygen-enriched atmospheres increase the potential for fires by their ability to contribute to combustion or to chemically react with flammable compounds and promote auto-ignition.

Examples of instruments included under this grouping include the AreaRAE/AreaRAE Pro/MultiRAE Pro (LEL and O<sub>2</sub> as part of multi-gas meter).

- Toxic Gas Sensors

Toxic gas sensors are compound-specific electrochemical sensors, designed and calibrated to identify and quantify a specific compound or class of compounds in either gaseous or vapor form. Cross-sensitivity to air pollutants not of interest may lead to erroneous results. Common toxic gas sensors include carbon monoxide, hydrogen sulfide, sulfur dioxide, nitric oxide, nitrogen dioxide, ammonia, chlorine, hydrogen cyanide, and phosphine.





# STANDARD OPERATING PROCEDURES

SOP: ERT-PROC-2008-20

PAGE: 19 of 26

REV: 1.1

EFFECTIVE DATE: 10/19/20

## GENERAL AIR MONITORING AND SAMPLING GUIDELINES

---

Examples of instruments included under this grouping include the AreaRAE/AreaRAE Pro and MultiRAE Pro (user-selected toxic sensors are components of multi-gas meter).

- Aerosol/Particulate Monitors

Aerosol/particulate monitors are utilized when the contaminant of concern is associated with particulates, and when responding to fires. The Thermo Scientific DataRAM-4 (DataRAM-4) is a Real-time Aerosol/Particulate Monitor that uses a dual-wavelength nephelometer whose light scattering sensing configuration has been optimized for the measurement of the fine particle fraction of airborne dust, smoke, fumes and mists in ambient, atmospheric, industrial, research, and indoor environments. The DataRAM-4 also has an integrated datalogger.

The Met-One e-BAM beta attenuation monitor employs the absorption of beta radiation by solid particles extracted from the airflow.

Both the DataRAM-4 and the e-BAM can be configured to measure total particulates, or PM<sub>10</sub> or PM<sub>2.5</sub> fractions.

The TSI Dusttrak DRX is a light-scattering laser photometer that uses both particle cloud and single particle detection to differentiate mass fraction measurements of PM<sub>1</sub>, PM<sub>2.5</sub>, PM<sub>10</sub> and total particulates. It will output and log data from all four size categories at the same time.

- Colorimetric detectors

### Colorimetric Tubes

A chemical detector tube is a hollow, tube-shaped, glass body containing one or more layers of chemically impregnated inert material. To use, the fused ends are broken off and a manufacturer-specified volume of air is drawn through the tube with a pump to achieve a given detection limit. The chemicals contained within the packing material undergo a chemical reaction with the airborne pollutant, if present, and produce a color change during the intake of each pump stroke. The concentration of a pollutant is indicated by the length of discoloration on a calibrated scale printed on the detector tube.

The instruments included under this grouping consist of Dräger Tubes.

### Chemically-impregnated tapes (i.e. Chemcassettes)

A chemcassette is a chemically impregnated tape that reacts with a specific chemical or class of chemicals in a sample stream, if present, to generate a colorimetric response. The response is measured by an optical scanning device programmed to provide ppb or ppm results of a particular gas.

The instruments included under this grouping consist of the Single Point Monitor (SPM) or SPM Flex.

- Radiation Detectors

Radiation detectors determine the presence and level of radiation at a site. The meters use a gas or solid ion detection media that becomes ionized when radiation is present. The meters are normally calibrated to one probe. Meters that detect alpha, beta, and gamma radiation are available.

Examples of instruments included under this grouping consist of the Ludlum 2241 and AreaRAE Gamma.



# STANDARD OPERATING PROCEDURES

SOP: ERT-PROC-2008-20

PAGE: 20 of 26

REV: 1.1

EFFECTIVE DATE: 10/19/20

## GENERAL AIR MONITORING AND SAMPLING GUIDELINES

---

- Gold Film (Hydrogen Sulfide and Mercury Vapor) Monitors

Hydrogen sulfide (H<sub>2</sub>S) and mercury (Hg) monitors operate on the principle that electric resistivity increases across a gold film as a function of H<sub>2</sub>S or Hg concentration. These monitors provide rapid and relatively low detection limits for H<sub>2</sub>S or Hg in air. After extensive sampling periods or exposure to elevated airborne concentrations of H<sub>2</sub>S and Hg at a site, the gold film must be heated to remove contamination and return the monitor to its original sensitivity.

The instruments included under this grouping consist of the Jerome 431-X (Hg), Jerome 405 (Hg) and Jerome 631-X (H<sub>2</sub>S).

- Differential Zeeman Atomic Absorption Spectroscopy Analyzers

These high sensitivity and selectivity instruments are portable multifunctional differential atomic absorption spectrometers with the direct Zeeman effect for interference-free measurement of mercury and benzene vapor concentrations in air and gases. The mercury analyzer uses atomic absorption spectrometry at 254 nanometers (nm) with Zeeman correction for background absorption and does not require gold amalgam pre-concentration and subsequent regeneration steps. The BA-15 uses differential absorption spectrometry with the direct Zeeman effect. Both instruments are intended for measuring mercury or benzene vapor concentrations in ambient air and in the air of residential and production areas, and can be used in stationary and continuous modes.

The instruments included in this grouping are the RA-915M and the RA-915+ mercury vapor analyzers as well as the BA-15 benzene vapor analyzer.





# STANDARD OPERATING PROCEDURES

SOP: ERT-PROC-2008-20

PAGE: 21 of 26

REV: 1.1

EFFECTIVE DATE: 10/19/20

## GENERAL AIR MONITORING AND SAMPLING GUIDELINES

---

### APPENDIX B

Air Sampling Equipment and Media/Devices

SOP: ERT-PROC-2008-20

October 2020



# STANDARD OPERATING PROCEDURES

SOP: ERT-PROC-2008-20

PAGE: 22 of 26

REV: 1.1

EFFECTIVE DATE: 10/19/20

## GENERAL AIR MONITORING AND SAMPLING GUIDELINES

---

### AIR SAMPLING EQUIPMENT

- High-Volume PS-1 Samplers

High-volume PS-1 samplers draw a sample through polyurethane foam (PUF) or a combination foam and XAD-2 resin plug, and a glass quartz filter at a rate of 5-10 cubic feet per minute (CFM; ft<sup>3</sup>/min) (144 to 282 liters per minute [L/min]). This system is excellent for measuring low concentrations of Semivolatile organic compounds (SVOCs), polychlorinated biphenyls (PCBs), pesticides, or chlorinated dioxins in ambient air.

- Area Sampling Pumps

These pumps provide flow-rate ranges between 2-20 L/min and have a telescopic sampling mast associated with the sampling train. Because of the higher volume that this pump is able to collect, this pump is suitable for sampling low concentrations of airborne contaminants (i.e., asbestos sampling). These pumps are also used to support metals, pesticides, and PAH sampling methods, which require large sample volumes.

- Personal Sampling Pumps

Personal sampling pumps are reliable portable sampling devices that draw air samples through a number of different types of sampling media including resin tubes, impingers, and filters. Flow rates are usually adjustable from 1 to 4 L/min (or 0.01 to .75 L/min with a restrictive orifice) and can remain constant for up to 8 hours on one battery charge or continuously with an alternating current (AC) charger/converter.

- Canister Samplers

Evacuated canister sampling systems use the pressure differential between the evacuated canister and ambient pressure to bleed air into the canister. The sample is bled into the canister at a constant rate over the sampling period using a critical orifice, a mechanically compensated regulator, or a mass flow control device until the canister is near atmospheric pressure.





# STANDARD OPERATING PROCEDURES

SOP: ERT-PROC-2008-20

PAGE: 23 of 26

REV: 1.1

EFFECTIVE DATE: 10/19/20

## GENERAL AIR MONITORING AND SAMPLING GUIDELINES

---

### AIR SAMPLING MEDIA/DEVICES

If possible, before employing a specific sampling method, consult the laboratory that will conduct the analyses. Many of the methods can be modified to provide results that best support the project objectives or to provide a wider range of analytical results.

- SUMMA Canisters

SUMMA canisters are highly polished passivated stainless steel cylinders. The SUMMA polishing process brings chrome and nickel to the surface of the canisters, which results in an inert surface. This surface restricts adsorption or reactions that occur on the canister's inner surface after collection. Alternatively, a fused-silica lining may be incorporated on the canister's inner surface (e.g. Silocan, Silcosteel). At the site, the canister may be paired with a flow controller to collect a time-weighted average sample over a given sample period (e.g. 24-hours) or opened directly to collect a grab sample. Typical applications use 6-liter Summa canisters for VOC and/or permanent gas analysis.

- Passive Dosimeters

Passive dosimeters are clip-on vapor monitors (samplers) in which the diffused contaminants are adsorbed on specially prepared active surfaces. Industrial hygienists commonly use dosimeters to obtain time-weighted averages or concentrations of chemical vapors, as they can trap over 130 organic compounds. Selective dosimeters have also been developed for a number of chemicals including formaldehyde, ethylene oxide, hydrogen sulfide, mercury vapor, nitrogen dioxide, sulfur dioxide, and ozone. Dosimeters must be sent to a laboratory for analysis.

- Polyurethane Foam (PUF)

PUF is a sorbent used with a glass filter for the collection of SVOCs such as pesticides, PCBs, chlorinated dioxins and furans, and polycyclic aromatic hydrocarbons (PAHs). Fewer artifacts (chemical changes that occur to collected compounds) are produced than with some other solid sorbents. Polyurethane foam (PUF) is used with the PS-1 sampler and U.S. EPA Method TO-13. PUF can also be used with personal sampling pumps when sampling for pesticides and PCBs following EPA Method TO-10A. Breakthrough of the more volatile PCBs and PAHs may occur when using PUF.

- Sampling Bags (Tedlar)

Sampling bags, like canisters, transport air samples to the laboratory for analysis. Samples are generally collected using a lung system, in which a pump creates a vacuum around the bag in a vacuum box (lung box), causing the sample to flow from a source into the bag. This method is used for VOCs, fixed gases (carbon dioxide [CO<sub>2</sub>], O<sub>2</sub> and nitrogen [N<sub>2</sub>]), sulfur compounds, and methane. If samples are shipped to an off-site laboratory, it is good practice to collect duplicate bags for each sample, minimizing sample loss due to sample bags breaking or leaking.

- Impingers

An impinger allows an air sample to be bubbled through a solution, which collects a specific contaminant by either chemical reaction or absorption. For long sampling periods, the impinger may need to be kept in an ice bath to prevent the solution from evaporating during sampling. The sample is drawn through the impinger by using a sampling pump or more elaborate sampling trains with multiple impingers.



# STANDARD OPERATING PROCEDURES

SOP: ERT-PROC-2008-20

PAGE: 24 of 26

REV: 1.1

EFFECTIVE DATE: 10/19/20

## GENERAL AIR MONITORING AND SAMPLING GUIDELINES

---

- Sorbent Tubes/Cartridges

A variety of sampling media are available in sorbent tubes, which are used primarily for industrial hygiene. A few examples are carbon cartridges, carbon molecular sieves, Tenax tubes, and tubes containing the XAD-2 polymer. Depending upon the sorbent material, tubes can be analyzed using either a solvent extraction or thermal desorption. The former technique uses standard laboratory equipment and allows for multiple analyses of the same sample. The latter technique requires special, but readily available, laboratory equipment and allows only one analysis per sample. In addition, thermal desorption typically allows for lower detection limits by two or more orders of magnitude. Whenever sorbent tubes are being used for thermal desorption, they should be certified as "clean" by the laboratory doing the analysis.

### Thermally Desorbed Media

During thermal desorption, high-temperature gas streams are used to remove the compounds collected on a sorbent medium. The gas stream is injected and often cryofocused into an analytical instrument, such as a gas chromatograph (GC), for compound analysis:

- Tenax Tubes

Tenax tubes are made from commercially available polymer (p-phenylene oxide) packed in glass or stainless steel tubes through which air samples are drawn or sometimes pumped. These tubes are used in U.S. EPA Method TO-1 and volatile organic sampling trains (VOST) for volatile nonpolar organic, some polar organic, and some of the more volatile semivolatile organics. Tenax is not appropriate for many of the highly volatile organics (with vapor pressure greater than approximately 200 millimeter (mm) Hg).

- Carbonized Polymers

The carbon molecular sieve (CMS), a carbonized polymer, is a commercially available, carbon sorbent packed in stainless-steel sampling tubes through which air samples are drawn or sometimes pumped. These are used in U.S. EPA Method TO-2 for highly volatile nonpolar compounds that have low-breakthrough volumes on other sorbents. When high-thermal desorption temperatures are used with CMS, more variability in analysis may occur than with other sorbents.

- Mixed Sorbent Tubes

Sorbent tubes can contain two type of sorbents. Combining the advantages of each sorbent into one tube increases the possible types of compounds to be sampled. The combination of two sorbents can also reduce the chance that highly volatile compounds will break through the sorbent media. An example of a mixed sorbent tube is the combination of Tenax and charcoal with a carbonized molecular sieve. A potential problem with mixed sorbent tubes is the breakthrough of a compound from an earlier sorbent to a later sorbent from which it cannot be desorbed.

### Solvent-Extracted Media

Solvent-extracted media use the principle of chemical extraction to remove compounds collected on a sorbent media. The chemical solvent is injected into an instrument, such as a GC, for analysis of compounds. Examples of solvent-extracted media follow:





# STANDARD OPERATING PROCEDURES

SOP: ERT-PROC-2008-20

PAGE: 25 of 26

REV: 1.1

EFFECTIVE DATE: 10/19/20

## GENERAL AIR MONITORING AND SAMPLING GUIDELINES

---

- Chemically Treated Silica Gel

Silica gel is a sorbent that can be treated with various chemicals. The chemically treated silica gel can be used to sample for specific compounds in air. Examples include the 2,4-dinitrophenylhydrazine (DNPH)-coated silica gel cartridge used with EPA Method TO-11A.

- XAD-2 Polymers

XAD-2 polymers usually are placed in tubes, custom-packed sandwich-style with polyurethane foam, and prepared for use with EPA Method TO-13 or the semi-VOST method. The polymers are used for the collection of semivolatile polar and nonpolar organic compounds. The compounds collected on the XAD-2 polymer are chemically extracted for analysis.

- Charcoal Cartridges

Charcoal cartridges, consisting of primary and backup sections, trap compounds by adsorption. The design of the cartridges enables ambient air to be drawn through both the primary and backup sections, but the backup section is used to verify that breakthrough of the analytes captured in the first section did not occur (and the sample collection was quantitative). Quantitative sample collection is evident by the presence of target chemicals on the first charcoal section and the absence of target chemicals on the second section. The adsorbed compounds must be eluted, usually with a solvent extraction, and analyzed by GC with a detector, such as a Mass Spectrometer (MS).

- Tenax Tubes

Cartridges are used in OSHA and NIOSH methods in a manner similar to charcoal cartridges but typically for less volatile compounds.

### Particulate Filters

Particulate filters are used by having a sampling pump pass air through them. The filter collects the particulates present in the air, and the filter is analyzed for particulate mass, chemical composition, or radiological composition. Particulate filters are made from different materials that are described below.

- Mixed Cellulose Ester (MCE)

MCE is manufactured from mixed esters of cellulose which are a blend of nitro-cellulose and cellulose acetate. MCE filters are often used for metals sampling.

- Glass Fiber

Glass fiber is manufactured from glass fibers without a binder. Particulate filters with glass fiber provide high flow rates, wet strength, and solid holding capacity. Generally, the filters are used for gravimetric analysis of particulates.

- Polyvinyl Chloride

Particulate filters made with polyvinyl chloride are resistant to concentrated acids and alkalis. The low moisture pickup and light tare weight of these filters make them ideal for gravimetric analysis.



# STANDARD OPERATING PROCEDURES

SOP: ERT-PROC-2008-20

PAGE: 26 of 26

REV: 1.1

EFFECTIVE DATE: 10/19/20

## GENERAL AIR MONITORING AND SAMPLING GUIDELINES

---

- Teflon

Teflon is manufactured from polytetrafluoroethylene (PTFE). Particulate filters with Teflon are easy to handle and exceptionally durable. PTFE is the optimal choice for particle size-selective samplers.

- Cellulose

Particulate filters made with cellulose contain less than 0.01% ash. These filters are used to collect particulates.





# STANDARD OPERATING PROCEDURES

SOP: ERT-PROC-2130-20

PAGE: 1 of 15

REV: 1.0

EFFECTIVE DATE: 01/31/20

## OPERATION OF DRYCAL DEFENDER SERIES PRIMARY FLOW CALIBRATOR

---

### CONTENTS

#### DISCLAIMERS

1.0 SCOPE AND APPLICATION

2.0 METHOD SUMMARY

3.0 SAMPLE PRESERVATION, CONTAINERS, HANDLING, AND STORAGE

4.0 INTERFERENCES AND POTENTIAL PROBLEMS

5.0 EQUIPMENT/APPARATUS

6.0 PROCEDURES

6.1 Air Flow Train Setup

6.2 Panel Buttons

6.3 Power ON

6.4 Take Readings

6.4.1 Single Flow Reading

6.4.2 Continuous Mode Reading

6.5 Stop and Reset

7.0 CALCULATIONS

8.0 QUALITY ASSURANCE/QUALITY CONTROL

8.1 General Quality Assurance/Quality Control Procedures

8.2 Annual Calibration

9.0 DATA VALIDATION

10.0 HEALTH AND SAFETY

11.0 REFERENCES

12.0 APPENDICES

A - Specifications

B - Quarterly Maintenance Procedures



## STANDARD OPERATING PROCEDURES

SOP: ERT-PROC-2130-20

PAGE: 2 of 15

REV: 1.0

EFFECTIVE DATE: 01/31/20

### OPERATION OF DRYCAL DEFENDER SERIES PRIMARY FLOW CALIBRATOR

---

*The policies and procedures established in this document are intended solely for the guidance of OLEM employees of the U.S. Environmental Protection Agency (EPA). They are not intended and cannot be relied upon to create any rights, substantive or procedural, enforceable by any party in litigation with the United States. EPA reserves the right to act at variance with these policies and procedures, and to change them at any time without public notice. EPA strongly encourages all readers to verify the validity of the information contained in this document by consulting the most recent Code of Federal Regulations (CFR) and updated guidance documents.*

*Mention of trade names or commercial products does not constitute U.S. Environmental Protection Agency (U.S. EPA) endorsement or recommendation for use.*





# STANDARD OPERATING PROCEDURES

SOP: ERT-PROC-2130-20

PAGE: 3 of 15

REV: 1.0

EFFECTIVE DATE: 01/31/20

## OPERATION OF DRYCAL DEFENDER SERIES PRIMARY FLOW CALIBRATOR

---

### 1.0 SCOPE AND APPLICATION

This standard operating procedure (SOP) describes the start-up, operation and routine use of the Bios International Corporation DryCal® Primary Flow Calibrator. The procedures and figures contained in this SOP are taken from the *DryCal® Manual* (2004) with the written consent (11/19/2015) of Bios International Corporation and Mesa Labs.

The DryCal Defender is a field portable primary flow calibrator that is used for industrial hygiene, environmental and laboratory measurement applications. The DryCal Defender is a National Institute of Standards and Technology (NIST) primary calibration standard that uses dry piston technology and infrared sensors to obtain volumetric flow rates. The DryCal Defender can be used to measure gas flow for either a vacuum flow source or a pressure flow source. Applications include precise calibration of secondary standard calibration equipment, such as rotameters, and industrial hygiene and environmental air sampling bags or pumps. Rapid calibrations are accomplished without the use of a soap solution thus reducing the uncertainty associated with other flow meters or rotameters.

A Quality Assurance Project Plan (QAPP) in Uniform Federal Policy (UFP) format describing the project objectives must be prepared prior to deploying for a sampling event. The sampler needs to ensure that the methods used are adequate to satisfy the data quality objectives listed in the UFP-QAPP for a particular site.

The procedures in this SOP may be varied or changed as required, dependent on site conditions, equipment limitations or other procedural limitations. In all instances, the procedures employed must be documented on a Field Change Form and attached to the UFP-QAPP. These changes must be documented in the final deliverable.

### 2.0 METHOD SUMMARY

The DryCal Defender is a primary flow standard. The time required for a graphite composite piston to traverse a known distance within a glass flow cell is precisely measured, and an internal computer calculates the flow. When a flow reading begins, an internal valve closes, diverting gas into the glass flow cell for measurement. The piston rises at the rate of gas flow between two collimated light beams at a known distance apart. After a suitable acceleration period, the rate of piston travel between the beams is timed. As the piston passes the second beam, the flow reading ends, the valve opens, the gas is released, and the piston drops. The volumetric flow measurement, based upon the parameters of length and time, is instantly displayed on the liquid crystal display (LCD) in milliliters per minute (mL/min) or liters per minute (LPM).

### 3.0 SAMPLE PRESERVATION, CONTAINERS, HANDLING, AND STORAGE

- Air samples require no preservation or special handling.
- DryCal Defender calibrators can remain on charge until needed without causing damage to the battery.
- If the calibrator is stored for long periods of time, the battery should be charged at least once every three months.
- Always store calibrators in a clean, dry environment with intake/exhaust valve caps on and recharge the unit prior to use after long-term storage.



# STANDARD OPERATING PROCEDURES

SOP: ERT-PROC-2130-20

PAGE: 4 of 15

REV: 1.0

EFFECTIVE DATE: 01/31/20

## OPERATION OF DRYCAL DEFENDER SERIES PRIMARY FLOW CALIBRATOR

---

### 4.0 INTERFERENCES AND POTENTIAL PROBLEMS

- Flow reading error sources include:
  - When the DryCal Defender is used with pump models that pulsate (small shifts in flow rate during pulsation) the readings are affected accordingly.
  - Closure of the calibrator valve at the beginning of each flow reading results in a small pressure spike in the flow stream that can impact flow rate reading.
- Air containing cigarette smoke, excessive dust, or other particulates interferes with readings.
- Potential safety problems are presented in *Section 11.0 Health and Safety*.

### 5.0 EQUIPMENT/APPARATUS

The following equipment is provided for the operation and transport of the DryCal Defender Primary Flow Calibrator:

- DryCal Defender Flow Calibrator

Model	Optimum Flow Range ( $\pm 1\%$ )	Type/Type per Measurement
520L / 530L	5–500 mL/min	Single, Continuous, Burst /(1-15sec)
520M / 530M	50–5,000 mL/min	Single, Continuous, Burst /(1-15sec)
520H / 530H	300–30,000 mL/min	Single, Continuous, Burst /(1-15sec)

- Single-Station Battery Charger
- Tubing Kit
- Leak-test Accessory
- Additional High Flow Tubing with L, M, and H models
- Certificate of Calibration
- Instruction Manual

### 6.0 REAGENTS

This section is not applicable to this SOP.

### 7.0 PROCEDURES

#### 7.1 Air Flow Train Setup

An isolation device is recommended to smooth the pulsation input and calibrator valve pressure spikes. To smooth flow, install a 25-millimeter (mm), 0.8-micrometer ( $\mu\text{m}$ ) filter cassette in the flow train to create a suitable backpressure as needed.





# STANDARD OPERATING PROCEDURES

SOP: ERT-PROC-2130-20

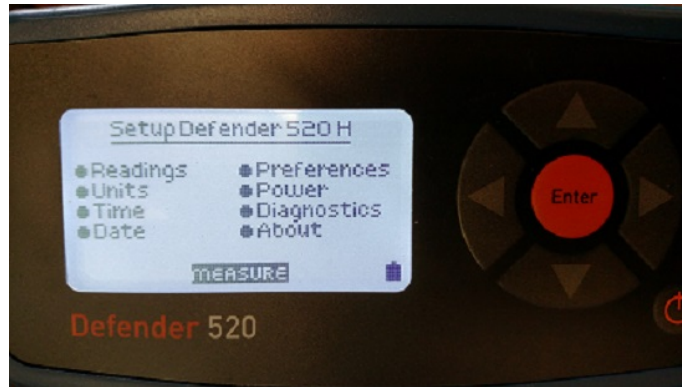
PAGE: 5 of 15

REV: 1.0

EFFECTIVE DATE: 01/31/20

## OPERATION OF DRYCAL DEFENDER SERIES PRIMARY FLOW CALIBRATOR

### 7.2 Panel Buttons



### 7.3 Power ON

1. Press the **ON** button to turn the calibrator on.
2. An initializing screen will be displayed first showing the computer revision number then the standard flow display screen, choose **SETUP** to proceed.

**Note: A Reset button is located on the lower back panel. If pressed, this button will quickly reset the unit to the initializing screen.**

**Note: The Defender has an “energy saving” 5 minute inactivity shut-off feature.**

3. Press and hold the **POWER** button, choose the **ON/OFF** button then scroll down to **CONFIRM** setup.

### 7.4 Take Readings

#### 7.4.1 Single Flow Reading

1. Connect tubing between the calibrator and the flow source with both instruments **ON**.

**Note: The calibrator connecting air flow ports are located on the right side of the unit. The upper port is for suction (outlet) and the lower port is for pressure (inlet).**



## STANDARD OPERATING PROCEDURES

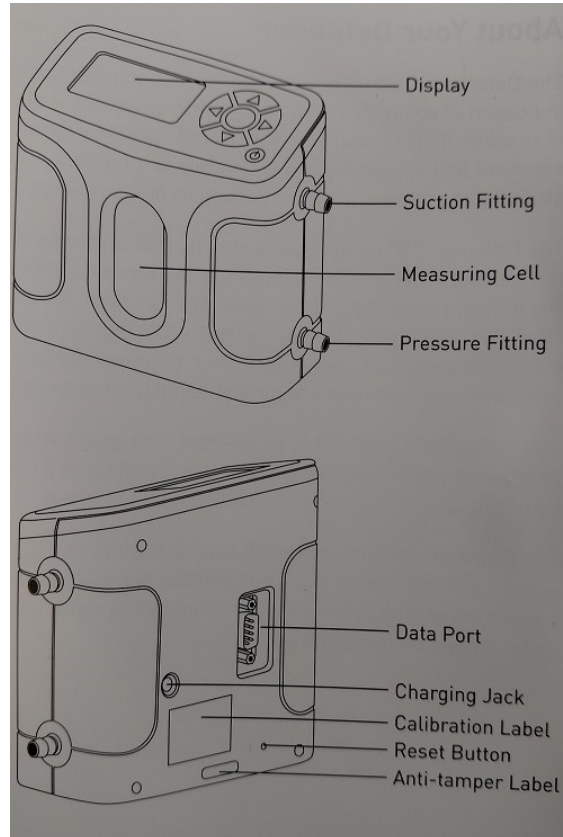
SOP: ERT-PROC-2130-20

PAGE: 6 of 15

REV: 1.0

EFFECTIVE DATE: 01/31/20

### OPERATION OF DRYCAL DEFENDER SERIES PRIMARY FLOW CALIBRATOR



**Note: For industrial hygiene or environmental applications, the sampling medium should also be connected in-line.**

2. Press the **READ** button **once** to obtain a single flow measurement display on the LCD screen.
3. A reading begins when the valve clicks shut, the white light-emitting diodes (LEDs) light, and the piston rises within the flow cell.
4. Continue the procedure to obtain the required number of flow readings.

**Note: All successive readings in an averaging sequence will be used to calculate the average flow. The unit will automatically clear the average after ten readings and begin a new averaging sequence.**

#### 7.4.2 Continuous Mode Reading

1. From main menu choose **Preferences** > press **Enter**; under **Read Defaults** choose **“Single”**, **“Continuous”** or **“Burst”** and scroll down to Confirm setup.
2. To stop the continuous read session, press the **STOP** button once.





# STANDARD OPERATING PROCEDURES

SOP: ERT-PROC-2130-20

PAGE: 7 of 15

REV: 1.0

EFFECTIVE DATE: 01/31/20

## OPERATION OF DRYCAL DEFENDER SERIES PRIMARY FLOW CALIBRATOR

---

The display will indicate the current flow reading (FLOW), the average flow value (AVERAGE) and the number of readings in the average (NUMBER IN AVERAGE) with a maximum of 10 readings as the average flow rate.

### 7.5 Stop and Reset

1. To stop a flow reading at any time, press and release **STOP** button.
2. To reset, press and hold the **STOP** button for two full seconds.
3. For a **Hard Reset** when the calibrator does not respond to push-button commands, press the recessed button on lower right side of the back panel near the parallel port.

### 8.0 CALCULATIONS

The DryCal Defender Primary Flow Calibrator is a direct reading instrument requiring no calculations.

The flow rate is calculated by the unit. The time required for a graphite composite piston to traverse a known distance within a glass flow cell is precisely measured, and an internal computer calculates the flow. The time the piston takes to move the known distance and implied volume yields the volumetric flow as:

$$q = \frac{v}{t} = \pi r^2 h/t$$

Where:

- $q$  = volumetric flow rate
- $v$  = measurement volume
- $t$  = measurement time
- $r$  = radius
- $h$  = measurement path length

### 9.0 QUALITY ASSURANCE/QUALITY CONTROL

#### 9.1 General Quality Assurance/Quality Control Procedures

- All data must be documented on field data sheets or in site logbooks.
- The instrument must be operated according to this SOP and the operating instructions supplied by the manufacturer, unless otherwise specified in the UFP- QAPP.
- Consult *Appendix B* Maintenance Records “Blue Book” (Quarterly Defender Bios Calibrator) for quarterly maintenance procedures.
- Records must be maintained, documenting the level of competency for the Contractor’s personnel who will operate the instrument.

#### 9.2 Annual Calibration

The DryCal Defender must be calibrated annually by an accredited vendor.



# STANDARD OPERATING PROCEDURES

SOP: ERT-PROC-2130-20

PAGE: 8 of 15

REV: 1.0

EFFECTIVE DATE: 01/31/20

## OPERATION OF DRYCAL DEFENDER SERIES PRIMARY FLOW CALIBRATOR

---

### 10.0 DATA VALIDATION

The operator will ensure that the DryCal® Defender Primary Flow Calibrator was operated in accordance with this SOP within instrument specifications and all operational checks have been completed and are within the criteria specified in the site-specific UFP-QAPP. The contractor's Task Leader is responsible for completing the UFP-QAPP verification checklist for each project.

### 11.0 HEALTH AND SAFETY

Based on Occupational Safety and Health Administration (OSHA) requirements, a site-specific health and safety plan (HASP) must be prepared for response operations under the Hazardous Waste Operations and Emergency Response (HAZWOPER) standard, [29 CFR 1910.120](#). Field personnel working for EPA's Environmental Response Team (ERT) should consult the Emergency Responder Health and Safety Manual currently located at <https://response.epa.gov/HealthSafetyManual/manual-index.htm> for the development of the HASP, required personal protective equipment (PPE) and respiratory protection.

Safety concerns specific to the operation of the DryCal Defender include:

- The DryCal Defender is not rated intrinsically safe and is not for use with explosive gases or for use in explosive environments.
- The Defender is not designed for pressurization above 0.35 bar (5 pounds per square inch [PSI]) or gas flows above the rated specifications of the flow cell in use. Consult *Appendix A: Specifications* for acceptable gas flow ranges.
- Use only with clean laboratory air or other inert, non-corrosive gases only.

### 12.0 REFERENCES

Mesa Laboratories, Inc. 2017. *Defender™ 500 Series User Manual (MK01-24 REV F)*.  
Mesa Laboratories, Inc. 2016. *Defender™ 530+ User Manual (MK01-51 REV A)*.

### 13.0 APPENDICES

A - Specifications  
B – Quarterly Maintenance Procedures





# STANDARD OPERATING PROCEDURES

SOP: ERT-PROC-2130-20

PAGE: 9 of 15

REV: 1.0

EFFECTIVE DATE: 01/31/20

## OPERATION OF DRYCAL DEFENDER SERIES PRIMARY FLOW CALIBRATOR

---

### APPENDIX A

#### Specifications

SOP: ERT-PROC-2130-20

January 2020

(Source: Bios International Corporation. - 2004. *DryCal® Defender Manual*)



# STANDARD OPERATING PROCEDURES

SOP: ERT-PROC-2130-20

PAGE: 10 of 15

REV: 1.0

EFFECTIVE DATE: 01/31/20

## OPERATION OF DRYCAL DEFENDER SERIES PRIMARY FLOW CALIBRATOR

### Defender 500 Series Specifications

#### Models:

510L/520L, from 5-500 mL/min

510M/520M, from 50-5,000 mL/min

510H/520H, from 300-30,000 mL/min

#### Measurements:

**Volumetric Accuracy:**  $\pm 1\%$  of reading

**Time per Measurement:** 1-15 seconds (approximate)

**Type:** Single, Continuous or Burst

**Volumetric Flow Units:** cc/min, mL/min, L/min, cf/min

**Pressure Units (Defender 520):** mmHg, PSI, kPa

**Temperature Units (Defender 520):** °C, °F

#### Basics:

**Dimensions (H x W x D):** 5.5 x 6 x 3 in / 140 x 150 x 75 mm

**Weight:** 29 oz / 820 g

**Configuration:** Integrated flow measuring cell, valve and timing mechanism

**Temperature & Pressure Sensors (Defender 520 model only):**

In the flow stream

Press.: 3.5 mmHg (typical), 7.0 mm (max);

Temp.: 0.8° C (typical), 1.3° C (max)

**AC Adapter/Charger:** 12V DC, >250ma, 2.5 mm, center positive

**Battery:** 6V rechargeable, sealed lead-acid, 6-8 hours typical operation





## STANDARD OPERATING PROCEDURES

SOP: ERT-PROC-2130-20

PAGE: 11 of 15

REV: 1.0

EFFECTIVE DATE: 01/31/20

### OPERATION OF DRYCAL DEFENDER SERIES PRIMARY FLOW CALIBRATOR

---

**Battery Operational Time (5 cycles/min):**

3 hrs backlight on, 8 hrs backlight off

**Pressure & Suction Fittings:** ¼" barbed tube fittings

**Display:** Backlit graphical LCD

**Usage:**

**Flow Modes:** Suction or Pressure

**Operating Pressure (Absolute):** 15 PSI

**Operating Temperature:** 0-50° C

**Ambient Humidity:** 0-70%, non-condensing

**Storage Temperature:** 0-70 °C

**Warranty:** 1 year; battery 6 months

**Bios Optimizer Software**

Requires Windows XP-SP2 or Windows 2000-SP3 compatible PC and RS-232 (serial) connection

Bios Optimizer 110 installation CD (supplied);  
no restrictions apply

RS-232 cable (supplied) for Defender 500 Series data port to  
PC RS-232 (serial) port connection

PC Card (optional and as necessary) creates an RS-232 port  
on your PC

Licensed upgrade to Bios Optimizer 120 is available



# STANDARD OPERATING PROCEDURES

SOP: ERT-PROC-2130-20

PAGE: 12 of 15

REV: 1.0

EFFECTIVE DATE: 01/31/20

## OPERATION OF DRYCAL DEFENDER SERIES PRIMARY FLOW CALIBRATOR

---

### 7.0 Defender 530+ Series Specifications

#### Technical data about your Defender 530+

**Models:**

530+ L, from 5-500 cc/min

530+ M, from 50-5,000 cc/min

530+ H, from 300-30,000 cc/min

**Measurements:**

**Standardized Accuracy:**  $\pm 1\%$  of reading

**Volumetric Accuracy:**  $\pm 0.75\%$  of reading

**Time per Measurement:** 1-15 seconds (approximate)

**Type:** Single, Continuous or Burst

**Volumetric Flow Units:** cc/min, mL/min, L/min, cf/min

**Standardized Flow Units:** scc/min, smL/min, sL/min, scf/min

**Pressure Units (Defender 530+):** mmHg, PSI, kPa

**Temperature Units (Defender 530+):** °C, °F

**Basics:**

**Dimensions (H x W x D):** 5.5 x 6 x 3 in / 140 x 150 x 75 mm

**Weight:** 29 oz / 820 g

**Configuration:** Integrated flow measuring cell, valve and timing mechanism

**Temperature & Pressure Sensors:** In the flow stream

**Press Accuracy:** 3.5 mmHg (typical), 7.0 mm (max);

**Temp Accuracy:** 0.8° C (typical), 1.3° C (max)

**AC Power Adapter/Charger:** 12VDC, >250ma, 2.5 mm, center positive

**Battery:** 6V rechargeable, sealed lead-acid, 6-8 hours typical operation





## STANDARD OPERATING PROCEDURES

SOP: ERT-PROC-2130-20

PAGE: 13 of 15

REV: 1.0

EFFECTIVE DATE: 01/31/20

### OPERATION OF DRYCAL DEFENDER SERIES PRIMARY FLOW CALIBRATOR

---

**Battery Operational Time (5 cycles/min):** 3 hrs backlight on, 8 hrs backlight off  
**Pressure & Suction Fittings:** 1/4" ID Swagelock® fittings for Low and Medium models, 3/8" ID for High model  
**Display:** Backlit graphical LCD

**Usage:**

**Flow Modes:** Suction or Pressure

**Operating Pressure (Absolute):** 15 PSI

**Operating Temperature:** 0-50°C

**Ambient Humidity:** 0-70%, non-condensing

**Storage Temperature:** 0-70°C

**Warranty:** 1 year; battery 6 months

**DryCal Pro Software:**

DryCal Pro Software System Requirements

- Windows® XP, Windows® 7
- Microsoft Excel® 2003 and up
- RS-232 port, or if your PC does not have an RS-232 port you will need a USB to RS-232 adapter



# STANDARD OPERATING PROCEDURES

SOP: ERT-PROC-2130-20

PAGE: 14 of 15

REV: 1.0

EFFECTIVE DATE: 01/31/20

## OPERATION OF DRYCAL DEFENDER SERIES PRIMARY FLOW CALIBRATOR

---

### APPENDIX B

Quarterly Maintenance Procedures

SOP: ERT-PROC-2130-20

January 2020

(Source: "Quarterly Defender Bios Calibrator")





# STANDARD OPERATING PROCEDURES

SOP: ERT-PROC-2130-20

PAGE: 15 of 15

REV: 1.0

EFFECTIVE DATE: 01/31/20

## OPERATION OF DRYCAL DEFENDER SERIES PRIMARY FLOW CALIBRATOR

Name: \_\_\_\_\_

Date: \_\_\_\_\_

**Prior to verification of each Unit check if below parameters are set correctly.**

Connect SKC pump via Tygon® tubing to "Suction Port" of the Defender unit.

"Setup Readings" (Press Enter) > "No. in Avg": 010 / "Time Between": 00 / "Type": Vol > Press Confirm & Exit

"Setup Units" (Press Enter) > "ml/min/Pressure": mmHg / "Temp": F > Press Confirm & Exit

Setup "Time and Date" following Menu as above.

"Preferences" (Press Enter) > "Read Default": Continuous / "Default Settings": No / "Data Port": BIOS / "Magnification": Detail > Press Confirm & Exit; now the Unit is ready for flow verification readings in ml/min.

Back to main menu and press "Measure" > "Continuous" = Record readings under "Readings ±1%"

Pass = Volumetric count functioning properly. Fail = Unit/Display/Counter not working; specify in comments.

Model Type	Volumetric Range	Unit S/N	Last Cal. Date	Cal. Due Date	Pass	Fail	Comments
Defender 520-L	5 - 500ml/min	111952					
Defender 520-L	5 - 500ml/min	111953					
Defender 530-L	5 - 500ml/min	136257					
Defender 530-L	5 - 500ml/min	136258					
Defender 520-M	50 - 500ml/min	111888					
Defender 520-M	50 - 500ml/min	111889					
Defender 530-M	50 - 500ml/min	136224					
Defender 530-M	50 - 500ml/min	136225					
Defender 520-H	300 - 30000ml/min	111511					
Defender 520-H	300 - 30000ml/min	111512					
Defender 530-H	300 - 30000ml/min	136060					
Defender 530-H	300 - 30000ml/min	136061					

## **Appendix E Data Evaluation and Reporting Process for Samples that Initially Received the Short List of Parameters.**

- To make this process as efficient as possible, the NS project team will provide the laboratory with a master list of all samples that need to be evaluated and reported at the beginning of this project.

Select samples from the Norfolk Southern EPTD site that were originally analyzed and reported under Appendix D will follow these steps:

1. The initial sample laboratory Job/Entry Group will be used for all data processing.
2. The laboratory will enter a new “Job Series” with all applicable samples within the existing/initial Job/Entry Group. This will use the existing laboratory and client sample IDs. Using this process will allow us to electronically upload the data into our TALS LIMS system, removing any potential errors due to manual entry.
3. Each designated sample will receive a new TALS method reference that will include the App E target COPCs with the short list of compounds removed.
  - a. Only new compound data will be reported during this process. The original short list of compounds will not be reevaluated or re-reported.
4. The technical departments will load the data into the new job series.
  - a. Calibration, detections, identification, quality control samples, blanks, surrogates, internal standards, etc. will be evaluated by a primary analyst.
    - i. Note: compounds that did not pass calibration criteria will not be reported.  
There is a potential for benzaldehyde to be removed from the SVOC list.
  - b. Second level review will be performed by each technical group for completeness and correctness.
  - c. Data will be evaluated to the RL for consistency with Appendix D reporting.
  - d. Any non-conformances/QC flags will be documented within the analysis report.
5. Analysis reports and EDD formats will be generated by the Project Management team and sent to the appropriate contacts.
  - a. Data will only be reported for the “new” compounds being evaluated. These will be stand-alone reports and EDDs.
  - b. Preliminary deliverables (laboratory report and EDD) will be provided for each reprocessed SDG.
6. Preliminary deliverables will be loaded to the data portal and to the NS EQUIS database. Upload loading to EQUIS, the reprocessed samples will be assigned a test\_type in dt\_test of “INITIAL3”. A preliminary data export will be provided to EPA for internal use only.
7. Reprocessed data will be subjected to Stage 2A data validation. Any observed errors will be corrected prior to data finalization. 10% of the reprocessed data will additionally be subjected to Stage 3 data validation, consistent with the QAPP.
8. Data usability qualifiers and reason codes will be added to the NS EQUIS database, consistent with the QAPP and DMP.
9. Upon data finalization, data validation reports and final laboratory reports will be posted to the NS Data Portal. EDDs containing final validated data will be loaded to the EPA R5 database.