



LED Flood Lights

V-TAC's LED Floodlights are ideal for lighting Driveways, Gardens and Buildings. These energy efficient lights emit Bright, Vibrant Light and are an eco friendly replacement for traditional Halogen Floodlights and Metal Halide fixtures.

Product Features

- Available in White , Warm White, Day White and RGB light output option
- Available from 10W up to 1000W
- Premium Quality Aluminium Alloy body
- Corrosion Resistant
- Fascia glass sealed with SILICONE RUBBER ensuring superior waterproof /airtight performance
- High Power LED chip
- Built in constant current driver
- Built in Power supply, No external ballast required



Applications

Widely used for Lighting Driveways, Gardens & Buildings, Commercial Bill Boards & Hoardings, Plazas, Sports Grounds & Parking Lots

LUMINOUS INTENSITY DISTRIBUTION DIAGRAM

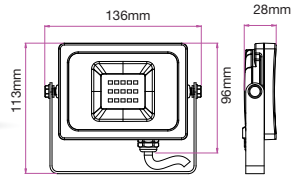
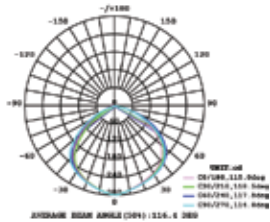

10W VT-4911

- 5771 - 3000K Warm White
- 5772 - 4000K Day White
- 5773 - 6400K White

EAN Code

- 3800157614450
- 3800157614467
- 3800157614474



Sensor Compatible:	Yes	Beam Angle:	100°
Voltage/Frequency:	AC:220-240V/50Hz	Color of Fixture:	White
Luminous Flux:	800lm	Body Type:	Aluminium Die Cast
CRI:	>70	IP Rating:	IP65
PF:	>0.9	Dimension:	113x126x28mm

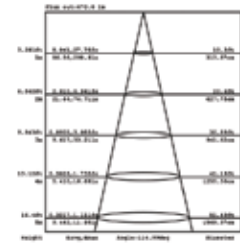

Note: The Curves Indicate the illuminated area and the average illumination when the luminaire is at different distance.

LUMINOUS INTENSITY DISTRIBUTION DIAGRAM

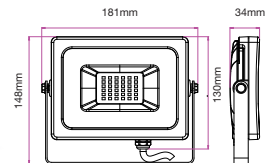
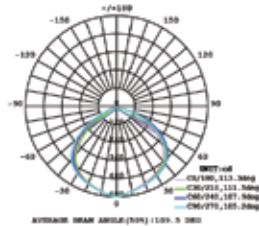

20W VT-4922

- 5789 - 3000K Warm White
- 5790 - 4000K Day White
- 5791 - 6400K White

EAN Code

- 3800157614634
- 3800157614641
- 3800157614658



Sensor Compatible:	Yes	Beam Angle:	100°
Voltage/Frequency:	AC:220-240V/50Hz	Color of Fixture:	White
Luminous Flux:	1600lm	Body Type:	Aluminium Die Cast
CRI:	>70	IP Rating:	IP65
PF:	>0.9	Dimension:	148x181x34mm

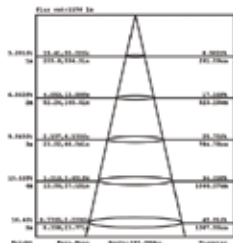

Note: The Curves Indicate the illuminated area and the average illumination when the luminaire is at different distance.

LUMINOUS INTENSITY DISTRIBUTION DIAGRAM

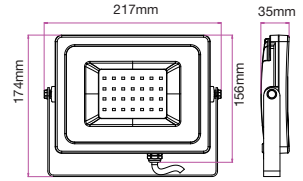
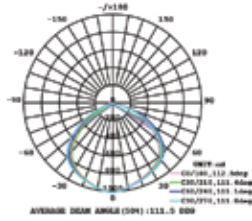

30W VT-4933

EAN Code

- 5807 - 3000K Warm White
- 5808 - 4000K Day White
- 5809 - 6400K White

- 3800157614818
- 3800157614825
- 3800157614832



Sensor Compatible:	Yes	Beam Angle:	100°
Voltage/Frequency:	AC:220-240V/50Hz	Color of Fixture:	White
Luminous Flux:	2550lm	Body Type:	Aluminium Die Cast
CRI:	>70	IP Rating:	IP65
PF:	>0.9	Dimension:	174 x 217 x 35mm

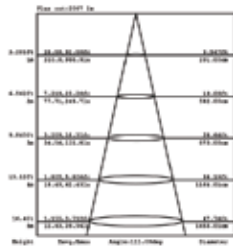

Note: The Curves indicate the illuminated area and the average illumination when the luminance is at different distance.

LUMINOUS INTENSITY DISTRIBUTION DIAGRAM

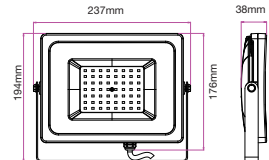
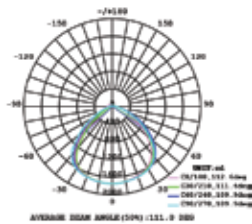

50W VT-4955

EAN Code

- 5825 - 3000K Warm White
- 5826 - 4000K Day White
- 5827 - 6400K White

- 3800157614993
- 3800157615006
- 3800157615013



Sensor Compatible:	Yes	Beam Angle:	100°
Voltage/Frequency:	AC:220-240V/50Hz	Color of Fixture:	White
Luminous Flux:	4250lm	Body Type:	Aluminium Die Cast
CRI:	>70	IP Rating:	IP65
PF:	>0.9	Dimension:	194 x 237 x 38mm

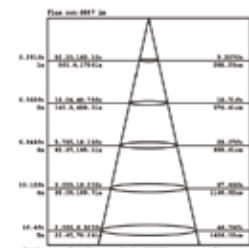

Note: The Curves indicate the illuminated area and the average illumination when the luminance is at different distance.

LUMINOUS INTENSITY DISTRIBUTION DIAGRAM

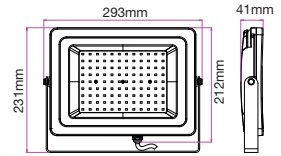
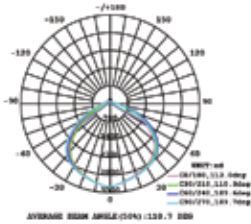

100W VT-49100

EAN Code

- 5843 - 3000K Warm White
- 5844 - 4000K Day White
- 5845 - 6400K White

- 3800157615174
- 3800157615181
- 3800157615198



Sensor Compatible: Yes	Beam Angle: 100°
Voltage/Frequency: AC:220-240V/50Hz	Color of Fixture: White
Luminous Flux: 8500lm	Body Type: Aluminium Die Cast
CRI: >70	IP Rating: IP65
PF: >0.9	Dimension: 231x 293 x41mm

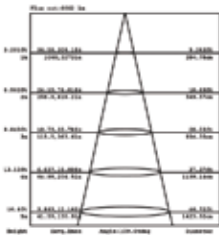

Note: The Curves indicate the illuminated area and the average illumination when the luminaire is at different distance.

LUMINOUS INTENSITY DISTRIBUTION DIAGRAM

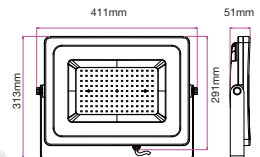
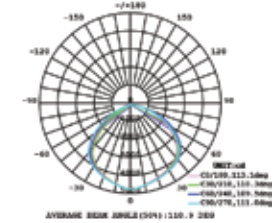

150W VT-49150

EAN Code

- 5855 - 3000K Warm White
- 5856 - 4000K Day White
- 5857 - 6400K White

- 3800157615297
- 3800157615303
- 3800157615310



Sensor Compatible: Yes	Beam Angle: 100°
Voltage/Frequency: AC:220-240V/50Hz	Color of Fixture: White
Luminous Flux: 12750lm	Body Type: Aluminium Die Cast
CRI: >70	IP Rating: IP65
PF: >0.9	Dimension: 313 x 411x 51mm

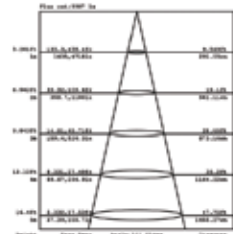

Note: The Curves indicate the illuminated area and the average illumination when the luminaire is at different distance.



200W VT-49200

EAN Code

5909 - 4000K Day White
5910 - 6400K White

3800157619431
3800157619448



Sensor Compatible:	Yes	Beam Angle:	100°
Voltage/Frequency:	AC:200-240V/50Hz	Color of Fixture:	White
Luminous Flux:	17000lm	Body Type:	Aluminium Die Cast
CRI:	>70	IP Rating:	IP65
PF:	>0.9	Dimension:	340 x 454x 56mm

LUMINOUS INTENSITY DISTRIBUTION DIAGRAM

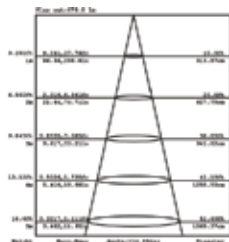
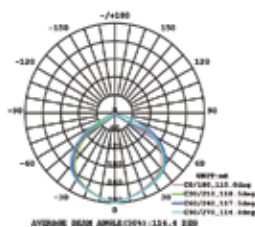

Note: The Curves indicate the illuminated area and the average illumination when the luminaire is at different distance.

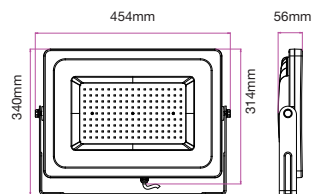

LUMINOUS INTENSITY DISTRIBUTION DIAGRAM

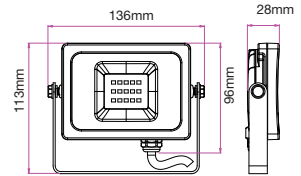
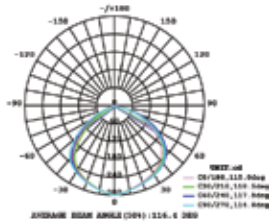

10W VT-4911

EAN Code

- 5774 - 3000K Warm White
- 5775 - 4000K Day White
- 5776 - 6400K White

- 3800157614481
- 3800157614498
- 3800157614504



Sensor Compatible:	Yes	Beam Angle:	100°
Voltage/Frequency:	AC:220-240V/50Hz	Color of Fixture:	Grey / Black
Luminous Flux:	800lm	Body Type:	Aluminium Die Cast
CRI:	>70	IP Rating:	IP65
PF:	>0.9	Dimension:	113x136x28mm

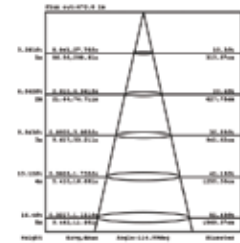

Note: The Curves Indicate the illuminated area and the average illumination when the luminaire is at different distance.

LUMINOUS INTENSITY DISTRIBUTION DIAGRAM

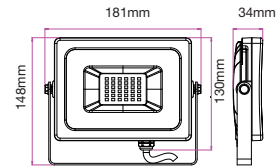
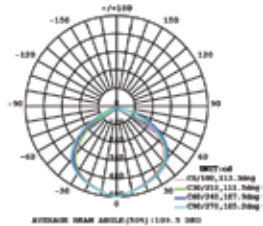

20W VT-4922

EAN Code

- 5792 - 3000K Warm White
- 5793 - 4000K Day White
- 5794 - 6400K White

- 3800157614665
- 3800157614672
- 3800157614689



Sensor Compatible:	Yes	Beam Angle:	100°
Voltage/Frequency:	AC:220-240V/50Hz	Color of Fixture:	Grey / Black
Luminous Flux:	1600lm	Body Type:	Aluminium Die Cast
CRI:	>70	IP Rating:	IP65
PF:	>0.9	Dimension:	148x181x34mm

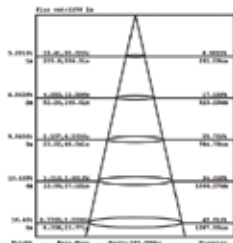

Note: The Curves Indicate the illuminated area and the average illumination when the luminaire is at different distance.

LUMINOUS INTENSITY DISTRIBUTION DIAGRAM

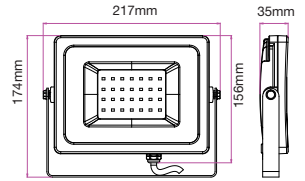
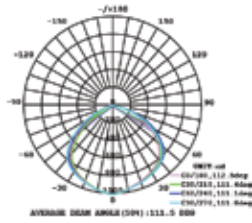

30W VT-4933

EAN Code

- 5810 - 3000K Warm White
- 5811 - 4000K Day White
- 5812 - 6400K White

- 3800157614849
- 3800157614856
- 3800157614863



Sensor Compatible:	Yes	Beam Angle:	100°
Voltage/Frequency:	AC:220-240V/50Hz	Color of Fixture:	Grey / Black
Luminous Flux:	2550lm	Body Type:	Aluminium Die Cast
CRI:	>70	IP Rating:	IP65
PF:	>0.9	Dimension:	174 x 217 x 35mm

LUMINOUS INTENSITY DISTRIBUTION DIAGRAM

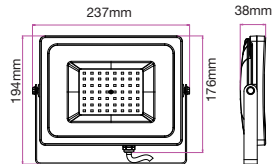
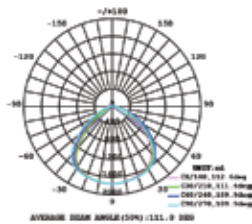

50W VT-4955

EAN Code

- 5828 - 3000K Warm White
- 5829 - 4000K Day White
- 5830 - 6400K White

- 3800157615020
- 3800157615037
- 3800157615044



Sensor Compatible:	Yes	Beam Angle:	100°
Voltage/Frequency:	AC:220-240V/50Hz	Color of Fixture:	Grey / Black
Luminous Flux:	4250lm	Body Type:	Aluminium Die Cast
CRI:	>70	IP Rating:	IP65
PF:	>0.9	Dimension:	194 x 237 x 38mm

LUMINOUS INTENSITY DISTRIBUTION DIAGRAM

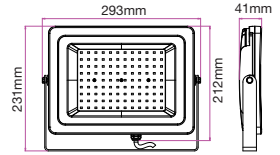
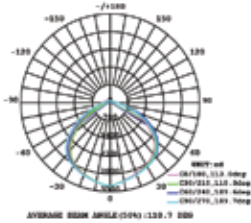

100W VT-49100

EAN Code

- 5846 - 3000K Warm White
- 5847 - 4000K Day White
- 5848 - 6400K White

- 3800157615204
- 3800157615211
- 3800157615228



Sensor Compatible:	Yes	Beam Angle:	100°
Voltage/Frequency:	AC:220-240V/50Hz	Color of Fixture:	Grey / Black
Luminous Flux:	8500lm	Body Type:	Aluminium Die Cast
CRI:	>70	IP Rating:	IP65
PF:	>0.9	Dimension:	231x 293 x41mm

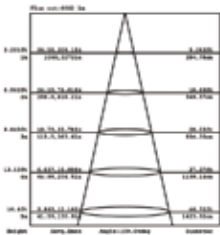

Note: The Curves indicate the illuminated area and the average illumination when the luminaire is at different distance.

LUMINOUS INTENSITY DISTRIBUTION DIAGRAM

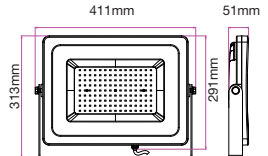
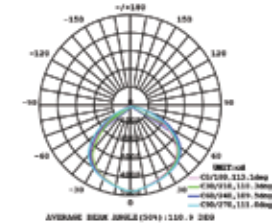

150W VT-49150

EAN Code

- 5858 - 3000K Warm White
- 5859 - 4000K Day White
- 5860 - 6400K White

- 3800157615327
- 3800157615334
- 3800157615341



Sensor Compatible:	Yes	Beam Angle:	100°
Voltage/Frequency:	AC:220-240V/50Hz	Color of Fixture:	Grey / Black
Luminous Flux:	12750lm	Body Type:	Aluminium Die Cast
CRI:	>70	IP Rating:	IP65
PF:	>0.9	Dimension:	313 x 411x 51mm

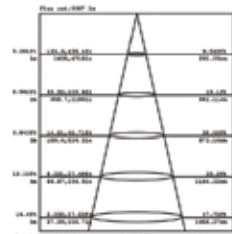

Note: The Curves indicate the illuminated area and the average illumination when the luminaire is at different distance.

LUMINOUS INTENSITY DISTRIBUTION DIAGRAM

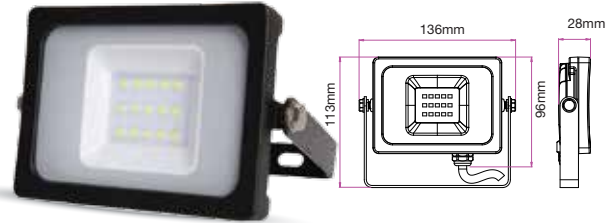
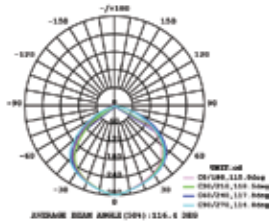

10W VT-4911

EAN Code

- 5777 - 3000K Warm White
- 5778 - 4000K Day White
- 5779 - 6400K White

- 3800157614511
- 3800157614528
- 3800157614535



Sensor Compatible:	Yes	Beam Angle:	100°
Voltage/Frequency:	AC:220-240V/50Hz	Color of Fixture:	Black
Luminous Flux:	800lm	Body Type:	Aluminium Die Cast
CRI:	>70	IP Rating:	IP65
PF:	>0.9	Dimension:	113x136x28mm

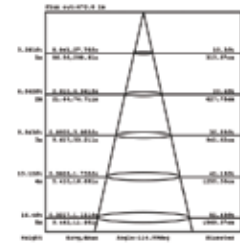

Note: The Curves Indicate the illuminated area and the average illumination when the luminaire is at different distance.

LUMINOUS INTENSITY DISTRIBUTION DIAGRAM

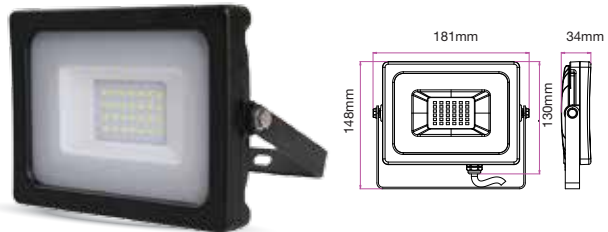
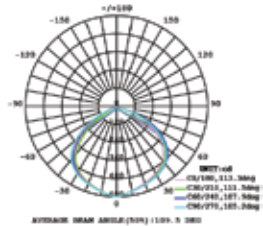

20W VT-4922

EAN Code

- 5795 - 3000K Warm White
- 5796 - 4000K Day White
- 5797 - 6400K White

- 3800157614696
- 3800157614702
- 3800157614719



Sensor Compatible:	Yes	Beam Angle:	100°
Voltage/Frequency:	AC:220-240V/50Hz	Color of Fixture:	Black
Luminous Flux:	1600lm	Body Type:	Aluminium Die Cast
CRI:	>70	IP Rating:	IP65
PF:	>0.9	Dimension:	148x181x34mm

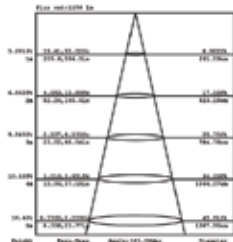

Note: The Curves Indicate the illuminated area and the average illumination when the luminaire is at different distance.

LUMINOUS INTENSITY DISTRIBUTION DIAGRAM

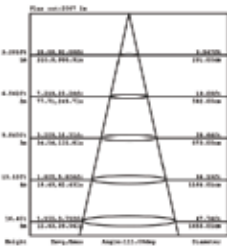
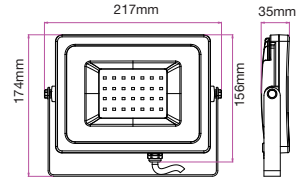
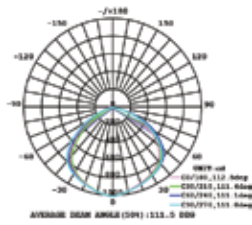

Note: The Curves indicate the illuminated area and the average illumination when the luminaire is at different distance.

30W VT-4933

EAN Code

- 5813 - 3000K Warm White
- 5814 - 4000K Day White
- 5815 - 6400K White

- 3800157614870
- 3800157614887
- 3800157614894



Sensor Compatible:	Yes	Beam Angle:	100°
Voltage/Frequency:	AC:220-240V/50Hz	Color of Fixture:	Black
Luminous Flux:	2550lm	Body Type:	Aluminium Die Cast
CRI:	>70	IP Rating:	IP65
PF:	>0.9	Dimension:	174 x 217 x 35mm

LUMINOUS INTENSITY DISTRIBUTION DIAGRAM

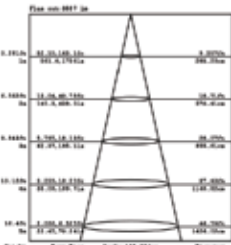
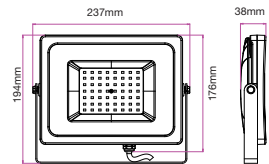
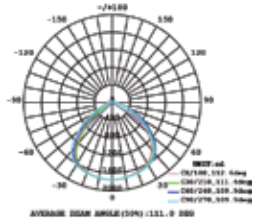

Note: The Curves indicate the illuminated area and the average illumination when the luminaire is at different distance.

50W VT-4955

EAN Code

- 5831 - 3000K Warm White
- 5832 - 4000K Day White
- 5833 - 6400K White

- 3800157615051
- 3800157615068
- 3800157615075



Sensor Compatible:	Yes	Beam Angle:	100°
Voltage/Frequency:	AC:220-240V/50Hz	Color of Fixture:	Black
Luminous Flux:	4250lm	Body Type:	Aluminium Die Cast
CRI:	>70	IP Rating:	IP65
PF:	>0.9	Dimension:	194 x 237 x 38mm



LUMINOUS INTENSITY DISTRIBUTION DIAGRAM

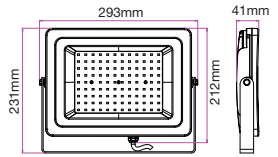
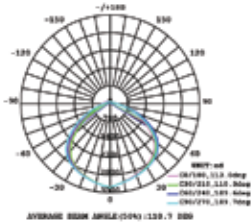

100W VT-49100

EAN Code

- 5849 - 3000K Warm White
- 5850 - 4000K Day White
- 5851 - 6400K White

- 3800157615235
- 3800157615242
- 3800157615259



Sensor Compatible:	Yes	Beam Angle:	100°
Voltage/Frequency:	AC:220-240V/50Hz	Color of Fixture:	Black
Luminous Flux:	8500lm	Body Type:	Aluminium Die Cast
CRI:	>70	IP Rating:	IP65
PF:	>0.9	Dimension:	231x 293 x41mm

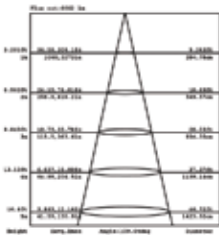

Note: The Curves indicate the illuminated area and the average illumination when the luminaire is at a different distance.

LUMINOUS INTENSITY DISTRIBUTION DIAGRAM

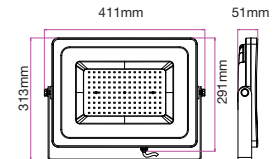
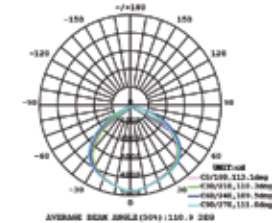

150W VT-49150

EAN Code

- 5861 - 3000K Warm White
- 5862 - 4000K Day White
- 5863 - 6400K White

- 3800157615358
- 3800157615365
- 3800157615372



Sensor Compatible:	Yes	Beam Angle:	100°
Voltage/Frequency:	AC:220-240V/50Hz	Color of Fixture:	Black
Luminous Flux:	12750lm	Body Type:	Aluminium Die Cast
CRI:	>70	IP Rating:	IP65
PF:	>0.9	Dimension:	313 x 411x 51mm

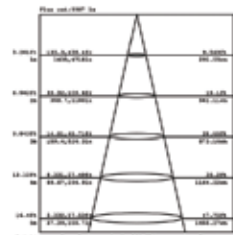

Note: The Curves indicate the illuminated area and the average illumination when the luminaire is at a different distance.

LUMINOUS INTENSITY DISTRIBUTION DIAGRAM

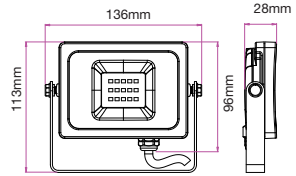
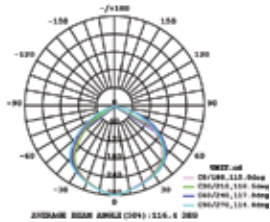

10W VT-4911

- 5780 - 3000K Warm White
- 5781 - 4000K Day White
- 5782 - 6400K White

EAN Code

- 3800157614542
- 3800157614559
- 3800157614566



Sensor Compatible: Yes	Beam Angle: 100°
Voltage/Frequency: AC:220-240V/50Hz	Color of Fixture: Grey
Luminous Flux: 800lm	Body Type: Aluminium Die Cast
CRI: >70	IP Rating: IP65
PF: >0.9	Dimension: 113x136x28mm

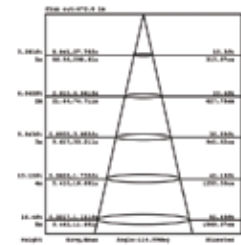

LUMINOUS INTENSITY DISTRIBUTION DIAGRAM

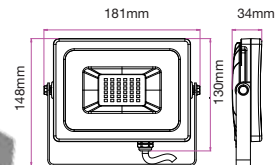
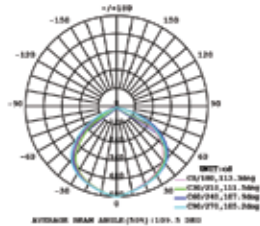

20W VT-4922

- 5798 - 3000K Warm White
- 5799 - 4000K Day White
- 5800 - 6400K White

EAN Code

- 3800157614726
- 3800157614733
- 3800157614740



Sensor Compatible: Yes	Beam Angle: 100°
Voltage/Frequency: AC:220-240V/50Hz	Color of Fixture: Grey
Luminous Flux: 1600lm	Body Type: Aluminium Die Cast
CRI: >70	IP Rating: IP65
PF: >0.9	Dimension: 148x181x34mm

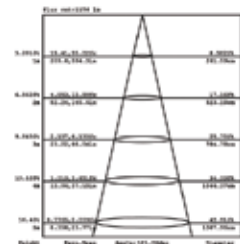

LUMINOUS INTENSITY DISTRIBUTION DIAGRAM

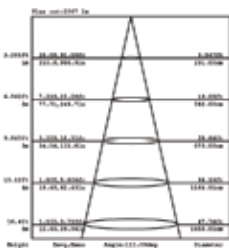
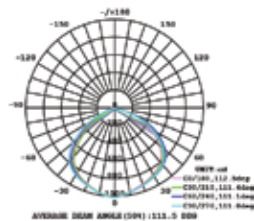

Note: The Curves indicate the illuminated area and the average illumination when the luminaire is at different distance.

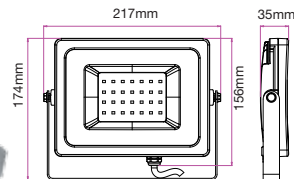

30W VT-4933

EAN Code

- 5816 - 3000K Warm White
- 5817 - 4000K Day White
- 5818 - 6400K White

- 3800157614900
- 3800157614917
- 3800157614924



Sensor Compatible: Yes	Beam Angle: 100°
Voltage/Frequency: AC:220-240V/50Hz	Color of Fixture: Grey
Luminous Flux: 2550lm	Body Type: Aluminium Die Cast
CRI: >70	IP Rating: IP65
PF: >0.9	Dimension: 174 x 217 x 35mm

LUMINOUS INTENSITY DISTRIBUTION DIAGRAM

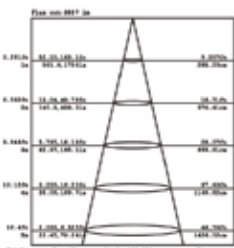
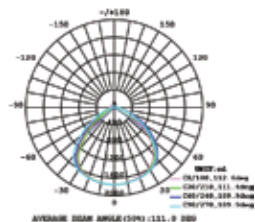

Note: The Curves indicate the illuminated area and the average illumination when the luminaire is at different distance.

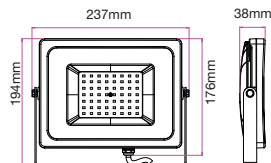

50W VT-4955

EAN Code

- 5834 - 3000K Warm White
- 5835 - 4000K Day White
- 5836 - 6400K White

- 3800157615082
- 3800157615099
- 3800157615105



Sensor Compatible: Yes	Beam Angle: 100°
Voltage/Frequency: AC:220-240V/50Hz	Color of Fixture: Grey
Luminous Flux: 4250lm	Body Type: Aluminium Die Cast
CRI: >70	IP Rating: IP65
PF: >0.9	Dimension: 194 x 237 x 38mm

LUMINOUS INTENSITY DISTRIBUTION DIAGRAM

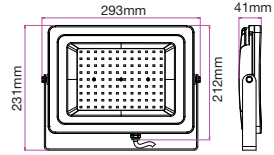
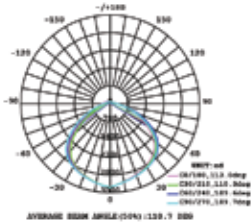

100W VT-49100

EAN Code

- 5852 - 3000K Warm White
- 5853 - 4000K Day White
- 5854 - 6400K White

- 3800157615266
- 3800157615273
- 3800157615280



Sensor Compatible:	Yes	Beam Angle:	100°
Voltage/Frequency:	AC:220-240V/50Hz	Color of Fixture:	Grey
Luminous Flux:	8500lm	Body Type:	Aluminium Die Cast
CRI:	>70	IP Rating:	IP65
PF:	>0.9	Dimension:	231x 293 x41mm

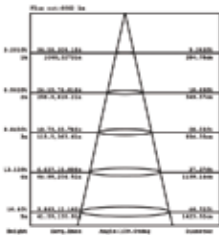

Note: The Curve indicate the illuminated area and the average illumination when the luminaire is at different distance.

LUMINOUS INTENSITY DISTRIBUTION DIAGRAM

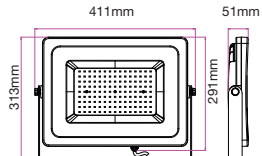
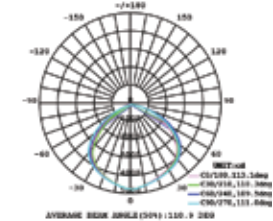

150W VT-49150

EAN Code

- 5864 - 3000K Warm White
- 5865 - 4000K Day White
- 5866 - 6400K White

- 3800157615389
- 3800157615396
- 3800157615402



Sensor Compatible:	Yes	Beam Angle:	100°
Voltage/Frequency:	AC:220-240V/50Hz	Color of Fixture:	Grey
Luminous Flux:	12750lm	Body Type:	Aluminium Die Cast
CRI:	>70	IP Rating:	IP65
PF:	>0.9	Dimension:	313 x 411x 51mm

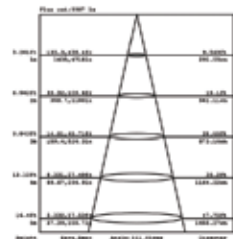

Note: The Curve indicate the illuminated area and the average illumination when the luminaire is at different distance.



200W VT-49200

EAN Code

5913 - 4000K Day White
5914 - 6400K White

3800157619479
3800157619486



Sensor Compatible:	Yes	Beam Angle:	100°
Voltage/Frequency:	AC:200-240V/50Hz	Color of Fixture:	Grey
Luminous Flux:	17000lm	Body Type:	Aluminium Die Cast
CRI:	>70	IP Rating:	IP65
PF:	>0.9	Dimension:	340 x 454x 56mm

LUMINOUS INTENSITY DISTRIBUTION DIAGRAM

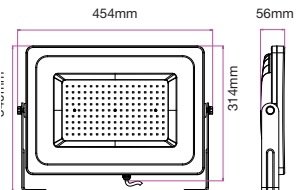
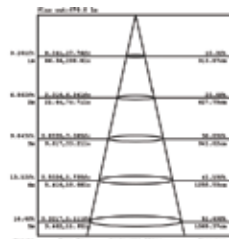
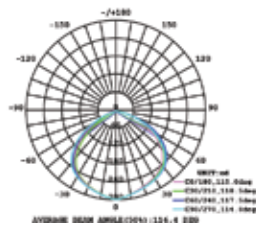

LUMINOUS INTENSITY DISTRIBUTION DIAGRAM
Luminous Intensity Distribution Curve

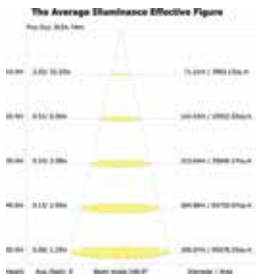
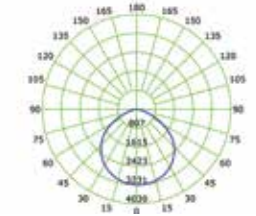

Note: The Curves indicate the illuminated area and the average illumination when the luminaire is at different distance.

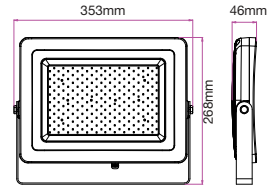

100W VT-48100-1

EAN Code

5766 / 5713 - 4500K Day White
5767 / 5714 - 6000K White

3800157611787 / 3800157604543
3800157611794 / 3800157604550



Sensor Compatible:	Yes	Beam Angle:	100°
Voltage/Frequency:	AC:220-240V,50/60Hz	Color of Fixture:	Grey & Black
Luminous Flux:	8000lm	Body Type:	Aluminium Die Cast
CRI:	>70	IP Rating:	IP65
PF:	>0.9	Dimension:	353 x 268 x 46mm

LUMINOUS INTENSITY DISTRIBUTION DIAGRAM

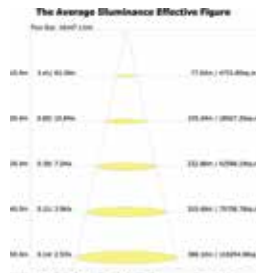
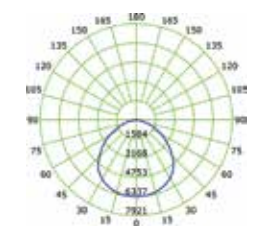

Note: The Curves indicate the illuminated area and the average illumination when the luminaire is at different distance.

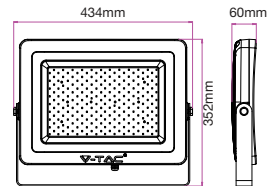

200W VT-48202

EAN Code

5873 / 5729 - 4500K Day White
5874 / 5730 - 6000K White

3800157606134 / 3800157615969
3800157615952 / 3800157606127



Sensor Compatible:	Yes	Beam Angle:	100°
Voltage/Frequency:	AC:220-240V,50/60Hz	Color of Fixture:	Grey & Black
Luminous Flux:	16000lm	Body Type:	Aluminium Die Cast
CRI:	>70	IP Rating:	IP65
PF:	>0.9	Dimension:	434 x 352 x 60 mm



300W VT-48302

5731 - 4500K Day White
5732 - 6000K White

EAN Code

3800157606141
3800157606158



Sensor Compatible:	Yes	Beam Angle:	100°
Voltage/Frequency:	AC:220-240V,50/60Hz	Color of Fixture:	Grey & Black
Luminous Flux:	24000lm	Body Type:	Aluminium Die Cast
CRI:	>70	IP Rating:	IP65
PF:	>0.9	Dimension:	532 x 443 x 70 mm

LUMINOUS INTENSITY DISTRIBUTION DIAGRAM

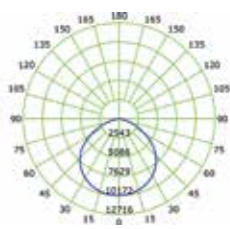

The Average Illuminance Effective Figure

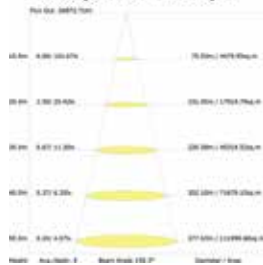

Note: The Curves indicate the illuminated area and the average illumination when the luminaire is at different distance.

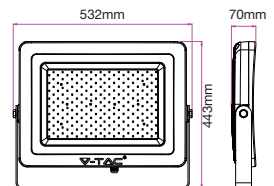

LUMINOUS INTENSITY DISTRIBUTION DIAGRAM

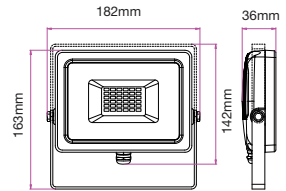
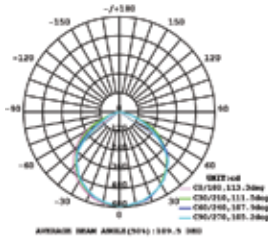

20W VT-4820

EAN Code

A+ Green LED

5760 / 5718 - Green

3800157611725 / 3800157604970

Sensor Compatible:	Yes	Beam Angle:	100°
Voltage/Frequency:	AC:220-240V,50/60Hz	Color of Fixture:	Grey & Black
Luminous Flux:	1600lm	Body Type:	Aluminium Die Cast
CRI:	>70	IP Rating:	IP65
PF:	>0.95	Dimension:	182 x 142 x 36mm

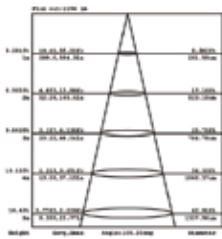

Note: The Curve indicate the illuminated area and the average illumination when the luminance is at different distance.

LUMINOUS INTENSITY DISTRIBUTION DIAGRAM

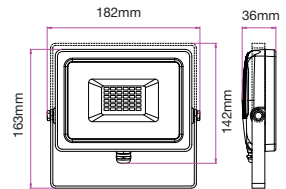
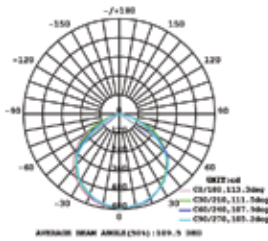

20W VT-4820

EAN Code

A+ Blue LED

5719 - Blue

3800157604987

Sensor Compatible:	Yes	Beam Angle:	100°
Voltage/Frequency:	AC:220-240V,50/60Hz	Color of Fixture:	Grey & Black
Luminous Flux:	1600lm	Body Type:	Aluminium Die Cast
CRI:	>70	IP Rating:	IP65
PF:	>0.95	Dimension:	182 x 142 x 36mm

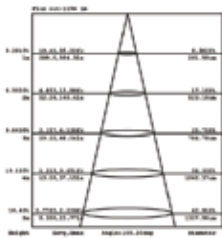

Note: The Curve indicate the illuminated area and the average illumination when the luminance is at different distance.

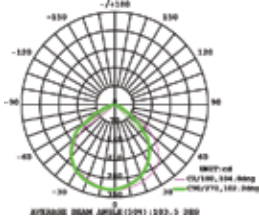

10W VT-4611

5898 - 3000K Warm White
5899 - 4500K Day White
5900 - 6000K White

EAN Code

3800157619219
3800157619226
3800157619233

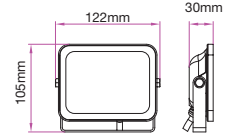

Sensor Compatible:	Yes	Beam Angle:	110°
Voltage/Frequency:	AC:200-240,50Hz	Color of Fixture:	White
Luminous Flux:	850lm	Body Type:	Aluminium Die Cast
CRI:	>70	IP Rating:	IP65
PF:	>0.9	Dimension:	122 x 105 x 30mm

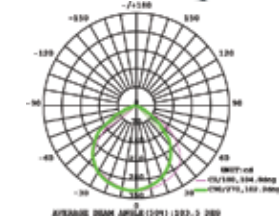

10W VT-4611

5875 - 3000K Warm White
5876 - 4500K Day White
5877 - 6000K White

EAN Code

3800157615976
3800157615983
3800157615990

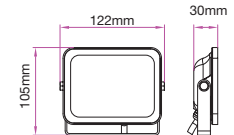

Sensor Compatible:	Yes	Beam Angle:	110°
Voltage/Frequency:	AC:200-240,50Hz	Color of Fixture:	Black
Luminous Flux:	850lm	Body Type:	Aluminium Die Cast
CRI:	>70	IP Rating:	IP65
PF:	>0.9	Dimension:	122 x 105 x 30mm

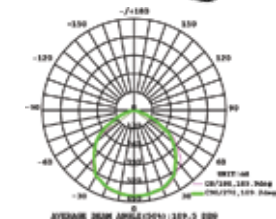

20W VT-4621

5878 - 3000K Warm White
5879 - 4500K Day White
5880 - 6000K White

EAN Code

3800157616003
3800157616010
3800157616027

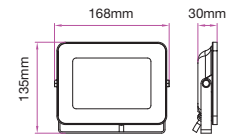

Sensor Compatible:	Yes	Beam Angle:	110°
Voltage/Frequency:	AC:200-240,50Hz	Color of Fixture:	Black
Luminous Flux:	1700lm	Body Type:	Aluminium Die Cast
CRI:	>70	IP Rating:	IP65
PF:	>0.9	Dimension:	168 x 135 x 30 mm



30W VT-4631

- 5881 - 3000K Warm White**
- 5882 - 4500K Day White**
- 5883 - 6000K White**

EAN Code

- 3800157616034
- 3800157616041
- 3800157616058

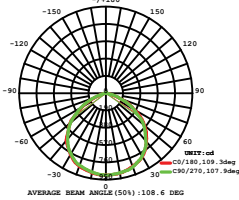
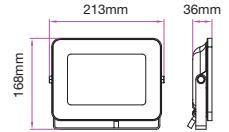

Sensor Compatible:	Yes	Beam Angle:	110°
Voltage/Frequency:	AC:200-240,50Hz	Color of Fixture:	Black
Luminous Flux:	2550lm	Body Type:	Aluminium Die Cast
CRI:	>70	IP Rating:	IP65
PF:	>0.9	Dimension:	213 x 168 x 32



50W VT-4651

- 5884 - 3000K Warm White**
- 5885 - 4500K Day White**
- 5886 - 6000K White**

EAN Code

- 3800157616065
- 3800157616072
- 3800157616089

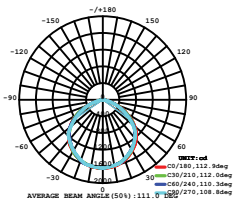
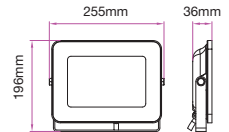

Sensor Compatible:	Yes	Beam Angle:	110°
Voltage/Frequency:	AC:200-240,50Hz	Color of Fixture:	Black
Luminous Flux:	4250lm	Body Type:	Aluminium Die Cast
CRI:	>70	IP Rating:	IP65
PF:	>0.9	Dimension:	255 x 196 x 36mm



50W VT-4651

- 5904 - 3000K Warm White**
- 5905 - 4500K Day White**
- 5906 - 6000K White**

EAN Code

- 3800157619370
- 3800157619387
- 3800157619394

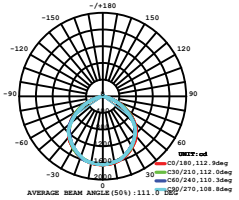
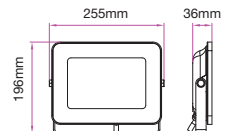

Sensor Compatible:	Yes	Beam Angle:	110°
Voltage/Frequency:	AC:200-240,50Hz	Color of Fixture:	White
Luminous Flux:	4250	Body Type:	Aluminium Die Cast
CRI:	>70	IP Rating:	IP65
PF:	>0.9	Dimension:	255 x 196 x 36

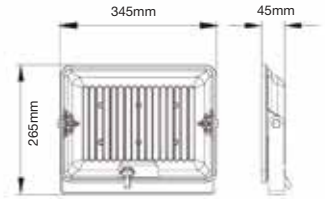

New!

100W VT-46100

EAN Code

5887 - 3000K Warm White

3800157616096

5888 - 4500K Day White

3800157616102

5889 - 6000K White

3800157616119

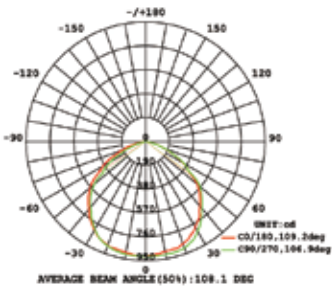

Sensor Compatible: Yes	Beam Angle: 110°
Voltage/Frequency: AC:220-240V,50/60Hz	Color of Fixture: Black
Luminous Flux: 8500lm	Body Type: Aluminium Die Cast
CRI: >70	IP Rating: IP65
PF: >0.9	Dimension: 345 x 265 x 45mm

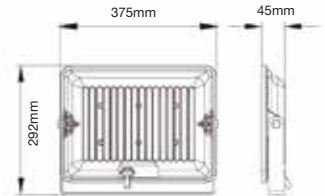

New!

150W VT-46150

EAN Code

5890 - 4500K Day White

3800157616126

5891 - 6000K White

3800157616133



Sensor Compatible: Yes	Beam Angle: 110°
Voltage/Frequency: AC:220-240V,50/60Hz	Color of Fixture: Black
Luminous Flux: 12750lm	Body Type: Aluminium Die Cast
CRI: >70	IP Rating: IP65
PF: >0.9	Dimension: 375 x 292 x 45mm

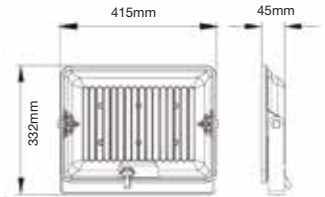

New!

200W VT-46200

EAN Code

5892 - 4500K Day White
5893 - 6000K White

3800157616140
3800157616157

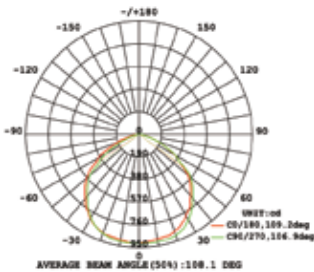

Sensor Compatible:	Yes	Beam Angle:	110°
Voltage/Frequency:	AC:220-240V,50/60Hz	Color of Fixture:	Black
Luminous Flux:	17000lm	Body Type:	Aluminium Die Cast
CRI:	>70	IP Rating:	IP65
PF:	>0.9	Dimension:	415 x 332 x 45mm

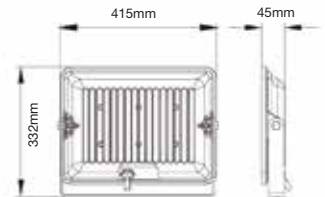

New!

200W VT-46200

EAN Code

5907 - 4500K Day White
5908 - 6000K White

3800157619400
3800157619417

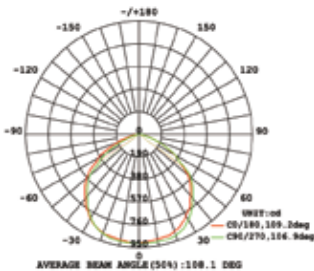

Sensor Compatible:	Yes	Beam Angle:	110°
Voltage/Frequency:	AC:220-240V,50/60Hz	Color of Fixture:	White
Luminous Flux:	17000lm	Body Type:	Aluminium Die Cast
CRI:	>70	IP Rating:	IP65
PF:	>0.9	Dimension:	415 x 332 x 45mm

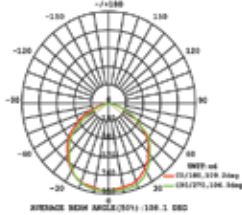

New!

10W VT-4011

- 5943 - 3000K Warm White
- 5944 - 4000K Day White
- 5945 - 6500K White

EAN Code

- 3800157625364
- 3800157625371
- 3800157625388

A+

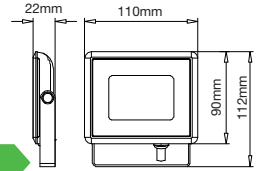

Sensor Compatible:	Yes	Beam Angle:	110°
Voltage/Frequency:	AC:220-240V,50Hz	Color of Fixture:	White
Luminous Flux:	850lm	Body Type:	Aluminium
CRI:	>70	IP Rating:	IP65
PF:	>0.9	Dimension:	110 x 112 x 22mm

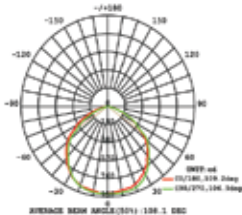

New!

20W VT-4021

- 5949 - 3000K Warm White
- 5950 - 4000K Day White
- 5951 - 6500K White

EAN Code

- 3800157625425
- 3800157625432
- 3800157625449

A+

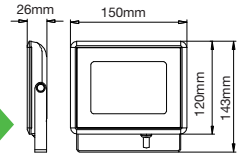

Sensor Compatible:	Yes	Beam Angle:	110°
Voltage/Frequency:	AC:220-240V,50Hz	Color of Fixture:	White
Luminous Flux:	1700lm	Body Type:	Aluminium
CRI:	>70	IP Rating:	IP65
PF:	>0.9	Dimension:	150 x 143 x 26mm

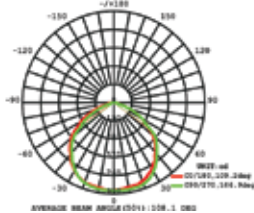

New!

30W VT-4031

- 5955 - 3000K Warm White
- 5956 - 4000K Day White
- 5957 - 6500K White

EAN Code

- 3800157625487
- 3800157625494
- 3800157625500

A+

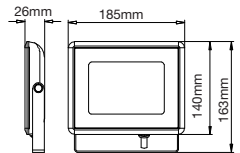

Sensor Compatible:	Yes	Beam Angle:	110°
Voltage/Frequency:	AC:220-240V,50Hz	Color of Fixture:	White
Luminous Flux:	2550lm	Body Type:	Aluminium
CRI:	>70	IP Rating:	IP65
PF:	>0.9	Dimension:	185 x 163 x 26mm

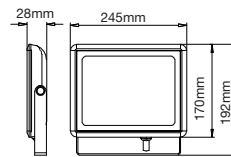

New!

50W VT-4051

EAN Code

- 5961 - 3000K Warm White
- 5962 - 4000K Day White
- 5963 - 6500K White

- 3800157625548
- 3800157625555
- 3800157625562

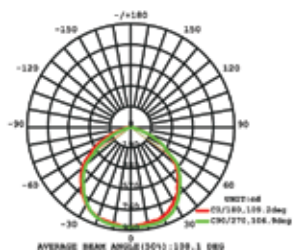

Sensor Compatible:	Yes	Beam Angle:	110°
Voltage/Frequency:	AC:220-240V,50Hz	Color of Fixture:	White
Luminous Flux:	4250lm	Body Type:	Aluminium
CRI:	>70	IP Rating:	IP65
PF:	>0.9	Dimension:	245 x 192 x 28mm

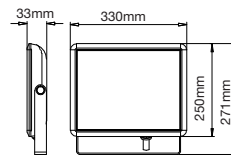

New!

100W VT-40101

EAN Code

- 5967 - 3000K Warm White
- 5968 - 4000K Day White
- 5969 - 6500K White

- 3800157625609
- 3800157625616
- 3800157625623

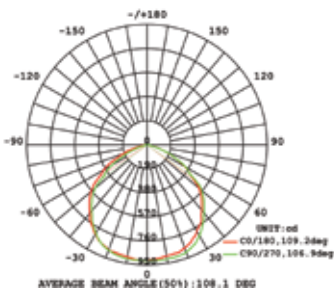

Sensor Compatible:	Yes	Beam Angle:	110°
Voltage/Frequency:	AC:220-240V,50Hz	Color of Fixture:	White
Luminous Flux:	8500lm	Body Type:	Aluminium
CRI:	>70	IP Rating:	IP65
PF:	>0.9	Dimension:	330 x 271 x 33mm

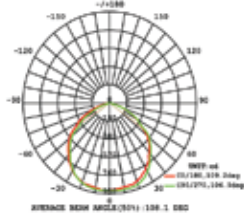

New!

10W VT-4011

- 5940 - 3000K Warm White
- 5941 - 4000K Day White
- 5942 - 6500K White

EAN Code

- 3800157625333
- 3800157625340
- 3800157625357

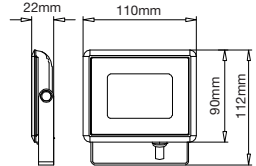

Sensor Compatible:	Yes	Beam Angle:	110°
Voltage/Frequency:	AC:220-240V,50Hz	Color of Fixture:	Black
Luminous Flux:	850lm	Body Type:	Aluminium
CRI:	>70	IP Rating:	IP65
PF:	>0.9	Dimension:	110 x 112 x 22mm

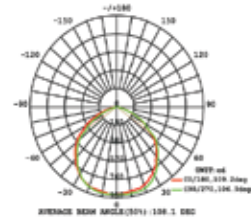

New!

20W VT-4021

- 5946 - 3000K Warm White
- 5947 - 4000K Day White
- 5948 - 6500K White

EAN Code

- 3800157625395
- 3800157625401
- 3800157625418

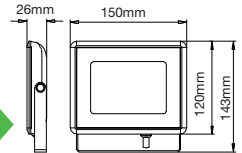

Sensor Compatible:	Yes	Beam Angle:	110°
Voltage/Frequency:	AC:220-240V,50Hz	Color of Fixture:	Black
Luminous Flux:	1700lm	Body Type:	Aluminium
CRI:	>70	IP Rating:	IP65
PF:	>0.9	Dimension:	150 x 143 x 26mm

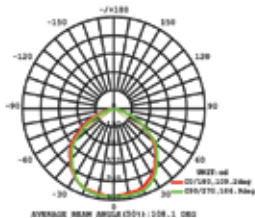

New!

30W VT-4031

- 5952 - 3000K Warm White
- 5953 - 4000K Day White
- 5954 - 6500K White

EAN Code

- 3800157625456
- 3800157625463
- 3800157625470

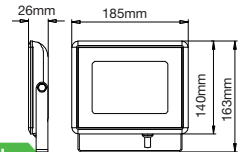

Sensor Compatible:	Yes	Beam Angle:	110°
Voltage/Frequency:	AC:220-240V,50Hz	Color of Fixture:	Black
Luminous Flux:	2550lm	Body Type:	Aluminium
CRI:	>70	IP Rating:	IP65
PF:	>0.9	Dimension:	185 x 163 x 26mm

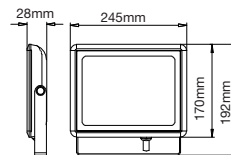

New!

50W VT-4051

EAN Code

- 5958 - 3000K Warm White
- 5959 - 4000K Day White
- 5960 - 6500K White

- 3800157625517
- 3800157625524
- 3800157625531

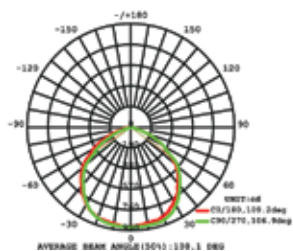

Sensor Compatible: Yes	Beam Angle: 110°
Voltage/Frequency: AC:220-240V,50Hz	Color of Fixture: Black
Luminous Flux: 4250lm	Body Type: Aluminium
CRI: >70	IP Rating: IP65
PF: >0.9	Dimension: 245 x 192 x 28mm

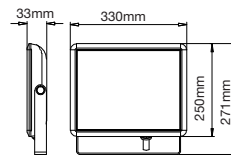

New!

100W VT-40101

EAN Code

- 5964 - 3000K Warm White
- 5965 - 4000K Day White
- 5966 - 6500K White

- 3800157625579
- 3800157625586
- 3800157625593

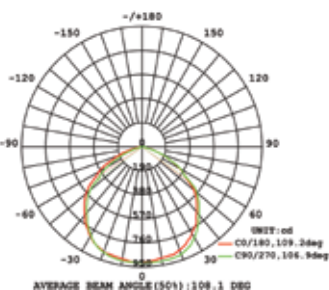

Sensor Compatible: Yes	Beam Angle: 110°
Voltage/Frequency: AC:220-240V,50Hz	Color of Fixture: Black
Luminous Flux: 8500lm	Body Type: Aluminium
CRI: >70	IP Rating: IP65
PF: >0.9	Dimension: 330 x 271 x 33mm



LUMINOUS INTENSITY DISTRIBUTION DIAGRAM

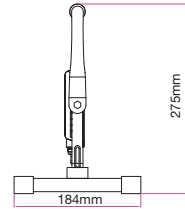
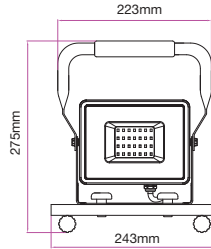
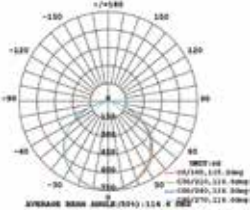

New!

3 METER WIRE WITH BS PLUG

30W VT-4230

5927 - 4000K Day White
5928 - 6400K White

EAN Code

3800157622837
3800157622844



Sensor Compatible:	Yes	Beam Angle:	100°
Voltage/Frequency:	AC: 220-240V, 50Hz	Color of Fixture:	Black
Luminous Flux:	2550lm	Body Type:	Aluminium Die Cast
CRI:	>70	IP Rating:	IP65
PF:	>0.9	Dimension:	243x 275x 184mm



LUMINOUS INTENSITY DISTRIBUTION DIAGRAM

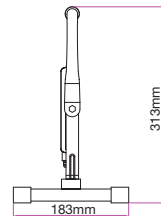
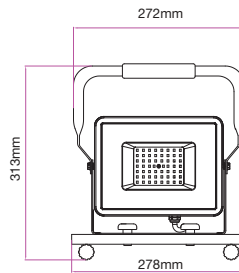
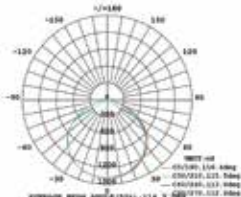

New!

3 METER WIRE WITH EU PLUG

50W VT-4250

5929 - 4000K Day White
5930 - 6400K White

EAN Code

3800157622851
3800157622868



Sensor Compatible:	Yes	Beam Angle:	100°
Voltage/Frequency:	AC: 220-240V, 50Hz	Color of Fixture:	Black
Luminous Flux:	4250lm	Body Type:	Aluminium Die Cast
CRI:	>70	IP Rating:	IP65
PF:	>0.9	Dimension:	278 x 313 x 183mm



LUMINOUS INTENSITY DISTRIBUTION DIAGRAM

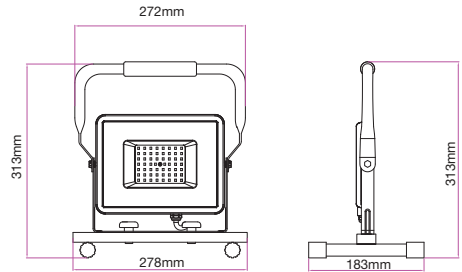
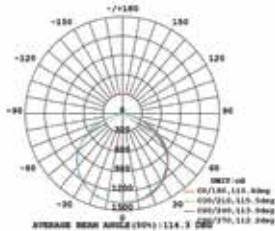

New!

3 METER WIRE WITH BS PLUG

50W VT-4251

EAN Code

5933 - 6400K White

'3800157622899



Sensor Compatible:	Yes	Beam Angle:	100°
Voltage/Frequency:	AC:220-240V,50/60Hz	Color of Fixture:	Black
Luminous Flux:	4250lm	Body Type:	Aluminium Die Cast
CRI:	>70	IP Rating:	IP65
PF:	>0.9	Dimension:	278x 313x 183mm



LUMINOUS INTENSITY DISTRIBUTION DIAGRAM

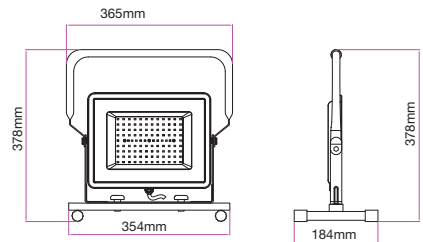
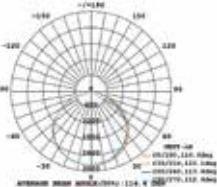

New!

3 METER WIRE WITH EU PLUG

100W VT-42100

EAN Code

5931 - 4000K Day White
5932 - 6400K White

3800157622875
3800157622882



Sensor Compatible:	Yes	Beam Angle:	100°
Voltage/Frequency:	AC: 220-240V, 50Hz	Color of Fixture:	Black
Luminous Flux:	8500lm	Body Type:	Aluminium Die Cast
CRI:	>70	IP Rating:	IP65
PF:	>0.9	Dimension:	354 x 378 x 184mm



New!

100W VT-49101

EAN Code

5970 - 3000K Warm White

3800157626231

5971 - 4000K Day White

3800157626248

5972 - 6400K White

3800157626255

A+

Sensor Compatible:	Yes	Beam Angle:	100°
Voltage/Frequency:	AC:220-240V/50Hz	Color of Fixture:	Grey
Luminous Flux:	8500lm	Body Type:	Aluminium Die Cast
CRI:	>70	IP Rating:	IP65
PF:	>0.9	Dimension:	291x 240 x 30mm

LUMINOUS INTENSITY DISTRIBUTION DIAGRAM

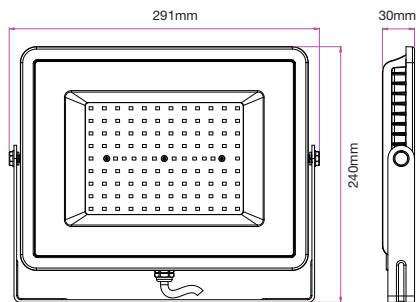
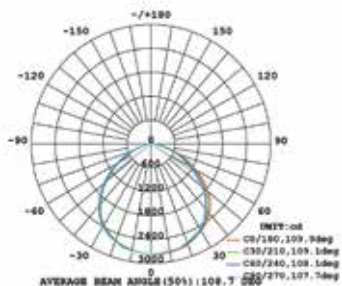



New!

500W VT-49500

EAN Code

5934 - 4500K Day White
5935 - 6000K White

3800157623605
3800157623612



Sensor Compatible:	Yes	Beam Angle:	100°
Voltage/Frequency:	AC: 200-240, 50Hz	Color of Fixture:	Black
Luminous Flux:	60000lm	Body Type:	Aluminium Die Cast
CRI:	>70	IP Rating:	IP65
PF:	>0.9	Dimension:	658 x 537 x 154mm

Luminous Intensity Distribution Curve(cd/klm)

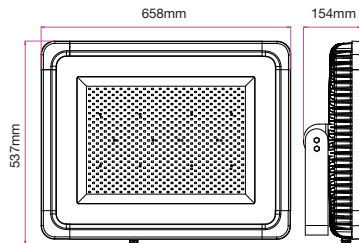
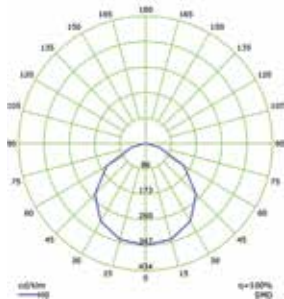



New!

WITH LENS

MW
MEAN WELL
Your Reliable Power Partner



500W VT-49501

EAN Code

5936 - 4000K Day White
5937 - 6000K White

3800157624985
3800157624992



Sensor Compatible:	Yes	Beam Angle:	60°
Voltage/Frequency:	AC:100-240V, 50/60Hz	Color of Fixture:	Black
Luminous Flux:	60000lm	Body Type:	Aluminium Die Cast
CRI:	>70	IP Rating:	IP65
PF:	>0.9	Dimension:	658 x 537 x 154mm

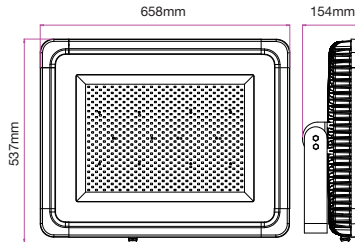
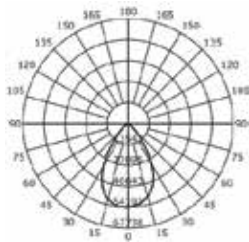



WITH LENS

MW
MEAN WELL
Your Reliable Power Partner



New!

1000W VT-491001

EAN Code

5938 - 4000K Day White
5939 - 6000K White

3800157625005
3800157625012

A++

Sensor Compatible:	Yes	Beam Angle:	60°
Voltage/Frequency:	AC:100-240V, 50/60Hz	Color of Fixture:	Black
Luminous Flux:	120000lm	Body Type:	Aluminium Die Cast
CRI:	>70	IP Rating:	IP65
PF:	>0.9	Dimension:	748 x 762 x 154mm

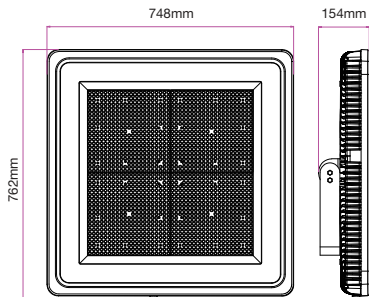
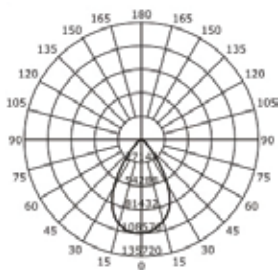



1000W VT-491000

5915 - 4500K Day White
5916 - 6400K White

EAN Code

3800157619752
3800157619769



120⁺⁺
LM/W
HIGH LUMENS



Your Reliable Power Partner

Sensor Compatible:	Yes	Beam Angle:	100°
Voltage/Frequency:	AC: 100-240, 50/60HzV	Color of Fixture:	Black
Luminous Flux:	120000lm	Body Type:	Aluminium Die Cast
CRI:	>70	IP Rating:	IP65
PF:	>0.9	Dimension:	748 x 762 x 154mm

LUMINOUS INTENSITY DISTRIBUTION DIAGRAM

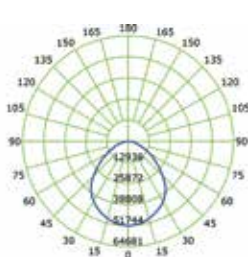

The Average Illuminance Effective Figure

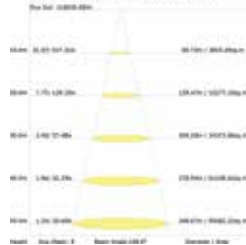

Note: The Curves indicate the illuminated area and the average illumination when the luminaire is at different distance.

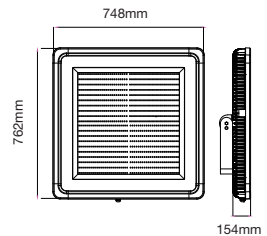

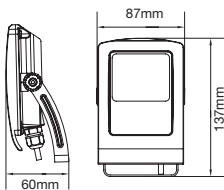

10W VT-4714

EAN Code

- 5655 - 3000K Warm White
- 5656 - 4500K Day White
- 5657 - 6000K White

- 3800157603027
- 3800157603034
- 3800157603041



LUMINOUS INTENSITY DISTRIBUTION DIAGRAM

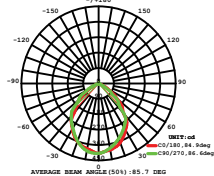

Sensor Compatible:	Yes	Beam Angle:	85°
Voltage/Frequency:	AC:200-240,50Hz	Color of Fixture:	Grey
Luminous Flux:	800lm	Body Type:	Aluminium Die Cast
CRI:	>70	IP Rating:	IP65
PF:	>0.9	Dimension:	137 x 87 x 60mm

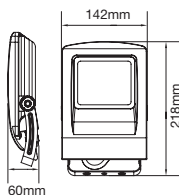

20W VT-4724

EAN Code

- 5658 - 3000K Warm White
- 5659 - 4500K Day White
- 5660 - 6000K White

- 3800157603058
- 3800157603065
- 3800157603072



LUMINOUS INTENSITY DISTRIBUTION DIAGRAM

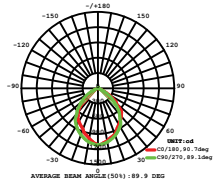

Sensor Compatible:	Yes	Beam Angle:	90°
Voltage/Frequency:	AC:200-240,50Hz	Color of Fixture:	Grey
Luminous Flux:	1600lm	Body Type:	Aluminium Die Cast
CRI:	>70	IP Rating:	IP65
PF:	>0.9	Dimension:	218 x 142 x 60mm

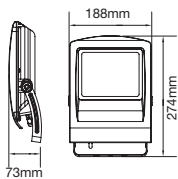

30W VT-4734

EAN Code

- 5661 - 3000K Warm White
- 5662 - 4500K Day White
- 5663 - 6000K White

- 3800157603089
- 3800157603096
- 3800157603102



LUMINOUS INTENSITY DISTRIBUTION DIAGRAM

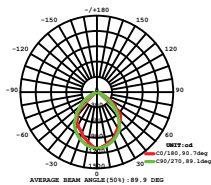

Sensor Compatible:	Yes	Beam Angle:	90°
Voltage/Frequency:	AC:200-240,50Hz	Color of Fixture:	Grey
Luminous Flux:	2400lm	Body Type:	Aluminium Die Cast
CRI:	>70	IP Rating:	IP65
PF:	>0.9	Dimension:	274 x 188 x 73mm

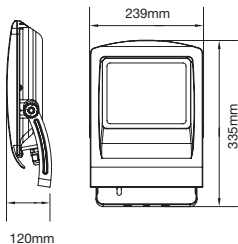

50W VT-4754

EAN Code

- 5664 - 3000K Warm White
- 5665 - 4500K Day White
- 5666 - 6000K White

- 3800157603119
- 3800157603126
- 3800157603133



LUMINOUS INTENSITY DISTRIBUTION DIAGRAM

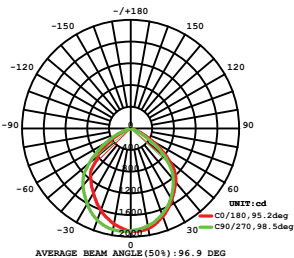

Sensor Compatible:	Yes	Beam Angle:	100°
Voltage/Frequency:	AC:200-240,50Hz	Color of Fixture:	Grey
Luminous Flux:	4000lm	Body Type:	Aluminium Die Cast
CRI:	>70	IP Rating:	IP65
PF:	>0.9	Dimension:	335 x 239 x 120mm



100W VT-47104

EAN Code

5667 - 3000K Warm White

3800157603140

5668 - 4500K Day White

3800157603157

5669 - 6000K White

3800157603164

Sensor Compatible:	Yes	Beam Angle:	100°
Voltage/Frequency:	AC:200-240,50Hz	Color of Fixture:	Grey
Luminous Flux:	8000lm	Body Type:	Aluminium Die Cast
CRI:	>70	IP Rating:	IP65
PF:	>0.9	Dimension:	405 x 288 x 130mm

LUMINOUS INTENSITY DISTRIBUTION DIAGRAM

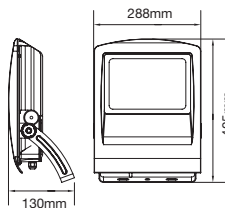
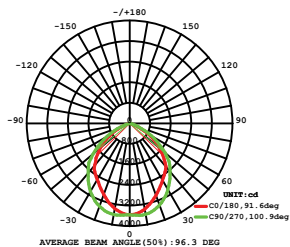

LUMINOUS INTENSITY DISTRIBUTION DIAGRAM

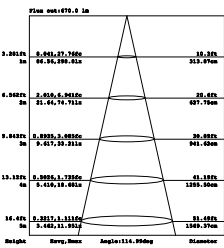
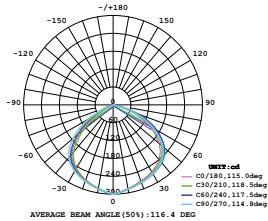

Note: The Curves indicate the illuminated area and the average illumination when the luminaire is at different distance.

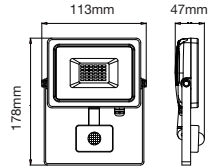

10W VT-4911

5786 - 3000K Warm White
5787 - 4000K Day White
5788 - 6400K White

EAN Code

3800157614603
3800157614610
3800157614627

Detection Angle: 120°
Detection Distance: 2-8 Meters



Watts:	10W	Beam Angle:	100°
Voltage/Frequency:	AC:200-240,50Hz	Color of Fixture:	White
Luminous Flux:	800lm	Body Type:	Aluminium Die Cast
CRI:	>70	IP Rating:	IP44
PF:	>0.9	Dimension:	136 x 169x 56mm

LUMINOUS INTENSITY DISTRIBUTION DIAGRAM

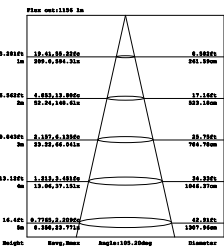
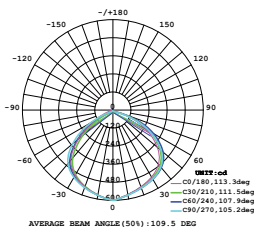

Note: The Curves indicate the illuminated area and the average illumination when the luminaire is at different distance.

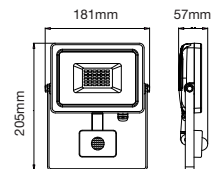

20W VT-4922

5804 - 3000K Warm White
5805 - 4000K Day White
5806 - 6400K White

EAN Code

3800157614788
3800157614795
3800157614801

Detection Angle: 120°
Detection Distance: 2-8 Meters



Watts:	20W	Beam Angle:	100°
Voltage/Frequency:	AC:200-240,50Hz	Color of Fixture:	White
Luminous Flux:	1600lm	Body Type:	Aluminium Die Cast
CRI:	>70	IP Rating:	IP44
PF:	>0.9	Dimension:	181 x 205 x 57mm

LUMINOUS INTENSITY DISTRIBUTION DIAGRAM

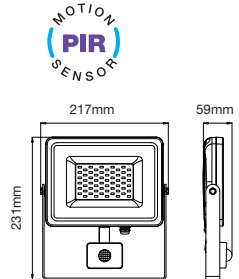
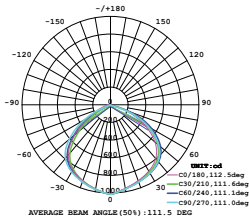

30W VT-4933

EAN Code

Detection Angle: **120°**
 Detection Distance: **2-8 Meters**

- 5822 - 3000K Warm White
- 5823 - 4000K Day White
- 5824 - 6400K White

- 3800157614962
- 3800157614979
- 3800157614986



Watts:	30W	Beam Angle:	100°
Voltage/Frequency:	AC:200-240,50Hz	Color of Fixture:	White
Luminous Flux:	2550lm	Body Type:	Aluminium Die Cast
CRI:	>70	IP Rating:	IP44
PF:	>0.9	Dimension:	217 x 231 x 59mm

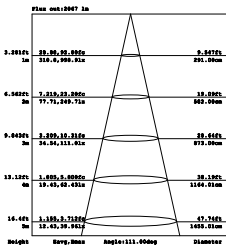

Note: The Curves indicate the illuminated area and the average illumination when the luminaire is at different distance.

LUMINOUS INTENSITY DISTRIBUTION DIAGRAM

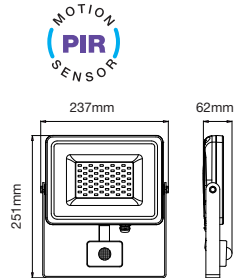
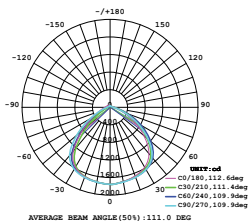

50W VT-4955

EAN Code

Detection Angle: **120°**
 Detection Distance: **2-8 Meters**

- 5840 - 3000K Warm White
- 5841 - 4000K Day White
- 5842 - 6400K White

- 3800157615143
- 3800157615150
- 3800157615167



Watts:	50W	Beam Angle:	100°
Voltage/Frequency:	AC:200-240,50Hz	Color of Fixture:	White
Luminous Flux:	4250lm	Body Type:	Aluminium Die Cast
CRI:	>70	IP Rating:	IP44
PF:	>0.9	Dimension:	237 x 251 x 62mm

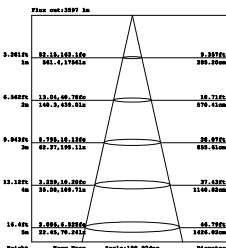

Note: The Curves indicate the illuminated area and the average illumination when the luminaire is at different distance.

LUMINOUS INTENSITY DISTRIBUTION DIAGRAM

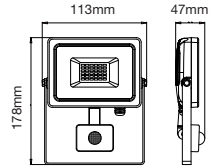
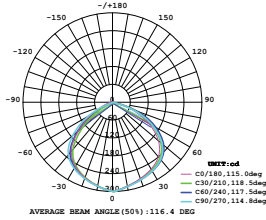

10W VT-4911

- 5783 - 3000K Warm White
- 5784 - 4000K Day White
- 5785 - 6400K White

EAN Code

- 3800157614573
- 3800157614580
- 3800157614597

Detection Angle: 120°
Detection Distance: 2-8 Meters



Watts:	10W	Beam Angle:	100°
Voltage/Frequency:	AC:200-240,50Hz	Color of Fixture:	Black
Luminous Flux:	800lm	Body Type:	Aluminium Die Cast
CRI:	>70	IP Rating:	IP44
PF:	>0.9	Dimension:	136 x 169 x 56mm

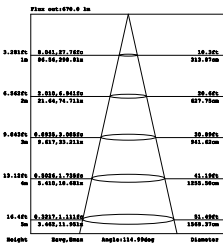

Note: The Curves indicate the illuminated area and the average illumination when the luminaire is at different distance.

LUMINOUS INTENSITY DISTRIBUTION DIAGRAM

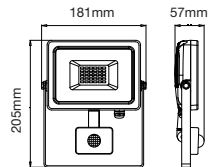
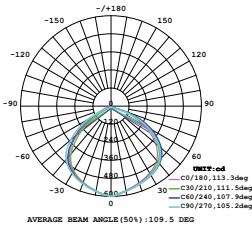

20W VT-4922

- 5801 - 3000K Warm White
- 5802 - 4000K Day White
- 5803 - 6400K White

EAN Code

- 3800157614757
- 3800157614764
- 3800157614771

Detection Angle: 120°
Detection Distance: 2-8 Meters



Watts:	20W	Beam Angle:	100°
Voltage/Frequency:	AC:200-240,50Hz	Color of Fixture:	Black
Luminous Flux:	1600lm	Body Type:	Aluminium Die Cast
CRI:	>70	IP Rating:	IP44
PF:	>0.9	Dimension:	181 x 205 x 57mm

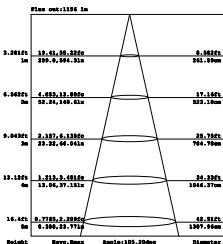

Note: The Curves indicate the illuminated area and the average illumination when the luminaire is at different distance.



LUMINOUS INTENSITY DISTRIBUTION DIAGRAM

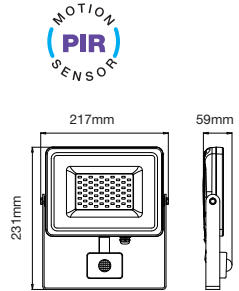
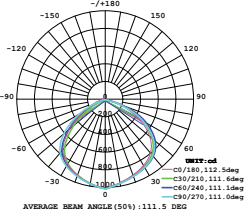

30W VT-4933

5819 - 3000K Warm White
5820 - 4000K Day White
5821 - 6400K White

EAN Code

3800157614931
3800157614948
3800157614955

Detection Angle: 120°
Detection Distance: 2-8 Meters



Watts:	30W	Beam Angle:	100°
Voltage/Frequency:	AC:200-240,50Hz	Color of Fixture:	Black
Luminous Flux:	2550lm	Body Type:	Aluminium Die Cast
CRI:	>70	IP Rating:	IP44
PF:	>0.9	Dimension:	217 x 231 x 59mm

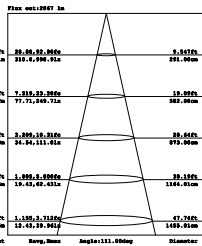

Note: The Curves indicate the illuminated area and the average illumination when the luminaire is at different distance.

LUMINOUS INTENSITY DISTRIBUTION DIAGRAM

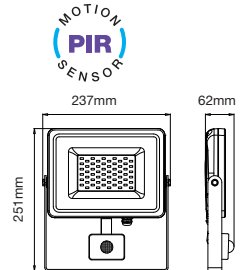
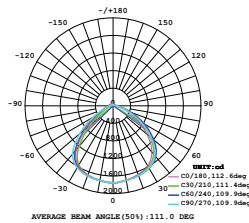

50W VT-4955

5837 - 3000K Warm White
5838 - 4000K Day White
5839 - 6400K White

EAN Code

3800157615112
3800157615129
3800157615136

Detection Angle: 120°
Detection Distance: 2-8 Meters



Watts:	50W	Beam Angle:	100°
Voltage/Frequency:	AC:200-240,50Hz	Color of Fixture:	Black
Luminous Flux:	4250lm	Body Type:	Aluminium Die Cast
CRI:	>70	IP Rating:	IP44
PF:	>0.9	Dimension:	237 x 251 x 62mm

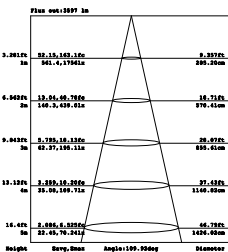

Note: The Curves indicate the illuminated area and the average illumination when the luminaire is at different distance.

LUMINOUS INTENSITY DISTRIBUTION DIAGRAM

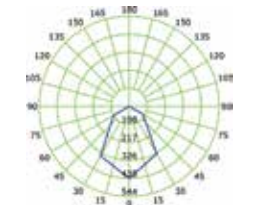

The average illuminance effective figure

Distance	Beam Angle	Beam Area	Average Illuminance
1.0m	19.20°	455.96cm ²	1.64lx / 15.0lx/m ²
2.0m	38.40°	1823.85cm ²	0.41lx / 37.75lx/m ²
3.0m	57.60°	4050.96cm ²	0.18lx / 16.67lx/m ²
4.0m	76.80°	7224.24cm ²	0.10lx / 9.38lx/m ²
5.0m	96.00°	11250.00cm ²	0.07lx / 6.22lx/m ²
6.0m	115.20°	16020.00cm ²	0.05lx / 4.62lx/m ²
7.0m	134.40°	21525.00cm ²	0.04lx / 3.44lx/m ²
8.0m	153.60°	27760.00cm ²	0.03lx / 2.57lx/m ²
9.0m	172.80°	34725.00cm ²	0.02lx / 1.87lx/m ²
10.0m	192.00°	42500.00cm ²	0.02lx / 1.39lx/m ²

Note: The Curves indicate the illuminated area and the average illumination when the luminaire is at different distance.

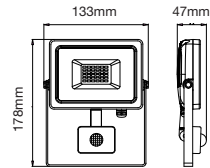

10W VT-4810-1 PIR

5746 - 3000K Warm White
5747 - 4500K Day White
5748 - 6000K White

EAN Code

3800157608206
3800157608213
3800157608220

Detection Angle: **120°**

Detection Distance: **2-8 Meters**



Watts:	10W	Beam Angle:	100°
Voltage/Frequency:	AC:200-240,50Hz	Color of Fixture:	White
Luminous Flux:	800lm	Body Type:	Aluminium Die Cast
CRI:	>70	IP Rating:	IP44
PF:	>0.9	Dimension:	133x178x47mm

LUMINOUS INTENSITY DISTRIBUTION DIAGRAM

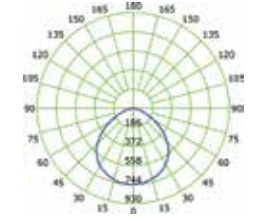

The average illuminance effective figure

Distance	Beam Angle	Beam Area	Average Illuminance
1.0m	19.20°	455.96cm ²	3.28lx / 30.0lx/m ²
2.0m	38.40°	1823.85cm ²	0.82lx / 75.75lx/m ²
3.0m	57.60°	4050.96cm ²	0.36lx / 33.33lx/m ²
4.0m	76.80°	7224.24cm ²	0.20lx / 18.75lx/m ²
5.0m	96.00°	11250.00cm ²	0.14lx / 13.00lx/m ²
6.0m	115.20°	16020.00cm ²	0.10lx / 9.38lx/m ²
7.0m	134.40°	21525.00cm ²	0.07lx / 6.52lx/m ²
8.0m	153.60°	27760.00cm ²	0.05lx / 4.69lx/m ²
9.0m	172.80°	34725.00cm ²	0.04lx / 3.47lx/m ²
10.0m	192.00°	42500.00cm ²	0.03lx / 2.59lx/m ²

Note: The Curves indicate the illuminated area and the average illumination when the luminaire is at different distance.

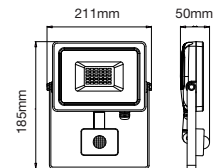

20W VT-4820-1 PIR

5756 - 3000K Warm White
5749 - 4500K Day White
5750 - 6000K White

EAN Code

3800157611688
3800157608862
3800157608879

Detection Angle: **120°**

Detection Distance: **2-8 Meters**



Watts:	20W	Beam Angle:	100°
Voltage/Frequency:	AC:200-240,50Hz	Color of Fixture:	White
Luminous Flux:	1600lm	Body Type:	Aluminium Die Cast
CRI:	>70	IP Rating:	IP44
PF:	>0.9	Dimension:	185x211x50mm

LUMINOUS INTENSITY DISTRIBUTION DIAGRAM

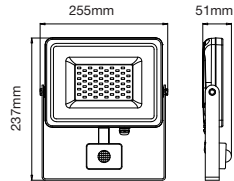
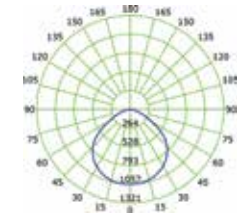

The average illuminance effective figure

Flux (lm)	Beam Angle	Beam Diameter
1.0m (27.22)	120°	0.45m
2.0m (13.61)	120°	0.90m
3.0m (9.07)	120°	1.35m
4.0m (6.80)	120°	1.80m
5.0m (5.44)	120°	2.25m
6.0m (4.53)	120°	2.70m
7.0m (3.88)	120°	3.15m
8.0m (3.40)	120°	3.60m
9.0m (3.02)	120°	4.05m
10.0m (2.72)	120°	4.50m

Note: The Curves indicate the illuminated area and the average illumination when the luminaire is at different distance.

30W VT-4830-1 PIR

- 5757 - 3000K Warm White
- 5751 - 4500K Day White
- 5752 - 6000K White

EAN Code

- 3800157611695
- 3800157608886
- 3800157608893

Detection Angle: **120°**
Detection Distance: **2-8 Meters**



Watts:	30W	Beam Angle:	100°
Voltage/Frequency:	AC:200-240,50Hz	Color of Fixture:	White
Luminous Flux:	2400lm	Body Type:	Aluminium Die Cast
CRI:	>70	IP Rating:	IP44
PF:	>0.9	Dimension:	237x255x51mm

LUMINOUS INTENSITY DISTRIBUTION DIAGRAM

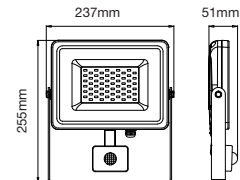
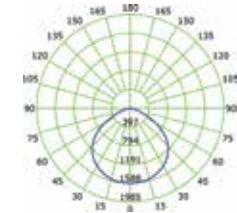

The average illuminance effective figure

Flux (lm)	Beam Angle	Beam Diameter
1.0m (37.22)	120°	0.45m
2.0m (18.61)	120°	0.90m
3.0m (12.41)	120°	1.35m
4.0m (9.31)	120°	1.80m
5.0m (7.45)	120°	2.25m
6.0m (6.21)	120°	2.70m
7.0m (5.44)	120°	3.15m
8.0m (4.88)	120°	3.60m
9.0m (4.40)	120°	4.05m
10.0m (4.02)	120°	4.50m

Note: The Curves indicate the illuminated area and the average illumination when the luminaire is at different distance.

50W VT-4850-1 PIR

- 5758 - 3000K Warm White
- 5753 - 4500K Day White
- 5754 - 6000K White

EAN Code

- 3800157611701
- 3800157608909
- 3800157608916

Detection Angle: **120°**
Detection Distance: **2-8 Meters**



Watts:	50W	Beam Angle:	100°
Voltage/Frequency:	AC:200-240,50Hz	Color of Fixture:	White
Luminous Flux:	4000lm	Body Type:	Aluminium Die Cast
CRI:	>70	IP Rating:	IP44
PF:	>0.9	Dimension:	237x255x51mm

LUMINOUS INTENSITY DISTRIBUTION DIAGRAM

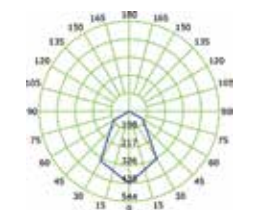

The average illuminance effective figure

Max Lux: 737.00lx

1.5m	19.20x45.90lx	0.46lx / 0.46lx
2.0m	14.10x34.35lx	0.35lx / 0.35lx
3.0m	6.70x45.90lx	0.20lx / 0.20lx
4.0m	4.95x27.22lx	0.15lx / 0.15lx
5.0m	3.20x17.44lx	0.11lx / 0.11lx
6.0m	2.27x12.12lx	0.08lx / 0.08lx
7.0m	1.67x9.84lx	0.06lx / 0.06lx
8.0m	1.22x8.22lx	0.05lx / 0.05lx
9.0m	0.93x7.24lx	0.04lx / 0.04lx
10.0m	0.70x6.24lx	0.03lx / 0.03lx

Beam Angle: 120°
Beam Area: 120°
Dimension: 133x178mm

Note: The Curves indicate the illuminated area and the average illumination when the luminaire is at different distance.

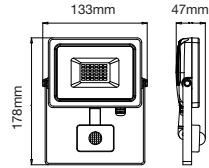

10W VT-4810 PIR

- 5723 - 3000K Warm White
- 5724 - 4500K Day White
- 5725 - 6000K White

EAN Code

- 3800157605724
- 3800157605731
- 3800157605748

Detection Angle: **120°**
Detection Distance: **2-8 Meters**



Watts:	10W	Beam Angle:	100°
Voltage/Frequency:	AC:200-240,50Hz	Color of Fixture:	Black
Luminous Flux:	800lm	Body Type:	Aluminium Die Cast
CRI:	>70	IP Rating:	IP44
PF:	>0.9	Dimension:	133x178x47mm

LUMINOUS INTENSITY DISTRIBUTION DIAGRAM

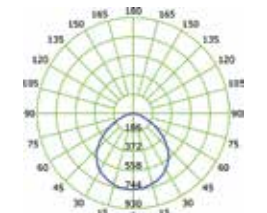

The average illuminance effective figure

Max Lux: 1676.07lx

1.5m	196.76x144.80lx	0.46lx / 0.46lx
2.0m	141.40x108.60lx	0.35lx / 0.35lx
3.0m	67.40x81.45lx	0.20lx / 0.20lx
4.0m	4.70x45.90lx	0.15lx / 0.15lx
5.0m	3.24x28.47lx	0.11lx / 0.11lx
6.0m	2.22x20.60lx	0.08lx / 0.08lx
7.0m	1.61x14.44lx	0.06lx / 0.06lx
8.0m	1.20x12.12lx	0.05lx / 0.05lx
9.0m	0.90x9.84lx	0.04lx / 0.04lx
10.0m	0.70x7.24lx	0.03lx / 0.03lx

Beam Angle: 120°
Beam Area: 120°
Dimension: 185x211mm

Note: The Curves indicate the illuminated area and the average illumination when the luminaire is at different distance.

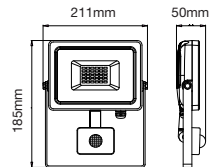

20W VT-4820 PIR

- 5697 - 3000K Warm White
- 5698 - 4500K Day White
- 5715 - 6000K White

EAN Code

- 3800157604338
- 3800157604345
- 3800157604949

Detection Angle: **120°**
Detection Distance: **2-8 Meters**



Watts:	20W	Beam Angle:	100°
Voltage/Frequency:	AC:200-240,50Hz	Color of Fixture:	Black
Luminous Flux:	1600lm	Body Type:	Aluminium Die Cast
CRI:	>70	IP Rating:	IP44
PF:	>0.9	Dimension:	185x211x50mm

LUMINOUS INTENSITY DISTRIBUTION DIAGRAM

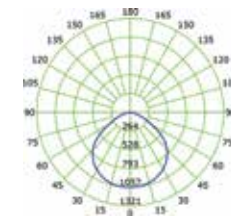

The average illuminance effective figure

Flux (lm)	Beam Angle (°)	Distance (m)
1.0m (240lm)	100°	1.0m (240lm)
2.0m (60lm)	100°	2.0m (60lm)
3.0m (40lm)	100°	3.0m (40lm)
4.0m (30lm)	100°	4.0m (30lm)
5.0m (24lm)	100°	5.0m (24lm)
6.0m (20lm)	100°	6.0m (20lm)
7.0m (18lm)	100°	7.0m (18lm)
8.0m (16lm)	100°	8.0m (16lm)
9.0m (15lm)	100°	9.0m (15lm)
10.0m (14lm)	100°	10.0m (14lm)

Note: The Curves indicate the illuminated area and the average illumination when the luminaire is at different distance.

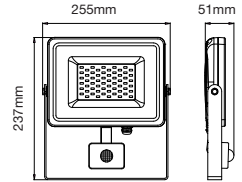

30W VT-4830 PIR

5699 - 3000K Warm White
5700 - 4500K Day White
5716 - 6000K White

EAN Code

3800157604352
3800157604369
3800157604956

Detection Angle: **120°**
Detection Distance: **2-8 Meters**



Watts:	30W	Beam Angle:	100°
Voltage/Frequency:	AC:200-240,50Hz	Color of Fixture:	Black
Luminous Flux:	2400lm	Body Type:	Aluminium Die Cast
CRI:	>70	IP Rating:	IP44
PF:	>0.9	Dimension:	237x255x51mm

LUMINOUS INTENSITY DISTRIBUTION DIAGRAM

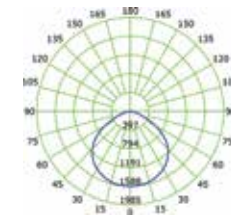

The average illuminance effective figure

Flux (lm)	Beam Angle (°)	Distance (m)
1.0m (400lm)	100°	1.0m (400lm)
2.0m (100lm)	100°	2.0m (100lm)
3.0m (67lm)	100°	3.0m (67lm)
4.0m (50lm)	100°	4.0m (50lm)
5.0m (40lm)	100°	5.0m (40lm)
6.0m (33lm)	100°	6.0m (33lm)
7.0m (29lm)	100°	7.0m (29lm)
8.0m (26lm)	100°	8.0m (26lm)
9.0m (24lm)	100°	9.0m (24lm)
10.0m (23lm)	100°	10.0m (23lm)

Note: The Curves indicate the illuminated area and the average illumination when the luminaire is at different distance.

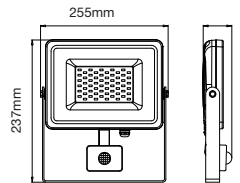

50W VT-4850 PIR

5701 - 3000K Warm White
5702 - 4500K Day White
5717 - 6000K White

EAN Code

3800157604376
3800157604383
3800157604963

Detection Angle: **120°**
Detection Distance: **2-8 Meters**



Watts:	50W	Beam Angle:	100°
Voltage/Frequency:	AC:200-240,50Hz	Color of Fixture:	Black
Luminous Flux:	4000lm	Body Type:	Aluminium Die Cast
CRI:	>70	IP Rating:	IP44
PF:	>0.9	Dimension:	237x255x51mm

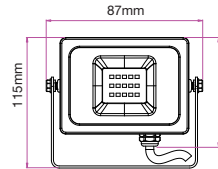

RF

Remote Control

10W VT-4711

RGB 5894

EAN Code

3800157617512



Watts:	10W	Beam Angle:	100°
Voltage/Frequency:	AC:200-240,50/60Hz	Color of Fixture:	Grey
Luminous Flux:	800lm	Body Type:	Aluminium Die Cast
CRI:	> 80	IP Rating:	IP65
PF:	>0.9	Dimension:	115x87x85mm

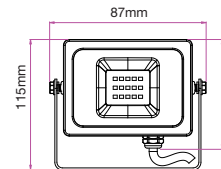

Infrared

Remote Control

10W VT-4711

RGB 5895

EAN Code

3800157617529



Watts:	10W	Beam Angle:	100°
Voltage/Frequency:	AC:200-240,50/60Hz	Color of Fixture:	Grey
Luminous Flux:	800lm	Body Type:	Aluminium Die Cast
CRI:	> 80	IP Rating:	IP65
PF:	>0.95	Dimension:	115x87x85mm



RF

Remote Control

30W VT-4732

EAN Code

RGB 5755

3800157609517

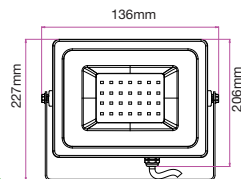

Watts:	30W	Beam Angle:	120°
Voltage/Frequency:	AC: 90-240V, 50/60Hz	Color of Fixture:	Grey
Luminous Flux:	2400lm	Body Type:	Aluminium Die Cast
CRI:	> 80	IP Rating:	IP65
PF:	>0.95	Dimension:	230x136x206mm



RF

Remote Control

50W VT-4752

EAN Code

RGB 5691

3800157603508

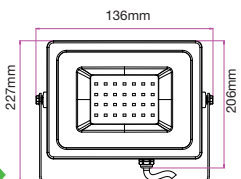

Watts:	50W	Beam Angle:	120°
Voltage/Frequency:	AC:100-240V,50/60Hz	Color of Fixture:	Grey
Luminous Flux:	4000lm	Body Type:	Aluminium Die Cast
CRI:	> 80	IP Rating:	IP65
PF:	>0.95	Dimension:	230x136x206mm



Rechargeable

Portable

20W VT-4822

EAN Code

5692 - 4500K Day White

3800157603515

5735 - 6000K White

3800157606929



Watts:	20W	Beam Angle:	100°
Voltage/Frequency:	AC:100-240V,50/60Hz	Color of Fixture:	Green
Luminous Flux:	1600lm	Body Type:	Plastic + Aluminium Die Cast
CRI:	/	IP Rating:	IP44
PF:	>0.7	Dimension:	208 x 204 x 355mm

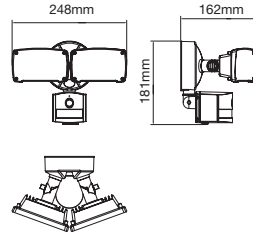

Wi-Fi Series

18W VT-4818

5745 - 6000K White

EAN Code

3800157608268



Power:	AC100-240V	Material:	ABS +Aluminium Die Cast
Output:	18W	Image sensor:	1/4 " 1Megapixel CMOS
Detection Range:	0-12M	Video Compression:	H.264 /MJPEG dual video stream
Detect Angle:	180°	Max Image Resolution:	1280*720
Delay Time:	0-30S	Pixels:	1 million pixels
LED:	42PCS 0.2W	Size:	248x 162x 181mm
Luminous Flux:	600lm	Color of Fixture:	White

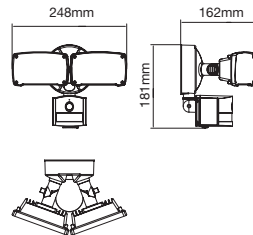

Wi-Fi Series

18W VT-4818

5917 - 6000K White

EAN Code

3800157620925



Power:	AC100-240V	Material:	ABS +Aluminium Die Cast
Output:	18W	Image sensor:	1/4 " 1Megapixel CMOS
Detection Range:	0-12M	Video Compression:	H.264 /MJPEG dual video stream
Detect Angle:	180°	Max Image Resolution:	1280*720
Delay Time:	0-30S	Pixels:	1 million pixels
LED:	42PCS 0.2W	Size:	248x 162x 181mm
Luminous Flux:	600lm	Color of Fixture:	Black

LUMINOUS INTENSITY DISTRIBUTION DIAGRAM

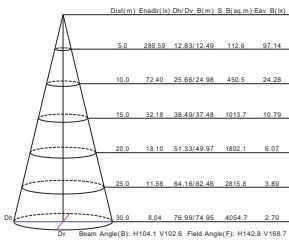
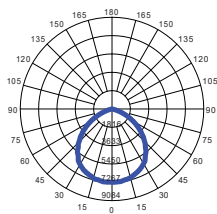

Note: The Curves indicate the illuminated area and the average illumination when the luminaire is at different distance.

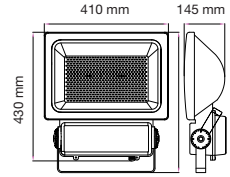

300W VT-47300

EAN Code

5386 - 6000K White

3800230627438



Sensor Compatible:	Yes	Beam Angle:	120°
Voltage/Frequency:	AC:90-240V,50/60Hz	Color of Fixture:	Grey
Luminous Flux:	24000lm	Body Type:	Aluminium Die Cast
CRI:	> 70	IP Rating:	IP65
PF:	> 0.9	Dimension:	430 x 410 x 145mm

LUMINOUS INTENSITY DISTRIBUTION DIAGRAM

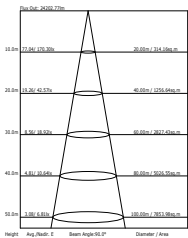
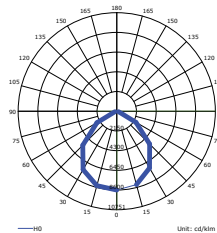

Note: The Curves indicate the illuminated area and the average illumination when the luminaire is at different distance.

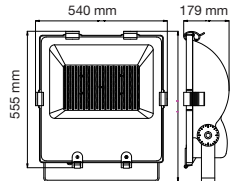

400W VT-47400

EAN Code

5649 - 6000K White

3800157601269



Sensor Compatible:	Yes	Beam Angle:	120°
Voltage/Frequency:	AC:90-240V,50/60Hz	Color of Fixture:	Black
Luminous Flux:	32000lm	Body Type:	Aluminium Die Cast
CRI:	> 70	IP Rating:	IP65
PF:	> 0.9	Dimension:	555 x 540 x 179mm

LUMINOUS INTENSITY DISTRIBUTION DIAGRAM

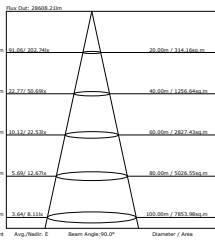
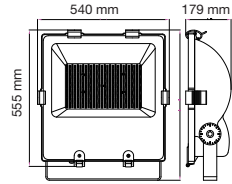
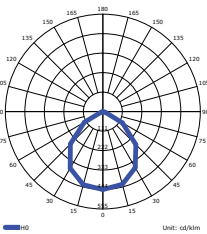

Note: The Curves indicate the illuminated area and the average illumination when the luminaire is at different distance.

500W VT-47500
5966 - 600K White

EAN Code
3800157603812



Sensor Compatible: Yes	Beam Angle: 120°
Voltage/Frequency: AC:100-240V,50/60Hz	Color of Fixture: Black
Luminous Flux: 40000lm	Body Type: Aluminium Die Cast
CRI: >70	IP Rating: IP65
PF: >0.9	Dimension: 555 x 540 x 179mm

LUMINOUS INTENSITY DISTRIBUTION DIAGRAM

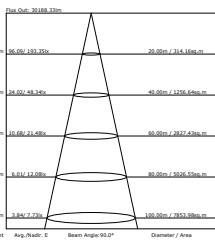
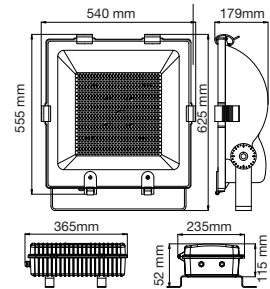
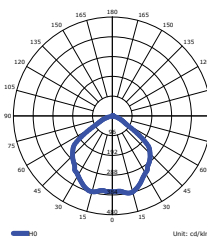

Note: The Curves indicate the illuminated area and the average illumination when the luminaire is at different distance.

600W VT-47600
5726 - 4500K Day White

EAN Code
3800157605854



Sensor Compatible: Yes	Beam Angle: 120°
Voltage/Frequency: AC:100-240V,50/60Hz	Color of Fixture: Black
Luminous Flux: 48000lm	Body Type: Aluminium Die Cast
CRI: >70	IP Rating: IP65
PF: >0.9	Dimension: 540x555x625mm

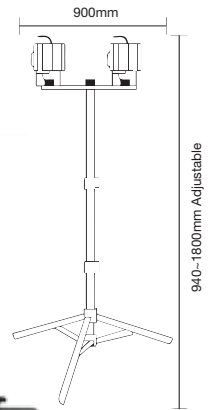

Tripod Stand for Flood Lights (Yellow)

Model No	VT-41150
SKU Code	9104
EAN Code	3800230626202



Tripod Stand for Flood Lights (Black)

Model No	VT-41150
SKU Code	9546
EAN Code	3800157604925

Waterproof Box Terminal Block



RESISTANT



Wire range:0.5-2.5mm² Inside Terminal Block

Model No:	VT-7224
SKU Code:	3578
EAN Code:	3800157605335
Voltage:	250V Max
Material:	Polypropylene (PP)
Size:	123x46x33mm

Model No	VT-792
SKU Code	3621
EAN Code	3800157607735

Wire range:4-6.5mm



RESISTANT



Wire range:0.5-2.5mm² Inside Terminal Block

Model No:	VT-7224
SKU Code:	5897
EAN Code:	3800157619202
Voltage:	250V Max
Material:	Polypropylene (PP)
Size:	123x46x33mm

Model No	VT-792
SKU Code	5896
EAN Code	3800157619196

Wire range:4-6.5mm

Billboard Stand For Flood Lights

Model No	VT-794
SKU Code	3623
EAN Code	3800157607810

85cm Suitable For:
10w - 20w - 30w - 50w

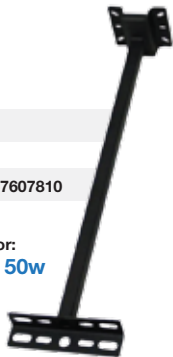

Model No	VT-793
SKU Code	3622
EAN Code	3800157607803

87cm Suitable For:
70w - 100w - 120w - 150w - 200w





LED Bulbs

An extensive collection of LED Bulbs which have been retrofitted to suit most standard Lighting Fixtures, with a wide range of wattage from 2W to 40W

Product Features

- Lasts 20 times longer than Standard Bulbs
- Broad Range of holders like E27, E14, B22, B15,G24 and R7S
- Uses 80% less energy than Standard Bulbs
- Glass & Thermoplastic Body options available
- Excellent Heat Radiation Efficiency
- Customized exterior for stronger body
- High Power LED Chips
- Wide beam angle up to 300°
- Non – Flickering
- Dimmable & Non Dimmable options

Applications

Widely used in residential lighting. LED Bulbs are the best replacement for conventional incandescent or fluorescent bulbs.



New!

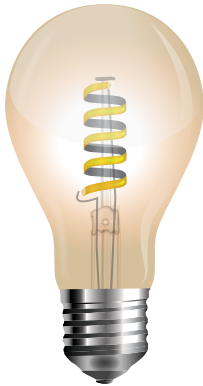

LED Spiral Filament Bulb- E27 Amber Glass

4W VT-2154

EAN Code

7335 2200k Warm White

3800157625197

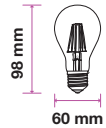

EQ. Watts:	40W	PF:	>0.4
Voltage/Frequency:	AC:220-240V,50Hz	Beam Angle:	300°
Luminous Flux:	400lm	Base:	E27
Commercial Type:	A60	Body Type:	Glass
LED Type:	COB	Dimension:	60mm x 98mm
CRI:	>80		

New!



LED Spiral Filament Bulb- E27 Clear Glass

4W VT-2164

EAN Code

7336 - 2700k Warm White

3800157625203

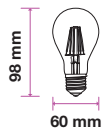

EQ. Watts:	40W	PF:	>0.4
Voltage/Frequency:	AC:220-240V,50Hz	Beam Angle:	300°
Luminous Flux:	400lm	Base:	E27
Commercial Type:	A60	Body Type:	Glass
LED Type:	COB	Dimension:	60mm x 98mm
CRI:	>80		



New!

LED Filament Bulb - ST60 - E27 Amber Glass

4W VT-2144

EAN Code

7327 - 2700K Warm White

3800157624718



EQ. Watts:	40W	PF:	>0.4
Voltage/Frequency:	AC: 220-240V, 50Hz	Beam Angle:	300°
Luminous Flux:	400lm	Base:	E27
Commercial Type:	ST60	Body Type:	Glass
LED Type:	Filament	Dimension:	60mmx107mm
CRI:	>80		



New!

LED Double Filament Bulb-G125 - E27 Amber Glass

6W VT-2126

EAN Code

7328 2200k Warm White

3800157624725



EQ. Watts:	55W	PF:	> 0.5
Voltage/Frequency:	AC: 220-240V, 50/60Hz	Beam Angle:	300°
Luminous Flux:	480lm	Base:	E27
Commercial Type:	G125	Body Type:	Glass
LED Type:	COB	Dimension:	125mm x 175mm
CRI:	>70		



Curve Filament - A60 Amber Cover

3W VT-2063

EAN Code

7219 - 2200K Warm White

3800157617277

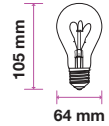

EQ. Watts:	20W	PF:	>0.4
Voltage/Frequency:	AC: 220-240v, 50Hz	Beam Angle:	300°
Luminous Flux:	150lm	Base:	E27
Commercial Type:	A60	Body Type:	Glass
LED Type:	Curve Filament	Dimension:	64mm x 105mm
CRI:	>80		

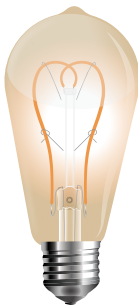

Curve Filament - ST64 Amber Cover

5W VT-2066

EAN Code

7220 - 2200K Warm White

3800157617284

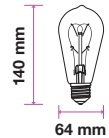

EQ. Watts:	30W	PF:	>0.4
Voltage/Frequency:	AC: 220-240v, 50Hz	Beam Angle:	300°
Luminous Flux:	300lm	Base:	E27
Commercial Type:	ST64	Body Type:	Glass
LED Type:	Curve Filament	Dimension:	64mmx140mm
CRI:	>80		

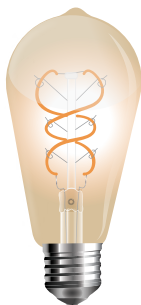

Curve Filament - ST64 Amber Cover

5W VT-2065

EAN Code

7218 - 2200K Warm White

3800157617260

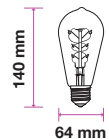

EQ. Watts:	30W	PF:	>0.4
Voltage/Frequency:	AC: 220-240v, 50Hz	Beam Angle:	300°
Luminous Flux:	300lm	Base:	E27
Commercial Type:	ST64	Body Type:	Glass
LED Type:	Curve Filament	Dimension:	64mmx140mm
CRI:	>80		

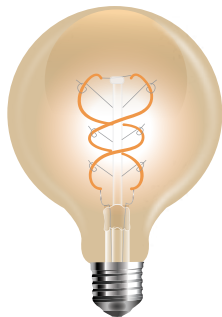

Curve Filament - G95 Amber Cover

5W VT-2075

EAN Code



7217 - 2200K Warm White

3800157617253



EQ. Watts:	30W	PF:	>0.4
Voltage/Frequency:	AC: 220-240v, 50Hz	Beam Angle:	300°
Luminous Flux:	300lm	Base:	E27
Commercial Type:	G95	Body Type:	Glass
LED Type:	Curve Filament	Dimension:	95mm x138 mm
CRI:	>80		

Old fashioned
in **New Style**



Curve Filament - G125 Amber Cover

5W VT-2085

EAN Code



7216 - 2200K Warm White

3800157617246



EQ. Watts:	30W	PF:	>0.4
Voltage/Frequency:	AC: 220-240v, 50Hz	Beam Angle:	300°
Luminous Flux:	300lm	Base:	E27
Commercial Type:	G125	Body Type:	Glass
LED Type:	Curve Filament	Dimension:	125mm x 175mm
CRI:	>80		



8 Filament - G80 Amber Cover

4W VT-2004

EAN Code

7148 - 2200K Warm White

3800157610636

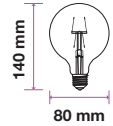

EQ. Watts:	35W	PF:	>0.4
Voltage/Frequency:	AC: 220-240V,50Hz	Beam Angle:	300°
Luminous Flux:	400lm	Base:	E27
Commercial Type:	G80	Body Type:	Glass
LED Type:	Filament	Dimension:	80mm x 140mm
CRI:	>80		

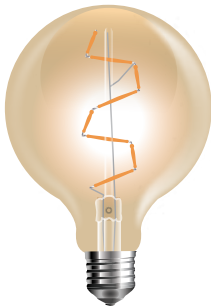

S-Shape Filament - G95 Amber Cover

4W VT-2024

EAN Code

7146 - 2200K Warm White

3800157610612

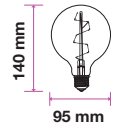

EQ. Watts:	35W	PF:	>0.4
Voltage/Frequency:	AC: 220-240V,50Hz	Beam Angle:	300°
Luminous Flux:	400lm	Base:	E27
Commercial Type:	G95	Body Type:	Glass
LED Type:	Filament	Dimension:	95mm x 140mm
CRI:	>80		



Long Filament - G95 Amber Cover

7W VT-2027

EAN Code

7147 - 2200K Warm White

3800157610629

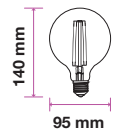

EQ. Watts:	60W	PF:	>0.5
Voltage/Frequency:	AC: 220-240V,50Hz	Beam Angle:	300°
Luminous Flux:	700lm	Base:	E27
Commercial Type:	G95	Body Type:	Glass
LED Type:	Filament	Dimension:	95mm x 140mm
CRI:	>80		



16 Filament - G95 Amber Cover

8W VT-2019

EAN Code

7145 - 2200K Warm White

3800157610605

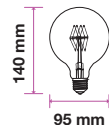

EQ. Watts:	65W	PF:	>0.5
Voltage/Frequency:	AC: 220-240V,50Hz	Beam Angle:	300°
Luminous Flux:	800lm	Base:	E27
Commercial Type:	G95	Body Type:	Glass
LED Type:	Filament	Dimension:	95mm x 140mm
CRI:	>80		

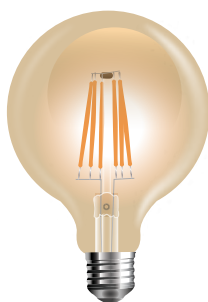

Long Filament - G125 Amber Cover

6W VT-1956

EAN Code

4473 - 2200K Warm White

3800157609074



EQ. Watts:	55W	PF:	>0.5
Voltage/Frequency:	AC: 220-240V,50Hz	Beam Angle:	300°
Luminous Flux:	550lm	Base:	E27
Commercial Type:	G125	Body Type:	Glass
LED Type:	Filament	Dimension:	125mm x 165mm
CRI:	>80		



T-30-Clear Glass

2W VT-2042

7251 - 2700K Warm White

EAN Code

3800157620826

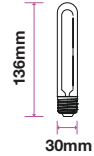

EQ. Watts:	20W	PF:	>0.4
Voltage/Frequency:	AC:220-240V,50Hz	Beam Angle:	300°
Luminous Flux:	200lm	Base:	E27
Commercial Type:	T30	Body Type:	Glass
LED Type:	Filament	Dimension:	30mm x 136mm
CRI:	>80		



T-30-Amber Cover

2W VT-2052

7252 - 2200K Warm White

EAN Code

3800157620833

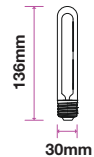

EQ. Watts:	20W	PF:	>0.4
Voltage/Frequency:	AC:220-240V,50Hz	Beam Angle:	300°
Luminous Flux:	200lm	Base:	E27
Commercial Type:	T30	Body Type:	Glass
LED Type:	Filament	Dimension:	30mm x 136mm
CRI:	>80		



T-30-300 Amber Cover

5W VT-2005

EAN Code

7142 - 2200K Warm White

3800157610575

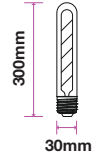

EQ. Watts:	45W	PF:	>0.4
Voltage/Frequency:	AC: 220-240V,50Hz	Beam Angle:	300°
Luminous Flux:	500lm	Base:	E27
Commercial Type:	T30-300	Body Type:	Glass
LED Type:	Filament	Dimension:	30mm x 300mm
CRI:	>80		

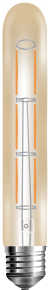

T-30-185 Amber Cover

6W VT-2006

EAN Code

7143 - 2200K Warm White

3800157610582

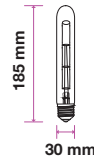

EQ. Watts:	50W	PF:	>0.5
Voltage/Frequency:	AC: 220-240V,50Hz	Beam Angle:	300°
Luminous Flux:	600lm	Base:	E27
Commercial Type:	T30-185	Body Type:	Glass
LED Type:	Filament	Dimension:	30mm x 185mm
CRI:	>80		



T-30-300 Amber Cover

8W VT-2008

EAN Code

7144 - 2200K Warm White

3800157610599

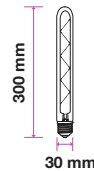

EQ. Watts:	60W	PF:	>0.5
Voltage/Frequency:	AC: 220-240V,50Hz	Beam Angle:	300°
Luminous Flux:	700lm	Base:	E27
Commercial Type:	T30-300	Body Type:	Glass
LED Type:	Filament	Dimension:	30mm x 300mm
CRI:	>80		



Candle Filament - E14 Amber Cover

4W VT-1955

EAN Code

3800157609883



7113 - 2200K Warm White



EQ. Watts:	40W	PF:	>0.4
Voltage/Frequency:	AC: 220-240V,50Hz	Beam Angle:	300°
Luminous Flux:	350lm	Base:	E14
Commercial Type:	Candle	Body Type:	Glass
LED Type:	Filament	Dimension:	35mm x 100mm
CRI:	>80		



Candle Filament - E14 Amber Cover

4W VT-1948

EAN Code

3800157609906



7115 - 2200K Warm White



EQ. Watts:	35W	PF:	>0.4
Voltage/Frequency:	AC: 220-240V,50Hz	Beam Angle:	300°
Luminous Flux:	350lm	Base:	E14
Commercial Type:	Candle	Body Type:	Glass
LED Type:	Filament	Dimension:	35mm x 100mm
CRI:	>80		



Candle Flame Filament - E14 Amber Cover

4W VT-1949

EAN Code

3800157609890



7114 - 2200K Warm White

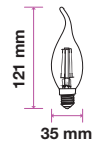

EQ. Watts:	35W	PF:	>0.4
Voltage/Frequency:	AC: 220-240V,50Hz	Beam Angle:	300°
Luminous Flux:	350lm	Base:	E14
Commercial Type:	Candle Flame	Body Type:	Glass
LED Type:	Filament	Dimension:	35mm x 121mm
CRI:	>80		



Candle Filament - E14 Amber Cover

4W VT-1947

EAN Code

7116 - 2200K Warm White

3800157609913



EQ. Watts:	35W	PF:	>0.4
Voltage/Frequency:	AC: 220-240V,50Hz	Beam Angle:	300°
Luminous Flux:	350lm	Base:	E14
Commercial Type:	Candle Flame	Body Type:	Glass
LED Type:	Filament	Dimension:	35mm x 121mm
CRI:	>80		



P45 Filament - E14 Amber Cover

4W VT-1953

EAN Code

4499 - 2200K Warm White

3800157609746

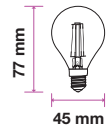

EQ. Watts:	40W	PF:	>0.4
Voltage/Frequency:	AC: 220-240V,50Hz	Beam Angle:	300°
Luminous Flux:	350lm	Base:	E14
Commercial Type:	P45	Body Type:	Glass
LED Type:	Filament	Dimension:	45 x 77mm
CRI:	>80		



G45 Filament - E27 Amber Cover

4W VT-1957

EAN Code

7100 - 2200K Warm White

3800157609753

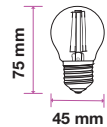

EQ. Watts:	35W	PF:	>0.4
Voltage/Frequency:	AC: 220-240V,50Hz	Beam Angle:	300°
Luminous Flux:	350lm	Base:	E27
Commercial Type:	G45	Body Type:	Glass
LED Type:	Filament	Dimension:	45 x 75mm
CRI:	>80		



A60 - E27 Amber Cover

4W VT-1954

EAN Code

4498 - 2200K Warm White

3800157609739

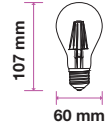

EQ. Watts:	35W	PF:	>0.4
Voltage/Frequency:	AC: 220-240V,50Hz	Beam Angle:	300°
Luminous Flux:	350lm	Base:	E27
Commercial Type:	A60	Body Type:	Glass
LED Type:	Filament	Dimension:	60 x 107mm
CRI:	>80		



A67 - E27 Amber Cover

8W VT-1958

EAN Code

4472 - 2200K Warm White

3800157609067



EQ. Watts:	60W	PF:	>0.5
Voltage/Frequency:	AC: 220-240V,50Hz	Beam Angle:	300°
Luminous Flux:	720lm	Base:	E27
Commercial Type:	A67	Body Type:	Glass
LED Type:	Filament	Dimension:	67 x 123mm
CRI:	>80		



A67 - E27 Amber Cover

10W VT-2028

EAN Code

7157 - 2200K Warm White

3800157612227

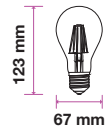

EQ. Watts:	65W	PF:	>0.5
Voltage/Frequency:	AC: 220-240V,50Hz	Beam Angle:	300°
Luminous Flux:	900lm	Base:	E27
Commercial Type:	A67	Body Type:	Glass
LED Type:	Filament	Dimension:	67mm x 123mm
CRI:	>80		



G95 - E27 Amber Cover

6W VT-2026D

EAN Code

7156 - 2200K Warm White

3800157612210



EQ. Watts:	50W	Dimmable:	Yes
Voltage/Frequency:	AC: 220-240V, 50Hz	PF:	>0.5
Luminous Flux:	500lm	Beam Angle:	300°
Commercial Type:	G95	Base:	E27
LED Type:	Filament	Body Type:	Glass
CRI:	>80	Dimension:	95mm x 135mm



Dimmable G125 - E27 Amber Cover

8W VT-2018D

EAN Code

7155 - 2200K Warm White

3800157612203



EQ. Watts:	60W	Dimmable:	Yes
Voltage/Frequency:	AC: 220-240V, 50Hz	PF:	>0.5
Luminous Flux:	700lm	Beam Angle:	300°
Commercial Type:	G125	Base:	E27
LED Type:	Filament	Body Type:	Glass
CRI:	>80	Dimension:	125mm x 177mm

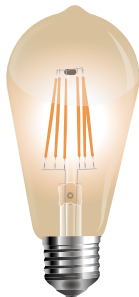

Dimmable ST64 - E27 Amber Cover

4W VT-1964D

EAN Code

4368 - 2200K Warm White

3800157602945

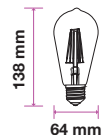

EQ. Watts:	30W	Dimmable:	Yes
Voltage/Frequency:	AC:220-240V, 50Hz	PF:	>0.4
Luminous Flux:	300lm	Beam Angle:	300°
Commercial Type:	ST64	Base:	E27
LED Type:	Filament	Body Type:	Glass
CRI:	>80	Dimension:	64mm x 138mm

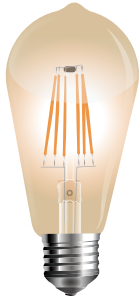

ST64 - E27 Amber Cover

4W VT-1964

EAN Code

4361 - 2200K Warm White

3800157602754

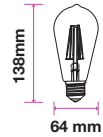

EQ. Watts:	40W	PF:	>0.4
Voltage/Frequency:	AC:220-240V, 50Hz	Beam Angle:	300°
Luminous Flux:	350lm	Base:	E27
Commercial Type:	ST64	Body Type:	Glass
LED Type:	Filament	Dimension:	64mm x 138mm
CRI:	>80		

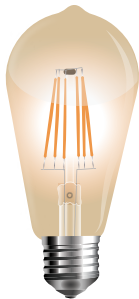

ST64 - E27 Amber Cover

6W VT-1966

EAN Code

4362 - 2200K Warm White

3800157602754



EQ. Watts:	45W	PF:	>0.5
Voltage/Frequency:	AC:220-240V, 50Hz	Beam Angle:	300°
Luminous Flux:	500lm	Base:	E27
Commercial Type:	ST64	Body Type:	Glass
LED Type:	Filament	Dimension:	64mm x 138mm
CRI:	>80		

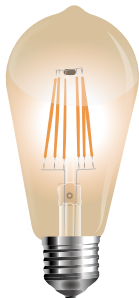

ST64 - E27 Amber Cover

8W VT-1968

EAN Code

4421 - 2200K Warm White

3800157606356



EQ. Watts:	60W	PF:	>0.5
Voltage/Frequency:	AC:220-240V,50Hz	Beam Angle:	300°
Luminous Flux:	700lm	Base:	E27
Commercial Type:	ST64	Body Type:	Glass
LED Type:	Filament	Dimension:	64mm x 138 mm
CRI:	>80		



Candle - E14 White Cover

4W VT-1924

EAN Code

7101 - 2700K Warm White

3800157609760

7102 - 4000K Day White

3800157609777

7103 - 6400K White

3800157609784

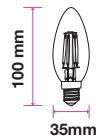

EQ. Watts:	35W	PF:	>0.4
Voltage/Frequency:	AC: 220-240V,50Hz	Beam Angle:	300°
Luminous Flux:	350lm	Base:	E14
Commercial Type:	Candle	Body Type:	Glass
LED Type:	Filament	Dimension:	35mm x 100mm
CRI:	>80		



New!

Candle - E14 Cross Filament White Cover

4W VT-1924

EAN Code

71031 - 6400K White

3800157624244

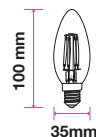

EQ. Watts:	35W	PF:	>0.4
Voltage/Frequency:	AC: 220-240V,50Hz	Beam Angle:	300°
Luminous Flux:	350lm	Base:	E14
Commercial Type:	Candle	Body Type:	Glass
LED Type:	Filament	Dimension:	35mm x 100mm
CRI:	>80		



Candle Flame - E14 White Cover

4W VT-1927

EAN Code

7104 - 2700K Warm White
7105 - 4000K Day White
7106 - 6400K White

3800157609791
 3800157609807
 3800157609814



EQ. Watts:	40W	PF:	>0.4
Voltage/Frequency:	AC: 220-240V,50Hz	Beam Angle:	300°
Luminous Flux:	350lm	Base:	E14
Commercial Type:	Candle	Body Type:	Glass
LED Type:	Filament	Dimension:	35mm x 121mm
CRI:	>80		



New!

Cross Filament Candle Flame - E14 White Cover

4W VT-1927

EAN Code

71041 - 2700K Warm White

3800157624299



EQ. Watts:	40W	PF:	>0.4
Voltage/Frequency:	AC: 220-240V,50Hz	Beam Angle:	300°
Luminous Flux:	350lm	Base:	E14
Commercial Type:	Candle	Body Type:	Glass
LED Type:	Filament	Dimension:	35mm x 121mm
CRI:	>80		



A60 - E27 White Cover

4W VT-1939

EAN Code

4489 - 2700K Warm White
4490 - 4000K Day White
4491 - 6400K White

3800157609647
 3800157609654
 3800157609661

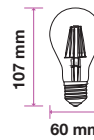

EQ. Watts:	40W	PF:	>0.4
Voltage/Frequency:	AC: 220-240V,50Hz	Beam Angle:	300°
Luminous Flux:	350lm	Base:	E27
Commercial Type:	A60	Body Type:	Glass
LED Type:	Filament	Dimension:	60mm x 107mm
CRI:	>80		



Candle - E14 Frost Cover

4W VT-1936

EAN Code

4474 - 2700K Warm White

3800157609081

4475 - 4000K Day White

3800157609098

4476 - 6400K White

3800157609104

A++

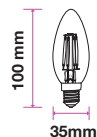

EQ. Watts:	40W	PF:	>0.4
Voltage/Frequency:	AC: 220-240V,50Hz	Beam Angle:	300°
Luminous Flux:	400lm	Base:	E14
Commercial Type:	Candle	Body Type:	Glass
LED Type:	Filament	Dimension:	35mm x 100mm
CRI:	>80		



Candle Flame - E14 Frost Cover

4W VT-1937

EAN Code

4477 - 2700K Warm White

3800157609111

4478 - 4000K Day White

3800157609128

4479 - 6400K White

3800157609135

A++



EQ. Watts:	40W	PF:	>0.4
Voltage/Frequency:	AC: 220-240V,50Hz	Beam Angle:	300°
Luminous Flux:	400lm	Base:	E14
Commercial Type:	Candle Flame	Body Type:	Glass
LED Type:	Filament	Dimension:	35mm x 121mm
CRI:	>80		



New!

Candle - E14 Cross Filament Frost Cover

4W VT-1928

EAN Code

71071 - 2700K Warm White

3800157624213

71081 - 4000K Day White

3800157624220

71091 - 6400K White

3800157624237

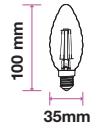

EQ. Watts:	40W	PF:	>0.4
Voltage/Frequency:	AC: 220-240V,50Hz	Beam Angle:	300°
Luminous Flux:	400lm	Base:	E14
Commercial Type:	Candle	Body Type:	Glass
LED Type:	Filament	Dimension:	35mm x 100mm
CRI:	>80		



Candle - E14 Frost Cover

4W VT-1928

EAN Code

7107 - 2700K Warm White

3800157609821

7108 - 4000K Day White

3800157609838

7109 - 6400K White

3800157609845

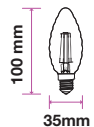

EQ. Watts:	40W	PF:	>0.4
Voltage/Frequency:	AC: 220-240V,50Hz	Beam Angle:	300°
Luminous Flux:	400lm	Base:	E14
Commercial Type:	Candle	Body Type:	Glass
LED Type:	Filament	Dimension:	35mm x 100mm
CRI:	>80		



Dimmable

Dimmable Candle Flame - E14 Frost Cover

4W VT-2056D

EAN Code

A++

7177 - 2700K Warm White

3800157615532



EQ. Watts:	35W	Dimmable:	Yes
Voltage/Frequency:	AC: 220-240V,50Hz	PF:	>0.5
Luminous Flux:	350lm	Beam Angle:	300°
Commercial Type:	Candle Flame	Base:	E14
LED Type:	Filament	Body Type:	Glass
CRI:	>80	Dimension:	35mm x 121mm



Candle Flame - E14 Frost Cover

4W VT-1923

EAN Code

A++

7110 - 2700K Warm White

3800157609852

7111 - 4000K Day White

3800157609869

7112 - 6400K White

3800157609876



EQ. Watts:	40W	PF:	>0.4
Voltage/Frequency:	AC: 220-240V,50Hz	Beam Angle:	300°
Luminous Flux:	400lm	Base:	E14
Commercial Type:	Candle Flame	Body Type:	Glass
LED Type:	Filament	Dimension:	35mm x 121mm
CRI:	>80		



Dimmable

Dimmable Candle - E14 Frost Cover

4W VT-2054D

EAN Code

A++

7176 - 2700K Warm White

3800157615525

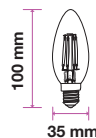

EQ. Watts:	35W	Dimmable:	Yes
Voltage/Frequency:	AC: 220-240V,50Hz	PF:	>0.4
Luminous Flux:	350lm	Beam Angle:	300°
Commercial Type:	Candle	Base:	E14
LED Type:	Filament	Body Type:	Glass
CRI:	>80	Dimension:	35mm x 100mm

**P45 - E14 Frost Cover****4W** VT-1835

EAN Code

4492 - 2700K Warm White

3800157609678

4493 - 4000K Day White

3800157609685

4494 - 6400K White

3800157609692



EQ. Watts:	40W	PF:	>0.4
Voltage/Frequency:	AC: 220-240V,50Hz	Beam Angle:	300°
Luminous Flux:	400lm	Base:	E14
Commercial Type:	P45	Body Type:	Glass
LED Type:	Filament	Dimension:	45mm x 77mm
CRI:	>80		

**New!****P45 - E14 Cross Filament Frost Cover****4W** VT-1835

EAN Code

44921 - 2700K Warm White

3800157624268

44931 - 4000K Day White

3800157624275

44941 - 6400K White

3800157624282

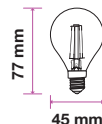

EQ. Watts:	40W	PF:	>0.4
Voltage/Frequency:	AC: 220-240V,50Hz	Beam Angle:	300°
Luminous Flux:	400lm	Base:	E14
Commercial Type:	P45	Body Type:	Glass
LED Type:	Filament	Dimension:	45mm x 77mm
CRI:	>80		

**G45 - E27 Frost Cover****4W** VT-1974

EAN Code

4495 - 2700K Warm White

3800157609708

4496 - 4000K Day White

3800157609715

4497 - 6400K White

3800157609722



EQ. Watts:	40W	PF:	>0.4
Voltage/Frequency:	AC: 220-240V,50Hz	Beam Angle:	300°
Luminous Flux:	400lm	Base:	E27
Commercial Type:	G45	Body Type:	Glass
LED Type:	Filament	Dimension:	45mm x 75mm
CRI:	>80		



A60 - E27 Frost Cover

4W VT-1934

EAN Code

4486 - 2700K Warm White

3800157609616

4487 - 4000K Day White

3800157609623

4488 - 6400K White

3800157609630



EQ. Watts:	40W	PF:	>0.4
Voltage/Frequency:	AC: 220-240V,50Hz	Beam Angle:	300°
Luminous Flux:	400lm	Base:	E27
Commercial Type:	A60	Body Type:	Glass
LED Type:	Filament	Dimension:	60mm x 107mm
CRI:	>80		



New!

A60 - E27 Cross Filament Frost Cover

6W VT-1935

EAN Code

44801 - 2700K Warm White

3800157624091

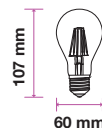

EQ. Watts:	55W	PF:	>0.5
Voltage/Frequency:	AC: 220-240V,50Hz	Beam Angle:	300°
Luminous Flux:	660lm	Base:	E27
Commercial Type:	A60	Body Type:	Glass
LED Type:	Filament	Dimension:	60mm x 107mm
CRI:	>80		



New!

A60 - E27 Cross Filament Frost Cover

7W VT-2047

EAN Code

71811 - 2700K Warm White

3800157624107

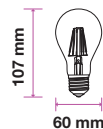

EQ. Watts:	60W	PF:	>0.5
Voltage/Frequency:	AC: 220-240V,50Hz	Beam Angle:	300°
Luminous Flux:	840lm	Base:	E27
Commercial Type:	A60	Body Type:	Glass
LED Type:	Filament	Dimension:	60mm x 107mm
CRI:	>80		



A60 - E27 Frost Cover

6W VT-1835
 4480 - 2700K Warm White
 4481 - 4000K Day White
 4482 - 6400K White

EAN Code
 3800157609142
 3800157609159
 3800157609166

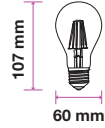

EQ. Watts:	55W	PF:	>0.5
Voltage/Frequency:	AC: 220-240V,50Hz	Beam Angle:	300°
Luminous Flux:	660lm	Base:	E27
Commercial Type:	A60	Body Type:	Glass
LED Type:	Filament	Dimension:	60mm x 107mm
CRI:	>80		



A67 - E27 Frost Cover

8W VT-1938
 4483 - 2700K Warm White
 4484 - 4000K Day White
 4485 - 6400K White

EAN Code
 3800157609586
 3800157609593
 3800157609609

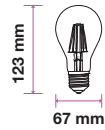

EQ. Watts:	60W	PF:	>0.5
Voltage/Frequency:	AC: 220-240V,50Hz	Beam Angle:	300°
Luminous Flux:	800lm	Base:	E27
Commercial Type:	A67	Body Type:	Glass
LED Type:	Filament	Dimension:	67mm x 123mm
CRI:	>80		



A67 - E27 Frost Cover

10W VT-2023
 7152 - 2700K Warm White
 7153 - 4000K Day White
 7154 - 6400K White

EAN Code
 3800157612173
 3800157612180
 3800157612197

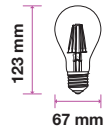

EQ. Watts:	75W	PF:	>0.5
Voltage/Frequency:	AC: 220-240V,50Hz	Beam Angle:	300°
Luminous Flux:	1055lm	Base:	E27
Commercial Type:	A67	Body Type:	Glass
LED Type:	Filament	Dimension:	67mm x 123mm
CRI:	>80		

**A60 - E27 Frost Cover****5W** VT-2045

7178 - 2700K Warm White

7179 - 4000K Day White

7180 - 6400K White

EAN Code

3800157615549

3800157615556

3800157615563

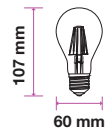

EQ. Watts:	50W	PF:	>0.5
Voltage/Frequency:	AC: 220-240V,50Hz	Beam Angle:	300°
Luminous Flux:	600lm	Base:	E27
Commercial Type:	A60	Body Type:	Glass
LED Type:	Filament	Dimension:	60mm x 107mm
CRI:	>80		

**A60 - E27 Frost Cover****7W** VT-2047

7181 - 2700K Warm White

7182 - 4000K Day White

7183 - 6400K White

EAN Code

3800157615570

3800157615587

3800157615594



EQ. Watts:	60W	PF:	>0.5
Voltage/Frequency:	AC: 220-240V,50Hz	Beam Angle:	300°
Luminous Flux:	840lm	Base:	E27
Commercial Type:	A60	Body Type:	Glass
LED Type:	Filament	Dimension:	60mm x 107mm
CRI:	>80		

**A67 - E27 Frost Cover****9W** VT-2049

7184 - 2700K Warm White

7185 - 4000K Day White

7186 - 6400K White

EAN Code

3800157615600

3800157615617

3800157615624



EQ. Watts:	80W	PF:	>0.5
Voltage/Frequency:	AC: 220-240V,50Hz	Beam Angle:	300°
Luminous Flux:	1100lm	Base:	E27
Commercial Type:	A67	Body Type:	Glass
LED Type:	Filament	Dimension:	67mm x 123mm
CRI:	>80		



G125 - E27 Frost Cover

7W VT-2067

EAN Code

7189 - 2700K Warm White
7190 - 6400K White

3800157615655
3800157615662



EQ. Watts:	60W	PF:	>0.5
Voltage/Frequency:	AC: 220-240V, 50Hz	Beam Angle:	300°
Luminous Flux:	840lm	Base:	E27
Commercial Type:	G125	Body Type:	Glass
LED Type:	Filament	Dimension:	125 x 177mm
CRI:	>80		



G125 - E27 Frost Cover

7W VT-2067D

EAN Code

7191 - 2700K Warm White

3800157615679



EQ. Watts:	55W	PF:	>0.5
Voltage/Frequency:	AC: 220-240V, 50Hz	Beam Angle:	300°
Luminous Flux:	750lm	Base:	E27
Commercial Type:	G125	Body Type:	Glass
LED Type:	Filament	Dimension:	125 x 177mm
CRI:	>80		



G95 - E27 Frost Cover

7W VT-2057

EAN Code

7187 - 2700K Warm White
7188 - 6400K White

3800157615631
3800157615648



EQ. Watts:	60W	PF	>0.5
Voltage/Frequency:	AC: 220-240V, 50Hz	Beam Angle:	300°
Luminous Flux:	840lm	Base:	E27
Commercial Type:	G95	Body Type:	Glass
LED Type:	Filament	Dimension:	95 x 135mm
CRI:	>80		



A60 - E27 Clear Glass

4W VT-1885

EAN Code

4259 - 2700K Warm White

3800230627179

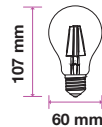

EQ. Watts:	40W	PF:	> 0.4
Voltage/Frequency:	AC: 220-240V, 50Hz	Beam Angle:	300°
Luminous Flux:	400lm	Base:	E27
Commercial Type:	A60	Body Type:	Glass
LED Type:	Filament	Dimension:	60mm x 107mm
CRI:	> 80		



Dimmable A60 - E27 Clear Glass

4W VT-1885D

EAN Code

4364 - 2200K Warm White

3800157602907



EQ. Watts:	30W	Dimmable:	Yes
Voltage/Frequency:	AC: 220-240V, 50Hz	PF:	> 0.5
Luminous Flux:	320lm	Beam Angle:	300°
Commercial Type:	A60	Base:	E27
LED Type:	Filament	Body Type:	Glass
CRI:	> 80	Dimension:	60mm x 107mm

New!



Dimmable

Dimmable A60 - E27 Cross Filament Clear Glass

4W VT-1885D

EAN Code

43641 - 2200K Warm White

3800157624305



EQ. Watts:	30W	Dimmable:	Yes
Voltage/Frequency:	AC: 220-240V, 50Hz	PF:	> 0.5
Luminous Flux:	350lm	Beam Angle:	300°
Commercial Type:	A60	Base:	E27
LED Type:	Filament	Body Type:	Glass
CRI:	> 80	Dimension:	60mm x 107mm



New!

A60 - E27 Cross Filament Clear Glass

4W VT-1885

EAN Code

42591 - 2700K Warm White

3800157624312

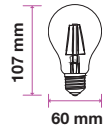

EQ. Watts:	40W	PF:	> 0.4
Voltage/Frequency:	AC: 220-240V, 50Hz	Beam Angle:	300°
Luminous Flux:	400lm	Base:	E27
Commercial Type:	A60	Body Type:	Glass
LED Type:	Filament	Dimension:	60mm x 107mm
CRI:	> 80		



New!

A60 - E27 Clear Glass

4W VT-2114

EAN Code

7283 - 2700K Warm White

3800157623735



EQ. Watts:	40W	PF:	> 0.4
Voltage/Frequency:	AC: 220-240V, 50Hz	Beam Angle:	300°
Luminous Flux:	400lm	Base:	E27
Commercial Type:	A60	Body Type:	Glass
LED Type:	Filament	Dimension:	60mm x 107mm
CRI:	> 80		



A60 - B22 Clear Glass

5W VT-2035

EAN Code

7170 - 2700K Warm White

3800157615464

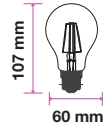

EQ. Watts:	50W	PF:	>0.5
Voltage/Frequency:	AC:220-240V,50Hz	Beam Angle:	300°
Luminous Flux:	600lm	Base:	B22
Commercial Type:	A60	Body Type:	Plastic
LED Type:	Filament	Dimension:	60 x 107mm
CRI:	>80		



A60 - E27 Clear Glass

6W VT-1887

EAN Code

4272 - 2700K Warm White
4303 - 4000K Day White

3800230627667
3800157600064

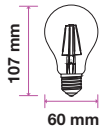

EQ. Watts:	55W	PF:	> 0.5
Voltage/Frequency:	AC: 220-240V, 50Hz	Beam Angle:	300°
Luminous Flux:	660lm	Base:	E27
Commercial Type:	A60	Body Type:	Glass
LED Type:	Filament	Dimension:	60mm x 107mm
CRI:	> 80		



A60 - E27 Clear Glass

8W VT-1988

EAN Code

4363 - 2700K Warm White

3800157602891



EQ. Watts:	75W	PF:	>0.5
Voltage/Frequency:	AC:220-240V, 50/60Hz	Beam Angle:	300°
Luminous Flux:	1000lm	Base:	E27
Commercial Type:	A60	Body Type:	Glass
LED Type:	Filament	Dimension:	60mm x 105mm
CRI:	>80		



A67 - E27 Clear Glass

8W VT-1989

EAN Code

4406 - 2700K Warm White

3800157605342

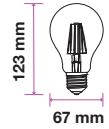

EQ. Watts:	75W	PF:	>0.5
Voltage/Frequency:	AC:220-240V,50Hz	Beam Angle:	300°
Luminous Flux:	1000lm	Base:	E27
Commercial Type:	A67	Body Type:	Glass
LED Type:	Filament	Dimension:	67mm x 123mm
CRI:	>80		



A67 - E27 Clear Glass

8W VT-1978

EAN Code

4407 - 2700K Warm White
4408 - 4000K Day White
4409 - 6400K White

3800157606165
3800157606172
3800157606189



EQ. Watts:	60W	PF:	>0.5
Voltage/Frequency:	AC:220-240V,50Hz	Beam Angle:	300°
Luminous Flux:	800lm	Base:	E27
Commercial Type:	A67	Body Type:	Glass
LED Type:	Filament	Dimension:	67mm x 123mm
CRI:	>80		



A67 - E27 Clear Glass

10W VT-1981

EAN Code

4410 - 2700K Warm White
4411 - 4000K Day White
4412 - 6400K White

3800157606196
3800157606202
3800157606219



EQ. Watts:	75W	PF:	>0.5
Voltage/Frequency:	AC:220-240V,50Hz	Beam Angle:	300°
Luminous Flux:	1055lm	Base:	E27
Commercial Type:	A67	Body Type:	Glass
LED Type:	Filament	Dimension:	67mm x 123mm
CRI:	>80		

**ST26 - E14 Clear Glass****2W** VT-1952

EAN Code

4444 - 3000K Warm White

3800157607858

4445 - 4000K Day White

3800157607865

4446 - 6400K White

3800157607872

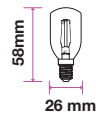

EQ. Watts:	20W	PF:	> 0.4
Voltage/Frequency:	AC:220-240V,50Hz	Beam Angle:	300°
Luminous Flux:	180lm	Base:	E14
Commercial Type:	ST 26	Body Type:	Glass
LED Type:	Filament	Dimension:	26 x 58 mm
CRI:	>80		

**Candle - B22 Clear Glass****4W** VT-2064

EAN Code

7225 - 2700K Warm White

3800157617550

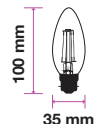

EQ. Watts:	40W	PF:	>0.4
Voltage/Frequency:	AC:220-240V,50Hz	Beam Angle:	300°
Luminous Flux:	400lm	Base:	B22
Commercial Type:	Candle	Body Type:	Glass
LED Type:	Filament	Dimension:	35 x 100mm
CRI:	>80		

**G45 - B22 Clear Glass****4W** VT-2074

EAN Code

7226 - 2700K Warm White

3800157617567

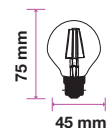

EQ. Watts:	40W	PF	> 0.4
Voltage/Frequency:	AC: 220-240V, 50Hz	Beam Angle:	300°
Luminous Flux:	400lm	Base:	B22
Commercial Type:	G45	Body Type:	Glass
LED Type:	Filament	Dimension:	45 x 75mm
CRI:	> 80		



Candle Flame - E14 Clear Glass

4W VT-1995

EAN Code

4308 - 2700K Warm White

3800157600354

4431 - 4000K Day White

3800157606455

4432 - 6400K White

3800157606462



EQ. Watts:	40W	PF:	> 0.4
Voltage/Frequency:	AC: 220-240V, 50Hz	Beam Angle:	300°
Luminous Flux:	400lm	Base:	E14
Commercial Type:	Candle Flame	Body Type:	Glass
LED Type:	Filament	Dimension:	35mm x 121mm
CRI:	> 80		



Dimmable Candle Flame - E14 Clear Glass

4W VT-1995D

EAN Code

4388 - 2700K Warm White

3800157603973



EQ. Watts:	30W	Dimmable:	Yes
Voltage/Frequency:	AC: 220-240V, 50Hz	PF:	> 0.5
Luminous Flux:	320lm	Beam Angle:	300°
Commercial Type:	Candle Flame	Base:	E14
LED Type:	Filament	Body Type:	Glass
CRI:	> 80	Dimension:	35mm x 121mm



Dimmable Candle Flame - E14 Cross Filament Clear Glass

4W VT-1995D

EAN Code

43881 - 2700K Warm White

3800157624251



EQ. Watts:	30W	Dimmable:	Yes
Voltage/Frequency:	AC: 220-240V, 50Hz	PF:	> 0.5
Luminous Flux:	350lm	Beam Angle:	300°
Commercial Type:	Candle Flame	Base:	E14
LED Type:	Filament	Body Type:	Glass
CRI:	> 80	Dimension:	35mm x 121mm



Candle Flame - E14 Clear Glass

4W VT-1997

EAN Code

- 4302 - 2700K Warm White
- 4429 - 4000K Day White
- 4430 - 6400K White

- 3800230629968
- 3800157606431
- 3800157606448



EQ. Watts:	40W	PF	> 0.4
Voltage/Frequency:	AC: 220-240V, 50Hz	Beam Angle:	300°
Luminous Flux:	400lm	Base:	E14
Commercial Type:	Candle Flame	Body Type:	Glass
LED Type:	Filament	Dimension:	35mm x 121mm
CRI:	> 80		



New!

Candle Flame - E14 Cross Filament Clear Glass

4W VT-1997

EAN Code

- 44291 - 4000K Day White
- 44301 - 6400K White

- 3800157624190
- 3800157624206



EQ. Watts:	40W	PF	> 0.4
Voltage/Frequency:	AC: 220-240V, 50Hz	Beam Angle:	300°
Luminous Flux:	400lm	Base:	E14
Commercial Type:	Candle Flame	Body Type:	Glass
LED Type:	Filament	Dimension:	35mm x 121mm
CRI:	> 80		



Dimmable Candle Flame - E14 Clear Glass

4W VT-1997D

EAN Code

- 4366 - 2700K Warm White

- 3800157602921



EQ. Watts:	30W	Dimmable:	Yes
Voltage/Frequency:	AC:220-240V, 50Hz	PF	>0.5
Luminous Flux:	320lm	Beam Angle:	300°
Commercial Type:	Candle Flame	Base:	E14
LED Type:	Filament	Body Type:	Glass
CRI:	>80	Dimension:	35mm x 121mm



New!

Dimmable Candle - E14 Cross Filament Clear Glass

4W VT-1986D

EAN Code

43651 - 2700K Warm White

3800157624176



EQ. Watts:	30W	Dimmable:	Yes
Voltage/Frequency:	AC:220-240V, 50Hz	PF:	>0.5
Luminous Flux:	350lm	Beam Angle:	300°
Commercial Type:	Candle	Base:	E14
LED Type:	Filament	Body Type:	Glass
CRI:	>80	Dimension:	35mm x 100mm



New!

Candle - E14 Cross Filament Clear Glass

4W VT-1985

EAN Code

43071 - 2700K Warm White

3800157624183

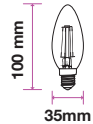

EQ. Watts:	40W	PF:	> 0.4
Voltage/Frequency:	AC: 220-240V, 50Hz	Beam Angle:	300°
Luminous Flux:	400lm	Base:	E14
Commercial Type:	Candle Flame	Body Type:	Glass
LED Type:	Filament	Dimension:	35mm x 100mm
CRI:	> 80		



Candle - E14 Clear Glass

4W VT-1985

EAN Code

4307 - 2700K Warm White

3800157600347

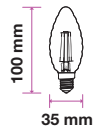

EQ. Watts:	40W	PF:	> 0.4
Voltage/Frequency:	AC: 220-240V, 50Hz	Beam Angle:	300°
Luminous Flux:	400lm	Base:	E14
Commercial Type:	Candle	Body Type:	Glass
LED Type:	Filament	Dimension:	35mm x 100mm
CRI:	> 80		



Dimmable Candle - E14 Clear Glass

4W VT-1985D

EAN Code

4367 - 2700K Warm White

3800157602938

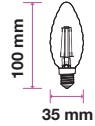

EQ. Watts:	30W	Dimmable:	Yes
Voltage/Frequency:	AC:220-240V, 50Hz	PF:	>0.5
Luminous Flux:	320lm	Beam Angle:	300°
Commercial Type:	Candle	Base:	E14
LED Type:	Filament	Body Type:	Glass
CRI:	>80	Dimension:	35mm x 100mm



New!

Candle - E14 Clear Glass

4W VT-2104

EAN Code

7282 - 2700K Warm White

3800157623728

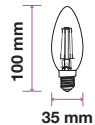

EQ. Watts:	40W	PF:	> 0.4
Voltage/Frequency:	AC: 220-240V, 50Hz	Beam Angle:	300°
Luminous Flux:	400lm	Base:	E14
Commercial Type:	Candle	Body Type:	Glass
LED Type:	Filament	Dimension:	35mm x 100mm
CRI:	> 80		



New!

Dimmable Candle - E14 Clear Glass

4W VT-2134D

EAN Code

7284 - 2700K Warm White

3800157623742

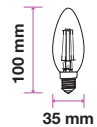

EQ. Watts:	30W	Dimmable:	Yes
Voltage/Frequency:	AC: 220-240V,50Hz	PF:	> 0.5
Luminous Flux:	350lm	Beam Angle:	300°
Commercial Type:	Candle	Base:	E14
LED Type:	Filament	Body Type:	Glass
CRI:	> 80	Dimension:	35mm x 100mm



Candle - E14 Clear Glass

4W VT-1986

- 4301 - 2700K Warm White
- 4413 - 4000K Day White
- 4414 - 6400K White

EAN Code

- 3800230629951
- 3800157606226
- 3800157606233



EQ. Watts:	40W	PF:	> 0.4
Voltage/Frequency:	AC: 220-240V, 50Hz	Beam Angle:	300°
Luminous Flux:	400lm	Base:	E14
Commercial Type:	Candle	Body Type:	Glass
LED Type:	Filament	Dimension:	35mm x 100mm
CRI:	> 80		



New!

Candle - E14 Cross Filament Clear Glass

4W VT-1986

- 43011 - 2700K Warm White
- 44141 - 6400K White

EAN Code

- 3800157624114
- 3800157624121



EQ. Watts:	40W	PF:	> 0.4
Voltage/Frequency:	AC: 220-240V, 50Hz	Beam Angle:	300°
Luminous Flux:	400lm	Base:	E14
Commercial Type:	Candle	Body Type:	Glass
LED Type:	Filament	Dimension:	35mm x 100mm
CRI:	> 80		



Dimmable Candle - E14 Clear Glass

4W VT-1986D

- 4365 - 2700K Warm White

EAN Code

- 3800157602914

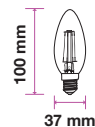

EQ. Watts:	30W	Dimmable:	Yes
Voltage/Frequency:	AC:220-240V, 50Hz	PF:	>0.5
Luminous Flux:	350lm	Beam Angle:	300°
Commercial Type:	Candle	Base:	E14
LED Type:	Filament	Body Type:	Glass
CRI:	>80	Dimension:	37mm x 100mm

New!



G45 - E27 Cross Filament Clear Glass

4W VT-1980

EAN Code

43061 - 2700K Warm White

3800157624329

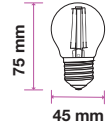

EQ. Watts:	40W	PF	> 0.4
Voltage/Frequency:	AC: 220-240V, 50Hz	Beam Angle:	300°
Luminous Flux:	400lm	Base:	E27
Commercial Type:	G45	Body Type:	Glass
LED Type:	Filament	Dimension:	45mm x 75mm
CRI:	> 80		

G45 - E27 Clear Glass



4W VT-1980

EAN Code

4306 - 2700K Warm White

3800157600330

4427 - 4000K Day White

3800157606417

4428 - 6400K White

3800157606424



EQ. Watts:	40W	PF	> 0.4
Voltage/Frequency:	AC: 220-240V, 50Hz	Beam Angle:	300°
Luminous Flux:	400lm	Base:	E27
Commercial Type:	G45	Body Type:	Glass
LED Type:	Filament	Dimension:	45mm x 75mm
CRI:	> 80		

Dimmable G45 - E27 Clear Glass



4W VT-1980D

EAN Code

4395 - 2700K Warm White

3800157604796



EQ. Watts:	30W	Dimmable:	Yes
Voltage/Frequency:	AC:220-240V,50Hz	PF:	>0.5
Luminous Flux:	320lm	Beam Angle:	300°
Commercial Type:	G45	Base:	E27
LED Type:	Filament	Body Type:	Glass
CRI:	>80	Dimension:	45mm x 75mm



P45 - E14 Clear Glass

4W VT-1996

EAN Code

- 4300 - 2700K Warm White
- 4425 - 4000K Day White
- 4426 - 6400K White

- 3800230629944
- 3800157606394
- 3800157606400



EQ. Watts:	40W	PF:	> 0.4
Voltage/Frequency:	AC: 220-240V, 50Hz	Beam Angle:	300°
Luminous Flux:	400lm	Base:	E14
Commercial Type:	P45	Body Type:	Glass
LED Type:	Filament	Dimension:	45mm x 77mm
CRI:	> 80		



P45 - E14 Cross Filament Clear Glass

4W VT-1996

EAN Code

- 43001 - 2700K Warm White

- 3800157624138



EQ. Watts:	40W	PF:	> 0.4
Voltage/Frequency:	AC: 220-240V, 50Hz	Beam Angle:	300°
Luminous Flux:	400lm	Base:	E14
Commercial Type:	P45	Body Type:	Glass
LED Type:	Filament	Dimension:	45mm x 75mm
CRI:	> 80		



Dimmable P45- E14 Clear Glass

4W VT-1996D

EAN Code

- 4394 - 2700K Warm White

- 3800157604314

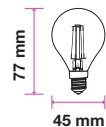

EQ. Watts:	30W	Dimmable:	Yes
Voltage/Frequency:	AC:220-240V,50Hz	PF	>0.5
Luminous Flux:	320lm	Beam Angle:	300°
Commercial Type:	P45	Base:	E14
LED Type:	Filament	Body Type:	Glass
CRI:	>80	Dimension:	45mm x 77mm



Dimmable G125 - E27 Clear Glass

4W VT-1994D

EAN Code

4399 - 2700K Warm White

3800157605021



EQ. Watts:	30W	Dimmable:	Yes
Voltage/Frequency:	AC:220-240V,50Hz	PF:	>0.5
Luminous Flux:	320lm	Beam Angle:	300°
Commercial Type:	G125	Base:	E27
LED Type:	Filament	Body Type:	Glass
CRI:	>80	Dimension:	125mm x 177mm



G125 - E27 Clear Glass

6W VT-1983

EAN Code

4304 - 2700K Warm White

3800157600316



EQ. Watts:	60W	PF:	> 0.5
Voltage/Frequency:	AC: 220-240V, 50Hz	Beam Angle:	300°
Luminous Flux:	660lm	Base:	E27
Commercial Type:	G125	Body Type:	Glass
LED Type:	Filament	Dimension:	125mm x 177mm
CRI:	> 80		



G95- E27 Clear Glass

6W VT-1993

EAN Code

4305 - 2700K Warm White

3800157600323

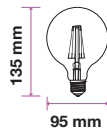

EQ. Watts:	60W	PF	> 0.5
Voltage/Frequency:	AC: 220-240V, 50Hz	Beam Angle:	300°
Luminous Flux:	550lm	Base:	E27
Commercial Type:	G95	Body Type:	Glass
LED Type:	Filament	Dimension:	95mm x 135mm
CRI:	> 80		



G125 - E27 Clear Glass

10W VT-1979

EAN Code

- 4422 - 2700K Warm White
- 4423 - 4500K Day White
- 4424 - 6000K White

- 3800157606363
- 3800157606370
- 3800157606387



EQ. Watts:	75W	PF:	>0.5
Voltage/Frequency:	AC:220-240V,50Hz	Beam Angle:	300°
Luminous Flux:	1055lm	Base:	E27
Commercial Type:	G125	Body Type:	Glass
LED Type:	Filament	Dimension:	125mm x 177 mm
CRI:	>80		





R7S Bulb

7W VT-1917

- 7123 - 3000K Warm White
- 7124 - 4000K Day White
- 7125 - 6400K White

EAN Code

- 3800157610032
- 3800157610049
- 3800157610056

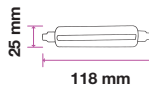

EQ. Watts:	40W	PF:	>0.5
Voltage/Frequency:	AC: 220-240V, 50Hz	Beam Angle:	360°
Luminous Flux:	470lm	Base:	R7S
Commercial Type:	R7S	Body Type:	Thermoplastic
LED Type:	SMD	Dimension:	25mm x 118mm
CRI:	>80		



R7S Bulb

10W VT-1990

- 4369 - 3000K Warm White
- 4389 - 4000K Day White
- 4390 - 6400K White

EAN Code

- 3800157602952
- 3800157604130
- 3800157604147

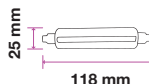

EQ. Watts:	60W	PF:	>0.5
Voltage/Frequency:	AC:220-240V, 50Hz	Beam Angle:	360°
Luminous Flux:	1000lm	Base:	R7S
Commercial Type:	R7S	Body Type:	Thermoplastic
LED Type:	SMD	Dimension:	25mm x 118mm
CRI:	>80		

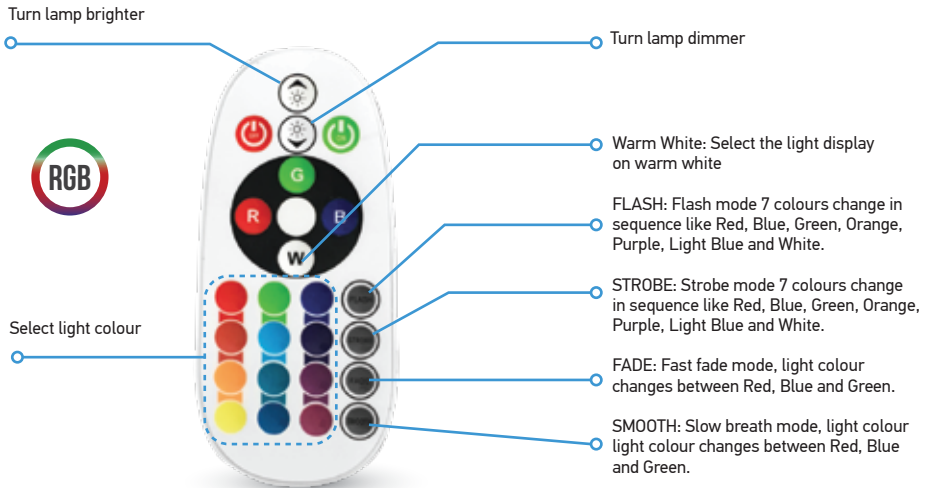

Under these 4 modes you can choose the Brighter / Dimmer key on the controller to make the speed faster / slower.

RGB Bulb

6W VT-2022

7121 RGB + 2700K Warm White
7150 RGB + 4000K Day White
7151 RGB + 6400K White

EAN Code
3800157609975
3800157610711
3800157610728

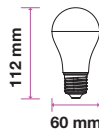

EQ. Watts:	40W	PF:	>0.5
Voltage/Frequency:	AC: 220-240V,50Hz	Beam Angle:	200°
Luminous Flux:	470lm	Base:	E27
Commercial Type:	A60	Body Type:	Thermoplastic
LED Type:	SMD	Dimension:	60mm x 112mm
CRI:	>80		

RGB Bulb Blister Pack

6W VT-2022

7324 RGB + 270K Warm White
7325 RGB + 4000K Day White
7326 RGB + 6400K White

EAN Code
3800157624602
3800157624619
3800157624626

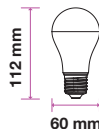

EQ. Watts:	40W	PF:	>0.5
Voltage/Frequency:	AC: 220-240V,50Hz	Beam Angle:	200°
Luminous Flux:	470lm	Base:	E27
Commercial Type:	A60	Body Type:	Thermoplastic
LED Type:	SMD	Dimension:	60mm x 112mm
CRI:	>80		

A60 With Sensor Light

Our smart sensor bulbs are built in with photocells with transmits Signal to light source as per lumen conditions smartly and saves power by going onto Light mode, enabling you to save power and reduce consumption of power when not required.



9W VT-2016

4459 - 2700K Warm White
4460 - 4500K Day White
4461 - 6000K White

EAN Code

3800157608237
 3800157608244
 3800157608251

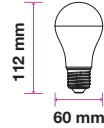

EQ. Watts:	60W	PF:	>0.5
Voltage/Frequency:	AC:220-240V,50Hz	Beam Angle:	200°
Luminous Flux:	806lm	Base:	E27
Commercial Type:	A60	Body Type:	Thermoplastic
LED Type:	SMD	Dimension:	60mm x 112 mm
CRI:	>80		



New!

A60 With Sensor Light

9W VT-2109

7285 - 2700K Warm White
7286 - 4000K Day White
7287 - 6400K White

EAN Code

3800157623759
 3800157623766
 3800157623773



EQ. Watts:	60W	PF	>0.5
Voltage/Frequency:	AC:220-240V,50Hz	Beam Angle:	200°
Luminous Flux:	806lm	Base:	E27
Commercial Type:	A60	Body Type:	Thermoplastic
LED Type:	SMD	Dimension:	60mm x 112 mm
CRI:	>80		

DC24V

Ideal Use for marine, solar/wind systems, fishing, motor home/RV, buses, vehicles systems, etc.



9W VT-2059

7224 - 6400K White

EAN Code

3800157617543

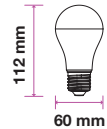

EQ. Watts:	55W	PF:	>0.5
Voltage/Frequency:	DC:24V	Beam Angle:	200°
Luminous Flux:	720lm-At 100% ON	Base:	E27
Commercial Type:	A60	Body Type:	Thermoplastic
LED Type:	SMD	Dimension:	60mm x 112 mm
CRI:	>80		

A60 3-Step Dimming | Smart Dimming Technology Without A Dimmer!

At the click of button, change the lighting Power from 100% to 50% and if need to Reduce more click again to go to 15%.



9W VT-2011
 4447 - 2700K Warm White
 4448 - 4000K Day White
 4449 - 6400K White

EAN Code
 3800157607988
 3800157607995
 3800157608008



EQ. Watts:	60W	PF:	>0.5
Voltage/Frequency:	AC:220-240V,50Hz	Beam Angle:	200°
Luminous Flux:	806lm	Base:	E27
Commercial Type:	A60	Body Type:	Thermoplastic
LED Type:	SMD	Dimension:	60mm x 112 mm
CRI:	>80		



New!

A60 - 3 Step Dimming

9W VT-2129
 7288 - 2700K Warm White
 7289 - 4000K Day White
 7290 - 6400K White

EAN Code
 3800157623780
 3800157623797
 3800157623803

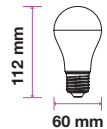

EQ. Watts:	60W	PF:	>0.5
Voltage/Frequency:	AC:220-240V,50Hz	Beam Angle:	200°
Luminous Flux:	806lm	Base:	E27
Commercial Type:	A60	Body Type:	Thermoplastic
LED Type:	SMD	Dimension:	60mm x 112 mm
CRI:	>80		



New!

A60 -Color Changing E27 Bulb

9W VT-2149

EAN Code

7309 - 3 IN 1 - Blister Pack

3800157623995

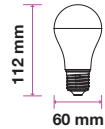

EQ. Watts:	60W	PF	>0.5
Voltage/Frequency:	AC:220-240V,50Hz	Beam Angle:	200°
Luminous Flux:	806lm	Base:	E27
Commercial Type:	A60	Body Type:	Thermoplastic
LED Type:	SMD	Dimension:	60mm x 112 mm
CRI:	>80		

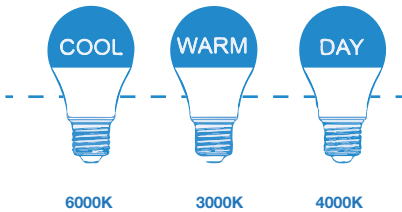

HOW IT WORKS



1. Switch the light on for cool white.
2. Turn the Switch off and on again for warm white.
3. Turn the Switch off and on again for day white.
4. Switch between these to select your ideal colour.



New!

A60 -Color Changing E27 Bulb

9W VT-2119

EAN Code

7317 - 3 IN 1 - Single Pack

3800157624497

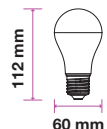

EQ. Watts:	60W	PF	>0.5
Voltage/Frequency:	AC:220-240V,50Hz	Beam Angle:	200°
Luminous Flux:	806lm	Base:	E27
Commercial Type:	A60	Body Type:	Thermoplastic
LED Type:	SMD	Dimension:	60mm x 112 mm
CRI:	>80		



SKU Code **7341 -RED** EAN Code 3800157626033



SKU Code **7342 - YELLOW** EAN Code 3800157626040



SKU Code **7343 - GREEN** EAN Code 3800157626057



SKU Code **7344 - BLUE** EAN Code 3800157626064

New!

A60 -Color E27 Bulb

9W VT-2000

A+

EQ. Watts:	60W	PF	>0.5
Voltage/Frequency:	AC:220-240V,50Hz	Beam Angle:	200°
Luminous Flux:	806lm	Base:	E27
Commercial Type:	A60	Body Type:	Thermoplastic
LED Type:	SMD	Dimension:	60mm x 112 mm
CRI:	>80		

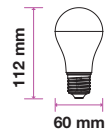



A60 - E27 Bulb

9W VT-1900

7240 - 2700K Warm White

7241 - 4000K Day White

7242 - 6400K White

EAN Code

3800157620130

3800157620147

3800157620154



EQ. Watts:	60W	PF:	> 0.5
Voltage/Frequency:	AC:220-240V,50Hz	Beam Angle:	200°
Luminous Flux:	806lm	Base:	E27
Commercial Type:	A60	Body Type:	Thermoplastic
LED Type:	SMD	Dimension:	60mm x 112mm
CRI:	>80		



A60 - B22 Bulb

9W VT-2069

7246 - 2700K Warm White

EAN Code

3800157620192



EQ. Watts:	60W	PF:	> 0.5
Voltage/Frequency:	AC:220-240V,50Hz	Beam Angle:	200°
Luminous Flux:	806lm	Base:	B22
Commercial Type:	A60	Body Type:	Thermoplastic
LED Type:	SMD	Dimension:	60mm x 112mm
CRI:	>80		



New!

A55 - E27 Bulb

5W VT-2055



- 7266 - 2700K Warm White
- 7267 - 4000K Day White
- 7268 - 6400K White

EAN Code

- 3800157622981
- 3800157622998
- 3800157623001

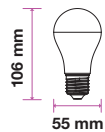

EQ. Watts:	35W	PF:	> 0.5
Voltage/Frequency:	AC: 220-240V, 50Hz	Beam Angle:	200°
Luminous Flux:	420lm	Base:	E27
Commercial Type:	A55	Body Type:	Thermoplastic
LED Type:	SMD	Dimension:	55mm x 106mm
CRI:	> 80		

A60 - E27 Bulb

7W VT-2007

EAN Code

- 4376 - 2700K Warm White
- 4377 - 4000K Day White
- 4378 - 6400K White

- 3800157603850
- 3800157603867
- 3800157603874

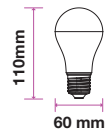

EQ. Watts:	40W	PF:	>0.5
Voltage/Frequency:	AC:220-240V, 50Hz	Beam Angle:	200°
Luminous Flux:	470lm	Base:	E27
Commercial Type:	A60	Body Type:	Thermoplastic
LED Type:	SMD	Dimension:	60mm x 110mm
CRI:	>80		



New!

A60 - E27 Bulb

9W VT-2099

- 7260 - 2700K Warm White
- 7261 - 4000K Day White
- 7262 - 6400K White

EAN Code

- 3800157622110
- 3800157622127
- 3800157622134

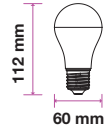

EQ. Watts:	60W	PF	>0.5
Voltage/Frequency:	AC:220-240V,50Hz	Beam Angle:	200°
Luminous Flux:	806lm	Base:	E27
Commercial Type:	A60	Body Type:	Thermoplastic
LED Type:	SMD	Dimension:	60mm x 112 mm
CRI:	>80		



New!

A60 - E27 Bulb

9W VT-2139

- 7294 - 2700K Warm White
- 7295 - 4000K Day White
- 7296 - 6400K White

EAN Code

- 3800157623841
- 3800157623858
- 3800157623865



EQ. Watts:	60W	PF	>0.5
Voltage/Frequency:	AC:220-240V,50Hz	Beam Angle:	200°
Luminous Flux:	806lm	Base:	E27
Commercial Type:	A60	Body Type:	Thermoplastic
LED Type:	SMD	Dimension:	60mm x 112 mm
CRI:	>80		



A60 - E27 Bulb

10W VT-1853

- 4209 - 2700K Warm White
- 4226 - 4000K Day White
- 4227 - 6400K White

EAN Code

- 3800230623591
- 3800230626271
- 3800230626288



EQ. Watts:	60W	PF:	> 0.5
Voltage/Frequency:	AC: 220-240V,50Hz	Beam Angle:	200°
Luminous Flux:	806lm	Base:	E27
Commercial Type:	A60	Body Type:	Thermoplastic
LED Type:	SMD	Dimension:	60mm x 112mm
CRI:	> 80		



New!

A60 - E27 Bulb

11W VT-2112

- 7350 - 2700K Warm White
- 7349 - 4000K Day White
- 7351 - 6400K White

EAN Code

- 3800157627399
- 3800157627320
- 3800157627405

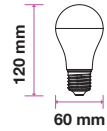

EQ. Watts:	75W	PF	>0.5
Voltage/Frequency:	AC:220-240V,50Hz	Beam Angle:	200°
Luminous Flux:	1055lm	Base:	E27
Commercial Type:	A60	Body Type:	Thermoplastic
LED Type:	SMD	Dimension:	60mm x 120mm
CRI:	>80		



New!

A60 - E27 Bulb

11W VT-2111

- 7297 - 2700K Warm White
- 7298 - 4000K Day White
- 7299 - 6400K White

EAN Code

- 3800157623872
- 3800157623889
- 3800157623896

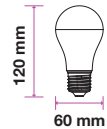

EQ. Watts:	75W	PF	>0.5
Voltage/Frequency:	AC:220-240V,50Hz	Beam Angle:	200°
Luminous Flux:	1055lm	Base:	E27
Commercial Type:	A60	Body Type:	Thermoplastic
LED Type:	SMD	Dimension:	60mm x 120mm
CRI:	>80		



A60 - E27 Bulb

New!

11W VT-2113

- 7352 - 2700K Warm White
- 7353 - 4000K Day White
- 7354 - 6400K White

EAN Code

- 3800157627412
- 3800157627429
- 3800157627436



EQ. Watts:	75W	PF	>0.5
Voltage/Frequency:	AC:220-240V,50Hz	Beam Angle:	200°
Luminous Flux:	1055lm	Base:	E27
Commercial Type:	A60	Body Type:	Thermoplastic
LED Type:	SMD	Dimension:	60mm x 120mm
CRI:	>80		



A60 - E27 Bulb

12W VT-1864

- 4228 - 2700K Warm White
- 4229 - 4000K Day White
- 4230 - 6400K White

EAN Code

- 3800230626295
- 3800230626301
- 3800230626318



EQ. Watts:	75W	PF	> 0.5
Voltage/Frequency:	AC: 220-240V,50Hz	Beam Angle:	200°
Luminous Flux:	1055lm	Base:	E27
Commercial Type:	A60	Body Type:	Thermoplastic
LED Type:	SMD	Dimension:	60mm x 120mm
CRI:	> 80		



Dimmable A60 - E27 Bulb

12W VT-1864D

- 4275 - 2700K Warm White

EAN Code

- 3800230627872

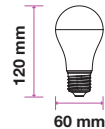

EQ. Watts:	75W	Dimmable:	Yes
Voltage/Frequency:	AC: 220-240V,50Hz	PF	> 0.7
Luminous Flux:	1055lm	Beam Angle:	200°
Commercial Type:	A60	Base:	E27
LED Type:	SMD	Body Type:	Thermoplastic
CRI:	> 80	Dimension:	60mm x 120mm



A65 - E27 Bulb

15W VT-2015

- 4453 - 2700K Warm White
- 4454 - 4000K Day White
- 4455 - 6400K White

EAN Code

- 3800157608091
- 3800157608107
- 3800157608114



EQ. Watts:	100W	PF:	>0.5
Voltage/Frequency:	AC:220-240V,50Hz	Beam Angle:	200°
Luminous Flux:	1500lm	Base:	E27
Commercial Type:	A65	Body Type:	Thermoplastic
LED Type:	SMD	Dimension:	66.5mm x 134mm
CRI:	>80		



New!

A65 - E27 Bulb

15W VT-2117

- 7300 - 2700K Warm White
- 7301 - 4000K Day White
- 7302 - 6400K White

EAN Code

- 3800157623902
- 3800157623919
- 3800157623926



EQ. Watts:	100W	PF	>0.5
Voltage/Frequency:	AC:220-240V,50Hz	Beam Angle:	200°
Luminous Flux:	1500lm	Base:	E27
Commercial Type:	A65	Body Type:	Thermoplastic
LED Type:	SMD	Dimension:	66.5 mm x 134mm
CRI:	>80		



A65 - E27 Bulb

17W VT-2017

- 4456 - 2700K Warm White
- 4457 - 4000K Day White
- 4458 - 6400K White

EAN Code

- 3800157608121
- 3800157608138
- 3800157608145

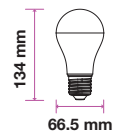

EQ. Watts:	130W	PF:	>0.5
Voltage/Frequency:	AC:220-240V,50Hz	Beam Angle:	200°
Luminous Flux:	1800lm	Base:	E27
Commercial Type:	A65	Body Type:	Thermoplastic
LED Type:	SMD	Dimension:	66.5 mm x 134mm
CRI:	>80		



A60 - B22 Bulb

7W VT-1828

- 4175 - 2700K Warm White
- 4197 - 4000K Day White
- 4176 - 6400K White

EAN Code

- 3800230620859
- 3800230624437
- 3800230620866

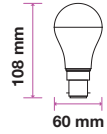

EQ. Watts:	45W	PF:	> 0.5
Voltage/Frequency:	AC: 220-240V,50Hz	Beam Angle:	270°
Luminous Flux:	470lm	Base:	B22
Commercial Type:	A60	Body Type:	Thermoplastic
LED Type:	SMD	Dimension:	60mm x 108mm
CRI:	> 80		

A60 - B22 Bulb

10W VT-1853

- 4442 - 2700K Warm White
- 4443 - 4000K Day White
- 4324 - 6400K White

EAN Code

- 3800157607681
- 3800157607698
- 3800157601061

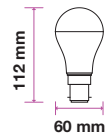

EQ. Watts:	60W	PF	> 0.5
Voltage/Frequency:	AC: 220-240V,50Hz	Beam Angle:	200°
Luminous Flux:	806lm	Base:	B22
Commercial Type:	A60	Body Type:	Thermoplastic
LED Type:	SMD	Dimension:	60mm x 112mm
CRI:	> 80		



A60 - B22 Bulb

12W VT-1864

- 7221 - 2700K Warm White
- 7222 - 4000K Day White
- 7223 - 6400K White

EAN Code

- 3800157617314
- 3800157617321
- 3800157617338

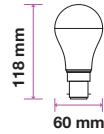

EQ. Watts:	75W	PF:	> 0.7
Voltage/Frequency:	AC: 220-240V,50Hz	Beam Angle:	200°
Luminous Flux:	1055lm	Base:	B22
Commercial Type:	A60	Body Type:	Thermoplastic
LED Type:	SMD	Dimension:	60mm x 118mm
CRI:	> 80		



A65 - B22 Bulb

15W VT-2015

- 7229 - 2700K Warm White

EAN Code

- 3800157619554

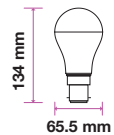

EQ. Watts:	100W	PF	>0.5
Voltage/Frequency:	AC:220-240V,50Hz	Beam Angle:	200°
Luminous Flux:	1500lm	Base:	B22
Commercial Type:	A65	Body Type:	Thermoplastic
LED Type:	SMD	Dimension:	65.5mm x 134mm
CRI:	>80		



G45 - B22 Bulb

3W VT-2053

7232 - 2700K Warm White
7233 - 6400K White

EAN Code

3800157619776
3800157619783

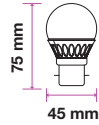

EQ. Watts:	25W	PF:	> 0.4
Voltage/Frequency:	AC: 220-240V,50Hz	Beam Angle:	180°
Luminous Flux:	250lm	Base:	B22
Commercial Type:	G45	Body Type:	Thermoplastic
LED Type:	SMD	Dimension:	45mm x 75mm
CRI:	> 80		



G45 - B22 Bulb

6W VT-1973

4441 - 2700K Warm White

EAN Code

3800157607674

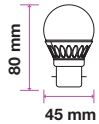

EQ. Watts:	40W	PF	>0.5
Voltage/Frequency:	AC:220-240V,50Hz	Beam Angle:	180°
Luminous Flux:	470lm	Base:	B22
Commercial Type:	G45	Body Type:	Thermoplastic
LED Type:	SMD	Dimension:	45mm x 80mm
CRI:	>80		



Candle -B22 Bulb

3W VT-2073

7230 - 2700K Warm White
7231 - 6400K White

EAN Code

3800157619578
3800157619585

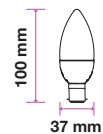

EQ. Watts:	25W	PF:	>0.4
Voltage/Frequency:	AC: 220-240V,50Hz	Beam Angle:	200°
Luminous Flux:	250lm	Base:	B22
Commercial Type:	Candle	Body Type:	Thermoplastic
LED Type:	SMD	Dimension:	37mm x 100mm
CRI:	> 80		



New!

Candle - B15 Bulb

5.5W VT-1857

7347 - 2700k Warm White
7348 - 6400k White

EAN Code

3800157627290
3800157627306

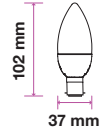

EQ. Watts:	40W	PF:	>0.5
Voltage/Frequency:	AC:220-240V,50Hz	Beam Angle:	180°
Luminous Flux:	470lm	Base:	B15
Commercial Type:	Candle	Body Type:	Thermoplastic
LED Type:	SMD	Dimension:	37mm x102mm
CRI:	>80		



New!

Candle - B22 Bulb

5.5W VT-1965

7345 - 2700k Warm White
7346 - 6400k White

EAN Code

3800157627276
3800157627283

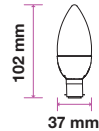

EQ. Watts:	40W	PF:	>0.5
Voltage/Frequency:	AC:220-240V,50Hz	Beam Angle:	200°
Luminous Flux:	470lm	Base:	B22
Commercial Type:	Candle	Body Type:	Thermoplastic
LED Type:	SMD	Dimension:	37mm x 102mm
CRI:	>80		



Candle - B22 Bulb

6W VT-1965

4440 - 2700K Warm White

EAN Code

3800157607667

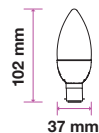

EQ. Watts:	40W	PF:	>0.5
Voltage/Frequency:	AC:220-240V,50Hz	Beam Angle:	200°
Luminous Flux:	470lm	Base:	B22
Commercial Type:	Candle	Body Type:	Thermoplastic
LED Type:	SMD	Dimension:	37mm x 102mm
CRI:	>80		



Candle - E14 Bulb

3W VT-2033

- 7196 - 2700K Warm White
- 7197 - 4000K Day White
- 7198 - 6400K White

EAN Code

- 3800157615808
- 3800157615815
- 3800157615822

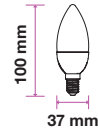

EQ. Watts:	25W	PF:	> 0.4
Voltage/Frequency:	AC: 220-240V,50Hz	Beam Angle:	200°
Luminous Flux:	250lm	Base:	E14
Commercial Type:	Candle	Body Type:	Thermoplastic
LED Type:	SMD	Dimension:	37mm x 100mm
CRI:	> 80		



Candle -E14 Bulb

4W VT-1818

- 4216 - 2700K Warm White
- 4166 - 4000K Day White
- 4122 - 6400K White

EAN Code

- 3800230624796
- 3800230620675
- 3800230620668

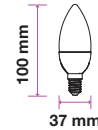

EQ. Watts:	30W	PF:	> 0.4
Voltage/Frequency:	AC: 220-240V,50Hz	Beam Angle:	200°
Luminous Flux:	320lm	Base:	E14
Commercial Type:	Candle	Body Type:	Thermoplastic
LED Type:	SMD	Dimension:	37mm x 100mm
CRI:	> 80		



New!

Candle - E14 Bulb

5.5W VT-1855

- 42411- 2700K Warm White

EAN Code

- 3800157624411

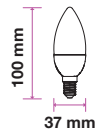

EQ. Watts:	40W	PF	> 0.5
Voltage/Frequency:	AC: 220-240V,50Hz	Beam Angle:	200°
Luminous Flux:	470lm	Base:	E14
Commercial Type:	Candle	Body Type:	Thermoplastic
LED Type:	SMD	Dimension:	37mm x 100mm
CRI:	> 80		



New!

Candle - E14 Bulb

5.5W VT-2076

- 7263 - 2700K Warm White
- 7264 - 4000K Day White
- 7265 - 6400K White

EAN Code

- 3800157622950
- 3800157622967
- 3800157622974

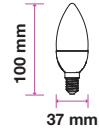

EQ. Watts:	40W	PF:	> 0.5
Voltage/Frequency:	AC: 220-240V,50Hz	Beam Angle:	200°
Luminous Flux:	470lm	Base:	E14
Commercial Type:	Candle	Body Type:	Thermoplastic
LED Type:	SMD	Dimension:	37mm x 100mm
CRI:	> 80		



New!

Candle - E14 bulb

5.5W VT-2106

- 7291 - 2700K Warm White
- 7292 - 4000K Day White
- 7293 - 6400K White

EAN Code

- 3800157623810
- 3800157623827
- 3800157623834

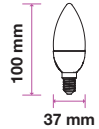

EQ. Watts:	40W	PF	>0.5
Voltage/Frequency:	AC:220-240V,50Hz	Beam Angle:	200°
Luminous Flux:	470lm	Base:	E14
Commercial Type:	Candle	Body Type:	Thermoplastic
LED Type:	SMD	Dimension:	37mm x 100mm
CRI:	>80		



New!

Candle - E27 Bulb

5.5W VT-1821

- 43421 - 2700K Warm White
- 43431 - 4000K Day White
- 43441 - 6400K White

EAN Code

- 3800157624381
- 3800157624398
- 3800157624404

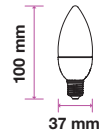

EQ. Watts:	40W	PF	>0.5
Voltage/Frequency:	AC: 220-240V,50Hz	Beam Angle:	200°
Luminous Flux:	470lm	Base:	E27
Commercial Type:	Candle	Body Type:	Thermoplastic
LED Type:	SMD	Dimension:	37mm x 100mm
CRI:	>80		



Candle - E27 Bulb

6W VT-1821

- 4342 - 2700K Warm White
- 4343 - 4000K Day White
- 4344 - 6400K White

EAN Code

- 3800157601733
- 3800157601740
- 3800157601757

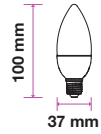

EQ. Watts:	40W	PF	>0.5
Voltage/Frequency:	AC:220-240V, 50Hz	Beam Angle:	200°
Luminous Flux:	470lm	Base:	E27
Commercial Type:	Candle	Body Type:	Thermoplastic
LED Type:	SMD	Dimension:	37mm x 100mm
CRI:	>80		



Candle - E14 Bulb

6W VT-1855

- 4215 - 2700K Warm White
- 4258 - 4000K Day White
- 4241 - 6400K White

EAN Code

- 3800230624789
- 3800230627155
- 3800230626790

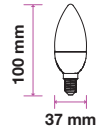

EQ. Watts:	40W	PF	> 0.5
Voltage/Frequency:	AC: 220-240V,50Hz	Beam Angle:	200°
Luminous Flux:	470lm	Base:	E14
Commercial Type:	Candle	Body Type:	Thermoplastic
LED Type:	SMD	Dimension:	37mm x 100mm
CRI:	> 80		



Dimmable Candle - E14 Bulb

6W VT-1854D

- 4213 - 2700K Warm White

EAN Code

- 3800230624765

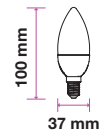

EQ. Watts:	40W	Dimmable:	Yes
Voltage/Frequency:	AC: 220-240V,50Hz	PF:	> 0.5
Luminous Flux:	470lm	Beam Angle:	200°
Commercial Type:	Candle	Base:	E14
LED Type:	SMD	Body Type:	Thermoplastic
CRI:	> 80	Dimension:	37mm x 100mm

New!

Candle - E14 Bulb



7W VT-2097

- 7318 - 3000K Warm White
- 7319 - 4000K Day White
- 7320 - 6400K White

EAN Code

- 3800157624503
- 3800157624510
- 3800157624527

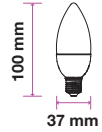

EQ. Watts:	55W	PF:	>0.5
Voltage/Frequency:	AC: 220-240V, 50Hz	Beam Angle:	200°
Luminous Flux:	750lm	Base:	E14
Commercial Type:	Candle	Body Type:	Thermoplastic
LED Type:	SMD	Dimension:	37mm x 100mm
CRI:	>80		

Candle Flame - E14 Bulb



4W VT-1818 TP

- 4164 - 2700K Warm White
- 4156 - 4000K Day White
- 4354 - 6400K White

EAN Code

- 3800230620743
- 3800230620736
- 3800157602457

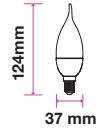

EQ. Watts:	30W	PF	> 0.4
Voltage/Frequency:	AC: 220-240V,50Hz	Beam Angle:	200°
Luminous Flux:	320lm	Base:	E14
Commercial Type:	Candle Flame	Body Type:	Thermoplastic
LED Type:	SMD	Dimension:	37mm x 124mm
CRI:	> 80		

Candle Flame -E14 Bulb



6W VT-1855TP

- 4351 - 3000K Warm White
- 4352 - 4500K Day White
- 4353 - 6000K White

EAN Code

- 3800157602426
- 3800157602433
- 3800157602440

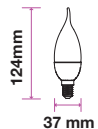

EQ. Watts:	40W	PF:	>0.5
Voltage/Frequency:	AC: 220-240V,50Hz	Beam Angle:	200°
Luminous Flux:	470lm	Base:	E14
Commercial Type:	Candle Flame	Body Type:	Thermoplastic
LED Type:	SMD	Dimension:	37mm x 124mm
CRI:	>80		



ST26-E14

2W VT-2032

7237 - 2700K Warm White
7238 - 4000K Day White
7239 - 6400K White

EAN Code

3800157620109
3800157620116
3800157620123

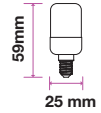

EQ. Watts:	20W	PF:	> 0.4
Voltage/Frequency:	AC: 220-240V,50Hz	Beam Angle:	150°
Luminous Flux:	180lm	Base:	E14
Commercial Type:	ST26	Body Type:	Thermoplastic
LED Type:	SMD	Dimension:	25mm x 59mm
CRI:	> 80		



T37 - E14 Bulb

9W VT-2029

7173 - 2700K Warm White
7174 - 4000K Day White
7175 - 6400K White

EAN Code

3800157615495
3800157615501
3800157615518

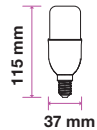

EQ. Watts:	50W	PF:	>0.5
Voltage/Frequency:	AC:220-240V,50Hz	Beam Angle:	230°
Luminous Flux:	750lm	Base:	E14
Commercial Type:	T37	Body Type:	Thermoplastic
LED Type:	SMD	Dimension:	37mm x 115mm
CRI:	>80		



T37 - 27 Bulb

9W VT-2089

7256 - 2700K Warm White
7257 - 4000K Day White
7258 - 6400K White

EAN Code

3800157621915
3800157621922
3800157621939

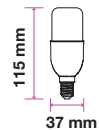

EQ. Watts:	50W	PF:	>0.5
Voltage/Frequency:	AC:220-240V,50Hz	Beam Angle:	230°
Luminous Flux:	750lm	Base:	E27
Commercial Type:	T37	Body Type:	Thermoplastic
LED Type:	SMD	Dimension:	37mm x 115mm
CRI:	>80		



G45 - E27 Bulb

3W VT-2053

- 7202 - 2700K Warm White
- 7203 - 4000K Day White
- 7204 - 6400K White

EAN Code

- 3800157615860
- 3800157615877
- 3800157615884

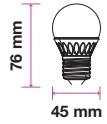

EQ. Watts:	25W	PF:	> 0.4
Voltage/Frequency:	AC: 220-240V,50Hz	Beam Angle:	180°
Luminous Flux:	250lm	Base:	E27
Commercial Type:	G45	Body Type:	Thermoplastic
LED Type:	SMD	Dimension:	45mm x 76mm
CRI:	> 80		



G45 - E27 Bulb

4W VT-1830

- 4160 - 2700K Warm White
- 4162 - 4000K Day White
- 4207 - 6400K White

EAN Code

- 3800230621047
- 3800230621054
- 3800230624611

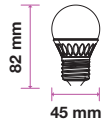

EQ. Watts:	30W	PF:	> 0.4
Voltage/Frequency:	AC: 220-240V,50Hz	Beam Angle:	180°
Luminous Flux:	320lm	Base:	E27
Commercial Type:	G45	Body Type:	Thermoplastic
LED Type:	SMD	Dimension:	45mm x 82mm
CRI:	> 80		



G45 - E27 Bulb

6W VT-1879

- 4247 - 2700K Warm White
- 4248 - 4000K Day White
- 4249 - 6400K White

EAN Code

- 3800230627018
- 3800230627025
- 3800230627032

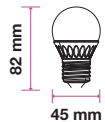

EQ. Watts:	40W	PF	> 0.5
Voltage/Frequency:	AC: 220-240V,50Hz	Beam Angle:	180°
Luminous Flux:	470lm	Base:	E27
Commercial Type:	G45	Body Type:	Thermoplastic
LED Type:	SMD	Dimension:	45mm x 82mm
CRI:	> 80		



P45 - E14 Bulb

3W VT-2043

7199 - 2700K Warm White
7200 - 4000K Day White
7201 - 6000K White

EAN Code

3800157615839
3800157615846
3800157615853

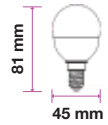

EQ. Watts:	25W	PF:	> 0.4
Voltage/Frequency:	AC: 220-240V,50Hz	Beam Angle:	180°
Luminous Flux:	250lm	Base:	E14
Commercial Type:	P45	Body Type:	Thermoplastic
LED Type:	SMD	Dimension:	45mm x 81mm
CRI:	> 80		



P45 - E14 Bulb

4W VT-1819

4123 - 2700K Warm White
4174 - 4000K Day White
4124 - 6000K White

EAN Code

3800230620996
3800230621009
3800230621016

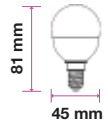

EQ. Watts:	30W	PF:	> 0.4
Voltage/Frequency:	AC: 220-240V,50Hz	Beam Angle:	180°
Luminous Flux:	320lm	Base:	E14
Commercial Type:	P45	Body Type:	Thermoplastic
LED Type:	SMD	Dimension:	45mm x 81mm
CRI:	> 80		



P45 - E14 Bulb **New!**

5.5W VT-1880

42501 - 2700K Warm White
42511 - 4000K Day White
42521 - 6400K White

EAN Code

3800157624367
3800157626408
3800157624374

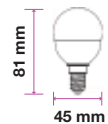

EQ. Watts:	40W	PF:	> 0.5
Voltage/Frequency:	AC: 220-240V,50Hz	Beam Angle:	180°
Luminous Flux:	470lm	Base:	E14
Commercial Type:	P45	Body Type:	Thermoplastic
LED Type:	SMD	Dimension:	45mm x 81mm
CRI:	> 80		



P45 - E14 Bulb

6W VT-1880

- 4250 - 2700K Warm White
- 4251 - 4000K Day White
- 4252 - 6400K White

EAN Code

- 3800230627049
- 3800230627056
- 3800230627063

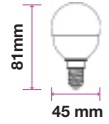

EQ. Watts:	40W	PF	> 0.5
Voltage/Frequency:	AC: 220-240V, 50Hz	Beam Angle:	180°
Luminous Flux:	470lm	Base:	E14
Commercial Type:	P45	Body Type:	Thermoplastic
LED Type:	SMD	Dimension:	45mm x 81mm
CRI:	> 80		

New!



P45 - E14 Bulb

7W VT-2098

- 7321 - 2700K Warm White
- 7322 - 4000K Day White
- 7323 - 6400K White

EAN Code

- 3800157624534
- 3800157624541
- 3800157624558

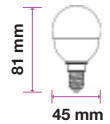

EQ. Watts:	55W	PF:	>0.5
Voltage/Frequency:	AC: 220-240V, 50Hz	Beam Angle:	180°
Luminous Flux:	750lm	Base:	E14
Commercial Type:	P45	Body Type:	Thermoplastic
LED Type:	SMD	Dimension:	45mm x 81mm
CRI:	>80		



R39 - E14 Bulb

3W VT-1861

- 4219 - 3000K Warm White
- 4220 - 4000K Day White
- 4242 - 6400K White

EAN Code

- 3800230625472
- 3800230625489
- 3800230626806



EQ. Watts:	25W	PF:	> 0.4
Voltage/Frequency:	AC: 220-240V,50Hz	Beam Angle:	120°
Luminous Flux:	210lm	Base:	E14
Commercial Type:	R39	Body Type:	Thermoplastic
LED Type:	SMD	Dimension:	39mm x 67mm
CRI:	> 80		



R50 - E14 Bulb

6W VT-1876

- 4243 - 3000K Warm White
- 4138 - 4000K Day White
- 4246 - 6400K White

EAN Code

- 3800230626813
- 3800230620897
- 3800230626967

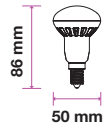

EQ. Watts:	40W	PF	> 0.5
Voltage/Frequency:	AC: 220-240V,50Hz	Beam Angle:	120°
Luminous Flux:	400lm	Base:	E14
Commercial Type:	R50	Body Type:	Thermoplastic
LED Type:	SMD	Dimension:	50mm x 86mm
CRI:	> 80		



R63 - E27 Bulb

8W VT-1862

- 4221 - 3000K Warm White
- 4140 - 4000K Day White
- 4244 - 6400K White

EAN Code

- 3800230625496
- 3800230620903
- 3800230626820

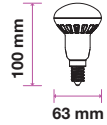

EQ. Watts:	60W	PF:	> 0.5
Voltage/Frequency:	AC: 220-240V, 50Hz	Beam Angle:	120°
Luminous Flux:	500lm	Base:	E27
Commercial Type:	R63	Body Type:	Thermoplastic
LED Type:	SMD	Dimension:	63mm x 100mm
CRI:	> 80		



R80 - E27 Bulb

10W VT-1894

- 4339 - 3000K Warm White
- 4340 - 4000K Day White
- 4341 - 6400K White

EAN Code

- 3800157601702
- 3800157601719
- 3800157601726

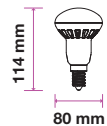

EQ. Watts:	75W	PF	>0.5
Voltage/Frequency:	AC:220-240V, 50Hz	Beam Angle:	120°
Luminous Flux:	800lm	Base:	E27
Commercial Type:	R80	Body Type:	PlasticThermoplastic
LED Type:	SMD	Dimension:	80mm x 114mm
CRI:	>80		



PL - E27 Bulb

6W VT-2046

7211 - 3000K Warm White

EAN Code

3800157617031

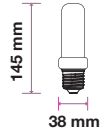

EQ. Watts:	50W	PF:	>0.5
Voltage/Frequency:	AC: 220-240V, 50Hz	Beam Angle:	120°
Luminous Flux:	480lm	Base:	E27
Commercial Type:	PL	Body Type:	Plastic + Aluminum
LED Type:	SMD	Dimension:	38 x 145mm
CRI:	>80		



PL - E27 Bulb

10W VT-2050

7215 - 3000K Warm White

EAN Code

3800157617079

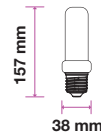

EQ. Watts:	85W	PF	>0.5
Voltage/Frequency:	AC: 220-240V, 50Hz	Beam Angle:	120°
Luminous Flux:	820lm	Base:	E27
Commercial Type:	PL	Body Type:	Plastic + Aluminum
LED Type:	SMD	Dimension:	157 x 38mm
CRI:	>80		



PL - G24 Bulb

6W VT-2046

- 7210 - 3000K Warm White
- 7209 - 4000K Day White
- 7208 - 6400K White

EAN Code

- 3800157617024
- 3800157617017
- 3800157617000

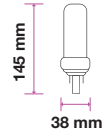

EQ. Watts:	50W	PF:	>0.5
Voltage/Frequency:	AC: 220-240V, 50Hz	Beam Angle:	120°
Luminous Flux:	480lm	Base:	G24
Commercial Type:	PL	Body Type:	Plastic + Aluminum
LED Type:	SMD	Dimension:	38 x 145mm
CRI:	>80		



PL - G24 Bulb

10W VT-2050

- 7214 - 3000K Warm White
- 7213 - 4000K Day White
- 7212 - 6400K White

EAN Code

- 3800157617062
- 3800157617055
- 3800157617048

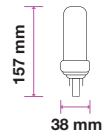

EQ. Watts:	85W	PF	>0.5
Voltage/Frequency:	AC: 220-240V, 50Hz	Beam Angle:	120°
Luminous Flux:	820lm	Base:	G24
Commercial Type:	PL	Body Type:	Plastic + Aluminum
LED Type:	SMD	Dimension:	38 x 157mm
CRI:	>80		



G95 - E27 Globe Bulb

10W VT-1893

4276 - 3000K Warm White

4277 - 4000K Day White

4278 - 6400K White

EAN Code

3800230627889

3800230627896

3800230627902

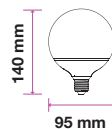

EQ. Watts:	60W	PF:	> 0.5
Voltage/Frequency:	AC: 220-240V,50Hz	Beam Angle:	200°
Luminous Flux:	810lm	Base:	E27
Commercial Type:	G95	Body Type:	Thermoplastic
LED Type:	SMD	Dimension:	95mm x 140mm
CRI:	> 80		



Dimmable G95 - E27 Globe Bulb

10W VT-1893D

4279 - 3000K Warm White

EAN Code

3800230627919

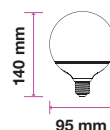

EQ. Watts:	60W	Dimmable:	Yes
Voltage/Frequency:	AC: 220-240V,50Hz	PF:	> 0.5
Luminous Flux:	810lm	Beam Angle:	200°
Commercial Type:	G95	Base:	E27
LED Type:	SMD	Body Type:	Thermoplastic
CRI:	> 80	Dimension:	95mm x 140mm



G120 - E27 Globe Bulb

13W VT-1883

- 4253 - 3000K Warm White
- 4273 - 4000K Day White
- 4274 - 6400K White

EAN Code

- 3800230627094
- 3800230627858
- 3800230627865



EQ. Watts:	75W	PF:	> 0.7
Voltage/Frequency:	AC: 220-240V,50Hz	Beam Angle:	200°
Luminous Flux:	1055lm	Base:	E27
Commercial Type:	G120	Body Type:	Thermoplastic
LED Type:	SMD	Dimension:	120mm x 164mm
CRI:	> 80		



Dimmable

Dimmable G120 - E27 Globe Bulb

13W VT-1884D

- 4254 - 2700K Warm White

EAN Code

- 3800230627100

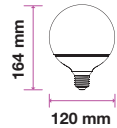

EQ. Watts:	75W	Dimmable:	Yes
Voltage/Frequency:	AC: 220-240V,50Hz	PF:	> 0.7
Luminous Flux:	1055lm	Beam Angle:	200°
Commercial Type:	G120	Base:	E27
LED Type:	SMD	Body Type:	Thermoplastic
CRI:	> 80	Dimension:	120mm x 164mm



G120 - E27 Globe Bulb

18W VT-1899

- 4433 - 2700K Warm White
- 4434 - 4000K Day White
- 4435 - 6400K White

EAN Code

- 3800157606806
- 3800157606813
- 3800157606820

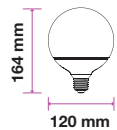

EQ. Watts:	130W	PF:	>0.5
Voltage/Frequency:	AC:220-240V,50Hz	Beam Angle:	200°
Luminous Flux:	1800lm	Base:	E27
Commercial Type:	G120	Body Type:	Thermoplastic
LED Type:	SMD	Dimension:	120mm x 164mm
CRI:	>80		



New!

T80 - E27 LED Big Ripple Plastic Bulb

18W VT-2121

EAN Code

7272 - 3000K Warm White

3800157623629

7273 - 4000K Day White

3800157623636

7274 - 6400K White

3800157623643



EQ. Watts:	100W	PF	>0.5
Voltage/Frequency:	AC: 220-240V, 50Hz	Beam Angle:	200°
Luminous Flux:	1400lm	Base:	E27
Commercial Type:	T80	Body Type:	Plastic
LED Type:	SMD	Dimension:	80mm x 150mm
CRI:	>80		



New!

T100 - E27 LED Big Ripple Plastic Bulb

24W VT-2125

EAN Code

7275 - 3000K Warm White

3800157623650

7276 - 4000K Day White

3800157623667

7277 - 6400K White

3800157623674



EQ. Watts:	150W	PF	>0.5
Voltage/Frequency:	AC: 220-240V, 50Hz	Beam Angle:	200°
Luminous Flux:	2080lm	Base:	E27
Commercial Type:	T100	Body Type:	Plastic
LED Type:	SMD	Dimension:	100mm x 174mm
CRI:	>80		



New!

T120 - E27 LED Big Ripple Plastic Bulb

36W VT-2137

EAN Code

7278 - 4000K Day White

3800157623681

7279 - 6400K White

3800157623698



EQ. Watts:	205W	PF	>0.5
Voltage/Frequency:	AC: 220-240V, 50Hz	Beam Angle:	200°
Luminous Flux:	2680lm	Base:	E27
Commercial Type:	T120	Body Type:	Plastic
LED Type:	SMD	Dimension:	118mm x 204mm
CRI:	>80		



New!

T140 - E27 LED Big Ripple Plastic Bulb

48W VT-2148

EAN Code

7280 - 4000K Day White

3800157623704

7281 - 6400K White

3800157623711



EQ. Watts:	285W	PF	>0.5
Voltage/Frequency:	AC: 220-240V, 50Hz	Beam Angle:	200°
Luminous Flux:	3570lm	Base:	E27
Commercial Type:	T140	Body Type:	Plastic
LED Type:	SMD	Dimension:	138mm x 230mm
CRI:	>80		



New!

T160 - E27 LED Big Ripple Plastic Bulb

60W VT-2060

EAN Code

7313 - 4000K Day White
7314 - 6400K White

3800157624459
3800157624466

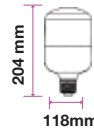

EQ. Watts:	310W	PF	>0.5
Voltage/Frequency:	AC: 220-240V, 50Hz	Beam Angle:	200°
Luminous Flux:	4200lm	Base:	E27
Commercial Type:	T160	Body Type:	Plastic
LED Type:	SMD	Dimension:	160mm x 282mm
CRI:	>80		

UFO Ceiling Lamp- E27



15W VT-2116

EAN Code

- 7158 - 3000K Warm White
- 7159 - 4000K Day White
- 7160 - 6400K White

- 3800157612494
- 3800157612500
- 3800157612517

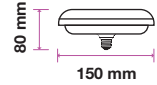

EQ. Watts:	90W	PF:	>0.5
Voltage/Frequency:	AC: 220-240V, 50Hz	Beam Angle:	120°
Luminous Flux:	1350lm	Base:	E27
Commercial Type:	F150	Body Type:	PC
LED Type:	SMD	Dimension:	150 x 80 mm
CRI:	>80		

UFO Ceiling Lamp- E27



24W VT-2124

EAN Code

- 7161 - 3000K Warm White
- 7162 - 4000K Day White
- 7163 - 6400K White

- 3800157612524
- 3800157612531
- 3800157612548

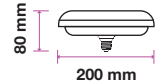

EQ. Watts:	160W	PF	>0.5
Voltage/Frequency:	AC: 220-240V, 50Hz	Beam Angle:	120°
Luminous Flux:	2610lm	Base:	E27
Commercial Type:	F200	Body Type:	PC
LED Type:	SMD	Dimension:	200 x 80mm
CRI:	>80		

UFO Ceiling Lamp- E27



36W VT-2136

EAN Code

- 7164 - 3000K Warm White
- 7165 - 4000K Day White
- 7166 - 6400K White

- 3800157612555
- 3800157612562
- 3800157612579

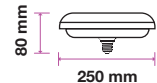

EQ. Watts:	190W	PF	>0.9
Voltage/Frequency:	AC: 220-240V, 50Hz	Beam Angle:	120°
Luminous Flux:	3240lm	Base:	E27
Commercial Type:	F250	Body Type:	PC
LED Type:	SMD2835	Dimension:	250 x 80mm
CRI:	>80		



ED-90 - E27 Bulb

40W VT-1940

7132 - 3000K Warm White

7133 - 4000K Day White

7134 - 6500K White

EAN Code

3800157610285

3800157610292

3800157610308

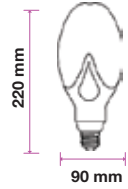

EQ. Watts:	250W	PF:	>0.9
Voltage/Frequency:	AC:220-240V,50Hz	Beam Angle:	265°
Luminous Flux:	3500lm	Base:	E27
Commercial Type:	ED-90	Body Type:	Aluminum+PC
LED Type:	SMD	Dimension:	90mm x 220mm
CRI:	>80		





B22-E14 Converter

SKU Code **3420**



B22-E27 Converter

SKU Code **3419**



E40-E27 Converter

SKU Code **3417**



LED String Light With Euro Plug And WP Socket

VT-713

SKU Code **3673**

15 Meter Long String

15 Holders With 1 Meter Distance





LED Spot Lights

Introducing sustainable & energy efficient substitute for the power consuming 35W and 50W Halogen Spotlights. An extensive range of LED SPOTLIGHTS (1.2W - 8W)

Product Features

- Lasts 20 times longer than Standard Bulbs
- Uses 80% less energy than Standard Bulbs
- Excellent Heat Radiation Efficiency
- Customized exterior for stronger body
- Choice of beam angle from 38° to 300°
- Non – Flickering
- Premium Quality Power Driver
- Broad Range of holders like GU10, MR16, G9 and G4
- Wide Voltage Range from AC: 180 – 240 V , 50/60 Hz & 12 v options
- Dimmable & Non Dimmable options



Applications

Perfect choice for Hotels, Bars, Commercial & Residential Lighting and Exhibition Stands



GU 10 with Lens

7W VT-2666

- 1657 - 3000K Warm White
- 1658 - 4000K Day White
- 1659 - 6400K White

EAN Code

- 3800157601641
- 3800157601658
- 3800157601665

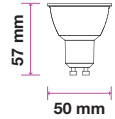

EQ. Watts:	50W	PF:	>0.5
Voltage/Frequency:	AC:220-240V,50Hz	Beam Angle:	38°
Luminous Flux:	550lm	Base:	GU10
LED Type:	SMD	Body Type:	Plastic
CRI:	>80	Dimension:	50mm x 57mm



Dimmable



Dimmable GU 10 with Lens

7W VT-2886D

- 1666 - 3000K Warm White
- 1667 - 4000K Day White
- 1668 - 6400K White

EAN Code

- 3800157602075
- 3800157602082
- 3800157602099



EQ. Watts:	50W	PF:	>0.5
Voltage/Frequency:	AC:220-240V,50Hz	Beam Angle:	38°
Luminous Flux:	550lm	Base:	GU10
LED Type:	SMD	Body Type:	Plastic
CRI:	>80	Dimension:	50mm x 57mm
Dimmable:	Yes		



GU 10 with Lens

7W VT-2778

- 1672 - 3000K Warm White
- 1673 - 4000K Day White
- 1674 - 6400K White

EAN Code

- 3800157602136
- 3800157602143
- 3800157602150

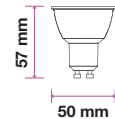

EQ. Watts:	45W	PF:	>0.5
Voltage/Frequency:	AC: 220-240V,50Hz	Beam Angle:	110°
Luminous Flux:	500lm	Base:	GU10
LED Type:	SMD	Body Type:	Plastic
CRI:	> 80	Dimension:	50mm x 57mm



MR 16 with Lens

7W VT-1967

- 1663 - 3000K Warm White
- 1664 - 4000K Day White
- 1665 - 6400K White

EAN Code

- 3800157602044
- 3800157602051
- 3800157602068

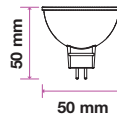

EQ. Watts:	50W	PF:	>0.5
Voltage/Frequency:	AC/DC: 12V,50Hz	Beam Angle:	38°
Luminous Flux:	550lm	Base:	GU5.3
LED Type:	SMD	Body Type:	Plastic
CRI:	>80	Dimension:	50mm x 50mm



GU 10 with Lens

8W VT-2889

- 1693 - 3000K Warm White
- 1694 - 4000K Day White
- 1695 - 6400K White

EAN Code

- 3800157608947
- 3800157608954
- 3800157608961



EQ. Watts:	80W	PF	> 0.5
Voltage/Frequency:	AC: 220-240V,50Hz	Beam Angle:	38°
Luminous Flux:	750lm	Base:	GU10
LED Type:	SMD	Body Type:	Plastic
CRI:	> 80	Dimension:	50mm x 55mm

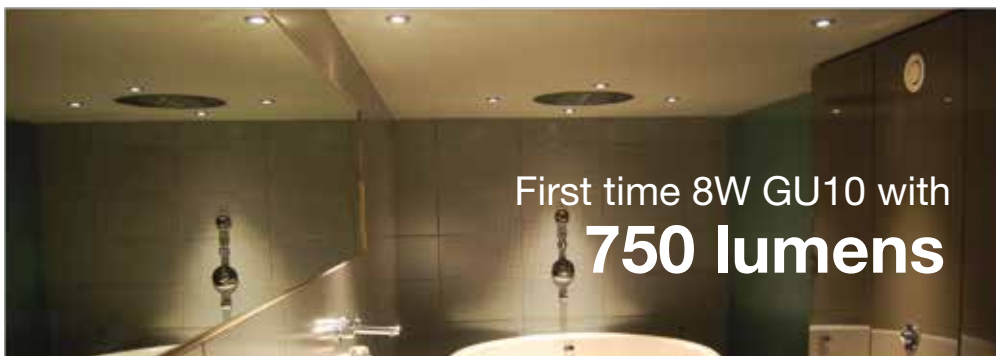

First time 8W GU10 with
750 lumens



Milky Cover GU10

7W VT-2779

- 1682 - 3000K Warm White
- 1683 - 4000K Day White
- 1684 - 6400K White

EAN Code

- 3800157605359
- 3800157605366
- 3800157605373

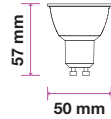

EQ. Watts:	45W	PF:	>0.5
Voltage/Frequency:	AC:220-240V,50Hz	Beam Angle:	110°
Luminous Flux:	500lm	Base:	GU10
LED Type:	SMD	Body Type:	Plastic
CRI:	>80	Dimension:	50mm x 57mm



Dimmable Milky Cover GU10

7W VT-2887D

- 1669 - 3000K Warm White
- 1670 - 4000K Day White
- 1671 - 6400K White

EAN Code

- 3800157602105
- 3800157602112
- 3800157602129



EQ. Watts:	45W	PF:	>0.5
Voltage/Frequency:	AC:220-240V,50Hz	Beam Angle:	110°
Luminous Flux:	500lm	Base:	GU10
LED Type:	SMD	Body Type:	Plastic
CRI:	>80	Dimension:	50mm x 57mm
Dimmable:	Yes		



Milky Cover MR16

7W VT-1977

- 1688 - 3000K Warm White
- 1689 - 4000K Day White
- 1690 - 6400K White

EAN Code

- 3800157606950
- 3800157606967
- 3800157606974

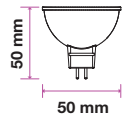

EQ. Watts:	45W	PF:	>0.5
Voltage/Frequency:	AC/DC: 12V,50Hz	Beam Angle:	110°
Luminous Flux:	500lm	Base:	GU5.3
LED Type:	SMD	Body Type:	Plastic
CRI:	>80	Dimension:	50mm x 50mm



New!

LED Spotlight- GU10

6W VT-2107

- 7303 - 3000K Warm White
- 7304 - 4000K Day White
- 7305 - 6400K White

EAN Code

- 3800157623933
- 3800157623940
- 3800157623957



EQ. Watts:	40W	PF	> 0.5
Voltage/Frequency:	AC:220-240V,50Hz	Beam Angle:	110°
Luminous Flux:	500lm	Base:	GU10
LED Type:	SMD	Body Type:	Plastic
CRI:	> 80	Dimension:	50mm x 57mm



New!

Dimmable Spotlight- GU10

6.5W VT-2108D

- 7306 - 3000K Warm White
- 7307 - 4000K Day White
- 7308 - 6400K White

EAN Code

- 3800157623964
- 3800157623971
- 3800157623988

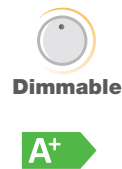

EQ. Watts:	40W	Dimmable:	Yes
Voltage/Frequency:	AC:220-240V,50Hz	PF:	> 0.5
Luminous Flux:	450lm	Beam Angle:	38°
LED Type:	SMD	Base:	GU10
CRI:	> 80	Body Type:	Plastic
		Dimension:	50mm x 57mm

New!

Milky Cover GU10

6W VT-2096

- 7310 - 3000K Warm White
- 7311 - 4000K Day White
- 7312 - 6400K White

EAN Code

- 3800157624435
- 3800157624459
- 3800157624442



EQ. Watts:	45W	PF	>0.5
Voltage/Frequency:	AC: 220-240V, 50Hz	Beam Angle:	110°
Luminous Flux:	500LM	Base:	GU10
LED Type:	SMD	Body Type:	Plastic
CRI:	>80	Dimension:	50mm x 57mm



New!

Milky Cover GU10

5W VT-2095

- 7269 - 3000K Warm White
- 7270 - 4000K Day White
- 7271 - 6400K White

EAN Code

- 3800157623018
- 3800157623025
- 3800157623032



EQ. Watts:	35W	PF	>0.4
Voltage/Frequency:	AC:220-240V,50Hz	Beam Angle:	110°
Luminous Flux:	400lm	Base:	GU10
LED Type:	SMD	Body Type:	Plastic
CRI:	>80	Dimension:	50mm x 57mm



Milky Cover GU10

5W VT-1975

- 1685 - 3000K Warm White
- 1686 - 4000K Day White
- 1687 - 6400K White

EAN Code

- 3800157606240
- 3800157606257
- 3800157606264



EQ. Watts:	40W	PF:	>0.4
Voltage/Frequency:	AC:220-240V,50Hz	Beam Angle:	110°
Luminous Flux:	320lm	Base:	GU10
LED Type:	SMD	Body Type:	Plastic
CRI:	>80	Dimension:	50mm x 57mm



Milky Cover GU10

3W VT-1933

- 7126 - 3000K Warm White
- 7127 - 4000K Day White
- 7128 - 6400K White

EAN Code

- 3800157610148
- 3800157610155
- 3800157610162



EQ. Watts:	25W	PF	>0.4
Voltage/Frequency:	AC:220-240V,50Hz	Beam Angle:	110°
Luminous Flux:	210lm	Base:	GU10
LED Type:	SMD	Body Type:	Plastic
CRI:	>80	Dimension:	50mm x 57mm

GU10 Spotlight

2W VT-2002

7167 - 3000K Warm White
7168 - 4000K Day White
7169 - 6400K White

EAN Code

3800157612807
 3800157612814
 3800157612821



EQ. Watts:	15W	PF	>0.4
Voltage/Frequency:	AC:220-240V,50Hz	Beam Angle:	38°
Luminous Flux:	180lm	Base:	GU10
LED Type:	SMD	Body Type:	Plastic
CRI:	>80	Dimension:	35mm x 46.5mm

MR 11 Spot light

2W VT-1992

1679 - 3000K Warm White
1680 - 4000K Day White
1681 - 6400K White

EAN Code

3800157605038
 3800157605045
 3800157605052

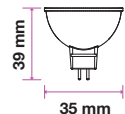

EQ. Watts:	15W	PF:	>0.4
Voltage/Frequency:	AC/DC:12V,50/60Hz	Beam Angle:	38°
Luminous Flux:	140lm	Base:	GU4
LED Type:	SMD	Body Type:	Plastic
CRI:	>80	Dimension:	35mm x 39mm



New!

LED Spotlight-Square

5W VT-1100

- 7332 - 3000K Warm White
- 7333 - 4000K Day White
- 7334 - 6400K White

EAN Code

- 3800157624855
- 3800157624862
- 3800157624879

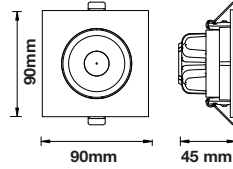

EQ. Watts:	35W	PF	>0.9
Voltage/Frequency:	AC:100-240V,50/60Hz	Beam Angle:	68°
Luminous Flux:	350lm	Body Type:	PC+ABS
LED Type:	SMD	Dimension:	90 x 90 x 45mm
CRI:	>80	Cutting Size:	Ø75mm



New!

LED Spotlight-Round

5W VT-1100

- 7329 - 3000K Warm White
- 7330 - 4000K Day White
- 7331 - 6400K White

EAN Code

- 3800157624824
- 3800157624831
- 3800157624848

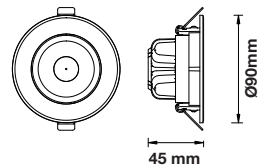

EQ. Watts:	35W	PF	>0.9
Voltage/Frequency:	AC:100-240V,50/60Hz	Beam Angle:	68°
Luminous Flux:	350lm	Body Type:	PC+ABS
LED Type:	SMD	Dimension:	Ø90mm x 45mm
CRI:	>80	Cutting Size:	Ø75mm

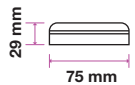

Recessed G53



7W VT-1969

EAN Code

- 4437 - 3000K Warm White
- 4438 - 4000K Day White
- 4439 - 6400K White

- 3800157607032
- 3800157607049
- 3800157607056

EQ. Watts:	45W	PF	> 0.5
Voltage/Frequency:	AC:220-240V,50Hz	Beam Angle:	110°
Luminous Flux:	550lm	Base:	Recessed Gx53
Commercial Type:	GX53	Body Type:	Thermoplastic
LED Type:	SMD	Dimension:	75mmx 29mm
CRI:	> 80		

G4 Spot light 1pc Pack

1.5W VT-1942

EAN Code

- 463 - 3000K Warm White
- 464 - 4000K Day White
- 465 - 6400K White

- 3800157608978
- 3800157608985
- 3800157608992

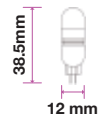

EQ. Watts:	15W	PF:	>0.4
Voltage/Frequency:	AC/DC:12V	Beam Angle:	300°
Luminous Flux:	100lm	Base:	G4
LED Type:	SMD	Body Type:	Plastic
CRI:	> 80	Dimension:	12mm x 38.5mm



G9 Spot light

2.5W VT-1946

1pc Pack

EAN Code

- 7205 - 3000K Warm White 3800157616317
- 7206 - 4000K Day White 3800157616324
- 7207 - 6400K White 3800157616331

3pc Blister Pack EAN Code

- 4358 - 3000K Warm White 3800157602716
- 4359 - 4000K Day White 3800157602723
- 4360 - 6400K White 3800157602730

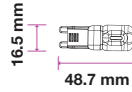

EQ. Watts:	25W	PF:	>0.4
Voltage/Frequency:	AC: 220-240V,50Hz	Beam Angle:	300°
Luminous Flux:	200lm	Base:	G9
LED Type:	SMD	Body Type:	Plastic
CRI:	>80	Dimension:	16.5mm x 48.7mm



G9 Spot light

3W VT-2003

EAN Code

- 7243 - 2700K Warm White 3800157620161
- 7244 - 4000K Day White 3800157620178
- 7245 - 6400K White 3800157620185

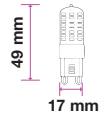

EQ. Watts:	30W	PF:	>0.4
Voltage/Frequency:	AC:220-240V,50Hz	Beam Angle:	300°
Luminous Flux:	300lm	Base:	G9
LED Type:	SMD	Body Type:	Plastic
CRI:	>80	Dimension:	17mm x 49mm



Dimmable Milky Cover-G9

3W VT-2083D

EAN Code

- 7253 - 2700K Warm White 3800157621656
- 7254 - 4000K Day White 3800157621663
- 7255 - 6400K White 3800157621670

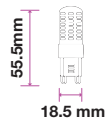

EQ. Watts:	30W	PF:	>0.4
Voltage/Frequency:	AC:220-240V,50Hz	Beam Angle:	360°
Luminous Flux:	225lm	Base:	G9
LED Type:	SMD	Body Type:	Plastic
CRI:	>80	Dimension:	18.5 x 55.5mm
Dimmable:	Yes		



New!

G9 Spotlight

2W VT-2102

EAN Code

7337 - 3000K Warm White

3800157625210

7338 - 4000K Day White

3800157625227

7339 - 6000K White

3800157625234

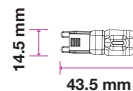

EQ. Watts:	20W	PF	>0.4
Voltage/Frequency:	AC: 200-240V,50/60Hz	Beam Angle:	230°
Luminous Flux:	230lm	Base:	G9
LED Type:	COB	Body Type:	GLASS
CRI:	>80	Dimension:	14.5 x 43.5mm



New!

G9 Spotlight -Blister Pack

2W VT-2102

EAN Code

7340 - 3000K Warm White

3800157625630

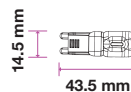

EQ. Watts:	20W	PF	>0.4
Voltage/Frequency:	AC: 200-240V,50/60Hz	Beam Angle:	230°
Luminous Flux:	230lm	Base:	G9
LED Type:	COB	Body Type:	GLASS
CRI:	>80	Dimension:	14.5 x 43.5mm



New!

Satin Nickel - GU10 Fixed Fire Rated Downlight Fitting

Model No	VT-701
SKU Code:	3680
Base	GU10
Material:	Steel
Shape:	Round
Color of Fixture:	Satin Nickel
Dimension:	80 x 115mm
Cutting Size:	65mm
EAN Code:	3800157626859
IP Rating:	IP20

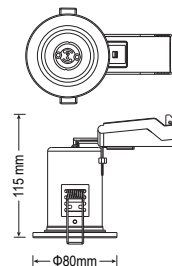

New!

White - GU10 Fixed Fire Rated Downlight Fitting

Model No	VT-701
SKU Code:	3681
Base	GU10
Material:	Steel
Shape:	Round
Color of Fixture:	White
Dimension:	80 x 115mm
Cutting Size:	65mm
EAN Code:	3800157626866
IP Rating:	IP20

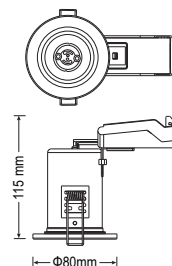

New!

Chrome - GU10 Fixed Fire Rated Downlight Fitting

Model No	VT-701
SKU Code:	3682
Base	GU10
Material:	Steel
Shape:	Round
Color of Fixture:	Chrome
Dimension:	80 x 115mm
Cutting Size:	65mm
EAN Code:	3800157626873
IP Rating:	IP20

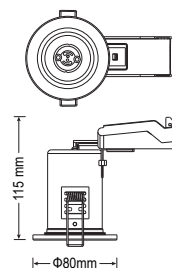



New! IP65 RATED

Satin Nickel - GU10 Shower Fire Rated Downlight Fitting

Model No	VT-702
SKU Code:	3683
Base	GU10
Material:	Steel
Shape:	Round
Color of Fixture:	Satin Nickel
Dimension:	86 x 115mm
Cutting Size:	65mm
EAN Code:	3800157626880
IP Rating:	IP65

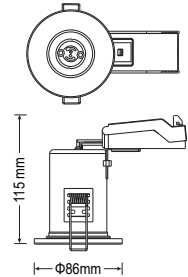

New! IP65 RATED

White - GU10 Fixed Fire Rated Downlight Fitting

Model No	VT-702
SKU Code:	3684
Base	GU10
Material:	Steel
Shape:	Round
Color of Fixture:	White
Dimension:	86 x 115mm
Cutting Size:	65mm
EAN Code:	3800157626897
IP Rating:	IP65

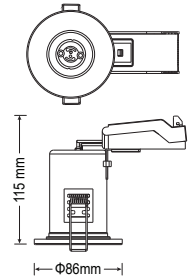

New! IP65 RATED

Chrome - GU10 Fixed Fire Rated Downlight Fitting

Model No	VT-702
SKU Code:	3685
Base	GU10
Material:	Steel
Shape:	Round
Color of Fixture:	Chrome
Dimension:	86 x 115mm
Cutting Size:	65mm
EAN Code:	3800157626903
IP Rating:	IP65

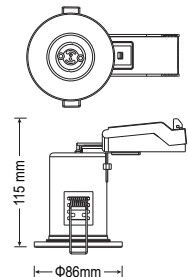



New!

Satin Nickel - GU10 Tilt Fire Rated Downlight Fitting

Model No	VT-703
SKU Code:	3686
Base	GU10
Material:	Steel
Shape:	Round
Color of Fixture:	Satin Nickel
Dimension:	82 x 130mm
Cutting Size:	68mm
EAN Code:	3800157626910
IP Rating:	IP20

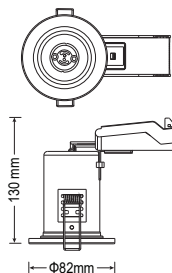

New!

White - GU10 Tilt Fire Rated Downlight Fitting

Model No	VT-703
SKU Code:	3687
Base	GU10
Material:	Steel
Shape:	Round
Color of Fixture:	White
Dimension:	82 x 130mm
Cutting Size:	68mm
EAN Code:	3800157626927
IP Rating:	IP20

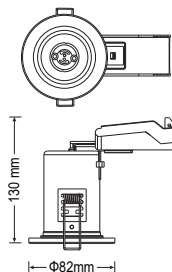

New!

Chrome - GU10 Tilt Fire Rated Downlight Fitting

Model No	VT-703
SKU Code:	3688
Base	GU10
Material:	Steel
Shape:	Round
Color of Fixture:	Chrome
Dimension:	82 x 130mm
Cutting Size:	68mm
EAN Code:	3800157626934
IP Rating:	IP20

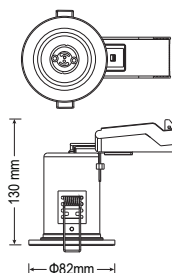

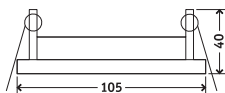

Gx53 Fittings

New!

Model No	VT-715
SKU Code:	3675
Base	Gx53
Material:	Iron
Shape:	Round
Color of Fixture:	White
Dimension:	Ø105mm X 40mm
Cutting Size:	Ø90mm
EAN Code:	3800157625241

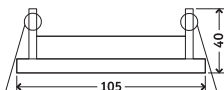

Gx53 Fittings

New!

Model No	VT-715
SKU Code:	3676
Base	Gx53
Material:	Iron
Shape:	Round
Color of Fixture:	Gold
Dimension:	Ø105mm X 40mm
Cutting Size:	Ø90mm
EAN Code:	3800157625258

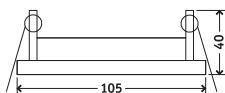

Gx53 Fittings

New!

Model No	VT-715
SKU Code:	3677
Base	Gx53
Material:	Iron
Shape:	Round
Color of Fixture:	Chrome
Dimension:	Ø105mm X 40mm
Cutting Size:	Ø90mm
EAN Code:	3800157625265

GU10 SOCKET
 NOT INCLUDED

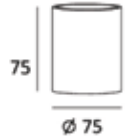
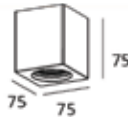

Gypsum Fitting

New!

New!

Model No:	VT-716	VT-716
SKU Code:	3666	3667
Base:	1XGU10	1XGU10
Material:	Gypsum	Gypsum
Shape:	Square	Round
Color of Fixture:	White	White
Dimension:	70 x 70 x 75mm	∅70 x 75mm
EAN Code:	3800157624732	3800157624749

GU10 SOCKET
 NOT INCLUDED

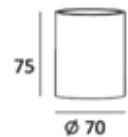
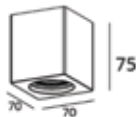

Aluminium Fitting

New!

New!

Model No:	VT-727	VT-727
SKU Code:	3664	3665
Base:	GU10	GU10
Material:	Gypsum	Gypsum
Shape:	Square	Round
Color of Fixture:	White	White
Dimension:	70 x 70 x 75mm	∅70 x 75mm
EAN Code:	3800157624589	3800157624596

GU10 SOCKET

NOT INCLUDED

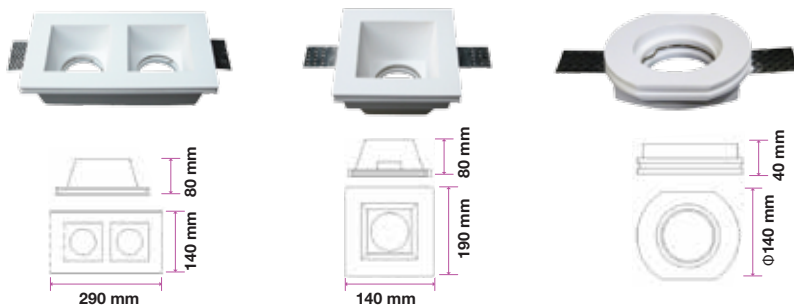

Gypsum Fitting

Model No:	VT-762	VT-763	VT-764
SKU Code:	3648	3649	3650
Base:	GU10	GU10	GU10
Material:	Gypsum	Gypsum	Gypsum
Shape:	Square	Square	Round
Color of Fixture:	White	White	White
Dimension:	290 x 140 x 80mm	190 x 140 x 80mm	Φ140 x 40mm
Cutting Size:	215 x 120mm	120 x 120mm	Φ100mm
EAN Code:	3800157618588	3800157618595	3800157618601

GU10 SOCKET

NOT INCLUDED

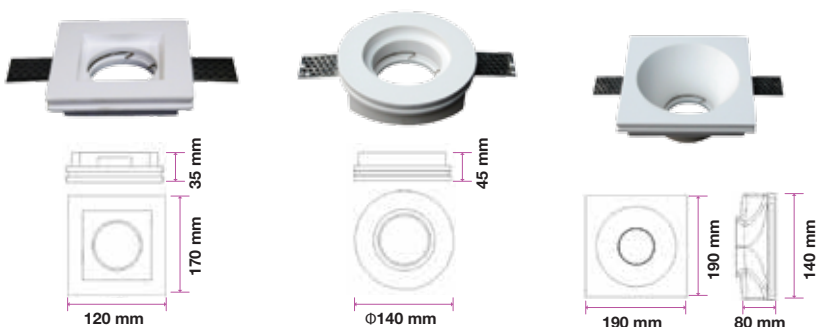

Gypsum Fitting

Model No:	VT-765	VT-771	VT-772
SKU Code:	3651	3652	3653
Base:	GU10	GU10	GU10
Material:	Gypsum	Gypsum	Gypsum
Shape:	Square	Round	Square
Color of Fixture:	White	White	White
Dimension:	170 x 120 x 35mm	Φ140 x 140 x 45mm	190 x 140 x 80mm
Cutting Size:	100 x 100mm	Φ103mm	121 x 121mm
EAN Code:	3800157618618	3800157618625	3800157618632

IP Rating:



GU10 SOCKET

■ NOT INCLUDED ■

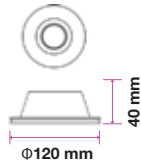
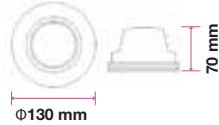

Gypsum Fitting

Model No:	VT-773	VT-776
SKU Code:	3654	3640
Base:	GU10	GU10
Material:	Gypsum	Gypsum
Shape:	Round	Round
Color of Fixture:	White	White
Dimension:	Φ130 x 70mm	Φ120 x 40mm
Cutting Size:	Φ132mm	Φ50mm
EAN Code:	3800157618649	3800157616348

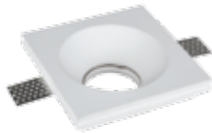

GU10 SOCKET

■ NOT INCLUDED ■

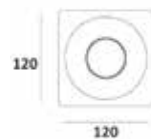
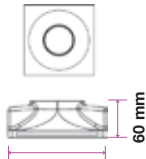

Aluminium Fitting

Model No:	VT-776	VT-714
SKU Code:	3641	3674
Base:	GU10	GU10
Material:	Gypsum	Gypsum
Shape:	Square	Square
Color of Fixture:	White	White
Dimension:	190 x 140 x 60mm	120 x 120 x 45mm
Cutting Size:	120x 50mm	
EAN Code:	3800157616355	3800157625180

New!

GU10 SOCKET
■ NOT INCLUDED ■

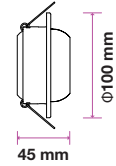
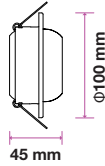

Ferrum Fitting

Model No:	VT-780	VT-780
SKU Code:	3593	3594
Base:	GU10	GU10
Material:	Ferrum	Ferrum
Shape:	Round	Round
Color of Fxture:	White	Satin Nickel
Dimension:	Φ100 x 45mm	Φ100 x 45mm
Cutting Size:	Φ90mm	Φ90mm
EAN Code:	3800157607223	3800157607230
IP Rating:		

GU10 SOCKET
■ NOT INCLUDED ■

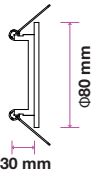
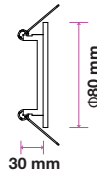
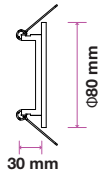

Ferrum Fitting

Model No:	VT-778	VT-778	VT-778
SKU Code:	3584	3585	3586
Base:	GU10	GU10	GU10
Material:	Ferrum	Ferrum	Ferrum
Shape:	Round	Round	Round
Color of Fxture:	White	Satin Nickel	Chrome
Dimension:	Φ80 x 30mm	Φ80 x 30mm	Φ80 x 30mm
Cutting Size:	Φ65mm	Φ65mm	Φ65mm
EAN Code:	3800157607131	3800157607148	3800157607155

GU10 SOCKET

■ NOT INCLUDED ■

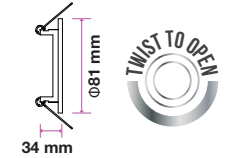
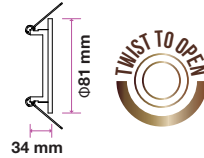
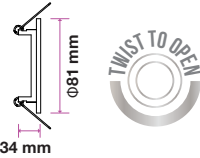

Aluminium Fitting

Model No:	VT-774	VT-774	VT-774
SKU Code:	3642	3643	3644
Base:	GU10	GU10	GU10
Material:	Aluminium	Aluminium	Aluminium
Shape:	Round	Round	Round
Color of Fixture:	White	Satin Nickel	Metallic Grey
Dimension:	Ø81 x 34mm	Ø81 x 34mm	Ø81 x 34mm
Cutting Size:	Ø73mm	Ø73mm	Ø73mm
EAN Code:	3800157617086	3800157617093	3800157617109

GU10 SOCKET

■ NOT INCLUDED ■

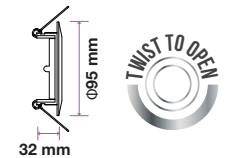
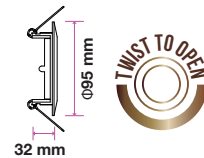
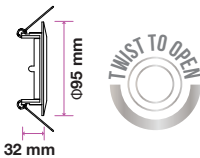

Aluminium Fitting

Model No:	VT-775	VT-775	VT-775
SKU Code:	3645	3646	3647
Base:	GU10	GU10	GU10
Material:	Aluminium	Aluminium	Aluminium
Shape:	Round	Round	Round
Color of Fixture:	White	Satin Nickel	Metallic Grey
Dimension:	Ø95 x 32mm	Ø95 x 32mm	Ø95 x 32mm
Cutting Size:	Ø85mm	Ø85mm	Ø85mm
EAN Code:	3800157617116	3800157617123	3800157617130

GU10 SOCKET
 NOT INCLUDED

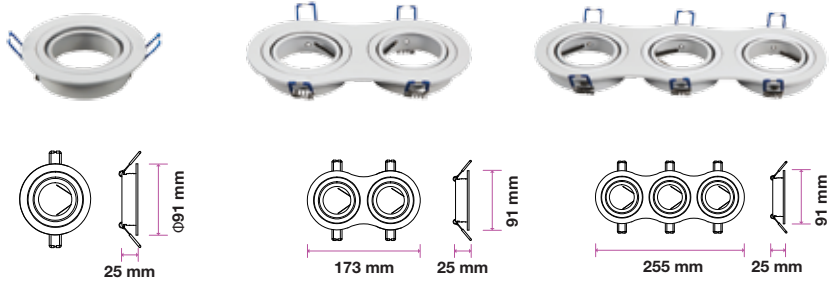

Aluminium Fitting

Model No:	VT-782	VT-783	VT-784
SKU Code:	3599	3601	3603
Base:	GU10	GU10	GU10
Material:	Aluminum	Aluminum	Aluminum
Shape:	Round	Round	Round
Color of Fxture:	White	White	White
Dimension:	Ø91 x 25mm	173 x 91 x 25mm	255 x 91 x 25
Cutting Size:	Ø75mm	155 x 75mm	235 x 75
EAN Code:	3800157607285	3800157607308	3800157607322

GU10 SOCKET
 NOT INCLUDED



Aluminium Fitting

Model No:	VT-782	VT-783	VT-784
SKU Code:	3600	3602	3604
Base:	GU10	GU10	GU10
Material:	Aluminum	Aluminum	Aluminum
Shape:	Round	Round	Round
Color of Fxture:	Aluminum Brush	Aluminum Brush	Aluminum Brush
Dimension:	Ø91 x 25mm	173 x 91 x 25mm	255 x 91 x 25mm
Cutting Size:	Ø75mm	155 x 75mm	235 x 75mm
EAN Code:	3800157607292	3800157607315	3800157607339

GU10 SOCKET
NOT INCLUDED

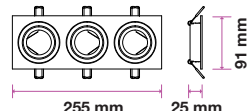
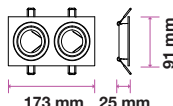
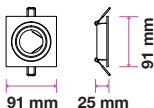

Aluminium Fitting

Model No:	VT-782	VT-783	VT-784
SKU Code:	3605	3607	3609
Base:	GU10	GU10	GU10
Material:	Aluminum	Aluminum	Aluminum
Shape:	Square	Square	Square
Color of Fixture:	White	White	White
Dimension:	91 x 91 x 25mm	173 x 91 x 25mm	255 x 91 x 25mm
Cutting Size:	75mm	155 x 75mm	235 x 75mm
EAN Code:	3800157607346	3800157607360	3800157607384

GU10 SOCKET
NOT INCLUDED

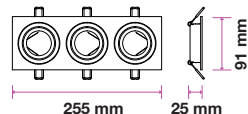
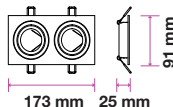
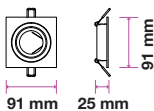

Aluminium Fitting

Model No:	VT-782	VT-783	VT-784
SKU Code:	3606	3608	3610
Base:	GU10	GU10	GU10
Material:	Aluminum	Aluminum	Aluminum
Shape:	Square	Square	Square
Color of Fixture:	Aluminum Brush	Aluminum Brush	Aluminum Brush
Dimension:	91 x 91 x 25mm	173 x 91 x 25mm	255 x 91 x 25mm
Cutting Size:	75mm	155 x 75mm	235 x 75mm
EAN Code:	3800157607353	3800157607377	3800157607391

GU10 SOCKET
■ NOT INCLUDED ■

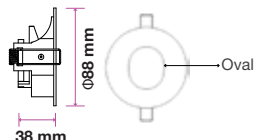
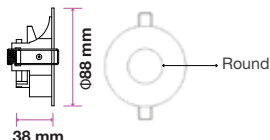

Aluminium Fitting

Model No:	VT-785	VT-786
SKU Code:	3611	3612
Base:	GU10	GU10
Material:	Aluminum	Aluminum
Shape:	Round	Round
Color of Fixture:	White	White
Dimension:	Ø88 x 38mm	Ø88 x 38mm
Cutting Size:	Ø75mm	Ø75mm
EAN Code:	3800157607407	3800157607414

GU10 SOCKET
■ NOT INCLUDED ■

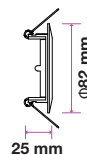
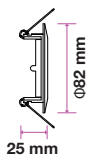
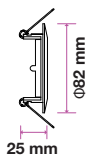

Aluminium Fitting

Model No:	VT-7227	VT-7227	VT-7227
SKU Code:	3469	3470	3471
Base:	GU10	GU10	GU10
Material:	Ferrum	Ferrum	Ferrum
Shape:	Round	Round	Round
Color of Fixture:	White	Satin Nickel	Stainless Steel
Dimension:	Ø82 x 25mm	Ø82 x 25mm	Ø82 x 25mm
Cutting Size:	Ø74mm	Ø74mm	Ø74mm
EAN Code:	3800157605885	3800157605892	3800157605908

GU10 SOCKET
 NOT INCLUDED

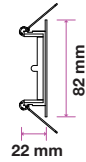
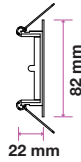
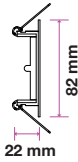

Aluminium Fitting

Model No:	VT-7227	VT-7227	VT-7227
SKU Code:	3472	3473	3474
Holder:	GU10	GU10	GU10
Material:	Ferrum	Ferrum	Ferrum
Based:	Recessed	Recessed	Recessed
Body Color:	White	Satin Nickel	Stainless Steel
Shape:	Square	Square	Square
Dimension:	82 x 82 x22mm	82 x 82 x22mm	82 x 82 x22mm
Cutting Size:	74 x74mm	74 x74mm	74 x74mm
EAN Code:	3800157605915	3800157605922	3800157605939

Aluminium Fitting

New!

GU10 SOCKET
 NOT INCLUDED

IP54
 RATED

Model No:	VT-711
SKU Code:	3669
Base:	GU10
Material:	Aluminum
Shape:	Round
Color of Fixture:	White
Dimension:	Ø82 x 101mm
EAN Code:	3800157625135
IP Rating:	IP54

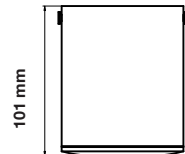
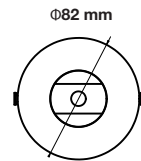

GU10 SOCKET
 NOT INCLUDED

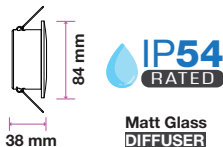
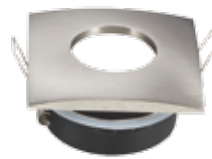
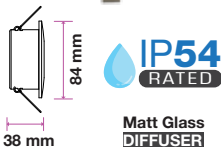

Aluminium Fitting

Model No:	VT-787	VT-787
SKU Code:	3615	3616
Base:	GU10	GU10
Material:	Zinc alloy+Ferrum +Glass	Zinc alloy+Ferrum +Glass
Shape:	Square	Square
Color of Fixture:	White	Satin Nickel
Dimension:	84 x 84 x 38mm	84 x 84 x 38mm
Cutting Size:	Ø75mm	Ø75mm
EAN Code:	3800157607445	3800157607452
IP Rating:	IP54	IP54

GU10 SOCKET
 NOT INCLUDED

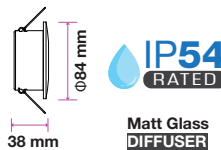
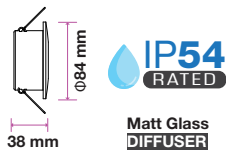
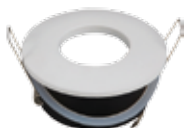

Aluminium Fitting

Model No:	VT-787	VT-787
SKU Code:	3613	3614
Base:	GU10	GU10
Material:	Zinc alloy+Ferrum +Glass	Zinc alloy+Ferrum +Glass
Shape:	Round	Round
Color of Fixture:	White	Satin Nickel
Dimension:	Ø84 x 38mm	Ø84 x 38mm
Cutting Size:	Ø75	Ø75mm
EAN Code:	3800157607421	3800157607438
IP Rating:	IP54	IP54

GU10 SOCKET
■ NOT INCLUDED ■

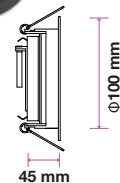
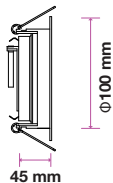

Aluminum+Ferrum Fitting

Model No:	VT-781	VT-781
SKU Code:	3595	3596
Base:	GU10	GU10
Material:	Aluminum+Ferrum	Aluminum+Ferrum
Shape:	Round	Round
Color of Fixture:	White	Satin Nickel
Dimension:	Ø100 x 45mm	Ø100 x 38mm
Cutting Size:	Ø90mm	Ø90mm
EAN Code:	3800157607247	3800157607254

GU10 SOCKET
■ NOT INCLUDED ■

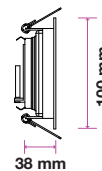
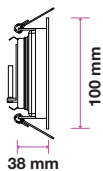

Aluminum+Ferrum Fitting

Model No:	VT-781	VT-781
SKU Code:	3597	3598
Base:	GU10	GU10
Material:	Aluminum+Ferrum	Aluminum+Ferrum
Shape:	Square	Square
Color of Fixture:	White	Satin Nickel
Dimension:	100 x 100 x 38mm	100 x 100 x 38mm
Cutting Size:	90 x 90mm	90 x 90mm
EAN Code:	3800157607261	3800157607278

GU10 SOCKET

■ NOT INCLUDED ■

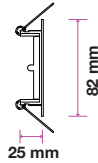
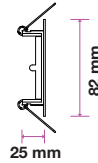
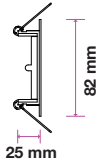

Zinc Alloy Fitting

Model No:	VT-779	VT-779	VT-779
SKU Code:	3590	3591	3592
Base:	GU10	GU10	GU10
Material:	Zinc alloy	Zinc alloy	Zinc alloy
Shape:	Square	Square	Square
Color of Fixture:	White	Satin Nickel	Chrome
Dimension:	82 x 82 x25mm	82 x 82 x25mm	82 x 82 x25mm
Cutting Size:	Φ74mm	Φ74mm	Φ74mm
EAN Code:	3800157607193	3800157607209	3800157607216

GU10 SOCKET

■ NOT INCLUDED ■

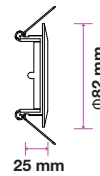
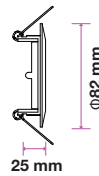
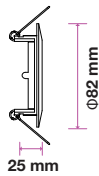

Zinc Alloy Fitting

Model No:	VT-779	VT-779	VT-779
SKU Code:	3587	3588	3589
Base:	GU10	GU10	GU10
Material:	Zinc Alloy	Zinc alloy	Zinc alloy
Shape:	Round	Round	Round
Color of Fixture:	White	Satin Nickel	Chrome
Dimension:	Φ82 x 25mm	Φ82 x 25mm	Φ82 x 25mm
Cutting Size:	Φ74mm	Φ74mm	Φ74mm
EAN Code:	3800157607162	3800157607179	3800157607186



**SURFACE MOUNTED
GU10 FITTINGS**

Easy Installation

Elegant Design



GU10 SOCKET
NOT INCLUDED

GU10 Fittings
Surface Mounted

Model No	VT-797
Colour:	White
SKU Code:	3630
Holder:	GU10
Material:	Ferrum
Dimension:	142 x 100 x 100 mm
EAN Code:	3800157612074

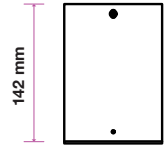
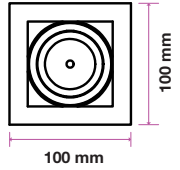

GU10 SOCKET
NOT INCLUDED

GU10 Fittings
Surface Mounted

Model No	VT-797
Colour:	Black
SKU Code:	3631
Holder:	GU10
Material:	Ferrum
Dimension:	142 x 100 x 100 mm
EAN Code:	3800157612081

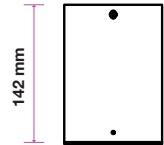
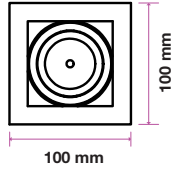

GU10 SOCKET
NOT INCLUDED

GU10 Fittings
Surface Mounted

Model No	VT-797
Colour:	Satin Nickle
SKU Code:	3632
Holder:	GU10
Material:	Ferrum
Dimension:	142 x 100 x 100 mm
EAN Code:	3800157612098

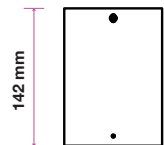
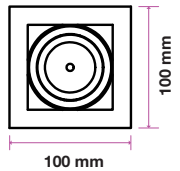



GU10 SOCKET
■ NOT INCLUDED ■

GU10 Fittings
Surface Mounted

Model No	VT-796
Colour:	White
SKU Code:	3627
Holder:	GU10
Material:	Ferrum
Dimension:	142 x 100 mm
EAN Code:	3800157612043

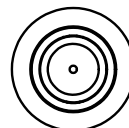

Ø100 mm

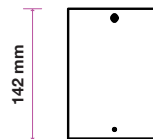

GU10 SOCKET
■ NOT INCLUDED ■

GU10 Fittings
Surface Mounted

Model No	VT-796
Colour:	Black
SKU Code:	3628
Holder:	GU10
Material:	Ferrum
Dimension:	142 x 100 mm
EAN Code:	3800157612050

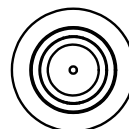

Ø100 mm

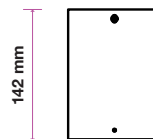

GU10 SOCKET
■ NOT INCLUDED ■

GU10 Fittings
Surface Mounted

Model No	VT-796
Colour:	Satin Nickle
SKU Code:	3629
Holder:	GU10
Material:	Ferrum
Dimension:	142 x 100 mm
EAN Code:	3800157612067

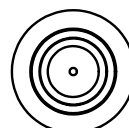

Ø100 mm

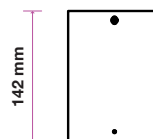

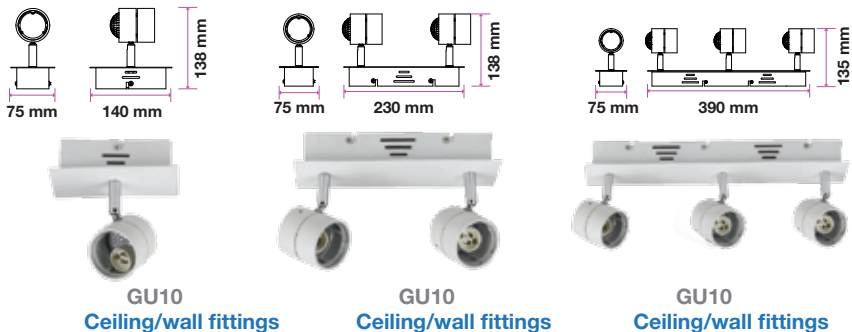

Aluminium Fitting

SKU CODE	3617	3618	3619
DESCRIPTION	1 x GU10 Track Fitting White	2 x GU10 Track Fitting White	3 x GU10 Track Fitting White
EAN CODE	3800157607469	3800157607476	3800157607483



GU10 Lamp Holder
With PVC Cable

5 PCS PACK AVAILABLE
SKU-34235



GU10 Lamp Holder
With PVC Cable

SKU Code	3423	ModelNo.	VT-791
Material	Ceramic	SKU Code	3620
Wire Length	150mm	Material	Ceramic
EAN Code	3800157607827	Wire Length	158mm
		EAN Code	3800157607704



MR16 Lamp Holder
With PVC Cable

5 PCS PACK

ModelNo.	VT-7889
SKU Code	36265
Material	Ceramic
Wire Length	150mm
EAN Code	3800157609999

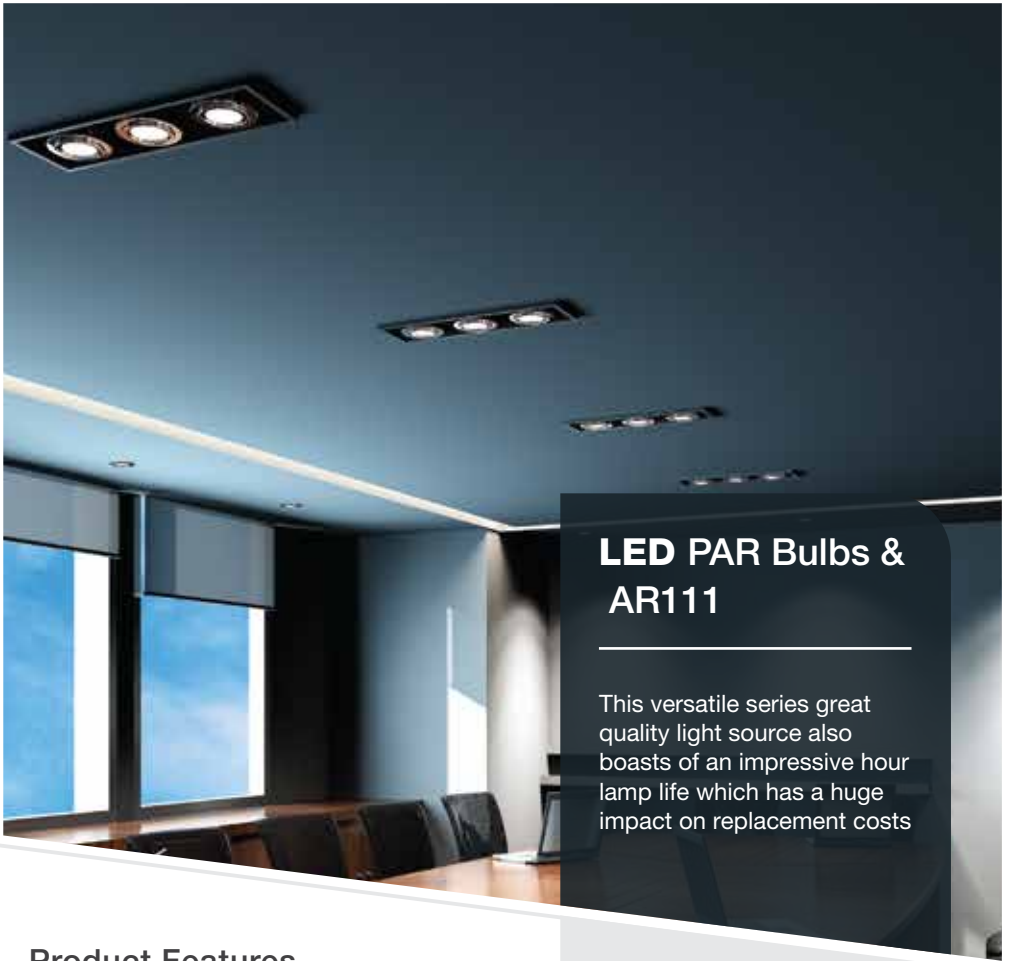

LED PAR Bulbs & AR111

This versatile series great quality light source also boasts of an impressive hour lamp life which has a huge impact on replacement costs

Product Features

- Eco friendly and Power Saving alternative for Standard Halogen Par Lamps with a longer life.
- Each lamp is a direct retrofit for a comparable Halogen Par Lamp e.g. AR111, PAR 30 & PAR 38
- Exceptional Heat Radiation Efficiency
- Non - Flickering
- No UV Radiation
- Premium Quality Power Driver
- Creates better Lighting effect than the old halogen bulb
- Dimmable & Non Dimmable options available

Applications

Widely used in Showrooms, Exhibition Stands, Stores, Offices and Reception areas, Hotels, Bars and Commercial Lighting



AR111 with Driver

20W VT-1120

- 1243 - 3000K Warm White
- 1244 - 4500K Day White
- 1245 - 6000K White

EAN Code

- 3800157606004
- 3800157606011
- 3800157606028

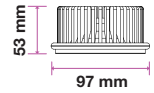

EQ. Watts:	100W	PF:	> 0.7
Voltage/Frequency:	AC: 220-240V, 50/60Hz	Beam Angle:	20°
Luminous Flux:	1800lm	Body Type:	Aluminum Die Cast
Commercial Type:	AR111	Life span:	20,000 Hours
LED Type:	COB	Dimension:	Ø97 x 53mm
CRI:	> 80		

AR111 with Driver

20W VT-1120

- 1246 - 3000K Warm White
- 1247 - 4500K Day White
- 1248 - 6000K White

EAN Code

- 3800157606035
- 3800157606042
- 3800157606059

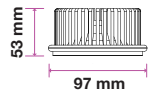

EQ. Watts:	100W	PF:	> 0.7
Voltage/Frequency:	AC: 220-240V, 50/60Hz	Beam Angle:	40°
Luminous Flux:	1800lm	Body Type:	Aluminum Die Cast
Commercial Type:	AR111	Life span:	20,000 Hours
LED Type:	COB	Dimension:	Ø97 x 53mm
CRI:	> 80		



Driver included in Set



94,5 x 45,5 x 28mm

Dimmable G53 AR111

15W VT-1110 D

4099 - 3000K Warm White

4106 - 4000K Day White

4086 - 6400K White

EAN Code

3800230620088

3800230620071

3800230626486



Dimmable

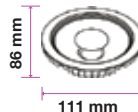

EQ. Watts:	75W	Dimmable:	Yes
Voltage/Frequency:	AC: 220V, 50Hz	PF:	> 0.9
Luminous Flux:	780lm	Beam Angle:	20°
Commercial Type:	AR111	Base:	G53
LED Type:	COB	Body Type:	Plastic Clad Aluminum
CRI:	> 80	Dimension:	111 x 86 mm



G53 AR111

15W VT-1110

4257 - 3000K Warm White

4256 - 4000K Day White

4255 - 6400K White

EAN Code

3800230628664

3800230628657

3800230628640

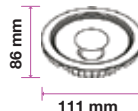

EQ. Watts:	75W	PF:	> 0.9
Voltage/Frequency:	AC: 12V, 50Hz	Beam Angle:	40°
Luminous Flux:	780lm	Base:	G53
Commercial Type:	AR111	Body Type:	Plastic Clad Aluminum
LED Type:	COB	Dimension:	111 x 86 mm
CRI:	> 80		



G53 AR111

15W VT-1110

4084 - 3000K Warm White

4062 - 4000K Day White

4061 - 6400K White

EAN Code

3800230620064

3800230620057

3800230620040

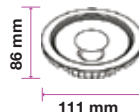

EQ. Watts:	75W	PF:	>0.5
Voltage/Frequency:	AC: 12V, 50Hz	Beam Angle:	20°
Luminous Flux:	780lm	Base:	G53
Commercial Type:	AR111	Body Type:	Plastic Clad Aluminum
LED Type:	COB	Dimension:	111 x 86 mm
CRI:	> 80		



GU10 AR111

12W VT-1112

4224 - 2700K Warm White

4223 - 4000K Day White

4225 - 6400K White

EAN Code

3800230626257

3800230626219

3800230626264

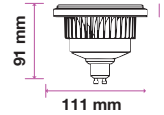

EQ. Watts:	60W	PF:	> 0.9
Voltage/Frequency:	AC: 220-240V, 50Hz	Beam Angle:	40°
Luminous Flux:	650lm	Base:	GU10
Commercial Type:	AR111	Body Type:	Plastic Clad Aluminum
LED Type:	COB	Dimension:	111 x 91 mm
CRI:	> 80		



Dimmable GU10 AR111

12W VT-1112D

7234 - 2700K Warm White

7235 - 4000K Day White

7236 - 6400K White

EAN Code

3800157620055

3800157620062

3800157620079

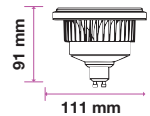

EQ. Watts:	60W	Dimmable:	Yes
Voltage/Frequency:	AC: 200-240V, 50Hz	PF:	> 0.9
Luminous Flux:	650lm	Beam Angle:	40°
Commercial Type:	AR111	Base:	GU10
LED Type:	COB	Body Type:	Plastic Clad Aluminum
CRI:	> 80	Dimension:	111 x 91 mm

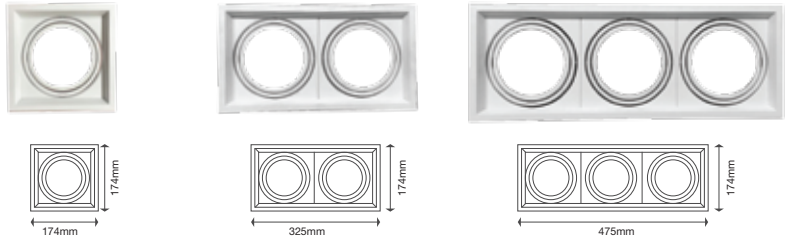

Aluminum Fitting

Model No. :	VT-7221	VT-7222	VT-7223
SKU Code :	3575	3576	3577
Color :	White	White	White
Holder :	1xAR111	2xAR111	3xAR111
Body Type :	Aluminum	Aluminum	Aluminum
Dimension :	174 x 174 mm	325 x 174 mm	475 x 174 mm
Cutting Size :	168x155mm	305 x 168 mm	455 x 168 mm
EAN Code :	3800157604765	3800157604772	3800157604789

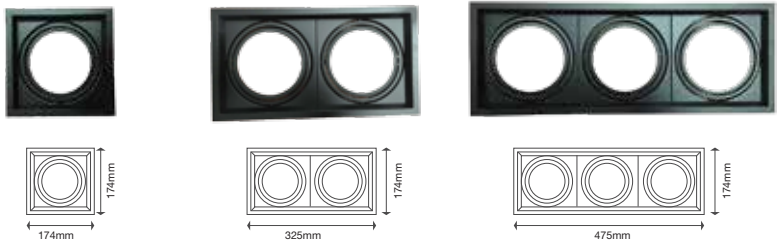

Aluminum Fitting

Model No. :	VT-7221	VT-7222	VT-7223
SKU Code :	3581	3582	3583
Color :	Black	Black	Black
Holder :	1xAR111	2xAR111	3xAR111
Body Type :	Aluminum	Aluminum	Aluminum
Dimension :	174 x 174 mm	325 x 174 mm	475 x 174 mm
Cutting Size :	168x155mm	305 x 168 mm	455 x 168 mm
EAN Code :	3800157607063	3800157607070	3800157607087

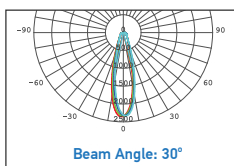

PAR 38 - E27

15W VT-1215

4415 - 3000K Warm White

4416 - 4000K Day White

4417 - 6400K White



EAN Code

3800157606271

3800157606288

3800157606295

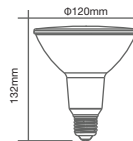

EQ. Watts:	100W	PF:	> 0.5
Voltage/Frequency:	AC: 220-240V, 50Hz	Beam Angle:	40°
Luminous Flux:	1000lm	Base:	E27
LED Type:	SMD	Body Type:	Plastic Coated Aluminum
Commercial Type :	PAR38	IP Rating:	IP65
CRI:	> 80	Dimension:	Φ120 x 132mm



Green



Red



Blue

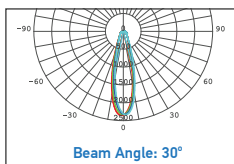

PAR 38 - E27

15W VT-1125

4418 Green

4419 Red

4420 Blue



EAN Code

3800157606301

3800157606318

3800157606325

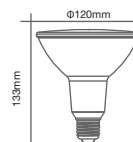

EQ. Watts:	100W	PF:	> 0.5
Voltage/Frequency:	AC: 180-240V, 50/60Hz	Beam Angle:	30°
Luminous Flux:	1200lm	Base:	E27
LED Type:	SMD	Body Type:	Plastic Coated Aluminum
Commercial Type :	PAR38	IP Rating:	IP65
CRI:	> 80	Dimension:	Φ120 x 133mm



Garden Spike Single Head

VT-728 EAN Code
7044 3800157606332

Type:	Outdoor	Compatible:	PAR 38
Suitable:	VT-1125 Bulb	Color:	Black
Holder:	E27	IP Rating:	IP44
Material:	ABS	Dimension:	450 x 27mm

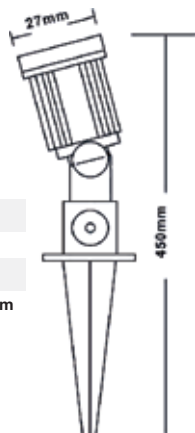

Garden Spike Double Head

VT-729 EAN Code
7045 3800157606349

Type:	Outdoor	Compatible:	PAR 38
Suitable:	VT-1125 Bulb	Color:	Black
Holder:	E27	IP Rating:	IP44
Material:	ABS	Dimension:	450 x 205 mm

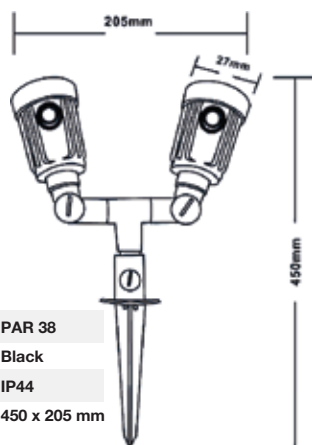

LED Nano Plastic Tubes

A revolutionary LED Lighting Solution



High Lumen
SMD

A clear nine point advantage over any conventional glass LED tube!



Nano plastic tube has better light transmittance



The bending endurance is twice better than the normal polycarbonate lens



This product is almost unbreakable



The thickness of a Nano plastic tube is just 0.4 to 0.5 mm



Light emitted is softer



This new material has super thermal conductivity



Light emitted is even across the angle and hence diffuses the glare



The internal convection holes can release a great amount of heat from the tube light



The luminous efficiency of the light can reach up to 92%



CE/EMC

2 YEAR WARRANTY



LED Tube Lights

Transform your existing space and make it more sustainable & beautify.

V-TAC LED Tube Series perfectly fit into existing linear fixtures and provide comparably better light levels to current Linear fluorescent systems .

Product Features

- Cost effective, safe retrofit for T8 Tubes
- Perfectly matches with the traditional daylight tube fixture
- Easy Installation
- No Lead or Mercury content hence Environment friendly
- No Ultraviolet or Infrared rays
- Non - flickering
- Long Lifespan, Low maintenance and energy saving
- Available in 60 cm, 120 cm, 150 cm & 180 cm
- Ballast or Starter NOT REQUIRED – DIRECT AC POWER



Applications

Widely used for Domestic and Commercial Lighting, Offices, Supermarkets, Shops, Hotels & similar environment



T8 - Nano Plastic

10W VT-6072

6229 - 3000K Warm White
6230 - 4000K Day White
6231 - 6400K White

EAN Code

3800157605212
3800157605229
3800157605236



EQ. Watts:	18W	PF:	>0.5	Holder:	G13
Voltage/Frequency:	AC:220-240V,50Hz	Beam Angle:	160°	On/Off:	>15000
Luminous Flux:	850lm	Body Type:	Nano-Plastic	Life span:	20,000 Hours
LED Type:	SMD	Dimension:	27.9mm x 600mm	Gross weight:	125 g
CRI:	>80	Instant start :	0-100% in <1s		

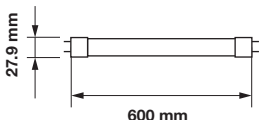

Dummy Starter
Included



NON-ROTATABLE

T8 - Nano Plastic

10W VT-6072

6392 - 3000K Warm White
6393 - 4000K Day White
6394 - 6400K White

EAN Code

3800157625296
3800157625302
3800157625319



EQ. Watts:	18W	PF:	>0.5	Holder:	G13
Voltage/Frequency:	AC:220-240V,50Hz	Beam Angle:	160°	On/Off:	>15000
Luminous Flux:	850lm	Body Type:	Nano-Plastic	Life span:	20,000 Hours
LED Type:	SMD	Dimension:	27.9mm x 600mm	Gross weight:	125 g
CRI:	>80	Instant start :	0-100% in <1s		

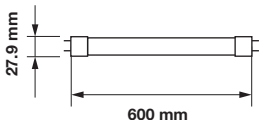

Dummy Starter
Included



Dummy Starter
Included

T8 - Nano Plastic

14W VT-9077

6272 - 4000K Day White
6262 - 6400K White



EAN Code

3800157615419
3800157612128

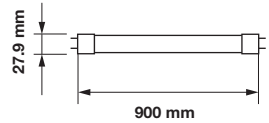

EQ. Watts:	25W	PF:	>0.5	Holder:	G13
Voltage/Frequency:	AC:220-240V,50Hz	Beam Angle:	160°	On/Off:	>15000
Luminous Flux:	1200lm	Body Type:	Nano-Plastic	Life span:	20,000 Hours
LED Type:	SMD	Dimension:	27.9mm x 900mm	Gross weight:	145.6 g
CRI:	>80	Instant start :	0-100% in <1s		



Dummy Starter
Included

T8 - Nano Plastic

18W VT-1277

6263 - 3000K Warm White
6273 - 4000K Day White
6264 - 6400K White



EAN Code

3800157612135
3800157615426
3800157612142

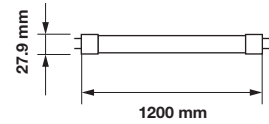

EQ. Watts:	36W	PF:	>0.5	Holder:	G13
Voltage/Frequency:	AC:220-240V,50Hz	Beam Angle:	160°	On/Off:	>15000
Luminous Flux:	1700lm	Body Type:	Nano-Plastic	Life span:	20,000 Hours
LED Type:	SMD	Dimension:	27.9mm x 1200mm	Gross weight:	200 g
CRI:	>80	Instant start :	0-100% in <1s		



Dummy Starter
Included

T8 - Nano Plastic

22W VT-1577

6265 - 3000K Warm White
6309 - 4000K Day White
6310 - 6400K White



EAN Code

3800157612159
3800157617437
3800157617444

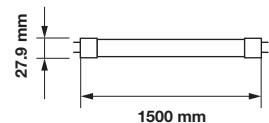

EQ. Watts:	58W	PF:	>0.5	Holder:	G13
Voltage/Frequency:	AC:220-240V,50Hz	Beam Angle:	160°	On/Off:	>15000
Luminous Flux:	2000lm	Body Type:	Nano-Plastic	Life span:	20,000 Hours
LED Type:	SMD	Dimension:	27.9mm x1500mm	Gross weight:	283.4 g
CRI:	>80	Instant start :	0-100% in <1s		



Dummy Starter
Included

60CM



9W VT-6085

6299 - 3000K Warm White
6301 - 4000K Day White
6302 - 6400K White



EAN Code

3800157617345
3800157617352
3800157617369

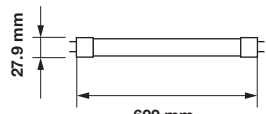

120⁺⁺
LM/W
HIGH LUMENS

EQ. Watts:	25W	PF:	>0.5	Holder:	G13
Voltage/Frequency:	AC:220-240V,50Hz	Beam Angle:	160°	On/Off:	>15000
Luminous Flux:	1100lm	Body Type:	Nano-Plastic	Life span:	20,000 Hours
LED Type:	SMD	Dimension:	27.9mm x 600mm	Gross weight:	125 g
CRI:	>80	Instant start :	0-100% in <1s		



Dummy Starter
Included

120CM

18W VT-1285

6303 - 3000K Warm White
6304 - 4000K Day White
6305 - 6400K White



EAN Code

3800157617376
3800157617383
3800157617390

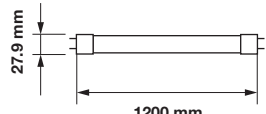

120⁺⁺
LM/W
HIGH LUMENS

EQ. Watts:	45W	PF:	>0.5	Holder:	G13
Voltage/Frequency:	AC:220-240V,50Hz	Beam Angle:	160°	On/Off:	>15000
Luminous Flux:	2250lm	Body Type:	Nano-Plastic	Life span:	20,000 Hours
LED Type:	SMD	Dimension:	27.9mm x 1200mm	Gross weight:	200 g
CRI:	>80	Instant start :	0-100% in <1s		



Dummy Starter
Included

150CM

22W VT-1585

6306 - 3000K Warm White
6307 - 4000K Day White
6308 - 6400K White



EAN Code

3800157617406
3800157617413
3800157617420

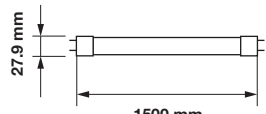

120⁺⁺
LM/W
HIGH LUMENS

EQ. Watts:	75W	PF:	>0.5	Holder:	G13
Voltage/Frequency:	AC:220-240V,50Hz	Beam Angle:	160°	On/Off:	>15000
Luminous Flux:	3000lm	Body Type:	Nano-Plastic	Life span:	20,000 Hours
LED Type:	SMD	Dimension:	27.9mm x1500mm	Gross weight:	283.4 g
CRI:	>80	Instant start :	0-100% in <1s		



T8 - Shoplite Nano Plastic

18W VT-6077

6313 - 4000K Day White
6314 - 6400K White

EAN Code

3800157618656
3800157618663



120⁺⁺ LM/W
HIGH LUMENS

EQ. Watts:	36W	PF:	>0.5	Holder:	G13
Voltage/Frequency:	AC: 200-240V 50/60Hz	Beam Angle:	160°	On/Off:	>15000
Luminous Flux:	2500lm	Body Type:	Nano Plastic	Life span:	20,000 Hours
LED Type:	SMD	Dimension:	18.5mm x 549mm	Gross weight:	250 g
CRI:	>80	Instant start :	0-100% in <1s		

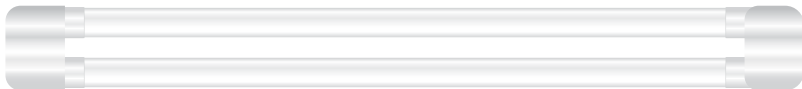

T8 - Shoplite Nano Plastic

36W VT-12077

6315 - 4000K Day White
6316 - 6400K White

EAN Code

3800157618670
3800157618687



120⁺⁺ LM/W
HIGH LUMENS

EQ. Watts:	72W	PF:	>0.5	Holder:	G13
Voltage/Frequency:	AC: 200-240V 50/60Hz	Beam Angle:	160°	On/Off:	>15000
Luminous Flux:	4500lm	Body Type:	Nano Plastic	Life span:	20,000 Hours
LED Type:	SMD	Dimension:	18.5mm x 1149mm	Gross weight:	400 g
CRI:	>80	Instant start :	0-100% in <1s		



T5 - Glass with PET

8W VT-6005

6318 - 4000K Day White
6319 - 6400K White

EAN Code

3800157619271
3800157619288

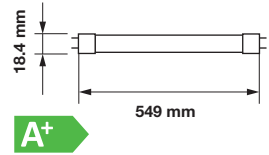

EQ. Watts:	14W	PF:	>0.9	Holder:	G5
Voltage/Frequency:	AC:200-240V, 50Hz	Beam Angle:	160°	On/Off:	>15000
Luminous Flux:	800lm	Body Type:	Glass with PET	Life span:	20,000 Hours
LED Type:	SMD	Dimension:	18.4mm x 549mm	Gross weight:	128 g
CRI:	>80	Instant start :	0-100% in <1s		



T5 - Glass with PET

16W VT-1225

6320 - 4000K Day White
6321 - 6400K White

EAN Code

3800157619295
3800157619301

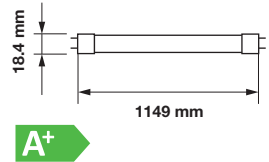

EQ. Watts:	28W	PF:	>0.9	Holder:	G5
Voltage/Frequency:	AC:200-240V, 50Hz	Beam Angle:	160°	On/Off:	>15000
Luminous Flux:	1600lm	Body Type:	Glass with PET	Life span:	20,000 Hours
LED Type:	SMD	Dimension:	18.4mm x 1149mm	Gross weight:	213 g
CRI:	>80	Instant start :	0-100% in <1s		



T8 - Aluminum Body

40W VT-1840

6251 - 4500K Day White
6250 - 6000K White

EAN Code

3800157607841
3800157607834

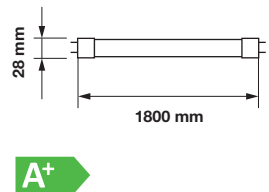

EQ. Watts:	80W	PF:	>0.9	Holder:	G13
Voltage/Frequency:	AC:85-265V,50/60Hz	Beam Angle:	120°	On/Off:	>15000
Luminous Flux:	3800lm	Body Type:	Aluminum+PC	Life span:	20,000 Hours
LED Type:	SMD	Dimension:	28mm x 1800mm	Gross weight:	700g
CRI:	>80	Instant start :	0-100% in <1s		



T8 - Glass Bakery Tube

18W VT-1228
SKU 6322



EAN Code
3800157619318

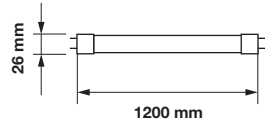

EQ. Watts:	36W	PF:	>0.9	Holder:	G13
Voltage/Frequency:	AC:180-240V, 50Hz	Beam Angle:	160°	On/Off:	>15000
Luminous Flux:	990lm	Body Type:	Glass with PET	Life span:	20,000 Hours
LED Type:	SMD	Dimension:	26mm x 1200mm	Gross weight:	380 g
CRI:	>95	Instant start :	0-100% in <1s		



T8 - Glass Meat Tube

18W VT-1228
SKU 6323



EAN Code
3800157619325

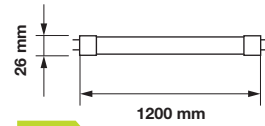

EQ. Watts:	36W	PF:	>0.9	Holder:	G13
Voltage/Frequency:	AC:180-240V, 50Hz	Beam Angle:	160°	On/Off:	>15000
Luminous Flux:	1530lm	Body Type:	Glass with PET	Life span:	20,000 Hours
LED Type:	SMD	Dimension:	26mm x 1200mm	Gross weight:	380 g
CRI:	>95	Instant start :	0-100% in <1s		



T8 - Glass Vegetable

18W VT-1228
SKU 6324



EAN Code
3800157619332

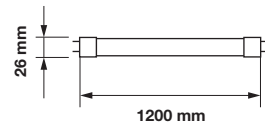

EQ. Watts:	36W	PF:	>0.9	Holder:	G13
Voltage/Frequency:	AC:180-240V, 50Hz	Beam Angle:	160°	On/Off:	>15000
Luminous Flux:	990lm	Body Type:	Glass with PET	Life span:	20,000 Hours
LED Type:	SMD	Dimension:	26mm x 1200mm	Gross weight:	380 g
CRI:	>95	Instant start :	0-100% in <1s		

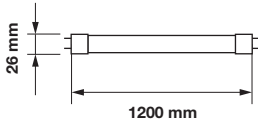

T8 - Glass Seafood Tube



18W VT-1228
SKU 6325

EAN Code
3800157619349



EQ. Watts:	36W	PF:	>0.9	Holder:	G13
Voltage/Frequency:	AC:180-240V, 50Hz	Beam Angle:	160°	On/Off:	>15000
Luminous Flux:	1530lm	Body Type:	Glass with PET	Life span:	20,000 Hours
LED Type:	SMD	Dimension:	26mm x 1200mm	Gross weight:	380 g
CRI:	>95	Instant start :	0-100% in <1s		

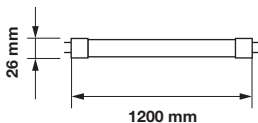

T8 - Glass Plant Growing Tube



18W VT-1228
SKU 6326

EAN Code
3800157619356



EQ. Watts:	36W	PF:	>0.9	Holder:	G13
Voltage/Frequency:	AC:180-240V, 50Hz	Beam Angle:	160°	On/Off:	>15000
Luminous Flux:	860lm	Body Type:	Glass with PET	Life span:	20,000 Hours
LED Type:	SMD	Dimension:	26mm x 1200mm	Gross weight:	380 g
CRI:	>95	Instant start :	0-100% in <1s		



New!

120CM - Linkable Led Batten Fitting

40W VT-80404

EAN Code

- 6389 - 3000K Warm White
- 6390 - 4000K Day White
- 6391 - 6400K White

- 3800157625104
- 3800157625111
- 3800157625128



Watts:	40W	PF:	>0.9	On/0ff:	>15, 000
Voltage/Frequency:	AC:100-240V,50/60Hz	Beam Angle:	120°	Life span:	30, 000 hours
Luminous Flux:	3200lm	Body Type:	Aluminum+Plastic	Gross weight:	
LED Type:	SMD	IP Rating:	IP20		
CRI:	>80	Dimension:	1200 x 75 x 26mm		

Prismatic Fittings

Providing comparatively better light levels to current linear fluorescent systems, V-TAC's Prismatic fittings are available in three colour options and sizes as mentioned below.



30CM

10w | 800 lm

A+

60CM

20w | 1600 lm

A+

120CM

40w | 3200 lm

A+

150CM

50w | 4000 lm

A+

180CM

60w | 4800 lm

A+

Salient Features

- ❖ Stable SMD technology which makes the product more reliable and long-lasting.
- ⚡ 50% less power consumption compared to traditional grill fitting lighting
- 🌀 Sturdy Aluminium body of the fitting controls heat transmittance
- ☀️ PC diffuser allows for even light distribution
- 📏 Stylish shapes present opportunities to install anywhere
- 🌊 Soft light emission
- 📏 Variety of sizes to choose from



30CM - Prismatic

10W VT-8013

- 4987 - 3000K Warm White
- 4988 - 4000K Day White
- 4989 - 6000K White

EAN Code

- 3800157601955
- 3800157601962
- 3800157601979

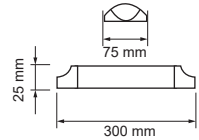

Watts:	10W	PF:	> 0.5	On/Off:	>15000
Voltage/Frequency:	AC:100-240V,50Hz	Beam Angle:	110°	Life span:	20,000 Hours
Luminous Flux:	900lm	Body Type:	Aluminum+Plastic	Gross weight:	260 g
LED Type:	SMD	Dimension:	300 x 75 x 25mm		
CRI:	>80	Instant start :	0-100% in <1s		



60CM - Prismatic

20W VT-8020

- 4990 - 3000K Warm White
- 4991 - 4000K Day White
- 4992 - 6000K White

EAN Code

- 3800157601986
- 3800157601993
- 3800157602006

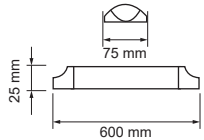

Watts:	20W	PF:	> 0.5	On/Off:	>15000
Voltage/Frequency:	AC:100-240V,50Hz	Beam Angle:	110°	Life span:	20,000 Hours
Luminous Flux:	1800lm	Body Type:	Aluminum+Plastic	Gross weight:	420 g
LED Type:	SMD	Dimension:	600 x 75 x 25mm		
CRI:	>80	Instant start :	0-100% in <1s		



120CM - Prismatic

40W VT-8040

- 4993 - 3000K Warm White
- 4994 - 4000K Day White
- 4995 - 6000K White

EAN Code

- 3800157602013
- 3800157602020
- 3800157602037

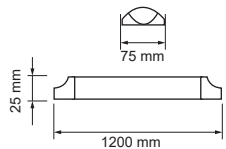

Watts:	40W	PF:	>0.9	On/Off:	>15000
Voltage/Frequency:	AC:100-240V,50Hz	Beam Angle:	110°	Life span:	20,000 Hours
Luminous Flux:	3600lm	Body Type:	Aluminum+Plastic	Gross weight:	840 g
LED Type:	SMD	Dimension:	1200 x 75 x 25mm		
CRI:	>80	Instant start :	0-100% in <1s		



150CM - Prismatic

50W VT-8050

6254 - 4000K Day White
6253 - 6000K White

EAN Code

3800157609579
3800157609562

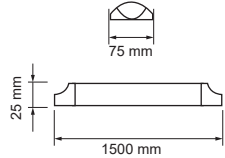

Watts:	50W	PF:	>0.9	On/Off:	>10000
Voltage/Frequency:	AC: 100-240V, 50Hz	Beam Angle:	110°	Life span:	20,000 Hours
Luminous Flux:	4000 lm	Body Type:	Aluminum+Plastic	Gross weight:	1000g
LED Type:	SMD	Dimension:	1500 x 75 x 25mm		
CRI:	>80	Instant start :	0-100% in <1s		



180CM - Prismatic

60W VT-8060

6311 - 4000K Day White
6312 - 6000K White

EAN Code

3800157617574
3800157617581

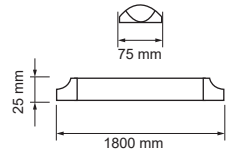

Watts:	60W	PF:	>0.9	On/Off:	>10000
Voltage/Frequency:	AC: 100-240V, 50Hz	Beam Angle:	110°	Life span:	20,000 Hours
Luminous Flux:	4800lm	Body Type:	Aluminum+Plastic	Gross weight:	1200g
LED Type:	SMD	Dimension:	1800 x 75 x 25mm		
CRI:	>80	Instant start :	0-100% in <1s		

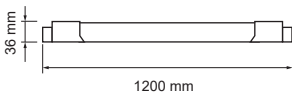

120CM - Linear Light

36W VT-12042

6202 - 4500K Day White
6203 - 6000K White

8071 Wire
8072 Joint

EAN Code

3800157604024
3800157604031



Watts:	36W	PF:	>0.9	On/Off:	>15000
Voltage/Frequency:	AC:85-265V/50-60Hz	Beam Angle:	120°	Life span:	20,000 Hours
Luminous Flux:	2900lm	Body Type:	IRON+PC	Gross weight:	700 g
LED Type:	SMD	Dimension:	1187 x 54 x 36mm		
CRI:	>80	Instant start :	0-100% in <1s		

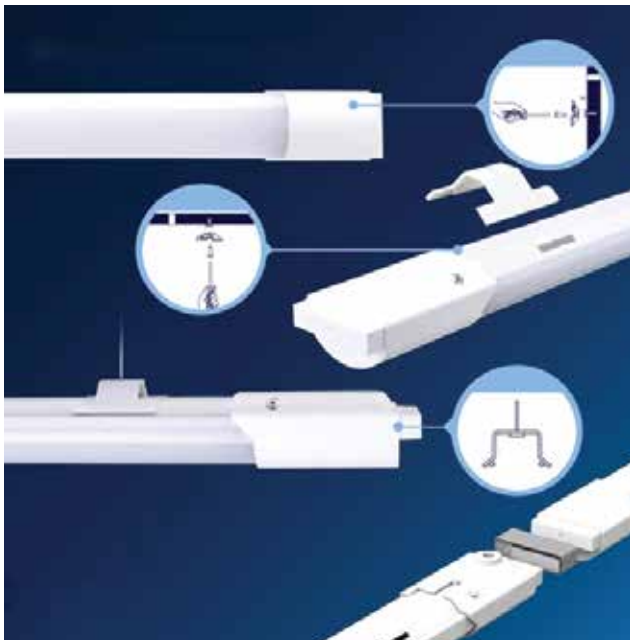



On/Off switch
Feeding Cable - 100mm with open ends

30CM
T5 Complete Fixture
4W VT-3033

- 6166 - 3000K Warm White
- 6167 - 4500K Day White
- 6168 - 6000K White



EAN Code
3800230629159
3800230629166
3800230629173

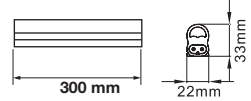

Watts:	4W	PF:	> 0.5	On/Off:	>10000
Voltage/Frequency:	AC:200-240V, 50/60Hz	Beam Angle:	120°	Life span:	20,000 Hours
Luminous Flux:	360lm	Body Type:	Plastic	Gross weight:	140 g
LED Type:	SMD	Dimension:	300 x 22 x 33mm		
CRI:	>80	Instant start :	0-100% in <1s		

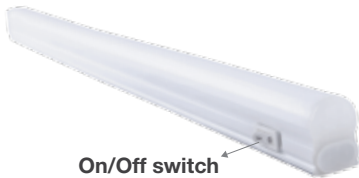

On/Off switch
Feeding Cable - 100mm with open ends

60CM
T5 Complete Fixture
7W VT-6073

- 6169 - 3000K Warm White
- 6170 - 4500K Day White
- 6171 - 6000K White



EAN Code
3800230629180
3800230629197
3800230629203

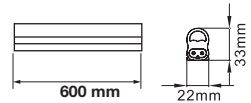

Watts:	7W	PF:	> 0.5	On/Off:	>10000
Voltage/Frequency:	AC:200-240V, 50/60Hz	Beam Angle:	120°	Life span:	20,000 Hours
Luminous Flux:	630lm	Body Type:	Plastic	Gross weight:	210 g
LED Type:	SMD	Dimension:	600 x 22 x 33mm		
CRI:	>80	Instant start :	0-100% in <1s		



120CM - T5 Tube
With Fitting

14W VT-1273

- 6172 - 3000K Warm White
- 6173 - 4500K Day White
- 6174 - 6000K White



EAN Code
3800230629210
3800230629227
3800230629234

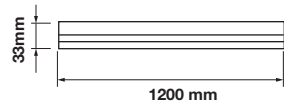

Watts:	14W	PF:	> 0.5	On/Off:	>10000
Voltage/Frequency:	AC:200-240V, 50/60Hz	Beam Angle:	120°	Life span:	20,000 Hours
Luminous Flux:	1260lm	Body Type:	Plastic	Gross weight:	300 g
LED Type:	SMD	Dimension:	1200x 22 x 33mm		
CRI:	>80	Instant start :	0-100% in <1s		



ROTATABLE

Cabinet Light

10W VT-8112

- 5068 - 3000K Warm White
- 5069 - 4500K Day White
- 5070 - 6000K White

EAN Code

- 3800157606714
- 3800157606721
- 3800157606738

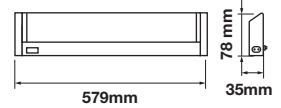

Watts:	10W	PF:	> 0.5	On/Off:	>15000
Voltage/Frequency:	AC:220-240V,50/60Hz	Beam Angle:	110°	Life span:	20,000 Hours
Luminous Flux:	800lm	Body Type:	Aluminum Body, Plastic Diffuser	Gross weight:	600 g
LED Type:	SMD	Dimension:	579 x 78 x 35mm		
CRI:	>80	Instant start :	0-100% in <1s		



Wall Fitting

10W VT-8111

- 5071 - 3000K Warm White
- 5072 - 4500K Day White
- 5073 - 6000K White

EAN Code

- 3800157606745
- 3800157606752
- 3800157606769

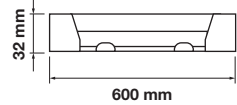

Watts:	10W	PF:	> 0.5	On/Off:	>15000
Voltage/Frequency:	AC:85-265V,50/60Hz	Beam Angle:	120°	Life span:	20,000 Hours
Luminous Flux:	900lm	Body Type:	Aluminum+PC	Gross weight:	240 g
LED Type:	SMD	Dimension:	600 x 32 x 25mm		
CRI:	>80	Instant start :	0-100% in <1s		



Wall Fitting

20W VT-8121

- 5074 - 3000K Warm White
- 5075 - 4500K Day White
- 5076 - 6000K White

EAN Code

- 3800157606776
- 3800157606783
- 3800157606790

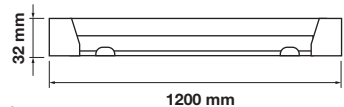

Watts:	20W	PF:	> 0.9	On/Off:	>15000
Voltage/Frequency:	AC:85-265V,50/60Hz	Beam Angle:	120°	Life span:	20,000 Hours
Luminous Flux:	1800lm	Body Type:	Aluminum+PC	Gross weight:	370 g
LED Type:	SMD	Dimension:	1200x 32 x 25mm		
CRI:	>80	Instant start :	0-100% in <1s		



MODEL No.	VT-16010	VT-12020	VT-15020	VT-18011
SKU Code	6052	6054	6056	6151
Body Type	Aluminum	Aluminum	Aluminum	Aluminum
IP Rating	IP20	IP20	IP20	IP20
Size	635 x 45 x 80mm	1235 x 45 x 80mm	1530 x 45 x 80mm	1830 x 45 x 80mm
EAN Code	3800230624642	3800230624666	3800230624680	3800230627926



MODEL No.	VT-16011	VT-12021	VT-15021
SKU Code	6053	6055	6057
Body Type	Aluminum	Aluminum	Aluminum
IP Rating	IP20	IP20	IP20
Size	635 x 110 x 80mm	1235 x 110 x 80mm	1530 x 110 x 80mm
EAN Code	3800230624659	3800230624673	3800230624697

Batten Fixtures for our T8 LED Tubes so they can be used in a variety of different applications such as public areas like hotels, restaurants or hospitals.

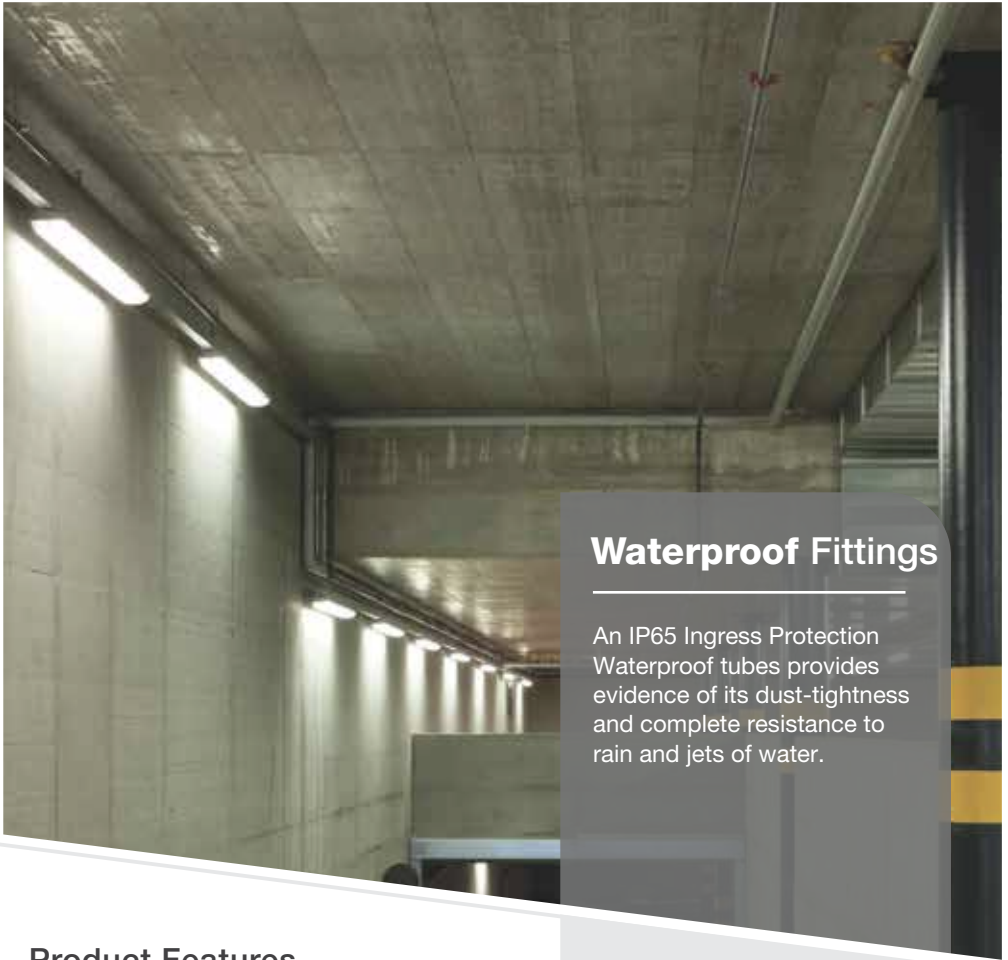

Waterproof Fittings

An IP65 Ingress Protection Waterproof tubes provides evidence of its dust-tightness and complete resistance to rain and jets of water.

Product Features

- Luminous efficacy up to 120lm/W and 80lm/W
- Easy to install
- IP65, free from water and dirt
- Without opening the lampshade for direct wiring
- Perfect replacement for the whole set of T8 fluorescent lighting fixture
- Save up to 80% in electricity consumption compared to fluorescent lighting fixture



Applications

Parking lots, Gas stations, Tunnels, Warehouse etc.

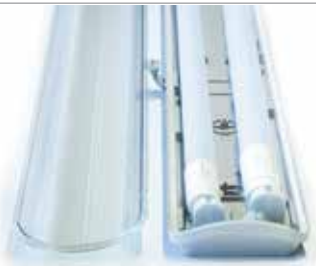

New!

120CM x 2 - Fitting

2 x 18W VT-12023

6387 - 4000K Day White

6399 - 6400K White

EAN Code

3800157625036

3800157626385



Watts:	2 x 18W	Body Type:	ABS+PC
Voltage/Frequency:	AC:200-240V, 50/60Hz	IP Rating:	IP65
Luminous Flux:	3400lm	Dimension:	1260 x 112 x 63mm
LED Type:	SMD	On/Off:	>15000
CRI:	>80	Life span:	20,000 Hours
PF:	>0.9	Gross weight:	
Beam Angle:	120°		

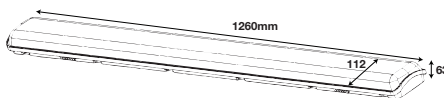

New!

150CM x 2 - Fitting

2 x 22W VT-15022

6388 - 4000K Day White

6400 - 6400K White

EAN Code

3800157625043

3800157626392



Watts:	2 x 22W	Body Type:	ABS+PC
Voltage/Frequency:	AC:200-240V,50/60Hz	IP Rating:	IP65
Luminous Flux:	4000lm	Dimension:	1560 x 112 x 63mm
LED Type:	SMD	On/Off:	>15000
CRI:	>80	Life span:	20,000 Hours
PF:	>0.9	Gross weight:	
Beam Angle:	120°		

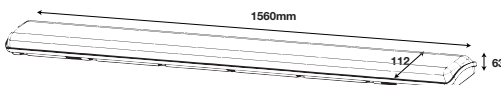



New!

120CM - Fitting

36W VT-1238

6395 - 4000K Day White
6396 - 6400K White

EAN Code

3800157625999
3800157626002

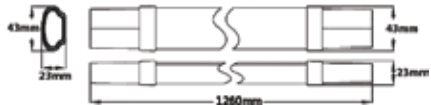

Watts:	36W	PF:	>0.6	On/Off:	>10000
Voltage/Frequency:	AC:220-240V,50/60Hz	Beam Angle:	120°	Life span:	30,000 Hours
Luminous Flux:	3200lm	Body Type:	PC	Gross weight:	
LED Type:	SMD	IP Rating:	IP65		
CRI:	>70	Dimension:	1260 x 43 x 23mm		



New!

150CM - Fitting

45W VT-1545

6397 - 4000K Day White
6398 - 6400K White

EAN Code

3800157626019
3800157626026

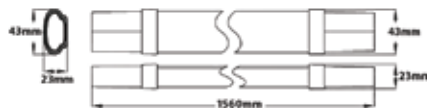

Watts:	45W	PF:	>0.6	On/Off:	>10000
Voltage/Frequency:	AC:220-240V,50/60Hz	Beam Angle:	120°	Life span:	30,000 Hours
Luminous Flux:	4100lm	Body Type:	PC	Gross weight:	
LED Type:	SMD	IP Rating:	IP65		
CRI:	>70	Dimension:	1560 x 43 x 23mm		



60CM - Fitting

18W VT-6076

6283 - 4000K Day White
6282 - 6400K White

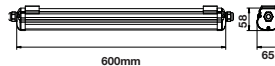

EAN Code

3800157616478
3800157616461



Watts:	18W	PF:	>0.5	On/Off:	>10000
Voltage/Frequency:	AC:220-240V,50Hz	Beam Angle:	120°	Life span:	20,000 Hours
Luminous Flux:	1440lm	Body Type:	ABS+PC	Gross weight:	560 g
LED Type:	SMD	IP Rating:	IP65		
CRI:	>70	Dimension:	600 x 65 x 58mm		



120CM - Fitting

36W VT-1249

6285 - 4000K Day White
6284 - 6400K White

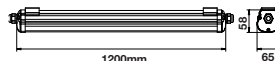

EAN Code

3800157616492
3800157616485



Watts:	36W	PF:	>0.9	On/Off:	>10000
Voltage/Frequency:	AC:220-240V,50Hz	Beam Angle:	120°	Life span:	20,000 Hours
Luminous Flux:	2880lm	Body Type:	ABS+PC	Gross weight:	916 g
LED Type:	SMD	IP Rating:	IP65		
CRI:	>70	Dimension:	1200 x 65 x 58mm		



150CM - Fitting

48W VT-1574

6287 - 4000K Day White
6286 - 6400K White



EAN Code

3800157616515
3800157616508



Watts:	48W	PF:	>0.9	On/Off:	>10000
Voltage/Frequency:	AC:220-240V,50Hz	Beam Angle:	120°	Life span:	20,000 Hours
Luminous Flux:	3840lm	Body Type:	ABS+PC	Gross weight:	1150 g
LED Type:	SMD	IP Rating:	IP65		
CRI:	>70	Dimension:	1500 x 65 x 58mm		



120CM - Fitting

36W VT-1248

6200 - 4500K Day White
6201 - 6000K White

EAN Code

3800157603270
3800157603287



Watts:	36W	PF:	>0.9	On/Off:	>10000
Voltage/Frequency:	AC:200-240V,50Hz	Beam Angle:	120°	Life span:	20,000 Hours
Luminous Flux:	2880lm	Body Type:	Plastic	Gross weight:	1450 g
LED Type:	SMD	IP Rating:	IP65		
CRI:	>70	Dimension:	1200 x 76 x 66mm		

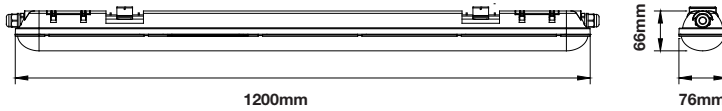

150CM - Fitting

48W VT-1548

6184 - 4500K Day White
6185 - 6000K White

EAN Code

3800157602389
3800157602396



Watts:	48W	PF:	>0.9	On/Off:	>10000
Voltage/Frequency:	AC:200-240V,50Hz	Beam Angle:	120°	Life span:	20,000 Hours
Luminous Flux:	3920lm	Body Type:	Plastic	Gross weight:	1800 g
LED Type:	SMD	Dimension:	IP65		
CRI:	>70	Instant start :	1480 x 76 x 66mm		

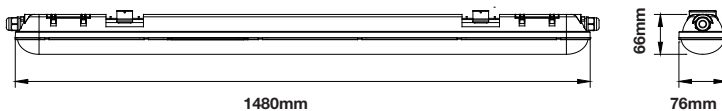



120CM - Fitting

60W VT-1260 SMD

EAN Code

6179 - 4000K Day White
6062 - 6000K White

3800157601610
3800230625212



120⁺⁺
LM/W
HIGH LUMENS



Watts:	60W	PF:	> 0.9	On/Off:	>10000
Voltage/Frequency:	AC: 200-240V, 50Hz	Beam Angle:	120°	Life span:	20,000 Hours
Luminous Flux:	7200lm	Body Type:	Plastic + Aluminium	Gross weight:	2100 g
LED Type:	SMD	IP Rating:	IP65		
CRI:	>70	Dimension:	1200 x 86 x 70mm		

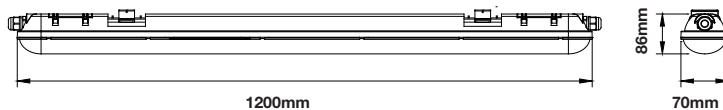

150CM - Fitting

70W VT-1573

EAN Code

6266 - 4000K Day White
6267 - 6000K White

3800157612586
3800157612593



120⁺⁺
LM/W
HIGH LUMENS



Watts:	70W	PF:	> 0.9	On/Off:	>10000
Voltage/Frequency:	AC:200-240V, 50/60Hz	Beam Angle:	120°	Life span:	20,000 Hours
Luminous Flux:	8400lm	Body Type:	Plastic + Aluminium	Gross weight:	2750 g
LED Type:	SMD	IP Rating:	IP65		
CRI:	>70	Dimension:	1500x 86 x70mm		

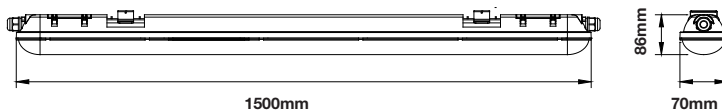



LED Panels

Uniform radiance coupled with consistent illumination and zero hot or cold spots, just pure systematic radiance with the V-TAC LED Light Panels. Practical, Economical and friendly

Product Features

- Ultra Slim Design
- Contemporary & Elegant Design
- Higher Light Transmission Rate
- Exterior shell, cannot be easily damaged
- No infrared, does not attract flies
- Easy to install
- No Lead or Mercury content hence environment friendly
- Dimmable options available in selected models



Applications

- Office Lighting (Conference Room, Hospitals, Hotels, Shopping Malls, Showroom and lobby cabin etc.) Kitchen and Domestic Lighting

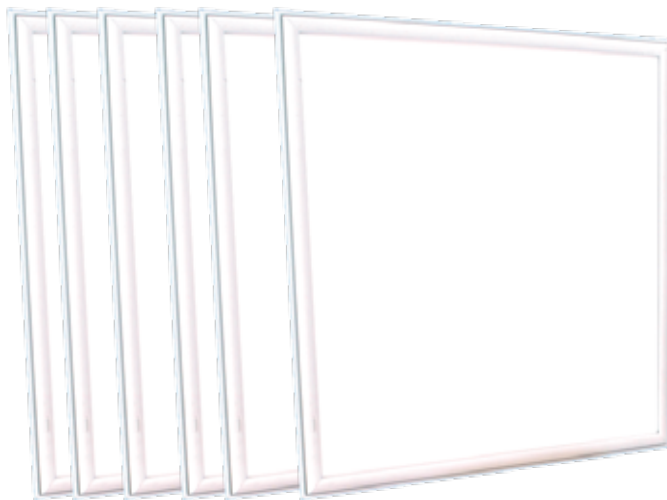

New!

60 x 60 LED Panel

45W VT-6165

6419 3000k Warm White
6420 4000k Day White
6421 6400k White

EAN Code

3800157626828
3800157626835
3800157626842

6
Pack

A+



Emergency Pack:	Available	PF:	> 0.9
Voltage/Frequency:	AC:220-240V,50Hz	Beam Angle:	120°
Luminous Flux:	3400lm	Body Type:	Aluminium+PMMA
LED Type:	SMD	Shape:	Square
CRI:	>80	Dimension:	595 x 595 x14mm

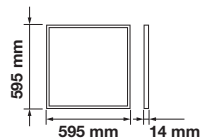

Drivers for Panels (EMC Approved)

SKU: **6269**

Type: **Dimmable**

Power: **45W**

EAN Code: **3800157614429**

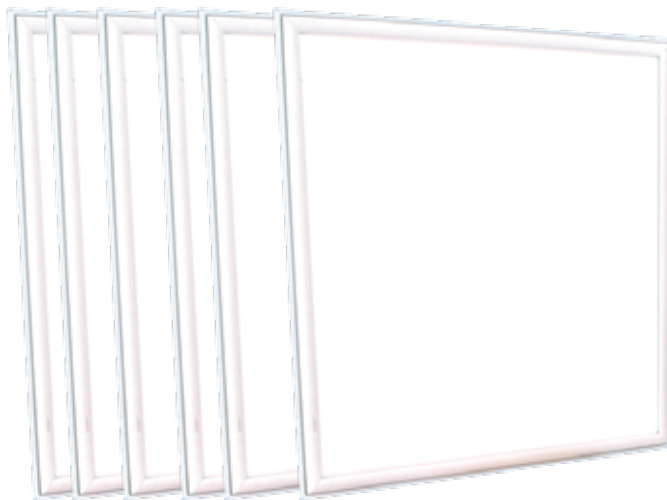

60 x 60 LED Panel

45W VT-6060

EAN Code

6
Pack

60286 - 3000K Warm White 3800230624482

60246 - 4000K Day White 3800230623652

60256 - 6400K White 3800230623584

A+

Emergency Pack:	Available	PF:	> 0.9
Voltage/Frequency:	AC:220-240V,50Hz	Beam Angle:	120°
Luminous Flux:	3600lm	Body Type:	Aluminium+PMMA+PP
LED Type:	SMD	Shape:	Square
CRI:	>80	Dimension:	595 x 595 x14mm

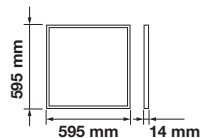

Drivers for Panels (EMC Approved)

SKU:	6019	6029	} Compatible with	
Type:	Dimmable	Tridonic		60286 / 62206
Power:	45W	45W		60246 / 6218 6
EAN Code:	3800157604017	N/A		60256 / 62196



60 x 60 LED Panel



45W VT-6068

EAN Code

62206 - 3000K Warm White 3800157619516

62186 - 4000K Day White 3800157609265

62196 - 6400K White 3800157609272

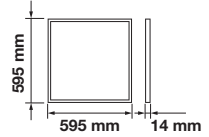

Emergency Pack:	45W	PF:	> 0.9
Voltage/Frequency:	AC:220-240V,50Hz	Beam Angle:	120°
Luminous Flux:	3600lm	Body Type:	Aluminium+PMMA+PP
LED Type:	SMD	Shape:	Square
CRI:	>80	Dimension:	595 x 595 x14mm



62 x 62 LED Panel



45W VT-6069

EAN Code

6222 - 3000K Warm White 3800157604918

6217 - 4000K Day White 3800157604857

6221 - 6400K White 3800157604901

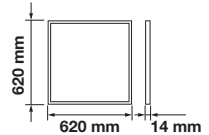

Emergency Pack:	Available	PF:	>0.9
Voltage/Frequency:	AC:220-240V,50Hz	Beam Angle:	120°
Luminous Flux:	3600lm	Body Type:	Aluminium+PMMA+PP
LED Type:	SMD	Shape:	Square
CRI:	>80	Dimension:	620 x 620 x14mm

Drivers for Panels (EMC Approved)

SKU:	6019	6029	} Compatible with	Compatible with
Type:	Dimmable	Tridonic		
Power:	45W	45W		
EAN Code:	3800157604017	N/A		
			60286 / 62206	6222
			60246 / 6218 6	6217
			60256 / 62196	6221

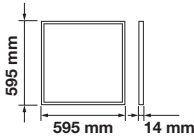

60 x 60 LED Panel

29W VT-6129

- 62406 / 6240 - 3000K Warm White
- 62416 / 6241 - 4000K Day White
- 62426 / 6242 - 6400K White

EAN Code

- 3800157619608 / 3800157608169
- 3800157609289 / 3800157608176
- 3800157609296 / 3800157608183

120⁺⁺
LM/W
HIGH LUMENS



Emergency Pack:	29W	PF:	>0.9
Voltage/Frequency:	AC:220-240V,50/60Hz	Beam Angle:	120°
Luminous Flux:	3600lm	Body Type:	Aluminium+PMMA+PC
LED Type:	SMD	Shape:	Square
CRI:	>80	Dimension:	595 x 595 x14mm

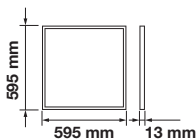

60 x 60 LED Panel

45W VT-6145

- 63776 - 3000K Warm White
- 62366 / 6236 - 4000K Day White
- 62376 / 6237 - 6400K White

EAN Code

- 3800157622158
- 3800157615723 / 3800157607612
- 3800157615730 / 3800157607629

120⁺⁺
LM/W
HIGH LUMENS



Emergency Pack:	Available	PF:	>0.9
Voltage/Frequency:	AC:220-240V,50/60Hz	Beam Angle:	120°
Luminous Flux:	5400lm	Body Type:	Aluminium+PMMA+PP
LED Type:	SMD	Shape:	Square
CRI:	>80	Dimension:	595 x 595 x13mm

Drivers for Panels (EMC Approved)

SKU: **6269**
 Type: **Dimmable**
 Power: **45W**
 EAN Code: **3800157614429**

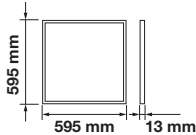

60 x 60 LED Panel

36W VT-6136

6376 - 3000K Warm White
6238 - 4000K Day White
6239 - 6400K White

EAN Code

3800157622141
 3800157607636
 3800157607643

120⁺⁺ LM/W
HIGH LUMENS



Emergency Pack:	36W	PF:	>0.9
Voltage/Frequency:	AC:220-240V,50/60Hz	Beam Angle:	120°
Luminous Flux:	4320lm	Body Type:	Aluminium+PMMA+PC
LED Type:	SMD	Shape:	Square
CRI:	>80	Dimension:	595 x 595 x13mm

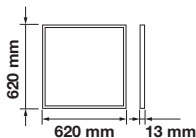

62 x 62 LED Panel

36W VT-6137

63786 - 3000K Warm White
62436 / 6243 - 4000K Day White
63796 - 6400K White

EAN Code

3800157622165
 3800157619622 / 3800157608190
 3800157622172

120⁺⁺ LM/W
HIGH LUMENS



Emergency Pack:	Available	PF:	>0.9
Voltage/Frequency:	AC:220-240V,50/60Hz	Beam Angle:	120°
Luminous Flux:	4320lm	Body Type:	Aluminium+PMMA+PC
LED Type:	SMD	Shape:	Square
CRI:	>80	Dimension:	620 x 620 x13mm

Drivers for Panels (EMC Approved)

SKU: **6019**
 Type: **Dimmable**
 Power: **45W**
 EAN Code: **3800157604017**



120⁺⁺ LM/W
HIGH LUMENS

IP65
 RATED

60 x 60 LED Panel

40W VT-6140

6331 - 4000K Day White
6330 - 6400K White

EAN Code

3800157620093
 3800157620086

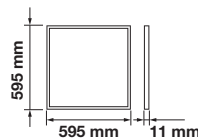

Emergency Pack:	Available	PF:	> 0.9
Voltage/Frequency:	AC:220-240V,50Hz	Beam Angle:	120°
Luminous Flux:	4960lm	Body Type:	Aluminium+PS
LED Type:	SMD	Shape:	Square
CRI:	>80	Dimension:	595 x 595 x14mm

2 IN 1
RECESSED OR SURFACE



New!

60 x 60 LED Panel

36W VT-6139

EAN Code

6380 - 4000K Day White
6381 - 6400K White

3800157624008
3800157624015

A+

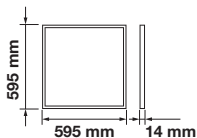

Emergency Pack:	Available	PF:	> 0.9
Voltage/Frequency:	AC:200-240V,50/60Hz	Beam Angle:	120°
Luminous Flux:	2880lm	Body Type:	Aluminium+PMMA+PP
LED Type:	SMD	Shape:	Square
CRI:	>80	Dimension:	595 x 595 x14mm



Drivers for Panels (EMC Approved)

SKU:	6019	6029
Type:	Dimmable	Tridonic
Power:	45W	45W
EAN Code:	3800157604017	N/A

120⁺⁺
LM/W
HIGH LUMENS

30 x 120 LED Panel

29W VT-12031 EAN Code

6256 - 3000K Warm White	3800157610414
6257 - 4000K Day White	3800157610421
6258 - 6400K White	3800157610438

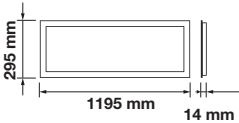

Emergency Pack:	Available	PF:	>0.9
Voltage/Frequency:	AC:200-240V,50/60Hz	Beam Angle:	120°
Luminous Flux:	3400lm	Body Type:	Aluminium+PMMA+PS
LED Type:	SMD	Shape:	Rectangle
CRI:	>80	Dimension:	1195 x 295 x14mm



Drivers for Panels (EMC Approved)

SKU:	6386
Type:	Non-Dimmable
Power:	45W
EAN Code:	

New!

120⁺⁺
LM/W
HIGH LUMENS

30 x 120 LED Panel

45W VT-12046 EAN Code

6384 - 4000K Day White	3800157624770
6385 - 6400K White	3800157624787

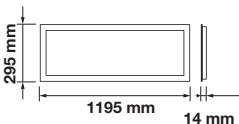

Emergency Pack:	Available	PF:	>0.9
Voltage/Frequency:	DC:30-42,50/60Hz	Beam Angle:	120°
Luminous Flux:	5400lm	Body Type:	
LED Type:	SMD	Shape:	Rectangle
CRI:	>80	Dimension:	1195 x 295 x14mm



30 x 120 LED Panel

45W VT-12030

60696 / 6069 - 3000K Warm White
60266 / 6026 - 4000K Day White
60276 / 6027 - 6400K White



EAN Code

3800157609326 / 3800230628466
3800157609302 / 3800230623638
3800157609319 / 3800230623621

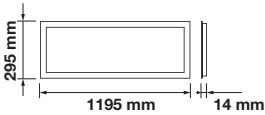

Emergency Pack:	Available	PF:	> 0.9
Voltage/Frequency:	AC:200-240V,50/60Hz	Beam Angle:	120°
Luminous Flux:	3600lm	Body Type:	Aluminium+PMMA+PS
LED Type:	SMD	Shape:	Rectangle
CRI:	>80	Dimension:	1195 x 295 x14mm



30 x 120 LED Panel



45W VT-12032

6329 - 4000K Day White

EAN Code

3800157619615

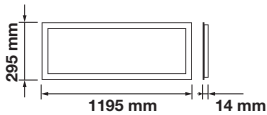

Emergency Pack:	Available	PF:	> 0.9
Voltage/Frequency:	AC:200-240V,50/60Hz	Beam Angle:	120°
Luminous Flux:	3600lm	Body Type:	Aluminium+PMMA+PS
LED Type:	SMD	Shape:	Rectangle
CRI:	>80	Dimension:	1195 x 295 x14mm

Drivers for Panels (EMC Approved)

SKU:	6019	6029
Type:	Dimmable	Tridonic
Power:	45W	45W
EAN Code:	3800157604017	N/A



New!

60 x 120 LED Panel

45W VT-12047

6425 4000k Day White
6426 6400k White

120⁺⁺ LM/W
HIGH LUMENS

EAN Code

3800157626972
3800157626989

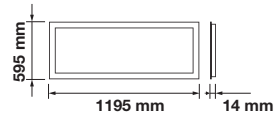

Emergency Pack:	Available	PF:	>0.9
Voltage/Frequency:	AC:220-240V,50/60Hz	Beam Angle:	120°
Luminous Flux:	5400lm	Body Type:	Aluminium+PMMA+PS
LED Type:	SMD	Shape:	Rectangle
CRI:	>80	Dimension:	1195 x 595 x14mm

Drivers for Panels (EMC Approved)

SKU: **6427**
 Type: **Non -Dimmable**
 Power: **45W**
 EAN Code: **3800157626996**

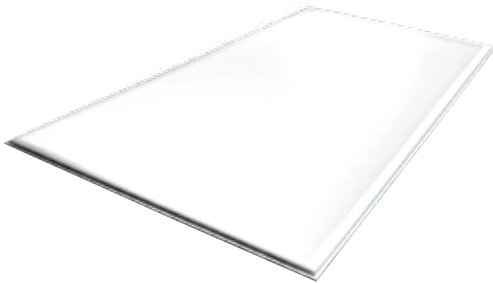

120⁺⁺
LM/W
HIGH LUMENS

60 x 120 LED Panel

45W VT-12045

EAN Code

6332 - 4000K Day White
6333 - 6400K White

3800157620321
3800157620338

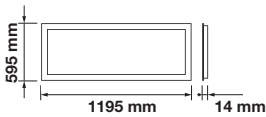

Emergency Pack:	Available	PF:	>0.9
Voltage/Frequency:	AC:200-240V,50/60Hz	Beam Angle:	120°
Luminous Flux:	5400lm	Body Type:	Aluminium+PMMA+PS
LED Type:	SMD	Shape:	Rectangle
CRI:	>80	Dimension:	1195 x 595 x14mm

Drivers for Panels (EMC Approved)

SKU: **6386**
Type: **Non -Dimmable**
EAN Code: **3800157624886**

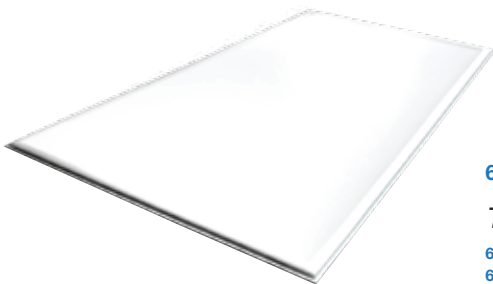

60 x 120 LED Panel

72W VT-12060

EAN Code

6051 - 4000K Day White
6050 - 6400K White

3800230624543
3800230624536

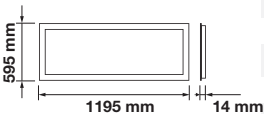

Emergency Pack:	Available	PF:	> 0.9
Voltage/Frequency:	AC: 170-240V, 50Hz	Beam Angle:	120°
Luminous Flux:	5600lm	Body Type:	Aluminium+PMMA+PS
LED Type:	SMD 2835	Shape:	Rectangle
CRI:	>80	Dimension:	1195 x 595 x14mm

Drivers for Panels (EMC Approved)

SKU: **6088**
Type: **EMC Approved -Dimmable**
Power: **72W**
EAN Code: **3800157602334**



LED Surface Panel

36W VT-6050 EAN Code

6091 - 3000K Warm White 3800157604048
6092 - 4000K Day White 3800157604055
6093 - 6400K White 3800157604062

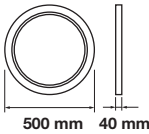

Emergency Pack:	Available	PF:	>0.9
Voltage/Frequency:	AC:100-265V,50/60Hz	Beam Angle:	120°
Luminous Flux:	2880lm	Body Type:	Die Cast Aluminium
LED Type:	SMD	Shape:	Round
CRI:	>80	Dimension:	Ø500mm x 40mm



LED Surface Panel

48W VT-6148 EAN Code

6261 - 3000K Warm White 3800157612111
6260 - 6400K White 3800157612104

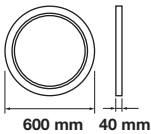

Emergency Pack:	Available	PF:	>0.9
Voltage/Frequency:	AC:220-240V,50/60Hz	Beam Angle:	110°
Luminous Flux:	3850lm	Body Type:	Aluminium
LED Type:	SMD	Shape:	Round
CRI:	>80	Dimension:	Ø600 x 40mm



DALI
Constant Current Dimming Driver



DALI
Multi-current Driver



DALI
Master

Model No:	VT-24030	VT-24045	VT-24050
SKU Code:	3110	3106	3107
Voltage:	AC:220V	20-39V -1050mp	N/A
Emergency Pack:	Max 30	40W/45W	<10W
EAN Code:	3800157622103	3800157606868	3800157606844

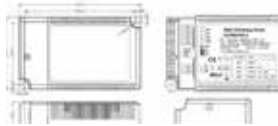
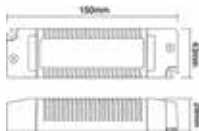

DALI
Touch Panel Controller



DALI
Bus Power Supply

Model No:	VT-24049	VT-24048
SKU Code:	3108	3109
Emergency Pack:	0.1W	4W
EAN Code:	3800157606851	

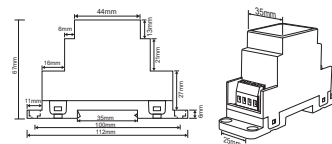
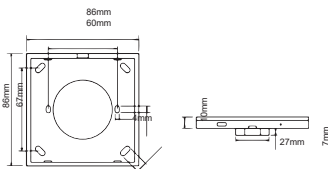

Driver for LED Panels



120⁺⁺
LM/W
HIGH LUMENS



45W



120⁺⁺
LM/W
HIGH LUMENS



29W

SKU Code:	6270	6427	6271
Type:	Non-Dimmable	Non-Dimmable	Non-Dimmable
Voltage:	200-240V	200-240V	200-240V
Emergency Pack:	45W	45W	29W
EAN Code:	3800157614436	3800157626996	3800157614443

Drivers for LED Panels



SKU Code	6268	6269	6328
Type	Dimmable	Dimmable	Dimmable
Voltage	200-240V	200-240V	200-240V
Watts	29W	45W	70W
EAN Code	3800157614412	3800157614429	3800157619592



120⁺⁺
LM/W
HIGH LUMENS



120⁺⁺
LM/W
HIGH LUMENS



In order to make the slim panels more compatible, V-TAC has developed accessories so that the products can be installed in different types of option. This allows all our panels to be installed in three different types as required by the clients. They are :

- Recessed type
- Suspended mounted
- Surface mounted

Below are the accessories which support in making this type of installation possible:

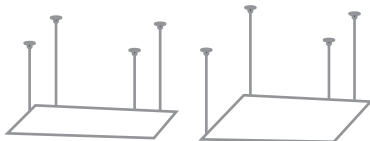

Hanging Wires Fittings Kit

for Suspended Panels

PRODUCT SKU : 6018

EAN CODE: 3800230623669

Adjustable height from 0.3 to 1m

This product can be used for all sizes of panels , that is

- 300 x 300
- 600 x 600
- 1200 x 300
- 1200 x 600

Case for External mounting for panels



Mounting for 1200x 600

Product SKU: 9989



Mounting for 620 x 620

Product SKU: 9997



Case for External mounting for panels

We provide mounting cases with variety of sizes to fit our panels. Convert the recessed panel to surface panel and install it easily on solid surfaces.



Mounting for 300 x 300

Product SKU: [9970](#)
EAN Code: 3800230623690



Mounting for 600 x 600

Product SKU : [9999](#)
EAN Code: 3800230623676



Mounting for 1200 x 300

Product SKU : [9969](#)
EAN Code: 3800230623683



Extension Frame for 625 x 625

Product SKU : [9968](#)
EAN Code: 3800230623706

Mounting for 600 x 600

Product SKU : 3678
 EAN Code: 3800157625272

Plain sides,
 No visible screws



Mounting for 600 x 600

Product SKU : 6327
 EAN Code: 3800157619424



Mounting for 295 x 1195

Product SKU : 3679
 EAN Code: 3800157625289

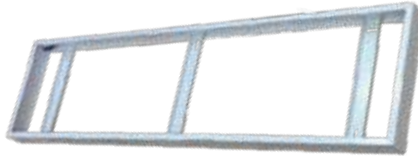

Installation Instruction for the Surface Mounted fixture of led Panel light

Here shows two installation methods, it should be installed differently according to your brought installation accessories.

Ceiling Mounted Type

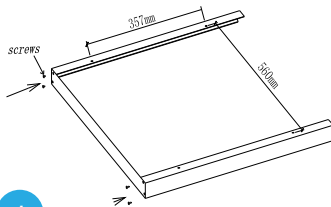

1

1. Install and fix the 3 pieces of Aluminium profile into together in screws

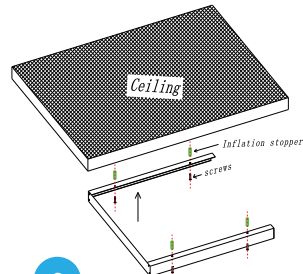

2

2. Install the fixed fixture with 3 sides on the ceiling

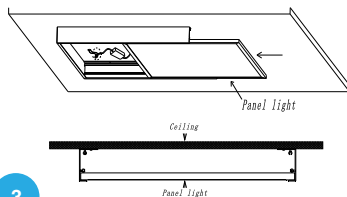

3

3. place the led panel into the fixture.

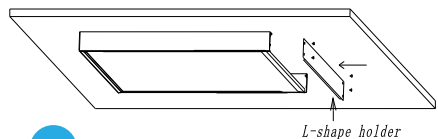

5

4. Install the last L shape Aluminium profile to the fixed fixtures with 3 sides, installation is finish turn on the power and light the luminaire

Emergency Pack SLIM & SLEEK

3Hr LED emergency lighting kit, designed to suit a wide range of LED types and circuits. The models have sealed Ni-Cd batteries able to guarantee high efficiency with high temperatures.

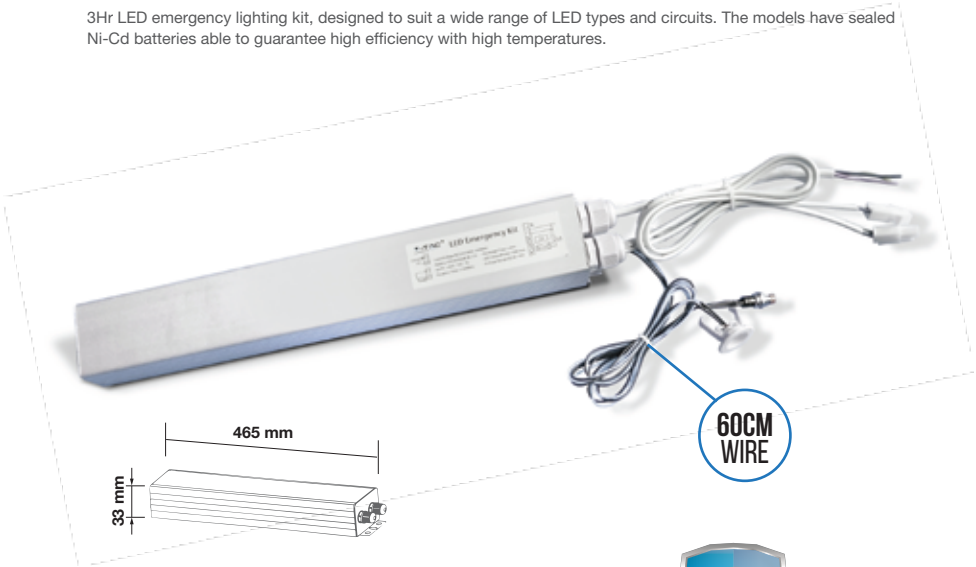

VT-518

EAN Code

SKU Code 60303
Suitable for 45W LED Panels

3800157617451



Voltage:	AC:220-240V,50/60Hz	Battery:	NI-CD, 7,12V, 4000 mAh
Led output power:	10W Max	Color of Fixture:	Aluminium+PMMA+PS
Panel output power:	45W	Body Type:	Square
Charging time:	≤ 36 hours	Size:	465 x52 x 33mm
Working time:	3 hours	Emergency switch on time:	< 1 Second

Wire diagram:

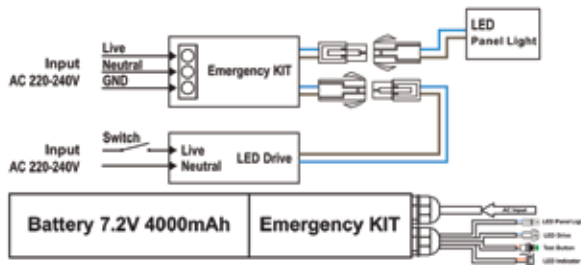



LED Liner Light **New!**

10W VT-10001

EAN Code

- 6401 3000k Warm White
- 6402 4000k Day White
- 6403 6000k White

- 3800157626620
- 3800157626637
- 3800157626644



Emergency Pack:	Available	PF:	>0.5
Voltage/Frequency:	AC:85-265V	Beam Angle:	161°
Luminous Flux:	750lm	Body Type:	Aluminium
LED Type:	EPISTAR	Dimension:	160 x 45 x 65mm
CRI:	>80	Cuting Size:	138 x 32mm



LED Liner Light **New!**

20W VT-20001

EAN Code

- 6404 3000k Warm White
- 6405 4000k Day White
- 6406 6000k White

- 3800157626651
- 3800157626668
- 3800157626675



Emergency Pack:	Available	PF:	>0.5
Voltage/Frequency:	AC:85-265V	Beam Angle:	161°
Luminous Flux:	1600lm	Body Type:	Aluminium
LED Type:	EPISTAR	Dimension:	290 x 45 x 65mm
CRI:	>80	Cuting Size:	170 x 32mm



LED Liner Light **New!**

30W VT-30001

EAN Code

- 6407 3000k Warm White
- 6408 4000k Day White
- 6409 6000k White

- 3800157626682
- 3800157626699
- 3800157626705



Emergency Pack:	Available	PF:	>0.5
Voltage/Frequency:	AC:85-265V	Beam Angle:	161°
Luminous Flux:	2400lm	Body Type:	Aluminium
LED Type:	EPISTAR	Dimension:	430 x 45 x 65mm
CRI:	>80	Cuting Size:	405 x 32mm



LED Liner Light **New!**

10W VT-10002

EAN Code

- 6410 3000k Warm White
- 6411 4000k Day White
- 6412 6000k White

- 3800157626712
- 3800157626729
- 3800157626736



Emergency Pack:	Available	PF:	>0.5
Voltage/Frequency:	AC:85-265V	Beam Angle:	161°
Luminous Flux:	700lm	Body Type:	Aluminium
LED Type:	EPISTAR	Dimension:	160 x 45 x 72mm
CRI:	>80	Cuting Size:	138 x 32mm



LED Liner Light **New!**

20W VT-20002

EAN Code

- 6413 3000k Warm White
- 6414 4000k Day White
- 6415 6000k White

- 3800157626743
- 3800157626750
- 3800157626767



Emergency Pack:	Available	PF:	>0.5
Voltage/Frequency:	AC:85-265V	Beam Angle:	161°
Luminous Flux:	1400lm	Body Type:	Aluminium
LED Type:	EPISTAR	Dimension:	290 x 45 x 72mm
CRI:	>80	Cuting Size:	170 x 32mm



LED Liner Light **New!**

30W VT-30002

EAN Code

- 6416 3000k Warm White
- 6417 4000k Day White
- 6418 6000k White

- 3800157626774
- 3800157626781
- 3800157626798



Emergency Pack:	Available	PF:	>0.5
Voltage/Frequency:	AC:85-265V	Beam Angle:	161°
Luminous Flux:	2100lm	Body Type:	Aluminium
LED Type:	EPISTAR	Dimension:	430 x 45 x 72mm
CRI:	>80	Cuting Size:	405 x 32mm

The innovation of SMD lighting brought about the creation of the slim panels – a game changing answer to traditional downlight fixtures! Classy as it is, a mini panel fixture with built in LEDs also amounts to less than the old fittings.

Mini panels transform every setting into an ambiance with a modern touch to it with its systematic radiance and uniform lighting.

V-TAC offers the widest range in this product category. We also stock all three colour outputs from white to warm white and day light .They all come in retrofit cut out sizes from 4 inches, 6 inches and 8 inches.



Salient Features

|| Ultra Slim Design

≡ Contemporary & Elegant Design

⦿ Higher Light Transmission Rate

□ Exterior robust shell

🔧 Easy to install - Plug and play version



LED Panel

3W VT-307 RD

6292 - 3000K Warm White
6293 - 4000K Day White
6294 - 6400K White

EAN Code

3800157616751
3800157616768
3800157616775

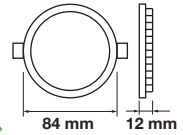

Emergency Pack:	Available	Beam Angle:	120°
Voltage/Frequency:	AC: 85-265V, 50/60Hz	Body Type:	Aluminium+PMMA+PS
Luminous Flux:	210lm	Shape:	Round
LED Type:	SMD	Dimension:	Ø84mm x 12mm
CRI:	>80	Cutting Size:	Ø73mm
PF:	> 0.5		



LED Panel

6W VT-607 RD

4854 / 48549 - 3000K Warm White
4855 / 48559 4000K Daywhit
4856 / 48569 - 6400K White

EAN Code

3800230629753
3800230629760
3800230629777

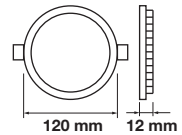

Driver for Panel

SKU: **8120**
EAN Code: **3800157627337**

Emergency Pack:	Available	Beam Angle:	120°
Voltage/Frequency:	AC: 200-240V, 50/60Hz	Body Type:	Aluminium+PMMA+PS
Luminous Flux:	420lm	Shape:	Round
LED Type:	SMD	Dimension:	Ø120mm x 12mm
CRI:	>80	Cutting Size:	Ø105mm
PF:	> 0.5		



LED Panel

12W VT-1207 RD

4857 / 48579 - 3000K Warm White
4858 / 48589 - 4000K Day White
4859 / 48599 - 6400K White

EAN Code

3800230629784
3800230629791
3800230629807

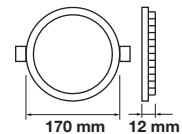

Driver for Panel

SKU: **8121**
EAN Code: **3800157627344**

Emergency Pack:	Available	Beam Angle:	120°
Voltage/Frequency:	AC: 200-240V, 50/60Hz	Body Type:	Aluminium+PMMA+PS
Luminous Flux:	1000lm	Shape:	Round
LED Type:	SMD	Dimension:	Ø170mm x 12mm
CRI:	>80	Cutting Size:	Ø155mm
PF:	> 0.6		



LED Panel

18W VT-1807 RD

4860 / 48609 - 3000K Warm White
4861 / 48619 - 4000K Day White
4862 / 48629 - 6400K White

EAN Code

3800230629814
 3800230629821
 3800230629838

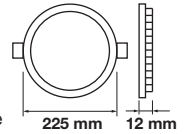

Driver for Panel

SKU: **8122**
 EAN Code: **3800157627351**

Emergency Pack:	Available	Beam Angle:	120°
Voltage/Frequency:	AC: 200-240V, 50/60Hz	Body Type:	Aluminium+PMMA+PS
Luminous Flux:	1500lm	Shape:	Round
LED Type:	SMD	Dimension:	Ø225mm x 12mm
CRI:	>80	Cutting Size:	Ø205mm
PF:	> 0.6		



LED Panel

22W VT-2207 RD

6422 3000k Warm White
6423 4000k Day White
6424 6400k White

EAN Code

3800157626941
 3800157626958
 3800157626965

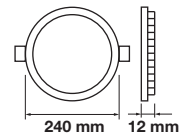

Driver for Panel

SKU:
 EAN Code:

Emergency Pack:	Available	Beam Angle:	120°
Voltage/Frequency:	AC: 200-240V, 50/60Hz	Body Type:	Aluminium+PMMA+PS
Luminous Flux:	1800LM	Shape:	Round
LED Type:	SMD 2835	Dimension:	Ø240mm x 12mm
CRI:	>80	Cutting Size:	Ø220mm
PF:	>0.9		



LED Panel

24W VT-2407 RD

4872 / 48729 - 3000K Warm White
4873 / 48739 - 4000K Day White
4874 / 48749 - 6400K White

EAN Code

3800157601559
 3800157601566
 3800157601573

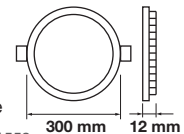

Driver for Panel

SKU: **8123**
 EAN Code: **3800157627368**

Emergency Pack:	Available	Beam Angle:	120°
Voltage/Frequency:	AC:200-240V,50Hz	Body Type:	Aluminium+PMMA+PS
Luminous Flux:	2000lm	Shape:	Round
LED Type:	SMD	Dimension:	Ø300mm x 12mm
CRI:	>80	Cutting Size:	Ø285mm
PF:	>0.9		



LED Panel

3W VT-307 SQ

- 6295 - 3000K Warm White
- 6296 - 4000K Day White
- 6297 - 6400K White

EAN Code

- 3800157616782
- 3800157616799
- 3800157616805

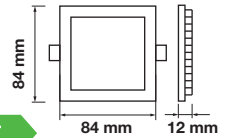

Emergency Pack:	Available	Beam Angle:	120°
Voltage/Frequency:	AC: 85-265V, 50/60Hz	Body Type:	Aluminium+PMMA+PS
Luminous Flux:	210lm	Shape:	Square
LED Type:	SMD	Dimension:	84 x 84 x 12mm
CRI:	>80	Cutting Size:	73 x 73mm
PF:	> 0.5		



LED Panel

6W VT-607 SQ

- 4863 / 48639 - 3000K Warm White
- 4864 / 48649 - 4000K Day White
- 4865 / 48659 - 6400K White

EAN Code

- 3800230629845
- 3800230629852
- 3800230629869

Driver for Panel

SKU: **8120**

EAN Code: **3800157627337**

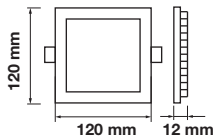

Emergency Pack:	Available	Beam Angle:	120°
Voltage/Frequency:	AC: 200-240V, 50/60Hz	Body Type:	Aluminium+PMMA+PS
Luminous Flux:	420lm	Shape:	Square
LED Type:	SMD	Dimension:	120 x120 x 12mm
CRI:	>80	Cutting Size:	105mm x105mm
PF:	> 0.5		



LED Panel

12W VT-1207 SQ

- 4866 / 48669 - 3000K Warm White
- 4867 / 48679 - 4000K Day White
- 4868 / 48689 - 6400K White

EAN Code

- 3800230629876
- 3800230629883
- 3800230629890

Driver for Panel

SKU: **8121**

EAN Code: **3800157627344**

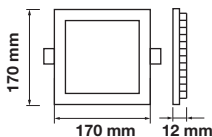

Emergency Pack:	Available	Beam Angle:	120°
Voltage/Frequency:	AC: 200-240V, 50/60Hz	Body Type:	Aluminium+PMMA+PS
Luminous Flux:	1000lm	Shape:	Square
LED Type:	SMD	Dimension:	170 x170 x 12mm
CRI:	>80	Cutting Size:	155mm x155mm
PF:	> 0.6		



Driver for Panel

SKU: **8122**
 EAN Code: **3800157627351**

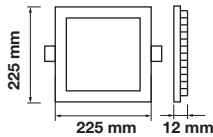

LED Panel

18W VT-1807 SQ EAN Code

4869 / 48699 - 3000K Warm White 3800230629906
4870 / 48709 - 4000K Day White 3800230629913
4871 / 48719 - 6400K White 3800230629920



Emergency Pack:	Available	Beam Angle:	120°
Voltage/Frequency:	AC: 200-240V, 50/60Hz	Body Type:	Aluminium+PMMA+PS
Luminous Flux:	1500lm	Shape:	Square
LED Type:	SMD	Dimension:	225 x 225 x 12mm
CRI:	>80	Cutting Size:	205mm x205mm
PF:	> 0.6		



Driver for Panel

SKU: **8123**
 EAN Code: **3800157627368**

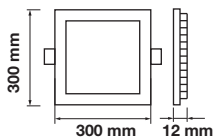

LED Panel

24W VT-2407 SQ EAN Code

4887 / 48879 - 3000K Warm White 3800157602198
4888 / 48889 - 4000K Day White 3800157602204
4889 / 48899 - 6400K White 3800157602211



Emergency Pack:	Available	Beam Angle:	120°
Voltage/Frequency:	AC:200-240V,50Hz	Body Type:	Aluminium+PMMA+PS
Luminous Flux:	2000lm	Shape:	Square
LED Type:	SMD	Dimension:	300 x300 x 12mm
CRI:	>80	Cutting Size:	285mm x285mm
PF:	>0.9		

Dimmable Drivers for Premium Panels



SKU Code:	8073	8074	8075
Emergency Pack:	6W	12W	18W
Description:	LED Driver Dimmable	LED Driver Dimmable	LED Driver Dimmable
EAN Code:	3800157605823	3800157605830	3800157605847
Size:	110x42xH26mm	110x42xH26mm	110x42xH26mm

Compatible with

48549 /48559 /48569/ 48639 /48649/ 48659

Compatible with

48579 /48589 /48599/ 48669 /48679/
48689

Compatible with

48609 /48619 /48629/ 48699 /48709/
48719



SKU Code:	8076	8070
Emergency Pack:	24W	18w +24W
Description:	LED Driver Dimmable	LED Driver Dimmable
EAN Code:	3800157605946	3800157616836
Size:	132x45xH26mm	132x45xH26mm

Compatible with

48729 /48739 /48749/ 48879 /48889/ 48899

Compatible with

4860 /4861 /4862 /4872 /4873 /4874
4869 /4870 /4871 /4887 /4888 /4889

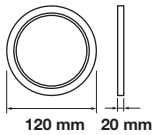

LED Panel

8W VT-800 RD

EAN Code

100⁺⁺
LM/W
HIGH LUMENS

- 4823 - 3000K Warm White 3800230622594
- 4822 - 4000K Day White 3800230624963
- 4821 - 6400K White 3800230622587



Emergency Pack:	Available	Beam Angle:	120°
Voltage/Frequency:	AC:110-265V, 50/60Hz	Body Type:	Aluminium(PKW)
Luminous Flux:	800lm	Shape:	Round
LED Type:	SMD	Dimension:	Ø120mm x 20mm
CRI:	>80	Cutting Size:	Ø105mm
PF:	>0.9		

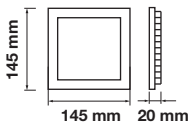

LED Panel

8W VT-800 SQ

EAN Code

100⁺⁺
LM/W
HIGH LUMENS

- 4820 - 3000K Warm White 3800230622570
- 4819 - 4000K Day White 3800230624970
- 4818 - 6400K White 3800230622563



Emergency Pack:	Available	Beam Angle:	120°
Voltage/Frequency:	AC:110-265V, 50/60Hz	Body Type:	Aluminium(PKW)
Luminous Flux:	800lm	Shape:	Square
LED Type:	SMD	Dimension:	145 x145 x 20mm
CRI:	>80	Cutting Size:	125 x125mm
PF:	>0.9		

Drivers for Panels (EMC Approved)

SKU:	8036	8058
Type:	Non-dimmable	Dimmable
Power:	8W	8W
EAN Code:	3800230625519	3800230625540

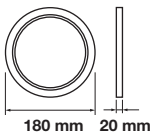

LED Panel

15W VT-1500 RD

EAN Code

- 4829 - 3000K Warm White
- 4828 - 4000K Day White
- 4827 - 6400K White

- 3800230622631
- 3800230624987
- 3800230622624

100⁺⁺
LM/W
HIGH LUMENS



Emergency Pack:	Available	Beam Angle:	120°
Voltage/Frequency:	AC:110-265V, 50/60Hz	Body Type:	Aluminium(PKW)
Luminous Flux:	1500lm	Shape:	Round
LED Type:	SMD	Dimension:	Ø180mm x 20mm
CRI:	>80	Cutting Size:	Ø160mm
PF:	>0.9		

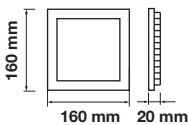

LED Panel

15W VT-1500 SQ

EAN Code

- 4826 - 3000K Warm White
- 4825 - 4000K Day White
- 4824 - 6400K White

- 3800230622617
- 3800230624994
- 3800230622600

100⁺⁺
LM/W
HIGH LUMENS



Emergency Pack:	Available	Beam Angle:	120°
Voltage/Frequency:	AC:110-265V, 50/60Hz	Body Type:	Aluminium(PKW)
Luminous Flux:	1500lm	Shape:	Square
LED Type:	SMD	Dimension:	160 x160 x 20mm
CRI:	>80	Cutting Size:	140 x140mm
PF:	>0.9		

Drivers for Panels (EMC Approved)

SKU:	8037	8059
Type:	Non-dimmable	Dimmable
Power:	15W	15W
EAN Code:	3800230625526	3800230625557

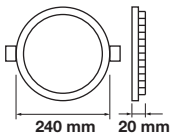

LED Panel

22W VT-2200 RD

- 4835 - 3000K Warm White
- 4834 - 4000K Day White
- 4833 - 6400K White

EAN Code

- 3800230622679
- 3800230625007
- 3800230622662

100⁺⁺
LM/W
HIGH LUMENS

A⁺

Emergency Pack:	Available	Beam Angle:	120°
Voltage/Frequency:	AC: 110-265V, 50/60Hz	Body Type:	Aluminium (PKW)
Luminous Flux:	2200lm	Shape:	Round
LED Type:	SMD	Dimension:	Ø240mm x 20mm
CRI:	> 80	Cutting Size:	Ø220mm
PF:	> 0.9		

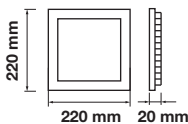

LED Panel

22W VT-2200 SQ

- 4832 - 3000K Warm White
- 4831 - 4000K Day White
- 4830 - 6400K White

EAN Code

- 3800230622655
- 3800230625014
- 3800230622648

100⁺⁺
LM/W
HIGH LUMENS

A⁺

Emergency Pack:	Available	Beam Angle:	120°
Voltage/Frequency:	AC: 110-265V, 50/60Hz	Body Type:	Aluminium(PKW)
Luminous Flux:	2200lm	Shape:	Square
LED Type:	SMD	Dimension:	220 x220 x 20mm
CRI:	>80	Cutting Size:	195 x195mm
PF:	> 0.9		

Drivers for Panels (EMC Approved)

SKU:	8038	8060
Type:	Non-Dimmable	Dimmable Driver
Power:	22W	22W
EAN Code:	3800230625533	3800230625564

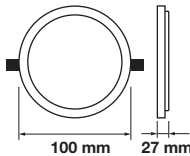

LED Panel

8W VT-888 RD

EAN Code

- 4931 - 3000K Warm White
- 4932 - 4000K Day White
- 4933 - 6400K White

- 3800157606479
- 3800157606486
- 3800157606493



Emergency Pack:	Available	Beam Angle:	110°
Voltage/Frequency:	AC:220-240V,50/60Hz	Body Type:	Die Cast Aluminium
Luminous Flux:	800lm	Shape:	Round
LED Type:	SMD	Dimension:	Ø100mm x 27mm
CRI:	>80	Cutting Size:	Ø90mm
PF:	>0.9		

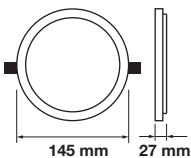

LED Panel

15W VT-1515 RD

EAN Code

- 4934 - 3000K Warm White
- 4935 - 4000K Day White
- 4936 - 6400K White

- 3800157606509
- 3800157606516
- 3800157606523



Emergency Pack:	Available	Beam Angle:	110°
Voltage/Frequency:	AC:220-240V,50/60Hz	Body Type:	Die Cast Aluminium
Luminous Flux:	1500lm	Shape:	Round
LED Type:	SMD	Dimension:	Ø145mm x 27mm
CRI:	>80	Cutting Size:	Ø135mm
PF:	>0.9		



LED Panel

22W VT-2222 RD

EAN Code

- 4937 - 3000K Warm White
- 4938 - 4000K Day White
- 4939 - 6400K White

- 3800157606530
- 3800157606547
- 3800157606554

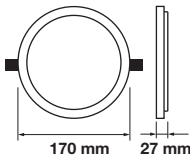

Emergency Pack:	Available	Beam Angle:	110°
Voltage/Frequency:	AC:220-240V,50/60Hz	Body Type:	Die Cast Aluminium
Luminous Flux:	2200lm	Shape:	Round
LED Type:	SMD	Dimension:	Ø170mm x 27mm
CRI:	>80	Cutting Size:	Ø160mm
PF:	>0.9		



LED Panel

29W VT-2929 RD

EAN Code

- 4940 - 3000K Warm White
- 4941 - 4000K Day White
- 4942 - 6400K White

- 3800157606561
- 3800157606578
- 3800157606585

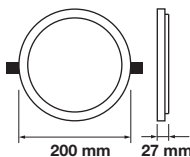

Emergency Pack:	Available	Beam Angle:	110°
Voltage/Frequency:	AC:220-240V,50/60Hz	Body Type:	Die Cast Aluminium
Luminous Flux:	2800lm	Shape:	Round
LED Type:	SMD	Dimension:	Ø200mm x 27mm
CRI:	>80	Cutting Size:	Ø185mm
PF:	>0.9		

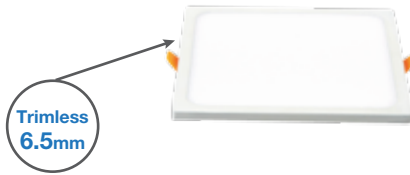

LED Panel

8W VT-888 SQ

EAN Code

- 4943 - 3000K Warm White
- 4944 - 4000K Day White
- 4945 - 6400K White

- 3800157606592
- 3800157606608
- 3800157606615

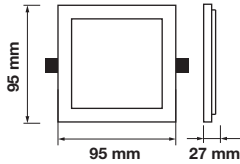

Emergency Pack:	Available	Beam Angle:	110°
Voltage/Frequency:	AC:220-240V,50/60Hz	Body Type:	Die Cast Aluminium
Luminous Flux:	800lm	Shape:	Square
LED Type:	SMD	Dimension:	95 x 95x 27mm
CRI:	>80	Cutting Size:	85mm x 85mm
PF:	>0.9		



LED Panel

15W VT-1515 SQ

EAN Code

- 4946 - 3000K Warm White
- 4947 - 4000K Day White
- 4948 - 6400K White

- 3800157606622
- 3800157606639
- 3800157606646

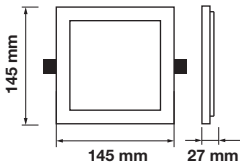

Emergency Pack:	Available	Beam Angle:	110°
Voltage/Frequency:	AC:220-240V,50/60Hz	Body Type:	Die Cast Aluminium
Luminous Flux:	1500lm	Shape:	Square
LED Type:	SMD	Dimension:	145 x145 x 27mm
CRI:	>80	Cutting Size:	135mm x 135mm
PF:	>0.9		



LED Panel

22W VT-2222 SQ

EAN Code

- 4949 - 3000K Warm White
- 4797 - 4000K Day White
- 4798 - 6400K White

- 3800157606653
- 3800157606660
- 3800157606677

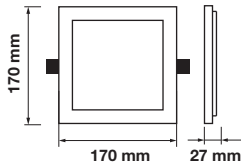

Emergency Pack:	Available	Beam Angle:	110°
Voltage/Frequency:	AC:220-240V,50/60Hz	Body Type:	Die Cast Aluminium
Luminous Flux:	2200lm	Shape:	Square
LED Type:	SMD	Dimension:	170 x170 x 27mm
CRI:	>80	Cutting Size:	160mm x 160mm
PF:	>0.9		



LED Panel

29W VT-2929 SQ

EAN Code

- 4952 - 3000K Warm White
- 4953 - 4000K Day White
- 4954 - 6400K White

- 3800157606684
- 3800157606691
- 3800157606707

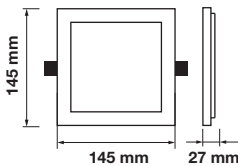

Emergency Pack:	Available	Beam Angle:	110°
Voltage/Frequency:	AC:220-240V,50/60Hz	Body Type:	Die Cast Aluminium
Luminous Flux:	2800lm	Shape:	Square
LED Type:	SMD	Dimension:	200 x 200 x 27mm
CRI:	>80	Cutting Size:	185mm x 185mm
PF:	>0.9		

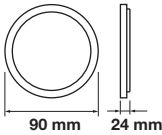

LED SurfacePanel

6W VT-605 RD

- 4904 - 3000K Warm White
- 4905 - 4000K Day White
- 4906 - 6400K White

EAN Code

- 3800157605380
- 3800157605397
- 3800157605403



Emergency Pack:	Available	PF:	>0.5
Voltage/Frequency:	AC:85-265V,50/60Hz	Beam Angle:	120°
Luminous Flux:	420lm	Body Type:	Aluminium
LED Type:	SMD	Shape:	Round
CRI:	>80	Dimension:	Ø90mm x 24mm

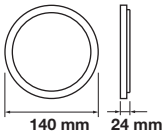

LED SurfacePanel

12W VT-1205 RD

- 4910 - 3000K Warm White
- 4911 - 4000K Day White
- 4912 - 6400K White

EAN Code

- 3800157605441
- 3800157605458
- 3800157605465



Emergency Pack:	Available	PF:	>0.6
Voltage/Frequency:	AC:85-265V,50/60Hz	Beam Angle:	120°
Luminous Flux:	900lm	Body Type:	Aluminium
LED Type:	SMD	Shape:	Round
CRI:	>80	Dimension:	Ø140mm x 24mm

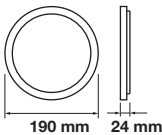

LED SurfacePanel

18W VT-1805 RD

- 4916 - 3000K Warm White
- 4917 - 4000K Day White
- 4918 - 6400K White

EAN Code

- 3800157605502
- 3800157605519
- 3800157605526



Emergency Pack:	Available	PF:	>0.6
Voltage/Frequency:	AC:85-265V,50/60Hz	Beam Angle:	120°
Luminous Flux:	1440lm	Body Type:	Aluminium
LED Type:	SMD	Shape:	Round
CRI:	>80	Dimension:	Ø190mm x 24mm

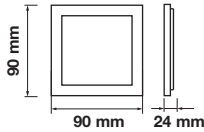

LED SurfacePanel

6W VT-605 SQ

- 4907 - 3000K Warm White
- 4908 - 4000K Day White
- 4909 - 6400K White

EAN Code

- 3800157605410
- 3800157605427
- 3800157605434



Emergency Pack:	Available	PF:	>0.5
Voltage/Frequency:	AC:85-265V,50/60Hz	Beam Angle:	120°
Luminous Flux:	420lm	Body Type:	Aluminium
LED Type:	SMD	Shape:	Square
CRI:	>80	Dimension:	90 x 90 x 24mm

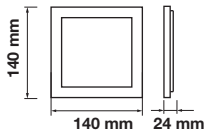

LED SurfacePanel

12W VT-1205 SQ

- 4913 - 3000K Warm White
- 4914 - 4000K Day White
- 4915 - 6400K White

EAN Code

- 3800157605472
- 3800157605489
- 3800157605496



Emergency Pack:	Available	PF:	>0.6
Voltage/Frequency:	AC:85-265V,50/60Hz	Beam Angle:	120°
Luminous Flux:	900lm	Body Type:	Aluminium
LED Type:	SMD	Shape:	Square
CRI:	>80	Dimension:	140 x 140 x 24mm

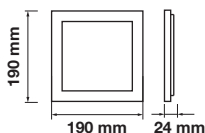

LED SurfacePanel

18W VT-1805 SQ

- 4919 - 3000K Warm White
- 4920 - 4000K Day White
- 4921 - 6400K White

EAN Code

- 3800157605533
- 3800157605540
- 3800157605557



Emergency Pack:	Available	PF:	>0.6
Voltage/Frequency:	AC:85-265V,50/60Hz	Beam Angle:	120°
Luminous Flux:	1440lm	Body Type:	Aluminium
LED Type:	SMD	Shape:	Square
CRI:	>80	Dimension:	190 x 190 x 24mm



100⁺⁺
LM/W
HIGH LUMENS



LED Panel

8W VT-1408 RD

- 4805 - 3000K Warm White
- 4804 - 4000K Day White
- 4803 - 6400K White

EAN Code

- 3800230622730
- 3800230622723
- 3800230622716

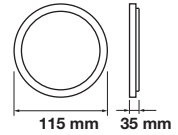

Emergency Pack:	Available	PF:	> 0.9
Voltage/Frequency:	AC: 85-265V, 50/60Hz	Beam Angle:	120°
Luminous Flux:	800lm	Body Type:	Aluminium
LED Type:	SMD	Shape:	Round
CRI:	>80	Dimension:	Ø115mm x 35mm



100⁺⁺
LM/W
HIGH LUMENS



LED Panel

15W VT-1415 RD

- 4811 - 3000K Warm White
- 4810 - 4000K Day White
- 4809 - 6400K White

EAN Code

- 3800230622792
- 3800230622785
- 3800230622778

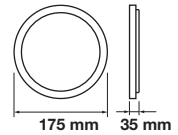

Emergency Pack:	Available	PF:	>0.9
Voltage/Frequency:	AC: 85-265V, 50/60Hz	Beam Angle:	120°
Luminous Flux:	1500lm	Body Type:	Aluminium
LED Type:	SMD	Shape:	Round
CRI:	>80	Dimension:	Ø175mm x 35mm



100⁺⁺
LM/W
HIGH LUMENS



LED Panel

22W VT-1422 RD

- 4817 - 3000K Warm White
- 4816 - 4000K Day White
- 4815 - 6400K White

EAN Code

- 3800230622853
- 3800230622846
- 3800230622839

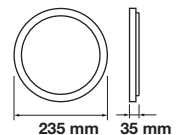

Emergency Pack:	Available	PF:	> 0.9
Voltage/Frequency:	AC: 85-265V, 50/60Hz	Beam Angle:	120°
Luminous Flux:	2200lm	Body Type:	Aluminium
LED Type:	SMD 5630	Shape:	Round
CRI:	> 80	Dimension:	Ø235mm x 35mm



100⁺⁺
LM/W
HIGH LUMENS

Surface

LED Panel

8W VT-1408 SQ

4802 - 3000K Warm White
4801 - 4000K Day White
4800 - 6400K White

EAN Code

3800230622709
3800230622693
3800230622686

A⁺

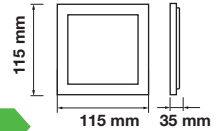

Emergency Pack:	Available	PF:	> 0.9
Voltage/Frequency:	AC: 85-265V, 50/60Hz	Beam Angle:	120°
Luminous Flux:	800lm	Body Type:	Aluminium
LED Type:	SMD 5630	Shape:	Square
CRI:	>80	Dimension:	115 x 115 x 35mm



100⁺⁺
LM/W
HIGH LUMENS

Surface

LED Panel

15W VT-1415 SQ

4808 - 3000K Warm White
4807 - 4000K Day White
4806 - 6400K White

EAN Code

3800230622761
3800230622754
3800230622747

A⁺

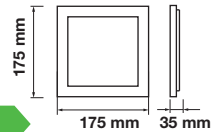

Emergency Pack:	Available	PF:	> 0.9
Voltage/Frequency:	AC: 85-265V, 50/60Hz	Beam Angle:	120°
Luminous Flux:	1500lm	Body Type:	Aluminium
LED Type:	SMD 5630	Shape:	Square
CRI:	>80	Dimension:	175 x 175 x 35mm



100⁺⁺
LM/W
HIGH LUMENS

Surface

LED Panel

22W VT-1422 SQ

4814 - 3000K Warm White
4813 - 4000K Day White
4812 - 6400K White

EAN Code

3800230622822
3800230622815
3800230622808

A⁺

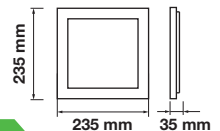

Emergency Pack:	Available	PF:	> 0.9
Voltage/Frequency:	AC: 85-265V, 50/60Hz	Beam Angle:	120°
Luminous Flux:	2200lm	Body Type:	Aluminium
LED Type:	SMD 5630	Shape:	Square
CRI:	> 80	Dimension:	235 x 235 x 35mm



Round Chrome

6W VT-607CH

- 6334 - 3000K Warm White
- 6335 - 4000K Day White
- 6336 - 6400K White

EAN Code

- 3800157621182
- 3800157621199
- 3800157621205

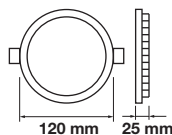

Emergency Pack:	Available	Beam Angle:	120°
Voltage/Frequency:	AC: 85-265V, 50/60Hz	Body Type:	Aluminium+Chrome
Luminous Flux:	420lm	Shape:	Round
LED Type:	SMD	Dimension:	Ø120mm x 25mm
CRI:	>80	Cutting Size:	Ø105mm
PF:	> 0.5		



Round Chrome

12W VT-1207CH

- 6340 - 3000K Warm White
- 6341 - 4000K Day White
- 6342 - 6400K White

EAN Code

- 3800157621243
- 3800157621250
- 3800157621267

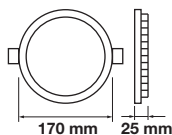

Emergency Pack:	Available	Beam Angle:	120°
Voltage/Frequency:	AC: 85-265V, 50/60Hz	Body Type:	Aluminium+Chrome
Luminous Flux:	1000lm	Shape:	Round
LED Type:	SMD	Dimension:	Ø170mm x 25mm
CRI:	>80	Cutting Size:	Ø155mm
PF:	> 0.6		



Round Chrome

18W VT-1807CH

- 6346 - 3000K Warm White
- 6347 - 4000K Day White
- 6348 - 6400K White

EAN Code

- 3800157621304
- 3800157621311
- 3800157621328

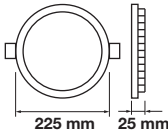

Emergency Pack:	Available	Beam Angle:	120°
Voltage/Frequency:	AC: 85-265V, 50/60Hz	Body Type:	Aluminium+Chrome
Luminous Flux:	1500lm	Shape:	Round
LED Type:	SMD	Dimension:	Ø225mm x 25mm
CRI:	>80	Cutting Size:	Ø205mm
PF:	> 0.6		



Round Chrome

24W VT-2407CH

- 6352 - 3000K Warm White
- 6353 - 4000K Day White
- 6354 - 6400K White

EAN Code

- 3800157621366
- 3800157621373
- 3800157621380

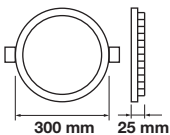

Emergency Pack:	Available	Beam Angle:	120°
Voltage/Frequency:	AC: 85-265V, 50/60Hz	Body Type:	Aluminium+Chrome
Luminous Flux:	2000lm	Shape:	Round
LED Type:	SMD	Dimension:	Ø300mm x 25mm
CRI:	>80	Cutting Size:	Ø285mm
PF:	>0.9		



Round-Satin Nickel

6W VT-607SN

- 6337 - 3000K Warm White
- 6338 - 4000K Day White
- 6339 - 6400K White

EAN Code

- 3800157621212
- 3800157621229
- 3800157621236

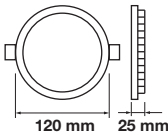

Emergency Pack:	Available	Beam Angle:	120°
Voltage/Frequency:	AC: 85-265V, 50/60Hz	Body Type:	Aluminium+Satin Nickel
Luminous Flux:	420lm	Shape:	Round
LED Type:	SMD	Dimension:	Ø120mm x 25mm
CRI:	>80	Cutting Size:	Ø105mm
PF:	> 0.5		



Round-Satin Nickel

12W VT-1207SN

- 6343 - 3000K Warm White
- 6344 - 4000K Day White
- 6345 - 6400K White

EAN Code

- 3800157621274
- 3800157621281
- 3800157621298

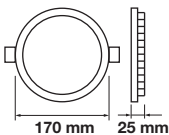

Emergency Pack:	Available	Beam Angle:	120°
Voltage/Frequency:	AC: 85-265V, 50/60Hz	Body Type:	Aluminium+Satin Nickel
Luminous Flux:	1000lm	Shape:	Round
LED Type:	SMD	Dimension:	Ø170mm x 25mm
CRI:	>80	Cutting Size:	Ø155mm
PF:	> 0.6		



Round-Satin Nickel

18W VT-1807SN

- 6349 - 3000K Warm White
- 6350 - 4000K Day White
- 6351 - 6400K White

EAN Code

- 3800157621335
- 3800157621342
- 3800157621359

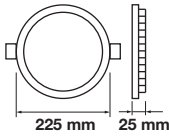

Emergency Pack:	Available	Beam Angle:	120°
Voltage/Frequency:	AC: 85-265V, 50/60Hz	Body Type:	Aluminium+Satin Nickel
Luminous Flux:	1500lm	Shape:	Round
LED Type:	SMD	Dimension:	Ø225mm x 25mm
CRI:	>80	Cutting Size:	Ø205mm
PF:	> 0.6		



Round-Satin Nickel

24W VT-2407SN

- 6355 - 3000K Warm White
- 6356 - 4000K Day White
- 6357 - 6400K White

EAN Code

- 3800157621397
- 3800157621403
- 3800157621410

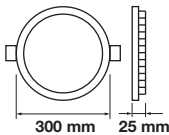

Emergency Pack:	Available	Beam Angle:	120°
Voltage/Frequency:	AC: 85-265V, 50/60Hz	Body Type:	Aluminium+Satin Nickel
Luminous Flux:	2000lm	Shape:	Round
LED Type:	SMD	Dimension:	Ø300mm x 25mm
CRI:	>80	Cutting Size:	Ø285mm
PF:	>0.7		



Round Chrome

6W VT-605CH

- 6358 - 3000K Warm White
- 6359 - 4000K Day White
- 6360 - 6400K White

EAN Code

- 3800157621427
- 3800157621434
- 3800157621441

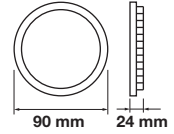

Emergency Pack:	Available	PF:	>0.5
Voltage/Frequency:	AC:85-265V,50/60Hz	Beam Angle:	120°
Luminous Flux:	420lm	Body Type:	Aluminium
LED Type:	SMD	Shape:	Round
CRI:	>80	Dimension:	Ø90mm x 24mm



Round Chrome

12W VT-1205CH

- 6364 - 3000K Warm White
- 6365 - 4000K Day White
- 6366 - 6400K White

EAN Code

- 3800157621489
- 3800157621496
- 3800157621502

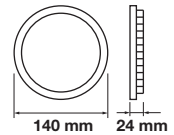

Emergency Pack:	Available	PF:	>0.6
Voltage/Frequency:	AC:85-265V,50/60Hz	Beam Angle:	120°
Luminous Flux:	1000lm	Body Type:	Aluminium
LED Type:	SMD	Shape:	Round
CRI:	>80	Dimension:	Ø140mm x 24mm



Round Chrome

18W VT-1805CH

- 6370 - 3000K Warm White
- 6371 - 4000K Day White
- 6372 - 6400K White

EAN Code

- 3800230629876
- 3800230629883
- 3800230629890

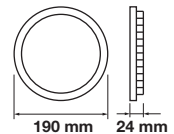

Emergency Pack:	Available	PF:	>0.6
Voltage/Frequency:	AC:85-265V,50/60Hz	Beam Angle:	120°
Luminous Flux:	1500lm	Body Type:	Aluminium
LED Type:	SMD	Shape:	Round
CRI:	>80	Dimension:	Ø190mm x 24mm



Round-Satin Nickel

6W VT-605SN

- 6361 - 3000K Warm White
- 6362 - 4000K Day White
- 6363 - 6400K White

EAN Code

- 3800157621458
- 3800157621465
- 3800157621472

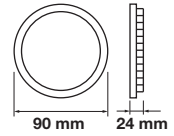

Emergency Pack:	Available	PF:	>0.5
Voltage/Frequency:	AC:85-265V,50/60Hz	Beam Angle:	120°
Luminous Flux:	420lm	Body Type:	Aluminium
LED Type:	SMD	Shape:	Round
CRI:	>80	Dimension:	Ø90mm x 24mm



Round-Satin Nickel

12W VT-1205SN

- 6367 - 3000K Warm White
- 6368 - 4000K Day White
- 6369 - 6400K White

EAN Code

- 3800157621519
- 3800157621526
- 3800157621533

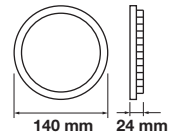

Emergency Pack:	Available	PF:	>0.6
Voltage/Frequency:	AC:85-265V,50/60Hz	Beam Angle:	120°
Luminous Flux:	1000lm	Body Type:	Aluminium
LED Type:	SMD	Shape:	Round
CRI:	>80	Dimension:	Ø140mm x 24mm



Round-Satin Nickel

18W VT-1805SN

- 6373 - 3000K Warm White
- 6374 - 4000K Day White
- 6375 - 6400K White

EAN Code

- 3800157621571
- 3800157621588
- 3800157621595

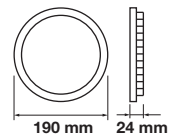

Emergency Pack:	Available	PF:	>0.6
Voltage/Frequency:	AC:85-265V,50/60Hz	Beam Angle:	120°
Luminous Flux:	1500lm	Body Type:	Aluminium
LED Type:	SMD	Shape:	Round
CRI:	>80	Dimension:	Ø190mm x 24mm



LED Panel

8W VT-809 SQ

- 4922 - 3000K Warm White
- 4923 - 4000K Day White
- 4924 - 6400K White

EAN Code

- 3800157605564
- 3800157605571
- 3800157605588

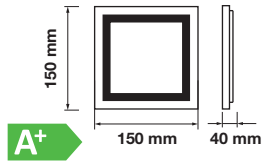

Emergency Pack:	Available	PF:	>0.9
Voltage/Frequency:	AC:100-240V,50/60Hz	Beam Angle:	120°
Luminous Flux:	800lm	Body Type:	PKW
LED Type:	SMD	Shape:	Square
CRI:	>80	Dimension:	150 x 150 x 40mm



LED Panel

15W VT-1509 SQ

- 4925 - 3000K Warm White
- 4926 - 4000K Day White
- 4927 - 6400K White

EAN Code

- 3800157605595
- 3800157605601
- 3800157605618

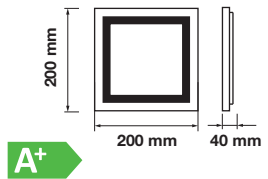

Emergency Pack:	Available	PF:	>0.9
Voltage/Frequency:	AC:100-240V,50/60Hz	Beam Angle:	120°
Luminous Flux:	1500lm	Body Type:	PKW
LED Type:	SMD	Shape:	Square
CRI:	>80	Dimension:	200 x 200 x 40mm



LED Panel

22W VT-2209 SQ

- 4928 - 3000K Warm White
- 4929 - 4000K Day White
- 4930 - 6400K White

EAN Code

- 3800157605625
- 3800157605632
- 3800157605649

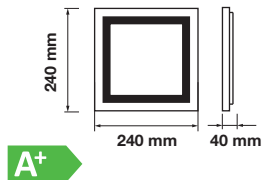

Emergency Pack:	Available	PF:	>0.9
Voltage/Frequency:	AC:100-240V,50/60Hz	Beam Angle:	120°
Luminous Flux:	2200lm	Body Type:	PKW
LED Type:	SMD	Shape:	Square
CRI:	>80	Dimension:	240 x 240 x 40mm



LED Panel

8W VT-809

- 4890 - 3000K Warm White
- 4891 - 4000K Day White
- 4892 - 6400K White

EAN Code

- 3800157602594
- 3800157602600
- 3800157602617

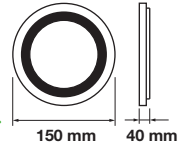

Emergency Pack:	Available	PF:	>0.9
Voltage/Frequency:	AC:100-240V,50/60Hz	Beam Angle:	120°
Luminous Flux:	800lm	Body Type:	PKW
LED Type:	SMD	Shape:	Round
CRI:	>80	Dimension:	Ø150mm x 40mm



LED Panel

15W VT-1509

- 4893 - 3000K Warm White
- 4894 - 4000K Day White
- 4895 - 6400K White

EAN Code

- 3800157602624
- 3800157602631
- 3800157602648

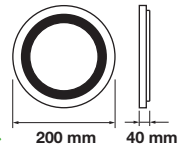

Emergency Pack:	Available	PF:	>0.9
Voltage/Frequency:	AC:100-240V,50/60Hz	Beam Angle:	120°
Luminous Flux:	1500lm	Body Type:	PKW
LED Type:	SMD	Shape:	Round
CRI:	>80	Dimension:	Ø200mm x 40mm



LED Panel

22W VT-2209

- 4896 - 3000K Warm White
- 4897 - 4000K Day White
- 4898 - 6400K White

EAN Code

- 3800157602655
- 3800157602662
- 3800157602679

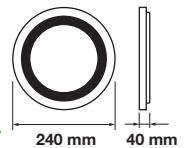

Emergency Pack:	Available	PF:	>0.9
Voltage/Frequency:	AC:100-240V,50/60Hz	Beam Angle:	120°
Luminous Flux:	2200lm	Body Type:	PKW
LED Type:	SMD	Shape:	Round
CRI:	>80	Dimension:	Ø240mm x 40mm



LED Panel

6W VT-602G RD

4740 - 3000K Warm White
6277 - 4000K Day White
4739 - 6400K White

EAN Code

3800230622891
3800157615754
3800230622884

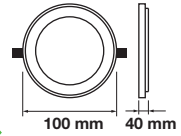

Emergency Pack:	Available	Beam Angle:	120°
Voltage/Frequency:	AC: 100-240V, 50/60Hz	Body Type:	Glass+Aluminium
Luminous Flux:	420lm	Shape:	Round
LED Type:	SMD	Dimension:	Ø100mm x40mm
CRI:	>80	Cutting Size:	Ø75mm
PF:	>0.5		



LED Panel

12W VT-1202G RD

4744 - 3000K Warm White
6279 - 4000K Day White
4743 - 6400K White

EAN Code

3800230622938
3800157615778
3800230622921

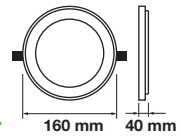

Emergency Pack:	Available	Beam Angle:	120°
Voltage/Frequency:	AC: 100-240V, 50/60Hz	Body Type:	Glass+Aluminium
Luminous Flux:	840lm	Shape:	Round
LED Type:	SMD	Dimension:	Ø160mm x40mm
CRI:	>80	Cutting Size:	Ø120mm
PF:	> 0.5		



LED Panel

18W VT-1881G RD

4760 - 3000K Warm White
6281 - 4000K Day White
4759 - 6400K White

EAN Code

3800230622976
3800157615792
3800230622969

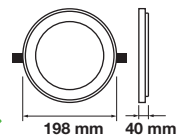

Emergency Pack:	Available	Beam Angle:	120°
Voltage/Frequency:	AC: 100-240V, 50/60Hz	Body Type:	Glass+Aluminium
Luminous Flux:	1260lm	Shape:	Round
LED Type:	SMD	Dimension:	Ø198mm x40mm
CRI:	>80	Cutting Size:	Ø145mm
PF:	> 0.5		

**LED Panel****6W** VT-602G SQ

4738 - 3000K Warm White
 6276 - 4000K Day White
 4737 - 6400K White

EAN Code

3800230622877
 3800157615747
 3800230622860

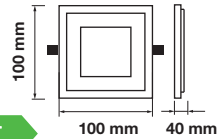

Emergency Pack:	Available	Beam Angle:	120°
Voltage/Frequency:	AC: 100-240V, 50/60Hz	Body Type:	Glass+Aluminium
Luminous Flux:	420lm	Shape:	Round
LED Type:	SMD	Dimension:	100 x 100 x 40mm
CRI:	>80	Cutting Size:	75mm x 75mm
PF:	>0.5		

**LED Panel****12W** VT-1202G SQ

4742 - 3000K Warm White
 6278 - 4000K Day White
 4741 - 6400K White

EAN Code

3800230622914
 3800157615761
 3800230622907

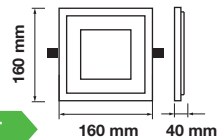

Emergency Pack:	Available	Beam Angle:	120°
Voltage/Frequency:	AC: 100-240V, 50/60Hz	Body Type:	Glass+Aluminium
Luminous Flux:	840lm	Shape:	Round
LED Type:	SMD	Dimension:	160 x 160 x 40mm
CRI:	>80	Cutting Size:	120mm x 120mm
PF:	> 0.5		

**LED Panel****18W** VT-1881G SQ

4746 - 3000K Warm White
 6280 - 4000K Day White
 4745 - 6400K White

EAN Code

3800230622952
 3800157615785
 3800230622945

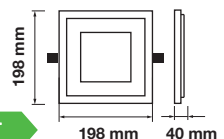

Emergency Pack:	Available	Beam Angle:	120°
Voltage/Frequency:	AC: 100-240V, 50/60Hz	Body Type:	Glass+Aluminium
Luminous Flux:	1260lm	Shape:	Round
LED Type:	SMD	Dimension:	198x 198 x 40mm
CRI:	>80	Cutting Size:	145mm x 145mm
PF:	> 0.5		



LED Highbays

Designed to provide drastic reductions in both energy consumption and maintenance requirements, V-TAC's LED High Bay Series provide uniform light with no dark patches and good colour rendering. Available models 50W - 200W

Product Features

- Powerful LED light source with a unique design
- Extensive Options can replace all types of Standard MH High bays
- Aluminium Diffuser with multiple Beam Angle's to choose from 45°D / 90°D / 120°D
- Shatter Proof Perspex Lens
- High Thermal Conductivity, Low Luminous Decay, Pure Colours & No Heavy Shade
- The unique design of Radiator fuses with the Lamp Box perfectly hence diffuses the heat conduction efficiently which reduces the temperature of inside lamp & ensures the LED long life span
- Non - Flickering
- No UV Radiation



Applications

- Perfect fit for Industrial Usage, Warehouse & Super Markets, Workshop's, Factories, Warehouse's, Highway, toll Stations, Gas Stations, Malls, Exhibition Halls, Stadium's & other vast areas



120⁺⁺
LM/W
HIGH LUMENS

120°
BEAM ANGLE

IP65
RATED

UFO HIGHBAY
With Mean Well Driver



100W VT-9120

EAN Code

5550 - 4500K Day White
5551 - 6400K White

3800157619714
3800157619721

A++

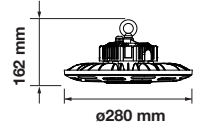

Luminous Intensity Distribution Curve

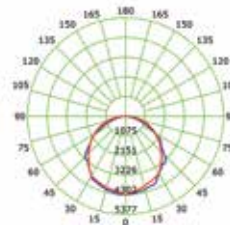

Sensor Compatible:	Yes	PF:	>0.9
Voltage/Frequency:	AC:220-240V,50Hz	Beam Angle:	120°
Luminous Flux:	12000lm	Body Type:	Diecast Aluminium
LED Type:	SMD	IP Rating:	IP65
CRI:	>70	Dimension:	ø280 x 162 mm



120⁺⁺
LM/W
HIGH LUMENS

120°
BEAM ANGLE

IP65
RATED

UFO HIGHBAY
With Mean Well Driver



150W VT-9170

EAN Code

5552 - 4500K Day White
5553 - 6400K White

3800157619738
3800157619745

A++

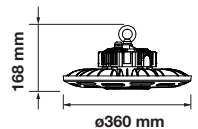

Luminous Intensity Distribution Curve

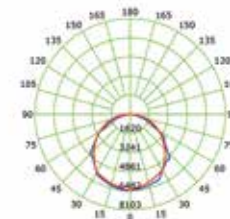

Sensor Compatible:	Yes	PF:	>0.9
Voltage/Frequency:	AC:220-240V,50Hz	Beam Angle:	120°
Luminous Flux:	18000lm	Body Type:	Diecast Aluminium
LED Type:	SMD	IP Rating:	IP65
CRI:	>70	Dimension:	ø360 x 168 mm



120⁺⁺
LM/W
HIGH LUMENS

UFO HIGHBAY

100W VT-9111
5543 - 4500K Day White
5544 - 6400K White

120°
BEAM ANGLE

IP65
RATED



EAN Code
3800157610476
3800157610483

A⁺⁺

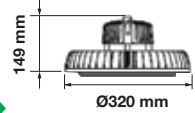

LUMINOUS INTENSITY DISTRIBUTION DIAGRAM

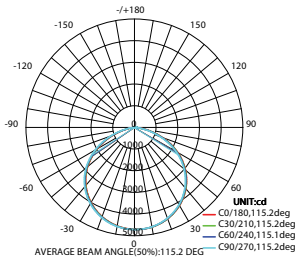

Sensor Compatible:	Yes	PF:	>0.9
Voltage/Frequency:	AC: 100-265V, 50/60Hz	Beam Angle:	120°
Luminous Flux:	13500lm	Body Type:	Aluminium
LED Type:	SMD	IP Rating:	IP65
CRI:	> 70	Dimension:	Ø320mm x 149mm



120⁺⁺
LM/W
HIGH LUMENS

UFO HIGHBAY

150W VT-9166
5556 - 4500K Day White
5545 - 6400K White

120°
BEAM ANGLE

IP65
RATED



EAN Code
3800157621892
3800157610490

A⁺⁺

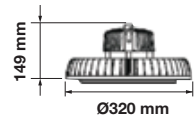
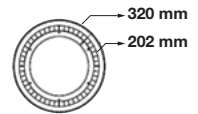

LUMINOUS INTENSITY DISTRIBUTION DIAGRAM

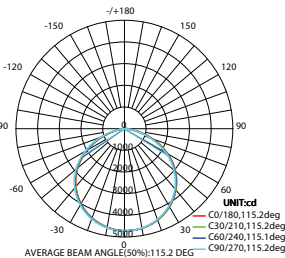

Sensor Compatible:	Yes	PF:	>0.9
Voltage/Frequency:	AC: 100-277V, 50/60Hz	Beam Angle:	120°
Luminous Flux:	21750lm	Body Type:	Aluminium
LED Type:	SMD	IP Rating:	IP65
CRI:	>70	Dimension:	Ø320mm x 149mm



New!

120⁺⁺
LM/W
HIGH LUMENS

UFO HIGHBAY
With Mean Well Driver

100W VT-9107

5587 - 4000K Day White
5588 - 6400K White



90°
BEAM ANGLE

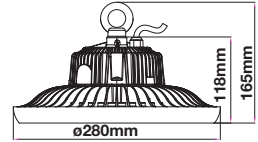

EAN Code

3800157622295
3800157622301

A++

LUMINOUS INTENSITY DISTRIBUTION DIAGRAM

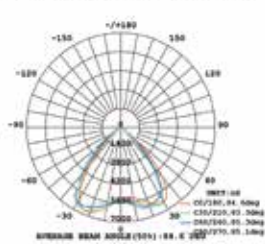

Sensor Compatible:	Yes	PF	>0.9
Voltage/Frequency:	AC:100-240V 50/60Hz	Beam Angle	90°
Luminous Flux:	13000lm	Body Type	Aluminium Diecasting
LED Type:	SMD	IP Rating	IP44
CRI:	>70	Dimension	280 x 165mm



New!

120⁺⁺
LM/W
HIGH LUMENS

UFO HIGHBAY
With Mean Well Driver

100W VT-9117

5585 - 4000K Day White
5586 - 6400K White



120°
BEAM ANGLE

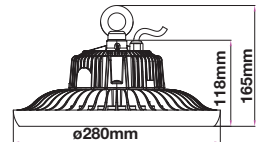

EAN Code

3800157622271
3800157622288

A++

LUMINOUS INTENSITY DISTRIBUTION DIAGRAM

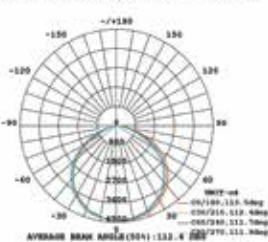

Sensor Compatible:	Yes	PF	>0.9
Voltage/Frequency:	AC:100-240V 50/60Hz	Beam Angle	120°
Luminous Flux:	13000lm	Body Type	Aluminium Diecasting
LED Type:	SMD	IP Rating	IP44
CRI:	>70	Dimension	280 x 165mm

New!

120⁺⁺
LM/W
HIGH LUMENS

LED HIGHBAY

150W VT-9167

5591 - 4000K Day White
5592 - 6400K White



90°
BEAM ANGLE

EAN Code

3800157622332
3800157622349

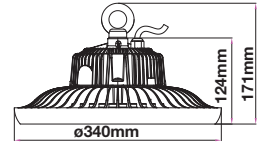

LUMINOUS INTENSITY DISTRIBUTION DIAGRAM

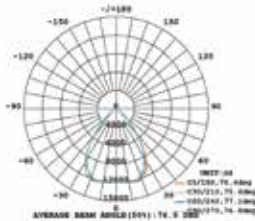

Sensor Compatible:	Yes	PF:	>0.9
Voltage/Frequency:	AC:100-240V 50/60Hz	Beam Angle:	90°
Luminous Flux:	19500lm	Body Type:	Aluminium Diecasting
LED Type:	SMD	IP Rating:	IP44
CRI:	>70	Dimension:	340 x 171mm



New!

120⁺⁺
LM/W
HIGH LUMENS

LED HIGHBAY

150W VT-9177

5589 - 4000K Day White
5590 - 6400K White



120°
BEAM ANGLE

EAN Code

3800157622318
3800157622325

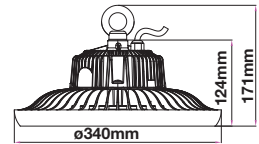

LUMINOUS INTENSITY DISTRIBUTION DIAGRAM

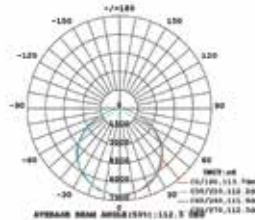

Sensor Compatible:	Yes	PF:	>0.9
Voltage/Frequency:	AC:100-240V 50/60Hz	Beam Angle:	120°
Luminous Flux:	19500lm	Body Type:	Aluminium Diecasting
LED Type:	SMD	IP Rating:	IP44
CRI:	>70	Dimension:	340 x 171mm



LUMINOUS INTENSITY DISTRIBUTION DIAGRAM

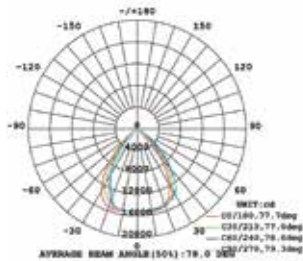

New!

120⁺⁺
LM/W
HIGH LUMENS

LED HIGHBAY

200W VT-9207

5595 - 4000K Day White
5596 - 6400K White



90°
BEAM ANGLE

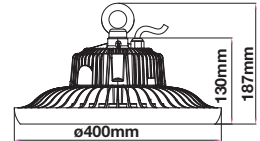

EAN Code
3800157622370
3800157622387

A⁺⁺

Sensor Compatible:	Yes	PF	>0.9
Voltage/Frequency:	AC:100-240V 50/60Hz	Beam Angle	90°
Luminous Flux:	26000lm	Body Type	Aluminium Diecasting
LED Type:	SMD	IP Rating	IP44
CRI:	>70	Dimension	400 x 187mm



LUMINOUS INTENSITY DISTRIBUTION DIAGRAM

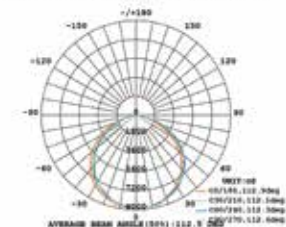

New!

120⁺⁺
LM/W
HIGH LUMENS

LED HIGHBAY

200W VT-9217

5593 - 4000K Day White
5594 - 6400K White



120°
BEAM ANGLE

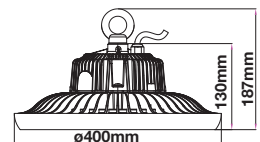

EAN Code
3800157622356
3800157622363

A⁺⁺

Sensor Compatible:	Yes	PF	>0.9
Voltage/Frequency:	AC:100-240V 50/60Hz	Beam Angle	120°
Luminous Flux:	26000lm	Body Type	Aluminium Diecasting
LED Type:	SMD	IP Rating	IP44
CRI:	>70	Dimension	400 x 187mm



New!

120⁺⁺
LM/W
HIGH LUMENS

LED HIGHBAY

500W VT-9500

5607 - 4000K Day White
5608 - 6000K White



EAN Code

3800157625050
3800157625067



Sensor Compatible:	Yes	PF	>0.9
Voltage/Frequency:	AC:90-295,50Hz	Beam Angle	120°
Luminous Flux:	65000lm	Body Type	Aluminium Diecasting
LED Type:	SMD	IP Rating	IP65
CRI:	>80	Dimension	

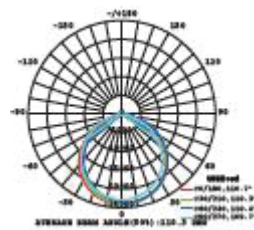
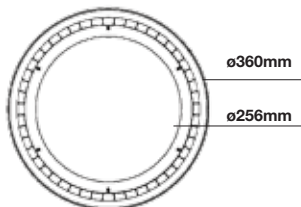
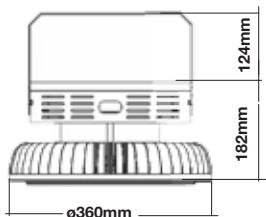



120⁺⁺
LM/W
HIGH LUMENS

120°
BEAM ANGLE

60°
BEAM ANGLE

LED Highbay

50W VT-9052

EAN Code

5540 - 4500K Day White
5539 - 6000K White

3800157608831
3800157608824

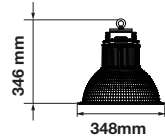

Luminous Intensity Distribution Curve

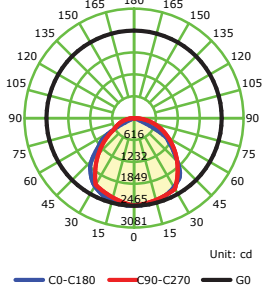

Sensor Compatible:	Yes	PF:	> 0.9
Voltage/Frequency:	AC: 100-240V, 50/60Hz	Beam Angle:	60°/120°
Luminous Flux:	6200lm	Body Type:	Aluminium Diecasting
LED Type:	SMD	IP Rating:	IP44
CRI:	>70	Dimension:	60°:348x 346mm 120°:445x 308mm



120⁺⁺
LM/W
HIGH LUMENS

120°
BEAM ANGLE

60°
BEAM ANGLE

LED Highbay

70W VT-9073

EAN Code

5535 - 4500K Day White
5536 - 6000K White

3800157608824
3800157608831

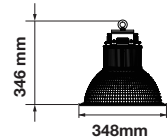

Luminous Intensity Distribution Curve

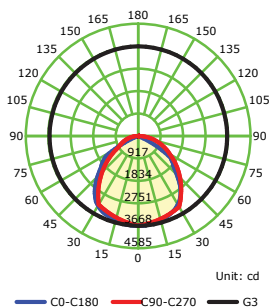

Sensor Compatible:	Yes	PF:	> 0.9
Voltage/Frequency:	AC: 100-240V, 50/60Hz	Beam Angle:	60°/120°
Luminous Flux:	8680lm	Body Type:	Aluminium Diecasting
LED Type:	SMD	IP Rating:	IP44
CRI:	>70	Dimension:	60°:348x 346mm 120°:445x 308mm



120⁺⁺
LM/W
HIGH LUMENS

120°
BEAM ANGLE

90°
BEAM ANGLE

LED Highbay

100W VT-9104

5534 - 4500K Day White
5532 - 6000K White

EAN Code

3800157608725
3800157607780

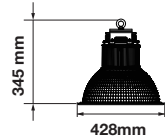

Luminous Intensity Distribution Curve

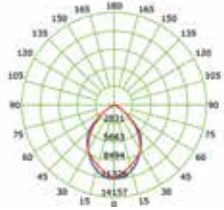

Sensor Compatible:	Yes	PF:	> 0.9
Voltage/Frequency:	AC: 100-265V, 50/60Hz	Beam Angle:	90°/120°
Luminous Flux:	12000lm	Body Type:	Aluminium
LED Type:	SMD	IP Rating:	IP44
CRI:	> 70	Dimension:	90°:428x 345mm 120°:535x 306mm



120⁺⁺
LM/W
HIGH LUMENS

120°
BEAM ANGLE

90°
BEAM ANGLE

LED Highbay

150W VT-9155

5537 - 4500K Day White
5538 - 6000K White

EAN Code

3800157608848
3800157608855

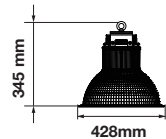

Luminous Intensity Distribution Curve

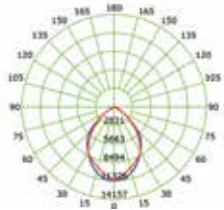

Sensor Compatible:	Yes	PF	>0.9
Voltage/Frequency:	AC: 100-240V, 50/60Hz	Beam Angle	90°/120°
Luminous Flux:	18600lm	Body Type	Aluminium Diecasting
LED Type:	SMD	IP Rating	IP44
CRI:	>70	Dimension	90°:428 x 345mm 120°:535 x 306mm



UFO HIGHBAY

50W VT-9053

EAN Code

5554 - 4500K Day White
5555 - 6400K White

3800157620895
3800157620901

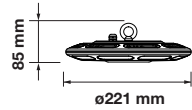

Sensor Compatible:	Yes	PF:	>0.9
Voltage/Frequency:	AC:220-240V,50Hz	Beam Angle:	120°
Luminous Flux:	4000lm	Body Type:	Diecast Aluminium
LED Type:	SMD	IP Rating:	IP44
CRI:	>70	Dimension:	221x 85 mm



UFO HIGHBAY

100W VT-9106

EAN Code

5546 - 4500K Day White
5547 - 6400K White

3800157619677
3800157619684

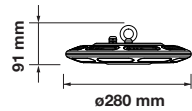

Sensor Compatible:	Yes	PF:	>0.9
Voltage/Frequency:	AC:220-240V,50Hz	Beam Angle:	120°
Luminous Flux:	8000lm	Body Type:	Diecast Aluminium
LED Type:	SMD	IP Rating:	IP44
CRI:	>70	Dimension:	280 x 91 mm



UFO HIGHBAY

150W VT-9156

EAN Code

5548 - 4500K Day White
5549 - 6400K White

3800157619691
3800157619707

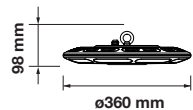

Sensor Compatible:	Yes	PF	>0.9
Voltage/Frequency:	AC:220-240V,50Hz	Beam Angle	120°
Luminous Flux:	12000lm	Body Type	Diecast Aluminium
LED Type:	SMD	IP Rating	IP44
CRI:	>70	Dimension	360 x 98 mm



New!

120°
BEAM ANGLE

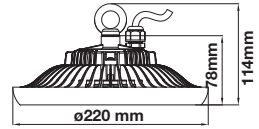

LED HIGHBAY

50W VT-9065

EAN Code

5609 - 3000K Warm White

3800157626507

5610 - 4000K Day White

3800157626514

5611 - 6400K White

3800157626521

A+

LUMINOUS INTENSITY DISTRIBUTION DIAGRAM

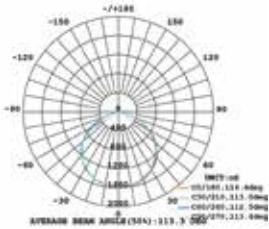

Sensor Compatible:	Yes	PF:	>0.9
Voltage/Frequency:	AC: 220-240V, 50Hz	Beam Angle:	120°
Luminous Flux:	4000lm	Body Type:	Aluminium Diecasting
LED Type:	SMD	IP Rating:	IP44
CRI:	>70	Dimension:	ø220 x 114mm



New!

120°
BEAM ANGLE

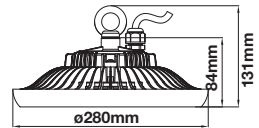

LED HIGHBAY

100W VT-9115

EAN Code

5612 - 3000K Warm White

3800157626538

5613 - 4000K Day White

3800157626545

5614 - 6400K White

3800157626552

A+

LUMINOUS INTENSITY DISTRIBUTION DIAGRAM

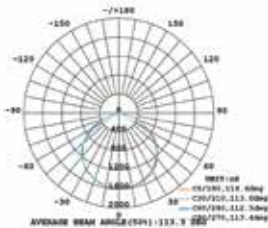

Sensor Compatible:	Yes	PF:	>0.9
Voltage/Frequency:	AC: 220-240V, 50Hz	Beam Angle:	120°
Luminous Flux:	8000lm	Body Type:	Aluminium Diecasting
LED Type:	SMD	IP Rating:	IP44
CRI:	>70	Dimension:	ø280 x 131mm



New!

LED Highbay

50W VT-9055

5559 - 4000K Day White
5560 - 6400K White

90°
BEAM ANGLE

EAN Code

3800157621960
3800157621977

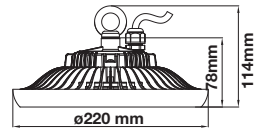

A+

LUMINOUS INTENSITY DISTRIBUTION DIAGRAM

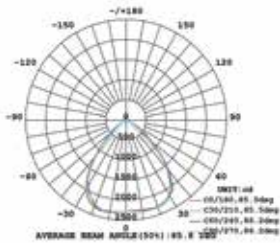

Sensor Compatible:	Yes	PF:	>0.9
Voltage/Frequency:	AC: 220-240V, 50Hz	Beam Angle:	90°
Luminous Flux:	4000lm	Body Type:	Aluminium Diecasting
LED Type:	SMD	IP Rating:	IP44
CRI:	>70	Dimension:	ø220 x 114mm



New!

LED Highbay

50W VT-9065

5557 - 4000K Day White
5558 - 6400K White

120°
BEAM ANGLE

EAN Code

3800157621946
3800157621953

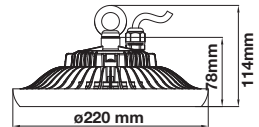

A+

LUMINOUS INTENSITY DISTRIBUTION DIAGRAM

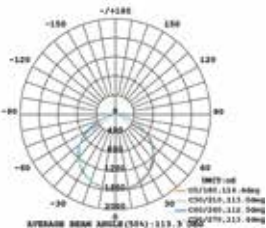

Sensor Compatible:	Yes	PF:	>0.9
Voltage/Frequency:	AC: 220-240V, 50Hz	Beam Angle:	120°
Luminous Flux:	4000lm	Body Type:	Aluminium Diecasting
LED Type:	SMD	IP Rating:	IP44
CRI:	>70	Dimension:	ø220 x 114mm



New!

LED HIGHBAY

100W VT-9105

5575 - 4000K Day White
5576 - 6400K White

90°
BEAM ANGLE

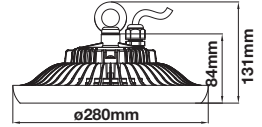

EAN Code

3800157622004
3800157622011

A+

LUMINOUS INTENSITY DISTRIBUTION DIAGRAM

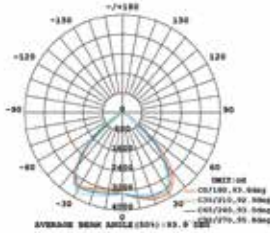

Sensor Compatible:	Yes	PF	>0.9
Voltage/Frequency:	AC: 220-240V, 50Hz	Beam Angle	90°
Luminous Flux:	8000lm	Body Type	Aluminium Diecasting
LED Type:	SMD	IP Rating	IP44
CRI:	>70	Dimension	ø280 x 131mm



New!

LED HIGHBAY

100W VT-9115

5573 - 4000K Day White
5574 - 6400K White

120°
BEAM ANGLE

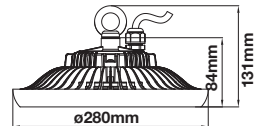

EAN Code

3800157621984
3800157621991

A+

LUMINOUS INTENSITY DISTRIBUTION DIAGRAM

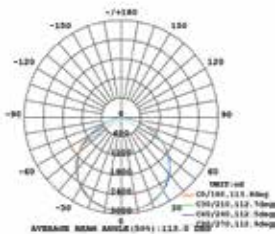

Sensor Compatible:	Yes	PF	>0.9
Voltage/Frequency:	AC: 220-240V, 50Hz	Beam Angle	120°
Luminous Flux:	8000lm	Body Type	Aluminium Diecasting
LED Type:	SMD	IP Rating	IP44
CRI:	>70	Dimension	ø280 x 131mm



New!

LED HIGHBAY

150W VT-9165

5579 - 4000K Day White
5580 - 6400K White

90°
BEAM ANGLE

EAN Code

3800157622042
3800157622059

A+

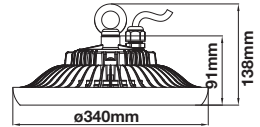

LUMINOUS INTENSITY DISTRIBUTION DIAGRAM

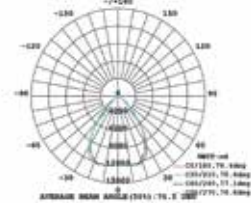

Sensor Compatible:	Yes	PF:	>0.9
Voltage/Frequency:	AC: 220-240V, 50Hz	Beam Angle:	90°
Luminous Flux:	12000lm	Body Type:	Aluminium Diecasting
LED Type:	SMD	IP Rating:	IP44
CRI:	>70	Dimension:	ø340 x 138mm



New!

LED HIGHBAY

150W VT-9175

5577 - 4000K Day White
5578 - 6400K White

120°
BEAM ANGLE

EAN Code

3800157622028
3800157622035

A+

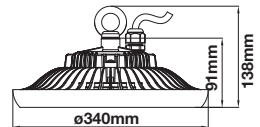

LUMINOUS INTENSITY DISTRIBUTION DIAGRAM

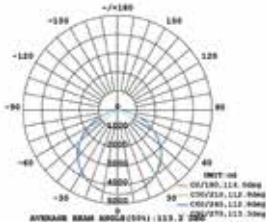

Sensor Compatible:	Yes	PF:	>0.9
Voltage/Frequency:	AC: 220-240V, 50Hz	Beam Angle:	120°
Luminous Flux:	12000lm	Body Type:	Aluminium Diecasting
LED Type:	SMD	IP Rating:	IP44
CRI:	>70	Dimension:	ø340 x 138mm



New!

LED HIGHBAY

200W VT-9205

5583 - 4000K Day White
5584 - 6400K White

90°
BEAM ANGLE

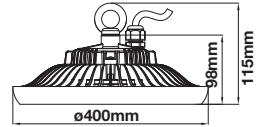

EAN Code

3800157622080
3800157622097

A+

LUMINOUS INTENSITY DISTRIBUTION DIAGRAM

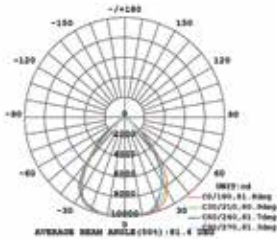

Sensor Compatible:	Yes	PF	>0.9
Voltage/Frequency:	AC: 220-240V, 50Hz	Beam Angle	90°
Luminous Flux:	16000lm	Body Type	Aluminium Diecasting
LED Type:	SMD	IP Rating	IP44
CRI:	>70	Dimension	400 x 115mm



New!

LED HIGHBAY

200W VT-9215

5581 - 4000K Day White
5582 - 6400K White

120°
BEAM ANGLE

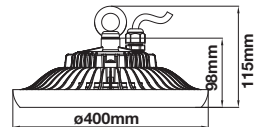

EAN Code

3800157622066
3800157622073

A+

LUMINOUS INTENSITY DISTRIBUTION DIAGRAM

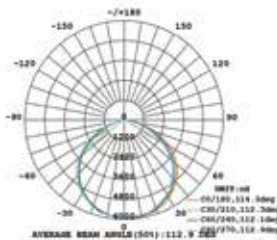

Sensor Compatible:	Yes	PF	>0.9
Voltage/Frequency:	AC: 220-240V, 50Hz	Beam Angle	120°
Luminous Flux:	16000lm	Body Type	Aluminium Diecasting
LED Type:	SMD	IP Rating	IP44
CRI:	>70	Dimension	400 x 115mm

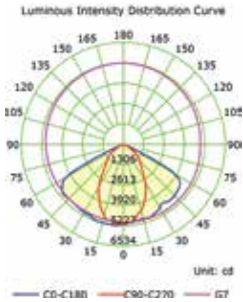

New!

LED HIGHBAY

100W VT-9108

5599 - 4000K Day White
5600 - 6000K White

EAN Code

3800157624909
3800157624916

A+

120°
BEAM ANGLE

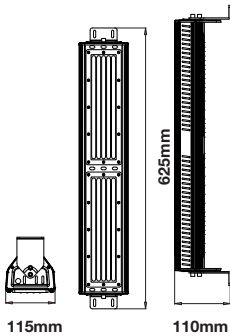

Sensor Compatible:	Yes	PF	>0.9
Voltage/Frequency:	AC :220-240V, 50Hz	Beam Angle	120°
Luminous Flux:	10000lm	Body Type	Aluminium Die Cast
LED Type:	SMD	IP Rating	IP44
CRI:	>70	Dimension	625 x 110 x 115mm

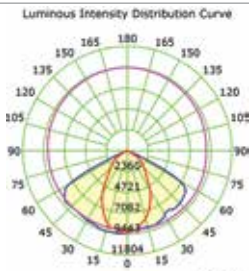

New!

LED HIGHBAY

150W VT-9158

5601 - 4000K Day White
5602 - 6000K White

EAN Code

3800157624923
3800157624930

A+

120°
BEAM ANGLE

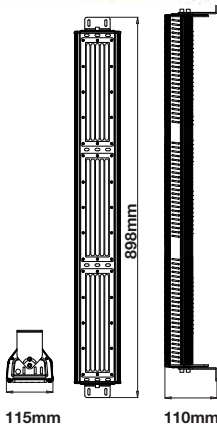

Sensor Compatible:	Yes	PF	>0.9
Voltage/Frequency:	AC: 220-240V, 50Hz	Beam Angle	120°
Luminous Flux:	15000lm	Body Type	Aluminium Die Cast
LED Type:	SMD	IP Rating	IP44
CRI:	>70	Dimension	898 x 110 x 115mm

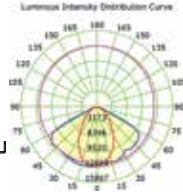

New!

LED HIGHBAY

200W VT-9208

5603 - 4000K Day White
5604 - 6000K White

EAN Code

3800157624947
3800157624954



120°
BEAM ANGLE

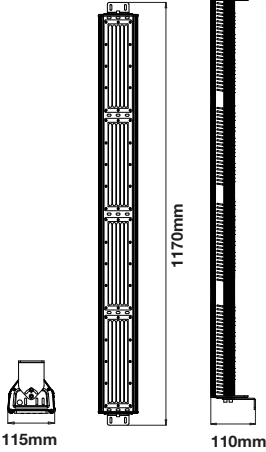

Sensor Compatible:	Yes	PF	>0.9
Voltage/Frequency:	AC :220-240V, 50Hz	Beam Angle	120°
Luminous Flux:	20000lm	Body Type	Aluminium Die Cast
LED Type:	SMD	IP Rating	IP44
CRI:	>70	Dimension	1170 x 110 x 115mm

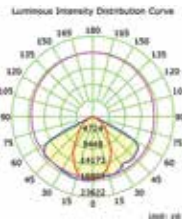

New!

LED HIGHBAY

300W VT-9308

5605 - 4000K Day White
5606 - 6000K White

EAN Code

3800157624961
3800157624978



120°
BEAM ANGLE

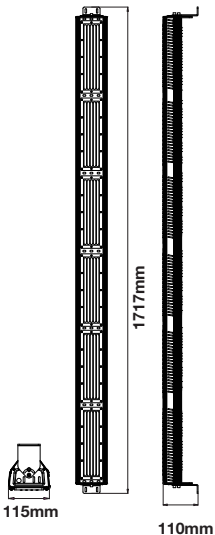

Sensor Compatible:	Yes	PF	>0.9
Voltage/Frequency:	AC: 220-240V, 50Hz	Beam Angle	120°
Luminous Flux:	30000lm	Body Type	Aluminium Die Cast
LED Type:	SMD	IP Rating	IP44
CRI:	>70	Dimension	1717 x 110 x 115mm



E40
HOLDER

LED LOWBAY

85W VT-9185

5541 - 4500K Day White
5542 - 6000K White

A+

EAN Code

3800157610001
3800157610018

- Warehouses, shipping docks, stairwells and parking garages.
- Lightweight, Compact structure
- Indoor and outdoor
- Replacement of 500W CFL

Sensor Compatible:	Yes	PF:	> 0.9
Voltage/Frequency:	AC: 220-240V, 50/60Hz	Beam Angle:	120°
Luminous Flux:	6800lm	Body Type:	Aluminium
LED Type:	SMD	IP Rating:	IP20
CRI:	> 80	Dimension:	222mm x 270mm



New!

E40
HOLDER

LED LOWBAY

85W VT-9186

5597 - 4000K Day White
5598 - 6400K White

A+

EAN Code

3800157624565
3800157624572

Sensor Compatible:	Yes	PF:	0.9
Voltage/Frequency:	AC: 220-240V, 50Hz	Beam Angle:	110°
Luminous Flux:	6800lm	Body Type:	Plastic
LED Type:	SMD	IP Rating:	IP20
CRI:	>80	Dimension:	ø260 x 307

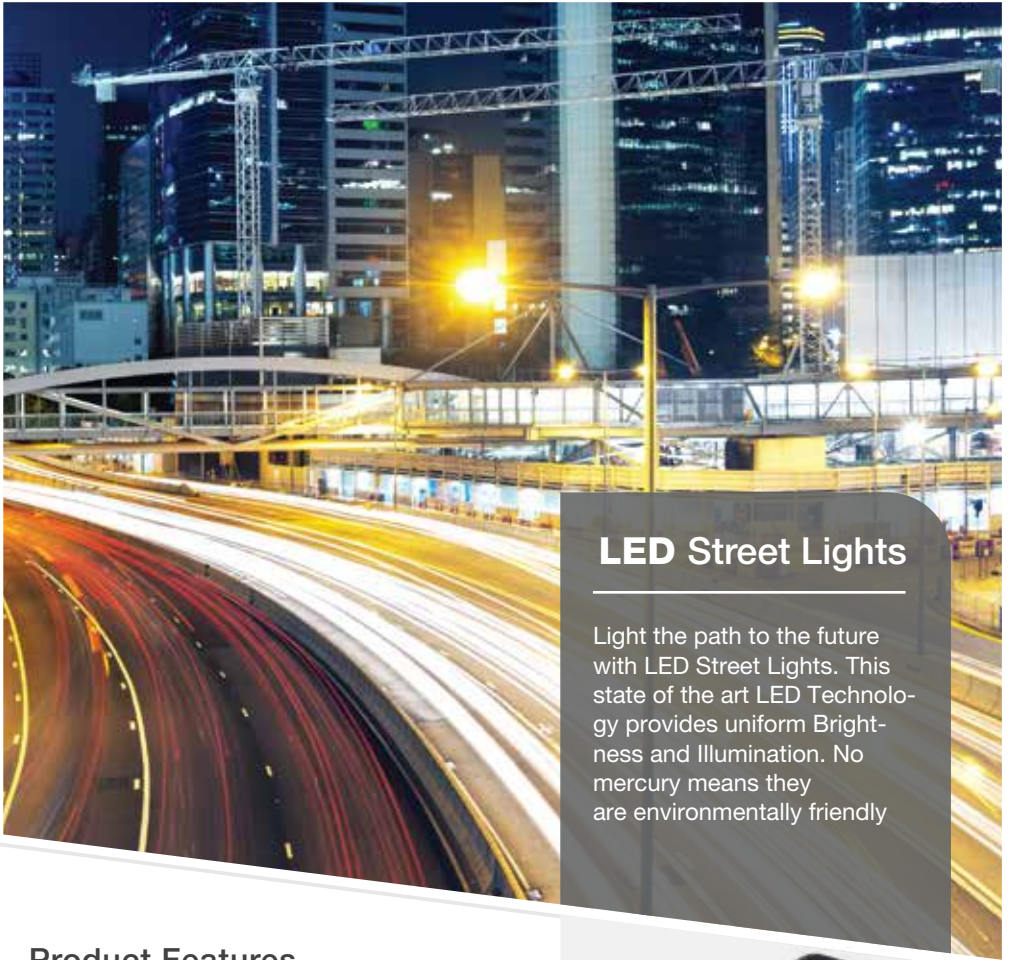

LED Street Lights

Light the path to the future with LED Street Lights. This state of the art LED Technology provides uniform Brightness and Illumination. No mercury means they are environmentally friendly

Product Features

- Perfect replacement for traditional lights
- Saves 80% Electricity cost, Better Efficiency, Longer Life Span
- Dedicated IP65 Sealed Optical Cavities
- Optically Optimized Glass Lenses
- Uniformity in Light Distribution – Maximizes Efficiency
- Fully Operational in Extreme Weather up to -20° Celsius
- Low maintenance & Low Power consumption
- Reduced CO² emissions



Applications

- Out Door Applications like Streets, Projects, Cross Roads, Tunnels, Car Parks, Industrial Facilities etc



IP65
RATED

LED Street Light

30W VT-15135ST

5480 - 6400K White

120⁺⁺
LM/W
HIGH LUMENS



EAN Code
3800157616164

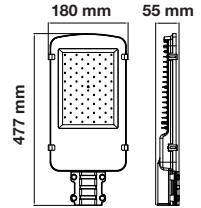

Sensor Compatible:	Yes	Beam Angle:	100°
Voltage/Frequency:	AC:100-240V, 50/60Hz	Color of Fixture:	Black/Grey
Luminous Flux:	3720lm	Body Type:	Aluminum Diecasting
LED Type:	SMD	IP Rating:	IP65
CRI:	>70	Dimension:	477 x 180 x 55mm
PF:	>0.95		

Luminous Intensity Distribution Curve

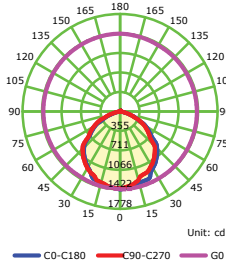

IP65
RATED

LED Street Light

50W VT-15165ST

5482 - 6400K White

120⁺⁺
LM/W
HIGH LUMENS



EAN Code
3800157616188

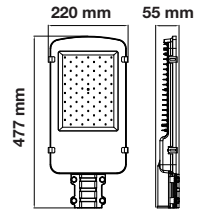

Sensor Compatible:	Yes	Beam Angle:	100°
Voltage/Frequency:	AC:100-240V, 50/60Hz	Color of Fixture:	Black/Grey
Luminous Flux:	6200lm	Body Type:	Aluminum Diecasting
LED Type:	SMD	IP Rating:	IP65
CRI:	>70	Dimension:	477 x 220 x 55mm
PF:	>0.95		

Luminous Intensity Distribution Curve

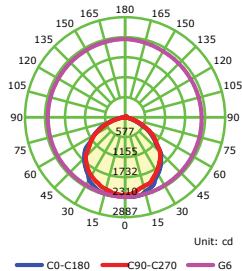



Luminous Intensity Distribution Curve

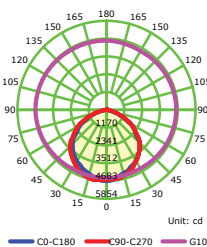

LED Street Light

100W VT-15115ST

5481 - 6400K White

120⁺⁺
HIGH LUMENS



EAN Code
3800157616171

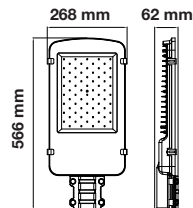

Sensor Compatible:	Yes	Beam Angle:	100°
Voltage/Frequency:	AC:100-240V, 50/60Hz	Color of Fixture:	Black/Grey
Luminous Flux:	12400lm	Body Type:	Aluminum Diecasting
LED Type:	SMD	IP Rating:	IP65
CRI:	>70	Dimension:	566 x 268 x 62mm
PF:	>0.95		



LED Street Light

30W VT-15131ST

- 5471 - 3000K Warm White
- 5472 - 4500K Day White
- 5473 - 6000K White

120⁺⁺
LM/W
HIGH LUMENS



EAN Code

- 3800157608732
- 3800157608749
- 3800157608756

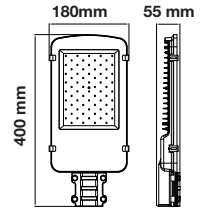

Sensor Compatible:	Yes	Beam Angle:	100°
Voltage/Frequency:	AC:100-240V, 50/60Hz	Color of Fixture:	Black/Grey
Luminous Flux:	3720lm	Body Type:	Aluminum Diecasting
LED Type:	SMD	IP Rating:	IP65
CRI:	>70	Dimension:	400 x 180 x 55mm
PF:	>0.95		



LED Street Light

50W VT-15151ST

- 5474 - 3000K Warm White
- 5475 - 4500K Day White
- 5476 - 6000K White

120⁺⁺
LM/W
HIGH LUMENS



EAN Code

- 3800157608763
- 3800157608770
- 3800157608787

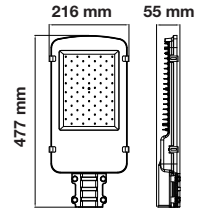

Sensor Compatible:	Yes	Beam Angle:	100°
Voltage/Frequency:	AC:100-240V, 50/60Hz	Color of Fixture:	Black/Grey
Luminous Flux:	6200lm	Body Type:	Aluminum Diecasting
LED Type:	SMD	IP Rating:	IP65
CRI:	>70	Dimension:	477 x216 x 55mm
PF:	>0.95		



LED Street Light

100W VT-15105ST

- 5477 - 4500K Day White
- 5478 - 6000K White

120⁺⁺
LM/W
HIGH LUMENS



EAN Code

- 3800157608794
- 3800157608800

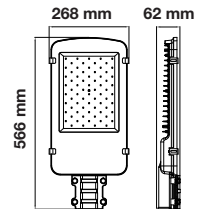

Sensor Compatible:	Yes	Beam Angle:	100°
Voltage/Frequency:	AC:100-240V, 50/60Hz	Color of Fixture:	Black/Grey
Luminous Flux:	12400lm	Body Type:	Aluminum Diecasting
LED Type:	SMD	IP Rating:	IP65
CRI:	>70	Dimension:	566 x268 x 62mm
PF:	>0.95		



Luminous Intensity Distribution Curve

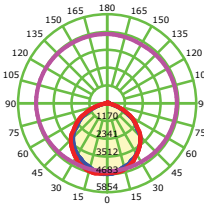

Unit: cd

— C0-C180 — C90-C270 — G10



LED Street Light

100W VT-15104 ST

5468 - 6000K White

120⁺⁺
LM/W
HIGH LUMENS

EAN Code

3800157607797

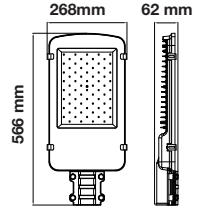

Sensor Compatible:	Yes	Beam Angle:	100°
Voltage/Frequency:	AC:85-265V,50/60Hz	Color of Fixture:	Black/Grey
Luminous Flux:	12000lm	Body Type:	Die Cast Aluminum
LED Type:	SMD	IP Rating:	IP65
CRI:	>70	Dimension:	703 x 297 x 70mm
PF:	>0.95	PoleSize:	Ø60mm



Luminous Intensity Distribution Curve

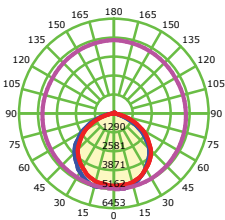

Unit: cd

— C0-C180 — C90-C270 — G7



LED Street Light

120W VT-15121ST

5479 - 6000K White

120⁺⁺
LM/W
HIGH LUMENS

EAN Code

3800157608817

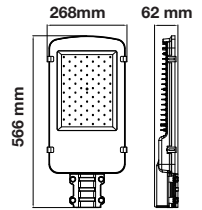

Sensor Compatible:	Yes	Beam Angle:	100°
Voltage/Frequency:	AC:100-240V, 50/60Hz	Color of Fixture:	Black/Grey
Luminous Flux:	14880lm	Body Type:	Aluminum Diecasting
LED Type:	SMD	IP Rating:	IP65
CRI:	>70	Dimension:	566 x 268 x 62mm
PF:	>0.95	PoleSize:	Ø60mm



New!

LED Street Light

30W VT-15030ST

5487 - 4000K Day White
5488 - 6400K White

IP65
RATED

EAN Code

3800157623469
3800157623476

A+

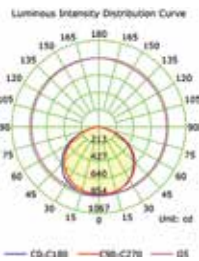
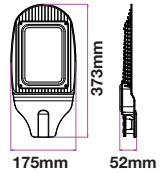

Sensor Compatible:	Yes	Beam Angle:	100°
Voltage/Frequency:	AC: 190-240V, 50/60Hz	Color of Fixture:	Grey
Luminous Flux:	2400lm	Body Type:	Aluminium Die Cast
LED Type:	SMD2835	IP Rating:	IP65
CRI:	>70	Dimension:	175 x 373 x 52mm
PF:	>0.9		



PHOTOCELL SENSOR
Auto Turns On At Night
Auto Turns Off At Day Time



New!

LED Street Light

30W VT-15031ST

5489 - 4000K Day White
5490 - 6400K White

IP65
RATED

EAN Code

3800157623483
3800157623490

A+

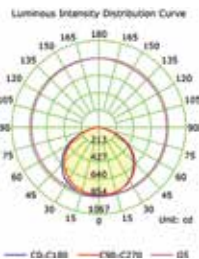
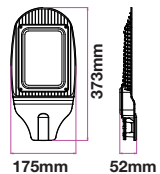

Sensor Included:	Yes	Beam Angle:	100°
Voltage/Frequency:	AC: 190-240V, 50/60Hz	Color of Fixture:	Grey
Luminous Flux:	2400lm	Body Type:	Aluminium Die Cast
LED Type:	SMD2835	IP Rating:	IP65
CRI:	>70	Dimension:	175 x 373 x 52mm
PF:	>0.9		



New!

LED Street Light

50W VT-15051ST

5491 - 4000K Day White
5492 - 6400K White

IP65
RATED

EAN Code

3800157623506
3800157623513

A+

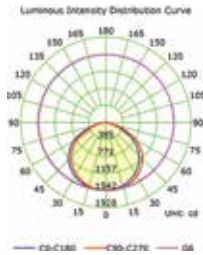
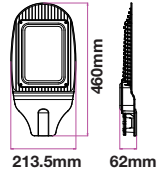

Sensor Compatible:	Yes	Beam Angle:	100°
Voltage/Frequency:	AC: 190-240V, 50/60Hz	Color of Fixture:	Grey
Luminous Flux:	4000lm	Body Type:	Aluminium Die Cast
LED Type:	SMD2835	IP Rating:	IP65
CRI:	>70	Dimension:	213.5 x 460 x 62mm
PF:	>0.9		



PHOTOCELL SENSOR
Auto Turns On At Night
Auto Turns Off At Day Time



New!

LED Street Light

50W VT-15052ST

5493 - 4000K Day White
5494 - 6400K White

IP65
RATED

EAN Code

3800157623520
3800157623537

A+

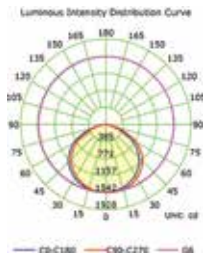
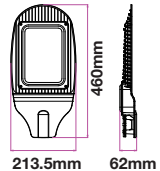

Sensor Included:	Yes	Beam Angle:	100°
Voltage/Frequency:	AC: 190-240V, 50/60Hz	Color of Fixture:	Grey
Luminous Flux:	4000lm	Body Type:	Aluminium Die Cast
LED Type:	SMD2835	IP Rating:	IP65
CRI:	>70	Dimension:	213.5 x 460 x 62mm
PF:	>0.9		

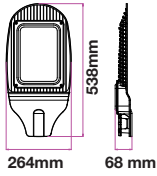

New!

LED Street Light



100W VT-15101ST

EAN Code

5495 - 4000K Day White
5496 - 6400K White

3800157623544
3800157623551

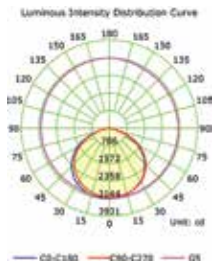

Sensor Compatible:	Yes	Beam Angle:	100°
Voltage/Frequency:	AC: 190-240V, 50/60Hz	Color of Fixture:	Grey
Luminous Flux:	8000lm	Body Type:	Aluminium Diecasting
LED Type:	SMD	IP Rating:	IP65
CRI:	>70	Dimension:	264 x 538 x 68mm
PF:	>0.9		

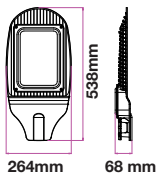

New!

LED Street Light



120W VT-15123ST

EAN Code

5497 - 4000K Day White
5498 - 6400K White

3800157623568
3800157623575

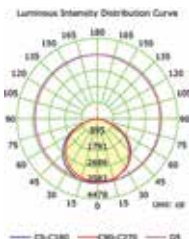

Sensor Compatible:	Yes	Beam Angle:	100°
Voltage/Frequency:	AC: 190-240V, 50/60Hz	Color of Fixture:	Grey
Luminous Flux:	9600lm	Body Type:	Aluminium Diecasting
LED Type:	SMD	IP Rating:	IP65
CRI:	>70	Dimension:	264 x 538 x 68mm
PF:	>0.9		



New!

LED Street Light

150W VT-15156ST

5499 - 4000K Day White
5500 - 6400K White

IP65
RATED

EAN Code

3800157623582
3800157623599

A+

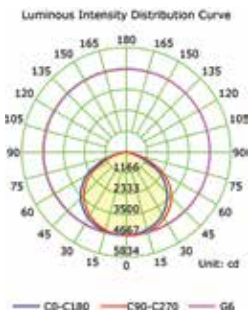
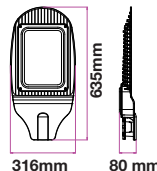

Sensor Compatible:	Yes	Beam Angle:	100°
Voltage/Frequency:	AC: 190-240V, 50/60Hz	Color of Fixture:	Grey
Luminous Flux:	12000lm	Body Type:	Aluminium Diecasting
LED Type:	SMD	IP Rating:	IP65
CRI:	>70	Dimension:	316 x 635 x 80mm
PF:	>0.9		

LED Street Light

Adapter

VT-795

3624

Color: **Dark grey**

Body: **Diecast Aluminium**

EAN Code

3800157608152

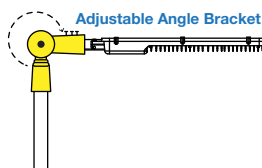
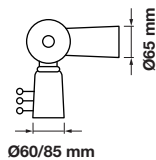

Compatible with **100W, 120W and 150W** models, this adapter allows the angle of the streetlight to be adjusted as per client's requirements

LED Street Light

Adapter

VT-795

3668

Color: **Dark grey**

Body: **Diecast Aluminium**

EAN Code

3800157625029



Compatible with **30W and 50W** models, this adapter allows the angle of the streetlight to be adjusted as per client's requirements

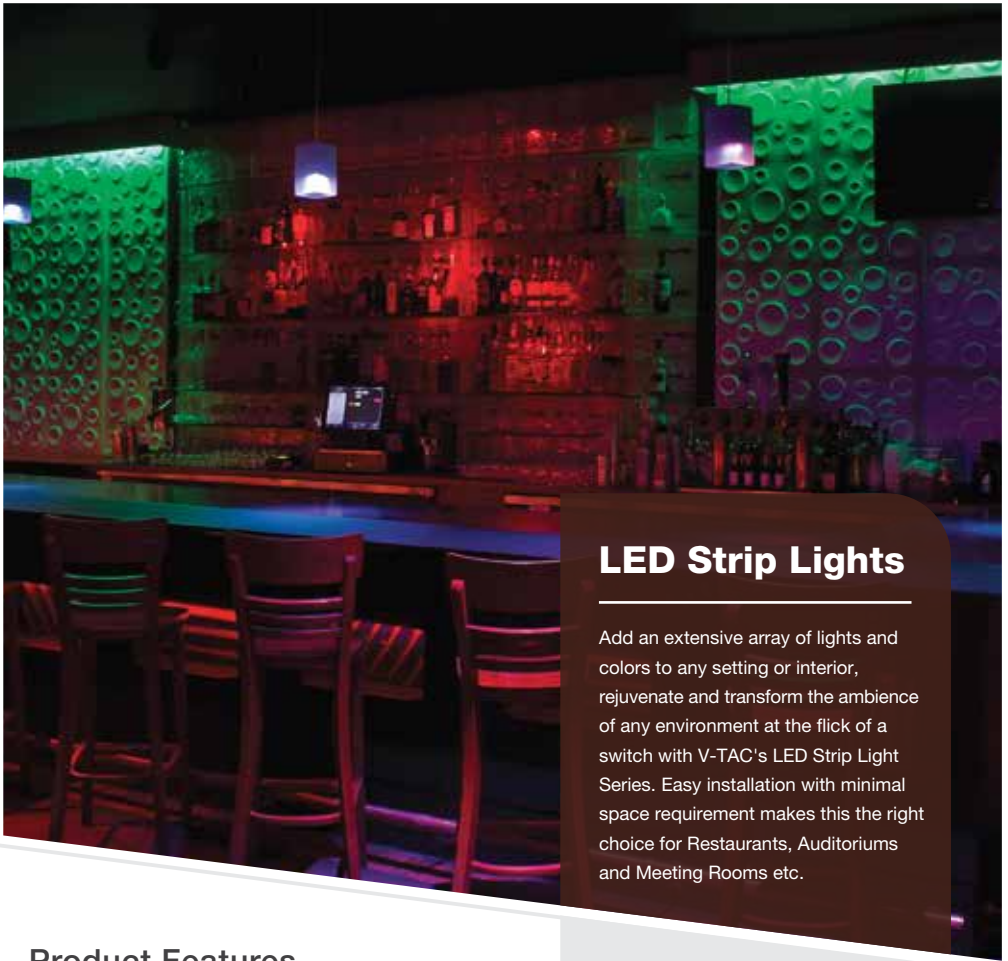

LED Strip Lights

Add an extensive array of lights and colors to any setting or interior, rejuvenate and transform the ambience of any environment at the flick of a switch with V-TAC's LED Strip Light Series. Easy installation with minimal space requirement makes this the right choice for Restaurants, Auditoriums and Meeting Rooms etc.

Product Features

- LED strip is a low Voltage flexible Ribbon available in DC:12V
- Flexible & easy installation
- Exceptionally low power consumption
- Multiple visual effects in unending colours and shades
- Available in DC:12V and 220V with different color range from Warm White to RGB
- Available in IP20 and IP65 rating
- Available in 8mm or 10mm width
- Available in 1 or 1.5 meter rigid bar options with different options of Aluminium Profiles



Applications

- Ideal for illuminating Borders, Edges, Cabinets, Bars and any area with limited space for installation.



- ✔ 5 Meter Roll
- ✔ Power Supply

VT-5050 60

2545 - 3000K Warm White
 2546 - 6000K White
 2534 - Pink

EAN Code

3800157626804
 3800157626811
 3800157625326



- ✔ 5 Meter Roll
- ✔ Power Supply
- ✔ RGB Remote Control With Battery

VT-5050 60

2544 - RGB

EAN Code

3800157625975



LED Type:	SMD 5050	lm/M:	1000lm
Watt/M:	10W	lm/LED:	9-11 lm
Current/M:	1.5A	Beam Angle:	120°
Voltage:	AC: 100-265V,50/60Hz	IP Rating:	IP20
LED Qty	60	Width:	8mm



3000lm/m
HIGH LUMENS

CRI >80

240
LED/M

IP20
RATED

5M ROLL

2835-NON WP | 240 LED/M

A++

18W 2835-NON WP

EAN Code

2164 - 3000K Warm White

3800157610117

2165 - 4500K Day White

3800157610124

2166 - 6000K White

3800157610131



LED Type:	2835	lm/M:	3000lm
Watt/M:	18W	lm/LED:	20-22 lm
Current/M:	1.5A	Beam Angle:	120°
Voltage:	DC:12V	IP Rating:	IP20
LED Qty:	240	Width:	10mm



CRI >80

204
LED/M

IP20
RATED

5M ROLL

2835-NON WP | 204 LED/M

A+

18W 2835-NON WP

EAN Code

2461 - 3000K Warm White

3800157612234

2462 - 4500K Day White

3800157612241

2463 - 6000K White

3800157612258



LED Type:	2835	lm/M:	1700lm
Watt/M:	18W	lm/LED:	9-11 lm
Current/M:	1.5A	Beam Angle:	120°
Voltage:	DC:12V	IP Rating:	IP20
LED Qty:	204	Width:	8mm



3000lm/m
HIGH LUMENS

CRI >95

120
LED/M

IP20
RATED

5M ROLL

5730-NON WP | 120 LED/M **A++**

18W 5730-NON WP

- 2162 - 3000K Warm White
- 2163 - 4500K Day White
- 2161 - 6000K White

EAN Code

- 3800157610094
- 3800157610100
- 3800157610087

LED Type:	5730	lm/M:	3000lm
Watt/M:	18W	lm/LED:	20-22 lm
Current/M:	1.5A	Beam Angle:	120°
Voltage:	DC:12V	IP Rating:	IP20
LED Qty:	120	Width:	8mm



30 LED/M **A+**
4.8W 5050 - WP

500
lm/M

IP65
RATED



LED Type:	5050	Color:	SKU Code:	EAN Code:
Watt/M:	4.8W	White	2144	3800230621399
Current/M:	0.4A	Warm White	2145	3800230621412
Voltage:	DC:12V	Day White	2460	3800157612166
LED Qty:	30	Red	2129	3800157619974
lm/LED:	14lm-16lm	RGB	2118	3800230621528
Beam Angle:	120°			
IP Rating:	IP65			
Width:	10mm			



30 LED/M **A+**
4.8W 5050 - NON WP

500
lm/M

IP20
RATED



LED Type:	5050	Color:	SKU Code:	EAN Code:
Watt/M:	4.8W	White	2133	3800230621382
Current/M:	4A	Warm White	2135	3800230621405
Voltage:	DC:12V	RGB	2124	3800230621535
LED Qty:	30			
lm/LED:	14lm-16lm			
Beam Angle:	120°			
IP Rating:	IP20			
Width:	10mm			



60 LED/M **A+**
10.8W 5050 - WP

1000 **IP65**
 lm/M **RATED**



LED Type:	5050	Color:	SKU Code:	EAN Code:
Watt/M:	10.8W	White	2148	3800230621498
Current/M:	0.8A	Warm White	2149	3800230621511
Voltage:	DC:12V	Day White	2150	3800230621474
LED Qty:	60	Red	2152	3800230624775
lm/LED:	14lm-16lm	Green	2153	3800230621450
Beam Angle:	120°	Blue	2151	3800230621436
IP Rating:	IP65	RGB	2155	3800230621559
Width:	10mm			

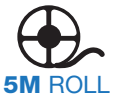

60 LED/M **A+**
10.8W 5050 - NON WP

1000 **IP20**
 lm/M **RATED**



LED Type:	5050	Color:	SKU Code:	EAN Code:
Watt/M:	10.8W	White	2126	3800230621481
Current/M:	0.8A	Warm White	2122	3800230621504
Voltage:	DC:12V	Day White	2143	3800230621467
LED Qty:	60	Red	2128	3800230624468
lm/LED:	14lm-16lm	Green	2138	3800230621443
Beam Angle:	120°	Blue	2137	3800230621429
IP Rating:	IP20	Yellow	2156	3800230628824
Width:	10mm	RGB	2120	3800230621542



60 LED/M **A+**
3.6W 3528 - WP



LED Type:	3528	Color:	SKU Code:	EAN Code:
Watt/M:	3.6W	White	2031	3800230621146
Current/M:	0.3A	Warm White	2032	3800230621177
Voltage:	DC:12V	Day White	2043	3800230621191
LED Qty:	60	Red	2036	3800230621276
lm/LED:	5lm -6lm	Green	2034	3800230621238
Beam Angle:	120°	Blue	2035	3800230621245
IP Rating:	IP65	Yellow	2033	3800230621207
Width:	8mm			



60 LED/M **A+**
3.6W 3528 - NON WP



LED Type:	3528	Color:	SKU Code:	EAN Code:
Watt/M:	3.6W	White	2005	3800230621153
Current/M:	0.3A	Warm White	2016	3800230621160
Voltage:	DC:12V	Day White	2041	3800230621184
LED Qty:	60	Red	2015	3800230621269
lm/LED:	5lm -6lm	Green	2011	3800230621221
Beam Angle:	120°	Blue	2013	3800230621252
IP Rating:	IP20	Yellow	2009	3800230621214
Width:	8mm			



120 LED/M **A+**
7.2W 3528 - WP

600
lm/M

IP65
RATED



LED Type:	3528	Color:	SKU Code:	EAN Code:
Watt/M:	7.2W	White	2037	3800230621290
Current/M:	0.6A	Warm White	2038	3800230621313
Voltage:	DC:12V	Day White	2044	3800230621337
LED Qty:	120	Red	2039	3800230621375
lm/LED:	5lm -6lm	Blue	2027	3800230621351
Beam Angle:	120°			
IP Rating:	IP65			
Width:	8mm			



120 LED/M **A+**
7.2W 3528 - NON WP

600
lm/M

IP20
RATED



LED Type:	3528	Color:	SKU Code:	EAN Code:
Watt/M:	7.2W	White	2002	3800230621283
Current/M:	0.6A	Warm White	2025	3800230621306
Voltage:	DC:12V	Day White	2042	3800230621320
LED Qty:	120	Red	2030	3800230621368
lm/LED:	5lm -6lm			
Beam Angle:	120°			
IP Rating:	IP20			
Width:	8mm			

LED Strip Lights



www.v-tac.eu | www.vtacexports.com



204 LED/M **A+**
18W 3014 - NON WP



LED Type:	3014	Color:	SKU Code:	EAN Code:
Watt/M:	18W	White	2403	3800230628053
Current/M:	1.5A	Warm White	2404	3800230628060
Voltage:	DC:12V	Day White	2405	3800157600309
LED Qty:	204			
lm/LED:	9-11lm			
Beam Angle:	120°			
IP Rating:	IP20			
Width:	10mm			



60 LED/M **A+**
RGB + W
10.8W 5050 - NON WP



LED Type:	5050	Color:	SKU Code:	EAN Code:
Watt/M:	10.8W	RGB	2159(RGB+W)	3800230629623
Current/M:	1.2A			
Voltage:	DC:12V			
LED Qty:	30:30			
lm/LED:	15lm			
Beam Angle:	120°			
IP Rating:	IP20			
Width:	10mm			



60 LED/M **A+**
9W 5050 - NON WP



LED Type:	5050	Color:	SKU Code:	EAN Code:
Watt/M:	9W	White	2430	3800230621566
Current/M:	0.3A	Warm White	2431	3800230621573
Voltage:	DC:24V	Day White	2459	3800157612036
LED Qty:	60			
lm/LED:	14lm-16lm			
Beam Angle:	120°			
IP Rating:	IP20			
Width:	10mm			



CE/EMC

2 YEAR **WARRANTY**



INTRODUCING

LED NEON FLEX



10M ROLL

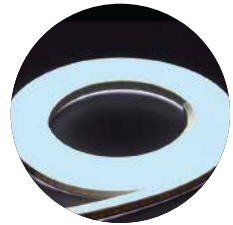
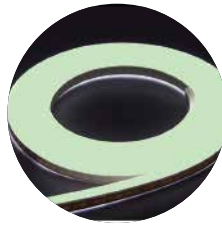

Model No:	VT-555	VT-555	VT-555
SKU Code:	2512	2513	2514
Color / Temperature:	White	Warm White	Day White
Lumen lm/M:	320±5%	320±5%	320±5%
FPC Width MM:	7.5	7.5	7.5
Power W/M:	8-10W	8-10W	8-10W
Jacket Dia:	9 x16.5 mm	9 x16.5 mm	9 x16.5 mm
EAN Code:	3800157605656	3800157605663	3800157605670



10M ROLL

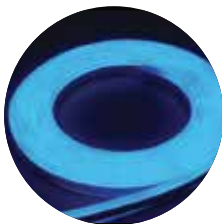

Model No:	VT-555	VT-555	VT-555
SKU Code:	2515	2516	2517
Color / Temperature:	Blue	RED	Green
Lumen lm/M:	320±5%	320±5%	320±5%
FPC Width MM:	7.5	7.5	7.5
Power W/M:	8-10	8-10	8-10
Jacket Dia:	9 x16.5 mm	9 x16.5 mm	9 x16.5 mm
EAN Code:	3800157605687	3800157605694	3800157605700



Model No:	VT-555	VT-555	VT-555
SKU Code:	2518	2529	2531
Color / Temperature:	Yellow	Pink	Violet
Lumen lm/M:	320±5%	320±5%	320±5%
FPC Width MM:	7.5	7.5	7.5
Power W/M:	8-10	8-10	8-10
Jacket Dia:	9 x16.5 mm	9 x16.5 mm	9 x16.5 mm
EAN Code:	3800157605717	3800157619523	3800157619547



6PCS
INCLUDED



Item:	Profile
SKU Code:	2527
EAN Code:	3800157608404



Item:	Power cord without plug	Pin	End safe cap
SKU Code:	3331	3333	3334
EAN Code:	3800157608268	3800157607889	3800157607896



LED Strip Sets PLUG AND PLAY

LED STRIP LIGHT set is a complete kit where we provide you with 5 meters of LED STRIP LIGHT ,along with the POWER SUPPLY and CONNECTOR and REMOTE CONTROL (optional) ,to make it a complete kit . Available and made in different colour options as per requirement.

- LED Strip
- Remote control (included)
- Driver (included)
- Packing: Blister Pack, 5 meters roll

SKU Code:	Description:	EAN Code:
2351	LED Strip Set SMD3528 60 LEDs 4500K IP20	3800230621634
2350	LED Strip Set SMD5050 30 LEDs RGB IP20	3800230621641
2352	LED Strip Set SMD5050 30 LEDs RGB IP65	3800230621658
2353	LED Strip Set SMD5050 60 LEDs RGB IP20	3800230621665
2354	LED Strip Set SMD5050 60 LEDs RGB IP65	3800230621672
2355	LED Strip Set SMD5050 60 LEDs White IP20	3800230621689
2356	LED Strip Set SMD5050 60 LEDs White IP65	3800230621696

LED Strip ACCESSORIES



SKU Code:	Description:	EAN Code:
3500	Flexible Connector - LED Strip 3528	3800230622051
3501	Flexible Connector - LED Strip 5050	3800230622068
3502	Flexible Connector - LED Strip 5050 RGB	3800230622075
3503	Connector - LED Strip 3528	3800230622082
3504	Connector - LED Strip 5050	3800230622099
3505	Connector - LED Strip 5050 RGB	3800230622105
3507	Flexible Connector - LED Strip 3528 DC Female	3800230622112
3508	Flexible Connector - LED Strip 5050 DC Female	N/A
3509	Connector - LED Strip 3528 Cross Type	N/A
3510	Connector - LED Strip 5050 Cross Type	N/A
3511	Connector - LED Strip 5050 L Type	N/A
3512	Connector - LED Strip DC Female	N/A

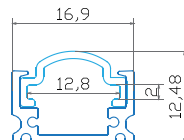
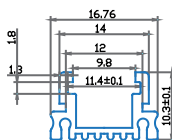
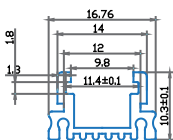

Aluminum Profiles

Model No:	VT-7101	VT-7101	VT-7102
SKU Code	9981	9982	9983
Dimension:	16.76 x 10.3 x 1000 mm	16.76 x 10.3 x 1000 mm	16.9 x 12.48 x 1000 mm
Color of Fixture:	Transparent	Matt	Transparent
EAN Code:	3800230622129	3800230622136	3800230622143

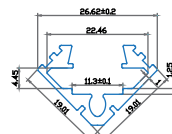
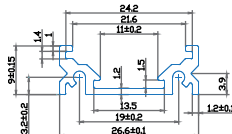
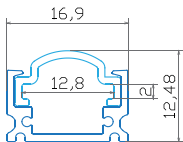
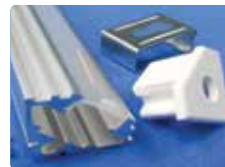

Aluminum Profiles

Model No:	VT-7102	VT-7103	VT-7104
SKU Code	9984	Transparent: 9985 / Matt : 9986	9987
Dimension:	16.9 x 12.48 x 1000 mm	26.5 x 9 x 1000 mm	19 x 19 x 1000 mm
Color of Fixture:	Matt	Transparent / Matt	Matt
EAN Code:	3800230622150	Transparent : 3800230622167 Matt: 3800230622174	3800230622181

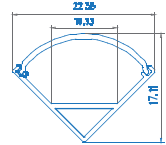
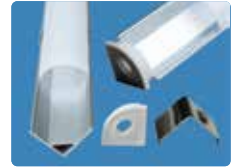
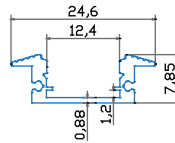
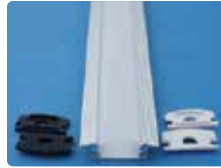
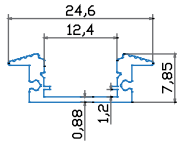

Aluminum Profiles

Model No:	VT-7105	VT-7105	VT-7109
SKU Code	9990	9991	9947
Dimension:	24.6 x 7.85 x 1000 mm	24.6 x 7.85 x 2000 mm	22x17x1000mm
Color of Fixture:	Milky	Milky	Milky
EAN Code:	3800230628077	3800230628794	3800157617208

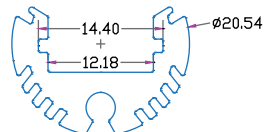
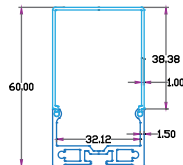
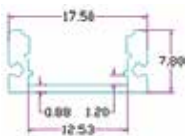
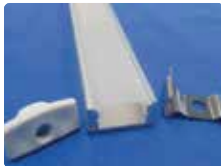

Aluminum Profiles

Model No:	VT-7106	VT-7107	VT-7108
SKU Code	1000mm:9992 / 2000mm: 9993	9994	9995
Dimension:	17.5 x 7.8 x1000 / 2000 mm	60 x 35.1 x 1000 mm	ø20.54 x 1000 mm
Color of Fixture:	Milky / Milky	Milky	Milky
EAN Code:	1000mm : 3800230628800 2000mm : 3800230628817	3800157601399	3800157601405

**2PCS
PACK**



New!

LED Bar - NON WP

18W VT-4014 144

1700
lm/M

IP20
RATED



Power:	18W	Color:	SKU Code:	EAN Code:
Current:	1.5A	Warm White	2535	3800157625883
Voltage:	12V	Day White	2536	3800157625890
Lumens/LED:	20-24lm/LED	White	2537	3800157625906
LM/M:	1700lm			
Size:	1.0M			
LED Type:	SMD 4014			
IP Rating:	IP20			

**10PCS
PACK**



New!

LED Bar - NON WP

18W VT-4014 144

1700
lm/M

IP20
RATED



Power:	18W	Color:	SKU Code:	EAN Code:
Current:	1.5A	Warm White	2538	3800157625913
Voltage:	12V	Day White	2539	3800157625920
Lumens/LED:	20-24lm/LED	White	2540	3800157625937
LM/M:	1700lm			
Size:	1.0M			
LED Type:	SMD 4014			
IP Rating:	IP20			

**10PCS
PACK**



New!

LED BAR Profile Complete Set

18W VT-4014 144

1700
lm/M

IP20
RATED



LED Type:	18W	Color:	SKU Code:	EAN Code:
Watt/M:	1.5A	Warm White	2541	3800157625944
Current/M:	12V	Day White	2542	3800157625951
Voltage:	20-24lm/LED	White	2543	3800157625968
LED Qty:	1700lm			
lm/LED:	1.0M			
Beam Angle:	SMD 4014			
Width:	12mm			
IP Rating:	IP20			



Strip Controllers

SKU Code:	3300	3303	3304
Model No:	VT-2402	VT-2404	VT-2401
Description:	Dimmer for LED Strip with Remote Control	Radio Controller with Remote Control 4 Buttons	Infrared Controller with Remote Control 24 Buttons
Max Current /Watt:	8A, 96W	12A, 144W	6A, 72W
Input Voltage:	DC 12/24 V	DC 12/24 V	DC 12/24 V
Size:	115 x 55 x 35 mm	105 x 65 x 20 mm	65 x 35 x 22 mm
EAN Code:	3800230622198	3800230622204	3800230622211



Strip Controllers

SKU Code:	3307	3312	3317
Model No:	VT- DMX 512	VT-2405	VT-2401
Description:	DMX 512 Controller	Radio Controller with Touch Remote Control	Infrared Controller with Remote Control 44 Buttons
Max Current /Watt:	4A x3, 360W	3A x4, 144W	6A, 72W
Input Voltage:	DC:12V	DC 12/24 V	DC 12/24 V
Size:	165 x 75 x 25 mm	130 x 65 x 25 mm	125 x 56 x 7 mm
EAN Code:	3800230622266	3800230622273	3800230622228



Strip Controllers

SKU Code:	3625	3318	3320
Model No:	VT-2472	N/A	N/A
Description:	Infrared Controller with Remote Control 24 Buttons	Radio Controller with Remote Control	Mini RF Controller
Max Current /Watt:	6A, 72W	500W	N/A
Input Voltage:	DC 12/24 V	DC:12V	DC:12V
Size:	N/A	120 x 75 x 25 mm	N/A
EAN Code:	3800157609920	3800230622235	3800230628022



Strip Controllers

SKU Code:	3319	3321	3663
Model No:	N/A	N/A	VT-2410
Description:	24B Mini Controller	Wi-Fi Single Controller	Wi-Fi Single Controller
Max Current /Watt:	N/A	N/A	6A 216W/432W
Input Voltage:	DC:12V	DC:12V	DC 12/24 V
EAN Code:	3800230628015	3800230628039	3800157619509



Strip Controllers

SKU Code:	3322	3326	3327
Description:	Wi-Fi RGB Controller	5050 60 RGB with LED Controller	RGB+W Amplifier
Input Voltage:	DC:12V	DC:12V	DC:12V
EAN Code:	3800230628046	3800230629630	3800157601047



Strip Controllers

SKU Code:	3328	3009	3018
Description:	360W RF Controller	5050 RGB Strip Amplifier	5050 RGB Strip Mini-Amplifier
Input Voltage:	DC:12V	DC:12V	DC:12V
EAN Code:	3800157601054	3800230622259	3800230622242



Complete range of modules for
SIGNAGE INDUSTRY

Model No:	VT-50503
Watts:	0.72W/PC
Lumens:	66lm/PC
Beam Angle:	160 °
CRI:	75
Voltage/Frequency:	DC:12V
Unit Size:	67 x 15 x 8.5mm
IP Rating:	IP67
Material:	ABS + PCB

SKU Code:	EAN Code:
WHITE: 5116	3800157610209
RED: 5117	3800157610216
BLUE: 5118	3800157610223
BLACK: 5119	3800157610230



Model No:	VT-28353
Watts:	1W/PC
Lumens:	100lm/PC
Beam Angle:	120 °
CRI:	75
Voltage/Frequency:	DC:12V
Unit Size:	53x12x4.6mm
IP Rating:	IP67
Material:	ABS+Aluminum Plate

SKU Code:	EAN Code:
WHITE: 5120	3800157610247
RED: 5121	3800157610254
BLUE: 5122	3800157610261
GREEN: 5123	3800157610278





Model No:	VT-28356
Watts	1.5
Voltage/Frequency	DC 12V
Luminous Flux	120-150lm
LED Type	SMD2835
CRI	>75
Beam Angle	120°
Color of Fixture	White
Body Type	ABS+Aluminium
Dimension	87 x 15 x 10mm
IP Rating	IP67

SKU Code:	EAN Code:
WARM WHITE: 5124	3800157621687
WHITE: 5125	3800157621694
RED: 5126	3800157621700
BLUE: 5127	3800157621717
GREEN: 5128	3800157621724



Model No:	VT-28358
Watts	1.44
Voltage/Frequency	DC 12V
Luminous Flux	120-135lm
LED Type	SMD2835
CRI	>75
Beam Angle	160°
Color of Fixture	White
Body Type	ABS+Aluminum
Dimension	37x 37 x 6.8mm
IP Rating	IP68

SKU Code:	EAN Code:
WARM WHITE: 5129	3800157621731
WHITE: 5130	3800157621748
RED: 5131	3800157621755
BLUE: 5132	3800157621762
GREEN: 5133	3800157621779



Model No:	VT-50501
Watts	0.24
Voltage/Frequency	DC 12V
Luminous Flux	20-22lm
LED Type	SMD5050
CRI	>75
Beam Angle	120°
Body Type	PVC
IP Rating	IP68

SKU Code:	EAN Code:
WARM WHITE: 5135	3800157621793
WHITE: 5136	3800157621809
RED: 5137	3800157621816
YELLOW: 5138	3800157621823
BLUE: 5139	3800157621830
GREEN: 5140	3800157621847



Model No:	VT-50506
Watts	0.72
Voltage/Frequency	DC 12V
Luminous Flux	20-22lm
LED Type	SMD5050
CRI	>75
Beam Angle	120°
Body Type	ABS + PCB
Dimension	68 x 19.5 x 5.7mm
IP Rating	IP67

SKU Code:	EAN Code:
RGB: 5134	3800157621786

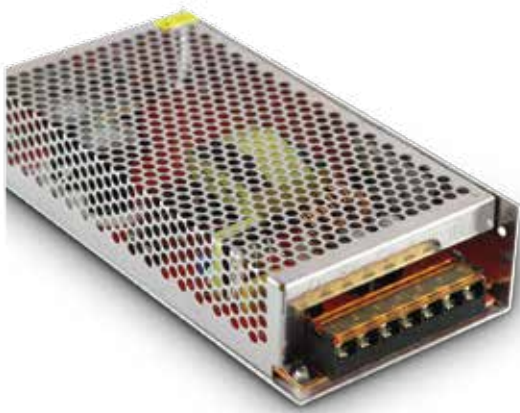

LED Strip Power Supply Metal Driver (SMPS) Series

Product Features:

- Switching Metal Power Supply for all types of strip lights, led lighting , led display , etc
- With short circuit protection, over load protection , stable output voltage
- Built in EMI Filter
- High efficiency , low temperature
- 100% load tested
- Protection Rating : IP20
- CE, ROHS, EMC approved

Model:	SKU Code:	Watts	Current Capacity	Output	Unit Size	EAN Code:
VT-20025	3050	25W	2.1A	DC:12V	85x 58 x 34 mm	3800230621726
VT-20040	3058	40W	3.3A	DC:12V	108 x 78 x 35 mm	3800230625731
VT-20045	3051	45W	3.8A	DC:12V	110 x 78 x 35 mm	3800230621733
VT-20060	3052	60W	5A	DC:12V	110 x 78 x 36 mm	3800230621740
VT-20075	3053	75W	6A	DC:12V	160 x 98 x 38 mm	3800230621757
VT-20100	3060	100W	8.3A	DC:12V	199 x 98 x 42 mm	3800230625755
VT-20120	3054	120W	10A	DC:12V	160 x 98 x 42 mm	3800230621764
VT-20150	3055	150W	12.5A	DC:12V	199 x 98 x 42 mm	3800230621771
VT-20200	3061	200W	16.5A	DC:12V	200 x 110 x 50 mm	3800230625762
VT-20250	3056	250W	20A	DC:12V	200 x 110 x 50 mm	3800230621788
VT-20350	3057	350W	30A	DC:12V	215 x 115 x 50 mm	3800230621795
VT-20500	3062	500W	42A	DC:12V	215 x 115 x 50 mm	3800157608411

New!

LED Strip Power Supply

Metal Driver (SMPS) Series



Model:	SKU Code:	Watts	Current Capacity	Output	Unit Size	EAN Code:
VT-20026	3228	25W	2.1A	DC:12V	140 x 33 x 27mm	3800157622929
VT-20061	3229	60W	5A	DC:12V	160 x 40 x 32mm	3800157622936
VT-20076	3230	75W	6A	DC:12V	188 x 47 x 35mm	3800157622943
VT-20121	3226	120W	10A	DC:12V	188 x 47 x 35mm	3800157622905
VT-20151	3227	150W	12.5A	DC:12V	200 x 58 x 40mm	3800157622912

LED Strip Power Supply

Rainproof Power Supply Series

Product Features:

- RAIN PROOF DRIVER for all types of STRIP LIGHTS, LED LIGHTING, LED DISPLAY, etc.
- Industrial specifications and standards.
- With short circuit protection, over load protection and stable output voltage.
- Built in EMI Filter.
- High efficiency and low temperature.
- 100% load tested.
- Protection Rating: IP44
- CE, ROHS and EMC approved.



Model:	SKU Code:	Watts	Current Capacity	Output	Unit Size	EAN Code:
VT-21060	3070	60W	5A	DC:12V	155 x 105 x 50 mm	3800230621801
VT-21080	3069	80W	6.6A	DC:12V	155 x 105 x 50 mm	3800230621818
VT-21120	3071	120W	10A	DC:12V	195 x 115 x 53 mm	3800230621825
VT-21150	3072	150W	12.5A	DC:12V	195 x 115 x 53 mm	3800230621832
VT-21250	3073	250W	20A	DC:12V	233 x 153 x 66 mm	3800230621856
VT-21300	3081	300W	25A	DC:12V	233 x 153 x 66 mm	3800157601542
VT-21400	3074	400W	33A	DC:12V	233 x 153 x 66 mm	3800230621863

24V

VT-21080	3075	80W	3.3A	DC:24V	155 x 105 x 50 mm	3800230621870
VT-21150	3076	150W	6.2A	DC:24V	195 x 115 x 53 mm	3800230621880
VT-21200	3078	200W	8.3A	DC:24V	233 x 153 x 66mm	3800230621849
VT-21400	3077	400W	16.6A	DC:24V	232 x 153 x 65 mm	3800230621894

IP65
RATED



LED Strip Power Supply

Waterproof Power Supply Series

Product Features:

- WATERPROOF DRIVER for all types of STRIP LIGHTS , LED LIGHTING , LED DISPLAY , etc.
- Industrial specifications and standards .
- With short circuit protection, over load protection and stable output voltage.
- Built in EMI Filter .
- High efficiency and low temperature.
- 100% load tested.
- Protection Rating: IP65.
- CE, ROHS, EMC approved

Model:	SKU Code:	Watts	Current Capacity	Output	Unit Size	EAN Code:
VT-22030	3100	30W	2.5A	DC:12V	201 x 30.5 x 20 mm	3800230621900
VT-22045	3090	45W	3.75A	DC:12V	250 x 40 x 23 mm	3800230621917
VT-22060	3091	60W	5A	DC:12V	180 x 72 x 45 mm	3800230621924
VT-22100	3092	100W	8.5A	DC:12V	253 x 72 x 45 mm	3800230621931
VT-22120	3093	120W	10A	DC:12V	253 x 72 x 45 mm	3800230621948
VT-22150	3094	150W	12.5A	DC:12V	253 x 72 x 45 mm	3800230621955
VT-22200	3098	200W	16.6A	DC:12V	200 x 120 x 53 mm	3800230625779
VT-22300	3219	300W	25A	DC:12V	201 x 30.5 x 20 mm	3800157604932
VT-22360	3099	360W	30A	DC:12V	256 x 102 x 65 mm	3800230625786

24V

VT-22020	3214	20W	0.83A	DC:24V	201 x 30.5 x 20 mm	3800230621962
VT-22030	3215	30W	1.25A	DC:24V	201 x 30.5 x 20 mm	3800230629562
VT-22045	3095	45W	1.88A	DC:24V	250 x 40 x 23 mm	3800230621979
VT-22101	3101	100W	4.2A	DC:24V	201 x 30.5 x 20 mm	3800157605991
VT-22150	3096	150W	6.25A	DC:24V	253 x 72 x 45 mm	3800230621986
VT-22200	3097	200W	8.3A	DC:24V	231 x 120 x 53 mm	3800230621993



LED STRIP POWER SUPPLY

Plastic Adaptor Series

Product Features:

- Plastic DRIVER for all types of STRIP LIGHTS, LED LIGHTING, LED DISPLAY, etc.
- With specifications and Industrial standards.
- With short circuit protection, over load protection and stable output voltage.
- Built in EMI Filter.
- High efficiency and low temperature.
- 100% load tested.
- Protection Rating: IP 20.
- CE, Rosh, EMC approved.
- Options available with BS STANDARD 3 PIN PLUG.

Model:	SKU Code:	Watts	Current Capacity	Output	Voltage / Frequency	EAN Code:
VT-23018	3017	18W	1.5A	DC:12V	AC 110-240V, 50/60Hz	3800230622006
VT-23002 *	3030	24W	2A	DC:12V	AC 85-240V, 50/60Hz	3800230625298
VT-23030	3007	30W	2.5A	DC:12V	AC 110-240V, 50/60Hz	3800230622013
VT-23042	3016	42W	3.5A	DC:12V	AC 110-240V, 50/60Hz	3800230622020
VT-23003 *	3031	42W	3.5A	DC:12V	AC 85-240V, 50/60Hz	3800230625304
VT-23060	3008	60W	5A	DC:12V	AC 110-240V, 50/60Hz	3800230622037
VT-23005*	3032	60W	5A	DC:12V	AC 85-240V, 50/60Hz	3800230625311
VT-23080	3019	78W	6.5A	DC:12V	AC 110-240V, 50/60Hz	3800230622044



Plastic Adaptor Series (EMC Approved)



Model:	SKU Code:	Watts	Current Capacity	Output	Voltage / Frequency	EAN Code:
VT-23024	3036	24W	2A	DC:12V	AC 110-240V, 50/60Hz	3800157601474
VT-23024 W*	3038	24W	2A	DC:12V	AC 110-240V, 50/60Hz	3800157601535
VT-23060	3035	60W	5A	DC:12V	AC 110-240V, 50/60Hz	3800157601085
VT-23060 *	3037	60W	5A	DC:12V	AC 110-240V, 50/60Hz	3800157601528
VT-23078	3034	78W	6.5A	DC:12V	AC 110-240V, 50/60Hz	3800157601078



LED Track Lights

Perfect ecological alternative to Old Halogen Lights, Track lights are the extensive range of modern LED Track Lights! Delivering high performance, excellent durability and remarkable light output to serve the general Commercial and Retail market.

Product Features

- Available from 10W up to 45W
- Saves 80% energy
- No Ultraviolet or Infrared Rays
- Totally flexible, Compact & Adjustable design
- No Lead or Mercury content hence environment friendly
- Provides Uniform Radiance & Enhances appeal of any environment.
- Enhances measurable levels of performance as compared to older versions of high wattage halogen & HID light sources in retail & Commercial Lighting applications.

Applications

- Perfect choice for Exhibition Stands, Hotels, Bars, Commercial & Residential Lighting.





15-60 Degree Beam Angle Adjustable by Rotating

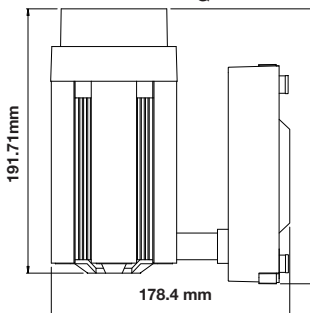
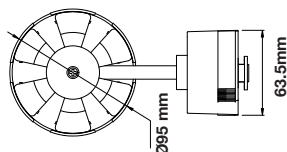
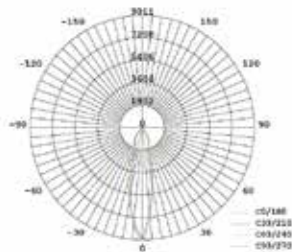

New!

COB Series

35W VT-4735

EAN Code

1357 - 3000K Warm White

3800157625074

1358 - 4000K Day White

3800157625081

1359 - 6400K White

3800157625098



Sensor Compatible:	Yes	PF:	>0.9
Voltage/Frequency:	AC 220~240V, 50/60Hz	Beam Angle:	15°-60° (Adjustable)
Luminous Flux:	2800lm	Color of Fixture:	White
LED Type:	CREE COB	Body Type:	Aluminium
CRI:	>80	Dimension:	178.4 x 197.7 x95mm



COB Series

10W VT-4512

- 1332 - 3000K Warm White
- 1333 - 4000K Day White
- 1334 - 6400K White

EAN Code

- 3800157620604
- 3800157620611
- 3800157620628



Sensor Compatible:	Yes	PF:	>0.9
Voltage/Frequency:	AC:220-240V,50/60Hz	Beam Angle:	24°
Luminous Flux:	800lm	Color of Fixture:	Black + White
LED Type:	COB	Body Type:	Aluminum
CRI:	>80		

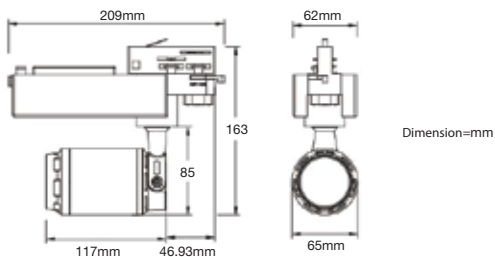
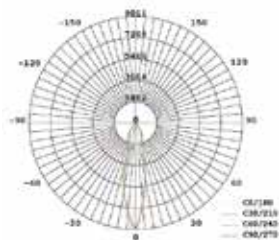

COB Series

25W VT-4528

- 1335 - 3000K Warm White
- 1336 - 4000K Day White
- 1337 - 6400K White

EAN Code

- 3800157620635
- 3800157620642
- 3800157620659



Sensor Compatible:	Yes	PF:	>0.9
Voltage/Frequency:	AC:220-240V,50/60Hz	Beam Angle:	24°
Luminous Flux:	2100lm	Color of Fixture:	Black + White
LED Type:	COB	Body Type:	Aluminum
CRI:	>80		

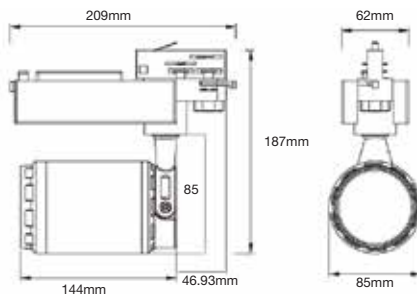
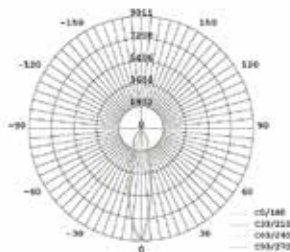

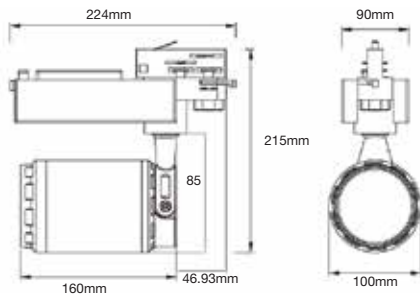
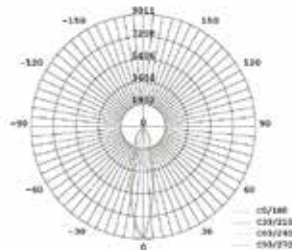

COB Series

35W VT-4537

- 1338 - 3000K Warm White
- 1339 - 4000K Day White
- 1340 - 6400K White

EAN Code

- 3800157620666
- 3800157620673
- 3800157620680



Sensor Compatible:	Yes	PF:	>0.9
Voltage/Frequency:	AC:220-240V,50/60Hz	Beam Angle:	24°
Luminous Flux:	2850lm	Color of Fixture:	Black + White
LED Type:	COB	Body Type:	Aluminum
CRI:	>80		



COB Series

15W VT-4615

- 1298 - 3000K Warm White
- 1299 - 4000K Day White
- 1300 - 6400K White

EAN Code

- 3800157619851
- 3800157619868
- 3800157619875



Sensor Compatible:	Yes	PF:	>0.9
Voltage/Frequency:	AC:220-240V,50/60Hz	Beam Angle:	24°
Luminous Flux:	1350lm	Color of Fixture:	White
LED Type:	COB	Body Type:	Aluminum
CRI:	>95	Dimension:	180 x 97 x 155mm

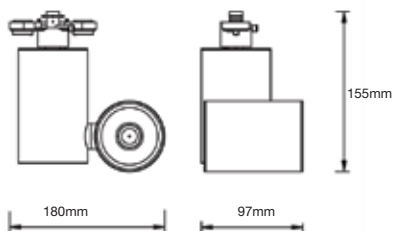
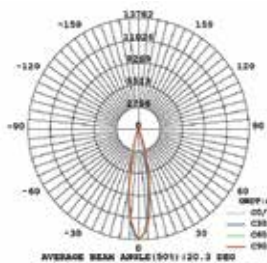

COB Series

15W VT-4615

- 1301 - 3000K Warm White
- 1302 - 4000K Day White
- 1303 - 6400K White

EAN Code

- 3800157619882
- 3800157619899
- 3800157619905



Sensor Compatible:	Yes	PF:	>0.9
Voltage/Frequency:	AC:220-240V,50/60Hz	Beam Angle:	24°
Luminous Flux:	1350lm	Color of Fixture:	Black
LED Type:	COB	Body Type:	Aluminum
CRI:	>95	Dimension:	180 x 97 x 155mm

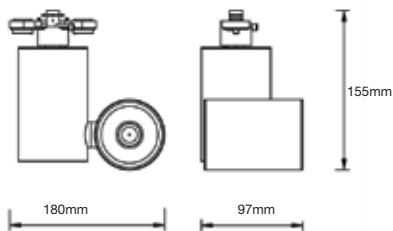
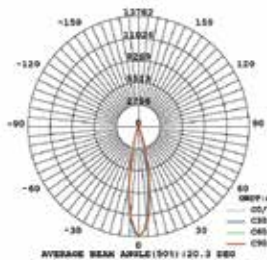



COB Series

30W VT-4635

1292 - 3000K Warm White

1293 - 4000K Day White

1294 - 6400K White

EAN Code

3800157619790

3800157619806

3800157619813



Sensor Compatible:	Yes	PF:	>0.9
Voltage/Frequency:	AC:220-240V,50/60Hz	Beam Angle:	24°
Luminous Flux:	2700lm	Color of Fixture:	White
LED Type:	COB	Body Type:	Aluminum
CRI:	>95	Dimension:	180 x 140 x 215mm

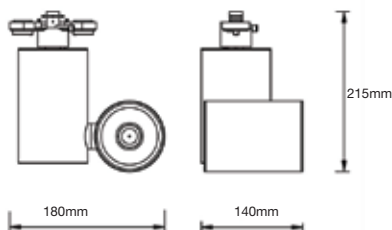
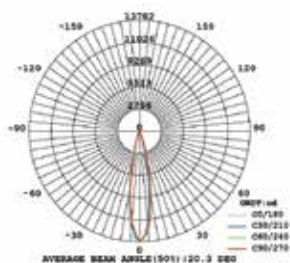

COB Series

30W VT-4635

1295 - 3000K Warm White

1296 - 4000K Day White

1297 - 6400K White

EAN Code

3800157619820

3800157619837

3800157619844



Sensor Compatible:	Yes	PF:	>0.9
Voltage/Frequency:	AC:220-240V,50/60Hz	Beam Angle:	24°
Luminous Flux:	2700lm	Color of Fixture:	Black
LED Type:	COB	Body Type:	Aluminum
CRI:	>95	Dimension:	180 x 140 x 215mm

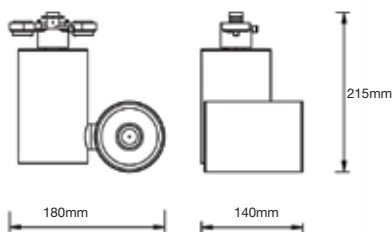
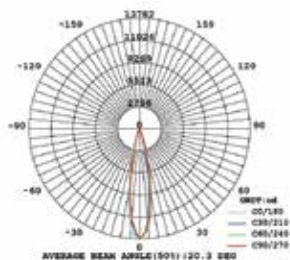



LUMINOUS INTENSITY DISTRIBUTION

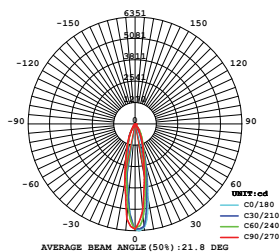

SUITABLE FOR 4-LINE TRACKS

FITS INTO ANY EUROPEAN STANDARD 3-PHASE TRACK

4-Line Tracks

33W VT-4535

1233 - 3000K Warm White

1234 - 4000K Day White

1235 - 5000K White

EAN Code

3800157603720

3800157603737

3800157603744

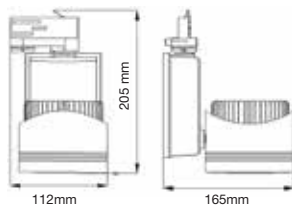

112mm

205mm

165mm



Sensor Compatible:	Yes	PF:	> 0.9
Voltage/Frequency:	AC: 100-240V,50/60Hz	Beam Angle:	25°
Luminous Flux:	1800lm	Color of Fixture:	Black
LED Type:	SMD	Body Type:	Die Cast Aluminum
CRI:	> 95	Dimension:	112 x 165 x 205mm



Experience The True Colors with CRI95 TRACKS



LUMINOUS INTENSITY DISTRIBUTION

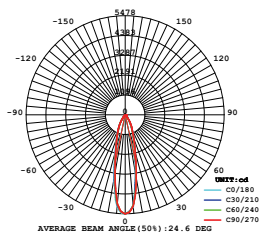

SUITABLE FOR 4-LINE TRACKS

FITS INTO ANY EUROPEAN STANDARD 3-PHASE TRACK

4-Line Tracks

45W VT-4545

1236 - 3000K Warm White

1237 - 4000K Day White

1238 - 5000K White

EAN Code

3800157603751

3800157603768

3800157603775

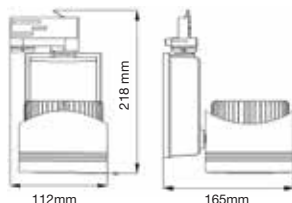

112mm

218mm

165mm



Sensor Compatible:	Yes	PF:	>0.9
Voltage/Frequency:	AC: 100-240V,50/60Hz	Beam Angle:	25°
Luminous Flux:	2300lm	Color of Fixture:	Black
LED Type:	COB	Body Type:	Die Cast Aluminum
CRI:	>95	Dimension:	112 x 165 x 218mm



4-LINE TRACK

23W VT-4521T

1202 - 5000K White

EAN Code
3800157600187

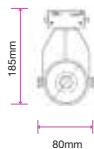

Sensor Compatible:	Yes	PF:	>0.9
Voltage/Frequency:	AC:100-240V,50/60Hz	Beam Angle:	46°
Luminous Flux:	1500lm	Color of Fixture:	Black
LED Type:	COB	Body Type:	Die Cast Aluminum
CRI:	>80	Dimension:	80 x 185mm



4-LINE TRACK

23W VT-4521T

1201 - 5000K White

EAN Code
3800157600170

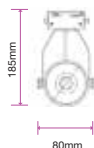

Sensor Compatible:	Yes	PF:	>0.9
Voltage/Frequency:	AC:100-240V,50/60Hz	Beam Angle:	46°
Luminous Flux:	1500lm	Color of Fixture:	White
LED Type:	COB	Body Type:	Die Cast Aluminum
CRI:	>80	Dimension:	80 x 185mm



4-LINE TRACK

35W VT-4540T

1191 - 3000K Warm White
1192 - 4000K Day White

EAN Code
3800230629548
3800230629555

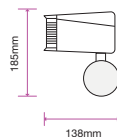

Sensor Compatible:	Yes	PF:	>0.9
Voltage/Frequency:	AC:220-240V,50/60Hz	Beam Angle:	22°
Luminous Flux:	2600lm	Color of Fixture:	Black
LED Type:	COB	Body Type:	Aluminum
CRI:	>70	Dimension:	225 x 185 x 138mm



4-LINE TRACK

33W VT-4534

EAN Code

- 1242 - 3000K Warm White
- 1231 - 4000K Day White
- 1232 - 5000K White

- 3800157604000
- 3800157602525
- 3800157602532



Sensor Compatible:	Yes	PF:	>0.9
Voltage/Frequency:	AC:220-240V,50/60Hz	Beam Angle:	22°
Luminous Flux:	2300lm	Color of Fixture:	Black
LED Type:	COB	Body Type:	Die Cast Aluminum
CRI:	>80	Dimension:	106 x 208 x 206mm

LUMINOUS INTENSITY DISTRIBUTION

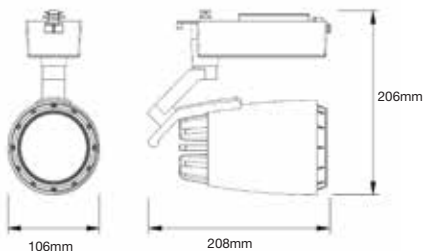
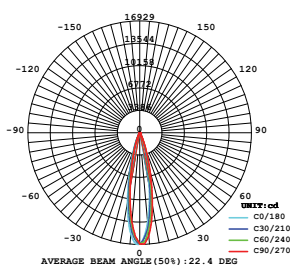

4-LINE TRACK

33W VT-4534

EAN Code

- 1241 - 3000K Warm White
- 1229 - 4000K Day White
- 1230 - 5000K White

- 3800157603997
- 3800157602501
- 3800157602518



Sensor Compatible:	Yes	PF:	>0.9
Voltage/Frequency:	AC:220-240V,50/60Hz	Beam Angle:	22°
Luminous Flux:	2300lm	Color of Fixture:	White
LED Type:	COB	Body Type:	Die Cast Aluminum
CRI:	>80	Dimension:	106 x 208 x 206mm

LUMINOUS INTENSITY DISTRIBUTION

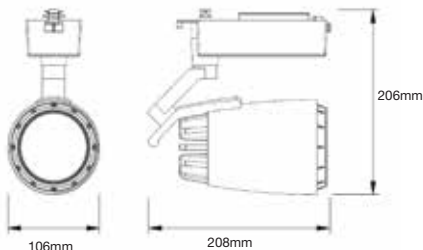
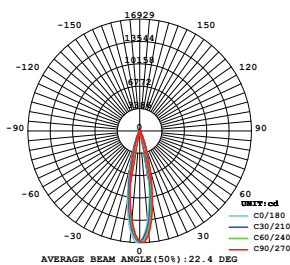



4-LINE TRACK

45W VT-4546

EAN Code

- 1249 - 3000K Warm White
- 1250 - 4500K Day White
- 1251 - 6000K White

- 3800157607490
- 3800157607505
- 3800157607513



Sensor Compatible:	Yes	PF:	>0.95
Voltage/Frequency:	AC:220-240V,50/60Hz	Beam Angle:	20°
Luminous Flux:	3250lm	Color of Fixture:	White
LED Type:	COB	Body Type:	PC + Aluminum
CRI:	>80	Dimension:	110 x 255mm

LUMINOUS INTENSITY DISTRIBUTION

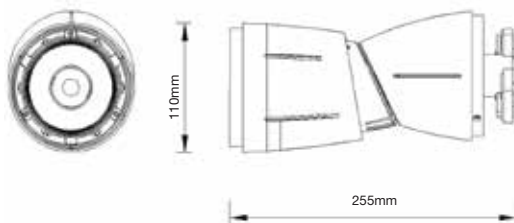
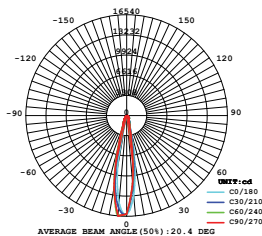

4-LINE TRACK

45W VT-4546

EAN Code

- 1252 - 3000K Warm White
- 1253 - 4500K Day White
- 1254 - 6000K White

- 3800157607520
- 3800157607537
- 3800157607544



Sensor Compatible:	Yes	PF:	>0.95
Voltage/Frequency:	AC:220-240V,50/60Hz	Beam Angle:	20°
Luminous Flux:	3250lm	Color of Fixture:	White
LED Type:	COB	Body Type:	PC + Aluminum
CRI:	>80	Dimension:	110 x 255mm

LUMINOUS INTENSITY DISTRIBUTION

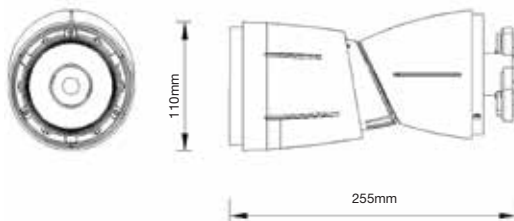
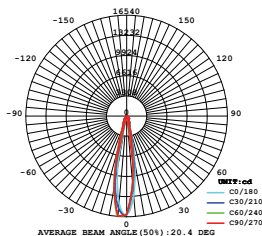



4-LINE TRACK

35W VT-4536

- 1255 - 3000K Warm White
- 1256 - 4500K Day White
- 1257 - 6000K White

EAN Code

- 3800157607551
- 3800157607568
- 3800157607575



Sensor Compatible:	Yes	PF:	>0.9
Voltage/Frequency:	AC:220-240V,50/60Hz	Beam Angle:	24°
Luminous Flux:	3500lm	Color of Fixture:	White
LED Type:	COB	Body Type:	Aluminum
CRI:	>80	Dimension:	92 x 165 x 192mm

LUMINOUS INTENSITY DISTRIBUTION

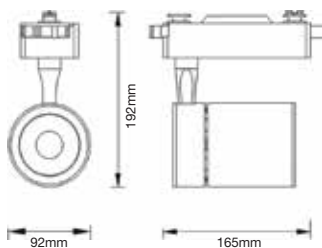
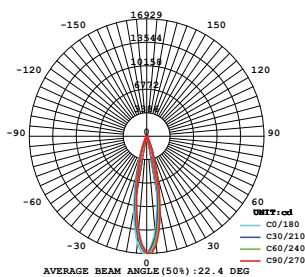

4-LINE TRACK

35W VT-4536

- 1285 - 3000K Warm White
- 1286 - 4000K Day White
- 1287 - 6000K White

EAN Code

- 3800157618694
- 3800157618700
- 3800157618717



Sensor Compatible:	Yes	PF:	>0.9
Voltage/Frequency:	AC:220-240V,50/60Hz	Beam Angle:	24°
Luminous Flux:	3500lm	Color of Fixture:	White
LED Type:	COB	Body Type:	Aluminum
CRI:	>80	Dimension:	92 x 165 x 192mm

LUMINOUS INTENSITY DISTRIBUTION

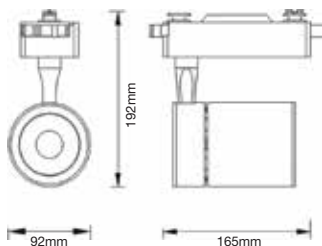
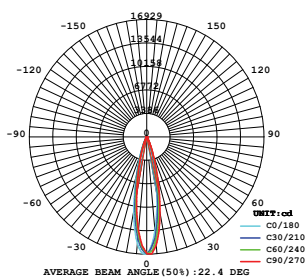

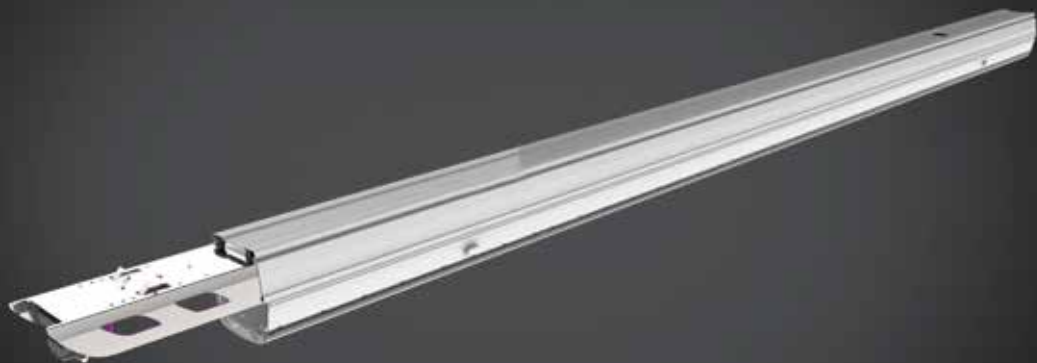

90°
LENS



120°
LENS



Double Asymmetric
LENS

LED Linear Follow Trunking
90° Lens

SKU Code **1363 - 4000K Day White**
EAN Code 3800157625678

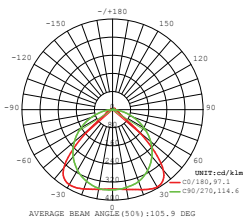

LED Linear Follow Trunking
120° Lens

SKU Code **1364 - 4000K Day White**
EAN Code 3800157625685

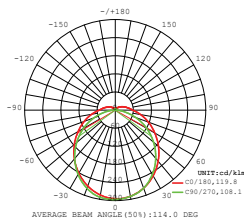

LED Linear Follow Trunking
Double Asymmetric Lens

SKU Code **1365 - 4000K Day White**
EAN Code 3800157625692

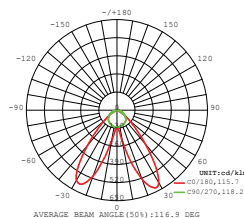

New!

50W VT-4550D

Sensor Compatible:	Yes	Color of Fixture:	White
Voltage/Frequency:	AC:180-240V	Body Type:	Steel
Luminous Flux:	8000lm	Dimension:	1500mm
LED Type:	SMD	ON/OFF Time:	>15000 Times
CRI:	>80	Life Span:	50000 Hours
PF:	>0.9		

A++

160⁺⁺
LM/W
HIGH LUMENS



CE/EMC

2 YEAR WARRANTY

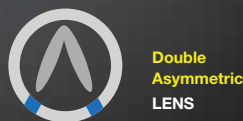
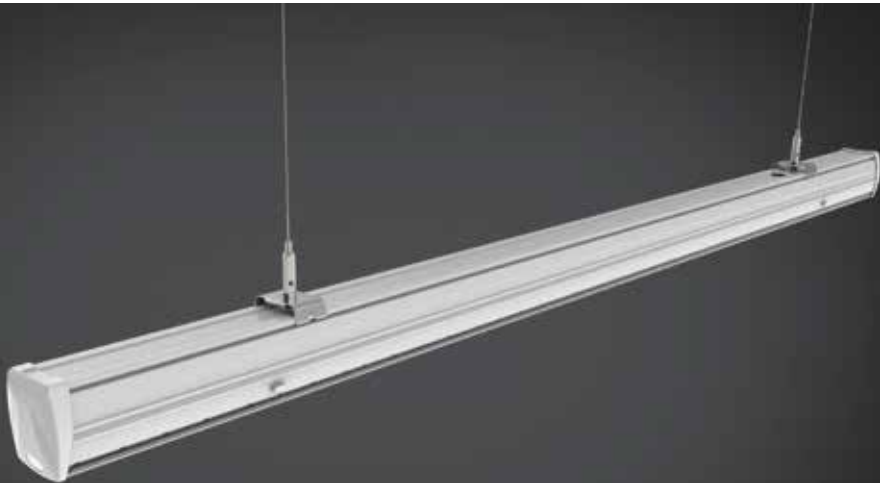

**LED Linear Master Trunking
90° Lens**

SKU Code **1360 - 4000K Day White**
EAN Code 3800157625647

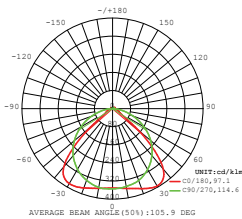

**LED Linear Master Trunking
120° Lens**

SKU Code **1361 - 4000K Day White**
EAN Code 3800157625654

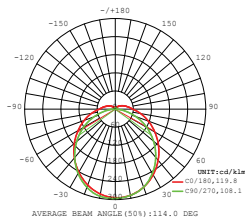

**LED Linear Master Trunking
Double Asymmetric Lens**

SKU Code **1362 - 4000K Day White**
EAN Code 3800157625661

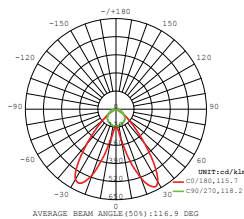

New!

50W VT-4551D

Sensor Compatible:	Yes	Color of Fixture:	White
Voltage/Frequency:	AC:180-240V	Body Type:	Steel
Luminous Flux:	8000lm	Dimension:	1500mm
LED Type:	SMD	ON/OFF Time:	>15000 Times
CRI:	>80	Life Span:	50000 Hours
PF:	>0.9		

A++

160⁺⁺
LM/W
HIGH LUMENS



VT-4549

SKU Code

1382

Description

LED Linear Truncking Tracklight Module

EAN Code

3800157626415



SKU Code

1366

Description

End Cap-white

EAN Code

3800157625708

1367

Suspended Cord-steel

3800157625715

1368

Feed-in Male Connector 5 Wires

3800157625722



SKU Code

1383

Description

L Node Connector,8 Wires

EAN Code

3800157626422

1384

T Node Connector,8 Wires

3800157626439

1385

X Node Connector,8 Wires

3800157626446



Track Fittings

SKU code:	3545	3546	3555
Description:	GU10 Fitting	GU10 Fitting	E27- PAR20 Fitting
Track Line:	2 Line Black	2 Line White	2 Line Black
EAN code:	3800230628305	3800230628312	3800230628404



Track Fittings

SKU code:	3556	3549	3550
Description:	E27- PAR20 Fitting	E27- PAR30 Fitting	E27- PAR30 Fitting
Track Line:	2 Line White	2 Line Black	2 Line White
EAN code:	3800230628411	3800230628343	3800230628350



PAR 20-30-38
Compatible



PAR 20-30-38
Compatible



Track Fittings

SKU code:	3569	3568	3572
Description:	E27- PAR38 Fitting	E27 Fitting	E27 Fitting
Track Line:	2 Line White	2 Line White	2 Line Black
EAN code:	3800157604246	3800157602419	3800157604277



Track Fittings

SKU code:	3544	3543	3554
Description:	GU10 Fitting	GU10 Fitting	E27-PAR20 Fitting
Track Line:	4 Line White	4 Line Black	4 Line White
EAN code:	3800230628299	3800230628282	3800230628398



Track Fittings

SKU code:	3553	3548	3547
Description:	E27- PAR20 Fitting	E27- PAR 30 Fitting	E27- PAR30 Fitting
Track Line:	4 Line Black	4 Line White	4 Line Black
EAN code:	3800230628381	3800230628336	3800230628329



PAR 20-30-38
Compatible



PAR 20-30-38
Compatible



Track Fittings

SKU code:	3570	3567	3574
Description:	E27- PAR38 Fitting	E27 Fitting	E27 Fitting
Track Line:	4 Line White	4 Line White	4 Line Black
EAN code:	3800157604252	3800157602402	3800157604291



SKU Code

3656

3655

Description

4I Track Light Accessory Mini Black

4I Track Light Accessory Mini White

EAN Code

3800157619110

3800157619103



SKU Code

3522

3523

Description

4I Track Light Accessory White

4I Track Light Accessory Black

EAN Code

3800230623232

3800230623195



SKU Code

3524

3525

3526

Description

4T Track Light Accessory Black

4T Track Light Accessory White

4X Track Light Accessory Black

EAN Code

3800230623201

3800230623249

3800230623218



SKU Code	3527	3528	3529
Description	4X Track Light Accessory White	4L Track Light Accessory Black	4L Track Light Accessory White
EAN Code	3800230623256	3800230623225	3800230623263



SKU Code	3635	3636	3637
Description	2I Track Accessory-Black	2I Track Accessory-white	2L Track Accessory-Black
EAN Code	3800157612715	3800157612722	3800157612739



SKU Code	3638	3639
Description	2L Track Accessory-white	2T Track Accessory-Black
EAN Code	3800157612746	3800157612753



SKU Code
Description
EAN Code

3557	130mm 4 Line Black	3800230628428
3558	130mm 4 Line White	3800230628435



SKU Code
Description
EAN Code

3559	Flexible Joint 4 Line Black	3800230628442
3560	Flexible Joint 4 Line White	3800230628459



SKU Code
Description
EAN Code

3565	Hanging Track Line Kit 1m Black	3800157600019
3566	Hanging Track Line Kit 1m White	3800157600026

2 Core
TRACK



SKU Code
Description
EAN Code

3633
2M 2 Core Track-Black
3800157612692

3634
2M 2 Core Track-white
3800157612708

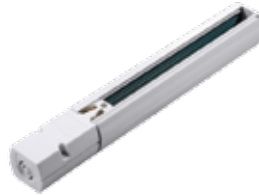

EU Standard

SKU Code
Description
EAN Code

9944
1 Meter Black 4 Core Track
3800230623133

9945
1 Meter White 4 Core Track
3800230623164

9952
1.5 Meters Black 4 Core Track
3800230623140

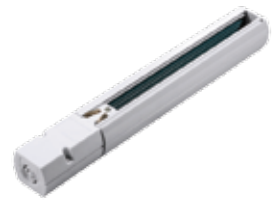
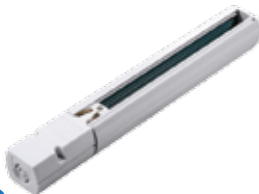

EU Standard

SKU Code
Description
EAN Code

9953
1.5 Meters White 4 Core Track
3800230623171

9954
2 Meters Black 4 Core Track
3800230623157

9955
2 Meters White 4 Core Track
3800230623188

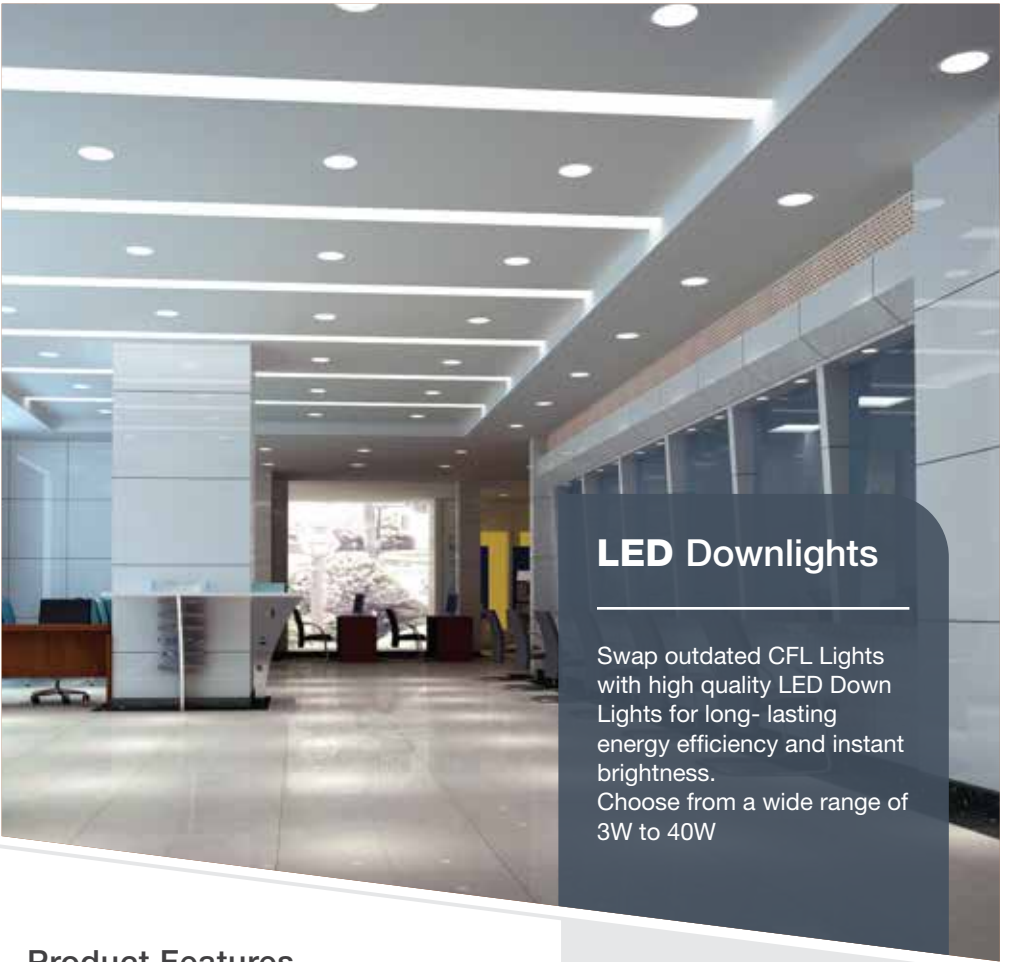

LED Downlights

Swap outdated CFL Lights with high quality LED Down Lights for long- lasting energy efficiency and instant brightness. Choose from a wide range of 3W to 40W

Product Features

- Innumerable styles & Elegant appearance
- Non - Flickering
- No UV Radiation
- Best Quality LED Chips from companies like CREE & SAMSUNG
- Premium Quality Power Driver with lowest power factor saver & high RA
- Easy Installation
- Varied finishes with strong die cast Aluminium body
- Low Maintenance
- All down lights come with premium quality power



Applications

Residences, Showrooms, Hotels & Boutiques etc.



Reflector Downlight

10W VT-26101

- 1270 - 3000K Warm White
- 1271 - 4000K Day White
- 1272 - 6400K White

EAN Code

- 3800157611923
- 3800157611930
- 3800157611947

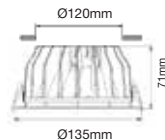

A++ **120⁺⁺** LM/W
HIGH LUMENS

LUMINOUS INTENSITY DISTRIBUTION DIAGRAM

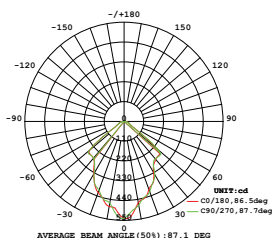

Sensor Compatible:	Yes	Beam Angle:	120 °
Voltage/Frequency:	AC: 100-277V, 50/60Hz	Body Type:	PKW (White)
Luminous Flux:	1200lm	Shape:	Round
LED Type:	COB	Dimension:	Ø 135mm x 71mm
CRI:	>80	Cutting Size:	Ø120mm
PF	> 0.5		



Reflector Downlight

20W VT-26201

- 1273 - 3000K Warm White
- 1274 - 4000K Day White
- 1275 - 6400K White

EAN Code

- 3800157611954
- 3800157611961
- 3800157611978

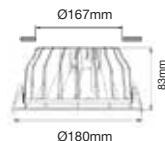

A++ **120⁺⁺** LM/W
HIGH LUMENS

LUMINOUS INTENSITY DISTRIBUTION DIAGRAM

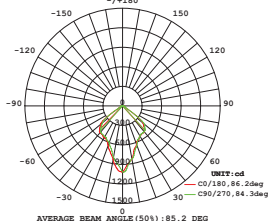

Sensor Compatible:	Yes	Beam Angle:	120 °
Voltage/Frequency:	AC: 200-240V, 50/60Hz	Body Type:	PKW (White)
Luminous Flux:	2400lm	Shape:	Round
LED Type:	COB	Dimension:	Ø 180mm x 83mm
CRI:	>80	Cutting Size:	Ø167mm
PF	> 0.5		



Reflector Downlight

30W VT-26301

- 1276 - 3000K Warm White
- 1277 - 4000K Day White
- 1278 - 6400K White

EAN Code

- 3800157611985
- 3800157611992
- 3800157612005



120⁺⁺
LM/W
HIGH LUMENS

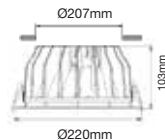

LUMINOUS INTENSITY DISTRIBUTION DIAGRAM

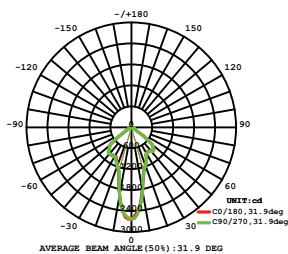

Sensor Compatible:	Yes	Beam Angle:	120 °
Voltage/Frequency:	AC: 100-277V, 50/60Hz	Body Type:	PKW (White)
Luminous Flux:	3600lm	Shape:	Round
LED Type:	COB	Dimension:	Ø 220mm x 103mm
CRI:	>80	Cutting Size:	Ø207mm
PF	> 0.9		



Reflector Downlight

40W VT-26451

- 1279 - 4000K Day White
- 1280 - 6400K White

EAN Code

- 3800157612012
- 3800157612029



120⁺⁺
LM/W
HIGH LUMENS

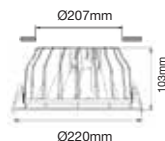

LUMINOUS INTENSITY DISTRIBUTION DIAGRAM

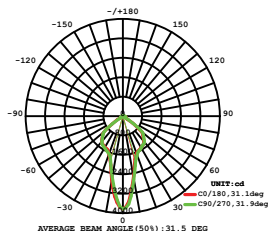

Sensor Compatible:	Yes	Beam Angle:	120 °
Voltage/Frequency:	AC: 100-277V, 50/60Hz	Body Type:	PKW (White)
Luminous Flux:	4800lm	Shape:	Round
LED Type:	COB	Dimension:	Ø 220mm x 103mm
CRI:	>80	Cutting Size:	Ø207mm
PF	> 0.9		



Reflector Downlight

10W VT-2610

EAN Code

- 1102 - 3000K Warm White
- 1101 - 4000K Day White
- 1100 - 6400K White

- 3800230622396
- 3800230622389
- 3800230622372

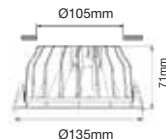

LUMINOUS INTENSITY DISTRIBUTION DIAGRAM

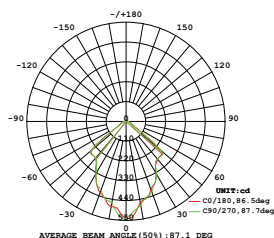

Sensor Compatible:	Yes	Beam Angle:	120 °
Voltage/Frequency:	AC: 220-240V, 50Hz	Body Type:	PKW (White)
Luminous Flux:	730lm	Shape:	Round
LED Type:	COB	Dimension:	Ø 135mm x 71mm
CRI:	>80	Cutting Size:	Ø105mm
PF	> 0.5		



Reflector Downlight

20W VT-2620

EAN Code

- 1108 - 3000K Warm White
- 1104 - 4000K Day White
- 1103 - 6400K White

- 3800230625410
- 3800230622419
- 3800230622402

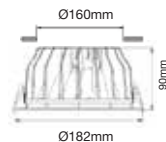

LUMINOUS INTENSITY DISTRIBUTION DIAGRAM

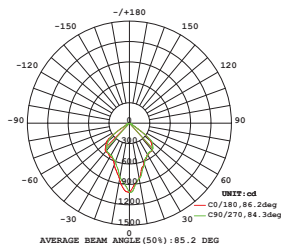

Sensor Compatible:	Yes	Beam Angle:	120 °
Voltage/Frequency:	AC: 220-240V, 50Hz	Body Type:	PKW (White)
Luminous Flux:	1500lm	Shape:	Round
LED Type:	COB	Dimension:	Ø 182mm x 90mm
CRI:	>80	Cutting Size:	Ø160mm
PF	> 0.5		



Reflector Downlight

30W VT-2630

- 1107 - 3000K Warm White
- 1106 - 4000K Day White
- 1105 - 6400K White

EAN Code

- 3800230625021
- 3800230622433
- 3800230622426

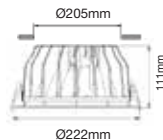

LUMINOUS INTENSITY DISTRIBUTION DIAGRAM

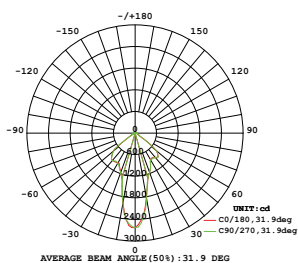

Sensor Compatible:	Yes	Beam Angle:	120 °
Voltage/Frequency:	AC: 220-240V, 50Hz	Body Type:	PKW (White)
Luminous Flux:	2400lm	Shape:	Round
LED Type:	COB	Dimension:	Ø 222mm x 111mm
CRI:	>80	Cutting Size:	Ø205mm
PF	> 0.9		



Reflector Downlight

40W VT-2645

- 1163 - 3000K Warm White
- 1164 - 4000K Day White
- 1165 - 6400K White

EAN Code

- 3800230627285
- 3800230627292
- 3800230627308

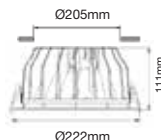

LUMINOUS INTENSITY DISTRIBUTION DIAGRAM

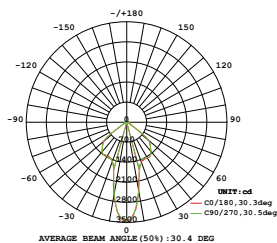

Sensor Compatible:	Yes	Beam Angle:	120 °
Voltage/Frequency:	AC: 220-240V, 50Hz	Body Type:	PKW (White)
Luminous Flux:	3200lm	Shape:	Round
LED Type:	COB	Dimension:	Ø 222mm x 111mm
CRI:	≥80	Cutting Size:	Ø205mm
PF	> 0.9		



COB Downlight

3W VT-1123 RD

EAN Code

5098 - 3000K Warm White

3800157609401

5099 - 4500K Day White

3800157609418

5107 - 6000K White

3800157609425



Sensor Compatible:	Yes	Beam Angle:	60 °
Voltage/Frequency:	AC: 85-265V, 50/60Hz	Body Type:	Aluminum
Luminous Flux:	200lm	Shape:	Round
LED Type:	COB	Dimension:	Ø45 x 35mm
CRI:	>80	Cutting Size:	Ø36mm
PF	> 0.5		



COB Downlight

3W VT-1123 SQ

EAN Code

5108 - 3000K Warm White

3800157609432

5109 - 4500K Day White

3800157609449

5110 - 6000K White

3800157609456



Sensor Compatible:	Yes	Beam Angle:	60 °
Voltage/Frequency:	AC: 85-265V, 50/60Hz	Body Type:	Aluminum
Luminous Flux:	200lm	Shape:	Square
LED Type:	COB	Dimension:	45 x 45 x 35mm
CRI:	>80	Cutting Size:	36 x 36 mm
PF	> 0.5		



COB Downlight

3W VT-1133 RD

EAN Code

5092 - 3000K Warm White

3800157609340

5093 - 4500K Day White

3800157609357

5094 - 6000K White

3800157609364

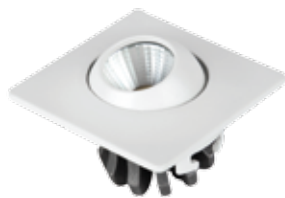

Sensor Compatible:	Yes	Beam Angle:	60 °
Voltage/Frequency:	AC: 85-265V, 50/60Hz	Body Type:	Aluminum
Luminous Flux:	200lm	Shape:	Round
LED Type:	COB	Dimension:	Ø55 x 42mm
CRI:	>80	Cutting Size:	Ø45mm
PF	> 0.5		

**COB Downlight****3W** VT-1133 SQ

EAN Code

5095 - 3000K Warm White

3800157609371

5096 - 4500K Day White

3800157609388

5097 - 6000K White

3800157609395



Sensor Compatible:	Yes	Beam Angle:	60°
Voltage/Frequency:	AC: 85-265V, 50/60Hz	Body Type:	Aluminum
Luminous Flux:	200lm	Shape:	Square
LED Type:	COB	Dimension:	55 x 55 x 42mm
CRI:	>80	Cutting Size:	45 x 45mm
PF	> 0.5		

**COB Downlight****8W** VT-2908 RD

EAN Code

1116 - 3000K Warm White

380023062514

1117 - 4000K Day White

3800230625151

1118 - 6000K White

3800230625168

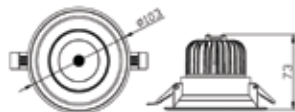

Sensor Compatible:	Yes	Beam Angle:	24°
Voltage/Frequency:	AC: 100-240V, 50/60Hz	Body Type:	Powder Coating Die cast
Luminous Flux:	550lm	Shape:	Round
LED Type:	COB	Dimension:	Ø103 x 75mm
CRI:	>80	Cutting Size:	Ø90mm
PF	> 0.5		

**COB Downlight****8W** VT-2908 SQ

EAN Code

1113 - 3000K Warm White

3800230625175

1114 - 4000K Day White

3800230625182

1115 - 6000K White

3800230625199



Sensor Compatible:	Yes	Beam Angle:	24°
Voltage/Frequency:	AC: 100-240V, 50/60Hz	Body Type:	Powder Coating Die cast
Luminous Flux:	550lm	Shape:	Square
LED Type:	COB	Dimension:	103 x 103 x 75mm
CRI:	>80	Cutting Size:	90 x 90mm
PF	> 0.5		



Custom Angle

7W VT-2807

EAN Code

1110 - 5000K Day White

3800230622440



Sensor Compatible:	Yes	Beam Angle:	20°
Voltage/Frequency:	AC: 170-240V, 50/60Hz	Body Type:	Ivory White
Luminous Flux:	550lm	Shape:	Zoom
LED Type:	COB.CREE	Dimension:	Ø100 x 76mm
CRI:	>80	Cutting Size:	Ø86mm
PF:	> 0.8		



Custom Angle

22W VT-2822

EAN Code

1111 - 4000K Day White

3800230622457



Sensor Compatible:	Yes	Beam Angle:	25°
Voltage/Frequency:	AC: 170-240V, 50/60Hz	Body Type:	Ivory White
Luminous Flux:	1570lm	Shape:	Zoom
LED Type:	COB.CREE	Dimension:	Ø158 x 150mm
CRI:	>80	Cutting Size:	Ø140mm
PF:	> 0.8		



Custom Angle

30W VT-2830

EAN Code

1112 - 4000K Day White

3800230622464



Sensor Compatible:	Yes	Beam Angle:	25°
Voltage/Frequency:	AC: 170-240V, 50/60Hz	Body Type:	Ivory White
Luminous Flux:	2100lm	Shape:	Zoom
LED Type:	COB.CREE	Dimension:	Ø190 x 160mm
CRI:	>80	Cutting Size:	Ø175mm
PF:	> 0.9		



Zoom Light

30W VT-2930

- 1306 - 3000K Warm White
- 1307 - 4500K Day White
- 1289 - 6000K White

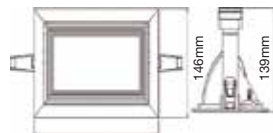

EAN Code

- 3800157619936
- 3800157619943
- 3800157619646



235mm

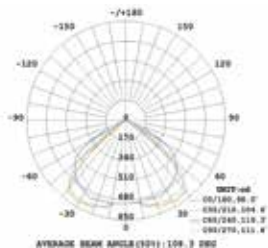

Sensor Compatible:	Yes	Beam Angle:	99°
Voltage/Frequency:	AC: 220-240V, 50Hz	Body Type:	Aluminum, White
Luminous Flux:	2450lm	Shape:	Rectangle
LED Type:	COB	Dimension:	235 x 146 x 139mm
CRI:	≥80	Cutting Size:	220 x 132mm
PF:	> 0.9		



Zoom Light

33W VT-2933

- 1304 - 3000K Warm White
- 1305 - 4500K Day White
- 1288 - 6000K White

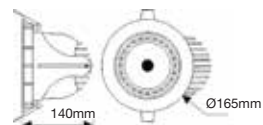

EAN Code

- 3800157619912
- 3800157619929
- 3800157619639



140mm

Ø165mm

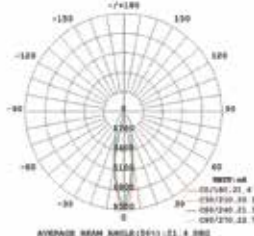

Sensor Compatible:	Yes	Beam Angle:	24°
Voltage/Frequency:	AC: 220-240V, 50Hz	Body Type:	Aluminum, White
Luminous Flux:	2650lm	Shape:	Round
LED Type:	COB	Dimension:	Ø 165x140mm
CRI:	≥80	Cutting Size:	Ø 155
PF:	> 0.9		



Step Light

2W VT-1142

1315 - 3000K Warm White
1314 - 4000K Day White

EAN Code

3800157620437
3800157620420

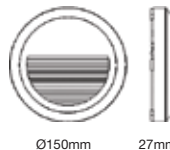

Sensor Compatible:	Yes	PF:	> 0.5
Voltage/Frequency:	AC100-240V, 50/60 Hz	Beam Angle:	55 °
Luminous Flux:	60LM	Color of Fixture:	White
Body Type:	PC	Shape:	Round
CRI:	>80	Dimension:	ø150 x 27mm



Step Light

2W VT-1142

1317 - 3000K Warm White
1316 - 4000K Day White

EAN Code

3800157620451
3800157620444

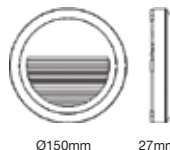

Sensor Compatible:	Yes	PF:	> 0.5
Voltage/Frequency:	AC100-240V, 50/60 Hz	Beam Angle:	55 °
Luminous Flux:	60LM	Color of Fixture:	Black
Body Type:	PC	Shape:	Round
CRI:	>80	Dimension:	ø150 x 27mm



Step Light

2W VT-1142

1319 - 3000K Warm White
1318 - 4000K Day White

EAN Code

3800157620475
3800157620468

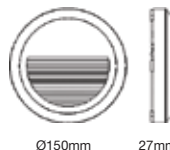

Sensor Compatible:	Yes	PF:	> 0.5
Voltage/Frequency:	AC100-240V, 50/60 Hz	Beam Angle:	55 °
Luminous Flux:	60LM	Color of Fixture:	Grey
Body Type:	PC	Shape:	Round
CRI:	>80	Dimension:	ø150 x 27mm



Step Light

2W VT-1152

1321 - 3000K Warm White
1320 - 4000K Day White

EAN Code

3800157620499
3800157620482

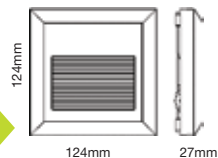

Sensor Compatible:	Yes	PF:	> 0.5
Voltage/Frequency:	AC100-240V, 50/60 Hz	Beam Angle:	55 °
Luminous Flux:	60lm	Color of Fixture:	White
Body Type:	PC	Shape:	Square
CRI:	>80	Dimension:	124 x 124 x 27mm



Step Light

2W VT-1152

1323 - 3000K Warm White
1322 - 4000K Day White

EAN Code

3800157620512
3800157620505

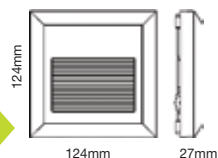

Sensor Compatible:	Yes	PF:	> 0.5
Voltage/Frequency:	AC100-240V, 50/60 Hz	Beam Angle:	55 °
Luminous Flux:	60lm	Color of Fixture:	Black
Body Type:	PC	Shape:	Square
CRI:	>80	Dimension:	124 x 124 x 27mm

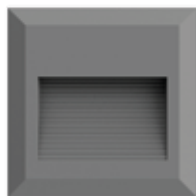

Step Light

2W VT-1152

1325 - 3000K Warm White
1324 - 4000K Day White

EAN Code

3800157620536
3800157620529

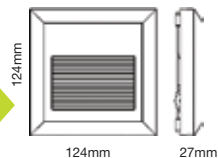

Sensor Compatible:	Yes	PF:	> 0.5
Voltage/Frequency:	AC100-240V, 50/60 Hz	Beam Angle:	55 °
Luminous Flux:	60lm	Color of Fixture:	Grey
Body Type:	PC	Shape:	Square
CRI:	>80	Dimension:	124 x 124 x 27mm

Step Light

3W VT-1162

1327 - 3000K Warm White
1326 - 4000K Day White

EAN Code

3800157620550
3800157620543

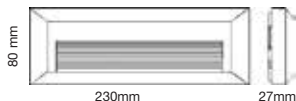

Sensor Compatible:	Yes	PF:	> 0.5
Voltage/Frequency:	AC100-240V, 50/60 Hz	Beam Angle:	55 °
Luminous Flux:	110LM	Color of Fixture:	White
Body Type:	PC	Shape:	Rectangle
CRI:	>80	Dimension:	230 x 80 x 27mm

Step Light

3W VT-1162

1329 - 3000K Warm White
1328 - 4000K Day White

EAN Code

3800157620574
3800157620567

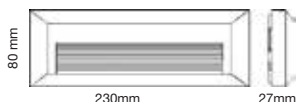
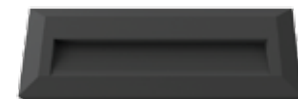

Sensor Compatible:	Yes	PF:	> 0.5
Voltage/Frequency:	AC100-240V, 50/60 Hz	Beam Angle:	55 °
Luminous Flux:	110LM	Color of Fixture:	White
Body Type:	PC	Shape:	Rectangle
CRI:	>80	Dimension:	230 x 80 x 27mm

Step Light

3W VT-1162

1331 - 3000K Warm White
1330 - 4000K Day White

EAN Code

3800157620598
3800157620581

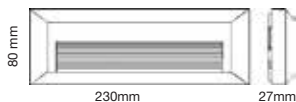

Sensor Compatible:	Yes	PF:	> 0.5
Voltage/Frequency:	AC100-240V, 50/60 Hz	Beam Angle:	55 °
Luminous Flux:	110LM	Color of Fixture:	White
Body Type:	PC	Shape:	Rectangle
CRI:	>80	Dimension:	230 x 80 x 27mm



Step Light

3W VT-1109 RD

1207 - 3000K Warm White
1208 - 4200K Day White

EAN Code

3800157600231
 3800157600248

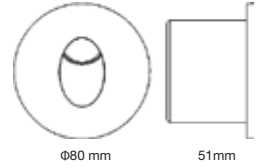

LUMINOUS INTENSITY DISTRIBUTION

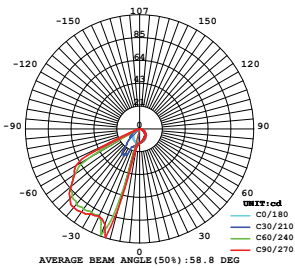

Sensor Compatible: Yes	Beam Angle: 15 °
Voltage/Frequency: AC: 100-240V, 50/60Hz	Color of Fixture: PKW (White)
Luminous Flux: 120lm	Shape: Round
Body Type: Aluminum	Dimension: Ø80 x 51mm
CRI: > 80	Cutting Size: Ø62mm
PF: > 0.5	



Step Light

3W VT-1109 SQ

1209 - 3000K Warm White
1210 - 4200K Day White
1223 - 6000K White

EAN Code

3800157600255
 3800157600262
 3800157601504

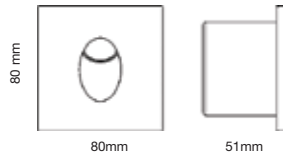

LUMINOUS INTENSITY DISTRIBUTION

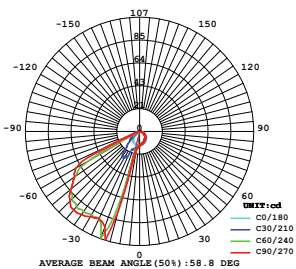

Sensor Compatible: Yes	Beam Angle: 15°
Voltage/Frequency: AC: 100-240V, 50/60Hz	Color of Fixture: PKW (White)
Luminous Flux: 120lm	Shape: Square
Body Type: Aluminum	Dimension: 80 x 80 x 51mm
CRI: > 80	Cutting Size: 62 x 62mm
PF: > 0.5	

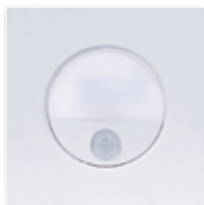

Step Light with Sensor

3W VT-8035

EAN Code

5570 - 4500K Day White

3800157617291

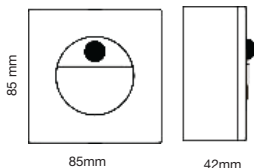

Sensor Included:	Yes	PF:	> 0.5
Voltage/Frequency:	AC: 85-265V, 50/60Hz	Beam Angle:	45 °
Luminous Flux:	100lm	Color of Fixture:	PKW (White)
Body Type:	Die cast Aluminum	Shape:	Square
CRI:	> 80	Dimension:	85 x 85 x 42mm



Step Light

3W VT-1143

EAN Code

1284 - 4000K Day White

3800157617307

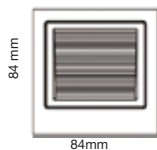

Sensor Compatible:	Yes	Beam Angle:	83 °
Voltage/Frequency:	AC: 85-265V, 50/60Hz	Color of Fixture:	PKW (White)
Luminous Flux:	100lm	Shape:	Square
Body Type:	Die cast Aluminum	Dimension:	84 x 84 x 43mm
CRI:	> 80	Cutting Size:	72 x 72mm
PF:	> 0.5		



LED Dome Lights

Introducing a customized innovation to an old problem LED DOME LIGHTS, Compact and Easy to install elegant replacement for traditional full round Dome Lights, Creates a perfect fusion between bright and dark spots for ambience of any environment

Product Features

- 80% Electricity savings as compared to traditional Incandescent Bulbs
- 20,000 hours Lifespan
- Non – Flickering
- No UV Radiation
- Easy Installation
- Premium Quality LED Chip
- Premium Quality Power Driver
- Instant start 0-100% in 0.01 seconds
- Extreme Weather toleration (-20 to + 45 Degrees Centigrade)

Applications

- Mostly used in Parking Lots, Passage's in big areas, Exterior Walls of Prestigious Buildings for ambience, Airports, Ports and Malls



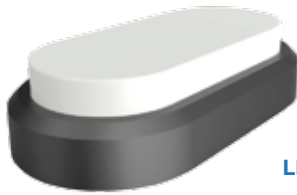

LED Oval Dome Light

8W VT-8038

- 1308 - 3000k Warm White
- 1309 - 4000K Day White
- 1310 - 6400k White

EAN Code

- 3800157620260
- 3800157620277
- 3800157620284

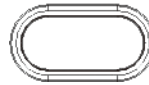
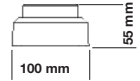
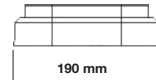

Sensor Compatible:	Yes	Beam Angle:	120°
Voltage/Frequency:	AC: 220-240V, 50/60Hz	Body Type:	PC
Luminous Flux:	560lm	Shape:	Rectangle
LED Type:	SMD	IP Rating:	IP54
CRI:	>70	Color of Fixture	Black
PF:	> 0.5	Dimension:	190 x 100 x 55mm



LED Oval Dome Light

8W VT-8038

- 1311 - 3000k Warm White
- 1312 - 4000K Day White
- 1313 - 6400k White

EAN Code

- 3800157620291
- 3800157620307
- 3800157620314

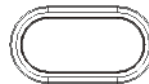
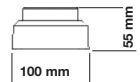
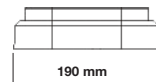

Sensor Compatible:	Yes	Beam Angle:	120°
Voltage/Frequency:	AC: 220-240V, 50/60Hz	Body Type:	PC
Luminous Flux:	560lm	Shape:	Rectangle
LED Type:	SMD	IP Rating:	IP54
CRI:	>70	Color of Fixture	White
PF:	> 0.5	Dimension:	190 x 100 x 55mm



LED Dome Light

15W VT-8033

- 1388 - 3000k Warm White
- 5566 - 4000K Day White
- 1389 - 6000k White

EAN Code

- 3800157626453
- 3800157610353
- 3800157626460

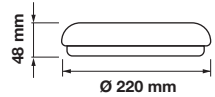

Sensor Compatible:	Yes	Beam Angle:	120°
Voltage/Frequency:	AC: 220-240V, 50Hz	Body Type:	PC
Luminous Flux:	1250lm	Shape:	Round
LED Type:	SMD	IP Rating:	IP44
CRI:	>80	Dimension:	Ø 220mm x 48mm
PF:	> 0.6		

**EASY TO USE
PLUG AND PLAY**

**Luxurious Finish
SURFACE MOUNTED**

TRIMLESS



LED Dome Light

15W VT-8033

- 1390 - 3000k Warm White
- 5567 - 4000K Day White
- 1391 - 6000k White

EAN Code

- 3800157626477
- 3800157610360
- 3800157626484

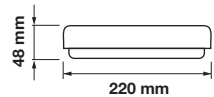

Sensor Compatible:	Yes	Beam Angle:	120°
Voltage/Frequency:	AC: 220-240V, 50Hz	Body Type:	PC
Luminous Flux:	1250lm	Shape:	Square
LED Type:	SMD	IP Rating:	IP44
CRI:	>80	Dimension:	220 x 220 x 48mm
PF:	> 0.6		



Led Dome Light

12W VT-8031

5563 - 4000K Day White
5562 6500K White

EAN Code

3800157610322
3800157610315

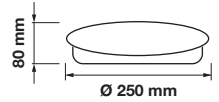

Sensor Compatible:	Yes	Beam Angle:	120°
Voltage/Frequency:	AC: 220-240V, 50Hz	Body Type:	Metal + PMMA
Luminous Flux:	800lm	Shape:	Round
LED Type:	SMD	IP Rating:	IP20
CRI:	>80	Dimension:	Ø 250 x 80mm
PF:	> 0.6		



MAXIMUM LIGHT OUTPUT AND
ENERGY EFFICIENT



Led Dome Light

24W VT-8032

5565 - 4000K Day White
5564 6500K White

EAN Code

3800157610339
3800157610346

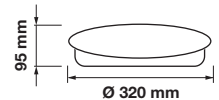

Sensor Compatible:	Yes	Beam Angle:	120°
Voltage/Frequency:	AC: 220-240V, 50Hz	Body Type:	Metal + PMMA
Luminous Flux:	1700lm	Shape:	Round
LED Type:	SMD	IP Rating:	IP20
CRI:	>80	Dimension:	Ø 320 x 95mm
PF:	> 0.6		



**SENSOR
INSIDE**



**IP65
RATED**

Led Dome Light

12W VT-8008

4984 - 4500K Day White
4985 - 6000k White

EAN Code

3800157601290
3800157601306

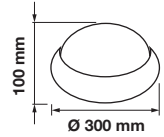

Sensor Type:	Microwave	Detection Distance:	*10%/50%/100%
Color:	White	Time Delay:	10s/1min/5min/10min/30min
Detection Range:	Max.(0 x H): 10m x 4m, 360°	Luminous Flux:	840lm
Voltage:	AC: 200-240V,50/60Hz	Body Type:	ABS+Plastic+PMMA
Rated Load:	12W	IP Rating:	IP65
Sensor Compatible:	12W	Dimension:	Ø300 x 100mm



**IP65
RATED**

Without Sensor

Led Dome Light

12W VT-8007

4983 - 4500K Day White

EAN Code

3800157601283

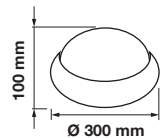

Sensor Compatible:	Yes	Beam Angle:	110°
Voltage/Frequency:	AC: 200-240V, 50/60Hz	Color of Fixture:	White
Luminous Flux:	840lm	Body Type:	ABS+Plastic+PMMA
IP Rating:	IP65	Shape:	Full Round
CRI:	>70	Dimension:	Ø300 x 100mm
PF:	>0.9		



**SENSOR
INSIDE**



**IP65
RATED**

Led Dome Light

12W VT-8008

4981 - 3000k Warm White
4971 - 4500K Day White
4980 - 6000k White

EAN Code

3800230629586
3800230629036
3800230629579

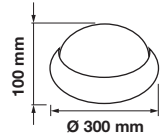

Sensor Type:	Microwave	Detection Distance:	*10%/50%/100%
Color:	Black	Time Delay:	*10s/1min/5min/10min/30min
Detection Range:	Max.(0 x H): 10m x 4m, 360°	Luminous Flux:	840lm
Voltage:	AC: 200-240V,50/60Hz	Body Type:	ABS+Plastic+PMMA
Rated Load:	12W	IP Rating:	IP65
Sensor Compatible:	12W	Dimension:	Ø300 x 100mm



**IP65
RATED**

Without Sensor

Led Dome Light

12W VT-8007

4970 - 4500K Day White

EAN Code

3800230629029

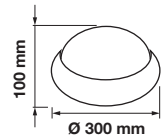

Sensor Compatible:	Yes	Beam Angle:	110°
Voltage/Frequency:	AC: 200-240V,50/60Hz	Color of Fixture:	Black
Luminous Flux:	840lm	Body Type:	ABS+Plastic+PMMA
IP Rating:	IP65	Shape:	Full Round
CRI:	>70	Dimension:	Ø300 x 100mm
PF:	>0.9		



Led Dome Light

16W VT-8001C

1281 - 3000k Warm White
4965 - 4500K Day White
1282 - 6000k White

EAN Code

3800157612678
3800230625809
3800157612685

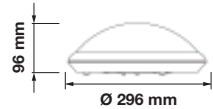

Sensor Type:	Microwave	Detection Distance:	*1-8m (radius)
Color:	White	Time Delay:	*10 sec to 12 min
Detection Range:	360°	Luminous Flux:	1300lm
Voltage:	AC: 220-240V,50Hz	Body Type:	PC Cover
Rated Load:	16W	IP Rating:	IP54
Watts:	16W	Dimension:	Ø296 x 96mm



Led Dome Light

Max. 60W VT-8002C

4966

EAN Code

3800230625816

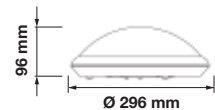

Sensor Type:	Microwave	Detection Distance:	*1-8m (radius)
Color:	White	Time Delay:	*10 sec to 12 min
Detection Range:	360°	Body Type:	ABS+Plastic+PC
Voltage:	AC: 220-240V,50Hz	IP Rating:	IP44
Rated Load:	Uses Max. 60W(E27)	Dimension:	Ø296 x 96mm
Watts:	As per E27 bulb		



Led Dome Light

12W VT-8017

- 5057 - 3000k Warm White
- 5058 - 4000K Day White
- 5059 - 6400k White

EAN Code

- 3800157605250
- 3800157605267
- 3800157605274

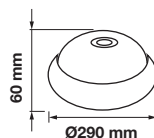

Sensor Type:	PIR Sensor
Color:	White
Detection Range:	360°
Voltage:	AC: 110-240V, 50Hz
Rated Load:	12W (24PCS LED)
Detection Distance:	max.6m(<24°C)
Time Delay:	*10 sec to 3 min
Luminous Flux:	800lm
Body Type:	ABS+Plastic+PMMA
IP Rating:	IP20
Dimension:	Ø290 x 60mm





Led Dome Light

8W VT-8014

- 1267 - 3000k Warm White
- 1266 - 4500K Day White
- 1268 - 6000k White

EAN Code

- 3800157611893
- 3800157611886
- 3800157611909

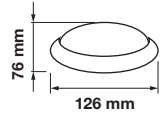

Sensor Compatible:	Yes	Beam Angle:	110°
Voltage/Frequency:	AC: 200-240V, 50Hz	Color of Fixture:	Black
Luminous Flux:	560lm	Body Type:	Plastic Clad Aluminum
IP Rating:	IP54	Shape:	Full Oval
CRI:	>70	Dimension:	126 x 187 x 76mm
PF:	>0.5		



Led Dome Light

12W VT-8016

- 5056 - 4500K Day White
- 5055 - 6000k White

EAN Code

- 3800157603980
- 3800157603348

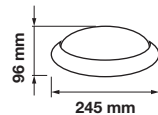

Sensor Compatible:	Yes	Beam Angle:	120°
Voltage/Frequency:	AC: 200-240V, 50Hz	Color of Fixture:	Black
Luminous Flux:	840lm	Body Type:	Plastic Clad Aluminum
IP Rating:	IP54	Shape:	Full Oval
CRI:	>70	Dimension:	245 x 165 x 96mm
PF:	>0.5		



Led Dome Light

8W VT-8014

1264 - 3000k Warm White

1263 - 4500K Day White

1265 - 6000k White

EAN Code

3800157611862

3800157611855

3800157611879

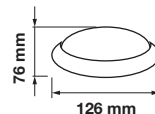

Sensor Compatible:	Yes	Beam Angle:	110°
Voltage/Frequency:	AC: 200-240V, 50Hz	Color of Fixture:	White
Luminous Flux:	560lm	Body Type:	Plastic Clad Aluminum
IP Rating:	IP54	Shape:	Full Oval
CRI:	>70	Dimension:	126 x 187 x 76mm
PF:	>0.5		



Led Dome Light

12W VT-8016

5054 - 4500K Day White

5053 - 6000k White

EAN Code

3800157603331

3800157603324

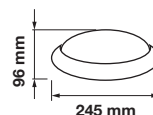

Sensor Compatible:	Yes	Beam Angle:	120°
Voltage/Frequency:	AC: 200-240V, 50Hz	Color of Fixture:	White
Luminous Flux:	840lm	Body Type:	Plastic Clad Aluminum
IP Rating:	IP54	Shape:	Full Oval
CRI:	>70	Dimension:	245 x 165 x 96mm
PF:	>0.5		



New!

Led Dome Light

12W VT-8015

4998 - 3000k Warm White

5050 - 4500K Day White

4996 - 6000k White

EAN Code

3800157602549

3800157603294

3800157602228

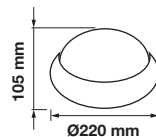

Sensor Compatible:	Yes	Beam Angle:	120°
Voltage/Frequency:	AC: 200-240V, 50Hz	Color of Fixture:	White
Luminous Flux:	840lm	Body Type:	Plastic Clad Aluminum
IP Rating:	IP54	Shape:	Round
CRI:	>70	Dimension:	Ø220 x 105mm
PF:	>0.5		



New!

Led Dome Light

12W VT-8015

1349 - 3000k Warm White

5052 - 4500K Day White

5051 - 6000k White

EAN Code

3800157624046

3800157603317

3800157603300

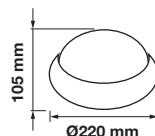

Sensor Compatible:	Yes	Beam Angle:	120°
Voltage/Frequency:	AC: 200-240V, 50Hz	Color of Fixture:	Black
Luminous Flux:	840lm	Body Type:	Plastic Clad Aluminum
IP Rating:	IP54	Shape:	Round
CRI:	>70	Dimension:	Ø220 x 105mm
PF:	>0.5		



Led Dome Light

12W VT-8009

4972 - 4500K Day White

EAN Code

3800230629043

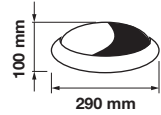

Sensor Compatible:	Yes	Beam Angle:	110°
Voltage/Frequency:	AC: 200-240V,50/60Hz	Color of Fixture:	Black
Luminous Flux:	840lm	Body Type:	Plastic Clad Aluminum
IP Rating:	IP54	Shape:	Half-Oval
CRI:	>70	Dimension:	290 x 200 x 100mm
PF:	>0.9		



Led Dome Light

12W VT-8010

1351 - 3000k Warm White
1352 - 4000K Day White
1353 - 6400K White



EAN Code

3800157624060
3800157624077
3800157624084

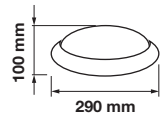

Sensor Compatible:	Yes	Beam Angle:	110°
Voltage/Frequency:	AC: 200-240V,50/60Hz	Color of Fixture:	White
Luminous Flux:	840lm	Body Type:	Plastic Clad Aluminum
IP Rating:	IP66	Shape:	Full Oval
CRI:	>70	Dimension:	290 x 200 x 100mm
PF:	>0.9		



Led Dome Light

12W VT-8010

1350 - 3000k Warm White
4973 - 4000K Day White
1269 - 6400k White



EAN Code

3800157624053
3800230629050
3800157611916

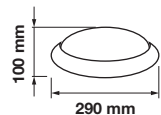

Sensor Compatible:	Yes	Beam Angle:	110°
Voltage/Frequency:	AC: 200-240V,50/60Hz	Color of Fixture:	Black
Luminous Flux:	840lm	Body Type:	Plastic Clad Aluminum
IP Rating:	IP66	Shape:	Full Oval
CRI:	>70	Dimension:	290 x 200 x 100mm
PF:	>0.9		



Led Dome Light

8W VT-8014

4999 - 3000k Warm White
 1259 - 4500K Day White
 4997 - 6000k White

EAN Code

3800157602556
 3800157611817
 3800157602259

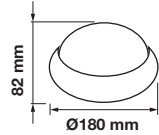

Sensor Compatible:	Yes	Beam Angle:	120°
Voltage/Frequency:	AC: 200-240V, 50/60Hz	Color of Fixture:	White
Luminous Flux:	560lm	Body Type:	Plastic Clad Aluminum
IP Rating:	IP54	Shape:	Round
CRI:	>70	Dimension:	Ø180 x 82mm
PF:	>0.5		



Led Dome Light

8W VT-8014

1261 - 3000k Warm White
 1260 - 4500K Day White
 1262 - 6000k White

EAN Code

3800157611831
 3800157611824
 3800157611848

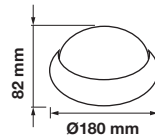

Sensor Compatible:	Yes	Beam Angle:	120°
Voltage/Frequency:	AC: 200-240V, 50Hz	Color of Fixture:	Black
Luminous Flux:	560lm	Body Type:	Plastic Clad Aluminum
IP Rating:	IP54	Shape:	Round
CRI:	>70	Dimension:	Ø180 x 82mm
PF:	>0.5		



Led Dome Light

12W VT-8006

4969 - 4500K Day White



EAN Code

3800230629012

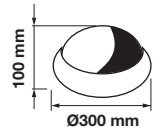

Sensor Compatible:	Yes	Beam Angle:	110°
Voltage/Frequency:	AC: 200-240V,50/60Hz	Color of Fixture:	Black
Luminous Flux:	840lm	Body Type:	Plastic Clad Aluminum
IP Rating:	IP65	Shape:	Half-Round
CRI:	>70	Dimension:	Ø300 x 100mm
PF:	>0.9		



Led Dome Light

12W VT-8006

4986 - 4500K Day White



EAN Code

3800157601313

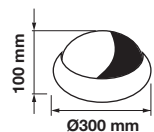

Sensor Compatible:	Yes	Beam Angle:	110°
Voltage/Frequency:	AC: 200-240V,50/60Hz	Color of Fixture:	White
Luminous Flux:	840lm	Body Type:	Plastic Clad Aluminum
IP Rating:	IP65	Shape:	Half-Round
CRI:	>70	Dimension:	Ø300 x 100mm
PF:	>0.9		



New!

LED Ceiling Dome Light Bling Star Cover

8W VT-8061

EAN Code

1370 - 3000K Warm White
1371 - 4000K Day White
1372 - 6400K White

3800157626262
3800157626279
3800157626286

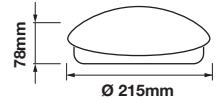

A+

Sensor Compatible:	Yes	Beam Angle:	120°
Voltage/Frequency:	AC: 220-240V,50Hz	Color of Fixture:	White
Luminous Flux:	560lm	Body Type:	Iron+PMMA
IP Rating:	IP20	Shape:	Round
CRI:	>80	Dimension:	Ø215 x 78mm
PF:	>0.5		



New!

LED Ceiling Dome Light Bling Star Cover

12W VT-8062

EAN Code

1373 - 3000K Warm White
1374 - 4000K Day White
1375 - 6400K White

3800157626293
3800157626309
3800157626316

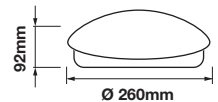

A+

Sensor Compatible:	Yes	Beam Angle:	120°
Voltage/Frequency:	AC: 220-240V,50Hz	Color of Fixture:	White
Luminous Flux:	840lm	Body Type:	Iron+PMMA
IP Rating:	IP20	Shape:	Round
CRI:	>80	Dimension:	Ø260 x 92mm
PF:	>0.5		



New!

LED Ceiling Dome Light Bling Star Cover

18W VT-8063

1376 - 3000K Warm White
1377 - 4000K Day White
1378 - 6400K White

EAN Code

3800157626323
3800157626330
3800157626347

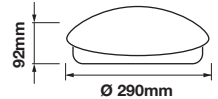

A+

Sensor Compatible:	Yes	Beam Angle:	120°
Voltage/Frequency:	AC: 220-240V,50Hz	Color of Fixture:	White
Luminous Flux:	1260lm	Body Type:	Iron+PMMA
IP Rating:	IP20	Shape:	Round
CRI:	>80	Dimension:	Ø290 x 92mm
PF:	>0.5		



New!

LED Ceiling Dome Light Bling Star Cover

24W VT-8064

1379 - 3000K Warm White
1380 - 4000K Day White
1381 - 6400K White

EAN Code

3800157626354
3800157626361
3800157626378

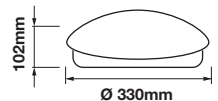

A+

Sensor Compatible:	Yes	Beam Angle:	120°
Voltage/Frequency:	AC: 220-240V,50Hz	Color of Fixture:	White
Luminous Flux:	1680lm	Body Type:	Iron+PMMA
IP Rating:	IP20	Shape:	Round
CRI:	>80	Dimension:	Ø330 x 102mm
PF:	>0.5		

New!

2D LED Bulkhead

8W VT-8039

1345 4000K Day White
EAN Code
3800157623087



Watts:	8W
Lumens:	720lm
No. Of Led:	40
Beam Angle:	120°
Voltage/Frequency:	AC: 200-240V, 50/60Hz
On/Off Time:	<0.5s
Life Span:	30,000 Hours
Unit Size:	Ø 260 x 90mm
IP Rating:	IP65
Body Type	Full PC

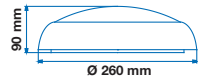

New!

2D LED Bulkhead with Microwave Sensor

8W VT-8041

1346 4000K Day White
EAN Code
3800157623094



Watts:	8W
Lumens:	720lm
Voltage/Frequency:	AC: 200-240V, 50/60Hz
On/Off Time:	<0.5s
Life Span:	30,000 Hours
Unit Size:	Ø 260 x 90mm
IP Rating:	IP65
Body Type	Full PC
Detection Angle:	360° ceiling mounting ,120° wall mounting
Detection Distance:	3M, 5M, 8M, 10M optional
Detection Range:	Max D10M x 4M
Hold Time:	10Sec, 1min, 5min, 10min customized
Day light Sensor:	Day, 10LUX, 30LUX, 50LUX optional
Dimmable Function:	Yes, 0,10%, 20%, 30% optional
Detection Motion Speed:	0.5~3m/s

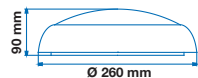

2_{IN}1 **New!**

**2D LED Bulkhead
Emergency Battery Backup**

10W VT-8042

1347 4000K Day White

EAN Code
3800157623100

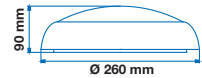

Watts:	10W
Lumens:	720lm
Voltage/Frequency:	AC: 200-240V, 50/60Hz
On/Off Time:	<0.5s
Life Span:	30,000 Hours
Unit Size:	Ø 260 x 90mm
IP Rating:	IP65
Body Type:	Full PC
Emergency Operation time:	> 3 Hours
Emergency Standby Watts:	>1.2 Watts
Battery Charging Current:	60mA
Battery Discharging Current:	200mA
Battery Type:	Ni-CDAA, 7.2V 1.0Ah
Charging indicate:	Green LED
Including battery protection circuit & inhibiting mode	

3_{IN}1 **New!**

**2D LED Bulkhead
Built In Emergency Battery
Back Up & Microwave Sensor**

10W VT-8043

1348 4000K Day White

EAN Code
3800157623117

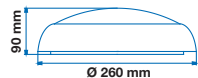

Watts:	10W
Lumens:	720lm
Detection Angle:	360° ceiling mounting ,120° wall mounting
Detection Distance:	3M, 5M, 8M, 10M optional
Detection Range:	Max D10M x 4M
Hold Time:	105, 1min, 5min, 10min customized
Day light Sensor:	Day, 10LUX, 30LUX, 50LUX optional
Dimmable Function:	Yes, 0,10%, 20%, 30% optional
Detection Motion Speed:	0.5~3m/s
IP Rating:	IP65
Body Type:	Full PC
Emergency Operation time:	> 3 Hours
Emergency Standby Watts:	>1.2 Watts
Battery Charging Current:	60mA
Battery Discharging Current:	200mA
Battery Type:	Ni-CDAA, 7.2V 1.0Ah
Charging indicate:	Green LED
Including battery protection circuit & inhibiting mode	

New!

2D LED Bulkhead

15W VT-8044

1341 4000K Day White



EAN Code
3800157623049



Watts:	15W
Lumens:	1400lm
No. Of Led:	72
Beam Angle:	120°
Voltage/Frequency:	AC: 200-240V, 50/60Hz
On/Off Time:	<0.5s
Life Span:	30,000 Hours
Unit Size:	Ø 320 x 100mm
IP Rating:	IP65
Body Type:	Full PC

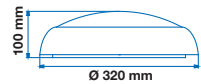

New!

2D LED Bulkhead with Microwave Sensor

15W VT-8045

1342 4000K Day White



EAN Code
3800157623056



Watts:	15W
Lumens:	1400lm
Voltage/Frequency:	AC: 200-240V, 50/60Hz
On/Off Time:	<0.5s
Life Span:	30,000 Hours
Unit Size:	Ø 320 x 100mm
IP Rating:	IP65
Body Type	Full PC
Detection Angle:	360° ceiling mounting ,120° wall mounting
Detection Distance:	3M, 5M, 8M, 10M optional
Detection Range:	Max D10M x 4M
Hold Time:	105, 1min, 5min, 10min customized
Day light Sensor:	Day, 10LUX, 30LUX, 50LUX optional
Dimmable Function:	Yes, 0,10%, 20%, 30% optional
Detection Motion Speed:	0.5~3m/s

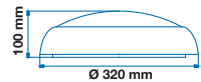

2_{1N1} **New!**

2D LED Bulkhead

Emergency Battery Backup

17W VT-8046

1343 4000K Day White

EAN Code

3800157623063

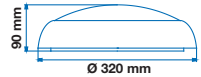

Watts:	17W
Lumens:	1400lm
Voltage/Frequency:	AC: 200-240V, 50/60Hz
On/Off Time:	<0.5s
Life Span:	30,000 Hours
Unit Size:	Ø 320 x 90mm
IP Rating:	IP65
Body Type:	Full PC
Emergency Operation time:	> 3 Hours
Emergency Standby Watts:	>1.2 Watts
Battery Charging Current:	60mA
Battery Discharging Current:	200mA
Battery Type:	Ni-CDAA, 7.2V 1.0Ah
Charging indicate:	Green LED

Including battery protection circuit & inhibiting mode

3_{1N1} **New!**

2D LED Bulkhead

Built In Emergency Battery Back Up & Microwave Sensor

17W VT-8047

1344 4000K Day White

EAN Code

3800157623070

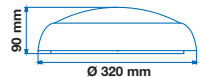

Watts:	17W
Lumens:	1400lm
Detection Angle:	360° ceiling mounting ,120° wall mounting
Detection Distance:	3M, 5M, 8M, 10M optional
Detection Range:	Max D10M x 4M
Hold Time:	105, 1min, 5min, 10min customized
Day light Sensor:	Day, 10LUX, 30LUX, 50LUX optional
Dimmable Function:	Yes, 0,10%, 20%, 30% optional
Detection Motion Speed:	0.5~3m/s
IP Rating:	IP65
Body Type:	Full PC
Emergency Operation time:	> 3 Hours
Emergency Standby Watts:	>1.2 Watts
Battery Charging Current:	60mA
Battery Discharging Current:	200mA
Battery Type:	Ni-CDAA, 7.2V 1.0Ah
Charging indicate:	Green LED

Including battery protection circuit & inhibiting mode

LED Emergency Lights

V-TAC features a line of premium quality LED emergency lights for clear and bright emergency illumination. Inclusive of evident exit signs, these signs are powered by high performance batteries, rendering a longer lifespan and lower maintenance. V-TAC's emergency lights and signs are a practical and valuable asset to many applications inclusive of offices, hotels, hospitals and residential areas.



Walls/Surface Mount
 2w | 120 Im



Walls/Surface Hanging
 2w | 120 Im



Recessed Hanging
 2w | 120 Im



Recessed Fixed
 2w | 120 Im



Bulkhead
 3w | 140 Im



Bulkhead
 4w | 190 Im



Wall Mounted
 7w | 600 Im

Salient Features

- Thermoplastic PC housing, Rectangular type plastic with different signs
- Single or double face configuration
- ✓ Universal (wall, side or ceiling) mounting
- ⚡ Low energy consumption only 2.0 watts at 120V
- Ⓞ LED indicator light and push button test switch
- LED LEDs mounted on print circuit board
- ⌚ 24 hours recharge after more than 3 Hours discharge
- 🔍 Efficient thermal management technology
- ⚡ Corrosion free mounting clamps
- 🔋 High performance Ni-Cd batteries made for Longevity & low maintenance
- ✓ Reliable Emergency backup of 3 hours

Applications

Widely used in applications such as Hotels, Restaurant, Hospital, Buildings, etc.



Easy Installation Types



Walls/Surface Mount

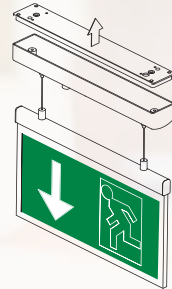
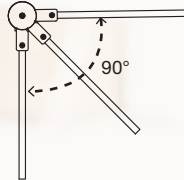

Walls/Surface Hanging

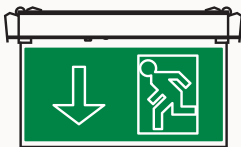

Recessed Fixed

Model	Watts	Lumens	Charging Current	Discharging Current	Operation time	IP Tating
VT-519	2	160	30mA	160mA	>3 Hours	IP20
VT-520	2	120	40~80mA	200~280mA	>3 Hours	IP20
VT-521	2	120	40~80mA	200~280mA	>3 Hours	IP20
VT-522	2	120	40~80mA	200~280mA	>3 Hours	IP20
VT-523	3	150	70~150mA	100~450mA	>3 Hours	IP65
VT-524	4	190	60~120mA	180~250mA	>3 Hours	IP65
VT-526	7	600	150~180mA	400~600mA	>3 Hours	IP65

**Emergency LED Exit Sign
Walls/Surface Mount**

2W VT-519

EAN Code

SKU 8099

3800157623155

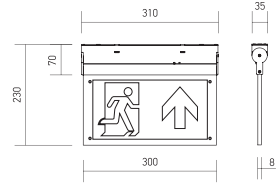

Lamp Type:	16 SMD Leds
Colour:	White - 6000K
Lumens:	160lm(AC)/140lm(DC)
Input Voltage:	AC: 220-240V, 50/60Hz
Protection Rating:	IP20
Material :	100% PC
Exit Lamp Type:	Surface/Ceiling Mounted
Viewing Distance:	22 meters from both side
Emergency Operation Time:	> 3Hours
Battery:	Ni-Cd 4.8V, 600mAh
Recharging Time:	24 hours (initial charge 36 hours)
Test Button:	Green light indicator test button
Stickers:	4 Stickers include
Legends:	4 Ways legends available

**Emergency LED Exit Sign
Walls/Surface Hanging**

2W VT-520

EAN Code

SKU 8100

3800157623162

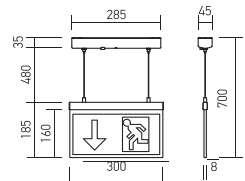

Lamp Type:	16 SMD Leds
Colour:	White - 6000K
Lumens:	160lm(AC)/140lm(DC)
Input Voltage:	AC: 220-240V, 50/60Hz
Protection Rating:	IP20
Viewing Distance:	22 meters from both side
Exit Lamp Type:	Surface/Ceiling Mounted
Emergency Operation Time:	> 3Hours
Battery:	Ni-CD 3.6V,600mAh
Recharging Time:	24 hours (initial charge 36 hours)
Test Button:	Green light indicator test button
Legends:	4 Ways legends available
Material:	100% PC
Stickers:	4 Stickers include



**Emergency LED Exit Sign
Recessed Hanging**

2W VT-521

EAN Code

SKU 8200

3800157623179

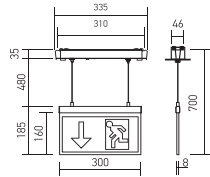

Lamp Type:	16 SMD Leds
Colour:	White - 6000K
Lumens:	160lm(AC)/140lm(DC)
Input Voltage:	AC: 220-240V, 50/60Hz
Protection Rating:	IP20
Viewing Distance:	22 meters from both side
Emergency Operation Time:	> 3Hours
Battery:	Ni-CD 3.6V,600mAh
Recharging Time:	24 hours (initial charge 36 hours)
Test Button:	Green light indicator test button
Legends:	4 Way legends available
Material:	100% PC

**Emergency LED Exit Sign
Recessed Fixed**

2W VT-522

EAN Code

SKU 8201

3800157623186

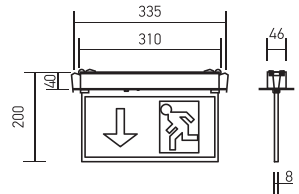

Lamp Type:	16 SMD Leds
Colour:	White - 6000K
Lumens:	160lm(AC)/140lm(DC)
Input Voltage:	AC: 220-240V, 50/60Hz
Protection Rating:	IP20
Viewing Distance:	22 meters from both side
Emergency Operation Time:	> 3Hours
Battery:	Ni-CD 4.8V,600mAh
Recharging Time:	24 hours (initial charge 36 hours)
Test Button:	Green light indicator test button
Legends:	4 Way legends available
Material:	100% PC

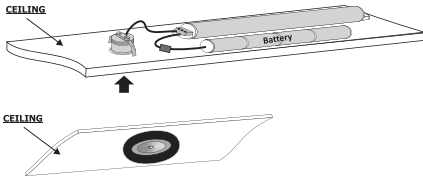

LED Emergency Downlight

3W VT-503 EAN Code
8274 - 6400K White 3800157627269

Material:	Poly Carbonate & Aluminum	Charging Current:	90ma
Mounded:	Ceiling Recessed	Convert Voltage:	155v : AC
Life Time Of Battery:	2 Years	Discharging Current:	300ma
Light Output (Emergency):	140lm	Discharge Duration:	3 Hours
Lamp Protection:	Over Charge And Discharge Protection	Spec Of Battery:	3.6v 1800mah Ni-cd Battery
Led Indicator:	Green Indicator	Packing:	38.5 X 22 X 25cm
Charging Current:	90ma	IP Rating:	IP20

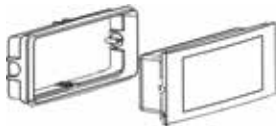

LED Emergency Light

3.8W VT-511 EAN Code
8249 - 6400K White 3800157626491

Watts:	3.8W	Charging Current:	200mA
Lumens:	85lm	Discharging Current:	280mA
Input:	AC:220-240V,50-60Hz	Battery:	4V2.0AH Lead Acid battery
IP Rating:	IP20	Material:	ABS+PC
Lamp Type:	SMD 2835 20PCS	Dimension:	292 x 79 x 102mm
Exit Lamp Type:	Bulkhead		With recessed-292 x 93.7 x 102mm
Operation Time:	>3 Hours	Legends:	4 Ways legends available



LED Emergency Light Bulkhead

3W VT-523

EAN Code

SKU 8096

3800157623124

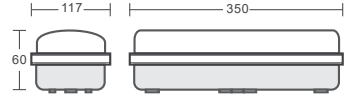

Lamp Type:	16 SMD Leds
Colour:	White - 6000K
Lumens :	140lm
Input Voltage:	AC: 220-240V, 50/60Hz
Protection Rating:	IP65
Exit Lamp Type:	Wall - Bulkhead
Viewing Distance:	22 meters from one side
Emergency Operation Time:	> 3Hours
Battery:	Ni-Cd 3.6V, 1500mAh
Recharging Time:	24 hours (initial charge 36 hours)
Test Button:	Green light indicator test button
Legends:	4 Ways legends available
Material:	100% PC



LED Emergency Light Bulkhead

4W VT-524

EAN Code

SKU 8097

3800157623131

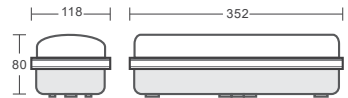

Lamp Type:	30 SMD Leds
Colour:	White - 6000K
Lumens:	190lm
Input Voltage:	AC: 220-240V, 50/60Hz
Protection Rating:	IP65
Exit Lamp Type:	Wall - Bulkhead
Viewing Distance:	22 meters from one side
Emergency Operation Time:	> 3Hours
Battery:	Ni-Cd 4.8V, 900mAh
Recharging Time:	24 hours (initial charge 36 hours)
Test Button:	Green light indicator test button
Legends:	4 Ways legends available
Material:	100% PC



Emergency Twin Spot Light

Wall Mounted

7W VT-526

EAN Code

3800157623148

SKU 8098



Lamp Type:	2 x 15 SMD Leds
Colour:	White - 6000K
Lumens:	600lm
Input Voltage:	AC: 220-240V, 50/60Hz
Protection Rating:	IP65
Exit Lamp Type:	Wall mounted
Emergency Operation Time:	> 3Hours
Battery:	Ni-Cd 9.6V, 2200mAh
Recharging Time:	24 hours (initial charge 36 hours)
Indicator:	Green light indicator
Material :	100% PC

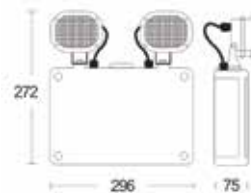



Motion Sensor

Many areas like lobbies, parking garages, staircases remain unused for long hours, but do need lighting to be lit automatically in case of movement. A motion sensor is a device which detects movements, and in some cases light conditions and then transmits a signal for illumination.

Product Features

- Power saving
- Available for in-door and out door purposes
- Compatible with most of our models
- Proven quality from reliable suppliers
- Wide range of models to choose from



Applications

- Outdoor Areas like parking garages, Gardens compounds and yards
- Indoor areas like walkways, lobbies and staircases.



Infrared Sensor

Max **1000W** VT-8027 EAN Code
5086 3800157609173

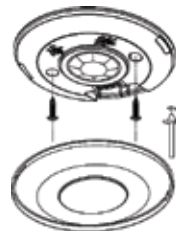

Sensor Type:	Infrared	Time Delay:	*10sec±3sec-15min±2min
Color:	White	Ambient Light:	*<3-2000LUX
Detection Range:	360°	Body Type:	PC
Voltage:	AC: 220-240V,50/60Hz	Detector:	One
Rated Load:	Max.1000W(LED)	IP Rating:	IP20
Detection Distance:	Max.6m (<24° C)	Dimension:	115x25mm



Infrared Sensor

Max **1000W** VT-8027 EAN Code
5087 3800157609180

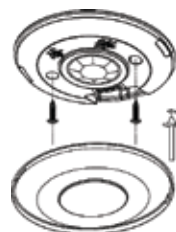

Sensor Type:	Infrared	Time Delay:	*10sec±3sec-15min±2min
Color:	Black	Ambient Light:	*<3-2000LUX
Detection Range:	360°	Body Type:	PC
Voltage:	AC: 220-240V,50/60Hz	Detector:	One
Rated Load:	Max.1000W(LED)	IP Rating:	IP20
Detection Distance:	Max.6m (<24° C)	Dimension:	115x25mm



Infrared Sensor

Max. **400W** VT-8028
5088

IP44
RATED

EAN Code
3800157609197



Sensor Type:	Infrared	Time Delay:	*10sec±3sec-15min±2min
Color:	White	Ambient Light:	*<3-2000LUX
Detection Range:	180°	Body Type:	PC
Voltage:	AC: 220-240V,50/60Hz	IP Rating:	IP44
Rated Load:	Max.400W(LED)	Dimension:	80x55x70mm
Detection Distance:	Max.12m (<24° C)		



Infrared Sensor

Max. **400W** VT-8028
5089

IP44
RATED

EAN Code
3800157609203



Sensor Type:	Infrared	Time Delay:	*10sec±3sec-15min±2min
Color:	Black	Ambient Light:	*<3-2000LUX
Detection Range:	180°	Body Type:	PC
Voltage:	AC: 220-240V,50/60Hz	IP Rating:	IP44
Rated Load:	Max.400W(LED)	Dimension:	80x55x70mm
Detection Distance:	Max.12m (<24° C)		

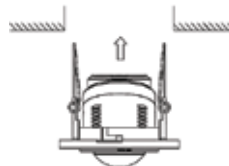

Infrared Sensor-PIR Sensor Moving Head

Max. **400W** VT-8030 EAN Code
5091 3800157609227



Sensor Type:	Infrared	Time Delay:	*10sec±3sec-15min±2min
Color:	White	Ambient Light:	*<3-2000LUX
Detection Range:	360°	Body Type:	PC
Voltage:	AC: 220-240V,50/60Hz	IP Rating:	IP20
Rated Load:	Max.400W(LED)	Dimension:	80 x 63 x 71mm
Detection Distance:	Max.8m (<24° C)		

Infrared Sensor

Max. **300W** VT-8029 EAN Code
5090 3800157609210

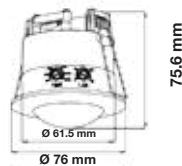

Sensor Type:	Infrared	Time Delay:	*10sec±3sec-15min±2min
Color:	White	Ambient Light:	*<3-2000LUX
Detection Range:	360°	Body Type:	PC
Voltage:	AC: 220-240V,50/60Hz	IP Rating:	IP20
Rated Load:	Max.300W(LED)	Dimension:	76 x 75.6mm
Detection Distance:	Max.6m (<24° C)		

Infrared Sensor

IP44
RATED

Max. **300W** VT-8003
4967

EAN Code
3800230625823



Sensor Type:	Infrared	Time Delay:	*10sec±3sec-7min±2min
Color:	White	Ambient Light:	*<3-2000LUX
Detection Range:	180°	Body Type:	PC
Voltage:	AC: 220-240V,50/60 Hz	Detector:	One
Rated Load:	Max.300W(LED)	IP Rating:	IP44
Detection Distance:	max.12m (<24° C)	Dimension:	86.4 x 60.4 x 98mm

Infrared Sensor

IP44
RATED

Max. **300W** VT-8003
5077

EAN Code
3800157606875



Sensor Type:	Infrared	Time Delay:	*10sec±3sec-7min±2min
Color:	Black	Ambient Light:	*<3-2000LUX
Detection Range:	180°	Body Type:	PC
Voltage:	AC: 220-240V,50/60 Hz	Detector:	One
Rated Load:	Max.300W(LED)	IP Rating:	IP44
Detection Distance:	max.12m (<24° C)	Dimension:	86.4 x 60.4 x 98mm



Infrared Sensor

Max. **60W** VT-8005
4982

EAN Code
 3800157600071

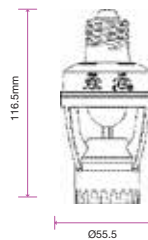

Sensor Type:	Infrared	Time Delay:	*10sec±3sec-5min±1min
Color:	White	Ambient Light:	*<3-2000LUX
Detection Range:	360°	Body Type:	PC
Voltage:	AC: 110-240V, 50/60Hz	IP Rating:	IP20
Rated Load:	Max.60W(E27)	Dimension:	Ø55.5 x 116.5mm
Detection Distance:	Max.6m (<24° C)		

Infrared Sensor

Max. **300W** VT-8004
4968

EAN Code
 3800230625830

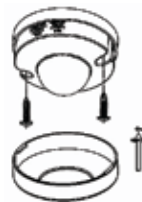

Sensor Type:	Infrared	Time Delay:	*10sec±3sec-15min±2min
Color:	White	Ambient Light:	*<3-2000LUX
Detection Range:	360°	Body Type:	PC
Voltage:	AC: 220-240V,50/60Hz	Detector:	Three
Rated Load:	Max.300W(LED)	IP Rating:	IP20
Detection Distance:	max.12m (<24° C)		
	Dimension:	88 x 55mm	

New!

Infrared Sensor

Max **1200W** VT-8048 EAN Code
1354 3800157624794



Sensor Type:	Infrared	Time Delay:	*Min.10sec±3sec-
Colour:	White		Max 7min±2min
Detection Range:	180°	Ambient Light:	*<3-2000LUX
Voltage:	AC:220-240V,50/60Hz	Body Type:	PC
Rated Load:	Max 1200w	IP Rating:	IP44
Detection Distance:	12m (<24° C)	Dimension:	86.4 x 60.4 x 98mm

MANUAL OVERRIDE FUNCTION:

1. Automatic Sensor Override Mode - Turn the switch OFF and ON within 3 Seconds, the sensor will be overridden and switched off. The light will work continuously and normally.(Make sure the automatic mode is switched ON before using this functionality)
2. Sensor Switch On - Turn the switch OFF for 20 seconds and switch it back ON. The sensor will restart and work as per the settings adjusted.
3. If the light is left idle for a longer period of time, the sensor will automatically switch back to automatic mode(Possible when the outside light reaches 100Lux)

New!

Infrared Sensor

Max **1200W** VT-8049 EAN Code
1355 3800157624800

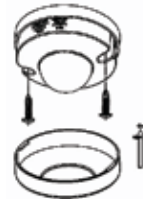

Sensor Type:	Infrared	Time Delay:	*Min.10sec±3sec-
Colour:	White		Max 15min±2min
Detection Range:	360°	Ambient Light:	*<3-2000LUX
Voltage:	AC:220-240V,50/60Hz	Body Type:	PC
Rated Load:	Max 1200w	IP Rating:	IP20
Detection Distance:	12m	Dimension:	Ø 88 x 55mm

MANUAL OVERRIDE FUNCTION:

1. Automatic Sensor Override Mode - Turn the switch OFF and ON within 3 Seconds, the sensor will be overridden and switched off. The light will work continuously and normally.(Make sure the automatic mode is switched ON before using this functionality)
2. Sensor Switch On - Turn the switch OFF for 20 seconds and switch it back ON. The sensor will restart and work as per the settings adjusted.
3. If the light is left idle for a longer period of time, the sensor will automatically switch back to automatic mode(Possible when the outside light reaches 100Lux)



New!

Infrared Sensor

Max **300W** VT-8051
1356

EAN Code
 3800157624817

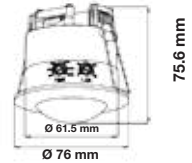

Sensor Type:	Infrared	Time Delay:	*Min.10sec±3sec-
Colour:	White	Ambient Light:	Max 15min±2min
Detection Range:	Max 6m(<24° C)	Ambient Light:	*<3-2000LUX
Voltage:	AC:220-240V,50/60Hz	Body Type:	PC
Rated Load:	Max 300w(LED)	IP Rating:	IP20
Detection Distance:	12m	Dimension:	Ø 76 x 75.6mm

MANUAL OVERRIDE FUNCTION:

1. Automatic Sensor Override Mode - Turn the switch OFF and ON within 3 Seconds, the sensor will be overridden and switched off. The light will work continuously and normally.(Make sure the automatic mode is switched ON before using this functionality)
2. Sensor Switch On - Turn the switch OFF for 20 seconds and switch it back ON. The sensor will restart and work as per the settings adjusted.
3. If the light is left idle for a longer period of time, the sensor will automatically switch back to automatic mode(Possible when the outside light reaches 100Lux)



Daylight Sensor **New!**

Max.**000** VT-8059
1369

EAN Code
 3800157625982

Sensor Type:	--	Time Delay:	--
Colour:		Ambient Light:	
Detection Range:		Body Type:	
Voltage:		Detector:	
Rated Load:		IP Rating:	
Detection Distance:		Dimension:	

Daylight sensor supplies a simple and effective solution for daylight harvesting. Connecting to 1-10V Power source and using with LED dimmable driver.The illuminations level of lamps will get darker when ambient Light gets brighter. When daylight is insufficient, the lamp will be in 100% Illumination level, and turns to 1 % Level when daylight is sufficient enough, then gradually back to 100% level when it is getting darker.

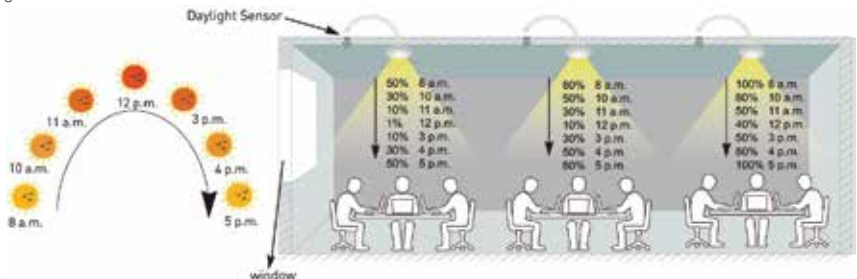



On/Off via moving hand

Motion Sensor

Max. **200W** VT-8025

5084

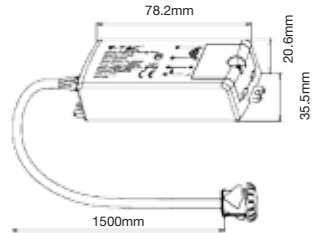

EAN Code

3800157608046



Sensor Type:	Infrared	Detection Distance:	5-6cm (<24°C)
Color:	White	Body Type:	Plastic
Detection Range:	30°	Detector:	One
Voltage:	AC: 110-240V, 50/60Hz	IP Rating:	IP20
Rated Load:	Max.200W(LED)	Dimension:	35.5 x 78.2 x 20.6mm



On/Off via the opening and closing of the door

Motion Sensor

Max. **200W** VT-8026

5085

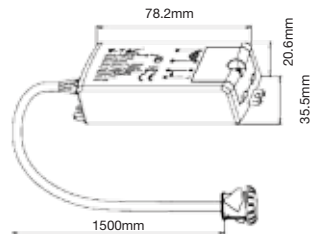

EAN Code

3800157608053



Sensor Type:	Infrared	Detection Distance:	5-6cm (<24°C)
Color:	White	Body Type:	Plastic
Detection Range:	30°	Detector:	One
Voltage:	AC: 110-240V, 50/60Hz	IP Rating:	IP20
Rated Load:	Max.200W(LED)	Dimension:	35.5 x 78.2 x 18.7mm

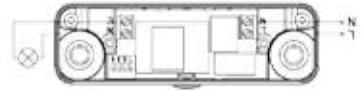

Microwave Sensor

Max. **200W** VT-8036
5571

EAN Code
3800157620246

Sensor Type:	Microwave	Time Delay:	*5sec±90sec-3min±20min
Color:	White	Ambient Light:	*<25-2000LUX
Detection Range:	180°	Body Type:	PC
Voltage:	AC: 220-240V,50/60Hz	IP Rating:	IP65
Rated Load:	Max.200W	Dimension:	115 x 35 x25mm
Detection Distance:	5m /10m		

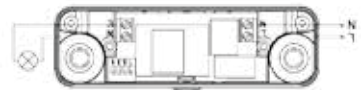

Microwave Sensor

Max. **200W** VT-8036
5572

EAN Code
3800157620253

Sensor Type:	Microwave	Time Delay:	*5sec±90sec-3min±20min
Color:	Black	Ambient Light:	*<25-2000LUX
Detection Range:	180°	Body Type:	PC
Voltage:	AC: 220-240V,50/60Hz	IP Rating:	IP65
Rated Load:	Max.200W	Dimension:	115 x 35 x25mm
Detection Distance:	5m /10m		



Housing for Microwave Snsor

VT-8021
5079

EAN Code
3800157606899

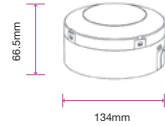

Sensor Type:	Microwave
Color:	White
IP Rating:	IP65
Dimension:	Ø134 x 66.5mm

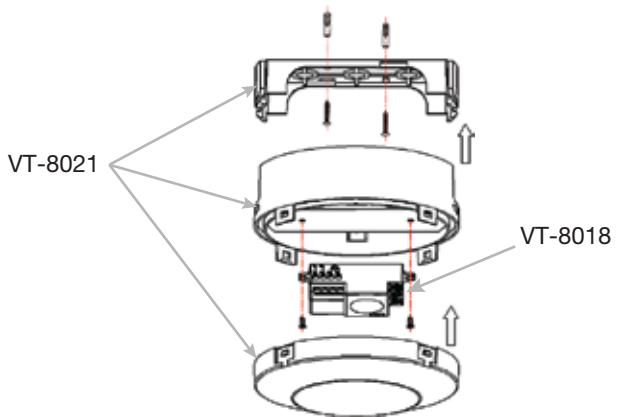

Microwave Sensor

Max. **300W** VT-8018
5078

EAN Code
3800157606882

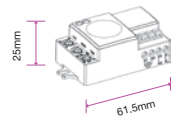

Sensor Type:	Microwave	Time Delay:	*10sec±3sec-12min±1min
Color:	White	Ambient Light:	*<3-2000LUX
Detection Range:	180/360°	Body Type:	Plastic
Voltage:	AC: 220-240V,50/60Hz	Detector:	One
Rated Load:	Max.300W (LED)	IP Rating:	IP20
Detection Distance:	*1-8m (radius)	Dimension:	61.5 x 37x 25 mm



Photocell Sensor

IP44
RATED

VT-8019

EAN Code

5081

3800157608015



Sensor Type:	Photocell	Ambient Light:	*<5-15LUX
Color:	White	Body Type:	Plastic
Detection Range:	360°	Detector:	One
Voltage:	AC: 220-240V, 50/60Hz	IP Rating:	IP44
Rated Current:	6A	Dimension:	35.5 x 46 x 44.1mm



Infrared Sensor

IP44
RATED

Max. **800W** VT-8022

EAN Code

5082

3800157608022

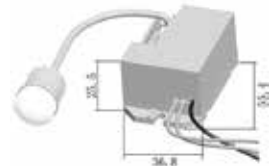

Sensor Type:	Infrared	Time Delay:	*5 sec to 8 min
Color:	White	Ambient Light:	*10 Lux/2000 Lux
Detection Range:	120/360°	Body Type:	PC
Voltage:	AC: 220-240V , 50Hz	Detector:	Three
Rated Load:	Max.500/800W	IP Rating:	IP44
Detection Distance:	3m/6m(choice) (<24°C)	Dimension:	36.8 x 25.5 x 55.4mm



Microwave Sensor

Max. **1200W** VT-8023

EAN Code

5083

3800157608039

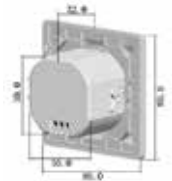

Sensor Type:	Microwave	Time Delay:	*10Sec+3Sec to 12min+1min
Color:	White	Ambient Light:	*<3-2000LUX
Detection Range:	180°	Body Type:	Plastic
Voltage:	AC: 220-240V, 50/60Hz	Detector:	One
Rated Load:	Max.1200W	IP Rating:	IP20
Detection Distance:	*5m - 15m	Dimension:	80 x 80 x 32mm



LED Table Lamps

Our most cozy and favorite corners, be it at work or at home, while you are working, or relaxing and reading a book, always deserve the best lighting conditions. To cater to this need we bring to you an exclusive range of LED table lamps designed with a touch of class, these lamps deliver very smooth lighting with suitable functions to set the right mood and ambiance.

Product Features

- Energy efficient ways of keeping it that way.
- Adjustable direction.
- Multiple functions like dimming, color changing.
- With USB charging functionality.
- Sleek and modern design.

Applications

- Table lamps can be used in any space, though they are most often found in bedrooms, living rooms at home next to sofas, chairs or beds. it is also a good accessory to be a part of the office decor.





Silver

4W VT-1014

EAN Code

3800157616980



- 7098 { 3000K Warm White
- 4000K Day White
- 5000K White

Voltage/Frequency:	AC: 100-240V, 50/60Hz	Beam Angle:	120°
Luminous Flux:	120lm	Color:	White + Silver
IP Rating:	IP20	Body Type:	ABS + PC + Aluminum
CRI:	> 80	Dimension:	200 x 50 x 263mm
PF:	>0.45		



Gold

4W VT-1014

EAN Code

3800157616997



- 7099 { 3000K Warm White
- 4000K Day White
- 5000K White

Voltage/Frequency:	AC: 100-240V, 50/60Hz	Beam Angle:	120°
Luminous Flux:	120lm	Color:	White + Gold
IP Rating:	IP20	Body Type:	ABS + PC + Aluminum
CRI:	> 80	Dimension:	200 x 50 x 263mm
PF:	>0.45		



Black

4W VT-1014

EAN Code

3800157617215



- 8500 { 3000K Warm White
- 4000K Day White
- 5000K White

Voltage/Frequency:	AC: 100-240V, 50/60Hz	Beam Angle:	120°
Luminous Flux:	120lm	Color:	Black
IP Rating:	IP20	Body Type:	ABS + PC + Aluminum
CRI:	> 80	Dimension:	200 x 50 x 263mm
PF:	>0.45		



Grey

7W VT-1007D
7034 - 5000K White



EAN Code
 3800157603836

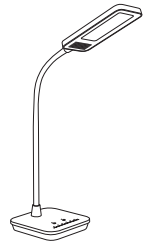

Voltage/Frequency:	AC: 100-240V, 50/60Hz	PF:	>0.45
Luminous Flux:	400lm	Beam Angle:	120°
IP Rating:	IP20	Color:	Grey
CRI:	> 80	Body Type:	ABS
		Dimension:	170 x 135 x 415mm



Pink

7W VT-1007D
7042 - 5000K White



EAN Code
 3800157605311



Voltage/Frequency:	AC: 100-240V, 50/60Hz	PF:	>0.45
Luminous Flux:	400lm	Beam Angle:	120°
IP Rating:	IP20	Color:	Pink
CRI:	> 80	Body Type:	ABS
		Dimension:	170 x 135 x 415mm



Blue

7W VT-1007D
7043 - 5000K White



EAN Code
 3800157605328



Voltage/Frequency:	AC: 100-240V, 50/60Hz	PF:	>0.45
Luminous Flux:	400lm	Beam Angle:	120°
IP Rating:	IP20	Color:	Blue
CRI:	> 80	Body Type:	ABS
		Dimension:	170 x 135 x 415mm



White

7W VT-1009D

EAN Code

3800157605281



- 7039** {
 3000K Warm White
 4000K Day White
 5000K White



Voltage/Frequency:	AC: 100-240V, 50/60Hz	Beam Angle:	120°
Luminous Flux:	650lm	Color:	White
IP Rating:	IP20	Body Type:	ABS + Aluminum
CRI:	> 80	Dimension:	240 x 396 x 180mm
PF:	>0.45		



Black And White

7W VT-1009D

EAN Code

3800157605298



- 7040** {
 3000K Warm White
 4000K Day White
 5000K White



Voltage/Frequency:	AC: 100-240V, 50/60Hz	Beam Angle:	120°
Luminous Flux:	650lm	Color:	Black + White
IP Rating:	IP20	Body Type:	ABS + Aluminum
CRI:	> 80	Dimension:	240 x 396 x 180mm
PF:	>0.45		



White With Silver

10W VT-1010D



EAN Code

3800157603829



- 7033** {
 3000K Warm White
 4000K Day White
 5000K White

Voltage/Frequency:	AC: 100-240V, 50/60Hz	Beam Angle:	120°
Luminous Flux:	700lm	Color:	White with Silver
IP Rating:	IP20	Body Type:	ABS + Aluminum
CRI:	> 80	Dimension:	325 x 425 x 205mm
PF:	>0.45		



White

7W VT-1008D
7035 - 5000K White

EAN Code
3800157603843



Voltage/Frequency:	AC: 100-240V, 50/60Hz	PF:	>0.45
Luminous Flux:	400lm	Beam Angle:	120°
IP Rating:	IP20	Color:	White
CRI:	> 80	Body Type:	ABS
		Dimension:	170 x 352 x 113mm



White

5W VT-1015
7051 - 4000K Day White

EAN Code
3800157610650



Voltage/Frequency:	AC: 100-240V, 50/60Hz	PF:	>0.45
Luminous Flux:	360lm	Beam Angle:	90°
IP Rating:	IP20	Color:	White
CRI:	> 80	Body Type:	ABS + Metal
		Dimension:	210 x 136 x 32mm



Black

5W VT-1015
7052 - 4000K Day White

EAN Code
3800157610667



Voltage/Frequency:	AC: 100-240V, 50/60Hz	PF:	>0.45
Luminous Flux:	360lm	Beam Angle:	90°
IP Rating:	IP20	Color:	Black
CRI:	> 80	Body Type:	ABS + Metal
		Dimension:	210 x 136 x 32mm



New!

White

5.5W VT-1046

8514 3000K Warm White
8515 4000K White

A+

EAN Code

3800157627245
3800157627252

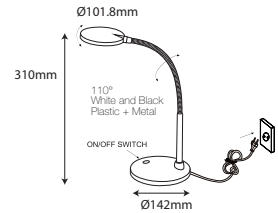

Voltage/Frequency:	AC: 220-240V, 50Hz	Beam Angle:	110°
Luminous Flux:	420lm	Color:	White and Black
IP Rating:	IP20	Body Type:	Plastic + Metal
CRI:	> 80	Dimension:	142 x 101.8 x 310mm
PF:	>0.5		



White

7W VT-1017

7053 - 4000K Day White

A+

EAN Code

3800157610674

Voltage/Frequency:	AC: 100-240V, 50/60Hz	Beam Angle:	120°
Luminous Flux:	420lm	Color:	White
IP Rating:	IP20	Body Type:	ABS + Metal
CRI:	> 80	Dimension:	376 x 166 x 270mm
PF:	>0.45		



Black

7W VT-1017

7054 - 4000K Day White

A+

EAN Code

3800157610681

Voltage/Frequency:	AC:100-240V,50/60Hz	Beam Angle:	120°
Luminous Flux:	420lm	Color:	Black
IP Rating:	IP20	Body Type:	ABS + Metal
CRI:	>80	Dimension:	376 x 166 x 270mm
PF:	>0.45		



Light Wooden

6W VT-1012

SKU 7049

EAN Code

3800157610452



Voltage/Frequency:	AC:100-240V,50/60Hz	Beam Angle:	360°
Luminous Flux:	230lm	Color:	Light Wooden
IP Rating:	IP20	Body Type:	ACRYLIC + ABS
CRI:	>80	Dimension:	Ø108 x 172mm
PF:	>0.45		



Matt White

6W VT-1012

SKU 7050

EAN Code

3800157610469



Voltage/Frequency:	AC:100-240V,50/60Hz	Beam Angle:	360°
Luminous Flux:	230lm	Color:	Matt White
IP Rating:	IP20	Body Type:	ACRYLIC + ABS
CRI:	>80	Dimension:	Ø108 x 172mm
PF:	>0.45		

Mood Lighting

Control your lights the way you want



Dimmable Table Lamp With Smart Speakers



VT-1045D

RED 8509 3000K RGB
EAN Code 3800157621601



VT-1045D

BLUE 8510 3000K RGB
EAN Code 3800157621618



VT-1045D

BLACK 8511 3000K RGB
EAN Code 3800157621625



VT-1045D

PINK 8512 3000K RGB
EAN Code 3800157621632



VT-1045D

WHITE 8513 3000K RGB
EAN Code 3800157621649

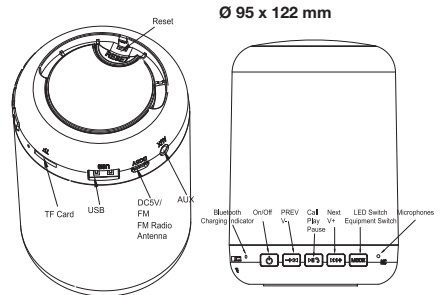

Color:	RGB + WW	Frequency response:	87-108 MHz
Watts:	5W	The sensitivity:	90db
Beam angle:	360°	Signal to noise ratio:	>80db
Voltage:	AC: 100-240v, 50/60Hz	Material:	ABS
Rating input:	DC: 5V	Built-in lithium battery:	2000 mAh
USB output:	5V 2A	Charging time:	2-3 hours
Transmission distance:	<10m	Working time:	3-4 hours (minimum), 20-24 hours (maximum)
Dimmable:	Yes		





Purple

5W VT-1035

8501 4000K



TOUCH DIMMING

EAN Code

3800157620345



Watts:	5W	PF:	>0.4
Voltage/Frequency:	AC:100-240V,50/60Hz	Beam Angle:	90°
Luminous Flux:	300lm	Color:	Chrome + Purple
IP Rating:	IP20	Body Type:	PC + Metal
CRI:	>80	Dimension:	Ø150 x233mm



Purple Wall Lamp

7W VT-1036

8504 4000K

EAN Code

3800157620376



Watts:	7W	PF:	>0.4
Voltage/Frequency:	AC:100-240V,50/60Hz	Beam Angle:	90°
Luminous Flux:	360lm	Color:	Chrome + Purple
IP Rating:	IP20	Body Type:	PC + Metal
CRI:	>80	Dimension:	Ø150 x151 x1241mm



White

5W VT-1035

8502 4000K



TOUCH DIMMING

EAN Code

3800157620352



Watts:	5W	PF:	>0.4
Voltage/Frequency:	AC:100-240V,50/60Hz	Beam Angle:	90°
Luminous Flux:	300lm	Color:	Chrome + White
IP Rating:	IP20	Body Type:	PC + Metal
CRI:	>80	Dimension:	Ø150 x233mm



White Wall Lamp

7W VT-1036

8505 4000K

EAN Code

3800157620383



Watts:	7W	PF:	>0.4
Voltage/Frequency:	AC:100-240V,50/60Hz	Beam Angle:	90°
Luminous Flux:	360lm	Color:	Chrome + White
IP Rating:	IP20	Body Type:	PC + Metal
CRI:	>80	Dimension:	Ø150 x151 x1241mm



BLUE

5W VT-1035

8503 4000K



TOUCH DIMMING

EAN Code

3800157620369



Watts:	5W	PF:	>0.4
Voltage/Frequency:	AC:100-240V,50/60Hz	Beam Angle:	90°
Luminous Flux:	300lm	Color:	Chrome + Blue
IP Rating:	IP20	Body Type:	PC + Metal
CRI:	>80	Dimension:	Ø150 x233mm



BLUE Wall Lamp

7W VT-1036

8506 4000K

EAN Code

3800157620390



Watts:	7W	PF:	>0.4
Voltage/Frequency:	AC:100-240V,50/60Hz	Beam Angle:	90°
Luminous Flux:	360lm	Color:	Chrome + Blue
IP Rating:	IP20	Body Type:	PC + Metal
CRI:	>80	Dimension:	Ø150 x151 x1241mm



Silver

Max. **60W** VT-7500

7056

EAN Code

3800157610704



Max. Watts:	60W	Color:	White
Voltage/Frequency:	AC:220-240V,50Hz	Body Type:	ABS + Metal
Holder:	E27	Dimension:	Ø250 x H1800mm
IP Rating:	IP20		

Black

Max. **60W** VT-7500

7055

EAN Code

3800157610698



Max. Watts:	60W	Color:	Black
Voltage/Frequency:	AC:220-240V,50Hz	Body Type:	ABS + Metal
Holder:	E27	Dimension:	Ø250 x H1800mm
IP Rating:	IP20		



White

Max. **60W** VT-7600

EAN Code

3704 Floor Lamp

3800157610773

Max. Watts:	60W	Color:	White
Voltage/Frequency:	AC:220-240V,50Hz	Body Type:	Aluminum + Glass
Holder:	E27	Dimension:	200 x 200 x 1600mm
IP Rating:	IP20		



Black

Max. **60W** VT-7600

EAN Code

3703 Floor Lamp

3800157610766

Max. Watts:	60W	Color:	Matt Black
Voltage/Frequency:	AC:220-240V,50Hz	Body Type:	Aluminum + Glass
Holder:	E27	Dimension:	200 x 200 x 1600mm
IP Rating:	IP20		



White

7W VT-7700

EAN Code

8507 - 4000K Day White

3800157620406



Built In **LED**

Watts:	7W	PF:	>0.5
Voltage/Frequency:	AC: 100-240V, 50/60Hz	Beam Angle:	120°
Luminous Flux:	420lm	Color:	White
IP Rating:	IP20	Body Type:	ABS + Metal
CRI:	> 80	Dimension:	220 x440 x H1035.5mm



Black

7W VT-7700

EAN Code

8508 - 4000K Day White

3800157620413



Built In **LED**

Watts:	7W	PF:	>0.5
Voltage/Frequency:	AC:100-240V,50/60Hz	Beam Angle:	120°
Luminous Flux:	420lm	Color:	Black
IP Rating:	IP20	Body Type:	ABS + Metal
CRI:	>80	Dimension:	220 x440 x H1035.5mm



LED Innovative Lights

Transform the exteriors of a Building or a Garden into a Beautiful piece of Architecture.

Simultaneously help navigate obstacles at night, prevent accidents and provide security.

Product Features

- Perfect replacement for traditional fittings as they are more flexible & efficient
- Work perfectly in extreme temperatures from -20° to $+45^{\circ}$ without any adverse effects
- Specifically designed for Outdoor use
- IP65/67 Protection Rating to ensure safety
- Low Maintenance
- Outstanding Colour options and settings

Applications

- Used for Gardens, Outdoor Residential Areas, Walkways & Passages, Driveways, Fountains, Lawns, Entrance, Patio or Terrace and similar environments



White

1.5W VT-767

3000K Warm White } 7096
4000K Day White }

EAN Code
3800157616966

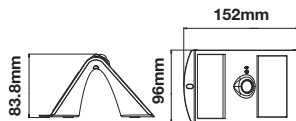

Watts:	1.5W	Sensing Range	2-6 mtrs
Voltage:	3.7V Lithium Battery 1200mA	Charging Time:	6-7 hrs Sunlight Charging
Lumens:	200lm	Working Time:	Min 8 hrs and Max 24 hrs
Color:	4000K + 3000K	Protection Rating:	IP65
No. of LED:	10pcs (Front 8pcs, Back 2 pcs)	Material:	High quality Mono crystal Silicon
Detecting Angle:	120°	Dimension:	152 x 96 x 83.8mm



Black

1.5W VT-767

3000K Warm White } 7097
4000K Day White }

EAN Code
3800157616973

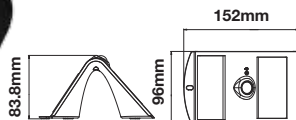

Watts:	1.5W	Sensing Range	2-6 mtrs
Voltage:	3.7V Lithium Battery 1200mA	Charging Time:	6-7 hrs Sunlight Charging
Lumens:	200lm	Working Time:	Min 8 hrs and Max 24 hrs
Color:	4000K + 3000K	Protection Rating:	IP65
No. of LED:	10pcs (Front 8pcs, Back 2 pcs)	Material:	High quality Mono crystal Silicon
Detecting Angle:	120°	Dimension:	152 x 96 x 83.8mm

White & Grey

2W VT-718

9853 - 3000K Warm White

9854 - 4000K Day White

9852 - 6000K White

EAN Code

3800157622806

3800157622813

3800157622790

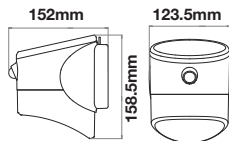

Watts:	2W	Charging Time:	6-7 hrs Sunlight Charging
Lumens:	200lm	Working Time:	Min 5-8 hrs and Max 24 hrs
Color:	3000K , 4000K , 6000K	Protection Rating:	IP65
No. of LED:	18pcs (SMD 2835)	Material:	ABS + PC
Voltage:	3.7V Lithium Battery 1200 mAh	Size:	152 x 158.5x 123.5mm
Detecting Angle:	120°	Housing color:	White + Grey
Sensing Range	2-6 mtrs		



White & Black

3W VT-768

3000K Warm White } 7523
4000K Day White }

EAN Code

3800157619363

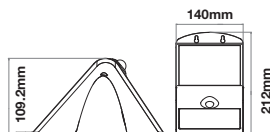

Watts:	3W	Sensing Range	2-6 mtrs
Voltage:	3.7V Lithium Battery 2000mA	Charging Time:	6-7 hrs Sunlight Charging
Lumens:	400lm	Working Time:	Min 5-8 hrs and Max 24 hrs
Color:	4000K + 3000K	Protection Rating:	IP65
No. of LED:	30pcs (Front 28pcs, Back 2 pcs)	Material:	ABS + PC
Detecting Angle:	60°	Dimension:	140 x 212 x 109.2

No Wiring



Wireless



Battery Free



New!

Battery Free Wireless One Gang Switch Set

VT-541 EAN Code
8229 3800157624336

Switch

Working Type: **Push -Button**
 Power Mode: **Self Powered**
 Control Distance: **Up to 30 meters**
 Switch Lifetime: **>200,000**
 Operating Temp: **-5~40°C**
 Humidity: **0-95%RH**
 Dimensions: **Ø70X15.5mm**
 IP Rating: **IP20**

Receiver

Input Voltage: **AC:200-265V,50/60Hz**
 Load Power: **Max 200W**
 Controller: **RF Receiver**
 Dimensions: **D:48x25mm**

Switch Mounting Base

VT-540 EAN Code
8231 3800157624336
Dimensions: **-86 x 86 x 11mm**



No Wiring



Wireless



Battery Free

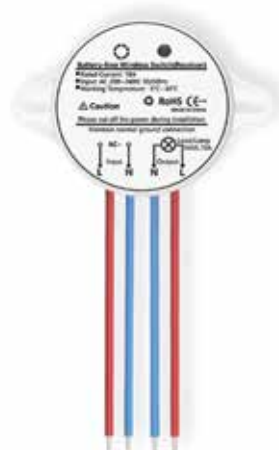

New!

Battery Free Wireless Two Gang Switch Set

VT-542 EAN Code

8230 3800157624343

Switch

Working Type:	Push -Button
Power Mode:	Self Powered
Control Distance:	Up to 30 meters
Switch Lifetime:	>200,000
Operating Temp:	-5~40°C
Humidity:	0-95%RH
Dimensions:	Ø70X15.5mm
IP Rating:	IP20

Receiver

Input Voltage:	AC:200-265V,50/60Hz
Load Power:	Max 200W
Controller:	RF Receiver
Dimensions:	D:48x25mm

Switch Mounting Base

VT-540 EAN Code

8231 3800157624336
Dimensions: **-86 x 86 x 11mm**



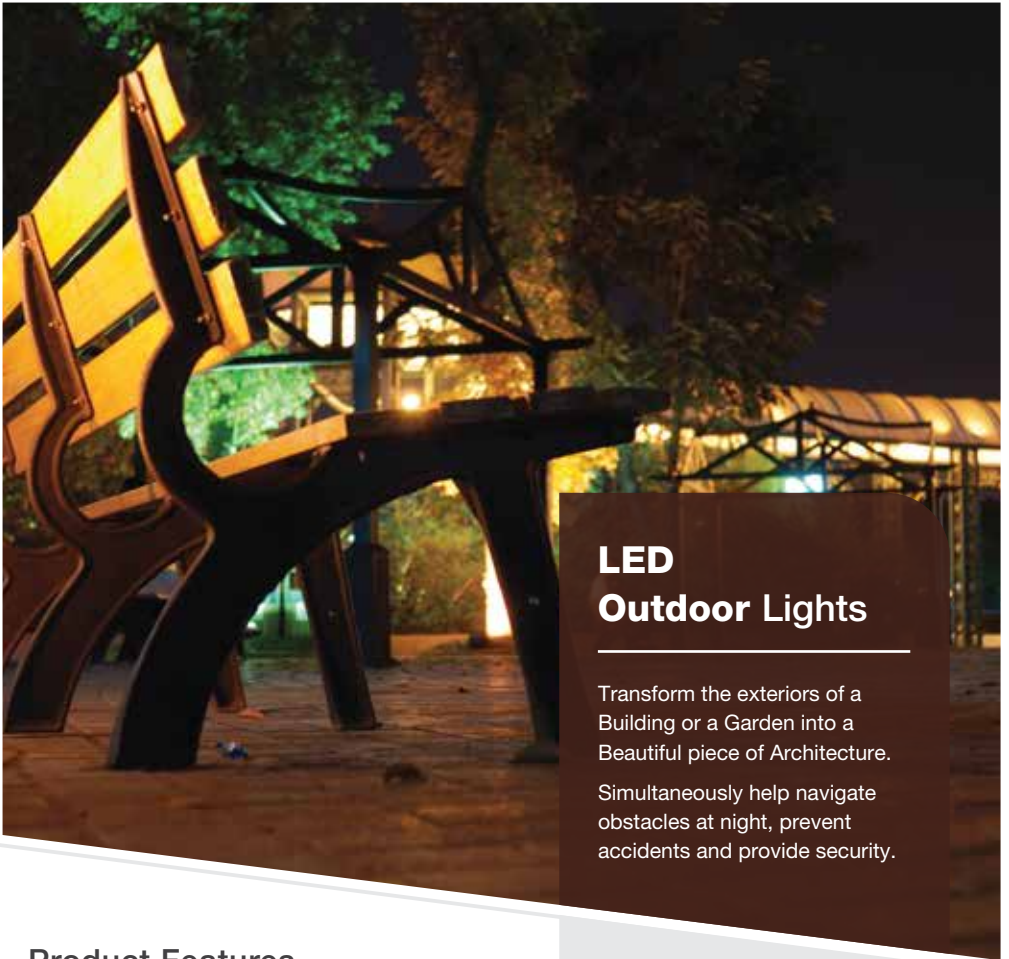

LED Outdoor Lights

Transform the exteriors of a Building or a Garden into a Beautiful piece of Architecture.

Simultaneously help navigate obstacles at night, prevent accidents and provide security.

Product Features

- Perfect replacement for traditional fittings as they are more flexible & efficient
- Work perfectly in extreme temperatures from -20° to $+45^{\circ}$ without any adverse effects
- Specifically designed for Outdoor use
- IP65/67 Protection Rating to ensure safety
- Low Maintenance
- Outstanding Colour options and settings

Applications

- Used for Gardens, Outdoor Residential Areas, Walkways & Passages, Driveways, Fountains, Lawns, Entrance, Patio or Terrace and similar environments





UP
AND
DOWN LIGHTS



Wall Fixtures

Model No:	VT-722	VT-726
SKU:	4793	7032
Type:	Wall	Wall
Holder:	2 x GU10	E27
Material:	304SS, Glass	304SS Lampbody, Frosted PC
Color of Fixture:	Silver	Satin Nickel
IP Rating:	IP44	IP44
Dimension:	Ø60 x 156mm	Ø102 x 200mm
EAN Code:	3800230625281	3800157603713



UP
AND
DOWN LIGHTS



Wall Fixtures

Model No:	VT-7621	VT-7622
SKU:	7501	7500
Type:	Wall	Wall
Holder:	GU10	2 x GU10
Material:	Stainless Steel	Stainless Steel
Color of Fixture:	Stainless Steel Brush	Stainless Steel Brush
IP Rating:	IP44	IP44
Dimension:	Ø93 x 85 x 118mm	Ø93 x 85 x 163mm
EAN Code:	3800157617604	3800157617598



Wall Fixtures

Model No:	VT-7621 PIR Sensor	VT-7622 PIR Sensor	VT-7631
SKU:	7502	7503	7505
Type:	Wall	Wall	Wall
Holder:	GU10	2 x GU10	GU10
Material:	Stainless Steel	Stainless Steel	Stainless Steel
Color of Fixture:	Stainless Steel Brush	Stainless Steel Brush	Stainless Steel Brush
IP Rating:	IP44	IP44	IP44
Dimension:	Ø110 x 67 x 163mm	Ø110 x 67 x 220mm	Ø110 x 60 x 125mm
EAN Code:	3800157617611	3800157617628	3800157617642



Wall Fixtures

Model No:	VT-7632	VT-7641	VT-7642
SKU:	7504	7506	7507
Type:	Wall	Wall	Wall
Holder:	2 x GU10	GU10	2 x GU10
Material:	Stainless Steel	Stainless Steel	Stainless Steel
Color of Fixture:	Stainless Steel Brush	Stainless Steel Brush	Stainless Steel Brush
IP Rating:	IP44	IP44	IP44
Dimension:	Ø110 x 60 x 178mm	Ø105 x 76 x 118mm	Ø105 x 76 x 207mm
EAN Code:	3800157617635	3800157617659	3800157617666



Wall Fixtures

Model No:	VT-7651	VT-7651
SKU:	7508	7510
Type:	Wall	Wall
Holder:	GU10	GU10
Material:	Aluminium	Aluminium
Color of Fixture:	Black	Black
IP Rating:	IP44	IP44
Dimension:	Ø92 x 68 x 80mm	92 x 68 x 80mm
EAN Code:	3800157617673	3800157617697



LIGHTS



LIGHTS



LIGHTS



Wall Fixtures

Model No:	VT-7652	VT-7652	VT-7662
SKU:	7509	7511	7512
Type:	Wall	Wall	Wall
Holder:	2 x GU10	2 x GU10	2 x GU10
Material:	Aluminium	Aluminium	Stainless Steel
Color of Fixture:	Black	Black	Black
IP Rating:	IP44	IP44	IP44
Dimension:	Ø92 x 68 x 150mm	92 x 68 x 150mm	85 x 87 x 250mm
EAN Code:	3800157617680	3800157617703	3800157617710



Underground Fixtures

Model No:	VT-721 UG	VT-7677	VT-7677
SKU:	4791	7515	7516
Type:	Underground	Underground	Underground
Holder:	GU10	GU10	GU10
Material:	Aluminum, 304SS, Glass	Stainless Steel	Stainless Steel
Color of Fixture:	Black Lamp Body	Black	Black
IP Rating:	IP65	IP65	IP65
Dimension:	101 x 109 x 145mm	Ø110 x 110 x 120mm	110 x 110 x 120mm
EAN Code:	3800230625267	3800157617741	3800157617758



Garden Spikes

Model No:	VT-723 UG	VT-769	VT-770
SKU:	4792	7517	7518
Type:	Garden Spike	Garden Spike	Garden Spike
Holder:	GU10	GU10	GU10
Material:	Aluminum, 304SS, Glass	Aluminium	Stainless Steel
Color of Fixture:	Black Lamp Body	Black	Silver
IP Rating:	IP67	IP44	IP44
Dimension:	Ø95 x 317mm	95 x 95 x 335mm	60 x 60 x 420mm
EAN Code:	3800230625274	3800157617765	3800157617772



18W VT-1233

- 5103 -RGB
- 5106 - 3000K Warm White
- 5102 - 6000K White

EAN Code

- 3800230627124
- 3800157601115
- 3800230627117



Sensor Compatible:	Yes	Body Type:	Thick Glass
Voltage/Frequency:	AC: 12V, 50/60Hz	IP Rating:	IP68
Luminous Flux:	1100lm	Dimension:	D: 168mm x 105mm
Beam AngleRl:	120°		



18W VT-1235

- 5105 - 3000K Warm white
- 5104 - 6000K White

EAN Code

- 3800157601108
- 3800157601092



Sensor Compatible:	Yes	Body Type:	PVC Case
Voltage/Frequency:	AC: 12V, 50/60Hz	IP Rating:	IP68
Luminous Flux:	1100lm	Dimension:	D: 298mm x 76mm
Beam AngleRl:	180°		



Garden Lamps

VTAC LED presents, the perfect outdoor lighting to make your garden glow after the sun goes down. Step outside with our wide range of contemporary outdoor lighting and decorate your pathways, walls, floors and ceilings with our modern designs.

Product Features

- Traditional Garden Lamps designed to fit the Modern day requirements
- Available in different designs, shapes and sizes
- Waterproof Lamps available in series of IP rating from IP 44 to IP 66
- Easy installation
- Applicable with GU10 -E27 base lights
- Suitable for Walls, Floor, Pathways and Ceiling Lights



Applications

Suitable for Outdoor Lighting



Wall Lamp

**PLASTIC
DIFFUSER**

VT-745
7064

EAN Code
3800157614399

Voltage:	AC: 220-240V
Max.Watts:	40W
IP Rating:	IP54
Holder:	E27
Color of Fixture:	Matt Black
Body Type:	Aluminium + Plastic
Size:	145 x 265mm

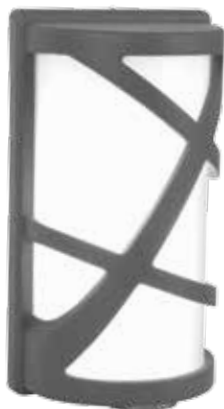
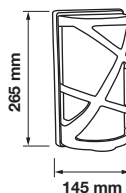

Wall Lamp

**PLASTIC
DIFFUSER**

VT-745
7065

EAN Code
3800157614405

Voltage:	AC: 220-240V
Max.Watts:	40W
IP Rating:	IP54
Holder:	E27
Color of Fixture:	Dark Grey
Body Type:	Aluminium + Plastic
Size:	145 x 265mm

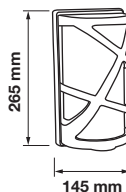

**Wall Lamp****PLASTIC
DIFFUSER**

VT-754

EAN Code

7077

3800157616300

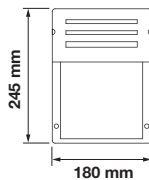
Voltage: **AC: 220-240V**Max. Watts: **40W**IP Rating: **IP44**Holder: **E27**Color of Fixture: **White**Body Type: **Aluminium + Plastic**Size: **245 x 180 x 93mm****Wall Lamp****PLASTIC
DIFFUSER**

VT-754

EAN Code

7076

3800157616294

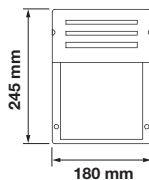
Voltage: **AC: 220-240V**Max. Watts: **40W**IP Rating: **IP44**Holder: **E27**Color of Fixture: **Black**Body Type: **Aluminium + Plastic**Size: **245 x 180 x 93mm**

Wall Lamp



VT-7670
7513

EAN Code
3800157617727

Voltage:	AC: 220-240V
Max.Watts:	14W
IP Rating:	IP44
Holder:	E27
Color of Fixture:	White
Body Type:	Stainless Steel + PC
Size:	250 x 90 x 100mm

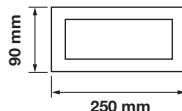

Wall Lamp



VT-7680
7514

EAN Code
3800157617734

Voltage:	AC: 220-240V
Max.Watts:	14W
IP Rating:	IP44
Holder:	E27
Color of Fixture:	White
Body Type:	Stainless Steel + PC
Size:	250 x 90 x 100mm

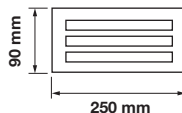



Wall Lamp

VT-730

EAN Code

7046

3800157610391

Voltage:	AC: 220-240V
Max.Watts:	40W
IP Rating:	IP44
Holder:	E27
Color of Fixture:	Black
Body Type:	Aluminum + Glass
Size:	200 x 238mm

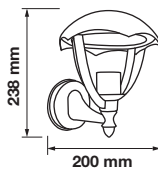

Wall Lamp

VT-731

EAN Code

7047

3800157610407

Voltage:	AC: 220-240V
Max.Watts:	40W
IP Rating:	IP44
Holder:	E27
Color of Fixture:	Black
Body Type:	Aluminum + Glass
Size:	200 x 238mm

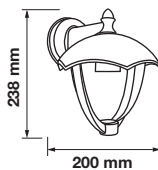

Wall Lamp



VT-751
7070

EAN Code
3800157616232

Voltage:	AC: 220-240V
Max.Watts:	40W
IP Rating:	IP44
Holder:	E27
Color of Fixture:	Black
Body Type:	Aluminium + Glass
Size:	215 x375 x 170mm

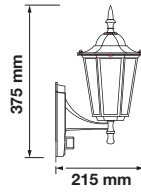

Detection Distance
12CM



Detection Angle
120°

Wall Lamp



VT-751
7071

EAN Code
3800157616249

Voltage:	AC: 220-240V
Max.Watts:	40W
IP Rating:	IP44
Holder:	E27
Color of Fixture:	White
Body Type:	Aluminium + Glass
Size:	215 x375 x 170mm



Detection Distance
12CM



Detection Angle
120°

Wall Lamp

VT-749

EAN Code

7066

3800157616195

Voltage:	AC: 220-240V
Max.Watts:	40W
IP Rating:	IP44
Holder:	E27
Color of Fixture:	Black
Body Type:	Aluminium + Glass
Size:	208 x 360 x170 mm

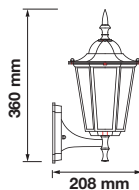
**Wall Lamp**

VT-749

EAN Code

7067

3800157616201

Voltage:	AC: 220-240V
Max.Watts:	40W
IP Rating:	IP44
Holder:	E27
Color of Fixture:	White
Body Type:	Aluminium + Glass
Size:	208 x 360 x170 mm

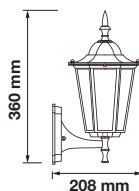



Wall Lamp

VT-750 EAN Code
 7068 3800157616218

Voltage:	AC: 220-240V
Max.Watts:	40W
IP Rating:	IP44
Holder:	E27
Color of Fixture:	Black
Body Type:	Aluminium + Glass
Size:	208 x 360 x170 mm

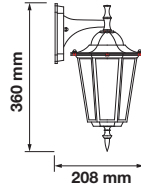

Wall Lamp

VT-750 EAN Code
 7069 3800157616225

Voltage:	AC: 220-240V
Max.Watts:	40W
IP Rating:	IP44
Holder:	E27
Color of Fixture:	White
Body Type:	Aluminium + Glass
Size:	208 x 360 x170 mm

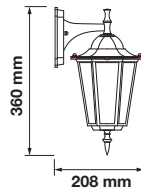

**Wall Lamp - Short up**

VT-760 EAN Code
7519 3800157617789

Voltage:	AC: 220-240V
Max.Watts:	60W
IP Rating:	IP44
Holder:	E27
Color of Fixture:	Matt Black
Body Type:	Aluminium + Glass
Size:	225 x 400 x 148mm

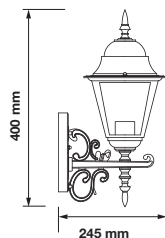
**Wall Lamp - Short up**

VT-760 EAN Code
7520 3800157617796

Voltage:	AC: 220-240V
Max.Watts:	60W
IP Rating:	IP44
Holder:	E27
Color of Fixture:	Matt White
Body Type:	Aluminium + Glass
Size:	225 x 400 x 148mm

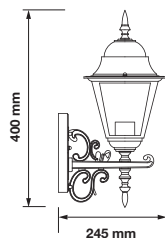



Wall Lamp - Long up

VT-761 EAN Code
 7521 3800157617802

Voltage:	AC: 220-240V
Max.Watts:	60W
IP Rating:	IP44
Holder:	E27
Color of Fixture:	Matt Black
Body Type:	Aluminium + Glass
Size:	245 x 445 x 185mm

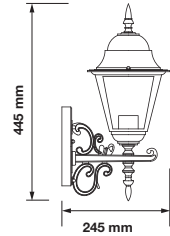

Wall Lamp - Long up

VT-761 EAN Code
 7522 3800157617819

Voltage:	AC: 220-240V
Max.Watts:	60W
IP Rating:	IP44
Holder:	E27
Color of Fixture:	Matt White
Body Type:	Aluminium + Glass
Size:	245 x 445 x 185mm

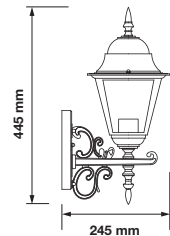



Ceiling Lamp

VT-752 EAN Code
7072 3800157616256

Voltage:	AC: 220-240V
Max.Watts:	40W
IP Rating:	IP44
Holder:	E27
Color of Fixture:	Black
Body Type:	Aluminium + Glass
Size:	170 x 170 x 840mm

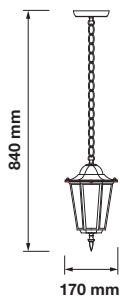

Ceiling Lamp

VT-752 EAN Code
7073 3800157616263

Voltage:	AC: 220-240V
Max.Watts:	40W
IP Rating:	IP44
Holder:	E27
Color of Fixture:	White
Body Type:	Aluminium + Glass
Size:	170 x 170 x 840mm

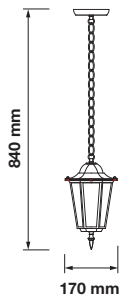



Ceiling Lamp

VT-735 EAN Code
7058 3800157612616

Voltage:	AC: 220-240V
Max.Watts:	60W
IP Rating:	IP44
Holder:	E27
Color of Fixture:	Black
Body Type:	Aluminum + Glass
Size:	170 x 720mm

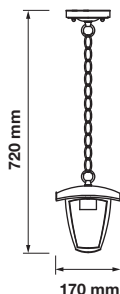

Stand Lamp

VT-736 EAN Code
7059 3800157612623

Voltage:	AC: 220-240V
Max.Watts:	60W
IP Rating:	IP44
Holder:	E27
Color of Fixture:	Black
Body Type:	Aluminum + Glass
Size:	170 x 600mm

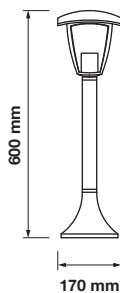



Stand Lamp

VT-753 EAN Code
7074 3800157616270

Voltage:	AC: 220-240V
Max.Watts:	40W
IP Rating:	IP44
Holder:	E27
Color of Fixture:	Black
Body Type:	Aluminium + Glass
Size:	170 x 170 x 403mm



Stand Lamp

VT-753 EAN Code
7075 3800157616287

Voltage:	AC: 220-240V
Max.Watts:	40W
IP Rating:	IP44
Holder:	E27
Color of Fixture:	White
Body Type:	Aluminium + Glass
Size:	170 x 170 x 403mm

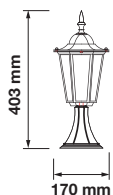

Stand Lamp

VT-754 EAN Code
7057 3800157612609

Voltage:	AC: 220-240V
Max.Watts:	60W
IP Rating:	IP65
Holder:	E27
Color of Fixture:	Black
Body Type:	Aluminum + Glass
Size:	170 x 290mm

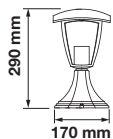



Stand Lamp

VT-737 EAN Code
7060 3800157612630

Voltage:	AC: 220-240V
Max.Watts:	60W
IP Rating:	IP44
Holder:	E27
Color of Fixture:	Black
Body Type:	Aluminum + Glass
Size:	345 x 1365mm

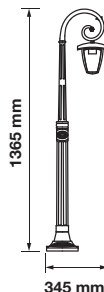

Stand Lamp

VT-738 EAN Code
7061 3800157612647

Voltage:	AC: 220-240V
Max.Watts:	60W x 2
IP Rating:	IP44
Holder:	E27
Color of Fixture:	Black
Body Type:	Aluminum + Glass
Size:	480 x 1410mm

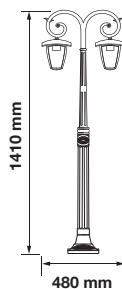



Stand Lamp

VT-739 EAN Code
7062 3800157612654

Voltage:	AC: 220-240V
Max.Watts:	60W x 2
IP Rating:	IP44
Holder:	E27
Color of Fixture:	Black
Body Type:	Aluminum + Glass
Size:	500 x 1990mm

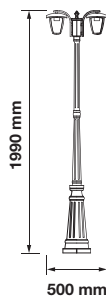

Stand Lamp

VT-740 EAN Code
7063 3800157612661

Voltage:	AC: 220-240V
Max.Watts:	60W x 3
IP Rating:	IP44
Holder:	E27
Color of Fixture:	Black
Body Type:	Aluminum + Glass
Size:	500 x 1990mm

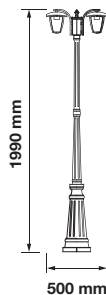



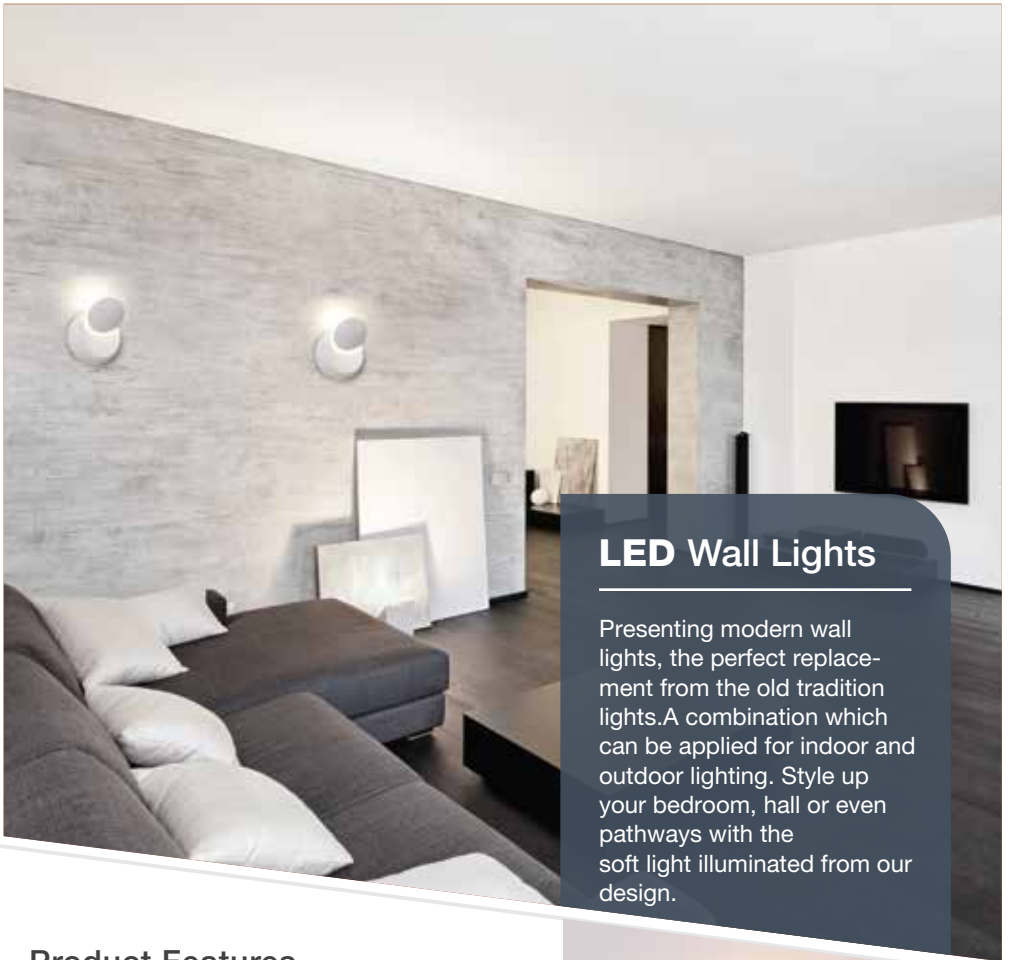

LED Wall Lights

Presenting modern wall lights, the perfect replacement from the old tradition lights. A combination which can be applied for indoor and outdoor lighting. Style up your bedroom, hall or even pathways with the soft light illuminated from our design.

Product Features

- Modern Wall lights available in sleek and stylish designs.
- Adjustable Beam Angle.
- Available in Black, Grey & White Colors
- Easy installation
- Perfect for Halls, Pathways, Bedroom, Kitchen & Terrace



Applications

Suitable for Residential lighting, Hotels, Restaurants, Resorts, Residential Lighting and similar environment

37 mm



Wall Lamp

6W VT-741

7524 - 3000K Warm White
7525 - 4000K Day White



EAN Code

3800157620017
3800157620024

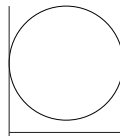

ø 135 mm

Sensor Compatible:	6W	PF:	0.55
Voltage/Frequency:	AC220-240V, 50/60 Hz	Beam Angle:	360°
Luminous Flux:	660lm	Color of Fixture:	White
IP Rating:	IP65	Shape:	Die-cast Aluminum
CRI:	>80	Dimension:	Ø135 mm



Wall Lamp

9W VT-743

7526 - 3000K Warm White
7527 - 4000K Day White



EAN Code

3800157620031
3800157620048

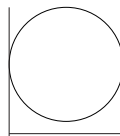

ø 180 mm

Sensor Compatible:	9W	PF:	0.55
Voltage/Frequency:	AC220-240V, 50/60 Hz	Beam Angle:	360°
Luminous Flux:	990lm	Color of Fixture:	White
IP Rating:	IP65	Shape:	Die-cast Aluminum
CRI:	>80	Dimension:	Ø180 mm



**Black Wall Light-
Adjustable Beam Angle**

6W VT-759

7078 - 3000K Warm White
7087 - 4000K Day White

EAN Code

3800157616379
3800157616874

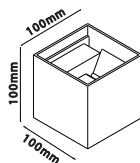

Sensor Compatible:	6W	PF:	>0.45
Voltage/Frequency:	AC: 110-240V, 50/60Hz	Beam Angle:	10~120°
Luminous Flux:	660lm	Color of Fixture:	Black
IP Rating:	IP65	Body Type:	Aluminium
CRI:	> 80	Dimension:	100 x 100 x 100mm

UP AND DOWN LIGHTS



**White Wall Light-
Adjustable Beam Angle**

6W VT-759

7079 - 3000K Warm White
7088 - 4000K Day White

EAN Code

3800157616386
3800157616881

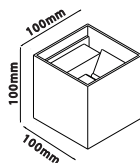

Sensor Compatible:	6W	PF:	>0.45
Voltage/Frequency:	AC: 110-240V, 50/60Hz	Beam Angle:	10~120°
Luminous Flux:	660lm	Color of Fixture:	White
Body Type:	IP65	Body Type:	Aluminium
CRI:	> 80	Dimension:	100 x 100 x 100mm

UP AND DOWN LIGHTS



**Grey Wall Light-
Adjustable Beam Angle**

6W VT-759

7080 - 3000K Warm White
7089 - 4000K Day White

EAN Code

3800157616393
3800157616898

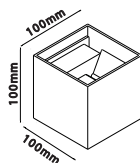

Sensor Compatible:	6W	PF:	>0.45
Voltage/Frequency:	AC: 110-240V, 50/60Hz	Beam Angle:	10~120°
Luminous Flux:	660lm	Color of Fixture:	Grey
IP Rating:	IP65	Body Type:	Aluminium
CRI:	> 80	Dimension:	100 x 100 x 100mm

UP AND DOWN LIGHTS



**Black Wall Light-
Adjustable Beam Angle**

6W VT-756

EAN Code

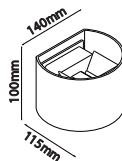

7081 - 3000K Warm White
7090 - 4000K Day White

3800157616409
3800157616904



Sensor Compatible:	6W	PF:	>0.45
Voltage/Frequency:	AC: 110-240V, 50/60Hz	Beam Angle:	10-120°
Luminous Flux:	660lm	Color of Fixture:	Black
IP Rating:	IP65	Body Type:	Aluminium
CRI:	> 80	Dimension:	140 x 100 x 115mm

UP AND DOWN LIGHTS



**White Wall Light-
Adjustable Beam Angle**

6W VT-756

EAN Code

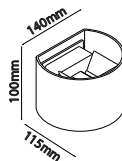

7082 - 3000K Warm White
7091 - 4000K Day White

3800157616416
3800157616911



Sensor Compatible:	6W	PF:	>0.45
Voltage/Frequency:	AC: 110-240V, 50/60Hz	Beam Angle:	10-120°
Luminous Flux:	660lm	Color of Fixture:	White
Body Type:	IP65	Body Type:	Aluminium
CRI:	> 80	Dimension:	140 x 100 x 115mm

UP AND DOWN LIGHTS



**Grey Wall Light-
Adjustable Beam Angle**

6W VT-756

EAN Code

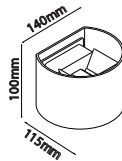

7083 - 3000K Warm White
7092 - 4000K Day White

3800157616423
3800157616928



Sensor Compatible:	6W	PF:	>0.45
Voltage/Frequency:	AC: 110-240V, 50/60Hz	Beam Angle:	10-120°
Luminous Flux:	660lm	Color of Fixture:	Grey
IP Rating:	IP65	Body Type:	Aluminium
CRI:	> 80	Dimension:	140 x 100 x 115mm

UP AND DOWN LIGHTS



Wall Light-Rotatable

5W VT-757

7086 - 3000K Warm White
7093 - 4000K Day White

EAN Code

3800157616454
3800157616935

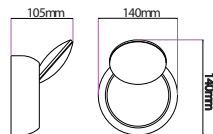

Sensor Compatible:	5W	PF:	>0.45
Voltage/Frequency:	AC: 110-240V, 50/60Hz	Beam Angle:	10-360°
Luminous Flux:	560lm	Color of Fixture:	White
IP Rating:	IP20	Body Type:	Aluminium
CRI:	> 80	Dimension:	D:140 x 65mm-close Ø140 x 105mm-open



Black Wall Light

5W VT-758

7084 - 3000K Warm White
7094 - 4000K Day White

EAN Code

3800157616430
3800157616942

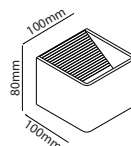

Sensor Compatible:	5W	PF:	>0.45
Voltage/Frequency:	AC: 110-240V, 50/60Hz	Beam Angle:	120°
Luminous Flux:	560lm	Color of Fixture:	Black
Body Type:	IP20	Body Type:	Aluminium
CRI:	> 80	Dimension:	100 x 80 x 100mm

UP AND DOWN LIGHTS



White Wall Light

5W VT-758

7085 - 3000K Warm White
7095 - 4000K Day White

EAN Code

3800157616447
3800157616959

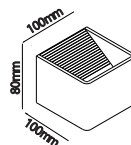

Sensor Compatible:	5W	PF:	>0.45
Voltage/Frequency:	AC: 110-240V, 50/60Hz	Beam Angle:	120°
Luminous Flux:	560lm	Color of Fixture:	White
IP Rating:	IP20	Body Type:	Aluminium
CRI:	> 80	Dimension:	100 x 80 x 100mm

UP AND DOWN LIGHTS



New!

LED Landscape Outdoor Soft Light

12W VT-8054

EAN Code

8233 - 3000K Warm White
8234 - 4000K Day White
8235 - 6400K White

3800157625739
3800157625746
3800157625753

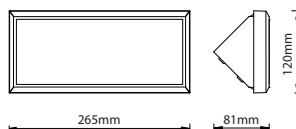

Sensor Compatible:	12W	PF:	>0.9
Voltage/Frequency:	AC: 100-240V, 50/60Hz	Beam Angle:	110°
Luminous Flux:	600lm	Color of Fixture:	Grey
IP Rating:	IP65	Body Type:	PC
CRI:	>80	Dimension:	265 x 120 x 81mm



New!

LED Landscape Outdoor Soft Light

20W VT-8055

EAN Code

8236 - 3000K Warm White
8237 - 4000K Day White
8238 - 6400K White

3800157625760
3800157625777
3800157625784

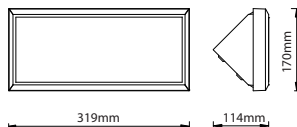

Sensor Compatible:	20W	PF:	>0.9
Voltage/Frequency:	AC: 100-240V, 50/60Hz	Beam Angle:	110°
Luminous Flux:	1000lm	Color of Fixture:	Grey
IP Rating:	IP65	Shape:	PC
CRI:	>80	Dimension:	319 x 170 x 114mm

New!



LED Up/down Outdoor Soft Light

9W VT-8056

EAN Code

8239 - 3000K Warm White

3800157625791

8240 - 4000K White

3800157625807

8241 - 6400K White

3800157625814

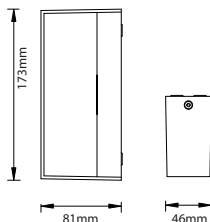

Sensor Compatible:	9W	PF:	>0.9
Voltage/Frequency:	AC: 100-240V, 50/60Hz	Beam Angle:	110°
Luminous Flux:	400lm	Color of Fixture:	Grey
IP Rating:	IP65	Body Type:	PC
CRI:	>80	Dimension:	173X81X46mm

New!



LED Up/down Outdoor Soft Light

12W VT-8057

EAN Code

8242 - 3000K Warm White

3800157625821

8243 - 4000K Day White

3800157625838

8244 - 6400K White

3800157625845

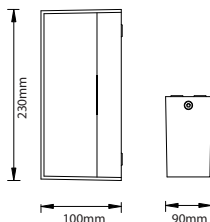

Sensor Compatible:	12W	PF:	>0.9
Voltage/Frequency:	AC: 100-240V, 50/60Hz	Beam Angle:	110°
Luminous Flux:	600lm	Color of Fixture:	Grey
Body Type:	IP65	Body Type:	PC
CRI:	>80	Dimension:	230 x 100 x 90mm

New!



LED Bulkhead with Soft Light

12W VT-8058

EAN Code

8245 - 3000K Warm White

3800157625852

8246 - 4000K Day White

3800157625869

8247 - 6000K White

3800157625876

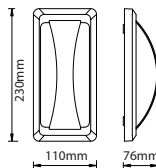

Sensor Compatible:	12W	PF:	>0.9
Voltage/Frequency:	AC: 100-240V, 50/60Hz	Beam Angle:	110°
Luminous Flux:	500lm	Color of Fixture:	Grey
IP Rating:	IP65	Body Type:	PC
CRI:	>80	Dimension:	230 x 110 x 76mm

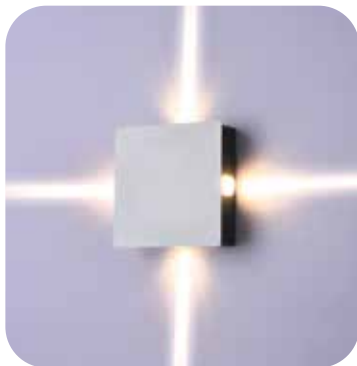

New!

LED Wall Light

4W VT-704

8209 - 3000K Warm White
8210 - 4000K Day White

EAN Code

3800157623261
3800157623278

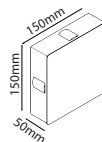

Sensor Compatible:	4W	PF:	>0.5
Voltage/Frequency:	AC:220-240V,50/60Hz	Beam Angle:	360°
Luminous Flux:	440lm	Color of Fixture:	White
IP Rating:	IP65	Body Type:	Aluminium+Acrylic
CRI:	>80	Dimension:	150 x 150 x 50mm

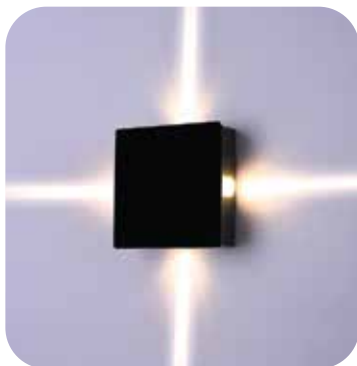

New!

LED Wall Light

4W VT-704

8211 - 3000K Warm White
8212 - 4000K Day White

EAN Code

3800157623285
3800157623292

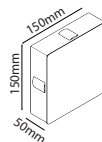

Sensor Compatible:	4W	PF:	>0.5
Voltage/Frequency:	AC:220-240V,50/60Hz	Beam Angle:	360°
Luminous Flux:	440lm	Color of Fixture:	Black
Body Type:	IP65	Body Type:	Aluminium+Acrylic
CRI:	>80	Dimension:	150 x 150 x 50mm



New!

LED Wall Light

5W VT-705

8208 - 3000K Warm White
8232 - 4000K Day White

EAN Code

3800157623254
3800157624756

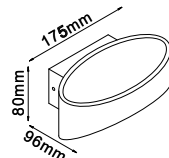

Sensor Compatible:	5W	PF:	>0.5
Voltage/Frequency:	AC:220-240V/50/60Hz	Beam Angle:	150°
Luminous Flux:	550lm	Color of Fixture:	White
IP Rating:	IP20	Body Type:	Aluminium
CRI:	>80	Dimension:	175 x 80 x 96mm



New!

LED WallLight

4W VT-706

8213 - 3000K Warm White
8214 - 4000K Day White



EAN Code

3800157623308
3800157623315

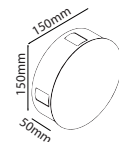

Sensor Compatible:	4W	PF:	>0.5
Voltage/Frequency:	AC:220-240V/50/60Hz	Beam Angle:	360°
Luminous Flux:	440lm	Color of Fixture:	White
IP Rating:	IP65	Body Type:	Aluminium+Acrylic
CRI:	>80	Dimension:	Ø150 x 50mm

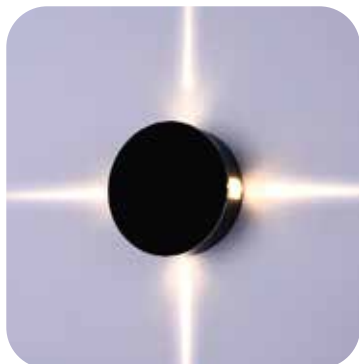

New!

LED WallLight

4W VT-706

8215 - 3000K Warm White
8216 - 4000K Day White

EAN Code

3800157623322
3800157623339

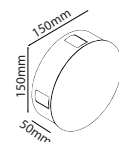

Sensor Compatible:	4W	PF:	>0.5
Voltage/Frequency:	AC:220-240V/50/60Hz	Beam Angle:	360°
Luminous Flux:	440lm	Color of Fixture:	Black
IP Rating:	IP65	Shape:	Aluminium+Acrylic
CRI:	>80	Dimension:	Ø150 x 50mm



New!

LED WallLight

7W VT-707

8217 - 3000K Warm White
8218 - 4000K Day White

EAN Code

3800157623346
3800157623353

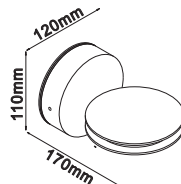

Sensor Compatible:	Yes	PF:	>0.5
Voltage/Frequency:	AC:220-240V, 50/60Hz	Beam Angle:	360°
Luminous Flux:	770lm	Color of Fixture:	White
IP Rating:	IP65	Body Type:	Aluminium
CRI:	>80	Dimension:	110 x 120 x 170mm



New!

LED WallLight

7W VT-707

8219 - 3000K Warm White
8220 - 4000K Day White

EAN Code

3800157623360
3800157623377

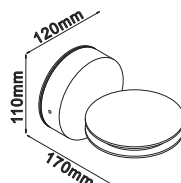

Sensor Compatible:	Yes	PF:	>0.5
Voltage/Frequency:	AC:220-240V, 50/60Hz	Beam Angle:	360°
Luminous Flux:	770lm	Color of Fixture:	Black
IP Rating:	IP65	Shape:	Aluminium
CRI:	>80	Dimension:	110 x 120 x 170mm

New!

LED Wall Light

9W VT-709

8221 - 3000K Warm White
8222 - 4000K Day White

EAN Code

3800157623384
3800157623391

A+

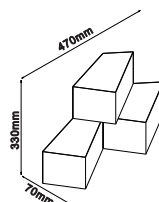

Sensor Compatible:	Yes	PF:	>0.5
Voltage/Frequency:	AC:220-240V, 50/60Hz	Beam Angle:	360°
Luminous Flux:	990lm	Color of Fixture:	White
IP Rating:	IP20	Body Type:	Aluminium
CRI:	>80	Dimension:	440 x 335 x 75mm



New!

LED Wall Light

9W VT-709

8223 - 3000K Warm White
8224 - 4000K Day White

EAN Code

3800157623407
3800157623414

A+

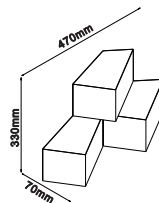

Sensor Compatible:	Yes	PF:	>0.5
Voltage/Frequency:	AC:220-240V, 50/60Hz	Beam Angle:	360°
Luminous Flux:	990lm	Color of Fixture:	Black
IP Rating:	IP20	Body Type:	Aluminium
CRI:	>80	Dimension:	440 x 335 x 75mm

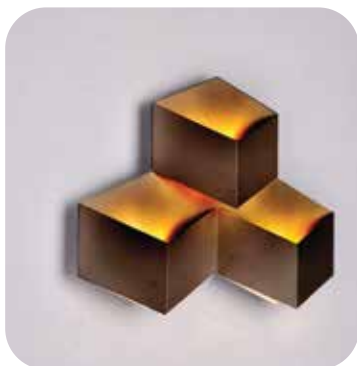

New!**LED Wall Light****9W** VT-7108225 - 3000K Warm White
8226 - 4000K Day White

EAN Code

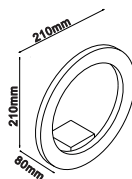
3800157623421
3800157623438**A+**

Sensor Compatible:	Yes	PF:	>0.5
Voltage/Frequency:	AC:220-240V, 50/60Hz	Beam Angle:	360°
Luminous Flux:	990lm	Color of Fixture:	White
Body Type:	IP20	Body Type:	Aluminium+Acrylic
CRI:	>80	Dimension:	Ø210 x 80mm

New!**LED Wall Light****9W** VT-7108227 - 3000K Warm White
8228 - 4000K Day White

EAN Code

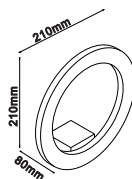
3800157623445
3800157623452**A+**

Sensor Compatible:	Yes	PF:	>0.5
Voltage/Frequency:	AC:220-240V, 50/60Hz	Beam Angle:	360°
Luminous Flux:	990lm	Color of Fixture:	Black
IP Rating:	IP20	Body Type:	Aluminium+Acrylic
CRI:	>80	Dimension:	Ø210 x 80mm



New!

LED Wall Light

12W VT-712

8202 - 3000K Warm White
8203 - 4000K Day White

A+

EAN Code

3800157623193
3800157623209

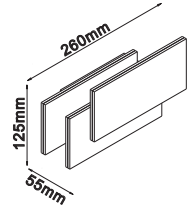

Sensor Compatible:	Yes	PF:	>0.5
Voltage/Frequency:	AC:100-240V/50/60Hz	Beam Angle:	360°
Luminous Flux:	1100lm	Color of Fixture:	White
IP Rating:	IP20	Body Type:	Aluminium+Acrylic
CRI:	>80	Dimension:	260 x 125 x 55mm

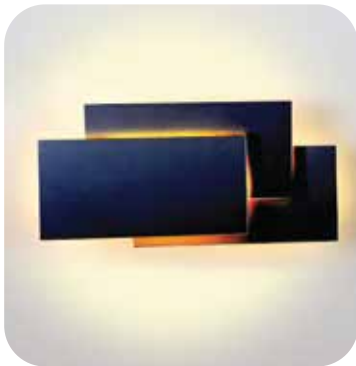

New!

LED Wall Light

12W VT-712

8204 - 3000K Warm White
8205 - 4000K Day White

A+

EAN Code

3800157623216
3800157623223

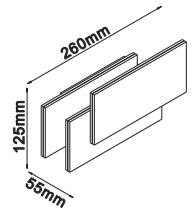

Sensor Compatible:	Yes	PF:	>0.5
Voltage/Frequency:	AC:100-240V/50/60Hz	Beam Angle:	360°
Luminous Flux:	1100lm	Color of Fixture:	Black
Body Type:	IP20	Body Type:	Aluminium+Acrylic
CRI:	>80	Dimension:	260 x 125 x 55mm



New!

LED Wall Light

12W VT-712

8206 - 3000K Warm White
8207 - 4000K Day White

A+

EAN Code

3800157623230
3800157623247

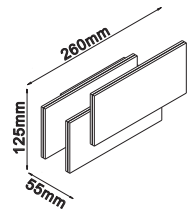

Sensor Compatible:	Yes	PF:	>0.5
Voltage/Frequency:	AC:100-240V/50/60Hz	Beam Angle:	360°
Luminous Flux:	990lm	Color of Fixture:	Grey
IP Rating:	IP20	Body Type:	Aluminium+Acrylic
CRI:	>80	Dimension:	260 x 125 x 55mm



New!

LED WallLight

4.5W VT-805

EAN Code

8262 - 3000K Warm White
8264 - 4000K Day White

3800157627122
3800157627146

A+

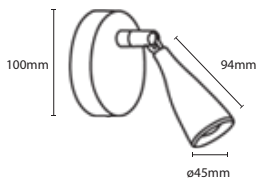

Sensor Compatible:	Yes	PF:	>0.5
Voltage/Frequency:	AC:220-240V/50Hz	Beam Angle:	100°
Luminous Flux:	360lm	Color of Fixture:	White
IP Rating:	IP20	Body Type:	Plastic+Metal
CRI:	>80		



New!

LED WallLight

4.5W VT-805

EAN Code

8263 - 3000K Warm White
8265 - 4000K Day White

3800157627139
3800157627153

A+

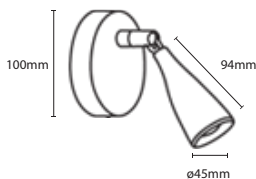

Sensor Compatible:	Yes	PF:	>0.5
Voltage/Frequency:	AC:220-240V/50Hz	Beam Angle:	100°
Luminous Flux:	360lm	Color of Fixture:	Black
IP Rating:	IP20	Shape:	Plastic+Metal
CRI:	>80		



New!

LED WallLight

9W VT-810

EAN Code

8266 - 3000K Warm White
8268 - 4000K Day White

3800157627160
3800157627184

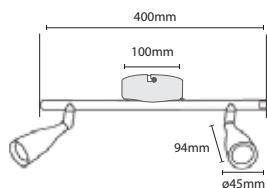

Sensor Compatible:	Yes	PF:	>0.5
Voltage/Frequency:	AC:220-240V/50Hz	Beam Angle:	100°
Luminous Flux:	680lm	Color of Fixture:	White
IP Rating:	IP20	Body Type:	Plastic+Metal
CRI:	>80		



New!

LED WallLight

9W VT-810

EAN Code

8267 - 3000K Warm White
8269 - 4000K Day White

3800157627177
3800157627191

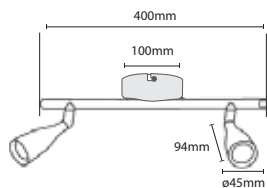

Sensor Compatible:	Yes	PF:	>0.5
Voltage/Frequency:	AC:220-240V/50Hz	Beam Angle:	100°
Luminous Flux:	680lm	Color of Fixture:	Black
IP Rating:	IP20	Shape:	Plastic+Metal
CRI:	>80		



New!

LED WallLight

13.5W VT-813

8270 - 3000K Warm White
8272 - 4000K Day White

EAN Code

3800157627207
3800157627221

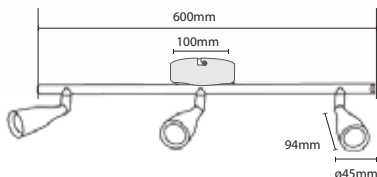

A+

Sensor Compatible:	Yes	PF:	>0.5
Voltage/Frequency:	AC:220-240V/50Hz	Beam Angle:	100°
Luminous Flux:	1000lm	Color of Fixture:	White
IP Rating:	IP20	Body Type:	Plastic+Metal
CRI:	>80		



New!

LED WallLight

13.5W VT-813

8271 - 3000K Warm White
8273 - 4000K Day White

EAN Code

3800157627214
3800157627238

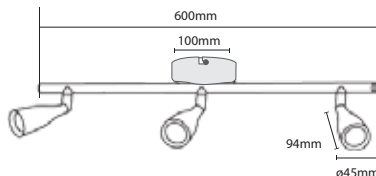

A+

Sensor Compatible:	Yes	PF:	>0.5
Voltage/Frequency:	AC:220-240V/50Hz	Beam Angle:	100°
Luminous Flux:	1000lm	Color of Fixture:	Black
IP Rating:	IP20	Shape:	Plastic+Metal
CRI:	>80		



New!

LED WallLight

6W VT-806

EAN Code

8250 - 3000K Warm White

3800157627009

8252 - 4000K Day White

3800157627023

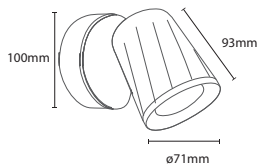

Sensor Compatible:	Yes	PF:	>0.5
Voltage/Frequency:	AC:220-240V/50Hz	Beam Angle:	100°
Luminous Flux:	480lm	Color of Fixture:	White
IP Rating:	IP20	Body Type:	Plastic+Metal
CRI:	>80		



New!

LED WallLight

6W VT-806

EAN Code

8251 - 3000K Warm White

3800157627016

8253 - 4000K Day White

3800157627030

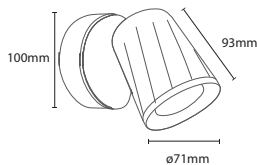

Sensor Compatible:	Yes	PF:	>0.5
Voltage/Frequency:	AC:220-240V/50Hz	Beam Angle:	100°
Luminous Flux:	480lm	Color of Fixture:	Black
IP Rating:	IP20	Shape:	Plastic+Metal
CRI:	>80		



New!

LED WallLight

12W VT-812

8254 - 3000K Warm White
8256 - 4000K Day White

EAN Code

3800157627047
3800157627061

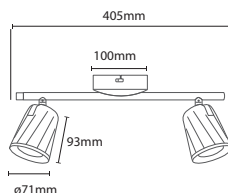

Sensor Compatible:	Yes	PF:	>0.5
Voltage/Frequency:	AC:220-240V/50Hz	Beam Angle:	100°
Luminous Flux:	960lm	Color of Fixture:	White
IP Rating:	IP20	Body Type:	Plastic+Metal
CRI:	>80		



New!

LED WallLight

12W VT-812

8255 - 3000K Warm White
8257 - 4000K Day White

EAN Code

3800157627054
3800157627078

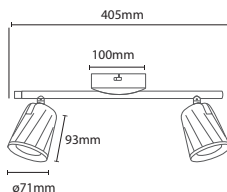

Sensor Compatible:	Yes	PF:	>0.5
Voltage/Frequency:	AC:220-240V/50Hz	Beam Angle:	100°
Luminous Flux:	960lm	Color of Fixture:	Black
IP Rating:	IP20	Shape:	Plastic+Metal
CRI:	>80		



New!

LED WallLight

18W VT-818

8258 - 3000K Warm White
8260 - 4000K Day White

EAN Code

3800157627085
3800157627108

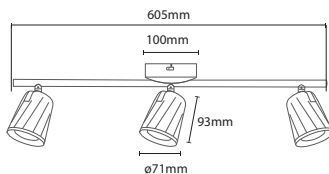

Sensor Compatible:	Yes	PF:	>0.5
Voltage/Frequency:	AC:220-240V/50Hz	Beam Angle:	100°
Luminous Flux:	1440lm	Color of Fixture:	White
IP Rating:	IP20	Body Type:	Plastic+Metal
CRI:	>80		



New!

LED WallLight

18W VT-818

8259 - 3000K Warm White
8261 - 4000K Day White

EAN Code

3800157627092
3800157627115

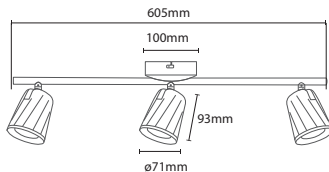

Sensor Compatible:	Yes	PF:	>0.5
Voltage/Frequency:	AC:220-240V/50Hz	Beam Angle:	100°
Luminous Flux:	1440lm	Color of Fixture:	Black
IP Rating:	IP20	Shape:	Plastic+Metal
CRI:	>80		



LED Display Screen

VTAC LED's Display screen series perfectly designed for the best video output and display of images and information. Offering Display color of 281 trillions(synchronized). The perfect product for advertising and marketing.

Product Features

- Powerful LED display screen available in Indoor and Outdoor series
- Displays digital content such as Video, Images & Information
- Good Brand Value addition for Advertising
- Easy Installation



Applications

Suitable for Outdoor and Indoor Advertising, Hotel conference room, Restaurants, Showrooms, Casinos, Government facilities, Theaters, Retail outlets, Traffic control room, Security monitoring room, Stage background, HD cinema, Shopping malls, Railway stations, Airports.



Outdoor Display Screen

P6 Outdoor LED Finished Cabinet

SKU **11078** EAN Code **3800157617475**



Screen Parameter

Pixel Density	27777dots/sqm
Brightness	6500nits
Optimum View Distance	more than 6m
Gray Scale	16bits
Display Color	281 Trillions(synchronized)
Operation Power	220V-240V
Max Power Consumption	1350W/sqm
Control Mode	Synchronized
Refresh Frequency	400-800HZ
Fram Frequency	60HZ
Support Signal Input	S-Video,RGBHV,YUV etc.
Control Distance	Utp140m, Single Mode Fiber 15km
Operating Humidity	10%-90%
Life Span(50% Brightness)	100000hrs
IP(Front/rear)	IP65/IP45

LED Cabinet Parameter

Cabinet Size(L*h*d)	768*768mm
Cabinet Resolution	128*128
Module Quantity Each Cabinet	4*4=16
Average Power Consumption	800w/cabinet
Cabinet Material	Iron
Cabinet Size	25kg/cabinet

LED Module Parameter

Pixel Pitch	6mm
Led Specification	SMD3535
Led Configuration	SMD 3 in 1
Module Size	192*192mm
Module Resolution	32*32=1024dot
Drive Method	1/8 scan constant current
Drive IC	SM16106



Indoor Display Screen

P5 Indoor LED Finished Cabinet

SKU EAN Code
11077 3800157617468 **A++**



Screen Parameter

Pixel Density	40000dots/sqm
Brightness	1800nits
Optimum View Distance	more than 5m
Gray Scale	16bits
Display Color	281 trillions(synchronized)
Operation Power	220V-240V
Max Power Consumption	750W/sqm
Control Mode	Synchronized
Refresh Frequency	400-700HZ
Fram Frequency	60HZ
Surport Signal Input	S-Video,RGBHV,YUV etc.
Control Distance	UTP140M,SINGLE MODE FIBER 15KM
Life Span(50% Brightness)	100000hrs
IP(Front/rear)	IP20

LED Cabinet Parameter

Cabinet Size(L*h*d)	640*640mm
Cabinet Resolution	128*128
Module Quantity Each Cabinet	2*4=8
Average Power Consumption	300w/cabinet
Cabinet Material	Iron
Cabinet Size	8kg/cabinet

LED Module Parameter

Pixel Pitch	5mm
Led Specification	SMD3528
Led Configuration	SMD 3 in 1
Module Size	320*160mm
Module Resolution	64*32=2048dot
Drive Method	1/16 scan constant current
Drive IC	SM16106



Indoor Display Screen

P4 Indoor LED Display Screen

SKU **11079** EAN Code **3800157619493**



Plug & Play



Ideal For Renting Purpose



Portable Moving For Events

Screen Parameter

Pixel Density	62500dots/sqm
Brightness	1100nits
Optimum View Distance	more than 5m
Gray Scale	16bits
Display Color	281 trillions(synchronized)
Operation Power	AC 220V-240V/ 50/60Hz
Power Consumption	300W/cabinet
Control Mode	Synchronized
Refresh Frequency	400-700HZ
Support Signal Input	S-Video,RGBHV,YUV etc.
Control Distance	UTP140M,SINGLE MODE FIBER 15KM
Life Span(50% Brightness)	100000hrs
IP(Front)	IP40
Control System	PCTV nonlinearity card, DVI display card Linsn control system

LED Cabinet Parameter

Cabinet Size(L*h*d)	512*512*85mm
Cabinet Resolution	128*128
Module Quantity Each Cabinet	2*4=8
Power Consumption	300w/cabinet
Cabinet Material	Iron
Cabinet Weight	8kg/cabinet

LED Module Parameter

Pixel Pitch	4mm
Led Specification	SMD 3 in 1
Led Configuration	SMD 3 in 1
Module Size	256*128mm
Module Resolution	64*32=2048dot
Drive Method	1/16 scan constant current
Drive IC	SM16106
Power Consumption	25-30W

Windows 10



DUAL DISPLAY TOUCH SCREEN



	SKU	EAN Code
Media Player	11088	3800157622820

Features:

- | | |
|---|---|
| <input checked="" type="checkbox"/> LED Display Player with Industrial PC | <input checked="" type="checkbox"/> Input - AC:120-260V |
| <input checked="" type="checkbox"/> One TS802 sending card inside | <input checked="" type="checkbox"/> 1 x Audio In |
| <input checked="" type="checkbox"/> Dual Display - Supports Max 1280*800 | <input checked="" type="checkbox"/> 1 x Audio Out |
| <input checked="" type="checkbox"/> Supports SD Memory Card/USB/HDMI Out/Internet | <input checked="" type="checkbox"/> 1 x DVI In |
| <input checked="" type="checkbox"/> USB and SD Card Memory Playing | <input checked="" type="checkbox"/> 1 x HDMI Out |
| <input checked="" type="checkbox"/> Compact and Easy to Install | <input checked="" type="checkbox"/> 4 USB Interface |
| <input checked="" type="checkbox"/> 7" Touch Screen with windows 10 Inside | |
| <input checked="" type="checkbox"/> Size - 320*180*50mm | |

Accessories:



Sending Box

SKU 500082



Sending Card 802

SKU 500081



Bright Displaying
Light Weight **Cabinet**
High-definition



Stylish

Pendants

Includes all mounting hardware for quick and easy installation and filament vintage style bulb recommended (sold separately).

Product Features

- Stylish pendant lamps available in various shapes, material and sizes.
- Most suitable with A60, Candle, ST-64 & Globe Bulb Series.
- Easy to Install.
- Vibrant & elegant colors available.
- Applicable with E14 & E27 base.
- Pendant holders available in Bottle Shape, Chrome, Wooden, Concrete, Metal & Porcelain series.

Applications

Perfect choice for Hotels, Bars, Commercial & Residential Lighting.



VT-7350
Huge Transparent

SKU: 3879
EAN Code: 3800157620970
Material: Glass + Metal
Size: 330 x 260 x 1000mm

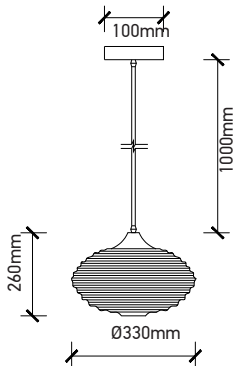

VT-7350
Huge Black

SKU: 3880
EAN Code: 3800157620987
Material: Glass + Metal
Size: 330 x 260 x 1000mm

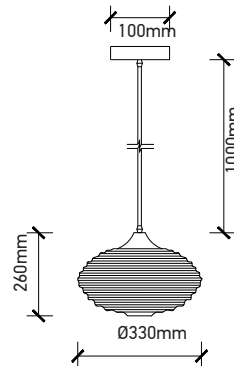



VT-7306

Transparent chrome

3 wire suspension

- SKU:** 3883
- EAN Code:** 3800157621014
- Material:** Glass
- Size:** Ø300 x 265 x 1000mm

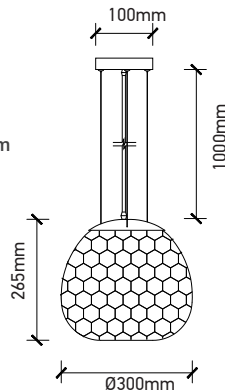



VT-7292

Gun Grey- 3 wire suspension

SKU: 3887
EAN Code: 3800157621052
Material: Glass
Size: Ø300 x 265 x 1000mm

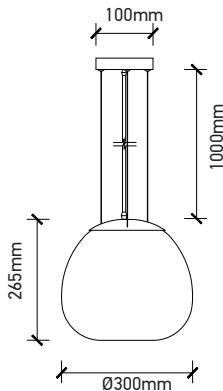

VT-7380

Gun Grey- 3 wire suspension

SKU: 3888
EAN Code: 3800157621069
Material: Glass
Size: Ø380 x 330 x 1000mm

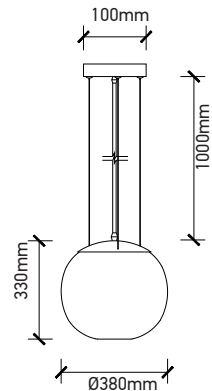

VT-7303

Amber Globe Shape

SKU:	3866
EAN Code:	3800157620765
Material:	Glass + Metal
Size:	300 x 280 x 1000mm

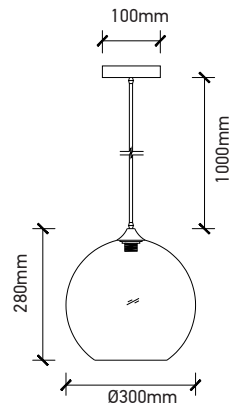



VT-7302
Transparent Globe Glass

SKU: 3865
EAN Code: 3800157620758
Material: Glass + Metal
Size: 300 x 280 x 1000mm
100mm

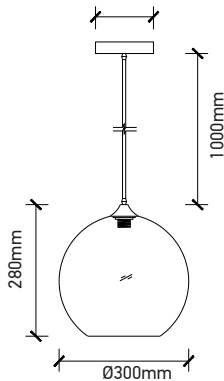

VT-7229
Transparent Artistic Shape

SKU: 3867
EAN Code: 3800157620772
Material: Glass + Metal
Size: 265 x 190 x 1000mm
100mm

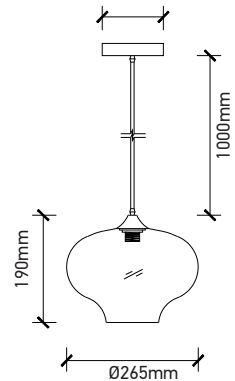



VT-7304
Double Glass- Amber + White

SKU: 3875
EAN Code: 3800157620932
Material: Glass + Metal
Size: 250 x 420 x 1000mm

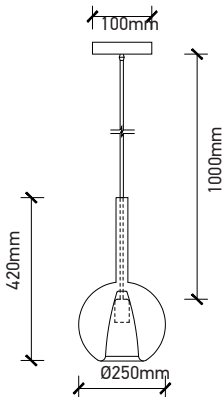

VT-7181
Double Glass- Amber + White

SKU: 3878
EAN Code: 3800157620963
Material: Glass + Metal
Size: 180 x 350 x 1000mm

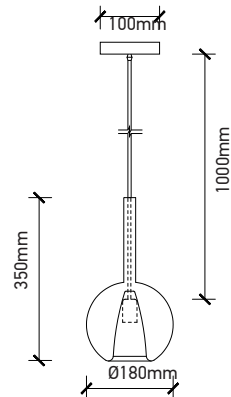



VT-7304

Double Glass- Gungrey+White

SKU: 3876
EAN Code: 3800157620949
Material: Glass + Metal
Size: 250 x 420 x 1000mm

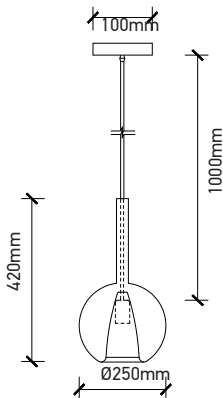

VT-7181

Double Glass- Gungrey+White

SKU: 3877
EAN Code: 3800157620956
Material: Glass + Metal
Size: 180 x 350 x 1000mm

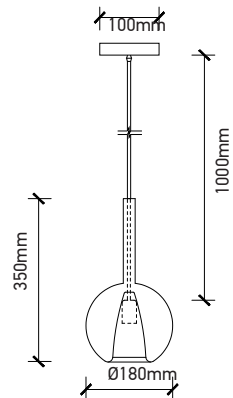



VT-7281
White Glass

SKU: 3884
EAN Code: 3800157621021
Material: Glass + Metal
Size: 285 x440 x1000mm

VT-7281
Black Glass

SKU: 3885
EAN Code: 3800157621038
Material: Glass + Metal
Size: 285 x440 x1000mm

VT-7281
Amber Glass

SKU: 3886
EAN Code: 3800157621045
Material: Glass + Metal
Size: 285 x440 x1000mm

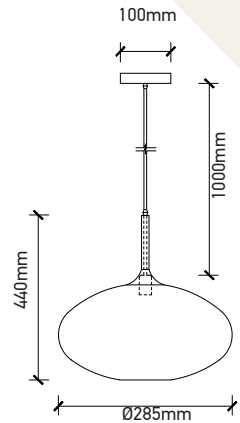
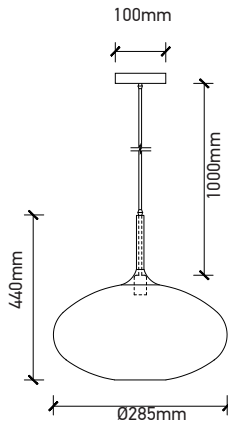
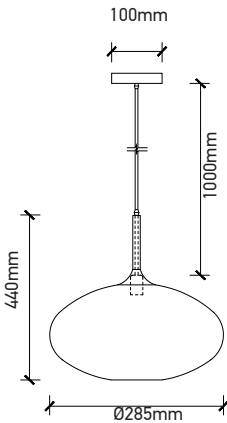



VT-7210
Transparent Glass

SKU: 3730
EAN Code: 3800157611039
Material: Glass + Metal
Size: 245 x 230 x 1100mm

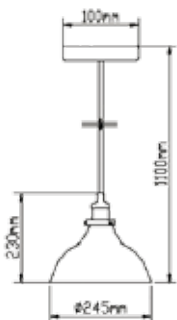

VT-7140
Amber Glass

SKU: 3736
EAN Code: 3800157611091
Material: Glass + Metal
Size: 140 x 240 x 1130mm

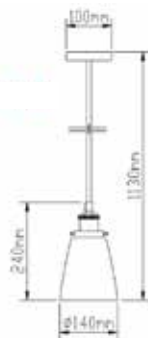



VT-7140

Transparent Glass

- SKU:** 3735
- EAN Code:** 3800157611084
- Material:** Glass + Metal
- Size:** 140 x 240 x1130mm

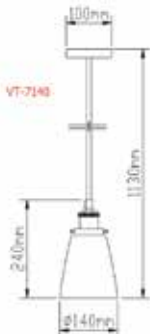

VT-7185

Transparent Glass

- SKU:** 3738
- EAN Code:** 3800157611114
- Material:** Glass + Metal
- Size:** 180 x 230 x1110mm

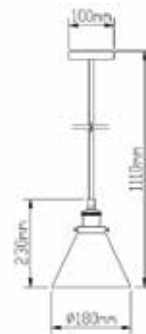



VT-7250

Transparent Glass

SKU: 3739
EAN Code: 3800157611121
Material: Glass + Metal
Size: 250 x 330 x 1220mm

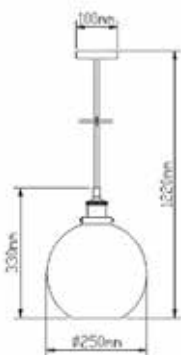

E27 Holder | **Max 60W**



VT-7290

Amber Glass

SKU: 3741
EAN Code: 3800157611145
Material: Glass + Metal
Size: 260 x 260 x 1150mm

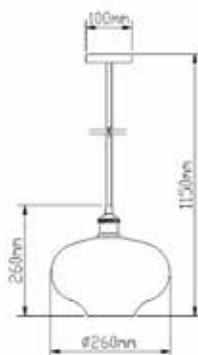

**Bulbs not included*



VT-7300

Transparent Glass

SKU: 3737
EAN Code: 3800157611107
Material: Glass + Metal
Size: 300 x 250 x 1150mm

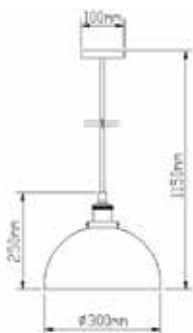

VT-7320

Amber Glass

SKU: 3740
EAN Code: 3800157611138
Material: Glass + Metal
Size: 250 x 280 x 1180mm

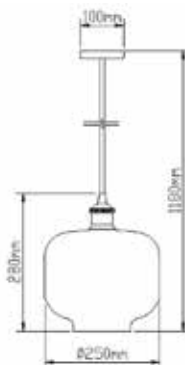



VT-7150
Amber Glass

SKU: 3732
EAN Code: 3800157611053
Material: Glass + Metal
Size: 145 x 160 x 1050mm

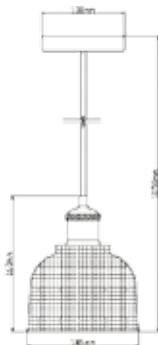

VT-7150
Green Glass

SKU: 3734
EAN Code: 3800157611077
Material: Glass + Metal
Size: 145 x 160 x 1050mm

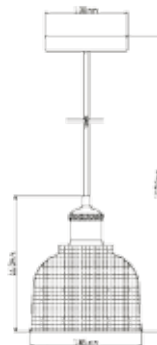



VT-7150
Red Glass

SKU: 3731
EAN Code: 3800157611046
Material: Glass + Metal
Size: 145 x 160 x 1050mm

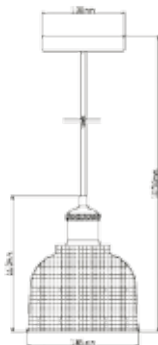

VT-7150
Clear Glass

SKU: 3733
EAN Code: 3800157611060
Material: Glass + Metal
Size: 145 x 160 x 1050mm

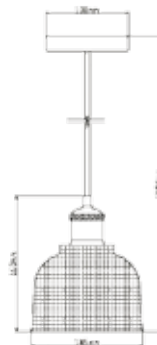



VT-7220
Transparent Glass

SKU: 3727
EAN Code: 3800157611008
Material: Glass + Metal
Size: 220 x 280 x 1150mm



VT-7220
Amber Glass

SKU: 3726
EAN Code: 3800157610995
Material: Glass + Metal
Size: 220 x 280 x 1150mm



E27 Holder | Max 60W

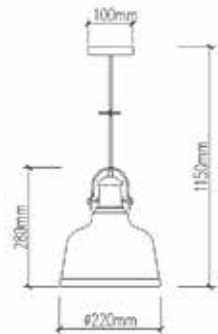

*Bulbs not included



VT-7130

Transparent Glass

SKU: 3818
EAN Code: 3800157615433
Material: Glass + Wood
Size: 135 x 240 x 1150mm

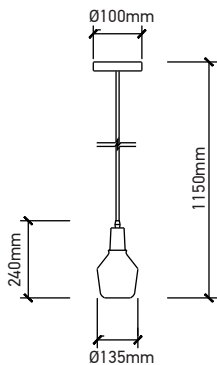

VT-7170

Transparent Glass

SKU: 3819
EAN Code: 3800157615440
Material: Glass + Wood
Size: 165 x 220 x 1100mm

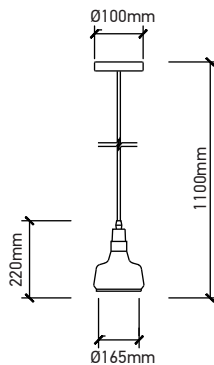



VT-7307
Amber Glass

New!

SKU: 3926
EAN Code: 3800157626217
Material: Glass + Wood
Size: 300 x 1300mm

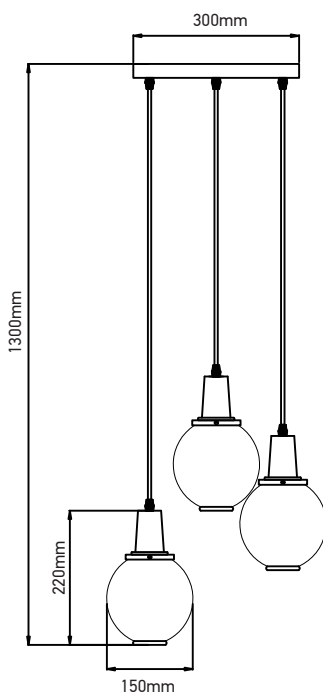



3D Glass

VT-7015

Glass

SKU: 3830
EAN Code: 3800157616652
Material: Glass
Size: 150 x 140 x 1200mm

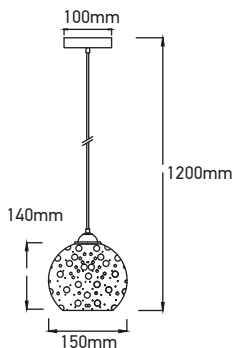

VT-7240

Transparent Glass

SKU: 3820
EAN Code: 3800157615457
Material: Glass + Wood
Size: 235 x 140 x 1050mm

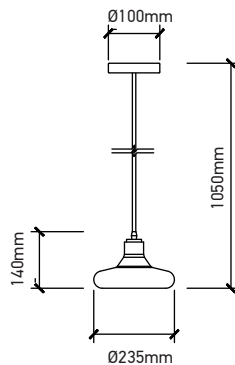



VT-7422

Black

SKU: 3728
EAN Code: 3800157611015
Material: Aluminum
Size: 230 x 310 x 1150mm

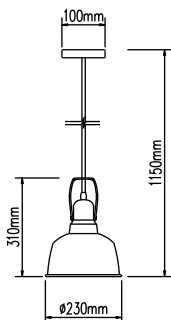

VT-7422

White

SKU: 3729
EAN Code: 3800157611022
Material: Aluminum
Size: 230 x 310 x 1150mm

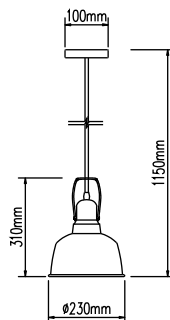



VT-7180

Transparent V Shape

SKU: 3863
EAN Code: 3800157620734
Material: Glass + Metal
Size: Ø250 x 90mm

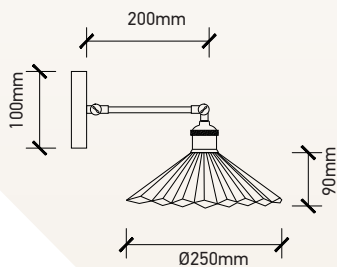

VT-7226

Transparent Globe Shape

SKU: 3864
EAN Code: 3800157620741
Material: Glass + Metal
Size: Ø250 x 230mm

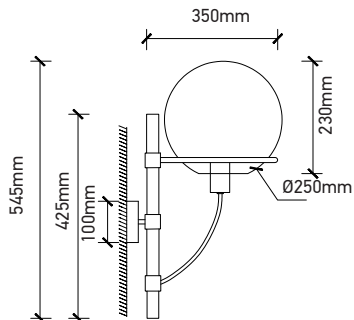



New!

VT-7151
Green Glass Cover

SKU: 3912
EAN Code: 3800157626071
Material: Glass + Metal



New!

VT-7151
Blue Glass Cover

SKU: 3913
EAN Code: 3800157626088
Material: Glass + Metal



New!

VT-7151
Gold Glass Cover

SKU: 3914
EAN Code: 3800157626095
Material: Glass + Metal

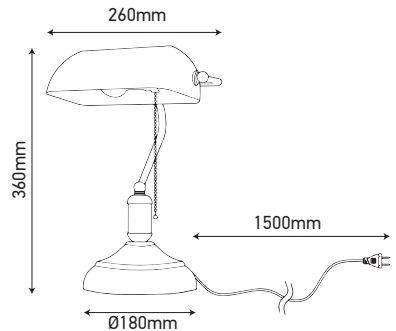



VT-7142

Transparent Cone Shape

SKU: 3861
EAN Code: 3800157620710
Material: Glass + Metal
Size: 140 x 160mm

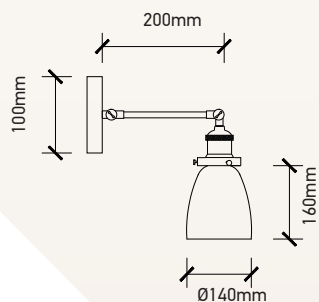

VT-7143

Transparent V Shape

SKU: 3862
EAN Code: 3800157620727
Material: Glass + Metal
Size: 185 x 140 mm

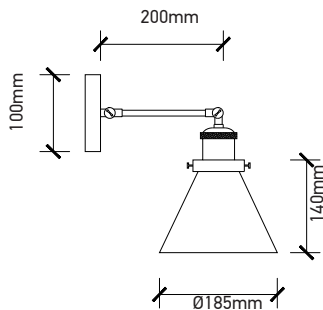



VT-7400

Modern 6 Bulb Chandelier -Movable

SKU: 3889

EAN Code: 3800157621076

Material: Metal

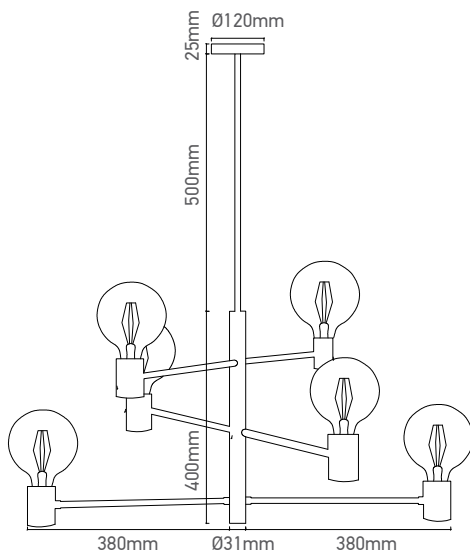



VT-7200

Matt Grey

SKU: 3822
EAN Code: 3800157616577
Material: Metal
Size: 200 x 270 x 1300mm

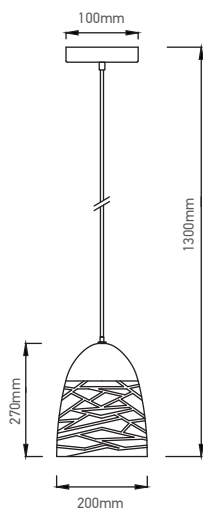



VT-7200
Champagne Gold

SKU: 3821
EAN Code: 3800157616560
Material: Metal
Size: 200 x 270 x 1300mm



VT-7200
Matt White

SKU: 3823
EAN Code: 3800157616584
Material: Metal
Size: 200 x 270 x 1300mm

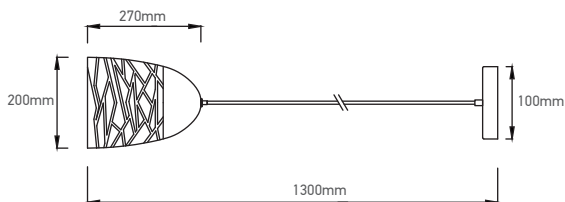



VT-7131
Champagne Gold

SKU: 3824
EAN Code: 3800157616591
Material: Metal
Size: 130 x 250 x 1300mm

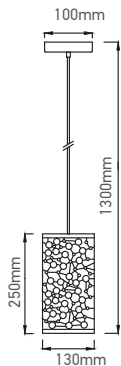

VT-7131
Matt Black

SKU: 3825
EAN Code: 3800157616607
Material: Metal
Size: 130 x 250 x 1300mm

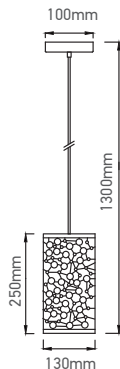



VT-7131
Matt White

SKU: 3826
EAN Code: 3800157616614
Material: Metal
Size: 130 x 250 x 1300mm

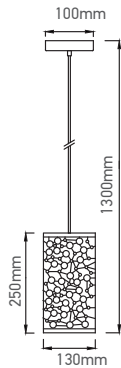

VT-7132
Champagne Gold

SKU: 3827
EAN Code: 3800157616621
Material: Metal
Size: 130 x 220 x 1300mm

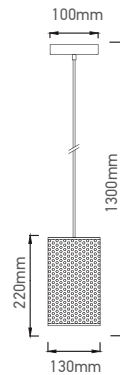



VT-7132
Matt Black

SKU: 3828
EAN Code: 3800157616638
Material: Metal
Size: 133 x 250 x 1300mm

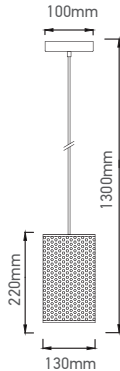

VT-7132
Matt White

SKU: 3829
EAN Code: 3800157616645
Material: Metal
Size: 130 x 220 x 1300mm

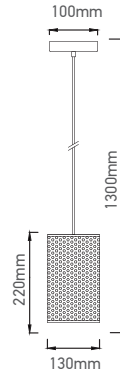



VT-7332
Black Metal Globe Mesh

SKU: 3859
EAN Code: 3800157620697
Material: Metal
Size: Ø290 x 1000 x 1340mm

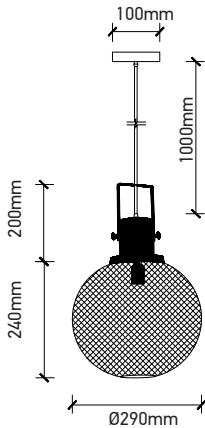

VT-7252
Black Metal V Shape

SKU: 3860
EAN Code: 3800157620703
Material: Metal
Size: Ø290 x 1000 x 1340mm

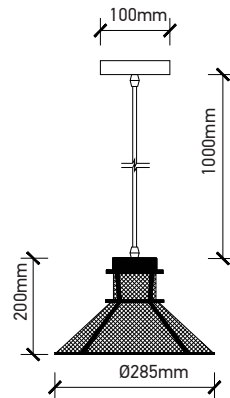

LED Pendants | Copper Series



VT-8300

Rose Gold

SKU: 3710

EAN Code: 3800157610834

Material: Iron with Electric
Copper Paint

Size: Ø300mm





VT-8150
Rose Gold

SKU: 3713
EAN Code: 3800157610865
Material: Iron with Electric
Copper Paint
Size: Ø150mm



VT-8220
Rose Gold

SKU: 3711
EAN Code: 3800157610841
Material: Iron with Electric
Copper Paint
Size: Ø220mm



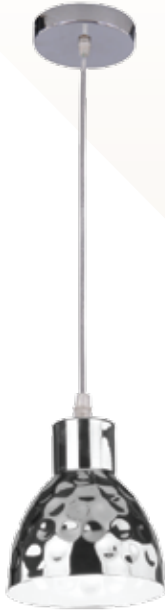

VT-8150
Chrome

SKU: 3712
EAN Code: 3800157610865
Material: Iron with Electric
Copper Paint
Size: Ø150mm



VT-8255
Rose Gold

SKU: 3709
EAN Code: 3800157610827
Material: Iron with Electric
Copper Paint
Size: Ø250mm





VT-8180
Chrome

SKU: 3707
EAN Code: 3800157610803
Material: Iron with Electric
Copper Paint
Size: Ø180mm



VT-8180
Rose Gold

SKU: 3708
EAN Code: 3800157610810
Material: Iron with Electric
Copper Paint
Size: Ø180mm





VT-8170
Rose Gold

SKU: 3714
EAN Code: 3800157610872
Material: Iron with Electric
Copper Paint
Size: Ø170mm



VT-8230
Rose Gold

SKU: 3715
EAN Code: 3800157610889
Material: Iron with Electric
Copper Paint
Size: Ø230mm





VT-8175
Chrome

SKU: 3705
EAN Code: 3800157610780
Material: Iron with Electric
Copper Paint
Size: Ø170mm



VT-8175
Rose Gold

SKU: 3706
EAN Code: 3800157610797
Material: Iron with Electric
Copper Paint
Size: Ø170mm





VT-8200
Rose Gold

SKU: 3716
EAN Code: 3800157610896
Material: Iron with Electric Copper Paint
Size: Ø200mm



VT-8250
Rose Gold

SKU: 3717
EAN Code: 3800157610902
Material: Iron with Electric Copper Paint
Size: Ø250mm





VT-7205

White Glass

SKU: 3759
EAN Code: 3800157611329
Material: Glass + Wood
Size: 190 x 320 x 1120mm

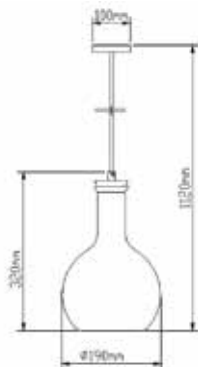



VT-7175
White Glass

SKU: 3758
EAN Code: 3800157611312
Material: Glass + Wood
Size: 170 x 320 x 1120mm

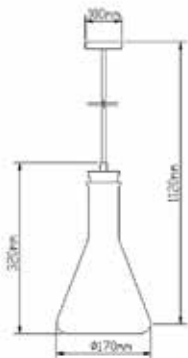

VT-7177
Clear Glass

SKU: 3760
EAN Code: 3800157611336
Material: Glass + Wood
Size: 170 x 320 x 1120mm

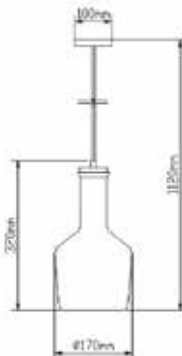



VT-7162
White

SKU: 3868
EAN Code: 3800157620789
Material: Aluminum
Size: Ø160 x350 x600mm

VT-7162
Black

SKU: 3869
EAN Code: 3800157620796
Material: Aluminum
Size: Ø160 x350 x600mm

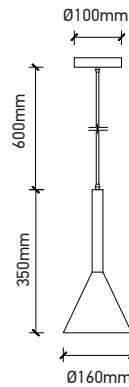
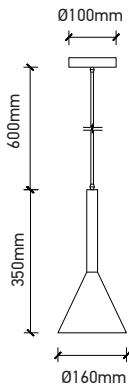



VT-7330

SKU: 3849
EAN Code: 3800157618984
Material: Concrete and Iron
Size: 400 x 250 x 1100mm

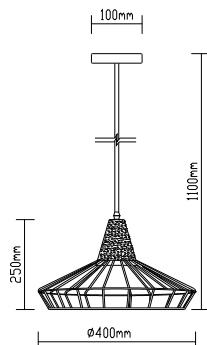



VT-7253

SKU: 3848
EAN Code: 3800157618977
Material: Concrete and Iron
Size: 250 x 310 x 1200mm

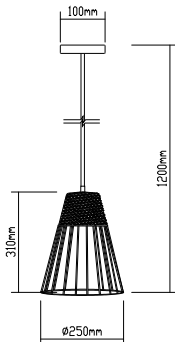

VT-7121

SKU: 3847
EAN Code: 3800157618960
Material: Concrete and Iron
Size: 120 x 380 x 1300mm

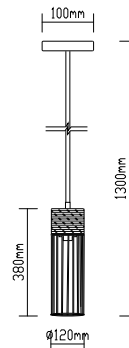



VT-7155

SKU: 3850
EAN Code: 3800157618991
Material: Concrete
Size: 160 x 290 x 1250mm

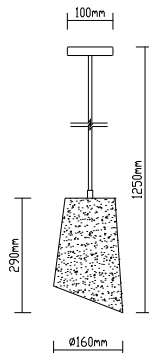



VT-7202

SKU: 3853
EAN Code: 3800157619028
Material: Concrete
Size: 180 x 160 x 1100mm

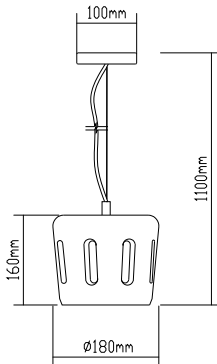

VT-7291

SKU: 3854
EAN Code: 3800157619035
Material: Concrete with Wood
Size: 265 x 260 x 1050mm

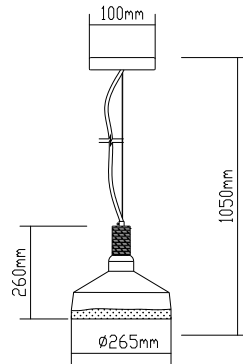



VT-7132

White

SKU: 3858
EAN Code: 3800157619073
Material: Concrete with Wood
Size: 290 x 250 x 1150mm

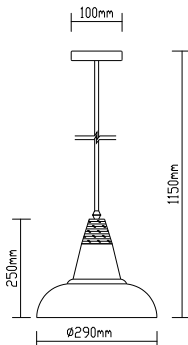

VT-7125

Grey

SKU: 3855
EAN Code: 3800157619042
Material: Concrete with Wood
Size: 120 x 210 x 1080mm

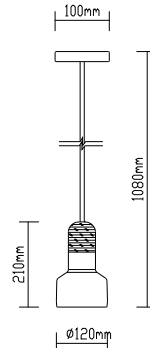



VT-7125
Green

SKU: 3856
EAN Code: 3800157619059
Material: Concrete with Wood
Size: 120 x 210 x 1080mm

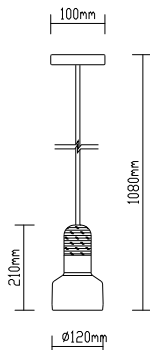

VT-7125
Red

SKU: 3857
EAN Code: 3800157619066
Material: Concrete with Wood
Size: 120 x 210 x 1080mm

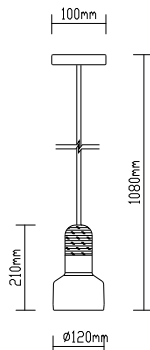



VT-7160

SKU: 3851
EAN Code: 3800157619004
Material: Concrete
Size: 160 x 150 x 2000mm

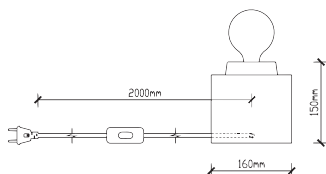

VT-7171

SKU: 3852
EAN Code: 3800157619011
Material: Concrete
Size: 180 x 130 x 2000mm

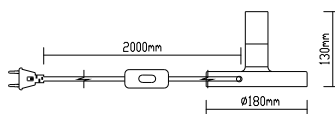



VT-7141
Champagne Gold

SKU: 3831
EAN Code: 3800157616669
Material: Metal
Size: 250 x 190 x 1250mm

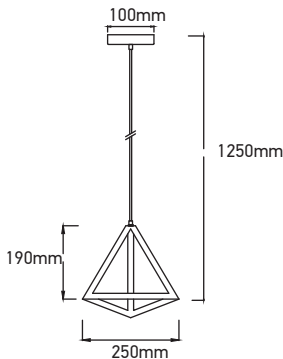

E27 Holder | **Max 60W**



VT-7141
Matt Black

SKU: 3832
EAN Code: 3800157616676
Material: Metal
Size: 250 x 190 x 1250mm

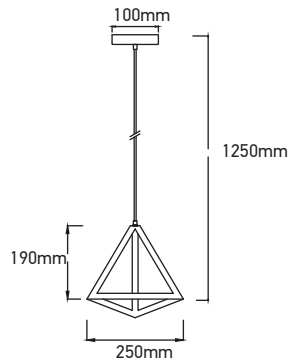

**Bulbs not included*



VT-7161
Champagne Gold

SKU: 3833
EAN Code: 3800157616683
Material: Metal
Size: 225 x 225x 1250mm

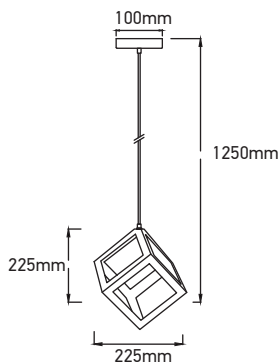

VT-7161
Matt Black

SKU: 3834
EAN Code: 3800157616690
Material: Metal
Size: 225 x 225x 1250mm

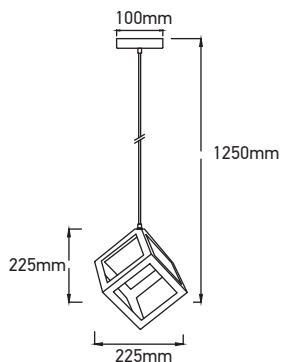



VT-7144

New!

Matt Black - 3PC SET

SKU: 3927
EAN Code: 3800157626224
Material: Metal
Size: 300 x1300mm

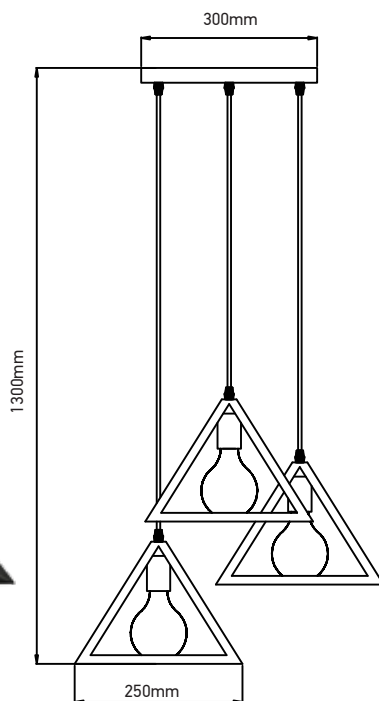



VT-7320
Champagne Gold

SKU: 3835
EAN Code: 3800157616706
Material: Metal
Size: 320 x 320x 1350mm

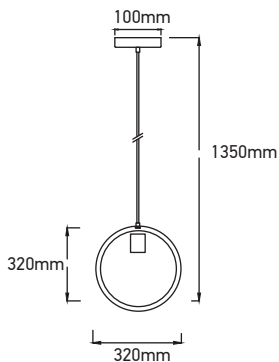

VT-7320
Matt Black

SKU: 3836
EAN Code: 3800157616713
Material: Metal
Size: 320 x 320x 1350mm

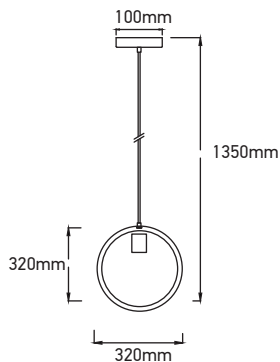



VT-7321
Champagne Gold

SKU: 3837
EAN Code: 3800157616720
Material: Metal
Size: 320 x 320x 1350mm

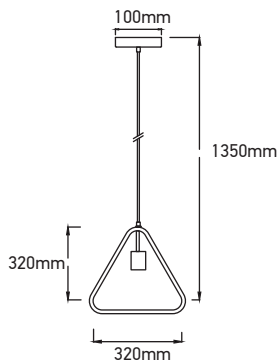

VT-7321
Matt Black

SKU: 3838
EAN Code: 3800157616737
Material: Metal
Size: 320 x 320x 1350mm

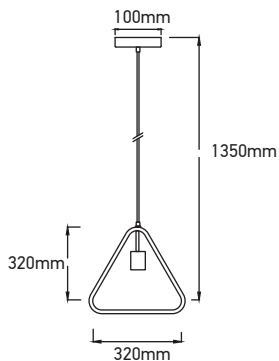



VT-7225
Red Bronze

SKU: 3816
EAN Code: 3800157612760
Material: Aluminum+ Sand finish
Size: 260 x 330 x 1100 mm

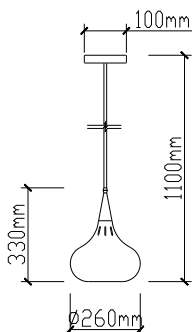

VT-7340
Red Bronze

SKU: 3817
EAN Code: 3800157612777
Material: Aluminum+ Sand finish
Size: 360 x 420 x 1200mm

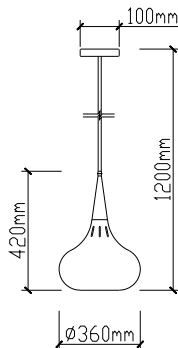



VT-7520

Sand Black

- SKU:** 3700
EAN Code: 3800157610735
Material: Aluminum + Sand finish
Size: 220 x 310 x 1375mm

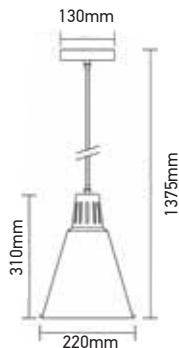



VT-7520
Sand Grey

SKU: 3701
EAN Code: 3800157610742
Material: Aluminum + Sand finish
Size: 220 x 310 x 1375mm

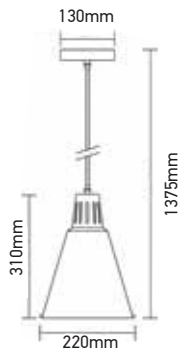

VT-7520
Sand White

SKU: 3702
EAN Code: 3800157610759
Material: Aluminum + Sand finish
Size: 220 x 310 x 1375mm

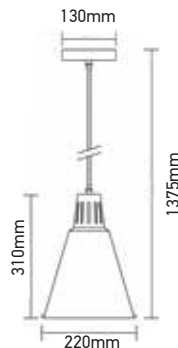



VT-7425

White

SKU: 3756
EAN Code: 3800157611299
Material: Aluminum + Wooden Top
Size: 250 x 200x 1100mm

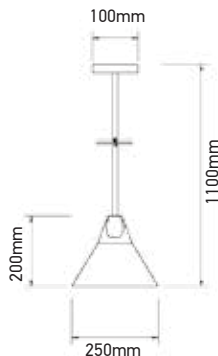

VT-7425

Black

SKU: 3757
EAN Code: 3800157611305
Material: Aluminum + Wooden Top
Size: 250 x 200x 1100mm

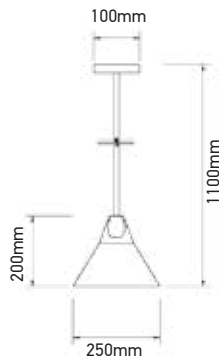



VT-7525

White

SKU: 3761
EAN Code: 3800157611343
Material: Iron + Wooden Top
Size: 250 x 400x 1200mm

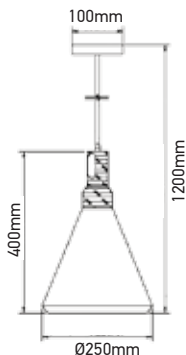

VT-7525

Black

SKU: 3762
EAN Code: 3800157611350
Material: Iron + Wooden Top
Size: 250 x 400x 1200mm

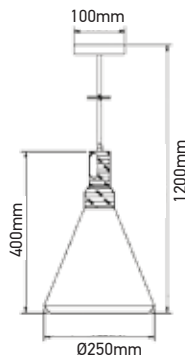



VT-7535

White

SKU: 3763
EAN Code: 3800157611367
Material: Iron + Wooden Top
Size: 350 x 300x 1100mm

VT-7535

Black

SKU: 3764
EAN Code: 3800157611374
Material: Iron + Wooden Top
Size: 350 x 300x 1100mm

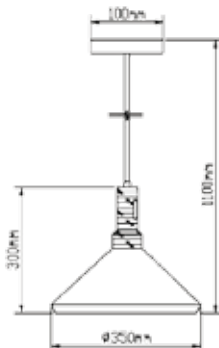
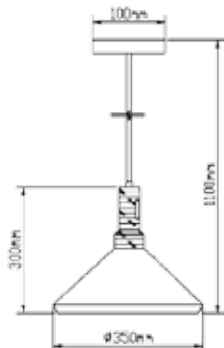



VT-7545

White

SKU: 3765
EAN Code: 3800157611381
Material: Iron + Wooden Top
Size: 350 x 300x 1100mm

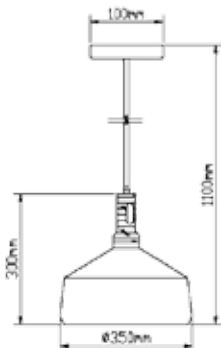

VT-7545

Black

SKU: 3766
EAN Code: 3800157611398
Material: Iron + Wooden Top
Size: 350 x 300x 1100mm

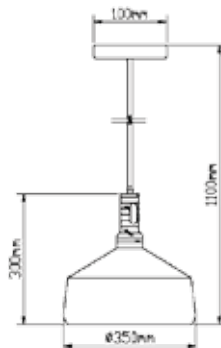



New!

VT-7100
White

SKU: 3920
EAN Code: 3800157626156
Material: Plastic + Aluminium
Size: Ø180 x 100x 1200mm



New!

VT-7100
Black

SKU: 3921
EAN Code: 3800157626163
Material: Plastic + Aluminium
Size: Ø180 x 100x 1200mm



New!

VT-7100
Gray

SKU: 3922
EAN Code: 3800157626170
Material: Plastic + Aluminium
Size: Ø180 x 100x 1200mm

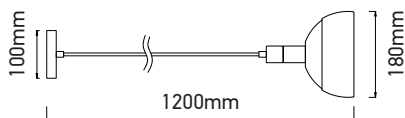



VT-7100
Pink **New!**

SKU: 3923
EAN Code: 3800157626187
Material: Plastic + Aluminium
Size: Ø180 x 100x 1200mm



VT-7100
Red **New!**

SKU: 3924
EAN Code: 3800157626194
Material: Plastic + Aluminium
Size: Ø180 x 100x 1200mm



VT-7100
Blue **New!**

SKU: 3925
EAN Code: 3800157626200
Material: Plastic + Aluminium
Size: Ø180 x 100x 1200mm

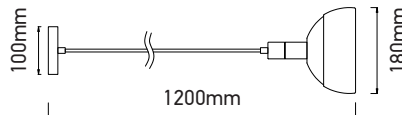



VT-7777
Rose Gold

SKU: 3751
EAN Code: 3800157611244
Material: Metal
Size: 300 x 90x 1000mm

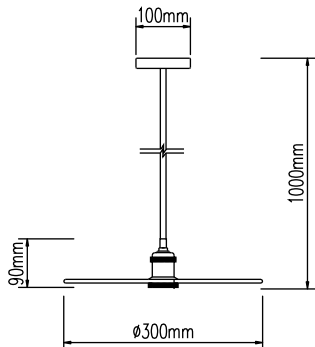

VT-7777
Matt Gold

SKU: 3752
EAN Code: 3800157611251
Material: Metal
Size: 300 x 90x 1000mm

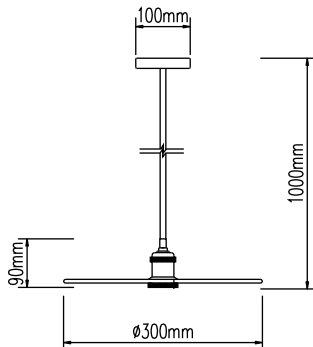



VT-7424

Black

SKU: 3753
EAN Code: 3800157611268
Material: Metal
Size: 260 x 170x 1080mm

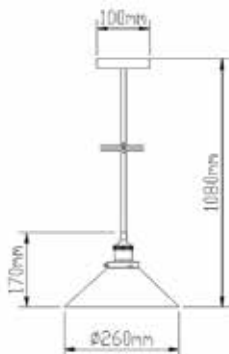

Adjustable
Height

VT-7201

Black

SKU: 3845
EAN Code: 3800157617192
Material: Metal
Size: 220 x 140x 600-1600mm

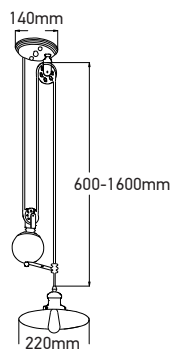



VT-7251
Globe Pendant

SKU: 3839
EAN Code: 3800157616744
Material: Acrylic glass
Size: 250 x 250x 1300mm

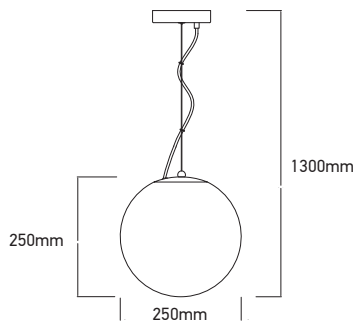

VT-7118
Rope

SKU: 3754
EAN Code: 3800157611275
Material: Rope
Size: 45x 57x 1500mm

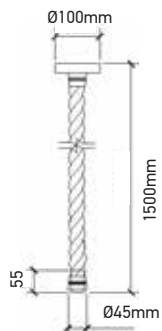



VT-7558
Green

SKU: 3767
EAN Code: 3800157611404
Material: Glass
Size: Ø72 x 280x 1150mm



VT-7558
Blue

SKU: 3768
EAN Code: 3800157611411
Material: Glass
Size: Ø72 x 280x 1150mm



VT-7558
Red

SKU: 3769
EAN Code: 3800157611428
Material: Glass
Size: Ø72 x 280x 1150mm



VT-7558
Amber

SKU: 3770
EAN Code: 3800157611435
Material: Glass
Size: Ø72 x 280x 1150mm

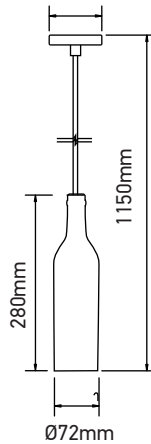

VT-7558
Transparent

SKU: 3771
EAN Code: 3800157611442
Material: Glass
Size: Ø72 x 280x 1150mm



VT-7558
Pink

SKU: 3772
EAN Code: 3800157611459
Material: Glass
Size: Ø72 x 280x 1150mm



VT-7558
Yellow

SKU: 3773
EAN Code: 3800157611466
Material: Glass
Size: Ø72 x 280x 1150mm



VT-7558
Rose

SKU: 3774
EAN Code: 3800157611473
Material: Glass
Size: Ø72 x 280x 1150mm



VT-7558
Grey

SKU: 3775
EAN Code: 3800157611480
Material: Glass
Size: Ø72 x 280x 1150mm

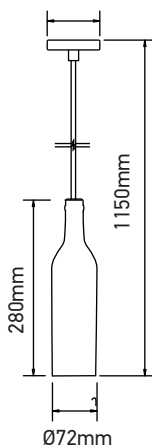

VT-7558
Brown

SKU: 3776
EAN Code: 3800157611497
Material: Glass
Size: Ø72 x 280x 1150mm



VT-7778
White Wire

SKU: 3720
EAN Code: 3800157610933
Material: Wooden
Size: Ø73 x 102x 1000mm



VT-7778
Black Wire

SKU: 3721
EAN Code: 3800157610940
Material: Wooden
Size: Ø73 x 102x 1000mm



VT-7778
Blue Wire

SKU: 3722
EAN Code: 3800157610957
Material: Wooden
Size: Ø73 x 102x 1000mm



VT-7778
Red Wire

SKU: 3723
EAN Code: 3800157610964
Material: Wooden
Size: Ø73 x 102x 1000mm



VT-7778
Purple Wire

SKU: 3724
EAN Code: 3800157610971
Material: Wooden
Size: Ø73 x 102x 1000mm

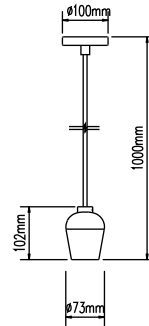

VT-7778
Green Wire

SKU: 3725
EAN Code: 3800157610988
Material: Wooden
Size: Ø73 x 102x 1000mm



VT-7555
Red Bronze

SKU: 3840
EAN Code: 3800157617147
Base: E27
Size: Ø50x90x900mm



VT-7555
Brown Bronze

SKU: 3841
EAN Code: 3800157617154
Base: E27
Size: Ø50x90x900mm



VT-7555
Brass Bronze

SKU: 3842
EAN Code: 3800157617161
Base: E27
Size: Ø50x90x900mm



VT-7555
Bronze

SKU: 3843
EAN Code: 3800157617178
Base: E27
Size: Ø50x90x900mm



VT-7555
Gold

SKU: 3844
EAN Code: 3800157617185
Base: E27
Size: Ø50x90x900mm

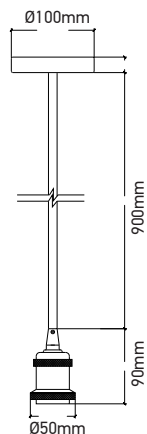

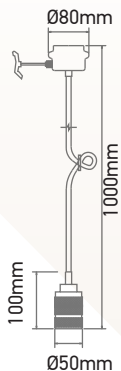

VT-7999
Gold Aluminum

SKU: 3811
EAN Code: 3800157612425
Base: E27
Size: Ø50 x 100mm

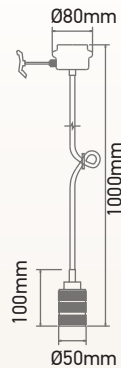

VT-7999
Gold Aluminum

SKU: 3812
EAN Code: 3800157612432
Base: E27
Size: Ø50 x 100mm

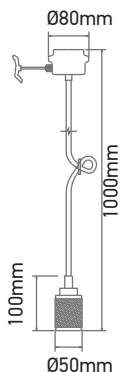

VT-7999
Bronze Aluminum

SKU: 3813
EAN Code: 3800157612449
Base: E27
Size: Ø50 x 100mm



Adjustable
Canopy

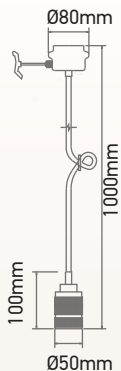

VT-7999

Bronze Aluminum

SKU: 3814
EAN Code: 3800157612456
Base: E27
Size: Ø50 x 100mm

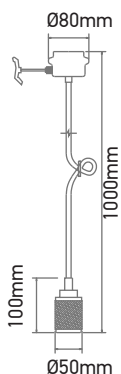

VT-7999

Rose Gold Aluminum

SKU: 3815
EAN Code: 3800157612463
Base: E27
Size: Ø50 x 100mm



**Adjustable
Canopy**



VT-7998
White

SKU: 3803
EAN Code: 3800157612340
Base: E27
Size: Ø47x64x680mm



VT-7998
Black

SKU: 3804
EAN Code: 3800157612357
Base: E27
Size: Ø47x64x680mm



VT-7998
Green

SKU: 3805
EAN Code: 3800157612364
Base: E27
Size: Ø47x64x680mm



VT-7998
Blue

SKU: 3806
EAN Code: 3800157612371
Base: E27
Size: Ø47x64x680mm



VT-7998
Red

SKU: 3807
EAN Code: 3800157612388
Base: E27
Size: Ø47x64x680mm



VT-7998
Grey

SKU: 3808
EAN Code: 3800157612395
Base: E27
Size: Ø47x64x680mm



VT-7998
Yellow

SKU: 3809
EAN Code: 3800157612401
Base: E27
Size: Ø47x64x680mm

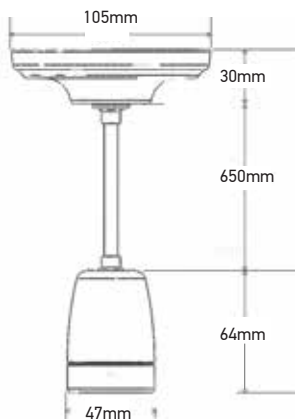

VT-7998
Brown

SKU: 3810
EAN Code: 3800157612418
Base: E27
Size: Ø47x64x680mm



VT-799
White

SKU: 3795
EAN Code: 3800157612265
Base: E27
Size: Ø47x64mm



VT-799
Black

SKU: 3796
EAN Code: 3800157612272
Base: E27
Size: Ø47x64mm



VT-799
Green

SKU: 3797
EAN Code: 3800157612289
Base: E27
Size: Ø47x64mm



VT-799
Blue

SKU: 3798
EAN Code: 3800157612296
Base: E27
Size: Ø47x64mm



VT-799
Red

SKU: 3799
EAN Code: 3800157612302
Base: E27
Size: Ø47x64mm



VT-799
Grey

SKU: 3800
EAN Code: 3800157612319
Base: E27
Size: Ø47x64mm



VT-799
Yellow

SKU: 3801
EAN Code: 3800157612326
Base: E27
Size: Ø47x64mm

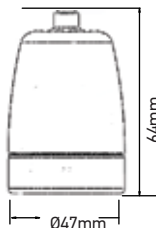

VT-799
Brown

SKU: 3802
EAN Code: 3800157612333
Base: E27
Size: Ø47x64mm



VT-7668
Green

SKU: 3742
EAN Code: 3800157611152
Base: E27
Size: Ø50x95x1050mm



VT-7668
Red

SKU: 3743
EAN Code: 3800157611169
Base: E27
Size: Ø50x95x1050mm



VT-7668
Blue

SKU: 3744
EAN Code: 3800157611176
Base: E27
Size: Ø50x95x1050mm



VT-7668
Yellow

SKU: 3745
EAN Code: 3800157611183
Base: E27
Size: Ø50x95x1050mm



VT-7668
White

SKU: 3746
EAN Code: 3800157611190
Base: E27
Size: Ø50x95x1050mm



VT-7668
Black

SKU: 3747
EAN Code: 3800157611206
Base: E27
Size: Ø50x95x1050mm



VT-7668
Grey

SKU: 3748
EAN Code: 3800157611213
Base: E27
Size: Ø50x95x1050mm



VT-7668
Brown

SKU: 3749
EAN Code: 3800157611220
Base: E27
Size: Ø50x95x1050mm



VT-7668
Beige

SKU: 3750
EAN Code: 3800157611237
Base: E27
Size: Ø50x95x1050mm

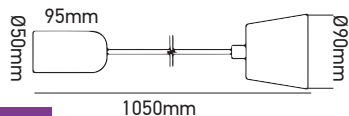

VT-7338

Base: E27
Size: Ø39x 60mm



VT-7448
Rose Gold Set

SKU: 3777
EAN Code: 3800157611503
Base: E27
Size: Ø39x 60mm



White
SKU: 3755
EAN Code: 3800157611282



Black
SKU: 3782
EAN Code: 3800157611558



Blue
SKU: 3783
EAN Code: 3800157611565



Brown
SKU: 3784
EAN Code: 3800157611572



Green
SKU : 3785
EAN Code: 3800157611589



Grey
SKU: 3786
EAN Code: 3800157611596



Light Blue
SKU: 3787
EAN Code: 3800157611602



Orange
SKU: 3788
EAN Code: 3800157611619



Pink
SKU: 3789
EAN Code: 3800157611626



Purple
SKU: 3790
EAN Code: 3800157611633



Red
SKU: 3791
EAN Code: 3800157611640



Rose Red
SKU: 3792
EAN Code: 3800157611657



Yellow
SKU: 3793
EAN Code: 3800157611664



Beige
SKU: 3794
EAN Code: 3800157611671

VT-7228

Base: E27
Length: 1000mm



Brown
SKU: 3475
EAN Code: 3800157607919



Blue
SKU: 3476
EAN Code: 3800157607926



White
SKU: 3477
EAN Code: 3800157607933



Black
SKU: 3478
EAN Code: 3800157607940



Pink
SKU: 3479
EAN Code: 3800157607957



Red
SKU: 3480
EAN Code: 3800157607964



Grey
SKU: 3481
EAN Code: 3800157607971



Light Blue
SKU: 3482
EAN Code: 3800157609463



Purple
SKU: 3483
EAN Code: 3800157609470



Orange
SKU: 3484
EAN Code: 3800157609487



Yellow
SKU: 3485
EAN Code: 3800157609494



Green
SKU: 3486
EAN Code: 3800157609500



Designer Sleek

LED Pendants

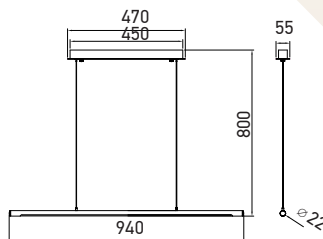

Chrome Finish

10W VT-7018



SKU

3890 - 4000K Day White

EAN Code

3800157621083

Built In LED

Watts:	10W	Beam Angle:	120°
Voltage/Frequency:	220-240V, 50Hz	No. of LED:	90
Luminous Flux:	1350lm	Material :	Stainless steel + Metal +PMMA
LED Type:	SMD	Unit GW :	1.38KG
CRI:	>80	Life Span:	20,000h
PF:	≥0.8	Size :	940 x 55 x 800mm

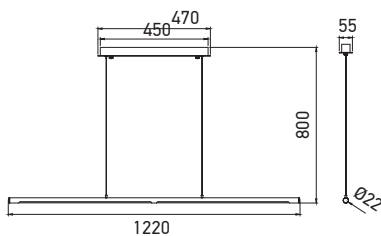

Chrome Finish

24W VT-7024



SKU
3891 - 4000K Day White

EAN Code
3800157621090

Built In LED

Watts:	24W	Beam Angle:	120°
Voltage/Frequency:	AC:220-240V,50Hz	No. of LED:	120
Luminous Flux:	1800lm	Material :	Stainless steel+metal+PMMA
LED Type:	SMD	Unit GW :	1.59KG
CRI:	>80	Life Span:	20,000h
PF:	≥0.8	Size :	1220 x 55 x 800mm

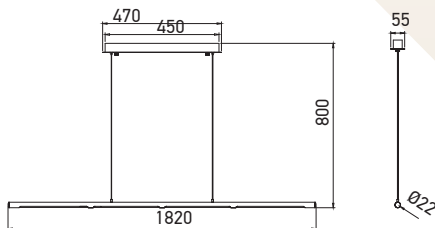

Chrome Finish

36W VT-7036



SKU
3892 - 4000K Day White

EAN Code
3800157621106

Built In LED

Watts:	36W	Beam Angle:	120°
Voltage/Frequency:	AC:220-240V,50Hz	No. of LED:	180
Luminous Flux:	2700lm	Material :	Stainless steel+metal+PMMA
LED Type:	SMD	Unit GW :	1.82KG
CRI:	>80	Life Span:	20,000h
PF:	≥0.8	Size :	1820 x 55 x 800mm



Chrome Finish

36W VT-7037

A

SKU

3893 - 4000K Day White

EAN Code

3800157621113

Built In LED

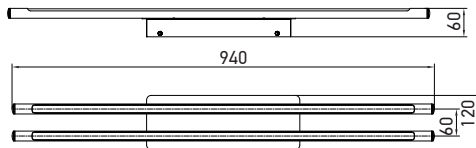

Watts:	36W	Beam Angle:	120°
Voltage/Frequency:	AC:220-240V,50Hz	No. of LED:	180
Luminous Flux:	2700lm	Material :	Stainless steel+metal+PMMA
LED Type:	SMD	Unit GW :	2.24KG
CRI:	>80	Life Span:	20,000h
PF:	≥0.8	Size :	940 x 120 x 60mm



Chrome Finish

8W VT-7008



SKU
3894 - 4000K Day White

EAN Code
3800157621120 **Built In LED**

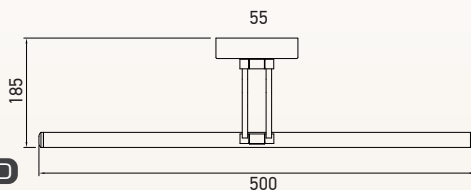

Watts:	8W	Beam Angle:	120°
Voltage/Frequency:	AC:220-240V,50Hz	No. of LED:	40
Luminous Flux:	600	Material :	metal+PMMA
LED Type:	SMD	Unit GW :	0.72KG
CRI:	>80	Life Span:	20,000H
PF:	≥0.5	Size :	500 x 55 x 185mm



Chrome Finish

12W VT-7012



SKU
3895 - 4000K Day White

EAN Code
3800157621137 **Built In LED**

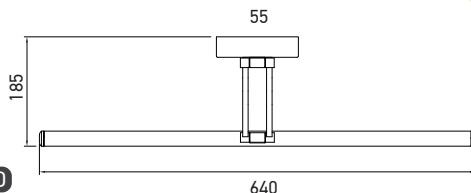

Watts:	12W	Beam Angle:	120°
Voltage/Frequency:	AC:220-240V,50Hz	No. of LED:	60
Luminous Flux:	900lm	Material :	metal+PMMA
LED Type:	SMD	Unit GW :	0.82KG
CRI:	>80	Life Span:	20,000h
PF:	≥0.5	Size :	640 x 55 x 185mm

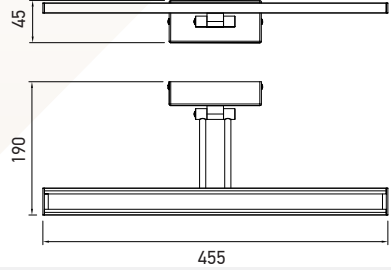
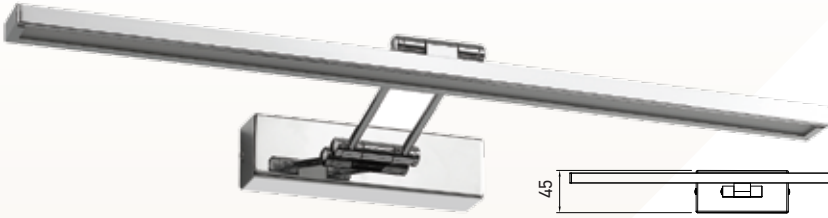

Chrome Finish

8W VT-7009CH



SKU
3900 - 4000K Day White

EAN Code
3800157621854 **Built In LED**

Watts:	8W	Beam Angle:	120°
Voltage/Frequency:	AC:220-240V,50Hz	No. of LED:	40
Luminous Flux:	600lm	Material :	Stainless steel+aluminum+PMMA
LED Type:	SMD	Unit GW :	0.8KG
CRI:	>80	Life Span:	20,000h
PF:	≥0.8	Size :	455 x 45 x 190mm

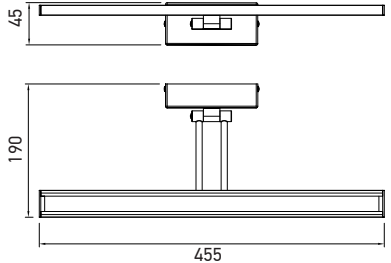
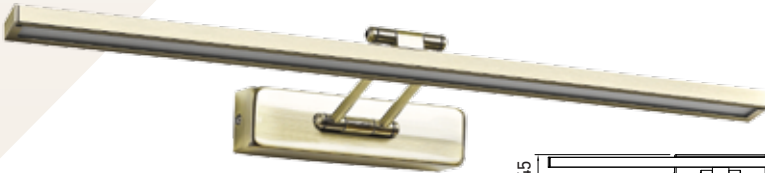

Gold Finish

8W VT-7009



SKU
3901 - 4000K Day White

EAN Code
3800157621861 **Built In LED**

Watts:	8W	Beam Angle:	120°
Voltage/Frequency:	AC:220-240V,50Hz	No. of LED:	40
Luminous Flux:	600lm	Material :	Stainless steel+aluminum+PMMA
LED Type:	SMD	Unit GW :	0.8KG
CRI:	>80	Life Span:	20,000h
PF:	≥0.8	Size :	455 x 45 x 190mm

New!



Chorme Cap

10W VT-7010

A+

SKU

3916 - 4000K Day White
3917 - 6400K White

EAN Code

3800157626118
3800157626125

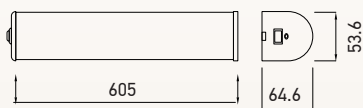

Built In **LED**

Watts:	10W	Beam Angle:	150°
Voltage/Frequency:	AC:220-240V, 50/60Hz	Material :	Aluminium + PC
Luminous Flux:	950lm	Unit GW :	6.80KG/CTN
LED Type:	SMD	Life Span:	30,000 Hours
CRI:	>80	Size :	605 x 53.6 x 64.6mm
PF:	0.5		



New!

White Cap

10W VT-7010

A+

SKU

3918 - 4000K Day White
3919 - 6400K White

EAN Code

3800157626132
3800157626149

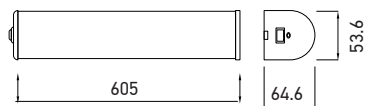

Built In **LED**

Watts:	10W	Beam Angle:	150°
Voltage/Frequency:	AC:220-240V, 50/60Hz	Material :	Aluminium + PC
Luminous Flux:	950lm	Unit GW :	6.80KG/CTN
LED Type:	SMD	Life Span:	30,000 Hours
CRI:	>80	Size :	605 x 53.6 x 64.6mm
PF:	0.5		



Chrome Finish Ceiling Lamp

12W VT-7014



SKU
3902 - 4000K Day White

EAN Code
3800157621878 **Built In LED**

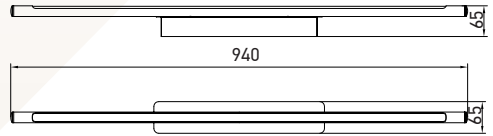

Watts:	12W	Beam Angle:	120°
Voltage/Frequency:	AC:220-240V,50Hz	No. of LED:	60
Luminous Flux:	900lm	Material :	Stainless steel+metal+PMMA
LED Type:	SMD	Unit GW :	1.08
CRI:	>80	Life Span:	20,000H
PF:	≥0.8	Size :	640 x 65 x65mm



Chrome Finish Ceiling Lamp

18W VT-7021



SKU
3903 - 4000K Day White

EAN Code
3800157621885 **Built In LED**

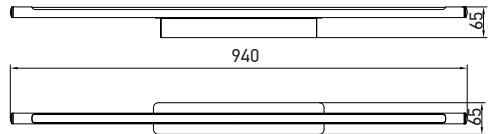

Watts:	18W	Beam Angle:	120°
Voltage/Frequency:	AC:220-240V,50Hz	No. of LED:	90
Luminous Flux:	1350lm	Material :	Stainless steel+metal+PMMA
LED Type:	SMD	Unit GW :	1.28
CRI:	>80	Life Span:	20,000h
PF:	≥0.8	Size :	940 x 65 x65mm



Glass Wall Fixture

12W VT-7013



SKU **Built In LED**
3896 - 4000K Day White

EAN Code
3800157621144

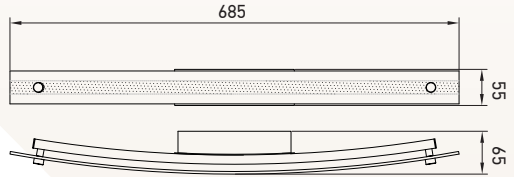

Watts:	12W	Beam Angle:	120°
Voltage/Frequency:	AC:220-240V,50Hz	No. of LED:	60
Luminous Flux:	900lm	Material :	Stainless steel+metal+glass
LED Type:	SMD	Unit GW :	1.01KG
CRI:	>80	Life Span:	20,000H
PF:	≥0.8	Size :	685 x 55 x 65mm



Glass Wall Fixture

18W VT-7019



SKU **Built In LED**
3897 - 4000K Day White

EAN Code
3800157621151

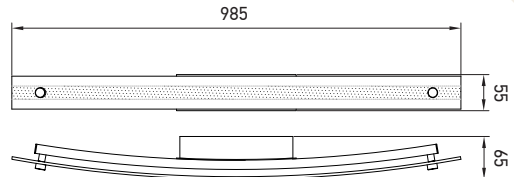

Watts:	18W	Beam Angle:	120°
Voltage/Frequency:	AC:220-240V,50Hz	No. of LED:	90
Luminous Flux:	1350lm	Material :	Stainless steel+metal+glass
LED Type:	SMD	Unit GW :	1.50KG
CRI:	>80	Life Span:	20,000h
PF:	≥0.8	Size :	985 x 55 x 65mm



Glass Hanging Pendant

18W VT-7020



SKU **Built In LED**
3898 - 4000K Day White

EAN Code
3800157621168

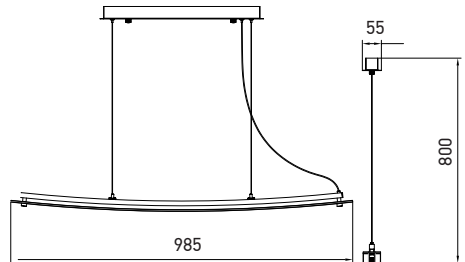

Watts:	18W	Beam Angle:	120°
Voltage/Frequency:	AC:220-240V,50Hz	No. of LED:	90
Luminous Flux:	1350lm	Material :	Stainless steel+metal+glass
LED Type:	SMD	Unit GW :	1.98KG
CRI:	>80	Life Span:	20,000h
PF:	≥0.8	Size :	985 x 55 x 800mm

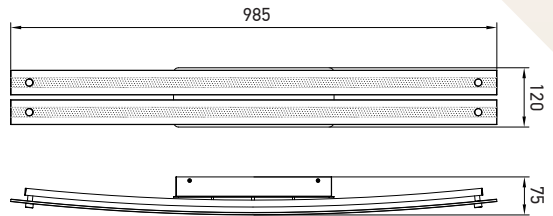
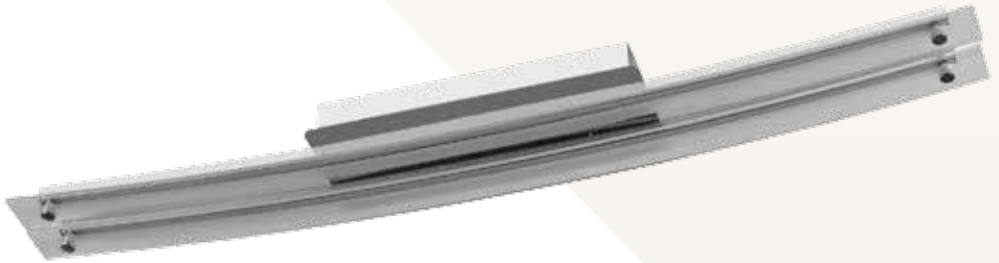

Glass Ceiling Surface SKU **Built In LED**
3899 - 4000K Day White

36W VT-7038



EAN Code
 3800157621175

Watts:	36W	Beam Angle:	120°
Voltage/Frequency:	AC:220-240V,50Hz	No. of LED:	180
Luminous Flux:	2700lm	Material :	Stainless steel+metal+glass
LED Type:	SMD	Unit GW :	3.53KG
CRI:	>80	Life Span:	20,000h
PF:	≥0.8	Size :	985 x 120 x75mm



Modern Circular

Chandeliers & Pendants

With Built in LED lights



New!

Gold Lampshade

6W VT-7333

SKU

3928 - 4000K Day White



EAN Code

3800157626569

Built In LED



New!

White Lampshade

6W VT-7333

SKU

3929 - 4000K Day White



EAN Code

3800157626576

Built In LED

Watts:	aaa	Beam Angle:	aaa
Voltage/Frequency:	aaaa	No. of LED:	aaaa
Luminous Flux:	aaaaaa	Material :	aaaaaa
LED Type:	aaaaaa	Unit GW :	aaaaaa
CRI:	aaaaaaaa	Life Span:	aaaaaaaa
PF:	aaaaaa	Size :	aaaaaa



New!

Gold Lampshade

6W VT-7444

SKU

3930 - 4000K Day White

EAN Code

3800157626583 **Built In** **LED**

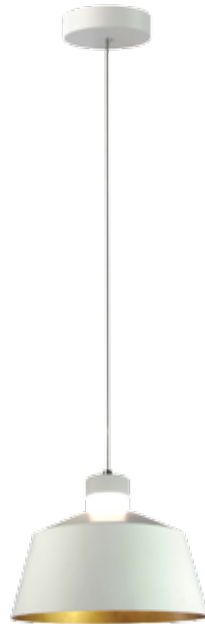

New!

White Lampshade

6W VT-7444

SKU

3931 - 4000K Day White

EAN Code

3800157626590 **Built In** **LED**

A

Watts:	aaa	Beam Angle:	aaa
Voltage/Frequency:	aaaa	No. of LED:	aaaa
Luminous Flux:	aaaaaa	Material :	aaaaaa
LED Type:	aaaaaa	Unit GW :	aaaaaa
CRI:	aaaaaaaa	Life Span:	aaaaaaaa
PF:	aaaaaa	Size :	aaaaaa

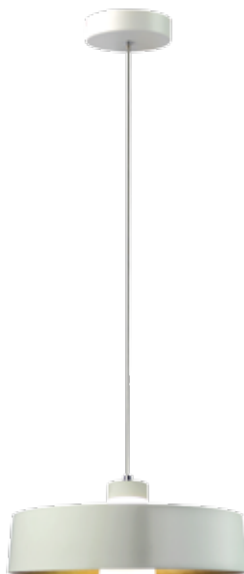
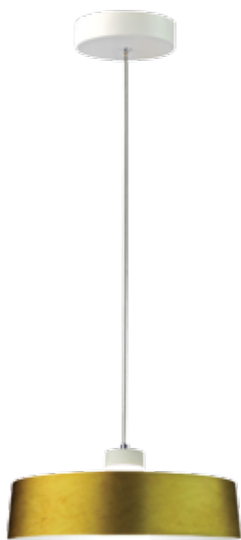

New!

Gold Lampshade

6W VT-7666

SKU

3932 - 4000K Day White



EAN Code

3800157626606 **Built In LED**

New!

White Lampshade

6W VT-7666

SKU

3933 - 4000K Day White



EAN Code

3800157626613 **Built In LED**

Watts:	aaa	Beam Angle:	aaa
Voltage/Frequency:	aaaa	No. of LED:	aaaa
Luminous Flux:	aaaaaa	Material :	aaaaaa
LED Type:	aaaaaa	Unit GW :	aaaaaa
CRI:	aaaaaaaa	Life Span:	aaaaaaaa
PF:	aaaaaa	Size :	aaaaaa

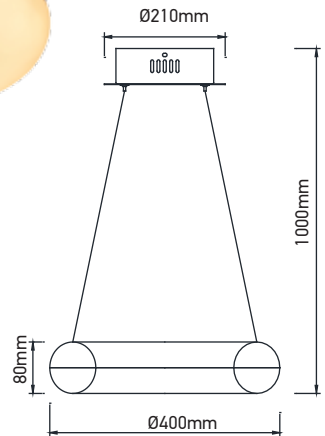

Soft Light Chandelier

40W VT-40-1



SKU

3874 - 3000K Warm White

EAN Code

3800157620888

Built In **LED**

Watts:	40W	Beam Angle:	120°
Voltage/Frequency:	AC100-240V/50HZ	No. of LED:	240pcs
Luminous Flux:	3300lm	Material :	Steel+PC
LED Type:	SMD-2835	Unit GW :	3.90kgs
CRI:	>80	Life Span:	20,000h
PF:	>0.9		

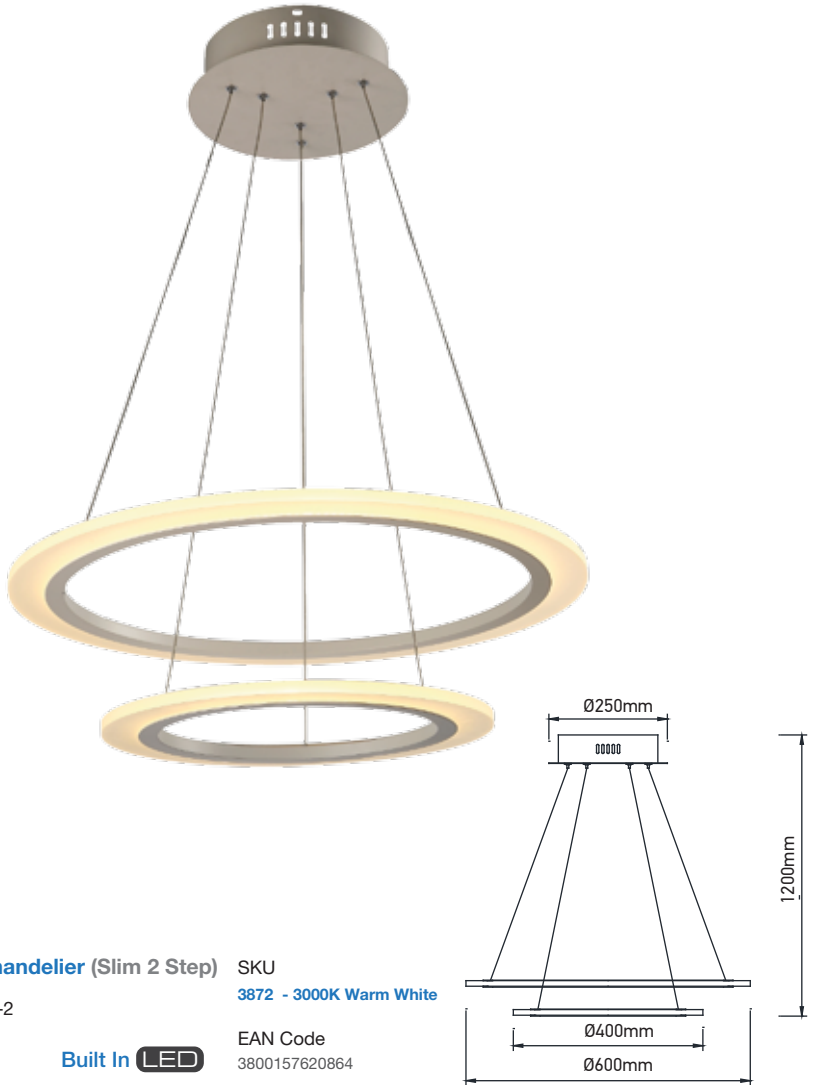

Soft Light Chandelier (Slim 2 Step)

SKU

60W VT-60-2

3872 - 3000K Warm White



Built In LED

EAN Code

3800157620864

Watts:	60W	Beam Angle:	120°
Voltage/Frequency:	AC100-240V/50HZ	No. of LED:	340pcs
Luminous Flux:	5500lm	Material :	Acrylic+Aluminum+Steel
LED Type:	SMD-2835	Unit GW :	5.8kgs
CRI:	>80	Life Span:	20,000h
PF:	>0.9		



Soft Light Chandelier (Slim 3 Step)

Built In **LED**



70W VT-70-3D



SKU **Dimmable**

3904 - 3000K Warm White

3905 - 4000K Day White

EAN Code

3800157624633

3800157624640

70W VT-70-3

SKU

3873 - 3000K Warm White

EAN Code

3800157620871

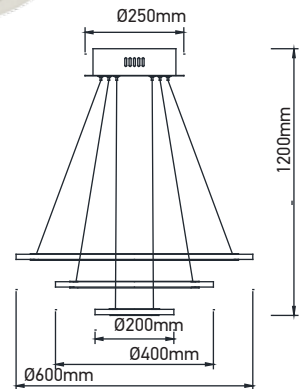

Watts:	70W	Beam Angle:	120°
Voltage/Frequency:	AC100-240V/50HZ	No. of LED:	360pcs
Luminous Flux:	6000lm	Material :	Acrylic+Aluminum+Steel
LED Type:	SMD-2835	Unit GW :	6.70kgs
CRI:	>80	Life Span:	20,000h
PF:	>0.9		

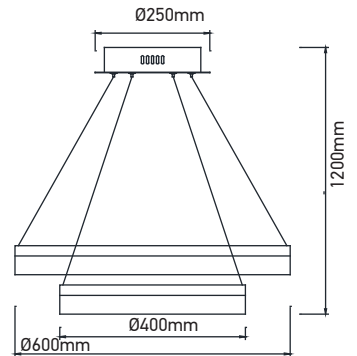

Soft Light Chandelier (2 Step)

70W VT-70-2



Built In **LED**

SKU
3870 - 3000K Warm White

EAN Code
3800157620840

Watts:	70W	Beam Angle:	120°
Voltage/Frequency:	AC:100-240V/50HZ	No. of LED:	420pcs
Luminous Flux:	5600lm	Material :	Acrylic+Aluminum+Steel
LED Type:	SMD	Unit GW :	6.30kgs
CRI:	>80	Life Span:	20,000h
PF:	>0.9		



Soft Light Chandelier (3 Step)

Built In **LED** **A+**

80W VT-80-3D **New!**

SKU **Dimmable**

3906 - 3000K Warm White

3907 - 4000K Day White

EAN Code

3800157624657

3800157624664

80W VT-80-3

SKU

3871 - 3000K Warm White

EAN Code

3800157620857

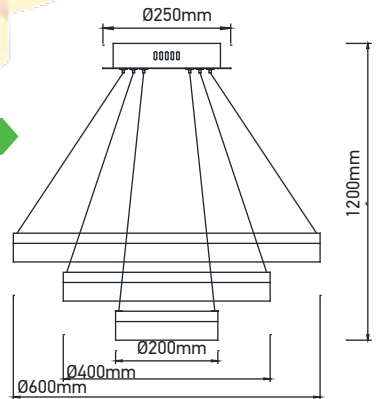

Watts:	80W	Beam Angle:	120°
Voltage/Frequency:	AC:100-240V/50HZ	No. of LED:	510pcs
Luminous Flux:	5900lm	Material :	Acrylic+Aluminum+Steel
LED Type:	SMD	Unit GW :	7.30kgs
CRI:	>80	Life Span:	20,000h
PF:	>0.9		

Soft Light Chandelier (3 Step)
SURFACE

Built In **LED**



85W VT-85-3D



SKU **Dimmable**

EAN Code

3910 - 3000K Warm White

3800157624695

3911 - 4000K Day White

3800157624701

Watts:	-	Beam Angle:	-
Voltage/Frequency:		No. of LED:	
Luminous Flux:		Material :	
LED Type:		Unit GW :	
CRI:		Life Span:	
PF:			