



## Reparasjons håndbok



### Diagnoseveiledning

Utgave 08.2022





## Innholdsfortegnelse

<b>01 - Egendiagnose</b> .....	<b>1</b>
<b>1 Beskrivelse av diagnose</b> .....	<b>1</b>
1.1 Forord .....	1
1.2 Diagnosetrinn 1 .....	2
1.2.1 Egendiagnose .....	2
1.2.2 Prosess ved egendiagnose .....	2
1.2.3 Evaluering av egendiagnosefiler .....	3
1.3 Diagnosetrinn 2 .....	3
1.3.1 Støtte ved diagnose .....	3
1.4 Diagnosetrinn 3 .....	3
1.4.1 Diagnose på stedet .....	3
<b>2 Oppdatering og konfigurering av styreenhetene</b> .....	<b>4</b>
2.1 Oversikt .....	4
2.1.1 Kort veiledning (rekkefølge) .....	4
2.1.2 Kataloger .....	5
2.2 Kalibrering .....	5
2.2.1 Kalibrere posisjonssensor T-boks 1 og 2 .....	5
2.3 Oppdatere .....	6
2.3.1 Oppdatere MPU på T-boks 1 .....	6
2.3.2 Oppdatere EMS ved hjelp av OBD-boks .....	7
2.3.3 Tildel adresser til omformerne .....	7
2.3.4 Oppdatere BMU, SECC, T-boks, CCU, HCU, Power Module (AC/DC, DC/DC) ved hjelp av OBD-boksen .....	9
2.3.5 Oppdatere CMU (batterier) ved hjelp av OBD-boksen .....	9
2.3.6 Stille inn AC-måleren .....	10
2.3.7 Konfigurere LEM IP .....	10
2.4 Håndtering .....	11
2.4.1 Slå av den fleksible ladestolpen (AFC) med en PC .....	11
2.4.2 Lese av programvare .....	12
2.4.3 Lese av DTC-er .....	12
2.5 Oppdatere styreenheter enkeltvis .....	13
2.5.1 Opprette programvarepakke til OBD-boks .....	13
2.5.2 Oppdatere AC/DC- og DC/DC-omformere .....	14
2.5.3 Oppdatere batterienes CMU .....	14
2.5.4 Konfigurere LEM IP .....	15
<b>3 EMS DTC Matrix</b> .....	<b>16</b>
3.1 EMS DTC Code Table .....	16
3.2 EMS Reaction Table .....	32
3.3 EMS Action Table .....	44



3.4	EMS Repair Action .....	46
<b>4</b>	<b>CCU DTC Matrix</b> .....	<b>54</b>
4.1	CCU DTC Code Table .....	54
4.2	CCU Action Table .....	59
4.3	CCU Repair Action .....	68
<b>5</b>	<b>BMS DTC Matrix</b> .....	<b>72</b>
5.1	BMS DTC Code Table .....	72
5.2	BMS Action Table .....	75
5.3	BMS Repair Action .....	101
<b>6</b>	<b>Programvareversjoner</b> .....	<b>104</b>
6.1	Styreenhetenes programvareversjoner .....	104



# 01 - Egendiagnose

## 1 Beskrivelse av diagnose

V1.2\_20220825\_NB\_NO

### 1.1 Forord

Den fleksible ladestolpen har ulike muligheter for støtte ved diagnose, konfigurering og parametrisering av systemet.

Disse mulighetene omfatter f.eks.

- ◆ Nettgrensesnitt til konfigurering av parametrene ved idriftsetting
- ◆ Feilmelding som loggfil via operatørens serverdel gjennom evaluering av loggfilene
- ◆ Diagnose på stedet med bærbar PC og spesiell diagnose-maskinvare og -programvare
- ◆ Støtte ved hjelp av spesielle diagnosefunksjoner på en produsentserverdel

## 1.2 Diagnosetrinn 1

### 1.2.1 Egendiagnose

-Dataene for egen-diagnose evalueres og lagres kontinuerlig av sentralstyreenheten (EMS). Når avvik er registrert, overføres en fil ved hjelp av CAN-protokoll til T-boks 1-styreenheten, hvor den lagres lokalt. Filene som opprettes på denne måten, lagres i T-boks 1 i sju dager. Deretter overskrives dataene, og de kan ikke lenger overføres til en serverdel.

- ☐ Merk: Det er alltid de siste sju dagene som lagres, så en forespørsel bør sendes i tilsvarende intervaller. Det må komme en forespørsel fra serverdelen (operatørens serverdel) for at de lagrede egendiagnosedataene skal kunne evalueres. Først da blir kan datapakkene overført til operatørens serverdel.

- ☐ Merk: Den nødvendige konfigureringen av operatørens serverdel er ikke beskrevet i denne dokumentasjonen. Innstillingene som er nødvendige for forespørselen, må utføres av den ansvarlige serverdeloperatøren.

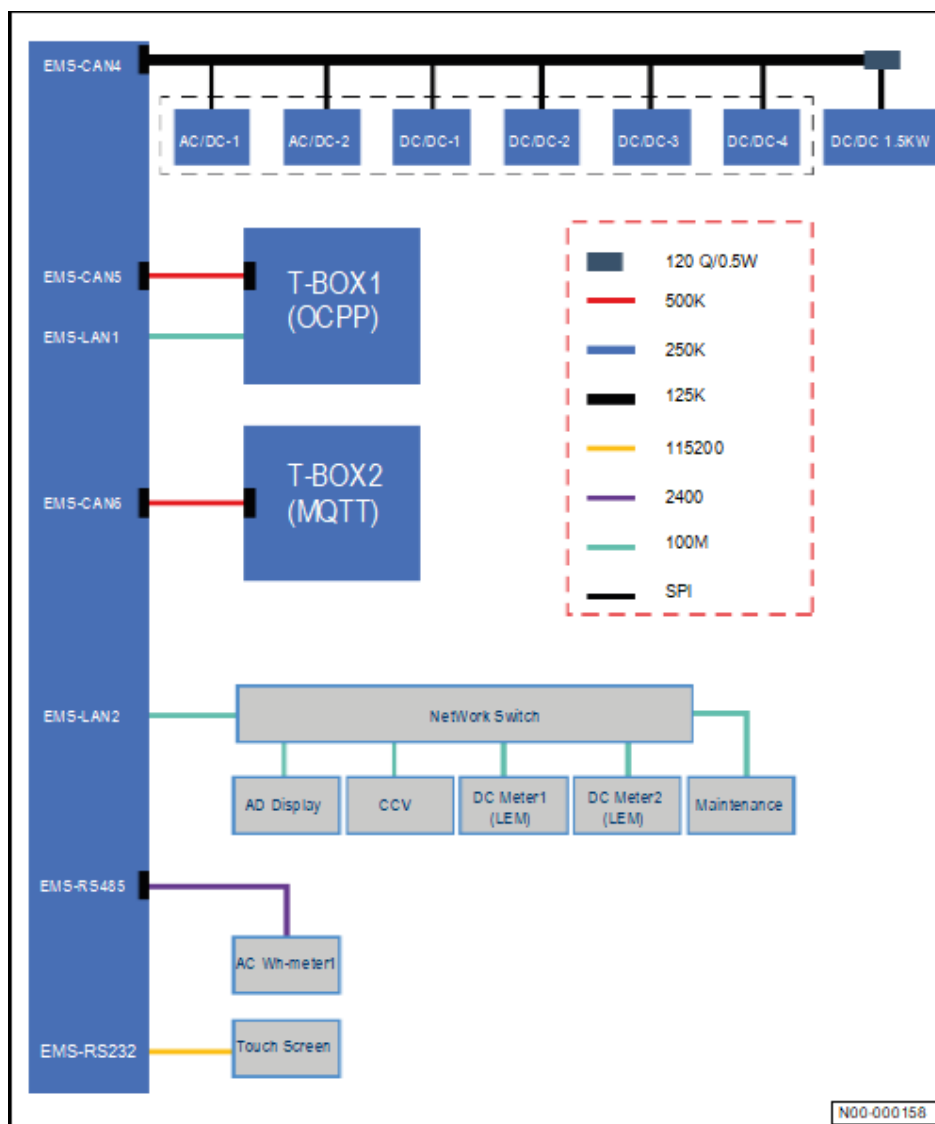

### 1.2.2 Prosess ved egendiagnose

Dataene fra T-boks 1 sendes til serverdelen i samsvar med konfigureringen av operatørens serverdel. Dataene fra T-boks 1 overføres i filformatet .json, og må lagres og evalueres i tilsvarende format der.

#### Tips

Overføring av dataene krever tilstrekkelig mobildekning. For lav overføringskvalitet kan føre til forsinket dataoverføring. Siden dataene lagres i sju dager, skal det alltid være en fil å evaluere.



## 1.2.3 Evaluering av egendiagnosefiler

- Evaluering av dataene i Notepad:

Åpne filen med et redigeringsverktøy, f.eks. Notepad++, noter de relevante feilkodene. I feiltabellen ...

- Evaluere dataene med et diagnoseverktøy:

- ◆ f.eks. Diagra x Viewer

Først må filen omformateres. Filen kan omformateres til en MDF-fil ved hjelp av en programvare. Deretter kan den opprettede filen evalueres.

## 1.3 Diagnosetrinn 2

### 1.3.1 Støtte ved diagnose

Dataene for diagnosetrinn 2 befinner seg i T-boks 2 og overføres til operatørens serverdel på samme måte.

Autoriserte personer på servicenivå 3 har tilgang til denne serverdelen og kan på forespørsel støtte operatøren (CPO) med diagnosen.

Der registreres og lagres kun ekstra måledata for å støtte en forutgående diagnose som operatøren har utført.

#### Tips

Av hensyn til personvernet registreres ingen kundedata eller data for avregning her.

## 1.4 Diagnosetrinn 3

### 1.4.1 Diagnose på stedet

Diagnosetrinn 3 brukes til diagnose på stedet og vedlikeholdsarbeider. Den utføres lokalt på ladestolpen og er bare tilgjengelig for autorisert personale som har fått opplæring i dette.

#### Tips

Diagnosetrinn 3 krever egnet ekstra maskinvare og programvare med lisens. Dette kan kjøpes etter at en person har meldt seg på opplæringen.

- Nødvendig maskinvare

Følgende er nødvendig:

- ◆ Standard bærbar PC med Windows-operativsystem
- ◆ Ekstra diagnoseadapter fra KVaser
- ◆ Adapterkabel til å koble diagnoseadapteren til diagnosekontakten på ladestolpen
- Tilkobling til ladestolpen



Koble diagnoseadapteren fra KVaser til en ledig USB-port på PC-en. Koble adapterkabelen mellom diagnosekontakten på ladestolpen og diagnoseadapteren på PC-en.

- Starte programvaren

Start diagnoseprogramvaren etter at forbindelsen til ladestolpen er opprettet.

Etter at Diagra X-programvaren er åpnet, må du utføre en konfigurasjon for at diagnosedataene skal kunne leses.

### Tips

Det fins ferdig forberedte måleeksperimenter som gjør diagnosen enklere.

- Opplasting av diagnosekonfigurasjonen eksperimenter

Last opp filen i Diagra X Viewer ved hjelp av funksjonen XXX TBD til applikasjonen. Mer informasjon senere.

## 2 Oppdatering og konfigurering av styreenhetene

### 2.1 Oversikt

#### 2.1.1 Kort veiledning (rekkefølge)

1. Kalibrere posisjonssensor T-boks 1 og 2

- ◆ Program: PCAN-View
- ◆ Krever ekstern strømforsyning

⇒ "Kalibrere posisjonssensor T-boks 1 og 2" på side 5

2. Oppdatere T-boks 1 MPU

- ◆ Program: Quectel\_FW\_Download
- ◆ Krever USB-tilkobling

⇒ "Oppdatere MPU på T-boks 1" på side 6

3. Oppdatere EMS

- ◆ Via OBD-boks

⇒ "Oppdatere EMS ved hjelp av OBD-boks" på side 7

4. Adressere omformerne

- ◆ Koble PC-en til omformeren med CAN-kabelen
- ◆ Send adresser via PCAN-View

⇒ "Tildele adresser til omformerne" på side 7

5. Oppdatere BMS, CCU, SECC, T-boks, SECC, Power Module

- ◆ Via OBD-boks

⇒ "Oppdatere BMU, SECC, T-boks, CCU, HCU, Power Module (AC/DC, DC/DC) ved hjelp av OBD-boksen" på side 9



## 6. Oppdatere CMU

- ◆ Via OBD-boks

⇒ "Oppdatere CMU (batterier) ved hjelp av OBD-boksen" på side 9

## 7. Stille inn AC-måler

- ◆ Innstilling i menyen til 3P3

⇒ "Stille inn AC-måleren" på side 10

- ◆ 8. IP-tildeling LEM-visningsenhet

⇒ "Konfigurere LEM IP" på side 10

## 2.1.2 Kataloger

Programmer som skal oppdateres, ligger som snarvei på skrivebordet i mappen Flash\_Programme.

- ◆ Den oppdaterte programvaren ligger som snarvei på skrivebordet i mappen Software\_AFC.
- ◆ DTC-tabellene ligger i mappen AFC på stasjon D.
- ◆ De nødvendige programmene og programvaren ligger i mappen AFC på stasjon D.

## 2.2 Kalibrering

### 2.2.1 Kalibrere posisjonssensor T-boks 1 og 2

1. Koble til T-boks ved hjelp av den eksterne adapteren og PEAK-adapteren.





2. Åpne PCAN-View på den bærbare PC-en, og bruk følgende innstillinger for forbindelsen.

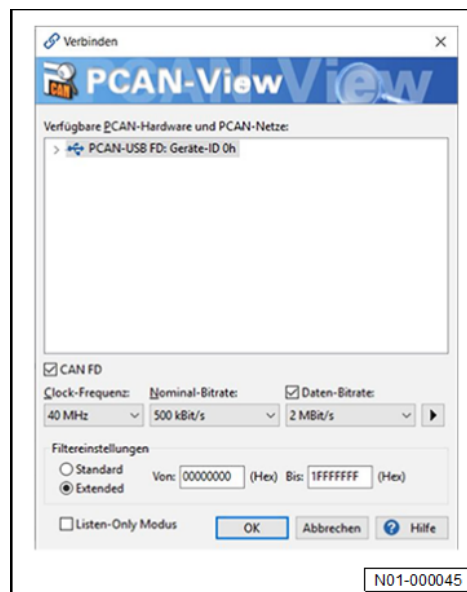

N01-000045

3. Dobbeltklikk på CAN-ID for å sende T-boks Calibration-meldingen til T-boks (CAN-ID: 181D02F1h).

4. Deretter skal utløseren (Trigger) stå på manuell, og antall (Anzahl) skal stå på 1, og stolpen skal svare på CAN ID: 1802F102h med følgende melding: 00 00 00 00 00 00 00 00 00 00 00 00 00 00 01 00

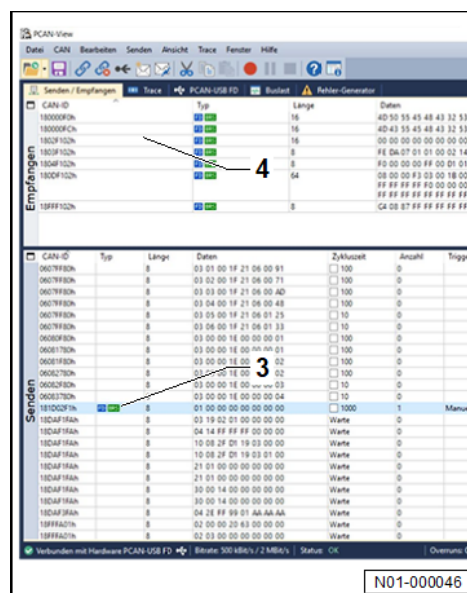

N01-000046

## 2.3 Oppdatere

### 2.3.1 Oppdatere MPU på T-boks 1

1. Koble T-boks til PC-en med mikro-USB.
2. Åpne Quectel\_Customer Download Tool på PC-en.



3. Last inn oppdatert programvare for T-boksens MPU.

Filbane for programvaren:

- ◆ D:\AFC\\_SW\ X.X.X \T-Box\MPU0E001R450\_20210812\Firmware\ AG35EVAR08A06T4G\update\firehose\ partition\_complete\_p2K\_b128K.mbn X.X.X = oppdatert programvareversjon, f.eks. 4.5.0

4. COM-porten må overføres fra enhetsbehandleren ved hjelp av Quectel USB DM-porten.

- ◆ Åpne enhetsbehandler.
- ◆ Tilkoblinger (COM og LTP)
- ◆ Quectel USB DM PORT (COM ...)

5. Start oppdateringen.

6. Prosessen varer ca. 100 sekunder, og deretter skal PASS kunne leses.

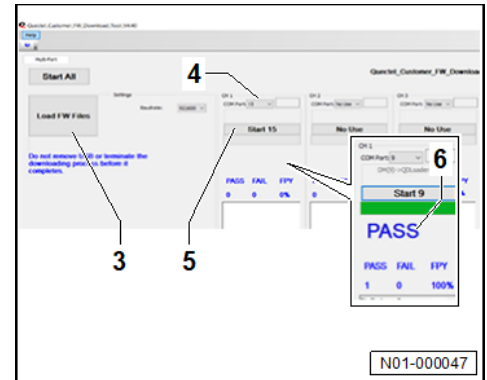

### 2.3.2 Oppdatere EMS ved hjelp av OBD-boks

1. Koble OBD-boksen til datamaskinen med en USB-kabel.
2. Kopier den opprettede programvarepakken for EMS til OBD-boks.
3. Slå på stolpen (uten AC-tilkobling).
4. Koble OBD-boks til stolpens OBD-plugg, og trykk på knappen på boksen. Nå skal lysdioden skal blinke raskt grønt. Så snart prosessen er avsluttet, høres et lydsignal fra OBD-boksen, og den lyser blått.

(Oppdateringen bør ta ca. 5 min.)

Det opprettes en loggfil på OBD-boksen som du kan lese av med datamaskinen. Der kan du se om prosessen er utført.

### 2.3.3 Tildele adresser til omformerne

1. Alle omformerne må være koblet til (CAN-kabel).
2. HV og AC-tilkobling må være tilgjengelig.
3. Koble PCAN-adapteren med omformernes CAN-kabel.



4. Åpne PCAN-View, og bruk følgende innstillinger for forbindelsen.

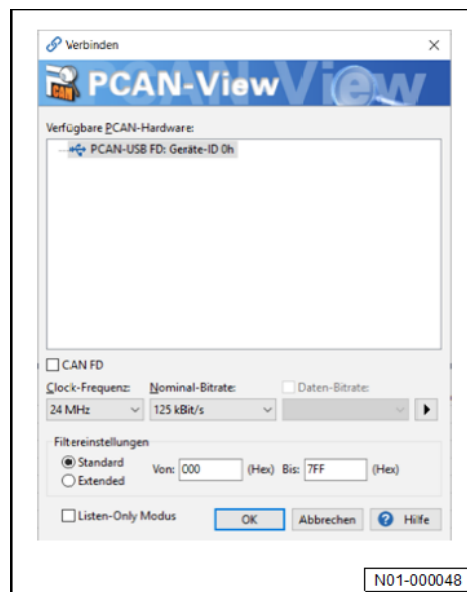

5. Ved adressering trenger du de siste fire tallene i datoen -1- samt tallene og bokstavene i nummeret -2-.

- ◆ Pass på rekkefølgen på omformerne fra venstre mot høyre (G4, G3, G6, G5, G2, G1).



6. Høyreklikk for å åpne meldingen for den relevante omformer.

7. Klikk på rediger melding.

- ◆ Kun meldinger med betegnelsen G1 til G6 bak skal redigeres.

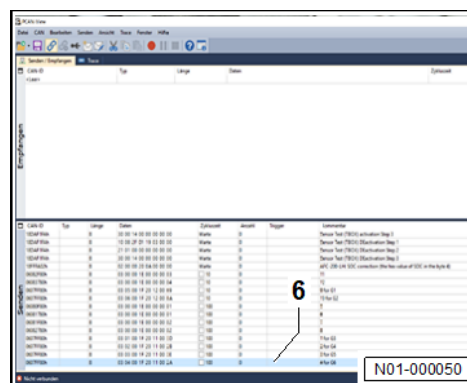

8. Legg inn dataene fra omformerer i de siste fire feltene (dato -1- og nummer -2-).

- ◆ Sørg for at riktig melding velges under Kommentar.

9. Bekreft med OK.

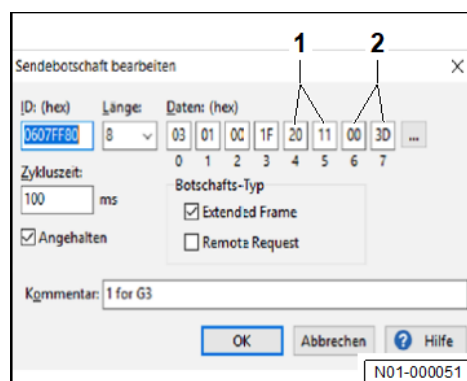

10. Still inn adresseringen for alle omformerne, -G1- til -G9-, på denne måten (gjenta punkt 6 til 9).

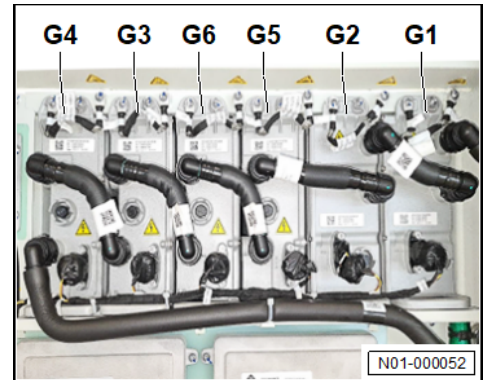

11. Send meldingene i rekkefølgen 1–12 etter at adressene er tildelt (ref. Kommentar).

12. Klikk i boksen under syklustid (Zykluszeit), og la den være aktiv i ca. 10 sekunder for å sende (antall 200 eller 2000). Klikk på nytt for å deaktivere.

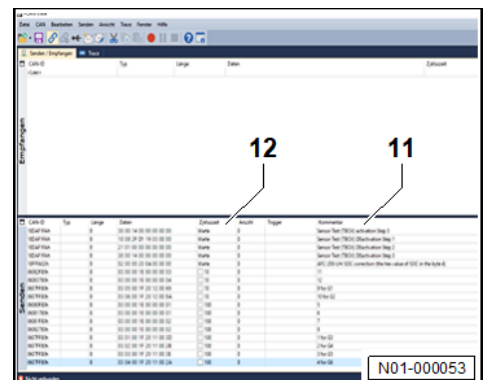

### 2.3.4 Oppdatere BMU, SECC, T-boks, CCU, HCU, Power Module (AC/DC, DC/DC) ved hjelp av OBD-boksen

1. Koble OBD-boksen til datamaskinen med en USB-kabel.
2. Kopier den opprettede programvarepakken for styreenheten til OBD-boksen.
3. Slå på stolpen, AC-tilkoblingen må være koblet til.
4. Koble OBD-boksen til stolpens OBD-plugg, vent litt og trykk på knappen på boksen. Nå skal lysdioden blinke raskt grønt. Så snart prosessen er avsluttet, høres et lydssignal fra OBD-boksen, og den lyser blått. Avhengig av hvor mange styreenheter som ble lagt til, kan prosessen ta opptil 45 min.

Det opprettes en loggfil på OBD-boksen som du kan lese av med datamaskinen. Der kan du se om prosessen er utført.

### 2.3.5 Oppdatere CMU (batterier) ved hjelp av OBD-boksen

1. Koble OBD-boksen til datamaskinen med en USB-kabel.
2. Kopier programvarepakken som er opprettet for CMU-ene, til OBD-boks.
3. Slå på stolpen (uten AC-tilkobling).
4. Koble OBD-boksen til stolpens OBD-plugg, vent litt og trykk på knappen på boksen. Nå skal lysdioden blinke raskt grønt. Så snart prosessen er avsluttet, høres et lydssignal fra OBD-boksen, og den lyser blått. Oppdateringen bør ta ca. 20 min.



Det opprettes en loggfil på OBD-boksen som du kan lese av med datamaskinen. Der kan du se om prosessen er utført.

### 2.3.6 Stille inn AC-måleren

1. Hold E-tasten inne til PASS vises.
2. Still inn 1000 med piltastene M og P.
3. Hold E-tasten inne for å bekrefte.
4. Bla med P-tasten til du kommer til Sys (visning av 3P4).
5. Hold E-tasten inne til 3P4 blinker.
6. Still inn 3P3 med M- eller P-tasten.
7. Hold E-tasten inne for å bekrefte.
8. Trykk på U/I-tasten for å lukke menyen.

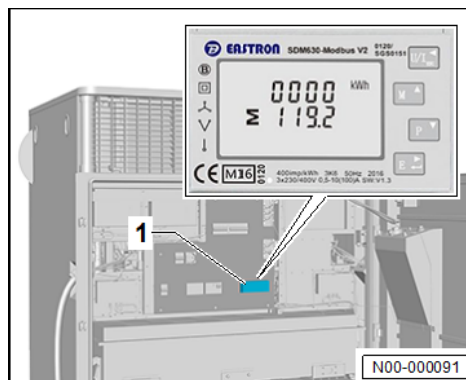

### 2.3.7 Konfigurere LEM IP

1. Åpne LEM Configurator-mappen.
2. Kjør filen 1\_LEM\_IP\_Vergabe.bat (passord = W!!!kommen).
3. Kjør 2\_DC-Meter-Configurator.exe.

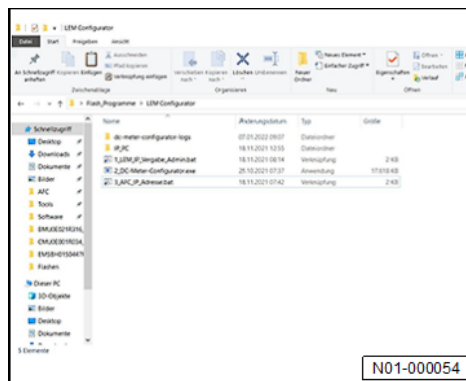

4. Koble LEM-visningsenheten til datamaskinen med en nettverkskabel -1-.

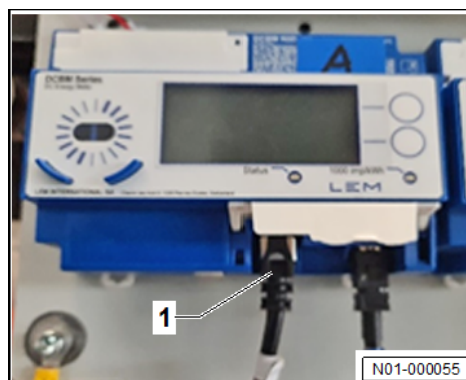



LEM-visningsenheten som er tilkoblet, skal vises etter kort tid -4-.

5. Klikk på knapp A for LEM A eller knapp B for LEM B i programmet.

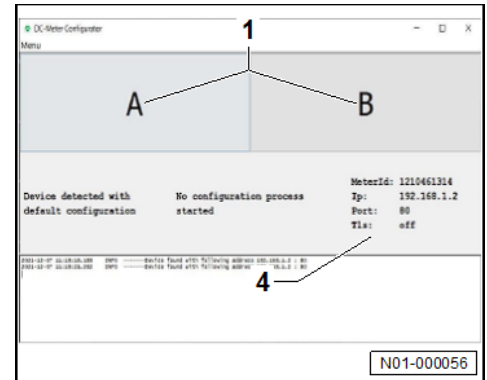

6. Vent til endringen er bekreftet.

7. Gjenta trinn 4 til 6 for den andre LEM-enheten.

8. Koble stolpens nettverkskabel til LEM-visningsenhetene igjen.

9. Kjør 3\_AFC\_IP\_Adresse.bat (passord = W!!!kommen).



## 2.4 Håndtering

### 2.4.1 Slå av den fleksible ladestolpen (AFC) med en PC

Betingelse

- Aktiver LAN-porten -1- med et spesielt RFID-kort.

1. Still inn datamaskinens IP-adresse.

- ◆ 192.168.1.101 IP-adresse
- ◆ 255.255.255.0 Gateway

2. Koble den bærbare PC-en til ladestolpen med en nettverkskabel.

3. Åpne en nettleser på den bærbare PC-en, og skriv inn følgende IP-adresse i adressefeltet.

- ◆ 192.168.1.1

4. Legg inn påloggingsdetaljene.

- ◆ Brukernavn: dupower
- ◆ Passord: 123456

5. Åpne systemkonfigurasjonen.

6. Velg avslutte systemet (System Shut Down), og klikk på Lagre.

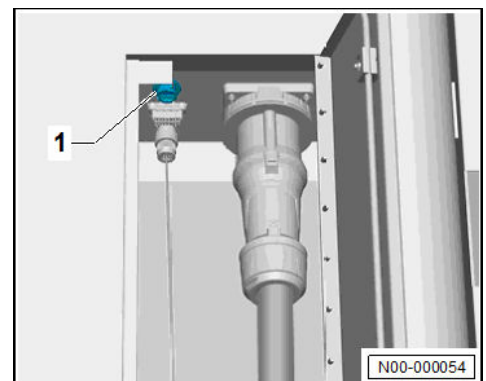



7. Ladestolpen slår nå av HV. Deretter kan strømkretsavbryteren til 12 V-batteriet slås av. Se: ⇒ Idriftsetting / Slå av den fleksible ladestolpen

## 2.4.2 Lese av programvare

Betingelse

- Aktiver LAN-porten -1- med et spesielt RFID-kort.

1. Still inn datamaskinens IP-adresse.

- ◆ 192.168.1.101 IP-adresse
- ◆ 255.255.255.0 Gateway

2. Koble PC-en til stolpen med en nettverkskabel.

3. Åpne en nettleser på datamaskinen, og legg inn følgende IP-adresse i adressefeltet.

- ◆ 192.168.1.1

4. Legg inn påloggingsdetaljene.

- ◆ Brukernavn: dupower
- ◆ Passord: 123456

5. Deaktiver brannmuren.

6. Kjør filen "Softwareversions.bat".

7. Åpne filen "versions.txt".

8. Aktiver brannmuren igjen!

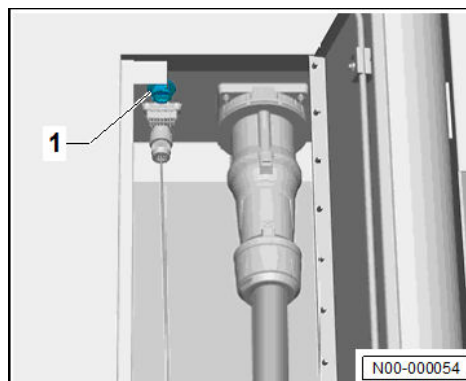

## 2.4.3 Lese av DTC-er

1. Åpne PCAN-View med følgende innstillinger.

2. Koble til CAN1 (BMS1) eller CAN3 (BMS2).

3. Feilkodene vises på følgende CAN-ID-er og kan tolkes ved hjelp av DTC-tabellene.

- ◆ CAN-ID:18AA2701 -> BMS1/2, CAN1=BMS1, CAN3=BMS2
- ◆ CAN-ID:18AAFAF1 -> EMS, CAN1 og CAN3 likt
- ◆ CAN-ID:18AAFAF2 -> CCU1/2, CAN1=CCU1, CAN3=CCU2

Hvis ingen DTC-er er tilgjengelige, skal det stå 00 00 00 FF FF FF FF FF.

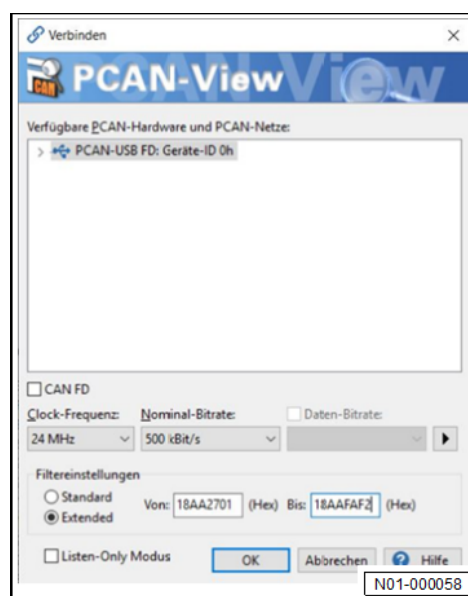



## 2.5 Oppdatere styreenheter enkeltvis

### 2.5.1 Opprette programvarepakke til OBD-boks EMS, CCU, BMU, SECC, MCU for T-boks 1, AC/DC, DC/DC, CMU

Betingelse

- Du bør opprette programvarepakker separat for følgende styreenheter
- ◆ EMS
- ◆ BMU, SECC, T-boks, CCU, HCU, Power Module (AC/DC, DC/DC)
- ◆ CMU (batterier)

1. Åpne AFCController\_V.1.1.4.
2. Åpne AFCCOnfig med +-symbolet.

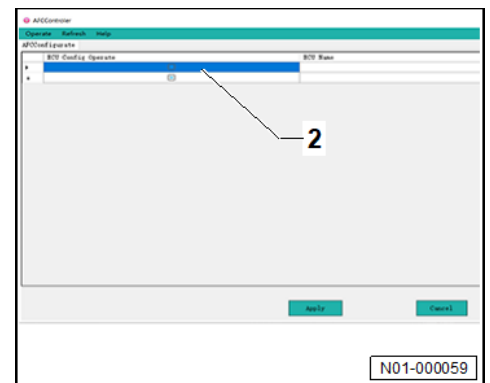

3. Velg styreenhet.
4. Velg oppdatert programvare for den valgte styreenheten.
5. Bekreft valget og trykk på Bruk (Apply).

- ◆ Conversion succeeded -> OK

Programvaren for hver styreenhet som skal oppdateres, må legges til på denne måten med +-symbolet. (Gjenta trinn 2–5.)

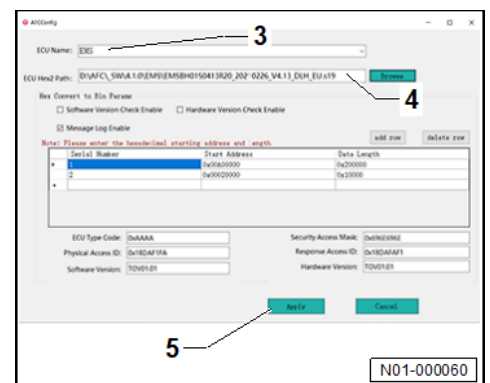

7. Alle styreenheter som skal oppdateres, er lagt til.

8. Bekreft valget med Bruk (Apply).

- ◆ Execution succeed -> OK

9. Lukk programmet med Avbryt (Cancel).

10. Filene i katalogen "Stasjon D: -> AFC -> SGM -> AFCController\_V.1.1.4 -> output" opprettes på nytt hver gang programmet startes. Vi anbefaler at du kopierer filene i katalogen til en annen mappe etter at de er opprettet, slik at du bare trenger å utføre trinnene ovenfor én gang.

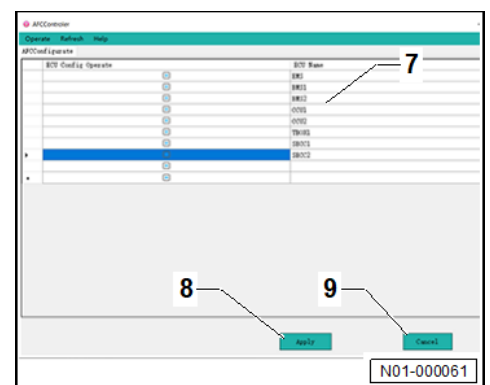

## 2.5.2 Oppdatere AC/DC- og DC/DC-omformere

1. HV er nødvendig for å oppdatere DC/DC-omformere, og la-detil kobling er nødvendig for å oppdatere AC/DC-omformere.
2. Koble fra alle omformernes CAN-støpsler.
3. Bruk PCAN og adapterstøpslet og opprett direkte forbindelse med omformeren som skal oppdateres.
4. Start UBoot V1.3.4.

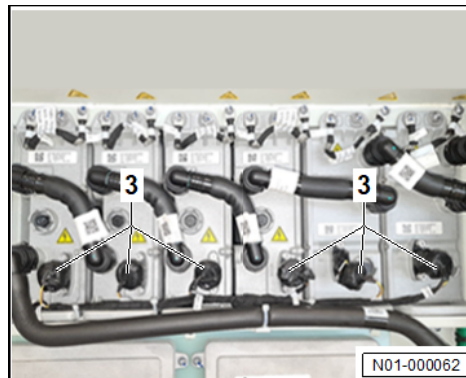

5. Last inn oppdatert programvare for AC/DC-, DC/DC-omformere.
6. Velg omformerne som skal oppdateres (fra venstre mot høyre)
7. Bekreft valget.
8. Start prosessen.
9. Når teksten har grønn bakgrunn, er prosessen utført.
10. Koble PCAN-adapteren til neste omformer, og gjenta trinn -5- til -8-.



## 2.5.3 Oppdatere batterienes CMU

1. Stolpen må være avslått.
2. Fjern CAN-støpslet fra hvert batteri.
3. Koble batteriet som skal oppdateres, til den bærbare PC-en ved hjelp av den eksterne adapteren og PEAK-adapteren.
4. Åpne CMU\_4\_1Bootloader\_V1.1.6.



5. Aktiver APP & Calibration (APP og kalibrering) om nødvendig.

6. Velg oppdatert programvare for CMU.

Betingelse

- APP Path = ... .hex-fil
- Calibration Path = ...Data... .hex-fil

7. Velg CMU for det tilkoblede batteriet.

Betingelse

- (Ovenfra og ned CMU1, CMU2, CMU1, CMU2)

8. Start innlastingen (Load).

9. Gjenta prosessen for hvert batteri, og pass på at riktig CMU stilles inn.

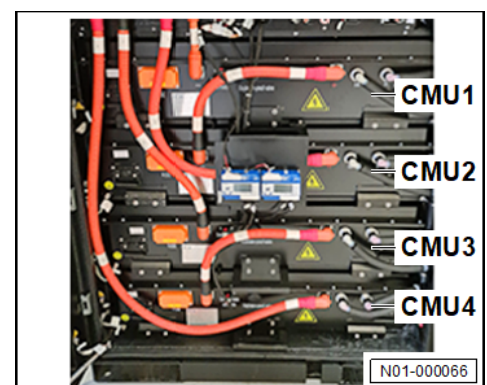
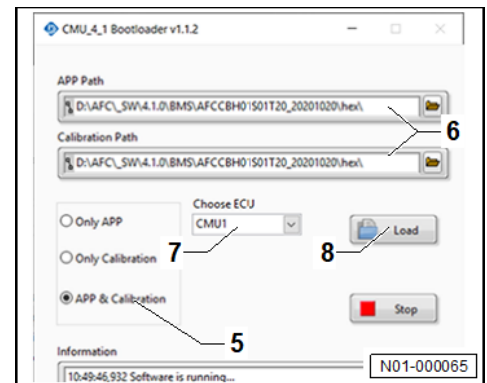

## 2.5.4 Konfigurere LEM IP

1. Stolpen må være slått på (HV tilgjengelig).

2. Still inn den bærbare PC-ens IP-adresse 192.168.1.101.

3. Koble den bærbare PC-en til den relevante LEM-visningsenheten med en nettverkskabel (fjern først den tilkoblede nettverkskabelen).

4. Åpne NetAssist på den bærbare PC-en.

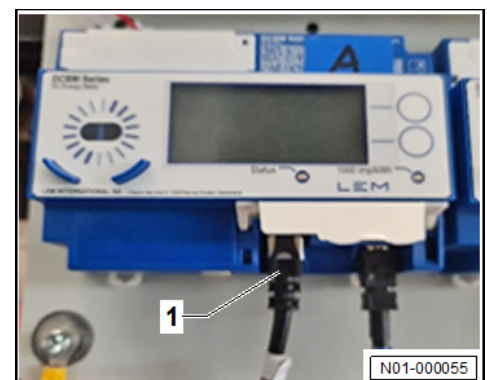

5. Bruk følgende innstillinger:

- ◆ TCP-klient
- ◆ 192.168.1.2 (relevant IP for LEM-visningsenheten)
- ◆ 80

6. Klikk på Koble til (Connect) (forbindelsen opprettes).

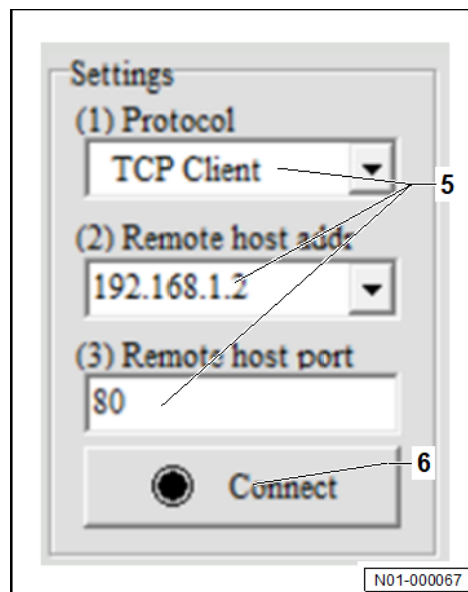

7. Kopier følgende tekst inn i tekstfeltet i programmet, og send den (pass på hvilken LEM-visningsenhet som er tilkoblet med nettverkskabel).

#### For LEM-A

```
PUT /v1/settings HTTP/1.1
Content-Type: application/json
Content-Length: 74
```

```
{"ipAddress": " 192.168.1.20 ", "http": {"tls_on": false,"httpPort": 50007}}
```

#### For LEM-B

```
PUT /v1/settings HTTP/1.1
Content-Type: application/json
Content-Length: 74
```

```
{"ipAddress": " 192.168.1.40 ", "http": {"tls_on": false,"httpPort": 50008}}
```

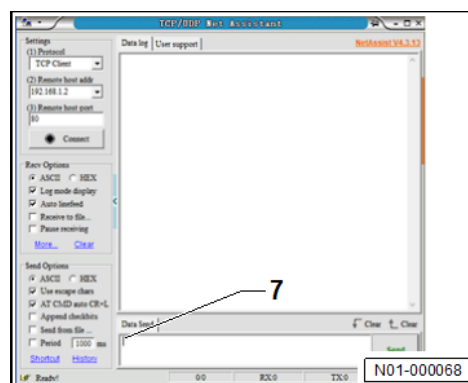

## 3 EMS DTC Matrix

### 3.1 EMS DTC Code Table

- ◆ ⇒ "EMS Reaction Table" på side 32
- ◆ ⇒ "EMS Action Table" på side 44
- ◆ ⇒ "EMS Repair Action" på side 46



Position	DTC code	DTC Description	Component
1	P0101F0	12V over-voltage failure	Backup Battery
2	P0101F1	12V high-voltage failure	Backup Battery
3	P0102F0	12V under-voltage failure	Backup Battery
4	P0102F1	12V low-voltage failure	Backup Battery
5	P010300	24V over-voltage failure	EMS-LVS1
6	P010400	24V under-voltage failure	EMS-LVS1
7	P010500	Battery circuit breaker open failure	CB2/FU7
8	P010600	Accessory load relay open failure	KA4
9	P010700	Accessory load relay adhesion failure	KA4
10	P010800	Advertising screen relay failure (open/adhesion)	KA3
11	P0108F1	Advertising screen relay failure (open/adhesion)	KA3
12	P010900	Lightning protection device open failure	FVC1
13	P011000	Lightning protection device circuit open failure	CB1
14	P011100	Three-phase switch contactor open failure	KM1(KA2)
15	P011200	Three-phase switch contactor adhesion failure	KM1(KA2)
16	P011300	Three-phase switch contactor Lifetime failure	KM1(KA2)
17	P011400	Pack A Recharge positive relay open failure	K9
18	P011500	Pack A Recharge positive relay adhesion failure	K9
19	P011600	Pack A Recharge positive relay Lifetime failure	K9
20	P0117F0	Insulation level 1 failure detection	
21	P0117F1	Insulation level 2 failure detection	
22	P0117F2	Insulation level 3 failure detection	



Position	DTC code	DTC Description	Component
23	U010187	TBOX1 CAN communication timeout failure	EMS-T-BOX1
24	U010287	BMS1 CAN communication timeout failure	EMS-BMS1
25	U010387	Touch screen communication timeout failure (RS232)	EMS-HMI
26	U010487	Card Reader communication timeout failure	EMS-POS
27	U010587	A gun dc electric meter communication timeout failure	EMS-DCWh meter1
28	U010687	B gun dc electric meter communication timeout failure	EMS-DCWh meter2
29	U010787	CCU1 CAN communication timeout failure	EMS-CCU1
30	U010887	CCU1 CAN communication timeout failure	EMS-CCU2
31	U010987	Three-phase ac electric meter communication timeout failure	EMS-ACWh meter
32	U011087	ACDC_1 communication timeout failure	EMS-ACDC1
33	P0118F0	ACDC_1 internal Level 1 failure (Snapshot record detail information)	G1
34	P0118F1	ACDC_1 internal Level 2 failure (Snapshot record detail information)	G1
35	P0118F2	ACDC_1 internal Level 3 failure (Snapshot record detail information)	G1
36	U011187	ACDC_2 communication timeout failure	G2
37	P0119F0	ACDC_2 internal Level 1 failure (Snapshot record detail information)	G2
38	P0119F1	ACDC_2 internal Level 2 failure (Snapshot record detail information)	G2
39	P0119F2	ACDC_2 internal Level 3 failure (Snapshot record detail information)	G2
40	U011287	DCDC_1 communication timeout failure	EMS-DCDC1



Position	DTC code	DTC Description	Component
41	P0120F0	DCDC_1 internal Level 1 failure (Snapshot record detail information)	G3
42	P0120F1	DCDC_1 internal Level 2 failure (Snapshot record detail information)	G3
43	P0120F2	DCDC_1 internal Level 3 failure (Snapshot record detail information)	G3
44	U011387	DCDC_2 communication timeout failure	EMS-DCDC2
45	P0121F0	DCDC_2 internal Level 1 failure (Snapshot record detail information)	G4
46	P0121F1	DCDC_2 internal Level 2 failure (Snapshot record detail information)	G4
47	P0121F2	DCDC_2 internal Level 3 failure (Snapshot record detail information)	G4
48	U011487	DCDC_3 communication timeout failure	EMS-DCDC3
49	P0122F0	DCDC_3 internal Level 1 failure (Snapshot record detail information)	G5
50	P0122F1	DCDC_3 internal Level 2 failure (Snapshot record detail information)	G5
51	P0122F2	DCDC_3 internal Level 3 failure (Snapshot record detail information)	G5
52	U011587	DCDC_4 communication timeout failure	EMS-DCDC4
53	P0123F0	DCDC_4 internal Level 1 failure (Snapshot record detail information)	G6
54	P0123F1	DCDC_4 internal Level 2 failure (Snapshot record detail information)	G6
55	P0123F2	DCDC_4 internal Level 3 failure (Snapshot record detail information)	G6
56	U011687	Thermal management unit communication failure	EMS-TMS
57	P012400	Fuse of ACDC1 output over current failure	FU1



Position	DTC code	DTC Description	Component
58	P012500	24V DCDC front-end fuse voltage rationality check out of range	EMS-HVS2+
59	P012600	24 VDCDC output voltage rationality check out of range	EMS-LVS1
60	P012700	ACDC output fuse Open failure	
61	U011788	CAN1 Busoff failure	EMS-BMS1-CCU1-HCU
62	U011888	CAN4 Busoff failure	EMS-Power Module
63	U011988	CAN3 Busoff failure	EMS-BMS2-CCU2
64	P012800	EMS Hardware Watchdog failure (judge by reading the reset source)	EMS
65	P012900	EMS_Abnormal shut down failure	EMS
66	P0130F1	Water Immersion level 1 failure	Water sensor
67	P0130F2	Water Immersion level 2 failure	Water sensor
68	P013100	Door Open failure	Door
69	P013200	A gun current rationality out of range	Gun A current
70	P013300	B gun current rationality out of range	Gun B current
71	P0134F0	BMS1 level 1 failure	BMS1
72	P0134F1	BMS1 level 2 failure	BMS1
73	P0134F2	BMS1 level 3 failure	BMS1
74	P0135F0	CCU1 level 1 failure	CCU1
75	P0135F1	CCU1 level 2 failure	CCU1
76	P0135F2	CCU1 level 3 failure	CCU1
77	P0136F0	CCU2 level 1 failure	CCU2
78	P0136F1	CCU2 level 2 failure	CCU2





Position	DTC code	DTC Description	Component
79	P0136F2	CCU2 level 3 failure	CCU2
80	P0137F0	HCU level 1 failure	TMS
81	P0137F1	HCU level 2 failure	TMS
82	P0137F2	HCU level 3 failure	TMS
83	P013800	ACDC1 output over current	G1
84	P013900	ACDC1 output short circuit	G1
85	P014000	ACDC1 input under voltage	G1
86	P014100	ACDC1 input over voltage	G1
87	P014200	ACDC1 input phase loss	G1
88	P014300	ACDC1 self-test failure	G1
89	P014400	ACDC2 output over current	G2
90	P014500	ACDC2 output short circuit	G2
91	P014600	ACDC2 input under voltage	G2
92	P014700	ACDC2 input over voltage	G2
93	P014800	ACDC2 input phase loss	G2
94	P014900	ACDC2 self-test failure	G2
95	P015000	DCDC1 output short circuit	G3
96	P015100	DCDC1 self-test failure	G3
97	P015200	DCDC1 hardware output over-voltage	G3
98	P015300	DCDC1 output over current	G3
99	P015400	DCDC2 output short circuit	G4
100	P015500	DCDC2 self-test failure	G4



Position	DTC code	DTC Description	Component
101	P01560 0	DCDC2 hardware output over-voltage	G4
102	P01570 0	DCDC2 output over current	G4
103	P01580 0	DCDC3 output short circuit	G5
104	P01590 0	DCDC3 self-test failure	G5
105	P01600 0	DCDC3 hardware output over-voltage	G5
106	P01610 0	DCDC3 output over current	G5
107	P01620 0	DCDC4 output short circuit	G6
108	P01630 0	DCDC4 self-test failure	G6
109	P01640 0	DCDC4 hardware output over-voltage	G6
110	P01650 0	DCDC4 output over current	G6
111	P01660 0	Pack A Recharge negative relay open failure	K10
112	P01670 0	Pack A Recharge negative relay adhesion failure	K10
113	P01680 0	Pack A Recharge negative relay Lifetime failure	K10
114	P01690 0	DCDC input positive relay open failure	
115	P01700 0	DCDC input positive relay Lifetime failure	
116	P01710 0	DCDC input negative relay Open failure	
117	P01720 0	DCDC input negative relay Lifetime failure	
118	P01730 0	Cross A positive relay open failure	K5
119	P01740 0	Cross A positive relay adhesion failure	K5
120	P01750 0	Cross A positive relay Lifetime failure	K5
121	P01760 0	Cross A negative relay open failure	K6
122	P01770 0	Cross A negative relay adhesion failure	K6



Position	DTC code	DTC Description	Component
123	P01780 0	Cross A negative relay Lifetime failure	K6
124	P01790 0	Thermal management unit power fuse Open failure	FU9
125	P01800 0	AFC initialization failure	AFC
126	P01810 0	EMS initialization failure	EMS
127	P01820 0	EMS System Basic Chip failure	EMS
128	P01830 0	EMS Memory access failure	EMS
129	P01840 0	BMS/T-Box wakeup output pin short circuit to ground	EMS
130	P01850 0	BMS/T-Box wakeup output pin short circuit to battery	EMS
131	P01860 0	BMS/T-Box wakeup output pin open circuit	EMS
132	P01870 0	Three phase power supply control relay drive short circuit to ground(low side)	EMS
133	P01880 0	Three phase power supply control relay drive short circuit to battery(low side)	EMS
134	P01890 0	Three phase power supply control relay drive short circuit to ground(high side)	EMS
135	P01900 0	Three phase power supply control relay drive short circuit to battery(high side)	EMS
136	P01910 0	Three phase power supply control relay drive open circuit	EMS
137	P01920 0	Three phase power supply control relay drive over-current failure	EMS
138	P01930 0	Three-phase switch contactor drive short circuit to ground(low side)	EMS
139	P01940 0	Three-phase switch contactor drive short circuit to battery (low side)	EMS
140	P01950 0	Three-phase switch contactor drive short circuit to ground(high side)	EMS



Position	DTC code	DTC Description	Component
141	P01960 0	Three-phase switch contactor drive short circuit to battery (high side)	EMS
142	P01970 0	Three-phase switch contactor drive open circuit	EMS
143	P01980 0	Three-phase switch contactor drive over-current failure	EMS
144	P01990 0	Cross A positive relay drive short circuit to ground(low side)	EMS
145	P02000 0	Cross A positive relay drive short circuit to battery(low side)	EMS
146	P02010 0	Cross A positive relay drive short circuit to ground(high side)	EMS
147	P02020 0	Cross A positive relay drive short circuit to battery(high side)	EMS
148	P02030 0	Cross A positive relay drive open circuit	EMS
149	P02040 0	Cross A positive relay drive over current failure	EMS
150	P02050 0	Cross A negative relay drive short circuit to ground(low side)	EMS
151	P02060 0	Cross A negative relay drive short circuit to battery(low side)	EMS
152	P02070 0	Cross A negative relay drive short circuit to ground(high side)	EMS
153	P02080 0	Cross A negative relay drive short circuit to battery(high side)	EMS
154	P02090 0	Cross A negative relay drive open circuit	EMS
155	P02100 0	Cross A negative relay drive over current failure	EMS
156	P021100	TMS power supply1 positive relay drive short circuit to ground (low side)	EMS
157	P02120 0	TMS power supply1 positive relay drive short circuit to battery(low side)	EMS



Position	DTC code	DTC Description	Component
158	P02130 0	TMS power supply1 positive relay drive short circuit to ground (high side)	EMS
159	P02140 0	TMS power supply1 positive relay drive short circuit to battery(high side)	EMS
160	P02150 0	TMS power supply1 positive relay drive open circuit	EMS
161	P02160 0	TMS power supply1 positive relay drive over-current failure	EMS
162	P02170 0	TMS power supply1 negative relay drive short circuit to ground (low side)	EMS
163	P02180 0	TMS power supply1 negative relay drive short circuit to battery(low side)	EMS
164	P02190 0	TMS power supply1 negative relay drive short circuit to ground (high side)	EMS
165	P02200 0	TMS power supply1 negative relay drive short circuit to battery(high side)	EMS
166	P02210 0	TMS power supply1 negative relay drive open circuit	EMS
167	P02220 0	TMS power supply1 negative relay drive over-current failure	EMS
168	P02230 0	AD screen FAN power supply relay drive short circuit to ground (low side)	EMS
169	P02240 0	AD screen FAN power supply relay drive short circuit to battery(low side)	EMS
170	P02250 0	AD screen FAN power supply relay drive short circuit to ground (high side)	EMS
171	P02260 0	AD screen FAN power supply relay drive short circuit to battery(high side)	EMS
172	P02270 0	AD screen FAN power supply relay drive open circuit	EMS
173	P02280 0	AD screen FAN power supply relay drive over current failure	EMS
174	P02290 0	AD screen power supply relay drive short circuit to ground (low side)	EMS



Position	DTC code	DTC Description	Component
175	P02300	AD screen power supply relay drive short circuit to battery(low side)	EMS
176	P02310	AD screen power supply relay drive short circuit to ground (high side)	EMS
177	P02320	AD screen power supply relay drive short circuit to battery(high side)	EMS
178	P02330	AD screen power supply relay drive open circuit	EMS
179	P02340	AD screen power supply relay drive over current failure	EMS
180	P02350	Accessory load relay drive short circuit to ground (low side)	EMS
181	P02360	Accessory load relay drive short circuit to battery (low side)	EMS
182	P02370	Accessory load relay relay drive short circuit to ground (high side)	EMS
183	P02380	Accessory load relay drive short circuit to battery (high side)	EMS
184	P02390	Accessory load relay driver open circuit	EMS
185	P02400	Accessory load relay drive over-current failure	EMS
186	P0241F	12V over-voltage failure for T-Box power supply	
187	P0242F	12V high-voltage failure for T-Box power supply	
188	P0243F	12V under-voltage failure for T-Box power supply	
189	U01208	Timeout failure between EMS and T-Box communication(CANFD)	T-BOX1
190	U01218	Timeout failure between EMS and T-Box communication (Ethernet)	T-BOX1
191	U01228	Busoff failure between EMS and T-Box	T-BOX1
192	P02440	Storage failure T-Box T-Box internal	T-BOX1
193	P02450	Wifi failure in T-Box	T-BOX1



Position	DTC code	DTC Description	Component
194	P024600	Bluetooth failure in T-Box	T-BOX1
195	P024700	4G model failure in T-Box	T-BOX1
196	P024800	GPS failure in T-Box	T-BOX1
197	P024900	Collision Event	T-BOX1
198	P025000	Falling Event	T-BOX1
199	P025100	Time deviation error	T-BOX1
200	P025200	Fuse of ACDC2 output over current failure	FU2
201	P025300	Fuse of DCDC1 input over current failure	FU5
202	P025400	Fuse of DCDC2 input over current failure	FU5
203	P025500	Fuse of DCDC3 input over current failure	FU6
204	P025600	Fuse of DCDC4 input over current failure	FU6
205	U012387	BMS1 CAN communication timeout high level failure	EMS-BMS1
206	P025700	Advertising screen FAN relay failure (open/adhesion)	KA1
207	U012487	TBOX2 CAN communication timeout failure	EMS-T-BOX2
208	U012587	BMS2 CAN communication timeout failure	EMS-BMS2
209	U012687	BMS2 CAN communication timeout high level failure	EMS-BMS2
210	P025800	24V DCDC front-front fuse voltage rationality check out of range	EMS-HVS1+
211	P025900	TMS front-end fuse voltage rationality check out of range	EMS-HVS3+
212	P026000	12 VDCDC output voltage rationality check out of range	EMS-LVS2
213	P026100	Backup Battery output voltage rationality check out of range	EMS-LVS3
214	P026200	Both cross positive relay open failure	K17



Position	DTC code	DTC Description	Component
215	P026300	Both cross positive relay adhesion failure	K17
216	P026400	Both cross positive relay Lifetime failure	K17
217	P026500	Both cross negative relay open failure	K18
218	P026600	Both cross negative relay adhesion failure	K18
219	P026700	Both cross negative relay Lifetime failure	K18
220	P026800	Cross B positive relay open failure	K7
221	P026900	Cross B positive relay adhesion failure	K7
222	P027000	Cross B positive relay Lifetime failure	K7
223	P027100	Cross B negative relay open failure	K8
224	P027200	Cross B negative relay adhesion failure	K8
225	P027300	Cross B negative relay Lifetime failure	K8
226	P027400	Pack B Recharge positive relay open failure	K11
227	P027500	Pack B Recharge positive relay adhesion failure	K11
228	P027600	Pack B Recharge positive relay Lifetime failure	K11
229	P027700	Pack B Recharge negative relay open failure	K12
230	P027800	Pack B Recharge negative relay adhesion failure	K12
231	P027900	Pack B Recharge negative relay Lifetime failure	K12
232	P028000	TMS power supply1 positive relay open failure	K21
233	P028100	TMS power supply1 positive relay adhesion failure	K21
234	P028200	TMS power supply1 positive relay Lifetime failure	K21
235	P028300	TMS power supply1 negative relay open failure	K22
236	P028400	TMS power supply1 negative relay adhesion failure	K22





Position	DTC code	DTC Description	Component
237	P02850	TMS power supply1 negative relay Lifetime failure	K22
238	P02860	TMS power supply2 positive relay open failure	K23
239	P02870	TMS power supply2 positive relay adhesion failure	K23
240	P02880	TMS power supply2 positive relay Lifetime failure	K23
241	P02890	TMS power supply2 negative relay open failure	K24
242	P02900	TMS power supply2 negative relay adhesion failure	K24
243	P02910	TMS power supply2 negative relay Lifetime failure	K24
244	P02920	Cross B positive relay drive short circuit to ground(low side)	EMS
245	P02930	Cross B positive relay drive short circuit to battery(low side)	EMS
246	P02940	Cross B positive relay drive short circuit to ground(high side)	EMS
247	P02950	Cross B positive relay drive short circuit to battery(high side)	EMS
248	P02960	Cross B positive relay drive open circuit	EMS
249	P02970	Cross B positive relay drive over current failure	EMS
250	P02980	Cross B negative relay drive short circuit to ground(low side)	EMS
251	P02990	Cross B negative relay drive short circuit to battery(low side)	EMS
252	P08000	Cross B negative relay drive short circuit to ground(high side)	EMS
253	P08010	Cross B negative relay drive short circuit to battery(high side)	EMS
254	P08020	Cross B negative relay drive open circuit	EMS
255	P08030	Cross B negative relay drive over current failure	EMS



Position	DTC code	DTC Description	Component
256	P080400	Both cross positive relay drive short circuit to ground(low side)	EMS
257	P080500	Both cross positive relay drive short circuit to battery(low side)	EMS
258	P080600	Both cross positive relay drive short circuit to ground(high side)	EMS
259	P080700	Both cross positive relay drive short circuit to battery(high side)	EMS
260	P080800	Both cross positive relay drive open circuit	EMS
261	P080900	Both cross positive relay drive over current failure	EMS
262	P081000	Both cross negative relay drive short circuit to ground(low side)	EMS
263	P081100	Both cross negative relay drive short circuit to battery(low side)	EMS
264	P081200	Both cross negative relay drive short circuit to ground(high side)	EMS
265	P081300	Both cross negative relay drive short circuit to battery(high side)	EMS
266	P081400	th cross negative relay drive open circuit	EMS
267	P081500	Both cross negative relay drive over current failure	EMS
268	P081600	TMS power supply2 positive relay drive short circuit to ground (low side)	EMS
269	P081700	TMS power supply2 positive relay drive short circuit to battery(low side)	EMS
270	P081800	TMS power supply2 positive relay drive short circuit to ground (high side)	EMS
271	P081900	TMS power supply2 positive relay drive short circuit to battery(high side)	EMS
272	P082000	TMS power supply2 positive relay drive open circuit	EMS



Position	DTC code	DTC Description	Component
273	P082100	TMS power supply2 positive relay drive over-current failure	EMS
274	P082200	TMS power supply2 negative relay drive short circuit to ground (low side)	EMS
275	P082300	TMS power supply2 negative relay drive short circuit to battery(low side)	EMS
276	P082400	TMS power supply2 negative relay drive short circuit to ground (high side)	EMS
277	P082500	TMS power supply2 negative relay drive short circuit to battery(high side)	EMS
278	P082600	TMS power supply2 negative relay drive open circuit	EMS
279	P082700	TMS power supply2 negative relay drive over-current failure	EMS
280	P0828F0	BMS2 level 1 failure	BMS2
281	P0828F1	BMS2 level 2 failure	BMS2
282	P0828F2	BMS2 level 3 failure	BMS2
283	P082900	Emergency Stop	
284	P0830F0	12V over-voltage failure for T-Box2 power supply	
285	P0831F1	12V high-voltage failure for T-Box2 power supply	
286	P0832F0	12V under-voltage failure for T-Box2 power supply	
287	U012787	Timeout failure between EMS and T-Box2 communication(CANFD)	EMS-T-BOX2
288	U012887	Timeout failure between EMS and T-Box2 communication(Ethernet)	EMS-T-BOX2
289	U012988	Busoff failure between EMS and T-Box2	EMS-T-BOX2
290	P083300	Storage failure T-Box2 T-Box2 internal	T-BOX2
291	P083400	Wifi failure in T-Box2	T-BOX2



Position	DTC code	DTC Description	Component
292	P083500	Bluetooth failure in T-Box2	T-BOX2
293	P083600	4G model failure in T-Box2	T-BOX2
294	P083700	GPS failure in T-Box2	T-BOX2
295	P083800	Collision Event	T-BOX2
296	P083900	Falling Event	T-BOX2
297	P084000	Time deviation error	T-BOX2
298	P086800	24 VDCDC front-end fuse open failure	FU10
299	P086900	Three-phase feed-in relay always open failure	KA5
300	P087000	Three-phase feed-in relay always adhesion failure	KA5
301	P087100	24V DCDC failure	P1
302	P087200	The fuse of TMS fan power supply open failure	FU8
303	P087300	24V transfor 12V DCDC failure	P2
304	P087400	15W DCDC failure	P3
305	P087500	The relay of GUN A adhesion failure	CCU1
306	P087600	The relay of GUN B adhesion failure	CCU2
307	P087700	GUN A over temperature	CCU1
308	P087800	GUN B over temperature	CCU2
309	U013087	Lost the communication between cloud and T-Box1	T-BOX1
310	U013187	Lost the communication between cloud and T-Box2	T-BOX2

### 3.2 EMS Reaction Table

- ◆ ⇒ "EMS DTC Code Table" på side 16
- ◆ ⇒ "EMS Action Table" på side 44
- ◆ ⇒ "EMS Repair Action" på side 46



Position	DTC code	Red Lights	System A	System B
1	P0101F0		A0	A0
2	P0101F1	Light up two-guns red lights	A10	A11
3	P0102F0		A0	A0
4	P0102F1	Light up two-guns red lights	A10	A11
5	P010300		A0	A0
6	P010400		A0	A0
7	P010500		A1	A1
8	P010600	Light up two-guns red lights	A10	A11
9	P010700		A0	A0
10	P010800		A0	A0
11	P0108F1		A1	A1
12	P010900	Light up two-guns red lights	A10	A11
13	P011000	Light up two-guns red lights	A10	A11
14	P011100		A5	A9
15	P011200		A1	A1
16	P011300		A1	A1
17	P011400		A5	A0
18	P011500		A2	A0
			A3	A0
19	P011600		A1	A0
20	P0117F0		#NV	#NV
21	P0117F1		#NV	#NV
22	P0117F2		#NV	#NV
23	U010187		A1	A0
24	U010287		A1	A0
			A5	A0
25	U010387		A1	A1
26	U010487		A1	A1
27	U010587	Light up gun-A red lights	A2	A0
			A3	A0
			A4	A0
28	U010687	Light up gun-B red lights	A0	A6
			A0	A7
			A0	A8



Position	DTC code	Red Lights	System A	System B
29	U010787	Light up gun-A red lights	A2	A0
			A3	A0
			A4	A0
30	U010887	Light up gun-B red lights	A0	A6
			A0	A7
			A0	A8
31	U010987		A1	A1
32	U011087		A2	A6
			A3	A6
			A5	A6
33	P0118F0		A1	A0
34	P0118F1		A2	A6
			A3	A6
			A5	A6
35	P0118F2		A2	A6
			A3	A6
			A5	A6
36	U011187		A2	A6
			A2	A7
			A2	A9
37	P0119F0		A0	A1
38	P0119F1		A2	A6
			A2	A7
			A2	A9
39	P0119F2		A2	A6
			A2	A7
			A2	A9
40	U011287		A4	A0
41	P0120F0		A1	A0
42	P0120F1		A4	A0
43	P0120F2		A4	A0
44	U011387		A4	A0
45	P0121F0		A1	A0
46	P0121F1		A4	A0
47	P0121F2		A4	A0
48	U011487		A4	A0
49	P0122F0		A0	A1
50	P0122F1		A0	A8



Position	DTC code	Red Lights	System A	System B
51	P0122F2		A0	A8
52	U011587		A0	A8
53	P0123F0		A0	A1
54	P0123F1		A0	A8
55	P0123F2		A0	A8
56	U011687	Light up two-guns red lights	A10	A11
57	P012400		A2	A6
			A3	A6
			A5	A6
58	P012500		A0	A0
59	P012600		A0	A0
60	P012700		#NV	#NV
61	U011788	Light up gun-A red lights	A10	A0
62	U011888	Light up two-guns red lights	A10	A11
63	U011988	Light up gun-B red lights	A0	A11
64	P012800		A1	A1
65	P012900		A0	A0
66	P0130F1	Light up two-guns red lights	A10	A11
67	P0130F2		A10	A11
68	P013100	Light up two-guns red lights	A10	A11
69	P013200		A1	A0
70	P013300		A0	A1
71	P0134F0		A1	A0
72	P0134F1		A1	A0
			A5	A0
73	P0134F2		A1	A0
			A5	A0
74	P0135F0		A1	A0
75	P0135F1	Light up gun-A red lights	A1	A0
			A3	A0
			A4	A0
76	P0135F2	Light up gun-A red lights	A1	A0
			A3	A0
			A4	A0



Position	DTC code	Red Lights	System A	System B
77	P0136F0		A0	A1
78	P0136F1	Light up gun-B red lights	A0	A1
			A0	A7
			A0	A8
79	P0136F2	Light up gun-B red lights	A0	A1
			A0	A7
			A0	A8
80	P0137F0		A1	A1
81	P0137F1	Light up two-guns red lights	A1	A1
82	P0137F2	Light up two-guns red lights	A10	A11
83	P013800		A1	A1
			A3	A6
			A5	A6
84	P013900		A1	A1
			A3	A6
			A5	A6
85	P014000		A2	A6
			A3	A6
			A5	A6
86	P014100		A2	A6
			A3	A6
			A5	A6
87	P014200		A2	A6
			A3	A6
			A5	A6
88	P014300		A1	A1
			A3	A6
			A5	A6
89	P014400		A1	A1
			A2	A7
			A2	A9
90	P014500		A1	A1
			A2	A7
			A2	A9
91	P014600		A2	A6
			A2	A7
			A2	A9





Position	DTC code	Red Lights	System A	System B
92	P014700		A2	A6
			A2	A7
			A2	A9
93	P014800		A2	A6
			A2	A7
			A2	A9
94	P014900		A1	A1
			A2	A7
			A2	A9
95	P015000		A1	A0
96	P015100		A1	A0
97	P015200		A1	A0
98	P015300		A1	A0
99	P015400		A1	A0
100	P015500		A1	A0
101	P015600		A1	A0
102	P015700		A1	A0
103	P015800		A0	A1
104	P015900		A0	A1
105	P016000		A0	A1
106	P016100		A0	A1
107	P016200		A0	A1
108	P016300		A0	A1
109	P016400		A0	A1
110	P016500		A0	A1
111	P016600		A5	A0
112	P016700		A2	A1
			A3	A0
113	P016800		A1	A0
114	P016900		#NV	A0
115	P017000		#NV	A0
116	P017100	Light up two-guns red lights	#NV	A0
117	P017200		#NV	A0
118	P017300		A2	A0
			A3	A0
119	P017400		A5	A6
120	P017500		A1	A0



Position	DTC code	Red Lights	System A	System B
121	P017600		A2	A0
			A3	A0
122	P017700		A1	A6
123	P017800		A1	A0
124	P017900	Light up two-guns red lights	A10	A11
125	P018000		A1	A1
126	P018100		A1	A1
127	P018200		A1	A1
128	P018300		A1	A1
129	P018400		A1	A1
130	P018500		A1	A1
131	P018600		A1	A1
132	P018700		A1	A1
133	P018800		A1	A1
			A1	A1
			A1	A1
134	P018900		A1	A1
			A1	A1
			A1	A1
135	P019000		A1	A1
136	P019100		A1	A1
			A1	A1
			A1	A1
137	P019200		A1	A1
138	P019300		A1	A1
139	P019400		A1	A1
			A1	A1
			A1	A1
140	P019500		A1	A1
			A1	A1
			A1	A1
141	P019600		A1	A1
142	P019700		A1	A1
			A1	A1
			A1	A1
143	P019800		A1	A1
144	P019900		A1	A1



Position	DTC code	Red Lights	System A	System B
145	P020000		A1	A1
			A1	A1
146	P020100		A1	A1
			A1	A1
147	P020200		A1	A1
148	P020300		A1	A1
			A1	A1
149	P020400		A1	A1
150	P020500		A1	A1
151	P020600		A1	A1
			A1	A1
152	P020700		A1	A1
			A1	A1
153	P020800		A1	A1
154	P020900		A1	A1
			A1	A1
155	P021000		A1	A1
156	P021100		A1	A1
157	P021200		A1	A1
158	P021300		A1	A1
159	P021400		A1	A1
160	P021500		A1	A1
161	P021600		A1	A1
162	P021700		A1	A1
163	P021800		A1	A1
164	P021900		A1	A1
165	P022000		A1	A1
166	P022100		A1	A1
167	P022200		A1	A1
168	P022300		A1	A1
169	P022400		A1	A1
170	P022500		A1	A1
171	P022600		A1	A1
172	P022700		A1	A1
173	P022800		A1	A1
174	P022900		A1	A1
175	P023000		A1	A1
176	P023100		A1	A1



Position	DTC code	Red Lights	System A	System B
177	P023200		A1	A1
178	P023300		A1	A1
179	P023400		A1	A1
180	P023500		A1	A1
181	P023600		A1	A1
182	P023700		A1	A1
183	P023800		A1	A1
184	P023900		A1	A1
185	P024000		A1	A1
186	P0241F0		A0	A0
187	P0242F1		A0	A0
188	P0243F0		A0	A0
189	U012087		A0	A0
190	U012187		A0	A0
191	U012288		A0	A0
192	P024400		A0	A0
193	P024500		A0	A0
194	P024600		A0	A0
195	P024700		A0	A0
196	P024800		A0	A0
197	P024900		A10	A11
198	P025000		A10	A11
199	P025100		A0	A0
200	P025200		A2	A6
			A2	A7
			A2	A9
201	P025300		A4	A0
202	P025400		A4	A0
203	P025500		A0	A8
204	P025600		A0	A8
205	U012387	Light up gun-A red lights	A10	A0
206	P025700		A0	A0
207	U012487		A0	A0
208	U012587		A0	A1
			A0	A9
209	U012687	Light up gun-B red lights	A0	A11
210	P025800		A0	A0



Position	DTC code	Red Lights	System A	System B
211	P025900		A0	A0
212	P026000		A0	A0
213	P026100		A0	A0
214	P026200		A2	A6
215	P026300		A2	A6
			A3	A7
			A5	A9
216	P026400		A0	A0
217	P026500		A2	A2
218	P026600		A2	A6
			A3	A7
			A5	A9
219	P026700		A0	A0
220	P026800		A0	A6
			A0	A7
221	P026900		A2	A9
222	P027000		A0	A1
223	P027100		A0	A6
			A0	A7
224	P027200		A2	A9
225	P027300		A0	A1
226	P027400		A0	A9
227	P027500		A0	A6
			A0	A7
228	P027600		A0	A1
229	P027700		A0	A9
230	P027800		A0	A6
			A0	A7
231	P027900		A0	A1
232	P028000		A1	A1
233	P028100		A1	A1
234	P028200		A1	A1
235	P028300		A1	A1
236	P028400		A1	A1
237	P028500		A1	A1
238	P028600		A1	A1
239	P028700		A1	A1
240	P028800		A1	A1



Position	DTC code	Red Lights	System A	System B
241	P028900		A1	A1
242	P029000		A1	A1
243	P029100		A1	A1
244	P029200		A0	A1
245	P029300		A0	A1
			A0	A7
246	P029400		A0	A1
			A0	A7
247	P029500		A0	A1
248	P029600		A0	A1
			A0	A7
249	P029700		A0	A1
250	P029800		A0	A1
251	P029900		A0	A1
			A0	A7
252	P080000		A0	A1
			A0	A7
253	P080100		A0	A1
254	P080200		A0	A1
255	P080300		A0	A7
256	P080400		A0	A1
257	P080500		A1	A1
258	P080600		A1	A1
259	P080700		A1	A1
260	P080800		A1	A1
261	P080900		A1	A1
262	P081000		A1	A1
263	P081100		A1	A1
264	P081200		A1	A1
265	P081300		A1	A1
266	P081400		A1	A1
267	P081500		A1	A1
268	P081600		A1	A1
269	P081700		A1	A1
270	P081800		A1	A1
271	P081900		A1	A1
272	P082000		A1	A1
273	P082100		A1	A1



Position	DTC code	Red Lights	System A	System B
274	P082200		A1	A1
275	P082300		A1	A1
276	P082400		A1	A1
277	P082500		A1	A1
278	P082600		A1	A1
279	P082700		A1	A1
280	P0828F0		A0	A1
281	P0828F1		A0	A1
			A0	A9
282	P0828F2		A0	A1
			A0	A9
283	P082900		A0	A0
284	P0830F0		A0	A0
285	P0831F1		A0	A0
286	P0832F0		A0	A0
287	U012787		A0	A0
288	U012887		A0	A0
289	U012988		A0	A0
290	P083300		A0	A0
291	P083400		A0	A0
292	P083500		A0	A0
293	P083600		A0	A0
294	P083700		A0	A0
295	P083800		A10	A11
296	P083900		A10	A11
297	P084000		A0	A0
298	P086800		A10	A11
299	P086900		A2	A6
			A3	A7
			A5	A9
300	P087000		A1	A1
301	P087100		A10	A11
302	P087200		A10	A11
303	P087300		A10	A11
304	P087400		A10	A11
305	P087500		A10	A11
306	P087600		A10	A11



Position	DTC code	Red Lights	System A	System B
307	P087700		A2	A0
			A3	A0
			A4	A0
308	P087800		A0	A6
			A0	A7
			A0	A8
309	U013087		A1	A1
310	U013187		A1	A1

### 3.3 EMS Action Table

- ◆ ⇒ "EMS DTC Code Table" på side 16
- ◆ ⇒ "EMS Reaction Table" på side 32
- ◆ ⇒ "EMS Repair Action" på side 46

Item	Fault Performance	System Action
A0	Normal	NA
A1	Storage error code	Storage error code
A2	Disable Gun-A both cross discharge	<ul style="list-style-type: none"> <li>◆ 1.While K5/K6 enable,disable K17/ K18,even CCUB power request more than 120KW</li> <li>◆ 2.While K5/K6 disable,enable K17/K18 if CCUB power request more than 120KW, and keep K5/K6 disable before K17/K18 disable</li> </ul>
A3	Disable Gun-A cross discharge	1.Disable K5/K6(EMS)
A4	Disable Gun-A DC/DC discharge	1.Configuring DC/DC of Gun-A offline(EMS)
A5	Disable Pack A recharge	1.Disable K9/ K10(EMS→BMS1)





Item	Fault Performance	System Action
A6	Disable Gun-B both cross discharge	<ul style="list-style-type: none"> <li>◆ 1.While K7/K8 enable,disable K17/ K18,even CCUA power request more than 120KW</li> <li>◆ 2.While K5/K6 disable,enable K17/K18 if CCUB power request more than 120KW, and keep K5/K6 disable before K17/K18 disable</li> </ul>
A7	Disable Gun-B cross discharge	1.Disable K7/K8(EMS)
A8	Disable Gun-B DC/DC discharge	1.Configuring DC/DC of Gun-B offline(EMS)
A9	Disable Pack B recharge	1.Disable K11/ K12(EMS→BMS2)
A10	High voltage power down of system A,Gun-A red light	<ul style="list-style-type: none"> <li>◆ 1.Disable K5/ K6(EMS)</li> <li>◆ 2.Disable K21/ K22(EMS)</li> <li>◆ 3.Disable K1/ K2(EMS→CCU1)</li> <li>◆ 4.Disable K9/ K10(EMS→BMS1)</li> <li>◆ 5.Disable K13/ K14(EMS→BMS1)</li> </ul>



Item	Fault Performance	System Action
A11	High voltage power down of system B, Gun-B red light	<ul style="list-style-type: none"> <li>◆ 1.Disable K7/ K8(EMS)</li> <li>◆ 2.Disable K23/ K24(EMS)</li> <li>◆ 3.Disable K3/ K4(EMS→CCU2)</li> <li>◆ 4.Disable K11/ K12(EMS→BMS2)</li> <li>◆ 5.Disable K15/ K16(EMS→BMS2)</li> </ul>
A12	When A10 and A11 are detected last 5min, The whole machine high voltage and low voltage power down, two guns do not light	<ul style="list-style-type: none"> <li>◆ 1.Disable KA5 if fault detected, including Collision and Falling</li> <li>◆ 2.Disable KA2</li> <li>◆ 3.Disable K1/K2, K3/ K4(EMS→CCU1,2)</li> <li>◆ 4.Disable K5/K6, K7/ K8(EMS)</li> <li>◆ 5.Disable K9/ K10, K11/ K12(EMS→BMS1,2)</li> <li>◆ 6.Disable KA1, KA3, KA4</li> <li>◆ 7.Disable K21/ K22, K23/ K24(EMS)</li> <li>◆ 8.Disable K13/ K14, K15/ K16(EMS→BMS1,2)</li> <li>◆ 9.BMS1, BMS2 Sleep(EMS→BMS1, 2)</li> <li>◆ 10.EMS Sleep</li> </ul>

### 3.4 EMS Repair Action

- ◆ ⇒ "EMS DTC Code Table" på side 16
- ◆ ⇒ "EMS Reaction Table" på side 32
- ◆ ⇒ "EMS Action Table" på side 44

Position	DTC code	Repair Action
1	P0101F0	
2	P0101F1	
3	P0102F0	
4	P0102F1	



Position	DTC code	Repair Action
5	P010300	
6	P010400	
7	P010500	
8	P010600	
9	P010700	
10	P010800	
11	P0108F1	
12	P010900	
13	P011000	
14	P011100	
15	P011200	
16	P011300	
17	P011400	
18	P011500	
19	P011600	
20	P0117F0	
21	P0117F1	
22	P0117F2	
23	U010187	
24	U010287	
25	U010387	
26	U010487	
27	U010587	
28	U010687	
29	U010787	
30	U010887	
31	U010987	
32	U011087	
33	P0118F0	
34	P0118F1	
35	P0118F2	
36	U011187	
37	P0119F0	
38	P0119F1	
39	P0119F2	
40	U011287	
41	P0120F0	
42	P0120F1	
43	P0120F2	



Position	DTC code	Repair Action
44	U011387	
45	P0121F0	
46	P0121F1	
47	P0121F2	
48	U011487	
49	P0122F0	
50	P0122F1	
51	P0122F2	
52	U011587	
53	P0123F0	
54	P0123F1	
55	P0123F2	
56	U011687	
57	P012400	
58	P012500	
59	P012600	
60	P012700	
61	U011788	
62	U011888	
63	U011988	
64	P012800	
65	P012900	
66	P0130F1	
67	P0130F2	
68	P013100	
69	P013200	
70	P013300	
71	P0134F0	
72	P0134F1	
73	P0134F2	
74	P0135F0	
75	P0135F1	
76	P0135F2	
77	P0136F0	
78	P0136F1	
79	P0136F2	
80	P0137F0	
81	P0137F1	
82	P0137F2	



Position	DTC code	Repair Action
83	P013800	
84	P013900	
85	P014000	
86	P014100	
87	P014200	
88	P014300	
89	P014400	
90	P014500	
91	P014600	
92	P014700	
93	P014800	
94	P014900	
95	P015000	
96	P015100	
97	P015200	
98	P015300	
99	P015400	
100	P015500	
101	P015600	
102	P015700	
103	P015800	
104	P015900	
105	P016000	
106	P016100	
107	P016200	
108	P016300	
109	P016400	
110	P016500	
111	P016600	
112	P016700	
113	P016800	
114	P016900	
115	P017000	
116	P017100	
117	P017200	
118	P017300	
119	P017400	
120	P017500	
121	P017600	



Position	DTC code	Repair Action
122	P017700	
123	P017800	
124	P017900	
125	P018000	
126	P018100	
127	P018200	
128	P018300	
129	P018400	
130	P018500	
131	P018600	
132	P018700	
133	P018800	
134	P018900	
135	P019000	
136	P019100	
137	P019200	
138	P019300	
139	P019400	
140	P019500	
141	P019600	
142	P019700	
143	P019800	
144	P019900	
145	P020000	
146	P020100	
147	P020200	
148	P020300	
149	P020400	
150	P020500	
151	P020600	
152	P020700	
153	P020800	
154	P020900	
155	P021000	
156	P021100	
157	P021200	
158	P021300	
159	P021400	
160	P021500	



Position	DTC code	Repair Action
161	P021600	
162	P021700	
163	P021800	
164	P021900	
165	P022000	
166	P022100	
167	P022200	
168	P022300	
169	P022400	
170	P022500	
171	P022600	
172	P022700	
173	P022800	
174	P022900	
175	P023000	
176	P023100	
177	P023200	
178	P023300	
179	P023400	
180	P023500	
181	P023600	
182	P023700	
183	P023800	
184	P023900	
185	P024000	
186	P0241F0	
187	P0242F1	
188	P0243F0	
189	U012087	
190	U012187	
191	U012288	
192	P024400	
193	P024500	
194	P024600	
195	P024700	
196	P024800	
197	P024900	
198	P025000	
199	P025100	



Position	DTC code	Repair Action
200	P025200	
201	P025300	
202	P025400	
203	P025500	
204	P025600	
205	U012387	
206	P025700	
207	U012487	
208	U012587	
209	U012687	
210	P025800	
211	P025900	
212	P026000	
213	P026100	
214	P026200	
215	P026300	
216	P026400	
217	P026500	
218	P026600	
219	P026700	
220	P026800	
221	P026900	
222	P027000	
223	P027100	
224	P027200	
225	P027300	
226	P027400	
227	P027500	
228	P027600	
229	P027700	
230	P027800	
231	P027900	
232	P028000	
233	P028100	
234	P028200	
235	P028300	
236	P028400	
237	P028500	
238	P028600	





Position	DTC code	Repair Action
239	P028700	
240	P028800	
241	P028900	
242	P029000	
243	P029100	
244	P029200	
245	P029300	
246	P029400	
247	P029500	
248	P029600	
249	P029700	
250	P029800	
251	P029900	
252	P080000	
253	P080100	
254	P080200	
255	P080300	
256	P080400	
257	P080500	
258	P080600	
259	P080700	
260	P080800	
261	P080900	
262	P081000	
263	P081100	
264	P081200	
265	P081300	
266	P081400	
267	P081500	
268	P081600	
269	P081700	
270	P081800	
271	P081900	
272	P082000	
273	P082100	
274	P082200	
275	P082300	
276	P082400	
277	P082500	



Position	DTC code	Repair Action
278	P082600	
279	P082700	
280	P0828F0	
281	P0828F1	
282	P0828F2	
283	P082900	
284	P0830F0	
285	P0831F1	
286	P0832F0	
287	U012787	
288	U012887	
289	U012988	
290	P083300	
291	P083400	
292	P083500	
293	P083600	
294	P083700	
295	P083800	
296	P083900	
297	P084000	
298	P086800	
299	P086900	
300	P087000	
301	P087100	
302	P087200	
303	P087300	
304	P087400	
305	P087500	
306	P087600	
307	P087700	
308	P087800	
309	U013087	
310	U013187	

## 4 CCU DTC Matrix

### 4.1 CCU DTC Code Table

- ◆ ⇒ "CCU Action Table" på side 59
- ◆ ⇒ "CCU Repair Action" på side 68



Position	DTC code	DTC Description
1	P030100	CCU_Over-current protection failure
2	P030200	DCDC output over-voltage Alarm
3	P030300	CCU_current rationality out of range
4	U030487	CCU and EMS CAN communication timeout
5	U030588	EMS CAN Busoff
6	U030687	CCU and SECC communication timeout
7	U030788	SECC CAN Busoff
8	U030887	CCU and SECC communication interruption
9	P030900	The gun positive temperature sensor short circuit to battery or open circuit
10	P031000	The gun positive temperature sensor short circuit to ground
11	P031100	The gun negative temperature sensor short circuit to battery or open circuit
12	P031200	The gun negative temperature sensor short circuit to ground
13	P0313F0	Gun over-temperature level 1 failure
14	P0314F1	Gun over-temperature level 2 failure
15	P0315F2	Gun over-temperature level 3 failure
16	P0315F3	Gun over-temperature too many times
17	P031600	DC positive relay lifetime failure
18	P031700	DC positive relay drive short circuit to battery
19	P031800	DC positive relay drive short circuit to ground
20	P031900	DC positive relay drive open circuit
21	P032000	DC positive relay drive over-current
22	P032100	DC negative relay drive short circuit to battery
23	P032200	DC negative relay drive short circuit to ground
24	P032300	DC negative relay drive open circuit



Position	DTC code	DTC Description
25	P032400	DC negative relay drive over-current
26	P032500	DC positive relay open failure
27	P032600	DC positive relay adhesion failure
28	P032700	Dc negative relay open failure
29	P032800	DC negative relay adhesion failure
30	P032900	Fuse failure
31	P0330F1	Insulation level 1 failure detection
32	P0331F2	Insulation level 2 failure detection
33	P0332F3	Insulation level 3 failure detection
34	P033300	Insulation detection circuit hardware failures
35	P033400	CCU_System basic chip internal failure
36	P033500	CCU_System basic chip internal CAN failure
37	P033900	Voltage outside of DC positive relay less than AFC minimum output voltage
38	P034000	Voltage outside of DC positive relay greater than AFC maximum output voltage
39	P035900	DC output voltage exceeds BCL requirement voltage
40	P036000	DC output current exceeds BCL requirement voltage
41	P038300	Battery maximum allowable voltage less than AFC minimum output voltage
42	P038400	CCU internal failure
43	P038500	DC positive relay contact detected abnormal
44	P038600	DC negative relay contact detected abnormal
45	P038800	PreCableCheck failure
46	P060100	DB_INIT_ERROR_GENERAL
47	P060200	DB_INIT_ERROR_IFADDR
48	P060300	DB_INIT_ERROR_THREAD
49	P060400	DB_INIT_ERROR_OPENCHANNEL
50	P060500	DB_INIT_ERROR_KEY
51	P060600	DB_SLAC_ERROR_GENERAL
52	P060700	DB_SLAC_ERROR_TIMER_INIT



Position	DTC code	DTC Description
53	P060800	DB_SLAC_ERROR_TIMER_TIMEOUT
54	P060900	DB_SLAC_ERROR_TIMER_MISC
55	P061000	DB_SLAC_ERROR_PARAM_TIMEOUT
56	P061100	DB_SLAC_ERROR_PARAM_SOCKET
57	P061200	DB_SLAC_ERROR_START_ATTEN_CHAR_TIMEOUT
58	P061300	DB_SLAC_ERROR_MNBC_SOUND_TIMEOUT
59	P061400	DB_SLAC_ERROR_ATTEN_CHAR_TIMEOUT
60	P061500	DB_SLAC_ERROR_ATTEN_CHAR_SOCKET
61	P061600	DB_SLAC_ERROR_VALIDATE_1_TIMEOUT
62	P061700	DB_SLAC_ERROR_VALIDATE_1_SOCKET
63	P061800	DB_SLAC_ERROR_VALIDATE_2_TIMEOUT
64	P061900	DB_SLAC_ERROR_VALIDATE_2_SOCKET
65	P062000	DB_SLAC_ERROR_BCB_TOGGLE_TIMEOUT
66	P062100	DB_SLAC_ERROR_MATCH_TIMEOUT
67	P062200	DB_SLAC_ERROR_MATCH_SOCKET
68	P062300	DB_SLAC_ERROR_READ_SOCKET
69	P062400	DB_SDP_ERROR_GENERAL
70	P062500	DB_SDP_ERROR_INIT_SOCKET
71	P062600	DB_SDP_ERROR_INIT_SOCKET_OPT1
72	P062700	DB_SDP_ERROR_INIT_SOCKET_OPT2
73	P062800	DB_SDP_ERROR_INIT_BIND
74	P062900	DB_SDP_ERROR_THREAD_SOCKET1
75	P063000	DB_SDP_ERROR_THREAD_SOCKET2
76	P063100	DB_SDP_ERROR_TIMEOUT



Position	DTC code	DTC Description
77	P063200	DB_DIN_ERROR_GENERAL
78	P063300	DB_DIN_ERROR_INIT_SOCKET
79	P063400	DB_DIN_ERROR_INIT_SOCKET_OPT
80	P063500	DB_DIN_ERROR_INIT_BIND
81	P063600	DB_DIN_ERROR_INIT_LISTEN
82	P063700	DB_DIN_ERROR_INIT_SELECT
83	P063800	DB_DIN_ERROR_INIT_ACCEPT
84	P063900	DB_DIN_ERROR_TIMEOUT
85	P064000	DB_DIN_ERROR_V2GTP_HEADER
86	P064100	DB_DIN_ERROR_V2GTP_HEADER_LEN
87	P064200	DB_DIN_ERROR_DECODE_EXI
88	P064300	DB_DIN_ERROR_CREATE_RESPONSE
89	P064400	DB_DIN_ERROR_ENCODE_EXI
90	P064500	DB_DIN_ERROR_V2GTP_HEADER_WRITE
91	P064600	DB_DIN_ERROR_SOCKET_EXCEPTION
92	P064700	DB_DIN_ERROR_SOCKET_SEND
93	P064800	DB_DIN_ERROR_NO_PROTOCOL
94	P064900	DB_ISO15118_ERROR_GENERAL
95	P065000	DB_ISO15118_ERROR_INIT_SOCKET
96	P065100	DB_ISO15118_ERROR_INIT_SOCKETOPT
97	P065200	DB_ISO15118_ERROR_INIT_BIND
98	P065300	DB_ISO15118_ERROR_INIT_LISTEN
99	P065400	DB_ISO15118_ERROR_INIT_SELECT
100	P065500	DB_ISO15118_ERROR_INIT_ACCEPT
101	P065600	DB_ISO15118_ERROR_TIMEOUT
102	P065700	DB_ISO15118_ERROR_V2GTP_HEADER



Position	DTC code	DTC Description
103	P065800	DB_ISO15118_ER-ROR_V2GTP_HEADER_LEN
104	P065900	DB_ISO15118_ERROR_DECODE_EXI
105	P066000	DB_ISO15118_ERROR_CREATE_RESPONSE
106	P066100	DB_ISO15118_ERROR_ENCODE_EXI
107	P066200	DB_ISO15118_ER-ROR_V2GTP_HEADER_WRITE
108	P066300	DB_ISO15118_ERROR_SOCKET_EXCEPTION
109	P066400	DB_ISO15118_ERROR_SOCKET_SEND
110	P066500	DB_ISO15118_ER-ROR_NO_PROTOCOL
111	P037600	DCDC output out of range
112	U031587	CCU and SECC communication timeout
113	P037000	Precharge timeout
114	P034100	Vehicle Voltage out of CML
115	P051000	precablecheck temp fault
116	P051100	Insulation PE off line
117	P036300	CP off line

## 4.2 CCU Action Table

- ◆ ⇒ "CCU DTC Code Table" på side 54
- ◆ ⇒ "CCU Repair Action" på side 68

Position	DTC code	Charge Fault Level	System Action
1	P030100	10	Directly cut off the relay, end of charge.
2	P030200	10	Directly cut off the relay, end of charge.
3	P030300	4	Derate power CCU reported failure rating (request EMS derating power 50%. Don't cut off the relay. Fault can be recovery.



Position	DTC code	Charge Fault Level	System Action
4	U03048 7	7	According to the charging end process (send CST message to EMS and car controller), stop charging or prohibit to start charging.
5	U03058 8	7	According to the charging end process (send CST message to EMS and car controller), stop charging or prohibit to start charging.
6	U03068 7	1	Warning alarm, no operation;
7	U03078 8	7	According to the charging end process (send CST message to EMS and car controller), stop charging or prohibit to start charging.
8	U03088 7	7	According to the charging end process (send CST message to EMS and car controller), stop charging or prohibit to start charging.
9	P03090 0	4	Derate power CCU reported failure rating (request EMS derating power 50%. Don't cut off the relay. Fault can be recovery.
10	P03100 0	4	Derate power CCU reported failure rating (request EMS derating power 50%. Don't cut off the relay. Fault can be recovery.
11	P03110 0	4	Derate power CCU reported failure rating (request EMS derating power 50%. Don't cut off the relay. Fault can be recovery.
12	P03120 0	4	Derate power CCU reported failure rating (request EMS derating power 50%. Don't cut off the relay. Fault can be recovery.





Position	DTC code	Charge Fault Level	System Action
13	P0313F0	1	Warning alarm, no operation;
14	P0314F1	4	Derate power CCU reported failure rating (request EMS derating power 50%. Don't cut off the relay. Fault can be recovery.
15	P0315F2	7	According to the charging end process (send CST message to EMS and car controller), stop charging or prohibit to start charging.
16	P0315F3	10	Directly cut off the relay, end of charge.
17	P031600	1	Warning alarm, no operation;
18	P031700	1	Warning alarm, no operation;
19	P031800	1	Warning alarm, no operation;
20	P031900	1	Warning alarm, no operation;
21	P032000	1	Warning alarm, no operation;
22	P032100	1	Warning alarm, no operation;
23	P032200	1	Warning alarm, no operation;
24	P032300	1	Warning alarm, no operation;
25	P032400	1	Warning alarm, no operation;
26	P032500	10	Directly cut off the relay, end of charge.
27	P032600	10	Directly cut off the relay, end of charge.
28	P032700	10	Directly cut off the relay, end of charge.
29	P032800	10	Directly cut off the relay, end of charge.
30	P032900	10	Directly cut off the relay, end of charge.
31	P0330F1	1	Warning alarm, no operation;



Position	DTC code	Charge Fault Level	System Action
32	P0331F2	4	Derate power CCU reported failure rating (request EMS dreating power 50%. Don't cut off the relay. Fault can be recovery.
33	P0332F3	7	According to the charging end process (send CST message to EMS and car controller), stop charging or prohibit to start charging.
34	P033300	7	According to the charging end process (send CST message to EMS and car controller), stop charging or prohibit to start charging.
35	P033400	7	According to the charging end process (send CST message to EMS and car controller), stop charging or prohibit to start charging.
36	P033500	7	According to the charging end process (send CST message to EMS and car controller), stop charging or prohibit to start charging.
37	P033900	7	According to the charging end process (send CST message to EMS and car controller), stop charging or prohibit to start charging.
38	P034000	7	According to the charging end process (send CST message to EMS and car controller), stop charging or prohibit to start charging.
39	P035900	10	Directly cut off the relay, end of charge.
40	P036000	10	Directly cut off the relay, end of charge.



Position	DTC code	Charge Fault Level	System Action
41	P038300	7	According to the charging end process (send CST message to EMS and car controller), stop charging or prohibit to start charging.
42	P038400	1	Warning alarm, no operation;
43	P038500	10	Directly cut off the relay, end of charge.
44	P038600	10	Directly cut off the relay, end of charge.
45	P038800	7	According to the charging end process (send CST message to EMS and car controller), stop charging or prohibit to start charging.
46	P060100	1	Warning alarm, no operation;
47	P060200	7	According to the charging end process (send CST message to EMS and car controller), stop charging or prohibit to start charging.
48	P060300	7	According to the charging end process (send CST message to EMS and car controller), stop charging or prohibit to start charging.
49	P060400	7	According to the charging end process (send CST message to EMS and car controller), stop charging or prohibit to start charging.
50	P060500	1	Warning alarm, no operation;
51	P060600	1	Warning alarm, no operation;
52	P060700	7	According to the charging end process (send CST message to EMS and car controller), stop charging or prohibit to start charging.



Position	DTC code	Charge Fault Level	System Action
53	P060800	7	According to the charging end process (send CST message to EMS and car controller), stop charging or prohibit to start charging.
54	P060900	7	According to the charging end process (send CST message to EMS and car controller), stop charging or prohibit to start charging.
55	P061000	1	Warning alarm, no operation;
56	P061100	1	Warning alarm, no operation;
57	P061200	1	Warning alarm, no operation;
58	P061300	1	Warning alarm, no operation;
59	P061400	1	Warning alarm, no operation;
60	P061500	1	Warning alarm, no operation;
61	P061600	1	Warning alarm, no operation;
62	P061700	1	Warning alarm, no operation;
63	P061800	1	Warning alarm, no operation;
64	P061900	1	Warning alarm, no operation;
65	P062000	1	Warning alarm, no operation;
66	P062100	1	Warning alarm, no operation;
67	P062200	1	Warning alarm, no operation;
68	P062300	1	Warning alarm, no operation;
69	P062400	1	Warning alarm, no operation;



Position	DTC code	Charge Fault Level	System Action
70	P062500	7	According to the charging end process (send CST message to EMS and car controller), stop charging or prohibit to start charging.
71	P062600	7	According to the charging end process (send CST message to EMS and car controller), stop charging or prohibit to start charging.
72	P062700	7	According to the charging end process (send CST message to EMS and car controller), stop charging or prohibit to start charging.
73	P062800	7	According to the charging end process (send CST message to EMS and car controller), stop charging or prohibit to start charging.
74	P062900	7	According to the charging end process (send CST message to EMS and car controller), stop charging or prohibit to start charging.
75	P063000	7	According to the charging end process (send CST message to EMS and car controller), stop charging or prohibit to start charging.
76	P063100	1	Warning alarm, no operation;
77	P063200	1	Warning alarm, no operation;
78	P063300	7	According to the charging end process (send CST message to EMS and car controller), stop charging or prohibit to start charging.



Position	DTC code	Charge Fault Level	System Action
79	P06340 0	7	According to the charging end process (send CST message to EMS and car controller), stop charging or prohibit to start charging.
80	P06350 0	7	According to the charging end process (send CST message to EMS and car controller), stop charging or prohibit to start charging.
81	P06360 0	7	According to the charging end process (send CST message to EMS and car controller), stop charging or prohibit to start charging.
82	P06370 0	1	Warning alarm, no operation;
83	P06380 0	1	Warning alarm, no operation;
84	P06390 0	1	Warning alarm, no operation;
85	P06400 0	1	Warning alarm, no operation;
86	P06410 0	1	Warning alarm, no operation;
87	P06420 0	1	Warning alarm, no operation;
88	P06430 0	1	Warning alarm, no operation;
89	P06440 0	1	Warning alarm, no operation;
90	P06450 0	1	Warning alarm, no operation;
91	P06460 0	1	Warning alarm, no operation;
92	P06470 0	1	Warning alarm, no operation;
93	P06480 0	1	Warning alarm, no operation;
94	P06490 0	1	Warning alarm, no operation;



Position	DTC code	Charge Fault Level	System Action
95	P065000	7	According to the charging end process (send CST message to EMS and car controller), stop charging or prohibit to start charging.
96	P065100	7	According to the charging end process (send CST message to EMS and car controller), stop charging or prohibit to start charging.
97	P065200	7	According to the charging end process (send CST message to EMS and car controller), stop charging or prohibit to start charging.
98	P065300	7	According to the charging end process (send CST message to EMS and car controller), stop charging or prohibit to start charging.
99	P065400	1	Warning alarm, no operation;
100	P065500	1	Warning alarm, no operation;
101	P065600	1	Warning alarm, no operation;
102	P065700	1	Warning alarm, no operation;
103	P065800	1	Warning alarm, no operation;
104	P065900	1	Warning alarm, no operation;
105	P066000	1	Warning alarm, no operation;
106	P066100	1	Warning alarm, no operation;
107	P066200	1	Warning alarm, no operation;
108	P066300	1	Warning alarm, no operation;
109	P066400	1	Warning alarm, no operation;



Position	DTC code	Charge Fault Level	System Action
110	P066500	1	Warning alarm, no operation;
111	P037600	7	According to the charging end process (send CST message to EMS and car controller), stop charging or prohibit to start charging.
112	U031587	7	According to the charging end process (send CST message to EMS and car controller), stop charging or prohibit to start charging.
113	P037000	7	According to the charging end process (send CST message to EMS and car controller), stop charging or prohibit to start charging.
114	P034100	7	According to the charging end process (send CST message to EMS and car controller), stop charging or prohibit to start charging.
115	P051000	7	According to the charging end process (send CST message to EMS and car controller), stop charging or prohibit to start charging.
116	P051100	10	Directly cut off the relay, end of charge.
117	P036300	7	According to the charging end process (send CST message to EMS and car controller), stop charging or prohibit to start charging.

### 4.3 CCU Repair Action

- ◆ ⇒ "CCU DTC Code Table" på side 54
- ◆ ⇒ "CCU Action Table" på side 59

Position	DTC code	Repair Action
1	P030100	
2	P030200	



Position	DTC code	Repair Action
3	P030300	
4	U030487	
5	U030588	
6	U030687	
7	U030788	
8	U030887	
9	P030900	
10	P031000	
11	P031100	
12	P031200	
13	P0313F0	
14	P0314F1	
15	P0315F2	
16	P0315F3	
17	P031600	
18	P031700	
19	P031800	
20	P031900	
21	P032000	
22	P032100	
23	P032200	
24	P032300	
25	P032400	
26	P032500	
27	P032600	
28	P032700	
29	P032800	
30	P032900	
31	P0330F1	
32	P0331F2	
33	P0332F3	
34	P033300	
35	P033400	
36	P033500	
37	P033900	
38	P034000	
39	P035900	
40	P036000	
41	P038300	



Position	DTC code	Repair Action
42	P038400	
43	P038500	
44	P038600	
45	P038800	
46	P060100	
47	P060200	
48	P060300	
49	P060400	
50	P060500	
51	P060600	
52	P060700	
53	P060800	
54	P060900	
55	P061000	
56	P061100	
57	P061200	
58	P061300	
59	P061400	
60	P061500	
61	P061600	
62	P061700	
63	P061800	
64	P061900	
65	P062000	
66	P062100	
67	P062200	
68	P062300	
69	P062400	
70	P062500	
71	P062600	
72	P062700	
73	P062800	
74	P062900	
75	P063000	
76	P063100	
77	P063200	
78	P063300	
79	P063400	
80	P063500	



Position	DTC code	Repair Action
81	P063600	
82	P063700	
83	P063800	
84	P063900	
85	P064000	
86	P064100	
87	P064200	
88	P064300	
89	P064400	
90	P064500	
91	P064600	
92	P064700	
93	P064800	
94	P064900	
95	P065000	
96	P065100	
97	P065200	
98	P065300	
99	P065400	
100	P065500	
101	P065600	
102	P065700	
103	P065800	
104	P065900	
105	P066000	
106	P066100	
107	P066200	
108	P066300	
109	P066400	
110	P066500	
111	P037600	
112	U031587	
113	P037000	
114	P034100	
115	P051000	
116	P051100	
117	P036300	



## 5 BMS DTC Matrix

### 5.1 BMS DTC Code Table

- ◆ ⇒ "BMS Action Table" på side 75
- ◆ ⇒ "BMS Repair Action" på side 101

Position	DTC code	DTC Description
1	P0563F0	Power supply overvoltage level1
2	P0562F0	Power supply undervoltage level1
3	P0B0100	Power supply open circuit
4	P0B3C00	Power supply circuit fault
5	P0E03F0	Cell temperature diff is too big level 1 failure
6	P064100	Pack current sensor power supply fault
7	P0B3BF3	MSD FAULT
8	P002000	HWInitFlt
9	P002100	SysInitFlt
10	P0B0200	watchdog reset
11	U007388	PT CAN Busoff
12	U070000	PT CAN EMS timeout
13	U0701F2	PT CAN HALL timeout
14	P0A7DF2	Low SOC level 1 fault
15	P0A7DF3	Low SOC level 2 fault
16	P0DF6F0	Low SOH level 1 fault
17	P0DF6F1	Low SOH level 2 fault
18	P0DF6F2	Low SOH level 3 fault
19	P0DF7F0	Over discharging power level 1 fault
20	P0DF7F1	Over discharging power level 2 fault
21	P0DF7F2	Over discharging power level 3 fault
22	P0DF8F0	Over charging power level 1 fault
23	P0DF8F1	Over charging power level 2 fault
24	P0DF8F2	Over charging power level 3 fault
25	P0DE7F0	Cell overvoltage level 1 failure
26	P0DE7F1	Cell overvoltage level 2 failure
27	P0DE7F2	Cell overvoltage level 3 failure
28	P0DFEF3	Cell overcharging failure
29	P0DE6F0	Cell undervoltage level 1 failure



Position	DTC code	DTC Description
30	P0DE6F1	Cell undervoltage level 2 failure
31	P0DE6F2	Cell undervoltage level 3 failure
32	P0DFFF3	Cell undercharging failure
33	P072429	Cell voltage rationality failure
34	P0E00F2	Cell voltage diff is too big level 3 failure
35	P0E01F0	Cell overtemperature level 1 failure
36	P0E01F1	Cell overtemperature level 2 failure
37	P0E01F2	Cell overtemperature level 3 failure
38	P0E01F3	Cell overtemperature failure
39	P0E03F0	Cell temperature diff is too big level 1 failure
40	P072529	Cell temperature rationality failure
41	P0AFBF1	Pack overvoltage level 1 failure
42	P0AFBF2	Pack overvoltage level 2 failure
43	P0AFAF1	Pack undervoltage level 1 failure
44	P0AFAF2	Pack undervoltage level 2 failure
45	P0DF7F3	Pack overcurrent failure
46	P0DEA00	Current rationality failure
47	P0AF800	Pack voltage rationality failure
48	P0B5000	Precharge voltage rationality failure
49	P0ADC00	The driver of positive relay short to power supply
50	P0ADBF3	The driver of positive relay short to ground
51	P0AD900	The driver of positive relay open circuit
52	P0AE000	The driver of negative relay short to power supply
53	P0ADFF3	The driver of negative relay short to ground
54	P0ADD00	The driver of negative relay open circuit
55	P0AE700	The driver of precharge relay short to power supply
56	P0AE6F3	The driver of precharge relay short to ground or open circuit
57	P070000	The driver of pack1 relay short to power supply



Position	DTC code	DTC Description
58	P0701F3	The driver of pack1relay short to ground
59	P070200	The driver of pack2 relay short to power supply
60	P0703F3	The driver of pack2 relay short to ground
61	P0AA2F3	Open failure for positive relay
62	P0AA1F1	Adhesion failure for positive relay
63	P0AA5F3	Open failure for negative relay
64	P0AA400	Adhesion failure for negative relay
65	P0AE3F3	Open failure for pre-charge relay
66	P0AE2F3	Adhesion failure for pre-charge relay
67	P0714F0	Adhesion failure of Pack1 relay
68	P0715F0	Adhesion failure of Pack2 relay
69	P073100	Open failure of pack1 relay
70	P073200	Open failure of pack2 relay
71	P0718F3	Open failure of fuse
72	P0B0300	Cut off with load
73	P0B09F3	Precharging failure
74	P0B0AF3	Short circuit of pre-charge load
75	P0AA6F0	Insulation level 1 failure detection
76	P0AA6F1	Insulation level 2 failure detection
77	P0AA6F2	Insulation level 3 failure detection
78	P0A0A00	Open failure of HVIL
79	P0A0D00	Short to power supply of HVIL
80	P0A0C00	Short to ground of HVIL
81	P0B4400	Balance resistance overtemperature
82	P0B4500	Balance circuit running without command
83	P0B4600	Balance circuit not running without command
84	P0B5A00	Internal NVM failure
85	P0B39F0	The driver of CMU power supply short to power supply
86	P0B3AF3	The driver of CMU power supply short to ground or open circuit



Position	DTC code	DTC Description
87	P0DD900	Internal failure of CMU1
88	P0DDB00	Internal failure of CMU2
89	U000987	Communication failure of CMU1
90	U000A87	Communication failure of CMU2
91	P0DE900	Internal failure of SBC
92	U001287	SBC CAN failure
93	P070800	Inlet temperature rationality failure of pack1
94	P070900	Outlet temperature rationality failure of pack1
95	P071000	Inlet temperature rationality failure of pack2
96	P071100	Outlet temperature rationality failure of pack2
97	P073500	

## 5.2 BMS Action Table

- ◆ ⇒ "BMS DTC Code Table" på side 72
- ◆ ⇒ "BMS Repair Action" på side 101



Position	DTC code	Charge Fault Level	System Action	DisCharge Fault Level	System Action
1	P0563F0	7	Derate power2 In charging: Derating the charge power to 0% within 10s, (K13/K14/K19) / (K15/K16/K20) are not opened; After the fault recovery,the charging power returned to normal.	7	Derate power2 In discharging: Derating the discharge power to 0% within 10s, (K13/K14/K19) / (K15/K16/K20) are not opened; After the fault recovery,the discharging power returned to normal.
2	P0562F0	7	Derate power2 In charging: Derating the charge power to 0% within 10s, (K13/K14/K19) / (K15/K16/K20) are not opened; After the fault recovery,the charging power returned to normal.	7	Derate power2 In discharging: Derating the discharge power to 0% within 10s, (K13/K14/K19) / (K15/K16/K20) are not opened; After the fault recovery,the discharging power returned to normal.
3	P0B0100	1	Warning	1	Warning
4	P0B3C00	1	Warning	1	Warning
5	P0E03F0	0	Normal	0	Normal





Position	DTC code	Charge Fault Level	System Action	Discharge Fault Level	System Action
6	P064100	1	Warning	1	Warning
7	P0B3BF3	10	Derating the charging or discharging power to 0% within 10s, open (K13/K14/K19) / (K15/K16/K20) and the relay are not allowed to be closed this time. If no current fault after next power on, fault cleared.	10	Derating the charging or discharging power to 0% within 10s, open (K13/K14/K19) / (K15/K16/K20) and the relay are not allowed to be closed this time. If no current fault after next power on, fault cleared.
8	P002000	7	Derate power2 In charging: Derating the charge power to 0% within 10s, (K13/K14/K19) / (K15/K16/K20) are not opened; After the fault recovery, the charging power returned to normal.	7	Derate power2 In discharging: Derating the discharge power to 0% within 10s, (K13/K14/K19) / (K15/K16/K20) are not opened; After the fault recovery, the discharging power returned to normal.
9	P002100	1	Warning	1	Warning
10	P0B0200	1	Warning	1	Warning



Position	DTC code	Charge Fault Level	System Action	DisCharge Fault Level	System Action
11	U007388	1	Warning	1	Warning
12	U070000	1	Warning	1	Warning
13	U0701F2	7	Derate power2 In charging: Derating the charge power to 0% within 10s, (K13/K14/K19) / (K15/K16/K20) are not opened; After the fault recovery,the charging power returned to normal.	7	Derate power2 In discharging: Derating the discharge power to 0% within 10s, (K13/K14/K19) / (K15/K16/K20) are not opened; After the fault recovery,the discharging power returned to normal.
14	P0A7DF2	0	Normal	1	Warning
15	P0A7DF3	0	Normal	7	Derate power2 In discharging: Derating the discharge power to 0% within 10s, (K13/K14/K19) / (K15/K16/K20) are not opened; After the fault recovery,the discharging power returned to normal.



Position	DTC code	Charge Fault Level	System Action	DisCharge Fault Level	System Action
16	P0DF6F0	1	Warning	1	Warning
17	P0DF6F1	1	Warning	1	Warning
18	P0DF6F2	1	Warning	1	Warning
19	P0DF7F0	0	Normal	1	Warning
20	P0DF7F1	0	Normal	4	Derate power1 In discharging: Derating the discharge power to 50% within 10s, (K18/K19/K20) / (K15/K16/K20) are not opened; After the fault recovery, the discharging power returned to normal.



Position	DTC code	Charge Fault Level	System Action	DisCharge Fault Level	System Action
21	P0DF7F 2	0	Normal	7	Derate power2 In discharging: Derating the discharge power to 0% within 10s, (K13/K14/K19) / (K15/K16/K20) are not opened; After the fault recovery,the discharging power returned to normal.
22	P0DF8F 0	1	Warning	0	Normal
23	P0DF8F 1	4	Derate power1 In charging: Derating the charge power to 50% within 10s, (K18/K19/K20) / (K15/K16/K20) are not opened; After the fault recovery,the charging power returned to normal.	0	Normal



Position	DTC code	Charge Fault Level	System Action	DisCharge Fault Level	System Action
24	P0DF8F 2	7	Derate power2 In charging: Derating the charge power to 0% within 10s, (K13/K14/K19) / (K15/K16/K20) are not opened; After the fault recovery,the charging power returned to normal.	0	Normal
25	P0DE7F 0	1	Warning	0	Normal
26	P0DE7F 1	4	Derate power1 In charging: Derating the charge power to 50% within 10s, (K18/K19/K20) / (K15/K16/K20) are not opened; After the fault recovery,the charging power returned to normal.	0	Normal



Position	DTC code	Charge Fault Level	System Action	DisCharge Fault Level	System Action
27	P0DE7F2	7	Derate power2 In charging: Derating the charge power to 0% within 10s, (K13/K14/K19) / (K15/K16/K20) are not opened; After the fault recovery,the charging power returned to normal.	0	Normal
28	P0DFEF3	10	Dereating the charging or discharging power to 0% within 10s, open (K13/K14/K19) / (K15/K16/K20) and the relay are not allowed to be closed this time. If no current fault after next power on, fault cleared.	0	Normal
29	P0DE6F0	0	Normal	1	Warning



Position	DTC code	Charge Fault Level	System Action	Discharge Fault Level	System Action
30	P0DE6F 1	0	Normal	4	Derate power1 In discharging: Derating the discharge power to 50% within 10s, (K18/K19/K20) / (K15/K16/K20) are not opened; After the fault recovery, the discharging power returned to normal.
31	P0DE6F 2	4	Derate power1 In charging: Derating the charge power to 50% within 10s, (K18/K19/K20) / (K15/K16/K20) are not opened; After the fault recovery, the charging power returned to normal.	7	Derate power2 In discharging: Derating the discharge power to 0% within 10s, (K13/K14/K19) / (K15/K16/K20) are not opened; After the fault recovery, the discharging power returned to normal.



Position	DTC code	Charge Fault Level	System Action	DisCharge Fault Level	System Action
32	P0DFFF 3	4	Derate power In charging: Derating the charge power to 50% within 10s, (K18/K19/K20) / (K15/K16/K20) are not opened; After the fault recovery, the charging power returned to normal.	10	Dereating the charging or discharging power to 0% within 10s, open (K13/K14/K19) / (K15/K16/K20) and the relay are not allowed to be closed this time. If no current fault after next power on, fault cleared.
33	P07242 9	10	Dereating the charging or discharging power to 0% within 10s, open (K13/K14/K19) / (K15/K16/K20) and the relay are not allowed to be closed this time. If no current fault after next power on, fault cleared.	10	Dereating the charging or discharging power to 0% within 10s, open (K13/K14/K19) / (K15/K16/K20) and the relay are not allowed to be closed this time. If no current fault after next power on, fault cleared.





Position	DTC code	Charge Fault Level	System Action	DisCharge Fault Level	System Action
34	P0E00F2	4	Derate power1 In charging: Derating the charge power to 50% within 10s, (K18/K19/K20) / (K15/K16/K20) are not opened; After the fault recovery, the charging power returned to normal.	4	Derate power1 In discharging: Derating the discharge power to 50% within 10s, (K18/K19/K20) / (K15/K16/K20) are not opened; After the fault recovery, the discharging power returned to normal.
35	P0E01F0	1	Warning	1	Warning
36	P0E01F1	4	Derate power1 In charging: Derating the charge power to 50% within 10s, (K18/K19/K20) / (K15/K16/K20) are not opened; After the fault recovery, the charging power returned to normal.	4	Derate power1 In discharging: Derating the discharge power to 50% within 10s, (K18/K19/K20) / (K15/K16/K20) are not opened; After the fault recovery, the discharging power returned to normal.



Position	DTC code	Charge Fault Level	System Action	DisCharge Fault Level	System Action
37	P0E01F2	7	Derate power2 In charging: Derating the charge power to 0% within 10s, (K13/K14/K19) / (K15/K16/K20) are not opened; After the fault recovery,the charging power returned to normal.	7	Derate power2 In discharging: Derating the discharge power to 0% within 10s, (K13/K14/K19) / (K15/K16/K20) are not opened; After the fault recovery,the discharging power returned to normal.
38	P0E01F3	10	Dereating the charging or discharging power to 0% within 10s, open (K13/K14/K19) / (K15/K16/K20) and the relay are not allowed to be closed this time. If no current fault after next power on, fault cleared.	10	Dereating the charging or discharging power to 0% within 10s, open (K13/K14/K19) / (K15/K16/K20) and the relay are not allowed to be closed this time. If no current fault after next power on, fault cleared.
39	P0E03F0	1	Warning	1	Warning



Position	DTC code	Charge Fault Level	System Action	DisCharge Fault Level	System Action
40	P072529	10	Dereating the charging or discharging power to 0% within 10s, open (K13/K14/K19) / (K15/K16/K20) and the relay are not allowed to be closed this time. If no current fault after next power on, fault cleared.	10	Dereating the charging or discharging power to 0% within 10s, open (K13/K14/K19) / (K15/K16/K20) and the relay are not allowed to be closed this time. If no current fault after next power on, fault cleared.
41	P0AFBF1	4	Derate power1 In charging: Derating the charge power to 50% within 10s, (K18/K19/K20) / (K15/K16/K20) are not opened; After the fault recovery, the charging power returned to normal.	0	Normal



Position	DTC code	Charge Fault Level	System Action	DisCharge Fault Level	System Action
42	P0AFBF 2	7	Derate power2 In charging: Derating the charge power to 0% within 10s, (K13/K14/K19) / (K15/K16/K20) are not opened; After the fault recovery,the charging power returned to normal.	0	Normal
43	P0AFAF 1	0	Normal	4	Derate power1 In discharging: Derating the discharge power to 50% within 10s, (K18/K19/K20) / (K15/K16/K20) are not opened; After the fault recovery,the discharging power returned to normal.



Position	DTC code	Charge Fault Level	System Action	DisCharge Fault Level	System Action
44	P0AFAF 2	0	Normal	7	Derate power In discharging: Derating the discharge power to 0% within 10s, (K13/K14/K19) / (K15/K16/K20) are not opened; After the fault recovery, the discharging power returned to normal.
45	P0DF7F 3	10	Dereating the charging or discharging power to 0% within 10s, open (K13/K14/K19) / (K15/K16/K20) and the relay are not allowed to be closed this time. If no current fault after next power on, fault cleared.	10	Dereating the charging or discharging power to 0% within 10s, open (K13/K14/K19) / (K15/K16/K20) and the relay are not allowed to be closed this time. If no current fault after next power on, fault cleared.
46	P0DEA 00	1	Warning	1	Warning
47	P0AF80 0	1	Warning	1	Warning
48	P0B500 0	1	Warning	1	Warning



Position	DTC code	Charge Fault Level	System Action	DisCharge Fault Level	System Action
49	P0ADC00	1	Warning	1	Warning
50	P0ADB F3	1	Warning	1	Warning
51	P0AD900	1	Warning	1	Warning
52	P0AE000	1	Warning	1	Warning
53	P0ADF F3	1	Warning	1	Warning
54	P0ADD00	1	Warning	1	Warning
55	P0AE700	1	Warning	1	Warning
56	P0AE6F3	1	Warning	1	Warning
57	P070000	1	Warning	1	Warning
58	P0701F3	10	Dereating the charging or discharging power to 0% within 10s, open (K13/K14/K19) / (K15/K16/K20) and the relay are not allowed to be closed this time. If no current fault after next power on, fault cleared.	7	Derate power2 In discharging: Derating the discharge power to 0% within 10s, (K13/K14/K19) / (K15/K16/K20) are not opened; After the fault recovery, the discharging power returned to normal.
59	P070200	1	Warning	1	Warning



Position	DTC code	Charge Fault Level	System Action	DisCharge Fault Level	System Action
60	P0703F3	10	Dereating the charging or discharging power to 0% within 10s, open (K13/K14/K19) / (K15/K16/K20) and the relay are not allowed to be closed this time. If no current fault after next power on, fault cleared.	7	Derate power2 In discharging: Dereating the discharge power to 0% within 10s, (K13/K14/K19) / (K15/K16/K20) are not opened; After the fault recovery, the discharging power returned to normal.
61	P0AA2F3	10	Dereating the charging or discharging power to 0% within 10s, open (K13/K14/K19) / (K15/K16/K20) and the relay are not allowed to be closed this time. If no current fault after next power on, fault cleared.	10	Dereating the charging or discharging power to 0% within 10s, open (K13/K14/K19) / (K15/K16/K20) and the relay are not allowed to be closed this time. If no current fault after next power on, fault cleared.



Position	DTC code	Charge Fault Level	System Action	DisCharge Fault Level	System Action
62	P0AA1F 1	10	Dereating the charging or discharging power to 0% within 10s, open (K13/K14/K19) / (K15/K16/K20) and the relay are not allowed to be closed this time. If no current fault after next power on, fault cleared.	10	Dereating the charging or discharging power to 0% within 10s, open (K13/K14/K19) / (K15/K16/K20) and the relay are not allowed to be closed this time. If no current fault after next power on, fault cleared.
63	P0AA5F 3	10	Dereating the charging or discharging power to 0% within 10s, open (K13/K14/K19) / (K15/K16/K20) and the relay are not allowed to be closed this time. If no current fault after next power on, fault cleared.	10	Dereating the charging or discharging power to 0% within 10s, open (K13/K14/K19) / (K15/K16/K20) and the relay are not allowed to be closed this time. If no current fault after next power on, fault cleared.





Position	DTC code	Charge Fault Level	System Action	DisCharge Fault Level	System Action
64	P0AA400	10	Dereating the charging or discharging power to 0% within 10s, open (K13/K14/K19) / (K15/K16/K20) and the relay are not allowed to be closed this time. If no current fault after next power on, fault cleared.	10	Dereating the charging or discharging power to 0% within 10s, open (K13/K14/K19) / (K15/K16/K20) and the relay are not allowed to be closed this time. If no current fault after next power on, fault cleared.
65	P0AE3F3	10	Dereating the charging or discharging power to 0% within 10s, open (K13/K14/K19) / (K15/K16/K20) and the relay are not allowed to be closed this time. If no current fault after next power on, fault cleared.	10	Dereating the charging or discharging power to 0% within 10s, open (K13/K14/K19) / (K15/K16/K20) and the relay are not allowed to be closed this time. If no current fault after next power on, fault cleared.



Position	DTC code	Charge Fault Level	System Action	DisCharge Fault Level	System Action
66	P0AE2F3	10	Dereating the charging or discharging power to 0% within 10s, open (K13/K14/K19) / (K15/K16/K20) and the relay are not allowed to be closed this time. If no current fault after next power on, fault cleared.	10	Dereating the charging or discharging power to 0% within 10s, open (K13/K14/K19) / (K15/K16/K20) and the relay are not allowed to be closed this time. If no current fault after next power on, fault cleared.
67	P0714F0	1	Warning	1	Warning
68	P0715F0	1	Warning	1	Warning
69	P073100	10	Dereating the charging or discharging power to 0% within 10s, open (K13/K14/K19) / (K15/K16/K20) and the relay are not allowed to be closed this time. If no current fault after next power on, fault cleared.	10	Dereating the charging or discharging power to 0% within 10s, open (K13/K14/K19) / (K15/K16/K20) and the relay are not allowed to be closed this time. If no current fault after next power on, fault cleared.



Position	DTC code	Charge Fault Level	System Action	DisCharge Fault Level	System Action
70	P073200	10	Dereating the charging or discharging power to 0% within 10s, open (K13/K14/K19) / (K15/K16/K20) and the relay are not allowed to be closed this time. If no current fault after next power on, fault cleared.	10	Dereating the charging or discharging power to 0% within 10s, open (K13/K14/K19) / (K15/K16/K20) and the relay are not allowed to be closed this time. If no current fault after next power on, fault cleared.
71	P0718F3	10	Dereating the charging or discharging power to 0% within 10s, open (K13/K14/K19) / (K15/K16/K20) and the relay are not allowed to be closed this time. If no current fault after next power on, fault cleared.	7	Derate power2 In discharging: Dereating the discharge power to 0% within 10s, (K13/K14/K19) / (K15/K16/K20) are not opened; After the fault recovery, the discharging power returned to normal.
72	P0B0300	1	Warning	1	Warning



Position	DTC code	Charge Fault Level	System Action	DisCharge Fault Level	System Action
73	P0B09F3	10	Dereating the charging or discharging power to 0% within 10s, open (K13/K14/K19) / (K15/K16/K20) and the relay are not allowed to be closed this time. If no current fault after next power on, fault cleared.	10	Dereating the charging or discharging power to 0% within 10s, open (K13/K14/K19) / (K15/K16/K20) and the relay are not allowed to be closed this time. If no current fault after next power on, fault cleared.
74	P0B0AF3	10	Dereating the charging or discharging power to 0% within 10s, open (K13/K14/K19) / (K15/K16/K20) and the relay are not allowed to be closed this time. If no current fault after next power on, fault cleared.	10	Dereating the charging or discharging power to 0% within 10s, open (K13/K14/K19) / (K15/K16/K20) and the relay are not allowed to be closed this time. If no current fault after next power on, fault cleared.
75	P0AA6F0	1	Warning	1	Warning



Position	DTC code	Charge Fault Level	System Action	DisCharge Fault Level	System Action
76	P0AA6F 1	4	Derate power1 In charging: Derating the charge power to 50% within 10s, (K18/K19/K20) / (K15/K16/K20) are not opened; After the fault recovery,the charging power returned to normal.	4	Derate power1 In discharging: Derating the discharge power to 50% within 10s, (K18/K19/K20) / (K15/K16/K20) are not opened; After the fault recovery,the discharging power returned to normal.
77	P0AA6F 2	10	Dereating the charging or discharging power to 0% within 10s, open (K13/K14/K19) / (K15/K16/K20) and the relay are not allowed to be closed this time. If no current fault after next power on, fault cleared.	10	Dereating the charging or discharging power to 0% within 10s, open (K13/K14/K19) / (K15/K16/K20) and the relay are not allowed to be closed this time. If no current fault after next power on, fault cleared.



Position	DTC code	Charge Fault Level	System Action	DisCharge Fault Level	System Action
78	P0A0A0 0	10	Dereating the charging or discharging power to 0% within 10s, open (K13/K14/K19) / (K15/K16/K20) and the relay are not allowed to be closed this time. If no current fault after next power on, fault cleared.	10	Dereating the charging or discharging power to 0% within 10s, open (K13/K14/K19) / (K15/K16/K20) and the relay are not allowed to be closed this time. If no current fault after next power on, fault cleared.
79	P0A0D0 0	1	Warning	1	Warning
80	P0A0C0 0	1	Warning	1	Warning
81	P0B440 0	1	Warning	1	Warning
82	P0B450 0	1	Warning	1	Warning
83	P0B460 0	1	Warning	1	Warning
84	P0B5A0 0	1	Warning	1	Warning
85	P0B39F 0	1	Warning	1	Warning



Position	DTC code	Charge Fault Level	System Action	DisCharge Fault Level	System Action
86	P0B3AF3	7	Derate power2 In charging: Derating the charge power to 0% within 10s, (K13/K14/K19) / (K15/K16/K20) are not opened; After the fault recovery,the charging power returned to normal.	7	Derate power2 In discharging: Derating the discharge power to 0% within 10s, (K13/K14/K19) / (K15/K16/K20) are not opened; After the fault recovery,the discharging power returned to normal.
87	P0DD900	1	Warning	1	Warning
88	P0DDB00	1	Warning	1	Warning
89	U000987	7	Derate power2 In charging: Derating the charge power to 0% within 10s, (K13/K14/K19) / (K15/K16/K20) are not opened; After the fault recovery,the charging power returned to normal.	7	Derate power2 In discharging: Derating the discharge power to 0% within 10s, (K13/K14/K19) / (K15/K16/K20) are not opened; After the fault recovery,the discharging power returned to normal.



Position	DTC code	Charge Fault Level	System Action	DisCharge Fault Level	System Action
90	U000A87	7	Derate power2 In charging: Derating the charge power to 0% within 10s, (K13/K14/K19) / (K15/K16/K20) are not opened; After the fault recovery,the charging power returned to normal.	7	Derate power2 In discharging: Derating the discharge power to 0% within 10s, (K13/K14/K19) / (K15/K16/K20) are not opened; After the fault recovery,the discharging power returned to normal.
91	P0DE900	1	Warning	1	Warning
92	U001287	1	Warning	1	Warning
93	P070800	1	Warning	1	Warning
94	P070900	1	Warning	1	Warning
95	P071000	1	Warning	1	Warning





Position	DTC code	Charge Fault Level	System Action	Discharge Fault Level	System Action
96	P071100	1	Warning	1	Warning
97	P073500	10	Dereating the charging or discharging power to 0% within 10s, open (K13/K14/K19) / (K15/K16/K20) and the relay are not allowed to be closed this time. If no current fault after next power on, fault cleared.	10	Dereating the charging or discharging power to 0% within 10s, open (K13/K14/K19) / (K15/K16/K20) and the relay are not allowed to be closed this time. If no current fault after next power on, fault cleared.

### 5.3 BMS Repair Action

- ◆ ⇒ "BMS DTC Code Table" på side 72
- ◆ ⇒ "BMS Action Table" på side 75

Position	DTC code	Repair Action
1	P0563F0	
2	P0562F0	
3	P0B0100	
4	P0B3C00	
5	P0E03F0	
6	P064100	
7	P0B3BF3	
8	P002000	
9	P002100	
10	P0B0200	
11	U007388	
12	U070000	
13	U0701F2	



Position	DTC code	Repair Action
14	P0A7DF2	
15	P0A7DF3	
16	P0DF6F0	
17	P0DF6F1	
18	P0DF6F2	
19	P0DF7F0	
20	P0DF7F1	
21	P0DF7F2	
22	P0DF8F0	
23	P0DF8F1	
24	P0DF8F2	
25	P0DE7F0	
26	P0DE7F1	
27	P0DE7F2	
28	P0DFEF3	
29	P0DE6F0	
30	P0DE6F1	
31	P0DE6F2	
32	P0DFFF3	
33	P072429	
34	P0E00F2	
35	P0E01F0	
36	P0E01F1	
37	P0E01F2	
38	P0E01F3	
39	P0E03F0	
40	P072529	
41	P0AFBF1	
42	P0AFBF2	
43	P0AFAF1	
44	P0AFAF2	
45	P0DF7F3	
46	P0DEA00	
47	P0AF800	
48	P0B5000	
49	P0ADC00	
50	P0ADB3F3	
51	P0AD900	
52	P0AE000	



Position	DTC code	Repair Action
53	P0ADFF3	
54	P0ADD00	
55	P0AE700	
56	P0AE6F3	
57	P070000	
58	P0701F3	
59	P070200	
60	P0703F3	
61	P0AA2F3	
62	P0AA1F1	
63	P0AA5F3	
64	P0AA400	
65	P0AE3F3	
66	P0AE2F3	
67	P0714F0	
68	P0715F0	
69	P037100	
70	P037200	
71	P0718F3	
72	P0B0300	
73	P0B09F3	
74	P0B0AF3	
75	P0AA6F0	
76	P0AA6F1	
77	P0AA6F2	
78	P0A0A00	
79	P0A0D00	
80	P0A0C00	
81	P0B4400	
82	P0B4500	
83	P0B4600	
84	P0B5A00	
85	P0B39F0	
86	P0B3AF3	
87	P0DD900	
88	P0DDB00	
89	U000987	
90	U000A87	
91	P0DE900	



Position	DTC code	Repair Action
92	U001287	
93	P070800	
94	P070900	
95	P071000	
96	P071100	
97	P073500	

## 6 Programvareversjoner

### 6.1 Styreenhetenes programvareversjoner

Betingelse

- Denne versjonen gjelder kun som eksempel. De aktuelle maskin- og programvareversjonene oppdateres kontinuerlig, derfor må du undersøke hvilken versjon som gjelder til enhver tid.

Component	SW-Version	HW-Version	Param-Version	Remarks
EMS	EMS0E00 1R450			previous version: EMS0E00 1R432
BMU1	BMU0E02 1R316			previous version: 17.06.2021 : BMU0E00 1R310
BMU2	BMU0E02 1R316			previous version: 17.06.2021 : BMU0E00 1R310
CCU1	CCU0E00 1R313			previous version: 17.06.2021 : CCU0E00 1R310
CCU2	CCU0E00 1R313			previous version: 17.06.2021 : CCU0E00 1R310



Component	SW-Version	HW-Version	Param-Version	Remarks
SECC1	SEC-CA100R031			
SECC2	SEC-CA100R031			
CMU1 - A	CMU0E001R034			previous version: 17.06.2021 : CMU0E001R032_20210517 CMU0E001R031
CMU2 - A	CMU0E001R034			previous version: 17.06.2021 : CMU0E001R032_20210517 CMU0E001R031
CMU1 - B	CMU0E001R034			previous version: 17.06.2021 : CMU0E001R032_20210517 CMU0E001R031
CMU2 - B	CMU0E001R034			previous version: 17.06.2021 : CMU0E001R032_20210517 CMU0E001R031
HCU (TMS)	TMS0D101T323			
TBOX1 (MCU)	MCU0E001R450			previous version: 17.06.2021 : MCUEHC2S0447R21_20210526



Component	SW-Version	HW-Version	Param-Version	Remarks
TBOX1 (MPU)	MCU0E001R450		MAC address	previous version: 17.06.2021 : MPUEHC2 S0431R21 _20210531
TBOX2 (MCU)	TBO-XE001T037			
TBOX2 (MPU)			MAC address	
AC Meter	SDM630-Modbus V2		630Mod-Bus_app_aligned210305	Exchanged with new version and flashed
DC Meter				
AC/DC G1	AC20A101R008 I1E2d0_UpgradeBL_ICS_A1d0 (specific APP) J1E3d0_BL_DuPower_A1d2 (BL)			addresses configured previous version: AC20A101R004 I1E2d0_UpgradeBL_ICS_A1d0 (specific APP) J1E3d0_BL_DuPower_A1d2 (BL)
AC/DC G2	AC20A101R008 I1E2d0_UpgradeBL_ICS_A1d0 (specific APP) J1E3d0_BL_DuPower_A1d2 (BL)			addresses configured previous version: AC20A101R004 I1E2d0_UpgradeBL_ICS_A1d0 (specific APP) J1E3d0_BL_DuPower_A1d2 (BL)



Component	SW-Version	HW-Version	Param-Version	Remarks
DC/DC G3	DC60A101 R009 I1E2d0_Up da- teBL_ICS_ A1d0 (spe- cific APP) J1E3d0_B L_DuPo- wer_A1d2 (BL)			addresses configured
DC/DC G3	DC60A101 R009 I1E2d0_Up da- teBL_ICS_ A1d0 (spe- cific APP) J1E3d0_B L_DuPo- wer_A1d2 (BL)			addresses configured
DC/DC G5	DC60A101 R009 I1E2d0_Up da- teBL_ICS_ A1d0 (spe- cific APP) J1E3d0_B L_DuPo- wer_A1d2 (BL)			addresses configured
DC/DC G6	DC60A101 R009 I1E2d0_Up da- teBL_ICS_ A1d0 (spe- cific APP) J1E3d0_B L_DuPo- wer_A1d2 (BL)			addresses configured
CCV	62.13.01			TID: 44262044
HMI	HMI 2.2.8- eon Kiosk-2.7.0			



Component	SW-Version	HW-Version	Param-Version	Remarks
Ad			01-tv-d30-v30-eon_global_drive_30Hero.mp4	
DC/DC (HV to LV)				