



VEHICLE SAFETY MANUFACTURING



WOM Lighting Your Way®



Lighting Your Way®

SINCE 1979

FULL LINE CATALOG

NEW PRODUCTS

VEHICLE SAFETY MANUFACTURING, LLC.

ALL MAKES ONE SOURCE

306A



P. 77



5016LED P. 41



3305

P. 31

P. 78



4500M 4500AK

P. 9



988172

45644A 45644



P. 24

P. 67
P. 68
P. 69



645W

655W

635W

7464

P. 37



6466

P. 22



3400A

3400W

3400

P. 90

9369TW



9362TW

P. 72



665W

P. 66

COMPANY PROFILE



Vehicle Safety Manufacturing has been a quality manufacturer of heavy duty vehicle components for almost 35 years. Today we manufacture literally thousands of heavy duty lighting and safety components for both the Original Equipment Manufacturers and the Aftermarket. Using techniques such as Total Quality Management, Continuous Process Improvement and Statistical Process Control, Vehicle Safety Manufacturing has built a solid reputation for producing quality and durable products.

Today, our commitment to quality and service is greater than ever. By continually investing in better technologies VSM is focused on designing and developing products to ensure that every product we manufacture provides you with the best possible performance and reliability.

Vehicle Safety Manufacturing is certified in ISO/TS 16949 and ISO 14001, we are continually refining and improving every aspect of our production, distribution and customer service operations to provide you the best products and services.



VEHICLE SAFETY MANUFACTURING, LLC



TABLE OF CONTENTS

Index

TURN SIGNAL SWITCHES, FLASHERS, RELAYS & CONNECTORS

Universal Turn Signal Switches.....	4-5,15	OEM Replacement Turn Signal Switches.....	6-15
Flashers & Relays.....	16	Flasher Connectors.....	17

LED LIGHTING

LED High Count Multi Diode Lamps.....	18-20	LED Mid-Turn Signal Lamp.....	50
LED Stop, Tail, Turn Signal Lamps.....	18-24	LED Cab Marker Lamps.....	51-53
LED Auxiliary Panel Lamps.....	25	LED Identification Bars.....	63-66
LED Clearance Marker Lamps	26-32, 54		

STOP, TAIL, TURN SIGNAL LAMPS

LED Stop, Tail, Turn Signal Lamps.....	18,20-24	OEM Rear Combination Lamps.....	38-41
Sealed Rear Signal Lamps.....	32-34	Metri Pack Combination Lamps.....	39
Oval Lamps in Stainless Panels.....	35	LED OEM Rear Combination Lamps.....	40-41
Replaceable Bulb Rear.....	36-37		

TURN SIGNAL LAMPS

Die Cast Front & Rear Turn Signal Lamps.....	42	LED Front Turn Signal Lamps.....	43
LED Die Cast Front & Rear Turn Signal Lamps...	43	Mid-Turn Signal Lamps.....	48
OEM Front Turn Signal Lamps.....	44-46		

CLEARANCE, MARKER LAMPS

Cab Marker Lamps	49-51	Armored Clearance Marker Lamps.....	60
Sealed Clearance Marker Lamps.....	52-58	Identification Bars.....	61-64
Replaceable Bulb Clearance Marker Lamps....	58-60		

AUXILIARY LIGHTING

Fog Lamps.....	65	Off-Road Lamps.....	65-71
Rubber Housing Auxiliary Lamps.....	65-66	LED Work Lights.....	66-71
Die Cast Auxiliary Lamps.....	65-71		

BACK-UP, DOME, UTILITY LAMPS, LICENSE PLATE LAMPS

Back-Up Lamps.....	72	License Plate Lamps.....	74
Dome & Utility Lamps.....	73	License Plate & Lamp Brackets.....	75



TABLE OF CONTENTS



Index

STROBE WARNING LAMPS, PLUG ADAPTERS & HARNESSSES

Strobe Lighting.....	76-77	Pigtails	79
Mini Bars.....	77	Plug Adapters	80
Potable LED Warning Lamps.....	78	Harness Connectors.....	81
		Metri Pack Connectors.....	81

MOUNTING ACCESSORIES, EMERGENCY LIGHTING, REFLEX REFLECTOR & CONSPICUITY TAPE

Mounting Grommets & Kits with Plugs.....	82	Reflex Reflectors, Round, Rectangular.....	86-87
Mounting Brackets	83	Narrow Rail Acrylic Reflector.....	87
Stainless Panels for Oval Lamps.....	84	Conspicuity Tape Rolls & Strips	88-89
Chrome Bezels.....	84	Conspicuity Reflector Strips.....	89
Fusee Cases & Brackets.....	85		
Lamp, Bulb, Fuse Hi-Way Safety Case.....	85		
Armored Type Reflectors.....	86		
Adhesive Back Reflectors.....	86-87		

ACCESSORIES , LED DISPLAYS, LENSES

Junction Terminal Blocks, Junction Box.....	90	Slow Moving Vehicle Emblem	91
Fuse-In-Lines & Holders.....	90	Glad Hand Lock & Grip.....	91
Back-Up Alarms.....	91	King Pin Lock.....	91
Circuit Testers.....	91		

Replacement Lenses.....92-93

PRODUCT INTERCHANGE.....	94-100
PART NUMBER TO PAGE INDEX.....	101-103
FEDERAL REGULATIONS	104-112



VSM TURN SIGNAL SWITCHES

Palanca Direccionales

All turn signal switches 12V standard



900

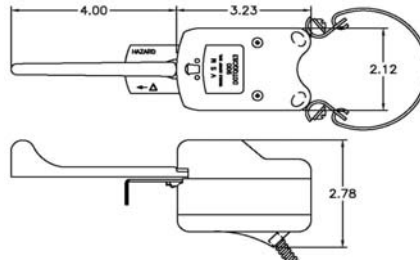

Features:

- Durable die cast construction
- Die cast handle with heavy duty flare tab
- Heavy gauge mounting strap and hardware
- Long lasting contacts extend switch life
- Heavy duty wiring



900HD

vsm900 7-Wire Harness, Flat Black

- For use on vehicles having combination stop and turn signal lamps and requiring brake light circuit

Replacement Bulb: 53

vsm900HD 7-Wire, Flat Black-Heavy Duty Handle

Replacement Bulb: 53

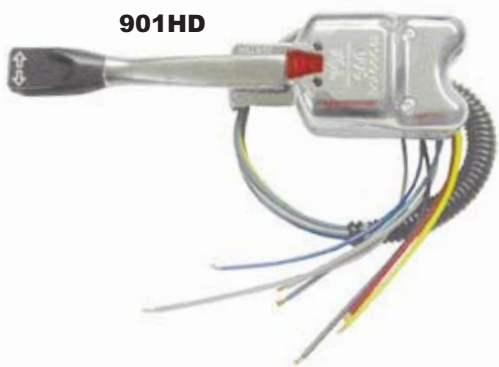

901HD

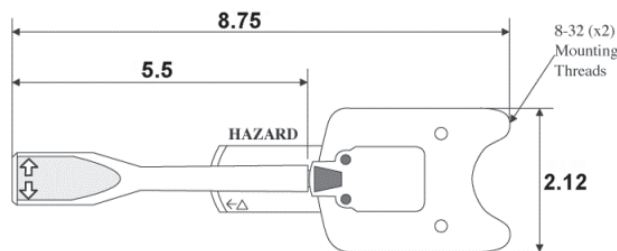

vsm901 7-Wire, Chrome Finish With Std. Handle

vsm901HD 7-Wire, Chrome Finish With HD Handle

- Heavy die cast construction
- Highest tested reliability in the industry

Replacement Bulb: 53

vsm902 4-Wire Harness Flat Black Housing

vsm903 4-Wire Harness Chrome Housing

For use on vehicles with separate, rear, stop and turn signal lamps.

- Separate green pilot lights to indicate left and right turns
- Separate red pilot light for hazard warning
- Simultaneously flashes turn signal lamps for hazard warning
- Ten bulb capacity for hazard warning, five bulbs per side for turn signal flashing
- Positive pilot action
- Does not include flasher or fuse-in-line

Replacement Bulb: 53

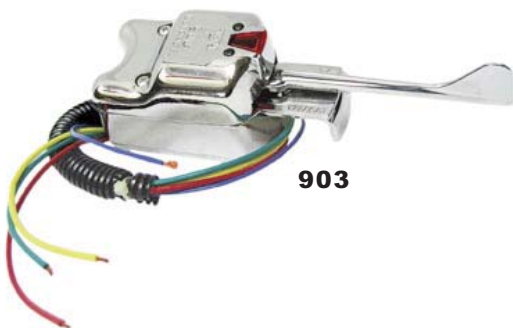

903

TURN SIGNAL SWITCHES



TURN SIGNAL SWITCHES



Palancas Direccionales

All turn signal switches 12V standard

HEAVY DUTY OEM DIE CAST UNIVERSAL TURN SIGNAL SWITCHES

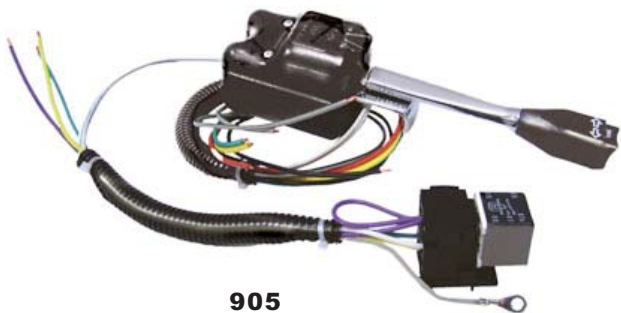

905

vsm905 11-Wire Harness, Flat Black Housing **vsm905C 11-Wire Harness, Chrome Housing**

- With built in push button, high/low beam switch
- Upgrades the 900 switch by moving high/low beam selector switch from floor to handle
- 11 wire harness with relay
- Same ease of operation and maintenance as vsm900
- No pilot lights



910

vsm910 7-Wire Harness, Flat Black Housing

- Heavy Duty Chrome Handle
- Heavy duty contacts
- 16-bulb capacity for hazard warning
- 8-bulbs per side for turn signal
- With pilot light

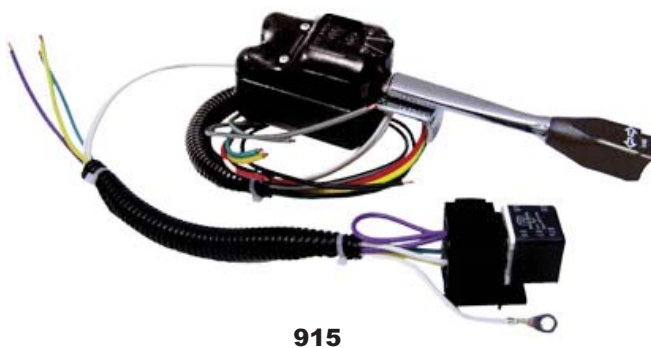

915

vsm915 11-Wire Harness with Relay, Flat Black Housing

- Heavy Duty contacts and Relay with High/Low Beam Switch
- For use on vehicles having combination stop and turn signal lamps requiring brake light circuit
- HD 16 bulb capacity for hazard warning, 8 bulbs per side for turn signal flashing
- No pilot lights
- Increased wire gauge for heavier loads
- Die cast metal housing and handle
- Retains same ease of operation and maintenance as vsm900
- Flasher and fuse line not included



935

vsm935 Heavy Duty Brake Light Override System

- Allows brake lights to function in rear hazard mode
- 16 bulb capacity
- Flasher and fuse line not included

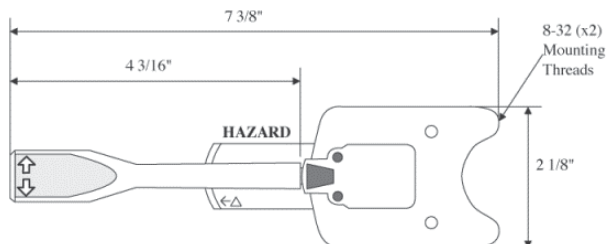

TURN SIGNAL SWITCHES





OEM TURN SIGNAL SWITCHES

Palancas Direccionales Para Equipo Original

VSM/OEM REPLACEMENT CHART

FORD

VSM #	FORD #
900Y170	E5HT13B302AA E5HZ13341A
900Y177	E9HT13B302AB E9HZ13341E
900Y179	FOHT-138203AB

FREIGHTLINER

VSM #	FREIGHTLINER #
999124	680-545-01-24
999490	A14-13495-000
999491	A06-22743-002***
999495	A14-13495-005
999496	A06-44025-000***
999177	GR01481177
999182	GR01481182
915Y113	A06-13867-002 A06-17126-000
915Y108	681-545-00-24

KENWORTH

VSM #	KENWORTH #
999836	480836
999839	480839H
999295	K301295-3
900Y96	K-301-182
915Y103	K301D230 18500D044
915Y704	K301-357
900Y209	K301D182

MACK

VSM #	MACK #
999574	1MR574
999575	1MR575
910Y601	1MR572
915Y703	1MR571
900Y73	1MR2201P2 1MR2201P1
900Y150	1MR3412 1MR3412P2

***NEW SWITCHES

NAVISTAR

VSM #	NAVISTAR #
900Y206	1663595C91
900Y114	1663595C91 775863C93 523848C91
999392	3544933C92
915Y118	1616317C91

PETERBILT

VSM #	PETERBILT #
999827	480827G
915Y104	16-03827
915Y114	16-04415
915Y124	16-06432
915Y121	16-05713

VSM UNIVERSAL SWITCHES

999282	Universal
900	Universal
905	Universal

VOLVO/GM

VSM #	VOLVO/GM #
900Y129	84401-0005
915Y105	84401-3203
915Y116	3081534
915Y117	3081533 84401-0020
988172	3172172***
988173	3172173***
988838	20797838***

WESTERN STAR

VSM #	WESTERN STAR #
918Y116	84401-3421
918Y994	84401-3429
918Y998	84401-3431

All Makes. One Source.



All Makes. One Source. The thought became a concept... and VSM made the idea a reality. VSM's turn signal switches feature modular plug-in harnesses that allow OEM replacements without rewiring for virtually every heavy duty vehicle make. They are highly reliable, having survived over one million cycles and proven cost effective under actual driving tests.

Features:

- Exceeds class A, SAE, QQC, and FMVSS108 specs
- Heavy Duty unitized construction
- Positive detent for better "driver feel" when signalling
- Capacity to flash 18 bulbs in hazard mode, 9 bulbs per side for turn signal flashing
- Heavy Duty hazard tab for long life and reliability in 4-way flasher operation
- Integrated stop lamp circuitry
- Durable, long lasting contacts for longer life
- Handle lift-to-dim high/low beam selector
- Integral mounting bracket provides a sturdy assembly
- Grease-free contact area

TURN SIGNAL SWITCHES

OEM TURN SIGNAL SWITCHES

Palancas Direccionales Para Equipo Original

All turn signal switches 12V standard

FREIGHTLINER



vsm999177

Replacement Turn Signal Switch for:
Freightliner GR01481177



vsm999490

Replacement Turn Signal Switch for:
Freightliner A14-13495-000
Handle is shadow gray in color.

vsm999495

Replacement Turn Signal Switch for:
Freightliner A14-13495-005
Handle is black in color.



vsm915Y108

Replacement Turn Signal Switch for:
Freightliner 681-545-00-24

- 8 wire harness
- Handle features built-in push button high/low beam selector
- 16 bulb capacity for hazard warning
- 8 bulbs per side for turn signal flashing



vsm999182

Replacement Turn Signal Switch for:
Freightliner GR01481182



vsm999124

Replacement Turn Signal Switch for:
Freightliner 680-545-01-24



vsm915Y113

Replacement Turn Signal Switch for
Freightliner A06-13867-002; A06-17126-000

- 10 wire harness
- Handle features built-in push button high/low beam selector
- 16 bulb capacity for hazard warning
- 8 bulbs per side for turn signal flashing

OEM TURN SIGNAL SWITCHES

VSM™ OEM TURN SIGNAL SWITCHES

FREIGHTLINER



vsm999124
Replacement Turn Signal Switch for:
Freightliner REF # 680-545-01-24



vsm999491
Replacement Turn Signal Switch for:
Freightliner REF # A06-22743-002
Handle is shadow gray in color



vsm999496
Replacement Turn Signal Switch for:
Freightliner REF # A06-44025-000
Handle is black in color



SELF CANCELING TURN SIGNAL SWITCHES



OEM TURN SIGNAL SWITCHES



All turn signal switches 12V standard

VOLVO



vsm988172
Replacement Turn Signal Switch for:
VOLVO OEM REF # 3172172

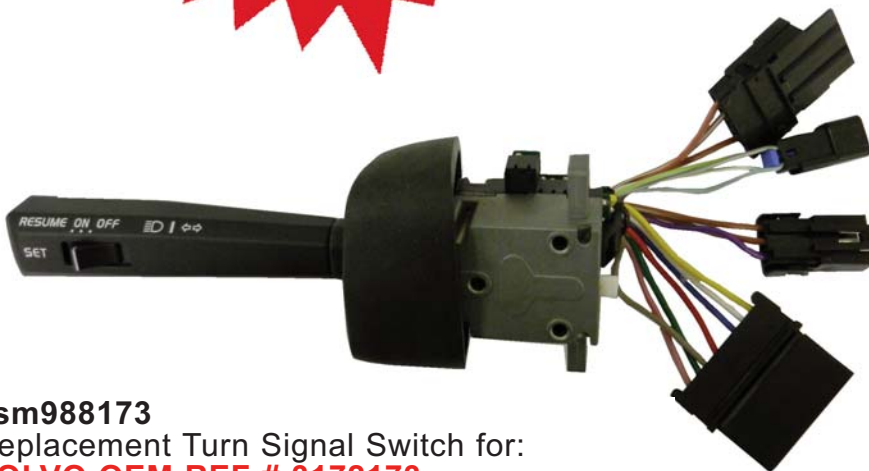

vsm988173
Replacement Turn Signal Switch for:
VOLVO OEM REF # 3172173

OEM TURN SIGNAL SWITCHES



VSM OEM TURN SIGNAL SWITCHES

Palancas Direccionales Para Equipo Original

MACK TRUCK



vsm999574
Replacement Turn Signal Switch for:
Mack 1MR574



vsm999575
Replacement Turn Signal Switch for:
Mack 1MR575



vsm900Y150
Replacement Turn Signal Switch for:
Mack 1MR3412; 1MR3412P2



vsm915Y703
Replacement Turn Signal Switch for:
Mack 1MR571



vsm900Y73
Replacement Turn Signal Switch for:
Mack 1MR2201P2; 1MR2201P1



vsm910Y601
Replacement Turn Signal Switch for:
Mack 1MR572

TURN SIGNAL SWITCHES

OEM TURN SIGNAL SWITCHES

Palancas Direccionales Para Equipo Original

All turn signal switches 12V standard

VOLVO



vsm915Y117

Replacement Turn Signal Switch for:
VOLVO/GM 3081533, 84401-0020

- 8 wire harness
- Handle features built-in push button high/low beam selector switch
- 16 bulb capacity for hazard warning
- 8 bulbs per side for turn signal flashing



vsm915Y116

Replacement Turn Signal Switch for:
VOLVO/GM 3081534, 84401-3421

- 8 wire harness
- Handle features built-in push button high/low beam selector switch
- 16 bulb capacity for hazard warning
- 8 bulbs per side for turn signal flashing



vsm915Y105

Replacement Turn Signal Switch for:
VOLVO/GM 84401-3203

- 8 wire harness
- Handle features built-in push button high/low beam selector switch
- 16 bulb capacity for hazard warning
- 8 bulbs per side for turn signal flashing



vsm900Y129

Replacement Turn Signal Switch for:
VOLVO/GM 84401-0005

- Pilot light for turn signal & hazard warning
- 10 bulb capacity for hazard warning, 5 bulbs per side for turn signal flashing

OEM TURN SIGNAL SWITCHES

VSM OEM TURN SIGNAL SWITCHES

Palancas Direccionales Para Equipo Original All turn signal switches 12V standard

KENWORTH



vsm999295
Replacement Turn Signal Switch for:
KENWORTH K301-295-3



vsm999839
Replacement Turn Signal Switch for:
KENWORTH 480839H



vsm915Y704
Replacement Turn Signal Switch for:
KENWORTH K301-357
• Handle features built-in push button
high/low beam selector switch



vsm915Y103
Replacement Turn Signal Switch for:
KENWORTH K301D230;18500D044
• 8 wire harness
• Handle features built-in push button high/low
beam selector switch
• 16 bulb capacity for hazard warning
• 8 bulbs per side for turn signal flashing



vsm999836
Replacement Turn Signal Switch for:
KENWORTH 480836E.



vsm900Y96
Replacement Turn Signal Switch for:
KENWORTH K-301-182
• Features pilot light for turn signal &
hazard warning
• 6 wire harness



vsm900Y209
Replacement Turn Signal Switch for:
KENWORTH K301D182
• 10 bulb capacity for hazard warning
• 5 bulbs per side for turn signal flashing

OEM TURN SIGNAL SWITCHES

Palancas Direccionales Para Equipo Original

All turn signal switches 12V standard

PETERBILT



vsm999827

Replacement Turn Signal Switch for:
PETERBILT 480827G



vsm915Y114

Replacement Turn Signal Switch for:
PETERBILT 16-04415

- 8 wire harness
- Handle features built-in push button high/low beam selector switch
- 16 bulb capacity for hazard warning
- 8 bulbs per side for turn signal flashing



vsm915Y121

Replacement Turn Signal Switch for:
PETERBILT 16-05713

- 18 wire harness
- Handle features built-in push button high/low beam selector switch



vsm915Y124

Replacement Turn Signal Switch for:
PETERBILT 16-06432

- 8 wire harness
- Handle features built-in push button high/low beam selector switch
- 16 bulb capacity for hazard warning
- 8 bulbs per side for signal flashing



vsm915Y104

Replacement Turn Signal Switch for:
PETERBILT 16-03827

- 17 wire harness
- Handle features built-in push button high/low beam selector switch
- 16 bulb capacity for hazard warning
- 8 bulbs per side for signal flashing

OEM TURN SIGNAL SWITCHES

VSM OEM TURN SIGNAL SWITCHES

Palancas Direccionales Para Equipo Original All turn signal switches 12V standard

FORD



vsm900Y170

Replacement for:

FORD E5HT13B302AA; E5HZ13341A

- 6 wire harness
- Pilot light for turn signal & hazard warning
- 10 bulb capacity for hazard warning
- 5 bulbs per side for signal flashing



vsm900Y179

Replacement for:

FORD FOHT-13B302AB

- Brake override
- 6 wire harness
- 10 bulb capacity for hazard warning
- 5 bulbs per side for turn signal flashing
- Pilot light for turn signal & hazard warning



vsm900Y177

Replacement for:

FORD E9HT13B302AB; E9HZ13341E

- 6 wire harness
- Pilot light for turn signal & hazard warning
- 10 bulb capacity for hazard warning
- 5 bulbs per side for turn signal flashing

NAVISTAR



vsm999392 Replacement Turn Signal Switch for:
NAVISTAR 3544933C92



vsm900Y114

Replacement Switch for:

NAVISTAR 1663595C91;
775863C93; 523848C91

- 6 wire harness
- Pilot light for turn signal & hazard warning
- 10 bulb capacity for hazard warning
- 5 bulbs per side for turn signal flashing



vsm915Y118

Replacement for:

NAVISTAR 1616317C91

- Turn signal switch dimmer
- 8 wire harness
- Handle features push-button high/low beam selector switch
- 16 bulb capacity for hazard warning
- 8 bulbs per side for turn signal flashing



vsm900Y206

Replacement switch for:

NAVISTAR 1663595C91

- 6 wire harness
- 10 bulb capacity for hazard warning
- 5 bulbs per side for turn signal flashing



OEM TURN SIGNAL SWITCHES

Palancas Direccionales Para Equipo Original

All turn signal switches 12V standard

WESTERN STAR



vsm918Y998
Replacement Turn Signal Switch for:
WESTERN STAR 84401-3431



vsm918Y994
Replacement Turn Signal Switch for:
WESTERN STAR 84401-3429



vsm918Y116
Replacement Turn Signal Switch for:
WESTERN STAR 84401-3421

UNIVERSAL



vsm999282
UNIVERSAL REPLACEMENT SWITCH
OEM Engineered Signal Switch for All Applications



vsm900
UNIVERSAL REPLACEMENT SWITCH
OEM Engineered Signal Switch for All Applications



vsm905
UNIVERSAL REPLACEMENT SWITCH
OEM Engineered for All Signal Switch Applications

vsm920
UNIVERSAL REPLACEMENT SWITCH



Golf Cart Applications

8WIRE, HORN BUTTON FEATURE

- Popular replacement switch for golf carts
- Fits "NEV's" Neighborhood Electric Vehicles
- Horn Push-Button Feature In Handle
- Die Cast Black Housing
- Heavy Duty Chrome Handle
- Heavy Duty Contacts and Wire

OEM TURN SIGNAL SWITCHES



VSM FLASHERS & RELAYS

Destelladores & Reles

FLASHERS & RELAYS

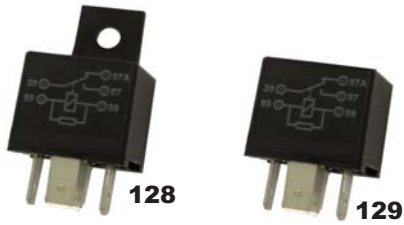

vsm129 Heavy Duty ISO Base Relay 12 volt

30 amp OEM relay designed for turn signal switches, headlight dimming. Also applies to horn, fog light, radio kill switch, clearance or marker light flasher

vsm128 Same as 129 except with tab



vsm254 2-Pin Flasher

Flasher 12 volt, 2-pin, 20 lamp, 45 amp

vsm255 2-Pin Electronic Flasher

3-pin, 20 lamp, 45 amp. electronic flasher

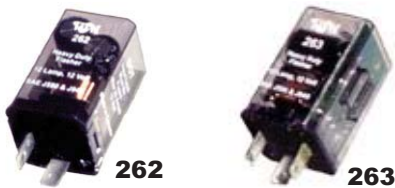
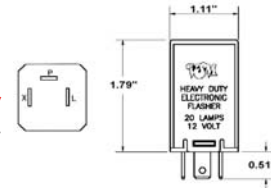

vsm262 12 Lamp Electronic Flasher

2-pin, 12 lamp, electronic flasher

vsm263 12 Lamp Electronic Flasher

3-pin, 12 lamp, electronic flasher

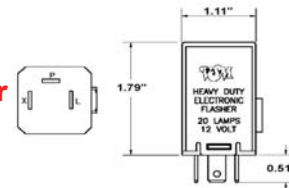

vsm557 2-Pin Electronic Flasher

2-pin, 10 lamp heavy duty electronic flasher

vsm558 3-Pin Electronic Flasher

3-pin, 10 lamp heavy duty electronic flasher

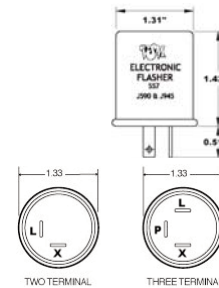

vsm285 2-Pin LED Solid State Flasher with ground wire

vsm287 3-Pin LED Solid State Flasher with ground wire

- Lamp Rating: .10 to 25 amp
- Rated Voltage: 11 to 15 volts DC
- Flash Rate: 60 to 120 flashes per minute

Meet or exceed DOT and SAE specifications.

Operates from 1 milliamps up to 6 amps- allowing the use of two incandescent signal lamps with LED stop, tail, turn signal lamps (i.e. side turn signals as vsm 6164A can be used in conjunction with vsm4464 LED lamps). Size: 1 $\frac{1}{8}$ " w x 1 $\frac{5}{8}$ " H

TURN SIGNAL SWITCHES

FLASHERS & CONNECTORS



Destelladores & Conectores

FLASHER/RELAY CONNECTORS

vsm9183 Universal Flasher/Bulb Connector

For use with plug in flashers or sealed beams

- Nylon housing
- 7" color coded wire leads with 16 gauge wire
- Without fuse-in-line
- For 12v or 24v applications

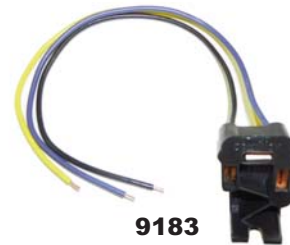

vsm9185 Relay Connector

- Nylon housing
- With 12" 14 gauge wire
- 12v or 24v applications

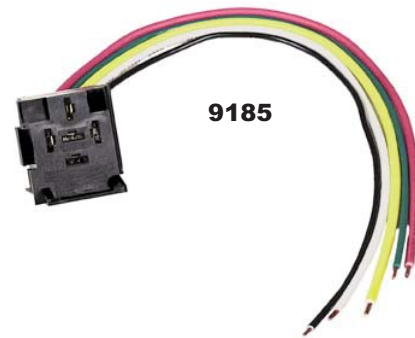

vsm9186 Flasher Connector

- Includes 15 amp blade type fuse, ring terminal on lead wire
- 7" color coded wire leads with 16 gauge wire
- Fuse-in-line included
- 12v or 24v applications



vsm9187 Universal Flasher Connector

Design provides for 2 or 3 pin flasher

- Includes 15 amp blade type fuse
- Ring terminal on lead wire
- 12v or 24v applications



VSM HIGH COUNT MULTIDIODE

Multi-Diodo LEDs

All Lamps 12 V Standard • Red Lens Standard

STOP/TAIL/TURN LED LAMPS

4" Round Sealed Lamps



4468X

44
DIODES

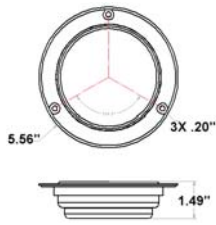

Features:

- Sonically welded high-impact polycarbonate lens and housing
- Nickel plated connector
- Electronics are totally sealed in epoxy resin for complete moisture, corrosion and vibration protection
- Industry standard connection hard wired
- 100,000 hour rated life

4" Round S/T/T Signal Lamps

Grommet Mount

4464X



4464X Red 44 Diode S/T/T Lamp Grommet Mount

4464AX Amber 44 Diode Turn Signal Lamp Grommet Mount

Welded Flange Mount

4468X Red 44 Diode S/T/T Lamp Welded Flange Mount

4468AX Amber 44 Diode Turn Signal Lamp Welded Flange Mount



4464AX

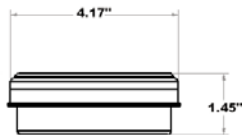

Replacement Parts:

Mounting Grommet **vsm9127** • Pigtails **vsm9124**, **vsm9128**



9127

HIGH COUNT/MULTI-DIODE LEDS

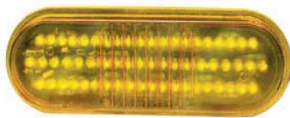

6464AX

52
DIODES

6" Oval Sealed S/T/T Signal Lamps

6464AX Amber 52 Diode Turn Signal Lamp for Grommet Mount

6464X Red 52 Diode S/T/T Lamp for Grommet Mount



6468X

6468AX

Flange Mount

6468AX Amber 52 Diode Turn Signal Lamp With Welded Flange Mount

6468X Red 52 Diode S/T/T Lamp With Welded Flange Mount

Replacement Parts:

Mounting Grommet **vsm9526** (sold separately)

Pigtails: **vsm9124**, **vsm9128**

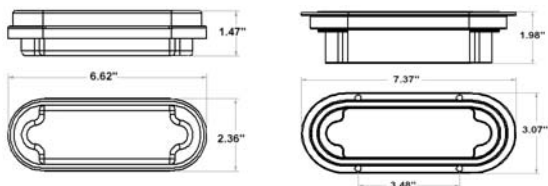

9526



HIGH COUNT / MULTIDIODE



Multi diodo

All Lamps 12 V Standard • Red Lens Standard

HIGH COUNT/MULTI-DIODE CLEARANCE/MARKER LED LAMPS

- Sonically welded high-impact Polycarbonate Lens And Housing
- Electronics Totally Sealed In Epoxy Resin For Complete Moisture, Corrosion and Vibration Protection
- Uses Standard Industry Grommets and Pigtail Connection

2 1/2" Round Sealed Clearance/Marker Lamps

- 1015AX** Amber 13 Diode Clearance/Marker Lamp
1015X Red 13 Diode Clearance/Marker Lamp
1015ACX Amber 13 Diode w/Clear Lens Clearance/Marker Lamp
1015RCX Red 13 Diode w/ Clear Lens Clearance/Marker Lamp
 Replacement Parts: Mounting Grommet vsm9119 • Pigtail vsm9122

13
DIODES



1015AX

1015X

2" Round Sealed Clearance/Marker Lamps

- 1035AX** Amber 10 Diode Clearance/Marker Lamp
1035X Red 10 Diode Clearance/Marker Lamp
1035ACX Amber 10 Diode w/Clear Lens Clearance/Marker Lamp
1035RCX Red 10 Diode w/Clear Lens Clearance/Marker Lamp
 Replacement Parts: Mounting Grommet vsm9139 • Pigtail vsm9122

10
DIODES



1035X

1035AX

2 1/2" 1500 Series Sealed Clearance/Marker Lamps

- 1505AX** Amber 8 Diode Clearance/Marker Lamp
1505X Red 8 Diode Clearance/Marker Lamp
 Mounts To Industry Standard Brackets, Replacement Pigtail vsm9122

8
DIODES



1505AX

1505X

4" 1900 Series Sealed Clearance/Marker Lamps

- Uses Industry Standard Mounting Brackets And Pigtail Connections
- 1905AX** Amber 12 Diode Clearance/Marker Lamp
1905X Red 12 Diode Clearance/Marker Lamp

12
DIODES



1905X

1905AX

Double Bulls Eye Clearance/ Marker Lamps

- Standard Industry Connections
- 1255X** Red 16 Diode Double Bulls Eye Clearance/Marker Lamp
1255AX Amber 16 Diode Double Bulls Eye Clearance/Marker Lamp

16
DIODES



1255X

1255AX

HIGH COUNT / MULTIDIODE LEDS



VSM LED STOP/TAIL/TURN LAMPS

Lamparas LED de Freno/Traseras/Direccionales

All Lamps 12 V Standard • 24 V also available

LED STOP/TAIL/TURN LAMPS

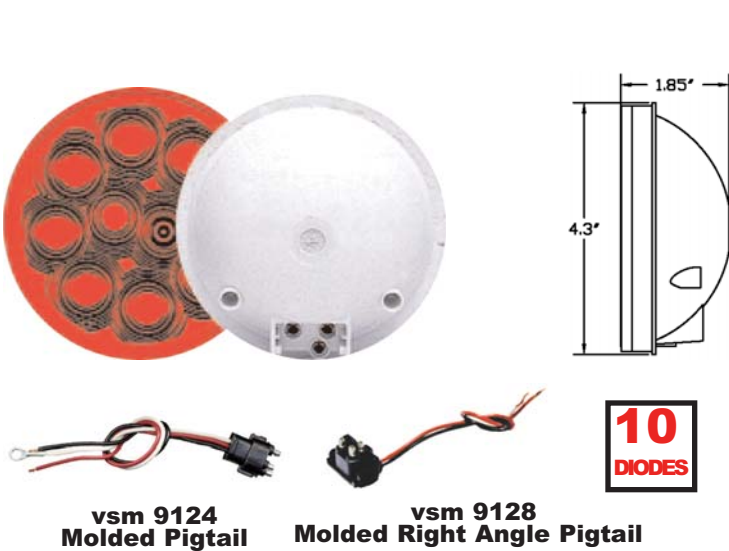

4400 SERIES

4" Round Sealed LED Stop/Tail/Turn Lamps

Features:

- Polycarbonate Lens and Housing
- 10 Super Flux LED Diodes
- Designed at 12.8 Volts, .210/.090 Amps Industry Standard Connections and Pin Out
- Circuitry Protected Against Voltage Surge and Spikes

Lamp Part Numbers

vsm4464 4" Red LED Stop/Tail/Turn Lamp

vsm4464A 4" Amber LED Auxiliary Signal Lamp

Clear Lens Low Profile LED Lamps

vsm4464RC 4" Red LED Stop/Tail/Turn Signal Lamp with Clear Lens

vsm4464AC 4" Amber LED Auxiliary Signal Lamp with Clear Lens

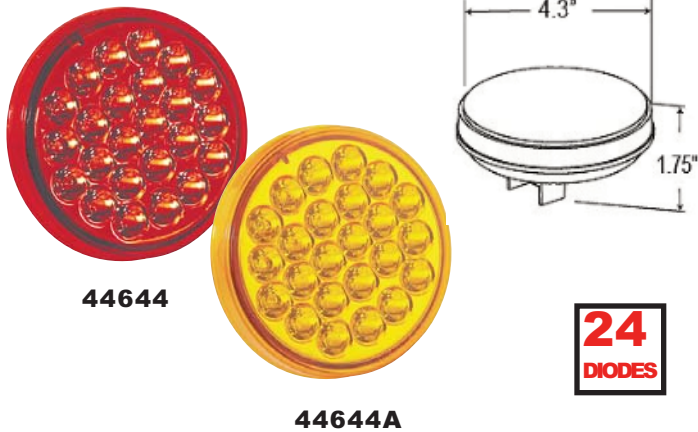

HIGH COUNT LED 4400 SERIES

- Super Flux 24 LED -Light Emitting Diodes
- Designed at 13.5V 0.42/0.12 Amp
- Sonically Sealed Polycarbonate Housing and Lens

4" Round Sealed Stop, Turn & Tail Light

vsm44644 24 LED Red Lamp

vsm44544 Kit (Lamp, Grommet, 3 Wire Plug)

4" Round Sealed Turn Signal & Parking Light

vsm44644A 24 LED Amber Lamp

vsm44544A Kit (Lamp, Grommet, 3 Wire Plug)

vsm9127 Grommet

vsm9128 3 Wire Plug Right Angle

vsm9124 Standard 3 Wire Plug



LOW PROFILE LED 4400 SERIES

4" Round Housing Design

- 10 diode LED Low Profile Housing Only 1 1/2" Thin
- Sure Seal Connection
- Sonically Sealed Housing and Lens

vsm4440 4" Red LED Stop/Tail/Turn Lamp

vsm9127 Grommet

vsm9427 Standard Harness to Sure Seal Plug



LED STOP/TAILOTURN LAMPS



Lamparas LED de Freno/Traseras/Direccionales

All Lamps 12 V Standard • 24 V also available

4400 SERIES LED LAMP KITS 4" Round Sealed LED S/T/T Lamps

LED Lamps Kits with PVC Grommet and Pigtail

- Kit includes 4400 Series LED lamp, vsm9127 PVC Grommet and vsm9124 Molded Rubber Pigtail

vsm4454 Red Stop, Tail, Turn Signal Lamp Kit

vsm4454A Amber Auxiliary Lamp Kit

vsm4454RC Clear lens Red Stop, Tail, Turn Signal Lamp Kit

vsm4454AC Clear lens Amber Auxiliary Lamp Kit



4454

10
DIODES

LED Lamps with Grey Flange

- Lamp with ABS Grey Flange for flush mounting - Lamp w/Clear lens is available

vsm4467 Red Stop, Tail, Turn Signal Lamp with ABS Gray Flange

vsm4467A Amber Auxiliary Lamp with ABS Gray Flange

vsm4467RC and **vsm4467AC**

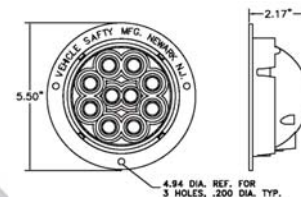

4467

10
DIODES

Lamp Kits with Grey Flange and Molded Pigtail

- Kit includes 4400 Series 4" round LED lamp, ABS Grey Flange and vsm9124 Molded Rubber Pigtail

vsm4457 Red Stop, Tail, Turn Signal Lamp with Flange and Pigtail

vsm4457A Amber Auxiliary Lamp with Flange and pigtail

vsm4457RC and **vsm4457AC**

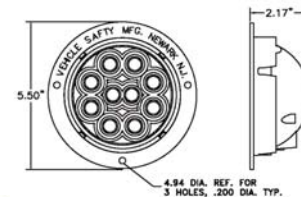

4458A

10
DIODES

Lamps with Black Flange

- Lamp with ABS Black Flange for flush mounting- Lamp w/Clear lens is available

vsm4468 Red Stop, Tail, Turn Signal Lamp with ABS Black Flange

vsm4468A Amber Auxiliary Lamp with ABS Black Flange

vsm4468RC and **vsm4468AC**

Lamp Kits with Black Flange and Molded Pigtail

- Kit includes 4400 Series 4" round LED Lamp, ABS Black Flange for flush mount and vsm9124 Molded Rubber Pigtail

vsm4458 Red Stop, Tail, Turn Signal Lamp with Flange and Pigtail

vsm4458A Amber Auxiliary Lamp with Flange and Pigtail

vsm4458RC and **vsm4458AC**

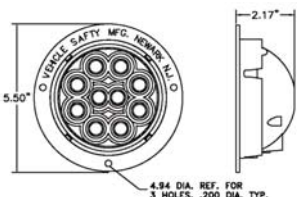

4459

10
DIODES

Lamps with ABS Chrome Flange

- Lamp with ABS Chrome Flange for flush mounting - Lamp w/Clear lens is available

vsm4469 Red Stop, Tail, Turn Signal Lamp with ABS Chrome Flange

vsm4469A Amber Auxiliary Lamp with ABS Chrome Flange

vsm4469RC and **vsm4469AC**

Lamp Kits with ABS Chrome Flange and Molded Pigtail

- Kit includes 4400 Series 4" round LED Lamp, ABS Chrome Flange for flush mount and vsm9124 Molded Rubber Pigtail

vsm4459 Red Stop, Tail, Turn Signal Lamp with Flange and Pigtail

vsm4459A Amber Auxiliary Lamp with Flange and Pigtail

vsm4459RC and **vsm4459AC**

LED STOP/TAILOTURN SIGNAL LAMPS



VSM LED STOP/TAIL/TURN LAMPS

Lamparas Led de Freno/Traseras/ Direccionales

All Lamps 12 V Standard • 24 V also available

LED STOP/TAIL/TURN LAMPS



6464A

6464

10
DIODES



6454



9124

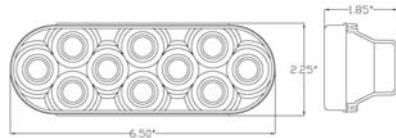

6400 SERIES LED Sealed Oval LED S/T/T Lamps

Features:

- Polycarbonate Lens and Housing
- Super Flux LED Diodes
- Designed at 12.8 Volts, .210/.090 Amps
- Sonically sealed lens and housing
- Industry Standard Connections and Pin Out
- Circuitry Protected Against Voltage Surge and Spikes

vsm6464 Red Oval LED Stop/Tail/Turn Lamp

vsm6464A Amber Oval LED Auxiliary Lamp

6400 Series Sealed Oval LED Lamp Kits

Kits include 6400 Series Lamp, vsm9526 Rubber Grommet and vsm9124 Pigtail

vsm6454 6464 Red LED lamp with vsm9526 Grommet and vsm9124 Pigtail

vsm6454A 6464A Amber LED Lamp with vsm9526 Grommet and vsm9124 Pigtail



6464RC

6454RC

10
DIODES



9124

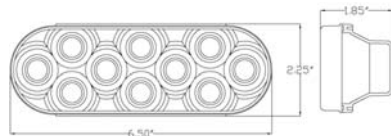

CLEAR LENS LED LAMPS & KITS Sealed Oval LED Lamps

vsm6464RC RED Oval LED Stop/Tail/Turn Signal Lamp with Clear Lens

vsm6464AC AMBER Oval LED Auxiliary Signal Lamp with Clear Lens

6400 Series Sealed Oval LED Lamp Kits

Kits include 6400 Series Lamp, vsm9526 Rubber Grommet and vsm9124 Pigtail

vsm6454RC RED Clear Lens LED Lamp with vsm9526 Grommet and vsm9124 Pigtail

vsm6454AC AMBER Clear Lens LED Lamp with vsm9526 Grommet and vsm9124 Pigtail



6466

10
DIODES



9866

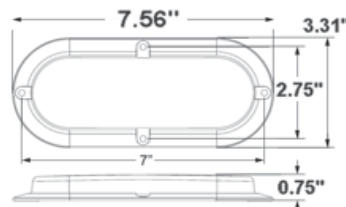

6" Oval Surface Mount LED S/T/T Lamp

Features:

- Surface mount unit does not require panel cutout
- Super Flux 10 LED-Light Emitting Diodes
- Designed at 13.5V 0.21/0.1 Amp
- Sonically Sealed Polycarbonate Housing and Lens
- Hard wired with 3 lead wires

6466 Series Stop/Tail/Turn LED Lamp

vsm6466 6" Oval Surface Mnt. LED S/T/T Lamp

vsm6456 6" Oval Surface Mnt. LED S/T/T Lamp Kit with **9866** Chrome bezel

vsm9866 Chrome bezel only for 6466 Series lamp

LED STOP/TAILETURN LAMPS



Lamparas LED de Freno/Traseras/Direccionales

All Lamps 12 V Standard • 24 V also available

6400 SERIES LED LAMP KITS

10 Diode 6" Oval Sealed LED Stop/Tail/Turn Lamps

LED Lamps Kits with Flange and Pigtail

- Kit includes 6400 Series LED lamp w/Flange & vsm9124 Molded Rubber Pigtail

LED Lamps with Grey Flange

- Lamp comes with Grey Flange for flush mounting
- vsm6467** Red Stop, Tail, Turn Signal Lamp with Grey Flange
- vsm6467A** Amber Auxiliary Lamp with Grey Flange
- vsm6467W** White Utility Lamp with Grey Flange

Lamp Kits with Grey Flange and Molded Pigtail

- Kit includes flush mount lamp, and vsm9124 Molded Pigtail
- vsm6457** Red Stop, Tail, Turn Signal Lamp with Grey Flange
- vsm6457A** Amber Auxiliary Lamp with Grey Flange
- vsm6457W** White Utility Lamp with Grey Flange



9124

6467

10
DIODES

Lamps with Black Flange

- Lamp comes with Black Flange for flush mounting
- vsm6468** Red Stop, Tail, Turn Signal Lamp with Black Flange
- vsm6468A** Amber Auxiliary Lamp with Black Flange
- vsm6468W** White Utility Lamp with Black Flange

Lamp Kits with Black Flange and Molded Pigtail

- Kit includes flush mount lamp, and vsm9124 Molded Pigtail
- vsm6458** Red Stop, Tail, Turn Signal Lamp with Black Flange
- vsm6458A** Amber Auxiliary Lamp with Black Flange
- vsm6458W** White Utility Lamp with Black Flange



9124

6468W

10
DIODES

Lamps with Chrome Flange

- Lamp includes Chrome Flange for flush mounting
- vsm6469** Red Stop, Tail, Turn Signal Lamp with Chrome Flange
- vsm6469A** Amber Auxiliary Lamp with Chrome Flange
- vsm6469W** White Utility Lamp with Chrome Flange

Lamp Kits with Chrome Flange and Molded Pigtail

- Kit includes flush mount lamp, and vsm9124 Molded Pigtail
- vsm6459** Red Stop, Tail, Turn Signal Lamp with Chrome Flange
- vsm6459A** Amber Auxiliary Lamp with Chrome Flange
- vsm6459W** White Utility Lamp with Chrome Flange



9124

6469A

10
DIODES

LED STOP/TAILETURN SIGNAL LAMPS

VSM LED STOP/TAILETURN LAMPS

All Lamps 12 V Standard • Red Lens Standard

24 Diodes Sealed LED Stop/Tail/Turn Lamps

- Polycarbonate lens & hsg.
- Super Flux LED Diodes
- Designed @ 13.5Volts, .380/.030 Amp



RECTANGULAR 4500 SERIES

- 24 Diodes pattern design with shining interior chrome reflector
- Unique optics design displays a full pattern of light
- Sonically sealed waterproof construction
- Epoxy encapsulated electronics
- Suitable for horizontal or vertical orientation
- Uses standard PL-3 connection

VSM45644 Red Stop, Tail, Turn Signal lamp
VSM45644A Amber Park/Turn Lamp

VSM9175 – Grommet 4500 Series

VSM9124 – 3 wire Plug

VSM9128 – 3 wire Plug Right Angle

VSM9287 – Steel Mtg. Bracket w/Flange

24
DIODES



24
DIODES

4" ROUND 4400 SERIES

- 24 Diodes pattern design with shining interior chrome reflector
- Unique optics design displays a full pattern of light
- Sonically sealed waterproof construction
- Epoxy encapsulated electronics
- Uses standard PL-3 connection

VSM44644 Red Stop, Tail, Turn Signal Lamp

VSM44644RC Red with Clear lens

VSM44644A Amber Park/Turn Lamp

VSM44644AC Amber with Clear lens

VSM44634W Round Back Up Lamp

VSM9127 – Grommet 4400 Series

VSM9137 – Closed back Grommet

VSM9124 – 3 wire Plug

VSM9128 – 3 wire Plug Right Angle

VSM9238 – Steel Mtg. Bracket w/Flange

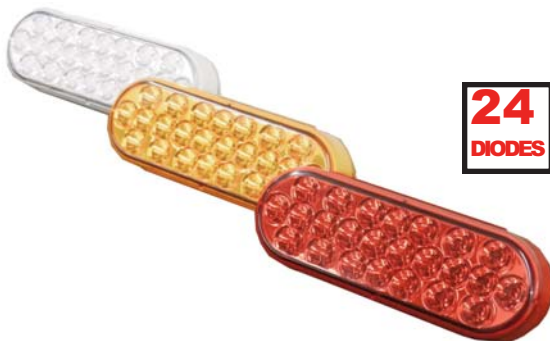
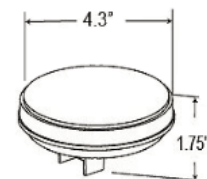

24
DIODES

6" OVAL 6400 SERIES

- 24 Diodes pattern design with shining interior chrome reflector
- Unique optics design displays a full pattern of light
- Sonically sealed waterproof construction
- Epoxy encapsulated electronics
- Suitable for horizontal or vertical orientation
- Uses standard PL-3 connection

VSM64644 Red Stop, Tail, Turn Signal Lamp

VSM64644RC Red with Clear lens

VSM64644A Amber Park/Turn Lamp

VSM64644AC Amber with Clear lens

VSM64634W Oval Back up Lamp

VSM9526 – Grommet 6400 Series

VSM9167 – Closed back Grommet

VSM9124 – 3 wire Plug

VSM9128 – 3 wire Plug Right Angle

VSM9525 – Steel Mtg. Bracket w/Flange

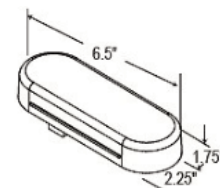

LED STOP/TAILETURN LAMPS



LED AUXILIARY LAMP PANELS

Lamparas Led Auxiliares

All Lamps 12 V Standard • Red Lens Standard

6400 SERIES SEALED LAMPS IN STAINLESS STEEL PANELS

The 6400 Series panel LED lamps are available with clear lenses. For Red LED order part number and add suffix "RC" (e.g.6491RC)
For Amber LED order part number and add "C" suffix (e.g.6493AC)

Features:

- 10 Diode VSM 6400 Series LED lamps mounted in a hi-polished HD corrosion-resistant stainless steel panel
- Includes rubber mounting grommet and custom Daisy-Chain Harness system

Single LED Oval Lamp in 8.25 inch Stainless Steel Mount

- Includes vsm9526 Grommet and vsm9128 Right Angle Plug Harness

vsm6491 Red 6464 Lamp in Single-Hole Bracket

vsm6491A Amber 6464A Lamp in Single-Hole Bracket

vsm9561 Stainless Steel Oval Single-Hole Bracket Only

vsm9525 Black Powder Coated Steel Oval Single-Hole Bracket

vsm9526 Oval Rubber Grommet

10
DIODES



6491

6491RC
Clear Lens Red LED

Two LED Oval Lamps in 16.5 inch Stainless Steel Mount

- Includes 9526 Grommets & 91282 Right Angle 2-Plug String Harness

vsm6492 Two Red 6464 Lamps in 2-Hole Bracket

vsm6492A Two Amber 6464A Lamps in 2-Hole Bracket

vsm9562 Stainless Steel Oval 2-Hole Bracket Only

vsm91282 Molded Right Angle 2-Plug String Harness

vsm9526 Oval Grommet

10
DIODES



6492

Three Sealed Oval Lamps in 25 inch Stainless Steel Mount

- Includes 9526 Grommets & 91283 Right Angle 3-Plug String Harness

vsm6493 Three Red 6464 Lamps in 3-Hole Bracket

vsm6493A Three Amber 6464A Lamps in 3-Hole Bracket

vsm9563 Stainless Steel Oval 3-Hole Bracket Only

vsm91283 Molded Right Angle 3-Plug String Harness

vsm9526 Oval Grommet

10
DIODES



6493A

Four LED Oval Lamps In 33 inch Stainless Steel Mount

- Includes 9526 Grommets & 91284 Right Angle 4-Plug String Harness

vsm6494 Four Red 6464 Lamps in 4-Hole Bracket

vsm6494A Four Amber 6464A Lamps in 4-Hole Bracket

vsm9564 Stainless Steel Oval 4-Hole Bracket Only

vsm91284 Molded Right Angle 4-Plug String Harness

vsm9526 Oval Grommet

10
DIODES



6494A

LED AUXILIARY LAMP PANELS



VSM LED CLEARANCE / MARKER LAMPS

Lamparas Led para Despeje/Marcadoras

All Lamps 12 V Standard • Red Lens Standard

The 1015 Series LED lamps are available with clear lenses. For Red LED order part number and add suffix "RC" (e.g.1015RC)
For Amber LED order part number and add "C" suffix (e.g.1015AC)

1015 SERIES 2.5 inch Sealed LED Clearance/ Markers

Features:

- Designed at 14 Volt, .060 Amps
- Operates in Both Polarities
- Polycarbonate Housing and Lens
- Sonically welded lens and base for water-tight construction
- Protective Encapsulation of Electronic



Encapsulated Diodes
Four LED configuration assures optimal lighting performance and cost effectiveness.



Standard Connections
VSM's 1015 Series LED 2 1/2" lamps have industry standard connections

LED CLEARANCE / MARKER LAMPS



1015 SERIES CLEARANCE/MARKERS

- vsm1015** Red LED 2 1/2" Round Sealed Clearance Side Marker
- vsm1015A** Amber LED 2 1/2" Round Sealed Clearance Side Marker
- vsm1025** Red LED 2 1/2" Round Sealed Clearance Side Marker / Rflx Lens
- vsm1025A** Amber LED 2 1/2" Round Sealed Clearance Side Marker / Rflx Lens

LAMP KITS

Kits include 1015a and 1025 Series Lamp and vsm 9219 Rubber Grommet/Pigtail Kit

- vsm1015K** 1015 Red Lamp with Grommet and Pigtail
- vsm1015AK** 1015A Amber Lamp with Grommet and Pigtail
- vsm1025K** 1025 Red Lamp with Grommet and Pigtail
- vsm1025AK** 1025A Amber Lamp with Grommet and Pigtail

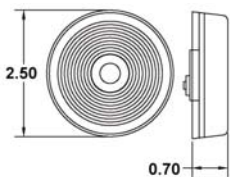

vsm9219 2 1/2" Grommet & Pigtail Kit

Includes vsm9119 rubber grommet and vsm9122 pigtail



FLANGE MOUNT LAMPS

Flush Mount Lamps

Plastic flange protects lamp against damage and theft

- vsm1015F**
1015 Red LED Lamp with Gray Polycarbonate Flush Mount Flange

- vsm1015AF**
1015A Amber LED Lamp with Gray Polycarbonate Flush Mount Flange

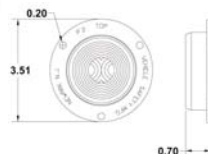

Surface Mount Lamps

- vsm1015SF**
1015 Red LED with Gray Polycarbonate Surface Mount Flange

- vsm1015ASF**
1015A Amber LED with Gray Polycarbonate Surface Mount Flange

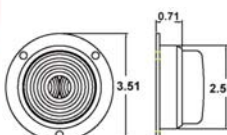

1015SF

LED CLEARANCE / MARKER LAMPS

Lamparas Led para Despeje/Marcadoras

All Lamps 12 V Standard • Red Lens Standard

The 1035 Series LED lamps are available with clear lenses. For Red LED order part number and add suffix "RC" (e.g.1035RC)
For Amber LED order part number and add "C" suffix (e.g.1035AC)

1035 SERIES 2 inch Sealed LED Clearance/ Markers

Features:

- Designed at 14 Volt, .060 Amps
- Operates in Both Polarities
- Polycarbonate Housing and Lens
- Sonically welded lens and base for water-tight construction
- Protective Encapsulation of Electronic



Encapsulated Diodes
Four LED configuration assures optimal lighting performance and cost effectiveness.



Standard Connections
VSM's 1035 Series LED 2" lamps have industry standard connections

1035 SERIES CLEARANCE/MARKERS

vsm 1035 Red LED 2" Round Sealed Clearance Side Marker

vsm 1035A Amber LED 2" Round Sealed Clearance Side Marker

FLANGE MOUNT LAMPS

Flush Mount

Plastic flange protects lamp against damage and theft

vsm1035F

1035 Red LED lamp with gray polycarbonate flush mount flange

vsm1035AF

1035A Amber LED lamp with gray polycarbonate flush mount flange



Surface Mount

vsm1035SF

1035 Red LED lamp with gray polycarbonate surface mount flange

vsm1035ASF

1035A Amber LED lamp with gray polycarbonate surface mount flange

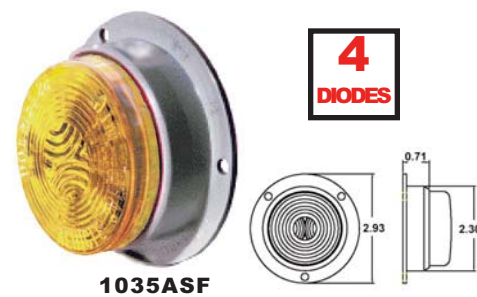

LAMP KITS

Kits include 1035 Series Lamp and vsm9239 Rubber Grommet/Pigtail Kit

vsm1035K 1035 Red LED lamp with Grommet and Pigtail

vsm1035AK 1035A Amber LED lamp with Grommet and Pigtail



vsm9239 2" Grommet & Pigtail Kit

Consists of vsm9139 Rubber Grommet and vsm9122 Pigtail



LED CLEARANCE MARKER LAMPS

VSM LED CLEARANCE / MARKER LAMPS

Led de Despeje/Marcadoras

All Lamps 12 V Standard • Red Lens Standard

The 1905 Series LED lamps are available with clear lenses. For Red LED order part number and add suffix "RC" (e.g.1905RC)
For Amber LED order part number and add "C" suffix (e.g.1905AC)

1905 SERIES

3.87 inch Sealed Rectangular LED Clearance / Marker Lamps

Features:

- Designed at 14 Volt, .060 Amps
- Operates in Both Polarities
- Polycarbonate Housing and Lens
- Sealed Water Tight Construction
- Protective Encapsulation of Electronics



Encapsulated Diodes

The 1905 Series lamps have four (red) or four (amber) completely sealed LED configurations. Assures optimal lighting performance and cost effectiveness.

1905 SERIES SEALED RECTANGULAR LED LAMPS

3.87" L x 1.2" W x .80" D

- vsm1905** Red rectangular sealed LED lamp
- vsm1905A** Amber rectangular sealed LED lamp



STANDARD CONNECTIONS

The 1905 Series lamps have industry standard connections and pin-out.

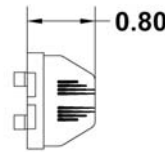
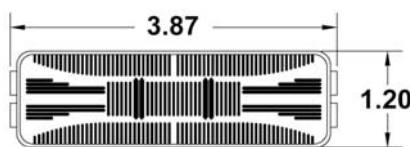

1905 SERIES LED LAMP KITS

Kits consist of 1905 series lamp, surface mounting bracket and a hot wire.

- vsm1989K** Red Rectangular Lamp with Surface Mount Bracket and Hot Wire Kit
- vsm1989AK** Amber Rectangular Lamp with Surface Mount Bracket and Hot Wire Kit

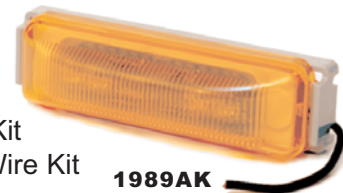

1905 Series Base Mount Kit & Assembly

- vsm9389** Gray ABS Surface Mount Bracket with Hot Wire Kit
- vsm9256** Hot Wire for 1905 Series lamps

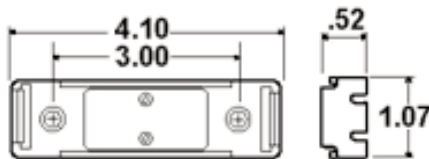

LED CLEARANCE / MARKER LAMPS



LED CLEARANCE / MARKER LAMPS

Led de Despeje/Marcadoras

All Lamps 12 V Standard • Red Lens Standard

The 1505 Series LED lamps are available with clear lenses. For Red LED order part number and add suffix "RC" (e.g. 1505RC)
For Amber LED order part number and add "C" suffix (e.g. 1505AC)

1505 SERIES 2.5 inch Sealed Rectangular LED Clearance / Marker Lamps

Features:

- Designed at 14 Volt, .060 Amps
- Operates in Both Polarities
- Polycarbonate Housing and Lens
- Sealed Water Tight Construction
- Protective Encapsulation of Electronics



Encapsulated Diodes

The 1505 Series lamps have two (red) or three (amber) completely sealed LED configurations. Assures optimal lighting performance and cost effectiveness.

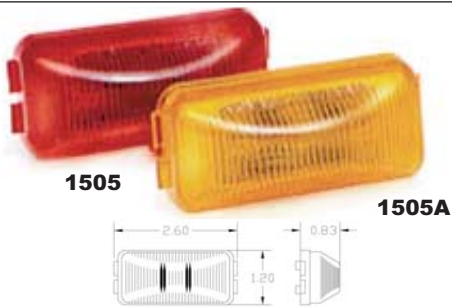

1505 SERIES SEALED RECTANGULAR LED LAMPS 2.5" L x 1.2" W x .830" D

- vsm1505** Red rectangular sealed LED lamp
- vsm1505A** Amber rectangular sealed LED lamp
- vsm1505W** White rectangular sealed LED lamp



Standard Connections

The 1505 Series lamps have industry standard connections and pin-out.

1505 SERIES LAMP KITS

1505 Series LED Sealed Lamp, Bracket and Pigtail or Hot Wire

- vsm1581K** Red Lamp with 9381 ABS Chrome Bracket and 9122 Pigtail
- vsm1581AK** Amber Lamp with 9381 ABS Chrome Bracket and 9122 Pigtail

- vsm1587K** Red Lamp with 9387 ABS Header Mount and 9122 Pigtail
- vsm1587AK** Amber Lamp with 9387 ABS Header Mount and 9122 Pigtail

- vsm1593K** Red Lamp with 9393 ABS Branch Deflector Bracket and Hot Wire
- vsm1593AK** Amber Lamp with 9393 ABS Branch Deflector Bracket and Hot Wire



1581K

1587AK

1593K



SURFACE MOUNT BRACKETS FOR 1500 SERIES LAMPS



vsm9361
Black ABS Surface
Mount Bracket



vsm9381
Chrome ABS Surface
Mount Bracket



vsm9387
White ABS Header
Mount Bracket



vsm9393
Gray ABS Deflector
Mount Bracket with
Hot Wire

LED CLEARANCE MARKER LAMPS



VSM LED CLEARANCE / MARKER LAMPS

Led de Despeje/Marcadoras

All Lamps 12 V Standard • Red Lens Standard

The 2105 and 1255 Series LED lamps are available with clear lenses. For Red LED order part number and add suffix "RC" (e.g.2105RC)
For Amber LED order part number and add "C" suffix (e.g.1255AC)

2105 SERIES 6 inch Sealed Rectangular LED Clearance / Marker Lamps

Features:

- Designed at 14 Volt, .060 Amp
- ABS Housing Acrylic Lens
- Sealed Water Tight Construction

4
DIODES



- vsm2105** Red Rectangular Clearance/Marker
- vsm2105A** Amber Rectangular Clearance/Marker

**2105 SERIES CLEARANCE/MARKER KITS
Kit includes 9221 Hot Wire**



vsm9221
Hot Wire for the 2105 Series lamps

- vsm2105K** 6" Red 2105 lamp with Hot Wire
- vsm2105AK** 6" Amber 2105A lamp with Hot Wire

1255 SERIES Double Bulls-Eye LED Clearance /Markers

Features:

- Designed at 14 Volt, .060 Amps
- Permamold Housing.
- Standard Connections and Mount
- Protective Encapsulation of Electronics
- Replaceable Acrylic Lens



- vsm1255** Red Double Bulls-Eye LED clearance/marker
- vsm1255A** Amber Double Bulls-Eye LED clearance/marker

10
DIODES

Replacement Lenses:
vsm9007 Red acylic lens; vsm9007A Amber acrylic Lens

LED CLEARANCE / MARKER LAMPS



LED CLEARANCE / MARKER LAMPS

Led de Despeje/Marcadoras

All Lamps 12 V Standard • Red Lens Standard



3
SMT
DIODES

LED MICRO-MARKER LAMP WITH GROMMET

FEATURES AND BENEFITS:

- P2PC rated for combination Clearance/Marker applications.
- 180° field of illumination.
- Uses 3 SMT diodes.
- LEDs are solid state devices and have no filaments and therefore are not susceptible to shock and vibration, rated life of 100,000 hours.
- Polycarbonate construction offers superior high impact resistance.
- Electronics completely sealed in Epoxy to resist corrosion and moisture.
- Designed at 14 Volts, 0.08 Amps.
- 100% maintenance free.
- Chrome bezel option available.

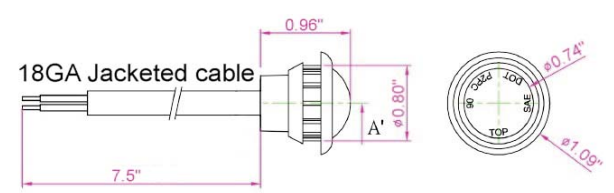

PANEL THICKNESS UP TO 0.250"
Ø 0.75" MOUNTING HOLE



SHOWN WITH 9835 CHROME BEZEL

PART No. DESCRIPTION

3305	LED MICRO-MARKER LIGHT W/GROMMET, RED
3305Y180	LED MICRO-MARKER LIGHT W/GROMMET & MOLDED .180 BULLET TERMINAL, RED
3305Y183	LED MICRO-MARKER 3 LIGHT ID HARNESS ASSEMBLY, RED
3305RC	LED MICRO-MARKER LIGHT W/GROMMET, RED LED / CLEAR LENS
3305RCY180	LED MICRO-MARKER LIGHT W/GROMMET & MOLDED .180 BULLET TERMINAL, RED LED / CLEAR HOUSING
3305A	LED MICRO-MARKER LIGHT W/GROMMET, AMBER
3305AY180	LED MICRO-MARKER LIGHT W/GROMMET & MOLDED .180 BULLET TERMINAL, AMBER
3305AC	LED MICRO-MARKER LIGHT W/GROMMET, AMBER LED / CLEAR LENS
3305ACY180	LED MICRO-MARKER LIGHT W/GROMMET & MOLDED .180 BULLET TERMINAL, AMBER LED / CLEAR HOUSING
3305B	LED MICRO-AUXILIARY LIGHT W/GROMMET, BLUE
3305BY180	LED MICRO-AUXILIARY LIGHT W/GROMMET & MOLDED .180 BULLET TERMINAL, BLUE
3305G	LED MICRO-AUXILIARY LIGHT W/GROMMET, GREEN
3305GY180	LED MICRO-AUXILIARY LIGHT W/GROMMET & MOLDED .180 BULLET TERMINAL, GREEN
3305W	LED MICRO-UTILITY LIGHT W/GROMMET, CLEAR
3305WY180	LED MICRO-UTILITY LIGHT W/GROMMET & MOLDED .180 BULLET TERMINAL, CLEAR
9135	REPLACEMENT MOUNTING GROMMET
9835	CHROME BEZEL, 3305 SERIES



LED CLEARANCE MARKER LAMPS



VSM™ SEALED STOP/TAILOUTURNS

Lamparas de Freno/ Traseras/Direccionales

All Lamps 12 V Standard • Red Lens Standard

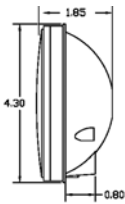

4064

4000 SERIES 4" Round Sealed Lamps

Features:

- Sonically sealed polycarbonate housing and lens
- Shock Safe bulb mount extends bulb life
- Accepts standard 3-prong and right angle oem plugs

Double Contact Combination Stop, Tail, Turn Signal

vsm4064 With red lens • Replaces Truck Lite #40202

vsm4064A With amber lens

4000 SERIES LAMP KITS WITH GROMMET & PIGTAIL

Double Contact Lamps

vsm4054 Red 4064 lamp with 9127 grommet and 9124 molded pigtail

vsm4054A Amber lamp 4064A with 9127 grommet and 9124 molded pigtail



4054

4000 SERIES LAMPS WITH ABS GRAY SNAP-IN FLANGE

Double Contact Lamps

vsm4067 Red 4064 lamp with ABS gray flange

vsm4067A Amber 4064A lamp with gray ABS flange

4000 Series Lamp Kits with Gray Flange & Pigtail

vsm4057 Red 4064 lamp with ABS gray flange and 9124 molded pigtail

vsm4057A Amber 4064A lamp with ABS gray flange and 9124 molded pigtail

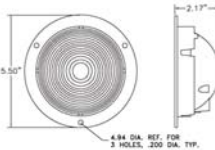

4057

4000 SERIES LAMPS WITH ABS BLACK SNAP-IN FLANGE

Double Contact Lamps

vsm4068 Red 4064 lamp with ABS black flange

vsm4068A Amber lamp with ABS black flange

4000 Series Lamp Kits with Black Flange & Pigtail

vsm4058 Red 4064 lamp with ABS black flange and 9124 molded pigtail

vsm4058A Amber 4064A lamp with ABS black flange and 9124 molded pigtail

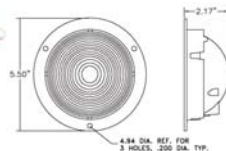

4058

SEALED STOP/TAILOUTTURN SIGNAL LAMPS

SEALED STOP/TAILETURN



Lamparas de Freno/ Traseras/Direccionales

All Lamps 12 V Standard • Red Lens Standard

4000 SERIES LAMPS WITH CHROME SNAP-ON FLANGE

Double Contact Lamps

vsm4069 Red 4064 lamp with ABS chrome flange

vsm4069A Amber 4064A lamp with ABS chrome flange

4000 Series Lamp Kits with Chrome Flange & Pigtail

vsm4059 Red 4064 lamp with ABS chrome flange and 9124 molded pigtail

vsm4059A Amber 4064A lamp with ABS chrome flange and 9124 molded pigtail

vsm9132C Chrome Flange only for 4000 & 4400 Series Lamps

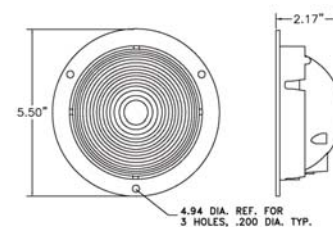

6000 SERIES Oval Sealed Lamps

Features:

- Sonically sealed polycarbonate housing and lens
- Double contact Shock Safe bulb mount
- Industry standard connections and pin out
- Legal in vertical or horizontal position

Combination Stop/Tail/Turn Signal Lamps

vsm6064 With red lens • Replaces Truck Lite #60202

vsm6064A With amber lens

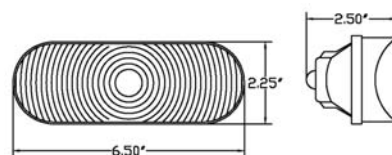

6064

6000 Series Lamp Kits With Grommet and Pigtail

Includes 6000 Series oval lamp, 9526 rubber grommet and 9124 molded pigtail

vsm6054 Red 6064 lamp with grommet and molded pigtail

• Replaces Truck Lite #60002

vsm6054A Amber 6064A lamp with grommet and molded pigtail

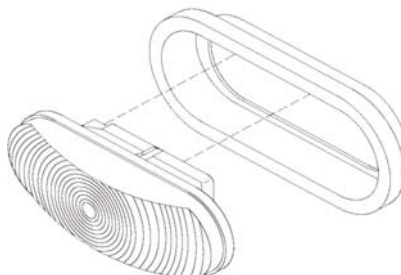

6054

SEALED STOP / TAIL / TURN SIGNAL LAMPS

VSM STOP/TAI/TURN SIGNALS

Lamparas de Freno/ Traseras/Direccionales

All Lamps 12 V Standard • Red Lens Standard



4564A

4564

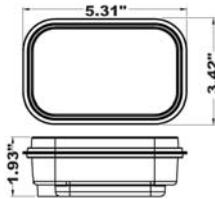

4500 SERIES Rectangular Sealed Lamps

Features:

- Sonically sealed polycarbonate housing and lens
- Standard plug-in industry connection
- High impact polycarbonate construction
- Uses standard mounting hole
- Heavy duty bulb shock mount

4500 Series Sealed Lamps

vsm4564 4500 Series combination stop, tail, turn lamp. Red lens

vsm4564A 4500 Series turn signal lamp. Amber Lens

4500 Series Lamp Kits

Kits consist of lamp, vsm9175 grommet and vsm9124 pigtail

vsm4554 Red 4564 lamp with 9175 grommet and 9124 pigtail

vsm4554A Amber 4564A lamp with 9175 grommet and 9124 pigtail

SEALED STOP/TAI/TURN SIGNALS LAMPS



4563W

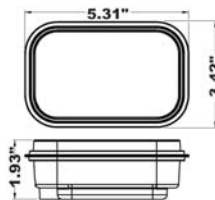

4500 Series Sealed Back-Up Lamp with Reflector Lens

Features:

- Sonically sealed polycarbonate housing and reflector lens
- Standard plug-in industry connection
- High impact polycarbonate construction
- Uses standard mounting hole
- Heavy duty bulb shock mount

vsm4563W 4500 Series Back-Up lamp with reflector lens

4500 Series Back-Up Lamp With Grommet/Pigtail

vsm4553W Back-Up lamp with 9175 grommet and 9124 pigtail



9175

VSM9175

Rubber Grommet for 4500 Series Sealed Lamps

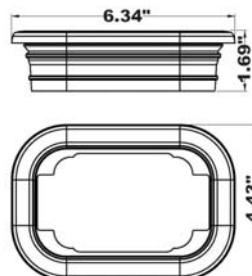

STOP/TAILOTURN LAMPS



Lamparas Selladas

All Lamps 12 V Standard • Red Lens Standard

6000 SERIES

Sealed Lamps in Stainless Steel Panels

Features:

- VSM 6000 Series sealed lamps mounted in a Hi-Polished HD corrosion-resistant stainless steel mount
- Includes rubber mounting grommet and custom Daisy-Chain Harness system

Single Sealed Oval Lamp in 8.25 inch Stainless Steel Mount

Includes 9526 Grommet and 9128 Right Angle Plug Harness

vsm6091 Red 6064 Lamp in Single-Hole Bracket

vsm6091A Amber 6064A Lamp in Single-Hole Bracket

vsm9561 Stainless Steel Oval Single-Hole Bracket Only

vsm9525 Black Powder Coated Steel Oval Single-Hole Bracket

vsm9526 Oval Rubber Grommet



6091A

Two Sealed Oval Lamps in 16.5 inch Stainless Steel Mount

Includes 9526 Grommets & 91282 Right Angle 2-Plug String Harness

vsm6092 Two Red 6064 Lamps in 2-Hole Bracket

vsm6092A Two Amber 6064A Lamps in 2-Hole Bracket

vsm9562 Stainless Steel Oval 2-Hole Bracket Only

vsm91282 Molded Right Angle 2-Plug String Harness

vsm9526 Oval Grommet



6092

Three Sealed Oval Lamps in 25 inch Stainless Steel Mount

Includes 9526 Grommets & 91283 Right Angle 3-Plug String Harness

vsm6093 Three Red 6064 Lamps in 3-Hole Bracket

vsm6093A Three Amber 6064A Lamps in 3-Hole Bracket

vsm9563 Stainless Steel Oval 3-Hole Bracket Only

vsm91283 Molded Right Angle 3-Plug String Harness

vsm9526 Oval Grommet



6093A

Four Sealed Oval Lamps 33 inch Stainless Steel Mount

Includes 9526 Grommets & 91284 Right Angle 4-Plug String Harness

vsm6094 Four Red 6064 Lamps in 4-Hole Bracket

vsm6094A Four Amber 6064A Lamps in 4-Hole Bracket

vsm9564 Stainless Steel Oval 4-Hole Bracket Only

vsm91284 Molded Right Angle 4-Plug String Harness

vsm9526 Oval Grommet



6094A

SEALED STOP / TAIL / TURN LAMPS

VSM STOP/TAIL/TURN LAMPS

Lamparas de Freno/ Traseras/Direccionales

All Lamps 12 V Standard • Red Lens Standard



522

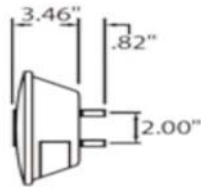

REPLACEABLE BULB TYPE

ROUND 2-STUD MOUNT LAMP

vsm 522 Stop/Tail/Turn Lamp

- Rustproof
- Rugged non-corrosive permamold housing
- Snap-on lens.
- With license plate illuminator
- Replaces Signal-Stat #540

Mounting: 2 $\frac{1}{4}$ " diameter $\frac{27}{32}$ " long mounting studs on 2" centers • Replacement Parts: Lens vsm9041; Bulb 1157



STEEL FLUSH MOUNT LAMPS

vsm4212 Double Contact Stop, Tail, Turn Signal Lamp

- Steel black enamel housing
- Fast, easy lens removal
- Lens interchangeable with all snap ring lamps
- Flush housing protects lens against breakage
- Rubber sealed socket

Size: $5\frac{1}{2}$ " Diameter x 2" D under flange.

Mounting: Mounts through $4\frac{1}{2}$ " Dia. cutout. Three #10 screws on $4\frac{15}{16}$ " bolt circle. **Replacement Parts:** Lens Kit vsm9030 • Lens vsm9029;

- Lexan lens vsm9031 • Snap ring vsm9039 • Double contact bulb 1157
- vsm9107 Two wire pigtail



4212

FLUSH MOUNT STEEL BLACK ENAMEL LAMPS

- Tightly sealed against dirt and dust.

Size: $5\frac{1}{4}$ " Diameter x $1\frac{1}{8}$ " D under flange.

Mounting: Mounts through $4\frac{1}{2}$ " Dia. cutout. Three #10 screws on $4\frac{7}{8}$ " bolt circle. **Replacement Parts:** Lens Kit vsm9021 • Lens vsm9016;

- Pigtail: Two wire vsm9101; One wire vsm9102 • Single contact bulb 1156;
- Double contact bulb 1157

Single Contact Flush Mount Turn Signal Lamp

vsm2601 Red lens flush mount turn signal lamp

vsm2601A Amber lens flush mount turn signal lamp



2601

SEALED STOP/TAIL/TURN SIGNALS



STOP/TAILETURN LAMPS



Lamparas de Freno/Traseras/Direccionales

All Lamps 12 V Standard • Red Lens Standard

REPLACEABLE BULB TYPE

FLUSH MOUNT RUBBER HOUSING

- Rubber housing stays flexible, even at low temperatures
- Snap-in lens
- Completely non-ferrous
- All brass socket and bracket assembly

Size: 5½" diameter. Mounting: Three 7/32" diameter mounting holes
Mounts in a 4½" x 1½" deep hole.

Replacement Parts: Red lens: vsm 9029; Amber lens vsm 9029A

- Pigtail vsm9101 • Double contact bulb 1157



4522

Double Contact Stop, Tail, Turn Signal Lamp

vsm4522 With red lens for use as combination rear lamp

THINLINE LED S/T/T LIGHT BAR

vsm7464 for use as combination rear lamp

- Low profile hard wire design
- Sealed polycarbonate waterproof construction
- Surface mount on 16 1/8" centers
- 17"L x 1 3/8" W x 1" H
- 8-14 VDC, .350/.22 Amp
- 11 Superflux LED



7464

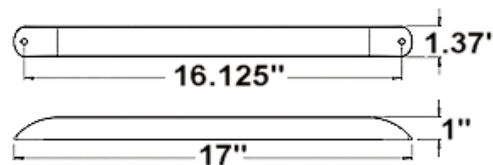

11
DIODES

UNIVERSAL SURFACE MOUNT

Ideal for light duty trailers, golf carts and industrial vehicles.

- Raised polycarbonate lens with pillow optics
- Stamped galvanized back plate

Replacement Parts: Red lens vsm9372; Amber lens vsm9372A
Single contact bulb 1156; Double contact bulb 1157

Double Contact Stop, Tail, Turn Signal Lamp

vsm548 With red lens for use as combination rear lamp

vsm548A With amber lens for use as park and turn signal lamp



548

548A

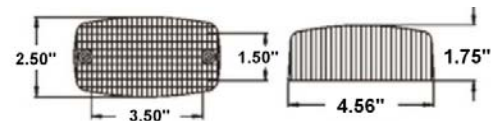

LED UNIVERSAL SURFACE MOUNT

vsm550 Rectangular Surface Mount S/T/T lamp with 18 diodes

- Ideal for light duty trailers, golf carts and industrial vehicles
- Raised polycarbonate lens
- Double contact
- Available in red LED only



550

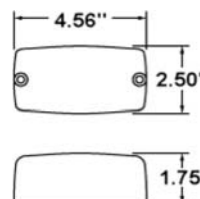

18
DIODES

STOP/TAILETURN LAMPS



VSM OEM REAR COMBINATION LAMPS

Combinacion de Lamparas Traseras Para Equipo Original

All Lamps 12 V Standard • Red Lens Standard

VSM/OEM REPLACEMENT CHART

FORD	VSM #	FORD #
4023		D9HZ13405A & B
4024		D9HZ13404A & B
FREIGHTLINER	VSM #	FREIGHTLINER #
5014		681-544-04-1
5024		681-544-05-03
4023Y106		A06-13581-001
4024Y106		A06-13581-000
MACK	VSM #	MACK #
5016		14M052AM
		14M052M
4028		4028
NAVISTAR	VSM #	NAVISTAR #
5014Y102		1661282C9
		2009909C9
5023Y102		1661281C91
		2009908C9
4015		467707C91
		424538C91
4016		467708C91
		424539C91
PETERBILT	VSM #	PETERBILT #
5013		16-06160L
5014		16-06160R
		16-06292
5023		16-06291
VOLVO/GM	VSM #	VOLVO/GM #
5013		5565731
		15574697
		15613943
		15684994
5014		15565732
		15574696
		15684995
5014Y101		8067856
5023		8067855
4013		715104
4014		715103
UNIVERSAL	VSM #	APPLICATION
4027		3 Stud 12"
4028		2 Stud 39"
4029		2 Stud 12"

OEM REAR COMBINATION LAMPS

REPLACEABLE BULB TYPE

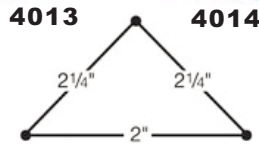

Left Side Replacement Combination Lamp

vsm4013 3 Stud

Replacement for VOLVO/GM 715104

vsm4015 3 Stud

Replacement for NAVISTAR 467707C91; 424538C91

Right Side Replacement Combination Lamp

vsm4014 3 Stud

Replacement for: VOLVO/GM 715103

vsm4016 3 Stud

Replacement for NAVISTAR 467708C91; 424539C91

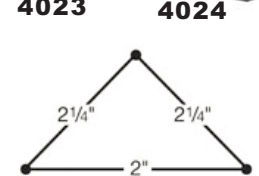

Left Side OE Replacement Combination Lamp

vsm4023 3 Stud

Replacement for FORD D9HZ13405A & B

vsm4023Y106 3 Stud

Replacement for FREIGHTLINER A06-13581-001

Right Side OEM Replacement Combination Lamp

vsm4024 3 Stud

Replacement for FORD D9HZ13404A & B

vsm4024Y106 3 Stud

Replacement for FREIGHTLINER A06-13581-000

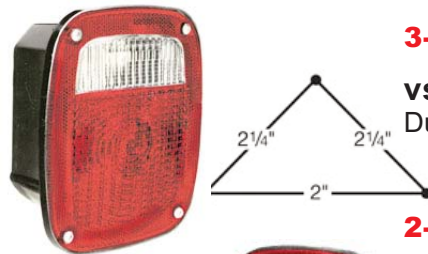

4027

3-Stud Universal Rear Combination Lamp

vsm4027 UNIVERSAL Fits virtually all applications. Dual optic lens. Rear pigtail connection

2-Stud OEM Mack Replacement w/Harness

vsm 4028 Shock-Safe. With OEM 39" pigtail. Right & Left Side Direct OEM Replacement for: MACK 14MO444RP1; 14MO444RP4

vsm4029 Standard Mount Pigtail. OE Replacement



4028

Replacement Lens: vsm9049 for all Rear Combination Lamps



OEM REAR COMBINATION LAMPS

Combinacion de Lamparas Traseras Para Equipo Original

All Lamps 12 V Standard • Red Lens Standard

REPLACEABLE BULB TYPE

METRI-PACK

COMBINATION STOP/TAIL/SIGNAL LAMPS

3-Stud with Metri-Pack Connector on Right Side

vsm5013 Left Side Replacement for: **PETERBILT** 16-06160L
GM 15565731; 15574697; 15613943; 15684994
FREIGHTLINER 681-544-04-03



3-Stud with Metri-Pack Connector on Left Side

vsm 5014 Right Side Replacement for:
PETERBILT 16-06160R; 16-06292
GM 15565732; 15574696; 15613944; 15684994

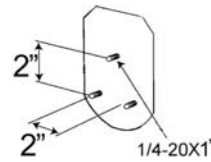

3-Stud with Metri-Pack Connector on Left Side

vsm 5014Y101 Right Side Replacement for: **VOLVO/GM** 8067856
vsm 5014Y102 Right Side Replacement for: **NAVISTAR** 1661282C91; 2009909C91

2-Stud with Metri-Pack Connector on Left Side

vsm 5016
 Replacement for **MACK** 14M052AM; 14M052M



2-Stud with Metri-Pack Connector on Right Side

vsm 5015

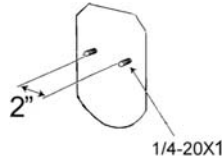

5016

3-Stud w/Double Left & Right Side Metri-Packs

vsm5023 Left Side Replacement for: **PETERBILT** 16-06291,
VOLVO/GM 8067855

vsm 5023Y102 Left Side Replacement for
NAVISTAR 1661281C91; 2009908C91

vsm5024 Right Side Replacement for:
FREIGHTLINER 681-544-05-03

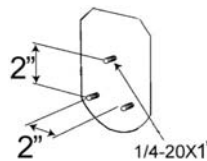

5023

METRI-PACK HARNESSES

vsm9464 4-Wire Harness • 22" in length, 16 gauge wire.

vsm9466 Cross-Over Harness • 78" in length, 16 gauge wire.

vsm9469 Daisy Chain Harness • 36" in length, 16 gauge wire.

vsm9470 5-Wire Harness • 22" in length, 16 gauge wire.

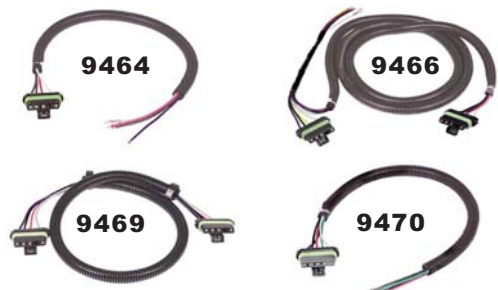

OEM REAR COMBINATION LAMPS



VSM™ OEM REAR COMBINATION LAMPS

Combinacion de Lamparas Traseras Para Equipo Original

All Lamps 12 V Standard



MULTI-FUNCTION LED BOXLAMP

COMBINATION STOP/TAIL/SIGNAL LAMPS



New from Vehicle Safety Manufacturing:

Full function integrated LED combination lamp. Functions include stop/tail/turn/back-up/reflex reflector/ and license illuminator.

- All functions utilize Super Flux LED technology.
- Attractive multiple diode design
- Gasket between lens and housing protects against moisture intrusion.
- Epoxy encapsulated electronics for protection against moisture, vibration and corrosion.
- Contains 16 S/T/T diodes, 18 back-up diodes and 4 license illuminator diodes.
- Mounting Hardware included.
- Polycarbonate housing / Acrylic lens.
- Voltage 12-13.5 Volts.

16
DIODES
S/T/T

18
DIODES
BACK UP

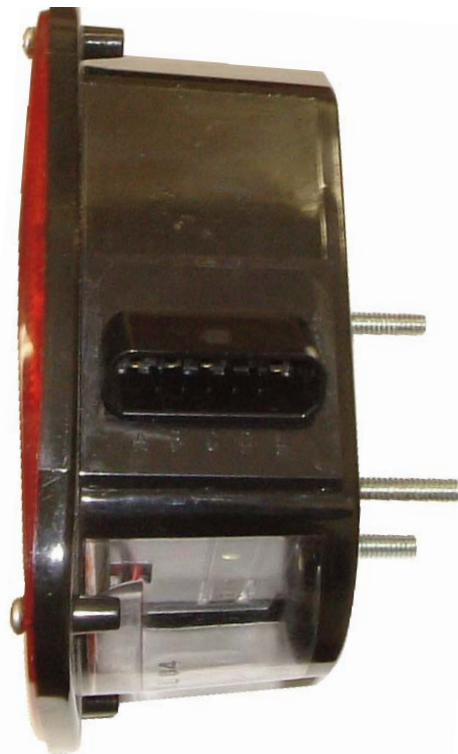
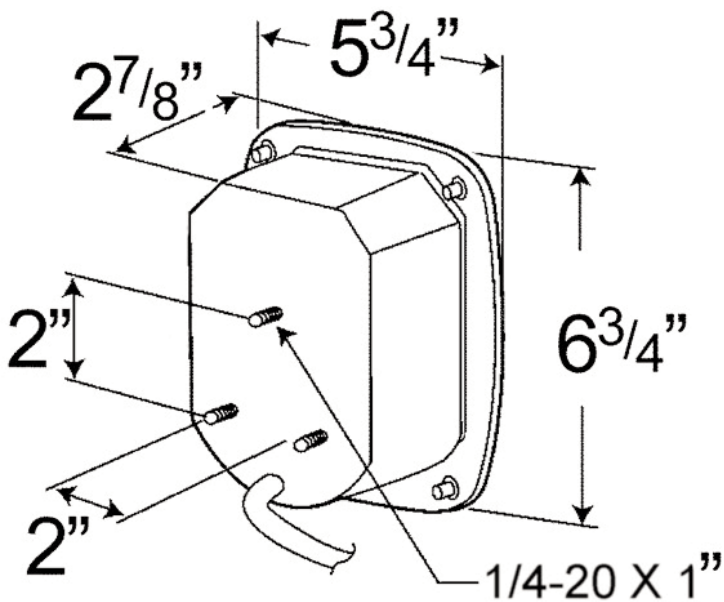

OEM REAR COMBINATION LAMPS

OEM REAR COMBINATION LAMPS

Combinacion de Lamparas Traseras Para Equipo Original

All Lamps 12 V Standard

OEM LED UPGRADE

COMBINATION STOP/TAIL/TURN/BACK-UP/ REFLECTOR/LICENSE ILLUMINATOR



5014LED

3-Stud with Metri-Pack Connector on Right Side

VSM5013LED LH LED Upgrade for: PETERBILT 16-06160L
 FREIGHTLINER 681-544-04-03
 GM 15565731; 15574697; 15613943; 15684994
 OSKOSH2078210

3 Stud with Metri-Pack Connector on Left Side

VSM5014LED RH LED Upgrade for:
 PETERBILT 16-06160R; 16-06292
 GM 15565732; 15574696; 15613944; 15684995
 OSHKOSH 2078200

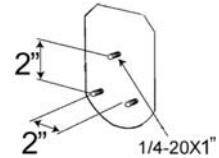

5016LED

2-Stud with Metri-Pack Connector on Left Side

VSM5016LED
 LED Upgrade for MACK14M052AM; 14M052M



16
 DIODES
 S/T/T

18
 DIODES
 BACK UP

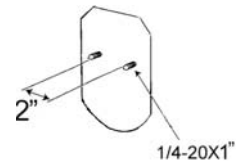

5023LED

3-Stud w/Double Left & Right Side Metri-Packs

VSM 5023LED LH LED Upgrade for: PETERBILT 16-06291
 VOLVO/GM 80678553

3-Stud w/Double Left & Right Side Metri-Packs

VSM5024LED RH LED Upgrade for:
 FREIGHTLINER 681-544-05-03

16
 DIODES
 S/T/T

18
 DIODES
 BACK UP

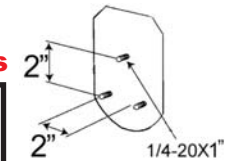

4027LED

3 Stud Universal LED Rear Combination Lamp

VSM4027LED
 3 wire 12" rear pigtail harness connection.
 Grounding function through mounting studs.



16
 DIODES
 S/T/T

18
 DIODES
 BACK UP

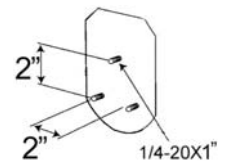

4028LED

2 Stud Mack LED Rear Combination Lamp

VSM4028LED
 OEM 39" pigtail harness w/ring terminals.
 LED Upgrade for MACK 14M0444RP1;
 14M0444RP4.
 Grounding function through mounting studs.

16
 DIODES
 S/T/T

18
 DIODES
 BACK UP

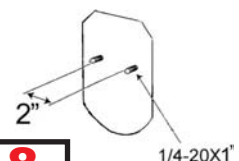

OEM REAR COMBINATION LAMPS

VSM™ DIE CAST STOP/TAILETURN LAMPS

Lamparas de Aluminio Moldeado de Freno/Traseras/Direccionales

All Lamps 12 V Standard

DIE CAST REPLACEABLE BULB TYPE



2702

SINGLE FACE • STUD MOUNT

Double contact wiring for use as combination stop, tail and turn signal lamps.

Size: 4 1/8" diameter x 2" D 1/2"-20 Stud 7/8" Long

BLACK FINISH

Double Contact Stop, Tail, Signal Lamps

vsm2702 Red lens. Stop, tail, turn signal lamp

vsm2702A Amber lens. Turn signal lamp

DOUBLE FACE • STUD MOUNT

Pigtail with spring and thermoplastic wire

Unique bulls-eye lens designed for maximum light output.

Size: 4 1/8" diameter x 2 1/2" D 1/2"-20 Stud 7/8" Long



2801

3802

BLACK FINISH

Single Contact, Double Face Signal Lamp

vsm2801 Red/Amber lenses

vsm2801AA Amber/Amber lenses

Double Contact, Double Face Park, Signal Lamp

vsm2803 Red/Amber lenses

vsm2803AA Amber/Amber lenses

CHROME FINISH

Single Contact Double Face, Chrome Die Cast Housing

vsm3802 Single Contact (one wire). Red/Amber lenses

Double Contact Double Face, Chrome Die Cast Housing

vsm3812 Double Contact (two wires) Red/Amber lenses

REPLACEMENT PARTS for above lamps.

Lens Kit: Lens, Gasket, Screws: Red vsm9016K; Amber vsm9016AK • Lens Only: Red vsm9016; Amber vsm9016A.

Pigtail: One wire vsm 9102, Two wire vsm9101 • Bulb: Single Contact 1156; Double Contact 1157.



LED STOP/TAILETURN LAMPS



21 Diodes Sealed LED Stop/Tail/Turn Lamps

- Polycarbonate lens
- Zinc die cast housing
- SMD Diodes



2705

SINGLE FACE BLACK HOUSING

- 21 SMD Diode pattern design
 - Unique optics design displays a full pattern of light
 - Very low power consumption
 - Epoxy encapsulated electronics
 - Sonically sealed waterproof construction
 - Extremely long service life
 - Zinc die cast housing with black finish
 - Mounting hardware included
 - Designed at 12.8V Major .250 / .019 Amp (RED LED)
- 2705 - Single Face Red LED
 2705A - Single Face Amber LED
 2705W - Single face White LED

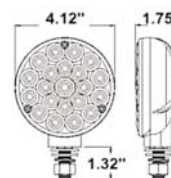

3705A

21 LED COUNT SINGLE FACE CHROME HOUSING

- 21 SMD Diode pattern design
 - Unique optics design displays a full pattern of light
 - Very low power consumption
 - Epoxy encapsulated electronics
 - Sonically sealed waterproof construction
 - Extremely long service life
 - Zinc die cast housing with chrome plating finish
 - Mounting Hardware included
 - Designed at 12.8V Major .475 / .025 Amp (AMBER LED)
- 3705 - Single Face Red LED
 3705A - Single Face Amber LED
 3705W - Single face White LED

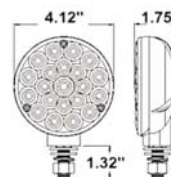

3812LED

DOUBLE FACE CHROME HOUSING

- 21 SMD Diode pattern for the Amber and the Red lens
 - Unique optics design displays a full pattern of light
 - Very low power consumption
 - Epoxy encapsulated electronics
 - sealed waterproof construction
 - Extremely long service life
 - Zinc die cast housing with chrome plating finish
 - 1 Stud mount suitable for horizontal or vertical orientation
 - Mounting Hardware included
 - Designed at 12.8V Major .625 / .045 Amp
- 3812LED - Double face Red/Amber LED

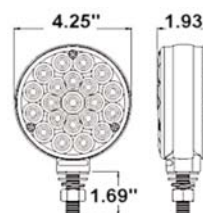

LED STOP/TAILETURN SIGNAL LAMPS





OEM FRONT TURN SIGNAL LAMPS

All Lamps 12 V Standard

VSM/OEM REPLACEMENT CHART

FORD

VSM #	FORD #
4852	D3TZ133678A
4853	D3TZ133678B

PETERBILT

VSM #	PETERBILT #
4800	4800
4801	4801

FREIGHTLINER

VSM #	FREIGHTLINER #
4805AAY115	681-8220-020
4805AAY118	681-8220-120
4805AY116	A06-18900-000
4805AY117	A06-18900-001

VOLVO

VSM #	VOLVO #
4800	4800
4801	4801
4805	4805

GM

VSM #	GM #
4854	6994628
4855	694627
4872AA	2029217
4874AA	796315

WESTERN STAR

VSM #	WESTERN STAR #
4800	4800
4801	4801

MACK

VSM #	MACK #
4805AAY2	47M0453AM2
4805AAY4	47M0453AM4
3801Y67	47M0251P1
3802Y67	47M0251P2

NAVISTAR

VSM #	NAVISTAR #
4842	444659C91 444660C91



vsm4800 Black vsm4801 Chrome
Replacement Front Turn Signal Lamps for:
GM, PETERBILT, VOLVO, WESTERN STAR

- Lens: Signal **vsm9063**, Lens **vsm9063A**
- Bulb: Signal **1156**, Marker **1895**



MACK

vsm3801Y67 Black vsm3802Y67 Chrome
Replacement Front Signal Replacement Front Signal
for **MACK 47M0251P1** for **MACK 47M0251P2**

- Lens Kit **vsm9021** • Lens **vsm9016**
- Single contact bulb **1156**



MACK

vsm4805AAY2 Black vsm4805AAY4 Chrome
Replacement Front Signal Replacement Front Signal
for **MACK 47M0453AM2** for **MACK 47M0453AM4**

- Lens: Signal **vsm9079A**
- Bulb: Signal **1156**, Marker **1895**

OEM FRONT TURN SIGNALS



OEM FRONT TURN SIGNAL LAMPS



Lamparas de Freno/Traseras/Direccionales

All Lamps 12 V Standard



FREIGHTLINER

vsm4805AAY115

Front Turn Signal Lamp with 7" OEM Harness
Replacement for **FREIGHTLINER** 681-8220-020

- Lens: Signal **vsm9079A**, Marker **vsm9080A**
- Bulb: Signal **vsm1156**, Marker **vsm1895**



FREIGHTLINER

vsm4805AAY118

Front Turn Signal Lamp with 75" OEM Harness
Replacement for **FREIGHTLINER** 681-8220-120

- Lens: Signal **vsm9079A**, Marker **vsm9080A**
- Bulb: Signal **vsm1156**, Marker **vsm1895**



FREIGHTLINER

vsm4805AY116 (Left Side)

Front Turn Signal Lamp with 49" OEM Harness
Replacement for **FREIGHTLINER** A06-18900-000

- Two 5/16" studs on 2" centers
- Lens: Signal **vsm9063** and **vsm9063A**
- Bulb: Signal **vsm1156**, Marker **vsm1895**



FREIGHTLINER

vsm4805AY117 (Right Side)

Front Turn Signal Lamp with 49" OEM Harness.
Replacement for **FREIGHTLINER** A06-18900-001

- Two 5/16" studs on 2" centers
- Lens: Signal **vsm9063** and **vsm9063A**
- Bulb: Signal **vsm1156**, Marker **vsm1895**

OEM FRONT TURN SIGNALS



VSM FRONT TURN SIGNALS

Lamparas de Freno/Traseras/Direccionales

All Lamps 12 V Standard

OEM FRONT TURN SIGNALS



NAVISTAR

vsm4842

Replacement Front Turn Signal Lamp for: **NAVISTAR** 444659C91 (Right Side) / 444660C91 (Left Side)

- Lens: Signal **vsm9079**, and **vsm9079A**
- Bulb: Signal **vsm1156**, Marker **vsm1895**



GM

vsm4854 (Right Side)

Replacement Front Turn Signal Lamp for **GM** 694628

- Lens: Signal **vsm9063A**
- Bulb: Signal **vsm1156**, Marker **vsm1895**



GM

vsm4855 (Left Side)

Replacement Front Turn Signal Lamp for **GM** 694627

- Lens: Signal **vsm9063A**
- Bulb: Signal **vsm1156**, Marker **vsm1895**



GM

vsm4872AA

Replacement Front Turn Signal Lamp for **GM** 2029217 (To be used on Left or Right Side)

- Lens **vsm9063A** • Bulb **vsm1157**



GM

vsm4874AA (Left or Right Side)

Replacement Front Turn Signal Lamp for **GM** 796315

- Lens **vsm9063A** • Bulb **vsm1157**



VOLVO

vsm4805

Replacement Front Turn Signal Lamp for **VOLVO**

- Lens: Signal **vsm9063A**
- Bulb: Signal **vsm1156**, Marker **vsm1895**



LED FRONT TURN SIGNALS



Lamparas de Freno/Traseras/Direccionales

All Lamps 12 V Standard

LED DOUBLE FACE TURN SIGNAL LAMP

FEATURES AND BENEFITS:

- All functions utilize Super Flux LED technology
- Amber and Red face each containing 21 Super LED
- Attractive multiple diode design
- Left and Right options with side marker
- Side marker contains 3 Super LED
- Mounting Hardware included
- Voltage/Amp 12.8V -0.61/011 amp



4801LEDR AND 4801LEDL

- Chrome plated
- 1 stud housing with polycarbonate lenses
- Built in side marker with reflector
- Epoxy encapsulated electronics and waterproof construction

21 RED DIODES	21 AMBER DIODES	3 DIODES SIDE MRKR
----------------------------	------------------------------	---------------------------------



4801LEDR 4801LEDL

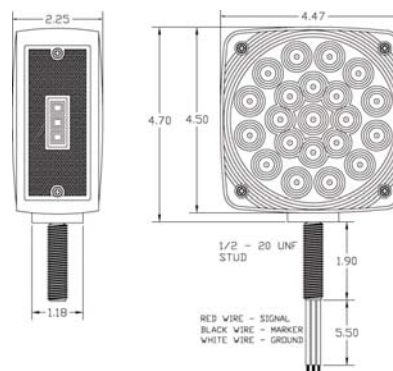

4805LEDR AND 4805LEDL

- Chrome plated
- 2 stud housing with polycarbonate lenses
- Built in side marker with reflector
- Epoxy encapsulated electronics and waterproof construction

21 RED DIODES	21 AMBER DIODES	3 DIODES SIDE MRKR
----------------------------	------------------------------	---------------------------------



4805LEDR 4805LEDL

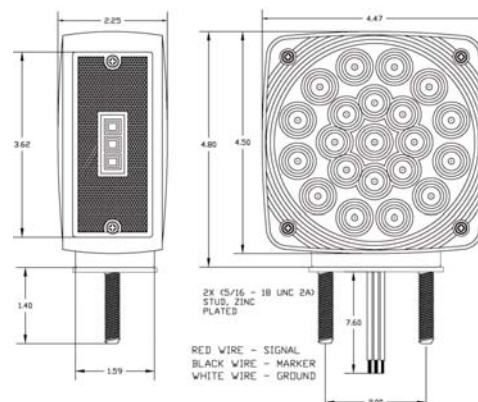

OEM FRONT TURN SIGNAL LAMPS



VSM MID-TURN SIGNAL LAMP

Lamparas de Giro Media Vuelta

All Lamps 12 V Standard



2264A

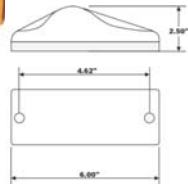

vsm 2264A Mid-Turn Signal Lamp

- Auxiliary side-turn marker/clearance lamp
- Lens and housing sealed against vibration
- Heavy-Duty Shock-Safe mounted bulb
- Uses Industry Standard Connection
- Accommodates vsm9128 pigtail



6164A

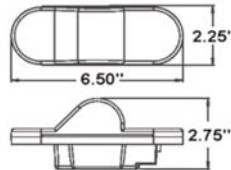

vsm 6164A Mid-Turn Signal

- Sealed polycarbonate lens and housing
- "Shock-Safe" bulb mount
- Standard plug-in connection

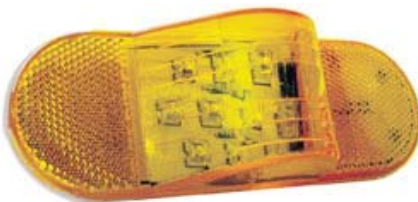

6564A

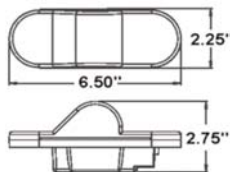

vsm 6564A LED Sealed Mid-Turn Signal Lamp

- Amber sealed 9 Diode LED auxiliary turn/marker lamp
- Polycarbonate lens and housing. Designed at 14V
- .210/.090 amps.
- Uses industry standard plug-in connection



1348A

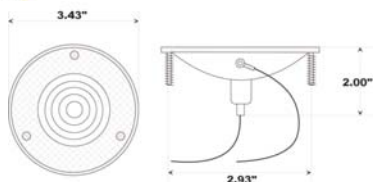

vsm 1348A Mack OEM Replacement Marker Lamp

- Amber replacement side fender marker for Mack
- Gasket included
- Ground wire for mounting on non-metallic surfaces

vsm 1348AY93 Mack OEM Replacement with 93" OEM Harness

- Direct OEM side fender marker replacement lamp
- With 93" OEM harness
- Replacement for MACK 38MO343RP3

vsm 1349A Mack Side Fender Lamp

- Steel plated housing
- Gasket included - No ground wire
- Replacement Parts: • vsm9092A • Bulb 67

vsm 1355A Replacement Marker LED Lamp

- 4 LED Amber replacement side fender marker for Mack
- Gasket included
- Ground wire for mounting on non-metallic surfaces
- Design at 14V, .060 Amps
- Operates in both polarities

MID-TURN SIGNAL LAMPS

LED CAB MARKER LAMPS



Lamparas Led Marcadas de Cabina

All Lamps 12 V Standard

Small OEM Style Aerodynamic Cab Marker Lamp

Available as LED or Incandescent Models.

vsm1376A LED Lamp

vsm1375A Incandescent Lamp

- Used on MACK, NAVISTAR, FORD, FREIGHTLINER, and PETERBILT Trucks

- Can be used with Chrome Bezel vsm9375

Size: 2 5/8" W x 7 9/16" L x 2 1/8" H

Replacement Parts: Amber Lens **vsm9475A** • Bulb 168



1376A LED
1375A Incandescent

vsm9375 Chrome Bezel

Fits **vsm1375A** and **vsm1376A** Aerodynamic Cab Markers



9375

LED RETROFIT KIT MODULE ONLY

Converts Bulb Replaceable Small Aerodynamic Cab Marker to LED

vsm1375AM Amber LED Retrofit Module

- Conversion takes a few minutes, no tools required
- Simply remove the incandescent bulb and insert the LED module
- Provides greater safety with less current draw
- Lamp assembly not included



vsm1375AM
LED Retrofit Module

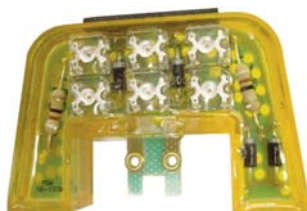

Shown Above:
VSM's 1375AM Retrofit LED Module inserted in the existing base of an incandescent marker lamp will upgrade the lamp to LED.

Large OEM Style Aerodynamic Cab Marker

vsm1385A

Large OEM Style Aerodynamic Cab Marker

Used on FORD, NAVISTAR and FREIGHTLINER

Size: 3 3/16" W x 11" L x 3 1/8" H



1385A

LED CAB MARKER LAMPS



VSM CAB MARKER LAMPS

Lamparas Led Marcadoras de Cabina

All Lamps 12 V Standard



1301A

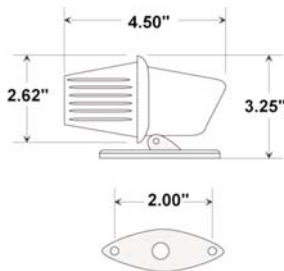

Die Cast Chrome With Shock Safe Bulb Mount

Replacement Cab Marker for Navistar & Universal Applications

vsm1301 Red Chrome Shock Safe Cab Marker

vsm1301A Amber Chrome Shock Safe Cab Marker

- Strong die cast housing with adjustable base and snap out lens
- "O" ring secures lens and seals out dirt and moisture
- Thick molded rubber-mounting pad
- Chrome plated housing

Size: 4 1/2" L x 3 1/4" H x 2 5/8" W

Mounting: Use two #10 screws on 2" center

Replacement Parts:

Lens: Red vsm9008

- Amber vsm9008A
- Bulb 67



1310A



vsm1310A Sonically Sealed Cab Marker

Replacement Cab Marker for Ford & Universal Applications

- Contains one #168 wedge base bulb
- Amber lens and housing are sonically sealed

Size: 5 15/16" L x 3 5/8" W x 1 5/8" H

Mounting: Use two #10 screws on 2 3/4" centers



1313A

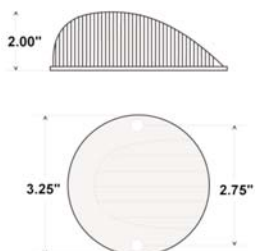

vsm1313A Cab Marker With Rubber Base Housing

Replacement Cab Marker Lamp for Chevy / GMC

- Polycarbonate lens
- Amber lenses only

Size: 3 1/4" Diameter X 2" D

Mounting: Use two #10 screws on 2 3/4" center

Replacement Parts: Amber lens vsm9069A

CAB MARKER LAMPS





CAB MARKERS LAMP



Lamparas Marcadoras de Cabina

All Lamps 12 V Standard

vsm1320A Plastic Housing - Flush Mount Cab Marker

Ford OEM Replacement Cab Marker Lamp

- Single screw, amber lens mounting
- Rust and corrosion proof
- Includes mounting gasket

Size: 5 $\frac{9}{16}$ " L x 2 $\frac{3}{8}$ " W x 1 $\frac{3}{4}$ " H

Mounting: Use two #10 screws on 3" centers on flat or curved surfaces

Replacement Parts: Amber lens **vsm9067A**



1320A

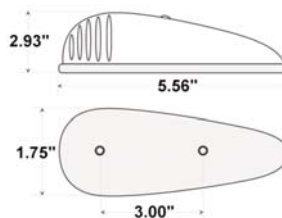

vsm1340A Torpedo Design Chrome Shock Safe

Replacement Cab Marker Lamp for Kenworth and Mack

- Amber lens sturdy, but lightweight
- Strong molded plastic housing - chrome plated
- Shock safe for longer bulb life
- External ground wire
- Mounting pad. Two screw holes for mounting through roof
- Lens attached with three mounting screws

Size: 15 $\frac{1}{2}$ " L x 3 $\frac{1}{2}$ " Diameter

Mounting: Two screw holes for mounting through roof. Use two $\frac{1}{4}$ " screws on 10" centers

Replacement Parts: Bulb **67** • Screw-on 2-hole amber lens **vsm9033A**

- Twist-on amber lens **vsm9032A**



1340A

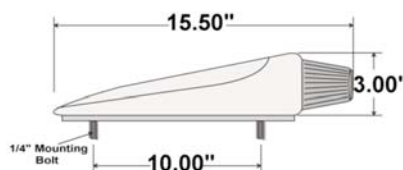

vsm1346A Large OEM Style Cab Marker Lamp

Used on Peterbilt, Kenworth, Ford, Navistar & Western Star Trucks

- High impact plastic, chrome plated
- Thick neoprene mounting pad
- Superior protection against rust and corrosion
- Amber lens

Size: 10 $\frac{7}{8}$ " L x 4 $\frac{9}{16}$ " W x 2 $\frac{3}{4}$ " H

Mounting: Two holes for #10 screws on 9 $\frac{1}{8}$ " centers

Replacement Parts: Bulb **194**



1346A

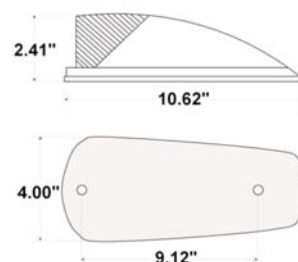

CAB MARKER LAMPS



VSM CLEARANCE / MARKERS

Led de Despeje/Marcadoras

ML2K SERIES

Oblong LED & Incandescent Marker Lamps

Size: 6.6" L x 2.2" W x .92" H

Mounts with 2 # 8 screws on 4.625" centers

Features:

- Popular Oblong Design
- Completely Sealed and Water Tight
- Corrosion Resistant Chrome-Plated Bezel
- No Exposed Fasteners. Surface Mount
- vsm9122 Industry Standard Plug-in Connection
- D.O.T. Compliant
- Made in U.S.A.



2005A

4
DIODES

INCANDESCENT BULB VERSION

14v / .33 amp / 2 cp

vsm2000 ML2K Red Lamp w/Chrome Bezel

vsm2000A ML2K Amber Lamp w/Chrome Bezel

Incandescent Lamps with Reflex Lens & Chrome Bezel

vsm2011 ML2K with Red Reflex Lens & Chrome Bezel

vsm2011A ML2K with Amber Reflex Lens & Chrome Bezel

ML2K LED VERSION

4 Diodes /14v / .065 amp

vsm2005 ML2K Red LED Lamp w/Chrome Bezel

vsm2005A ML2K Amber LED Lamp w/Chrome Bezel

vsm2005RC Red LED Lamp w/Clear Lens & Chrome Bezel

vsm2005AC Amber LED Lamp w/Clear Lens & Chrome Bezel

ML2K LED Lamps with Reflex Lens & Chrome Bezel

vsm2015 ML2K LED w/Red Reflex Lens & Chrome Bezel

vsm2015A ML2K LED w/Amber Reflex Lens & Chrome Bezel

vsm2015RC Red LED w/Clear Reflex Lens & Chrome Bezel

vsm2015AC Amber LED w/Clear Reflex Lens & Chrome Bezel

Lamps are also available with 2 way metripack connector or .180 molded bullet terminals



Add suffix (Y100) to std part No. for lamps with metripack connector



Add suffix (Y180) to std part No. for lamps with .180 molded terminals

ML3K SERIES

Oval LED & Incandescent Marker Lamps

Size: 3" L X 2" W X .94" H

Mounts with 2 # 8 screws on 1.282" centers

Features:

- Corrosion Resistant Chrome-Plated Bezel
- D.O.T. Compliant
- Made in U.S.A.



3000A

2
DIODES

INCANDESCENT BULB VERSION

14v / .33 amp / 2 cp

vsm3000 ML3K Red Lamp w/Chrome Bezel

vsm3000A ML3K Amber Lamp w/Chrome Bezel

ML3K LED VERSION

2-Diodes /14v / .065 amp

vsm3005 ML3K LED Lamp w/Red Lens and with Chrome Bezel

vsm3005A ML3K LED Lamp w/Amber Lens with Chrome Bezel

vsm3005RC LED Lamp, Red Diodes, Clear Lens with Chrome Bezel

vsm3005AC LED Lamp, Amber Diodes, Clear Lens with Chrome Bezel

ML4K SERIES

ML4K LED VERSION

- Operates from 8 - 16 Volts
- 2 SMD LEDs /14v / .05 amp
- Mounts on 1.937" centers



1405 & 1405A

• 1415 and 1415A Kits include chrome bezel

vsm1405 LED Marker Lamp, Red Diodes

vsm1405A LED Marker Lamp, Amber Diodes

vsm1415 LED Marker Lamp, Red Diodes and Chrome Bezel

vsm1415A LED Marker Lamp, Amber Diodes and Chrome Bezel



1415A

2
DIODES

CLEARANCE/MARKERS LAMPS

SEALED CLEARANCE/MARKERS



Lamparas Selladas de Despeje/Marcadoras

All Lamps 12 V Standard • Red Lens Standard

INCANDESCENT BULB TYPE

2300 SERIES GUARDIAN SEALED LAMPS

Combination 2-Bulb Sealed Clearance/Side Marker Lamps**Features:**

- 12 volt, Two 12,000 Hour Rated Bulbs
- Vibration-Resistant Heavy Duty Shock Mounting System
- Sealed Lens and High Impact Base Housing
- .156 Brass Male Bullet Terminals
- Uses Industry Standard 2-Pin Plug-in Connection

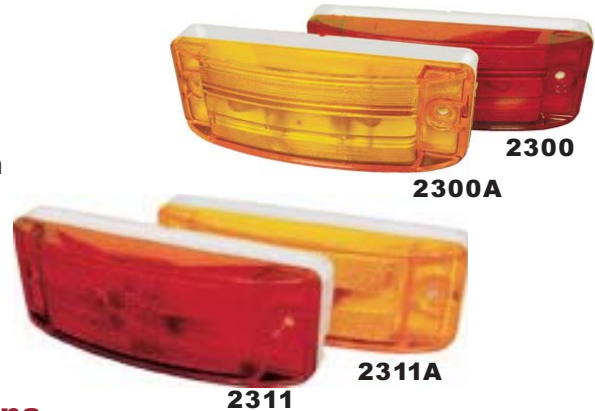
vsm2300 Red 2-Bulb Sealed M/C Lamp**vsm2300A** Amber 2-Bulb sealed M/C Lamp**2300 Series Sealed Lamps With Reflex Lens****vsm2311** Red 2-Bulb Sealed Clearance/Marker with Reflex Lens**vsm2311A** Amber 2-Bulb Sealed Clearance/Marker with Reflex Lens

Industry standard 2-male pin plug-in connection

2400 SERIES CENTURIAN SEALED LAMPS

Combination Clearance/Marker & Auxiliary Stop/Side Turn Signal Position Indicator**Features:**

- 12.8 volt, Single #571 HD Bulb 32/3 cp
- Vibration-resistant Heavy Duty Shock Mounting System
- Sealed Lens and High Impact Base Housing
- .156 Brass Male Bullet Terminals
- Uses 9134 pigtail

vsm2464 Red sealed multi-function lamp**vsm2464A** Amber sealed multi-function lamp

Industry standard 3-male pin plug-in connection



SEALED CLEARANCE/MARKER LAMPS

VSM™ SEALED CLEARANCE / MARKERS

Lamparas Selladas de Despeje/Marcadoras

All Lamps 12 V Standard • Red Lens Standard

INCANDESCENT BULB TYPE

1010 SERIES

2.5 inch Clearance/ Marker Lamps

Features

- Sonically sealed
- Polycarbonate housing and lens
- 14 volt, .33 amp 15,000 hour bulb rated at 2.0 cp
- Quick connect plug vsm 9122



SEALED CLEARANCE/MARKER LAMPS

vsm1010 Red 2½" Sealed Lamp
vsm1010A Amber 2½" Sealed Lamp

1010 SERIES LAMP KITS

Kits include lamp, vsm9119 Rubber Grommet and vsm9122 Pigtail
vsm1010K 1010 Red lamp with 9119 grommet and 9122 pigtail
vsm1010AK 1010A Amber lamp with 9119 grommet and 9122 pigtail



LAMPS WITH FLUSH MOUNT FLANGE

1010 Series sealed lamps with gray polycarbonate flush mount flange

vsm1010F
 1010 Red lamp with gray flush mount flange
vsm1010AF
 1010A Amber lamp with gray flush mount flange



LAMPS WITH SURFACE MOUNT FLANGE

1010 Series lamps with gray polycarbonate surface mount flange

vsm1010SF
 1010 Red lamp with gray polycarbonate surface mount flange
vsm1010ASF
 1010A Amber lamp with gray polycarbonate surface mount flange

1011 SERIES



2.5 inch Clearance/ Markers With Reflector Lens

- Sonically sealed polycarbonate housing and reflector lens
- 14 volt, .33 amp bulb rated at 2.0 cp
- 15,000 hour rated bulb
- Size: 2½" diameter x ¾" depth
- Mounting: Use vsm9122 plug-in connection. Mount between 15" to 60" from ground level when used as a reflector and lamp on trailers less than 80" wide

vsm1011 Red 2½" Sealed Lamp with Reflector Lens
vsm1011A Amber 2½" Sealed Lamp with Reflector Lens

SEALED CLEARANCE/MARKER LAMPS

SEALED CLEARANCE / MARKERS



Lamparas Selladas de Despeje/Marcadoras

All Lamps 12 V Standard • Red Lens Standard

INCANDESCENT BULB TYPE

1030 SERIES

2 inch Sealed Clearance/ Marker lamps

- Features**
- Sonically sealed
 - Polycarbonate housing and lens
 - 14 volt, .33 amp 15,000 hour bulb, rated at 2.0 cp
 - Size: 2" diameter x 3/4" depth
 - Mounting: Use quick connect plug-in vsm9122

1030 SERIES CLEARANCE/MARKER LAMPS

vsm1030 Red 2" Sealed Lamp

vsm1030A Amber 2" Sealed Lamp

LAMPS WITH FLUSH MOUNT FLANGE

1030 Series sealed lamps with gray polycarbonate flush mount flange

vsm1030F 1030 Red lamp with gray polycarbonate flush mount flange

vsm1030AF 1030A Amber sealed lamp w/gray polycarbonate flush mount flange

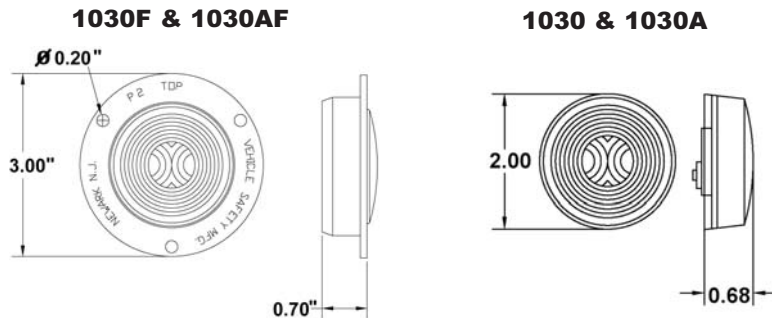

1030 SERIES SURFACE MOUNT LAMPS

1030 Series sealed lamps with gray polycarbonate surface mount flange

vsm1030SF 1030 Red sealed lamp with gray polycarbonate surface mount flange

vsm1030ASF 1030A Amber sealed lamp with gray polycarbonate surface mount flange

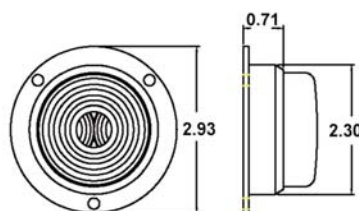

1030ASF

1030SF & 1030ASF

SEALED CLEARANCE / MARKER LAMPS

VSM™ SEALED CLEARANCE / MARKERS

Lamparas Selladas de Despeje/Marcadoras

All Lamps 12 V Standard • Red Lens Standard

INCANDESCENT BULB TYPE

1500 SERIES

2.5 inch Sealed Rectangular One Bulb Clearance/Marker Lamps

- Features**
- Hi-impact polycarbonate resists breakage and corrosion
 - Sonically welded one-piece design protects against moisture and corrosion
 - Sealed one bulb lamp, 15,000 hour rated bulb life
 - Plug-in contacts specially treated to ensure positive electrical connection
 - Size: 2.5" L x 1.25" W x 0.875" D
 - Replaces Truck Lite #15200



1500 SERIES SEALED RECTANGULAR LAMPS

- vsm1500** Red Rectangular Sealed One Bulb Lamp
- vsm1500A** Amber Rectangular Sealed One Bulb Lamp
- vsm1500W** Clear Rectangular Sealed One Bulb Lamp

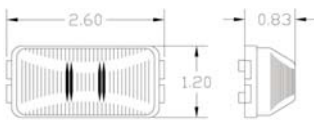

Standard Connection

The 1500 Series lamps have industry standard connections

1500 SERIES LAMP KITS WITH BRACKET & PIGTAIL

1505 Series Lamp Kits with Bracket and Pigtail

- vsm1560K** Red Lamp with 9361 ABS Black Bracket and 9122 Pigtail
- vsm1560AK** Amber Lamp with 9361 ABS Black Bracket and 9122 Pigtail
- vsm1580K** Red Lamp with 9381 ABS Chrome Bracket and 9122 Pigtail
- vsm1580AK** Amber Lamp with 9381 ABS Chrome Bracket and 9122 Pigtail
- vsm1586K** Red Lamp with 9387 ABS Header Mount and 9122 Pigtail
- vsm1586AK** Amber Lamp with 9387 ABS Header Mount and 9122 Pigtail
- vsm1592K** Red Lamp with 9393 ABS Branch Deflector Bracket and Hot Wire
- vsm1592AK** Amber Lamp with 9393 ABS Branch Deflector Bracket and Hot Wire



SURFACE MOUNT BRACKETS FOR 1500 & 1505 SERIES LAMPS



vsm9361 Black ABS Surface Mount Bracket



vsm9381 Chrome ABS Surface Mount Bracket



vsm9387 White ABS Header Mount Bracket



vsm9393 Gray ABS Deflector Mount Bracket with 9526 Hot Wire

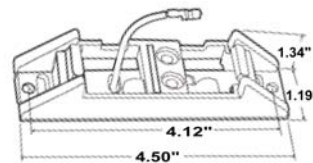
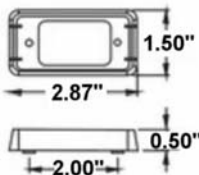
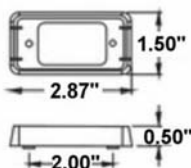

SEALED CLEARANCE/MARKER LAMPS

SEALED CLEARANCE / MARKERS



Lamparas Selladas de Despeje/Marcadoras

All Lamps 12 V Standard • Red Lens Standard

INCANDESCENT BULB TYPE

1900 SERIES

3.87 inch Sealed Rectangular Two Bulb Clearance/ Marker Lamps

Features

- Replaces Truck Lite #19200
- Sonically sealed polycarbonate lens and housing
- PC rating allows lamp to function as both a marker and clearance lamp when properly mounted
- 15,000 hour rated bulb life



Standard Connection

The 1900 Series lamps have industry standard connections

1900 SERIES SEALED RECTANGULAR LAMPS

Size: 3.87" L x 1.2" W x .830" D

vsm1900 Red rectangular sealed clearance/marker lamp**vsm1900A** Amber rectangular sealed clearance/marker lamp**vsm1900W** Clear rectangular sealed utility lamp

1900A

1900

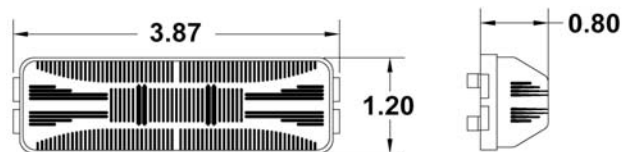

1900 SERIES LAMP KITS

Kits consist of 1900 series lamp, surface mounting bracket and a hot wire

vsm1988K Red rectangular lamp with 9389 surface mount bracket and hot wire kit**vsm1988AK** Amber rectangular lamp with surface mount bracket and hot wire kit

1988AK

1900 SERIES BASE MOUNT KIT & ASSEMBLY

vsm9389 Gray ABS surface mount bracket with hot wire kit**vsm9256** Hot Wire for 1900 Series lamps

9389

9256

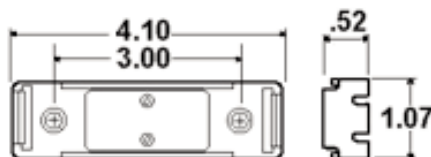

Lens Colors: Red Standard -ADD suffix (A) for Amber; (W) for Clear accessory use only

SEALED CLEARANCE / MARKER LAMPS

VSM CLEARANCE / MARKERS

Lamparas Selladas de Despeje/Marcadoras

All Lamps 12 V Standard • Red Lens Standard

SEALED INCANDESCENT BULB TYPE

2100 SERIES

6 inch Sealed Rectangular Clearance/Marker Lamps

Features:

- ABS housing with acrylic lens
- Shock mounted, internal electrical connections sealed in epoxy for maximum weather resistance
- 12V designed at 14V, .33 Amp, 2cp



2101A

vsm2101 Sealed Red Incandescent Style Clearance/Marker

vsm2101A Sealed Amber Incandescent Style Clearance/Marker



2102

2102A

vsm9221

Hot Wire for 2100 Series lamps

2100 SERIES CLEARANCE/MARKER KITS

Kit includes 9221 Hot Wire

vsm2102 Red 2101 lamp with Hot Wire

vsm2102A Amber 2101A lamp with Hot Wire

SEALED CLEARANCE / MARKERS

REPLACEABLE BULB TYPE

1200 SERIES Double Bulls-Eye Clearance/Markers

Available With Die Cast Base or Permamold Housing

Die Cast Base, Shock Safe 1200 Series Lamps

vsm1203 Red Double Bulls-Eye Clearance/Marker

vsm1203A Amber Double Bulls-Eye Clearance/Marker

- Durable die cast base
- Shock Safe for maximum bulb life
- Rubber "O" ring **vsm 9180** secures snap-on lens

Permamold Housing 1200 Series Lamps

- Hi-Impact, corrosion-proof ABS plastic housing
- Two heavy duty 194 bulbs

vsm1211 Red Double Bulls-Eye Clearance/Marker

vsm1211A Amber Double Bulls-Eye Clearance/Marker



1211A

1203

Size: 4" L x 2" W x 1 1/8" D

Mounting: Two #10 screws on 3" centers

Replacement Parts:

• Lens only: Red vsm9007; Amber vsm9007A • Bulb194



vsm9179 Die Cast Chrome Safeguard

Provides extra lens and lamp protection for vsm1200 Series lamps

Size: 5 7/16" L x 2 3/8" W x 1 1/8" D • Mounting: Two #10 screws on 4 3/4" centers

Lens Colors: Red Standard -.ADD suffix (A) for Amber; (W) for Clear accessory use only

CLEARANCE / MARKERS



Lamparas Despeje/Marcadoras

All Lamps 12 V Standard • Red Lens Standard

REPLACEABLE BULB TYPE

OBLONG TWO-BULB WITH REFLEX LENS

vsm1261

vsm1261A

- High-Impact ABS base
- Shock safe bulb sockets
- Strong acrylic lens, fade-resistant
- Snap-on lens

Size: 4 1/8" L x 2" W x 1 1/32" H

Mounting: Two holes on 3" centers #10 screws

Replacement Parts: Red Lens vsm9011 Amber Lens vsm9011A • Bulb 194

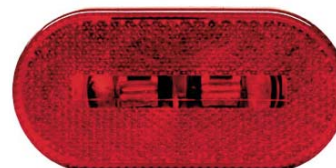

1261

1259 SERIES Cats-Eye Optic Clearance /Markers

vsm1259 Red Cats-Eye Optic Clearance/Marker Lamp

vsm1259A Amber Cats-Eye Optic Clearance/Marker Lamp

- Hi-Impact ABS housing
- Two heavy duty 194 bulbs
- Snap-on lens

Size: 4" L x 2" W x 1"D

Mounting: Two #10 screws on 3" centers

Replacement Parts: Red Lens vsm9093 • Amber Lens vsm9093A • Bulb 194



1259

1259A

THIN-LINE CLEARANCE/MARKER

vsm1549

vsm1549A

- High impact materials
- Snap-on lens
- Heavy duty wedge base bulb
- Side or rear wire exit

Size: 5" L x 2 5/32" W x 1 15/32" H

Mounting: Two 1/4" holes on 4" centers

Replacement Parts: Red Lens vsm9009 • Amber Lens vsm9009A • Bulb 194



1549

SURFACE MOUNT CLEARANCE/MARKER

vsm1550 & vsm1550A

- Corrosion-proof outside mounting
- Snap-on lens
- Heavy duty wedge base bulb
- Fruehauf side marker

Size: 4 1/8" L x 1 11/32" W x 1 15/32" H

Mounting: Two 13/64" holes on 3 5/8" centers

Replacement Parts: Lens Kit for Fruehauf vsm9061 • Red Lens vsm9059 • Amber Lens vsm9059A • Bulb 194



1550A

VSM CLEARANCE / MARKERS

Lamparas Despeje/Marcadoras

All Lamps 12 V Standard • Red Lens Standard

REPLACEABLE BULB TYPE



1001A

RIGHT ANGLE BRACKET BEEHIVE

vsm1001 Red Beehive with Right Angle bracket

vsm1001A Amber Beehive with Right Angle Bracket

vsm1001W Clear Beehive with Right Angle bracket

- Rubber sealed socket, black housing
- 2½" diameter Acrylic lens
- Fully insulated socket wire

Size: 2¾" H x 4¼" D x 2½" H

Mounting: Use two #10 screws on 1" centers

Replacement Parts: Lens: Red vsm9004; Amber vsm9004A • Bulb #67

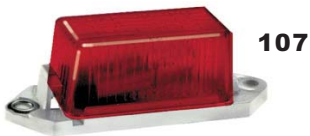

107



157

MINI-LITE

Replacement for Peterson #107

vsm107 Red Mini-Lite

vsm107A Amber Mini-Lite

vsm107W Clear Mini-Lite

vsm157 Red LED Mini-Lite

vsm157A Amber LED Mini-Lite

- Acrylic lens available in red & amber locks into base
- Permamold base • All metal parts are corrosion resistant
- 100,000 hour rated bulb • 15,000 hour rated bulb

Size: ¾" L x 1" W x ¼" H

Mounting: Two holes on 2¾" centers, #10 screws

Replacement Parts: Lens: Red vsm9091; Amber vsm9091A • Bulb #193



1101A

STEEL ARMORED LAMPS

vsm1101 Red - Armored Lamp

vsm1101A Amber - Armored Lamp

vsm1101W Clear - Armored Lamp

- Steel armored, high guard fully protects lens
- Quick-click lens removal
- Pressure pad tightly seals lens • 3 cp bulb

Size: 4⅞" L x 1⅞" W x 1¼" D

Mounting: Four #10 screws on 3⅞" centers 1⅜" apart

Replacement Parts: Lens: Red vsm9005; Amber vsm9005A

• Lens Pressure Pad vsm9177 • 12v Bulb 168



1559

ALUMINUM ARMORED LAMPS

vsm1559 Red Armored Lamp

vsm1559A Amber Armored Lamp

- Stainless clip socket
- Aluminum die cast housing
- Universal mounting

Size: 5⅞" L x 2⅞" W x 1½" H

Mounting: Two ¼" holes on 4⅞" centers on four 1⅜" holes on 3⅞" x 1⅜" centers

Replacement Parts: Lens: Red vsm9014; Amber vsm9014A • Bulb 67



1520A

SURFACE MOUNT CLEARANCE MARKER

vsm1520 Red Armored Lamp

vsm1520A Amber Armored Lamp

- Molded housing and snap-on lens
- Shock safe for extended bulb life
- Corrosion-proof • Easy bulb and lens replacement • 2 cp bulb (RV)

Size: 3½" L x ¾" W x 1" H • Mounting: Two screws on 3" centers

Replacement Parts: Lens: Red vsm9082; Amber vsm9082A • Bulb 194

Lens Colors: Red Standard - ADD suffix (A) for Amber; (W) for Clear use only

CLEARANCE / MARKERS

LED IDENTIFICATION BARS



Barras de Identificacion Con Led

All Lamps 12 V Standard • Red Lens Standard



10153



1015A3S

1015 SERIES 2.5" LED IDENTIFICATION CLUSTER BARS

- Industry standard mounting holes.
- Three sealed 2.5" LED lamps mounted on 6" centers. Bar 16" L x 2" W.
- Includes vsm9309 3-plug harness

With Black Powder Coated Steel Bar

vsm10153 Three 1015 Red Lamps / Black Powder Coated Steel Bar

vsm1015A3 Three 1015A Amber Lamps / Black Powder Coated Steel Bar

With Heavy-Duty Stainless Steel Bar

vsm10153S Three 1015 Red Lamps / HD Corrosion-Proof Stainless Steel Bar

vsm1015A3S Three 1015A Amber Lamps / HD Corrosion-Proof Stainless Steel Bar

- Replacement Parts: Black Powder Coated Bar vsm9313
- Stainless Steel Bar vsm9313S
- 3-plug Harness vsm9309



9309

LED IDENTIFICATION BARS



10353



1035A3S

1035 SERIES 2" LED IDENTIFICATION CLUSTER BARS

- Industry standard mounting holes.
- Three sealed 2" LED lamps mounted on 6" centers. Bar 16" L x 2" W.
- Includes vsm9309 3-strand harness

With Black Powder Coated Steel Bar

vsm10353 Three 1035 Red Lamps / Black Powder Coated Steel Bar

vsm1035A3 Three 1035A Amber Lamps / Black Powder Coated Steel Bar

With Heavy-Duty Stainless Steel Bar

vsm10353S Three 1035 Red Lamps / HD Corrosion-Proof Stainless Steel Bar

vsm1035A3S Three 1035A Amber Lamps / HD Corrosion-Proof Stainless Steel Bar

- Replacement Parts: Black Powder Coated Bar vsm9313
- Stainless Steel Bar vsm9313S
- 3-plug Harness vsm9309



9309

VSM LED IDENTIFICATION BARS

Barras de Identificacion Con Led

All Lamps 12 V Standard • Red Lens Standard

LED IDENTIFICATION BAR



1505A3



15053S

1505 SERIES 2.5" LED IDENTIFICATION CLUSTER BARS

- Industry standard mounting holes.
- Three sealed 2.5" L x 1.2" W x .830 D rectangular LED lamps mounted on a cluster bar.
- Includes 9309 "3-plug harness"

With Black Permamold Bar

17.5" L x 1.5" W x 1.25" D

vsm15053 Three 1505 Red LED Lamps / Black Permamold Bar

vsm1505A3 Three 1505A Amber LED Lamps / Black Permamold Bar

With Hi-polished Stainless Steel Bar

16.5" L x 1.37" W x 1.58" D

vsm15053S Three 1505 Red LED Lamps / Hi-polished Stainless Steel Bar

- Replacement Parts: Black Permamold Bar vsm9315 • Stainless Steel Bar vsm9315S
- 3-plug Harness vsm9309 • Available in Amber



9309

LED IDENTIFICATION BARS



1905A3

19053

1905 SERIES LED IDENTIFICATION CLUSTER BARS

- Industry standard mounting holes.
- Three sealed 3.78" L x 1.2" W x .830 D rectangular LED lamps mounted on a cluster bar.
- Includes 9339 "3-plug harness"

With Black Permamold Bar

17.5" L x 1.5" W x 1.25" D

vsm19053 Three 1905 Red LED Lamps / Black Permamold Bar

vsm1905A3 Three 1905A Amber LED Lamps / Black Permamold Bar

- Replacement Parts: Black Permamold Bar vsm9319
- 3-plug Harness vsm9339



9339

SEALED IDENTIFICATION BARS



Barras de Identificacion Con Luces Selladas All Lamps 12 V Standard • Red Lens Standard

INCANDESCENT BULB TYPE



1013



1013AS

1010 SERIES 2.5" IDENTIFICATION CLUSTER BARS

- Industry standard mounting holes.
- Three sealed 2.5" lamps mounted on 6" centers. Bar 16" L x 2" W x 1.25" D.
- 9309 3-plug harness.

With Black Powder Coated Steel Bar

vsm1013 Three 1010 Red Lamps / Black Powder Coated Steel Bar

vsm1013A Three 1010A Amber Lamps / Black Powder Coated Steel Bar



9309

With Heavy-Duty Stainless Steel Bar

vsm1013S Three 1010 Red Lamps / HD Corrosion-Proof Stainless Steel Bar

vsm1013AS Three 1010A Amber Lamps / HD Corrosion-Proof Stainless Steel Bar

- Replacement Parts: Black Powder Coated Bar vsm9313 • Stainless Steel Bar vsm9313S
- 3-plug harness vsm9309

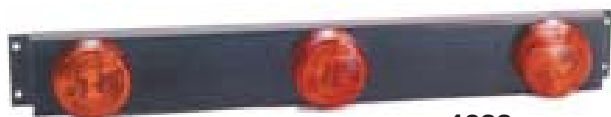

1033



1033AS

1030 SERIES 2" IDENTIFICATION CLUSTER BARS

- Industry standard mounting holes.
- Three sealed 2" lamps mounted on 6" centers. Bar 16" L x 2" W.
- Includes 9309 3-plug harness.

With Black Powder Coated Steel Bar

vsm1033 Three 1030 Red Lamps / Black Powder Coated Steel Bar

vsm1033A Three 1030A Amber Lamps / Black Powder Coated Steel Bar



9309

With Heavy-Duty Stainless Steel Bar

vsm1033S Three 1030 Red Lamps / HD Corrosion-Proof Stainless Steel Bar

vsm1033AS Three 1030A Amber Lamps / HD Corrosion-Proof Stainless Steel Bar

- Replacement Parts: Black Powder Coated Bar vsm9313 • Stainless Steel Bar vsm9313S
- 3-plug harness vsm9309



1503A



1503S

1500 SERIES IDENTIFICATION CLUSTER BARS

- Industry standard mounting holes.
- Three sealed 2.5" L x 1.25" W x .830 D rectangular lamps mounted on a cluster bar.
- Includes 9309 3-plug harness.

With Black Permamold Bar

17.5" L x 1.5" W x 1.25" D

vsm1503 Three 1500 Sealed Red / Black Permamold Bar

vsm1503A Three 1500A Sealed Amber Lamps / Black Permamold Bar



9309

With Hi-polished Stainless Steel Bar

16.5" L x 1.37" W x 1.58" D

vsm1503S Three 1500 Sealed Red Lamps / Hi-polished Stainless Steel Bar

vsm1503AS Three 1500A Sealed Amber Lamps / Hi-polished Stainless Steel Bar

- Replacement Parts: Black Permamold Bar vsm9315 • Stainless Steel Bar vsm9315S
- 3-plug harness vsm9309

VSM IDENTIFICATION BARS

Barras de Lamparas de Identificacion

All Lamps 12 V Standard • Red Lens Standard

SEALED INCANDESCENT BULB TYPE

1900 SERIES

SEALED IDENTIFICATION CLUSTER BARS

- Industry standard mounting holes
- Three 3.78" L x 1.2" W x .830 D rectangular sealed lamps mounted on a cluster bar
- Includes 9339 3-strand harness



With Black Permamold Bar

17.5" L x 1.5" W x 1.25" D

vsm1903 Three 1900 Sealed Red Lamps / Black Permamold Bar

vsm1903A Three 1900A Sealed Amber Lamps / Black Permamold Bar

- Replacement Parts: Black Permamold Bar vsm9319
- 3-strand Harness vsm9339



IDENTIFICATION BARS

REPLACEABLE BULB TYPE

107 SERIES MINI-LITE IDENTIFICATION CLUSTER BARS

- Three Mini-Lites mounted on an enameled steel bar
- Mounting: Use two #8 screws on 16" centers

With White Steel Bar

16.5" L x 1" W

vsm109 Three 107 Red Mini-Lite Lamps / White Enameled Steel Bar

vsm109A Three 107A Amber Mini-Lite Lamps / White Enameled Steel Bar

- Replacement Parts: Red Lens vsm9091; Amber Lens vsm9091A; 193 Bulb



109

1215 SERIES THREE LAMP IDENTIFICATION CLUSTER BARS

- Three dual bulb 1211 lamps mounted on an black powder coated steel bar
- Industry standard mounting holes

With Black Steel Bar

17.75" L x 2.25" W x 1.50" D

vsm1215 Three 1211 Red Lamps / Black Powder Coated Steel Bar

vsm1215A Three 1211A Amber Lamps / Black Powder Coated Steel Bar

With White Steel Bar

17.75" L x 2.25" W x 1.50" D

vsm1216 Three 1211 Red Lamps / White Powder Coated Steel Bar

vsm1216A Three 1211A Amber Lamps / White Powder Coated Steel Bar

- Replacement Parts: Lens: Red vsm9007; Amber vsm9007A



1215

BEEHIVE STYLE IDENTIFICATION CLUSTER BARS

- Three beehive lamps mounted on a pre-wired black steel bar
- Mounting: Use four #10 screws on 20 1/16" centers

With Black Steel Bar

24" L x 1 1/4" W

vsm1003 Three Red Beehive Lamps / Black Enameled Steel Bar

vsm1003A Three Amber Beehive Lamps / Black Enameled Steel Bar

- Replacement Parts: Lens Kit w/Snap Ring: Red vsm9003; Amber vsm9003A
- Lens Only: Red vsm9004; Amber vsm9004A Pigtail vsm9104
- Bulb 67



1003

AUXILIARY LIGHTING



Iluminacion Auxiliar

All Lamps 12 V Standard

PAR 36 RUBBER HOUSING LAMPS

vsm 620W Par 36, Rubber Housing Work Lamp

• With #4411 sealed beam. Serves as tractor, utility, alley or hook-up lamp for fifth wheels. All-purpose lamp in weather sealed rubber housing for long life. Protects against shock and vibration. No rust or corrosion.

- Size: 4½" diameter x 3" D, 5/16" - 18 x 1" diameter stud
- Mounting: Stud with adjustable bracket
- Replacement Parts: Rubber par 36 housing only vsm620H;
Sealed Beam: #4411 12V - 35W (3,000cp)

vsm 620WV24 Par 36 Rubber Housing Work lamp

Sealed Beam: 4589 24V - 50W (5,000cp)

vsm 620A Par 36 Rubber Housing Fog lamp

Sealed Beam: 4415A 12V - 35W (7,000cp)

vsm 620WH3 Par 36 Rubber Hsg, H3 Halogen Work Lamp

With halogen bulb H3-55 watt, 12 volts

vsm 620WH3V24 With 24V H3 Halogen Work Lamp

Replacement Halogen Bulb: H3-70W-24V



620W



620A

PAR 46 RUBBER HOUSING LAMPS

vsm 630W Par 46, Rubber Work Lamp

- Size: 5¾" diameter par 46 sealed beam
- Mounting: ½" - 13 x 1 ½" mounting bolt with adjustable bracket
- Replacement Parts: Rubber par 46 housing only vsm630H
Sealed Beam: #4413

vsm 630A Par 46, Rubber Fog Lamp

- Replacement Parts: Rubber par 46 housing only vsm630H
Sealed Beam: #4412A 12V - 35W (8,800cp)

vsm 632W Par 46, Rubber Halogen Flood Lamp

- Replacement Parts: Sealed Beam #H7609



630W

630A

RECTANGULAR (165mm) RUBBER HOUSING LAMPS

vsm 625W7935 Rubber Housing, Halogen Spot Lamp

• Heavy duty spot lamp with 12V rectangular #7935 lamp. 175,000 CP, 50 watt all-purpose lamp in weather sealed rubber housing for long life. Protects against shock and vibration. No rust or corrosion. All mounting hardware included

- **Size:** 7¼" W x 4¾" H x 4¼" D
- Mounting: ½" diameter stud with adjustable bracket
- **Replacement Parts:** Rubber rectangular housing only vsm625H
Rectangular 12V lamp: 7935 (175,000 cp, 50 watt)

vsm 625W4651 Rubber Housing Halogen High Beam Lamp

- With 50 watt, 55,000 cp, halogen bulb. 12 volts.

vsm 625H Rubber Rectangular Housing Only

- Heavy duty steel reinforced rubber housing
- Size: 7¼" W x 4¾" H x 5" D • Mounting: ½" diameter stud



625W7935

vsm 726500 4½" Chrome Plated Fog/Utility Light

- Zinc die cast housing, chrome plated finish
- 12vdc, ratchet bracket and 5/16" - 18 x 1¾" bolt
- 4½" (114mm) diameter

Replacement Sealed Beam: #4415 par 36, 12V - 35W (9,000cp)



726500

AUXILIARY LIGHTING

VSM™ AUXILIARY LIGHTING

Iluminacion Auxiliar

All Lamps 12 V Standard

VSM615W - PAR 36 LED RUBBER HOUSING WORK LIGHT

FEATURES AND BENEFITS:

- Works perfect for the most demanding environments such as material handling, construction, agricultural, forestry, mining and other off road equipment and truck applications.
- Protects against shock and vibration.
- 8 powerful High Output LEDs.
- Multi-voltage allowed for optimum brightness.
- Includes adjustable mounting bracket and bolt.



615W

**8
HIGH OUTPUT
WHITE LEDs**

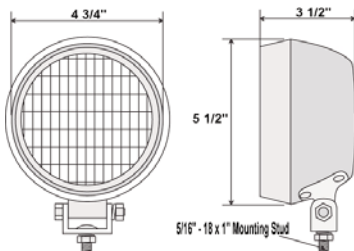

SPECIFICATIONS

- Lens - Polycarbonate, Clear Coated.
- 800 Lumens Light Output.
- Trapezoid Beam Pattern.
- Voltage 9V-36V 16.2W.
- TPR Rubber Housing.
- Light Source: 8 High Output White LEDs.

VSM665W - LED MINI WORK LIGHT

FEATURES AND BENEFITS:

- Works perfect for the most demanding environments such as material handling, construction, agricultural, forestry, mining and other off road equipment and truck applications.
- 1 SMD High-Power LED
- Ultra lightweight housing design only 170 grams.
- Multi-voltage allows optimum brightness thru all voltage ranges.
- Includes adjustable stainless steel mounting bracket and bolt.



**1 SMD
HIGH - POWER
10 WATTS LED**

SPECIFICATIONS

- Uniform pattern without hotspots
- Ultra compact size 50mm x 50mm
- 1 SMD high power 10W LED
- 800 Lumens Light Output (2000 CD)
- Flood Beam Pattern
- Rated IP67
- Temperature -30°C to 50°C
- 18AWG 20" Cable lead wires
- Voltage 9~36VDC
- Current Draw:
12.8V @ 0.91A / 28V @ 0.42A / 36V @ 0.31A

FLOOD BEAM PATTERN

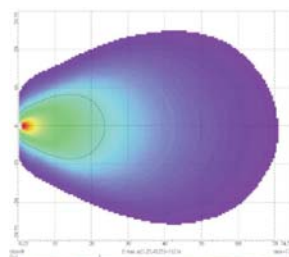
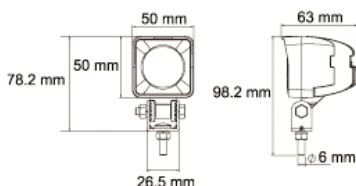

LED WORK LIGHTS

AUXILIARY LIGHTING



All Lamps 12 V Standard



10
HIGH OUTPUT
WHITE LEDS



VSM635W
High Output
LED Work Lamp



FEATURES AND BENEFITS:

- Vehicle Safety Mfg's new 635W is built for the most demanding work environments including material handling, construction, agricultural, forestry, mining and other off road equipment and truck applications.
- Life of 30000+ hours - means no more replacing broken bulbs. Emits clear white light output to illuminate your work areas and equipment.
- Waterproof sealed design with a rugged die cast metal housing protects the LEDs from vibration and moisture.
- 10 diode pattern, 900 Lumens.
- Black powder coated aluminum die cast housing is compact and stylish.
- Lamp size 4 1/2" H x 1 1/2" D.
- 18 AWG, 20" cable lead wires.
- Lamp operates at full brightness between 9-36 VDC, allows for multi-voltage applications.
- Low current draw 1.3 Amp @ 12.8V.
- Includes adjustable stainless steel mounting bracket and bolt.



LED WORKLIGHTS

VSM™ AUXILIARY LIGHTING

All Lamps 12 V Standard



8
HIGH OUTPUT
WHITE LEDS



VSM645W **High Output** **LED Work Lamp**

FEATURES AND BENEFITS:

- Vehicle Safety Mfg's new 645W is built for the most demanding work environments including material handling, construction, agricultural, forestry, mining and other off road equipment and truck applications.
- Life of 30000+ hours - means no more replacing broken bulbs. Emits clear white light output to illuminate your work areas and equipment.
- Waterproof sealed design with a rugged die cast metal housing protects the LEDs from vibration and moisture.
- 8 diode pattern, 700 Lumens.
- Black powder coated aluminum die cast housing is compact and stylish.
- Lamp size 4 3/8" L x 4 7/8" H x 1 7/8" D.
- Mounts on 5/16" - 18x 1" size.
- 18 AWG, 20" cable lead wires.
- Lamp operates at full brightness between 9-36 VDC, allows for multi-voltage applications.
- Low current draw 1.3 Amp @ 12.8V.
- Includes adjustable stainless steel mounting bracket and bolt.



LED WORK LIGHTS

AUXILIARY LIGHTING



All Lamps 12 V Standard



10
HIGH OUTPUT
WHITE LEDS



VSM655W
High Output
LED Work Lamp

FEATURES AND BENEFITS:



- Vehicle Safety Mfg's new 655W is built for the most demanding work environments including material handling, construction, agricultural, forestry, mining and other off road equipment and truck applications.
- Life of 30000+ hours - means no more replacing broken bulbs. Emits clear white light output to illuminate your work areas and equipment.
- Waterproof sealed design with a rugged die cast metal housing protects the LEDs from vibration and moisture.
- 10 diode pattern, 900 Lumens.
- Black powder coated aluminum die cast housing is compact and stylish.
- Lamp size 4 3/8" L x 3 7/8" H x 1 7/8" D.
- Mounts on 5/16" - 18 x 1" stud size.
- 18 AWG, 20" cable lead wires.
- Lamp operates at full brightness between 9-36 VDC, allows for multi-voltage applications.
- Low current draw 1.3 Amp @ 12.8V.
- Includes adjustable stainless steel mounting bracket and bolt.



LED WORKLIGHTS

VSM™ AUXILIARY LIGHTING

All Lamps 12 V Standard

SPECIFICATIONS

VSM 4411LED CONVERTS ANY PAR 36 INCANDESCENT LAMP INTO A SOLID STATE LED WORK LIGHT. WITH STANDARD CONNECTIONS. USERS CAN UPGRADE AN EXISTING INCANDESCENT OR HALOGEN SEALED BEAM LAMP, CONVERTING IT INTO A SUPER BRIGHT LED WORK LIGHT THAT LASTS LONGER, SHINES BRIGHTER AND DELIVERS BETTER VALUE, WITHOUT REMOVING THE ORIGINAL FIXTURE FROM THE VEHICLE.



8
HIGH OUTPUT
WHITE LEDS

FEATURES & BENEFITS

- Built to last in the most demanding environments such as material handling, construction, agricultural, forestry, mining and other off road equipment and truck applications.
- Threaded mounting holes on back of housing allow lamp to be mounted as stand alone device.
- Push on terminals makes conversion quick and easy.
- Trapezoid Beam pattern.
- Lamp operates at full brightness between 9-36 VDC, allows for multi-voltage applications.
- Waterproof sealed design with a rugged die cast metal housing that protects the LEDs from vibration and moisture.

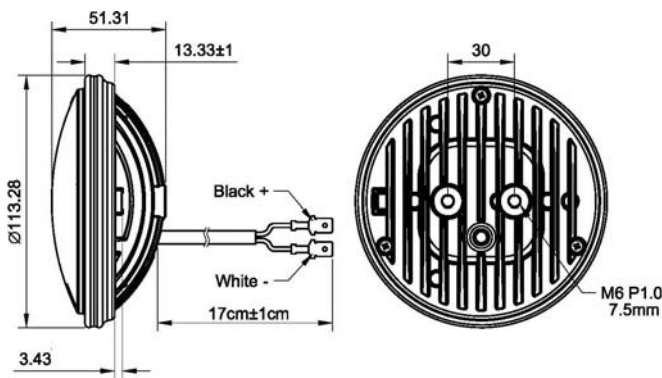

SPECIFICATIONS

- POLYCARBONATE LENS WITH CLEAR HARD COAT.
- BLACK POWDER COATED ALUMINUM DIE CAST HOUSING.
- 800 LUMENS LIGHT OUTPUT.
- 8 POWERFUL HIGH OUTPUT LEDS.
- VOLTAGE 9V-36V.
- ALUMINUM PCB
- CURRENT DRAW 1.14 AMPS @ 12.8 VDC

TRAPEZOID BEAM PATTERN

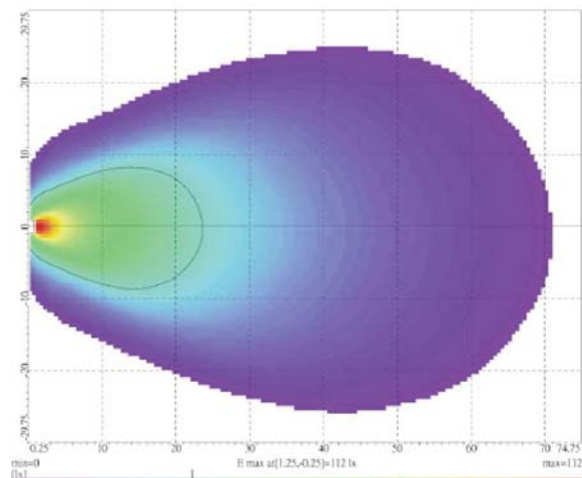

LED WORK LIGHTS



AUXILIARY LIGHTING



All Lamps 12 V Standard

SPECIFICATIONS

VSM 4415LED CONVERTS ANY PAR 36 INCANDESCENT LAMP INTO A SOLID STATE LED WORK LIGHT. WITH STANDARD CONNECTIONS. USERS CAN UPGRADE AN EXISTING INCANDESCENT OR HALOGEN SEALED BEAM LAMP, CONVERTING IT INTO A SUPER BRIGHT LED WORK LIGHT THAT LASTS LONGER, SHINES BRIGHTER AND DELIVERS BETTER VALUE, WITHOUT REMOVING THE ORIGINAL FIXTURE FROM THE VEHICLE.



8
HIGH OUTPUT
WHITE LEDS

FEATURES & BENEFITS

- Built to last in the most demanding environments such as material handling, construction, agricultural, forestry, mining and other off road equipment and truck applications.
- Threaded mounting holes on back of housing allow lamp to be mounted as stand alone device.
- Push on terminals makes conversion quick and easy.
- Trapezoid Beam pattern.
- Lamp operates at full brightness between 9-36 VDC, allows for multi-voltage applications.
- Waterproof sealed design with a rugged die cast metal housing that protects the LEDs from vibration and moisture.

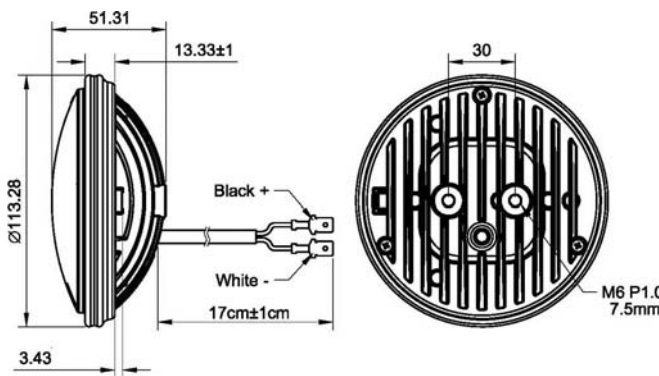

SPECIFICATIONS

- POLYCARBONATE LENS WITH CLEAR HARD COAT.
- BLACK POWDER COATED ALUMINUM DIE CAST HOUSING.
- 800 LUMENS LIGHT OUTPUT.
- 8 POWERFUL HIGH OUTPUT LEDS.
- VOLTAGE 9V-36V.
- ALUMINUM PCB
- CURRENT DRAW 1.14 AMPS @ 12.8 VDC

SPOT BEAM PATTERN

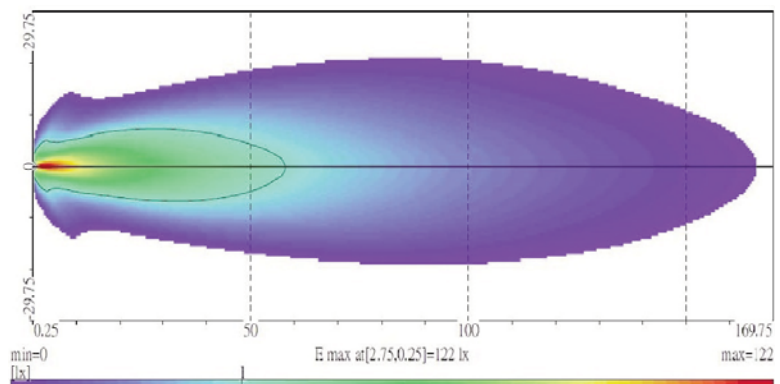

LED WORKLIGHTS





VSM™ BACKUP, UTILITY, DOME LAMPS

Illuminacion Auxiliar

All Lamps 12 V Standard



549W

vsm549W Surface Mount Back-Up Lamp

- Clear back-up lamp, surface mount
- Raised polycarbonate lens (#9372W) with pillow optics for maximum light dispersion
- Single contact bulb #1156

vsm549SW Clear Dome Lamp with Switch

- Surface mount with switch
- Single contact bulb #1141, lens #9373W



6054W

vsm6064W Sealed Oval Back-Up Lamp

- White lens
- Double contact
- Polycarbonate lens and housing
- Suitable for vertical or horizontal orientation
- Use 9128 plug and 9526 grommet



6464W

vsm6054W Sealed Back-Up Lamp Kit

The 6064W lamp with kit consisting of the 9128 plug and 9526 grommet.

vsm6464W Sealed LED Auxiliary Lamp

- 10 diode white oval lamp with clear lens for auxiliary applications
- Sealed polycarbonate lens and housing
- Use VSM9526 grommet and PL3 pigtail connection

10
DIODES



4211W

vsm4211W Black Metal Housing - Flush Mount

- Snap-ring lens • Size: 5 " diameter, 2" depth under flange,
- Mounting: Mounts through 4.5" diameter cutout with three #10 screws on 4.93" diameter bolt circle
- Rpl. Parts: Lens vsm9031CX • Snap ring vsm9039 • Bulb #1156



9362W

9362WT

6

SMD
DIODES

vsm9362W LED Interior Dome Lamp

vsm9362WT LED Interior Dome Lamp with Touch Switch

- Ultra slim profile • Surface mounting design • Clear Lens
- Size: 2.95" O.D x 0.34" H • Mounts with 2 # 8 screws on 2.32" centers
- 6 SMD White LEDs
- Voltage: 12/24V



9369W

9369WT

15

SMD
DIODES

vsm9369W LED Interior Dome Lamp

vsm9369WT LED Interior Dome Lamp with Touch Switch

- Ultra slim profile • Surface mounting design • Frosted Lens
- Size: 9.23" L x 4.92" W x 0.51" H
- Mounts with 2 # 8 screws on 7.87" centers
- 15 SMD White LEDs
- Voltage: 12/24V



9367SW

vsm9367SW Dome Light with Switch

vsm9367W Dome Light without Switch

- Flange-less model, Twist-off lens, • Nylon washer for single wire pigtail
- Size: 5.5" O.D x 1.46" H
- Mounting: Three 0.20" mounting holes on a 5.98" circle
- Bulb #1141

BACK-UP, UTILITY, DOME LAMPS





BACK-UP, UTILITY LAMPS



Lamparas de Utilidad

All Lamps 12 V Standard

vsm44631W 4" Round led Back Up Lamp

- 10 SMD LED Pattern
- Clear lens with interior chrome reflector
- Use vsm9127 standard grommet mount, 9123 plug
- Voltage / Amp : 13.55V - 0.30Amp
- Mounting: Through 4 $\frac{1}{2}$ " diameter hole

10
SMD
DIODES



4.25"

1.62"

44631W

vsm4054C Double Contact Sealed 4" Round Utility Lmp Kit vsm4054W White Lens, 4" Round Back Up Lmp Kit

- Clear or White lens, double contact
- Use vsm9127 grommet mount, vsm9124 plug or R/A plug vsm9128
- Size: 4 $\frac{3}{8}$ " Diameter x 2" depth under grommet flange
- Mounting: Through 4 $\frac{1}{2}$ " diameter hole



4064C

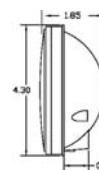

vsm4064W White Lens, 4" Round Back Up Lamp

vsm4064C Double Contact Sealed 4" Round Utility Lamp

vsm4464W Sealed LED 4" Round Auxiliary Lamp

- 10 diode white LED lamp with clear lens for auxiliary applications
- Use industry standard grommet and pigtail connection

vsm3615W Flush Mount BOC Chrome Lamp

- Shallow profile for exterior back of cab applications
- Narrow depth fits in trucks & vans with limited access
- 21 SMD LED pattern design
- Unique bubble optic design displays a full pattern of light
- Environmentally sealed electronics
- Sonically sealed water proof construction
- Zinc die cast housing with chrome plating finish
- Voltage / Amp : 12.8V - 0.40Amp

21
SMD
DIODES

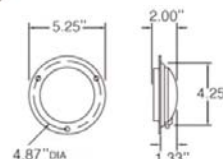

3615W

vsm4063C Sealed 4" Round Utility Lamp

- Clear lens, single contact
- Use vsm9127 standard grommet mount, 9123 plug
- Size: 4 $\frac{3}{8}$ " Diameter x 2" depth under grommet flange
- Mounting: Through 4 $\frac{1}{2}$ " diameter hole



4063C

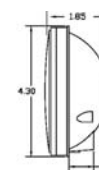

vsm4063W White Lens, 4" Round Back Up Lamp

vsm4463W 4" Round Clear LED Back Up Lamp

- 36 LED pattern
- Use vsm9127 grommet mount, vsm9123
- Voltage / Amp : 12.8V - 0.22Amp
- Mounting: Through 4 $\frac{1}{2}$ " Diameter hole

36
DIODES



4463W

BACK-UP, UTILITY LAMPS



VSM LICENSE PLATE LAMPS

Luces de Matricula

All Lamps 12 V Standard

LICENSE PLATE LAMPS/BRACKETS



420W

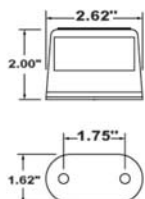

vsm 420W

Standard License Plate Lamp

Replaces Grote #60001. Gray Housing

- Size: 2⁵/₈" L x 1⁵/₈" W x 2" D
- Mounting: Uses two #10 screws on 1³/₄" centers
- Replacement Parts: Cover and Lens vsm9055W • Bulb 168

vsm 422W With Chrome Housing

Otherwise, same specifications as 420W

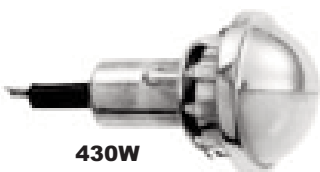

430W

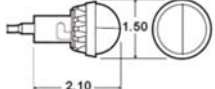

vsm 430W

Chrome License Plate Lamp

For use as license plate illuminator as well as step, courtesy and instrument illuminator. General purpose light

- Size: 1¹/₂" diameter x 1¹/₂" depth under flange
- Mounting: 1¹/₄" diameter hole thru .060 - .250 thick panel
- Replacement Parts: Bulb 67



431W

vsm 431W

Steel Chrome License Plate Lamp

Heavy duty chrome plated steel housing

- Size: 2³/₄" L x 1¹/₂" W x 2¹/₄" D
- Mounting: Uses two 1/4" screws on 2" centers
- Replacement Parts: Bulb 67

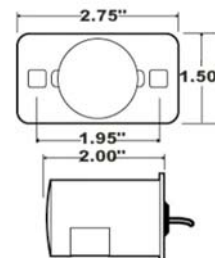

432W

vsm 432W

Universal-Center Hole Stud License Plate Lamp

Same as 431W except mounting is 5/16" hollow stud with nut and lock washer



1502W

vsm 1502W

Sealed One-Bulb License Lamp

- 15,000 hour rated bulb life
- Requires 15729 base for mounting
- Polycarbonate lens and housing

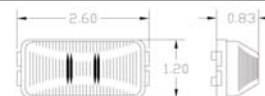

1901W

vsm 1901W

Sealed Two-Bulb License Lamp

- Polycarbonate lens and housing
- Requires 9389 base for mounting



vsm 426WK

License Light w/Black Steel Bracket

- 2 wire design
- Stainless steel mounting base
- Polycarbonate lens w/ Grey ABS hood
- Bulb # 168
- Voltage/Amp: 14V / 0.35 Amp

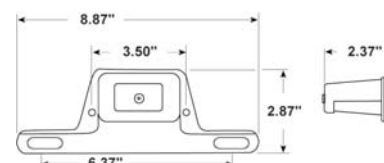

LICENSE PLATE LAMPS



LICENSE PLATE LAMPS



Luces de Matricula

All Lamps 12 V Standard

LICENSE PLATE LAMPS/BRACKETS

vsm437

License Plate Lamp, Black Finish

High-impact plastic body with steel base, acrylic lens, stainless steel and nylon pigtail, stainless screws and rubber gasket. 12V # 67 bulb

- Size: 4 1/8" L x 3 7/16" H x 2 3/16" D
- Mounting: Two 1/4" mounting holes on 3 5/8" centers

vsm438 Chrome Finish Otherwise the same specs. as vsm437



437

vsm 15011

Gray License Lamp Mounting Bracket Kit

Gray high impact polycarbonate bracket complete with vsm1502W lamp and vsm9122 pigtail

vsm15012

Black License Lamp Mounting Bracket Kit

Black high-impact polycarbonate bracket complete with vsm1502W lamp and vsm9122 pigtail

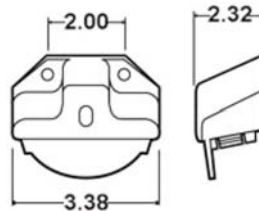

15011

vsm 15511

Gray License LED Lamp Mounting Bracket Kit

Gray high impact polycarbonate bracket complete with vsm1515W LED lamp with hard wired leads and .156" diameter insulated female receptacles

vsm15512

Black License LED Lamp Mounting Bracket Kit

Black high-impact polycarbonate bracket complete with vsm1515W LED lamp with hard wired leads and .156" diameter insulated female receptacles

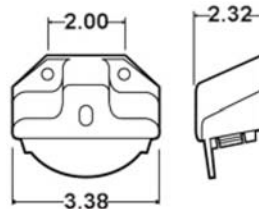

15512

vsm15729

Gray License Lamp Mounting Bracket

High-impact polycarbonate bracket with snap-in lamp mount. Use with 1500 series license lamps

vsm15730

Black License Lamp Mounting Bracket

High-impact polycarbonate bracket with snap-in lamp mount. Use with 1500 series license lamps

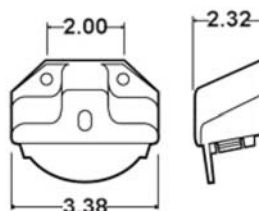

15729

LICENSE PLATE LAMPS/BRACKETS



VSM WARNING LAMPS

Luces de Advertencia & Emergencia

All Lamps 12 V Standard

STROBE WARNING LAMPS

310A



310AM



HI-PROFILE 360°STROBE WARNING LIGHTS

- 6.75" diameter aluminum base, diode protected
- 6.25" amber high profile lens
- SAE-J1318, SAE-class 1 & 2
- Epoxy coated electronics protect against excessive moisture and vibration
- 15 Joules Quad Flash • 12-24 VDC

HI-PROFILE 360° LED STROBE WARNING LIGHTS

- 24 LEDs per head, replaceable
- 12-48 VDC • Current Draw: .8Amp max @ 12VDC / .3Amp @ 48VDC
- 11 different flash patterns: Quad (4fpm), Rapid (120fpm), Double (80 fpm) Single Slow Flash (60 fpm), Quint flash (80 fpm), Single (80fpm)

vsm310A Hi-Profile Permanent Mount Strobe Warning Lamp

Mounting: Permanent mount with 1" pipe mount standard

vsm310AM Hi-Profile Magnetic Mount Strobe Warning Lamp

Mounting: Magnetic mount with cigarette lighter adapter



vsm315A Hi-Profile Permanent Mount LED Strobe Warning Lamp

Mounting: Permanent mount with 1" pipe mount standard

Replacement Parts for Hi-Profile 310 & 315 Series Strobes

vsm9113A Amber high profile lens

vsm9340W Clear high profile dust cover

vsm88310 Quad flash tube

vsm88315 Quad LED strobe tube

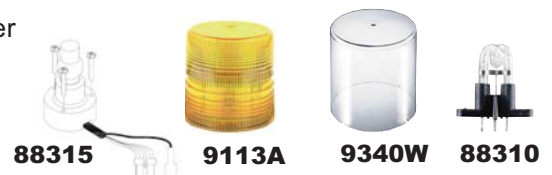

LOW PROFILE 360°STROBE WARNING LIGHTS

310ALP



310ALPM



- 6.75" diameter aluminum base, diode protected
- 4.5" amber low profile lens
- SAE-J1318, SAE-class 1 & 2
- Epoxy coated electronics protect against excessive moisture and vibration
- 15 Joules Quad Flash • 12-24 VDC

vsm310ALP Low Profile Permanent Mount Strobe Light

• Mounting: Permanent mount with 1" pipe mount standard

vsm310ALPM Low Profile 360° Magnetic Mount Strobe Light

• Mounting: Magnetic mount with cigarette lighter adapter

Replacement Parts for Low Profile 310 Series Strobes

vsm9113AL Amber low profile lens

vsm88310 Quad flash tube



RUBBER BASE STROBE WARNING LIGHT

vsm303A Double Flash Rubber Base Strobe Light

- 4" diameter from center to center x 4 5/8" H amber low profile lens
- Diode protected
- SAE-J1318, class 3
- 2.5 Joules, Double Flash • 12-48 VDC
- Mounting: Rubber base, permanent mount

303A





WARNING LAMPS



Luces de Advertencia & Emergencia

All Lamps 12 V Standard

MULTI-VOLTAGE STROBE WARNING LIGHTS

- 5" diameter ABS base & 3-hole with metal ring
- 3 5/8" Low Profile. • Diode protected
- SAE – J 1318, class 3, SAE-UL and CE approved
- 2 Joules, Single Flash • 12 - 80 VDC

vsm307A Multi-Voltage Permanent Mount Strobe Light

Also available in LED (vsm307ALED)

- Mounting: Permanent mount

vsm313A Multi-Voltage Magnetic Mount Strobe Light

- Mounting: Magnetic Mount with cigarette plug kit

Replacement Parts for Multi-Voltage Strobes

vsm9374A Amber low profile dome lens

vsm88307 Flash tube



9374A



88307



307A

313A

MULTI-VOLTAGE STROBE WARNING LIGHT

vsm306A Multi-Voltage Compact Industrial Strobe Light

Also available in LED (vsm306ALED)

- Compact Strobe ideal for the material handling market
- 5" H x 2 3/4" Base Diameter
- Mounting # 10 screws on 3 3/8" centers
- Flash rate : 72 FPM 2 Joules, Single Flash
- 12 - 120 VDC / 0.24 Amp
- Polycarbonate Base and Dome provide excellent durability



New

306A

LED SELF-CONTAINED STROBE WARNING LIGHT

vsm46644A 4" Round LED Quad Flash Strobe Light

- Lamp Dimension 4 1/4" Dia x 1 3/4" H
- 9 ~ 36 VDC, 0.38 Amp Quad Flash
- 24 Super-flux High output LEDs
- Polycarbonate Lens & Housing
- SAE J845 Class 2 on 12V application
- Uses regular open or closed back grommets and dbl contact pigtailed



46644A

New

vsm66644A 6" Oval LED Quad Flash Strobe Light

- Lamp Dimension 6 1/2" L x 2 1/4" W x 1 3/4" H
- 9 ~ 36 VDC, 0.38 Amp Quad Flash
- 24 Super-flux High output LEDs
- Polycarbonate Lens & Housing
- SAE J845 Class 2 on 12V application
- Uses regular open or closed back grommets and dbl contact pigtailed



66644A

vsm69644A 6" Oval LED Arrow Sequential Warning Light

- Lamp Dimension 6 1/2" L x 2 1/4" W x 1 7/8" H
- 9 ~ 36 VDC, 0.38 Amp
- 35 Super-flux High output LEDs
- Polycarbonate Lens & Housing
- SAE J845 Class 2 on 12V application
- Used as Auxiliary Mid-turn Signal or Warning Light
- Arrow Sequential moving pattern or Steady on
- Uses regular open or closed back grommets and dbl contact pigtailed



69644A

STROBE WARNING LAMPS



VSM LED WARNING LAMPS

Luces de Advertencia/Emergencia

All Lamps 12 V Standard

PORTABLE LED WARNING LAMPS

VSM4500M & VSM4500K LED WARNING LIGHTS ARE COMPACT UNITS THAT ARE GREAT FOR THE FOLLOWING APPLICATIONS:

- Roadside Emergency signal - Stalled or Disabled
- Temporary Barricade - Highway Detour, Accident Site, utility work, traffic obstructions, crime scenes, etc.
- Marine use - Locator Signal on Buoys / Floats
- Agricultural use - Marker for Farm Vehicles on Public Roads
- Locator Signal – Place in window for others to locate address
- Trucking Companies
- Utility & Service Vehicles
- EMS
- Law Enforcement
- Fire Departments
- Highway Departments
- Construction Contractors

18
DIODES

4500AK

4500M



4500K Bracket Mount is designed to provide Logging Trucks with a convenient way to quickly mark the end of their load, by mounting the light to the end of the Longest Extending Log.

FEATURES & BENEFITS

- Dual Functions – Flashing & Steady Signal
- Super Bright LED's
- Visibility – Up to 1.3 Miles
- Magnetic Backing for attaching to metal surface
- Bracket mounting with screws
- Slide out stanchion – Self Supporting Stand
- Weather Resistant Design
- Compact Size
- Completely Portable
- Non hazardous environmentally friendly alternative to safety flares

SPECIFICATIONS

- 4500M - Red Warning Light w/ Magnetic
- 4500AM - Amber warning Light w/ Magnetic
- 4500K - Red Warning Light w/ Mounting Bracket
- 4500AK - Amber Warning Light w/ Mounting Bracket
- 6 3/8" Long x 4" Wide x 1 3/4" High
- Net weight .420 lbs (6.72 oz) without batteries requires four (1.5V) AA batteries



4500M

PORTABLE WARNING LAMPS

MOUNTING ACCESSORIES



PIGTAILS / PLUG CONNECTORS

vsm9122 Molded 2-Prong Plug Connector

- Plug connector for sealed 2" and 2½" round and vsm1500 series incandescent and LED lamps



9122

vsm9122Y106 Multiple 2-Prong Plug Connector Harness

vsm9122Y110 Multiple 2-Prong Plug Connector Harness

vsm9122Y112 Multiple 2-Prong Plug Connector Harness

- Coiled harness with 100 vsm9122 two-prong plugs mounted on 10" centers
- Also available in coils with 100 plugs on 6" centers and coils with 100 plugs on 12" centers



9122Y106

9122Y110

9122Y112

vsm9123 Molded Rubber Plug for Single Contact Lamps

- Plug for single contact lamps with ground wire



9124

vsm9124 Molded Rubber Plug for Double Contact Lamps

- Plug for double contact lamps with ground wire
- Plug connector for vsm4000 and 6000 series sealed incandescent and LED lamps

vsm9128 Molded Right Angle Plug

- 3-wire 90-degree plug-in pigtail for vsm4000 and 6000 series sealed incandescent and LED lamps with stop, tail, turn function



9128

vsm9130 Molded Right Angle Tail Plug

- 2-wire 90-degree plug in pigtail for vsm4000 and 6000 series sealed incandescent and LED lamps with auxiliary tail function

vsm9170 Female Bullet Plug

- Single .180 female bullet plug with 10 inch wire length



9170

vsm9170Y116 Multiple Female Bullet Plug Harness

- Coiled harness with 100 vsm9170 female bullet plugs mounted on 16" centers



9170Y116

vsm9221 Hot Wire

- For vsm2100 series sealed incandescent and LED lamps



9221

vsm9256 Hot Wire

- For vsm1900 series sealed incandescent and LED lamps



9256

vsm9444 Electronic Flasher Strobe Module

- Converts an LED lamp into a strobe lamp • 9-16 VDC, Max 15 Amps
- Continuous hyper strobing 850 FPM flash rate
- Design for use in a flashing circuit w/ vehicle flasher controlling the rate of flashes per minute



9444

vsm9446 LED Strobe Flasher Module

- SAE J595 6 Pulse Flash/Pause Strobe Pattern
- Makes a standard LED lamp flash/strobe
- Connect in-line between LED lamps & Power Source
- Operate up to 40 LED lamps with one module
- Fully sealed encapsulated electronics • 9-16 VDC, Max 15 Amps
- Compact Size 1" x .75" x .75" with 6" color coded wire leads



9446

VSM MOUNTING ACCESSORIES

Accesorios de Montaje

STOP/TAIL/TURN LAMP TO VEHICLE HARNESS PLUG ADAPTERS



vsm9420 Plug Adapter:
Grote Harness to standard 3-pin
 • Adapts Grote harness to industry standard 9128- 3-pin style termination

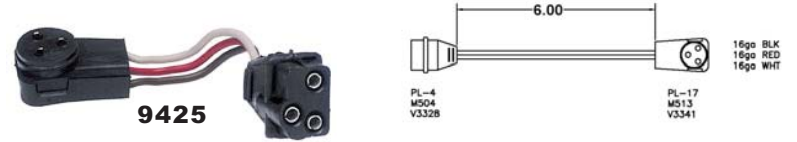

vsm9425 Plug Adapter:
Grote Male Pin Lamp to 3-pin Harness
 • Adapts Grote male pin lamp to standard 3-pin harness

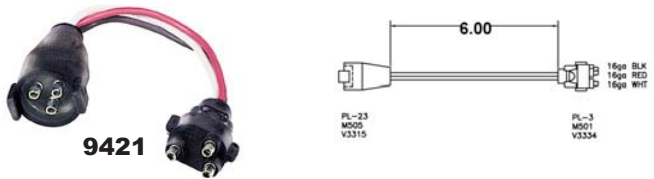

vsm9421 Plug Adapter:
Grote Harness to standard 3-pin
 • Adapts Grote harness to industry standard 9124- 3-pin style termination

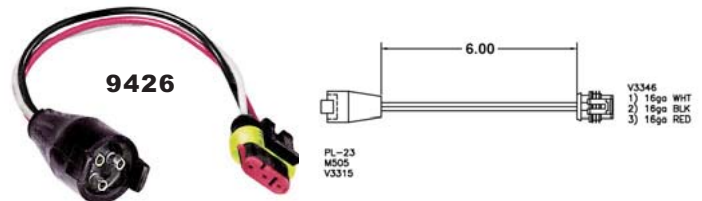

vsm9426 Plug Adapter:
Grote Harness to Sure Seal Plug
 • Adapts Grote harness to Sure Seal plug LED lamps

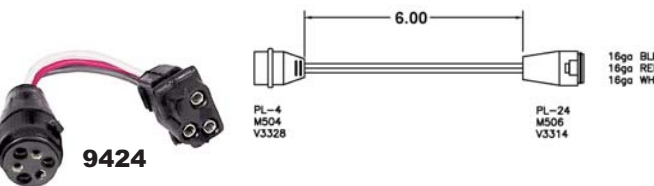

vsm9424 Plug Adapter
to standard R/A 3-pin
 • Adapts male pin lamp to standard 3-pin

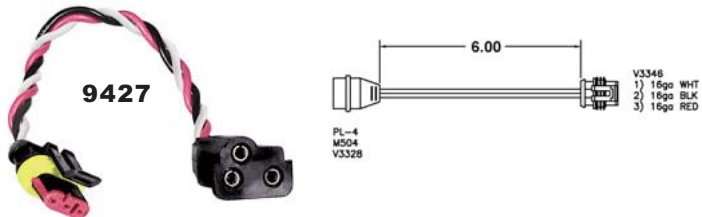

vsm9427 Plug Adapter:
Standard Harness to Sure Seal Plug
 • Adapts standard harness to Sure Seal plug LED lamps
 • Replaces Truck-Lite 94706

PIGTAILS



vsm9101 Double Contact
 • With "in-line" guide for lamps with indexing, bayonet, candelabra type bases. All bakelite (e.g. 1157 bulbs)



vsm9102 Single Contact
 • For lamps with bayonet, candelabra type bases (e.g. 67, 1156 bulbs)



vsm9103 Single Contact
 • For lamps with miniature bayonet type bases (e.g. 1895 bulbs)



vsm9104 Single Contact
 • For lamps with bayonet, candelabra type bases. Rubber plug (e.g. 1156,67 bulbs)



vsm9107 Double Contact
 • With "in-line" guide pin for lamps with indexing, bayonet, candelabra type bases. Rubber plug (e.g. 1157 bulbs)

MOUNTING ACCESSORIES

MOUNTING ACCESSORIES



Accesorios de Montaje

HARNESS CONNECTORS

vsm91282 2-Plug String Harness

- Molded right angle 2-plug string harness for vsm6000 or vsm6400 series two lamp auxiliary light panels



vsm91283 3-Plug String Harness

- Molded right angle 3-plug string harness for vsm6000 or vsm6400 series three lamp auxiliary light panels



vsm91284 4-Plug String Harness

- Molded right angle 4-plug string harness for vsm6000 or vsm6400 series four lamp auxiliary light panels

vsm9309 3-Strand Plug Harness

- For all vsm1000 and vsm1500 series incandescent and LED 3-cluster identification bar lamps



vsm9339 3-Strand Plug Harness

- For all vsm1900 series incandescent and LED 3-cluster identification lamps



METRI-PACK HARNESSES

vsm9464 Metri-Pack 4-Wire Harness

- 4 wire Metri-Pack harness 22" in length
- 16 gauge wire



vsm9466 Metri-Pack Cross-Over Harness

- Metri-Pack harness 78" in length
- 16 gauge wire



vsm9469 Metri-Pack Daisy Chain Harness

- Metri-Pack harness 36" in length
- 16 gauge wire



vsm9470 Metri-Pack 5-Wire Harness

- 5-wire Metri-Pack harness 22" in length
- 16 gauge wire



VSM MOUNTING ACCESSORIES

Accesorios de Montaje



9119

MOUNTING GROMMETS

vsm9119

2 1/2" Sealed Lamp Rubber Mounting Grommet

- Mounting cup (open back - for 2 3/4" diameter mounting hole)
- For vsm1010, 1011, 1015 series lamps
- Size: 3 3/16" diameter x 1 3/16" D

vsm9119

2 1/2" Sealed Lamp Closed back Rubber Mounting Grommet



9139

vsm9139

2" Sealed Lamp Rubber Mounting Grommet

- Mounting cup (open back - for 2 5/16" mounting hole)
- For vsm1030, 1035 series lamps
- Size: 2 3/16" diameter x 1 3/16" D

vsm9159

2" Sealed Lamp Closed Back Rubber Mounting Grommet



9127

vsm9127

Mounting Grommet for 4" Sealed Lamps

- Shock-proof
- Black rubberized vinyl
- Replacement mounting grommet for all vsm4000 series incandescent and vsm4400 series LED lamps

vsm9137

Mounting Grommet Closed Back for 4" Sealed Lamps



9526

vsm9526

Mounting Grommet for Oval Lamps

- For mounting vsm6000 series incandescent and vsm6400 series LED sealed lamps and vsm9525 mounting bracket

vsm9167

Mounting Grommet Closed Back for Oval Lamps

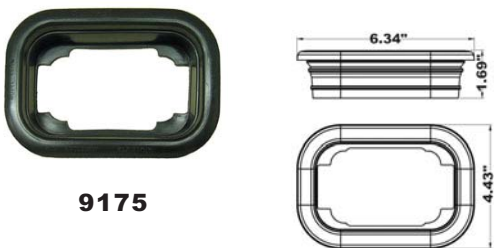

9175

vsm9175

Mounting Grommet For Rectangular Lamps

- Fits vsm4500 series Lamps



9219

9239

GROMMET/PLUG KITS

vsm9219

Mounting Kit for 2 1/2" Lamps

- Mounting kit for 2 1/2" sealed lamps
- Includes vsm9119 grommet and vsm9122 plug for vsm1010, 1011, 1015 series lamps

vsm9239

Mounting Kit for 2" Lamps

- Mounting kit for 2" sealed lamps
- Includes vsm9139 grommet and vsm9122 plug for vsm1030, 1035 lamps

MOUNTING ACCESSORIES



Accesorios de Montaje

SURFACE MOUNT BRACKETS

vsm9361 Black Surface Mount Bracket

- For use with 1500 and 1505 Series, requires vsm9122 pigtail



9361

vsm9381 Chrome Surface Mount Bracket

- For use with 1500 and 1505 Series
requires vsm9122 pigtail



9381

vsm9387 White ABS Header Mount Bracket

- For use with 1500 and 1505 Series
requires vsm9122 pigtail



9387

vsm9393 Gray Branch Deflector Mount Bracket

- For use with 1500 and 1505 Series
Includes Hot Wire



9393

vsm9389 Gray Surface Mount Bracket

- For vsm1900 series incandescent and vsm1905 series LED lamps
Includes Hot Wire



9389

vsm9391 Branch Deflector

- For use with 1010, 1011, 1015 and 1025 Series
requires vsm 9119 and vsm 9122



9391

9395

vsm 9395 Branch Deflector

- For use with 1030, 1035 Series
requires vsm 9139 and vsm 9122

vsm9397 2" "L" Mounting Bracket

- For use with 1030, 1035 Series
requires vsm 9139 and vsm 9122



9397

9398

vsm9398 2½" "L" Mounting Bracket

- For use with 1010, 1011, 1015 and 1025 Series
requires vsm 9119 and vsm 9122

vsm9238 Steel Mounting Bracket with Flange

- 4½" hole for mounting 4" lamps
- Powder coated black steel housing
- **Mounting:** Two ⅜" diameter holes on 4" centers



9238

vsm9237 Steel Mounting Bracket without Flange

- 4½" hole for mounting 4" lamps

VSM MOUNTING ACCESSORIES

Accesorios de Montaje

STAINLESS STEEL OVAL LAMP PANELS

Hi-Polished HD Corrosion-Resistant Stainless Steel



9562



9563

vsm9561 Single Hole Oval Lamp Bracket

- Stainless steel, 8.25" long. Accommodates one lamp

vsm9525 Black Powder Coated Single Hole Bracket

- Steel, 8.25" long. Accommodates one lamp

vsm9562 Two-Hole Oval Lamp Bracket

- Stainless steel, 18.5" long. Accommodates 2 lamps

vsm9563 Three-Hole Oval Lamp Bracket

- Stainless steel, 25" long. Accommodates 3 lamps

vsm9564 Four-Hole Oval Lamp Bracket

- Stainless steel, 33" long. Accommodates 4 lamps

CHROME BEZELS

Chrome-Polished High-Impact Plastic Bezels



9812



9810



9814



9824

Features:

- Includes stainless mounting screws
- Fits all standard mounting applications

vsm9812 2 Inch Round Bezel Without Visor

- Fits all 2" diameter round lamps

vsm9810 2.5 Inch Round Bezel Without Visor

- Fits all 2.5" diameter round lamps

vsm9814 4 Inch Round Bezel Without Visor

- Fits all 4" diameter round lamps

vsm9824 Stainless Steel Trim Ring for 4" Lamp

- Fits all 4" diameter round lamps

VISORED CHROME BEZELS



9813



9811



9815

vsm9813 2 Inch Round Bezel With Visor

- Fits all 2" diameter round lamps

vsm9811 2.5 Inch Round Bezel With Visor

- Fits all 2.5" diameter round lamps

vsm9815 4 Inch Round Bezel With Visor

- Fits all 4" diameter round lamps

OVAL CHROME BEZELS



9816



9817



9866

vsm9816 6 Inch Oval Bezel Without Visor

- Fits all 6" oval lamps

vsm9817 6 Inch Oval Bezel With Visor

- Fits all 6" oval lamps

vsm9866 6 Inch Oval Bezel

- Fits VSM 6664 oval surface mount led lamp

HI-WAY EMERGENCY ITEMS



Productos de Emergencia para el Camino

LAMP, BULB AND FUSE CASE

vsm B105 (Case Only)



B105

- The perfect way to store spare sealed beams, H1-904 headlamp and assorted bulbs and fuses so that they will always be handy when needed
- Rattle-free compartments securely hold and protect components. Special "inside lid" compartment makes it easy to find the proper fuse when needed
- The bright red case is constructed of hi-density polyethelene to withstand rugged use and provide long life
- Case features an internal hinge and sturdy clasp
- Overall Size: 7" high x 11" wide x 9" deep



Suggested B105 Hi-Way Safety Box Combinations

The case is sold empty. The following are only suggested parts. You may tailor items to your own specifications and needs.

Suggested Components		Suggested Components		Suggested Components	
Qty.	Description	Qty.	Description	Qty.	Description
One	6062 Hi-Lo Beam	One	4651 Hi-Beam	One	6064 Hi-Lo Beam
One	4064 Stop/Tail/Turn	One	4652 Lo-Beam	One	4064 Stop/Tail/Turn
One	Relay	One	4064 Stop.Tail/ Turn	One	Relay
One	Heavy Duty Flasher	One	Relay	One	Heavy Duty Flasher
Two	1157 or 1156 Bulbs	One	Heavy Duty Flasher	Two	1157 or 1156 Bulbs
Two	194 or 1895 Bulbs	Two	1157 or 1156 Bulbs	Two	194 or 1895 Bulbs
One	Box Assorted Fuses	Two	194 or 1895 Bulbs	One	Box Assorted Fuses
One	Safety Glow Light Stik	One	Box Assorted Fuses	One	Safety Glow Light Stik
		One	Safety Glow Light Stik		



300

FUSEE CASES WITH BRACKETS (Case & Bracket Only)

VSM Fusee Cases are constructed of non-corrosive, heavy duty polyethylene. Screw-on cap and O-Ring provide a water-proof, dust-proof seal that assures flares are kept dry and ready for use until needed. Complete with wrap-around mounting bracket for quick, easy access to tube and fusees.



300S

vsm300 Wire/No Spike Fusee Case & Bracket

Case and mounting bracket only. Tube will hold three all sizes 15 minute fusees or three 20 minute wire/no spike fusees

- Size: 2 3/4" dia. x 12" long

vsm300S Spike Fusee Case & Bracket

- Size: 2 3/4" dia. x 19" long

Case and mounting bracket only. Tube will hold three sizes 15-20-30 minute fusees or three 20 minute spike fusees



742

vsm742 Fusee Bracket

- Size: 11 7/8" L x 3 3/8" W

Black powder coated steel bracket. Holds up to three spike type fusees. Spring clips hold fusees firmly in place. Mounting: Four screw holes for easy mounting.

HI-WAY EMERGENCY KITS



REFLEX REFLECTORS

Reflectores



20A



22

RETRO-FLEX ADHESIVE-BACKED REFLECTORS

Features:

- Ultra thin design - just .012" thick
- Easy to install on flat or curved surfaces
- Industrial strength adhesive
- Meets/exceeds requirements of ASTM D4956 and SAE A DOT (SAE J594f)

Rectangle With Adhesive-Back

- Size: 2 $\frac{3}{4}$ " W x 1 $\frac{3}{4}$ " H

vsm20 Red Rectangle Reflector. Adhesive back

vsm20A Amber Rectangle Reflector. Adhesive back

Round With Adhesive Back

- Size: 2.88" Diameter

vsm22 Red round reflector. Adhesive back

vsm22A Amber round reflector. Adhesive back

VSM Reflex Reflectors

The following VSM reflectors feature Acrylic Plastic lenses that are shatter resistant, warp free and will not fade or craze. Available with universal mounting holes or adhesive back mounting.



31A

Rectangular Reflector with Adhesive Back

Rectangular adhesive back requires no tools for installation.

- Size: 3 $\frac{3}{16}$ " L x 1 $\frac{7}{8}$ " H x $\frac{1}{4}$ " D • Mounting: Stick-on clean flat surface

vsm31 Red rectangular acrylic reflector. Adhesive back

vsm31A Amber rectangular acrylic reflector. Adhesive back



32

Rectangular Reflector, Chrome Bezel, Adhesive Back

Rectangular reflector with chrome plated bezel. Adhesive back

- Size: 3 $\frac{1}{2}$ " L x 1 $\frac{3}{4}$ " H x $\frac{1}{4}$ " D • Mounting: Stick-on clean flat surface

vsm32 Red rectangular acrylic reflector. Adhesive back

vsm32A Amber rectangular acrylic reflector. Adhesive back



41A

Aluminum Housing-Flush Type Reflector

Completely rustproof. Protective guard shields lens against damage

- Size: 4 $\frac{1}{2}$ " L x 3 $\frac{3}{4}$ " W x $\frac{3}{8}$ " D • Mounting: Two $\frac{1}{4}$ " holes at 3 $\frac{15}{16}$ " centers

vsm41 Red flush-type reflector. Aluminum housing

vsm41A Amber flush-type reflector. Aluminum housing



44

Steel Plated Housing - Armored Type Reflector

Steel plated armored guard protects lens against impact.

- Size: 4 $\frac{1}{2}$ " L x 3 $\frac{3}{4}$ " W
- Mounting: Two $\frac{1}{4}$ " holes at 3 $\frac{15}{16}$ " centers

vsm44 Red steel housing. Armored-type reflector

vsm44A Amber steel housing. Armored-Type reflector





REFLEX REFLECTORS



Reflectores

3 Inch Round With Adhesive Back

- Size: 3 $\frac{3}{16}$ " diameter x $\frac{1}{4}$ " D • Mounting: Stick-on clean flat surface

vsm47 Red round acrylic reflector. Adhesive back

vsm47A Amber round acrylic reflector. Adhesive back

vsm47W White round acrylic reflector. Adhesive back

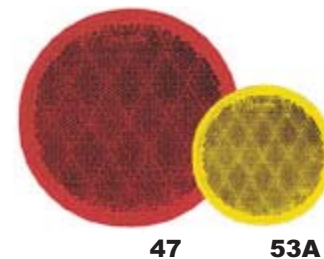

2 Inch Round With Adhesive Back

- Size: 2 $\frac{3}{16}$ " diameter x $\frac{1}{4}$ " D • Mounting: Stick-on clean flat surface

vsm53 Red Round Acrylic Reflector. Adhesive back

vsm53A Amber Round Acrylic Reflector. Adhesive back

Round Center Hole Reflectors

- Mounting: One #10 screw.
- Fast, permanent installation with nail, screw or rivet.
- $\frac{1}{4}$ " reinforced center hole.

2 Inch Diameter Size: 2 $\frac{3}{16}$ " diameter x $\frac{1}{4}$ " D

vsm52 Red 2" round center hole reflector

vsm52A Amber 2" round center hole reflector

3 Inch Diameter Size: 3 $\frac{1}{4}$ " diameter x $\frac{3}{8}$ " D

vsm57 Red 3 $\frac{1}{4}$ " round center hole reflector

vsm57A Amber 3 $\frac{1}{4}$ " round center hole reflector

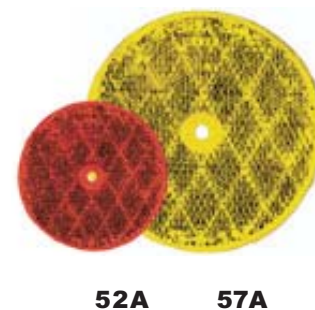

Hermetically Sealed Oval Housing Reflectors

Interchangeable with most reflectors. Size: 4 $\frac{3}{8}$ " L x 1 $\frac{7}{8}$ " W x $\frac{5}{16}$ " D.

Standard Two Hole Mount Mounting: Two #10 screws at 3 $\frac{15}{16}$ " centers

vsm54 Red standard two hole mount oval reflector

vsm54A Amber standard two hole mount oval reflector

Adhesive Back or Standard Two Hole Mount

- Can be used either as a stick-on or standard two hole mount reflector.
- Mounting: Stick-on or two #10 screws at 3 $\frac{15}{16}$ " centers

vsm55 Red oval reflector for adhesive back or two hole mounting

vsm55A Amber oval reflector for adhesive back or two hole mounting



For Either Adhesive Back Or Two Hole Mounting

- Fits between narrow rails and in other tight spaces.
- All standard applications for cars, recreational vehicles and trucks.
- Size: 1 $\frac{1}{8}$ " W x 4 $\frac{7}{16}$ " L • Mounting: Stick-on or two #8 screws on 3 $\frac{15}{16}$ " centers

vsm56 Red rectangular reflector for adhesive back or two hole mount

vsm56A Amber rectangular reflector for adhesive back or two hole mount



Rectangular Conspicuity Strips

12" x 1" strips with end screw holes and adhesive backer.

vsm58 Red rectangular conspicuity strip

vsm58C Clear rectangular conspicuity strip

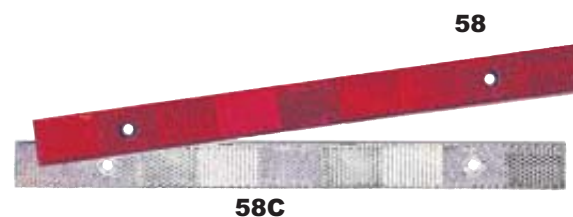

VSM CONSPICUITY TAPE

Cinta Reflectiva

CONSPICUITY TAPE



28



27

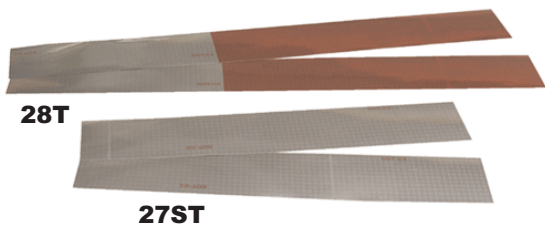

28T

27ST

OEM GRADE CONSPICUITY TAPE

Features:

- **Warranty** Manufacturer's seven year-warranty, including high pressure and mechanical wash
- **Durability** Highest performance available polyester-based film resists cracking and lifting. Impact and abrasion resistant
- **Construction** Single ply .008" thin; NOT open cell construction Impact resistant, withstands a hammer blow and still reflects
- **Adhesion** 100% surface adhesion
- **Angularity** Reflects at all applicable angles on the roadway
- **Candle Power** Minimum 100 cpl typically 1000 cpl. exceeding requirements by four times
- **Application** Apply wet or dry, adheres to corners
- **Specifications** Exceeds NHTSA & FHWA specifications, DOT-C2 markings

For Continuous Side Pattern or Multiple Vehicle Applications

vsm27S 7-year white DOT tape, 2" x 150' roll

vsm28 7-year DOT tape, 7" white-11" red, 2" x 150' roll

For Non-Continuous Side Pattern Applications

vsm27ST 7-year white DOT tape, 2" x 12" strip

vsm28T 7-year DOT tape, 7" white-11" red 2" x 18" strip

Recommended Material Requirements for Non-Continuous Side Pattern

Vehicle Length	Recommended No. 18" Strips/Vehicle	Space Between Strips
28 ft.	20	17 3/8"
42 ft.	30	16 3/4"
45 ft.	32	16 3/4"
48 ft.	34	16 7/8"
53 ft.	38	16 3/8"

Note: the above table represents minimum amount of material specified by NHTSA Additional material may be used to improve the overall conspicuity of the vehicle

CONSPICUITY TAPE



Cinta Reflectiva

DAYBRIGHT CONSPICUITY TAPE

Features:

- An excellent choice to retrofit older trailers and equipment
- Gives an enhanced daytime appearance on trucks and trailers
- Typically exceeds 600 cpl, 2.5 times greater than DOT-C2 brightness requirements
- Alternating 11" red x 7" white pattern
- Virtually unbreakable; single ply material is .008" thin, no open cells
- Withstands impact damage without losing reflectivity
- 100% permanent surface adhesion
- 3-year manufacturer's warranty including pressure washing
- Reflects light at all applicable angles on the road
- Can be applied wet or dry



29

For Continuous Side Pattern or Multiple Vehicle applications

vsm29S 3-year white DOT tape, 2" x 150' roll

vsm29 3-year DOT tape, 7" white-11" red, 2" x 150' roll

vsm30 3-year DOT tape, red/white 2" x 150' roll
Kisscut - precut every 18" at color break



29S

For Non-Continuous Side Pattern Applications

vsm29ST 3-year white DOT tape, 2" x 12" strip

vsm29T 3-year DOT tape, 7" white-11" red, 2" x 18" strip



29T



29ST

CONSPICUITY TAPE

VSM ACCESSORIES

Accesorios



3400W



3400G



3400



3400A



3400B

3400 SERIES FLEX-LED STRIP LIGHTING

For Automotive, Marine, Residential & Commercial Applications

vsm3412A AMBER 12" (9 LED) strip w/ 10" lead wires on 1 end
vsm3424RD RED 24" (18 LED) strip w/10" lead wires on 2 ends
vsm3436G GREEN 36" (27 LED) strip w/10" lead wires on 1 end
vsm3448WD WHITE 48" (36 LED) strip w/10" lead wires on 2 ends
vsm3400 RED 197" (150 LED) Bulk roll

- FLEX-LED interior/exterior strip lighting
- Fully encapsulated & very flexible
- 120 degree viewing angle/5050 PLCC SMD LED
- Space saving low profile design .100" (2.5mm) thick
- Automotive grade 3M double stick tape
- FLEX PCB: White 10mm Width
- LED to LED 28mm centers
- UV resistant silicone gel
- Water proof IP65 rated
- 12.8 VDC - 480ma per meter
- 18 GA GPT wires
- Custom lengths and connectors available upon request
- Available Colors: Suffix (A) Amber (B) Blue (G) Green (R) Red (W) White



3120

JUNCTION BOX

vsm3120 Junction Box

- Universal 7 position junction box with replaceable terminal block
- Extra strong, black non-corrosive construction
- Terminal grommets included
- Size: 8" L x 4" W x 8" H
- Mounting: Two holes on 7 11/32" centers



4755

TERMINAL/JUNCTION BLOCKS

vsm4755 Five Gang

- #10-24 stud terminals
- Molded high temperature thermo-plastic insulator base
- Overall Size: 5 1/4" L x 1 1/2" W x 3/4" H



9407

FUSE-IN-LINES

- One size fits all AGC standard fuses
- Polycarbonate, non-shorting and insulating

vsm9407 Fuse-In-Line with 30 amp fuse



9503

FUSE HOLDERS

vsm9503 Fuse Holder, 20 amps

vsm9504 Fuse Holder, 30 amps heavy duty

ACCESSORIES



Accesorios



322

BACK-UP ALARM

VSM322 Back-Up Alarm

- 97db, Digital Circuitry, 12-24 Volt Operation
- Encapsulated circuit protects against moisture, vibration, shock
- ½ amp (or less) current draw
- Meets all standards SAEJ994
- Tough nylon housing
- Mounting: Base: 3.25" center; Rear: 3 - 3.5" center



27000

CIRCUIT TESTER

vsm27000 Heavy Duty Circuit Tester

- Checks all 6 and 12 volt systems
- Tests circuits on trucks, trailers, SUVs, cars, motorcycles, boats, mopeds
- 5 feet of heavy gauge wire
- Spring supported strain relief
- Heavy duty ground clip and insulator
- Impact and chemical-resistant housing

GLAD HAND GRIP

vsm 10GHG Glad Hand Grip

- ½" NPT.
- Quick, easy disconnect for air hose connection
- Machined steel core
- D.O.T. standard red and blue grips
- Made in the U.S.A.



10GHG



9900

KING PIN LOCK

vsm9900 King Pin Lock

- A security collar on the king pin of a trailer
- Prevents theft by obstructing locking-on of the fifth wheel
- Easily installed or removed with proper key
- Useful as internal trailer control
- Common key available



vsm39

Manifest Document Holder

39

- Convenient way to protect & store documents
- Lightweight aluminum body, stainless steel hinge and latch
- Outside: 13" x 8" x 1-1/2"
- Inside 11-1/2" x 6-1/2" x 1-1/4"

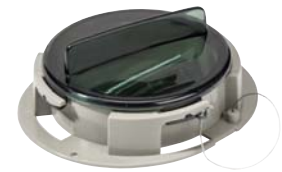

40

vsm40

Round Document Holder

- Convenient way to protect & store documents
- Cam-On Opaque cover w/gasketed seal ensures moisture resistance
- UV-Resistant Polycarbonate Lens & Housing
- Retaining Spring Holds Documents in Place

GLAD HAND LOCK

vsm12000

Glad Hand Lock

- Low cost theft deterrent
- Fits 99% of all glad hands
- Easy to install and remove
- Used in "spotting" trailers
- Available keyed alike

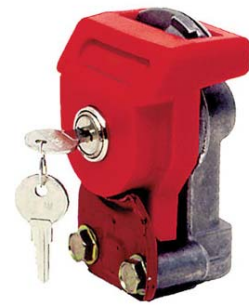

12000

SLOW MOVING VEHICLE EMBLEM

vsm796 Triangular Safety Emblem

- Triangular warning safety emblem meets DOT standards
- For use on all vehicles using public roads moving slower than 25 MPH
- Size: 16" W x 14" H x 3/8" thick
- Mounting: Two 9/32" diameter holes on 6" centers

796



VSM REPLACEMENT LENSES

Lentes De Reemplazo

**NOTE: PART NUMBERS ARE FOR RED LENSES UNLESS OTHERWISE NOTED:
For other colored lenses add suffix for: (A) Amber; (W) Clear .**

REPLACEMENT LENSES

 <p>vsm9004 1000 series lamps.</p>	 <p>vsm9005A 1101 series lamps</p>	 <p>vsm9005W 9369W series lamps</p>	 <p>vsm9006 1200 series "O" ring lens kit</p>	 <p>vsm9007 & vsm9007A 1203/1211 series lamps</p>
 <p>vsm9008A 1301 series lamps</p>	 <p>vsm9011A 1261 series lamps</p>	 <p>vsm9014 1559 series lamps</p>	 <p>vsm9016 2600, 2700, 2800, 3600, 3700, & 3800 series</p>	 <p>vsm9016K Lens kit for 2600, 2700, 2800, 3600, 3700 & 3800</p>
 <p>vsm9029W 4211W lamp</p>	 <p>vsm9030 4000 series lamps</p>	 <p>vsm9031 4000 series lamps</p>	 <p>vsm9032A 1340 series twist-on lens</p>	 <p>vsm9033A 1340 series screw-on lens</p>
 <p>vsm9041 522 lamp lens</p>	 <p>vsm9049 4011 thru 4029 series & 5013 thru 5024 series</p>	 <p>vsm9055W 420 series lamp lens with cover</p>	 <p>vsm9059A 1550 series lamp</p>	 <p>vsm9063 4800 series lamps lens kit</p>















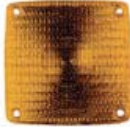

REPLACEMENT LENSES



Lentes De Reemplazo

**NOTE: PART NUMBERS ARE FOR RED LENSES UNLESS OTHERWISE NOTED:
For other colored lenses add suffix for: (A) Amber; (W) Clear for Accessory
use only**

 <p>vsm9067A 1320 lamp lens</p>	 <p>vsm9068W 9367W series lamp</p>	 <p>vsm9069A 1313A lamp lens</p>	 <p>vsm9074A 4800 series Ford park lens kit</p>
 <p>vsm9078A 4800 series GMC park lens kit</p>	 <p>vsm9079A 4842 lamp lens kit</p>	 <p>vsm9085A 303A strobe lens</p>	 <p>vsm9091 107 series lamps</p>
 <p>vsm9093 1259 series lamps</p>	 <p>vsm9113A 310A high profile strobe lens</p>	 <p>vsm9113AL 310AL low profile strobe lens</p>	 <p>vsm9372 548 & 549 series lamps</p>
 <p>vsm9373W 548 & 549 series clear lens with switch hole</p>	 <p>vsm9372W 549W back-up lens clear</p>	 <p>vsm9374A 307A, 313A strobe lens</p>	 <p>vsm9475A 1376A LED and 1375A cab marker</p>

REPLACEMENT LENSES



VSM PRODUCT INTERCHANGE

Referencia para Intercambio de Productos

GROTE

GROTE Part No.	VSM Part No.	CODE	GROTE Part No.	VSM Part No.	CODE	GROTE Part No.	VSM Part No.	CODE	GROTE Part No.	VSM Part No.	CODE	GROTE Part No.	VSM Part No.	CODE
4450	262	D	44810	557	C	46873	2311A	NH	52892	6064	A	60301	1900W	D
10073	7311	C	44820	558	C	46882	107	B	52893	6064A	A	60351	438	D
10073	7323	C	44890	287	D	46883	107A	B	52902	4024	C	61491	548SW	D
10073	7324	D	45022	1001	D	47072	2105	C	52912	4023	D	61491	549SW	D
12072	7052	C	45023	1001A	D	47073	2105A	C	53000	3812	C	62021	92W	D
12111	7053	C	45142	1900V24	D	47082	1505	B	53020	2803	C	62151	4211W	C
12164	7048	C	45143	1900AV24	D	47083	1505A	B	53023	2803AA	C	62171	4063W	C
12182	7046	C	45162	1500V24	D	47092	1905	B	53032	3712	D	62231	6064W	D
12201	7038	C	45163	1500AV24	D	47093	1905A	B	53052	2702	D	62251	6054W	D
12320	7039	C	45172	1105	D	47102	1040	C	53062	5364	NH	62291	548W	D
16023	7084	C	45173	1105A	D	47112	1035	B	53063	5364A	NH	62291	549W	D
16053	7085	C	45262	1259	A	47113	1035A	B	53132	548	C	64071	675W	D
16092	7083	C	45263	1259A	A	47122	1015	A	53133	548A	C	64111	651W	D
16202	7055	D	45333	1312A	D	47123	1015A	A	53252	4454	B	64111	656W	D
16212	7004	C	45462	1233	D	47183	1376A	C	53252	4464	A	64231	653W	D
28032	7310	C	45463	1233A	D	47212	1045	C	53253	4454A	C	64314	652W	D
40052	47	C	45812	1010	A	47213	1045A	C	53253	4464A	A	64441	650W	D
40053	47A	C	45813	1010A	A	47222	1055	C	53282	4467	C	64441	725056	D
40072	53	C	45821	1030W	D	47223	1055A	C	53283	4467A	C	64890	625H	D
40073	53A	C	45822	1030	A	48072	900	A	53292	4468	C	64930	620H	D
40092	52	C	45823	1030A	A	48072	901	C	53293	4468A	C	64931	620W	B
40093	52A	C	45832	1011	A	48192	900Y155	D	53712	5013	C	64931	725058	C
40132	56	C	45832	1101	C	48272	902	C	53773	4064A	A	64940	630H	D
40133	56A	C	45833	1011A	A	48282	999282	C	55092	4211	C	64941	630W	D
40152	57	C	45833	1101A	C	49002	1003	D	55450	4854	C	66830	9424	NH
40153	57A	C	45932	1222	C	49072	1215	D	55450	4872AA	C	66831	9421	NH
40232	41	C	45932	1261	C	49140	9313	C	55460	4855	C	66843	9128	A
40233	41A	C	45933	1222A	C	50232	4112	C	55470	4842	C	67000	9124	A
41022	42	C	45933	1261A	C	50232	4212	C	55572	4063	D	67006	9426	NH
41023	42A	C	45993	1340A	D	50502	4522	C	55612	4111	C	67010	9123	D
41032	54	C	46292	1559	D	50852	522	D	55702	5014	C	67011	9420	NH
41033	54A	C	46293	1559A	D	50852	4029	C	55722	5015	C	67050	9122	A
41042	55	C	46412	1500	A	50902	4014	C	55722	5016	C	68680	9464	C
41043	55A	C	46413	1500A	A	50912	4013	C	55762	5023	C	69500	900Y96	D
41121	58C	NH	46433	1385A	NH	50942	4012	C	55890	4852	C	69530	900Y114	D
41122	58	NH	46543	1320A	D	50942	4015	C	55900	4853	C	69540	900Y129	C
43022	9392	D	46742	1900	A	50952	4011	C	56000	3802	C	69550	900Y150	A
43362	9525	B	46743	1900A	A	50952	4016	C	56020	2801	C	69560	902Y19	C
43362	9561S	C	46782	1203	A	50972	4027	C	56032	3711	D	69580	915Y105	D
43370	9387	D	46783	1203A	A	52202	4564	C	56052	2701	D	69590	915Y103	D
43380	1241	C	46792	1211	A	52203	4564A	C	60001	420W	A	69600	900Y170	D
43424	51	C	46793	1211A	A	52513	6164A	C	60011	422W	C	69610	905Y104	D
43572	9238	C	46813	1310A	C	52543	6154A	C	60011	4212W	C	69610	915Y113	C
43830	15729	D	46813	1375A	C	52602	4028	C	60101	430W	D	69610	99610	NH
43980	9391	D	46832	2300	NH	52770	4066	D	60151	431W	D	69620	915Y104	D
44450	129	C	46833	2300A	NH	52772	4064	A	60261	1502W	D	69650	900Y73	C
44540	263	D	46872	2101	C	52782	4054	A	60271	1500W	D	69660	900Y100	D
44710	254	D	46872	2311	NH	52783	4054A	A	60280	1501		69690	99690	NH
44810	257	D	46873	2101A	C	52882	4068	B	10202C	1010WV24		71152	796	D

POPULARITY CODE:

A = Fastest moving • B = Very active • C = Steady movement • D = Stock only as demand dictates • ** = OEM p/n's • NH = New part number no sales history

PRODUCT INTERCHANGE

PRODUCT INTERCHANGE



Referencia para Intercambio de Productos

GROTE

GROTE Part No.	VSM Part No.	CODE	GROTE Part No.	VSM Part No.	CODE
71422	798	D	481187	999295	NH
73040	322	D	481381	999827	NH
73050	325	D	481385	999495	NH
73080	326	D	484071	999574	A
76033	333A	D	484075	999575	A
76033	381A	D	484371	999839	NH
76035	381B	D	644471	725018	D
76202	374	D	43411-3	50	C
76203	374A	D	43673-5	9179	C
76205	374B	D	48272/69510	900Y112	C
76332	370	D	48272/69510	905Y112	D
76803	6200A	C	48272/69530	900Y101	D
77043	310A	D	48272/69680	903	D
77083	310ALP	D	60081-3	9192	D
90011	9029W	D	82-2160	9406	NH
90012	9029	D	82-2161	9405	NH
90013	9029A	D	82-2163	9407	NH
90051	9005A	C	82-2164	9501	NH
90052	9005	D	82-2164	9502	NH
90053	9005W	C	82-2164	9503	NH
90122	9093	C	82-2165	9504	NH
90123	9093A	C	82-2167	9401	NH
90202	9011	C	82-2311	4745	D
90762	9031	C	82-2312	4744	D
90971	H3-55		83-6006	9602	NH
91302	9049	C	83-6006-3	9603	NH
91400	9119	A	83-6018	9614	NH
91582	9016K	D	83-6018-3	9615	NH
91583	9016AK	D	83-6026	9616	NH
91740	9127	A	83-6026-3	9617	NH
91962	9007	B	83-6104	9604	NH
91963	9007A	B	83-6116	9610	NH
91964	9007G	D	83-8003	3004	NH
91965	9007B	C	85-6028	9606	NH
92183	1375AM	NH			
92420	9526	B			
92452	367	D			
92453	367A	D			
92583	9375	C			
92701	H3-100				
93455	367B	D			
94100	9139	C			
94100	9239	D			
94180	9175	C			
99595	9039	B			
102014	7044	C			
167244	7000	C			
481177	999177	D			
481182	999182	NH			

PRODUCT INTERCHANGE

VSM PRODUCT INTERCHANGE

Referencia Cruzada de Productos

PETERSON

PETERSON Part No.	VSM Part No.	CODE	PETERSON Part No.	VSM Part No.	CODE	PETERSON Part No.	VSM Part No.	CODE	PETERSON Part No.	VSM Part No.	CODE	PETERSON Part No.	VSM Part No.	CODE
45	50	C	142ABS	1010ABS	D	335	2801	C	442L	4016	C	608	7046	C
95A	1550A	D	142R	1010	A	335-2	2803	C	442R	4013	C	608	7311	C
95R	1550	D	142R-24V	1010V24	D	337	3802	C	445	4027	C	615	7000	C
98A	1301A	D	143-18	9119	A	337-2	3812	C	445-25	9071	C	618	7083	C
101-15A	9005A	C	143-18	9219	D	352A	6164A	C	446	5014	C	754A	352A	D
101-15R	9005	D	143A	1011A	A	352KA	6154A	C	446-09	9464	C	754R	352	D
101R	1105	D	143A-24V	1011AV24	D	352R	6164	D	446L	5013	C	755R	370	D
101Y	1105A	D	143FA	1010AF	D	389	9367SW	C	447	5023	C	759A	374A	D
106	1261	C	143FR	1010F	D	391	548SW	D	448	4029	C	759B	374B	D
106-09	9179	C	143R	1011	A	393	548W	D	448	5015	C	759R	374	D
107-3A	109A	C	143R-24V	1011V24	D	393C	92W	D	449	798	D	790A	303A	D
107-3R	109	C	145A	1040A	C	400	420W	A	454	4028	C	809	7310	C
107A	107A	B	145KS	1040ABS	D	410-15R	9029	D	455-25	9049	C	830	7052	C
107R	107	B	145R	1040	C	410-15Y	9029A	D	459	796	D	831	7053	C
108-15	9011	C	146-18	9139	C	410-21	9039	B	470A	42A	C	M110R	1001	D
109A	1312A	D	146-18K	9239	D	410-25R	9031	C	470R	42	C	M110Y	1001A	D
110-15A	9004A	C	146A	1030A	A	411R	4211	C	472A	41A	C	M124A	1101A	C
110-15B	9004B	D	146C	1030W	D	411SR	4111	C	472R	41	C	M124R	1101	C
110-15C	9004C	D	146FA	1030AF	C	413	4112	C	475A	47A	C	M150A	1500A	A
110-15C	9004G	D	146FR	1030F	C	415	4063W	C	475R	47	C	M150C	1502W	D
110-15R	9004	C	146R	1030	A	416	6064C	C	477A	52A	C	M150R	1500	A
111R	1003	D	146SA	1030ASF	D	416K	6054C	C	477R	52	C	M150W	1500W	D
118-15A	9067A	D	146SR	1030SF	D	417-491	9427	NH	479A	54A	C	M153A	1505A	B
118A	1320A	D	150-092/142-49			417-491MP	9426	NH	479R	54	C	M153R	1505	B
134-15A	9093A	C	9381	C		420-2	6464	A	480A	55A	C	M154A	1900A	A
134-15R	9093	C	150-14	15729	D	421-09	9525	B	480R	55	C	M154C	1900W	D
135A	1259A	A	150-141	15730	D	421-18	9526	B	481A	53A	C	M154C	1901W	D
135R	1259	A	150-3A	1503A	D	421-49	9130	C	481R	53	C	M154R	1900	A
138-15A	9007A	B	150-3R	1503	D	421-491	9128	A	483A	31A	C	M158-1A	2105A	C
138-15C	9007C	C	150-49	9309	C	421A	6064A	A	483R	31	C	M158-1R	2105	C
138-15G	9007G	D	154-09K	9389	C	421KA	6054A	B	486A	57A	C	M161A	1905A	B
138-15R	9007	B	155A	2101A	C	421KR	6054	B	486R	57	C	M161R	1905	B
138-18B	9007B	C	155R	2101	C	421R	6064	A	487A	56A	C	M162A	1015A	A
138A	1211A	A	164FA	1035AF	C	424	9123B	D	487R	56	C	M162R	1015	A
138A-V24	1211AV24	D	164FR	1035F	C	424R	4068	B	500	900	A	M163FA	1015AF	D
138B	1211B	D	166A	1045A	C	426-09	9237	C	500	901	C	M163FR	1015F	D
138B-24V	1211BV24	D	166R	1045	C	426-18	9127	A	504HT	625W7935C		M164KR	1035K	C
138C	1211C	D	306A	548A	C	426A	4064A	A	505	642WK	D	M164KY	1035AK	C
138C-24V	1211CV24	D	306R	548	C	426KA	4054A	A	507	620W	B	M164R	1035	B
138G	1211G	D	320	4854	C	426KR	4054	A	507LU	620H	D	M164Y	1035A	B
138G-24V	1211GV24	D	321	4855	C	426R	4064	A	549	H3-100		M2760A	4464A	A
138R	1211	A	324	4872AA	C	428	522	D	550	H3-55		M2760AF-2	4458A	C
138R-V24	1211V24	D	325	4874AA	C	429R	4066	D	555	580K	NH	M2875A	6464A	B
139R	1203	A	326	4842	C	431-49	9123	D	570	250	D	M350A	6564A	C
139Y	1203A	A	326-15A	9079A	D	431-491	9124	A	571	252	D	M413	4212	C
142-09	9391	D	334-15A	9016AK	D	435	431W	D	600	7038	C	M417KR-2	4454	B
142-49	9122	A	334-15R	9016K	D	436	422W	C	602	7048	C	M417R-2	4464	A
142A	1010A	A	334-15R	9021	D	438	430W	D	603	7039	C	M418R-2	4468	C
142A-24V	1010AV24	D	334-15Y	9021A	D	442	4011	C	603L	7044	C	V418KR-2	4458	C

POPULARITY CODE:

A = Fastest moving • B = Very active • C = Steady movement • D = Stock only as demand dictates • ** = OEM p/n's • NH = New part number no sales history

PRODUCT INTERCHANGE



PRODUCT INTERCHANGE



Referencia Cruzada de Productos

PETERSON SIGNAL-STAT

PETERSON Part No.	VSM Part No.	CODE	SIGNAL-STAT Part No.	VSM Part No.	CODE	SIGNAL-STAT Part No.	VSM Part No.	CODE	SIGNAL-STAT Part No.	VSM Part No.	CODE	SIGNAL-STAT Part No.	VSM Part No.	CODE
V7004	9813	NH	31ADB	31A	C	625W	625W7935	C	900Y177	900Y177	D	915Y114	915Y114	C
V7005	9812	NH	31DB	31	C	630H	630H	D	900Y179	900Y179	D	915Y117	915Y117	C
V7006	9811	NH	41A	41A	C	630W	630W	D	900Y209	900Y209	D	915Y118	915Y118	D
V7007	9810	NH	41R	41	C	640WK	642WK	D	901	901	C	915Y119	915Y119	D
V7008	9815	NH	42AD	42A	C	650W	650W	D	901Y108	901Y108	D	915Y120	915Y120	D
V7009	9814	NH	42D	42	C	650W	655W	D	901Y109	901Y109	D	915Y122	915Y122	D
V7010	9817	NH	45A	53A	C	651W	656W	D	901Y73	901Y73	D	915Y124	915Y124	C
V7011	9816	NH	45R	53	C	656W	653W	D	902	902	C	915Y703	915Y703	B
			47-3	47	C	656W	658W	D	902Y108	902Y108	D	915Y704	915Y704	D
			47A-3	47A	C	675W	675W	D	902Y110	902Y110	D	920	920	D
			50	50	C	677W	652W	D	902Y115	902Y115** **		935	935	D
			51	51	C	689D	H3-55		902Y116	902Y116** **		950	950	D
			52-3	52	C	699-4	H3-70V24		903	903	D	955	955	D
			52A-3	52A	C	699D	H3-100		905	905	C	956AA	956AA	D
			54A	54A	C	742	742	C	905Y104	905Y104	D	957AA	957AA	D
			54ATD	55A	C	796	796	D	905Y105	905Y105	D	1001	1001	D
			54R	54	C	798	798	D	905Y106	905Y106	D	1001 A	1001A	D
			54TD	55	C	900	900	A	905Y107	905Y107	D	1003	1003	D
			56A	56A	C	900Y49	900Y49	D	905Y111	905Y111	D	1010	1010	A
			56R	56	C	900Y73	900Y73	C	905Y112	905Y112	D	1010- 4	1010V24	D
			57-3	57	C	900Y80	900Y80	D	905Y113	905Y113	D	1010 A	1010A	A
			57A-3	57A	C	900Y88	900Y88	D	905Y114	905Y114	D	1010A-4	1010AV24	D
			92WD	92W	D	900Y96	900Y96	D	905Y115	905Y115	C	1010W	1010WV24D	
			242	250	D	900Y100	900Y100	D	905Y116	905Y116	D	1011	1011	A
			243	252	D	900Y101	900Y101	D	905Y117	905Y117	D	1011A	1011A	A
			263	558	C	900Y105	900Y105	D	905Y200	905Y200	D	1011A-3	1011AV24	D
			307A	307A	D	900Y106	900Y106	D	905Y206	905Y206	D	1018	1040	C
			311	374	D	900Y110	900Y110	D	910	910	C	1018A	1040A	C
			311A	374A	D	900Y112	900Y112	C	910Y102	910Y102	D	1030	1030	A
			312	370	D	900Y114	900Y114	D	910Y104	910Y104	C	1030A	1030A	A
			313A	313A	D	900Y120	900Y120	D	910Y105	910Y105	D	1030ABS	1030ABS	D
			322	322	D	900Y121	900Y121	D	910Y106	910Y106	D	1030W	1030W	D
			327	325	D	900Y128	900Y128	D	910Y110	910Y110	D	1050	1015R	C
			330	352	D	900Y129	900Y129	C	910Y111	910Y111	D	1050A	1015A	C
			330A	352A	D	900Y137	900Y137	D	910Y112	910Y112	D	1101	1101	C
			333	333	D	900Y14	900Y14	D	910Y113	910Y113	D	1101A	1101A	C
			333A	333A	D	900Y141	900Y141	D	910Y114	910Y114	D	1105	1105	D
			356	326	D	900Y150	900Y150	A	910Y116	910Y116	D	1105A	1105A	D
			420W-3	420W	A	900Y151	900Y151	D	910Y117	910Y117	D	1113	1559	D
			423W	422W	C	900Y155	900Y155	D	910Y601	910Y601	C	1113A	1559A	D
			430W	430W	D	900Y158	900Y158	D	915	915	D	1203	1203	A
			431W	431W	D	900Y160	900Y160	D	915Y102	915Y102	D	1203A	1203A	A
			540	522	D	900Y166	900Y166	D	915y103	915Y103	D	1211	1211	A
			548	548	C	900Y167	900Y167	D	915Y104	915Y104	D	1211A	1211A	A
			548A	548A	C	900Y170	900Y170	D	915Y105	915Y105	D	1215	1215	D
			548SW	548SW	D	900Y171	900Y171	D	915Y107	915Y107	D	1222	1222	C
			580K	580K	NH	900Y173	900Y173	D	915Y109	915Y109	D	1222A	1222A	C
			620H	620H	D	900Y174	900Y174	D	915Y111	915Y111	C			
			620W	620W	B	900Y175	900Y175	D	915Y113	915Y113	C			

PRODUCT INTERCHANGE



VSM PRODUCT INTERCHANGE

Referencia Cruzada de Productos

SIGNAL-STAT

SIGNAL-STAT Part No.	VSM Part No.	CODE	SIGNAL-STAT Part No.	VSM Part No.	CODE	SIGNAL-STAT Part No.	VSM Part No.	CODE	SIGNAL-STAT Part No.	VSM Part No.	CODE
1233	1233	D	4070	6064	A	7323	7323	C	9123	9130	C
1233A	1233A	D	4070A	6064A	A	7324	7324	D	9124	9124	A
1259	1259	A	4071W	6064C	C	8931	9014	D	9127	9127	A
1301A	1301A	D	4072	6054	B	8931A	9014A	D	9128	9128	A
1312A	1312A	D	4073A	6164A	C	8933	9011	C	9139	9139	C
1320	1320A	D	4073AK	6054A	B	9004	9004	C	9145	9145	D
1340A	1340A	D	4073AK	6154A	C	9004A	9004A	C	9157	9526	B
1360A	1310A	C	4111	4111	C	9004B	9004B	D	9175	9175	C
1400	2101	C	4112	4112	C	9004G	9004G	D	9179	1204	D
1400A	2101A	C	4211	4211	C	9004W	9004C	D	9180	9180	D
1400AK	2102A	C	4212	4212	C	9111A	367A	D	9183	9183	C
1400K	2102	C	4501	4553W	C	9111B	367B	D	9185	130	D
1500	1500	A	4501W	4563	C	9111G	367G	D	9190	9190	C
1500A	1500A	A	4522	4522	C	9179-3	9179	C	9191	9143	C
1500W	1500W	D	4800	4800	C	9179A	1204A	D	9191	9191	D
1502W	1502W	D	4801	4801	D	9005	9005	D	9192	9192	D
1507	107	B	4805	4805	D	9005A	9005A	C	9196	9196	D
1507A	107A	B	4805AAY115	4805AAY115	C	9007	9007	B	9238	9238	C
1508A	109A	C	4805AAY118	4805AAY118	C	9007A	9007A	B	9290S	9562S	C
1508R	109	C	4805AY116	4805AY116	C	9007B	9007B	C	9292	9525	B
1550A	1550A	D	4805AY117	4805AY117	C	9007G	9007G	D	9292S	9561S	C
1550	1550	D	4842	4842	C	9007W	9007C	C	9380SWD	9367SW	C
1900	1900	A	4852	4853	C	9008A	9008A	C	9381	9381	C
1900A	1900A	A	4853	4852	C	9016	9016K	D	9387	9387	D
1900W	1900W	D	4854	4854	C	9016A	9016AK	D	9391	9391	D
1901W	1901W	D	4855	4855	C	9016A	9021A	D	9393	1241	C
2660	1255	C	4872AA	4872AA	C	9016W	9021C	D	9393	9393	C
2701	2701	D	4874AA	4874AA	C	9029	9029	D	9397	9397	D
2701A	2701A	D	5013	5013	C	9029A	9029A	D	9420	9420	NH
2702	2702	D	5014	5014	C	9029W	9029C	D	9424	9424	NH
2702A	2702A	D	5015	5015	C	9031	9031	C	9464	9464	C
3051	1035RC	C	5016	5016	C	9039	9039	B	9466	9466	C
3051A	1305AC	C	5023	5023	C	9049	9049	C	9469	9469	C
4013	4013	C	6801A	310A	D	9063	9063	D	9470	9470	C
4014	4014	C	6801MA	310AM	C	9063A	9063A	D	16000	1035	B
4014A	4063A	D	6810A	310ALP	D	9063A	9083A	D	16000A	1035A	B
4015	4015	C	6810MA	310ALPM	C	9067A	9067A	D	17000	1015	A
4016	4016	C	7010	7000	C	9071	9071	C	17000A	1015A	A
4017	4011	C	7038	7038	C	9074A	9074A	C	20801	9602	NH
4023	4023	D	7039	7039	C	9078	9078A	D	20802	9604	NH
4024	4024	C	7044	7044	C	9079	9079	D	20803	9606	NH
4027	4027	C	7048	7048	C	9079A	9079A	D	2660A	1255A	C
4028	4028	C	7054	7053	C	9093	9093	C	44002	4464	A
4030	4064A	A	7073	7046	C	9093A	9093A	C	92524Y	6200A	C
4040	4064	A	7076	7052	C	9111	367	D			
4041W	4063W	C	7083	7083	C	9119	9119	A			
4042	4054	A	7084	7084	C	9119	9219	D			
4046	4066	D	7085	7085	C	9122	9122	A			
4062	4068	B	7313	7310	C	9123	9123	D			

POPULARITY CODE:

A = Fastest moving • B = Very active • C = Steady movement • D = Stock only as demand dictates • ** = OEM p/n's • NH = New part number no sales history

PRODUCT INTERCHANGE



PRODUCT INTERCHANGE



Referencia Cruzada de Productos

TRUCK-LITE

TRUCK-LITE Part No.	VSM Part No.	CODE	TRUCK-LITE Part No.	VSM Part No.	CODE	TRUCK-LITE Part No.	VSM Part No.	CODE	TRUCK-LITE Part No.	VSM Part No.	CODE	TRUCK-LITE Part No.	VSM Part No.	CODE
129	129		4051	44644RC		15745Y	1505A3	C	30200C	1030W	D	60075Y	6564A	C
172	262		4051A	44644AC		19021R	1989K	D	30200R	1030	A	60083R	6054	B
173	263		4060C	44634W		19021Y	1989AK	D	30200Y	1030A	A	60083Y	6054A	B
282	254		4550	45644		19200C	1900W	D	30221R	1030F	C	60202YR	6064	A
283	255		4550A	45644A		19200R	1900	A	30221Y	1030AF	C	60202Y	6064A	A
285	285		6050	64644		19200Y	1900A	A	30222R	1030SF	D	60204C	6064C	C
300A	307ALED		6050A	64644A		19206	1901W	D	30222Y	1030ASF	D	60215R	6164	D
301A	313ALED		6060C	64634W		19250R	1905	B	30250R	1035	B	60215Y	6164A	C
307A	307A	D	6810A	310ALP	D	19250Y	1905A	B	30250Y	1035A	B	60250R	6464	A
313A	313A	D	6810AM	310ALPM	C	19251R	1905RC	B	30251R	1035F	C	60284C	6054W	D
548	548		6811A	310A		19251Y	1905AC	B	30251Y	1035AF	C	60700	9526	B
620W-4	620WV24		6811MA	310AM		19721	9389	C	30401	9239	D	60703	9816	NH
630H	630H		7232	1375AM	NH	20201Y	2101A	C	30700	9139	C	60705	9817	NH
630W	630W		9424	9424	NH	21002R	2102	C	30705	9812	NH	60720	9525	B
650W	655W	D	10050R	1015K	C	21002Y	2102A	C	33050R	3305		60730	9561	C
900	900	A	10050Y	1015AK	C	21051R	2105K	C	33050Y	3305A		60737	9562	C
901	901		10202R	1010	A	21051Y	2105AK	C	33060C	3305W		60738	9563	C
902	902		10202Y	1010A	A	21201R	2101	C	40001R	4053	D	60739	9564	C
903	903		10205R	1011	A	21251R	2105	C	40001Y	4053A	D	62291	549W	
905	905	C	10205Y	1011A	A	21251Y	2105AK	C	40002R	4054	A	70300	3805	D
910	910		10250R	1015	A	22202Y	2264A	NH	40002Y	4054A	A	70310R	2803	C
1050	1015X		10250Y	1015A	A	25760Y	1310A	C	40201R	4063	D	80220	4411LED	
1050A	1015AX	C	10251R	1015F	D	26301R	1259	A	40202R	4064	A	80311R	4027	C
1051	1015RC		10251Y	1015AF	D	26301Y	1259A	A	40202Y	4064A	A	80330R/L	4011	C
1051A	1015AC		10700	9119	A	26302R	1211	A	40204	4063W	C	80330R/L	4013	C
1155	155		10700	9219	D	26302Y	1211A	A	40222R	4067	B	80331R	4024	C
1155A	155A		10719	9811	NH	26303R	1203	A	40222Y	4067A	B	80331R	4016	C
1264	1261		10725	9391	D	26303Y	1203A	A	40223R	4068	B	80334R	4212	C
1264A	1261A		10740	9810	NH	26304R	1261	C	40223Y	4068A	B	80339R	4522	C
1319	1301		10744R	1013		26304Y	1261A	C	40700	9127	A	80360	620W	B
1319A	1301A	D	15008R	1550	D	26311R	1559	D	40705	9814	NH	80362	630W	D
1350A	1346A	C	15008Y	1550A	D	26311Y	1559A	D	40719	9237	C	80380	5014	C
1507	107		15011	15011	C	26315R	1101	C	40720	9238	C	80380R	5013	C
1507A	107A		15012	15012	C	26315Y	1101A	C	44030R	4454	B	80382	5016	C
1508R	109	C	15033Y	1581AK	D	26322R	1001	D	44032R	4457	C	80382R	5015	C
1508Y	109A	C	15039R	1593K	D	26322Y	1001A	D	44036R	4458	C	80383	5023	C
1590A	1348AY93		15039Y	1593AK	D	26330	431W	D	44302R	4464	A	80395	625W7935	C
2660	1255	C	15200C	1500W	D	26331	430W	D	44322R	4467	C	81305Y	4872AA	C
2660A	1255A	C	15200R	1500	A	26335	420W	A	44326R	4468	C	81307	4852	C
2753	4801LEDL		15200Y	1500A	A	26371	422W	C	44700	9815	NH	81308	4855	C
2756	4801LEDR		15208	1502W	D	26720	9179	C	45002	4454	C	81309	4854	C
2758	4805LEDR		15250R	1505	B	26740R	1003	D	45002Y	4554A	C	81310	4842	C
2759	4805LEDL		15250Y	1505A	B	26742R	1215	D	45004	4453W	C	92560	306A	
3050	1035X		15401	9393	C	26760Y	1340A	D	45202R	4564	C	92901	322	D
3050A	1035AX		15406	9381	C	26765Y	1320A	D	45202Y	4564A	C	93906	9309	C
3051	1035RC		15727	9387	D	29202R	2300		45204	4563W	C	94706	9427	NH
3051A	1035AC		15729	15729	D	29202Y	2300A		45700	9175	C	94902	9122	A
4050	44644		15730	15730	D	30050R	1035K	C	60015R	6154	D	94925	9123	D
4050A	44644A		15745R	15053	C	30050Y	1035AK	C	60015Y	6154A	C	94926	9124	A

PRODUCT INTERCHANGE



VSM PRODUCT INTERCHANGE

Referencia Cruzada de Productos

TRUCK-LITE

TRUCK-LITE Part No.	VSM Part No.	CODE	TRUCK-LITE Part No.	VSM Part No.	CODE
94991	9130	C	99077R	9016K	D
94993	9128	C	99077R	9021	D
95000	9464	C	99077Y	9016AK	D
95000	9466	C	99077Y	9021A	D
95001	9426	H	99112R	9005	D
95007	9469	C	99112Y	9005A	C
96939	9221	D	99128R	9079	D
97904	9039	B	99128Y	9079A	D
97934	9180	D	99130Y	9074A	C
97980	620H	D	99130Y	9078A	D
97989	625H		99160R	9014	D
98003R	56	C	99160Y	9014A	D
98003Y	56A	C	99164R	9049	C
98004R	42	C			
98004Y	42A	C			
98005R	47	C			
98005Y	47A	C			
98006R	57	C			
98006Y	57A	C			
98007R	52	C			
98007Y	52A	C			
98008R	53	C			
98008Y	53A	C			
98030R	41	C			
98030Y	41A	C			
98031R	54	C			
98031Y	54A	C			
98032R	55	C			
98032Y	55A	C			
98035R	31	C			
98035Y	31R	C			
98153	58C	NH			
98154R	58	NH			
99008R	9029	D			
99008Y	9029A	D			
99039B	9004B	D			
99039G	9004G	D			
99039R	9004	C			
99039Y	9004Y	C			
99053B	9007B	C			
99053G	9007G	D			
99053R	9007	B			
99053Y	9007A	B			
99055R	9093	C			
99055Y	9093A	C			
99065Y	9008A	C			
99067Y	9067A	D			
99068R	9071	C			

POPULARITY CODE:

A = Fastest moving • B = Very active • C = Steady movement • D = Stock only as demand dictates • ** = OEM p/n's • NH = New part number no sales history

PRODUCT INTERCHANGE



NUMERICAL INDEX



Indice Numerico

VSM Part No.	PAGE No.	VSM Part No.	PAGE No.	VSM Part No.	PAGE No.	VSM Part No.	PAGE No.	VSM Part No.	PAGE No.	VSM Part No.	PAGE No.
10GHG	91	157A	60	632W	65	1003	64	1035ASF	27	1415A	52
20	86	254	16	635W	67	1003A	64	1035AX	19	1500	56
20A	86	255	16	645W	68	1010	54	1035ACX	19	1500A	56
22	86	262	16	655W	69	1010A	54	1035F	27	1500W	56
22A	86	263	16	665W	66	1010AF	54	1035K	27	1502W	74
27S	88	285	16	742	85	1010ASF	54	1035RC	27	1503	63
27ST	88	287	16	796	91	1010F	54	1035RCX	19	1503A	63
28	88	300	85	900	4,15	1010K	54	1035SF	27	1503AS	63
28T	88	300S	85	900HD	4	1010AK	54	1035X	19	1503S	63
29	89	303A	76	900Y73	10	1010SF	54	1101	60	1505	29
29S	89	306A	77	900Y96	12	1011	54	1101A	60	1505A	29
29ST	89	306ALED	77	900Y114	14	1011A	54	1101W	60	1505W	29
29T	89	307A	77	900Y129	11	1013	63	1203	58	1505AC	29
30	89	307ALED	77	900Y150	10	1013A	63	1203A	58	1505AX	19
31	86	310A	76	900Y170	14	1013S	63	1203W	58	1505RC	29
31A	86	310ALP	76	900Y177	14	1013AS	63	1211	58	1505X	19
32	86	310ALPM	76	900Y179	14	1015	26	1211A	58	1520	60
32A	86	310AM	76	900Y206	14	1015A	26	1211W	58	1520A	60
39	91	313A	77	900Y209	12	1015AC	26	1215	64	1549	59
40	91	315A	76	901	4	1015AF	26	1215A	64	1549A	59
41	86	322	91	901HD	4	1015AK	26	1216	64	1550	59
41A	86	420W	74	902	4	1015ASF	26	1216A	64	1550A	59
44	86	422W	74	903	4	1015AX	19	1255	30	1559	60
44A	86	426WK	74	905	5,15	1015ACX	19	1255A	30	1559A	60
47	87	430W	74	905C	5	1015F	26	1255AX	19	1560K	56
47A	87	431W	74	910	5	1015K	26	1255RC	call VSM	1560AK	56
47W	87	432W	74	910Y601	10	1015RC	26	1255X	19	1580K	56
52	87	437	75	915	5	1015RCX	19	1259	59	1580AK	56
52A	87	438	75	915Y103	12	1015SF	26	1259A	59	1581K	29
53	87	522	36	915Y104	13	1015X	19	1261	59	1581AK	29
53A	87	548	37	915Y105	11	1025	26	1261A	59	1586K	56
54	87	548A	37	915Y108	7	1025A	26	1301	50	1586AK	56
54A	87	549SW	72	915Y113	7	1025K	26	1301A	50	1587K	29
55	87	549W	72	915Y114	13	1025AK	26	1310A	50	1587AK	29
55A	87	550	37	915Y116	11	1030	55	1313A	50	1592K	56
56	87	557	16	915Y117	11	1030A	55	1320A	51	1592AK	56
56A	87	558	16	915Y118	14	1030AF	55	1340A	51	1593K	29
57	87	615W	66	915Y121	13	1030ASF	55	1346A	51	1593AK	29
57A	87	620A	65	915Y124	13	1030F	55	1348A	48	1900	57
58	87	620H	65	915Y703	10	1030SF	55	1348AY93	48	1900A	57
58C	87	620W	65	915Y704	12	1033	63	1349A	48	1900W	57
107	60	620WH3	65	918Y116	15	1033A	63	1355A	48	1901W	74
107A	60	620WH3V24	65	918Y994	15	1033S	63	1375A	49	1903	64
107W	60	620WV24	65	918Y998	15	1033AS	63	1375AM	49	1903A	64
109	64	625H	65	920	15	1035	27	1376A	49	1905	28
109A	64	625W4651	65	935	5	1035A	27	1385A	49	1905A	28
128	16	625W7935	65	1001	60	1035AC	27	1405	52	1905AC	28
129	16	630A	65	1001A	60	1035AF	27	1405A	52	1905A3	62
157	60	630W	65	1001W	60	1035AK	27	1415	52		





Indice Numerico

VSM Part No.	PAGE No.	VSM Part No.	PAGE No.	VSM Part No.	PAGE No.	VSM Part No.	PAGE No.	VSM Part No.	PAGE No.	VSM Part No.	PAGE No.
1905AX	19	3005AC	52	4054C	73	4464W	73	4872AA	46	6464W	72
1905RC	28	3005RC	52	4054W	73	4464X	18	4874AA	46	6464X	18
1905X	19	3120	90	4057	32	44644	20,24	5013	39	64644	22,24
1988K	57	3305	31	4057A	32	44644A	20,24	5013LED	41	64644A	22,24
1988AK	57	3305A	31	4058	32	44644AC	24	5014	39	64644AC	24
1989K	28	3305AY180	31	4058A	32	44644RC	24	5014Y101	39	64644RC	24
1989AK	28	3305ACY180	31	4059	33	4467	21	5014Y102	39	6466	22
2000	52	3305AC	31	4059A	33	4467A	21	5014LED	41	6467	23
2000A	52	3305B	31	4063C	73	4467AC	21	5015	39	6467A	23
2005	52	3305BY180	31	4063W	73	4467RC	21	5016	39	6467W	23
2005A	52	3305G	31	4064	32	4468	21	5016LED	41	6468	23
2005AC	52	3305GY180	31	4064A	32	4468A	21	5023	39	6468A	23
2005RC	52	3305RC	31	4064C	73	4468AC	21	5023Y102	39	6468W	23
2011	52	3305RCY180	31	4064W	73	4468RC	21	5023LED	41	6468AX	18
2011A	52	3305W	31	4067	32	4468AX	18	5024	39	6468X	18
2015	52	3305WY180	31	4067A	32	4468X	18	5024LED	41	6469	23
2015A	52	3305Y180	31	4068	32	4469	21	6054	33	6469A	23
2015AC	52	3305Y183	31	4068A	32	4469A	21	6054A	33	6469W	23
2015RC	52	3400	90	4069	33	4469AC	21	6054W	72	6491	25
2101	58	3400A	90	4069A	33	4469RC	21	6064	33	6491A	25
2101A	58	3400B	90	4211W	72	4500AK	78	6064A	33	6491AC	25
2102	58	3400G	90	4212	36	4500AM	78	6064W	72	6491RC	25
2102A	58	3400W	90	4411LED	70	4500K	78	6091	35	6492	25
2105	30	3412A	90	4415LED	71	4500M	78	6091A	35	6492A	25
2105A	30	3424RD	90	4440	20	4522	37	6092	35	6492AC	25
2105AC	30	3436	90	4454	21	4553W	34	6092A	35	6492RC	25
2105AK	30	3448	90	4454A	21	4554	34	6093	35	6493	25
2105K	30	3615W	73	4454AC	21	4554A	34	6093A	35	6493A	25
2105RC	30	3705	43	4454RC	21	4563W	34	6094	35	6493AC	25
2264A	48	3705A	43	44544	20	4564	34	6094A	35	6493RC	25
2300	53	3705W	43	44544A	20	4564A	34	6164A	48	6494	25
2300A	53	3801Y67	44	4457	21	45644	24	6454	22	6494A	25
2311	53	3802	42	4457A	21	45644A	24	6454A	22	6494AC	25
2311A	53	3802Y67	44	4457AC	21	46644A	77	6454AC	22	6494RC	25
2464	53	3812	42	4457RC	21	4755	90	6454RC	22	6564A	48
2464A	53	3812LED	43	4458	21	4800	44	6456	22	66644A	77
2601	36	4013	38	4458A	21	4801	44	6457	23	69644A	77
2601A	36	4014	38	4458AC	21	4801LEDL	47	6457A	23	7464	37
2702	42	4015	38	4458RC	21	4801LEDR	47	6457W	23	9004	92
2702A	42	4016	38	4459	21	4805	46	6458	23	9004A	92
2705	43	4023	38	4459A	21	4805AAY115	45	6458A	23	9004W	92
2705A	43	4023Y106	38	4459AC	21	4805AAY118	45	6458W	23	9005	92
2705W	43	4024	38	4459RC	21	4805AAY2	44	6459	23	9005A	92
2801	42	4024Y106	38	4463W	73	4805AAY4	44	6459A	23	9005W	92
2801AA	42	4027	38	44631W	73	4805AY116	45	6459W	23	9006	92
2803	42	4027LED	41	44634W	24	4805AY117	45	64634W	24	9006A	92
2803AA	42	4028	38	4464	20	4805LEDL	47	6464	22	90073	30,58,92
3000	52	4028LED	41	4464A	20	4805LEDR	47	6464A	22	9007A	30,58,92
3000A	52	4029	38	4464AC	20	4842	46	6464AC	22	9007W	92
3005	52	4054	32	4464AX	18	4854	46	6464AX	18	9008	50,92
3005A	52	4054A	32	4464RC	20	4855	46	6464RC	22	9008A	50,92

NUMERICAL INDEX



VSM Part No.	PAGE No.	VSM Part No.	PAGE No.	VSM Part No.	PAGE No.	VSM Part No.	PAGE No.
9011	92	9122Y110	79	9395	83	15511	75
9011A	92	9122Y112	79	9397	83	15512	75
9014	92	9123	79	9398	83	15729	75
9014A	92	9124	24,79	9407	90	15730	75
9016	44,92	9127	24,82	9420	80	19053	62
9016A	92	9128	24,79	9421	80	27000	91
9016K	92	9130	79	9424	80	726500	65
9016AK	92	9134	53	9425	80	88307	77
9016W	92	9135	31	9426	80	88310	76
9021	44	9137	24,82	9427	80	88315	76
9029	92	9139	82	9444	79	91282	25,81
9029A	92	9156	82	9446	79	91283	25,81
9029W	92	9159	82	9464	39,81	91284	25,81
9030	92	9167	24,82	9466	39,81	988172	9
9030A	92	9170	79	9469	39,81	988173	9
9031	92	9170Y116	79	9470	39,81	999124	7,8
9031A	92	9175	24,34,82	9475A	93	999177	7
9032A	51,92	9179	58	9503	90	999182	7
9033A	51,92	9183	17	9504	90	999282	15
9041	92	9185	17	9525	25,84	999295	12
9049	92	9186	17	9526	25,82	999392	14
9055W	92	9187	17	9561	25,84	999490	7
9059	92	9219	26,82	9562	25,84	999491	7
9059A	92	9221	30,58,79	9563	25,84	999495	7
9059W	92	9237	83	9564	84	999496	8
9063	44,45,92	9238	24,83	9810	84	999574	10
9063A	44,45,92	9239	27,82	9811	84	999575	10
9067	93	9256	28,57,79	9812	84	999578	call vsm
9067A	51,93	9287	24	9813	84	999827	13
9068W	93	9309	62,81	9814	84	999836	12
9069A	93	9339	62,81	9815	84	999839	12
9074	93	9340W	76	9816	84	B105	85
9074A	93	9340WL	76	9817	84		
9078A	93	9361	29,56,83	9824	84		
9079	45,93	9362W	72	9835	31		
9079A	44,45,93	9362WT	72	9866	22,84		
9085A	93	9369W	72	9900	91		
9091	93	9369WT	72	10153	61		
9091A	93	9367SW	72	10153S	61		
9093	93	9367W	72	1015A3	61		
9093A	93	9372	93	1015A3S	61		
9101	80	9372A	93	10353	61		
9102	80	9372W	93	1035A3	61		
9103	80	9373W	93	10353S	61		
9104	80	9374A	77,93	1035A3S	61		
9107	80	9375	49	12000	91		
9113A	76,93	9381	29,56,83	15011	75		
9113AL	76,93	9387	29,56,83	15012	75		
9119	82	9389	28,57,83	15053	62		
9122	79	9391	83	1505A3	62		
9122Y106	79	9393	29,56,83	15053S	62		

VSM FEDERAL REGULATIONS

Reglamento Federal de Luces

TRAILER EQUIPMENT LOCATION REQUIREMENTS

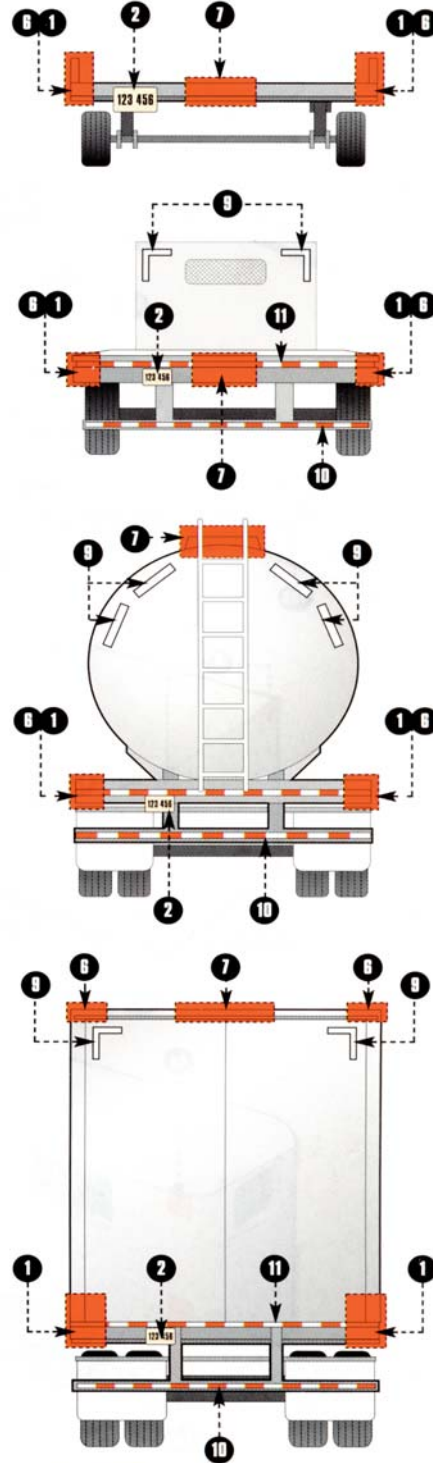
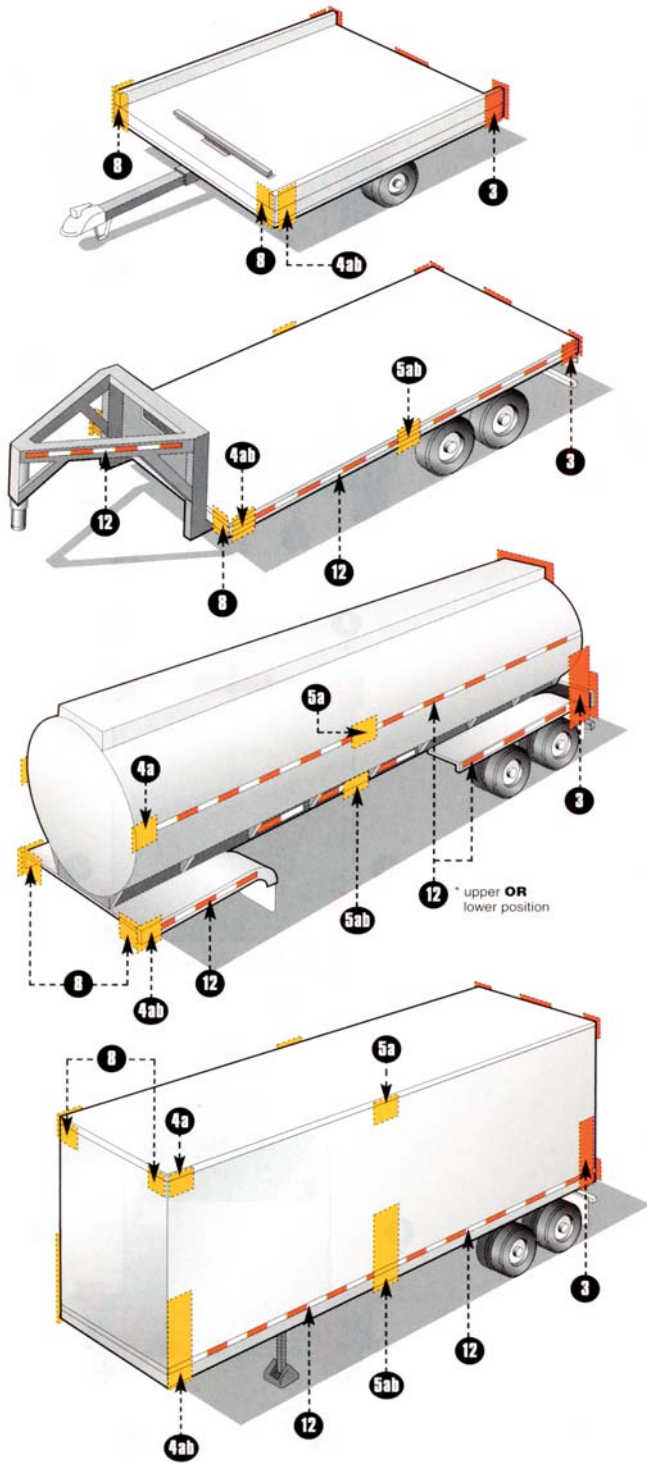

FEDERAL REGULATIONS



FEDERAL REGULATIONS



Reglamento Federal de Luces

TRAILER EQUIPMENT LOCATION REQUIREMENTS

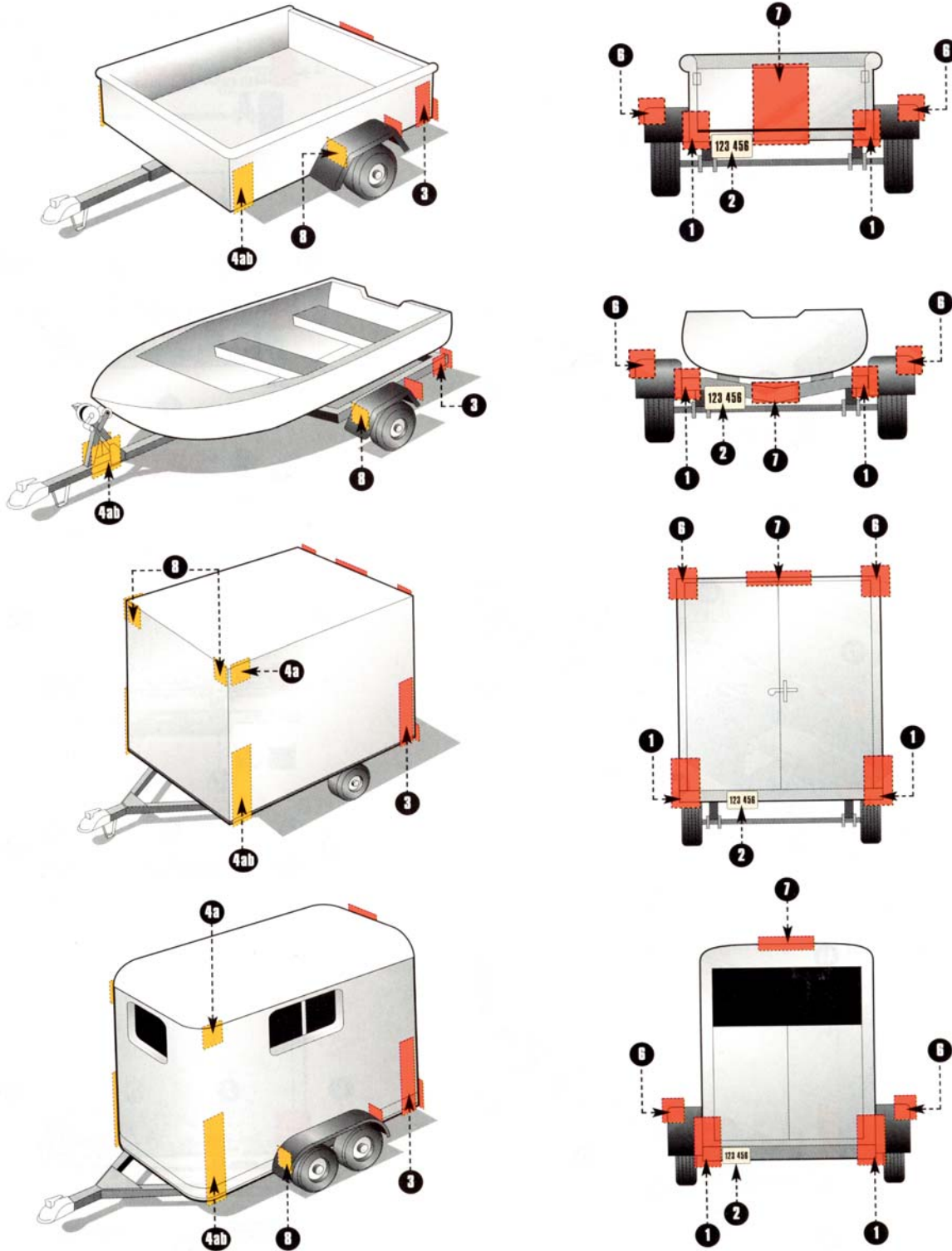

FEDERAL REGULATIONS



VSM FEDERAL REGULATIONS

Reglamento Federal de Luces

IMPORTANT NOTE: Every lamp, reflex reflector, and conspicuity treatment must be permanently attached in the location specified below and must comply with all applicable requirements prescribed for it by FMVSS/CMVSS 108. The face of any device on the front/rear and sides should be, respectively perpendicular and parallel to the vehicles centerline unless it is photometrically certified at installation angle. No part of the vehicle shall prevent any device from meeting its prescribed requirements unless an auxiliary device meeting all prescribed requirements is installed. IN CANADA: Manufacturers and importers of vehicles must have the proper certification test records demonstrating compliance of lighting components with all prescribed requirements.

BASIC EQUIPMENT REQUIRED ON ALL TRAILERS

DESCRIPTION				MANDATORY REQUIREMENTS			
Area	Equipment	SAE Lens Coding	Functional Purpose	Quantity	Color	Location	Height mm (in.) from ground
1	Tail Lamps	(T)	Indicate vehicle's presence and width	Minimum 2	Red	On the rear - symmetrical as far apart as practicable	380-1830 (15-72)
	Stop Lamps	(S)	Indicate braking	Minimum 2	Red	On the rear - symmetrical as far apart as practicable	380-1830 (15-72)
	Rear Turn Signal Lamps	(I)	Indicate direction of turn	Minimum 2	Red or Yellow	On the rear - symmetrical as far apart as practicable	380-2110 (15-83)
	Rear Reflex Reflectors	(A)	Indicate vehicle's presence and width	Minimum 2	Red	On the rear - symmetrical as far apart as practicable facing forward	380-1530 (15-60)
2	License Plate Lamp(s)	(L)	Illuminates license plate	Minimum 1	White	On the rear - above or at the sides of license plate	No requirement
3	Rear Side Marker Lamps	(P2, PC* OR P3, PC2*) *photometrically certified at installation angle	Indicate vehicle's presence and length	Minimum 2	Red	Each side at rear as far back as practicable	380-1530 (15-60) no max. for veh. under 2032mm (80") wide
	Rear Side Reflex Reflectors	(A)	Indicate vehicle's presence and length	Minimum 2	Red	Each side at rear as far back as practicable facing sideward	380-1530 (15-60)
4	a Front Side Marker Lamps	(P2, PC* OR P3, PC2*) *photometrically certified at installation angle	Indicate vehicle's presence and length	Minimum 2	Yellow	Each side at front as far forward as practicable	380 (15) minimum
	b Front Side Reflex Reflectors	(A)	Indicate vehicle's presence and length	Minimum 2	Yellow	Each side at front as far forward as practicable facing sideward	380-1530 (15-60)

ADDITIONAL EQUIPMENT FOR TRAILERS EXCEEDING THE FOLLOWING PARAMETERS Length 9.1m (30 ft.) or longer

DESCRIPTION				MANDATORY REQUIREMENTS			
Area	Equipment	SAE Lens Coding	Functional Purpose	Quantity	Color	Location	Height mm (in.) from ground
5	a Intermediate Side Marker Lamps	(P2 or P3)	Indicate presence of a long vehicle	Minimum 2	Yellow	Each side near center facing sideward	380 (15) minimum
	b Intermediate Side Reflex Reflectors	(A)	Indicate presence of a long vehicle	Minimum 2	Yellow	Each side near center facing sideward	380-1530 (15-60)



FEDERAL REGULATIONS



Reglamento Federal de Luces

ADDITIONAL EQUIPMENT FOR TRAILERS EXCEEDING THE FOLLOWING PARAMETERS Width 2032mm (80 in.) or wider

DESCRIPTION				MANDATORY REQUIREMENTS			
Area	Equipment	SAE Lens Coding	Functional Purpose	Quantity	Color	Location	Height mm (in.) from ground
6	Rear Clearance Lamps	(P2, PC* OR P3, PC2*) *photometrically certified at installation angle	Show vehicle's width MAY NOT be combined with tail lamps	Minimum 2	Red	At widest point symmetrical on the rear or near the rear facing rearward	As high as practicable may be lower only if ID lamps are at the top
7	Rear Identification (ID) Lamps	(P2 or P3)	Indicate presence of a wide vehicle	Exactly 3	Red	On the rear - centre horizontally spaced 150mm (6 in.) to 300mm (12 in.) apart facing rearward	At the top - may be lower if door header narrower than 25mm
8	Front Clearance Lamps	(P2, PC* OR P3, PC2*) *photometrically certified at installation angle	Show vehicle's width	Minimum 2	Yellow	At widest point symmetrical on the front or near the front facing forward	As high as practicable

ADDITIONAL EQUIPMENT FOR TRAILERS EXCEEDING THE FOLLOWING PARAMETERS Width 2032mm (80 in.) or wider AND GVWR 4536 kg (10,000 lb.) or more

DESCRIPTION				MANDATORY REQUIREMENTS			
Area	Conspicuity Treatment	DOT Coding	Quantity	Color	Location	Height	Options
9	Rear Upper Body Markings	DOT-C DOT-C2 DOT-C3 DOT-C4	Exactly 2 pairs of 300mm long strips	White	On the rear upper corners facing rearward	At the top	Reflex reflectors may not be required if they are replaced in their required location with conspicuity treatment
10	Bumper Bar Marking	DOT-C DOT-C2 DOT-C3 DOT-C4	Continuous	Red/White	On the rear bumper bar's horizontal element full width - facing rearward	No requirement	Optional in Canada: Rear lower body and side conspicuity treatment may also be solid white, solid yellow, or white and yellow
11	Rear Lower Body Marking	DOT-C DOT-C2 DOT-C3 DOT-C4	Continuous	Red/White (see options)	On the rear full width of the vehicle facing rearward	As horizontal as practicable and as close as practicable to the range of 375 to 1525mm from the ground	
12	Side Marking	DOT-C DOT-C2 DOT-C3 DOT-C4	(see location)	Red/White (see options)	Each side-facing sideward continuous, or evenly spaced over minimum of 50% of length starts and ends as close to the front and rear of the vehicle as practicable	As horizontal as practicable and as close as practicable to the range of 375 to 1525mm from the ground	

NOTE: The edge of red conspicuity tape shall not be closer than 75 mm to the edge of any amber lamp and the edge of white conspicuity tape shall not be closer than 75 mm to the edge of any lamp

FEDERAL REGULATIONS





VSM FEDERAL REGULATIONS

Reglamento Federal de Luces

TRUCK, BUS, MPV EQUIPMENT LOCATION REQUIREMENTS

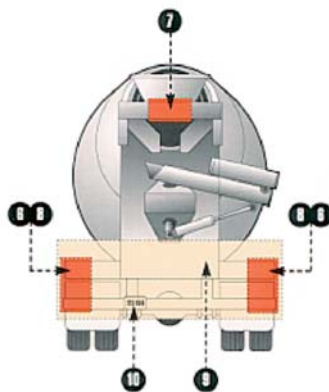
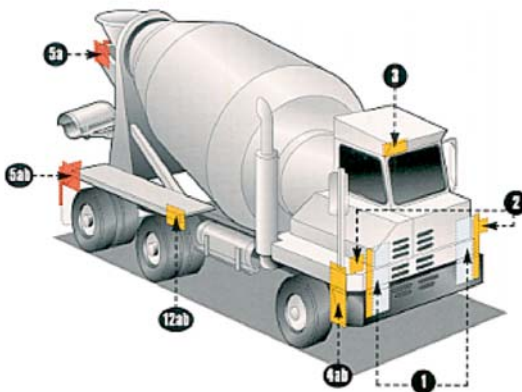
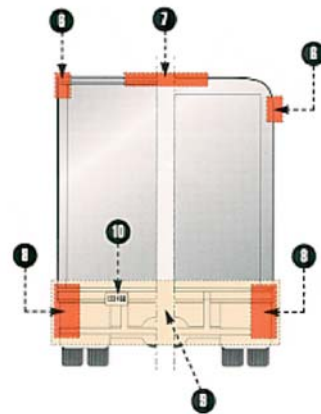
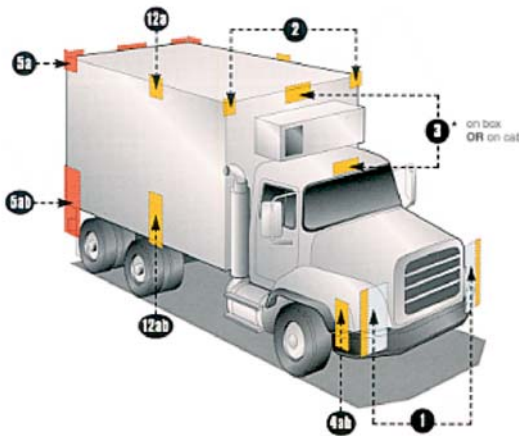
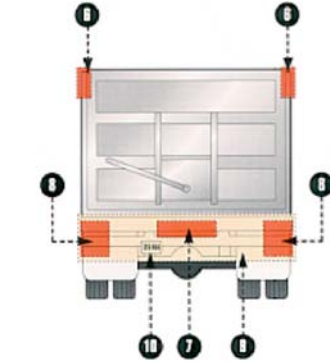
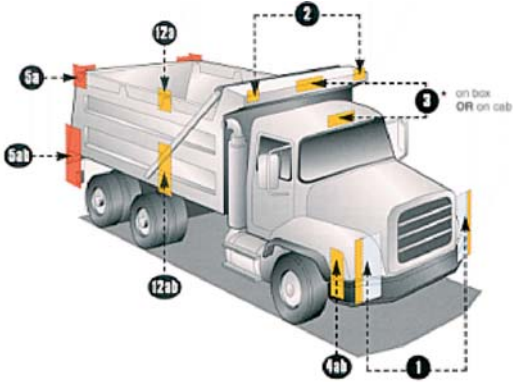
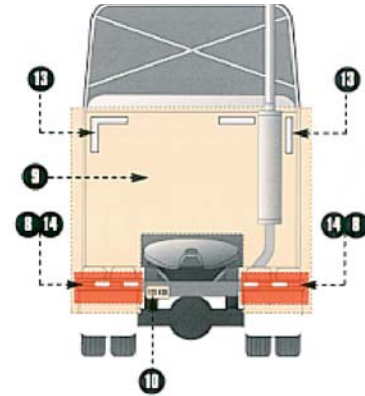
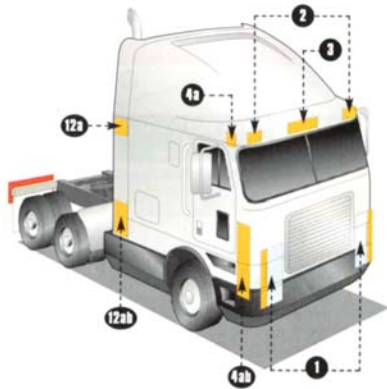

FEDERAL REGULATIONS





FEDERAL REGULATIONS



Reglamento Federal de Luces

TRUCK, BUS, MPV EQUIPMENT LOCATION REQUIREMENTS

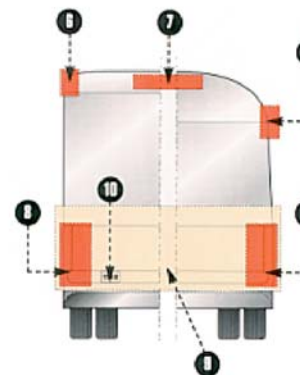
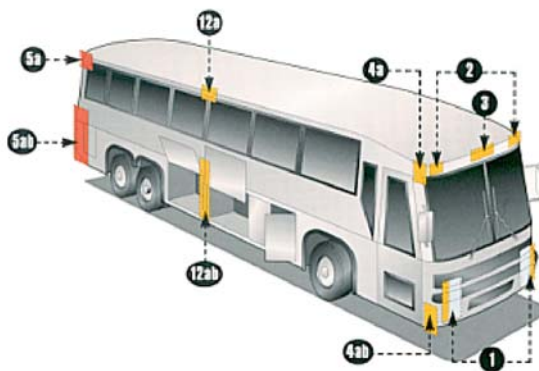
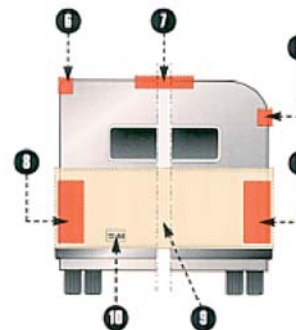
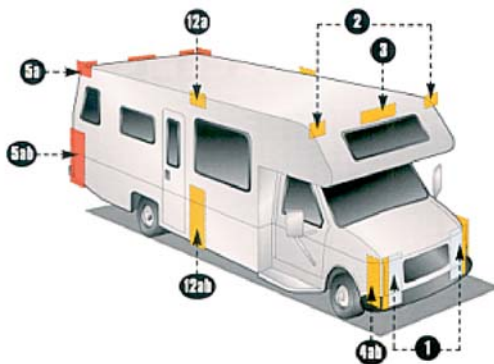
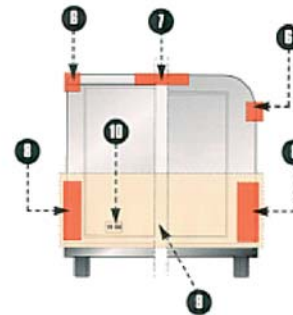
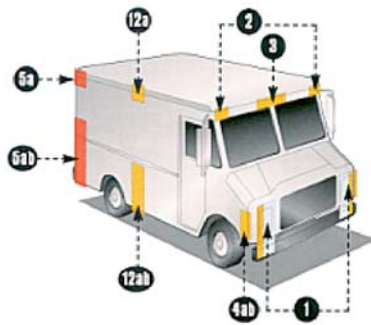

FEDERAL REGULATIONS





Reglamento Federal de Luces

BASIC EQUIPMENT REQUIRED ON ALL TRUCKS, BUSES & MPVs

Area	Equipment	DESCRIPTION		MANDATORY REQUIREMENTS			
		SAE Lens Coding	Functional Purpose	Quantity	Color	Location	Height mm (in.) from ground
1	Headlamps - Lower Beam	(H, HR) Attention: US: "DOT" lettering required on lens Attention: US & Canada: light source code required on lens	Forward road illumination	Minimum 2	White	On the front - symmetrical - as far apart as practicable (If 4 lamp system - outboard or above upper beams)	560-1370 (22-54)
	Headlamps - Upper Beam	(H, HR) Attention: US: "DOT" lettering required on lens Attention: US & Canada: light source code required on lens	Forward road illumination	Minimum 2	White	On the front - symmetrical (If 4 lamp system - inboard or below lower beams)	560-1370 (22-54)
	Parking Lamps- Attention: Required only on vehicles less than 2032mm wide	(P)	Indicate parked vehicle	Minimum 2	White or Yellow	Front - symmetrical - as far apart as practicable	380-1530 (15-60)
	Daytime Running Lamps	(Y2) Attention: for Canada required, for US optional. Attention: for US, "DRL" lettering required on lens if device is not headlamp	Indicate in-use vehicle	Minimum 2	White or Yellow	Front - symmetrical - as far apart as practicable	380 (15) minimum Maximum depends on type of DRL
	Front Turn Signal/Hazard Warning Lamps	(I)	Indicate direction of turn / identify disabled vehicle	Minimum 2	Yellow	Front - symmetrical - as far apart as practicable	380-2110 (15-83)
2	Front Clearance Lamps- Attention: Required for vehicles 2032mm wide or wider	(P2, PC* or P3*, PC2) *photometrically certified at installation angle	Show vehicle's width	Minimum 2	Yellow	At widest point - symmetrical - on the front or near the front - facing forward	As high as practicable
3	Front Identification Lamps (ID)	(P2 or P3)	Indicate presence of a wide vehicle	Exactly 3	Yellow	On the front - center - horizontally spaced 150 mm (6 in.) to 300 mm (12 in.) apart	As high as practicable or on top of cab
4a	Front Side Marker Lamps	(P2, PC* or P3 PC2*) *photometrically certified at installation angle		Minimum 2	Yellow	Each side at front - as far forward as practicable	380 (15) minimum
4b	Front Side Reflex Reflectors	(A)	Front and Rear side marker lamps / side reflex reflector indicate vehicle's presence and length	Minimum 2	Yellow	At front - symmetrical - as far forward as practicable - facing sideward	380-1530 (15-60)

FEDERAL REGULATIONS



Reglamento Federal de Luces

BASIC EQUIPMENT REQUIRED ON ALL TRUCKS, BUSES & MPVs, cont.

Area	Equipment	DESCRIPTION		MANDATORY REQUIREMENTS			
		SAE Lens Coding	Functional Purpose	Quantity	Color	Location	Height mm (in.) from ground
5a	Rear Side Marker Lamps **	(P2, PC* or P3, PC2*) *photometrically certified at installation angle	Front and Rear side marker lamps / side reflex reflector indicate vehicle's presence and length	Minimum 2	Red	Each side at rear - as far back as practicable	380 (15) minimum
5b	Rear Side Reflex Reflectors** ** not required on Truck Tractors	(A)		Minimum 2	Red	Each side at rear - as far back as practicable - facing sideward	380-1530 (15-60)
6	Rear Clearance Lamps Attention: Required for vehicles 2032mm wide or wider, but not required on Truck Tractors	(P2, PC* or P3, PC2*) *photometrically certified at installation angle	Show vehicle's width MAY NOT be combined with tail lamps	Minimum 2	Red	At widest point - symmetrical - on the rear or near the rear - facing rearward	As high as practicable-may be lower only if rear ID lamps are at the top
7	Rear Identification Lamps (ID) Attention: Required for vehicles 2032mm wide or wider, but not required on Truck Tractors	(P2 or P3)	Indicate presence of a wide vehicle	Exactly 3	Red	Rear - center - horizontally spaced 150 mm (6 in.) to 300 mm (12 in.) apart, facing rearward	<u>in Canada</u> : at the top - maybe lower if door header narrower than 25mm <u>in USA</u> : as high as practicable
8	Tail Lamps	(T)	Indicate vehicle's presence and width	Minimum 2	Red	On the rear - symmetrical - as far apart as practicable	380-1830 (15-72)
	Stop Lamps	(S)	Indicate braking	Minimum 2	Red	On the rear - symmetrical - as far apart as practicable	380-1830 (15-72)
	Rear Turn Signal/Hazard Warning Lamps	(I)	Indicate direction of turn/ identifies disabled veh.	Minimum 2	Red or Yellow	On the rear - symmetrical - as far apart as practicable	380-2110 (15-83)
	Rear Reflex Reflectors	(A)	Show vehicle's presence and width	Minimum 2	Red	On the rear - symmetrical - as far apart as practicable - facing rearward	380-1530 (15-60)
9	Backup Lamp	(R)	Illuminate ground behind the vehicle and alert road users	Minimum 1	White	Rear	No requirement
10	License Plate Lamp(s)	(L)	Illuminates license plate	Minimum 1	White	On the rear - above or at the sides of license plate	No requirement
11	Center High Mounted Stop Lamp Attention: Required for vehicles less than 2032mm wide and 4536kg	(U3)	Indicates braking	Minimum 1	Red	On the rear - centerline of the vehicle	860 (34) minimum

FEDERAL REGULATIONS



FEDERAL REGULATIONS

Reglamento Federal de Luces

ADDITIONAL EQUIPMENT FOR SPECIFIC VEHICLES Vehicles 9.1m (30 ft.) Long or Longer

DESCRIPTION				MANDATORY REQUIREMENTS			
Area	Equipment	SAE Lens Coding	Functional Purpose	Quantity	Color	Location	Height mm (in.) from ground
12a	Intermediate Side Marker Lamps	(P2 or PC)	Indicate presence of a long vehicle	Minimum 2	Yellow	Each side near center	380 (15) minimum
12b	Intermediate Side Reflex Reflectors	(A)	Indicate presence of a long vehicle	Minimum 2	Yellow	Each side near center - facing sideward	380-1530 (15-60)

Truck Tractors

DESCRIPTION			MANDATORY REQUIREMENTS				
Area	Conspicuity Treatment	DOT Code	Quantity	Color	Location	Height	Options
13	Rear Upper Body Marking	DOT-C, DOT-C2, DOT-C3, or DOT-C4	Exactly 2 pairs of 300mm long strips	White	Rear upper corners of cab - facing rearward	As high as practicable excluding fairings	
14	Rear Marking	DOT-C, DOT-C2, DOT-C3, or DOT-C4	Exactly 2 sections of min. 600mm each	Red/White	Rear - facing rearward - on fenders, on mud flaps brackets, or within 300mm below of the top of mud flaps	As horizontal as practicable and not higher than 1525 mm from the ground	If mud flaps not used - on the cab or frame mounted brackets

Watch us  youtube.com/vsm

Follow us  twitter.com/vsm

Like us  facebook.com/vsm



VEHICLE SAFETY MANUFACTURING, LLC.

408 CENTRAL AVENUE, NEWARK, NJ 07107, USA

PHONE: 800.832.7233 • FAX: 888.832.7237 • WWW.VEHICLESAFETYMFG.COM