

U.S. SEAL MFG.



DEMAND U.S. SEAL MFG.

DEMAND QUALITY...

SERVING THESE INDUSTRIES



AGRICULTURAL



HVAC



INDUSTRIAL



MINING

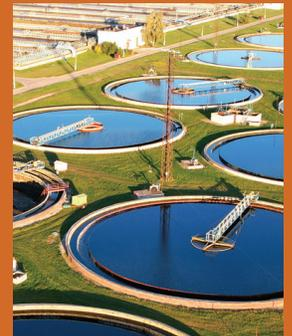

WASTEWATER

FOR OVER 60 YEARS

U.S. SEAL MFG.

Trusted Supplier of Quality Mechanical Seals and Supporting Products for more than 60 years.

Serving many industries including Agriculture, Construction, HVAC,
Mine & Ore Processing, Pool & Spa and Wastewater.

PS Line

- Aftermarket Industry Standard
- U.S. SEAL MFG. part numbers most imitated
- See our catalog for extensive OEM Cross-Reference
- Wide variety of designs and materials
- Seal sizes from .250" to 5.625"



Value Guard Line

- Inch sizes are cost competitive and similar to our PS Line
- Metric sizes include specialty seals for Aquascape, Ebara, Flygt, GPM, Grundfos, Hanjin, Honda Trash Pump, KSB, Travaini, Tsurumi and Wilo

VGS
VALUE GUARD SEAL



Supporting Products

Cyclone Abrasive Separators

- Nylon
- 316SS

O-Ring Kits

- O-Ring Kits for Flygt and Reliance

Replacement Seal Kits

- Seal Kits for A-C Pump, Aurora®, Gorman Rupp, Hoffman Pumps, Paco, Peerless and Taco®
- Kits contain mechanical seal and associated parts that are included in the OEM kits

Packing and Packing Accessories

- PTFE Lantern Ring Strips
- Packing Hooks, Cutters and Tool Kits
- Packing for General and Chemical Service, Severe Service, Food and Beverage Service

U.S. SEALUBE (Seal Installation Lubricant)

- 1 cc Pillow Pack
- 10 ml Tube
- 4 and 8 oz. Bottles



See Inside Cover for Head Types,
Mating Ring Designs, and Material Code

U.S. SEAL MFG. HEAD TYPES



Type A

Equal to:
John Crane
Type 6



Type B

Equal to:
John Crane
Type 6A

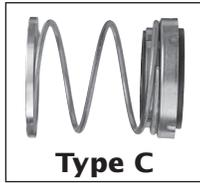

Type C

Equal to:
John Crane
Type 21

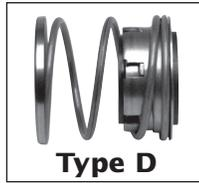

Type D

Equal to:
John Crane
Type 2

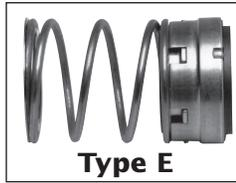

Type E

Equal to:
John Crane
Type 1

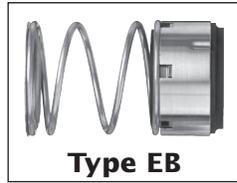

Type EB

Equal to:
John Crane Type 1
Balanced



Type G

Equal to:
John Crane Types
2100 & 2106



Type K

Equal to:
John Crane
Type 21 Double



Type Q

Equal to:
John Crane
Type 11A

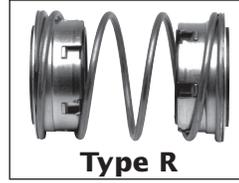

Type R

Equal to:
John Crane
Type 2 Double

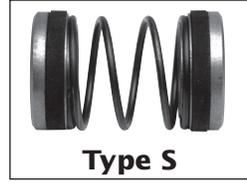

Type S

Equal to:
John Crane
Type 8 Special

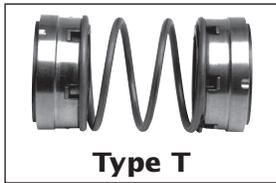

Type T

Equal to:
John Crane
Type 1 Double

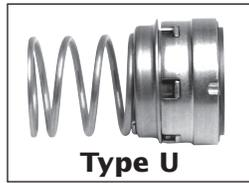

Type U

Equal to:
John Crane
Type 1 w/ Spring Adapter

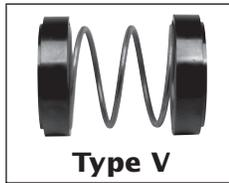

Type V

Equal to:
John Crane
Type 8D

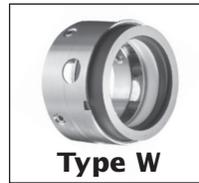

Type W

Equal to:
John Crane
Types 9 & 9T



Type X

Equal to:
John Crane
Types 8-1 & 8-1T

U.S. SEAL MFG. MATING RING DESIGNS

(Available in a wide variety of materials)



Cup Mounted

1



L-Shaped

2



O-Ring

3

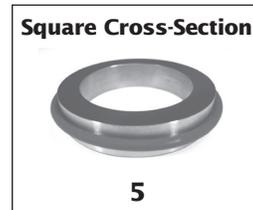

Square Cross-Section

5



Shaft Mounted

8



Shaft Mounted

9



Shaft Mounted

11

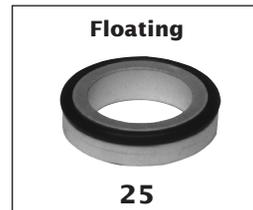

Floating

25



**Clamped-In
(Full)**

27



IMO Style

28



**Cup Mounted
w/ Adapter**

31



**Cup Mounted
w/ Adapter**

32

U.S. SEAL MFG. MATERIAL CODE

SECONDARY SEALS	PRIMARY RINGS	METAL PARTS	MATING RINGS	SPRINGS
B. Buna	A. Bronze	D. Brass	A. Bronze	E. Monel®
N. Neoprene	C. Carbon	E. Monel®	G. Cast Iron	F. Stainless Steel
Q. EPR	H. Glass Filled PTFE	F. Stainless Steel	J. Ceramic	P. Plated Steel
T. PTFE	L. Silicon Carbide	P. Plated Steel	K. Ni-Resist	
V. Viton®	M. Molded Plastic		L. Silicon Carbide	
X. AFLAS®	R. Silicon Carbide (CVR)		O. Stellite	
Y. Kalrez®	S. Toolled Steel		S. Toolled Steel	
	Z. Tungsten Carbide		Z. Tungsten Carbide	



AFLAS® is a registered trademark of Asahi Glass Co., Ltd.
 Kalrez® is a registered trademark of DuPont Performance Elastomers, LLC

Monel® is a registered trademark of Special Metals Corporation
 Viton® is a registered trademark of DuPont Performance Elastomers, LLC

SECONDARY SEAL TEMPERATURE LIMITS

AFLAS® +450°F Buna +225°F EPR +300°F Neoprene +175°F Viton® +400°F

TYPICAL TYPE D

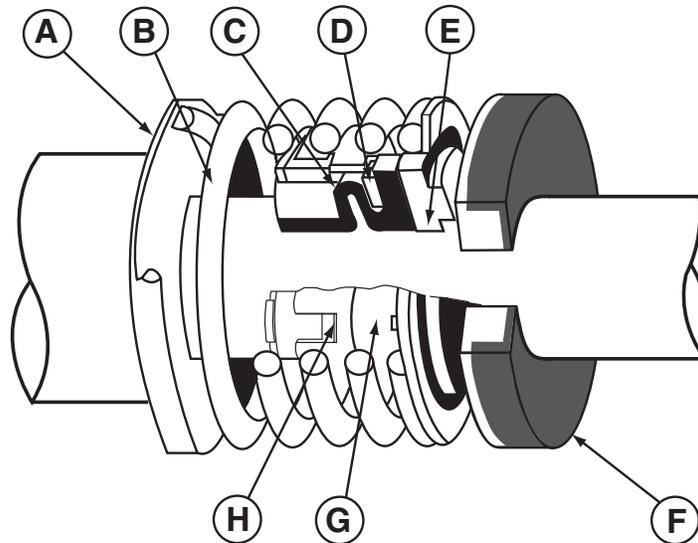

SEAL PARTS

- | | |
|------------------------|-------------------------------|
| A Spring Holder | E Primary Ring |
| B Spring | F Mating Ring Assembly |
| C Bellows | G Retainer |
| D Disc | H Drive Band |

HOW TO USE THIS CATALOG

Using the **Pump Manufacturers' Cross-Reference** (Pages 6-114), identify the correct replacement seal for the pump manufacturers' part number. If part number is not found, refer to the **Seal Sizing Guide** on Page 4. With this information, turn to the **Dimensional Cross-Reference** section (Pages 126-179). Locate the needed seal size, then the head and mating ring type. Cross-reference with the material code to obtain the correct U.S. Seal Mfg. part number.

CONTENTS

	PAGE
U.S. Seal Mfg. - Quality Mechanical Seals	2
Features of Seal Types A-X	3
Seal Sizing Guide	4
Inch and Metric Conversion Chart	5
Pump Manufacturers' Cross-Reference	6-114
Use the Right Seal for Your Pool & Spa Pumps	115
Pool & Spa Pump Replacement Seals	116-119
Material Recommendation Chart	120-124
Seal Installation Instructions	125
Seal Installation Lubricant - U.S. SEALUBE	125
Dimensional Cross-Reference	126-179
Value Guard - Inch.	180-185
Value Guard - Metric	186-195
Cyclone Abrasive Separators.	196
Packing - Includes Packing, PTFE Lantern Ring Strip and Tools.	197-203
PS Seal Index	204-229
Identifying Causes of Seal Leakage	230
Warranty.	230
Unable to Find the Seal You Require? Need To Send a Sample?.	231



***Supplying a Complete Line of Quality Seals
For More Than 60 Years***

U.S. SEAL MFG. QUALITY MECHANICAL SEALS

Our seals are designed to give long life, provide automatic self-adjustment and reduce maintenance costs. Additionally, mechanical seals offer these important advantages.



ABSOLUTE SEALING

Proper selection and installation of our seals results in less pumpage loss, cleaner facilities, less fire hazard, no danger from fumes and no contamination of the fluid being pumped.



NO RUBBING FRICTION BETWEEN SHAFT AND SEAL PARTS

Replace packing with a mechanical seal and avoid expensive shaft or sleeve replacements.



FLEXIBLE SEALS MEANS LONGER SERVICE LIFE

Compared to packing, mechanical seals are more flexible, and are able to compensate for shaft deflection, axial and radial end play, vibration and seal face wear.



LESS FRICTION MEANS VALUABLE POWER SAVINGS

Mechanical seals use less friction than packing. Therefore, they require less horsepower consumption.



PRECISION LAPPED SEALING SURFACES

Positively control leakage and eliminate "break in" runs.



HIGHER SPEEDS AND PRESSURES

Our seals are designed for higher speeds and pressures.

FLAT SURFACES OF MATING FACES

Sealing surfaces are precision lapped to a flatness of one to three light bands, which maintains the necessary face film lubrication, resulting in positive leakage control.

BROAD SELECTION OF MATERIALS OF CONSTRUCTION

Our seals come in a wide variety of materials. Choose the correct combination of elastomer, metallurgy and sealing faces for your application. See pages 120-124 for the Material Recommendation Chart.

MECHANICAL SEALS CAN BE FOUND IN ...

- Centrifugal Pumps
- Compressors
- Gear Boxes
- Gear Pumps
- Jet Pumps
- Petrochemical Pumps
- Pool and Spa Pumps
- Progressive Cavity Pumps
- Rotary Lobe Pumps
- Slurry Pumps
- Submersible Pumps
- Turbine Pumps

FEATURES OF SEAL TYPES A, B, C, D, E, G, Q, W, X

TYPE A (Seal Sizes .312–1.000)

FEATURES: Compact, unitized, single spring, elastomer bellows seal. The factory-assembled, one piece design permits fast, easy installation and the full-convolution elastomer bellows provides maximum flexibility in compensating for shaft movement and wear.

SERVICES: Centrifugal water pumps, deep and shallow well jet pumps, swimming pool and wastewater pumps. Pressures to 75 PSI. Temperature: -40°F to +400°F.



TYPE B (Seal Sizes .375–1.000)

FEATURES: A full-convolution elastomer bellows provide maximum flexibility in compensating for shaft movement while torsional stress on the bellows is controlled by a dent and groove positive drive arrangement.

SERVICES: Centrifugal water pumps, sump pumps, submersible and swimming pool pumps. Pressures to 75 PSI. Temperature: -40°F to +400°F.



TYPE C (Seal Sizes .312–5.500)

FEATURES: Elastomer bellows seal, non-clogging, single coil spring, The drive band's notch design eliminates overstressing of the bellows.

SERVICES: Rotary and turbine pumps, compressors, mixers, blenders and chillers. Pressures to 150 PSI. Temperature: -40°F to +400°F.



TYPE D, E (Seal Sizes .500–5.625)

FEATURES: Self adjusting elastomer bellows compensate for abnormal shaft end play and primary face sealing wear. Effects of radial and axial shaft end play are minimized by uniform spring pressure.

Positive drive is transmitted through the drive band and drive notches, which absorb breakout and running torque. Damaging stresses on the elastomer bellows are prevented. Slippage is eliminated, thus protecting shaft and sleeve against wear and scoring. The result is long seal life.

The seal's large single-coil spring is much sturdier than a multiple spring construction design. The spring is non-clogging, self-cleaning and will not foul up due to fluid contact. Corrosion and clogging problems are eliminated.

SERVICES: All types of rotary shaft equipment such as pumps, mixers, blenders, and compressors. Wide range of services from water and steam to chemicals and corrosives.

Pressures to 350 PSI. Temperature: -40°F to +425°F

Balanced Seals - Pressures to 1200 PSI. Temperature: -40°F to +450°F



TYPE D



TYPE E

TYPE G (Seal Sizes .437–3.500)

FEATURES: A compact unitized single spring elastomeric bellows shaft seal. Innovative full convolution bellows and interlocking drive band design allows for positive drive and greater tolerance to misalignment. Interference fit of primary ring insures positive drive while avoiding high face distortions associated with crimped designs.

SERVICES: Small centrifugal pumps used in Pool & Spa, Well Water, & HVAC applications. Pressures to 150 PSI. Temperature -30°F to +300°F.



TYPE Q (Seal Sizes .500–2.250)

FEATURES: Press fitted, rubber diaphragm protects metal components, spring loaded

SERVICES: Ice maker and appliance applications, general purpose food service.

Pressures to 30 PSI. Temperature -40°F to +400°F.



TYPE W (Seal Sizes .500–6.000)

FEATURES: Multi Spring, PTFE wedge design for use in extreme temperatures / chemical applications. Unitized construction. Also available in a balanced design

SERVICES: Corrosive fluid applications, extreme temperatures. Pressures to 350 PSI. Temperature -75°F to +500°F.



TYPE X (Seal Sizes .250–6.000)

FEATURES: Multi Spring, O-ring design, unitized construction, flexible design compensates for shaft misalignment for high performance and longer seal life. Also available in a balanced design.

SERVICES: Wide usage in chemicals and corrosives. Pressures to 350 PSI. Temperature -20°F to +400°F.



SEAL SIZING GUIDE

1. Remove seal to be replaced from shaft and/or sleeve.
2. Make note of materials used for the old seal parts using U.S. Seal Mfg. Material Code found in the front of this catalog.
3. Identify Head type (see front cover fold-out.) Use caliper to measure inside diameter (ID) and outside diameter (OD).

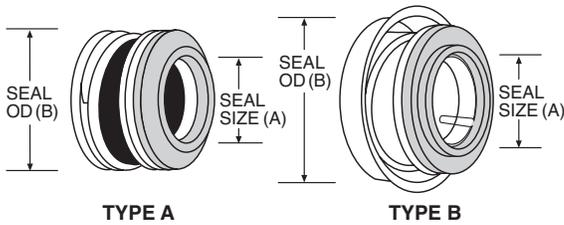

SEAL HEADS – TYPES A and B

- Identify seal head type - Determine Seal Size:
- Measure the inside diameter (ID) (dimension A)
- Measure the outside diameter (OD) (dimension B)

The operating height is generally the same for all A and B seals of the same shaft size. More positive identification will result from calculating the mating ring dimensions below. If unable to positively identify the seal, consult U.S. Seal Mfg.

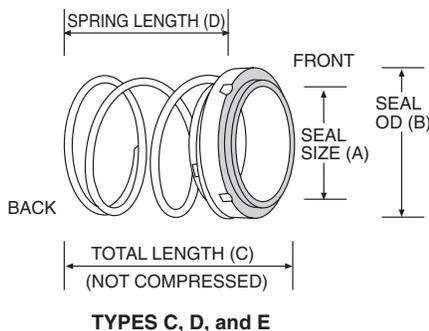

SEAL HEADS – TYPES C, D and E

- Identify seal head type - Determine Seal Size:
- Measure ID of the bellows (dimension A) as installed in the seal head. Add approximately .016" additional for rubber squeeze.
- Measure the head OD (dimension B)
 - Step 1. Measure the total free length (dimension C) of the rotating portion of the assembled seal. (Do not include the mating ring).
 - Step 2. Disassemble seal and measure the free length of the spring (dimension D).
 - Step 3. Take half of the measurement obtained in step 2.
 - Step 4. Subtract the figure obtained in step 3 from the measurement (dimension C) in step 1. The result is the approximate operating height of the seal.

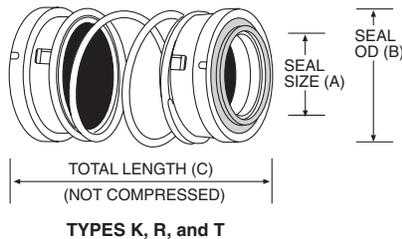

SEAL HEADS – TYPES K, R and T

- Identify seal head type - Determine Seal Size:
- Measure the inside diameter of the bellows (dimension A).
- Add approximately .016" additional for rubber squeeze.
- Measure the head OD (dimension B)
- Calculate the operating height of the seal as follows:
 - Step 1. Measure the total length of the rotating seal (dimension C). (Not compressed).
 - Step 2. Multiply the total length (dimension C) by .73. The result is the approximate operating height of the seal.

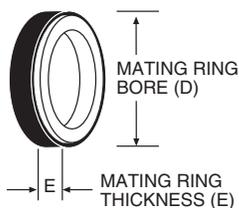

MATING RING and GASKET

- Identify the mating ring design from those shown on inside of front cover.
- Measure OD of the gasket while assembled on mating ring and subtract approximately .016" additional for rubber squeeze to obtain bore dimension (dimension D).
- Measure the combined insert and gasket width (dimension E).
- Use the Dimensional Cross Reference guide (pages 126-179) to find the part number of the seal you need. Start with Seal Size and find the line in the tables that matches the dimensions and material code.

INCH AND METRIC CONVERSION CHART

Fraction	Decimal	MM
1/64	.0156	0.397
1/32	.0312	0.794
3/64	.0468	1.191
1/16	.0625	1.588
5/64	.0781	1.984
3/32	.0937	2.381
7/64	.1099	2.778
1/8	.1250	3.175
9/64	.1406	3.572
5/32	.1562	3.969
11/64	.1718	4.366
3/16	.1875	4.763
13/64	.2031	5.159
7/32	.2187	5.556
15/64	.2343	5.953
1/4	.2500	6.350
17/64	.2656	6.747
9/32	.2812	7.144
19/64	.2968	7.541
5/16	.3125	7.938
21/64	.3281	8.334
11/32	.3437	8.731
23/64	.3593	9.128
3/8	.3750	9.525
25/64	.3906	9.922
13/32	.4062	10.319
27/64	.4218	10.716
7/16	.4375	11.113
29/64	.4531	11.509
15/32	.4687	11.906
31/64	.4843	12.303
1/2	.5000	12.700

Fraction	Decimal	MM
33/64	.5156	13.097
17/32	.5312	13.494
35/64	.5468	13.891
.5625	.5625	14.288
37/64	.5781	14.684
19/32	.5937	15.081
39/64	.6093	15.478
5/8	.6250	15.875
41/64	.6406	16.272
21/32	.6562	16.669
43/64	.6718	17.066
11/16	.6875	17.463
45/64	.7031	17.859
23/32	.7187	18.256
47/64	.7343	18.653
3/4	.7500	19.050
49/64	.7656	19.447
25/32	.7812	19.844
51/64	.7968	20.241
13/16	.8125	20.638
53/64	.8281	21.034
27/32	.8437	21.431
55/64	.8593	21.828
7/8	.8750	22.225
57/64	.8906	22.622
29/32	.9062	23.019
59/64	.9218	23.416
.9375	.9375	23.813
61/64	.9531	24.209
31/32	.9687	24.606
63/64	.9843	25.003
1	1.000	25.400

MM	Inches	MM	Inches
.1	.0039	46	1.811
.2	.0079	47	1.850
.3	.0118	48	1.889
.4	.0157	49	1.929
.5	.0197	50	1.968
.6	.0236	51	2.007
.7	.0276	52	2.047
.8	.0315	53	2.086
.9	.0354	54	2.126
1	.0394	55	2.165
2	.0787	56	2.204
3	.1181	57	2.244
4	.1575	58	2.283
5	.1969	59	2.322
6	.2362	60	2.362
7	.2752	61	2.401
8	.3150	62	2.440
9	.3543	63	2.480
10	.3937	64	2.519
11	.4331	65	2.559
12	.4724	66	2.598
13	.5118	67	2.637
14	.5512	68	2.677
15	.5906	69	2.716
16	.6299	70	2.755
17	.6693	71	2.795
18	.7087	72	2.834
19	.7480	73	2.874
20	.7874	74	2.913
21	.8268	75	2.952
22	.8661	76	2.992
23	.9055	77	3.031
24	.9449	78	3.070
25	.9843	79	3.110
26	1.023	80	3.149
27	1.063	81	3.189
28	1.102	82	3.228
29	1.141	83	3.267
30	1.181	84	3.307
31	1.221	85	3.346
32	1.259	86	3.385
33	1.299	87	3.425
34	1.338	88	3.464
35	1.378	89	3.503
36	1.417	90	3.543
37	1.456	91	3.582
38	1.496	92	3.622
39	1.535	93	3.661
40	1.574	94	3.700
41	1.614	95	3.740
42	1.653	96	3.779
43	1.692	97	3.818
44	1.732	98	3.858
45	1.771	99	3.897
		100	3.937



See Pages 186-195 for Metric Seal Selection

PUMP MANUFACTURERS' CROSS-REFERENCE

U.S. Seal Mfg. Part No.	Seal Size	Head	Mating Ring	Mating Ring Bore	Material Code	Notes	Pump Nameplate Data	Mfg. Part No.
ABEC, INC.								
PS-22182	.750	C	5	1.383	QCFZF	316SS		590158
PS-22172	1.250	C	5	1.883	QCFZF	316SS		590159
PS-22181	1.250	C	5	1.883	VCFZF	316SS		590175
PS-22180	1.500	C	5	2.125	QCFZF	316SS		590160
PS-3292	2.000	C	5	2.750	QCFZF	316SS		590169
PS-3293	2.000	C	5	2.750	QLFLF	316SS		590161
ABS USA (SULZER)								
PS-851	.750	A	1	1.375	BCFJF			11107939
PS-446	1.750	C	1	2.500	BCFJF			11116013
PS-267	2.000	C	1	2.750	BCFJF			11116014
PS-1679	2.250	C	1	3.125	BCFJF			11116015
PS-2116	3.000	C	3	3.875	BCFJF	S		11116016
A C COMPRESSOR CORPORATION								
PS-9708	3.750	WB	1	4.375	T/VCFKF	316SS		16-630-048-09-1
A-C PUMP (A XYLEM Brand)								
FA-10	.500	B	—	—	BMF-F			
PS-200	.625	A	1	1.250	BMFJF		CI, CR, DDH, DG, DGH, HH HHS, R, RH, RHS, RS, WH	52104969803 52104969813 52104969823
FA-642	.625	B	—	—	BMF-F			52105071801
PS-447V-P66	.625	B	8	—	VCFJF	A/I		52114660803
PS-118	.625	C	1	1.187	BCFJF			
PS-359	.625	C	1	1.250	BCFJF			
PS-7689	.625	C	1	1.250	QCFKF	I		52126378801
PS-735	.625	D	3	1.250	BCDJF			52104945805
FA-647	.750	B	—	—	BMF-F			
PS-358	.750	C	1	1.375	BCFJF			
PS-750	.750	D	1	1.375	BCDJF			
PS-703	.875	D	1	1.500	BCDJF			
PS-360	1.000	A	1	1.625	BCFJF			52104969806 52104969816
PS-357	1.000	C	1	1.625	BCFKF			52113094802
PS-460	1.000	D	1	1.625	BCFKF			
FA-912	1.000	E	—	—	BCF-F			52110870809
PS-754	1.000	E	1	1.625	BCFJF			
PS-557	1.000	E	3	1.625	B/VCFJF	S		52104870809
PS-754V	1.000	E	3	1.625	VCFJF	S		52116831801 52116831804
PS-276	1.000	T	1	1.625	BCFJF			52105275808
PS-277	1.000	T	1	1.625	BCFKF			52105275858
FA-9349	1.000	WT	—	—	TCF-F	316SS		52108896803
FA-1800	1.125	C	—	—	BCF-F			
PS-355	1.125	C	1	1.750	BCFKF			52104946803
PS-605	1.125	D	1	1.750	BCFKF			52104945803
PS-204	1.125	E	1	1.750	BCFJF		3X2-1/2, 2-1/2X2 SJH	08-216-526-001
PS-867	1.125	E	3	1.750	BCFKF	S		52104870806
PS-185	1.250	C	1	1.875	BCFJF			52113592801
PS-2122	1.250	C	1	1.875	BCFJF			52114901807
PS-756	1.250	C	1	1.875	BCFKF			
PS-598	1.250	C	3	1.875	BCFKF			
PS-466	1.250	C	1	2.000	BCFJF			
PS-2230	1.250	C	3	2.000	BCFJF		Series 2000	52119056801
PS-1018	1.250	C	3	2.000	BCFKF		Series 2000	52118510801
PS-3045	1.250	C	3	2.000	BCFZF	I	Series 2000	
PS-1018-EPR-P66	1.250	C	3	2.000	QCFKF	I		52126211801
PS-2200	1.250	C	3	2.000	VCFKF	I		52114659808
FA-189	1.250	E	—	—	BCF-F			52110870807
PS-361	1.250	E	1	1.875	BCFJF		C16 with 215T & smaller Frame Motors F2L-1, F2L-3 F2L-5 and F2L-6	52104609813 52105609816 52114605805
PS-137	1.250	E	1	1.875	BCFKF			52106609813 52106609817
PS-108	1.250	E	1	1.875	NCPKP			52105383807

PUMP MANUFACTURERS' CROSS-REFERENCE

U.S. Seal Mfg. Part No.	Seal Size	Head	Mating Ring	Mating Ring Bore	Material Code	Notes	Pump Nameplate Data	Mfg. Part No.
A-C PUMP (A XYLEM Brand) (continued)								
PS-546	1.250	E	3	1.875	BCFV/JF	S		52104870807 52114890807
PS-2211	1.250	T	3	1.875	BCFJF	S		52105275801
FA-177	1.375	C	—	—	BCF-F			52111322801
PS-177	1.375	C	1	2.000	BCFJF		6X4X12, 8X5X12, 8X6X12 MAXEAL®-V	52115605801 52122693801A
PS-2134	1.375	C	1	2.000	BCFJF			52121998801
PS-210	1.375	C	1	2.000	BCFKF		Custom V	52114713801
PS-1667	1.375	C	1	2.000	BCFKF		Series 8000	52117036801
PS-3689	1.375	C	1	2.000	QCFZF			52126872801
PS-3213	1.375	C	3	2.000	VCFKF	I		52114659801
FA-4087	1.375	E	—	—	VCF-F	316SS/C		52118-671802 52118671803
PS-354	1.375	E	1	2.000	BCFJF		SS-CH, SS-DH, SS-HH, SS-L	
PS-677	1.375	E	1	2.000	BCFKF			52105382801
PS-677V	1.375	E	3	2.000	VCFKF	S		52118679801
FA-9328	1.375	WT	—	—	TCF-F	316SS		52118672802
PS-758	1.500	C	1	2.125	BCFJF			52112870801
PS-553	1.500	C	3	2.125	BCFKF			52118591001
PS-382	1.500	D	1	2.125	BCFJF			52104945801 52104945806
PS-371	1.500	D	1	2.125	BCFKF			52101848082 52104946801
PS-314	1.500	E	3	2.000	BCFJF		4X3 SH	08-301-766-066-04
PS-316	1.500	E	3	2.000	BCFKF		4X2-1/2 SKH	08-301-766-020-36
PS-4473	1.500	EB	3	2.000	BCFJF			52161211801
PS-4088	1.500	EB	3	2.000	QCFJF	I		52161209801
PS-238	1.625	C	1	2.375	BCFJF			52110870811 52114043805
PS-239	1.625	C	1	2.375	BCFKF			52118511002 52118512002
PS-2202	1.625	C	3	2.625	BCFJF		Series 2000	52119056802
PS-1019	1.625	C	3	2.625	BCFKF		Series 2000	52118510802
PS-3078	1.625	C	3	2.625	BCFKF	316SS		
PS-2201	1.625	C	3	2.625	QCFKF	I		52126211802
PS-4288	1.625	C	3	2.625	QCFZF			52126874802
PS-609	1.625	E	1	2.312	BCDJF		KSH	08-303-611-07-001 08-306-539-015-03 52115315801
PS-281	1.625	R	3	2.375	BCDKF	S		
PS-446	1.750	C	1	2.500	BCFJF		MAXEAL® V Series 5000	52115605802
PS-2135	1.750	C	1	2.500	BCFJF			52121998802
PS-1674	1.750	C	1	2.500	BCFKF		Series 8000	52117036802
PS-1674-EPR-P66	1.750	C	1	2.500	QCFKF	I		52126489802
PS-448V-TC-P66	1.750	C	1	2.500	VCFZF	I		52122513802
PS-550	1.750	C	3	2.500	BCFJF	S		52112693802
PS-436V-P66	1.750	C	3	2.500	VCFKF	I/S		52114659802
FA-366	1.750	E	—	—	BCF-F			52110870802
PS-317	1.750	E	1	2.487	BCFJF		5X5 KSG	08-303-611-07-004
PS-205	1.750	E	1	2.500	BCFJF		C16, C17S, F2-2, F2-5, F2-8 F2L-2, F2L-4 MAXEAL V11®	08-212-616-001
PS-366	1.750	E	1	2.500	BCFKF			52110871802
PS-535	1.750	E	3	2.500	BCFJF	S		52114901802 52122588806 52104870802
PS-262	1.750	E	3	2.500	BCFKF	S		52114890802
PS-1197	1.750	K	1	2.500	BCFKF			
PS-1608	1.875	C	1	2.625	BCFKF			52114713805
PS-2114	1.875	C	3	2.625	BCFJF	S		52122693805 52129471805
PS-2069	1.875	E	1	2.625	BCFJF		3X2 MM-2	
PS-2070	1.875	E	1	2.625	BCFKF		3X2 MM-2	08-301-766-02-065
PS-2071	1.875	E	3	2.625	BCFJF	S		52122588814

NOTE: C. COMPLETE WITH COLLAR
I. ABRASION RESISTANT CARBON (P66)
S. SLOTTED MATING RING

PUMP MANUFACTURERS' CROSS-REFERENCE

U.S. Seal Mfg. Part No.	Seal Size	Head	Mating Ring	Mating Ring Bore	Material Code	Notes	Pump Nameplate Data	Mfg. Part No.
A-C PUMP (A XYLEM Brand) (continued)								
PS-7884	1.875	EB	3	2.500	BCFKF	S		52121754802
PS-1693	1.875	K	1	2.625	BCFKF			52110280801
PS-7352	1.875	K	1	2.625	BCFKF			52110280807
PS-1105	1.875	V	25	2.640	BMFJF		4X4X11 F7N-2	
PS-2133	2.000	C	1	2.750	BCFJF			52119056803 52121998803
PS-267	2.000	C	1	2.750	BCFJF			52122693807A
PS-1017	2.000	C	1	2.750	BCFKF		Series 8000	52117036803
PS-267-EPR	2.000	C	1	2.750	QCFJF			52161212806A
PS-3674	2.000	C	1	2.750	QCFKF	I		52126489803
PS-3580	2.000	C	1	2.750	QCFZF	I		52126872803
PS-1017-TC-SEAT	2.000	C	3	2.750	BCFZF	S		52161177803
PS-7309	2.000	C	3	2.750	QCFZF	I/S		52126870806
PS-1020	2.000	C	3	3.000	BCFKF		Series 2000	52118510803
PS-1020-EPR-P66	2.000	C	3	3.000	QCFKF	I	Series 2000	52126211803
PS-319	2.000	E	1	2.687	BCFJF		MAXEAL® VII Series 2000	08-212-617-001 52115315803
PS-478	2.000	E	1	2.687	BCFKF		MAXEAL® VII and KS	
PS-530	2.000	E	3	2.750	BCFJF	S		52104870803 52116823810
PS-477	2.000	E	3	2.750	BCFKF	S		52123692801
PS-477V	2.000	E	3	2.750	VCFKF	S		52115946803
PS-477V-TC-SEAT	2.000	E	3	2.750	VCFZF	S		52115720807
PS-1040	2.000	K	3	2.750	BCFKF	S		52237862801
PS-7196V	2.000	K	3	2.750	VCFJF	S		52237862802
PS-1687	2.125	D	1	3.000	BCFKF			52104945802
FA-3502	2.125	E	—	—	BCF-F	316SS		52129173802
PS-327	2.125	E	3	3.000	BCFJF	S		52129172801
PS-1678	2.250	C	3	3.125	BCFJF	S		52122693804
PS-1676	2.250	C	3	3.125	BCFKF	S		52118949802
PS-323	2.250	E	1	3.125	BCDJF			08-216-036-001
PS-351	2.250	E	1	3.125	BCDKF			08-630-132-009
PS-849	2.250	E	3	3.125	BCDKF	S		52104870804
PS-1688	2.250	E	3	3.125	BCFJF	S		52121998808 52122588808
PS-351V	2.250	E	3	3.125	VCDKF	S		52114660804
PS-279	2.500	E	3	3.375	BCFJF	S		
PS-349	2.500	E	3	3.375	BCFKF			52104870805
PS-349V	2.500	E	3	3.375	VCFKF	S		52115946804
PS-3714	2.500	EB	3	2.750	BCFJF	316SS		52161211804
PS-836	2.750	C	3	3.500	BCFJF	S		52122693806
PS-483	2.750	C	3	3.500	BCFKF	S		52114713804
PS-838	2.750	E	3	3.500	V/BCFJF	S		08-210-902-045 52114890810 52115315805 52122588813
PS-321	2.750	E	3	3.500	V/BCFKF	S	CUSTOM VII	08-216-035-001 52104870808
PS-321V	2.750	E	3	3.500	VCFKF	S		52114660805
PS-7936	2.750	E	3	3.500	VCFZF	316SS		52121756805
PS-4504	2.750	K	3	3.500	BCFJF	S	NSWG, NSWV, 8X8X14 Model 250	52109719805
PS-322	2.750	K	3	3.500	BCFKF	S	NSWG, NSWV, Series 300	52109719802
PS-5737	2.875	EB	3	3.500	BCFJF	S		52114786804 52161211808
PS-324	3.000	E	3	3.875	BCDJF	S	12X12 SD	08-210-902-04-037
PS-2141	3.000	K	3	3.875	BCFKF	S		52237805801
PS-6228	3.000	K	3	3.875	VCFJF			52237805803
PS-7244	3.250	K	3	4.125	BCFKF	S		52237806801
PS-4113	3.500	T	3	4.375	BCFKF	S		52115082801
PS-8028	3.875	X	3	4.750	VCFKF	316SS/I/S		08-217-897-801
PS-8055	3.875	X	3	4.750	VCFJF	316SS/I/S	3409 (AC9100)	52240979001
PS-8037	4.125	XBT	3	3.875	VCFJF	316SS/I/S		52261343801
PS-2741	5.000	K	3	6.000	BCFJF			52238383804
PS-2140	5.000	K	3	6.000	BCFKF			52115055801 52238383801

PUMP MANUFACTURERS' CROSS-REFERENCE

Value Guard Part No.	Seal Size	Head	Mating Ring	Mating Ring Bore	Material Code	Mfg. Part No.
A-C PUMP (A XYLEM Brand) - Replacement Seal Kits for Series AC 2000						
VGK-2000	1.250	C	3	2.000	BCFLF	52-051-447
VGK-2001	1.250	C	3	2.000	BCFLF	52-051-404
VGK-2002	1.250	C	3	2.000	BCFLF	52-051-406
VGK-2003	1.625	C	3	2.625	BCFLF	52-051-405
VGK-2004	1.625	C	3	2.625	BCFLF	52-051-448
VGK-2005	1.625	C	3	2.625	BCFLF	52-051-453

Kits include mechanical seal, bronze shaft sleeve, spacer, gland, key, washer, impeller nut and stud, sleeve and case o-rings.

A-C PUMP is not affiliated with U.S. SEAL MFG.
Products supplied are manufactured or purchased by U.S. SEAL MFG. from sources other than the company listed.



U.S. Seal Mfg. Part No.	Seal Size	Head	Mating Ring	Mating Ring Bore	Material Code	Notes	Pump Nameplate Data	Mfg. Part No.
ACE ENGINEERING								
PS-633	.625	C	1	1.250	BCFKF			1743-2CS
PS-112	.750	C	1	1.375	BCFKF			2043-3CS
ACE PUMP CORPORATION								
PS-953	.625	A	1	1.187	BCFJF			
PS-100	.625	A	1	1.187	BMFJF		ACH-25, 33, 50, 75, 100, ACL-75 ACO & BCH-25, 33, 50, 75	
PS-4114	.625	B	8	—	VCFFF	A		ECL-7V
PS-2734	.625	B	8	1.109	BCFFF	A		ECL-7SG, 80040F
PS-3102	.625	B	11	—	BCFJF	A	Has Seat Adaptor	Z-BAC-7B
PS-3103	.625	B	11	—	VCFJF	A	Has Seat Adaptor	Z-BAC-7V, Z-BAC-7VZ
PS-2819	.625	B	11	—	QLFLF	A	Has Seat Adaptor	Z-BAC-7SCE
PS-3106	.625	B	11	—	VLFLF	A	Has Seat Adaptor	Z-BAC-7SC
PS-3005	.625	G	25	1.250	VLFLF	316SS		Z-BAC-7SC-205V
PS-22169	.625	K	3	1.250	VCFJF			Z-BAC-7-WS
PS-851	.750	A	1	1.375	BCFJF		ACH-150, 200, 300, 500 ACXH-150, BCH-100, 200, 300	30220F
PS-2735	.750	B	3	1.375	VCFJF	316SS		Z-BAC-7-660V
PS-3104	.750	B	3	1.375	VLFLF	316SS		Z-BAC-7SC-660V
PS-2820	.750	G	3	1.375	BCFJF			Z-BAC-7-650B
PS-3107	.750	G	3	1.375	VCFJF			Z-BAC-7-650
PS-3105	.750	G	25	1.375	VLFLF		Light Spring Load	Z-BAC-7SC-650
PS-3214	.750	K	3	1.375	VCFJF			Z-BAC-7-650-WS
PS-22170	.750	K	3	1.375	VCFLF			Z-BAC-7CSC-650-WS
PS-892V	.875	K	3	1.500	VCFJF			Z-BAC-7-750V
PS-22171	.875	K	3	1.500	VCFLF			Z-BAC-7CSC-750V
PS-3112	25MM	C	1	1.625	VCFJF			Z-TYPE21-984
PS-360	1.000	A	1	1.625	BCFJF		BCH-300, 500, 750, 1000 100S, 133S, 150S, 175S	
PS-360V-CMS	1.000	A	1	1.625	VCFJF			42120F, GE-7V
PS-235V-CMS	1.000	C	1	1.625	VCFJF			21-098-16
PS-185V-CMS	1.250	C	1	1.875	VCFJF		Spring Holder Not Required	Z-TYPE21-1.250
PS-185V-SC-SC	1.250	C	1	1.875	VLFLF			30266F
PS-2810	1.250	K	3	1.875	VCFJF	S		Z-BAC-7-850V
ACURA SPA SYSTEMS, INC.								
PS-1000	.625	B	1	1.250	BMFJF		Aquaheat, Aquaheat Plus Magnaflow, Magnaflow 56 Maverick, Supercharger Supercharger II	1090-A
ADAMATION, INC.								
PS-3159	.625	B	8	—	BCFJF	A		55-6301-305-6154
PS-3100	1.000	Q	—	—	NMDKF	Unitized		75-7050-020
PS-758	1.500	C	1	2.125	BCFJF			55-6301-364-6193

NOTE: A. MOUNTS ON SHAFT
S. SLOTTED MATING RING

PUMP MANUFACTURERS' CROSS-REFERENCE

U.S. Seal Mfg. Part No.	Seal Size	Head	Mating Ring	Mating Ring Bore	Material Code	Notes	Pump Nameplate Data	Mfg. Part No.
ADVANCED PROCESS TECHNOLOGY, INC.								
PS-3226	.500	C	3	1.000	VCFKF			95603
PS-112V	.750	C	3	1.375	VCFKF			90551
PS-756V	1.250	C	3	1.875	VCFKF			90119

ADVANTAGE ENGINEERING, INC.								
PS-552	.625	C	3	1.250	B/VCFJF			
PS-552-EPR-P66	.625	C	3	1.250	QCFJF	I		6491000
PS-633V-P66	.625	C	3	1.250	VCFKF	I/S		6490000, 6495301
PS-598-EPR	1.250	C	3	1.875	QCFKF			6495612
PS-553	1.500	C	3	2.125	BCFKF			6480000
PS-4361	1.625	D	1	2.375	BLFZF	316SS		6480005

AERMOTOR PUMPS (A PENTAIR Brand)								
PS-100	.625	A	1	1.187	BMFJF			
PS-200	.625	A	1	1.250	BMFJF			SJ-45
PS-2016	.625	E	1	1.250	BCFJF			
PS-201	.750	A	1	1.375	BMFJF			SJ-47
PS-275	.750	C	1	1.375	BCFJF			
PS-2122	1.250	C	1	1.875	BCFJF			34510, 33545

AFTON PUMPS, INC.								
PS-252	1.000	D	3	1.625	BCFKF	S	94-471-M16-IHX	
PS-8712	2.250	XB1	3	2.750	VCFZF	316SS/S	MPV-HPV-GSV	

AIR-O-LATOR CORPORATION								
PS-618	1.250	C	3	1.875	BCFJF	S		37SM-125CC
PS-598-SC-SC	1.250	C	3	1.875	BLFLF	S		37SM-125SC
PS-816	1.500	C	3	2.125	BCFJF	S		37SM-150CC
PS-3101	1.500	C	3	2.125	BLFLF	S		37SM-150SC
PS-2217	1.500	C	3	2.125	BZFZF	S		37SM-150TC
PS-550	1.750	C	3	2.500	BCFJF	S		37SM-175CC
PS-436-SC-SC	1.750	C	3	2.500	BLFLF	S		37SM-175SC
PS-436-TC-TC	1.750	C	3	2.500	BZFZF	S		37SM-175TC
PS-532	2.000	C	3	2.750	BCFJF	S		37SM-200CC

ALCO								
PS-832	2.000	D	3	2.750	BCDKF	S	244D and 539	2250033-2, 5250013-3

ALFA LAVAL								
FA-9327	1.125	W	—	—	TCF-F	316SS		480079

ALLIS CHALMERS (See A-C PUMP)

Value Guard Part No.	Shaft Size	Head	Mating Ring	Mating Ring Bore	Material Code	Notes	Pump Nameplate Data	Mfg. Part No.
ALL PRIME PUMPS								
VG-7080	1.250	VGD	Special	Special	VLZFZ		S3, S4, S6	
VG-7079	1.250	VGD	Special	Special	VZFZF		S3, S4, S6	
VG-7094	1.250	VGDU	Special	Special	VLFLF		S3, S4, S6	
VG-7095	1.250	VGDU	Special	Special	VZFZF		S3, S4, S6	
VG-7082	1.250	VGD	Special	Special	VLFLF		S8	
VG-7081	1.250	VGD	Special	Special	VZFZF		S8	

Features:

- Tungsten Carbide and Silicon Carbide faces for severe abrasive service.
- Solid drive band extends seal life during periods of vibration and cavitation.
- Full convolution elastomer bellows for maximum self aligning capabilities.
- Pump sleeve, o-ring and impeller shim kit supplied for ease of installation.



PUMP MANUFACTURERS' CROSS-REFERENCE

U.S. Seal Mfg. Part No.	Seal Size	Head	Mating Ring	Mating Ring Bore	Material Code	Notes	Pump Nameplate Data	Mfg. Part No.
AMERICAN DISH SERVICE								
PS-162	.500	A	1	1.000	BMFJF			389
AMERICAN MACHINE AND TOOL COMPANY (AMT)								
PS-200	.625	A	1	1.250	BMFJF			
PS-200V-CMS	.625	A	1	1.250	VCFJF			MS-624V, 1640-161-91
FA-3300	.625	B	—	—	BCF-F			1646-001-00
FA-642	.625	B	—	—	BMF-F			
PS-3124	.625	B	1	1.087	BCFJF			1642-251-00
FA-10034	.625	C	—	—	VCF-F			1646-005-00
PS-3005	.625	G	25	.406	VLFLF	316SS		1642-353-00
PS-201	.750	A	1	1.375	BMFJF			MS-756B
PS-9711	.750	W Special	2	1.375	TCFJF	316SS		16473-541-00
FA-10038	1.125	C	—	—	VCF-F			1645-000-00
PS-356	1.125	C	1	1.750	BCFJF			287-15A/B
PS-356V	1.125	C	3	1.750	VCFJF	S		1640-163-91
AMERICAN-MARSH PUMPS (A WILO USA Brand)								
PS-633V	.625	C	3	1.250	VCFKF	S		890031
PS-112V	.750	C	3	1.375	VCFKF			890004
PS-687V	.875	C	3	1.500	VCFKF			890036
PS-185	1.250	C	1	1.875	BCFJF			10-1400-02
PS-756	1.250	C	1	1.875	BCFKF			890003
PS-2208	1.250	C	1	1.875	BZFZF			10-1400-02S4
PS-185V-CMS	1.250	C	1	1.875	VCFJF			800-011-869
PS-185V-TC-TC	1.250	C	1	1.875	VZFZF			999-0009-638
PS-756V	1.250	C	3	1.875	VCFKF			890044
PS-3724	1.250	E	3	1.875	QCCKF	S		
PS-210V	1.375	C	3	2.000	VCFKF	S		890037
PS-7702	1.375	EB	3	1.875	BCFJF	S		10-0516-05 800-0047-851
PS-3991	1.375	EB	3	1.875	BCFKF			10-0516-NIR 800-0047-853
PS-758	1.500	C	1	2.125	BCFJF			10-1401-01
PS-4374	1.625	EB	3	2.125	BCFJF	S		10-0517-04 800-0048-851 999-0007-331
PS-446	1.750	C	1	2.500	BCFJF			10-1402-00
PS-7827	1.875	EB	3	2.500	BCFJF	S		800-0049-851
PS-7884V	1.875	EB	3	2.500	VCFKF	S		10-0518-034 800-0049-853
PS-267	2.000	C	1	2.750	BCFJF			10-1403-09
PS-267V	2.000	C	3	2.750	VCFJF	S		890023
PS-3714	2.500	EB	3	2.750	BCFJF	316SS		800-0050-851
PS-1696-CMS	3.000	C	1	3.875	BCFJF			800-0025-869
AMERICAN PRODUCTS								
FA-10	.500	B	—	—	BMF-F			
PS-1000	.625	B	1	1.250	BMFJF		Americana II®, Bronze-Bronze® Eagle® Maxim, Power-Glass® Ultra-Flo®	397012, 397020
PS-201	.750	A	1	1.375	BMFJF		Americana®, Bronze-Noryl®	395005
AMPCO PUMPS COMPANY								
PS-359V-CMS	.625	C	1	1.250	VCFJF			GS625002
PS-633V-CMS	.625	C	1	1.250	VCFKF			GS625003
PS-357	1.000	C	1	1.625	BCFKF			GS5009976
PS-356V-CMS	1.125	C	1	1.750	VCFJF			GS1125008
PS-2122	1.250	C	1	1.875	BCFJF			GS8106850
PS-7908	1.250	C	1	1.875	BCFJF	316SS/I		GS5097400, GS8103410
PS-756	1.250	C	1	1.875	BCFKF			GS5009974
PS-2122V-CMS	1.250	C	1	1.875	VCFJF			GS8105960
PS-4525	1.625	C	1	2.375	BCFJF	316SS		GS5098499
PS-3543	1.625	C	1	2.375	VCFZF	316SS/I		GS5098409

NOTE: I. ABRASION RESISTANT CARBON (P66)
S. SLOTTED MATING RING

PUMP MANUFACTURERS' CROSS-REFERENCE

U.S. Seal Mfg. Part No.	Seal Size	Head	Mating Ring	Mating Ring Bore	Material Code	Notes	Pump Nameplate Data	Mfg. Part No.
AMPCO-DIACLEAR, INC.								
PS-163	.500	B	1	1.000	BMFJF		Dia Cast, Lexan®-200 Series	AP-504D
PS-1000	.625	B	1	1.250	BMFJF		Dura-Flo®, Noryl® Turbo, XL 600	AP-304D
ANTHONY & SYLVAN CORPORATION								
PS-100	.625	A	1	1.187	BMFJF			04547
PS-1000	.625	B	1	1.250	BMFJF			04380
A.O. SMITH CORPORATION								
PS-162	.500	A	1	1.000	BMFJF			55831, 64135
PS-506	.500	A	1	1.000	BMFKF			9708-1, 9708-4
PS-752	.750	D	1	1.375	BCDKF			
APOLLO DENTAL PRODUCTS, INC.								
FA-62	.625	A	—	—	BCF-F			MMS71110
PS-4323	.750	C	3	1.187	BCFJF	H		MMS71102, MMS71107
AQUA-CHEM, INC.								
PS-3191	.750	C	1	1.375	VCFJF	316SS		925-7520
PS-235	1.000	C	1	1.625	BCFJF			925-7526
PS-251	1.000	E	3	1.625	BCFKF	S		925-7509
PS-618	1.250	C	3	1.875	BCFJF	S		925-7563
PS-264	1.250	E	3	1.875	BCFKF			925-7680
PS-177	1.375	C	1	2.000	BCFJF			925-7523
PS-309-P66	1.875	C	1	1.500	BCFJF	I		925-7562, 07571-000

Value Guard Part No.	Seal Size	Head	Mating Ring Thick	Mating Ring Bore	Material Code	Oper. Hgt.	
AQUASCAPE® (Used in Waterfalls and Decorative Ponds)							
VGM-2966	12 MM	VGMH	5 MM	25 MM	VC/LFLF	30.3 MM	 <p style="text-align: center;">Type VGMH</p>
VGM-2967	12 MM	VGMH	5 MM	26 MM	VC/LFLF	30.3 MM	
VGM-2968	12 MM	VGMH	5 MM	28 MM	VC/LFLF	30.3 MM	
VGM-2969	14 MM	VGMH	5 MM	26 MM	VC/LFLF	38.3 MM	
VGM-2970	14 MM	VGMH	5 MM	28 MM	VC/LFLF	38.3 MM	
VGM-2971	14 MM	VGMH	5 MM	30 MM	VC/LFLF	38.3 MM	

U.S. Seal Mfg. Part No.	Seal Size	Head	Mating Ring	Mating Ring Bore	Material Code	Notes	Pump Nameplate Data	Mfg. Part No.
ARBE CORPORATION								
PS-235	1.000	C	1	1.625	BCFJF			
PS-351	2.250	E	1	3.125	BCDKF			
ARDE BARINCO, INC.								
PS-3065	1.000	K	1	1.625	VCFRF			A315-18V
PS-3765	2.125	K	1	3.000	VCFRF			A63-18V
ARMSTRONG PUMPS, INC.								
PS-8066	.250		1	.864	QCFLF		Gemini / 10	180200-277, 880200-277
PS-2727	.437	G	1	1.181	VCFLF			180202-677
PS-3844	.500	C	1	.938	BCFJF			816706-001, 816706-002 816706-021, 916706-021
PS-401A	.500	C	1	.938	BCFJF	N		816549-091
PS-392	.500	C	1	.938	B/QMFJF			816032-000
PS-3843	.500	C	1	.938	VCFJF			116706-021, 116706-023 816706-003, 816706-004 816706-023, 916706-023
PS-359V-CMS	.625	C	1	1.250	VCFJF			810134-000, 910134-000
PS-358V	.750	C	3	1.375	VCFJF			816707-001, 816707-002
PS-3559	.750	C	5	1.275	Special			110120-009
PS-752	.750	D	1	1.375	BCDKF			
PS-750V-CMS-P66	.750	D	1	1.375	VCDJF	I		116707-003, 116707-004
PS-750V	.750	D	3	1.375	VCDJF			816707-003

PUMP MANUFACTURERS' CROSS-REFERENCE

U.S. Seal Mfg. Part No.	Seal Size	Head	Mating Ring	Mating Ring Bore	Material Code	Notes	Pump Nameplate Data	Mfg. Part No.
ARMSTRONG PUMPS, INC. (continued)								
PS-204-EPR	1.125	E	1	1.750	QCFJF			810150-143
PS-8006	1.125	XB2	27	2.343	VCFJF	316SS	Series 4300	975002-003
PS-978-P66	1.250	C	1	1.765	BCFJF	B/I		975000-958
PS-979	1.250	C	1	1.765	BCFKF	B		
PS-185-EPR-P66	1.250	C	1	1.875	QCFJF	I		975000-991
PS-618-EPR-P66	1.250	C	3	1.875	QCFJF	I/S		810150-125
PS-2203	1.250	C	3	1.875	QCFKF	I		
PS-976	1.250	D	1	1.765	BCFJF			825458-001
PS-977	1.250	D	1	1.765	BCFKF			
PS-3023	1.250	D	1	1.875	QCFLF	I		975000-981, 975000-982 9975000-981
PS-517	1.250	D	3	1.875	BCFKF			810150-137
PS-517-TC-SEAT	1.250	D	3	1.875	BCFZF	S		810150-133
PS-383V	1.250	D	3	1.875	VCFKF			810150-127
PS-3030	1.625	C	1	2.375	QCFJF	I		975000-993
PS-7017	1.625	C	3	2.375	QCFKF	I/S		975000-961
PS-514	1.625	D	1	2.375	BCDJF			811339-000
PS-461	1.625	D	1	2.375	BCDKF			
PS-3025	1.625	D	1	2.375	QCFLF	I		975000-983, 975000-984 9975000-983
PS-8040	1.625	XB2	27	2.843	VCFJF	316SS		975000-956, 975002-033
PS-205	1.750	E	1	2.500	BCFJF			425920-001
PS-338-EPR	2.125	C	3	3.000	QCFJF	S		975000-997, 9975000-997
PS-543V	2.125	C	3	3.000	VCFKF	S		D101166-108
PS-3035	2.125	D	1	3.000	QCFLF	I		975000-985, 975000-987 9975000-987
PS-8035	2.125	XB2	27	3.375	VCFJF	316SS		975000-957, 975002-073
PS-853	2.500	C	3	3.375	BCFKF	S	4600 12X10X12.5	D101166-010

Value Guard Part No.	Seal Size	Head	Mating Ring	Mating Ring Bore	Material Code	Notes	Mfg. Part No.
ARMSTRONG PUMPS, INC. - SERIES 4300							
VG-975002304	1.125	VGXB2	Special	2.343	XCFLF	316SS	975002-304
VG-975002334	1.625	VGXB2	Special	2.843	XCFLF	316SS	975002-334
VG-975002374	2.125	VGXB2	Special	3.343	XCFLF	316SS	975002-374
VG-975002394	2.625	VGXB2	Special	4.375	XCFLF	316SS	975002-397
Features		<ul style="list-style-type: none"> ▪ External Seal Design ▪ Pressure Balanced ▪ Handles Temperatures to 450°F ▪ Set Screw Driven for Positive Drive 					
		 <p style="text-align: center;">Type VGXB2</p>					

U.S. Seal Mfg. Part No.	Seal Size	Head	Mating Ring	Mating Ring Bore	Material Code	Notes	Pump Nameplate Data	Mfg. Part No.
ARNESON PRODUCTS, INC.								
PS-200	.625	A	1	1.250	BMFJF		Pool Sweep	A-8
ARROW ENGINE COMPANY								
PS-2707	1.562	Special	Special	2.250	NCPGF			XBM-10465-B
ASTRAL POOL								
PS-200	.625	A	1	1.250	BMFJF		Sena	Series 1800
PS-1000	.625	B	1	1.250	BMFJF		Astramax	Series 1600
ATLANTIC FLUIDICS, INC.								
PS-1000	.625	B	1	1.250	BMFJF			
PS-601	.750	B	1	1.375	BMFJF			
PS-356	1.125	C	1	1.750	BCFJF			
PS-185	1.250	C	1	1.875	BCFJF			
PS-177	1.375	C	1	2.000	BCFJF			

NOTE: B. TAPERED SPRING
I. ABRASION RESISTANT CARBON (P66)
S. SLOTTED MATING RING

PUMP MANUFACTURERS' CROSS-REFERENCE

U.S. Seal Mfg. Part No.	Seal Size	Head	Mating Ring	Mating Ring Bore	Material Code	Notes	Pump Nameplate Data	Mfg. Part No.
ATLAS COPCO								
PS-6090	1.750	E	3	2.500	B/VCFKF	S		1627413064
PS-2152V	2.750	C	3	3.500	VCFKF			1627413065
PS-6177	3.375	C	3	4.250	VCFKF	S		2014502706
AURORA PUMPS (A PENTAIR Brand)								
PS-7553	15MM	C	1	1.250	BCFJF			
PS-3093	15MM	C	1	1.250	BCFJF	I		712-6444-753
PS-7520	15MM	C	1	1.250	BCFKF	I		712-6444-749
PS-3140	15MM	C	1	1.250	VCFJF			712-6444-764
PS-7520V	15MM	C	1	1.250	VCFKF	I		712-6444-745
PS-129	15MM	D	1	1.250	BCFJF		#4 Series Pump	712-0703-754
PS-1675	15MM	D	1	1.250	BCFKF		14AS114ABF	712-0703-752
PS-22058	15MM	D	1	1.250	VCFJF	I		712-0753-764
PS-3192	15MM	D	1	1.250	VCFKF	I		712-0753-745
PS-22059	15MM	D	1	1.250	VCFZF	I		712-0753-767
PS-100	.625	A	1	1.187	BMFJF			712-7042-750
PS-2204	.625	A	1	1.250	VCFZF			712-2042-767
PS-359	.625	C	1	1.250	BCFJF			712-0903-753
PS-290	.625	C	1	1.250	BCFJF	N	BJ, BJH, BJV, BJF w/ Motors thru .75 HP 1750 RPM, thru 1-1/2 HP 3500 RPM	712-1003-753
PS-633	.625	C	1	1.250	BCFKF			712-1003-749
PS-358	.750	C	1	1.375	BCFJF		BJ, BJH, BJV, BJF w/ Motors 1HP 1750 RPM Up, 2 HP 3500 RPM Up. GAFA, GAHA, GAPB, GAVA GA-4, 5, 6, 7 and 9.	
PS-2800	.750	C	1	1.375	BCFJF	H/I		712-1004-753
PS-4330	.750	C	1	1.375	BCFKF	I		712-1004-749
PS-4531	.750	C	1	1.375	QCFZF	H/I		712-1004-769
PS-3162	.750	C	1	1.375	QZFLF			712-1004-497
PS-7843	.750	C	1	1.375	VCFJF	I		712-1004-764
PS-2229V-P66	.750	C	1	1.375	VCFKF	I		712-1004-745
PS-22057	.750	C	1	1.375	VCFZF	I		712-1004-767
PS-3156	.750	C	1	1.375	VLFLF	H		712-1004-576
PS-752	.750	D	1	1.375	BCDKF			712-0705-755
PS-8714	.750	XB2	3	1.375	VCFJF		Verti Line	
PS-135	20MM	D	1	1.500	BCDJF		#5 Series Turbine Pump	712-0707-752 712-0707-754
PS-614	20MM	D	1	1.500	BCDKF	H/I		712-0707-755
PS-22056	20MM	D	1	1.500	BCFJF	I		712-0707-753
PS-3135	20MM	D	1	1.500	BCFKF	I		712-0707-749
PS-22055	20MM	D	1	1.500	VCFJF	I		712-0707-764
PS-4517	25MM	D	1	1.625	BCFJF			712-6452-753
PS-3900	25MM	D	1	1.625	BCFKF	H/I		712-6452-755
PS-3728	25MM	D	1	1.625	VCFJF			712-6452-764
PS-3167	25MM	D	1	1.625	VCFZF	I		712-6452-727
PS-380	1.000	D	1	1.625	BCFJF			712-0709-754
PS-460-P66	1.000	D	1	1.625	BCFKF	I		712-0709-755
PS-356	1.125	C	1	1.750	BCFJF			
PS-356-P66	1.125	C	1	1.750	BCFJF	I		712-0907-753
PS-355	1.125	C	1	1.750	BCFKF			712-0907-756
PS-355-P66	1.125	C	1	1.750	BCFKF	I		712-0907-749
PS-7325	1.125	C	1	1.750	QCFZF	I		712-0907-769
PS-356V-CMS	1.125	C	1	1.750	VCFJF			712-0907-764
PS-355V-CMS	1.125	C	1	1.750	VCFKF			712-0907-745
PS-3239	1.125	C	1	1.750	VCFZF	I		712-0907-767
PS-801	1.125	C	3	1.750	B/VCFJF	S		712-2732-753
PS-2226	1.125	C	3	1.750	QCFZF	I/S		712-0937-769

PUMP MANUFACTURERS' CROSS-REFERENCE

U.S. Seal Mfg. Part No.	Seal Size	Head	Mating Ring	Mating Ring Bore	Material Code	Notes	Pump Nameplate Data	Mfg. Part No.
AURORA PUMPS (A PENTAIR Brand) (continued)								
PS-384	1.125	E	1	1.750	BCFKF			712-0454-749
PS-867	1.125	E	3	1.750	BCFKF	S		712-0354-756
PS-3163	1.125	E	5	1.750	BCFZF	316SS/I		712-1431-747
PS-3109	1.125	E	5	1.750	QCDZF	I		712-1431-769
PS-136	30MM	D	1	1.875	BCDJF		#6 Series Turbine Pump	712-0713-754
PS-1179-P66	30MM	D	1	1.875	BCDKF	I		712-0713-755
PS-2737	30MM	D	1	1.875	BCFJF	I		712-0713-753
PS-1179V-P66	30MM	D	1	1.875	VCDKF	I		712-0713-774
PS-22054	30MM	D	1	1.875	VCFJF	I		712-0713-764
PS-3938	30MM	D	1	1.875	VCFZF	I		712-0713-727
PS-306	1.187	E	1	1.875	BCDJF		GGU,KCM,KCMF,KGG,KU,KUF	712-0305-754
PS-185	1.250	C	1	1.875	BCFJF			712-0908-753
PS-137	1.250	E	1	1.875	BCFKF		GMC & GAC	712-0306-755
PS-758	1.500	C	1	2.125	BCFJF		GBHA & GBVA	712-1010-753
PS-2705	1.500	C	1	2.125	BCFJF			712-0910-753
PS-2232	1.500	C	1	2.125	BCFKF	I		712-0910-749
PS-3166	1.500	C	1	2.125	BZFLF	316SS		
PS-2209	1.500	C	1	2.125	BZFZF			712-0910-678
PS-4171	1.500	C	1	2.125	QCFJF	I		
PS-3224	1.500	C	1	2.125	QCFZF			712-0910-769
PS-3165	1.500	C	1	2.125	VCFJF	I		712-0910-764
PS-3141	1.500	C	1	2.125	VCFKF	I		712-0910-745
PS-7747	1.500	C	1	2.125	VCFZF	I		712-0910-767
PS-3174	1.500	C	3	2.125	BCFKF	S		712-0940-749
PS-3160	1.500	C	3	2.125	QCFZF	I/S		712-0940-769
PS-758V	1.500	C	3	2.125	VCFJF	S		
PS-22053	1.500	C	3	2.125	VCFJF	S		712-0940-717
PS-382	1.500	D	1	2.125	BCFJF			712-0718-754
PS-305	1.500	E	1	2.125	BCFJF			
PS-7933	1.500	E	1	2.125	QCFZF	I		712-0409-769
PS-395	1.500	E	3	2.125	BCFJF	S		712-0459-753
PS-258	1.500	E	3	2.125	BCFKF			712-0359-753
PS-7562	1.500	E	3	2.125	QCFZF	I/S		712-0359-769
PS-305V	1.500	E	3	2.125	VCFJF	S		712-0359-764
PS-22052	1.500	E	5	2.125	BCFZF	I		712-1432-747
PS-4368	1.500	E	5	2.125	QCFZF	I		712-1432-769
PS-7609	1.500	E	5	2.125	QZFLF			712-1432-798
PS-664	1.562	E	3	2.375	BCFJF	S		712-0310-754
PS-238	1.625	C	1	2.375	BCFJF			712-0911-753
PS-6263	1.625	G	1	2.375	QCFZF	316SS/I		712-6492-730
PS-446	1.750	C	1	2.500	BCFJF		OJ Power Series #4	712-1012-753
PS-448-P66	1.750	C	1	2.500	BCFKF	I		712-1012-749
PS-446V-CMS	1.750	C	1	2.500	VCFJF			712-1012-764
PS-4153	1.750	C	1	2.500	VCFJF	316SS		
PS-448V-TC-P66	1.750	C	1	2.500	VCFZF	I		712-0912-767
PS-7820	1.750	C	1	2.500	VLFLF			712-1012-576
PS-3125	1.750	C	3	2.500	BCFJF	I/S	Springholder not required	712-1042-753
PS-436-P66	1.750	C	3	2.500	BCFKF	I/S		712-1042-749
PS-7035	1.750	C	3	2.500	QCFZF	I/S		712-1042-769
PS-205-P66	1.750	E	1	2.500	BCFJF	I		712-0412-753
PS-3177	1.750	E	1	2.500	BCFKF	I		712-0412-749
PS-7736	1.750	E	1	2.500	QCFZF	I		712-0412-769 712-0462-769
PS-366V-CMS-P66	1.750	E	1	2.500	VCFKF	I		712-0412-745
PS-535	1.750	E	3	2.500	BCFJF	S		712-0462-753
PS-4429	1.750	E	5	2.500	BCFZF	I		712-1433-747
PS-4372	1.750	E	5	2.500	QCFZF	I		712-1433-769
PS-267-P66	2.000	C	1	2.750	BCFJF	I	OJ Power Series #4	712-1014-753

NOTE: I. ABRASION RESISTANT CARBON (P66)
S. SLOTTED MATING RING

PUMP MANUFACTURERS' CROSS-REFERENCE

U.S. Seal Mfg. Part No.	Seal Size	Head	Mating Ring	Mating Ring Bore	Material Code	Notes	Pump Nameplate Data	Mfg. Part No.
AURORA PUMPS (A PENTAIR Brand) (continued)								
PS-842-P66	2.000	C	1	2.750	BCFKF	I		712-1014-749
PS-2219	2.000	C	1	2.750	BZFZF			712-1014-678
PS-3580	2.000	C	1	2.750	QCFZF	I		712-1014-769
PS-267V-CMS	2.000	C	1	2.750	VCFJF		Series #410	712-1014-764
PS-842V-P66-CMS	2.000	C	1	2.750	VCFKF	I		712-1014-745
PS-332	2.000	C	3	2.750	BCFKF	S		712-1044-749
PS-479V	2.000	E	3	2.750	VCFJF			
PS-3708	2.000	E	5	2.750	BCFZF	I		712-1434-747
PS-3108	2.000	E	5	2.750	QCFZF	I		712-1434-769
PS-3708V	2.000	E	5	2.750	VCFZF	I		712-1434-767
PS-1678	2.250	C	3	3.125	BCFJF	S		
PS-3075	2.250	E	3	3.281	BZFZF			712-6409-678
PS-7766	2.250	K	3	3.125	BCFJF			712-6478-753
PS-7060	2.250	K	3	3.281	BCFKF	I		712-6410-749
PS-3210	2.250	V	3	3.281	BCFKF	I		712-6411-749
PS-268-CMS	2.375	C	1	3.250	BCFJF			712-0917-753 712-1017-753
PS-492-CMS-P66	2.375	C	1	3.250	BCFKF	I		712-0917-749 712-1017-749 712-2717-749
PS-22051	2.375	C	1	3.250	VCFJF			712-1017-764
PS-268	2.375	C	3	3.250	BCFJF		OJ Power Series #5	712-1047-753
PS-492	2.375	C	3	3.250	BCFKF			712-1047-749
PS-3127	2.375	C	3	3.250	VCFJF	I		712-1047-764
PS-278	2.375	E	3	3.250	BCFJF	S		712-0467-753
PS-350	2.375	E	3	3.250	BCFKF	S		712-0462-756 712-0467-756
PS-278V	2.375	E	3	3.250	VCFJF	S		712-0467-764
PS-4006	2.375	E	5	3.250	BCFZF	I		712-1435-747
PS-3187	2.375	E	5	3.250	QCFZF	I		712-1435-769
PS-269	2.500	C	3	3.375	BCFJF	S	SPHER-Flo Series 4A-4B	712-1048-753 712-1012-739
PS-22050	2.500	E	3	3.250	BCFJF	C/I	c/w L Shaped Collar	712-6390-753
PS-3924	2.500	E	3	3.250	BCPKF			712-6390-756
PS-279	2.500	E	3	3.375	BCFJF	S		712-0468-753
PS-349	2.500	E	3	3.375	BCFKF			712-0468-756
PS-2205	2.500	E	3	3.375	BCFKF	I/S		712-0468-755
PS-2205-EPR	2.500	E	3	3.375	QCFKF	I/S		
PS-3164	2.500	E	5	3.375	BCFZF	I		712-1436-747
PS-1695	2.500	K	3	3.375	BCFKF			712-2743-749
PS-270	2.875	C	3	3.750	BCFJF	S	Type OJ Power Series #6	
PS-329-P66	2.875	E	3	3.750	BCFJF	I/S		712-0471-753
PS-841-P66	2.875	E	3	3.750	BCFKF	I/S		712-0471-755
PS-4341	2.875	E	5	3.750	BCFZF			712-1437-747
PS-2116	3.000	C	3	3.875	BCFJF	S		712-7010-739
PS-3836	3.000	U	3	3.875	BCFJF	C/S		712-7038-753
PS-3262	3.625	E	3	4.781	BZFZF			712-6414-678
PS-22049	3.625	T	3	4.781	BCFJF	I		712-6415-753
PS-3553	3.625	T	3	4.781	BCFKF	I		712-6415-749
PS-8127	3.625	V	3	4.781	BCFJF			712-6416-753
PS-8054	3.625	V	3	4.781	BCFKF	I		712-6416-749
PS-272	3.750	C	3	4.625	BCFJF	S	SPHER-Flo Series 5A,5B,5C,5D	
PS-4613	5.000	V	3	6.781	BCFJF		Model 600 Frame 6	712-6421-753
PS-4414	5.000	V	3	6.781	BCFKF			712-6421-749

PUMP MANUFACTURERS' CROSS-REFERENCE

Value Guard Part No.	Seal Size	Head	Mating Ring	Mating Ring Bore	Material Code	Notes	Pump Nameplate Data	Mfg. Part No.
AURORA PUMPS (A PENTAIR Brand) REPLACEMENT SEAL KITS								
VGK-1127	1.125	C	1	1.750	BCFJF			
VGK-1124	1.125	C	1	1.750	BCFKF			476-0250-644
VGK-1128	1.125	C	1	1.750	VCFJF			
VGK-1126	1.125	C	1	1.750	VCFKF			
VGK-1130	1.500	C	1	2.125	BCFJF			
VGK-1125	1.500	C	1	2.125	BCFKF			476-0253-644
VGK-1131	1.500	C	1	2.125	VCFJF			
VGK-1129	1.500	C	1	2.125	VCFKF			

- Kits include gaskets, pins, o-rings, sleeve, and mechanical seal.
- AURORA PUMPS is not affiliated with U.S. SEAL MFG.
- Products supplied are manufactured or purchased by U.S. SEAL MFG. from sources other than the company listed.



VGK-1125

U.S. Seal Mfg. Part No.	Seal Size	Head	Mating Ring	Mating Ring Bore	Material Code	Notes	Pump Nameplate Data	Mfg. Part No.
AUTOMATIC ICE & BEVERAGE - (Ice Machines)								
PS-3120	1.000	Q	Special	1.625	Special			9121026-91
A.Y. McDONALD MFG. COMPANY								
PS-166	.625	A	1	1.187	BMFJF			5MCD1
PS-22229	.625	A	1	1.250	NMFCF			6422-500, 3129-909
PS-501	.625	A	1	1.250	BMFJF		Jet Well 3000, 4000 and 4100	5MCD4
PS-201	.750	A	1	1.375	BMFJF			5MCD5
PS-521	1.125	D	1	1.875	BCFKF			5MCD2
B&P LITTLEFORD								
PS-2015	.750	E	3	1.375	BCFKF			225X0396
PS-1699V	1.625	E	3	2.375	VCFKF	S		225X0671
BAKER-HYDRO (Division of WATERCO USA)								
PS-200	.625	A	1	1.250	BMFJF			35B1175, 35B1178
PS-1904	.750	B	1	1.375	VLFLF	316SS		6340162
PS-185	1.250	C	1	1.875	BCFJF			19B5032
PS-446	1.750	C	1	2.500	BCFJF			19B5033
BAKER MFG. COMPANY, LLC								
FA-112	.500	C	—	—	BCF-F			E93B
FA-10033	.500	C	—	—	VCF-F			E93V
PS-1002V	.500	C	1	1.000	VCFJF			E18FMW
PS-3172	.500	C	3	1.000	BCFKF			E18AM
PS-22142	.500	C	3	1.000	VCFJF			E18FMV
PS-2802	.500	C	3	1.000	NCFKF	I		E18CMN
FA-10034	.625	C	—	—	VCF-F			F93V
PS-732	.625	C	3	1.250	BCFKF			F18AM, F18AMP
PS-3133	.625	C	3	1.250	NCFKF			F18CMN
PS-359V	.625	C	3	1.250	VCFJF			F18FMV
PS-633V	.625	C	3	1.250	VCFKF	S		F18BMVP
PS-3132	.625	D	3	1.250	NCFLF			F18MNN
FA-1600	.875	C	—	—	BCF-F			H93B
PS-617	.875	C	3	1.500	BCFKF			H18AM, H18AMP
PS-309V	.875	C	3	1.500	VCFJF			H18FMV
PS-687V	.875	C	3	1.500	VCFKF			H18BMV, H18BMVF H18BMVP
PS-4318	.875	D	1	1.500	NCFLF			H18MNN
PS-3116	.875	D	3	1.500	VCFLF	316SS		H18MNV
PS-22143	.875	DB	3	1.375	VCFLF	I/S		H18VT2B

NOTE: I. ABRASION RESISTANT CARBON (P66)
S. SLOTTED MATING RING

PUMP MANUFACTURERS' CROSS-REFERENCE

U.S. Seal Mfg. Part No.	Seal Size	Head	Mating Ring	Mating Ring Bore	Material Code	Notes	Pump Nameplate Data	Mfg. Part No.
BALBOA WATER GROUP®								
PS-3086	1.375	G	3	2.000	QCFLF	316SS/S		6001575
BALDOR-RELIANCE (Member of the ABB GROUP)								
PS-356	1.125	C	1	1.750	BCFJF			64262-12L
PS-185	1.250	C	1	1.875	BCFJF		Motor Frame 140	64262-12A
PS-2208	1.250	C	1	1.875	BZFZF		Motor Frame 140	64262-20A
PS-185V-CMS	1.250	C	1	1.875	VCFJF		Motor Frame 140	64262-13A
PS-185V-TC-TC	1.250	C	1	1.875	VZFZF		Motor Frame 140	64262-20AA
PS-618-TC-TC	1.250	C	3	1.875	BZFZF	S	Motor Frame 140	64262-15E
PS-618V-TC-SEAT	1.250	C	3	1.875	VCFZF	S		64262-23A
PS-381	1.250	D	1	1.875	BCFJF		Motor Frame 140	64262-8A
PS-381-SC-SC	1.250	D	1	1.875	BLFLF			64262-39A
PS-6229	1.250	K	3	1.875	BCFJF	316SS		64262-41D
PS-4134	1.375	X Special	Special	1.875	B/NCPGF			64147-24R
PS-758	1.500	C	1	2.125	BCFJF		Motor Frame 140 or 180	64262-12B
PS-758-SC-SC	1.500	C	1	2.125	BLFLF		Motor Frame 140 or 180	64262-39B
PS-2209	1.500	C	1	2.125	BZFZF		Motor Frame 140 or 180	64262-20B
PS-7409	1.500	C	1	2.125	VCFJF	316SS	Motor Frame 140 or 180	64262-13B
PS-758V-SC-SC	1.500	C	1	2.125	VLFLF		Motor Frame 140 or 180	64262-39BB
PS-758V-TC-SC-CMS	1.500	C	1	2.125	VZFLF			64262-25BB
PS-659V-TC-VS-TC	1.500	C	1	2.125	VZFZF		Motor Frame 140 or 180	64262-20BB
PS-553	1.500	C	3	2.125	BCFKF			611725-005D
PS-2223	1.500	C	3	2.125	VCFZF			64262-23B
PS-382	1.500	D	1	2.125	BCFJF		Motor Frame 140 or 180	64262-8B
PS-446	1.750	C	1	2.500	BCFJF		Motor Frame 180 or 210	64262-12C
PS-446-TC-TC	1.750	C	1	2.500	BZFZF		Motor Frame 180 or 210	64262-20C
PS-446V-CMS	1.750	C	1	2.500	VCFJF		Motor Frame 180 or 210	64262-13C
PS-7820	1.750	C	1	2.500	VLFLF		Motor Frame 180 or 210	64262-39CC
PS-446V-TC-TC	1.750	C	1	2.500	VZFZF		Motor Frame 180 or 210	64262-20CC
PS-436-SC-SC	1.750	C	3	2.500	BLFLF	S	Motor Frame 180 or 210	64262-39C
PS-436-TC-TC	1.750	C	3	2.500	BZFZF	S	Motor Frame 140 or 180	64262-15C
PS-2207	1.750	C	3	2.500	VCFZF	S	Motor Frame 180 or 210	64262-23C
PS-237	1.750	D	1	2.500	BCDJF		Motor Frame 180 or 210	64262-8C
PS-6217	1.750	D	1	2.500	VZFLF	316SS	Motor Frame 180 or 210	64262-25CC
PS-267	2.000	C	1	2.750	BCFJF		Motor Frame 210 or 250	64262-12D
PS-267-SC-SC-CMS	2.000	C	1	2.750	BLFLF		Motor Frame 210 or 250	64262-39D
PS-2219	2.000	C	1	2.750	BZFZF		Motor Frame 210 or 250	64262-20D
PS-267V-CMS	2.000	C	1	2.750	VCFJF		Motor Frame 210 or 250	64262-13D
PS-6224	2.000	C	1	2.750	VLFLF		Motor Frame 210 or 250	64262-39DD
PS-6218	2.000	C	1	2.750	VZFZF		Motor Frame 210 or 250	64262-25DD
PS-6213	2.000	C	1	2.750	VZFZF	316SS	Motor Frame 210 or 250	64262-20DD
PS-267V-TC-SEAT	2.000	C	3	2.750	VCFZF		Motor Frame 210 or 250	64262-23D
PS-2143	2.000	K	1	2.750	BCFJF			
PS-7196	2.000	K	3	2.750	BCFJF	S		64262-41E
PS-1057	2.125	C	3	3.000	B/VCFKF	S		61175-005B
PS-1679	2.250	C	1	3.125	BCFJF		Motor Frame 250	64262-12E
PS-3182	2.250	C	1	3.125	BLFLF		Motor Frame 250	64262-39E
PS-7064	2.250	C	1	3.125	BZFZF		Motor Frame 250	64262-20E
PS-1678V	2.250	C	3	3.125	VCFJF		Motor Frame 250	64262-13E
PS-7766	2.250	K	3	3.125	BCFJF			64262-41C
PS-6205	2.750	C	1	3.500	BCFJF		Motor Frame 320	64262-18F
PS-2154-SC-TC-CMS	2.750	C	1	3.500	BLFZF		Motor Frame 320	64262-25N
PS-4308	2.750	C	1	3.500	BZFZF			64262-20G
PS-6908	2.750	C	1	3.500	BZFZF		Motor Frame 320	64262-20N
PS-6207	2.750	C	3	3.500	VCFJF		Motor Frame 320	64262-18N
PS-483V-TC-SEAT	2.750	C	3	3.500	VCFZF	S		64262-23G
PS-2154V-TC-TC	2.750	C	3	3.500	VZFZF	S	Motor Frame 320	64262-20NN
PS-2153-SC-SC-CMS	3.000	C	1	3.875	BLFLF		Motor Frame 320	64262-39M
PS-7875	3.000	C	1	3.875	BZFZF		Motor Frame 360	64262-20H
PS-7998	3.000	C	1	3.875	BZFZF		Motor Frame 360	64262-20M
PS-3539	3.000	C	1	3.875	VZFZF		Motor Frame 360	64262-20MM
PS-6214	3.000	C	1	3.875	VZFZF		Motor Frame 320	64262-20HH

PUMP MANUFACTURERS' CROSS-REFERENCE

U.S. Seal Mfg. Part No.	Seal Size	Head	Mating Ring	Mating Ring Bore	Material Code	Notes	Pump Nameplate Data	Mfg. Part No.
BALDOR RELIANCE (Member of the ABB GROUP) (continued)								
PS-2116	3.000	C	3	3.875	BCFJF	S	Motor Frame 360	64262-12G
PS-2153	3.000	C	3	3.875	BCFJF	S	Motor Frame 320	64262-18G
PS-6206V	3.000	C	3	3.875	VCFJF	S	Motor Frame 320	64262-18L
PS-3232	3.000	C	3	3.875	VCFZF			64262-23H
PS-6225	3.000	C	3	3.875	VLFLF		Motor Frame 360	64262-39HH
PS-2709	3.000	D	1	3.875	BLFLF			64262-39H
PS-6202	3.000	D	1	3.875	BZFZF		Motor Frame 360	64262-8H, 64262-62HH
PS-6219	3.000	D	3	3.875	BZFLF			64262-25H
PS-6228	3.000	K	3	3.875	VCFJF			64262-41B
PS-6226	3.250	C	3	4.125	VLFLF		Motor Frame 360	64262-39KK
PS-7172	3.250	D	3	4.125	BCFJF		Motor Frame 360	64262-008J, 64262-63C
PS-3827	3.250	D	3	4.125	BZFZF	S	Motor Frame 360	64262-8K, 64262-20K
PS-6201	3.250	D	3	4.125	VCFJF		Motor Frame 360	64262-008F, 64262-36KK
PS-6227	3.250	K	3	4.125	VCFJF			64262-41A
PS-6204	3.500	C	3	4.375	BCFJF	S		64262-12K
PS-6221	3.500	D	3	4.375	V/BZFZF			64262-33A
PS-3745	3.500	D	3	4.375	VZFZF			64262-37PP
PS-6203	3.750	D	3	4.625	VCFJF			64262-008M
BALTIMORE AIRCOIL COMPANY								
FA-26	.625	A	—	—	BMF-F			300329
FA-64	.750	A	—	—	BCF-F			300331
FA-1109	1.250	C	—	—	BCF-F			300389
BALZER, INC.								
PS-618	1.250	C	3	1.875	BCFJF	S		33013
PS-598-SC-SC	1.250	C	3	1.875	BLFLF	S		36755
BANJO CORPORATION								
PS-3985	.750	B	1	1.375	BCFJF	316SS		12713BN, 12733BN
PS-4056	.750	B	1	1.375	QCFJF		150P3, 200P3 & 5	12713, 12733
PS-3986	.750	B	1	1.375	VCFJF			12713V, 12733V
PS-601V	.750	B	3	1.375	VCFJF			127135
PS-3785	1.000	C	1	1.625	VCFJF		150/200-P1-3, 200P1-5	17035, 17135
PS-3959	1.000	K	1	1.625	VCFJF			17235
PS-3813	1.500	C	1	2.125	VCFJF	B/H	300-P1-8, 300PB/PO1	18025, 18125
BARNES, JOHN S.								
FA-400	.500	C	—	—	BMF-F			PA-4947
FA-1350	.625	C	—	—	BCF-F			PA-2408
PS-508	.625	D	1	1.250	BCDJF			
FA-160	.875	D	—	—	BCD-F			PA-2421
FA-1700	1.000	C	—	—	BCF-F			PA-1525
FA-1800	1.125	C	—	—	BCF-F			PA-4386
PS-383	1.250	D	1	1.875	BCFKF			Y-42
PS-461	1.625	D	1	2.375	BCDKF			Y-45
FA-593	1.875	D	—	—	BCD-F			PA-3684
BEACH RUSS								
FA-400	.500	C	—	—	BMF-F			
FA-564	.750	C	—	—	BCF-F			
PS-185	1.250	C	1	1.875	BCFJF			
BELL & GOSSETT (A XYLEM Brand)								
PS-8066	.250	X Special	1	.864	QCFLF			189144
FA-401	.500	C	—	—	BCF-F	N		118614
FA-400	.500	C	—	—	BMF-F			
PS-401A	.500	C	1	.938	BCFJF	N	PD-35, PD-37 Series 1522	Kit #3, 186681
PS-393	.500	C	1	.938	BMFKF			
PS-392	.500	C	1	.938	B/QMFJF		Bronze 3/4 thru 3 Boosters BPD35 BPD37-Series 1522-PD35 & PD37 Series 60AA 1522 Cast Iron	Kit #7, 118681 189102, 189182

NOTE: B. TAPERED SPRING SPRING HOLDER NOT INCLUDED
H. TAPERED SPRING SPRING HOLDER NOT INCLUDED
N. NON-STANDARD SPRING HOLDER
S. SLOTTED MATING RING

PUMP MANUFACTURERS' CROSS-REFERENCE

U.S. Seal Mfg. Part No.	Seal Size	Head	Mating Ring	Mating Ring Bore	Material Code	Notes	Pump Nameplate Data	Mfg. Part No.
BELL & GOSSETT (A XYLEM Brand) (continued)								
PS-7712	.500	C	1	1.125	BMFJF			Kit #20
PS-4349	.500	G	1	.938	QLFLF			P86261
PS-516	.625	A	1	1.250	BCFJF			DP0304
PS-200	.625	A	1	1.250	BMFJF			180013
PS-118	.625	C	1	1.187	BCFJF			186879
PS-359	.625	C	1	1.250	BCFJF			
PS-2160	.625	C	1	1.250	BCFJF			DP0302, 180014
PS-2747	.625	C	1	1.375	BCFJF	H		DP0478
PS-2770	.625	G	1	1.250	QCFLF		E90 Series	186094LF, P2000805
FA-152	.750	D	—	—	BCD-F			
PS-437	.750	D	1	1.275	BCDJF		1512-PD39, BPD39 and 60A	Kit #2, 172553, 185260 186433, 186499
PS-4098	.750	D	1	1.275	QCDJF			
PS-4024	.750	G	1	1.275	QLFLF			P86262
PS-309	.875	C	1	1.500	BCFJF			DP0294
FA-1700	1.000	C	—	—	BCF-F			
PS-235	1.000	C	1	1.625	BCFJF			180011
PS-2748	1.000	C	1	1.625	BCFJF			DP0296
FA-1800	1.125	C	—	—	BCF-F			
PS-356	1.125	C	1	1.750	BCFJF			
PS-3712	1.125	D	3	1.750	VCFZF	I		DP0476, 180017
PS-384	1.125	E	1	1.750	BCFKF			
PS-978	1.250	C	1	1.765	BCFJF	B	All Iron-Series 1510, 1515, 1531 (Small Frame) Types M1 and M2	186860, 186862
PS-979	1.250	C	1	1.765	BCFKF	B		
PS-978-EPR-TC	1.250	C	1	1.765	QCFZF	B		186861
PS-978-EPR-SC-SC	1.250	C	1	1.765	QLFLF	B		P75423
PS-4204	1.250	C	1	1.765	QRFLF	B		
PS-978V	1.250	C	1	1.765	VCFJF	B		185060
PS-185-P66	1.250	C	1	1.875	BCFJF	I		P70511
PS-185V-CMS	1.250	C	1	1.875	VCFJF			P70513, 186877
PS-4559	1.250	C	3	2.000	QCFZF	I		AC3047
FA-190	1.250	D	—	—	BCF-F			
PS-976	1.250	D	1	1.765	BCFJF	H	Series 1510, 1515, 1531 Universal (Small Frame) Types M1 and M2	Kit #1, 185011, 186680
PS-977	1.250	D	1	1.765	BCFKF			
PS-6261	1.250	G	1	1.875	QCFJF	316SS/I		P75221
PS-6260	1.250	G	1	1.875	QCFZF	316SS/I		P75223
PS-20001	1.250	G	1	1.875	QLFLF	316SS	Series e-82SC	P2001703
PS-6264	1.250	G	1	1.875	VCFJF	316SS/I		P75225
FA-177	1.375	C	—	—	BCF-F			AC5228
FA-10166	1.375	C	—	—	BCF-F	I		P63336
PS-177	1.375	C	1	2.000	BCFJF			DP0298
PS-3689	1.375	C	1	2.000	QCFZF			
FA-376E	1.375	D	—	—	QCD-F	I		P63316
PS-491	1.375	D	1	2.000	BCDJF			186827
PS-186	1.375	D	1	2.000	BCDKF		VSC 4X4X9-3/4, 5X5X9-3/4, 5X5X12, 6X6X9-3/4	P77084
PS-7803	1.375	D	1	2.000	QCDZF	I		186834
PS-186V	1.375	D	3	2.000	VCDKF	S		
PS-224	1.500	E	3	2.125	NCFKF			
PS-238	1.625	C	1	2.375	BCFJF			186544
PS-3831	1.625	C	1	2.375	BCFJF	B		
PS-238-EPR	1.625	C	1	2.375	QCFJF			
PS-1019	1.625	C	3	2.625	BCFKF			185043
PS-2201	1.625	C	3	2.625	QCFKF	I		AC0634
PS-4288	1.625	C	3	2.625	QCFZF			AC3048
PS-514	1.625	D	1	2.375	BCDJF		Series 1531, 1510 Universal (Large Frame) M2 and C	Kit #8, 186543
PS-461	1.625	D	1	2.375	BCDKF			
PS-514-EPR-TC	1.625	D	1	2.375	QCDZF			185225

PUMP MANUFACTURERS' CROSS-REFERENCE

U.S. Seal Mfg. Part No.	Seal Size	Head	Mating Ring	Mating Ring Bore	Material Code	Notes	Pump Nameplate Data	Mfg. Part No.
BELL & GOSSETT (A XYLEM Brand) (continued)								
PS-6262	1.625	G	1	2.375	QCFJF	316SS/I		P75222
PS-6263	1.625	G	1	2.375	QCFZF	316SS/I		P75224
FA-1660	1.750	C	—	—	BCF-F			AC5229
FA-10168	1.750	C	—	—	BCF-F	I		P63337
PS-446V	1.750	C	3	2.500	VCFJF	S		F4992S
PS-237	1.750	D	1	2.500	BCDJF			186826
PS-288	1.750	D	1	2.500	BCDKF		VSC 6X6X12, 8X8X10-1/2 & 13	P77033
PS-7652	1.750	D	1	2.500	QCDZF	I		186835
FA-2000	2.000	C	—	—	BCF-F			AC0642, AC5230
PS-4345	2.000	C	3	3.000	BCFJF	I		AC3046, P70517
PS-1020-EPR-P66	2.000	C	3	3.000	QCFKF	I		186574
PS-3027	2.000	C	3	3.000	QCFZF			AC3049
PS-4357	2.000	G	25	2.750	QCFLF	316SS	VSX	P5001889
PS-3019	2.000	G	25	2.750	QLFLF	316SS		P5001028
PS-3170	2.000	G	25	2.750	VCFLF	316SS		P5001890
PS-3020	2.125	G	3	3.000	QCFJF	316SS/S		P75396
PS-834	2.375	D	3	3.250	BCFJF	S	VSC 10X10X13 12X12X13	186828
PS-594	2.375	D	3	3.250	BCFKF		VSC 10X10X13 12X12X13	
VG-3804	2.500	Special	25	3.375	QCFLF		VSX	P5001891
PS-4490	2.500	G	25	3.375	QLFLF	316SS		P5001086
PS-7909	2.625	D	3	3.375	BCFJF	I/S		P75572, 185377
PS-3188	2.625	D	3	3.375	QCFZF			185378
PS-328-P66	2.625	E	3	3.375	BCFJF	I/S		
PS-3802	3.000	G	3	3.875	QCFLF		VSX-VSH 18X10X22A	P5001893
PS-3793	3.500	G	3	4.375	QCFLF		VSX-VSC 14X16X17	P5001895

Value Guard Part No.	Seal Size	Head	Mating Ring	Mating Ring Bore	Material Code	Notes	Mfg. Part No.
BELL & GOSSETT - Series 80-SC							
VG-P75202	1.250	VGXB2	Special 27	2.000	XCFLF	316SS	Mating ring has lube hole
VG-975002334	1.625	VGXB2	Special 27	2.875	XCFLF	316SS	Mating ring has lube hole

Features

- External Seal Design
- Pressure Balanced
- Handles Temperatures to 450°F
- Set Screw Driven for Positive Drive



Type VGXB2

Value Guard Part No.	Seal Size	Head	Mating Ring	Mating Ring Bore	Material Code	Mfg. Part No.
BELL & GOSSETT - Models 80-S, 1510-S, 1531-S, VSC-S*, VSCS-S*						
VG-P85070	1.250	VGRO	25	2.000	XZFCF	P87050
VG-185050	1.625	VGRO	25	2.375	XZFCF	185050
VG-185051	2.000	VGRO	25	3.000	XZFCF	185051
VG-185054	2.625	VGRO	25	3.625	XLFCF	185054
VG-185052	2.625	VGRO	25	3.625	XZFCF	185052
VG-185055	3.750	VGRO	25	5.000	XLFCF	185055
VG-185053	3.750	VGRO	25	5.000	XZFCF	185053

Features

- Handles temperatures to 450°F
- Set screw driven for positive drive
- Multiple springs create consistent face pressure
- Unitized rotating assembly simplifies installation



Type VGRO

* Split Case Pumps - Require 2 Seals

NOTE: I. ABRASION RESISTANT CARBON (P66)
S. SLOTTED MATING RING

PUMP MANUFACTURERS' CROSS-REFERENCE

U.S. Seal Mfg. Part No.	Seal Size	Head	Mating Ring	Mating Ring Bore	Material Code	Notes	Pump Nameplate Data	Mfg. Part No.
BEMATEK PRODUCTS								
FA-10047	2.000	C	—	—	VCF-F			20178-P2347
BENNETT PUMP COMPANY								
FA-400	.500	C	—	—	BMF-F			541-M-1003
FA-1520	.750	C	—	—	BCF-F			541-M-1001
BERGSTROM MFG. COMPANY								
PS-3225	.500	A	1	1.000	BCFJF			573630
BERKELEY PUMPS (A PENTAIR Brand) See PENTAIR for Additional Part Numbers								
PS-516	.625	A	1	1.250	BCFJF			S20788, S20789, S20994
PS-200	.625	A	1	1.250	BMFJF		New Style Mid-Jet S4 HS, CIMPS, CIMPHS, CIXPS CIXPRS, C1-1/4MPS, B-1/2APKS D1-1/2MPKS	S20790
PS-202	.625	B	11	—	BMFJF	A	BM-3081 Mid-Jet 49-53 B1MRS, B1MRHS, B1XRHS B1-1/4MRS, B1-1/2MRS	S05053, S05645 S16844, S20900 S20996
PS-202V	.625	B	11	—	VCFJF	A		S18150
PS-3960	.625	G	1	1.250	BCFJF			S08019
VGM-4802	16 MM	VGM	Special	—	VLFLF		BVMI 15-12-100	B86598
VGM-4805	16 MM	VGM	Special	—	QLFLF		BVMI 15-12-100	B86599
PS-851	.750	A	1	1.375	BCFJF			S20794, S21961
PS-973	.750	A	1	1.375	BCFKF			S22380
PS-201	.750	A	1	1.375	BMFJF		New Style: C1-1/2TPLS, C2TPMS, C2-1/2TPMS, B1-1/2MQKS C2TPMS, C2.5TPMS, B1XQHS B1-1/4MQS, B1-1/2MQS	S05646, S20791, S20792 S21962
PS-921	.750	A	1	1.375	BMFKF			S20793, S32280
PS-201V-CMS	.750	A	1	1.375	VCFJF			S18662
PS-440	.750	B	11	—	BMFJF	A		S20997
PS-7618	.750	B	11	1.375	BMFJF			S06405
PS-750	.750	D	1	1.375	BCDJF		142MPKS, 1-1/2MQKS	S05647
PS-752	.750	D	1	1.375	BCDKF			S20780
PS-2008	.750	D	1	1.375	BCFJF			S20779
PS-360	1.000	A	1	1.625	BCFJF			S08742, S09583, S20795 S20796
PS-460	1.000	D	1	1.625	BCFKF			S20781
PS-754	1.000	E	1	1.625	BCFJF			S14867
PS-236	1.000	E	1	1.625	BCFKF			S20764, S20765
PS-356	1.125	C	1	1.750	BCFJF			S32690
PS-2227	1.125	C	1	1.750	BCFJF			S32689
PS-604	1.125	D	1	1.750	BCFJF			S16812
PS-605	1.125	D	1	1.750	BCFKF			S20783
PS-204	1.125	E	1	1.750	BCFJF		BZR, BZQ	S07216
PS-384	1.125	E	1	1.750	BCFKF		BZR, BZQ	S20767, S20768, S20995
VG-3387	1.125	HV	1	1.750	BCFJF		B3ZRM	
PS-185	1.250	C	1	1.875	BCFJF			S32014
PS-2122	1.250	C	1	1.875	BCFJF			S32013
PS-381	1.250	D	1	1.875	BCFJF		2TPKHS, 3TQKHS, 2TQKIS, 3TQKHS, 22TQKHS, 2TRKHS	S05649, S20784, S20785
PS-383	1.250	D	1	1.875	BCFKF			S20786
PS-361	1.250	E	1	1.875	BCFJF		All Models A Row Pump except 6YPH, 4EPBL & 6YP	S05648, S20770
PS-137	1.250	E	1	1.875	BCFKF			S15368, S20769
PS-1185	1.250	E	1	1.875	NCPJP			S20771
PS-883	1.250	K	1	1.875	BCFJF			S39485
PS-305	1.500	E	1	2.125	BCFJF		6YPH, 4EPBL, B1-1/2TQLS, B2TQMS, 2-1/2TQMS, B3TQMS	S05650, S20774
PS-374	1.500	E	1	2.125	BCFKF			S15385
PS-258	1.500	E	3	2.125	BCFKF			S20773, S20775
PS-374V	1.500	E	3	2.125	VCFKF			S15538
PS-821	1.625	D	3	2.375	BCDJF	S		S16656
PS-446	1.750	C	1	2.500	BCFJF			S32015
PS-2142	1.750	C	1	2.500	BCFJF			S32692

PUMP MANUFACTURERS' CROSS-REFERENCE

U.S. Seal Mfg. Part No.	Seal Size	Head	Mating Ring	Mating Ring Bore	Material Code	Notes	Pump Nameplate Data	Mfg. Part No.
BERKELEY PUMPS (A PENTAIR Brand) See PENTAIR for Additional Part Numbers (continued)								
PS-237	1.750	D	1	2.500	BCDJF			S16768
PS-288	1.750	D	1	2.500	BCDKF			
PS-205	1.750	E	1	2.500	BCFJF		A Row Pump, B3TPMS	S07277, S20776, S20777
PS-366	1.750	E	1	2.500	BCFKF			
PS-593	1.875	D	3	2.625	BCDKF	S		S20787, S20993
PS-2069	1.875	E	1	2.625	BCFJF			S15213, S20778
PS-2072	1.875	E	3	2.625	BCFKF	S		S20884
PS-479	2.000	E	1	2.750	BCFJF			S13481
PS-4508	2.125	C	3	3.000	BCFJF	S		S32016
PS-537	2.125	E	1	3.000	BCFJF			S15894, S15950
PS-353	2.125	E	1	3.000	BCFKF			S16076
PS-327	2.125	E	3	3.000	BCFJF	S		S17274
PS-835	2.500	D	3	3.375	BCDJF	S		S18337

Value Guard Part No.	Seal Size MM	Head	Mating Ring	Material Code	Notes	Mfg. Part No.
BJM PUMPS®						
VGM-01325V	20	VGMA	1	VCFJF / VLFLF		M01325V
VGM-01352CV	25	VGMA	1	VCFJF / VLFLF		M01352CV
VGM-2992V *	30	VGM562	1	VCFJF / VLFLF		M01368V
VGM-01362V	32	VGMA	1	VCFJF / VLFLF		M01362V
VGM-01366E	35	VGMA	1	QCFJF / QLFLF		M01366E
VGM-01366V	35	VGMA	1	VCFJF / VLFLF		M01366V
VGM-1355 *	45	VGM562	1	BLFLF / BLFLF		M01355
VGM-1355V *	45	VGM562	1	VLFLF / VLFLF		M01355V



Type VGMA

* Includes retaining plate

U.S. Seal Mfg. Part No.	Seal Size	Head	Mating Ring	Mating Ring Bore	Material Code	Notes	Pump Nameplate Data	Mfg. Part No.
BLACKMER								
PS-303	.875	D	1	1.500	BCDKF			333030
PS-9007	1.000	W	Special	2.156	TCFJF	316SS	SNP 1-1/4 X 1-1/2	333102
PS-9338	1.062	W	3	1.812	TCFKF	316SS/S		331277
PS-7967	1.125	E	3	2.000	BCPKP			BLK-0020-8000-890
PS-9016	1.375	W	27					
			Special	2.656	QCFJF	316SS		332202
PS-9304	1.437	W	27	2.687	TCFKF	316SS		BLK-0240-8001-920
VGM-83942	35 MM	Special	Special	57.5 MM	VCFLF		Model XL2	334491
VGM-83943	35 MM	Special	Special	57.5 MM	VSFLF		Model XL2	333919
VGM-9550	45 MM	Special	Special	66.0 MM	VCFSF		Model XL3	335129
VGM-85937	45 MM	Special	Special	76.0 MM	VCFSF		Model XL4	332054
VGM-9699	45 MM	Special	Special	76.0 MM	VSFLF		Model XL3	335147
VGM-83935	55 MM	Special	Special	79.5 MM	VCFSF		Model MXL4	337008

BLAKESLEE, INC. (Dishwashers and Prep Equipment)								
PS-235V	1.000	C	3	1.625	VCFJF		PUMPAKS Models 30-010 thru 30-023	32-036
PS-3401	1.000	Q	9	—	NMDKF	A		02255

BORETS US								
PS-3316	.875	D	3	1.500	XLFLF			605401, 915912
PS-3318	1.375	D	3	2.000	XLFLF	S		915918
PS-7874	1.500	D	3	2.125	BLFLF	S		408182
PS-3303	1.500	D	3	2.125	XLFLF	S		2000427

BOWSER								
FA-564	.750	C	—	—	BCF-F			27A09
PS-466	1.250	C	1	2.000	BCFJF			28A09

BRADEN WINCH (A PACCAR COMPANY)								
PS-201	.750	A	1	1.375	BMFJF		Model 1003	

NOTE: A. MOUNTS ON SHAFT
S. SLOTTED MATING RING

PUMP MANUFACTURERS' CROSS-REFERENCE

U.S. Seal Mfg. Part No.	Seal Size	Head	Mating Ring	Mating Ring Bore	Material Code	Notes	Pump Nameplate Data	Mfg. Part No.
BSM PUMP CORPORATION								
PS-358	.750	C	1	1.375	BCFJF			466-142-1
PS-235	1.000	C	1	1.625	BCFJF			466-137-1
PS-3312	1.000	C	1	1.625	BCFJF	316SS		466-137-2
PS-185	1.250	C	1	1.875	BCFJF			213-744-274
PS-185-P66	1.250	C	1	1.875	BCFJF	I		466-292
PS-185V-CMS	1.250	C	1	1.875	VCFJF			466-292-1
PS-186	1.375	D	1	2.000	BCDKF			466-143-1
PS-237	1.750	D	1	2.500	BCDJF			213-752-274
BUFFALO PUMPS								
PS-290	.625	C	1	1.250	BCFJF	N	BPL,BPM,BPO	CC-10900
PS-235	1.000	C	1	1.625	BCFJF		BPL,BPM,BPO	CC-10901
PS-384	1.125	E	1	1.750	BCFKF		1-1/2, 2 & 3SL, 1-1/2 & 2SA W/ Solid Shafts, 2-1/2SW	
PS-137	1.250	E	1	1.875	BCFKF		1-1/2, 2 & 3SL, SA Sleeved	231-31-330
PS-22224	1.250	E	3	1.875	QCFJF	316SS/ C/S		231-31-1779
FA-354	1.375	E	—	—	BCF-F			231-31-412, 231-31-1012 231-31-1573
PS-354	1.375	E	1	2.000	BCFJF			
PS-677	1.375	E	1	2.000	BCFKF			
PS-374	1.500	E	1	2.125	BCFKF		4SL, 3SA, 2RR, 284 Stage, 6SLH & 4HSM	
PS-374-P66	1.500	E	1	2.125	BCFKF	I		231-31-332
PS-2058	1.625	E	1	2.375	BCFKF		5SL, 4S, Large Frame	13564-6, 231-31-316 231-31-333
PS-340	1.875	C	1	2.625	BCFJF			231-31-435
PS-340-EPR-TC-CMS	1.875	C	1	2.625	QCFZF			231-31-1602
PS-340V-TC-SC	1.875	C	3	2.625	VZFLF	S		231-31-1461
PS-2069	1.875	E	1	2.625	BCFJF			231-31-1357
PS-2070	1.875	E	1	2.625	BCFKF		6SL, 4RR, 6HSM, 2 Stage D1 Dbl. Suction, 4SL Extra Heavy	13564-8
PS-2069-TC-SEAT	1.875	E	1	2.625	BCFZF			231-31-1278
PS-7869	1.875	E	1	2.625	QCFZF	I		231-31-1150
PS-4592	1.875	U	5	2.500	BCFZF	316SS		231-31-1292
PS-350	2.375	E	3	3.250	BCFKF	S	D2 Dbl. Suction Pumps, 6S & 6SU	
PS-279	2.500	E	3	3.375	BCFJF	S		231-31-1724
PS-349	2.500	E	3	3.375	BCFKF		8SL	
PS-321	2.750	E	3	3.500	V/BCFKF	S		231-31-410
PS-8563	4.000	X1	5	4.875	BCEZE		16VSHM-1	
BURKS® PUMPS (Division of CRANE PUMPS & SYSTEMS)								
PS-3913	.500	C	1	1.000	BCFJF	H		21727
PS-200	.625	A	1	1.250	BMFJF			17038
PS-290	.625	C	1	1.250	BCFJF	N		8514, 23846
PS-290V	.625	C	1	1.250	VCFJF	N		9652, 9676, 9762, 3CJSM
PS-2206	.625	C	3	1.250	QCFKF	S		20764-C
PS-1156V	.625	C	3	1.250	VCFKF			20498-C
PS-201	.750	A	1	1.375	BMFJF			17039
PS-3149	.750	C	1	1.375	BCFJF			08991
PS-358V	.750	C	3	1.375	VCFJF			9813
PS-185	1.250	C	1	1.875	BCFJF			9917
PS-756-EPR	1.250	C	1	1.875	QCFKF			
PS-185V-CMS	1.250	C	1	1.875	VCFJF			9926
PS-598-EPR	1.250	C	3	1.875	QCFKF			23559
PS-381	1.250	D	1	1.875	BCFJF			
PS-4044	1.375	C	1	2.125	BCFJF			
PS-238	1.625	C	1	2.375	BCFJF			21136
PS-238V-CMS	1.625	C	1	2.375	VCFJF			21189
PS-1068	1.750	C	1	2.500	BCFKF			M-3842-C
BUSCH MANUFACTURING LLC								
PS-22194	35 MM	G	25	50 MM	VCFLF			0487923100
PS-22196	45 MM	G	25	63 MM	VCFLF	316SS		0487923700

PUMP MANUFACTURERS' CROSS-REFERENCE

U.S. Seal Mfg. Part No.	Seal Size	Head	Mating Ring	Mating Ring Bore	Material Code	Notes	Pump Nameplate Data	Mfg. Part No.
BYRON JACKSON® (Division of FLOWERVE)								
PS-775	.875	D	3	1.500	BCDJF		Series 400	D-30903
PS-428	.875	R	1	1.500	BCDJF		Series 400	D-30904
PS-2033	1.000	D	3	1.625	BCFJF		Series 513	D-30433
PS-8111	1.437	XB2	3	2.125	BCFKF	316SS		
PS-382	1.500	D	1	2.125	BCFJF			
CAMAC INDUSTRIES								
PS-3191	.750	C	1	1.375	VCFJF	316SS		Series 50
CAMERON COMPRESSION SYSTEMS								
PS-185	1.250	C	1	1.875	BCFJF			2-01S-073-003
PS-1018	1.250	C	3	2.000	BCFKF			Z2-01S-140-001
PS-177	1.375	C	1	2.000	BCFJF			Z109-500
PS-3213	1.375	C	3	2.000	VCFKF	I		Z024-616
PS-239	1.625	C	1	2.375	BCFKF			2-01S-077-001
PS-1019	1.625	C	3	2.625	BCFKF			2-01S-140-001
PS-535	1.750	E	3	2.500	BCFJF	S		ZJA-043-000
PS-5224	2.000	C	1	2.750	BCFJF			2-01S-077-003
CARLYLE COMPRESSOR								
FA-2752	1.500	D	—	—	NLF-F			05GA404147 05GA503534
PS-6058	1.500	E	Plate	Plate	NCPGP			5F40276
FA-6104	2.000	E	—	—	NCP-P			5H40-477
PS-6007	2.000	E Special	Plate	5.875	NCPGP			5H40276
CARRIER CORPORATION								
PS-6019	1.000	D	3	1.625	NCPGF			20-22-778
FA-2754	1.500	D	—	—	NCF-F			17-44132-00Z
PS-2706	1.500	D Special	3	2.110	NLFLF			17-44770-00
CARTER PUMPS, INC.								
PS-100	.625	A	1	1.187	BMFJF			1S-5010
PS-200	.625	A	1	1.250	BMFJF			1S-5005A, 1S-5054
PS-290	.625	C	1	1.250	BCFJF	N		1S-5023, 1S-5035
PS-201	.750	A	1	1.375	BMFJF			1S-5039
PS-360	1.000	A	1	1.625	BCFJF			2S-5050, 2S-5054 2S-5089, 2S-5112
PS-383	1.250	D	1	1.875	BCFKF			2S-5116, 2S-5119 3S-5239
PS-186	1.375	D	1	2.000	BCDKF			4S-5106, 4S-5151
PS-553	1.500	C	3	2.125	BCFKF			4S-5215
PS-446	1.750	C	1	2.500	BCFJF			4S-5052
PS-237	1.750	D	1	2.500	BCDJF			6S-5202
PS-288	1.750	D	1	2.500	BCDKF			5S-5029
CARVER PUMP COMPANY								
PS-200	.625	A	1	1.250	BMFJF		B20-1, B1-2-1.25	
PS-200V-CMS	.625	A	1	1.250	VCFJF			091-062-02-2322
PS-359	.625	C	1	1.250	BCFJF		BB20-1	
PS-201	.750	A	1	1.375	BMFJF		K.5, L20-11	
PS-358	.750	C	1	1.375	BCFJF		T14C6	
PS-188	.875	E	1	1.500	BCFJF	316SS		
PS-229	.875	E	3	1.500	BCFKF	316SS		091-087-02-0212
PS-3507	.875	E	3	1.500	VZFLF	316SS		091-087-02-02AQ
PS-360	1.000	A	1	1.625	BCFJF		KN-3LC	
PS-356	1.125	C	1	1.750	BCFJF			
PS-627	1.125	C	1	1.750	BCFJF	B	26C6, 2.5YC7, 2YC7, 3YC9	
PS-185	1.250	C	1	1.875	BCFJF		K2L-20-9	
PS-525	1.250	C	3	1.875	BCFKF	B		
PS-466	1.250	C	1	2.000	BCFJF			090-125-01-0101
PS-466V	1.250	C	1	2.000	VCFJF			090-125-01-0103
PS-4131	1.250	C	1	2.000	VCFJF	316SS		090-125-01-0114
PS-3185	1.250	C	1	2.000	VCFKF			090-125-01-0104
PS-3178	1.250	C	1	2.000	VCFLF	316SS		090-125-01-0166

NOTE: B. TAPERED SPRING
I. ABRASION RESISTANT CARBON (P66)
N. NON-STANDARD SPRING HOLDER
S. SLOTTED MATING RING

PUMP MANUFACTURERS' CROSS-REFERENCE

U.S. Seal Mfg. Part No.	Seal Size	Head	Mating Ring	Mating Ring Bore	Material Code	Notes	Pump Nameplate Data	Mfg. Part No.
CARVER PUMP COMPANY (continued)								
PS-22225	1.250	C	1	2.000	VCFZF			090-125-01-0135
PS-4040	1.250	C	1	2.000	VLFZF	316SS		090-125-01-0136
PS-381	1.250	D	1	1.875	BCFJF		KN-2H-2L-3N	
PS-4073	1.250	D	3	1.875	VCFLF			091-125-99-0007
PS-1183-P66	1.250	E	3	1.875	BCFKF	I		090-125-02-0236
PS-137V-P66	1.250	E	3	1.875	VCFKF	I		090-125-02-0299
PS-4049	1.250	E	3	1.875	VCFLF	316SS		090-125-02-1269
PS-4377	1.250	T	3	2.000	BCFKF			090-125-02-1304
PS-681	1.250	U	1	1.875	BCD/FJF		1, 1-1/4, 1-1/2, 2, 3, 4L, 1-1/4, 1-1/2, 2, 2-1/2, 3, 4LA, 1LB, 1-1/4, 2, 2-1/2, 3, 4H, 1-1/4, 1-1/2, 2, 2-1/2, 3, 4HA	
PS-186	1.375	D	1	2.000	BCDKF		4GHC, 4GHB, 4B, 4BB	
PS-22226	1.625	D	3	2.375	BCFZF	316SS/S		091-162-02-2021
PS-745	1.625	E	1	2.375	BCDJF			090-162-02-4608
PS-822	1.625	E	3	2.375	BCDKF	S		
PS-1699	1.625	E	3	2.375	BCFKF	S		091-162-02-0212
PS-1683V	1.625	E	3	2.375	VCFJF	S		090-162-02-0203
PS-262-EPR-P66	1.750	E	3	2.500	QCFKF	I/S		090-175-02-0246
PS-7252	1.750	E	1	2.625	BCFJF			090-175-01-0110
PS-2130	1.750	E	3	2.625	BCFJF			
PS-22195	1.750	E	3	2.625	BCFJF	316SS		090-175-01-0101
PS-4535	1.750	E	3	2.625	BCFKF	316SS		090-175-01-0102
PS-4290	1.750	E	3	2.625	QCFLF			
PS-4512	1.750	E	3	2.625	QCFLF	316SS		090-175-02-B3DW
PS-4141	1.750	E	3	2.625	QCFZF	I		090-175-01-0137
PS-3227	1.750	E	3	2.625	VCFJF	316SS		090-175-01-0114
PS-3169	1.750	E	3	2.625	VCFKF	316SS		090-175-01-0104 090-175-02-B3AM
PS-3054	1.750	E	3	2.625	VCFLF	316SS		090-175-01-0166
PS-4228	1.750	E	3	2.625	VCFZF	316SS/I		090-175-01-0105
PS-8124	1.875	XB	3	2.375	QCFLF	316SS/S		090-187-02-J6DW
PS-8010	1.875	XB	3	2.375	VCFZF	316SS/I/S		090-187-02-9958
PS-8059	1.875	XBT	3	2.375	QCFZF	316SS/S		090-187-02-99AZ
PS-3522	2.000	E	3	2.750	BCFKF	316SS/I/S		090-200-02-0236
PS-477	2.000	E	3	2.750	BCFKF	S		
PS-3079	2.000	E	3	2.750	VCFKF	I/S		090-200-02-0299
PS-3999	2.000	U	3	2.750	VCFZF	316SS/S		091-200-02-1678
PS-3134	2.125	E	3	3.000	QCFLF	316SS/S		090-212-02-02DW
PS-353V	2.125	E	3	3.000	VCFKF	S		090-212-02-0204
PS-3122	2.125	E	3	3.125	BCFJF	316SS		090-212-02-1001 0909-212-02-1069
PS-3576	2.250	E	3	3.125	VCFJF	316SS/I		090-225-02-02EG
PS-2098V	2.375	E	3	3.250	VCFKF	S		090-237-02-0204
PS-8121	2.375	XB	3	3.000	QCFLF	316SS/S		090-237-02-J6DW
PS-7936	2.750	E	3	3.500	VCFZF	316SS		091-275-99-0003
CATERPILLAR, INC.								
FA-642	.625	B	—	—	BMF-F			4S-7805
PS-3313	.750	C	1	1.171	BZFZE	H		5N-6649, 5N-9547
FA-647	.750	B	—	—	BMF-F			1N-9177
PS-235	1.000	C	1	1.625	BCFJF			6N-4743, 6N-9313
C-B TOOL COMPANY								
FA-10	.500	B	—	—	BMF-F			4761
PS-200	.625	A	1	1.250	BMFJF			2661
PS-201	.750	A	1	1.375	BMFJF			1661
PS-357	1.000	C	1	1.625	BCFKF			4400 Series
CDS - JOHN BLUE COMPANY								
PS-879	1.000	K	1	1.625	BCFJF			S3565
PS-879V-CMS	1.000	K	1	1.625	VCFJF		S3220, (Serial # below 9920)	S3565S
VG-2656V-CMS	1.375	HDV	1	2.062	VCFJF		S3220, (3", 43005)	S3645V

PUMP MANUFACTURERS' CROSS-REFERENCE

U.S. Seal Mfg. Part No.	Seal Size	Head	Mating Ring	Mating Ring Bore	Material Code	Notes	Pump Nameplate Data	Mfg. Part No.
CENCO								
PS-452	.625	B	9	—	BMFJF	A		P-35332
PS-441	.750	B	9	—	BMFKF	A		P-35334
PS-112	.750	C	1	1.375	BCFKF			
PS-1026	.750	D	1	1.437	BCDKF			P-35219
PS-547	1.375	C	3	2.000	BCFKF	S		P-29538
CENTREX								
FA-26	.625	A	—	—	BMF-F			
PS-360	1.000	A	1	1.625	BCFJF			201-491, 201-493
CENTRILIFT, INC.								
PS-3316	.875	D	3	1.500	XLFLF			AL-136752
PS-3318	1.375	D	3	2.000	XLFLF	S		AL-548225
PS-205V	1.750	E	3	2.500	VCFJF	S		C57585
CH&E MFG. COMPANY								
PS-516	.625	A	1	1.250	BCFJF			W105-7A
PS-200	.625	A	1	1.250	BMFJF			W105-7
PS-200V-SC-SC	.625	A	1	1.250	VLF LF			W105-7C
PS-851	.750	A	1	1.375	BCFJF			W105-1
PS-201V-CMS	.750	A	1	1.375	VCFJF			W105-1V
PS-1125-SC-SC	.750	C	1	1.375	BLFLF			W105-1D
PS-7434	1.000	C	1	1.625	BCFJF			W105-2
PS-380	1.000	D	1	1.625	BCFJF			W105-10
PS-185-SC-SC	1.250	C	1	1.875	BLFLF			W105-15A
PS-758	1.500	C	1	2.125	BCFJF			W105-4
PS-758-SC-SC	1.500	C	1	2.125	BLFLF			W105-4C
PS-541	1.500	K	1	2.125	BCFJF			W105-6A
PS-432	1.500	R	1	2.125	BCFKF			W105-6
PS-449	1.750	K	1	2.500	BCFJF			W105-11A
CHALLENGE MFG. COMPANY								
FA-642	.625	B	—	—	BMF-F			
FA-647	.750	B	—	—	BMF-F			
PS-235	1.000	C	1	1.625	BCFJF			D-97
PS-357V	1.000	C	3	1.625	VCFKF	S		D-98
PS-355	1.125	C	1	1.750	BCFKF			E-97
PS-659	1.500	C	1	2.125	BCFKF			H-97
PS-659V	1.500	C	3	2.125	VCFKF			H-98
CHAMPION INDUSTRIES (Dishwashers)								
PS-200	.625	A	1	1.250	BMFJF		 <p>PS-3100</p>	106467
PS-4479	.625	B	8	1.109	QCFJF	A		108426
PS-3100	1.000	Q	—	—	NMDKF	Unitized		110276
PS-758	1.500	C	1	2.125	BCFJF			110611
CHEMINEER (Division of NOV, INC.)								
PS-2702	.875	C	3	1.500	VCFJF	316SS		472-00009
PS-818	1.625	C	3	2.375	BCFJF	S		472-00242
PS-238V	1.625	C	3	2.375	VCFJF	S		472-00082
CHEM-TROL, INC.								
PS-8110	1.375	XB2	3	2.000	VCFJF	316SS		SMV-1137
CHICAGO PUMP (Division of GRUNDFOS, INC.)								
PS-100	.625	A	1	1.187	BMFJF			
PS-200	.625	A	1	1.250	BMFJF			2658090
PS-263	.625	D	1	1.187	BCDKF			266910
PS-750	.750	D	1	1.375	BCDJF			2655888, 2663071
PS-265	.750	D	3	1.375	BCDKF			

NOTE: A. MOUNTS ON SHAFT
S. SLOTTED MATING RING

PUMP MANUFACTURERS' CROSS-REFERENCE

U.S. Seal Mfg. Part No.	Seal Size	Head	Mating Ring	Mating Ring Bore	Material Code	Notes	Pump Nameplate Data	Mfg. Part No.
CHICAGO PUMP (Division of GRUNDFOS, INC.) (continued)								
PS-250	.875	D	3	1.500	BCDKF			2675339
PS-188	.875	E	1	1.500	BCFJF			2657110, 2663072
PS-229	.875	E	3	1.500	BCFKF			267338
PS-380	1.000	D	1	1.625	BCFJF			
PS-252	1.000	D	3	1.625	BCFKF	S		2675341
PS-754	1.000	E	1	1.625	BCFJF			2655887
PS-251	1.000	E	3	1.625	BCFKF	S		2675340
PS-604	1.125	D	1	1.750	BCFJF			2658071
PS-605	1.125	D	1	1.750	BCFKF			2655131
PS-254	1.125	D	3	1.750	BCFKF	S		2675344
PS-253	1.125	E	3	1.750	BCFKF	S		2675343
PS-306	1.187	E	1	1.875	BCDJF			2655886
PS-255	1.187	E	3	1.875	BCDKF			2675345
PS-361	1.250	E	1	1.875	BCFJF			
PS-256	1.250	E	3	1.875	BCFKF			2675347
PS-264	1.250	E	3	1.875	BCFKF			2675318
PS-354	1.375	E	1	2.000	BCFJF			2655089
PS-257	1.375	E	3	2.000	BCFKF	S		2675350 000
PS-258	1.500	E	3	2.125	BCFKF			2675351
PS-259	1.500	E	3	2.125	BCFKF			2675352 000
PS-868	1.500	T	1	2.125	BCFJF		VPM-LLC4	
PS-446	1.750	C	1	2.500	BCFJF			117185
PS-262	1.750	E	3	2.500	BCFKF	S	VPM-LMC4	2675354
CLAY EQUIPMENT CORPORATION								
PS-185	1.250	C	1	1.875	BCFJF			0-902718-0
PS-758	1.500	C	1	2.125	BCFJF			0-902719-0
CLAYTON MARK								
PS-501	.625	A	1	1.250	BMFJF			29304B
CLEARWATER INDUSTRIES								
PS-163	.500	B	1	1.000	BMFJF			516069
CLEAVER-BROOKS								
PS-358	.750	C	1	1.375	BCFJF			925-65
CLEVELAND GEAR COMPANY, INC.								
PS-5082	1.000	C	2	1.750	BCFKF	H		Z1032N
PS-254	1.125	D	3	1.750	BCFKF	S		Z1028C
PS-7245	1.250	D	3	1.937	VCPGP			Z1028D
PS-4363	1.500	D	3	2.187	BCFGF			Z1028E
PS-3026	1.625	D	3	2.437	BCDGF			Z1028F
PS-333	2.000	D	3	2.812	NCPGP		Reducer 400	Z1028G
PS-335V	2.500	D	3	3.375	VCPGP			Z1028H
PS-3713	3.000	D	3	4.000	NCPGP			Z1028J
PS-3314	3.875	D	3	5.125	VCFGP		Speed Reducer Model 900 and 1000	Z1028M
CLIMAX ENGINE								
PS-380	1.000	D	1	1.625	BCFJF			
CLOW CORPORATION (See YEOMANS CHICAGO CORPORATION)								
COLUMBIA POOL PRODUCTS								
PS-142	.500	B	1	1.000	BMFJF			
CONSOLIDATED DIESEL ELECTRIC								
PS-758	1.500	C	1	2.125	BCFJF			0338-0275
CONSTRUCTION MACHINE (See CRANE PUMPS & SYSTEMS)								
CONTINENTAL ULTRA PUMPS								
PS-359	.625	C	1	1.250	BCFJF			U8-150
PS-290	.625	C	1	1.250	BCFJF	N		V8-15Q
PS-359-EPR-CMS	.625	C	1	1.250	QCFJF			
PS-3110	.750	C	1	1.375	BLFLF			U8-56QA/R
PS-358V-CMS	.750	C	1	1.375	VCFJF			U8-56F

PUMP MANUFACTURERS' CROSS-REFERENCE

U.S. Seal Mfg. Part No.	Seal Size	Head	Mating Ring	Mating Ring Bore	Material Code	Notes	Pump Nameplate Data	Mfg. Part No.
COOPER ENERGY SERVICES (See CAMERON COMPRESSION SYSTEMS)								
CORCORAN COMPANY, R.S.								
PS-22228	.750	C	1	1.375	VCFJF	316SS		2006-21V
PS-358V	.750	C	3	1.375	VCFJF			
PS-446V	1.750	C	3	2.500	VCFJF	S		
CORKEN, INC.								
PS-22186	1.125	XB	3	1.625	BCFLF	S		5242-1XA6.
PS-22193	1.125	XB	3	1.625	VCFLF	S		5242-1XD6
PS-598	1.250	C	3	1.875	BCFKF			2994-XA
PS-756V	1.250	C	3	1.875	VCFKF			2994-XD
PS-6008	1.625	X Special	25 Special	2.410	BCPGF			2298-XA2
PS-22183	1.625	XB	3	2.375	BCPLF	I		4937-XA6
PS-22184	1.625	XB	Special	2.406	BCPLF	I		2298-XA6
PS-22187	1.625	XB	3	2.375	VCFLF			4937-XD6
PS-22189	1.625	XB	Special	2.406	NCPLF	I		2298-XB6
PS-22191	1.625	XB	Special	2.406	QCPLF	I		2298-XG6
PS-22188	1.625	XB	Special	2.406	VCPLF	I		2298-XD6
PS-22192	1.625	XB	3	2.375	NCPLF	I		4937-XB6
PS-22185	1.875	X Special	3	2.625	BCFLF	316SS/I/S		4938-XA6
PS-22190	1.875	X Special	3	2.625	VCFLF	316SS/I/S		4938-XD6
CORNELL PUMP COMPANY								
PS-3960	.625	G	1	1.250	BCFJF			A14997G-40
PS-618	1.250	C	3	1.875	BCFJF	S		A17161J-40, A17161P-40
PS-546	1.250	E	3	1.875	BCFV/JF	S		A15002C-40, A15002E-40 A17161X-40
PS-137V	1.250	E	3	1.875	VCFKF			A15002D-40
PS-22077	1.250	E	3	1.875	VFLVL			A17161N-40
PS-3229	1.250	R	3	1.875	VZFLF	S		A17161Z-40
PS-2211	1.250	T	3	1.875	BCFJF	S		A16003B-40
PS-3607	1.250	T	3	1.875	NAFGF		Includes Spacer	A15002I-40
PS-3084	1.250	T	3	1.875	NAFZF			A15002K-40
PS-22076	1.250	T	3	1.875	NCFGF			A16003J-40
PS-864	1.375	E	3	2.000	BCFJF	S		A15003J-40
PS-821	1.625	D	3	2.375	BCDJF	S		A15005H-40
PS-1698	1.625	D	3	2.375	BCFJF			A17064M-40
PS-3223	1.625	D	3	2.375	BZFLF	S		A17064K-40
PS-3186	1.625	D	3	2.375	VCFLF	316SS/S		A20769J-40
PS-3772	1.625	D	3	2.375	VZFLF	S		A17064X-40
PS-595	1.625	E	3	2.375	BCDJF	S		A15005D-40
PS-822	1.625	E	3	2.375	BCDKF	S		A15005C-40
PS-1683	1.625	E	3	2.375	BCFJF	S		A15005A-40, A17064Q-40 A17064R-40
PS-1699	1.625	E	3	2.375	BCFKF	S		A15005Y-40, A20769I-40
PS-2717	1.625	E	3	2.375	BZFLF	S		A17064E-40
PS-22082	1.625	E	3	2.375	BZFLF			A20769A-40
PS-22078	1.625	E	3	2.375	QCFZF			A16166O-40
PS-1699V	1.625	E	3	2.375	VCFKF	S		A15005X-40
PS-4471	1.625	E	3	2.375	VCFLF	316SS/S		A17064V-40
PS-22079	1.625	E	3	2.375	VZFLF			A16936O-40
PS-22083	1.625	E	3	2.375	VZFLF			A20769F-40
PS-3071	1.625	R	3	2.375	NAFGF	S		A15005I-40
PS-22080	1.625	R	3	2.375	NAFZF			A17064D-40
PS-22081	1.625	R	3	2.375	VZFLF			A17064U-40-Q13
PS-9718	1.625	W Special	2	2.375	TCFKF	316SS		A15005S-40
PS-436-TC-VS-SC	1.750	C	3	2.500	B/VZFLF	S		A15006J-40
PS-550	1.750	C	3	2.500	BCFJF	S		A15006F-40, A15006M-40
PS-7035	1.750	C	3	2.500	QCFZF	I/S		A15006I-40
PS-22084	1.750	C	3	2.500	VZFLF	H/S		A15006H-40
PS-22086	1.750	C	3	2.500	VZFLF	S		A25047B-40
PS-3267	1.750	D	3	2.500	BZFLF	316SS/S		A15006D-40
PS-535	1.750	E	3	2.500	BCFJF	S		A15006N-40

NOTE: H. SPRING HOLDER NOT INCLUDED
I. ABRASION RESISTANT CARBON (P66)
S. SLOTTED MATING RING

PUMP MANUFACTURERS' CROSS-REFERENCE

U.S. Seal Mfg. Part No.	Seal Size	Head	Mating Ring	Mating Ring Bore	Material Code	Notes	Pump Nameplate Data	Mfg. Part No.
CORNELL PUMP COMPANY (continued)								
PS-22085	1.750	E	3	2.500	VZFLF	316SS		A15006W-40
PS-532	2.000	C	3	2.750	BCFJF	S		A20777G-40
PS-833	2.000	D	3	2.750	BCDJF	S		A15007D-40, A17264P-40
PS-2075	2.000	D	3	2.750	BCFJF	S		A15007M-40
PS-3153	2.000	D	3	2.750	BZFLF	S		A15007Y-40
PS-3142	2.000	D	3	2.750	VZFLF	316SS/H/S		A17264Q-40, N00138-40
PS-530	2.000	E	3	2.750	BCFJF	S		A15007B-40, A15007C-40
PS-4600	2.000	E	3	2.750	BZFZF	316SS		A16899B-40
PS-22087	2.000	E	3	2.750	VZFLF	316SS		A17264Y-40
PS-2143	2.000	K	1	2.750	BCFJF			
PS-7196	2.000	K	3	2.750	BCFJF	S		A15007J-40
PS-468	2.500	D	3	3.250	BCDJF			A15008E-40
PS-22090	2.500	D	3	3.375	BCFJF	S		A15008F-40, A21705R-40
PS-463-TC-SC	2.500	D	3	3.375	BZFLF	S	Springholder not required	A20526U-40
PS-22091	2.500	D	3	3.375	VCFJF			A25641A-40
PS-3888	2.500	D	3	3.375	VZFLF	S		A20526R-40
PS-22094	2.500	D	3	3.375	VZFLF	316SS		A16421D-40
PS-279	2.500	E	3	3.375	BCFJF	S		A15008B-40, A20526D-40
PS-349	2.500	E	3	3.375	BCFKF			A16421B-40
PS-22067	2.500	E	3	3.375	BZFLF			A16421H-40
PS-7985	2.500	E	3	3.375	QCFZF			A16421L-40
PS-349V-TC-SC	2.500	E	3	3.375	VZFLF	S		A17258V-40, A20526F-40
PS-1613	2.500	K	3	3.375	BCFJF	S		A15008R-40
PS-4523	2.500	V	3	3.250	BCFJF			
PS-7875	3.000	C	1	3.875	BZFZF			A22335E-40
PS-22092	3.000	D	3	3.875	BCFJF			A20564T-40
PS-6219	3.000	D	3	3.875	BZFLF			A169721-40
PS-4033	3.000	D	3	3.875	VZFLF	S		A20564P-40
PS-2710	3.000	D	3	3.875	VZFLF	S		A169720-40, N00137-40
PS-22093	3.000	E	3	3.875	VZFLF			A16972Q-40
PS-7873	3.000	K	3	3.875	BCFJF			A15009G-40
PS-2116	3.000	C	3	3.875	BCFJF	S		A22335G-40
PS-324	3.000	E	3	3.875	BCDJF	S		A15009A-40, A20564D-40
PS-324SS	3.000	E	3	3.875	BCFJF	S		A15009H-40
PS-3222	3.250	D	3	4.125	VZFLF	S		A22646A-40
PS-6203	3.750	D	3	4.625	VCFJF			A21879C-40
PS-2719	4.000	D	3	4.875	VZFLF			A15010H-40
PS-2772	4.000	D	3	4.875	VZFZF			A15010F-40
PS-4598	6.000	D	3	7.000	VZFZF	316SS	Model 30NNT-VF30	A21164A-40
CRANE-DEMING (Division of CRANE PUMPS & SYSTEMS)								
PS-1002	.500	C	1	1.000	BCFJF			0058125
PS-106	.500	C	1	1.000	BCFKF			0058216
PS-1002V	.500	C	1	1.000	VCFJF			0055716
PS-200	.625	A	1	1.250	BMFJF		Fig. 4910-63, 4357, 4358	
PS-501	.625	A	1	1.250	BMFJF		Fig. 4910, 11, 12, 13, 4963, 66, 67	
PS-507	.625	A	1	1.250	BMFKF			
PS-200V-CMS	.625	A	1	1.250	VCFJF			0040861
PS-507V-CMS	.625	A	1	1.250	VCFKF			8009530
PS-493	.625	C	1	1.187	BCFKF			0006841, 0006876
PS-359	.625	C	1	1.250	BCFJF			0034427
PS-633	.625	C	1	1.250	BCFKF			115515
PS-359V-CMS	.625	C	1	1.250	VCFJF			115835
PS-226	.625	D	1	1.187	BCDKF			0006875, 0020444
PS-201	.750	A	1	1.375	BMFJF		Fig. 4910, 4911, 3305, 3352, 4352	
PS-750	.750	D	1	1.375	BCDJF			
FA-1600	.875	C	—	—	BCF-F			6880
PS-309	.875	C	1	1.500	BCFJF		Fig. 4001, Dwg. 116-386	0030876
PS-687	.875	C	1	1.500	BCFKF		Fig. 4001	0030877
PS-309V	.875	C	3	1.500	VCFJF			0084876
PS-687V	.875	C	3	1.500	VCFKF			0084877
PS-790	.875	D	1	1.437	BCDJF		Fig. 4001, Dwg. 112-041	

PUMP MANUFACTURERS' CROSS-REFERENCE

U.S. Seal Mfg. Part No.	Seal Size	Head	Mating Ring	Mating Ring Bore	Material Code	Notes	Pump Nameplate Data	Mfg. Part No.
CRANE-DEMING (Division of CRANE PUMPS & SYSTEMS) (continued)								
PS-892	.875	K	1	1.500	BCFJF		Fig. 4001	0030894
PS-878	.875	K	1	1.500	BCFKF		Fig. 4001	0030895
PS-428	.875	R	1	1.500	BCDJF		Fig. 4001, Dwg. 113-068	
PS-2145	1.000	C	3	1.437	BCFJF			0065187
PS-3755	1.000	C	3	1.437	VCFJF			0075513
PS-235	1.000	C	1	1.625	BCFJF			0030878
PS-357	1.000	C	1	1.625	BCFKF		Fig. 4011, Dwg. 115-313	0030879
PS-460	1.000	D	1	1.625	BCFKF		Fig. 4011	
PS-4882	1.000	E	3	1.437	BCFJF			0099273
PS-879	1.000	K	1	1.625	BCFJF			
PS-3126	1.000	K	1	1.625	BCFKF			0030897
PS-429	1.000	R	1	1.625	BCFJF			
PS-9018	1.000	W	27	2.156	TCFJF	316SS		0118912
PS-608	1.125	E	1	1.687	BCFKF		Fig. 4012, Size 1A	
PS-384	1.125	E	1	1.750	BCFKF			0029177
PS-185	1.250	C	1	1.875	BCFJF			0030880, 0070713
PS-756	1.250	C	1	1.875	BCFKF			0030881
PS-185V-CMS	1.250	C	1	1.875	VCFJF			0088458, 0088459
PS-598-TC-SEAT	1.250	C	3	1.875	BCFZF	S		8030880
PS-756V	1.250	C	3	1.875	VCFKF			0084881
PS-381	1.250	D	1	1.875	BCFJF			
PS-383	1.250	D	1	1.875	BCFKF		7180	
FA-189	1.250	E	—	—	BCF-F			0078876
PS-546	1.250	E	3	1.875	BCFV/JF	S		0078879
PS-883	1.250	K	1	1.875	BCFJF			0030898
PS-890	1.250	K	1	1.875	BCFKF			0030899
PS-2211	1.250	T	3	1.875	BCFJF	S		0045935
PS-186	1.375	D	1	2.000	BCDKF			0030882
PS-2234	1.437	E	3	2.062	BCFKF		1523, 1535	0036636
PS-758	1.500	C	1	2.125	BCFJF			0030884
PS-659	1.500	C	1	2.125	BCFKF		Fig. 4021HD	0030885
PS-2209	1.500	C	1	2.125	BZFZF			8030885
PS-659V-CMS	1.500	C	1	2.125	VCFKF			0084885
PS-382	1.500	D	1	2.125	BCFJF		Fig. 4021HD	
PS-3128	1.500	K	1	2.125	BCFJF			0030900
PS-3130	1.500	K	1	2.125	BCFKF			0030901
PS-431	1.500	R	1	2.125	BCFJF			
PS-432	1.500	R	1	2.125	BCFKF			
PS-238	1.625	C	1	2.375	BCFJF			0030886
PS-239	1.625	C	1	2.375	BCFKF			0030887
PS-238V-CMS	1.625	C	1	2.375	VCFJF			106330
PS-239V-CMS	1.625	C	1	2.375	VCFKF			106331
PS-446	1.750	C	1	2.500	BCFJF		7360	0030888
PS-2142	1.750	C	1	2.500	BCFJF			0030904
PS-448	1.750	C	1	2.500	BCFKF			0030889
PS-3286	1.750	C	3	2.500	VCFKF	S		0117185
PS-2207	1.750	C	3	2.500	VCFZF	S		117779
PS-237	1.750	D	1	2.500	BCDJF			
FA-366	1.750	E	—	—	BCF-F			0078877
PS-535	1.750	E	3	2.500	BCFJF	S	3065	0078882
PS-4097	1.750	EB	3	2.500	BCFKF			124410
PS-449	1.750	K	1	2.500	BCFJF		Fig.4031- Fig.7182	
PS-3115	1.750	T	3	2.500	BCFJF	S		0045936
PS-340	1.875	C	1	2.625	BCFJF			0046389
PS-1608	1.875	C	1	2.625	BCFKF			0046390
PS-312	1.875	C	3	2.625	BCFKF	S		
PS-312V	1.875	C	3	2.625	VCFKF	S		0075518
PS-543	2.125	C	1	3.000	BCFKF	S		0030891
PS-338	2.125	C	3	3.000	BCFJF	S		0030890
PS-543V	2.125	C	3	3.000	VCFKF	S		119412
PS-353	2.125	E	1	3.000	BCFKF			

NOTE: S. SLOTTED MATING RING

PUMP MANUFACTURERS' CROSS-REFERENCE

U.S. Seal Mfg. Part No.	Seal Size	Head	Mating Ring	Mating Ring Bore	Material Code	Notes	Pump Nameplate Data	Mfg. Part No.
CRANE-DEMING (Division of CRANE PUMPS & SYSTEMS) (continued)								
PS-2086	2.125	E	3	3.000	BCFKF	S		
PS-2126	2.125	T	3	3.000	BCFJF	S		0043483, 0045937
PS-1679	2.250	C	1	3.125	BCFJF			0030892
PS-1676	2.250	C	3	3.125	BCFKF	S		0030893
PS-1676V	2.250	C	3	3.125	VCFKF	S		0075520
PS-2132	2.250	T	3	3.125	BCDJF			0068385
CRANE PUMPS & SYSTEMS								
PS-3000	12MM	G	1	26MM	BLFLF			112566B
PS-200	.625	A	1	1.250	BMFJF			0000015
PS-507	.625	A	1	1.250	BMFKF			0009530
PS-4587	.625	B	8	1.109	Special	A		098678
PS-359	.625	C	1	1.250	BCFJF			0115514
PS-633-EPR-CMS	.625	C	1	1.250	QCCKF			124476
PS-4603	.625	C	1	1.250	VCFJF			
PS-7547	.625	C	1	1.250	VLFLF			005080SK
PS-732	.625	C	3	1.250	BCFKF			21752
PS-5625	.625	Special	1	1.250	QC-J-			23568
PS-851	.750	A	1	1.375	BCFJF			0000059
PS-1125	.750	C	1	1.375	BCFJF			2-31017
PS-3110	.750	C	1	1.375	BLFLF			110395SD
PS-3916	.750	C	3	1.375	BCFJF			110395
PS-767	.750	C	3	1.375	B/VCFJF			63599
PS-9339	.750	W	2	1.375	TCFJF	316SS		21741
PS-8064	.750	X	3	1.375	BLFLF	316SS		083459-A
PS-309	.875	C	1	1.500	BCFJF			M-3824-B, 0030876
PS-3907	.875	C	1	1.500	BCFJF			2-31006
PS-687V-CMS	.875	C	1	1.500	VCFKF			120941
PS-774	.875	C	3	1.500	BCFV/JF			111131
PS-3176	.875	C	3	1.500	BLFLF			111131SD
PS-8065	.875	X	3	1.500	BLFLF	316SS		082827-A
PS-235	1.000	C	1	1.625	BCFJF			M-4292-B
PS-357	1.000	C	1	1.625	BCFKF		5MPK, 6MFP, 9MFP, 16PK, CC1-1/2-1-1/2, CC1-1/2-2	M-4292-C
PS-2145	1.000	C	3	1.437	BCFJF			0068157
PS-235V	1.000	C	3	1.625	VCFJF	S		M-4292-G, 7841-0
PS-9018	1.000	W	27	2.156	TCFJF	316SS		121838
PS-4302	1.125	C	1	1.750	BCFJF			21942-P
PS-355-SC-SC	1.125	C	1	1.750	BLFLF			070712SD
PS-604	1.125	D	1	1.750	BCFJF			M-4274-C
PS-521	1.125	D	1	1.875	BCFKF			
PS-756	1.250	C	1	1.875	BCFKF			019146, 110697
PS-2208	1.250	C	1	1.875	BZFZF			070713SB
PS-1081	1.250	C	1	1.875	NCFJF			22197
PS-185V-CMS	1.250	C	1	1.875	VCFJF			23109, 121448
PS-185V-TC-SEAT	1.250	C	1	1.875	VCFZF			0118359
PS-185V-TC-TC	1.250	C	1	1.875	VZFZF			123284
PS-466	1.250	C	1	2.000	BCFJF			M-3957-C
PS-598-TC-SEAT	1.250	C	3	1.875	BCFZF	S		121918
PS-756V	1.250	C	3	1.875	VCFKF			20500-C, 84881
FA-189	1.250	E	—	—	BCF-F			78876
PS-546	1.250	E	3	1.875	BCFV/JF	S		40684
PS-7323	1.250	K	1	1.875	BZ/CFZ/JF			060817
PS-4537	1.250	K	1	1.875	BZFZF			060817SC
PS-467	1.375	C	1	2.125	BCFKF			M-3983-C
PS-177V	1.375	C	3	2.000	VCFJF	S		7842-0
PS-758	1.500	C	1	2.125	BCFJF			0030884
PS-758-SC-TC-CMS	1.500	C	1	2.125	BLFZF			0030885B
PS-2209	1.500	C	1	2.125	BZFZF			0030885A
PS-816	1.500	C	3	2.125	BCFJF	S		133029
PS-395	1.500	E	3	2.125	BCFJF	S		0099274
PS-238	1.625	C	1	2.375	BCFJF			0030886

PUMP MANUFACTURERS' CROSS-REFERENCE

U.S. Seal Mfg. Part No.	Seal Size	Head	Mating Ring	Mating Ring Bore	Material Code	Notes	Pump Nameplate Data	Mfg. Part No.
CRANE PUMPS & SYSTEMS (continued)								
PS-3664	1.625	C	1	2.375	BZFFZ			131710
PS-238V-P66-TC	1.625	C	1	2.375	VCFZF	I		131793
PS-7806	1.625	C	1	2.375	VLFLF			115595, 121755, 125579
PS-3144	1.625	C	1	2.375	VZFFZ			122825
PS-239-EPR	1.625	C	3	2.375	QCFKF	S		21721
PS-239V	1.625	C	3	2.375	VCFKF	S		23150
PS-2212	1.750	C	1	2.500	BCFJF			M-3842-F
PS-1068	1.750	C	1	2.500	BCFKF			M-3842-C
PS-446-TC-TC	1.750	C	1	2.500	BZFFZ			071559
PS-4410	1.750	C	1	2.500	BZFFZ			M-3842-L
PS-7820	1.750	C	1	2.500	VLFLF			M-3842-V
PS-550	1.750	C	3	2.500	BCFJF	S		053605, 125852
PS-436-SC-SC	1.750	C	3	2.500	BLFLF	S		125852SD
PS-4035	1.750	C/X Special	1	2.500	BCFJF			M-9262
PS-4491	1.750	DB	3	2.375	BCFZF			
PS-859-TC-SEAT	1.750	E	3	2.500	BCFZF	S		117781, 8078882
PS-340	1.875	C	1	2.625	BCFJF			0046389
PS-2114	1.875	C	3	2.625	BCFJF	S		129900
PS-2729	1.875	C	3	2.625	BLFLF	S		129900SD
PS-3190	1.875	K	1	2.625	BZFFZ			060818SC
PS-1028	2.000	C	1	2.750	BCFKF			
PS-2219	2.000	C	1	2.750	BZFFZ			71560
PS-1145	2.000	C	3	2.750	VCFKF	S		0-536026-E
PS-7892	2.000	EB	3	2.625	BCFKF	S		9054995
PS-7196	2.000	K	3	2.750	BCFJF	S		00103045
PS-543	2.125	C	1	3.000	BCFKF			0030891
PS-353V	2.125	E	3	3.000	VCFKF	S		0081432
PS-3727	2.125	E	3	3.000	VLFLF	S		122556
PS-1679	2.250	C	1	3.125	BCFJF			0030892
PS-3289	2.250	C	3	3.125	BLFLF	S		130117
PS-1688	2.250	E	3	3.125	BCFJF	S		0099278
PS-3651	2.500	C/X	1	3.375	BCFJ*		* Special Wave Spring	M-9439
PS-468	2.500	D	3	3.250	BCDJF			M-4272-B
PS-6205	2.750	C	1	3.500	BCFJF			85980
PS-6908	2.750	C	1	3.500	BZFFZ			85981
PS-2153-CMS	3.000	C	1	3.875	BCFJF			085983
CREPACO (A SPXFLOW Brand)								
FA-1700	1.000	C	—	—	BCF-F			549S6407F
FA-10037	1.000	C	—	—	VCF-F			549S6408F
FA-756	1.250	C	—	—	BCF-F			549S6407
CROWN PUMPS (Division of CRANE PUMPS & SYSTEMS)								
PS-235-EPR	1.000	C	1	1.625	QCFJF			BM7274
PS-185V-CMS	1.250	C	1	1.875	VCFJF			BM7275
CULLIGAN INTERNATIONAL								
PS-4489	.750	A	1	1.375	BMFJF			325494
CURTIS								
PS-605	1.125	D	1	1.750	BCFKF			
PS-288	1.750	D	1	2.500	BCDKF			
DAKON								
FA-10	.500	B	—	—	BMF-F		Seat is Impeller	
DARLEY, W.S. & COMPANY								
PS-6006	.750	D	3	1.375	BCDLF		Springholder not Required	1841502
PS-22138	.875	D	3	1.500	BCDLF	H/S		1842903
PS-254	1.125	D	3	1.750	BCFKF	S		1841101
PS-4246	1.250	D	3	1.875	BCDLF	H/S		1841203, 1841205
PS-22135	1.250	DB	3	1.750	BCFLF	H/S		1843602

NOTE: H. SPRING HOLDER NOT INCLUDED
I. ABRASION RESISTANT CARBON (P66)
S. SLOTTED MATING RING

PUMP MANUFACTURERS' CROSS-REFERENCE

U.S. Seal Mfg. Part No.	Seal Size	Head	Mating Ring	Mating Ring Bore	Material Code	Notes	Pump Nameplate Data	Mfg. Part No.
DARLEY, W.S. & COMPANY (continued)								
PS-22136	1.375	D	3	2.000	BCDLF	S		1841403
PS-22132	1.500	D	3	2.125	BCFLF	H/S		1842201
PS-22139	1.500	E	3	2.125	BCDLF	S		1844800, 1844800X
PS-448	1.750	C	1	2.500	BCFKF			1842300
PS-22137	1.750	D	3	2.500	BCDLF	S		1844501
PS-22130	1.750	E	3	2.500	BCDLF	H/S		1845400X
PS-22133	1.875	D	3	2.625	BCDLF	H/S		1843804, 1843804X
PS-22131	1.875	E	3	2.625	BCDLF	H/S		1844900, 1844900X
PS-22134	2.000	D	3	2.750	BCFLF	S		1846300, 1846300X
DAYTON (See TEEL PUMP)								
DEAN PUMPS (See MET-PRO for Additional Part Numbers)								
PS-3589	1.000	E	5	1.625	VCFZF			
DECATUR PUMP (See CRANE PUMPS & SYSTEMS)								
PS-501	.625	A	1	1.250	BMFJF			20888
PS-359	.625	C	1	1.250	BCFJF			
PS-290	.625	C	1	1.250	BCFJF	N		8514
PS-290V	.625	C	1	1.250	VCFJF	N		9762
PS-750	.750	D	1	1.375	BCDJF			
PS-185	1.250	C	1	1.875	BCFJF			9917
PS-598-EPR	1.250	C	3	1.875	QCFKF			21271
DEFECO, INC.								
PS-359V-CMS	.625	C	1	1.250	VCFJF		D-520	A2518
VG-879V-SC-SC-CMS	1.000	HVD	1	1.625	VLFLF			A2517ED
PS-360V-CMS	1.000	A	1	1.625	VCFJF			A2519, A720GE-A-715
DEKKER VACUUM PUMPS								
VGM-4730	30MM	G	25	45MM	VCFLF			6220-0030-000
VGM-4719	30MM	VGMH	25	45MM	VCFLF	316SS		
VGM-4731	55MM	W	25	75MM	TCFLF	316SS		
VGM-4711	55MM	VGMH	25	75MM	VCFLF	316SS		6220-0055-000
VGM-4732	75MM	W	25	97MM	TCFLF	316SS		6220-0075-001
VGM-8263	75MM	VGMH	25	97MM	VCFLF	316SS		6220-0075-000
DeLAVAL (See IMO INDUSTRIES, INC.)								
DELAVAN FLUID POWER								
PS-200V-CMS	.625	A	1	1.250	VCFJF			34943
PS-1061	.562	A	1	1.250	VCFJF			
DELTA T SYSTEMS, INC.								
PS-3147	.625	C	3	1.250	QCFKF	I		108-00001-00
PS-2167-EPR-P66	.875	C	1	1.437	QCFJF	I		108-00006-00
PS-2224	.875	C	3	1.437	QCFKF	I		108-00002-00
DEMING® (See CRANE PUMPS & SYSTEMS)								
DEMPSTER INDUSTRIES, LLC								
PS-162	.500	A	1	1.000	BMFJF			
PS-200	.625	A	1	1.250	BMFJF			907-06030
PS-202	.625	B	11	—	BMFJF	A		
PS-441	.750	B	9	—	BMFKF	A		907-06001
PS-440	.750	B	11	—	BMFJF	A		907-06006
PS-358	.750	C	1	1.375	BCFJF			907-06043
PS-309	.875	C	1	1.500	BCFJF			907-06033
PS-309V	.875	C	3	1.500	VCFJF			907-06034
PS-598	1.250	C	3	1.875	BCFKF			907-06035
PS-756V	1.250	C	3	1.875	VCFKF			907-06046
DENISON HYDRAULICS (PARKER HANNIFIN CORPORATION)								
PS-5676	1.375	C	2	2.187	B/VCFJF	316SS		
PS-5711	1.375	C	2	2.187	B/VCFKF	316SS	New Design	623-00006-0
PS-5676V	1.375	C	2	2.187	VCFJF	316SS		623-00006-5

PUMP MANUFACTURERS' CROSS-REFERENCE

U.S. Seal Mfg. Part No.	Seal Size	Head	Mating Ring	Mating Ring Bore	Material Code	Notes	Pump Nameplate Data	Mfg. Part No.
DENISON HYDRAULICS (PARKER HANNIFIN CORPORATION) (continued)								
PS-5074	1.375	C	3	2.000	BCFKF	316SS		623-08981-0, 623-11038
PS-5720	1.500	C	2	2.125	BCFKF			623-00012-0
PS-5002	1.687	D	2	2.500	BCFKF			623-12260-0
PS-5194	1.687	D	2	2.500	VCFKF			623-12263-0
PS-5342	1.875	C	2	3.000	BCFJF	N		623-00016-0
PS-5712	1.875	C	2	3.000	B/VCFKF	N		623-00016-0
PS-5679	1.875	C	2	3.000	QCFJF			623-00016-4
PS-5717	1.875	C	2	3.000	VCFJF			623-00016-5
PS-5011	1.875	C	Plate	3.528	BCFGF			623-00002-0
PS-5721	1.875	C	Plate	Plate	VCFGF			623-00002-5
PS-5706	2.125	C	2	3.000	VCFKF	316SS		623-00015-5
PS-5005	2.187	D	2	3.000	BCFKF			623-12322-0
PS-5024	2.187	D	2	3.000	VCFKF			623-12331-0
DETROIT HARVESTER COMPANY								
FA-1	.500	A	—	—	BMF-F			3-6
FA-26	.625	A	—	—	BMF-F		H,SM-F,PM,.25HP, Seat is Impeller.	4-6
PS-100	.625	A	1	1.187	BMFJF			
DEUBLIN COMPANY (HOERBIGER ROTARY SOLUTIONS)								
FA-1700	1.000	C	—	—	BCF-F			954-211
PS-235V	1.000	C	3	1.625	VCFJF	S		
DeVILBISS AIR POWER COMPANY								
PS-508	.625	D	1	1.250	BCDJF			QM-4507
PS-358	.750	C	1	1.375	BCFJF			QM-4509
PS-752	.750	D	1	1.375	BCDKF			QMW-4509
DIACLEAR (AMPRO DIACLEAR)								
PS-142	.500	B	1	1.000	BMFJF			36100
DISCFLO PUMP CORPORATION, INC.								
PS-446V-SC-SEAT	1.750	C	3	2.500	VCFLF	S		P-170-100097
PS-7488	1.750	E	3	2.500	VLF LF	S		P-170-100034
PS-3123	1.750	T	3	2.500	VLF LF/ VCFLF	316SS/S	P-170-100258	
PS-338V-SC-SC	2.125	C	3	3.000	VLF LF	S		P-170-100036
PS-3877	2.500	C	3	3.375	VLF LF			P-170-100035
DOERR								
PS-359	.625	C	1	1.250	BCFJF			
DOMESTIC PUMP								
PS-200	.625	A	1	1.250	BMFJF			180013
PS-359	.625	C	1	1.250	BCFJF			180014
PS-201	.750	A	1	1.375	BMFJF			
PS-358	.750	C	1	1.375	BCFJF			180010
PS-360	1.000	A	1	1.625	BCFJF			
PS-235	1.000	C	1	1.625	BCFJF			180011
PS-177	1.375	C	1	2.000	BCFJF			180015
DOOSAN PORTABLE POWER								
PS-22026	1.125	C	3 Special	1.750	VCFKF	316SS		35606979
PS-22025	1.250	C	3 Special	1.937	VCFKF	316SS		35593482
PS-5722	1.562	C	Special	2.250	VCFKF	316SS		35593490
PS-5740	2.250	C	2	3.125	BCFKF			35214105
PS-5741	2.250	C	Special	Special	VLFZF			35593516
PS-5742	2.250	C	3 Special	3.125	VLFZF	316SS		35593524
PS-4070	2.250	D	3	3.125	VAFLF	S		39919485
PS-3498	2.500	D	3	3.375	VAFLF	N/S		39929351, 46619402
PS-6602	2.750	C	Special	3.625	VCFKF			35596626
PS-22000	3.875	D	3	4.750	VZFLF	S		39858717

NOTE: N. NON-STANDARD SPRING HOLDER
S. SLOTTED MATING RING

PUMP MANUFACTURERS' CROSS-REFERENCE

U.S. Seal Mfg. Part No.	Seal Size	Head	Mating Ring	Mating Ring Bore	Material Code	Notes	Pump Nameplate Data	Mfg. Part No.
DOUGHBOY INDUSTRIES (Division of H.I.I.)								
PS-671	.375	B	1	.875	BMFJF			306-1003
PS-200	.625	A	1	1.250	BMFJF			306-1006
FA-642	.625	B	—	—	BMF-F			306-1005, 308-1264
PS-1000	.625	B	1	1.250	BMFJF			306-1002
PS-202	.625	B	11	—	BMFJF	A		306-1001
FA-201	.750	A	—	—	BMF-F			308-1202
DOUGLAS MOTOR CORPORATION								
PS-201	.750	A	1	1.375	BMFJF			47406
PS-210	1.375	C	1	2.000	BCFKF			46154
DOWDELL COMPANY, J.L. (DOWCO PUMP)								
PS-202	.625	B	11	—	BMFJF	A		D1101S-.625
PS-440	.750	B	11	—	BMFJF	A		D1101S-.75
DRESSER RAND								
PS-9714	.625	W Dbl.	3	1.250	TCFJF	316SS	D511	
PS-768	.750	C	3	1.375	BCFKF			SEL 244
PS-553	1.500	C	3	2.125	BCFKF			W27658P2
PS-3136	1.500	D	2	2.125	BCDKF	H		W27658P1
PS-3931	1.625	E	2	2.312	BCDKF			W35548P1
PS-3952	2.000	E Special	3	3.031	NCDKF		Includes Sleeve	000-049-082
PS-611	2.125	E	3	2.812	BCFJF			
PS-556	2.125	U	1	3.000	BCFKF			720025J1
PS-4172	3.000	E	3	3.875	VCFKF	316SS		050-825-201
DUFF-NORTON								
FA-1350	.625	C	—	—	BCF-F			732015C
PS-185	1.250	C	1	1.875	BCFJF			464901C
DUNHAM, C.A.								
PS-508	.625	D	1	1.250	BCDJF			614
DUNHAM-BUSH (MEPCO: Marshall Engineered Products Company)								
PS-1002	.500	C	1	1.000	BCFJF			S-996
PS-106	.500	C	1	1.000	BCFKF			996 New
PS-118	.625	C	1	1.187	BCFJF			
PS-359	.625	C	1	1.250	BCFJF			S-472
PS-552-SC-SC	.625	C	1	1.250	BLFLF			S-5099
PS-633V-CMS	.625	C	1	1.250	VCFKF			S-2143, S-5549
PS-552-EPR	.625	C	3	1.250	QCFJF			S-5011
PS-552-EPR-P66	.625	C	3	1.250	QCFJF	I		S-4940
PS-3147	.625	C	3	1.250	QCFKF	I		S-4981
PS-633V-TC SEAT	.625	C	3	1.250	VCFZF	S		S-472-TC-V
PS-750	.750	D	1	1.375	BCDJF			40088878W
PS-188	.875	E	1	1.500	BCFJF	316SS		40090790W
PS-982	1.000	C	1	1.625	BCFN/KF			860
PS-499	1.000	C	3	1.625	BCFKF	S		GA-1781-4
PS-983	1.125	C	1	1.750	BCFKF	S		861
PS-185	1.250	C	1	1.875	BCFJF			S-4998
PS-756	1.250	C	1	1.875	BCFKF			S-3179
PS-756V-CMS	1.250	C	1	1.875	VCFKF			S-5548
PS-618-EPR-P66	1.250	C	3	1.875	QCFJF	I/S		S-4982, S-5085
PS-239	1.625	C	1	2.375	BCFKF			S-3291
PS-3616	1.625	C	1	2.375	QCFKF			S-4932
DURIRON (See FLOWERVE CORPORATION)								
PS-866	1.125	E	3	1.750	BCFJF	S		
PS-867	1.125	E	3	1.750	BCFKF	S		
PS-886	1.125	T	3	1.750	BCFJF	S		
PS-918	1.125	T	3	1.750	BCFKF	S		
PS-3792	1.375	E	3	2.125	VCFJF	316SS/C	Mark III Group 1K	
PS-3783	1.375	E	3	2.125	VCFLF	316SS/C	Mark III Group 1K	
PS-4452	1.375	E	3	2.125	VCFZF	316SS/C		
PS-2069	1.875	E	1	2.625	BCFJF			
PS-7559	1.875	E	3	2.625	BCFJF	C/S		

PUMP MANUFACTURERS' CROSS-REFERENCE

U.S. Seal Mfg. Part No.	Seal Size	Head	Mating Ring	Mating Ring Bore	Material Code	Notes	Pump Nameplate Data	Mfg. Part No.
DURIRON (See FLOWERVE CORPORATION) (continued)								
PS-2072	1.875	E	3	2.625	BCFKF	S		
PS-3046	1.875	E	3	2.625	QCFJF	316SS/H/S		
PS-3049	1.875	E	3	2.625	QZFLF	316SS/H/S	Mark III Group 2	
PS-3929	1.875	E	3	2.625	VCFJF	316SS/C/S	Mark III Group 2	
PS-7698V-LC	1.875	E	3	2.625	VCFKF	C/S		
PS-7878	1.875	T	1	2.625	BCFJF			
PS-743	1.875	T	1	2.625	BCFKF			
PS-4392	2.625	E	3	3.625	QCFLF	C/S		
DURO PUMP COMPANY								
PS-452	.625	B	9	—	BMFJF	A		5486
PS-508	.625	D	1	1.250	BCDJF			5485
PS-102	.625	D	1	1.250	BCDKF		DV-30, 50, 70, 100, VX-30, 50, 70, 100 DJ-70, 100, SJ-70, 100	B-170
EAST SIDE MFG.								
PS-100	.625	A	1	1.187	BMFJF			P-28322
PS-200	.625	A	1	1.250	BMFJF			
PS-1000	.625	B	1	1.250	BMFJF		BTH	
PS-359	.625	C	1	1.250	BCFJF			
PS-201	.750	A	1	1.375	BMFJF			
PS-358	.750	C	1	1.375	BCFJF			
PS-750	.750	D	1	1.375	BCDJF			MF-1
PS-360	1.000	A	1	1.625	BCFJF		Series C, CM and CH	P-28175
EASTERN ENGINEERING (See PULSAFEEDER)								

Value Guard Part No.	Seal Size	Head	Mating Ring	Material Code	Notes
EBARA PUMPS					
VGM-2971V *	13 MM	VGM562	Spec/1	VLFLF / VCFJF	
VGM-2982V *	14 MM	VGM562	Spec/1	VLFLF / VCFJF	
VGM-2979V *	15 MM	VGM562	Spec/1	VLFLF / VCFJF	
VGM-2974V *	16 MM	VGM562	Spec/1	VLFLF / VCFJF	
VGM-2980V	20 MM	VGM562	Spec/1	VLFLF / VCFJF	
VGM-2975V	25 MM	VGM562	Spec/1	VLFLF / VCFJF	
VGM-2992V	30 MM	VGM562	Spec/1	VLFLF / VCFJF	
VGM-2976V	35 MM	VGM562	Spec/1	VLFLF / VCFJF	
VGM-2977V	40 MM	VGM562	Spec/1	VLFLF / VCFJF	
VGM-2978V	45 MM	VGM562	Spec/1	VLFLF / VCFJF	
VGM-2983V	50 MM	VGM562	Spec/1	VLFLF / VCFJF	

***Does not include retaining plate**

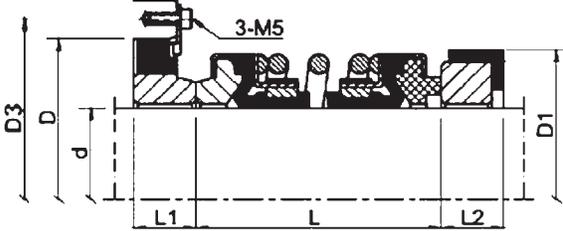



Type VGM562 with Plate

d	L	D	L1	D1	L2	D3
13	26	25	5	25	5	-
14	26	30	5	30	5	-
15	26	30	5	30	5	-
16	26	30	5	30	5	-
20	35	44	8	38	8	60
25	35	50	8	44	8	60
30	40	57	10	50	9	70
35	42	64	10	58	9	80
40	45	70	11	64	9	85
45	46	70	10	66	9	90
50	50	80	10	72	9	95

PUMP MANUFACTURERS' CROSS-REFERENCE

U.S. Seal Mfg. Part No.	Seal Size	Head	Mating Ring	Mating Ring Bore	Material Code	Notes	Pump Nameplate Data	Mfg. Part No.
ECONOMY PUMP								
PS-100	.625	A	1	1.187	BMFJF			
PS-360	1.000	A	1	1.625	BCFJF			
PS-1067	1.125	E	1	1.875	BCFKF			
PS-395	1.500	E	3	2.125	BCFJF	S		
EDWARDS ENGINEERING CORPORATION								
PS-867V	1.125	E	3	1.750	VCFKF	S		220000
ELECTROMOTIVE DIVISION								
PS-632	.500	C	1	1.000	BCFKF	N		822832
PS-602	.875	D	1	1.562	BCDJF			5876888
ELGIN SWEEPER COMPANY (Street Sweepers)								
PS-5625	.625	Special	1	1.250	QC-J-			
 <p>PS-5625</p>								
ELKINGTON DISHWASHER								
PS-3440	1.000	C	1	1.750	BCFJF			
ENPO PUMP COMPANY (Division of CRANE PUMPS & SYSTEMS)								
PS-961	.625	B	1	1.250	BCFJF			
PS-452	.625	B	9	—	BMFJF	A		
PS-201	.750	A	1	1.375	BMFJF			
PS-360	1.000	A	1	1.625	BCFJF			
PS-466	1.250	C	1	2.000	BCFJF			M-3957-F
PS-466V	1.250	C	1	2.000	VCFJF			M-3957-G
PS-546	1.250	E	3	1.875	BCFV/JF	S		
PS-467	1.375	C	1	2.125	BCFKF			M-3983-C
PS-1683	1.625	E	3	2.375	BCFJF	S		
PS-2212	1.750	C	1	2.500	BCFJF			M-3842-F
PS-1068	1.750	C	1	2.500	BCFKF			M-3842-C
PS-449	1.750	K	1	2.500	BCFJF			
PS-2139	2.000	C	1	2.750	BCFJF			M 4414-F
PS-842	2.000	C	1	2.750	BCFKF	S		
PS-1040	2.000	K	3	2.750	BCFKF	S		
PS-1041	2.375	K	3	3.250	BCFKF	S		
PS-1613	2.500	K	3	3.375	BCFJF	S		
ENVIRONMENT ONE CORPORATION								
PS-2033	1.000	D	3	1.625	BCFJF			A-2021B110
PS-3241	1.000	D	3	1.625	BCFLF	S		
PS-3042	1.000	G	3	1.625	BCFJF	S		NB0053PO1
ESSICK AIR PRODUCTS, INC.								
PS-358	.750	C	1	1.375	BCFJF			9014009
PS-175	.750	K	1	1.375/ 1.500	BCFJF			9014225
PS-185	1.250	C	1	1.875	BCFJF			9014025
PS-177	1.375	C	1	2.000	BCFJF			9014027
PS-495	1.375	K	1	2.000	BCFJF			9014140
EUROPLAST LTD.								
PS-201	.750	A	1	1.375	BMFJF			60985AA, 6513207
EVERITE								
FA-10	.500	B	—	—	BMF-F		Seat Is Impeller	1205
PS-200	.625	A	1	1.250	BMFJF			2544
PS-501	.625	A	1	1.250	BMFJF			
PS-359	.625	C	1	1.250	BCFJF			2584

PUMP MANUFACTURERS' CROSS-REFERENCE

U.S. Seal Mfg. Part No.	Seal Size	Head	Mating Ring	Mating Ring Bore	Material Code	Notes	Pump Nameplate Data	Mfg. Part No.
FAIRBANKS NIJHUIS (See PENTAIR, INC. for Additional Part Numbers)								
PS-506	.500	A	1	1.000	BMFKF			91325
PS-200	.625	A	1	1.250	BMFJF		H, HC, HV	8247075
PS-501	.625	A	1	1.250	BMFJF		H500, 649, 650 Shallow Well and all 49 Ejectors to 1 HP 300, 500 and 750 VS-VD	8263560, 8270275
PS-507	.625	A	1	1.250	BMFKF		UL 25 Westco Shallow Well	8248060
PS-359	.625	C	1	1.250	BCFJF			
PS-508	.625	D	1	1.250	BCDJF			8248075
PS-102	.625	D	1	1.250	BCDKF			82698
PS-201	.750	A	1	1.375	BMFJF		AC, AEC, AES, AS	
PS-877	.750	C	1	1.375	BCFJF			8273860, HYDE2
PS-750	.750	D	1	1.375	BCDJF			4008878
PS-188	.875	E	1	1.500	BCFJF			HYD1Q1
PS-229	.875	E	3	1.500	BCFKF			Westco BR545
PS-235	1.000	C	1	1.625	BCFJF			CND-1726D, 1726O LV411900X01
PS-356	1.125	C	1	1.750	BCFJF		1-1/2, 2, 3, 4, Fig. 5553N Frame 213 & Up	HYD1AC
PS-204	1.125	E	1	1.750	BCFJF			HYD1Q2
PS-6812	1.187	C	1	1.875	BCFJF			LV7140047753
PS-8074	1.187	XB	3	1.687	Special	316SS/C		HYD1BT3
PS-185	1.250	C	1	1.875	BCFJF			HYD1AC2
PS-756	1.250	C	1	1.875	BCFKF			HYD1BX8
PS-381	1.250	D	1	1.875	BCFJF			Westco 2G
PS-510	1.250	D	1	2.000	BCFJF		Fig. 5554, 5554A	HYD1E2
PS-883	1.250	K	1	1.875	BCFJF			HYD1AD2
PS-865	1.375	E	3	2.000	BCFKF	S		HYD1Q3
PS-3198	1.375	V	3	2.140	BCFJF			HYD1S3
PS-1104	1.375	V	25	2.140	BCFJF		Frame 25	
PS-8079	1.437	XB5	3	1.937	Special	316SS		HYD1BT6
PS-758	1.500	C	1	2.125	BCFJF			
PS-305	1.500	E	1	2.125	BCFJF			ND2502A1
PS-395	1.500	E	3	2.125	BCFJF	S	3" & 4" Fig. 5821, 2" & 3" Fig. 5822 2" & 2-1/2" Fig. 5823, 3" Fig. 5874A	HYD1AA1, HYD1X3
PS-395-EPR	1.500	E	3	2.125	QCFJF	S		FMB088775CO1
PS-515	1.500	E	3	2.250	BCFJF		2" Fig. 5812, 3", 4" Fig. 5811	HYD1A2
PS-514	1.625	D	1	2.375	BCDJF			ND1246A4
PS-1683	1.625	E	3	2.375	BCFJF	S		HYD1BG1
PS-446	1.750	C	1	2.500	BCFJF			HYD1AC3, HYD1AD1
PS-6241	1.750	C	3	2.500	BLFLF	S		HYD1EH2
PS-3963	1.750	C	3	2.500	BLFZF	S		HYD1CM2
PS-3719	1.750	C	3	2.500	B/VLFZF	S		HYD1DJ2
PS-3687	1.750	C	3	2.500	BZFZF	S		HYD1CD2
PS-3718V	1.750	C	3	2.500	VCFJF	S		HYD1CR2
PS-3902	1.750	E	3	2.500	VCFJF	316SS/C/H/S		HYD1HC3
PS-4136	1.750	E	3	2.500	VCFLF	316SS/C/S		HYD1HF3
PS-449	1.750	K	1	2.500	BCFJF		5421 BP, KTPA-10031	
PS-6246	1.750	K	1	2.500	BCFJF			HYD1AD7
PS-6242	1.750	T	3	2.500	VCFJF	316SS/S		HYD1EN2
PS-1070	1.750	U	3	2.375	BCFJF		5" Fig. 5821, 6" Fig. 5821, 4" Fig. 5822 3" Fig. 5823, 4" Fig. 5874A, 3" Fig. 5876A 2" Fig. 5972A, 2-1/2" Fig. 5972A	HYD1AA3
PS-519	1.750	U	3	2.500	BCFJF	S	Fig. 5822A, Size 4	HYD1T2
PS-2069	1.875	E	1	2.625	BCFJF			HYD1E4
PS-2070	1.875	E	1	2.625	BCFKF			HYD1Q4
PS-3964	1.875	T	3	2.625	BCFJF			HYD1CW1 FMB064413B01
PS-5087	1.875	T	3	2.625	BZFZF	316SS		FMB076475X01 FMB093097B01

NOTE: C. COMPLETE WITH COLLAR
H. SPRING HOLDER NOT INCLUDED
S. SLOTTED MATING RING

PUMP MANUFACTURERS' CROSS-REFERENCE

U.S. Seal Mfg. Part No.	Seal Size	Head	Mating Ring	Mating Ring Bore	Material Code	Notes	Pump Nameplate Data	Mfg. Part No.
FAIRBANKS NIJHUIS (See PENTAIR, INC. for Additional Part Numbers) (continued)								
PS-4521	1.875	T	3	2.625	VCFKF			FMB091484C01 FMB091513C01
PS-898	1.875	U	3	2.500	BCFJF		8" Fig. 5821, 5" & 6" Fig. 5822 4" & 5" Fig. 5823, 5" Fig. 5874A	HYD1AA4 HYD1S16
PS-4467	1.875	V	3	2.625	BCFJF			
PS-1105	1.875	V	25	2.640	BMFJF		Frame 28	
PS-8077	1.875	X Special	3	2.500	VCFJF	316SS		HYD1BT10
PS-7781-SC-TC	2.000	C	1	2.750	BLFZF			HYD1CK2, HYD1CN2
PS-3993	2.000	C	3	2.750	BCFJF	S		HYD1CB1
PS-4015	2.000	C	3	2.750	BCFKF	S		HYD1CE2
PS-332	2.000	C	3	2.750	BCFKF	S	Collar supplied upon request	HYD1BX1
PS-6238	2.000	C	3	2.750	BLFLF			HYD1EH1
PS-3721	2.000	C	3	2.750	BLFZF	S		HYD1CM1, HYD1DJ1
PS-3688	2.000	C	3	2.750	BZFZF	N/S		HYD1D1CD1
PS-6247V	2.000	C	3	2.750	VCFKF			HYD1CS2
PS-4178	2.000	C	3	2.750	VLFLF	N		HYD1S1
PS-530	2.000	E	3	2.750	BCFJF	S		HYD1BG2
PS-2143	2.000	K	1	2.750	BCFJF			
PS-4478	2.000	K	1	2.750	BCFJF			HYD1AD8
PS-338	2.125	C	3	3.000	BCFJF	S	Frame 30 Model 5500	HYD1AC4
PS-327	2.125	E	3	3.000	BCFJF	S		HYD1Q5
PS-887	2.125	K	1	3.000	BCFJF			HYD1AD3
PS-1102	2.125	V	3	3.140	BCFJF		Frame 32	HYD1S5
PS-7782	2.250	C	1	3.125	BCFKF			HYD1CE1
PS-1676	2.250	C	3	3.125	BCFKF	S	Collar supplied upon request	HYD1BX10
PS-3966	2.250	C	3	3.125	BLFZF			HYD1CN1
PS-6248	2.250	C	3	3.125	VCFKF			HYD1CS1
PS-7431	2.250	K	1	3.125	BCFJF			HYD1AD9
PS-269	2.500	C	3	3.375	BCFJF	S		HYD1AD4 FMB027764A01
PS-853	2.500	C	3	3.375	BCFKF	S	Collar supplied upon request	HYD1BX3
PS-3247	2.500	C	3	3.375	BLFZF			FMB064189B01
PS-279	2.500	E	3	3.375	BCFJF	S	Collar supplied upon request	HYD1AA6, HYD1BG3
PS-6254	2.500	E	3	3.500	BCFJF			HYD1CX2
PS-1613	2.500	K	3	3.375	BCFJF	S		HYD1AD10
PS-4072	2.500	T	3	3.500	BCFJF			HYD1CW2
PS-6244	2.500	T	3	3.500	VCFJF			HYD1EN4
PS-6243	2.500	T	3	3.500	VLZF			HYD1ES4, FMB1403087
PS-328	2.625	E	3	3.375	BCFJF	316SS/S		HYD1AA8, HYD1Q6
PS-542	2.625	E	3	3.375	BCFKF			
PS-3994	2.750	C	3	3.500	BCFJF			HYD1CB3
PS-6239	2.750	C	3	3.500	BLFLF			HYD1EH3
PS-4366	2.750	C	3	3.500	BLFZF			HYD1CM3
PS-2154-TC-SEAT	2.750	C	3	3.500	B/VCZFZ	S		FMB060882X01
PS-3661	2.750	C	3	3.500	VLZF			HYD1DJ3
PS-2148	2.750	K	3	3.500	BCFJF	S		HYD1AD11
PS-329	2.875	E	3	3.750	BCFJF	S		HYD1Q7
PS-2153	3.000	C	3	3.875	BCFJF	S		HYD1EF3
PS-2115	3.000	C	3	3.875	BCFKF	S	Collar supplied upon request	HYD1BX4
PS-3600	3.000	C	3	3.875	BCFKF			HYD1CE3
PS-2115-TC-SEAT	3.000	C	3	3.875	BCFZF			FMB060882X02
PS-6240	3.000	C	3	3.875	BLFLF			HYD1EH4
PS-3701	3.000	C	3	3.875	BLFZF			HYD1CM4
PS-6249-SC-TC	3.000	C	3	3.875	BLFZF			HYD1CN3
PS-6249	3.000	C	3	3.875	BZFZF			HYD1CK3
PS-6250	3.000	C	3	3.875	VCFKF			HYD1CS3
PS-3245S	3.000	E	3	3.875	BCFJF	S		HYD1BG4
PS-5252	3.000	E	3	3.875	BCFKF	S		HYD1BE4
PS-3969	3.000	E	3	4.000	BCFJF	C		HYD1CX3
PS-7993	3.000	T	3	4.000	BCFJF			HYD1CW, HYD1DE3
PS-3836	3.000	U	3	3.875	BCFJF	C/S		HYD1AA7
PS-7215	3.000	V	3	4.000	BCFJF	316SS		HYD1S18

PUMP MANUFACTURERS' CROSS-REFERENCE

U.S. Seal Mfg. Part No.	Seal Size	Head	Mating Ring	Mating Ring Bore	Material Code	Notes	Pump Nameplate Data	Mfg. Part No.
FAIRBANKS NIJHUIS (See PENTAIR, INC. for Additional Part Numbers) (continued)								
PS-4069	3.000	V	3	4.000	BCFZF			FMB061419X01
PS-3181	3.000	V	3	4.250	BCFJF	316SS		HYD1S7
PS-4127	3.250	C	3	4.125	BCFJF	S		HYD1EF4
PS-6258	3.250	C	3	4.125	BCFKF			HYD1CE4
PS-3702	3.250	C	3	4.125	BLFZF			HYD1CN4
PS-6253	3.250	C	3	4.125	VCFJF			HYD1CR4
PS-3827	3.250	D	3	4.125	BZFZF			FMB060881P01
PS-330	3.250	E	3	4.125	BCDJF			HYD1Q8
PS-6245	3.500	C	3	4.375	BCFKF			HYD1BX6
PS-4019	3.500	E	3	4.375	BCFJF	I		HYD1BG5
PS-4881	3.500	E	3	4.375	BCFKF			HYD1BE5
PS-3238	3.500	U	3	4.750	BCFJF			HYD1AA10
PS-3499	3.625	E	3	4.625	BCFJF	C		HYD1CX4
PS-3684	3.625	T	3	4.625	BCFJF			HYD1CW4
PS-6237	3.625	T	3	4.625	BCFZF			FMB083739B01 FMB213293X01
PS-3645	3.625	T	3	4.625	BLFZF			
PS-3779	3.625	V	3	4.625	BCFJF			HYD1S19
PS-4014	3.750	D	3	4.625	BLFZF			HYD1DB3, HYD1DC1
FEDERAL PUMP CORPORATION								
PS-501	.625	A	1	1.250	BMFJF			
PS-293	.625	A	Spec	.814	BMFKF		Seat is Metal to Metal Press Fit	
PS-293-EPR	.625	A	Spec	.814	QCFKF		Seat is Metal to Metal Press Fit	
PS-293V	.625	A	Spec	.814	VCFKF		Seat is Metal to Metal Press Fit	
PS-245	1.000	C	1	1.625	BCFJF	B/H		
PS-248	1.000	C	1	1.625	BCFKF	B/H		
PS-380	1.000	D	1	1.625	BCFJF			
PS-246	1.250	C	1	1.875	BCFJF	B/H		
PS-249	1.250	C	1	1.875	BCFKF	B/H		
PS-381	1.250	D	1	1.875	BCFJF			
PS-547	1.375	C	3	2.000	BCFKF	S		
PS-682	1.500	C	1	2.156	BCFJF	B/H		
PS-247	1.500	C	1	2.156	BCFKF	B/H		
PS-382	1.500	D	1	2.125	BCFJF			
PS-446	1.750	C	1	2.500	BCFJF			
PS-205	1.750	E	1	2.500	BCFJF			
FINISH THOMPSON, INC.								
PS-359-EPR-CMS	.625	C	1	1.250	QCFJF			J101256
PS-22031	.875	D	3	1.500	VCFJF			J100108
PS-22032	.875	K	3	1.500	VCFJF			J100110
PS-185V-CMS	1.250	C	1	1.875	VCFJF			J103501
PS-3216	1.375	D	3 Special	2.000	VCFJF	316SS		J100122
PS-3196	1.375	K	3	2.000	VCFJF	S		J100124
PS-8110	1.375	XB2	3	2.000	VCFJF	316SS		J100123
FINN CORPORATION								
PS-185	1.250	C	1	1.875	BCFJF			080485
FLINT & WALLING (Division of ZOELLER PUMP COMPANY)								
PS-165	.500	B	9	.906	BMFJF	A		132891/92
PS-800	.625	C	1	1.156	BMFJF	H	BPA, C, C6267,CA	131100, 132377
PS-201	.750	A	1	1.375	BMFJF		81, 82, 83, 605, 607, 609 Shallow Well 64, 65, 66, 67, 68 Deep Well	126544, 126545
PS-687	.875	C	1	1.500	BCFKF			121224
PS-357	1.000	C	1	1.625	BCFKF		Series C211	129868
PS-204	1.125	E	1	1.750	BCFJF			
PS-185	1.250	C	1	1.875	BCFJF		Spring Supplied by Customer	136557
FLO FAB								
PS-185V-SC-SC	1.250	C	1	1.875	VFLF			

NOTE: A. MOUNTS ON SHAFT
 B. TAPERED SPRING
 C. COMPLETE WITH COLLAR
 H. SPRING HOLDER NOT INCLUDED
 I. ABRASION RESISTANT CARBON (P66)
 S. SLOTTED MATING RING

PUMP MANUFACTURERS' CROSS-REFERENCE

U.S. Seal Mfg. Part No.	Seal Size	Head	Mating Ring	Mating Ring Bore	Material Code	Notes	Pump Nameplate Data	Mfg. Part No.
FLOWAY® (A TRILLIUM FLOW TECHNOLOGIES™ Brand)								
PS-252	1.000	D	3	1.625	BCFKF	S		542949-2010
PS-264	1.250	E	3	1.875	BCFKF			545305-1010, 231-31-413
FLOWERVE CORPORATION (See DURCO, BYRON JACKSON, IDP, SIHI and WORTHINGTON)								
55954	.562	C	—	—	BCF-F		1 GAM	055954-00, 27337583
PS-4292	.562	C	3	1.031	BCFKF		1 GAM	
PS-3542	.562	C	3	1.031	VCFKF		1 GAM	74744277
PS-516	.625	A	1	1.250	BCFJF			74297284
PS-528	.625	A	1	1.375	BMFJF			28518652
PS-637	.625	A	3	1.250	BMFJF			60311669
PS-2734	.625	B	8	1.109	BCFFF			69207298
PS-22178	.625	B	8	1.109	BCFKF	A		60722782
FA-1350	.625	C	—	—	BCF-F			055955-00, 27337591
PS-359	.625	C	1	1.250	BCFJF			74908237
PS-359V-CMS	.625	C	1	1.250	VCFJF			74315409
PS-4458	.625	C	1	1.375	VCFJF	316SS	Includes Sleeve	28518660, PO2099-00
PS-7635	.625	C	3	1.062	VCFKF		2 GA	74744285
PS-951	.625	C	3	1.375	VCFKF			74262767, PO2752-00
FA-564	.750	C	—	—	BCF-F			024439-00, 27197623
PS-2236	.750	C	3	1.375	BCFJF			60721792, 60980901
PS-4283	.750	C	3	1.375	QCFKF			60724614, 75696202
PS-3068	.750	C	3	1.375	QLFLF		SMP	
PS-2235	.750	C	3	1.375	VCFJF			60724572
PS-3074	.750	C	3	1.375	VLFLF		SMP 2000	
PS-4093	.750	E	3	1.187	QCFKF		3&4 GAM	
PS-7994	.750	E	3	1.187	VCFKF		3&4 GAM	1802AJCTYP1RO75XP171
PS-7960	.750	E	3	1.187	VCPKP			74744293
PS-602	.875	D	1	1.562	BCDJF			60110418
24440	.875	E	—	—	BCF-F			024440-00, 27197631
PS-7859V	.875	E	3	1.312	VCFKF	316SS	5&6 GAM	74744301
PS-845	.937	U	3	1.562	BCFKF			27252691, 4007827
PS-560V	.937	U	3	1.562	VCFKF			031446-01, 74744319
PS-252	1.000	D	3	1.625	BCFKF	S		82230962
PS-8112	1.000	XB2	3	1.625	BCFKF	316SS		81918547
FA-1800	1.125	C	—	—	BCF-F			28518934, PO2885-00
FA-10038	1.125	C	—	—	VCF-F			74262874, PO2889-00
PS-356	1.125	C	1	1.750	BCFJF			74908260
PS-801	1.125	C	3	1.750	B/VCFJF	S		
PS-355V	1.125	C	3	1.750	VCFKF	S		39633201
PS-604	1.125	D	1	1.750	BCFJF			60110434
PS-605	1.125	D	1	1.750	BCFKF			60110442, CPM-10055
FA-866	1.125	E	—	—	BCF-F			68885854, 68885870 68885896
FA-608V	1.125	E	—	—	VCF-F			60954690
PS-607	1.125	E	1	1.687	BCFJF			60110327
PS-384	1.125	E	1	1.750	BCFKF			60110616
PS-867	1.125	E	3	1.750	BCFKF	S		69237592
PS-4262	1.125	E	3	1.750	B/VCFKF	S		68885862, 68885904
PS-204V	1.125	E	3	1.750	VCFJF	S		60954682
PS-3060	1.125	E	3	1.750	VCFJF	316SS/ C/I/S		78925468
PS-867V-TC-SEAT	1.125	E	3	1.750	VCFZF	S		60954716
PS-1636	1.125	E	3	1.812	B/VCFJF			60514098
PS-1637	1.125	E	3	1.812	B/VCFKF			60514254
PS-723	1.187	T	1	1.875	BCDJF			60111267
PS-185	1.250	C	1	1.875	BCFJF			75630517
PS-618	1.250	C	3	1.875	BCFJF	S		60721800, 60980918 60980919
PS-618-EPR-P66	1.250	C	3	1.875	QCFJF	I/S		74737990
PS-2203	1.250	C	3	1.875	QCFKF	I		68867910
PS-7436	1.250	C	3	1.875	QCFZF	I/S		60671328
PS-185V	1.250	C	3	1.875	VCFJF	S		68867902

PUMP MANUFACTURERS' CROSS-REFERENCE

U.S. Seal Mfg. Part No.	Seal Size	Head	Mating Ring	Mating Ring Bore	Material Code	Notes	Pump Nameplate Data	Mfg. Part No.
FLOWERVE CORPORATION (See DURCO, BYRON JACKSON, IDP, SIHI and WORTHINGTON)								
PS-756V	1.250	C	3	1.875	VCFKF			74898800
PS-618V-TC-SEAT	1.250	C	3	1.875	VCFZF	S		60727401
PS-7972	1.250	G	1	1.875	BLFLF	316SS	4MSX7 See PS-7971 for Upper Seal	81955064 - Lower Seal
PS-22177	1.250	G	1	2.000	VLFLF	316SS		87022497
PS-394	1.250	U	3	1.875	BCF/DKF			031448-01, 74296924
PS-394V	1.250	U	3	1.875	VCF/DKF			031448-03, 78978772
PS-22173	1.250	U	3	1.875	VCFKF			74780040
FA-177	1.375	C	—	—	BCF-F			28518868, PO2886-00
FA-10165	1.375	C	—	—	QCF-F	I		74332321, 80631400
FA-10041	1.375	C	—	—	VCF-F			28518884, PO2890-00
FA-4163	1.375	E	—	—	QCF-F	316SS/C/I		74712241
FA-2104V	1.375	E	—	—	VCF-F			74816034
FA-4087	1.375	E	—	—	VCF-F	316SS/C		PO2874-00
PS-3925	1.375	E	3	2.125	VCFJF	S		74816117
PS-22179	1.375	G	1	2.000	BLFLF	316SS		88382681
PS-3014	1.375	G	1	2.000	BLFZF	316SS		81981193
PS-725	1.375	T	1	2.000	BCFJF			60111275
PS-561SS	1.375	U	1	2.000	BCFKF			050498-00, 026457-00 27215094, 27328830
FA-9341	1.375	WT	—	—	TCF-F	316SS		74839721
PS-7971	35MM	G	1	50MM	BCFJF	316SS	See PS-7972 for Lower Seal	81955072 - Upper Seal
PS-8111	1.437	XB2	3	2.125	BCFKF	316SS		81918523
FA-305	1.500	E	—	—	BCF-F			05484500, 27335819 68886167, 68886175 69170181
FA-305V	1.500	E	—	—	VCF-F			60506169, 60549581 74332164, 80612400
PS-258	1.500	E	3	2.125	BCFKF			68886100, 68886118
PS-22176	1.500	E	3	2.125	QCFZF	316SS/I/S		75329474
PS-305V	1.500	E	3	2.125	VCFJF	S		68886068, 6886092
PS-4034	1.500	E	3	2.312	BCFZF			60514148
PS-1648	1.500	E	3	2.312	B/VCFKF	S		60514130, 60514288
PS-1651	1.500	E	3	2.312	VCFJF		H/HC	60514122
PS-1652	1.500	E	3	2.312	VCFKF			60514726
PS-818	1.625	C	3	2.375	BCFJF	S		60721818, 68825975
PS-239-EPR	1.625	C	3	2.375	QCFKF	S		60727328
PS-609	1.625	E	1	2.312	BCDJF			60110343
PS-610	1.625	E	1	2.312	BCFKF			60110350
FA-1660	1.750	C	—	—	BCF-F			28518876
FA-10159	1.750	C	—	—	BRF-F			74334681, 80996900
FA-2108E	1.750	C	—	—	QCF-F	I		80631500
FA-10045	1.750	C	—	—	VCF-F			74262882, PO2891-00
FA-366	1.750	E	—	—	BCF-F			28518785, PO2871-00
PS-7950	1.750	E	3	2.312	QCFZF	I/S		74840992
PS-366V	1.750	E	3	2.500	VCFKF	S		74780065
PS-3016	1.750	G	1	2.500	BLFLF			81974883
PS-4216	1.750	G	1	2.500	BLFZF			81974917
PS-22175	1.750	G	1	2.500	VLFLF			88375433
PS-3884	1.750	U	1	2.500	VCFZF			
FA-9400	1.750	WT	—	—	TCF-F			28518843, PO2883-00
FA-513V	1.875	E	—	—	VCF-F			60954765
FA-4193	1.875	E	—	—	VCF-F	316SS/H		AY38032C-HF50
PS-2072	1.875	E	3	2.625	BCFKF	S		60433083, 60434321 68885987
PS-7951	1.875	E	3	2.625	QCFZF	316SS/I/S		60433125
PS-1659	1.875	E	3	2.625	VCFJF	S		60954757
PS-1660	1.875	E	3	2.625	VCFKF	S		60954807
PS-4193	1.875	E	3	2.625	VCFZF	316SS/S		
PS-3648	1.875	EB	Special	2.687	VCFZF			60502697
PS-3017	1.875	G	1	2.625	BCFKF	316SS		81974875

NOTE: C. COMPLETE WITH COLLAR I. ABRASION RESISTANT CARBON (P66)
H. SPRING HOLDER S. SLOTTED MATING RING
NOT INCLUDED

PUMP MANUFACTURERS' CROSS-REFERENCE

U.S. Seal Mfg. Part No.	Seal Size	Head	Mating Ring	Mating Ring Bore	Material Code	Notes	Pump Nameplate Data	Mfg. Part No.
FLOWERVE CORPORATION (See DURCO, BYRON JACKSON, IDP, SIHI and WORTHINGTON)								
PS-3018	1.875	G	1	2.625	BLFLF	316SS		81974909
PS-3203	1.875	T	3	2.625	VLZFZ/ VCFJF	316SS/S		
PS-9709	1.875	WT	3	2.625	T/VCFJF	316SS/S		78934213
PS-530	2.000	E	3	2.750	BCFJF	S		60110780
PS-477	2.000	E	3	2.750	BCFKF	S		03145000, 60110756 74295940
PS-22174	2.000	E	3	2.750	BCFKF	C/S		69261352
PS-477V	2.000	E	3	2.750	VCFKF	S		78945368
PS-8053	2.000	XB1T	3	2.500	VCFZF	316SS/I/S	A Line	
PS-456-EPR	2.000	U	3	2.750	QCFKF	S		75329441
PS-3591	2.000	U	3	2.750	QCFZF	I/S		75329490
PS-456V	2.000	U	3	2.750	VCFKF	S		75329540
PS-8119	2.000	XBT	3	2.500	VCFJF	316SS		
FA-2120	2.125	C	—	—	BCF-F			PO2888-00
PS-1612	2.125	E	3	2.812	BCFKF			60110376
PS-4146	2.125	EB	5	2.625	BCFZF		100 Series S Line	
PS-8562	2.125	X1T	3	2.875	VCFJF	316SS/S		1802AJC81TA212XF1C1
FA-350V	2.375	E	—	—	VCF-F			60969805
PS-278V	2.375	E	3	3.250	VCFJF	S		60969797
PS-4492	2.375	E	3	3.250	VLFLF	S	10X8X13HOC	
PS-3936V-TC-SEAT	2.375	EB	3	3.125	VCFZF	S		
PS-3073	2.375	G	1	3.125	BCFLF	316SS		88380754
PS-3008	2.375	G	1	3.250	BCFJF			81974891
PS-3022	2.375	G	1	3.250	BLFZF			81974941
PS-8113	2.375	XBT	3	3.250	VCFJF	316SS	8X10X13HOC	
PS-2205-EPR	2.500	E	3	3.375	QCFKF	I/S		60647260
PS-279V	2.500	E	3	3.375	VCFJF	S	8X6X13 HOC-3	74816125 1802AJCTYP1A250-XF1C1
PS-349V	2.500	E	3	3.375	VCFKF	S		75514554
PS-4392	2.625	E	3	3.625	QCFLF	C/S		
PS-4626	2.625	E	3	3.625	VLZFZ	C/S	Mark II, Group 3	
PS-8102	2.750	XB	3	3.375	VCFZF	316SS		
FA-475SS	3.000	E	—	—	BCF-F			05484800, 05542500 74315847
PS-5252	3.000	E	3	3.875	BCFKF	S		60434883, 74841065
PS-8144	3.000	XB1	3	3.500	VCFZF	316SS/S		5221614
PS-325SS	3.250	U	3	4.125	BCFKF	C/S	S Line, 8X14SD, 10X14SD	CPM-325S429X7 69261378
PS-4475	3.250	U	3	4.125	QCFJF	316SS/C		
PS-4483	3.250	U	3	4.125	VCFKF	C		75386078
PS-3157	3.250	U	3	4.125	VCFZF	C		69981555
FA-4027	3.500	U	—	—	BCF-F			80600800, 80611900
PS-7986	3.750	U	3	4.625	BCDKF			60311578

Flygt Model No.	Seal Size MM	Upper Seal Part No.	Materials of Construction	Lower Seal Part No.	Seal Size MM	Materials of Construction	Buna O-Ring Kit Part No.
FLYGT (A XYLEM Brand)							
2066	20	VGF-02020	Ca/TC/B	VGF-03020	20	TC/TC/V	VGF-2066-OKIT
2102.040	22	VGF-09022	TC/TC/B	VGF-10022	22	TC/TC/V	VGF-2102-OKIT
2102.041	22	VGF-07022	TC/TC/B	VGF-08022	22	TC/TC/V	VGF-2102-OKIT
2102.210	22	VGF-07022	TC/TC/B	VGF-08022	22	TC/TC/V	VGF-2102-OKIT
2125	28	VGF-19028	TC/TC/B	VGF-20028	28	TC/TC/V	VGF-2125-OKIT
2140	28	VGF-19028	TC/TC/B	VGF-20028	28	TC/TC/V	VGF-2140-OKIT
2151.010	35	VGF-21035	TC/TC/B	VGF-22035	35	TC/TC/V	VGF-2151-OKIT
2151.011	35	VGF-21035	TC/TC/B	VGF-23035	35	TC/TC/V	VGF-2151-OKIT
2151.050	35	VGF-21035	TC/TC/B	VGF-23035	35	TC/TC/V	VGF-2151-OKIT
2201.011LT	45	VGF-28045	Ca/TC/B	VGF-29045	45	TC/TC/V	VGF-2201-OKIT
2250	60	VGF-30060	Ca/TC/B	VGF-31060	60	TC/TC/V	VGF-2250-OKIT
2400	60	VGF-34060	TC/TC/B	VGF-35060	60	TC/TC/V	VGF-2400-OKIT

PUMP MANUFACTURERS' CROSS-REFERENCE

Flygt Model No.	Seal Size MM	Upper Seal Part No.	Materials of Construction	Lower Seal Part No.	Seal Size MM	Materials of Construction	Buna O-Ring Kit Part No.
FLYGT (A XYLEM Brand) (continued)							
3066	20	VGf-04020	Ce/Ca/B	VGf-05020	20	TC/TC/V	VGf-3066-OKIT
3067.090	20	VGf-04020	Ce/Ca/B	VGf-05020	20	TC/TC/V	VGf-3067-OKIT
3067.170	20	VGf-04020	Ce/Ca/B	VGf-05020	20	TC/TC/V	VGf-3067-OKIT
3067.180	20	VGf-04020	Ce/Ca/B	VGf-05020	20	TC/TC/V	VGf-3067-OKIT
3067.250	20	VGf-04020	Ce/Ca/B	VGf-05020	20	TC/TC/V	VGf-3067-OKIT
3067.590	20	VGf-04020	Ce/Ca/B	VGf-05020	20	TC/TC/V	VGf-3067-OKIT
3067.690	20	VGf-04020	Ce/Ca/B	VGf-05020	20	TC/TC/V	VGf-3067-OKIT
3067.890	20	VGf-04020	Ce/Ca/B	VGf-05020	20	TC/TC/V	VGf-3067-OKIT
3082	22	VGf-09022	TC/TC/B	VGf-10022	22	TC/TC/V	VGf-3082-OKIT
3085.091	20	VGf-04020	Ce/Ca/B	VGf-05020	20	TC/TC/V	VGf-3085-OKIT
3085.092	20	VGf-04020	Ce/Ca/B	VGf-05020	20	TC/TC/V	VGf-3085-OKIT
3085.120	20	VGf-04020	Ce/Ca/B	VGf-05020	20	TC/TC/V	VGf-3085-OKIT
3085.170	20	VGf-04020	Ce/Ca/B	VGf-05020	20	TC/TC/V	VGf-3085-OKIT
3085.171	20	VGf-04020	Ce/Ca/B	VGf-05020	20	TC/TC/V	VGf-3085-OKIT
3085.172	20	VGf-04020	Ce/Ca/B	VGf-05020	20	TC/TC/V	VGf-3085-OKIT
3085.180	20	VGf-04020	Ce/Ca/B	VGf-05020	20	TC/TC/V	VGf-3085-OKIT
3085.181	20	VGf-04020	Ce/Ca/B	VGf-05020	20	TC/TC/V	VGf-3085-OKIT
3085.182	20	VGf-04020	Ce/Ca/B	VGf-05020	20	TC/TC/V	VGf-3085-OKIT
3085.280	20	VGf-04020	Ce/Ca/B	VGf-05020	20	TC/TC/V	VGf-3085-OKIT
3085.290	20	VGf-04020	Ce/Ca/B	VGf-05020	20	TC/TC/V	VGf-3085-OKIT
3085.890	20	VGf-04020	Ce/Ca/B	VGf-05020	20	TC/TC/V	VGf-3085-OKIT
3085.891	20	VGf-04020	Ce/Ca/B	VGf-05020	20	TC/TC/V	VGf-3085-OKIT
3101	28	VGf-17028	TC/TC/B	VGf-18028	28	TC/TC/V	VGf-3101-OKIT
3102	25	VGf-14025	Ce/TC/B	VGf-15025	25	TC/TC/V	VGf-3102-OKIT
3126.090	35	VGf-21035	TC/TC/B	VGf-22035	35	TC/TC/V	VGf-3126-OKIT
3126.091	35	VGf-21035	TC/TC/B	VGf-25035	35	TC/TC/V	VGf-3126-OKIT
3126.180	35	VGf-21035	TC/TC/B	VGf-22035	35	TC/TC/V	VGf-3126-OKIT
3126.181	35	VGf-24035	Ca/TC/B	VGf-25035	35	TC/TC/V	VGf-3126-OKIT
3126.280	35	VGf-21035	TC/TC/B	VGf-25035	35	TC/TC/V	VGf-3126-OKIT
3126.290	35	VGf-21035	TC/TC/B	VGf-25035	35	TC/TC/V	VGf-3126-OKIT
3127	35	VGf-24035	Ca/TC/B	VGf-25035	35	TC/TC/V	VGf-3127-OKIT
3140	45	VGf-28045	Ca/TC/B	VGf-29045	45	TC/TC/V	VGf-3140-OKIT
3152	45	VGf-28045	Ca/TC/B	VGf-29045	45	TC/TC/V	VGf-3152-OKIT
3170	60	VGf-32060	Ca/TC/B	VGf-33060	60	TC/TC/V	VGf-3201-OKIT
3201	60	VGf-32060	Ca/TC/B	VGf-33060	60	TC/TC/V	VGf-3201-OKIT
3300.091	90	VGf-36090	TC/TC/B	VGf-37080	80	TC/TC/V	VGf-3300-OKIT
3300.181	90	VGf-36090	TC/TC/B	VGf-37080	80	TC/TC/V	VGf-3300-OKIT
3300.280	90	VGf-36090	TC/TC/B	VGf-37080	80	TC/TC/V	VGf-3300-OKIT
3300.980	90	VGf-36090	TC/TC/B	VGf-37080	80	TC/TC/V	VGf-3300-OKIT
3530	90	VGf-36090	TC/TC/B	VGf-39120	120	TC/TC/V	TBA

Materials of Construction Explanation:

Ca/TC/B - Carbon vs Tungsten Carbide with Buna Elastomers
 Ce/Ca/B - Ceramic vs Carbon with Buna Elastomers
 TC/TC/B - Tungsten Carbide vs Tungsten Carbide with Buna Elastomers
 TC/TC/V - Tungsten Carbide vs Tungsten Carbide with Viton® Elastomers

- Please call for models not shown
- Also available upon request
 Machined metal version of seals
 Viton® O-Ring kits



PUMP MANUFACTURERS' CROSS-REFERENCE

Flygt Model No.	Seal Size MM	Value Guard Part No.	Materials of Construction	Buna O-Ring Kit Part No.
FLYGT PLUG-IN™				
2610	20	VG-20000*	TC/TC/V // TC/Ce/V	VG-2610-OKIT
2620	20	VG-20000*	TC/TC/V // TC/Ce/V	VG-2620-OKIT
2630	20	VG-20000*	TC/TC/V // TC/Ce/V	VG-2630-OKIT
2640	20	VG-20000*	TC/TC/V // TC/Ce/V	VG-2640-OKIT
2660	25	VG-20001	SIC/SIC/V // TC/Ce/V	VG-2660-OKIT
2670	35	VG-20002	TC/TC/V // TC/TC/V	VG-2670-OKIT
3153	35	VG-20002	TC/TC/V // TC/TC/V	VG-3153-OKIT
3171	45	VG-20003	TC/TC/V // TC/TC/V	VG-3171-OKIT
3202	60	VG-20004	TC/TC/V // TC/TC/V	VG-3202-OKIT
3301	80	VG-20005	TC/TC/V // TC/TC/V	VG-3301-OKIT
4610	20	VG-20000*	TC/TC/V // TC/Ce/V	VG-4610-OKIT
4620	20	VG-20000*	TC/TC/V // TC/Ce/V	VG-4610-OKIT
4630	25	VG-20001	SIC/SIC/V // TC/Ce/V	VG-4630-OKIT
4640	25	VG-20001	SIC/SIC/V // TC/Ce/V	VG-4630-OKIT
4650	45	VG-20003	TC/TC/V // TC/TC/V	VG-4650-OKIT
4660	45	VG-20003	TC/TC/V // TC/TC/V	VG-4650-OKIT
4670	60	VG-20004	TC/TC/V // TC/TC/V	VG-4670-OKIT
4680	60	VG-20004	TC/TC/V // TC/TC/V	VG-4670-OKIT
5100.210	35	VG-20002	TC/TC/V // TC/TC/V	VG-5100-210-OKIT
5100.211	35	VG-20002	TC/TC/V // TC/TC/V	VG-5100-211-OKIT
5100.220	35	VG-20002	TC/TC/V // TC/TC/V	VG-5100-220-OKIT
5100.221	35	VG-20002	TC/TC/V // TC/TC/V	VG-5100-211-OKIT
5100.250	45	VG-20003	TC/TC/V // TC/TC/V	VG-5100-250-OKIT
5100.251	45	VG-20003	TC/TC/V // TC/TC/V	VG-5100-250-OKIT
5100.260	45	VG-20003	TC/TC/V // TC/TC/V	VG-5100-250-OKIT
5100.261	45	VG-20003	TC/TC/V // TC/TC/V	VG-5100-250-OKIT
5100.300	60	VG-20004	TC/TC/V // TC/TC/V	VG-5100-300-OKIT
5100.310	60	VG-20004	TC/TC/V // TC/TC/V	VG-5100-300-OKIT
5150.300	60	VG-20004	TC/TC/V // TC/TC/V	VG-5150-300-OKIT
5150.310	60	VG-20004	TC/TC/V // TC/TC/V	VG-5150-300-OKIT
5150.350	80	VG-20005	TC/TC/V // TC/TC/V	VG-5150-350-OKIT
5150.360	80	VG-20005	TC/TC/V // TC/TC/V	VG-5150-350-OKIT

Materials of Construction Explanation:

SIC/SIC/V // TC/Ce/V

SIC/SIC/V - Silicon Carbide vs Silicon Carbide with Viton® Elastomers
 TC/Ce/V - Tungsten Carbide vs Ceramic with Viton® Elastomers

TC/TC/V // TC/Ce/V

TC/TC/V - Tungsten Carbide vs Tungsten Carbide with Viton® Elastomers
 TC/Ce/V - Tungsten Carbide vs Ceramic with Viton® Elastomers

TC/TC/V // TC/TC/V

TC/TC/V - Tungsten Carbide vs Tungsten Carbide with Viton® Elastomers
 TC/TC/V - Tungsten Carbide vs Tungsten Carbide with Viton® Elastomers

Features

- Compact design
- Double cartridge seal
- Faces are protected during installation
- Factory assembled as a unit
- Fool proof mounting
- Springs are isolated from the pump media

Please call for models not shown.



U.S. Seal Mfg. Part No.	Seal Size	Head	Mating Ring	Mating Ring Bore	Material Code	Notes	Pump Nameplate Data	Mfg. Part No.
FOOTE-JONES®								
PS-383	1.250	D	1	1.875	BCFKF			
PS-186	1.375	D	1	2.000	BCDKF			
PS-371	1.500	D	1	2.125	BCFKF			
PS-462	2.000	D	1	2.750	BCDKF			

PUMP MANUFACTURERS' CROSS-REFERENCE

U.S. Seal Mfg. Part No.	Seal Size	Head	Mating Ring	Mating Ring Bore	Material Code	Notes	Pump Nameplate Data	Mfg. Part No.
FRANKLIN ELECTRIC COMPANY, INC.								
PS-200	.625	A	1	1.250	BMFJF			1000206, 106196105
PS-200V-CMS	.625	A	1	1.250	VCFJF			240316, 106196106
PS-1021	.625	B	8	—	BMFJF	A		292456101
PS-2750	.625	C	1	1.187	BCFJF	H/I		30400194
PS-3914	.625	C	3	1.250	BCFJF			926051
PS-3960	.625	G	1	1.250	BCFJF			240104
PS-201	.750	A	1	1.375	BMFJF			10150209
PS-877	.750	C	1	1.375	BCFJF			10120301, 10123010001 106196102
PS-360	1.000	A	1	1.625	BCFJF			240180
PS-360V-CMS	1.000	A	1	1.625	VCFJF			240369
PS-235	1.000	C	1	1.625	BCFJF			10129906
PS-2122	1.250	C	1	1.875	BCFJF			10036903
PS-185V-CMS	1.250	C	1	1.875	VCFJF			240359
PS-546	1.250	E	3	1.875	BCFV/JF	S		10153104, 10619601
PS-758V-CMS	1.500	C	1	2.125	VCFJF			240362
PS-2142	1.750	C	1	2.500	BCFJF			10037000, 305463204
PS-3189	2.750	D	3	3.500	VLZFF	316SS/S		30400195
PS-2803	3.250	D	3	4.125	VLZFF	S		30400190
PS-200	.625	A	1	1.250	BMFJF			
FREDERICK PUMP COMPANY								
PS-952	.625	A	1	1.250	BCFJF			
PS-360	1.000	A	1	1.625	BCFJF			
PS-185	1.250	C	1	1.875	BCFJF			
PS-756V	1.250	C	3	1.875	VCFKF			80912
PS-1042	1.750	U	1	2.500	BCFJF			
FREEZING EQUIPMENT SALES (See GEA for Additional Part Numbers)								
PS-9703	2.000	WB	Special	2.500	T/NCFKF	316SS		260-000010-000
PS-4547	3.625	R	3	5.125	NCFKP			020-000300-004
FRICK COMPANY (See JOHNSON CONTROLS for Additional Part Numbers)								
PS-492-CMS	2.375	C	1	3.250	BCFKF		80BA2-47	
PS-4028	2.875	K	3 Special	4.500	NCFGF		MRI-90	
FULLER COMPRESSOR								
PS-4547	3.625	R	3	5.125	NCFKP			C-175-200

Value Guard Part No.	Seal Size	Head	Mating Ring	Mating Ring Bore	Material Code	Notes	Pump Nameplate Data	Mfg. Part No.
FYBROC® (Division of MET-PRO CORPORATION)								
FA-9012	.500	W	—	—	TCF-F	316SS		760P04-777
PS-356V	1.125	C	3	1.750	VCFJF	S		76P101-181
PS-22158	1.375	XB2	Special	2.682	VLFLF	316/HC		08976C050
VG-81375	1.375	VGXB2	Special	2.682	X/TCFJF	316/HC		08976C010
VG-81376	1.375	VGXB2	Special	2.682	X/TCFLF	316/HC		08976C100
PS-22155	1.375	XT Dbl.	Special	2.000	VCFJF	316SS/S		08944C0102
PS-8132	2.125	X Dbl.	3	2.875	VCFJF	316SS/S		08931C0402
PS-22157	2.125	XB2	Special	3.567	VLFLF	316/HC		08975C050
PS-22156	2.125	XT Dbl.	3	2.875	VLFLF/ VCFJF	316SS/S		08931C0702
PS-8702	2.125	XT Spec.	3	2.875	VCFJF	316SS/S		08931C0102
VG-82125	2.125	VGXB2	Special	3.555	X/TCFJF	316/HC		08975C010
VG-82126	2.125	VGXB2	Special	3.555	X/TCFLF	316/HC		08975C070
PS-8701	2.875	XT Dbl.	3	3.750	V/TCFJF	316SS/S		08973C0102
VG-82875	2.875	VGXB2	Special	4.375	X/TCFJF	316/HC		08974C010
VG-82876	2.875	VGXB2	Special	4.375	X/TCFLF	316/HC		—



VG-82126

Value Guard Type VGXB2

- Multi-spring
- Outside mounted
- Full clamp flush design mating ring

NOTE: A. MOUNTS ON SHAFT
 C. COMPLETE WITH COLLAR
 H. SPRING HOLDER NOT INCLUDED
 I. ABRASION RESISTANT CARBON (P66)
 S. SLOTTED MATING RING

PUMP MANUFACTURERS' CROSS-REFERENCE

U.S. Seal Mfg. Part No.	Seal Size	Head	Mating Ring	Mating Ring Bore	Material Code	Notes	Pump Nameplate Data	Mfg. Part No.
GALION								
FA-1520	.750	C	—	—	BCF-F			
FA-1700	1.000	C	—	—	BCF-F			
GARDNER DENVER								
PS-441	.750	B	9	—	BMFKF	A		60BN-1
PS-373	.750	C	1	1.375	BCFKF			60AY-10
PS-360	1.000	A	1	1.625	BCFJF			60BT-11
PS-370	1.000	A	1	1.625	BCFKF			60BT-1
PS-2814	1.000	C	3	1.625	NCFGF		Model #1397 Sargent Welch	41-1491
PS-357V	1.000	C	3	1.625	VCFKF	S		
PS-3240	1.000	C	3	1.812	VCFKF			60DD-79
PS-236	1.000	E	1	1.625	BCFKF			60AY-2,16 &18
PS-605	1.125	D	1	1.750	BCFKF			60BC-10
PS-384	1.125	E	1	1.750	BCFKF			60AY-11 &13
PS-3173	1.250	C	3	1.875	VCFKF	S		60DD-591
PS-383	1.250	D	1	1.875	BCFKF			60BC-3
PS-6036	1.250	D	2	1.875	VCPFP			60DD-597
PS-186	1.375	D	1	2.000	BCDKF			60BC-14
PS-6048	1.375	D	3	2.000	VCPSP			60DD-594
PS-354	1.375	E	1	2.000	BCFJF			
PS-7367	1.437	C	Special	2.718	VCFGF			60DD-52
PS-6055	1.437	E	27	2.718	VCPGP			60DD-105
PS-6056	1.437	X	27 Special	2.718	VCFSF	316SS		60DD-593
PS-382	1.500	D	1	2.125	BCFJF			
PS-371	1.500	D	1	2.125	BCFKF			
PS-374	1.500	E	1	2.125	BCFKF			60AY-21
PS-239V	1.625	C	3	2.375	VCFKF	S		60BC-25
PS-6005	1.625	C	3	2.375	VCFKF			60DD-86
PS-6075	1.625	D	3	2.375	VCPSP			60DD-592
PS-312V	1.875	C	3	2.625	VCFKF	S		60DD-98
PS-593	1.875	D	3	2.625	BCDKF	S		60BC-9, 12
PS-6094	1.875	D	3	2.625	VCPSP	S		60DD-599
PS-2070	1.875	E	1	2.625	BCFKF			60AY-20
PS-1676V	2.250	C	3	3.125	VCFKF	S		60DD-104
PS-3955	2.250	C	27 Special	3.125	VCFGF			60DD-53
PS-5358	2.250	D	3	3.125	Special			60DD-595
PS-351	2.250	E	1	3.125	BCDKF			60AY-15
PS-463	2.500	D	3	3.375	BCDKF	S		60BC-8
PS-6154	2.750	C	27	4.406	VCFGF			60DD-54
PS-6174	3.000	E	3	3.875	VCDGP			00519056 0030
PS-8700	3.750	X	27	5.421	VCFSF	316SS		60DD-602
GARDNER DENVER LeROI								
PS-687V	.875	C	3	1.500	VCFKF			125.907
PS-460V	1.000	D	3	1.625	VCFKF	S		125.988
PS-598	1.250	C	3	1.875	BCFKF			125.775
PS-383V	1.250	D	3	1.875	VCFKF			125.983
PS-22020	1.250	D	3	1.875	VCFLF	316SS		125.983.2
PS-4431	1.250	D	3	1.875	VLFLF			125.983.1
PS-467	1.375	C	1	2.125	BCFKF			
PS-210V	1.375	C	3	2.000	VCFKF	S		125.940
PS-1062	1.375	C	3	2.125	VCFKF			125.188.2
PS-22023	1.375	D	3	2.000	VCFKF			125.978
PS-22022	1.500	D	3	2.125	VCFLF			125.982.2
PS-22019	1.500	D	3	2.125	VCFLF	316SS		125.982.3
PS-371V-SC-SC	1.500	D	3	2.125	VLFLF	S		125.982.1
PS-436V	1.750	C	3	2.500	VCFKF	S		125.693.2
PS-22024	1.750	D	3	2.500	VCFKF			125.965
PS-22018	1.750	D	3	2.500	VCFLF	316SS		125.965.2
PS-1676V	2.250	C	3	3.125	VCFKF	S		125.927
PS-22021	2.250	D	3	3.125	VCFKF			125.986
PS-6155	2.750	C	3	3.500	VCFKF	S		125.711
PS-6002	2.625	D	3	3.375	VCFKF	S		125.848
PS-22017	3.000	D Special	3	3.875	VCFKF			125.920

PUMP MANUFACTURERS' CROSS-REFERENCE

U.S. Seal Mfg. Part No.	Seal Size	Head	Mating Ring	Mating Ring Bore	Material Code	Notes	Pump Nameplate Data	Mfg. Part No.
GARWOOD INDUSTRIES								
PS-303	.875	D	1	1.500	BCDKF			206556
PS-227	1.000	D	1	1.750	BCFKF			
PS-210	1.375	C	1	2.000	BCFKF			2016264
FA-186	1.375	D	—	—	BCD-F			2039056
GE OSMONICS (See SUEZ WTS)								
GEA								
PS-22062	1.000	D	3	1.625	NLFLF			290-000820-100
PS-22064	2.000	WB	3	2.500	TCFN/KF	316SS/S		250-000020-064
PS-9703	2.000	WB	Special	2.500	T/NCFKF	316SS		260-000010-000
PS-22063	2.000	WB	3 Special	2.468	TCFN/KF	316SS		350-000020-163
PS-22065	2.375	XB1	2.875	2.875	NCFGF	316SS/S		350-000220-204
PS-22066	2.406	K	3	3.305	NCFGF			020-000300-002
PS-9710	2.500	WB	Special	3.125	TCFN/KF	316SS		260-000020-000
PS-22069	2.750	K	3	4.000	NCFGF			020-000300-003
PS-22068	2.750	WB	3 Special	3.456	TCFN/KF	316SS/S		240-000230-019
PS-22070	2.875	WB	Special	4.248	TCFKF	316SS		350-000020-255
PS-22072	3.000	WB	3	3.500	TCFN/KF	316SS/S		250-000020-132
PS-22071	3.000	WB	Special	3.758	TCFN/KF	316SS		260-000030-000
PS-22073	3.500	WB	3 Special	4.500	TCFN/KF	316SS/S		240-000230-023
PS-4547	3.625	R	3	5.125	NCFKP			020-000300-004
PS-22074	3.625	WB	Special	4.996	TCFN/KF	316SS		350-000020-321
PS-22075	4.000	WB	3 Special	5.016	TCFN/KF	316SS		240-000230-028
GEARMASTER								
PS-1043	.500	C	1	1.000	BMFJF			A34-3970
GECKO ALLIANCE, INC.								
PS-200	.625	A	1	1.250	BMFJF		Circ-Master®, Dominator® High Head Dominator® Medium Head, Flo-Master® Pond-Flo, Tub-Master®	92500150 92500151
PS-200-EPR	.625	A	1	1.250	QCFJF			92502020, 92501000
PS-200V-CMS	.625	A	1	1.250	VCFJF			92500152
PS-2131	.625	A	31	—	BMFJF	G	Flo-Master®, Tub-Master®	91049000
FA-642	.625	B	—	—	BMF-F			
PS-1000	.625	B	1	1.250	BMFJF		A, B and D Series A, C and D Series, Dominator® High and Medium head – pre 1995	92509040 92500050
PS-1021	.625	B	8	—	BMFJF	A	K-81159 PU10	
PS-201	.750	A	1	1.375	BMFJF			
PS-309	.875	C	1	1.500	BCFJF		AC Series	92500000
PS-774	.875	C	3	1.500	BCFV/JF			
PS-361	1.250	E	1	1.875	BCFJF			
GECO SALES								
PS-1000	.625	B	1	1.250	BMFJF			
GENERAL MOTORS CORPORATION (GMC)								
FA-642	.625	B	—	—	BMF-F			5121751
FA-1350	.625	C	—	—	BCF-F			5186571
PS-752	.750	D	1	1.375	BCDKF			5186113
PS-192	1.500	C	3 Special	2.125	NCFGF			
GENERAL PUMP								
PS-200	.625	A	1	1.250	BMFJF			
PS-810	.625	C	1	1.250	N/BCFJF	B		
GEORGIA PACIFIC PUMP								
PS-200	.625	A	1	1.250	BMFJF			
GG INDUSTRIES								
PS-200	.625	A	1	1.250	BMFJF			
FA-642	.625	B	—	—	BMF-F			
PS-1000	.625	B	1	1.250	BMFJF			P-Seal 4 / P-Seal 5 Mark III

NOTE: A. MOUNTS ON SHAFT
B. TAPERED SPRING
G. MOUNTS IN PLASTIC
S. SLOTTED MATING RING

PUMP MANUFACTURERS' CROSS-REFERENCE

U.S. Seal Mfg. Part No.	Seal Size	Head	Mating Ring	Mating Ring Bore	Material Code	Notes	Pump Nameplate Data	Mfg. Part No.
GILBARCO VEEDER-ROOT								
PS-1000	.625	B	1	1.250	BMFJF			K81159X
PS-756	1.250	C	1	1.875	BCFKF			K74050X
PS-514	1.625	D	1	2.375	BCDJF			
PS-461	1.625	D	1	2.375	BCDKF			
GLT, INC. (Dishwashers / Disposals)								
PS-6313	.500	Q	1	1.019	BCFJF			185694-1
PS-1085V	.625	C	1	1.250	B/VCFJF	B		114696
PS-6318	1.125	Q	9	1.578	VMFAF			117071
GORMAN-RUPP COMPANY								
FA-10	.500	B	—	—	BMF-F		Seat is Impeller	S8243-4
PS-788	.500	B	1	1.000	BMFKF			
PS-106	.500	C	1	1.000	BCFKF			25271-801
PS-106V	.500	C	1	1.000	VCFKF			25271-802
FA-62	.625	A	—	—	BCF-F			12873-002
PS-200	.625	A	1	1.250	BMFJF			S756, S1531, 12874-010
PS-507	.625	A	1	1.250	BMFKF			
FA-3300	.625	B	—	—	BCF-F			08243-12
PS-2804	.625	B	1	1.250	VCFJF			25271-412
PS-118	.625	C	1	1.187	BCFJF			S809
PS-359	.625	C	1	1.250	BCFJF			25271-824
PS-1080	.625	C	1	1.250	NCFKF			25270-113
PS-3121	.625	C	1	1.250	VCFKF	I		25271-821
PS-1045	.625	C	3	1.250	VCFJF			
PS-508	.625	D	1	1.250	BCDJF			S217
PS-795	.625	S	8	1.187	NAPSP			GS-625
PS-22046	.625	W	27	1.718	TCFJF	316SS		S1219
PS-851	.750	A	1	1.375	BCFJF			S1190
PS-601	.750	B	1	1.375	BMFJF		83E-F13	26822-008
FA-564	.750	C	—	—	BCF-F			S32
PS-358	.750	C	1	1.375	BCFJF			S936
PS-358-P66	.750	C	1	1.375	BCFJF	I		S1575
PS-112	.750	C	1	1.375	BCFKF			S1679
PS-358V-CMS	.750	C	1	1.375	VCFJF			25271-850
PS-373V	.750	C	1	1.375	VCFKF			25271-021
PS-358V-SC-SC	.750	C	1	1.375	VLFLF			25271-846
PS-112V	.750	C	3	1.375	VCFKF	H		25271-841
PS-5728	.750	C	3	1.375	VLFLF			25284-921
PS-750	.750	D	1	1.375	BCDJF		82T-A8	S383
PS-752	.750	D	1	1.375	BCDKF		82T-A8	
PS-2010	.750	D	3	1.375	BCFJF			S33
PS-792	.750	S	8	1.500	NAPSP			GS-750
PS-22039	.750	G	1	1.375	VCFJF	316SS		25276-617
PS-309V-CMS	.875	C	1	1.500	VCFJF			25271-853
PS-617	.875	C	3	1.500	BCFKF			25271-159, 25271-855
PS-22042	.875	C	3	1.500	QCFJF			25271-858
PS-687V	.875	C	3	1.500	VCFKF	H		25271-851
PS-2027V	.875	D	3	1.500	VCFKF			
PS-360	1.000	A	1	1.625	BCFJF			S2147
FA-1700	1.000	C	—	—	BCF-F			S237
PS-235	1.000	C	1	1.625	BCFJF			S1832, S1906
PS-357	1.000	C	1	1.625	BCFKF			
PS-22044	1.000	C	1	1.625	VCFKF	H		25271-866
PS-499	1.000	C	3	1.625	BCFKF	S		25271-869
PS-357V	1.000	C	3	1.625	VCFKF	S		25271-870
PS-380	1.000	D	1	1.625	BCFJF			S1415
PS-22045	1.000	D	1	1.625	BCFJF	H		S298
PS-460	1.000	D	1	1.625	BCFKF			S363, S364
PS-4253	1.000	DB	3	1.500	VCFKF	316SS		25276-251
PS-236	1.000	E	1	1.625	BCFKF			
PS-791	1.000	E	3	1.625	BCFKF	S		S388
PS-557	1.000	E	3	1.625	B/VCFJF	S		25271-032
PS-793	1.000	S	8	1.750	NAPSP		13A2-B	GS-1000
PS-4638	1.000	Spec	9	—	BCPGP			25276-031
FA-6987	1.000	W	—	—	TCF-F	316SS		25275-333

PUMP MANUFACTURERS' CROSS-REFERENCE

U.S. Seal Mfg. Part No.	Seal Size	Head	Mating Ring	Mating Ring Bore	Material Code	Notes	Pump Nameplate Data	Mfg. Part No.
GORMAN-RUPP COMPANY (continued)								
PS-9018	1.000	W	27	2.156	TCFJF	316SS		S1212
FA-1800	1.125	C	—	—	BCF-F			92055-1112
PS-867	1.125	E	3	1.750	BCFKF	S		25271-039
PS-867V	1.125	E	3	1.750	VCFKF	S		25271-037
PS-756	1.250	C	1	1.875	BCFKF			S1621
PS-185-EPR	1.250	C	1	1.875	QCJFJ			25271-893
PS-598	1.250	C	3	1.875	BCFKF			25271-889
PS-185V	1.250	C	3	1.875	VCFJF	S		25271-888
PS-756V	1.250	C	3	1.875	VCFKF			25271-836, 25271-886
PS-381	1.250	D	1	1.875	BCFJF			S321
PS-383	1.250	D	1	1.875	BCFKF			S37, S493
PS-517	1.250	D	3	1.875	BCFKF			S493C
PS-981	1.250	D	3	1.875	BCFKF			S321A
PS-22041	1.250	D	3	1.875	BCFKF	H		25271-295
PS-3685	1.250	D	3	1.875	VCFKF	H		25271-192
PS-361	1.250	E	1	1.875	BCFJF			S335
PS-137	1.250	E	1	1.875	BCFKF			S350
PS-546	1.250	E	3	1.875	BCFV/JF	S		42029, 25271-044
PS-137V	1.250	E	3	1.875	VCFKF			
PS-4396	1.250	E	3	1.875	VCFKF	316SS		25271-043
PS-6259	1.250	G	1	1.875	VCFJF	316SS		25276-633
PS-794	1.250	S	8	2.125	NAPSP		14C2B	GS-1250
PS-9719	1.250	W	3	1.875	T/VCFKF	316SS		25271-743
PS-2234	1.437	E	3	2.062	BCFKF			25271-051
PS-2234V	1.437	E	3	2.062	VCFKF			25271-056
PS-758	1.500	C	1	2.125	BCFJF			S1150
PS-553	1.500	C	3	2.125	BCFKF			25271-907
PS-659V	1.500	C	3	2.125	VCFKF		Do Not Use Springholder	25271-903
PS-5727	1.500	C	3	2.125	VRFRF	316SS		25284-961
PS-382	1.500	D	1	2.125	BCFJF		Do Not Use Springholder	25271-215, S1934
PS-371	1.500	D	1	2.125	BCFKF			S283, S317, S774
PS-534	1.500	D	3	2.125	BCFKF			
PS-371V	1.500	D	3	2.125	VCFKF			25271-207
PS-374	1.500	E	1	2.125	BCFKF			S239
PS-9318	1.500	W	27	2.781	TCFJF	316SS		S1681
PS-8002	1.500	X Special	3	2.125	BCFJF	S		25271-554
PS-2762	1.625	C	1	2.375	VCFLF	316SS	Model 65A31-B 6x5	
PS-544	1.625	C	3	2.375	BCFKF	S		25271-922
PS-239V	1.625	C	3	2.375	VCFKF	S		25271-921
PS-2058	1.625	E	1	2.375	BCFKF			25271-061
PS-595	1.625	E	3	2.375	BCDJF			
PS-1683	1.625	E	3	2.375	BCFJF	S		25271-064
PS-446	1.750	C	1	2.500	BCFJF			S1822
PS-2212	1.750	C	1	2.500	BCFJF			25271-947
PS-446V-CMS	1.750	C	1	2.500	VCFJF			25271-942
PS-436	1.750	C	3	2.500	BCFKF	S		25271-943
PS-22038	48MM	G	25	66MM	VLFLF	316SS		25276-681
PS-267	2.000	C	1	2.750	BCFJF			25271-971
PS-267V-CMS	2.000	C	1	2.750	VCFJF			
PS-332	2.000	C	3	2.750	BCFKF	S		S1929
PS-1145	2.000	C	3	2.750	VCFKF	S		25271-983
PS-3142	2.000	D	3	2.750	VZFLF	316SS/H/S		26835-545
PS-22047	2.250	D	3	3.125	VLFLF	S		25271-288
PS-22048	2.250	D	3	3.125	VLFLF	316SS/S		25271-289
PS-1688	2.250	E	3	3.125	BCFJF	S		25271-095
PS-22043	2.500	C	1	3.375	VCFJF			25271-985
PS-463	2.500	D	3	3.375	BCDKF	S		
PS-22040	2.500	D	3	3.375	BCFKF			25271-291
PS-3888	2.500	D	3	3.375	VZFLF			26835-541
PS-349V-TC-SC	2.500	E	3	3.375	VZFLF	S		26835-544, 26835-546
PS-22037	75MM	G	25	97MM	VLFLF	316SS		25276-683
PS-6219	3.000	D	3	3.875	BZFLF			26835-548
PS-4033	3.000	D	3	3.875	VZFLF	S		26835-542
PS-324SS	3.000	E	3	3.875	BCFJF	S		25271-098
PS-3180	3.250	C	3	4.125	VCFJF			25271-994

NOTE: H. SPRING HOLDER NOT INCLUDED
S. SLOTTED MATING RING

PUMP MANUFACTURERS' CROSS-REFERENCE

Value Guard Part No.	Seal Size	Head	Mating Ring	Mating Ring Bore	Material Code	Pump Nameplate Data	Mfg. Part No.
GORMAN-RUPP COMPANY - S SERIES - Submersible Pump							
Please Note: Seals in the S-Series do not include Pump Sleeve, O-Ring or Impeller Shim Kit.							
VG-3011	1.000	VGR	Special	Special	BZFZF	S3A1	46512-044
VG-7101	1.500	VGD	Special	Special	VZFZF	S4A1, S4B1, S6C1	12430
PS-382	1.500	D	1	2.125	BCFJF	Use for Upper Seal	S1934
VG-7101	1.500	VGD	Special	Special	VZFZF	S6B1, S8A1, S8B1	12430A
PS-382	1.500	D	1	2.125	BCFJF	Use for Upper Seal	S1934
VG-7102	1.750	VGD	Special	Special	VZFZF	S8C1	46512-055
PS-2212	1.750	C	1	2.500	BCFJF	Use for Upper Seal	25271-947

Value Guard Part No.	Shaft Size	Head	Mating Ring	Mating Ring Bore	Material Code	Pump Nameplate Data	Mfg. Part No.
GORMAN-RUPP COMPANY - T SERIES - Self Priming Pump							
VG-7080	1.250	VGD	Special	Special	VLZFZ	T3, T4, T6	
VG-7079	1.250	VGD	Special	Special	VZFZF	T3, T4, T6	46512-047, 12364A
VG-7094	1.250	VGDU	Special	Special	VLFLF	T3, T4, T6	46513-151
VG-7095	1.250	VGDU	Special	Special	VZFZF	T3, T4, T6	46513-150
VG-7082	1.500	VGD	Special	Special	VLFLF	T8	
VG-7081	1.500	VGD	Special	Special	VZFZF	T8	
VG-7182	1.500	VGDU	Special	Special	VLFLF		45613-154

Features:

- Tungsten Carbide and Silicon Carbide faces for severe abrasive service.
- Solid drive band extends seal life during periods of vibration and cavitation.
- Full convolution elastomer bellows for maximum self aligning capabilities.
- Pump sleeve, o-ring and impeller shim kit supplied for ease of installation.



U.S. Seal Mfg. Part No.	Seal Size	Head	Mating Ring	Mating Ring Bore	Material Code	Notes	Pump Nameplate Data	Mfg. Part No.
GOULDS PUMPS								
VGM-1602	12MM	G	25	23MM	QCFLF		e-SV Series - Models 1SV, 3SV, 5SV	10K170
VGM-1606	12MM	G	25	23MM	QLFLF		e-SV Series - Models 1SV, 3SV, 5SV	10K174
VGM-1600	12MM	G	25	23MM	VCFLF		e-SV Series - Models 1SV, 3SV, 5SV	10K168
VGM-1604	12MM	G	25	23MM	VLFLF		e-SV Series - Models 1SV, 3SV, 5SV	10K172
VGM-1608	12MM	G	25	23MM	XCFLF		e-SV Series - Models 1SV, 3SV, 5SV	10K218
PS-1002	.500	C	1	1.000	BCFJF		Fig. 3604	742070050
PS-631	.500	C	1	1.000	BCFJF	N		
PS-1002V	.500	C	1	1.000	VCFJF			742080050, 742090050
VGM-9661	16MM	G	25	27MM	QCFLF		e-SV Series - Models 10SV, 15SV, 22SV	10K171
VGM-9622	16MM	G	25	27MM	QLFLF		e-SV Series - Models 10SV, 15SV, 22SV	10K175
VGM-9660	16MM	G	25	27MM	VCFLF		e-SV Series - Models 10SV, 15SV, 22SV	10K169
VGM-9662	16MM	G	25	27MM	VLFLF		e-SV Series - Models 10SV, 15SV, 22SV	10K173
VGM-9669	16MM	G	25	27MM	XCFLF		e-SV Series - Models 10SV, 15SV, 22SV	10K173
PS-4240	.625	A	1	1.187	BCFJF			10K10, 10K121
PS-518-SC-SC	.625	A	1	1.187	BLFLF			10K63
PS-702	.625	A	1	1.187	BMFJF		Balanced Flow BF-03 Series G, LD, LS, M, O, XS05 15, 20, 30, 50 Jetomatic Fig. 3642,3672,3742 10K1,10K6,20831100	704705062, 725981062
PS-4462	.625	A	1	1.187	BMFJF			10K2
PS-701	.625	A	1	1.187	BMFKF		Balanced Flow BF-03 Figs.3628,3638,3642,3648,3728 3738,3742,3748,3788,3811	725983062

PUMP MANUFACTURERS' CROSS-REFERENCE

U.S. Seal Mfg. Part No.	Seal Size	Head	Mating Ring	Mating Ring Bore	Material Code	Notes	Pump Nameplate Data	Mfg. Part No.
GOULDS PUMPS (continued)								
PS-702-EPR	.625	A	1	1.187	QCFJF			10K110, 725988082
PS-702V	.625	A	1	1.187	VCFJF			
PS-3977	.625	A	1	1.187	VLFLF			10K105, 10K120 3481008, 725987062
PS-200V-SC-SC	.625	A	1	1.250	VLFLF			
PS-600	.625	B	1	1.187	BMFJF		Fig. 3231	
PS-700	.625	B	1	1.187	BMFJF		Fig. 3631	10K7
PS-1000V	.625	B	3	1.250	VCFJF			696-0442
PS-3926	.625	B	9	1.062	VCFKF	316SS		10K127
PS-411V	.625	B	11	—	VCFJF	A		
PS-1155	.625	C	1	1.187	BCFJF			
PS-493	.625	C	1	1.187	BCFKF		Fig. 3377 and 3371 Multi Stage	10K3
PS-4222	.625	C	1	1.187	QCFLF	316SS/H		920551062
PS-3201	.625	C	1	1.187	QCFLF	316SS/H	Light Spring Load	10K18
PS-3707	.625	C	1	1.187	QLFLF	316SS/H		10K81
PS-1155V	.625	C	1	1.187	VCFJF			
PS-4031	.625	C	1	1.187	VCFLF	316SS/H		10K46, 10K55
PS-4226	.625	C	1	1.187	VLFLF	316SS/H		10K62
PS-2701	.625	D	3	1.250	VCFZF	316SS		278C957SL
PS-6267	.625	G	1	1.187	QLFLF	316SS		10K-167, A00576C1
FA-201	.750	A	—	—	BMF-F			7501000
PS-750	.750	D	1	1.375	BCDJF			10K4
PS-3306	.750	DB	3	1.250	QCFZF	316SS	39355	
VGM-53523	22MM	Special	25	37MM	QCFLF	316SS	e-SV Series-Models 33SV,46SV,66SV,92SV	10L40
VGM-53522	22MM	Special	25	37MM	QLFLF		e-SV Series-Models 33SV,46SV,66SV,92SV	10L37
VGM-53525	22MM	Special	25	37MM	VCFLF		e-SV Series-Models 33SV,46SV,66SV,92SV	10L38
VGM-53524	22MM	Special	25	37MM	VLFLF	316SS	e-SV Series-Models 33SV,46SV,66SV,92SV	10L39
VGM-53526	22MM	Special	25	37MM	XCFLF	316SS	e-SV Series-Models 33SV,46SV,66SV,92SV	10L38
PS-3996	.875	C	1	1.500	VCFLF			10K40, 764072087
PS-703	.875	D	1	1.500	BCDJF		XS15,20,50 Aqua Lawn Jetomatic Fig. 3629,3649,3729,3749,3639 3739, 3678 and 3789	10K8
PS-303	.875	D	1	1.500	BCDKF			704704087
FA-10037	1.000	C	—	—	VCF-F			41355000000
PS-235	1.000	C	1	1.625	BCFJF			10K12
PS-754	1.000	E	1	1.625	BCFJF		Fig. 3169M, 3450, 3650 3655, 3750S, 3755	707831100
PS-236	1.000	E	1	1.625	BCFKF			691272100
PS-557	1.000	E	3	1.625	B/VCFJF	S		916661000, 916701000
PS-3976	1.000	E	3	1.625	VCFJF	316SS	3655 / 3755S	
PS-8020	1.000	XB2	3 Special	1.750	VCFJF	316SS		
PS-710	1.062	E	1	1.750	BCFJF		Fig. 3405, 3305S	707833106
PS-356	1.125	C	1	1.750	BCFJF		Fig. 3643	10K21
PS-355-SC-SC	1.125	C	1	1.750	BLFLF			10K28
PS-356-SC-TC	1.125	C	1	1.750	BLFZF			10K22
PS-588	1.125	C	3	1.750	BCFKF	B/S	Fig. 3643	10K9, 764071112
PS-3325	1.125	E	27	2.135	BCFJF	316SS/C	3197T	
PS-185	1.250	C	1	1.875	BCFJF		Fig. 3656	9152071001
PS-4463	1.250	C	1	1.875	BCFJF	316SS		10K13
PS-2208	1.250	C	1	1.875	BZFZF			9152071002
PS-4464	1.250	C	1	1.875	QCFKF	316SS		
PS-3131	1.250	C	1	1.875	QCFLF	316SS/H		10K19, 764070125
PS-3062	1.250	C	1	1.875	QLFLF	316SS		10K126, 764071125
PS-185V-CMS	1.250	C	1	1.875	VCFJF			10K25, A06101A02
PS-3538	1.250	C	1	1.875	VCFLF	316SS		10K27, 764078125
PS-4176	1.250	C	1	1.875	VCFZF	316SS		A06101A07
PS-4101	1.250	C	1	1.875	VLFLF	316SS		
PS-4150	1.250	C	1	1.875	VLFLF	316SS/H		10K64, 10K188
PS-4321	1.250	C	3	1.875	XLFLF	316SS		
PS-3215	1.250	C	25	2.261	VLFLF	B		46075200000

NOTE: A. MOUNTS ON SHAFT
 B. TAPERED SPRING
 C. COMPLETE WITH COLLAR
 H. SPRING HOLDER NOT INCLUDED
 S. SLOTTED MATING RING

PUMP MANUFACTURERS' CROSS-REFERENCE

U.S. Seal Mfg. Part No.	Seal Size	Head	Mating Ring	Mating Ring Bore	Material Code	Notes	Pump Nameplate Data	Mfg. Part No.
GOULDS PUMPS (continued)								
PS-510	1.250	D	1	2.000	BCFJF			51010
PS-361	1.250	E	1	1.875	BCFJF		2" Fig. 3460	
PS-2128	1.250	E	3	1.875	BCFJF	S	3316-3405 Group S	
PS-2129	1.250	E	3	1.875	BCFKF			
PS-4628	1.250	E	27	2.354	BCFJF	316SS/ C/I	3316 Group S	MSC-1140
PS-3288	1.250	EB	3	1.750	VCFZF	316SS	3316-3405 Group S	
PS-177	1.375	C	1	2.000	BCFJF			
PS-7919	1.375	C	3	2.000	B/VLFLF			4335000000
PS-4194	1.375	D	1	2.000	VLFLF			A05616E000
PS-354	1.375	E	1	2.000	BCFJF		Fig. 3345, 3320	
PS-677	1.375	E	1	2.000	BCFKF			
PS-864	1.375	E	3	2.000	BCFJF	S	3196ST	
PS-865	1.375	E	3	2.000	BCFKF	S	3196ST	
PS-3901	1.375	E	3	2.000	VCFJF	316SS/ C/H/S	3196STX	A04710A01
PS-3205	1.375	E	3	2.000	VCFLF	316SS/ C/H/S	3196ST, 3196STX	
PS-4574	1.375	E	3	2.000	VCFZF	316SS/ C/S	3196ST	
PS-4277	1.375	E	3	2.000	VLFLF	C/S	3196STX	
PS-3732	1.375	EB	3	2.000	QCFJF	316SS/ C/S	3196ST	
PS-3086	1.375	G	3	2.000	QCFLF	316SS/S	Fig. 3355	
PS-4515	1.375	T	3	2.000	VCFJF	316SS/S	3196ST	
FA-9328	1.375	WT	—	—	TCF-F	316SS		904320001
PS-8135	1.375	X1T	3	2.000	QCFJF	316SS/S		
PS-705	1.437	E	3	2.062	BCFJF		Fig. 3405M, 3305M	707833143
FA-10167	1.500	E	—	—	BCF-F	I		916710001
PS-305	1.500	E	1	2.125	BCFJF		Fig. 3169, 3650, 3655, 3750 For Group M and K, 2-1/2" Fig. 3430	707831150
PS-374	1.500	E	1	2.125	BCFKF			
PS-395	1.500	E	3	2.125	BCFJF	S		776A9082
PS-4476	1.500	EB	3	2.125	VCFJF		3755M	
PS-8109	1.500	XB2	3 Special	2.125	VCFJF	316SS		
PS-4597	1.625	C	1	2.375	BCFJF			10K16
PS-238-EPR-SC	1.625	C	1	2.375	QCFLF			10K20
PS-238V-CMS	1.625	C	1	2.375	VCFJF			10K26
PS-238V-SC-CMS	1.625	C	1	2.375	VCFLF			10K45
PS-7806	1.625	C	1	2.375	VLFLF			10K65, 10K189
PS-818	1.625	C	3	2.375	BCFJF	S		4516200000 4698300000
PS-238V	1.625	C	3	2.375	VCFJF	S		4698400000
PS-238V-SC-SEAT	1.625	C	3	2.375	VCFLF	S		A05632E000
PS-544V-SC-SC	1.625	C	3	2.375	VLFLF	S		10K186
PS-7497	1.625	C	25	2.500	B/VCFJF			A05669E000R
PS-7497V	1.625	C	25	2.500	VCFJF			A05670E0005
PS-4653	1.625	EB	3	2.125	VCFJF	316SS/S	3405M & 3316M	
PS-8071	1.625	XB1T	3	2.062	VCFZF	316SS	3316, 3405 Group M	
FA-1660	1.750	C	—	—	BCF-F			92055 1175
PS-446	1.750	C	1	2.500	BCFJF		10K181-See PS-267 for Upper Seal	10K157, 9152091001
PS-446-SC-SC	1.750	C	1	2.500	BLFLF			10K31
PS-446V-CMS	1.750	C	1	2.500	VCFJF			9152091003
PS-3719	1.750	C	3	2.500	B/VLFZF	S		10K83
PS-3718	1.750	C	3	2.500	BCFJF	S		10K82
PS-3963	1.750	C	3	2.500	BLFZF	S		
PS-4884	1.750	C	3	2.500	VCFJF	316SS/S		4713400000
PS-4487	1.750	D	1	2.500	VLFLF	316SS		A05620E000
PS-1684	1.750	E	3	2.312	BCFJF		3316, 3405 Group M	
PS-4326	1.750	E	3	2.312	VCFJF	316SS/ C/S		

PUMP MANUFACTURERS' CROSS-REFERENCE

U.S. Seal Mfg. Part No.	Seal Size	Head	Mating Ring	Mating Ring Bore	Material Code	Notes	Pump Nameplate Data	Mfg. Part No.
GOULDS PUMPS (continued)								
PS-4149	1.750	E	3	2.312	VCFZF	C/S	3316, 3405 Group M	
PS-535	1.750	E	3	2.500	BCFJF	S	3196MT - 3735/36M	
PS-262	1.750	E	3	2.500	BCFKF	S		
PS-3726	1.750	E	3	2.500	B/VCFJF	C/H/I/S	3196MT	
PS-4112	1.750	E	3	2.500	QCFLF	316SS/ C/S	3196MT	
PS-3902	1.750	E	3	2.500	VCFJF	316SS/ C/H/S	3196MT	A04754A01 090161-1006
PS-4136	1.750	E	3	2.500	VCFLF	316SS/ C/S	3196MT	A04754A02
PS-7560	1.750	E	3	2.500	VCFZF	316SS/ C/S		
PS-1078	1.750	E	27	3.000	BCFJF		3316-3405M	
PS-4618	1.750	E	27	3.000	BCFJF	316SS/C	3316-3405M	
PS-4096	1.750	EB	3	2.500	VCFLF	316SS/ C/S		
PS-3123	1.750	T	3	2.500	VLFLF/ VCFLF	316SS/S		
PS-3754	1.750	V	3	2.750	BCFJF			43424000000
PS-8800	1.750	X1T	3	2.500	VCFLF	316SS/S	3196MT	A04757A02
PS-8063	1.750	X1T	3	2.500	VCFZF	316SS/ I/S	3196MTX	
PS-9014	1.750	WT	27	2.969	TCFJF	316SS	3196MT	
PS-4563	1.875	DB	3	2.375	VCFZF	316SS/S	3355 2.5x4-88	
PS-267	2.000	C	1	2.750	BCFJF		10K181-Upper Seal 10K182-Lower Seal See PS-446 for Lower Seal	9152101002
PS-2219	2.000	C	1	2.750	BZFZF			9152101001
PS-6218	2.000	C	1	2.750	VZFZF			9152101004
PS-3993	2.000	C	3	2.750	BCFJF	S		10K142, 764074200
PS-4239	2.000	C	3	2.750	BCFJF	H/S		10K84
PS-3721	2.000	C	3	2.750	BLFZF	S		10K85, 764079200
PS-267V-SC-SC	2.000	C	3	2.750	VLFLF	S		43434000000
PS-3066	2.000	D	1	2.750	VLFLF			A05622E000
PS-707	2.062	E	3	2.875	BCDKF		Fig. 3305, 3306, 3405, 3406 Group L	
PS-3897	2.125	E	3	2.875	VCFJF	316SS/ C/S	3196LT	A05166A01
PS-8562	2.125	X1T	3	2.875	VCFJF	316SS/S	3410	
PS-1679	2.250	C	1	3.125	BCFJF			9152111001
PS-848	2.250	E	3	3.125	BCDJF	S		
PS-849	2.250	E	3	3.125	BCDKF	S		
PS-3067	2.250	E	3	3.125	BCFZF	316SS	3405-3316 Group L	
PS-3951	2.250	E	27	3.906	VCFKF		3405L 10X12-14	
PS-3806	2.500	E	3	3.250	VCFJF	316SS/C		
PS-3206	2.500	E	3	3.250	VCFLF	316SS		
PS-4466	2.500	E	3	3.250	VZFLF	316SS/ C/S	3196XLTX	
PS-3059	2.750	E	3	3.500	QCFLF	316SS/ C/S	3410L	
PS-4583	2.750	E	3	3.500	VCFJF	316SS/C	3410L	
PS-4089	2.750	E	3	3.500	VCFLF	316SS/S	3410L	261C677SL
PS-4544	2.750	E	3	3.500	VLFLF	316SS/S	3410L	
PS-2153-CMS	3.000	C	1	3.875	BCFJF			9152141005
PS-4481	3.000	C	3	3.875	VZFZF			9152141006
PS-3050	3.250	EB	3	3.875	BCFJF		3410XL	
PS-8104	3.750	X	3	4.625	VCFJF	316SS/S		
PS-8060	4.375	X	3	5.375	BCFKF	316SS/S	Fig. 3415 Group M	

PUMP MANUFACTURERS' CROSS-REFERENCE

Value Guard Part No.	Seal Size	Head	Mating Ring	Material Code	Notes	Mfg. Part No.
GPM, INC. (Eliminator)						
VGM-8500	40 MM	VGMHD	3	VLFLF		30154-050
VGM-1969	50 MM	VGMHD	3	VLFLF		
VGM-2362	60 MM	VGMHD	3	VLFLF		
VGM-2756	70 MM	VGMHD	3	VLFLF		84-40404-050 84-60406-040 84-BCLH4-050
VGM-3250	3.250	VGMHD	3	VLFLF		



Type VGMHD

U.S. Seal Mfg. Part No.	Seal Size	Head	Mating Ring	Mating Ring Bore	Material Code	Notes	Pump Nameplate Data	Mfg. Part No.
GRAHAM ENGINEERING CORPORATION								
PS-1688	2.250	E	3	3.125	BCFJF	S		65100021
GRAINGER (See TEEL PUMP)								
GRISWOLD PUMP COMPANY								
PS-2122	1.250	C	1	1.875	BCFJF			GRI-10036903
PS-2123V-CMS	1.250	C	1	1.875	VCFKF			GRI-10036903CNV
PS-7805	1.250	C	1	1.875	VLFLF			GRI-10036903SSV
PS-3218	1.375	E	3	2.000	BCFJF	316SS/ C/H/S		GRI-22049-2-1
PS-3901	1.375	E	3	2.000	VCFJF	316SS/ C/H/S		GRI-22049-4-1
PS-3205	1.375	E	3	2.000	VCFLF	316SS/ C/H/S		GRI-22049-7-1
PS-4574	1.375	E	3	2.000	VCFZF	316SS/ C/S		GRI-22049-6-1
PS-9021	1.375	WT	3	2.000	T/VCFJF	316SS/S		GRI-22045-1-1
PS-9706	1.375	WT	3	2.000	T/VCFKF	316SS/S		GRI-22045-2-1
PS-758	1.500	C	1	2.125	BCFJF			
PS-446	1.750	C	1	2.500	BCFJF			GRI-10037002
PS-448V-CMS	1.750	C	1	2.500	VCFKF			GRI-10037002CNV
PS-4697	1.750	C	1	2.500	VCFLF			GRI-10037000CSV
PS-3271	1.750	C	1	2.500	VLFLF	S		GRI-10037000SSV
PS-6217	1.750	D	1	2.500	VZFLF	316SS		GRI-10037000STV
PS-3726	1.750	E	3	2.500	B/VCFJF	C/H/I/S		GRI-22163-1-1
PS-3902	1.750	E	3	2.500	VCFJF	316SS/ C/H/S		GRI-22163-4-1
PS-3637	1.750	E	3	2.500	VCFKF	C/S		GRI-22163-5-1
PS-4136	1.750	E	3	2.500	VCFLF	316SS/ C/S		GRI-22163-7-1
PS-7560	1.750	E	3	2.500	VCFZF	316SS/ C/S		GRI-22163-6-1
PS-9023	1.750	WT	3	2.500	T/VCFJF	316SS/S		GRI-22057-1-1
PS-9064	1.750	WT	3	2.500	T/VCFZF	316SS/S		GRI-22057-3-1
PS-4243	2.125	E	3	2.875	BCFKF	316SS/ C/S		GRI-22175-2-1
PS-3897	2.125	E	3	2.875	VCFJF	316SS/ C/S		GRI-22175-4-1
GRUNDFOS, INC.								
PS-4027	.625	A	1	1.250	QCFJF		JP5	465126
PS-200V-CMS	.625	A	1	1.250	VCFJF			98833732
PS-4424	.625	A	1	1.250	VCFJF		JP5	465133
PS-1618	.625	C	1	1.250	BCFJF	B		91868262, 14032695
PS-2149	.625	C	3	1.250	BCFKF	B		91868256
PS-22204	.625	C	3	1.250	VCFKF			9186214

PUMP MANUFACTURERS' CROSS-REFERENCE

U.S. Seal Mfg. Part No.	Seal Size	Head	Mating Ring	Mating Ring Bore	Material Code	Notes	Pump Nameplate Data	Mfg. Part No.
GRUNDFOS, INC. (continued)								
FA-64	.750	A	—	—	BCF-F			91867994
PS-22199	.750	C	1	1.375	BCFJF			47U09007
PS-22200	.750	C	1	1.375	VCFJF			47U09008
PS-768	.750	C	3	1.375	BCFKF			91868257
PS-112V	.750	C	3	1.375	VCFKF			91868215
PS-22205	1.000	C	1	1.625	BCFJF			91868624
PS-22203	1.000	C	3	1.625	BCFKF	S		91868258
PS-22212	1.125	C	3	1.750	BCFJF	S		96677295
FA-756	1.250	C	—	—	BCF-F			91868171
PS-185	1.250	C	1	1.875	BCFJF			91868317
PS-2122	1.250	C	1	1.875	BCFJF			91868265
PS-22209	1.250	C	1	1.875	VLFZF			99469724
PS-2122V	1.250	C	3	1.875	VCFJF	S		96748363
PS-1109V	1.250	C	3	1.875	VCFKF			91868217
FA-189	1.250	E	—	—	BCF-F			91868030
PS-361-P66	1.250	E	1	1.875	BCFJF	I		91867954
PS-1183-P66	1.250	E	3	1.875	BCFKF	I		91867962
PS-137V-P66	1.250	E	3	1.875	VCFKF	I		91867976
PS-22207	1.250	E	3	1.875	VLFZF	S		97792063
PS-3974	1.375	DB	1	1.875	BCFJF			91867955
PS-22220	1.375	DB	3	1.875	VCFZF	S		99489372
FA-1850	1.500	C	—	—	BCF-F			91868172
PS-22210	1.500	C	3	2.125	BCFLF			96748409
FA-305	1.500	E	—	—	BCF-F			91868014
FA-1660	1.750	C	—	—	BCF-F			14032145, 91868173
FA-10045	1.750	C	—	—	VCF-F			91868252
PS-2142	1.750	C	1	2.500	BCFJF			14032700, 91868269
PS-22213	1.750	C	1	2.500	VLFZF			97747791
PS-2151	1.750	C	3	2.500	BCFKF	S		91868260
PS-2151V	1.750	C	3	2.500	VCFKF	S		91868219
PS-2151V-TC-SEAT	1.750	C	3	2.500	VCFZF	S		91868230
PS-22202	1.750	D	3	2.500	VCDZF	S		96842887
FA-366	1.750	E	—	—	BCF-F			91868003, 91868293
PS-205	1.750	E	1	2.500	BCFJF			91867956
PS-22221	1.750	E	1	2.500	QZFZF			92582493
PS-205V-CMS-P66	1.750	E	1	2.500	VCFJF	I		96702875
PS-535	1.750	E	3	2.500	BCFJF	S		96909436
PS-262	1.750	E	3	2.500	BCFKF	S		91867963
PS-22218	1.750	E	3	2.500	XCFLF	316SS/S		99404291
PS-22217	1.750	EB	3	2.375	QZFZF	S		99416109
PS-449	1.750	K	1	2.500	BCFJF			91868291
PS-674	1.750	T	1	2.500	BCFJF			91868024
PS-22206	1.875	DB	1	2.500	BCDJF			91868268
FA-2000	2.000	C	—	—	BCF-F			91868174
PS-477-P66	2.000	E	3	2.750	BCFKF	I/S		91868207
FA-2250	2.205	C	—	—	BCF-F			91686175
PS-3537	2.250	C	1	3.125	BCFJF			91868272
PS-3041	2.250	C	3	3.125	BCFKF			91868261
PS-22222	2.250	E	1	3.125	BZFZF			99531111
PS-22215	2.250	E	3	3.125	QCFJF	S		99419811
PS-22216	2.250	EB	3	3.000	QCFJF	I		99370877
PS-22219	2.250	EB	3	3.000	QZFZF	S		99418877
PS-22211	2.375	C	3	3.250	BCFZF	S		96697227
PS-22201	2.375	EB	1	3.125	BCFJF			91868284
PS-2711	2.375	R	3	3.250	BCFJF	S		91868448
PS-2708	2.750	C	3	3.500	VCFLF	S		96697120
PS-22208	2.750	E	3	3.500	QCFJF	I/S		99331701
PS-22214	3.000	C	1	3.875	BCFJF			96702878
FA-10144	3.250	EB	—	—	BCF-F			91868313
PS-4236	3.500	R	3	4.375	BCFJF			91868286
PS-22223	4.000	E	3	4.875	BCFJF	316SS		96771941

NOTE: I. ABRASION RESISTANT CARBON (P66)
S. SLOTTED MATING RING

PUMP MANUFACTURERS' CROSS-REFERENCE

Value Guard Part No.	Seal Size	Head	Material Code	Pump Nameplate Data	Mfg. Part No.
GRUNDFOS, INC.					
BELLOWS COMPONENT SEALS					
VGMG-1300	12 MM	VGM706B	QLFLF	CR2, CRN2(S), CR4, CRN4(S), CR8	405096
VGMG-1301	12 MM	VGM706B	VLFLF	CR2, CRN2(S), CR4, CRN4(S), CR8	405347
VGMG-1302	12 MM	VGM706B	VZFZF	CR2, CRN2(S), CR4, CRN4(S), CR8	405347TC
VGMG-1303	16 MM	VGM706B	QLFLF	CR8, CRN8(S), CR16, CRN16(S)	425763
VGMG-1304	16 MM	VGM706B	VLFLF	CR8, CRN8(S), CR16, CRN16(S)	425762
VGMG-1305	16 MM	VGM706B	VZFZF	CR8, CRN8(S), CR16, CRN16(S)	425762TC
O-RING COMPONENT SEALS					
VGMG-1516*	12 MM	VGM706D	VCFLF	SPK 1, 2, 4 & 8	3950008
VGMG-1515	12 MM	VGM706D	VLFLF		
VGMG-1400	12 MM	VGM706E	VZFZF	Used in CNP-CDL Pumps	
VGMG-1401	16 MM	VGM706E	VZFZF	Used in CNP-CDL Pumps	

* Allows for easy installation where the impeller spline shaft can not be removed.



**Grundfos Type B
Type VGM706B**



Type VGM706D



Type VGM706E

Value Guard Part No.	Seal Size	Head	Material Code	Pump Nameplate Data	Mfg. Part No.
GRUNDFOS, INC.					
CARTRIDGE STYLE - Threaded Retainer					
Pump Models CR, CR8, CRI, CRN3, CRN5, CRNE1, CRNE3-23HS					
VGMG-1500	12 MM	VGM706C	QCFZF		96455082
VGMG-1518	12 MM	VGM706C	QLFLF		96455086
VGMG-1501	12 MM	VGM706C	QZFZF		96455084
VGMG-1521	12 MM	VGM706C	VLFLF		96455089
VGMG-1502	12 MM	VGM706C	VCFZF		96455083
VGMG-1503	12 MM	VGM706C	VLFLF		96455087
VGMG-1504	12 MM	VGM706C	VZFZF		96455085
Pump Models CR, CRI, CRN10, CRN15, CRN20					
VGMG-1505	16 MM	VGM706C	QCFZF		96511836
VGMG-1519	16 MM	VGM706C	QLFLF		96484071, 96511844
VGMG-1506	16 MM	VGM706C	QZFZF		96511840
VGMG-1507	16 MM	VGM706C	VCFZF		96511837
VGMG-1508	16 MM	VGM706C	VLFLF		96511845
VGMG-1509	16 MM	VGM706C	VZFZF		96511841
CARTRIDGE STYLE - Clamped Retainer					
Pump Models CR, CRN32, CRN45, CRN64, CRN90					
VGMG-1510	22 MM	VGM706C	QCFZF		96416584
VGMG-1520	22 MM	VGM706C	QLFLF		96525458
VGMG-1511	22 MM	VGM706C	QZFZF		96433365
VGMG-1512	22 MM	VGM706C	VCFZF		96525459
VGMG-1513	22 MM	VGM706C	VLFLF		96525490
VGMG-1514	22 MM	VGM706C	VZFZF		96436728

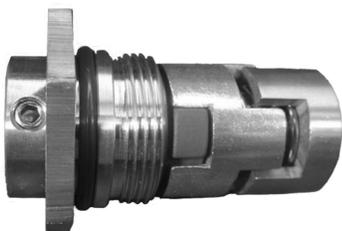

**Grundfos Type H
Type VGM706C**



**Grundfos Type E
Type VGM706C**

PUMP MANUFACTURERS' CROSS-REFERENCE

U.S. Seal Mfg. Part No.	Seal Size	Head	Mating Ring	Mating Ring Bore	Material Code	Notes	Pump Nameplate Data	Mfg. Part No.
GUSHER PUMPS								
PS-164	.500	B	9	—	BMFKF	A		
PS-1002	.500	C	1	1.000	BCFJF			84076-3
PS-957	.625	A	1	1.187	BCFJF			84081
PS-701V	.625	A	1	1.187	VCFKF			84090
PS-359	.625	C	1	1.250	BCFJF			84000-2, 84000-30
PS-1079	.625	C	1	1.250	NCFJF			
PS-1080	.625	C	1	1.250	NCFKF			
PS-359-EPR-CMS	.625	C	1	1.250	QCFJF			84000-39
PS-3265	.625	C	1	1.250	QLFLF			84000-36
PS-359V-CMS	.625	C	1	1.250	VCFJF			84000-24
PS-359V-SC-CMS	.625	C	1	1.250	VCFLF			84000-38
PS-633V-TC-SC	.625	C	1	1.250	VZFLF	S		84000-29
PS-441	.750	B	9	—	BMFKF	A		84082
PS-358V-TC-TC	.750	C	1	1.375	VZFZF			84064-6
PS-309	.875	C	1	1.500	BCFJF			84079-2
PS-3941	.875	C	1	1.500	VLFLF			84079-9
PS-2026	.875	D	3	1.500	B/VCFJF			84138-1
PS-370	1.000	A	1	1.625	BCFKF			84089
PS-235	1.000	C	1	1.625	BCFJF			84001-2, 84001-12
PS-235V-CMS	1.000	C	1	1.625	VCFJF			84001-10
PS-235V-SC-SC	1.000	C	1	1.625	VLFLF			84001-14
PS-2216V-CMS	1.000	C	1	1.625	VZFZF			
PS-185	1.250	C	1	1.875	BCFJF			84217-4
PS-2122	1.250	C	1	1.875	BCFJF			84002-31
PS-2123	1.250	C	1	1.875	BCFKF			84002-17
PS-3146	1.250	C	1	1.875	BZFLF			84002-53
PS-1081	1.250	C	1	1.875	NCFJF			
PS-1083	1.250	C	1	1.875	NCFJF			
PS-1082	1.250	C	1	1.875	NCFKF			
PS-1084	1.250	C	1	1.875	NCFKF			
PS-2215	1.250	C	1	1.875	QCFJF	I		84002-3, 84002-18 84002-33
PS-4053	1.250	C	1	1.875	QLFLF			84002-57
PS-185V-CMS	1.250	C	1	1.875	VCFJF			84217-3
PS-2123V-CMS	1.250	C	1	1.875	VCFKF			84002-12
PS-7983V	1.250	C	1	1.875	VCFZF			84002-34
PS-185V-SC-SC	1.250	C	1	1.875	VLFLF			84217-1
PS-7805	1.250	C	1	1.875	VLFLF			84002-22, 84002-50
PS-3119	1.250	C	1	1.875	VZFLF			84002-41, 84002-58 84002-59, 84006-59
PS-361	1.250	E	1	1.875	BCFJF			84003-14
PS-210V-CMS	1.375	C	1	2.000	VCFKF			84105-7
PS-177V-SC-SEAT	1.375	C	1	2.000	VCFLF			84144-10
PS-177V-SC-SC	1.375	C	1	2.000	VLFLF			84105-18
PS-210V-TC-SC	1.375	C	3	2.000	VZFLF	S		84105-5
PS-4574	1.375	E	3	2.000	VCFZF	316SS/C/S		84140-1, 84140-3
PS-3117	1.375	K	1	2.000	VCFJF			84144-2
PS-758	1.500	C	1	2.125	BCFJF			84109-1
PS-758V-CMS	1.500	C	1	2.125	VCFJF			84109-3
PS-758V-SC-SC	1.500	C	1	2.125	VLFLF			84109-2
FA-1620	1.625	C	—	—	BCF-F			
PS-238	1.625	C	1	2.375	BCFJF			84004-28
PS-4525	1.625	C	1	2.375	BCFJF	316SS		84004-59
PS-239	1.625	C	1	2.375	BCFKF			84004-18
PS-4389	1.625	C	1	2.375	BCFLF			84004-51
PS-3145	1.625	C	1	2.375	BZFLF			84004-40
PS-3664	1.625	C	1	2.375	BZFZF			84004-30
PS-238-EPR	1.625	C	1	2.375	QCFJF			84004-34
PS-238-EPR-SC	1.625	C	1	2.375	QCFLF			84004-52
PS-7902	1.625	C	1	2.375	VCFJF			
PS-238V-CMS	1.625	C	1	2.375	VCFJF			84004-26
PS-239V-CMS	1.625	C	1	2.375	VCFKF			84004-7
PS-238V-SC-CMS	1.625	C	1	2.375	VCFLF			84004-54
PS-238V-P66-TC	1.625	C	1	2.375	VCFZF	I		84004-20
PS-7806	1.625	C	1	2.375	VLFLF			84004-23, 84004-39
PS-3294	1.625	C	1	2.375	VLFLF	316SS		84004-61
PS-238V-TC-SC-CMS	1.625	C	1	2.375	VZFLF			84004-42, 84004-49 84004-55

PUMP MANUFACTURERS' CROSS-REFERENCE

U.S. Seal Mfg. Part No.	Seal Size	Head	Mating Ring	Mating Ring Bore	Material Code	Notes	Pump Nameplate Data	Mfg. Part No.
GUSHER PUMPS (continued)								
PS-2749	1.625	C	1	2.375	VZFLF	316SS		84004-48
PS-3144	1.625	C	1	2.375	VZFZF			84004-35
PS-2057	1.625	E	1	2.375	BCFJF			84005-2, 84005-15
PS-2058V-TC-SEAT	1.625	E	1	2.375	VCFZF			84005-28
PS-1699V	1.625	E	3	2.375	VCFKF	S		84005-20
PS-3113	1.625	E	3	2.375	XZFLF	316SS/S		84005-29
PS-3111	1.625	K	1	2.375	VLFLF			84056-22
PS-3114	1.750	C	1	2.500	BZFZF	C		84006-8, 84006-13
PS-3118	1.750	C	1	2.500	VCFJF	C		84006-11
PS-22106	1.750	C	1	2.500	VLFLF	C		84006-36
PS-4461	1.750	C	1	2.500	VZFLF			84006-17, 84006-35
PS-3114V	1.750	C	1	2.500	VZFZF	C		84006-24
PS-7561	1.750	E	3	2.500	VCFZF	C/I/S		84007-15
PS-7901	1.750	EB	1	2.375	BCFJF	316SS		
PS-4539	1.750	K	1	2.500	VLFLF	316SS		84058-19
PS-3123	1.750	T	3	2.500	VLFLF/ VCFLF	316SS/S		84065-3
PS-9106	1.750	W	2	2.500	TCFJF	316SS		84010-01
PS-267	2.000	C	1	2.750	BCFJF			84176-1
PS-267V-CMS	2.000	C	1	2.750	VCFJF			84176-2
PS-6224	2.000	C	1	2.750	VLFLF			84176-4
PS-22107	2.000	C	1	2.750	VZFLF			84176-6
PS-1613	2.500	K	3	3.375	BCFJF	S		84059-5
HAIGHT PUMP (Division of BAKER MFG. COMPANY, LLC.)								
PS-825	1.750	D	3	2.500	BCDKF	S		AP13.518X
PS-237V	1.750	D	3	2.500	VCDJF	S		AP13.518Y
HALE PRODUCTS, INC.								
PS-851	.750	A	1	1.375	BCFJF			296-5040-00
PS-201	.750	A	1	1.375	BMFJF			292-5040-00-3
PS-360	1.000	A	1	1.625	BCFJF			296-5010-00 296-5011-00-0
PS-235	1.000	C	1	1.625	BCFJF		20FD 106434	25D-G444, 1001-02-20-00
PS-1048	1.000	C	1	1.625	BCFJF	H		296-5050-00-0
PS-1049	1.000	C	3	1.625	BCFJF	H		
PS-548	1.000	C	3	1.625	BCFJF	S		296-5060-06-0
PS-356	1.125	C	1	1.750	BCFJF			296-5220-00
PS-177	1.375	C	1	2.000	BCFJF			296-5250-99
PS-495	1.375	K	1	2.000	BCFJF			296-5070-00
PS-758	1.500	C	1	2.125	BCFJF			296-5021-03
PS-347	1.500	C	1	2.125	BCFJF	B/H		
PS-659	1.500	C	1	2.125	BCFKF			296-5021-01
PS-378	1.500	C	1	2.125	BCFKF	B/H		296-5020-06
PS-2209	1.500	C	1	2.125	BZFZF			296-5021-06-0
PS-446-SC-SEAT	1.750	C	1	2.500	BCFLF			296-5312-00-0
PS-267	2.000	C	1	2.750	BCFJF			296-5210-00
HALL SCOTT								
PS-200	.625	A	1	1.250	BMFJF			
PS-750	.750	D	1	1.375	BCDJF			
HAMMONDS TECHNICAL								
PS-359V	.625	C	3	1.250	VCFJF			141006

Value Guard Part No.	Seal Size	Head	Material Code	Mfg. Part No.
HANJIN PUMP COMPANY, LTD				
Series 2921 / 2924 / 2926				
VGM-2921	20 MM	VGM562	VLFLF / VCFJF	 <p style="text-align: center;">Type VGM562</p>
VGM-2922	25 MM	VGM562	VLFLF / VCFJF	
VGM-2923	30 MM	VGM562	VLFLF / VCFJF	
VGM-2924	35 MM	VGM562	VLFLF / VCFJF	
VGM-2925	40 MM	VGM562	VLFLF / VCFJF	
VGM-2926	45 MM	VGM562	VLFLF / VCFJF	
				SP-1026 HTV-3-5.5-18 HTV-4-4.5-18 HTV-4-11-48 HTV-4-15-48 SP-3026 SP-4026 SP-5026

PUMP MANUFACTURERS' CROSS-REFERENCE

U.S. Seal Mfg. Part No.	Seal Size	Head	Mating Ring	Mating Ring Bore	Material Code	Notes	Pump Nameplate Data	Mfg. Part No.
HARTFORD COMPRESSORS, INC.								
PS-9703	2.000	WB	Special	2.500	T/NCFKF	316SS		SEL 24A
PS-9710	2.500	WB	Special	3.125	T/NCFKF	316SS		SEL 22A
HAYWARD GORDON								
PS-436-TC-TC	1.750	C	3	2.500	BZFFZ	S		54099158
PS-2114	1.875	C	3	2.625	BCFJF	S		5403016
PS-477-TC-TC	2.000	E	3	2.750	BZFFZ	S		54099121
PS-4564	2.750	T	3	3.750	BZFFZ	316SS		540499174
HAYWARD INDUSTRIES, INC.								
PS-516	.625	A	1	1.250	BCFJF			SP1250XZ2C
PS-200	.625	A	1	1.250	BMFJF		Cast Iron	SPX1250XZ2C
PS-2131	.625	A	31	—	BMFJF	G	Power-Flo LX, Power-Flo®Matrix Power-Flo II®, Turbo Flo®	SPX1500KA
PS-3960	.625	G	1	1.250	BCFJF			SPX1250XZ2, SPX2700SA
PS-3867	.625	G	1	1.250	VCFJF			SPX2700XAV
PS-3890	.625	G	1	1.381	BCFJF	316SS	EcoStar®, NorthStar, Tri-Star	SPX3200SA, SPX4000 SPX4000SA, SPX4000SA2
PS-2808	.625	G	1	1.381	QLFLF	316SS		SPX4000SAFC
PS-4280	.625	G	1	1.381	VCFJF			SP-4000SAV
PS-851	.750	A	1	1.375	BCFJF			SP1600Z3
PS-201	.750	A	1	1.375	BMFJF		Max-Flo®, Super Pump®, Super Pump II®	SPX1600Z2, SPX1600Z2G
PS-201V-CMS	.750	A	1	1.375	VCFJF			SPX1600Z2GV, SP1600VIT
PS-370	1.000	A	1	1.625	BCFKF			
HOBART CORPORATION - (Dishwashers / Disposals)								
PS-631	.500	C	1	1.000	BCFJF	N		R-23682
PS-663	.500	Q	1	1.000	BMFJF			C115710
PS-6313	.500	Q	1	1.019	BCFJF			
PS-1085V	.625	C	1	1.250	B/VCFJF	B		A104329, 00-114696
PS-3985	.750	B	1	1.375	BCFJF	316SS		C44A
PS-4520	.750	B	3	1.375	VCFJF			00-274227-00006
PS-235	1.000	C	1	1.625	BCFJF			R-79205
PS-539	1.000	C	1	1.625	BCFJF	H		R-87809
PS-754V	1.000	E	3	1.625	VCFJF	S		A104330
PS-6318	1.125	Q	9	1.578	VMFAF			00-117071
PS-3854	1.375	Q	9	2.000	BMPAP			C-114144
PS-6317	1.375	Q	9	2.000	VMPSP			00-114144
PS-4041	2.250	Q	1	3.375	VMPSP			00-117072

Value Guard Part No.	Seal Size	Head	Mating Ring	Mating Ring Bore	Material Code	Notes	Pump Nameplate Data	Mfg. Part No.
HOFFMAN PUMPS - Replacement Seal Kits								
VGK-1087	.625	A	1	1.250	BMFJF			180013
VGK-1088	.625	C	1	1.250	BCFJF			180014
VGK-1085	.750	C	1	1.375	BCFJF			180010
VGK-1086	1.000	C	1	1.625	BCFJF			180011
VGK-1089	1.375	C	1	2.000	BCFJF			180015

- Kits for HOFFMAN PUMPS include gaskets and mechanical seal.
- HOFFMAN PUMPS is not affiliated with U.S. SEAL MFG.
- Products supplied are manufactured or purchased by U.S. SEAL MFG. from sources other than the company listed.



VGK-1087

NOTE: B. TAPERED SPRING
G. MOUNTS IN PLASTIC
H. SPRING HOLDER NOT INCLUDED
N. NON-STANDARD SPRING HOLDER
S. SLOTTED MATING RING

PUMP MANUFACTURERS' CROSS-REFERENCE

U.S. Seal Mfg. Part No.	Seal Size	Head	Mating Ring	Mating Ring Bore	Material Code	Notes	Pump Nameplate Data	Mfg. Part No.
HOLLAND PUMP MFG.								
PS-758	1.500	C	1	2.125	BCFJF			
PS-2209	1.500	C	1	2.125	BZFZF			
PS-237	1.750	D	1	2.500	BCDJF			
PS-2060-TC-TC	1.750	D	1	2.500	BZFZF			6TP
PS-340	1.875	C	1	2.625	BCFJF			
PS-340-TC-TC	1.875	C	1	2.625	BZFZF			8TP
PS-874	2.250	D	1	3.125	BCDJF			
PS-22002	2.500	D	3	3.250	BCFJF			
PS-836	2.750	C	3	3.500	BCFJF	S		

HOMART-SEARS								
PS-162	.500	A	1	1.000	BMFJF			259-043, W6476
PS-100	.625	A	1	1.187	BMFJF			42G2377W
PS-508	.625	D	1	1.250	BCDJF			759-31

HOMELITE CORPORATION								
PS-200	.625	A	1	1.250	BMFJF			62729
PS-711	.625	A	3	1.187	BMFJF			A-62861-2
PS-201	.750	A	1	1.375	BMFJF			A-75911
PS-601	.750	B	1	1.375	BMFJF			43271
PS-4056	.750	B	1	1.375	QCFJF	AP215, AP220		43303-A
PS-601V-CMS	.750	B	1	1.375	VCFJF	AP302, AP502		48299
PS-360	1.000	A	1	1.625	BCFJF			A-62403
PS-1086	1.000	A	3	2.000	BCFJF			A-62713, A-62713-1
PS-235	1.000	C	1	1.625	BCFJF			47046
PS-466	1.250	C	1	2.000	BCFJF			46150

Value Guard Part No.	Seal Size	Head	Mating Ring	Mating Ring Bore	Material Code	Notes	Pump Nameplate Data	Mfg. Part No.
HONDA TRASH PUMP								
VGM-2964	20 MM	VGM-BV	1	35MM	BCFJF		WT20X, WT30X	
VGM-8502	20 MM	VGM-BV	1	35MM	VLFLF		WT20X, WT30X	78130-YB4-901
VGM-2965	30 MM	VGM-BV	1	48MM	BCFJF		WT40X	
VGM-8501	30 MM	VGM-BV	1	48MM	VLFLF		WT40X	

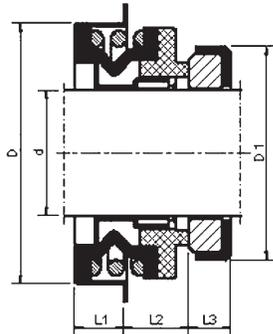

d	D	D1	L1	L2	L3
20	40	35	9.5	6.0	5
30	52	48	10.0	9.5	8



Type VGM-BV

U.S. Seal Mfg. Part No.	Seal Size	Head	Mating Ring	Mating Ring Bore	Material Code	Notes	Pump Nameplate Data	Mfg. Part No.
HOYT CORPORATION								
PS-6301	2.250	Q	3	3.000	NMPAP			28-488
HYDRAMATIC PUMP COMPANY (See PENTAIR, INC. for Additional Part Numbers)								
PS-1621	.500	Q	9	—	BMFJF	A		54840001
FA-26	.625	A	—	—	BMF-F			000830021, 000830071
PS-200	.625	A	1	1.250	BMFJF			00083000, 00083001 14525A010
PS-200V-CMS	.625	A	1	1.250	VCFJF			830101
PS-447	.625	B	8	—	BCFJF	A		75480001
PS-359	.625	C	1	1.250	BCFJF			015560001
PS-6216	.625	C	1	1.250	VZFZF			113970011

PUMP MANUFACTURERS' CROSS-REFERENCE

U.S. Seal Mfg. Part No.	Seal Size	Head	Mating Ring	Mating Ring Bore	Material Code	Notes	Pump Nameplate Data	Mfg. Part No.
HYDROMATIC PUMP COMPANY (See PENTAIR, INC. for Additional Part Numbers) (continued)								
PS-851	.750	A	1	1.375	BCFJF			170480001
PS-201V-CMS	.750	A	1	1.375	VCFJF			170480011
PS-1622	.750	B	9	—	BMFJF	A		049170001
PS-358	.750	C	1	1.375	BCFJF			1000001
PS-703	.875	D	1	1.500	BCDJF			11716A011
PS-235	1.000	C	1	1.625	BCFJF		HPLX200	3000001
PS-235-SC-SC	1.000	C	1	1.625	BLFLF			003000041
PS-2216	1.000	C	1	1.625	BZFFZ			006960001
PS-235V-CMS	1.000	C	1	1.625	VCFJF			003000011
PS-235V-SC-SC	1.000	C	1	1.625	VLFLF			003000051
PS-2216V-CMS	1.000	C	1	1.625	VZFZF			003000031
PS-185	1.250	C	1	1.875	BCFJF			049160001
PS-185-SC-SC	1.250	C	1	1.875	BLFLF			049160031
PS-2208	1.250	C	1	1.875	BZFFZ			049160011
PS-185E-SC-CMS	1.250	C	1	1.875	QCFLF			049160051
PS-185V-CMS	1.250	C	1	1.875	VCFJF			049160021
PS-185V-TC-SC	1.250	C	1	1.875	VZFLF			049160061
PS-185V-TC-TC	1.250	C	1	1.875	VZFZF			049160041
PS-347	1.500	C	1	2.125	BCFJF	B/H		081000005
PS-758	1.500	C	1	2.125	BCFJF			009200011
PS-758-SC-SC	1.500	C	1	2.125	BLFLF			009200131
PS-758-SC-TC-CMS	1.500	C	1	2.125	BLFZF			009200111
PS-2209	1.500	C	1	2.125	BZFFZ			009200041
PS-7409	1.500	C	1	2.125	VCFJF	316SS		009200031, 009200051 009200071
PS-659V-TC-VS-TC	1.500	C	1	2.125	VZFZF			009200091, 009200141
PS-446	1.750	C	1	2.500	BCFJF			110490011
PS-446-TC-TC	1.750	C	1	2.500	BZFFZ			110490021
PS-4410	1.750	C	1	2.500	BZFFZ			21181A015
PS-340	1.875	C	1	2.625	BCFJF			148590001
PS-340-TC-SC	1.875	C	1	2.625	BZFLF			148590031
PS-340-TC-TC	1.875	C	1	2.625	BZFFZ			148590011
PS-267	2.000	C	1	2.750	BCFJF			019570001
PS-267-SC-SC-CMS	2.000	C	1	2.750	BLFLF			019570051
PS-2219	2.000	C	1	2.750	BZFFZ			019570021
PS-267V-CMS	2.000	C	1	2.750	VCFJF			019570011
PS-6218	2.000	C	1	2.750	VZFZF			019570041
PS-1087	2.250	C	1	3.125	BCFJF			080730001
PS-3182	2.250	C	1	3.125	BLFLF			080730061
PS-7064	2.250	C	1	3.125	BZFFZ			080730011
PS-1679V-CMS	2.250	C	1	3.125	VCFJF			080730031
PS-4800	2.250	D	1	3.125	BCFLF	316SS		080732251
PS-3530	2.250	E	3	3.125	B/VCFZF	S		1100148SC2
PS-4801	2.500	G	3	3.375	BCFLF	316/S		27994A001
PS-4647	2.875	D	3	3.750	VCFLF	316SS		27996A000
PS-1088	3.000	C	3	3.875	BCFJF	B/S		037180001
PS-4352	3.000	C	3	3.875	BLFZF	B/S	60 MPH & 60 MMPH	037180041
PS-761	3.000	D	3	3.875	BCDJF	S		434210011
PS-4646	3.000	G	3	3.875	VCFLF	316SS/S		03718001
HYPRO CORPORATION (See PENTAIR, INC. for Additional Part Numbers)								
PS-2807	12MM	G	1	23MM	BCFJF	316SS		23459-SHW
FA-112	.500	C	—	—	BCF-F			10522C-SHU
PS-22088	.500	G	3	1.000	BCFJF			24604-SHU
PS-3001	.500	G	3	1.000	VCFJF			24608-SHU
PS-3002	.500	G	3	1.000	VCFJF	316SS		24766-SHU
PS-22089	.500	W	2	1.000	TCFJF	316SS		24612-SHU
PS-516	.625	A	1	1.250	BCFJF		9501-3	2120-0008
PS-200V-CMS	.625	A	1	1.250	VCFJF		9203, 9401C, 9300CHM	2120-0009
PS-3741	.625	B	1	1.250	VLFLF			24466-SHU
PS-3159	.625	B	8	—	BCFJF	A		12314-SHU
PS-3667	.625	B	9	—	BLFLF	A		24054-SHW

NOTE: A. MOUNTS ON SHAFT
B. TAPERED SPRING
H. SPRING HOLDER NOT INCLUDED
S. SLOTTED MATING RING

PUMP MANUFACTURERS' CROSS-REFERENCE

U.S. Seal Mfg. Part No.	Seal Size	Head	Mating Ring	Mating Ring Bore	Material Code	Notes	Pump Nameplate Data	Mfg. Part No.
HYPRO CORPORATION (See PENTAIR, INC. for Additional Part Numbers) (continued)								
PS-22097	.625	C	3	1.250	NCFLF	316SS		2120-0059
PS-2743	.625	C	3	1.250	Special	I		22850-SHU
PS-4442	.625	C	3	1.250	VCFKF			2120-0003
PS-3204	.625	G	1	1.250	BCFJF			24605-SHU
PS-3006	.625	G	1	1.250	BCFJF	316SS		24275-SHU
PS-22098	.625	G	1	1.250	QCFJF	316SS		25258-SHU
PS-22096	.625	G	1	1.250	QLFLF	316SS		2120-0064
PS-4220	.625	G	1	1.250	VCFJF			24609-SHU
PS-3200	.625	G	1	1.250	VCFJF	316SS		24276-SHU
PS-3005	.625	G	25	1.250	VLFLF	316SS		2120-0039
PS-22095	.625	W	2	1.250	TCFJF	316SS		24613-SHU
PS-851	.750	A	1	1.375	BCFJF			2120-0010
PS-201V-CMS	.750	A	1	1.375	VCFJF		9000 Series	2120-0011
PS-22099	.750	B	1	1.375	VCFJF			2120-0036
PS-2718	.750	B	8	1.250	BMFJF			15955, 15955-SHW
PS-22100	.750	G	2	1.375	VLFLF	316SS		2120-0040
PS-2723	20MM	B	1 Special	33.88MM	BLFLF	Unitized		25080-SHW
PS-22103	20MM	G	1	35MM	BCFJF	316SS		24606-SHU
PS-4273	20MM	G	1	35MM	VCFJF	316SS		24610-SHU, 24768A-SHU
PS-3009	.875	G	1	1.500	BCFJF	316SS		24458-SHU
PS-22104	25MM	G	1	40MM	BCFJF	316SS/I		23512-SHW
PS-2736	25MM	G	1	40MM	BLFLF	316SS		24511-SHW
PS-1909	25MM	G	1	1.625	VLFLF	316SS		23837, 23837-SHW
PS-360V-CMS	1.000	A	1	1.625	VCFJF			2120-0034
PS-22105	1.000	G	1	1.625	BCFJF			24607-SHU
PS-3295	1.000	G	1	1.625	VCFJF			24611-SHU
PS-22101	1.000	G	3	1.625	B/VLFLF	316SS/S		2120-0053
PS-4425	1.125	G	1	1.750	BLFLF	316SS		23906-SHW
PS-3015	1.375	G	25	2.000	VLFLF	316SS		2120-0043
PS-22102	1.375	K	3	2.000	VCFLF			2120-0061
ICEE™								
PS-359	.625	C	1	1.250	BCFJF			401G
PS-6234	.625	C	1	1.250	BCFJF			0-ID1339
IMO INDUSTRIES, INC.								
PS-2138	.500	C	Special	1.360	BCFGF			PP046JCE
PS-3729	.500	X Special	3	1.000	BCFKF	S		PP046JRF
PS-7727	.500	X Special	3	1.000	VCFGF	S		PP046JRH
PS-4588	.500	X Special	3	1.000	VCFLF	S		
PS-22159	.625	C	28	2.500	BCFKF			PP046JCG
PS-4313	.625	C	3 Special	1.500	VCFGF			PP046JC/C
PS-22160	.625	G	3	1.250	VCFKF	316SS/S		PP046KMJ-CR
PS-752	.750	D	1	1.375	BCDKF			PP046DP
PS-687	.875	C	1	1.500	BCFKF			PP046H
PS-7991	25MM	D	2	1.625	BCPGP			PP046DF
PS-499	1.000	C	3	1.625	BCFKF	S		PP046JKN
PS-3824	1.000	C	28	2.438	BCFKF			PP046JM
PS-1034V	1.000	C	28	2.438	VCFKF			PP046JCH
PS-4579	1.000	DB	3	1.500	NCPLF			PP046KDA
PS-4255	1.000	DB	3	1.500	VCZFS	S		
PS-22168	1.000	G	3	1.625	VCFKF	316SS/S		PP046KML
PS-8091	1.000	X	3	1.625	VCFRF	316SS/S		PP046JZ/CR
PS-8705	1.000	XB1	3	1.500	VCFLF	316SS/S		PP046KLY
PS-254	1.125	D	3	1.750	BCFKF	S		PP046JGF
PS-1044	1.187	C	28	2.834	BCFKF			PP046JL
PS-1044V	1.187	C	28	2.834	VCFKF			PP046JHG
PS-4152	1.250	C	3	1.875	BCFGF	S		PP046JLC/C
PS-1036	1.250	C	28	2.835	BCFKF			PP046JH, PP046JH/C
PS-1036V	1.250	C	28	2.835	VCFKF			PP046JN, PP046JN/C
PS-4431	1.250	D	3	1.875	VLFLF			
PS-22161	1.250	X	3	1.875	VCFLF	316SS/S		PP046JSK/CR/PP046JSK
PS-8073	1.250	X	28	2.832	VCFKF	316SS		PP046JBS/PP046JBS/CR
PS-22162	1.375	X	3	2.000	VCFLF	316SS/S		PP046KBS

PUMP MANUFACTURERS' CROSS-REFERENCE

U.S. Seal Mfg. Part No.	Seal Size	Head	Mating Ring	Mating Ring Bore	Material Code	Notes	Pump Nameplate Data	Mfg. Part No.
IMO INDUSTRIES, INC. (continued)								
PS-22163	1.375	G	3	2.000	VCFKF	316SS/S		PP046KMS/CR
PS-22164	1.375	XB5	3	2.000	VCFKF	316SS/S		PP046KHF
PS-3979	1.500	C	Special	2.740	BCFKF			PP046JAH
PS-371	1.500	D	1	2.125	BCFKF			PP046DAA
PS-238V-SC-SEAT	1.625	C	3	2.375	VCFLF	S		PP046JHL
PS-1035	1.625	C	28	3.544	BCFKF			PP046JK
PS-1039	1.625	C	28	3.544	VCFKF			PP046JR, PP046JRC
PS-22198	1.625	X	3	2.375	VCFLF	316SS/S		PP046JHP/CR
PS-436-SC-SEAT	1.750	C	3	2.500	BCFLF	S		PP046JDT/CR
PS-1038	1.750	C	28	3.544	BCFKF			PP046JG
PS-8058	1.750	X	3	2.500	VCFLF	316SS/S		PP046JWF
PS-8133	1.750	X	3	2.500	VZFLF	316SS/S		
PS-22165	1.875	XB1	3	2.375	VCFLF	316SS/S		PP046KEZ
PS-1037	2.000	C	28	4.330	BCFKF			PP046JJ/C
PS-1037V	2.000	C	28	4.330	VCFKF			PP046JP/C
PS-462	2.000	D	1	2.750	BCDKF			PP046BP
PS-8134	2.000	X	3	2.750	VZFLF	316SS		
PS-1676	2.250	C	3	3.125	BCFKF	S		PP046JCD
PS-3051	2.375	C	3	3.250	BCFLF	S		PP046JWH
PS-1677	2.375	C	28	5.118	BCFKF			PP046FBY/C/CR
PS-1677V	2.375	C	28	5.118	VCFKF			PP046JC/CR
PS-8003	2.375	X	3	3.250	VCFLF	316SS/S		PP046JTT
PS-8560	2.375	X	3	3.250	Special	S		PP046JYM
PS-22166	2.500	D	3	3.375	VCFKF	S		PP046KJZ
PS-22167	2.750	C	3	3.500	VCFKF	316SS/S		PP046KHB
PS-3862	3.500	X	3	4.375	VCFKF	316SS		PP046JZM
INGERSOLL RAND (Compressors)								
PS-5722	1.562	C	Special	2.250	VCFKF	316SS		35593490
PS-5740	2.250	C	2	3.125	BCFKF			35214105
PS-5741	2.250	C	Special	Special	VLZSF	316SS		35593516
PS-5742	2.250	C	Special	3.125	VLZSF	316SS		35, 593, 524
PS-4070	2.250	D	3	3.125	VAFLF	S		39919485
PS-3498	2.500	D	3	3.375	VAFLF	N/S		39929351
PS-6602	2.750	C	Special	3.625	VCFKF			35596626
PS-22000	3.875	D	3	4.750	VZFLF	S		39858717
INGERSOLL-DRESSER PUMPS AND COMPRESSORS (See FLOWERVE CORPORATION)								
PS-164	.500	B	9	—	BMFKF	A		
PS-200	.625	A	1	1.250	BMFJF			CPM-6252C1, CPM-6258C1
PS-507V	.625	A	3	1.250	VCFKF			CPM-625271, CPM-625871
PS-600	.625	B	1	1.187	BMFJF		Bronze Fitted KRUSA-3/4, 1-1/4, Model B 1/4 to 1-1/2 HP Motors	CPM-10015
PS-616	.625	B	1	1.187	BMFKF		Iron Fitted KRUSA-3/4, 1-1/4, Model B 1/4 to 1-1/2 HP Motors	CPM-10029, 60110269
PS-359	.625	C	1	1.250	BCFJF		1X4, 3/4, 1, 1-1/4, 2X5 HK & HOK	CPM-6251C1
PS-633	.625	C	1	1.250	BCFKF		1X4, 3/4, 1, 1-1/4, 1-1/2, 2X5 HK	CPM-625171
PS-760	.750	A	3	1.375	BMFJF		SMP1000 & SMP2000	CPM-10600A
PS-601	.750	B	1	1.375	BMFJF			CPM-10034, 60116225
PS-606	.750	B	1	1.375	BMFKF			CPM-10035, 60110301
FA-564	.750	C	—	—	BCF-F			024439-00
PS-3654	.750	C	1	1.375	BCFKF		SMP2000	
PS-2236	.750	C	3	1.375	BCFJF		SMP2000	1802ATY210RM075BF1C1 60721792, 60980901
PS-2235	.750	C	3	1.375	VCFJF			CPM-10606A, 60724572
PS-7994	.750	E	3	1.187	VCFKF			1802AJCTYPIR075XP171
PS-303	.875	D	1	1.500	BCDKF		SMP2000	W-11448, W-20168
PS-602	.875	D	1	1.562	BCDJF		KRVS-1-1/2, 2, 3-1/4 to 1-1/2 HP	CPM-10052
PS-603	.875	D	1	1.562	BCDKF		KRVS	CPM-10053
PS-7859V	.875	E	3	1.312	VCFKF	316SS		74744301
PS-560V	.937	U	3	1.562	VCFKF		7GA	03144601, 74744319
PS-801	1.125	C	3	1.750	B/VCFJF	S	3X5 HK, 3X6 HK	CPM-1121C1, 60487089
PS-2226	1.125	C	3	1.750	QCFZF	I/S	3X5 HK, 3X6 HK	CPM-112171
PS-355V	1.125	C	3	1.750	VCFKF	S		39633201, 39757141

NOTE: A. MOUNTS ON SHAFT
I. ABRASION RESISTANT CARBON (P66)
N. NON-STANDARD SPRING HOLDER
S. SLOTTED MATING RING

PUMP MANUFACTURERS' CROSS-REFERENCE

U.S. Seal Mfg. Part No.	Seal Size	Head	Mating Ring	Mating Ring Bore	Material Code	Notes	Pump Nameplate Data	Mfg. Part No.
INGERSOLL-DRESSER PUMPS AND COMPRESSORS (See FLOWERVE CORPORATION) (continued)								
PS-604	1.125	D	1	1.750	BCFJF		Bronze Fitted KRVS-1	CPM-10026, CPM-10054 60110434
PS-605	1.125	D	1	1.750	BCFKF		Iron Fitted KRVS-1	CPM-10055, 60110442
PS-521	1.125	D	1	1.875	BCFKF			
PS-607	1.125	E	1	1.687	BCFJF		Bronze Fitted 1, 2 RVN-1 1-1/2, 2, 3 RVNL, 1-1/2, 2 RV and RVH-3RVS 1-1/2 RVL	CPM-10043, 60110327
PS-608	1.125	E	1	1.687	BCFKF		Iron Fitted 1, 2 RVN-1 1-1/2, 2, 3 RVNL, 1-1/2, 2 RV and RVH-3RVS, 1-1/2 RVL	CPM-10044, CPM-10087 60110335
PS-3291	1.125	E	2	1.812	QCFZF	316SS	Extended Carbon	
PS-867	1.125	E	3	1.750	BCFKF	S		68885865, 69237592
PS-4421	1.125	E	3	1.750	QCFJF	316SS/S		
PS-204V	1.125	E	3	1.750	VCFJF	S		CPM-10715A, 60954682 1802AJCTYP1A112XF1C1
PS-867V	1.125	E	3	1.750	VCFKF	S		CPM-10715B, 68885847
PS-867V-TC-SEAT	1.125	E	3	1.750	VCFZF	S		1802AJCTYP1A112XF1D1 60954716
PS-619	1.125	E	3	1.812	BCFJF		Extended Carbon	CPM-10217A, CPM-10220A
PS-948	1.125	E	3	1.812	BCFKF		Extended Carbon	CPM-10220B, CPM-10217B
PS-1668	1.125	E	3	1.812	BCFZF			CPM-10465C, CPM-10470C
PS-1636	1.125	E	3	1.812	B/VCFJF		H/HC/VOC/HOC	CPM-10465A, CPM-10470A
PS-1637	1.125	E	3	1.812	B/VCFKF		H/HC/VOC/HOC	CPM-10465B, CPM-10470B
PS-1172V	1.125	E	3	1.812	VCFJF		6VOC, 7HOC	CPM-10406A
PS-1639V	1.125	E	3	1.812	VCFKF			CPM-10406B
PS-3511	1.125	T	3	1.750	VCFJF	S	HOC2, VOC2	1802AJCTYP1DBLXF1C1
PS-310	1.187	E	1	1.875	BCDJF			CPM-118S429X5
PS-343	1.187	E	1	1.875	BCDKF			CPM-118S429X2
PS-723	1.187	T	1	1.875	BCDJF		DHV, DMV	CPM-118S429X4 60111267
PS-724	1.187	T	1	1.875	BCDKF		DHV, DMV	CPM-118S429X3
PS-185	1.250	C	1	1.875	BCFJF			CPM-10601A
PS-756	1.250	C	1	1.875	BCFKF			
PS-618	1.250	C	3	1.875	BCFJF	S	SMP2000 & SMP3000	1802ATY210RM125BF1C1 60721800, 60980918 60980919, CPM-10601A
PS-598-EPR	1.250	C	3	1.875	QCFKF			CPM-10604A
PS-2203	1.250	C	3	1.875	QCFKF	I		1802ATY210RM125028F171 68867910
PS-185V	1.250	C	3	1.875	VCFJF	S		1802ATY210RMXF1C1 68867902, CPM-10613A 74898800
PS-756V	1.250	C	3	1.875	VCFKF			
PS-618V-TC-SEAT	1.250	C	3	1.875	VCFZF	S		CPM-10709, 60727401
FA-190	1.250	D	—	—	BCF-F			W-32652, 74898800
PS-3973	1.250	U	2	1.875	BCPKF			
PS-467	1.375	C	1	2.125	BCFKF			W-21642, W-28861
PS-5003	1.375	C	2	2.125	NCFKF	316SS		
PS-354	1.375	E	1	2.000	BCFJF			CPM-137S429X5
PS-677	1.375	E	1	2.000	BCFKF			CPM-137S429X2
PS-3925	1.375	E	3	2.125	VCFJF	S		1802AJCTYPEA138XF1C1 74816117
PS-3878	1.375	E	3	2.125	VCFJF	316SS/S	HOC3, Group 1	
PS-725	1.375	T	1	2.000	BCFJF			CPM-137S429X4 60111275
PS-726	1.375	T	1	2.000	BCFKF			CPM-137S429X3
PS-371	1.500	D	1	2.125	BCFKF			W-27658
FA-305	1.500	E	—	—	BCF-F			3879AJCTYP1A150BF1-1 68886183, 68886175
FA-305V	1.500	E	—	—	VCF-F			CPM-10369ABC CPM-10407ABC 3879AJCTYP1A150-XFI 80612400

PUMP MANUFACTURERS' CROSS-REFERENCE

U.S. Seal Mfg. Part No.	Seal Size	Head	Mating Ring	Mating Ring Bore	Material Code	Notes	Pump Nameplate Data	Mfg. Part No.
INGERSOLL-DRESSER PUMPS AND COMPRESSORS (See FLOWERVE CORPORATION) (continued)								
PS-305	1.500	E	1	2.125	BCFJF		GTB	CPM-10367A, CPM-10368A
PS-395	1.500	E	3	2.125	BCFJF	S		CPM-10132
PS-258	1.500	E	3	2.125	BCFKF		GTB	CPM-10129, CPM-10367B CPM-10368B, 6886100
PS-305V	1.500	E	3	2.125	VCFJF	S	GTB	CPM-10369A, 1802AJCTYP1A150XF1C1 68886068, 68886092
PS-374V	1.500	E	3	2.125	VCFKF		GTB	CPM-10369B 1802AJCTYPIRX171 1802AJCTYP1A150XF171
PS-620	1.500	E	3	2.312	BCFJF		Extended Carbon	CPM-10218A, CPM-10221A
PS-629	1.500	E	3	2.312	BCFKF		Extended Carbon	CPM-10218B, CPM-10221B
PS-4034	1.500	E	3	2.312	BCFZF			CPM-10466C, 60514148
PS-1647	1.500	E	3	2.312	B/VCFJF		H/HC	CPM-10466A, CPM-10471A
PS-1648	1.500	E	3	2.312	B/VCFKF	S	H/HC	CPM-10466B CPM-10471B, 60514288
PS-1651	1.500	E	3	2.312	VCFJF		H/HC	CPM-10473A, 60514122
PS-620V	1.500	E	3	2.312	VCFJF		Extended Carbon	CPM-10224A
PS-1652	1.500	E	3	2.312	VCFKF		H/HC	CPM-10473B, 60514726
PS-1691	1.500	E	3	2.312	VCFKF		Extended Carbon	CPM-10224B
PS-1692	1.500	E	3	2.312	VCFZF		Extended Carbon	CPM-10224C
PS-818	1.625	C	3	2.375	BCFJF	S	SMP3000	CPM-10602A, 60721818
PS-609	1.625	E	1	2.312	BCDJF		2,3,4 and 5RVL-3 RVH-1-1/2 ORVL	CPM-10045, 60110343
PS-346	1.625	E	1	2.312	BCFJF		3 RVL	CPM-10028
PS-610	1.625	E	1	2.312	BCFKF		2,3,4 and 5RVL-3 RVH-1-1/2 ORVL	CPM-10046, 60110350
PS-7950	1.750	E	3	2.312	QCFZF	I/S		74840992
PS-262	1.750	E	3	2.500	BCFKF	S		1802AJCTYP1G175BF171
PS-859-TC-SEAT	1.750	E	3	2.500	BCFZF	S	S-Row Series 100	CPM-10347
PS-4139	1.750	E	3	2.625	VCFKF	S		1802ATCTYP1R175XF171
PS-674	1.750	T	1	2.500	BCFJF		3, 4, 5 RVL and CRVL	CPM-10024
PS-722	1.771	E	1	2.625	BCFJF			CPM-1775429X5
PS-719	1.771	E	1	2.625	BCFKF			CPM-1775429X2
PS-727	1.771	T	1	2.625	BCFJF			CPM-1775429X4
PS-728	1.771	T	1	2.625	BCFKF			CPM-1775429X3
PS-340-EPR-CMS	1.875	C	1	2.625	QCFJF			CPM-10656
PS-4885	1.875	C	1	2.625	QCFJF	I		60647203
PS-2069	1.875	E	1	2.625	BCFJF			CPM-10370A
PS-2071	1.875	E	3	2.625	BCFJF	S		CPM-10371A
PS-2072	1.875	E	3	2.625	BCFKF	S	3GT	CPM-10158, CPM-10370B CPM-10371B 1802AJCTYP1A188BF171 6043421, 68885987
PS-1659	1.875	E	3	2.625	VCFJF	S	GTB	CPM-10372A 1802AJCTYP1A188XF1C1 60954757
PS-1660	1.875	E	3	2.625	VCFKF	S	GTB	CPM-10372B 60954807, 68859601
PS-1661	1.875	E	3	2.625	VCFZF			CPM-10716C 1802AJCTYP1A188-XF1D1
PS-949	1.875	E	3	2.687	BCFKF		Extended Carbon	CPM-10219B, CPM-10222B
PS-1664	1.875	E	3	2.687	B/VCFJF		VOC/HOC	CPM-10219A, CPM-10222A CPM-10461A, CPM-10467B CPM-10472B
PS-7020	1.875	E	3	2.687	VCFJF			CPM-10225A, CPM-10408A CPM-10467A
PS-1653	1.875	T	3	2.687	VCFJF		HOC 6X4X13	CPM-10278
PS-530	2.000	E	3	2.750	BCFJF	S		
PS-477	2.000	E	3	2.750	BCFKF	S	S Line	CPM-2005429X2 CPM-2005429X7
PS-342	2.000	E	3	2.750	NCPKP		1-1/2, 2 and 3 VM-1-1/2 and 3 VL 3 VLA Vertical Pumps and S Line	CPM-10130 CPM-2005429X1
PS-611	2.125	E	3	2.812	BCFJF		All Bronze Fitted Pump- 1-1/2 2 MRV-5 RVH, 6 RVL, 50 RVL	CPM-10047

NOTE: I. ABRASION RESISTANT CARBON (P66)
S. SLOTTED MATING RING

PUMP MANUFACTURERS' CROSS-REFERENCE

U.S. Seal Mfg. Part No.	Seal Size	Head	Mating Ring	Mating Ring Bore	Material Code	Notes	Pump Nameplate Data	Mfg. Part No.
INGERSOLL-DRESSER PUMPS AND COMPRESSORS (See FLOWERVE CORPORATION) (continued)								
PS-1612	2.125	E	3	2.812	BCFKF		All Iron Fitted Pumps - 1-1/2 2 MRV-5 RVH, 6 RVL, 50RVL D	CPM-10048, 60110376
PS-2086	2.125	E	3	3.000	BCFKF	S	Series 100S	CPM-10351
PS-5076	2.250	C	3 Special	3.125	VCFKF			35593508
PS-3498	2.500	D	3	3.375	VAFLF	N/S		39929351
PS-278	2.375	E	3	3.250	BCFJF	S	HOC	CPM-10469A
PS-350	2.375	E	3	3.250	BCFKF	S	4GT/S/HOC	CPM-10159, CPM-10469B
PS-278V	2.375	E	3	3.250	VCFJF	S	HOC	1802AJCTYP1A238-XF1C1 6003427, 60969797
PS-2098V	2.375	E	3	3.250	VCFKF	S		CPM-10718B, CPM-10251B
PS-3498	2.500	D	3	3.375	VAFLF	N/S		39929351
PS-279	2.500	E	3	3.375	BCFJF	S		CPM-10134
PS-349	2.500	E	3	3.375	BCFKF		S Line	CPM-250S429X2 CPM-250S429X7 69261360
PS-321	2.750	E	3	3.500	V/BCFKF	S	S Line Series 100	CPM-10355
PS-5252	3.000	E	3	3.875	BCFKF	S	6GT	
PS-325SS	3.250	U	3	4.125	BCFKF	C/S	S Line, 8X14SD, 10X14SD	CPM-325S429X7 69261378
INSINGER MACHINE COMPANY (Dishwashers)								
PS-204	1.125	E	1	1.750	BCFJF			B15
ITT INDUSTRIES (See A-C Pump, Bell & Gossett, Domestic Pump, Jabsco®, Marlow)								
ITT R & CW (ITT RESIDENTIAL & COMMERCIAL WATER PUMPS)								
PS-3926	.625	B	9	1.062	VCFKF	316SS	Model 20 EVP	A00202C 1
PS-544V-SC-SC	1.625	C	3	2.375	VLFLF	S		764073625
PS-3993	2.000	C	3	2.750	BCFJF	S		764074200
PS-4239	2.000	C	3	2.750	BCFJF	H/S		764071200
JABSCO® (Division of ITT INDUSTRIES)								
FA-642	.625	B	—	—	BMF-F		Seat is Impeller	
PS-382	1.500	D	1	2.125	BCFJF			3200, 3200-01, 3200-21
VGM-9479	25MM	VGMA	Special	40MM	VCFLF		Model 18370-0000	6408-0000
JACKSON®								
PS-3733	.875	C	3	1.500	VCFJF	N		5330-300-06-27
PS-3440	1.000	C	1	1.750	BCFJF			5330-011-71-98
JACUZZI								
PS-162	.500	A	1	1.000	BMFJF			10-563
PS-165	.500	B	9	.906	BMFJF	A		10-0380-00
PS-631	.500	C	1	1.000	BCFJF	N	5AM	10-564
PS-200	.625	A	1	1.250	BMFJF		Cygnat K,KM, Vector LVLA, J, JCM, LCM, LCU and LR Series	10-467, 10-0002-06 10-1436-00
PS-359	.625	C	1	1.250	BCFJF			10-478, 10-506
PS-290	.625	C	1	1.250	BCFJF	N		10-1202, 10-1203 7524000
PS-102	.625	D	1	1.250	BCDKF			10-502
PS-201	.750	A	1	1.375	BMFJF		5RP, SF, Magnum, RC-Series	10-120, 10-477, 10-486 10-1390-04, 10-1502-09
PS-358	.750	C	1	1.375	BCFJF			10-479
PS-877	.750	C	1	1.375	BCFJF		8M	10-1203-01, 10-1203-19
PS-683	.750	C	1	1.500	BCFJF			10-100
PS-750	.750	D	1	1.375	BCDJF			10-503
PS-235	1.000	C	1	1.625	BCFJF		10M	10-504, 10-1299-06
PS-204	1.125	E	1	1.750	BCFJF			10-505
PS-185	1.250	C	1	1.875	BCFJF			10-0369-29, 10-1400-02
PS-2122	1.250	C	1	1.875	BCFJF			10-0369-03
PS-758	1.500	C	1	2.125	BCFJF			10-1348-07
PS-2142	1.750	C	1	2.500	BCFJF			10-0307-00
PS-205	1.750	E	1	2.500	BCFJF			10-330
PS-874	2.250	D	1	3.125	BCDJF			10-365

PUMP MANUFACTURERS' CROSS-REFERENCE

U.S. Seal Mfg. Part No.	Seal Size	Head	Mating Ring	Mating Ring Bore	Material Code	Notes	Pump Nameplate Data	Mfg. Part No.
JAEGER								
PS-201	.750	A	1	1.375	BMFJF			
PS-360	1.000	A	1	1.625	BCFJF			
PS-356	1.125	C	1	1.750	BCFJF			80237
PS-177	1.375	C	1	2.000	BCFJF			81031-1
PS-461	1.625	D	1	2.375	BCDKF			66319-1
PS-876	2.000	D	1	2.625	BCDKF			66435-1
JANDY® (A FLUIDRA Brand)								
PS-1000	.625	B	1	1.250	BMFJF		PB4-60	P55
PS-3890	.625	G	1	1.381	BCFJF	316SS	PB4-60Q	P84-3
PS-4577	.625	G	1	1.381	QCFJF		PB4-SQ	R0747800
PS-4280	.625	G	1	1.381	VCFJF		FHP, JEP, MHP, PHP SHP, SWF, WFTR	R00479400
PS-4231	.625/ .750	G	1	1.375/ 1.381	VCFJF		PHPM, PHPF New & Old Style Contains PS-4280 and PS-3868	R0445500
PS-601	.750	B	1	1.375	BMFJF		HHP, HHPU, MHP, MHPU	R0338200
JOHN BEAN TECHNOLOGIES								
FA-1700	1.000	C	—	—	BCF-F			401-50-0001
FA-1850	1.500	C	—	—	BCF-F			401-50-0006
JOHNSON CONTROLS								
PS-4026	1.750	D	3	2.500	NCFKF			029 22359 001
PS-4554	2.625	EB	5	3.375	BCFZF			
PS-4028	2.875	K	3 Special	4.500	NCFGF			523B0201G01
JOY MFG. (See SULLIVAN-PALATEK, INC.)								
KADY INTERNATIONAL								
PS-687	.875	C	1	1.500	BCFKF			91381
PS-2703	1.000	D	3	1.625	VLFZF	S		94555
PS-210	1.375	C	1	2.000	BCFKF			91379
PS-3541	1.375	T	3	2.000	VZFZF	316SS/S		92795
KASCO MARINE								
PS-2700	.500	G	1	1.000	BCFJF			990500
PS-3960	.625	G	1	1.250	BCFJF			840500
PS-3910	.625	G	1	1.250	BLFLF			840370
KEEN PUMP								
PS-3289	2.250	C	3	3.125	BLFLF	S		K0104-1-02
KENCO								
PS-162	.500	A	1	1.000	BMFJF		Type 62, 63, 64, 65	
PS-163	.500	B	1	1.000	BMFJF			AE001A1
PS-165	.500	B	9	.906	BMFJF	A	59A, 140A	
PS-200	.625	A	1	1.250	BMFJF		139A New Style	
PS-452	.625	B	9	—	BMFJF	A	109A New Style	
PS-762	.750	A	3	1.375	BMFKF		114	6A001A1
KINNEY VACUUM PUMP								
PS-358	.750	C	1	1.375	BCFJF			KC2.5-15, KC-5 KC-8(491), KS-13
PS-358V	.750	C	3	1.375	VCFJF			65046
FA-1600	.875	C	—	—	BCF-F			SK-549
PS-357	1.000	C	1	1.625	BCFKF			KS-27-47
PS-159	1.000	D	3	1.625	NCPGP			65024
PS-355	1.125	C	1	1.750	BCFKF			KC-46
PS-659	1.500	C	1	2.125	BCFKF			KD-110, KDH-130
PS-238V-CMS	1.625	C	1	2.375	VCFJF			065241A000
PS-366	1.750	E	1	2.500	BCFKF			KD-220, KDH-220
PS-462	2.000	D	1	2.750	BCDKF			
PS-658	2.000	R	1	2.750	BCDKF			KBM-1200, MB-17
KLEIN PRODUCTS OF TEXAS, INC.								
PS-547	1.375	C	3	2.000	BCFKF	S		33011197
PS-3138	1.625	C	1	2.375	BCFKF			33024421
PS-3179	1.625	C	1	2.375	BCFLF			33024421HD

NOTE: A. MOUNTS ON SHAFT
S. SLOTTED MATING RING

PUMP MANUFACTURERS' CROSS-REFERENCE

U.S. Seal Mfg. Part No.	Seal Size	Head	Mating Ring	Mating Ring Bore	Material Code	Notes	Pump Nameplate Data	Mfg. Part No.
KNIGHT EQUIPMENT (Dishwashers)								
PS-200-EPR	.625	A	1	1.250	QCFFJ			9600745
KOBELCO USA								
PS-9712	2.000	WB	3	2.500	TCFGF	316SS		P-GA05-007
KRAISSL COMPANY								
FA-10	.500	B	—	—	BMF-F		Seat is Impeller	

Value Guard Part No.	Seal Size	Head	Mating Ring	Material Code	Notes	Pump Nameplate Data	Mfg. Part No.
KSB CENTRIFUGAL PUMP							
VGM-3950	10 MM	VGMC-1	1	VLFLF			KU 010
VGM-3951	15 MM	VGMC-1	1	VLFLF			KU 015
VGM-3952	16 MM	VGMC-12S	1	VLFLF			—
VGM-3242	22 MM	VGMC-12S	1	VLFLF			KU 022
VGM-3243	28 MM	VGMC-12S	1	VLFLF			NU 028
VGM-3244	38 MM	VGMC-12S	1	VLFLF			NU 038
VGM-3245	48 MM	VGMC-12S	1	VLFLF			NU 048

D0	D1	D2	L1	L2
10.00	19.20	20.00	25.90	6.60
15.00	24.60	25.00	28.40	6.60
16.00	27.00	26.00	22.20	12.10
22.00	37.00	36.00	25.40	12.10
28.00	43.00	47.00	35.60	14.40
38.00	56.00	58.00	41.80	13.20
48.00	66.00	69.00	50.40	9.60

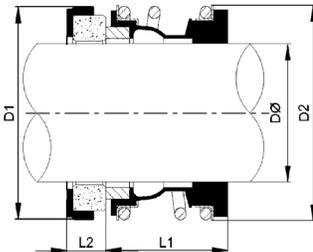

Value Guard Part No.	Seal Size	Head	Mating Ring	Material Code	Notes	Pump Nameplate Data	Mfg. Part No.
KSB SUBMERSIBLE PUMP							
VGM-1410U	10MM	VGMC-1	1	VCFLF			
VGM-1410L	10MM	VGMC-1	1	VLFLF			SU 010
VGM-1415U	15MM	VGMC-1	1	VCFLF			
VGM-1415L	15MM	VGMC-1	1	VLFLF			SU 015
VGM-1425U	25MM	VGMC-1	1	VCFLF			
VGM-1425L	25MM	VGMC-1	1	VLFLF			SU 025
VGM-1428U	28MM	VGMC-1	1	VCFLF			
VGM-1428L	28MM	VGMC-1	1	VLFLF			SU 028
VGM-1430U	30MM	VGMC-1	1	VCFLF			
VGM-1430L	30MM	VGMC-1	1	VLFLF			SU 030
VGM-1433U	33MM	VGMC-1	1	VCFLF			
VGM-1433L	33MM	VGMC-1	1	VLFLF			SU 033
VGM-1443U	43MM	VGMC-1	1	VCFLF			
VGM-1443L	43MM	VGMC-1	1	VLFLF			SU 043
VGM-1448U	48MM	VGMC-1	1	VCFLF			
VGM-1448L	48MM	VGMC-1	1	VLFLF			SU 048
VGM-1475U	75MM	VGMC-1	1	VCFLF			
VGM-1475L	75MM	VGMC-1	1	VLFLF			SU 075
VGM-1490U	90MM	VGMC-1	1	VCFLF			
VGM-1490L	90MM	VGMC-1	1	VLFLF			SU 090

D0	D1	D2	L1	L2
10.00	19.20	20.00	14.50	6.50
15.00	24.60	28.00	17.00	7.00
25.00	38.00	41.00	23.00	7.50
28.00	43.00	47.00	26.50	9.00
30.00	45.00	47.00	26.50	10.50
33.00	48.00	51.00	27.50	11.00
43.00	61.00	62.20	30.00	12.00
48.00	66.00	69.00	30.50	11.50
75.00	97.00	102.00	40.00	14.00
90.00	115.00	126.00	45.00	15.00

Other Materials Available Upon Request

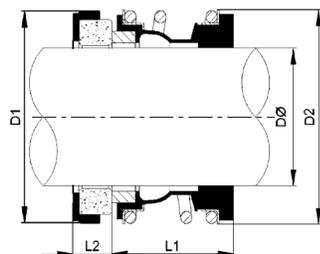

Type VGMC-1

PUMP MANUFACTURERS' CROSS-REFERENCE

U.S. Seal Mfg. Part No.	Seal Size	Head	Mating Ring	Mating Ring Bore	Material Code	Notes	Pump Nameplate Data	Mfg. Part No.
LABCONCO CORPORATION (Dishwashers)								
PS-6308	.687	Q	9	1.250	Special	A		4485800
LANCASTER PUMP COMPANY								
FA-10	.500	B	—	—	BMF-F		Seat is Impeller, 376 Laundro Pak	4761
PS-1002	.500	C	1	1.000	BCFJF		Converto, Supreme Jet, MTR Jet, Type M 901 thru 906 Type P All Models	1061
PS-200	.625	A	1	1.250	BMFJF			2661
PS-1000	.625	B	1	1.250	BMFJF			5236
PS-151	.625	B	1	1.375	BMFJF		Types S & SD Lancaster Dutchman 1182, 1183, 1192, 1193	2461
PS-1005A	.625	B	1	1.375	BMFKF			2561
PS-447	.625	B	8	—	BCFJF	A	570, 575, 1775	
PS-493	.625	C	1	1.187	BCFKF			5256
PS-201	.750	A	1	1.375	BMFJF		Types S & SD Lancaster Dutchman 1182, 1183, 1192, 1193	1661
PS-358	.750	C	1	1.375	BCFJF		Self Priming Pump 673	1361
PS-703	.875	D	1	1.500	BCDJF		Turbo Pak 523BF- 524 BG	429 .875
PS-360	1.000	A	1	1.625	BCFJF		Type M-907 and M-908	7561
PS-381	1.250	D	1	1.875	BCFJF		Type M-909 and M-910	909-61
LEAR SIEGLER (See SHERWOOD PUMP)								
LEHIGH								
PS-752	.750	D	1	1.375	BCDKF			D-811
PS-108	1.250	E	1	1.875	NCPKP			D-845
LELAND FARADAY PUMP								
PS-142	.500	B	1	1.000	BMFJF			
PS-163	.500	B	1	1.000	BMFJF		LFP-43000	
PS-1000	.625	B	1	1.250	BMFJF		LFP-2075, 2100, 2150, 2200	
PS-800	.625	C	1	1.156	BMFJF	H	LFP-333-615, 14107-14120	
PS-877	.750	C	1	1.375	BCFJF		LFP-533-1100, 5050, 5075, 5100	
LEROY-SOMER								
PS-3893	.875	C	3 Special	1.500	VCFGF			90243401
PS-3945	1.250	C	3 Special	1.875	VCFGF			90311601
PS-3584	1.375	C	3 Special	2.000	VCFGF			90300001
PS-3943	1.500	C	3 Special	2.125	VCFGF			90348301
LEWIS® PUMPS								
PS-381	1.250	D	1	1.875	BCFJF			
PS-3555	1.250	D	1	1.875	QLFLF			10282
PS-3032	1.250	D	1	1.875	VLFLF			
PS-205	1.750	E	1	2.500	BCFJF			
PS-205-P66	1.750	E	1	2.500	BCFJF	I		21353
PS-366	1.750	E	1	2.500	BCFKF			10283
PS-3031	1.750	E	1	2.500	VLFLF	316SS		
PS-858-EPR-SC-SC	1.750	E	3	2.500	QLFLF	S		14690
LIBERTY PUMPS								
PS-4064	.625	Special	Special	.950	BMFJF	Unitized		50980A0
PS-4065	.625	Special	Special	1.110	BMFJF	Unitized		5120000
PS-4066	.750	Special	Special	1.334	BLFLF	Unitized		5633000
LIGHTNIN								
PS-4532	2.500	D Special	3 Special	3.250	VCFZF	316SS	Side Entry Mixer	
LINK-BELT								
PS-357	1.000	C	1	1.625	BCFKF			WB-35
PS-355	1.125	C	1	1.750	BCFKF			WB-40
PS-461	1.625	D	1	2.375	BCDKF			WB-60
PS-288	1.750	D	1	2.500	BCDKF			WB-70
LITTLE GIANT PUMP COMPANY (Division of FRANKLIN ELECTRIC COMPANY, INC.)								
PS-3048	.500	B	1	1.000	BCFJF			926029, 926030
PS-163	.500	B	1	1.000	BMFJF			926024
PS-165	.500	B	9	.906	BMFJF	A		108112, 926031

NOTE: A. MOUNTS ON SHAFT
H. SPRING HOLDER
NOT INCLUDED

I. ABRASION RESISTANT CARBON (P66)
S. SLOTTED MATING RING

PUMP MANUFACTURERS' CROSS-REFERENCE

U.S. Seal Mfg. Part No.	Seal Size	Head	Mating Ring	Mating Ring Bore	Material Code	Notes	Pump Nameplate Data	Mfg. Part No.
LITTLE GIANT PUMP COMPANY (Division of FRANKLIN ELECTRIC COMPANY, INC.) (continued)								
PS-961	.625	B	1	1.250	BCFJF			926034
PS-1000	.625	B	1	1.250	BMFJF			
FA-1350	.625	C	—	—	BCF-F			926052
PS-356V	1.125	C	3	1.750	VCFJF	S		926042, 926043
LOBEE PUMP & MACHINERY COMPANY								
PS-9009	.875	W	2	1.500	TCFJF	316SS	RLX2016	CAM1215
LOCKWOOD PUMP								
PS-301	.750	A	1	1.375	BMFJF			
PS-360	1.000	A	1	1.625	BCFJF		CM Pump	
LOGANSPOUT PUMPS								
FA-400	.500	C	—	—	BMF-F			P-9809
PS-106	.500	C	1	1.000	BCFKF			P-17251
FA-135	.625	D	—	—	BCD-F		SF-4, SF-10	P-14883
FA-564	.750	C	—	—	BCF-F		SF-80, 100, 125, 150	P-9518
LOMART (Division of H.I.I.)								
FA-10	.500	B	—	—	BMF-F		Seat is Impeller	
PS-142	.500	B	1	1.000	BMFJF			
PS-163	.500	B	1	1.000	BMFJF			40-027, 40-029
PS-1000	.625	B	1	1.250	BMFJF			
LOUIS PUMP COMPANY								
PS-370	1.000	A	1	1.625	BCFKF		AV-MV	
LOU-RICH, INC.								
PS-2806	1.000	Q	9	1.625	BCFJF			28599
PS-6305	1.000	Q	9	1.625	BMDAF			13417
LUITWEILER CORPORATION								
PS-201	.750	A	1	1.375	BMFJF		GSX	72344
PS-361	1.250	E	1	1.875	BCFJF		BDAC	052016
LYCO WAUSAU, INC.								
PS-446	1.750	C	1	2.500	BCFJF			1100-17
MAGNETROL (See SCHAUB ENGINEERING COMPANY)								
MAGNUM PRODUCTS, LLC.								
PS-516	.625	A	1	1.250	BCFJF			48273
PS-851	.750	A	1	1.375	BCFJF			48244
PS-185-SC-SC	1.250	C	1	1.875	BLFLF			48253
PS-758	1.500	C	1	2.125	BCFJF			48265
PS-541	1.500	K	1	2.125	BCFJF			42764
MANITOWOC COMPANY, INC. - (Ice Machines)								
PS-360	1.000	A	1	1.625	BCFJF			003705011
MARLOW (Division of ITT INDUSTRIES)								
PS-151	.625	B	1	1.375	BMFJF			42513000000
PS-2161	.625	B	1	1.375	BMFJF		SCT Series, Stainless Steel	46328000000
PS-411	.625	B	11	—	BMFJF	A	H23EC-A 1.5 HP, 2AF Series 25353000000, 25353-20 26467000000	23736000000
PS-411V	.625	B	11	—	VCFJF	A	29163000000, 29163Z	27678000000
PS-201	.750	A	1	1.375	BMFJF		Argonaut®, Mardur®	38592000000
PS-405	1.000	A	25	1.625	B/VCFJF			26473000000
PS-413	1.000	C	25	1.625	BCFJF			20760000000
							25355000000	
PS-978	1.250	C	1	1.765	BCFJF	B	L Series	45672-20
PS-979	1.250	C	1	1.765	BCFKF	B		
PS-923	1.250	C	25	2.250	BCFJF	B		27233-20, 27452000000
FA-190	1.250	D	—	—	BCF-F			27453000000
PS-416A	1.250	D	25	2.250	BCFJF		3B Series 27224000000 27225000000, 3B28EC-C2	27223000000

PUMP MANUFACTURERS' CROSS-REFERENCE

U.S. Seal Mfg. Part No.	Seal Size	Head	Mating Ring	Mating Ring Bore	Material Code	Notes	Pump Nameplate Data	Mfg. Part No.
MARLOW (Division of ITT INDUSTRIES) (continued)								
PS-7919	1.375	C	3	2.000	B/VLFLF			43350000000
PS-929	1.375	C	25	2.000	BCFJF			25481000000
PS-404	1.375	D	25	2.000	BCDJF			25356000000, 25356-20 26477000000
PS-8048	1.375	XT	3	2.125	VCFJF	316SS		45184000000
PS-3832	1.625	C	1	2.375	QCFLF	B/I		
PS-818	1.625	C	3	2.375	BCFJF	S		46983000000
PS-544V-SC-SC	1.625	C	3	2.375	VLFLF	S		43435000000
PS-7497	1.625	C	25	2.500	B/VCFJF		ICA 067, 4SPC	28146000000 A05669E000R
PS-514	1.625	D	1	2.375	BCDJF		L Series	45673-20
PS-446	1.750	C	1	2.500	BCFJF			25357000000
PS-550	1.750	C	3	2.500	BCFJF	S	6EL	47182000000
PS-3040	1.750	K	3	2.750	BCFJF			4DW165B
PS-267	2.000	C	1	2.750	BCFJF			25358000000
PS-478	2.000	E	1	2.687	BCFKF			
PS-7963	2.000	K	3	3.000	BCFJF			43426000000
MASSEY FERGUSON NORTH AMERICA								
FA-642	.625	B	—	—	BMF-F			892-563M1
FA-647	.750	B	—	—	BMF-F			1019-293M1
MEGATOR CORPORATION								
PS-359	.625	C	1	1.250	BCFJF			5079
PS-359V-CMS	.625	C	1	1.250	VCFJF			5079V
PS-358	.750	C	1	1.375	BCFJF			5479
PS-309	.875	C	1	1.500	BCFJF			5679
PS-309V-CMS	.875	C	1	1.500	VCFJF			5679V
PS-356	1.125	C	1	1.750	BCFJF			5879
PS-356-TC-TC	1.125	C	1	1.750	BZFZF			5879TC
PS-356V-CMS	1.125	C	1	1.750	VCFJF			5879V
PS-185	1.250	C	1	1.875	BCFJF			5779
PS-185V-CMS	1.250	C	1	1.875	VCFJF			5779V
PS-758	1.500	C	1	2.125	BCFJF			5979
PS-758V-CMS	1.500	C	1	2.125	VCFJF			5979V
MEMPHIS PUMP & MFG. COMPANY, INC.								
PS-100	.625	A	1	1.187	BMFJF			0625-6BC
PS-118	.625	C	1	1.187	BCFJF			
PS-1091	.625	C	1	1.187	VCFJF			
PS-508	.625	D	1	1.250	BCDJF			
PS-201	.750	A	1	1.375	BMFJF			
PS-1093	.750	C	1	1.375	VCFJF			
PS-1092	.750	C	1	1.375	VCFKF			
PS-1094	1.000	C	1	1.625	VCFJF			
MEPCO (MARSHALL ENGINEERED PRODUCTS COMPANY) (See DUNHAM-BUSH)								
METAL MASTER								
FA-10	.500	B	—	—	BMF-F		Seat is Impeller	12515
PS-680	.625	A	1	1.187	BCFJF			19023
PS-702	.625	A	1	1.187	BMFJF			15110
PS-200	.625	A	1	1.250	BMFJF			
PS-153	.625	A	1	1.250	BMFKF			
PS-151	.625	B	1	1.375	BMFJF			
MET-PRO CORPORATION								
PS-1000V	.625	B	3	1.250	VCFJF			6960440
PS-3962	.625	W Special	2	1.250	TCFJF	316SS		6960444
FA-10037	1.000	C	—	—	VCF-F			6765570
PS-236V	1.000	E	3	1.625	VCFKF	S		6764554
FA-9349	1.000	WT	—	—	TCF-F	316SS		6765575
PS-9349	1.000	WT	27	2.000	TCFZF	316SS		
PS-4505	1.125	C	3	1.750	VCFLF	S	Light Spring Load	6765938
FA-2104V	1.375	E	—	—	VCF-F			6767102

NOTE: B. TAPERED SPRING
I. ABRASION RESISTANT CARBON (P66)
S. SLOTTED MATING RING

PUMP MANUFACTURERS' CROSS-REFERENCE

U.S. Seal Mfg. Part No.	Seal Size	Head	Mating Ring	Mating Ring Bore	Material Code	Notes	Pump Nameplate Data	Mfg. Part No.
MET-PRO CORPORATION (continued)								
FA-9341	1.375	WT	—	—	TCF-F	316SS		6767108
PS-1056V	1.750	C	3	2.500	VCFKF	S		6765941
PS-1056V-SC-SEAT	1.750	C	3	2.500	VCFLF	S		6765942
PS-366V	1.750	E	3	2.500	VCFKF	S		6764540, 6765965
FA-9316	1.750	WT	—	—	TCF-F	316SS		6765804
PS-8125	1.750	XB1	5	2.125	YCFZF	316SS		
FA-8000	1.750	XB1T	—	—	Special			6765776
PS-8122	2.000	XB1	3	2.500	XCFLF	316SS/S		6765945
MIDLAND PRODUCTS (Division of CRANE PUMPS & SYSTEMS)								
PS-201	.750	A	1	1.375	BMFJF			6070-0
PS-360	1.000	A	1	1.625	BCFJF		5M, 7M and 18M	6007-0
PS-177	1.375	C	1	2.000	BCFJF		40M and 40W	
PS-805	1.375	C	3	2.000	BCFJF	S		6368-0
PS-550	1.750	C	3	2.500	BCFJF	S		6412-0
PS-532	2.000	C	3	2.750	BCFJF	S		6428-0
MILE HIGH EQUIPMENT COMPANY (Ice Machines)								
PS-3120	1.000	Q	Special	1.625	Special			9121026-91
PS-6311	1.625	Q	Special	2.375	N/BMDAF			9121025-91
PS-4133	1.750	Q	Special	2.500	Special			9021142-01
MILRECO								
PS-448	1.750	C	1	2.500	BCFKF			
MODY SUBMERSIBLE PUMPS								
VG-462325	1.000	D	1	1.585	BZFZF	316SS	Double Seal	535-022-00
VG-462326	1.000	D	1	1.585	VLFLF	316SS	Double Seal	535-038-00
VGM-2210	32MM	D	1	50.67MM	VLFLF	316SS	Double Seal	535-034-00
VGM-2204	32MM	D	1	50.67MM	VZFZF	316SS	Double Seal	535-020-00
VGM-2224	35MM	D	1	53.95MM	VLFLF	316SS	Double Seal	
VGM-2211	35MM	D	1	53.95MM	VZFZF	316SS	Double Seal	535-021-00
VGM-53501	35MM	Special	3	53.95MM	VZMZF	316SS	Single Seal	535-017-00
VGM-53502	45MM	D	5	67.70MM	BZFZF	316SS	Double Seal	535-041-00
VGM-53503	45MM	D	5	67.70MM	VLFLF	316SS	Double Seal	535-042-00
VGM-2207	70MM	K	25	95MM/ 105MM	VLFLF	316SS	Double Seal	535-504-00
MOJONNIER®								
PS-227	1.000	D	1	1.750	BCFKF			750062149
MONARCH PUMPS (Division of FRANKLIN ELECTRIC COMPANY, INC.)								
PS-200	.625	A	1	1.250	BMFJF			240160
PS-200V-CMS	.625	A	1	1.250	VCFJF		ATH, AT600	240136
PS-851	.750	A	1	1.375	BCFJF			240260
PS-201	.750	A	1	1.375	BMFJF			240170, MS17
PS-201V-CMS	.750	A	1	1.375	VCFJF		BSGF 6&8, B2U	240344, MS44
PS-460	1.000	D	1	1.625	BCFKF			240060
PS-185	1.250	C	1	1.875	BCFJF			240070
PS-185V-CMS	1.250	C	1	1.875	VCFJF		8BSGF	240359
PS-186	1.375	D	1	2.000	BCDKF			240367
PS-758V-CMS	1.500	C	1	2.125	VCFJF			240362
PS-3972	1.500	K	3	2.500/ 2.125	VLFLF	S	BSGF-12-GS	240306
PS-448	1.750	C	1	2.500	BCFKF			240120
PS-436V	1.750	C	3	2.500	VCFKF	S		240387
PS-835	2.500	D	3	3.375	BCDJF	S		240363
PS-838	2.750	E	3	3.500	V/BCFJF	S		240290
MONTGOMERY WARD								
PS-358	.750	C	1	1.375	BCFJF			24181
MORETRENCH								
PS-7766	2.250	K	3	3.125	BCFJF			
MOYNO, INC. (A NOV Brand)								
PS-1002	.500	C	1	1.000	BCFJF			3204215000
PS-4214	.500	C	1	1.000	BCFJF			3206480000
PS-631	.500	C	1	1.000	BCFJF	N		

PUMP MANUFACTURERS' CROSS-REFERENCE

U.S. Seal Mfg. Part No.	Seal Size	Head	Mating Ring	Mating Ring Bore	Material Code	Notes	Pump Nameplate Data	Mfg. Part No.
MOYNO, INC. (A NOV Brand) (continued)								
PS-1002-EPR	.500	C	1	1.000	QCFJF			3206497000
PS-1002V	.500	C	1	1.000	VCFJF			3206037000
PS-200	.625	A	1	1.250	BMFJF			
PS-359	.625	C	1	1.250	BCFJF			3202424000
PS-1119	.625	C	1	1.250	BCFJF		EC & EM	3202423000
PS-359-EPR-CMS	.625	C	1	1.250	QCFJF			3206379000
PS-359V-CMS	.625	C	1	1.250	VCFJF			3206501000
PS-22034	.625	C	1	1.250	VCFJF			3208709005
PS-633V-TC-SC	.625	C	1	1.250	VZFLF			
PS-851	.750	A	1	1.375	BCFJF		48-65C	3201625000
PS-358	.750	C	1	1.375	BCFJF			3203945000
PS-3208	.750	C	1	1.375	VCFJF			3206510000
PS-7305	.750	C	1	1.375	VLFLF	316SS		3206507000
PS-5723	25MM	C	1	1.575	QCFLF	316SS		4230509001
PS-360	1.000	A	1	1.625	BCFJF		EC-67	
PS-548	1.000	C	3	1.625	BCFJF	S		3201750000
PS-380	1.000	D	1	1.625	BCFJF			
PS-4029	1.250	C	1	1.875	QCFZF	316SS		0040689211
PS-8592	1.312	X	3	1.937	VCFZF	316SS		0040763641
PS-262	1.750	E	3	2.500	BCFKF	S		
PS-3158	45MM	G	25	63MM	VLFLF	A		4241749045
PS-3276	60MM	G	25	80MM	VLFLF	316SS/B		4241749060
PS-22035	3.250	E	3	4.125	VCFLF	C/S	c/w L shaped collar	4220998000
PS-3255	3.250	T	3	4.125/ 4.500	VLFLF			40402041-1A
PS-22036	3.750	E	3	4.625	VCFLF	C/S	c/w L shaped collar	4221075000
MP PUMPS, INC. (Division of GARDNER DENVER)								
PS-114	.312	A	1	1.000	BMDJF			
PS-162	.500	A	1	1.000	BMFJF			21609
PS-165	.500	B	9	.906	BMFJF	A		
PS-113	.625	B	1	1.093	BMFJF			13385
PS-447V	.625	B	8	—	VCFJF	A		21580
PS-359V-CMS	.625	C	1	1.250	VCFJF			35052
PS-4520	.750	B	3	1.375	VCFJF			28048
PS-358	.750	C	1	1.375	BCFJF			15151
PS-112	.750	C	1	1.375	BCFKF			15112
PS-3110	.750	C	1	1.375	BLFLF			34611
PS-22009	.750	C	1	1.375	NCFJF	B		24898
PS-2746	.750	C	1	1.375	VCFJF	B		26640
PS-22003	.750	D	1	1.375	VCFLF	316SS		29168
PS-3788	.750	G	3	1.375	VCFJF			30061
PS-9339	.750	W	2	1.375	TCFJF	316SS		30054
PS-703	.875	D	1	1.500	BCDJF			9524
PS-245V-CMS	1.000	C	1	1.625	VCFJF	B/H	Flomax 5 & 8	22272 - Old Style
PS-248V-CMS	1.000	C	1	1.625	VCFKF	B/H		22274
PS-380	1.000	D	1	1.625	BCFJF			14233
PS-3266	1.000	D	3	1.625	VCFLF	I	Springholder may not be required	29773
PS-22007	1.000	D	3	1.625	VRFLF			26460
PS-4195	1.000	G	1	1.625	VCFJF	316SS	Flomax 5 & 8	22273
PS-604	1.125	D	1	1.750	BCFJF			
PS-22008	1.250	D	3	2.125	VCFLF	I		33507
PS-758	1.500	C	1	2.125	BCFJF			37203
PS-347	1.500	C	1	2.125	BCFJF	B/H		14421, 14424
PS-347V-CMS	1.500	C	1	2.125	VCFJF	B/H	Flomax 10 & 15	22361
PS-4482	1.500	C	1	2.125	VCFKF	B/H		22363
PS-3249	1.500	C	3	2.125	NLFLF	B/S		35840
PS-382	1.500	D	1	2.125	BCFJF			
PS-22005	1.500	D	1	2.125	VCFLF	316SS/H		35651
PS-22004	1.500	D	3	2.125	VCFLF	316SS/S		34933
PS-3992	1.500	G	1	2.125	VCFJF			31374
PS-7587	1.500	W	2	2.125	TCFJF	316SS		26565
PS-446V-CMS	1.750	C	1	2.500	VCFJF			26685
PS-22006	1.750	D	1	2.500	VCFLF	316SS		35712
PS-7959	1.750	D	3	2.500	VRZFZ	S		26752

NOTE: A. MOUNTS ON SHAFT
 B. TAPERED SPRING
 C. COMPLETE WITH COLLAR
 H. SPRING HOLDER NOT INCLUDED
 I. ABRASION RESISTANT CARBON (P66)
 S. SLOTTED MATING RING

PUMP MANUFACTURERS' CROSS-REFERENCE

U.S. Seal Mfg. Part No.	Seal Size	Head	Mating Ring	Mating Ring Bore	Material Code	Notes	Pump Nameplate Data	Mfg. Part No.
MTH TOOL COMPANY, INC. / MTH PUMPS								
PS-3133	.625	C	3	1.250	NCFKF			12-5013-01-478
FA-10036	.875	C	—	—	VCF-F	I		12-1068-01-494
FA-9009	.875	W	—	—	TCF-F	316SS		12-3300-01-509
PS-9317	1.375	W	2	2.000	TCFJF	316SS		12-1675-01-509
MURPHY DIESEL								
PS-358	.750	C	1	1.375	BCFJF			MD-4090
MUSKIN								
PS-163	.500	B	1	1.000	BMFJF			09-2001
PS-142	.500	B	1	1.000	BMFJF			09-2013
MYERS, F.E. (See PENTAIR, INC. for Additional Part Numbers)								
PS-162	.500	A	1	1.000	BMFJF			21607A015
PS-4038	.500	Q	8	.906	BMFJF	A		21607A001
PS-200	.625	A	1	1.250	BMFJF			10840A1,14525A000
							1425A010, 16275A	
PS-200V-CMS	.625	A	1	1.250	VCFJF			21181A044
PS-3845	.625	B	8	—	BMFJF	A		25053A000
PS-359	.625	C	1	1.250	BCFJF	H		22447A000
PS-359V-CMS	.625	C	1	1.250	VCFJF			21181A021
PS-508	.625	D	1	1.250	BCDJF			
PS-968	.750	A	1	1.437	BCFJF			11416A000
PS-101	.750	A	1	1.437	BMFJF		H, HN, K, MHN	11416A010
PS-902	.750	B	9	—	BMFKF	A		21579A
PS-1125	.750	C	1	1.375	BCFJF			25370A000
PS-7514	.750	C	1	1.437	BCFJF	N	2C200	21181A017
PS-309	.875	C	1	1.500	BCFJF			21576A000
PS-3907	.875	C	1	1.500	BCFJF			21576A010
PS-3749	.875	C	1	1.500	BCFJF			21576A011
PS-7130	.875	C	1	1.500	BCFJF		WG-20-21-15	
PS-703	.875	D	1	1.500	BCDJF		125 Centri-Thrift	11716A1
PS-204	1.125	E	1	1.750	BCFJF			
PS-867V-TC-SEAT	1.125	E	3	1.750	VCFKF	S		21181A6
PS-185	1.250	C	1	1.875	BCFJF			22577A000
PS-185-SC-SC	1.250	C	1	1.875	BLFLF			21181A062
PS-2208	1.250	C	1	1.875	BZFZF			21181A019
PS-381	1.250	D	1	1.875	BCFJF			21181A016
PS-758	1.500	C	1	2.125	BCFJF			22922A000, 009200011
PS-2209	1.500	C	1	2.125	BZFZF			21181A013
PS-758V-CMS	1.500	C	1	2.125	VCFJF			21181A022, 009200031
PS-659V-TC-VS-TC	1.500	C	1	2.125	VZFZF			21181A064
PS-238	1.625	C	1	2.375	BCFJF			21181A032
PS-2212	1.750	C	1	2.500	BCFJF			22883A000
PS-446	1.750	C	1	2.500	BCFJF			110490011
PS-237	1.750	D	1	2.500	BCDJF			
PS-7138	2.250	C	1	3.125	BCFJF			23605A000
PS-7138-TC-TC	2.250	C	1	3.125	BZFZF			21181A020
PS-1088	3.000	C	3	3.875	BCFJF	B/S		25449A000
NASH (Division of GARDNER DENVER)								
PS-100	.625	A	1	1.187	BMFJF			
PS-100V-CMS	.625	A	1	1.187	VCFJF			PK-0389
PS-600	.625	B	1	1.187	BMFJF			PK-0339
PS-600V-CMS	.625	B	1	1.187	VCFJF			PK-0654
PS-452	.625	B	9	—	BMFJF	A	S1.25C	
PS-764	.750	A	1	1.375	BCFJF			PK-0482
PS-866	1.125	E	3	1.750	BCFJF	S		PK-0295, PK-0754
PS-282	1.125	U	3	1.750	BCFKF	S		PK-0334
PS-177	1.375	C	1	2.000	BCFJF		MH-50, MH-80	PK-0874
PS-177V	1.375	C	3	2.000	VCFJF	S		PK-2044
PS-354	1.375	E	1	2.000	BCFJF		AL 621	PK-0475
PS-864	1.375	E	3	2.000	BCFJF	S		PK-0873

PUMP MANUFACTURERS' CROSS-REFERENCE

U.S. Seal Mfg. Part No.	Seal Size	Head	Mating Ring	Mating Ring Bore	Material Code	Notes	Pump Nameplate Data	Mfg. Part No.
NASH (Division of GARDNER DENVER) (continued)								
PS-758	1.500	C	1	2.125	BCFJF			PK-0791
PS-2223	1.500	C	3	2.125	VCFZF	S		PK-0959
PS-382	1.500	D	1	2.125	BCFJF		MPS-673	PK-0624
PS-817	1.500	D	3	2.125	BCFJF	S		PK-0302, PK-0306
PS-305	1.500	E	1	2.125	BCFJF		MP-40	PK-0678
PS-884	1.500	K	1	2.125	BCFKF		MPS-40	
PS-238V	1.625	C	3	2.375	VCFJF	S		
PS-4516	1.625	C	3	2.375	VCFJF	316SS/S		PK-3437
PS-3125	1.750	C	3	2.500	BCFJF	I/S		PK-0900
PS-446V-P66	1.750	C	3	2.500	VCFJF	I/S		PK-1531
PS-340	1.875	C	1	2.625	BCFJF			PK-0893
PS-338V	2.125	C	3	3.000	VCFJF	S		PK-3438
PS-9122	2.125	W	2	3.000	TCFJF	316SS		PK-2510
PS-874	2.250	D	1	3.125	BCDJF		1-1/2 H-6	PK-0341
PS-2089	2.250	D	3	3.125	BCFJF	S		PK-0479
PS-9120	2.250	W	2	3.125	TCFJF	316SS	SC-4&5	PK-2516
PS-3233	2.375	C	3	3.250	VCFJF	316SS/S		PK-3439
PS-269V	2.500	C	3	3.375	VCFJF	S		PK-1772
PS-838	2.750	E	3	3.500	V/BCFJF	S		PK-0523
PS-9314	2.750	W	2	3.500	TCFJF	316SS		PK-3368
PS-8120	2.750	X	3	3.500	VCFZF	316SS		PK-3181
PS-2116	3.000	C	3	3.875	BCFJF	S	AD-303	PK-0937
PS-9140	3.000	W	2	3.875	TCFJF	316SS		PK-2522
PS-8706	3.375	X	3	4.250	V/TCFJF	316SS/S		PK-3529
PS-9351	4.000	W	2	4.875	TCFJF	316SS		PK-2549
PS-8126	4.250	X	3	5.250	VCFJF	316SS		PK-3513
NATIONAL OILWELL VARCO (NOV, INC.)								
PS-1002V	.500	C	1	1.000	VCFJF			3206037000
PS-359	.625	C	1	1.250	BCFJF			3202424000
PS-309V-SC-SC	.875	C	3	1.500	VLFLF			472-00129
PS-801	1.125	C	3	1.750	B/VCFJF	S		601500044
PS-4454	1.125	C	3	1.750	VZFZF	S		601500051
PS-2738	1.125	E	3	1.750	VCFKF	C/S	c/w Square lock collar & bronze bushing	603450602 10340316-001
PS-238V-SC-SEAT	1.625	C	3	2.375	VCFLF			
PS-3276	60MM	G	25	80MM	VLFLF	316SS		4241749060, A200-0118
PS-3143	3.500	E	3	4.375	VZFZF			658416102, 662010127
VG-3015	2.500	Special	3	3.375	VZFZF	316SS/S		22451-10
<p>VG-3015</p> <ul style="list-style-type: none"> Used in Mission™Magnum™ Mud Pumps Rugged design with machined 316SS retainer and drive band Mission™ Magnum™ is a registered trademark of National Oilwell Varco 								
								
NEW BRUNSWICK SCIENTIFIC								
PS-3082	.375	C	3	.875	Q/NCFJF			PO280-0072
PS-4465	.750	C	3	1.375	VCFJF	316SS		PO280-4582
PS-8036	.750	X	5	1.383	QCFZF	316SS		PO280-0120
PS-8123	.750	X	5	1.625	T/QCFZF	316SS/I		PO280-4590
PS-8101	.750	X Special	5	1.375	QCFZF	316SS		PO280-0420
PS-8116	1.000	X	5	1.633	QCFZF	316SS		PO280-4120
PS-8044	1.437	X	5	2.125	VCFZF	316SS		PO280-0131
PS-8600	1.500	X	5	2.133	QCFZF	316SS		PO280-0464
PS-8561	2.000	X	5	2.750	QCFZF	316SS		
PS-8128	2.750	X	5	3.500	QCFZF	316SS		PO280-0463

NOTE: C. COMPLETE WITH COLLAR
I. ABRASION RESISTANT CARBON (P66)
S. SLOTTED MATING RING

PUMP MANUFACTURERS' CROSS-REFERENCE

U.S. Seal Mfg. Part No.	Seal Size	Head	Mating Ring	Mating Ring Bore	Material Code	Notes	Pump Nameplate Data	Mfg. Part No.
OBERDORFER PUMPS (Division of GARDNER DENVER)								
PS-671	.375	B	1	.875	BMFJF		IGCC Pump	32373
PS-671V-CMS	.375	B	1	.875	VCFJF			
PS-22028	.375	C	3	.875	VCFJF	316SS		OB33065
PS-1098	.500	B	1	.875	BMFJF		142	32482
PS-2720	.500	C	3	1.000	BCFJF			32584
PS-3197	.500	C	3	1.000	VCFJF	316SS		OB32772
PS-3003	.500	G	3	1.000	BCFJF			32592
FA-642	.625	B	—	—	BMF-F		4GP, 9GP, RA-TV, RB-TB	A-5377, A-6019, 2913
PS-22027	.625	B	1	1.187	BLFLF	316SS		32006
PS-600	.625	B	1	1.187	BMFJF		4GP, 9GP, RA-TV, RB-TB	
FA-10034	.625	C	—	—	VCF-F			9798A
PS-359	.625	C	1	1.250	BCFJF			A-5935, 32156
PS-22029	.625	C	3	1.187	BCFJF			OB32202
PS-4346	.625	C	3	1.187	VCFJF	316SS		OB33109
PS-22030	.625	C	3	1.187	VCFJF	316SS		32235
PS-9354	.625	WA	3 Special	1.312	T/YCFKF			OB32211
PS-235	1.000	C	1	1.625	BCFJF			32315
PS-235V-CMS	1.000	C	1	1.625	VCFJF			32372
OHLER PUMP (Division of WS DARLEY)								
PS-235	1.000	C	1	1.625	BCFJF			
PS-357	1.000	C	1	1.625	BCFKF			
PS-185	1.250	C	1	1.875	BCFJF			
PS-186	1.375	D	1	2.000	BCDKF			
PACER PUMPS								
FA-2751	.750	B	—	—	QCF-F	316SS		58-0964-12
PS-3985	.750	B	1	1.375	BCFJF	316SS		58-714-11
PS-4056	.750	B	1	1.375	QCFJF		S1A150-704, S2A150-704	S2A150-975, S3A150-975 58-714-12
PS-601V-CMS	.750	B	1	1.375	VCFJF			58-714-14
PAC-FAB (PENTAIR POOL PRODUCTS, INC.)								
PS-952	.625	A	1	1.250	BCFJF		AV-7 Pump	23822
PS-200	.625	A	1	1.250	BMFJF		Challenger®, Dynamite, Dynamo® Dynatron®, Pinnacle®	354545
PS-201	.750	A	1	1.375	BMFJF		Hydropump®	354001
PACO								
PS-516	.625	A	1	1.250	BCFJF			14010242
PS-200	.625	A	1	1.250	BMFJF			SL-7101, SL-7741 K102-1, 91909744
PS-628	.625	A	3	1.250	BMFKF			K100-7, 14008630 K102-7, 91909687 91909747
PS-1618	.625	C	1	1.250	BCFJF	B		14032695
PS-2149	.625	C	3	1.250	BCFKF	B		14032688
PS-508	.625	D	1	1.250	BCDJF			SL-7100
PS-973	.750	A	1	1.375	BCFKF			K101-7, 91909722
PS-201	.750	A	1	1.375	BMFJF			K101-1, 91909719
PS-768	.750	C	3	1.375	BCFKF			14032689
PS-112V	.750	C	3	1.375	VCFKF			14032363
PS-750	.750	D	1	1.375	BCDJF		1.5LRV, 1.25JS	
PS-752	.750	D	1	1.375	BCDKF			SL-7104
PS-703	.875	D	1	1.500	BCDJF			SL-7098
PS-235	1.000	C	1	1.625	BCFJF			SL-7735
PS-380	1.000	D	1	1.625	BCFJF			SL-7087
PS-460	1.000	D	1	1.625	BCFKF			SL-7106
PS-754	1.000	E	1	1.625	BCFJF			14007521
PS-204	1.125	E	1	1.750	BCFJF			SL-7770
FA-756	1.250	C	—	—	BCF-F			14032143

PUMP MANUFACTURERS' CROSS-REFERENCE

U.S. Seal Mfg. Part No.	Seal Size	Head	Mating Ring	Mating Ring Bore	Material Code	Notes	Pump Nameplate Data	Mfg. Part No.
PACO (continued)								
PS-2122	1.250	C	1	1.875	BCFJF			14032698 K105-1, K107-1 91909832, 91909909
PS-185	1.250	C	1	1.875	BCFJF			14033710
PS-756	1.250	C	1	1.875	BCFKF			SL-7094
PS-1109	1.250	C	3	1.875	BCFKF			K105-7, 14032691 91909838
PS-756V	1.250	C	3	1.875	VCFKF			K107-6, 91909912
PS-1109V	1.250	C	3	1.875	VCFKF			K105-6, 14032365 91909837
PS-361	1.250	E	1	1.875	BCFJF		2CLSU-3ALR	14007099
PS-361-P66	1.250	E	1	1.875	BCFJF	I		14007083
PS-137	1.250	E	1	1.875	BCFKF			SL-8102
PS-1183-P66	1.250	E	3	1.875	BCFKF	I		14008102
PS-137V-P66	1.250	E	3	1.875	VCFKF	I		K600-6, 91911824
PS-3974	1.375	DB	1	1.875	BCFJF			14007089
PS-758	1.500	C	1	2.125	BCFJF			
PS-371	1.500	D	1	2.125	BCFKF			
FA-305	1.500	E	—	—	BCF-F			14010219
PS-305	1.500	E	1	2.125	BCFJF			SL-8223
PS-374	1.500	E	1	2.125	BCFKF			
FA-1660	1.750	C	—	—	BCF-F			14032145 14032355
PS-446	1.750	C	1	2.500	BCFJF			91909802
PS-2142	1.750	C	1	2.500	BCFJF			K104-1
PS-2150	1.750	C	3	2.500	BCFJF	S		K106-1, 91909874 K108-1, 91909944
PS-2151	1.750	C	3	2.500	BCFKF	S		K303-7, 14032693
PS-2151V	1.750	C	3	2.500	VCFKF	S		K106-6, 91909878 K108-6, 91909947
PS-2151V-TC-SEAT	1.750	C	3	2.500	VCFZF	S		14032384
PS-205	1.750	E	1	2.500	BCFJF		3CLSU	SL-7090, 14007090
PS-366	1.750	E	1	2.500	BCFKF			SL-8398
PS-262	1.750	E	3	2.500	BCFKF	S	KP3014-516	K307-71, 14008148 14008650, 14009965 29-5015-47001
PS-449	1.750	K	1	2.500	BCFJF			14033023
FA-1875	1.875	C	—	—	BCF-F			14033944
PS-3070	1.875	DB	3	2.500	BCDJF	S		
FA-513V	1.875	E	—	—	VCF-F			14034032
FA-2000	2.000	C	—	—	BCF-F			14032146
PS-479	2.000	E	1	2.750	BCFJF			K602-1, 91911836
PS-843	2.000	E	1	2.750	BCFKF			K602-7, 91911839
PS-530	2.000	E	3	2.750	BCFJF	S		K602-6, 91911838
PS-477	2.000	E	3	2.750	BCFKF	S		
PS-3537	2.250	C	1	3.125	BCFJF			14032701
PS-3041	2.250	C	3	3.125	BCFKF			14032694
PS-323	2.250	E	1	3.125	BCDJF			14001709 14007709
PS-351	2.250	E	1	3.125	BCDKF			14017123 29-60122-47001 K308-71
PS-1688	2.250	E	3	3.125	BCFJF	S		K111-1, 91910192
PS-2094V	2.250	E	3	3.125	VCFKF	S		K111-6, 91910195
PS-8089	2.500	XB1	3	3.125	QCFLF	316SS/I/S		
PS-4236	3.500	R	3	4.375	BCFJF			14032979

NOTE: I. ABRASION RESISTANT CARBON (P66)
S. SLOTTED MATING RING

PUMP MANUFACTURERS' CROSS-REFERENCE

Value Guard Part No.	Seal Size	Material Code	Bill of Materials	Mfg. Part No.
PACO (Replacement Seal Kits for Split Case Pumps)				
VGK-1000	1.750	BCFJF	Buna/Carbon/Ceramic/SS	K0303-1
VGK-1000B*	1.750	BCFJF	Buna/Carbon/Ceramic/SS	K0303-1
VGK-1001	1.750	VCFKF	Viton®/Carbon/Ni-Resist/SS	K0303-6
VGK-1001B*	1.750	VCFKF	Viton®/Carbon/Ni-Resist/SS	K0303-6
VGK-1002	1.750	BCFKF	Buna/Carbon/Ni-Resist/SS	K0303-7
VGK-1002B*	1.750	BCFKF	Buna/Carbon/Ni-Resist/SS	K0303-7
VGK-1003	1.750	BCFJF	Buna/Carbon/Ceramic/SS	K0308-1
VGK-1003B*	1.750	BCFJF	Buna/Carbon/Ceramic/SS	K0308-1
VGK-1004	1.750	VCFKF	Viton®/Carbon/Ni-Resist/SS	K0308-6
VGK-1004B*	1.750	VCFKF	Viton®/Carbon/Ni-Resist/SS	K0308-6
VGK-1005	1.750	BCFKF	Buna/Carbon/Ni-Resist/SS	K0308-7
VGK-1005B*	1.750	BCFKF	Buna/Carbon/Ni-Resist/SS	K0308-7

Kits include appropriate gaskets and o-rings, slingers and mechanical seals.

* Kits with the letter B in the part number include the items listed above PLUS the bearings and oil seal.



VGK-1003

Value Guard Part No.	Seal Size	Material Code	Bill of Materials	Old Paco No.	New Paco No.
PACO (Replacement Seal Kits for End Suction Pumps)					
VGK-1006	.625	BCFJF	Buna/Carbon/Ceramic/SS	K100-1	91909684
VGK-1007	.625	VCFKF	Viton®/Carbon/Ni-Resist/SS	K100-6	91909686
VGK-1008	.625	BCFKF	Buna/Carbon/Ni-Resist/SS	K100-7	91909687
VGK-1012	.625	BMFJF	Buna/Molded Plastic/Ceramic/SS	K102-1	91909744
VGK-1013	.625	VCFKF	Viton®/Carbon/Ni-Resist/SS	K102-6	91909746
VGK-1014	.625	BCFKF	Buna/Carbon/Ni-Resist/SS	K102-7	91909747
VGK-1009	.750	BMFJF	Buna/Molded Plastic/Ceramic/SS	K101-1	91909719
VGK-1010	.750	VCFKF	Viton®/Carbon/Ni-Resist/SS	K101-6	91909721
VGK-1011	.750	BCFKF	Buna/Carbon/Ni-Resist/SS	K101-7	91909722
VGK-1054	.875	BCFJF	Buna/Carbon/Ceramic/SS	K1503-1	91910735
VGK-1018	1.250	BCFJF	Buna/Carbon/Ceramic/SS	K105-1	91909832
VGK-1019	1.250	VCFKF	Viton®/Carbon/Ni-Resist/SS	K105-6	91909837
VGK-1020	1.250	BCFKF	Buna/Carbon/Ni-Resist/SS	K105-7	91909838
VGK-1024	1.250	BCFJF	Buna/Carbon/Ceramic/SS	K107-1	91909909
VGK-1025	1.250	VCFKF	Viton®/Carbon/Ni-Resist/SS	K107-6	91909912
VGK-1026	1.250	BCFKF	Buna/Carbon/Ni-Resist/SS	K107-7	91909913
VGK-1061	1.250	BCFJF	Buna/Carbon/Ceramic/SS	K453-1	91911801
VGK-1062	1.250	VCFKF	Viton®/Carbon/Ni-Resist/SS	K453-6	—
VGK-1063	1.250	BCFKF	Buna/Carbon/Ni-Resist/SS	K453-7	—
VGK-1070	1.250	BCFJF	Buna/Carbon/Ceramic/SS	K600-1	91911821
VGK-1071	1.250	VCFKF	Viton®/Carbon/Ni-Resist/SS	K600-6	91911824
VGK-1072	1.250	BCFKF	Buna/Carbon/Ni-Resist/SS	K600-7	91911825
VGK-1073	1.250	BCFJF	Buna/Carbon/Ceramic/SS	K601-1	91911832
VGK-1074	1.250	VCFKF	Viton®/Carbon/Ni-Resist/SS	K601-6	91911834
VGK-1075	1.250	BCFKF	Buna/Carbon/Ni-Resist/SS	K601-7	91911835
VGK-1079	1.250	BCFJF	Buna/Carbon/Ceramic/SS	K607-1	—
VGK-1080	1.250	VCFKF	Viton®/Carbon/Ni-Resist/SS	K607-6	91911848
VGK-1081	1.250	BCFKF	Buna/Carbon/Ni-Resist/SS	K607-7	—
VGK-1082	1.250	BCFJF	Buna/Carbon/Ceramic/SS	K608-1	—
VGK-1083	1.250	VCFKF	Viton®/Carbon/Ni-Resist/SS	K608-6	91911850
VGK-1084	1.250	BCFKF	Buna/Carbon/Ni-Resist/SS	K608-7	—
VGK-1058	1.250	BCFJF	Buna/Carbon/Ceramic/SS	K1815-1	91910839
VGK-1059	1.250	VCFKF	Viton®/Carbon/Ni-Resist/SS	K1815-6	91910841
VGK-1060	1.250	BCFKF	Buna/Carbon/Ni-Resist/SS	K1815-7	91910842
VGK-1055	1.375	BCFJF	Buna/Carbon/Ceramic/SS	K1575-1	—

PUMP MANUFACTURERS' CROSS-REFERENCE

Value Guard Part No.	Seal Size	Material Code	Bill of Materials	Old Paco No.	New Paco No.
PACO (Replacement Seal Kits for End Suction Pumps) (continued)					
VGK-1056	1.375	VCFKF	Viton®/Carbon/Ni-Resist/SS	K1575-6	—
VGK-1057	1.375	BCFKF	Buna/Carbon/Ni-Resist/SS	K1575-7	91910804
VGK-1015	1.750	BCFJF	Buna/Carbon/Ceramic/SS	K104-1	91909802
VGK-1016	1.750	VCFKF	Viton®/Carbon/Ni-Resist/SS	K104-6	91909805
VGK-1017	1.750	BCFKF	Buna/Carbon/Ni-Resist/SS	K104-7	91909806
VGK-1021	1.750	BCFJF	Buna/Carbon/Ceramic/SS	K106-1	91909874
VGK-1022	1.750	VCFKF	Viton®/Carbon/Ni-Resist/SS	K106-6	91909878
VGK-4022	1.750	VCFZF	Viton®/Carbon/Tungsten/SS		
VGK-1023	1.750	BCFKF	Buna/Carbon/Ni-Resist/SS	K106-7	91909879
VGK-1027	1.750	BCFJF	Buna/Carbon/Ceramic/SS	K108-1	91909944
VGK-1028	1.750	VCFKF	Viton®/Carbon/Ni-Resist/SS	K108-6	91909947
VGK-1029	1.750	BCFKF	Buna/Carbon/Ni-Resist/SS	K108-7	91909948
VGK-1033	1.750	BCFJF	Buna/Carbon/Ceramic/SS	K110-1	91910149
VGK-1034	1.750	VCFKF	Viton®/Carbon/Ni-Resist/SS	K110-6	91910150
VGK-1035	1.750	BCFKF	Buna/Carbon/Ni-Resist/SS	K110-7	91910151
VGK-1042	1.750	BCFJF	Buna/Carbon/Ceramic/SS	K127-1	91910609
VGK-1043	1.750	VCFKF	Viton®/Carbon/Ni-Resist/SS	K127-6	91910611
VGK-4043	1.750	VCFZF	Viton®/Carbon/Tungsten/SS		
VGK-4043	1.750	VCFZF	Viton®/Carbon/Tungsten/SS		
VGK-1044	1.750	BCFKF	Buna/Carbon/Ni-Resist/SS	K127-7	91910612
VGK-1045	1.750	BCFJF	Buna/Carbon/Ceramic/SS	K128-1	91910629
VGK-1046	1.750	VCFKF	Viton®/Carbon/Ni-Resist/SS	K128-6	91910631
VGK-4046	1.750	VCFZF	Viton®/Carbon/Tungsten/SS		
VGK-1047	1.750	BCFKF	Buna/Carbon/Ni-Resist/SS	K128-7	91910632
VGK-1051	1.750	BCFJF	Buna/Carbon/Ceramic/SS	K141-1	91910715
VGK-1052	1.750	VCFKF	Viton®/Carbon/Ni-Resist/SS	K141-6	91910717
VGK-4052	1.750	VCFZF	Viton®/Carbon/Tungsten/SS		
VGK-1053	1.750	BCFKF	Buna/Carbon/Ni-Resist/SS	K141-7	91910718
VGK-1064	1.750	BCFJF	Buna/Carbon/Ceramic/SS	K454-1	91911802
VGK-1065	1.750	VCFKF	Viton®/Carbon/Ni-Resist/SS	K454-6	—
VGK-1066	1.750	BCFKF	Buna/Carbon/Ni-Resist/SS	K454-7	91911803
VGK-1076	2.000	BCFJF	Buna/Carbon/Ceramic/SS	K602-1	91911836
VGK-1077	2.000	VCFKF	Viton®/Carbon/Ni-Resist/SS	K602-6	91911838
VGK-1078	2.000	BCFKF	Buna/Carbon/Ni-Resist/SS	K602-7	91911839
VGK-1030	2.250	BCFJF	Buna/Carbon/Ceramic/SS	K109-1	91910061
VGK-1031	2.250	VCFKF	Viton®/Carbon/Ni-Resist/SS	K109-6	91910065
VGK-1032	2.250	BCFKF	Buna/Carbon/Ni-Resist/SS	K109-7	91910066
VGK-1036	2.250	BCFJF	Buna/Carbon/Ceramic/SS	K111-1	91910192
VGK-1037	2.250	VCFKF	Viton®/Carbon/Ni-Resist/SS	K111-6	91910195
VGK-4037	2.250	VCFZF	Viton®/Carbon/Tungsten/SS		
VGK-1038	2.250	BCFKF	Buna/Carbon/Ni-Resist/SS	K111-7	91910196
VGK-1048	2.250	BCFJF	Buna/Carbon/Ceramic/SS	K140-1	91910707
VGK-1049	2.250	VCFKF	Viton®/Carbon/Ni-Resist/SS	K140-6	91910708
VGK-1050	2.250	BCFKF	Buna/Carbon/Ni-Resist/SS	K140-7	91910709
VGK-1067	2.250	BCFJF	Buna/Carbon/Ceramic/SS	K455-1	91911806
VGK-1068	2.250	VCFKF	Viton®/Carbon/Ni-Resist/SS	K455-6	—
VGK-1069	2.250	BCFKF	Buna/Carbon/Ni-Resist/SS	K455-7	—
VGK-1039	2.750	BCFJF	Buna/Carbon/Ceramic/SS	K112-1	91910246
VGK-1040	2.750	VCFKF	Viton®/Carbon/Ni-Resist/SS	K112-6	91910252
VGK-1041	2.750	BCFKF	Buna/Carbon/Ni-Resist/SS	K112-7	91910250

Kits include appropriate gaskets and o-rings, slingers and mechanical seals.

Loctite® is included, if required for installation.

PACO is not affiliated with U.S. Seal Mfg.

Products supplied are manufactured or purchased by U.S. Seal Mfg. from sources other than the company listed.



VGK-1021



VGK-1077

PUMP MANUFACTURERS' CROSS-REFERENCE

U.S. Seal Mfg. Part No.	Seal Size	Head	Mating Ring	Mating Ring Bore	Material Code	Notes	Pump Nameplate Data	Mfg. Part No.
PATTERSON PUMP COMPANY (A GORMAN RUPP COMPANY)								
PS-4417	1.875	EB	3	2.500	VCFJF	S		74020174-0917
PS-6600	2.750	E	3	4.125	VCFJF		SSC 10X8X17	74020182-0917
PS-6601	2.750	E	3	4.125	VCFLF	316SS	SSC	74020182A01-0917
PAUL MUELLER COMPANY								
PS-1002	.500	C	1	1.000	BCFJF			9841604
PS-5625	.625	Special	1	1.250	QC-J-			
PS-309	.875	C	1	1.500	BCFJF			9842885
PS-4350	1.000	C	3	1.625	QCFZF	S		
PS-356	1.125	C	1	1.750	BCFJF			9840339
PS-177	1.375	C	1	2.000	BCFJF			6840666
PS-4438	1.500	C	3	2.125	QCFZF	S		560173
PS-7309	2.000	C	3	2.750	QCFZF	I/S		
PEABODY BARNES MFG. (Division of CRANE PUMPS & SYSTEMS)								
PS-163	.500	B	1	1.000	BMFJF			18189
PS-165	.500	B	9	.906	BMFJF	A		29726
PS-200	.625	A	1	1.250	BMFJF		For Comet, Rocket Econo, 25, 31, 33, 35, 48, 49, 50, 52 102DM and 740DM	11397-12839, 12703
PS-359	.625	C	1	1.250	BCFJF			18873A
PS-3914	.625	C	3	1.250	BCFJF			023701
PS-508	.625	D	1	1.250	BCDJF			5080
PS-201	.750	A	1	1.375	BMFJF		Vertical Single and Multi Stage 152 152DM, 202D, 202DM, 302D 302DM and 502DM	13110, 14017122
PS-358	.750	C	1	1.375	BCFJF			15344, 67562
PS-235	1.000	C	1	1.625	BCFJF			18004-30090
PS-236	1.000	E	1	1.625	BCFKF			8022
PS-879	1.000	K	1	1.625	BCFJF			64434
PS-4301	1.000	K	1	1.625	BLFLF/ BCFJF			064434SD
PS-185	1.250	C	1	1.875	BCFJF		18ACG, 18, 19, 23 & 26 CCG	70713
PS-598	1.250	C	3	1.875	BCFKF		3TACG Int 1020	33289
PS-383	1.250	D	1	1.875	BCFKF			12074
PS-883	1.250	K	1	1.875	BCFJF			39485
PS-4282	1.250	K	1	1.875	BL/CFL/JF			39485SD
PS-7323	1.250	K	1	1.875	BZ/CFZ/JF			60817
PS-228	1.250	K	3	1.875	BCFKF		3TCCG	25328A
PS-3230	1.375	C	1	2.000	NCFJF			52601
PS-547	1.375	C	3	2.000	BCFKF	S		39463
PS-758	1.500	C	1	2.125	BCFJF			24998
PS-553	1.500	C	3	2.125	BCFKF			31000
PS-2062	1.750	D	3	2.500	BCFKF	S		13301
PS-2237	1.875	K	1	2.625	BCFJF			51938
PS-3753	1.875	K	1	2.625	BL/CFL/JF			51938SD, 60818SD
PS-332	2.000	C	3	2.750	BCFKF	S		53626
PEERLESS PUMP COMPANY (See GRUNDFOS, INC. for Additional Part Numbers)								
PS-162	.500	A	1	1.000	BMFJF			2665554
PS-100	.625	A	1	1.187	BMFJF			
PS-200	.625	A	1	1.250	BMFJF			2658090, 96667758
PS-300	.625	A	1	1.250	BMFJF		Convertible & Single Stage Jet Water King	2655294-V12271 1181377-2665624
PS-637	.625	A	3	1.250	BMFJF			26922-69 000, 96678617
PS-4320	.625	C	3	1.250	QCFJF			268049602 000
PS-3319	.625	C	3	1.250	QCFKF			96677200
PS-263	.625	D	1	1.187	BCDKF			2675336
PS-508	.625	D	1	1.250	BCDJF			2666910
PS-301	.750	A	1	1.375	BMFJF		Single Stage Jet: J2G, J3G 1J 2J, 3J, 15J, 75J, 1GJ	2655293, 26650131
PS-750	.750	D	1	1.375	BCDJF			2655888, 2663071
PS-265	.750	D	3	1.375	BCDKF			

PUMP MANUFACTURERS' CROSS-REFERENCE

U.S. Seal Mfg. Part No.	Seal Size	Head	Mating Ring	Mating Ring Bore	Material Code	Notes	Pump Nameplate Data	Mfg. Part No.
PEERLESS PUMP COMPANY (See GRUNDFOS, INC. for Additional Part Numbers) (continued)								
PS-303	.875	D	1	1.500	BCDKF			2655239, 2664873
PS-250	.875	D	3	1.500	BCDKF			2675339, 269042101
PS-188	.875	E	1	1.500	BCFJF	316SS		2657110, 2663072
PS-229	.875	E	3	1.500	BCFKF			2675338
PS-778	1.000	A	3	1.625	BCFKF	S		2692914, 96692081
PS-380	1.000	D	1	1.625	BCFJF		PE-200, PE-300, PE-500 Fluidyne	
PS-252	1.000	D	3	1.625	BCFKF	S		2664873, 269042102
PS-252-EPR	1.000	D	3	1.625	QCCKF	S		2675341 000
PS-754	1.000	E	1	1.625	BCFJF			2655887
PS-251	1.000	E	3	1.625	BCFKF	S		2656324, 2675340
PS-529	1.125	C	3	1.750	BCFKF	S		269794701000
PS-801	1.125	C	3	1.750	B/VCFJF	S		269987501000 96736765
PS-983V-TC-TC	1.125	C	3	1.750	VZFFZ	S		
PS-604	1.125	D	1	1.750	BCFJF			2658071
PS-605	1.125	D	1	1.750	BCFKF			2655131
PS-254	1.125	D	3	1.750	BCFKF	S		2655131, 2675344
PS-204	1.125	E	1	1.750	BCFJF			2663077
PS-253	1.125	E	3	1.750	BCFKF	S	300-90	2664886, 2675317 2675343
PS-4533	1.187	D	3	1.812	BCFKF			269042103000
PS-306	1.187	E	1	1.875	BCDJF			2655886
PS-255	1.187	E	3	1.875	BCDKF			2675345, 269042103
PS-3119	1.250	C	1	1.875	VZFLF			96744338
PS-1109-CER	1.250	C	3	1.875	BCFJF	S		269986601 000 96748361
PS-1109	1.250	C	3	1.875	BCFKF			2687165 000
PS-2769	1.250	C	3	1.875	BCFLF	S		96744339, 99267885
PS-1109-EPR	1.250	C	3	1.875	QCCKF			2687626 000 2687926 000
PS-2122V	1.250	C	3	1.875	VCFJF	S		269986602 000 96748363
PS-1109V	1.250	C	3	1.875	VCFKF			268716501
PS-361	1.250	E	1	1.875	BCFJF		PB-3, 3X4X10	
PS-256	1.250	E	3	1.875	BCFKF			2664893, 2675347
PS-264	1.250	E	3	1.875	BCFKF			2675318, 2687266
PS-547	1.375	C	3	2.000	BCFKF	S		269794702
PS-354	1.375	E	1	2.000	BCFJF			2655089, 2663075
PS-677	1.375	E	1	2.000	BCFKF			2663368, 2675349
PS-257	1.375	E	3	2.000	BCFKF	S		2675350
PS-7166	1.500	C	3	2.125	BCFJF	S		269986701, 96744341
PS-1110	1.500	C	3	2.125	BCFKF		F2-1044AM, 1230AM, 1240AM 3AE14	2687166 000
PS-3279	1.500	C	3	2.125	BCFZF	S		269986703 / 96748399
PS-2221	1.500	C	3	2.125	QCCKF			2691073
PS-2714	1.500	C	3	2.125	VCFJF	S		269986702, 96744346
PS-1110V	1.500	C	3	2.125	VCFKF			268716607
PS-2223-SC-SEAT	1.500	C	3	2.125	VCFLF	S		50512387
PS-382	1.500	D	1	2.125	BCFJF			2656981, 2675353
FA-10167	1.500	E	—	—	BCF-F	I		2689751 000
PS-305	1.500	E	1	2.125	BCFJF			2663008, 2675108
PS-258	1.500	E	3	2.125	BCFKF			2675351, 2691073 96706697
PS-259	1.500	E	3	2.125	BCFKF			2675352
PS-550	1.750	C	3	2.500	BCFJF	S		269359803 000 96700470
PS-436	1.750	C	3	2.500	BCFKF	S	AD IV-V	2693598 000
PS-436-EPR	1.750	C	3	2.500	QCCKF	S		2675319 000
PS-825	1.750	D	3	2.500	BCDKF	S	PE-Pumps	2675356
FA-366	1.750	E	—	—	BCF-F			2689752 000
PS-205	1.750	E	1	2.500	BCFJF			2663044
PS-535	1.750	E	3	2.500	BCFJF	S	MTP Frame	

NOTE: I. ABRASION RESISTANT CARBON (P66)
S. SLOTTED MATING RING

PUMP MANUFACTURERS' CROSS-REFERENCE

U.S. Seal Mfg. Part No.	Seal Size	Head	Mating Ring	Mating Ring Bore	Material Code	Notes	Pump Nameplate Data	Mfg. Part No.
PEERLESS PUMP COMPANY (See GRUNDFOS, INC. for Additional Part Numbers) (continued)								
PS-262	1.750	E	3	2.500	BCFKF	S		2675355
PS-262-EPR-P66	1.750	E	3	2.500	QCFKF	I/S		2675354 000
PS-2712	1.750	E	3	2.500	VCFJF	C/S	c/w Square Collar	96849274
PS-4639	1.750	T	3	2.500	VLFLF		8196MT	
PS-2114	1.875	C	3	2.625	BCFJF	S		269987701 000 96748439
PS-312	1.875	C	3	2.625	BCFKF	S		269794703, 96874175
PS-2072	1.875	E	3	2.625	BCFKF	S	AD Fig. 5130	2676205, 269825701 000 96733108
PS-532	2.000	C	3	2.750	BCFJF			26690109, 269359903 000
PS-332	2.000	C	3	2.750	BCFKF	S	AD Group IV, 8AE-12	2693599 000, 504293
PS-477-EPR	2.000	E	3	2.750	QCFKF	S		
PS-353	2.125	E	1	3.000	BCFKF		6A-16	
PS-327	2.125	E	3	3.000	BCFJF	S	6A-16	
PS-1676	2.250	C	3	3.125	BCFKF	S		2692217 000
PS-492	2.375	C	3	3.250	BCFKF	S		2693666 000
PS-4325	2.375	C	3	3.250	VCFLF	I/S	6AE18	
PS-2763	2.500	EB	3	3.250	VCFZF	316/S		99652653
PS-483	2.750	C	3	3.500	BCFKF	S		2693601 000
PS-2708	2.750	C	3	3.500	VCFLF	S		269360108 000
PS-5252	3.000	E	3	3.875	BCFKF	S		

Value Guard Part No.	Seal Size	Head	Mating Ring	Mating Ring Bore	Material Code		Mfg. Part No.
PEERLESS PUMP COMPANY - Replacement Seal Kits							
VGK-1123	1-1/4	C	3	1.875	BCFJF		BSE-2 - Buna/Ceramic 96828958
VGK-1090	1-1/4	C	3	1.875	BCFKF		BSE-2 - Buna/Ni-Resist
VGK-1120	1-1/4	C	3	1.875	VCFJF		BSE-2 - Viton®/Ceramic
VGK-1092	1-1/4	C	3	1.875	VCFKF		BSE-2 - Viton®/Ni-Resist
VGK-1133	1-1/4	C	3	1.875	BCFJF		ISE-2 - Buna/Ceramic
VGK-1132	1-1/4	C	3	1.875	BCFKF		ISE-2 - Buna/Ni-Resist
VGK-1135	1-1/4	C	3	1.875	VCFJF		ISE-2 - Viton®/Ceramic
VGK-1134	1-1/4	C	3	1.875	VCFKF		ISE-2 - Viton®/Ni-Resist
VGK-1121	1-1/2	C	3	2.125	BCFJF		BSE-3 - Buna/Ceramic 96828959
VGK-1091	1-1/2	C	3	2.125	BCFKF		BSE-3 - Buna/Ni-Resist
VGK-1122	1-1/2	C	3	2.125	VCFJF		BSE-3 - Viton®/Ceramic
VGK-1093	1-1/2	C	3	2.125	VCFKF		BSE-3 - Viton®/Ni-Resist
VGK-1137	1-1/2	C	3	2.125	BCFJF		ISE-3 - Buna/Ceramic
VGK-1136	1-1/2	C	3	2.125	BCFKF		ISE-3 - Buna/Ni-Resist
VGK-1138	1-1/2	C	3	2.125	VCFJF		ISE-3 - Viton®/Ceramic
VGK-1139	1-1/2	C	3	2.125	VCFKF		ISE-3 - Viton®/Ni-Resist

VGK-1090

Kits include gaskets, sleeve, impeller bolt, impeller washer, key, and mechanical seal.

BSE Kits have a Brass sleeve. ISE kits have a Stainless sleeve.

PEERLESS PUMP COMPANY is not affiliated with U.S.Seal Mfg.

Products supplied are manufactured or purchased by U.S.Seal Mfg. from sources other than the company listed.

U.S. Seal Mfg. Part No.	Seal Size	Head	Mating Ring	Mating Ring Bore	Material Code	Notes	Pump Nameplate Data	Mfg. Part No.
PELLERIN MILNOR CORPORATION (Laundry Equipment)								
PS-750	.750	D	1	1.375	BCDJF			245020
PENBERTHY INJECTOR								
PS-162	.500	A	1	1.000	BMFJF			D-1104
PS-165	.500	B	9	.906	BMFJF	A		
PS-1112	.500	Q	9	—	BMFJF	A		14036

PUMP MANUFACTURERS' CROSS-REFERENCE

U.S. Seal Mfg. Part No.	Seal Size	Head	Mating Ring	Mating Ring Bore	Material Code	Notes	Pump Nameplate Data	Mfg. Part No.
PENTAIR, INC. (See AURORA, BERKELEY, FAIRBANKS MORSE, HYDROMATIC, HYPRO, MYERS, F.E., STA-RITE)								
PS-359	.625	C	1	1.250	BCFJF			015560001
PS-633-TC-TC	.625	C	1	1.250	BZFFZ			21181A024
PS-851	.750	A	1	1.375	BCFJF			170480001
PS-358	.750	C	1	1.375	BCFJF			100001
PS-4020	.750	G	1	1.375	BCFJF			145730001
PS-235	1.000	C	1	1.625	BCFJF			003000001
PS-2216V-CMS	1.000	C	1	1.625	VZFFZ			003000021
PS-185	1.250	C	1	1.875	BCFJF			049160001, 22577A000
PS-185-SC-SC	1.250	C	1	1.875	BLFLF			049160031
PS-185V-CMS	1.250	C	1	1.875	VCFJF			21181A023
PS-2208	1.250	C	1	1.875	BZFFZ			21181A019
PS-466	1.250	C	1	2.000	BCFJF			21181A031
PS-3629	1.250	D	3	1.875	VLFZF			152570001
PS-758-SC-TC-CMS	1.500	C	1	2.125	BLFFZ			009200111
PS-2209	1.500	C	1	2.125	BZFFZ			009200041
PS-7409	1.500	C	1	2.125	VCFJF	316SS		009200051, 009200071
PS-758V-SC-SC	1.500	C	1	2.125	VLFLLF			009200101
PS-3284	1.500	D	1	2.125	BCFLF	316SS		009201001
PS-3283	1.750	G	3	2.500	BCFLF	316SS/S		110491001
PS-6224	2.000	C	1	2.750	VLFLLF			24509585920
PS-6218	2.000	C	1	2.750	VZFFZ			019570061
PS-1088-TC-TC-CMS	3.000	C	1	3.875	BZFFZ	B		25449A001
PS-1088V-TC-TC-CMS	3.000	C	1	3.875	VZFFZ	B		037180021
PS-1088V	3.000	C	3	3.875	VCFJF	B/S		037180051
PENTAIR POOL PRODUCTS								
PS-200	.625	A	1	1.250	BMFJF			353253S, 354545S
PS-961	.625	B	1	1.250	BCFJF			071734S, 071734SP 017164, 017165
PS-2742	.625	B	1	1.250	BCFJF	316SS		353096, 353096Z
PS-2744	.750	A	3 Special	1.375	Special		Seal contains EPR	U9-372SS
PS-1902	.750	G	1	1.375	VLFLLF	316SS		359607S
PENTAIR WATER FILTRATION								
PS-100	.625	A	1	1.187	BMFJF			U9-469
PERFECTING (Division of DUFF - NORTON)								
PS-359	.625	C	1	1.250	BCFJF			732015
PS-356	1.125	C	1	1.750	BCFJF			732049
PS-177	1.375	C	1	2.000	BCFJF			732057
PESCO								
PS-507	.625	A	1	1.250	BMFKF			
PFAUDLER, INC.								
PS-3893	.875	C	3 Special	1.500	VCFGF			3515444
PS-356	1.125	C	1	1.750	BCFJF			1621492
PS-758	1.500	C	1	2.125	BCFJF			1621350
PS-3943	1.500	C	3 Special	2.125	VCFGF			3512911
PS-3584	1.375	C	3 Special	2.000	VCFGF			3512910
PS-2707	1.562	Special	Special	2.250	NCPGF			2076130
PHILLIPS GASKET (See CATERPILLAR)								
PIONEER (See DETROIT HARVESTOR COMPANY)								
PIONEER PUMP								
PS-2739	1.625	D	3	2.375	VLFZF	316SS/S		30400193
PS-2740	2.500	D	3	3.375	VLFZF	316SS/S		30400194, 730400172
PS-3189	2.750	D	3	3.500	VLFZF	316SS/S		30400195, 730400173
PS-2803	3.250	D	3	4.125	VLFZF	S		30400190
PIQUA MACHINE (See ENPO PUMP COMPANY)								

NOTE: B. TAPERED SPRING
S. SLOTTED MATING RING

PUMP MANUFACTURERS' CROSS-REFERENCE

U.S. Seal Mfg. Part No.	Seal Size	Head	Mating Ring	Mating Ring Bore	Material Code	Notes	Pump Nameplate Data	Mfg. Part No.
PRECISION SCIENTIFIC COMPANY								
PS-1043	.500	C	1	1.000	BMFJF			342005
PS-732	.625	C	3	1.250	BCFKF			342003
PS-1113	.750	C	1	1.375	BCFKF			342027
PS-499	1.000	C	3	1.625	BCFKF	S		342012
PREMIER								
PS-1000	.625	B	1	1.250	BMFJF		Series 220/225 (Pre 1988), 455/456 500, 600	31-813
PS-201	.750	A	1	1.375	BMFJF		Series 120T, MKII 225/255, 300 325/355, 725/756	31-812
PRICE PUMP COMPANY								
PS-1002V	.500	C	1	1.000	VCFJF		S95M	
PS-516	.625	A	1	1.250	BCFJF			0118
PS-3159	.625	B	8	—	BCFJF	A		0538, 0538B
PS-22012	.625	B	8	—	NCFJF	A		0540
PS-4479	.625	B	8	1.109	QCFJF	A		0383
PS-22011	.625	B	8	1.109	VCFJF	A		0539, 0539B
PS-359	.625	C	1	1.250	BCFJF			0841
PS-22010	.625	C	1	1.250	QCFJF	316SS		0663
PS-4272V	.625	C	1	1.250	VCFJF	316SS		0553
PS-3092	.625	C	1	1.250	VLFLF	316SS		0492
PS-22014	.625	C	3	1.250	NCFJF	316SS/I		3635
PS-2715	.625	G	1	1.250	QLFLF			0542
PS-4155	.625	G	1	1.250	VLFLF			0541
PS-3885	.625	K	1	1.250	VCFJF		Includes Wave Spring	0985
PS-9155	.625	W	2	1.250	TLFLF	316SS	LT-25	
PS-22013	.625	X	3	1.250	VCFLF	316SS		2394-PU
PS-201	.750	A	1	1.375	BMFJF		SP-15	
PS-601	.750	B	1	1.375	BMFJF		PRYCO-100, 125, 150	
PS-358	.750	C	1	1.375	BCFJF			1112
PS-3191	.750	C	1	1.375	VCFJF	316SS		0549
PS-9339	.750	W	2	1.375	TCFJF	316SS		0551
PS-360	1.000	A	1	1.625	BCFJF			8303-111
PS-235	1.000	C	1	1.625	BCFJF			8304-111
PS-1094	1.000	C	1	1.625	VCFJF			8304-211
PS-355	1.125	C	1	1.750	BCFKF			E-97
PS-758	1.500	C	1	2.125	BCFJF		E150, E200	0121
PS-758-EPR-CMS	1.500	C	1	2.125	QCFJF			1025
PS-7409	1.500	C	1	2.125	VCFJF	316SS		0122
VG-6750	1.500	HV	3	2.125	VLFLF	316SS/S	Graphite Loaded Silicon Faces	0517
PS-7587	1.500	W	2	2.125	TCFJF	316SS		0123
PS-7806	1.625	C	1	2.375	VLFLF			1020
PS-446-EPR	1.750	C	1	2.500	QCFJF			3724
PS-446V-CMS	1.750	C	1	2.500	VCFJF			3516
PROCON PRODUCTS®								
PS-4060	.437	G	1	1.181	BCFJF			1034-A7
PS-4063	.437	G	1	1.181	VCFJF			1034-A2
PROSSER PUMPS								
PS-1002	.500	C	1	1.000	BCFJF			2-31036, 558312-2 558312-21
PS-359	.625	C	1	1.250	BCFJF		5 HP	2-31001
PS-3916	.750	C	3	1.375	BCFJF			
PS-3907	.875	C	1	1.500	BCFJF			2-31006
PS-185	1.250	C	1	1.875	BCFJF			2-31020
PS-756	1.250	C	1	1.875	BCFKF		25 and 40 HP 9-26032-3	
PULSAFEEDER (Division of IDEX CORPORATION)								
PS-9720	.312	W	2	.875	TCFLF	316SS		
PS-1065	.375	C	3	.875	BCFJF			307328
PS-1065V	.375	C	3	.875	VCFJF			Y0900921-316 with Y1000521-000
FA-10033	.500	C	—	—	VCF-F			Y0900121-316

PUMP MANUFACTURERS' CROSS-REFERENCE

U.S. Seal Mfg. Part No.	Seal Size	Head	Mating Ring	Mating Ring Bore	Material Code	Notes	Pump Nameplate Data	Mfg. Part No.
PULSAFEEDER (Division of IDEX CORPORATION) (continued)								
FA-10034	.625	C	—	—	VCF-F			Y0900421-316
PS-552	.625	C	3	1.250	B/VCFJF		2-17 Type 107	307414
FA-6987	1.000	W	—	—	TCF-F	316SS		A97001
PUREX HYDROTECH (See PAC-FAB)								
PS-100	.625	A	1	1.187	BMFJF		L Series™	P28280
PS-952	.625	A	1	1.250	BCFJF		AV-7 Pump	P23822
PS-501	.625	A	1	1.250	BMFJF		Aquatron®	071733
PS-3202	.625	B	1	1.250	QCFJF			071732
PS-3865R	.625	B	1	1.250	VCFJF		Whisperflo®	071734
PS-201	.750	A	1	1.375	BMFJF		AH Series™, L Series™	071728
PS-360	1.000	A	1	1.625	BCFJF		C Series	071725
QUINCY COMPRESSOR								
PS-6090	1.750	E	3	2.500	B/VCFKF	S		22578-1
PS-2152V	2.750	C	3	3.500	VCFKF			22592-1
PS-6177	3.375	C	3	4.250	VCFKF	S		22593-1
RAINBOW IRRIGATION SYSTEMS								
PS-185	1.250	C	1	1.875	BCFJF			14821
PS-446	1.750	C	1	2.500	BCFJF			13470
RAPID DAYTON (See TAIT)								
RED JACKET								
PS-106	.500	C	1	1.000	BCFKF		Deep and Shallow Well Type A & B Multi Stage 25A, 33A, 50A, 75A, 100A	540
PS-518	.625	A	1	1.187	BCFKF			076-183
PS-100	.625	A	1	1.187	BMFJF		SW-DW Jet Pump	C76-78A, C76-98A C176-037
PS-701	.625	A	1	1.187	BMFKF			C76-134
PS-711	.625	A	3	1.187	BMFJF			076-182
PS-493	.625	C	1	1.187	BCFKF		Centri Jet R and Centri Jet V 25R, 33R, 50R, 75R, 100, 101, 150, 151	500
PS-102	.625	D	1	1.250	BCDKF		Deep Well & Shallow Well Type H 25H, 33H, 50H, 75H, 100H	530
PS-201	.750	A	1	1.375	BMFJF			76-129, 76-189
PS-902	.750	B	9	—	BMFKF	A	Centri Jet X 33X and 50X CJ, CJM, and SJ Pumps	C76-99A, 555
PS-750	.750	D	1	1.375	BCDJF		All Types HB Centrifugal Jet Pumps	560
PS-370	1.000	A	1	1.625	BCFKF			76-132
PS-460	1.000	D	1	1.625	BCFKF			545
REDA PUMP (See SCHLUMBER LIMITED)								
REXNORD INDUSTRIES, LLC.								
PS-201	.750	A	1	1.375	BMFJF			X7718
FA-160	.875	D	—	—	BCD-F			X203565
PS-188	.875	E	1	1.500	BCFJF	316SS		X203224
FA-756	1.250	C	—	—	BCF-F			X7387
PS-185	1.250	C	1	1.875	BCFJF			X8023
PS-137	1.250	E	1	1.875	BCFKF			X203691
PS-177	1.375	C	1	2.000	BCFJF			X2U59-1
FA-593	1.875	D	—	—	BCD-F			X7235
PS-593	1.875	D	3	2.625	BCDKF	S		X2U59-6
RICE PUMP								
PS-200	.625	A	1	1.250	BMFJF			21-024
PS-201	.750	A	1	1.375	BMFJF			12-023
PS-750	.750	D	1	1.375	BCDJF			0330-9-6
ROBBINS & MYERS (Division of NOW)								
ROMAR ABRADO								
PS-200	.625	A	1	1.250	BMFJF			618-001

NOTE: A. MOUNTS ON SHAFT
S. SLOTTED MATING RING

PUMP MANUFACTURERS' CROSS-REFERENCE

U.S. Seal Mfg. Part No.	Seal Size	Head	Mating Ring	Mating Ring Bore	Material Code	Notes	Pump Nameplate Data	Mfg. Part No.
ROPER PUMP COMPANY								
FA-112	.500	C	—	—	BCF-F			G3-29, G14-263
FA-400	.500	C	—	—	BMF-F			G14-222-403, G14-263X
FA-10033	.500	C	—	—	VCF-F			G14-32
FA-1350	.625	C	—	—	BCF-F			G14-116
FA-10034	.625	C	—	—	VCF-F			G14-13
PS-633	.625	C	1	1.250	BCFKF			G14-225
FA-564	.750	C	—	—	BCF-F			G14-117
PS-768	.750	C	3	1.375	BCFKF			G14-226
PS-112V	.750	C	3	1.375	VCFKF			G14-471
PS-752	.750	D	1	1.375	BCDKF			G14-261, G14-266
FA-1600	.875	C	—	—	BCF-F			G14-324
PS-617	.875	C	3	1.500	BCFKF			G14-227
PS-687V	.875	C	3	1.500	VCFKF			G14-477
PS-703	.875	D	1	1.500	BCDJF			
PS-935	.875	E	1	1.500	BCFKF	316SS		
FA-1700	1.000	C	—	—	BCF-F			G14-320
FA-10037	1.000	C	—	—	VCF-F			G14-51
PS-235	1.000	C	1	1.625	BCFJF			G14-338X
PS-499	1.000	C	3	1.625	BCFKF	S	1AM-27	G14-338
PS-499-EPR	1.000	C	3	1.625	QCCKF	S		G14-312
PS-357V	1.000	C	3	1.625	VCFKF	S		
PS-20016	1.000	C	3 Spec	1.625	VCFKF			G14-172
PS-20015	1.000	C	3	1.750	B/VCFKF			G4-437
PS-7207	1.000	C	3	1.750	VCFKF		P2-C1219	
PS-3619	1.000	C	3	1.750	VCFKF			G4-398
FA-912	1.000	E	—	—	BCF-F			G14-120, G14-250
PS-236	1.000	E	1	1.625	BCFKF			G14-343
PS-891	1.000	K	1	1.625	BCFKF			G4-94
FA-6987	1.000	W	—	—	TCF-F	316SS		G14-94
PS-2155	1.062	C	3	1.750	BCFKF	S		G4-101, G14-489
PS-127	1.062	D	1	1.750	BCDKF			G14-288
PS-9303	1.062	W	3	1.750	TCFKF			G4-65
FA-1800	1.125	C	—	—	BCF-F			G14-278, G4-334
PS-529	1.125	C	3	1.750	BCFKF	S		G4-313
PS-355V	1.125	C	3	1.750	VCFKF	S		G4-15, G4-375
FA-9327	1.125	W	—	—	TCF-F	316SS		G14-339
FA-756	1.250	C	—	—	BCF-F			G14-429
FA-10040	1.250	C	—	—	VCF-F			G3-10, G3-36
PS-756	1.250	C	1	1.875	BCFKF			
PS-598	1.250	C	3	1.875	BCFKF			
PS-7938-BUNA	1.250	C	3	1.875	BCFKF	S		G14-229
FA-190	1.250	D	—	—	BCF-F			G14-121, G14-122
FA-177	1.375	C	—	—	BCF-F			G14-512
FA-10041	1.375	C	—	—	VCF-F			G14-510
PS-467	1.375	C	1	2.125	BCFKF			G14-579
PS-186	1.375	D	1	2.000	BCDKF			G14-248
PS-2156	1.437	C	3	2.250	BCFKF			G4-112
PS-2156V	1.437	C	3	2.250	VCFKF			G4-142
PS-9302	1.437	W	3	2.250	T/VCFKF			G4-165
FA-1850	1.500	C	—	—	BCF-F			G14-430
FA-10043	1.500	C	—	—	VCF-F			G3-35
PS-553	1.500	C	3	2.125	BCFKF			G4-267, G14-230
PS-7975	1.500	C	3	2.125	VCFKF	S		G4-75, G14-475
FA-200	1.500	D	—	—	BCF-F			G14-123, G14-124
PS-371	1.500	D	1	2.125	BCFKF			
PS-8810	1.500	X	3	2.125	VCFKF	316SS/S		G4-241
PS-1145	2.000	C	3	2.750	VCFKF	S		G4-46
PS-543V	2.125	C	3	3.000	VCFKF	S		G4-41
PS-338V-SC-SC	2.125	C	3	3.000	VLFLF	S		G4-535
PS-1676V	2.250	C	3	3.125	VCFKF	S		
PS-941	2.250	D	1	3.125	BCDKF			G14-223

PUMP MANUFACTURERS' CROSS-REFERENCE

U.S. Seal Mfg. Part No.	Seal Size	Head	Mating Ring	Mating Ring Bore	Material Code	Notes	Pump Nameplate Data	Mfg. Part No.
ROTARY COMPRESSION TECHNOLOGIES, INC. (See GARDNER DENVER LeROI)								
ROTH PUMP CO.								
PS-1120	.500	C	1	1.062	BCFJF		Size 00 and 100	F8A030VF
PS-118	.625	C	1	1.187	BCFJF		Size 0 and 10	F8B015VF / 086VL
PS-188	.875	E	1	1.500	BCFJF	316SS		FZD204FC
FA-6987	1.000	W	—	—	TCF-F	316SS		F8D427TF
FA-10038	1.125	C	—	—	VCF-F			F8E011UF
PS-7884V	1.875	EB	3	2.500	VCFKF	S		F7J2002FS
FA-10047	2.000	C	—	—	VCF-F			F8H056UF

Value Guard Part No.	Seal Size	Head	Mating Ring	Mating Ring Bore	Material Code	Notes	Pump Nameplate Data	Mfg. Part No.
ROTO-JET® (Division of TRILLIUM FLOW TECHNOLOGIES™)								
VG-3001	2.500	VGXAB	Special	Special	VLZFF	316SS	R-11	0660472SC/0652046-002TC
VG-3025	2.500	VGXAB	Special	Special	VCFZF	316SS	R-11	0660472TC/0652046-002TC
VG-3002	2.500	VGXAB	Special	Special	VZFFZ	316SS	R-11	0660472TC/0652046-002TC

- Roto-Jet® pumps are used in high pressure wash systems.



U.S. Seal Mfg. Part No.	Seal Size	Head	Mating Ring	Mating Ring Bore	Material Code	Notes	Pump Nameplate Data	Mfg. Part No.
RUHRPUMPEN								
PS-8111	1.437	XB2	3	2.125	BCFKF	316SS		1000660, 64000844
PS-327	2.125	E	3	3.000	BCFJF	S		28W0323
PS-3257	4.000	E	3	4.875	BCFJF			64003230

RUTH BERRY PUMP COMPANY								
PS-102	.625	D	1	1.250	BCDKF		610	
PS-201	.750	A	1	1.375	BMFJF		601, 601A	
PS-750	.750	D	1	1.375	BCDJF		620	

RUTHMAN PUMP & ENGINEERING								
PS-164	.500	B	9	—	BMFKF	A		906
PS-165	.500	B	9	.906	BMFJF	A		
PS-452	.625	B	9	—	BMFJF	A		
PS-633	.625	C	1	1.250	BCFKF			
PS-902	.750	B	9	—	BMFKF	A		
PS-360	1.000	A	1	1.625	BCFJF			
PS-235	1.000	C	1	1.625	BCFJF			

SAER ELETTO POMPE								
VGM-3445	20MM	Special	Special	Special	VCFLF			
VGM-3446	30MM	Special	Special	Special	VCFLF			

SAKURAGAWA PUMP MFG. COMPANY, LTD.								
VGM-2802	20MM	K	Special	38 MM	VZFZF/ VZFZF			
VGM-2801	30MM	K	Special	52 MM	VZFZF/ VZFZF			
VGM-2800R	45MM	Special	Special	78/70 MM	VZFZF/ VZFZF			
VGM-2804	45MM	K	Special	TBD	VZFZF/ VZFZF			
VGM-2805	45MM	K	Special	TBD	VZFZF/ VZFZF			

NOTE: A. MOUNTS ON SHAFT
S. SLOTTED MATING RING

PUMP MANUFACTURERS' CROSS-REFERENCE

U.S. Seal Mfg. Part No.	Seal Size	Head	Mating Ring	Mating Ring Bore	Material Code	Notes	Pump Nameplate Data	Mfg. Part No.
SCHAUB ENGINEERING COMPANY								
PS-493	.625	C	1	1.187	BCFKF			12-3113-001
PS-1123	1.000	C	1	1.625	BCFKF			12-3113-002
PS-598	1.250	C	3	1.875	BCFKF			12-3113-003
SCHLUMBERGER LIMITED								
PS-508	.625	D	1	1.250	BCDJF			17197A
PS-3299	.750	D	3	1.375	VCFJF	316SS		
PS-22108	.750	D	3	1.375	XLFLM			1046283
PS-703	.875	D	1	1.500	BCDJF			14011A
PS-22109	.875	D Special	3	1.500	BLFLE			7004526
PS-3317	.875	D Special	3	1.500	XLFLE			7004518
PS-188	.875	E	1	1.500	BCFJF	316SS		13131A
PS-380	1.000	D	1	1.625	BCFJF			13977A
PS-3315	1.187	D	3	1.875	XLFLE			7003304
PS-382	1.500	D	1	2.125	BCFJF			15114A
PS-22111	1.500	D	3	2.125	BLELE	S		7005564
PS-7874	1.500	D	3	2.125	BLFLE	S		99584-5
PS-3323	1.500	D	3	2.125	XLFLE	S		7004534
PS-22110	1.500	D Special	3	2.125	BLFLE	S		7004542
PS-4423	1.500	D Special	3	2.125	XLFLF	S		3920136
SCOT PUMP (A WILO USA Brand)								
PS-516	.625	A	1	1.250	BCFJF			101.000.110C 118.000.102, 118.000.110
PS-952	.625	A	1	1.250	BCFJF			118.000.340
PS-200	.625	A	1	1.250	BMFJF			101.000.340
PS-501	.625	A	1	1.250	BMFJF			118.000.340D
PS-200V-CMS	.625	A	1	1.250	VCFJF			101.000.110B
PS-22140	.625	B	1	1.250	BCFJF			101.000.198
PS-359V-CMS	.625	C	1	1.250	VCFJF			101.000.103
PS-3550	.625	C	1	1.250	VRFRF			101.000.239
PS-732-EPR	.625	C	3	1.250	QCCKF			101.000.173
PS-633V	.625	C	3	1.250	VCFKF	S		101.000.120, 101.000.316
PS-633V-P66	.625	C	3	1.250	VCFKF	I		101.000.225X
PS-9722	.625	W	27	1.437	HLFLF	316SS		101.000.242
PS-201	.750	A	1	1.375	BMFJF			101.000.102
PS-201V-CMS	.750	A	1	1.375	VCFJF			101.000.115
PS-112V	.750	C	3	1.375	VCFKF			101.003.171
PS-360	1.000	A	1	1.625	BCFJF			101.000.159
PS-185	1.250	C	1	1.875	BCFJF			101.000.104 101.000.104A
PS-185-P66	1.250	C	1	1.875	BCFJF	I		101.000.294
PS-756-EPR	1.250	C	1	1.875	QCCKF			101.000.124C 101.000.203
PS-185V-CMS	1.250	C	1	1.875	VCFJF			101.000.194
PS-756V-CMS	1.250	C	1	1.875	VCFKF			101.000.124
PS-2203	1.250	C	3	1.875	QCCKF	I		101.000.124A
PS-185V	1.250	C	3	1.875	VCFJF	S		
PS-756V	1.250	C	3	1.875	VCFKF			
PS-3872	1.250	E	1	1.875	QCCKF			
PS-883V-CMS	1.250	K	1	1.875	VCFJF			101.000.210
PS-228V-CMS	1.250	K	1	1.875	VCFKF			101.000.164
PS-758	1.500	C	1	2.125	BCFJF			101.000.168, 118.000.343 118.000.344, 118.000.577 118.000.636
PS-758V	1.500	C	3	2.125	VCFJF	S		101.000.175
PS-4212	1.500	C	3	2.125	VCFJF	I/S		101.000.191
PS-659V	1.500	C	3	2.125	VCFKF			101.000.182
PS-446	1.750	C	1	2.500	BCFJF			101.000.196
PS-446-P66	1.750	C	1	2.500	BCFJF	I		118.000.388
PS-446-EPR-SC	1.750	C	1	2.500	QCFLF			137.001.555
PS-436V	1.750	C	3	2.500	VCFKF	S		101.000.221
PS-836-CMS	2.750	C	1	3.500	BCFJF			137.001.692

PUMP MANUFACTURERS' CROSS-REFERENCE

U.S. Seal Mfg. Part No.	Seal Size	Head	Mating Ring	Mating Ring Bore	Material Code	Notes	Pump Nameplate Data	Mfg. Part No.
SCOTSMAN ICE SYSTEMS (Ice Machines)								
PS-380	1.000	D	1	1.625	BCFJF			2-383
PS-2806	1.000	Q	9	1.625	BCFJF		02-4599-01, 02-4599-21	
PS-6305	1.000	Q	9	1.625	BMDAF		02-1300-01 02-1300-01BK	
PS-4133	1.750	Q	Special	2.500	Special		02-0929-02	
SEEPEX, INC.								
PS-3158	45MM	G	25	63MM	VLFLF			GRDJ33045AS1S1
SERFILCO								
PS-1002	.500	C	1	1.000	BCFJF			55-434
PS-4237	.625	Q	8	1.062	VCFJF			55-560
PS-358	.750	C	1	1.375	BCFJF			55-407
PS-309	.875	C	1	1.500	BCFJF			55-488
PS-758V-CMS	1.500	C	1	2.125	VCFJF			55-481
SETHCO® (Division of CECO ENVIROMENTAL)								
FA-112	.500	C	—	—	BCF-F			760P04-320
PS-1002V	.500	C	1	1.000	VCFJF			
PS-359	.625	C	1	1.250	BCFJF			
PS-801	1.125	C	3	1.750	B/VCFJF	S		760P101-180
PS-356V	1.125	C	3	1.750	VCFJF	S		760P101-181
SHERWOOD PUMP								
PS-2807	12MM	G	1	23MM	BCFJF	316SS	G8000, GP8000	23459
PS-1002	.500	C	1	1.000	BCFJF			10522
PS-631	.500	C	1	1.000	BCFJF	N		5789
PS-200	.625	A	1	1.250	BMFJF			10159
PS-447	.625	B	8	—	BCFJF	A		12859
PS-452	.625	B	9	—	BMFJF	A		8388
PS-508	.625	D	1	1.250	BCDJF			10523
PS-2801	20MM	B	8	32.82MM	BLFLF			23799
FA-160	.875	D	—	—	BCD-F			8570
PS-703	.875	D	1	1.500	BCDJF			8578
PS-188	.875	E	1	1.500	BCFJF	316SS		9791
SHINMAYWA INDUSTRIES, LTD.								
VGM-8347	13MM	K	1	25MM	VLFLF / VCFJF		CN40	—
VGM-8346	15MM	K	1	30MM	VLFLF / VCFJF		CN501T	S45669-A
VGM-8345	20MM	K	Special	38MM	VLFLF / VLFLF		CN651	S47035-A
VGM-8344	25MM	K	Special	44MM	VLFLF / VLFLF		CN80	S64397-A
VGM-8343	30MM	K	Special	51MM	VLFLF / VLFLF		CN80	S64398-A
VGM-8342	35MM	K	Special	57MM	VLFLF / VLFLF		CN150	S64399-A
VGM-8339	40MM	K	Special	65MM	VLFLF / VLFLF		CNH100	S64508-A
VGM-8340	50MM	K	Special	72MM	VLFLF / VLFLF		CNH100	S64316-A
SHIPPENSBURG PUMP COMPANY (SHIPCO)								
PS-200V-CMS	.625	A	1	1.250	VCFJF			SDPS-00067V
PS-356-EPR	1.125	C	1	1.750	QCFJF			SDPS-00155
PS-4037	1.125	C	3	1.750	VLFLF	S		SDPS-00155SV
PS-185-EPR-P66	1.250	C	1	1.875	QCFJF	I		SDPS-00132
SID HARVEY INDUSTRIES, INC.								
FA-112	.500	C	—	—	BCF-F			
FA-1810	.500	C	—	—	BMF-F			A3-3ARAW
PS-200V-CMS	.625	A	1	1.250	VCFJF			0369RAW
SIEMENS WATER TECHNOLOGIES								
PS-4437	2.125	D	2	3.000	BCDKF			WTU18080
SIHI PUMPS AMERICAS (A FLOWERVE Brand)								
PS-732	.625	C	3	1.250	BCFKF			503750
PS-816	1.500	C	3	2.125	BCFJF	S		504290
PS-9353	1.500	W	25	2.125	TCFZF	316SS		43092280

NOTE: A. MOUNTS ON SHAFT
I. ABRASION RESISTANT CARBON (P66)
N. NON-STANDARD SPRING HOLDER
S. SLOTTED MATING RING

PUMP MANUFACTURERS' CROSS-REFERENCE

U.S. Seal Mfg. Part No.	Seal Size	Head	Mating Ring	Mating Ring Bore	Material Code	Notes	Pump Nameplate Data	Mfg. Part No.
SIHI PUMPS AMERICAS (continued)								
PS-818	1.625	C	3	2.375	BCFJF	S		43092930
PS-544	1.625	C	3	2.375	BCFKF	S		501483
PS-239V	1.625	C	3	2.375	VCFKF	S		502261
PS-312	1.875	C	3	2.625	BCFKF	S		501806
PS-1057	2.125	C	3	3.000	B/VCFKF	S		501980
PS-3606	2.125	C	3	3.000	VCFLF	S		43092920
PS-2708	2.750	C	3	3.500	VCFLF	S		43092949, 504797
PS-9314	2.750	W	2	3.500	TCFJF	316SS		43092281
PS-8104	3.750	X	3	4.625	VCFJF	316SS/S		43092969, 500793 504459
SIMFLO PUMPS, INC.								
PS-618	1.250	C	3	1.875	BCFJF	S		059-0220MA
PS-7702	1.375	EB	3	1.875	BCFJF	S		059-0180MA
PS-4159	1.625	EB	3	2.125	VCFJF	S		059-0200MA
PS-2114	1.875	C	3	2.625	BCFJF	S		059-0270MA
PS-532	2.000	C	3	2.750	BCFJF	S		059-0280MA
PS-1678	2.250	C	3	3.125	BCFJF	S		059-0290MA
PS-269	2.500	C	3	3.375	BCFJF	S		059-0300MA
PS-7703	2.625	EB	3	3.375	BCFJF	S		059-0201MA
SIMMONS PUMP CORPORATION								
PS-200	.625	A	1	1.250	BMFJF			
PS-359	.625	C	1	1.250	BCFJF			
PS-235	1.000	C	1	1.625	BCFJF			
SKIDMORE PUMP								
PS-663	.500	Q	1	1.000	BMFJF			50648
PS-100	.625	A	1	1.187	BMFJF			142-54049, 51294
PS-536	.625	C	3	1.187	BCFJF			53497
PS-359	.625	C	1	1.250	BCFJF			50625-1
PS-290	.625	C	1	1.250	BCFJF	N		142-54099
PS-508	.625	D	1	1.250	BCDJF		Condensate Pump	142-54052, P15, P15A
PS-309	.875	C	1	1.500	BCFJF			142-54055, 50625-2
PS-356	1.125	C	1	1.750	BCFJF			142-54058, 50625-3
SMITH & LOVELESS, INC.								
PS-1104	1.375	V	25	2.140	BCFJF		Frame 25	
VG-1105	1.875	HDV	1	2.640	BCFJF		B-Shaft	H60A119
VG-3315	1.875	HV	1	2.640	BCFJF		B-Shaft	H87A28
PS-1105	1.875	V	25	2.640	BMFJF		Frame 28	H60A119
VG-1107	2.125	HDV	1	3.187	BCFJF		C-Shaft	H60A120
VG-3316	2.125	HV	1	3.187	BCFJF		C-Shaft	H87A97
PS-1102	2.125	V	3	3.140	BCFJF		Frame 32	
VG-7532	3.000	VG DbI	2	4.125	BCFJF			H60A121



PUMP MANUFACTURERS' CROSS-REFERENCE

U.S. Seal Mfg. Part No.	Seal Size	Head	Mating Ring	Mating Ring Bore	Material Code	Notes	Pump Nameplate Data	Mfg. Part No.
SOMAT COMPANY (Ice Machines)								
PS-359	.625	C	1	1.250	BCFJF			54300
PS-309	.875	C	1	1.500	BCFJF			54302
PS-529	1.125	C	3	1.750	BCFKF	S		54311
PS-801	1.125	C	3	1.750	B/VCFJF	S		54310
PS-544	1.625	C	3	2.375	BCFKF	S		54325
PS-332	2.000	C	3	2.750	BCFKF	S		54326
PS-6302	2.250	Q	1	3.375	BMPAP			54306
SPECIALTY PACKAGING (Dishwashers / Disposals)								
PS-1085V	.625	C	1	1.250	B/VCFJF	B		00-114696
PS-539	1.000	C	1	1.625	BCFJF	H		00-104330
PS-6318	1.125	Q	9	1.578	VMFAF			00-117071
PS-6317	1.375	Q	9	2.000	VMPSP			00-114144
PS-758V-CMS	1.500	C	1	2.125	VCFJF			00-223422
PS-4041	2.250	Q	1	3.375	VMPSP			00-117072

Value Guard Part No.	Seal Size	Head	Mating Ring	Mating Ring Bore	Material Code	Notes	Pump Nameplate Data	Mfg. Part No.
SPECK PUMPS								
VG-200	.625	AV	1	1.250	BMFJF			2920060603 60603-200
VGM-2920	20MM	VGMA	1	35MM	BCFLF			2920343310

U.S. Seal Mfg. Part No.	Seal Size	Head	Mating Ring	Mating Ring Bore	Material Code	Notes	Pump Nameplate Data	Mfg. Part No.
STA-RITE INDUSTRIES (See PENTAIR, Inc. for Additional Part Numbers)								
PS-4225	12MM	G	1	23MM	QCFLF			M12169
PS-1615	.375	B	1	1.000	BMFJF		297A	U109-173
PS-162	.500	A	1	1.000	BMFJF			U109-103
PS-142	.500	B	1	1.000	BMFJF			
PS-163	.500	B	1	1.000	BMFJF		LT Series	U109-68SS, U109-321SS
PS-4360	.500	B	8	—	BLFLF			U9-439A/B
PS-663	.500	Q	1	1.000	BMFJF			U109-100
PS-957	.625	A	1	1.187	BCFJF			U9-106SS
PS-100	.625	A	1	1.187	BMFJF		AJ Series, Dura-Glas® Pre 1998, Dyna-Glas® and Dyna-Max®, Max-E-Glass™ pre 1998, PLBC Series Pre 1995 PLBC Series	U9-469, U109-6, U109-6A U109-93SS, 17351-0102S
PS-516	.625	A	1	1.250	BCFJF			S20788
PS-200	.625	A	1	1.250	BMFJF		Dura-Glas®, Max-E-Glas® Series PE, PEA, P2R and P2RA	17304-0100 17304-0100S, 17038
PS-501	.625	A	1	1.250	BMFJF			118-000-340
PS-200V-CMS	.625	A	1	1.250	VCFJF			21181A044, 2120-0009
PS-200V	.625	A	3	1.250	VCFJF			U9-196SS
PS-1000	.625	B	1	1.250	BMFJF		CF / CFA Series, HP Series,	U109-136SS
PS-3102	.625	B	11	—	BCFJF	A		S20990
PS-118	.625	C	1	1.187	BCFJF			U109-87, U9-102 U109-118
PS-2750	.625	C	1	1.187	BCFJF	H/I		U9-118
PS-493	.625	C	1	1.187	BCFKF			U9-1
PS-1618	.625	C	1	1.250	BCFJF	B		
PS-4267	.625	G	1	1.187	BCFJF			U9-6
PS-1900	.625	G	1	1.187	VLFLF	316SS		U9-437
PS-4390	.625	G	1	1.250	VLFLF	316SS		17304-0102
PS-851	.750	A	1	1.375	BCFJF			170480001, 37400-0027S
PS-201	.750	A	1	1.375	BMFJF		DJ/JS/JT Series Pre 01/01 Dura-Glas II® Pre 1998, Dura-Jet Dyna-Glas / Dyna-Max, Dyna-Jet™ JW/JWPA Series Max-E-Glas™ II Pre 1998	U109-358SS, U109-372SS 17351-0101
PS-851-EPR	.750	A	1	1.375	QCFJF			U109-122, 17351-0101A
PS-201V-CMS	.750	A	1	1.375	VCFJF			2120-0011

NOTE: A. MOUNTS ON SHAFT
 B. TAPERED SPRING
 H. SPRING HOLDER NOT INCLUDED
 I. ABRASION RESISTANT CARBON (P6G)
 S. SLOTTED MATING RING

PUMP MANUFACTURERS' CROSS-REFERENCE

U.S. Seal Mfg. Part No.	Seal Size	Head	Mating Ring	Mating Ring Bore	Material Code	Notes	Pump Nameplate Data	Mfg. Part No.
STA-RITE INDUSTRIES (See PENTAIR, Inc. for Additional Part Numbers) (continued)								
PS-1622	.750	B	9	—	BMFJF	A		
PS-4048	.750	B	9	1.312	BLFLF	A		U9-394SS
PS-358	.750	C	1	1.375	BCFJF			U109-99
PS-1125	.750	C	1	1.375	BCFJF			U9-267, U109-267
PS-128	.750	C	1	1.375	BCFJF	B		U9-99
PS-750	.750	D	1	1.375	BCDJF			U9-43
PS-4265	.750	G	1	1.375	BCFJF			37400-27S
PS-3868	.750	G	1	1.375	VCFJF		Dura-Glass II and Max-E Glas II (Series P4E, P4EA, P4R, P4RA) Max-E-Pro (Series P6E & P6RA)	
PS-687	.875	C	1	1.500	BCFKF			U9-18,20,22,25,29,32 U109-21, U109-30
PS-774	.875	C	3	1.500	BCFV/JF			U109-170
PS-235	1.000	C	1	1.625	BCFJF			16504
PS-380	1.000	D	1	1.625	BCFJF		AS-H-3	
PS-127	1.062	D	1	1.750	BCDKF			U109-31
PS-356	1.125	C	1	1.750	BCFJF			S32690
PS-204	1.125	E	1	1.750	BCFJF			U109-96
PS-866	1.125	E	3	1.750	BCFJF	S		U109-96SS
PS-867-EPR	1.125	E	3	1.750	QCFKF	S		U9-307
PS-185	1.250	C	1	1.875	BCFJF		CC/C Series, D Series CC/C Series, D Series pre 8/00 CSPH / CCSPH Series U109-200, U109-433SS	S32014
PS-2122	1.250	C	1	1.875	BCFJF			S32013
PS-246	1.250	C	1	1.875	BCFJF	B/H	CC / C Series, D Series	U109-220
PS-804	1.250	D	3	1.875	BCFJF	S	CC / C Series, D Series	
PS-3883	1.250	G	1	1.875	BCFJF			U9-433SS
PS-6265	1.250	G	1	1.875	VLFLF	316SS		U9-451SS
PS-758	1.500	C	1	2.125	BCFJF			16554
PS-446	1.750	C	1	2.500	BCFJF		CCPH / CCSPH Series	S32015
PS-2142	1.750	C	1	2.500	BCFJF			S32692
PS-535	1.750	E	3	2.500	BCFJF	S		U109-251
PS-340	1.875	C	1	2.625	BCFJF			S32694
PS-3211	1.875	C	1	2.625	BCFJF			S32693
PS-338	2.125	C	3	3.000	BCFJF	S		S39264
PS-327	2.125	E	3	3.000	BCFJF	S		U109-252
STERLING FLUID SYSTEMS								
PS-200	.625	A	1	1.250	BMFJF			96667758 1181377 000
PS-637	.625	A	3	1.250	BMFJF			96678617
PS-4320	.625	C	3	1.250	QCFJF			96677202
PS-4601	1.000	D	3	1.625	QCDKF	I		2675341000 96675558
PS-529	1.125	C	3	1.750	BCFKF	S		2697947010000
PS-1109V	1.250	C	3	1.875	VCFKF			97630629
PS-210V	1.375	C	3	2.000	VCFKF	S		648303-08000
PS-865	1.375	E	3	2.000	BCFKF	S		96875515
PS-354V	1.375	E	3	2.000	VCFJF	S	Lock Collar Supplied Separately	96885762
PS-865V-SC-SC	1.375	E	3	2.000	VLFLF	S	Lock Collar Supplied Separately	96853723
PS-1110	1.500	C	3	2.125	BCFKF			97937996
PS-2714	1.500	C	3	2.125	VCFJF	S		96744346
PS-258	1.500	E	3	2.125	BCFKF			269825601000
PS-436-EPR	1.750	C	3	2.500	QCFKF	S		96677366
FA-366	1.750	E	—	—	BCF-F			96677802
PS-7488	1.750	E	3	2.500	VLFLF	S	Lock Collar Supplied Separately	96853602
PS-2114	1.875	C	3	2.625	BCFJF	S		96748439
PS-2072	1.875	E	3	2.625	BCFKF	S		96733108

PUMP MANUFACTURERS' CROSS-REFERENCE

U.S. Seal Mfg. Part No.	Seal Size	Head	Mating Ring	Mating Ring Bore	Material Code	Notes	Pump Nameplate Data	Mfg. Part No.
STERLING FLUID SYSTEMS (DBA PEERLESS PUMP COMPANY)								
PS-3929	1.875	E	3	2.625	VCFJF	316SS/ C/S		96662531
PS-532	2.000	C	3	2.750	BCFJF	S		269359903 000 96690109
PS-1057	2.125	C	3	3.000	B/VCFKF	S		501908
PS-279V	2.500	E	3	3.375	VCFJF	S	Lock Collar Supplied Separately	96854658
PS-483	2.750	C	3	3.500	BCFKF	S		502365
PS-2708	2.750	C	3	3.500	VCFLF	S		96697120, 97619994
STERLING MACHINERY								
PS-201	.750	A	1	1.375	BMFJF			
FA-564	.750	C	—	—	BCF-F			
PS-358	.750	C	1	1.375	BCFJF			1616
PS-175	.750	K	1	1.375/ 1.500	BCFJF			
PS-303	.875	D	1	1.500	BCDKF			J81-E
PS-1681	.875	D	3	1.437	BCDKF			
PS-185	1.250	C	1	1.875	BCFJF			1636
PS-177	1.375	C	1	2.000	BCFJF			1706
PS-178	1.375	R	1	2.000	BCDJF			
PS-629	1.500	E	3	2.312	BCFKF			133861
PS-217	1.750	R	1	2.500	BCDKF			
PS-853	2.500	C	3	3.375	BCFKF	S		13498, 20125-H
STERLING PRODUCTS, INC.								
PS-3723	.625	C	3	1.437	QCFJF	I		081.00036.00 081.00036.01
PS-3981	.625	C	3	1.437	QCFKF	I		081.00037.00
PS-7872	.625	C	3	1.437	VCFKF	I		081.00039.00
PS-3826	.875	C	1	1.437	QCFJF	I		081.00034.00
PS-2224	.875	C	3	1.437	QCFKF	I		081.00024.00 081.00024.02
PS-3678	.875	C	3	1.437	QCFLF	I		081.00035-00
PS-4017	.875	C	3	1.437	VCFKF	I		081.00027.00
PS-758	1.500	C	1	2.125	BCFJF			081.00017.00
STERO								
PS-3159	.625	B	8	—	BCFJF	A		P571030
PS-3440	1.000	C	1	1.750	BCFJF			P571697
STEVENS PUMP COMPANY								
PS-200	.625	A	1	1.250	BMFJF			16-062-03
STOKES VACUUM PUMP								
VG-85296	1.812	Special	Special	2.561	VCFGF		212,412,612 Vacuums / GLV 1.5, 3.0 Pumps	085-029-600
STONE BENNETT CORPORATION								
PS-499	1.000	C	3	1.625	BCFKF	S		30016
STONE CONSTRUCTION								
PS-851	.750	A	1	1.375	BCFJF			32223, 322231H
PS-360	1.000	A	1	1.625	BCFJF			32224, 322241H
PS-185	1.250	C	1	1.875	BCFJF			37692
PS-758	1.500	C	1	2.125	BCFJF			37691, 376911H
PS-446	1.750	C	1	2.500	BCFJF			377281H
SUEZ WTS								
PS-4272	.625	C	1	1.250	BCFJF	316SS		1113515
PS-552-EPR-P66	.625	C	3	1.250	QCFJF	I		1114630
PS-3148	.625	E	3	1.250	BCFJF			1113517
PS-548	1.000	C	3	1.625	BCFJF	S		1121167
PS-22152	1.000	C	3	1.625	QCFJF	316SS		1122186
PS-235V	1.000	C	3	1.625	VCFJF	S		
PS-791	1.000	E	3	1.625	BCFKF	S		1114326
PS-3129	1.000	E	3	1.625	QCFZF			1201945
PS-2047V	1.375	D	3	2.000	VCFJF	S		3011311

NOTE: A. MOUNTS ON SHAFT I. ABRASION RESISTANT CARBON (P66)
C. COMPLETE WITH COLLAR S. SLOTTED MATING RING

PUMP MANUFACTURERS' CROSS-REFERENCE

U.S. Seal Mfg. Part No.	Seal Size	Head	Mating Ring	Mating Ring Bore	Material Code	Notes	Pump Nameplate Data	Mfg. Part No.
SULLAIR CORPORATION								
PS-6000	1.500	C	3	2.125	VCFGP			45755
PS-6098	1.875	C	3 Special	2.625	VCFKF	S		240048
PS-6097	1.875	X Special	3 Special	2.625	NCFPZ	316SS		250034-518
PS-22112	1.875	XT	3 Special	2.625	VCFLF	S		250034-516
PS-6120	2.125	K	3 Special	3.000	VCFZF			250038-066
PS-6121	2.125	K	3 Special	3.000	VCFZ/KF	I		250038-068
PS-22113	2.500	C	Special	3.375	VCFKF	H/S		2250047-091
PS-6138	2.500	C	3 Special	3.375	VCFKF			250038-093
PS-6997	2.500	K	3	3.375	NCFKF	S		250038-078
PS-6141	2.500	K	3 Special	3.375	VCFKF			250038-080
PS-6140	2.500	K	3 Special	3.375	VCFZF			250038-079
PS-8108	2.500	X1T	3 Special	3.375	VCFKF	316SS		250041-326
PS-6173	3.000	C	3 Special	3.875	VCFKF	S		250035-751
PS-6172	3.000	C	3 Special	3.875	VCFKF	H/S		250035-750
PS-6169	3.000	K	3 Special	3.875	NCFKF			250035-734
PS-6171	3.000	K	3 Special	3.875	VCFKF			250035-736
PS-6170	3.000	K	3 Special	3.875	VCFZF	S		250035-735
FA-3961	3.375	K	—	—	VCF-F			250014-770
PS-6179	3.375	X	3 Special	5.031	VCFKF	316SS		250035-013
SULLIVAN - PALATEK, INC.								
PS-1053	1.250	C	3	1.875	B/VCFKF	S		519056-08
PS-6180	1.375	C	3	2.000	VCFGF	S		519056-25
PS-210V	1.375	C	3	2.000	VCFKF	S		
PS-534	1.500	D	3	2.125	BCFKF		RP-250, RP-365	A-222599
FA-1055	1.750	C	—	—	BCF-F		RPV-125	
PS-3789	1.750	C	3	2.500	VCFGF			519058-0006
PS-1056V	1.750	C	3	2.500	VCFKF	S		519056-6
PS-4276	2.125	C	3	3.000	VCFKF			519056-13
PS-853	2.500	C	3	3.375	BCFKF		600	
PS-6174	3.000	E	3	3.875	VCDGP			519056-15
SUPERIOR EQUIPMENT SOLUTIONS								
PS-3100	1.000	Q	—	—	NMDKF	Unitized		75-7050-020
SWABY MFG. COMPANY								
PS-359	.625	C	1	1.250	BCFJF			
PS-758	1.500	C	1	2.125	BCFJF			
PS-446	1.750	C	1	2.500	BCFJF			
PS-2120	2.500	C	1	3.375	BCFJF			
SWIMQUIP								
PS-201	.750	A	1	1.375	BMFJF		XL VI/XL VII Series	37407-0009
SYNCROFLO, INC.								
PS-921	.750	A	1	1.375	BMFKF			13-690-0600
PS-360	1.000	A	1	1.625	BCFJF			13-650-0610
PS-370	1.000	A	1	1.625	BCFKF			13-690-0610
PS-235	1.000	C	1	1.625	BCFJF			13-690-0710
PS-355	1.125	C	1	1.750	BCFKF			13-900-0250
PS-185	1.250	C	1	1.875	BCFJF			13-950-0880
PS-756	1.250	C	1	1.875	BCFKF			13-690-2112
PS-1109	1.250	C	3	1.875	BCFKF			13-690-0611
PS-1018	1.250	C	3	2.000	BCFKF			13-690-2512
PS-361	1.250	E	1	1.875	BCFJF			13-650-1010
PS-137	1.250	E	1	1.875	BCFKF			13-690-0650
PS-3218	1.375	E	3	2.000	BCFJF	316SS/ C/H/S	P292-008-0001	
PS-3954	1.375	EB	1	1.875	BCFKF			13-690-2713
PS-3991	1.375	EB	3	1.875	BCFKF			13-690-0612
PS-659	1.500	C	1	2.125	BCFKF			13-900-0253
PS-7930	1.500	E	3	2.125	QCFZF	C/I/S		B282-140-7200
PS-238	1.625	C	1	2.375	BCFJF			13-950-0886
PS-1019	1.625	C	3	2.625	BCFKF			13-690-2515
PS-205	1.750	E	1	2.500	BCFJF			13-650-3011

PUMP MANUFACTURERS' CROSS-REFERENCE

U.S. Seal Mfg. Part No.	Seal Size	Head	Mating Ring	Mating Ring Bore	Material Code	Notes	Pump Nameplate Data	Mfg. Part No.
TACO								
PS-8100	.250	X Special	1	.875	QCFLF			185-026
PS-163	.500	B	1	1.000	BMFJF			106-031
PS-3561	.500	C	1	.938	BCFJF			180-097 180-108
PS-3563	.500	C	1	.938	QCFLF			180-240
PS-22127	.500	C	1	.938	VCFLF		HPL-33,50,75 & 100	180-1003
PS-1002	.500	C	1	1.000	BCFJF			121-008
PS-106	.500	C	1	1.000	BCFKF			131-031
PS-3583	.500	C	1	1.000	BCFKF			121-136
PS-2730	.500	C	1	1.000	QCFLF			185-201
PS-3004	.500	G	1	1.000	QCFLF			185-135
PS-3568	.500	G	1	1.000	QLFLF	316SS		185-151
PS-200	.625	A	1	1.250	BMFJF			172-009 172-017
PS-200V	.625	A	3	1.250	VCFJF			172-006
PS-1000V	.625	B	3	1.250	VCFJF			
FA-3525	.625	C	—	—	QCF-F	I		1600-305
PS-359	.625	C	1	1.250	BCFJF			121-009, 122-009
PS-633	.625	C	1	1.250	BCFKF			170-102RP 1600-170RP
PS-3525	.625	C	3	1.250	QCFKF	I		1600-170
PS-3586	.625	G	1	1.250	QCFJF	316SS		1600-846C
PS-3840	.750	C	1	1.275	BCFJF			180-162
PS-358	.750	C	1	1.375	BCFJF			180-206
PS-752	.750	D	1	1.375	BCDKF			142-043
PS-360	1.000	A	1	1.625	BCFJF			170-021 170-095
PS-754	1.000	E	1	1.625	BCFJF			900-012
PS-356	1.125	C	1	1.750	BCFJF			950-670RP 951-3161BRP
PS-355	1.125	C	1	1.750	BCFKF			950-664RP
PS-529-EPR	1.125	C	3	1.750	QCFKF	S		950-664BRP
PS-355V	1.125	C	3	1.750	VCFKF	S		950-667RP
PS-204	1.125	E	1	1.750	BCFJF			900-024
PS-384	1.125	E	1	1.750	BCFKF			840-128
PS-867	1.125	E	3	1.750	BCFKF	S		840-128BRP
PS-264	1.250	E	3	1.875	BCFKF			840-011
FA-2755	1.500	C	—	—	QCF-F	I		951-3168
PS-758	1.500	C	1	2.125	BCFJF			950-671RP
PS-22123	1.500	C	1	2.125	QLFLF			951-6212
PS-758-EPR	1.500	C	3	2.125	QCFJF	S		951-3162BRP
PS-659V	1.500	C	3	2.125	VCFKF			950-668RP
PS-305	1.500	E	1	2.125	BCFJF			862-029
PS-374	1.500	E	1	2.125	BCFKF			862-172
PS-544	1.625	C	3	2.375	BCFKF	S		950-673RP
PS-4068	1.625	C	3	2.375	QCFZF	I/S		950-676RP
PS-340-EPR-CMS	1.875	C	1	2.625	QCFJF			951-2968RP
PS-267	2.000	C	1	2.750	BCFJF			950-672RP
PS-842	2.000	C	1	2.750	BCFKF			950-666RP
PS-1145	2.000	C	3	2.750	VCFKF	S		950-669RP
PS-479	2.000	E	1	2.750	BCFJF			
FA-7750	2.250	C	—	—	QCF-F	I		950-280
PS-1676	2.250	C	3	3.125	BCFKF	S		
PS-1676-EPR-P66	2.250	C	3	3.125	QCFKF	I/S		950-674RP
PS-1676V-TC-SEAT	2.250	C	3	3.125	VCFZF	S		950-677RP
PS-5735	60MM	G	1	80MM	VCFLF	316SS		955-1840
PS-483	2.750	C	3	3.500	BCFKF	S		950-675RP
PS-3270	80MM	G	2	105MM	VCFLF	316SS		955-2403
PS-8806	3.375	XB	5	4.000	VCFLF	316SS		955-1847

NOTE: I. ABRASION RESISTANT CARBON (P66)
S. SLOTTED MATING RING

PUMP MANUFACTURERS' CROSS-REFERENCE

Value Guard Part No.	Seal Size		Material Code	Notes	Pump Nameplate Data	Mfg. Part No.
TACO - Replacement Seal Kits						
VGK-1096*	.625		BCFKF		Sleeve not Included in kit	1600-170BRP
VGK-1095*	.625		BCFJF		Sleeve not Included in kit	1600-170ERP
VGK-1097*	.625		BCFJF		Sleeve not Included in kit	1600-868CRP
VGK-1098	1.125		BCFKF			840-128BRP
VGK-1102	1.125		BCFKF			950-664BRP
VGK-1105	1.125		VCFZF			950-667BRP
VGK-1108	1.125		BCFJF			950-670BRP
VGK-1116	1.125		BCFKF			953-1549-1BRP
VGK-1117	1.125		BCFJF			953-1549-3BRP
VGK-1112	1.125		BCFKF			951-3159BRP
VGK-1114	1.125		BCFJF			951-3161BRP
VGK-1099	1.500		BCFKF			862-171BRP
VGK-1100	1.500		BCFKF			862-172BRP
VGK-1119	1.500		BCFJF			862-172ERP
VGK-1103	1.500		BCFKF			950-665BRP
VGK-1106	1.500		VCFZF			950-668BRP
VGK-1109	1.500		BCFJF			950-671BRP
VGK-1113	1.500		NCFKF			951-3160BRP
VGK-1115	1.500		BCFJF			951-3162BRP
VGK-1118	1.500		BCFJF			953-1549-6BRP
VGK-1101	1.875		BCFJF			950-1369BRP
VGK-1111	1.875		BCFJF			951-2968BRP
VGK-1104	2.000		BCFKF			950-666BRP
VGK-1107	2.000		VCFZF			950-669BRP
VGK-1110	2.000		BCFJF			950-672BRP

- Kits include gaskets, o-rings, sleeve*, rubber bonded washer, and mechanical seal.
- These kits do not include sleeve.
- TACO is not affiliated with U.S.SEAL MFG.
- Products supplied are manufactured or purchased from U.S.SEAL MFG. from sources other than the company listed.



VGK-1100

U.S. Seal Mfg. Part No.	Seal Size	Head	Mating Ring	Mating Ring Bore	Material Code	Notes	Pump Nameplate Data	Mfg. Part No.
TAIT MFG.								
PS-162	.500	A	1	1.000	BMFJF			W-6476
PS-201	.750	A	1	1.375	BMFJF			25062
PS-921	.750	A	1	1.375	BMFKF			24820
PS-1125	.750	C	1	1.375	BCFJF			16519
PS-703	.875	D	1	1.500	BCDJF			24584
PS-360	1.000	A	1	1.625	BCFJF			
PS-380	1.000	D	1	1.625	BCFJF			24963
PS-598	1.250	C	3	1.875	BCFKF			W-16524
PS-805	1.375	C	3	2.000	BCFJF	S		16538
PS-267	2.000	C	1	2.750	BCFJF			
TARBY ENGINEERING								
PS-4142	3.750	E	3	4.625	VCFLF	C		A200-0112
TECOGEN, INC.								
PS-6097	1.875	X Special	3 Special	2.625	NCFZF	316SS		78098
TECUMSEH PRODUCTS COMPANY, LLC.								
PS-350	2.375	E	3	3.250	BCFKF	S		K-509-9

PUMP MANUFACTURERS' CROSS-REFERENCE

U.S. Seal Mfg. Part No.	Seal Size	Head	Mating Ring	Mating Ring Bore	Material Code	Notes	Pump Nameplate Data	Mfg. Part No.
TEEL PUMP								
PS-392	.500	C	1	.938	B/QMFJF			5NC03
PS-631	.500	C	1	1.000	BCFJF	N		5P380, 5P418
PS-1002	.500	C	1	1.000	BCFJF		1P609, 1P610	1R305, 5NC02
PS-3542	.562	C	3	1.031	VCFKF			5P419
PS-100	.625	A	1	1.187	BMFJF		2P141, 2P894-2P899, 3P683-684-685, 3P-686-687-690-692-715-716, 1R311, 5P403, 5P404, 1R303, 5P407	
PS-516	.625	A	1	1.250	BCFJF		1P746-851-860-896-897-952-955-996, 1P998, 2P004-006-390, 2P091, 2P092 3P551-3P553 3P577	
PS-200	.625	A	1	1.250	BMFJF			1R312, 5P405, 5P406
PS-501	.625	A	1	1.250	BMFJF			1R315, 5P409, 5P410
PS-200V-SC-SC	.625	A	1	1.250	VLFLF			3ACE8
PS-200V	.625	A	3	1.250	VCFJF		1P862, 2P486 opt. for 1P746-851 1P854-856-860-884-896-897-952-955, 1P996-998, 2P004-006-290 3P551-553 3P577	1R300, 5P408
PS-113	.625	B	1	1.093	BMFJF		1P795	1R302, 5P366
PS-600	.625	B	1	1.187	BMFJF			5P367
PS-1000	.625	B	1	1.250	BMFJF		2P356, 2P360, 2P363, 2P366, 5P368, 5P369	1R317, 1R318
PS-447	.625	B	8	—	BCFJF	A	1P787-793-796-798-831-837 2P498-503-852, 3P736 1R306, 1P831, 5NC45, 5P402	
PS-447V	.625	B	8	—	VCFJF	A	Optional for 1P787-793-796-798-831 1P837, 2P498-503	1R324, 5P365
PS-800	.625	C	1	1.156	BMFJF	H	1P-849-850-879, 3P547-550 571-599-648 1P979-984 2P019-280, PC-18-2PC56 1R307, 5NC05, 5P387, 5P421	
PS-359	.625	C	1	1.250	BCFJF		1P898, 3P569A, 3P570A 1P557, 5P386, 1R304, 1R310	
PS-2160	.625	C	1	1.250	BCFJF		3P511, 3P512, 3P579, 1P861	5P420, 5NC06, 1R298
PS-359V	.625	C	3	1.250	VCFJF		1P555, 1P804, 3P569, 3P570	5NC07, 5P385
PS-508	.625	D	1	1.250	BCDJF			1R316, 5P382, 5P384
PS-851	.750	A	1	1.375	BCFJF		1P855-868-869-895, 1P913, 1P950 2P007-008, 2P333, 3P525 3P526, 3P600	5P414, 1R299
PS-201	.750	A	1	1.375	BMFJF			5P411, 5P412, 1R313
PS-101	.750	A	1	1.437	BMFJF			5P416, 1R319
PS-201V	.750	A	3	1.375	VCFJF		1P946; Optional for 1P855-868-869 1P895-913-950-979-984, 2P007-008 3P525-526-600	5P413, 1R245
PS-877	.750	C	1	1.375	BCFJF		Optional for 1P700-702-799-803-947, 1P949, 2P391, 2P392, 2P393, 2P394	5P389, 1R308
PS-877V	.750	C	1	1.375	VCFJF		1P700-702-799-803-947-949, 2P391 2P392, 2P393, 2P394	5P388, 1R309
PS-750	.750	D	1	1.375	BCDJF			5P383
PS-3941	.875	C	1	1.500	VLFLF			5NC21
PS-188V	.875	E	3	1.500	VCFJF	316SS		5NC27
VG-309	.875	HV	1	1.500	VCFJF			5NC08
PS-360	1.000	A	1	1.625	BCFJF			5NC01, 5P417
PS-380	1.000	D	1	1.625	BCFJF			5P423
PS-754	1.000	E	1	1.625	BCFJF			5P370
PS-754V-CMS	1.000	E	1	1.625	VCFJF			5NC28
VG-235	1.000	HV	1	1.625	BCFJF			5NC09, 5P390
PS-356	1.125	C	1	1.750	BCFJF		5NC11, 2P015, 2P141 3P582-601-604-609, 3P653-656-663, 3P664, 3P703-704-705-706, 3P707 3P737, 3P608, 5P391	

NOTE: A. MOUNTS ON SHAFT
H. SPRING HOLDER NOT INCLUDED
N. NON-STANDARD SPRING HOLDER

PUMP MANUFACTURERS' CROSS-REFERENCE

U.S. Seal Mfg. Part No.	Seal Size	Head	Mating Ring	Mating Ring Bore	Material Code	Notes	Pump Nameplate Data	Mfg. Part No.
TEEL PUMP (continued)								
PS-355	1.125	C	1	1.750	BCFKF			5P392
PS-529	1.125	C	3	1.750	BCFKF	S		5P393
PS-604	1.125	D	1	1.750	BCFJF			IR301
PS-204	1.125	E	1	1.750	BCFJF			5P373
PS-253	1.125	E	3	1.750	BCFKF			5P372
PS-204V	1.125	E	3	1.750	VCFJF			5NC29
PS-185	1.250	C	1	1.875	BCFJF		2P142, 3P660, 3P661, 3P662	5P394, IR439
PS-246	1.250	C	1	1.875	BCFJF	B/H		5P395
PS-756	1.250	C	1	1.875	BCFKF			5P396
PS-361	1.250	E	1	1.875	BCFJF			5P374
PS-177	1.375	C	1	2.000	BCFJF			5P397
PS-705	1.437	E	3	2.062	BCFJF			5P375
PS-758	1.500	C	1	2.125	BCFJF			5P398
PS-609	1.625	E	1	2.312	BCDJF			5P377
PS-610	1.625	E	1	2.312	BCFKF			5P376
PS-448	1.750	C	1	2.500	BCFKF			5P399
PS-205	1.750	E	1	2.500	BCFJF			5P378
PS-205V-CMS	1.750	E	1	2.500	VCFJF			5NC34
VG-446	1.750	HV	1	2.500	BCFJF			5NC16
PS-1659	1.875	E	3	2.625	VCFJF	S		5NC35
PS-479V	2.000	E	3	2.750	VCFJF	S		5NC36
VG-267	2.000	HV	1	2.750	BCFJF			5NC18
PS-322	2.750	K	3	3.500	BCFKF	S		5P401
TERRA PRODUCTS COMPANY								
PS-601V	.750	B	3	1.375	VCFJF			127135
PS-245V	1.000	C	3	1.625	VCFJF	B/H		17035
THELCO CORPORATION								
PS-4458	.625	C	1	1.375	VCFJF	316SS		SU1988
FA-1800	1.125	C	—	—	BCF-F			SU1774
FA-10038	1.125	C	—	—	VCF-F			SU1778
PS-394	1.250	U	3	1.875	BCF/DKF			20337
FA-177	1.375	C	—	—	BCF-F			SU1775
FA-172V	1.375	C	—	—	VCF-F			SU1789
FA-1660	1.750	C	—	—	BCF-F			SU1776
FA-10045	1.750	C	—	—	VCF-F			SU1780
THERMO KING								
PS-159	1.000	D	3	1.625	NCPPG			220203, 220378
THERMOTRON®								
PS-3833	1.125	C	2	1.750	BCFKF			555824
PS-239	1.625	C	1	2.375	BCFKF			1246366
THOMSEN® GROUP, LLC.								
PS-9700	.970	C	1	1.625	VCFJF			9122-VL
PS-185V-CMS	1.250	C	1	1.875	VCFJF			9123-VL
THOMPSON PUMP								
PS-3772	1.625	D	3	2.375	VZFLF			Q55-5162-1T2
PS-3142	2.000	D	3	2.750	VZFLF	316SS/S		Q55-5200-1T2
PS-3888	2.500	D	3	3.375	VZFLF			Q55-2520-1T2
PS-22141	2.500	E	3	3.375	VZFZF	316SS/S		Q55-5250-1T1
PS-4033	3.000	D	3	3.875	VZFLF	S		Q55-5300-1T2
THRUSH COMPANY, INC.								
PS-163	.500	B	1	1.000	BMFJF			
PS-106	.500	C	1	1.000	BCFKF		GT, GTB, GTN Series Circulators 1/3	
PS-600	.625	B	1	1.187	BMFJF			AA-190, AA-199
PS-290	.625	C	1	1.250	BCFJF	N	1-1/2TV.75, 2TV.75, J#s 1,2,3,4	
PS-633V-CMS	.625	C	1	1.250	VCFKF			TX-022/024
FA-1600	.875	C	—	—	BCF-F			9765-0260
PS-687	.875	C	1	1.500	BCFKF		1-1/2ATV1, 1-1/2TVI, 2TVB1-1/2 2VTB1, 2TV1, 2TV1-1/2, 2TV2, 3TV1, 3TV1-1/2, 3TV2, N#s 1,2,3,4	
PS-687V	.875	C	3	1.500	VCFKF			TX-026/028
FA-1800	1.125	C	—	—	BCF-F			9765-0300

PUMP MANUFACTURERS' CROSS-REFERENCE

U.S. Seal Mfg. Part No.	Seal Size	Head	Mating Ring	Mating Ring Bore	Material Code	Notes	Pump Nameplate Data	Mfg. Part No.
THRUSH COMPANY, INC. (continued)								
PS-355	1.125	C	1	1.750	BCFKF		2TV3, 2-1/2TV3, 2-1/2TV5, 3TV3 3TV5, 5ATV3, 5ATV5, 5TV3, 5TV5 Series R#s 1, 2, 3, 4	
FA-756	1.250	C	—	—	BCF-F			9765-0520
PS-598-EPR	1.250	C	3	1.875	QCFKF			7307-000-1
PS-756V	1.250	C	3	1.875	VCFKF			TX-052/054
FA-177	1.375	C	—	—	BCF-F			9765-0340
PS-210	1.375	C	1	2.000	BCFKF		2.5TV7-1/2, 3TV7-1/2, 3TV1 5ATV7-1/2, 2-1/2TV10, 4TV10 5TV15, Series V#s 3, 4	
PS-210V	1.375	C	3	2.000	VCFKF	S		TX-035/036
FA-1620	1.625	C	—	—	BCF-F			9765-0560
PS-239V	1.625	C	3	2.375	VCFKF	S		TX-056/058
TOLEDO PUMP COMPANY								
PS-501	.625	A	1	1.250	BMFJF			A14067
TONKAFLOW (See SUEZ WTS)								
TORO COMPANY								
PS-200V-CMS	.625	A	1	1.250	VCFJF			42088
TRANE TECHNOLOGIES™								
PS-4271	1.125	D	1	1.750	NCFJF	H		X0060542010
PS-192	1.500	C	3 Special	2.125	NCFGF			X0063400000
PS-6115	2.000	D	Plate	5.125	NCPGP			X0060064010
PS-22128	2.125	D	1	3.000	NCFJF			X0060542030
PS-22129	2.375	D	1	3.250	NCFJF	H		X0060542040

Value Guard Part No.	Seal Size	Head	Mating Ring Thick L1	Mating Ring Bore D1	Material Code	Oper Height L	Pump Nameplate Data	Mfg. Part No.
TRAVAINI PUMPS USA								
Dimensions in MM								
VGM-8251	22 MM	VGMH	10.3	37	27.5	VCFLF		950022SAC915 950022SAC916
VGM-8253	28 MM	VGMH	12.0	43	32.5	VCFLF		950028SAC915 950028SAC916
VGM-8255	35 MM	VGMH	12.0	50	32.5	VCFLF		950035SAC915 950035SAC916
VGM-8258	43 MM	VGMH	12.0	61	34.0	VCFLF		950043SAC915 950043SAC916
VGM-8261	55 MM	VGMH	13.5	75	34.5	VCFLF		950055SAC915 950055SAC916
VGM-8263	75 MM	VGMH	15.9	97	44.7	VCFLF		950075SAC915
VGM-8251Z	22 MM	VGMC-12	7.5	37	30.0	VCFLF		—
VGM-8253Z	28 MM	VGMC-12	7.5	43	35.0	VCFLF		—
VGM-8255Z	35 MM	VGMC-12	7.5	50	35.0	VCFLF		—
VGM-8258Z	43 MM	VGMC-12	9.0	61	36.0	VCFLF		—
VGM-8261Z	55 MM	VGMC-12	11.0	75	36.5	VCFLF		—
VGM-8263Z	75 MM	VGMC-12	11.3	97	48.7	VCFLF		—



**Type VGMH
Shown with LS3.**

- DIN 24960 ▪ Bi-Directional
- Elastomer Bellows ▪ Unbalanced

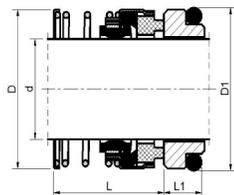

**Type VGMC-12
Shown with G6.
G60 is Optional**

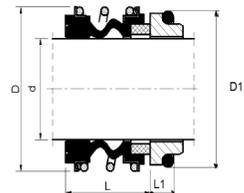

NOTE: H. SPRING HOLDER NOT INCLUDED
S. SLOTTED MATING RING

PUMP MANUFACTURERS' CROSS-REFERENCE

U.S. Seal Mfg. Part No.	Seal Size	Head	Mating Ring	Mating Ring Bore	Material Code	Notes	Pump Nameplate Data	Mfg. Part No.
TRUPAR								
PS-507	.625	A	1	1.250	BMFKF			P-1190
PS-102	.625	D	1	1.250	BCDKF			P-11048
PS-201	.750	A	1	1.375	BMFJF			P-11201
TRW (See SCHLUMBERGER LIMITED)								

Value Guard Part No.	Seal Size	Head		Material Code	Notes	Pump Nameplate Data	Mfg. Part No.
TSURUMI PUMP (AMERICA) INC.							
VGMW-14HL	14 MM	VGM562		VLFLF			W-14HL / 025-290-19
VGMHT-2530N	25/30 MM	VGM562		VLFLF			HT-2530N 025-000-01, 025-302-15
VGMH-30	30 MM	VGM562		VLFLF			H-30 / 025-194-12
VGMHT-3035N	30/35 MM	VGM562		VLFLF			HT-3035N 025-000-02, 025-303-16
VGMH-35	35 MM	VGM562		VLFLF			H-35 / 025-195-13
VGMHT-3540N	35/40 MM	VGM562		VLFLF			HT-3540N 025-000-03, 025-304-17
VGMNH-40	40 MM	VGM562		VLFLF	GPN		025-000-61
VGMH-45	45 MM	VGM562		VLFLF	KRS		025-197-15
VGMHT-4550N	45/50 MM	VGM562		VLFLF			HT-4550N 025-000-04, 025-305-18
VGMNH-50	50 MM	VGM562		VLFLF	GPN		025-210-15
VGMH-50T	50 MM	VGM562		VLFLF			H-50T / 025-268-18
VGMH-60	60 MM	VGM562		VLFLF			H-60 / 025-199-17
VGMH-70	70 MM	VGM562		VLFLF			H-70 / 025-200-12



Type VGM562

U.S. Seal Mfg. Part No.	Seal Size	Head	Mating Ring	Mating Ring Bore	Material Code	Notes	Pump Nameplate Data	Mfg. Part No.
TUTHILL PUMP (Division of INGERSOLL RAND)								
PS-22145	.437	C	3	1.000	VCFKF			ILA9-7-0519
PS-22144	.437	C	3	1.181	NCFJF			ILA9-5-9540
PS-633	.625	C	1	1.250	BCFKF			2C1B9
PS-3208	.750	C	1	1.375	VCFJF			065046 A000
PS-768	.750	C	3	1.375	BCFKF			065238 A000 / 3C1B9
PS-499	1.000	C	3	1.625	BCFKF	S		5C1B9
PS-252	1.000	D	3	1.625	BCFKF	S		065024 A000
PS-355V	1.125	C	3	1.750	VCFKF	S		065049 A000
FA-2678	1.250	C	—	—	BCF-F			065112 0000
FA-10040	1.250	C	—	—	VCF-F			065220 0000
PS-185V-CMS	1.250	C	1	1.875	VCFJF			065239 A000
PS-4123	1.375	D	3	2.000	VCP/FKF	S		005019-2-B
PS-4189	1.437	E	3	2.250	BCPKF			CC0919-1A
PS-4189V	1.437	E	3	2.250	VCPKF			CC0919-1B
PS-758V-CMS	1.500	C	1	2.125	VCFJF			065240 A000
PS-4546	1.500	D	3	2.125	B/VCPKP	S		065018 A000
PS-238V-CMS	1.625	C	1	2.375	VCFJF			065241 A000
PS-446V	1.750	C	3	2.500	VCFJF	S		065289 A000
FA-1875	1.875	C	—	—	BCF-F			065215 0000
FA-1875V	1.875	C	—	—	VCF-F			065219 0000

PUMP MANUFACTURERS' CROSS-REFERENCE

U.S. Seal Mfg. Part No.	Seal Size	Head	Mating Ring	Mating Ring Bore	Material Code	Notes	Pump Nameplate Data	Mfg. Part No.
TUTHILL PUMP (Division of INGERSOLL RAND) (continued)								
FA-2120	2.125	C	—	—	BCF-F			065214 0000
PS-1678V	2.250	C	3	3.125	VCFJF	S		065242 A000
PS-2116V	3.000	C	3	3.875	VCFJF	S		077408
U.S. ELECTRICAL MOTORS (A NIDEC Brand)								
PS-358	.750	C	1	1.375	BCFJF			PUL-2112
PS-356	1.125	C	1	1.750	BCFJF			
PS-320	1.500	C	1	2.250	BCFJF		Frame 213	
U.S. FILTER CORPORATION								
PS-1002V	.500	C	1	1.000	VCFJF			7802910
PS-290V	.625	C	1	1.250	VCFJF	N		7802918
PS-1687	2.125	D	1	3.000	BCFKF			U18080
VERTIFLO PUMP COMPANY								
PS-358	.750	C	1	1.375	BCFJF			SJ-2112-C1-00
PS-358V-CMS	.750	C	1	1.375	VCFJF			SJ-2112-C1-X2
PS-112V-CMS	.750	C	1	1.375	VCFKF			SJ-2112-71-X0
PS-7305	.750	C	1	1.375	VLF LF	316SS		SJ-2112-S1-X2
PS-185	1.250	C	1	1.875	BCFJF			SJ-2120-C1-00
PS-756	1.250	C	1	1.875	BCFKF			SJ-2120-71-00
PS-185V-CMS	1.250	C	1	1.875	VCFJF			SJ-2120-C1-X0
PS-3886	1.250	C	1	1.875	VCFJF	316SS		SJ-2120-C1-X2
PS-758	1.500	C	1	2.125	BCFJF			SJ-2124-C1-02
PS-659	1.500	C	1	2.125	BCFKF			SJ-2124-71-00
PS-758V-CMS	1.500	C	1	2.125	VCFJF			SJ-2124-C1-X0
PS-7409	1.500	C	1	2.125	VCFJF	316SS		SJ-2124-C1-X2
PS-659V-CMS	1.500	C	1	2.125	VCFKF			SJ-2124-71-X0
PS-238	1.625	C	1	2.375	BCFJF			SJ-2126-C1-00
PS-4525	1.625	C	1	2.375	BCFJF	316SS		SJ-2126-C1-02
PS-239	1.625	C	1	2.375	BCFKF			SJ-2126-71-00
PS-238V-CMS	1.625	C	1	2.375	VCFJF			SJ-2126-C1-X0
PS-239V-CMS	1.625	C	1	2.375	VCFKF			SJ-2126-71-X0
PS-3294	1.625	C	1	2.375	VLF LF	316SS		SJ-2126-S1-X2
PS-844	2.125	C	1	3.000	BCFJF			SJ-2134-C1-00
VIC CLEANING MACHINE								
PS-162	.500	A	1	1.000	BMFJF			22-907
PS-701	.625	A	1	1.187	BMFKF			42-607
VICAN PUMP (Division of IDEX CORPORATION)								
PS-7105	1.437	C	3	2.250	BCFKF			335-00-180-243
PS-4455	1.437	D	3	2.062	VCPKF			335-00-210-055
PS-6338	1.437	E	3	2.312	VCPKF			335-00-210-024
VICO (BALBOA WATER GROUP)								
PS-4274	.750	G	32	1.375/ 1.750	BCFJF	G	SuperFlo, UltraFlo, Ultima	PPSFSeal
VIKING INSTRUMENT								
PS-162	.500	A	1	1.000	BMFJF			1-3438-3
VIKING PUMP, INC. (Division of IDEX CORPORATION)								
PS-164	.500	B	9	—	BMFKF	A		2-471-008-999-00
PS-6321	.500	C	3	1.125	BCFKF			2-471-051-999-00
PS-22124	.500	C	3	1.125	NCFKF			2-471-059-999-00
PS-3735	.500	C	3	1.125	VCFKF			2-471-052-999-00
PS-3896	.500	E	Special	1.000	VCPKP			2-471-035-999-00
PS-7948	.500	E	Special	1.193	BCPKF			2-471-003-999-00
PS-4451	.500	E	Special	1.193	QCPKF			2-471-022-999-00
PS-7948V	.500	E	Special	1.193	VCPKF			2-471-017-999-00
PS-22114	.500	W	2	1.125	TCFKF	316SS		2-471-075-999-00
PS-9028	.500	W Special	Special	1.188	TCPKF			2-471-004-999-00
PS-1625	.625	C	3	1.250	BCFKF			2-472-014-999-00
PS-3133	.625	C	3	1.250	NCFKF			2-472-058-999-00
PS-1626	.625	C	3	1.250	VCFKF			2-472-015-999-00
PS-4375	.625	D	3	1.250	VCFZF			2-476-068-999-00

NOTE: A. MOUNTS ON SHAFT
G. MOUNTS IN PLASTIC
N. NON-STANDARD SPRING HOLDER
S. SLOTTED MATING RING

PUMP MANUFACTURERS' CROSS-REFERENCE

U.S. Seal Mfg. Part No.	Seal Size	Head	Mating Ring	Mating Ring Bore	Material Code	Notes	Pump Nameplate Data	Mfg. Part No.
VIKING PUMP, INC. (Division of IDEX CORPORATION) (continued)								
PS-9321	.625	W	2	1.250	TCFKF			2-472-006-999-00
PS-9322	.625	WT	Special	1.490	TCFOF	316SS		2-472-012-999-00
PS-7087	.750	D	3	1.375	BCPKF			2-473-003-999-00
PS-22116	.750	D	3	1.375	BCPLF			2-473-130-666-00
PS-7613	.750	D	3	1.375	NCPKF			2-473-009-999-00 2-473-120-999-00
PS-7613V	.750	D	3	1.375	VCPKF			2-473-018-999-00
PS-22118	.750	D	3	1.375	VCPLF			2-473-126-999-00
PS-22117	.750	E	3	1.375	VCPLF			2-473-131-999-00
PS-3935	.750	W	2	1.375	TCFKF	316SS		2-473-038-999-00
PS-9324	.750	W	2	1.375	TCFKF	316SS		2-473-006-999-00
PS-9323	.750	W Special	2	1.375	TCFKF	316SS		2-473-001-999-00
PS-9325	.750	W Special	2	1.375	TCFOF	316SS		2-473-034-999-00
PS-8772	.875	XB	3	1.375	BCPKF			2-474-003-999-00
PS-22126	25MM	G	1	40MM	VCFLF	316SS		2-475-224-999-00
PS-460	1.000	D	1	1.625	BCFKF			2-475-002-999-00
PS-6328	1.000	D	3	1.625	BCPKF			2-475-001-999-00
PS-6329	1.000	D	3	1.625	NCPKF			2-475-005-999-00
PS-3250	1.000	D	3	1.625	QCFJF			
PS-22119	1.000	D	3	1.625	VCFJF			2-475-209-999-00
PS-4137	1.000	D	3	1.625	VCPKF			2-475-010-999-00
PS-2805	1.000	D	3	1.625	VCPLF	H		2-475-267-999-00
PS-6331	1.000	E	3	1.625	BCPKF			2-475-115-999-00
PS-3803	1.000	E	3	1.625	VCFKF			2-475-012-999-00
PS-22115	1.000	E	3	1.625	VCFLF			2-475-278-999-00
PS-1631	1.000	T	3	1.625	NCPKF			2-475-004-999-00
PS-9313	1.000	W	2	1.625	TCFKF	316SS		2-475-019-999-00
PS-9334	1.000	W	2	1.625	TCFOF	316SS		2-475-025-999-00
PS-9715	1.000	W	Special	2.015	TCFGF	316SS		2-475-017-999-00
PS-7967	1.125	E	3	2.000	BCPKP			2-476-001-999-00
PS-3653	1.125	E	3	2.000	NCPGF	S		2-476-006-999-00
PS-3063	1.125	E	3	2.000	QCPKF			2-476-046-999-00
PS-6334	1.125	E	3	2.000	VCPKF			2-476-322-999-00
PS-7232	1.125	W	2	2.000	TCFKF	316SS		2-476-003-999-00
PS-9327	1.125	W	2	2.000	TCFOF	316SS		2-476-005-999-00
PS-9328	1.125	W	27	2.354	TCFKF	316SS		2-476-123-999-00
PS-9329	1.125	W	27	2.354	Special	316SS		2-476-133-999-00
PS-3731	1.125	Special	3	1.625	BCPKP			2-476-018-999-00
PS-22121	1.125	XB1	3	1.625	VCPKF			2-476-045-999-00
PS-6337	1.250	D	3	1.875	BCPKF			2-477-015-999-00
PS-6339	1.250	D	3	1.875	BCPKF			2-477-100-999-00
PS-3934	1.250	D	3	1.875	NCPKF			2-477-019-999-00
PS-1632V	1.250	D	3	1.875	VCPKF			2-477-020-999-00
PS-4637	1.250	D	3	1.875	VCPLF	H	AL, AK, AS 4193-4195	2-477-869-999-00
PS-4091	1.250	D	3	1.875	VLFLF	316SS/H		2-477-596-999-00
PS-3611	1.250	WT	2	1.875	TCFOF	316SS		2-477-140-999-00
PS-9724	1.250	WT	2	2.343	TCFOF	316SS		2-477-018-999-00
PS-7105	1.437	C	3	2.250	BCFKF			2-477-288-999-00
PS-7105V	1.437	C	3	2.250	VCFKF			2-477-289-999-00
PS-4067	1.437	E	3	2.125	VCPKF			2-477-042-999-00
PS-6340	1.437	E	3	2.171	BCPKF	H		2-477-173-999-00
PS-6342	1.437	E	3	2.171	VCPKF	H		2-477-180-999-00
PS-4189	1.437	E	3	2.250	BCPKF			
PS-1634	1.437	E	3	2.250	BCPKF			2-477-008-999-00
PS-3080	1.437	E	3	2.312	BAPKF			2-477-244-999-00
PS-3848	1.437	E	3	2.312	BCPKF			2-477-001-999-00
PS-6344	1.437	E	3	2.312	NCPKF			2-477-429-999-00
PS-6338	1.437	E	3	2.312	VCPKF			2-477-038-999-00
PS-4140	1.437	E	3	2.375	VCFLF			2-477-669-999-00
PS-1633	1.437	T	3	2.187	NCPKF			2-477-006-999-00
PS-9227	1.437	W	2	2.312	TCFKF			2-477-003-999-00

PUMP MANUFACTURERS' CROSS-REFERENCE

U.S. Seal Mfg. Part No.	Seal Size	Head	Mating Ring	Mating Ring Bore	Material Code	Notes	Pump Nameplate Data	Mfg. Part No.
VIKING PUMP, INC. (Division of IDEX CORPORATION) (continued)								
PS-9307	1.437	W	2	2.312	TCFOF			2-477-005-999-00
PS-9330	1.437	W	Special	2.484	TCFKF	316SS		2-477-179-999-00
PS-9707	1.437	W	2 Special	2.312	Special	316SS	Pinned Mating Ring	2-477-365-999-00
PS-9304	1.437	W	27	2.687	TCFKF	316SS		
PS-9721	1.437	W	27	2.687	TCFLF	316SS		2-477-933-999-00
PS-9717	1.437	W	27	2.687	Special	316SS		2-477-136-999-00
PS-9331	1.437	W	27	2.687	Special	316SS		2-477-346-999-00
PS-8131	1.437	XB Special	27 Special	2.687	VCFKF	316SS		2-477-794-999-00
PS-2812	38MM	G	1	2.205	BCFLF	316SS		2-478-234-999-00
PS-22125	38MM	G	1	54MM	VCFLF			2-478-239-999-00
PS-22022	1.500	D	3	2.125	VCFLF	S		2-478-447-999-00
PS-395V-SC-SEAT	1.500	E	3	2.125	VCFKF	S		2-478-397-999-00
PS-8141	1.500	XB	3	1.875	VCPKF		AS, AK, AL4195	2-478-074-999-00
PS-8807	1.500	XB	3	1.875	VZFLF	316SS	AS, AK, AL4195	2-478-416-999-00
PS-6348	1.625	E	3	2.375	BCPKF	S		2-478-041-999-00
PS-6351	1.625	E	3	2.375	NCPKF	S		2-478-223-999-00
PS-6349	1.625	E	3	2.375	VCPKF	S		2-478-046-999-00
PS-22120	1.625	W	2	2.375	TCFKF	316SS		2-478-257-999-00
PS-9017	1.625	WT	27	2.875	TCFKF	316SS		2-478-040-999-00
PS-9332	1.625	WT	27	2.875	TCFOF	316SS		2-478-026-999-00
PS-3278	43MM	G	1	61MM	VCFLF	316SS		2-478-219-999-00
PS-22122	1.750	D	3	2.500	BCFKF	316SS/S		2-478-218-999-00
PS-7580	2.437	E	3	3.437	BCPKP			2-480-001-999-00
PS-3751	2.437	E	3	3.437	VCPKF			2-480-004-999-00
PS-9333	2.437	W	27	4.000	TCFKF	316SS		2-480-051-999-00
PS-3505	3.437	U	3	4.375	VCPKF	S		2-481-006-999-00
PS-8106	3.437	X	3	4.312	VCFK*	S		2-481-124-999-00
VILTER MFG. LLC								
PS-6146	2.500	R	3	3.375	NCPGP			A-33483-A
PS-6175	3.000	R	3	3.875	NCPGP			A-33489-A
VULCAN HART CORPORATION								
PS-1618	.625	C	1	1.250	BCFJF	B		
PS-508	.625	D	1	1.250	BCDJF			
PS-360	1.000	A	1	1.625	BCFJF			97505
PS-236	1.000	E	1	1.625	BCFKF			97049
PS-1167	1.125	C	1	1.750	BCFKF	B		
PS-604	1.125	D	1	1.750	BCFJF			
WARREN PUMPS								
PS-4529	4.500	E	3	5.500	BCFJF	316SS/C		
WATER ACE PUMP COMPANY® (Part of PENTAIR PUMP GROUP)								
PS-3845	.625	B	8	—	BMFJF	A	RSP-7, 10, 15	25053A000
WATERCO USA								
PS-3985	.750	B	1	1.375	BCFJF	316SS	Supatuf	634016
PS-1904	.750	B	1	1.375	VLFLF	316SS		63401625
PS-360	1.000	A	1	1.625	BCFJF			63401629
PS-185	1.250	C	1	1.875	BCFJF			19B5032
PS-446	1.750	C	1	2.500	BCFJF			19B5033
WATEROUS COMPANY								
PS-778	1.000	A	3	1.625	BCFKF	S		V1888
PS-357	1.000	C	1	1.625	BCFKF			
PS-499	1.000	C	3	1.625	BCFKF	S		
PS-460V	1.000	D	3	1.625	VCFKF	S		V2672
PS-3010	1.000	G	3	1.625	BCFLF			V3386
PS-3193	1.062	D	3	1.750	VCDLF			V3385
PS-605	1.125	D	1	1.750	BCFKF			V1467
PS-3013	1.125	G	25	1.750	VCFLF	316SS		V3505
PS-598	1.250	C	3	1.875	BCFKF			V2145
PS-383V	1.250	D	3	1.875	VCFKF			V1150

NOTE: A. MOUNTS ON SHAFT
B. TAPERED SPRING
S. SLOTTED MATING RING

PUMP MANUFACTURERS' CROSS-REFERENCE

U.S. Seal Mfg. Part No.	Seal Size	Head	Mating Ring	Mating Ring Bore	Material Code	Notes	Pump Nameplate Data	Mfg. Part No.
WATEROUS CO. (continued)								
PS-22149	1.250	D	3	2.125	VCFLF			V4299
PS-6266	1.250	G	3	1.875	BCFLF	316SS		V3218
PS-659V	1.500	C	3	2.125	VCFKF			
PS-371V	1.500	D	3	2.125	VCFKF		No Springholder required	V2247
PS-3161	1.500	E	3	2.125	VCFLF			V2662
PS-22147	1.875	D	3	2.625	VCFLF			V2796
PS-22148	2.250	D	3	3.125	VCDKF	S		V2859
PS-22146	2.750	D	3	3.750	VCDLF	S		V2595
WATERWAY PLASTICS								
PS-671	.375	B	1	.875	BMFJF		Tiny Mite	
PS-200V-CMS	.625	A	1	1.250	VCFJF		EX2, Hi-Flo II, Supreme, Viper	319-3010B
PS-3212	.625	B	1	1.250	VCFJF		Iron Might, Spa Flo II	319-3110B
VG-9596	.625	BV	1	1.250	VCFLF*		Champion, Econoflo, Executive Hi-Flo, SMF, Spa Flo, Workman	319-3100B
PS-4577	.625	G	1	1.381	QCFJF		Booster Pump	319-3290B
WATTS WATER TECHNOLOGIES								
PS-680	.625	A	1	1.187	BCFJF			
PS-1000	.625	B	1	1.250	BMFJF			
WAUKESHA® CHERRY-BURRELL® (SPX FLOW)								
FA-3730	1.375	C	—	—	NFF-F			M549P122960
FA-8201	1.500	XB2	—	—	VCF-F	316SS		OC1114008
PS-544	1.625	C	3	2.375	BCFKF	S		5064131207
PS-239V	1.625	C	3	2.375	VCFKF	S		5164130809, PG4-45
PS-267V	2.000	C	3	2.750	VCFJF	S		
PS-1145	2.000	C	3	2.750	VCFKF	S		5065080809, PG4-46
PS-1676	2.250	C	3	3.125	BCFKF	S		5065711207
PS-1676V	2.250	C	3	3.125	VCFKF	S		5065710809
WAUKESHA ENGINE								
FA-642	.625	B	—	—	BMF-F			102320 & 20B
FA-201	.750	A	—	—	BMF-F			810350
PS-201	.750	A	1	1.375	BMFJF			152243-B
FA-647	.750	B	—	—	BMF-F			120828
PS-752	.750	D	1	1.375	BCDKF			
PS-685	.875	R	1	1.500	BCDKF			108025
PS-380	1.000	D	1	1.625	BCFJF			
PS-1619	1.000	Q	1	1.625	BCDJF			117177G-J
PS-604	1.125	D	1	1.750	BCFJF			157475, 157475E 157475K
PS-185	1.250	C	1	1.875	BCFJF			178033
WAYNE COMBUSTION SYSTEMS								
PS-162	.500	A	1	1.000	BMFJF			15717, 56106
PS-163	.500	B	1	1.000	BMFJF			15863, 56108
FA-400	.500	C	—	—	BMF-F			15189
PS-1137	.500	Q	1	1.000	BMFJF			15780, 56107
PS-200	.625	A	1	1.250	BMFJF		Series SJ-CJX	15559, 56104
FA-642	.625	B	—	—	BMF-F			
PS-1000	.625	B	1	1.250	BMFJF			15996, 56109
PS-1155	.625	C	1	1.187	BCFJF		Series J and S	15529
PS-201	.750	A	1	1.375	BMFJF			15693, 56105
PS-201V	.750	A	3	1.375	VCFJF			16229
WAYNE PUMPS								
FA-10	.500	B	—	—	BMF-F			16722
FA-64	.750	A	—	—	BCF-F			16829
FA-201	.750	A	—	—	BMF-F			16725
WAYNE WATER SYSTEMS								
PS-200-EPR	.625	A	1	1.250	QCFJF		CJX, SJD, SW	56393
PS-201V-CMS	.750	A	1	1.375	VCFJF		2.5" & 3 HP	56112
PS-4106	.750	B	1	1.375	VCFJF	316SS		16993-001, 16995-001

PUMP MANUFACTURERS' CROSS-REFERENCE

U.S. Seal Mfg. Part No.	Seal Size	Head	Mating Ring	Mating Ring Bore	Material Code	Notes	Pump Nameplate Data	Mfg. Part No.
WDM PUMPS-USA								
PS-354V	1.375	E	3	2.000	VCFJF	S		MSIXFCEA138
PS-436V	1.750	C	3	2.500	VCFKF	S		MS21XFNRAC134
WEBER INDUSTRIES, INC.								
PS-516	.625	A	1	1.250	BCFJF			70X102-M
PS-200V-CMS	.625	A	1	1.250	VCFJF			70X103-M
PS-3228	.625	A	1	1.250	VCFJF	316SS		70X130-M
PS-359V-CMS	.625	C	1	1.250	VCFJF			70X120-M
PS-3677	.625	D	3	1.250	BCDLF			70X110-M
PS-851	.750	A	1	1.375	BCFJF			70X107-M
PS-201V-CMS	.750	A	1	1.375	VCFJF			70X108-M
PS-358V-CMS	.750	C	1	1.375	VCFJF			70X121-M
PS-356V-CMS	1.125	C	1	1.750	VCFJF			70X118-M
PS-185	1.250	C	1	1.875	BCFJF			70X122-M
PS-185V-CMS	1.250	C	1	1.875	VCFJF			70X123-M
PS-446V-CMS	1.750	C	1	2.500	VCFJF			70X125-M
WEBSTER ELECTRIC								
FA-62	.625	A	—	—	BCF-F			
PS-467	1.375	C	1	2.125	BCFKF			151-26815
WEIL PUMP COMPANY, INC. (Part of WILO USA)								
PS-100	.625	A	1	1.187	BMFJF			17-30009-005 330.009.005
PS-600	.625	B	1	1.187	BMFJF			
PS-1000	.625	B	1	1.250	BMFJF			
PS-989	.625	C	1	1.187	N/BCFJF	B		
PS-851	.750	A	1	1.375	BCFJF			17-62372-008
PS-358	.750	C	1	1.375	BCFJF			205.016.101
PS-358V-CMS	.750	C	1	1.375	VCFJF			205.093.101
PS-750	.750	D	1	1.375	BCDJF			X1397, X2372
PS-617	.875	C	3	1.500	BCFKF			X3452
PS-380	1.000	D	1	1.625	BCFJF			X992
PS-2033	1.000	D	3	1.625	BCFJF			17-62427-000
PS-754	1.000	E	1	1.625	BCFJF			X993
PS-355-SC-SC	1.125	C	1	1.750	BLFLF			137-000-129
PS-604	1.125	D	1	1.750	BCFJF			X2428
PS-802	1.125	D	3	1.750	BCFJF	S	Springholder by Customer	17-62428-008 362.428.008
PS-204	1.125	E	1	1.750	BCFJF			
PS-384	1.125	E	1	1.750	BCFKF			X-217UKY
PS-866	1.125	E	3	1.750	BCFJF	S		17-61117-008
PS-381	1.250	D	1	1.875	BCFJF			X2174, X-2429UKY
PS-804	1.250	D	3	1.875	BCFJF	S		17-62429-006
PS-3184	1.250	K	3	2.000	BCFJF			305.511.001
PS-1623	1.250	K	3	2.125	BCFJ/KF			17-05511-001
PS-210	1.375	C	1	2.000	BCFKF		AS	
PS-758	1.500	C	1	2.125	BCFJF			205.228.001
PS-758-SC-SC	1.500	C	1	2.125	BLFLF			205.229.001
PS-758V-CMS	1.500	C	1	2.125	VCFJF			205.228.002
PS-758V-SC-SC	1.500	C	1	2.125	VLFLF			205.229.002
PS-926	1.500	C	3	2.312	BCFJF			
PS-514	1.625	D	1	2.375	BCDJF		Springholder by Customer	362.432.000
PS-446-SC-SC	1.750	C	1	2.500	BLFLF			205.311.001
PS-1142	1.750	K	3	2.500	BCFJ/KF	S		17-05514-005
PS-2069	1.875	E	1	2.625	BCFJF		AYM 4X5	
PS-267	2.000	C	1	2.750	BCFJF			205.258.001
PS-847	2.250	D	3	3.125	BCDKF	S	AYM 5 & 6	17-62550-009
WEINMAN® (Division of CRANE PUMPS & SYSTEMS)								
PS-501	.625	A	1	1.250	BMFJF		4, 5, 6 & 8ACK, 4&6AEK	
PS-4371	.625	A	1	1.250	VCFJF	I		Q26-77-Y25
PS-3816	.625	A	1	1.250	VCFKF	I		Q26-77-Y6

NOTE: B. TAPERED SPRING
I. ABRASION RESISTANT CARBON (P66)
S. SLOTTED MATING RING

PUMP MANUFACTURERS' CROSS-REFERENCE

U.S. Seal Mfg. Part No.	Seal Size	Head	Mating Ring	Mating Ring Bore	Material Code	Notes	Pump Nameplate Data	Mfg. Part No.
WEINMAN® (Division of CRANE PUMPS & SYSTEMS) (continued)								
PS-309	.875	C	1	1.500	BCFJF			Q26-394-Y2
PS-188	.875	E	1	1.500	BCFJF	316SS	2SB	Q26-177-Y2
PS-245	1.000	C	1	1.625	BCFJF	B/H	4AE, 6AC, 6AE	Q26-201-Y2
PS-248	1.000	C	1	1.625	BCFKF	B/H	4AE, 6AC, 6AE	Q26-143-Y34
PS-380	1.000	D	1	1.625	BCFJF			Q26-78-Y2
PS-4289	1.000	DB	3	1.500	VCFKF	I		Q26-409-Y6
PS-3273	1.000	DB	3	1.500	VCFZF			Q26-409-Y48
PS-204	1.125	E	1	1.750	BCFJF			Q26-184-Y2
PS-867	1.125	E	3	1.750	BCFKF	S		Q26-102-Y34
PS-185	1.250	C	1	1.875	BCFJF			Q26-395-Y2, Q26-395-Y21
PS-246	1.250	C	1	1.875	BCFJF	B/H	Group A-1G, 1-1/4G, 1-1/2G 1-1/2K, 1-1/2KH, 2G, GB, and KB. Group B-7-1/2. HP & Less at 1750 20 HP & less at 3500 RPM T1-1/2KH, 2K, 2-1/2G, 2-1/2K 3G, 3K, 4GL, and 4G	Q26-166-Y2
PS-249	1.250	C	1	1.875	BCFKF	B/H		Q26-276-Y34
PS-756	1.250	C	1	1.875	BCFKF			Q26-395-Y34
PS-185-TC-SEAT	1.250	C	1	1.875	BCFZF			Q26-395-Y10
PS-185-SC-SC	1.250	C	1	1.875	BLFLF			Q26-395-Y39
PS-2208	1.250	C	1	1.875	BZFZF			Q26-395-Y26
PS-4464	1.250	C	1	1.875	QCFKF	316SS		Q26-395-Y53
PS-4029	1.250	C	1	1.875	QCFZF	316SS		Q26-395-Y30
PS-1082	1.250	C	1	1.875	NCFKF			Q26-395-Y24
PS-185V-CMS-P66	1.250	C	1	1.875	VCFJF	I		Q26-395-Y25
PS-756V-CMS-P66	1.250	C	1	1.875	VCFKF	I		Q26-395-Y6
PS-185V-TC-SEAT	1.250	C	1	1.875	VCFZF			Q26-395-Y17
PS-185V-SC-SC	1.250	C	1	1.875	VLFLF			Q26-395-Y62
PS-756V	1.250	C	3	1.875	VCFKF			Q26-395-Y47
PS-381	1.250	D	1	1.875	BCFJF			Q26-79-Y2
PS-383	1.250	D	1	1.875	BCFKF			Q26-5-Y34
PS-361	1.250	E	1	1.875	BCFJF		When Seal is Mounted on Shaft 2L-4, 5, 6, 3L-6, 4L3, 5L3	Q26-243-Y2
PS-264	1.250	E	3	1.875	BCFKF			Q26-243-Y34 Q26-243-Y35
PS-137V-P66	1.250	E	3	1.875	VCFKF	I		Q26-243-Y6
PS-2657	1.250	E	3	1.875	VCFZF	S		Q26-243-Y17
PS-228	1.250	K	3	1.875	BCFKF		FR#11, 3UE-B11, 4UD-B11, 4UE-B11	Q26-190-Y34
PS-3587	1.375	CB	3	1.875	BCFZF	S		
PS-4119	1.375	CB	3	1.875	VCFKF	S		Q26-415-Y47
PS-7697V-TC-SEAT	1.375	CB	3	1.875	VCFZF	S		Q26-415-Y48
PS-2704	1.375	CB	3	1.875	VCFZF	I/S		Q26-415-Y17
PS-7702	1.375	EB	3	1.875	BCFJF	S		Q26-318-Y2
PS-3991	1.375	EB	3	1.875	BCFKF	S		Q26-318-Y34
PS-4145	1.375	EB	3	1.875	BCFZF			Q26-318-Y10
PS-3769	1.375	EB	3	1.875	VCFZF	I/S		Q26-318-Y17
PS-347	1.500	C	1	2.125	BCFJF	B/H	Group B-10 HP , Over at 1750; 25 HP Over at 3500 RPM 1-1/2KH, 2K, 2-1/2G 2-1/2K, 3G, 3K, 4GL, 4G. Group C TYP:- 2-1/2KH.	Q26-167-Y2
PS-378	1.500	C	1	2.125	BCFKF	B/H		Q26-175-Y34
PS-305	1.500	E	1	2.125	BCFJF		When Seal is Mounted on Sleeve: 2L-4, 2L-5, 3L-6, 4L-2, 4L-3, 5L-3 When Seal is Mounted on Shaft: 2-1/2JC, 3L-5, 4L-1, 5L-2, 6L-2, 6L03	Q26-264-Y2
PS-374	1.500	E	1	2.125	BCFKF			Q26-265-Y34
PS-395	1.500	E	3	2.125	BCFJF	S		Q26-178-Y2
PS-258	1.500	E	3	2.125	BCFKF			Q26-178-Y34 Q26-178-Y35
PS-305V-P66	1.500	E	3	2.125	VCFJF	I/S		Q26-178-Y25
PS-374V	1.500	E	3	2.125	VCFKF			Q26-178-Y47

PUMP MANUFACTURERS' CROSS-REFERENCE

U.S. Seal Mfg. Part No.	Seal Size	Head	Mating Ring	Mating Ring Bore	Material Code	Notes	Pump Nameplate Data	Mfg. Part No.
WEINMAN® (Division of CRANE PUMPS & SYSTEMS) (continued)								
PS-258V-P66	1.500	E	3	2.125	VCFKF	I		
PS-4317	1.500	EB	3	2.000	BCFKF			Q26-303-Y34
PS-818	1.625	C	3	2.375	BCFJF	S		Q26-373-Y2
PS-544	1.625	C	3	2.375	BCFKF	S		Q26-373-Y34
PS-238V	1.625	C	3	2.375	VCFJF	S		Q26-373-Y25
PS-239V	1.625	C	3	2.375	VCFKF	S		Q26-373-Y47
PS-2057	1.625	E	1	2.375	BCFJF		When Seal is Mounted on Shaft: 3JC, 4L-4, 5L-1, 8L-3	Q26-240-Y03
PS-2058	1.625	E	1	2.375	BCFKF			Q26-241-Y35
PS-1699	1.625	E	3	2.375	BCFKF	S		Q26-240-Y34 Q26-240-Y35
PS-205	1.750	E	1	2.500	BCFJF		When Seal is Mounted on Sleeve: 3L-4, 3L-5, 4L-1, 5L-2, 6L-2, 6L-3 When Seal is Mounted on Shaft: 2-1/2JC	Q26-222-Y2
PS-205-P66	1.750	E	1	2.500	BCFJF	I		Q26-179-Y21
PS-366	1.750	E	1	2.500	BCFKF			Q26-223-Y34
PS-205V-P66	1.750	E	3	2.500	VCFJF	I/S		Q26-179-Y25
PS-535	1.750	E	3	2.500	BCFJF	S		Q26-217-Y2
PS-262	1.750	E	3	2.500	BCFKF	S		Q26-217-Y34 Q26-217-Y35
PS-3540	1.750	E	3	2.500	QZFFZ	S		
PS-3183	1.625	E	3	2.375	VCFKF	I/S		Q26-240-Y6
PS-7774	1.750	EB	3	2.375	BCFJF	S		Q26-319-Y2
PS-2231	1.750	EB	3	2.375	BCFKF	S		Q26-304-Y34
PS-7821	1.750	EB	3	2.375	BCFZF	316SS/I/S		Q26-304-Y10
PS-449	1.750	K	1	2.500	BCFJF		Frame #12-3UE, 4UD, 4UE-B12 Frame #13: 4UF, 5UF, 6UG-B13	Q26-191-Y2
PS-2170	1.750	U	3	2.500	BCFJF	S		Q26-179-Y2
PS-4488	1.750	UB	3	2.375	BCFZF	S		
PS-479	2.000	E	1	2.750	BCFJF		When Seal is Mounted on Shaft: 6L-1, 8L-2, 10L-2, 10L-3 When Seal Mounted on Sleeve: 4L-4, 5L-1, 8L-3	Q26-267-Y2
PS-477	2.000	E	3	2.750	BCFKF	S		Q26-268-Y34
PS-3088	2.000	EB	3	2.500	QCFZF	316SS/I		Q26-305-Y30
PS-3304	2.000	EB	3	2.625	BCFJF	S		Q26-305-Y2
PS-7892	2.000	EB	3	2.625	BCFKF	S		Q26-305-Y34
PS-4291	2.000	EB	3	2.625	BCFZF			Q26-305-Y10
PS-4102	2.000	EB	3	2.625	VCFZF		5L1	
PS-4474	2.000	U	3	2.750	BCFJF			Q26-180-Y2
PS-385A	2.000	U	3	2.750	BCFKF	S	3JC and 5LI Split Case	Q26-180-Y34
PS-385AV	2.000	U	3	2.750	VCFKF	S		Q26-180-Y6
PS-4468	2.000	U	3	2.750	VCFLF			Q26-180-Y52
PS-4391	2.000	U	3	2.750	VLFLF		8L2	
PS-3784	2.250	EB	3	3.000	BCFJF	S		Q26-306-Y2
PS-2658	2.250	EB	3	3.000	BCFLF	S		Q26-306-Y39
PS-7749	2.250	EB	3	3.000	BCFZF	S		Q26-306-Y10
PS-3643	2.250	EB	3	3.000	B/VCFKF	S		Q26-306-Y34
PS-278	2.375	E	3	3.250	BCFJF	S	When Seal is Mounted on Shaft: 8L-1, 12L-2 When Seal is Mounted on Sleeve: 6L-1, 8L-2, 10L-3	Q26-181-Y2 Q26-273-Y2
PS-350	2.375	E	3	3.250	BCFKF	S		Q26-181-Y34 Q26-181-Y35 Q26-275-Y34
PS-350V-P66-TC	2.375	E	3	3.250	VCFZF	I/S		Q26-181-Y17
PS-279	2.500	E	3	3.375	BCFJF	S	10L-2, Seal is Mounted on Sleeve	Q26-182-Y2
PS-349	2.500	E	3	3.375	BCFKF	S		Q26-182-Y34
PS-2158	2.500	K	1	3.375	BCFJF			Q26-406-Y2
PS-542	2.625	E	3	3.375	BCFKF	S		Q26-406-Y34 Q26-408-Y35

NOTE: I. ABRASION RESISTANT CARBON (P66)
S. SLOTTED MATING RING

PUMP MANUFACTURERS' CROSS-REFERENCE

U.S. Seal Mfg. Part No.	Seal Size	Head	Mating Ring	Mating Ring Bore	Material Code	Notes	Pump Nameplate Data	Mfg. Part No.
WEINMAN® (Division of CRANE PUMPS & SYSTEMS) (continued)								
PS-7927	2.625	EB	3	3.375	BCFKF	S		Q26-340-Y34
PS-4485	2.625	EB	3	3.375	BLFZF	S		
PS-324SS	3.000	E	3	3.875	BCFJF	S	8L-1, 12L-2 Seal is Mounted on Sleeve	Q26-183-Y2
PS-5252	3.000	E	3	3.875	BCFKF	S		Q26-183-Y34 Q26-183-Y35
PS-4514	3.000	E	3	3.875	BLFLF	S		Q26-183-Y60
WEIR SPECIALTY PUMPS								
PS-356	1.125	C	1	1.750	BCFJF			157257
PS-3234	1.125	C	1	1.750	VZFLF			157548
PS-3287	1.187	D	3	1.875	BCDKF	I		542949-3
PS-758	1.500	C	1	2.125	BCFJF			157258
PS-659-TC	1.500	C	1	2.125	BCFZF			805169
PS-3166	1.500	C	1	2.125	BZFLF	316SS		157646
PS-2209	1.500	C	1	2.125	BZFZF			157666
PS-758V-CMS	1.500	C	1	2.125	VCFJF			157549
PS-7409	1.500	C	1	2.125	VCFJF	316SS		157256
PS-758V-TC-SC-CMS	1.500	C	1	2.125	VZFLF			157527
PS-541	1.500	K	1	2.125	BCFJF			157174
PS-3558	1.500	K	3	2.375	BCFJF			157319
PS-9713	1.500	WT Dbl.	3	2.375	VCFJF	316SS		157315
PS-550	1.750	C	3	2.500	BCFJF	A		52596
PS-3251	1.750	E	3	2.312	VCFLF	316SS/S		802328
PS-3236	1.750	K	1	2.500	BZFZF			157442
PS-4304	1.750	K	1	2.500	VZFZF			157472
PS-4353	1.750	K	3	2.500	BCFJF	S		157172
PS-267	2.000	C	1	2.750	BCFJF			157259
PS-267V-CMS	2.000	C	1	2.750	VCFJF			157554
PS-6218	2.000	C	1	2.750	VZFZF			808976
PS-4343	2.000	K	3	2.750	BZ/CFZ/JF			804820
PS-1679	2.250	C	1	3.125	BCFJF			52600
PS-2120	2.500	C	1	3.375	BCFJF			157599
PS-1613	2.500	K	3	3.375	BCFJF	S		157173
PS-4109	2.500	T	3	3.375	VZFLF	316SS		800724
PS-3235	3.000	C	1	3.875	BCFJF	316SS		157260
PS-7875	3.000	C	1	3.875	BZFZF			52605
PS-6204	3.500	C	3	4.375	BCFJF	S		157576
PS-22150	4.000	X	3	4.875	VCFKF	S		831335-016
WELLS BLOOMFIELD								
PS-359	.625	C	1	1.250	BCFJF			35902
WEMCO® - HIDROSTAL - TYPE M - REPLACEMENT SEALS								
VG-7085	1.125	VG	1	1.750	VZFLF		Lower Seal	157261
PS-356	1.125	C	1	1.750	BCFJF		Upper Seal	157257
VG-7086	1.500	VG	1	2.125	VZFLF		Lower Seal	157262
PS-758	1.500	C	1	2.125	BCFJF		Upper Seal	157258
VG-7087	2.000	VG	1	2.750	VZFLF		Lower Seal	157263
PS-267	2.000	C	1	2.750	BCFJF		Upper Seal	157259

Lower Seal

- Spring is covered by an elastomer boot which prevents seal clogging from stringy waste material.
- Durable Viton® elastomers and Tungsten Carbide rotating face.
- Sintered Silicon Carbide mating ring is standard.
- Dimensionally equivalent to the accompanying upper seal.

HIDROSTAL® Type G & X Seal Types Also Available



**VG-7087
Lower Seal**



**PS-267
Upper Seal**

PUMP MANUFACTURERS' CROSS-REFERENCE

Value Guard Part No.	Shaft Size	Head	Mating Ring	Mating Ring Bore	Material Code	Pump Nameplate Data	Mfg. Part No.
WEMCO® - SELF PRIMER							
VG-7080	1.250	VGD	Special	Special	VLZFZ	WSP3A, WSP4A, WSP6A	
VG-7079	1.250	VGD	Special	Special	VZFZF	WSP3A, WSP4A, WSP6A	
VG-7094	1.250	VGDU	Special	Special	VLFLF	WSP3A, WSP4A, WSP6A	
VG-7095	1.250	VGDU	Special	Special	VZFZF	WSP3A, WSP4A, WSP6A	
VG-7082	1.500	VGD	Special	Special	VLFLF	WSP8A	
VG-7081	1.500	VGD	Special	Special	VZFZF	WSP8A	

Features:

- Tungsten Carbide and Silicon Carbide faces for severe abrasive service.
- Solid drive band extends seal life during periods of vibration and cavitation.
- Full convoluted elastomer bellows for maximum self aligning capabilities.
- Pump sleeve, o-ring and impeller shim kit supplied for ease of installation.



U.S. Seal Mfg. Part No.	Seal Size	Head	Mating Ring	Mating Ring Bore	Material Code	Notes	Pump Nameplate Data	Mfg. Part No.
WESTINGHOUSE								
PS-663	.500	Q	1	1.000	BMFJF			69782
WHEELER, C.H.								
FA-62	.625	A	—	—	BCF-F			
PS-702	.625	A	1	1.187	BMFJF		Reuse Seat Housing	
WHITE								
PS-701	.625	A	1	1.187	BMFKF			
PS-200	.625	A	1	1.250	BMFJF			
WILDEN® PUMP & ENGINEERING								
PS-1002V	.500	C	1	1.000	VCFJF			
PS-6334	1.125	E	3	2.000	VCPKF			WIL-0020-8000-910
PS-22154	1.125	W	27 Special	2.410	TCFKF			WIL-0020-8001-920
PS-22153	1.437	E	3	2.310	BCPKF			WIL-0240-8000-900
PS-22151	1.437	E	3	2.310	VCPKF			WIL-0240-8000-910
PS-4407	1.500	E	1	2.125	QLFLF			S2477AFS99900

Value Guard Part No.	Seal Size	Head	Mating Ring	Mating Ring Bore	Material Code	Notes	Pump Nameplate Data	Mfg. Part No.
WILO USA								
VGM-4757	12MM	Special	Special	Special	QLFCF	316SS	Helix 2-4	4178559
VGM-4758	12MM	Special	Special	Special	QZFCF	316SS	Helix 2-4	4178597
VGM-4759	12MM	Special	Special	Special	VZFCF	316SS	Helix 2-4	4178620
VGM-4760	16MM	Special	Special	Special	QLFCF	316SS	Helix 10-16	4159696
VGM-4726	16MM	Special	Special	Special	QZFCF	316SS	Helix 10-16	4178598
* Assembly includes cartridge seal, 2 case o-rings and 4 bolt screws.								
WILO-EMU®								
VGM-2961	35 MM	Special	Special	Special	VLFLF	316SS		6037442
VGM-2962	50 MM	Special	Special	Special	VLFLF	316SS		6037443
VGM-2963	75 MM	Special	Special	Special	VLFLF	316SS		6037444

- Replacement seals for EBS® double cartridge seals
- Materials of Construction -
Viton® / Silicon Carbide / Silicon Carbide / 316SS



PUMP MANUFACTURERS' CROSS-REFERENCE

U.S. Seal Mfg. Part No.	Seal Size	Head	Mating Ring	Mating Ring Bore	Material Code	Notes	Pump Nameplate Data	Mfg. Part No.
WORTHINGTON (See FLOWERVE CORPORATION)								
55954	.562	C	—	—	BCF-F		1 GA	05595400
PS-200	.625	A	1	1.250	BMFJF		1.250CS-5, 1.250M-5	04300800
PS-507	.625	A	1	1.250	BMFKF		1.5PM3	
PS-528	.625	A	1	1.375	BMFJF		Delta 512 and 520	PO2098-00, 28518652
PS-200V	.625	A	3	1.250	VCFJF			05501600
FA-1350	.625	C	—	—	BCF-F		2GAR, 2GA	05595500
PS-359	.625	C	1	1.250	BCFJF			05067500
PS-359V-CMS	.625	C	1	1.250	VCFJF			74315409
PS-626	.625	C	1	1.375	VCFJF	316SS	Delta 520 (Seal Includes Sleeve)	PO2099-00
PS-951	.625	C	3	1.375	VCFKF		Delta 512 and 520	PO2752-00, 74262767
PS-201	.750	A	1	1.375	BMFJF		1.5PE, 3 & 4	
FA-564	.750	C	—	—	BCF-F		3 & 4 GA Pumps	02443900
PS-373	.750	C	1	1.375	BCFKF		Frame 1A, DN2	02649200, 02649300
PS-768	.750	C	3	1.375	BCFKF			SEL 244
FA-160	.875	D	—	—	BCD-F		5 & 6 AUM	
24440	.875	E	—	—	BCF-F		5 & 6 GAUM	02444000, 27197631
PS-560SS	.937	U	2	1.562	BCFKF		Frame 1	02645600, 03144600
PS-370	1.000	A	1	1.625	BCFKF			
FA-1800	1.125	C	—	—	BCF-F			PO2885-00, 28518934
PS-801	1.125	C	3	1.750	B/VCFJF	S	Frame 1 D-812, 820, 1012, 1020	PO2885-00 w/ PO2897-00
PS-529	1.125	C	3	1.750	BCFKF	S	Frame 1 D-812, 820, 1012, 1020	PO2885-00 w/ PO2893-00
PS-356V	1.125	C	3	1.750	VCFJF	S	Frame 1 D-812, 820, 1012, 1020	PO2889-00 w/ PO2897-00
PS-355V	1.125	C	3	1.750	VCFKF	S	Frame 1 D-812, 820, 1012, 1020	PO2889-00 w/ PO2893-00
PS-866	1.125	E	3	1.750	BCFJF	S	Frame 1 D-1011, 1021	PO2869-00 w/ PO2897-00
PS-867	1.125	E	3	1.750	BCFKF	S	Frame 1 D-1011, 1021	PO2869-00 w/ PO2893-00
PS-282	1.125	U	3	1.750	BCFKF	S	2.5 LR10	05161000
PS-394	1.250	U	3	1.875	BCF/DKF	S	2, 2.5 GRM1, 3GRWMC1	03144800, 74295924
PS-394V	1.250	U	3	1.875	VCF/DKF	S		03144801, 78945442
PS-805	1.375	C	3	2.000	BCFJF	S	Frame 2 D-812, 820, 1012, 1020	PO2886-00 w/ PO2898-00
PS-547	1.375	C	3	2.000	BCFKF	S	Frame 2 D-812, 820, 1012, 1020	PO2886-00 w/ PO2894-00
PS-177V	1.375	C	3	2.000	VCFJF	S	Frame 2 D-812, 820, 1012, 1020	PO2890-00 w/ PO2898-00
PS-210V	1.375	C	3	2.000	VCFKF	S	Frame 2 D-812, 820, 1012, 1020	PO2890-00 w/ PO2894-00
PS-864	1.375	E	3	2.000	BCFJF	S	Frame 2 D-811, 821, 1011, 1021	PO2870-00 w/ PO2898-00
PS-865	1.375	E	3	2.000	BCFKF	S	Frame 2 D-811, 821, 1011, 1021	PO2870-00 w/ PO2894-00
PS-561SS	1.375	U	1	2.000	BCFKF		Frame 2 2.5 LR-13	02645700, 050498-00 272150-94
FA-9341	1.375	WT	—	—	TCF-F	316SS		PO2878
FA-305	1.500	E	—	—	BCF-F			05484500
FA-305V	1.500	E	—	—	VCF-F			60506169
PS-395	1.500	E	3	2.125	BCFJF	S	3LR-9, 4,5 & 6LR-10, 3LR-12, 4LR-12, 1.5LLR-7, 1.5LLR-10, 2LLR-9	05170800 w/ 05313000
PS-258	1.500	E	3	2.125	BCFKF		3LR-9, 4,5,& 6LR-10, 3LR-12, 4LR-12, 1.5LLR-7, 1.5LLR-10, 2LLR-9	
PS-458	1.625	U	3	2.375	BCDKF	S	4LR-14, 5LR-13, 4LR-11	05161300 w/ 05313200
FA-1660	1.750	C	—	—	BCF-F			PO2887-00, 28518876
FA-10045	1.750	C	—	—	VCF-F			PO2891-00
PS-550	1.750	C	3	2.500	BCFJF	S	Frame 3 D-812, 820, 1012, 1020	PO2887-00 w/ PO2899-00
PS-436	1.750	C	3	2.500	BCFKF	S	Frame 3 D-812, 820, 1012, 1020	PO2887-00 w/ PO2895-00
PS-7679	1.750	C	3	2.500	VLFLF	S		
PS-535	1.750	E	3	2.500	BCFJF	S	Frame 3 D-811, 821, 1011, 1021	PO2871-00 w/ PO2899-00
PS-262	1.750	E	3	2.500	BCFKF	S	Frame 3 D-811, 821, 1011, 1021	PO2871-00 w/ PO2895-00
PS-555	1.750	U	1	2.500	BCF/DKF		Frame 3	02645800
PS-555SS	1.750	U	1	2.500	BCFKF		Frame 3	05049900
PS-2070	1.875	E	1	2.625	BCFKF		4GRWM	03144900
PS-1108	1.875	V	1	2.625	BMFJF		4FNC-10	
PS-582	2.000	C	3	3.000	BCFKF			
PS-477	2.000	E	3	2.750	BCFKF	S		031450-00, 31450-02 31450-04, 74295940
PS-477V	2.000	E	3	2.750	VCFKF	S		031450-01, 78945368

PUMP MANUFACTURERS' CROSS-REFERENCE

U.S. Seal Mfg. Part No.	Seal Size	Head	Mating Ring	Mating Ring Bore	Material Code	Notes	Pump Nameplate Data	Mfg. Part No.
WORTHINGTON (See FLOWERVE CORPORATION) (continued)								
PS-456	2.000	U	3	2.750	BCFKF	S	5LR-15, 6LR-13, 6LR-16, 8LR-13	051614-00 w/ 053133-00
PS-385A	2.000	U	3	2.750	BCFKF	S	8LR-14	
PS-3083	2.000	U	3	2.750	VCFLF	S	2LLR11	
PS-854	2.125	C	3	2.875	BCFJF	S	Frame 4 D-1012, 1020	PO2888-00 w/ PO2900-00
PS-855	2.125	C	3	2.875	BCFKF	S	Frame 4 D-1012, 1020	PO2888-00 w/ PO2896-00
PS-856	2.125	E	3	2.875	BCFJF	S	Frame 4 D-1011, 1021	PO2872-00 w/ PO2900-00
PS-857	2.125	E	3	2.875	BCFKF	S	Frame 4 D-1011, 1021	PO2872-00 w/ PO2896-00
PS-556	2.125	U	1	3.000	BCFKF		Frame 4	02645900, 05050000
PS-2771	2.750	U	3	3.750	BCFKF	S	5 GRMI	03145100, 03145103, 74295957
PS-5252	3.000	E	3	3.875	BCFKF	S	6LR-18, 10LR-15	055426-00 w/ 055425-00
PS-324SS	3.000	E	3	3.875	BCFJF	S	10FRBH182	53799771
PS-330	3.250	E	3	4.125	BCDJF		6 UZD-1	
XYLEM INC.								
PS-100	.625	A	1	1.187	BMFJF			1760371
PS-4024	.750	G	1	1.275	QLFLF			P86262
FA-4031	.625	C	—	—	VCF-F	316SS/H		92055 0062
PS-2160	.625	C	1	1.250	BCFJF			DP0302
PS-309	.875	C	1	1.500	BCFJF			DP0294
FA-4463	1.250	C	—	—	BCF-F	316SS/H		92055 1125
PS-6261	1.250	G	1	1.875	QCFJF	316SS/I		P75221
PS-6260	1.250	G	1	1.875	QCFZF	316SS/I		P75223
PS-6264	1.250	G	1	1.875	VCFJF	316SS/I		P75225
PS-177	1.375	C	1	2.000	BCFJF			DP0298
FA-376E	1.375	D	—	—	QCD-F	I		P63316
PS-6262	1.625	G	1	2.375	QCFJF	316SS/I		P75222
PS-6263	1.625	G	1	2.375	QCFZF	316SS/I		P75224
FA-2108E	1.750	C	—	—	QCF-F	I		AC5232
PS-3027	2.000	C	3	3.000	QCFZF			AC3049
PS-3020	2.125	G	3	3.000	QCFJF	316SS/S		P75396
PS-4490	2.500	G	25	3.375	QLFLF	316SS		P5001086
PS-7909	2.625	D	3	3.375	BCFJF	I/S		P75572
YOEMANS CHICAGO CORPORATION (Part of GRUNDFOS, INC.)								
PS-185	1.250	C	1	1.875	BCFJF			C3-2-57, 97809302
PS-2208	1.250	C	1	1.875	BZFZF			C3-2-72
PS-756V-CMS	1.250	C	1	1.875	VCFKF			C3-2-142
PS-383V	1.250	D	3	1.875	VCFKF			C3-2-12
PS-883	1.250	K	1	1.875	BCFJF			C3-2-82
PS-3150	32MM	G	1	1.890	VLFLF	316SS		C3-2-374, 97821064
PS-210V	1.375	C	3	2.000	VCFKF	S		C3-2-51
PS-758	1.500	C	1	2.125	BCFJF			C3-2-73
PS-2209	1.500	C	1	2.125	BZFZF			C3-2-58
PS-816	1.500	C	3	2.125	BCFJF	S		98114183
PS-446	1.750	C	1	2.500	BCFJF			C3-2-59
PS-2210	1.750	C	1	2.500	BCFZF			C3-2-93
PS-436V	1.750	C	3	2.500	VCFKF	S		C3-2-100
PS-3151	1.750	G	1	2.500	VLFLF	316SS		C3-2-376, 97809285
PS-449	1.750	K	1	2.500	BCFJF			C3-2-43
PS-267	2.000	C	1	2.750	BCFJF			C3-2-60
PS-842-TC-SEAT	2.000	C	1	2.750	BCFZF			C3-2-94
PS-2219	2.000	C	1	2.750	BZFZF			C3-2-75
PS-1145	2.000	C	3	2.750	VCFKF	S		C3-2-98
PS-2143	2.000	K	1	2.750	BCFJF			C3-2-47
PS-7196	2.000	K	3	2.750	BCFJF	S		04700050-000, 97806997
PS-3562	2.062	T	3	2.937	BCFKF			C3-2-153, 97873617
PS-844	2.125	C	1	3.000	BCFJF			C3-2-83
PS-887	2.125	K	1	3.000	BCFJF			C3-2-44
PS-1679	2.250	C	1	3.125	BCFJF			C3-2-61
PS-1676V	2.250	C	3	3.125	VCFKF	S		C3-2-99
PS-3077	2.250	R	1	3.125	BCFJF			00017293-000
PS-2158	2.500	K	1	3.375	BCFJF			C3-2-53

NOTE: H. SPRING HOLDER NOT INCLUDED
 I. ABRASION RESISTANT CARBON (P66)
 S. SLOTTED MATING RING

PUMP MANUFACTURERS' CROSS-REFERENCE

U.S. Seal Mfg. Part No.	Seal Size	Head	Mating Ring	Mating Ring Bore	Material Code	Notes	Pump Nameplate Data	Mfg. Part No.
YOEMANS CHICAGO CORPORATION (Part of GRUNDFOS, INC.) (continued)								
PS-1613	2.500	K	3	3.375	BCFJF	S		97881746
PS-3152	3.000	C	1	3.875	VLFLF	316SS		C3-2-274, 97809259
PS-3021	3.000	G	1	3.875	VLFLF	316SS		C3-2-378, 97809287
PS-3518	3.000	K	1	3.875	BCFJF			C3-2-45, 97809295
PS-3154	3.250	G	1	4.125	VLFLF	316SS		C3-2-380, 97816952
PS-6227	3.250	K	3	4.125	VCFJF			C3-2-143, 97881745
PS-3253	4.000	K	3	4.875	BCFZF			
PS-3155	5.000	K	3	6.000	BCFKF			C3-2-55, 97873678
YORK (See JOHNSON CONTROLS)								
ZODIAC® POOL SYSTEMS LLC								
PS-2733	.750	G	1	1.375	QCJFJ			A0580501, A0580502
ZOELLER PUMP COMPANY								
FA-4218	.500	B	—	—	BMF-F			009567
PS-2713	.500	Q	8	—	BCFJF	A		267027
PS-3033	.500	Q	8	.906	BCFKF	A		005095
PS-2732	.500	Q	8	1.000	VCFKF	A		014554
FA-3300	.625	B	—	—	BCF-F			001016
PS-7929	.625	B	1	1.250	VLFLF			012240
PS-447	.625	B	8	—	BCFJF	A		001017
PS-22061	.625	B	8	1.049	BCFKF	A/I		005098
PS-22060	.625	B	8	1.049	VCFKF	316SS/A		014557
PS-2745	.750	B	8	1.187	BCFJF	316SS/A		017885
PS-22033	.750	B	8	1.187	BCFLF	316SS/A		155706
FA-1700	1.000	C	—	—	BCF-F			007767
PS-356	1.125	C	1	1.750	BCFJF			006510
PS-4443	1.125	C	1	1.750	BCFLF			011125
PS-355-SC-SC	1.125	C	1	1.750	BLFLF			011124
PS-356-TC-TC	1.125	C	1	1.750	BZFZF			007019
PS-356V-SC-SC-CMS	1.125	C	1	1.750	VLFLF			011126
PS-185	1.250	C	1	1.875	BCFJF			008165
PS-185-SC-SC	1.250	C	1	1.875	BLFLF			011128
PS-2208	1.250	C	1	1.875	BZFZF			008166
PS-185V-CMS	1.250	C	1	1.875	VCFJF			008177
PS-185V-SC-SEAT	1.250	C	1	1.875	VCFLF			011131
PS-4101	1.250	C	1	1.875	VLFLF	316SS		011130
PS-758	1.500	C	1	2.125	BCFJF			006500
PS-758-SC-SEAT	1.500	C	1	2.125	BCFLF			011132
PS-659-TC	1.500	C	1	2.125	BCFZF			007024
PS-758-SC-SC	1.500	C	1	2.125	BLFLF			007023
PS-2209	1.500	C	1	2.125	BZFZF			007011
PS-758V-CMS	1.500	C	1	2.125	VCFJF			007027
PS-758V-SC-SEAT	1.500	C	1	2.125	VCFLF			011133
PS-758V-SC-SC	1.500	C	1	2.125	VLFLF			011134
PS-659V-TC-VS-TC	1.500	C	1	2.125	VZFZF			007026, 008180
PS-446	1.750	C	1	2.500	BCFJF			008168
PS-446-TC-TC	1.750	C	1	2.500	BZFZF			008169
PS-340	1.875	C	1	2.625	BCFJF			007131
PS-340-TC-SC	1.875	C	1	2.625	BZFLF			011139
PS-340-TC-TC	1.875	C	1	2.625	BZFZF			007440
PS-267	2.000	C	1	2.750	BCFJF			008171

NOTES

- | | |
|--|--|
| A. MOUNTS ON SHAFT
B. TAPERED SPRING
C. COMPLETE WITH COLLAR
G. MOUNTS IN PLASTIC | H. SPRING HOLDER NOT INCLUDED
I. ABRASION RESISTANT CARBON (P66)
N. NON-STANDARD SPRING HOLDER
S. SLOTTED MATING RING |
|--|--|

On the head styles C, D and E, springholders may be included with seal but may not be necessary for the seal installation. Inspect old seal to verify if the springholder is required.

USE THE RIGHT SEAL FOR YOUR POOL & SPA PUMPS

There ARE Different Seals For Different Applications

BASIC POOL APPLICATIONS

Basic Service

- Basic product offering for some pool pump manufacturers
- Materials of Construction:
 - Buna Elastomers, Molded Plastic Primary Ring, Ceramic Seat, Stainless Steel Hardware
- Generally reliable in residential chlorine pools
- Good for low temperatures



PS-200
Basic Service Seal

PREMIER VITON® SERVICE

- Great for any service whether ozonators, salt chlorine generators, bromine and chlorine, residential or commercial
- Materials of Construction:
 - Viton® Elastomers, Carbon Primary Ring, Polished Ceramic Seat, Stainless Steel Hardware
- More durable and an upgrade to our Basic Service seals
- Improved resistance to heat and chemicals
- Quickly becoming the seal of choice by pool pump manufacturers



PS-3867
Premier Viton® Service Version of PS-200

SCS/COMMERCIAL/RESIDENTIAL

- Use for your MOST demanding commercial and residential applications
- Materials of Construction:
 - Viton® Elastomers, Silicon Carbide Primary Ring, Silicon Carbide Seat, 316 Stainless Steel Hardware
- Superior materials deliver excellent abrasion, corrosion and chemical resistance
- Don't risk damage to your expensive variable speed motors
- Compatible with all Pool & Spa chemicals.



PS-1901
SCS Version of PS-200

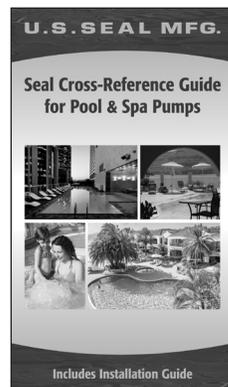

**Ask For Your Free Copies
of our
Seal Cross-Reference Guide
for Pool & Spa Pumps**

POOL & SPA PUMP REPLACEMENT SEALS

Pump Mfg.	Pump Model	Mfg. No.	Basic Service	Premier Viton® Service	SCS Series
Acura Spa Systems, Inc.	Aquaheat,	1090-A	PS-601	PS-3986	PS-1904
	Aquaheat Plus				
	Magnaflow,	1090-A	PS-601	PS-3986	PS-1904
	Magnaflow 56 Maverick Supercharger, Supercharger II	1090-A 1090-A	PS-601 PS-601	PS-3986 PS-3986	PS-1904 PS-1904
American Products (A Pentair Brand)	Americana®	395005	PS-201	PS-3868	PS-1902
	Americana II®	397012	PS-1000	PS-3865R	PS-1905
	Bronze-Bronze	397012	PS-1000	PS-3865R	PS-1905
	Bronze-Noryl®	395005	PS-201	PS-3868	PS-1902
	Eagle®	397012	PS-1000	PS-3865R	PS-1905
	Eagle®	397020	PS-1000	PS-3865R	PS-1905
	Maxim™	397012	PS-1000	PS-3865R	PS-1905
	Power-Glass®	397012	PS-1000	PS-3865R	PS-1905
	Ultra-Flo®	397020	PS-1000	PS-3865R	PS-1905
Ampro-Diaclear, Inc.	Dia Cast, Lexan®-200 Series	AP-504D	PS-163	PS-163V	—
	Dura-Flo, Noryl® Turbo, XL 600	AP-304D	PS-1000	PS-3865R	PS-1905
Anthony & Sylvan Corporation	AC, AC Series	04380	PS-1000	PS-3865R	PS-1905
	AJ Series	04547	PS-100	PS-3866	PS-1900
Arneson Products	Pool Sweep	A-8	PS-200	PS-3867	PS-1901
Astral Pool	Astramax	Series 1600	PS-1000	PS-3865R	PS-1905
	Sena	Series 1800	PS-200	PS-3867	PS-1901
	Spirit 2000	Series 1800	PS-201	PS-3868	PS-1902
Baker-Hydro		15B5032	PS-185	PS-185V-CMS	PS-185V-SC-SC
		15B5033	PS-446	PS-446V-CMS	PS-7820
		35B1175, 35B1178	PS-200	PS-3867	PS-1901
		634016	PS-3985	PS-3986	PS-1904
Columbia Pool Products			PS-142	PS-142V	—
Diaclear		36100	PS-142	PS-142V	—
Doughboy Industries		306-1002	PS-1000	PS-3865R	PS-1905
		306-1006	PS-2131	PS-3869	PS-1906
		306-1007	PS-200	PS-3867	PS-1901
Flo Tec (A Pentair Brand)	AT25101, AT251501		PS-201	PS-3868	PS-1902
	FP6022, FP6042		PS-201	PS-3868	PS-1902
	FPT20075, 20510, 20515		PS-201	PS-3868	PS-1902
Gecko Alliance, Inc. (Aqua Flo Pumps)		92501000 & 92502020	PS-200-EPR * Contains EPR	—	—
	A-Series	92500050	PS-1000	PS-3865R	PS-1905
	A & B Series	92509040	PS-1000	PS-3865R	PS-1905
	AC-Series	92500000	PS-309	PS-309V-CMS	PS-3941
	C-Series	92500050	PS-1000	PS-3865R	PS-1905
	D-Series	92500040	PS-1000	PS-3865R	PS-1905
	D-Series	92500050	PS-1000	PS-3865R	PS-1905
	Circ-Master®	92500151	PS-200	PS-3867	PS-1901
	Circ-Master® CP, HP, XP		PS-3960	PS-3867	PS-1901
	Dominator® High Head/Med Head	92500150	PS-200	PS-3867	PS-1901
	Flo-Master®	91049000	PS-2131	PS-3869	PS-1906
	Flo-Master®	92500150	PS-200	PS-3867	PS-1901
	Flo-Master® CP,HP		PS-200	PS-3867	PS-1901
	Flo-Master® XP2, XP2E		PS-200	PS-3867	PS-1901
	Flo-Master® XP3		PS-200	PS-3867	PS-1901
	Pond-Flo	92500151	PS-200	PS-3867	PS-1901
	Tub-Master®	91049000	PS-2131	PS-3869	PS-1906
Tub-Master®					
FMCP, FMHP, FMVP	92500150	PS-200	PS-3867	PS-1901	
Hayward Industries, Inc.	Booster Pump 5060	SPX1250XZ2	PS-200	PS-3867	PS-1901
	Booster Pump 6060	SPX2700SA	PS-3960	PS-3867	PS-1901
	Cast Iron	SPX1250XZ2	PS-200	PS-3867	PS-1901

* Contains EPR

POOL & SPA PUMP REPLACEMENT SEALS

Pump Mfg.	Pump Model	Mfg. No.	Basic Service	Premier Viton® Service	SCS Series
Hayward Industries, Inc.	EcoStar®, EcoStar® SVRS MaxFlo™ (SP2800X Series)	SPX3200SA SPX1600Z2	PS-3890 PS-201	PS-4280 PS-3868	PS-1907 PS-1902
	MaxFlo II™, MaxFloXL™	SPX1600Z2GV SPX2700SA	— PS-3960	PS-201V-CMS PS-3867	PS-1908 PS-1901
	MaxFlo VS™ 500 Omni	SPX2700SAV	—	PS-3867	PS-1901
	NorthStar™	SPX3200SA	PS-3890	PS-4280	PS-1907
	PowerFlo II™	SPX1500KA	PS-2131	PS-3869	PS-1906
	SP1700 Series				
	PowerFlo LX™	SPX1500KA	PS-2131	PS-3869	PS-1906
	SP1580 Series				
	PowerFlo Matrix®	SPX1500KA	PS-2131	PS-3869	PS-1906
	Super Pump®	SPX1600Z2	PS-201	PS-3868	PS-1902
	Super Pump® VS 700 Omni	SPX1600Z2VIT	—	PS-3868	PS-1902
	Super Pump™	SPX2605X7A	PS-201	PS-3868	PS-1902
	Super Pump II™	SPX2605X71	PS-201	PS-3868	PS-1902
	TriStar®, TriStar®VS	SPX3200SA	PS-3890	PS-4280	PS-1907
TriStar 900 Series	SPX4000SAV	—	PS-4280	—	
Turbo-Flo®	SPX1500KA	PS-2131	PS-3869	PS-1906	
Jacuzzi®	8M	10-1203-01	PS-877	PS-877V	—
	10M	10-1299-06	PS-235	PS-235V-CMS	—
	A, J, JCM Series	10-0002-06	PS-200	PS-3867	PS-1901
	Cygnnet	10-0002-06	PS-200	PS-3867	PS-1901
	B Series, CLR, Dominator		PS-501	PS-3864	PS-1903
	K, KM Series		PS-200	PS-3867	PS-1901
	L3 & L25		PS-200	PS-3867	PS-1901
	LCM, LCU Series, Vector		PS-200	PS-3867	PS-1901
	LH, LPC, LPH, LR	10-0002-06	PS-200	PS-3867	PS-1901
	LTH, LTPH, SLR	10-1502-09	PS-201	PS-3868	PS-1902
	Series Magnum®, RC-Series				
Splash Pak K		PS-200	PS-3867	PS-1901	
Vector (LVL)	10-0002-06	PS-200	PS-3867	PS-1901	
Jandy® (A FLUIDRA Brand)	ePump™ Variable Speed	R0479400	PS-3890	PS-4280	PS-1907
	FHP, JEP, MHP, PHP	R0479400	PS-3890	PS-4280	PS-1907
	FloPro™ (FHPM) Series	R0479400	PS-3890	PS-4280	PS-1907
	HHP, HHPU, JHP, JHPU	R0338200	PS-601	PS-3986	PS-1904
	Max HP Series	R0479400	PS-3890	PS-4280	PS-1907
	MHPM	R0445500	—	PS-4231**	—
	Plus HP (PHPF / PHPM) Series				
	New Style	R0479400	PS-3890	PS-4280	PS-1907
	Old Style	R0445500	—	PS-4231**	—
	SHP, SWF, WFTR	R0479400	PS-3890	PS-4280	PS-1907
	Stealth™ (SHPF / SHPM) Series				
New Style	R0479400	PS-3890	PS-4280	PS-1907	
Old Style	R0445500	—	PS-4231**	—	
VS FloPro™ Series, VS Plus HP Series	R0479400	PS-3890	PS-4280	PS-1907	
Water Feature Series	R0479400	PS-3890	PS-4280	PS-1907	
Lomart		40-027	PS-163	PS-163V	—
		40-029	PS-163	PS-163V	—

* Contains EPR

POOL & SPA PUMP REPLACEMENT SEALS

Pump Mfg.	Pump Model	Mfg. No.	Basic Service	Premier Viton® Service	SCS Series	
Marlow	2AF-Series	25353-00	PS-411	PS-411V	—	
	3B-Series	27223-00	PS-416A	—	PS-1910	
	4SPC	28146200000	PS-7497	PS-7497V	—	
	AF Series		PS-411	PS-411V	—	
	Argonaut*	38592-00	PS-201	PS-3868	PS-1902	
	H-Series		PS-411	PS-411V	—	
	L-Series	186862	PS-978	—	—	
	L-Series	186543	PS-514	PS-2055V-CMS	—	
	Mardur*	38592-00	PS-201	PS-3868	PS-1902	
	SCT Series SS	46328-00	PS-2161	—	—	
Muskin		09-2001	PS-163	PS-163V	—	
		09-2013	PS-142	—	—	
Pentair Pool Products		353096	PS-2742	—	—	
		353253S	PS-200	PS-3867	PS-1901	
		359607S	—	—	PS-1902	
		U9-372SS	PS-2744*	—	—	
	C Series (Commercial Bronze)	071725S	PS-360	PS-3874	PS-1909	
	CF6	U109-136SS	PS-1000	PS-3865R	PS-1905	
	Challenger*	354545	PS-200	PS-3867	PS-1901	
	Challenger* Centrifugal	354545S	PS-200	PS-3867	PS-1901	
	C-Series*	071725S	PS-360	PS-3874	PS-1909	
	Dynatron*	354545	PS-200	PS-3867	PS-1901	
	Dynamo* Aboveground	354545	PS-200	PS-3867	PS-1901	
	EQ SERIES	071725S	PS-360	PS-3874	PS-1909	
	Hydropump*	354001	PS-201	PS-3868	PS-1902	
	Intelliflo*	071734S	PS-961	PS-3865R	PS-1905	
	IntelliFlo* 011018	071734	PS-1000	PS-3865R	PS-1905	
	IntelliFlo* VSF	071734SP	PS-1000	PS-3865R	PS-1905	
	IntelliFloXF* VSP	17351-0101S	PS-201	PS-201V-CMS	PS-1908	
	L-Series™	071728	PS-201	PS-3868	PS-1902	
	L-Series™	17351-0102	PS-100	PS-3866	PS-1900	
	Optiflo* Aboveground	354545S	PS-200	PS-3867	PS-1901	
	Pinnacle*, Superflo*	354545S	PS-200	PS-3867	PS-1901	
	SuperFlo* VST	17351-0101S	PS-201	PS-201V-CMS	PS-1908	
	Universal Booster Pump	071734	PS-1000	PS-3865R	PS-1905	
	Waterfall Specialty Pump	354545S	PS-200	PS-3867	PS-1901	
	Whisperflo*	071734S	PS-1000	PS-3865R	PS-1905	
	Polaris®	Polaris® PB4-60 Booster Pump	P55	PS-1000	PS-3865R	PS-1905
		Polaris® PB4SQ™ Booster Pump	R0479400	PS-3890	PS-4280	PS-1907
Speck Pumps		2920060603	PS-200	PS-3867	PS-1901	
		60603-200	PS-200	PS-3867	PS-1901	
	72, BADU®, Easy Fit® Eco MV, Eco M3V, S90 A91, A91-11VSP, BADU® Pro Series ES90, ES90-II	2920343310 2921606204	VGM-2920 PS-200	VGM-2920V PS-3867	— PS-1901	
Sta-Rite Industries (A Pentair Brand)		U9-433SS	PS-3883	—	—	
		37400-0028S	—	PS-201V-CMS	PS-1908	
	C/CC Series	U109-433SS	PS-185	PS-185V-CMS	PS-185V-SC-SC	
	CF/CFA Series	U109-136SS	PS-1000	PS-3865R	PS-1905	
	CSPH/CCSPH (20 HP)	S-32015	PS-446	—	—	
	CSPH/CCSPH Series	S-32014	PS-185	PS-185V-CMS	PS-185V-SC-SC	
	D Series	U109-433SS	PS-185	PS-185V-CMS	PS-185V-SC-SC	
	DJ/JS/JT Series	37400-0027S	PS-201	PS-201V-CMS	PS-1908	
	Dura-Glas® - PE, PEA,P2R, P2RA	17304-0100S	PS-200	PS-3867	PS-1901	
	Dura-Glas®II	U109-358SS	PS-201	PS-201V-CMS	PS-1908	
	Dura-Glas®II- P4E, P4EA,P4R, P4RA	37400-0028S	PS-201	PS-201V-CMS	PS-1908	

* Contains EPR

POOL & SPA PUMP REPLACEMENT SEALS

Pump Mfg.	Pump Model	Mfg. No.	Basic Service	Premier Viton® Service	SCS Series
Sta-Rite Industries (A Pentair Brand)	Dura-Jet	U109-358SS	PS-201	PS-201V-CMS	PS-1908
	Dyna-Glas® / Dyna-Max®	37400-0027S	PS-201	PS-201V-CMS	PS-1908
	After June 2000	37400-0027S	PS-201	PS-201V-CMS	PS-1908
	Dyna-Jet™	17351-0101S	PS-201	PS-201V-CMS	PS-1908
	Dyna-Pro®, Dyna-Pro E	17351-0101S	PS-201	PS-201V-CMS	PS-1908
	Dyna-Wave®	17351-0101S	PS-201	PS-201V-CMS	PS-1908
	HP-Series	U109-136SS	PS-1000	PS-3865R	PS-1905
	IntelliPro® VSF		PS-851-EPR*	PS-185V-CMS	PS-185V-SC-SC
	JS Series		PS-201	PS-201V-CMS	PS-1908
	JW/JWPA Series	U109-358SS	PS-201	PS-201V-CMS	PS-1908
	After Jan. 2001	37400-0027S	PS-201	PS-201V-CMS	PS-1908
	LT Series	U109-68SS	PS-163	PS-163V	—
	Max-E-Glas™ PE, PEA,P2R,P2RA	17304-0100S	PS-200	PS-3867	PS-1901
	Max-E-Glas™II P4E, P4EA,P4R,P4RA	37400-0027S	PS-201	PS-201V-CMS	PS-1908
Max-E-Pro™ P6E, P6RA	37400-0028S	PS-201	PS-201V-CMS	PS-1908	
Max-E-ProXF® VS	17351-0101S	PS-201	PS-201V-CMS	PS-1908	
Sundance® Spas	Theramax / Theraflo	6500-281	PS-201	PS-201V-CMS	PS-1908
		6500-447	PS-200	PS-3867	PS-1901
Swim Quip	XL, VI/XL, VII Series	37407-0009	PS-201	PS-201V-CMS	PS-1908
Vico	SuperFlo, UltraFlo, Ultima	PPSFSEAL	PS-4274	PS-3870	—
Water Ace	RSP-7, 10, 15	25053A000	PS-3845	—	—
Waterco USA	Aquamite, Aquastream Hydrostar Self Priming, Hydrostream Supastream Supatuf Tiny Might - (Circulator Pump)		PS-601	PS-3986	PS-1904
		6340162	PS-601 PS-671	PS-3986 —	PS-1904 —
Waterway Plastics	CSA Supreme, E Series Center Discharge EX2, HI FLO 2 Iron Might (2013-Present) Spa Flo, Spa Flo II Viper, Supreme Champion 56- Frame CSA Hi-Flo II Side Discharge Executive - Viton® - 56 Frame Executive 48 & 56 Frame - Center Discharge Hi-Flo Side Discharge Iron Might (Pre-2013) Power Defender (Variations except Booster) SMF, SVL56 High Flow Workman Booster Pump	319-3010/B 319-3090/B	—	PS-3867	—
		319-3100/B, 319-3110	PS-1000	PS-3865R	PS-1905
		319-3100B 319-3290	— PS-4577*	VG-9596** PS-4280	— —
	**Contains graphite loaded silicon carbide mating ring and flange o-ring		15693	PS-201	PS-3868
Wayne Water Systems		15693	PS-201	PS-3868	PS-1902
Zodiac® Pool Systems		A0580501 & A0580502	PS-2733 Contains EPR	PS-3868	—

* Contains EPR

MATERIAL RECOMMENDATION CHART

FLUID	SEAL FAMILY		ARRANGEMENT	SECONDARY SEALS				SEAL FACES						METAL PARTS		
	NON-PUSHER	PUSHER		BUNA	VITON®	EPR	PTFE	CARBON	CAST IRON/NIREMIST	CERAMIC	TC	RE SIC	ALPHA SIC	304 SS	316 SS	ALLOY 20
Acetone	✓	✓	S			✓	✓	✓	✓	✓	✓	✓	✓	✓	✓	✓
Acetyl Chloride		✓	D		✓		✓	✓		✓	✓	✓	✓	✓	✓	✓
Acetylene, Gas	✓	✓	D	✓	✓	✓	✓	✓	✓	✓	✓	✓	✓	✓	✓	✓
Ammonia, Anhydrous	✓	✓	D			✓	✓	✓		✓		✓	✓	✓	✓	✓
Ammonium Carbonate, <60%	✓	✓	S		✓		✓	✓		✓	✓	✓	✓	✓	✓	✓
Ammonium Hydroxide, <30%	✓	✓	S			✓	✓	✓	✓	✓		✓	✓	✓	✓	✓
Ammonium Nitrate	✓	✓	S	✓		✓	✓	✓		✓		✓	✓	✓	✓	✓
Ammonium Phosphate (Dibasic), <40%	✓	✓	S	✓		✓	✓	✓		✓		✓	✓	✓	✓	✓
Amyl Alcohol	✓	✓	S			✓	✓	✓			✓	✓	✓	✓	✓	✓
Asphalt (Crude Oil Residue)	✓	✓	S		✓		✓	✓			✓	✓	✓	✓	✓	✓
Asphalt, Emulsified	✓	✓	S		✓		✓	✓	✓		✓	✓	✓	✓	✓	✓
Barium Hydroxide, <50%	✓	✓	D	✓	✓	✓	✓	✓		✓	✓	✓	✓	✓	✓	✓
Beer	✓	✓	S	✓	✓	✓	✓	✓		✓	✓	✓	✓	✓	✓	✓
Beer Wort	✓	✓	S	✓	✓	✓	✓	✓		✓	✓	✓	✓	✓	✓	✓
Beet Sugar	✓	✓	S	✓	✓	✓	✓	✓		✓	✓	✓	✓	✓	✓	✓
Bentonite	✓	✓	S			✓	✓	✓			✓	✓	✓	✓	✓	✓
Benzene, Benzol	✓	✓	D		✓		✓	✓		✓	✓	✓	✓	✓	✓	✓
Boric Acid, <30%	✓	✓	S	✓	✓	✓	✓	✓		✓		✓	✓	✓	✓	✓
Bunker C Fuel Oil	✓	✓	S	✓	✓		✓	✓	✓		✓	✓	✓	✓	✓	✓
Butadiene (Monomer)	✓	✓	D		✓		✓	✓	✓	✓	✓	✓	✓	✓	✓	✓
Butane, Gas	✓	✓	D	✓	✓		✓	✓	✓	✓	✓	✓	✓	✓	✓	✓
Butane, Liquid	✓	✓	S	✓	✓		✓	✓	✓	✓	✓	✓	✓	✓	✓	✓
Buttermilk	✓		S	✓	✓		✓	✓		✓	✓	✓	✓	✓	✓	✓
Butyl Alcohol (N), <10%	✓	✓	S		✓		✓	✓		✓	✓	✓	✓	✓	✓	✓
Butyl Alcohol (Sec), <15%	✓	✓	S		✓		✓	✓		✓	✓	✓	✓	✓	✓	✓
Butyl Alcohol (Tert)	✓	✓	S		✓		✓	✓		✓	✓	✓	✓	✓	✓	✓
Calcium Sulfate, <10%	✓	✓	S			✓	✓	✓		✓		✓	✓	✓	✓	✓
Calgon	✓	✓	S	✓	✓		✓	✓		✓	✓	✓	✓	✓	✓	✓
Carbon Dioxide, Gas	✓	✓	D	✓	✓	✓	✓	✓	✓	✓		✓	✓	✓	✓	✓
Carbon Dioxide, Liquid	✓	✓	S	✓	✓	✓	✓	✓		✓	✓	✓	✓	✓	✓	✓
Carbon Monoxide	✓	✓	D	✓	✓	✓	✓	✓	✓	✓	✓	✓	✓	✓	✓	✓
Carbonic Acid, <10%	✓	✓	S		✓	✓	✓	✓		✓		✓	✓	✓	✓	✓
Castor Oil	✓	✓	S	✓	✓		✓	✓		✓	✓	✓	✓	✓	✓	✓
Cement Slurry	✓	✓	S	✓	✓		✓	✓		✓	✓	✓	✓	✓	✓	✓
Chocolate	✓		S	✓	✓		✓	✓		✓	✓	✓	✓	✓	✓	✓
Citric Acid, <10%	✓	✓	S	✓	✓	✓	✓	✓		✓		✓	✓	✓	✓	✓
Clay Slurry	✓	✓	S	✓	✓	✓	✓	✓			✓	✓	✓	✓	✓	✓
Coal Slurry	✓	✓	S	✓	✓		✓	✓		✓	✓	✓	✓	✓	✓	✓
Cocoa Butter	✓	✓	S	✓	✓		✓	✓		✓	✓	✓	✓	✓	✓	✓
Coconut Oil	✓	✓	S	✓	✓		✓	✓		✓	✓	✓	✓	✓	✓	✓
Cooling Tower Water	✓	✓	S	✓	✓	✓	✓	✓		✓	✓	✓	✓	✓	✓	✓
Copper Acetate, <20%	✓	✓	D			✓	✓	✓		✓		✓	✓	✓	✓	✓
Copper Ammonium Acetate, <20%	✓	✓	D			✓	✓	✓		✓		✓	✓	✓	✓	✓
Copper Nitrate, <15%	✓	✓	S		✓		✓	✓			✓	✓	✓	✓	✓	✓
Copper Sulfate, <15%	✓	✓	S	✓	✓	✓	✓	✓		✓		✓	✓	✓	✓	✓
Corn Mash	✓	✓	S	✓	✓		✓	✓		✓	✓	✓	✓	✓	✓	✓
Corn Oil	✓	✓	S	✓	✓		✓	✓		✓	✓	✓	✓	✓	✓	✓
Cotton Seed Oil	✓	✓	S	✓	✓		✓	✓		✓	✓	✓	✓	✓	✓	✓

Non Pusher Seals - U.S. Seal Mfg. Type A, B, C, D, E, G, K, Q, S, T, U Pusher Seals - U.S. Seal Mfg. Type V,W,X
 Arrangement S=Single D=Double

MATERIAL RECOMMENDATION CHART

FLUID	SEAL FAMILY		ARRANGEMENT	SECONDARY SEALS				SEAL FACES						METAL PARTS		
	NON-PUSHER	PUSHER		BUNA	VITON®	EPR	PTFE	CARBON	CAST IRON/NIREMIST	CERAMIC	TC	RE SIC	ALPHA SIC	304 SS	316 SS	ALLOY 20
Crude Oil	✓	✓	S		✓		✓	✓			✓	✓	✓	✓	✓	✓
Cutting Oil (Typical)	✓	✓	S	✓	✓		✓	✓	✓	✓	✓	✓	✓	✓	✓	✓
Cyclohexane	✓	✓	S	✓	✓		✓	✓	✓	✓	✓	✓	✓	✓	✓	✓
Cyclohexanol	✓	✓	D	✓	✓		✓	✓		✓	✓	✓	✓	✓	✓	✓
Detergent (Typical), >15%	✓	✓	S	✓	✓	✓	✓	✓		✓	✓	✓	✓	✓	✓	✓
Dichlorohydrin	✓	✓	D			✓	✓	✓		✓	✓	✓	✓	✓	✓	✓
Diesel Fuel	✓	✓	S	✓	✓		✓	✓	✓	✓	✓	✓	✓	✓	✓	✓
Diethyl Carbonate	✓	✓	D			✓	✓	✓		✓	✓	✓	✓	✓	✓	✓
Di-isobutyl Ketone	✓	✓	D			✓	✓	✓		✓	✓	✓	✓	✓	✓	✓
Di-isopropyl Ketone	✓	✓	S			✓	✓	✓		✓	✓	✓	✓	✓	✓	✓
Dimethyl Ether	✓	✓	S	✓			✓	✓		✓	✓	✓	✓	✓	✓	✓
Dye Liquors	✓	✓	S		✓		✓	✓		✓	✓	✓	✓	✓	✓	✓
Ethane, Gas	✓	✓	D	✓	✓		✓	✓	✓	✓	✓	✓	✓	✓	✓	✓
Ethane, Liquid	✓	✓	S	✓	✓		✓	✓	✓	✓	✓	✓	✓	✓	✓	✓
Ethane/Propane Mix	✓	✓	S	✓	✓		✓	✓	✓	✓	✓	✓	✓	✓	✓	✓
Ethanol (10% Mixture w/Gasoline)	✓	✓	S	✓	✓		✓	✓	✓	✓	✓	✓	✓	✓	✓	✓
Ethyl Alcohol (Ethanol)	✓	✓	S			✓	✓	✓		✓	✓	✓	✓	✓	✓	✓
Ethyl Bromide	✓	✓	S		✓		✓	✓		✓	✓	✓	✓	✓	✓	✓
Ethyl Formate	✓	✓	S		✓		✓	✓		✓	✓	✓	✓	✓	✓	✓
Ethylbenzene		✓	✓		✓		✓	✓		✓	✓	✓	✓	✓	✓	✓
Ethylene Glycol	✓	✓	✓	✓	✓	✓	✓	✓		✓	✓	✓	✓	✓	✓	✓
Ferric Nitrate		✓	S	✓	✓	✓	✓	✓		✓	✓	✓	✓	✓	✓	✓
Ferric Sulfate, <15%	✓	✓	S	✓	✓	✓	✓	✓		✓	✓	✓	✓	✓	✓	✓
Fruit (Juice & Pulp), Typical	✓	✓	S	✓	✓	✓	✓	✓		✓	✓	✓	✓	✓	✓	✓
Fuel Oil #5 & #6	✓	✓	S		✓		✓	✓	✓	✓	✓	✓	✓	✓	✓	✓
Fumaric Acid	✓	✓	S	✓	✓		✓	✓		✓	✓	✓	✓	✓	✓	✓
Gasoline	✓	✓	S		✓		✓	✓	✓	✓	✓	✓	✓	✓	✓	✓
Gelatin	✓	✓	S	✓	✓	✓	✓	✓		✓	✓	✓	✓	✓	✓	✓
Glycerine (Glycerol)	✓	✓	S	✓	✓	✓	✓	✓		✓	✓	✓	✓	✓	✓	✓
Gypsum Slurry	✓	✓	S	✓	✓	✓	✓	✓		✓	✓	✓	✓	✓	✓	✓
Heat Transfer Fluids (Calflo, Dowtherm, Duratherm, Mobiltherm, Multitherm, Paratherm, Texatherm, Thermex, Thermina, Therminol, Ucon)	✓	✓	S		✓		✓	✓	✓		✓	✓	✓	✓	✓	✓
Helium, Gas	✓	✓	D	✓	✓	✓	✓	✓	✓	✓	✓	✓	✓	✓	✓	✓
Heptane, Liquid	✓	✓	S	✓	✓		✓	✓	✓	✓	✓	✓	✓	✓	✓	✓
Hexane, Liquid	✓	✓	S	✓	✓		✓	✓	✓	✓	✓	✓	✓	✓	✓	✓
Hexanol (Hexyl Alcohol)	✓	✓	S	✓	✓		✓	✓		✓	✓	✓	✓	✓	✓	✓
Hydraulic Oil	✓	✓	S	✓	✓		✓	✓		✓	✓	✓	✓	✓	✓	✓
Hydrogen Chloride, Dry Gas	✓	✓	D		✓	✓	✓	✓		✓	✓	✓	✓	✓	✓	✓
Hydrogen Peroxide, <30%	✓	✓	S		✓	✓	✓	✓		✓	✓	✓	✓	✓	✓	✓
Hydrogen, Gas	✓	✓	D	✓	✓	✓	✓	✓	✓	✓	✓	✓	✓	✓	✓	✓
Isobutyl Acetate	✓	✓	S			✓	✓	✓		✓	✓	✓	✓	✓	✓	✓
Isobutyl Alcohol	✓	✓	S		✓	✓	✓	✓	✓	✓	✓	✓	✓	✓	✓	✓
Isopentane		✓	S	✓	✓		✓	✓		✓	✓	✓	✓	✓	✓	✓
Isopropyl Alcohol (Isopropanol)	✓	✓	S		✓	✓	✓	✓	✓	✓	✓	✓	✓	✓	✓	✓
Jet Fuel JP-3, 4, 5, 6, 8	✓	✓	S	✓	✓		✓	✓	✓	✓	✓	✓	✓	✓	✓	✓
Kaolin (clay) Slurry	✓	✓	S	✓	✓	✓	✓	✓		✓	✓	✓	✓	✓	✓	✓

Non Pusher Seals - U.S. Seal Mfg. Type A, B, C, D, E, G, K, Q, S, T, U Pusher Seals - U.S. Seal Mfg. Type V,W,X
 Arrangement S=Single D=Double

MATERIAL RECOMMENDATION CHART

FLUID	SEAL FAMILY		ARRANGEMENT	SECONDARY SEALS				SEAL FACES						METAL PARTS		
	NON-PUSHER	PUSHER		BUNA	VITON®	EPR	PTFE	CARBON	CAST IRON/NIREZIST	CERAMIC	TC	RB SIC	ALPHA SIC	304 SS	316 SS	ALLOY 20
Kerosene	✓	✓	S	✓	✓		✓	✓	✓	✓	✓	✓	✓	✓	✓	✓
Ketchup	✓	✓	S	✓		✓	✓	✓		✓	✓	✓	✓	✓	✓	
Lactic Acid, <70%	✓	✓	S	✓	✓	✓	✓	✓		✓		✓	✓	✓	✓	✓
Lard	✓	✓	S	✓	✓		✓	✓		✓	✓	✓	✓	✓	✓	✓
Lauric Acid	✓	✓	S	✓	✓		✓	✓				✓	✓	✓	✓	
Linseed Oil	✓	✓	S	✓	✓		✓	✓		✓	✓	✓	✓	✓	✓	✓
Liquid Natural Gas (LNG)	✓	✓	S	✓	✓		✓	✓	✓	✓	✓	✓	✓	✓	✓	✓
Liquid Petroleum Gas (LPG)	✓	✓	S	✓	✓		✓	✓	✓	✓	✓	✓	✓	✓	✓	✓
Lithium Bromide	✓	✓	D			✓	✓	✓		✓		✓	✓	✓	✓	✓
Lubricating Oil (Petroleum Based)	✓	✓	S	✓	✓		✓	✓	✓	✓	✓	✓	✓	✓	✓	✓
Maelic Acid	✓	✓	S		✓		✓	✓		✓			✓	✓	✓	✓
Magnesium Hydroxide, <10%	✓	✓	S		✓	✓	✓	✓	✓	✓	✓	✓	✓	✓		✓
Magnesium Hydroxide, >10%	✓	✓	S		✓	✓	✓	✓	✓	✓	✓	✓	✓	✓		✓
Magnesium Sulfate, <40%	✓	✓	S		✓		✓	✓		✓	✓	✓	✓	✓	✓	✓
Magnesium Sulfate, <5%	✓	✓	S	✓	✓	✓	✓	✓		✓	✓	✓	✓	✓	✓	✓
Mercury	✓	✓	D	✓	✓	✓	✓	✓		✓	✓		✓	✓	✓	✓
Methane, Gas	✓	✓	D	✓	✓		✓	✓	✓	✓	✓		✓	✓	✓	✓
Methanol (Methyl Alcohol)	✓	✓	S			✓	✓	✓		✓	✓	✓	✓	✓	✓	✓
Methyl Benzoate		✓	S		✓		✓	✓	✓	✓		✓	✓	✓	✓	
Methyl Ethyl Ketone (MEK)	✓	✓	S			✓	✓	✓		✓		✓	✓	✓	✓	✓
Milk	✓	✓	S	✓	✓	✓	✓	✓		✓		✓	✓	✓	✓	
Molasses	✓	✓	S	✓	✓	✓	✓	✓		✓	✓	✓	✓	✓	✓	✓
Naphtha, Coal Tar	✓	✓	S		✓		✓	✓		✓	✓	✓	✓	✓	✓	
Naphthalene			S		✓		✓	✓			✓	✓	✓	✓	✓	✓
Nickel Sulfate	✓	✓	D	✓	✓	✓	✓	✓	✓	✓	✓	✓	✓	✓	✓	✓
Nitrogen, Gas		✓	D			✓	✓	✓	✓	✓	✓	✓	✓	✓	✓	✓
Nitrogen, Liquid	✓	✓	D	✓	✓	✓	✓	✓	✓	✓	✓	✓	✓	✓	✓	✓
Olive Oil	✓	✓	S	✓	✓		✓	✓	✓	✓	✓	✓	✓	✓	✓	✓
Ozone, <12%	✓	✓	S		✓	✓	✓	✓		✓	✓	✓	✓	✓	✓	✓
Paint, Oil Based	✓	✓	D		✓		✓					✓	✓	✓	✓	
Paint, Water Based	✓	✓	S		✓		✓	✓	✓	✓	✓	✓	✓	✓	✓	✓
Palm Oil	✓	✓	S	✓	✓		✓	✓		✓	✓	✓	✓	✓	✓	
Palmitic Acid	✓	✓	S	✓	✓		✓	✓		✓	✓	✓	✓	✓	✓	✓
Paraffin, Molten	✓	✓	S	✓	✓		✓	✓		✓	✓	✓	✓	✓	✓	✓
Paraformaldehyde, <30%	✓	✓	S			✓	✓	✓	✓	✓	✓	✓	✓	✓	✓	✓
Paraldehyde	✓	✓	D			✓	✓	✓		✓	✓	✓	✓	✓	✓	✓
Peanut Oil	✓	✓	S	✓	✓		✓	✓		✓	✓	✓	✓	✓	✓	✓
Penicillin	✓	✓	S		✓		✓	✓		✓	✓	✓	✓	✓	✓	✓
Pentane	✓	✓	S	✓	✓		✓	✓		✓	✓	✓	✓	✓	✓	✓
Perchloroethylene	✓	✓	S		✓		✓	✓		✓	✓	✓	✓	✓	✓	✓
Petroleum Oil	✓	✓	S		✓		✓	✓		✓	✓	✓	✓	✓	✓	✓
Phenylacetic Acid	✓	✓	S			✓	✓	✓	✓	✓	✓	✓	✓	✓	✓	✓
Phthalic Acid		✓	S			✓	✓	✓		✓	✓	✓	✓	✓	✓	✓
Pine Oil	✓	✓	D	✓	✓		✓	✓		✓			✓	✓	✓	
Pitch	✓	✓	S		✓		✓	✓		✓	✓		✓	✓	✓	
Polyethylene Glycol		✓	S			✓	✓	✓			✓	✓	✓	✓	✓	✓
Polyvinyl Acetate, Slurry	✓	✓	D			✓	✓	✓		✓	✓	✓	✓	✓	✓	✓
Potassium Bicarbonate, <30%	✓	✓	S			✓	✓	✓		✓	✓	✓	✓	✓	✓	✓

Non Pusher Seals - U.S. Seal Mfg. Type A, B, C, D, E, G, K, Q, S, T, U Pusher Seals - U.S. Seal Mfg. Type V,W,X
 Arrangement S=Single D=Double

MATERIAL RECOMMENDATION CHART

FLUID	SEAL FAMILY		ARRANGEMENT	SECONDARY SEALS				SEAL FACES						METAL PARTS		
	NON-PUSHER	PUSHER		BUNA	VITON®	EPR	PTFE	CARBON	CAST IRON/NIREZIST	CERAMIC	TC	RB SIC	ALPHA SIC	304 SS	316 SS	ALLOY 20
Potassium Carbonate (Potash), <20%	✓	✓	S			✓	✓	✓		✓		✓	✓	✓	✓	
Potassium Carbonate (Potash), >20%	✓	✓	S			✓	✓	✓		✓		✓	✓	✓	✓	
Potassium Dichromate, <55%		✓	S	✓	✓	✓	✓	✓		✓		✓	✓	✓	✓	
Potassium Hydroxide, <10%	✓	✓	D	✓	✓	✓	✓			✓		✓	✓	✓	✓	
Potassium Hydroxide, <10%		✓	S			✓	✓	✓		✓	✓	✓	✓	✓	✓	
Potassium Permanganate, <10%	✓	✓	S			✓	✓	✓		✓	✓	✓	✓	✓	✓	
Potassium Sulfate, <25%	✓	✓	S	✓	✓	✓	✓	✓		✓		✓	✓	✓	✓	
Propane, Gas	✓	✓	S	✓	✓		✓	✓		✓		✓	✓	✓	✓	
Propane, Liquid	✓	✓	D	✓	✓		✓	✓	✓	✓	✓	✓	✓	✓	✓	
Propyl Alcohol (Propanol)		✓	S	✓	✓	✓	✓	✓	✓	✓	✓	✓	✓	✓	✓	
Propylene	✓	✓	S		✓		✓	✓	✓	✓	✓	✓	✓	✓	✓	
Propylene Glycol	✓	✓	S			✓	✓	✓		✓	✓	✓	✓	✓		
Pyridine (Chlorinated)	✓	✓	S		✓		✓	✓		✓	✓	✓	✓	✓	✓	
R-22 & Mineral Oil/Alkybenzene	✓		S				✓	✓	✓	✓	✓	✓	✓	✓	✓	
Rapeseed Oil	✓		S		✓	✓	✓	✓	✓	✓	✓	✓	✓	✓	✓	
Refrigerant 11 (CFC)	✓	✓	S				✓	✓		✓		✓	✓	✓	✓	
Refrigerant 12 (CFC)	✓	✓	S				✓	✓	✓	✓	✓	✓	✓	✓	✓	
Refrigerant 13 (CFC)	✓	✓	S	✓		✓	✓	✓	✓	✓	✓	✓	✓	✓	✓	
Refrigerant 22 (HCFC)	✓	✓	S				✓		✓	✓	✓	✓	✓	✓	✓	
Refrigerant 113 (CFC)	✓	✓	S	✓			✓	✓	✓	✓	✓	✓	✓	✓	✓	
Refrigerant 114 (CFC)	✓	✓	S	✓	✓		✓	✓		✓	✓	✓	✓	✓	✓	
Refrigerant 134A (HFC)	✓	✓	S			✓	✓	✓		✓	✓	✓	✓	✓	✓	
Refrigerant 502 (CFC)	✓	✓	S			✓	✓	✓	✓	✓	✓	✓	✓	✓	✓	
Rosin Size		✓	S		✓		✓	✓		✓	✓	✓	✓	✓	✓	
Salicylic Acid	✓	✓	S		✓	✓	✓	✓		✓	✓	✓	✓	✓	✓	
Sewage, Sludge	✓	✓	S	✓	✓	✓	✓	✓		✓	✓	✓	✓	✓	✓	
Sewage, Treated	✓	✓	S	✓	✓		✓	✓		✓	✓	✓	✓	✓		
Silicone Fluid	✓	✓	S	✓	✓	✓	✓	✓		✓		✓	✓	✓	✓	
Sodium Acetate, <10%	✓	✓	S			✓	✓	✓		✓	✓	✓	✓	✓	✓	
Sodium Bicarbonate	✓	✓	S	✓	✓	✓	✓	✓		✓	✓	✓	✓	✓	✓	
Sodium Borate (Borax)	✓	✓	D	✓	✓	✓	✓	✓		✓	✓	✓	✓	✓		
Sodium Carbonate (Soda Ash)	✓	✓	S	✓	✓	✓	✓	✓		✓	✓	✓	✓	✓	✓	
Sodium Metasilicate	✓	✓	S			✓	✓			✓		✓	✓	✓		
Sodium Nitrate, <90%	✓	✓	S			✓	✓	✓		✓	✓	✓	✓	✓	✓	
Sodium Nitrite, <70%	✓	✓	S			✓	✓	✓		✓	✓	✓	✓	✓	✓	
Sodium Perchlorate	✓	✓	D			✓	✓	✓		✓	✓	✓	✓	✓		
Sodium Phosphate, Dibasic, <20%		✓	D	✓	✓	✓	✓	✓		✓		✓	✓	✓	✓	
Sodium Phosphate, Tribasic	✓	✓	S	✓	✓	✓		✓		✓	✓	✓	✓	✓	✓	
Sodium Sulfite, <50%	✓	✓	S	✓	✓	✓	✓	✓		✓	✓	✓	✓	✓	✓	
Soybean Oil	✓	✓	S	✓	✓		✓	✓		✓		✓	✓	✓	✓	
Starch	✓	✓	S	✓	✓	✓	✓	✓		✓	✓	✓	✓	✓		
Sugar, Carbonated Juice, <55%	✓	✓	S		✓		✓	✓		✓		✓	✓	✓	✓	
Sugar, Clear Juice, <50%	✓	✓	S	✓	✓		✓	✓		✓	✓	✓	✓	✓	✓	
Sugar, Diffuser Juice, <55%	✓	✓	S	✓	✓		✓	✓		✓	✓	✓	✓	✓	✓	
Sugar, Limed Juice, <55%	✓	✓	S	✓	✓	✓	✓	✓		✓	✓	✓	✓	✓	✓	
Sugar, Molten	✓	✓	S	✓	✓	✓	✓	✓		✓	✓	✓	✓	✓	✓	
Sugar, Syrup, <80%	✓	✓	S	✓	✓	✓	✓	✓		✓	✓	✓	✓	✓	✓	
Sulfolane	✓	✓	S			✓	✓	✓		✓	✓	✓	✓	✓	✓	

Non Pusher Seals - U.S. Seal Mfg. Type A, B, C, D, E, G, K, Q, S, T, U Pusher Seals - U.S. Seal Mfg. Type V,W,X
 Arrangement S=Single D=Double

MATERIAL RECOMMENDATION CHART

FLUID	SEAL FAMILY		ARRANGEMENT	SECONDARY SEALS				SEAL FACES						METAL PARTS		
	NON-PUSHER	PUSHER		BUNA	VITON®	EPR	PTFE	CARBON	CAST IRON/NIREXIST	CERAMIC	TC	RB SIC	ALPHA SIC	304 SS	316 SS	ALLOY 20
Sulfur Dioxide, Dry	✓	✓	S			✓	✓	✓		✓	✓	✓	✓	✓	✓	✓
Sulfur, Molten	✓	✓	D		✓		✓	✓		✓		✓	✓	✓	✓	
Tall Oil	✓	✓	S	✓	✓		✓	✓			✓	✓	✓	✓	✓	✓
Tallow		✓	S	✓	✓		✓	✓		✓	✓	✓	✓	✓	✓	✓
Tannic Acid	✓	✓	S	✓	✓	✓	✓	✓		✓	✓	✓	✓	✓	✓	✓
Tar (Coal)	✓	✓	S		✓		✓	✓		✓	✓	✓	✓	✓	✓	✓
Tartaric Acid, >20%	✓	✓	S	✓	✓		✓	✓			✓	✓	✓	✓	✓	✓
Terephthalic Acid, Slurry	✓	✓			✓	✓	✓		✓	✓	✓	✓	✓	✓		
Titanium Dioxide, Slurry	✓	✓	S			✓	✓	✓	✓	✓	✓	✓	✓	✓	✓	✓
Toluene	✓	✓	S		✓		✓	✓		✓	✓	✓	✓	✓	✓	✓
Transformer Oil	✓	✓	S	✓	✓		✓	✓	✓	✓	✓	✓	✓	✓	✓	✓
Transmission Fluid	✓	✓	S	✓	✓			✓	✓	✓	✓	✓	✓	✓	✓	✓
Trichloroethane, Dry	✓	✓	S		✓		✓	✓	✓	✓	✓	✓	✓	✓	✓	✓
Trichloroethylene, Dry	✓	✓	S		✓		✓	✓	✓	✓	✓	✓	✓	✓	✓	✓
Triethylene Glycol (TEG)	✓	✓	D			✓	✓	✓		✓		✓	✓	✓	✓	
Tung Oil	✓	✓	S	✓	✓		✓	✓			✓	✓	✓	✓	✓	✓
Turpentine	✓	✓	S	✓	✓		✓	✓	✓	✓	✓	✓	✓	✓	✓	✓
Urea, >5%	✓	✓	S			✓	✓	✓		✓	✓	✓	✓	✓	✓	✓
Varnish (Resin)	✓	✓	S		✓		✓	✓		✓	✓		✓	✓	✓	
Vegetable Juice	✓	✓	D		✓		✓	✓		✓	✓	✓	✓	✓	✓	✓
Vegetable Oil	✓	✓	S	✓	✓		✓	✓		✓	✓	✓	✓	✓	✓	✓
Water, Boiler Feed	✓	✓	S	✓	✓	✓	✓	✓		✓	✓	✓	✓	✓	✓	✓
Water, Chlorinated (<500 PPM)	✓	✓	S			✓	✓	✓			✓	✓	✓	✓	✓	✓
Water, Clean	✓	✓	S	✓	✓		✓	✓		✓	✓	✓	✓	✓	✓	
Water, Condensate	✓	✓	S	✓	✓	✓	✓	✓		✓	✓	✓	✓	✓	✓	✓
Water, Fresh River or Lake	✓	✓	S	✓	✓	✓	✓	✓			✓	✓	✓	✓	✓	✓
Water, Produced	✓	✓	S	✓	✓	✓	✓	✓		✓	✓	✓	✓	✓	✓	✓
Water, Sour (H 2S Only)	✓	✓	S	✓	✓		✓	✓		✓	✓	✓	✓	✓	✓	
Water, Ultra Pure (>10 Mohm/cm)	✓	✓	S			✓	✓	✓		✓	✓	✓	✓	✓	✓	
Whiskey	✓	✓	S	✓	✓	✓	✓	✓		✓		✓	✓	✓	✓	✓
Wine	✓	✓	S	✓	✓	✓	✓	✓		✓		✓	✓	✓	✓	✓
Xylen /Xylol (Ortho)	✓	✓		✓		✓	✓		✓	✓	✓	✓	✓	✓	✓	
Yeast		✓	S	✓	✓	✓	✓	✓		✓	✓	✓	✓	✓	✓	✓
Zinc Nitrate	✓	✓	S	✓	✓	✓	✓	✓		✓	✓	✓	✓	✓	✓	✓
Zinc Sulfate, <45%	✓	✓	S	✓	✓	✓	✓	✓		✓		✓	✓	✓	✓	✓

CAUTION: USE THIS CHART AS A GUIDE ONLY FOR THE SELECTION OF A MATERIAL.
 WE SUGGEST TESTS BE RUN FOR COMPATIBILITY, OR CONTACT U.S. SEAL MFG. FOR THEIR RECOMMENDATIONS.

Non Pusher Seals - U.S. Seal Mfg. Type A, B, C, D, E, G, K, Q, S, T, U Pusher Seals - U.S. Seal Mfg. Type V,W,X
 Arrangement S=Single D=Double

SEAL INSTALLATION INSTRUCTIONS

1. Disassemble pump cavity to expose seal.
2. Carefully remove existing seal head and mating ring, noting where and how it was installed. Avoid scratching shaft or mating ring counterbore.
3. Clean shaft and counterbore surfaces using fine emery cloth or equivalent. Remove rust, burrs, and wipe clean.
4. Lubricate shaft, mating ring counterbore, and rubber components of both seal head and mating ring with a lubricant compatible with seal elastomers. Never use PTFE or silicone based products.
 U.S. Seal Mfg. recommends U.S. SEALUBE, which has a water based formula specifically designed to lubricate rubber. It provides a high degree of lubricity to all rubber components and maintains its wetness for a short period of time, allowing for easy installation of mechanical seals.
5. Check seal surfaces to be sure they are free of any dirt, grit, or lubricants. Use an alcohol prep pad to clean the faces before final assembly.
6. Press mating ring into counterbore, making sure that it is bottomed square. The lapped and polished faces of the new seal are easily scratched and damaged. Protect them from damage, dirt, and fingerprints.
7. Slide seal head along shaft making sure that spring is correctly engaged into seal.
8. Re-assemble pump. Turn the shaft by hand a few rotations or bump the motor to check the seals for squeals or other unwanted noises.
9. Connect the pump and motor to the system.
10. Flood the pump with water before starting. NEVER RUN THE PUMP DRY. This damages or even destroys the seal.

SEAL INSTALLATION LUBRICANT

Use the Right Seal Installation Lubricant so your seals don't end up looking like these.



PTFE or Silicone Based Lubricants Damage Seals

USE THE WRONG LUBE . . . GET THE WRONG RESULTS

Silicone or PTFE based lubricants are a poor choice when installing mechanical seals.

During seal installation, lubricants can come in contact with the sealing faces. Silicone or PTFE based products are very difficult to remove from these faces.

When the pump is started, these products draw the carbon from the primary ring, transfers the material onto the mating ring face, causing a build up which leads to premature seal failure.

USE THE RIGHT LUBE . . . GET THE RIGHT RESULTS

U.S. SEALUBE is a water based formula specifically designed to lubricate rubber, allowing for fast and easy seal installations.

It provides a high degree of lubricity to all rubber components but unlike PTFE or silicone based lubricants, U.S. SEALUBE evaporates, allowing the elastomer to grip the shaft or bore. Elastomers are left dry to the touch. The lubricity is gone and will not return even in the presence of moisture.

Your seal is now locked in place.

U.S. SEALUBE

- Safe for incidental food contact and potable water applications.
- Meets FDA Regulation 21 CFR 178.3570 and is NSF-Registered as a H1 lubricant.
- Great for all seals and elastomers.
- 15 to 20 minutes work time before drying.
- Totally evaporates, leaving no residue.



U.S. SEALUBE

U.S. Seal Mfg. Part No.	Available In
LUBE-PP	1 cc Pillow Pak
LUBE-10ML	10 ml Tube
LUBE-4OZ	4 oz. Bottle
LUBE-8OZ	8 oz. Bottle

DIMENSIONAL CROSS-REFERENCE

SEAL HEAD			MATING RING			Material Code	NOTES	U.S. Seal Mfg. Part No.
Fig.	OD	Oper Hgt.	Fig.	Bore	Thick			
.250 (1/4")								
X Special	.781	.367	1	.864	.140	QCFLF		PS-8066
X Special	.781	.398	1	.875	.140	QCFLF		PS-8100
.312 (5/16")								
A	1.062	.656	1	1.000	.312	BMDJF		PS-114
C	.812	.812	3	.875	.312	VCFJF		PS-1064V
W	.843	.687	2	.875	.312	TCFLF	316SS	PS-9720
.375 (3/8")								
B	1.125	.375	1	.875	.165	BMFJF		PS-671
B	1.125	.375	1	.875	.165	VCFJF		PS-671V-CMS
B	1.125	.375	1	1.000	.203	BMFJF		PS-1615
C	.812	.687	3	.875	.312	Q/NCFJF		PS-3082
C	.812	.781	3	.875	.312	VCFJF	316SS	PS-22028
C	.812	.812	3	.875	.312	BCFJF		PS-1065
C	.812	.812	3	.875	.312	QCJFJ		PS-1065-EPR
C	.812	.812	3	.875	.312	VCFJF		PS-1065V
.437 (7/16")								
C	.875	.750	3	1.000	.312	VCFKF		PS-22145
C	.875	.750	3	1.181	.250	NCJFJ		PS-22144
C	.875	.750	1	1.181	.285	BCFJF		PS-1133
G	.866	.769	1	1.181	.281	BCFJF		PS-4060
G	.866	.769	1	1.181	.281	VCFJF		PS-4063
G	.866	.769	1	1.181	.281	VCFLF		PS-2727
.472 (12 MM)								
G	22MM	15MM	1	23MM	6MM	BCFJF	316SS	PS-2807
G	22MM	15MM	1	23MM	6MM	QCFLF		PS-4000
G	22MM	15MM	1	26MM	5MM	BLFLF		PS-3000
G	22MM	34MM	1	23MM	6MM	QCFLF	316SS	PS-4225
.500 (1/2")								
A	1.062	.656	—	—	—	BMF-F		FA-1
A	1.062	.656	1	1.000	.290	BMFKF		PS-506
A	1.062	.656	1	1.000	.312	BCFJF		PS-3225
A	1.062	.656	1	1.000	.312	BMFJF		PS-162
B	1.125	.547	—	—	—	BMF-F		FA-10
B	1.125	.547	—	—	—	BMF-F		FA-4218
B	1.125	.547	1	.875	.165	BMFJF		PS-1098
B	1.125	.547	1	1.000	.218	BMFJF		PS-142
B	1.125	.547	1	1.000	.218	VCFJF		PS-142V
B	1.125	.547	1	1.000	.290	BMFKF		PS-788
B	1.125	.547	1	1.000	.312	BCFJF		PS-3048
B	1.125	.547	1	1.000	.312	BMFJF		PS-163
B	1.125	.547	1	1.000	.312	VCFJF		PS-163V
B	1.125	.547	8	—	.312	BLFLF		PS-4360
B	1.125	.547	9	—	.312	BMFKF	A	PS-164
B	1.125	.547	9	.906	.312	BMFJF	A	PS-165
C	.922	.605	Special	1.360	.300	BCFGF		PS-2138
C	.922	.750	1	1.000	.312	BCFKF		PS-3583
C	.937	.591	1	1.000	.312	QCFLF		PS-2730
C	.937	.594	1	1.000	.187	BCFJF		PS-4214
C	.937	.611	1	.938	.250	BCFJF		PS-3561
C	.937	.611	1	.938	.250	QCFLF		PS-3563
C	.937	.625	1	.938	.213	BCFJF		PS-3844
C	.937	.625	1	.938	.218	VCFJF		PS-3843
C	.937	.640	1	1.000	.218	BMFJF		PS-7740
C	.937	.640	3	1.125	.265	NCFKF		PS-22124
C	.937	.718	—	—	—	BMF-F		FA-400
C	.937	.718	—	—	—	VCF-F		FA-110V
C	.937	.718	1	.938	.225	B/QCFJF	I	PS-392-P66
C	.937	.718	1	.938	.225	B/QMFJF		PS-392
C	.937	.718	1	.938	.225	BMFKF		PS-393
C	.937	.718	1	.938	.225	QCJFJ	I	PS-392-EPR-P66
C	.937	.718	1	.938	.225	V/QCFJF		PS-392V
C	.937	.718	1	.938	.225	V/QCFJF	I	PS-392V-P66

DIMENSIONAL CROSS-REFERENCE

SEAL HEAD			MATING RING			Material Code	NOTES	U.S. Seal Mfg. Part No.
Fig.	OD	Oper Hgt.	Fig.	Bore	Thick			
.500 (1/2") (continued)								
C	.937	.718	1	1.000	.218	BMFJF		PS-1043
C	.937	.718	1	1.062	.312	BCFJF		PS-1120
C	.937	.750	1	1.125	.237	BMFJF		PS-7712
C	.937	.750	3	1.000	.312	BCFJF		PS-2720
C	.937	.796	—	—	—	BMF-F		FA-1810
C	.937	.812	—	—	—	BCF-F		FA-112
C	.937	.812	—	—	—	BCF-F	N	FA-401
C	.937	.812	—	—	—	VCF-F		FA-10033
C	.937	.812	1	.938	.225	BCFJF	N	PS-401A
C	.937	.812	1	.938	.225	B/QCFJF		PS-1012
C	.937	.812	1	.938	.225	QCFJF	I	PS-3052
C	.937	.812	1	1.000	.312	BCFJF		PS-1002
C	.937	.812	1	1.000	.312	BCFJF	H	PS-3913
C	.937	.812	1	1.000	.312	BCFJF	I	PS-1002-P66
C	.937	.812	1	1.000	.312	BCFJF	N	PS-631
C	.937	.812	1	1.000	.312	BCFKF		PS-106
C	.937	.812	1	1.000	.312	BCFKF	N	PS-632
C	.937	.812	1	1.000	.312	QCFJF		PS-1002-EPR
C	.937	.812	1	1.000	.312	QCFKF	N	PS-106-EPR
C	.937	.812	1	1.000	.312	VCFJF		PS-1002V
C	.937	.812	1	1.000	.312	VCFKF		PS-106V
C	.937	.812	3	1.000	.312	BCFKF		PS-3172
C	.937	.812	3	1.000	.312	B/VCFJF		PS-4045
C	.937	.812	3	1.000	.312	NCFKF	I	PS-2802
C	.937	.812	3	1.000	.312	VCFJF		PS-22142
C	.937	.812	3	1.000	.312	VCFJF	316SS	PS-3197
C	.937	.812	3	1.000	.312	VCFKF		PS-3226
C	.937	.840	3	1.125	.265	BCFKF		PS-6321
C	.937	.840	3	1.125	.265	VCFKF		PS-3735
E	.937	1.140	Special	1.000	.687	VCPKF		PS-3896
E	.937	1.140	Special	1.193	.656	BCPKF		PS-7948
E	.937	1.140	Special	1.193	.656	QCPKF		PS-4451
E	.937	1.140	Special	1.193	.656	VCPKF		PS-7948V
G	.945	.591	1	.938	.294	QLFLF		PS-4349
G	.945	.591	1	1.000	.312	QCFLF		PS-3004
G	.945	.591	1	1.000	.312	QLFLF		PS-3568
G	.945	.591	1	1.000	.312	VCFJF		PS-4558
G	.945	.656	3	1.000	.312	BCFJF		PS-3003
G	.945	.696	1	1.000	.312	BCFJF		PS-2700
G	.945	.812	1	1.000	.312	BCFJF		PS-4180
G	.945	.812	1	1.000	.312	VFLFLF		PS-3450
G	.945	.812	3	1.000	.312	BCFJF		PS-22088
G	.945	.812	3	1.000	.312	VCFJF		PS-3001
G	.945	.812	3	1.000	.312	VCFJF	316SS	PS-3002
Q	1.125	.390	1	.938	.225	BMFJF		PS-749
Q	1.125	.390	1	1.000	.312	BMFJF		PS-663
Q	1.125	.390	8	—	.218	BMFJF	A	PS-4038
Q	1.125	.390	9	—	.171	BMFJF	A	PS-1621
Q	1.125	.390	9	—	.312	BMFJF	A	PS-1112
Q	1.125	.408	8	—	.213	BCFJF		PS-2713
Q	1.125	.408	8	1.000	.218	BCFKF		PS-3033
Q	1.125	.408	8	1.000	.218	VCFKF		PS-2732
Q	1.125	.418	1	1.000	.187	BMFJF		PS-1137
Q	1.139	.390	1	1.019	.208	BCFJF		PS-6313
Special	1.125	.710	Special	.950	Special	BMFJF	Unitized	PS-4064
W	1.031	.812	—	—	—	TCF-F	316SS	FA-9012
W	1.031	.812	2	1.000	.289	TCFJF	316SS	PS-22089
W	1.031	.812	2	1.125	.312	TCFKF	316SS	PS-22114
W Special	.937	1.109	Special	1.188	.656	TCPKF		PS-9028
X	1.031	.812	3	1.000	.312	VCFKF	316SS/S	PS-3800
X Special	.875	.527	3	1.000	.312	BCFKF	S	PS-3729
X Special	.875	.527	3	1.000	.312	VCFGF	S	PS-7727
X Special	.875	.527	3	1.000	.312	VCFLF	S	PS-4588

NOTE: A. MOUNTS ON SHAFT
H. SPRING HOLDER NOT INCLUDED
I. ABRASION RESISTANT CARBON (P66)
N. NON-STANDARD SPRING HOLDER
S. SLOTTED MATING RING

DIMENSIONAL CROSS-REFERENCE

SEAL HEAD			MATING RING			Material Code	NOTES	U.S. Seal Mfg. Part No.
Fig.	OD	Oper Hgt.	Fig.	Bore	Thick			
.562 (9/16")								
A	1.218	.718	1	1.250	.406	VCFJF		PS-1061
C	1.000	.808	3	1.031	.312	BCFKF		PS-4292
C	1.000	.808	3	1.031	.312	VCFKF		PS-3542
.590 (15MM)								
C	1.062	.875	1	1.250	.406	BCFJF		PS-7553
C	1.062	.875	1	1.250	.406	BCFJF	I	PS-3093
C	1.062	.875	1	1.250	.406	BCFKF	I	PS-7520
C	1.062	.875	1	1.250	.406	VCFJF		PS-3140
C	1.062	.875	1	1.250	.406	VCFKF	I	PS-7520V
D	1.312	.875	1	1.250	.406	BCFJF		PS-129
D	1.312	.875	1	1.250	.406	BCFKF		PS-1675
D	1.312	.875	1	1.250	.406	VCFKF	I	PS-3192
D	1.312	.938	1	1.250	.406	VCFJF	I	PS-22058
D	1.312	.938	1	1.250	.406	VCFZF	I	PS-22059
.625 (5/8")								
A	1.218	.718	—	—	—	BCF-F		FA-62
A	1.218	.718	—	—	—	BMF-F		FA-26
A	1.218	.718	1	—	.562	BCFJF	G	PS-2172
A	1.218	.718	1	1.187	.288	BCFJF		PS-680
A	1.218	.718	1	1.187	.288	BMFJF		PS-702
A	1.218	.718	1	1.187	.288	BMFKF		PS-701
A	1.218	.718	1	1.187	.288	QCFJF		PS-702-EPR
A	1.218	.718	1	1.187	.288	QCFKF		PS-701-EPR
A	1.218	.718	1	1.187	.288	VCFJF		PS-702V
A	1.218	.718	1	1.187	.288	VCFJF	I	PS-702V-CMS-P66
A	1.218	.718	1	1.187	.288	VCFKF		PS-701V
A	1.218	.718	1	1.187	.296	BCFJF		PS-4240
A	1.218	.718	1	1.187	.296	BCFKF		PS-518
A	1.218	.718	1	1.187	.296	BLFLF		PS-518-SC-SC
A	1.218	.718	1	1.187	.296	BMFJF		PS-4462
A	1.218	.718	1	1.187	.296	VCFLF		PS-4284
A	1.218	.718	1	1.187	.343	BCFJF		PS-957
A	1.218	.718	1	1.187	.343	BLFLF		PS-100-SC-SC
A	1.218	.718	1	1.187	.343	BMFJF		PS-100
A	1.218	.718	1	1.187	.343	BMFKF		PS-1150
A	1.218	.718	1	1.187	.343	QCFJF		PS-100-EPR
A	1.218	.718	1	1.187	.343	VCFJF		PS-100V-CMS
A	1.218	.718	1	1.187	.343	VCFJF	I	PS-100V-CMS-P66
A	1.218	.718	1	1.187	.343	VLFLF		PS-100V-SC-SC-CMS
A	1.218	.718	3	1.187	.343	BMFJF		PS-711
A	1.218	.718	3	1.187	.343	VCFJF		PS-100V
A	1.218	.718	1	1.250	.155	QCFJF		PS-4027
A	1.218	.718	1	1.250	.155	VCFJF		PS-4424
A	1.218	.718	1	1.250	.406	BCFJF		PS-516
A	1.218	.718	1	1.250	.406	BCFKF		PS-524
A	1.218	.718	1	1.250	.406	BLFLF		PS-200-SC-SC
A	1.218	.718	1	1.250	.406	BLFZF		PS-4355
A	1.218	.718	1	1.250	.406	BMFJF		PS-200
A	1.218	.718	1	1.250	.406	BMFJF		PS-300
A	1.218	.718	1	1.250	.406	BMFKF		PS-507
A	1.218	.718	1	1.250	.406	QCFJF		PS-200-EPR
A	1.218	.718	1	1.250	.406	QCFKF		PS-524-EPR
A	1.218	.718	1	1.250	.406	VCFJF		PS-200V-CMS
A	1.218	.718	1	1.250	.406	VCFJF	I	PS-200V-CMS-P66
A	1.218	.718	1	1.250	.406	VCFJF	316SS	PS-3228
A	1.218	.718	1	1.250	.406	VCFKF		PS-507V-CMS
A	1.218	.718	1	1.250	.406	VCFZF		PS-2204
A	1.218	.718	1	1.250	.406	VLFLF		PS-200V-SC-SC
A	1.218	.718	3	1.250	.406	BMFJF		PS-637
A	1.218	.718	3	1.250	.406	BMFKF		PS-628
A	1.218	.718	3	1.250	.406	VCFJF		PS-200V
A	1.218	.718	3	1.250	.406	VCFJF		PS-300V
A	1.218	.718	3	1.250	.406	VCFKF		PS-507V

DIMENSIONAL CROSS-REFERENCE

SEAL HEAD			MATING RING			Material Code	NOTES	U.S. Seal Mfg. Part No.
Fig.	OD	Oper Hgt.	Fig.	Bore	Thick			
.625 (5/8") (continued)								
A	1.218	.718	1	1.375	.562	BMFJF		PS-528
A	1.218	.718	1	1.375	.562	VCFJF		PS-528V
A	1.218	.718	Special	.814	.312	BMFKF		PS-293
A	1.218	.718	Special	.814	.312	QCCKF		PS-293-EPR
A	1.218	.718	Special	.814	.312	VCFKF		PS-293V
A	1.218	.718	31	—	—	BMFJF	G	PS-2131
A	1.218	.718	31	—	—	VCFJF	G	PS-2131V
A	1.218	.734	1	1.187	.296	VFLFL		PS-3977
A	1.218	.843	1	1.187	.343	BCFJF		PS-953
A	1.218	.843	1	1.187	.288	BCFKF		PS-955
A	1.218	.843	1	1.187	.343	BMFJF		PS-166
A	1.218	.843	1	1.250	.406	BCFJF		PS-952
A	1.218	.843	1	1.250	.406	BCFJF	I	PS-952-P66
A	1.218	.843	1	1.250	.406	BCFKF		PS-954
A	1.218	.843	1	1.250	.406	BMFJF		PS-501
A	1.218	.843	1	1.250	.406	BMFKF		PS-153
A	1.218	.843	1	1.250	.406	NMFCF		PS-22229
A	1.218	.843	1	1.250	.406	VCFJF		PS-3864
A	1.218	.843	1	1.250	.406	VCFJF		PS-501V-CMS
A	1.218	.843	1	1.250	.406	VCFJF	I	PS-4371
A	1.218	.843	1	1.250	.406	VCFKF		PS-954V-CMS
A	1.218	.843	1	1.250	.406	VCFKF	I	PS-3816
A	1.218	.843	1	1.250	.406	VFLFL		PS-1903
A	1.218	.843	3	1.250	.406	VCFJF		PS-501V
A	1.218	.843	3	1.250	.406	VCFKF		PS-153V
B	1.437	.615	1	1.250	.406	VCFJF		PS-3212
B	1.437	.615	1	1.250	.406	BCFJF	316SS	PS-2742
B	1.437	.615	1	1.250	.406	VCFJF	316SS	PS-2804
B	1.437	.615	8	1.049	.213	VCFKF	316SS/A	PS-22060
B	1.437	.615	8	1.049	.213	BCFKF	A/I	PS-22061
B	1.437	.615	1	1.250	.406	VFLFL		PS-3741
B	1.437	.615	—	—	—	BCF-F		FA-3300
B	1.437	.615	—	—	—	BMF-F		FA-642
B	1.437	.615	8	—	.211	NCFJF	A	PS-22012
B	1.437	.615	8	1.109	.211	VCFJF	A	PS-22011
B	1.437	.615	8	—	.213	VCFFF	A	PS-4114
B	1.437	.615	8	—	.215	BCFJF	A	PS-447
B	1.437	.615	8	—	.215	BCFJF	A	PS-3159
B	1.437	.615	8	—	.215	BCFKF	A	PS-453
B	1.437	.615	8	—	.215	BMFJF	A	PS-1021
B	1.437	.615	8	—	.215	VCFJF	A	PS-447V
B	1.437	.615	8	—	.215	VCFJF	A/I	PS-447V-P66
B	1.437	.615	8	—	.215	VCFKF	A	PS-453V
B	1.437	.615	8	—	.215	VLFSS	A	PS-4248V
B	1.437	.615	9	—	.237	BLFLF	A	PS-3667
B	1.437	.615	9	—	.312	BMFJF	A	PS-452
B	1.437	.615	9	—	.312	VCFJF	A	PS-452V
B	1.437	.615	11	—	.375	BCFJF	A	PS-3102
B	1.437	.615	11	—	.375	BMFJF	A	PS-202
B	1.437	.615	11	—	.375	VCFJF	A	PS-202V
B	1.437	.615	11	—	.375	VCFJF	A	PS-3103
B	1.437	.615	11	—	.487	BMFJF	A	PS-411
B	1.437	.615	11	—	.487	VCFJF	A	PS-411V
B	1.437	.615	9	1.062	.520	VCFKF	316SS	PS-3926
B	1.437	.615	1	1.087	.213	BCFJF		PS-3124
B	1.437	.615	1	1.093	.218	BMFJF		PS-113
B	1.437	.615	1	1.093	.218	V/BCFJF		PS-1089
B	1.437	.615	8	1.109	.213	BCFFF	A	PS-2734
B	1.437	.615	8	1.109	.213	QCFFJF	A	PS-4479
B	1.437	.615	8	1.109	.213	Special	A	PS-4587
B	1.437	.615	1	1.187	.180	BLFLF	316SS	PS-22027
B	1.437	.615	1	1.187	.180	BMFJF		PS-4557
B	1.437	.615	1	1.187	.288	BCFKF		PS-522
B	1.437	.615	1	1.187	.288	BMFJF		PS-700

NOTE: A. MOUNTS ON SHAFT
 G. MOUNTS IN PLASTIC
 I. ABRASION RESISTANT CARBON (P66)

DIMENSIONAL CROSS-REFERENCE

SEAL HEAD			MATING RING			Material Code	NOTES	U.S. Seal Mfg. Part No.
Fig.	OD	Oper Hgt.	Fig.	Bore	Thick			
.625 (5/8") (continued)								
B	1.437	.615	1	1.187	.288	BMFKF		PS-616
B	1.437	.615	1	1.187	.343	BCFJF		PS-963
B	1.437	.615	1	1.187	.343	BMFJF		PS-600
B	1.437	.615	1	1.187	.343	VCFJF		PS-600V-CMS
B	1.437	.615	1	1.187	.343	VCFJF	I	PS-600V-CMS-P66
B	1.437	.615	3	1.187	.343	BMFJF		PS-717
B	1.437	.615	3	1.187	.343	VCFJF		PS-600V
B	1.437	.615	11	—	.399	VLFLF	A	PS-3106
B	1.437	.615	11	—	.399	QLFLF	A	PS-2819
B	1.437	.615	1	1.250	.125	VLFLF		PS-7929
B	1.437	.615	1	1.250	.406	BCFJF		PS-961
B	1.437	.615	1	1.250	.406	BCFJF		PS-3047
B	1.437	.615	1	1.250	.406	BCFJF		PS-22140
B	1.437	.615	1	1.250	.406	BCFJF	I	PS-4560
B	1.437	.615	1	1.250	.406	BCFKF		PS-964
B	1.437	.615	1	1.250	.406	BMFJF		PS-1000
B	1.437	.615	1	1.250	.406	BMFKF		PS-1152
B	1.437	.615	1	1.250	.406	QCFJF		PS-3202
B	1.437	.615	1	1.250	.406	VCFJF	316SS	PS-2804
B	1.437	.615	1	1.250	.406	VCFJF		PS-3212
B	1.437	.615	1	1.250	.406	VCFJF		PS-1000V-CMS
B	1.437	.615	1	1.250	.406	VCFJF		PS-3865R
B	1.437	.615	1	1.250	.406	VLFLF		PS-3741
B	1.437	.615	1	1.250	.406	VLFLF	316SS	PS-1905
B	1.437	.615	3	1.250	.406	BMFJF		PS-715
B	1.437	.615	3	1.250	.406	BMFKF		PS-712
B	1.437	.615	3	1.250	.406	VCFJF		PS-1000V
B	1.437	.615	1	1.375	.288	BMFJF		PS-151
B	1.437	.615	1	1.375	.406	BMFJF		PS-2161
B	1.437	.615	1	1.375	.406	BMFKF		PS-1005A
B	1.625	.609	8	1.109	.218	BCFKF	A	PS-22178
B	1.637	.753	8	—	.219	BMFJF	A	PS-3845
C	1.046	.808	1	1.187	.343	BCFJF	H/I	PS-2750
C	1.046	.859	—	—	—	VCF-F	316SS/H	FA-4031
C	1.046	.859	25	1.062	.312	VLFLF	H	PS-4310
C	1.046	.859	1	1.187	.296	QLFLF	316SS/H	PS-3707
C	1.046	.859	1	1.187	.296	VCFLF	316SS/H	PS-4031
C	1.046	.859	1	1.187	.296	VLFLF	316SS/H	PS-4226
C	1.046	.859/.734	1	1.187	.296	QCFLF	316SS/H	PS-3201
C	1.046	.859/.734	1	1.187	.296	QCFLF	316SS/H	PS-4222
C	1.062	.609	3	1.187	.281	BCFJF		PS-22029
C	1.062	.609	3	1.187	.281	VCFJF	316SS	PS-22030
C	1.062	.609	1	1.250	.406	BCFJF		PS-6234
C	1.062	.609	1	1.250	.406	BCFKF		PS-1625-CMS
C	1.062	.609	1	1.250	.406	VCFKF		PS-1626-CMS
C	1.062	.609	3	1.250	.406	BCFKF		PS-1625
C	1.062	.609	3	1.250	.406	VCFKF		PS-1626
C	1.062	.619	3	1.250	.406	NCFKF		PS-3133
C	1.062	.687	28	2.500	.375	BCFKF		PS-22159
C	1.062	.715	1	1.187	.343	VCFJF		PS-1091
C	1.062	.718	3	1.187	.281	VCFJF	316SS	PS-4346
C	1.062	.718	1	1.250	.406	BCFJF		PS-2160
C	1.062	.718	1	1.250	.406	BCFJF	I	PS-7524
C	1.062	.718	1	1.250	.406	VCFJF		PS-2160V-CMS
C	1.062	.718	1	1.250	.406	VCFJF	I	PS-7524V
C	1.062	.718	3	1.250	.406	NCFLF	316SS	PS-22097
C	1.062	.718	3	1.250	.406	VCFJF		PS-1045
C	1.062	.718	3 Special	1.500	.406	VCFGF		PS-4313
C	1.062	.750	—	—	—	QCF-F	I	FA-3525
C	1.062	.750	1	1.250	.406	BCFJF		PS-3906
C	1.062	.750	1	1.250	.406	VCFJF		PS-4603
C	1.062	.765	1	1.187	.288	N/BCFJF	B	PS-989
C	1.062	.765	1	1.187	.343	N/BCFJF	B	PS-1016
C	1.062	.765	1	1.250	.406	N/BCFJF	B	PS-810
C	1.062	.765	1	1.250	.406	VCFJF	B	PS-810V-CMS
C	1.062	.812	1	1.250	.406	BCFKF		PS-1156
C	1.062	.812	3	1.250	.406	QCFKF	S	PS-2206

DIMENSIONAL CROSS-REFERENCE

SEAL HEAD			MATING RING			Material Code	NOTES	U.S. Seal Mfg. Part No.
Fig.	OD	Oper Hgt.	Fig.	Bore	Thick			
.625 (5/8") (continued)								
C	1.062	.812	3	1.250	.406	VCFKF		PS-1156V
C	1.062	.812	3	1.250	.406	VCFZF	I	PS-4402
C	1.062	.875	—	—	—	BCF-F		FA-1350
C	1.062	.875	—	—	—	VCF-F		FA-10034
C	1.062	.875	3	1.062	.406	VCFKF		PS-7635
C	1.062	.875	1	1.187	.288	BCFJF		PS-1155
C	1.062	.875	1	1.187	.288	BCFKF		PS-493
C	1.062	.875	1	1.187	.288	VCFJF		PS-1155V
C	1.062	.875	1	1.187	.288	VCFKF		PS-493V
C	1.062	.875	1	1.187	.288	VCFZF		PS-1155V-TC-SEAT
C	1.062	.875	1	1.187	.296	QCFJF		PS-2214
C	1.062	.875	1	1.187	.343	BCFJF		PS-118
C	1.062	.875	1	1.187	.343	BCFKF		PS-1154
C	1.062	.875	1	1.187	.343	BCFLF		PS-3747
C	1.062	.875	1	1.187	.343	VCFJF		PS-118V-CMS
C	1.062	.875	1	1.187	.343	VCFJF	I	PS-118V-CMS-P66
C	1.062	.875	3	1.187	.343	BCFJF		PS-536
C	1.062	.875	3	1.187	.343	VCFJF		PS-118V
C	1.062	.875	3	1.250	.250	QCFJF		PS-4320
C	1.062	.875	3	1.250	.250	QCFKF		PS-3319
C	1.062	.875	3	1.250	.312	VCFKF		PS-4442
C	1.062	.875	3	1.250	.375	QCFKF	I	PS-3525
C	1.062	.875	1	1.250	.406	BCFJF		PS-359
C	1.062	.875	1	1.250	.406	BCFJF	316SS	PS-4272
C	1.062	.875	1	1.250	.406	BCFJF	I	PS-359-P66
C	1.062	.875	1	1.250	.406	BCFJF	I/N	PS-290-P66
C	1.062	.875	1	1.250	.406	BCFJF	N	PS-290
C	1.062	.875	1	1.250	.406	BCFKF		PS-633
C	1.062	.875	1	1.250	.406	BLFLF		PS-552-SC-SC
C	1.062	.875	1	1.250	.406	BLFLF		PS-4495
C	1.062	.875	1	1.250	.406	BZFZF		PS-633-TC-TC
C	1.062	.875	1	1.250	.406	NCFJF		PS-1079
C	1.062	.875	1	1.250	.406	NCFKF		PS-1080
C	1.062	.875	1	1.250	.406	QCFJF		PS-359-EPR-CMS
C	1.062	.875	1	1.250	.406	QCFJF	I	PS-359-EPR-P66
C	1.062	.875	1	1.250	.406	QCFJF	N	PS-290-EPR
C	1.062	.875	1	1.250	.406	QCFJF	316SS	PS-22010
C	1.062	.875	1	1.250	.406	QCFKF		PS-633-EPR-CMS
C	1.062	.875	1	1.250	.406	QCFZF	I	PS-359-EPR-P66-TC
C	1.062	.875	1	1.250	.406	QLFLF		PS-3265
C	1.062	.875	1	1.250	.406	QLFLF	N	PS-290-EPR-SC-SC
C	1.062	.875	1	1.250	.406	VCFJF		PS-359V-CMS
C	1.062	.875	1	1.250	.406	VCFJF	316SS	PS-4272V
C	1.062	.875	1	1.250	.406	VCFJF	I	PS-359V-CMS-P66
C	1.062	.875	1	1.250	.406	VCFJF	I/N	PS-290V-P66
C	1.062	.875	1	1.250	.406	VCFJF	N	PS-290V
C	1.062	.875	1	1.250	.406	VCFKF		PS-633V-CMS
C	1.062	.875	1	1.250	.406	VCFLF		PS-359V-SC-CMS
C	1.062	.875	1	1.250	.406	VLFLF		PS-7547
C	1.062	.875	1	1.250	.406	VLFLF	316SS	PS-3092
C	1.062	.875	1	1.250	.406	VRFJF		PS-7524V-P90
C	1.062	.875	1	1.250	.406	VRFRF		PS-3550
C	1.062	.875	1	1.250	.406	VZFLF		PS-633V-TC-SC
C	1.062	.875	1	1.250	.406	VZFZF		PS-6216
C	1.062	.875	3	1.250	.406	BCFJF		PS-3914
C	1.062	.875	3	1.250	.406	BCFKF		PS-732
C	1.062	.875	3	1.250	.406	B/VCFJF		PS-552
C	1.062	.875	3	1.250	.406	NCFLF	316SS/I	PS-22014
C	1.062	.875	3	1.250	.406	QCFJF		PS-552-EPR
C	1.062	.875	3	1.250	.406	QCFJF	I	PS-552-EPR-P66
C	1.062	.875	3	1.250	.406	QCFKF		PS-732-EPR
C	1.062	.875	3	1.250	.406	QCFKF	I	PS-3147
C	1.062	.875	3	1.250	.406	QCFLF	I	PS-4358
C	1.062	.875	3	1.250	.406	Special	I	PS-2743
C	1.062	.875	3	1.250	.406	VCFJF		PS-359V

NOTE: I. ABRASION RESISTANT CARBON (P66)
N. NON-STANDARD SPRING HOLDER

DIMENSIONAL CROSS-REFERENCE

SEAL HEAD			MATING RING			Material Code	NOTES	U.S. Seal Mfg. Part No.
Fig.	OD	Oper Hgt.	Fig.	Bore	Thick			
.625 (5/8") (continued)								
C	1.062	.875	3	1.250	.406	VCFJF	I	PS-359V-P66
C	1.062	.875	3	1.250	.406	VCFKF		PS-633V
C	1.062	.875	3	1.250	.406	VCFKF	I	PS-633V-P66
C	1.062	.875	3	1.250	.406	VCFZF		PS-633V-TC-SEAT
C	1.062	.875	1	1.375	.406	BCFJF		PS-3791
C	1.062	.875	3	1.375	.406	VCFKF		PS-951
C	1.062	.875	3	1.437	.312	QCFJF	I	PS-3723
C	1.062	.875	3	1.437	.312	QCFKF	I	PS-3981
C	1.062	.875	3	1.437	.312	VCFKF	I	PS-7872
C	1.062	.968/1.093	1	1.250	.406	BCFJF		PS-1119
C	1.062	.968/1.093	1	1.250	.406	VCFJF		PS-1119V
C	1.062	1.187	1	1.156	.312	BMFJF	H	PS-800
C	1.062	1.187	1	1.156	.312	V/BMFJF	H	PS-800V
C	1.062	1.216	1	1.250	.406	VCFJF		PS-22034
C	1.093	.718	1	1.250	.406	QCFKF	I	PS-7689
C	1.093	.718	1	1.250	.406	QCFKF	I/N	PS-4356
C	1.093	.718	1	1.250	.406	VCFKF	I	PS-3121
C	1.187	.875	1	1.375	.406	VCFJF	316SS	PS-626
C	1.187	.875	1	1.375	.406	VCFJF	316SS	PS-4458
C	1.312	.937	1	1.250	.406	BCFJF	B	PS-1618
C	1.312	.937	1	1.250	.406	BCFJF	B	PS-1085
C	1.312	.937	1	1.250	.406	B/VCFJF	B	PS-1085V
C	1.312	.937	3	1.250	.406	BCFKF	B	PS-2149
C	1.312	.937	3	1.250	.406	NCFKF	B	PS-22204
D	1.375	.875	—	—	—	BCD-F		FA-135
D	1.375	.875	1	1.187	.288	BCDJF		PS-531
D	1.375	.875	1	1.187	.288	BCDKF		PS-226
D	1.375	.875	1	1.187	.343	BCDKF		PS-263
D	1.375	.875	1	1.187	.343	BCFJF		PS-2004
D	1.375	.875	1	1.187	.343	VCFKF		PS-263V
D	1.375	.875	3	1.187	.343	BCDJF		PS-737
D	1.375	.875	1	1.250	.406	BCDJF		PS-508
D	1.375	.875	1	1.250	.406	BCDKF		PS-102
D	1.375	.875	1	1.250	.406	BCFJF		PS-2000
D	1.375	.875	1	1.250	.406	QCDJF		PS-508-EPR
D	1.375	.875	1	1.250	.406	VCDJF		PS-508V-CMS
D	1.375	.875	1	1.250	.406	VCDJF	I	PS-508V-P66-CMS
D	1.375	.875	1	1.250	.406	VCFJF		PS-2000V-CMS
D	1.375	.875	3	1.250	.406	BCDJF		PS-735
D	1.375	.875	3	1.250	.406	BCDKF		PS-734
D	1.375	.875	3	1.250	.406	BCDLF		PS-3677
D	1.375	.875	3	1.250	.406	NCFLF		PS-3132
D	1.375	.875	3	1.250	.406	QCRLF	I	PS-735-EPR-P66-SCO
D	1.375	.875	3	1.250	.406	VCDJF		PS-508V
D	1.375	.875	3	1.250	.406	VCFZF		PS-4375
D	1.375	.875	3	1.250	.406	VCFZF	316SS	PS-2701
E	1.093	1.312	1	1.187	.343	BCFJF		PS-2020
E	1.093	1.312	1	1.187	.288	BCFKF		PS-2660
E	1.093	1.312	3	1.187	.343	BCFJF		PS-2022
E	1.093	1.312	2	1.250	.343	BCDKF		PS-1158
E	1.093	1.312	1	1.250	.406	BCDKF		PS-487
E	1.093	1.312	1	1.250	.406	BCFJF		PS-2016
E	1.093	1.312	1	1.250	.406	BCFKF		PS-2017
E	1.093	1.312	3	1.250	.406	BCFJF		PS-3148
G	1.024	.718	1	—	—	VLFLF	316SS/G	PS-1906
G	1.024	.718	1	1.187	.296	QLFLF	316SS	PS-6267
G	1.024	.718	1	1.187	.296	VLFLF	316SS	PS-1912
G	1.024	.718	1	1.187	.343	BCFJF		PS-4267
G	1.024	.718	1	1.187	.343	VCFJF		PS-3866
G	1.024	.718	1	1.187	.343	VLFLF	316SS	PS-1900
G	1.024	.718	1	1.250	.406	BCFJF		PS-3960
G	1.024	.718	1	1.250	.406	BCFJF	316SS	PS-3006
G	1.024	.718	1	1.250	.406	BLFLF		PS-3910
G	1.024	.718	1	1.250	.406	BLFLF	316SS	PS-3199
G	1.024	.718	1	1.250	.406	QCFJF	316SS	PS-3586

DIMENSIONAL CROSS-REFERENCE

SEAL HEAD			MATING RING			Material Code	NOTES	U.S. Seal Mfg. Part No.
Fig.	OD	Oper Hgt.	Fig.	Bore	Thick			
.625 (5/8") (continued)								
G	1.024	.718	1	1.250	.406	QCFJF	316SS	PS-22098
G	1.024	.718	1	1.250	.406	QLFLF		PS-2715
G	1.024	.718	1	1.250	.406	QLFLF	316SS	PS-22096
G	1.024	.718	1	1.250	.406	VCFJF		PS-3867
G	1.024	.718	1	1.250	.406	VCFJF	316SS	PS-3200
G	1.024	.718	1	1.250	.406	VLFLF		PS-4155
G	1.024	.718	1	1.250	.406	VLFLF	316SS	PS-4390
G	1.024	.718	1	1.250	.406	VLFLF	316SS	PS-1901
G	1.024	.718	3	1.250	.406	VCFLF		PS-4059
G	1.024	.718	25	1.250	.406	VLFLF	316SS	PS-3005
G	1.024	.718	1	1.381	.406	BCFJF		PS-3890
G	1.024	.718	1	1.381	.406	QCFJF		PS-4577
G	1.024	.718	1	1.381	.406	QLFLF	316SS	PS-2808
G	1.024	.718	1	1.381	.406	VCFJF		PS-4280
G	1.024	.718	1	1.381	.406	VLFLF	316SS	PS-1907
G	1.024	.718	31	—	—	BCFJF	G	PS-4275
G	1.024	.718	31	—	—	VCFJF	G	PS-3869
G	1.024	.875	1	1.250	.406	BCFJF		PS-3204
G	1.024	.875	1	1.250	.406	VCFJF		PS-4220
G	1.024	.875	3	1.250	.406	VCFKF	316SS/S	PS-22160
G	1.062	.875	1	1.250	.406	QCFLF		PS-2770
G	Special	.718	1	1.375/1.381	.406	VCFJF		PS-4231
K	1.047	1.030	1	1.250	.175	VCFJF	Wave Spring	PS-3885
K	1.062	1.187	3	1.25	.406	VCFJF		PS-22169
Q	1.312	.625	8	1.062	.218	VCFJF		PS-4237
S	1.312	1.395	8	1.187	.125	NAPSP		PS-795
W	1.187	.750	2	1.250	.383	TCFJF	316SS	PS-22095
W	1.187	.750	2	1.250	.406	TLFLF	316SS	PS-9155
W	1.187	.750	2	1.250	.531	TCFKF		PS-9321
W	1.187	.750	27	1.437	.593	HLFLF	316SS	PS-9722
W	1.187	.750	27	1.718	.812	TCFJF	316SS	PS-22046
W Dbl.	1.187	1.500	3	1.250	.406	TCFJF	316SS	PS-9714
WA	1.437	.727	3 Special	1.312	.375	T/YCFKF		PS-9354
WA	1.441	.622	Special	1.203	.484	TCFJF	316SS	PS-7250
W Special	1.437	.622	2	1.250	.390	TCFJF	316SS	PS-3962
WT	1.082	.937	Special	1.490	.625	TCFOF	316SS	PS-9322
X	1.188	.750	1	1.250	.406	VCFJF	316SS	PS-8137
X	1.188	.750	3	1.250	.406	VCFLF	316SS	PS-22013
Special	1.251	.718	1	1.250	.406	QC-J		PS-5625
Special	1.440	.760	Special	1.110	Special	BMFJF	Unitized	PS-4065
.687 (11/16")								
Q	1.593	.468	9	1.250	.156	Special	A	PS-6308
.750 (3/4")								
A	1.343	.700	1	1.375	.406	BMFJF		PS-4489
A	1.343	.718	—	—	—	BCF-F		FA-64
A	1.343	.718	—	—	—	BMF-F		FA-201
A	1.343	.718	1	1.375	.281	BCFJF		PS-764
A	1.343	.718	1	1.375	.281	BMFJF		PS-301
A	1.343	.718	1	1.375	.406	BCFJF		PS-851
A	1.343	.718	1	1.375	.406	BCFJF		PS-3061
A	1.343	.718	1	1.375	.406	BCFKF		PS-973
A	1.343	.718	1	1.375	.406	BMFJF		PS-201
A	1.343	.718	1	1.375	.406	BMFKF		PS-921
A	1.343	.718	1	1.375	.406	QCFJF		PS-851-EPR
A	1.343	.718	1	1.375	.406	VCFJF		PS-201V-CMS
A	1.343	.718	1	1.375	.406	VLFLF		PS-1908
A	1.343	.718	3	1.375	.406	BMFJF		PS-760
A	1.343	.718	3	1.375	.406	BMFKF		PS-762
A	1.343	.718	3	1.375	.406	VCFJF		PS-201V
A	1.343	.718	3 Special	1.375	.406	Special		PS-2744
A	1.343	.718	1	1.375/1.750	.406	BCFJF		PS-2136
A	1.343	.718	1	1.437	.406	BCFJF		PS-968
A	1.343	.718	1	1.437	.406	BMFJF		PS-101
A	1.343	.718	1	1.437	.406	VCFJF		PS-101V

NOTE: A. MOUNTS ON SHAFT
G. MOUNTS IN PLASTIC
S. SLOTTED MATING RING

DIMENSIONAL CROSS-REFERENCE

SEAL HEAD			MATING RING			Material Code	NOTES	U.S. Seal Mfg. Part No.
Fig.	OD	Oper Hgt.	Fig.	Bore	Thick			
.750 (3/4") (continued)								
A	1.343	.718	1	1.500	.250	BMFJF		PS-1525
B	1.518	.610	—	—	—	QCF-F	316SS	FA-2751
B	1.575	.615	—	—	—	BMF-F		FA-647
B	1.575	.615	9	—	.312	BMFJF	A	PS-1622
B	1.575	.615	9	—	.312	BMFKF	A	PS-902
B	1.575	.615	9	—	.312	VMFJF	A	PS-1622V
B	1.575	.615	9	—	.375	BMFKF	A	PS-441
B	1.575	.615	11	—	.437	BMFJF	A	PS-440
B	1.575	.615	8	1.187	.218	BCFJF	316SS	PS-2745
B	1.575	.615	8	1.187	.218	BCFLF	316SS/A	PS-22033
B	1.575	.615	9	1.312	.312	BLFLF	A	PS-4048
B	1.575	.615	Special	1.312	.312	B/NMDGF		PS-7964
B	1.575	.615	1	1.375	.203	VCFJF		PS-22099
B	1.575	.615	1	1.375	.406	BCFJF	316SS	PS-3985
B	1.575	.615	1	1.375	.406	BMFJF		PS-601
B	1.575	.615	1	1.375	.406	BMFKF		PS-606
B	1.575	.615	1	1.375	.406	QCFJF		PS-4056
B	1.575	.615	1	1.375	.406	VCFJF		PS-3986
B	1.575	.615	1	1.375	.406	VCFJF		PS-601V-CMS
B	1.575	.615	1	1.375	.406	VCFJF		PS-3882
B	1.575	.615	1	1.375	.406	VCFJF	316SS	PS-4106
B	1.575	.615	1	1.375	.406	VLFLF	316SS	PS-1904
B	1.575	.615	3	1.375	.406	BMDKF		PS-766
B	1.575	.615	3	1.375	.406	BMFJF		PS-765
B	1.575	.615	3	1.375	.406	VCFJF		PS-601V
B	1.575	.615	3	1.375	.406	VCFJF		PS-4520
B	1.575	.615	3	1.375	.406	VCFJF	316SS	PS-2735
B	1.575	.615	3	1.375	.406	VLFLF	316SS	PS-3104
B	1.575	.615	11	1.375	.406	BMFJF		PS-7618
B	1.718	.600	8	1.250	.352	BMFJF	A	PS-2718
C	1.171	.875	1	1.375	.406	BCFJF	H/I	PS-2800
C	1.171	.875	1	1.375	.406	BZFZE	H	PS-3313
C	1.171	.875	1	1.375	.406	QCFZF	H/I	PS-4531
C	1.171	.875	1	1.375	.406	VCFJF	I	PS-7843
C	1.171	.875	1	1.375	.406	VLFLF	H	PS-3156
C	1.171	.920	1	1.375	.406	VCFJF	B	PS-2746
C	1.187	.718	1	1.375	.281	BCFJF		PS-944
C	1.187	.718	1	1.375	.281	QCFJF		PS-944-EPR
C	1.187	.718	1	1.375	.281	VCFJF		PS-944V
C	1.187	.718	1	1.375	.312	BCFJF		PS-22199
C	1.187	.718	1	1.375	.312	VCFJF		PS-22200
C	1.187	.718	1	1.375	.406	BCFJF		PS-877
C	1.187	.718	1	1.375	.406	BCFJF		PS-1125
C	1.187	.718	1	1.375	.406	BCFJF	H	PS-2747
C	1.187	.718	1	1.375	.406	BCFJF	I	PS-1125-P66
C	1.187	.718	1	1.375	.406	BCFKF		PS-1113
C	1.187	.718	1	1.375	.406	BCFKF		PS-3654
C	1.187	.718	1	1.375	.406	BCFKF		PS-1160
C	1.187	.718	1	1.375	.406	BLFLF		PS-1125-SC-SC
C	1.187	.718	1	1.375	.406	QCFJF		PS-1125-EPR
C	1.187	.718	1	1.375	.406	QCFLF		PS-3894
C	1.187	.718	1	1.375	.406	QLFLF		PS-3194
C	1.187	.718	1	1.375	.406	VCFJF		PS-877V
C	1.187	.718	1	1.375	.406	VCFJF		PS-1093
C	1.187	.718	1	1.375	.406	VCFKF		PS-1092
C	1.187	.718	1	1.375	.406	VZFFZ		PS-1092-TC-TC
C	1.187	.718	3	1.375	.406	BCFJF		PS-2236
C	1.187	.718	3	1.375	.406	QCFJF		PS-4229
C	1.187	.718	3	1.375	.406	QCFKF		PS-4283
C	1.187	.718	3	1.375	.406	QLFLF		PS-3068
C	1.187	.718	3	1.375	.406	VCFJF		PS-2235
C	1.187	.718	3	1.375	.406	VCFKF		PS-4285
C	1.187	.718	3	1.375	.406	VLFLF		PS-3074
C	1.187	.718	3	1.375	.406	VLFZF		PS-2235-SC-TC
C	1.187	.718	1	1.437	.406	BCFJF	N	PS-7514

DIMENSIONAL CROSS-REFERENCE

SEAL HEAD			MATING RING			Material Code	NOTES	U.S. Seal Mfg. Part No.
Fig.	OD	Oper Hgt.	Fig.	Bore	Thick			
.750 (3/4") (continued)								
C	1.187	.843	1	1.375	.406	BCFJF		PS-3149
C	1.187	.843	1	1.375	.406	BCFJF	B	PS-128
C	1.187	.843	3	1.375	.406	VCFJF	B	PS-128V
C	1.187	.857	3	1.187	.406	BCFJF	H	PS-4323
C	1.187	.875	—	—	—	BCF-F		FA-1520
C	1.187	.875	1	1.275	.281	BCFJF		PS-3840
C	1.187	.875	5	1.275	.302	Special		PS-3559
C	1.187	.875	1	1.375	.281	BCFJF		PS-1510
C	1.187	.875	1	1.375	.281	VCFJF		PS-1510V
C	1.187	.875	1	1.375	.312	QCFJF		PS-3415
C	1.187	.875	1	1.375	.406	BCFJF		PS-358
C	1.187	.875	1	1.375	.406	BCFJF	I	PS-358-P66
C	1.187	.875	1	1.375	.406	BCFKF		PS-112
C	1.187	.875	1	1.375	.406	BCFKF	I	PS-4330
C	1.187	.875	1	1.375	.406	BLFLF		PS-3110
C	1.187	.875	1	1.375	.406	QCFJF		PS-358-EPR
C	1.187	.875	1	1.375	.406	QCFKF		PS-112-EPR
C	1.187	.875	1	1.375	.406	QLFLF		PS-358-EPR-SC-SC
C	1.187	.875	1	1.375	.406	QZFLF		PS-3162
C	1.187	.875	1	1.375	.406	VCFJF		PS-358V-CMS
C	1.187	.875	1	1.375	.406	VCFJF		PS-3208
C	1.187	.875	1	1.375	.406	VCFJF	316SS	PS-3191
C	1.187	.875	1	1.375	.406	VCFJF	I	PS-358V-CMS-P66
C	1.187	.875	1	1.375	.406	VCFKF		PS-112V-CMS
C	1.187	.875	1	1.375	.406	VCFKF	I	PS-2229V-P66
C	1.187	.875	1	1.375	.406	VCFZF		PS-358V-TC-CMS
C	1.187	.875	1	1.375	.406	VCFZF	I	PS-22057
C	1.187	.875	1	1.375	.406	VFLFLF		PS-358V-SC-SC
C	1.187	.875	1	1.375	.406	VFLFLF	316SS	PS-7305
C	1.187	.875	1	1.375	.406	VZFZF		PS-358V-TC-TC
C	1.187	.875	3	1.375	.406	BCFJF		PS-3916
C	1.187	.875	3	1.375	.406	BCFKF		PS-768
C	1.187	.875	3	1.375	.406	B/VCFJF		PS-767
C	1.187	.875	3	1.375	.406	NCFKF		PS-4121
C	1.187	.875	3	1.375	.406	QCFJF		PS-767-EPR
C	1.187	.875	3	1.375	.406	VCFJF		PS-358V
C	1.187	.875	3	1.375	.406	VCFJF	I	PS-358V-P66
C	1.187	.875	3	1.375	.406	VCFJF	316SS	PS-4465
C	1.187	.875	3	1.375	.406	VCFKF		PS-112V
C	1.187	.875	3	1.375	.406	VFLFLF		PS-5728
C	1.187	.875	5	1.383	.406	QCFZF	316SS	PS-22182
C	1.187	.875	1	1.437	.406	BCFJF		PS-7277
C	1.187	.875	1	1.500	.250	BCFJF		PS-683
C	1.187	.920	1	1.375	.406	BCFJF	B	PS-1754
C	1.187	1.153	1	1.375	.406	BLFLF		PS-3922
C	1.187	1.312	—	—	—	BCF-F		FA-564
C	1.187	1.312	1	1.375	.406	BCFJF		PS-275
C	1.187	1.312	1	1.375	.406	BCFKF		PS-373
C	1.187	1.312	1	1.375	.406	QCFJF		PS-275-EPR
C	1.187	1.312	1	1.375	.406	VCFKF		PS-373V
C	1.187	1.312	3	1.375	.406	BCFJF		PS-771
C	1.187	1.312	3	1.375	.406	BCFKF		PS-773
C	1.187	1.312	3	1.375	.406	VCFJF		PS-275V
C	1.218	.875	1	1.375	.406	VCFJF	316SS	PS-22228
C	1.445	.920	1	1.375	.406	NCFJF	B	PS-22009
D	1.500	.687	3	1.375	.250	BCPKF		PS-7087
D	1.500	.687	3	1.375	.250	NCPKF		PS-7613
D	1.500	.687	3	1.375	.250	VCPKF		PS-7613V
D	1.500	.845	3	1.375	.406	BCDLF		PS-6006
D	1.500	.875	—	—	—	BCD-F		FA-152
D	1.500	.875	1	1.275	.281	BCDJF		PS-437
D	1.500	.875	1	1.275	.281	BCDJF	I	PS-437-P66
D	1.500	.875	1	1.275	.281	QCDJF		PS-4098
D	1.500	.875	1	1.275	.281	VCDJF		PS-437V
D	1.500	.875	1	1.275	.281	VCDJF	I	PS-437V-P66

NOTE: B. TAPERED SPRING
H. SPRING HOLDER NOT INCLUDED
I. ABRASION RESISTANT CARBON (P66)

DIMENSIONAL CROSS-REFERENCE

SEAL HEAD			MATING RING			Material Code	NOTES	U.S. Seal Mfg. Part No.
Fig.	OD	Oper Hgt.	Fig.	Bore	Thick			
.750 (3/4") (continued)								
D	1.500	.875	1	1.275	.281	VLDLF		PS-437V-SC-SC
D	1.500	.875	1	1.375	.281	BCDJF		PS-1162
D	1.500	.875	1	1.375	.406	BCDJF		PS-750
D	1.500	.875	1	1.375	.406	BCDKF		PS-752
D	1.500	.875	1	1.375	.406	BCFJF		PS-2008
D	1.500	.875	1	1.375	.406	BCFKF		PS-2009
D	1.500	.875	1	1.375	.406	QCDJF		PS-750-EPR
D	1.500	.875	1	1.375	.406	VCDJF		PS-750V-CMS
D	1.500	.875	1	1.375	.406	VCDJF	I	PS-750V-CMS-P66
D	1.500	.875	1	1.375	.406	VCDKF		PS-752V-CMS
D	1.500	.875	1	1.375	.406	VCFLF	316SS	PS-22003
D	1.500	.875	3	1.375	.250	VCPLF		PS-22118
D	1.500	.875	3	1.375	.406	BCDKF		PS-265
D	1.500	.875	3	1.375	.406	BCFJF		PS-2010
D	1.500	.875	3	1.375	.406	VCDJF		PS-750V
D	1.500	.875	3	1.375	.406	VCDKF		PS-752V
D	1.500	.875	3	1.375	.406	VCFJF	316SS	PS-3299
D	1.500	.875	3	1.375	.406	VLFLF		PS-3855
D	1.500	.875	3	1.375	.406	XLFLM		PS-22108
D	1.500	.875	1	1.437	.406	BCDJF		PS-1161
D	1.500	.906	3	1.375	.406	BCPLF		PS-22116
D	1.500	1.000	1	1.437	.406	BCDKF		PS-1026
DB	1.500	1.187	3	1.250	.406	QCFZF	316SS	PS-3306
E	1.218	1.250	3	1.187	.406	VCFKF		PS-7994
E	1.218	1.250	1	1.375	.406	BCFJF		PS-4518
E	1.218	1.250	1	1.375	.406	QCFKF		PS-4484
E	1.218	1.250	3	1.375	.406	V/BCFJF		PS-2014
E	1.218	1.250	3	1.375	.406	BCFKF		PS-2015
E	1.218	1.250	3	1.375	.406	VCPLF		PS-22117
E	1.218	1.375	3	1.187	.406	QCFKF		PS-4093
E	1.218	1.375	3	1.187	.406	VCPKP		PS-7960
G	1.024	.718	1	1.375	.406	BLFLF		PS-3740
G	1.035	.718	1	1.375	.406	BCFJF		PS-4265
G	1.035	.718	3	1.375	.406	BCFJF		PS-2820
G	1.240	.718	2	1.375	.406	VLFLF	316SS	PS-22100
G	1.260	.718	1	1.375	.406	QCFJF		PS-2733
G	1.260	.718	1	1.375	.406	VCFJF		PS-3868
G	1.260	.718	1	1.375	.406	VLFLF		PS-3056
G	1.260	.718	1	1.375	.406	VLFLF	316SS	PS-1902
G	1.260	.718	1	1.375/1.750	.406	VCFJF		PS-3870
G	1.260	.718	3	1.375	.406	VCFJF		PS-3107
G	1.260	.718	25	1.375	.406	VLFLF		PS-3105
G	1.260	.718	32	1.375/1.750	—	BCFJF	G	PS-4274
G	1.260	.812	1	1.375	.406	BCFJF		PS-4020
G	1.260	.875	1	1.275	.281	QLFLF		PS-4024
G	1.260	.875	1	1.375	.406	BLFLF		PS-3937
G	1.260	.875	1	1.375	.406	VCFJF	316SS	PS-22039
G	1.260	.875	3	1.375	.406	VCFJF		PS-3788
K	1.187	1.187	1	1.375	.406	BCFJF		PS-1604
K	1.187	1.187	1	1.375/1.500	.281/.250	BCFJF		PS-175
K	1.187	1.187	3	1.375	.406	VCFJF		PS-3214
K	1.195	1.187	3	1.375	.406	VCFLF		PS-22170
S	1.625	1.953	8	1.500	.250	NAPSP		PS-792
Special	1.575	.437	Special	1.334	Special	BLFLF	Unitized	PS-4066
T	1.158	1.438	3	1.375	.406	VLFLF		PS-4144
W	1.312	.875	2	1.375	.375	TCFKF	316SS	PS-3935
W	1.312	.875	2	1.375	.375	TCFKF	316SS	PS-9324
W	1.312	.875	2	1.375	.406	TCFJF	316SS	PS-9339
W Special	1.500	.875	2	1.375	.312	TCFOF	316SS	PS-9325
W Special	1.500	.875	2	1.375	.343	TCFKF	316SS	PS-9323
W Special	1.576	.687	2	1.375	.406	TCFJF	316SS	PS-9711
X	1.312	.875	3	1.375	.406	BLFLF	316SS	PS-8064
X	1.312	.875	5	1.383	.406	QCFZF	316SS	PS-8036

DIMENSIONAL CROSS-REFERENCE

SEAL HEAD			MATING RING			Material Code	NOTES	U.S. Seal Mfg. Part No.
Fig.	OD	Oper Hgt.	Fig.	Bore	Thick			
.750 (3/4") (continued)								
X	1.312	.875	5	1.625	.406	T/QCFZF	316SS/I	PS-8123
XB2	1.500	1.000	3	1.375	.406	VCFJF	316SS	PS-8714
X Special	1.312	.875	5	1.375	.406	QCFZF	316SS	PS-8101
.787 (20MM)								
B	40MM	16.05MM	1 Special	33.88MM	9.45MM	BLFLF	Unitized	PS-2723
B	40MM	16.12MM	8	32.82MM	8.31MM	BLFLF		PS-2801
G	34MM	31.50MM	1	35MM	6MM	BCFJF		PS-22103
G	34MM	31.50MM	1	35MM	6MM	VCFJF	316SS	PS-4273
C	1.375	.781	1	1.500	.406	BCFJF		PS-4042
D	1.562	.937	1	1.500	.406	BCDJF		PS-135
D	1.562	.937	1	1.500	.406	BCDKF	H/I	PS-614
D	1.562	.937	1	1.500	.406	BCFJF	I	PS-22056
D	1.562	.937	1	1.500	.406	BCFKF	I	PS-3135
D	1.562	.937	1	1.500	.406	VCFJF	I	PS-22055
D	1.562	.937	3	1.500	.406	VCDKF	H	PS-614V
G	34MM	.937	3	1.500	.406	VCDKF	H	PS-614V
.875 (7/8")								
C	1.312	.718	3	1.437	.265	QCFLF	I	PS-3678
C	1.312	.718	3	1.437	.265	VCFKF	I	PS-4017
C	1.312	.718	1	1.500	.218	BCFJF		PS-7496
C	1.312	.718	1	1.500	.406	BCFKF		PS-3944
C	1.312	.812	1	1.437	.265	BCFJF		PS-2167
C	1.312	.812	1	1.437	.265	QCFJF	I	PS-2167-EPR-P66
C	1.312	.812	1	1.437	.265	QCFJF	I	PS-3826
C	1.312	.812	1	1.437	.265	VCFJF		PS-2167V
C	1.312	.812	3	1.437	.265	BCFKF		PS-2169
C	1.312	.812	3	1.437	.265	QCFKF	I	PS-2224
C	1.312	.812	3	1.437	.265	VCFKF		PS-2169V
C	1.312	.812	1	1.500	.218	BCFJF		PS-3749
C	1.312	.812	1	1.500	.218	BLFLF		PS-3749-SC-SC
C	1.312	.812	1	1.500	.406	BCFJF		PS-7130
C	1.312	.843	1	1.500	.406	BCFZF		PS-3970
C	1.312	.875	1	1.500	.406	BCFJF		PS-3907
C	1.312	.875	1	1.500	.406	BLFLF		PS-3911
C	1.312	.875	3 Special	1.500	.468	VCFGF		PS-3893
C	1.312	.919	1	1.500	.406	VCFLF	316SS	PS-3996
C	1.312	.937	—	—	—	BCF-F		FA-1600
C	1.312	.937	—	—	—	VCF-F		FA-208V
C	1.312	.937	—	—	—	VCF-F	I	FA-10036
C	1.312	.937	1	1.437	.265	BCFJF		PS-2166
C	1.312	.937	1	1.437	.265	QCFJF		PS-2166-EPR
C	1.312	.937	1	1.437	.265	VCFJF		PS-2166V
C	1.312	.937	3	1.437	.265	BCFKF		PS-2168
C	1.312	.937	3	1.437	.265	QCFKF		PS-2168-EPR
C	1.312	.937	3	1.437	.265	VCFKF		PS-2168V
C	1.312	.937	1	1.500	.406	BCELE		PS-4395
C	1.312	.937	1	1.500	.406	BCFJF		PS-309
C	1.312	.937	1	1.500	.406	BCFJF	I	PS-309-P66
C	1.312	.937	1	1.500	.406	BCFKF		PS-687
C	1.312	.937	1	1.500	.406	BLFLF		PS-309-SC-SC-CMS
C	1.312	.937	1	1.500	.406	BZFZF		PS-309-TC-TC-CMS
C	1.312	.937	1	1.500	.406	QCFJF		PS-309-EPR
C	1.312	.937	1	1.500	.406	VCFJF		PS-309V-CMS
C	1.312	.937	1	1.500	.406	VCFJF	I	PS-309V-P66-CMS
C	1.312	.937	1	1.500	.406	VCFKF		PS-687V-CMS
C	1.312	.937	1	1.500	.406	VCFZF		PS-309V-TC-CMS
C	1.312	.937	1	1.500	.406	VLFLF		PS-3941
C	1.312	.937	3	1.500	.406	BCFV/JF		PS-774
C	1.312	.937	3	1.500	.406	BCFKF		PS-617
C	1.312	.937	3	1.500	.406	BLFLF		PS-3176
C	1.312	.937	3	1.500	.406	QCFJF		PS-22042
C	1.312	.937	3	1.500	.406	VCFJF		PS-309V
C	1.312	.937	3	1.500	.406	VCFJF	I	PS-309V-P66
C	1.312	.937	3	1.500	.406	VCFJF	316SS	PS-2702

NOTE: H. SPRING HOLDER NOT INCLUDED
I. ABRASION RESISTANT CARBON (P66)

DIMENSIONAL CROSS-REFERENCE

SEAL HEAD			MATING RING			Material Code	NOTES	U.S. Seal Mfg. Part No.
Fig.	OD	Oper Hgt.	Fig.	Bore	Thick			
.875 (7/8") (continued)								
C	1.312	.937	3	1.500	.406	VCFKF		PS-687V
C	1.312	.937	3	1.500	.406	VCFZF		PS-4513
C	1.312	.937	3	1.500	.406	VLFLF		PS-309V-SC-SC
C	1.312	.937	1	1.562	.406	BCFJF		PS-1163
C	1.312	.937	1	1.562	.406	BCFKF		PS-294
C	1.406	.937	3	1.500	.406	VCFJF	N	PS-3733
D	1.615	.905	3	1.500	.406	BCDLF	H/S	PS-22138
D	1.625	.937	—	—	—	BCD-F		FA-160
D	1.625	.937	1	1.437	.265	BCDJF		PS-790
D	1.625	.937	1	1.437	.265	VCDJF		PS-790V
D	1.625	.937	3	1.437	.265	BCDKF		PS-1681
D	1.625	.937	3	1.437	.265	VCDKF		PS-1681V
D	1.625	.937	1	1.500	.406	BCDJF		PS-703
D	1.625	.937	1	1.500	.406	BCDJF	I	PS-703-P66
D	1.625	.937	1	1.500	.406	BCDKF		PS-303
D	1.625	.937	1	1.500	.406	BCDKF	I	PS-303-P66
D	1.625	.937	1	1.500	.406	BCFJF		PS-2024
D	1.625	.937	1	1.500	.406	NCFLF		PS-4318
D	1.625	.937	1	1.500	.406	VCDJF		PS-703V-CMS
D	1.625	.937	1	1.500	.406	VCDKF		PS-303V-CMS
D	1.625	.937	1	1.500	.406	VLFLF		PS-703VSS-SC-SC-CM
D	1.625	.937	3	1.500	.406	BCDJF		PS-775
D	1.625	.937	3	1.500	.406	BCDKF		PS-250
D	1.625	.937	3	1.500	.406	BCDZF	I	PS-4307
D	1.625	.937	3	1.500	.406	BCFKF		PS-2027
D	1.625	.937	3	1.500	.406	B/VCFJF		PS-2026
D	1.625	.937	3	1.500	.406	VCDJF		PS-703V
D	1.625	.937	3	1.500	.406	VCDKF		PS-303V
D	1.625	.937	3	1.500	.406	VCFJF		PS-22031
D	1.625	.937	3	1.500	.406	VCFKF		PS-2027V
D	1.625	.937	3	1.500	.406	VCFLF	316SS	PS-3116
D	1.625	.937	3	1.500	.406	VCFZF		PS-303V-TC-SEAT
D	1.625	.937	3	1.500	.406	XLFLF		PS-3316
D	1.625	.937	1	1.562	.406	BCDJF		PS-602
D	1.625	.937	1	1.562	.406	BCDKF		PS-603
D Special	1.625	.906	3	1.500	.406	BLFLE		PS-22109
D Special	1.625	.906	3	1.500	.406	XLFLF		PS-3317
DB	1.625	1.250	—	—	—	XCF-F		FA-4408
DB	1.625	1.250	3	1.375	.406	VCFLF	I/S	PS-22143
E	1.406	1.375	—	—	—	BCF-F	316SS	FA-5
E	1.406	1.375	3	1.312	.406	VCFKF	316SS	PS-7859V
E	1.406	1.375	1	1.500	.406	BCFJF	316SS	PS-188
E	1.406	1.375	1	1.500	.406	BCFKF	316SS	PS-935
E	1.406	1.375	1	1.500	.406	BCFKF	316SS	PS-2029
E	1.406	1.375	1	1.500	.406	VCFJF	316SS	PS-188V-CMS
E	1.406	1.375	1	1.500	.406	VCFKF	316SS	PS-935V-CMS
E	1.406	1.375	3	1.500	.406	BCFJF	316SS	PS-776
E	1.406	1.375	3	1.500	.406	BCFKF	316SS	PS-229
E	1.406	1.375	3	1.500	.406	NCFLF		PS-3260
E	1.406	1.375	3	1.500	.406	VCEZE		PS-7896
E	1.406	1.375	3	1.500	.406	VCFJF	316SS	PS-188V
E	1.406	1.375	3	1.500	.406	VCFKF	316SS	PS-229V
E	1.406	1.375	3	1.500	.406	VCFZF	316SS	PS-7992
E	1.406	1.375	3	1.500	.406	VZFLF	316SS	PS-3507
G	1.398	.787	1	1.500	.406	BCFJF	316SS	PS-3009
K	1.281	1.250	1	1.500	.406	BCFJF		PS-892
K	1.281	1.250	1	1.500	.406	BCFKF		PS-878
K	1.281	1.250	3	1.500	.406	VCFJF		PS-892V
K	1.312	1.250	3	1.500	.406	VCFJF		PS-22032
K	1.312	1.250	3	1.500	.406	VCFLF		PS-22171
R	1.562	1.625	1	1.500	.406	BCDJF		PS-428
R	1.562	1.625	1	1.500	.406	BCDKF		PS-685
W	1.437	.937	—	—	—	TCF-F	316SS	FA-9009
W	1.437	.937	2	1.500	.406	TCFJF	316SS	PS-9009
X	1.437	.937	3	1.500	.406	BLFLF	316SS	PS-8065
XB	1.562	1.015	3	1.375	.265	BCPKF		PS-8772

DIMENSIONAL CROSS-REFERENCE

SEAL HEAD			MATING RING			Material Code	NOTES	U.S. Seal Mfg. Part No.
Fig.	OD	Oper Hgt.	Fig.	Bore	Thick			
.937 (15/16") (continued)								
E	1.437	1.625	3	1.562	.437	QCFLF		PS-4506
U	1.437	1.656	2	1.562	.406	BCFKF		PS-560SS
U	1.437	1.656	3	1.562	.406	BCFGF		PS-845
U	1.437	1.656	3	1.562	.406	VCFKF		PS-560V
.970								
C	1.687	1.000	1	1.625	.375	VCFJF		PS-9700
.984 (25MM)								
C	1.508	1.181	1	1.575	.394	QCFLF	316SS	PS-5723
C	1.508	1.181	2	1.575	.394	VCFJF		PS-5729
C	1.687	1.000	1	1.625	.437	VCFJF		PS-3112
C	1.687	1.000	3 Special	1.750	.406	VCFLF		PS-4591
D	1.750	1.000	1	1.625	.437	BCFKF	H/I	PS-3900
D	1.812	1.000	1	1.625	.437	BCFJF		PS-4517
D	1.812	1.000	1	1.625	.437	VCFJF		PS-3728
D	1.812	1.000	1	1.625	.437	VCFKF	I	PS-7918
D	1.812	1.000	1	1.625	.437	VCFZF	I	PS-3167
D	1.812	1.000	2	1.625	.500	BCPGP		PS-7991
G	1.535	.787	1	1.575	.236	BLFLF	316SS	PS-2736
G	1.535	.787	1	1.625	.437	VLFLF	316SS	PS-1909
G	1.535	1.023	1	1.575	.236	BCFJF	316SS/I	PS-22104
G	1.535	1.338	1	1.575	.236	VCFLF	316SS/I	PS-22126
1.000 (1")								
A	1.687	.812	—	—	—	BCF-F		FA-70SS
A	1.687	.812	1	1.625	.437	BCFJF		PS-360
A	1.687	.812	1	1.625	.437	BCFJF		PS-5235
A	1.687	.812	1	1.625	.437	BCFKF		PS-370
A	1.687	.812	1	1.625	.437	VCFJF		PS-360V-CMS
A	1.687	.812	3	1.625	.437	BCFJF		PS-777
A	1.687	.812	3	1.625	.437	BCFKF	S	PS-778
A	1.687	.812	3	1.625	.437	VCFJF	S	PS-360V
A	1.687	.812	25	1.625	.625	B/VCFJF		PS-405
A	1.687	.812	3	2.000	.406	BCFJF		PS-1086
C	1.437	.750	1	1.625	.437	BCFJF	H	PS-1048
C	1.437	.750	1	1.625	.437	VCFJF	H	PS-1048V-CMS
C	1.437	.750	3	1.625	.437	BCFJF	H	PS-1049
C	1.437	.875	3	1.625	.250	NCFGF		PS-2814
C	1.437	1.562	1	1.625	.437	BCFJF	H	PS-539
C	1.437	1.562	1	1.625	.437	BCFKF	H	PS-779
C	1.437	1.562	1	1.625	.437	VCFJF	H	PS-539V-CMS
C	1.437	1.562	1	1.625	.437	VCFKF	H	PS-779V-CMS
C	1.437	1.562	2	1.750	.437	BCFKF	H	PS-5082
C	1.500	.812	1	1.625	.437	BCFJF		PS-5039
C	1.671	1.062	1	1.625	.375	BCFJF	B	PS-4081
C	1.675	1.000	1	1.625	.375	BCFJF	B	PS-2748
C	1.687	.812	1	1.625	.437	BCFJF		PS-7434
C	1.687	.812	1	1.625	.437	QCFLF		PS-1094-EPR
C	1.687	.812	1	1.625	.437	VCFJF		PS-1094
C	1.687	.812	1	1.625	.437	VCFJF	I	PS-1094-P66
C	1.687	.834	1	1.625	.406	BCFKF		PS-1123
C	1.687	.834	1	1.625	.406	BZFZF		PS-1123-TC-TC
C	1.687	.876	3	1.812	.343	VCFKF		PS-3240
C	1.687	1.000	—	—	—	BCF-F		FA-1700
C	1.687	1.000	—	—	—	NCF-F		FA-1700N
C	1.687	1.000	—	—	—	VCF-F		FA-10037
C	1.687	1.000	3	1.437	.437	BCFJF		PS-2145
C	1.687	1.000	3	1.437	.437	VCFJF		PS-3755
C	1.687	1.000	1	1.625	.437	BCFJF		PS-235
C	1.687	1.000	1	1.625	.437	BCFJF	316SS	PS-3312
C	1.687	1.000	1	1.625	.437	BCFJF	I	PS-235-P66
C	1.687	1.000	1	1.625	.437	BCFJF	B/H	PS-245
C	1.687	1.000	1	1.625	.437	BCFJF	B/H/I	PS-245-P66
C	1.687	1.000	1	1.625	.437	BCFKF		PS-357
C	1.687	1.000	1	1.625	.437	BCFKF	B/H	PS-248

NOTE: B. TAPERED SPRING
H. SPRING HOLDER NOT INCLUDED
I. ABRASION RESISTANT CARBON (P66)
S. SLOTTED MATING RING

DIMENSIONAL CROSS-REFERENCE

SEAL HEAD			MATING RING			Material Code	NOTES	U.S. Seal Mfg. Part No.
Fig.	OD	Oper Hgt.	Fig.	Bore	Thick			
1.000 (1") (continued)								
C	1.687	1.000	1	1.625	.437	BCFZF	B/H	PS-245-TC-SEAT
C	1.687	1.000	1	1.625	.437	BLFLF		PS-235-SC-SC
C	1.687	1.000	1	1.625	.437	BZFZF		PS-2216
C	1.687	1.000	1	1.625	.437	QCFJF		PS-235-EPR
C	1.687	1.000	1	1.625	.437	QCFJF	I	PS-235-EPR-P66
C	1.687	1.000	1	1.625	.437	QCFJF	B/H	PS-245-EPR
C	1.687	1.000	1	1.625	.437	QCFKF	B/H	PS-248-EPR
C	1.687	1.000	1	1.625	.437	QCFZF	I	PS-4379
C	1.687	1.000	1	1.625	.437	VCFJF		PS-235V-CMS
C	1.687	1.000	1	1.625	.437	VCFJF	B/H	PS-245V-CMS
C	1.687	1.000	1	1.625	.437	VCFJF	I	PS-235V-CMS-P66
C	1.687	1.000	1	1.625	.437	VCFKF		PS-357V-CMS
C	1.687	1.000	1	1.625	.437	VCFKF	B/H	PS-248V-CMS
C	1.687	1.000	1	1.625	.437	VCFKF	H	PS-22044
C	1.687	1.000	1	1.625	.437	VFLFL		PS-235V-SC-SC
C	1.687	1.000	1	1.625	.437	VZFFZ		PS-2216V-CMS
C	1.687	1.000	3	1.625	.437	BCFJF	S	PS-548
C	1.687	1.000	3	1.625	.437	BCFKF	S	PS-499
C	1.687	1.000	3	1.625	.437	QCFJF	316SS	PS-22152
C	1.687	1.000	3	1.625	.437	QCFKF	S	PS-499-EPR
C	1.687	1.000	3	1.625	.437	QCFZF	S	PS-4350
C	1.687	1.000	3	1.625	.437	VCFJF	S	PS-235V
C	1.687	1.000	3	1.625	.437	VCFJF	I	PS-235V-P66
C	1.687	1.000	3	1.625	.437	VCFJF	B/H	PS-245V
C	1.687	1.000	3	1.625	.437	VCFKF	S	PS-357V
C	1.687	1.000	3	1.625	.437	VCFKF	B/H/S	PS-248V
C	1.687	1.000	3	1.625	.437	VCFLF	I/S	PS-3807
C	1.687	1.000	3 Special	1.625	.437	VCFKF		PS-20016
C	1.687	1.000	25	1.625	.625	BCFJF		PS-413
C	1.687	1.000	25	1.625	.625	VCFJF		PS-413V
C	1.687	1.000	1	1.750	.437	BCFJF		PS-3440
C	1.687	1.000	1	1.750	.437	BCFKF		PS-2163
C	1.687	1.000	1	1.750	.437	V/BCFJF		PS-3440V
C	1.687	1.000	3	1.750	.437	BCFKF		PS-3220
C	1.687	1.000	3	1.750	.437	B/VCFKF		PS-20015
C	1.687	1.000	3	1.750	.437	VCFKF		PS-3619
C	1.687	1.000	3	1.750	.437	VCFKF		PS-7207
C	1.687	1.000	28	2.438	.437	BCFKF		PS-3824
C	1.687	1.000	28	2.438	.437	VCFKF		PS-1034V
C	1.687	1.062	1	1.625	.437	VCFJF	B/I	PS-4095
C	1.687	1.562	1	1.625	.437	BCFJF		PS-22205
C	1.687	1.562	1	1.625	.437	BCFN/KF		PS-982
C	1.687	1.562	1	1.625	.437	VCFN/KF		PS-982V-CMS
C	1.687	1.562	3	1.625	.437	BCFKF	S	PS-22203
C	1.687	1.755	1	1.625	.437	VCFJF	B	PS-4254
C	1.763	1.062	1	1.625	.437	VCFJF		PS-3785
D	1.750	1.000	3	1.625	.312	BCPKF		PS-6328
D	1.750	1.000	3	1.625	.312	NCPKF		PS-6329
D	1.750	1.000	3	1.625	.312	NLFLF		PS-22062
D	1.750	1.000	3	1.625	.312	QCFJF		PS-3250
D	1.750	1.000	3	1.625	.312	VCFJF		PS-22119
D	1.750	1.000	3	1.625	.312	VCPKF		PS-4137
D	1.750	1.000	3	1.625	.312	VCPLF	H	PS-2805
D	1.750	1.000	3	1.625	.312	VLFZF		PS-4394
D	1.750	1.062	1	1.625	.437	BCFJF	H	PS-22045
D	1.750	1.062	3	1.625	.437	QCCKF	I	PS-4601
D	1.750	1.062	3	1.625	.437	VRFLF		PS-22007
D	1.812	1.000	3	1.625	.312	BCPKF		PS-1630
D	1.812	1.000	1	1.625	.437	VLFZF		PS-4297
D	1.812	1.000	3	1.625	.437	NCPGF		PS-6019
D	1.812	1.000	3	1.625	.437	NCPGP		PS-159
D	1.812	1.000	3	1.625	.437	VCFLF	I	PS-3266
D	1.812	1.000	3	1.625	.437	VLFZF	S	PS-2703
D	1.812	1.062	—	—	—	BCF-F		FA-170
D	1.812	1.062	1	1.625	.437	BCFJF		PS-380

DIMENSIONAL CROSS-REFERENCE

SEAL HEAD			MATING RING			Material Code	NOTES	U.S. Seal Mfg. Part No.
Fig.	OD	Oper Hgt.	Fig.	Bore	Thick			
1.000 (1") (continued)								
D	1.812	1.062	1	1.625	.437	BCFKF		PS-460
D	1.812	1.062	1	1.625	.437	BCFKF	I	PS-460-P66
D	1.812	1.062	1	1.625	.437	VCFJF		PS-380V-CMS
D	1.812	1.062	1	1.625	.437	VCFKF		PS-460V-CMS
D	1.812	1.062	3	1.625	.437	BCFJF		PS-2033
D	1.812	1.062	3	1.625	.437	BCFKF	S	PS-252
D	1.812	1.062	3	1.625	.437	BCFKF	I/S	PS-252-P66
D	1.812	1.062	3	1.625	.437	BCFLF	S	PS-3241
D	1.812	1.062	3	1.625	.437	QCFKF	S	PS-252-EPR
D	1.812	1.062	3	1.625	.437	VCFJF	S	PS-380V
D	1.812	1.062	3	1.625	.437	VCFKF	S	PS-460V
D	1.812	1.062	1	1.750	.437	BCFJF		PS-2164
D	1.812	1.062	1	1.750	.437	BCFKF		PS-227
D	47MM	25MM	1	32MM	10.3MM	VCFJF		PS-4453
DB	1.812	1.312	3	1.500	.406	NCPLF		PS-4579
DB	1.812	1.312	3	1.500	.406	VCFKF	316SS	PS-4253
DB	1.812	1.312	3	1.500	.406	VCFKF	I	PS-4289
DB	1.812	1.312	3	1.500	.406	VCFZF		PS-3273
DB	1.812	1.312	3	1.500	.406	VCFZF	S	PS-4255
E	1.500	1.187	3	1.625	.312	VCFKF		PS-3803
E	1.500	1.187	3	1.625	.312	VCFLF		PS-22115
E	1.500	1.187	3	1.625	.437	BCFKF	S	PS-251
E	1.500	1.562	—	—	—	BCF-F		FA-912
E	1.500	1.562	3	1.437	.437	BCFJF		PS-4882
E	1.500	1.562	1	1.625	.437	BCFJF		PS-754
E	1.500	1.562	1	1.625	.437	BCFJF	I	PS-754-P66
E	1.500	1.562	1	1.625	.437	BCFKF		PS-236
E	1.500	1.562	1	1.625	.437	NCFKF		PS-236N
E	1.500	1.562	1	1.625	.437	VCFJF		PS-754V-CMS
E	1.500	1.562	1	1.625	.437	VCFJF	I	PS-754V-CMS-P66
E	1.500	1.562	1	1.625	.437	VCFKF		PS-236V-CMS
E	1.500	1.562	1	1.625	.437	VCFZF		PS-3625
E	1.500	1.562	3	1.625	.437	BCFKF	S	PS-791
E	1.500	1.562	3	1.625	.437	BCPKF		PS-6331
E	1.500	1.562	3	1.625	.437	B/VCFJF	S	PS-557
E	1.500	1.562	3	1.625	.437	QCFZF		PS-3129
E	1.500	1.562	3	1.625	.437	VCFJF	S	PS-754V
E	1.500	1.562	3	1.625	.437	VCFJF	316SS	PS-3976
E	1.500	1.562	3	1.625	.437	VCFKF	S	PS-236V
E	1.500	1.562	3	1.625	.437	VCFZF	316SS	PS-4412
E	1.500	1.562	5	1.625	.437	VCFZF		PS-3589
G	1.516	.787	3	1.625	.437	B/VFLF	316SS/S	PS-22101
G	1.535	.813	1	1.625	.437	VCFJF	316SS	PS-3874
G	1.535	.813	3	1.625	.437	BCFLF		PS-3010
G	1.535	.937	1	1.625	.437	VCFJF	316SS	PS-4195
G	1.535	.995	3	1.625	.437	VCFKF	316SS/S	PS-22168
G	1.535	1.000	1	1.625	.437	BCFJF		PS-22105
G	1.535	1.000	1	1.625	.437	VCFJF		PS-3295
G	1.535	1.000	3	1.625	.437	BCFJF	S	PS-3042
K	1.478	1.718	1	1.625	.437	VCFRF		PS-3065
K	1.671	1.625	3	1.875	.312	BCFKF		PS-4362
K	1.687	1.625	1	1.625	.437	BCFJF		PS-879
K	1.687	1.625	1	1.625	.437	BCFKF		PS-891
K	1.687	1.625	1	1.625	.437	BLFLF		PS-4129
K	1.687	1.625	1	1.625	.437	BLFLF/BCFJF		PS-4301
K	1.687	1.625	1	1.625	.437	BLFZF		PS-879-SC-TC
K	1.687	1.625	1	1.625	.437	VCFJF		PS-879V-CMS
K	1.687	1.625	1	1.625	.437	VCFJF		PS-3959
K	1.687	1.625	3	1.625	.437	BLFLF		PS-4590
K	1.687	1.875	1	1.625	.437	BCFKF		PS-3126
Q	1.625	.874	1	1.625	.437	BCDJF		PS-1619
Q	1.625	.885	Special	1.625	.312	Special		PS-3120
Q	1.875	.438	9	1.625	.312	BCFJF		PS-2806
Q	1.875	.438	9	1.625	.312	BMDAF		PS-6305
Q	1.875	.985	—	—	—	NMDKF	Unitized	PS-3100

NOTE: I. ABRASION RESISTANT CARBON (P66)
S. SLOTTED MATING RING

DIMENSIONAL CROSS-REFERENCE

SEAL HEAD			MATING RING			Material Code	NOTES	U.S. Seal Mfg. Part No.
Fig.	OD	Oper Hgt.	Fig.	Bore	Thick			
1.000 (1") (continued)								
Q	1.906	.471	9	—	.421	NMDKF	A	PS-3401
Q	1.925	.885	Special	1.625	.312	BMPAP		PS-6312
R	1.750	1.875	1	1.625	.437	BCFJF		PS-429
R	1.750	1.875	1	1.625	.437	BCFKF		PS-430
R	1.750	1.875	1	1.625	.437	VCFJF	I	PS-429V-CMS-P66
S	1.904	1.906	8	1.750	.250	NAPSP		PS-793
Special	2.250	.750	9	—	—	BCGP		PS-4638
T	1.500	1.968	3	1.625	.312	NCPKF		PS-1631
T	1.500	2.312	1	1.625	.437	BCFJF		PS-276
T	1.500	2.312	1	1.625	.437	BCFKF		PS-277
T	1.500	2.312	3	1.625	.437	QLFLF	S	PS-4210
W	1.562	1.000	—	—	—	TCF-F	316SS	FA-6987
W	1.562	1.000	2	1.625	.437	TCFKF	316SS	PS-9313
W	1.562	1.000	2	1.625	.437	TCFOF	316SS	PS-9334
W	1.562	1.000	Special	2.015	.593	TCFGF	316SS	PS-9715
W	1.562	1.000	Special	2.156	.656	TCFJF	316SS	PS-9007
W	1.562	1.000	27	2.156	.812	TCFJF	316SS	PS-9018
WT	1.437	1.000	—	—	—	TCF-F	316SS	FA-9349
WT	1.437	1.000	27	2.000	.625	TCFZF	316SS	PS-9349
X	1.562	1.000	3	1.625	.437	VCFRF	316SS/S	PS-8091
X	1.562	1.000	5	1.633	.437	QCFZF	316SS	PS-8116
XB1	1.562	1.312	3	1.500	.406	VCFLF	316SS/S	PS-8705
XB2	1.750	1.000	3	1.625	.437	BCFKF	316SS	PS-8112
XB2	1.750	1.000	3 Special	1.750	.437	VCFJF	316SS	PS-8020
1.062 (1-1/16")								
C	1.812	1.062	3	1.750	.437	BCFKF	S	PS-2155
D	1.875	1.062	1	1.750	.437	BCDKF		PS-127
D	1.875	1.062	3	1.750	.437	BCFJF	S	PS-797
D	1.996	1.062	3	1.750	.437	VCDLF		PS-3193
E	1.625	1.593	1	1.750	.437	BCFJF		PS-710
E	1.625	1.593	1	1.750	.437	BCFKF		PS-498
E	1.625	1.593	3	1.750	.437	BCFKF	S	PS-799
E	1.625	1.593	3	1.750	.437	VCFJF	S	PS-798V
W	1.625	1.000	3	1.812	.437	TCFKF	316SS/S	PS-9338
W	1.630	1.000	3	1.750	.437	TCFKF	316SS	PS-9303
1.125 (1-1/8")								
C	1.630	.875	3 Special	1.750	.660	VCFKF	316SS	PS-22026
C	1.812	1.062	—	—	—	BCF-F		FA-1800
C	1.812	1.062	—	—	—	VCF-F		FA-10038
C	1.812	.937	1	1.750	.437	BCFJF		PS-4302
C	1.812	1.062	1	1.750	.437	BCFJF		PS-356
C	1.812	1.062	1	1.750	.437	BCFJF	I	PS-356-P66
C	1.812	1.062	1	1.750	.437	BCFJF	B	PS-627
C	1.812	1.062	1	1.750	.437	BCFJF	B	PS-1682
C	1.812	1.062	1	1.750	.437	BCFKF		PS-355
C	1.812	1.062	1	1.750	.437	BCFKF	I	PS-355-P66
C	1.812	1.062	1	1.750	.437	BCFKF	B	PS-1167
C	1.812	1.062	1	1.750	.437	BCFLF		PS-4443
C	1.812	1.062	1	1.750	.437	BCFZF	I	PS-356-P66-TC-SEAT
C	1.812	1.062	1	1.750	.437	BLFLF		PS-355-SC-SC
C	1.812	1.062	1	1.750	.437	BLFZF		PS-356-SC-TC
C	1.812	1.062	1	1.750	.437	BZFZF		PS-356-TC-TC
C	1.812	1.062	1	1.750	.437	QCFJF		PS-356-EPR
C	1.812	1.062	1	1.750	.437	QCFJF	I	PS-356-EPR-P66
C	1.812	1.062	1	1.750	.437	QCFLF		PS-356-EPR-SC
C	1.812	1.062	1	1.750	.437	QCFLF	I	PS-3965
C	1.812	1.062	1	1.750	.437	QCFZF	I	PS-7325
C	1.812	1.062	1	1.750	.437	QLFLF	I	PS-356-EPR-SC-SC
C	1.812	1.062	1	1.750	.437	VCEZE		PS-4295
C	1.812	1.062	1	1.750	.437	VCFJF		PS-356V-CMS
C	1.812	1.062	1	1.750	.437	VCFJF	I	PS-356V-CMS-P66
C	1.812	1.062	1	1.750	.437	VCFKF		PS-355V-CMS
C	1.812	1.062	1	1.750	.437	VCFKF	I	PS-4047
C	1.812	1.062	1	1.750	.437	VCFZF	I	PS-3239

DIMENSIONAL CROSS-REFERENCE

SEAL HEAD			MATING RING			Material Code	NOTES	U.S. Seal Mfg. Part No.
Fig.	OD	Oper Hgt.	Fig.	Bore	Thick			
1.125 (1-1/8") (continued)								
C	1.812	1.062	1	1.750	.437	VFLF		PS-356V-SC-SC-CMS
C	1.812	1.062	1	1.750	.437	VZFLF		PS-3234
C	1.812	1.062	1	1.750	.437	VZFZF		PS-356V-TC-TC-CMS
C	1.812	1.062	2	1.750	.437	BCFKF		PS-3833
C	1.812	1.062	3	1.750	.437	BCFKF	S	PS-529
C	1.812	1.062	3	1.750	.437	BCFKF	B/S	PS-588
C	1.812	1.062	3	1.750	.437	B/VCFJF	S	PS-801
C	1.812	1.062	3	1.750	.437	QCFKF	S	PS-529-EPR
C	1.812	1.062	3	1.750	.437	QCFZF	I/S	PS-2226
C	1.812	1.062	3	1.750	.437	VCFJF	S	PS-356V
C	1.812	1.062	3	1.750	.437	VCFKF	S	PS-355V
C	1.812	1.062	3	1.750	.437	VCFLF	S	PS-355V-SC-SEAT
C	1.812	1.062	3	1.750	.437	VCFLF	S	PS-4505
C	1.812	1.062	3	1.750	.437	VCFLF	I/S	PS-529V-SC-P66
C	1.812	1.062	3	1.750	.437	VCFZF	S	PS-7608
C	1.812	1.062	3	1.750	.437	VFLF	S	PS-4037
C	1.812	1.062	3	1.750	.437	VZFZF	S	PS-4454
C	1.812	1.562	1	1.750	.437	BCFJF		PS-2227
C	1.812	1.562	1	1.750	.437	BCFKF	S	PS-983
C	1.812	1.562	3	1.750	.437	VCFKF	S	PS-983V
C	1.812	1.562	3	1.750	.437	VZFZF	S	PS-983V-TC-TC
C	1.812	1.619	3	1.750	.437	BCFJF	S	PS-22212
D	1.875	1.062	1	1.750	.437	NCFJF	H	PS-4271
D	1.937	1.062	1	1.750	.437	BCFJF		PS-604
D	1.937	1.062	1	1.750	.437	BCFKF		PS-605
D	1.937	1.062	1	1.750	.437	QCFJF		PS-604-EPR
D	1.937	1.062	1	1.750	.437	VCFJF		PS-604V-CMS
D	1.937	1.062	1	1.750	.437	VCFKF		PS-605V-CMS
D	1.937	1.062	1	1.750	.437	VCFKF	I	PS-3918
D	1.937	1.062	3	1.750	.437	BCFJF	S	PS-802
D	1.937	1.062	3	1.750	.437	BCFKF	S	PS-254
D	1.937	1.062	3	1.750	.437	VCFKF	S	PS-605V
D	1.937	1.062	3	1.750	.437	VCFZF	I	PS-3712
D	1.937	1.062	3	1.750	.437	VFLF	S	PS-3856
D	1.937	1.062	1	1.875	.437	BCFKF		PS-521
E	1.625	1.187	3	1.750	.437	BCFKF	S	PS-253
E	1.625	1.406	3	1.750	.437	VCFJF	316SS/C/I/S	PS-3060
E	1.625	1.546	27	2.135	.812	BCFJF	316SS/C	PS-3325
E	1.625	1.625	—	—	—	BCF-F		FA-866
E	1.625	1.625	—	—	—	VCF-F		FA-608V
E	1.625	1.625	1	1.687	.437	BCFJF		PS-607
E	1.625	1.625	1	1.687	.437	BCFKF		PS-608
E	1.625	1.625	1	1.750	.437	BCFJF		PS-204
E	1.625	1.625	1	1.750	.437	BCFJF	I	PS-204-P66
E	1.625	1.625	1	1.750	.437	BCFKF		PS-384
E	1.625	1.625	1	1.750	.437	QCFJF		PS-204-EPR
E	1.625	1.625	1	1.750	.437	VCFJF		PS-204V-CMS
E	1.625	1.625	1	1.750	.437	VCFJF	I	PS-204V-CMS-P66
E	1.625	1.625	1	1.750	.437	VCFKF		PS-384V-CMS
E	1.625	1.625	3	1.750	.437	BCFJF	S	PS-866
E	1.625	1.625	3	1.750	.437	BCFKF	S	PS-867
E	1.625	1.625	3	1.750	.437	B/VCFKF	S	PS-4262
E	1.625	1.625	3	1.750	.437	QCFJF	316SS/S	PS-4421
E	1.625	1.625	3	1.750	.437	QCFKF	S	PS-867-EPR
E	1.625	1.625	3	1.750	.437	QCFKF	I/S	PS-885-EPR-P66
E	1.625	1.625	3	1.750	.437	QCFZF	I/S	PS-4565
E	1.625	1.625	3	1.750	.437	VCFJF	S	PS-204V
E	1.625	1.625	3	1.750	.437	VCFKF	S	PS-867V
E	1.625	1.625	3	1.750	.437	VCFKF	C/S	PS-2738
E	1.625	1.625	3	1.750	.437	VCFLF	S	PS-4300
E	1.625	1.625	3	1.750	.437	VCFZF	S	PS-867V-TC-SEAT
E	1.625	1.625	5	1.750	.437	BCFZF	316SS/I	PS-3163
E	1.625	1.625	5	1.750	.437	QCDZF	I	PS-3109
E	1.625	1.625	3	1.812	.437	BCFJF		PS-1172
E	1.625	1.625	3	1.812	.437	BCFKF		PS-1173

NOTE: B. TAPERED SPRING
 C. COMPLETE WITH COLLAR
 H. SPRING HOLDER NOT INCLUDED
 I. ABRASION RESISTANT CARBON (P66)
 S. SLOTTED MATING RING

DIMENSIONAL CROSS-REFERENCE

SEAL HEAD			MATING RING			Material Code	NOTES	U.S. Seal Mfg. Part No.
Fig.	OD	Oper Hgt.	Fig.	Bore	Thick			
1.125 (1-1/8") (continued)								
E	1.625	1.625	3	1.812	.437	BCFZF		PS-1668
E	1.625	1.625	3	1.812	.437	B/VCFJF		PS-1636
E	1.625	1.625	3	1.812	.437	B/VCFKF		PS-1637
E	1.625	1.625	3	1.812	.437	VCFJF		PS-1172V
E	1.625	1.625	3	1.812	.437	VCFKF		PS-1639V
E	1.625	1.625	1	1.875	.437	BCFKF		PS-1067
E	1.625	2.000	2	1.812	.437	QCFZF		PS-3291
E	1.625	2.000	3	1.812	.437	BCFJF		PS-619
E	1.625	2.000	3	1.812	.437	BCFKF		PS-948
E	1.625	2.000	3	1.812	.437	VCFJF		PS-619V
E	1.937	1.333	3	2.000	.375	BCPKP		PS-7967
E	1.937	1.333	3	2.000	.375	NCPGF	S	PS-3653
E	1.937	1.333	3	2.000	.375	VCPKF		PS-6334
E	2.000	1.333	3	2.000	.375	QCPKF		PS-3063
EB	1.625	1.937	3	1.625	.437	BCFZF	I	PS-3817
G	1.654	1.024	1	1.750	.437	BLFLF	316SS	PS-4425
G	1.654	1.062	25	1.750	.437	VCFLF	316SS	PS-3013
K	1.812	1.625	1	1.750	.437	BCFJF		PS-1176
K	1.812	1.625	1	1.750	.437	BCFKF		PS-1177
K	1.812	1.625	1	1.750	.437	VL/CFL/JF		PS-4177
Q	1.578	.402	9	1.578	.234	VMFAF		PS-6318
Special	1.875	1.109	3	1.625	.312	BCPKP		PS-3731
T	1.625	2.125	3	1.750	.437	VCFJF	S	PS-3511
T	1.625	2.375	3	1.750	.437	BCFJF	S	PS-886
T	1.625	2.375	3	1.750	.437	BCFKF	S	PS-918
T	1.625	2.375	3	1.812	.437	BCFJF		PS-1178
U	1.625	1.688	3	1.750	.437	BCFKF	S	PS-282
U	1.625	1.688	3	1.750	.437	VCFKF	S	PS-282V
U	1.625	1.688	3	1.750	.437	VLFLF	S	PS-3263
W	1.687	1.062	—	—	—	TCF-F	316SS	FA-9327
W	1.687	1.062	27	2.354	.752	Special	316SS	PS-9329
W	1.687	1.062	27	2.354	.752	TCFKF	316SS	PS-9328
W	1.687	1.062	27 Special	2.410	.750	TCFKF		PS-22154
W	1.692	1.062	2	2.000	.484	TCFKF	316SS	PS-7232
W	1.692	1.062	2	2.000	.484	TCFOF	316SS	PS-9327
W	1.692	1.062	2	2.000	.484	TCFZF	316SS	PS-9355
XB	2.078	1.375	3	1.625	.437	BCFLF	S	PS-22186
XB	2.078	1.375	3	1.625	.437	VCFLF	S	PS-22193
XB1	1.875	1.109	3	1.625	.312	VCPKF		PS-22121
XB2	1.875	1.000	27	2.343	1.000	VCFJF	316SS	PS-8006
1.181 (30MM)								
D	2.000	1.062	1	1.875	.437	BCDJF		PS-136
D	2.000	1.062	1	1.875	.437	BCDKF		PS-1179
D	2.000	1.062	1	1.875	.437	BCDKF	I	PS-1179-P66
D	2.000	1.062	1	1.875	.437	BCFJF	I	PS-2737
D	2.000	1.062	1	1.875	.437	VCDJF		PS-136V-CMS
D	2.000	1.062	1	1.875	.437	VCDKF		PS-1179V
D	2.000	1.062	1	1.875	.437	VCDKF	I	PS-1179V-P66
D	2.000	1.062	1	1.875	.437	VCFJF	I	PS-22054
D	2.000	1.062	1	1.875	.437	VCFZF	I	PS-3938
D	2.000	1.062	3	1.875	.437	VCDJF	S	PS-136V
D	2.062	1.031	3	1.875	.437	XLFLF		PS-3315
1.187 (1-3/16")								
C	1.937	1.062	1	1.875	.437	BCFJF		PS-6812
C	1.937	1.062	1	1.875	.437	BCFKF		PS-2162
C	1.937	1.062	28	2.834	.500	BCFKF		PS-1044
C	1.937	1.062	28	2.834	.500	VCFKF		PS-1044V
D	2.062	1.000	1	1.875	.437	NCPJP		PS-297
D	2.062	1.062	3	1.812	.437	BCFKF		PS-4533
D	2.062	1.062	3	1.875	.437	BCDKF	I	PS-3287
D	2.062	1.062	3	1.875	.437	NCPKP		PS-4298
E	1.812	1.187	1	1.875	.437	BCDJF		PS-306
E	1.812	1.187	1	1.875	.437	BCDKF		PS-1180
E	1.812	1.187	3	1.875	.437	BCDKF		PS-255

DIMENSIONAL CROSS-REFERENCE

SEAL HEAD			MATING RING			Material Code	NOTES	U.S. Seal Mfg. Part No.
Fig.	OD	Oper Hgt.	Fig.	Bore	Thick			
1.187 (1-3/16") (continued)								
E	1.812	1.187	3	1.875	.437	VCFJF	S	PS-306V
E	1.812	1.625	1	1.875	.437	BCDJF		PS-310
E	1.812	1.625	1	1.875	.437	BCDKF		PS-343
T	1.812	2.375	1	1.875	.437	BCDJF		PS-723
T	1.812	2.375	1	1.875	.437	BCDKF		PS-724
T	1.812	2.375	1	1.875	.437	VCDJF		PS-723V-CMS
XB	1.687	1.125	3	1.687	.437	Special	316SS/C	PS-8074
1.250 (1-1/4")								
C	1.781	.969	3 Special	1.937	.640	VCFKF	316SS	PS-22025
C	1.799	1.062	1	1.875	.437	VCFJF		PS-5674
C	1.828	1.062	—	—	—	BCF-F	316SS/H	FA-4463
C	1.921	1.062	1	1.875	.437	QCFZF	316SS	PS-4029
C	1.921	1.062	1	1.875	.437	VCFLF	316SS	PS-3538
C	1.937	.734	—	—	—	BCF-F		FA-2678
C	1.937	.906	3 Special	1.875	.437	VCFGF		PS-3945
C	1.937	1.062	—	—	—	BCF-F		FA-756
C	1.937	1.062	—	—	—	VCF-F		FA-10040
C	1.937	1.062	1	1.765	.365	BCFJF	B	PS-978
C	1.937	1.062	1	1.765	.365	BCFJF	B/I	PS-978-P66
C	1.937	1.062	1	1.765	.365	BCFKF	B	PS-979
C	1.937	1.062	1	1.765	.365	BCFKF	B/I	PS-979-P66
C	1.937	1.062	1	1.765	.365	BCFZF	B	PS-978-TC-SEAT
C	1.937	1.062	1	1.765	.365	BLFZF	B	PS-978-SC-TC
C	1.937	1.062	1	1.765	.365	QCFJF	B	PS-978-EPR
C	1.937	1.062	1	1.765	.365	QCFJF	B/I	PS-978-EPR-P66
C	1.937	1.062	1	1.765	.365	QCFKF	B	PS-979-EPR
C	1.937	1.062	1	1.765	.365	QCFLF	B/I	PS-4332
C	1.937	1.062	1	1.765	.365	QCFZF	B	PS-978-EPR-TC
C	1.937	1.062	1	1.765	.365	QLFLF	B	PS-978-EPR-SC-SC
C	1.937	1.062	1	1.765	.365	QRFLF	B	PS-4204
C	1.937	1.062	1	1.765	.365	VCFJF	B	PS-978V
C	1.937	1.062	1	1.765	.365	VCFJF	B/I	PS-978V-P66
C	1.937	1.062	1	1.765	.365	VCFKF	B	PS-979V
C	1.937	1.062	1	1.765	.365	VCFKF	B/I	PS-979V-P66
C	1.937	1.062	1	1.765	.365	VCFLF	B/I	PS-978V-SC-P66
C	1.937	1.062	1	1.765	.365	VCFZF	B/I	PS-978V-P66-TC
C	1.937	1.062	1	1.765	.365	VLFLF	B	PS-978V-SC-SC
C	1.937	1.062	1	1.765	.365	VZFZF	B	PS-978V-TC-TC
C	1.937	1.062	3	1.875	.413	XLFZF	316SS/S	PS-4460
C	1.937	1.062	1	1.875	.437	BCEJE		PS-3933
C	1.937	1.062	1	1.875	.437	BCFJF		PS-185
C	1.937	1.062	1	1.875	.437	BCFJF	I	PS-185-P66
C	1.937	1.062	1	1.875	.437	BCFJF	316SS	PS-4463
C	1.937	1.062	1	1.875	.437	BCFJF	B/H	PS-246
C	1.937	1.062	1	1.875	.437	BCFKF		PS-756
C	1.937	1.062	1	1.875	.437	BCFKF	I	PS-756-P66
C	1.937	1.062	1	1.875	.437	BCFKF	B/H	PS-249
C	1.937	1.062	1	1.875	.437	BCFLF		PS-3738
C	1.937	1.062	1	1.875	.437	BCFZF		PS-185-TC-SEAT
C	1.937	1.062	1	1.875	.437	BLFLF		PS-185-SC-SC
C	1.937	1.062	1	1.875	.437	BLFLF	316SS	PS-4595
C	1.937	1.062	1	1.875	.437	BRFLF		PS-4211
C	1.937	1.062	1	1.875	.437	BZFZF		PS-2208
C	1.937	1.062	1	1.875	.437	NCFJF		PS-1081
C	1.937	1.062	1	1.875	.437	NCFKF		PS-1082
C	1.937	1.062	1	1.875	.437	QCFJF		PS-185-EPR
C	1.937	1.062	1	1.875	.437	QCFJF	I	PS-185-EPR-P66
C	1.937	1.062	1	1.875	.437	QCFJF	B/H/I	PS-246-EPR-P66
C	1.937	1.062	1	1.875	.437	QCFKF		PS-756-EPR
C	1.937	1.062	1	1.875	.437	QCFKF	316SS	PS-4464
C	1.937	1.062	1	1.875	.437	QCFKF	I	PS-2203-CMS
C	1.937	1.062	1	1.875	.437	QCFLF		PS-185E-SC-CMS
C	1.937	1.062	1	1.875	.437	QCFLF	316SS/H	PS-3131
C	1.937	1.062	1	1.875	.437	QLFLF		PS-4156
C	1.937	1.062	1	1.875	.437	QLFLF	316SS	PS-3062

NOTE: B. TAPERED SPRING
 C. COMPLETE WITH COLLAR
 H. SPRING HOLDER NOT INCLUDED
 I. ABRASION RESISTANT CARBON (P66)
 S. SLOTTED MATING RING

DIMENSIONAL CROSS-REFERENCE

SEAL HEAD			MATING RING			Material Code	NOTES	U.S. Seal Mfg. Part No.
Fig.	OD	Oper Hgt.	Fig.	Bore	Thick			
1.250 (1-1/4") (continued)								
C	1.937	1.062	1	1.875	.437	QZFLF	H	PS-3264
C	1.937	1.062	1	1.875	.437	VCFJF		PS-185V-CMS
C	1.937	1.062	1	1.875	.437	VCFJF	I	PS-185V-CMS-P66
C	1.937	1.062	1	1.875	.437	VCFJF	B/H	PS-246V-CMS
C	1.937	1.062	1	1.875	.437	VCFJF	B/H/I	PS-246V-CMS-P66
C	1.937	1.062	1	1.875	.437	VCFJF	316SS	PS-3886
C	1.937	1.062	1	1.875	.437	VCFKF		PS-756V-CMS
C	1.937	1.062	1	1.875	.437	VCFKF	I	PS-756V-CMS-P66
C	1.937	1.062	1	1.875	.437	VCFKF	B/H	PS-249V-CMS
C	1.937	1.062	1	1.875	.437	VCFLF		PS-185V-SC-SEAT
C	1.937	1.062	1	1.875	.437	VCFZF		PS-185V-TC-SEAT
C	1.937	1.062	1	1.875	.437	VCFZF	316SS	PS-4176
C	1.937	1.062	1	1.875	.437	VLFLF		PS-185V-SC-SC
C	1.937	1.062	1	1.875	.437	VLFLF	316SS	PS-4101
C	1.937	1.062	1	1.875	.437	VLFLF	316SS/H	PS-4150
C	1.937	1.062	1	1.875	.437	VLZFZ		PS-185V-SC-TC
C	1.937	1.062	1	1.875	.437	VRFLF		PS-3892
C	1.937	1.062	1	1.875	.437	VZFLF		PS-185V-TC-SC
C	1.937	1.062	1	1.875	.437	VZFZF		PS-185V-TC-TC
C	1.937	1.062	3	1.875	.437	BCFGF	S	PS-4152
C	1.937	1.062	3	1.875	.437	BCFJF	S	PS-618
C	1.937	1.062	3	1.875	.437	BCFKF		PS-598
C	1.937	1.062	3	1.875	.437	BCFKF	B	PS-525
C	1.937	1.062	3	1.875	.437	BCFKF	S	PS-7938-BUNA
C	1.937	1.062	3	1.875	.437	BCFZF	S	PS-598-TC-SEAT
C	1.937	1.062	3	1.875	.437	BLFLF	S	PS-598-SC-SC
C	1.937	1.062	3	1.875	.437	B/VCFKF	S	PS-1053
C	1.937	1.062	3	1.875	.437	BZFZF	S	PS-618-TC-TC
C	1.937	1.062	3	1.875	.437	QCFJF	I/S	PS-618-EPR-P66
C	1.937	1.062	3	1.875	.437	QCFKF		PS-598-EPR
C	1.937	1.062	3	1.875	.437	QCFKF	I	PS-2203
C	1.937	1.062	3	1.875	.437	QCFLF	S	PS-185-EPR-SC
C	1.937	1.062	3	1.875	.437	QCFZF	S	PS-185-EPR-TC
C	1.937	1.062	3	1.875	.437	QCFZF	I/S	PS-7436
C	1.937	1.062	3	1.875	.437	QZFZF		PS-4534
C	1.937	1.062	3	1.875	.437	VCFJF	S	PS-185V
C	1.937	1.062	3	1.875	.437	VCFJF	I/S	PS-185V-P66
C	1.937	1.062	3	1.875	.437	VCFJF	B/H/S	PS-246V
C	1.937	1.062	3	1.875	.437	VCFKF		PS-756V
C	1.937	1.062	3	1.875	.437	VCFKF	I	PS-756V-P66
C	1.937	1.062	3	1.875	.437	VCFKF	B/H	PS-249V
C	1.937	1.062	3	1.875	.437	VCFKF	S	PS-3173
C	1.937	1.062	3	1.875	.437	VCFKF	S	PS-7938
C	1.937	1.062	3	1.875	.437	VCFLF	S	PS-756V-SC-SEAT
C	1.937	1.062	3	1.875	.437	VCFZF	S	PS-618V-TC-SEAT
C	1.937	1.062	3	1.875	.437	VLZFZ	S	PS-756V-SC-TC
C	1.937	1.062	3	1.875	.437	VRFLF	S	PS-3940
C	1.937	1.062	3	1.875	.437	XLFLF	316SS	PS-4321
C	1.937	1.062	5	1.883	.437	QCFZF	316SS	PS-22172
C	1.937	1.062	5	1.883	.437	VCFZF	316SS	PS-22181
C	1.937	1.062	1	2.000	.437	BCFJF		PS-466
C	1.937	1.062	1	2.000	.437	BCFJF	I	PS-466-P66
C	1.937	1.062	1	2.000	.437	BCFKF		PS-1018-CMS
C	1.937	1.062	1	2.000	.437	BLFLF		PS-466-SC-SC
C	1.937	1.062	1	2.000	.437	VCFJF		PS-466V
C	1.937	1.062	1	2.000	.437	VCFJF	I	PS-466V-P66
C	1.937	1.062	1	2.000	.437	VCFJF	316SS	PS-4131
C	1.937	1.062	1	2.000	.437	VCFKF		PS-3185
C	1.937	1.062	1	2.000	.437	VCFLF	316SS	PS-3178
C	1.937	1.062	1	2.000	.437	VCFZF		PS-22225
C	1.937	1.062	1	2.000	.437	VLFLF		PS-466V-SC-SC-CMS
C	1.937	1.062	1	2.000	.437	VLZFZ	316SS	PS-4040
C	1.937	1.062	3	2.000	.437	BCFJF		PS-2230
C	1.937	1.062	3	2.000	.437	BCFJF	I	PS-7343
C	1.937	1.062	3	2.000	.437	BCFKF		PS-1018

DIMENSIONAL CROSS-REFERENCE

SEAL HEAD			MATING RING			Material Code	NOTES	U.S. Seal Mfg. Part No.
Fig.	OD	Oper Hgt.	Fig.	Bore	Thick			
1.250 (1-1/4") (continued)								
C	1.937	1.062	3	2.000	.437	BCFKF	I	PS-1018-P66
C	1.937	1.062	3	2.000	.437	BCFZF	I	PS-3045
C	1.937	1.062	3	2.000	.437	BLFLF		PS-1018-SC-SC
C	1.937	1.062	3	2.000	.437	QCFKF		PS-1018-EPR
C	1.937	1.062	3	2.000	.437	QCFKF	I	PS-1018-EPR-P66
C	1.937	1.062	3	2.000	.437	QCFZF	I	PS-4559
C	1.937	1.062	3	2.000	.437	VCFJF		PS-2230V
C	1.937	1.062	3	2.000	.437	VCFKF	I	PS-2200
C	1.937	1.062	3	2.000	.437	VCFKF		PS-1018V
C	1.937	1.062	28	2.835	.660	BCFKF		PS-1036
C	1.937	1.062	28	2.835	.660	VCFKF		PS-1036V
C	1.937	1.250	25	2.250	.625	BCFJF	B	PS-923
C	1.937	1.250	25	2.250	.625	QCFJF	B	PS-923-EPR
C	1.937	1.250	25	2.250	.625	VCFJF	B	PS-923V
C	1.937	1.625	—	—	—	BCF-F		FA-1109
C	1.937	1.625	1	1.875	.437	BCFJF		PS-2122
C	1.937	1.625	1	1.875	.437	BCFJF	I	PS-2122-P66
C	1.937	1.625	1	1.875	.437	BCFJF	316SS/I	PS-7908
C	1.937	1.625	1	1.875	.437	BCFKF		PS-2123
C	1.937	1.625	1	1.875	.437	BCFKF	I	PS-2123-P66
C	1.937	1.625	1	1.875	.437	BRFJF		PS-4247
C	1.937	1.625	1	1.875	.437	BZFLF		PS-3146
C	1.937	1.625	1	1.875	.437	NCFJF		PS-1083
C	1.937	1.625	1	1.875	.437	NCFKF		PS-1084
C	1.937	1.625	1	1.875	.437	QCFJF	I	PS-2215
C	1.937	1.625	1	1.875	.437	QLFLF		PS-4053
C	1.937	1.625	1	1.875	.437	VCFJF		PS-2122V-CMS
C	1.937	1.625	1	1.875	.437	VCFKF		PS-2123V-CMS
C	1.937	1.625	1	1.875	.437	VCFZF		PS-7983V
C	1.937	1.625	1	1.875	.437	VLFLF		PS-7805
C	1.937	1.625	1	1.875	.437	VLZFZ		PS-22209
C	1.937	1.625	1	1.875	.437	VRFJF		PS-3829
C	1.937	1.625	1	1.875	.437	VZFLF		PS-3119
C	1.937	1.625	3	1.875	.437	BCFJF	S	PS-1109-CER
C	1.937	1.625	3	1.875	.437	BCFKF		PS-1109
C	1.937	1.625	3	1.875	.437	BCFKF	I	PS-1109-P66
C	1.937	1.625	3	1.875	.437	BCFLF	S	PS-2769
C	1.937	1.625	3	1.875	.437	BLFZF	S	PS-1109-SC-TC
C	1.937	1.625	3	1.875	.437	BZFZF	S	PS-1109-TC-TC
C	1.937	1.625	3	1.875	.437	QCFKF		PS-1109-EPR
C	1.937	1.625	3	1.875	.437	QCFLF	I	PS-4336
C	1.937	1.625	3	1.875	.437	VCFJF	S	PS-2122V
C	1.937	1.625	3	1.875	.437	VCFKF		PS-1109V
C	1.937	1.625	3	1.875	.437	VCFLF	S	PS-1109V-SC-SEAT
C	2.043	1.273	25	2.261	.640	VLFLF	B	PS-3215
C	2.043	1.375	25	2.250	.625	VLFLF	B	PS-1910
C	2.187	1.062	1	1.875	.437	QCFLF		PS-3274
D	2.000	1.000	3	1.875	.375	VCPLF		PS-4637
D	2.000	1.000	3	1.875	.437	VLFLF	316SS/H	PS-4091
D	2.000	1.062	—	—	—	BCF-F		FA-190
D	2.000	1.062	1	1.765	.365	BCFKF		PS-977
D	2.000	1.062	1	1.765	.365	VCFJF		PS-976V
D	2.000	1.062	2	1.875	.187	VCPFP		PS-6036
D	2.000	1.062	1	1.875	.437	QCFLF	I	PS-3023
D	2.000	1.062	1	1.875	.437	QLFLF		PS-3555
D	2.000	1.062	3	1.875	.437	BCFKF		PS-981
D	2.000	1.062	3	1.875	.437	BCFKF	H	PS-22041
D	2.019	1.062	3	1.875	.437	BCDLF	H/S	PS-4246
D	2.019	1.062	3	1.875	.437	VCFKF	H	PS-3685
D	2.062	1.000	3	1.875	.375	BCPKF		PS-6337
D	2.062	1.000	3	1.875	.375	BCPKF		PS-6339
D	2.062	1.000	3	1.875	.375	NCPKF		PS-3934
D	2.062	1.000	3	1.875	.375	VCPKF		PS-1632V
D	2.062	1.000	3	1.937	.437	VCPGP		PS-7245
D	2.062	1.062	1	1.765	.365	BCFJF		PS-976

NOTE: B. TAPERED SPRING
H. SPRING HOLDER NOT INCLUDED
I. ABRASION RESISTANT CARBON (P66)
S. SLOTTED MATING RING

DIMENSIONAL CROSS-REFERENCE

SEAL HEAD			MATING RING			Material Code	NOTES	U.S. Seal Mfg. Part No.
Fig.	OD	Oper Hgt.	Fig.	Bore	Thick			
1.250 (1-1/4") (continued)								
D	2.062	1.062	1	1.875	.437	BCFJF		PS-381
D	2.062	1.062	1	1.875	.437	BCFJF	I	PS-381-P66
D	2.062	1.062	1	1.875	.437	BCFKF		PS-383
D	2.062	1.062	1	1.875	.437	BLFLF		PS-381-SC-SC
D	2.062	1.062	1	1.875	.437	QCFJF		PS-381-EPR
D	2.062	1.062	1	1.875	.437	VCFJF		PS-381V-CMS
D	2.062	1.062	1	1.875	.437	VCFKF		PS-383V-CMS
D	2.062	1.062	1	1.875	.437	VLFLF		PS-3032
D	2.062	1.062	3	1.875	.437	BCFJF	S	PS-804
D	2.062	1.062	3	1.875	.437	BCFKF		PS-517
D	2.062	1.062	3	1.875	.437	BCFZF	S	PS-517-TC-SEAT
D	2.062	1.062	3	1.875	.437	BZFZF	316SS	PS-3759
D	2.062	1.062	3	1.875	.437	QCFJF	I/S	PS-2659
D	2.062	1.062	3	1.875	.437	VCFJF	S	PS-381V
D	2.062	1.062	3	1.875	.437	VCFKF		PS-383V
D	2.062	1.062	3	1.875	.437	VCFLF		PS-4073
D	2.062	1.062	3	1.875	.437	VCFLF	I	PS-4071
D	2.062	1.062	3	1.875	.437	VCFLF	316SS	PS-22020
D	2.062	1.062	3	1.875	.437	VLFLF		PS-4431
D	2.062	1.062	3	1.875	.437	VLZFZ		PS-3629
D	2.062	1.062	2	1.875	.500	NCPGP		PS-3091
D	2.062	1.062	3	1.937	.437	BCFGF		PS-326
D	2.062	1.062	3	1.937	.437	VCFGF		PS-326V
D	2.062	1.062	1	2.000	.437	BCFJF		PS-510
D	2.062	1.062	3	2.125	.437	VCFLF	I	PS-22008
D	2.062	1.062	25	2.250	.625	BCFJF		PS-416A
DB	2.000	1.343	3	1.750	.437	BCFLF	H/S	PS-22135
E	1.812	1.187	1	1.875	.437	BCFJF		PS-5200
E	1.812	1.187	1	1.875	.437	QCFLF	316SS	PS-3528
E	1.812	1.187	1	1.875	.437	VCFKF		PS-256V-CMS
E	1.812	1.187	3	1.875	.437	BCFKF		PS-256
E	1.812	1.625	—	—	—	BCF-F		FA-189
E	1.812	1.625	1	1.875	.437	BCFJF		PS-361
E	1.812	1.625	1	1.875	.437	BCFJF	I	PS-361-P66
E	1.812	1.625	1	1.875	.437	BCFKF		PS-137
E	1.812	1.625	1	1.875	.437	BCFZF		PS-4428
E	1.812	1.625	1	1.875	.437	BLFLF		PS-361-SC-SC
E	1.812	1.625	1	1.875	.437	BLFZF		PS-361-SC-TC
E	1.812	1.625	1	1.875	.437	NCPJP		PS-1185
E	1.812	1.625	1	1.875	.437	NCPKP		PS-108
E	1.812	1.625	1	1.875	.437	QCFJF		PS-361-EPR
E	1.812	1.625	1	1.875	.437	QCFJF	I	PS-361-EPR-P66
E	1.812	1.625	1	1.875	.437	QCFKF		PS-3872
E	1.812	1.625	1	1.875	.437	QCFLF	316SS	PS-3515
E	1.812	1.625	1	1.875	.437	VCFJF		PS-361V-CMS
E	1.812	1.625	1	1.875	.437	VCFJF	I	PS-361V-CMS-P66
E	1.812	1.625	1	1.875	.437	VCFKF		PS-137V-CMS
E	1.812	1.625	1	1.875	.437	VCFLF		PS-361V-SC-SEAT
E	1.812	1.625	1	1.875	.437	VLFLF		PS-4538
E	1.812	1.625	1	1.875	.437	VLZFZ		PS-361V-SC-TC-CMS
E	1.812	1.625	1	1.875	.437	VZFZF		PS-137V-TC-TC
E	1.812	1.625	3	1.875	.437	BCFKF		PS-264
E	1.812	1.625	3	1.875	.437	BCFKF	I	PS-1183-P66
E	1.812	1.625	3	1.875	.437	BCFV/JF	S	PS-546
E	1.812	1.625	3	1.875	.437	BCFZF	I/S	PS-264-TC-P66
E	1.812	1.625	3	1.875	.437	QCFKF	S	PS-3724
E	1.812	1.625	3	1.875	.437	QCFLF		PS-4306
E	1.812	1.625	3	1.875	.437	QCFZF	I/S	PS-3863
E	1.812	1.625	3	1.875	.437	VCFJF	S	PS-361V
E	1.812	1.625	3	1.875	.437	VCFKF		PS-137V
E	1.812	1.625	3	1.875	.437	VCFKF	I	PS-137V-P66
E	1.812	1.625	3	1.875	.437	VCFKF	316SS	PS-4396
E	1.812	1.625	3	1.875	.437	VCFLF	316SS	PS-4049
E	1.812	1.625	3	1.875	.437	VCFZF	S	PS-2657
E	1.812	1.625	3	1.875	.437	VLFLF	S	PS-264V-SC-SC

DIMENSIONAL CROSS-REFERENCE

SEAL HEAD			MATING RING			Material Code	NOTES	U.S. Seal Mfg. Part No.
Fig.	OD	Oper Hgt.	Fig.	Bore	Thick			
1.250 (1-1/4") (continued)								
E	1.812	1.625	3	1.875	.437	VLFZF	S	PS-22207
E	1.812	1.625	3	1.875	.437	VZFLF	S	PS-22077
E	1.812	1.625	1	2.000	.437	BCFJF	I	PS-6802
E	1.812	1.625	1	2.000	.437	BCFKF		PS-1186
E	1.812	1.625	1	2.000	.437	VCFZF	I	PS-3638
E	1.812	2.000	3	1.875	.437	QCFJF	316SS/C/S	PS-22224
E	1.812	2.000	27	2.354	.812	BCFJF	316SS/I	PS-4628
E	1.812	2.281	1	1.875	.437	BCFKF		PS-5366
E	1.812	2.281	3	1.875	.437	BCFJF	S	PS-2128
E	1.812	2.281	3	1.875	.437	BCFKF		PS-2129
E	1.812	2.281	3	1.875	.437	VCFKF		PS-2129V
E	1.812	2.281	3	1.875	.437	VCFZF	I	PS-7719
EB	1.812	1.937	3	1.750	.437	VCFZF	316SS/S	PS-3288
G	1.811	1.024	1	1.875	.437	BCFJF	316SS	PS-3883
G	1.811	1.024	1	1.875	.437	VLFLF	316SS	PS-6265
G	1.811	1.024	1	2.000	.469	VLFLF	316SS	PS-22177
G	1.811	1.062	1	1.875	.437	BLFLF	316SS	PS-7972
G	1.811	1.062	1	1.875	.437	QCFJF	316SS/I	PS-6261
G	1.811	1.062	1	1.875	.437	QCFZF	316SS/I	PS-6260
G	1.811	1.062	1	1.875	.437	QLFLF	316SS	PS-20001
G	1.811	1.062	1	1.875	.437	VCFJF	316SS	PS-6259
G	1.811	1.062	1	1.875	.437	VCFJF	316SS/I	PS-6264
G	1.811	1.062	3	1.875	.437	BCFLF	316SS	PS-6266
K	1.923	1.734	1	1.875	.437	VLFLF		PS-4179
K	1.937	1.625	1	1.875	.437	B/HCFJF		PS-1118
K	1.937	1.625	1	1.875	.437	BL/CFL/JF		PS-4282
K	1.937	1.625	1	1.875	.437	VCFKF		PS-228V-CMS
K	1.937	1.625	3	1.875	.437	BCFJF	316SS	PS-6229
K	1.937	1.625	3	1.875	.437	BCFKF		PS-228
K	1.937	1.625	3	1.875	.437	VCFKF		PS-228V
K	1.924	1.625	3	1.875	.437	VCFJF	S	PS-2810
K	1.937	1.750	1	1.875	.437	BCFJF		PS-883
K	1.937	1.750	1	1.875	.437	BZ/CFZ/JF		PS-7323
K	1.937	1.750	1	1.875	.437	BZFZF		PS-4537
K	1.937	1.750	1	1.875	.437	VCFJF		PS-883V-CMS
K	1.937	1.875	1	1.875	.437	BCFKF		PS-890
K	1.937	1.875	1	1.875	.437	BLFLF		PS-4305
K	1.937	1.875	3	2.000	.375	BCFJF		PS-3184
K	1.937	2.000	3	2.125	.375	BCFJ/KF		PS-1623
R	2.000	1.875	3	1.875	.437	VZFLF	S	PS-3229
S	2.296	2.218	8	2.125	.281	NAPSP		PS-794
T	1.812	1.937	3	2.000	.312	BCKFK		PS-4377
T	1.812	2.375	1	1.875	.437	BCFJF		PS-1187
T	1.812	2.375	3	1.875	.437	BCFJF	S	PS-2211
T	1.812	2.375	3	1.875	.437	NAFGF		PS-3607
T	1.812	2.375	3	1.875	.437	NAFZF		PS-3084
T	1.812	2.375	3	1.875	.437	NCFGF	I	PS-4197
T	1.812	2.375	3	1.875	.437	NCPKF		PS-308
T	1.875	2.375	3	1.875	.437	NCFGF		PS-22076
U	1.750	1.526	3	1.875	.437	VCFKF	316SS/S	PS-22173
U	1.750	1.625	2	1.875	.437	BCKPF		PS-3973
U	1.750	1.625	3	1.875	.437	BCF/DKF		PS-394
U	1.750	1.625	3	1.875	.437	VCF/DKF		PS-394V
U	1.750	2.406	1	1.875	.437	BCD/FJF		PS-681
W	1.875	1.063	3	1.875	.437	T/VCFKF	316SS	PS-9719
WT	1.687	1.000	2	1.875	.359	TCFOF	316SS	PS-3611
WT	1.687	1.000	2	1.875	.375	TCFLF	316SS	PS-9659
WT	1.687	1.000	2	2.343	.375	TCFKF	316SS	PS-9724
X	1.875	1.062	3	1.875	.437	VCFLF	316SS/S	PS-22161
X	1.875	1.062	28	2.832	.665	VCFKF	316SS	PS-8073
XB2	2.000	1.000	27	2.606	.960	VCFLF	316SS/I	PS-8095
1.260 (32MM)								
G	1.811	1.024	1	1.890	.276	VLFLF	316SS	PS-3150

NOTE: C. COMPLETE WITH COLLAR
I. ABRASION RESISTANT CARBON (P66)
S. SLOTTED MATING RING

DIMENSIONAL CROSS-REFERENCE

SEAL HEAD			MATING RING			Material Code	NOTES	U.S. Seal Mfg. Part No.
Fig.	OD	Oper Hgt.	Fig.	Bore	Thick			
1.312 (1-5/16")								
X	1.942	1.125	3	1.937	.437	VCFZF	316SS	PS-8592
1.375 (1-3/8")								
C	1.886	.850	3	2.000	.250	BCFKF	316SS	PS-5074
C	1.933	1.250	2	2.125	.375	NCFKF	316SS	PS-5003
C	1.937	.925	2	2.187	.375	B/VCFJF	316SS	PS-5676
C	1.937	.925	2	2.187	.375	B/VCFKF	316SS	PS-5711
C	1.937	.925	2	2.187	.375	VCFJF	316SS	PS-5676V
C	2.046	.850	3	2.000	.250	VCFGF		PS-6180
C	2.062	.900	25	2.000	.500	BCFJF		PS-929
C	2.062	.906	3 Special	2.000	.437	VCFGF		PS-3584
C	2.062	1.125	—	—	—	BCF-F		FA-177
C	2.062	1.125	—	—	—	BCF-F	I	FA-10166
C	2.062	1.125	—	—	—	NFF-F		FA-3730
C	2.062	1.125	—	—	—	QCF-F	I	FA-10165
C	2.062	1.125	—	—	—	VCF-F		FA-10041
C	2.062	1.125	—	—	—	VLF-F		FA-172VSC
C	2.062	1.125	1	2.000	.437	BCFJF		PS-177
C	2.062	1.125	1	2.000	.437	BCFJF	I	PS-177-P66
C	2.062	1.125	1	2.000	.437	BCFKF		PS-210
C	2.062	1.125	1	2.000	.437	BLFZF		PS-177-SC-TC-CMS
C	2.062	1.125	1	2.000	.437	NCFJF		PS-3230
C	2.062	1.125	1	2.000	.437	QCFJF		PS-177-EPR
C	2.062	1.125	1	2.000	.437	VCFJF		PS-177V-CMS
C	2.062	1.125	1	2.000	.437	VCFJF	I	PS-177V-CMS-P66
C	2.062	1.125	1	2.000	.437	VCFKF		PS-210V-CMS
C	2.062	1.125	1	2.000	.437	VCFLF		PS-177V-SC-SEAT
C	2.062	1.125	1	2.000	.437	VFLF		PS-177V-SC-SC
C	2.062	1.125	1	2.000	.437	VZFZF		PS-210V-TC-TC
C	2.062	1.125	3	2.000	.437	BCFJF	S	PS-805
C	2.062	1.125	3	2.000	.437	BCFKF	S	PS-547
C	2.062	1.125	3	2.000	.437	BCFKF	I/S	PS-547-P66
C	2.062	1.125	3	2.000	.437	BLFLF	S	PS-547-SC-SC
C	2.062	1.125	3	2.000	.437	BZVZF	S	PS-547-TC-TC
C	2.062	1.125	3	2.000	.437	B/VLFLF		PS-7919
C	2.062	1.125	3	2.000	.437	QCFKF	S	PS-210-EPR
C	2.062	1.125	3	2.000	.437	QCFLF	S	PS-210-EPR-SC-SEAT
C	2.062	1.125	3	2.000	.437	QCFLF	I/S	PS-210-EPR-P66-SC
C	2.062	1.125	3	2.000	.437	QCFZF	I/S	PS-3038
C	2.062	1.125	3	2.000	.437	QLFLF	S	PS-4328
C	2.062	1.125	3	2.000	.437	VCFJF	S	PS-177V
C	2.062	1.125	3	2.000	.437	VCFJF	I/S	PS-177V-P66
C	2.062	1.125	3	2.000	.437	VCFKF	S	PS-210V
C	2.062	1.125	3	2.000	.437	VCFKF	I	PS-3213
C	2.062	1.125	3	2.000	.437	VCFLF	S	PS-210V-SC-SEAT
C	2.062	1.125	3	2.000	.437	VCFZF	S	PS-210V-TC-SEAT
C	2.062	1.125	3	2.000	.437	VLFZF	S	PS-210V-SC-TC
C	2.062	1.125	3	2.000	.437	VZFLF	S	PS-210V-TC-SC
C	2.062	1.125	1	2.125	.437	BLFLF		PS-4238
C	2.062	1.125	3	2.125	.437	QCFKF		PS-4057
C	2.062	1.125	3	2.125	.437	VCFJF		PS-6775V
C	2.062	1.156	3	2.125	.406	VCFKF		PS-1062
C	2.062	1.187	1	2.000	.437	QCFZF		PS-3689
C	2.062	1.187	1	2.125	.375	BCFJF		PS-4044
C	2.062	1.187	1	2.125	.437	BCFJF		PS-7199
C	2.062	1.187	1	2.125	.437	BCFKF		PS-467
C	2.062	1.500	1	2.000	.437	VZFLF	C	PS-4575
C	2.062	1.687	1	2.000	.437	BCFJF		PS-2134
C	2.062	1.687	1	2.000	.437	BCFJF	I	PS-2134-P66
C	2.062	1.687	1	2.000	.437	BCFKF		PS-1667
C	2.062	1.687	1	2.000	.437	QCFKF		PS-1667-EPR
C	2.062	1.687	1	2.000	.437	VCFJF	I	PS-2134V-CMS-P66
C	2.062	1.687	1	2.000	.437	VCFKF		PS-1667V
CB	2.062	1.437	—	—	—	BCF-F		FA-4268
CB	2.062	1.437	1	1.875	.437	QCFJF		PS-7696
CB	2.062	1.437	3	1.875	.437	BCFJF	S	PS-7697

DIMENSIONAL CROSS-REFERENCE

SEAL HEAD			MATING RING			Material Code	NOTES	U.S. Seal Mfg. Part No.
Fig.	OD	Oper Hgt.	Fig.	Bore	Thick			
1.375 (1-3/8") (continued)								
CB	2.062	1.437	3	1.875	.437	BCFKF		PS-7795
CB	2.062	1.437	3	1.875	.437	BCFZF	S	PS-3587
CB	2.062	1.437	3	1.875	.437	VCFKF		PS-7695
CB	2.062	1.437	3	1.875	.437	VCFKF	S	PS-4119
CB	2.062	1.437	3	1.875	.437	VCFZF	S	PS-7697V-TC-SEAT
CB	2.062	1.437	3	1.875	.437	VCFZF	I/S	PS-2704
D	2.250	1.006	3	2.000	.218	VCPSP		PS-6048
D	2.250	1.093	3	2.000	.437	BCDLF	S	PS-22136
D	2.250	1.093	25	2.000	.500	BCDJF		PS-404
D	2.250	1.125	—	—	—	BCD-F		FA-186
D	2.250	1.125	—	—	—	QCD-F	I	FA-376E
D	2.250	1.125	1	2.000	.437	BCDJF		PS-491
D	2.250	1.125	1	2.000	.437	BCDJF	I	PS-491-P66
D	2.250	1.125	1	2.000	.437	BCDKF		PS-186
D	2.250	1.125	1	2.000	.437	BCDZF		PS-3932
D	2.250	1.125	1	2.000	.437	BCFJF		PS-2045
D	2.250	1.125	1	2.000	.437	BCFKF		PS-2046
D	2.250	1.125	1	2.000	.437	BCFZF		PS-4117
D	2.250	1.125	1	2.000	.437	QCDJF		PS-491-EPR
D	2.250	1.125	1	2.000	.437	QCDLF		PS-186-EPR-SC-SEAT
D	2.250	1.125	1	2.000	.437	QCDZF	I	PS-7803
D	2.250	1.125	1	2.000	.437	VCDJF		PS-491V-CMS
D	2.250	1.125	1	2.000	.437	VCDJF	I	PS-491V-CMS-P66
D	2.250	1.125	1	2.000	.437	VCFKF		PS-186V-CMS
D	2.250	1.125	1	2.000	.437	VFLF		PS-4194
D	2.250	1.125	3	2.000	.437	BCDJF	S	PS-806
D	2.250	1.125	3	2.000	.437	BCDKF	S	PS-807
D	2.250	1.125	3	2.000	.437	BCFJF	S	PS-2047
D	2.250	1.125	3	2.000	.437	BCFKF	S	PS-2048
D	2.250	1.125	3	2.000	.437	VCDJF	S	PS-491V
D	2.250	1.125	3	2.000	.437	VCDKF	S	PS-186V
D	2.250	1.125	3	2.000	.437	VCFJF	S	PS-2047V
D	2.250	1.125	3	2.000	.437	VCFKF	S	PS-22023
D	2.250	1.125	3	2.000	.437	VCFZF	S	PS-186V-TC-SEAT
D	2.250	1.125	3	2.000	.437	XLFLF	S	PS-3318
D	2.250	1.125	3 Special	2.000	.437	VCFJF	316SS	PS-3216
D	2.250	1.256	3	2.000	.437	VCP/FKF	S	PS-4123
DB	2.250	1.437	1	1.875	.437	BCFJF		PS-3974
DB	2.250	1.437	1	1.875	.437	BCFKF		PS-7798
DB	2.250	1.437	1	1.875	.437	BCFZF		PS-4200
DB	2.250	1.437	1	1.875	.437	VCFJF		PS-3974V
DB	2.250	1.437	3	1.875	.437	VCFZF	S	PS-22220
E	1.875	1.625	3	2.125	.437	VCFJF	316SS/C	PS-3792
E	1.875	1.187	1	2.000	.437	QLFLF		PS-257E-SC-SC-CMS
E	1.875	1.187	3	2.000	.437	BCFKF	S	PS-257
E	1.875	1.187	3	2.000	.437	VCFKF	S	PS-257V
E	1.875	1.625	3	2.125	.437	VCFLF	316SS/C	PS-3783
E	1.875	1.625	3	2.125	.437	VCFZF	316SS/C	PS-4452
E	1.875	1.687	—	—	—	BCF-F		FA-354
E	1.875	1.687	—	—	—	VCF-F		FA-2104V
E	1.875	1.687	1	2.000	.437	BCFJF		PS-354
E	1.875	1.687	1	2.000	.437	BCFJF	I	PS-354-P66
E	1.875	1.687	1	2.000	.437	BCFKF		PS-677
E	1.875	1.687	1	2.000	.437	BZFZF		PS-677-TC-TC-CMS
E	1.875	1.687	1	2.000	.437	QCFJF	I	PS-354-EPR-P66
E	1.875	1.687	1	2.000	.437	QCFLF	I	PS-354-EPR-SC-P66
E	1.875	1.687	1	2.000	.437	VCFJF		PS-354V-CMS
E	1.875	1.687	1	2.000	.437	VCFJF	I	PS-354V-CMS-P66
E	1.875	1.687	1	2.000	.437	VZFZF		PS-4552
E	1.875	1.687	3	2.000	.437	BCFJF	S	PS-864
E	1.875	1.687	3	2.000	.437	BCFKF	S	PS-865
E	1.875	1.687	3	2.000	.437	BCFKF	I/S	PS-865-P66
E	1.875	1.687	3	2.000	.437	BCFLF	S	PS-865-SC-SEAT
E	1.875	1.687	3	2.000	.437	VCFJF	S	PS-354V
E	1.875	1.687	3	2.000	.437	VCFJF	I/S	PS-354V-P66

NOTE: C. COMPLETE WITH COLLAR
 I. ABRASION RESISTANT CARBON (P66)
 S. SLOTTED MATING RING

DIMENSIONAL CROSS-REFERENCE

SEAL HEAD			MATING RING			Material Code	NOTES	U.S. Seal Mfg. Part No.
Fig.	OD	Oper Hgt.	Fig.	Bore	Thick			
1.375 (1-3/8") (continued)								
E	1.875	1.687	3	2.000	.437	VCFKF	S	PS-677V
E	1.875	1.687	3	2.000	.437	VLFLF	S	PS-865V-SC-SC
E	1.875	1.687	3	2.000	.437	VLFZF	S	PS-865V-SC-TC
E	1.875	1.687	3	2.000	.437	VZFLF	S	PS-865V-TC-SC
E	1.875	1.687	3	2.125	.437	VCFJF	S	PS-3925
E	1.875	1.687	3	2.125	.437	VCFJF	316SS/S	PS-3878
E	1.875	1.687	3	2.125	.437	VCFLF	S	PS-3984
E	1.875	1.687	3	2.125	.437	VCFZF	S	PS-3087
E	1.875	2.031	—	—	—	QCF-F	316SS/C/I	FA-4163
E	1.875	2.031	—	—	—	VCF-F	316SS/C	FA-4087
E	1.875	2.031	3	2.000	.437	BCFJF	316SS/C/H/S	PS-3218
E	1.875	2.031	3	2.000	.437	QCFJF	316SS/C/H/S	PS-4566
E	1.875	2.031	3	2.000	.437	VCFJF	316SS/C/H/S	PS-3901
E	1.875	2.031	3	2.000	.437	VCFLF	316SS/C/H/S	PS-3205
E	1.875	2.031	3	2.000	.437	VCFZF	316SS/C/S	PS-4574
E	1.875	2.031	3	2.000	.437	VLFLF	C/S	PS-4277
E	1.875	2.031	3	2.000	.437	XLFLF	316SS/S	PS-4384
E	2.000	2.031	3	2.000	.437	XZFLF	316SS/C/S	PS-4433
EB	1.875	2.000	1	1.875	.437	BCFKF		PS-3954
EB	1.875	2.000	3	1.875	.437	BCFJF	S	PS-7702
EB	1.875	2.000	3	1.875	.437	BCFKF		PS-3991
EB	1.875	2.000	3	1.875	.437	BCFKF	S	PS-4170
EB	1.875	2.000	3	1.875	.437	BCFZF	S	PS-4145
EB	1.875	2.000	3	1.875	.437	QCFZF	316SS/S	PS-3799
EB	1.875	2.000	3	1.875	.437	VCFKF	316SS/S	PS-4420
EB	1.875	2.000	3	1.875	.437	VCFZF	I/S	PS-3769
EB	1.875	2.343	3	2.000	.437	QCFJF	316SS/C/S	PS-3732
G	1.929	1.024	1	2.000	.437	BLFLF	316SS	PS-22179
G	1.929	1.024	1	2.000	.437	BLFZF	316SS	PS-3014
G	1.929	1.024	3	2.000	.437	QCFLF	316SS/S	PS-3086
G	1.929	1.024	25	2.000	.437	VLFLF	316SS	PS-3015
G	1.929	1.358	3	2.000	.437	VCFKF	316SS/S	PS-22163
K	2.062	1.625	1	2.000	.437	BCFJF		PS-495
K	2.062	1.625	1	2.000	.437	QCFJF		PS-495-EPR
K	2.062	1.625	1	2.000	.437	VCFJF		PS-3117
K	2.062	1.625	3	2.000	.250	VCFLF		PS-22102
K	2.062	1.625	3	2.000	.437	VCFJF	S	PS-3196
Q	2.515	.908	9	2.000	.281	BMPAP		PS-3854
Q	2.515	.908	9	2.000	.281	VMPSP		PS-6317
R	2.187	2.187	1	2.000	.437	BCDJF		PS-178
T	1.875	2.437	1	2.000	.437	BCFJF		PS-725
T	1.875	2.437	1	2.000	.437	BCFKF		PS-726
T	1.875	2.437	1	2.000	.437	VCFJF		PS-725V
T	1.875	2.437	1	2.000	.437	VCFJF	316SS	PS-4456
T	1.875	2.437	3	2.000	.437	VZVFZ	316SS/S	PS-3541
T	1.875	2.687	3	2.000	.437	VCFJF	316SS/S	PS-4515
T	1.875	2.812	3	2.000	.437	VCFJF	316SS/S	PS-4206
U	1.875	2.125	1	2.000	.437	BCFKF		PS-561SS
U	1.875	2.125	3	2.000	.437	VCFKF	S	PS-561V
V	1.937	1.937	25	2.140	.437	BCFJF		PS-1104
V	1.937	2.000	3	2.140	.406	BCFJF		PS-3198
W	2.000	1.125	2	2.000	.437	TCFJF	316SS	PS-9317
W	2.000	1.125	27 Special	2.656	.625	QCFJF	316SS	PS-9016
WT	1.937	1.062	—	—	—	TCF-F	316SS	FA-9341
WT	1.937	1.062	—	—	—	TCF-F	316SS	FA-9328
WT	1.937	1.062	3	2.000	.437	T/VCFJF	316SS/S	PS-9021
WT	1.937	1.062	3	2.000	.437	T/VCFKF	316SS/S	PS-9706
WT	1.937	1.062	3	2.125	.437	T/VCFKF	316SS	PS-9150
WT	1.937	1.062	27	2.375	1.000	TCFJF	316SS	PS-7103
X1T	1.937	1.062	3	2.000	.437	QCFJF	316SS/S	PS-8135
XT	1.937	1.062	3	2.125	.437	VCFJF	316SS	PS-8048
XT Dbl.	1.937	1.875	3	2.000	.437	VCFJF	316SS	PS-22155
X	2.000	1.125	3	2.000	.437	VCFLF	316SS/S	PS-22162
XB2	2.250	1.115	3	2.000	.437	VCFJF	316SS/S	PS-8110
XB2	2.250	1.115	Special	2.682	1.000	VLFLF		PS-22158

DIMENSIONAL CROSS-REFERENCE

SEAL HEAD			MATING RING			Material Code	NOTES	U.S. Seal Mfg. Part No.
Fig.	OD	Oper Hgt.	Fig.	Bore	Thick			
1.375 (1-3/8") (continued)								
XBS	2.000	1.125	3	2.000	.437	VCFKF	316SS/S	PS-22164
X Special	3.500	.701	Special	1.875	.312	B/NCPCGF		PS-4134
1.378 (35MM)								
G	49MM	26MM	1	50MM	11MM	BCFJF	316SS	PS-7971
G	49MM	26MM	25	50MM	8MM	VCFLF		PS-22194
1.437 (1-7/16")								
C	2.125	1.125	3	2.250	.625	BCFKF		PS-2156
C	2.125	1.125	3	2.250	.625	VCFKF		PS-2156V
C	2.125	1.125	Special	2.718	.654	VCFGF		PS-7367
C	2.125	1.250	3	2.250	.375	BCFKF		PS-7105
C	2.125	1.250	3	2.250	.375	VCFKF		PS-7105V
D	2.250	1.093	3	2.062	.437	VCPKF		PS-4455
E	1.937	1.219	3	2.250	.375	BCPKF		PS-4189
E	1.937	1.219	3	2.250	.375	VCPKF		PS-4189V
E	1.937	1.244	3	2.375	.531	VCFLF		PS-4140
E	1.937	1.250	3	2.250	.375	BCPKP		PS-1634
E	1.937	1.250	3	2.250	.375	VCPKF		PS-1634V
E	1.937	1.688	3	2.062	.437	BCFJF		PS-705
E	1.937	1.688	3	2.062	.437	BCFKF		PS-2234
E	1.937	1.688	3	2.062	.437	VCFKF		PS-2234V
E	1.937	1.688	3	2.125	.437	VCPKF		PS-4067
E	1.937	1.688	3	2.171	.437	BCPKF	H	PS-6340
E	1.937	1.688	3	2.171	.437	VCPKF	H	PS-6342
E	1.937	1.688	27	2.718	.654	VCPGP		PS-6055
E	2.000	1.516	3	2.310	.359	BCPKF		PS-22153
E	2.000	1.516	3	2.310	.359	VCPKF		PS-22151
E	2.110	1.516	3	2.312	.360	BAPKF		PS-3080
E	2.110	1.516	3	2.312	.360	BCPKF		PS-3848
E	2.110	1.516	3	2.312	.360	NCPKF		PS-943
E	2.110	1.516	3	2.312	.360	NCPKF		PS-6344
E	2.110	1.516	3	2.312	.360	VCPKF		PS-6338
R	2.250	1.625	3	2.062	.437	VCFKF		PS-4400
T	2.109	2.125	3	2.187	.375	NCPKF		PS-1633
W	2.062	1.125	3	2.250	.625	T/VCFKF		PS-9302
W	2.062	1.125	2	2.312	.421	TCFKF		PS-9227
W	2.062	1.125	2	2.312	.421	TCFOF		PS-9307
W	2.062	1.125	2 Special	2.312	.421	Special	316SS	PS-9707
W	2.062	1.125	Special	2.484	.675	TCFKF	316SS	PS-9330
W	2.062	1.125	27	2.687	.625	Special	316SS	PS-9717
W	2.062	1.125	27	2.687	.625	TCFKF	316SS	PS-9304
W	2.062	1.125	27	2.687	.625	TCFLF	316SS	PS-9721
W	2.062	1.125	27	2.687	.625	Special	316SS	PS-9331
X	2.062	1.125	5	2.125	.437	VCFZF	316SS	PS-8044
X	2.062	1.125	27 Special	2.718	.656	VCFSF	316SS	PS-6056
XB Special	2.125	1.125	27 Special	2.687	.625	VCFKF	316SS	PS-8131
XB2	2.187	1.000	3	2.125	.312	BCFKF	316SS	PS-8111
XB5	2.125	1.500	3	1.937	.437	Special	316SS	PS-8079
1.496 (38MM)								
G	2.126	1.457	1	2.205	.315	BCFLF	316SS	PS-2812
G	2.126	1.457	1	2.205	.315	VCFLF		PS-22125
1.500 (1-1/2")								
C	2.062	1.125	2	2.125	.423	BCFKF		PS-5720
C	2.062	1.125	3	2.125	.437	VRFRF	316SS	PS-5727
C	2.187	.812	3	2.125	.312	VCFGP		PS-6000
C	2.187	.906	3 Special	2.125	.437	VCFGF		PS-3943
C	2.187	1.125	—	—	—	BCF-F		FA-1850
C	2.187	1.125	—	—	—	QCF-F	I	FA-2755
C	2.187	1.125	—	—	—	VCF-F		FA-10043
C	2.187	1.125	1	2.125	.437	BCFJF		PS-2705
C	2.187	1.125	1	2.125	.437	BCFJF		PS-758
C	2.187	1.125	1	2.125	.437	BCFJF	I	PS-758-P66
C	2.187	1.125	1	2.125	.437	BCFJF	B/H	PS-347
C	2.187	1.125	1	2.125	.437	BCFJF	B/H/I	PS-347-P66

NOTE: B. TAPERED SPRING
H. SPRING HOLDER NOT INCLUDED
I. ABRASION RESISTANT CARBON (P66)
S. SLOTTED MATING RING

DIMENSIONAL CROSS-REFERENCE

SEAL HEAD			MATING RING			Material Code	NOTES	U.S. Seal Mfg. Part No.
Fig.	OD	Oper Hgt.	Fig.	Bore	Thick			
1.500 (1-1/2") (continued)								
C	2.187	1.125	1	2.125	.437	BCFKF		PS-659
C	2.187	1.125	1	2.125	.437	BCFKF	B/H	PS-378
C	2.187	1.125	1	2.125	.437	BCFKF	I	PS-2232
C	2.187	1.125	1	2.125	.437	BCFLF		PS-758-SC-SEAT
C	2.187	1.125	1	2.125	.437	BCFZF		PS-659-TC
C	2.187	1.125	1	2.125	.437	BLFLF		PS-758-SC-SC
C	2.187	1.125	1	2.125	.437	BLFZF		PS-758-SC-TC-CMS
C	2.187	1.125	1	2.125	.437	BZFLF	316SS	PS-3166
C	2.187	1.125	1	2.125	.437	BZFZF		PS-2209
C	2.187	1.125	1	2.125	.437	QCFJF		PS-758-EPR-CMS
C	2.187	1.125	1	2.125	.437	QCFJF	I	PS-7953
C	2.187	1.125	1	2.125	.437	QCFJF	I	PS-4171
C	2.187	1.125	1	2.125	.437	QCFKF		PS-7413
C	2.187	1.125	1	2.125	.437	QCFLF	I	PS-7953-SC-SEAT
C	2.187	1.125	1	2.125	.437	QCFZF		PS-3224
C	2.187	1.125	1	2.125	.437	QCFZF	I	PS-7632
C	2.187	1.125	1	2.125	.437	QLFLF		PS-7937
C	2.187	1.125	1	2.125	.437	QLFLF	H	PS-22123
C	2.187	1.125	1	2.125	.437	VCFJF		PS-758V-CMS
C	2.187	1.125	1	2.125	.437	VCFJF	I	PS-758V-P66-CMS
C	2.187	1.125	1	2.125	.437	VCFJF	I	PS-3165
C	2.187	1.125	1	2.125	.437	VCFJF	B/H	PS-347V-CMS
C	2.187	1.125	1	2.125	.437	VCFJF	316SS	PS-7409
C	2.187	1.125	1	2.125	.437	VCFKF	I	PS-659V-CMS-P66
C	2.187	1.125	1	2.125	.437	VCFKF	I	PS-3141
C	2.187	1.125	1	2.125	.437	VCFKF		PS-659V-CMS
C	2.187	1.125	1	2.125	.437	VCFKF	B/H	PS-378V-CMS
C	2.187	1.125	1	2.125	.437	VCFLF		PS-758V-SC-SEAT
C	2.187	1.125	1	2.125	.437	VCFZF	I	PS-7747
C	2.187	1.125	1	2.125	.437	VLFLF		PS-758V-SC-SC
C	2.187	1.125	1	2.125	.437	VLFLF	316SS	PS-3252
C	2.187	1.125	1	2.125	.437	VLZF		PS-7792V-CMS
C	2.187	1.125	1	2.125	.437	VZFLF		PS-758V-TC-SC-CMS
C	2.187	1.125	1	2.125	.437	VZFZF		PS-659V-TC-VS-TC
C	2.187	1.125	3	2.125	.437	BCFJF	S	PS-816
C	2.187	1.125	3	2.125	.437	BCFKF		PS-553
C	2.187	1.125	3	2.125	.437	BCFKF	S	PS-3174
C	2.187	1.125	3	2.125	.437	BCFKF	I/S	PS-7674
C	2.187	1.125	3	2.125	.437	BLFLF	S	PS-3101
C	2.187	1.125	3	2.125	.437	BZFZF	S	PS-2217
C	2.187	1.125	3	2.125	.437	QCFJF	S	PS-758-EPR
C	2.187	1.125	3	2.125	.437	QCFKF		PS-553-EPR
C	2.187	1.125	3	2.125	.437	QCFZF	S	PS-3248
C	2.187	1.125	3	2.125	.437	QCFZF	I/S	PS-3160
C	2.187	1.125	3	2.125	.437	QCFZF	S	PS-4438
C	2.187	1.125	3	2.125	.437	VCFJF	S	PS-758V
C	2.187	1.125	3	2.125	.437	VCFJF	S	PS-22053
C	2.187	1.125	3	2.125	.437	VCFJF	I/S	PS-4212
C	2.187	1.125	3	2.125	.437	VCFKF		PS-659V
C	2.187	1.125	3	2.125	.437	VCFKF	I	PS-659V-P66
C	2.187	1.125	3	2.125	.437	VCFKF	S	PS-7975
C	2.187	1.125	3	2.125	.437	VCFLF	S	PS-2223-SC-SEAT
C	2.187	1.125	3	2.125	.437	VCFZF	S	PS-2223
C	2.187	1.125	3	2.125	.437	VCFZF	316SS/S	PS-3704
C	2.187	1.125	3	2.125	.437	VLFLF	S	PS-3736
C	2.187	1.125	3	2.125	.437	VLZF	S	PS-4447
C	2.187	1.125	5	2.125	.437	QCFZF	316SS	PS-22180
C	2.187	1.125	1	2.156	.437	BCFJF		PS-7694
C	2.187	1.125	1	2.156	.437	BCFJF	B/H	PS-682
C	2.187	1.125	1	2.156	.437	BCFKF	B/H	PS-247
C	2.187	1.125	1	2.250	.437	BCFJF		PS-320
C	2.187	1.125	3	2.312	.437	BCFJF		PS-926
C	2.187	1.125	3	2.500	.500	BZFZF	S	PS-7131
C	2.187	1.125	Special	2.740	.875	BCFKF		PS-3979
C	2.187	1.437	3 Special	2.125	.437	NCFGF		PS-192

DIMENSIONAL CROSS-REFERENCE

SEAL HEAD			MATING RING			Material Code	NOTES	U.S. Seal Mfg. Part No.
Fig.	OD	Oper Hgt.	Fig.	Bore	Thick			
1.500 (1-1/2") (continued)								
C	2.187	1.687	1	2.125	.437	BCFJF		PS-7201
C	2.187	1.687	3	2.125	.437	BCFJF	S	PS-7166
C	2.187	1.687	3	2.125	.437	BCFKF		PS-1110
C	2.187	1.687	3	2.125	.437	BCFLF	S	PS-22210
C	2.187	1.687	3	2.125	.437	QCFKF		PS-2221
C	2.187	1.687	3	2.125	.437	VCFKF		PS-1110V
C	2.187	1.687	3	2.125	.437	BCFZF	S	PS-3279
C	2.187	1.687	3	2.125	.437	VCFJF	S	PS-2714
C	2.312	1.093	1	2.125	.437	VCFJF	B/H	PS-3813
C	2.312	1.093	1	2.125	.437	VCFKF	B/H	PS-4482
C	2.312	1.093	3	2.125	.437	NLFLF	B/S	PS-3249
CB	2.187	1.437	3	2.000	.437	BCFJF	S	PS-3880
D	2.312	1.093	1	2.125	.437	VCFLF	316SS/H	PS-22005
D	2.312	1.093	3	2.125	.437	BCFLF	H/S	PS-22132
D	2.312	1.093	3	2.125	.437	VCFLF		PS-22149
D	2.312	1.093	2	2.125	.500	BCDKF	H	PS-3136
D	2.312	1.125	3	2.125	.437	VCFLF	S	PS-22022
D	2.312	1.125	3	2.125	.437	VCFLF	316SS/S	PS-22019
D	2.375	1.125	—	—	—	BCF-F		FA-200
D	2.375	1.125	1	2.125	.437	BCFJF		PS-382
D	2.375	1.125	1	2.125	.437	BCFJF	I	PS-382-P66
D	2.375	1.125	1	2.125	.437	BCFKF		PS-371
D	2.375	1.125	1	2.125	.437	QCFKF		PS-371-EPR
D	2.375	1.125	1	2.125	.437	VCFKF		PS-371V-CMS
D	2.375	1.125	1	2.125	.437	VFLFLF		PS-3642
D	2.375	1.125	3	2.125	.437	BCFJF	S	PS-817
D	2.375	1.125	3	2.125	.437	BCFKF		PS-534
D	2.375	1.125	3	2.125	.437	VCFKF		PS-371V
D	2.375	1.125	3	2.125	.437	VFLFLF	S	PS-371V-SC-SC
D	2.375	1.125	3	2.125	.437	XLFLF	S	PS-3303
D	2.375	1.125	3	2.125	.437	XLFZF	S	PS-4365
D	2.375	1.125	1	2.156	.437	BCFJF		PS-283
D	2.312	1.236	1	2.125	.437	BCFLF	316SS	PS-3284
D	2.375	1.000	3	2.187	.437	BCFGF		PS-4363
D	2.375	1.000	3	2.187	.437	BLELE	S	PS-22111
D	2.375	1.119	3	2.125	.443	BLFLE	S	PS-7874
D	2.375	1.125	3	2.125	.437	B/VCPKP	S	PS-4546
D	2.375	1.125	3	2.125	.437	VCFLF	316SS/S	PS-22004
D	2.375	1.125	3	2.125	.437	XLFLE	S	PS-3323
D	2.375	1.619	—	—	—	NCF-F		FA-2754
D	2.375	1.619	—	—	—	NLF-F		FA-2752
D Special	2.375	1.094	3	2.125	.437	BLFLE	S	PS-22110
D Special	2.375	1.094	3	2.125	.437	XLFLF	S	PS-4423
D Special	2.375	1.689	3	2.125	.437	NLFLF		PS-2706
E	2.000	1.187	1	2.125	.437	QCFLF		PS-259-EPR-CMS-SC
E	2.000	1.187	3	2.125	.437	BCFKF		PS-259
E	2.000	1.250	3	2.125	.437	QCFZF	316SS/I/S	PS-22176
E	2.000	1.688	—	—	—	BCF-F		FA-305
E	2.000	1.688	—	—	—	BCF-F	I	FA-10167
E	2.000	1.688	—	—	—	VCF-F		FA-305V
E	2.000	1.688	3	2.000	.437	BCFJF		PS-314
E	2.000	1.688	3	2.000	.437	BCFKF		PS-316
E	2.000	1.688	1	2.125	.437	BCFJF		PS-305
E	2.000	1.688	1	2.125	.437	BCFJF	I	PS-305-P66
E	2.000	1.688	1	2.125	.437	BCFKF		PS-374
E	2.000	1.688	1	2.125	.437	BCFKF	I	PS-374-P66
E	2.000	1.688	1	2.125	.437	BLFLF		PS-305-SC-SC
E	2.000	1.688	1	2.125	.437	BZFZF		PS-4354
E	2.000	1.688	1	2.125	.437	QCFJF		PS-305-EPR
E	2.000	1.688	1	2.125	.437	QCFJF	I	PS-305-EPR-P66
E	2.000	1.688	1	2.125	.437	QCFZF	I	PS-7933
E	2.000	1.688	1	2.125	.437	QLFLF		PS-4407
E	2.000	1.688	1	2.125	.437	VCFJF		PS-305V-CMS
E	2.000	1.688	1	2.125	.437	VCFJF	I	PS-305V-CMS-P66
E	2.000	1.688	1	2.125	.437	VCFKF		PS-374V-CMS

NOTE: B. TAPERED SPRING
H. SPRING HOLDER NOT INCLUDED
I. ABRASION RESISTANT CARBON (P66)
S. SLOTTED MATING RING

DIMENSIONAL CROSS-REFERENCE

SEAL HEAD			MATING RING			Material Code	NOTES	U.S. Seal Mfg. Part No.
Fig.	OD	Oper Hgt.	Fig.	Bore	Thick			
1.500 (1-1/2") (continued)								
E	2.000	1.688	1	2.125	.437	VCFZF		PS-305V-TC-SEAT
E	2.000	1.688	1	2.125	.437	VLFLF		PS-305V-SC-SC-CMS
E	2.000	1.688	1	2.125	.437	VZFZF		PS-305V-TC-TC
E	2.000	1.688	3	2.125	.437	BCFJF	S	PS-395
E	2.000	1.688	3	2.125	.437	BCFKF		PS-258
E	2.000	1.688	3	2.125	.437	B/VLFZF	S	PS-7491
E	2.000	1.688	3	2.125	.437	BZFLF	S	PS-258-TC-SC
E	2.000	1.688	3	2.125	.437	NCFKF		PS-224
E	2.000	1.688	3	2.125	.437	QCFJF	S	PS-395-EPR
E	2.000	1.688	3	2.125	.437	QCFKF		PS-5259
E	2.000	1.688	3	2.125	.437	QCFLF	I/S	PS-7504
E	2.000	1.688	3	2.125	.437	QCFZF	I/S	PS-4167
E	2.000	1.688	3	2.125	.437	QCFZF	I/S	PS-7562
E	2.000	1.688	3	2.125	.437	QCFZF	C/I/S	PS-7930
E	2.000	1.688	3	2.125	.437	QLFLF	S	PS-4459
E	2.000	1.688	3	2.125	.437	VCFJF	S	PS-305V
E	2.000	1.688	3	2.125	.437	VCFJF	I/S	PS-305V-P66
E	2.000	1.688	3	2.125	.437	VCFKF		PS-374V
E	2.000	1.688	3	2.125	.437	VCFKF	I	PS-258V-P66
E	2.000	1.688	3	2.125	.437	VCFLF		PS-3161
E	2.000	1.688	3	2.125	.437	VCFLF	S	PS-395V-SC-SEAT
E	2.000	1.688	3	2.125	.437	VCFZF	S	PS-1646
E	2.000	1.688	3	2.125	.437	VCFZF	I/S	PS-7889
E	2.000	1.688	3	2.125	.437	VLFLF	316SS/S	PS-3282
E	2.000	1.688	5	2.125	.437	BCFZF	I	PS-22052
E	2.000	1.688	5	2.125	.437	QCFZF	I	PS-4368
E	2.000	1.688	5	2.125	.437	QZFLF		PS-7609
E	2.000	1.688	1	2.250	.437	BCFJF		PS-2117
E	2.000	1.688	3	2.250	.437	BCFJF		PS-515
E	2.000	1.688	3	2.250	.437	VCFJF		PS-515V
E	2.000	1.688	3	2.312	.437	BCFZF		PS-4034
E	2.000	1.688	3	2.312	.437	B/VCFJF		PS-1647
E	2.000	1.688	3	2.312	.437	B/VCFKF	S	PS-1648
E	2.000	1.688	3	2.312	.437	VCFJF		PS-1651
E	2.000	1.688	3	2.312	.437	VCFKF		PS-1652
E	2.000	1.688	3	2.500	.500	VCFZF	S	PS-4201
E	2.000	2.062	3	2.312	.437	BCFJF		PS-620
E	2.000	2.062	3	2.312	.437	BCFKF		PS-629
E	2.000	2.062	3	2.312	.437	VCFJF		PS-620V
E	2.000	2.062	3	2.312	.437	VCFKF		PS-1691
E	2.000	2.062	3	2.312	.437	VCFZF		PS-1692
E	2.014	1.688	3	2.125	.437	BCDLF	S	PS-22139
E	2.154	2.054	Plate	Plate	Plate	NCPGP		PS-6058
EB	2.000	2.000	3	2.000	.437	BCFJF		PS-4473
EB	2.000	2.000	3	2.000	.437	BCFKF	S	PS-4317
EB	2.000	2.000	3	2.000	.437	QCFJF	I	PS-4088
EB	2.000	2.000	3	2.000	.437	VCFZF	I/S	PS-3615
EB	2.000	2.062	3	2.125	.437	VCFJF		PS-4476
G	2.125	1.181	1	2.125	.437	VCFJF	316SS	PS-3992
K	2.171	1.625	3	2.375	.437	BCFJF		PS-3558
K	2.187	1.625	1	2.125	.437	BCFJF		PS-541
K	2.187	1.625	1	2.125	.437	BCFKF		PS-884
K	2.187	1.625	3	2.125	.437	VCFJF	S	PS-541V
K	2.187	1.625	3	2.500/2.125	.437	VLFLF	S	PS-3972
K	2.187	1.875	1	2.125	.437	BCFJF		PS-3128
K	2.187	1.875	1	2.125	.437	BCFKF		PS-3130
R	2.312	1.875	1	2.125	.437	BCFJF		PS-431
R	2.312	1.875	1	2.125	.437	BCFKF		PS-432
T	2.000	2.437	1	2.125	.437	BCFJF		PS-868
W	2.125	1.125	2	2.125	.437	TCFJF	316SS	PS-7587
W	2.125	1.125	25	2.125	.437	TCFZF	316SS	PS-9353
W	2.125	1.125	27	2.781	.875	TCFJF	316SS	PS-9318
WT Dbl.	1.942	2.250	3	2.375	.437	VCFJF	316SS	PS-9713
X	2.125	1.125	3	2.125	.437	VCFKF	316SS/S	PS-8810
X	2.125	1.125	5	2.133	.437	QCFZF	316SS	PS-8600

DIMENSIONAL CROSS-REFERENCE

SEAL HEAD			MATING RING			Material Code	NOTES	U.S. Seal Mfg. Part No.
Fig.	OD	Oper Hgt.	Fig.	Bore	Thick			
1.500 (1-1/2") (continued)								
XB	2.312	1.187	3	1.875	.437	VCPKF	316SS	PS-8141
XB	2.312	1.187	3	1.875	.437	VZFLF	316SS	PS-8807
XB2	2.250	1.000	—	—	—	VCF-F	316SS	FA-8201
XB2	2.250	1.000	3 Special	2.125	.437	VCFJF	316SS	PS-8109
X Special	2.312	.937	3	2.125	.437	BCFJF	S	PS-8002
1.562 (1-9/16")								
C	2.193	1.062	Special	2.250	.703	VCFKF	316	PS-5722
E	2.250	1.688	3	2.375	.500	BCFJF	S	PS-664
Special	2.625	.937	Special	2.250	.406	NCPGF		PS-2707
1.625 (1-5/8")								
C	2.479	1.312	1	2.375	.500	BCFJF	B	PS-3831
C	2.500	1.062	3	2.375	.375	VCFKF		PS-6005
C	2.500	1.312	25	2.500	.812	B/VCFJF		PS-7497
C	2.500	1.312	25	2.500	.812	VCFJF		PS-7497V
C	2.500	1.375	—	—	—	BCF-F		FA-1620
C	2.500	1.375	1	2.375	.500	BCFJF		PS-238
C	2.500	1.375	1	2.375	.500	BCFJF	I	PS-238-P66
C	2.500	1.375	1	2.375	.500	BCFJF		PS-4597
C	2.500	1.375	1	2.375	.500	BCFJF	316SS	PS-4525
C	2.500	1.375	1	2.375	.500	BCFKF		PS-239
C	2.500	1.375	1	2.375	.500	BCFKF	I	PS-239-P66
C	2.500	1.375	1	2.375	.500	BCFLF		PS-4389
C	2.500	1.375	1	2.375	.500	BCFLF	I	PS-3967
C	2.500	1.375	1	2.375	.500	BLFLF		PS-238-SC-SC
C	2.500	1.375	1	2.375	.500	BLFZF		PS-238-SC-TC-CMS
C	2.500	1.375	1	2.375	.500	BZFLF		PS-3145
C	2.500	1.375	1	2.375	.500	BZFZF		PS-3664
C	2.500	1.375	1	2.375	.500	QCFJF		PS-238-EPR
C	2.500	1.375	1	2.375	.500	QCFKF		PS-3616
C	2.500	1.375	1	2.375	.500	QCFLF		PS-238-EPR-SC
C	2.500	1.375	1	2.375	.500	QCFZF		PS-3058
C	2.500	1.375	1	2.375	.500	VCFJF		PS-7902
C	2.500	1.375	1	2.375	.500	VCFJF		PS-238V-CMS
C	2.500	1.375	1	2.375	.500	VCFJF	316SS	PS-238V-CMS-316SS
C	2.500	1.375	1	2.375	.500	VCFKF		PS-239V-CMS
C	2.500	1.375	1	2.375	.500	VCFLF		PS-238V-SC-CMS
C	2.500	1.375	1	2.375	.500	VCFLF	316SS	PS-2762
C	2.500	1.375	1	2.375	.500	VCFZF	I	PS-238V-P66-TC
C	2.500	1.375	1	2.375	.500	VCFZF	316SS/I	PS-3543
C	2.500	1.375	1	2.375	.500	VLFLF		PS-7806
C	2.500	1.375	1	2.375	.500	VLFLF	316SS	PS-3294
C	2.500	1.375	1	2.375	.500	VZFLF		PS-238V-TC-SC-CMS
C	2.500	1.375	1	2.375	.500	VZFLF	316SS	PS-2749
C	2.500	1.375	1	2.375	.500	VZFZF		PS-3144
C	2.500	1.375	3	2.375	.500	BCFJF	S	PS-818
C	2.500	1.375	3	2.375	.500	BCFJF	I/S	PS-818-P66
C	2.500	1.375	3	2.375	.500	BCFKF	S	PS-544
C	2.500	1.375	3	2.375	.500	QCFKF	S	PS-239-EPR
C	2.500	1.375	3	2.375	.500	QCFKF	I/S	PS-7017
C	2.500	1.375	3	2.375	.500	QCFZF	I/S	PS-4068
C	2.500	1.375	3	2.375	.500	VCFJF	S	PS-238V
C	2.500	1.375	3	2.375	.500	VCFJF	316SS/S	PS-4516
C	2.500	1.375	3	2.375	.500	VCFKF	S	PS-239V
C	2.500	1.375	3	2.375	.500	VCFLF	S	PS-238V-SC-SEAT
C	2.500	1.375	3	2.375	.500	VCFZF	S	PS-239V-TC-SEAT
C	2.500	1.375	3	2.375	.500	VCFZF	I/S	PS-3523
C	2.500	1.375	3	2.375	.500	VLFLF	S	PS-544V-SC-SC
C	2.500	1.375	1	2.625	.500	BCFJF		PS-2202-CMS
C	2.500	1.375	1	2.625	.500	BCFKF		PS-1019-CMS
C	2.500	1.375	1	2.625	.500	BCFKF	I	PS-1019-CMS-P66
C	2.500	1.375	3	2.625	.500	BCFJF		PS-2202
C	2.500	1.375	3	2.625	.500	BCFJF	I	PS-2202-P66
C	2.500	1.375	3	2.625	.500	BCFKF		PS-1019
C	2.500	1.375	3	2.625	.500	BCFKF	316SS	PS-3078

NOTE: B. TAPERED SPRING
I. ABRASION RESISTANT CARBON (P66)
S. SLOTTED MATING RING

DIMENSIONAL CROSS-REFERENCE

SEAL HEAD			MATING RING			Material Code	NOTES	U.S. Seal Mfg. Part No.
Fig.	OD	Oper Hgt.	Fig.	Bore	Thick			
1.625 (1-5/8") (continued)								
C	2.500	1.375	3	2.625	.500	BLFLF		PS-1019-SC-SC
C	2.500	1.375	3	2.625	.500	QCFKF	I	PS-2201
C	2.500	1.375	3	2.625	.500	QCFZF		PS-4288
C	2.500	1.375	3	2.625	.500	VCFJF		PS-2202V
C	2.500	1.375	3	2.625	.500	VCFKF		PS-1019V
C	2.500	1.375	3	2.625	.500	VCFKF	I	PS-1019V-P66
C	2.500	1.375	3	2.625	.500	VCFZF		PS-1019-TC-SEAT
C	2.500	1.375	3	2.625	.500	VFLFLF		PS-1019V-SC-SC
C	2.500	1.375	28	3.544	1.250	BCFKF		PS-1035
C	2.500	1.375	28	3.544	1.250	VCFKF		PS-1039
C	2.500	2.468	1	2.375	.500	BCFKF		PS-3138
C	2.500	2.468	1	2.375	.500	BCFLF		PS-3179
C	2.550	1.312	1	2.375	.500	QCFLF	B/I	PS-3832
C	2.625	1.375	1	2.375	.500	QCFJF	I	PS-3030
D	2.718	1.062	3	2.375	.375	VCPSP		PS-6075
D	2.718	1.125	3	2.437	.500	BCDGF		PS-3026
D	2.718	1.375	1	2.375	.500	BCDJF		PS-514
D	2.718	1.375	1	2.375	.500	BCDJF	I	PS-514-P66
D	2.718	1.375	1	2.375	.500	BCDKF		PS-461
D	2.718	1.375	1	2.375	.500	BCDZF		PS-461-TC-SEAT
D	2.718	1.375	1	2.375	.500	BCFJF		PS-2055
D	2.718	1.375	1	2.375	.500	BCFKF		PS-2056
D	2.718	1.375	1	2.375	.500	BLDLF		PS-514-SC-SC
D	2.718	1.375	1	2.375	.500	BLFZF	316SS	PS-4361
D	2.718	1.375	1	2.375	.500	QCDJF		PS-514-EPR
D	2.718	1.375	1	2.375	.500	QCDJF	I	PS-514-EPR-P66
D	2.718	1.375	1	2.375	.500	QCDZF		PS-514-EPR-TC
D	2.718	1.375	1	2.375	.500	QCFLF	I	PS-3025
D	2.718	1.375	1	2.375	.500	VCDJF		PS-514V-CMS
D	2.718	1.375	1	2.375	.500	VCDJF	I	PS-514V-P66-CMS
D	2.718	1.375	1	2.375	.500	VCDKF		PS-461V-CMS
D	2.718	1.375	1	2.375	.500	VCDLF	I	PS-514V-P66-SC-CMS
D	2.718	1.375	1	2.375	.500	VCFJF		PS-2055V-CMS
D	2.718	1.375	1	2.375	.500	VLDLF		PS-514V-SC-SC-CMS
D	2.718	1.375	3	2.375	.500	BCDJF	S	PS-821
D	2.718	1.375	3	2.375	.500	BCDKF	S	PS-819
D	2.718	1.375	3	2.375	.500	BCFJF	S	PS-1698
D	2.718	1.375	3	2.375	.500	BCFKF	S	PS-1697
D	2.718	1.375	3	2.375	.500	BCFZF	S	PS-1697-TC-SEAT
D	2.718	1.375	3	2.375	.500	BCFZF	316SS/S	PS-22226
D	2.718	1.375	3	2.375	.500	BZFLF	S	PS-3223
D	2.718	1.375	3	2.375	.500	VCDJF	S	PS-514V
D	2.718	1.375	3	2.375	.500	VCDJF	I/S	PS-514V-P66
D	2.718	1.375	3	2.375	.500	VCDKF	S	PS-461V
D	2.718	1.375	3	2.375	.500	VCFLF	316SS/S	PS-3186
D	2.718	1.375	3	2.375	.500	VLDLF	S	PS-514V-SC-SC
D	2.718	1.375	3	2.375	.500	VLFZF	316SS/S	PS-2739
D	2.718	1.375	3	2.375	.500	VZFLF	S	PS-3772
D	2.718	1.375	3	2.375	.500	XLFLF	S	PS-3039
D	2.718	1.375	28	3.544	1.250	BCFKF		PS-4435
E	2.250	1.375	3	2.375	.500	BCPKF	S	PS-6348
E	2.250	1.375	3	2.375	.500	NCPKF	S	PS-6351
E	2.250	1.375	3	2.375	.500	VCPKF	S	PS-6349
E	2.250	2.000	1	2.312	.500	BCDJF		PS-609
E	2.250	2.000	1	2.312	.500	BCFJF		PS-346
E	2.250	2.000	1	2.312	.500	BCFJF	I	PS-346-P66
E	2.250	2.000	1	2.312	.500	BCFKF		PS-610
E	2.250	2.000	1	2.312	.500	VCFJF	316SS	PS-346V
E	2.250	2.000	1	2.312	.500	VCFKF		PS-610V
E	2.250	2.000	2	2.312	.562	BCDKF		PS-3931
E	2.250	2.000	1	2.375	.500	BCDJF		PS-745
E	2.250	2.000	1	2.375	.500	BCDJF	I	PS-745-P66
E	2.250	2.000	1	2.375	.500	BCDKF		PS-744
E	2.250	2.000	1	2.375	.500	BCFJF		PS-2057
E	2.250	2.000	1	2.375	.500	BCFKF		PS-2058

DIMENSIONAL CROSS-REFERENCE

SEAL HEAD			MATING RING			Material Code	NOTES	U.S. Seal Mfg. Part No.
Fig.	OD	Oper Hgt.	Fig.	Bore	Thick			
1.625 (1-5/8") (continued)								
E	2.250	2.000	1	2.375	.500	BLFLF		PS-4099
E	2.250	2.000	1	2.375	.500	VCDJF		PS-745V-CMS
E	2.250	2.000	1	2.375	.500	VCFZF		PS-2058V-TC-SEAT
E	2.500	2.000	1	2.375	.500	VLFLF	316SS	PS-3853
E	2.250	2.000	3	2.375	.500	BCDJF	S	PS-595
E	2.250	2.000	3	2.375	.500	BCDKF	S	PS-822
E	2.250	2.000	3	2.375	.500	BCDKF	I/S	PS-822-P66
E	2.250	2.000	3	2.375	.500	BCFJF	S	PS-1683
E	2.250	2.000	3	2.375	.500	BCFJF	I/S	PS-1683-P66
E	2.250	2.000	3	2.375	.500	BCFKF	S	PS-1699
E	2.250	2.000	3	2.375	.500	BZFLF	S	PS-2717
E	2.250	2.000	3	2.375	.500	BZFLF	H/S	PS-22082
E	2.250	2.000	3	2.375	.500	QCCKF	S	PS-822-EPR
E	2.250	2.000	3	2.375	.500	QCFZF	I/S	PS-22078
E	2.250	2.000	3	2.375	.500	VCDKF	S	PS-744V
E	2.250	2.000	3	2.375	.500	VCFJF	S	PS-745V
E	2.250	2.000	3	2.375	.500	VCFJF	S	PS-1683V
E	2.250	2.000	3	2.375	.500	VCFKF	S	PS-1699V
E	2.250	2.000	3	2.375	.500	VCFKF	I/S	PS-3183
E	2.250	2.000	3	2.375	.500	VCFLF	316SS/S	PS-4471
E	2.250	2.000	3	2.375	.500	VCFZF	I/S	PS-1699V-TC-P66
E	2.250	2.000	3	2.375	.500	VLZFZ	S	PS-1699V-SC-TC
E	2.250	2.000	3	2.375	.500	VZFLF	H/S	PS-22083
E	2.250	2.000	3	2.375	.500	VZFLF	S	PS-22079
E	2.250	2.000	3	2.375	.500	XZFLF	316SS/S	PS-3113
EB	2.250	2.375	3	2.125	.437	BCFJF	S	PS-4374
EB	2.250	2.375	3	2.125	.437	VCFJF	S	PS-4159
EB	2.250	2.375	3	2.125	.437	VCFJF	316SS/S	PS-4653
EB	2.250	2.375	3	2.125	.437	VCFZF	316SS/S	PS-4269
EB	2.250	2.375	5	2.125	.437	BCFZF		PS-4545
G	2.205	1.375	1	2.375	.500	QCFJF	316SS/I	PS-6262
G	2.205	1.375	1	2.375	.500	QCFZF	316SS/I	PS-6263
K	2.500	2.125	1	2.375	.500	BCFJF		PS-1195
K	2.500	2.125	1	2.375	.500	VL/CFL/JF		PS-4572
K	2.500	2.125	1	2.375	.500	VLFLF		PS-3111
Q	2.812	.973	Special	2.375	.390	N/BMDAF		PS-6311
R	2.625	2.125	3	2.375	.500	NAFGF	S	PS-3071
R	2.625	2.125	3	2.375	.500	NAFZF	S	PS-22080
R	2.625	2.125	3	2.375	.500	VZFLF	S	PS-22081
R	2.718	2.125	1	2.375	.500	BCDKF		PS-281-CMS
R	2.718	2.125	3	2.375	.500	BCDKF	S	PS-281
R	2.825	2.125	3	2.375	.500	NCFGF	S	PS-3988
U	2.250	2.093	1	2.375	.500	BCDKF		PS-458-CMS
U	2.250	2.093	3	2.375	.500	BCDKF	S	PS-458
W	2.250	1.156	2	2.375	.477	TCFKF	316SS	PS-22120
WT	2.250	1.156	27	2.875	.625	TCFKF	316SS	PS-9017
WT	2.250	1.156	27	2.875	.625	TCFOF	316SS	PS-9332
W Special	2.375	2.125	2	2.375	.500	TCFKF	316SS	PS-9718
X	2.375	1.375	3	2.375	.500	VCFLF	316SS/S	PS-22198
XB	2.718	1.375	3	2.375	.437	BCPLF	I	PS-22183
XB	2.718	1.375	3	2.375	.437	NCPLF	I	PS-22192
XB	2.718	1.375	3	2.375	.437	VCFLF	I	PS-22187
XB	2.718	1.375	Special	2.406	.406	BCPLF	I	PS-22184
XB	2.718	1.375	Special	2.406	.406	NCPLF	I	PS-22189
XB	2.718	1.375	Special	2.406	.406	QCPLF	I	PS-22191
XB	2.718	1.375	Special	2.406	.406	VCPLF	I	PS-22188
XB1	2.375	1.750	3	2.000	.381	QLFLF	316SS/S	PS-8118
XB1T	2.187	1.750	3	2.062	.437	VCFZF	316SS	PS-8071
XB2	2.437	1.156	27	2.843	1.000	VCFJF	316SS	PS-8040
X Special	2.718	1.375	25 Special	2.410	.406	BCPGF		PS-6008
1.687 (1-11/16")								
D	2.875	.875	2	2.500	.312	BCFKF		PS-5002
D	2.875	.875	2	2.500	.312	VCFKF		PS-5194
E	2.875	2.000	1	2.375	.500	BCFJF		PS-4094

NOTE: H. SPRING HOLDER NOT INCLUDED
 I. ABRASION RESISTANT CARBON (P66)
 S. SLOTTED MATING RING

DIMENSIONAL CROSS-REFERENCE

SEAL HEAD			MATING RING			Material Code	NOTES	U.S. Seal Mfg. Part No.
Fig.	OD	Oper Hgt.	Fig.	Bore	Thick			
1.692 (43MM)								
C	2.315	1.338	2	2.400	.434	VCFKF	316SS	PS-5654
G	2.322	1.456	1	2.400	.315	VCFJF	316SS	PS-2815
G	2.322	1.456	1	2.400	.315	VCFLF	316SS	PS-3278
G	2.322	1.456	1	2.400	.315	VLFLF	316SS	PS-4039
1.750 (1-3/4")								
C	2.392	1.375	1	2.500	.500	BCFJF		PS-5389-CMS
C	2.392	1.375	3	2.500	.500	BCFJF	S	PS-5389
C	2.604	1.375	3	2.500	.500	VCFKF	S	PS-3286
C/ X Special	2.609	1.250	1	2.500	.500	BCFJF		PS-4035
C	2.625	1.062	3	2.500	.500	BCFJF	S	PS-3718
C	2.625	1.062	3	2.500	.500	BLFLF	S	PS-6241
C	2.625	1.062	3	2.500	.500	BLFZF	S	PS-3963
C	2.625	1.062	3	2.500	.500	BZFFZ	S	PS-3687
C	2.625	1.062	3	2.500	.500	VCFJF	S	PS-3718V
C	2.625	1.125	—	—	—	BCF-F		FA-1055
C	2.625	1.125	3	2.500	.437	VCFGF		PS-3789
C	2.625	1.125	1	2.500	.500	BCFJF		PS-2212
C	2.625	1.125	1	2.500	.500	BCFKF		PS-1068
C	2.625	1.125	1	2.500	.500	BLFLF		PS-2212-SC-SC
C	2.625	1.125	1	2.500	.500	BZFFZ		PS-4410
C	2.625	1.125	3	2.500	.500	BCFKF	S	PS-1056
C	2.625	1.125	3	2.500	.500	B/VLFZF	S	PS-3719
C	2.625	1.125	3	2.500	.500	VCFKF	S	PS-1056V
C	2.625	1.125	3	2.500	.500	VCFLF	S	PS-1056V-SC-SEAT
C	2.625	1.250	3	2.500	.500	VCFJF	316SS/S	PS-4884
C	2.625	1.375	—	—	—	BCF-F		FA-1660
C	2.625	1.375	—	—	—	BCF-F	I	FA-10168
C	2.625	1.375	—	—	—	BRF-F		FA-10159
C	2.625	1.375	—	—	—	QCF-F	I	FA-2108E
C	2.625	1.375	—	—	—	VCF-F		FA-10045
C	2.625	1.375	1	2.500	.500	BCFJF		PS-446
C	2.625	1.375	1	2.500	.500	BCFJF	I	PS-446-P66
C	2.625	1.375	1	2.500	.500	BCFJF	316SS	PS-446-316SS
C	2.625	1.375	1	2.500	.500	BCFKF		PS-448
C	2.625	1.375	1	2.500	.500	BCFKF	I	PS-448-P66
C	2.625	1.375	1	2.500	.500	BCFLF		PS-446-SC-SEAT
C	2.625	1.375	1	2.500	.500	BCFZF		PS-2210
C	2.625	1.375	1	2.500	.500	BLFLF		PS-446-SC-SC
C	2.625	1.375	1	2.500	.500	BLFZF		PS-446-SC-TC-CMS
C	2.625	1.375	1	2.500	.500	BZFFZ		PS-446-TC-TC
C	2.625	1.375	1	2.500	.500	QCFJF		PS-446-EPR
C	2.625	1.375	1	2.500	.500	QCFJF	I	PS-446-EPR-P66
C	2.625	1.375	1	2.500	.500	QCFKF		PS-448-EPR
C	2.625	1.375	1	2.500	.500	QCFLF		PS-446-EPR-SC
C	2.625	1.375	1	2.500	.500	QCFZF	I	PS-7684
C	2.625	1.375	1	2.500	.500	QLFZF		PS-3857
C	2.625	1.375	1	2.500	.500	VCFJF		PS-446V-CMS
C	2.625	1.375	1	2.500	.500	VCFJF	C	PS-3118
C	2.625	1.375	1	2.500	.500	VCFJF	I	PS-446V-CMS-P66
C	2.625	1.375	1	2.500	.500	VCFJF	316SS	PS-4153
C	2.625	1.375	1	2.500	.500	VCFKF		PS-448V-CMS
C	2.625	1.375	1	2.500	.500	VCFKF	I	PS-448V-CMS-P66
C	2.625	1.375	1	2.500	.500	VCFZF		PS-446V-TC-SEAT
C	2.625	1.375	1	2.500	.500	VCFZF	I	PS-448V-TC-P66
C	2.625	1.375	1	2.500	.500	VLFLF		PS-7820
C	2.625	1.375	1	2.500	.500	VLFLF	316SS	PS-4205
C	2.625	1.375	1	2.500	.500	VLFZF		PS-448V-SC-TC
C	2.625	1.375	1	2.500	.500	VZFLF		PS-4461
C	2.625	1.375	1	2.500	.500	VZFZF		PS-446V-TC-TC
C	2.625	1.375	3	2.500	.500	BCFJF	S	PS-550
C	2.625	1.375	3	2.500	.500	BCFJF	I/S	PS-3125
C	2.625	1.375	3	2.500	.500	BCFKF	S	PS-436
C	2.625	1.375	3	2.500	.500	BCFKF	I/S	PS-436-P66
C	2.625	1.375	3	2.500	.500	BCFLF	S	PS-436-SC-SEAT

DIMENSIONAL CROSS-REFERENCE

SEAL HEAD			MATING RING			Material Code	NOTES	U.S. Seal Mfg. Part No.
Fig.	OD	Oper Hgt.	Fig.	Bore	Thick			
1.750 (1-3/4") (continued)								
C	2.625	1.375	3	2.500	.500	BLFLF	S	PS-436-SC-SC
C	2.625	1.375	3	2.500	.500	B/VZFLF	S	PS-436-TC-VS-SC
C	2.625	1.375	3	2.500	.500	BZFZF	S	PS-436-TC-TC
C	2.625	1.375	3	2.500	.500	QCCKF	S	PS-436-EPR
C	2.625	1.375	3	2.500	.500	QCFLF	I/S	PS-7607
C	2.625	1.375	3	2.500	.500	QCFZF	I/S	PS-7035
C	2.625	1.375	3	2.500	.500	QLFLF	S	PS-4596
C	2.625	1.375	3	2.500	.500	VCFJF	S	PS-446V
C	2.625	1.375	3	2.500	.500	VCFJF	I/S	PS-446V-P66
C	2.625	1.375	3	2.500	.500	VCFKF	S	PS-436V
C	2.625	1.375	3	2.500	.500	VCFKF	I/S	PS-436V-P66
C	2.625	1.375	3	2.500	.500	VCFLF	S	PS-446V-SC-SEAT
C	2.625	1.375	3	2.500	.500	VCFZF	S	PS-2207
C	2.625	1.375	3	2.500	.500	VLFLF	S	PS-7679
C	2.625	1.375	3	2.500	.500	VLFZF	S	PS-446V-SC-TC
C	2.625	1.375	3	2.500	.500	VZFLF	S	PS-22086
C	2.625	1.375	3	2.500	.500	VZFLF	H/S	PS-22084
C	2.625	1.375	3	2.500	.500	VZFZF	S	PS-436V-TC-TC
C	2.625	1.375	1	2.625	.500	BCFJF		PS-387-CMS
C	2.625	1.375	3	2.625	.500	BCFJF		PS-387
C	2.625	1.375	28	3.544	1.188	BCFKF		PS-1038
C	2.625	1.750	1	2.500	.500	BZFZF	C	PS-3114
C	2.625	1.750	1	2.500	.500	VLFLF	C	PS-22106
C	2.625	1.750	1	2.500	.500	VZFZF	C	PS-3114V
C	2.625	2.000	1	2.500	.500	BCFJF		PS-2135
C	2.625	2.000	1	2.500	.500	BCFJF	I	PS-2135-P66
C	2.625	2.000	1	2.500	.500	BCFJF		PS-2142
C	2.625	2.000	1	2.500	.500	BCFJF	I	PS-2142-P66
C	2.625	2.000	1	2.500	.500	BCFKF		PS-1674
C	2.625	2.000	1	2.500	.500	BCFLF		PS-1674-SC-SEAT
C	2.625	2.000	1	2.500	.500	BCFZF		PS-1674-TC-SEAT
C	2.625	2.000	1	2.500	.500	BLFLF		PS-2135-SC-SC
C	2.625	2.000	1	2.500	.500	BZFZF		PS-3272
C	2.625	2.000	1	2.500	.500	QCCKF	I	PS-1674-EPR-P66
C	2.625	2.000	1	2.500	.500	VCFJF		PS-2135V-CMS
C	2.625	2.000	1	2.500	.500	VCFLF		PS-4697
C	2.625	2.000	1	2.500	.500	VLFLF	S	PS-3271
C	2.625	2.000	1	2.500	.500	VLFZF		PS-22213
C	2.625	2.000	1	2.500	.500	VZFZF		PS-1674V-TC-TC-CM
C	2.625	2.000	3	2.500	.500	BCFJF	S	PS-2150
C	2.625	2.000	3	2.500	.500	BCFKF	S	PS-2151
C	2.625	2.000	3	2.500	.500	QCCKF	I/S	PS-2151-EPR-P66
C	2.625	2.000	3	2.500	.500	VCFKF	S	PS-2151V
C	2.625	2.000	3	2.500	.500	VCFZF	S	PS-2151V-TC-SEAT
D	2.750	1.312	1	2.500	.500	VCFLF	316SS	PS-22006
D	2.750	1.375	—	—	—	BCD-F		FA-288
D	2.750	1.375	1	2.500	.500	BCDJF		PS-237
D	2.750	1.375	1	2.500	.500	BCDJF	I	PS-237-P66
D	2.750	1.375	1	2.500	.500	BCDKF		PS-288
D	2.750	1.375	1	2.500	.500	BCDKF	I	PS-288-P66
D	2.750	1.375	1	2.500	.500	BCDZF		PS-237-TC-SEAT
D	2.750	1.375	1	2.500	.500	BCFJF		PS-2059
D	2.750	1.375	1	2.500	.500	BCFKF		PS-2060
D	2.750	1.375	1	2.500	.500	BLDLF		PS-237-SC-SC
D	2.750	1.375	1	2.500	.500	BZDZF		PS-237-TC-TC
D	2.750	1.375	1	2.500	.500	BZFZF		PS-2060-TC-TC
D	2.750	1.375	1	2.500	.500	QCDJF		PS-237-EPR
D	2.750	1.375	1	2.500	.500	QCDKF		PS-288-EPR
D	2.750	1.375	1	2.500	.500	QCDZF	I	PS-7652
D	2.750	1.375	1	2.500	.500	VCDJF		PS-237V-CMS
D	2.750	1.375	1	2.500	.500	VCDKF		PS-288V-CMS
D	2.750	1.375	1	2.500	.500	VCFJF		PS-2059V
D	2.750	1.375	1	2.500	.500	VLFLF	316SS	PS-4487
D	2.750	1.375	1	2.500	.500	VZFLF	316SS	PS-6217
D	2.750	1.375	3	2.500	.500	BCDJF	S	PS-826

NOTE: H. SPRING HOLDER NOT INCLUDED
 I. ABRASION RESISTANT CARBON (P66)
 S. SLOTTED MATING RING

DIMENSIONAL CROSS-REFERENCE

SEAL HEAD			MATING RING			Material Code	NOTES	U.S. Seal Mfg. Part No.
Fig.	OD	Oper Hgt.	Fig.	Bore	Thick			
1.750 (1-3/4") (continued)								
D	2.750	1.375	3	2.500	.500	BCDKF	S	PS-825
D	2.750	1.375	3	2.500	.500	BCDLF	S	PS-22137
D	2.750	1.375	3	2.500	.500	BCFJF	S	PS-2061
D	2.750	1.375	3	2.500	.500	BCFKF	S	PS-2062
D	2.750	1.375	3	2.500	.500	BCFKF	316SS/S	PS-22122
D	2.750	1.375	3	2.500	.500	BCFLF	S	PS-2061-SC-SEAT
D	2.750	1.375	3	2.500	.500	BZFLF	316SS/S	PS-3267
D	2.750	1.375	3	2.500	.500	VCDJF	S	PS-237V
D	2.750	1.375	3	2.500	.500	VCDJF	I/S	PS-237V-P66
D	2.750	1.375	3	2.500	.500	VCDKF	S	PS-288V
D	2.750	1.375	3	2.500	.500	VCDZF	S	PS-22202
D	2.750	1.375	3	2.500	.500	VCFKF	S	PS-22024
D	2.750	1.375	3	2.500	.500	VCFLF	316SS/S	PS-22018
D	2.750	1.375	3	2.500	.500	VRZF	S	PS-7959
D	2.750	1.375	3	2.500	.500	VZFLF	S	PS-7752
D	2.750	1.375	3	2.500	.500	XCFJF	S	PS-4399
D	2.806	1.031	3	2.500	.281	NCFKF		PS-4026
DB	2.750	1.750	3	2.375	.500	BCFZF	S	PS-4491
E	2.375	1.312	1	2.500	.500	QCFJF	S	PS-4187
E	2.375	1.312	1	2.500	.500	VCFZF	316SS	PS-3024
E	2.375	1.312	3	2.500	.500	VLFLF	S	PS-3982
E	2.375	1.312	1	2.625	.500	BCFJF		PS-7252
E	2.375	1.312	3	2.625	.500	BCFJF	316SS	PS-22195
E	2.375	1.312	3	2.625	.500	BCFKF	316SS	PS-4535
E	2.375	1.312	3	2.625	.500	QCFLF		PS-4290
E	2.375	1.312	3	2.625	.500	QCFLF	316SS	PS-4512
E	2.375	1.312	3	2.625	.500	QCFZF	I	PS-4141
E	2.375	1.312	3	2.625	.500	VCFJF		PS-4261
E	2.375	1.312	3	2.625	.500	VCFJF	316SS	PS-3227
E	2.375	1.312	3	2.625	.500	VCFKF		PS-4232
E	2.375	1.312	3	2.625	.500	VCFKF	316SS	PS-3169
E	2.375	1.312	3	2.625	.500	VCFLF	316SS	PS-3054
E	2.375	1.312	3	2.625	.500	VCFZF	316SS/I	PS-4228
E	2.375	1.412	3	2.500	.437	BCDLF	H/S	PS-22130
E	2.375	1.437	3	2.500	.500	B/VCFKF	S	PS-6090
E	2.375	1.937	3	2.312	.500	QCFZF	I/S	PS-7950
E	2.375	2.000	—	—	—	BCF-F		FA-366
E	2.375	2.000	—	—	—	XCF-F		FA-2109A
E	2.375	2.000	3	2.312	.500	BCFJF		PS-1684
E	2.375	2.000	3	2.375	.500	BCFJF		PS-7685
E	2.375	2.000	1	2.487	.500	BCFJF		PS-317
E	2.375	2.000	1	2.500	.500	BCFJF		PS-205
E	2.375	2.000	1	2.500	.500	BCFJF	I	PS-205-P66
E	2.375	2.000	1	2.500	.500	BCFKF		PS-366
E	2.375	2.000	1	2.500	.500	BCFKF	I	PS-3177
E	2.375	2.000	1	2.500	.500	BCFLF		PS-4327
E	2.375	2.000	1	2.500	.500	BCFZF		PS-366-TC-CMS
E	2.375	2.000	1	2.500	.500	BLFLF		PS-205-SC-SC
E	2.375	2.000	1	2.500	.500	BZFZF		PS-366-TC-TC
E	2.375	2.000	1	2.500	.500	QCFJF		PS-1196-EPR
E	2.375	2.000	1	2.500	.500	QZFZF		PS-22221
E	2.375	2.000	1	2.500	.500	QCFZF	I	PS-7736
E	2.375	2.000	1	2.500	.500	VCFJF		PS-205V-CMS
E	2.375	2.000	1	2.500	.500	VCFJF	I	PS-205V-CMS-P66
E	2.375	2.000	1	2.500	.500	VCFKF		PS-366V-CMS
E	2.375	2.000	1	2.500	.500	VCFKF	I	PS-366V-CMS-P66
E	2.375	2.000	1	2.500	.500	VCFLF		PS-366V-SC-CMS
E	2.375	2.000	1	2.500	.500	VCFZF		PS-205V-TC-SEAT
E	2.375	2.000	1	2.500	.500	VLFLF		PS-4115
E	2.375	2.000	1	2.500	.500	VLFLF	316SS	PS-3031
E	2.375	2.000	1	2.500	.500	VZFZF		PS-205V-TC-TC-CMS
E	2.375	2.000	3	2.500	.500	BCFJF	S	PS-3673
E	2.375	2.000	3	2.500	.500	BCFJF	S	PS-535
E	2.375	2.000	3	2.500	.500	BCFKF	S	PS-262

DIMENSIONAL CROSS-REFERENCE

SEAL HEAD			MATING RING			Material Code	NOTES	U.S. Seal Mfg. Part No.
Fig.	OD	Oper Hgt.	Fig.	Bore	Thick			
1.750 (1-3/4") (continued)								
E	2.375	2.000	3	2.500	.500	BCFZF	S	PS-859-TC-SEAT
E	2.375	2.000	3	2.500	.500	BCFZF	I/S	PS-535-P66-TC
E	2.375	2.000	3	2.500	.500	QCFJF	S	PS-535-EPR
E	2.375	2.000	3	2.500	.500	QCFKF	I/S	PS-262-EPR-P66
E	2.375	2.000	3	2.500	.500	QCFLF	S	PS-859-EPR-SC-SEAT
E	2.375	2.000	3	2.500	.500	QCFZF	I/S	PS-7363
E	2.375	2.000	3	2.500	.500	QLFLF	S	PS-858-EPR-SC-SC
E	2.375	2.000	3	2.500	.500	QZFZF	S	PS-3540
E	2.375	2.000	3	2.500	.500	VCFJF	S	PS-205V
E	2.375	2.000	3	2.500	.500	VCFJF	I/S	PS-205V-P66
E	2.375	2.000	3	2.500	.500	VCFKF	S	PS-366V
E	2.375	2.000	3	2.500	.500	VCFLF	S	PS-858V-SC-SEAT
E	2.375	2.000	3	2.500	.500	VCFLF	316SS/S	PS-7924
E	2.375	2.000	3	2.500	.500	VLFLF	S	PS-7488
E	2.375	2.000	3	2.500	.500	VZFLF	316SS/S	PS-22085
E	2.375	2.000	3	2.500	.500	VZFZF	S	PS-4509
E	2.375	2.000	3	2.500	.500	XCFLF	I/S	PS-4186
E	2.375	2.000	3	2.500	.500	XCFLF	316SS/S	PS-22218
E	2.375	2.000	5	2.500	.500	BCFZF	I	PS-4429
E	2.375	2.000	5	2.500	.500	QCFZF	I	PS-4372
E	2.375	2.000	5	2.500	.500	QZFLF	316SS	PS-7610
E	2.375	2.000	5	2.500	.500	VCFZF	S	PS-3690
E	2.375	2.000	1	2.625	.500	BCFJF		PS-2130-CMS
E	2.375	2.000	3	2.625	.500	BCFJF		PS-2130
E	2.375	2.000	3	2.625	.500	VCFKF		PS-4139
E	2.375	2.000	27	3.000	1.000	BCFJF		PS-1078
E	2.375	2.000	27	3.000	1.000	VCFJF		PS-1078V
E	2.375	2.375	3	2.312	.500	BCFZF	C/S	PS-4233
E	2.375	2.375	3	2.312	.500	VCFJF	316SS/C/S	PS-4326
E	2.375	2.375	3	2.312	.500	VCFLF	316SS/S	PS-3251
E	2.375	2.375	3	2.312	.500	VCFLF	316SS/C/S	PS-4586
E	2.375	2.375	3	2.500	.500	B/VCFJF	C/H/I/S	PS-3726
E	2.375	2.375	3	2.500	.500	QCFLF	316SS/C/S	PS-4112
E	2.375	2.375	3	2.500	.500	VCFJF	C/S	PS-2712
E	2.375	2.375	3	2.500	.500	VCFJF	316SS/C/H/S	PS-3902
E	2.375	2.375	3	2.500	.500	VCFKF	C/S	PS-3637
E	2.375	2.375	3	2.500	.500	VCFLF	C/S	PS-7839
E	2.375	2.375	3	2.500	.500	VCFLF	316SS/C/S	PS-4136
E	2.375	2.375	3	2.500	.500	VCFZF	316SS/C/S	PS-7560
E	2.375	2.375	3	2.500	.500	VCFZF	C/I/S	PS-7561
E	2.375	2.375	27	3.000	1.000	BCFJF	316SS/C	PS-4618
E	2.375	2.406	3	2.312	.500	VCFZF	C/S	PS-4149
EB	2.375	2.312	3	2.500	.500	VCFJF	316SS	PS-4221
EB	2.375	2.312	3	2.500	.500	VCFLF	316SS/C/S	PS-4096
EB	2.375	2.375	1	2.375	.500	BCFJF		PS-7901
EB	2.375	2.375	1	2.375	.500	BCFKF		PS-2231-CMS
EB	2.375	2.375	3	2.375	.500	BCFJF	S	PS-7774
EB	2.375	2.375	3	2.375	.500	BCFKF	S	PS-2231
EB	2.375	2.375	3	2.375	.500	BCFZF	316SS/S	PS-7821
EB	2.375	2.375	3	2.375	.500	QZFZF	S	PS-22217
EB	2.375	2.375	3	2.500	.500	BCFKF	S	PS-4097
G	2.402	1.181	1	2.500	.469	VLFLF	316SS	PS-22175
G	2.402	1.181	1	2.500	.500	BLFLF		PS-3016
G	2.402	1.181	1	2.500	.500	BLFZF		PS-4216
G	2.402	1.375	1	2.500	.500	VLFLF	316SS	PS-3151
G	2.625	1.181	3	2.500	.500	BCFLF	316SS/S	PS-3283
K	2.609	1.625	1	2.500	.500	BCFJF		PS-6246
K	2.609	2.125	1	2.500	.500	BCFJF		PS-449
K	2.609	2.125	1	2.500	.500	BCFKF		PS-1197
K	2.609	2.125	1	2.500	.500	BZFZF		PS-3236
K	2.609	2.125	1	2.500	.500	VLFLF	316SS	PS-4539
K	2.609	2.125	3	2.500	.500	BCFJF	S	PS-4353
K	2.609	2.125	3	2.500	.500	BCFJ/KF	S	PS-1142
K	2.609	2.250	3	2.750	.625	BCFJF		PS-3040
K	2.625	2.125	1	2.500	.500	VZFZF		PS-4304

NOTE: C. COMPLETE WITH COLLAR I. ABRASION RESISTANT CARBON (P66)
H. SPRING HOLDER NOT INCLUDED S. SLOTTED MATING RING

DIMENSIONAL CROSS-REFERENCE

SEAL HEAD			MATING RING			Material Code	NOTES	U.S. Seal Mfg. Part No.
Fig.	OD	Oper Hgt.	Fig.	Bore	Thick			
1.750 (1-3/4") (continued)								
Q	3.000	.689	Special	2.500	.412	Special		PS-4133
R	2.750	2.125	1	2.500	.500	BCDKF		PS-217
T	2.375	2.281	3	2.500	.500	VCFJF	316SS/S	PS-6242
T	2.375	2.750	3	2.500	.500	BCFJF	S	PS-2144
T	2.375	2.875	1	2.500	.500	BCFJF		PS-674
T	2.375	2.875	1	2.500	.500	BCFKF		PS-675
T	2.375	2.875	3	2.500	.500	BCFJF	S	PS-3115
T	2.375	2.875	3	2.500	.500	VCFJF	316SS/S	PS-4263
T	2.375	2.875	3	2.500	.500	VLFLF	S	PS-3650
T	2.375	2.937	3	2.500	.500	VCFLF/VCFJF	316SS/S	PS-4405
T	2.375	2.937	3	2.500	.500	VLFLF		PS-4639
T	2.375	2.937	3	2.500	.500	VLFLF/VCFLF	316SS/S	PS-3123
U	2.375	2.000	3	2.500	.500	BCFJF	S	PS-2170
U	2.375	2.000	3	2.500	.500	BCF/DKF	S	PS-2157
U	2.375	2.000	3	2.500	.500	BCFKF	S	PS-7090
U	2.375	2.250	3	2.375	.500	BCFJF		PS-1070
U	2.375	2.500	1	2.500	.500	BCFJF		PS-1042
U	2.375	2.500	1	2.500	.500	BCF/DKF		PS-555
U	2.375	2.500	1	2.500	.500	BCFKF		PS-555SS
U	2.375	2.500	1	2.500	.500	VCZFZ		PS-3884
U	2.375	2.500	3	2.500	.500	BCFJF	S	PS-519
U	2.375	2.500	3	2.500	.500	BCFJF	I/S	PS-519-P66
U	2.375	2.500	3	2.500	.500	BCFKF	S	PS-1199
U	2.375	2.000	3	2.500	.500	QCFZF	I/S	PS-3520
UB	2.375	2.375	3	2.375	.500	BCFZF	S	PS-4488
V	2.437	2.250	3	2.750	.625	BCFJF		PS-3754
W	2.500	1.375	2	2.500	.500	TCFJF	316SS	PS-9106
WT	2.312	1.375	—	—	—	TCF-F		FA-9400
WT	2.312	1.375	3	2.500	.500	T/VCFJF	316SS/S	PS-9023
WT	2.312	1.375	3	2.500	.500	T/VCFZF	316SS/S	PS-9064
WT	2.312	1.375	27	2.969	1.000	TCFJF	316SS	PS-9014
WT	2.406	1.375	—	—	—	TCF-F	316SS	FA-9316
X	2.500	1.375	3	2.500	.500	VCFLF	316SS/S	PS-8058
X	2.500	1.375	3	2.500	.500	VZFLF	316SS/S	PS-8133
XB1	2.312	1.750	5	2.125	.500	YCFZF	316SS	PS-8125
XBIT	2.312	1.750	—	—	—	Special		FA-8000
X1T	2.312	1.375	3	2.500	.500	VCFLF	316SS/S	PS-8800
X1T	2.312	1.375	3	2.500	.500	VCZFZ	316SS/S	PS-8063
1.771 (45MM)								
E	2.500	2.125	1	2.625	.500	BCFJF		PS-722
E	2.500	2.125	1	2.625	.500	BCFKF		PS-719
G	2.401	30MM	25	63MM	8MM	VLFLF		PS-3158
G	2.401	37MM	1	63MM	8MM	VLFLF	316SS	PS-6916
G	61 MM	37MM	25	63MM	8MM	VCFLF	316SS	PS-22196
T	2.500	3.000	1	2.625	.500	BCFJF		PS-727
T	2.500	3.000	1	2.625	.500	BCFKF		PS-728
1.875 (1-7/8")								
C	2.561	1.000	Plate	Plate	Plate	VCFGF		PS-5721
C	2.561	1.000	Plate	3.528	.437	BCFGF		PS-5011
C	2.645	1.110	2	3.000	.404	BCFJF	N	PS-5342
C	2.645	1.110	2	3.000	.404	QCFJF		PS-5679
C	2.645	1.110	2	3.000	.404	VCFJF		PS-5717
C	2.645	1.125	2	3.000	.474	B/VCFKF	N	PS-5712
C	2.750	1.000	3 Special	2.625	.500	VCFKP	S	PS-6098
C	2.750	1.500	—	—	—	BCF-F		FA-1875
C	2.750	1.500	—	—	—	VCF-F		FA-1875V
C	2.750	1.500	1	2.625	.500	BCFJF		PS-340
C	2.750	1.500	1	2.625	.500	BCFJF	I	PS-340-P66
C	2.750	1.500	1	2.625	.500	BCFKF		PS-1608
C	2.750	1.500	1	2.625	.500	BZFLF		PS-340-TC-SC
C	2.750	1.500	1	2.625	.500	BZFZF		PS-340-TC-TC
C	2.750	1.500	1	2.625	.500	QCFJF		PS-340-EPR-CMS
C	2.750	1.500	1	2.625	.500	QCFJF	I	PS-4885
C	2.750	1.500	1	2.625	.500	QCFZF		PS-340-EPR-TC-CMS

DIMENSIONAL CROSS-REFERENCE

SEAL HEAD			MATING RING			Material Code	NOTES	U.S. Seal Mfg. Part No.
Fig.	OD	Oper Hgt.	Fig.	Bore	Thick			
1.875 (1-7/8") (continued)								
C	2.750	1.500	1	2.625	.500	VCFJF		PS-340V-CMS
C	2.750	1.500	1	2.625	.500	VCFJF	I	PS-340V-CMS-P66
C	2.750	1.500	1	2.625	.500	VCFKF		PS-1608V-CMS
C	2.750	1.500	1	2.625	.500	VZFLF		PS-340V-TC-SC-CMS
C	2.750	1.500	3	2.625	.500	BCFJF	S	PS-2114
C	2.750	1.500	3	2.625	.500	BCFKF	S	PS-312
C	2.750	1.500	3	2.625	.500	BLFLF	S	PS-2729
C	2.750	1.500	3	2.625	.500	VCFJF	S	PS-340V
C	2.750	1.500	3	2.625	.500	VCFKF	S	PS-312V
C	2.750	1.500	3	2.625	.500	VZFLF	S	PS-340V-TC-SC
C	2.750	2.125	1	2.625	.500	BCFJF		PS-3211
C	2.921	.688	3	2.451	.312	VCFKF		PS-4219
D	2.875	1.500	—	—	—	BCD-F		FA-593
D	2.875	1.500	1	2.625	.500	BCDJF		PS-828
D	2.875	1.500	1	2.625	.500	BCDKF		PS-1097
D	2.875	1.500	3	2.625	.500	BCDKF	S	PS-593
D	2.875	1.500	3	2.625	.500	BCFJF	S	PS-4333
D	2.875	1.500	3	2.625	.500	BCFLF	S	PS-4107
D	2.875	1.500	3	2.625	.500	VCFLF	S	PS-22147
D	2.875	1.500	3	2.625	.500	VCPSF	S	PS-6094
D	2.891	1.454	3	2.625	.500	BCDLF	H/S	PS-22133
DB	2.875	1.875	1	2.500	.500	BCDZF		PS-3818
DB	2.875	1.875	1	2.500	.500	BCDJF		PS-22206
DB	2.875	1.875	3	2.500	.500	BCDJF	S	PS-3070
DB	2.875	1.875	3	2.500	.500	BCFJF	S	PS-4486
DB	2.875	1.875	3	2.375	.500	VCFZF	316SS/S	PS-4563
E	2.500	1.531	—	—	—	VCF-F	316SS/H	FA-4193
E	2.500	1.531	3	2.625	.500	QCFJF	316SS/H/S	PS-3046
E	2.500	1.531	3	2.625	.500	QZFLF	316SS/H/S	PS-3049
E	2.500	1.531	3	2.625	.500	VCFZF	316SS/S	PS-4193
E	2.500	1.531	3	2.625	.500	VZFZF	316SS/S	PS-4166
E	2.500	1.906	3	2.625	.500	BCFJF	C/S	PS-7559
E	2.500	1.906	3	2.625	.500	VCFJF	316SS/C/S	PS-3929
E	2.500	1.906	3	2.625	.500	VCFKF	C/S	PS-7698V-LC
E	2.500	1.906	3	2.625	.500	XCFZF	I/S	PS-4477
E	2.500	2.094	3	2.625	.500	BCDLF	H/S	PS-22131
E	2.500	2.125	—	—	—	VCF-F		FA-513V
E	2.500	2.125	1	2.625	.500	BCDJF		PS-523
E	2.500	2.125	1	2.625	.500	BCDKF		PS-513
E	2.500	2.125	1	2.625	.500	BCFJF		PS-2069
E	2.500	2.125	1	2.625	.500	BCFKF		PS-2070
E	2.500	2.125	1	2.625	.500	BCFZF		PS-2069-TC-SEAT
E	2.500	2.125	1	2.625	.500	QCFZF	I	PS-7869
E	2.500	2.125	1	2.625	.500	VCFJF		PS-1659V-CMS
E	2.500	2.125	3	2.625	.500	BCFJF	S	PS-2071
E	2.500	2.125	3	2.625	.500	BCFKF	S	PS-2072
E	2.500	2.125	3	2.625	.500	BCFKF	316SS/S	PS-7898
E	2.500	2.125	3	2.625	.500	BCFLF	S	PS-586-SC-SEAT
E	2.500	2.125	3	2.625	.500	BLFLF	S	PS-586-SC-SC
E	2.500	2.125	3	2.625	.500	BLFLF	316SS/S	PS-4270
E	2.500	2.125	3	2.625	.500	B/VCFKF	S	PS-7962
E	2.500	2.125	3	2.625	.500	BZFZF	S	PS-2072-TC-TC
E	2.500	2.125	3	2.625	.500	QCFZF	316SS/I/S	PS-7951
E	2.500	2.125	3	2.625	.500	VCFJF	S	PS-1659
E	2.500	2.125	3	2.625	.500	VCFKF	S	PS-1660
E	2.500	2.125	3	2.625	.500	VCFZF	S	PS-1661
E	2.500	2.125	3	2.625	.500	VLFZF	S	PS-586V-SC-TC
E	2.500	2.125	3	2.625	.500	VZFZF	S	PS-7862
E	2.500	2.125	3	2.687	.500	VCFJF		PS-7020
E	2.500	2.437	3	2.687	.500	BCFKF		PS-949
E	2.500	2.437	3	2.687	.500	B/VCFJF		PS-1664
EB	2.500	2.500	3	2.500	.500	BCFJF	S	PS-7827
EB	2.500	2.500	3	2.500	.500	BCFKF	S	PS-7884
EB	2.500	2.500	3	2.500	.500	VCFJF	S	PS-4417
EB	2.500	2.500	3	2.500	.500	VCFKF	S	PS-7884V

NOTE: C. COMPLETE WITH COLLAR
H. SPRING HOLDER NOT INCLUDED
I. ABRASION RESISTANT CARBON (P66)
S. SLOTTED MATING RING

DIMENSIONAL CROSS-REFERENCE

SEAL HEAD			MATING RING			Material Code	NOTES	U.S. Seal Mfg. Part No.
Fig.	OD	Oper Hgt.	Fig.	Bore	Thick			
1.875 (1-7/8") (continued)								
EB	2.500	2.500	Special	2.687	.500	VCFZF		PS-3648
G	64MM	30MM	1	2.625	0.5	BCFJF	316SS	PS-3017
G	2.520	1.181	1	2.625	.500	BLFLF	316SS	PS-3018
K	2.734	1.750	1	2.625	.500	BL/CFL/JF		PS-3753
K	2.750	1.750	1	2.625	.500	BCFJF		PS-2237
K	2.750	1.750	1	2.625	.500	BZ/CFL/JF		PS-4426
K	2.750	1.750	1	2.625	.500	BZFZF		PS-3190
K	2.750	1.843	1	2.625	.500	BZ/CFZ/JF		PS-4217
K	2.750	2.125	1	2.625	.500	BCFKF		PS-7352
K	2.750	3.000	1	2.625	.500	BCFJF		PS-318
K	2.750	3.000	1	2.625	.500	BCFKF		PS-1693
K	2.750	3.000	1	2.625	.500	BZFZF		PS-318-TC-TC
T	2.500	2.343	25	2.650	.406	BCFJF		PS-4046
T	2.500	2.500	3	2.625	.437	BCFJF		PS-3964
T	2.500	2.500	3	2.625	.437	BZFZF	316SS	PS-5087
T	2.500	2.500	3	2.625	.437	VCFKF		PS-4521
T	2.500	2.937	3	2.625	.500	VLFZF/VCFJF	316SS/S	PS-3203
T	2.500	3.000	1	2.625	.500	BCFJF		PS-7878
T	2.500	3.000	1	2.625	.500	BCFKF		PS-743
T	2.500	3.000	3	2.687	.500	VCFJF		PS-1653
U	2.500	2.125	5	2.500	.500	BCFZF	316SS	PS-4592
U	2.500	2.437	3	2.500	.500	BCFJF		PS-898
V	2.437	2.000	3	2.625	.437	BCFJF		PS-4467
V	2.500	2.000	1	2.625	.500	BMFJF		PS-1108
V	2.500	2.000	3	2.625	.437	BMFJF		PS-2146
V	2.500	2.000	25	2.640	.406	BMFJF		PS-1105
WT	2.510	1.375	3	2.625	.500	T/QCFZF	316SS/S	PS-9119
WT	2.510	1.375	3	2.625	.500	T/VCFJF	316SS/S	PS-9709
WT	2.510	1.375	3	2.625	.500	T/VCFZF	316SS/S	PS-9340
XB	2.500	1.750	3	2.375	.500	VCFZF	316SS/I/S	PS-8010
XB	2.625	1.750	3	2.375	.500	QCFLF	316SS/S	PS-8124
XB1	2.625	1.750	3	2.375	.500	VCFLF	316SS/S	PS-22165
XBT	2.510	1.750	3	2.375	.500	QCFZF	316SS/S	PS-8059
X Special	2.500	1.000	3 Special	2.625	.500	NCFZF	316SS	PS-6097
X Special	2.500	1.500	3	2.000	.500	VCFJF	316SS	PS-8077
X Special	2.968	1.370	3	2.625	.500	BCFLF	316SS/I/S	PS-22185
X Special	2.968	1.370	3	2.625	.500	VCFLF	316SS/I/S	PS-22190
XT	2.510	1.000	3 Special	2.625	.500	VCFLF	S	PS-22112
XT	2.510	1.375	3	2.625	.500	VCFZF	316SS/S	PS-8094V
XT	2.510	1.750	3	2.625	.437	VCFJF	316SS	PS-8076
48 MM (1.889")								
G	64MM	35MM	25	66MM	10MM	VLFLF	316SS	PS-22038
2.000 (2")								
C	2.598	1.500	1	2.750	.500	BCFJF	316SS	PS-5224
C	2.875	1.062	1	2.750	.500	BCFJF		PS-7781
C	2.875	1.062	1	2.750	.500	BLFZF		PS-7781-SC-TC
C	2.875	1.062	3	2.750	.500	BCFJF	S	PS-3993
C	2.875	1.062	3	2.750	.500	BCFJF	H/S	PS-4239
C	2.875	1.062	3	2.750	.500	BCFKF	S	PS-4015
C	2.875	1.062	3	2.750	.500	BLFLF	S	PS-6238
C	2.875	1.062	3	2.750	.500	BLFZF	S	PS-3721
C	2.875	1.062	3	2.750	.500	BZFZF	N/S	PS-3688
C	2.875	1.062	3	2.750	.500	VCFKF	S	PS-6247V
C	2.875	1.062	3	2.750	.500	VLFLF	N/S	PS-4178
C	2.875	1.062	3	3.000	.312	BCFKF		PS-582
C	2.875	1.250	1	2.750	.500	BCFJF		PS-2139
C	2.875	1.250	1	2.750	.500	BCFKF		PS-1028
C	2.875	1.250	1	2.750	.500	BZFZF		PS-3676
C	2.875	1.250	3	2.750	.500	BCFJF	S	PS-4416
C	2.875	1.250	3	2.750	.500	BCFKF	S	PS-3875
C	2.875	1.500	—	—	—	BCF-F		FA-2000
C	2.875	1.500	—	—	—	VCF-F		FA-10047
C	2.875	1.500	1	2.750	.500	BCFJF		PS-267
C	2.875	1.500	1	2.750	.500	BCFJF	I	PS-267-P66

DIMENSIONAL CROSS-REFERENCE

SEAL HEAD			MATING RING			Material Code	NOTES	U.S. Seal Mfg. Part No.
Fig.	OD	Oper Hgt.	Fig.	Bore	Thick			
2.000 (2") (continued)								
C	2.875	1.500	1	2.750	.500	BCFKF		PS-842
C	2.875	1.500	1	2.750	.500	BCFKF	I	PS-842-P66
C	2.875	1.500	1	2.750	.500	BCFZF		PS-842-TC-SEAT
C	2.875	1.500	1	2.750	.500	BLFLF		PS-267-SC-SC-CMS
C	2.875	1.500	1	2.750	.500	BZFZF		PS-2219
C	2.875	1.500	1	2.750	.500	QCFJF		PS-267-EPR
C	2.875	1.500	1	2.750	.500	QCFZF	I	PS-3580
C	2.875	1.500	1	2.750	.500	VCFJF		PS-267V-CMS
C	2.875	1.500	1	2.750	.500	VCFJF	I	PS-267V-CMS-P66
C	2.875	1.500	1	2.750	.500	VCFKF		PS-842V
C	2.875	1.500	1	2.750	.500	VCFKF	I	PS-842V-P66-CMS
C	2.875	1.500	1	2.750	.500	VCFKF	316SS	PS-4120
C	2.875	1.500	1	2.750	.500	VCFLF		PS-3716
C	2.875	1.500	1	2.750	.500	VFLFLF		PS-6224
C	2.875	1.500	1	2.750	.500	VLFZF		PS-267V-SC-TC-CMS
C	2.875	1.500	1	2.750	.500	VZFLF		PS-22107
C	2.875	1.500	1	2.750	.500	VZFZF		PS-6218
C	2.875	1.500	1	2.750	.500	VZFZF	316SS	PS-6213
C	2.875	1.500	3	2.750	.500	BCFJF	S	PS-532
C	2.875	1.500	3	2.750	.500	BCFKF	S	PS-332
C	2.875	1.500	3	2.750	.500	BCFLF	S	PS-4235
C	2.875	1.500	3	2.750	.500	BCFZF	S	PS-267-TC-SEAT
C	2.875	1.500	3	2.750	.500	BLFZF	C/S	PS-267-SC-TC-LC
C	2.875	1.500	3	2.750	.500	BLFZF	S	PS-267-SC-TC-SEAT
C	2.875	1.500	3	2.750	.500	QCFZF	I/S	PS-7309
C	2.875	1.500	3	2.750	.500	VCFJF	S	PS-267V
C	2.875	1.500	3	2.750	.500	VCFKF	S	PS-1145
C	2.875	1.500	3	2.750	.500	VCFZF	S	PS-267V-TC-SEAT
C	2.875	1.500	3	2.750	.500	VFLFLF	S	PS-267V-SC-SC
C	2.875	1.500	3	2.750	.500	VFLFLF		PS-7731
C	2.875	1.500	5	2.750	.500	QCFZF	316SS	PS-3292
C	2.875	1.500	5	2.750	.500	QLFLF	316SS	PS-3293
C	2.875	1.500	3	3.000	.500	BCFJF	I	PS-4345
C	2.875	1.500	3	3.000	.500	BCFKF		PS-1020
C	2.875	1.500	3	3.000	.500	QCFJF	I	PS-4287
C	2.875	1.500	3	3.000	.500	QCFKF	I	PS-1020-EPR-P66
C	2.875	1.500	3	3.000	.500	QCFZF		PS-3027
C	2.875	1.500	3	3.000	.500	VCFKF		PS-1020V
C	2.875	1.500	28	4.330	1.060	BCFKF		PS-1037
C	2.875	1.500	28	4.330	1.060	VCFKF		PS-1037V
C	2.875	2.125	1	2.750	.500	BCFJF		PS-2133
C	2.875	2.125	1	2.750	.500	BCFJF	I	PS-2133-P66
C	2.875	2.125	1	2.750	.500	BCFKF		PS-1017
C	2.875	2.125	1	2.750	.500	QCFKF	I	PS-3674
C	2.875	2.125	3	2.750	.500	BCFZF	S	PS-1017-TC-SEAT
D	3.000	1.500	1	2.625	.500	BCDKF		PS-876
D	3.000	1.500	1	2.750	.500	BCDJF		PS-445
D	3.000	1.500	1	2.750	.500	BCDKF		PS-462
D	3.000	1.500	1	2.750	.500	BCFJF		PS-2073
D	3.000	1.500	1	2.750	.500	VCDJF		PS-445V-CMS
D	3.000	1.500	1	2.750	.500	VFLFLF		PS-3066
D	3.000	1.500	1	2.750	.500	VLFZF		PS-2073V-SC-TC-CMS
D	3.000	1.500	3	2.750	.500	BCDJF	S	PS-833
D	3.000	1.500	3	2.750	.500	BCDKF	S	PS-832
D	3.000	1.500	3	2.750	.500	BCFJF	S	PS-2075
D	3.000	1.500	3	2.750	.500	BCFKF	S	PS-2076
D	3.000	1.500	3	2.750	.500	BZFLF	S	PS-3153
D	3.000	1.500	3	2.750	.500	NCPGP	S	PS-193
D	3.000	1.500	3	2.750	.500	VCDJF	S	PS-445V
D	3.000	1.500	3	2.750	.500	VCDKF	S	PS-462V
D	3.000	1.500	3	2.750	.500	VCFKF	316SS	PS-4154
D	3.000	1.500	3	2.750	.500	VZFLF	316SS/H/S	PS-3142
D	3.062	1.455	3	2.750	.500	BCFLF	H/S	PS-22134
D	3.093	1.125	3	2.812	.500	NCPGP		PS-333
D	3.187	1.653	Plate	5.125	—	NCPGP		PS-6115
E	2.625	2.125	1	2.625	.500	BCFKF		PS-1609

NOTE: C. COMPLETE WITH COLLAR
H. SPRING HOLDER NOT INCLUDED
I. ABRASION RESISTANT CARBON (P66)
S. SLOTTED MATING RING

DIMENSIONAL CROSS-REFERENCE

SEAL HEAD			MATING RING			Material Code	NOTES	U.S. Seal Mfg. Part No.
Fig.	OD	Oper Hgt.	Fig.	Bore	Thick			
2.000 (2") (continued)								
E	2.625	2.125	1	2.687	.500	BCFJF		PS-319
E	2.625	2.125	1	2.687	.500	BCFJF	I	PS-319-P66
E	2.625	2.125	1	2.687	.500	BCFKF		PS-478
E	2.625	2.125	1	2.687	.500	V/BCFJF		PS-319V
E	2.625	2.125	1	2.750	.500	BCFJF		PS-479
E	2.625	2.125	1	2.750	.500	BCFJF	I	PS-479-P66
E	2.625	2.125	1	2.750	.500	BCFKF		PS-843
E	2.625	2.125	1	2.750	.500	BLFZF		PS-479-SC-TC
E	2.625	2.125	1	2.750	.500	VCFJF	I	PS-479V-CMS-P66
E	2.625	2.125	1	2.750	.500	VCFKF		PS-843V-CMS
E	2.625	2.125	1	2.750	.500	VCFZF		PS-479V-TC-CMS
E	2.625	2.125	1	2.750	.500	VZFZF		PS-479V-TC-TC
E	2.625	2.125	3	2.750	.500	BCFJF	S	PS-530
E	2.625	2.125	3	2.750	.500	BCFKF	S	PS-477
E	2.625	2.125	3	2.750	.500	BCFKF	I/S	PS-477-P66
E	2.625	2.125	3	2.750	.500	BCFKF	316SS/I/S	PS-3522
E	2.625	2.125	3	2.750	.500	BCFZF	S	PS-477-TC-SEAT
E	2.625	2.125	3	2.750	.500	BLFLF	316SS	PS-4432
E	2.625	2.125	3	2.750	.500	BZFLF	S	PS-477-TC-SC
E	2.625	2.125	3	2.750	.500	BZFZF	S	PS-477-TC-TC
E	2.625	2.125	3	2.750	.500	BZFZF	316SS	PS-4600
E	2.625	2.125	3	2.750	.500	NCPKP	S	PS-342
E	2.625	2.125	3	2.750	.500	QCFJF	S	PS-4376
E	2.625	2.125	3	2.750	.500	QCFKF	S	PS-477-EPR
E	2.625	2.125	3	2.750	.500	QCFLF	S	PS-477-EPR-SC
E	2.625	2.125	3	2.750	.500	QCFZF	I/S	PS-3639
E	2.625	2.125	3	2.750	.500	VCFJF	S	PS-479V
E	2.625	2.125	3	2.750	.500	VCFKF	S	PS-477V
E	2.625	2.125	3	2.750	.500	VCFKF	I/S	PS-3079
E	2.625	2.125	3	2.750	.500	VCFZF	S	PS-477V-TC-SEAT
E	2.625	2.125	3	2.750	.500	VZFLF	S	PS-462V-TC-SC
E	2.625	2.125	3	2.750	.500	VZFLF	316SS/S	PS-22087
E	2.625	2.125	3	2.750	.500	VZFZF	S	PS-477V-TC-TC
E	2.625	2.125	3	3.000	.500	BCFKF		PS-4312
E	2.625	2.125	5	2.750	.500	BCFZF	I	PS-3708
E	2.625	2.125	5	2.750	.500	QCFZF	I	PS-3108
E	2.625	2.125	5	2.750	.500	VCFZF	I	PS-3708V
E	2.625	2.500	3	2.750	.500	BCFKF	C/S	PS-22174
E	2.730	2.165	—	—	—	NCP-P		FA-6104
EB	2.625	2.500	3	2.500	.500	QCFZF	316SS/I/S	PS-3088
EB	2.625	2.500	1	2.625	.500	BCFJF		PS-7910
EB	2.625	2.500	3	2.625	.500	BCFJF	S	PS-3304
EB	2.625	2.500	3	2.625	.500	BCFKF	S	PS-7892
EB	2.625	2.500	3	2.625	.500	BCFZF	S	PS-4291
EB	2.625	2.500	3	2.625	.500	VCFJF		PS-4419
EB	2.625	2.500	3	2.625	.500	VCFKF	S	PS-7890
EB	2.625	2.500	3	2.625	.500	VCFZF		PS-4102
E Special	2.625	1.843	3	2.750	.500	NCPKF	S	PS-3644
E Special	2.625	1.843	3	3.031	.500	NCDKF	Includes Sleeve	PS-3952
E Special	2.730	2.165	Plate	5.875	.750	NCPGP		PS-6007
G	2.598	1.500	25	2.750	.500	QCFLF	316SS	PS-4357
G	2.598	1.500	25	2.750	.500	QLFLF	316SS	PS-3019
G	2.598	1.500	25	2.750	.500	VCFLF	316SS	PS-3170
K	2.859	1.875	1	2.750	.500	BCFJF		PS-4478
K	2.859	2.125	3	2.750	.500	BCFKF	S	PS-1040
K	2.859	2.125	3	2.750	.500	BZ/CFZ/JF	S	PS-4343
K	2.875	1.500	1	2.775	.500	BL/CFZ/CF		PS-4294
K	2.875	2.125	1	2.750	.500	BCFJF		PS-2143
K	2.875	2.125	3	2.750	.500	BCFJF	S	PS-7196
K	2.875	2.125	3	2.750	.500	VCFJF	S	PS-7196V
K	2.875	2.125	3	2.750	.500	VZFZF	316SS/S	PS-3254
K	2.875	2.125	3	3.000	.500	BCFJF		PS-7963
R	3.000	2.125	1	2.750	.500	BCDJF		PS-1610
R	3.000	2.125	1	2.750	.500	BCDKF		PS-658
Special	2.750	.750	Special	2.750	.375	BCFAF		PS-4052

DIMENSIONAL CROSS-REFERENCE

SEAL HEAD			MATING RING			Material Code	NOTES	U.S. Seal Mfg. Part No.
Fig.	OD	Oper Hgt.	Fig.	Bore	Thick			
2.000 (2") (continued)								
T	2.625	3.000	3	2.750	.500	VZFFZ	S	PS-4208
U	2.625	2.000	3	2.750	.500	BCFJF	S	PS-4474
U	2.625	2.000	3	2.750	.500	BCFKF	S	PS-385A
U	2.625	2.000	3	2.750	.500	VCFKF	S	PS-385AV
U	2.625	2.000	3	2.750	.500	VCFLF	S	PS-4468
U	2.625	2.000	3	2.750	.500	VLFLF	S	PS-4391
U	2.625	2.000	3	2.750	.500	VZFLF	C/SS	PS-7616
U	2.625	2.125	3	2.750	.500	VCFZF	316SS/S	PS-3999
U	2.625	2.218	1	2.750	.500	BCFKF		PS-456-CMS
U	2.625	2.218	3	2.750	.500	BCFJF	S	PS-7400
U	2.625	2.218	3	2.750	.500	BCFKF	S	PS-456
U	2.625	2.218	3	2.750	.500	BZFLF	S	PS-4258
U	2.625	2.218	3	2.750	.500	QCFKF	S	PS-456-EPR
U	2.625	2.218	3	2.750	.500	QCFLF	316SS/S	PS-3044
U	2.625	2.218	3	2.750	.500	QCFZF	I/S	PS-3591
U	2.625	2.218	3	2.750	.500	VCFKF	S	PS-456V
U	2.625	2.218	3	2.750	.500	VCFLF	S	PS-3083
U	2.625	2.218	3	2.750	.500	VCFZF	S	PS-456V-TC-SEAT
U	2.625	2.218	3	2.750	.500	VLFLF	S	PS-456V-SC-SC
U	2.625	2.218	3	2.750	.500	XZFLF	S	PS-3649
W	2.750	1.375	3	2.750	.500	T/VCFJF	316SS/S	PS-9029
WB	2.750	1.750	3 Special	2.468	.937	TCFN/KF	316SS	PS-22063
WB	2.750	1.750	3	2.500	.500	TCFGF	316SS	PS-9712
WB	2.750	1.750	3	2.500	.500	TCFN/KF	316SS/S	PS-22064
WB	2.750	1.750	Special	2.500	.937	T/NCFKF	316SS	PS-9703
X	2.750	1.375	3	2.750	.500	VZFLF	316SS	PS-8134
X	2.750	1.375	5	2.750	.500	QCFZF	316SS	PS-8561
XB1	2.750	1.750	3	2.500	.500	XCFLF	316SS/S	PS-8122
XB1T	2.625	1.750	3	2.500	.500	VCFZF	316SS/I/S	PS-8053
XBT	2.625	1.750	3	2.500	.500	VCFJF	316SS	PS-8119
2.062 (2-1/16")								
E	2.812	2.375	3	2.875	.562	BCDKF		PS-707
T	2.812	3.375	3	2.937	.562	BCFKF		PS-3562
2.125 (2-1/8")								
C	2.812	1.197	2	3.000	.500	VCFKF	316SS	PS-5706
C	2.968	1.687	3	3.000	.562	QCFZF	S	PS-4314
C	3.000	1.687	—	—	—	BCF-F		FA-2120
C	3.000	1.687	3	2.875	.562	BCFJF	S	PS-854
C	3.000	1.687	3	2.875	.562	BCFKF	S	PS-855
C	3.000	1.687	1	3.000	.562	BCFJF		PS-844
C	3.000	1.687	1	3.000	.562	BCFJF	I	PS-844-P147
C	3.000	1.687	1	3.000	.562	BCFKF		PS-543
C	3.000	1.687	1	3.000	.562	VCFJF		PS-4436
C	3.000	1.687	3	3.000	.562	BCFJF	S	PS-338
C	3.000	1.687	3	3.000	.562	B/VCFKF	S	PS-1057
C	3.000	1.687	3	3.000	.562	QCFJF	S	PS-338-EPR
C	3.000	1.687	3	3.000	.562	VCFJF	S	PS-338V
C	3.000	1.687	3	3.000	.562	VCFKF	S	PS-543V
C	3.000	1.687	3	3.000	.562	VCFLF	S	PS-3606
C	3.000	1.687	3	3.000	.562	VLFLF	S	PS-338V-SC-SC
C	3.000	1.687	3	3.000	.562	VZFLF	S	PS-4570
C	3.000	2.375	3	3.000	.562	BCFJF	S	PS-4508
C	3.000	2.375	3	3.000	.562	VCFKF	S	PS-4276
D	3.250	1.687	1	3.000	.562	BCFJF		PS-1686
D	3.250	1.687	1	3.000	.562	BCFKF		PS-1687
D	3.250	1.687	1	3.000	.562	NCFJF		PS-22128
D	3.250	1.687	1	3.000	.562	QCFLF	I	PS-3035
D	3.250	1.687	2	3.000	.562	BCDKF		PS-4437
D	3.250	1.687	3	3.000	.562	BCFJF	S	PS-2093
D	3.250	1.687	3	3.000	.562	VCFLF	I/S	PS-4079
D	3.250	1.687	3	3.000	.562	VLFFZF	S	PS-3809
E	2.812	2.125	3	2.875	.562	BCEJE	S	PS-6912
E	2.812	2.312	3	2.875	.562	BCFKF	316SS/C/S	PS-4243
E	2.812	2.312	3	2.875	.562	VCFJF	316SS/C/S	PS-3897
E	2.812	2.375	—	—	—	BCF-F	316SS	FA-3502

NOTE: C. COMPLETE WITH COLLAR
 I. ABRASION RESISTANT CARBON (P66)
 S. SLOTTED MATING RING

DIMENSIONAL CROSS-REFERENCE

SEAL HEAD			MATING RING			Material Code	NOTES	U.S. Seal Mfg. Part No.
Fig.	OD	Oper Hgt.	Fig.	Bore	Thick			
2.125 (2-1/8") (continued)								
E	2.812	2.375	3	2.812	.437	BCFJF		PS-611
E	2.812	2.375	3	2.812	.437	BCFJF	I	PS-611-P66
E	2.812	2.375	3	2.812	.437	BCFKF		PS-1612
E	2.812	2.375	3	2.812	.437	VCFKF		PS-1612V
E	2.812	2.375	3	2.875	.562	BCFJF	S	PS-856
E	2.812	2.375	3	2.875	.562	BCFKF	S	PS-857
E	2.812	2.375	3	2.875	.562	VCFKF	S	PS-857V
E	2.812	2.375	3	2.875	.562	VCFZF	S	PS-857V-TC-SEAT
E	2.812	2.375	1	3.000	.562	BCFJF		PS-537
E	2.812	2.375	1	3.000	.562	BCFJF	I	PS-537-P66
E	2.812	2.375	1	3.000	.562	BCFKF		PS-353
E	2.812	2.375	3	3.000	.562	BCFJF	S	PS-327
E	2.812	2.375	3	3.000	.562	BCFKF	S	PS-2086
E	2.812	2.375	3	3.000	.562	QCFLF	316SS/S	PS-3134
E	2.812	2.375	3	3.000	.562	QCFLF	316SS/I/S	PS-3261
E	2.812	2.375	3	3.000	.562	VCFJF	S	PS-327V
E	2.812	2.375	3	3.000	.562	VCFKF	S	PS-353V
E	2.812	2.375	3	3.000	.562	VLFJF	316SS/S	PS-4434
E	2.812	2.375	3	3.000	.562	VFLF	S	PS-3727
E	2.812	2.375	3	3.125	.562	BCFJF	316SS	PS-3122
EB	2.812	2.750	3	2.750	.500	BCFJF	316SS/S	PS-3714
EB	2.812	2.750	3	2.750	.500	VCFJF	316SS/S	PS-4418
EB	2.812	2.750	5	2.625	.437	BCFZF		PS-4146
G	2.717	1.181	3	3.000	.562	QCFJF	316SS	PS-3020
K	2.968	2.125	1	3.000	.562	VCFRF		PS-3765
K	2.968	2.125	3	3.000	.562	VCFZF	S	PS-3765-TC-SEAT
K	3.000	2.125	1	3.000	.562	BCFJF		PS-887
K	3.000	2.125	3 Special	3.000	.562	VCFZF		PS-6120
K	3.000	2.125	3 Special	3.000	.562	VCFZ/KF	I	PS-6121
T	2.812	2.625	3	3.000	.562	BCFJF	316SS/S	PS-3879
T	2.812	3.375	3	3.000	.562	BCFJF	S	PS-2126
T	2.812	3.375	3	3.000	.562	BLFZF	S	PS-4388
U	2.812	2.812	3	2.750	.500	VCF/EJE	316SS/C	PS-4584
U	2.812	2.812	1	3.000	.562	BCFKF		PS-556
V	2.750	1.625	1	3.187	.875	BCFJF		PS-1107-CMS
V	2.750	2.562	3	3.140	.562	BCFJF		PS-1102
W	3.000	1.687	2	3.000	.562	QCFZF	316SS	PS-9400
W	3.000	1.687	2	3.000	.562	TCFJF	316SS	PS-9122
X1T	2.812	1.687	3	2.875	.562	VCFJF	316SS/S	PS-8562
X Double	2.812	2.625	3	2.875	.312	VCFJF	316SS/S	PS-8132
XT Double	2.812	2.625	3	2.875	.312	VL/CFL/JF	316SS/S	PS-22156
XT Special	2.812	2.625	3	2.875	.312	VCFJF	316SS/S	PS-8702
XB2	3.125	1.156	27	3.375	1.000	VCFJF	316SS	PS-8035
XB2	3.125	1.312	Special	3.562	.969	VFLF	316SS/H/C	PS-22157
XB2	3.125	1.312	27	3.562	1.000	VCFJF	316SS	PS-8057
2.165 (55MM)								
C	2.820	1.358	2	2.952	.437	VCFKF	316SS	PS-5019
2.187 (2-3/16")								
D	3.468	.969	2	3.000	.406	BCFKF		PS-5005
D	3.468	.969	2	3.000	.406	VCFKF		PS-5024
2.250 (2-1/4")								
C	2.937	1.339	Special	3.125	.875	VLFZF	316SS	PS-5742
C	2.937	1.812	Special	Special	Special	VLFZF	316SS	PS-5741
C	3.093	1.656	2	3.125	.531	BCFKF		PS-5740
C	3.125	1.187	1	3.125	.562	BCFJF		PS-7138
C	3.125	1.187	1	3.125	.562	BCFKF		PS-7782
C	3.125	1.187	1	3.125	.562	BZFZF		PS-7138-TC-TC
C	3.125	1.187	1	3.125	.562	VLFZF		PS-7138V-SC-TC-CMS
C	3.125	1.187	3	3.125	.562	BLFZF	S	PS-3966
C	3.125	1.187	3	3.125	.562	VCFKF	S	PS-6248
C	3.125	1.437	1	3.125	.562	BCFJF		PS-1087
C	3.125	1.437	1	3.125	.562	BZFZF		PS-7064
C	3.125	1.437	1	3.125	.562	VCFJF		PS-1087V-CMS

DIMENSIONAL CROSS-REFERENCE

SEAL HEAD			MATING RING			Material Code	NOTES	U.S. Seal Mfg. Part No.
Fig.	OD	Oper Hgt.	Fig.	Bore	Thick			
2.250 (2-1/4") (continued)								
C	3.125	1.437	1	3.125	.562	VLFZF		PS-1087V-SC-TC-CMS
C	3.125	1.667	3 Special	3.125	1.015	VCFKF		PS-5076
C	3.125	1.688	—	—	—	BCF-F		FA-2250
C	3.125	1.688	—	—	—	QCF-F	I	FA-7750
C	3.125	1.688	1	3.125	.562	BCFJF		PS-1679
C	3.125	1.688	1	3.125	.562	BCFJF	I	PS-1679-P66
C	3.125	1.688	1	3.125	.562	BCFKF		PS-1680
C	3.125	1.688	1	3.125	.562	BCFKF	I	PS-1680-P66
C	3.125	1.688	1	3.125	.562	BLFLF		PS-3182
C	3.125	1.688	1	3.125	.562	BZFZF		PS-1680-TC-TC
C	3.125	1.688	1	3.125	.562	VCFJF		PS-1679V-CMS
C	3.125	1.688	1	3.125	.562	VCFKF		PS-1680V
C	3.125	1.688	1	3.125	.562	VZFZF		PS-3773
C	3.125	1.688	3	3.125	.562	BCFJF	S	PS-1678
C	3.125	1.688	3	3.125	.562	BCFKF	S	PS-1676
C	3.125	1.688	3	3.125	.562	BLFLF	S	PS-3289
C	3.125	1.688	3	3.125	.562	B/VCFZF	S	PS-1676-TC-SEAT
C	3.125	1.688	3	3.125	.562	QCFJF	I/S	PS-1679-EPR-P66
C	3.125	1.688	3	3.125	.562	QCFKF	I/S	PS-1676-EPR-P66
C	3.125	1.688	3	3.125	.562	QCFZF	I/S	PS-7750
C	3.125	1.688	3	3.125	.562	VCFJF	S	PS-1678V
C	3.125	1.688	3	3.125	.562	VCFKF	S	PS-1676V
C	3.125	1.688	3	3.125	.562	VCFZF	S	PS-1676V-TC-SEAT
C	3.125	1.688	27 Special	3.125	.779	VCFGF		PS-3955
C	3.125	2.375	1	3.125	.562	BCFJF		PS-3537
C	3.125	2.375	1	3.125	.562	VCFJF		PS-3537V
C	3.125	2.375	3	3.125	.562	BCFKF	S	PS-3041
D	3.375	1.688	1	3.125	.562	BCDJF		PS-874
D	3.375	1.688	1	3.125	.562	BCDKF		PS-941
D	3.375	1.688	1	3.125	.562	BCFJF		PS-2087
D	3.375	1.688	1	3.125	.562	BCFKF		PS-2088
D	3.375	1.688	1	3.125	.562	QCDKF		PS-941-EPR
D	3.375	1.688	3	3.125	.562	BCDJF	S	PS-846
D	3.375	1.688	3	3.125	.562	BCDKF	S	PS-847
D	3.375	1.688	3	3.125	.562	BCFJF	S	PS-2089
D	3.375	1.688	3	3.125	.562	BCFKF	S	PS-2090
D	3.375	1.688	3	3.125	.562	VCFKF	S	PS-22021
D	3.375	1.688	3	3.125	.562	VCDKF	S	PS-941V
D	3.375	1.688	3	3.125	.562	VLFLF	S	PS-22047
D	3.375	1.688	3	3.125	.562	VLFLF	316SS/S	PS-22048
D	3.468	1.688	3	3.125	.562	Special		PS-5358
D	3.420	1.466	3	3.125	.562	VCDKS	S	PS-22148
D	3.470	1.593	1	3.125	.562	BCFLF	316SS	PS-4800
D	3.704	1.631	3	3.125	.562	VAFLF	N/S	PS-4070
E	2.938	2.375	1	3.125	.562	BCDJF		PS-323
E	2.938	2.375	1	3.125	.562	BCDJF	I	PS-323-P66
E	2.938	2.375	1	3.125	.562	BCDKF		PS-351
E	2.938	2.375	1	3.125	.562	BCFJF		PS-2091
E	2.938	2.375	1	3.125	.562	BCFKF		PS-2092
E	2.938	2.375	1	3.125	.562	BLFZF		PS-323-SC-TC-CMS
E	2.938	2.375	1	3.125	.562	BZFZF		PS-22222
E	2.938	2.375	1	3.125	.562	VCDJF		PS-323V-CMS
E	2.938	2.375	3	3.125	.562	BCDJF	S	PS-848
E	2.938	2.375	3	3.125	.562	BCDKF	S	PS-849
E	2.938	2.375	3	3.125	.562	BCFJF	S	PS-1688
E	2.938	2.375	3	3.125	.562	BCFKF	S	PS-2094
E	2.938	2.375	3	3.125	.562	BCFZF	316SS	PS-3067
E	2.938	2.375	3	3.125	.562	B/VCFZF	S	PS-3530
E	2.938	2.375	3	3.125	.562	BZFZF	316SS	PS-4549
E	2.938	2.375	3	3.125	.562	QCFJF	S	PS-22215
E	2.938	2.375	3	3.125	.562	QCFLF	316SS/I	PS-4409
E	2.938	2.375	3	3.125	.562	VCDKF	S	PS-351V
E	2.938	2.375	3	3.125	.562	VCFJF	316SS	PS-1688V
E	2.938	2.375	3	3.125	.562	VCFJF	316SS/I	PS-3576
E	2.938	2.375	3	3.125	.562	VCFKF	S	PS-2094V

NOTE: I. ABRASION RESISTANT CARBON (P66)
 N. NON-STANDARD SPRING HOLDER
 S. SLOTTED MATING RING

DIMENSIONAL CROSS-REFERENCE

SEAL HEAD			MATING RING			Material Code	NOTES	U.S. Seal Mfg. Part No.
Fig.	OD	Oper Hgt.	Fig.	Bore	Thick			
2.250 (2-1/4") (continued)								
E	2.938	2.375	3	3.281	.562	BZFFZ		PS-3075
E	2.938	2.375	27	3.906	1.000	VCFKF		PS-3951
EB	2.938	2.062	3	2.875	.562	VCFJF		PS-4105
EB	2.938	2.750	3	3.000	.562	BCFJF	S	PS-3784
EB	2.938	2.750	3	3.000	.562	BCFLF		PS-2658
EB	2.938	2.750	3	3.000	.562	BCFZF	S	PS-7749
EB	2.938	2.750	3	3.000	.562	B/VCFKF	S	PS-3643
EB	2.938	2.750	3	3.000	.562	QCFJF	I	PS-22216
EB	2.938	2.750	3	3.000	.562	QZFZF	S	PS-22219
EB	2.938	2.750	3	3.000	.562	VCFLF	I	PS-4380
K	3.109	2.562	3	3.281	.562	BCFKF	I	PS-7060
K	3.125	1.875	1	3.125	.562	BCFJF		PS-7431
K	3.125	2.125	3	3.125	.562	BCFJF	S	PS-7766
Q	3.500	.750	3	3.000	.406	NMPAP		PS-6301
Q	3.625	.750	1	3.375	.281	BMPAP		PS-6302
Q	3.660	.750	1	3.375	.281	VMSP		PS-4041
R	3.375	2.375	1	3.125	.562	BCFJF		PS-3077
T	2.938	3.375	3	3.125	.562	BCDJF	S	PS-2132
V	3.125	2.375	3	3.281	.750	BCFKF	I	PS-3210
W	3.125	1.687	2	3.125	.562	TCFJF	316SS	PS-9120
XB1	3.125	2.062	3	2.750	.500	VCFZF	316SS/S	PS-8712
2.362 (60MM)								
G	80MM	40.5MM	1	80MM	12MM	VCFLF	316SS	PS-5735
G	80MM	40.5MM	25	80MM	12MM	VLFLF	316SS	PS-3276
2.375 (2-3/8")								
C	3.250	1.812	1	3.250	.562	BCFJF		PS-268-CMS
C	3.250	1.812	1	3.250	.562	BCFJF	I	PS-268-CMS-P66
C	3.250	1.812	1	3.250	.562	BCFKF		PS-492-CMS
C	3.250	1.812	1	3.250	.562	BCFKF	I	PS-492-CMS-P66
C	3.250	1.812	1	3.250	.562	VCFJF		PS-22051
C	3.250	1.812	1	3.250	.562	VCFKF		PS-492V-CMS
C	3.250	1.812	3	3.250	.562	BCFJF	S	PS-268
C	3.250	1.812	3	3.250	.562	BCFJF	I/S	PS-268-P66
C	3.250	1.812	3	3.250	.562	BCFKF	S	PS-492
C	3.250	1.812	3	3.250	.562	BCFKF	I/S	PS-492-P66
C	3.250	1.812	3	3.250	.562	BCFLF	S	PS-3051
C	3.250	1.812	3	3.250	.562	BCFZF	S	PS-22211
C	3.250	1.812	3	3.250	.562	VCFJF	S	PS-268V
C	3.250	1.812	3	3.250	.562	VCFJF	316SS/S	PS-3233
C	3.250	1.812	3	3.250	.562	VCFJF	I/S	PS-3127
C	3.250	1.812	3	3.250	.562	VCFKF	I/S	PS-492V-P66
C	3.250	1.812	3	3.250	.562	VCFLF	I/S	PS-4325
C	3.250	1.812	3	3.250	.562	VCFZF	S	PS-492V-TC-SEAT
C	3.250	1.812	28	5.118	1.060	BCFKF		PS-1677
C	3.250	1.812	28	5.118	1.060	VCFKF		PS-1677V
D	3.435	1.750	1	3.250	.562	NCFJF	H	PS-22129
D	3.500	1.813	1	3.250	.562	BCFJF	I	PS-834-CMS-P66
D	3.500	1.813	3	3.250	.562	BCFJF	S	PS-834
D	3.500	1.813	3	3.250	.562	BCFJF	I/S	PS-834-P66
D	3.500	1.813	3	3.250	.562	BCFKF	S	PS-594
D	3.500	1.813	3	3.250	.562	BCFKF	I/S	PS-594-P66
D	3.500	1.813	3	3.250	.562	BCFZF	S	PS-834-TC-SEAT
D	3.500	1.813	3	3.250	.562	BCFKF	S	PS-2095
D	3.500	1.813	3	3.250	.562	QCFJF	S	PS-834-EPR
D	3.500	1.813	3	3.250	.562	QCFZF	S	PS-834-EPR-TC
E	3.062	2.500	—	—	—	BCF-F		FA-2098
E	3.062	2.500	—	—	—	VCF-F		FA-350V
E	3.062	2.500	1	3.250	.562	BCFJF		PS-2097-CMS
E	3.062	2.500	1	3.250	.562	BCFKF		PS-350-CMS
E	3.062	2.500	3	3.250	.562	BCFJF	S	PS-278
E	3.062	2.500	3	3.250	.562	BCFJF	I/S	PS-278-P66
E	3.062	2.500	3	3.250	.562	BCFKF	S	PS-350
E	3.062	2.500	3	3.250	.562	VCFJF	S	PS-278V
E	3.062	2.500	3	3.250	.562	VCFKF	S	PS-2098V
E	3.062	2.500	3	3.250	.562	VCFZF	I/S	PS-350V-P66-TC

NOTE: H. SPRING HOLDER NOT INCLUDED
 I. ABRASION RESISTANT CARBON (P66)
 S. SLOTTED MATING RING

DIMENSIONAL CROSS-REFERENCE

SEAL HEAD			MATING RING			Material Code	NOTES	U.S. Seal Mfg. Part No.
Fig.	OD	Oper Hgt.	Fig.	Bore	Thick			
2.375 (2-3/8") (continued)								
E	3.062	2.500	3	3.250	.562	VLFLF	S	PS-4492
E	3.062	2.500	3	3.250	.562	VZFLF	316SS/S	PS-7935
E	3.062	2.500	5	3.250	.562	BCFZF	I	PS-4006
E	3.062	2.500	5	3.250	.562	QCFZF	I	PS-3187
E	3.062	2.500	5	3.250	.562	VCFZF	I	PS-3085
E	3.062	2.875	3	3.250	.562	QLFLF	C/S	PS-4162
EB	3.062	2.875	1	3.125	.562	BCFJF		PS-22201
EB	3.062	2.875	3	3.125	.562	BCFKF	S	PS-3936
EB	3.062	2.875	3	3.125	.562	BCFZF	S	PS-3501
EB	3.062	2.875	3	3.125	.562	VCFKF	S	PS-3936V
EB	3.062	2.875	3	3.125	.562	VCFLF	S	PS-4108
EB	3.062	2.875	3	3.125	.562	VCFZF	S	PS-3936V-TC-SEAT
G	3.150	1.299	1	3.125	.531	BCFLF	316SS	PS-3073
G	3.150	1.299	1	3.250	.562	BCFJF		PS-3008
G	3.150	1.299	1	3.250	.562	BLFZF		PS-3022
K	3.250	2.125	3	3.250	.562	BCFJF	S	PS-1694
K	3.250	2.125	3	3.250	.562	BCFKF	S	PS-1041
R	3.500	2.375	3	3.250	.562	BCFJF	S	PS-2711
X	3.250	1.687	3	3.250	.562	Special	S	PS-8560
X	3.250	1.687	3	3.250	.562	VCFLF	316SS/S	PS-8003
XB	3.250	2.062	3	3.000	.562	QCFLF	316SS/S	PS-8121
XB	3.250	2.125	3	3.000	.500	VCFLF	316SS/S	PS-8069
XB1	3.250	2.062	3	2.875	.531	NCFGF	316SS/S	PS-22065
XBT	3.000	2.062	3	3.250	.562	VCFJF	316SS	PS-8113
2.406 (2-13/32")								
K	3.375	2.015	3	3.305	.500	NCFGF		PS-22066
2.437 (2-7/16")								
E	3.312	1.687	3	3.437	.375	BCPKP		PS-7580
E	3.312	1.687	3	3.437	.375	VCPKF		PS-3751
W	3.312	1.687	28	4.000	.750	TCFKF	316SS	PS-9333
2.500 (2-1/2")								
C	3.388	1.579	Special	3.375	.562	VCFKF	H/S	PS-22113
C	3.515	1.813	1	3.375	.562	BCFJF		PS-2120
C	3.515	1.813	1	3.375	.562	VCFJF		PS-22043
C	3.515	1.813	1	3.375	.562	VCFZF		PS-3764
C	3.515	1.813	3	3.375	.562	BCFJF	S	PS-269
C	3.515	1.813	3	3.375	.562	BCFKF	S	PS-853
C	3.515	1.813	3	3.375	.562	BLFZF	S	PS-3247
C	3.515	1.813	3	3.375	.562	VCFJF	S	PS-269V
C	3.515	1.813	3 Special	3.375	.562	VCFKF		PS-6138
C	3.515	1.862	3	3.375	.562	VLFLF	S	PS-3877
C/X	3.344	1.250	1	3.375	.500	BCFJ*		PS-3651
D	3.625	1.813	3	3.250	.437	BCDJF		PS-468
D	3.625	1.813	3	3.375	.562	BCDJF	S	PS-835
D	3.625	1.813	3	3.250	.437	BCDKF		PS-469
D	3.625	1.813	3	3.375	.562	BCDKF	S	PS-463
D	3.625	1.813	3	3.375	.562	BCFJF	S	PS-22090
D	3.625	1.813	3	3.250	.437	BCFJF		PS-22002
D	3.625	1.813	3	3.375	.562	BCFKF	S	PS-22040
D	3.625	1.813	3	3.375	.562	BZFLF	S	PS-463-TC-SC
D	3.625	1.813	3	3.375	.562	VCDKF	S	PS-463V
D	3.625	1.813	3	3.375	.562	VCFJF	S	PS-22091
D	3.625	1.813	3	3.375	.562	VCFLF	S	PS-463VSS-SC-SEAT
D	3.625	1.813	3	3.375	.562	VCFKF	S	PS-22166
D	3.625	1.813	3	3.375	.562	VLFZF	316SS/S	PS-2740
D	3.625	1.813	3	3.375	.562	VZFLF	S	PS-3888
D	3.625	1.813	3	3.375	.562	VZFLF	S/H	PS-22094
D	3.704	1.651	3	3.375	.562	VAFLF	S	PS-4070
D	3.718	1.250	3	3.375	.562	VCPGP		PS-335V
D	4.331	1.871	3	3.375	.562	VAFLF	N/S	PS-3498
D Special	4.062	2.078	3 Special	3.250	.875	VCFZF	316SS	PS-4532
E	3.187	1.813	3	3.500	.422	BCFJF		PS-6254
E	3.187	2.312	3	3.500	.422	VCFZF		PS-3076

NOTE: C. COMPLETE WITH COLLAR
H. SPRING HOLDER NOT INCLUDED
I. ABRASION RESISTANT CARBON (P66)
S. SLOTTED MATING RING

DIMENSIONAL CROSS-REFERENCE

SEAL HEAD			MATING RING			Material Code	NOTES	U.S. Seal Mfg. Part No.
Fig.	OD	Oper Hgt.	Fig.	Bore	Thick			
2.500 (2-1/2") (continued)								
E	3.187	2.500	3	3.250	.562	BCPKF	S	PS-3924
E	3.187	2.500	3	3.250	.562	QCFZF	I	PS-3516
E	3.187	2.500	1	3.375	.562	BCFJF	I	PS-279-CMS-P66
E	3.187	2.500	1	3.375	.562	BLFZF		PS-4411
E	3.187	2.500	3	3.375	.562	BCFJF	S	PS-279
E	3.187	2.500	3	3.375	.562	BCFKF	S	PS-349
E	3.187	2.500	3	3.375	.562	BCFKF	I/S	PS-2205
E	3.187	2.500	3	3.375	.562	BCFZF	S	PS-349-TC-SEAT
E	3.187	2.500	3	3.375	.562	BZFLF	H/S	PS-22067
E	3.187	2.500	3	3.375	.562	QCFJF	S	PS-3064
E	3.187	2.500	3	3.375	.562	QCFKF	I/S	PS-2205-EPR
E	3.187	2.500	3	3.375	.562	QCFZF	I/S	PS-7985
E	3.187	2.500	3	3.375	.562	VCFJF	S	PS-279V
E	3.187	2.500	3	3.375	.562	VCFKF	S	PS-349V
E	3.187	2.500	3	3.375	.562	VCFLF	S	PS-349V-SC-SEAT
E	3.187	2.500	3	3.375	.562	VLZF	S	PS-279V-SC-TC
E	3.187	2.500	3	3.375	.562	VZFLF	S	PS-349V-TC-SC
E	3.187	2.500	3	3.375	.562	VZFZF	316SS	PS-22141
E	3.187	2.500	5	3.375	.562	BCFZF	I	PS-3164
E	3.187	2.718	3	3.250	.562	BCFJF	C/I	PS-22050
E	3.187	2.718	3	3.250	.562	BCFKF	C	PS-7716
E	3.187	2.718	3	3.250	.562	VCFJF	316SS/C	PS-3806
E	3.187	2.718	3	3.250	.562	VCFLF	316SS	PS-3206
E	3.187	2.718	3	3.250	.562	VZFLF	316SS/C/S	PS-4466
EB	3.187	2.875	3	3.250	.562	VCFZF	316SS/S	PS-2763
G	3.268	1.299	3	3.375	.562	BCFLF	316SS/S	PS-4801
G	3.268	1.811	25	3.375	.562	QLFLF	316SS	PS-4490
K	3.344	1.750	3 Special	3.375	.562	VCFKF		PS-6141
K	3.344	2.125	1	3.375	.562	BCFJF		PS-2158
K	3.344	2.125	1	3.375	.562	BLFLF		PS-4311
K	3.344	2.125	1	3.375	.562	BZFZF		PS-2158-TC-TC
K	3.344	2.125	3	3.375	.562	BCFJF	S	PS-1613
K	3.344	2.125	3	3.375	.562	BCFKF	S	PS-1695
K	3.359	1.750	3	3.375	.562	NCFKF	S	PS-6997
K	3.375	1.750	3 Special	3.375	.562	VCFZF		PS-6140
R	3.625	2.562	3	3.375	.531	NCPGP		PS-6146
T	3.187	2.656	3	3.500	.422	BCFJF		PS-4072
T	3.187	2.656	3	3.500	.422	VCFJF		PS-6244
T	3.187	2.656	3	3.500	.422	VLZF		PS-6243
T	3.187	2.938	1	3.375	.563	VZFLF	316SS	PS-4580
T	3.187	2.938	3	3.375	.563	VZFLF	316SS/S	PS-4109
V	3.187	2.375	3	3.250	.562	BCFJF		PS-4523
WB	3.375	2.062	Special	3.125	1.062	T/NCFKF	316SS	PS-9710
X1T	3.125	1.375	3 Special	3.375	.562	VCFKF	316SS	PS-8108
XB1	3.375	2.062	3	3.125	.562	QCFLF	316SS/I/S	PS-8089
XB1	3.375	2.062	3	3.125	.562	VCFZF	316SS	PS-8103
2.625 (2-5/8")								
D	3.875	1.937	3	3.375	.625	BCFJF	I/S	PS-7909
D	3.875	1.937	3	3.375	.625	QCFZF	S	PS-3188
D	3.875	1.937	3	3.375	.625	VCFKF	S	PS-6002
E	3.375	2.625	3	3.625	.593	QCFLF	C/S	PS-4392
E	3.375	2.625	3	3.625	.593	VLZF	3166SS/C/S	PS-4626
E	3.375	2.750	3	3.375	.625	BCFJF	316SS/S	PS-328
E	3.375	2.750	3	3.375	.625	BCFJF	I/S	PS-328-P66
E	3.375	2.750	3	3.375	.625	BCFKF	S	PS-542
E	3.375	2.750	3	3.375	.625	BCFKF	S	PS-3300
E	3.375	2.750	3	3.375	.625	VLZF	S	PS-4472
EB	3.375	3.125	3	3.375	.562	BCFJF	S	PS-7703
EB	3.375	3.125	3	3.375	.562	BCFKF	S	PS-7927
EB	3.375	3.125	3	3.375	.562	BLFZF	S	PS-4485
EB	3.375	3.125	5	3.375	.562	BCFZF		PS-4554
2.750 (2-3/4")								
C	3.557	1.500	Special	3.625	.906	VCFKF		PS-6602
C	3.625	1.687	27	4.406	.779	VCFGF		PS-6154

DIMENSIONAL CROSS-REFERENCE

SEAL HEAD			MATING RING			Material Code	NOTES	U.S. Seal Mfg. Part No.
Fig.	OD	Oper Hgt.	Fig.	Bore	Thick			
2.750 (2-3/4") (continued)								
C	3.750	1.125	1	3.500	.625	BCFJF		PS-6205
C	3.750	1.125	1	3.500	.625	BCFZF		PS-2154-TC-CMS
C	3.750	1.125	1	3.500	.625	BLFZF		PS-2154-SC-TC-CMS
C	3.750	1.125	1	3.500	.625	BZFLF		PS-2154-TC-SC
C	3.750	1.125	1	3.500	.625	BZFZF		PS-6908
C	3.750	1.125	1	3.500	.625	VZFZF		PS-4381
C	3.750	1.125	3	3.500	.625	BCFJF	S	PS-2154
C	3.750	1.125	3	3.500	.625	B/VCFZF	S	PS-2154-TC-SEAT
C	3.750	1.125	3	3.500	.625	VCFJF	S	PS-6207
C	3.750	1.125	3	3.500	.625	VZFZF	S	PS-2154V-TC-TC
C	3.750	1.500	3	3.500	.625	BCFJF	S	PS-3994
C	3.750	1.500	3	3.500	.625	BLFLF	S	PS-6239
C	3.750	1.500	3	3.500	.625	BLFZF	S	PS-4366
C	3.750	1.500	3	3.500	.625	VLFZF	S	PS-3661
C	3.750	1.937	1	3.500	.625	BCFJF		PS-836-CMS
C	3.750	1.937	1	3.500	.625	BCFJF	I	PS-836-CMS-P66
C	3.750	1.937	1	3.500	.625	BZFZF		PS-4308
C	3.750	1.937	3	3.500	.625	BCFJF	S	PS-836
C	3.750	1.937	3	3.500	.625	BCFJF	I/S	PS-836-P66
C	3.750	1.937	3	3.500	.625	BCFKF	S	PS-483
C	3.750	1.937	3	3.500	.625	BCFLF	S	PS-3841
C	3.750	1.937	3	3.500	.625	BCFZF	S	PS-483-TC-SEAT
C	3.750	1.937	3	3.500	.625	BLFZF	C/S	PS-483-SC-TC-LC
C	3.750	1.937	3	3.500	.625	VCFKF	S	PS-6155
C	3.750	1.937	3	3.500	.625	VCFKF	316SS/S	PS-22167
C	3.750	1.937	3	3.500	.625	VCFLF	S	PS-2708
C	3.750	1.937	3	3.500	.625	VCFZF	S	PS-483V-TC-SEAT
C	3.750	2.000	3	3.500	.625	VCFKF	S	PS-2152V
D	4.000	1.937	3	3.500	.625	BCFJF	S	PS-837
D	4.000	1.937	3	3.500	.625	BCFJF	I/S	PS-837-P66
D	4.000	1.937	3	3.500	.625	BCFKF	S	PS-464
D	4.000	1.937	3	3.500	.625	BCFZF	S	PS-464-TC-SEAT
D	4.000	1.937	3	3.500	.625	VLFZF	316SS/S	PS-3189
D	4.000	1.968	3	3.750	.625	VCDLF	S	PS-22146
E	3.500	2.062	3	4.125	.500	VCFJF		PS-6600
E	3.500	2.062	3	4.125	.500	VCFLF	316SS	PS-6601
E	3.500	2.750	1	3.500	.625	BZFZF		PS-3037
E	3.500	2.750	3	3.500	.625	BCFZF	I/S	PS-321-P66-TCO
E	3.500	2.750	3	3.500	.625	BZFLF	316SS/S	PS-4788
E	3.500	2.750	3	3.500	.625	QCFJF	I/S	PS-22208
E	3.500	2.750	3	3.500	.625	V/BCFJF	S	PS-838
E	3.500	2.750	3	3.500	.625	V/BCFJF	I/S	PS-838-P66
E	3.500	2.750	3	3.500	.625	V/BCFJF	316SS/S	PS-838-316SS
E	3.500	2.750	3	3.500	.625	V/BCFKF	S	PS-321
E	3.500	2.750	3	3.500	.625	VCFKF	S	PS-321V
E	3.500	2.750	3	3.500	.625	VCFLF	316SS	PS-4089
E	3.500	2.750	3	3.500	.625	VCFZF	S	PS-321V-TC-SEAT
E	3.500	2.750	3	3.500	.625	VCFZF	316SS	PS-7936
E	3.500	2.750	3	3.500	.625	VZFZF	S	PS-4446
E	3.500	3.250	3	3.500	.625	QCFLF	316SS/C/S	PS-3059
E	3.500	3.250	3	3.500	.625	VCFJF	316SS/C/S	PS-4583
E	3.500	3.250	3	3.500	.625	VLFLF	316SS/S	PS-4544
K	3.593	3.750	3	3.500	.625	BCFJF	S	PS-4504
K	3.750	1.875	3	3.500	.625	BCFJF	S	PS-2148
K	3.750	2.515	3	4.000	.750	NCFGF		PS-22069
K	3.750	3.750	1	3.500	.625	BCFJF		PS-322-CMS
K	3.750	3.750	3	3.500	.625	BCFKF	S	PS-322
T	3.500	3.750	3	3.750	.625	BZFZF	316SS	PS-4564
U	3.500	2.750	3	3.750	.625	BCFKF	S	PS-2771
W	3.625	1.687	2	3.500	.625	TCFJF	316SS	PS-9314
WB	3.625	2.062	3 Special	3.456	1.063	TCFN/KF	316SS/S	PS-22068
X	3.625	1.687	3	3.500	.625	VCFZF	316SS/S	PS-8120
X	3.625	1.687	5	3.500	.625	QCFZF	316SS	PS-8128
XB	3.625	2.062	3	3.375	.562	VCFZF	316SS	PS-8102
XT	3.375	1.687	3	3.500	.625	V/TCFJF	316SS/S	PS-8136

NOTE: C. COMPLETE WITH COLLAR
 I. ABRASION RESISTANT CARBON (P66)
 S. SLOTTED MATING RING

DIMENSIONAL CROSS-REFERENCE

SEAL HEAD			MATING RING			Material Code	NOTES	U.S. Seal Mfg. Part No.
Fig.	OD	Oper Hgt.	Fig.	Bore	Thick			
2.875 (2-7/8") (continued)								
C	3.875	2.062	3	3.750	.625	BCFJF	S	PS-270
D	4.115	2.016	3	3.750	.625	VCFLF	316SS/S	PS-4647
E	3.625	2.875	3	3.750	.625	BCFJF	S	PS-329
E	3.625	2.875	3	3.750	.625	BCFJF	I/S	PS-329-P66
E	3.625	2.875	3	3.750	.625	BCFKF	S	PS-841
E	3.625	2.875	3	3.750	.625	BCFKF	I/S	PS-841-P66
E	3.625	2.875	3	3.750	.625	QCFKF	S	PS-841-EPR
E	3.625	2.875	5	3.750	.625	BCFZF		PS-4341
EB	3.625	3.250	3	3.500	.625	BCFJF	S	PS-5737
K	4.500	1.700	3 Special	4.500	.292	NCFGF		PS-4028
WB	3.750	2.062	Special	4.248	1.281	TCFKF	316SS	PS-22070
XT Double	3.500	2.250	3	3.750	.625	V/TCFJF	316SS/S	PS-8701
75MM (2.952")								
G	99 MM	48MM	25	97MM	12MM	VLFLF	316SS	PS-22037
3.000 (3")								
C	3.843	1.125	3 Special	3.875	.625	VCFKF	S	PS-6173
C	4.000	1.125	1	3.875	.625	BCFJF		PS-2153-CMS
C	4.000	1.125	1	3.875	.625	BCFZF		PS-2153-TC-CMS
C	4.000	1.125	1	3.875	.625	BLFLF		PS-2153-SC-SC-CMS
C	4.000	1.125	1	3.875	.625	BZFZF		PS-7998
C	4.000	1.125	1	3.875	.625	VLFLF	316SS	PS-3152
C	4.000	1.125	1	3.875	.625	VLZFZ		PS-4378
C	4.000	1.125	1	3.875	.625	VZFZF		PS-3539
C	4.000	1.125	3	3.875	.625	BCFJF	S	PS-2153
C	4.000	1.125	3	3.875	.625	BCFKF		PS-4367
C	4.000	1.125	3	3.875	.625	BLFZF		PS-6249-SC-TC
C	4.000	1.125	3	3.875	.625	BZFZF		PS-6249
C	4.000	1.125	3	3.875	.625	VCFJF	S	PS-6206V
C	4.000	1.125	3	3.875	.625	VCFKF		PS-6250
C	4.000	1.125	3	3.875	.625	VCFZF		PS-3232
C	4.000	1.125	3	3.875	.625	VZFZF	S	PS-2153V-TC-TC
C	4.062	1.312	1	3.875	.625	BCFJF	B	PS-1088-CMS
C	4.062	1.312	1	3.875	.625	BZFZF	B	PS-1088-TC-TC-CMS
C	4.062	1.312	1	3.875	.625	VCFJF	B	PS-1088V-CMS
C	4.062	1.312	1	3.875	.625	VZFZF	B	PS-1088V-TC-TC-CMS
C	4.062	1.312	3	3.875	.625	BCFJF	B/S	PS-1088
C	4.062	1.312	3	3.875	.625	BLFZF	B/S	PS-4352
C	4.062	1.312	3	3.875	.625	B/VZFZF	B/S	PS-1088-TC-TC
C	4.062	1.312	3	3.875	.625	VCFJF	B/S	PS-1088V
C	4.062	1.312	3	3.875	.625	VZFZF	B/S	PS-1088V-TC-TC
C	4.000	1.500	3	3.875	.625	BCFKF		PS-3600
C	4.000	1.500	3	3.875	.625	BLFLF		PS-6240
C	4.000	1.500	3	3.875	.625	BLFZF		PS-3701
C	4.000	2.062	1	3.875	.625	BCFJF		PS-1696-CMS
C	4.000	2.062	1	3.875	.625	BCFJF	316SS	PS-3235
C	4.000	2.062	1	3.875	.625	BZFZF		PS-7875
C	4.000	2.062	1	3.875	.625	VCFJF		PS-4086
C	4.000	2.062	1	3.875	.625	VCFLF		PS-3043
C	4.000	2.062	1	3.875	.625	VZFZF		PS-6214
C	4.000	2.875	1	3.875	.625	BCFJF		PS-22214
C	4.000	2.062	3 Special	3.875	.625	VCFKF	H/S	PS-6172
C	4.000	2.062	3	3.875	.625	BCFJF	S	PS-2116
C	4.000	2.062	3	3.875	.625	BCFKF	S	PS-2115
C	4.000	2.062	3	3.875	.625	BCFZF	S	PS-2115-TC-SEAT
C	4.000	2.062	3	3.875	.625	BLFLF	S	PS-2116-SC-SC
C	4.000	2.062	3	3.875	.625	VCFJF	S	PS-2116V
C	4.000	2.062	3	3.875	.625	VCFLF	S	PS-3777
C	4.000	2.062	3	3.875	.625	VCFZF		PS-3275
C	4.000	2.062	3	3.875	.625	VLFLF		PS-6225
C	4.000	2.062	3	3.875	.625	VZFZF		PS-4481
D	4.250	2.062	1	3.875	.625	BLFLF		PS-2709
D	4.250	2.062	1	3.875	.625	BZFZF		PS-6202
D	4.250	2.062	3	3.875	.625	BCDJF	S	PS-761
D	4.250	2.062	3	3.875	.625	BCDKF	S	PS-465

DIMENSIONAL CROSS-REFERENCE

SEAL HEAD			MATING RING			Material Code	NOTES	U.S. Seal Mfg. Part No.
Fig.	OD	Oper Hgt.	Fig.	Bore	Thick			
3.000 (3") (continued)								
D	4.250	2.062	3	3.875	.625	BCFJF	S	PS-22092
D	4.250	2.062	3	3.875	.625	BZFLF		PS-6219
D	4.250	2.062	3	3.875	.625	VCDKF	S	PS-465V
D	4.250	2.062	3	3.875	.625	VZFLF	S	PS-4033
D	4.250	2.062	3	3.875	.625	VZFLF	S	PS-2710
D	4.250	2.062	3	3.875	.625	VZFZF		PS-3776
D	4.250	2.062	3	4.000	.625	NCPGP		PS-3713
D	4.250	2.062	3	4.000	.625	VCDGF		PS-4324
D Special	4.250	2.062	3	3.875	.625	VCFKF	S	PS-22017
E	3.750	2.625	3	4.000	.500	BCFJF	C	PS-3969
E	3.750	2.875	—	—	—	BCF-F		FA-475SS
E	3.750	2.875	1	3.875	.625	BCDJF	I	PS-324-P66-CMS
E	3.750	2.875	1	3.875	.625	BLFZF		PS-324-SC-TC-CMS
E	3.750	2.875	3	3.875	.625	BCDJF	S	PS-324
E	3.750	2.875	3	3.875	.625	BCFJF	S	PS-324SS
E	3.750	2.875	3	3.875	.625	BCFJF	316SS/I	PS-4147
E	3.750	2.875	3	3.875	.625	BCFKF	S	PS-5252
E	3.750	2.875	3	3.875	.625	BLFLF	S	PS-4514
E	3.750	2.875	3	3.875	.625	BZFLF	S	PS-3770
E	3.750	2.875	3	3.875	.625	BZFZF	S	PS-324-TC-TC
E	3.750	2.875	3	3.875	.625	VCDGP		PS-6174
E	3.750	2.875	3	3.875	.625	VCDKF	S	PS-1060V
E	3.750	2.875	3	3.875	.625	VCFJF	S	PS-324SSV
E	3.750	2.875	3	3.875	.625	VCFKF	316SS	PS-4172
E	3.750	2.875	3	3.875	.625	VZFLF	H/S	PS-22093
E	3.750	2.875	3	4.000	.500	BCFJF		PS-4082
G	3.898	2.062	1	3.875	.625	VLFLF	316SS	PS-3021
G	3.898	1.575	3	3.875	.625	VLFLF	316SS/S	PS-4646
G	3.898	2.062	3	3.875	.625	QCFLF		PS-3802
K	3.968	1.750	3 Special	3.875	.625	NCFKF		PS-6169
K	3.968	1.750	3 Special	3.875	.625	VCFKF		PS-6171
K	3.968	1.750	3 Special	3.875	.625	VCFZF	S	PS-6170
K	4.000	2.062	3	3.875	.625	BZFZF	S	PS-4196
K	4.000	2.125	3	3.875	.625	BCFJF	S	PS-7873
K	4.000	2.500	1	3.875	.625	BCFJF		PS-3518
K	4.000	2.500	3	3.875	.625	BCFKF	S	PS-2141
K	4.000	2.500	3	3.875	.625	VCFJF		PS-6228
R	4.250	2.750	3	3.875	.625	BCDKF	S	PS-284
R	4.250	3.000	3	3.875	.562	NCPGP		PS-6175
T	3.750	3.125	3	4.000	.500	BCFJF		PS-7993
U	3.750	3.875	3	3.875	.625	BCFJF	C/S	PS-3836
V	3.750	2.750	3	4.000	.500	BCFJF	316SS	PS-7215
V	3.750	2.750	3	4.000	.500	BCFZF		PS-4069
V	3.750	2.750	3	4.250	.625	BCFJF	316SS	PS-3181
W	3.812	1.687	2	3.875	.625	TCFJF	316SS	PS-9140
WB	3.812	2.062	3	3.500	.625	TCFN/KF	316SS	PS-22072
WB	3.812	2.062	Special	3.758	.625	TCFN/KF	316SS	PS-22071
X	3.812	1.687	—	—	—	VCF-F	316SS	FA-8088
XB1	3.812	2.063	3	3.500	.625	VCFZF	316SS/S	PS-8144
3.125 (3-1/8")								
X	3.937	1.687	3	4.000	.781	VCFZF	316SS/S	PS-8086
3.149 (80MM)								
G	104MM	40MM	2	105MM	12.5MM	VCFLF	316SS	PS-3270
3.250 (3-1/4")								
C	4.250	2.187	3	4.125	.781	BCFJF	S	PS-7835
C	4.250	2.187	3	4.125	.781	VCFJF	S	PS-3180
C	4.250	2.187	3	4.125	.781	VLFLF	S	PS-6226
C	4.406	1.562	3	4.125	.781	BCFJF	S	PS-4127
C	4.406	1.562	3	4.125	.781	BCFKF	S	PS-6258
C	4.406	1.562	3	4.125	.781	BLFZF	S	PS-3702
C	4.406	1.562	3	4.125	.781	VCFJF	S	PS-6253
D	4.687	2.062	3	4.125	.781	VZFLF	S	PS-3222
D	4.687	2.187	3	4.125	.781	BZFZF	S	PS-3827

NOTE: C. COMPLETE WITH COLLAR I. ABRASION RESISTANT CARBON (P66)
H. SPRING HOLDER NOT INCLUDED S. SLOTTED MATING RING

DIMENSIONAL CROSS-REFERENCE

SEAL HEAD			MATING RING			Material Code	NOTES	U.S. Seal Mfg. Part No.
Fig.	OD	Oper Hgt.	Fig.	Bore	Thick			
3.250 (3-1/4") (continued)								
D	4.687	2.187	3	4.125	.781	BCFJF	S	PS-7172
D	4.687	2.187	3	4.125	.781	VCFJF	S	PS-6201
D	4.687	2.187	3	4.125	.781	VLFZF	S	PS-2803
D	4.687	2.187	3	4.500	.781	BCFKF		PS-4175
E	4.125	3.125	3	4.125	.781	BCDJF	S	PS-330
E	4.125	3.125	3	4.125	.781	BCFKF	S	PS-7754
E	4.125	3.125	3	4.125	.781	BLFZF	S	PS-3246
E	4.125	3.125	3	4.125	.781	VCFKF	S	PS-3072
E	4.125	3.625	3	4.125	.781	VCFLF	C/S	PS-22035
EB	4.125	3.500	—	—	—	BCF-F		FA-10144
EB	4.125	3.500	3	3.875	.625	BCFJF	S	PS-3050
EB	4.125	3.500	3	3.875	.625	VCFJF	316SS/S	PS-3256
EB	4.125	3.500	3	3.875	.625	VCFZF	316SS/S	PS-3268
G	4.094	2.187	1	4.125	.781	VLFLF	316SS	PS-3154
K	4.187	2.625	3	4.125	.781	VCFJF	C	PS-6227
K	4.187	2.875	3	4.125	.781	BCFLF	S	PS-4585
K	4.250	2.750	3	4.125	.781	VCFKF/VZFZF	S	PS-3258
K	4.250	2.875	3	4.125	.781	BCFKF	S	PS-7244
T	4.125	4.250	3	4.125/4.500	.781	VLFLF	S	PS-3255
U	4.125	3.032	3	4.125	.781	BCFJF	S	PS-4192
U	4.125	3.032	3	4.125	.781	BCFKF	C/S	PS-3255S
U	4.125	3.032	3	4.125	.781	VCFZF	C/S	PS-3157
U	4.125	3.437	3	4.125	.781	BZFZF	C/S	PS-4174
U	4.125	3.437	3	4.125	.781	QCFJF	316SS/C/S	PS-4475
U	4.125	3.437	3	4.125	.781	VCFKF	C/S	PS-4483
UB	4.125	3.812	5	3.883	.625	BCFZF	C	PS-4393
3.375 (3-3/8")								
C	4.500	2.187	3	4.250	.781	VCFKF	S	PS-6177
K	4.421	1.750	—	—	—	VCF-F		FA-3961
X	4.250	1.687	3	4.250	.781	V/TCFJF	316SS/S	PS-8706
X	4.250	1.687	3 Special	5.031	.750	VCFKF	316SS	PS-6179
XB	4.250	2.062	5	4.000	.781	VCFLF	316SS	PS-8806
3.437 (3-7/16)								
U	4.375	2.937	3	4.375	.781	VCPKF	S	PS-3505
X	4.312	1.687	3	4.312	.781	VCFK*	S	PS-8106
3.500 (3-1/2)								
C	4.625	2.187	3	4.375	.781	BCFJF	S	PS-6204
C	4.625	2.187	3	4.375	.781	BCFKF	S	PS-6245
C	4.625	2.187	5	4.375	.781	QCFZF		PS-4164
D	4.937	2.187	3	4.375	.781	V/BZFZF	S	PS-6221
D	4.937	2.187	3	4.375	.781	VZFZF	S	PS-3745
E	4.375	3.125	3	4.375	.781	BCFJF	I	PS-4019
E	4.375	3.125	3	4.375	.781	BCFKF	S	PS-4881
E	4.375	3.125	3	4.375	.781	VZFZF	S	PS-3143
G	4.402	2.189	3	4.375	.625	QCFLF		PS-3793
R	4.937	3.125	3	4.375	.781	BCFJF	S	PS-4236
T	4.375	3.562	3	4.375	.781	BCFKF	S	PS-4113
T	4.375	4.250	3	4.375	.781	BCFJF	S	PS-4168
U	4.375	3.125	—	—	—	BCF-F		FA-4027
U	4.375	3.625	3	4.750	.781	BCFJF		PS-3238
W	4.375	1.687	3	4.375	.781	T/VCFKF	316SS/S	PS-9352
W	4.375	1.687	3	4.375	.781	T/VCFZF	316SS/S	PS-9337
WB	4.370	2.063	3 Special	4.500	1.563	TCFN/KF	316SS	PS-22073
X	4.375	1.687	3	4.375	.781	VCFKF	316SS/S	PS-3862
3.625 (3-5/8")								
E	4.500	3.250	3	4.625	.781	BCFJF	S	PS-4043
E	4.500	3.250	3	4.781	.781	BZFZF		PS-3262
E	4.500	3.750	3	4.625	.562	BCFJF	C	PS-3499
R	5.125	3.765	3	5.125	.750	NCFKP		PS-4547
T	4.500	3.875	3	4.625	.562	BCFJF		PS-3684
T	4.500	3.875	3	4.625	.562	BCFZF		PS-6237
T	4.500	3.875	3	4.625	.562	BLFZF		PS-3645
T	4.500	3.875	3	4.781	.781	BCFJF	I	PS-22049

DIMENSIONAL CROSS-REFERENCE

SEAL HEAD			MATING RING			Material Code	NOTES	U.S. Seal Mfg. Part No.
Fig.	OD	Oper Hgt.	Fig.	Bore	Thick			
3.625 (3-5/8") (continued)								
T	4.500	3.875	3	4.781	.781	BCFKF	I	PS-3553
V	4.375	2.625	3	4.625	.562	BCFJF		PS-3779
V	4.500	3.875	3	4.781	.781	BCFJF		PS-8127
V	4.500	3.875	3	4.781	.781	BCFKF	I	PS-8054
WB	4.500	2.062	Special	4.996	1.437	TCFN/KF	316SS	PS-22074
3.750 (3-3/4")								
C	4.875	2.312	3	4.625	.781	BCFJF	S	PS-272
D	5.250	2.312	3	4.625	.781	VCFJF		PS-6203
D	5.406	1.562	3	4.625	.781	BLFZF		PS-4014
E	4.625	3.250	3	4.625	.781	BCFJF		PS-4278
E	4.625	3.687	3	4.625	.781	VCFLF	C/S	PS-22036
E	4.625	3.812	3	4.625	.856	VCFLF	C	PS-4142
K	4.875	2.875	3	4.625	.781	BLFLF		PS-3237
U	4.625	3.500	3	4.625	.781	BCDKF		PS-7986
WB	4.625	2.062	1	4.375	.781	T/VCFKF	316SS	PS-9708
X	4.625	1.687	3	4.625	.781	VCFJF	316SS/S	PS-8104
X	4.625	1.687	27	5.421	1.000	VCFSF	316SS	PS-8700
3.875 (3-7/8")								
D	5.437	2.437	3	5.125	.781	VCFGP		PS-3314
D	5.437	2.437	3	4.750	.781	VZFLF	S	PS-22000
X	4.750	1.688	3	4.750	.781	VCFJF	316SS/I/S	PS-8055
X	4.750	1.688	3	4.750	.781	VCFKF	316SS/I/S	PS-8028
4.000 (4")								
D	5.562	2.437	3	4.875	.781	VZFLF		PS-2719
D	5.562	2.437	3	4.875	.781	VZFZF	S	PS-2772
E	4.875	3.375	3	4.875	.781	BCFJF	316SS/I/S	PS-22223
E	4.875	3.375	3	4.875	.781	BCFJF	S	PS-3257
EB	4.880	3.750	3	4.625	.781	BCFJF		PS-7853
K	5.125	2.875	3	4.875	.781	BCFZF		PS-3253
W	4.875	1.687	2	4.875	.781	TCFJF	316SS	PS-9351
WB	4.875	2.062	3 Special	5.016	1.567	TCFN/KF	316SS	PS-22075
X	4.875	1.687	3	4.875	.781	VCFKF	S	PS-22150
XI	4.875	1.687	5	4.875	.781	BCEZE		PS-8563
4.125 (4-1/8")								
XBT	5.000	2.062	3	3.875	.781	VCFJF	316SS/I/S	PS-8037
4.250 (4-1/4")								
X	5.250	1.687	3	5.250	.781	VCFJF	316SS	PS-8126
4.375 (4-3/8")								
X	5.250	1.687	3	5.375	.781	BCFKF	316SS/S	PS-8060
4.500 (4-1/2")								
E	5.562	4.812	3	5.500	.781	BCFJF	316SS/C	PS-4529
4.625 (4-5/8")								
XB	5.625	2.062	3	5.375	.781	VCFZF	316SS	PS-8083
4.750 (4-3/4")								
D	6.500	3.000	3	5.750	.781	BCFJF		PS-4199
XB1	5.750	2.062	3	5.500	.781	BCFLF		PS-8067
5.000 (5")								
C	6.375	2.937	3	6.000	.781	VCFJF		PS-4430
E	6.375	4.125	—	—	—	VCF-F		FA-20137
E	6.375	4.125	3	6.000	.781	BCFJF		PS-4209
K	6.375	3.625	3	6.000	.781	BCFKF		PS-3155
K	6.375	3.781	3	6.000	.781	BCFJF		PS-2741
K	6.375	3.781	3	6.000	.781	BCFKF		PS-2140
V	6.125	4.968	—	—	—	BCF-F		FA-4414
V	6.125	4.968	3	6.781	.781	BCFJF		PS-4613
V	6.125	4.968	3	6.781	.781	BCFKF		PS-4414
X	6.000	1.688	3	6.000	.781	VLFZF	316SS	PS-8087
6.000 (6")								
D	8.062	2.343	3	7.000	.781	VZFZF	316SS/H/S	PS-4598

NOTE: C. COMPLETE WITH COLLAR I. ABRASION RESISTANT CARBON (P66)
H. SPRING HOLDER NOT INCLUDED S. SLOTTED MATING RING

HEAD TYPES

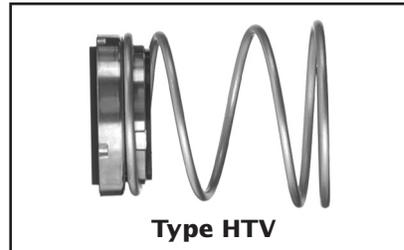
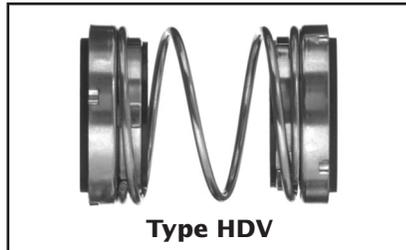
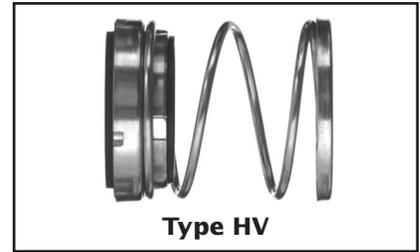
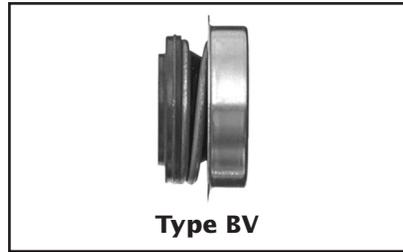
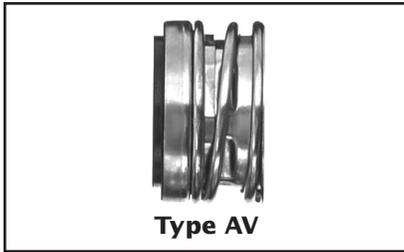

MATING RING DESIGNS

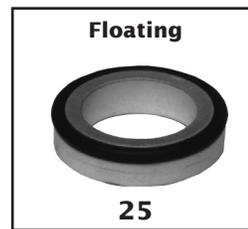

MATERIAL CODE

SECONDARY SEALS	PRIMARY RINGS	METAL PARTS	MATING RINGS	SPRINGS
B. Buna	C. Carbon	F. Stainless Steel	J. Ceramic	F. Stainless Steel
Q. EPR	L. Silicon Carbide		K. Ni-Resist	
V. Viton®	M. Molded Plastic		L. Silicon Carbide	
X. AFLAS®				

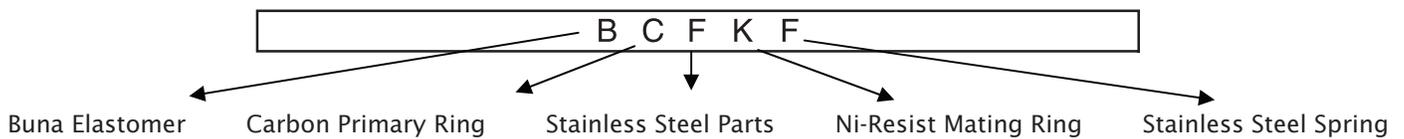

See Pages 186-195 for the Value Guard Metric Line.

INCH

SEAL HEAD			MATING RING			Material Code	NOTES	Value Guard Part No.
Fig.	OD	Oper Hgt.	Fig.	Bore	Thick			
.500 (1/2")								
AV	.928	.656	1	1.000	.312	BMFJF		VG-162
BV	1.125	.537	—	—	—	BMF-F		VG-150
BV	1.125	.537	1	1.000	.218	BMFJF		VG-142
BV	1.125	.537	1	1.000	.312	BMFJF		VG-163
HV	.898	.718	1	.938	.225	BCFJF		VG-392
HV	.898	.718	1	.938	.225	VCFJF		VG-392V
HV	.898	.812	1	1.000	.312	BCFJF		VG-1002
HV	.898	.812	1	1.000	.312	BCFKF		VG-106
HV	.898	.812	1	1.000	.312	VLFLF		VG-30750
HV	.937	.625	1	.938	.225	QLFLF		VG-3920
Special	.945	.812	1	1.000	.312	BLFLF		VG-3909
.625 (5/8")								
AV	1.200	.718	Special	—	—	BMFJ/MF	G	VG-2131
AV	1.200	.718	1	1.084	.175	BMFJF		VG-21084
AV	1.200	.718	1	1.187	.288	BMFJF		VG-702
AV	1.200	.718	1	1.187	.288	BMFKF		VG-701
AV	1.200	.718	1	1.187	.343	BMFJF		VG-100
AV	1.200	.718	1	1.187	.343	VCFJF		VG-100V-CMS
AV	1.200	.718	3	1.187	.343	VCFJF		VG-100V
AV	1.200	.718	1	1.250	.406	BCFJF		VG-516
AV	1.200	.718	1	1.250	.406	BMFJF		VG-200
AV	1.200	.718	1	1.250	.406	BMFJF		VG-300
AV	1.200	.718	1	1.250	.406	VCFJF		VG-200V-CMS
AV	1.200	.718	3	1.250	.406	VCFJF		VG-200V
AV	1.200	.718	1	1.375	.562	BMFJF		VG-528
AV	1.200	.718	3	1.437	.312	BMFJF		VG-2014
AV	1.200	.718	14	.815	.312	BMFKF		VG-293
AV	1.200	.812	1	1.250	.406	BMFJF		VG-501
AV	1.200	.812	3	1.250	.406	VCFJF		VG-501V
AV	1.200	.875	3	1.250	.406	BMFJF		VG-637
BV	1.437	.615	1	1.187	.288	BMFJF		VG-700
BV	1.437	.615	1	1.187	.343	BMFJF		VG-600
BV	1.437	.615	1	1.187	.343	VMFJF		VG-600V
BV	1.437	.615	1	1.250	.406	BCFJF		VG-961
BV	1.437	.615	1	1.250	.406	BMFJF		VG-1000
BV	1.437	.615	1	1.250	.406	VCFLF*	316SS	VG-9596
BV	1.437	.615	8	—	.215	BCFJF	A	VG-447
BV	1.437	.615	8	—	.215	VCFJF	A	VG-447V
BV	1.437	.615	11	—	.487	BMFJF	A	VG-411
BV	1.437	.615	11	—	.487	VMFJF	A	VG-411V
HTV	1.055	.875	1	1.250	.406	BCFJF	B	VG-508
HTV	1.055	.875	1	1.250	.406	BCFKF	B	VG-102
HV	1.055	.718	1	1.250	.406	BCFJF		VG-2160
HV	1.055	.844	1	1.187	.343	BCFJF		VG-118
HV	1.055	.844	1	1.250	.406	BCFJF		VG-290
HV	1.055	.844	1	1.250	.406	VCFJF		VG-290V
HV	1.055	.875	1	1.187	.288	BCFKF		VG-493
HV	1.055	.875	1	1.250	.406	BCFJF		VG-359
HV	1.055	.875	1	1.250	.406	BCFKF		VG-633
HV	1.055	.875	1	1.250	.406	VCFJF		VG-359V-CMS
HV	1.055	.875	3	1.250	.406	BCFJF		VG-552
HV	1.055	.875	3	1.250	.406	VCFJF		VG-359V
HV	1.055	.875	3	1.250	.406	VCFKF		VG-633V
HV	1.055	1.187	1	1.156	.312	BCFJF		VG-800
HV	1.055	1.312	1	1.250	.406	BCFJF		VG-274
HV	1.055	1.312	1	1.250	.406	BCFKF		VG-487
HV	1.062	.875	1	1.250	.406	VLFLF		VG-30760
HV	1.062	1.312	1	1.250	.406	VLFLF		VG-30810
.750 (3/4")								
AV	1.295	.718	1	1.375	.406	BMFJF		VG-201
AV	1.295	.718	1	1.375	.406	QMJFJ		VG-201E-CMS

INCH

SEAL HEAD			MATING RING			Material Code	NOTES	Value Guard Part No.
Fig.	OD	Oper Hgt.	Fig.	Bore	Thick			
.750 (3/4") (continued)								
AV	1.295	.718	1	1.375	.406	VCFJF		VG-201V-CMS
AV	1.295	.718	3	1.375	.406	VCFJF		VG-201V
AV	1.295	.718	1	1.437	.406	BMFJF		VG-101
BV	1.575	.615	1	1.375	.406	BMFJF		VG-601
BV	1.575	.615	3	1.375	.406	VCFJF		VG-601V
BV	1.575	.615	9	—	.281	BMFKF	A	VG-902
HTV	1.161	.843	1	1.375	.406	BCFJF	B	VG-128
HV	1.161	.718	1	1.375	.406	BCFJF		VG-877
HV	1.161	.718	1	1.375	.406	VCFJF		VG-877V-CMS
HV	1.161	.875	1	1.275	.281	BCFJF		VG-437
HV	1.161	.875	1	1.275	.281	VCFJF		VG-437V
HV	1.161	.875	1	1.375	.406	BCFJF		VG-358
HV	1.161	.875	1	1.375	.406	BCFKF		VG-112
HV	1.161	.875	1	1.375	.406	VCFJF		VG-358V-CMS
HV	1.161	.875	1	1.375	.406	VLFLF		VG-3018
HV	1.161	.875	1	1.375	.406	VLFLF		VG-30780
HV	1.161	.875	3	1.375	.406	VCFJF		VG-358V
HV	1.161	.875	3	1.375	.406	VCFKF		VG-112V
.875 (7/8")								
HDV	1.323	1.625	1	1.500	.406	BCFJF		VG-428
HV	1.323	.812	1	1.437	.265	BCFJF		VG-790
HV	1.323	.812	1	1.437	.265	VCFJF		VG-790V-CMS
HV	1.323	.937	1	1.500	.406	BCFJF		VG-309
HV	1.323	.937	1	1.500	.406	BCFKF		VG-687
HV	1.323	.937	1	1.500	.406	VCFJF		VG-309V
HV	1.323	.937	3	1.500	.406	BCFJF		VG-774
HV	1.323	.937	3	1.500	.406	BCFKF		VG-617
HV	1.323	1.375	1	1.500	.406	BCFJF		VG-188
HV	1.323	1.375	1	1.500	.406	BCFKF		VG-935
HV	1.323	1.375	3	1.500	.406	BCFJF		VG-776
HV	1.323	1.375	3	1.500	.406	BCFKF		VG-229
1.000 (1")								
AV	1.552	.812	1	1.625	.437	BMFJF		VG-360
AV	1.552	.812	25	1.625	.625	BMFJF		VG-405
HDV	1.539	1.625	1	1.625	.437	BCFJF		VG-879
HDV	1.539	1.625	1	1.625	.437	BCFKF		VG-891
HDV	1.539	1.875	1	1.625	.437	BCFJF		VG-429
HDV	1.539	1.875	1	1.625	.437	BCFKF		VG-430
HDV	1.539	1.875	1	1.625	.437	VLFLF		VG-879V-SC-SC-CMS
HTV	1.539	1.000	1	1.625	.437	BCFJF	B	VG-245
HTV	1.539	1.000	1	1.625	.437	VCFJF	B	VG-245V-CMS
HTV	1.539	1.000	25	1.625	.625	BCFLF	B	VG-413
HV	1.539	1.000	1	1.625	.437	BCFJF		VG-235
HV	1.539	1.000	1	1.625	.437	BCFKF		VG-357
HV	1.539	1.000	1	1.625	.437	VCFJF		VG-235V-CMS
HV	1.539	1.000	1	1.625	.437	VLFLF		VG-30790
HV	1.539	1.000	3	1.625	.312	BCFKF		VG-1630
HV	1.539	1.000	3	1.625	.437	BCFJF		VG-548
HV	1.539	1.000	3	1.625	.437	BCFKF		VG-499
HV	1.539	1.000	3	1.625	.437	VCFJF		VG-548V
HV	1.539	1.562	1	1.625	.437	BCFJF		VG-754
HV	1.539	1.562	1	1.625	.437	BCFKF		VG-236
HV	1.539	1.562	1	1.625	.437	VLFLF		VG-30820
HV	1.539	1.562	3	1.625	.437	BCFJF		VG-557
HV	1.539	1.562	3	1.625	.437	BCFKF		VG-791
1.062 (1-1/16")								
Special	1.625	1.593	3	1.750	.437	BCFJF		VG-798
Special	1.625	1.593	3	1.750	.437	VCFJF		VG-798V
HV	1.673	1.157	3	1.750	.345	VCFLF		VG-110608V
1.125 (1-1/8")								
HV	1.673	1.062	1	1.750	.437	BCFJF		VG-356
HV	1.673	1.062	1	1.750	.437	BCFKF		VG-355
HV	1.673	1.062	1	1.750	.437	VCFJF		VG-356V-CMS

INCH

SEAL HEAD			MATING RING			Material Code	NOTES	Value Guard Part No.
Fig.	OD	Oper Hgt.	Fig.	Bore	Thick			
1.125 (1-1/8") (continued)								
HV	1.673	1.062	1	1.750	.437	VCFKF		VG-355V
HV	1.673	1.062	1	1.750	.437	VLFLF		VG-3029
HV	1.673	1.062	3	1.750	.437	BCFJF		VG-801
HV	1.673	1.062	3	1.750	.437	BCFKF		VG-529
HV	1.673	1.062	3	1.750	.437	VCFJF		VG-356V
HV	1.673	1.625	1	1.750	.437	BCFJF		VG-204
HV	1.673	1.625	1	1.750	.437	BCFKF		VG-384
HV	1.673	1.625	1	1.750	.437	VCFJF		VG-204V-CMS
HV	1.673	1.625	3	1.750	.437	BCFJF		VG-866
HV	1.673	1.625	3	1.750	.437	BCFKF		VG-867
1.250 (1-1/4")								
HTV	1.795	1.062	1	1.765	.365	BCFJF	B	VG-978
HTV	1.795	1.062	1	1.765	.365	BCFKF	B	VG-979
HTV	1.795	1.062	1	1.765	.365	VCFJF	B	VG-978V
HTV	1.795	1.062	1	1.875	.437	BCFJF	B	VG-246
HTV	1.795	1.062	1	1.875	.437	BCFKF	B	VG-249
HTV	1.795	1.062	1	1.875	.437	VCFJF	B	VG-246V-CMS
HTV	1.795	1.062	25	2.250	.625	BCFJF	B	VG-416A
HV	1.795	1.062	1	1.875	.437	BCFJF		VG-185
HV	1.795	1.062	1	1.875	.437	BCFKF		VG-756
HV	1.795	1.062	1	1.875	.437	VCFJF		VG-185V-CMS
HV	1.795	1.062	1	1.875	.437	VCFKF		VG-756V-CMS
HV	1.795	1.062	1	1.875	.437	VLFLF		VG-3017
HV	1.795	1.062	1	1.875	.437	VLFLF		VG-30800
HV	1.795	1.062	1	1.875	.437	XCFLF		VG-4103
HV	1.795	1.062	3	1.875	.437	BCFKF		VG-598
HV	1.795	1.062	3	1.875	.437	VCFJF		VG-185V
HV	1.795	1.062	3	1.875	.437	VCFKF		VG-756V
HV	1.795	1.062	1	2.000	.437	BCFJF		VG-466
HV	1.795	1.062	1	2.000	.437	VCFJF		VG-466V-CMS
HV	1.795	1.062	3	2.000	.437	BCFJF		VG-2230
HV	1.795	1.062	3	2.000	.437	BCFKF		VG-1018
HV	1.795	1.625	1	1.875	.437	BCFJF		VG-361
HV	1.795	1.625	1	1.875	.437	BCFJF		VG-2122
HV	1.795	1.625	1	1.875	.437	BCFKF		VG-137
HV	1.795	1.625	1	1.875	.437	VCFJF		VG-2122V
HV	1.795	1.625	1	1.875	.437	VLFLF		VG-30830
HV	1.795	1.625	3	1.875	.437	BCFJF		VG-546
HV	1.795	1.625	3	1.875	.437	BCFKF		VG-1109
1.375 (1-3/8")								
HV	1.929	1.875	1	2.140	.437	BCFJF		VG-1104
HTV	1.929	.900	25	2.000	.500	BCFLF	B	VG-929
HV	1.929	1.125	1	2.000	.437	BCFJF		VG-177
HV	1.929	1.125	1	2.000	.437	BCFKF		VG-210
HV	1.929	1.125	1	2.000	.437	VLFLF		VG-177V-SC-SC-CMS
HV	1.929	1.125	3	2.000	.437	BCFJF		VG-805
HV	1.929	1.125	3	2.000	.437	BCFKF		VG-547
HV	1.929	1.687	1	2.000	.437	BCFJF		VG-354
HV	1.929	1.687	1	2.000	.437	BCFKF		VG-677
HV	1.929	1.687	3	2.000	.437	BCFJF		VG-864
HV	1.929	1.687	3	2.000	.437	BCFKF		VG-865
1.500 (1-1/2")								
HTV	2.047	1.125	1	2.125	.437	BCFJF	B	VG-347
HV	2.047	1.125	1	2.125	.437	BCFJF		VG-758
HV	2.047	1.125	1	2.125	.437	BCFKF		VG-659
HV	2.047	1.125	1	2.125	.437	VCFJF		VG-758V-CMS
HV	2.047	1.125	1	2.125	.437	VCFKF		VG-659V-CMS
HV	2.047	1.125	1	2.125	.437	VLFLF		VG-30770
HV	2.047	1.125	3	2.125	.437	BCFJF		VG-816
HV	2.047	1.125	3	2.125	.437	BCFKF		VG-553
HV	2.047	1.125	3	2.125	.437	VCFJF		VG-758V
HV	2.047	1.125	3	2.125	.437	VCFKF		VG-659V
HV	2.047	1.688	1	2.125	.437	BCFJF		VG-305

NOTE: B. TAPERED SPRING

INCH

SEAL HEAD			MATING RING			Material Code	NOTES	Value Guard Part No.
Fig.	OD	Oper Hgt.	Fig.	Bore	Thick			
1.500 (1-1/2") (continued)								
HV	2.047	1.688	1	2.125	.437	BCFKF		VG-374
HV	2.047	1.688	1	2.125	.437	VFLFLF		VG-30840
HV	2.047	1.688	3	2.125	.437	BCFJF		VG-395
HV	2.047	1.688	3	2.125	.437	BCFKF		VG-1110
HV	2.047	1.688	3	2.312	.437	VCFKF		VG-1648
1.625 (1-5/8")								
HTV	2.252	1.312	25	2.5	.812	BCFLF	B	VG-7497
HTV	2.252	1.375	1	2.375	.500	BCFJF	B	VG-514
HV	2.252	1.375	1	2.375	.500	BCFJF		VG-238
HV	2.252	1.375	1	2.375	.500	BCFKF		VG-239
HV	2.252	1.375	1	2.375	.500	VCFJF		VG-238V-CMS
HV	2.252	1.375	1	2.375	.500	VFLFLF		VG-30850
HV	2.252	1.375	3	2.625	.500	BCFKF		VG-1019
HV	2.252	2.000	1	2.375	.500	BCFJF		VG-745
HV	2.252	2.000	1	2.375	.500	BCFKF		VG-744
HV	2.252	2.000	3	2.375	.500	BCFJF		VG-1683
HV	2.252	2.000	3	2.375	.500	BCFKF		VG-822
HV	2.300	1.375	3	2.375	.500	BCFJF		VG-818
1.750 (1-3/4")								
HV	2.394	1.375	1	2.625	.500	BCFJF		VG-7252
HV	2.394	1.375	1	2.500	.500	BCFJF		VG-446
HV	2.394	1.375	1	2.500	.500	BCFKF		VG-448
HV	2.394	1.375	1	2.500	.500	VCFJF		VG-446V-CMS
HV	2.394	1.375	3	2.500	.500	BCFJF		VG-550
HV	2.394	1.375	3	2.500	.500	BCFKF		VG-436
HV	2.394	1.375	3	2.500	.500	VCFJF		VG-550V
HV	2.394	1.375	3	2.500	.500	VLFZF		VG-4361
HV	2.394	2.000	1	2.500	.500	BCFJF		VG-205
HV	2.394	2.000	1	2.500	.500	BCFKF		VG-366
HV	2.394	2.000	3	2.500	.500	BCFJF		VG-535
HV	2.394	2.000	3	2.500	.500	BCFKF		VG-262
1.875 (1-7/8")								
HV	2.516	2.000	1	2.640	.406	BCFJF		VG-1105
HV	2.516	1.500	1	2.625	.500	BCFJF		VG-340
HV	2.516	1.500	1	2.625	.500	BCFKF		VG-1608
HV	2.516	1.500	1	2.625	.500	VCFJF		VG-340V
HV	2.516	1.500	3	2.625	.500	BCFJF		VG-2114
HV	2.516	1.500	3	2.625	.500	BCFKF		VG-593
HV	2.516	2.125	1	2.625	.500	BCFJF		VG-523
HV	2.516	2.125	1	2.625	.500	BCFKF		VG-513
HV	2.516	2.125	3	2.625	.500	BCFJF		VG-2071
HV	2.516	2.125	3	2.625	.500	BCFKF		VG-2072
1.937 (1-15/16")								
HV	2.583	2.125	—	—	—	VCF-F		VG-1937
2.000 (2")								
AV	2.913	1.375	2	2.750	.375	VCFLF		VG-3004V
HV	2.583	1.500	1	2.750	.500	BCFJF		VG-267
HV	2.583	1.500	1	2.750	.500	BCFKF		VG-842
HV	2.583	1.500	3	2.750	.500	BCFJF		VG-532
HV	2.583	1.500	3	2.750	.500	BCFKF		VG-332
HV	2.583	2.125	1	2.750	.500	BCFJF		VG-479
HV	2.583	2.125	1	2.750	.500	BCFKF		VG-843
HV	2.583	2.125	1	2.750	.500	VCFJF		VG-479V
HV	2.583	2.125	3	2.750	.500	BCFJF		VG-530
HV	2.583	2.125	3	2.750	.500	BCFKF		VG-477
2.125 (2-1/8")								
HV	2.819	2.250	1	3.187	.562	BCFJF		VG-1107
HV	2.819	1.687	1	3.000	.562	BCFJF		VG-844
HV	2.819	1.687	1	3.000	.562	BCFKF		VG-543
HV	2.819	1.687	3	3.000	.562	BCFJF		VG-338
HV	2.819	1.687	3	3.000	.562	VLFZF		VG-4360
HV	2.819	2.375	1	3.000	.562	BCFJF		VG-537

INCH

SEAL HEAD			MATING RING			Material Code	NOTES	Value Guard Part No.
Fig.	OD	Oper Hgt.	Fig.	Bore	Thick			
2.250 (2-1/4")								
HV	2.819	2.375	1	3.000	.562	BCFKF		VG-353
HV	2.819	2.375	3	3.000	.562	BCFJF		VG-327
HV	2.819	2.375	3	3.000	.562	BCFKF		VG-2086
HV	3.027	1.688	1	3.125	.562	BCFJF		VG-1679
HV	3.027	1.688	1	3.125	.562	BCFKF		VG-1680
HV	3.027	1.688	1	3.125	.562	VCFJF		VG-1679V
HV	3.027	1.688	1	3.125	.562	VCFKF		VG-1680V
HV	3.027	1.688	3	3.125	.562	BCFJF		VG-1678
HV	3.027	1.688	3	3.125	.562	BCFKF		VG-1676
HV	3.027	2.375	1	3.125	.562	BCFJF		VG-323
HV	3.027	2.375	1	3.125	.562	BCFKF		VG-351
HV	3.027	2.375	3	3.125	.562	BCFJF		VG-848
HV	3.027	2.375	3	3.125	.562	BCFKF		VG-849
2.375 (2-3/8")								
HV	3.087	1.813	1	3.250	.562	BCFJF		VG-268-CMS
HV	3.087	1.813	1	3.250	.562	BCFKF		VG-492-CMS
HV	3.087	1.813	3	3.250	.562	BCFJF		VG-268
HV	3.087	1.813	3	3.250	.562	BCFKF		VG-492
HV	3.087	2.500	1	3.250	.562	BCFJF		VG-2097-CMS
HV	3.087	2.500	1	3.250	.562	BCFKF		VG-350-CMS
HV	3.087	2.500	3	3.250	.562	BCFJF		VG-2097
HV	3.087	2.500	3	3.250	.562	BCFKF		VG-350
2.500 (2-1/2")								
HV	3.197	1.813	3	3.375	.562	BCFJF		VG-269
HV	3.197	1.813	3	3.375	.562	BCFKF		VG-853
HV	3.197	2.500	3	3.375	.562	BCFJF		VG-279
HV	3.197	2.500	3	3.375	.562	BCFKF		VG-349
Spec	3.268	1.811	25	3.375	.562	QCFLF		VG-3804
2.625 (2-5/8")								
HV	3.327	1.937	3	3.375	.625	BCFJF		VG-7909
HV	3.327	2.750	3	3.375	.625	BCFJF		VG-328
HV	3.327	2.750	3	3.375	.625	BCFKF		VG-542
2.750 (2-3/4")								
HV	3.528	1.937	3	3.500	.625	BCFJF		VG-836
HV	3.528	1.937	3	3.500	.625	BCFKF		VG-483
HV	3.528	2.750	3	3.500	.625	BCFJF		VG-838
HV	3.528	2.750	3	3.500	.625	BCFKF		VG-321
HDV	3.528	3.750	1	3.500	.625	BCFKF		VG-322-CMS
HDV	3.528	3.750	3	3.500	.625	BCFKF		VG-322
3.000 (3")								
HV	2.386	2.000	1	2.500	.500	VFLF		VG-30860
HV	3.803	2.062	3	3.875	.625	BCFJF		VG-761
HV	3.803	2.062	3	3.875	.625	BCFKF		VG-465
HV	3.803	2.813	3	3.875	.625	BCFJF		VG-324
HV	3.803	2.813	3	3.875	.625	BCFKF		VG-475

Type VGMA - Complete Seal

Similar To:
AES B01, BT/Burgmann AR
Roten 37B, Vulcan 18

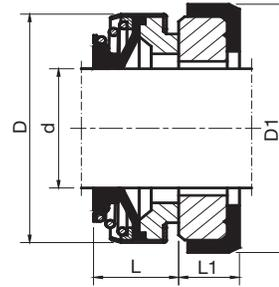

Features

Single Seal - Unbalanced
Bi-Directional
Elastomer Bellows

Materials*

Phenolic (plastic) Rotating Face
Ceramic Mating Ring
Buna Elastomer
304SS Metallurgy

* Other materials available upon request *

Seal Size d	Head		Mating Ring		Value Guard Part No.
	OD D	Oper. Hgt. L	Bore D1	Thick L1	
6	18	8	22.0	4.0	VGM-8062
8a	20	11	26.0	4.0	VGM-8063
8b	20	11	22.0	4.0	VGM-8064
8c	24	11	26.0	8.0	VGM-8065
9	24	11	26.0	8.0	VGM-8020
10	24	11	26.0	8.0	VGM-8021
11	24	11	26.0	8.0	VGM-8022
12a	24	13	26.0	5.5	VGM-8066
12b	24	13	26.0	8.0	VGM-8060
12c	32	13	35.0	8.0	VGM-8067
13	24	13	26.0	8.0	VGM-8023
14a	28	13	25.0	7.0	VGM-8068
14b	28	13	28.5	8.0	VGM-8024
14c	32	13	29.5	8.0	VGM-8070
14d	32	13	35.0	8.0	VGM-8071
15a	32	13	29.5	8.0	VGM-8025
15b	32	13	38.0	8.0	VGM-8072
15c	35	13	38.0	8.0	VGM-8073
16a	32	13	29.5	8.0	VGM-8026
16b	35	13	38.0	8.0	VGM-8074
16c	39	13	38.0	8.0	VGM-8075
16d	39	13	42.0	8.0	VGM-8076
17	39	13	42.0	8.0	VGM-8027
18	39	13	42.0	8.0	VGM-8028
19	39	13	42.0	8.0	VGM-8029
20a	39	13	42.0	8.0	VGM-8077
20b	42	13	45.0	10.0	VGM-8078
22	42	13	45.0	10.0	VGM-8030
23	47	14	50.0	10.0	VGM-8079
24	47	14	50.0	10.0	VGM-8031
25a	42	14	50.0	10.0	VGM-8032
25b	47	14	50.0	10.0	VGM-8080
26	47	14	50.0	10.0	VGM-8081
28	54	15	57.0	10.0	VGM-8033
30	54	15	57.0	10.0	VGM-8034
32	54	15	57.0	10.0	VGM-8035
35	60	16	63.0	10.0	VGM-8082
38	65	18	68.0	12.0	VGM-8036
40	65	18	68.0	12.0	VGM-8037
45	70	20	73.0	12.0	VGM-8083
50	85	23	88.0	15.0	VGM-8084
55	85	23	88.0	15.0	VGM-8085
60	105	30	110.0	15.0	VGM-8086
65	105	32	110.0	15.0	VGM-8098
70	105	32	110.0	15.0	VGM-8087

Type VGMB - Complete Seal

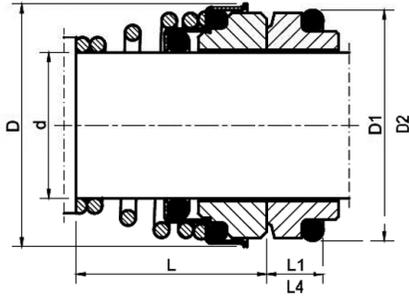

Similar To:
AES T04, BT/ Burgmann FN
Roten 3, Vulcan 13



Seal Size d	Head		Mating Ring				Value Guard Part No.
	OD D	Oper. Hgt. L	Bore D1	Bore D2	Thick L1	Thick L4	
10	20	15	18.1	—	5.5	—	VGM-8000
10	20	15	—	21	—	7.0	VGM-8000D
11	22	18	20.6	—	5.5	—	VGM-8001
12	22	18	20.6	—	5.5	—	VGM-8002
12	22	18	—	23	—	7.0	VGM-8002D
13	25	22	23.1	—	6.0	—	VGM-8003
14	25	22	23.1	—	6.0	—	VGM-8004
14	25	22	—	25	—	7.0	VGM-8004D
15	29	22	26.9	—	7.0	—	VGM-8005
16	29	23	26.9	—	7.0	—	VGM-8006
16	29	23	—	27	—	7.0	VGM-8006D
17	29	23	26.9	—	7.0	—	VGM-8007
18	33	24	30.9	—	8.0	—	VGM-8008
18	33	24	—	33	—	10.0	VGM-8008D
19	33	25	30.9	—	8.0	—	VGM-8009
20	33	25	30.9	—	8.0	—	VGM-8010
20	33	25	—	35	—	10.0	VGM-8010D
22	38	25	35.4	—	8.0	—	VGM-8011
22	38	25	—	37	—	10.0	VGM-8011D
24	38	27	35.4	—	8.0	—	VGM-8012
24	38	27	—	39	—	10.0	VGM-8012D
25	40	27	38.2	—	8.5	—	VGM-8013
25	40	27	—	40	—	10.0	VGM-8013D
28	46	29	43.3	—	9.0	—	VGM-8014
28	46	29	—	43	—	10.0	VGM-8014D
30	46	30	43.3	—	9.0	—	VGM-8015
30	46	30	—	45	—	10.0	VGM-8015D
32	46	30	43.3	—	9.0	—	VGM-8016
32	46	30	—	48	—	10.0	VGM-8016D
33	48	39	53.5	—	11.5	—	VGM-8099
33	48	39	—	48	—	10.0	VGM-8099D
35	50	39	53.5	—	11.5	—	VGM-8017
35	50	39	—	50	—	10.0	VGM-8017D
38	55	39	60.5	—	11.5	—	VGM-8018
38	55	39	—	56	—	13.0	VGM-8018D
40	55	39	60.5	—	11.5	—	VGM-8019
40	55	39	—	58	—	13.0	VGM-8019D

Features

D2 and L4 columns refer to DIN 24960
(Corresponding Part Numbers end in D)
Single Seal - Unbalanced
Uni-Directional
Conical Spring

Materials*

Ceramic Rotating Face
Carbon Mating Ring
Buna Elastomer
304SS Metallurgy

* Other materials available upon request *

Types VGMC-1 and VGMC-12 - Rotary Heads

Similar To:
AES B02 & B012, Burgmann MG1 & MG12
Vulcan 19 & 192

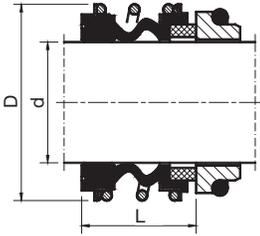

Type VGMC-1

Features

To DIN 24960 (VGMC-12)
Single Seal - Unbalanced
Bi-Directional
Elastomer Bellows

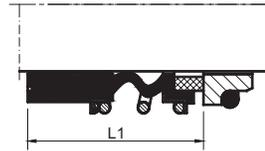

Type VGMC-12

Seal Size d	Head OD D
10	22.5
12	25.0
14	28.5
15	28.5
16	28.5
18	32.0
20	37.0
22	37.0
24	42.5
25	42.5
28	49.0
30	49.0
32	53.5
33	53.5
35	57.0
38	59.0
40	62.0
42	65.5
43	65.5
45	68.0
48	70.5
50	74.0
53	78.5
55	81.0
58	85.5
60	88.5
65	93.5
68	96.5
70	99.5
75	107.0
80	112.0
85	120.0
90	127.0
95	132.0
100	137.0

VGMC-1		
Oper. Hgt. L	Buna/Carbon Part No.	Viton®/SC Part No.
14.5	HD-8090M	HD-8125M
15.0	HD-8091M	HD-8126M
17.0	HD-8092M	HD-8127M
17.0	HD-8093M	HD-8128M
17.0	HD-8094M	HD-8129M
19.5	HD-8095M	HD-8130M
21.5	HD-8096M	HD-8131M
21.5	HD-8097M	HD-8132M
22.5	HD-8098M	HD-8133M
23.0	HD-8099M	HD-8038M
26.5	HD-8100M	HD-8046M
26.5	HD-8101M	HD-8134M
27.5	HD-8102M	HD-8135M
27.5	HD-8103M	HD-8136M
28.5	HD-8104M	HD-8137M
30.0	HD-8105M	HD-8138M
30.0	HD-8106M	HD-8139M
30.0	HD-8107M	HD-8140M
30.0	HD-8108M	HD-8141M
30.0	HD-8109M	HD-8047M
30.5	HD-8110M	HD-8142M
30.5	HD-8111M	HD-8048M
33.0	HD-8112M	HD-8143M
35.0	HD-8113M	HD-8144M
37.0	HD-8114M	HD-8145M
38.0	HD-8115M	HD-8146M
40.0	HD-8116M	HD-8147M
40.0	HD-8117M	HD-8148M
40.0	HD-8118M	HD-8049M
40.0	HD-8119M	HD-8050M
40.0	HD-8120M	HD-8149M
41.0	HD-8121M	HD-8150M
45.0	HD-8122M	HD-8151M
46.0	HD-8123M	HD-8152M
47.0	HD-8124M	HD-8153M

VGMC-12		
Oper. Hgt. L1	Buna/Carbon Part No.	Viton®/SC Part No.
25.9	HD-8154M	HD-8189M
25.9	HD-8155M	HD-8190M
28.4	HD-8156M	HD-8191M
28.4	HD-8157M	HD-8192M
28.4	HD-8158M	HD-8193M
30.0	HD-8159M	HD-8194M
30.0	HD-8160M	HD-8195M
30.0	HD-8161M	HD-8196M
32.5	HD-8162M	HD-8197M
32.5	HD-8163M	HD-8198M
35.0	HD-8164M	HD-8199M
35.0	HD-8165M	HD-8200M
35.0	HD-8166M	HD-8201M
35.0	HD-8167M	HD-8202M
35.0	HD-8168M	HD-8203M
36.0	HD-8169M	HD-8204M
36.0	HD-8170M	HD-8205M
36.0	HD-8171M	HD-8206M
36.0	HD-8172M	HD-8207M
36.0	HD-8173M	HD-8208M
36.0	HD-8174M	HD-8209M
38.0	HD-8175M	HD-8210M
36.5	HD-8176M	HD-8211M
36.5	HD-8177M	HD-8212M
41.5	HD-8178M	HD-8213M
41.5	HD-8179M	HD-8214M
41.5	HD-8180M	HD-8215M
41.5	HD-8181M	HD-8216M
48.7	HD-8182M	HD-8217M
48.7	HD-8183M	HD-8218M
48.0	HD-8184M	HD-8219M
46.0	HD-8185M	HD-8220M
51.0	HD-8186M	HD-8221M
51.0	HD-8187M	HD-8222M
51.0	HD-8188M	HD-8223M

Mating Rings sold separately. For part numbers, see pages 194-195.

* Additional Mating Ring Styles and Materials Available Upon Request.

Type VGMD - Rotary Head

Similar To:
Burgmann M2

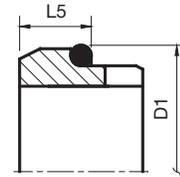
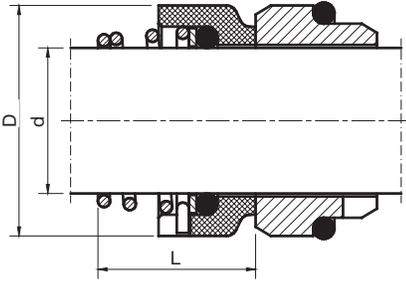

Seal Size d	VGMD Rotary Head	
	OD D	Oper. Hgt. L
6	15	—
8	18	—
10	20	17.5
12	22	17.5
14	25	17.5
15	27	18.0
16	27	19.5
18	30	20.5
20	32	22.0
22	35	23.5
24	38	25.0
25	40	26.5
26	41	26.5
28	43	26.5
30	47	26.5
32	48	28.5
35	53	28.5
38	56	33.5

Viton® / Carbon Specify Rotation	
Right Hand Part No.	Left Hand Part No.
HD-8224MRH	HD-8224MLH
HD-8225MRH	HD-8225MLH
HD-8226MRH	HD-8226MLH
HD-8227MRH	HD-8227MLH
HD-8228MRH	HD-8228MLH
HD-8229MRH	HD-8229MLH
HD-8230MRH	HD-8230MLH
HD-8231MRH	HD-8231MLH
HD-8232MRH	HD-8232MLH
HD-8233MRH	HD-8233MLH
HD-8234MRH	HD-8234MLH
HD-8235MRH	HD-8235MLH
HD-8236MRH	HD-8236MLH
HD-8237MRH	HD-8237MLH
HD-8238MRH	HD-8238MLH
HD-8239MRH	HD-8239MLH
HD-8240MRH	HD-8240MLH
HD-8241MRH	HD-8241MLH

Standard Mating Ring VGM-G9	
Bore D1	Thick L5
—	—
—	—
21	10.0
23	10.0
25	10.0
27	10.0
27	10.0
33	11.5
35	11.5
37	11.5
39	11.5
40	11.5
43	11.5
45	11.5
48	11.5
48	11.5
50	11.5
56	14.0

Features
To DIN 24960 Single Seal - Unbalanced Uni-Directional Conical Spring

Materials
Carbon Rotating Face Viton® Elastomer 304SS Metallurgy

Mating Ring Information
Alternate Mating Ring Styles VGM-G4 and VGM-G6.
Mating Rings sold separately.
For part numbers, see pages 194-195

* Additional Mating Ring Styles and Materials Available Upon Request.

Type VGME-1 - Rotary Head

Similar To:
AES T02, Burgmann M3N
Vulcan 8B

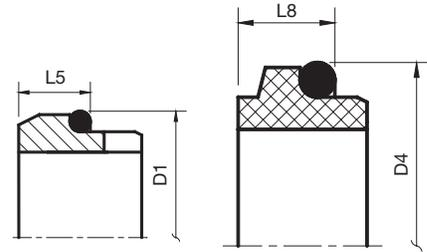
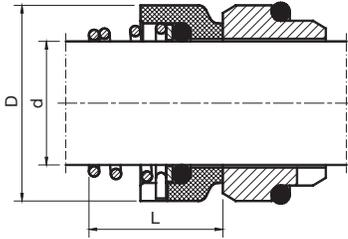

VGME-1		
Seal Size d	Rotary Head	
	OD D	Oper. Hgt. L
10	19	15.5
12	21	16.0
14	23	16.5
15	24	18.0
16	26	18.0
18	29	19.5
20	31	22.0
22	33	21.5
24	35	23.5
25	36	26.5
28	40	26.5
30	43	26.5
32	46	28.5
33	47	28.5
35	49	28.5
38	53	33.5
40	56	36.0
42	59	37.5
43	59	38.5
45	61	39.5
48	64	46.0
50	66	45.0
53	69	47.0
55	71	49.0
58	76	55.0
60	78	55.0
65	84	55.0
68	88	55.0
70	90	57.0
75	98	62.0
80	100	61.8

Viton® / 304SS Specify Rotation	
Right Hand Part No.	Left Hand Part No.
HD-8242MRH	HD-8242MLH
HD-8243MRH	HD-8243MLH
HD-8244MRH	HD-8244MLH
HD-8245MRH	HD-8245MLH
HD-8246MRH	HD-8246MLH
HD-8247MRH	HD-8247MLH
HD-8248MRH	HD-8248MLH
HD-8249MRH	HD-8249MLH
HD-8250MRH	HD-8250MLH
HD-8251MRH	HD-8251MLH
HD-8252MRH	HD-8252MLH
HD-8253MRH	HD-8253MLH
HD-8254MRH	HD-8254MLH
HD-8255MRH	HD-8255MLH
HD-8256MRH	HD-8256MLH
HD-8257MRH	HD-8257MLH
HD-8258MRH	HD-8258MLH
HD-8259MRH	HD-8259MLH
HD-8260MRH	HD-8260MLH
HD-8261MRH	HD-8261MLH
HD-8262MRH	HD-8262MLH
HD-8263MRH	HD-8263MLH
HD-8264MRH	HD-8264MLH
HD-8265MRH	HD-8265MLH
HD-8266MRH	HD-8266MLH
HD-8267MRH	HD-8267MLH
HD-8268MRH	HD-8268MLH
HD-8269MRH	HD-8269MLH
HD-8270MRH	HD-8270MLH
HD-8271MRH	HD-8271MLH
HD-8272MRH	HD-8272MLH

Standard Mating Rings			
VGM-G9		VGM-G13	
Bore D1	Thick L5	Bore D4	Thick L8
21	10.0	19.2	7.1
23	10.0	21.6	7.6
25	10.0	24.6	7.6
27	10.0	24.6	8.6
27	10.0	28.0	9.0
33	11.5	30.0	10.0
35	11.5	35.0	9.5
37	11.5	35.0	9.5
39	11.5	38.0	9.5
40	11.5	38.0	9.5
43	11.5	42.0	11.0
45	11.5	45.0	11.0
48	11.5	48.0	11.0
48	11.5	50.0	11.5
50	11.5	52.0	11.5
56	14.0	55.0	11.5
58	14.0	58.0	11.5
61	14.0	60.0	14.3
61	14.0	62.0	14.3
63	14.0	64.0	14.3
66	14.0	68.4	14.3
70	15.0	69.3	14.3
73	15.0	72.3	15.3
75	15.0	75.4	15.3
78	15.0	78.4	15.3
80	15.0	80.4	15.3
85	15.0	85.4	15.3
90	18.0	91.5	16.0
92	18.0	92.0	15.3
97	18.0	99.0	15.3
105	18.2	104.0	16.3

Features
To DIN 24960 Single Seal - Unbalanced Uni-Directional Conical Spring

Materials
304SS Rotating Face Viton® Elastomer 304SS Metallurgy

Mating Ring Information
Mating Rings sold separately. For part numbers, see pages 194-195

* Additional Mating Ring Styles and Materials Available Upon Request.

Type VGME-2 - Rotary Head

Similar To:
Burgmann M32

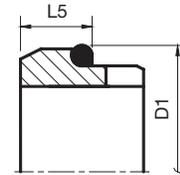
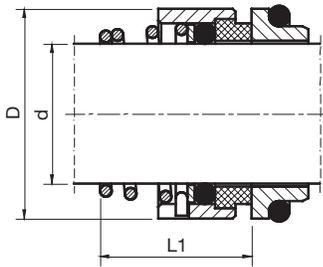

VGME-2		
Seal Size d	Rotary Head	
	OD D	Oper. Hgt. L1
10	19	16.9
12	21	17.4
14	23	17.4
15	24	17.4
16	26	19.5
18	29	20.5
20	31	22.0
22	33	23.5
24	35	25.0
25	36	26.5
28	40	26.5
30	43	25.0
32	46	28.5
33	47	28.5
35	49	28.5
38	53	32.2
40	56	34.7
42	59	37.3
43	59	37.3
45	61	39.2
48	64	44.7
50	66	45.7
53	69	49.0
55	71	49.0
58	76	52.0
60	78	53.0
65	84	54.3
68	88	55.3
70	90	56.3
75	98	56.3
80	103	59.3

Viton® / Carbon Specify Rotation	
Right Hand Part No.	Left Hand Part No.
HD-8088MRH	HD-8088MLH
HD-8089MRH	HD-8089MLH
HD-8320MRH	HD-8320MLH
HD-8321MRH	HD-8321MLH
HD-8322MRH	HD-8322MLH
HD-8323MRH	HD-8323MLH
HD-8324MRH	HD-8324MLH
HD-8325MRH	HD-8325MLH
HD-8326MRH	HD-8326MLH
HD-8327MRH	HD-8327MLH
HD-8328MRH	HD-8328MLH
HD-8329MRH	HD-8329MLH
HD-8330MRH	HD-8330MLH
HD-8331MRH	HD-8331MLH
HD-8332MRH	HD-8332MLH
HD-8333MRH	HD-8333MLH
HD-8334MRH	HD-8334MLH
HD-8335MRH	HD-8335MLH
HD-8336MRH	HD-8336MLH
HD-8337MRH	HD-8337MLH
HD-8338MRH	HD-8338MLH
HD-8339MRH	HD-8339MLH
HD-8340MRH	HD-8340MLH
HD-8341MRH	HD-8341MLH
HD-8342MRH	HD-8342MLH
HD-8343MRH	HD-8343MLH
HD-8344MRH	HD-8344MLH
HD-8345MRH	HD-8345MLH
HD-8346MRH	HD-8346MLH
HD-8347MRH	HD-8347MLH
HD-8348MRH	HD-8348MLH

Standard Mating Ring VGM-G9	
Bore D1	Thick L5
21	10.0
23	10.0
25	10.0
27	10.0
27	10.0
33	11.5
35	11.5
37	11.5
39	11.5
40	11.5
43	11.5
45	11.5
48	11.5
48	11.5
50	11.5
56	14.0
58	14.0
61	14.0
61	14.0
63	14.0
66	14.0
70	15.0
73	15.0
75	15.0
78	15.0
80	15.0
85	15.0
90	18.0
92	18.0
97	18.0
105	18.2

Features
To DIN 24960 Single Seal - Unbalanced Uni-Directional Conical Spring

Materials
Shrink-Fitted Carbon Rotating Face Viton® Elastomer 304SS Metallurgy

Mating Ring Information
Alternate Mating Ring Styles VGM-G4 and VGM-G6. Mating Rings sold separately. For part numbers, see pages 194-195

* Additional Mating Ring Styles and Materials Available Upon Request.

Type VGME-3 - Rotary Head

Similar To:

AES T01 DIN, Burgmann 37G, Vulcan 8 DIN

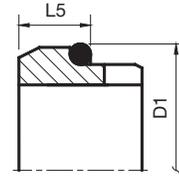
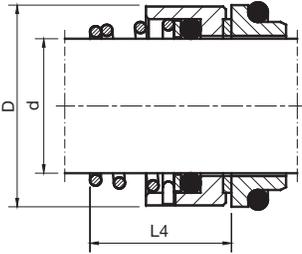

VGME-3		
Seal Size d	Rotary Head	
	OD D	Oper. Hgt. L4
10	19	16.5
12	21	16.5
14	23	16.5
15	24	16.5
16	26	16.5
18	29	18.0
20	31	19.0
22	33	20.5
24	35	22.0
25	36	23.5
28	40	24.5
30	43	24.5
32	46	28.0
33	47	28.0
35	49	28.0
38	53	31.0
40	56	34.0
42	59	35.0
43	59	36.0
45	61	36.5
48	64	42.0
50	66	43.0
53	69	43.0
55	71	47.0
58	76	50.0
60	78	51.0
65	84	52.0
68	88	52.7
70	90	54.0
75	98	54.0
80	100	58.0

Viton® / Silicon Carbide Specify Rotation	
Right Hand Part No.	Left Hand Part No.
HD-8382MRH	HD-8382MLH
HD-8350MRH	HD-8350MLH
HD-8351MRH	HD-8351MLH
HD-8352MRH	HD-8352MLH
HD-8353MRH	HD-8353MLH
HD-8354MRH	HD-8354MLH
HD-8355MRH	HD-8355MLH
HD-8356MRH	HD-8356MLH
HD-8357MRH	HD-8357MLH
HD-8358MRH	HD-8358MLH
HD-8359MRH	HD-8359MLH
HD-8360MRH	HD-8360MLH
HD-8361MRH	HD-8361MLH
HD-8362MRH	HD-8362MLH
HD-8363MRH	HD-8363MLH
HD-8364MRH	HD-8364MLH
HD-8365MRH	HD-8365MLH
HD-8366MRH	HD-8366MLH
HD-8367MRH	HD-8367MLH
HD-8368MRH	HD-8368MLH
HD-8369MRH	HD-8369MLH
HD-8370MRH	HD-8370MLH
HD-8371MRH	HD-8371MLH
HD-8372MRH	HD-8372MLH
HD-8373MRH	HD-8373MLH
HD-8374MRH	HD-8374MLH
HD-8375MRH	HD-8375MLH
HD-8376MRH	HD-8376MLH
HD-8377MRH	HD-8377MLH
HD-8378MRH	HD-8378MLH
HD-8379MRH	HD-8379MLH

Standard Mating Ring VGM-G9 Mating Ring	
Bore D1	Thick L5
21	10.0
23	10.0
25	10.0
27	10.0
27	10.0
33	11.5
35	11.5
37	11.5
39	11.5
40	11.5
43	11.5
45	11.5
48	11.5
48	11.5
50	11.5
56	14.0
58	14.0
61	14.0
61	14.0
63	14.0
66	14.0
70	15.0
73	15.0
75	15.0
78	15.0
80	15.0
85	15.0
90	18.0
92	18.0
97	18.0
105	18.2

Features
To DIN 24960 Single Seal - Unbalanced Uni-Directional Conical Spring

Materials
Shrink-Fitted Silicon Carbide Rotating Face
Viton® Elastomer
304SS Metallurgy

Mating Ring Information
Alternate Mating Ring Styles VGM-G4 and VGM-G6.
Mating Rings sold separately.
For part numbers, see pages 194-195

* Additional Mating Ring Styles and Materials Available Upon Request.

Type VGMH - Rotary Head

Similar To:
AES PO3, Sealol 43, Vulcan 24

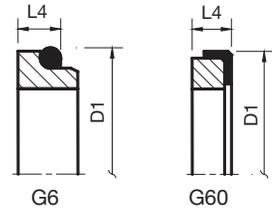
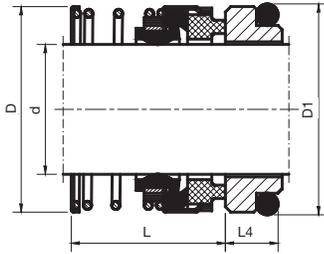

VGMH		
Seal Size d	Rotary Head	
	OD D	Oper. Hgt. L
12	22.8	23.9
14	22.8	26.4
16	26.4	26.4
18	29.5	27.5
20	33.6	27.5
22	33.6	27.5
24	38.0	30.0
25	39.1	30.0
28	42.5	32.5
30	45.6	32.5
32	45.6	32.5
33	49.0	32.5
35	49.0	32.5
38	52.0	34.0
40	57.2	34.0
43	60.6	34.0
45	60.6	34.0
48	63.8	34.0
50	65.6	34.5
55	76.9	34.5
58	78.4	39.5
60	78.4	39.5
63	81.2	39.5
65	84.5	39.5
68	89.6	37.2
70	89.6	44.7
75	96.6	44.7

Buna / Carbon Part No.	Viton® / SC Part No.
HD-8273M	HD-8293M
HD-8274M	HD-8294M
HD-8275M	HD-8295M
HD-8276M	HD-8296M
HD-8039M	HD-8297M
HD-8277M	HD-8298M
HD-8040M	HD-8299M
HD-8041M	HD-8300M
HD-8278M	HD-8301M
HD-8042M	HD-8302M
HD-8279M	HD-8303M
HD-8280M	HD-8304M
HD-8281M	HD-8305M
HD-8282M	HD-8306M
HD-8283M	HD-8307M
HD-8043M	HD-8308M
HD-8284M	HD-8309M
HD-8285M	HD-8310M
HD-8286M	HD-8311M
HD-8044M	HD-8312M
HD-8287M	HD-8313M
HD-8045M	HD-8314M
HD-8288M	HD-8315M
HD-8289M	HD-8316M
HD-8290M	HD-8317M
HD-8291M	HD-8318M
HD-8292M	HD-8319M

Standard Mating Rings VGM-G6 and VGM-G60	
Bore D1	Thick L4
23	6.6
25	6.6
27	6.6
33	6.6
35	7.5
37	7.5
39	7.5
40	7.5
43	7.5
45	7.5
48	7.5
48	7.5
50	7.5
56	9.0
58	9.0
61	9.0
63	9.0
66	9.0
70	9.5
75	11.0
78	11.0
80	11.0
83	11.0
85	11.0
90	11.3
92	11.3
97	11.3

Features
To DIN 24960 Single Seal - Unbalanced Bi-Directional Elastomer Bellows

Materials
Carbon or Silicon Carbide Rotating Face
Buna or Viton® Elastomer
304SS Metallurgy

Mating Ring Information
Mating Rings sold separately. For part numbers, see pages 194-195

* Additional Mating Ring Styles and Materials Available Upon Request.

Type VGM-G Mating Rings

Features

To DIN 24960

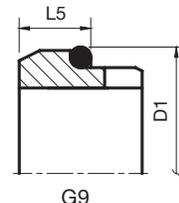
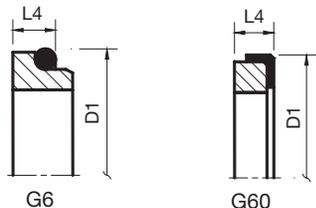

Seal Size d	Mating Ring		VGM-G6	VGM-G60
	Bore D1	Thick L4	Viton®/SC	
			Part No.	Part No.
10	21	6.6	STG6VSC10	STG60VSC10
12	23	6.6	STG6VSC12	STG60VSC12
14	25	6.6	STG6VSC14	STG60VSC14
15	27	6.6	STG6VSC15	STG60VSC15
16	27	6.6	STG6VSC16	STG60VSC16
18	33	7.5	STG6VSC18	STG60VSC18
20	35	7.5	STG6VSC20	STG60VSC20
22	37	7.5	STG6VSC22	STG60VSC22
24	39	7.5	STG6VSC24	STG60VSC24
25	40	7.5	STG6VSC25	STG60VSC25
28	43	7.5	STG6VSC28	STG60VSC28
30	45	7.5	STG6VSC30	STG60VSC30
32	48	7.5	STG6VSC32	STG60VSC32
33	48	7.5	STG6VSC33	STG60VSC33
35	50	7.5	STG6VSC35	STG60VSC35
38	56	9.0	STG6VSC38	STG60VSC38
40	58	9.0	STG6VSC40	STG60VSC40
42	61	9.0	STG6VSC42	STG60VSC42
43	61	9.0	STG6VSC43	STG60VSC43
45	63	9.0	STG6VSC45	STG60VSC45
48	66	9.0	STG6VSC48	STG60VSC48
50	70	9.5	STG6VSC50	STG60VSC50
53	73	11.0	STG6VSC53	STG60VSC53
55	75	11.0	STG6VSC55	STG60VSC55
58	78	11.0	STG6VSC58	STG60VSC58
60	80	11.0	STG6VSC60	STG60VSC60
65	85	11.0	STG6VSC65	STG60VSC65
68	90	11.3	STG6VSC68	STG60VSC68
70	92	11.3	STG6VSC70	STG60VSC70
75	97	11.3	STG6VSC75	STG60VSC75
80	105	12.0	STG6VSC80	STG60VSC80
85	110	14.0	STG6VSC85	STG60VSC85
90	115	14.0	STG6VSC90	STG60VSC90
95	120	14.0	STG6VSC95	STG60VSC95
100	125	14.0	STG6VSC100	STG60VSC100

Mating Ring Bore D1	Thick L5	VGM-G9	
		Viton®/Carbon Part No.	Viton®/SC Part No.
21	10.0	STG9VCA10	STG9VSC10
23	10.0	STG9VCA12	STG9VSC12
25	10.0	STG9VCA14	STG9VSC14
27	10.0	STG9VCA15	STG9VSC15
27	10.0	STG9VCA16	STG9VSC16
33	11.5	STG9VCA18	STG9VSC18
35	11.5	STG9VCA20	STG9VSC20
37	11.5	STG9VCA22	STG9VSC22
39	11.5	STG9VCA24	STG9VSC24
40	11.5	STG9VCA25	STG9VSC25
43	11.5	STG9VCA28	STG9VSC28
45	11.5	STG9VCA30	STG9VSC30
48	11.5	STG9VCA32	STG9VSC32
48	11.5	STG9VCA33	STG9VSC33
50	11.5	STG9VCA35	STG9VSC35
56	14.0	STG9VCA38	STG9VSC38
58	14.0	STG9VCA40	STG9VSC40
61	14.0	STG9VCA42	STG9VSC42
61	14.0	STG9VCA43	STG9VSC43
63	14.0	STG9VCA45	STG9VSC45
66	14.0	STG9VCA48	STG9VSC48
70	15.0	STG9VCA50	STG9VSC50
73	15.0	STG9VCA53	STG9VSC53
75	15.0	STG9VCA55	STG9VSC55
78	15.0	STG9VCA58	STG9VSC58
80	15.0	STG9VCA60	STG9VSC60
85	15.0	STG9VCA65	STG9VSC65
90	18.0	STG9VCA68	STG9VSC68
92	18.0	STG9VCA70	STG9VSC70
97	18.0	STG9VCA75	STG9VSC75
105	18.2	STG9VCA80	STG9VSC80
110	18.2	STG9VCA85	STG9VSC85
115	18.2	STG9VCA90	STG9VSC90
120	17.2	STG9VCA95	STG9VSC95
125	17.2	STG9VCA100	STG9VSC100

* Other materials available upon request *

Type VGM-G Mating Rings

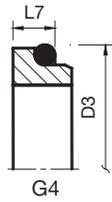

G4

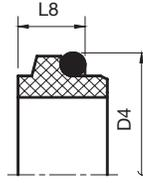

G13

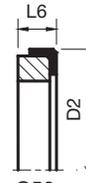

G50

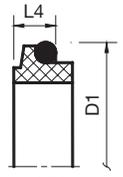

G606

Seal Size d	Mating Ring		VGM-G4	Mating Ring		VGM-G13	Mating Ring		VGM-G50	Mating Ring		VGM-G606
	Bore D3	Thick L7	Viton®/SC Part No.	Bore D4	Thick L8	Viton®/Carbon Part No.	Bore D2	Thick L6	Viton®/SC Part No.	Bore D1	Thick L4	Viton®/Carbon Part No.
10	19.2	6.6	STG4VSC10	19.2	7.1	STG13VCA10	24.60	9.0	STG50VSC10	21	6.6	STG606VCA10
12	21.6	5.6	STG4VSC12	21.6	7.6	STG13VCA12	27.80	9.0	STG50VSC12	23	6.6	STG606VCA12
14	24.6	5.6	STG4VSC14	24.6	7.6	STG13VCA14	30.95	10.5	STG50VSC14	25	6.6	STG606VCA14
15	24.6	6.6	STG4VSC15	24.6	8.6	STG13VCA15	30.95	10.5	STG50VSC15	27	6.6	STG606VCA15
16	28.0	7.5	STG4VSC16	28.0	9.0	STG13VCA16	30.95	10.5	STG50VSC16	27	6.6	STG606VCA16
18	30.0	8.0	STG4VSC18	30.0	10.0	STG13VCA18	34.15	10.5	STG50VSC18	33	7.5	STG606VCA18
20	35.0	7.5	STG4VSC20	35.0	9.5	STG13VCA20	35.70	10.5	STG50VSC20	35	7.5	STG606VCA20
22	35.0	7.5	STG4VSC22	35.0	9.5	STG13VCA22	37.30	10.5	STG50VSC22	37	7.5	STG606VCA22
24	38.0	7.5	STG4VSC24	38.0	9.5	STG13VCA24	40.50	10.5	STG50VSC24	39	7.5	STG606VCA24
25	38.0	7.5	STG4VSC25	38.0	9.5	STG13VCA25	40.50	10.5	STG50VSC25	40	7.5	STG606VCA25
28	42.0	9.0	STG4VSC28	42.0	11.0	STG13VCA28	47.65	12.0	STG50VSC28	43	7.5	STG606VCA28
30	45.0	10.5	STG4VSC30	45.0	11.0	STG13VCA30	50.80	12.0	STG50VSC30	45	7.5	STG606VCA30
32	48.0	10.5	STG4VSC32	48.0	11.0	STG13VCA32	50.80	12.0	STG50VSC32	48	7.5	STG606VCA32
33	50.0	11.0	STG4VSC33	50.0	11.5	STG13VCA33	54.00	12.0	STG50VSC33	48	7.5	STG606VCA33
35	52.0	11.0	STG4VSC35	52.0	11.5	STG13VCA35	54.00	12.0	STG50VSC35	50	7.5	STG606VCA35
38	55.0	10.3	STG4VSC38	55.0	11.5	STG13VCA38	57.15	12.0	STG50VSC38	56	9.0	STG606VCA38
40	58.0	10.8	STG4VSC40	58.0	11.5	STG13VCA40	60.35	12.0	STG50VSC40	58	9.0	STG606VCA40
42	62.0	12.0	STG4VSC42	60.0	14.3	STG13VCA42	63.50	12.0	STG50VSC42	61	9.0	STG606VCA42
43	62.0	12.0	STG4VSC43	62.0	14.3	STG13VCA43	63.50	12.0	STG50VSC43	61	9.0	STG606VCA43
45	64.0	11.6	STG4VSC45	64.0	14.3	STG13VCA45	63.50	12.0	STG50VSC45	63	9.0	STG606VCA45
48	68.4	11.6	STG4VSC48	68.4	14.3	STG13VCA48	66.70	12.0	STG50VSC48	66	9.0	STG606VCA48
50	69.3	11.6	STG4VSC50	69.3	14.3	STG13VCA50	69.85	13.5	STG50VSC50	70	9.5	STG606VCA50
53	72.3	12.3	STG4VSC53	72.3	15.3	STG13VCA53	73.05	13.5	STG50VSC53	73	11.0	STG606VCA53
55	75.4	13.3	STG4VSC55	75.4	15.3	STG13VCA55	76.20	13.5	STG50VSC55	75	11.0	STG606VCA55
58	78.4	13.3	STG4VSC58	78.4	15.3	STG13VCA58	79.40	13.5	STG50VSC58	78	11.0	STG606VCA58
60	80.4	13.3	STG4VSC60	80.4	15.3	STG13VCA60	79.40	13.5	STG50VSC60	80	11.0	STG606VCA60
65	85.4	13.0	STG4VSC65	85.4	15.3	STG13VCA65	92.10	16.0	STG50VSC65	85	11.0	STG606VCA65
68	91.5	13.7	STG4VSC68	91.5	16.0	STG13VCA68	95.25	16.0	STG50VSC68	90	11.3	STG606VCA68
70	92.0	13.0	STG4VSC70	92.0	15.3	STG13VCA70	95.25	16.0	STG50VSC70	92	11.3	STG606VCA70
75	99.0	14.0	STG4VSC75	99.0	15.3	STG13VCA75	101.60	16.0	STG50VSC75	97	11.3	STG606VCA75
80	104.0	15.0	STG4VSC80	104.0	16.3	STG13VCA80	114.30	20.0	STG50VSC80	105	12.0	STG606VCA80
85	109.0	14.8	STG4VSC85	109.0	16.3	STG13VCA85	117.50	20.0	STG50VSC85	110	14.0	STG606VCA85
90	114.0	14.8	STG4VSC90	114.0	16.3	STG13VCA90	123.85	20.0	STG50VSC90	115	14.0	STG606VCA90
95	120.3	15.8	STG4VSC95	120.3	17.3	STG13VCA95	127.00	20.0	STG50VSC95	120	14.0	STG606VCA95
100	123.3	15.8	STG4VSC100	123.3	17.3	STG13VCA100	133.35	20.0	STG50VSC100	125	14.0	STG606VCA100

* Other materials available upon request *

CYCLONE ABRASIVE SEPARATORS

Our cyclone separators provide a simple, yet effective, method of keeping abrasives away from the sealing faces, thereby increasing seal life and reducing maintenance costs.

Connected to the discharge side of the pump, the separator takes the abrasive-laden fluid and removes the foreign particles.

The clean fluid from the separator is injected into the stuffing box providing a positive circulation and cool environment for the seal.

Required Operating Conditions

Minimum pressure differential of 20 PSI should be maintained between pump suction and pump discharge.

Specific gravity of the particles being separated must be greater than the liquid.

Minimum particle size removed is 1 micron. Solids content of the pumped fluid should not exceed 10%.

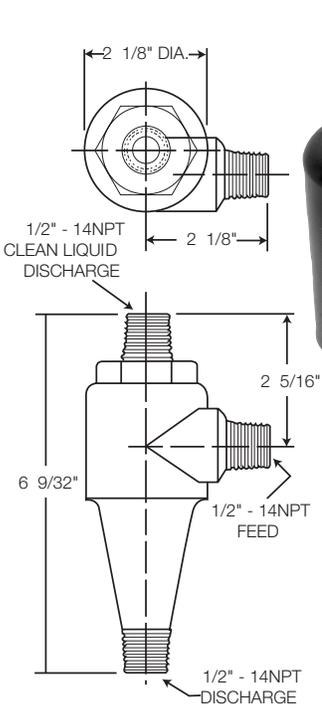
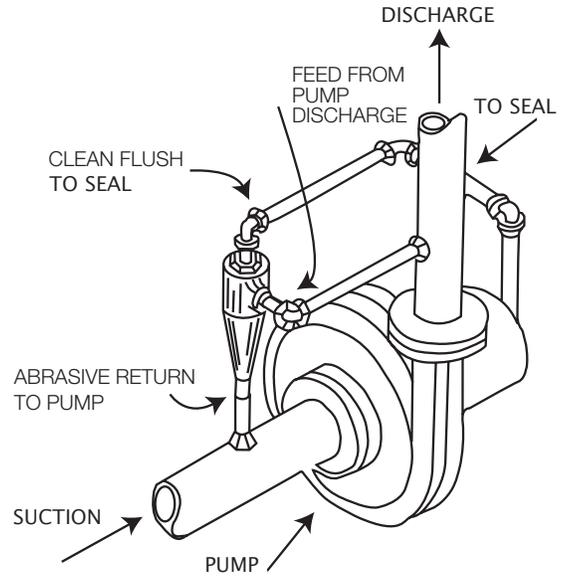

KY-1

Material: Nylon
Temp. Range: 0°F to +240°F
Pressures up to 650 PSI

Cyclone separators are only effective with products in suspension, such as sand, iron oxide, or dirt. Product dissolved in the liquid can not be removed by a cyclone separator.

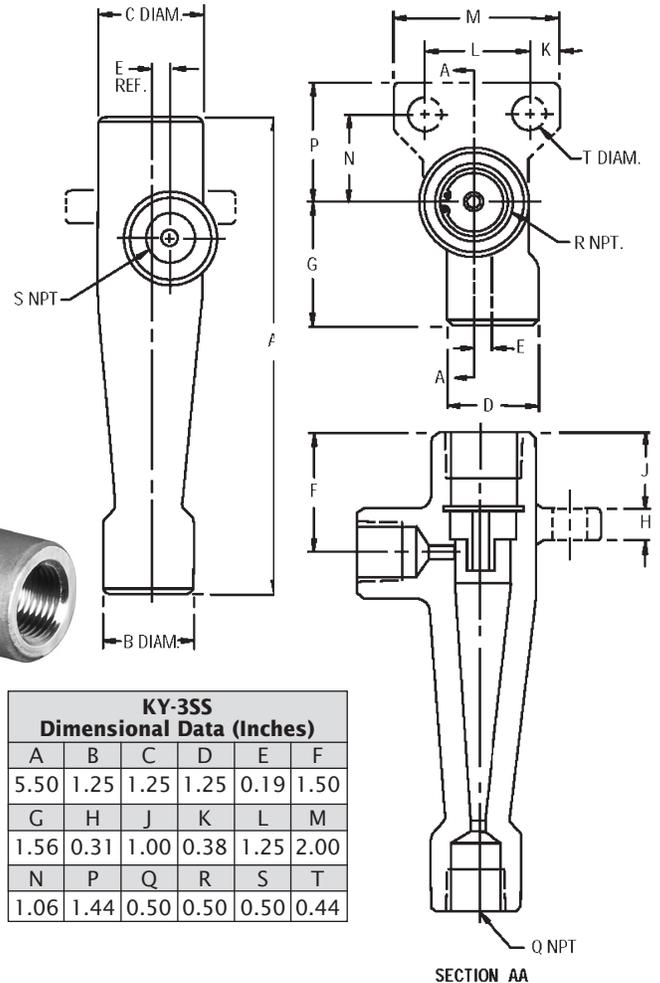

KY-3SS

Material: 316SS
Temp. Range: -20°F to +400°F
Pressures up to 2000 PSI

PACKING - STYLE 58

Graphited / PTFE Braided Packing for General and Chemical Service

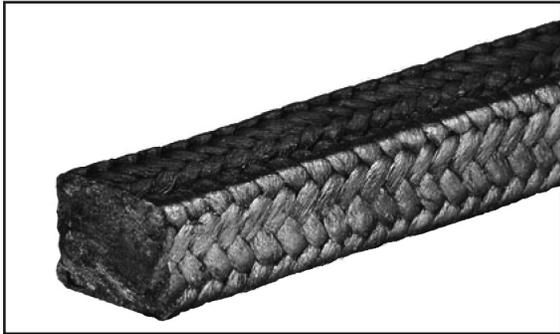

Product Description

Style 58 combines the chemical-resistant and low-friction generation characteristics of continuous PTFE filament yarns with the superior heat dissipation and self-lubricating properties of graphite.

An excellent choice for chemical resistance, this nonabrasive packing provides excellent conformability, adjustability and flexibility. A superior, low-maintenance choice where minimum field adjustment and fast break-in and start-up are necessary.

Style 58 Packing is ideal for controlled leakage and extrusion resistance at high pressures and shaft speeds. When used as a multipurpose packing, inventory costs are greatly reduced.

Applications

Air, ammonia, chemicals, condensate, corrosives, gases, liquor, oils, paper stock, solvents, steam, and water

Typical Equipment

Agitators, digesters, expansion joints, mixers, pumps, reciprocating and rotating equipment, valve stems

Industries Served

- Agriculture
 - Chemical
 - General Industry
 - Marine
 - Municipal
- Oil and Gas
 - Pharmaceutical
 - Power Generation
 - Pulp and Paper
 - Steel and Metals

Performance Capabilities

- Temperature
-350°F to +500°F
- Pressure
Pump Up to 20 bar / 300 psi
Valve Up to 275 bar / 4000 psi
- Speed
15 mps / 3000 fpm
- pH Range
0 to 14

Construction Features

Interlace Braid
Style 58 has individual continuous filament yarns which are impregnated with a high-purity graphite and high-temperature lubricant.

The graphite and lubricant assist with break-in, reduce friction, and dissipate heat throughout the stuffing box.

Call U.S. Seal Mfg. for additional styles and sizes.

One Pound Box		
Cross Section	U.S. Seal Mfg. Part Number	Feet/Box
1/8"	USP-012501058	89.93
3/16"	USP-018701058	39.34
1/4"	USP-025001058	22.01
5/16"	USP-031201058	14.13
3/8"	USP-037501058	9.78
7/16"	USP-043701058	7.20
1/2"	USP-050001058	5.50
9/16"	—	—
5/8"	—	—
3/4"	—	—
7/8"	—	—
1"	—	—

Five Pound Box		
Cross Section	U.S. Seal Mfg. Part Number	Feet/Box
1/8"	USP-012505058	449.64
3/16"	USP-018705058	196.70
1/4"	USP-025005058	110.06
5/16"	USP-031205058	70.66
3/8"	USP-037505058	48.91
7/16"	USP-043705058	36.02
1/2"	USP-050005058	27.51
9/16"	—	—
5/8"	—	—
3/4"	—	—
7/8"	—	—
1"	—	—

Ten Pound Box		
Cross Section	U.S. Seal Mfg. Part Number	Feet/Box
1/8"	—	—
3/16"	—	—
1/4"	—	—
5/16"	—	—
3/8"	—	—
7/16"	—	—
1/2"	—	—
9/16"	USP-056210058	43.56
5/8"	USP-062510058	35.22
3/4"	USP-075010058	24.46
7/8"	USP-087510058	17.97
1"	USP-100010058	13.74

Replaces: American Braiding - 8000T, 8100BIL, 8200BIL / Chemstar - 165, 165LA, 3165 / Chesterton - 1750, 1760
Garlock - Packmaster 6, 5100 / John Crane - C1070 / Marlo - 462 / New England Braiding - 102
Palmetto 1389 / Phelps - 2024 / Sepco - ML 3600, ML 4002, ML 8002 / Teadit - 2007 / Utex - 210, 244, 246

PACKING - STYLE 302

PTFE / Synthetic Braided Packing for General Service

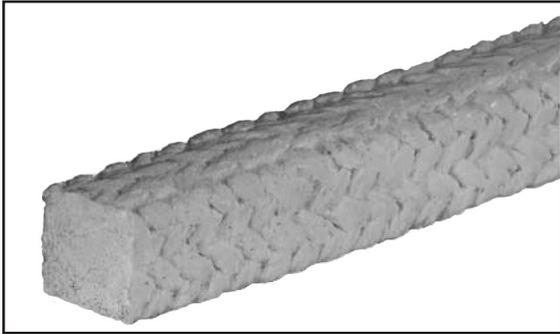

Product Description

Style 302 is a cost effective general service packing. It contains no graphite.

Constructed of the highest quality synthetic fibers and lubricants. Designed to handle a wide range of fluids at moderate to high temperatures, pressures and shaft speeds.

Style 302 packing is thoroughly impregnated with PTFE in order to enhance chemical resistance, lubricity and dimensional stability. This helps to ensure even gland load distribution, promoting longer packing life.

Applications

Gases, mild acids and caustics, non abrasives, oils, solvents, steam, water

Typical Equipment

Rotating and reciprocating equipment, valves and expansion joints

Industries Served

- Agriculture
- General Industry
- Marine
- Municipal
- Oil and Gas
- Power Generation
- Pulp and Paper
- Wastewater

Performance Capabilities

- Temperature
-170°F to +500°F
- Pressure
Pump Up to 20 bar / 300 psi
Valve Up to 68 bar / 1000 psi
- Speed
Up to 11 mps / 2250 fpm
- pH Range
2 to 12

Construction Features

Interlace Braid
Style 302 has spun synthetic fibers thoroughly impregnated with PTFE dispersion plus a general service compatible lubricant.

Call U.S. Seal Mfg. for additional styles and sizes.

One Pound Box		
Cross Section	U.S. Seal Mfg. Part Number	Feet/Box
1/8"	USP-012501302	116.28
3/16"	USP-018701302	54.73
1/4"	USP-025001302	29.06
5/16"	USP-031201302	18.66
3/8"	USP-037501302	12.91
7/16"	USP-043701302	9.51
1/2"	USP-050001302	7.27
9/16"	—	—
5/8"	—	—
3/4"	—	—
7/8"	—	—
1"	—	—

Five Pound Box		
Cross Section	U.S. Seal Mfg. Part Number	Feet/Box
1/8"	USP-012505302	581.40
3/16"	USP-018705302	273.67
1/4"	USP-025005302	145.31
5/16"	USP-031205302	93.28
3/8"	USP-037505302	64.54
7/16"	USP-043705302	47.55
1/2"	USP-050005302	36.33
9/16"	—	—
5/8"	—	—
3/4"	—	—
7/8"	—	—
1"	—	—

Ten Pound Box		
Cross Section	U.S. Seal Mfg. Part Number	Feet/Box
1/8"	—	—
3/16"	—	—
1/4"	—	—
5/16"	—	—
3/8"	—	—
7/16"	—	—
1/2"	—	—
9/16"	USP-056210302	57.50
5/8"	USP-062510302	40.84
3/4"	USP-075010302	32.28
7/8"	USP-087510302	23.72
1"	USP-100010302	18.16

Replaces: American Braiding - 3000N, 3000T / Chemstar - 1152, 11621B / Chesterton - 412W, 1710, 1774
 Garlock - Packmaster 1, 7223, 8922 / John Crane - 1335 / Marlo - 250 / New England Braiding - 142
 Palmetto 1347AF, 1392 / Phelps - 2072, 2172 / Sepco - ML2225, ML2550 / Teadit - 2019 / Utex - 234, 237

PACKING - STYLE 303

Graphite / Synthetic Braided Packing for General Service

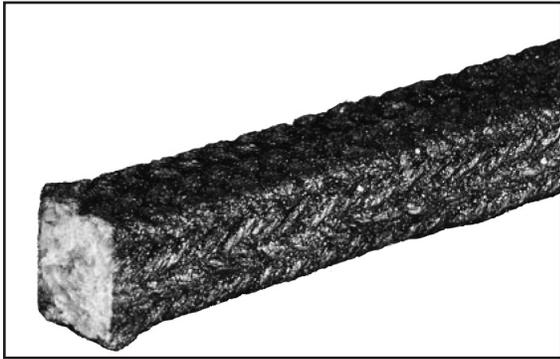

Performance Capabilities

- Temperature
-170°F to +500°F
- Pressure
Pump Up to 20 bar / 300 psi
Valve Up to 68 bar / 1000 psi
- Speed
Up to 10 mps / 2000 fpm
- pH Rang
4 to 10

Construction Features

Interlace Braid
Style 303 has spun synthetic fibers treated with a proprietary blend of petroleum-based lubricants plus an external coating of graphite

Call U.S. Seal Mfg. for additional styles and sizes.

Product Description

Style 303 is a cost effective graphite-coated general service packing constructed of the highest quality synthetic fibers and lubricants designed to handle a wide range of fluids at moderate to high temperatures, pressures, and shaft speeds.

Style 303 packing is thoroughly impregnated with lubricants to fill braided voids in order to reduce product penetration.

An external graphite coating is added for lubricity and to enhance heat dissipation for increased packing life.

Applications

Gases, mild acids and caustics, non abrasives, oils, solvents, steam, water

Typical Equipment

Rotating and reciprocating equipment, valves and expansion joints

Industries Served

- Agriculture
- General Industry
- Marine
- Municipal
- Oil and Gas
- Power Generation
- Pulp and Paper
- Wastewater

One Pound Box		
Cross Section	U.S. Seal Mfg. Part Number	Feet/Box
1/8"	USP-012501303	151.52
3/16"	USP-018701303	72.52
1/4"	USP-025001303	33.32
5/16"	USP-031201303	25.91
3/8"	USP-037501303	17.94
7/16"	USP-043701303	13.21
1/2"	USP-050001303	10.09
9/16"	—	—
5/8"	—	—
3/4"	—	—
7/8"	—	—
1"	—	—

Three Pound Box		
Cross Section	U.S. Seal Mfg. Part Number	Feet/Box
1/8"	USP-012503303	454.55
3/16"	USP-018703303	217.55
1/4"	USP-025003303	99.97
5/16"	USP-031203303	77.74
3/8"	USP-037503303	53.91
7/16"	USP-043703303	39.62
1/2"	USP-050003303	30.26
9/16"	—	—
5/8"	—	—
3/4"	—	—
7/8"	—	—
1"	—	—

Five Pound Box		
Cross Section	U.S. Seal Mfg. Part Number	Feet/Box
1/8"	—	—
3/16"	—	—
1/4"	—	—
5/16"	—	—
3/8"	—	—
7/16"	—	—
1/2"	—	—
9/16"	USP-056205303	39.78
5/8"	USP-062505303	31.89
3/4"	USP-075005303	22.98
7/8"	USP-087505303	16.46
1"	USP-100005303	12.94

Replaces: American Braiding - 3000G / Chemstar - 1398, 1430 / Garlock - Packmaster 2 or 3
Garlock - 8909, 8913 / John Crane - 1340 / Marlo - 259 / New England Braiding - 142G
Palmetto 1007AF, 1030AF / Phelps - 2075, 2175, 2176 / Sepco - ML402 / Teadit - 2255 / Utex - 233, 236

PACKING - STYLE 310

Polyimide / PTFE Braided Packing for Severe Service

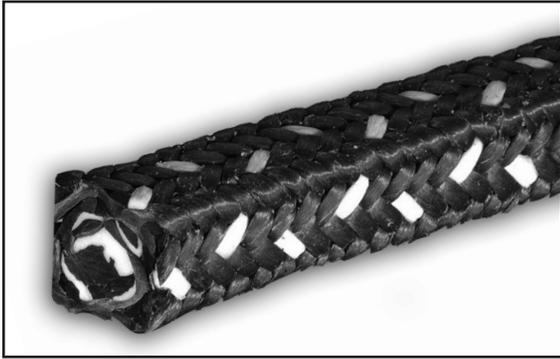

Product Description

Style 310 is an interlace braided polyimide and PTFE packing. It is impregnated with PTFE and a high temperature break-in lubricant for smoother start-ups.

This packing offers strength, abrasion and chemical resistance along with elevated temperature & pressure capabilities.

Shaft and/or sleeve wear is greatly reduced.

Performance Capabilities

- Temperature
-170°F to +550°F
- Pressure
Pump Up to 34 bar / 500 psi
Valve Up to 275 bar / 4000 psi
- Speed
13 mps / 2500 fpm
- pH Range
0 to 12

Construction Features

Lattice Braid

Applications

Abrasives, acids, asphalt, chemicals, mild caustics & liquors, solvents

Typical Equipment

Agitators, brine pumps, centrifugal and rotary pumps, coal slurry pumps, mixers, pulpers, refiners, sludge pumps, stock pumps, valves

Industries Served

- Chemical & Pharmaceutical
- Marine
- Mining & Minerals
- Municipal
- Oil & Gas
- Power Generation
- Pulp & Paper
- Steel & Metals
- Wastewater

One Pound Box		
Cross Section	U.S. Seal Mfg. Part Number	Feet/Box
1/8"	N/A	—
3/16"	USP-018701310	47.20
1/4"	USP-025001310	27.80
5/16"	USP-031201310	17.90
3/8"	USP-037501310	12.50
7/16"	USP-043701310	9.20
1/2"	USP-050001310	7.00
9/16"	—	—
5/8"	—	—
3/4"	—	—
7/8"	—	—
1"	—	—

Five Pound Box		
Cross Section	U.S. Seal Mfg. Part Number	Feet/Box
1/8"	N/A	—
3/16"	USP-018705310	236.00
1/4"	USP-025005310	139.00
5/16"	USP-031205310	89.50
3/8"	USP-037505310	62.50
7/16"	USP-043705310	46.00
1/2"	USP-050005310	35.00
9/16"	—	—
5/8"	—	—
3/4"	—	—
7/8"	—	—
1"	—	—

Ten Pound Box		
Cross Section	U.S. Seal Mfg. Part Number	Feet/Box
1/8"	—	—
3/16"	—	—
1/4"	—	—
5/16"	—	—
3/8"	—	—
7/16"	—	—
1/2"	USP-050010310	70.00
9/16"	USP-056210310	52.00
5/8"	USP-062510310	42.00
3/4"	USP-075010310	29.00
7/8"	USP-087510310	21.00
1"	USP-100010310	16.00

Replaces: American Braiding - 320 / Chemstar - 1190 / Chesterton - 1727
 Garlock - 1850 / John Crane - 1345 / Marlo - 270 / New England Braiding-162
 Palmetto 1392 / Sepco - ML2400, ML6225, ML6225A / Teadit - 2777 / Utex - 248,279

PACKING - STYLE 792

PTFE (FDA Compliant) Braided Packing for Food and Beverage Service

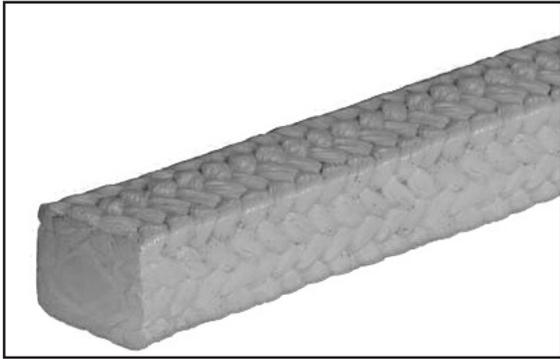

Product Description

Style 792 is a firm, yet pliable packing manufactured from the purest PTFE filaments.

Also an excellent choice for chemical resistance, this packing is free from color contamination for applications where color contamination can not be tolerated.

Style 792 contains a food grade lubricant which provides faster break-in and reduced shaft wear.

Performance Capabilities

- Temperature
-450°F to +500°F
- Pressure
Pump Up to 20 bar / 300 psi
Valve Up to 170 bar / 2500 psi
- Speed
10 mps / 2000 fpm
- pH Range
0 to 14

Applications

Food and Beverage packaging
Pharmaceutical production

Typical Equipment

Rotating and reciprocating equipment, valves

Industries Served

- Food and Beverage
- Pharmaceutical

Construction Features

Lattice Braid
Style 792's PTFE filament is compliant with FDA regulation 21 CFR 177.1550.

One Pound Box			Five Pound Box			Ten Pound Box		
Cross Section	U.S. Seal Mfg. Part Number	Feet/Box	Cross Section	U.S. Seal Mfg. Part Number	Feet/Box	Cross Section	U.S. Seal Mfg. Part Number	Feet/Box
1/8"	USP-012501792	89.93	1/8"	USP-012505792	449.64	1/8"	—	—
3/16"	USP-018701792	39.34	3/16"	USP-018705792	196.70	3/16"	—	—
1/4"	USP-025001792	22.01	1/4"	USP-025005792	110.06	1/4"	—	—
5/16"	USP-031201792	14.13	5/16"	USP-031205792	70.66	5/16"	—	—
3/8"	USP-037501792	9.78	3/8"	USP-037505792	48.91	3/8"	—	—
7/16"	USP-043701792	7.20	7/16"	USP-043705792	36.02	7/16"	—	—
1/2"	USP-050001792	5.50	1/2"	USP-050005792	27.51	1/2"	—	—
9/16"	—	—	9/16"	—	—	9/16"	USP-056210792	43.52
5/8"	—	—	5/8"	—	—	5/8"	USP-062510792	35.22
3/4"	—	—	3/4"	—	—	3/4"	USP-075010792	24.46
7/8"	—	—	7/8"	—	—	7/8"	USP-087510792	17.97
1"	—	—	1"	—	—	1"	USP-100010792	13.74

Replaces: American Braiding - 244FDA / Chemstar - 154 FDA / Chesterton - 425, 1725
Garlock - 5904 / John Crane - C1056 / New England Braiding- 110
Palmetto 1367FS / Phelps - 2031 / Sepco - ML2236FDA / Teadit - 2006FDA / Utex - 245

PTFE LANTERN RING STRIP

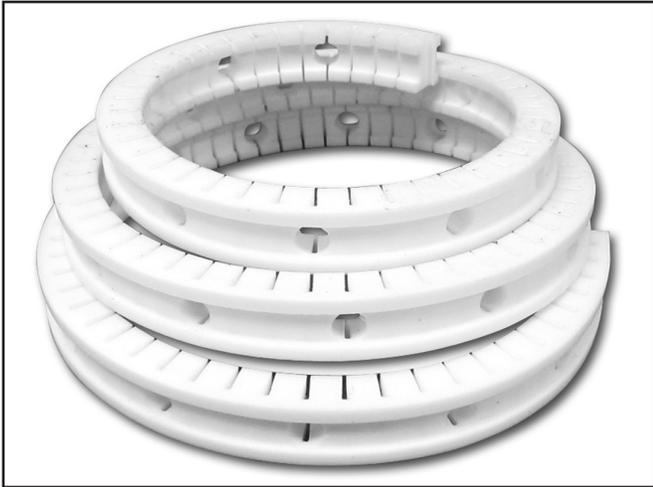

Product Description

PTFE lantern rings are widely used in applications where outside lubrication is necessary in order to keep packing lubricated, cool, and flushed of abrasives and chemicals. The use of lantern rings greatly increases the life of compression packing, resulting in less maintenance and downtime over the life of the equipment.

PTFE lantern rings will handle a wide range of fluids, offering maximum corrosion resistance and, unlike metallic rings, will not gall or score shafts or sleeves. They have also been successfully used in bearing assemblies as a conduit for grease or oil. The lantern ring works in aiding movement of the lubricant without risk of contamination or excess stuffing box wear.

Performance Capabilities

- Temperature
-400°F to +500°F
- Pressure
Pump 68 bar / 1000 psi
- Speed
Not Applicable
- pH Range
0 to 14

Construction Features

4 Foot Strip

Applications

Air, ammonia, boiler feed water, chemicals, condensate, corrosives, gases, liquor, oils, paper stock, solvents, steam, water

Typical Equipment

Rotating and reciprocating equipment, valves

Industries Served

- Chemical
- General Industry
- Mining and Minerals
- Municipal
- Oil and Gas
- Pharmaceutical
- Power Generation
- Pulp and Paper
- Steel and Metals
- Wastewater

Height	Width	Part Number
1/4"	3/8"	USP-02500375LRS
5/16"	7/16"	USP-03120437LRS
3/8"	1/2"	USP-03750500LRS
7/16"	9/16"	USP-04370562LRS
1/2"	5/8"	USP-05000625LRS
9/16"	11/16"	USP-05620687LRS
5/8"	3/4"	USP-06250750LRS
3/4"	7/8"	USP-07500875LRS
7/8"	1"	USP-08751000LRS

Height	Width	Part Number
1/4"	1/2"	USP-02500500LRS
5/16"	5/8"	USP-03120625LRS
3/8"	3/4"	USP-03750750LRS
7/16"	7/8"	USP-04370875LRS
1/2"	1"	USP-05001000LRS
9/16"	1"	USP-05621000LRS
5/8"	1"	USP-06251000LRS
3/4"	1"	USP-07501000LRS
1"	1"	USP-10001000LRS

If the products featured will be used in a potentially dangerous and/or hazardous process, your U.S. Seal Mfg. representative should be consulted prior to their selection and use. In the interest of continuous development, U.S. Seal Mfg. reserves the right to alter designs and specifications without prior notice. It is dangerous to smoke while handling products made from PTFE. Old and new PTFE products must not be incinerated.

PACKING ACCESSORIES

PACKING HOOKS - "T" Handled, Flexible with Replaceable Cork Screw Tips

Hook Size	Hook Length	Used for Packing Size	U.S. Seal Mfg. Part No.	Replaceable Tip Part No.
Midget	6-1/2"	5/32" and Up	USP-PKGMGT	—
Small	7-1/2"	5/16" and Up	USP-PKGHOOKSM	USP-REPLTIPSM
Medium	11"	7/16" and Up	USP-PKGHOOKMED	USP-REPLTIPMED
Large	14"	1/2" and Up	USP-PKGHOOKLG	USP-REPLTIPLG

PACKING TOOL KITS - Three Sizes Available

U.S. Seal Mfg. Part No.	No. of Pieces per Kit	Kit Contents
USP-TOOLKITSMALL	11	Contains hooks, picks, tips, wrench
USP-TOOLKITMED	17	Contains hooks, picks, tips, wrench
USP-TOOLKITLG	36	Contains hooks, picks, tips, thread adapters, brush sets, packing cutting knife with leather sheath

PACKING CUTTERS

Hand Held Packing Cutter

Size	U.S. Seal Mfg. Part No.	Type of Cuts	Max. Cross Section
Hand Held	USP-HTPKGCUT	Butt	Up to 3/4"
		Diagonal	Up to 5/8"



Hand Held

Guillotine Packing Cutter

Size	U.S. Seal Mfg. Part No.	Type of Cuts	Max. Cross Section	Max. Cross Section
Small	USP-SMPKGCUT	Butt	Up to 1"	Up to 4"
		Diagonal	Up to 3/4"	
Medium	USP-MEDPKGCUT	Butt	Up to 1"	Up to 10"
		Diagonal	Up to 3/4"	



Guillotine



PS SEAL INDEX

U.S. Seal Mfg. Part No.	Seal Size	Head Type	Mating Ring	Material Code
FA-1	.500	A	—	BMF-F
FA-5	.875	E	—	BCF-F
FA-10	.500	B	—	BMF-F
FA-26	.625	A	—	BMF-F
FA-62	.625	A	—	BCF-F
FA-64	.750	A	—	BCF-F
FA-70SS	1.000	A	—	BCF-F
FA-110V	.500	C	—	VCF-F
FA-112	.500	C	—	BCF-F
FA-135	.625	D	—	BCD-F
FA-152	.750	D	—	BCD-F
FA-160	.875	D	—	BCD-F
FA-170	1.000	D	—	BCF-F
FA-172VSC	1.375	C	—	VLV-F
FA-177	1.375	C	—	BCF-F
FA-186	1.375	D	—	BCD-F
FA-189	1.250	E	—	BCF-F
FA-190	1.250	D	—	BCF-F
FA-200	1.500	D	—	BCF-F
FA-201	.750	A	—	BMF-F
FA-208V	.875	C	—	VCF-F
FA-288	1.750	D	—	BCD-F
FA-305	1.500	E	—	BCF-F
FA-305V	1.500	E	—	VCF-F
FA-350V	2.375	E	—	VCF-F
FA-354	1.375	E	—	BCF-F
FA-366	1.750	E	—	BCF-F
FA-376E	1.375	D	—	QCD-F
FA-400	.500	C	—	BMF-F
FA-401	.500	C	—	BCF-F
FA-475SS	3.000	E	-	BCF-F
FA-513V	1.875	E	—	VCF-F
FA-564	.750	C	—	BCF-F
FA-593	1.875	D	—	BCD-F
FA-608V	1.125	E	—	VCF-F
FA-642	.625	B	—	BMF-F
FA-647	.750	B	—	BMF-F
FA-756	1.250	C	—	BCF-F
FA-866	1.125	E	—	BCF-F
FA-912	1.000	E	—	BCF-F
FA-1055	1.750	C	—	BCF-F
FA-1109	1.250	C	—	BCF-F
FA-1350	.625	C	—	BCF-F
FA-1520	.750	C	—	BCF-F
FA-1600	.875	C	—	BCF-F
FA-1620	1.625	C	—	BCF-F
FA-1660	1.750	C	—	BCF-F
FA-1700	1.000	C	—	BCF-F
FA-1700N	1.000	C	—	NCF-F
FA-1800	1.125	C	—	BCF-F
FA-1810	.500	C	—	BMF-F
FA-1850	1.500	C	—	BCF-F
FA-1875	1.875	C	—	BCF-F
FA-1875V	1.875	C	—	VCF-F
FA-2000	2.000	C	—	BCF-F
FA-2098	2.375	E	—	BCF-F
FA-2104V	1.375	E	—	VCF-F
FA-2108E	1.750	C	—	QCF-F
FA-2109A	1.750	E	—	XCF-F
FA-2120	2.125	C	—	BCF-F
FA-2250	2.250	C	—	BCF-F
FA-2678	1.250	C	—	BCF-F
FA-2751	.750	B	—	QCF-F
FA-2752	1.500	D	—	NLF-F
FA-2754	1.500	D	—	NCF-F
FA-2755	1.500	C	—	QCF-F

U.S. Seal Mfg. Part No.	Seal Size	Head Type	Mating Ring	Material Code
FA-3300	.625	B	—	BCF-F
FA-3502	2.125	E	—	BCF-F
FA-3525	.625	C	—	QCF-F
FA-3730	1.375	C	—	NFF-F
FA-3961	3.375	K	—	VCF-F
FA-4027	3.500	U	—	BCF-F
FA-4031	.625	C	—	VCF-F
FA-4087	1.375	E	—	VCF-F
FA-4163	1.375	E	—	QCF-F
FA-4193	1.875	E	—	VCF-F
FA-4218	.500	B	—	BMF-F
FA-4268	1.375	CB	—	BCF-F
FA-4408	.875	DB	—	XCF-F
FA-4414	5.000	V	—	BCF-F
FA-4463	1.250	C	—	BCF-F
FA-6104	2.000	E	—	NCP-P
FA-6987	1.000	W	—	TCF-F
FA-7750	2.250	C	—	QCF-F
FA-8000	1.750	XBIT	—	Special
FA-8088	3.000	X	—	VCF-F
FA-8201	1.500	XB2	—	VCF-F
FA-9009	.875	W	—	TCF-F
FA-9012	.500	W	—	TCF-F
FA-9316	1.750	WT	—	TCF-F
FA-9327	1.125	W	—	TCF-F
FA-9328	1.375	WT	—	TCF-F
FA-9341	1.375	WT	—	TCF-F
FA-9349	1.000	WT	—	TCF-F
FA-9400	1.750	WT	—	TCF-F
FA-10033	.500	C	—	VCF-F
FA-10034	.625	C	—	VCF-F
FA-10036	.875	C	—	VCF-F
FA-10037	1.000	C	—	VCF-F
FA-10038	1.125	C	—	VCF-F
FA-10040	1.250	C	—	VCF-F
FA-10041	1.375	C	—	VCF-F
FA-10043	1.500	C	—	VCF-F
FA-10045	1.750	C	—	VCF-F
FA-10047	2.000	C	—	VCF-F
FA-10144	3.250	EB	—	BCF-F
FA-10159	1.750	C	—	BRF-F
FA-10165	1.375	C	—	QCF-F
FA-10166	1.375	C	—	BCF-F
FA-10167	1.500	E	—	BCF-F
FA-10168	1.750	C	—	BCF-F
FA-20137	5.000	E	—	VCF-F
PS-100	.625	A	1	BMFJF
PS-100-EPR	.625	A	1	QCFJF
PS-100-SC-SC	.625	A	1	BLFLF
PS-100V	.625	A	3	VCFJF
PS-100V-CMS	.625	A	1	VCFJF
PS-100V-CMS-P66	.625	A	1	VCFJF
PS-100V-SC-SC-CMS	.625	A	1	VLFLF
PS-101	.750	A	1	BMFJF
PS-101V	.750	A	1	VCFJF
PS-102	.625	D	1	BCDKF
PS-106	.500	C	1	BCFKF
PS-106-EPR	.500	C	1	QCFKF
PS-106V	.500	C	1	VCFKF
PS-108	1.250	E	1	NCPKP
PS-112	.750	C	1	BCFKF
PS-112-EPR	.750	C	1	QCFKF
PS-112V	.750	C	3	VCFKF
PS-112V-CMS	.750	C	1	VCFKF
PS-113	.625	B	1	BMFJF
PS-114	.312	A	1	BMDJF

PS SEAL INDEX

U.S. Seal Mfg. Part No.	Seal Size	Head Type	Mating Ring	Material Code
PS-118	.625	C	1	BCFJF
PS-118V	.625	C	3	VCFJF
PS-118V-CMS	.625	C	1	VCFJF
PS-118V-CMS-P66	.625	C	1	VCFJF
PS-127	1.062	D	1	BCDKF
PS-128	.750	C	1	BCFJF
PS-128V	.750	C	3	VCFJF
PS-129	.590	D	1	BCFJF
PS-135	.787	D	1	BCDJF
PS-136	1.181	D	1	BCDJF
PS-136V	1.181	D	3	VCDJF
PS-136V-CMS	1.181	D	1	VCDJF
PS-137	1.250	E	1	BCFKF
PS-137V	1.250	E	3	VCFKF
PS-137V-CMS	1.250	E	1	VCFKF
PS-137V-P66	1.250	E	3	VCFKF
PS-137V-TC-TC	1.250	E	1	VZFZF
PS-142	.500	B	1	BMFJF
PS-142V	.500	B	1	VCFJF
PS-151	.625	B	1	BMFJF
PS-153	.625	A	1	BMFKF
PS-153V	.625	A	3	VCFKF
PS-159	1.000	D	3	NCPGP
PS-162	.500	A	1	BMFJF
PS-163	.500	B	1	BMFJF
PS-163V	.500	B	1	VCFJF
PS-164	.500	B	9	BMFKF
PS-165	.500	B	9	BMFJF
PS-166	.625	A	1	BMFJF
PS-175	.750	K	1	BCFJF
PS-177	1.375	C	1	BCFJF
PS-177-EPR	1.375	C	1	QCJFJ
PS-177-P66	1.375	C	1	BCFJF
PS-177-SC-TC-CMS	1.375	C	1	BLFZF
PS-177V	1.375	C	3	VCFJF
PS-177V-CMS	1.375	C	1	VCFJF
PS-177V-CMS-P66	1.375	C	1	VCFJF
PS-177V-P66	1.375	C	3	VCFJF
PS-177V-SC-SC	1.375	C	1	VLFLF
PS-177V-SC-SEAT	1.375	C	1	VCFLF
PS-178	1.375	R	1	BCDJF
PS-185	1.250	C	1	BCFJF
PS-185-EPR	1.250	C	1	QCJFJ
PS-185-EPR-P66	1.250	C	1	QCJFJ
PS-185-EPR-SC	1.250	C	3	QCFLF
PS-185-EPR-TC	1.250	C	3	QCFZF
PS-185E-SC-CMS	1.250	C	1	QCFLF
PS-185-P66	1.250	C	1	BCFJF
PS-185-SC-SC	1.250	C	1	BLFLF
PS-185-TC-SEAT	1.250	C	1	BCFZF
PS-185V	1.250	C	3	VCFJF
PS-185V-CMS	1.250	C	1	VCFJF
PS-185V-CMS-P66	1.250	C	1	VCFJF
PS-185V-P66	1.250	C	3	VCFJF
PS-185V-SC-SC	1.250	C	1	VLFLF
PS-185V-SC-SEAT	1.250	C	1	VCFLF
PS-185V-SC-TC	1.250	C	1	VLFZF
PS-185V-TC-SC	1.250	C	1	VZFLF
PS-185V-TC-SEAT	1.250	C	1	VCFZF
PS-185V-TC-TC	1.250	C	1	VZFZF
PS-186	1.375	D	1	BCDKF
PS-186-EPR-SC-SEAT	1.375	D	1	QCDLF
PS-186V	1.375	D	3	VCDKF
PS-186V-CMS	1.375	D	1	VCFKF
PS-186V-TC-SEAT	1.375	D	3	VCFZF
PS-188	.875	E	1	BCFJF

U.S. Seal Mfg. Part No.	Seal Size	Head Type	Mating Ring	Material Code
PS-188V	.875	E	3	VCFJF
PS-188V-CMS	.875	E	1	VCFJF
PS-192	1.500	C	3 Special	NCFGF
PS-193	2.000	D	3	NCPGP
PS-200	.625	A	1	BMFJF
PS-200-EPR	.625	A	1	QCJFJ
PS-200-SC-SC	.625	A	1	BLFLF
PS-200V	.625	A	3	VCFJF
PS-200V-CMS	.625	A	1	VCFJF
PS-200V-CMS-P66	.625	A	1	VCFJF
PS-200V-SC-SC	.625	A	1	VLFLF
PS-201	.750	A	1	BMFJF
PS-201V	.750	A	3	VCFJF
PS-201V-CMS	.750	A	1	VCFJF
PS-202	.625	B	11	BMFJF
PS-202V	.625	B	11	VCFJF
PS-204	1.125	E	1	BCFJF
PS-204-EPR	1.125	E	1	QCJFJ
PS-204-P66	1.125	E	1	BCFJF
PS-204V	1.125	E	3	VCFJF
PS-204V-CMS	1.125	E	1	VCFJF
PS-204V-CMS-P66	1.125	E	1	VCFJF
PS-205	1.750	E	1	BCFJF
PS-205-P66	1.750	E	1	BCFJF
PS-205-SC-SC	1.750	E	1	BLFLF
PS-205V	1.750	E	3	VCFJF
PS-205V-CMS	1.750	E	1	VCFJF
PS-205V-CMS-P66	1.750	E	1	VCFJF
PS-205V-P66	1.750	E	3	VCFJF
PS-205V-TC-SEAT	1.750	E	1	VCFZF
PS-205V-TC-TC-CMS	1.750	E	1	VZFZF
PS-210	1.375	C	1	BCFKF
PS-210-EPR	1.375	C	3	QCFLF
PS-210-EPR-P66-SC	1.375	C	3	QCFLF
PS-210-EPR-SC-SEAT	1.375	C	3	QCFLF
PS-210V	1.375	C	3	VCFKF
PS-210V-CMS	1.375	C	1	VCFKF
PS-210V-SC-SEAT	1.375	C	3	VCFLF
PS-210V-SC-TC	1.375	C	3	VLFZF
PS-210V-TC-SC	1.375	C	3	VZFLF
PS-210V-TC-SEAT	1.375	C	3	VCFZF
PS-210V-TC-TC	1.375	C	1	VZFZF
PS-217	1.750	R	1	BCDKF
PS-224	1.500	E	3	NCFKF
PS-226	.625	D	1	BCDKF
PS-227	1.000	D	1	BCFKF
PS-228	1.250	K	3	BCFKF
PS-228V	1.250	K	3	VCFKF
PS-228V-CMS	1.250	K	1	VCFKF
PS-229	.875	E	3	BCFKF
PS-229V	.875	E	3	VCFKF
PS-235	1.000	C	1	BCFJF
PS-235-EPR	1.000	C	1	QCJFJ
PS-235-EPR-P66	1.000	C	1	QCJFJ
PS-235-P66	1.000	C	1	BCFJF
PS-235-SC-SC	1.000	C	1	BLFLF
PS-235V	1.000	C	3	VCFJF
PS-235V-CMS	1.000	C	1	VCFJF
PS-235V-CMS-P66	1.000	C	1	VCFJF
PS-235V-P66	1.000	C	3	VCFJF
PS-235V-SC-SC	1.000	C	1	VLFLF
PS-236	1.000	E	1	BCFKF
PS-236N	1.000	E	1	NCFKF
PS-236V	1.000	E	3	VCFKF
PS-236V-CMS	1.000	E	1	VCFKF
PS-237	1.750	D	1	BCDJF

PS SEAL INDEX

U.S. Seal Mfg. Part No.	Seal Size	Head Type	Mating Ring	Material Code
PS-237-EPR	1.750	D	1	QCDJF
PS-237-P66	1.750	D	1	BCDJF
PS-237-SC-SC	1.750	D	1	BLDLF
PS-237-TC-SEAT	1.750	D	1	BCDZF
PS-237-TC-TC	1.750	D	1	BZDZF
PS-237V	1.750	D	3	VCDJF
PS-237V-CMS	1.750	D	1	VCDJF
PS-237V-P66	1.750	D	3	VCDJF
PS-238	1.625	C	1	BCFJF
PS-238-EPR	1.625	C	1	QCFJF
PS-238-EPR-SC	1.625	C	1	QCFLF
PS-238-P66	1.625	C	1	BCFJF
PS-238-SC-SC	1.625	C	1	BLFLF
PS-238-SC-TC-CMS	1.625	C	1	BLFZF
PS-238V	1.625	C	3	VCFJF
PS-238V-CMS	1.625	C	1	VCFJF
PS-238V-CMS-316SS	1.625	C	1	VCFJF
PS-238V-P66-TC	1.625	C	1	VCFZF
PS-238V-SC-CMS	1.625	C	1	VCFLF
PS-238V-SC-SEAT	1.625	C	3	VCFLF
PS-238V-TC-SC-CMS	1.625	C	1	VZFLF
PS-239	1.625	C	1	BCFKF
PS-239-EPR	1.625	C	3	QCFKF
PS-239-P66	1.625	C	1	BCFKF
PS-239V	1.625	C	3	VCFKF
PS-239V-CMS	1.625	C	1	VCFKF
PS-239V-TC-SEAT	1.625	C	3	VCFZF
PS-245	1.000	C	1	BCFJF
PS-245-EPR	1.000	C	1	QCFJF
PS-245-P66	1.000	C	1	BCFJF
PS-245-TC-SEAT	1.000	C	1	BCFZF
PS-245V	1.000	C	3	VCFJF
PS-245V-CMS	1.000	C	1	VCFJF
PS-246	1.250	C	1	BCFJF
PS-246-EPR-P66	1.250	C	1	QCFJF
PS-246V	1.250	C	3	VCFJF
PS-246V-CMS	1.250	C	1	VCFJF
PS-246V-CMS-P66	1.250	C	1	VCFJF
PS-247	1.500	C	1	BCFKF
PS-248	1.000	C	1	BCFKF
PS-248-EPR	1.000	C	1	QCFKF
PS-248V	1.000	C	3	VCFKF
PS-248V-CMS	1.000	C	1	VCFKF
PS-249	1.250	C	1	BCFKF
PS-249V	1.250	C	3	VCFKF
PS-249V-CMS	1.250	C	1	VCFKF
PS-250	.875	D	3	BCDKF
PS-251	1.000	E	3	BCFKF
PS-252	1.000	D	3	BCFKF
PS-252-EPR	1.000	D	3	QCFKF
PS-252-P66	1.000	D	3	BCFKF
PS-253	1.125	E	3	BCFKF
PS-254	1.125	D	3	BCFKF
PS-255	1.187	E	3	BCDKF
PS-256	1.250	E	3	BCFKF
PS-256V-CMS	1.250	E	1	VCFKF
PS-257	1.375	E	3	BCFKF
PS-257E-SC-SC-CMS	1.375	E	1	QLFLF
PS-257V	1.375	E	3	VCFKF
PS-258	1.500	E	3	BCFKF
PS-258-TC-SC	1.500	E	3	BZFLF
PS-258V-P66	1.500	E	3	VCFKF
PS-259	1.500	E	3	BCFKF
PS-259-EPR-CMS-SC	1.500	E	1	QCFLF
PS-262	1.750	E	3	BCFKF
PS-262-EPR-P66	1.750	E	3	QCFKF

U.S. Seal Mfg. Part No.	Seal Size	Head Type	Mating Ring	Material Code
PS-263	.625	D	1	BCDKF
PS-263V	.625	D	1	VCFKF
PS-264	1.250	E	3	BCFKF
PS-264-TC-P66	1.250	E	3	BCFZF
PS-264V-SC-SC	1.250	E	3	VLFLF
PS-265	.750	D	3	BCDKF
PS-267	2.000	C	1	BCFJF
PS-267-EPR	2.000	C	1	QCFJF
PS-267-P66	2.000	C	1	BCFJF
PS-267-SC-SC-CMS	2.000	C	1	BLFLF
PS-267-SC-TC-LC	2.000	C	3	BLFZF
PS-267-SC-TC-SEAT	2.000	C	3	BLFZF
PS-267-TC-SEAT	2.000	C	3	BCFZF
PS-267V	2.000	C	3	VCFJF
PS-267V-CMS	2.000	C	1	VCFJF
PS-267V-CMS-P66	2.000	C	1	VCFJF
PS-267V-SC-SC	2.000	C	3	VLFLF
PS-267V-SC-TC-CMS	2.000	C	1	VLFZF
PS-267V-TC-SEAT	2.000	C	3	VCFZF
PS-268	2.375	C	3	BCFJF
PS-268-CMS	2.375	C	1	BCFJF
PS-268-CMS-P66	2.375	C	1	BCFJF
PS-268-P66	2.375	C	3	BCFJF
PS-268V	2.375	C	3	VCFJF
PS-269	2.500	C	3	BCFJF
PS-269V	2.500	C	3	VCFJF
PS-270	2.875	C	3	BCFJF
PS-272	3.750	C	3	BCFJF
PS-275	.750	C	1	BCFJF
PS-275-EPR	.750	C	1	QCFJF
PS-275V	.750	C	3	VCFJF
PS-276	1.000	T	1	BCFJF
PS-277	1.000	T	1	BCFKF
PS-278	2.375	E	3	BCFJF
PS-278-P66	2.375	E	3	BCFJF
PS-278V	2.375	E	3	VCFJF
PS-279	2.500	E	3	BCFJF
PS-279-CMS-P66	2.500	E	1	BCFJF
PS-279V	2.500	E	3	VCFJF
PS-279V-SC-TC	2.500	E	3	VLFZF
PS-281	1.625	R	3	BCDKF
PS-281-CMS	1.625	R	1	BCDKF
PS-282	1.125	U	3	BCFKF
PS-282V	1.125	U	3	VCFKF
PS-283	1.500	D	1	BCFJF
PS-284	3.000	R	3	BCDKF
PS-288	1.750	D	1	BCDKF
PS-288-EPR	1.750	D	1	QCDKF
PS-288-P66	1.750	D	1	BCDKF
PS-288V	1.750	D	3	VCDKF
PS-288V-CMS	1.750	D	1	VCDKF
PS-290	.625	C	1	BCFJF
PS-290-EPR	.625	C	1	QCFJF
PS-290-EPR-SC-SC	.625	C	1	QLFLF
PS-290-P66	.625	C	1	BCFJF
PS-290V	.625	C	1	VCFJF
PS-290V-P66	.625	C	1	VCFJF
PS-293	.625	A	Special	BMFKF
PS-293-EPR	.625	A	Special	QCFKF
PS-293V	.625	A	Special	VCFKF
PS-294	.875	C	1	BCFKF
PS-297	1.187	D	1	NCPJP
PS-300	.625	A	1	BMFJF
PS-300V	.625	A	3	VCFJF
PS-301	.750	A	1	BMFJF
PS-303	.875	D	1	BCDKF

PS SEAL INDEX

U.S. Seal Mfg. Part No.	Seal Size	Head Type	Mating Ring	Material Code
PS-303-P66	.875	D	1	BCDKF
PS-303V	.875	D	3	VCDKF
PS-303V-CMS	.875	D	1	VCDKF
PS-303V-TC-SEAT	.875	D	3	VCFZF
PS-305	1.500	E	1	BCFJF
PS-305-EPR	1.500	E	1	QCFJF
PS-305-EPR-P66	1.500	E	1	QCFJF
PS-305-P66	1.500	E	1	BCFJF
PS-305-SC-SC	1.500	E	1	BLFLF
PS-305V	1.500	E	3	VCFJF
PS-305V-CMS	1.500	E	1	VCFJF
PS-305V-CMS-P66	1.500	E	1	VCFJF
PS-305V-P66	1.500	E	3	VCFJF
PS-305V-SC-SC-CMS	1.500	E	1	VLFLF
PS-305V-TC-SEAT	1.500	E	1	VCFZF
PS-305V-TC-TC	1.500	E	1	VZFZF
PS-306	1.187	E	1	BCDJF
PS-306V	1.187	E	3	VCFJF
PS-308	1.250	T	3	NCPKP
PS-309	.875	C	1	BCFJF
PS-309-EPR	.875	C	1	QCFJF
PS-309-P66	.875	C	1	BCFJF
PS-309-SC-SC-CMS	.875	C	1	BLFLF
PS-309-TC-TC-CMS	.875	C	1	BZFZF
PS-309V	.875	C	3	VCFJF
PS-309V-CMS	.875	C	1	VCFJF
PS-309V-P66	.875	C	3	VCFJF
PS-309V-P66-CMS	.875	C	1	VCFJF
PS-309V-SC-SC	.875	C	3	VLFLF
PS-309V-TC-CMS	.875	C	1	VCFZF
PS-310	1.187	E	1	BCDJF
PS-312	1.875	C	3	BCFKF
PS-312V	1.875	C	3	VCFKF
PS-314	1.500	E	3	BCFJF
PS-316	1.500	E	3	BCFKF
PS-317	1.750	E	1	BCFJF
PS-318	1.875	K	1	BCFJF
PS-318-TC-TC	1.875	K	1	BZFZF
PS-319	2.000	E	1	BCFJF
PS-319-P66	2.000	E	1	BCFJF
PS-319V	2.000	E	1	V/BCFJF
PS-320	1.500	C	1	BCFJF
PS-321	2.750	E	3	V/BCFKF
PS-321-P66-TCO	2.750	E	3	BCFZF
PS-321V	2.750	E	3	VCFKF
PS-321V-TC-SEAT	2.750	E	3	VCFZF
PS-322	2.750	K	3	BCFKF
PS-322-CMS	2.750	K	1	BCFJF
PS-323	2.250	E	1	BCDJF
PS-323-P66	2.250	E	1	BCDJF
PS-323-SC-TC-CMS	2.250	E	1	BLFZF
PS-323V-CMS	2.250	E	1	VCDJF
PS-324	3.000	E	3	BCDJF
PS-324-P66-CMS	3.000	E	1	BCDJF
PS-324-SC-TC-CMS	3.000	E	1	BLFZF
PS-324SS	3.000	E	3	BCFJF
PS-324SSV	3.000	E	3	VCFJF
PS-324-TC-TC	3.000	E	3	BZFZF
PS-325SS	3.250	U	3	BCFKF
PS-326	1.250	D	3	BCFGF
PS-326V	1.250	D	3	VCFGF
PS-327	2.125	E	3	BCFJF
PS-327V	2.125	E	3	VCFJF
PS-328	2.625	E	3	BCFJF
PS-328-P66	2.625	E	3	BCFJF
PS-329	2.875	E	3	BCFJF

U.S. Seal Mfg. Part No.	Seal Size	Head Type	Mating Ring	Material Code
PS-329-P66	2.875	E	3	BCFJF
PS-330	3.250	E	3	BCDJF
PS-332	2.000	C	3	BCFKF
PS-333	2.000	D	3	NCPGP
PS-335V	2.500	D	3	VCPGP
PS-338	2.125	C	3	BCFJF
PS-338-EPR	2.125	C	3	QCFJF
PS-338V	2.125	C	3	VCFJF
PS-338V-SC-SC	2.125	C	3	VLFLF
PS-340	1.875	C	1	BCFJF
PS-340-EPR-CMS	1.875	C	1	QCFJF
PS-340-EPR-TC-CMS	1.875	C	1	QCFZF
PS-340-P66	1.875	C	1	BCFJF
PS-340-TC-SC	1.875	C	1	BZFLF
PS-340-TC-TC	1.875	C	1	BZFZF
PS-340V	1.875	C	3	VCFJF
PS-340V-CMS	1.875	C	1	VCFJF
PS-340V-CMS-P66	1.875	C	1	VCFJF
PS-340V-TC-SC	1.875	C	3	VZFLF
PS-340V-TC-SC-CMS	1.875	C	1	VZFLF
PS-342	2.000	E	3	NCPKP
PS-343	1.187	E	1	BCDKF
PS-346	1.625	E	1	BCFJF
PS-346-P66	1.625	E	1	BCFJF
PS-346V	1.625	E	1	VCFJF
PS-347	1.500	C	1	BCFJF
PS-347-P66	1.500	C	1	BCFJF
PS-347V-CMS	1.500	C	1	VCFJF
PS-349	2.500	E	3	BCFKF
PS-349-TC-SEAT	2.500	E	3	BCFZF
PS-349V	2.500	E	3	VCFKF
PS-349V-SC-SEAT	2.500	E	3	VCFLF
PS-349V-TC-SC	2.500	E	3	VZFLF
PS-350	2.375	E	3	BCFKF
PS-350-CMS	2.375	E	1	BCFKF
PS-350V-P66-TC	2.375	E	3	VCFZF
PS-351	2.250	E	1	BCDKF
PS-351V	2.250	E	3	VCDKF
PS-353	2.125	E	1	BCFKF
PS-353V	2.125	E	3	VCFKF
PS-354	1.375	E	1	BCFJF
PS-354-EPR-P66	1.375	E	1	QCFJF
PS-354-EPR-SC-P66	1.375	E	1	QCFLF
PS-354-P66	1.375	E	1	BCFJF
PS-354V	1.375	E	3	VCFJF
PS-354V-CMS	1.375	E	1	VCFJF
PS-354V-CMS-P66	1.375	E	1	VCFJF
PS-354V-P66	1.375	E	3	VCFJF
PS-355	1.125	C	1	BCFKF
PS-355-P66	1.125	C	1	BCFKF
PS-355-SC-SC	1.125	C	1	BLFLF
PS-355V	1.125	C	3	VCFKF
PS-355V-CMS	1.125	C	1	VCFKF
PS-355V-SC-SEAT	1.125	C	3	VCFLF
PS-356	1.125	C	1	BCFJF
PS-356-EPR	1.125	C	1	QCFJF
PS-356-EPR-P66	1.125	C	1	QCFJF
PS-356-EPR-SC	1.125	C	1	QCFLF
PS-356-EPR-SC-SC	1.125	C	1	QLFLF
PS-356-P66	1.125	C	1	BCFJF
PS-356-P66-TC-SEAT	1.125	C	1	BCFZF
PS-356-SC-TC	1.125	C	1	BLFZF
PS-356-TC-TC	1.125	C	1	BZFZF
PS-356V	1.125	C	3	VCFJF
PS-356V-CMS	1.125	C	1	VCFJF
PS-356V-CMS-P66	1.125	C	1	VCFJF

PS SEAL INDEX

U.S. Seal Mfg. Part No.	Seal Size	Head Type	Mating Ring	Material Code
PS-356V-SC-SC-CMS	1.125	C	1	VFLFL
PS-356V-TC-TC-CMS	1.125	C	1	VZFFZ
PS-357	1.000	C	1	BCFKF
PS-357V	1.000	C	3	VCFKF
PS-357V-CMS	1.000	C	1	VCFKF
PS-358	.750	C	1	BCFJF
PS-358-EPR	.750	C	1	QCFJF
PS-358-EPR-SC-SC	.750	C	1	QLFLF
PS-358-P66	.750	C	1	BCFJF
PS-358V	.750	C	3	VCFJF
PS-358V-CMS	.750	C	1	VCFJF
PS-358V-CMS-P66	.750	C	1	VCFJF
PS-358V-P66	.750	C	3	VCFJF
PS-358V-SC-SC	.750	C	1	VFLFL
PS-358V-TC-CMS	.750	C	1	VCFZF
PS-358V-TC-TC	.750	C	1	VZFFZ
PS-359	.625	C	1	BCFJF
PS-359-EPR-CMS	.625	C	1	QCFJF
PS-359-EPR-P66	.625	C	1	QCFJF
PS-359-EPR-P66-TC	.625	C	1	QCFZF
PS-359-P66	.625	C	1	BCFJF
PS-359V	.625	C	3	VCFJF
PS-359V-CMS	.625	C	1	VCFJF
PS-359V-CMS-P66	.625	C	1	VCFJF
PS-359V-P66	.625	C	3	VCFJF
PS-359V-SC-CMS	.625	C	1	VCFLF
PS-360	1.000	A	1	BCFJF
PS-360V	1.000	A	3	VCFJF
PS-360V-CMS	1.000	A	1	VCFJF
PS-361	1.250	E	1	BCFJF
PS-361-EPR	1.250	E	1	QCFJF
PS-361-EPR-P66	1.250	E	1	QCFJF
PS-361-P66	1.250	E	1	BCFJF
PS-361-SC-SC	1.250	E	1	BLFLF
PS-361-SC-TC	1.250	E	1	BLFZF
PS-361V	1.250	E	3	VCFJF
PS-361V-CMS	1.250	E	1	VCFJF
PS-361V-CMS-P66	1.250	E	1	VCFJF
PS-361V-SC-SEAT	1.250	E	1	VCFLF
PS-361V-SC-TC-CMS	1.250	E	1	VLFZF
PS-366	1.750	E	1	BCFKF
PS-366-TC-CMS	1.750	E	1	BCFZF
PS-366-TC-TC	1.750	E	1	BZFFZ
PS-366V	1.750	E	3	VCFKF
PS-366V-CMS	1.750	E	1	VCFKF
PS-366V-CMS-P66	1.750	E	1	VCFKF
PS-366V-SC-CMS	1.750	E	1	VCFLF
PS-370	1.000	A	1	BCFKF
PS-371	1.500	D	1	BCFKF
PS-371-EPR	1.500	D	1	QCFKF
PS-371V	1.500	D	3	VCFKF
PS-371V-CMS	1.500	D	1	VCFKF
PS-371V-SC-SC	1.500	D	3	VFLFL
PS-373	.750	C	1	BCFKF
PS-373V	.750	C	1	VCFKF
PS-374	1.500	E	1	BCFKF
PS-374-P66	1.500	E	1	BCFKF
PS-374V	1.500	E	3	VCFKF
PS-374V-CMS	1.500	E	1	VCFKF
PS-378	1.500	C	1	BCFKF
PS-378V-CMS	1.500	C	1	VCFKF
PS-380	1.000	D	1	BCFJF
PS-380V	1.000	D	3	VCFJF
PS-380V-CMS	1.000	D	1	VCFJF
PS-381	1.250	D	1	BCFJF
PS-381-EPR	1.250	D	1	QCFJF

U.S. Seal Mfg. Part No.	Seal Size	Head Type	Mating Ring	Material Code
PS-381-P66	1.250	D	1	BCFJF
PS-381-SC-SC	1.250	D	1	BLFLF
PS-381V	1.250	D	3	VCFJF
PS-381V-CMS	1.250	D	1	VCFJF
PS-382	1.500	D	1	BCFJF
PS-382-P66	1.500	D	1	BCFJF
PS-383	1.250	D	1	BCFKF
PS-383V	1.250	D	3	VCFKF
PS-383V-CMS	1.250	D	1	VCFKF
PS-384	1.125	E	1	BCFKF
PS-384V-CMS	1.125	E	1	VCFKF
PS-385A	2.000	U	3	BCFKF
PS-385AV	2.000	U	3	VCFKF
PS-387	1.750	C	3	BCFJF
PS-387-CMS	1.750	C	1	BCFJF
PS-392	.500	C	1	B/QMFJF
PS-392-EPR-P66	.500	C	1	QCFJF
PS-392-P66	.500	C	1	B/QCFJF
PS-392V	.500	C	1	V/QCFJF
PS-392V-P66	.500	C	1	V/QCFJF
PS-393	.500	C	1	BMFKF
PS-394	1.250	U	3	BCF/DKF
PS-394V	1.250	U	3	VCF/DKF
PS-395	1.500	E	3	BCFJF
PS-395-EPR	1.500	E	3	QCFJF
PS-395V-SC-SEAT	1.500	E	3	VCFLF
PS-401A	.500	C	1	BCFJF
PS-404	1.375	D	25	BCDJF
PS-405	1.000	A	25	B/VCFJF
PS-411	.625	B	11	BMFJF
PS-411V	.625	B	11	VCFJF
PS-413	1.000	C	25	BCFJF
PS-413V	1.000	C	25	VCFJF
PS-416A	1.250	D	25	BCFJF
PS-428	.875	R	1	BCDJF
PS-429	1.000	R	1	BCFJF
PS-429V-CMS-P66	1.000	R	1	VCFJF
PS-430	1.000	R	1	BCFKF
PS-431	1.500	R	1	BCFJF
PS-432	1.500	R	1	BCFKF
PS-436	1.750	C	3	BCFKF
PS-436-EPR	1.750	C	3	QCFKF
PS-436-P66	1.750	C	3	BCFKF
PS-436-SC-SC	1.750	C	3	BLFLF
PS-436-SC-SEAT	1.750	C	3	BCFLF
PS-436-TC-TC	1.750	C	3	BZFFZ
PS-436-TC-VS-SC	1.750	C	3	B/VZFLF
PS-436V	1.750	C	3	VCFKF
PS-436V-P66	1.750	C	3	VCFKF
PS-436V-TC-TC	1.750	C	3	VZFFZ
PS-437	.750	D	1	BCDJF
PS-437-P66	.750	D	1	BCDJF
PS-437V	.750	D	1	VCDJF
PS-437V-P66	.750	D	1	VCDJF
PS-437V-SC-SC	.750	D	1	VLDLF
PS-440	.750	B	11	BMFJF
PS-441	.750	B	9	BMFKF
PS-445	2.000	D	1	BCDJF
PS-445V	2.000	D	3	VCDJF
PS-445V-CMS	2.000	D	1	VCDJF
PS-446	1.750	C	1	BCFJF
PS-446-316SS	1.750	C	1	BCFJF
PS-446-EPR	1.750	C	1	QCFJF
PS-446-EPR-P66	1.750	C	1	QCFJF
PS-446-EPR-SC	1.750	C	1	QCFJF
PS-446-P66	1.750	C	1	BCFJF

PS SEAL INDEX

U.S. Seal Mfg. Part No.	Seal Size	Head Type	Mating Ring	Material Code
PS-446-SC-SC	1.750	C	1	BLFLF
PS-446-SC-SEAT	1.750	C	1	BCFLF
PS-446-SC-TC-CMS	1.750	C	1	BLFZF
PS-446-TC-TC	1.750	C	1	BZFZF
PS-446V	1.750	C	3	VCFJF
PS-446V-CMS	1.750	C	1	VCFJF
PS-446V-CMS-P66	1.750	C	1	VCFJF
PS-446V-P66	1.750	C	3	VCFJF
PS-446V-SC-SEAT	1.750	C	3	BCFLF
PS-446V-SC-TC	1.750	C	3	VLFZF
PS-446V-TC-SEAT	1.750	C	1	VCFZF
PS-446V-TC-TC	1.750	C	1	VZFZF
PS-447	.625	B	8	BCFJF
PS-447V	.625	B	8	VCFJF
PS-447V-P66	.625	B	8	VCFJF
PS-448	1.750	C	1	BCFKF
PS-448-EPR	1.750	C	1	QCCKF
PS-448-P66	1.750	C	1	BCFKF
PS-448V-CMS	1.750	C	1	VCFKF
PS-448V-CMS-P66	1.750	C	1	VCFKF
PS-448V-SC-TC	1.750	C	1	VLFZF
PS-448V-TC-P66	1.750	C	1	VCFZF
PS-449	1.750	K	1	BCFJF
PS-452	.625	B	9	BMFJF
PS-452V	.625	B	9	VCFJF
PS-453	.625	B	8	BCFKF
PS-453V	.625	B	8	BCFKF
PS-456	2.000	U	3	BCFKF
PS-456-CMS	2.000	U	1	BCFKF
PS-456-EPR	2.000	U	3	QCCKF
PS-456V	2.000	U	3	VCFKF
PS-456V-SC-SC	2.000	U	3	VFLFL
PS-456V-TC-SEAT	2.000	U	3	VCFZF
PS-458	1.625	U	3	BCDKF
PS-458-CMS	1.625	U	1	BCDKF
PS-460	1.000	D	1	BCFKF
PS-460-P66	1.000	D	1	BCFKF
PS-460V	1.000	D	3	VCFKF
PS-460V-CMS	1.000	D	1	VCFKF
PS-461	1.625	D	1	BCDKF
PS-461-TC-SEAT	1.625	D	1	BCDZF
PS-461V	1.625	D	3	VCDKF
PS-461V-CMS	1.625	D	1	VCDKF
PS-462	2.000	D	1	BCDKF
PS-462V	2.000	D	3	VCDKF
PS-462V-TC-SC	2.000	E	3	VZFLF
PS-463	2.500	D	3	BCDKF
PS-463-TC-SC	2.500	D	3	BZFLF
PS-463V	2.500	D	3	VCDKF
PS-463VSS-SC-SEAT	2.500	D	3	VCFLF
PS-464	2.750	D	3	BCFKF
PS-464-TC-SEAT	2.750	D	3	BCFZF
PS-465	3.000	D	3	BCDKF
PS-465V	3.000	D	3	VCDKF
PS-466	1.250	C	1	BCFJF
PS-466-P66	1.250	C	1	BCFJF
PS-466-SC-SC	1.250	C	1	BLFLF
PS-466V	1.250	C	1	VCFJF
PS-466V-P66	1.250	C	1	VCFJF
PS-466V-SC-SC-CMS	1.250	C	1	VFLFL
PS-467	1.375	C	1	BCFKF
PS-468	2.500	D	3	BCDJF
PS-469	2.500	D	3	BCDKF
PS-477	2.000	E	3	BCFKF
PS-477-EPR	2.000	E	3	QCCKF
PS-477-EPR-SC	2.000	E	3	QCFLF

U.S. Seal Mfg. Part No.	Seal Size	Head Type	Mating Ring	Material Code
PS-477-P66	2.000	E	3	BCFKF
PS-477-TC-SC	2.000	E	3	BZFLF
PS-477-TC-SEAT	2.000	E	3	BCFZF
PS-477-TC-TC	2.000	E	3	BZFZF
PS-477V	2.000	E	3	VCFKF
PS-477V-TC-SEAT	2.000	E	3	VCFZF
PS-477V-TC-TC	2.000	E	3	VZFZF
PS-478	2.000	E	1	BCFKF
PS-479	2.000	E	1	BCFJF
PS-479-P66	2.000	E	1	BCFJF
PS-479-SC-TC	2.000	E	1	BLFZF
PS-479V	2.000	E	3	VCFJF
PS-479V-CMS-P66	2.000	E	1	VCFJF
PS-479V-TC-CMS	2.000	E	1	VCFZF
PS-479V-TC-TC	2.000	E	1	VZFZF
PS-483	2.750	C	3	BCFKF
PS-483-SC-TC-LC	2.750	C	3	BLFZF
PS-483-TC-SEAT	2.750	C	3	BCFZF
PS-483V-TC-SEAT	2.750	C	3	VCFZF
PS-487	.625	E	1	BCDKF
PS-491	1.375	D	1	BCDJF
PS-491-EPR	1.375	D	1	QCCKF
PS-491-P66	1.375	D	1	BCDJF
PS-491V	1.375	D	3	VCDJF
PS-491V-CMS	1.375	D	1	VCDJF
PS-491V-CMS-P66	1.375	D	1	VCDJF
PS-492	2.375	C	3	BCFKF
PS-492-CMS	2.375	C	1	BCFKF
PS-492-CMS-P66	2.375	C	1	BCFKF
PS-492-P66	2.375	C	3	BCFKF
PS-492V-CMS	2.375	C	1	VCFKF
PS-492V-P66	2.375	C	3	VCFKF
PS-492V-TC-SEAT	2.375	C	3	VCFZF
PS-493	.625	C	1	BCFKF
PS-493V	.625	C	1	VCFKF
PS-495	1.375	K	1	BCFJF
PS-495-EPR	1.375	K	1	QCCKF
PS-498	1.062	E	1	BCFKF
PS-499	1.000	C	3	BCFKF
PS-499-EPR	1.000	C	3	QCCKF
PS-499-EPR	1.000	C	3	QCCKF
PS-501	.625	A	1	BMFJF
PS-501V	.625	A	3	VCFJF
PS-501V-CMS	.625	A	1	VCFJF
PS-506	.500	A	1	BMFKF
PS-507	.625	A	1	BMFKF
PS-507V	.625	A	3	VCFKF
PS-507V-CMS	.625	A	1	VCFKF
PS-508	.625	D	1	BCDJF
PS-508-EPR	.625	D	1	QCCKF
PS-508V	.625	D	3	VCDJF
PS-508V-CMS	.625	D	1	VCDJF
PS-508V-P66-CMS	.625	D	1	VCDJF
PS-510	1.250	D	1	BCFJF
PS-513	1.875	E	1	BCDKF
PS-514	1.625	D	1	BCDJF
PS-514-EPR	1.625	D	1	QCCKF
PS-514-EPR-P66	1.625	D	1	QCCKF
PS-514-EPR-TC	1.625	D	1	QCCKF
PS-514-P66	1.625	D	1	BCDJF
PS-514-SC-SC	1.625	D	1	BLDLF
PS-514V	1.625	D	3	VCDJF
PS-514V-CMS	1.625	D	1	VCDJF
PS-514V-P66	1.625	D	3	VCDJF
PS-514V-P66-CMS	1.625	D	1	VCDJF
PS-514V-P66-SC-CMS	1.625	D	1	VCDLF

PS SEAL INDEX

U.S. Seal Mfg. Part No.	Seal Size	Head Type	Mating Ring	Material Code
PS-514V-SC-SC	1.625	D	3	VLDLF
PS-514V-SC-SC-CMS	1.625	D	1	VLDLF
PS-515	1.500	E	3	BCFJF
PS-515V	1.500	E	3	VCFJF
PS-516	.625	A	1	BCFJF
PS-517	1.250	D	3	BCFKF
PS-517-TC-SEAT	1.250	D	3	BCFZF
PS-518	.625	A	1	BCFKF
PS-518-SC-SC	.625	A	1	BLFLF
PS-519	1.750	U	3	BCFJF
PS-519-P66	1.750	U	3	BCFJF
PS-521	1.125	D	1	BCFKF
PS-522	.625	B	1	BCFKF
PS-523	1.875	E	1	BCDJF
PS-524	.625	A	1	BCFKF
PS-524-EPR	.625	A	1	QCCKF
PS-525	1.250	C	3	BCFKF
PS-528	.625	A	1	BMFJF
PS-528V	.625	A	1	VCFJF
PS-529	1.125	C	3	BCFKF
PS-529-EPR	1.125	C	3	QCCKF
PS-529V-SC-P66	1.125	C	3	VCFLF
PS-530	2.000	E	3	BCFJF
PS-531	.625	D	1	BCDJF
PS-532	2.000	C	3	BCFJF
PS-534	1.500	D	3	BCFKF
PS-535	1.750	E	3	BCFJF
PS-535-EPR	1.750	E	3	QCCKF
PS-535-P66-TC	1.750	E	3	BCFZF
PS-536	.625	C	3	BCFJF
PS-537	2.125	E	1	BCFJF
PS-537-P66	2.125	E	1	BCFJF
PS-539	1.000	C	1	BCFJF
PS-539V-CMS	1.000	C	1	VCFJF
PS-541	1.500	K	1	BCFJF
PS-541V	1.500	K	3	VCFJF
PS-542	2.625	E	3	BCFKF
PS-543	2.125	C	1	BCFKF
PS-543V	2.125	C	3	VCCKF
PS-544	1.625	C	3	BCFKF
PS-544V-SC-SC	1.625	C	3	VLFLF
PS-546	1.250	E	3	BCFV/JF
PS-547	1.375	C	3	BCFKF
PS-547-P66	1.375	C	3	BCFKF
PS-547-SC-SC	1.375	C	3	BLFLF
PS-547-TC-TC	1.375	C	3	BZVZF
PS-548	1.000	C	3	BCFJF
PS-550	1.750	C	3	BCFJF
PS-552	.625	C	3	B/VCFJF
PS-552-EPR	.625	C	3	QCCKF
PS-552-EPR-P66	.625	C	3	QCCKF
PS-552-SC-SC	.625	C	1	BLFLF
PS-553	1.500	C	3	BCFKF
PS-553-EPR	1.500	C	3	QCCKF
PS-555	1.750	U	1	BCF/DKF
PS-555SS	1.750	U	1	BCFKF
PS-556	2.125	U	1	BCFKF
PS-557	1.000	E	3	B/VCFJF
PS-560SS	.937	U	2	BCFKF
PS-560V	.937	U	3	VCFKF
PS-561SS	1.375	U	1	BCFKF
PS-561V	1.375	U	3	VCFKF
PS-582	2.000	C	3	BCFKF
PS-586-SC-SC	1.875	E	3	BLFLF
PS-586-SC-SEAT	1.875	E	3	BCFLF
PS-586V-SC-TC	1.875	E	3	VLFZF

U.S. Seal Mfg. Part No.	Seal Size	Head Type	Mating Ring	Material Code
PS-588	1.125	C	3	BCFKF
PS-593	1.875	D	3	BCDKF
PS-594	2.375	D	3	BCFKF
PS-594-P66	2.375	D	3	BCFKF
PS-595	1.625	E	3	BCDJF
PS-598	1.250	C	3	BCFKF
PS-598-EPR	1.250	C	3	QCCKF
PS-598-SC-SC	1.250	C	3	BLFLF
PS-598-TC-SEAT	1.250	C	3	BCFZF
PS-600	.625	B	1	BMFJF
PS-600V	.625	B	3	VCFJF
PS-600V-CMS	.625	B	1	VCFJF
PS-600V-CMS-P66	.625	B	1	VCFJF
PS-601	.750	B	1	BMFJF
PS-601V	.750	B	3	VCFJF
PS-601V-CMS	.750	B	1	VCFJF
PS-602	.875	D	1	BCDJF
PS-603	.875	D	1	BCDKF
PS-604	1.125	D	1	BCFJF
PS-604-EPR	1.125	D	1	QCCKF
PS-604V-CMS	1.125	D	1	VCFJF
PS-605	1.125	D	1	BCFKF
PS-605V	1.125	D	3	VCCKF
PS-605V-CMS	1.125	D	1	VCCKF
PS-606	.750	B	1	BMFKF
PS-607	1.125	E	1	BCFJF
PS-608	1.125	E	1	BCFKF
PS-609	1.625	E	1	BCDJF
PS-610	1.625	E	1	BCFKF
PS-610V	1.625	E	1	VCCKF
PS-611	2.125	E	3	BCFJF
PS-611-P66	2.125	E	3	BCFJF
PS-614	.787	D	1	BCDKF
PS-614V	.787	D	3	VCDKF
PS-614V	.787	G	3	VCDKF
PS-616	.625	B	1	BMFKF
PS-617	.875	C	3	BCFKF
PS-618	1.250	C	3	BCFJF
PS-618-EPR-P66	1.250	C	3	QCCKF
PS-618-TC-TC	1.250	C	3	BZVZF
PS-618V-TC-SEAT	1.250	C	3	VCFZF
PS-619	1.125	E	3	BCFJF
PS-619V	1.125	E	3	VCFJF
PS-620	1.500	E	3	BCFJF
PS-620V	1.500	E	3	VCFJF
PS-626	.625	C	1	VCFJF
PS-627	1.125	C	1	BCFJF
PS-628	.625	A	3	BMFKF
PS-629	1.500	E	3	BCFKF
PS-631	.500	C	1	BCFJF
PS-632	.500	C	1	BCFKF
PS-633	.625	C	1	BCFKF
PS-633-EPR-CMS	.625	C	1	QCCKF
PS-633-TC-TC	.625	C	1	BZVZF
PS-633V	.625	C	3	VCCKF
PS-633V-CMS	.625	C	1	VCCKF
PS-633V-P66	.625	C	3	VCCKF
PS-633V-TC-SC	.625	C	1	VZFLF
PS-633V-TC-SEAT	.625	C	3	VCFZF
PS-637	.625	A	3	BMFJF
PS-658	2.000	R	1	BCDKF
PS-659	1.500	C	1	BCFKF
PS-659-TC	1.500	C	1	BCFZF
PS-659V	1.500	C	3	VCCKF
PS-659V-CMS	1.500	C	1	VCCKF
PS-659V-CMS-P66	1.500	C	1	VCCKF

PS SEAL INDEX

U.S. Seal Mfg. Part No.	Seal Size	Head Type	Mating Ring	Material Code
PS-659V-P66	1.500	C	3	VCFKF
PS-659V-TC-VS-TC	1.500	C	1	VZFFZ
PS-663	.500	Q	1	BMFJF
PS-664	1.562	E	3	BCFJF
PS-671	.375	B	1	BMFJF
PS-671V-CMS	.375	B	1	VCFJF
PS-674	1.750	T	1	BCFJF
PS-675	1.750	T	1	BCFKF
PS-677	1.375	E	1	BCFKF
PS-677-TC-TC-CMS	1.375	E	1	BZFFZ
PS-677V	1.375	E	3	VCFKF
PS-680	.625	A	1	BCFJF
PS-681	1.250	U	1	BCD/FJF
PS-682	1.500	C	1	BCFJF
PS-683	.750	C	1	BCFJF
PS-685	.875	R	1	BCDKF
PS-687	.875	C	1	BCFKF
PS-687V	.875	C	3	VCFKF
PS-687V-CMS	.875	C	1	VCFKF
PS-700	.625	B	1	BMFJF
PS-701	.625	A	1	BMFKF
PS-701-EPR	.625	A	1	QCCKF
PS-701V	.625	A	1	VCFKF
PS-702	.625	A	1	BMFJF
PS-702-EPR	.625	A	1	QCCKF
PS-702V	.625	A	1	VCFJF
PS-702V-CMS-P66	.625	A	1	VCFJF
PS-703	.875	D	1	BCDJF
PS-703-P66	.875	D	1	BCDJF
PS-703V	.875	D	3	VCDJF
PS-703V-CMS	.875	D	1	VCDJF
PS-703VSS-SC-SC-CM	.875	D	1	VFLFL
PS-705	1.437	E	3	BCFJF
PS-707	2.062	E	3	BCDKF
PS-710	1.062	E	1	BCFJF
PS-711	.625	A	3	BMFJF
PS-712	.625	B	3	BMFKF
PS-715	.625	B	3	BMFJF
PS-717	.625	B	3	BMFJF
PS-719	1.771	E	1	BCFKF
PS-722	1.771	E	1	BCFJF
PS-723	1.187	T	1	BCDJF
PS-723V-CMS	1.187	T	1	VCDJF
PS-724	1.187	T	1	BCDKF
PS-725	1.375	T	1	BCFJF
PS-725V	1.375	T	1	VCFJF
PS-726	1.375	T	1	BCFKF
PS-727	1.771	T	1	BCFJF
PS-728	1.771	T	1	BCFKF
PS-732	.625	C	3	BCFKF
PS-732-EPR	.625	C	3	QCCKF
PS-734	.625	D	3	BCDKF
PS-735	.625	D	3	BCDJF
PS-735-EPR-P66-SCO	.625	D	3	QCCLF
PS-737	.625	D	3	BCDJF
PS-743	1.875	T	1	BCFKF
PS-744	1.625	E	1	BCDKF
PS-744V	1.625	E	3	VCDKF
PS-745	1.625	E	1	BCDJF
PS-745-P66	1.625	E	1	BCDJF
PS-745V	1.625	E	3	VCFJF
PS-745V-CMS	1.625	E	1	VCDJF
PS-749	.500	Q	1	BMFJF
PS-750	.750	D	1	BCDJF
PS-750-EPR	.750	D	1	QCCKF
PS-750V	.750	D	3	VCDJF

U.S. Seal Mfg. Part No.	Seal Size	Head Type	Mating Ring	Material Code
PS-750V-CMS	.750	D	1	VCDJF
PS-750V-CMS-P66	.750	D	1	VCDJF
PS-752	.750	D	1	BCDKF
PS-752V	.750	D	3	VCDKF
PS-752V-CMS	.750	D	1	VCDKF
PS-754	1.000	E	1	BCFJF
PS-754-P66	1.000	E	1	BCFJF
PS-754V	1.000	E	3	VCFJF
PS-754V-CMS	1.000	E	1	VCFJF
PS-754V-CMS-P66	1.000	E	1	VCFJF
PS-756	1.250	C	1	BCFKF
PS-756-EPR	1.250	C	1	QCCKF
PS-756-P66	1.250	C	1	BCFKF
PS-756V	1.250	C	3	VCFKF
PS-756V-CMS	1.250	C	1	VCFKF
PS-756V-CMS-P66	1.250	C	1	VCFKF
PS-756V-P66	1.250	C	3	VCFKF
PS-756V-SC-SEAT	1.250	C	3	VCLFL
PS-756V-SC-TC	1.250	C	3	VLFZF
PS-758	1.500	C	1	BCFJF
PS-758-EPR	1.500	C	3	QCCKF
PS-758-EPR-CMS	1.500	C	1	QCCKF
PS-758-P66	1.500	C	1	BCFJF
PS-758-SC-SC	1.500	C	1	BLFLF
PS-758-SC-SEAT	1.500	C	1	BCFLF
PS-758-SC-TC-CMS	1.500	C	1	BLFZF
PS-758V	1.500	C	3	VCFJF
PS-758V-CMS	1.500	C	1	VCFJF
PS-758V-P66-CMS	1.500	C	1	VCFJF
PS-758V-SC-SC	1.500	C	1	VFLFL
PS-758V-SC-SEAT	1.500	C	1	VCLFL
PS-758V-TC-SC-CMS	1.500	C	1	VZFLF
PS-760	.750	A	3	BMFJF
PS-761	3.000	D	3	BCDJF
PS-762	.750	A	3	BMFKF
PS-764	.750	A	1	BCFJF
PS-765	.750	B	3	BMFJF
PS-766	.750	B	3	BMDKF
PS-767	.750	C	3	B/VCFJF
PS-767-EPR	.750	C	3	QCCKF
PS-768	.750	C	3	BCFKF
PS-771	.750	C	3	BCFJF
PS-773	.750	C	3	BCFKF
PS-774	.875	C	3	BCFV/JF
PS-775	.875	D	3	BCDJF
PS-776	.875	E	3	BCFJF
PS-777	1.000	A	3	BCFJF
PS-778	1.000	A	3	BCFKF
PS-779	1.000	C	1	BCFKF
PS-779V-CMS	1.000	C	1	VCFKF
PS-788	.500	B	1	BMFKF
PS-790	.875	D	1	BCDJF
PS-790V	.875	D	1	VCDJF
PS-791	1.000	E	3	BCFKF
PS-792	.750	S	8	NAPSP
PS-793	1.000	S	8	NAPSP
PS-794	1.250	S	8	NAPSP
PS-795	.625	S	8	NAPSP
PS-797	1.062	D	3	BCFJF
PS-798V	1.062	E	3	VCFJF
PS-799	1.062	E	3	BCFKF
PS-800	.625	C	1	BMFJF
PS-800V	.625	C	1	V/BMFJF
PS-801	1.125	C	3	B/VCFJF
PS-802	1.125	D	3	BCFJF
PS-804	1.250	D	3	BCFJF

PS SEAL INDEX

U.S. Seal Mfg. Part No.	Seal Size	Head Type	Mating Ring	Material Code
PS-805	1.375	C	3	BCFJF
PS-806	1.375	D	3	BCDJF
PS-807	1.375	D	3	BCDKF
PS-810	.625	C	1	N/BCFJF
PS-810V-CMS	.625	C	1	VCFJF
PS-816	1.500	C	3	BCFJF
PS-817	1.500	D	3	BCFJF
PS-818	1.625	C	3	BCFJF
PS-818-P66	1.625	C	3	BCFJF
PS-819	1.625	D	3	BCDKF
PS-821	1.625	D	3	BCDJF
PS-822	1.625	E	3	BCDKF
PS-822-EPR	1.625	E	3	QCCKF
PS-822-P66	1.625	E	3	BCDKF
PS-825	1.750	D	3	BCDKF
PS-826	1.750	D	3	BCDJF
PS-828	1.875	D	1	BCDJF
PS-832	2.000	D	3	BCDKF
PS-833	2.000	D	3	BCDJF
PS-834	2.375	D	3	BCFJF
PS-834-CMS-P66	2.375	D	1	BCFJF
PS-834-EPR	2.375	D	3	QCFJF
PS-834-EPR-TC	2.375	D	3	QCFZF
PS-834-P66	2.375	D	3	BCFJF
PS-834-TC-SEAT	2.375	D	3	BCFZF
PS-835	2.500	D	3	BCDJF
PS-836	2.750	C	3	BCFJF
PS-836-CMS	2.750	C	1	BCFJF
PS-836-CMS-P66	2.750	C	1	BCFJF
PS-836-P66	2.750	C	3	BCFJF
PS-837	2.750	D	3	BCFJF
PS-837-P66	2.750	D	3	BCFJF
PS-838	2.750	E	3	V/BCFJF
PS-838-316SS	2.750	E	3	V/BCFJF
PS-838-P66	2.750	E	3	V/BCFJF
PS-841	2.875	E	3	BCFKF
PS-841-EPR	2.875	E	3	QCCKF
PS-841-P66	2.875	E	3	BCFKF
PS-842	2.000	C	1	BCFKF
PS-842-P66	2.000	C	1	BCFKF
PS-842-TC-SEAT	2.000	C	1	BCFZF
PS-842V	2.000	C	1	VCFKF
PS-842V-P66-CMS	2.000	C	1	VCFKF
PS-843	2.000	E	1	BCFKF
PS-843V-CMS	2.000	E	1	VCFKF
PS-844	2.125	C	1	BCFJF
PS-844-P147	2.125	C	1	BCFJF
PS-845	.937	U	3	BCFGF
PS-846	2.250	D	3	BCDJF
PS-847	2.250	D	3	BCDKF
PS-848	2.250	E	3	BCDJF
PS-849	2.250	E	3	BCDKF
PS-851	.750	A	1	BCFJF
PS-851-EPR	.750	A	1	QCFJF
PS-853	2.500	C	3	BCFKF
PS-854	2.125	C	3	BCFJF
PS-855	2.125	C	3	BCFKF
PS-856	2.125	E	3	BCFJF
PS-857	2.125	E	3	BCFKF
PS-857V	2.125	E	3	VCFKF
PS-857V-TC-SEAT	2.125	E	3	VCFZF
PS-858-EPR-SC-SC	1.750	E	3	QLFLF
PS-858V-SC-SEAT	1.750	E	3	VCFLF
PS-859-EPR-SC-SEAT	1.750	E	3	QCFLF
PS-859-TC-SEAT	1.750	E	3	BCFZF
PS-864	1.375	E	3	BCFJF

U.S. Seal Mfg. Part No.	Seal Size	Head Type	Mating Ring	Material Code
PS-865	1.375	E	3	BCFKF
PS-865-P66	1.375	E	3	BCFKF
PS-865-SC-SEAT	1.375	E	3	BCFLF
PS-865V-SC-SC	1.375	E	3	VLFLF
PS-865V-SC-TC	1.375	E	3	VLZF
PS-865V-TC-SC	1.375	E	3	VZFLF
PS-866	1.125	E	3	BCFJF
PS-867	1.125	E	3	BCFKF
PS-867-EPR	1.125	E	3	QCCKF
PS-867V	1.125	E	3	VCFKF
PS-867V-TC-SEAT	1.125	E	3	VCFZF
PS-868	1.500	T	1	BCFJF
PS-874	2.250	D	1	BCDJF
PS-876	2.000	D	1	BCDKF
PS-877	.750	C	1	BCFJF
PS-877V	.750	C	1	VCFJF
PS-878	.875	K	1	BCFKF
PS-879	1.000	K	1	BCFJF
PS-879-SC-TC	1.000	K	1	BLFZF
PS-879V-CMS	1.000	K	1	VCFJF
PS-883	1.250	K	1	BCFJF
PS-883V-CMS	1.250	K	1	VCFJF
PS-884	1.500	K	1	BCFKF
PS-885-EPR-P66	1.125	E	3	QCCKF
PS-886	1.125	T	3	BCFJF
PS-887	2.125	K	1	BCFJF
PS-890	1.250	K	1	BCFKF
PS-891	1.000	K	1	BCFKF
PS-892	.875	K	1	BCFJF
PS-892V	.875	K	3	VCFJF
PS-898	1.875	U	3	BCFJF
PS-902	.750	B	9	BMFKF
PS-918	1.125	T	3	BCFKF
PS-921	.750	A	1	BMFKF
PS-923	1.250	C	25	BCFJF
PS-923-EPR	1.250	C	25	QCFJF
PS-923V	1.250	C	25	VCFJF
PS-926	1.500	C	3	BCFJF
PS-929	1.375	C	25	BCFJF
PS-935	.875	E	1	BCFKF
PS-935V-CMS	.875	E	1	VCFKF
PS-941	2.250	D	1	BCDKF
PS-941-EPR	2.250	D	1	QCCKF
PS-941V	2.250	D	3	VCDKF
PS-943	1.437	E	3	NCPKF
PS-944	.750	C	1	BCFJF
PS-944-EPR	.750	C	1	QCFJF
PS-944V	.750	C	1	VCFJF
PS-948	1.125	E	3	BCFKF
PS-949	1.875	E	3	BCFKF
PS-951	.625	C	3	VCFKF
PS-952	.625	A	1	BCFJF
PS-952-P66	.625	A	1	BCFJF
PS-953	.625	A	1	BCFJF
PS-954	.625	A	1	BCFKF
PS-954V-CMS	.625	A	1	VCFKF
PS-955	.625	A	1	BCFKF
PS-957	.625	A	1	BCFJF
PS-961	.625	B	1	BCFJF
PS-963	.625	B	1	BCFJF
PS-964	.625	B	1	BCFKF
PS-968	.750	A	1	BCFJF
PS-973	.750	A	1	BCFKF
PS-976	1.250	D	1	BCFJF
PS-976V	1.250	D	1	VCFJF
PS-977	1.250	D	1	BCFKF

PS SEAL INDEX

U.S. Seal Mfg. Part No.	Seal Size	Head Type	Mating Ring	Material Code
PS-978	1.250	C	1	BCFJF
PS-978-EPR	1.250	C	1	QCFJF
PS-978-EPR-P66	1.250	C	1	QCFJF
PS-978-EPR-SC-SC	1.250	C	1	QLFLF
PS-978-EPR-TC	1.250	C	1	QCFZF
PS-978-P66	1.250	C	1	BCFJF
PS-978-SC-TC	1.250	C	1	BLFZF
PS-978-TC-SEAT	1.250	C	1	BCFZF
PS-978V	1.250	C	1	VCFJF
PS-978V-P66	1.250	C	1	VCFJF
PS-978V-P66-TC	1.250	C	1	VCFZF
PS-978V-SC-P66	1.250	C	1	VCFLF
PS-978V-SC-SC	1.250	C	1	VLFLF
PS-978V-TC-TC	1.250	C	1	VZFZF
PS-979	1.250	C	1	BCFKF
PS-979-EPR	1.250	C	1	QCFKF
PS-979-P66	1.250	C	1	BCFKF
PS-979V	1.250	C	1	VCFKF
PS-979V-P66	1.250	C	1	VCFKF
PS-981	1.250	D	3	BCFKF
PS-982	1.000	C	1	BCFN/KF
PS-982V-CMS	1.000	C	1	VCFN/KF
PS-983	1.125	C	1	BCFKF
PS-983V	1.125	C	3	VCFKF
PS-983V-TC-TC	1.125	C	3	VZFZF
PS-989	.625	C	1	N/BCFJF
PS-1000	.625	B	1	BMFJF
PS-1000V	.625	B	3	VCFJF
PS-1000V-CMS	.625	B	1	VCFJF
PS-1002	.500	C	1	BCFJF
PS-1002-EPR	.500	C	1	QCFJF
PS-1002-P66	.500	C	1	BCFJF
PS-1002V	.500	C	1	VCFJF
PS-1005A	.625	B	1	BMFKF
PS-1012	.500	C	1	B/QCFJF
PS-1016	.625	C	1	N/BCFJF
PS-1017	2.000	C	1	BCFKF
PS-1017-TC-SEAT	2.000	C	3	BCFZF
PS-1018	1.250	C	3	BCFKF
PS-1018-CMS	1.250	C	1	BCFKF
PS-1018-EPR	1.250	C	3	QCFKF
PS-1018-EPR-P66	1.250	C	3	QCFKF
PS-1018-P66	1.250	C	3	BCFKF
PS-1018-SC-SC	1.250	C	3	BLFLF
PS-1018V	1.250	C	3	VCFKF
PS-1019	1.625	C	3	BCFKF
PS-1019-CMS	1.625	C	1	BCFKF
PS-1019-CMS-P66	1.625	C	1	BCFKF
PS-1019-SC-SC	1.625	C	3	BLFLF
PS-1019-TC-SEAT	1.625	C	3	VCFZF
PS-1019V	1.625	C	3	VCFKF
PS-1019V-P66	1.625	C	3	VCFKF
PS-1019V-SC-SC	1.625	C	3	VLFLF
PS-1020	2.000	C	3	BCFKF
PS-1020-EPR-P66	2.000	C	3	QCFKF
PS-1020V	2.000	C	3	VCFKF
PS-1021	.625	B	8	BMFJF
PS-1026	.750	D	1	BCDKF
PS-1028	2.000	C	1	BCFKF
PS-1034V	1.000	C	28	VCFKF
PS-1035	1.625	C	28	BCFKF
PS-1036	1.250	C	28	BCFKF
PS-1036V	1.250	C	28	VCFKF
PS-1037	2.000	C	28	BCFKF
PS-1037V	2.000	C	28	VCFKF
PS-1038	1.750	C	28	BCFKF

U.S. Seal Mfg. Part No.	Seal Size	Head Type	Mating Ring	Material Code
PS-1039	1.625	C	28	VCFKF
PS-1040	2.000	K	3	BCFKF
PS-1041	2.375	K	3	BCFKF
PS-1042	1.750	U	1	BCFJF
PS-1043	.500	C	1	BMFJF
PS-1044	1.187	C	28	BCFKF
PS-1044V	1.187	C	28	VCFKF
PS-1045	.625	C	3	VCFJF
PS-1048	1.000	C	1	BCFJF
PS-1048V-CMS	1.000	C	1	VCFJF
PS-1049	1.000	C	3	BCFJF
PS-1053	1.250	C	3	B/VCFKF
PS-1056	1.750	C	3	BCFKF
PS-1056V	1.750	C	3	VCFKF
PS-1056V-SC-SEAT	1.750	C	3	VCFLF
PS-1057	2.125	C	3	B/VCFKF
PS-1060V	3.000	E	3	VCDKF
PS-1061	.562	A	1	VCFJF
PS-1062	1.375	C	3	VCFKF
PS-1064V	.312	C	3	VCFJF
PS-1065	.375	C	3	BCFJF
PS-1065-EPR	.375	C	3	QCFJF
PS-1065V	.375	C	3	VCFJF
PS-1067	1.125	E	1	BCFKF
PS-1068	1.750	C	1	BCFKF
PS-1070	1.750	U	3	BCFJF
PS-1078	1.750	E	27	BCFJF
PS-1078V	1.750	E	27	VCFJF
PS-1079	.625	C	1	NCFJF
PS-1080	.625	C	1	NCFKF
PS-1081	1.250	C	1	NCFJF
PS-1082	1.250	C	1	NCFKF
PS-1083	1.250	C	1	NCFJF
PS-1084	1.250	C	1	NCFKF
PS-1085	.625	C	1	BCFJF
PS-1085V	.625	C	1	B/VCFJF
PS-1086	1.000	A	3	BCFJF
PS-1087	2.250	C	1	BCFJF
PS-1087V-CMS	2.250	C	1	VCFJF
PS-1087V-SC-TC-CMS	2.250	C	1	VLZFZ
PS-1088	3.000	C	3	BCFJF
PS-1088-CMS	3.000	C	1	BCFJF
PS-1088-TC-TC	3.000	C	3	B/VZFZF
PS-1088-TC-TC-CMS	3.000	C	1	BZFZF
PS-1088V	3.000	C	3	VCFJF
PS-1088V-CMS	3.000	C	1	VCFJF
PS-1088V-TC-TC	3.000	C	3	VZFZF
PS-1088V-TC-TC-CMS	3.000	C	1	VZFZF
PS-1089	.625	B	1	V/BCFJF
PS-1091	.625	C	1	VCFJF
PS-1092	.750	C	1	VCFKF
PS-1092-TC-TC	.750	C	1	VZFZF
PS-1093	.750	C	1	VCFJF
PS-1094	1.000	C	1	VCFJF
PS-1094-EPR	1.000	C	1	QCFJF
PS-1094-P66	1.000	C	1	VCFJF
PS-1097	1.875	D	1	BCDKF
PS-1098	.500	B	1	BMFJF
PS-1102	2.125	V	3	BCFJF
PS-1104	1.375	V	25	BCFJF
PS-1105	1.875	V	25	BMFJF
PS-1107-CMS	2.125	V	1	BCFJF
PS-1108	1.875	V	1	BMFJF
PS-1109	1.250	C	3	BCFKF
PS-1109-CER	1.250	C	3	BCFJF
PS-1109-EPR	1.250	C	3	QCFKF

PS SEAL INDEX

U.S. Seal Mfg. Part No.	Seal Size	Head Type	Mating Ring	Material Code
PS-1109-P66	1.250	C	3	BCFKF
PS-1109-SC-TC	1.250	C	3	BLFZF
PS-1109-TC-TC	1.250	C	3	BZFZF
PS-1109V	1.250	C	3	VCFKF
PS-1109V-SC-SEAT	1.250	C	3	VCFLF
PS-1110	1.500	C	3	BCFKF
PS-1110V	1.500	C	3	VCFKF
PS-1112	.500	Q	9	BMFJF
PS-1113	.750	C	1	BCFKF
PS-1118	1.250	K	1	B/HCFJF
PS-1119	.625	C	1	BCFJF
PS-1119V	.625	C	1	VCFJF
PS-1120	.500	C	1	BCFJF
PS-1123	1.000	C	1	BCFKF
PS-1123-TC-TC	1.000	C	1	BZFZF
PS-1125	.750	C	1	BCFJF
PS-1125-EPR	.750	C	1	QCJFJ
PS-1125-P66	.750	C	1	BCFJF
PS-1125-SC-SC	.750	C	1	BLFLF
PS-1133	.437	C	1	BCFJF
PS-1137	.500	Q	1	BMFJF
PS-1142	1.750	K	3	BCFJ/KF
PS-1145	2.000	C	3	VCFKF
PS-1150	.625	A	1	BMFKF
PS-1152	.625	B	1	BMFKF
PS-1154	.625	C	1	BCFKF
PS-1155	.625	C	1	BCFJF
PS-1155V	.625	C	1	VCFJF
PS-1155V-TC-SEAT	.625	C	1	VCFZF
PS-1156	.625	C	1	BCFKF
PS-1156V	.625	C	3	VCFKF
PS-1158	.625	E	2	BCDKF
PS-1160	.750	C	1	BCFKF
PS-1161	.750	D	1	BCDJF
PS-1162	.750	D	1	BCDJF
PS-1163	.875	C	1	BCFJF
PS-1167	1.125	C	1	BCFKF
PS-1172	1.125	E	3	BCFJF
PS-1172V	1.125	E	3	VCFJF
PS-1173	1.125	E	3	BCFKF
PS-1176	1.125	K	1	BCFJF
PS-1177	1.125	K	1	BCFKF
PS-1178	1.125	T	3	BCFJF
PS-1179	1.181	D	1	BCDKF
PS-1179-P66	1.181	D	1	BCDKF
PS-1179V	1.181	D	1	VCDKF
PS-1179V-P66	1.181	D	1	VCDKF
PS-1180	1.187	E	1	BCDKF
PS-1183-P66	1.250	E	3	BCFKF
PS-1185	1.250	E	1	NCPJP
PS-1186	1.250	E	1	BCFKF
PS-1187	1.250	T	1	BCFJF
PS-1195	1.625	K	1	BCFJF
PS-1196-EPR	1.750	E	1	QCJFJ
PS-1197	1.750	K	1	BCFKF
PS-1199	1.750	U	3	BCFKF
PS-1510	.750	C	1	BCFJF
PS-1510V	.750	C	1	VCFJF
PS-1525	.750	A	1	BMFJF
PS-1604	.750	K	1	BCFJF
PS-1608	1.875	C	1	BCFKF
PS-1608V-CMS	1.875	C	1	VCFKF
PS-1609	2.000	E	1	BCFKF
PS-1610	2.000	R	1	BCDJF
PS-1612	2.125	E	3	BCFKF
PS-1612V	2.125	E	3	VCFKF

U.S. Seal Mfg. Part No.	Seal Size	Head Type	Mating Ring	Material Code
PS-1613	2.500	K	3	BCFJF
PS-1615	.375	B	1	BMFJF
PS-1618	.625	C	1	BCFJF
PS-1619	1.000	Q	1	BCDJF
PS-1621	.500	Q	9	BMFJF
PS-1622	.750	B	9	BMFJF
PS-1622V	.750	B	9	VMFJF
PS-1623	1.250	K	3	BCFJ/KF
PS-1625	.625	C	3	BCFKF
PS-1625-CMS	.625	C	1	BCFKF
PS-1626	.625	C	3	VCFKF
PS-1626-CMS	.625	C	1	VCFKF
PS-1630	1.000	D	3	BCPKF
PS-1631	1.000	T	3	NCPKF
PS-1632V	1.250	D	3	VCPKF
PS-1633	1.437	T	3	NCPKF
PS-1634	1.437	E	3	BCPKF
PS-1634V	1.437	E	3	VCPKF
PS-1636	1.125	E	3	B/VCFJF
PS-1637	1.125	E	3	B/VCFKF
PS-1639V	1.125	E	3	VCFKF
PS-1646	1.500	E	3	VCFZF
PS-1647	1.500	E	3	B/VCFJF
PS-1648	1.500	E	3	B/VCFKF
PS-1651	1.500	E	3	VCFJF
PS-1652	1.500	E	3	VCFKF
PS-1653	1.875	T	3	VCFJF
PS-1659	1.875	E	3	VCFJF
PS-1659V-CMS	1.875	E	1	VCFJF
PS-1660	1.875	E	3	VCFKF
PS-1661	1.875	E	3	VCFZF
PS-1664	1.875	E	3	B/VCFJF
PS-1667	1.375	C	1	BCFKF
PS-1667-EPR	1.375	C	1	QCJFJ
PS-1667V	1.375	C	1	VCFKF
PS-1668	1.125	E	3	BCFZF
PS-1674	1.750	C	1	BCFKF
PS-1674-EPR-P66	1.750	C	1	BCFKF
PS-1674-SC-SEAT	1.750	C	1	QCFLF
PS-1674-TC-SEAT	1.750	C	1	BCFZF
PS-1674V-TC-TC-CM	1.750	C	1	VZFZF
PS-1675	.590	D	1	BCFKF
PS-1676	2.250	C	3	BCFKF
PS-1676-EPR-P66	2.250	C	3	QCJFJ
PS-1676-TC-SEAT	2.250	C	3	B/VCFZF
PS-1676V	2.250	C	3	VCFKF
PS-1676V-TC-SEAT	2.250	C	3	VCFZF
PS-1677	2.375	C	28	BCFKF
PS-1677V	2.375	C	28	VCFKF
PS-1678	2.250	C	3	BCFJF
PS-1678V	2.250	C	3	VCFJF
PS-1679	2.250	C	1	BCFJF
PS-1679-EPR-P66	2.250	C	3	QCJFJ
PS-1679-P66	2.250	C	1	BCFJF
PS-1679V-CMS	2.250	C	1	VCFJF
PS-1680	2.250	C	1	BCFKF
PS-1680-P66	2.250	C	1	BCFKF
PS-1680-TC-TC	2.250	C	1	BZFZF
PS-1680V	2.250	C	1	VCFKF
PS-1681	.875	D	3	BCDKF
PS-1681V	.875	D	3	VCDKF
PS-1682	1.125	C	1	BCFJF
PS-1683	1.625	E	3	BCFJF
PS-1683-P66	1.625	E	3	BCFJF
PS-1683V	1.625	E	3	VCFJF
PS-1684	1.750	E	3	BCFJF

PS SEAL INDEX

U.S. Seal Mfg. Part No.	Seal Size	Head Type	Mating Ring	Material Code
PS-1686	2.125	D	1	BCFJF
PS-1687	2.125	D	1	BCFKF
PS-1688	2.250	E	3	BCFJF
PS-1688V	2.250	E	3	VCFJF
PS-1691	1.500	E	3	VCFKF
PS-1692	1.500	E	3	VCFZF
PS-1693	1.875	K	1	BCFKF
PS-1694	2.375	K	3	BCFJF
PS-1695	2.500	K	3	BCFKF
PS-1696-CMS	3.000	C	1	BCFJF
PS-1697	1.625	D	3	BCFKF
PS-1697-TC-SEAT	1.625	D	3	BCFZF
PS-1698	1.625	D	3	BCFJF
PS-1699	1.625	E	3	BCFKF
PS-1699V	1.625	E	3	VCFKF
PS-1699V-SC-TC	1.625	E	3	VLFZF
PS-1699V-TC-P66	1.625	E	3	VCFZF
PS-1754	.750	C	1	BCFJF
PS-1900	.625	G	1	VLFLF
PS-1901	.625	G	1	VLFLF
PS-1902	.750	G	1	VLFLF
PS-1903	.625	A	1	VLFLF
PS-1904	.750	B	1	VLFLF
PS-1905	.625	B	1	VLFLF
PS-1906	.625	G	1	VLFLF
PS-1907	.625	G	1	VLFLF
PS-1908	.750	A	1	VLFLF
PS-1909	.984	G	1	VLFLF
PS-1910	1.250	C	25	VLFLF
PS-1912	.625	G	1	VLFLF
PS-2000	.625	D	1	BCFJF
PS-2000V-CMS	.625	D	1	VCFJF
PS-2004	.625	D	1	BCFJF
PS-2008	.750	D	1	BCFJF
PS-2009	.750	D	1	BCFKF
PS-2010	.750	D	3	BCFJF
PS-2014	.750	E	3	V/BCFJF
PS-2015	.750	E	3	BCFKF
PS-2016	.625	E	1	BCFJF
PS-2017	.625	E	1	BCFKF
PS-2020	.625	E	1	BCFJF
PS-2022	.625	E	3	BCFJF
PS-2024	.875	D	1	BCFJF
PS-2026	.875	D	3	B/VCFJF
PS-2027	.875	D	3	BCFKF
PS-2027V	.875	D	3	VCFKF
PS-2029	.875	E	1	BCFKF
PS-2033	1.000	D	3	BCFJF
PS-2045	1.375	D	1	BCFJF
PS-2046	1.375	D	1	BCFKF
PS-2047	1.375	D	3	BCFJF
PS-2047V	1.375	D	3	VCFJF
PS-2048	1.375	D	3	BCFKF
PS-2055	1.625	D	1	BCFJF
PS-2055V-CMS	1.625	D	1	VCFJF
PS-2056	1.625	D	1	BCFKF
PS-2057	1.625	E	1	BCFJF
PS-2058	1.625	E	1	BCFKF
PS-2058V-TC-SEAT	1.625	E	1	VCFZF
PS-2059	1.750	D	1	BCFJF
PS-2059V	1.750	D	1	VCFJF
PS-2060	1.750	D	1	BCFKF
PS-2060-TC-TC	1.750	D	1	BZFZF
PS-2061	1.750	D	3	BCFJF
PS-2061-SC-SEAT	1.750	D	3	BCFLF
PS-2062	1.750	D	3	BCFKF

U.S. Seal Mfg. Part No.	Seal Size	Head Type	Mating Ring	Material Code
PS-2069	1.875	E	1	BCFJF
PS-2069-TC-SEAT	1.875	E	1	BCFZF
PS-2070	1.875	E	1	BCFKF
PS-2071	1.875	E	3	BCFJF
PS-2072	1.875	E	3	BCFKF
PS-2072-TC-TC	1.875	E	3	BZFZF
PS-2073	2.000	D	1	BCFJF
PS-2073V-SC-TC-CMS	2.000	D	1	VLFZF
PS-2075	2.000	D	3	BCFJF
PS-2076	2.000	D	3	BCFKF
PS-2086	2.125	E	3	BCFKF
PS-2087	2.250	D	1	BCFJF
PS-2088	2.250	D	1	BCFKF
PS-2089	2.250	D	3	BCFJF
PS-2090	2.250	D	3	BCFKF
PS-2091	2.250	E	1	BCFJF
PS-2092	2.250	E	1	BCFKF
PS-2093	2.125	D	3	BCFJF
PS-2094	2.250	E	3	BCFKF
PS-2094V	2.250	E	3	VCFKF
PS-2095	2.375	D	3	BCFKF
PS-2097-CMS	2.375	E	1	BCFJF
PS-2098V	2.375	E	3	VCFKF
PS-2114	1.875	C	3	BCFJF
PS-2115	3.000	C	3	BCFKF
PS-2115-TC-SEAT	3.000	C	3	BCFZF
PS-2116	3.000	C	3	BCFJF
PS-2116-SC-SC	3.000	C	3	BLFLF
PS-2116V	3.000	C	3	VCFJF
PS-2117	1.500	E	1	BCFJF
PS-2120	2.500	C	1	BCFJF
PS-2122	1.250	C	1	BCFJF
PS-2122-P66	1.250	C	1	BCFJF
PS-2122V	1.250	C	3	VCFJF
PS-2122V-CMS	1.250	C	1	VCFJF
PS-2123	1.250	C	1	BCFKF
PS-2123-P66	1.250	C	1	BCFKF
PS-2123V-CMS	1.250	C	1	VCFKF
PS-2126	2.125	T	3	BCFJF
PS-2128	1.250	E	3	BCFJF
PS-2129	1.250	E	3	BCFKF
PS-2129V	1.250	E	3	VCFKF
PS-2130	1.750	E	3	BCFJF
PS-2130-CMS	1.750	E	1	BCFJF
PS-2131	.625	A	31	BMFJF
PS-2131V	.625	A	31	VCFJF
PS-2132	2.250	T	3	BCDJF
PS-2133	2.000	C	1	BCFJF
PS-2133-P66	2.000	C	1	BCFJF
PS-2134	1.375	C	1	BCFJF
PS-2134-P66	1.375	C	1	BCFJF
PS-2134V-CMS-P66	1.375	C	1	VCFJF
PS-2135	1.750	C	1	BCFJF
PS-2135-P66	1.750	C	1	BCFJF
PS-2135-SC-SC	1.750	C	1	BLFLF
PS-2135V-CMS	1.750	C	1	VCFJF
PS-2136	.750	A	1	BCFJF
PS-2138	.500	C	Special	BCFGF
PS-2139	2.000	C	1	BCFJF
PS-2140	5.000	K	3	BCFKF
PS-2141	3.000	K	3	BCFKF
PS-2142	1.750	C	1	BCFJF
PS-2142-P66	1.750	C	1	BCFJF
PS-2143	2.000	K	1	BCFJF
PS-2144	1.750	T	3	BCFJF
PS-2145	1.000	C	3	BCFJF

PS SEAL INDEX

U.S. Seal Mfg. Part No.	Seal Size	Head Type	Mating Ring	Material Code
PS-2146	1.875	V	3	BMFJF
PS-2148	2.750	K	3	BCFJF
PS-2149	.625	C	3	BCFKF
PS-2150	1.750	C	3	BCFJF
PS-2151	1.750	C	3	BCFKF
PS-2151-EPR-P66	1.750	C	3	QCCKF
PS-2151V	1.750	C	3	VCFKF
PS-2151V-TC-SEAT	1.750	C	3	VCFZF
PS-2152V	2.750	C	3	VCFKF
PS-2153	3.000	C	3	BCFJF
PS-2153-CMS	3.000	C	1	BCFJF
PS-2153-SC-SC-CMS	3.000	C	1	BLFLF
PS-2153-TC-CMS	3.000	C	1	BCFZF
PS-2153V-TC-TC	3.000	C	3	VZFZF
PS-2154	2.750	C	3	BCFJF
PS-2154-SC-TC-CMS	2.750	C	1	BLFZF
PS-2154-TC-CMS	2.750	C	1	BCFZF
PS-2154-TC-SC	2.750	C	1	BZFLF
PS-2154-TC-SEAT	2.750	C	3	B/VCFZF
PS-2154V-TC-TC	2.750	C	3	VZFZF
PS-2155	1.062	C	3	BCFKF
PS-2156	1.437	C	3	BCFKF
PS-2156V	1.437	C	3	VCFKF
PS-2157	1.750	U	3	BCF/DKF
PS-2158	2.500	K	1	BCFJF
PS-2158-TC-TC	2.500	K	1	BZFZF
PS-2160	.625	C	1	BCFJF
PS-2160V-CMS	.625	C	1	VCFJF
PS-2161	.625	B	1	BMFJF
PS-2162	1.187	C	1	BCFKF
PS-2163	1.000	C	1	BCFKF
PS-2164	1.000	D	1	BCFJF
PS-2166	.875	C	1	BCFJF
PS-2166-EPR	.875	C	1	QCCKF
PS-2166V	.875	C	1	VCFJF
PS-2167	.875	C	1	BCFJF
PS-2167-EPR-P66	.875	C	1	QCCKF
PS-2167V	.875	C	1	VCFJF
PS-2168	.875	C	3	BCFKF
PS-2168-EPR	.875	C	3	QCCKF
PS-2168V	.875	C	3	VCFKF
PS-2169	.875	C	3	BCFKF
PS-2169V	.875	C	3	VCFKF
PS-2170	1.750	U	3	BCFJF
PS-2172	.625	A	1	BCFJF
PS-2200	1.250	C	3	VCFKF
PS-2201	1.625	C	3	QCCKF
PS-2202	1.625	C	3	BCFJF
PS-2202-CMS	1.625	C	1	BCFJF
PS-2202-P66	1.625	C	3	BCFJF
PS-2202V	1.625	C	3	VCFJF
PS-2203	1.250	C	3	QCCKF
PS-2203-CMS	1.250	C	1	QCCKF
PS-2204	.625	A	1	VCFZF
PS-2205	2.500	E	3	BCFKF
PS-2205-EPR	2.500	E	3	QCCKF
PS-2206	.625	C	3	QCCKF
PS-2207	1.750	C	3	VCFZF
PS-2208	1.250	C	1	BZFZF
PS-2209	1.500	C	1	BZFZF
PS-2210	1.750	C	1	BCFZF
PS-2211	1.250	T	3	BCFJF
PS-2212	1.750	C	1	BCFJF
PS-2212-SC-SC	1.750	C	1	BLFLF
PS-2214	.625	C	1	QCCKF
PS-2215	1.250	C	1	QCCKF

U.S. Seal Mfg. Part No.	Seal Size	Head Type	Mating Ring	Material Code
PS-2216	1.000	C	1	BZFZF
PS-2216V-CMS	1.000	C	1	VZFZF
PS-2217	1.500	C	3	BZFZF
PS-2219	2.000	C	1	BZFZF
PS-2221	1.500	C	3	QCCKF
PS-2223	1.500	C	3	VCFZF
PS-2223-SC-SEAT	1.500	C	3	VCFLF
PS-2224	.875	C	3	QCCKF
PS-2226	1.125	C	3	QCCKF
PS-2227	1.125	C	1	BCFJF
PS-2229V-P66	.750	C	1	VCFKF
PS-2230	1.250	C	3	BCFJF
PS-2230V	1.250	C	3	VCFJF
PS-2231	1.750	EB	3	BCFKF
PS-2231-CMS	1.750	EB	1	BCFKF
PS-2232	1.500	C	1	BCFKF
PS-2234	1.437	E	3	BCFKF
PS-2234V	1.437	E	3	VCFKF
PS-2235	.750	C	3	VCFJF
PS-2235-SC-TC	.750	C	3	VLFFZ
PS-2236	.750	C	3	BCFJF
PS-2237	1.875	K	1	BCFJF
PS-2657	1.250	E	3	VCFZF
PS-2658	2.250	EB	3	BCFLF
PS-2659	1.250	D	3	QCCKF
PS-2660	.625	E	1	BCFKF
PS-2700	.500	G	1	BCFJF
PS-2701	.625	D	3	VCFZF
PS-2702	.875	C	3	VCFJF
PS-2703	1.000	D	3	VLFFZ
PS-2704	1.375	CB	3	VCFZF
PS-2705	1.500	C	1	BCFJF
PS-2706	1.500	D Special	3	NLFLF
PS-2707	1.562	Special	Special	NCPGF
PS-2708	2.750	C	3	VCFLF
PS-2709	3.000	D	1	BLFLF
PS-2710	3.000	D	3	VZFLF
PS-2711	2.375	R	3	BCFJF
PS-2712	1.750	E	3	VCFJF
PS-2713	.500	Q	8	BCFJF
PS-2714	1.500	C	3	VCFJF
PS-2715	.625	G	1	QLFLF
PS-2717	1.625	E	3	BZFLF
PS-2718	.750	B	8	BMFJF
PS-2719	4.000	D	3	VZFLF
PS-2720	.500	C	3	BCFJF
PS-2723	.787	B	1 Special	BLFLF
PS-2727	.437	G	1	VCFLF
PS-2729	1.875	C	3	BLFLF
PS-2730	.500	C	1	QCCKF
PS-2732	.500	Q	8	VCFKF
PS-2733	.750	G	1	QCCKF
PS-2734	.625	B	8	BCFFF
PS-2735	.750	B	3	VCFJF
PS-2736	.984	G	1	BLFLF
PS-2737	1.181	D	1	BCFJF
PS-2738	1.125	E	3	VCFKF
PS-2739	1.625	D	3	VLFFZ
PS-2740	2.500	D	3	VLFFZ
PS-2741	5.000	K	3	BCFJF
PS-2742	.625	B	1	BCFJF
PS-2743	.625	C	3	Special
PS-2744	.750	A	3 Special	Special
PS-2745	.750	B	8	BCFJF
PS-2746	.750	C	1	VCFJF
PS-2747	.750	C	1	BCFJF

PS SEAL INDEX

U.S. Seal Mfg. Part No.	Seal Size	Head Type	Mating Ring	Material Code
PS-2748	1.000	C	1	BCFJF
PS-2749	1.625	C	1	VZFLF
PS-2750	.625	C	1	BCFJF
PS-2762	1.625	C	1	VCFLF
PS-2763	2.500	EB	3	VCFZF
PS-2769	1.250	C	3	BCFLF
PS-2770	.625	G	1	QCFLF
PS-2771	2.750	U	3	BCFKF
PS-2772	4.000	D	3	VZFZF
PS-2800	.750	C	1	BCFJF
PS-2801	.787	B	8	BLFLF
PS-2802	.500	C	3	NCFKF
PS-2803	3.250	D	3	VLFZF
PS-2804	.625	B	1	VCFJF
PS-2805	1.000	D	3	VCPLF
PS-2806	1.000	Q	9	BCFJF
PS-2807	.472	G	1	BCFJF
PS-2808	.625	G	1	QLFLF
PS-2810	1.250	K	3	VCFJF
PS-2812	1.496	G	1	BCFLF
PS-2814	1.000	C	3	NCFGF
PS-2815	1.692	G	1	VCFJF
PS-2819	.625	B	11	QLFLF
PS-2820	.750	G	3	BCFJF
PS-3000	.472	G	1	BLFLF
PS-3001	.500	G	3	VCFJF
PS-3002	.500	G	3	VCFJF
PS-3003	.500	G	3	BCFJF
PS-3004	.500	G	1	QCFLF
PS-3005	.625	G	25	VLFLF
PS-3006	.625	G	1	BCFJF
PS-3008	2.375	G	1	BCFJF
PS-3009	.875	G	1	BCFJF
PS-3010	1.000	G	3	BCFLF
PS-3013	1.125	G	25	VCFLF
PS-3014	1.375	G	1	BLFZF
PS-3015	1.375	G	25	VLFLF
PS-3016	1.750	G	1	BLFLF
PS-3017	1.875	G	1	BCFJF
PS-3018	1.875	G	1	BLFLF
PS-3019	2.000	G	25	QLFLF
PS-3020	2.125	G	3	QCJFJ
PS-3021	3.000	G	1	VLFLF
PS-3022	2.375	G	1	BLFZF
PS-3023	1.250	D	1	QCFLF
PS-3024	1.750	E	1	VCFZF
PS-3025	1.625	D	1	QCFLF
PS-3026	1.625	D	3	BCDGF
PS-3027	2.000	C	3	QCFZF
PS-3030	1.625	C	1	QCJFJ
PS-3031	1.750	E	1	VLFLF
PS-3032	1.250	D	1	VLFLF
PS-3033	.500	Q	8	BCFKF
PS-3035	2.125	D	1	QCFLF
PS-3037	2.750	E	1	BZFZF
PS-3038	1.375	C	3	QCFZF
PS-3039	1.625	D	3	XLFLF
PS-3040	1.750	K	3	BCFJF
PS-3041	2.250	C	3	BCFKF
PS-3042	1.000	G	3	BCFJF
PS-3043	3.000	C	1	VCFLF
PS-3044	2.000	U	3	QCFLF
PS-3045	1.250	C	3	BCFZF
PS-3046	1.875	E	3	QCJFJ
PS-3047	.625	B	1	BCFJF
PS-3048	.500	B	1	BCFJF

U.S. Seal Mfg. Part No.	Seal Size	Head Type	Mating Ring	Material Code
PS-3049	1.875	E	3	QZFLF
PS-3050	3.250	EB	3	BCFJF
PS-3051	2.375	C	3	BCFLF
PS-3052	.500	C	1	QCJFJ
PS-3054	1.750	E	3	VCFLF
PS-3056	.750	G	1	VLFLF
PS-3058	1.625	C	1	QCFZF
PS-3059	2.750	E	3	QCFLF
PS-3060	1.125	E	3	VCJFJ
PS-3061	.750	A	1	BCFJF
PS-3062	1.250	C	1	QLFLF
PS-3063	1.125	E	3	QCPKF
PS-3064	2.500	E	3	QCJFJ
PS-3065	1.000	K	1	VCFRF
PS-3066	2.000	D	1	VLFLF
PS-3067	2.250	E	3	BCFZF
PS-3068	.750	C	3	QLFLF
PS-3070	1.875	DB	3	BCDJF
PS-3071	1.625	R	3	NAFGF
PS-3072	3.250	E	3	VCFKF
PS-3073	2.375	G	1	BCFLF
PS-3074	.750	C	3	VLFLF
PS-3075	2.250	E	3	BZFZF
PS-3076	2.500	E	3	VCFZF
PS-3077	2.250	R	1	BCFJF
PS-3078	1.625	C	3	BCFKF
PS-3079	2.000	E	3	VCFKF
PS-3080	1.437	E	3	BAPKF
PS-3082	.375	C	3	Q/NCJFJ
PS-3083	2.000	U	3	VCFLF
PS-3084	1.250	T	3	NAFZF
PS-3085	2.375	E	5	VCFZF
PS-3086	1.375	G	3	QCFLF
PS-3087	1.375	E	3	VCFZF
PS-3088	2.000	EB	3	QCFZF
PS-3091	1.250	D	2	NCPGP
PS-3092	.625	C	1	VLFLF
PS-3093	.590	C	1	BCFJF
PS-3100	1.000	Q	—	NMDKF
PS-3101	1.500	C	3	BLFLF
PS-3102	.625	B	11	BCFJF
PS-3103	.625	B	11	VCJFJ
PS-3104	.750	B	3	VLFLF
PS-3105	.750	G	25	VLFLF
PS-3106	.625	B	11	VLFLF
PS-3107	.750	G	3	VCJFJ
PS-3108	2.000	E	5	QCFZF
PS-3109	1.125	E	5	QCDZF
PS-3110	.750	C	1	BLFLF
PS-3111	1.625	K	1	VLFLF
PS-3112	.984	C	1	VCJFJ
PS-3113	1.625	E	3	XZFLF
PS-3114	1.750	C	1	BZFZF
PS-3114V	1.750	C	1	VZFZF
PS-3115	1.750	T	3	BCFJF
PS-3116	.875	D	3	VCFLF
PS-3117	1.375	K	1	VCJFJ
PS-3118	1.750	C	1	VCJFJ
PS-3119	1.250	C	1	VZFLF
PS-3120	1.000	Q	Special	Special
PS-3121	.625	C	1	VCFKF
PS-3122	2.125	E	3	BCFJF
PS-3123	1.750	T	3	VLFLF/ VCFLF
PS-3124	.625	B	1	BCFJF
PS-3125	1.750	C	3	BCFJF

PS SEAL INDEX

U.S. Seal Mfg. Part No.	Seal Size	Head Type	Mating Ring	Material Code
PS-3126	1.000	K	1	BCFKF
PS-3127	2.375	C	3	VCFJF
PS-3128	1.500	K	1	BCFJF
PS-3129	1.000	E	3	QCFZF
PS-3130	1.500	K	1	BCFKF
PS-3131	1.250	C	1	QCFLF
PS-3132	.625	D	3	NCFLF
PS-3133	.625	C	3	NCFKF
PS-3134	2.125	E	3	QCFLF
PS-3135	.787	D	1	BCFKF
PS-3136	1.500	D	2	BCDKF
PS-3138	1.625	C	1	BCFKF
PS-3140	.590	C	1	VCFJF
PS-3141	1.500	C	1	VCFKF
PS-3142	2.000	D	3	VZFLF
PS-3143	3.500	E	3	VZFZF
PS-3144	1.625	C	1	VZFZF
PS-3145	1.625	C	1	BZFLF
PS-3146	1.250	C	1	BZFLF
PS-3147	.625	C	3	QCFKF
PS-3148	.625	E	3	BCFJF
PS-3149	.750	C	1	BCFJF
PS-3150	1.260	G	1	VLFLF
PS-3151	1.750	G	1	VLFLF
PS-3152	3.000	C	1	VLFLF
PS-3153	2.000	D	3	BZFLF
PS-3154	3.250	G	1	VLFLF
PS-3155	5.000	K	3	BCFKF
PS-3156	.750	C	1	VLFLF
PS-3157	3.250	U	3	VCFZF
PS-3158	1.771	G	25	VLFLF
PS-3159	.625	B	8	BCFJF
PS-3160	1.500	C	3	QCFZF
PS-3161	1.500	E	3	VCFLF
PS-3162	.750	C	1	QZFLF
PS-3163	1.125	E	5	BCFZF
PS-3164	2.500	E	5	BCFZF
PS-3165	1.500	C	1	VCFJF
PS-3166	1.500	C	1	BZFLF
PS-3167	.984	D	1	VCFZF
PS-3169	1.750	E	3	VCFKF
PS-3170	2.000	G	25	VCFLF
PS-3172	.500	C	3	BCFKF
PS-3173	1.250	C	3	VCFKF
PS-3174	1.500	C	3	BCFKF
PS-3176	.875	C	3	BLFLF
PS-3177	1.750	E	1	BCFKF
PS-3178	1.250	C	1	VCFLF
PS-3179	1.625	C	1	BCFLF
PS-3180	3.250	C	3	VCFJF
PS-3181	3.000	V	3	BCFJF
PS-3182	2.250	C	1	BLFLF
PS-3183	1.625	E	3	VCFKF
PS-3184	1.250	K	3	BCFJF
PS-3185	1.250	C	1	VCFKF
PS-3186	1.625	D	3	VCFLF
PS-3187	2.375	E	5	QCFZF
PS-3188	2.625	D	3	QCFZF
PS-3189	2.750	D	3	VLZFZ
PS-3190	1.875	K	1	BZFZF
PS-3191	.750	C	1	VCFJF
PS-3192	.590	D	1	VCFKF
PS-3193	1.062	D	3	VCDLF
PS-3194	.750	C	1	QLFLF
PS-3196	1.375	K	3	VCFJF
PS-3197	.500	C	3	VCFJF

U.S. Seal Mfg. Part No.	Seal Size	Head Type	Mating Ring	Material Code
PS-3198	1.375	V	3	BCFJF
PS-3199	.625	G	1	BLFLF
PS-3200	.625	G	1	VCFJF
PS-3201	.625	C	1	QCFLF
PS-3202	.625	B	1	QCFJF
PS-3203	1.875	T	3	VLZFZ/ VCFJF
PS-3204	.625	G	1	BCFJF
PS-3205	1.375	E	3	VCFLF
PS-3206	2.500	E	3	VCFLF
PS-3208	.750	C	1	VCFJF
PS-3210	2.250	V	3	BCFKF
PS-3211	1.875	C	1	BCFJF
PS-3212	.625	B	1	VCFJF
PS-3213	1.375	C	3	VCFKF
PS-3214	.750	K	3	VCFJF
PS-3215	1.250	C	25	VLFLF
PS-3216	1.375	D	3 Special	VCFJF
PS-3216	1.375	D	3 Special	VCFJF
PS-3218	1.375	E	3	BCFJF
PS-3220	1.000	C	3	BCFKF
PS-3222	3.250	D	3	VZFLF
PS-3223	1.625	D	3	BZFLF
PS-3224	1.500	C	1	QCFZF
PS-3225	.500	A	1	BCFJF
PS-3226	.500	C	3	VCFKF
PS-3227	1.750	E	3	VCFJF
PS-3228	.625	A	1	VCFJF
PS-3229	1.250	R	3	VZFLF
PS-3230	1.375	C	1	NCFJF
PS-3232	3.000	C	3	VCFZF
PS-3233	2.375	C	3	VCFJF
PS-3234	1.125	C	1	VZFLF
PS-3235	3.000	C	1	BCFJF
PS-3236	1.750	K	1	BZFZF
PS-3237	3.750	K	3	BLFLF
PS-3238	3.500	U	3	BCFJF
PS-3239	1.125	C	1	VCFZF
PS-3240	1.000	C	3	VCFKF
PS-3241	1.000	D	3	BCFLF
PS-3246	3.250	E	3	BLFZF
PS-3247	2.500	C	3	BLFZF
PS-3248	1.500	C	3	QCFZF
PS-3249	1.500	C	3	NLFLF
PS-3250	1.000	D	3	QCFJF
PS-3251	1.750	E	3	VCFLF
PS-3252	1.500	C	1	VLFLF
PS-3253	4.000	K	3	BCFZF
PS-3254	2.000	K	3	VZFZF
PS-3255	3.250	T	3	VLFLF
PS-3256	3.250	EB	3	VCFJF
PS-3257	4.000	E	3	BCFJF
PS-3258	3.250	K	3	VCFKF/ VZFZF
PS-3260	.875	E	3	NCFLF
PS-3261	2.125	E	3	QCFLF
PS-3262	3.625	E	3	BZFZF
PS-3263	1.125	U	3	VLFLF
PS-3264	1.250	C	1	QZFLF
PS-3265	.625	C	1	QLFLF
PS-3266	1.000	D	3	VCFLF
PS-3267	1.750	D	3	BZFLF
PS-3268	3.250	EB	3	VCFZF
PS-3270	3.149	G	2	VCFLF
PS-3271	1.750	C	1	VLFLF
PS-3272	1.750	C	1	BZFZF

PS SEAL INDEX

U.S. Seal Mfg. Part No.	Seal Size	Head Type	Mating Ring	Material Code
PS-3273	1.000	DB	3	VCFZF
PS-3274	1.250	C	1	QCFLF
PS-3275	3.000	C	3	VCFZF
PS-3276	2.362	G	25	VLFLF
PS-3278	1.692	G	1	VCFLF
PS-3279	1.500	C	3	BCFZF
PS-3282	1.500	E	3	VLFLF
PS-3283	1.750	G	3	BCFLF
PS-3284	1.500	D	1	BCFLF
PS-3286	1.750	C	3	VCFKF
PS-3287	1.187	D	3	BCDKF
PS-3288	1.250	EB	3	VCFZF
PS-3289	2.250	C	3	BLFLF
PS-3291	1.125	E	2	QCFZF
PS-3292	2.000	C	5	QCFZF
PS-3293	2.000	C	5	QLFLF
PS-3294	1.625	C	1	VLFLF
PS-3295	1.000	G	1	VCFJF
PS-3299	.750	D	3	VCFJF
PS-3300	2.625	E	3	BCFKF
PS-3303	1.500	D	3	XLFLF
PS-3304	2.000	EB	3	BCFJF
PS-3306	.750	DB	3	QCFZF
PS-3312	1.000	C	1	BCFJF
PS-3313	.750	C	1	BZFZE
PS-3314	3.875	D	3	VCFGP
PS-3315	1.181	D	3	XLFLF
PS-3316	.875	D	3	XLFLF
PS-3317	.875	D Special	3	XLFLF
PS-3318	1.375	D	3	XLFLF
PS-3318	1.375	D	3	XLFLF
PS-3319	.625	C	3	QCFKF
PS-3323	1.500	D	3	XLFLF
PS-3325	1.125	E	27	BCFJF
PS-3401	1.000	Q	9	NMDKF
PS-3415	.750	C	1	QCFJF
PS-3440	1.000	C	1	BCFJF
PS-3440V	1.000	C	1	V/BCFJF
PS-3450	.500	G	1	VLFLF
PS-3498	2.500	D	3	VAFLF
PS-3499	3.625	E	3	BCFJF
PS-3501	2.375	EB	3	BCFZF
PS-3505	3.437	U	3	VCPKF
PS-3507	.875	E	3	VZFLF
PS-3511	1.125	T	3	VCFJF
PS-3515	1.250	E	1	QCFLF
PS-3516	2.500	E	3	QCFZF
PS-3518	3.000	K	1	BCFJF
PS-3520	1.750	U	3	QCFZF
PS-3522	2.000	E	3	BCFKF
PS-3523	1.625	C	3	VCFZF
PS-3525	.625	C	3	QCFKF
PS-3528	1.250	E	1	QCFLF
PS-3530	2.250	E	3	B/VCFZF
PS-3537	2.250	C	1	BCFJF
PS-3537V	2.250	C	1	VCFJF
PS-3538	1.250	C	1	VCFLF
PS-3539	3.000	C	1	VZFZF
PS-3540	1.750	E	3	QZFZF
PS-3541	1.375	T	3	VZFZF
PS-3542	.562	C	3	VCFKF
PS-3543	1.625	C	1	VCFZF
PS-3550	.625	C	1	VFRFR
PS-3553	3.625	T	3	BCFKF
PS-3555	1.250	D	1	QLFLF
PS-3558	1.500	K	3	BCFJF

U.S. Seal Mfg. Part No.	Seal Size	Head Type	Mating Ring	Material Code
PS-3559	.750	C	5	Special
PS-3561	.500	C	1	BCFJF
PS-3562	2.062	T	3	BCFKF
PS-3563	.500	C	1	QCFLF
PS-3568	.500	G	1	QLFLF
PS-3576	2.250	E	3	VCFJF
PS-3580	2.000	C	1	QCFZF
PS-3583	.500	C	1	BCFJF
PS-3584	1.375	C	3 Special	VCFGF
PS-3586	.625	G	1	QCFJF
PS-3587	1.375	CB	3	BCFZF
PS-3589	1.000	E	5	VCFZF
PS-3591	2.000	U	3	QCFZF
PS-3600	3.000	C	3	BCFKF
PS-3606	2.125	C	3	VCFLF
PS-3607	1.250	T	3	NAFGF
PS-3611	1.250	WT	2	TCFOF
PS-3615	1.500	EB	3	VCFZF
PS-3616	1.625	C	1	QCFKF
PS-3619	1.000	C	3	VCFKF
PS-3625	1.000	E	1	VCFZF
PS-3629	1.250	D	3	VLZFZ
PS-3637	1.750	E	3	VCFKF
PS-3638	1.250	E	1	VCFZF
PS-3639	2.000	E	3	QCFZF
PS-3642	1.500	D	1	VLFLF
PS-3643	2.250	EB	3	B/VCFKF
PS-3644	2.000	E Special	3	NCPKF
PS-3645	3.625	T	3	BLFZF
PS-3648	1.875	EB	Special	VCFZF
PS-3649	2.000	U	3	XZFZF
PS-3650	1.750	T	3	VLFLF
PS-3651	2.500	C/X	1	BCFJ*
PS-3653	1.125	E	3	NCPGF
PS-3654	.750	C	1	BCFKF
PS-3661	2.750	C	3	VLZFZ
PS-3664	1.625	C	1	BZFZF
PS-3667	.625	B	9	BLFLF
PS-3673	1.750	E	3	BCFJF
PS-3674	2.000	C	1	QCFKF
PS-3676	2.000	C	1	BZFZF
PS-3677	.625	D	3	BCDLF
PS-3678	.875	C	3	QCFLF
PS-3684	3.625	T	3	BCFJF
PS-3685	1.250	D	3	VCFKF
PS-3687	1.750	C	3	BZFZF
PS-3688	2.000	C	3	BZFZF
PS-3689	1.375	C	1	QCFZF
PS-3690	1.750	E	5	VCFZF
PS-3701	3.000	C	3	BLFZF
PS-3702	3.250	C	3	BLFZF
PS-3704	1.500	C	3	VCFZF
PS-3707	.625	C	1	QLFLF
PS-3708	2.000	E	5	BCFZF
PS-3708V	2.000	E	5	VCFZF
PS-3712	1.125	D	3	VCFZF
PS-3713	3.000	D	3	NCPGP
PS-3714	2.125	EB	3	BCFJF
PS-3716	2.000	C	1	VCFLF
PS-3718	1.750	C	3	BCFJF
PS-3718V	1.750	C	3	VCFJF
PS-3719	1.750	C	3	B/VLFZF
PS-3721	2.000	C	3	BLFZF
PS-3723	.625	C	3	QCFJF
PS-3724	1.250	E	3	QCFKF
PS-3726	1.750	E	3	B/VCFJF

PS SEAL INDEX

U.S. Seal Mfg. Part No.	Seal Size	Head Type	Mating Ring	Material Code
PS-3727	2.125	E	3	VLFLF
PS-3728	.984	D	1	VCFJF
PS-3729	.500	X Special	3	BCFKF
PS-3731	1.125	Special	3	BCPKP
PS-3732	1.375	EB	3	QCFJF
PS-3733	.875	C	3	VCFJF
PS-3735	.500	C	3	VCFKF
PS-3736	1.500	C	3	VLFLF
PS-3738	1.250	C	1	BCFLF
PS-3740	.750	G	1	BLFLF
PS-3741	.625	B	1	VLFLF
PS-3745	3.500	D	3	VZFFZ
PS-3747	.625	C	1	BCFLF
PS-3749	.875	C	1	BCFJF
PS-3749-SC-SC	.875	C	1	BLFLF
PS-3751	2.437	E	3	VCPKF
PS-3753	1.875	K	1	BL/CFL/JF
PS-3754	1.750	V	3	BCFJF
PS-3755	1.000	C	3	VCFJF
PS-3759	1.250	D	3	BZFZF
PS-3764	2.500	C	1	VCFZF
PS-3765	2.125	K	1	VCFRF
PS-3765-TC-SEAT	2.125	K	3	VCFZF
PS-3769	1.375	EB	3	VCFZF
PS-3770	3.000	E	3	BZFLF
PS-3772	1.625	D	3	VZFLF
PS-3773	2.250	C	1	VZFFZ
PS-3776	3.000	D	3	VZFFZ
PS-3777	3.000	C	3	VCFLF
PS-3779	3.625	V	3	BCFJF
PS-3783	1.375	E	3	VCFLF
PS-3784	2.250	EB	3	BCFJF
PS-3785	1.000	C	1	VCFJF
PS-3788	.750	G	3	VCFJF
PS-3789	1.750	C	3	VCFGF
PS-3791	.625	C	1	BCFJF
PS-3792	1.375	E	3	VCFJF
PS-3793	3.500	G	3	QCFLF
PS-3799	1.375	EB	3	QCFZF
PS-3800	.500	X	3	VCFKF
PS-3802	3.000	G	3	QCFLF
PS-3803	1.000	E	3	VCFKF
PS-3806	2.500	E	3	VCFJF
PS-3807	1.000	C	3	VCFLF
PS-3809	2.125	D	3	VLFFZ
PS-3813	1.500	C	1	VCFJF
PS-3816	.625	A	1	VCFKF
PS-3817	1.125	EB	3	BCFZF
PS-3818	1.875	DB	1	BCDZF
PS-3824	1.000	C	28	BCFKF
PS-3826	.875	C	1	QCFJF
PS-3827	3.250	D	3	BZFZF
PS-3829	1.250	C	1	VRFJF
PS-3831	1.625	C	1	BCFJF
PS-3832	1.625	C	1	QCFLF
PS-3833	1.125	C	2	BCFKF
PS-3836	3.000	U	3	BCFJF
PS-3840	.750	C	1	BCFJF
PS-3841	2.750	C	3	BCFLF
PS-3843	.500	C	1	VCFJF
PS-3844	.500	C	1	BCFJF
PS-3845	.625	B	8	BMFJF
PS-3848	1.437	E	3	BCPKP
PS-3853	1.625	E	1	VLFLF
PS-3854	1.375	Q	9	BMPAP
PS-3855	.750	D	3	VLFLF

U.S. Seal Mfg. Part No.	Seal Size	Head Type	Mating Ring	Material Code
PS-3856	1.125	D	3	VLFLF
PS-3857	1.750	C	1	QLFZF
PS-3862	3.500	X	3	VCFKF
PS-3863	1.250	E	3	QCFZF
PS-3864	.625	A	1	VCFJF
PS-3865R	.625	B	1	VCFJF
PS-3866	.625	G	1	VCFJF
PS-3867	.625	G	1	VCFJF
PS-3868	.750	G	1	VCFJF
PS-3869	.625	G	31	VCFJF
PS-3870	.750	G	1	VCFJF
PS-3872	1.250	E	1	QCFKF
PS-3874	1.000	G	1	VCFJF
PS-3875	2.000	C	3	BCFKF
PS-3877	2.500	C	3	VLFLF
PS-3878	1.375	E	3	VCFJF
PS-3879	2.125	T	3	BCFJF
PS-3880	1.500	CB	3	BCFJF
PS-3882	.750	B	1	VCFJF
PS-3883	1.250	G	1	BCFJF
PS-3884	1.750	U	1	VCFZF
PS-3885	.625	K	1	VCFJF
PS-3886	1.250	C	1	VCFJF
PS-3888	2.500	D	3	VZFLF
PS-3890	.625	G	1	BCFJF
PS-3892	1.250	C	1	VRFLF
PS-3893	.875	C	3 Special	VCFGF
PS-3894	.750	C	1	QCFLF
PS-3896	.500	E	Special	VCPKP
PS-3897	2.125	E	3	VCFJF
PS-3900	.984	D	1	BCFKF
PS-3901	1.375	E	3	VCFJF
PS-3902	1.750	E	3	VCFJF
PS-3906	.625	C	1	BCFJF
PS-3907	.875	C	1	BCFJF
PS-3910	.625	G	1	BLFLF
PS-3911	.875	C	1	BLFLF
PS-3913	.500	C	1	BCFJF
PS-3914	.625	C	3	BCFJF
PS-3916	.750	C	3	BCFJF
PS-3918	1.125	D	1	VCFKF
PS-3922	.750	C	1	BLFLF
PS-3924	2.500	E	3	BCPKP
PS-3925	1.375	E	3	VCFJF
PS-3926	.625	B	9	VCFKF
PS-3929	1.875	E	3	VCFJF
PS-3931	1.625	E	2	BCDKF
PS-3932	1.375	D	1	BCDZF
PS-3932	1.375	D	1	BCDZF
PS-3933	1.250	C	1	BCEJE
PS-3934	1.250	D	3	NCPKF
PS-3935	.750	W	2	TCFKF
PS-3936	2.375	EB	3	BCFKF
PS-3936V	2.375	EB	3	VCFKF
PS-3936V-TC-SEAT	2.375	EB	3	VCFZF
PS-3937	.750	G	1	BLFLF
PS-3938	1.181	D	1	VCFZF
PS-3940	1.250	C	3	VRFLF
PS-3941	.875	C	1	VLFLF
PS-3943	1.500	C	3 Special	VCFGF
PS-3944	.875	C	1	BCFKF
PS-3945	1.250	C	3 Special	VCFGF
PS-3951	2.250	E	27	VCFKF
PS-3952	2.000	E Special	3	NCDKF
PS-3954	1.375	EB	1	BCFKF
PS-3955	2.250	C	27 Special	VCFGF

PS SEAL INDEX

U.S. Seal Mfg. Part No.	Seal Size	Head Type	Mating Ring	Material Code
PS-3959	1.000	K	1	VCFJF
PS-3960	.625	G	1	BCFJF
PS-3962	.625	W Special	2	TCFJF
PS-3963	1.750	C	3	BLFZF
PS-3964	1.875	T	3	BCFJF
PS-3965	1.125	C	1	QCFLF
PS-3966	2.250	C	3	BLFZF
PS-3967	1.625	C	1	BCFLF
PS-3969	3.000	E	3	BCFJF
PS-3970	.875	C	1	BCFZF
PS-3972	1.500	K	3	VLFLF
PS-3973	1.250	U	2	BCPKF
PS-3974	1.375	DB	1	BCFJF
PS-3974V	1.375	DB	1	VCFJF
PS-3976	1.000	E	3	VCFJF
PS-3977	.625	A	1	VLFLF
PS-3979	1.500	C	Special	BCFKF
PS-3981	.625	C	3	QCCKF
PS-3982	1.750	E	3	VLFLF
PS-3984	1.375	E	3	VCFLF
PS-3985	.750	B	1	BCFJF
PS-3986	.750	B	1	VCFJF
PS-3988	1.625	R	3	NCFGF
PS-3991	1.375	EB	3	BCFKF
PS-3992	1.500	G	1	VCFJF
PS-3993	2.000	C	3	BCFJF
PS-3994	2.750	C	3	BCFJF
PS-3996	.875	C	1	VCFLF
PS-3999	2.000	U	3	VCFZF
PS-4000	.472	G	1	QCFLF
PS-4006	2.375	E	5	BCFZF
PS-4014	3.750	D	3	BLFZF
PS-4015	2.000	C	3	BCFKF
PS-4017	.875	C	3	VCCKF
PS-4019	3.500	E	3	BCFJF
PS-4020	.750	G	1	BCFJF
PS-4024	.750	G	1	QLFLF
PS-4026	1.750	D	3	NCFKF
PS-4027	.625	A	1	QCJFJ
PS-4028	2.875	K	3 Special	NCFGF
PS-4029	1.250	C	1	QCZFZ
PS-4031	.625	C	1	VCFLF
PS-4033	3.000	D	3	VZFLF
PS-4034	1.500	E	3	BCFZF
PS-4035	1.750	C/X Special	1	BCFJF
PS-4037	1.125	C	3	VLFLF
PS-4038	.500	Q	8	BMFJF
PS-4038	.500	Q	9	BMFJF
PS-4039	1.692	G	1	VLFLF
PS-4040	1.250	C	1	VLZFZ
PS-4041	2.250	Q	1	VMPSP
PS-4042	.787	C	1	BCFJF
PS-4043	3.625	E	3	BCFJF
PS-4044	1.375	C	1	BCFJF
PS-4045	.500	C	3	B/VCFJF
PS-4046	1.875	T	25	BCFJF
PS-4047	1.125	C	1	VCCKF
PS-4048	.750	B	9	BLFLF
PS-4049	1.250	E	3	VCFLF
PS-4052	2.000	Special	Special	BCFAF
PS-4053	1.250	C	1	QLFLF
PS-4056	.750	B	1	QCJFJ
PS-4057	1.375	C	3	QCCKF
PS-4059	.625	G	3	VCFLF
PS-4060	.437	G	1	BCFJF
PS-4063	.437	G	1	VCFJF

U.S. Seal Mfg. Part No.	Seal Size	Head Type	Mating Ring	Material Code
PS-4064	.500	Special	Special	BMFJF
PS-4065	.625	Special	Special	BMFJF
PS-4066	.750	Special	Special	BLFLF
PS-4067	1.437	E	3	VCPKF
PS-4068	1.625	C	3	QCZFZ
PS-4069	3.000	V	3	BCFZF
PS-4070	2.250	D	3	VAFLF
PS-4070	2.500	D	3	VAFLF
PS-4071	1.250	D	3	VCFLF
PS-4072	2.500	T	3	BCFJF
PS-4073	1.250	D	3	VCFLF
PS-4079	2.125	D	3	VCFLF
PS-4081	1.000	C	1	BCFJF
PS-4082	3.000	E	3	BCFJF
PS-4086	3.000	C	1	VCJFJ
PS-4088	1.500	EB	3	QCJFJ
PS-4089	2.750	E	3	VCFLF
PS-4091	1.250	D	3	VLFLF
PS-4093	.750	E	3	QCCKF
PS-4094	1.687	E	1	BCFJF
PS-4095	1.000	C	1	VCJFJ
PS-4096	1.750	EB	3	VCFLF
PS-4097	1.750	EB	3	BCCKF
PS-4098	.750	D	1	QCDJF
PS-4099	1.625	E	1	BLFLF
PS-4101	1.250	C	1	VLFLF
PS-4102	2.000	EB	3	VCZFZ
PS-4105	2.250	EB	3	VCJFJ
PS-4106	.750	B	1	VCJFJ
PS-4107	1.875	D	3	BCFLF
PS-4108	2.375	EB	3	VCFLF
PS-4109	2.500	T	3	VZFLF
PS-4112	1.750	E	3	QCFLF
PS-4113	3.500	T	3	BCCKF
PS-4114	.625	B	8	VCFFF
PS-4114	.625	B	8	VCFFF
PS-4115	1.750	E	1	VLFLF
PS-4117	1.375	D	1	BCFZF
PS-4119	1.375	CB	3	VCCKF
PS-4120	2.000	C	1	VCCKF
PS-4121	.750	C	3	NCFKF
PS-4123	1.375	D	3	VCP/FKF
PS-4127	3.250	C	3	BCFJF
PS-4129	1.000	K	1	BLFLF
PS-4131	1.250	C	1	VCJFJ
PS-4133	1.750	Q	Special	Special
PS-4134	1.375	X Special	Special	B/NCPGF
PS-4136	1.750	E	3	VCFLF
PS-4137	1.000	D	3	VCPKF
PS-4139	1.750	E	3	VCCKF
PS-4140	1.437	E	3	VCFLF
PS-4141	1.750	E	3	QCZFZ
PS-4142	3.750	E	3	VCFLF
PS-4144	.750	T	3	VLFLF
PS-4145	1.375	EB	3	BCFZF
PS-4146	2.125	EB	5	BCFZF
PS-4147	3.000	E	3	BCFJF
PS-4149	1.750	E	3	VCZFZ
PS-4150	1.250	C	1	VLFLF
PS-4152	1.250	C	3	BCFGF
PS-4153	1.750	C	1	VCJFJ
PS-4154	2.000	D	3	VCCKF
PS-4155	.625	G	1	VLFLF
PS-4156	1.250	C	1	QLFLF
PS-4159	1.625	EB	3	VCJFJ
PS-4162	2.375	E	3	QLFLF

PS SEAL INDEX

U.S. Seal Mfg. Part No.	Seal Size	Head Type	Mating Ring	Material Code
PS-4164	3.500	C	3	QCFZF
PS-4166	1.875	E	3	VZFZF
PS-4167	1.500	E	3	QCFZF
PS-4168	3.500	T	3	BCFJF
PS-4170	1.375	EB	3	BCFKF
PS-4171	1.500	C	1	QCFJF
PS-4172	3.000	E	3	VCFKF
PS-4174	3.250	U	3	BZFZF
PS-4175	3.250	D	3	BCFKF
PS-4176	1.250	C	1	VCFZF
PS-4177	1.125	K	1	VL/CFL/JF
PS-4178	2.000	C	3	VLFLF
PS-4179	1.250	K	1	VLFLF
PS-4180	.500	G	1	BCFJF
PS-4186	1.750	E	3	XCFLF
PS-4187	1.750	E	1	QCFJF
PS-4189	1.437	E	3	BCPKF
PS-4189V	1.437	E	3	VCPKF
PS-4192	3.250	U	3	BCFJF
PS-4193	1.875	E	3	VCFZF
PS-4194	1.375	D	1	VLFLF
PS-4195	1.000	G	1	VCFJF
PS-4196	3.000	K	3	BZFZF
PS-4197	1.250	T	3	NCFGF
PS-4199	4.750	D	3	BCFJF
PS-4200	1.375	DB	1	BCFZF
PS-4201	1.500	E	3	VCFZF
PS-4204	1.250	C	1	QRFLF
PS-4205	1.750	C	1	VLFLF
PS-4206	1.375	T	3	VCFJF
PS-4208	2.000	T	3	VZFZF
PS-4209	5.000	E	3	BCFJF
PS-4210	1.000	T	3	QLFLF
PS-4211	1.250	C	1	BRFLF
PS-4212	1.500	C	3	VCFJF
PS-4214	.500	C	1	BCFJF
PS-4216	1.750	G	1	BLFZF
PS-4217	1.875	K	1	BZ/CFZ/JF
PS-4219	1.875	C	3	VCFKF
PS-4220	.625	G	1	VCFJF
PS-4221	1.750	EB	3	VCFJF
PS-4222	.625	C	1	QCFLF
PS-4225	.472	G	1	QCFLF
PS-4226	.625	C	1	VLFLF
PS-4228	1.750	E	3	VCFZF
PS-4229	.750	C	3	QCFJF
PS-4231	.625	G	1	VCFJF
PS-4232	1.750	E	3	VCFKF
PS-4233	1.750	E	3	BCFZF
PS-4235	2.000	C	3	BCFLF
PS-4236	3.500	R	3	BCFJF
PS-4237	.625	Q	8	VCFJF
PS-4238	1.375	C	1	BLFLF
PS-4239	2.000	C	3	BCFJF
PS-4240	.625	A	1	BCFJF
PS-4243	2.125	E	3	BCFKF
PS-4246	1.250	D	3	BCDLF
PS-4247	1.250	C	1	BRFJF
PS-4248V	.625	B	8	VLFSF
PS-4253	1.000	DB	3	VCFKF
PS-4254	1.000	C	1	VCFJF
PS-4255	1.000	DB	3	VCFZF
PS-4258	2.000	U	3	BZFLF
PS-4261	1.750	E	3	VCFJF
PS-4262	1.125	E	3	B/VCFKF
PS-4263	1.750	T	3	VCFJF

U.S. Seal Mfg. Part No.	Seal Size	Head Type	Mating Ring	Material Code
PS-4265	.750	G	1	BCFJF
PS-4267	.625	G	1	BCFJF
PS-4269	1.625	EB	3	VCFZF
PS-4270	1.875	E	3	BLFLF
PS-4271	1.125	D	1	NCFJF
PS-4272	.625	C	1	BCFJF
PS-4272V	.625	C	1	VCFJF
PS-4273	.787	G	1	VCFJF
PS-4274	.750	G	32	BCFJF
PS-4275	.625	G	31	BCFJF
PS-4276	2.125	C	3	VCFKF
PS-4277	1.375	E	3	VLFLF
PS-4278	3.750	E	3	BCFJF
PS-4280	.625	G	1	VCFJF
PS-4282	1.250	K	1	BL/CFL/JF
PS-4283	.750	C	3	QCFLF
PS-4284	.625	A	1	VCFLF
PS-4285	.750	C	3	VCFKF
PS-4287	2.000	C	3	QCFJF
PS-4288	1.625	C	3	QCFZF
PS-4289	1.000	DB	3	VCFKF
PS-4290	1.750	E	3	QCFLF
PS-4291	2.000	EB	3	BCFZF
PS-4292	.562	C	3	BCFKF
PS-4294	2.000	K	1	BL/CFZ/CF
PS-4295	1.125	C	1	VCEZE
PS-4297	1.000	D	1	VLZF
PS-4298	1.187	D	3	NCPKF
PS-4300	1.125	E	3	VCFLF
PS-4301	1.000	K	1	BLFLF/BCFJF
PS-4302	1.125	C	1	BCFJF
PS-4304	1.750	K	1	VZFZF
PS-4305	1.250	K	1	BLFLF
PS-4306	1.250	E	3	QCFLF
PS-4307	.875	D	3	BCDZF
PS-4308	2.750	C	1	BZFZF
PS-4310	.625	C	25	VLFLF
PS-4311	2.500	K	1	BLFLF
PS-4312	2.000	E	3	BCFKF
PS-4313	.625	C	3 Special	VCFGF
PS-4314	2.125	C	3	QCFZF
PS-4317	1.500	EB	3	BCFKF
PS-4318	.875	D	1	NCFLF
PS-4320	.625	C	3	QCFJF
PS-4321	1.250	C	3	XLFLF
PS-4323	.750	C	3	BCFJF
PS-4324	3.000	D	3	VCDGF
PS-4325	2.375	C	3	VCFLF
PS-4326	1.750	E	3	VCFJF
PS-4327	1.750	E	1	BCFLF
PS-4328	1.375	C	3	QLFLF
PS-4330	.750	C	1	BCFKF
PS-4332	1.250	C	1	QCFLF
PS-4333	1.875	D	3	BCFJF
PS-4336	1.250	C	3	QCFLF
PS-4341	2.875	E	5	BCFZF
PS-4343	2.000	K	3	BZ/CFZ/JF
PS-4345	2.000	C	3	BCFJF
PS-4346	.625	C	3	VCFJF
PS-4349	.500	G	1	QLFLF
PS-4350	1.000	C	3	QCFZF
PS-4352	3.000	C	3	BLFZF
PS-4353	1.750	K	3	BCFJF
PS-4354	1.500	E	1	BZFZF
PS-4355	.625	A	1	BLFZF

PS SEAL INDEX

U.S. Seal Mfg. Part No.	Seal Size	Head Type	Mating Ring	Material Code
PS-4356	.625	C	1	QCCKF
PS-4357	2.000	G	25	QCFLF
PS-4358	.625	C	3	QCFLF
PS-4360	.500	B	8	BLFLF
PS-4361	1.625	D	1	BLFZF
PS-4362	1.000	K	3	BCFKF
PS-4363	1.500	D	3	BCFGF
PS-4365	1.500	D	3	XLFZF
PS-4366	2.750	C	3	BLFZF
PS-4367	3.000	C	3	BCFKF
PS-4368	1.500	E	5	QCFZF
PS-4371	.625	A	1	VCFJF
PS-4372	1.750	E	5	QCFZF
PS-4374	1.625	EB	3	BCFJF
PS-4375	.625	D	3	VCFZF
PS-4376	2.000	E	3	QCFJF
PS-4377	1.250	T	3	BCKFK
PS-4378	3.000	C	1	VLFZF
PS-4379	1.000	C	1	QCFZF
PS-4380	2.250	EB	3	VCFLF
PS-4381	2.750	C	1	VZFZF
PS-4384	1.375	E	3	XLFLF
PS-4388	2.125	T	3	BLFZF
PS-4389	1.625	C	1	BCFLF
PS-4390	.625	G	1	VLFLF
PS-4391	2.000	U	3	VLFLF
PS-4392	2.625	E	3	QCFLF
PS-4393	3.250	UB	5	BCFZF
PS-4394	1.000	D	3	VLFZF
PS-4395	.875	C	1	BCELE
PS-4396	1.250	E	3	VCFKF
PS-4399	1.750	D	3	XCFJF
PS-4400	1.437	R	3	VCFKF
PS-4402	.625	C	3	VCFZF
PS-4405	1.750	T	3	VCFLF/ VCFJF
PS-4407	1.500	E	1	QLFLF
PS-4409	2.250	E	3	QCFLF
PS-4410	1.750	C	1	BZFZF
PS-4411	2.500	E	1	BLFZF
PS-4412	1.000	E	3	VCFZF
PS-4414	5.000	V	3	BCFKF
PS-4416	2.000	C	3	BCFJF
PS-4417	1.875	EB	3	VCFJF
PS-4418	2.125	EB	3	VCFJF
PS-4419	2.000	EB	3	VCFJF
PS-4420	1.375	EB	3	VCFKF
PS-4421	1.125	E	3	QCFJF
PS-4423	1.500	D Special	3	XLFLF
PS-4424	.625	A	1	VCFJF
PS-4425	1.125	G	1	BLFLF
PS-4426	1.875	K	1	BZ/CFL/JF
PS-4428	1.250	E	1	BCFZF
PS-4429	1.750	E	5	BCFZF
PS-4430	5.000	C	3	VCFJF
PS-4431	1.250	D	3	VLFLF
PS-4432	2.000	E	3	BLFLF
PS-4433	1.375	E	3	XZFLLF
PS-4434	2.125	E	3	VLFJF
PS-4435	1.625	D	28	BCFKF
PS-4436	2.125	C	1	VCFJF
PS-4437	2.125	D	2	BCDKF
PS-4438	1.500	C	3	QCFZF
PS-4442	.625	C	3	VCFKF
PS-4443	1.125	C	1	BCFLF
PS-4446	2.750	E	3	VZFZF

U.S. Seal Mfg. Part No.	Seal Size	Head Type	Mating Ring	Material Code
PS-4447	1.500	C	3	VLFZF
PS-4451	.500	E	Special	QCCKF
PS-4452	1.375	E	3	VCFZF
PS-4453	1.000	D	1	VCFJF
PS-4454	1.125	C	3	VZFZF
PS-4455	1.437	D	3	VCPKF
PS-4456	1.375	T	1	VCFJF
PS-4458	.625	C	1	VCFJF
PS-4459	1.500	E	3	QLFLF
PS-4460	1.250	C	3	XLFZF
PS-4461	1.750	C	1	VZFLF
PS-4462	.625	A	1	BMFJF
PS-4463	1.250	C	1	BCFJF
PS-4464	1.250	C	1	QCCKF
PS-4465	.750	C	3	VCFJF
PS-4466	2.500	E	3	VZFLF
PS-4467	1.875	V	3	BCFJF
PS-4468	2.000	U	3	VCFLF
PS-4471	1.625	E	3	VCFLF
PS-4472	2.625	E	3	VLFZF
PS-4473	1.500	EB	3	BCFJF
PS-4474	2.000	U	3	BCFJF
PS-4475	3.250	U	3	QCFJF
PS-4476	1.500	EB	3	VCFJF
PS-4477	1.875	E	3	XCFZF
PS-4478	2.000	K	1	BCFJF
PS-4479	.625	B	8	QCFJF
PS-4481	3.000	C	3	VZFZF
PS-4482	1.500	C	1	VCFKF
PS-4483	3.250	U	3	VCFKF
PS-4484	.750	E	1	QCCKF
PS-4485	2.625	EB	3	BLFZF
PS-4486	1.875	DB	3	BCFJF
PS-4487	1.750	D	1	VLFLF
PS-4488	1.750	UB	3	BCFZF
PS-4489	.750	A	1	BMFJF
PS-4490	2.500	G	25	QLFLF
PS-4491	1.750	DB	3	BCFZF
PS-4492	2.375	E	3	VLFLF
PS-4495	.625	C	1	BLFLF
PS-4504	2.750	K	3	BCFJF
PS-4505	1.125	C	3	VCFLF
PS-4506	.937	E	3	QCFLF
PS-4508	2.125	C	3	BCFJF
PS-4509	1.750	E	3	VZFZF
PS-4512	1.750	E	3	QCFLF
PS-4513	.875	C	3	VCFZF
PS-4514	3.000	E	3	BLFLF
PS-4515	1.375	T	3	VCFJF
PS-4516	1.625	C	3	VCFJF
PS-4517	.984	D	1	BCFJF
PS-4518	.750	E	1	BCFJF
PS-4520	.750	B	3	VCFJF
PS-4521	1.875	T	3	VCFKF
PS-4523	2.500	V	3	BCFJF
PS-4525	1.625	C	1	BCFJF
PS-4529	4.500	E	3	BCFJF
PS-4531	.750	C	1	QCFZF
PS-4532	2.500	D Special	3 Special	VCFZF
PS-4533	1.187	D	3	BCFKF
PS-4534	1.250	C	3	QZFZF
PS-4535	1.750	E	3	BCFKF
PS-4537	1.250	K	1	BZFZF
PS-4538	1.250	E	1	VLFLF
PS-4539	1.750	K	1	VLFLF
PS-4544	2.750	E	3	VLFLF

PS SEAL INDEX

U.S. Seal Mfg. Part No.	Seal Size	Head Type	Mating Ring	Material Code
PS-4545	1.625	EB	5	BCFZF
PS-4546	1.500	D	3	B/VCPKP
PS-4547	3.625	R	3	NCFKP
PS-4549	2.250	E	3	BZFZF
PS-4552	1.375	E	1	VZFZF
PS-4554	2.625	EB	5	BCFZF
PS-4557	.625	B	1	BMFJF
PS-4558	.500	G	1	VCFJF
PS-4559	1.250	C	3	QCFZF
PS-4560	.625	B	1	BCFJF
PS-4563	1.875	DB	3	VCFZF
PS-4564	2.750	T	3	BZFZF
PS-4565	1.125	E	3	QCFZF
PS-4566	1.375	E	3	QCFJF
PS-4570	2.125	C	3	VZFLF
PS-4572	1.625	K	1	VL/CFL/JF
PS-4574	1.375	E	3	VCFZF
PS-4575	1.375	C	1	VZFLF
PS-4577	.625	G	1	QCFJF
PS-4579	1.000	DB	3	NCPLF
PS-4580	2.500	T	1	VZFLF
PS-4583	2.750	E	3	VCFJF
PS-4584	2.125	U	3	VCF/EJE
PS-4585	3.250	K	3	BCFLF
PS-4586	1.750	E	3	VCFLF
PS-4587	.625	B	8	Special
PS-4588	.500	X Special	1	VCFLF
PS-4590	1.000	K	3	BLFLF
PS-4591	.984	C	3 Special	VCFLF
PS-4592	1.875	U	5	BCFZF
PS-4595	1.250	C	1	BLFLF
PS-4596	1.750	C	3	QLFLF
PS-4597	1.625	C	1	BCFJF
PS-4598	6.000	D	3	VZFZF
PS-4600	2.000	E	3	BZFZF
PS-4601	1.000	D	3	QCCKF
PS-4603	.625	C	1	VCFJF
PS-4613	5.000	V	3	BCFJF
PS-4618	1.750	E	27	BCFJF
PS-4626	2.625	E	3	VLZFZ
PS-4628	1.250	E	27	BCFJF
PS-4637	1.250	D	3	VCPLF
PS-4638	1.000	Special	9	BCPGP
PS-4639	1.750	T	3	VLFLF
PS-4646	3.000	G	3	VLFLF
PS-4647	2.875	D	3	VCFLF
PS-4653	1.625	EB	3	VCFJF
PS-4697	1.750	C	1	VCFLF
PS-4788	2.750	E	3	BZFLF
PS-4800	2.250	D	1	BCFLF
PS-4801	2.500	G	3	BCFLF
PS-4881	3.500	E	3	BCFKF
PS-4882	1.000	E	3	BCFJF
PS-4884	1.750	C	3	VCFJF
PS-4885	1.875	C	1	QCFJF
PS-5002	1.687	D	2	BCFKF
PS-5003	1.375	C	2	NCFKF
PS-5005	2.187	D	2	BCFKF
PS-5011	1.875	C	Plate	BCFGF
PS-5019	2.165	C	2	VCFKF
PS-5024	2.187	D	2	VCFKF
PS-5039	1.000	C	1	BCFJF
PS-5074	1.375	C	3	BCFKF
PS-5076	2.250	C	3 Special	VCFKF
PS-5082	1.000	C	2	BCFKF
PS-5087	1.875	T	3	BZFZF

U.S. Seal Mfg. Part No.	Seal Size	Head Type	Mating Ring	Material Code
PS-5194	1.687	D	2	VCFKF
PS-5200	1.250	E	1	BCFJF
PS-5224	2.000	C	1	BCFJF
PS-5235	1.000	A	1	BCFJF
PS-5252	3.000	E	3	BCFKF
PS-5259	1.500	E	3	QCCKF
PS-5342	1.875	C	2	BCFJF
PS-5358	2.250	D	3	Special
PS-5366	1.250	E	1	BCFKF
PS-5389	1.750	C	3	BCFJF
PS-5389-CMS	1.750	C	1	BCFJF
PS-5625	.625	Special	1	QC-J-
PS-5654	1.692	C	2	VCFKF
PS-5674	1.250	C	1	VCFJF
PS-5676	1.375	C	2	B/VCFJF
PS-5676V	1.375	C	2	VCFJF
PS-5679	1.875	C	2	QCFJF
PS-5706	2.125	C	2	VCFKF
PS-5711	1.375	C	2	B/VCFKF
PS-5712	1.875	C	2	B/VCFKF
PS-5717	1.875	C	2	VCFJF
PS-5720	1.500	C	2	BCFKF
PS-5721	1.875	C	Plate	VCFGF
PS-5722	1.562	C	Special	VCFKF
PS-5723	.984	C	1	QCFLF
PS-5727	1.500	C	3	VRFRF
PS-5728	.750	C	3	VLFLF
PS-5729	.984	C	2	VCFJF
PS-5735	2.362	G	1	VCFLF
PS-5737	2.875	EB	3	BCFJF
PS-5740	2.250	C	2	BCFKF
PS-5741	2.250	C	Special	VLZFZ
PS-5742	2.250	C	Special	VLZFZ
PS-6000	1.500	C	3	VCFGP
PS-6002	2.625	D	3	VCFKF
PS-6005	1.625	C	3	VCFKF
PS-6006	.750	D	3	BCDLF
PS-6007	2.000	E Special	Plate	NCPGP
PS-6008	1.625	X Special	25 Special	BCPGF
PS-6019	1.000	D	3	NCPGF
PS-6036	1.250	D	2	VCPFP
PS-6048	1.375	D	3	VCPSP
PS-6048	1.375	D	3	VCPSP
PS-6055	1.437	E	27	VCPGP
PS-6056	1.437	X	27 Special	VCFSF
PS-6058	1.500	E	Plate	NCPGP
PS-6075	1.625	D	3	VCPSP
PS-6090	1.750	E	3	B/VCFKF
PS-6094	1.875	D	3	VCPSP
PS-6097	1.875	X Special	3 Special	NCZFZ
PS-6098	1.875	C	3 Special	VCFKP
PS-6115	2.000	D	Plate	NCPGP
PS-6120	2.125	K	3 Special	VCFZF
PS-6121	2.125	K	3 Special	VCFZ/KF
PS-6138	2.500	C	3 Special	VCFKF
PS-6140	2.500	K	3 Special	VCFZF
PS-6141	2.500	K	3 Special	VCFKF
PS-6146	2.500	R	3	NCPGP
PS-6154	2.750	C	27	VCFGF
PS-6155	2.750	C	3	VCFKF
PS-6169	3.000	K	3 Special	NCFKF
PS-6170	3.000	K	3 Special	VCFZF
PS-6171	3.000	K	3 Special	VCFKF
PS-6172	3.000	C	3 Special	VCFKF
PS-6173	3.000	C	3 Special	VCFKF
PS-6174	3.000	E	3	VCDGP

PS SEAL INDEX

U.S. Seal Mfg. Part No.	Seal Size	Head Type	Mating Ring	Material Code
PS-6175	3.000	R	3	NCPGP
PS-6177	3.375	C	3	VCFKF
PS-6179	3.375	X	3 Special	VCFKF
PS-6180	1.375	C	3	VCFGF
PS-6201	3.250	D	3	VCFJF
PS-6202	3.000	D	1	BZFZF
PS-6203	3.750	D	3	VCFJF
PS-6204	3.500	C	3	BCFJF
PS-6205	2.750	C	1	BCFJF
PS-6206V	3.000	C	3	VCFJF
PS-6207	2.750	C	3	VCFJF
PS-6213	2.000	C	1	VZFZF
PS-6214	3.000	C	1	VZFZF
PS-6216	.625	C	1	VZFZF
PS-6217	1.750	D	1	VZFLF
PS-6218	2.000	C	1	VZFZF
PS-6219	3.000	D	3	BZFLF
PS-6221	3.500	D	3	V/BZFZF
PS-6224	2.000	C	1	VLFLF
PS-6225	3.000	C	3	VLFLF
PS-6226	3.250	C	3	VLFLF
PS-6227	3.250	K	3	VCFJF
PS-6228	3.000	K	3	VCFJF
PS-6229	1.250	K	3	BCFJF
PS-6234	.625	C	1	BCFJF
PS-6237	3.625	T	3	BCFZF
PS-6238	2.000	C	3	BLFLF
PS-6239	2.750	C	3	BLFLF
PS-6240	3.000	C	3	BLFLF
PS-6241	1.750	C	3	BLFLF
PS-6242	1.750	T	3	VCFJF
PS-6243	2.500	T	3	VLFZF
PS-6244	2.500	T	3	VCFJF
PS-6245	3.500	C	3	BCFKF
PS-6246	1.750	K	1	BCFJF
PS-6247V	2.000	C	3	VCFKF
PS-6248	2.250	C	3	VCFKF
PS-6249	3.000	C	3	BZFZF
PS-6249-SC-TC	3.000	C	3	BLFZF
PS-6250	3.000	C	3	VCFKF
PS-6253	3.250	C	3	VCFJF
PS-6254	2.500	E	3	BCFJF
PS-6258	3.250	C	3	BCFKF
PS-6259	1.250	G	1	VCFJF
PS-6260	1.250	G	1	QCZFZ
PS-6261	1.250	G	1	QCFJF
PS-6262	1.625	G	1	QCFJF
PS-6263	1.625	G	1	QCZFZ
PS-6264	1.250	G	1	VCFJF
PS-6265	1.250	G	1	VLFLF
PS-6266	1.250	G	3	BCFLF
PS-6267	.625	G	1	QLFLF
PS-6301	2.250	Q	3	NMPAP
PS-6302	2.250	Q	1	BMPAP
PS-6305	1.000	Q	9	BMDAF
PS-6308	.687	Q	9	Special
PS-6311	1.625	Q	Special	N/BMDAF
PS-6312	1.000	Q	Special	BMPAP
PS-6313	.500	Q	1	BCFJF
PS-6317	1.375	Q	9	VMPSP
PS-6318	1.125	Q	9	VMFAF
PS-6321	.500	C	3	BCFKF
PS-6328	1.000	D	3	BCPKF
PS-6329	1.000	D	3	NCPKF
PS-6331	1.000	E	3	BCPKF
PS-6334	1.125	E	3	VCPKF

U.S. Seal Mfg. Part No.	Seal Size	Head Type	Mating Ring	Material Code
PS-6337	1.250	D	3	BCPKF
PS-6338	1.437	E	3	VCPKF
PS-6339	1.250	D	3	BCPKF
PS-6340	1.437	E	3	BCPKF
PS-6342	1.437	E	3	VCPKF
PS-6344	1.437	E	3	NCPKF
PS-6348	1.625	E	3	BCPKF
PS-6349	1.625	E	3	VCPKF
PS-6351	1.625	E	3	NCPKF
PS-6600	2.750	E	3	VCFJF
PS-6601	2.750	E	3	VCFLF
PS-6602	2.750	C	Special	VCFKF
PS-6775V	1.375	C	3	VCFJF
PS-6802	1.250	E	1	BCFJF
PS-6812	1.187	C	1	BCFJF
PS-6908	2.750	C	1	BZFZF
PS-6912	2.125	E	3	BCEJE
PS-6916	1.771	G	1	VLFLF
PS-6997	2.500	K	3	NCFKF
PS-7017	1.625	C	3	QCCKF
PS-7020	1.875	E	3	VCFJF
PS-7035	1.750	C	3	QCZFZ
PS-7060	2.250	K	3	BCFKF
PS-7064	2.250	C	1	BZFZF
PS-7087	.750	D	3	BCPKF
PS-7090	1.750	U	3	BCFKF
PS-7103	1.375	WT	27	TCFJF
PS-7105	1.437	C	3	BCFKF
PS-7105V	1.437	C	3	VCFKF
PS-7130	.875	C	1	BCFJF
PS-7131	1.500	C	3	BZFZF
PS-7138	2.250	C	1	BCFJF
PS-7138-TC-TC	2.250	C	1	BZFZF
PS-7138V-SC-TC-CMS	2.250	C	1	VLFZF
PS-7166	1.500	C	3	BCFJF
PS-7172	3.250	D	3	BCFJF
PS-7196	2.000	K	3	BCFJF
PS-7196V	2.000	K	3	VCFJF
PS-7199	1.375	C	1	BCFJF
PS-7201	1.500	C	1	BCFJF
PS-7207	1.000	C	3	VCFKF
PS-7215	3.000	V	3	BCFJF
PS-7232	1.125	W	2	TCFKF
PS-7244	3.250	K	3	BCFKF
PS-7245	1.250	D	3	VCPGP
PS-7250	.625	WA	Special	TCFJF
PS-7252	1.750	E	1	BCFJF
PS-7277	.750	C	1	BCFJF
PS-7305	.750	C	1	VLFLF
PS-7309	2.000	C	3	QCZFZ
PS-7323	1.250	K	1	BZ/CFZ/JF
PS-7325	1.125	C	1	QCZFZ
PS-7343	1.250	C	3	BCFJF
PS-7352	1.875	K	1	BCFKF
PS-7363	1.750	E	3	QCZFZ
PS-7367	1.437	C	Special	VCFGF
PS-7400	2.000	U	3	BCFJF
PS-7409	1.500	C	1	VCFJF
PS-7413	1.500	C	1	QCCKF
PS-7431	2.250	K	1	BCFJF
PS-7434	1.000	C	1	BCFJF
PS-7436	1.250	C	3	QCZFZ
PS-7488	1.750	E	3	VLFLF
PS-7491	1.500	E	3	B/VLFZF
PS-7496	.875	C	1	BCFJF
PS-7497	1.625	C	25	B/VCFJF

PS SEAL INDEX

U.S. Seal Mfg. Part No.	Seal Size	Head Type	Mating Ring	Material Code
PS-7497V	1.625	C	25	VCFJF
PS-7504	1.500	E	3	QCFLF
PS-7514	.750	C	1	BCFJF
PS-7520	.590	C	1	BCFKF
PS-7520V	.590	C	1	VCFKF
PS-7524	.625	C	1	BCFJF
PS-7524V	.625	C	1	VCFJF
PS-7524V-P90	.625	C	1	VRFJF
PS-7547	.625	C	1	VLFLLF
PS-7553	.590	C	1	BCFJF
PS-7559	1.875	E	3	BCFJF
PS-7560	1.750	E	3	VCFZF
PS-7561	1.750	E	3	VCFZF
PS-7562	1.500	E	3	QCFZF
PS-7580	2.437	E	3	BCPKP
PS-7587	1.500	W	2	TCFJF
PS-7607	1.750	C	3	QCFLF
PS-7608	1.125	C	3	VCFZF
PS-7609	1.500	E	5	QZFLF
PS-7610	1.750	E	5	QZFLF
PS-7613	.750	D	3	NCPKF
PS-7613V	.750	D	3	VCPKF
PS-7616	2.000	U	3	VZFLF
PS-7618	.750	B	11	BMFJF
PS-7632	1.500	C	1	QCFZF
PS-7635	.625	C	3	VCFKF
PS-7652	1.750	D	1	QCDZF
PS-7674	1.500	C	3	BCFKF
PS-7679	1.750	C	3	VLFLLF
PS-7684	1.750	C	1	QCFZF
PS-7685	1.750	E	3	BCFJF
PS-7689	.625	C	1	QCFKF
PS-7694	1.500	C	1	BCFJF
PS-7695	1.375	CB	3	VCFKF
PS-7696	1.375	CB	1	QCFJF
PS-7697	1.375	CB	3	BCFJF
PS-7697V-TC-SEAT	1.375	CB	3	VCFZF
PS-7698V-LC	1.875	E	3	VCFKF
PS-7702	1.375	EB	3	BCFJF
PS-7703	2.625	EB	3	BCFJF
PS-7712	.500	C	1	BMFJF
PS-7716	2.500	E	3	BCFKF
PS-7719	1.250	E	3	VCFZF
PS-7727	.500	X Special	3	VCFGF
PS-7731	2.000	C	3	VLFLLF
PS-7736	1.750	E	1	QCFZF
PS-7740	.500	C	1	BMFJF
PS-7747	1.500	C	1	VCFZF
PS-7749	2.250	EB	3	BCFZF
PS-7750	2.250	C	3	QCFZF
PS-7752	1.750	D	3	VZFLF
PS-7754	3.250	E	3	BCFKF
PS-7766	2.250	K	3	BCFJF
PS-7774	1.750	EB	3	BCFJF
PS-7781	2.000	C	1	BCFJF
PS-7781-SC-TC	2.000	C	1	BLFZF
PS-7782	2.250	C	1	BCFKF
PS-7792V-CMS	1.500	C	1	VLFZF
PS-7795	1.375	CB	3	BCFKF
PS-7798	1.375	DB	1	BCFKF
PS-7803	1.375	D	1	QCDZF
PS-7803	1.375	D	1	QCDZF
PS-7805	1.250	C	1	VLFLLF
PS-7806	1.625	C	1	VLFLLF
PS-7820	1.750	C	1	VLFLLF
PS-7821	1.750	EB	3	BCFZF

U.S. Seal Mfg. Part No.	Seal Size	Head Type	Mating Ring	Material Code
PS-7827	1.875	EB	3	BCFJF
PS-7835	3.250	C	3	BCFJF
PS-7839	1.750	E	3	VCFLF
PS-7843	.750	C	1	VCFJF
PS-7853	4.000	EB	3	BCFJF
PS-7859V	.875	E	3	VCFKF
PS-7862	1.875	E	3	VZFZF
PS-7869	1.875	E	1	QCFZF
PS-7872	.625	C	3	VCFKF
PS-7873	3.000	K	3	BCFJF
PS-7874	1.500	D	3	BLFLE
PS-7875	3.000	C	1	BZFZF
PS-7878	1.875	T	1	BCFJF
PS-7884	1.875	EB	3	BCFKF
PS-7884V	1.875	EB	3	VCFKF
PS-7889	1.500	E	3	VCFZF
PS-7890	2.000	EB	3	VCFKF
PS-7892	2.000	EB	3	BCFKF
PS-7896	.875	E	3	VCEZE
PS-7898	1.875	E	3	BCFKF
PS-7901	1.750	EB	1	BCFJF
PS-7902	1.625	C	1	VCFJF
PS-7908	1.250	C	1	BCFJF
PS-7909	2.625	D	3	BCFJF
PS-7910	2.000	EB	1	BCFJF
PS-7918	.984	D	1	VCFKF
PS-7919	1.375	C	3	B/VLFLF
PS-7924	1.750	E	3	VCFLF
PS-7927	2.625	EB	3	BCFKF
PS-7929	.625	B	1	VLFLLF
PS-7930	1.500	E	3	QCFZF
PS-7933	1.500	E	1	QCFZF
PS-7935	2.375	E	3	VZFLF
PS-7936	2.750	E	3	VCFZF
PS-7937	1.500	C	1	QLFLF
PS-7938	1.250	C	3	VCFKF
PS-7938-BUNA	1.250	C	3	BCFKF
PS-7948	.500	E	Special	BCPKF
PS-7948V	.500	E	Special	BCPKF
PS-7950	1.750	E	3	QCFZF
PS-7951	1.875	E	3	QCFZF
PS-7953	1.500	C	1	QCFJF
PS-7953-SC-SEAT	1.500	C	1	QCFLF
PS-7959	1.750	D	3	VRFZF
PS-7960	.750	E	3	VCPKF
PS-7962	1.875	E	3	B/VCFKF
PS-7963	2.000	K	3	BCFJF
PS-7964	.750	B	Special	B/NMDGF
PS-7967	1.125	E	3	BCPKP
PS-7971	1.375	G	1	BCFJF
PS-7972	1.250	G	1	BLFLF
PS-7975	1.500	C	3	VCFKF
PS-7983V	1.250	C	1	VCFZF
PS-7985	2.500	E	3	QCFZF
PS-7986	3.750	U	3	BCDKF
PS-7991	.984	D	2	BCPGP
PS-7992	.875	E	3	VCFZF
PS-7993	3.000	T	3	BCFJF
PS-7994	.750	E	3	VCFKF
PS-7998	3.000	C	1	BZFZF
PS-8002	1.500	X Special	3	BCFJF
PS-8003	2.375	X	3	VCFLF
PS-8006	1.125	XB2	27	VCFJF
PS-8010	1.875	XB	3	VCFZF
PS-8020	1.000	XB2	3 Special	VCFJF
PS-8028	3.875	X	3	VCFKF

PS SEAL INDEX

U.S. Seal Mfg. Part No.	Seal Size	Head Type	Mating Ring	Material Code
PS-8035	2.125	XB2	27	VCFJF
PS-8036	.750	X	5	QCFZF
PS-8037	4.125	XBT	3	VCFJF
PS-8040	1.625	XB2	27	VCFJF
PS-8044	1.437	X	5	VCFZF
PS-8048	1.375	XT	3	VCFJF
PS-8053	2.000	XB1T	3	VCFZF
PS-8054	3.625	V	3	BCFKF
PS-8055	3.875	X	3	VCFJF
PS-8057	2.125	XB2	27	VCFJF
PS-8058	1.750	X	3	VCFLF
PS-8059	1.875	XBT	3	QCFZF
PS-8060	4.375	X	3	BCFKF
PS-8063	1.750	X1T	3	VCFZF
PS-8064	.750	X	3	BLFLF
PS-8065	.875	X	3	BLFLF
PS-8066	.250	X Special	1	QCFLF
PS-8067	4.750	XB1	3	BCFLF
PS-8069	2.375	XB	3	VCFLF
PS-8071	1.625	XB1T	3	VCFZF
PS-8073	1.250	X	28	VCFKF
PS-8074	1.187	XB	3	Special
PS-8076	1.875	XT	3	VCFJF
PS-8077	1.875	X Special	3	VCFJF
PS-8079	1.437	XB5	3	Special
PS-8083	4.625	XB	3	VCFZF
PS-8086	3.125	X	3	VCFZF
PS-8087	5.000	X	3	VLFZF
PS-8089	2.500	XB1	3	QCFLF
PS-8091	1.000	X	3	VCFRF
PS-8094V	1.875	XT	3	VCFZF
PS-8095	1.250	XB2	27	VCFLF
PS-8100	.250	X Special	1	QCFLF
PS-8101	.750	X Special	5	QCFZF
PS-8102	2.750	XB	3	VCFZF
PS-8103	2.500	XB1	3	VCFZF
PS-8104	3.750	X	3	VCFJF
PS-8106	3.437	X	3	VCFK*
PS-8108	2.500	X1T	3 Special	VCFKF
PS-8109	1.500	XB2	3 Special	VCFJF
PS-8110	1.375	XB2	3	VCFJF
PS-8111	1.437	XB2	3	BCFKF
PS-8112	1.000	XB2	3	BCFKF
PS-8113	2.375	XBT	3	VCFJF
PS-8116	1.000	X	5	QCFZF
PS-8118	1.625	XB1	3	QLFLF
PS-8119	2.000	XBT	3	VCFJF
PS-8120	2.750	X	3	VCFZF
PS-8121	2.375	XB	3	QCFLF
PS-8122	2.000	XB1	3	XCFLF
PS-8123	.750	X	5	T/QCFZF
PS-8124	1.875	XB	3	QCFLF
PS-8125	1.750	XB1	5	YCFZF
PS-8126	4.250	X	3	VCFJF
PS-8127	3.625	V	3	BCFJF
PS-8128	2.750	X	5	QCFZF
PS-8131	1.437	XB Special	27 Special	VCFKF
PS-8132	2.125	X Double	3	VCFJF
PS-8133	1.750	X	3	VZFLF
PS-8134	2.000	X	3	VZFLF
PS-8135	1.375	X1T	3	QCFJF
PS-8136	2.750	XT	3	V/TCFJF
PS-8137	.625	X	1	VCFJF
PS-8141	1.500	XB	3	VCPKF
PS-8144	3.000	XB1	3	VCFZF
PS-8560	2.375	X	3	Special

U.S. Seal Mfg. Part No.	Seal Size	Head Type	Mating Ring	Material Code
PS-8561	2.000	X	5	QCFZF
PS-8562	2.125	X1T	3	VCFJF
PS-8563	4.000	X1	5	BCEZE
PS-8592	1.312	X	3	VCFZF
PS-8600	1.500	X	5	QCFZF
PS-8700	3.750	X	27	VCFSF
PS-8701	2.875	XT Double	3	V/TCFJF
PS-8702	2.125	XT Special	3	VCFJF
PS-8705	1.000	XB1	3	VCFLF
PS-8706	3.375	X	3	V/TCFJF
PS-8712	2.250	XB1	3	VCFZF
PS-8714	.750	XB2	3	VCFJF
PS-8772	.875	XB	3	BCPKF
PS-8800	1.750	X1T	3	VCFLF
PS-8806	3.375	XB	5	VCFLF
PS-8807	1.500	XB	3	VZFLF
PS-8810	1.500	X	3	VCFKF
PS-9007	1.000	W	Special	TCFJF
PS-9009	.875	W	2	TCFJF
PS-9014	1.750	WT	27	TCFJF
PS-9016	1.375	W	27 Special	QCFJF
PS-9017	1.625	WT	27	TCFKF
PS-9018	1.000	W	27	TCFJF
PS-9021	1.375	WT	3	T/VCFJF
PS-9023	1.750	WT	3	T/VCFJF
PS-9028	.500	W Special	Special	TCPKF
PS-9029	2.000	W	3	T/VCFJF
PS-9064	1.750	WT	3	T/VCFZF
PS-9106	1.750	W	2	TCFJF
PS-9119	1.875	WT	3	T/QCFZF
PS-9120	2.250	W	2	TCFJF
PS-9122	2.125	W	2	TCFJF
PS-9140	3.000	W	2	TCFJF
PS-9150	1.375	WT	3	T/VCFKF
PS-9155	.625	W	2	TLFLF
PS-9227	1.437	W	2	TCFKF
PS-9302	1.437	W	3	T/VCFKF
PS-9303	1.062	W	3	TCFKF
PS-9304	1.437	W	27	TCFKF
PS-9307	1.437	W	2	TCFOF
PS-9313	1.000	W	2	TCFKF
PS-9314	2.750	W	2	TCFJF
PS-9317	1.375	W	2	TCFJF
PS-9318	1.500	W	27	TCFJF
PS-9321	.625	W	2	TCFKF
PS-9322	.625	WT	Special	TCFOF
PS-9323	.750	W Special	2	TCFKF
PS-9324	.750	W	2	TCFKF
PS-9325	.750	W Special	2	TCFOF
PS-9327	1.125	W	2	TCFOF
PS-9328	1.125	W	27	TCFKF
PS-9329	1.125	W	27	Special
PS-9330	1.437	W	Special	TCFKF
PS-9331	1.437	W	27	Special
PS-9332	1.625	WT	27	TCFOF
PS-9333	2.437	W	27	TCFKF
PS-9334	1.000	W	2	TCFOF
PS-9337	3.500	W	3	T/VCFZF
PS-9338	1.062	W	27	TCFKF
PS-9339	.750	W	2	TCFJF
PS-9340	1.875	WT	3	T/VCFZF
PS-9349	1.000	WT	27	TCFZF
PS-9351	4.000	W	2	TCFJF
PS-9352	3.500	W	3	T/VCFKF
PS-9353	1.500	W	25	TCFZF
PS-9354	.625	WA	3 Special	T/YCFKF

PS SEAL INDEX

U.S. Seal Mfg. Part No.	Seal Size	Head Type	Mating Ring	Material Code
PS-9355	1.125	W	2	TCFZF
PS-9400	2.125	W	2	QCFZF
PS-9659	1.250	WT	2	TCFLF
PS-9700	.970	C	1	VCFJF
PS-9703	2.000	WB	Special	T/NCFKF
PS-9706	1.375	WT	3	T/VCFKF
PS-9707	1.437	W	2 Special	Special
PS-9708	3.750	WB	1	T/VCFKF
PS-9709	1.875	WT	3	T/VCFJF
PS-9710	2.500	WB	Special	T/NCFKF
PS-9711	.750	W Special	2	TCFJF
PS-9712	2.000	WB	3	TCFGF
PS-9713	1.500	WT Dbl.	3	VCFJF
PS-9714	.625	W Dbl.	3	TCFJF
PS-9715	1.000	W	Special	TCFGF
PS-9717	1.437	W	27	Special
PS-9718	1.625	W Special	2	TCFKF
PS-9719	1.250	W	3	T/VCFKF
PS-9720	.312	W	2	TCFLF
PS-9721	1.437	W	27	TCFLF
PS-9722	.625	W	27	HLFLF
PS-9724	1.250	WT	2	TCFKF
PS-22000	3.875	D	3	VZFLF
PS-22001	1.250	G	1	QLFLF
PS-22002	2.500	D	3	BCFJF
PS-22003	.750	D	1	VCFLF
PS-22004	1.500	D	3	VCFLF
PS-22005	1.500	D	1	VCFLF
PS-22006	1.750	D	1	VCFLF
PS-22007	1.000	D	3	VRFLF
PS-22008	1.250	D	3	VCFLF
PS-22009	.750	C	1	NCFJF
PS-22010	.625	C	1	QCFJF
PS-22011	.625	B	8	VCFJF
PS-22012	.625	B	8	NCFJF
PS-22013	.625	X	3	VCFLF
PS-22014	.625	C	3	NCFLF
PS-20015	1.000	C	3	B/VCFKF
PS-20016	1.000	C	3 Special	VCFKF
PS-22017	3.000	D Special	3	VCFKF
PS-22018	1.750	D	3	VCFLF
PS-22019	1.500	D	3	VCFLF
PS-22020	1.250	D	3	VCFLF
PS-22021	2.250	D	3	VCFKF
PS-22022	1.500	D	3	VCFLF
PS-22023	1.375	D	3	VCFKF
PS-22024	1.750	D	3	VCFKF
PS-22025	1.250	C	3 Special	VCFKF
PS-22026	1.125	C	3 Special	VCFKF
PS-22027	.625	B	1	BLFLF
PS-22028	.375	C	3	VCFJF
PS-22029	.625	C	3	BCFJF
PS-22030	.625	C	3	VCFJF
PS-22031	.875	D	3	VCFJF
PS-22032	.875	K	3	VCFJF
PS-22033	.750	B	8	BCFLF
PS-22034	.625	C	1	VCFJF
PS-22035	3.250	E	3	VCFLF
PS-22036	3.750	E	3	VCFLF
PS-22037	75MM	G	25	VLFLF
PS-22038	48MM	G	25	VLFLF
PS-22039	.750	G	1	VCFJF
PS-22040	2.500	D	3	BCFKF
PS-22041	1.250	D	3	BCFKF
PS-22042	.875	C	3	QCFJF
PS-22043	2.500	C	1	VCFJF

U.S. Seal Mfg. Part No.	Seal Size	Head Type	Mating Ring	Material Code
PS-22044	1.000	C	1	VCFKF
PS-22045	1.000	D	1	BCFJF
PS-22046	.625	W	27	TCFJF
PS-22047	2.250	D	3	VLFLF
PS-22048	2.250	D	3	VLFLF
PS-22049	3.625	T	3	BCFJF
PS-22050	2.500	E	3	BCFJF
PS-22051	2.375	C	1	VCFJF
PS-22052	1.500	E	5	BCFZF
PS-22053	1.500	C	3	VCFJF
PS-22054	30MM	D	1	VCFJF
PS-22055	20MM	D	1	VCFJF
PS-22056	20MM	D	1	BCFJF
PS-22057	.750	C	1	VCFZF
PS-22058	15 MM	D	1	VCFJF
PS-22059	15 MM	D	1	VCFZF
PS-22060	.625	B	8	VCFKF
PS-22061	.625	B	8	BCFKF
PS-22062	1.000	D	3	NLFLF
PS-22063	2.000	WB	3 Special	TCFN/KF
PS-22064	2.000	WB	3	TCFN/KF
PS-22065	2.375	XB1	3	NCFGF
PS-22066	2.406	K	3	NCFGF
PS-22067	2.500	E	3	BZFLF
PS-22068	2.750	WB	3 Special	TCFN/KF
PS-22069	2.750	K	3	NCFGF
PS-22070	2.875	WB	Special	TCFKF
PS-22071	3.000	WB	Special	TCFN/KF
PS-22072	3.000	WB	3	TCFN/KF
PS-22073	3.500	WB	3 Special	TCFN/KF
PS-22074	3.625	WB	Special	TCFN/KF
PS-22075	4.000	WB	3 Special	TCFN/KF
PS-22076	1.250	T	3	NCFGF
PS-22077	1.250	E	3	VZFLF
PS-22078	1.625	E	3	QCFZF
PS-22079	1.625	E	3	VZFLF
PS-22080	1.625	R	3	NAFZF
PS-22081	1.625	R	3	VZFLF
PS-22082	1.625	E	3	BZFLF
PS-22083	1.625	E	3	VZFLF
PS-22084	1.750	C	3	VZFLF
PS-22085	1.750	E	3	VZFLF
PS-22086	1.750	C	3	VZFLF
PS-22087	2.000	E	3	VZFLF
PS-22088	.500	G	3	BCFJF
PS-22089	.500	W	2	TCFJF
PS-22090	2.500	D	3	BCFJF
PS-22091	2.500	D	3	VCFJF
PS-22092	3.000	D	3	BCFJF
PS-22093	3.000	E	3	VZFLF
PS-22094	2.500	D	3	VZFLF
PS-22095	.625	W	2	TCFJF
PS-22096	.625	G	1	QLFLF
PS-22097	.625	C	3	NCFLF
PS-22098	.625	G	1	QCFJF
PS-22099	.750	B	1	VCFJF
PS-22100	.750	G	2	VLFLF
PS-22101	1.000	G	3	B/VFLF
PS-22102	1.375	K	3	VCFLF
PS-22103	20MM	G	1	BCFJF
PS-22104	25MM	G	1	BCFJF
PS-22105	1.000	G	1	BCFJF
PS-22106	1.750	C	1	VLFLF
PS-22107	2.000	C	1	VZFLF
PS-22108	.750	D	3	XLFLM
PS-22109	.875	D Special	3	BLFLE

PS SEAL INDEX

U.S. Seal Mfg. Part No.	Seal Size	Head Type	Mating Ring	Material Code
PS-22110	1.500	D Special	3	BLFLE
PS-22111	1.500	D	3	BLELE
PS-22112	1.875	X1T	3 Special	VCFLF
PS-22113	2.500	C	Special	VCFKF
PS-22114	.500	W	2	TCFKF
PS-22115	1.000	E	3	VCFLF
PS-22116	.750	D	3	BCPLF
PS-22117	.750	E	3	VCPLF
PS-22118	.750	D	3	VCPLF
PS-22119	1.000	D	3	VCFJF
PS-22120	1.625	W	2	TCFKF
PS-22121	1.125	XB1	3	VCPKF
PS-22122	1.750	D	3	BCFKF
PS-22123	1.500	C	1	QLFLF
PS-22124	.500	C	3	NCFKF
PS-22125	38MM	G	1	VCFLF
PS-22126	25MM	G	1	VCFLF
PS-22127	.500	C	1	VCFLF
PS-22128	2.125	D	1	NCFJF
PS-22129	2.375	D	1	NCFJF
PS-22130	1.750	E	3	BCDLF
PS-22131	1.875	E	3	BCDLF
PS-22132	1.500	D	3	BCFLF
PS-22133	1.875	D	3	BCDLF
PS-22134	2.000	D	3	BCFLF
PS-22135	1.250	DB	3	BCFLF
PS-22136	1.375	D	3	BCDLF
PS-22137	1.750	D	3	BCDLF
PS-22138	.875	D	3	BCDLF
PS-22139	1.500	E	3	BCDLF
PS-22140	.625	B	1	BCFJF
PS-22141	2.500	E	3	VZFZF
PS-22142	.500	C	3	VCFJF
ps-22143	.875	DB	3	VCFLF
PS-22144	.437	C	3	NCFJF
PS-22145	.437	C	3	VCFKF
PS-22146	2.750	D	3	VCDLF
PS-22147	1.875	D	3	VCFLF
PS-22148	2.250	D	3	VCDKS
PS-22149	1.500	D	3	VCFLF
PS-22150	4.000	X	3	VCFKF
PS-22151	1.437	E	3	VCPKF
PS-22152	1.000	C	3	QCFJF
PS-22153	1.437	E	3	BCPKF
PS-22154	1.125	W	27 Special	TCFKF
PS-22155	1.375	XT Double	3	VCFJF
PS-22156	2.125	XT Double	3	VL/CFL/JF
PS-22157	2.125	XB2	Special	VLFLF
PS-22158	1.375	XB2	Special	VLFLF
PS-22159	.625	C	28	BCFKF
PS-22160	.625	G	3	VCFKF
PS-22161	1.250	X	3	VCFLF
PS-22162	1.375	X	3	VCFLF
PS-22163	1.375	G	3	VCFKF
PS-22164	1.375	XB5	3	VCFKF
PS-22165	1.875	XB1	3	VCFLF
PS-22166	2.500	D	3	VCFKF
PS-22167	2.750	C	3	VCFKF
PS-22168	25MM	G	3	VCFKF
PS-22169	.625	K	3	VCFJF
PS-22170	.750	K	3	VCFLF
PS-22171	.875	K	3	VCFLF
PS-22172	1.250	C	5	QCFZF
PS-22173	1.250	U	3	VCFKF
PS-22174	2.000	E	3	BCFKF
PS-22175	1.750	G	1	VLFLF

U.S. Seal Mfg. Part No.	Seal Size	Head Type	Mating Ring	Material Code
PS-22176	1.500	E	3	QCFZF
PS-22177	1.250	G	1	VLFLF
PS-22178	.625	B	8	BCFKF
PS-22179	1.375	G	1	BLFLF
PS-22180	1.500	C	5	QCFZF
PS-22181	1.375	C	5	VCFZF
PS-22182	.750	C	5	QCFZF
PS-22183	1.625	XB	3	BCPLF
PS-22184	1.625	XB	Special	BCPLF
PS-22185	1.875	X Special	3	BCFLF
PS-22186	1.125	XB	3	BCFLF
PS-22187	1.625	XB	3	VCFLF
PS-22188	1.625	XB	Special	VCPLF
PS-22189	1.625	XB	Special	NCPLF
PS-22190	1.875	X Special	3	VCFLF
PS-22191	1.625	XB	Special	QCPLF
PS-22192	1.625	XB	3	NCPLF
PS-22193	1.125	XB	3	VCFLF
PS-22194	35MM	G	25	VCFLF
PS-22195	1.750	E	3	BCFJF
PS-22196	45MM	G	25	VCFLF
PS-22198	1.625	X	3	VCFLF
PS-22199	.750	C	1	BCFJF
PS-22200	.750	C	1	VCFJF
PS-22201	2.375	EB	1	BCFJF
PS-22202	1.750	D	3	VCDZF
PS-22203	1.000	C	3	BCFKF
PS-22204	.625	C	3	NCFKF
PS-22205	1.000	C	1	BCFJF
PS-22206	1.875	DB	1	BCDJF
PS-22207	1.250	E	3	VLZFZ
PS-22208	2.750	E	3	QCFJF
PS-22209	1.250	C	1	VLZFZ
PS-22210	1.500	C	3	BCFLF
PS-22211	2.375	C	3	BCFZF
PS-22212	1.125	C	3	BCFJF
PS-22213	1.750	C	1	VLZFZ
PS-22214	3.000	C	1	BCFJF
PS-22215	2.250	E	3	QCFJF
PS-22216	2.250	EB	3	QCFJF
PS-22217	1.750	EB	3	QZFZF
PS-22218	1.750	E	3	XCFLF
PS-22219	2.250	EB	3	QZFZF
PS-22220	1.375	DB	3	VCZFZ
PS-22221	1.750	E	1	QZFZF
PS-22222	2.250	E	1	BZFZF
PS-22223	4.000	E	3	BCFJF
PS-22224	1.250	E	3	QCFJF
PS-22225	1.250	C	1	VCFZF
PS-22226	1.625	D	3	BCFZF
PS-22228	.750	C	1	VCFJF
PS-22229	.625	A	1	NMFCF

IDENTIFYING CAUSES OF SEAL LEAKAGE

Symptom	Possible Cause	Corrective Procedure
1. Cracked or broken mating ring.	Seal ran dry and heated up. When liquid reached seal faces, it was cooler and caused thermal cracks.	Check to insure seal chamber is full of liquid before starting pump. On high temperature applications, insure proper flushing at seal faces.
2. Carbon primary ring scored and grooved.	Dirty system.	Have system cleaned and flushed. Consider installation of a cyclone abrasive separator (see page 178).
3. Short seal life in treated system.	Treatment level and temperature higher than anticipated.	Advise U.S. Seal Mfg. of product temperature and PPM Treatment level, for alternate seal recommendation.
4. Primary ring worn unevenly.	Seal improperly installed.	Check installation instructions for proper assembly.
5. Bellows hard and brittle. Rapid carbon wear.	Temperature too high. Pump may have run dry and cavitated.	Cool seal chamber. Use EPR or Viton® elastomers, high temperature carbon, Ni-Resist or Tungsten Carbide mating rings.
6. Bellows soft and sticky. Appears to be dissolving.	Bellows not compatible with material being pumped.	Consult U.S. Seal Mfg. for recommendation, advising pumpage and temperature.
7. Retainer drive tabs badly worn or broken.	Vibration or coupling misalignment. Periodic loss of lubrication at seal faces.	Realign pump and motor. Insure proper flushing at seal faces.
8. Flexible bellows broken.	Coupling misalignment.	Realign pump and motor.
9. Seal wears out shaft.	Shaft end play. Radial shaft movement. Shaft not straight.	Replace bearings. Replace shaft.

WARRANTY

U.S. Seal Mfg. warrants its seals, material and workmanship will meet applicable manufacturers' specifications and will perform according to industry standards, providing the purchaser has selected the correct seal and material and proper installation has been made by the end user.

Since it is beyond our control to assure proper selection of materials or ensure proper installation, U.S. Seal Mfg. assumes no responsibility for damage after its products have been installed.

Any product found to be defective prior to use or installation will be replaced without cost or the purchase price will be refunded at our option. This is the maximum of our liability. The sale of any U.S. Seal Mfg. product under any other warranty or guarantee, expressed or implied, is not authorized by U.S. Seal Mfg.

The foregoing is in addition to Seller's Standard Terms and Conditions of Sale which shall apply to all sales. Copies available upon request.

UNABLE TO FIND THE SEAL YOU REQUIRE?

Complete this worksheet and fax to U.S. Seal Mfg. at 877-849-7325
OR

E-mail completed worksheet and pictures to info@ussealmfg.com

EQUIPMENT DATA

1. Pump Mfg. Name. (Found on Nameplate) _____
2. Model Number _____
3. Serial Number _____
4. Seal Part Number _____

SEAL DESIGN - See Front Cover Fold-Out

1. Head Type _____
2. Mating Ring Type _____
3. Manufacturer _____
4. Manufacturers' Part Number _____

OPERATING CONDITIONS - *This Section MUST Be Completed*

1. Product Handled _____
2. If Concentrated, What % ? _____
3. Temperature F. _____ C. _____

DIMENSIONAL DATA

- A. Shaft / Sleeve OD _____
- B. Counterbore of Stuffing Box _____
- C. Bore of Gland for Mating Ring Unit or Housing _____
If pump is equipped with a stuffing box,
what is the counterbore? _____
- D. Width of Mating Ring _____
- E. Operating Height of Seal _____
- F. OD of Seal _____

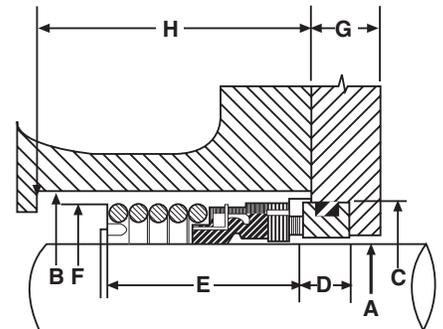

Your Name and Company _____
Phone _____ Fax _____
E-mail _____

Need To Send a Sample For Identification?

- Please include this completed form.
- It is most important that we know the service conditions. i.e. What Are You Pumping?
- Samples must be clean. Please include a copy of the MSDS form.
- Please Note - **Seals received not cleaned will be returned without identification.**



Tel: 800-243-5489 | USSeal@USSealmfg.com
www.ussealmfg.com