

DrayTek

Vigor2135 Series

Gigabit Broadband Router



QUICK START GUIDE (RF MODEL)

V1.1

Vigor2135 Series Gigabit Broadband Router Quick Start Guide (for RF Model)

Version: 1.1

Firmware Version: V4.3.2.1

(For future update, please visit DrayTek web site)

Date: November 16, 2021

Intellectual Property Rights (IPR) Information

Copyrights

© All rights reserved. This publication contains information that is protected by copyright. No part may be reproduced, transmitted, transcribed, stored in a retrieval system, or translated into any language without written permission from the copyright holders.

Trademarks

The following trademarks are used in this document:

- Microsoft is a registered trademark of Microsoft Corp.
- Windows 8, 10 and Explorer are trademarks of Microsoft Corp.
- Apple and Mac OS are registered trademarks of Apple Inc.
- Other products may be trademarks or registered trademarks of their respective manufacturers.

Safety Instructions and Approval

Safety Instructions

- Read the installation guide thoroughly before you set up the router.
- The router is a complicated electronic unit that may be repaired only by authorized and qualified personnel. Do not try to open or repair the router yourself.
- Do not place the router in a damp or humid place, e.g. a bathroom.
- Do not stack the routers.
- The router should be used in a sheltered area, within a temperature range of 0 to +45 Celsius.
- Do not expose the router to direct sunlight or other heat sources. The housing and electronic components may be damaged by direct sunlight or heat sources.
- Do not deploy the cable for LAN connection outdoor to prevent electronic shock hazards.
- Keep the package out of reach of children.
- When you want to dispose of the router, please follow local regulations on conservation of the environment.

Warranty

We warrant to the original end user (purchaser) that the router will be free from any defects in workmanship or materials for a period of two (2) years from the date of purchase from the dealer. Please keep your purchase receipt in a safe place as it serves as proof of date of purchase. During the warranty period, and upon proof of purchase, should the product have indications of failure due to faulty workmanship and/or materials, we will, at our discretion, repair or replace the defective products or components, without charge for either parts or labor, to whatever extent we deem necessary to restore the product to proper operating condition. Any replacement will consist of a new or re-manufactured functionally equivalent product of equal value, and will be offered solely at our discretion. This warranty will not apply if the product is modified, misused, tampered with, damaged by an act of God, or subjected to abnormal working conditions. The warranty does not cover the bundled or licensed software of other vendors. Defects which do not significantly affect the usability of the product will not be covered by the warranty. We reserve the right to revise the manual and online documentation and to make changes from time to time in the contents hereof without obligation to notify any person of such revision or changes.

CE Declaration of Conformity

Hereby, DrayTek Corporation declares that the radio equipment type Vigor2135 is in compliance with Directive 2014/53/EU.

The full text of the EU Declaration of Conformity is available at the following internet address:

<https://www.draytek.com.tw/ftp/Vigor2135/Document/CE/>

Manufacturer: DrayTek Corp.

Address: No.26, Fushing Rd., Hukou, Hsinchu Industrial Park, Hsinchu 303, Taiwan

Product: Vigor2135 Series

Frequency Information for Europe area:

2.4G WLAN	2412MHz - 2472 MHz, max. TX power: 19.98dBm *1
5G WLAN	5160MHz - 5340 MHz, max. TX power: 22dBm *2 5480MHz - 5720 MHz, max. TX power: 27dBm
	Requirements in AT/BE/BG/CZ/DZ/DK/EE/FR/DE/IS/IE/IT/EL/ES/CY/LV/LI/LT/LU/HU/MT/NL/NO/PL/PT/RO/SI/SK/TR/FI/SE/CH/UK/HR. 5150MHz~5350MHz is for indoor use only.

(*1: for 2.4G WLAN model; *2: for 5G WLAN model)

This product is designed for 2.4GHz /5GHz WLAN network throughout the EC region.

External Power Supply ErP Information

*The external power supply used for each product will be model dependent.

	1	2	3	4	5	6	7	8	9
A Manufacturer	CWT	CWT	CWT	CWT	CWT	APD	APD	APD	APD
B Address	No. 222, Sec. 2, Nankan Rd., Lujhu Township, Taoyuan County 338, Taiwan	No. 222, Sec. 2, Nankan Rd., Lujhu Township, Taoyuan County 338, Taiwan	No. 222, Sec. 2, Nankan Rd., Lujhu Township, Taoyuan County 338, Taiwan	No. 222, Sec. 2, Nankan Rd., Lujhu Township, Taoyuan County 338, Taiwan	No. 222, Sec. 2, Nankan Rd., Lujhu Township, Taoyuan County 338, Taiwan	No. 5, Lane 83, Lung-Sou St., Taoyuan City 330, Taiwan	No. 5, Lane 83, Lung-Sou St., Taoyuan City 330, Taiwan	No. 5, Lane 83, Lung-Sou St., Taoyuan City 330, Taiwan	No. 5, Lane 83, Lung-Sou St., Taoyuan City 330, Taiwan
C Model identifier	2ABB012F UK 2ABB012F EU	2ABB018F UK 2ABB018F EU	2ABL024F UK 2ABL024F EU	2ABL030F UK 2ABL030F EU	2ABN036F UK 2ABN036F EU	WA-12M12FG WA-12M12FK	WB-18D12FG WB-18D12FK	WA-24Q12FG WA-24Q12FK	WA-36A12FG WA-36A12FK
D Input voltage	100-240V	100-240V	100-240V	100-240V	100-240V	100-240V	100-240V	100-240V	100-240V
E Input AC frequency	50/60Hz	50/60Hz	50/60Hz	50/60Hz	50/60Hz	50/60Hz	50/60Hz	50/60Hz	50/60Hz
Output voltage DC	12.0V	12.0V	12.0V	12.0V	12.0V	12.0V	12.0V	12.0V	12.0V
F Output current	1.0A	1.5A	2.0A	2.5A	3.0A	1.0A	1.5A	2.0A	3.0A
G Output power	12.0W	18.0W	24.0W	30.0W	36.0W	12.0W	18.0W	24.0W	36.0W
H Average active efficiency	84.9%	86.2%	87.6%	87.8%	89.8%	83.7%	85.4%	88.6%	88.2%
I Efficiency at low load 10%	73.6%	78.0%	81.3%	83.3%	83.7%	74.5%	80.5%	86.4%	85.4%
J No-load power consumption	0.07W	0.07W	0.07W	0.07W	0.07W	0.07W	0.10W	0.07W	0.10W

For more update, please visit www.draytek.com.





Regulatory Information

Federal Communication Commission Interference Statement

This equipment has been tested and found to comply with the limits for a Class B digital device, pursuant to Part 15 of the FCC Rules. These limits are designed to provide reasonable protection against harmful interference in a residential installation. This equipment generates, uses and can radiate radio frequency energy and, if not installed and used in accordance with the instructions, may cause harmful interference to radio communications. However, there is no guarantee that interference will not occur in a particular installation. If this equipment does cause harmful interference to radio or television reception, which can be determined by turning the equipment off and on, the user is encouraged to try to correct the interference by one of the following measures:

- Reorient or relocate the receiving antenna.
- Increase the separation between the equipment and receiver.
- Connect the equipment into an outlet on a circuit different from that to which the receiver is connected.
- Consult the dealer or an experienced radio/TV technician for help.

This device complies with Part 15 of the FCC Rules. Operation is subject to the following two conditions:

- (1) This device may not cause harmful interference, and
- (2) This device may accept any interference received, including interference that may cause undesired operation.

RF Exposure Warning

This equipment must be installed and operated in accordance with provided instructions and the antenna(s) used for this transmitter must be installed to provide a separation distance of at least 20 cm from all persons and must not be co-located or operating in conjunction with any other antenna or transmitter. End-users and installers must be provided with antenna installation instructions and transmitter operating conditions for satisfying RF exposure compliance.

USA Local Representative	Company name	ABP International Inc.		
	Address	13988 Diplomat Drive Suite 180 Dallas TX 75234		
	ZIP Code	75234	E-mail	rmesser@abptech.com
	Contact Person	Mr. Robert Messer	Tel.	19728311600

Caution

Any changes or modifications not expressly approved by the grantee of this device could void the user's authority to operate the equipment.

The antenna/transmitter should be kept at least 20 cm away from human body.

Table of Contents

1. Package Content	1
2. Panel Explanation.....	2
3. Hardware Installation	5
3.1 Network Connection.....	5
3.2 Wall-Mounted Installation.....	6
4. Software Configuration	7
5. Customer Service	12

1. Package Content

Take a look at the package content. If there is anything missed or damaged, please contact DrayTek or dealer immediately.



Vigor Router

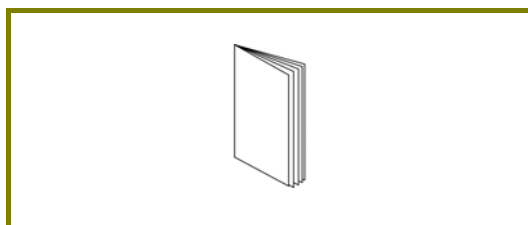

Quick Start Guide

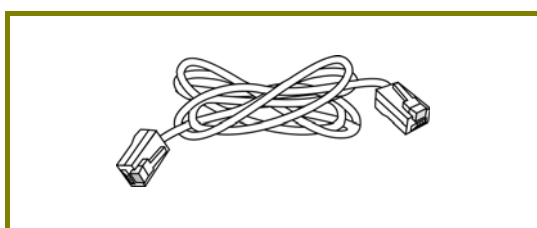

RJ-45 Cat-5 Ethernet Cable

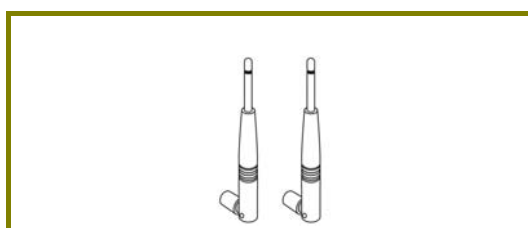

Antenna

The type of the power adapter depends on the country that the router will be installed. * The maximum power consumption is *18 Watts*.

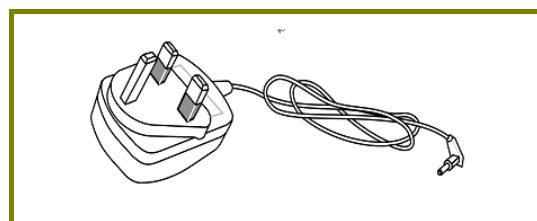

UK-type Power Adapter

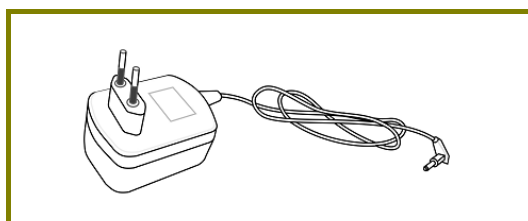

EU-type Power Adapter

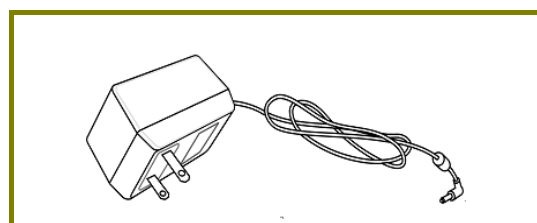

USA/Taiwan-type Power Adapter

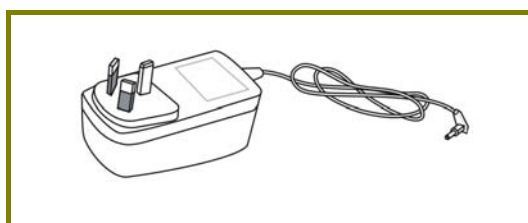

AU/NZ-type Power Adapter











Note

Remove the protective film from the router before use to ensure ventilation.

2. Panel Explanation

LED





LED	Status	Explanation
 (Activity)	Blinking	The router is powered on and running normally.
	Blinking (quickly)	When both ACT and WLAN LEDs blink quickly, it means the WPS function is enabled and active. The system is waiting for a wireless station of connection.
	Off	The router is powered off.
 WAN	On	Internet connection is ready.
	Blinking	The data is transmitting.
	Off	Internet connection is not ready.
 1, 2 (for "V" model)	On	The phone connected to this port is off-hook.
	Off	The phone connected to this port is on-hook.
	Blinking	A phone call comes.
 ~  WLAN	On	Wireless access point is ready.
	Blinking	Ethernet packets are transmitting over wireless LAN.
	Blinking (quickly)	When both ACT and WLAN LEDs blink quickly, it means the WPS function is enabled and active. The system is waiting for a wireless station of connection.
	Off	The WLAN function is inactive.
 ~  LAN1/2/3/4	On	The LAN port is connected.
	Blinking	The data is transmitting.
	Off	The LAN port is disconnected.
 USB	On	A USB device is connected and active.
	Blinking	The data is transmitting.

Connectors



Interface	Description
Wireless LAN ON/OFF/WPS	<p>WLAN On - Press the button and release it within 2 seconds. When the wireless function is ready, the green LED will be on.</p> <p>WLAN Off - Press the button and release it within 2 seconds to turn off the WLAN function. When the wireless function is not ready, the LED will be off.</p> <p>WPS - When WPS function is enabled by web user interface, press this button for more than 2 seconds to wait for client's device making network connection through WPS.</p>
Factory Reset	<p>Restore the default settings.</p> <p>Usage: Turn on the router (ACT LED is blinking). Press the hole and keep for more than 5 seconds. When you see the ACT LED begins to blink rapidly than usual, release the button. Then the router will restart with the factory default configuration.</p>
USB1~USB2	Connector for a USB device (USB Modem or printer).
P4~P1	Connectors for local networked devices.
WAN	Connector for remote networked devices (by Ethernet cable).

	
WAN (FVAc) 	Connector for fiber connection for accessing the Internet.
Phone2/Phone1 (for "V" model)	Connector of analog phone for VoIP communication.
ON/OFF	Power switch.
PWR	Connector for a power adapter.

3. Hardware Installation

This section will guide you to install the router through hardware connection and configure the router's settings through web browser.

Before starting to configure the router, you have to connect your devices correctly. Here we take Vigor2135ac as an example.

3.1 Network Connection

1. Connect the cable Modem/DSL Modem/Media Converter to any WAN port of router with Ethernet cable (RJ-45).
2. Connect one port of 4-port switch to your computer with a RJ-45 cable. This device allows you to connect 4 PCs directly.
3. Connect one end of the power cord to the power port of this device. Connect the other end to the wall outlet of electricity.
4. Connect detachable antennas to the router. Power on the router.
5. Check the **ACT** and **WAN**, **LAN** LEDs to assure network connection.

(For the detailed information of LED status, please refer to section 2. Panel Explanation)

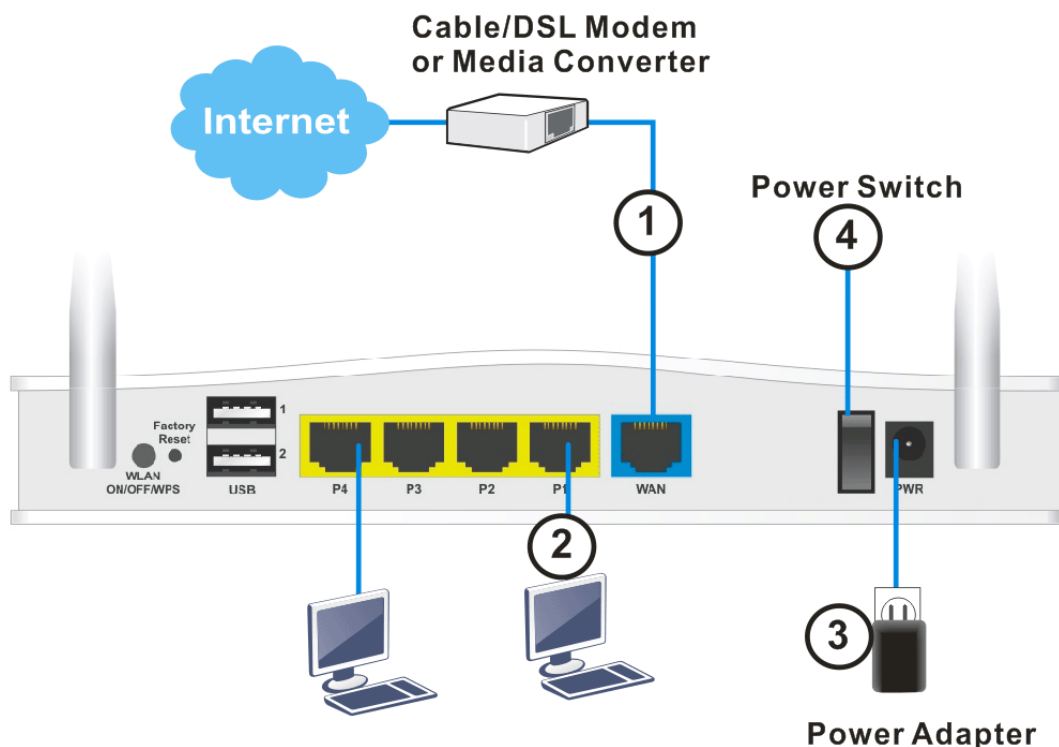

3.2 Wall-Mounted Installation

Vigor2135 series has keyhole type mounting slots on the underside.

1. Drill two holes on the wall. The distance between the holes shall be 168mm.
2. Fit screws into the wall using the appropriate type of wall plug.
3. With the screws installed, the router can be slotted into place.

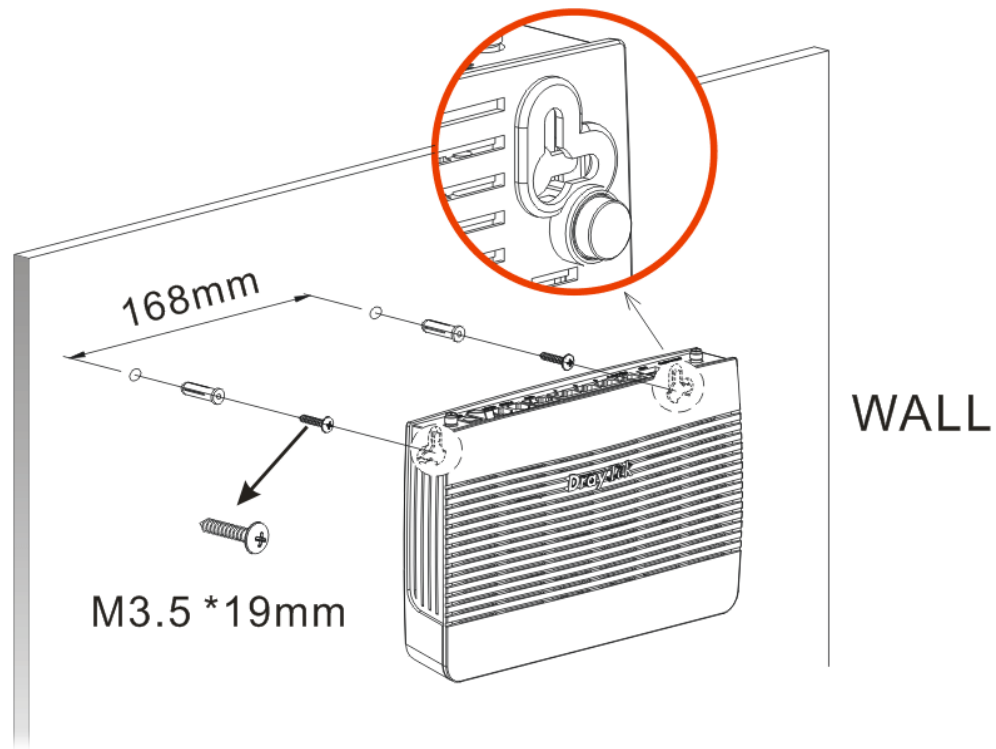

Note

The recommended drill diameter shall be 6.5mm (1/4").

4. When you finished about procedure, the router has been mounted on the wall firmly.

4. Software Configuration

To access Internet, please finish basic configuration after completing the hardware installation.

The **Quick Start Wizard** is designed for you to easily set up your router for Internet access. You can directly access the **Quick Start Wizard** via Web Configurator.

1. Make sure your PC connects to the router correctly.



Note

You may either simply set up your computer to get IP dynamically from the router or set up the IP address of the computer to be the same subnet as the **default IP address of Vigor router 192.168.1.1**. For the detailed information, please refer to the section - Trouble Shooting in the User's Guide.

2. Open a web browser on your PC and type **http://192.168.1.1**. A pop-up window will open to ask for username and password. Please type "admin/admin" as the Username/Password and click **Login**.

DrayTek **Vigor2135 Series**

Login

Username

Password

Language ▼

Login

Copyright© 2000-2021 DrayTek Corp. All Rights Reserved.

- Now, the Main Screen will pop up. Click **Wizards>>Quick Start Wizard**.

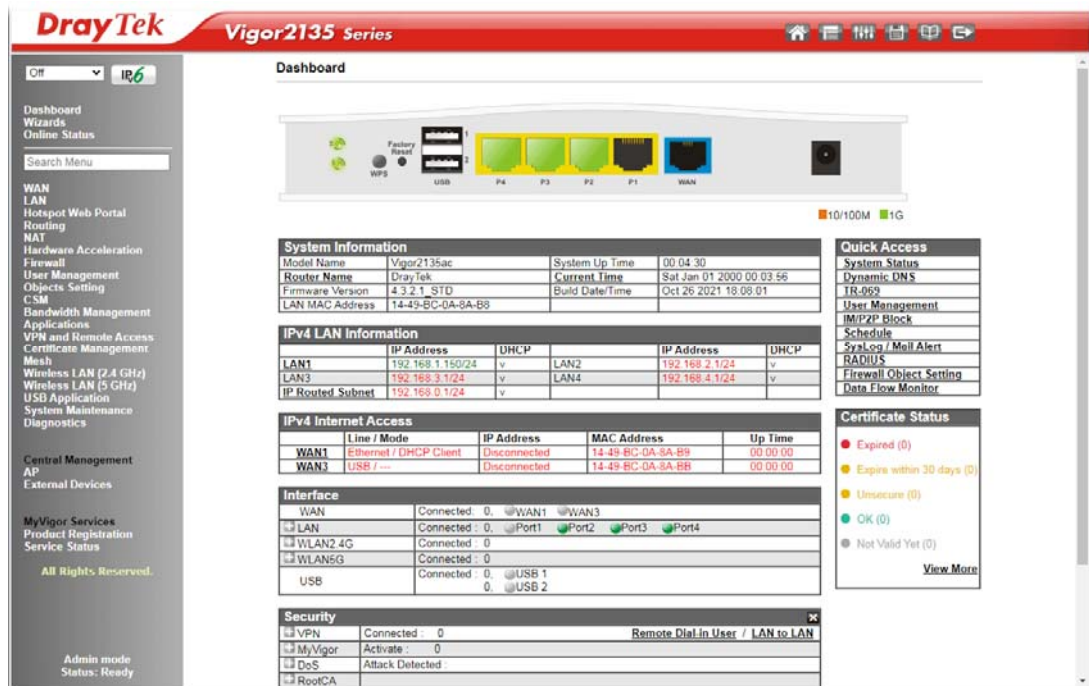

Note

The home page will change slightly in accordance with the router you have.

- Enter the login password on the field of **New Password** and retype it on the field of **Confirm Password**. Then click **Next** to continue.

Quick Start Wizard

Enter login password

Please enter an alpha-numeric string as your **Password** (Max 83 characters)

Old Password

New Password

Confirm Password

Password Strength: Weak Medium Strong

Strong password requirements:

- Have at least one upper-case letter and one lower-case letter.
- Including non-alphanumeric characters is a plus.

Hint: If you want to keep the password unchanged, leave the password blank and press "Next" button to skip this process.

< Back Next > Finish Cancel

5. On the next page as shown below, please select the WAN interface that you use and click **Next**. If Ethernet interface is used, please choose WAN1; if 3G USB modem is used, please choose WAN3. Then click **Next** for next step.

Quick Start Wizard

Select WAN Interface

Select WAN Interface:	WAN1 ▾
Display Name:	<input type="text"/>
Physical Mode:	Ethernet
Physical Type:	Auto negotiation ▾
VLAN Tag insertion	Disable ▾

< Back Next > Finish Cancel

6. On the next page as shown below, please select the appropriate protocol according to the information from your ISP. For example, you should select PPPoE mode if the ISP provides you PPPoE interface. Then click **Next** for next step.

Quick Start Wizard

Connect to Internet

WAN 1
Select one of the following Internet Access types provided by your ISP.

- PPPoE
- PPTP
- L2TP
- Static IP
- DHCP

< Back Next > Finish Cancel

PPPoE: If you click **PPPoE** as the protocol, after clicking **Next**, you will get the following web page. Please manually enter the Username/Password provided by your ISP. Then click **Next**.

Quick Start Wizard

PPPoE Client Mode

WAN 1	
Enter the user name and password provided by your ISP.	
Service Name (optional)	CHT
Username	84005657@hinet.net
Password	*****
Confirm Password	*****

< Back Next > Finish Cancel

PPTP/L2TP: if you click **PPTP/L2TP**, you will get the following page. Please type in all the information originally provided by your ISP. Then click **Next** for next step.

Quick Start Wizard

PPTP Client Mode

WAN 1	
Enter the username, password, WAN IP configuration and PPTP server IP provided by your ISP.	
Username	5477aec
Password	*****
Confirm Password	*****
WAN IP Configuration	
<input checked="" type="radio"/> Obtain an IP address automatically	
<input type="radio"/> Specify an IP address	
IP Address	
Subnet Mask	
Gateway	172.16.3.15
Primary DNS	8.8.8.8
Second DNS	8.8.4.4
PPTP Server	172.16.3.25

< Back Next > Finish Cancel

Static IP: if you click Static IP, you will get the following page. Please type in the IP address information originally provided by your ISP. Then click Next for next step.

Quick Start Wizard

Static IP Client Mode

WAN 1	
Enter the Static IP configuration provided by your ISP.	
WAN IP	<input type="text" value="192.168.3.102"/>
Subnet Mask	<input type="text" value="255.255.255.0"/>
Gateway	<input type="text" value="192.168.3.1"/>
Primary DNS	<input type="text" value="8.8.8.8"/>
Secondary DNS	<input type="text" value="8.8.4.4"/> (optional)

DHCP: if you click DHCP, you will get the following page. Simply click Next to continue.

Quick Start Wizard

DHCP Client Mode

WAN 1	
If your ISP requires you to enter a specific host name or specific MAC address, please enter it in.	
Host Name	<input type="text"/> (optional)
MAC	<input type="text" value="14"/> <input type="text" value="-49"/> <input type="text" value="-BC"/> <input type="text" value="-0A"/> <input type="text" value="-8A"/> <input type="text" value="-B9"/> (optional)

- Now you can see the following screen. It indicates that the setup is complete. Different types of connection modes will have different summary. Click **Finish** and then restart the router. Afterward, you will enjoy surfing on the Internet.

Quick Start Wizard

Please confirm your settings:

WAN Interface:	WAN1
Physical Mode:	Ethernet
Physical Type:	AUTO
Internet Access:	DHCP

Click **Back** to modify changes if necessary. Otherwise, click **Finish** to save the current settings and restart the Vigor router.

< Back

Next >

Finish

Cancel

5. Customer Service

If the router cannot work correctly after trying many efforts, please contact your dealer/DrayTek for further help right away. For any questions, please feel free to send e-mail to support@draytek.com.

Be a Registered Owner

Web registration is preferred. You can register your Vigor router via <https://myvigor.draytek.com>.

Firmware & Tools Updates

Due to the continuous evolution of DrayTek technology, all routers will be regularly upgraded. Please consult the DrayTek web site for more information on newest firmware, tools and documents.

<https://www.draytek.com>