

# NETGEAR®

## AirCard® Smart Cradle

Model DC112A

User Manual



August 2015  
202-11417-02

350 East Plumeria Drive  
San Jose, CA 95134  
USA

## Support

Contact NETGEAR at 1 800 17 22 44 for technical support.

## Compliance

For regulatory compliance information, visit <http://www.netgear.com/about/regulatory>.

See the regulatory compliance document before connecting the power supply.

## Trademarks

© NETGEAR, Inc. NETGEAR, Inc. NETGEAR, the NETGEAR Logo, ReadySHARE, and AirCard, are trademarks of NETGEAR, Inc. Information is subject to change without notice.

# Contents

## Chapter 1 Hardware Setup

Unpack Your AirCard Smart Cradle.....	9
Front Panel.....	9
Rear Panel.....	11
Attach the External WiFi Antennas.....	11
Dock the Mobile Hotspot in the Smart Cradle.....	12
Undock the Mobile Hotspot from the Smart Cradle.....	14
Position the Smart Cradle.....	14
Install Your Smart Cradle.....	15

## Chapter 2 Connect to the AirCard Smart Cradle

Connect to the AirCard Smart Cradle.....	18
Wired Connection.....	18
WiFi Connection.....	18
Types of Logins.....	19
Change the Language.....	19
Log In to the AirCard Smart Cradle.....	19
Access the AirCard Smart Cradle with NETGEAR genie Apps.....	20

## Chapter 3 Internet Setup

Manage a Mobile Hotspot.....	22
Use a WAN Internet Connection with Failover.....	22
Specify the Broadband Failover Detection Method.....	24
Manually Set Up the Internet Connection.....	25
Specify an Internet Connection Without a Login.....	25
Specify an Internet Connection That Uses a Login.....	26
Specify WAN Ethernet IPv6 Internet Connections.....	28
Requirements for Entering IPv6 Addresses.....	30
Use Auto Detect for an IPv6 Internet Connection.....	30
Use Auto Config for an IPv6 Internet Connection.....	31
Set Up an IPv6 6to4 Tunnel Internet Connection.....	33
Set Up an IPv6 Pass Through Internet Connection.....	34
Set Up an IPv6 Fixed Internet Connection.....	35
Set Up an IPv6 DHCP Internet Connection.....	36
Set Up an IPv6 PPPoE Internet Connection.....	38
Change the MTU Size.....	39

**Chapter 4 Control Internet Access**

Set Up Parental Controls . . . . .	43
Allow or Block Access to Your Network . . . . .	45
Manage Network Access Control Lists . . . . .	47
Use Keywords to Block Internet Sites . . . . .	48
Delete Keywords from the List to Be Blocked . . . . .	49
Block Services from the Internet . . . . .	49
Schedule When to Block Internet Sites and Services . . . . .	51
Avoid Blocking on a Trusted Computer . . . . .	52
Set Up Security Event Email Notifications . . . . .	52
Set Up Port Forwarding to a Local Server . . . . .	54
Add a Custom Port Forwarding Service . . . . .	55
Edit a Port Forwarding Service . . . . .	56
Delete a Port Forwarding Entry . . . . .	57
Application Example: Make a Local Web Server Public . . . . .	57
How the Cradle Implements the Port Forwarding Rule . . . . .	58
Set Up Port Triggering . . . . .	58
Add a Port Triggering Service . . . . .	59
Enable Port Triggering . . . . .	60
Application Example: Port Triggering for Internet Relay Chat . . . . .	61

**Chapter 5 Optimize Performance**

Optimize Internet Gaming with Upstream QoS . . . . .	63
Add QoS Rules . . . . .	64
Set Up QoS for Applications and Online Gaming . . . . .	64
Set Up QoS for a LAN Port on the AirCard Smart Cradle . . . . .	66
Set Up QoS for a MAC Address . . . . .	67
Edit an Upstream QoS Policy . . . . .	68
Delete an Upstream QoS Policy . . . . .	68
Improve Network Connections with Universal Plug and Play . . . . .	69
Wi-Fi Multimedia Quality of Service . . . . .	70

**Chapter 6 Network Settings**

View WAN Settings . . . . .	72
Set Up the AirCard Smart Cradle as a Default DMZ Server . . . . .	73
Configure DMZ on an AirCard Mobile Hotspot . . . . .	74
Change the Cradle's Device Name . . . . .	75
Change the LAN TCP/IP Settings . . . . .	75
Specify the IP Addresses That the Cradle Assigns . . . . .	77
Disable the DHCP Server Feature in the Cradle . . . . .	78
Reserve LAN IP Addresses . . . . .	79
Reserve an IP Address . . . . .	79
Edit a Reserved IP Address Entry . . . . .	80
Delete a Reserved IP Address Entry . . . . .	80
Use the WPS Wizard for WiFi Connections . . . . .	81
Specify Basic WiFi Settings . . . . .	81

Change the WiFi Data Speed Rate Settings	83
Change the WiFi Password or Security Level	84
Set Up a Guest Network	85
Control the Wireless Radios	87
Set Up a Wireless Schedule	88
Specify WPS Settings	89
Use the Smart Cradle as a Wireless Access Point	90
Set Up the AirCard Smart Cradle in Bridge Mode	92
Set Up a Facebook WiFi Guest Network	94

## Chapter 7 Manage the AirCard Smart Cradle

Update the AirCard Smart Cradle Firmware	97
Change the admin Password	98
Recover the admin Password	99
View AirCard Smart Cradle Status	100
Display Internet Port Statistics	101
Check the Internet Connection Status	102
Manage the AirCard Smart Cradle Configuration File	103
Back Up Settings	103
Restore Configuration Settings	103
Erase the Current Configuration Setting	104
View and Customize Log Information	105
Custom Static Routes	106
Set Up a Static Route	106
Edit a Static Route	107
Delete a Static Route	108
View Devices Currently Connected to the AirCard Smart Cradle	108
Remote Management	109
Monitor Internet Traffic	111
Set Up the AirCard Smart Cradle to Respond to Pings on the Internet Port	112

## Chapter 8 Share a USB Device Attached to the AirCard Smart Cradle

USB Device Requirements	115
Access a USB Device	115
Back Up Windows Computers with ReadySHARE Vault	117
Back Up Mac Computers with Time Machine	117
Set Up a USB Hard Drive on a Mac	117
Prepare to Back Up a Large Amount of Data	118
Use Time Machine to Back Up onto a USB Hard Drive	118
Control Access to the USB Device	119
Use FTP Within the Network	120
View Network Folders on a USB Device	121
Add a Network Folder on a USB Device	122
Edit a Network Folder on a USB Device	123
Approve USB Devices	124
Safely Remove a USB Device	125

## Chapter 9 Access USB Devices Through the Internet

Access USB Devices Through the Internet. . . . .	128
Set Up FTP Access Through the Internet. . . . .	128
Access USB Devices Through the Internet with FTP . . . . .	130
Your Personal FTP Server. . . . .	130
Dynamic DNS. . . . .	131
Set Up a New Dynamic DNS Account . . . . .	132
Specify a DNS Account That You Already Use . . . . .	133
Change the Dynamic DNS Settings . . . . .	134
Set Up Your Personal FTP Server . . . . .	134

## Chapter 10 Share a USB Printer

Install the Printer Driver and Cable the Printer. . . . .	136
Download the ReadySHARE Printer Utility . . . . .	136
Install the ReadySHARE Printer Utility . . . . .	137
Use the Shared Printer . . . . .	138
View or Change the Status of a Printer . . . . .	139
Use the Scan Feature of a Multifunction USB Printer . . . . .	140
Change NETGEAR USB Control Center Settings. . . . .	141

## Chapter 11 Troubleshooting

Troubleshoot with the LEDs. . . . .	145
Standard LED Behavior When the AirCard Smart Cradle is Powered On . . . . .	145
Power LED Is Off or Blinking. . . . .	145
Power LED Stays Amber . . . . .	145
LEDs Never Turn Off . . . . .	145
Internet LED Is Off . . . . .	146
WiFi LEDs Are Off . . . . .	146
Cannot Log In to the Cradle. . . . .	146
Cannot Access the Internet . . . . .	147
Troubleshoot PPPoE . . . . .	148
Troubleshoot Internet Browsing . . . . .	149
Changes Not Saved. . . . .	149
Cellular Network Connectivity . . . . .	150
WiFi Connectivity . . . . .	150
Troubleshoot Your Network Using the Ping Utility . . . . .	150
Test the LAN Path to Your Smart Cradle . . . . .	151
Test the Path from Your Computer to a Remote Device. . . . .	151

## Appendix A Supplemental Information

Factory Settings . . . . .	154
Technical Specifications . . . . .	156

**Appendix B Tips and Safety Guidelines for Lithium-Ion Batteries**

Battery Tips ..... 157  
General Battery Safety..... 157  
Appropriate Batteries and Chargers..... 158  
Battery Disposal..... 158

# Hardware Setup

---

# 1

The AirCard Smart Cradle allows you to transform your AirCard mobile hotspot into a powerful LTE router by combining the benefits of a home router and a WiFi signal booster. It charges your mobile hotspot battery, boosts the mobile hotspot's 4G/3G signal, extends WiFi coverage, and expands your mobile hotspot connection to both wired and wireless devices. This AirCard Smart Cradle can also be used as a standalone 802.11ac dual-band WiFi router.



**Figure 1. AirCard Smart Cradle in a home**

This chapter covers the following topics:

- *Unpack Your AirCard Smart Cradle*
- *Front Panel*
- *Rear Panel*
- *Attach the External WiFi Antennas*
- *Dock the Mobile Hotspot in the Smart Cradle*
- *Undock the Mobile Hotspot from the Smart Cradle*
- *Position the Smart Cradle*
- *Install Your Smart Cradle*



## Unpack Your AirCard Smart Cradle

Your package contains the following items.



Figure 2. Package contents

## Front Panel

A USB port, an adjustable holder for the mobile hotspot, and the status LEDs are located on the front of the cradle.

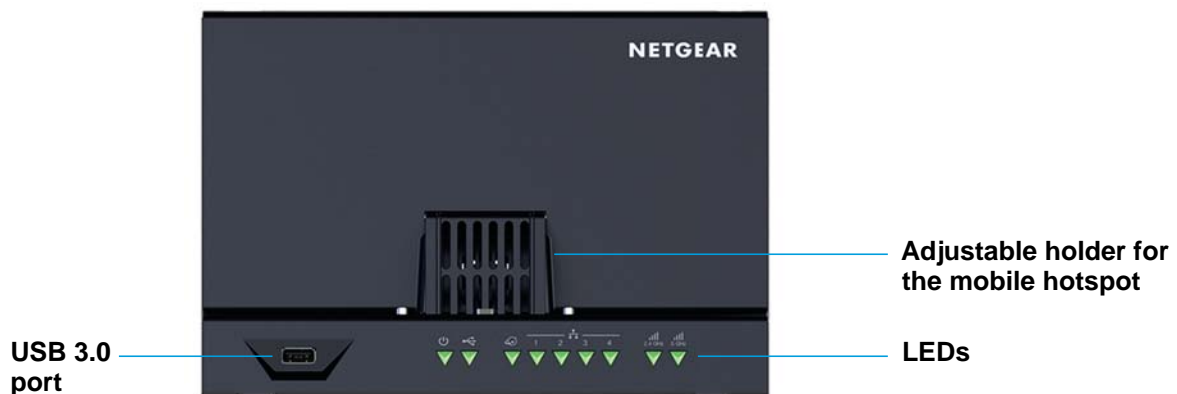







Figure 3. Smart Cradle USB port and LEDs

You can slide the adjustable holder forward to secure your mobile hotspot when it is docked.

**Table 1. LED descriptions**

LED	Description
Power 	<ul style="list-style-type: none"> <li>• <b>Solid amber.</b> The cradle is booting.</li> <li>• <b>Blinking amber.</b> The firmware is upgrading, or someone pressed the <b>Reset</b> button.</li> <li>• <b>Solid green.</b> The cradle powered on and ready.</li> <li>• <b>Blinking green.</b> The firmware is corrupted. Contact your Internet service provider for technical support</li> <li>• <b>Off.</b> Power is not supplied to the cradle.</li> </ul>
USB port 	<ul style="list-style-type: none"> <li>• <b>Solid green.</b> A USB device is connected and is ready.</li> <li>• <b>Solid red.</b> A USB device is connected but unrecognized.</li> <li>• <b>Off.</b> No USB device is connected or someone clicked the <b>Safely Remove Hardware</b> button, and it is now safe to remove the attached USB device.</li> </ul>
Internet 	<ul style="list-style-type: none"> <li>• <b>Solid green.</b> The Internet connection is ready.</li> <li>• <b>Solid amber.</b> The cradle is not connected to the Internet.</li> <li>• <b>Off.</b> The Smart Cradle does not detect a docked mobile hotspot.</li> </ul>
Ethernet ports 1–4 	<ul style="list-style-type: none"> <li>• <b>Solid green.</b> A powered-on device is connected to this Ethernet port.</li> <li>• <b>Off.</b> No device is connected to this Ethernet port.</li> </ul>
2.4 GHz Wireless 	<ul style="list-style-type: none"> <li>• <b>Solid green.</b> The 2.4 GHz WiFi radio is operating.</li> <li>• <b>Blinking.</b> The cradle is in WPS mode.</li> <li>• <b>Off.</b> The WiFi radio is off.</li> </ul>
5 GHz WiFi 	<ul style="list-style-type: none"> <li>• <b>Solid green.</b> The 5 GHz WiFi radio is operating.</li> <li>• <b>Blinking.</b> The cradle is in WPS mode.</li> <li>• <b>Off.</b> The WiFi radio is off.</li> </ul>

## Rear Panel

The rear panel connections and buttons are shown in the following figure.

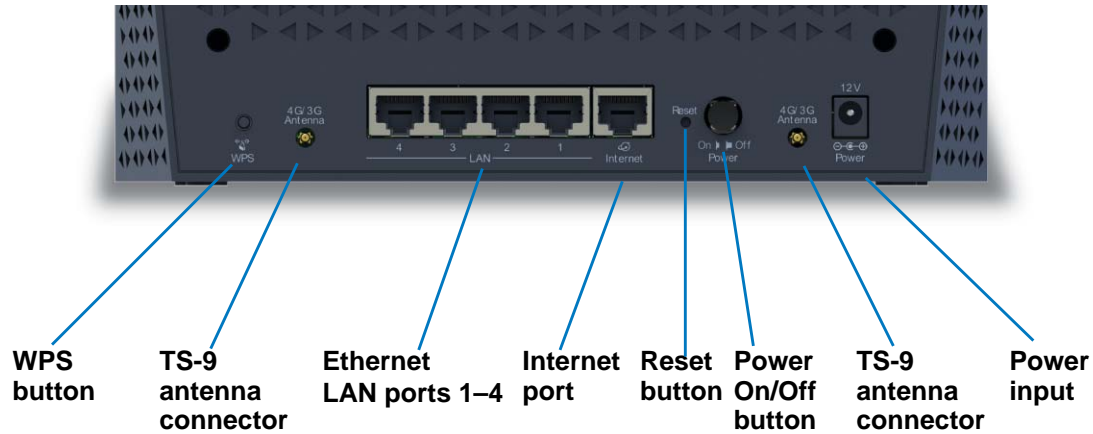

**Figure 4. Cradle rear panel**

Pressing the **WPS** button lets you add a computer or WiFi device to the WiFi network without typing the WiFi network password (security key). For more information about WPS, see [Connect to the AirCard Smart Cradle](#) on page 18.

Pressing the **Reset** button restores the factory settings. For more information about the factory settings, see [Factory Settings](#) on page 154.

## Attach the External WiFi Antennas

For the best WiFi performance, attach both antennas.

### ➤ To attach the external WiFi antennas:

1. Align the antennas with the antenna posts on the Smart Cradle.
2. Attach the antennas on the threaded antenna posts, ensuring that the connection is secure.
3. Adjust the antenna positions so that they point straight up.



## Dock the Mobile Hotspot in the Smart Cradle

➤ **To dock the mobile hotspot in the Smart Cradle:**

1. Slide the antenna covers on the bottom of the mobile hotspot to the open position.



2. Slide the Smart Cradle's plastic holder back to allow enough room for the mobile hotspot.



3. Dock the mobile hotspot in the Smart Cradle.

Docking the mobile hotspot for the first time aligns the connectors, so the unit might be stiff going in and out.



- Slide the plastic holder forward to secure the mobile hotspot.



**Note:** A gap of up to 1.5 mm between the plastic holder and the mobile hotspot is normal. Do not try to push the holder forward to fill the gap.

When the Smart Cradle detects your mobile hotspot's Internet connection, the Internet LED lights green and the Smart Cradle uses the mobile hotspot's Internet connection. The mobile hotspot must have an active Internet service account.

When your mobile hotspot detects that it is docked, the mobile hotspot LCD and home page indicate that it is docked in the Smart Cradle. The mobile hotspot uses the Smart Cradle's more powerful internal 3G/4G antennas for better network coverage and charges itself through the Smart Cradle.

The mobile hotspot disables its WiFi signal so that you can connect to the Smart Cradle's stronger WiFi signal.

---

**Note:** Some hotspots require a firmware update before they automatically disable WiFi when docked. If your mobile hotspot broadcasts its WiFi signal when docked, manually set up your mobile hotspot to disable WiFi.

---

See the mobile hotspot user guide for more information.

## Undock the Mobile Hotspot from the Smart Cradle

### ➤ To undock the mobile hotspot from the Smart Cradle:

1. Lift the mobile hotspot out of the AirCard Smart Cradle.

Docking the mobile hotspot for the first time aligns the connectors, so the unit might be stiff going in and out.

2. If the mobile hotspot is difficult to lift, gently wiggle it side to side to disconnect it from the AirCard Smart Cradle.

When you remove the mobile hotspot from the Smart Cradle, the Smart Cradle loses its Internet connection, but it can be used as a WiFi router. The mobile hotspot enables its own WiFi again after being undocked so that you can connect to the mobile hotspot WiFi.



## Position the Smart Cradle

The cradle lets you access your network anywhere within the operating range of your wireless network. However, the operating distance or range of your wireless connection can vary significantly depending on the physical placement of your cradle. For example, the thickness and number of walls the wireless signal passes through can limit the range.

Additionally, other wireless access points in and around your home might affect your cradle's signal. Wireless access points are routers, repeaters, WiFi range extenders, and any other devices that emit a wireless signal for network access.

### ➤ Position your cradle according to the following guidelines:

Position your cradle according to the following guidelines:

- Place your cradle near the center of the area where your computers and other devices operate, and within line of sight to your wireless devices.
- Make sure that the cradle is within reach of an AC power outlet and near Ethernet cables for wired computers.
- Place the cradle in an elevated location, minimizing the number walls and ceilings between the cradle and your other devices.
- Place the cradle away from electrical devices such as these:
  - Ceiling fans
  - Home security systems
  - Microwaves

- Computers
- Base of a cordless phone
- 2.4 GHz cordless phone
- Place the cradle away from large metal surfaces, large glass surfaces, and insulated walls such as these:
  - Solid metal doors
  - Aluminum studs
  - Fish tanks
  - Mirrors
  - Brick
  - Concrete

## Install Your Smart Cradle

➤ **To install your cradle:**

1. Place the cradle in your preferred location.
2. Connect the Smart Cradle's power adapter and plug it into an electrical outlet.

The Power LED lights green within one minute. If the Power LED does not light, press the **Power On/Off** button on the rear panel of the cradle.

The cradle's internal fan turns on momentarily when the cradle is powering up and then turns off.

**Note:** After power up, the cradle's internal fan turns on only when the cradle senses high temperatures of 40C (104° F) or higher. This might happen during continuous high-data rate transmissions or if the cradle is in a warm location. The fan protects the mobile hotspot and the cradle from high temperatures. Once the mobile hotspot and cradle temperatures return to lower levels, the fan switches off.

3. Dock the mobile hotspot in the cradle.

See *Dock the Mobile Hotspot in the Smart Cradle* on page 12

4. Check the cradle's Internet LED.

When the cradle detects your mobile hotspot's Internet connection, the Internet LED lights green and the Smart Cradle uses the mobile hotspot's Internet connection. The mobile hotspot Internet service account must be active.

When your mobile hotspot detects that it is docked, the mobile hotspot LCD and home page indicate that it is docked in the Smart Cradle. The mobile hotspot uses the Smart Cradle's more powerful internal 3G/4G antennas for better network coverage and charges itself through the Smart Cradle.

The mobile hotspot disables its WiFi signal so that you can connect to the cradle's stronger WiFi signal.

**Note:** Some hotspots require a firmware update before they automatically disable WiFi when docked. If your mobile hotspot broadcasts its WiFi signal when docked, manually set up your mobile hotspot to disable WiFi when USB is connected.

See the mobile hotspot user guide for more information.

**5.** Connect to the Smart Cradle's WiFi network.

On your computer or WiFi device, find and connect to the WiFi network name on the Smart Cradle label



# 2

## 2. Connect to the AirCard Smart Cradle

---

This chapter covers the following topics:

- *Connect to the AirCard Smart Cradle*
- *Types of Logins*
- *Change the Language*
- *Log In to the AirCard Smart Cradle*
- *Access the AirCard Smart Cradle with NETGEAR genie Apps*

## Connect to the AirCard Smart Cradle

You can connect to the cradle's network through a wired or WiFi connection. If you set up your computer to use a static IP address, change the settings so that it uses Dynamic Host Configuration Protocol (DHCP).

### Wired Connection

You can connect your computer to the cradle using the supplied Ethernet cable and join the cradle's local area network (LAN).

➤ **To connect your computer to the cradle with an Ethernet cable:**

1. Make sure that power is supplied to the cradle (its Power LED is lit).
2. Connect an Ethernet cable to an Ethernet port on your computer.
3. Connect the other end of the Ethernet cable to one of the numbered Ethernet ports.

Your computer connects to the local area network (LAN). A message might display on your computer screen to notify you that an Ethernet cable is connected.

### WiFi Connection

You can connect to the cradle's WiFi network with Wi-Fi Protected Setup (WPS) or you can find and select the WiFi network.

➤ **To use WPS to connect to the WiFi network:**

1. Make sure that power is supplied to the cradle (its Power LED is lit).
2. Check the WPS instructions for your computer or wireless device.
3. Press the **WPS** button on the cradle.
4. Within two minutes, on your computer or WiFi device, press its **WPS** button or follow its instructions for WPS connections.

Your computer or wireless device connects to the WiFi network.

➤ **To find and select the WiFi network:**

1. Make sure that power is supplied to the cradle (its Power LED is lit).
2. On your computer or wireless device, find and select the WiFi network.

The WiFi network name is on the cradle's label.

3. Join the WiFi network and enter the WiFi password.

The password is on the cradle's label.

Your wireless device connects to the WiFi network.

## Types of Logins

Separate types of logins serve different purposes. It is important that you understand the difference so that you know which login to use.

Types of logins:

- **Mobile broadband account login.** The login that your ISP gave you at the time of purchase logs you in to your Internet service. Your service provider gave you this login information in a letter or some other way. If you cannot find this login information, contact your service provider.
- **WiFi network key or password.** Your cradle is preset with a unique wireless network name (SSID) and password for wireless access. This information is on the cradle label.
- **Cradle login.** This logs you in to the cradle interface from a web browser as admin.

## Change the Language

By default, the language is set as Auto.

### ➤ To change the language:

1. Launch a web browser from a computer or wireless device that is connected to the Smart Cradle.
2. In the address field of the browser, enter **http://netgear.cradle** or **http://192.168.100.1**.  
A login prompt displays.
3. Enter the cradle user name and password.  
The user name is **admin**. The default password is **password**. The user name and password are case-sensitive.  
The BASIC Home screen displays.
4. In the upper right corner, select a language from the list.
5. When prompted, click the **OK** button to confirm this change.  
The screen refreshes with the language that you selected.

## Log In to the AirCard Smart Cradle

You can log in to the cradle to view or change its settings.

### ➤ To log in to the AirCard Smart Cradle:

1. Connect a computer to the Smart Cradle:
  - For a WiFi connection, on your computer or WiFi device, find and connect to the WiFi network name on the Smart Cradle label.

- For a wired connection, use an Ethernet cable to connect a computer to an Ethernet LAN port on the rear panel of the Smart Cradle.
2. Launch a web browser.
  3. In the address field of the browser, enter **http://netgear.cradle** or **http://192.168.100.1**  
A login prompt displays.
  4. Enter the cradle user name and password.  
The user name is **admin**. The default password is **password**. The user name and password are case-sensitive.  
The BASIC Home screen displays.

## Access the AirCard Smart Cradle with NETGEAR genie Apps

The genie app is the easy dashboard for managing, monitoring, and repairing your home network. The genie app can help you with the following:

- Automatically repair common wireless network problems.
- Easily manage cradle features like Live Parental Controls, guest access, Internet traffic meter, speed test, and more.

### ➤ To use the genie app to access the cradle:

1. Visit the NETGEAR genie web page at [www.NETGEAR.com/genie](http://www.NETGEAR.com/genie).
2. Follow the onscreen instructions to install the app on your smartphone, tablet, or computer.
3. Launch the genie app.

The genie app dashboard screen displays.

## 3. Internet Setup

---

This chapter covers the following topics:

- *Manage a Mobile Hotspot*
- *Use a WAN Internet Connection with Failover*
- *Specify the Broadband Failover Detection Method*
- *Manually Set Up the Internet Connection*
- *Specify WAN Ethernet IPv6 Internet Connections*
- *Change the MTU Size*

## Manage a Mobile Hotspot

When you use a web browser to log in to the AirCard Smart Cradle, you can open a tab in the browser to configure a mobile hotspot. The mobile hotspot must be docked in the Smart Cradle.

➤ **To manage a mobile hotspot:**

1. Launch a web browser from a computer or wireless device that is connected to the Smart Cradle.
2. In the address field of the browser, enter **http://netgear.cradle** or **http://192.168.100.1**.

A login prompt displays.

3. Enter the cradle user name and password.

The user name is **admin**. The default password is **password**. The user name and password are case-sensitive.

The BASIC Home screen displays.

4. Select **Hotspot Manager**.

The mobile hotspot's web-based home page opens in a new tab. For more information, see the user manual for your mobile hotspot. To view the hotspot's user manual, click the link on the hotspot's home page.

## Use a WAN Internet Connection with Failover

You can set up the Smart Cradle to use a WAN Internet connection and to failover to your mobile hotspot's Internet connection if the WAN connection goes offline.



**Figure 5. Smart Cradle using an Ethernet WAN Internet connection**

➤ To set up a WAN Internet connection with backup failover to your mobile hotspot:

1. Use an Ethernet cable to connect your modem with Internet service to the Internet port on the rear panel of the Smart Cradle.

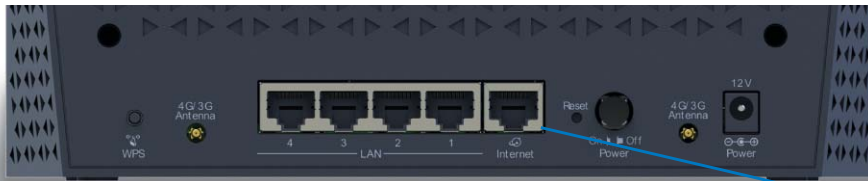

Internet port

2. Launch a web browser from a computer or wireless device that is connected to the Smart Cradle.
3. In the address field of the browser, enter **http://netgear.cradle** or **http://192.168.100.1**.

A login prompt displays.

4. Enter the cradle user name and password.

The user name is **admin**. The default password is **password**. The user name and password are case-sensitive.

The BASIC Home screen displays.

5. Select **Internet**.

The screenshot shows the 'Internet Setup' configuration page. At the top, there are 'Apply', 'Cancel', and 'Test' buttons. Under 'Internet source', the 'Failover Mode - WAN as primary and Mobile Hotspot as backup' radio button is selected. Below this, there are fields for 'Account Name' (DC112A) and 'Domain Name'. The 'Internet IP Address' section has 'Get Dynamically from ISP' selected, with fields for IP Address (192.168.1.1), IP Subnet Mask (255.255.255.0), and Gateway IP Address (192.168.1.1). The 'Domain Name Server (DNS) Address' section has 'Get Automatically from ISP' selected. The 'Router MAC Address' section has 'Use Default Address' selected, with a field showing 00:20:14:07:07:02. The bottom of the page shows 'Help Center' and 'Show/Hide Help Center' links.

6. In the Internet source section, select the **Failover Mode - WAN as a primary and Mobile Hotspot as backup** radio button.
7. Click the **Apply** button.

Your settings are saved. If the mobile broadband connection is not working, the Smart Cradle will attempt to access the Internet through the modem that is connected to its Internet port.

## Specify the Broadband Failover Detection Method

You can specify how the Smart Cradle verifies broadband Internet connectivity. By default, the Smart Cradle uses DNS lookup using a WAN DNS server.

### ➤ To change the broadband failover detection method:

1. Launch a web browser from a computer or wireless device that is connected to the Smart Cradle.
2. In the address field of the browser, enter **http://netgear.cradle** or **http://192.168.100.1**.

A login prompt displays.

3. Enter the cradle user name and password.

The user name is **admin**. The default password is **password**. The user name and password are case-sensitive.

The BASIC Home screen displays.

4. Select **Advanced > Setup > Broadband Settings**.

5. To use DNS lookup by host name, select the **DNS lookup by a hostname** radio button and type the host name in the field.
6. To use ping, do the following:
  - a. Select the **Ping this IP address** radio button.
  - b. Type the IP address in the field.
  - c. Complete the fields to specify the retry interval and failover after values.
7. Click the **Apply** button.

Your settings are saved.



## Manually Set Up the Internet Connection

You can view or change the cradle's Internet connection settings.

### Specify an Internet Connection Without a Login

➤ **To specify the Internet connection settings:**

1. Launch a web browser from a computer or wireless device that is connected to the Smart Cradle.
2. In the address field of the browser, enter **http://netgear.cradle** or **http://192.168.100.1**.  
A login prompt displays.

3. Enter the cradle user name and password.

The user name is **admin**. The default password is **password**. The user name and password are case-sensitive.

The BASIC Home screen displays.

4. Select **Internet**.

By default, in the Internet source section, the **Only use mobile broadband (wireless network provider)** radio button is selected. With this setting, the cradle only uses your mobile hotspot's Internet connection.

5. In the Internet source section, select a radio button for an Ethernet WAN Internet connection.

6. For the Does your Internet connection require a login? setting, leave the **No** radio button selected.
7. If your Internet connection requires an account name or host name, type it in the **Account Name (If Required)** field.
8. If your Internet connection requires a domain name, type it in the **Domain Name (If Required)** field.

For the other sections in this screen, the default settings usually work, but you can change them.

9. Select an Internet IP Address radio button:
  - **Get Dynamically from ISP.** Your ISP uses DHCP to assign your IP address. Your ISP automatically assigns these addresses.
  - **Use Static IP Address.** Enter the IP address, IP subnet mask, and the gateway IP address that your ISP assigned. The gateway is the ISP gateway to which your cradle connects.
10. Select a Domain Name Server (DNS) Address radio button:
  - **Get Automatically from ISP.** Your ISP uses DHCP to assign your DNS servers. Your ISP automatically assigns this address.
  - **Use These DNS Servers.** If you know that your ISP requires specific servers, select this option. Enter the IP address of your ISP's primary DNS server. If a secondary DNS server address is available, enter it also.
11. Select a Router MAC Address radio button:
  - **Use Default Address.** Use the default MAC address.
  - **Use Computer MAC Address.** The cradle captures and uses the MAC address of the computer that you are now using. You must use the one computer that the ISP allows.
  - **Use This MAC Address.** Enter the MAC address that you want to use.
12. Click the **Apply** button.

Your settings are saved.
13. Click the **Test** button to test your Internet connection.

If the NETGEAR website does not display within one minute, see *Chapter 11, Troubleshooting*.

## Specify an Internet Connection That Uses a Login

- **To view or change the basic Internet setup:**
1. Launch a web browser from a computer or wireless device that is connected to the Smart Cradle.
  2. In the address field of the browser, enter **http://netgear.cradle** or **http://192.168.100.1**.

A login prompt displays.
  3. Enter the cradle user name and password.

The user name is **admin**. The default password is **password**. The user name and password are case-sensitive.

The BASIC Home screen displays.

4. Select **Internet**.

The screenshot shows the 'Internet Setup' configuration window. At the top, there are three buttons: 'Apply', 'Cancel', and 'Test'. Below these are several sections:
 

- Internet source:** Four radio buttons are present. The first, 'Only use mobile broadband (wireless network provider)', is selected.
- Does your Internet connection require a login?:** Two radio buttons are present. The 'Yes' button is selected.
- Internet Service Provider:** A dropdown menu is set to 'PPPoE'.
- Login:** A text field contains 'guest'.
- Service Name (if Required):** An empty text field.
- Connection Mode:** A dropdown menu is set to 'Dial on Demand'.
- Idle Timeout (In Minutes):** A text field contains '5'.
- Internet IP Address:** Two radio buttons are present. The first, 'Get Dynamically from ISP', is selected.
- Domain Name Server (DNS) Address:** Four empty text fields.

 A vertical scrollbar is visible on the right side of the form, and an arrow points to it from the text 'Scroll to view more settings'.

← Scroll to view more settings

By default, in the Internet source section, the **Only use mobile broadband (wireless network provider)** radio button is selected. With this setting, the cradle only uses your mobile hotspot's Internet connection.

5. In the Internet source section, select a radio button for an Ethernet WAN Internet connection.
6. In the Does your Internet connection require a login? section, select the **Yes** radio button. The screen adjusts.
7. In the **Internet Service Provider** list, select the encapsulation method: **PPPoE**, **PPTP**, or **L2TP**.
8. In the **Login** field, enter the login name your ISP gave you. This login name is often an email address.
9. In the **Password** field, type the password that you use to log in to your Internet service.
10. If your ISP requires a service name, type it in the **Service Name (if Required)** field.
11. In the **Connection Mode** list, select **Always On**, **Dial on Demand**, or **Manually Connect**.
12. To change the number of minutes until the Internet login times out, in the **Idle Timeout (In minutes)** field, type the number of minutes.

This is how long the cradle keeps the Internet connection active when no one on the network is using the Internet connection. A value of 0 (zero) means never log out.

13. Select an Internet IP Address radio button:

- **Get Dynamically from ISP.** Your ISP uses DHCP to assign your IP address. Your ISP automatically assigns these addresses.
  - **Use Static IP Address.** Enter the IP address, IP subnet mask, and the gateway IP address that your ISP assigned. The gateway is the ISP gateway to which your cradle connects.
14. Select a Domain Name Server (DNS) Address radio button:
- **Get Automatically from ISP.** Your ISP uses DHCP to assign your DNS servers. Your ISP automatically assigns this address.
  - **Use These DNS Servers.** If you know that your ISP requires specific servers, select this option. Enter the IP address of your ISP's primary DNS server. If a secondary DNS server address is available, enter it also.
15. Select a Router MAC Address radio button:
- **Use Default Address.** Use the default MAC address.
  - **Use Computer MAC Address.** The cradle captures and uses the MAC address of the computer that you are now using. You must use the one computer that the ISP allows.
  - **Use This MAC Address.** Enter the MAC address that you want to use.
16. Click the **Apply** button.
- Your settings are saved.
17. Click the **Test** button to test your Internet connection.
- If the NETGEAR website does not display within one minute, see [Chapter 11, Troubleshooting](#).

## Specify WAN Ethernet IPv6 Internet Connections

Some Internet service providers (ISPs) and carriers support IPv6 Internet connections. You can set up the cradle to use an IPv6 pass through connection, but this setting requires some additional configuration options.

Before you set up the cradle to use an IPv6 Internet connection, read this section so that you understand how this connection is implemented. The cradle IPv6 pass through Internet connection works as follows:

- Your existing IPv4 connection and setup continue to operate as normal.
- Your LAN and WiFi clients obtain IPv6 addresses using AutoConfig (Neighbor Discovery Protocol) directly from your docked mobile hotspot.
- The cradle acts as a bridge for IPv6 only, so your existing firewall and parental controls are not enforced.
- Your IPv4 NAT, firewall, and parental controls still operate as normal.
- You can use failover mode with IPv6, but your IPv6 pass through selection is used for both WAN Internet as well as mobile broadband for IPv6. This means that you must test IPv6 to make sure that it works with your WAN Internet and the pass through setting, so it can operate in WAN Internet mode before falling back to Mobile Broadband.

Future cradle software releases will allow other IPv6 settings for mobile broadband connection besides pass through, and allow configuration of IPv6 on WAN Internet independent of the mobile broadband setting.

To use a WAN Ethernet Internet connection, you must select an Internet source option in the Internet Setup screen that includes Ethernet WAN. See [Use a WAN Internet Connection with Failover](#) on page 22.

---

**Note:** To use a docked mobile hotspot with IPv6 data connection, the IPv6 Internet Connection Type should be set as Pass Through. See [Set Up an IPv6 Pass Through Internet Connection](#) on page 34.

---

You can set up an IPv6 Internet connection if genie does not detect it automatically.

➤ **To set up an IPv6 Internet connection:**

1. Launch a web browser from a computer or wireless device that is connected to the Smart Cradle.

2. In the address field of the browser, enter **http://netgear.cradle** or **http://192.168.100.1**.  
A login prompt displays.

3. Enter the cradle user name and password.

The user name is **admin**. The default password is **password**. The user name and password are case-sensitive.

The BASIC Home screen displays.

4. Select **ADVANCED > Advanced Setup > IPv6**.

The Basic Settings screen displays.

5. In the **Internet Connection Type** list, select the IPv6 connection type:

- If your ISP did not provide details, select **IPv6 Tunnel**.
- If you are not sure, select **Auto Detect** so that the cradle detects the IPv6 type that is in use.
- If your Internet connection does not use PPPoE or DHCP, or is not fixed, but is IPv6, select **Auto Config**.

Your Internet service provider (ISP) can provide this information. For more information about IPv6 Internet connection, see the following sections:

- [Use Auto Detect for an IPv6 Internet Connection](#) on page 30
- [Use Auto Config for an IPv6 Internet Connection](#) on page 31
- [Set Up an IPv6 6to4 Tunnel Internet Connection](#) on page 33
- [Set Up an IPv6 Pass Through Internet Connection](#) on page 34
- [Set Up an IPv6 Fixed Internet Connection](#) on page 35
- [Set Up an IPv6 DHCP Internet Connection](#) on page 36

- [Set Up an IPv6 PPPoE Internet Connection](#) on page 38

6. Click the **Apply** button.

Your changes take effect.

## Requirements for Entering IPv6 Addresses

IPv6 addresses are denoted by eight groups of hexadecimal quartets that are separated by colons. You can reduce any four-digit group of zeros within an IPv6 address to a single zero or omit it. The following errors invalidate an IPv6 address:

- More than eight groups of hexadecimal quartets
- More than four hexadecimal characters in a quartet
- More than two colons in a row

## Use Auto Detect for an IPv6 Internet Connection

➤ **To set up an IPv6 Internet connection through auto detection:**

1. Launch a web browser from a computer or wireless device that is connected to the Smart Cradle.
2. In the address field of the browser, enter **http://netgear.cradle** or **http://192.168.100.1**.

A login prompt displays.

3. Enter the cradle user name and password.

The user name is **admin**. The default password is **password**. The user name and password are case-sensitive.

The BASIC Home screen displays.

4. Select **ADVANCED > Advanced Setup > IPv6**.

The IPv6 screen displays.

5. In the **Internet Connection Type** list, select **Auto Detect**.

The screen adjusts:

The screenshot shows the 'Basic Settings' page for IPv6 configuration. At the top, there are three buttons: 'Apply', 'Cancel', and 'Status Refresh'. Below these, the 'Internet Connection Type' is set to 'Auto Detect'. The 'Connection Type' is 'DHCP/Auto Detect'. The 'Router's IPv6 Address On WAN' is 'Not Available'. The 'LAN Setup' section shows 'Router's IPv6 Address On LAN' as 'Not Available' and 'IP Address Assignment' with 'Auto Config' selected. There is a checkbox for 'Use This Interface ID' which is unchecked.

The cradle automatically detects the information in the following fields:

- **Connection Type.** This field indicates the connection type that is detected.
  - **Router's IPv6 Address on WAN.** This field shows the IPv6 address that is acquired for the cradle's WAN (or Internet) interface. The number after the slash (/) is the length of the prefix, which is also indicated by the underline ( ) under the IPv6 address. If no address is acquired, the field displays Not Available.
  - **Router's IPv6 Address on LAN.** This field shows the IPv6 address that is acquired for the cradle's LAN interface. The number after the slash (/) is the length of the prefix, which is also indicated by the underline ( ) under the IPv6 address. If no address is acquired, the field displays Not Available.
6. Select an IP Address Assignment radio button:
- **Use DHCP Server.** This method passes more information to LAN devices, but some IPv6 systems might not support the DHCv6 client function.
  - **Auto Config.** This is the default setting.

This setting specifies how the cradle assigns IPv6 addresses to the devices on your home network (the LAN).

7. (Optional) Select the **Use This Interface ID** check box and specify the interface ID to be used for the IPv6 address of the cradle's LAN interface.

If you do not specify an ID here, the cradle generates one automatically from its MAC address.

8. Click the **Apply** button.

Your settings are saved.

## Use Auto Config for an IPv6 Internet Connection

➤ **To set up an IPv6 Internet connection through auto configuration:**

1. Launch a web browser from a computer or wireless device that is connected to the Smart Cradle.
2. In the address field of the browser, enter **http://netgear.cradle** or **http://192.168.100.1**.

A login prompt displays.

3. Enter the cradle user name and password.

The user name is **admin**. The default password is **password**. The user name and password are case-sensitive.

The BASIC Home screen displays.

4. Select **ADVANCED > Advanced Setup > IPv6**.

The IPv6 screen displays.

5. In the **Internet Connection Type** list, select **Auto Config**.

The screen adjusts:

The cradle automatically detects the information in the following fields:

- **Router's IPv6 Address on WAN.** This field shows the IPv6 address that is acquired for the cradle's WAN (or Internet) interface. The number after the slash (/) is the length of the prefix, which is also indicated by the underline ( ) under the IPv6 address. If no address is acquired, the field displays Not Available.
  - **Router's IPv6 Address on LAN.** This field shows the IPv6 address that is acquired for the cradle's LAN interface. The number after the slash (/) is the length of the prefix, which is also indicated by the underline ( ) under the IPv6 address. If no address is acquired, the field displays Not Available.
6. (Optional) In the **DHCP User Class (If Required)** field, enter a host name.  
Most people can leave this field blank, but if your ISP gave you a specific host name, enter it here.
  7. (Optional) In the **DHCP Domain Name (If Required)** field, enter a domain name.  
You can type the domain name of your IPv6 ISP. Do not enter the domain name for the IPv4 ISP here. For example, if your ISP's mail server is mail.xxx.yyy.zzz, type xxx.yyy.zzz as the domain name. If your ISP provided a domain name, type it in this field. For example, Earthlink Cable might require a host name of home, and Comcast sometimes supplies a domain name.
  8. Select an IP Address Assignment radio button:
    - **Use DHCP Server.** This method passes more information to LAN devices but some IPv6 systems might not support the DHCv6 client function.
    - **Auto Config.** This is the default setting.

This setting specifies how the cradle assigns IPv6 addresses to the devices on your home network (the LAN).

9. (Optional) Select the **Use This Interface ID** check box and specify the interface ID to be used for the IPv6 address of the cradle's LAN interface.

If you do not specify an ID here, the cradle generates one automatically from its MAC address.



- Click the **Apply** button.

Your settings are saved.

## Set Up an IPv6 6to4 Tunnel Internet Connection

The remote relay gateway is the gateway to which your cradle creates a 6to4 tunnel. Make sure that the IPv4 Internet connection is working before you apply the 6to4 tunnel settings for the IPv6 connection.

### ➤ To set up an IPv6 Internet connection by using a 6to4 tunnel:

- Launch a web browser from a computer or wireless device that is connected to the Smart Cradle.

- In the address field of the browser, enter **http://netgear.cradle** or **http://192.168.100.1**.

A login prompt displays.

- Enter the cradle user name and password.

The user name is **admin**. The default password is **password**. The user name and password are case-sensitive.

The BASIC Home screen displays.

- Select **ADVANCED > Advanced Setup > IPv6**.

The IPv6 screen displays.

- In the **Internet Connection Type** list, select **6to4 Tunnel**.

The screen adjusts:

The screenshot shows the 'Basic Settings' page for IPv6 configuration. At the top, there are three buttons: 'Apply', 'Cancel', and 'Status Refresh'. Below that, the 'Internet Connection Type' is set to '6to4 Tunnel'. The 'Remote 6to4 Relay Router' section has 'Auto' selected. The 'LAN Setup' section shows 'Router's IPv6 Address On LAN' as 'Not Available'. Under 'IP Address Assignment', 'Auto Config' is selected. There is a checkbox for 'Use This Interface ID' which is currently unchecked.

The cradle automatically detects the information in the Router's IPv6 Address on LAN field. This field shows the IPv6 address that is acquired for the cradle's LAN interface. The number after the slash (/) is the length of the prefix, which is also indicated by the underline ( ) under the IPv6 address. If no address is acquired, the field displays Not Available.

- Select an IP Address Assignment radio button:

- **Auto.** Your cradle uses any remote relay gateway that is available on the Internet. This is the default setting.
  - **Static IP Address.** Enter the static IPv4 address of the remote relay gateway. Your IPv6 ISP usually provides this address.
7. Select an IP Address Assignment radio button:
- **Use DHCP Server.** This method passes more information to LAN devices but some IPv6 systems might not support the DHCv6 client function.
  - **Auto Config.** This is the default setting.

This setting specifies how the cradle assigns IPv6 addresses to the devices on your home network (the LAN).

8. (Optional) Select the **Use This Interface ID** check box and specify the interface ID to be used for the IPv6 address of the cradle's LAN interface.

If you do not specify an ID here, the cradle generates one automatically from its MAC address.

9. Click the **Apply** button.

Your settings are saved.

## Set Up an IPv6 Pass Through Internet Connection

In pass-through mode, the cradle works as a Layer 2 Ethernet switch with two ports (LAN and WAN Ethernet ports) for IPv6 packets. The cradle does not process any IPv6 header packets.

---

**Note:** To use a docked mobile hotspot with IPv6 data connection, the IPv6 Internet connection type should be set as pass through. Before you set up this connection, see [Specify WAN Ethernet IPv6 Internet Connections](#) on page 28 so that you understand how the connection is implemented.

---

➤ **To set up a pass-through IPv6 Internet connection:**

1. Launch a web browser from a computer or wireless device that is connected to the Smart Cradle.
2. In the address field of the browser, enter **http://netgear.cradle** or **http://192.168.100.1**.

A login prompt displays.

3. Enter the cradle user name and password.

The user name is **admin**. The default password is **password**. The user name and password are case-sensitive.

The BASIC Home screen displays.

4. Select **ADVANCED > Advanced Setup > IPv6**.  
The IPv6 screen displays.
5. In the **Internet Connection Type** list, select **Pass Through**.  
The screen adjusts, but no additional fields display.
6. Click the **Apply** button.  
Your settings are saved.

## Set Up an IPv6 Fixed Internet Connection

### ➤ To set up a fixed IPv6 Internet connection:

1. Launch a web browser from a computer or wireless device that is connected to the Smart Cradle.
2. In the address field of the browser, enter **http://netgear.cradle** or **http://192.168.100.1**.  
A login prompt displays.
3. Enter the cradle user name and password.  
The user name is **admin**. The default password is **password**. The user name and password are case-sensitive.  
The BASIC Home screen displays.
4. Select **ADVANCED > Advanced Setup > IPv6**.  
The IPv6 screen displays.
5. In the **Internet Connection Type** list, select **Fixed**.  
The screen adjusts:

The screenshot shows the IPv6 configuration interface. At the top, there are 'Apply' and 'Cancel' buttons. Below that, the 'Internet Connection Type' is set to 'Fixed'. The 'WAN Setup' section includes fields for 'IPv6 Address Prefix Length', 'Default IPv6 Gateway', 'Primary DNS', and 'Secondary DNS'. The 'LAN Setup' section has 'IP Address Assignment' with 'Auto Config' selected and a field for 'IPv6 Address Prefix Length'.

6. Configure the fixed IPv6 addresses for the WAN connection:
  - **IPv6 Address/Prefix Length**. The IPv6 address and prefix length of the cradle WAN interface.

- **Default IPv6 Gateway.** The IPv6 address of the default IPv6 gateway for the cradle's WAN interface.
- **Primary DNS Server.** The primary DNS server that resolves IPv6 domain name records for the cradle.
- **Secondary DNS Server.** The secondary DNS server that resolves IPv6 domain name records for the cradle.

**Note:** If you do not specify the DNS servers, the cradle uses the DNS servers that are configured for the IPv4 Internet connection on the Internet Setup screen. (See *Manually Set Up the Internet Connection* on page 25.)

7. Select an IP Address Assignment radio button:
  - **Use DHCP Server.** This method passes more information to LAN devices but some IPv6 systems might not support the DHCv6 client function.
  - **Auto Config.** This is the default setting.

This setting specifies how the cradle assigns IPv6 addresses to the devices on your home network (the LAN).

8. In the **IPv6 Address/Prefix Length** fields, specify the static IPv6 address and prefix length of the cradle's LAN interface.

If you do not specify an ID here, the cradle generates one automatically from its MAC address.

9. Click the **Apply** button.  
Your settings are saved.

## Set Up an IPv6 DHCP Internet Connection

### ➤ To set up an IPv6 Internet connection with a DHCP server:

1. Launch a web browser from a computer or wireless device that is connected to the Smart Cradle.
2. In the address field of the browser, enter **http://netgear.cradle** or **http://192.168.100.1**.  
A login prompt displays.
3. Enter the cradle user name and password.  
The user name is **admin**. The default password is **password**. The user name and password are case-sensitive.  
The BASIC Home screen displays.
4. Select **ADVANCED > Advanced Setup > IPv6**.  
The IPv6 screen displays.
5. In the **Internet Connection Type** list, select **DHCP**.

The screen adjusts:

The cradle automatically detects the information in the following fields:

- **Router's IPv6 Address on WAN.** This field shows the IPv6 address that is acquired for the cradle's WAN (or Internet) interface. The number after the slash (/) is the length of the prefix, which is also indicated by the underline (\_\_) under the IPv6 address. If no address is acquired, the field displays Not Available.
  - **Router's IPv6 Address on LAN.** This field shows the IPv6 address that is acquired for the cradle's LAN interface. The number after the slash (/) is the length of the prefix, which is also indicated by the underline (\_\_) under the IPv6 address. If no address is acquired, the field displays Not Available.
6. (Optional) In the **User Class (If Required)** field, enter a host name.  
Most people can leave this field blank, but if your ISP gave you a specific host name, enter it here.
  7. (Optional) In the **Domain Name (If Required)** field, enter a domain name.  
You can type the domain name of your IPv6 ISP. Do not enter the domain name for the IPv4 ISP here. For example, if your ISP's mail server is mail.xxx.yyy.zzz, type xxx.yyy.zzz as the domain name. If your ISP provided a domain name, type it in this field.
  8. Select an IP Address Assignment radio button:
    - **Use DHCP Server.** This method passes more information to LAN devices but some IPv6 systems might not support the DHCPv6 client function.
    - **Auto Config.** This is the default setting.
 This setting specifies how the cradle assigns IPv6 addresses to the devices on your home network (the LAN).
  9. (Optional) Select the **Use This Interface ID** check box and specify the interface ID to be used for the IPv6 address of the cradle's LAN interface.  
If you do not specify an ID here, the cradle generates one automatically from its MAC address.
  10. Click the **Apply** button.

Your settings are saved.

## Set Up an IPv6 PPPoE Internet Connection

### ➤ To set up a PPPoE IPv6 Internet connection:

1. Launch a web browser from a computer or wireless device that is connected to the Smart Cradle.
2. In the address field of the browser, enter **http://netgear.cradle** or **http://192.168.100.1**.

A login prompt displays.

3. Enter the cradle user name and password.

The user name is **admin**. The default password is **password**. The user name and password are case-sensitive.

The BASIC Home screen displays.

4. Select **ADVANCED > Advanced Setup > IPv6**.

The IPv6 screen displays.

5. In the **Internet Connection Type** list, select **PPPoE**.

The screen adjusts:

The cradle automatically detects the information in the following fields:

- **Router's IPv6 Address on WAN.** This field shows the IPv6 address that is acquired for the cradle's WAN (or Internet) interface. The number after the slash (/) is the length of the prefix, which is also indicated by the underline ( \_ ) under the IPv6 address. If no address is acquired, the field displays Not Available.
- **Router's IPv6 Address on LAN.** This field shows the IPv6 address that is acquired for the cradle's LAN interface. The number after the slash (/) is the length of the prefix, which is also indicated by the underline ( \_ ) under the IPv6 address. If no address is acquired, the field displays Not Available.

6. In the **Login** field, enter the login information for the ISP connection.

This is usually the name that you use in your email address. For example, if your main mail account is JerAB@ISP.com, you would type JerAB in this field. Some ISPs (like Mindspring, Earthlink, and T-DSL) require that you use your full email address when you log in. If your ISP requires your full email address, type it in this field.

7. In the **Password** field, enter the password for the ISP connection.
8. In the **Service Name** field, enter a service name.

If your ISP did not provide a service name, leave this field blank.

**Note:** The default setting of the **Connection Mode** list is **Always On** to provide a steady IPv6 connection. The cradle never terminates the connection. If the connection is terminated, for example, when the modem is turned off, the cradle attempts to reestablish the connection immediately after the PPPoE connection becomes available again.

9. Select an IP Address Assignment radio button:
  - **Use DHCP Server.** This method passes more information to LAN devices but some IPv6 systems might not support the DHCv6 client function.
  - **Auto Config.** This is the default setting.

This setting specifies how the cradle assigns IPv6 addresses to the devices on your home network (the LAN).

10. (Optional) Select the **Use This Interface ID** check box and specify the interface ID to be used for the IPv6 address of the cradle's LAN interface.

If you do not specify an ID here, the cradle generates one automatically from its MAC address.

11. Click the **Apply** button.

Your settings are saved.

## Change the MTU Size

The maximum transmission unit (MTU) is the largest data packet a network device transmits. When one network device communicates across the Internet with another, the data packets travel through many devices along the way. If a device in the data path uses a lower MTU setting than the other devices, the data packets must be split or "fragmented" to accommodate the device with the smallest MTU.

The best MTU setting for NETGEAR equipment is often the default value. In some situations, changing the value fixes one problem but causes another. Leave the MTU unchanged unless one of these situations occurs:

- You experience problems connecting to your ISP or other Internet service, and the technical support of the ISP. These web-based applications might require an MTU change:

- A secure website that does not open, or displays only part of a web page
- Yahoo email
- MSN portal
- America Online's DSL service
- You use VPN and experience severe performance problems.
- You used a program to optimize MTU for performance reasons and now you are experiencing connectivity or performance problems.

---

**Note:** An incorrect MTU setting can cause Internet communication problems. For example, you might not be able to access certain websites, frames within websites, secure login pages, or FTP or POP servers.

---

➤ **To change the MTU size:**

1. Launch a web browser from a computer or wireless device that is connected to the Smart Cradle.
2. In the address field of the browser, enter **http://netgear.cradle** or **http://192.168.100.1**.  
A login prompt displays.
3. Enter the cradle user name and password.  
The user name is **admin**. The default password is **password**. The user name and password are case-sensitive.  
The BASIC Home screen displays.
4. Select **ADVANCED > Setup > WAN Setup**.

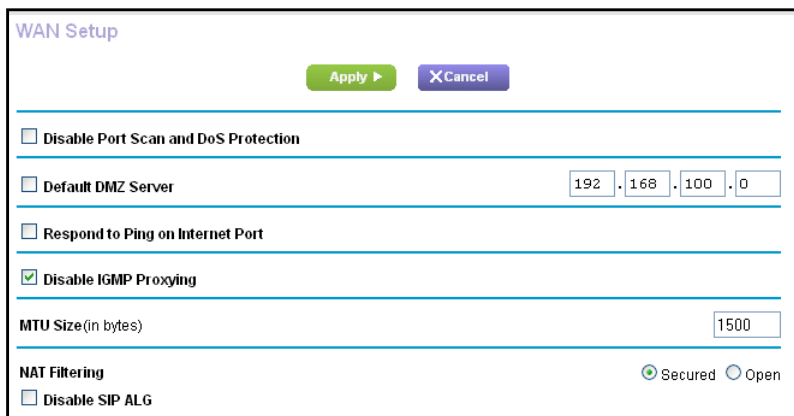

WAN Setup

Apply Cancel

Disable Port Scan and DoS Protection

Default DMZ Server 192 . 168 . 100 . 0

Respond to Ping on Internet Port

Disable IGMP Proxying

MTU Size (in bytes) 1500

NAT Filtering  Secured  Open

Disable SIP ALG

5. In the **MTU Size** field, enter a value from 64 to 1500.
6. Click the **Apply** button.  
Your settings are saved.



If you suspect an MTU problem, a common solution is to change the MTU to 1400. If you are willing to experiment, you can gradually reduce the MTU from the maximum value of 1500 until the problem goes away. The following table describes common MTU sizes and applications.

**Table 2. Common MTU sizes**

<b>MTU</b>	<b>Application</b>
1500	The largest Ethernet packet size. This setting is typical for connections that do not use PPPoE or VPN and is the default value for the cradle.
1492	Used in PPPoE environments.
1472	Maximum size to use for pinging. (Larger packets are fragmented.)
1468	Used in some DHCP environments.
1460	Usable by AOL if you do not send or receive large email attachments, for example.
1436	Used in PPTP environments or with VPN.
1400	Maximum size for AOL DSL.
576	Typical value to connect to dial-up ISPs.

## 4. Control Internet Access

---

This chapter covers the following topics:

- *Set Up Parental Controls*
- *Allow or Block Access to Your Network*
- *Use Keywords to Block Internet Sites*
- *Block Services from the Internet*
- *Schedule When to Block Internet Sites and Services*
- *Avoid Blocking on a Trusted Computer*
- *Set Up Security Event Email Notifications*
- *Set Up Port Forwarding to a Local Server*
- *Set Up Port Triggering*

## Set Up Parental Controls

The first time that you select **Parental Controls** from the BASIC Home screen, your browser goes to the Live Parental Controls website, where you can learn more about Live Parental Controls and download the application.

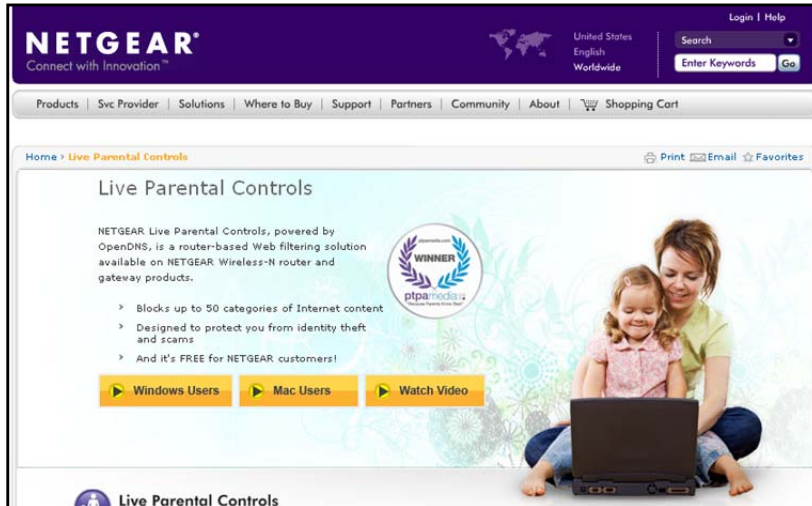

### ➤ To set up Live Parental Controls:

1. Launch a web browser from a computer or wireless device that is connected to the Smart Cradle.
2. In the address field of the browser, enter **http://netgear.cradle** or **http://192.168.100.1**.  
A login prompt displays.

3. Enter the cradle user name and password.

The user name is **admin**. The default password is **password**. The user name and password are case-sensitive.

The BASIC Home screen displays.

4. Select **Parental Controls**.

If your Internet connection is working, the browser automatically goes online and displays the Parental Controls web page.

5. Click either the **Windows Users** or **Mac Users** button.
6. Follow the onscreen instructions to download and install the NETGEAR Live Parental Controls management utility.

After installation, Live Parental Controls automatically starts.

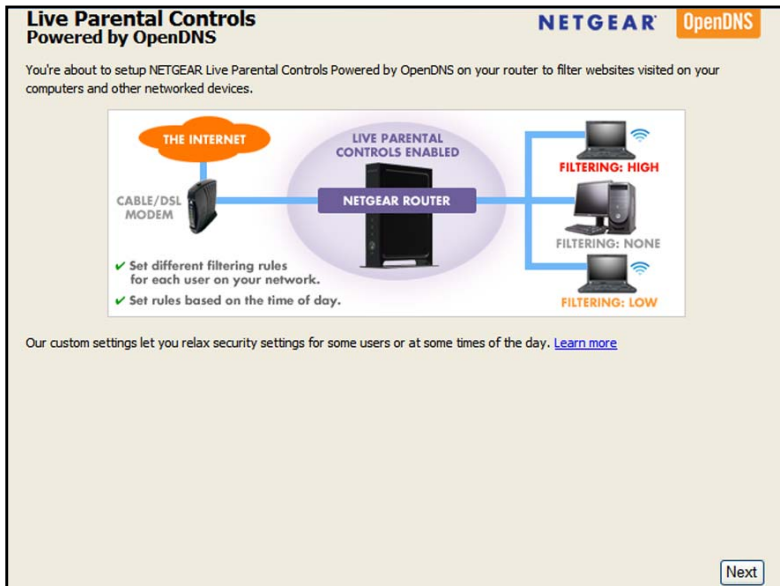

7. Click the **Next** button.
8. Read the note, and click the **Next** button again to proceed.

Because Live Parental Controls uses free OpenDNS accounts, you are prompted to log in or create a free account.

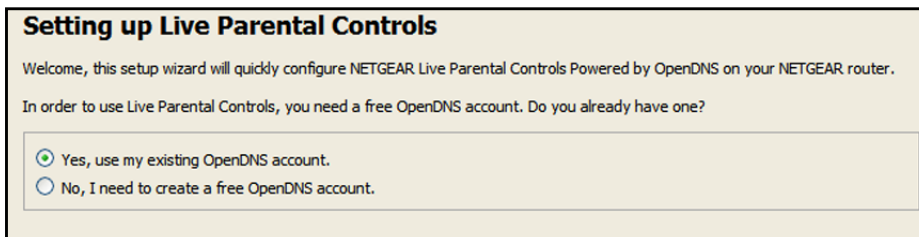

9. Select the radio button that applies to you:
  - If you already created an OpenDNS account, leave the **Yes** radio button selected.
  - If you did not yet create an OpenDNS account, select the **No** radio button.
10. Click the **Next** button.

If you are creating an account, the following screen displays:

11. Complete the fields and click the **Next** button.

After you log on or create your account, the filtering level screen displays:

**Live Parental Controls: choose a filtering level for your network**

All computers connected to your router will be protected from the content you select below. You can customize your Live Parental Controls later on our website.

**High**  
Protects against all adult-related sites, illegal activity, social networking sites, video sharing sites, phishing attacks and general time-wasters.

**Moderate**  
Protects against all adult-related sites, illegal activity and phishing attacks.

**Low**  
Protects against pornography and phishing attacks.

**Minimal**  
Protects only against phishing attacks.

**None**  
Nothing blocked.

12. Select a filtering level and click the **Next** button.

The Setup is complete screen displays.

13. Click the **Take me to the status screen** button.

Parental controls are now set up for the Smart Cradle. The BASIC Home screen shows Parental Controls as Enabled.

## Allow or Block Access to Your Network

You can use access control to block or allow access to your network.

### ➤ To set up access control:

1. Launch a web browser from a computer or wireless device that is connected to the Smart Cradle.
2. In the address field of the browser, enter **http://netgear.cradle** or **http://192.168.100.1**.

A login prompt displays.

3. Enter the cradle user name and password.

The user name is **admin**. The default password is **password**. The user name and password are case-sensitive.

The BASIC Home screen displays.

4. Select **ADVANCED > Security > Access Control**.

Access Control

Apply Cancel

You can use Access Control to allow or block computers or electronic devices from accessing your network.

Turn on Access Control

**Access Rule:** This is a general rule. You can also allow or block individual devices.

Allow all new devices to connect

Block all new devices from connecting

Allow Block Refresh

<input type="checkbox"/>	Status	Device Name	IP Address	MAC Address	Connection Type
<input type="checkbox"/>	Allowed	techpubs	192.168.100.2	00:1A:6B:6D:8F:19	Wired

▶ View list of allowed devices not currently connected to the network

▶ View list of blocked devices not currently connected to the network

5. Select the **Turn on Access Control** check box.

You must select this check box before you can specify an access rule and use the **Allow** and **Block** buttons. When this check box is cleared, all devices are allowed to connect, even if the device is in the blocked list.

6. Select an access rule:

- **Allow all new devices to connect.** With this setting, if you add a new device, it can access your network. You don't need to enter its MAC address in this screen.
- **Block all new devices from connecting.** With this setting, if you add a new device, before it can access your network, you must enter its MAC address for an Ethernet connection and its MAC address for a WiFi connection in the allowed list.

The access rule does not affect previously blocked or allowed devices. It applies only to devices joining your network in the future after you apply these settings.

7. To view allowed or blocked devices that are not connected, click the following links:

- **View list of allowed devices not currently connected to the network**
- **View list of blocked devices not currently connected to the network**

The list displays.

8. To allow the computer or device that you're currently using to continue to access the network, select the check box next to your computer or device, and click the **Allow** button.

9. Click the **Apply** button.

Your changes take effect.

## Manage Network Access Control Lists

You can use access control to block or allow access to your network.

### ➤ To manage devices that are allowed or blocked:

1. Launch a web browser from a computer or wireless device that is connected to the Smart Cradle.
2. In the address field of the browser, enter **http://netgear.cradle** or **http://192.168.100.1**.

A login prompt displays.

3. Enter the cradle user name and password.

The user name is **admin**. The default password is **password**. The user name and password are case-sensitive.

The BASIC Home screen displays.

4. Select **ADVANCED > Security > Access Control**.

Access Control

---

You can use Access Control to allow or block computers or electronic devices from accessing your network.

Turn on Access Control

**Access Rule:** This is a general rule. You can also allow or block individual devices.

Allow all new devices to connect  
 Block all new devices from connecting

---

	Status	Device Name	IP Address	MAC Address	Connection Type
<input type="checkbox"/>	Allowed	techpubs	192.168.100.2	00:1A:6B:6D:8F:19	Wired

5. Click the **View list of allowed devices not currently connected to the network** link.

The list displays.

6. Select the check box for a device.
7. Use the **Add** button, **Edit** button, and **Remove from the List** button as needed.
8. Click the **Apply** button.

Your changes take effect.

## Use Keywords to Block Internet Sites

You can use keywords to block certain Internet sites from your network. You can use blocking all the time or based on a schedule.

### ➤ To block Internet sites:

1. Launch a web browser from a computer or wireless device that is connected to the Smart Cradle.
2. In the address field of the browser, enter **http://netgear.cradle** or **http://192.168.100.1**.

A login prompt displays.

3. Enter the cradle user name and password.

The user name is **admin**. The default password is **password**. The user name and password are case-sensitive.

The BASIC Home screen displays.

4. Select **ADVANCED > Security > Block Sites**.

5. Select a keyword blocking option:
  - **Per Schedule**. Turn on keyword blocking according to a schedule that you set. (See [Schedule When to Block Internet Sites and Services](#) on page 51.)
  - **Always**. Turn on keyword blocking all the time, independent of the Schedule screen.
6. In the **Type keyword or domain name here** field, enter a keyword or domain that you want to block.

For example:

- Specify **XXX** to block <http://www.badstuff.com/xxx.html>.
- Specify **.com** if you want to allow only sites with domain suffixes such as **.edu** or **.gov**.
- Enter a period (**.**) to block all Internet browsing access.

7. Click the **Add Keyword** button.



The keyword is added to the keyword list. The keyword list supports up to 32 entries.

8. Click the **Apply** button.  
Keyword blocking takes effect.

## Delete Keywords from the List to Be Blocked

➤ **To delete keywords from the list:**

1. Launch a web browser from a computer or wireless device that is connected to the Smart Cradle.
2. In the address field of the browser, enter **http://netgear.cradle** or **http://192.168.100.1**.  
A login prompt displays.
3. Enter the cradle user name and password.  
The user name is **admin**. The default password is **password**. The user name and password are case-sensitive.  
The BASIC Home screen displays.
4. Select **ADVANCED > Security > Block Sites**.
5. Do one of the following:
  - To delete a single word, select it and click the **Delete Keyword** button.  
The keyword is removed from the list.
  - To delete all keywords on the list, click the **Clear List** button.  
All keywords are removed from the list.
6. Click the **Apply** button.  
Your changes are saved.

## Block Services from the Internet

You can block Internet services on your network based on the type of service. You can block the services all the time or based on a schedule.

➤ **To block services:**

1. Launch a web browser from a computer or wireless device that is connected to the Smart Cradle.
2. In the address field of the browser, enter **http://netgear.cradle** or **http://192.168.100.1**.  
A login prompt displays.
3. Enter the cradle user name and password.  
The user name is **admin**. The default password is **password**. The user name and password are case-sensitive.

The BASIC Home screen displays.

4. Select **ADVANCED > Security > Block Services**.

5. Specify when to block the services:

- To block the services all the time, select the **Always** radio button.
- To block the services based on a schedule, select the **Per Schedule** radio button.

For information about how to specify the schedule, see [Schedule When to Block Internet Sites and Services](#) on page 51.

6. Click the **Add** button.

The Block Services Setup screen displays:

7. To add a service that is in the **Service Type** list, select the application or service.

The settings for this service automatically display in the fields.

8. To add a service or application that is not the list, select **User Defined** and do the following:

- If you know that the application uses either TCP or UDP, select the appropriate protocol; otherwise, select **TCP/UDP** (both).
- Enter the starting port and ending port numbers.

If the service uses a single port number, enter that number in both fields. To find out which port numbers the service or application uses, you can contact the publisher of the application, ask user groups or newsgroups, or search on the Internet.

9. Select a filtering option:

- **Only This IP Address.** Block services for a single computer.
- **IP Address Range.** Block services for a range of computers with consecutive IP addresses on your network.
- **All IP Addresses.** Block services for all computers on your network.

10. Click the **Add** button.

Your changes are saved.

## Schedule When to Block Internet Sites and Services

When you schedule blocking, the same schedule is used to block sites and to block services. For information about how to specify what you want the cradle to block, see [Use Keywords to Block Internet Sites](#) on page 48 and [Block Services from the Internet](#) on page 49.

### ➤ To schedule blocking:

1. Launch a web browser from a computer or wireless device that is connected to the Smart Cradle.
2. In the address field of the browser, enter **http://netgear.cradle** or **http://192.168.100.1**.

A login prompt displays.

3. Enter the cradle user name and password.

The user name is **admin**. The default password is **password**. The user name and password are case-sensitive.

The BASIC Home screen displays.

4. Select **ADVANCED > Security > Schedule**.

The screenshot shows the 'Schedule' configuration page. At the top, there are 'Apply' and 'Cancel' buttons. Below that, the 'Days to Block' section has checkboxes for 'Every Day', 'Sunday', 'Monday', 'Tuesday', 'Wednesday', 'Thursday', 'Friday', and 'Saturday', all of which are checked. The 'Time of day to block' section has a radio button for 'All Day' which is selected. Below this are input fields for 'Start Blocking' (0 Hour 0 Minute) and 'End Blocking' (24 Hour 0 Minute). The 'Time Zone' section shows a dropdown menu set to '(GMT-08:00) Pacific Time (US & Canada): Tijuana' and an unchecked checkbox for 'Automatically adjust for daylight savings time'. At the bottom, the 'Current Time' is displayed as 'Wednesday, 01 Jan 2003 00:01:44'.

5. Specify when to block keywords and services:

- **Days to Block.** Select the check box for each day that you want to block the keywords or select the **Every Day** check box, which automatically selects the check boxes for all days.
  - **Time of Day to Block.** Select a start and end time in 24-hour format, or select **All Day** for 24-hour blocking.
6. Select your time zone from the list.
  7. If you live in a region that observes daylight saving time, select the **Automatically adjust for daylight savings time** check box.
  8. Click the **Apply** button.
- Your settings are saved.

## Avoid Blocking on a Trusted Computer

You can exempt one trusted computer from blocking. The computer you exempt must be assigned a fixed IP address. You can use the reserved IP address feature to specify the IP address. See [Reserve LAN IP Addresses](#) on page 79.

### ➤ To specify a trusted computer:

1. Launch a web browser from a computer or wireless device that is connected to the Smart Cradle.
  2. In the address field of the browser, enter **http://netgear.cradle** or **http://192.168.100.1**.  
A login prompt displays.
  3. Enter the cradle user name and password.  
The user name is **admin**. The default password is **password**. The user name and password are case-sensitive.  
The BASIC Home screen displays.
  4. Select **ADVANCED > Security > Block Sites**.
  5. Scroll down and select the **Allow trusted IP address to visit blocked sites** check box.
  6. In the **Trusted IP Address** field, enter the IP address of the trusted computer.
  7. Click the **Apply** button.
- Your changes are saved.

## Set Up Security Event Email Notifications

The cradle can email you its logs of its activity. The log records cradle activity and security events such as attempts to access blocked sites or services.

➤ **To set up email notifications:**

1. Launch a web browser from a computer or wireless device that is connected to the Smart Cradle.

2. In the address field of the browser, enter **http://netgear.cradle** or **http://192.168.100.1**.

A login prompt displays.

3. Enter the cradle user name and password.

The user name is **admin**. The default password is **password**. The user name and password are case-sensitive.

The BASIC Home screen displays.

4. Select **ADVANCED > Security > E-mail**.

5. Select the **Turn Email Notification On** check box.

6. In the **Your Outgoing Mail Server** field, enter the name of your ISP outgoing (SMTP) mail server (such as mail.myISP.com).

You might be able to find this information in the configuration screen of your email program. If you leave this field blank, log and alert messages are not sent.

7. In the **Send to This E-mail Address** field, type the email address to which logs and alerts are to be sent.

This email address is also used for the From address. If this field is blank, log and alert messages are not sent.

8. If your outgoing email server requires authentication, select the **My Mail Server requires authentication** check box and do the following:

- a. In the **User Name** field, type the user name for the outgoing email server.

- b. In the **Password** field, type the password for the outgoing email server.

9. (Optional) Select the **Send Alerts Immediately** check box.

Email alerts are sent immediately when someone attempts to visit a blocked site.

10. To send logs based on a schedule, specify these settings:
  - From **Send logs according to this schedule** list, select the schedule type.
  - From the **Day** list, select the day.
  - From the **Time** list, select the time, and select the **am** or **pm** radio button.
11. Click the **Apply** button.

Your settings are saved.

Logs are sent automatically according to the schedule that you set. If the log fills before the specified time, it is sent. After the log is sent, it is cleared from the cradle memory. If the cradle cannot email the log and the log buffer fills, the cradle overwrites the log.

## Set Up Port Forwarding to a Local Server

If your home network includes a server, you can allow certain types of incoming traffic to reach the server. For example, you might want to make a local web server, FTP server, or game server visible and available to the Internet.

The cradle can forward incoming traffic with specific protocols to computers on your local network. You can specify the servers for applications and you can also specify a default DMZ server to which the cradle forwards all other incoming protocols.

### ➤ To forward specific incoming protocols:

1. Decide which type of service, application, or game you want to provide.
2. Find the local IP address of the computer on your network that will provide the service.

You can usually find this information by contacting the publisher of the application or user groups or news groups.

The server computer must always use the same IP address. Assign the server computer a reserved IP address. See *Reserve LAN IP Addresses* on page 79.

3. Launch a web browser from a computer or wireless device that is connected to the Smart Cradle.
4. In the address field of the browser, enter **http://netgear.cradle** or **http://192.168.100.1**.

A login prompt displays.

5. Enter the cradle user name and password.

The user name is **admin**. The default password is **password**. The user name and password are case-sensitive.

The BASIC Home screen displays.

6. Select **ADVANCED > Advanced Setup > Port Forwarding/Port Triggering**.

Port Forwarding / Port Triggering

Please select the service type.

Port Forwarding  
 Port Triggering

Service Name: FTP Server IP Address: 192 . 168 . 100 .

#	Service Name	External Start Port	Internal Start Port	Internal IP address

7. Leave the **Port Forwarding** radio button selected as the service type.
8. From the **Service Name** list, select the service name.  
 If the service that you want to add is not in the list, create a custom service. See [Add a Custom Port Forwarding Service](#) on page 55.
9. In the **Server IP Address** field, enter the IP address of the computer that will provide the service.
10. Click the **Add** button.  
 The service displays in the list.

## Add a Custom Port Forwarding Service

### ➤ To add a custom service:

- Find out which port number or range of numbers the application uses.  
 You can usually find this information by contacting the publisher of the application or user groups or news groups.
- Launch a web browser from a computer or wireless device that is connected to the Smart Cradle.
- In the address field of the browser, enter **http://netgear.cradle** or **http://192.168.100.1**.  
 A login prompt displays.
- Enter the cradle user name and password.  
 The user name is **admin**. The default password is **password**. The user name and password are case-sensitive.  
 The BASIC Home screen displays.
- Select **ADVANCED > Advanced Setup > Port Forwarding/Port Triggering**.  
 The Port Forwarding/Port Triggering screen displays.
- Leave the **Port Forwarding** radio button selected as the service type.

- Click the **Add Custom Service** button.

Ports - Custom Services

Apply Cancel

Service Name

Protocol TCP/UDP

External Port Range  (1~65534)  
 (Specify ports and/or port ranges split by commas, example: 30, 50-60, 65500-65510)

Use the same port range for Internal port

Internal Port Range  (1~65534)  
 (Specify ports and/or port ranges split by commas, example: 30, 50-60, 65500-65510)

Internal IP address

Or select from currently attached devices

	IP Address	Device Name
<input type="radio"/>	192.168.100.2	techpubs

- In the **Service Name** field, enter a descriptive name.
- In the **Protocol** list, select the protocol.  
 If you are unsure, select **TCP/UDP**.
- In the **External Port Range** field, enter the port range.  
 If the application uses a single port, enter that port number.
- Specify the internal ports by one of these methods:
  - Leave the **Use the same port range for Internal port** check box selected.
  - Type the port numbers in the **Internal Port Range** fields.
- In the **Internal IP address** field, type the IP address or select the radio button for an attached device listed in the table.
- Click the **Apply** button.  
 The service is now in the list on the Port Forwarding/Port Triggering screen.

## Edit a Port Forwarding Service

- **To edit a port forwarding entry:**
  - Launch a web browser from a computer or wireless device that is connected to the Smart Cradle.
  - In the address field of the browser, enter **http://netgear.cradle** or **http://192.168.100.1**.  
 A login prompt displays.
  - Enter the cradle user name and password.  
 The user name is **admin**. The default password is **password**. The user name and password are case-sensitive.  
 The BASIC Home screen displays.
  - Select **ADVANCED > Advanced Setup > Port Forwarding/Port Triggering**.  
 The Port Forwarding/Port Triggering screen displays.



5. Leave the **Port Forwarding** radio button selected as the service type.
6. In the table, select the radio button next to the service name.
7. Click the **Edit Service** button.  
The Ports - Custom Services screen displays.
8. Change the settings as needed:
9. Click the **Apply** button.  
Your changes are saved.

## Delete a Port Forwarding Entry

➤ **To delete a port forwarding entry:**

1. Launch a web browser from a computer or wireless device that is connected to the Smart Cradle.
2. In the address field of the browser, enter **http://netgear.cradle** or **http://192.168.100.1**.  
A login prompt displays.
3. Enter the cradle user name and password.  
The user name is **admin**. The default password is **password**. The user name and password are case-sensitive.  
The BASIC Home screen displays.
4. Select **ADVANCED > Advanced Setup > Port Forwarding/Port Triggering**.  
The Port Forwarding/Port Triggering screen displays.
5. Select the **Port Forwarding** radio button as the service type.
6. In the table, select the radio button next to the service name.
7. Click the **Delete Service** button.  
The service is deleted.

## Application Example: Make a Local Web Server Public

If you host a web server on your local network, you can use port forwarding to allow web requests from anyone on the Internet to reach your web server.

➤ **To make a local web server public:**

1. Assign your web server either a fixed IP address or a dynamic IP address using DHCP address reservation.  
In this example, your cradle always gives your web server an IP address of 192.168.100.33.
2. In the Port Forwarding/Port Triggering screen, configure the cradle to forward the HTTP service to the local address of your web server at **192.168.100.33**.

HTTP (port 80) is the standard protocol for web servers.

3. (Optional) Register a host name with a Dynamic DNS service and specify that name in the Dynamic DNS screen of the cradle.

Dynamic DNS makes it much easier to access a server from the Internet because you can type the name in the Internet browser. Otherwise, you must know the IP address that the ISP assigned, which typically changes.

## How the Cradle Implements the Port Forwarding Rule

The following sequence shows the effects of a port forwarding rule:

1. When you type the URL `www.example.com` in your browser, the browser sends a web page request message with the following destination information:
  - **Destination address.** The IP address of `www.example.com`, which is the address of your cradle.
  - **Destination port number.** 80, which is the standard port number for a web server process.
2. Your cradle receives the message and finds your port forwarding rule for incoming port 80 traffic.
3. The cradle changes the destination in the message to IP address `192.168.100.123` and sends the message to that computer.
4. Your web server at IP address `192.168.100.123` receives the request and sends a reply message to your cradle.
5. Your cradle performs Network Address Translation (NAT) on the source IP address, and sends the reply through the Internet to the computer or wireless device that sent the web page request.

## Set Up Port Triggering

Port triggering is a dynamic extension of port forwarding that is useful in these cases:

- An application must use port forwarding to more than one local computer (but not simultaneously).
- An application must open incoming ports that are different from the outgoing port.

With port triggering, the cradle monitors traffic to the Internet from an outbound “trigger” port that you specify. For outbound traffic from that port, the cradle saves the IP address of the computer that sent the traffic. The cradle temporarily opens the incoming port or ports that you specify in your rule and forwards that incoming traffic to that destination.

Port forwarding creates a static mapping of a port number or range of ports to a single local computer. Port triggering can dynamically open ports to any computer when needed and close the ports when they are no longer needed.

---

**Note:** If you use applications such as multiplayer gaming, peer-to-peer connections, real-time communications such as instant messaging, or remote assistance (a feature in Windows XP), enable Universal Plug and Play (UPnP). See *Improve Network Connections with Universal Plug and Play* on page 69.

---

## Add a Port Triggering Service

### ➤ To add a port triggering service:

1. Launch a web browser from a computer or wireless device that is connected to the Smart Cradle.
2. In the address field of the browser, enter **http://netgear.cradle** or **http://192.168.100.1**.  
A login prompt displays.

3. Enter the cradle user name and password.

The user name is **admin**. The default password is **password**. The user name and password are case-sensitive.

The BASIC Home screen displays.

4. Select **ADVANCED > Advanced Setup > Port Forwarding/Port Triggering**.

The Port Forwarding/Port Triggering screen displays.

5. Select the **Port Triggering** radio button.
6. Click the **Add Service** button.

The screenshot shows the 'Port Triggering - Services' configuration page. At the top right are 'Apply' and 'Cancel' buttons. The 'Service' section includes a text field for 'Service Name', a dropdown for 'Service User' (set to 'Any'), a dotted IP address field for 'Service User', a dropdown for 'Service Type' (set to 'TCP'), and a text field for 'Triggering Port' with a '(1~65534)' range indicator. The 'Inbound Connection' section includes a dropdown for 'Connection Type' (set to 'TCP/UDP'), and text fields for 'Starting Port' and 'Ending Port', both with '(1~65534)' range indicators.

7. In the **Service Name** field, type a descriptive service name.
8. From the **Service User** list, select a user option:
  - **Any** (the default) allows any computer on the Internet to use this service.
  - **Single address** restricts the service to a particular computer.
9. From the **Service Type** list, select **TCP** or **UDP** or **TCP/UDP** (both).  
If you are not sure, select **TCP/UDP**.

10. In the **Triggering Port** field, enter the number of the outbound traffic port that will open the inbound ports.
11. Complete the **Connection Type**, **Starting Port**, and **Ending Port** fields.
12. Click the **Apply** button.

The service is now in the Portmap table. You must enable port triggering before the cradle uses port triggering. See [Enable Port Triggering](#) on page 60.

## Enable Port Triggering

### ➤ To enable port triggering:

1. Launch a web browser from a computer or wireless device that is connected to the Smart Cradle.
2. In the address field of the browser, enter **http://netgear.cradle** or **http://192.168.100.1**.  
A login prompt displays.

3. Enter the cradle user name and password.

The user name is **admin**. The default password is **password**. The user name and password are case-sensitive.

The BASIC Home screen displays.

4. Select **ADVANCED > Advanced Setup > Port Forwarding/Port Triggering**.  
The Port Forwarding/Port Triggering screen displays.
5. Select the **Port Triggering** radio button.

Port Forwarding / Port Triggering

Apply Cancel

Please select the service type.

Port Forwarding

Port Triggering

Disable Port Triggering

Port Triggering Time-out (in minutes) 20

Port Triggering Portmap Table

#	Enable	Service Name	Service Type	Inbound Connection	Service User

+ Add Service Edit Service X Delete Service

6. Clear the **Disable Port Triggering** check box.

If this check box is selected, the cradle does not use port triggering even if you use specified port triggering settings.

7. In the **Port Triggering Timeout** field, enter a value up to 9999 minutes.

This value controls how long the inbound ports stay open when the cradle detects no activity. This value is required because the cradle cannot detect when the application terminates.

## Application Example: Port Triggering for Internet Relay Chat

Some application servers, such as FTP and IRC servers, send replies to multiple port numbers. Using port triggering, you can tell the cradle to open more incoming ports when a particular outgoing port starts a session.

An example is Internet Relay Chat (IRC). Your computer connects to an IRC server at destination port 6667. The IRC server not only responds to your originating source port but also sends an “identify” message to your computer on port 113. Using port triggering, you can tell the cradle, “When you initiate a session with destination port 6667, you must also allow incoming traffic on port 113 to reach the originating computer.” The following sequence shows the effects of this port triggering rule:

1. You open an IRC client program to start a chat session on your computer.
2. Your IRC client composes a request message to an IRC server using a destination port number of 6667, the standard port number for an IRC server process. Your computer then sends this request message to your cradle.
3. Your cradle creates an entry in its internal session table describing this communication session between your computer and the IRC server. Your cradle stores the original information, performs Network Address Translation (NAT) on the source address and port, and sends this request message through the Internet to the IRC server.
4. Noting your port triggering rule and observing the destination port number of 6667, your cradle creates another session entry to send any incoming port 113 traffic to your computer.
5. The IRC server sends a return message to your cradle using the NAT-assigned source port (for example, port 33333) as the destination port and sends an “identify” message to your cradle with destination port 113.
6. When your cradle receives the incoming message to destination port 33333, it checks its session table to see if a session is active for port number 33333. Finding an active session, the cradle restores the original address information replaced by NAT and sends this reply message to your computer.
7. When your cradle receives the incoming message to destination port 113, it checks its session table and finds an active session for port 113 associated with your computer. The cradle replaces the message’s destination IP address with your computer’s IP address and forwards the message to your computer.
8. When you finish your chat session, your cradle eventually senses a period of inactivity in the communications. The cradle then removes the session information from its session table and incoming traffic is no longer accepted on port numbers 33333 or 113.

# 5. Optimize Performance

---

# 5

This chapter contains the following sections:

- *Optimize Internet Gaming with Upstream QoS*
- *Add QoS Rules*
- *Improve Network Connections with Universal Plug and Play*
- *Wi-Fi Multimedia Quality of Service*

## Optimize Internet Gaming with Upstream QoS

Upstream Quality of Service (QoS) assigns high priority to Internet traffic from your console gaming system.

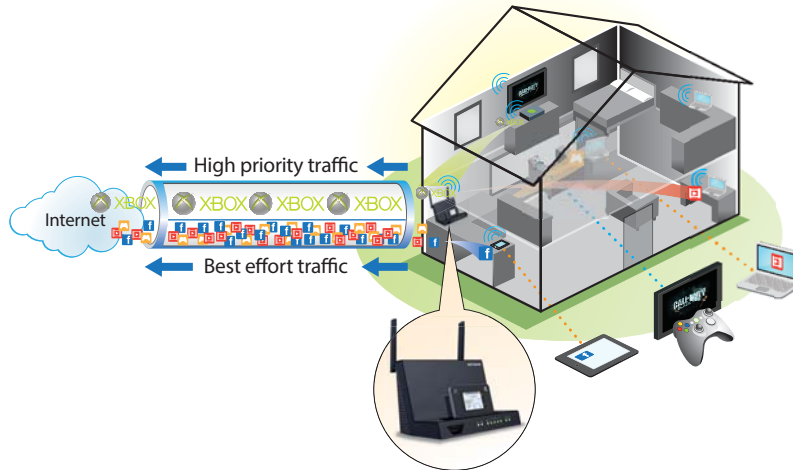

**Figure 6. Upstream QoS assigns high priority to gaming traffic from your gaming console**

Best practice is for only gamers to enable the Upstream QoS feature. If you do not game and you turn on this feature, some applications might not perform as well as usual.

### ➤ To enable upstream QoS:

1. Launch a web browser from a computer or wireless device that is connected to the Smart Cradle.
2. In the address field of the browser, enter **http://netgear.cradle** or **http://192.168.100.1**.

A login prompt displays.

3. Enter the cradle user name and password.

The user name is **admin**. The default password is **password**. The user name and password are case-sensitive.

The BASIC Home screen displays.

4. Select **ADVANCED > Setup > QoS Setup**.

5. Select the **Enable Upstream QoS (Optimized for Gaming)** check box.
6. Specify the maximum uplink bandwidth for your Internet connection:
  - If you know what your uplink bandwidth is, type it in the **Uplink bandwidth Maximum** field.
  - If you are not sure, click the **Speedtest** button.

Speedtest verifies the upstream speed of your Internet connection. The **Uplink bandwidth Maximum** field displays the result of the test.
7. Click the **Apply** button.

The cradle assigns a high priority to Internet traffic from your gaming devices to the Internet.

## Add QoS Rules

You can give prioritized Internet access to the following types of traffic:

- Specific applications
- Specific online games
- Individual Ethernet LAN ports of the cradle
- A specific device by MAC address

To specify prioritization of traffic, create a policy for the type of traffic and add the policy to the QoS Policy table in the QoS Setup screen. For convenience, the QoS Policy table lists many common applications and online games that can benefit from QoS handling.

## Set Up QoS for Applications and Online Gaming

- **To create a QoS policy for applications and online games:**
1. Launch a web browser from a computer or wireless device that is connected to the Smart Cradle.
  2. In the address field of the browser, enter **http://netgear.cradle** or **http://192.168.100.1**.

A login prompt displays.
  3. Enter the cradle user name and password.

The user name is **admin**. The default password is **password**. The user name and password are case-sensitive.

The BASIC Home screen displays.
  4. Select **ADVANCED > Setup > QoS Setup**.

The QoS Setup screen displays.



5. Click the **Setup QoS rule** button.

QoS Priority Rule list

Apply Cancel

	#	QoS Policy	Priority	Description
<input type="radio"/>	1	MSN Messenger	High	MSN Messenger Applications
<input type="radio"/>	2	Skype	Highest	Skype Applications
<input type="radio"/>	3	Yahoo Messenger	High	Yahoo Messenger Applications
<input type="radio"/>	4	IP Phone	Highest	IP Phone Applications
<input type="radio"/>	5	Vonage IP Phone	Highest	Vonage IP Phone Applications
<input type="radio"/>	6	NetMeeting	High	NetMeeting Applications
<input type="radio"/>	7	AIM	High	AIM Applications
<input type="radio"/>	8	Google Talk	Highest	Google Talk Applications
<input type="radio"/>	9	Netgear EVA	Highest	Netgear EVA Applications
<input type="radio"/>	10	SSH	High	SSH Applications
<input type="radio"/>	11	Telnet	High	Telnet Applications
<input type="radio"/>	12	VPN	High	VPN Applications
<input type="radio"/>	13	FTP	Normal	FTP Applications
<input type="radio"/>	14	SMTP	Normal	SMTP Applications
<input type="radio"/>	15	WWW	Normal	WWW Applications
<input type="radio"/>	16	DNS	Normal	DNS Applications
<input type="radio"/>	17	ICMP	Normal	ICMP Applications
<input type="radio"/>	18	eMule / eDonkey	Low	eMule / eDonkey Applications

Help Center Show/Hide Help Center

6. To add a priority rule, scroll down to the bottom of the QoS Setup screen and click the **Add Priority Rule** button.

QoS - Priority Rules

Apply Cancel

**Priority**

QoS Policy for

Priority Category

Applications

Priority

---

**Specified Port Range**

Connection Type

Starting Port  (1~65535)

Ending Port  (1~65535)

7. In the **QoS Policy** for field, type the name of the application or game.
8. From the **Priority Category** list, select either **Applications** or **Online Gaming**.  
A list of applications or games displays.
9. Scroll and select **Add a New Application**, or **Add a New Game**, as applicable.
10. If prompted, in the **Connection Type** list, select either **TCP**, **UDP**, or **TCP/UDP** (both).  
Specify the port number or range of port numbers that the application or game uses.
11. From the **Priority** list, select the priority for Internet access for this traffic relative to other applications and traffic.  
The options are **Low**, **Normal**, **High**, and **Highest**.
12. Click the **Apply** button.  
The rule is saved.

## Set Up QoS for a LAN Port on the AirCard Smart Cradle

- **To create a QoS policy for a device connected to one of the cradle's LAN ports:**
  1. Launch a web browser from a computer or wireless device that is connected to the Smart Cradle.
  2. In the address field of the browser, enter **http://netgear.cradle** or **http://192.168.100.1**.  
A login prompt displays.
  3. Enter the cradle user name and password.  
The user name is **admin**. The default password is **password**. The user name and password are case-sensitive.  
The BASIC Home screen displays.
  4. Select **ADVANCED > Setup > QoS Setup**.  
The QoS Setup screen displays.
  5. Select the **Turn Internet Access QoS On** check box.
  6. Click the **Setup QoS Rule** button.  
The QoS Priority Rule list displays.
  7. Scroll down and click the **Add Priority Rule** button.  
The QoS - Priority Rules screen displays.
  8. From the **Priority Category** list, select **Ethernet LAN Port**.

The screenshot shows the 'QoS - Priority Rules' configuration page. At the top, there are two buttons: 'Apply' (green) and 'Cancel' (purple). Below the buttons, there is a form with the following fields:

<b>Priority</b>	
QoS Policy for	LAN Port 1
Priority Category	Ethernet LAN Port
LAN Port	1
Priority	Normal

9. From the **QoS Policy for** list, select the LAN port.
10. From the **Priority** list, select the priority for Internet access for this port's traffic relative to other applications.  
The options are **Low**, **Normal**, **High**, and **Highest**.
11. Click the **Apply** button.  
The rule is saved in the QoS Policy list.

## Set Up QoS for a MAC Address

➤ **To create a QoS policy for traffic from a specific MAC address:**

1. Launch a web browser from a computer or wireless device that is connected to the Smart Cradle.
2. In the address field of the browser, enter **http://netgear.cradle** or **http://192.168.100.1**.

A login prompt displays.

3. Enter the cradle user name and password.

The user name is **admin**. The default password is **password**. The user name and password are case-sensitive.

The BASIC Home screen displays.

4. Select **ADVANCED > Setup > QoS Setup**.

The QoS Setup screen displays.

5. Click the **Setup QoS Rule** button.

The QoS Priority Rule list displays.

6. Scroll down and click the **Add Priority Rule** button.

The QoS Priority Rules screen displays.

7. From the **Priority Category** list, select **MAC Address**.

QoS - Priority Rules

Apply Cancel

**Priority**

QoS Policy for

Priority Category MACAddress

**MAC Device List**

	QoS Policy	Priority	Device Name	MAC Address
<input type="radio"/>	Pri_MAC_GD8F19	Normal	techpubs	00:1A:6B:6D:8F:19

MAC Address

Device Name

Priority Normal

8. If the device is in the MAC Device List, select its radio button.

The information from the MAC Device List populates the policy name, **MAC Address**, and **Device Name** fields. If the device is not in the MAC Device List, click the **Refresh** button. If it still does not display, complete these fields.

9. From the **Priority** list, select **Highest**.

This is the priority for Internet access for this device's traffic relative to other applications and traffic. The options are **Low**, **Normal**, **High**, and **Highest**.

10. Click the **Apply** button.

This rule is saved.

## Edit an Upstream QoS Policy

➤ **To edit a QoS policy:**

1. Launch a web browser from a computer or wireless device that is connected to the Smart Cradle.
2. In the address field of the browser, enter **http://netgear.cradle** or **http://192.168.100.1**.  
A login prompt displays.
3. Enter the cradle user name and password.  
The user name is **admin**. The default password is **password**. The user name and password are case-sensitive.  
The BASIC Home screen displays.
4. Select **ADVANCED > Setup > QoS Setup**.  
The QoS Setup screen displays.
5. Click the **Setup QoS Rule** button.  
The QoS Priority Rules screen displays.
6. Select the radio button for the QoS policy.
7. Scroll down and click the **Edit** button
8. Change the policy settings.
9. Click the **Apply** button.  
Your changes are saved.

## Delete an Upstream QoS Policy

➤ **To delete a QoS policy:**

1. Launch a web browser from a computer or wireless device that is connected to the Smart Cradle.
2. In the address field of the browser, enter **http://netgear.cradle** or **http://192.168.100.1**.  
A login prompt displays.
3. Enter the cradle user name and password.  
The user name is **admin**. The default password is **password**. The user name and password are case-sensitive.  
The BASIC Home screen displays.
4. Select **ADVANCED > Setup > QoS Setup**.  
The QoS Setup screen displays.
5. Click the **Setup QoS Rule** button.

The QoS Priority Rules screen displays.

6. Select the radio button for the QoS policy.
7. Click the **Delete** button.

The QoS Policy is removed from the list.

## Improve Network Connections with Universal Plug and Play

Universal Plug and Play (UPnP) helps devices, such as Internet appliances and computers, access the network and connect to other devices as needed. UPnP devices can automatically discover the services from other registered UPnP devices on the network.

If you use applications such as multiplayer gaming, peer-to-peer connections, or real-time communications such as instant messaging or remote assistance (a feature in Windows XP), enable UPnP.

### ➤ To enable Universal Plug and Play:

1. Launch a web browser from a computer or wireless device that is connected to the Smart Cradle.
2. In the address field of the browser, enter **http://netgear.cradle** or **http://192.168.100.1**.

A login prompt displays.

3. Enter the cradle user name and password.

The user name is **admin**. The default password is **password**. The user name and password are case-sensitive.

The BASIC Home screen displays.

4. Select **ADVANCED > Advanced Setup > UPnP**.

The UPnP screen displays.

5. Select the **Turn UPnP On** check box.

By default, this check box is selected. UPnP for automatic device configuration can be enabled or disabled. If the **Turn UPnP On** check box is cleared, the Smart Cradle does not allow any device to automatically control router resources, such as port forwarding.

6. Type the advertisement period in minutes.

The advertisement period specifies how often the Smart Cradle broadcasts its UPnP information. This value can range from 1 to 1440 minutes. The default period is 30 minutes. Shorter durations ensure that control points receive current device status at the expense of more network traffic. Longer durations can compromise the freshness of the device status, but can significantly reduce network traffic.

7. Type the advertisement time to live in hops.

The time to live for the advertisement is measured in hops (steps) for each UPnP packet sent. Hops are the steps a packet takes between routers. The number of hops can range from 1 to 255. The default value for the advertisement time to live is 4 hops, which should be fine for most home networks. If you notice that some devices are not being updated or reached correctly, it might be necessary to increase this value.

8. Click the **Apply** button.

The UPnP Portmap Table displays the IP address of each UPnP device that is accessing the Smart Cradle and which ports (internal and external) that device has opened. The UPnP Portmap Table also displays what type of port is open and whether that port is still active for each IP address.

9. To refresh the information in the UPnP Portmap Table, click the **Refresh** button.

## Wi-Fi Multimedia Quality of Service

Wi-Fi Multimedia Quality of Service (WMM QoS) prioritizes wireless voice and video traffic over the WiFi link. WMM QoS is automatically enabled for the cradle.

WMM QoS prioritizes wireless data packets from different applications based on four access categories: voice, video, best effort, and background. For an application to receive the benefits of WMM QoS, WMM must be enabled in the AirCard Smart Cradle and the client running that application. Legacy applications that do not support WMM and applications that do not require QoS are assigned to the best effort category, which receives a lower priority than voice and video.

### ➤ To disable WMM QoS:

1. Launch a web browser from a computer or wireless device that is connected to the Smart Cradle.
2. In the address field of the browser, enter **http://netgear.cradle** or **http://192.168.100.1**.

A login prompt displays.

3. Enter the cradle user name and password.

The user name is **admin**. The default password is **password**. The user name and password are case-sensitive.

The BASIC Home screen displays.

4. Select **ADVANCED > Setup > QoS Setup**.

The QoS Setup screen displays.

5. Clear the **Enable WMM (Wi-Fi multimedia) settings (2.4 GHz b/g/n)** check box.
6. Clear the **Enable WMM (Wi-Fi multimedia) settings (5 GHz b/g/n)** check box.
7. Click the **Apply** button.

Your changes are saved.

## 6 Network Settings

---

This chapter covers the following topics:

- *View WAN Settings*
- *Set Up the AirCard Smart Cradle as a Default DMZ Server*
- *Configure DMZ on an AirCard Mobile Hotspot*
- *Change the Cradle's Device Name*
- *Change the LAN TCP/IP Settings*
- *Specify the IP Addresses That the Cradle Assigns*
- *Disable the DHCP Server Feature in the Cradle*
- *Reserve LAN IP Addresses*
- *Use the WPS Wizard for WiFi Connections*
- *Specify Basic WiFi Settings*
- *Change the WiFi Password or Security Level*
- *Set Up a Guest Network*
- *Control the Wireless Radios*
- *Set Up a Wireless Schedule*
- *Specify WPS Settings*
- *Use the Smart Cradle as a Wireless Access Point*
- *Set Up the AirCard Smart Cradle in Bridge Mode*
- *Set Up a Facebook WiFi Guest Network*

## View WAN Settings

You can view or configure wide area network (WAN) settings for the Internet port. You can set up a DMZ (demilitarized zone) server, change the maximum transmit unit (MTU) size, and enable the cradle to respond to a ping to its WAN (Internet) port.

### ➤ To view the WAN settings:

1. Launch a web browser from a computer or wireless device that is connected to the Smart Cradle.

In the address field of the browser, enter **http://netgear.cradle** or **http://192.168.100.1**.

A login prompt displays.

2. Enter the cradle user name and password.

The user name is **admin**. The default password is **password**. The user name and password are case-sensitive.

The BASIC Home screen displays.

3. Select **ADVANCED > Setup > WAN Setup**.

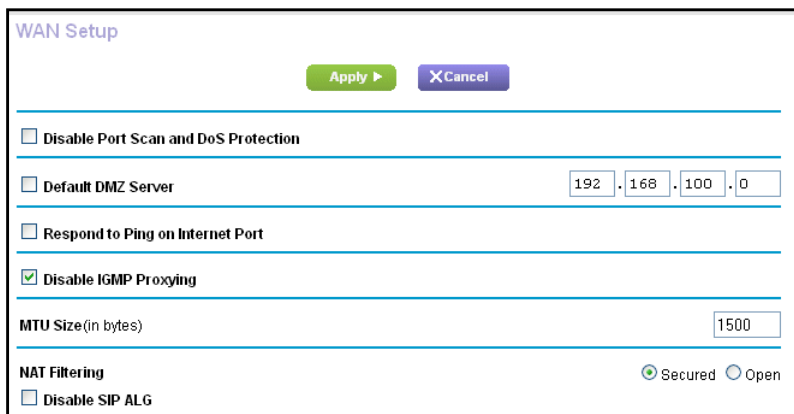

WAN Setup

Apply Cancel

Disable Port Scan and DoS Protection

Default DMZ Server 192 . 168 . 100 . 0

Respond to Ping on Internet Port

Disable IGMP Proxying

MTU Size (in bytes) 1500

NAT Filtering  Secured  Open

Disable SIP ALG

The following settings display:

- **Disable Port Scan and DoS Protection.** DoS protection protects your LAN against denial of service attacks such as Syn flood, Smurf Attack, Ping of Death, and many others. Select this check box only in special circumstances.
- **Default DMZ Server.** This feature is sometimes helpful when you are playing online games or videoconferencing, but it makes the firewall security less effective. See [Set Up the AirCard Smart Cradle as a Default DMZ Server](#) on page 73.
- **Respond to Ping on Internet Port.** This feature allows your cradle to be discovered. Use this feature only as a diagnostic tool or for a specific reason.
- **Disable IGMP Proxying.** IGMP proxying allows a computer on the local area network (LAN) to receive the multicast traffic it is interested in from the Internet. If you do not need this feature, you can select this check box to disable it.



- **MTU Size (in bytes).** The normal MTU (maximum transmit unit) value for most Ethernet networks is 1500 bytes, or 1492 bytes for PPPoE connections. Change the MTU only if you are sure that it is necessary for your ISP connection. See [Change the MTU Size](#) on page 39.
  - **NAT Filtering.** Network Address Translation (NAT) determines how the cradle processes inbound traffic. Secured NAT protects computers on the LAN from attacks from the Internet but might prevent some Internet games, point-to-point applications, or multimedia applications from working. Open NAT provides a much less secured firewall but allows almost all Internet applications to work.
4. Click the **Apply** button.
- Your changes are saved.

## Set Up the AirCard Smart Cradle as a Default DMZ Server

The default DMZ server feature is helpful when you are using some online games and videoconferencing applications that are incompatible with Network Address Translation (NAT). The cradle is programmed to recognize some of these applications and to work correctly with them, but other applications might not function well. In some cases, one local computer can run the application correctly if the IP address for that computer is entered as the default DMZ server.



### WARNING:

**DMZ servers pose a security risk. A computer designated as the default DMZ server loses much of the protection of the firewall and is exposed to exploits from the Internet. If compromised, the DMZ server computer can be used to attack other computers on your network.**

The cradle usually detects and discards incoming traffic from the Internet that is not a response to one of your local computers or a service that you configured in the Port Forwarding/Port Triggering screen. Instead of discarding this traffic, you can specify that the cradle forwards the traffic to one computer on your network. This computer is called the default DMZ server.

### ➤ To set up a default DMZ server:

1. Launch a web browser from a computer or wireless device that is connected to the Smart Cradle.
2. In the address field of the browser, enter **http://netgear.cradle** or **http://192.168.100.1**.  
A login prompt displays.
3. Enter the cradle user name and password.  
The user name is **admin**. The default password is **password**. The user name and password are case-sensitive.

The BASIC Home screen displays.

4. Select **ADVANCED > Setup > WAN Setup**.

The WAN Setup screen displays.

5. Select the **Default DMZ Server** check box.
6. Type the IP address.
7. Click the **Apply** button.

Your change takes effect.

## Configure DMZ on an AirCard Mobile Hotspot

The mobile hotspot must be docked in the Smart Cradle.

### ➤ To use your browser to configure DMZ on a mobile hotspot:

1. Launch a web browser from a computer or wireless device that is connected to the Smart Cradle.
2. In the address field of the browser, enter **192.168.1.1**.

A login prompt displays.

3. Enter the user name and password.

The user name is **admin**. The default password is **password**. The user name and password are case-sensitive.

The Home screen displays.

4. Select **Settings > Network > Router**.
5. Scroll down to DMZ.
6. Select the DMZ Enabled **On** radio button.
7. In **DMZ address** field type **192.168.1.4**.

This is the default IP address assigned by the mobile hotspot to cradle.

8. Click the **Submit** button.

The cradle reboots. The cradle is on the mobile hotspot DMZ.

## Change the Cradle's Device Name

The cradle's device name is DC112A. This device name displays in the file manager when you browse your network.

### ➤ To change the cradle's device name:

1. Launch a web browser from a computer or wireless device that is connected to the Smart Cradle.
2. In the address field of the browser, enter **http://netgear.cradle** or **http://192.168.100.1**.  
A login prompt displays.
3. Enter the cradle user name and password.  
The user name is **admin**. The default password is **password**. The user name and password are case-sensitive.  
The BASIC Home screen displays.
4. Select **ADVANCED > Setup > LAN Setup**.  
The LAN Setup screen displays.
5. In the **Device Name** field, type a new name.
6. Click the **Apply** button.  
Your change is saved.

## Change the LAN TCP/IP Settings

The cradle is preconfigured to use private IP addresses on the LAN side and to act as a DHCP server. The cradle's default LAN IP configuration is as follows:

- **LAN IP address.** 192.168.1.1
- **Subnet mask.** 255.255.255.0

These addresses are part of the designated private address range for use in private networks and are suitable for most applications. If your network requires a different IP addressing scheme, you can change these settings.

You might want to change these settings if you need a specific IP subnet that one or more devices on the network use, or if competing subnets on your network use the same IP scheme.

### ➤ To change the LAN TCP/IP settings:

1. Launch a web browser from a computer or wireless device that is connected to the Smart Cradle.
2. In the address field of the browser, enter **http://netgear.cradle** or **http://192.168.100.1**.  
A login prompt displays.

3. Enter the cradle user name and password.

The user name is **admin**. The default password is **password**. The user name and password are case-sensitive.

The BASIC Home screen displays.

4. Select **ADVANCED > Setup > LAN Setup**.

LAN Setup

Apply Cancel

Device Name DC112A

LAN TCP/IP Setup

IP Address 192 . 168 . 100 . 1

IP Subnet Mask 255 . 255 . 255 . 0

RIP Direction Both

RIP Version Disabled

Use Router as DHCP Server

Starting IP Address 192 . 168 . 100 . 2

Ending IP Address 192 . 168 . 100 . 254

Address Reservation

#	IP Address	Device Name	MAC Address

+Add Edit Delete

5. In the **IP Address** field, type the IP address.

6. In the **IP Subnet Mask**, type the subnet mask of the cradle.

The IP address and subnet mask identify which addresses are local to a specific device and which must be reached through a gateway or cradle.

7. Change the RIP settings.

Router Information Protocol (RIP) allows the cradle to exchange routing information with other routers.

- a. In the **RIP Direction** list, select one of the following:

- **Both**. The cradle broadcasts its routing table periodically and incorporates information that it receives.
- **Out Only**. The cradle broadcasts its routing table periodically.
- **In Only**. The cradle incorporates the RIP information that it receives.

- b. In the **RIP Version** list, select one of the following:

- **Disabled**. This is the default setting.
- **RIP-1**. This format is universally supported. It is adequate for most networks, unless your network setup is unusual.
- **RIP-2**. This format carries more information. Both RIP-2B and RIP-2M send the routing data in RIP-2 format. RIP-2B uses subnet broadcasting. RIP-2M uses multicasting.

8. Click the **Apply** button.

Your changes are saved.

If you changed the LAN IP address of the cradle, you are disconnected when this change takes effect.

- To reconnect, close your browser, relaunch it, and log in to the cradle.

## Specify the IP Addresses That the Cradle Assigns

By default, the cradle acts as a Dynamic Host Configuration Protocol (DHCP) server. The cradle assigns IP, DNS server, and default gateway addresses to all computers connected to the LAN. The assigned default gateway address is the LAN address of the cradle.

These addresses must be part of the same IP address subnet as the cradle's LAN IP address. Using the default addressing scheme, define a range between 192.168.100.2 and 192.168.100.254, although you can save part of the range for devices with fixed addresses.

### ➤ To specify the pool of IP addresses that the cradle assigns:

- Launch a web browser from a computer or wireless device that is connected to the Smart Cradle.
- In the address field of the browser, enter **http://netgear.cradle** or **http://192.168.100.1**.

A login prompt displays.

- Enter the cradle user name and password.

The user name is **admin**. The default password is **password**. The user name and password are case-sensitive.

The BASIC Home screen displays.

- Select **ADVANCED > Setup > LAN Setup**.

LAN Setup

Apply Cancel

Device Name DC112A

LAN TCP/IP Setup

IP Address 192 . 168 . 100 . 1

IP Subnet Mask 255 . 255 . 255 . 0

RIP Direction Both

RIP Version Disabled

Use Router as DHCP Server

Starting IP Address 192 . 168 . 100 . 2

Ending IP Address 192 . 168 . 100 . 254

Address Reservation

#	IP Address	Device Name	MAC Address

+Add Edit Delete

- Make sure that the **Use Router as DHCP Server** check box is selected.

6. Specify the range of IP addresses that the cradle assigns:
  - a. In the **Starting IP Address** field, type the lowest number in the range.  
This IP address must be in the same subnet as the cradle.
  - b. In the **Ending IP Address** field, type the number at the end of the range of IP addresses.  
This IP address must be in the same subnet as the cradle.
7. Click the **Apply** button.  
Your settings are saved.

The cradle delivers the following parameters to any LAN device that requests DHCP:

- An IP address from the range that you define
- Subnet mask
- Gateway IP address (the cradle's LAN IP address)
- DNS server IP address (the cradle's LAN IP address)

## Disable the DHCP Server Feature in the Cradle

By default, the cradle acts as a DHCP server. The cradle assigns IP, DNS server, and default gateway addresses to all computers connected to the LAN. The assigned default gateway address is the LAN address of the cradle.

You can use another device on your network as the DHCP server or specify the network settings of all your computers.

### ➤ To disable the DHCP server feature in the cradle:

1. Launch a web browser from a computer or wireless device that is connected to the Smart Cradle.
2. In the address field of the browser, enter **http://netgear.cradle** or **http://192.168.100.1**.  
A login prompt displays.
3. Enter the cradle user name and password.  
The user name is **admin**. The default password is **password**. The user name and password are case-sensitive.  
The BASIC Home screen displays.
4. Select **ADVANCED > Setup > LAN Setup**.  
The Lan Setup screen displays.
5. Clear the **Use Router as DHCP Server** check box.
6. Click the **Apply** button.
7. (Optional) If this service is disabled and no other DHCP server is on your network, set your computer IP addresses manually so that they can access the cradle.

## Reserve LAN IP Addresses

When you specify a reserved IP address for a computer on the LAN, that computer always receives the same IP address each time it accesses the cradle's DHCP server. Assign reserved IP addresses to computers or servers that require permanent IP settings.

### Reserve an IP Address

➤ **To reserve an IP address:**

1. Launch a web browser from a computer or wireless device that is connected to the Smart Cradle.
2. In the address field of the browser, enter **http://netgear.cradle** or **http://192.168.100.1**.  
A login prompt displays.

3. Enter the cradle user name and password.

The user name is **admin**. The default password is **password**. The user name and password are case-sensitive.

The BASIC Home screen displays.

4. Select **ADVANCED > Setup > LAN Setup**.

The LAN Setup screen displays.

5. In the Address Reservation section, click the **Add** button.

The Address Reservation screen displays.

6. In the **IP Address** field, type the IP address to assign to the computer or server.

Choose an IP address from the cradle's LAN subnet, such as 192.168.100.x.

7. Type the MAC address of the computer or server.

**Tip:** If the computer is already on your network, you can copy its MAC address from the Attached Devices screen and paste it here.

8. Click the **Apply** button.

The reserved address is entered into the table.

The reserved address is not assigned until the next time the computer contacts the cradle's DHCP server. Reboot the computer, or access its IP configuration and force a DHCP release and renew.

## Edit a Reserved IP Address Entry

➤ **To edit a reserved IP address entry:**

1. Launch a web browser from a computer or wireless device that is connected to the Smart Cradle.
2. In the address field of the browser, enter **http://netgear.cradle** or **http://192.168.100.1**.  
A login prompt displays.
3. Enter the cradle user name and password.  
The user name is **admin**. The default password is **password**. The user name and password are case-sensitive.  
The BASIC Home screen displays.
4. Select **ADVANCED > Setup > LAN Setup**.  
The LAN Setup screen displays.
5. Select the radio button next to the reserved address.
6. Click the **Edit** button.  
The Address Reservation screen displays.
7. Change the settings.
8. Click the **Apply** button.  
Your changes are saved.

## Delete a Reserved IP Address Entry

➤ **To delete a reserved IP address entry:**

1. Launch a web browser from a computer or wireless device that is connected to the Smart Cradle.
2. In the address field of the browser, enter **http://netgear.cradle** or **http://192.168.100.1**.  
A login prompt displays.
3. Enter the cradle user name and password.  
The user name is **admin**. The default password is **password**. The user name and password are case-sensitive.  
The BASIC Home screen displays.
4. Select **ADVANCED > Setup > LAN Setup**.  
The LAN Setup screen displays.
5. Select the radio button next to the reserved address.
6. Click the **Delete** button.



The address is removed.

## Use the WPS Wizard for WiFi Connections

The WPS Wizard helps you add a wireless computer or device to your WiFi network without typing the WiFi password.

### ➤ To use the WPS Wizard:

1. Launch an Internet browser from a computer or wireless device that is connected to the Smart Cradle.
2. In the address field of the browser, enter **http://netgear.cradle** or **http://192.168.100.1**  
A login screen displays.
3. Enter the user name and password.

The user name is **admin**. The default password is **password**. The user name and password are case-sensitive.

The BASIC Home screen displays.

4. Select **ADVANCED > WPS Wizard**.

A note explaining WPS displays.

5. Click the **Next** button.
6. Select a setup method:
  - **Push button**. Click the **WPS** button on this screen.
  - **PIN Number**. The screen adjusts. Enter the client security PIN and click the **Next** button.
7. Within two minutes, go to the client device and use its WPS software to connect to the WiFi network.

The WPS process automatically sets up your wireless computer with the network password when it connects. The cradle WPS screen displays a confirmation message.

## Specify Basic WiFi Settings

The cradle WiFi network name (SSID), network key (password), and security option (encryption protocol) are preset in the factory. You can find the preset SSID and password on the cradle label. The preset SSID and password are uniquely generated for every device to protect and maximize your wireless security.

You don't need to change your preset security settings. If you change your preset security settings, make a note of the new settings and store it in a safe place where you can easily find it.

If you use a WiFi connection when you change the SSID or other wireless security settings, you are disconnected when you click the **Apply** button. To avoid this problem, use a computer with a wired connection to access the cradle.

➤ **To specify basic wireless settings:**

1. Launch a web browser from a computer or wireless device that is connected to the Smart Cradle.
2. In the address field of the browser, enter **http://netgear.cradle** or **http://192.168.100.1**  
A login prompt displays.

3. Enter the cradle user name and password.

The user name is **admin**. The default password is **password**. The user name and password are case-sensitive.

The BASIC Home screen displays.

4. Select **Wireless**.

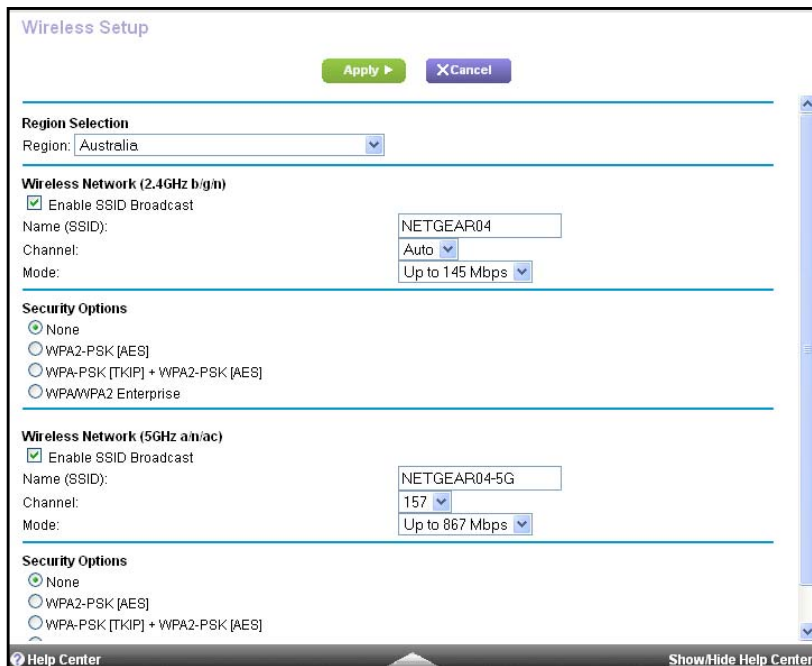

You can specify the settings for the 2.4 GHz band and for the 5 GHz bands.

5. In the **Region** list, select your region.

In some locations, you cannot change this setting.

6. To control the SSID broadcast, select or clear the **Enable SSID Broadcast** check box.

When this check box is selected, the cradle broadcasts its network name (SSID) so that it displays when you scan for local WiFi networks on your computer or wireless device.

7. To change the network name (SSID), type a new name in the **Name (SSID)** field.

The name can be up to 32 characters long and it is case-sensitive. The default SSID is randomly generated and is on the cradle's label. If you change the name, make sure to write down the new name and keep it in a safe place.

8. To change the wireless channel, select a number in the **Channel** list.

In some regions, not all channels are available. Do not change the channel unless you experience interference (shown by lost connections or slow data transfers). If this happens, experiment with different channels to see which is the best.

When you use multiple access points, it is better if adjacent access points use different channels to reduce interference. The recommended channel spacing between adjacent access points is four channels (for example, use Channels 1 and 5, or 6 and 10).

9. Click the **Apply** button.

Your settings are saved.

If you connected wirelessly to the network and you changed the SSID, you are disconnected from the network.

10. Make sure that you can connect wirelessly to the network with its new settings.

If you cannot connect wirelessly, check the following:

- Is your computer or wireless device connected to another wireless network in your area? Some wireless devices automatically connect to the first open network without wireless security that they discover.
- Is your computer or wireless device trying to connect to your network with its old settings (before you changed the settings)? If so, update the wireless network selection in your computer or wireless device to match the current settings for your network.

## Change the WiFi Data Speed Rate Settings

The data rate for high-speed transmissions is commonly specified in megabits per second (Mbps). By default, the cradle is set to operate with up to 600 Mbps in the 2.4 GHz WiFi band and up to 1,300 Mbps in the two 5 GHz WiFi bands. You can select slower settings.

### ➤ To change the WiFi Mbps settings:

1. Launch a web browser from a computer or wireless device that is connected to the Smart Cradle.
2. In the address field of the browser, enter **http://netgear.cradle** or **http://192.168.100.1**.

A login prompt displays.

3. Enter the cradle user name and password.

The user name is **admin**. The default password is **password**. The user name and password are case-sensitive.

The BASIC Home screen displays.

#### 4. Select **Wireless**.

Wireless Setup

Apply Cancel

**Region Selection**  
Region: Australia

**Wireless Network (2.4GHz b/g/n)**  
 Enable SSID Broadcast  
 Name (SSID): NETGEAR04  
 Channel: Auto  
 Mode: Up to 145 Mbps

**Security Options**  
 None  
 WPA2-PSK [AES]  
 WPA-PSK [TKIP] + WPA2-PSK [AES]  
 WPA/WPA2 Enterprise

**Wireless Network (5GHz a/n/ac)**  
 Enable SSID Broadcast  
 Name (SSID): NETGEAR04-5G  
 Channel: 157  
 Mode: Up to 867 Mbps

**Security Options**  
 None  
 WPA2-PSK [AES]  
 WPA-PSK [TKIP] + WPA2-PSK [AES]

Help Center Show/Hide Help Center

5. For the 2.4 GHz WiFi band, in the Wireless Network (2.4 GHz b/gn/n) section, select a setting from the **Mode** list.  
**Up to 300 Mbps** is the default setting.
6. For the 5 GHz WiFi band, in the Wireless Network 5 GHz a/n/ac section, select a setting from the **Mode** list.  
**Up to 867 Mbps** is the default setting, which allows 802.11ac and 802.11a wireless devices to join the network.
7. Click the **Apply** button.  
Your settings are saved.

## Change the WiFi Password or Security Level

Your cradle comes with preset WPA2 or WPA security. The password that you enter to connect to your network is unique to your cradle and is on the cradle label. Best practice is to use the preset security, but you can change the settings. do not disable security.

### ➤ To change the WPA settings:

1. Launch a web browser from a computer or wireless device that is connected to the Smart Cradle.
2. In the address field of the browser, enter **http://netgear.cradle** or **http://192.168.100.1**.  
A login prompt displays.

3. Enter the cradle user name and password.

The user name is **admin**. The default password is **password**. The user name and password are case-sensitive.

The BASIC Home screen displays.

4. Select **Wireless**.

The Wireless Setup screen displays.

5. Under Security Options, select a radio button for a security option.

The WPA2 option uses the newest standard for the strongest security, but some older computers and wireless devices cannot use WPA2. By default, the **WPA-PSK [TKIP] + WPA2-PSK [AES]** radio button is selected so that new or old computers and wireless devices can connect to the WiFi network by using either WPA2 or WPA security.

The **Passphrase** field displays.

6. In the **Passphrase** field, enter the network key (password).

It is a text string from 8 to 63 characters.

7. Write down the new password and keep it in a secure place for future reference.

8. Click the **Apply** button.

Your changes are saved.

## Set Up a Guest Network

Guest networks allows visitors at your home to use the Internet without using your wireless security key. You can add a guest network for the 2.4 GHz WiFi band and for each of the two 5.0 GHz WiFi bands.

### ➤ To set up a guest network:

1. Launch a web browser from a computer or wireless device that is connected to the Smart Cradle.
2. In the address field of the browser, enter **http://netgear.cradle** or **http://192.168.100.1**.

A login prompt displays.

3. Enter the cradle user name and password.

The user name is **admin**. The default password is **password**. The user name and password are case-sensitive.

The BASIC Home screen displays.

#### 4. Select **Guest Network**.

#### 5. Scroll to the section for the guest WiFi network that you want to set up.

The default guest wireless network names (SSIDs) are as follows:

- **NETGEAR-Guest** is for the 2.4 GHz WiFi band.
- **NETGEAR-5G-Guest** is for the 5 GHz WiFi band.

#### 6. Select any of the following wireless settings:

- **Enable Guest Network.** When this check box is selected, the guest network is enabled, and guests can connect to your network using the SSID of this profile.
- **Enable SSID Broadcast.** If this check box is selected, the wireless access point broadcasts its name (SSID) to all wireless stations. Stations with no SSID can adopt the correct SSID for connections to this access point.
- **Allow guest to see each other and access my local network.** If this check box is selected, anyone who connects to this SSID can access your local network, not just your Internet connection.

#### 7. Give the guest network a name.

The guest network name is case-sensitive and can be up to 32 characters. You then manually configure the wireless devices in your network to use the guest network name in addition to the main SSID.

#### 8. Select a radio button for a security option.

The WPA2 option uses the newest standard for the strongest security, but some older computers and wireless devices cannot use it. Best practice is to select the **WPA-PSK [TKIP] + WPA2-PSK [AES]** radio button. This setting protects your WiFi network and lets

computers and wireless devices can connect to the WiFi network by using either WPA2 or WPA security.

9. Click the **Apply** button.

Your Smart Cradle settings are saved.

## Control the Wireless Radios

The cradle's internal wireless radios broadcast signals in the 2.4 GHz and 5 GHz range. By default, the radios are on so that you can connect wirelessly to the cradle. When the wireless radios are off, you can still use an Ethernet cable for a LAN connection to the cradle.

You can log in to the cradle and enable or disable the wireless radios. You can also turn the WiFi radios off and on based on a schedule. (See *Set Up a Wireless Schedule* on page 88).

### ➤ To enable or disable the wireless radios:

1. Launch a web browser from a computer or wireless device that is connected to the Smart Cradle.
2. In the address field of the browser, enter **http://netgear.cradle** or **http://192.168.100.1**.

A login prompt displays.

3. Enter the cradle user name and password.

The user name is **admin**. The default password is **password**. The user name and password are case-sensitive.

The BASIC Home screen displays.

4. Select **ADVANCED > Advanced Setup > Wireless Settings**.

5. In the 2.4 GHz and 5 GHz sections, select or clear the **Enable Wireless Radio** check boxes.  
Clearing these check boxes turns off the WiFi feature of the cradle for each band.
6. Click the **Apply** button.

## Set Up a Wireless Schedule

You can turn off the wireless signal from your cradle at times when you do not need a wireless connection. For example, you might turn it off for the weekend if you leave town.

### ➤ To set up the wireless schedule:

1. Launch a web browser from a computer or wireless device that is connected to the Smart Cradle.
2. In the address field of the browser, enter **http://netgear.cradle** or **http://192.168.100.1**.  
A login prompt displays.
3. Enter the user name and password.  
The user name is **admin**. The default password is **password**. The user name and password are case-sensitive.  
The BASIC Home screen displays.
4. Select **ADVANCED > Advanced Setup > Wireless Settings**.



The Advanced Wireless Settings screen displays.

- Click the **Add a new period** button.

- Use the lists, radio buttons, and check boxes to set up a period during which you want to turn off the wireless signal.
- Click the **Apply** button.

The Advanced Wireless Settings screen displays.

- Select the **Turn off wireless signal by schedule** check box to activate the schedule.
- Click the **Apply** button.

Your settings are saved.

## Specify WPS Settings

Wi-Fi Protected Setup (WPS) lets you join the WiFi network without typing the WiFi password.

### ➤ To specify WPS Settings:

- Launch a web browser from a computer or wireless device that is connected to the Smart Cradle.
- In the address field of the browser, enter **http://netgear.cradle** or **http://192.168.100.1**.

A login prompt displays.

- Enter the cradle user name and password.

The user name is **admin**. The default password is **password**. The user name and password are case-sensitive.

The BASIC Home screen displays.

- Select **ADVANCED > Advanced Setup > Wireless Settings**.

The Wireless Setup screen displays.

The Router's PIN field displays the PIN that you use on a registrar (for example, from the Network Explorer on a Vista Windows computer) to configure the cradle's wireless settings through WPS.

5. (Optional) Select or clear the **Enable Router's PIN** check box.

The PIN function might temporarily be disabled when the cradle detects suspicious attempts to break into the cradle's wireless settings by using the cradle's PIN through WPS. You can manually enable the PIN function by selecting the **Enable Router's PIN** check box.

6. (Optional) Select or clear the **Keep Existing Wireless Settings** check box.

By default, the **Keep Existing Wireless Settings** check box is selected. Best practice is to leave this check box selected.

If you clear this check box, the next time a new wireless client uses WPS to connect to the cradle, the cradle wireless settings change to an automatically generated random SSID and security key.

7. Click the **Apply** button.

Your changes are saved.

## Use the Smart Cradle as a Wireless Access Point

You can set up the cradle to run as an access point (AP) on the same local network as another router.

---

**Note:** When you use the cradle as a wireless AP, the cradle charges the mobile hotspot, but does not use the mobile hotspot's wireless broadband Internet connection.

---

### ➤ To set up the router as an AP:

1. Use an Ethernet cable to connect the Internet port of the cradle to a LAN port in the router.



Cable this port to a LAN port on a router

2. Launch an Internet browser from a computer or wireless device that is connected to the Smart Cradle.
3. In the address field of the browser, enter **http://netgear.cradle** or **http://192.168.100.1**.  
A login prompt displays.
4. Enter the router user name and password.  
The user name is **admin**. The default password is **password**. The user name and password are case-sensitive.  
The BASIC Home screen displays.
5. Select **ADVANCED > Advanced Setup > Wireless AP**.

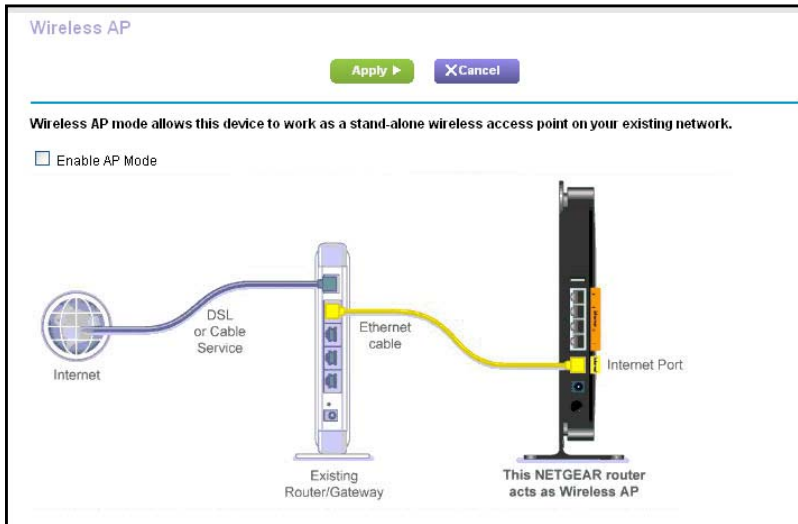

6. Select the **Enable AP Mode** check box.
7. Scroll down and select the radio button for the IP address setting that you want to use:
  - **Get dynamically from existing router.** The other router on the network assigns an IP address to this router while this router is in AP mode.
  - **Enable fixed IP settings on this device (not recommended).** Use this setting if you want to manually assign a specific IP address to this router while it is in AP mode. Using this option effectively requires advanced network experience.

**Note:** To avoid interference with other routers or gateways in your network, NETGEAR recommends that you use different wireless settings on each router. You can also turn off the wireless radio on the other router or gateway and use the DC112A only for wireless client access.

8. Click the **Apply** button.  
The IP address of the router changes, and you are disconnected.
9. In the address field of the browser, enter **http://netgear.cradle** or **http://192.168.100.1**.  
A login prompt displays.

## Set Up the AirCard Smart Cradle in Bridge Mode

You can use your cradle in bridge mode to connect multiple devices wirelessly at the faster 802.11ac speed. You need another router in your network with an Ethernet Internet connection.

---

**Note:** When you use the cradle in bridge mode, the cradle charges the mobile hotspot, but does not use the mobile hotspot's wireless broadband Internet connection.

---

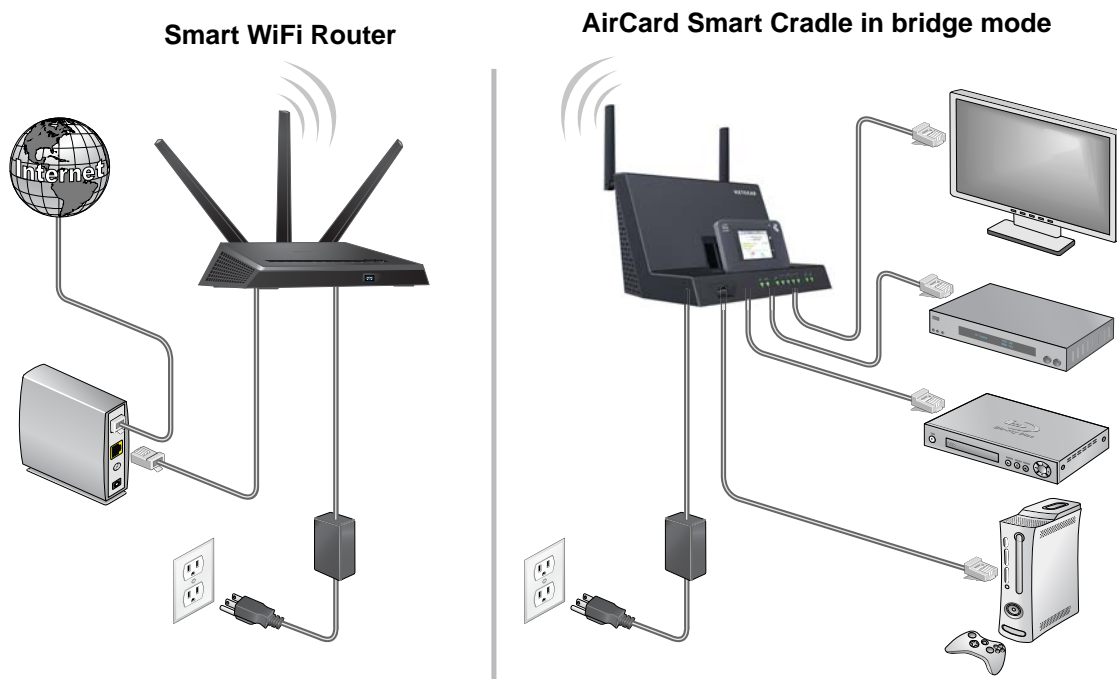

**Figure 7. Cradle in bridge mode with an 802.11ac WiFi connection**

Installing your cradle as a bridge offers the following benefits:

- Take advantage of gigabit WiFi speeds on current devices.
- Use Gigabit WiFi for applications like video and gaming.
- Connect multiple devices like NAS, Smart TV, NeoTV, Blu-ray player, and game consoles at gigabit WiFi speeds using a WiFi link.
- Avoid the need for separate WiFi adapters for each device.

For example, you can install your router in a room like a home office that has your Ethernet WAN Internet connection, then set up the cradle in bridge mode. Place the cradle in a different room that has your home entertainment center. Cable the cradle to your Smart TV, DVR, game console or Blu-ray player, and use its 802.11ac WiFi connection to the router.

➤ **To set up bridge mode:**

1. Make a note of the WiFi settings of the router to which the cradle will connect.  
You need to know the SSID, WiFi security mode, WiFi password, and operating frequency (either 2.4 GHz or 5 GHz).

2. Launch a web browser from a computer or WiFi device that is connected to the Smart Cradle.

3. In the address field of the browser, enter **http://netgear.cradle** or **http://192.168.100.1**.  
A login prompt displays.

4. Enter the user name and password.  
The user name is **admin**. The default password is **password**. The user name and password are case-sensitive.

The BASIC Home screen displays.

5. Select **ADVANCED > Advanced Setup > Wireless Settings**.

6. Scroll down and select the **Use other operation mode** check box and the **Enable Bridge mode** radio button.

The screen adjusts.

7. Click the **setup bridge mode wireless settings** button.

8. Specify the settings of the other cradle to which this cradle will connect.
  - a. Select the wireless network frequency (**2.4 GHz** or **5 GHz**).  
For 802.11ac mode, select **5 GHz**.
  - b. In the **Name (SSID)** field, enter the wireless network name (SSID).
  - c. In the **Security Option** section, select a radio button.
  - d. If prompted, type the passphrase (the WiFi password that you use to connect wirelessly to the other router).

9. Click the **Apply** button.

The settings for the other router are saved and the Advanced Wireless Settings screen displays.

10. Click the **Apply** button on the Advanced Wireless Settings screen.

Your changes take effect.

## Set Up a Facebook WiFi Guest Network

Facebook WiFi turns your Smart Cradle into a WiFi mobile hotspot, prompting customers searching for WiFi to check in and like your Facebook page before using the web for free. (This does not work on a personal Facebook page.) Facebook WiFi opens the door to building closer relationships with your customers by sharing offers and announcements, boosting engagement on your Facebook page, and accessing aggregate insights about your customer base.

You must set up a guest network before you set up Facebook WiFi. See [Set Up a Guest Network](#) on page 85.

### ➤ To set up Facebook WiFi:

1. Launch a web browser from a computer or wireless device that is connected to the Smart Cradle.
2. In the address field of the browser, enter **http://netgear.cradle** or **http://192.168.100.1**

A login prompt displays.

3. Enter the cradle user name and password.

The user name is **admin**. The default password is **password**. The user name and password are case-sensitive.

The BASIC Home screen displays.

4. Select **ADVANCED > Advanced Setup > Facebook WiFi**.

Facebook Wi-Fi

Apply Cancel

---

Facebook Wi-Fi is an application for small businesses. The application turns the router into a Wi-Fi hotspot, allow patrons to check in and like your Facebook Page before using the web for free.

Please visit and read the setup procedure  
<http://www.netgear.com/facebookwifi/>

**Enable Facebook Wi-Fi enables this device to support Facebook Wi-Fi function.**

This only applies to the Wi-Fi guest network, so the Wi-Fi guest network needs to be enabled on the router for this to work.

Click **Configure** to link the router to your existing Facebook Page.  
 (To enable the "Configure" button, please check the "Enable Facebook Wi-Fi" option and click the "Apply" button)

Configure

5. Select the **Enable Facebook WiFi** check box.

6. Click the **Apply** button.

Your settings are saved.

7. Click the **Configure** button.

The Facebook Login screen displays.

8. Log in to your Facebook business account.

The Facebook WiFi Configuration screen displays.

9. Select a Facebook business page from the Select a Page list.

10. To allow customers to skip check-in, select the **Skip check-in link** radio button.

If you select this radio button, customers can check in to your Facebook business page or skip the check-in.

11. To allow customers to access your business WiFi by entering a WiFi code, select the **Require Wi-Fi code** radio button and type a WiFi code in the field that displays.

If you select this radio button, customers can check in to your Facebook business page or skip the check-in by using the WiFi code.

**Note:** The WiFi code is different from your guest network passphrase. If you select this radio button, you must give customers the WiFi code for them to use your business WiFi.

12. From the **Session Length** list, select a length of time that you want to allow your customers to be able to access your business WiFi after they check in.

13. To add terms of service to your Facebook check-in screen, select the **Terms of Service** check box and type your terms of service.

14. Click the **Save Settings** button.

Facebook WiFi is enabled.

## 7. Manage the AirCard Smart Cradle

---

This chapter covers the following topics:

- *Update the AirCard Smart Cradle Firmware*
- *Change the admin Password*
- *Recover the admin Password*
- *View AirCard Smart Cradle Status*
- *Manage the AirCard Smart Cradle Configuration File*
- *View and Customize Log Information*
- *Custom Static Routes*
- *View Devices Currently Connected to the AirCard Smart Cradle*
- *Remote Management*
- *Monitor Internet Traffic*
- *Set Up the AirCard Smart Cradle to Respond to Pings on the Internet Port*



## Update the AirCard Smart Cradle Firmware

The cradle firmware (routing software) is stored in flash memory. You might see a message at the top of the genie screens when new firmware is available. You can respond to that message to update the firmware or you can check to see if new firmware is available, and to update your product. (Visit <http://support.netgear.com>.)

➤ **To check for new firmware and update your cradle:**

1. Launch a web browser from a computer that is connected to the Smart Cradle.  
Best practice is to use the provided Ethernet cable to connect your computer to an Ethernet LAN port on the cradle
2. In the address field of the browser, enter **http://netgear.cradle** or **http://192.168.100.1**.  
A login prompt displays.
3. Enter the cradle user name and password.  
The user name is **admin**. The default password is **password**. The user name and password are case-sensitive.  
The BASIC Home screen displays.
4. Select **Advanced > Administration > Router Update**.  
The Router Update screen displays.
5. Click the **Check** button.  
The cradle finds new firmware information if any is available and displays a message asking if you want to download and install it.
6. Click the **Yes** button.  
The cradle locates and downloads the firmware and begins the update.



**WARNING:**

**To avoid the risk of corrupting the firmware, do not interrupt the update. For example, do not close the browser, click a link, or load a new page. Do not turn off the cradle.**

When the upload is complete, your cradle restarts. The update process typically takes about one minute. Read the new firmware release notes to find out if you must reconfigure the cradle after updating.

## Change the admin Password

You can change the default password that is used to log in to the cradle with the user name admin. This password is not the one that you use for WiFi access.

Be sure to change the password for the user name admin to a secure password. The ideal password contains no dictionary words from any language and contains uppercase and lowercase letters, numbers, and symbols. It can be up to 30 characters.

➤ **To set the password for the user name admin:**

1. Launch a web browser from a computer or wireless device that is connected to the Smart Cradle.
2. In the address field of the browser, enter **http://netgear.cradle** or **http://192.168.100.1**.

A login prompt displays.

3. Enter the cradle user name and password.

The user name is **admin**. The default password is **password**. The user name and password are case-sensitive.

The BASIC Home screen displays.

4. Select **ADVANCED > Administration > Set Password**.

5. Type the old password, and type the new password twice.
6. To be able to recover the password, select the **Enable Password Recovery** check box.  
Best practice is to enable password recovery.
7. Click the **Apply** button.  
Your changes take effect.

## Recover the admin Password

Best practice is to enable password recovery if you change the password for the cradle user name admin. Then you can recover the password if it is forgotten. This recovery process is supported in Internet Explorer, Firefox, and Chrome browsers but not in the Safari browser.

➤ **To set up password recovery:**

1. Launch a web browser from a computer or wireless device that is connected to the Smart Cradle.
2. In the address field of the browser, enter **http://netgear.cradle** or **http://192.168.100.1**.  
A login prompt displays.
3. Enter the cradle user name and password.  
The user name is **admin**. The default password is **password**. The user name and password are case-sensitive.  
The BASIC Home screen displays.
4. Select **ADVANCED > Administration > Set Password**.  
The Set Password screen displays.
5. Select the **Enable Password Recovery** check box.
6. Select two security questions and provide answers to them.
7. Click the **Apply** button.  
Your changes are saved.

➤ **To recover your password:**

1. In the address field of your browser, type **http://netgear.cradle**.  
A login screen displays.
2. Click the **Cancel** button.  
If password recovery is enabled, you are prompted to enter the serial number of the cradle.  
The serial number is on the product label.
3. Enter the serial number of the cradle.
4. Click the **Continue** button.  
A screen displays requesting the answers to your security questions.
5. Enter the saved answers to your security questions.
6. Click the **Continue** button.  
A screen displays your recovered password.
7. Click the **Login again** button.

A login screen displays.

- With your recovered password, log in to the cradle.

## View AirCard Smart Cradle Status

### ➤ To view cradle status and usage information:

- Launch a web browser from a computer or wireless device that is connected to the Smart Cradle.
- In the address field of the browser, enter **http://netgear.cradle** or **http://192.168.100.1**.

A login prompt displays.

- Enter the cradle user name and password.

The user name is **admin**. The default password is **password**. The user name and password are case-sensitive.

The BASIC Home screen displays.

- Click the **ADVANCED** tab.

The screenshot displays the Advanced Settings page of the AirCard Smart Cradle. It is organized into a grid of sections:

- Router Information:** Shows hardware and software details. Hardware Version: DC112A; Firmware Version: V1.0.0.20\_1.0.60; GUI Language Version: V1.0.0.20\_2.1.38.1. LAN Port: MAC Address 6C:B0:CE:BE:42:CD; IP Address 192.168.100.1; DHCP On. Includes a Reboot button.
- Internet Port:** Shows network configuration. MAC Address 6C:B0:CE:BE:42:CE; IP Address 192.168.1.4; Connection DHCP; IP Subnet Mask 255.255.255.0; Domain Name Server 192.168.1.1. Includes Show Statistics and Connection Status buttons.
- Wireless Settings (2.4GHz):** Name (SSID) NETGEAR05; Region Australia; Channel Auto (6); Mode Up to 145 Mbps; Wireless AP On; Broadcast Name On; Wi-Fi Protected Setup Configured.
- Wireless Settings (5GHz):** Name (SSID) NETGEAR05-5G; Region Australia; Channel 149 + 153(F) + 157 + 161; Mode Up to 867 Mbps; Wireless AP On; Broadcast Name On; Wi-Fi Protected Setup Configured.
- Guest Network (2.4 GHz):** Name (SSID) NETGEAR-Guest; Wireless AP Off; Broadcast Name On; Allow guests to see each other and access my local network Off.
- Guest Network (5 GHz):** Name (SSID) NETGEAR-5G-Guest; Wireless AP Off; Broadcast Name On; Allow guests to see each other and access my local network Off.

- For information about the displayed settings, click the **Show/Hide Help Center** link at the bottom of the screen.

## Display Internet Port Statistics

➤ **To display Internet port statistics:**

1. Launch a web browser from a computer or wireless device that is connected to the Smart Cradle.
2. In the address field of the browser, enter **http://netgear.cradle** or **http://192.168.100.1**.

A login prompt displays.

3. Enter the cradle user name and password.

The user name is **admin**. The default password is **password**. The user name and password are case-sensitive.

The BASIC Home screen displays.

4. Click the **ADVANCED** tab.

The ADVANCED Home screen displays.

5. In the Internet Port pane, click the **Show Statistics** button.

**Show Statistics**

System Up Time 00:03:14

Port	Status	TxPkts	RxPkts	Collisions	Tx B/s	Rx B/s	Up Time
WAN	LTE	3687	1085	0	3406	2404	00:02:35
LAN1	Link Down	--	--	--	--	--	--
LAN2	Link Down	--	--	--	--	--	--
LAN3	Link Down	--	--	--	--	--	--
LAN4	Link Down	--	--	--	--	--	--
2.4G WLAN b/g/n	145M	5923	4781	0	32093	3607	00:02:56
5G WLAN a/n/ac	867M	0	0	0	0	0	00:02:56

Poll Interval:  (5-86400 Seconds)

The following information displays:

- **System Up Time.** The time elapsed since the cradle was last restarted.
- **Port.** The statistics for the WAN (Internet) and LAN (Ethernet) ports. For each port, the screen displays the following information:
  - **Status.** The link status of the port.
  - **TxPkts.** The number of packets transmitted on this port since reset or manual clear.
  - **RxPkts.** The number of packets received on this port since reset or manual clear.
  - **Collisions.** The number of collisions on this port since reset or manual clear.
  - **Tx B/s.** The current transmission (outbound) bandwidth used on the WAN and LAN ports.
  - **Rx B/s.** The current reception (inbound) bandwidth used on the WAN and LAN ports.
  - **Up Time.** The time elapsed since this port acquired the link.

- **Poll Interval.** The interval at which the statistics are updated in this screen.
6. To change the polling frequency, enter a time in seconds in the **Poll Interval** field and click the **Set Interval** button.

To stop the polling entirely, click the **Stop** button.

## Check the Internet Connection Status

### ➤ To check the Internet connection status:

1. Launch a web browser from a computer or wireless device that is connected to the Smart Cradle.
2. In the address field of the browser, enter **http://netgear.cradle** or **http://192.168.100.1**.  
A login prompt displays.
3. Enter the cradle user name and password.  
The user name is **admin**. The default password is **password**. The user name and password are case-sensitive.  
The BASIC Home screen displays.
4. Click the **ADVANCED** tab.  
The ADVANCED Home screen displays.
5. In the Internet Port pane, click the **Connection Status** button.

Connection Status	
IP Address	192.168.1.4
Subnet Mask	255.255.255.0
Default Gateway	192.168.1.1
DHCP Server	192.168.1.1
DNS Server	192.168.1.1
Lease Obtained	0 days,12 Hours,0 Minutes
Lease Expires	0 days,11 Hours,58 Minutes
<input type="button" value="Release"/> <input type="button" value="Renew"/>	
<input type="button" value="Close Window"/>	

The following information displays:

- **IP Address.** The IP address that is assigned to the cradle.
- **Subnet Mask.** The subnet mask that is assigned to the cradle.
- **Default Gateway.** The IP address for the default gateway that the cradle communicates with.
- **DHCP Server.** The IP address for the Dynamic Host Configuration Protocol server that provides the TCP/IP configuration for all the computers that are connected to the cradle.

- **DNS Server.** The IP address of the Domain Name Service server that provides translation of network names to IP addresses.
  - **Lease Obtained.** The date and time when the lease was obtained.
  - **Lease Expires.** The date and time that the lease expires.
6. To return the status of all items to 0, click the **Release** button.
  7. To refresh the screen, click the **Renew** button.
- To exit the screen, click the **Close Window** button.

## Manage the AirCard Smart Cradle Configuration File

The configuration settings of the cradle are stored within the cradle in a configuration file. You can back up (save) this file to your computer, restore it, or reset it to the factory default settings.

### Back Up Settings

➤ **To back up the cradle's configuration settings:**

1. Launch a web browser from a computer or wireless device that is connected to the Smart Cradle.
2. In the address field of the browser, enter **http://netgear.cradle** or **http://192.168.100.1**.  
A login prompt displays.
3. Enter the cradle user name and password.  
The user name is **admin**. The default password is **password**. The user name and password are case-sensitive.  
The BASIC Home screen displays.
4. Select **Advanced > Administration > Backup Settings**.  
The Backup Settings screen displays.
5. Click the **Back Up** button.
6. When prompted, specify a location on your network and click the **OK** button.  
A copy of the current settings is saved in the location you specified.

### Restore Configuration Settings

➤ **To restore configuration settings that you backed up:**

1. Launch a web browser from a computer or wireless device that is connected to the Smart Cradle.
2. In the address field of the browser, enter **http://netgear.cradle** or **http://192.168.100.1**  
A login prompt displays.

3. Enter the cradle user name and password.

The user name is **admin**. The default password is **password**. The user name and password are case-sensitive.

The BASIC Home screen displays.

4. Select **ADVANCED > Administration > Backup Settings**.

The Backup Settings screen displays.

5. Click the **Browse** button to find and select the `.cfg` file.

6. Click the **Restore** button.

The file is uploaded to the cradle and the cradle reboots.



**WARNING:**

**Do not interrupt the reboot process.**

## Erase the Current Configuration Setting

You can erase the current configuration and restore the factory default settings. You might want to do this if you move the cradle to a different network. (See *Factory Settings* on page 154.)

➤ **To erase the configuration settings:**

1. Launch a web browser from a computer or wireless device that is connected to the Smart Cradle.

2. In the address field of the browser, enter **http://netgear.cradle** or **http://192.168.100.1**.

A login prompt displays.

3. Enter the cradle user name and password.

The user name is **admin**. The default password is **password**. The user name and password are case-sensitive.

The BASIC Home screen displays.

4. Select **Advanced > Administration > Backup Settings**.

The Backup Settings screen displays.

5. Click the **Erase** button.

The factory default settings are restored. The password for admin is password, and the LAN IP address is 192.168.100.1. DHCP is enabled.



## View and Customize Log Information

### ➤ To view and customize the log information:

1. Launch a web browser from a computer or wireless device that is connected to the Smart Cradle.
2. In the address field of the browser, enter **http://netgear.cradle** or **http://192.168.100.1**  
A login prompt displays.
3. Enter the cradle user name and password.

The user name is **admin**. The default password is **password**. The user name and password are case-sensitive.

The BASIC Home screen displays.

4. Select **Advanced > Administration > Logs**.

The screenshot shows the 'Logs' configuration page. At the top, there are 'Apply' and 'Cancel' buttons. Below that, the current time is displayed as 'Sunday, Nov 09, 2014 10:20:16'. A scrollable log list contains the following entries:

```
[Admin login] from source 192.168.100.3, Sunday, Nov 09, 2014 10:17:54
[DHCP IP: (192.168.100.3)] to MAC address 74:E5:0B:57:B8:50, Sunday, Nov 09, 2014 10:17:47
[Time synchronized with NTP server] Sunday, Nov 09, 2014 10:17:32
[Internet connected] IP address: 192.168.1.4, Sunday, Nov 09, 2014 10:17:31
[DHCP IP: (192.168.100.2)] to MAC address 28:6A:BA:70:E7:0E, Sunday, Nov 09, 2014 10:17:29
[Time synchronized with NTP server] Sunday, Nov 09, 2014 10:17:16
[Internet connected] IP address: 192.168.1.4, Sunday, Nov 09, 2014 10:17:15
[Internet disconnected] Sunday, Nov 09, 2014 10:17:14
```

Below the log list are three buttons: 'Refresh', 'Clear Log', and 'Send Log'. Underneath, there is a section titled 'Include in Log' with a list of log categories, each with a checked checkbox:

- Attempted access to allowed sites
- Attempted access to blocked sites and services
- Connections to the Web-based interface of this Router
- Router operation (startup, get time etc)
- Known DoS attacks and Port Scans
- Port Forwarding / Port Triggering
- Wireless access
- Automatic Internet connection reset
- Turn off wireless signal by schedule

5. Select or clear the check boxes to customize the log setting.
6. Click the **Apply** button.

Your settings are saved.

## Custom Static Routes

Typically, you do not need to add static routes unless your network includes multiple routers or multiple IP subnets.

As an example of when a static route is needed, consider the following case:

- Your main Internet access is through a cable modem to an ISP.
- You use an ISDN cradle on your home network for connecting to the company where you are employed. This cradle's address on your LAN is 192.168.100.100.
- Your company's network address is 134.177.0.0.

When you set up your cradle, two implicit static routes were created. A default route was created with your ISP as the gateway, and a second static route was created to your local network for all 192.168.100.x addresses. With this configuration, if you try to access a device on the 134.177.0.0 network, your cradle forwards your request to the ISP. The ISP forwards your request to the company where you are employed, and the company firewall is likely to deny the request.

In this case you must define a static route, telling your cradle to access 134.177.0.0 through the ISDN cradle at 192.168.100.100. Here is an example:

- The **Destination IP Address** and **IP Subnet Mask** fields specify that this static route applies to all 134.177.x.x addresses.
- The **Gateway IP Address** field specifies that all traffic for these addresses will be forwarded to the ISDN cradle at 192.168.100.100.
- A metric value of 1 works because the ISDN cradle is on the LAN.
- The **Private** check box is selected only as a precautionary security measure in case RIP is activated.

## Set Up a Static Route

### ➤ To set up a static route:

1. Launch a web browser from a computer or wireless device that is connected to the Smart Cradle.
2. In the address field of the browser, enter **http://netgear.cradle** or **http://192.168.100.1**.  
A login prompt displays.
3. Enter the cradle user name and password.  
The user name is **admin**. The default password is **password**. The user name and password are case-sensitive.  
The BASIC Home screen displays.
4. Select **ADVANCED > Advanced Setup > Static Routes**.  
The Static Routes screen displays.

5. Click the **Add** button.

The screen adjusts.

6. In the **Route Name** field, type a name for this static route (for identification purposes only).
7. To limit access to the LAN only, select the **Private** check box.

If the **Private** check box is selected, the static route is not reported in RIP.

8. To make this route effective, select the **Active** check box.
9. Type the IP address of the final destination.
10. Type the IP subnet mask for this destination.

If the destination is a single host, type **255.255.255.255**.

11. Type the gateway IP address, which must be on the same LAN segment as the cradle.
12. Type a number from 1 through 15 as the metric value.

This value represents the number of cradles between your network and the destination. Usually, a setting of 2 or 3 works, but if this is a direct connection, set it to **1**.

13. Click the **Apply** button.

The static route is added.

## Edit a Static Route

### ➤ To edit a static route:

1. Launch a web browser from a computer or wireless device that is connected to the Smart Cradle.
2. In the address field of the browser, enter **http://netgear.cradle** or **http://192.168.100.1**.

A login prompt displays.

3. Enter the cradle user name and password.

The user name is **admin**. The default password is **password**. The user name and password are case-sensitive.

The BASIC Home screen displays.

4. Select **ADVANCED > Advanced Setup > Static Routes**.

The Custom Static Routes screen displays.

5. In the table, select the radio button for the route.
6. Click the **Edit** button.

The Static Routes screen adjusts.

7. Edit the route information.
8. Click the **Apply** button.

Your changes are saved.

## Delete a Static Route

➤ **To delete a static route:**

1. Launch a web browser from a computer or wireless device that is connected to the Smart Cradle.
2. In the address field of the browser, enter **http://netgear.cradle** or **http://192.168.100.1**

A login prompt displays.

3. Enter the cradle user name and password.

The user name is **admin**. The default password is **password**. The user name and password are case-sensitive.

The BASIC Home screen displays.

4. Select **ADVANCED > Advanced Setup > Static Routes**.

The Custom Static Routes screen displays.

5. In the table, select the radio button for the route.
6. Click the **Delete** button.

The route is removed from the table.

## View Devices Currently Connected to the AirCard Smart Cradle

You can view all computers or devices that are currently connected to your network.

➤ **To view devices on the network:**

1. Launch a web browser from a computer or wireless device that is connected to the Smart Cradle.
2. In the address field of the browser, enter **http://netgear.cradle** or **http://192.168.100.1**.

A login prompt displays.

3. Enter the cradle user name and password.

The user name is **admin**. The default password is **password**. The user name and password are case-sensitive.

The BASIC Home screen displays.

#### 4. Select **Attached Devices**.

Attached Devices

Go to [Access Control](#) to allow or block devices.

Access Control: Turned Off [Refresh](#)

**Wired Devices**

#	IP Address	MAC Address	Device Name
1	192.168.100.2	00:1A:6B:6D:8F:19	techpubs

**2.4G Wireless Devices (Wireless intruders also show up here)**

SSID	IP Address	MAC Address	Device Name
------	------------	-------------	-------------

**5G Wireless Devices (Wireless intruders also show up here)**

SSID	IP Address	MAC Address	Device Name
------	------------	-------------	-------------

The Wired Devices section lists devices that are connected to the cradle with Ethernet cables. The other sections list devices that are connected to each WiFi band in the WiFi network. The following information is displayed for wireless devices:

- **SSID.** The wireless network name (SSID).
- **IP Address.** The IP address that the cradle assigned to this device when it joined the network. This number can change if a device is disconnected and rejoins the network.
- **MAC Address.** The unique MAC address for each device does not change. The MAC address is typically shown on the product label.
- **Device Name.** If the device name is known, it is shown here.

To update this screen, click the **Refresh** button.

## Remote Management

You can access your cradle over the Internet to view or change its settings. You must know the cradle's WAN IP address to use this feature. For information about remote access using Dynamic DNS, see [Chapter 9, Access USB Devices Through the Internet](#).

Be sure to change the password for the user name admin to a secure password. The ideal password contains no dictionary words from any language and contains uppercase and lowercase letters, numbers, and symbols. It can be up to 30 characters. See [Change the admin Password](#) on page 98.

#### ➤ To set up remote management:

1. Launch a web browser from a computer or wireless device that is connected to the Smart Cradle.

2. In the address field of the browser, enter **http://netgear.cradle** or **http://192.168.100.1**.  
A login prompt displays.
3. Enter the cradle user name and password.  
The user name is **admin**. The default password is **password**. The user name and password are case-sensitive.  
The BASIC Home screen displays.
4. Select **Advanced > Administration > Remote Management**.

5. Select the **Turn Remote Management On** check box.
6. In the Allow Remote Access By section, specify the external IP addresses to be allowed to access the cradle's web management interface remotely.

**Note:** For enhanced security, restrict access to as few external IP addresses as practical.

Select one of the following:

- **Only This Computer.** Allow access from a single IP address on the Internet. Enter the IP address to be allowed access.
  - **IP Address Range.** Allow access from a range of IP addresses on the Internet. Enter a beginning IP address and an ending IP address to define the allowed range.
  - **Everyone.** Allow access from any IP address on the Internet.
7. Specify the port number for accessing the web management interface.  
Normal web browser access uses the standard HTTP service port 80. For greater security, enter a custom port number for the remote web management interface. Choose a number from 1024 to 65535, but do not use the number of any common service port. The default is 8080, which is a common alternate for HTTP.
  8. Click the **Apply** button.  
Your changes take effect.

## Monitor Internet Traffic

Traffic metering allows you to monitor the volume of Internet traffic that passes through the cradle Internet port. You can set limits for traffic volume.

### ➤ To monitor Internet traffic:

1. Launch a web browser from a computer or wireless device that is connected to the Smart Cradle.

2. In the address field of the browser, enter **http://netgear.cradle** or **http://192.168.100.1**.  
A login prompt displays.

3. Enter the cradle user name and password.

The user name is **admin**. The default password is **password**. The user name and password are case-sensitive.

The BASIC Home screen displays.

4. Select **Advanced > Administration > Traffic Meter**.

5. Select the **Enable Traffic Meter** check box.

6. (Optional) Control the volume of Internet traffic.

You can use either the traffic volume control feature or the connection time control feature:

- Select the **Traffic volume control by** radio button and then select a limit:
  - **No Limit**. No restriction is applied when the traffic limit is reached.
  - **Download only**. The restriction is applied to incoming traffic only.
  - **Both Directions**. The restriction is applied to both incoming and outgoing traffic.

- Select the **Connection time control** radio button and enter the allowed hours in the **Monthly limit** field.
- 7. (Optional) If your ISP charges for extra data volume when you make a new connection, enter the extra data volume in MB in the **Round up data volume for each connection by** field.
- 8. In the Traffic Counter section, set the traffic counter to begin at a specific time and date.  
To start the traffic counter immediately, click the **Restart Counter Now** button.
- 9. In the Traffic Control section, specify whether the cradle issues a warning message before the monthly limit of Mbytes or hours is reached.  
By default, the value is 0 and no warning message is issued. You can select one of the following to occur when the limit is attained:
  - The Internet LED blinks green or amber.
  - The Internet connection is disconnected and disabled.
- 10. Click the **Apply** button.  
The Internet Traffic Statistics section helps you to monitor the data traffic.
- 11. To update the Traffic Statistics section, click the **Refresh** button.  
To display more information about the data traffic on your cradle and to change the poll interval, click the **Traffic Status** button.

## Set Up the AirCard Smart Cradle to Respond to Pings on the Internet Port

- **To set up responses to pings on the Internet port:**
1. Launch a web browser from a computer or wireless device that is connected to the Smart Cradle.
  2. In the address field of the browser, enter **http://netgear.cradle** or **http://192.168.100.1**.  
A login prompt displays.
  3. Enter the cradle user name and password.  
The user name is **admin**. The default password is **password**. The user name and password are case-sensitive.  
The BASIC Home screen displays.



4. Select **Advanced > Setup > WAN Setup**.

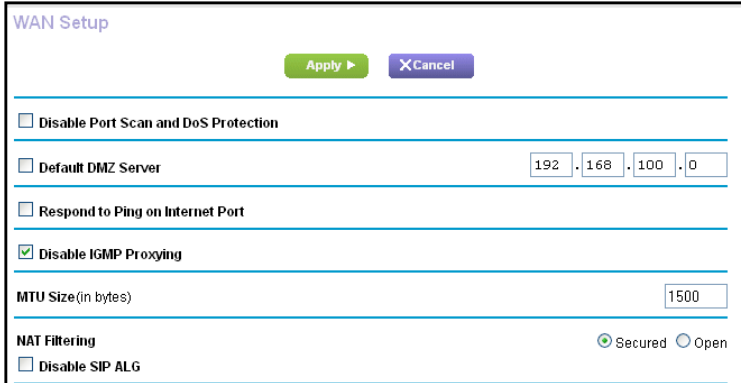

WAN Setup

Apply Cancel

Disable Port Scan and DoS Protection

Default DMZ Server 192 . 168 . 100 . 0

Respond to Ping on Internet Port

Disable IGMP Proxying

MTU Size (in bytes) 1500

NAT Filtering  Secured  Open

Disable SIP ALG

5. Select the **Respond to Ping on Internet Port** check box.
6. Click the **Apply** button.

Your settings are saved.

# 8 Share a USB Device Attached to the AirCard Smart Cradle

---

# 8

This chapter describes how to access and configure USB storage devices attached to your cradle. The USB port on the cradle can be used only to connect USB storage devices like flash drives or hard drives or a printer. Do not connect computers, USB modems, CD drives, or DVD drives to the cradle USB port.

This chapter contains the following sections:

- *USB Device Requirements*
- *Access a USB Device*
- *Back Up Windows Computers with ReadySHARE Vault*
- *Back Up Mac Computers with Time Machine*
- *Control Access to the USB Device*
- *Use FTP Within the Network*
- *View Network Folders on a USB Device*
- *Add a Network Folder on a USB Device*
- *Edit a Network Folder on a USB Device*
- *Approve USB Devices*
- *Safely Remove a USB Device*

For more information about ReadySHARE features, visit [www.netgear.com/readystatechange](http://www.netgear.com/readystatechange).

## USB Device Requirements

The cradle works with most USB-compliant external flash and hard drives. For the most up-to-date list of USB devices that the cradle supports, visit <http://kbserver.netgear.com/readystatechange>.

Some USB external hard drives and flash drives require you to load the drivers onto the computer before the computer can access the USB device. Such USB devices do not work with the cradle.

The cradle supports the following file system types for full read/write access:

- FAT16
- FAT32
- NTFS
- NTFS with compression format enabled
- Ext2
- Ext3
- Ext4
- HFS
- HFS+

## Access a USB Device

ReadySHARE lets you access and share a USB device connected to the cradle USB port. (If your USB device uses special drivers, it is not compatible.)

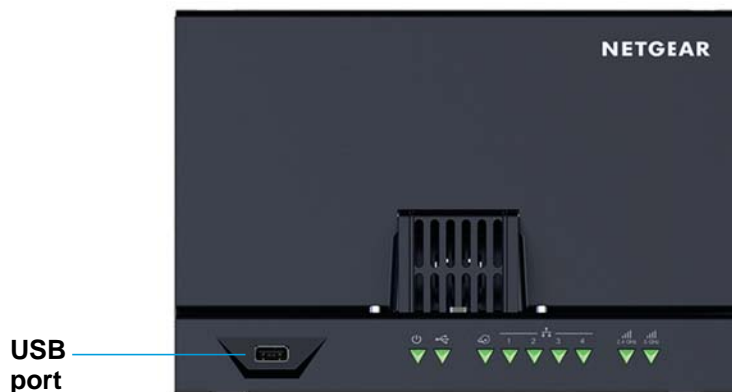

Figure 8. The blue USB 3.0 port on the front of the cradle provides the fastest access

### ➤ To connect a USB device:

1. Insert your USB storage drive into the USB port on the front of the cradle.
2. If your USB device uses a power supply, connect it.

You must use the power supply when you connect the USB device to the cradle.

When you connect the USB device to the cradle USB port, it might take up to two minutes before it is ready for sharing. By default, the USB device is available to all computers on your local area network (LAN).

➤ **To access the USB device from a Mac:**

1. Select **Go > Connect to Server**.
2. Enter **smb://readyshare** as the server address.
3. Click the **Connect** button.

➤ **To access the USB device from a Windows computer:**

1. Select **Start > Run**.
2. Enter **\\readyshare** in the dialog box and click the **OK** button.

➤ **To map the USB device to a Windows network drive:**

1. Visit [www.netgear.com/readyshare](http://www.netgear.com/readyshare).
2. In the ReadySHARE USB Storage Access pane, click **PC Utility** link.

The `readyshareconnect.exe` file is downloaded to your computer.

3. Launch `readyshareconnect.exe`.

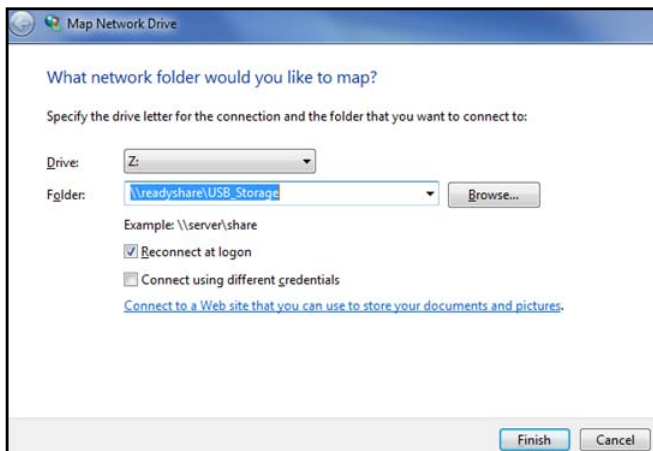

4. Select the drive letter to map to the network folder.
5. To connect to the USB device as a different user, select the **Connect using different credentials** check box and do the following:
  - a. Type the user name and password.
  - b. Click the **OK** button.
6. Click the **Finish** button.

The USB device is mapped to the drive letter that you specified.

## Back Up Windows Computers with ReadySHARE Vault

Your cradle comes with free backup software for all the Windows computers in your home. Connect a USB hard disk drive (HDD) to the USB port on your Smart Cradle for centralized, continuous, and automatic backup.

➤ **To back up your Windows computer:**

1. Connect a USB HDD to a USB port on the cradle.
2. Install the genie app on each Windows computer.

To download the genie app, visit [www.netgear.com/genie](http://www.netgear.com/genie).

3. Download ReadySHARE Vault from [www.netgear.com/readysware](http://www.netgear.com/readysware) and install it on each Windows computer.
4. Launch ReadySHARE Vault.
5. Use the dashboard or the **Backup** tab to set up and run your backup.

## Back Up Mac Computers with Time Machine

You can use Time Machine to back up your Mac computers onto a USB hard drive that is connected to the cradle's USB port. You can access the connected USB hard drive from your Mac with a wired or wireless connection to your cradle.

### Set Up a USB Hard Drive on a Mac

Best practice is to use a new USB HDD or format your old USB disk to do the Time Machine backup for the first time. Use a blank partition to prevent some issues during backup using Time Machine. The cradle supports GUID or MBR partitions.

➤ **To format your USB hard disk drive and specify partitions:**

1. Physically connect the USB hard drive to your Mac.
2. On your Mac, go to **Spotlight** (or the magnifying glass) at the top right of the screen and search for **Disk Utility**.
3. To format your USB device, open the Disk Utility, click the **Erase** tab, and click the **Erase** button.
4. Click the **Partition** tab.
5. Click **Partition Layout** and set the number of partitions that you want to use.
6. Click the **Options** button.

The Partition options display.

7. Select the **GUID Partition Table** or **Master Boot Record** radio button.
8. For the format, select **Mac OS Extended (Journaled)**.
9. Click the **OK** button.

10. Click the **Apply** button.

Your settings are saved.

## Prepare to Back Up a Large Amount of Data

Before you back up a large amount of data with Time Machine, Best practice is to follow this procedure.

- **To prepare to back up a large amount of data:**
  1. Upgrade the operating system of the Mac computer.
  2. Verify and repair the backup disk and the local disk.
  3. Verify and repair the permissions on the local disk.
  4. Set Energy Saver:
    - a. From the **Apple** menu, select **System Preferences**.
    - b. From the **View** menu, select **Energy Saver**.
    - c. Click the **Power Adapter** tab.
    - d. Select the **Wake for Wi-Fi network access** check box.
    - e. Click the **Back arrow** to save the changes and exit the screen.
  5. Modify your security settings:
    - a. From the **Apple** menu, select **System Preferences**.
    - b. From the **View** menu, select **Security**.
    - c. Click the **Advanced** button at the bottom of the screen.
    - d. Leave the **Log out after minutes of inactivity** check box cleared.

## Use Time Machine to Back Up onto a USB Hard Drive

You can use Time Machine to back up your Mac computers onto a USB hard disk drive that is connected to the cradle USB ports.

- **To back up your Mac onto a USB hard drive:**
  1. Prepare your USB device with a compatible format and partitions.  
See *Set Up a USB Hard Drive on a Mac* on page 117.  
If you plan to back up a large amount of data, see *Prepare to Back Up a Large Amount of Data* on page 118.
  2. Insert your USB storage drive into the USB port on the cradle.

**Note:** If your USB device uses a power supply, you must use it when you connect the USB device to the cradle.

When you connect the USB device to the cradle USB port, it might take up to two minutes before it is ready for sharing. By default, the USB device is available to all computers on your local area network (LAN).

3. On your Mac computer, select **Go > Connect to Server**.
4. Type **afp://netgear.cradle**.
5. When prompted to enter your name and password, select the **Guest** radio button.
6. Click the **Connect** button.

A list of connected devices displays. This list includes the name admin when you log in as admin.

7. From the **Apple** menu, select **System Preferences**.
8. Open Time Machine.
9. Click the **Select Backup Disk** button and select your USB device from the list.
10. Click the **Use for Backup** button.

**Note:** If you do not see the USB partition that you want in the Time Machine disk list, go to Mac finder and click that USB partition. It displays in the Time Machine list.

11. When prompted to enter your name and password, select the **Guest** radio button and click the **Connect** button.

When the setup is complete, the Mac automatically schedules a full backup. You can back up immediately if you want.

## Control Access to the USB Device

You can specify the device name, workgroups, and network folders for your USB device.

### ➤ To specify the USB access settings:

1. Launch a web browser from a computer or wireless device that is connected to the Smart Cradle.
2. In the address field of the browser, enter **http://netgear.cradle** or **http://192.168.100.1**.

A login prompt displays.

3. Enter the cradle user name and password.

The user name is **admin**. The default password is **password**. The user name and password are case-sensitive.

The BASIC Home screen displays.

4. Select **ADVANCED > USB Storage > Advanced Settings**.

The USB Storage (Advanced Settings) screen displays.

5. Specify access to the USB storage device:

- **Network Device Name.** This is the name used to access the USB device connected to the cradle. The default is readyshare.
  - **Workgroup.** If you are using a Windows workgroup rather than a domain, the workgroup name is displayed here. The name works only in an operating system that supports NetBIOS, such as Microsoft Windows.
  - **Access Method.** Select the check boxes for the access methods that you want:
    - **Network Neighborhood/MacShare.** Enabled by default.
    - **HTTP.** Enabled by default. You can type **http://readyshare.routerlogin.net/shares** to access the USB device.
    - **HTTP (via Internet).** Disabled by default. If you enable this feature, remote users can type **http://<public IP address/shares>** (for example, **http://1.1.10.102/shares**) or a URL domain name to access the USB device over the Internet. This feature supports file uploading only.
    - **FTP.** Disabled by default.
    - **FTP (via Internet).** Disabled by default. If you select this check box, remote users can access the USB device through FTP over the Internet. This feature supports both downloading and uploading of files.
6. If you changed the settings, click the **Apply** button.  
Your changes are saved.

## Use FTP Within the Network

File Transfer Protocol (FTP) lets you send and receive large files faster.

### ➤ To set up FTP access:

1. Launch a web browser from a computer or wireless device that is connected to the Smart Cradle.
2. In the address field of the browser, enter **http://netgear.cradle** or **http://192.168.100.1**.  
A login prompt displays.
3. Enter the cradle user name and password.

The user name is **admin**. The default password is **password**. The user name and password are case-sensitive.

The BASIC Home screen displays.



4. Select **ADVANCED > USB Storage > Advanced Settings**.

USB Storage (Advanced Settings)

---

Network Device Name :

Workgroup :

Enable	Access Method	Link	Port
<input checked="" type="checkbox"/>	Network Neighborhood/MacShare	\\readyshare	-
<input checked="" type="checkbox"/>	HTTP	<a href="http://readyshare.routerlogin.net/shares">http://readyshare.routerlogin.net/shares</a>	80
<input type="checkbox"/>	HTTPS (via internet)	<a href="https://0.0.0.0/shares">https://0.0.0.0/shares</a>	443
<input type="checkbox"/>	FTP	<a href="ftp://readyshare.routerlogin.net/shares">ftp://readyshare.routerlogin.net/shares</a>	21
<input type="checkbox"/>	FTP (via internet)	<a href="ftp://0.0.0.0/shares">ftp://0.0.0.0/shares</a>	21

---

Available Network Folders

	Share Name	Read Access	Write Access	Folder Name	Volume Name	Total Space	Free Space
<input checked="" type="radio"/>	\\readyshare\USB_Storage	All - no password	All - no password	U:\	TRAVELDRIVE	978.8M	171.8M

---

5. Select the **FTP** check box.

6. Click the **Apply** button.

Your changes are saved.

## View Network Folders on a USB Device

You can view or change the network folders on the USB storage device.

➤ **To view network folders:**

1. Launch a web browser from a computer or wireless device that is connected to the Smart Cradle.
2. In the address field of the browser, enter **http://netgear.cradle** or **http://192.168.100.1**.

A login prompt displays.

3. Enter the cradle user name and password.

The user name is **admin**. The default password is **password**. The user name and password are case-sensitive.

The BASIC Home screen displays.

#### 4. Select **ADVANCED > USB Storage > Advanced Settings**.

USB Storage (Advanced Settings)

Apply Refresh

Network Device Name : readyshare

Workgroup : Workgroup

Enable	Access Method	Link	Port
<input checked="" type="checkbox"/>	Network Neighborhood/MacShare	\\readyshare	-
<input checked="" type="checkbox"/>	HTTP	<a href="http://readyshare.routerlogin.net/shares">http://readyshare.routerlogin.net/shares</a>	80
<input type="checkbox"/>	HTTPS (via internet)	<a href="https://0.0.0.0/shares">https://0.0.0.0/shares</a>	443
<input type="checkbox"/>	FTP	<a href="ftp://readyshare.routerlogin.net/shares">ftp://readyshare.routerlogin.net/shares</a>	21
<input type="checkbox"/>	FTP (via internet)	<a href="ftp://0.0.0.0/shares">ftp://0.0.0.0/shares</a>	21

Available Network Folders

	Share Name	Read Access	Write Access	Folder Name	Volume Name	Total Space	Free Space
<input checked="" type="checkbox"/>	\\readyshare\USB_Storage	All - no password	All - no password	U:\	TRAVELDRIVE	978.8M	171.8M

Edit Create Network Folder Delete

Safely Remove USB Device

#### 5. Scroll down to the Available Networks Folder section, and to view the following settings:

- **Share Name.** The default share name is USB\_Storage.

You can click the name or you can type it in the address field of your web browser. If Not Shared is shown, the default share was deleted and no other share for the root folder exists.

- **Read Access and Write Access.** Show the permissions and access controls on the network folder. All–no password (the default) allows all users to access the network folder. The password for admin is the same one that you use to log in to the cradle.
- **Folder Name.** Full path of the network folder.
- **Volume Name.** Volume name from the storage device (either USB device or HDD).
- **Total Space and Free Space.** Show the current utilization of the storage device.

## Add a Network Folder on a USB Device

You can add network folders on the USB storage device.

### ➤ To add a network folder:

1. Launch a web browser from a computer or wireless device that is connected to the Smart Cradle.
2. In the address field of the browser, enter **http://netgear.cradle** or **http://192.168.100.1**.  
A login prompt displays.
3. Enter the cradle user name and password.

The user name is **admin**. The default password is **password**. The user name and password are case-sensitive.

The BASIC Home screen displays.

4. Select **ADVANCED > USB Storage > Advanced Settings**.

The USB Storage (Advanced Settings) screen displays.

5. Click the **Create Network Folder** button.

Create Network Folder	
USB Device	U: (TRAVELDRIVE) ▾
Folder	<input type="text"/> <input type="button" value="Browse"/>
Share Name	<input type="text"/>
Read Access	All - no password ▾
Write Access	All - no password ▾
<input type="button" value="Apply"/>	
<input type="button" value="Close Window"/>	

If this screen does not display, your web browser might be blocking pop-ups. If it is, change the browser settings to allow pop-ups.

6. In the **USB Device** list, select the USB device.
7. Click the **Browse** button and in the **Folder** field, select the folder.
8. In the **Share Name** field, type the name of the share.
9. In the **Read Access** list and the **Write Access** list, select the settings that you want.

The user name (account name) for All–no password is guest. The password for admin is the same one that is used to log in to the cradle. By default, it is password.

10. Click the **Apply** button.

The folder is added on the USB device.

## Edit a Network Folder on a USB Device

You can add network folders on the USB storage device.

### ➤ To edit a network folder:

1. Launch a web browser from a computer or wireless device that is connected to the Smart Cradle.
2. In the address field of the browser, enter **http://netgear.cradle** or **http://192.168.100.1**.

A login prompt displays.

3. Enter the cradle user name and password.

The user name is **admin**. The default password is **password**. The user name and password are case-sensitive.

The BASIC Home screen displays.

4. Select **ADVANCED > USB Storage > Advanced Settings**.

The USB Storage (Advanced Settings) screen displays.

5. Click the **Edit** button.

The Edit Network Folder screen displays the same settings shown in the Add a Network Folder screen.

6. Change the settings in the fields as needed.

7. Click the **Apply** button.

Your changes are saved.

## Approve USB Devices

For more security, you can set up the cradle to share only USB devices that you approve.

### ➤ To approve USB devices:

1. Launch a web browser from a computer or wireless device that is connected to the Smart Cradle.

2. In the address field of the browser, enter **http://netgear.cradle** or **http://192.168.100.1**  
A login prompt displays.

3. Enter the cradle user name and password.

The user name is **admin**. The default password is **password**. The user name and password are case-sensitive.

The BASIC Home screen displays.

4. Select **ADVANCED > Advanced Setup > USB Settings**.



By default the **Enable any USB Device connection to the USB port** radio button is selected. This setting lets you connect and access all your USB devices.

5. Select the **No** radio button.

- Click the **Approved Devices** button.

USB Drive Approved Devices

Apply Refresh

Allow only approved devices

Approved USB Devices

	Volume Name	Device Name	Capacity
<input checked="" type="checkbox"/>	HP v100w	HP v100w	1.9GB

Delete

Available USB Devices

	Volume Name	Device Name	Capacity
<input checked="" type="checkbox"/>	HP v100w	HP v100w	1.9GB

Add

The approved and available USB devices display.

- In the Available USB Devices list, select the drive that you want to approve.
- Click the **Add** button.

The USB device is added to the Approved USB Devices list.

- Select the **Allow only approved devices** check box.
  - Click the **Apply** button.
- Your settings are saved.
- To work with another USB device, first click the **Safely Remove USB Device** button for the currently connected USB device. Connect the other USB device, and repeat this process.

## Safely Remove a USB Device

Before you physically disconnect a USB device from the cradle USB port, log in to the cradle and take the drive offline.

### ➤ To remove a USB disk drive safely:

- Launch a web browser from a computer or wireless device that is connected to the Smart Cradle.
- In the address field of the browser, enter **http://netgear.cradle** or **http://192.168.100.1**.

A login prompt displays.

- Enter the cradle user name and password.

The user name is **admin**. The default password is **password**. The user name and password are case-sensitive.

The BASIC Home screen displays.

- Select **USB Storage > Basic Settings**.

The USB Settings screen displays.

5. Click the **Safely Remove USB Device** button.

This takes the drive offline.

6. Physically disconnect the USB device.

# 9

## 9. Access USB Devices Through the Internet

---

With Dynamic DNS, you can use the Internet to access a USB hard drive attached to the Smart Cradle's USB port when you're not home. This chapter includes the following sections:

- *Access USB Devices Through the Internet*
- *Access USB Devices Through the Internet with FTP*
- *Your Personal FTP Server*
- *Set Up Your Personal FTP Server*

For information about how to connect the USB device and specify its settings, see *Chapter 8, Share a USB Device Attached to the AirCard Smart Cradle*.

## Access USB Devices Through the Internet

You can access USB devices through the Internet when you're not home.

➤ **To access USB devices from a remote computer:**

1. Launch a web browser on a computer that is not on your home network.
2. Connect to your Smart Cradle:

- To connect with Dynamic DNS, type the DNS name.

To use a Dynamic DNS account, you must enter the account information in the Dynamic DNS screen. See *Dynamic DNS* on page 131.

- To connect without Dynamic DNS, type the cradle's Internet port IP address.

You can view the cradle's Internet IP address on the BASIC Home screen.

You can use FTP to share files on a USB device connected to the cradle.

## Set Up FTP Access Through the Internet

➤ **To set up FTP access:**

1. Launch a web browser from a computer or wireless device that is connected to the Smart Cradle.
2. In the address field of the browser, enter **http://netgear.cradle** or **http://192.168.100.1**.  
A login prompt displays.
3. Enter the cradle user name and password.

The user name is **admin**. The default password is **password**. The user name and password are case-sensitive.

The BASIC Home screen displays.



4. Select **ADVANCED > USB Storage > Advanced Settings**.

USB Storage (Advanced Settings)

---

Network/Device Name :

Workgroup :

Enable	Access Method	Link	Port
<input checked="" type="checkbox"/>	Network Neighborhood/MacShare	\\readysshare	-
<input checked="" type="checkbox"/>	HTTP	http://readysshare.routerlogin.net/shares	80
<input type="checkbox"/>	HTTPS (via internet)	https://0.0.0.0/shares	443
<input type="checkbox"/>	FTP	ftp://readysshare.routerlogin.net/shares	21
<input type="checkbox"/>	FTP (via internet)	ftp://0.0.0.0/shares	21

---

Available Network Folders

	Share Name	Read Access	Write Access	Folder Name	Volume Name	Total Space	Free Space
<input checked="" type="radio"/>	\\readysshare\USB_Storage	All - no password	All - no password	U:\	TRAVELDRIVE	978.8M	171.8M

---

5. Select the **FTP (via Internet)** check box.

6. Click the **Apply** button.

Your changes are saved.

7. To limit access to the admin user, click the **Edit** button.

Edit Network Folder

---

USB Device	U: (HP v100w)
File System	FAT
Folder	U:\ <input type="button" value="Browse"/>
Share Name	USB_Storage
Read Access	admin
Write Access	admin

8. In the **Read Access** list, select **admin**.

9. In the **Write Access** list, select **admin**.

10. Click the **Apply** button.

Your changes are saved.

## Access USB Devices Through the Internet with FTP

You must first set up FTP through Internet access as described in [Set Up FTP Access Through the Internet](#) on page 128.

➤ **To access a USB device with FTP from a remote computer:**

1. To download, launch a web browser.
2. To upload, use an FTP client such as filezilla.
3. Type **ftp://** and the Internet port IP address in the address field of the browser.

For example, type **ftp://10.1.65.4**.

If you are using Dynamic DNS, type the DNS name.

For example, type **ftp://MyName.mynetgear.com**.

4. When prompted, log in:
  - To log in as admin, in the **user name** field, enter **admin** and in the **password** field, enter the same password that you use to log in to the cradle.
  - To log in as guest, in the **user name** field, enter **guest**.

The guest user name does not use a password. To restrict access to the USB device, you can specify that only the admin user can access it. See [Control Access to the USB Device](#) on page 119.

The files and folders display for the USB device that your account can access. For example, you might see `share/partition1/directory1`.

## Your Personal FTP Server

With your customized free URL, you can use FTP to access your network when you aren't home through Dynamic DNS. To set up your FTP server, you must register for a free

NETGEAR Dynamic DNS (DDNS) service account and specify the account settings. See [Set Up a New Dynamic DNS Account](#) on page 132.

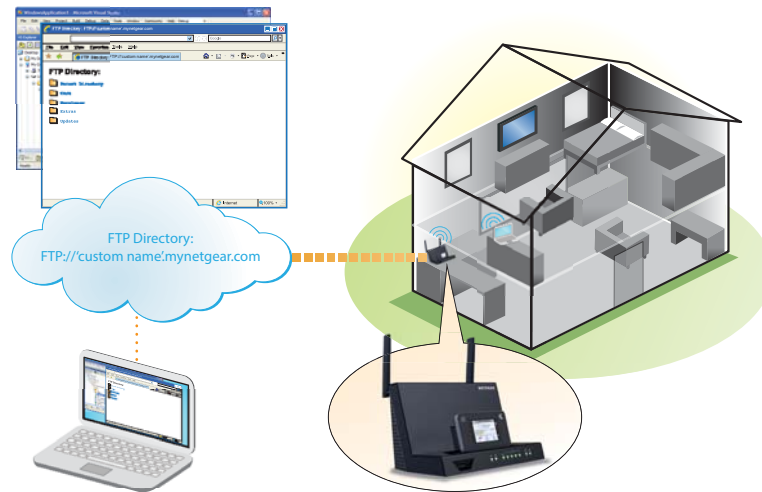

**Figure 9.** You can access your network through the Internet when you're not home

---

**Note:** The cradle supports only basic DDNS and the login and password might not be secure. You can use DDNS with a VPN tunnel for a secure connection.

---

## Dynamic DNS

Internet service providers (ISPs) assign numbers called IP addresses to identify each Internet account. Most ISPs use dynamically assigned IP addresses. This means that the IP address can change at any time. You can use the IP address to access your network remotely, but most people don't know what their IP addresses are or when this number changes.

To make it easier to connect, you can get a free account with a Dynamic DNS service that lets you use a domain name to access your home network. To use this account, you must set up the cradle to use Dynamic DNS. Then the cradle notifies the Dynamic DNS service provider whenever its IP address changes. When you access your Dynamic DNS account, the service finds the current IP address of your home network and automatically connects you.

If your ISP assigns a private WAN IP address (such as 192.168.x.x or 10.x.x.x), the Dynamic DNS service does not work because private addresses are not routed on the Internet.

## Set Up a New Dynamic DNS Account

➤ **To set up Dynamic DNS and register for a free NETGEAR account:**

1. Launch a web browser from a computer or wireless device that is connected to the Smart Cradle.
2. In the address field of the browser, enter **http://netgear.cradle** or **http://192.168.100.1**.

A login prompt displays.

3. Enter the cradle user name and password.

The user name is **admin**. The default password is **password**. The user name and password are case-sensitive.

The BASIC Home screen displays.

4. Select **ADVANCED > Advanced Settings > Dynamic DNS**.

Dynamic DNS

powered by no-ip

Use a Dynamic DNS Service

Service Provider: NETGEAR

Do you have a NETGEAR DDNS or a No-IP DDNS account?

Yes  
 No

Please enter the following information for registration.

Host Name: \_\_\_\_\_ .mynetgear.com

Email: \_\_\_\_\_

Password (6-32 characters): \_\_\_\_\_

By submitting this form I agree to the [terms of service](#) and that I will only create one free account.

5. Select the **Use a Dynamic DNS Service** check box.
6. In the **Service Provider** list, select **NETGEAR**.
7. Select the **No** radio button.
8. In the **Host Name** field, type the name that you want to use for your URL.  
The host name is sometimes called the domain name. Your free URL includes the host name that you specify and ends with mynetgear.com. For example, specify *MyName.mynetgear.com*.
9. In the **Email** field, type the email address for your account.
10. In the **Password (6-32 characters)** field, type the password for your account.
11. Click the **Register** button.
12. Follow the onscreen instructions to register for your NETGEAR Dynamic DNS service.

## Specify a DNS Account That You Already Use

If you already use a Dynamic DNS account with NETGEAR no-ip, www.no-ip.com, or Dyn.com, you can set up the cradle to use your account.

➤ **To set up Dynamic DNS if you already use an account:**

1. Launch a web browser from a computer or wireless device that is connected to the Smart Cradle.
2. In the address field of the browser, enter **http://netgear.cradle** or **http://192.168.100.1**.  
A login prompt displays.

3. Enter the cradle user name and password.

The user name is **admin**. The default password is **password**. The user name and password are case-sensitive.

The BASIC Home screen displays.

4. Select **ADVANCED > Advanced Settings > Dynamic DNS**.

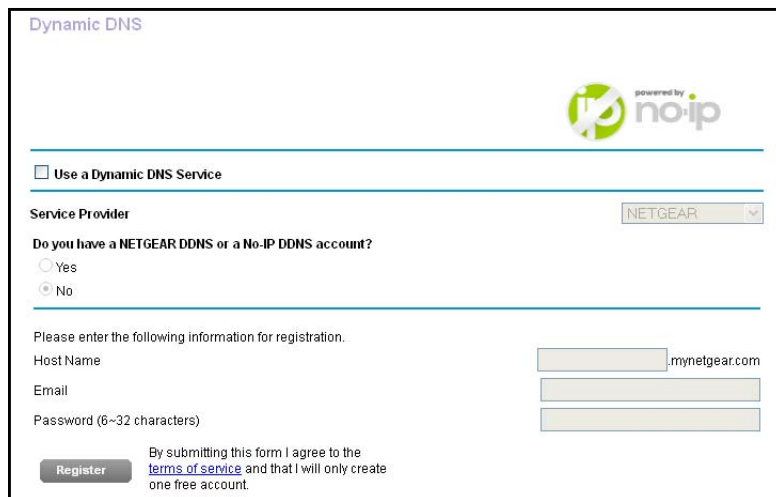

5. Select the **Use a Dynamic DNS Service** check box.

6. Select a service provider from the list.

7. Select the **Yes** radio button.

The screen adjusts and displays the **Show Status**, **Cancel**, and **Apply** buttons.

8. In the **Host Name** field, type the host name (sometimes called the domain name) for your account.
9. For a www.no-ip or Dyn.com account, in the **User Name** field, type the user name for your account.
10. For a NETGEAR account at www.no-ip, in the **Email** field, type the email address for your account.
11. In the **Password (6-32 characters)** field, type the password for your DDNS account.
12. Click the **Apply** button.

Your changes are saved.

13. To verify that your Dynamic DNS service is enabled in the cradle, click the **Show Status** button.

A message displays the Dynamic DNS status.

## Change the Dynamic DNS Settings

### ➤ To change your settings:

1. Launch a web browser from a computer or wireless device that is connected to the Smart Cradle.

2. In the address field of the browser, enter **http://netgear.cradle** or **http://192.168.100.1**.

A login prompt displays.

3. Enter the cradle user name and password.

The user name is **admin**. The default password is **password**. The user name and password are case-sensitive.

The BASIC Home screen displays.

4. Select **ADVANCED > Advanced Settings > Dynamic DNS**.

The Dynamic DNS screen displays.

5. Change your DDNS account settings as necessary.

6. Click the **Apply** button.

Your changes are saved.

## Set Up Your Personal FTP Server

### ➤ To set up your personal account and use FTP:

1. Get your free NETGEAR Dynamic DNS domain name.

See *Your Personal FTP Server* on page 130.

2. Make sure that your Internet connection is working.

Your cradle must use a direct Internet connection. It cannot connect to a different router to access the Internet.

3. Connect a USB hard disk drive to the USB port on the cradle.

4. Set up FTP access in the cradle.

See *Set Up FTP Access Through the Internet* on page 128.

5. On a remote computer with Internet access, you can use FTP to access your cradle using `ftp://yourname.mynetgear.com`.

## 10. Share a USB Printer

---

# 10

The ReadySHARE Printer utility lets you share a USB printer that is connected to the USB port on your cradle. You can share this USB printer among the Windows and Mac computers on your network.

This chapter contains the following sections:

- *Install the Printer Driver and Cable the Printer*
- *Download the ReadySHARE Printer Utility*
- *Install the ReadySHARE Printer Utility*
- *Use the Shared Printer*
- *View or Change the Status of a Printer*
- *Use the Scan Feature of a Multifunction USB Printer*
- *Change NETGEAR USB Control Center Settings*

## Install the Printer Driver and Cable the Printer

Some USB printer manufacturers (for example, HP and Lexmark) request that you do not connect the USB cable until the installation software prompts you to do so.

➤ **To install the driver and cable the printer:**

1. On each computer on your network that shares the USB printer, install the driver software for the USB printer.

If you cannot find the printer driver, contact the printer manufacturer.

2. Use a USB printer cable to connect the USB printer to the cradle USB port.

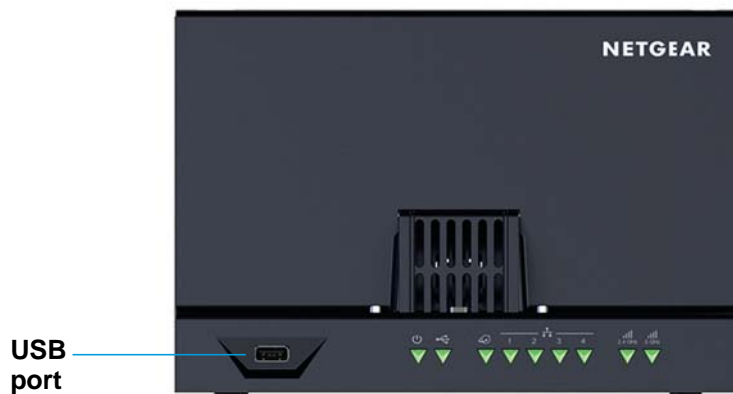

## Download the ReadySHARE Printer Utility

The utility works on Windows and Mac computers.



➤ **To download the utility:**

1. Visit [www.netgear.com/readysware](http://www.netgear.com/readysware).



2. In the ReadySHARE Printer pane, click the **PC Utility** or **Mac Utility** link.
3. Follow the onscreen instructions to download the file.

## Install the ReadySHARE Printer Utility

You must install the ReadySHARE Printer utility on each computer that will share the printer. After you install it, the utility displays as NETGEAR USB Control Center on your computer.

➤ **To install the utility:**

1. Double-click the ReadySHARE Printer utility setup file that you downloaded.

The InstallShield wizard displays.



2. Follow the wizard instructions to install NETGEAR USB Control Center.

After the InstallShield Wizard completes the installation, the NETGEAR USB Control Center prompts you to select a language:



3. Select a language from the list and click the **OK** button.

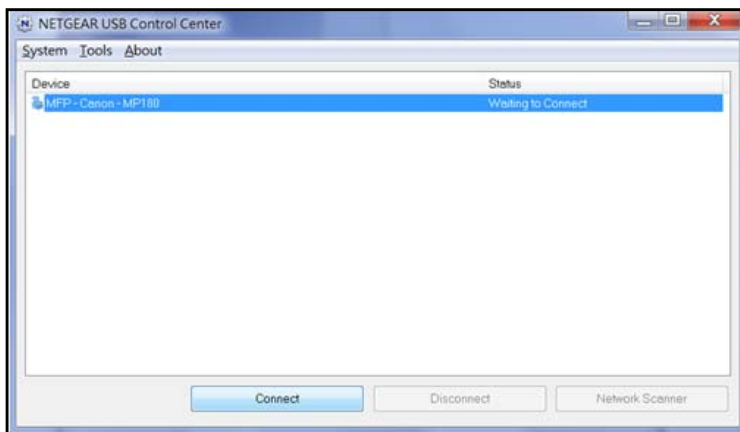

Some firewall software, such as Comodo, blocks NETGEAR USB Control Center from accessing the USB printer. If you do not see the USB printer displayed in the screen, you can disable the firewall temporarily to allow the utility to work.

4. Select the printer and click the **Connect** button.

The printer status changes to Manually connected by *Mycomputer*. Now only your computer can use the printer.

5. Click the **Disconnect** button.

The status changes to Available. Now all computers on the network can use the printer.

6. To exit the utility, select **System > Exit**.

## Use the Shared Printer

For each computer, after you click the **Connect** and **Disconnect** buttons once, the utility automatically manages the printing queue and handling. By default, the utility starts automatically whenever you log on to Windows and runs in the background.

➤ **To manually connect and print:**

1. Click the **NETGEAR USB Control Center** icon .

The main screen displays.

2. Click the **Connect** button.

The printer status changes to Manually connected by *Mycomputer*. Now, only the computer you are using can use this printer.

3. Use the print feature in your application to print your document.
4. To release the printer so that all computers on the network can use it, click the **Disconnect** button.

➤ **To print and release the printer to any computer on the network:**

1. To print your document, use the print feature in your application.

The NETGEAR USB Control Center automatically connects your computer to the USB printer and prints the document. If another computer is already connected to the printer, your print job goes into a queue to wait to be printed.

2. If your document does not print, use the NETGEAR USB Control Center to check the status. See [View or Change the Status of a Printer](#).

## View or Change the Status of a Printer

➤ **To view or change the status:**

1. Click the **NETGEAR USB Control Center** icon .

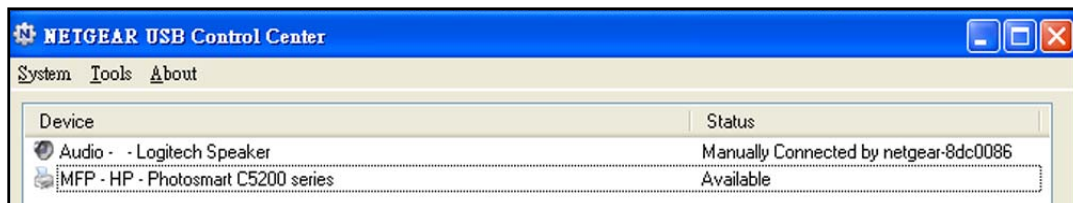

The Status column shows the status for each device:

- **Available.** No print jobs are in process. You can use the USB printer from any computer in the network.
  - **Connected.** Your computer is connected to the printer and will be released when your print job is done.
  - **Manually Connected by.** Only the connected computer can use the printer.
  - **Waiting to Connect.** Your computer is not connected to the shared printer yet.
2. To print from your computer when the status shows Manually connected by *another computer*, click the **Disconnect** button.

The printer is released from the connection and the status changes to Available.

3. To print from your computer when the status shows Waiting to Connect:

- a. Click the **Connect** button.

The printer status changes to Manually connected by *Mycomputer*. Now, only your computer can use the printer.

- b. To allow the printer to be shared, click the **Disconnect** button.

The printer is released from the connection and the status changes to Available.

## Use the Scan Feature of a Multifunction USB Printer

If your USB printer supports scanning, you can also use the USB printer for scanning. For example, the USB printer displayed in the Windows Printers and Faxes window is ready for print jobs.

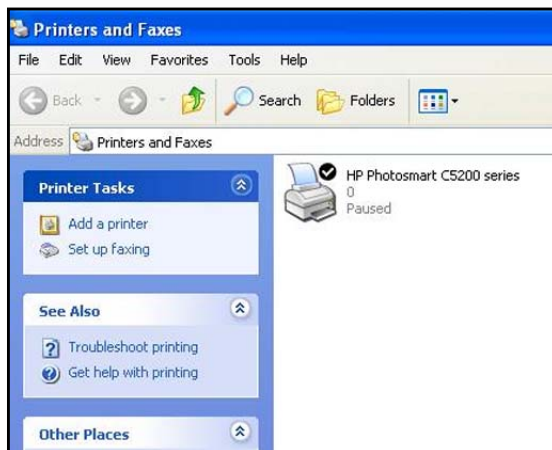

- To use the scan feature of a multifunction USB printer:

1. Click the **NETGEAR USB Control Center** icon .

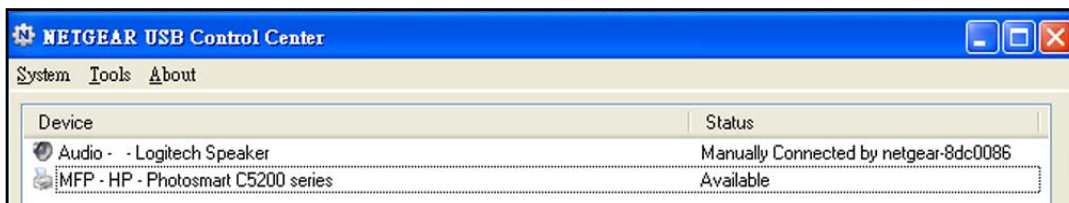

2. Make sure that the printer status shows as Available.

3. Click the **Network Scanner** button.

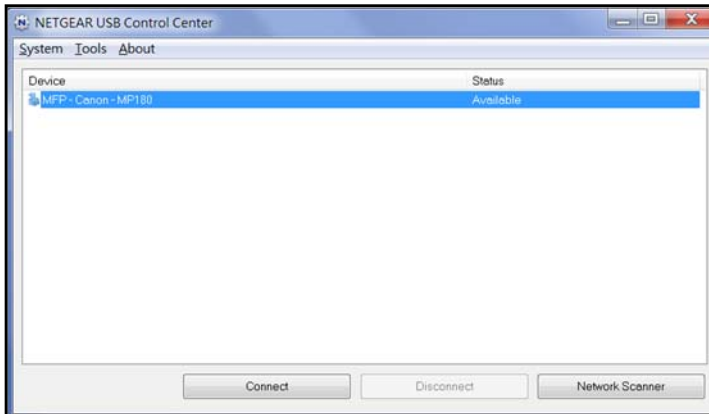

The scanner screen displays so that you can use the USB printer for scanning.

## Change NETGEAR USB Control Center Settings

You can stop the NETGEAR USB Control Center from starting automatically when you log in to Windows. You can also change the language and specify the time-out to release the printer connection.

- **To turn off automatic NETGEAR USB Control Center startup:**

1. Click the **NETGEAR USB Control Center** icon .

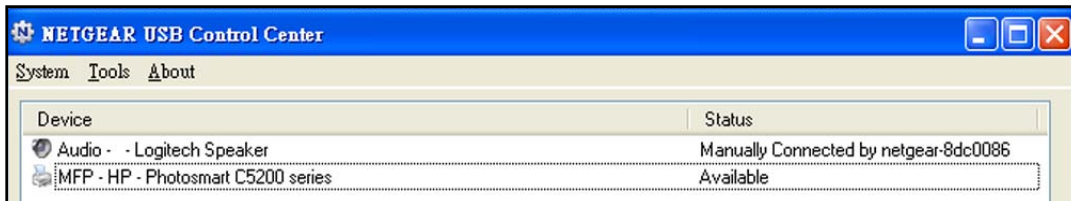

2. Select **Tools > Configuration**.

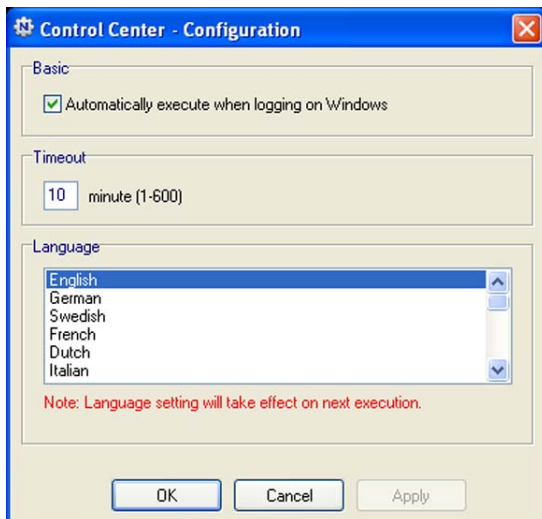

3. Clear the **Automatically execute when logging on Windows** check box.

4. Click the **OK** button.

Your change is saved.

➤ **To change the language:**

1. Click the **NETGEAR USB Control Center** icon .

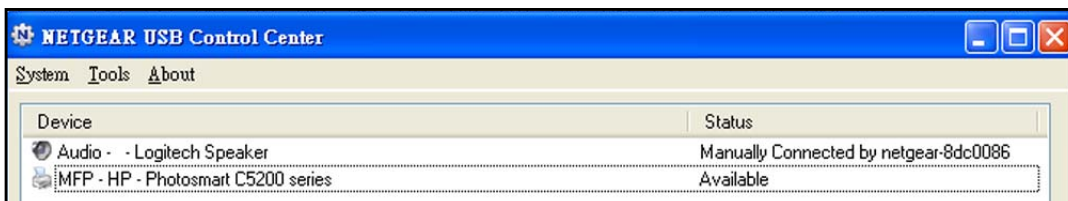

2. Select **Tools > Configuration**.

3. In the **Language** list, select a language.

4. Click the **OK** button.

The next time NETGEAR USB Control Center starts, the language changes.

➤ **To specify the time-out:**

1. Click the **NETGEAR USB Control Center** icon .

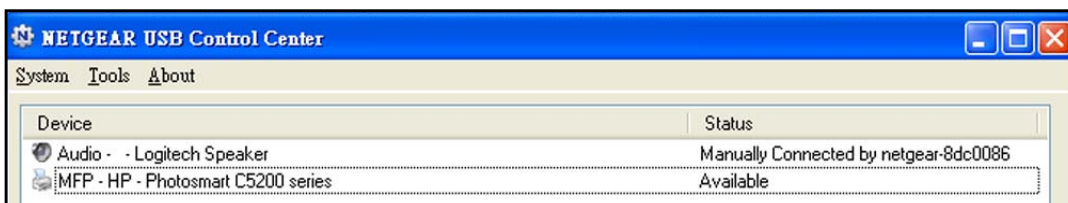

2. Select **Tools > Configuration**.

3. In the **Timeout** field, type the number of minutes.

The time-out is the number of minutes that a computer holds its connection to the printer when the connection isn't being used.

4. Click the **OK** button.

Your change is saved.

# 11 Troubleshooting

---

# 11

This chapter provides information to help you diagnose and solve problems you might have with your cradle.

This chapter contains the following sections:

- *Troubleshoot with the LEDs*
- *Cannot Log In to the Cradle*
- *Cannot Access the Internet*
- *Changes Not Saved*
- *Cellular Network Connectivity*
- *WiFi Connectivity*
- *Troubleshoot Your Network Using the Ping Utility*



## Troubleshoot with the LEDs

You can use the LEDs to help identify the cause of problems and troubleshoot.

### Standard LED Behavior When the AirCard Smart Cradle is Powered On

After you turn on power to the cradle, verify that the following sequence of events occurs:

1. When power is first applied, verify that the Power LED  is lit.
2. After approximately 30 seconds, verify the following:
  - The Power LED is solid green.
  - The Internet LED is lit.
  - The WiFi LED is lit unless you turned off the wireless radio.

You can use the LEDs on the front panel of the cradle for troubleshooting.

### Power LED Is Off or Blinking

Make sure that the power adapter is securely connected to your cradle and securely connected to a working power outlet.

Check that you are using the power adapter that NETGEAR supplied for this product.

If the Power LED blinks slowly and continuously, the cradle firmware is corrupted. This can happen if a firmware upgrade is interrupted, or if the cradle detects a problem with the firmware. If the error persists, a hardware problem occurred.

### Power LED Stays Amber

When the cradle is turned on, the Power LED turns amber for about 20 seconds and then turns green. If the LED does not turn green, a problem occurred in cradle.

If the Power LED is still amber one minute after you turn on power to the cradle, do the following:

1. Turn off the power and then turn it back on to see if the cradle recovers.
2. Press and hold the **Reset** button to return the cradle to its factory settings.

See *Factory Settings* on page 154.

If the error persists, it is possible that a hardware problem occurred.

### LEDs Never Turn Off

When the cradle is turned on, the LEDs light for about 10 seconds and then turn off. If all the LEDs stay on, this indicates a fault within the cradle.

If all LEDs are still lit one minute after power-up, do the following:

- Cycle the power to see if the cradle recovers.
- Press and hold the **Reset** button to return the cradle to its factory settings. For more information, see *Factory Settings* on page 154.

If the error persists, it is possible that a hardware problem occurred.

## Internet LED Is Off

If the Internet LED does not light, check the following:

- The mobile hotspot might not be securely docked. Undock the mobile hotspot and then dock it again.
- For an Ethernet WAN connection, make sure that the Ethernet cable connections are secure at the cradle and at the modem or computer.
- Make sure that power is turned on to the connected modem or computer.
- Be sure that you are using the correct cable.

## WiFi LEDs Are Off

If the WiFi LED stays off, check to see if someone logged in and disabled the wireless radios. The WiFi LEDs are lit when the wireless radio is turned on.

## Cannot Log In to the Cradle

If you are unable to log in to the cradle from a computer on your local network, check the following:

- If you are using an Ethernet-connected computer, check the Ethernet connection between the computer and the cradle.
- Make sure that the IP address of your computer is on the same subnet as the cradle. If you are using the recommended addressing scheme, your computer's address is in the range of 192.168.100.2 to 192.168.100.254.
- If your computer's IP address is shown as 169.254.x.x, recent versions of Windows and Mac OS generate and assign an IP address if the computer cannot reach a DHCP server. These autogenerated addresses are in the range of 169.254.x.x. If your IP address is in this range, check the connection from the computer to the cradle, and reboot your computer.
- If your cradle's IP address was changed and you do not know the current IP address, clear the cradle's configuration to factory defaults. This sets the cradle's IP address to 192.168.100.1. For more information, see *Factory Settings* on page 154.
- Make sure that your Java, JavaScript, or ActiveX is enabled in your browser. If you are using Internet Explorer, click the **Refresh** button to be sure that the Java applet is loaded.
- Try quitting the browser and launching it again.

- Make sure that you are using the correct login information. The user name is **admin**, and the default password is **password**. Make sure that Caps Lock is off when you enter this information.
- If you are attempting to set up your NETGEAR cradle as a replacement for an ADSL gateway in your network, the cradle cannot perform many gateway services. For example, the cradle cannot convert ADSL or cable data into Ethernet networking information.

## Cannot Access the Internet

If you can access your cradle but not the Internet, check to see if the cradle can obtain an IP address from your Internet service provider (ISP). Unless your ISP provides a fixed IP address, your cradle requests an IP address from the ISP. You can determine whether the request was successful using the ADVANCED Home screen.

### ➤ To check the WAN IP address:

1. Launch a web browser from a computer or wireless device that is connected to the Smart Cradle.
2. In the address field of the browser, enter **http://netgear.cradle** or **http://192.168.100.1**  
A login prompt displays.
3. Enter the cradle user name and password.

The user name is **admin**. The default password is **password**. The user name and password are case-sensitive.

The BASIC Home screen displays.

4. Click the **ADVANCED** tab.  
The ADVANCED Home screen displays.
5. Check that an IP address is shown for the Internet port. If 0.0.0.0 is shown, your cradle did not obtain an IP address from your ISP.

If your cradle cannot obtain an IP address from the ISP, you might need to force your cable or DSL modem to recognize your new cradle by restarting your network.

If your cradle is still unable to obtain an IP address from the ISP, the problem might be one of the following:

- Your Internet service provider (ISP) might require a login program. Ask your ISP whether they require PPP over Ethernet (PPPoE) or some other type of login.
- If your ISP requires a login, the login name and password might be set incorrectly.
- Your ISP might check for your computer's host name. Assign the computer host name of your ISP account as the account name in the Internet Setup screen.

- If your ISP allows only one Ethernet MAC address to connect to Internet and might check for your computer's MAC address. In this case, do one of the following:
  - Inform your ISP that you have bought a new network device, and ask them to use the cradle's MAC address.
  - Configure your cradle to clone your computer's MAC address.

If your cradle was assigned an IP address but your computer does not load any web pages from the Internet, it might be due to one or more of the following reasons:

- Your computer might not recognize any DNS server addresses.

A DNS server is a host on the Internet that translates Internet names (such as www addresses) to numeric IP addresses. Typically, your ISP provides the addresses of one or two DNS servers for your use. If you entered a DNS address during the cradle's configuration, reboot your computer, and verify the DNS address. You can configure your computer manually with DNS addresses, as explained in your operating system documentation.
- The cradle might not be configured as the TCP/IP gateway on your computer.

If your computer obtains its information from the cradle by DHCP, reboot the computer, and verify the gateway address.
- You might be running login software that is no longer needed.

If your ISP provided a program to log you in to the Internet (such as WinPoET), you no longer need to run that software after installing your cradle. You might need to go to Internet Explorer and select **Tools > Internet Options**, click the **Connections** tab, and select **Never dial a connection**. Other browsers provide similar options.

## Troubleshoot PPPoE

If you are using PPPoE, try troubleshooting your Internet connection.

### ➤ To troubleshoot a PPPoE connection:

1. Launch a web browser from a computer or wireless device that is connected to the Smart Cradle.
2. In the address field of the browser, enter **http://netgear.cradle** or **http://192.168.100.1**

A login prompt displays.
3. Enter the cradle user name and password.

The user name is **admin**. The default password is **password**. The user name and password are case-sensitive.

The BASIC Home screen displays.
4. Click the **ADVANCED** tab.

The ADVANCED Home screen displays.
5. In the Internet Port pane, click the **Connection Status** button.

The Connection Status screen displays.

6. Check the Connection Status screen to see if your PPPoE connection is up and working. If the connection is not working, click the **Connect** button.

The cradle continues to attempt to connect indefinitely.

7. If you cannot connect after several minutes, the cradle might be set up with an incorrect service name, user name, or password, or your ISP might be experiencing a provisioning problem.

Unless you connect manually, the cradle does not authenticate using PPPoE until data is transmitted to the network.

## Troubleshoot Internet Browsing

If your cradle can obtain an IP address but your computer is unable to load any web pages from the Internet, check the following:

- Your computer might not recognize any DNS server addresses. A DNS server is a host on the Internet that translates Internet names (such as www addresses) to numeric IP addresses.

Typically, your ISP provides the addresses of one or two DNS servers for your use. If you entered a DNS address during the cradle's configuration, restart your computer.

Alternatively, you can configure your computer manually with a DNS address, as explained in the documentation for your computer.

- The cradle might not be configured as the default gateway in your computer.

Reboot the computer and verify that the cradle address (192.168.100.1) is listed by your computer as the default gateway address.

- You might be running login software that is no longer needed. If your ISP provided a program to log you in to the Internet (such as WinPoET), you no longer need to run that software after installing your cradle. You might need to go to Internet Explorer and select **Tools > Internet Options**, click the **Connections** tab, and select the **Never dial a connection**. Other browsers have similar features.

## Changes Not Saved

If the cradle does not save the changes you make in the cradle interface, do the following:

- When entering configuration settings, always click the **Apply** button before moving to another screen or tab, or your changes are lost.
- Click the **Refresh** or **Reload** button in the web browser. It is possible that the changes occurred, but the old settings might be in the web browser's cache.

## Cellular Network Connectivity

If you are not able to access the Internet through the cellular network, do the following:

- Make sure you are in an area with cellular network coverage by checking if your phone has signal.
- Make sure that the Internet service for your mobile hotspot is active and the SIM card is correctly installed.
- Make sure that the Auto connect feature on the mobile hotspot is set to ON.

## WiFi Connectivity

If you are experiencing trouble connecting wirelessly to the cradle, try to isolate the problem:

- Does the wireless device or computer that you are using find your wireless network?

If not, check the WiFi LED on the front of the cradle. If it is off, you can press the **WiFi On/Off** button on the cradle to turn the cradle wireless radios back on.

If you disabled the cradle's SSID broadcast, then your wireless network is hidden and does not display in your wireless client's scanning list. (By default, SSID broadcast is enabled.)

- Does your wireless device support the security that you are using for your wireless network (WPA or WPA2)?
- If you want to view the wireless settings for the cradle, use an Ethernet cable to connect a computer to a LAN port on the cradle. Then log in to the cradle and select **BASIC > Wireless**.

**Note:** Be sure to click the **Apply** button if you change settings.

If your wireless device finds your network but the signal strength is weak, check these conditions:

- Is your cradle too far from your computer or too close? Place your computer near the cradle but at least 6 feet (1.8 meters) away and see whether the signal strength improves.
- Are objects between the cradle and your computer blocking the WiFi signal?

## Troubleshoot Your Network Using the Ping Utility

Most network devices and routers contain a ping utility that sends an echo request packet to the designated device. The device then responds with an echo reply. You can easily troubleshoot a network using the ping utility in your computer or workstation.

## Test the LAN Path to Your Smart Cradle

You can ping the cradle from your computer to verify that the LAN path to your cradle is set up correctly.

➤ **To ping the cradle from a Windows computer:**

1. From the Windows toolbar, click **Start** and select **Run**.
2. In the field provided, type `ping` followed by the IP address of the cradle, as in this example:

```
ping http://192.168.100.1
```

3. Click the **OK** button.

You see a message like this one:

```
Pinging <IP address > with 32 bytes of data
```

If the path is working, you see this message:

```
Reply from < IP address >: bytes=32 time=NN ms TTL=xxx
```

If the path is not working, you see this message:

```
Request timed out
```

If the path is not functioning correctly, you might be experiencing one of the following problems:

- Wrong physical connections

For a wired connection, make sure that the numbered LAN port LED is lit for the port to which you are connected.

Check that the appropriate LEDs are on for your network devices. If your cradle and computer are connected to a separate Ethernet switch, make sure that the link LEDs are lit for the switch ports that are connected to your computer and cradle.

- Wrong network configuration

Verify that the Ethernet card driver software and TCP/IP software are both installed and configured on your computer.

Verify that the IP address for your cradle and your computer are correct and that the addresses are on the same subnet.

## Test the Path from Your Computer to a Remote Device

After verifying that the LAN path works correctly, test the path from your computer to a remote device.

1. From the Windows toolbar, click the **Start** button and select **Run**.
2. In the Windows Run window, type

```
ping -n 10 <IP address>
```

where <IP address> is the IP address of a remote device such as your ISP DNS server.

If the path is functioning correctly, messages display that are similar to those shown in [Test the LAN Path to Your Smart Cradle](#) on page 151.

If you do not receive replies, check the following:

- Check that the IP address of your cradle listed in your computer as the default gateway. If DHCP assigns the IP configuration of your computers, this information is not visible in your computer Network Control Panel.
- Check to see that the network address of your computer (the portion of the IP address specified by the subnet mask) is different from the network address of the remote device.
- Check that your cable or DSL modem is connected and functioning.
- If your ISP assigned a host name to your computer, enter that host name as the account name in the Internet Setup screen.
- Your ISP might be rejecting the Ethernet MAC addresses of all but one of your computers.

Many broadband ISPs restrict access by allowing traffic only from the MAC address of your broadband modem. Some ISPs additionally restrict access to the MAC address of a single computer connected to that modem. If your ISP does this, configure your cradle to “clone” or “spoof” the MAC address from the authorized computer.



# A Supplemental Information

---

# A

This appendix includes technical information about your Smart Cradle.

This appendix covers the following topics:

- *Factory Settings*
- *Technical Specifications*

## Factory Settings

You can return the AirCard Smart Cradle its factory settings. Use the end of a paper clip or a similar object to press and hold the **Reset** button on the back of the AirCard Smart Cradle for at least seven seconds. The AirCard Smart Cradle resets and cradle returns to the factory configuration settings shown in the following table. When the AirCard Smart Cradle restarts, all LEDs on the front panel light.

**Table 3. Factory default settings**

Feature		Default behavior
Smart Cradle login	User login URL	netgear.cradle or http://192.168.100.1
	User name (case-sensitive)	admin
	Login password (case-sensitive)	password
Internet connection	WAN MAC address	Use default hardware address
	WAN MTU size	1500
	Port speed	AutoSensing
Local network (LAN)	LAN IP	http://192.168.100.1
	Subnet mask	255.255.255.0
	DHCP server	Enabled
	DHCP range	192.168.100.2 to 192.168.100.254
	Time zone	Pacific time
	DHCP starting IP address	192.168.100.2
	DHCP ending IP address	192.168.100.254
	DMZ	Disabled
	Time zone	GMT for WW except NA and GR, GMT+1 for GR, GMT-8 for NA, GMT+10 for AU
	Time zone adjusted for daylight saving time	Disabled
	SNMP	Disabled
Firewall	Inbound (communications coming in from the Internet)	Disabled (except traffic on port 80, the HTTP port)
	Outbound (communications going out to the Internet)	Enabled (all)
	Source MAC filtering	Disabled

**Table 3. Factory default settings (continued)**

Feature		Default behavior
WiFi	Wireless communication	Enabled
	SSID name	See the product label
	WiFi password or security key	See the product label.
	Security	WPA2-PSK (AES)
	Broadcast SSID	Enabled
	Transmission speed	Auto <sup>1</sup>
	Country/region	United States in the US; otherwise, varies by region
	RF channel	2.4GHz, CH 153 for 5 GHz (depending on the region)
	Operating mode	Up to 300 Mbps at 2.4 GHz, 867 Mbps at 5 GHz

*1. Maximum wireless signal rate derived from IEEE Standard 802.11 specifications. Actual throughput can vary. Network conditions and environmental factors, including volume of network traffic, building materials and construction, and network overhead, lower actual data throughput rate*

## Technical Specifications

**Table 4. Cradle specifications**

Feature	Description
Data and routing protocols	TCP/IP, RIP-1, RIP-2, DHCP, PPPoE, PPTP, Dynamic DNS, UPnP, and SMB
Power adapter	240V, 50 Hz, input 12V/2.5A DC output
Dimensions	157 x 230.4 x 148.75 mm (6.18 x 9.07 x 5.86 in.)
Weight	800 g (1.76 lbs)
Operating temperature	0° to 40° C (32° to 104° F)
Operating humidity	90% maximum relative humidity, noncondensing
LAN	10BASE-T or 100BASE-TX or 1000BASE-T, RJ-45
WAN	10BASE-T or 100BASE-TX or 1000BASE-T, RJ-45
Wireless	Maximum wireless signal rate complies with the IEEE 802.11 standard. <sup>1</sup>
Radio data rates	Auto Rate Sensing
Data encoding standards	<ul style="list-style-type: none"> <li>• IEEE® 802.11 b/g/n 2.4 GH</li> <li>• IEEE® 802.11 a/n/ac 5.0 GHz</li> </ul>
Maximum computers per wireless network	Limited by the amount of wireless network traffic generated by each node (typically 15 nodes).
Frequency bands supported	700 MHz (B28) / 850 MHz (B5) / 900 MHz (B8) / 1800 MHz (B3) / 1900 MHz (B2) / 2100 MHz (B1) 2600 (B7)
External WiFi frequency range	2.4 GHz and 5 GHz
LTE bands	700/850/900/1800/2100/2600 MHz with 2 x 2 MIMO
HSPA + DC	850/900/1900/2100 MHz
802.11 security	<ul style="list-style-type: none"> <li>• WPA2-PSK(AES)</li> <li>• WPA-PSK(TKIP) + WPA2-PSK (AES)</li> <li>• WPA/WPA2 Enterprise</li> </ul>

<sup>1</sup>. Maximum wireless signal rate derived from IEEE Standard 802.11 specifications. Actual throughput can vary. Network conditions and environmental factors, including volume of network traffic, building materials and construction, and network overhead, lower actual data throughput rate.

# Tips and Safety Guidelines for Lithium-Ion Batteries

---

## Battery Tips

- Charge batteries in a room-temperature environment, which is generally between 68° F and 79° F (20° C and 26° C). Charging may be temporarily disabled if the battery temperature exceeds 113° F (60° C).
- If a battery exhibits significantly shorter runtime or discharge capacity compared to new, it may have reached the end of its reasonable lifetime; consider replacing it.
- A battery that does not charge or exhibits excessive charging time may have reached the end of its life and may need to be replaced.
- All batteries degrade and lose charge capacity over time as a result of use or storage, and eventually need to be replaced.
- Batteries are best stored in a cool, dark, dry place. Avoid storage in direct sunlight and in vehicles parked outdoors.
- Batteries may get warm while charging and discharging; this is normal behavior for all batteries.
- Use the AC adapter and the USB cable that came with this device.
- Use the latest firmware; check for updates on a regular basis.
- Device performance and runtime are affected by workload or usage. Higher workloads or usage can lead to higher battery temperatures and faster battery power consumption.
- Streaming large amounts of data affects the power consumption and reduces the operating time of the battery.

## General Battery Safety

- Stop using a battery if its case appears damaged, swollen, or compromised. Examples include, but are not limited to, leaking, odors, dents, corrosion, rust, cracks, swelling, melting, and scratches.
- Do not expose batteries to fire or other heat- generating environments.
- Do not place the battery or the device in areas that may get hot. Examples include, but are not limited to, on or near a space heater, cooking surface, cooking appliance, iron, radiator, or fireplace.

- Do not get the battery or the device wet. Even though they may dry and appear to operate normally, the circuitry can slowly corrode and defeat its safety circuitry.
- Do not crush, puncture, deform, or put a high degree of pressure on the battery, which can cause an internal short circuit, resulting in overheating.
- Avoid dropping the battery or the device. Dropping it, especially on a hard surface, may cause damage to the battery and the device. If you suspect damage to the battery or the device, replace it.
- When the battery is outside the device, do not allow the battery to come in contact with metal objects, such as coins, keys, jewelry, or tools.
- Do not disassemble or modify batteries. Do not use a battery for anything other than its intended purpose.

## Appropriate Batteries and Chargers

- Use only approved batteries in the device. Only purchase products and accessories recommended by NETGEAR or your carrier. Use of unapproved batteries, products, or accessories will void your warranty.
- Do not use incompatible batteries and chargers. Some websites and second-hand dealers, not associated with reputable manufacturers and carriers, may sell incompatible or even counterfeit batteries and chargers.
- If you are unsure about whether a replacement battery or charger is compatible, contact NETGEAR.

## Battery Disposal

- Disposal regulations vary by region. Dispose of old batteries and equipment in compliance with your local regulations.
- Proper disposal might include recycling programs for batteries, cell phones, or other electronic waste.
- Do not dispose of batteries in a fire.