

55BDL5055P/11
V1.10



www.philips.com/welcome
User Manual (English)

PHILIPS
Signage*Solutions*

Safety Instructions

Safety precautions and maintenance



WARNING: Use of controls, adjustments or procedures other than those specified in this documentation may result in exposure to shock, electrical hazards and/or mechanical hazards.

Read and follow these instructions when connecting and using your display:

Operation:

- Keep the display out of direct sunlight and away from stoves or any other heat sources.
- Remove any object that could fall into ventilation holes or prevent proper cooling of the display's electronics.
- Do not block the ventilation holes on the cabinet.
- When positioning the display, make sure the power plug and outlet are easily accessible.
- When turning off the display by detaching the power cord, wait 6 seconds before re-attaching the power cord for normal operation.
- Ensure the use of an approved power cord provided by Philips at all times. If your power cord is missing, please contact your local service center.
- Do not subject the display to severe vibration or high impact conditions during operation.
- Do not knock or drop the display during operation or transportation.
- For doors or covers intended to be removed by operator for installation of accessory devices, instructions shall be provided for the correct removal and reinstallation of the door.

Maintenance:

- To protect your display from possible damage, do not put excessive pressure on the LCD panel. When moving your display, grasp the frame to lift; do not lift the display by placing your hand or fingers on the LCD panel.
- Unplug the display if you are not going to use it for an extensive period of time.
- Unplug the display if you need to clean it with a slightly damp cloth. The screen may be wiped with a dry cloth when the power is off. However, never use organic solvent, such as, alcohol, or ammonia-based liquids to clean your display.
- To avoid the risk of shock or permanent damage to the set, do not expose the display to dust, rain, water or an excessively moist environment.
- If your display becomes wet, wipe it with dry cloth as soon as possible.
- If a foreign substance or water gets in your display, turn the power off immediately and disconnect the power cord. Then remove the foreign substance or water, and send the unit to the maintenance center.
- Do not store or use the display in locations exposed to heat, direct sunlight or extreme cold.
- In order to maintain the best performance of your display and ensure a longer lifetime, we strongly recommend using the display in a location that falls within the following temperature and humidity ranges.
 - Temperature: 0-40°C 32-104°F
 - Humidity: 20-80% RH

IMPORTANT: Always activate a moving screen saver program when you leave your display unattended. Always activate a periodic screen refresh application if the unit will display unchanging static content. Uninterrupted display of still or static images over an extended period may cause "burn in", also known as "after-imaging" or "ghost imaging", on your screen. This is a well-known phenomenon in LCD panel technology. In most cases, the "burned in" or "after-imaging" or "ghost imaging" will disappear gradually over a period of time after the power has been switched off.

WARNING: Severe "burn-in" or "after-image" or "ghost image" symptoms will not disappear and cannot be repaired. This is also not covered under the terms of your warranty.

Service:

- The casing cover should be opened only by qualified service personnel.
- If there is any need for repair or integration, please contact your local service center.
- Do not leave your display under direct sunlight.



If your display does not operate normally, having followed the instructions set out in this document, please contact a technician or your local service center.

Read and follow these instructions when connecting and using your display:

- Unplug the display if you are not going to use it for an extensive period of time.
- Unplug the display if you need to clean it with a slightly damp cloth. The screen may be wiped with a dry cloth when the power is off. However, never use alcohol, solvents or ammonia-based liquids.
- Consult a service technician if the display does not operate normally when you have followed the instructions in this manual.
- The casing cover should be opened only by qualified service personnel.
- Keep the display out of direct sunlight and away from stoves or any other heat sources.
- Remove any object that could fall into the vents or prevent proper cooling of the display's electronics.
- Do not block the ventilation holes on the cabinet.
- Keep the display dry. To avoid electric shock, do not expose it to rain or excessive moisture.
- When turning off the display by detaching the power cable or DC power cord, wait for 6 seconds before re-attaching the power cable or DC power cord for normal operation.
- To avoid the risk of shock or permanent damage to the set do not expose the display to rain or excessive moisture.
- When positioning the display, make sure the power plug and outlet are easily accessible.
- **IMPORTANT:** Always activate a screen saver program during your application. If a still image in high contrast remains on the screen for an extended period of time, it may leave an 'after-image' or 'ghost image' on the front of the screen. This is a well-known phenomenon that is caused by the shortcomings inherent in LCD technology. In most cases the afterimage will disappear gradually over a period of time after the power has been switched off. Be aware that the after-image symptom cannot be repaired and is not covered under warranty.

Table Of Contents

1. Unpacking and Installation	1
1.1. Unpacking.....	1
1.2. Package Contents.....	1
1.3. Installation Notes.....	1
1.4. Installing and Removing Table Stands (optional)	2
1.5. Mounting on a Wall.....	3
1.6. Mounting in Portrait Position.....	4
1.7. Operating Instructions of Edge Alignment Kit.....	5
2. Parts and Functions.....	6
2.1. Control Panel.....	6
2.2. Input/Output Terminals.....	7
2.3. Remote Control.....	8
3. Connecting External Equipment.....	13
3.1. Connecting External Equipment (DVD/VCR/ VCD)	13
3.2. Connecting a PC.....	13
3.3. Connecting Audio Equipment.....	15
3.4. Connecting Multiple Displays in a Daisy-chain Configuration	15
3.5. IR connection	17
3.6. IR Pass-through Connection.....	17
4. Operation.....	18
4.1. Watch the Connected Video Source.....	18
4.2. Change Picture Format	18
4.3. Overview.....	18
4.4. Media Player introduction:.....	19
4.5. Browser manual.....	21
4.6. PDF reader play.....	24
4.7. CMND & Play.....	25
4.8. Custom App.....	26
5. Signage display	27
5.1. Setting.....	27
5.2. Ethernet.....	27
5.3. Proxy.....	27
5.4. Signage Display.....	28
5.5. System Tools	35
5.6. Clone Media File	36
5.7. Display	37
5.8. Storage.....	37
5.9. Apps.....	37
5.10. Security.....	37
5.11. Date & time	37
5.12. About	38
6. OSD Menu	39
6.1. Navigating the OSD Menu.....	39
6.2. OSD Menu Overview	39
7. USB device compatibility.....	48
8. Input Mode.....	50
9. Pixel Defect Policy.....	51
9.1. Pixels and Sub-Pixels.....	51
9.2. Types of Pixel Defects + Dot Definition	51
9.3. Bright Dot Defects.....	51
9.4. Dark Dot Defects.....	52
9.5. Proximity of Pixel Defects	52
9.6. Pixel Defect Tolerances	52
9.7. MURA.....	52
10. Cleaning and Troubleshooting.....	53
10.1. Cleaning.....	53
10.2. Troubleshooting.....	54
11. Technical Specifications	56

1. Unpacking and Installation

1.1. Unpacking

- This product is packed in a carton, together with the standard accessories.
- Any other optional accessories will be packed separately.
- Due to the size and weight of this display it is recommended for two people to move it.
- After opening the carton, ensure that the contents are complete and in good condition.

1.2. Package Contents

Please verify that you received the following items with your package content:

- LCD display
- Remote control with AAA batteries
- Warranty card
- Quick start guide
- Power cord
- RS232 cable
- RS232 daisy chain cable
- DVI-D cable
- D-sub cable
- DVI/D-sub converter
- Philips Logo
- Edge Alignment Kit-1: 2PCS
- Edge Alignment Kit-2: 1PCS
- Thumb Screw: 8PCS



Remote Control and AAA Batteries

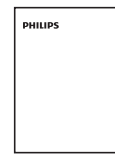

Warranty card

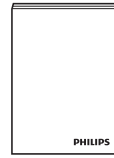

Quick start guide

* The supplied power cord varies depending on destination.



Power Cord

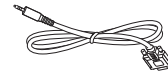

RS232 Cable

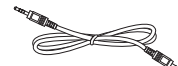

RS232 Daisy Chain Cable



DVI-D Cable



D-sub Cable



DVI/D-sub converter



Philips logo



Thumb Screw x 8



Edge Alignment Kit-1 x 2



Edge Alignment Kit-2 x 1

* Differences according to regions

Display design and accessories may differ from those illustrated above.

NOTES:

- For all other regions, apply a power cord that conforms to the AC voltage of the power socket and has been approved by and complies with the safety regulations of the particular country (Type H05W-F, 2G or 3G, 0.75 or 1 mm² should be used).
- You might like to save the package box and packing material for shipping the display.

1.3. Installation Notes

- Due to the high power consumption, always use the plug exclusively designed for this product. If an extended line is required, please consult your service agent.
- The product should be installed on a flat surface to avoid tipping. The distance between the back of the product and the wall should be maintained for proper ventilation. Avoid installing the product in the kitchen, bathroom or any other places with high humidity so as not to shorten the service life of the electronic components.
- The product can normally operate only under 3000m in altitude. In installations at altitudes above 3000m, some abnormalities may be experienced.

1.4. Installing and Removing Table Stands (optional)

To install table stands:

1. Ensure your display is powered off.
2. Spread a protective sheet on a flat surface.
3. Grab the carrying handles and place the display face-down on the protective sheet.
4. After inserting the stand in the guide block, tighten the screws on both sides of the display.

NOTE: The longer side of the stand should face the front of the display.

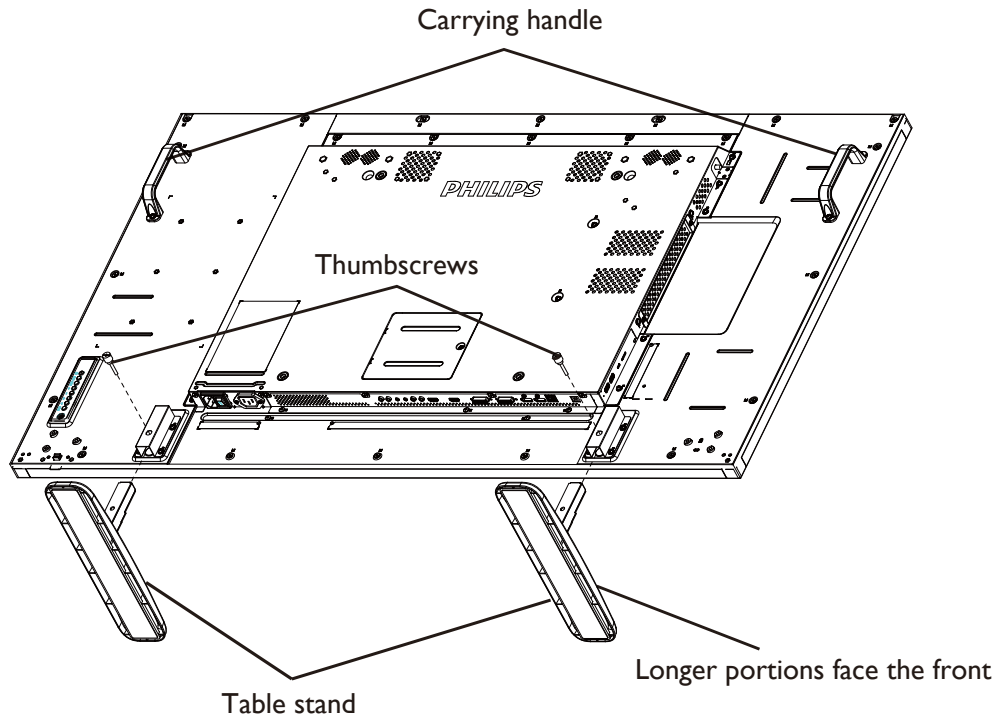

To remove table stands:

1. Power off the display.
2. Spread a protective sheet on a flat surface.
3. Grab the carrying handles and place the display face-down on the protective sheet.
4. Remove screws using a screwdriver and place them in a safe place for reuse.

1.5. Mounting on a Wall

To mount this display to a wall, you will have to obtain a standard wall-mounting kit (commercially available). We recommend using a mounting interface that complies with TUV-GS and/or UL1678 standard in North America.

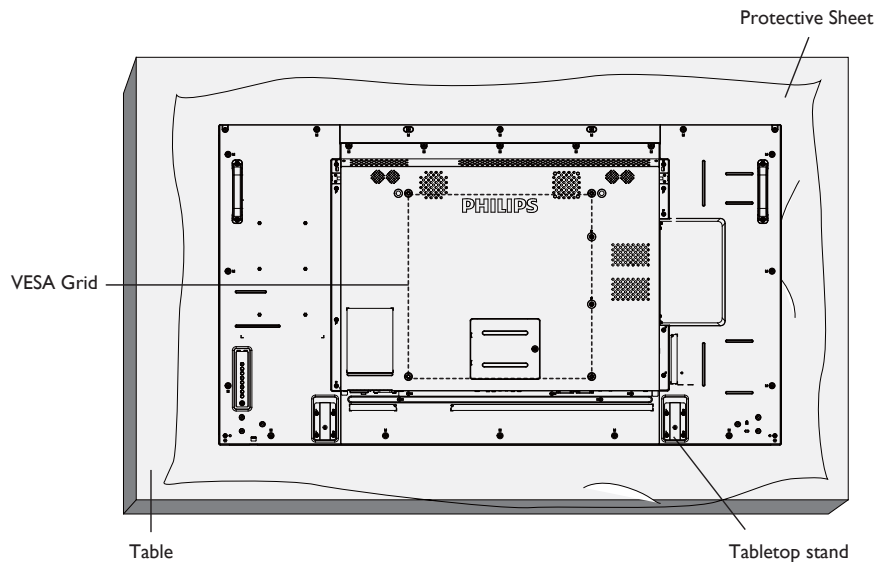

1. Lay a protective sheet on a table, which was wrapped around the display when it was packaged, beneath the screen surface so as not to scratch the screen face.
2. Ensure you have all accessories for mounting this display (wall mount, ceiling mount, table stand, etc).
3. Follow the instructions that come with the base mounting kit. Failure to follow correct mounting procedures could result in damage to the equipment or injury to the user or installer. Product warranty does not cover damage caused by improper installation.
4. For the wall-mounting kit, use M6 mounting screws (having a length 10 mm longer than the thickness of the mounting bracket) and tighten them securely.

1.5.1. VESA Grid

55BDL5055P	400(H) x 400(V) mm
------------	--------------------

Caution:

To prevent the display from falling:

- For wall or ceiling installation, we recommend installing the display with metal brackets which are commercially available. For detailed installation instructions, refer to the guide received with the respective bracket.
- To lessen the probability of injury and damage resulting from fall of the display in case of earthquake or other natural disaster, be sure to consult the bracket manufacturer for installation location.

Ventilation Requirements for enclosure locating

To allow heat to disperse, leave space between surrounding objects as shown in the diagram below.

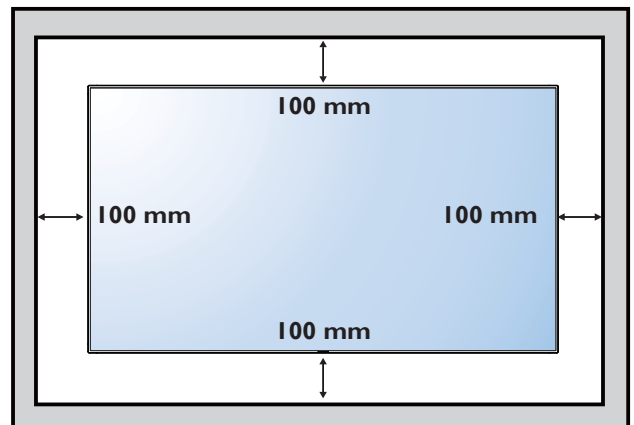

1.6. Mounting in Portrait Position

This display can be installed in portrait position.

1. Remove the table stand, if attached.
2. Rotate 90 degrees clockwise. The "**PHILIPS**" logo should be on the LEFT side when facing the display.

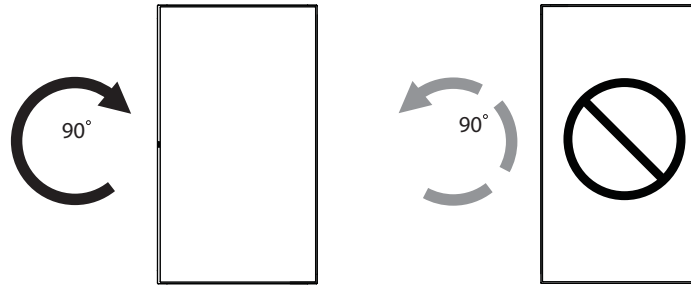

1.7. Operating Instructions of Edge Alignment Kit

1.7.1. Installing Edge Alignment Kit

- Using "Edge Alignment Kit-1" on adjacent two displays.
- Install the "Edge Alignment Kit-1" with 2 PCS of M3 screw.

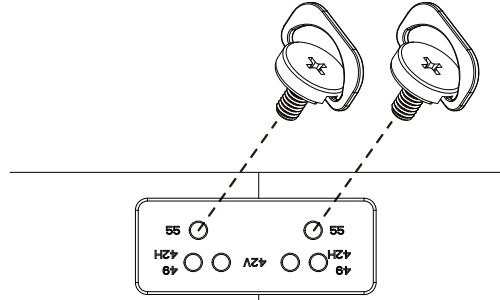

- Using "Edge Alignment Kit-2" on adjacent four displays.

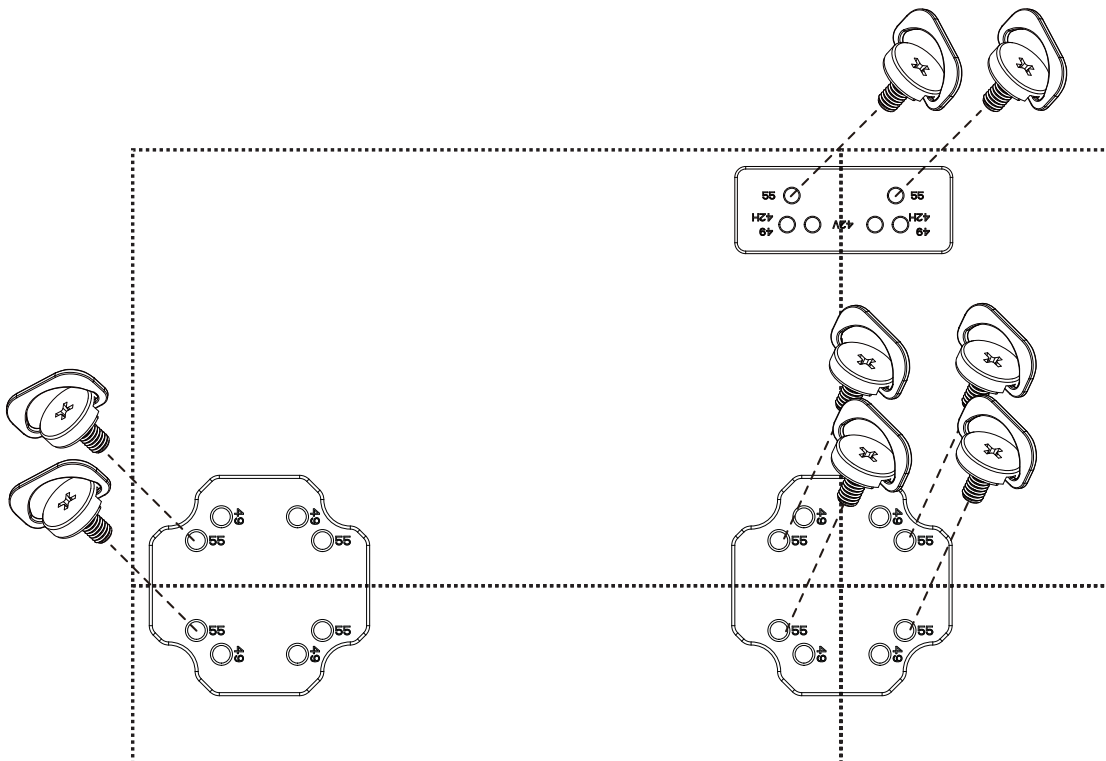

NOTE: When installing the edge alignment kit, please consult a professional technician for proper installation. We accept no liability for installations not performed by a professional technician.

2. Parts and Functions

2.1. Control Panel

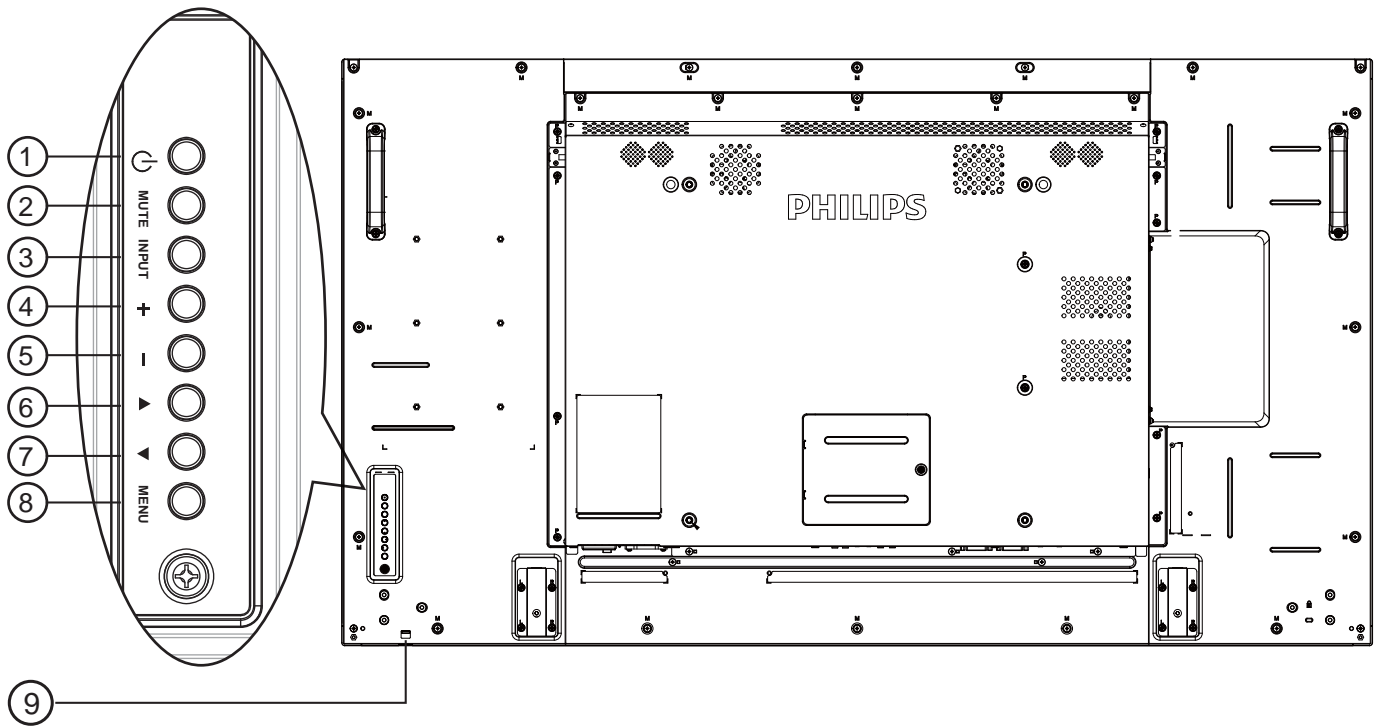

① [Power] button

Use this button to turn the display on or put the display to standby.

② [MUTE] button

Switch the audio mute ON/OFF.

③ [INPUT] button

Choose the input source.

- Used as [OK] button in the On-Screen-Display menu.

④ [++] button

Increase the adjustment while OSD menu is on, or increase the audio output level while OSD menu is off.

⑤ [–] button

Decrease the adjustment while OSD menu is on, or decrease the audio output level while OSD menu is off.

⑥ [▲] button

Move the highlight bar up to adjust the selected item while OSD menu is on.

⑦ [▼] button

Move the highlight bar down to adjust the selected item while OSD menu is on.

⑧ [MENU] button

Return to previous menu while OSD menu is on, or to activate the OSD menu when OSD menu is off.

⑨ Remote control sensor and power status indicator

- Receives command signals from the remote control.
- Indicates the operating status of the display without OPS:
 - Lights green when the display is turned on
 - Lights red when the display is in standby mode
 - When {SCHEDULE} is enabled, the light blinks green and red
 - If the light blinks red, it indicates that a failure has been detected
 - Lights off when the main power of the display is turned off
- Pull down the lens to have better remote control performance and easy to observe the light information of power status.
- Push up the lens before mounting the display for video wall application.
- Pull/Push the lens until hearing the click sound.

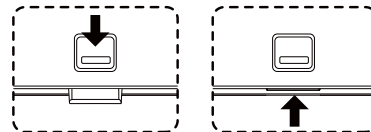

2.2. Input/Output Terminals

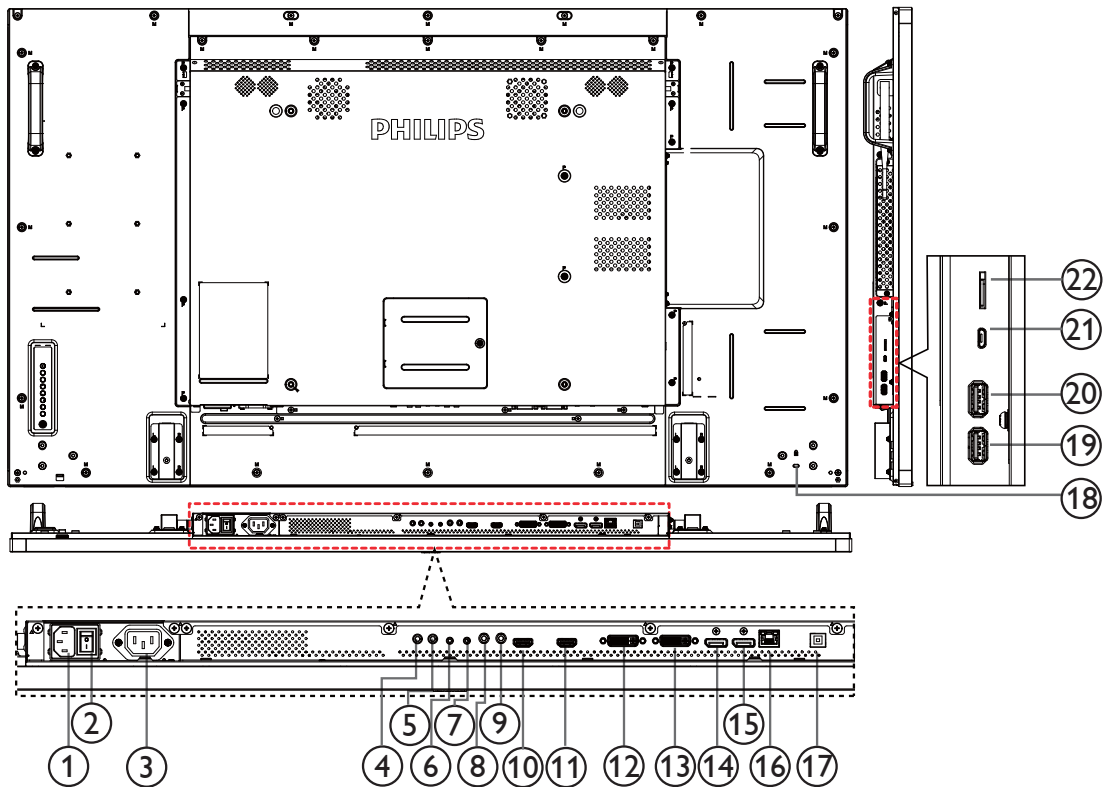

① AC IN

AC power input from the wall outlet.

② MAIN POWER SWITCH

Switch the main power on/off.

③ AC OUT

AC power supply to the AC IN jack of a media player.

④ IR IN / ⑤ IR OUT

IR signal input / output for the loop-through function.

NOTES:

- This display's remote control sensor will stop working if the jack [IR IN] is connected.
- To remotely control your A/V device via this display, refer to page 14 for or IR Pass Through connection.

⑥ RS232C IN / ⑦ RS232C OUT

RS232C network input / output for the loop-through function.

⑧ LINE IN

Audio input for VGA source (3.5mm stereo phone).

⑨ AUDIO OUT

Audio output to external AV device.

⑩ HDMI1 IN / ⑪ HDMI2 IN

HDMI video/audio input.

⑫ DVI-I IN

DVI-D video input.

⑬ DVI OUT / VGA OUT

DVI or VGA video output.

⑭ DisplayPort IN / ⑮ DisplayPort OUT

DisplayPort video input / output.

⑯ RJ-45

LAN control function for the use of remote control signal from control center.

⑰ USB PORT B

Connect to PC.

⑱ SECURITY LOCK

Used for security and theft prevention.

⑲ USB PORT A

Connect your USB storage device.

⑳ USB PORT A (only for charging)



㉑ MICRO USB

Connect your USB storage device.

㉒ MICRO SD CARD

Connect your MICRO SD CARD.

2.3. Remote Control

2.3.1. General functions

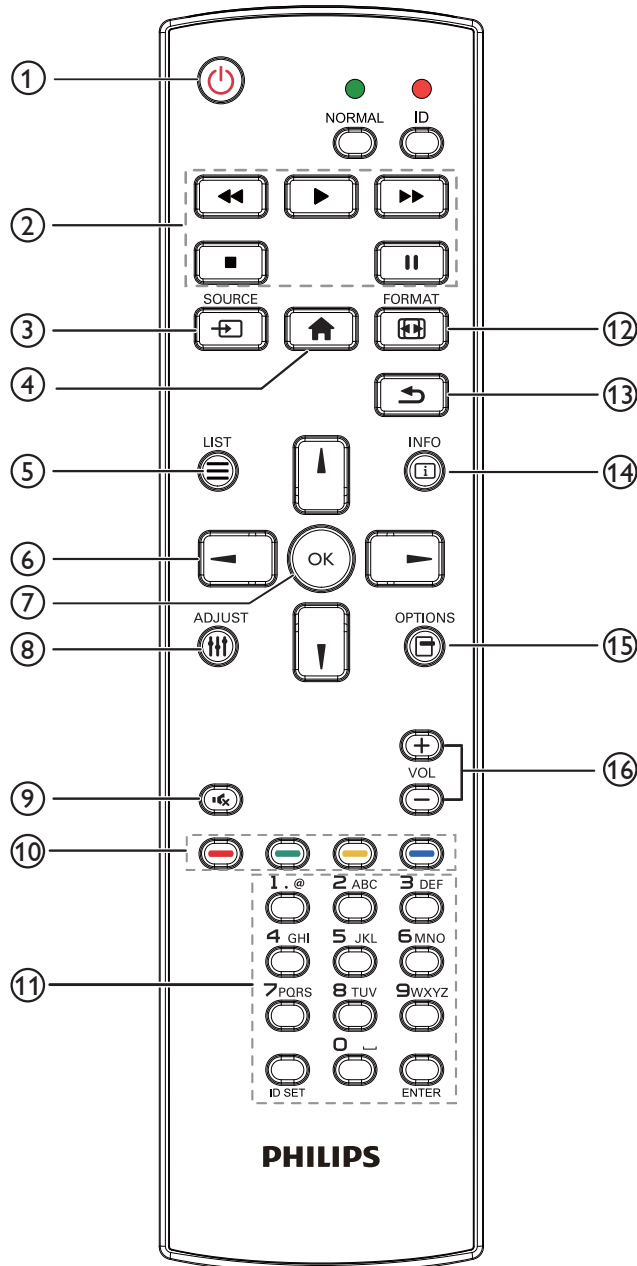

① **[POWER] POWER button**

Power ON/OFF.

② **[PLAY] buttons**

Control playback of media files.(for Media Input only)

Freeze feature

Pause: Freeze hot key for all inputs content.

Play: Unfreeze hot key for all input content.

③ **[SOURCE] SOURCE button**

Root Menu: Go to Video source OSD.

④ **[HOME] HOME button**

Root Menu: Go to Main Menu OSD.

Others: Exit OSD.

⑤ **[LIST] LIST button**

No function.

⑥ **NAVIGATION buttons**



Root Menu: Go to Smart picture OSD.

Main Menu: Move the highlight bar up to adjust the selected item.

IR Daisy Chain Menu: Increase controlled Group ID number.



Root Menu: Go to Audio source OSD.

Main Menu: Move the highlight bar down to adjust the selected item.

IR Daisy Chain Menu: Decrease controlled Group ID number.



Main Menu: go to previous level menu.

Source Menu: Exit source menu.

Volume Menu: Decrease Audio Volume.



Main Menu: go to next level menu or set selected option.

Source Menu: Go to selected source.

Volume Menu: Increase Audio Volume.

⑦ **[OK] OK button**

Root Menu: Go to IR daisy chain OSD in Primary/Secondary mode.

Main Menu: Confirm an entry or selection.

⑧ **[ADJUST] ADJUST button**

Go to Auto Adjust OSD for VGA only.

⑨ **[MUTE] MUTE button**

Toggle Audio Mute/Unmute.

⑩ **[COLOR] COLOR buttons**

Choose tasks or options.(for Media Input only)

[GREEN] Hot key for Window selection function.

⑪ **[Number/ ID SET/ ENTER] button**

Enter text for network setting.

Press to set the display ID. Refer to **2.3.2. ID Remote Control** for more detail.

⑫ **[FORMAT] FORMAT button**

Change Image Zoom Mode [Full][4:3][1:1][16:9][21:9][Custom].

⑬ **[BACK] BACK button**

Return to the previous menu page or exit from the previous function.

⑭ **[INFO] INFO button**

Show Information OSD

⑮ **[OPTIONS] OPTIONS button**

No function.

⑯ **[VOL] VOLUME button**

Adjust volume.

2.3.2. ID Remote Control

You can set the remote control ID when you want to use this remote control on one of several different displays.

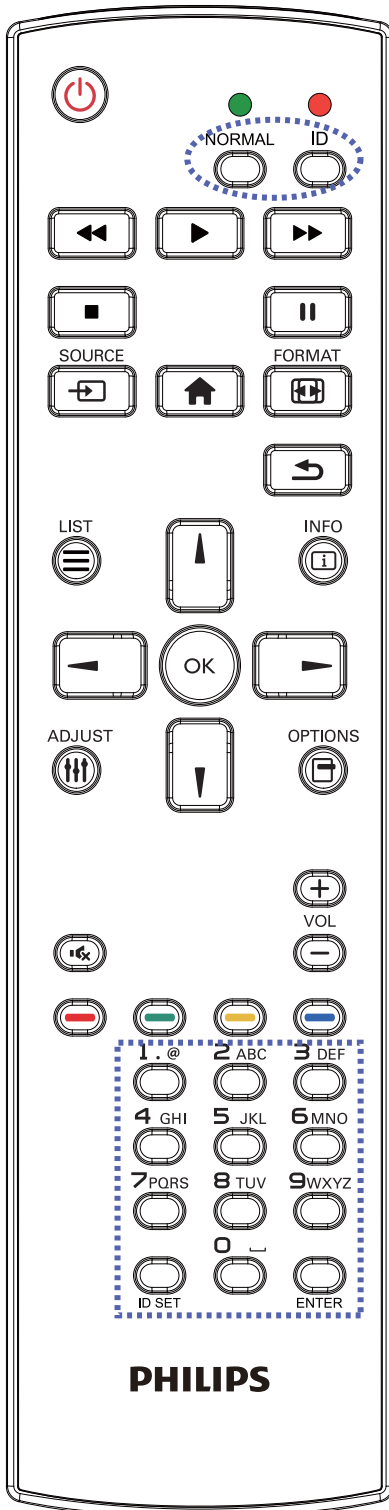

Press [ID] button. The red LED blinks twice.

1. Press [ID SET] button for more than 1 second to enter the ID Mode. The red LED lights up. Press the [ID SET] button again will exit the ID Mode. The red LED lights off.

Press the digit numbers [0] ~ [9] to select the display you want to control.

For example: press [0] and [1] for display No.1, press [1] and [1] for display No.11.

The numbers available are from [01] ~ [255].

2. Not pressing any button within 10 seconds will exit the ID Mode.
3. If an error pressing of buttons other than the digits occurred, wait 1 second after the red LED lights off and then lights up again, then press the correct digits again.
4. Press [ENTER] button to confirm. The red LED blinks twice and then lights off.

NOTE:

- Press [NORMAL] button. The green LED blinks twice, indicating the display is in normal operation.
- It is necessary to set up the ID number for each display before selecting its ID number.

2.3.3. Remote Control buttons on Android source

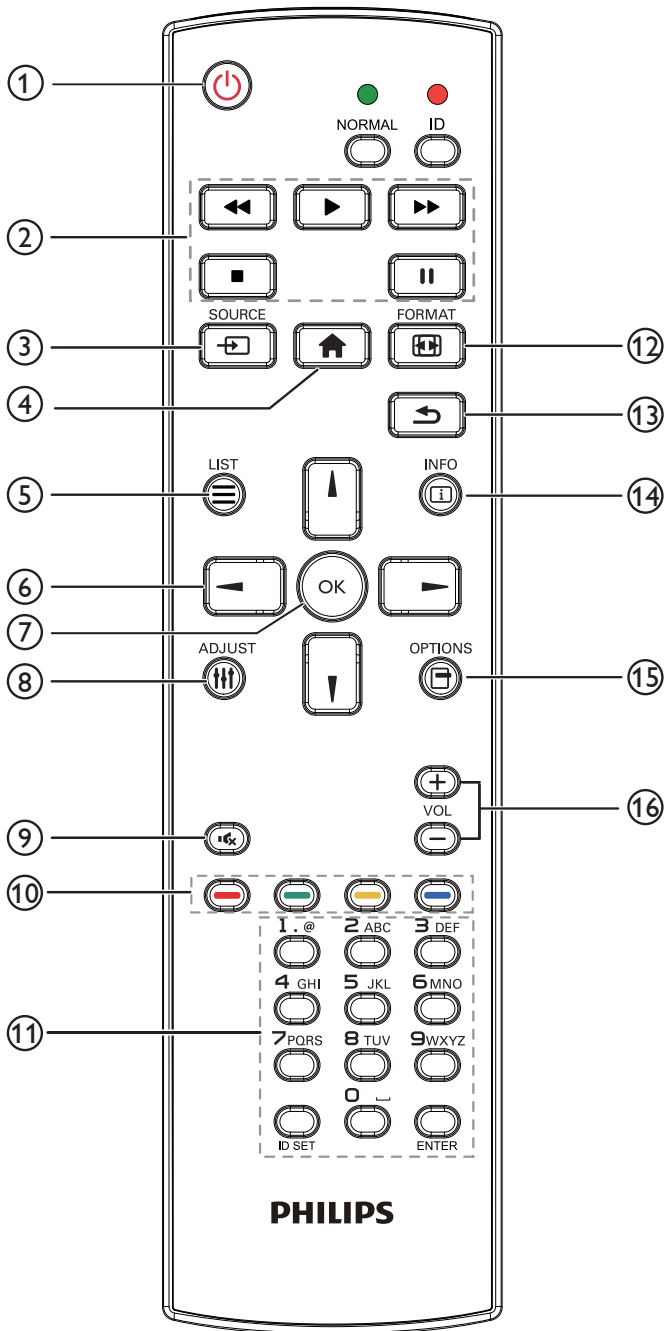

① [POWER] POWER button

Turn the display on or put the display to standby.
The button is only controlled by Scalar.

② [PLAY] buttons

1. Control playback of media(video/audio/picture) files.

There are 4 ways to play media files.

1) File Manager

Find the media file from the File Manager and select it to play.
2) Media Player -> Compose -> edit or new add playlist -> choose any media files -> press to play the media file directly.

3) Media Player -> Play -> choose non-empty play list -> press to play all the media files in the play list.

4) Set media playlist in Boot on Source or Schedule by OSD menu.

2. Play PDF file

There are 3 ways to play media files.

1) File Manager

Find the pdf file from the File Manager and select it to play.

2) PDF Player -> Play -> choose non-empty play list -> press to play all the PDF files in the play list.

3) Set pdf playlist in Boot on Source or Schedule by OSD menu.

3. When playing PDF, video or music, press to stop playing.

Then if pressing again, playing will be started from the beginning of the file.

4. When playing PDF, video or music, press button to pause playing.

5. All media or pdf files should be put at the folder, which is named "philips" with sub-folder, under the root directory of the specified storage (internal/USB/SD Card). All sub-folders (video/photo/music/pdf) are named by media types and shouldn't be changed.

videos: {root dir of storage}/philips/video/

photos: {root dir of storage}/philips/photo/

music : {root dir of storage}/philips/music/

pdfs : {root dir of storage}/philips/pdf/

Note that the root directories of three storages are

Internal storage: /sdcard

USB storage: /mnt/usb_storage

SD card : /mnt/external_sd

③ [SOURCE] SOURCE button

Choose input source.

The button is only controlled by Scalar.

④ [HOME] HOME button

Access OSD menu.





The button is only controlled by Scalar.

⑤ [LIST] LIST button

1. In the content of the web page, move the focus up to the next clickable items.

2. Move the focus up to the next control or widget such as buttons.

⑥ NAVIGATION buttons

1. Navigate through menus and choose items.
2. In the content of the web page, these buttons are to control the scroll bar of the screen. Press  or  is for moving vertical scroll bar up or down. Press  or  is for moving horizontal scroll bar left or right.

3. For PDF files,
» when zoom in/out has been performed,

Press , ,  or  to adjust the position of the screen.

» when zoom in/out has been not performed,

Press  to go to the next page.

Press  to go to the previous page.

⑦ [OK] button

Confirm an entry or selection.

⑧ [||||] ADJUST button

1. In the content of the web page, move the focus down to the next clickable items.
2. Move the focus down to the next control or widget such as buttons.

⑨ [MUTE] MUTE button

Press to turn the mute function on/off.

The button is only controlled by Scalar.

⑩ [COLOR] COLOR buttons

1.   : No function on Android source. These two buttons are only controlled by Scalar.

2. For PDF files,

press  button to perform zoom-in;

press  button to perform zoom-out.

After zoom-in or zoom-out, press  button to revert the pdf file to the original size.

⑪ [Number/ ID SET/ ENTER] button

1. No functions for ID SET  and ENTER  on Android source. These buttons are only controlled by Scalar.

2. For PDF file, enter the page number by pressing number buttons and then press  button to jump to the specific page.

⑫ [FORMAT] FORMAT button

Change picture format. The button is only controlled by Scalar.

⑬ [BACK] BACK button

Return to the previous page or exit from the previous function.

⑭ [i] INFO button

1. Display information about current input signal. It is shown by Scalar.

2. Media Player -> Compose -> edit or new add playlist -> choose any media files -> press  to show the information of the chosen media file.

⑮ [OPTIONS] OPTIONS button

Open toolbox in Media Player or PDF Player:

1. Media Player -> Compose -> Edit or new add playlist -> press  to open toolbox. Toolbox will be slide from the left side of the screen.

2. PDF Player -> Compose -> Edit or new add playlist -> press  to open toolbox. Toolbox will be slide from the left side of the screen.

⑯ [VOLUME] VOLUME button

Adjust volume. The buttons are only controlled by Scalar.

2.3.4. Inserting the batteries in the remote control

The remote control is powered by two 1.5V AAA batteries.

To install or replace batteries:

1. Press and then slide the cover to open it.
2. Align the batteries according to the (+) and (-) indications inside the battery compartment.
3. Replace the cover:

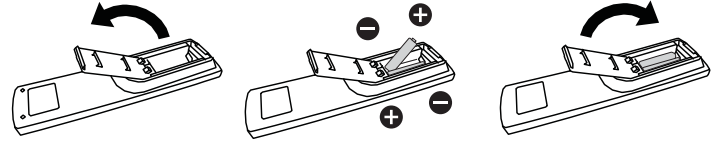

Caution:

The incorrect use of batteries can result in leaks or bursting. Be sure to follow these instructions:

- Place “AAA” batteries matching the (+) and (-) signs on each battery to the (+) and (-) signs of the battery compartment.
- Do not mix battery types.
- Do not combine new batteries with used ones. It causes shorter life or leakage of batteries.
- Remove the dead batteries immediately to prevent them from liquid leaking in the battery compartment. Don't touch exposed battery acid, as it can damage your skin.

NOTE: If you do not intend to use the remote control for a long period, remove the batteries.

2.3.5. Handling the remote control

- Do not subject to strong shock.
- Do not allow water or other liquid to splash the remote control. If the remote control gets wet, wipe it dry immediately.
- Avoid exposure to heat and steam.
- Other than to install the batteries, do not open the remote control.

2.3.6. Operating range of the remote control

Point the top of the remote control toward the display's remote control sensor when pressing a button.

Use the remote control within a distance of less than 8m/26ft from the display's sensor, and a horizontal and vertical angle of less than 30 degrees.

NOTE: The remote control may not function properly when the remote control sensor on the display is under direct sunlight or strong illumination, or when there is an obstacle in the path of signal transmission.

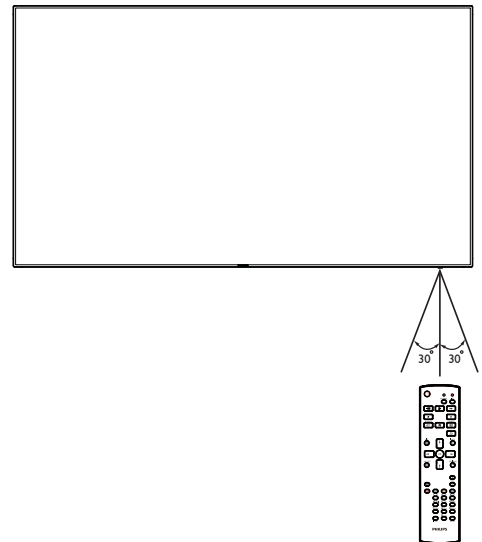

3. Connecting External Equipment

3.1. Connecting External Equipment (DVD/VCR/VCD)

3.1.1. Using HDMI video input

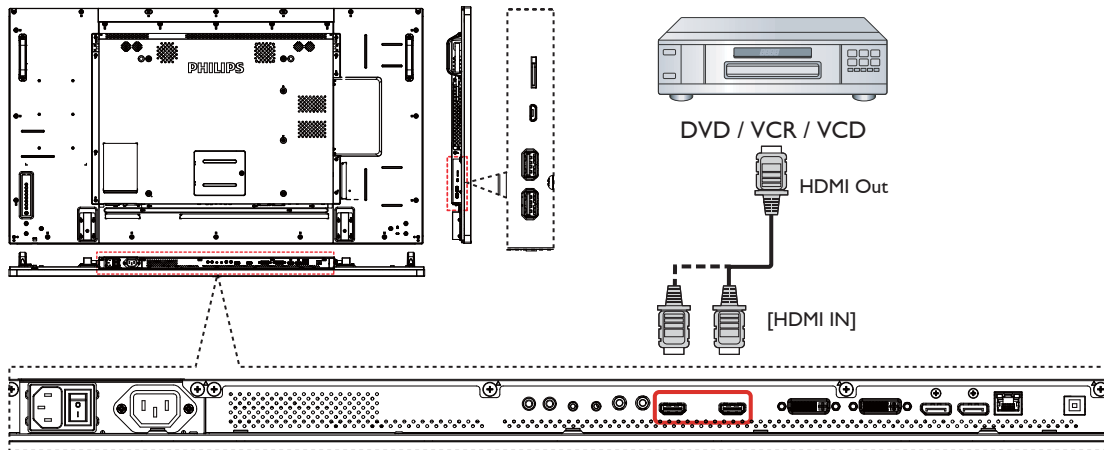

3.2. Connecting a PC

3.2.1. Using DVI-I input

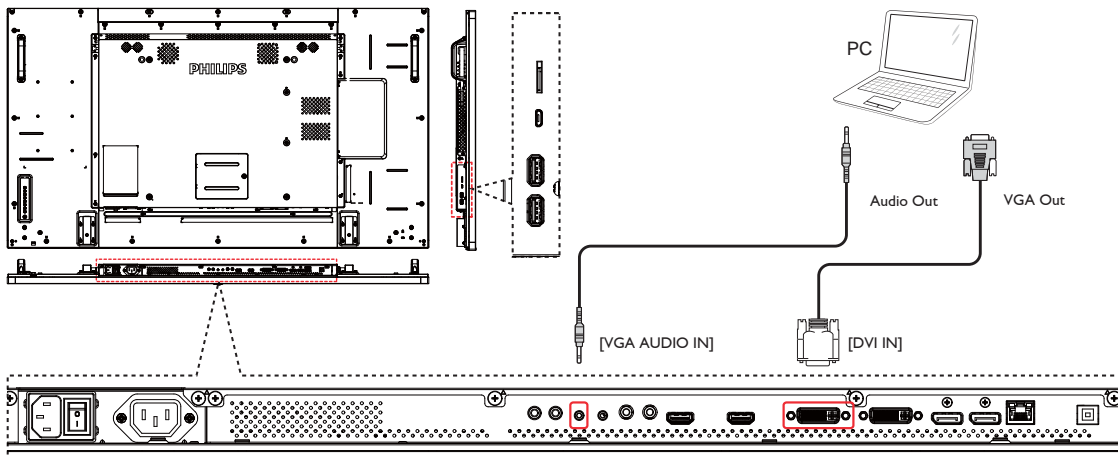

3.2.2. Using DVI input

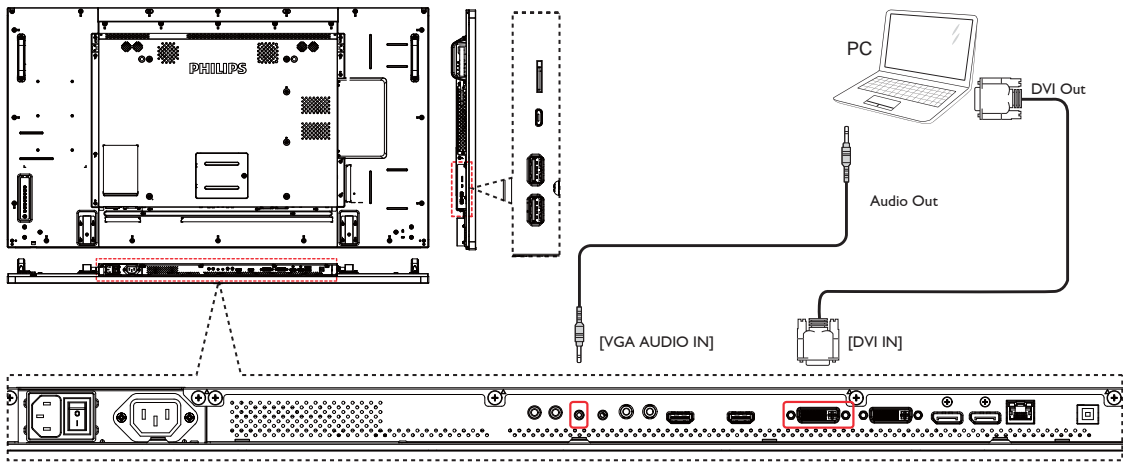

3.2.3. Using HDMI input

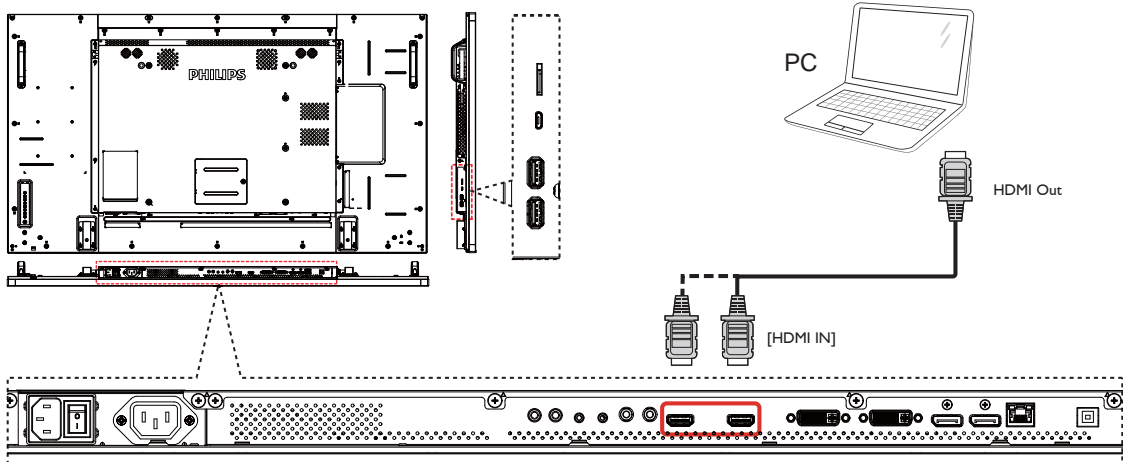

3.2.4. Using DisplayPort input

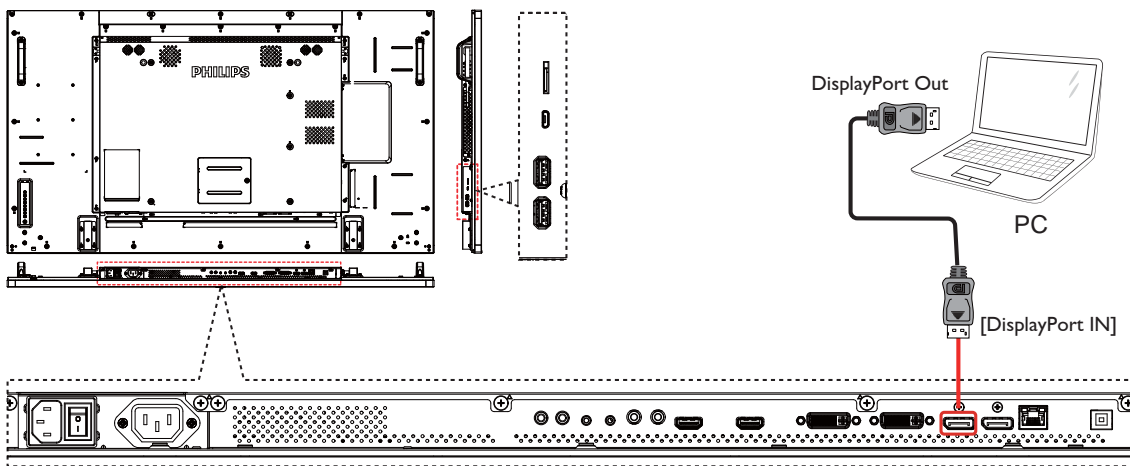

3.3. Connecting Audio Equipment

3.3.1. Connecting an external audio device

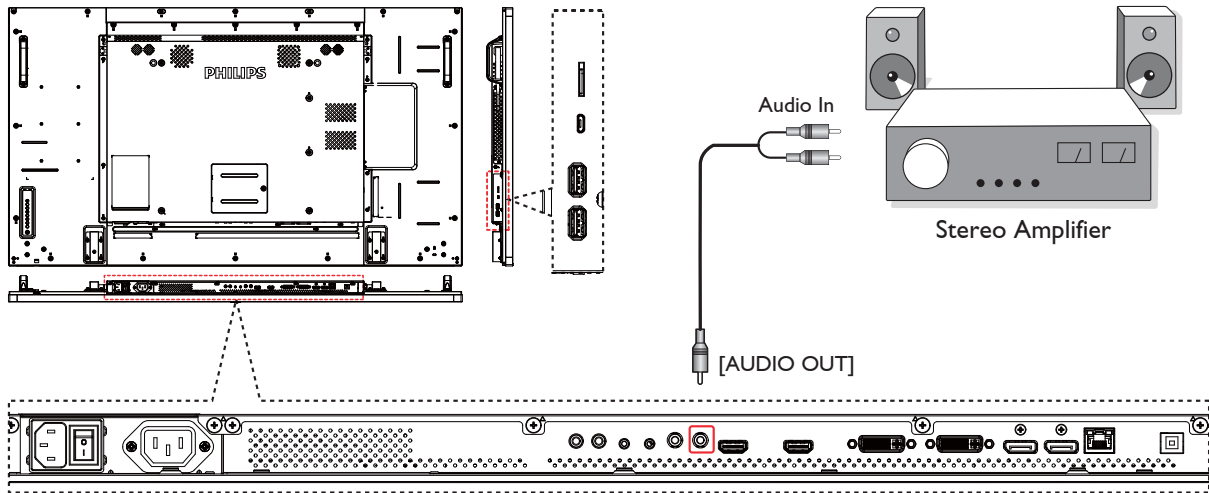

3.4. Connecting Multiple Displays in a Daisy-chain Configuration

You can interconnect multiple displays to create a daisy-chain configuration for applications such as a video wall.

NOTE: Maximum 25 displays (5x5) can be used in a DVI daisy-chain configuration. For VGA daisy-chain, Maximum 9 displays can be used.

3.4.1. Display control connection

Connect the [RS232 OUT] connector of DISPLAY 1 to the [RS232 IN] connector of DISPLAY 2.

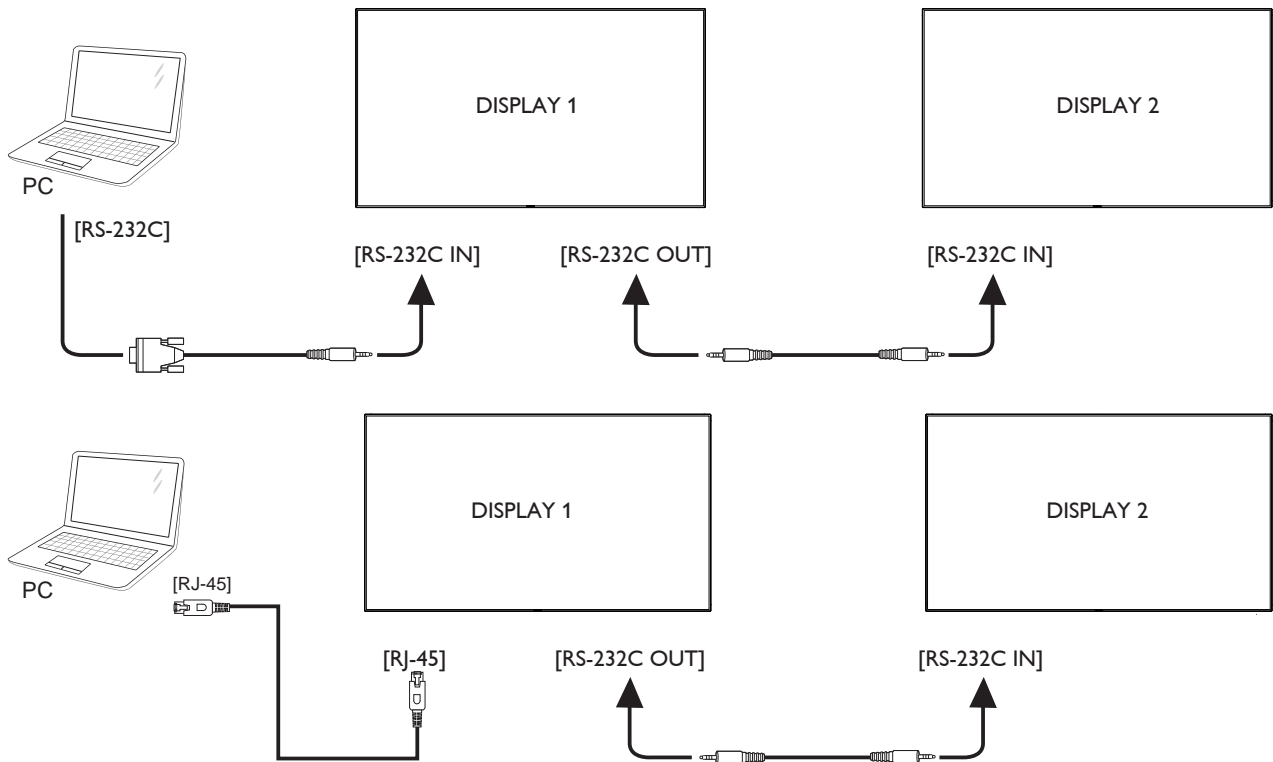

3.4.2. Digital video connection

Connect the [DVI OUT / DVI-I OUT] connector of DISPLAY 1 to the [DVI IN] connector of DISPLAY 2.

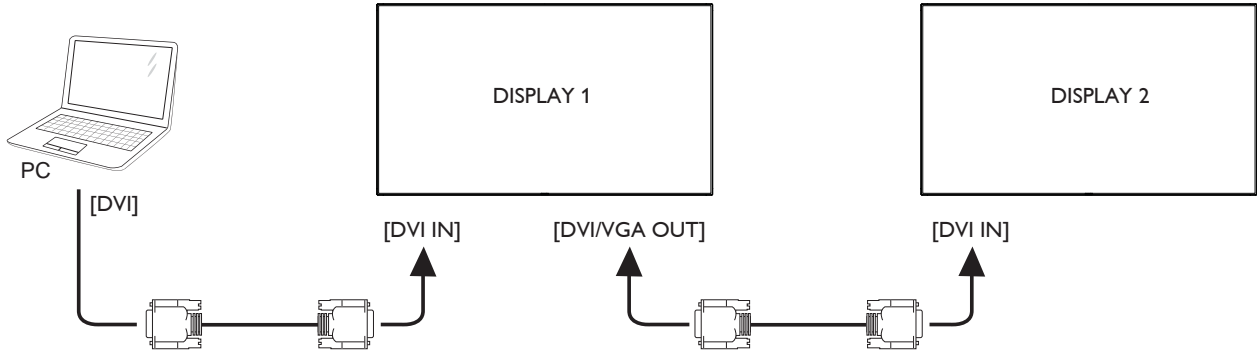

Connect the [DP OUT] connector of DISPLAY 1 to the [DP IN] connector of DISPLAY 2.

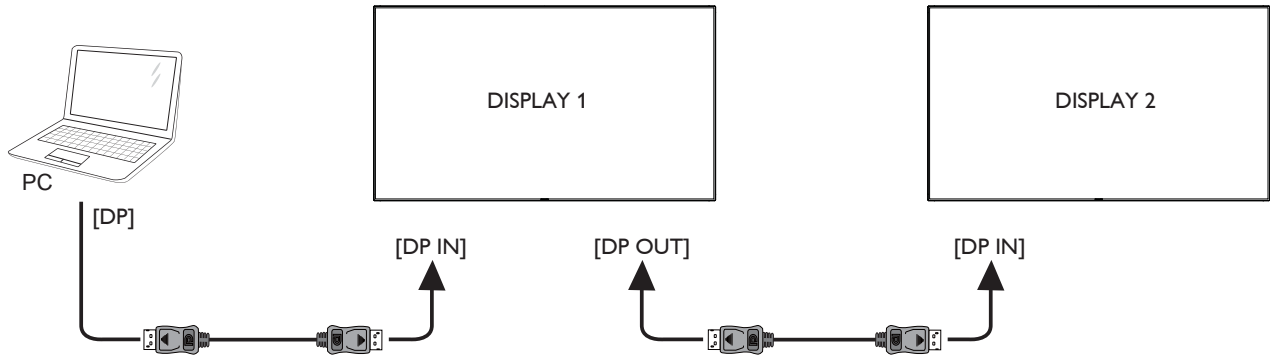

Connect the [DVI OUT] connector of DISPLAY 1 to the [DVI IN] connector of DISPLAY 2.

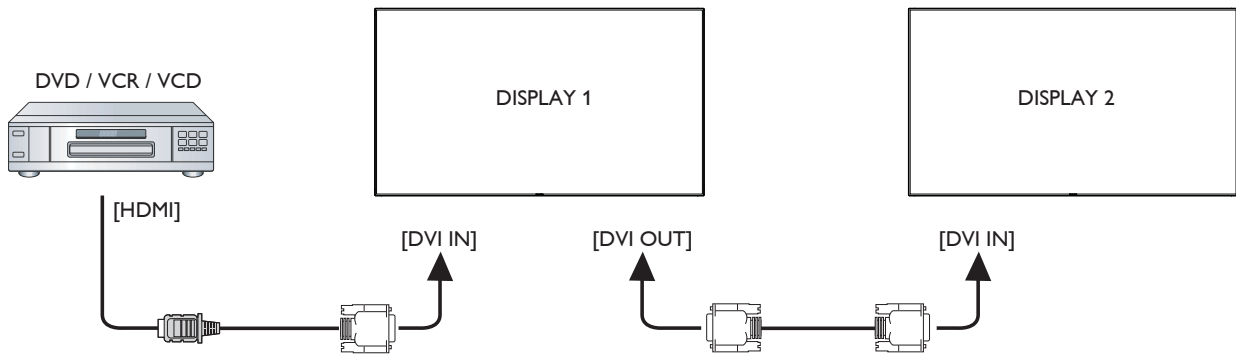

3.4.3. Analog video connection

Connect the [DVI-I OUT] connector of DISPLAY 1 to the [DVI-I IN] connector of DISPLAY 2.

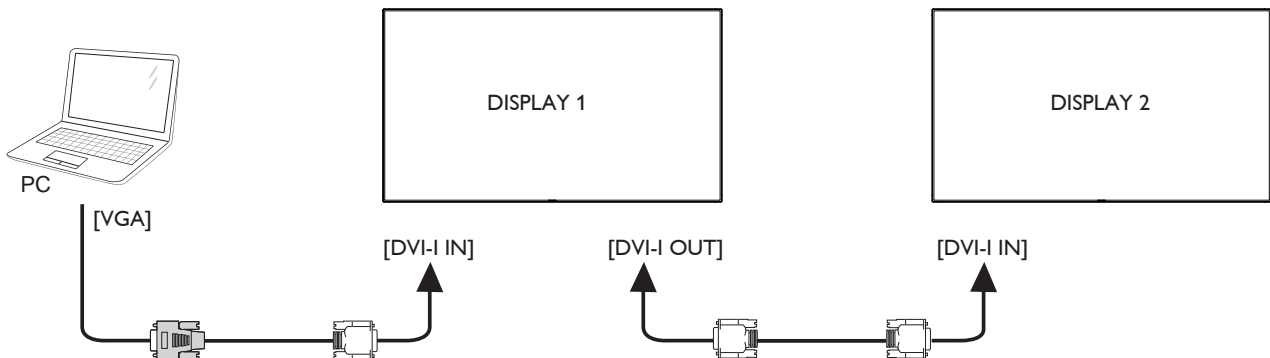

3.5. IR connection

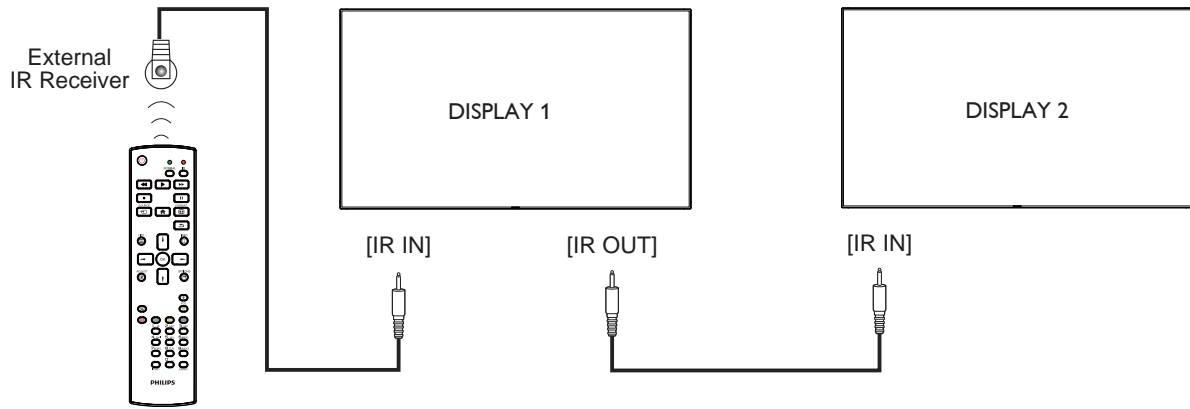

NOTE:

1. This display's remote control sensor will stop working if the [IR IN] is connected.
2. IR loop through connection can support up to 9 displays.

3.6. IR Pass-through Connection

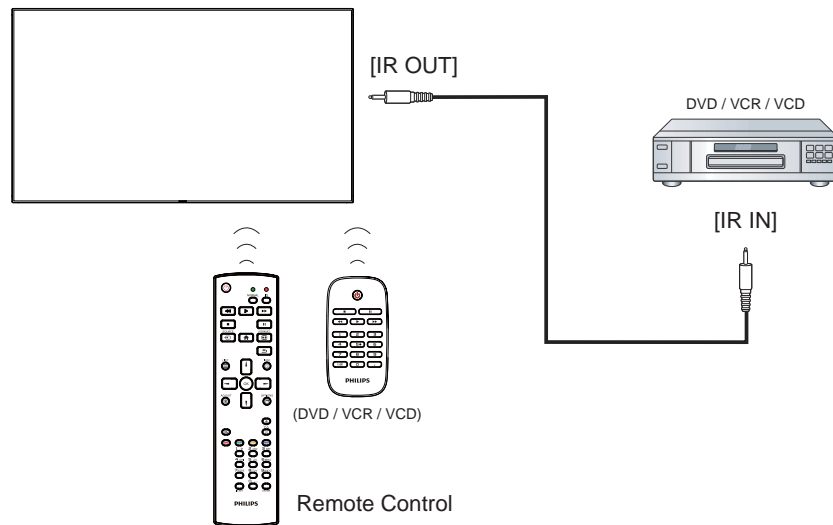

4. Operation

NOTE: The control button described in this section is mainly on the remote control unless specified otherwise.

4.1. Watch the Connected Video Source

See page 13 for external equipments connection.

1. Press **[→]** **SOURCE** button.
2. Press **[M]** or **[T]** button to choose a device, then press **[OK]** button.

4.2. Change Picture Format

You can change the picture format to suit the video source. Each video source has its available picture formats.

The available picture formats depend on the video source:

1. Press **[F]** **FORMAT** button.
2. Press **[M]** or **[T]** button to choose a picture format, then press **[OK]** button.
 - PC mode: {Full} / {4:3} / {1:1} / {16:9} / {21:9} / {Custom}.
 - Video mode: {Full} / {4:3} / {1:1} / {16:9} / {21:9} / {Custom}.

4.3. Overview

1. Android PD launcher:
 - Android PD launcher is black page, as below:



- Every apps leave by press back key, the screen will go to android PD launcher.
- When you return to android PD launcher, the screen will show hint image, the hint image only show 5 second, as below:
- The hint image will notify you can press source key to change source.



2. Admin mode:
 - You can press "Home + 1888" to startup admin mode.
 - Admin mode will show four icons: "Settings", "Apps", "Network" and "Help".
 - When you leave admin mode, system will return to last source.

1) Home page of admin mode, this page has four items: "Settings", "Apps", "Network" and "Help".

Settings : go to settings app.

Applications : show all apps.

Network : set Ethernet and Mobile network (optional).

Help : display QRcode.

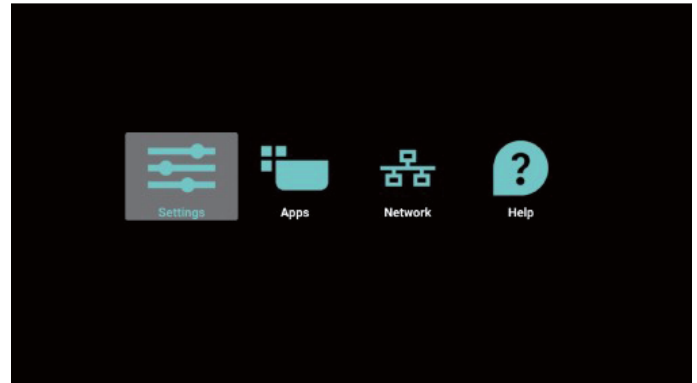

2.) Application page:

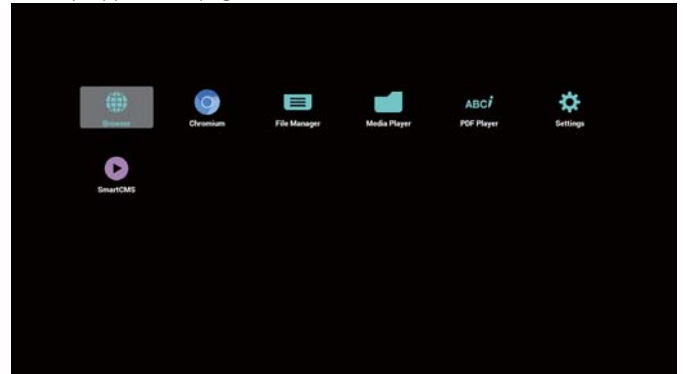

3) Network page

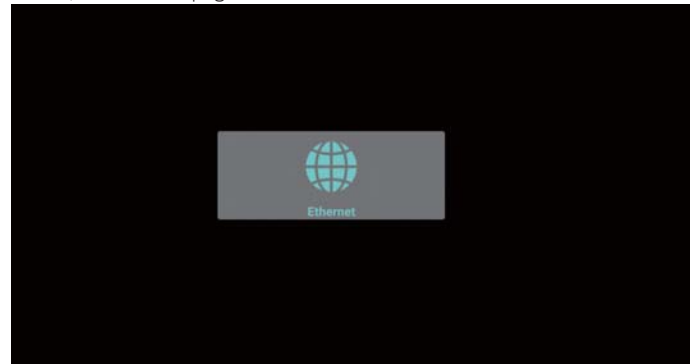

4) Ethernet page



6) Help page:

Display QRcode page.



2. Select "Play" on home page, first you should choose one playlist to play between FILE 1 and FILE 7.
The pencil icon means the playlist is non-empty.

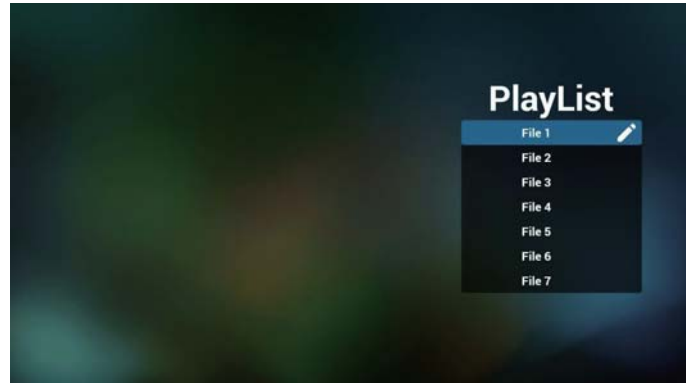

3. Select "Compose" on home page, first you should choose one playlist to edit between FILE 1 and FILE 7.
The pencil icon means the playlist is non-empty.

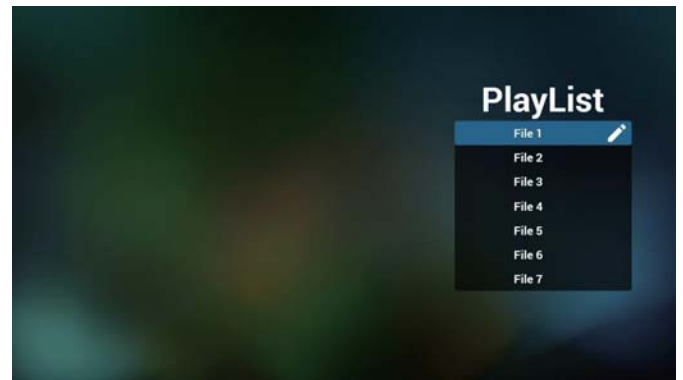

4.4. Media Player introduction:

1. Home page of Media Player; this page has three items: "Play", "Compose" and "Settings".
Play :select playlist to play.
Compose: edit playlist.
Settings: setting play properties.

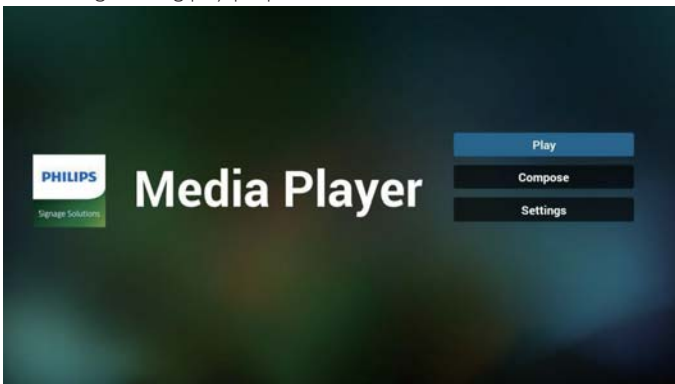

4. If an empty playlist is chosen, the app will guide you to select the media source.
All media files should be placed in /philips/ of root directory.
For example,
- videos in /root/philips/video/
- photos in /root/philips/photo/
- music in /root/philips/music/

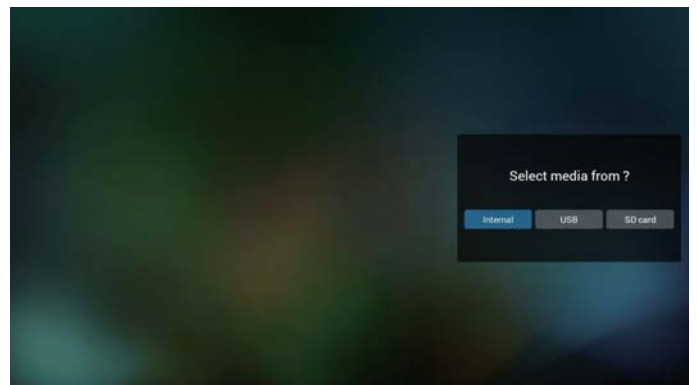

- You could edit or delete a non-empty playlist, just choose the desired playlist which is with pencil icon.

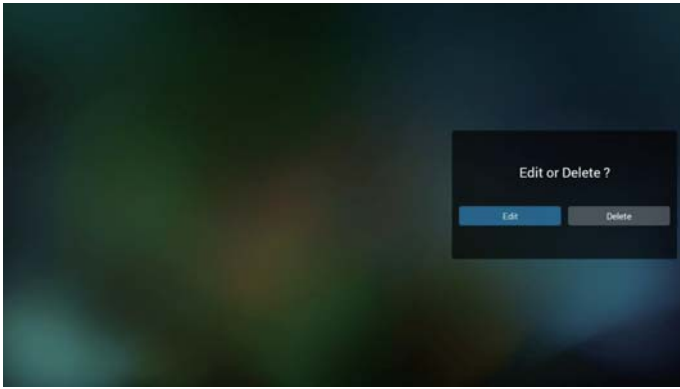

- Once you start to edit a playlist, you will see below screen.
 Source - files in storage.
 Playlist – files in playlist.
 There are 4 icons which map to the keys of remote controller:
 Option key – launch slide bar
 Play key – play media file.
 Info key – show media info.
 Ok key – select/unselect file.

6-1 In the slide bar, it helps you to do the following:

- select all : select all storage files.
- delete all : delete all playlist files.
- add/remove : update playlist from source.
- sort : sort playlist.
- save/abort : save or abort playlist.
- back : return.

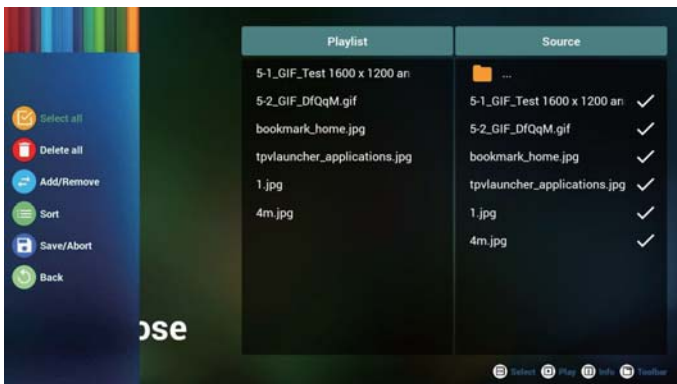

- If you choose "Sort" in the slide bar, you can change the order of files one by one.

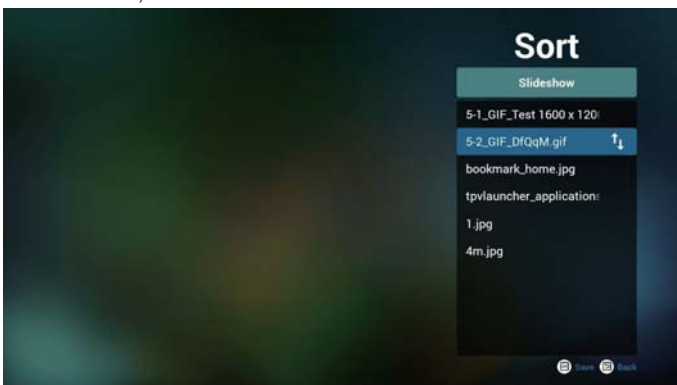

- Press info key after you choose desired file, you will get the detail information.

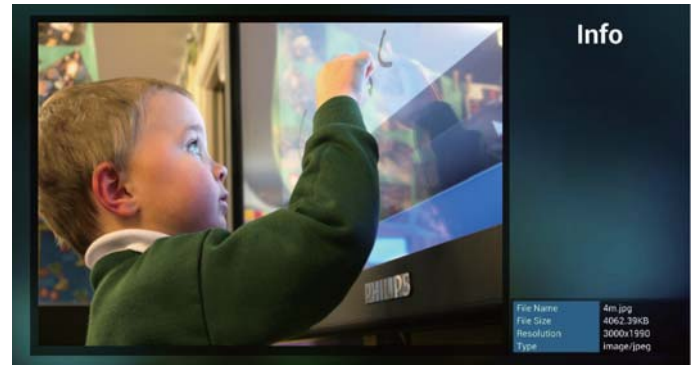

- Press play key after you choose desired file, you will play the media file directly.



- If you make a playlist with all images files, before saving, the app will ask you if you want to have background music while playing slideshow.

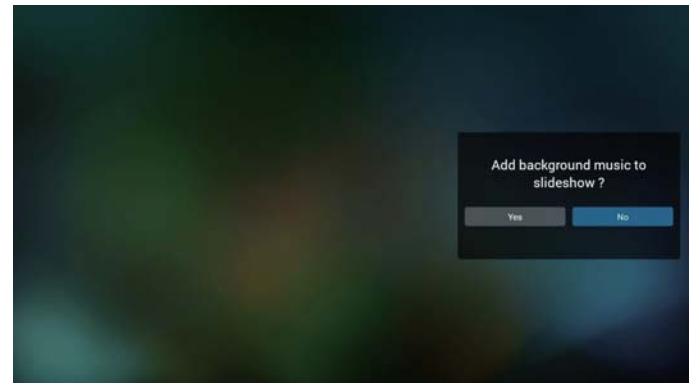

- Select "Settings" on home page, this page has three parts, "Repeat Mode", "Slideshow Effect" and "Effect Duration".

Repeat Mode : play mode.
 Slideshow Effect : photo slideshow effect.
 Effect Duration : photo effect duration.

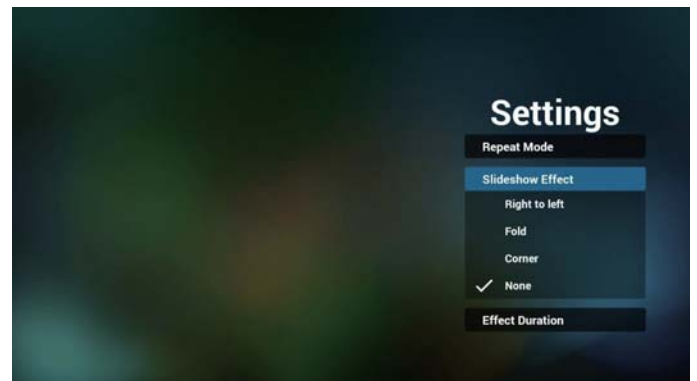

12. Media Hotkey
 - Play : Playback file.
 - Pause: Pause file.
 - Fast forward: forward 10 second.
 - Rewind: back 10 second.
 - Stop: Stop file and return to start. If the gif file, it like the pause.

13. Import text file

Step 1. Create media player text file.

- File name : mpplaylistX.txt, "X" means playlist number(1,2,3,4,5,6,7).Ex. mpplaylist1.txt, mpplaylist2.txt
- Content :

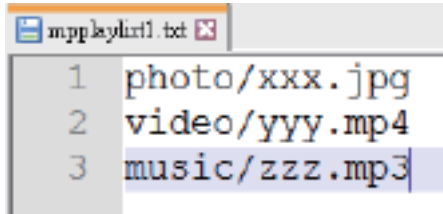

Note : if playlist file contains video and music, when the pd plays music file, the screen will be black.

Step 2. Copy mpplaylistX.txt to "philips" folder of internal storage. You may use FTP to do this.

- File path : /storage/emulated/legacy/philips (for DL, PL)
Ex. /storage/emulated/legacy/philips/mpplaylist1.txt

Step 3. Prepare media files to "photo", "video" and "music" folder under "philips" folder, internal storage only.

- Ex. /storage/emulated/legacy/philips/photo/xxx.jpg
/storage/emulated/legacy/philips/video/yyy.mp4
/storage/emulated/legacy/philips/photo/zzz.mp3

Step 4. Start media player app, it will auto import media player text file.

Note : Once the playlist file (text) is imported, if an user change playlist by remote controller, this change will not be written to playlist text file.

4.5. Browser manual

1. Home page of Browser app, this page has one item: "Settings". Press Settings then enter next page.

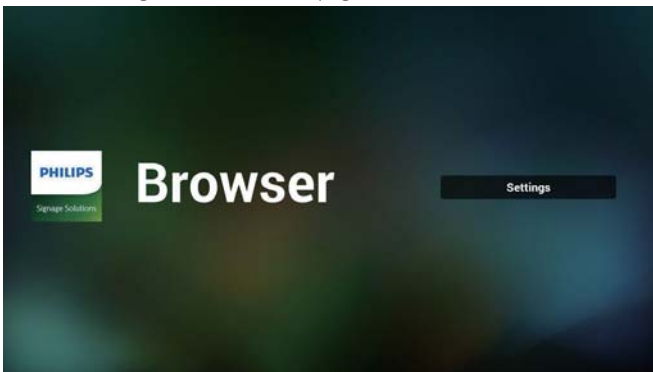

2. Users can choose 1~7.
Press any one will show a dialog.

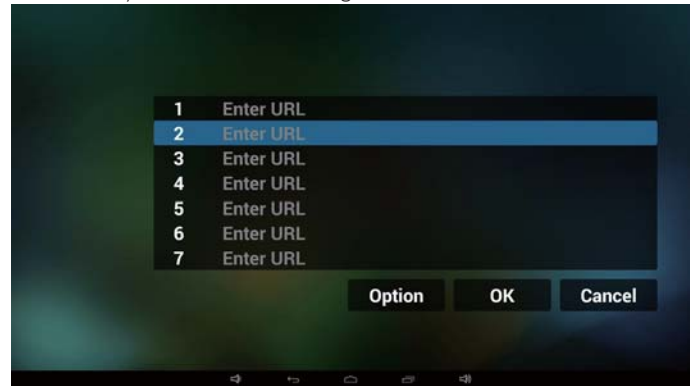

3. Enter url and press OK then data will save on List

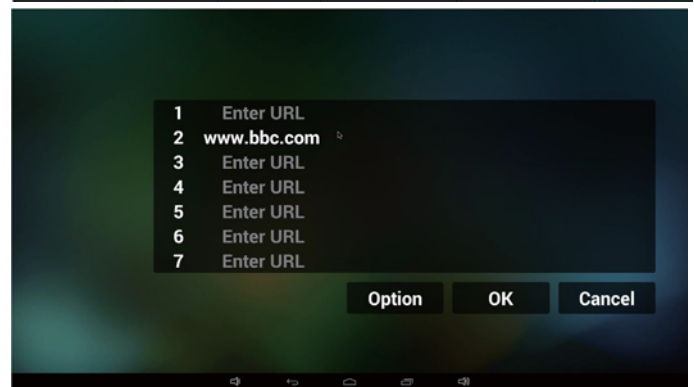
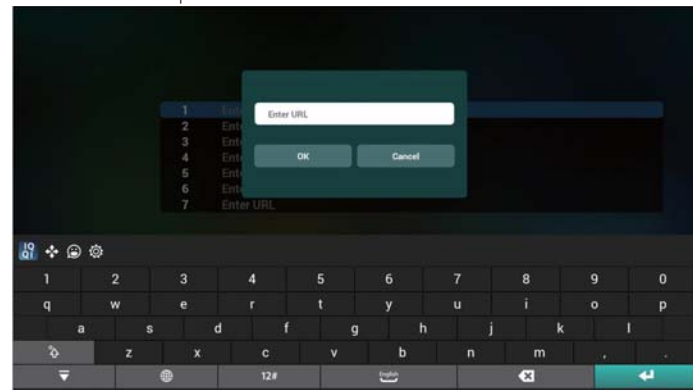

4. Press "Option" then left side will pop up a list
 - Import : Import url list file
 - Export : Export url list file
 - Delete all : Delete all url record on right side
 - Back : left side list will be closed.

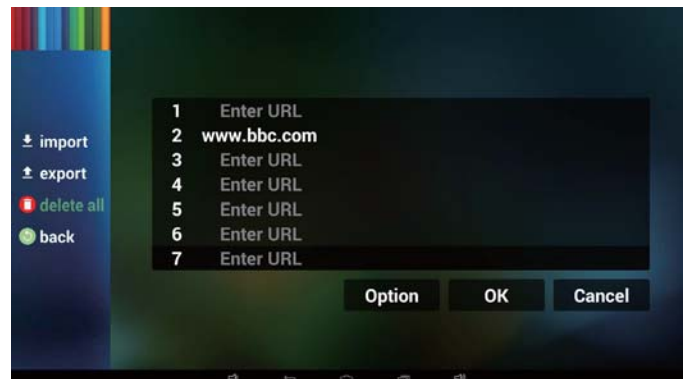

4.1 Import

- Click import



- Choose storage

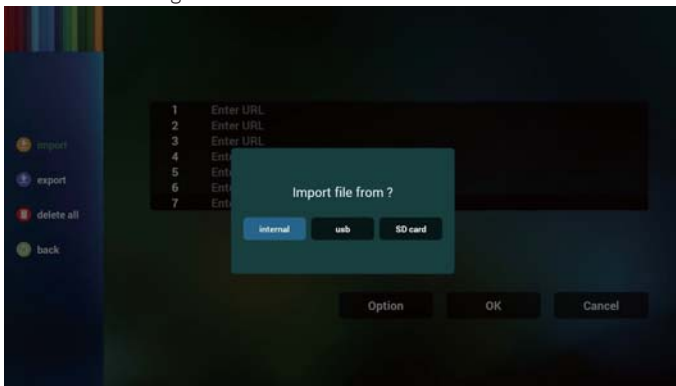

- Choose file contains urls

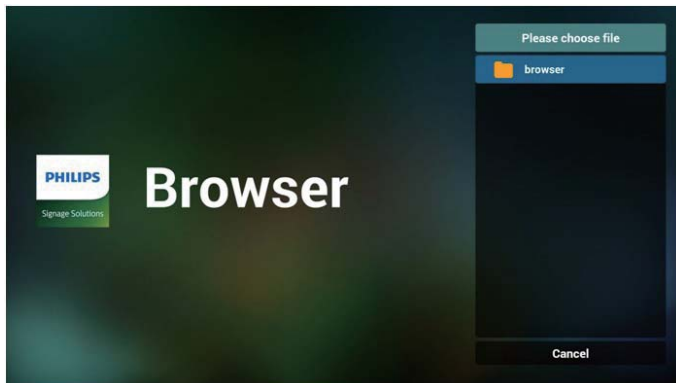

- Import file and url will show on list

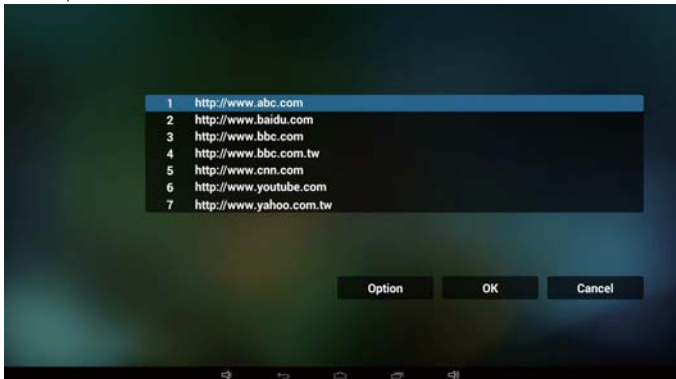

- File format for import
Format should be like below with file extension "txt"

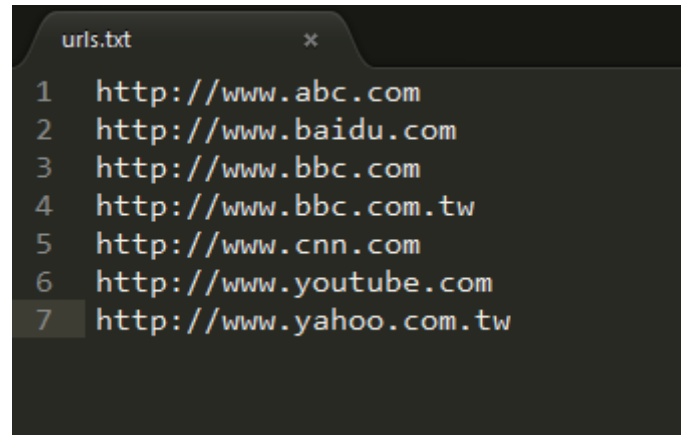

4.2 Export:

- Click export

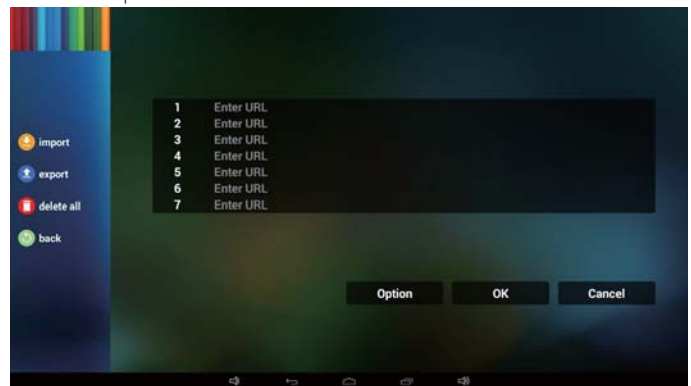

- Choose storage

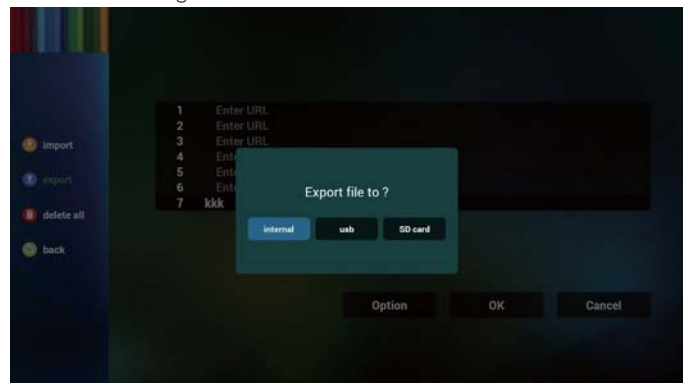

- Dialog shows path file will be saved and file's name.
Press "save" button then urls on list will be saved.

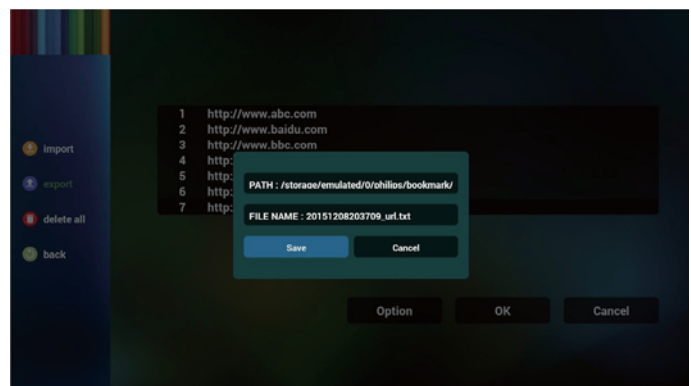

5. Press OK then url records will be saved

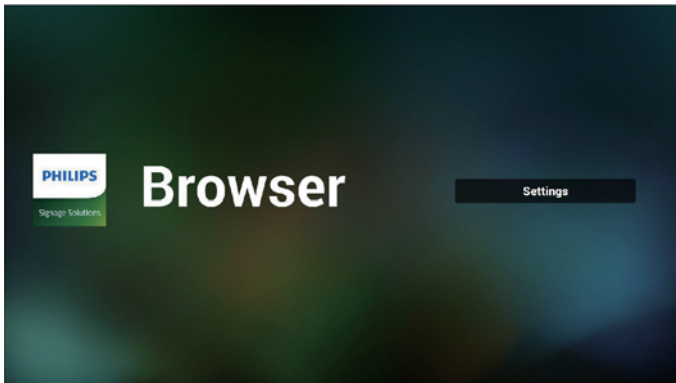
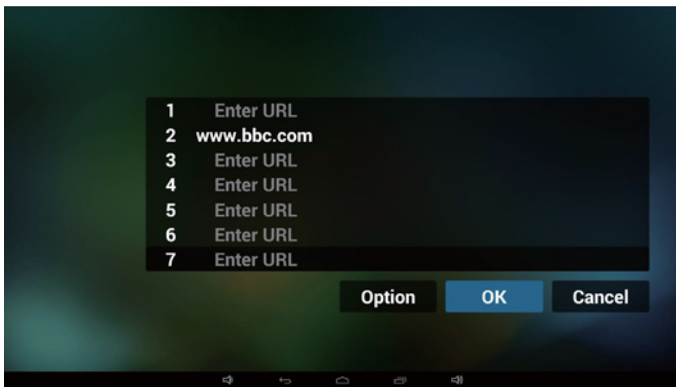

6. On url list page, if you select non-empty item, it will show a dialog to ask edit or play url. If press "Edit", it will show edit url dialog, if press "Play", it will show web page of item's url.

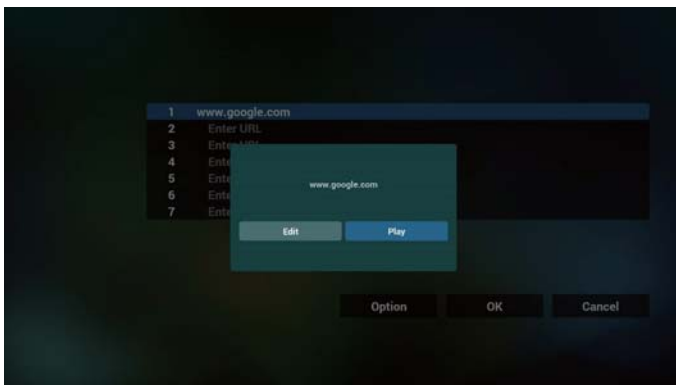

7. OSD menu interaction with Browser

7.1 Boot on source

- Set OSD menu => Configuration1 => Boot on source => Input be BROWSER Play List be 0. Then PD will show Browser after reboot.

- Set OSD menu => Configuration1 => Boot on source => Input be BROWSER Play List be 1. Then PD will show web page with 1st Url in Browser app.

7.2 Schedule

Set OSD menu => Advanced option => Schedule =>

On time1, Off time2, Input be BROWSER, any day you want of week, and Play List.

Finally check the right box.

Then PD will show web page with Url in Browser app at time1 and finish at time2.

8. Offline browsing

When Url 1 has set address, and use osd schedule to open Url 1 web page, browser app will auto save Url 1 address home web page data to local storage.

If network is disconnect and OSD schedule open browser app, browser app will auto open Url 1 address home page in local storage. If browser can not to find Url 1 address home page data in local storage, the screen will be black.

Note:

a. Browser app only can save Url 1 address home page data, other Url 2 to Url 7 can not to save.

b. Local storage : /storage/emulated/legacy/Download/OfflineBrowsing

c. If local storage has Url 1 address home page data, the settings page will show "Clear cache" button, press this button can clear Url 1 address home page data in local storage.

9. Import text file

Step 1. Create browser text file.

- File name : bookmarklist.txt.

- Content :



Step 2. Copy bookmarklist.txt to "philips" folder of internal storage. You may use FTP to do this.

- File path : /storage/emulated/legacy/philips (for DL, PL)
Ex. /storage/emulated/legacy/philips/bookmarklist.txt

Step 3. Start browser app, it will auto import browser text file.

Note : Once the playlist file (text) is imported, if an user change playlist by remote controller; this change will not be written to playlist text file.

4.6. PDF reader play

1. Home page of PDF Player; this page has three items: "Play", "Compose" and "Settings".

Play : select playlist to play.

Compose: edit playlist.

Settings: setting play properties.

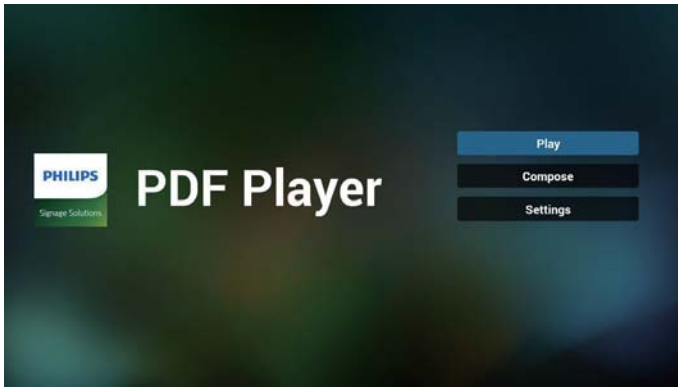

2. Select "Play" on home page, first you should choose one playlist to play between FILE 1 and FILE 7.

The pencil icon means the playlist is non-empty.

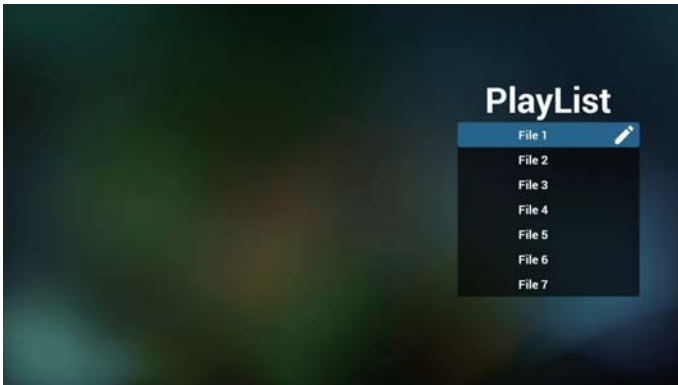

3. Select "Compose" on home page, first you should choose one playlist to edit between FILE 1 and FILE 7.

The pencil icon means the playlist is non-empty.

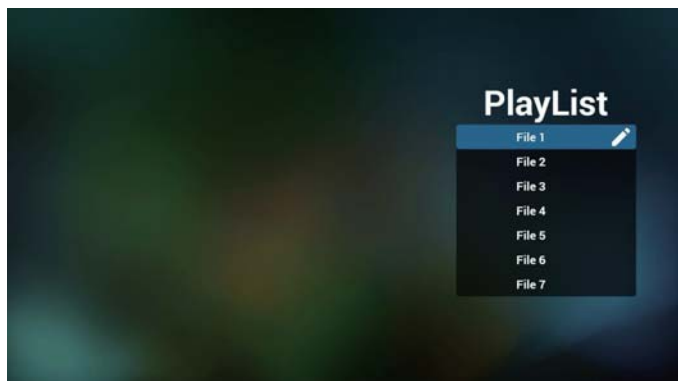

4. If an empty playlist is chosen, the app will guide you to select the media source.

All media files should be placed in /philips/ of root directory. For example,

- pdfs in /root/philips/pdf/

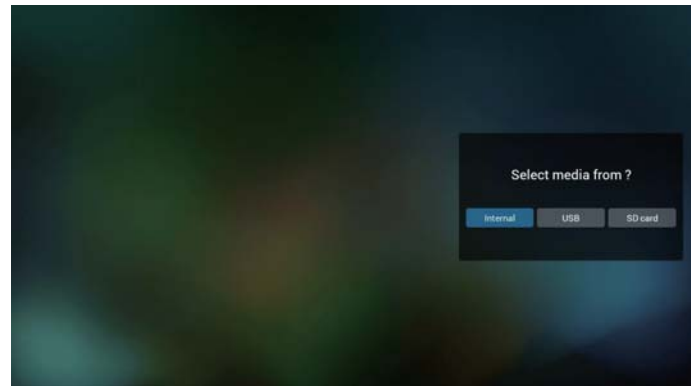

5. You could edit or delete a non-empty playlist, just choose the desired playlist which is with pencil icon.

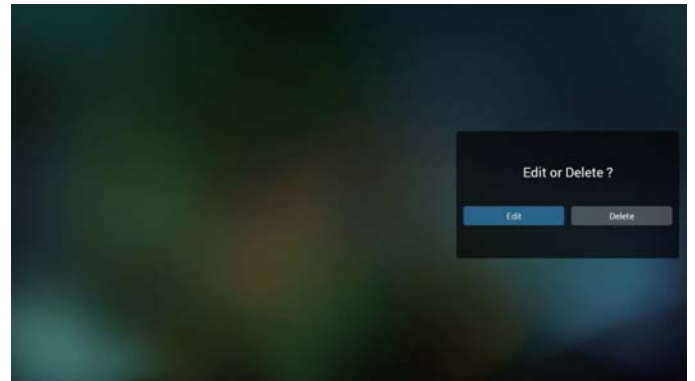

6. Once you start to edit a playlist, you will see below screen.

Source - files in storage.

Playlist – files in playlist.

There are 4 icons which map to the keys of remote controller:

Option key – launch slide bar

Play key – play media file.

Info key – show media info.

Ok key – select/unselect file.

6-1. In the slide bar, it helps you to do the following:

- select all : select all storage files.

- delete all : delete all playlist files.

- add/remove : update playlist from source.

- sort : sort playlist.

- save/abort : save or abort playlist.

- back : return.

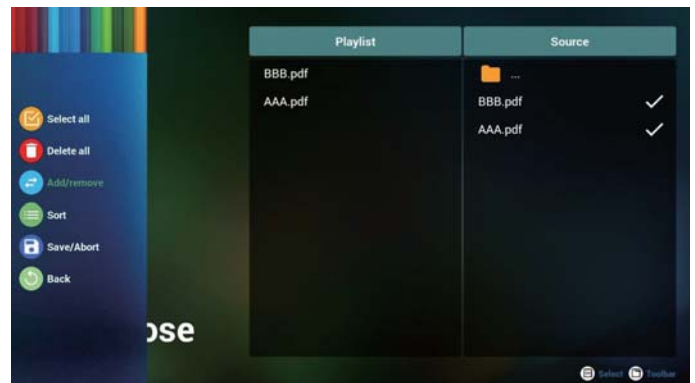

7. If you choose "Sort" in the slide bar, you can change the order of files one by one.

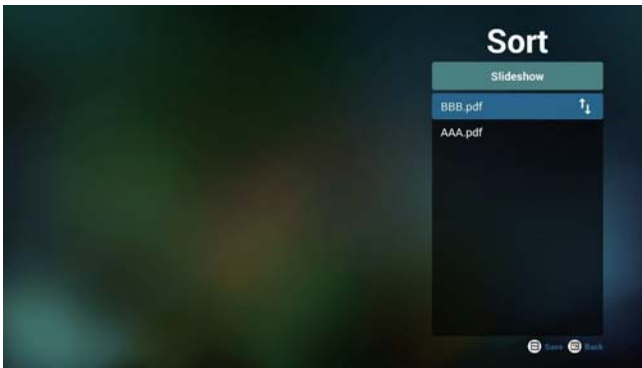

8. Select "Settings" on home page, this page has two parts, "Repeat Mode" and "Effect Duration".

Repeat Mode : play mode.

Effect Duration : photo effect duration.

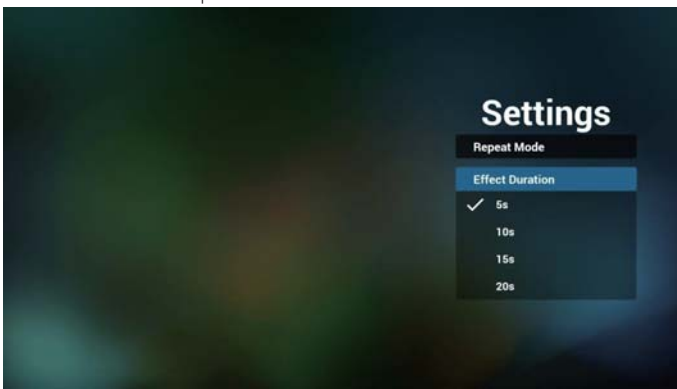

Media Hotkey:

Play : Playback file.

Pause: Pause page.

Fast forward: go to next page, if the page is end of the file, it will go to next file.

Rewind: back to last page, if the page is first of the file, it will back to last file.

Stop: return to first page of file

Color Hotkey:

Blue : Zoom in.(+10%)

Yellow : Zoom out.(-10%)

OK : Restore zoom

Arrow keys:

Up/Down/Left/Right : Adjust page. (When the page has zoomed in/out)

Left : Previous Page. (When the page has not zoomed in/out)

Right : Next Page. (When the page has not zoomed in/out)

Combination key:

Number key + OK key : select specific page, and press ok key to change page.

- Press number key.

- Press OK key, the bottom of the page will show the page number; if page number over total page number, it will not change page and show current page number at the bottom of the page.

9. Import Text File

Step 1. Create pdf player text file.

- File name : pdfplaylistX.txt, "X" means playlist number(1,2,3,4,5,6,7).
Ex. pdfplaylist1.txt, pdfplaylist2.txt

- Content :

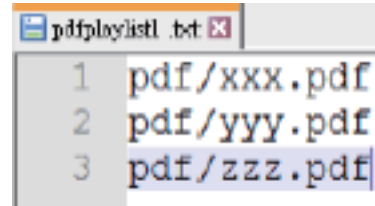

Step 2. Copy pdfplaylistX.txt to "philips" folder of internal storage. You may use FTP to do this.

- File path : /storage/emulated/legacy/philips (for DL, PL)
Ex. /storage/emulated/legacy/philips/pdfplaylist1.txt

Step 3. Prepare pdf files to "pdf" folder under "philips" folder; internal storage only.

- Ex. /storage/emulated/legacy/philips/pdf/xxx.pdf
/storage/emulated/legacy/philips/pdf/yyy.pdf
/storage/emulated/legacy/philips/pdf/zzz.pdf

Step 4. Start pdf player app, it will auto import pdf player text file.

Note : Once the playlist file (text) is imported, if an user change playlist by remote controller, this change will not be written to playlist text file.

4.7. CMND & Play

1) Server

Setup CMND & Play server address

2) Account

Setup CMND & Play account

3) PIN Code

Setup CMND & Play PIN code

(4) Version

There are two options, Ver.2 and Ver.3

Ver. 2

use 2.0/2.2 agreement

Ver. 3

use 3.0/3.1 agreement

(5) Content

There are internal storage/SD card/USB storage 3 options for selecting.

When Ver.2, Server/Account/PIN code will be gray and unavailable.



When Ver.3, Server/Account/PIN code is available.



4.8. Custom App

User can set up the application for Customer Source

Note:

- (1) Only display User Installed app.
- (2) Will not show up system pre-install app.

4.8.1. OSD Menu operation:

RCU: Source -> Custom

If set up customer APK, PD will open customer app when switch source to Customer mode.

If no set up customer APK, PD will show Black screen when switch source to Customer mode.

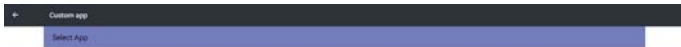

4.8.2. Function Introduction

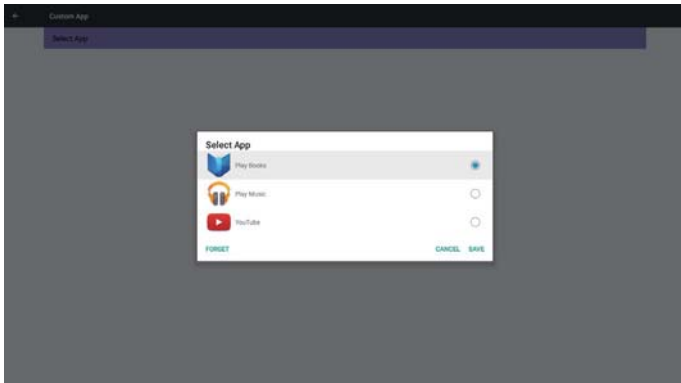

Save

Select the App, click the Save will perform the function of storage.

Forget

After press the Forget, can remove previously stored information.

Cancel

Don't do any change, directly closed Windows.

If no customer installed apk, the list will be blank.

The list will be blank and "Save""Forget" will be gray and useless.

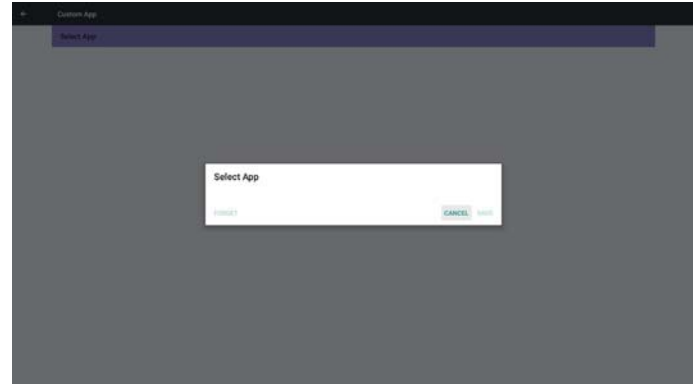

If customer installed apk,user can select customer installed apk in list

- Case 1: Not set up Custom App case.
Customer app will show up and focus on first item automatically.

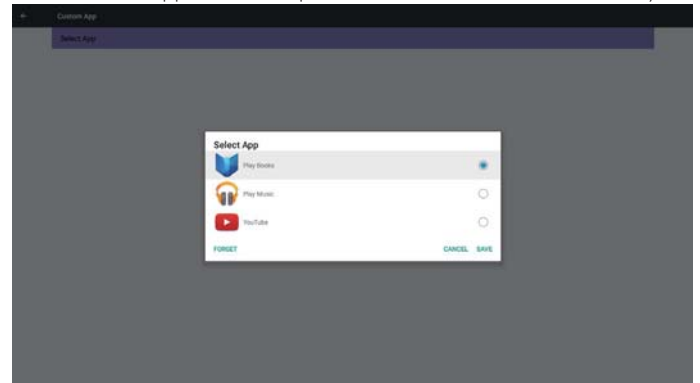

- Case 2: Set up Custom App case(there is entity circle to the right of icon)

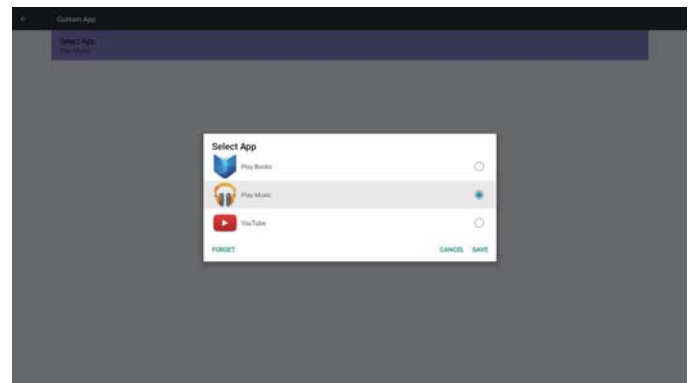

5. Signage display

5.1. Setting

Main items:

- (1) Ethernet
- (2) Proxy
- (5) Signage Display
- (6) System Tools
- (7) Display
- (8) Storage
- (9) Apps
- (10) Security (Show up when 4G module connected)
- (11) Date & time
- (12) Developer options
- (13) About

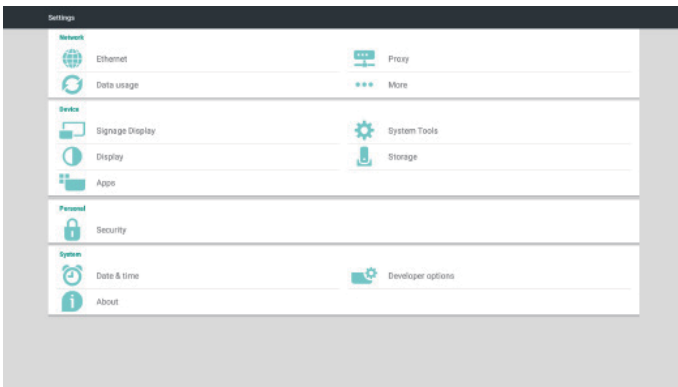

5.2. Ethernet

Enable/Disable to turn on/off Ethernet

After enable Ethernet, the settings will show:

- (1) Connection Type (Available connection type: DHCP/Static IP)
 - A. DHCP
 - B. Static IP
 - C. IP Address
 - D. Netmask
 - E. DNS Address
 - F. Gateway
- (2) Mac Address

5.2.1. DHCP

DHCP mode:

- (1) Cannot modify IP Address, Netmask, DNS Address and Gateway.
- (2) If connect successfully, it will display current network configuration.

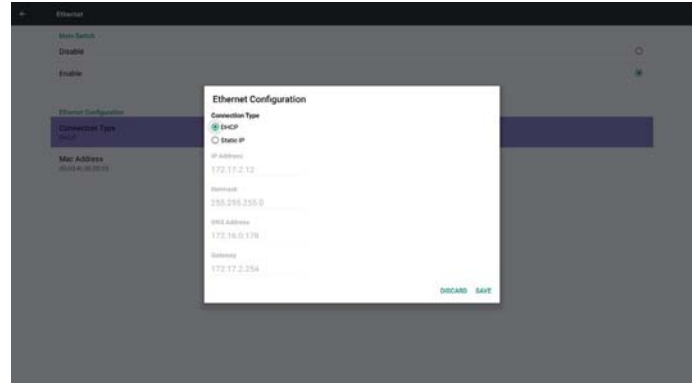

5.2.2. Static IP

In Static IP mode, user can input IP Address, Netmask, DNS address and Gateway

Note:

IP address, netmask, DNS address and gateway address input limitation

- (1)Format:
 - I. number 0-9
 - II. decimal point “.”

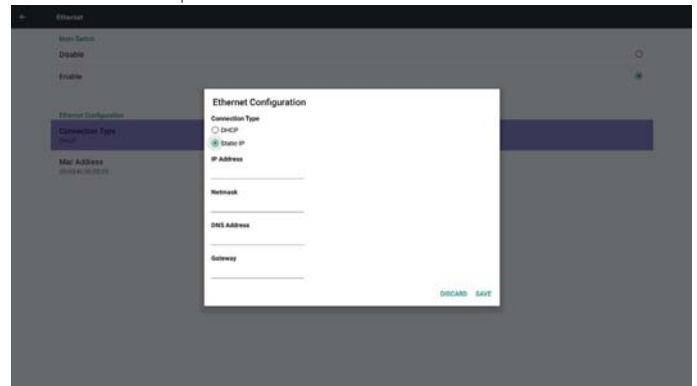

5.3. Proxy

Browser connect to Proxy server and ask Proxy server to connect some website on Internet.

Enable/Disable to turn on/off Proxy server.

- Click “Enable” to switch proxy function “ON”
- Input the “Proxy hostname”. (Proxy server IP address)
- Input the “Proxy port”. (Proxy server port number)
- Select an “Type”. (Proxy server type.)
- Done.
 - If the proxy server is need an authentication to connect, please “check on” the Authentication and input Username & Password.
 - If the proxy server is not need an authentication to connect.



Note:

- Proxy type in HTTP, HTTPS, SOCKS4, SOCKS5 are support.
- Only support the connection through the proxy server with TCP port 80 & 443 & 5228.
- Proxy server with authentication on Windows Sever Series is not support.

5.4. Signage Display

Divide into 4 groups: General Settings / Server Settings / Source Settings / Security

- (1) General Settings
 - A. Signage Display Name
 - B. Boot Logo
 - C. Screenshot
- (2) Server Settings
 - A. Email Notification
 - B. FTP
 - C. Remote Control
 - D. SSCP Network Port
- (3) Source Settings
 - A. Media Player
 - B. Browser
 - C. CMND & Play
 - D. PDF Player
 - E. Custom app
- (4) Additional settings
 - A. Tiling Tool
- (5) Security
 - A. External Storage
- (6) Other
 - A. TeamViewer Support
 - B. Platform Web API



5.4.1. General Settings

1. Signage Display Name

Set up PD name "PD_" + Ethernet Mac Address.

Note:

Input limitation:

- (1) length: Max 36 characters
- (2) format: no limit

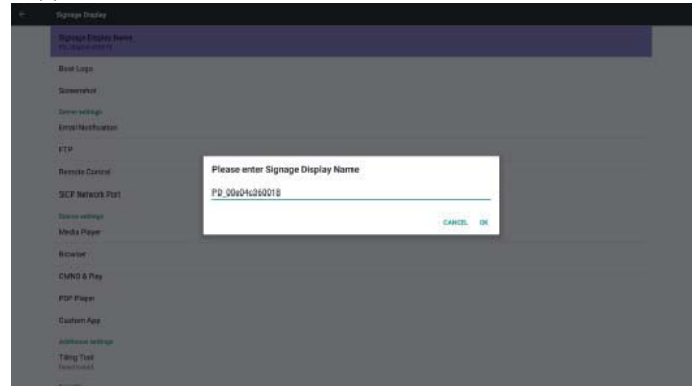

2. Boot Logo

- 1) Scalar OSD menu to control Android boot logo enable/disable
Scalar OSD menu operation

RCU: Home -> Configuration2 -> Logo -> On/Off/User

In user mode, user can choose their own boot logo animation file.

Note:

- (1) Boot animation file name: bootanimzation.zip
- (2) Will pop-up a window for user to select USB and SD card. No priority issue.



- 2) When boot logo selected, PD will check if there is bootanimzation.zip under USB and SD card.

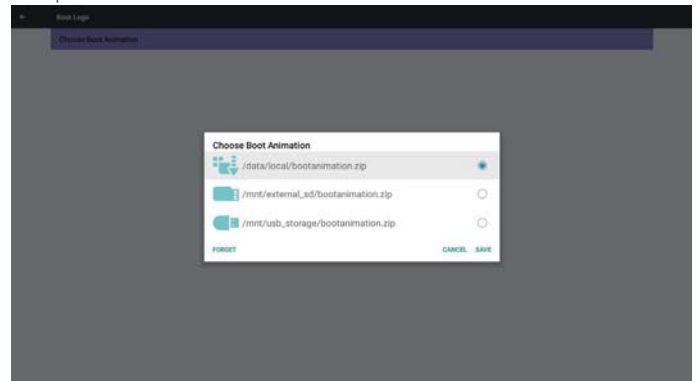

Function introduction:

a. Option description

/data/local

Use customized boot animation file which is copied from SD card or USB

/mnt/external_sd

Use boot animations file under SD card

/mnt/usb_storage

Use boot animations file under USB

b. Save

Press save key to save SD card or USB bootanimation.zip to /data/local and set it as boot logo.

c. Forget

Press Forget key to delete /data/local/bootanimation.zip and not show boot logo.

d. Cancel

Close dialogue w/o changes.

Scenario introduction:

Case 1

The user don't settle customized boot logo. PD does not find any bootanimation.zip file under SD and USB. The list will be blank. Save and Forget button will be gray and useless.

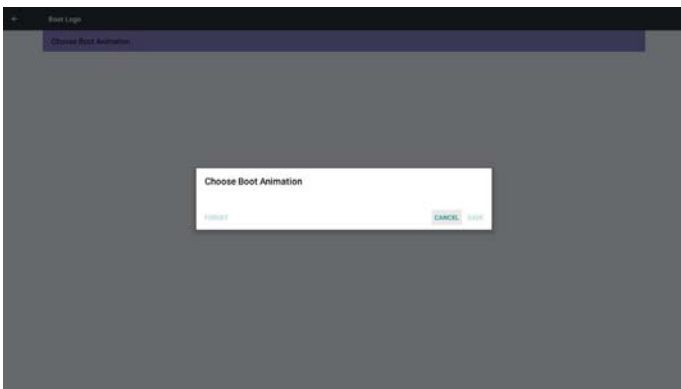

Case 2

The users do not settle customized boot logo. PD find bootanimation.zip file under SD and USB. The screen will show bootanimation.zip and select the first file automatically.

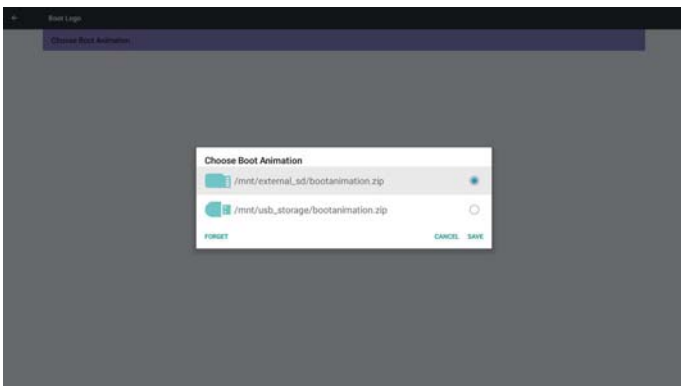

Case 3

The user settle customized boot logo, the screen will show /data/local/bootanimation.zip.

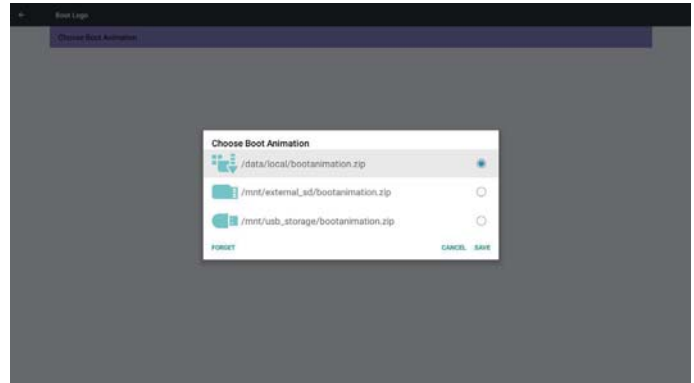

3) If OSD menu Logo item is On or Off, the users cannot choose boot animation in Android settings.

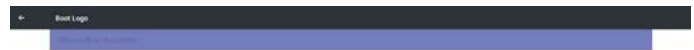

3. Screenshot

Via Enable/Disable to control screenshot On/Off.

After Enable, user can set screenshot timeslot and save path.

Note:

Time slot of deletion and screenshot:

(1) Will delete picture at initial time 0 sec.

(2) Will screenshot at first 40 sec.



1) Interval

Set up interval timeframe. 30 mins or 60 mins.

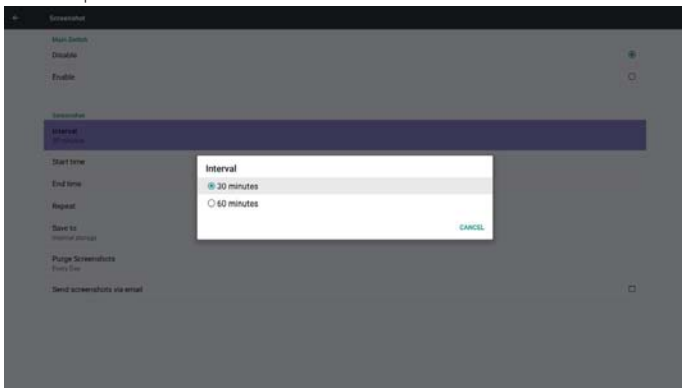

2) Start Time

Set up screenshot start time.

Note:

- (1) If no start time, the screen will show current time automatically
- (2) Just press Back key to exit dialog for Set up
- (3) Start time cannot be newer than End time.

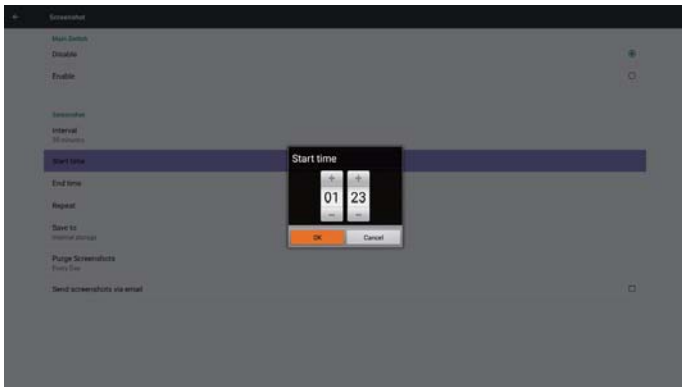

3) End Time

Set up screenshot End time

Note :

- (1) If no End time, the screen will show current time automatically
- (2) Start time cannot be newer than End time.

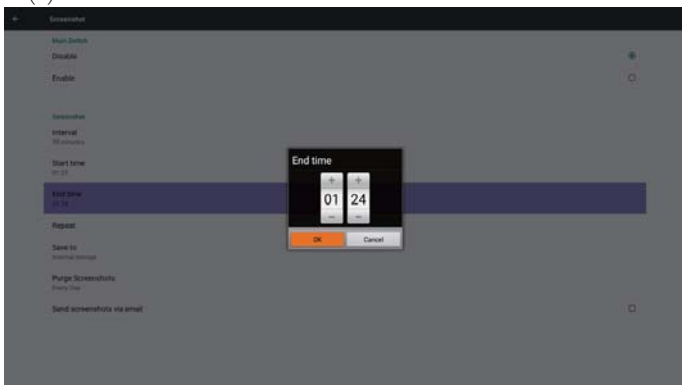

4) Repeat

Set screenshot repeat cycle. User can choose screenshot time frame. (Multiple selection)



5) Save to

Set up screenshot save path. Internal storage, SD card or USB storage.)

Note:

picture storage path

- (1) In root of internal storage/usb storage/sd card, PD will create folder automatically.
- (2) The picture will save to philips/Screenshot/.

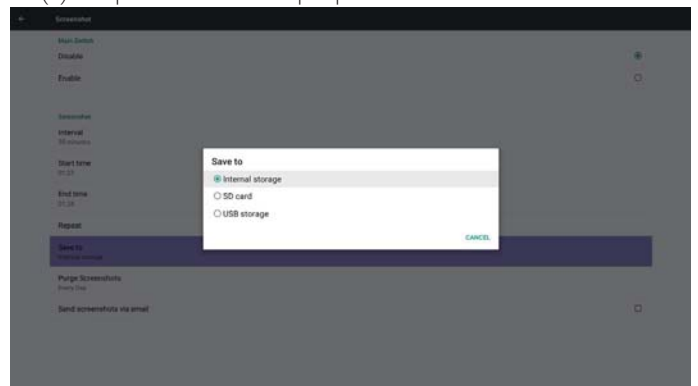

6) Purge Screenshots

Set up purge timeframe. One day or One week.

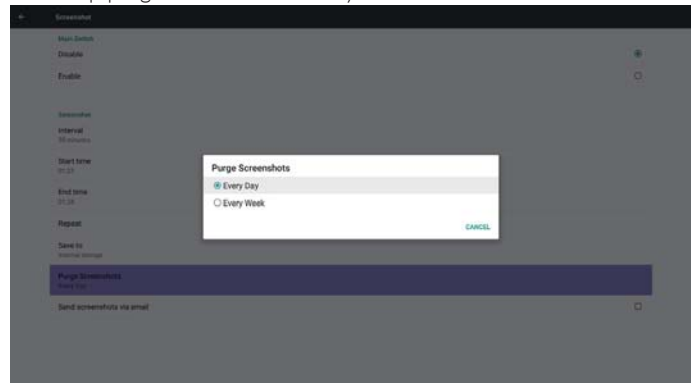

(7) Send screenshots via email

After check this item, it will send screenshot to email of administrator
Please refer to 6.2.1 Email notification

Note:

- Please confirm Email setting is done.
- Each screenshot will be sent immediately

5.4.2. Server Settings

1. Email Notification

Via Enable/Disable to control Email On/Off

After Enable, user can set up Email notification configuration.

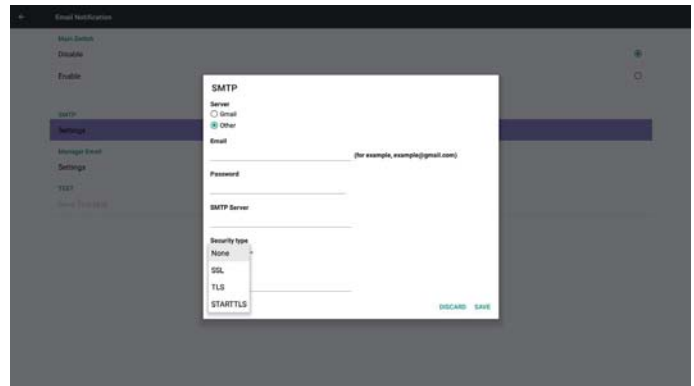
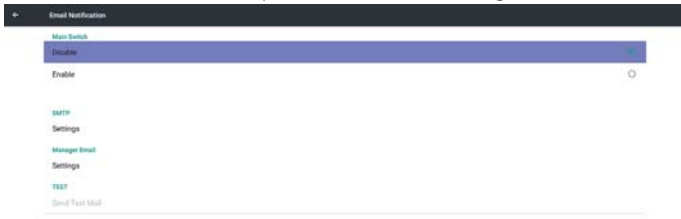

1) SMTP

Set SMTP configuration)

User can set Gmail account or other mail account.

User can select other mail account and set up SMTP server; Security type and port item

Note

Password input limitation

(1) Length: 6-20 characters

(2) Format: no limit

(3) unavailable port: 5000

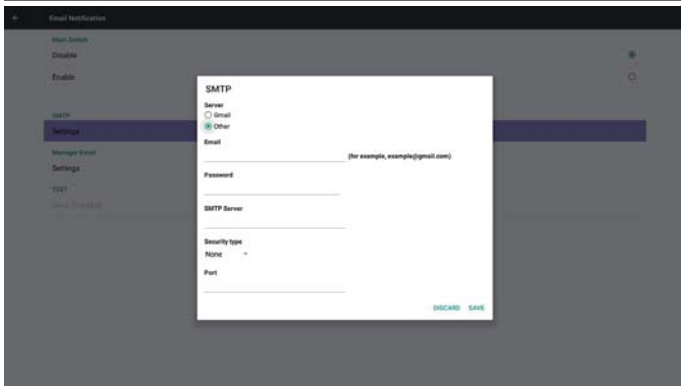
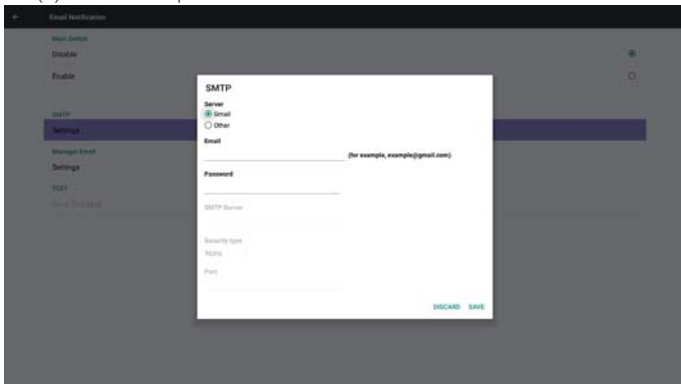

Gmail safety setting

If Gmail is not working when setting is complete, please test Gmail account via PC and link below URL

<https://www.google.com/settings/security/lesssecureapps>

And confirm "Access for less secure apps" item is Turn On

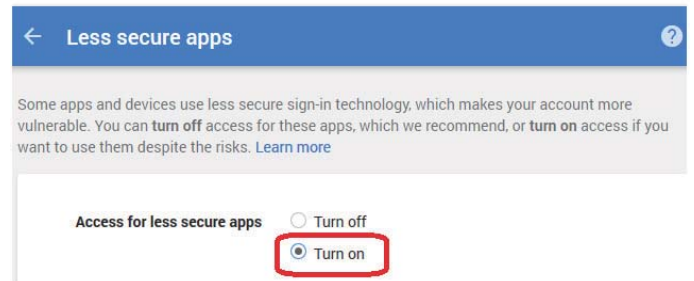

Yahoo Email Security Setting

If Yahoo Email is not working when setting complete, please confirm "Allow apps that use less secure sign in" item is enabled.

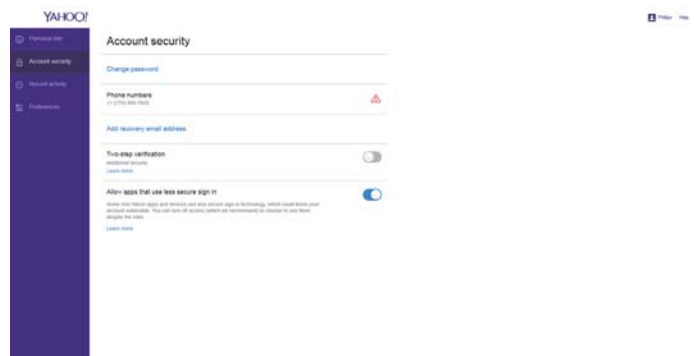

2) Manager Email

Set up Receiver mail account

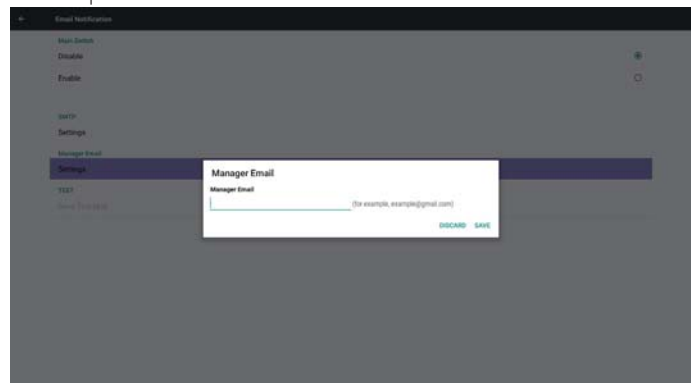

3)Test

Send Test Mail

To test Gmail account receive/send function.

Note

(1) When Email is Disable, "Send Test Mail Button" button will gray out

2. FTP

Via Enable/Disable to control FTP On/Off. After set up, PD can share FTP files.

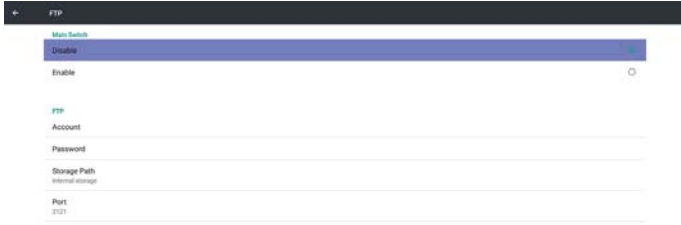

(2) After set up, the password text will show as "*" symbol.

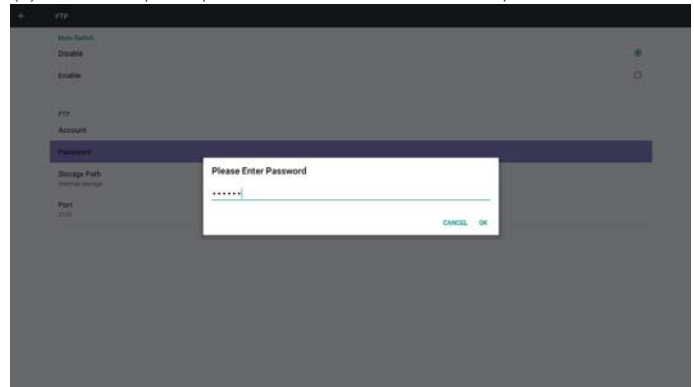

3)Storage Path

Show default path: Internal storage

Note:

Can only display Internal storage, cannot be modified.(Only show path)



1) Account

Set up FTP account

Note:

Input limitation

(1) Length: 4-20 characters

(2) Format:

- I. English a-z and A-Z
- II. Number 0-9

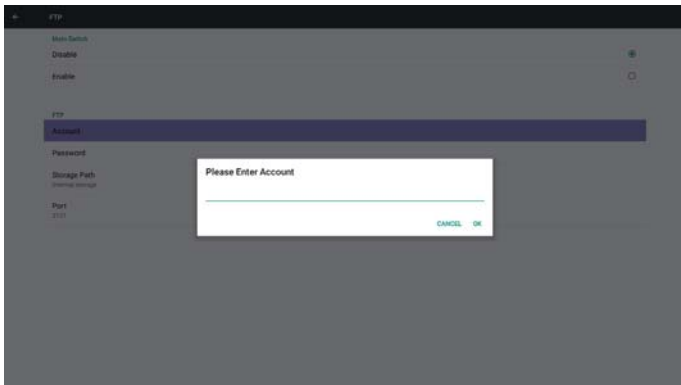

2) Password

Set up FTP password.

Note:

Input limitation

(1) Length: 6-20 characters

(2) Format:

- I. English a-z and A-Z
- II. Number 0-9

FTP password display

(1) Will show "*" symbol to instead password if set up password via remote control.

4) Will show Server is unbinded if Remote control server feedback unbinded status.

5) Port

Set up FTP port number. Default: 2121

Note:

Input limitation

(1) Length: Max 5 characters

(2) Range: 1024 ~ 65535

(3) Format: Number 0-9

(4) Unavailable port: 5000

(5) The port number must more than 1024



3. Remote Control

Via Enable/Disable to Control Remote Control On/Off

User can input Server address. If server does not registered, it will ask user for PIN code.

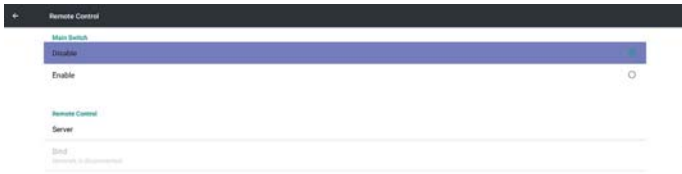

Bind status:

- (1) Will show network is disconnected if not yet connects to network.
- (2) Will show Server is disconnected if network connected but remote control server disconnected.
- (3) Will show Server is unbinded if Remote control server feedback unbinded status.
- (4) Will show Server is binded if Sever binded successfully.
- (5) Will show Error PIN code if input incorrect PIN code.

4. SICP Network Port

Change SICP Network Port.

- (1) Length: Max 5 characters
- (2) Range: 1025-65535
- (3) Format: Number 0-9
- (4) Connection port must bigger than 1024
- (5) Do not use the port: 15220, 28123, 28124



5.4.3. Source Settings

1. Media Player

Can Edit Media Player play list and effect settings.



(1) Open Media Player Player List edit page.

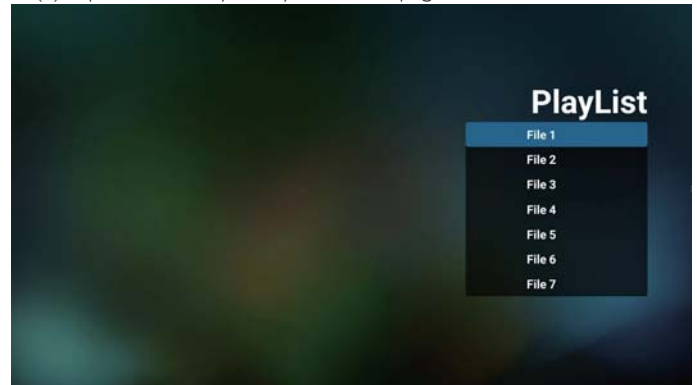

(2) Open Media Player slideshow effect edit page.

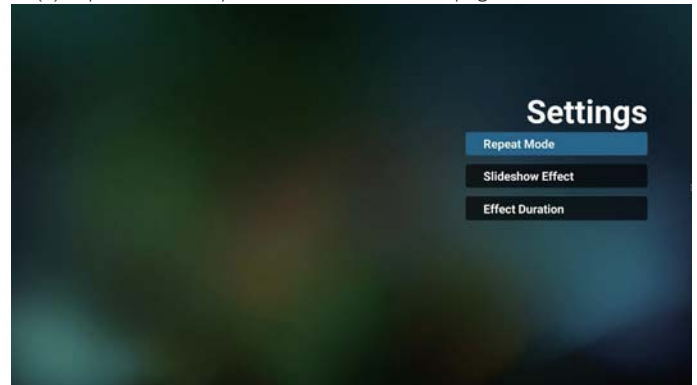

2. Browser

Can edit Bookmark configuration.



(1) Open Browser setting page.

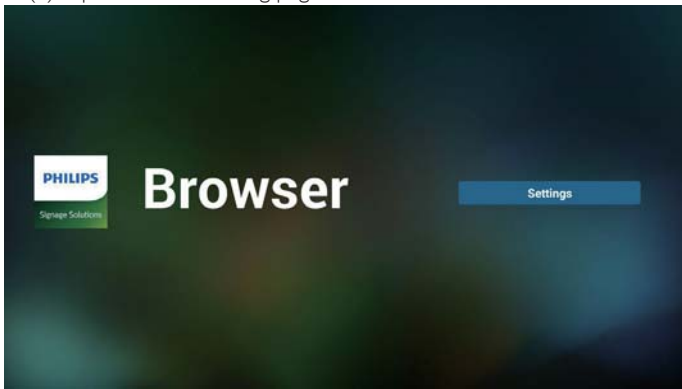

4. PDF Player

(1) Open PDF Player Player List edit page.

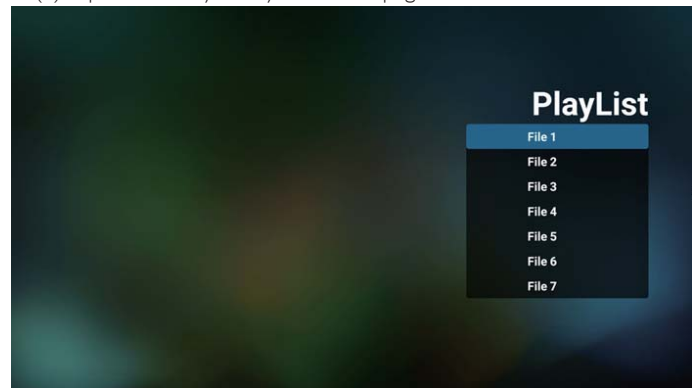

(2) Open PDF Player effect edit page.

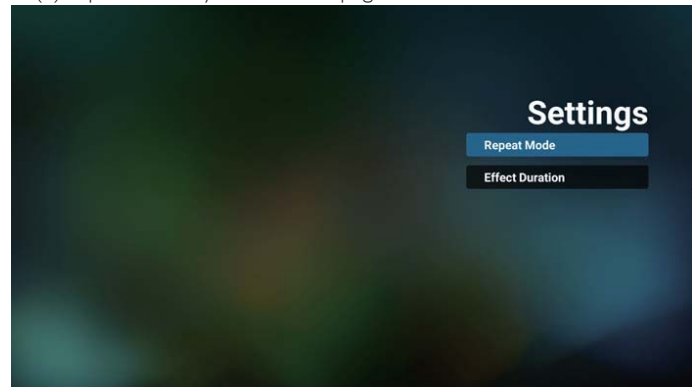

5. Custom App

Please refer to Page 26 Custom App

5.4.4. Additional Settings

When the customer payment, can get activate code, after successful input, can enable the function of tiling tool.

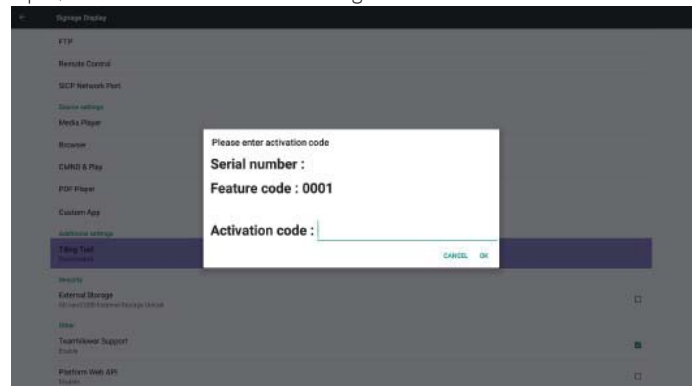

3. CMND & Play

1) Server

Setup CMND & Play server address

2) Account

Setup CMND & Play account

3) PIN Code

Setup CMND & Play PIN code

(4) Version

There are two options, Ver:2 and Ver:3

Ver: 2

Use 2.0/2.2 agreement

Ver: 3

Use 3.0/3.1 agreement

(5) Content

There are internal storage/SD card/USB storage 3 options for selecting.

When Ver:2, Server/Account/PIN code will be gray and unavailable.



When Ver:3, Server/Account/PIN code is available.

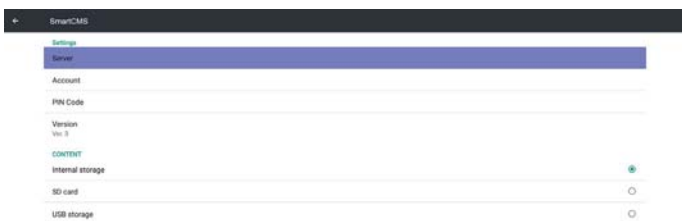

5.4.5. Security

1. External Storage

Lock/Unlock external storage.

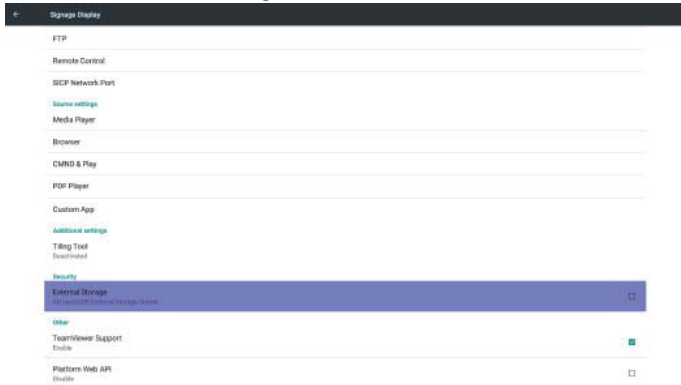

5.4.6. Others

1. TeamViewer Support

Enable / Disable TeamViewer support.

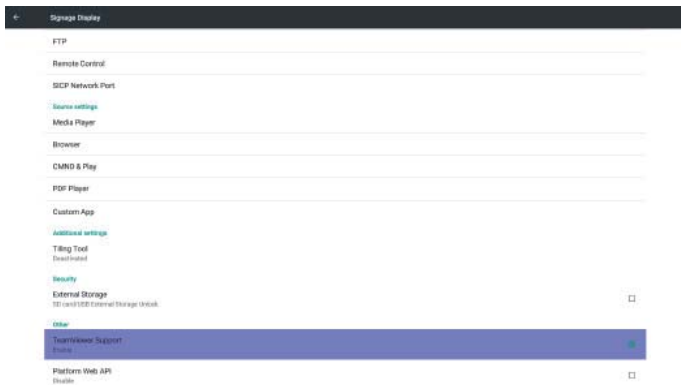

2. Platform Web API

Enable / Disable Platform Web API.

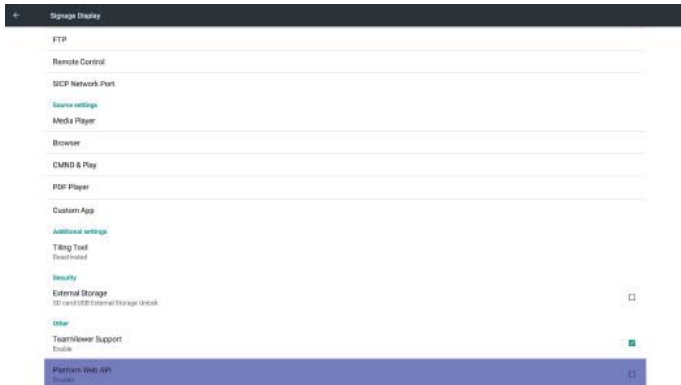

5.5. System Tools

System tools 4 main functions:

- (1) Clear Storage
- (2) Factory Reset
- (3) Import & Export
- (4) Clone Media Files

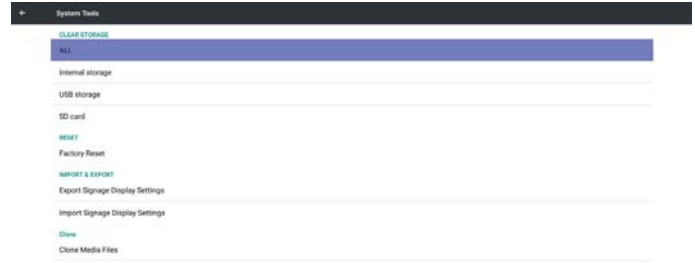

5.5.1. Clear Storage

The purpose is to clear all data in Philips folders.

Divided into 4 mode:

- (1) Clear all Philips folders
- (2) Only clear Philips folder under Internal storage.
- (3) Only clear Philips folder under USB storage.
- (4) Only clear Philips folder under SD card.

Pop-up the window to display all folders which can be clear.

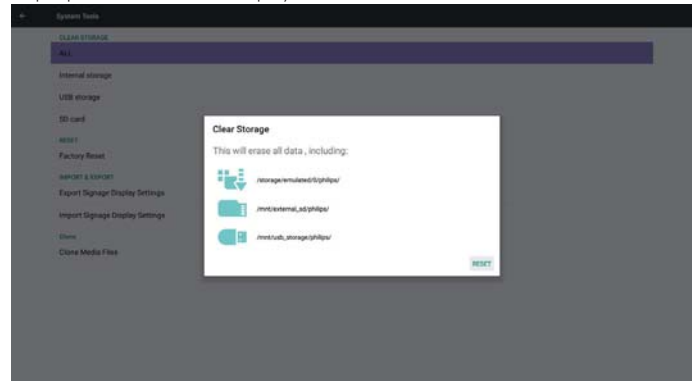

5.5.2. Factory Reset

Factory Reset can recover to Factory default settings.

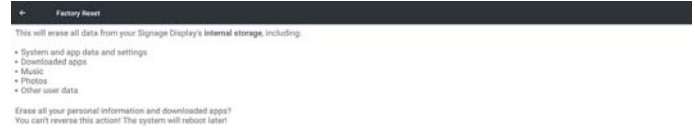

FACTORY RESET

Press OK to execute Reset function automatically.

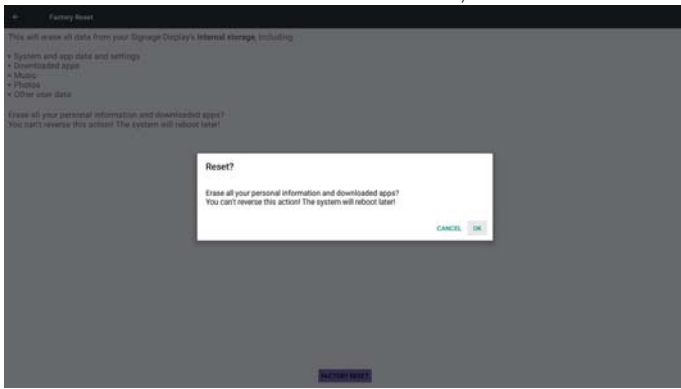

Show notification dialog before database import

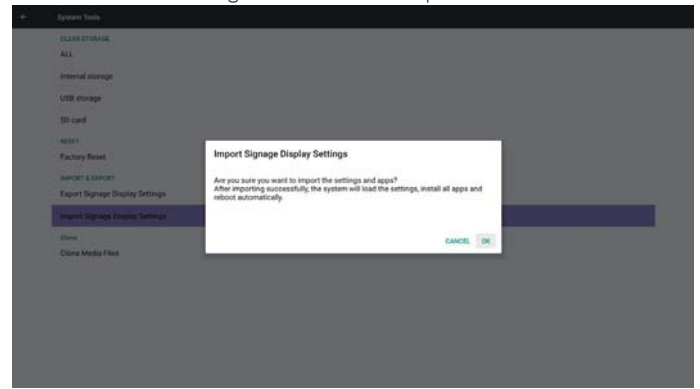

5.5.3. Import & Export

The function of Import & Export PD settings.

Notes.

- (1) Settings.db (Saved file name: settings.db)
- (2) Will save to Philips folder in storage

5.5.3.1 Export Signage Display Settings

Will export to Philips folder under USB or SD card

- (1) Export settings.db
- (2) Export 3rd party apk to Philips/app/

Note:

If no Philips folder exists in USB or SD card, it will be created automatically.

List all available storage (internal/SD/USB)

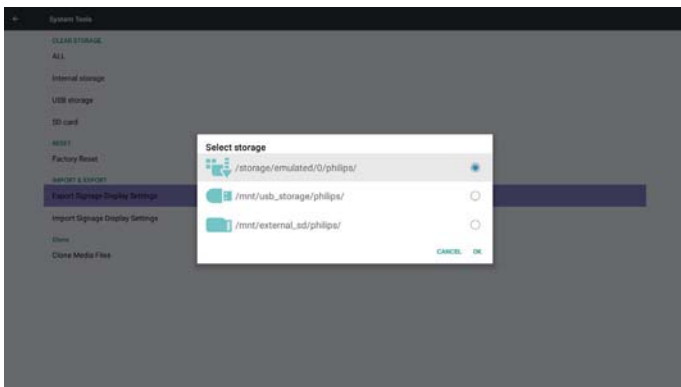

5.6. Clone Media File

Clone media file from Internal, SD or USB Philips folder.

1. The cloned folder name under Philips folder

- (1) philips/photo
- (2) philips/music
- (3) philips/video
- (4) philips/cms
- (5) philips/pdf
- (6) philips/browser

2. The cloned file extension name is ".cms"

Clone Source

- (1) Internal storage
 - (a) check FTP
 - (b) check /Philips/
- (2) SD / USB

Files under root

Target Location

- (1) Internal storage
 - Save to /Philips/
- (2) SD / USB
 - Save to root

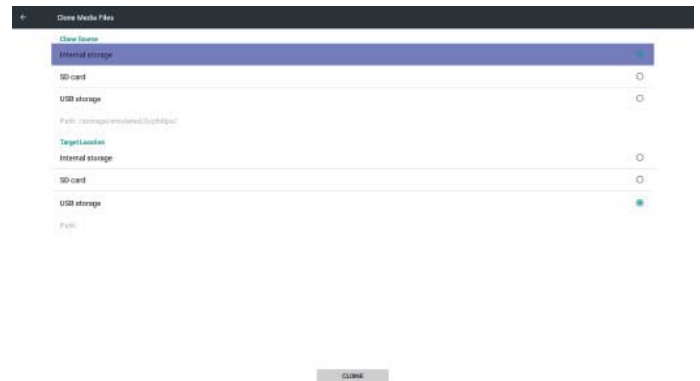

5.5.3.2 Import Signage Display Settings

Import settings.db from Philips folder under USB or SD card.

- (1) Import settings.db
- (2) Auto install 3rd party apk from Philips/app/

List all available storage (Internal/SD/USB)

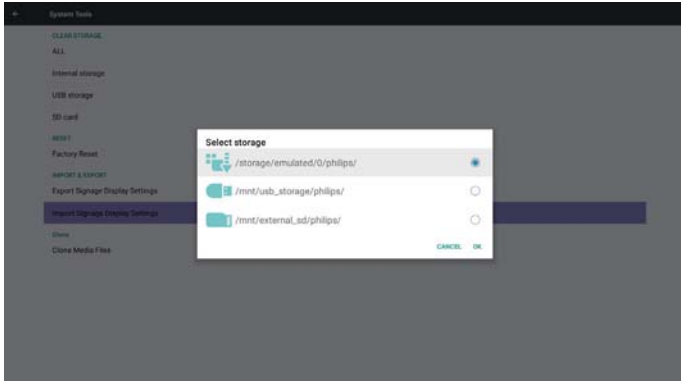

5.7. Display

User can modify the font size, can choose: Small/Normal/Large/Huge



5.8. Storage

Display current PD Android storage information.

Note

(1) User option key on RCU to show setting option



SD CARD and USB STORAGE :

Need to insert SD card or USB, the information will show up total space and available of SD card or USB storage.

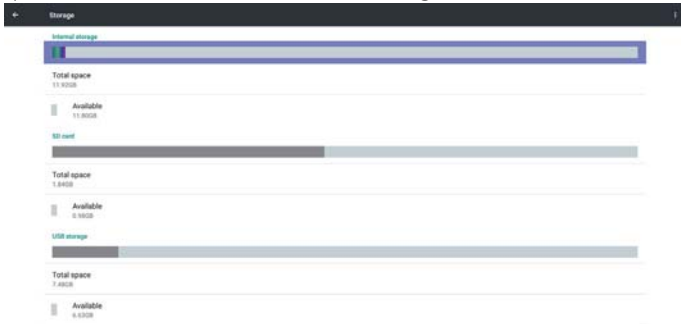

5.9. Apps

Display applications information.

Note

(1) User options key on RCU to show setting option.

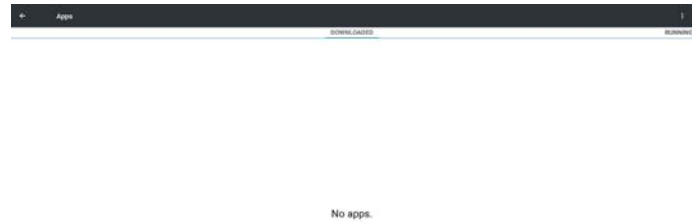

5.10. Security

Setup/Disable SIM PIN code.

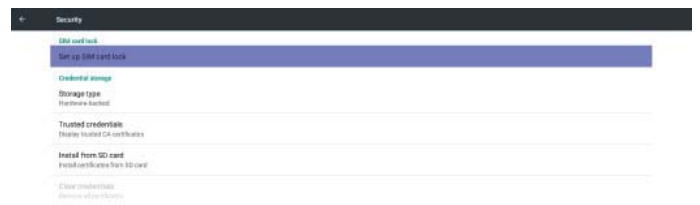

5.10.1. Credential storage

Set credential related functions.

After installation credential, if you want to unlock when start up, please use the mouse to unlock.

5.11. Date & time

Via Scalar OSD menu to control Auto Time On/Off.

Note:

Add new NTP server to display current server IP.



5.12. About

Main info in About:

- (1) System updates
- (2) Legal information
- (3) Android version
- (4) Kernel version
- (5) Build number

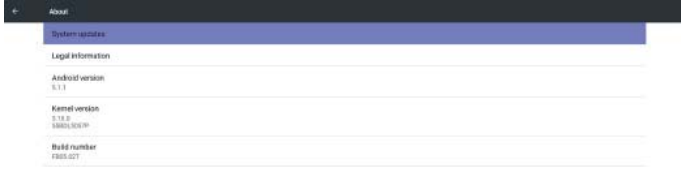

5.12.2. Legal Information

Show the open source licenses.



5.12.1. System updates

1. Will automatically search update.zip in USB or SD card.
Will be shown in list for user selection if found
2. After select update.zip file, PD will restart and start to update.
3. If not found update.zip. The dialog is no content and the Ok button will be gray and useless.

Note:

- (1) Only support Android Full image.
- (2) File name should be update.zip.
- (3) The file should be located in root of storage.

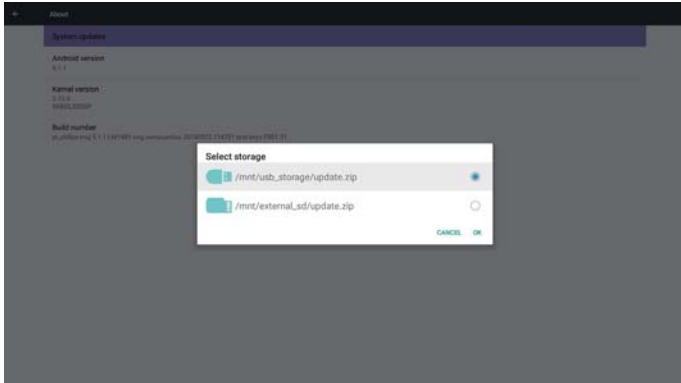

6. OSD Menu

An overall view of the On-Screen Display (OSD) structure is shown below. You can use it as a reference for further adjusting your display.

6.1. Navigating the OSD Menu

6.1.1. Navigating the OSD menu using the remote control

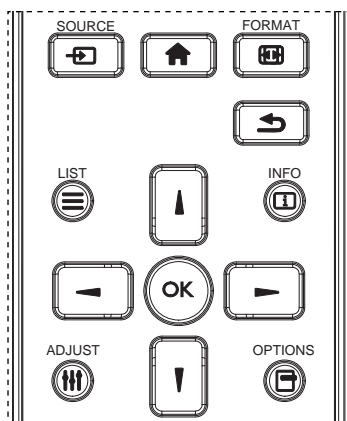

1. Press [**HOME**] button on the remote control to display the OSD menu.
2. Press [**UP**] or [**DOWN**] button to choose the item you want to adjust.
3. Press [**OK**] or [**RIGHT**] button to enter the submenu.
4. In the submenu, press [**UP**] or [**DOWN**] button to toggle among items, press [**LEFT**] or [**RIGHT**] button to adjust settings. If there is a submenu, press [**OK**] or [**RIGHT**] button to enter the submenu.
5. Press [**BACK**] button to return to the previous menu, or press [**HOME**] button to exit the OSD menu.

NOTES:

- When there is no OSD menu on the screen, press [**UP**] to display the menu of {Smart picture}.
- When there is no OSD menu on the screen, press [**DOWN**] to display the menu of {Audio source}.

6.1.2. Navigating the OSD menu using the display's control buttons

1. Press [**MENU**] button to display the OSD menu.
2. Press [**+**] or [**-**] button to choose the item you want to adjust.
3. Press [**+**] button to enter the submenu.
4. In the submenu, press [**▲**] or [**▼**] button to toggle among items, press [**+**] or [**-**] button to adjust settings. If there is a submenu, press [**+**] button to enter the submenu.
5. Press [**MENU**] button to return to the previous menu, or press [**MENU**] button several times to exit the OSD menu.

6.2. OSD Menu Overview

6.2.1. Picture menu

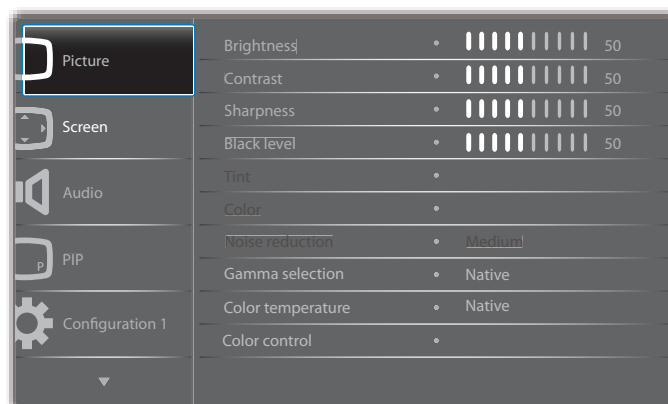

Brightness(Picture)

Adjust the overall image and background screen brightness(backlight).

Contrast

Adjust the image contrast ratio for the input signal.

Sharpness

This function is digitally capable to keep crisp image at any timings. It is adjustable to get a distinct image or a soft one as you prefer and set independently for each picture mode.

Black level

Adjust the image brightness for the background.

NOTE: sRGB picture mode is standard and cannot be changed.

Tint(Hue)

Adjust the tint of the screen.

Press + button the flesh tone color becomes greenish.

Press - button the flesh tone color becomes purplish.

NOTE:VIDEO mode only.

Color(Saturation)

Adjust the color of the screen.

Press + button to increase color depth.

Press - button to decrease color depth.

NOTE:VIDEO mode only

Noise Reduction

Adjust the noise reduction level.

Gamma selection

Select a display gamma, It's refer to the brightness performance curve of signal input. Choose from {Native} / {2.2} / {2.4} / {s gamma} / {D-image}.

NOTE: sRGB picture mode is standard and cannot be changed.

Color temperature

It is used to adjust the color temperature.

The image becomes reddish as the color temperature decreases, and becomes bluish as the color:

CCT	10000° K	9300 ° K	7500 ° K	6500 ° K	5000 ° K	4000 ° K	3000 ° K
X	0.279 ± 0.030	0.283 ± 0.030	0.299 ± 0.030	0.313 ± 0.030	0.346± 0.030	0.382± 0.030	0.440± 0.030
Y	0.292 ± 0.030	0.298 ± 0.030	0.315 ± 0.030	0.329 ± 0.030	0.359± 0.030	0.384± 0.030	0.403± 0.030

Color control

The color levels of red, green, and blue are adjusted by the color bars.

R: Red gain, G: Green gain, B: Blue gain.

Smart picture

PQ setting

PC mode: {Standard} / {Highbright} / {sRGB}.

Video mode: {Standard} / {Highbright} / {Cinema}.

Smart Contrast

Auto detect black data and white data on content and set suitable backlight.

Surface Ratio	Backlight Setting
5%-90%	(MaxBacklight-MinBacklight)* Surface Ratio/100
<5%	Min Backlight
>90%	Max Backlight

Smart power

Smart Power control is not relative to brightness control:

- Initial setting Brightness
 - 70 (in the range from 0-100)
 - Power consumption 70% of maximum power consumption
- Smart Power
 - OFF: no adaptation
 - MEDIUM: 80% of power consumption relative to current settings
 - HIGH: 65% of power consumption relative to current settings
- Panel saving/Brightness ON: 40% of maximum power consumption
 - The controls settings should only be visible on its own controls. It should not have secondary effects on other controls (ea brightness setting changes when smart power setting has changed).

Overscan

Change the display area of the image.

ON: Set to display area about 95%.

OFF: Set to display area about 100%.

Picture reset

Reset all settings in the Picture menu.

Select "Yes" and press "SET" button to restore to factory preset data.

Press "EXIT" button to cancel and then return to the previous menu.

6.2.2. Screen menu

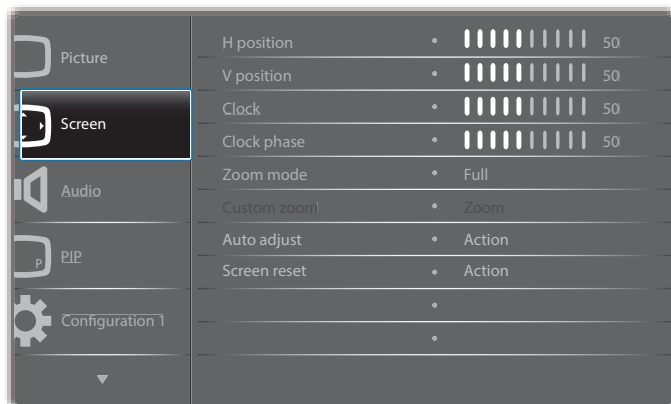

H position

Control Horizontal Image position within the display area of the LCD.

Press + button to move screen to right.

Press - button to move screen to left.

V position

Control Vertical Image position within the display area of the LCD.

Press + button to move screen to up.

Press - button to move screen to down.

Clock

Press + button to expand the width of the image on the screen the right.

Press - button to narrow the width of the image on the screen the left.

NOTE:VGA input only.

Clock phase

Improves focus, clarity and image stability by increasing or decreasing this setting.

NOTE:VGA input only

Zoom mode

PC mode: {Full} / {4:3} / {1:1} / {16:9} / {21:9} / {Custom}.

Video mode: {Full} / {4:3} / {1:1} / {16:9} / {21:9} / {Custom}.

*Zoom mode setting is by input. If input in multi-windows, the setting will apply for windows with the same input.

And the INFO OSD will show the latest setting.





	<p>Full</p> <p>This mode restores the correct proportions of pictures transmitted in 16:9 using the full screen display.</p>
	<p>4:3</p> <p>The picture is reproduced in 4:3 format and a black band is displayed on either side of the picture.</p>
	<p>1:1</p> <p>This mode displays the image pixel-by-pixel on screen without scaling the original image size.</p>
	<p>16:9</p> <p>The picture is reproduced in 16:9 format and a black band at the top and bottom.</p>
	<p>21:9</p> <p>The picture is reproduced in 21:9 format and a black band at the top and bottom.</p>
	<p>Custom</p> <p>Choose to apply the custom zoom settings in the Custom Zoom submenu.</p>

Custom zoom

You can use this function to further customize the zoom settings to suit the image you want to display.

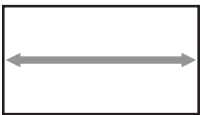
NOTE: This item is functional only when the {Zoom mode} is set to {Custom}.

	<p>Zoom</p> <p>Expands the horizontal and vertical sizes of the image simultaneously.</p>
--	--

	H zoom Expands the horizontal size of the image only.
	V zoom Expands the vertical size of the image only.
	H position Moves the horizontal position of the image left or right.
	V position Moves the vertical position of the image up or down.

Auto adjust

Press "Set" to detect and adjust H position, V position, Clock, Phase automatically.

Screen reset

Reset all settings in the **Screen** menu to factory preset values.
Select "Yes" and press "SET" button to restore the factory preset data.
Press "EXIT" button to cancel and then return to the previous menu.

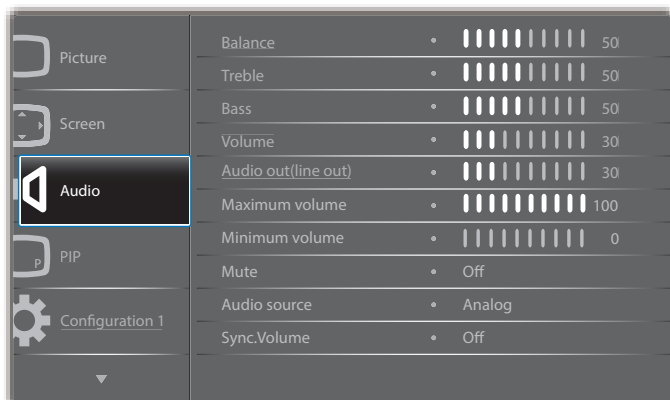
6.2.3. Audio menu**Balance**

Adjust to emphasize left or right audio output balance.

Treble

Adjust to increase or decrease higher-pitched sounds.

Bass

Adjust to increase or decrease lower-pitched sounds.

Volume

Adjust to increase or decrease the audio output level.

Audio out (line out)

Adjust to increase or decrease line out output level.

Maximum volume

Adjust your own limitation for the maximum volume setting. This stops the volume from being played too loudly.

Minimum volume

Adjust your own limitation for the minimum volume setting.

Mute

Turn the mute function on/off.

Audio source

Select the audio input source.

Analog: audio from audio input

Digital : audio from HDMI/DVI audio.

Displayport: audio from DP.

Sync Volume

Enable/disable audio out (line out) volume adjustability to sync with internal speakers.

Card OPS audio

Select the analog or digital audio mode for card OPS.

Audio reset

Reset all settings in the **Audio** menu to factory preset values.

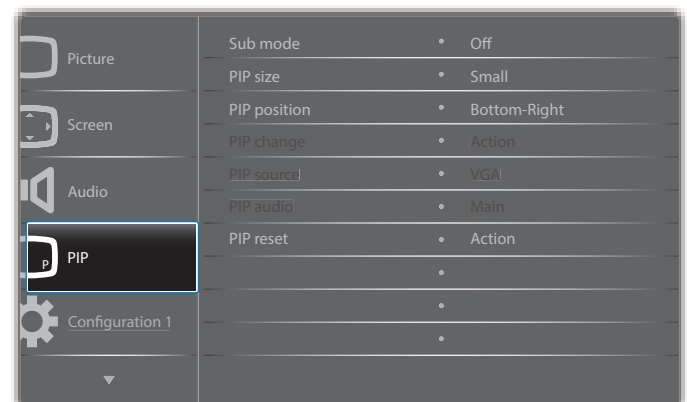
6.2.4. PIP menu**Sub mode**

Select the sub mode.

Choose from: {Off} / {PIP} / {Quick swap} / {PBP}.

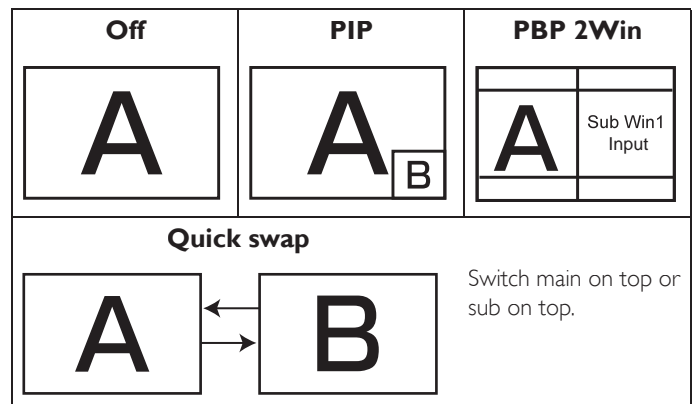
**PIP size**

Select the size of the sub picture in the PIP (Picture-in-Picture) mode.

Choose from: {Small} / {Medium} / {Large}.

PIP position

Select the position of the sub picture in the PIP (Picture-in-Picture) mode, {Bottom-Right}/{Bottom-Left}/{Top-Right}/{Top-Left}/{Center}/{Custom}.

PIP position/Custom feature:

Left/Right {0-10}: adjust PIP windows from Left to Right corner.

Up/Down {0-10}: adjust PIP windows from Up to bottom of screen.

Size {0-10}: adjust PIP window size.

When PIP sub window moving to the border of screen, corresponding setting of position/size will be fixed and cannot adjust.

PIP change

Exchange Main and PIP / PBP / Quick swap input signal.

PIP source

Select the input signal for the sub picture.

PIP audio

Select the audio source in the Sub mode.

- {Main} - Select audio from the main picture
- {Sub} - Select audio from the sub picture.

PIP reset

Reset all settings in the PIP menu to factory preset values.

- The PIP function is available only for certain signal source combinations as shown in the table below.

	HDMI1	HDMI2	DVI	DisplayPort	VGA	MediaPlayer	Browser	SmartCMS	PDF Reader	Custom	CardOPS
HDMI1	○	×	×	○	○	×	×	×	×	×	×
HDMI2	×	○	×	○	○	×	×	×	×	×	×
DVI	×	×	○	○	○*	×	×	×	×	×	×
DisplayPort	○	○	○	○	○	○	○	○	○	○	○
VGA	○	○	○*	○	○	○	○	○	○	○	○
Media Player	×	×	×	○	○	○	×	×	×	×	×
Browser	×	×	×	○	○	×	○	×	×	×	×
SmartCMS	×	×	×	○	○	×	×	○	×	×	×
PDF Reader	×	×	×	○	○	×	×	×	○	×	×
Custom	×	×	×	○	○	×	×	×	×	○	×
CardOPS	×	×	×	○	○	×	×	×	×	×	○

(○: PIP function available, ×: PIP function unavailable)

- The availability of the PIP function will also depend on the resolution of the input signal being used.

Note: Touch function is only for single full screen. Multiple screen touch event will be incorrect corresponding.

6.2.5. Configuration1 menu

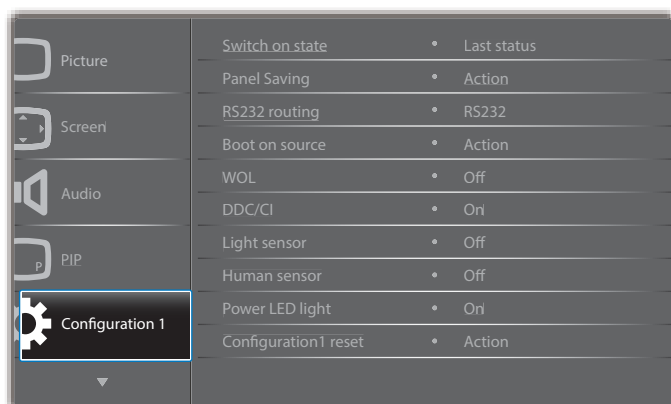

Switch on state

Select the display status used for the next time you connect the power cord.

- {Power off} - The display will remain off when the power cord is connected to a wall outlet.
- {Forced on} - The display will turn on when the power cord is connected to a wall outlet.
- {Last status} - The display will return to the previous power status (on/off/standby) when removing and replacing the power cord.

Panel saving

Choose to enable the panel saving functions and thus reduce the risk of "image persistence" or "ghost-imaging".

- {Brightness} - Select {On} and the image brightness will be reduced to an appropriate level. The Brightness setting in the Picture menu will be unavailable when selected.
- {Pixel shift} - Select the time interval ({Auto} / {10 ~ 900} Seconds / {Off}) for the display to slightly expand the image size and shift the position of pixels in four directions (up, down, left, or right). Activating Pixel Shift will disable H Position, V Position and Zoom Mode in the Screen Menu.

RS232 routing

Select the network control port.

Choose from: {RS232} / {CardOPSR232 (OPS model only)} / {LAN -> RS232}.

Boot on source

Choose to select source when boot up.

Input: select input source when bootup.

Playlist: select playlist index for Media player; Browser; PDF player.

0: no play list. Same as switch source from OSD. 1~7: playlist number.

WOL

Choose to turn on or off the wake on LAN function.

Choose from : {Off} / { On}

DDC/CI

Choose to turn on or off the DDC/CI communication function. (*VGA support only)

Select {On} for normal use.

Light sensor (require Philips accessory CRD41 External Sensor Box)

Choose to turn on or off backlight adjustment according to environment brightness.

Choose from : {Off} / { On}

Human sensor (require Philips accessory CRD41 External Sensor Box)

The Human sensor can detect if people approach the display or not.

The display will turn off backlight if detect nothing in setting time.

The display will back to backlight on when people approach it.

The options are:

- {Off}(Default), {10 Min.}, {20 Min.}, {30 Min.}, {40 Min.}, {50 Min.}, {60 Min.}

Power LED light

Choose to set power indicate LED on or off.

Choose {On} for normal use.

Configuration1 reset

Reset all settings in **Configuration1** menu to the factory preset values.

Factory reset

Reset all settings in the OSD menus of {Picture}, {Screen}, {Audio}, {PIP}, {Configuration1}, {Configuration2}, and {Advanced option} to the factory preset values.

Android settings will also reset when factory reset.

Press [←] or [→] button to select {Reset}, and press [OK] button to do the reset.

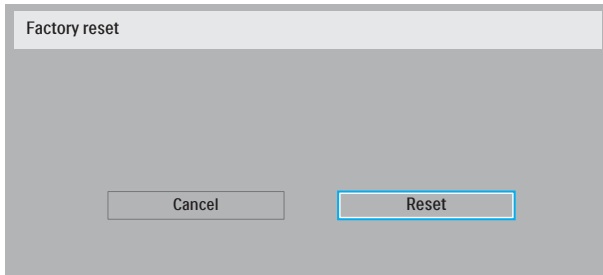

6.2.6. Configuration2 menu

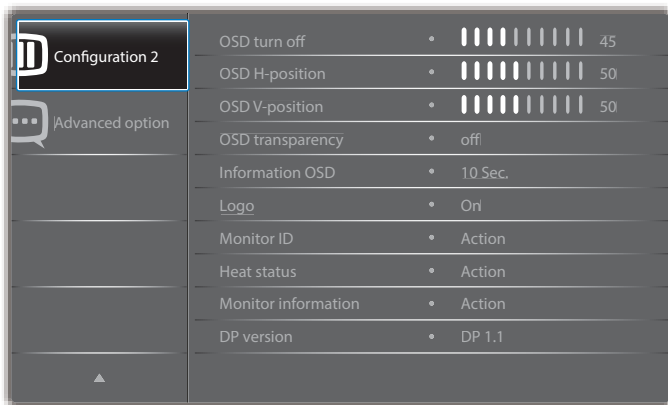

OSD turn off

Set the period of time the OSD (on-screen display) menu stays on the screen.

The options are: {0 ~ 120} seconds.

*{0} does not disappear automatically.

OSD H-position

Adjust the horizontal position of the OSD menu.

OSD V-position

Adjust the vertical position of the OSD menu.

OSD Transparency

Adjust OSD transparency.

- {Off} - Transparency off.
- {1-100} - Transparency level 1-100.

Information OSD

Set the period of time the information OSD is displayed on the upper right corner of the screen. The information OSD will display when input signal is changed.

The information OSD will remain on the screen with {Off} selection.

The options are: {1 ~ 60} seconds.

Logo

Choose to enable or disable the picture of Logo when turn on your display.

The options are:

- {Off}
 - {On} (Default)
 - {User}
1. If Logo set to ON, both scalar Philips logo and android animation Philips logo will show.
 2. If Log set to OFF, neither scalar Philips logo nor android animation logo will not show.
 3. If Logo set to USER, custom logo option in android is not set, then there will be no boot logo when power on.
 4. If Logo set to USER, custom logo option in android is set, there will be only custom logo when power up.
- * Logo will NOT rotate with rotation setting/detection.

Monitor ID

Set the ID number for controlling the display via the RS232C connection. Each display must have a unique ID number when multiple sets of this display are connected. Monitor ID number range is between 1 to 255.

The option are: {Monitor group} / {Tiling matrix} / {Auto ID}

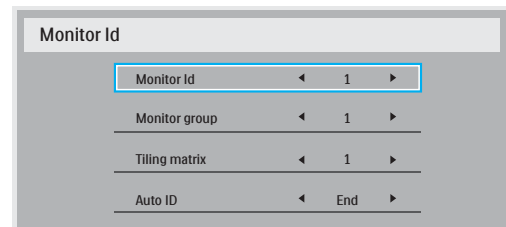

{Monitor group}

The options are: {Off} / {1-254}

- {Off} – {Monitor group} are not supported.
- {1-254} – {Monitor group} are supported. The default setting is 1.

{Tiling matrix}

Tiling matrix number range is between 1 to 15. 1 is default setting. The {Auto ID} setup function enables setting up {Monitor ID} of connected machine according to {Tiling matrix} settings.

Example: Tiling matrix sets as 4

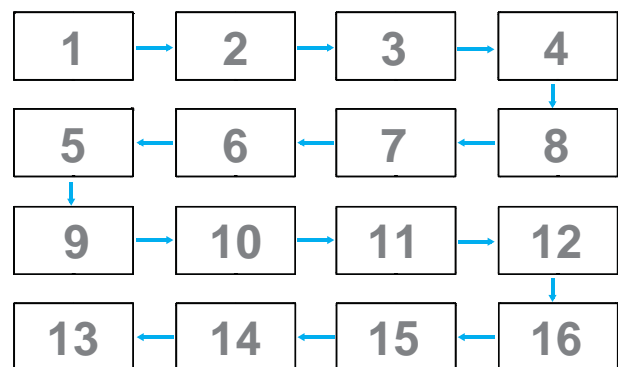

{Auto ID}

The option are: {Start} / {End}. The default is {End}.

- Switch to Start option to set up IDs of machines backward from current one.
- Once the setup is completed, the option exits to End automatically.
- To use this function, serial connect all machines with RS-232 cable and set their Control ports to RS-232 too.

Heat status

This function allows you to check the thermal status at any time.

Monitor information

Shows information about your display, including model number, serial number, operating hours and software version.

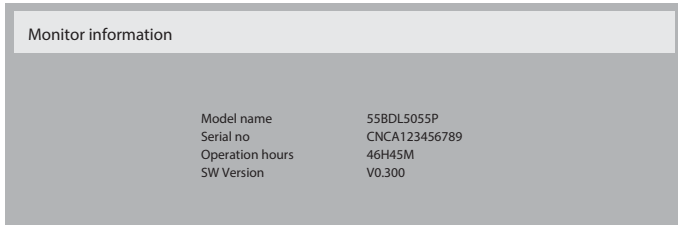

DP version

DisplayPort support mode.

The options are:

- {DP 1.1} (Default) : DP 1.1 single stream(clone mode)
- {DP 1.2 SST}; DP 1.2 Single stream(clone mode)
- {DP 1.2 MST}; DP 1.2 Multi-Stream

*NOTE:

The DP version must be set the same for all daisy chain displays.

Window selection

Select the window for adjusting setting.The selected window will be highlight green border.

Window selection will set to Main after power on.

The options are:

- {Main}(Default), {PIP }
- [] Hot key for Window selection function.

Rotation

Set the rotation of Main/Sub/OSD

Auto Rotate :	Off/On	Default : Off
OSD Rotate :	Landscape/Portrait	Default : Landscape
Image Rotate:		
All :	Off/On	Default : Off
Main :	Off/On	Default : Off
Sub :	Off/On	Default : Off

Auto Rotate: {Off}, {On} when value is On,automatically detect whether the PD rotation, Off is set by OSD.

OSD Rotate: {Off}, {On} when value is on, OSD rotate 90 °, Off is restored.

All: {Off}, {On} when value is on, all Window screen rotate 90 °, Off the reference set individual window.

Main: {Off}, {On} when value is onn, Main window screen rotate 90 °, Off is restored.

Sub: {Off}, {On} when value is on, Sub1 Window screen rotate 90 °, Off is restored.

* When the Main / Sub source is the same, rotation is given priority to with Sub.

* Not supported De-Interlacing function in rotation mode.

Language

Select the language used in the OSD menu.

The options are: English/Deutsch/ 简体中文 /Français/Italiano/Español/ Русский/Польски/Türkçe/ 繁體中文 / 日本語 /Português/ العربية /Danish/ Svenska/Finnish/Norsk/Nederlands.

Configuration2 reset

Reset all settings in Configuration2 menu to the factory preset values.

6.2.7. Advanced option menu

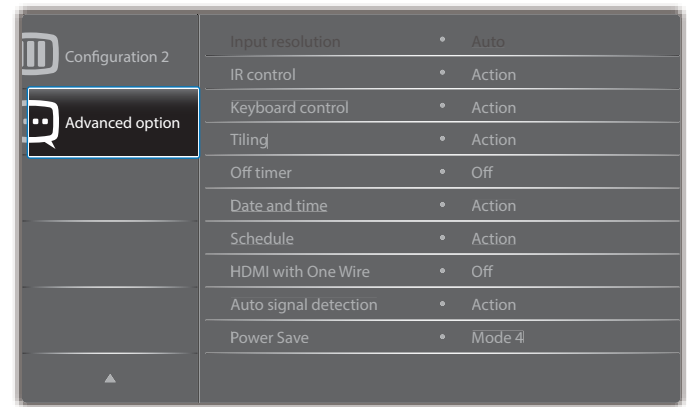

Input resolution

Set the resolution of the VGA input.This is only required when the display is unable to detect the VGA input resolution correctly.

NOTE: This item is functional for VGA input only.

The options are:

- {1024x768 / 1280x768 / 1360x768 / 1366x768}
- {1400x1050 / 1680x1050}
- {1600x1200 / 1920x1200}
- {Auto}: Determines the resolution automatically.

The selected settings will become effective after turning off the power and turning it on again.

IR control

Select the operation mode of the remote control when multiple displays are connected via an RS232C connection.

- {Normal} - All displays can be operated normally by the remote control unit.
- {Primary} - Designate this display as the primary display for remote control operation. Only this display can be operated by the remote control. (In primary mode, IR key will always be processed regardless the monitor id/group settings).
- {Secondary} - Designate this display as the secondary display.This display can not be operated by the remote control, and will only receive the control signal from the primary display via the RS232C connection.
- {Lock All} / {Lock all but Volume} / {Lock all but Power} / {Lock all except PWR & VOL}- Lock the remote control function of this display.To unlock, press and hold the [i] INFO button on the remote control for 6 (six) seconds.

Keyboard control

Choose to enable or disable the display keyboard (control buttons) function.

- {Unlock} - Enable the keyboard function.
- {Lock All} / {Lock all but Volume} / {Lock all but Power} / {Lock all except PWR & VOL} - Disable the keyboard function.

NOTE: "Keyboard Control Lock Mode" This function completely disables the access to all Keyboard Control functions.To enable or disable the keyboard control lock, press both [+] and [] buttons and hold down continuously for more than 3 seconds.

Tiling

With this function you can create a single large-screen matrix (video wall) that consists of up to 150 sets of this display (**up to 10-sets on the vertical and 15-sets on the horizontal sides**). This function requires a daisy-chain connection.

- **Switch on delay:** Set the power-on delaying time (in seconds). The default option {Auto} allows a sequential powering-on for each display by their ID number when multiple displays are connected. The options are: {Off (0) / Auto(1) / 2-255}
- **Brightness:** {Normal}/{ACS}
 - {Normal}: Adjust the overall image and background screen brightness (backlight).
 - {ACS}: Apply brightness value (backlight) which is adjusted by MIC tool. The default value before adjustment is the same as OSD brightness value, e.g., 70)
- **Type:** {Manual}/{Tiling tool}
- **Source resolution:** {Full HD}{Default}/ {4K}
- **H monitors** - Select the number of displays on the horizontal side.
- **V monitors** - Select the number of displays on the vertical side.
- **Position** - Select the position of this display in the screen matrix.
- **Frame comp.** - Choose to turn the frame compensation function on or off. If selected {Yes}, the display will adjust the image to compensate for the width of the display bezels in order to accurately display the image.

NOTE: Doesn't support screen format function in tiling using cascade mode.

Off Timer

Set automatically power off time (in hours).

Date and time

Adjust the current date and time for the display's internal clock.

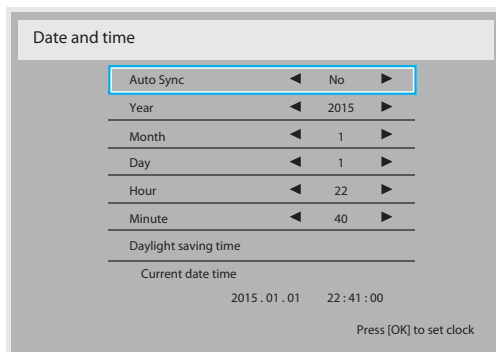

1. Press [OK] button to enter the submenu.
2. Press [▲] or [▼] button to toggle between {Year}, {Month}, {Day}, {Hour}, {Minute}, and {Daylight saving time}.
3. Press [←] or [→] button to adjust all settings except {Daylight saving time}.
4. Press [OK] button to enter the {Daylight saving time} submenu.
5. Press [←] or [→] button to select item, press [▲] or [▼] button to adjust.

The Daylight saving time definition and behavior:

The current implementation of daylight saving is a reminder tool for the customer which doesn't know how to adjust the clock for daylight saving on and off. It does not adjust the real time clock automatically. Problem is that there are no stable rules per region, or country when to adjust the clock. To solve this the user must be able to set the daylight saving start and stop date. When daylight saving correction is on (user

selectable) then the real time clock should be adjusted at the moment in time set in the daylight saving on and off date. At daylight start date the clock should be put forward 1 hour at 2 o'clock. At daylight stop date the clock should be put back 1 hour at 2 o'clock.

The existing daylight on/off menu item should be replaced with the following menu structure:

- Menu item <Daylight saving setup> opens submenu containing the following items:
- Menu item <Daylight-saving start date> Selection item <1st, 2nd, 3rd, 4th, last> Sunday of selection item <1-12 month>
- Menu item <Daylight-saving stop date> Selection item <1st, 2nd, 3rd, 4th, last> Sunday of selection item <1-12 month>
- optional
- Menu item <Correction time> Selection item <0.5, 1.0, 1.5, 2.0> hour
- Menu item <Daylight saving correction> Selection item <on, off>

when "daylight saving" is "on" the real time clock would have been adjusted automatically for winter and summer time when passing the critical moment in time (eg march 29, 2009, 02.00 o'clock: time will be set 1 hour later or October 25, 2009, 02.00 o'clock: time will be set 1 hour earlier)

Schedule

This function allows you to program up to 7 (seven) different scheduled time intervals for the display to activate.

You can select:

- The time for the display to turn on and turn off.
- The days in a week for the display to activate.
- Which input source the display will use for each scheduled activation period.

NOTE: We recommend you to set up current date and time in the {Date and time} menu before using this function.

1. Press [OK] or [←] button to enter the submenu.

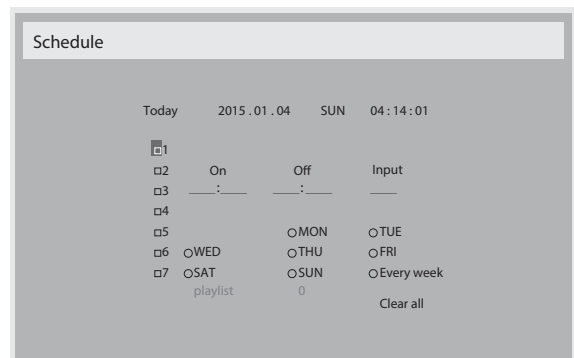

2. Press [▲] or [▼] button to select a schedule item (item number 1 ~ 7), and then press [OK] button to mark it the item number:

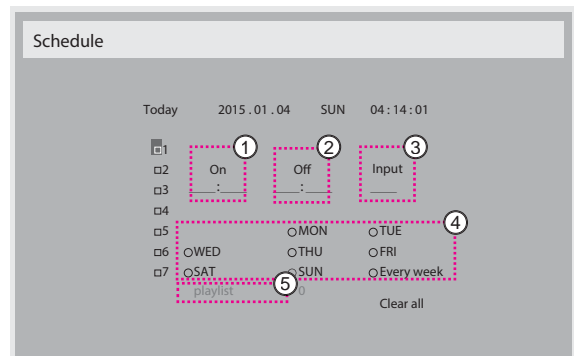

3. Press [←] or [→] button to select the schedule:
 - ① **Power-on** schedule: Press [H] or [M] button to set the hour and minute for the display to turn on.
 - ② **Power-off** schedule: Press [H] or [M] button to set the hour and minute for the display to turn off.

Select or leave an empty “_” for both the hour and minute slot if you do not want to use this power-on or power-off schedule.

 - ③ **Input-source** selection: Press [H] or [M] button to select an input source. If no input source is selected, the input source will remain the same as last selected.
 - ④ **Date** schedule: Press [→] button to select which day in a week this schedule item will be take effect, and then press the [OK] button.
 - ⑤ When **Input-source** select to **USB**, enable to access **playlist** setting:
4. For additional schedule settings, press [↶], then repeat the steps above. A check mark in the box next to the number of the schedule item indicates that the selected schedule is in effect.

NOTES:

- If the schedules overlap, the scheduled power-on time takes priority over scheduled power-off time.
- If there are two schedule items programmed for the same time, the highest numbered schedule takes priority. For example, if schedule items #1 and #2 both set the display to power on at 7:00 AM and off at 5:00 PM, then only schedule item # 2 will take effect.

HDMI with One Wire

CEC control.

- {Off} - Disable CEC.(Default)
- {On} - Enable CEC.

Auto signal detection

Choose to let the display detect and display available signal sources automatically.

- {Off} - Once a signal is connected, it can only be selected manually.

If the selected input is no signal, set the display to display the image automatically according to the search order of each option.

The options are: {All} / {Failover}

- {All}: DP -> HDMI1 -> HDMI2 -> DVI -> VGA ->Media Player -> Browser -> SmartCMS -> PDF Reader -> Custom.
- {Failover}
 - Failover 1: User-defined setting. Default:HDMI 1.
 - Failover 2: User-defined setting. Default:HDMI 1.
 - Failover 3: User-defined setting. Default:HDMI 1.
 - Failover 4: User-defined setting. Default:HDMI 1.
 - Failover 5: User-defined setting. Default:HDMI 1.
 - Failover 6: User-defined setting. Default:HDMI 1.
 - Failover 7: User-defined setting. Default:HDMI 1.
 - Failover 8: User-defined setting. Default:HDMI 1.
 - Failover 9: User-defined setting. Default:HDMI 1.
 - Failover 10: User-defined setting. Default:HDMI 1.

Power Save

Mode 1 [TCP off,WOL on, auto off]

Mode 2 [TCP off,WOL on, auto on/off]

Mode 3 [TCP on,WOL off, auto on/off]

Mode 4 [TCP on,WOL off, no auto on/off]

Power save modes

Mode 1: DC off -> Power off. LED: Red.

Power Save -> Power off, LED: Red

Mode 2: DC off -> Power off, LED: Red.

Power Save -> Power Saving, LED: Orange. Can be wake up.

Mode 3: DC off -> Back light off, LED: Red

Power Save -> Back light off, LED: Orange. Can be wake up.

Mode 4: DC off -> Back light off, LED: Red

Power Save -> Will not enter power save mode. show “no signal” only.

	RCU Power Button Off	No Signal	Android
Mode 1	DC OFF	DC OFF	board power off
Mode 2	DC OFF	when signal is back, system wake up	board power off
Mode 3	Backlight OFF	Backlight OFF	keep power on
Mode 4	Backlight OFF	Backlight ON, show no signal	keep power on

Following table is the action for Android board with different power mode.

DC off/on: press power button by RC

Power mode in OSD	Mode 1/2	Mode 3/4
DC off	shutdown	1. The current source APK(such as MediaPlayer, Broswer, PDF or SmartCMS) will be closed. 2. Android system will go to the default black launcher.
DC on	Boot up	1.Android system reboots

Scalar FW Update

Update scalar FW by USB.

USB cloning

Copy PD settings from one set to another.

Import: Copy settings from file to display

Export: Copy PD settings into file.

* Cloned data stores in USB.

* PIP/PBP status will be applied after AC off/on action.

OPS setting

Set OPS status.

- {Always off} - Disable OPS
- {Always on} - Enable OPS (Default)

* OPS model only

Advanced option reset

Reset all settings except {Date and Time} in the **Advanced option** menu to factory preset values.

1. Press [OK] or [▶] button to enter the submenu.
2. Press [◀] or [▶] button to select {Reset} and press the [OK] button to restore settings to factory preset values.
3. Press the [↶] button or select {Cancel} and press the [OK] button to cancel and then return to the previous menu.

7. USB device compatibility

USB Multimedia Codec Formats

Video Decode						
Type	Video Codec	Container	Decode	Encode	Channel	Remark
MPEG1/2	MPEG1/2	File Format: DAT, MPG, VOB, TS	V			Supported Image Size: 48x48pixels to 1920x1088pixels Maximum Frame Rate: 30fps Maximum Bit Rate: 80Mbps Audio Codec: MP2, MP3
MPEG-4	MPEG4	File Format: AVI, MKV, MP4, MOV, 3GP	V			Supported Image Size: 48x48pixels to 1920x1088pixels Maximum Frame Rate: 30fps Maximum Bit Rate: 38.4Mbps Audio Codec: MP2, MP3, AAC, PCM, (1) Not support MS MPEG4 v1/v2/v3 (2) Not support GMC(global motion compensation)
H.263	H.263	File Format: 3GP, MOV, MP4	V			Supported Image Size: SQCIF(128x96), QCIF(176x144), CIF(352x288), 4CIF(704x576) Maximum Frame Rate: 30fps Maximum Bit Rate: 38.4Mbps Audio Codec: MP3 (1) Not support H.263+
H.264	H.264	File Format: AVI, MKV, MP4, MOV, 3GPTS, FLV	V			Supported Image Size: 48x48pixels to 1920x1088pixels Maximum Frame Rate: 30fps Maximum Bit Rate: 57.2Mbps Audio Codec: MP2, MP3, AAC, PCM (1) Not support MBAFF
GOOGLE VP8	VP8	File Format: WEBM	V			Supported Image Size: 48x48pixels to 1920x1088pixels Maximum Frame Rate: 30fps Maximum Bit Rate: 38.4Mbps Audio Codec: Ogg Vorbis
Motion JPEG	MJPEG	File Format: AVI, MOV	V			Supported Image Size: 48x48pixels to 1920x1088pixels Maximum Frame Rate: 30fps Maximum Bit Rate: 38.4Mbps Audio Codec: MP2, MP3, AAC, PCM

Audio Decode

Type	Audio Codec	Container	Decode	Encode	Channel	Remark
MPEG Audio	MPEG1/2/2.5 Audio Layer1/2/3	Decode: MP1, MP2, MP3	V		2	Bit Rate: 8kbps~320Kbps, CBR and VBR Sampling Rate: 8KHZ~48KHZ
Windows Media Audio	WMA Version 4,4.1, 7, 8, 9, wmapro	Decode: WMA	V		2	Bit Rate: 8kbps~320Kbps Sampling Rate: 8KHZ~48KHZ Non-support WMA Pro, lossless and MBR
AAC Audio	MAIN, ADIF, ATDS Header AAC-LC and AAC-HE	File Format: AAC, M4A	V		5.1	Bit Rate: N/A Sampling Rate: 8KHZ~48KHZ

Image Decode

Type	Image Codec	Photo	Decode	Encode	Channel	Remark
JPEG	JFIF file format 1.02	File Format: JPG, JPEG	√			Decode: Resolution 48X48 to 8176X8176 (1) Not Support Non-interleaved Scan (2) Software support SRGB JPEG (3) Software support Adobe RGB JPEG
BMP	BMP	File Format: BMP	√			MaximumSupported Image Size:4096x4096 pixels
GIF	GIF	File Format: GIF	√			Resolution No Restriction
PNG	PNG	File Format: PNG	√			Resolution No Restriction

NOTES:

- Sound or video may not work if the contents have a standard bit rate/frame rate above the compatible Frame/sec listed in the table above.
- Video content with a Bit rate or Frame rate larger than the rate specified in the table above can cause choppy video during playback.

8. Input Mode

VGA Resolution:

Standard Resolution	Active Resolution		Refresh Rate	Pixel Rate	Aspect Ratio	Stand for Mode
	H Pixels	V Lines				
VGA	640	480	60 Hz	25.175 MHz	4:3	Video Graphic Array
			72 Hz	31.5 MHz		
			75 Hz	31.5 MHz		
WVGA	720	400	70 Hz	33.75 MHz	16:9	WideVideo Graphic Array
SVGA	800	600	60 Hz	40 MHz	4:3	SuperVGA
			75 Hz	49.5 MHz		
XGA	1024	768	60 Hz	65 MHz	4:3	Extended Graphic Array
			75 Hz	78.75 MHz		
WXGA	1280	768	60 Hz	79.5 MHz	5:3	Wide XGA
WXGA	1280	800	60 Hz	79.5 MHz	16:10	Wide XGA
SXGA	1280	1024	60 Hz	108 MHz	5:4	Super XGA
WXGA	1360	768	60 Hz	85.5 MHz	16:9	Wide XGA
UXGA	1600	1200	60 Hz	162 MHz	4:3	Ultra XGA
HD1080	1920	1080	60 Hz	148.5 MHz	16:9	HD1080

Note: 1280x768/60Hz can be supported but not shown in EDID table.

SD Resolution:

Standard Resolution	Active Resolution		Refresh Rate	Pixel Rate	Aspect Ratio
	H Pixels	V Lines			
480i	720	480	29.97 Hz	13.5 MHz	4:3
480p			59.94 Hz	27 MHz	
576i	720	576	25 Hz	13.5 MHz	4:3
576p			50 Hz	27 MHz	

HD Resolution:

Standard Resolution	Active Resolution		Refresh Rate	Pixel Rate	Aspect Ratio
	H Pixels	V Lines			
720p	1280	720	50 Hz	74.25 MHz	16:9
			60 Hz		
1080i	1920	1080	25 Hz	74.25 MHz	16:9
			30 Hz		
1080p	1920	1080	50 Hz	148.5 MHz	16:9
			60 Hz		

- The PC text quality is optimum in HD 1080 mode (1920 × 1080, 60Hz).
- Your PC display screen might appear different depending on the manufacturer (and your particular version of Windows).
- Check your PC instruction book for information about connecting your PC to a display.
- If a vertical and horizontal frequency-select mode exists, select 60Hz (vertical) and 31.5KHz (horizontal). In some cases, abnormal signals (such as stripes) might appear on the screen when the PC power is turned off (or if the PC is disconnected). If so, press the [INPUT] button to enter the video mode. Also, make sure that the PC is connected.
- When horizontal synchronous signals seem irregular in RGB mode, check PC power saving mode or cable connections.
- The display settings table complies to the IBM/VESA standards, and based on the analog input.
- The DVI support mode is regarded as same to the PC support mode.
- The best timing for the vertical frequency to each mode is 60Hz.

9. Pixel Defect Policy

We strive to deliver the highest quality products and use some of the industry's most advanced manufacturing processes whilst practicing stringent quality control. However, pixel or sub-pixel defects on the PDP / TFT panels used in Plasma- & LCD- displays are sometimes unavoidable. No manufacturer can guarantee that all panels will be free from pixel defects, but Philips guarantees that any Plasma- & LCD- displays with an unacceptable number of defects will be repaired during the warranty period in line with your local guarantee conditions.

This notice explains the different types of pixel defects and defines the acceptable defect level for the LCD screen. In order to qualify for repair under warranty, the number of pixel defects must exceed a certain level as shown in the reference table. If the LCD screen is within specification a warranty exchange / claim back will be refused. Additionally, because some types or combinations of pixel defects are more noticeable than others, Philips sets even higher quality standards for those.

9.1. Pixels and Sub-Pixels

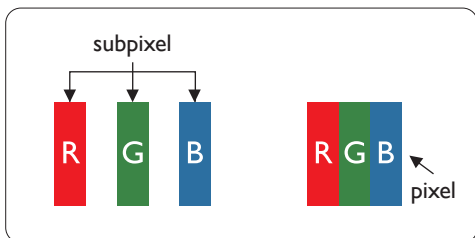

A pixel, or picture element, is composed of three sub-pixels in the primary colors of red, green and blue. Many pixels together form an image. When all sub-pixels of a pixel are lit, the three colored sub-pixels together appear as a single white pixel. When all are dark, the three colored sub-pixels together appear as a single black pixel. Other combinations of lit and dark sub-pixels appear as single pixels of other colors.

9.2. Types of Pixel Defects + Dot Definition

Pixel and sub-pixel defects appear on the screen in different ways. There are three categories of pixel defects and several types of sub-pixel defects within each category.

Dot definition = What is a defective "Dot"?

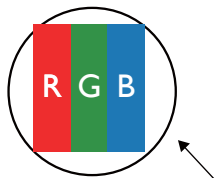

One or more defective, adjacent sub-pixel are defined as one "dot". The no. of defective sub-pixels are not relevant to define a defective dot. This means that a defective dot can consist of one, two or three defective sub-pixels which can be dark or lit.



One dot = One Pixel; consists of three sub-pixels of Red, Green, and Blue.

9.3. Bright Dot Defects

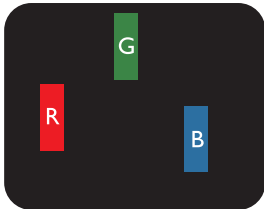
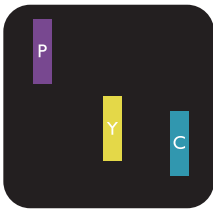
Bright dot defects appear as pixels or sub-pixels that are always lit or "on". These are the examples of bright dot defects:

 <p>One lit red, green or blue sub pixel</p>	 <p>Two adjacent lit sub pixels: Red + Blue = Purple Red + Green = Yellow Green + Blue = Cyan (Light Blue)</p>	 <p>Three adjacent lit sub pixels (one white pixel)</p>
---	--	--

9.4. Dark Dot Defects

Black dot defects appear as pixels or sub-pixels that are always dark or "off". These are the examples of black dot defects:

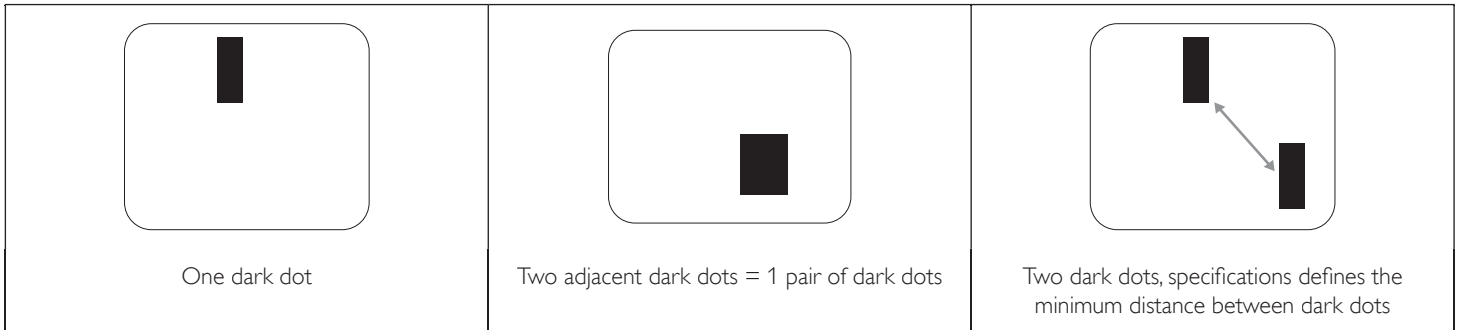

9.5. Proximity of Pixel Defects

Because pixel and sub-pixels defects of the same type that are nearby one another may be more noticeable, Philips also specifies tolerances for the proximity of pixel defects. In the table below you can find specifications about:

- Allowed amount of adjacent dark dots = (adjacent dark dots = 1 pair of dark dots)
- Minimum distance between dark dots
- Total no. of all defective dots

9.6. Pixel Defect Tolerances

In order to qualify for repair due to pixel defects during the warranty period, a PDP / TFT panel in a Philips Plasma / LCD- display must have pixel or sub-pixel defects exceeding the tolerances listed in the following table.

BRIGHT DOT EFFECT	ACCEPTABLE LEVEL
1 lit sub pixel	2
BLACK DOT EFFECT	ACCEPTABLE LEVEL
1 dark sub pixel	10
TOTAL DOT DEFECTS OF ALL TYPES	12

NOTE: * 1 or 2 adjacent sub pixel defects = 1 dot defect

9.7. MURA

Dark spots or patches may occasionally appear on some liquid crystal display (LCD) panels. This is known within the industry as Mura, which is a Japanese term for "unevenness." It is used to describe an irregular pattern or area in which uneven screen uniformity appears under certain conditions. Mura is a result of the deterioration of the liquid crystal alignment layer and is most commonly caused by long-term operation under high ambient temperatures. It is an industry- wide phenomenon and Mura is not repairable. It is also not covered by our warranty terms.

Mura has been around since the introduction of LCD technology and with screens getting bigger and in operation 24/7, many displays are running in low light conditions. This all adds to the possibility of Mura affecting displays.

HOW TO SPOT MURA

There are many symptoms of Mura and also multiple causes. Several of these are listed below:

- Impurities or foreign particles in the crystal matrix
- Uneven distribution of LCD matrix during manufacturing
- Non-uniform luminance distribution of the backlight
- Panel assembly induced stress
- Flaws within the LCD cells
- Thermal induced stress - high temperature operation over long periods of time

HOW TO AVOID MURA

Although we can not guarantee the complete eradication of Mura every time, in general the appearance of Mura can be minimized by these methods:

- Lower the backlight brightness
- Use a screen saver
- Reduce the ambient temperature around the unit

10. Cleaning and Troubleshooting

10.1. Cleaning

Caution When Using the Display

- Do not bring your hands, face or objects close to the ventilation holes of the display. The top of the display is usually very hot due to the high temperature of exhaust air being released through the ventilation holes. Burns or personal injuries may occur if any body parts are brought too close. Placing any object near the top of the display could also result in heat related damage to the object as well as the display itself.
- Be sure to disconnect all cables before moving the display. Moving the display with its cables attached may damage the cables and thus cause fire or electric shock.
- Disconnect the power plug from the wall outlet as a safety precaution before carrying out any type of cleaning or maintenance procedure.

Front Panel Cleaning Instructions

- The front of the display has been specially treated. Wipe the surface gently using only a cleaning cloth or a soft, lint-free cloth.
- If the surface becomes dirty, soak a soft, lint-free cloth in a mild detergent solution. Wring the cloth to remove excess liquid. Wipe the surface of the display to remove dirt. Then use a dry cloth of the same type to dry.
- Do not scratch or hit the surface of the panel with fingers or hard objects of any kind.
- Do not use volatile substances such as insect sprays, solvents and thinners.

Cabinet Cleaning Instructions

- If the cabinet becomes dirty, wipe the cabinet with a soft, dry cloth.
- If the cabinet is extremely dirty, soak a lint-free cloth in a mild detergent solution. Wring the cloth to remove as much moisture as possible. Wipe the cabinet. Use another dry cloth to wipe over until the surface is dry.
- Do not allow any water or detergent to come into contact with the surface of the display. If water or moisture gets inside the unit, operating problems, electrical and shock hazards may result.
- Do not scratch or hit the cabinet with fingers or hard objects of any kind.
- Do not use volatile substances such as insect sprays, solvents and thinners on the cabinet.
- Do not place anything made from rubber or PVC near the cabinet for any extended periods of time.

10.2. Troubleshooting

Symptom	Possible Cause	Remedy
No picture is displayed	<ol style="list-style-type: none"> 1. The power cord is disconnected. 2. The main power switch on the back of the display is not switched on. 3. The selected input has no connection. 4. The display is in standby mode. 	<ol style="list-style-type: none"> 1. Plug in the power cord. 2. Make sure the power switch is switched on. 3. Connect a signal connection to the display.
Interference displayed on the display or audible noise is heard	Caused by surrounding electrical appliances or fluorescent lights.	Move the display to another location to see if the interference is reduced.
Color is abnormal	The signal cable is not connected properly.	Make sure that the signal cable is attached firmly to the back of the display.
Picture is distorted with abnormal patterns	<ol style="list-style-type: none"> 1. The signal cable is not connected properly. 2. The input signal is beyond the capabilities of the display. 	<ol style="list-style-type: none"> 1. Make sure that the signal cable is attached firmly. 2. Check the video signal source to see if it is beyond the range of the display. Please verify its specifications with this display's specification section.
Display image doesn't fill up the full size of the screen	<ol style="list-style-type: none"> 1. The zoom mode is not set correctly. 2. Scan Mode may be set incorrectly to underscan. 3. If the image exceeds the screen size, Scan Mode may need to be set to Underscan. 	Use the Zoom mode or Custom zoom function in the Screen menu to fine tune display geometry and time frequency parameter.
Can hear sound, but no picture	Improperly connected source signal cable.	Make sure that both video inputs and sound inputs are correctly connected.
Can see picture but no sound is heard	<ol style="list-style-type: none"> 1. Improperly connected source signal cable. 2. Volume is turned all the way down. 3. {Mute} is turned on. 4. No external speaker connected. 	<ol style="list-style-type: none"> 1. Make sure that both video inputs and sound inputs are correctly connected. 2. Press [+] or [-] button to hear sound. 3. Switch MUTE off by using the [MUTE] button. 4. Connect external speakers and adjust the volume to a suitable level.
Some picture elements do not light up	Some pixels of the display may not turn on.	This display is manufactured using an extremely high level of precision technology; however, sometimes some pixels of the display may not display. This is not a malfunction.
After-Images can still be seen on the display after the display is powered off. (Examples of still pictures include logos, video games, computer images, and images displayed in 4:3 normal mode)	A still picture is displayed for an over extended period of time	Do not allow a still image to be displayed for an extended period of time as this can cause a permanent after-image to remain on the display.

<p>How to setup the settings in the menu to control all the monitors at the same time and individually via RC?</p>	<p>Daisy chained by RS232 and no IR cable</p>	<p>1. The first display sets as "Primary" on OSD (Advanced option/IR control item), others set as "Secondary".</p> <p>2. The setup OSD will show on Top-Left of display. (Toggle MENU will show again if it disappear)</p> <p>3. Default setting: ID NO: 0, GP NO: 0, this setting can control all displays by IR.</p> <p>The "+", "-" can change "ID NO" to control signal display by "Monitor ID".</p> <p>The "UP", "DOWN" can change "GP NO" to control multi-display by "Group ID".</p> <p>*The first display always be controlled by IR.</p>
<p>How is the RC working?</p>	<p>Daisy chain : no RS232 connected and IR cable</p>	<p>No need setting, just to connect with IR cables and control by IR.</p> <p>*This way has out-of-synchronism phenomenon. Suggest to use above setting with RS-232 cable.</p>

11. Technical Specifications

Display:

Item	Specifications
Screen Size (Active Area)	138.7 cm (54.6" diagonal)
Aspect Ratio	16:9
Number of pixels	1920 (H) × 1080 (V)
Pixel pitch	0.630 (H) × 0.630 (V) [mm]
Displayable colors	10 bits(D), 1.07 Billion colors
Brightness (typical)	500 cd/m ²
Contrast ratio (typical)	1300:1
Viewing angle	178 degrees

In/Out Terminals:

Item	Specifications
Speaker Output	Internal Speakers 10W (L) + 10W (R) [RMS]/8Ω 1 Way 1 Speaker System 82 dB/W/M/160 Hz ~ 13 KHz
Audio Output	3.5mm phone jack × 1 0.5V [rms] (Normal) / 2 Channel (L+R)
Audio Input	3.5mm phone jack × 1 0.5V [rms] (Normal) / 2 Channel (L+R)
RS232C	2.5mm Phone jack × 2 RS232C in/RS232C out
RJ-45	RJ-45 Jack × 1 (8 pin) 10/100 LAN Port
HDMI Input	HDMI Jack × 2 (Type A) (19 pin) Digital RGB: TMDS (Video + Audio) MAX: Video - 720p, 1080p, 1920 × 1080/60 Hz (WUXGA) Audio - 48 KHz/ 2 Channel (L+R) Supports LPCM only
DVI-I (DVI-D&VGA) Input	DVI-I jack Digital RGB: TMDS (Video) Analog RGB: 0.7V [p-p] (75Ω), H/CS/V: TTL (2.2kΩ), SOG: 1V [p-p] (75Ω) MAX: 720p, 1080p, 1920 × 1080/60 Hz (WUXGA)
DVI-I (DVI-D & VGA) Output	DVI-I Jack × 1 (29 pin) Digital RGB: TMDS (Video) Analog RGB: 0.7V [p-p] (75Ω), H/CS/V: TTL (2.2kΩ), SOG: 1V [p-p] (75Ω) MAX: 720p, 1080p, 1920 × 1080/60 Hz (WUXGA)
Displayport in/out	Displayport Jack × 2 (20 pin) Digital RGB: TMDS (Video + Audio) MAX: Video - 720p, 1080p, 1920 × 1080/60 Hz (WUXGA) Audio - 48 KHz/ 2 Channel (L+R) Supports LPCM only

General:

Item	Specifications
Power Input	100 - 240V~, 50 - 60Hz, 6A
Power Output	100 - 240V~, 50 - 60Hz, 2.5A
Power Consumption (Max)	230 W
Power Consumption (typ.)	110 W
Power Consumption (Standby & Off)	<0.5 W (RS232 in active)
Dimensions (Without Stand) [W x H x D]	1228.6 x 699.4 x 71.1 mm
Weight (Without Stand)	25.2 Kg
Gross Weight (Without Stand)	31.6 Kg

Product Fiche :

Item	Specifications
Energy Efficiency Class	B
Visible Screen Size	138.7 cm / 54.6 inch
On Mode Power Consumption (W)	124 W
Annual Energy Consumption (kWh)	181 kWh
Standby Power Consumption (W)	0.50 W
Off Mode Power Consumption (W)	0.50 W
Display Resolution (Pixels)	1920 x 1080p
Network Standby (W)	0.36 W

Environmental Condition:

Item	Specifications	
Temperature	Operational	0 ~ 40°C
	Storage	-20 ~ 60°C
Humidity	Operational	20 ~ 80% RH (No condensation)
	Storage	5 ~ 95% RH (No condensation)
Altitude	Operational	0 ~ 3,000 m
	Storage / Shipment	0 ~ 9,000 m

Internal Speaker:

Item	Specifications
Type	1 Way 1 Speaker
Input	10 W (RMS)
Impedance	8Ω
Output Sound Pressure	82 dB/W/M
Frequency Response	160 Hz ~ 13 KHz



2017 © Koninklijke Philips N.V. All rights reserved.

Philips and the Philips Shield Emblem are registered trademarks of Koninklijke Philips N.V. and are used under license from Koninklijke Philips N.V.

Specifications are subject to change without notice.