

**BDL4678XL**  
V2.00



[www.philips.com/welcome](http://www.philips.com/welcome)  
User Manual (English)

**PHILIPS**

# Safety Instructions

## Safety precautions and maintenance



**WARNING:** Use of controls, adjustments or procedures other than those specified in this documentation may result in exposure to shock, electrical hazards and/or mechanical hazards.

### Read and follow these instructions when connecting and using your display:

#### Operation:

- Keep the display out of direct sunlight and away from stoves or any other heat sources.
- Remove any object that could fall into ventilation holes or prevent proper cooling of the display's electronics.
- Do not block the ventilation holes on the cabinet.
- When positioning the display, make sure the power plug and outlet are easily accessible.
- When turning off the display by detaching the power cord, wait 6 seconds before re-attaching the power cord for normal operation.
- Ensure the use of an approved power cord provided by Philips at all times. If your power cord is missing, please contact your local service center.
- Do not subject the display to severe vibration or high impact conditions during operation.
- Do not knock or drop the display during operation or transportation.

#### Maintenance:

- To protect your display from possible damage, do not put excessive pressure on the LCD panel. When moving your display, grasp the frame to lift; do not lift the display by placing your hand or fingers on the LCD panel.
- Unplug the display if you are not going to use it for an extensive period of time.
- Unplug the display if you need to clean it with a slightly damp cloth. The screen may be wiped with a dry cloth when the power is off. However, never use organic solvent, such as, alcohol, or ammonia-based liquids to clean your display.
- To avoid the risk of shock or permanent damage to the set, do not expose the display to dust, rain, water or an excessively moist environment.
- If your display becomes wet, wipe it with dry cloth as soon as possible.
- If a foreign substance or water gets in your display, turn the power off immediately and disconnect the power cord. Then remove the foreign substance or water, and send the unit to the maintenance center.
- Do not store or use the display in locations exposed to heat, direct sunlight or extreme cold.
- In order to maintain the best performance of your display and ensure a longer lifetime, we strongly recommend using the display in a location that falls within the following temperature and humidity ranges.
  - Temperature: 0-40°C 32-104°F
  - Humidity: 20-80% RH

**IMPORTANT:** Always activate a moving screen saver program when you leave your display unattended. Always activate a periodic screen refresh application if the unit will display unchanging static content. Uninterrupted display of still or static images over an extended period may cause "burn in", also known as "after-imaging" or "ghost imaging", on your screen. This is a well-known phenomenon in LCD panel technology. In most cases, the "burned in" or "after-imaging" or "ghost imaging" will disappear gradually over a period of time after the power has been switched off.

**WARNING:** Severe "burn-in" or "after-image" or "ghost image" symptoms will not disappear and cannot be repaired. This is also not covered under the terms of your warranty.

#### Service:

- The casing cover should be opened only by qualified service personnel.
- If there is any need for repair or integration, please contact your local service center.
- Do not leave your display under direct sunlight.



If your display does not operate normally, having followed the instructions set out in this document, please contact a technician or your local service center.

## Read and follow these instructions when connecting and using your display:



- Unplug the display if you are not going to use it for an extensive period of time.
- Unplug the display if you need to clean it with a slightly damp cloth. The screen may be wiped with a dry cloth when the power is off. However, never use alcohol, solvents or ammonia-based liquids.
- Consult a service technician if the display does not operate normally when you have followed the instructions in this manual.
- The casing cover should be opened only by qualified service personnel.
- Keep the display out of direct sunlight and away from stoves or any other heat sources.
- Remove any object that could fall into the vents or prevent proper cooling of the display's electronics.
- Do not block the ventilation holes on the cabinet.
- Keep the display dry. To avoid electric shock, do not expose it to rain or excessive moisture.
- When turning off the display by detaching the power cable or DC power cord, wait for 6 seconds before re-attaching the power cable or DC power cord for normal operation.
- To avoid the risk of shock or permanent damage to the set do not expose the display to rain or excessive moisture.
- When positioning the display, make sure the power plug and outlet are easily accessible.
- **IMPORTANT:** Always activate a screen saver program during your application. If a still image in high contrast remains on the screen for an extended period of time, it may leave an 'after-image' or 'ghost image' on the front of the screen. This is a well-known phenomenon that is caused by the shortcomings inherent in LCD technology. In most cases the afterimage will disappear gradually over a period of time after the power has been switched off. Be aware that the after-image symptom cannot be repaired and is not covered under warranty.

## Regulatory Information

### CE Declaration of Conformity

This device complies with the requirements set out in the Council Directive on the Approximation of the Laws of the Member States relating to Electromagnetic Compatibility (2014/30/EU), Low-voltage Directive (2014/35/EU), Erp Directive (2009/125/EC) and RoHS directive (2011/65/EU).

This product has been tested and found to comply with the harmonized standards for Information Technology Equipment, these harmonized standards published under Directives of Official Journal of the European Union.

### Federal Communications Commission (FCC) Notice (U.S. Only)



This equipment has been tested and found to comply with the limits for a Class B digital device, pursuant to part 15 of the FCC Rules. These limits are designed to provide reasonable protection against harmful interference in a residential installation. This equipment generates, uses and can radiate radio frequency energy and, if not installed and used in accordance with the instructions, may cause harmful interference to radio communications. However, there is no guarantee that interference will not occur in a particular installation. If this equipment does cause harmful interference to radio or television reception, which can be determined by turning the equipment off and on, the user is encouraged to try to correct the interference by one or more of the following measures:

- Reorient or relocate the receiving antenna.
- Increase the separation between the equipment and receiver.
- Connect the equipment into an outlet on a circuit different from that to which the receiver is connected.
- Consult the dealer or an experienced radio/TV technician for help.



Changes or modifications not expressly approved by the party responsible for compliance could void the user's authority to operate the equipment.

Use only an RF shielded cable that was supplied with the display when connecting this display to a computer device.

To prevent damage which may result in fire or shock hazard, do not expose this appliance to rain or excessive moisture.

THIS CLASS B DIGITAL APPARATUS MEETS ALL REQUIREMENTS OF THE CANADIAN INTERFERENCE- CAUSING EQUIPMENT REGULATIONS.



This device complies with Part 15 of the FCC Rules. Operation is subject to the following two conditions: (1) this device may not cause harmful interference, and (2) this device must accept any interference received, including interference that may cause undesired operation.

## Polish Center for Testing and Certification Notice

The equipment should draw power from a socket with an attached protection circuit (a three-prong socket). All equipment that works together (computer, display, printer, and so on) should have the same power supply source.

The phasing conductor of the room's electrical installation should have a reserve short-circuit protection device in the form of a fuse with a nominal value no larger than 16 amperes (A).

To completely switch off the equipment, the power supply cable must be removed from the power supply socket, which should be located near the equipment and easily accessible.

A protection mark "B" confirms that the equipment is in compliance with the protection usage requirements of standards PN-93/T-42107 and PN-89/E-06251.

### ***Wymagania Polskiego Centrum Badań i Certyfikacji***

Urządzenie powinno być zasilane z gniazda z przyłączonym obwodem ochronnym (gniazdo z kolkiem). Współpracujące ze sobą urządzenia (komputer, monitor, drukarka) powinny być zasilane z tego samego źródła.

Instalacja elektryczna pomieszczenia powinna zawierać w przewodzie fazowym rezerwową ochronę przed zwarciami, w postaci bezpiecznika o wartości znamionowej nie większej niż 16A (amperów).

W celu całkowitego wyłączenia urządzenia z sieci zasilania, należy wyjąć wtyczkę kabla zasilającego z gniazdka, które powinno znajdować się w pobliżu urządzenia i być łatwo dostępne.

Znak bezpieczeństwa "B" potwierdza zgodność urządzenia z wymaganiami bezpieczeństwa użytkowania zawartymi w PN-93/T-42107 i PN-89/E-06251.

### ***Pozostałe instrukcje bezpieczeństwa***

- Nie należy używać wtyczek adapterowych lub usuwać kolka obwodu ochronnego z wtyczki. Jeżeli konieczne jest użycie przedłużacza to należy użyć przedłużacza 3-żyłowego z prawidłowo połączonym przewodem ochronnym.
- System komputerowy należy zabezpieczyć przed nagłymi, chwilowymi wzrostami lub spadkami napięcia, używając eliminatora przepięć, urządzenia dopasowującego lub bezzakłóceńowego źródła zasilania.
- Należy upewnić się, aby nie leżało na kablach systemu komputerowego, oraz aby kable nie były umieszczone w miejscu, gdzie można byłoby na nie nadeptywać lub potykać się o nie.
- Nie należy rozlewać napojów ani innych płynów na system komputerowy.
- Nie należy wpychać żadnych przedmiotów do otworów systemu komputerowego, gdyż może to spowodować pożar lub porażenie prądem, poprzez zwarcie elementów wewnętrznych.
- System komputerowy powinien znajdować się z dala od grzejników i źródeł ciepła. Ponadto, nie należy blokować otworów wentylacyjnych. Należy unikać kładzenia luźnych papierów pod komputer oraz umieszczania komputera w ciasnym miejscu bez możliwości cyrkulacji powietrza wokół niego.

## Electric, Magnetic and Electromagnetic Fields ("EMF")

1. We manufacture and sell many products targeted at consumers, which, like any electronic apparatus, in general have the ability to emit and receive electromagnetic signals.
2. One of our leading Business Principles is to take all necessary health and safety measures for our products, to comply with all applicable legal requirements and to stay well within the EMF standards applicable at the time of producing the products.
3. We are committed to develop, produce and market products that cause no adverse health effects.
4. We confirm that if its products are handled properly for their intended use, they are safe to use according to scientific evidence available today.
5. We play an active role in the development of international EMF and safety standards, enabling us to anticipate further developments in standardization for early integration in its products.

## Information for U.K. only

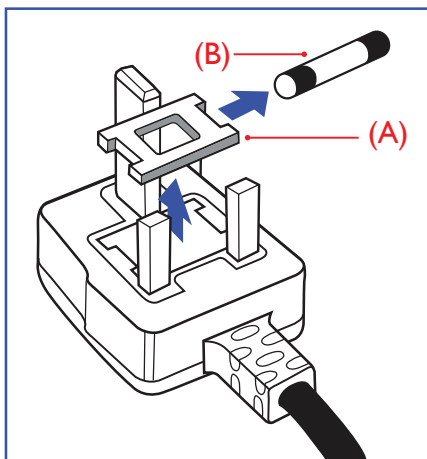

### **WARNING - THIS APPLIANCE MUST BE EARTHED.**

#### **Important:**

This apparatus is supplied with an approved moulded 13A plug. To change a fuse in this type of plug proceed as follows:

1. Remove fuse cover and fuse.
2. Fit new fuse which should be a BS 1362 5A, A.S.T.A. or BSI approved type.
3. Refit the fuse cover.

If the fitted plug is not suitable for your socket outlets, it should be cut off and an appropriate 3-pin plug fitted in its place.

If the mains plug contains a fuse, this should have a value of 5A. If a plug without a fuse is used, the fuse at the distribution board should not be greater than 5A.

NOTE: The severed plug must be destroyed to avoid a possible shock hazard should it be inserted into a 13A socket elsewhere.

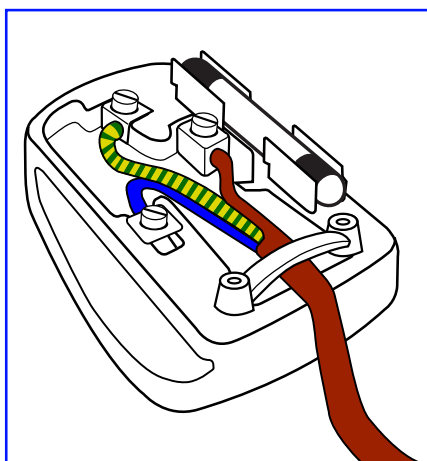

#### **How to connect a plug**

The wires in the mains lead are coloured in accordance with the following code:

BLUE - "NEUTRAL" ("N")

BROWN - "LIVE" ("L")

GREEN & YELLOW - "EARTH" ("E")

1. The GREEN & YELLOW wire must be connected to the terminal in the plug which is marked with the letter "E" or by the Earth symbol or coloured GREEN or GREEN & YELLOW.
2. The BLUE wire must be connected to the terminal which is marked with the letter "N" or coloured BLACK.
3. The BROWN wire must be connected to the terminal which marked with the letter "L" or coloured RED.

Before replacing the plug cover, make certain that the cord grip is clamped over the sheath of the lead - not simply over the three wires.

## China RoHS

电子电气产品有害物质限制使用标识要求 (中国RoHS法规标识要求) 产品中有害物质的名称及含量。

零部件名称	有害物质					
	铅 (Pb)	汞 (Hg)	镉 (Cd)	六价铬 (Cr (VI))	多溴联苯 (PBB)	多溴二苯醚 (PBDE)
塑料外框	○	○	○	○	○	○
后壳	○	○	○	○	○	○
LCD panel	CCFL	×	×	○	○	○
	LED	×	○	○	○	○
电路板组件*	×	○	○	○	○	○
底座	○	○	○	○	○	○
电源线	×	○	○	○	○	○
其他线材	×	○	○	○	○	○
遥控器	×	○	○	○	○	○

\*: 电路板组件包括印刷电路板及其构成的零部件, 如电阻、电容、集成电路、连接器等。

本表格依据SJ/T 11364的规定编制。

○: 表示该有害物质在该部件所有均质材料中的含量均在 GB/T 26572 标准规定的限量要求以下。

×: 表示该有害物质至少在该部件的某一均质材料中的含量超出 GB/T 26572 标准规定的限量要求。

上表中打“×”的部件中, 应功能需要, 部分有害物质含量超出GB/T 26572规定的限量要求, 但是符合欧盟RoHS法规要求(属于豁免部分)。

备注: 上表仅做为范例, 实际标示时应依照各产品的实际部件及所含有害物质进行标示。



### 环保使用期限

此标识指期限(十年), 电子信息产品中含有的有害物质在正常使用的条件下不会发生外泄或突变, 电子信息产品用户使用该电子信息产品不会对环境造成严重污染或对其人身、财产造成严重损害的期限。

## 《废弃电器电子产品回收处理管理条例》提示性说明

为了更好地关爱及保护地球，当用户不再需要此产品或产品寿命终止时，请遵守国家废弃电器电子产品回收处理相关法律法规，将其交给当地具有国家认可的回收处理资质的厂商进行回收处理。

單元	限用物質及其化學符號					
	鉛 (Pb)	汞 (Hg)	鎘 (Cd)	六價鉻 (Cr <sup>+6</sup> )	多溴聯苯 (PBB)	多溴二苯醚 (PBDE)
塑料外框	○	○	○	○	○	○
後殼	○	○	○	○	○	○
液晶面板	—	○	○	○	○	○
電路板組件	—	○	○	○	○	○
底座	○	○	○	○	○	○
電源線	—	○	○	○	○	○
其他線材	—	○	○	○	○	○
遙控器	—	○	○	○	○	○
備考1. “○” 係指該項限用物質之百分比含量未超出百分比含量基準值。						
備考2. “—” 係指該項限用物質為排除項目。						

警語：使用過度恐傷害視力。

注意事項：

- (1) 使用30分鐘請休息10分鐘。
- (2) 未滿2歲幼兒不看螢幕，2歲以上每天看螢幕不要超過1小時。

**Turkey RoHS:**

Türkiye Cumhuriyeti: EEE Yönetmeliğine Uygundur

**Ukraine RoHS:**

Обладнання відповідає вимогам Технічного регламенту щодо обмеження використання деяких небезпечних речовин в електричному та електронному обладнанні, затвердженого постановою Кабінету Міністрів України від 3 грудня 2008 № 1057

## North Europe (Nordic Countries) Information

Placering/Ventilation

**VARNING:**

FÖRSÄKRA DIG OM ATT HUVUDBRYTARE OCH UTTAG ÄR LÄTÅTKOMLIGA, NÄR DU STÄLLER DIN UTRUSTNING PÅPLATS.

Placering/Ventilation

**ADVARSEL:**

SØRG VED PLACERINGEN FOR, AT NETLEDNINGENS STIK OG STIKKONTAKT ER NEMT TILGÆNGELIGE.

Paikka/Ilmankierto

**VAROITUS:**

SIIJOITA LAITE SITEN, ETTÄ VERKKOJOHTO VOIDAAN TARVITTAESSA HELPOSTI IRROTTAA PISTORASIESTA.

Plassering/Ventilasjon

**ADVARSEL:**

NÅR DETTE UTSTYRET PLOSSERES, MÅ DU PASSE PÅ AT KONTAKTENE FOR STØMTILFØRSEL ER LETTE Å NÅ.

## End-of-Life Disposal

Your new Public Information Display contains materials that can be recycled and reused. Specialized companies can recycle your product to increase the amount of reusable materials and to minimize the amount to be disposed of.

Please find out about the local regulations on how to dispose of your old display from your local Philips dealer.

### (For customers in Canada and U.S.A.)

This product may contain lead and/or mercury. Dispose of in accordance to local-state and federal regulations. For additional information on recycling contact [www.eia.org](http://www.eia.org) (Consumer Education Initiative)

## Waste Electrical and Electronic Equipment-WEEE

### Attention users in European Union private households



This marking on the product or on its packaging illustrates that, under European Directive 2012/19/EU governing used electrical and electronic appliances, this product may not be disposed of with normal household waste. You are responsible for disposal of this equipment through a designated waste electrical and electronic equipment collection. To determine the locations for dropping off such waste electrical and electronic, contact your local government office, the waste disposal organization that serves your household or the store at which you purchased the product.

### Attention users in United States:

Please dispose of according to all Local, State and Federal Laws. For the disposal or recycling information, contact: [www.mygreenelectronics.com](http://www.mygreenelectronics.com) or [www.eiae.org](http://www.eiae.org).

### End of Life Directives-Recycling



Your new Public Information Display contains several materials that can be recycled for new users.

Please dispose of according to all Local, State, and Federal laws.

## Restriction on Hazardous Substances statement (India)

This product complies with the "E-Waste (Management) Rules, 2016" CHAPTER V, rule 16, sub-rule (1) .Whereas New Electrical and Electronic Equipment and their components or consumables or parts or spares do not contain Lead, Mercury, Cadmium, Hexavalent Chromium, polybrominated biphenyls and polybrominated diphenyl ethers beyond a maximum concentration value of 0.1% by weight in homogenous materials for lead, mercury, hexavalent chromium, polybrominated biphenyls and polybrominated diphenyl ethers and of 0.01% by weight in homogenous materials for cadmium, except of exemptions set in Schedule 2 of the Rule.



## E-Waste Declaration for India



This symbol on the product or on its packaging indicates that this product must not be disposed of with your other household waste. Instead it is your responsibility to dispose of your waste equipment by handing it over to a designated collection point for the recycling of waste electrical and electronic equipment. The separate collection and recycling of your waste equipment at the time of disposal will help to conserve natural resources and ensure that it is recycled in a manner that protects human health and the environment. For more information about E -waste please visit <http://www.india.philips.com/about/sustainability/recycling/index.page> and to know where you can drop off your waste equipment for recycling in India please contact on below given contact details.

Helpline number: 1800-425-6396 (Monday to Saturday, 9 a.m. to 5:30 pm)

Centralized E-waste collection center

Address:TPV Technology India Private Limited,  
59, Maheswari Nagar, 1st Main Road, Mahadevapura Post, Whitefield Road  
Bangalore, Karnataka, PIN: 560048, Tel: 080-3023-1000

E-mail: india.callcentre@tpv-tech.com

## Batteries



For EU: The crossed-out wheeled bin implies that used batteries should not be put to the general household waste! There is a separate collection system for used batteries, to allow proper treatment and recycling in accordance with legislation.

Please contact your local authority for details on the collection and recycling schemes.

For Switzerland: The used battery is to be returned to the selling point.

For other non-EU countries: Please contact your local authority for correct method of disposal of the used battery.

**According to EU directive 2006/66/EC, the battery can't be disposed improperly. The battery shall be separated to collect by local service.**

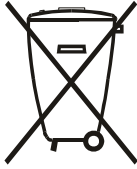

Após o uso, as pilhas e/ou baterias deverão ser entregues ao estabelecimento comercial ou rede de assistência técnica autorizada.

Information for EAC	
Month and year of manufacturing	please refer information in Rating label.
Name and location of manufacturer	ООО "Профтехника" Адрес: 3-й Проезд Марьиной роши, 40/1 офис 1. Москва, 127018, Россия
Importer and information	Наименование организации: ООО "Профтехника" Адрес: 3-й Проезд Марьиной роши, 40/1 офис 1. Москва, 127018, Россия Контактное лицо: Наталья Астафьева, +7 495 640 20 20 <a href="mailto:nat@profdisplays.ru">nat@profdisplays.ru</a>

# Table Of Contents

<b>1. Unpacking and Installation.....</b>	<b>1</b>		
1.1. Unpacking.....	1		
1.2. Package Contents.....	1		
1.3. Installation Notes.....	1		
1.4. Installing and Removing Table Stands (optional).....	2		
1.5. Mounting on a Wall.....	3		
1.5.1. VESA Grid.....	3		
1.6. Mounting in Portrait Position.....	4		
1.7. Operating Instructions of Edge Alignment Kit / Pin.....	4		
1.7.1. Installing Edge Alignment Pin.....	5		
1.7.2. Installing Edge Alignment Kit.....	5		
1.8. Installing OPS device.....	7		
<b>2. Parts and Functions.....</b>	<b>8</b>		
2.1. Control Panel.....	8		
2.2. Input/Output Terminals.....	9		
2.3. Remote Control.....	10		
2.3.1. General functions.....	10		
2.3.2. ID Remote Control.....	11		
2.3.3. Inserting the batteries in the remote control.....	12		
2.3.4. Handling the remote control.....	12		
2.3.5. Operating range of the remote control.....	12		
<b>3. Connecting External Equipment.....</b>	<b>13</b>		
3.1. Connecting External Equipment.....	13		
3.2. Connecting Remote Control.....	14		
3.2.1. Single Display Control.....	14		
3.2.2. IR Pass Through Control.....	14		
3.3. Connecting Multiple Displays in a Daisy- chain Configuration.....	15		
3.3.1. Display control connection.....	15		
3.3.2. Digital video connection.....	15		
3.3.3. Analog video connection.....	15		
3.3.4. IR daisy-chain Connection.....	16		
<b>4. OSD Menu.....</b>	<b>17</b>		
4.1. Navigating the OSD Menu.....	17		
4.1.1. Navigating the OSD menu using the remote control.....	17		
4.1.2. Navigating the OSD menu using the display's control buttons.....	17		
4.2. OSD Menu Overview.....	17		
4.2.1. Picture menu.....	17		
4.2.2. Screen menu.....	18		
4.2.3. Audio menu.....	19		
4.2.4. PIP menu.....	19		
4.2.5. Configuration1 menu.....	20		
4.2.6. Configuration2 menu.....	21		
4.2.7. Advanced option menu.....	22		
<b>5. Input Mode.....</b>	<b>26</b>		
<b>6. Pixel Defect Policy.....</b>	<b>27</b>		
6.1. Pixels and Sub-Pixels.....	27		
6.2. Types of Pixel Defects + Dot Definition.....	27		
6.3. Bright Dot Defects.....	27		
6.4. Dark Dot Defects.....	28		
6.5. Proximity of Pixel Defects.....	28		
6.6. Pixel Defect Tolerances.....	28		
6.7. MURA.....	28		
<b>7. Cleaning and Troubleshooting.....</b>	<b>29</b>		
7.1. Cleaning.....	29		
7.2. Troubleshooting.....	30		
<b>8. Technical Specifications.....</b>	<b>31</b>		

# 1. Unpacking and Installation

## 1.1. Unpacking

- This product is packed in a carton, together with the standard accessories.
- Any other optional accessories will be packed separately.
- Due to the size and weight of this display it is recommended for two people to move it.
- After opening the carton, ensure that the contents are complete and in good condition.

## 1.2. Package Contents

Please verify that you received the following items with your package content:

- LCD display
- Remote control with AAA batteries
- Power cord
- VGA cable
- RS232 cable
- IR sensor cable
- 3.5mm Jack IR cable
- Quick start guide
- Power switch cover
- Screw for Power switch cover (M3, 8mm x 1)
- Edge Alignment Kit-1: 1PCS
- Edge Alignment Kit-2: 2PCS
- Screw: 8PCS
- Edge Alignment Pin: 2PCS

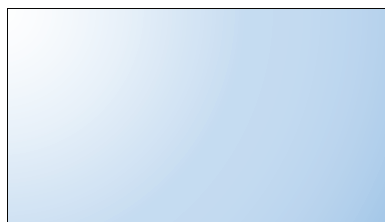

\* The supplied power cord varies depending on destination.



Power Cord

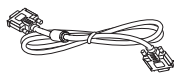

RS232 Cable



IR Sensor Cable



Video Signal Cable  
(D-SUB to D-SUB Cable)

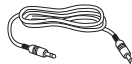

IR Cable

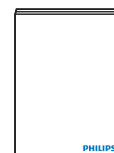

Quick start guide

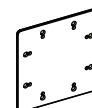

Edge Alignment Kit-1



Screw

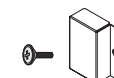

Power switch cover  
and screw (M3x8) x1

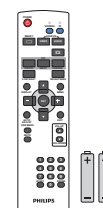

Remote Control  
and AAA Batteries



Edge Alignment Kit-2



Edge Alignment Pin

\* Differences according to regions

Display design and accessories may differ from those illustrated above.

### NOTES:

- For all other regions, apply a power cord that conforms to the AC voltage of the power socket and has been approved by and complies with the safety regulations of the particular country.
- You might like to save the package box and packing material for shipping the display.

## 1.3. Installation Notes

- Due to the high power consumption, always use the plug exclusively designed for this product. If an extended line is required, please consult your service agent.
- The product should be installed on a flat surface to avoid tipping. The distance between the back of the product and the wall should be maintained for proper ventilation. Avoid installing the product in the kitchen, bathroom or any other places with high humidity so as not to shorten the service life of the electronic components.
- The product can normally operate only under 3000m in altitude. In installations at altitudes above 3000m, some abnormality may be experienced.

## 1.4. Installing and Removing Table Stands (optional)

### To install table stands:

1. Ensure your display is powered off.
2. Spread a protective sheet on a flat surface.
3. Grab the carrying handles and place the display face-down on the protective sheet.
4. After inserting the stand in the guide block, tighten the screws on both sides of the display.

NOTE: The longer side of the stand should face the front of the display.

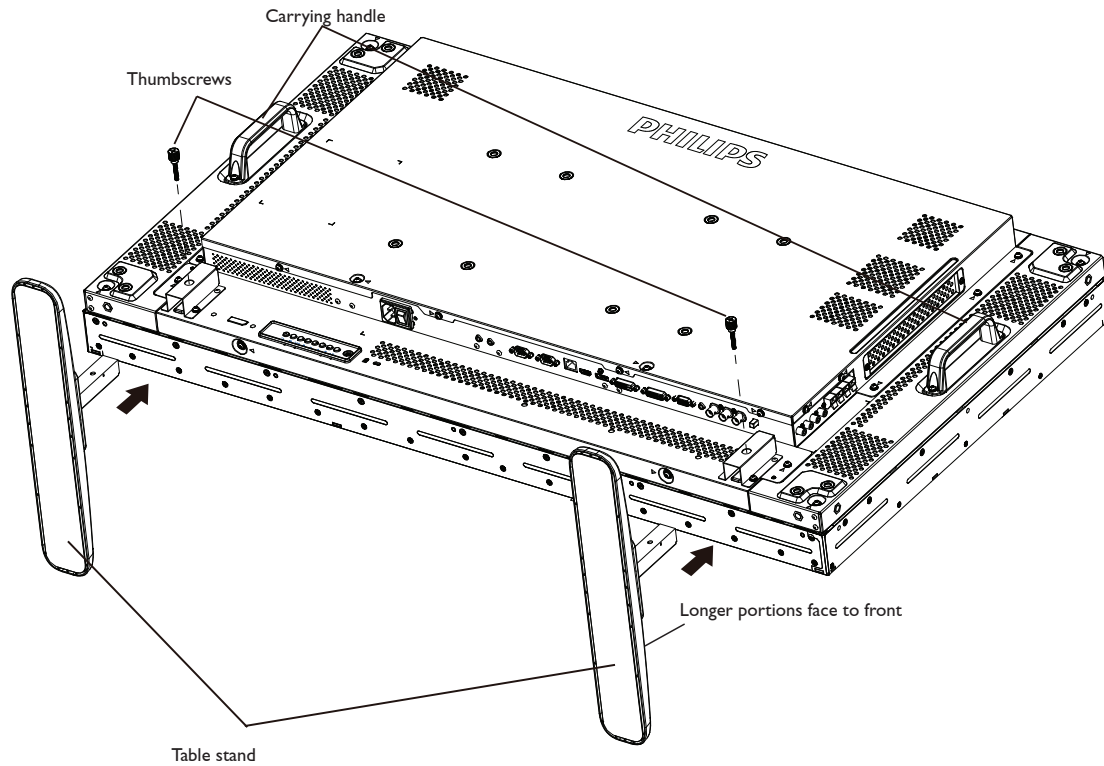

### To remove table stands:

1. Power off the display.
2. Spread a protective sheet on a flat surface.
3. Grab the carrying handles and place the display face-down on the protective sheet.
4. Remove screws using a screwdriver and place them in a safe place for reuse.

## 1.5. Mounting on a Wall

To mount this display to a wall, you will have to obtain a standard wall-mounting kit (commercially available). We recommend using a mounting interface that complies with TUV-GS and/or UL1678 standard in North America.

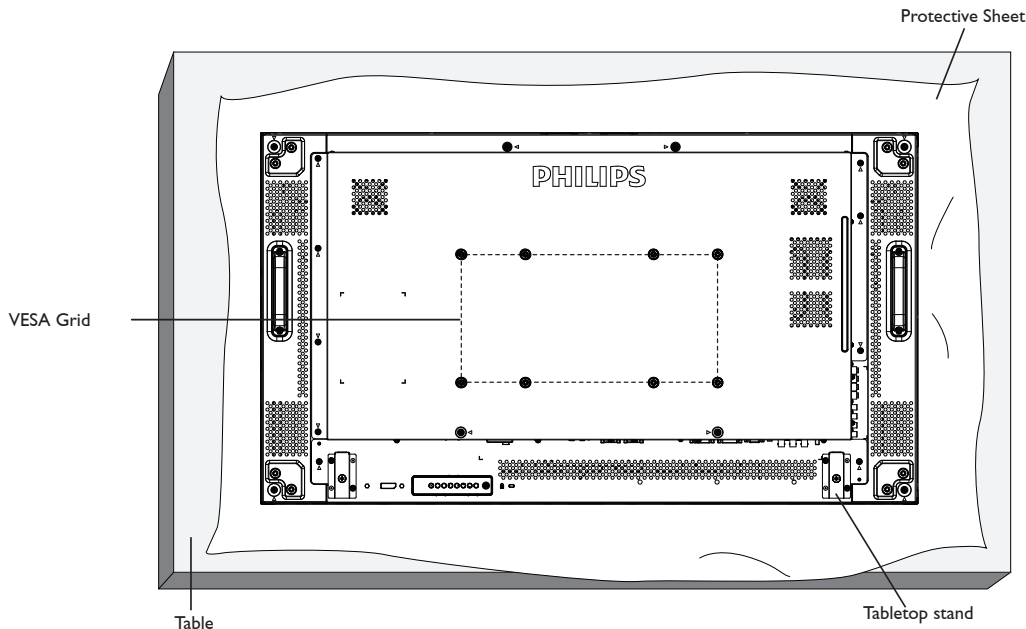

1. Lay a protective sheet on a table, which was wrapped around the display when it was packaged, beneath the screen surface so as not to scratch the screen face.
2. Ensure you have all accessories for mounting this display (wall mount, ceiling mount, table stand, etc).
3. Follow the instructions that come with the base mounting kit. Failure to follow correct mounting procedures could result in damage to the equipment or injury to the user or installer. Product warranty does not cover damage caused by improper installation.
4. For the wall-mounting kit, use M6 mounting screws (having a length 10 mm longer than the thickness of the mounting bracket) and tighten them securely.

### 1.5.1. VESA Grid

<b>BDL4678XL</b>	400(H) × 200(V) mm
	200(H) × 200(V) mm

#### Caution:

To prevent the display from falling:

- For wall or ceiling installation, we recommend installing the display with metal brackets which are commercially available. For detailed installation instructions, refer to the guide received with the respective bracket.
- To lessen the probability of injury and damage resulting from fall of the display in case of earthquake or other natural disaster, be sure to consult the bracket manufacturer for installation location.

#### Ventilation Requirements for enclosure locating

To allow heat to disperse, leave space between surrounding objects as shown in the diagram below.

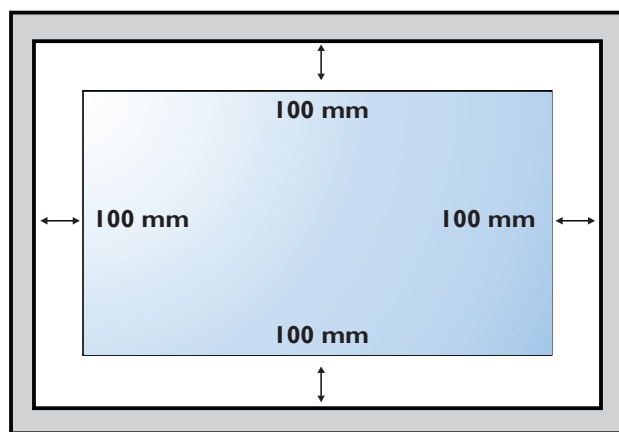

## 1.6. Mounting in Portrait Position

This display can be installed in portrait position.

1. Remove the table stand, if attached.
2. Rotate 90 degrees anticlockwise. The "PHILIPS" logo should be bristling when facing the display at the back.

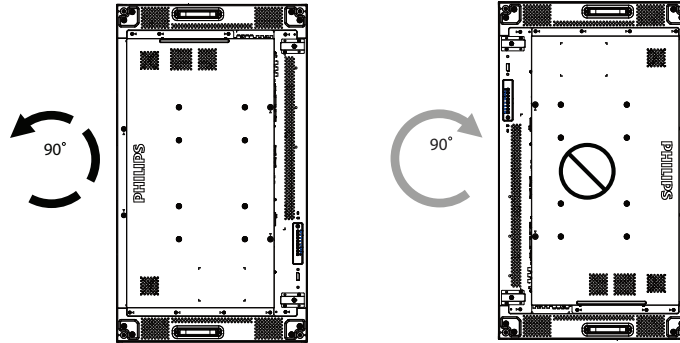

## 1.7. Operating Instructions of Edge Alignment Kit / Pin

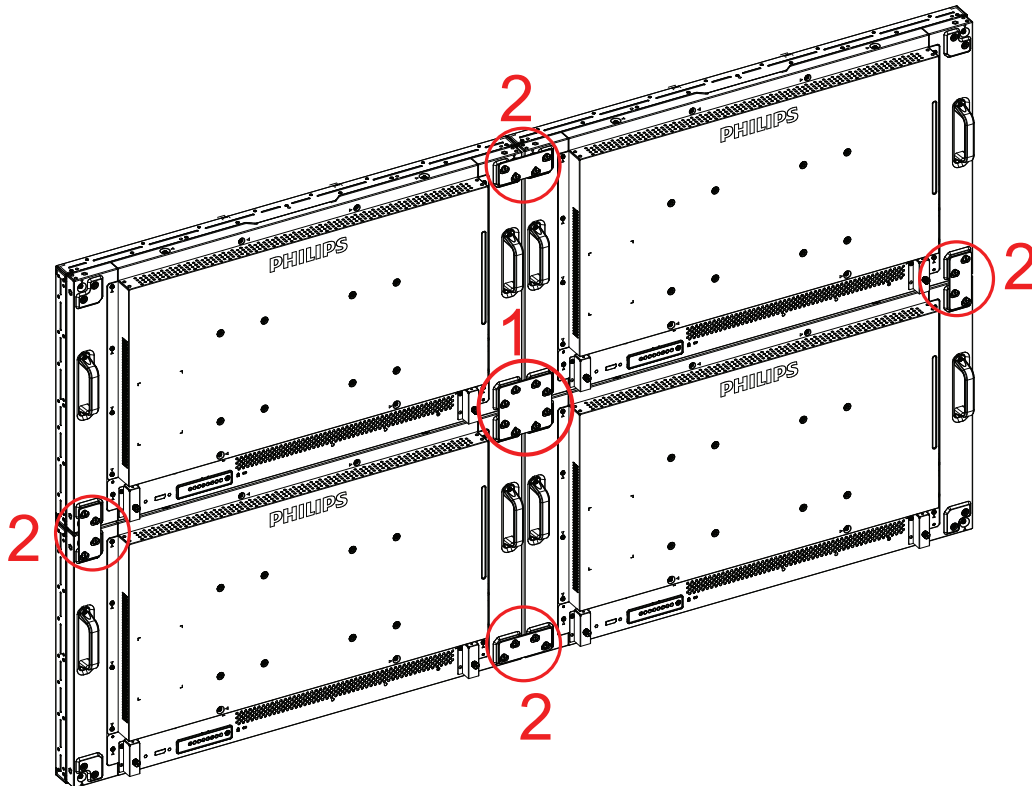

### 1.7.1. Installing Edge Alignment Pin

- During mounting displays to video wall frame, using "Edge Alignment Pin" to secure the flatness of adjacent displays.
- Don't let edge alignment pin to touch the side surface of panel, panel will damage due to incorrect installation.
- Using "Edge Alignment Pin" on adjacent displays.

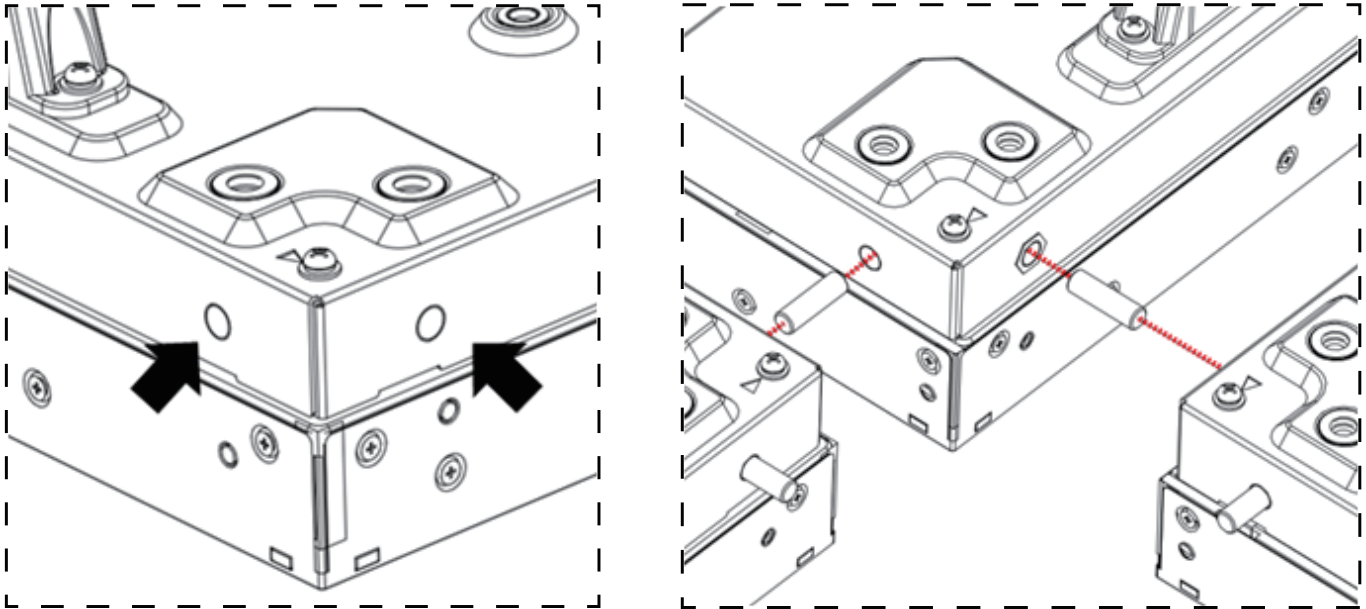

There are 8 holes on the four corners of displays designed for plug-in the edge alignment pin.

### 1.7.2. Installing Edge Alignment Kit

- Before install edge alignment kit, displays must be mounted to video wall frame correctly.
- Using "Edge Alignment Kit-1" on adjacent four displays.

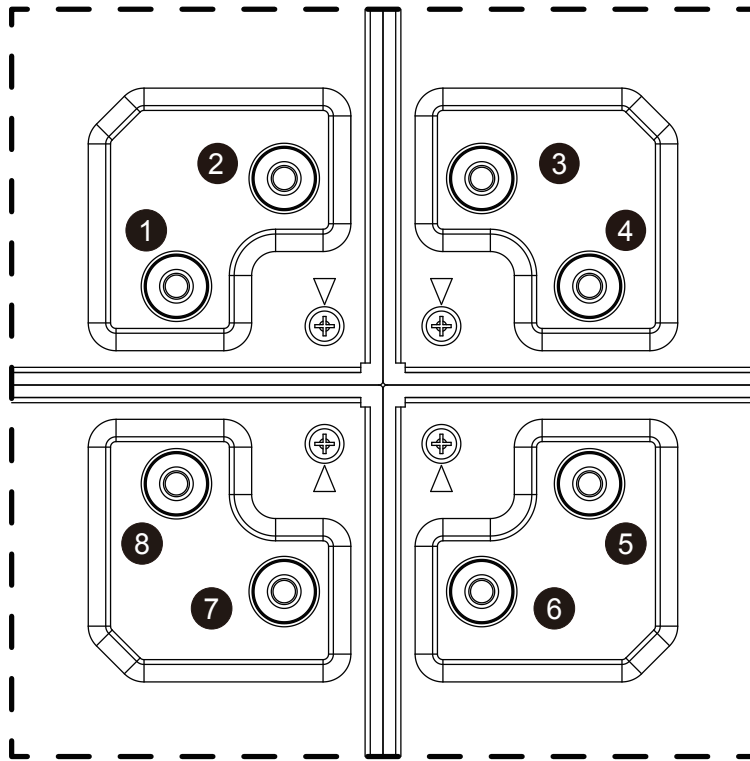

- Install "Edge Alignment Kit-1" with 8 PCS of screw on outer; bigger holes.

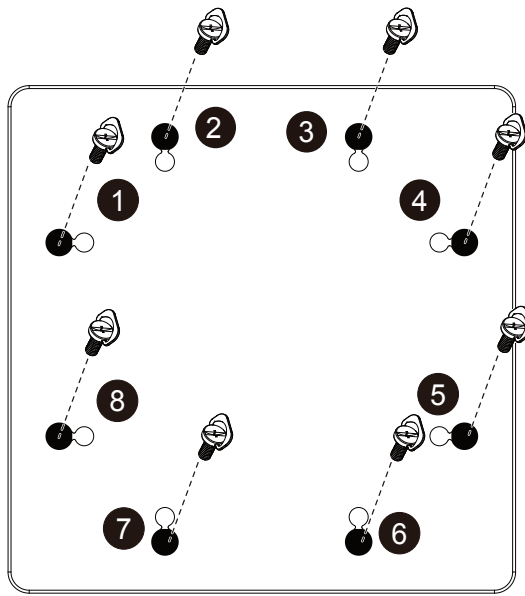

- Using "Edge Alignment Kit-2" on adjacent two displays.

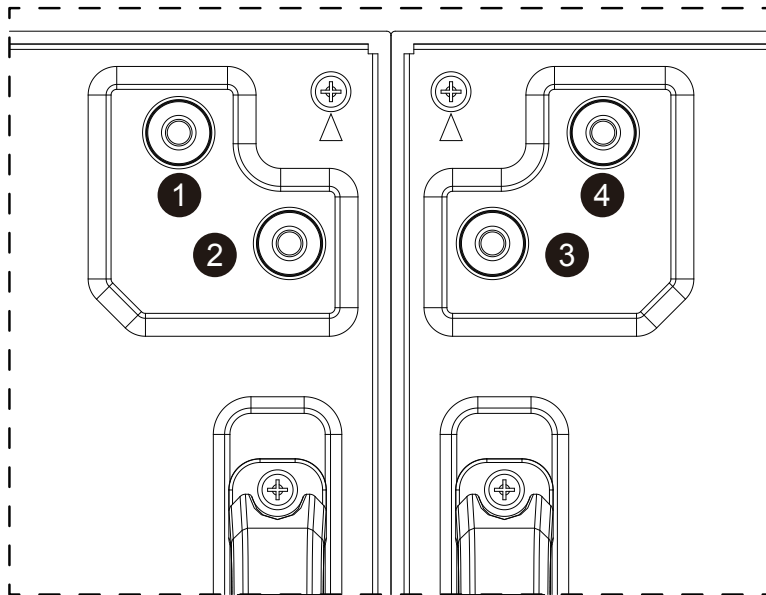

- Install "Edge Alignment Kit-2" with 4 PCS of screw on outer; bigger holes.

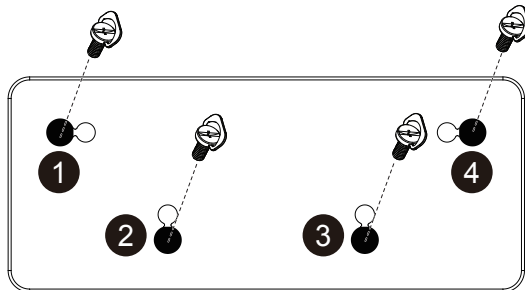



## 1.8. Installing OPS device

To install OPS device to display:

1. Remove the screws of handle, then remove the handle.
2. Remove the screws of OPS cover:
3. Install the OPS device.
4. Fix the OPS device by screws.
5. Fix the handle by screws.

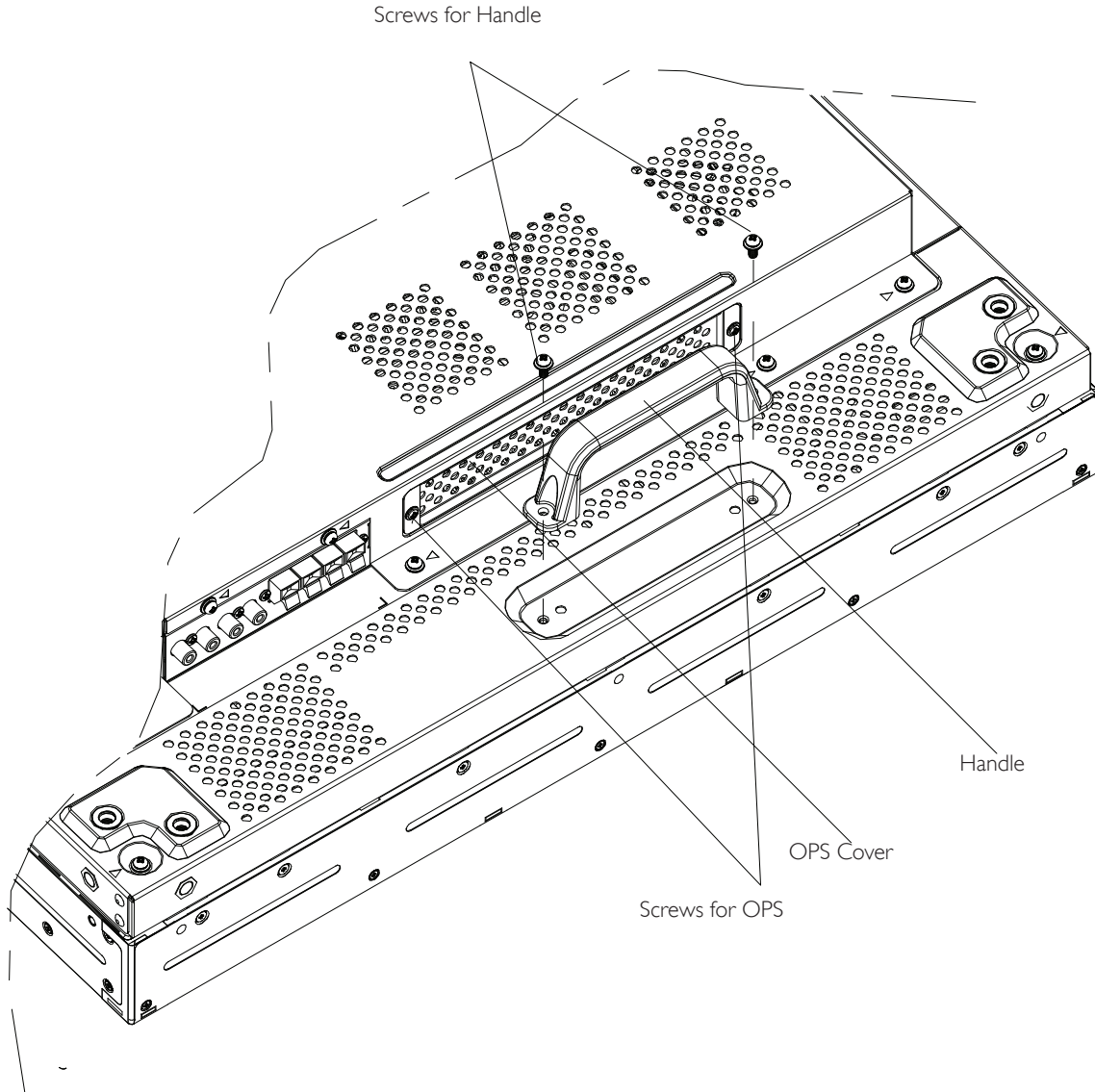

## 2. Parts and Functions

### 2.1. Control Panel

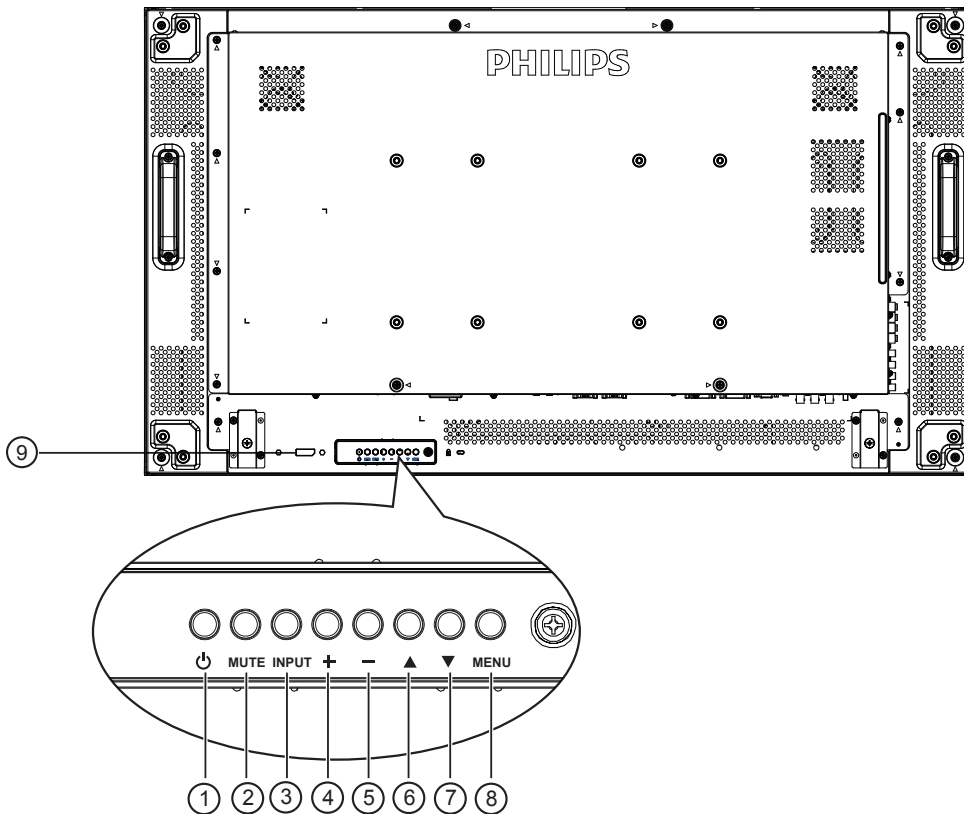

#### ① POWER button

Use this button to turn the display on or put the display to standby.

#### ② MUTE button

Switch the audio mute ON/OFF.

#### ③ INPUT button

Use this button to select the input source.

#### ④ [ + ] button

Increase the adjustment while OSD menu is on, or increase the audio output level while OSD menu is off.

#### ⑤ [ - ] button

Decrease the adjustment while OSD menu is on, or decrease the audio output level while OSD menu is off.

#### ⑥ [▲] button

Move the highlight bar up to adjust the selected item while OSD menu is on.

#### ⑦ [▼] button

Move the highlight bar down to adjust the selected item while OSD menu is on.

#### ⑧ MENU button

Return to previous menu while OSD menu is on, or to activate the OSD menu when OSD menu is off.

#### ⑨ Remote control sensor and power status indicator

- Receives command signals from the remote control.
- Indicates the operating status of the display without OPS:
  - Lights green when the display is turned on
  - Lights red when the display is in standby mode
  - Lights amber when the display enters APM mode
  - When {SCHEDULE} is enabled, the light blinks green and red
  - If the light blinks red, it indicates that a failure has been detected
  - Lights off when the main power of the display is turned off
- Indicates the operating status of the display with OPS:
  - Lights green when the display is on, but the OPS is off
  - Lights blue when the display and the OPS are on
  - Lights red when the display is in standby mode
  - Lights amber when the display enters APM mode
  - When {SCHEDULE} is enabled, the light blinks green and red
  - If the light blinks red, it indicates that a failure has been detected
  - Lights off when the main power of the display is turned off

**NOTE:** “Keyboard Control Lock Mode” This function completely disables the access to all Keyboard Control functions. To enable or disable the keyboard control lock, press both [ + ] and [ - ] buttons and hold down continuously for more than 3 (three) seconds.

## 2.2. Input/Output Terminals

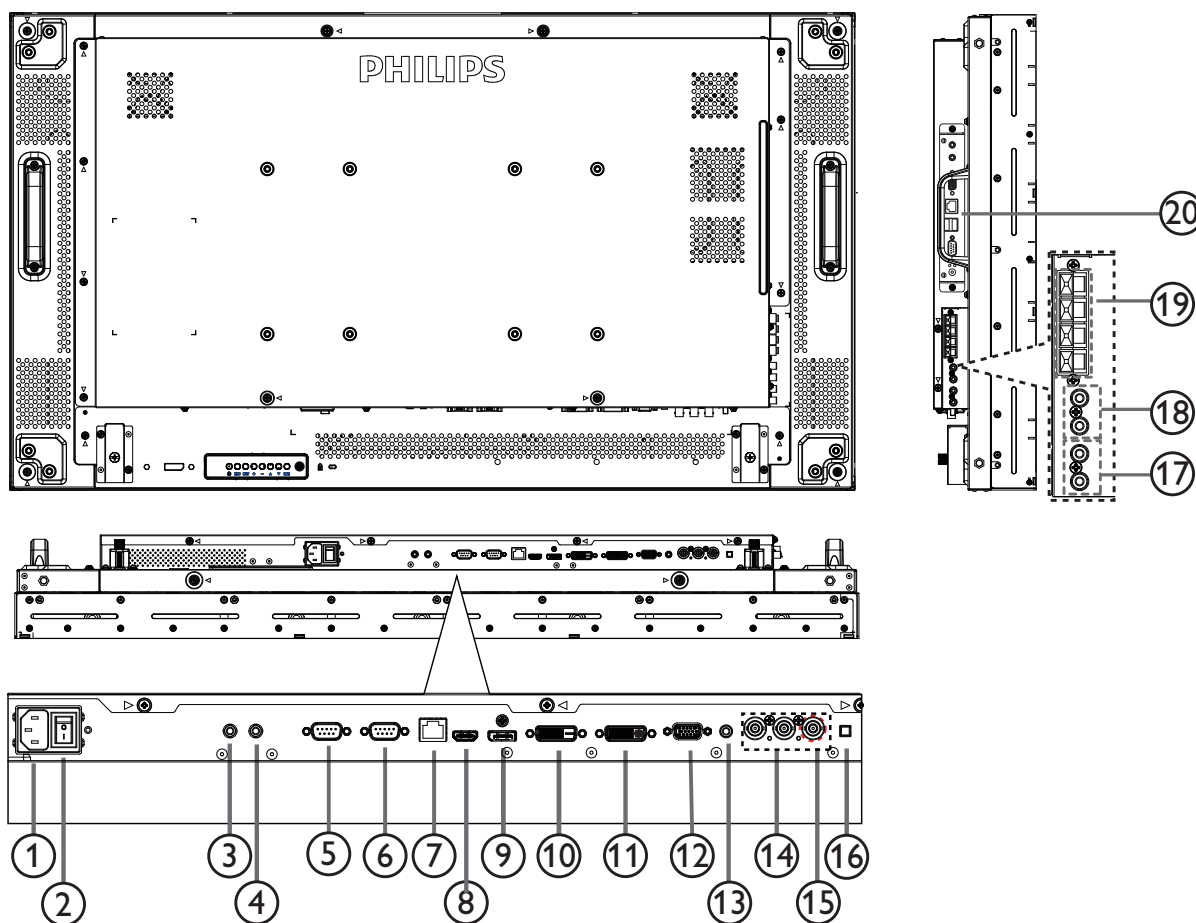

- ① **AC IN**  
AC power input from the wall outlet.
- ② **MAIN POWER SWITCH**  
Switch the main power on/off.
- ③/④ **IR IN / IR OUT**  
Reserved for the wired connection of the IR control.  
NOTE: If an external IR receiver is connected to [IR IN], there is no function on the display's remote sensor.
- ⑤ **RS232C OUT:**  
RS232C network output for the loop-through function.
- ⑥ **RS232C IN**  
RS232C network input for the loop-through function.
- ⑦ **RJ-45**  
LAN control function for the use of remote control signal from control center.
- ⑧ **HDMI IN**  
HDMI video/audio input.
- ⑨ **DisplayPort**  
DisplayPort video input.
- ⑩ **DVI IN**  
DVI-D video input.
- ⑪ **DVI OUT / VGA OUT**  
DVI or VGA video output.
- ⑫ **VGA IN (D-Sub)**  
VGA video input.
- ⑬ **VGA AUDIO IN**  
Audio input for VGA source (3.5mm stereo phone).
- ⑭ **COMPONENT IN (BNC)**  
Component YPbPr video source input.
- ⑮ **Y/CVBS**  
Video source input.
- ⑯ **SPEAKER SWITCH**  
Internal speaker on/off switch.
- ⑰ **AUDIO IN**  
Audio input from external AV device (RCA).
- ⑱ **AUDIO OUT (RCA)**  
Audio output from the AUDIO IN jack to an external AV device.
- ⑲ **SPEAKERS OUT**  
External speakers output.
- ⑳ **OPS SLOT**  
Slot for installing the optional OPS module.

## 2.3. Remote Control

### 2.3.1. General functions

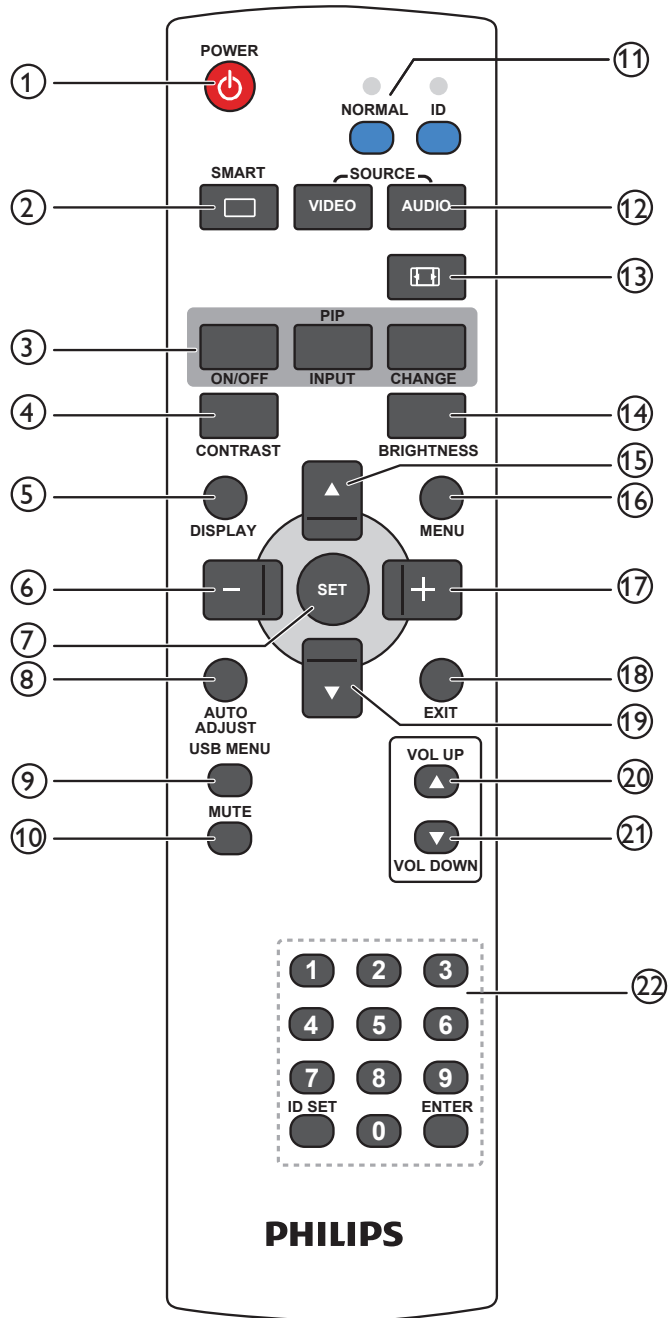

① **[POWER] button**

Press to switch on the display from standby mode. Press again to turn it off and back into standby mode.

② **[SMART] button**

Press to activate Smart Menu. Press [▲] or [▼] button to select menu options. Press [SET] button to confirm and exit the selection.

- **Standard:** Used for normal images (factory setting).
- **Highbriht:** Used for moving image such as Video.
- **sRGB:** Used for text based images (only for PC mode).
- **Cinema:** Used for movies (only for Video mode).

③ **[PIP] (Picture In Picture) button**

[ON/OFF]: Turn PIP mode ON/OFF.

[INPUT]: Select the input signal for the sub-picture.

[CHANGE]: Toggle between the main picture and sub picture.

④ **[CONTRAST] button**

Press to activate Contrast Menu. Press [+ ] or [- ] button to adjust the value. Press [MENU] button to confirm and exit.

⑤ **[DISPLAY] button**

Press to turn on/off the information OSD displayed on the upper right corner of the screen.

⑥ **[-] button**

- Press to move the selection left in OSD menu.
- Press to decrease the value in OSD menu.
- Press to move the sub-picture left in PIP mode.

⑦ **[SET] button**

Press to activate the setting inside the OSD menu.

⑧ **[AUTO ADJUST] button**

Press to run the Auto Adjust function.

NOTE: This button is functional for VGA input only.

⑨ **[USB MENU] button**

Use for model with USB multimedia function (not supported)

⑩ **[MUTE] button**

Press to turn the mute function on/off.

⑪ **[NORMAL / ID] button**

Press to set the remote control ID when you want to use this remote control on one of several different displays. .

⑫ **[VIDEO SOURCE] button**

Press to toggle Video Source Menu. Press [▲] or [▼] button to select one of the video sources among **Displayport, DVI-D, VGA, HDMI, Component, Video, or Card OPS**. Press [SET] button to confirm and exit.

**[AUDIO SOURCE] button**

Press to toggle Audio Source Menu. Press [▲] or [▼] button to select one of the audio sources among **Displayport, HDMI, Audio1, Audio2, or Card OPS**. Press [SET] button to confirm and exit.

⑬ **Picture Format button** [ ]

Press to switch screen aspect ratio.

- For PC signal: **FULL, NORMAL, CUSTOM, and REAL.**

- For Video signal: **FULL, NORMAL, DYNAMIC, CUSTOM, REAL, and 21:9.**

⑭ **[BRIGHTNESS] button**

Press to toggle Brightness Menu. Press [+ ] or [- ] button to adjust the value.

⑮ **[▲] button**

- Press to move the selection up in OSD menu.
- Press to move the sub-picture up in PIP mode.

⑯ **[MENU] button**

Press to turn the OSD menu on/off.

⑰ **[+] button**

- Press to move the selection right in OSD menu.
- Press to increase the value in OSD menu.
- Press to move the sub-picture right in PIP mode.

⑱ **[EXIT] button**

Press to turn back to the previous OSD menu.

19 **[▼] button**

- Press to move the selection down in OSD menu.
- Press to move the sub-picture down in PIP mode.

20 **[VOL UP] button**

Press to increase the audio output level.

21 **[VOL DOWN] button**

Press to decrease the audio output level.

22 **[Number / ID SET / ENTER] button**

Press to set the display ID.

2. Press the digit numbers [0] ~ [9] to select the display you want to control.  
For example: press [0] and [1] for display No.1, press [1] and [1] for display No.11.  
The numbers available are from [01] ~ [99].
3. Not pressing any button within 10 seconds will exit the ID Mode.
4. If an error pressing of buttons other than the digits occurred, wait 1 second after the red LED lights off and then lights up again, then press the correct digits again.
5. Press **[ENTER]** button to confirm. The red LED blinks twice and then lights off.

**NOTE:**

- Press **[NORMAL]** button. The green LED blinks twice, indicating the display is in normal operation.
- It is necessary to set up the ID number for each display before selecting its ID number.

### 2.3.2. ID Remote Control

You can set the remote control ID when you want to use this remote control on one of several different displays.

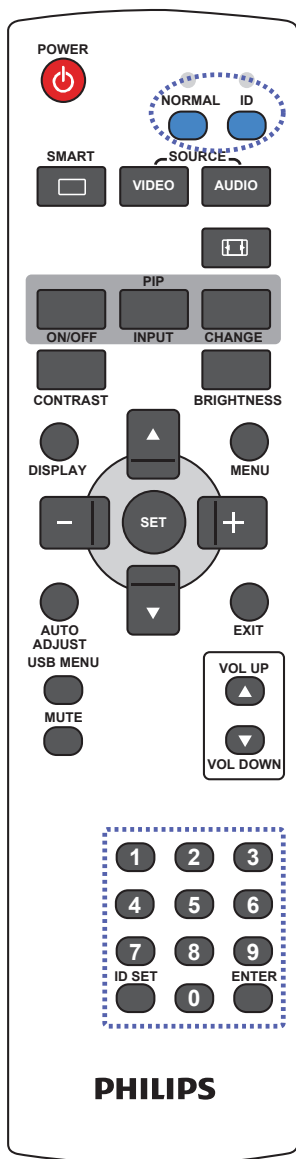

Press **[ID]** button. The red LED blinks twice.

1. Press **[ID SET]** button for more than 1 second to enter the ID Mode. The red LED lights up.  
Press the **[ID SET]** button again will exit the ID Mode. The red LED lights off.

### 2.3.3. Inserting the batteries in the remote control

The remote control is powered by two 1.5V AAA batteries.

To install or replace batteries:

1. Press and then slide the cover to open it.
2. Align the batteries according to the (+) and (-) indications inside the battery compartment.
3. Replace the cover.

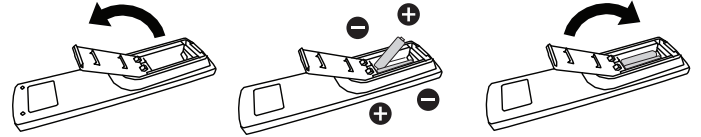

#### Caution:

The incorrect use of batteries can result in leaks or bursting. Be sure to follow these instructions:

- Place "AAA" batteries matching the (+) and (-) signs on each battery to the (+) and (-) signs of the battery compartment.
- Do not mix battery types.
- Do not combine new batteries with used ones. It causes shorter life or leakage of batteries.
- Remove the dead batteries immediately to prevent them from liquid leaking in the battery compartment. Don't touch exposed battery acid, as it can damage your skin.

NOTE: If you do not intend to use the remote control for a long period, remove the batteries.

### 2.3.4. Handling the remote control

- Do not subject to strong shock.
- Do not allow water or other liquid to splash the remote control. If the remote control gets wet, wipe it dry immediately.
- Avoid exposure to heat and steam.
- Other than to install the batteries, do not open the remote control.

### 2.3.5. Operating range of the remote control

Point the top of the remote control toward the display's remote control sensor (back side) when pressing a button.

Use the remote control within the range which is shown in the following table.

Operation Angle	RC operational distance
$\theta = 0^\circ$ (for H & V)	$\geq 8\text{m}$
$\theta = 20^\circ$ (for H & V)	$\geq 5\text{m}$
$\theta = 45^\circ$ (for H only)	$\geq 2\text{m}$

NOTE: The remote control may not function properly when the remote control sensor on the display is under direct sunlight or strong illumination, or when there is an obstacle in the path of signal transmission.

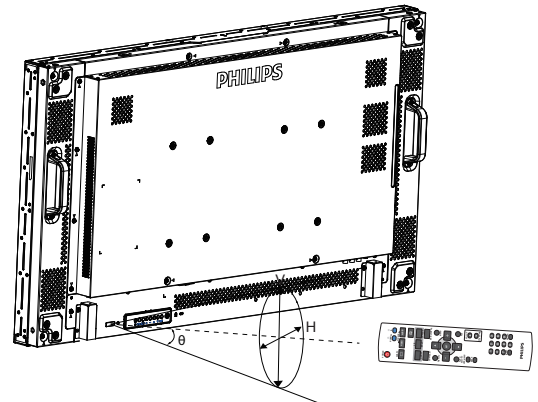

### 3. Connecting External Equipment

NOTE: The peripherals and cables shown are for example purposes only.

#### 3.1. Connecting External Equipment

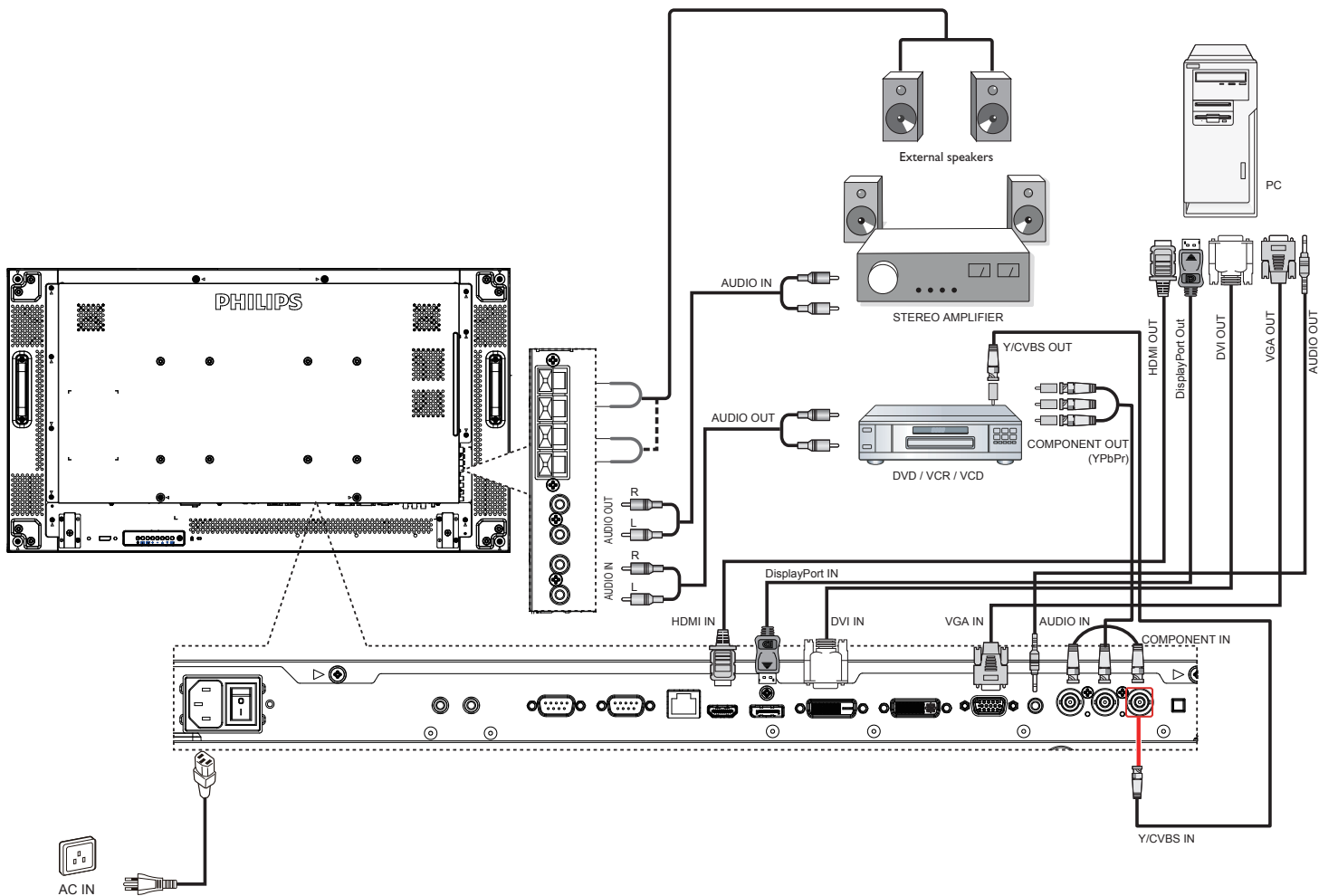

## 3.2. Connecting Remote Control

### 3.2.1. Single Display Control

To control one display, connect the "IR Sensor Cable" to the [IR IN] port.

Point the top of the remote control toward the "IR Sensor Cable" when pressing a button.

NOTE: The Display's remote control sensor will stop working after connected with the "IR Sensor Cable".

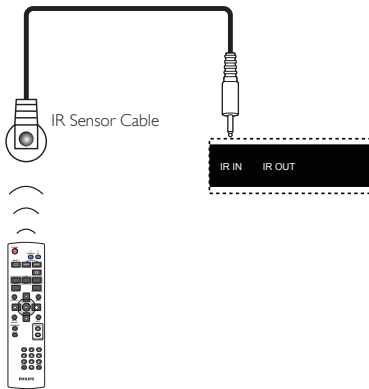

### 3.2.2. IR Pass Through Control

To control a Video-Wall set up by multiple displays, use the "IR Sensor Cable" and the "IR Cable" to achieve the function.

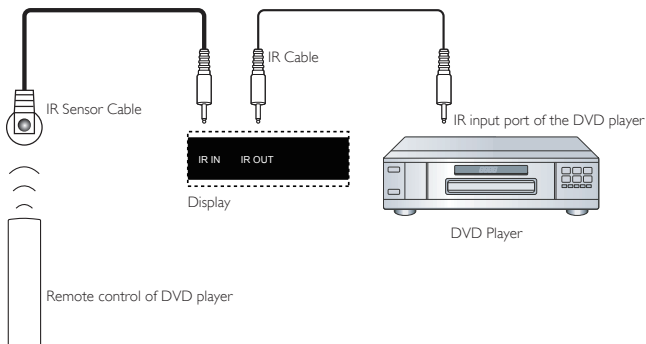

1. Connect the "IR Sensor Cable" to the [IR IN] port of the display.
2. Connect with the "IR Cable" from the [IR OUT] port of the display to the IR input port of the DVD player.
3. IR signal will be passed to DVD player when pressing a button.

NOTE: The remote control may not function properly if the "IR Sensor Cable" is under direct sunlight or strong illumination, or when there is obstacle in the path of signal transmission.



### 3.3. Connecting Multiple Displays in a Daisy-chain Configuration

You can interconnect multiple displays to create a daisy-chain configuration for applications such as a video wall.

NOTE: Maximum 25 displays (5x5) can be used in a daisy-chain configuration.

#### 3.3.1. Display control connection

Connect the [RS232C OUT] connector of DISPLAY 1 to the [RS232C IN] connector of DISPLAY 2.

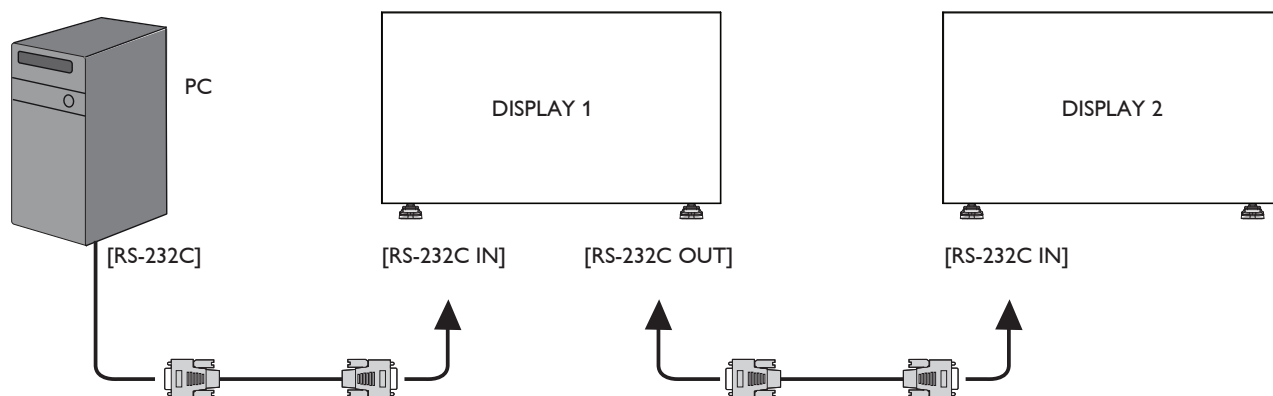

#### 3.3.2. Digital video connection

Connect the [DVI OUT / VGA OUT] connector of DISPLAY 1 to the [DVI IN] connector of DISPLAY 2.

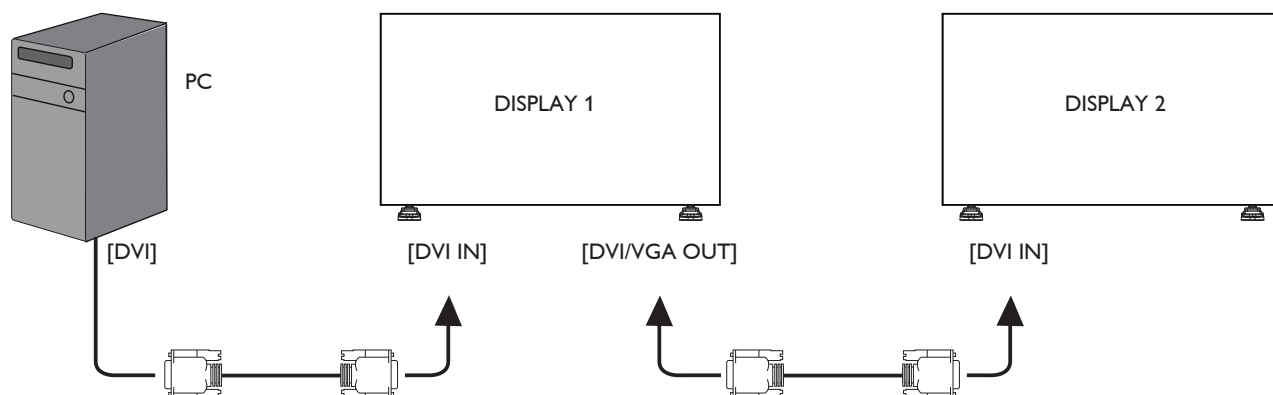

#### 3.3.3. Analog video connection

Connect the [DVI OUT / VGA OUT] connector of DISPLAY 1 to the [VGA IN] connector of DISPLAY 2.

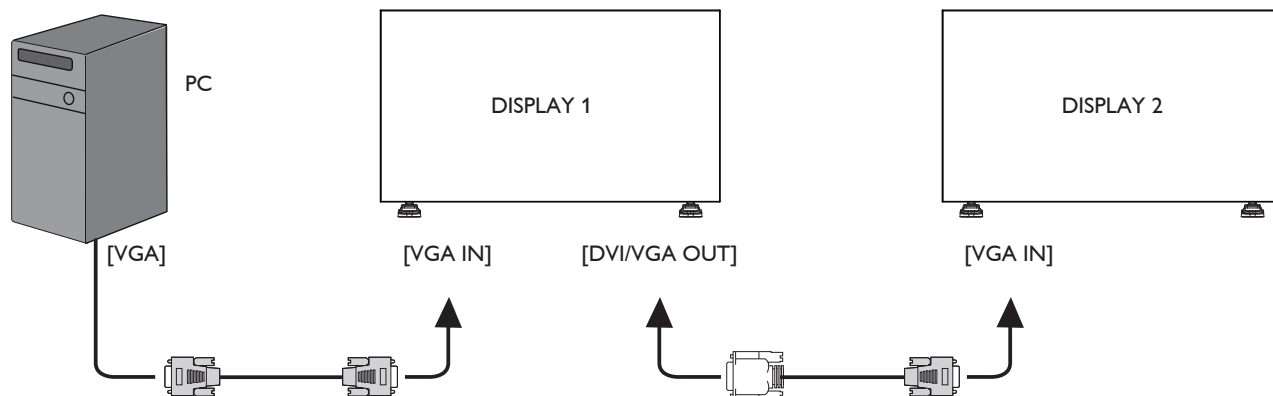

### 3.3.4. IR daisy-chain Connection

Connect [IR Sensor Cable] to DISPLAY 1, and connect the [RS232C OUT] connector of DISPLAY 1 to the [RS232C IN] connector of DISPLAY 2.

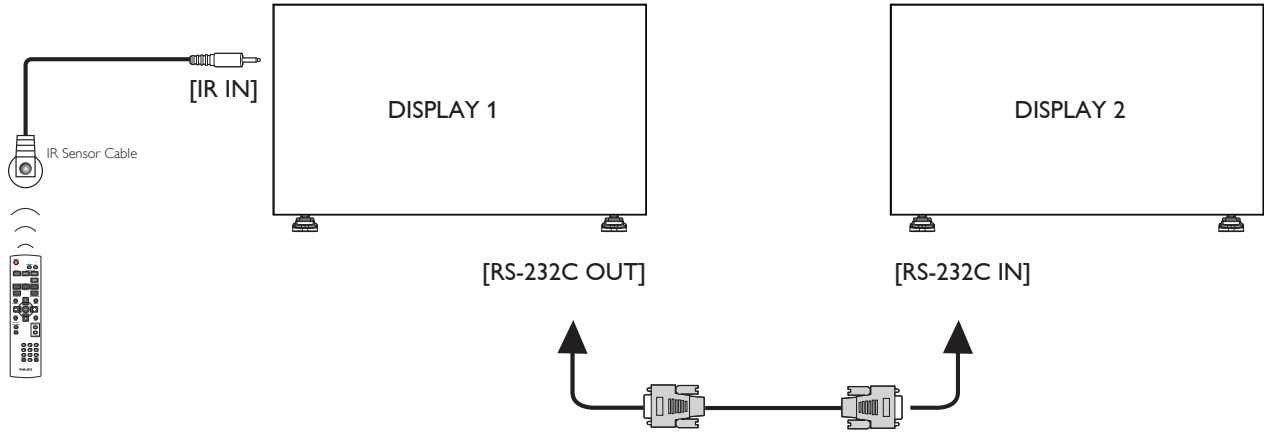

## 4. OSD Menu

An overall view of the On-Screen Display (OSD) structure is shown below. You can use it as a reference for further adjusting your display.

### 4.1. Navigating the OSD Menu

#### 4.1.1. Navigating the OSD menu using the remote control

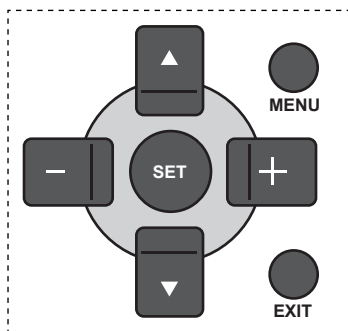

1. Press [**MENU**] button on the remote control to display the OSD menu.
2. Press [**▲**] or [**▼**] button to choose the item you want to adjust.
3. Press [**SET**] or [**+**] button to enter the submenu.
4. In the submenu, press [**▲**] or [**▼**] button to toggle among items, press [**+**] or [**-**] button to adjust settings. If there is a submenu, press [**SET**] or [**+**] button to enter the submenu.
5. Press [**EXIT**] button to return to the previous menu, or press [**MENU**] button to exit the OSD menu.

#### 4.1.2. Navigating the OSD menu using the display's control buttons

1. Press [**MENU**] button to display the OSD menu.
2. Press [**+**] or [**-**] button to choose the item you want to adjust.
3. Press [**+**] button to enter the submenu.
4. In the submenu, press [**▲**] or [**▼**] button to toggle among items, press [**+**] or [**-**] button to adjust settings. If there is a submenu, press [**+**] button to enter the submenu.
5. Press [**MENU**] button to return to the previous menu, or press [**MENU**] button several times to exit the OSD menu.

## 4.2. OSD Menu Overview

### 4.2.1. Picture menu

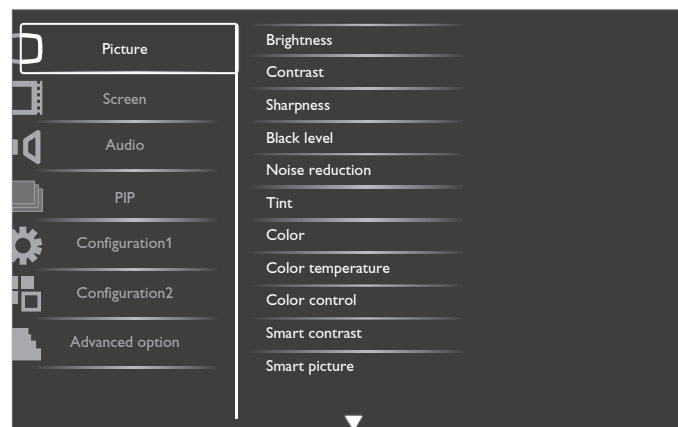

#### Brightness

Adjust the overall image brightness by changing the intensity of the LCD panel's backlight.

#### Contrast

Adjust to sharpen the picture quality. The black portions of the picture become richer in darkness and the white become brighter.

#### Sharpness

Adjust to improve the image detail.

#### Black level

Video black level is defined as the level of brightness at the darkest (black) part of a visual image. Adjust to change the image brightness.

#### Noise reduction

Adjust to remove the noise in the image. You can select a suitable noise reduction level.

Choose from: {Off} / {Low} / {Medium} / {High}.

NOTE: This item is functional for **HDMI**(Video mode), **Video**, and **YPbPr** inputs only.

#### Tint

Adjust to change the color tint of the image.

Use the [**+**] or [**-**] button to adjust. Press the [**+**] button and the flesh tone color turns slightly green. Press the [**-**] button and the flesh tone color turns slightly purple.

NOTE: This item is functional for **HDMI**(Video mode), **Video**, and **YPbPr** inputs only.

#### Color

Adjust to increase or decrease the intensity of colors in the image.

NOTE: This item is functional for **HDMI**(Video mode), **Video** and **YPbPr** inputs only.

#### Color temperature

Select a color temperature for the image. A lower color temperature will have a reddish tint, whilst a higher color temperature gives off a more bluish tint.

Choose from: {3000K} / {4000K} / {5000K} / {6500K} / {7500K} / {9300K} / {10000K} / {Native} / {User}.

#### Color control

With this function you can adjust the color tones of the image precisely by changing the R (Red), G (Green) and B (Blue) settings independently.

NOTE: This item is functional only when {Color temperature} is set to {User}.

**Smart contrast**

Smart contrast function is to enhance image contrast on darker scenes when activated. The Brightness setting in the Picture menu will be disabled when Smart Contrast is activated.

**Smart picture**

The following smart picture modes are available for:

- PC mode: {Standard} / {Highbright} / {sRGB}.
- Video mode: {Standard} / {Highbright} / {Cinema}.

**Video source**

Select a video input source.

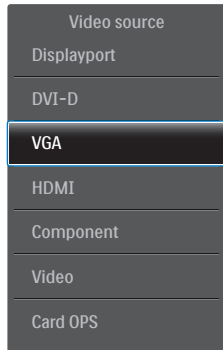

**Picture reset**

Reset all settings in the Picture menu.

**4.2.2. Screen menu**

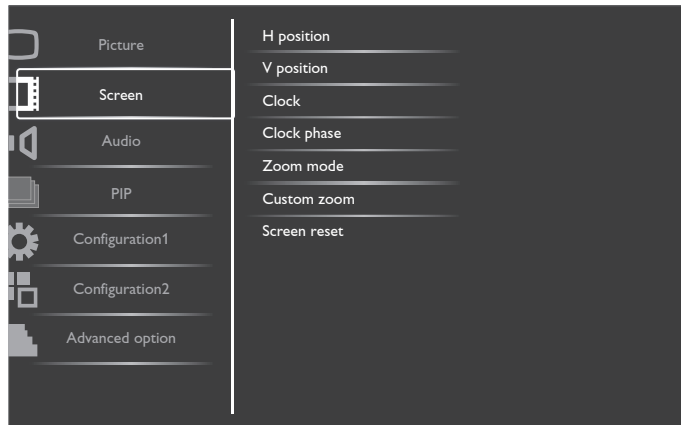

**H position**

Press the [+ ] button to move the image to the right, or [- ] to move the image to the left.

NOTE:

- H position adjustment is functional on all inputs, except HDMI , Card OPS , and DisplayPort in video mode.
- H position cannot be adjusted when Pixel Shift is activated.

**V position**

Press the [+ ] button to move the image up, or [- ] to move the image down.

NOTE:

- V position adjustment is functional on all inputs, except HDMI , Card OPS , and DisplayPort in video mode.
- V position cannot be adjusted when Pixel Shift is activated.

**Clock**

Adjust the width of the image.

NOTE: This item is functional for VGA input only.

**Clock phase**

Adjust to improve the focus, clarity and stability of the image.

NOTE: This item is functional for VGA input only.

**Zoom mode**

The pictures you receive may be transmitted in 16:9 format (wide screen) or 4:3 format (conventional screen). The 16:9 pictures sometimes have a black band at the top and bottom of the screen (letterbox format). **Zoom Mode will be deactivated when Pixel Shift is activated or turned on.**

This function allows you to optimize the picture display on screen. The following zoom modes are available for:

- PC mode: {Full} / {Normal} / {Custom} / {Real}.
- Video mode: {Full} / {Normal} / {Dynamic} / {Custom} / {Real} / {21:9}.



	<b>Full</b> This mode restores the correct proportions of pictures transmitted in 16:9 using the full screen display.
	<b>Normal</b> The picture is reproduced in 4:3 format and a black band is displayed on either side of the picture.
	<b>Dynamic</b> Fill the entire screen by stretching 4:3 pictures non-proportionally.
	<b>Custom</b> Choose to apply the custom zoom settings in the Custom Zoom submenu.
	<b>Real</b> This mode displays the image pixel-by-pixel on screen without scaling the original image size.
	<b>21:9</b> The picture is enlarged to 16:9 format. This mode is recommended when displaying pictures that have black bands at the top and bottom (letterbox format).

**Custom zoom**

You can use this function to further customize the zoom settings to suit the image you want to display.

NOTE: This item is functional only when the Zoom mode setting is set to Custom.

	<b>Zoom</b> Expands the horizontal and vertical sizes of the image simultaneously.
	<b>H zoom</b> Expands the horizontal size of the image only.

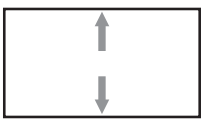
	<b>V zoom</b> Expands the vertical size of the image only.
	<b>H position</b> Moves the horizontal position of the image left or right.
	<b>V position</b> Moves the vertical position of the image up or down.

**Screen reset**

Reset all settings in the **Screen** menu to factory preset values.

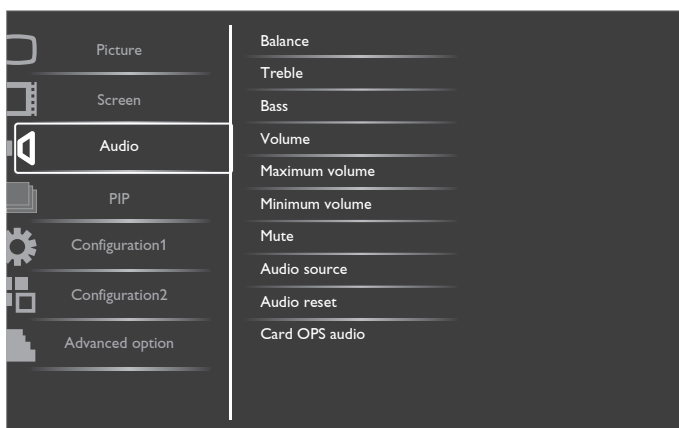
**4.2.3. Audio menu****Balance**

Adjust to emphasize left or right audio output balance.

**Treble**

Adjust to increase or decrease higher-pitched sounds.

**Bass**

Adjust to increase or decrease lower-pitched sounds.

**Volume**

Adjust to increase or decrease the audio output level.

**Maximum volume**

Adjust your own limitation for the maximum volume setting. This stops the volume from being playing at too loud a level.

**Minimum volume**

Adjust your own limitation for the minimum volume setting.

**Mute**

Turn the mute function on/off.

**Audio source**

Select the audio input source according to the audio signal source connected to the audio input and HDMI sockets on the display.

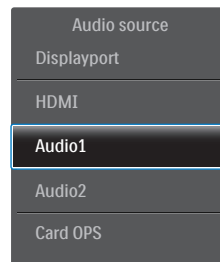

Choose from: {Displayport} / {HDMI} / {Audio1} / {Audio2} / {Card OPS}.

**Audio reset**

Reset all settings in the **Audio** menu to factory preset values.

**Card OPS audio**

Select the analog or digital audio mode for card OPS.

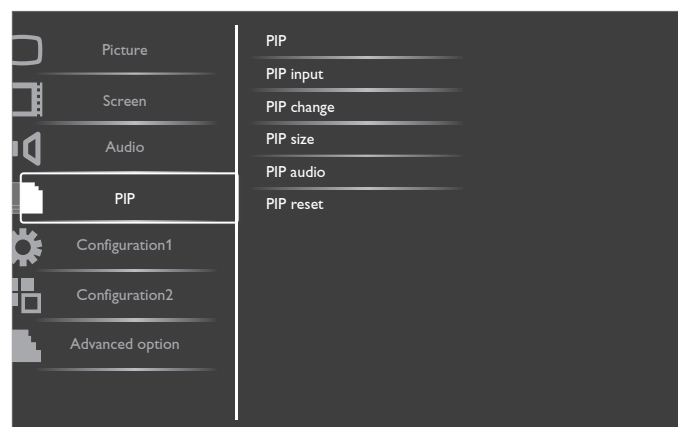
**4.2.4. PIP menu****PIP**

Select the PIP (Picture-in-Picture) mode.

Choose from: {Off} / {PIP} / {POP} / {PBP aspect} / {PBP full}.

**PIP input**

Select the input signal for the sub-picture.

**PIP change**

Enlarges the smaller picture to become the main picture, and vice versa.

**PIP size**

Select the size of the sub picture in the PIP (Picture-in-Picture) mode.

Choose from: {Small} / {Medium} / {Large}.

**PIP audio**

Select the audio source in the PIP (Picture-in-Picture) mode.

- {Main} - Select audio from the main picture
- {Sub} - Select audio from the sub picture.

**PIP reset**

Reset all settings in the **PIP** menu to factory preset values.

**NOTES:**

- The PIP function is available only for the following condition: {Configuration1} - {Panel saving} - {Pixel shift} setting to [Off] and {Advanced option} - {Tiling} - {Enable} setting to [No].

- The PIP function is available only for certain signal source combinations as shown in the table below.
- The availability of the PIP function will also depend on the resolution of the input signal being used.

Main Picture Sub Picture	Displayport	HDMI	DVI-D	VGA	YPbPr	Video	Card OPS
Displayport	X	X	X	○	○	○	X
HDMI	X	X	X	○	○	○	X
DVI-D	X	X	X	○	○	○	X
VGA	○	○	○	X	X	X	○
YPbPr	○	○	○	X	X	X	○
Video	○	○	○	X	X	X	○
Card OPS	X	X	X	○	○	○	X

(○: PIP function available, X: PIP function unavailable)

By pressing the [PIP ON/OFF] button on the remote control, you can change the mode in the order shown below:

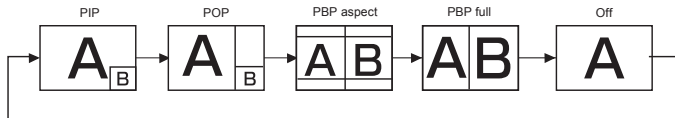

The resolutions in the PIP and POP modes are configured as follows:

PIP SIZE {Small} : 320 × 240 pixels  
 {Medium} : 480 × 320 pixels  
 {Large} : 640 × 480 pixels

POP SIZE: 474 × 355 pixels

NOTE: The images displayed in the sub picture always fit the PIP sizes shown above irrespective of the aspect ratio of the input image.

#### 4.2.5. Configuration1 menu

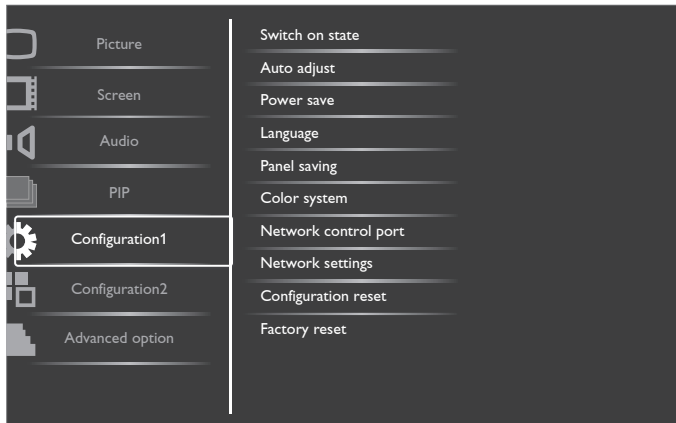

##### Switch on state

Select the display status used for the next time you connect the power cord.

- {Power off} - The display will remain off when the power cord is connected to a wall outlet.
- {Forced on} - The display will turn on when the power cord is connected to a wall outlet.
- {Last status} - The display will return to the previous power status (on/off/standby) when removing and replacing the power cord.

##### Auto adjust

Use this function to automatically optimize the display of VGA input image.

NOTE: This item is functional for VGA input only.

##### Power save

Use this setting to reduce the power automatically.

- {RGB} - Select {On} to let the display enter Power save mode when no signal is detected from the HDMI Graphic mode, DVI-D, or VGA inputs after three successive cycles.
- {VIDEO} - Select {On} to enter power saving mode when no signal is detected from the HDMI Video mode, Video input, or Component inputs after three successive cycles.

##### Language

Select the language used in the OSD menu.

The options are: {English} / {Deutsch} / { 简体中文 } / {Français} / {Italiano} / {Español} / {Русский} / {Polski} / {Türkçe} / { 繁體中文 } / { العربية } / { 日本語 }.

##### Panel saving

Choose to enable the panel saving functions and thus reduce the risk of "image persistence" or "ghost-imaging".

- {Cooling Fan} - Select {On} to turn on the cooling fan all the time. Select {Auto} to turn on/off the cooling fan according to the display's temperature.

NOTES:

- The default {Auto} option will start running the cooling fan if the temperature of 60°C (140°F) is reached, and stop running the cooling fan if the temperature of 58°C (136°F).
- A temperature-warning message will be shown on the screen if the temperature reaches 69°C (156°F). All key functions except [Power] key will then be disabled.
- Once the temperature reaches 70°C (158°F), the display power will be shut down automatically.
- {Brightness} - Select {On} and the image brightness will be reduced to an appropriate level. The Brightness setting in the Picture menu will be unavailable when selected.
- {Pixel shift} - Select the time interval ({Auto} / {10 ~ 900} Seconds / {Off}) for the display to slightly expand the image size and shift the position of pixels in four directions (up, down, left, or right). Activating Pixel Shift will disable H Position, V Position and Zoom Mode in the Screen Menu.

##### Color system

Selects the Color System depending on your input video format.

The options are: {Auto} / {NTSC} / {PAL} / {SECAM} / {4.43NTSC} / {PAL-60}.

NOTE: This item is functional for VIDEO input only.

##### Network control port

Select the network control port.

Choose from: {RS232} / {LAN(RJ45)} / {Card OPS RS232}.

NOTES:

- If {LAN(RJ45)} is selected, then {RS232} will not be activated, even if a cable is attached, and vice versa.
- The option {Card OPS RS232} is functional after connected with your OPS device.

## Network settings

Assign {IP address}, {Subnet Mask}, and {Default gateway} for the display.

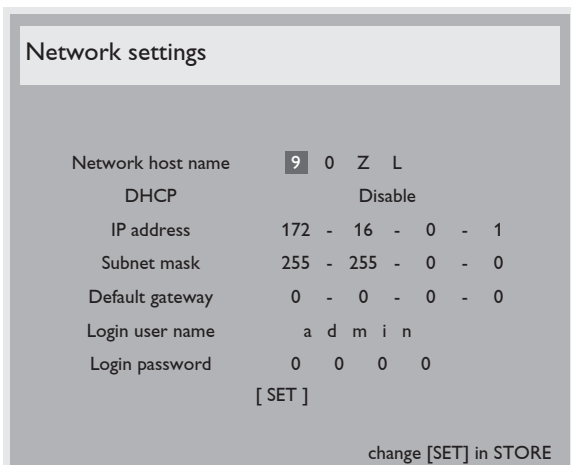

- DHCP - Choose to enable or disable the DHCP function. If enabled, the display will be assigned IP address, Subnet mask and Default gateway automatically. If disabled, you will be prompted to enter the following values manually. When finished, press [SET] button to store and save the chosen values.
- IP address
- Subnet mask
- Default gateway
- Login user name (The default user name is {admin})
- Login password (The default password is {0000})

## Configuration reset

Reset all settings in **Configuration1** menu to the factory preset values.

### Factory reset

Reset all settings in the OSD menus of {Picture}, {Screen}, {Audio}, {PIP}, {Configuration1}, {Configuration2}, and {Advanced option} to the factory preset values.

Press [+ ] or [- ] button to select [Reset], and then press [SET] button to do the reset.

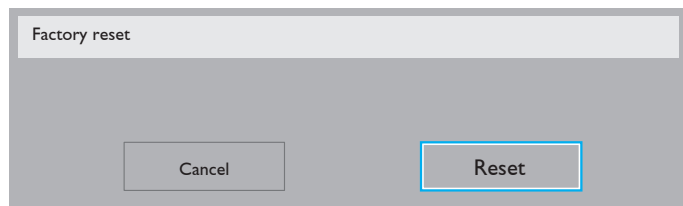

## 4.2.6. Configuration2 menu

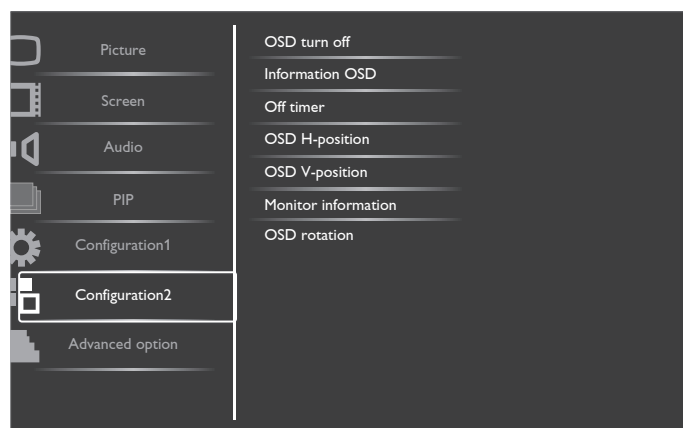

## OSD turn off

Set the period of time the OSD (on-screen display) menu stays on the screen.

The options are: {5 ~ 120} seconds.

## Information OSD

Set the period of time the information OSD is displayed on the upper right corner of the screen. The information OSD will display when input signal is changed.

The information OSD will remain on the screen with {Off} selection.

The options are: {1 ~ 60} seconds.

## Off Timer

Set the display to turn itself off to standby mode within an amount of time specified.

The options are: {Off, 1 ~ 24} hours from current time.

NOTE: When the "Off timer" is activated, the "Schedule" settings will be disabled.

## OSD H-position

Adjust the horizontal position of the OSD menu.

## OSD V-position

Adjust the vertical position of the OSD menu.

## Monitor information

Shows information about your display, including model number, serial number, operating hours and software version.

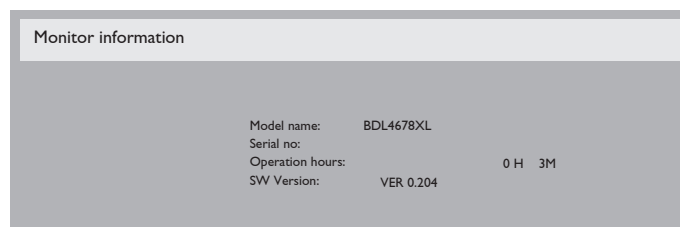

## OSD rotation

Rotate the OSD Menu.

The options are:

- {Landscape} (Default)
- {Portrait}

## DVI color

Usage: The user can set the suitable color format via this item for DVI input.

Option: Auto(default) / RGB / YCbCr 444 / YCbCr 222

## 4.2.7. Advanced option menu

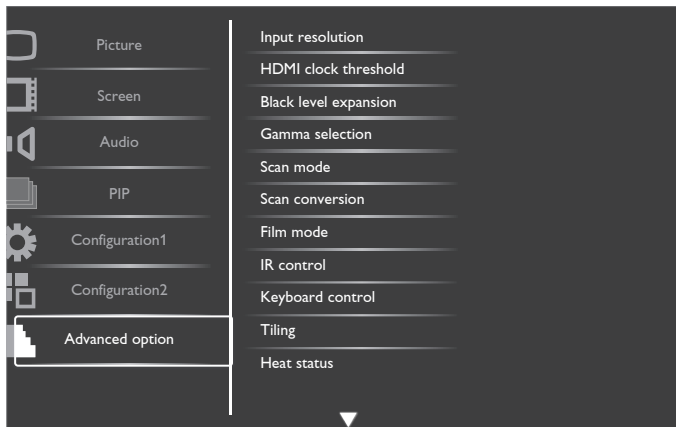

### Input resolution

Set the resolution of the VGA input. This is only required when the display is unable to detect the VGA input resolution correctly.

NOTE: This item is functional for **VGA** input only.

The options are:

- {1024x768 / 1280x768 / 1360x768 / 1366x768}
- {1400x1050 / 1680x1050}
- {1600x1200 / 1920x1200}
- {Auto}: Determines the resolution automatically.

The selected settings will become effective after turning off the power and turning it on again.

### HDMI clock threshold

Adjust HDMI link clock.

- {Min} - 600KHz.(Default)
- {Max} - 5000KHz.

NOTE: Threshold clock is for HDMI signals only. HDMI Threshold clock applies to the deviation of HDMI pixel clock. At times, HDMI pixel clock from some devices may not be stable. The display may treat the unstable signal as video mode change and mute the video. Threshold clock allows for the adjustment of the clock tolerance to avoid video mute.

### Black level expansion

This feature offers deeper blacks for an even better image quality.

The options are: {Off} / {Low} / {Medium} / {High}.

NOTE: This item is functional for **Video** mode input only.

### Gamma selection

Gamma is what controls the overall brightness of an image. Images which are not corrected properly can appear too white or too dark, so controlling the gamma properly can have a huge influence on the overall picture quality of your display.

The options are: {Native} / {2.2} / {2.4} / {S gamma}.

### Scan mode

Change the display area of the image.

- {Overscan} - Display about 95% of the original size of the image. The rest of the areas surrounding the image will be cut off.
- {Underscan} - Display the image in its original size.

NOTE: This item is functional for **Video** mode input only.

### Scan conversion

Choose to enable or disable the IP (Interlace to Progressive) conversion function.

- {Progressive} - Enable the IP conversion function (recommended). Once enabled, the interlace input signal will be converted to progressive format for better display quality.
- {Interlace} - Disable the IP function. This mode is suitable for displaying motion pictures, but it increases the chance of image retention.

### Film mode

Choose to turn on or off the film mode frame conversion function.

- {Auto} - Enable the film mode frame conversion function for movies and motion pictures. The display converts a 24 frames-per-second (24 fps) input signal format to DVD video signal format. Once this function is enabled, it is recommended that you set the {Scan conversion} function to {Progressive}.
- {Off} - Disable the film mode frame conversion function. This mode is suitable for TV broadcasting and VCR signals.

### IR control

Select the operation mode of the remote control when multiple displays are connected via an RS232C connection.

- {Normal} - All displays can be operated normally by the remote control unit.
- {Primary} - Designate this display as the primary display for remote control operation. Only this display can be operated by the remote control.
- {Secondary} - Designate this display as the secondary display. This display can not be operated by the remote control, and will only receive the control signal from the primary display via the RS232C connection.
- {Lock All} / {Lock all but Volume} / {Lock all but Power} - Lock the remote control function of this display. To unlock, press and hold the [DISPLAY] button on the remote control for 5 (five) seconds..

### Keyboard control

Choose to enable or disable the display keyboard (control buttons) function.

- {Unlock} - Enable the keyboard function.
- {Lock All} / {Lock all but Volume} / {Lock all but Power} - Disable the keyboard function.

### Tiling

With this function you can create a single large-screen matrix (video wall) that consists of up to 150 sets of this display (**up to 10-sets on the vertical and 15-sets on the horizontal sides**). This function requires a daisy-chain connection.

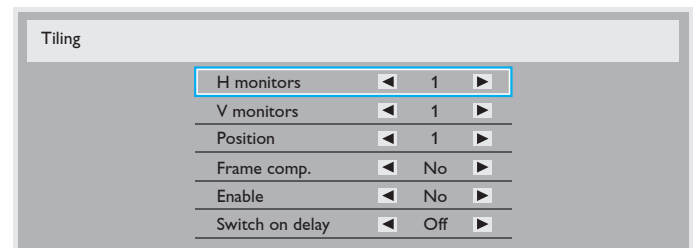



**Example: 2 x 2 screen matrix (4 displays)**

H monitors = 2 displays

V monitors = 2 displays

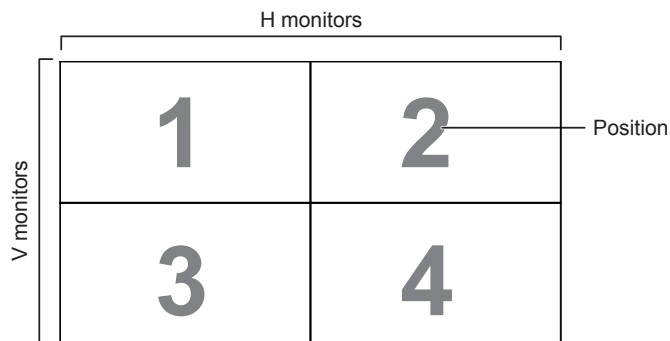
**Example: 5 x 5 screen matrix (25 displays)**

H monitors = 5 displays

V monitors = 5 displays

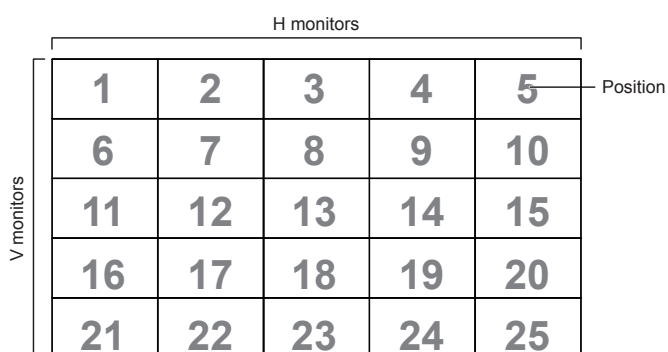

- **H monitors** - Select the number of displays on the horizontal side.
- **V monitors** - Select the number of displays on the vertical side.
- **Position** - Select the position of this display in the screen matrix.
- **Frame comp.** - Choose to turn the frame compensation function on or off. If selected **{Yes}**, the display will adjust the image to compensate for the width of the display bezels in order to accurately display the image.

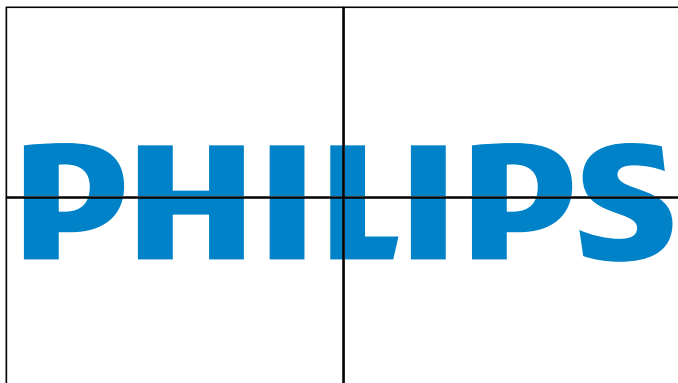
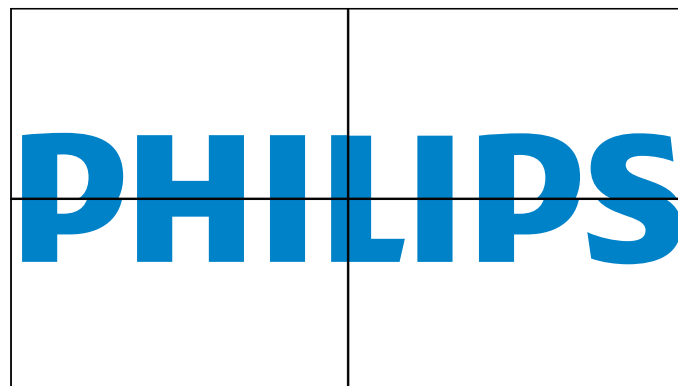
**Frame comp. - Yes****Frame comp. - No**

- **Enable:** Choose to enable or disable the Tiling function. If enabled, the display will apply the settings in **{H monitors}**, **{V monitors}**, **{Position}**, and **{Frame comp.}**.
- **Switch on delay:** Set the power-on delaying time (in seconds). The default option **{Auto}** allows a sequential powering-on for each display by their ID number when multiple displays are connected. The options are: **{Off / Auto / 2, 4, 6, 8, 10, 20, 30, 40, 50}**

NOTE: The Tiling function will be disabled when the **[ON/OFF]** button for PIP is pressed.

**Heat status**

This function allows you to check the thermal status of the display at any time.

**Date and time**

Adjust the current date and time for the display's internal clock.

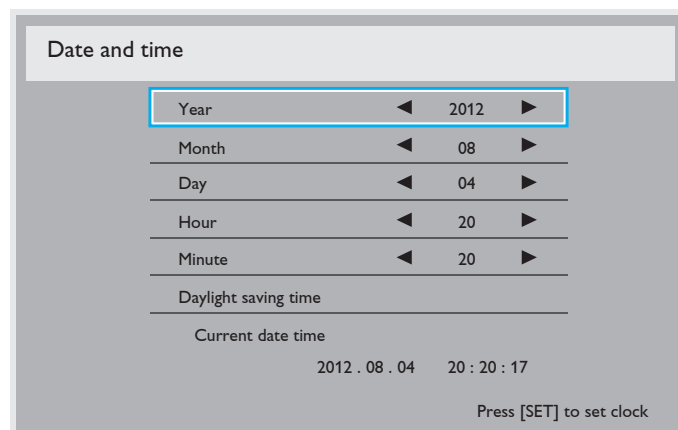

1. Press **[+]** button to enter the submenu.
2. Press **[▲]** or **[▼]** button to toggle between **{Year}**, **{Month}**, **{Day}**, **{Hour}**, **{Minute}**, and **{Daylight saving time}**.
3. Press **[+]** or **[-]** button to adjust all settings except **{Daylight saving time}**.
4. Press **[SET]** button to enter the **{Daylight saving}** submenu.
5. Press **[+]** or **[-]** button to select item, press **[▲]** or **[▼]** button to adjust.

## Schedule

This function allows you to program up to 7 (seven) different scheduled time intervals for the display to activate.

You can select:

- The time for the display to turn on and turn off.
- The days in a week for the display to activate.
- Which input source the display will use for each scheduled activation period.

NOTE: We recommend you to set up current date and time in the **{Date and time}** menu before using this function.

1. Press **[SET]** or **[+]** button to enter the submenu.

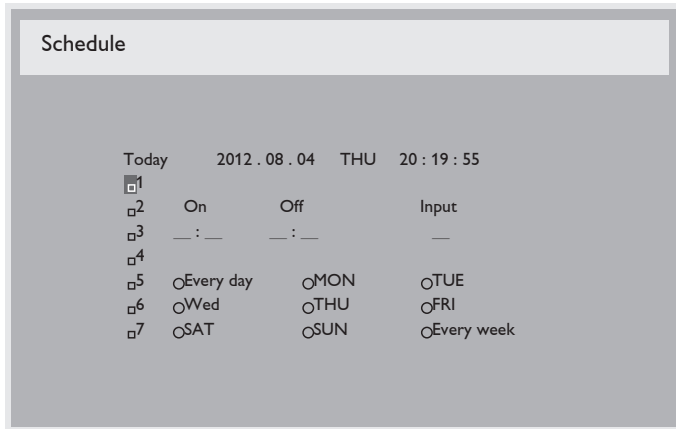

2. Press **[▲]** or **[▼]** button to select a schedule item (item number 1 ~ 7), and then press **[+]** button to mark it the item number:

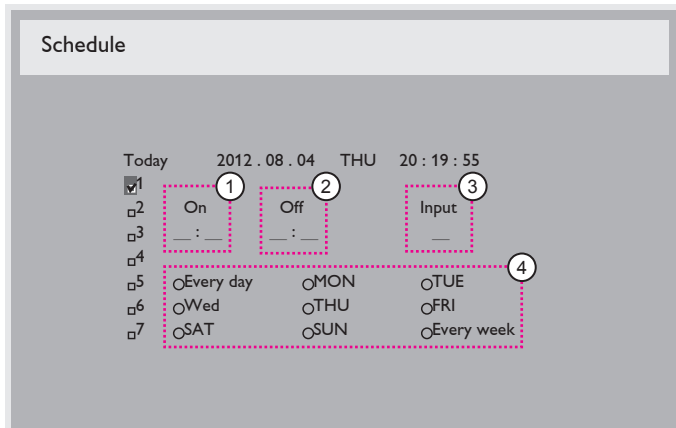

3. Press **[+]** or **[-]** button to select the schedule:
  - ① **Power-on** schedule: Press **[▲]** or **[▼]** button to set the hour and minute for the display to turn on.
  - ② **Power-off** schedule: Press **[▲]** or **[▼]** button to set the hour and minute for the display to turn off.  
Select or leave an empty “\_” for both the hour and minute slot if you do not want to use this power-on or power-off schedule.
  - ③ **Input-source** selection: Press **[▲]** or **[▼]** button to select an input source. If no input source is selected, the input source will remain the same as last selected.
  - ④ **Date** schedule: Press **[+]** button to select which day in a week this schedule item will be take effect, and then press the **[SET]** button.
4. For additional schedule settings, press **[EXIT]**, then repeat the steps above. A check mark in the box next to the number of the schedule item indicates that the selected schedule is in effect.

## NOTES:

- The **{Every day}** selection in a schedule item takes priority over the other weekly schedules.
- If the schedules overlap, the scheduled power-on time takes priority over scheduled power-off time.
- If there are two schedule items programmed for the same time, the highest numbered schedule takes priority. For example, if schedule items #1 and #2 both set the display to power on at 7:00 AM and off at 5:00 PM, then only schedule item # 1 will take effect.

## Monitor ID

Set the ID number for controlling the display via the RS232C connection. Each display must have a unique ID number when multiple sets of this display are connected. Monitor ID number range is between 1 to 255.

The option are: **{Monitor group}** / **{Tiling matrix}** / **{Auto ID}**

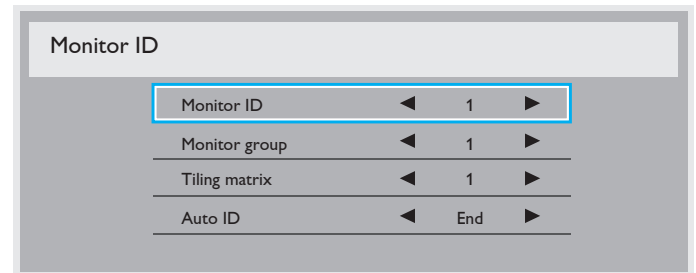

- **{Monitor group}**  
The option are: **{Off}** / **{1-254}**
  - **{Off}** – **{Monitor group}** are not supported.
  - **{1-254}** – **{Monitor group}** are supported. The default setting is 1.
- **{Tiling matrix}**:  
Tiling matrix number range is between 1 to 15. 1 is default setting. The **{Auto ID}** setup function enables setting up **{Monitor ID}** of connected machine according to **{Tiling matrix}** settings.  
Example: Tiling matrix sets as 4

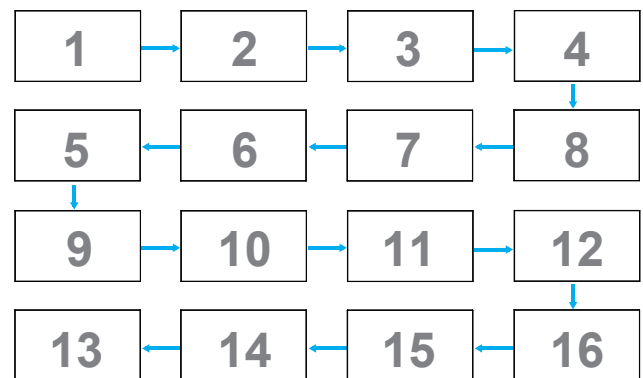

- **{Auto ID}**

The option are: **{Start}** / **{End}**.The default is **{End}**.

- Switch to Start option to set up IDs of machines backward from current one.
- Once the setup is completed, the option exits to End automatically.
- To use this function, serial connect all machines with RS-232 cable and set their Control ports to RS-232 too.

## DDC/CI

Choose to turn on or off the DDC/CI communication function. Select **{On}** for normal use.

DDC/CI (Command Interface) specifies a means for a computer to send commands to the monitor; as well as receive sensor data from the monitor; over the bidirectional link such as DDC2Ab/Bi/B+.

Specific commands to control monitors are defined in a separate Monitor Control Command Set (MCCS) standard.

DDC/CI monitors are sometimes supplied with an external color sensor to allow automatic calibration of the monitor's color balance. Some tilting DDC/CI monitors support an auto pivot function, where a rotation sensor in the monitor enables the operating system to keep the display upright as the monitor is moved between its portrait and landscape positions.

The following DDC/CI commands should be supported via command line:

No.	Commands
1	Set Brightness
2	set Contrast
3	Set Red Gain
4	Set Green Gain
5	Set Blue Gain
6	Get Brightness
7	Get Contrast
8	Get Red Gain
9	Get Green Gain
10	Get Blue

## HDMI with One Wire

CEC control.

- **{Off}** - Disable CEC.(Default)
- **{On}** - Enable CEC.

## Smart power

Set the display to reduce the power consumption.

The options are: **{Off}** / **{Medium}** / **{High}**.

## Auto signal detection

Choose to let the display detect and display available signal sources automatically.

- **{Off}** - Once a signal is connected, it can only be selected manually. No signal, set the display to display the image automatically according to the search order of each option.

The options are: **{All}** / **{PC source only}** / **{Video source only}** / **{Failover}**

- **{All}** - Search order: DP -> DVI->VGA -> HDMI -> Component-> Video -> Card OPS
- **{PC source only}** - Search order: DP -> DVI ->VGA -> HDMI -> Card OPS
- **{Video source only}** - Search order: HDMI -> Component -> Video

- **{Failover}**

- Failover 1: User-defined setting. Default:HDMI.
- Failover 2: User-defined setting. Default:HDMI.
- Failover 3: User-defined setting. Default:HDMI.
- Failover 4: User-defined setting. Default:HDMI.
- Failover 5: User-defined setting. Default:HDMI.
- Failover 6: User-defined setting. Default:HDMI.
- Failover 7: User-defined setting. Default:HDMI.

## APM (Advanced Power Management)

Power save setting.

- **{Off}** - No signal, direct shutdown. ( Default )
- **{On}** - No signal, enter into Power Save mode.

## OPS settings

Set the OPS configuration under each power condition.

- **{Auto}** - After selecting **{Card OPS}** for video source input, the OPS will be set to off when the display power is set to off, or set to on when the display power is set to on. When set to other video source inputs, the OPS will always be set to on.
- **{Always off}** - The OPS will always be set to off.
- **{Always on}** - The OPS will always be set to on.

## Advanced option reset

Reset all settings in the **Advanced option** menu to factory preset values.

1. Press **[SET]** or **[+]** button to enter the submenu.
2. Press **[+]** or **[-]** button to select **{Reset}** and press the **[SET]** button to restore settings to factory preset values.
3. Press the **[EXIT]** button or select **{Cancel}** and press the **[SET]** button to cancel and then return to the previous menu.

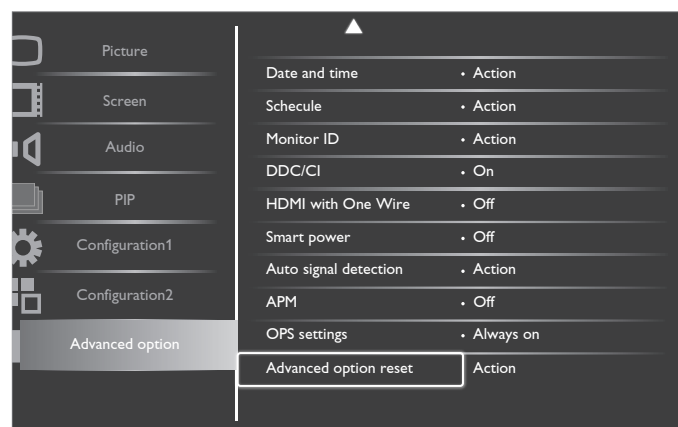

## 5. Input Mode

### VGA Resolution:

Standard Resolution	Active Resolution		Refresh Rate	Pixel Rate	Aspect Ratio	Stand for Mode
	H Pixels	V Lines				
VGA	640	480	60 Hz	25.175 MHz	4:3	Video Graphic Array
			72 Hz	31.5 MHz		
			75 Hz	31.5 MHz		
WVGA	720	400	70 Hz	33.75 MHz	16:9	Wide Video Graphic Array
SVGA	800	600	60 Hz	40 MHz	4:3	Super VGA
			75 Hz	49.5 MHz		
XGA	1024	768	60 Hz	65 MHz	4:3	Extended Graphic Array
			75 Hz	78.75 MHz		
WXGA	1280	768	60 Hz	79.5 MHz	5:3	Wide XGA
WXGA	1280	800	60 Hz	79.5 MHz	16:10	Wide XGA
SXGA	1280	960	60 Hz	108 MHz	4:3	Super XGA
SXGA	1280	1024	60 Hz	108 MHz	5:4	Super XGA
WXGA	1360	768	60 Hz	85.5 MHz	16:9	Wide XGA
WXGA	1366	768	60 Hz	85.5 MHz	16:9	Wide XGA
UXGA	1600	1200	60 Hz	162 MHz	4:3	Ultra XGA
HD1080	1920	1080	60 Hz	148.5 MHz	16:9	HD1080

### SDTV Resolution:

Standard Resolution	Active Resolution		Refresh Rate	Pixel Rate	Aspect Ratio	Stand for Mode
	H Pixels	V Lines				
480i	720	480	29.97 Hz	13.5 MHz	4:3	Modified NTSC Standard
480p			59.94 Hz	27 MHz		
576i	720	480	25 Hz	13.5 MHz	4:3	Modified PAL Standard
576p			50 Hz	27 MHz		

### HDTV Resolution:

Standard Resolution	Active Resolution		Refresh Rate	Pixel Rate	Aspect Ratio	Stand for Mode
	H Pixels	V Lines				
720p	1280	720	50 Hz	74.25 MHz	16:9	Normally DVB Mode
			60 Hz			
1080i	1920	1080	25 Hz	74.25 MHz	16:9	Normally ATSC Mode
			30 Hz			
1080p	1920	1080	50 Hz	148.5 MHz	16:9	Normally ATSC Mode
			60 Hz			

- The PC text quality is optimum in HD1080 mode (1920 × 1080, 60Hz).
- Your PC display screen might appear different depending on the manufacturer (and your particular version of Windows).
- Check your PC instruction book for information about connecting your PC to a display.
- If a vertical and horizontal frequency-select mode exists, select 60Hz (vertical) and 31.5KHz (horizontal). In some cases, abnormal signals (such as stripes) might appear on the screen when the PC power is turned off (or if the PC is disconnected). If so, press the [INPUT] button to enter the video mode. Also, make sure that the PC is connected.
- When horizontal synchronous signals seem irregular in RGB mode, check PC power saving mode or cable connections.
- The display settings table complies to the IBM/VESA standards, and based on the analog input.
- The DVI support mode is regarded as same to the PC support mode.
- The best timing for the vertical frequency to each mode is 60Hz.

## 6. Pixel Defect Policy

We strive to deliver the highest quality products and use some of the industry's most advanced manufacturing processes whilst practicing stringent quality control. However, pixel or sub-pixel defects on the PDP / TFT panels used in Plasma- & LCD- displays are sometimes unavoidable. No manufacturer can guarantee that all panels will be free from pixel defects, but Philips guarantees that any Plasma- & LCD- displays with an unacceptable number of defects will be repaired during the warranty period in line with your local guarantee conditions.

This notice explains the different types of pixel defects and defines the acceptable defect level for the LCD screen. In order to qualify for repair under warranty, the number of pixel defects must exceed a certain level as shown in the reference table. If the LCD screen is within specification a warranty exchange / claim back will be refused. Additionally, because some types or combinations of pixel defects are more noticeable than others, Philips sets even higher quality standards for those.

### 6.1. Pixels and Sub-Pixels

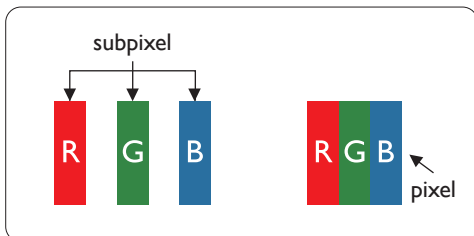

A pixel, or picture element, is composed of three sub-pixels in the primary colors of red, green and blue. Many pixels together form an image. When all sub-pixels of a pixel are lit, the three colored sub-pixels together appear as a single white pixel. When all are dark, the three colored sub-pixels together appear as a single black pixel. Other combinations of lit and dark sub-pixels appear as single pixels of other colors.

### 6.2. Types of Pixel Defects + Dot Definition

Pixel and sub-pixel defects appear on the screen in different ways. There are three categories of pixel defects and several types of sub-pixel defects within each category.

#### Dot definition = What is a defective "Dot"?

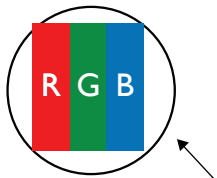

One or more defective, adjacent sub-pixel are defined as one "dot". The no. of defective sub-pixels are not relevant to define a defective dot. This means that a defective dot can consist of one, two or three defective sub-pixels which can be dark or lit.



One dot = One Pixel; consists of three sub-pixels of Red, Green, and Blue.

### 6.3. Bright Dot Defects

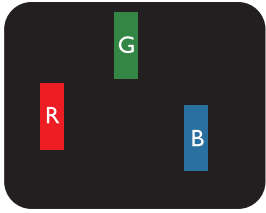
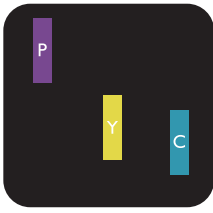
Bright dot defects appear as pixels or sub-pixels that are always lit or "on". These are the examples of bright dot defects:

 <p>One lit red, green or blue sub pixel</p>	 <p>Two adjacent lit sub pixels: Red + Blue = Purple Red + Green = Yellow Green + Blue = Cyan (Light Blue)</p>	 <p>Three adjacent lit sub pixels (one white pixel)</p>
---	---	--

## 6.4. Dark Dot Defects

Black dot defects appear as pixels or sub-pixels that are always dark or "off". These are the examples of black dot defects:

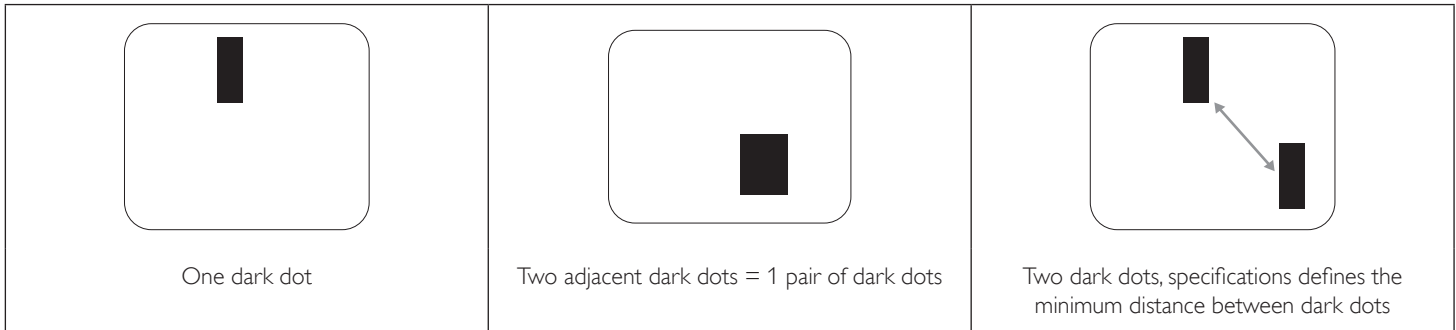

## 6.5. Proximity of Pixel Defects

Because pixel and sub-pixels defects of the same type that are nearby one another may be more noticeable, Philips also specifies tolerances for the proximity of pixel defects. In the table below you can find specifications about:

- Allowed amount of adjacent dark dots = (adjacent dark dots = 1 pair of dark dots)
- Minimum distance between dark dots
- Total no. of all defective dots

## 6.6. Pixel Defect Tolerances

In order to qualify for repair due to pixel defects during the warranty period, a PDP / TFT panel in a Philips Plasma / LCD- display must have pixel or sub-pixel defects exceeding the tolerances listed in the following table.

BRIGHT DOT EFFECT	ACCEPTABLE LEVEL
1 lit sub pixel	2
BLACK DOT EFFECT	ACCEPTABLE LEVEL
1 dark sub pixel	10
TOTAL DOT DEFECTS OF ALL TYPES	12

NOTE: \* 1 or 2 adjacent sub pixel defects = 1 dot defect

## 6.7. MURA

Dark spots or patches may occasionally appear on some liquid crystal display (LCD) panels. This is known within the industry as Mura, which is a Japanese term for "unevenness." It is used to describe an irregular pattern or area in which uneven screen uniformity appears under certain conditions. Mura is a result of the deterioration of the liquid crystal alignment layer and is most commonly caused by long-term operation under high ambient temperatures. It is an industry- wide phenomenon and Mura is not repairable. It is also not covered by our warranty terms.

Mura has been around since the introduction of LCD technology and with screens getting bigger and in operation 24/7, many displays are running in low light conditions. This all adds to the possibility of Mura affecting displays.

### HOW TO SPOT MURA

There are many symptoms of Mura and also multiple causes. Several of these are listed below:

- Impurities or foreign particles in the crystal matrix
- Uneven distribution of LCD matrix during manufacturing
- Non-uniform luminance distribution of the backlight
- Panel assembly induced stress
- Flaws within the LCD cells
- Thermal induced stress - high temperature operation over long periods of time

### HOW TO AVOID MURA

Although we can not guarantee the complete eradication of Mura every time, in general the appearance of Mura can be minimized by these methods:

- Lower the backlight brightness
- Use a screen saver
- Reduce the ambient temperature around the unit

---

## 7. Cleaning and Troubleshooting

### 7.1. Cleaning

#### Caution When Using the Display

- Do not bring your hands, face or objects close to the ventilation holes of the display. The top of the display is usually very hot due to the high temperature of exhaust air being released through the ventilation holes. Burns or personal injuries may occur if any body parts are brought too close. Placing any object near the top of the display could also result in heat related damage to the object as well as the display itself.
- Be sure to disconnect all cables before moving the display. Moving the display with its cables attached may damage the cables and thus cause fire or electric shock.
- Disconnect the power plug from the wall outlet as a safety precaution before carrying out any type of cleaning or maintenance procedure.

#### Front Panel Cleaning Instructions

- The front of the display has been specially treated. Wipe the surface gently using only a cleaning cloth or a soft, lint-free cloth.
- If the surface becomes dirty, soak a soft, lint-free cloth in a mild detergent solution. Wring the cloth to remove excess liquid. Wipe the surface of the display to remove dirt. Then use a dry cloth of the same type to dry.
- Do not scratch or hit the surface of the panel with fingers or hard objects of any kind.
- Do not use volatile substances such as insect sprays, solvents and thinners.

#### Cabinet Cleaning Instructions

- If the cabinet becomes dirty, wipe the cabinet with a soft, dry cloth.
- If the cabinet is extremely dirty, soak a lint-free cloth in a mild detergent solution. Wring the cloth to remove as much moisture as possible. Wipe the cabinet. Use another dry cloth to wipe over until the surface is dry.
- Do not allow any water or detergent to come into contact with the surface of the display. If water or moisture gets inside the unit, operating problems, electrical and shock hazards may result.
- Do not scratch or hit the cabinet with fingers or hard objects of any kind.
- Do not use volatile substances such as insect sprays, solvents and thinners on the cabinet.
- Do not place anything made from rubber or PVC near the cabinet for any extended periods of time.

## 7.2. Troubleshooting

Symptom	Possible Cause	Remedy
No picture is displayed	<ol style="list-style-type: none"> <li>1. The power cord is disconnected.</li> <li>2. The main power switch on the back of the display is not switched on.</li> <li>3. The selected input has no connection.</li> <li>4. The display is in standby mode.</li> </ol>	<ol style="list-style-type: none"> <li>1. Plug in the power cord.</li> <li>2. Make sure the power switch is switched on.</li> <li>3. Connect a signal connection to the display.</li> </ol>
Interference displayed on the display or audible noise is heard	Caused by surrounding electrical appliances or fluorescent lights.	Move the display to another location to see if the interference is reduced.
Color is abnormal	The signal cable is not connected properly.	Make sure that the signal cable is attached firmly to the back of the display.
Picture is distorted with abnormal patterns	<ol style="list-style-type: none"> <li>1. The signal cable is not connected properly.</li> <li>2. The input signal is beyond the capabilities of the display.</li> </ol>	<ol style="list-style-type: none"> <li>1. Make sure that the signal cable is attached firmly.</li> <li>2. Check the video signal source to see if it is beyond the range of the display. Please verify its specifications with this display's specification section.</li> </ol>
Display image doesn't fill up the full size of the screen	<ol style="list-style-type: none"> <li>1. The zoom mode is not set correctly.</li> <li>2. Scan Mode may be set incorrectly to underscan.</li> <li>3. If the image exceeds the screen size, Scan Mode may need to be set to Underscan.</li> </ol>	Use the Zoom mode or Custom zoom function in the Screen menu to fine tune display geometry and time frequency parameter.
Can hear sound, but no picture	Improperly connected source signal cable.	Make sure that both video inputs and sound inputs are correctly connected.
Can see picture but no sound is heard	<ol style="list-style-type: none"> <li>1. Improperly connected source signal cable.</li> <li>2. Volume is turned all the way down.</li> <li>3. [MUTE] is turned on.</li> <li>4. No external speaker connected.</li> </ol>	<ol style="list-style-type: none"> <li>1. Make sure that both video inputs and sound inputs are correctly connected.</li> <li>2. Press [VOL UP] or [VOL DOWN] button to hear sound.</li> <li>3. Switch MUTE off by using the [MUTE] button.</li> <li>4. Connect external speakers and adjust the volume to a suitable level.</li> </ol>
Some picture elements do not light up	Some pixels of the display may not turn on.	This display is manufactured using an extremely high level of precision technology; however, sometimes some pixels of the display may not display. This is not a malfunction.
After-Images can still be seen on the display after the display is powered off. (Examples of still pictures include logos, video games, computer images, and images displayed in 4:3 normal mode)	A still picture is displayed for an over extended period of time	Do not allow a still image to be displayed for an extended period of time as this can cause a permanent after-image to remain on the display.



## 8. Technical Specifications

### Display:

Item	Specifications
Screen Size (Active Area)	46" (116.8 cm) LCD
Aspect Ratio	16:9
Number of pixels	1920 (H) × 1080 (V)
Pixel pitch	0.53025 (H) × 0.53025 (V) [mm]
Displayable colors	16.7M colors
Brightness (typical)	500 cd/m <sup>2</sup>
Contrast ratio (typical)	3500:1
Viewing angle	178 degrees

### In/Out Terminals:

Item	Specifications
Speaker Output	Internal Speakers External Speakers
	10W (L) + 10W (R) [RMS]/8Ω 1 Way 1 Speaker System 82 dB/W/M/160 Hz ~ 13 KHz
Audio Output	RCA Jack × 2
	0.5V [rms] (Normal) / 2 Channel (L+R)
Audio Input	RCA Jack × 2 3.5 mm Stereo × 1
	0.5V [rms] (Normal) / 2 Channel (L+R)
RS232C	D-Sub Jack × 2 (9 pin)
	TXD + RXD (1:1)
RJ-45	RJ-45 Jack × 1 (8 pin)
	10/100 LAN Port
HDMI Input	HDMI Jack × 1 (Type A) (18 pin)
	Digital RGB: TMDS (Video + Audio) MAX: Video - 720p, 1080p, 1920 × 1080/60 Hz (WUXGA) Audio - 48 KHz/ 2 Channel (L+R) Supports LPCM only
DVI-D Input	DVI-D jack
	Digital RGB: TMDS (Video)
VGA Input	D-Sub Jack × 1 (15 pin)
	Analog RGB: 0.7V [p-p] (75Ω), H/CS/V: TTL (2.2kΩ), SOG: 1V [p-p] (75Ω) MAX: 720p, 1080p, 1920 × 1080/60 Hz (WUXGA)
DVI-I (DVI-D & VGA) Output	DVI-I Jack × 1 (29 pin)
	Digital RGB: TMDS (Video) Analog RGB: 0.7V [p-p] (75Ω), H/CS/V: TTL (2.2kΩ), SOG: 1V [p-p] (75Ω) MAX: 720p, 1080p, 1920 × 1080/60 Hz (WUXGA)
Component Input	BNC Jack × 3
	Y: 1V [p-p] (75Ω), Pb: 0.7V [p-p] (75Ω), Pr: 0.7V [p-p] (75Ω) MAX: 480i, 576i, 480p, 576p, 720p, 1080i, 1080p
Video Input	BNC × 1 (Share with Component_Y)
	Composite 1V [p-p] (75Ω)
Displayport Input	Displayport Jack × 1 (20 pin)
	Digital RGB: TMDS (Video + Audio) MAX: Video - 720p, 1080p, 1920 × 1080/60 Hz (WUXGA) Audio - 48 KHz/ 2 Channel (L+R) Supports LPCM only
IR Input	3.5mm Stereo × 1
	External IR input
IR Output	3.5mm Stereo × 1
	External IR output

### General:

Item	Specifications
Power Supply	AC 100 - 240V, 50 - 60Hz
Power Consumption (Max)	234 W
Power Consumption (typ.)	115 W
Power Consumption (Standby & Off)	<0.5W (RS232 in active)
Dimensions (With Stand) [W × H × D]	1023.98 × 629.41 × 400.0 mm

Dimensions (Without Stand) [W × H × D]	1023.98 × 578.57 × 125.7 mm
Weight (With Stand)	25.3 Kg
Weight (Without Stand)	23.0 Kg
Gross Weight (Without Stand)	33.4 Kg

**Environmental Condition:**

Item		Specifications
Temperature	Operational	0 ~ 40°C
	Storage	-20 ~ 60°C
Humidity	Operational	20 ~ 80% RH (No condensation)
	Storage	5 ~ 95% RH (No condensation)
Altitude	Operational	0 ~ 3,000 m
	Storage / Shipment	0 ~ 9,000 m

**Internal Speaker:**

Item	Specifications
Type	1 Way 1 Speaker
Input	10 W (RMS)
Impedance	8Ω
Output Sound Pressure	82 dB/W/M
Frequency Response	160 Hz ~ 13 KHz



2014 © Koninklijke Philips N.V. All rights reserved.

Philips and the Philips Shield Emblem are registered trademarks of Koninklijke Philips N.V. and are used under license from Koninklijke Philips N.V.

Specifications are subject to change without notice.