

# Communicator 1.0

## Spare Parts

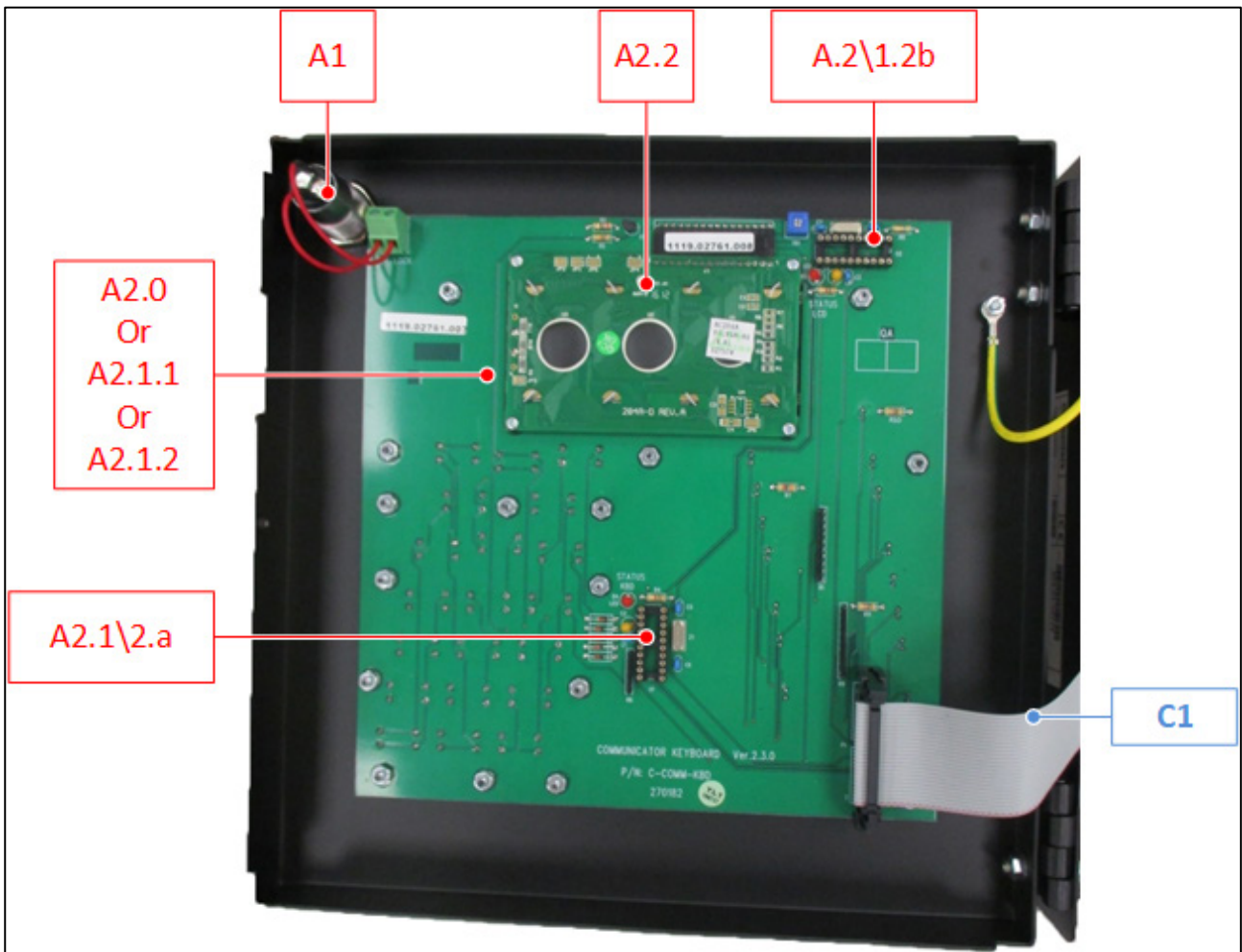

## Communicator Door Spare Parts



| ID No.          | Description  | Order Catalog Number | Remarks |
|-----------------|--|----------------------|---------|
| <b>A1</b>       | COMMUNICATOR LOCK (SP-COMM-LOCK)                       | MPN: 999-99-00170    |         |
|                 |  | DPN: 78SPCOMMLOCK    |         |
| <b>A2.0</b>     | COMMUNICATOR-POU-KEYBOARD CARD W/O DISPLAY (COMM-KBED) | MPN: 904-99-00012    | OR      |
|                 |  | DPN: 78CCOMMKBD      |         |
| <b>A2.1.1</b>   | COMMUNICATOR KEYBOARD CARD WITH LCD (SP-COMM-CDOOR)    | MPN: 904-99-00093    | OR      |
|                 |  | DPN:                 |         |
| <b>A2.1.2</b>   | COMMUNICATOR KEYBOARD CARD WITH RUS LCD                | MPN: 904-99-00096    |         |
|                 |  | DPN:                 |         |
| <b>A2\2.1.a</b> | LPC (A-LPC-762), "KBD"                                 | MPN: 999-99-00129    | U1      |
|                 |  | DPN: 78ALPC76250     |         |
| <b>A2\2.1.b</b> | LPC (A-LPC-762), "LCD"                                 | MPN: 999-99-00064    | U2      |
|                 |  | DPN:                 |         |

| ID No. | Description                        | Order Catalog Number | Remarks |
|--------|------------------------------------|----------------------|---------|
| A2.2   | COMMUNICATOR DISPLAY (SP-COMM-LCD) | MPN: 904-99-00064    |         |
|        |                                    | DPN: 78SPCOMMLCD     |         |

### 3.2 Communicator Main Container Spare Parts

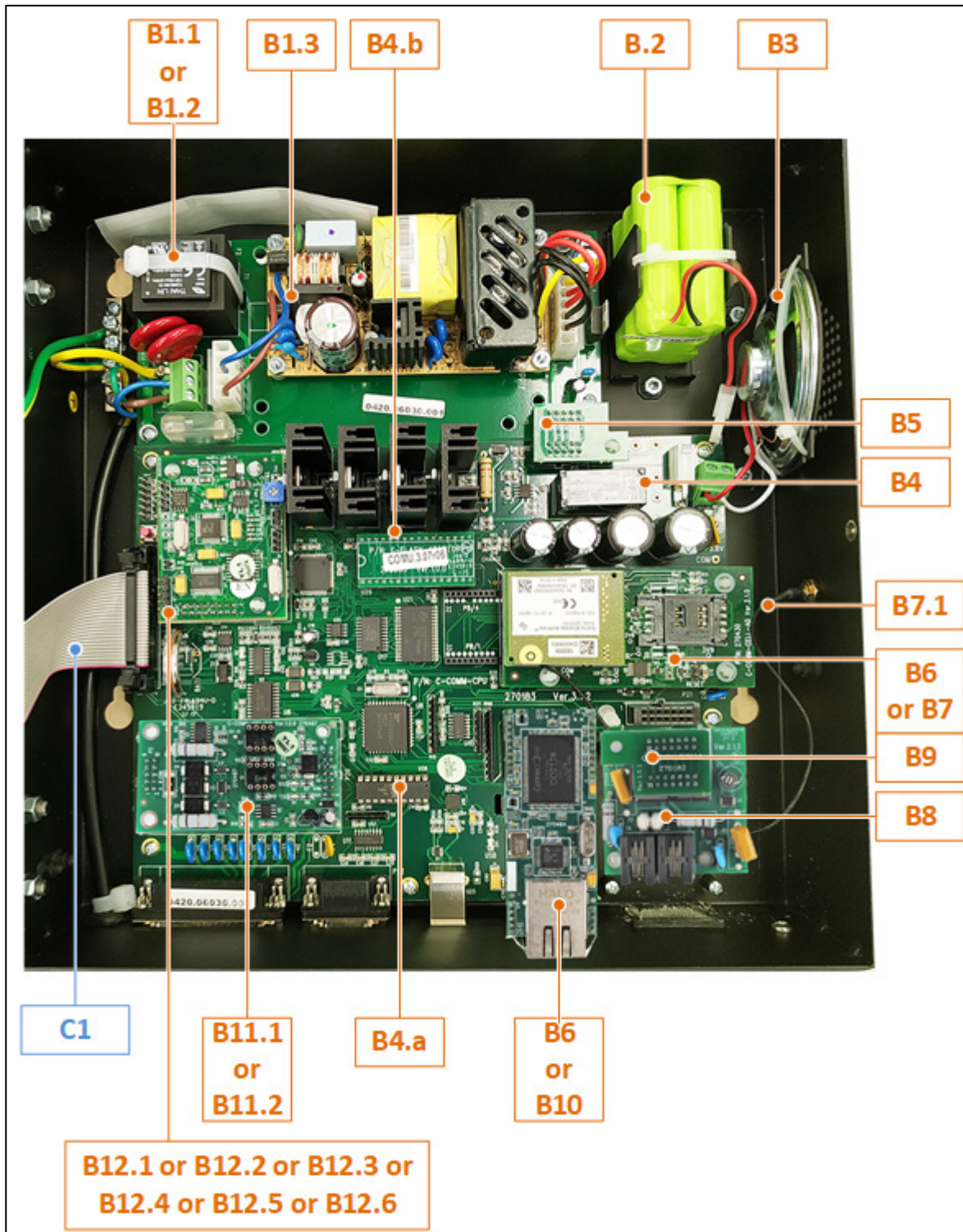

| ID No. | Description                                 | Order Catalog Number |
|--------|---|----------------------|
| C1     | FLAT FF26P 16cm(COMM) <F"D_F"D> (SP-COMM-F) | MPN: 999-99-00368    |
|        |   | DPN: 78ACOMMRIB      |

| ID No. | Description   | Order Catalog Number | Remarks |
|--------|---|----------------------|---------|
| B1.1   | COMMUNICATOR -POU- POWER SUPPLY CARD 115Volt (COMM-PS-V1) | MPN: 904-99-00017    | OR      |
|        |   | DPN: 78CCOMMPSV1     |         |
| B1.2   | COMMUNICATOR -POU- POWER SUPPLY CARD 230VOLT (COMM-PS-V2) | MPN: 904-99-00018    | OR      |
|        |   | DPN: 78CCOMMPSV2     |         |
| B1.3   | SWPS UP0402S-01 Umec / RPD-60A Mean Well (SP-370126)      | MPN: 904-99-00094    |         |
|        |   | DPN:                 |         |
| B2     | COMMUNICATOR BT PACK (SP-COMM-BAT)                        | MPN: 999-99-00036    |         |
|        |   | DPN: 78SPCOMMBAT     |         |
| B3     | COMMUNICATOR VOICE SPEAKER (SP-COMM-SPEAKER)              | MPN: SP-COMM-SPEAKER |         |
|        |   | DPN: 78SPCOMMSPEAKER |         |
| B4     | COMMUNICATOR -POU- CPU CARD (COMM-CPU)                    | MPN: 904-99-00006    |         |
|        |   | DPN: 78CCOMMCPU      |         |
| B4.a   | COMMUNICATOR U28 PLD SPARE PART (SP-COMM-PLD)             | MPN: 999-99-00109    | U28     |
|        |   | DPN:                 |         |
| B4.b   | FLASH ADAPTOR CARD  | MPN: 999-99-00470    | U29     |
|        |   | DPN:                 |         |
| B5     | COMMUNICATOR -POU- POWER TO CPU JUMPER CARD (COMM-RJM10)  | MPN: 904-99-00023    |         |
|        |   | DPN: 78CCOMMLMRJM10  |         |
| B6     | COMMUNICATOR -POU- LINE MODEM MODULE ONLY (COMM-LM-M)     | MPN: 904-99-00014    |         |
|        |   | DPN: 78COMMO         |         |
| B7     | COMMUNICATOR MODEM 3G SIERRA CARD                         | MPN: 904-99-00033    |         |
|        |   | DPN:                 |         |
| B7.1   | MULTI CABLE GSM 20cm M SMA-UFL(WITH STRIPPED END)         | MPN: 904-99-00095    |         |
|        |   | DPN:                 |         |

| ID No.       | Description  | Order Catalog Number                     | Remarks |
|--------------|--|--|---------|
| <b>B7.2</b>  | ANTENNA FOR COMMUNICATOR 1 CELLULAR MODEM                | MPN: 904-99-00077                        |         |
|              |  | DPN:                                     |         |
| <b>B8</b>    | COMMUNICATOR -POU- LINE MODEM PROTECT CARD (COMM-LM-PRO) | MPN: 904-99-00015                        |         |
|              |  | DPN: 78CCOMMLMPRO                        |         |
| <b>B9</b>    | COMMUNICATOR -POU- LM TO CPU JUMPER CARD (C-COMM-RJM14)  | MPN: 904-99-00040<br>DPN: 78CCOMMLMRJM14 |         |
| <b>B10</b>   | COMMUNICATOR ETHERNET MODEM CARD (COMM-ETH-CARD)         | MPN: 904-99-00054                        |         |
| <b>B11.1</b> | COMMUNICATOR -POU- RS485 ISOLATED CARD (COMM-485-ISO)    | MPN: 904-99-00003                        | OR      |
|              |  | DPN: 78CCOMM485                          |         |
| <b>B11.2</b> | COMMUNICATOR -POU- RS232 CARD (COMM-RS232)               | MPN: 904-99-00001                        |         |
|              |  | DPN: 78CCOMM232                          |         |
| <b>B12.1</b> | COMMUNICATOR -POU- EN-VOICE CARD (COMM-VOICE2)           | MPN: 904-99-00007                        |         |
|              |  | DPN: 78CCOMMVOICE                        |         |

# Communication Box Spare Parts

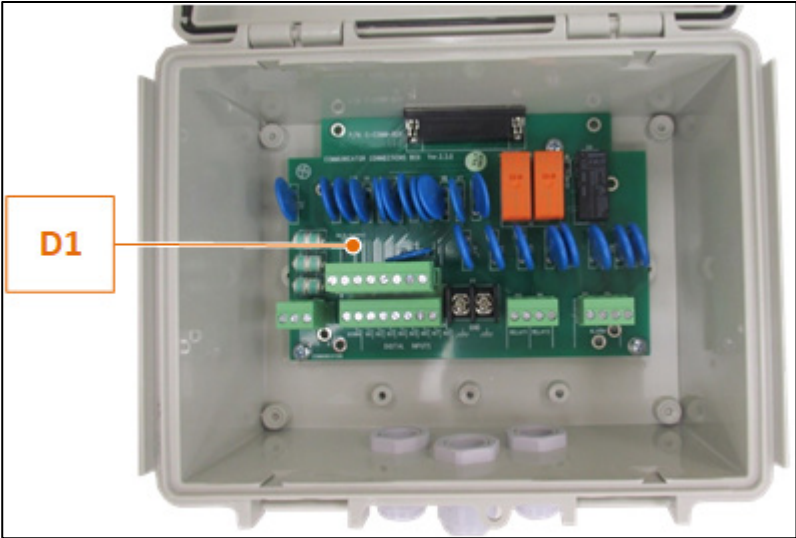

| ID No. | Description                       | Order Catalog Number | Remarks |
|--------|-----------------------------------|----------------------|---------|
| D1     | COMMUNICATOR -POU- CONNECTION BOX | MPN: 999-99-00107    |         |
|        |                                   | DPN: 78CJUNCTION     |         |

# RPLP-1 Power Line Protector

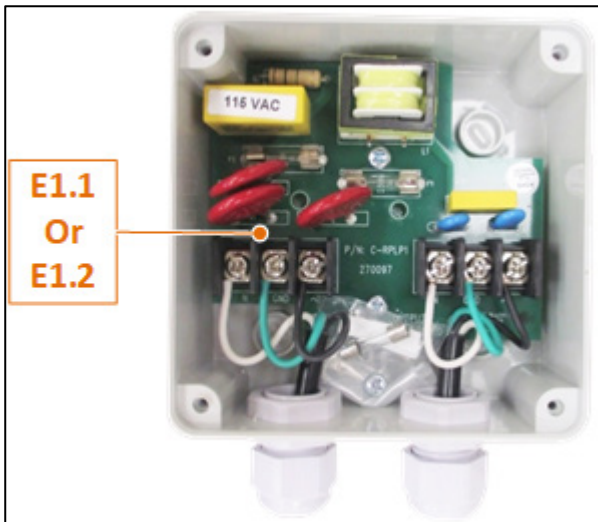
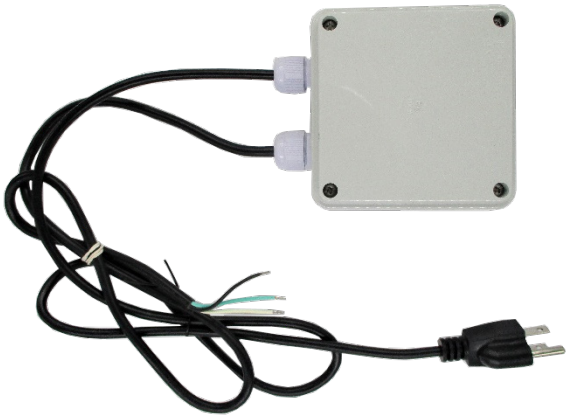

| ID No. | Description                         | Order Catalog Number | Remarks |
|--------|-------------------------------------|----------------------|---------|
| E1.1   | RPLP1 -POU- CARD 115Volt (RPLP1-V1) | MPN: 922-99-00001    | OR      |
|        |                                     | DPN: 78MBRPL         |         |
| E1.2   | RPLP1 -POU- CARD 230Volt (RPLP1-V2) | MPN: 922-99-00002    |         |
|        |                                     | DPN:                 |         |

# Additional Options

| ID NO.  | Description   | Order Cat. No.    |
|---------|---|-------------------|
| ADO 1   | COMMUNICATOR -POU- LINE MODEM SET (COMM-LM-S)                       | MPN: 904-99-00016 |
|         |   | DPN: 78PCOMMLMS   |
| ADO 2   | COMMUNICATOR -POU- 3G MODEM SET + ANTENNA UPGRADE KIT (COMM-3G-UPG) | MPN: 904-99-00033 |
|         |   | DPN:              |
| ADO 3   | COMMUNICATOR ETHERNET SET (SP-COMM-ETH-S)                           | MPN: 999-99-00037 |
|         |   | DPN: 78SPCOMMETHS |
| ADO 4.1 | RPLP-1 POWER LINE PROTECTOR 115 Volt                                | MPN: 922-01-00001 |
|         |   | DPN: 78RLPPS      |
| ADO 4.2 | RPLP-1 POWER LINE PROTECTOR 230 Volt                                | MPN: 922-01-00002 |
|         |   | DPN: 78PRPLP1V2   |



# Cards



- Communicator Door Cards
- Communicator Main Container Cards
- Communicator Box Card
- RPLP-1 Cards

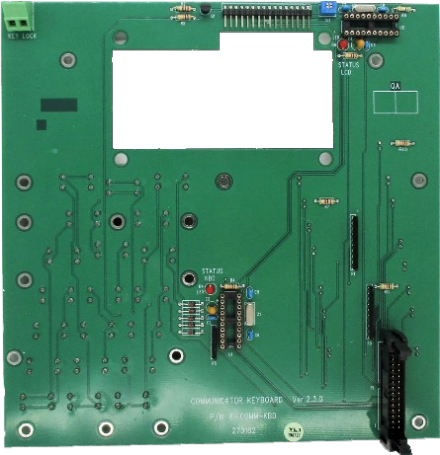

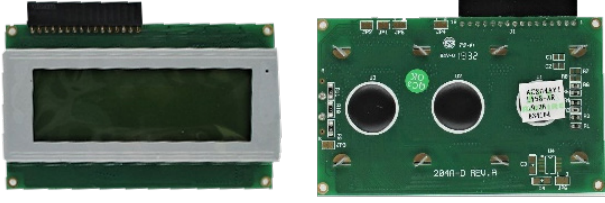

## Communicator Door Cards

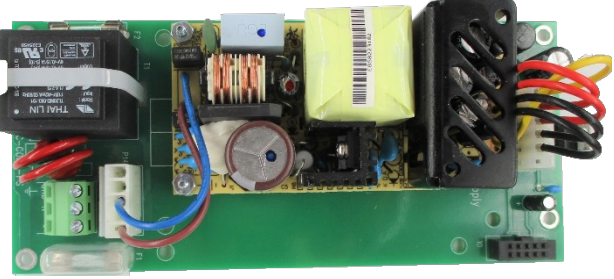

| Card   | Description   | Munters Ordering Number    |
|--|---|----------------------------|
|  | R-COMM-KBD:<br>COMMUNICATOR<br>KEYBOARD CARD<br>W/O DISPLAY | 904-99-00012<br>78CCOMMKBD |
|  |   |                            |

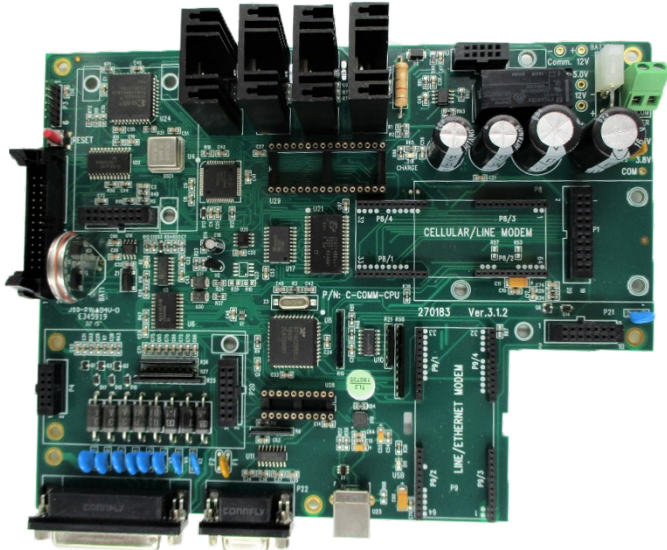
| Card  | Description   | Munters Ordering Number             |
|---|---|-------------------------------------|
|  | <p>250035: LCD 20*4<br/>AC204AYILY58A(R)<br/>EUR/ENG Ampire</p> | <p>904-99-00064<br/>78SPCOMMLCD</p> |

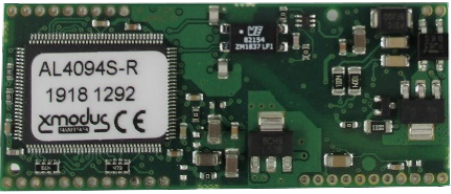
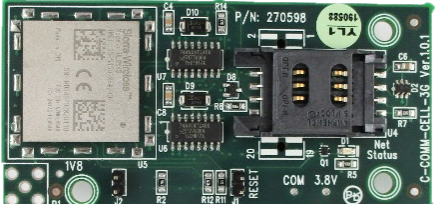
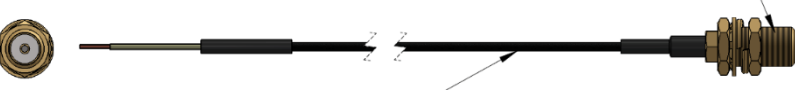
### Communicator Main Container Cards

| Card  | Description   | Munters Ordering Number   |
|---|---|---|
|   | <p>R-COMM-PS-V1:<br/>COMMUNICATOR<br/>POWER SUPPLY<br/>CARD 115Volt</p> <p>R-COMM-PS-V2:<br/>COMMUNICATOR<br/>POWER SUPPLY<br/>CARD 230Volt</p> | <p>904-99-00017<br/>78CCOMMPSV1</p> <p>904-99-00018<br/>78CCOMMPSV2</p> |
|  | <p>370126: SWPS<br/>UP0402S-01 Umec<br/>/ RPD-60A Mean<br/>Well</p>   | <p>904-99-<br/>00094</p>  |
|  | <p>450008: BAT AA<br/>NiMh<br/>2100MAH*6/7.2V<br/>+12cm WIRE GP</p>   | <p>999-99-00036<br/>78SPCOMMBAT</p>                                     |

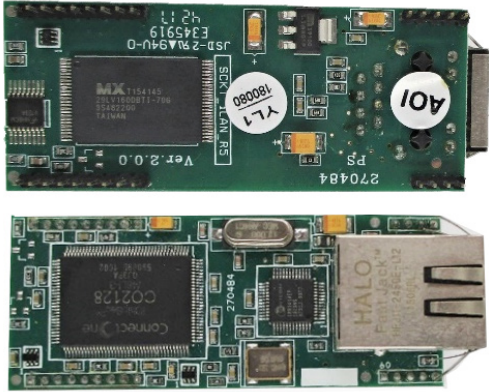
| Card  | Description  | Munters Ordering Number        |
|---|--|--------------------------------|
|  <p>A green printed circuit board (PCB) populated with various electronic components. It features a central microcontroller, several integrated circuits, and connectors for power, data, and communication. Labels on the board include 'CELLULAR/LINE MODEM', 'LINE/ETHERNET MODEM', and 'P/N: C-COMM-CPU 270183 Ver.3.1.2'.</p> | R-COMM-CPU:<br>COMMUNICATOR<br>CPU CARD  | 904-99-00006<br>78CCOMMCPU     |
|  <p>A small green PCB with a header of pins on one side. It is labeled 'Ver.1.0.1' and 'C-COMM-RJM10 270182'.</p>   | R-COMM-RJM10:<br>COMMUNICATOR<br>POWER TO CPU<br>JUMPER CARD                         | 904-99-00023<br>78CCOMMLMRJM10 |
|  <p>A green PCB featuring a large integrated circuit labeled 'AL4094S-R 1918 1292 xmodus CE'. It includes various passive components and connectors.</p>   | 480003: MODEM<br>LINE AL4094S-<br>R(FCC part 68)Altec                                | 904-99-00014<br>78COMMO        |
|  <p>A green PCB with a SIM card slot and various electronic components. It is labeled 'P/N: 270598' and 'C-COMM-CELL-3G Ver.3.0.1'.</p>  | R-COMM-CELL-3G:<br>COMMUNICATOR<br>MODEM 3G<br>SIERRA CARD                           | 904-99-00034<br>78PCOMMGSMS    |
|  <p>A black multi-core cable with an SMA connector on one end and a stripped end on the other. The length is indicated as 20cm.</p>  | 490045: MULTI<br>CABLE GSM 20cm<br>M SMA-UFL(WITH<br>STRIPPED END)                   | 904-99-<br>00095               |
|  <p>A black antenna assembly consisting of a pentagonal antenna element connected to a 3m length of RG-174 coaxial cable, which terminates in an SMA-male connector.</p>   | 491005:<br>ANTENNA<br>FMAG35153-SM-<br>3K PENTAMAG<br>WITH 3M RG-174<br>AND SMA-MALE | 904-99-<br>00077               |

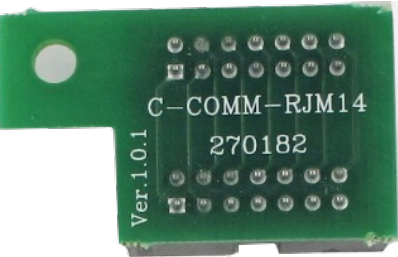
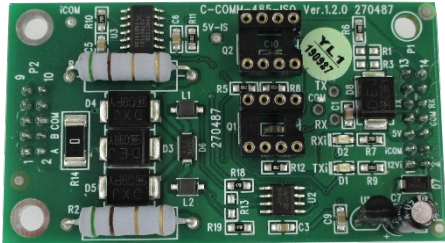
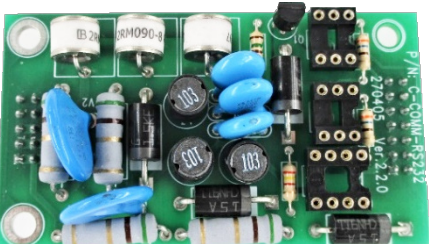
| Card  | Description   | Munters Ordering Number      |
|---|---|------------------------------|
|    | R-COMM-ETH-CARD:<br>COMMUNICATOR<br>ETHERNET CARD             | 904-99-00054                 |
|   | R-COMM-LM-PRO:<br>COMMUNICATOR<br>LINE MODEM<br>PROTECT CARD  | 904-99-00015<br>78CCOMMLMPRO |
|  | R-COMM-RJM14:<br>COMMUNICATOR<br>LM TO CPU<br>JUMPER CARD     | 904-99-00040                 |
|  | R-COMM-485-ISO:<br>RS485 ISOLATED<br>CARD FOR<br>COMMUNICATOR | 904-99-00003<br>78CCOMM485   |
|  | R-COMM-RS232:<br>COMMUNICATOR<br>RS232 CARD                   | 904-99-00001<br>78CCOMM232   |

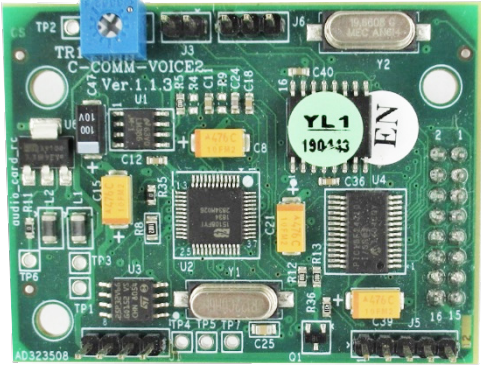
| Card  | Description                                  | Munters Ordering Number      |
|---|--|------------------------------|
|  | R-COMM-VOICE2:<br>COMMUNICATOR<br>VOICE CARD |                              |
|   | EN-VOICE CARD                                | 904-99-00007<br>78CCOMMVOICE |
|   |  |                              |

## Communicator Junction Box Card

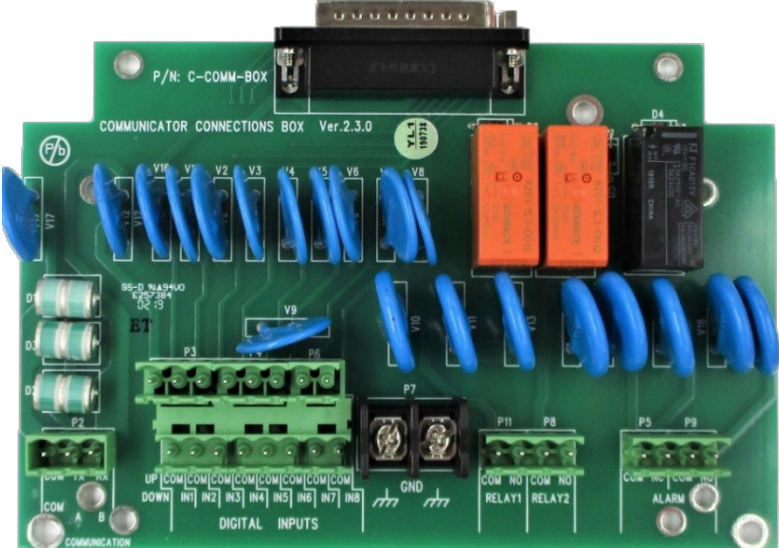
| Card  | Description   | Munters Ordering Number  |
|---|---|--------------------------|
|  <p>P/N: C-COMM-BOX<br/>COMMUNICATOR CONNECTIONS BOX Ver.2.3.0</p> <p>COMMUNICATION<br/>DIGITAL INPUTS<br/>RELAY1<br/>RELAY2<br/>ALARM</p> | <p>R-COMM-BOX:<br/>COMMUNICATOR<br/>CONNECTION<br/>BOX CARD</p> | <p>904-99-<br/>00005</p> |

## RPLP-1 Cards

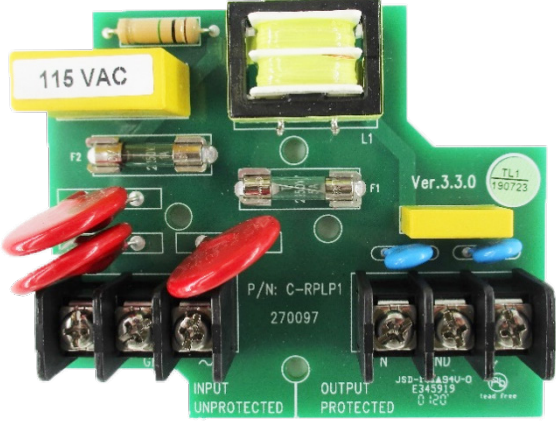
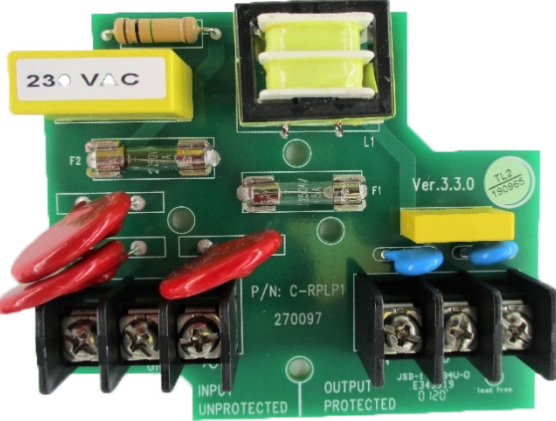
| Card   | Description                                | Munters Ordering Number         |
|--|--|---------------------------------|
|  <p>The image shows a green printed circuit board (PCB) for a 115V RPLP-1 card. It features a yellow transformer with a primary winding labeled '115 VAC'. A secondary winding is connected to a bridge rectifier. The PCB includes a fuse (F1), a fuse holder (F2), and a terminal block with four terminals labeled 'N', 'NU', 'GND', and 'G'. The board is marked with 'Ver. 3.3.0', 'TL1 190723', and 'P/N: C-RPLP1 270097'. The input is labeled 'INPUT UNPROTECTED' and the output is labeled 'OUTPUT PROTECTED'. Other markings include 'JSD-1 LA94U-D E245313 0.120' and 'lead free'.</p> | <p>R-RPLP1-V1: RPLP-1 CARD<br/>115Volt</p> | <p>922-99-00001<br/>78MBRPL</p> |
|  <p>The image shows a green printed circuit board (PCB) for a 230V RPLP-1 card. It features a yellow transformer with a primary winding labeled '230 VAC'. A secondary winding is connected to a bridge rectifier. The PCB includes a fuse (F1), a fuse holder (F2), and a terminal block with four terminals labeled 'N', 'NU', 'GND', and 'G'. The board is marked with 'Ver. 3.3.0', 'TL2 00565', and 'P/N: C-RPLP1 270097'. The input is labeled 'INPUT UNPROTECTED' and the output is labeled 'OUTPUT PROTECTED'. Other markings include 'JSD-1 LA94U-D E245313 0.120' and 'lead free'.</p> | <p>R-RPLP1-V2: RPLP-1 CARD<br/>230Volt</p> | <p>922-99-00002</p>             |