

# distform

Equipment and furniture for  
the hospitality industry



**GENERAL CATALOGUE**  
MAY 2023

# distform

## **OVER 30 YEARS ALONGSIDE KITCHEN PROFESSIONALS**

Distform is the industry's leading national manufacturer. We've spent years perfecting our products and striving to offer excellent design and performance solutions. Since its founding in 1991, it's been a pioneer in the world of static preparation and self-service, offering a wide range of top-quality products using environmentally friendly manufacturing.

The new factory and offices span an area of over 12,000 m<sup>2</sup>, which was part of the company's expansion plan. These new facilities use cutting-edge management technologies focused on Industry 4.0, reducing manufacturing times and further raising the quality level and traceability of manufactured products to become one of the most advanced factories in the industry.

**OVER 30 YEARS OF OFFERING HIGH QUALITY SOLUTIONS FOR PROFESSIONAL KITCHENS.**

**OVER 30 YEARS OF HELPING OUR MOST DEMANDING CUSTOMERS TO GROW.**



# AVAILABILITY

## MORE THAN 12,000 ITEMS IN STOCK

Distform has more than 12,000 active items, so you can find one that best suits your business' needs. Our products' versatility, their numerous customisation options and their range of accessories make this the most comprehensive catalogue on the market.

## +35% WAREHOUSE STOCK CAPACITY

We've increased our factory warehouse stock by 35%, thereby further increasing the flexibility and speed of our products' delivery to meet the needs of even our most demanding customers.



# THE BEST SOLUTION FOR EVERY KITCHEN AND CUSTOMER

## CUSTOMISATION AND UNIQUE FINISHES

Our products stand out for their high quality and finishes: stainless steel, a functional design adapted to a kitchen's needs and excellent finishes guarantee our products' high resistance and durability. Distform furniture thus helps catering and culinary professionals improve the productivity and ergonomics of their workplace.



# PROFITABILITY

We offer the best value in terms of our products' performance and quality at a competitive price. In this way, we help our clients increase the profitability of their business.



# SPEED & FLEXIBILITY

## WE RENEW OUR COMMITMENT TO SHIPMENTS WITHIN 24/48 HOURS

80% of our products are delivered in 24 hours. Our digitised and delivery-oriented manufacturing and logistics systems allow us to react quickly and be as flexible as possible for our customers' orders.



# RELIABILITY

## 30 YEARS OF INDUSTRY EXPERIENCE

Our history and 30 years of industry involvement mean we have the knowledge and experience to offer the best solutions catered to market needs.

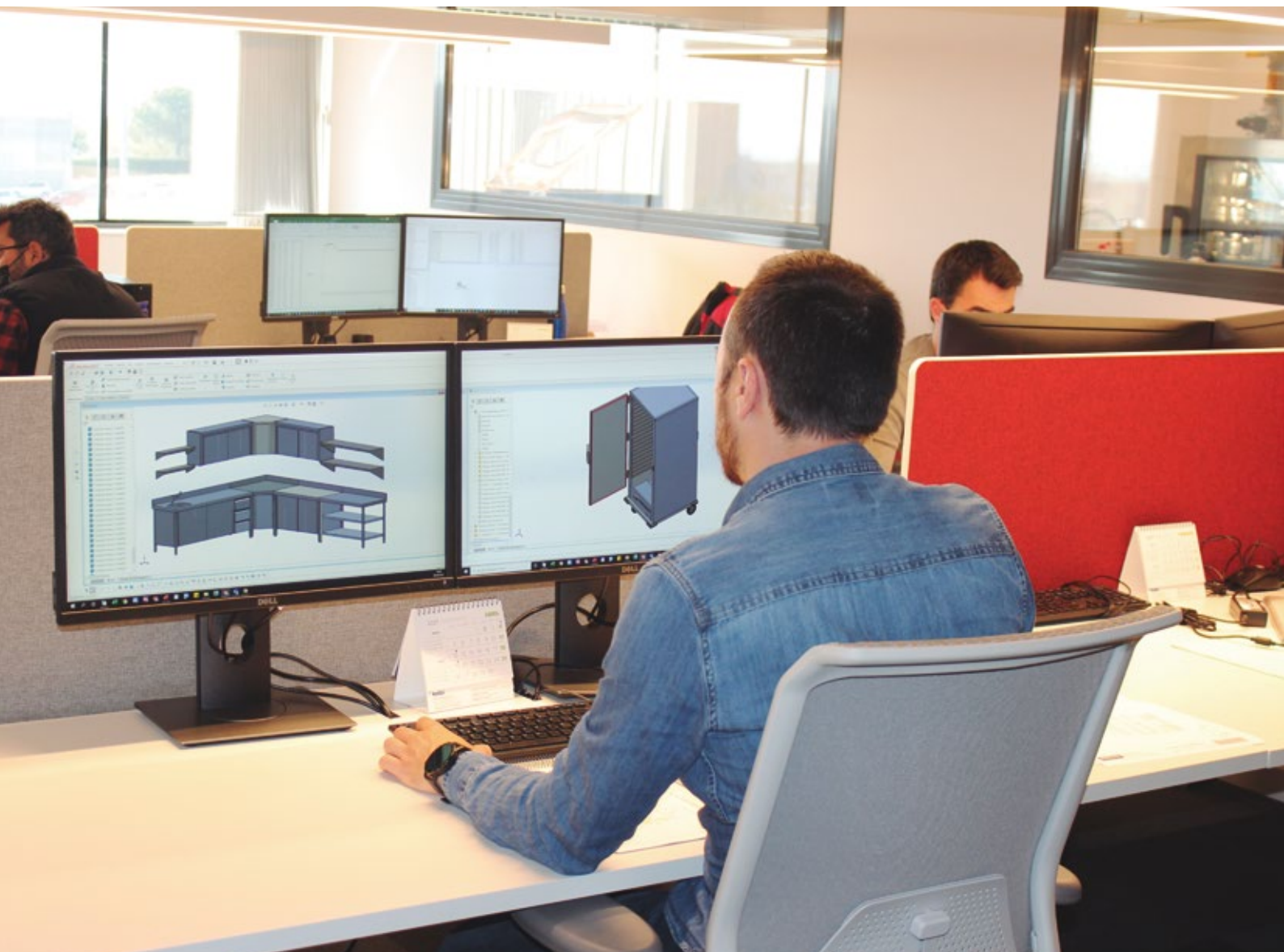

# INNOVATION

Innovation is the cornerstone of everything we do: from a product's conception to development, we are constantly making technological advancements in our manufacturing process through rigorous quality and durability checks.

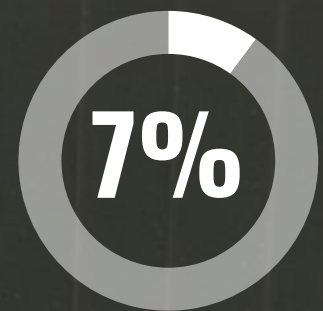
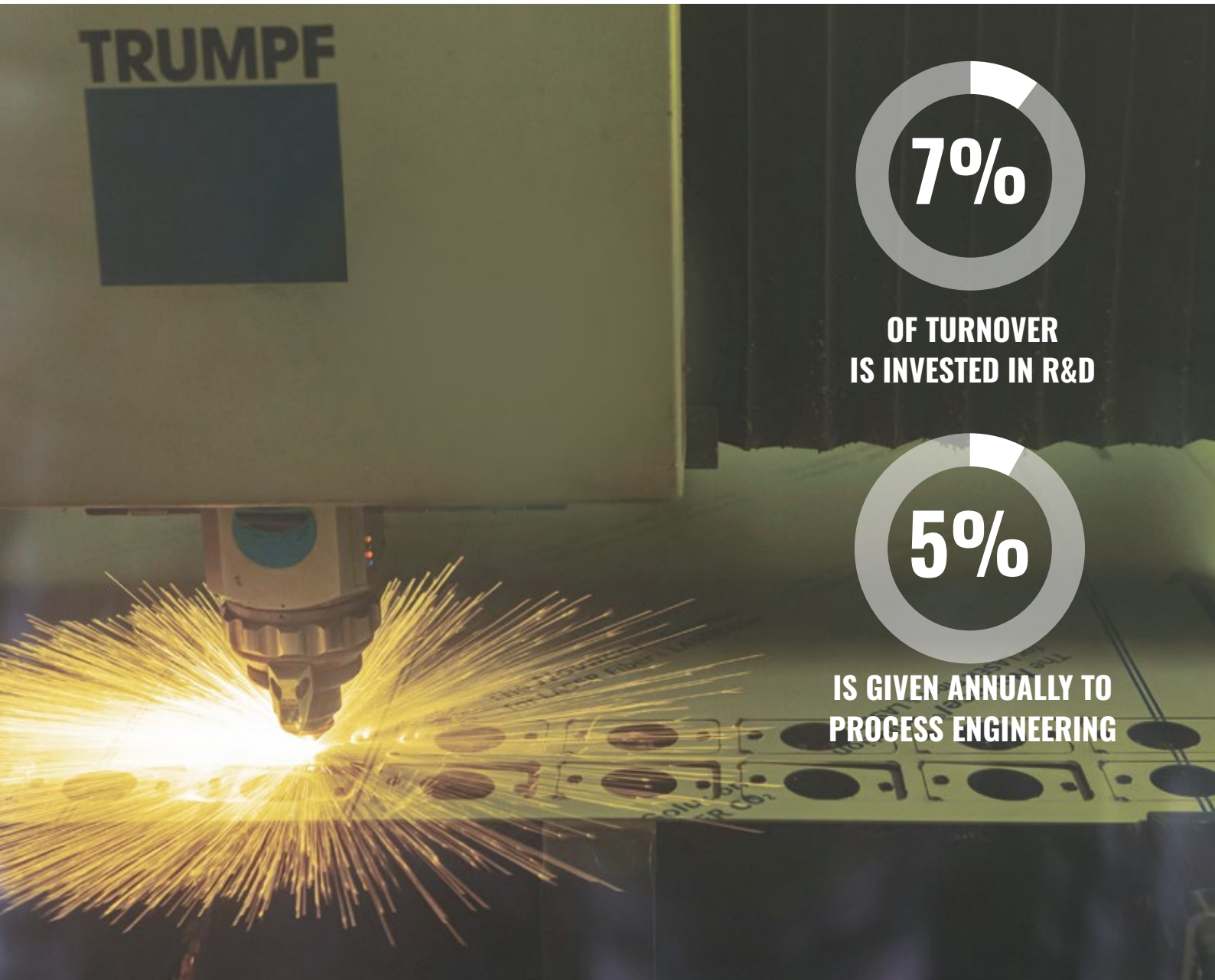

**OF TURNOVER  
IS INVESTED IN R&D**

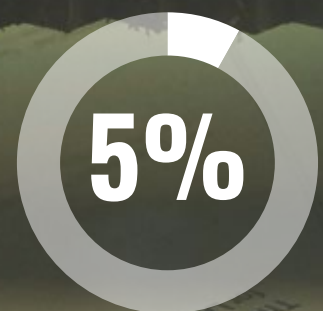

**IS GIVEN ANNUALLY TO  
PROCESS ENGINEERING**



# COMMITMENT

Our customers are our partners, their success is our success. As with our suppliers, we are committed to finding the best solutions through close collaboration with our customers. We are prepared to overcome conventional barriers to build synergies that drive the growth of distributors, end customers and the market as a whole.

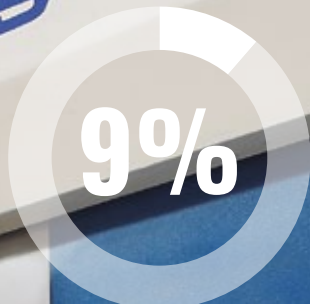

**9%**  
**OF PRODUCTS CREATED  
IN COLLABORATION WITH  
CUSTOMERS**

# INTEGRITY

We think about what we say and we do what we say. The transparency and honesty we establish with our employees, customers, and suppliers enable us to build lasting relationships based on mutual respect. Our integrity is the foundation on which we build and maintain trust inside and outside the company.

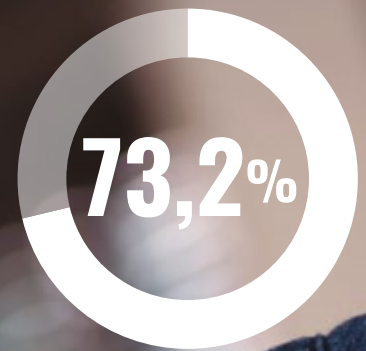

OF CUSTOMERS HAVE  
BEEN LOYAL TO OUR  
BRAND FOR MORE THAN  
**15 YEARS**

# RESPONSIBILITY

Our sense of responsibility and respect for the planet and people's health makes us consider the effects of everything we do. From our production line, to job creation and customer service, in every decision we make, we are committed to acting with a long-term vision for the benefit of our stakeholders, society, and the environment.



**SAVING TONS OF  
CO2 EMISSIONS DUE  
TO PHOTOVOLTAIC  
INSTALLATIONS IN FACTORY**



**RECYCLING IN THE  
PRODUCTION PLANT**

NEW

# DURBLOCK

## MORE ROBUST THAN ANY WELDING

The **DURBLOCK** system is made of a special structural steel alloy that guarantees the robustness of the Distform tables, regardless of the length. This steel alloy receives a specific treatment that protects the parts from abrasive agents for years.

A welded table is more prone to rust, as the welding is done with stainless steel and galvanised steel, which causes these two metals to undergo temperature changes and to be exposed to extreme conditions such as corrosion.

This corrosion generates wear and tear that weakens the strength of these tables, resulting in costly and often irrecoverable repairs.



Welding oxidation

With the DURBLOCK fastening system, the leg is bolted to the worktop and is not subject to wear and tear, guaranteeing the maximum robustness of the tables, the stainless steel does not corrode and does not rust, maintaining all its properties.

A totally innovative system that provides greater robustness and durability. Designed to improve and increase the useful life of Distform tables.

FIXING SYSTEM  
**DURBLOCK**  
WORK TABLES

**SPECIAL ALLOY  
STRUCTURAL STEEL**

**MAXIMUM ROBUSTNESS  
THANKS TO THE FIXING  
SYSTEM**

**DURBLOCK IS RUST-FREE  
AND LASTS FOR AT LEAST  
20 YEARS**

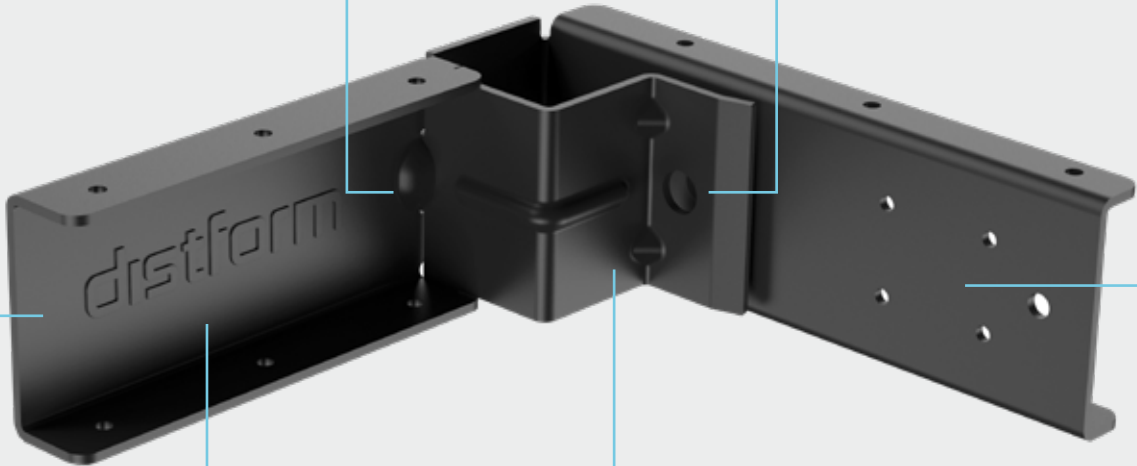

**INNOVATIVE, EASY-TO-  
ASSEMBLE DESIGN**

**SURFACE TREATMENT THAT  
PROTECTS THE PART FOR YEARS**

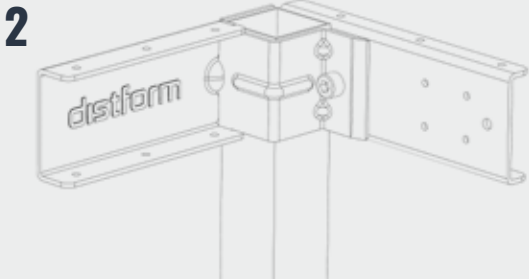
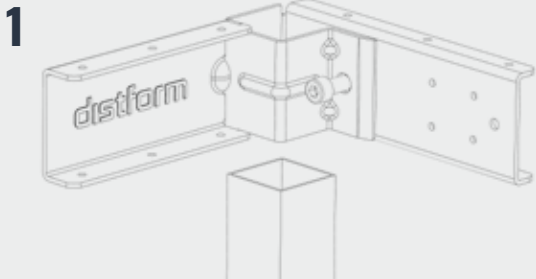

# INDEX



# STATIC PREPARATION



**INDUSTRIAL SINKS, HAND SINKS,  
AND WASHING AREA**  
PAGE 19



**TAPS**  
PAGE 43



**WORK TABLES**  
PAGE 51



**HOT FOOD AND BAIN-MARIE TABLES**  
PAGE 89



**MODULES AND COUNTERTOPS  
FOR COOKING**  
PAGE 95



**CABINETS**  
PAGE 119



**SHELVING**  
PAGE 125

# FOOD DISTRIBUTION AND DISPLAY



**TRANSPORT TROLLEYS**  
PAGE 159



**TEMPERATURE  
MAINTENANCE  
AND BAIN-MARIE TROLLEYS**  
PAGE 171



**GASTRONORM CONTAINERS**  
PAGE 179



**DROP-IN**  
PAGE 185



**SELF-SERVICE**  
PAGE 211



**CHILDREN'S SELF-SERVICE**  
PAGE 237





# STATIC PREPARATION

**INDUSTRIAL SINKS, HAND SINKS, AND  
WASHING AREA**  
PAGE 19

---

**TAPS**  
PAGE 43

---

**WORK TABLES**  
PAGE 51

---

**HOT FOOD AND  
BAIN-MARIE TABLES**  
PAGE 89

---

**MODULES AND  
COUNTERTOPS FOR COOKING**  
PAGE 95

---

**CABINETS**  
PAGE 119

---

**SHELVING**  
PAGE 125



STATIC PREPARATION

# INDUSTRIAL SINKS, HAND SINKS, AND WASHING AREA



## INDUSTRIAL SINKS

PAGE 20



## FOOD PREPARATION

PAGE 32



## INDUSTRIAL SINK ACCESSORIES

PAGE 33



## HAND SINKS

PAGE 34



## WASHING AREA

PAGE 36

# INDUSTRIAL SINK



01  
Stands out for its  
durability

02  
Careful finishes in  
detail

03  
Multiple  
customisation options

Industrial sinks with inlaid basins and sound-proof protection



Adjustable legs can be raised as high as 920 mm

105 mm high backsplash with rounded safety edges, fully welded, for wall units



65 mm fully-welded front cover with rounded safety edges.



Countertops and industrial sinks made of AISI 304 stainless steel 18/10 with perfect finishes



## NEW UPDATES

✓ OPTION OF HEIGHT ADJUSTABLE LEGS FROM 950 MM TO 1000 MM

✓ UNIQUE FASTENING SYSTEM FOR A SOLID CONNECTION

✓ ROLLER TABLES

# SEMI-PROFESSIONAL INDUSTRIAL SINKS 500 SERIES

## INDUSTRIAL SINK

- Made entirely of AISI grade 304 stainless steel (18/10).
- Basins inlaid with sound-proofing protection.
- Drainage valve and plug included in each basin.
- Backsplash and 30 mm front cover.
- 340 mm x 365 mm x 150 mm basin.

RELATED PRODUCTS

**TAPS** page 43

## FRAME

- Frames made entirely of stainless steel.
- Structure with fully welded tubes.
- 30 x 30 mm square stainless steel legs are extendable, allowing you to raise the height of the unit from 850 to 880 mm.

## INDUSTRIAL SINK WITH FRAME AND DOORS

- Made of AISI grade 304 stainless steel (18/10).
- Backsplash and 30 mm front cover.
- Structure with fully welded tubes.
- 30 x 30 mm square stainless steel legs allow you to raise the height of the unit from 850 to 880 mm.
- Available with hinged or sliding doors depending on the model.
- Open rear section to facilitate access to installations.
- **No assembly required.**
- **Optional door latches OPC00001**

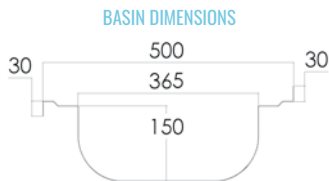

Total dimensions (mm)	Industrial sink	Industrial sink with frame	Industrial sink with frame and shelf	Industrial sink with frame and doors
800 x 500	• T085331D	• FSD50080	• FSD15080	• FBPD5080 SL
	• T085331I	• FSI50080	• FSI15080	• FBPI5080 SL
1000 x 500	• T105331D	• FSD50100	• FSD15100	• FBPD5100 SL
	• T105331I	• FSI50100	• FSI15100	• FBPI5100 SL
1200 x 500	• T125332D	• FSD50120	• FSD15120	• FBPD5120 SL
	• T125332I	• FSI50120	• FSI15120	• FBPI5120 SL
1350 x 500	• T135332D	• FSD50135	• FSD15135	• FBPD5135 SL:
	• T135332I	• FSI50135	• FSI15135	• FBPI5135 SL





• **SL** - Sliding Door



## INDUSTRIAL SINK WITH FRAME, DOORS, AND SPACE FOR GLASSWASHERS

- Made of AISI grade 304 stainless steel (18/10).
- Backsplash and 30 mm front cover.
- Structure with fully welded tubes.
- 30 x 30 mm square stainless steel legs allow you to raise the height of the unit from 850 to 880 mm.
- Swinging doors.
- Open rear section to facilitate access to installations.
- **No assembly required.**
- **Optional door latches OPC00001**



Total dimensions (mm)	Industrial sink with frame and doors	Doors
1000 x 500	<ul style="list-style-type: none"> <li>• FBPLD510 </li> <li>• FBPLI510 </li> </ul>	1
1350 x 500	<ul style="list-style-type: none"> <li>• FBPLD513 </li> <li>• FBPLI513 </li> </ul>	2

 - Compatible with glass washers

## INDUSTRIAL SINKS, HAND SINKS, AND WASHING AREA

# ACCESSORIES

### GLASS WASHER STAND

- Made of stainless steel.
- **Fully welded structure.**



Total dimensions (mm)	Code
510 x 510 x 120	• FP000500

### BRACKETS FOR 500 SERIES INDUSTRIAL SINKS

- Made of AISI grade 304 stainless steel (18/10).
- Set of 2 brackets (right and left)
- 1.5 mm thick.



Code
• FBCA0001



# INDUSTRIAL SINKS 550 SERIES

## INDUSTRIAL SINK

- Made entirely of AISI grade 304 stainless steel (18/10).
- Basins inlaid with sound-proofing protection.
- Inlaid drain valve and overflow pipe included in each basin.
- 105 mm backsplash and 65 mm front panel with rounded safety edges, fully welded.
- Taps not included.

### RELATED PRODUCTS

**TAPS** page 43

## FRAME

- Frames made entirely of stainless steel.
- The frame adapts easily to the industrial sink thanks to a simple assembly method.
- This unit's special attachment system allows the industrial sink to fit snugly into the frame, ensuring that there are no gaps.
- 40 x 40 mm square stainless steel legs allow you to raise the height of the unit from 850 to 920 mm.
- Rear legs raised 40 mm to allow you to set the frame on a floor with a sanitary radius.
- Designed to include a lower shelf (optional), page 33.
- **Easy assembly in 3 minutes.**
- **Optional:**
  - **Round legs:**
    - For 850-950 mm height: **FPBR0001**
    - For 950-1000 mm height: **FPBR0002**
  - **Height adjustable legs from 950 to 1000 mm (page 33).**



BASIN DIMENSIONS

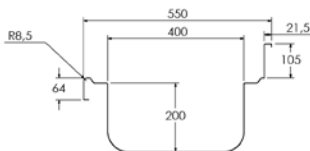

Total dimensions (mm)	Basin dimensions (mm)	Industrial sink	Industrial sink with frame	Industrial sink with frame and shelf
1000 x 550	400 x 400 x 200	• L105541D	• FBD05100	• FBDE5100
	400 x 400 x 200	• L105541I	• FBI05100	• FBIE5100
1200 x 550	400 x 400 x 200	• L125541D	• FBD05120	• FBDE5120
	400 x 400 x 200	• L125541I	• FBI05120	• FBIE5120
1400 x 550	400 x 400 x 200	• L145544D	• FBD05140	• FBDE5140
	400 x 400 x 200	• L145544I	• FBI05140	• FBIE5140
	400 x 400 x 200	• L145542D	• FBD05142	• FBDE5142
	400 x 400 x 200	• L145542I	• FBI05142	• FBIE5142











## INDUSTRIAL SINK WITH FRAME AND DOORS

- Made of AISI grade 304 stainless steel (18/10).
- 105 mm backsplash and 65 mm front panel with rounded safety edges, fully welded.
- 40 x 40 mm square stainless steel legs allow you to raise the height of the unit from 850 to 920 mm.
- Rear legs raised 40 mm to allow you to set the frame on a floor with a sanitary radius.
- Open rear section to facilitate access to installations.
- **No assembly required.**
- **Optional:**  
**Door latches OPC00001**  
**Height adjustable legs from 950 to 1000 mm (page 33).**







Total dimensions (mm)	Basin dimensions (mm)	Industrial sink with frame and doors
1000 x 550	 400 x 400 x 200	• FBPD5510 Sliding Doors
	 400 x 400 x 200	• FBPI5510 Sliding Doors
1200 x 550	 400 x 400 x 200	• FBPD5512 Sliding Doors
	 400 x 400 x 200	• FBPI5512 Sliding Doors
1400 x 550	 400 x 400 x 200	• FBPD5514 Sliding Doors
	 400 x 400 x 200	• FBPI5514 Sliding Doors

## INDUSTRIAL SINK WITH FRAME AND SPACE FOR DISHWASHER

- Designed to incorporate a standard glass washer or dishwasher under the dish drying table.
- 105 mm backsplash and 65 mm front panel with rounded safety edges, fully welded.
- Inlaid drain valve and overflow pipe included in each basin.
- 40 x 40 mm square stainless steel legs allow you to raise the height of the unit from 850 to 920 mm.
- Rear legs raised 40mm to allow you to set the frame on a floor with a sanitary radius.
- **Easy assembly in 3 minutes.**
- **Models with doors are shipped assembled (except sink).**
- **Optional:**  
**Door latches OPC00001**  
**Height adjustable legs from 950 to 1000 mm (page 33).**



Total dimensions (mm)	Basin dimensions (mm)	Industrial sink with frame	Industrial sink with frame and shelf	Industrial sink with frame and doors
1200 x 550	 400 x 400 x 200	• FBD0L512	• FBDEL512	• FBPDL512 SW
	 400 x 400 x 200	• FBI0L512	• FBIEL512	• FBPIL512 SW
1400 x 550	 400 x 400 x 200	• FBD0L514	• FBDEL514	• FBPDL514 SW
	 400 x 400 x 200	• FBI0L514	• FBIEL514	• FBPIL514 SW

• **SW** - Swinging Doors

# INDUSTRIAL SINKS 600 SERIES

## INDUSTRIAL SINK

- Made entirely of AISI grade 304 stainless steel (18/10).
- Basins inlaid with sound-proofing protection.
- Inlaid drain valve and overflow pipe included in each basin.
- 105 mm backsplash and 65 mm front panel with rounded safety edges, fully welded.
- Taps not included.

### RELATED PRODUCTS

**TAPS** page 43

## FRAME

- Frames made entirely of stainless steel.
- The frame adapts easily to the industrial sink thanks to a simple assembly method.
- This unit's special attachment system allows the industrial sink to fit snugly into the frame, ensuring that there are no gaps.
- 40 x 40 mm square stainless steel legs allow you to raise the height of the unit from 850 to 920 mm.
- Rear legs raised 40 mm to allow you to set the frame on a floor with a sanitary radius.
- Designed to include a lower shelf (optional), page 33.
- **Easy assembly in 3 minutes.**
- **Optional:**
  - **Round legs:**
    - For 850-950 mm height: **FPBR0001**
    - For 950-1000 mm height: **FPBR0002**
  - **Height adjustable legs from 950 to 1000 mm (page 33).**

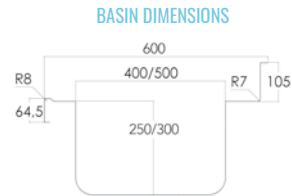

Total dimensions (mm)	Basin dimensions (mm)	Industrial sink	Industrial sink with frame	Industrial sink with frame and shelf
600 x 600	500 x 400 x 250	• L0665410	• FB006060	• FB0E6060
700 x 600	500 x 500 x 300	• L0765510	• FB006070	• FB0E6070
1000 x 600	400 x 400 x 250	• L106441D	• FBD06100	• FBDE6100
	400 x 400 x 250	• L106441I	• FBI06100	• FBIE6100
1200 x 600	400 x 400 x 250	• L1064420	• FB206100	• FB2E6100
	500 x 400 x 250	• L126541D	• FBD06120	• FBDE6120
1300 x 600	500 x 400 x 250	• L126541I	• FBI06120	• FBIE6120
	500 x 400 x 250	• L1265420	• FB206120	• FB2E6120
1300 x 600	500 x 400 x 300	• L136551D	• FBD06130	• FBDE6130
	500 x 400 x 300	• L136551I	• FBI06130	• FBIE6130
1400 x 600	500 x 500 x 300	• L1365520	• FB206130	• FB2E6130
	400 x 400 x 250	• L146442D	• FBD06142	• FBDE6142
1400 x 600	400 x 400 x 250	• L146442I	• FBI06142	• FBIE6142
	500 x 400 x 250	• L146541D	• FBD06140	• FBDE6140
	500 x 400 x 250	• L146541I	• FBI06140	• FBIE6140
1600 x 600	500 x 400 x 250	• L166542D	• FBD06160	• FBDE6160
	500 x 400 x 250	• L166542I	• FBI06160	• FBIE6160
1800 x 600	500 x 400 x 300	• L186542D	• FBD06180	• FBDE6180
	500 x 400 x 300	• L186542I	• FBI06180	• FBIE6180
2000 x 600	500 x 400 x 250	• L2065420	• FB006200	• FB0E6200



## INDUSTRIAL SINK WITH FRAME AND DOORS

- Made of AISI grade 304 stainless steel (18/10).
- 105 mm backsplash and 65 mm front panel with rounded safety edges, fully welded.
- 40 x 40 mm square stainless steel legs allow you to raise the height of the unit from 850 to 920 mm.
- Rear legs raised 40 mm to allow you to set the frame on a floor with a sanitary radius.
- Available with hinged or sliding doors depending on the model.
- Open rear section to facilitate access to installations.
- **No assembly required.**
- **Optional:**  
**Door latches OPC00001**  
**Height adjustable legs from 950 to 1000 mm (page 33).**



Total dimensions (mm)	Basin dimensions (mm)	Industrial sink with frame and doors	
600 x 600	500 x 400 x 250	• FBP06060	Swinging doors
1000 x 600	400 x 400 x 250	• FBPD6100	Sliding Doors
	400 x 400 x 250	• FBPI6100	Sliding Doors
1200 x 600	400 x 400 x 250	• FBPD6100	Sliding Doors
	500 x 400 x 250	• FBPD6120	Sliding Doors
	500 x 400 x 250	• FBPI6120	Sliding Doors
	500 x 400 x 250	• FBP06120	Sliding Doors
1400 x 600	400 x 400 x 250	• FBPD2614	Sliding Doors
	400 x 400 x 250	• FBPI2614	Sliding Doors
	500 x 400 x 250	• FBPD6140	Sliding Doors
	500 x 400 x 250	• FBPI6140	Sliding Doors
1600 x 600	500 x 400 x 250	• FBPD6160	Sliding Doors
	500 x 400 x 250	• FBPI6160	Sliding Doors
1800 x 600	500 x 400 x 250	• FBPD6180	Sliding Doors
	500 x 400 x 250	• FBPI6180	Sliding Doors
2000 x 600	500 x 400 x 250	• FBP06200	Sliding Doors

## INDUSTRIAL SINK WITH FRAME AND SPACE FOR DISHWASHER

- Designed to incorporate a standard glass washer or dishwasher under the dish drying table.
- Inlaid drain valve and overflow pipe included in each basin.
- 40 x 40 mm square stainless steel legs allow you to raise the height of the unit from 850 to 920 mm.
- Rear legs raised 40mm to allow you to set the frame on a floor with a sanitary radius.
- 105 mm backsplash and 65 mm front panel with rounded safety edges, fully welded.
- **Easy assembly in 3 minutes.**
- **Models with doors are shipped assembled (except sink).**
- **Optional:**  
**Door latches OPC00001**  
**Height adjustable legs from 950 to 1000 mm (page 33).**



Total dimensions (mm)	Basin dimensions (mm)	Industrial sink with frame	Industrial sink with frame and shelf	Industrial sink with frame and doors
1200 x 600	500 x 400 x 250	• FBDL0612	• FBDLE612	• FBPDL612 SW
	500 x 400 x 250	• FBIL0612	• FBILE612	• FBPIL612 SW
1400 x 600	500 x 400 x 250	• FBDL0614	• FBDLE614	• FBPDL614 SW
	500 x 400 x 250	• FBIL0614	• FBILE614	• FBPIL614 SW
1800 x 600	500 x 400 x 250	• FBDL0618	• FBDLE618	• FBPDL618 SL
	500 x 400 x 250	• FBIL0618	• FBILE618	• FBPIL618 SL

• **SW** - Swinging Doors / **SL** - Sliding Doors

# INDUSTRIAL SINKS 700 SERIES

## SINK

- Made entirely of AISI grade 304 stainless steel (18/10).
- Basins inlaid with sound-proofing protection.
- Inlaid drain valve and overflow pipe included in each basin.
- 105 mm backsplash and 65 mm front panel with rounded safety edges, fully welded.
- Taps not included.

### RELATED PRODUCTS

**TAPS** page 43



## FRAME

- Frames made entirely of stainless steel.
- The frame adapts easily to the industrial sink thanks to a simple assembly method.
- This unit's special attachment system allows the industrial sink to fit snugly into the frame, ensuring that there are no gaps.
- 40 x 40 mm square stainless steel legs allow you to raise the height of the unit from 850 to 920 mm.
- Rear legs raised 40 mm to allow you to set the frame on a floor with a sanitary radius.
- Designed to include a lower shelf (optional), page 33.
- **Easy assembly in 3 minutes.**
- **Optional:**  
**Round legs:**
  - For 850-950 mm height: **FPBR0001**
  - For 950-1000 mm height: **FPBR0002**
- **Height adjustable legs from 950 to 1000 mm (page 33).**

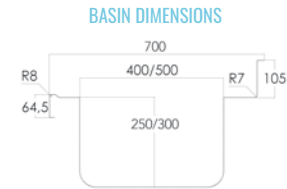

Total dimensions (mm)	Basin dimensions (mm)	Industrial sink	Industrial sink with frame	Industrial sink with frame and shelf
700 x 700	500 x 500 x 300	• L0775510	• FB007070	• FB0E7070
800 x 700	600 x 500 x 300	• L0876510	• FB007080	• FB0E7080
1000 x 700	500 x 500 x 300	• L107551D	• FBD07100	• FBDE7100
	500 x 500 x 300	• L107551I	• FBI07100	• FBIE7100
1200 x 700	400 x 500 x 250	• L1074520	• FB207100	• FB2E7100
	500 x 500 x 300	• L127551D	• FBD07120	• FBDE7120
1300 x 700	500 x 500 x 300	• L127551I	• FBI07120	• FBIE7120
	500 x 500 x 300	• L1275520	• FB207120	• FB2E7120
1400 x 700	600 x 500 x 300	• L137551D	• FBD07130	• FBDE7130
	600 x 500 x 300	• L137551I	• FBI07130	• FBIE7130
1600 x 700	600 x 500 x 300	• L147651D	• FBD07140	• FBDE7140
	600 x 500 x 300	• L147651I	• FBI07140	• FBIE7140
1800 x 700	600 x 500 x 300	• L1476520	• FB207140	• FB2E7140
	500 x 500 x 300	• L167552D	• FBD07160	• FBDE7160
2000 x 700	500 x 500 x 300	• L167552I	• FBI07160	• FBIE7160
	500 x 500 x 300	• L187552D	• FBD07180	• FBDE7180
2200 x 700	500 x 500 x 300	• L187552I	• FBI07180	• FBIE7180
	500 x 500 x 300	• L1875530	• FB307180	• FB3E7180
2200 x 700	600 x 500 x 300	• L217652D	• FBD07200	• FBDE7200
	600 x 500 x 300	• L217652I	• FBI07200	• FBIE7200
2200 x 700	600 x 500 x 300	• L2576522	• FBD07220	• FBDE7220



## INDUSTRIAL SINK WITH FRAME AND DOORS

- Made of AISI grade 304 stainless steel (18/10).
- 105 mm backsplash and 65 mm front panel with rounded safety edges, fully welded.
- 40 x 40 mm square stainless steel legs allow you to raise the height of the unit from 850 to 920 mm.
- Rear legs raised 40 mm to allow you to set the frame on a floor with a sanitary radius.
- Available with hinged or sliding doors depending on the model.
- Open rear section to facilitate access to installations.
- **No assembly required.**
- **Optional:**  
**Door latches OPC00001**  
**Height adjustable legs from 950 to 1000 mm (page 33).**



Total dimensions (mm)	Basin dimensions (mm)	Industrial sink with frame and doors
700 x 700	500 x 500 x 300	• FBPD07070 Swinging Doors
	500 x 500 x 300	• FBPD7100 Sliding Doors
1000 x 700	500 x 500 x 300	• FBPI7100 Sliding Doors
	400 x 500 x 250	• FBPD7100 Sliding Doors
	500 x 500 x 300	• FBPD7120 Sliding Doors
1200 x 700	500 x 500 x 300	• FBPI7120 Sliding Doors
	500 x 500 x 300	• FBPD7120 Sliding Doors
	600 x 500 x 300	• FBPD7130 Sliding Doors
1300 x 700	600 x 500 x 300	• FBPI7130 Sliding Doors
	600 x 500 x 300	• FBPD7140 Sliding Doors
1400 x 700	600 x 500 x 300	• FBPI7140 Sliding Doors
	600 x 500 x 300	• FBPD7140 Sliding Doors
	500 x 500 x 300	• FBPD7160 Sliding Doors
1600 x 700	500 x 500 x 300	• FBPI7160 Sliding Doors
	500 x 500 x 300	• FBPD7180 Sliding Doors
1800 x 700	500 x 500 x 300	• FBPI7180 Sliding Doors
	500 x 500 x 300	• FBPD37180 Sliding Doors
	600 x 500 x 300	• FBPD7200 Sliding Doors
2000 x 700	600 x 500 x 300	• FBPI7200 Sliding Doors

## INDUSTRIAL SINK WITH FRAME AND SPACE FOR DISHWASHER

- Designed to incorporate a standard glass washer or dishwasher under the dish drying table.
- Inlaid drain valve and overflow pipe included in each basin.
- 40 x 40 mm square stainless steel legs allow you to raise the height of the unit from 850 to 920 mm.
- Rear legs raised 40mm to allow you to set the frame on a floor with a sanitary radius.
- 105 mm backsplash and 65 mm front panel with rounded safety edges, fully welded.
- **Easy assembly in 3 minutes.**
- **Models with doors are shipped assembled (except sink).**
- **Optional:**  
**Door latches OPC00001**  
**Height adjustable legs from 950 to 1000 mm (page 33).**



Total dimensions (mm)	Basin dimensions (mm)	Industrial sink with frame	Industrial sink with frame and shelf	Industrial sink with frame and doors
1200 x 700	500 x 500 x 300	• FBDL0712	• FBDLE712	• FBPD712 SW
	500 x 500 x 300	• FBIL0712	• FBILE712	• FBPI712 SW
1400 x 700	600 x 500 x 300	• FBDL0714	• FBDLE714	• FBPD714 SW
	600 x 500 x 300	• FBIL0714	• FBILE714	• FBPI714 SW
1800 x 700	500 x 500 x 300	• FBDL0718	• FBDLE718	• FBPD718 SL
	500 x 500 x 300	• FBIL0718	• FBILE718	• FBPI718 SL

• **SW** - Swinging Doors / **SL** - Sliding Doors

# INDUSTRIAL SINKS 700 SERIES / HIGH CAPACITY

## INDUSTRIAL SINK

- Made entirely of AISI grade 304 stainless steel (18/10).
- Basins inlaid with sound-proofing protection.
- Inlaid drain valve and overflow pipe included in each basin.
- 105 mm backsplash and 65 mm front panel with rounded safety edges, fully welded.
- Taps not included.

**RELATED PRODUCTS**

**TAPS** page 43

## FRAME

- Made entirely of stainless steel.
- The frame adapts easily to the industrial sink thanks to a simple assembly method.
- This unit's special attachment system allows the industrial sink to fit snugly into the frame, ensuring that there are no gaps.
- 40 x 40 mm square stainless steel legs allow you to raise the height of the unit from 850 to 920 mm.
- Rear legs raised 40 mm to allow you to set the frame on a floor with a sanitary radius.
- Designed to include a lower shelf (optional), page 33.
- **Easy assembly in 3 minutes.**
- **Optional:**  
**Round legs:**
  - For 850-950 mm height: **FPBR0001**
  - For 950-1000 mm height: **FPBR0002**
- **Height adjustable legs from 950 to 1000 mm (page 33).**



## INDUSTRIAL SINK WITH FRAME AND DOORS

- Made of AISI grade 304 stainless steel (18/10).
- 40 x 40 mm square stainless steel legs allow you to raise the height of the unit from 850 to 920 mm.
- Rear legs raised 40 mm to allow you to set the frame on a floor with a sanitary radius.
- Suspended sliding doors glide very smoothly. This design does not use bottom runners, facilitating cleaning.
- Open rear section to facilitate access to installations.
- **No assembly required.**
- **Optional:**  
**Door latches OPC00001**  
**Height adjustable legs from 950 to 1000 mm (page 33).**

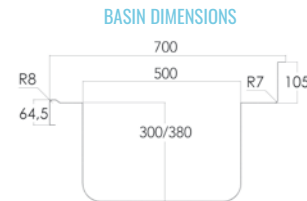

Total Dimensions (mm)	Basin dimensions (mm)	Industrial sink	Industrial sink with frame	Industrial sink with frame and shelf	Industrial sink with frame and doors
1000 x 700	860 x 500 x 380	• L1078650	• FBG00710	• FBG0E710	• FBPG7100
1200 x 700	1060 x 500 x 380	• L1271050	• FBG00712	• FBG0E712	• FBPG7120
1400 x 700	1200 x 500 x 380	• L1471250	• FBG00714	• FBG0E714	• FBPG7140
1600 x 700	860 x 500 x 380	• L167851D	• FBGD0716	• FBGDE716	• FBPG716D
	860 x 500 x 380	• L167851I	• FBGI0716	• FBGIE716	• FBPG716I
1800 x 700	1160 x 500 x 380	• L187151D	• FBGD0718	• FBGDE718	• FBPG718D
	1160 x 500 x 380	• L187151I	• FBGI0718	• FBGIE718	• FBPG718I
	500 x 500 x 300	• L1875530	• FBG30718	• FBG3E718	• FBPG7183
2000 x 700	800 x 500 x 380	• L1878520	• FBG20718	• FBG2E718	• FBPG7182
	1160 x 500 x 380	• L207151D	• FBGD0720	• FBGDE720	• FBPG720D
	1160 x 500 x 380	• L207151I	• FBGI0720	• FBGIE720	• FBPG720I



INDUSTRIAL SINKS, HAND SINKS, AND WASHING AREA

# INDUSTRIAL SINKS WITH BASIN AND WASTE CHUTE

## INDUSTRIAL SINK

- Made entirely of AISI grade 304 stainless steel (18/10).
- 105 mm backsplash and 65 mm front panel with rounded safety edges, fully welded.
- Basin with inlaid drain valve and overflow pipe included.
- Countertop waste hole with rubber ring for throwing trash directly into a bin beneath the counter.

## FRAME

- Made entirely of stainless steel.
- 40 x 40 mm square stainless steel legs allow you to raise the height of the unit from 850 to 900 mm.
- Waste container not included.
- **Easy assembly in 3 minutes.**
- **Optional:**
- **Round legs:**
- For 850-950 mm height: FPBR0001
- For 950-1000 mm height: FPBR0002
- Height adjustable legs from 950 to 1000 mm (page 33).

RELATED PRODUCTS

**TAPS** page 43 / **WASTE CONTAINERS** page 167



INDUSTRIAL SINK DIMENSIONS 1400 MM

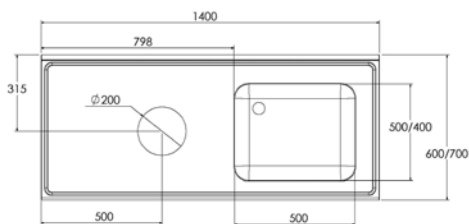

INDUSTRIAL SINK DIMENSIONS 1800 MM

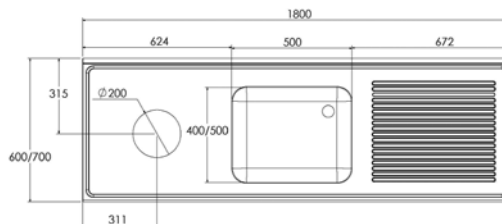

### 600 SERIES

Total dimensions (mm)	Basin dimensions (mm)	Industrial sink	Industrial sink with frame	Industrial sink with frame and space for dishwasher
1400 x 600	500 x 400 x 300	• LFAD146D	• FBAD0614	–
	500 x 400 x 300	• LFAD146I	• FBAD0614	–
1800 x 600	500 x 400 x 250	• LFAD186D	• FBAD0618	• FBADL618
	500 x 400 x 250	• LFAD186I	• FBAD0618	• FBADL618

### 700 SERIES

Total dimensions (mm)	Basin dimensions (mm)	Industrial sink	Industrial sink with frame	Industrial sink with frame and space for dishwasher
1400 x 700	500 x 500 x 300	• LFAD147D	• FBAD0714	–
	500 x 500 x 300	• LFAD147I	• FBAD0714	–
1800 x 700	500 x 500 x 250	• LFAD187D	• FBAD0718	• FBADL718
	500 x 500 x 250	• LFAD187I	• FBAD0718	• FBADL718

## TABLE FOR PREPARING VEGETABLES, MEAT, AND FISH

- Specifically designed for the preparation of fresh foods.
- Made of AISI grade 304 (18/10) brushed stainless steel.
- 105 mm backsplash and 65 mm front panel with rounded safety edges, fully welded.
- Countertop waste chute with rubber ring for throwing trash directly into a bin (not included) beneath the counter.
- 40 x 40 mm square stainless steel legs allow you to raise the height of the unit from 850 to 920 mm.
- Rear legs raised 40 mm to allow you to set the frame on a floor with a sanitary radius.

- The vegetable cutting table includes a large-capacity basin with drain valve; GN containers 1/3, 1/2, 1/1, 2/3 can be placed inside. Also includes 20mm thick polyethylene cutting board.
- Table for meat and fish includes a perforated tray for draining or defrosting. Recess in diamond-tip finish with Ø17 mm drain in center.
- Taps and waste container not included.
- **Easy assembly in 3 minutes.**
- **Optional:**
- **Round legs:**
  - For 850-950 mm height: FPBR0001
  - For 950-1000 mm height: FPBR0002
- **Height adjustable legs from 950 to 1000 mm (page 33).**

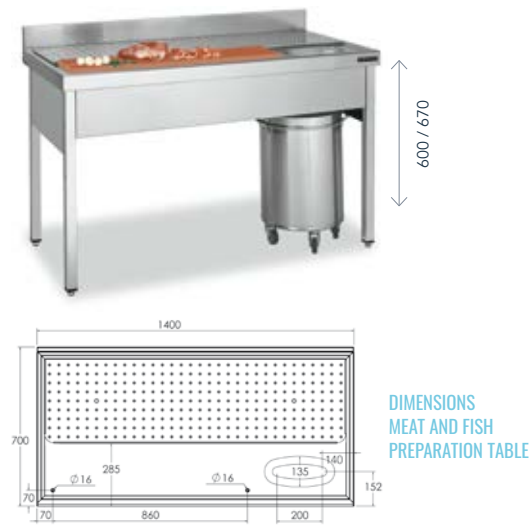

### 700 SERIES

Model	Total dimensions (mm)	Basin dimensions (mm)	Countertop	Countertop with frame
Preparation table for vegetables	1400 x 700 x 850	1250 x 310 x 170	• LMLV1470	• FBV07014
Preparation table for meat and fish	1400 x 700 x 850	—	• LMPC1470	• FBC07014

## WASTE INDUSTRIAL SINK

- **Designed for filling and emptying large containers.**
- Made entirely of stainless steel.
- Includes movable grille to support large containers.
- 105 mm backsplash and 65 mm front panel with rounded safety edges, fully welded.
- 40 x 40 mm square stainless steel legs allow you to raise the height of the unit from 555 to 605 mm.
- Rear legs raised 40 mm to allow you to set the frame on a floor with a sanitary radius.
- **No assembly required.**

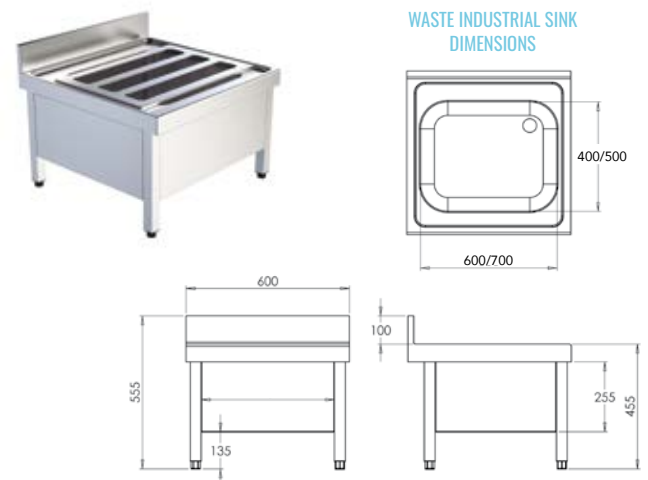

Total Dimensions (mm)	Basin dimensions (mm)	Code
600 x 600 x 555	500 x 400 x 250	• FBV66055
700 x 700 x 555	500 x 500 x 300	• FBV77055





# INDUSTRIAL SINKS ACCESSORIES

## DETACHABLE SIDE SPLASH FOR INDUSTRIAL SINKS

- Made of AISI grade 304 stainless steel (18/10).
- This item's design is very solid and makes assembly easy.
- Can be integrated into any Distform industrial sink.



Model	Side	Code
550 Series	Right	• CPE00011
	Left	• CPE00012
600 Series	Right	• CPE00001
	Left	• CPE00002
700 Series	Right	• CPE00003
	Left	• CPE00004

## PERFORATED BASES FOR INDUSTRIAL SINKS

- Perforated bases make cleaning food easier, keeping it off the bottom of the sink.
- Made entirely of AISI grade 304 brushed stainless steel (18/10).



Total dimensions (mm)	Drain placement	Code
500 x 400	Right	• R005400D
	Left	• R005400I
500 x 500	Right	• R005500D
	Left	• R005500I
600 x 500	Right	• R006500D
	Left	• R006500I

## INDUSTRIAL SINK SUPPORTS

- Made of AISI grade 304 stainless steel (18/10).
- Compatible with 600/700 Range except large capacity sinks and 600x600 sinks.
- Price per unit.



Model	Code
Support with leg	• F0020309
Wall mount	• F0020310

## HEIGHT ADJUSTABLE LEGS FROM 950 TO 1000 MM

- Made of AISI 304 18/10 stainless steel.
- They replace the standard sink legs.
- Easy assembly in 3 minutes.
- It is necessary to indicate the model of the sink when ordering.

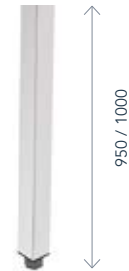

Model	Code
4 legs	• F4PB0950

## TAP HOLE

- Hole that is 33 mm in diameter
- For a frame with space for a dishwasher, the hole cannot be between the strainer and the tray.

Model	Position	Code
Right		• LAVA0001
Left		• LAVA0002
Center		• LAVA0003
Between basins		• LAVA0004

## ADDITIONAL SHELF FOR FRAME

Dimensions (mm)	550 Series	600 Series	700 Series
600	-	• FBE60060	-
700	-	• FBE60070	• FBE70070
800	-	-	• FBE70080
1000	• FBE55100	• FBE60100	• FBE70100
1200	• FBE55120	• FBE60120	• FBE70120
1300	-	• FBE60130	• FBE70130
1400	• FBE55140	• FBE60140	• FBE70140
1600	-	• FBE60160	• FBE70160
1800	-	• FBE60180	• FBE70180
2000	-	• FBE60200	• FBE70200
2200	-	-	• FBE70220

## ADDITIONAL SHELF FOR FRAME WITH SPACE FOR DISHWASHER

Dimensions (mm)	550 Series	600 Series	700 Series
1200	• FBEL5512	• FBEL6012	• FBEL7012
1400	• FBEL5514	• FBEL6014	• FBEL7014
1800	-	• FBEL6018	• FBEL7018



# HAND SINKS

## WALL-MOUNTED HAND SINKS

- Made entirely of stainless steel.
- **Swivel spout model:** Tap has swivel spout and pedal.
- **Electronic tap model:** Electronic tap with 230V/1/50 Hz electrical connection.
- Hot and cold water mixing valve.

### HAND SINKS DIMENSIONS

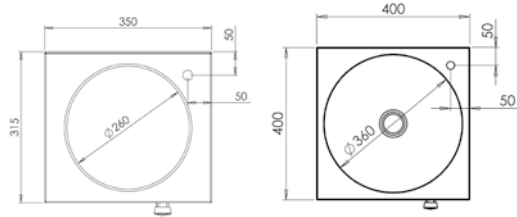

### SWIVEL SPOUT

Model	Total dimensions (mm)	Basin dimensions (mm)	Code
Swivel spout	350 x 315 x 120	Ø 260 x 100	• F0253000
Swivel spout	400 x 400 x 173	Ø 360 x 130	• F0252000
Swivel spout + soap dispenser	400 x 400 x 173	Ø 360 x 130	• F0252001

### HAND SINKS DIMENSIONS

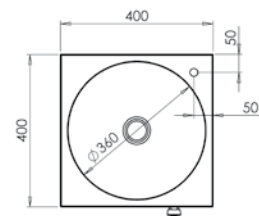

### ELECTRONIC TAP

Model	Total dimensions (mm)	Basin dimensions (mm)	Code
Electronic tap	400 x 400 x 173	Ø 360 x 130	• F0252200
Electronic tap + soap dispenser	400 x 400 x 173	Ø 360 x 130	• F0252201

## WALL BACKSLASH FOR HAND SINKS

- Made entirely of stainless steel.
- Easy assembly on all hand sinks except for model F0253000.
- Easy assembly.

Total Dimensions (mm)	Code
400 x 300 x 23	• F0250301



## FREESTANDING HAND SINKS

- Made entirely of stainless steel.
- Ø360 x 130 mm basin.
- Tap has swivel spout and foot pedal or electronic tap, depending on the model.
- Electronic tap with 230V/1/50 Hz electrical connection.
- The hand sink with two pedals includes one for hot water and one for cold.
- Hot and cold water mixing valve.
- Removable front door.



## SWIVEL SPOUT

Model	Total dimensions (mm)	Code
Swivel spout	400 x 440 x 850	• F0251000
Swivel spout + soap dispenser	400 x 440 x 850	• F0251001
Swivel spout + 2 pedals	400 x 440 x 850	• F0251200
Swivel spout + 2 pedals + soap dispenser	400 x 440 x 850	• F0251201

## FREESTANDING HAND SINKS DIMENSIONS

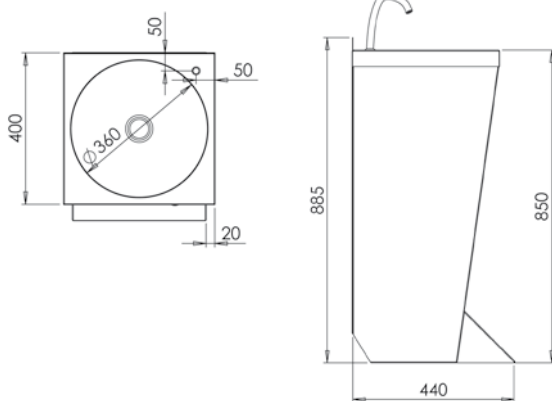

## ELECTRONIC TAP

Model	Total dimensions (mm)	Code
Electronic tap	400 x 440 x 850	• F0251300
Electronic tap + soap dispenser	400 x 440 x 850	• F0251301

# WASHING AREA



**POSSIBILITY OF CUSTOMISING LENGTH**

Please indicate desired length, price and code of the next higher model (\*)



Line of specific elements for the washing area of an industrial kitchen

Wide range of prewash tables, with waste chute, input and output, and roller tables

Universal crimping products, adaptable to any type of dishwasher



## TABLES WITH WASTE CHUTES

- Made of AISI 304 stainless steel (18/10).
- 65 mm fully welded front panel with sanitary radius, fully welded.
- Reinforcement omega brackets are attached with an anti-vibration sound-proof adhesive.
- 40 x 40 mm square stainless steel legs allow you to raise the height of the unit from 850 to 920 mm.
- No-drip edge.
- Black rubber easy-install waste chute ring.
- **Easy assembly in 3 minutes.**
- **Optional:**  
 Height adjustable legs from 950 to 1000 mm (page 33).  
 Round legs (page 82).

RELATED PRODUCTS

**WASTE CONTAINERS** page 167



Total dimensions (mm)	With reinforcing frame	With partial shelving
1400 x 700 x 850	• F0501470	• F05E1470
1600 x 700 x 850	• F0501670	• F05E1670
1800 x 700 x 850	• F0501870	• F05E1870
2000 x 700 x 850	• F0502070	• F05E2070



# TABLES FOR DISHWASHERS



**POSSIBILITY OF CUSTOMISING LENGTH**

Please indicate desired length, price and code of the next higher model (\*)



## INPUT/OUTPUT TABLES

- AISI grade 304 stainless steel (18/10) countertops.
- Stainless steel shelf.
- Quick assembly with Allen screws (key included).
- Easy to connect to any dishwasher with universal clamping system.
- Fully reversible. Can be clamped on both sides.
- Smooth sloped surface for quick and easy cleaning.
- 40 x 40 mm square stainless steel legs allow you to raise the height of the unit from 850 to 900 mm.
- 158-mm-high backsplash on wall-facing tables.
- **Easy assembly in 3 minutes.**
- **Optional:**  
 Round legs (page 82).  
 Height adjustable legs from 950 to 1000 mm (page 33).

CENTER TABLE DIMENSIONS

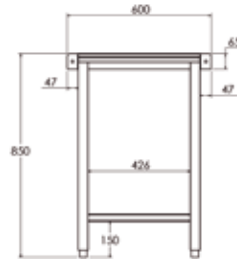

WALL-FACING TABLE DIMENSIONS

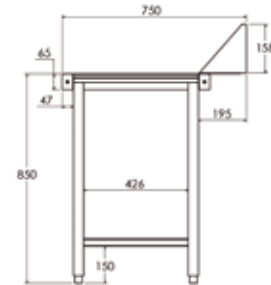

### CENTER

Total dimensions (mm)
600 x 600 x 850
1100 x 600 x 850
1600 x 600 x 850



No shelf
• FESCS066
• FESCS116
• FESCS166



With shelf
• FESCE066
• FESCE116
• FESCE166



### WALL-FACING

Total dimensions (mm)
700 x 750 x 850
1100 x 750 x 850
1600 x 750 x 850
2100 x 750 x 850



No shelf
• FESMS077
• FESMS117
• FESMS167
• FESMS217



With shelf
• FESME077
• FESME117
• FESME167
• FESME217

# WASHING AREA



**POSSIBILITY OF CUSTOMISING LENGTH**

Please indicate desired length, price and code of the next higher model (•)



## PRE-WASH TABLES

- AISI grade 304 stainless steel (18/10) countertops.
- Stainless steel shelf.
- Easy to connect to any dishwasher with universal clamping system.
- Basin with inlaid drain valve and overflow pipe included.
- 40 x 40 mm square stainless steel legs allow you to raise the height of the unit from 850 to 920 mm.
- 158-mm-high backsplash.
- Tap not included.
- **Easy assembly in 3 minutes.**
- **Optional:**  
 Round legs (page 82).  
 Height adjustable legs from 950 to 1000 mm (page 33).

RELATED PRODUCTS

**Taps** page 43



PRE-WASH TABLE DIMENSIONS

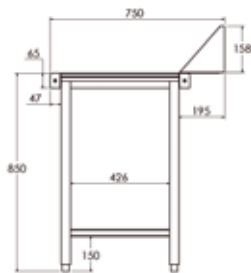

### LEFT BASIN

Total dimensions (mm)	Basin dimensions (mm)	No shelf	With shelf
700 x 750 x 850	500 x 400 x 250	• FPMSC07I	• FPMEC07I
1100 x 750 x 850	500 x 400 x 250	• FPMSC11I	• FPMEC11I
1600 x 750 x 850	500 x 400 x 250	• FPMSC16I	• FPMEC16I
2100 x 750 x 850	500 x 400 x 250	• FPMSC21I	• FPMEC21I



### RIGHT BASIN

Total dimensions (mm)	Basin dimensions (mm)	No shelf	With shelf
700 x 750 x 850	500 x 400 x 250	• FPMSC07D	• FPMEC07D
1100 x 750 x 850	500 x 400 x 250	• FPMSC11D	• FPMEC11D
1600 x 750 x 850	500 x 400 x 250	• FPMSC16D	• FPMEC16D
2100 x 750 x 850	500 x 400 x 250	• FPMSC21D	• FPMEC21D





**POSSIBILITY OF CUSTOMISING LENGTH**  
Please indicate desired length, price and code of the next higher model (\*)

RELATED PRODUCTS

**TAPS** page 43

**WASTE CONTAINERS** page 167



## PRE-WASH TABLES WITH WASTE CHUTE

- AISI grade 304 stainless steel (18/10) countertops.
- Stainless steel shelf.
- Basin with inlaid drain valve and overflow pipe included.
- Countertop waste chute with rubber ring for throwing trash directly into a bin beneath the counter.
- 40 x 40 mm square stainless steel legs allow you to raise the height of the unit from 850 to 920 mm.
- 158-mm-high backsplash.
- Tap and waste container not included.
- **Easy assembly in 3 minutes.**
- **Optional:**  
**Round legs (page 82).**  
**Height adjustable legs from 950 to 1000 mm (page 33).**

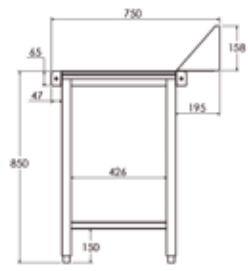

### LEFT BASIN + RING

Total dimensions (mm)	Basin dimensions (mm)	No shelf	With shelf
1100 x 750 x 850	400 x 400 x 250	• FPMAC11I	• FPAEC11I
1600 x 750 x 850	500 x 400 x 250	• FPMAC16I	• FPAEC16I
2100 x 750 x 850	500 x 400 x 250	• FPMAC21I	• FPAEC21I



### RIGHT BASIN + RING

Total dimensions (mm)	Basin dimensions (mm)	No shelf	With shelf
1100 x 750 x 850	400 x 400 x 250	• FPMAC11D	• FPAEC11D
1600 x 750 x 850	500 x 400 x 250	• FPMAC16D	• FPAEC16D
2100 x 750 x 850	500 x 400 x 250	• FPMAC21D	• FPAEC21D



• 3-DAY SHIPPING

# ROLLER TABLES

## STRAIGHT ROLLER OUTFEED TABLE

- Made of AISI 304 18/10 stainless steel.
- Removable PVC rollers and stainless steel shaft.
- Easy connection to any dishwasher by means of a universal crimping system.
- Reversible. It can be crimped on both sides.
- Square stainless steel legs 40 x 40 mm to raise the height from 850 to 920 mm.
- Quick assembly with Allen screws (key included).
- **Optional:**
  - **Round legs:**
    - For 850-950 mm height: FPBR0001
    - For 950-1000 mm height: FPBR0002
  - Height adjustable legs from 950 to 1000 mm (page 33).



Total dimensions (mm)	Code
1100 x 600 x 850	• FMREU110
1600 x 600 x 850	• FMREU160

## ANGULAR ROLLER OUTFEED TABLE

- Made of AISI 304 18/10 stainless steel.
- Removable PVC rollers and stainless steel shaft.
- Easy connection on both sides to the straight roller table.
- Square stainless steel legs 40 x 40 mm to raise the height from 850 to 920 mm.
- Quick assembly with Allen screws (key included).
- **Optional:**
  - **Round legs:**
    - For 850-950 mm height: FPBR0001
    - For 950-1000 mm height: FPBR0002
  - Height adjustable legs from 950 to 1000 mm (page 33).



Total dimensions (mm)	Code
1050 x 1050 x 850	• FMREU090





# WASHING AREA ACCESSORIES

## TABLETOP SHELF FOR DISH RACKS

- Made of AISI 304 stainless steel (18/10).
- Ø30 mm tube legs with anchor rod for the table.
- 500 x 500 mm standard dish rack size
- It has a built-in drain
- **No assembly required.**

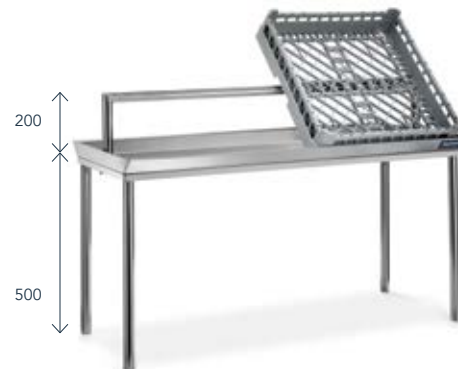

Total dimensions (mm)	Code
1100 x 500	• F0030201
1600 x 500	• F0030202

## INCLINED WALL SHELVING FOR DISH RACKS

- Made of AISI 304 stainless steel (18/10).
- Wall-mountable brackets with Ø8 mm drill holes (screws and plugs included)
- It has a built-in drain
- **Comes fully welded.**



Total dimensions (mm)	Code
1100 x 500	• F0100301
1600 x 500	• F0100302

## ACCESSORIES FOR PRE-WASH TABLES

Model	Code
Stainless steel prewash basket for 400 x 400 x 250 basin	• ECU00013
Stainless steel prewash basket for 500 x 400 x 250 basin	• ECU00012
Ø200 mm Waste chute	• CAD00001
Waste chute cover	• RTAPAD01



## HEIGHT ADJUSTABLE LEGS FROM 950 TO 1000 MM

- Made of AISI 304 18/10 stainless steel.
- They replace the standard legs of the washing area table.
- **Easy assembly in 3 minutes.**
- **It is necessary to indicate the model of the washing area table when ordering.**

Model	Code
4 legs	• F4P00950
6 legs	• F6P00950





STATIC PREPARATION

# TAPS



## SPRAYING TAPS

PAGE 44



## INDUSTRIAL TAPS

PAGE 47



## ELECTRONIC TAPS

PAGE 48



## TIMED TAPS

PAGE 49



## EXTENDABLE TAPS

PAGE 49

# SPRAYING TAPS

**High-quality, durable, ergonomic spraying taps designed for intensive use in commercial kitchens.**

- Made of high-density chrome-plated brass with stainless steel springs and a flexible tube that is resistant to high temperature and water pressure.
- Includes flexible water connection tubes.
- Includes all accessories necessary for assembly.

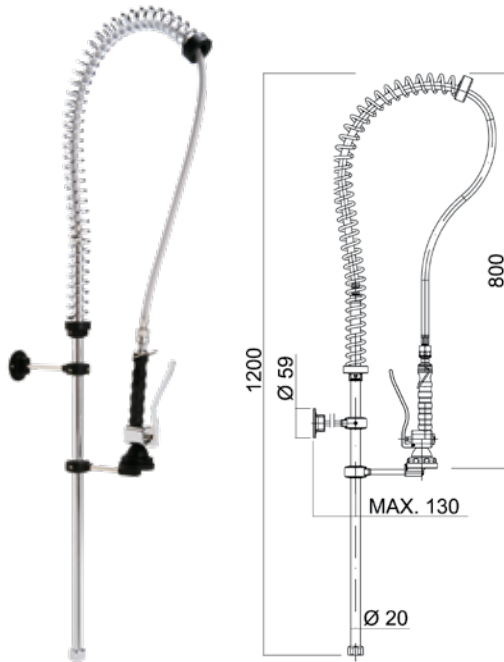

**Model** Code

Spraying tap with no temperature controls • R0020203

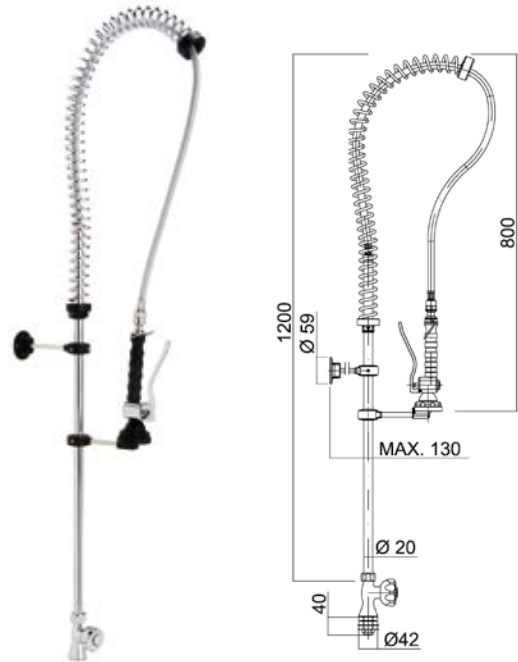

**Model** Code

Single temperature spraying tap • R0020200

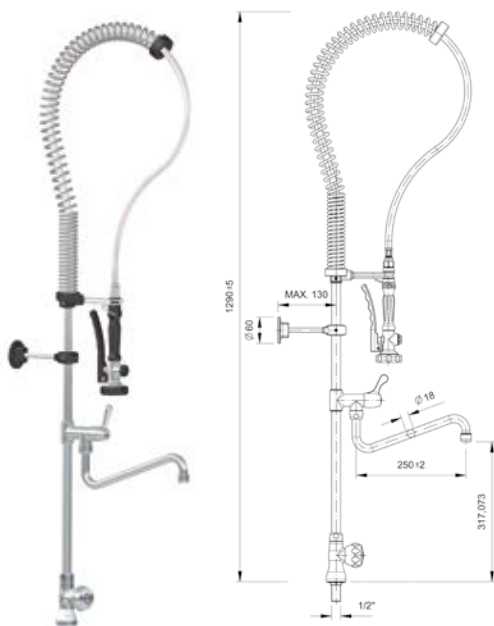

**Model** Code

Single temperature spraying tap with extra tap • R0020300

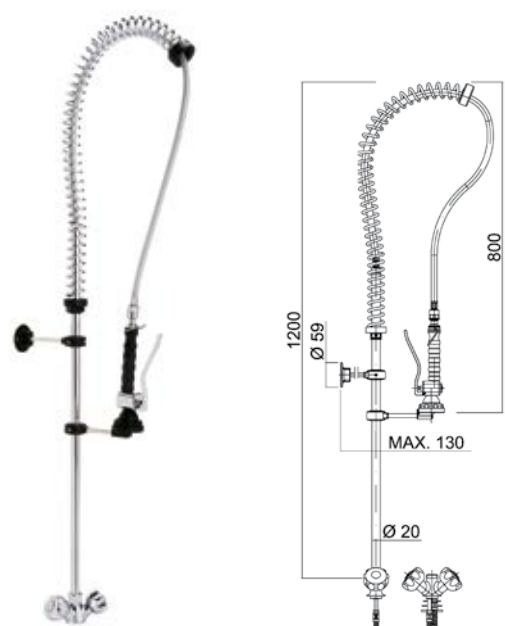

**Model** Code

Spraying tap with hot/cold controls • R0020201





**Model** Single-handle spraying tap  
**Code** • R0020206

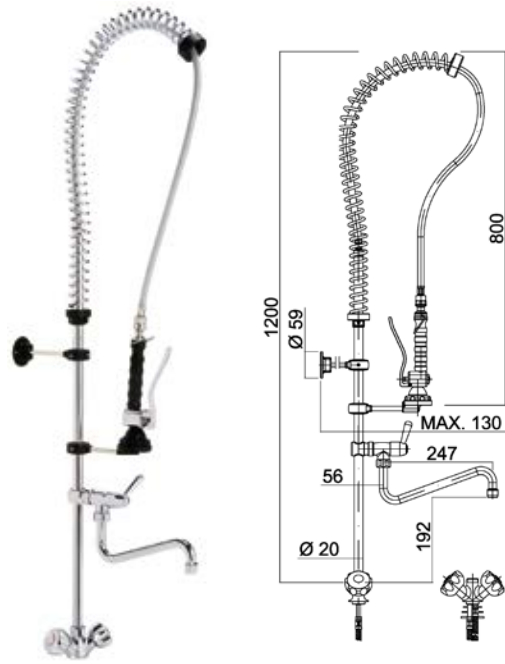

**Model** Spraying tap with hot/cold controls and extra tap  
**Code** • R0020301

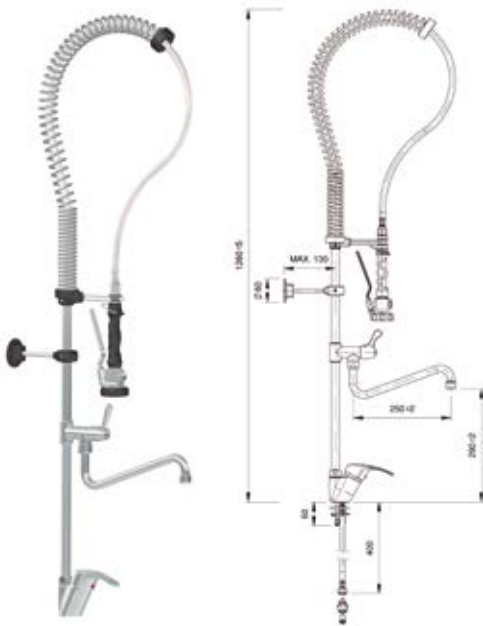

**Model** Single-handle Spraying tap with extra tap  
**Code** • R0020302

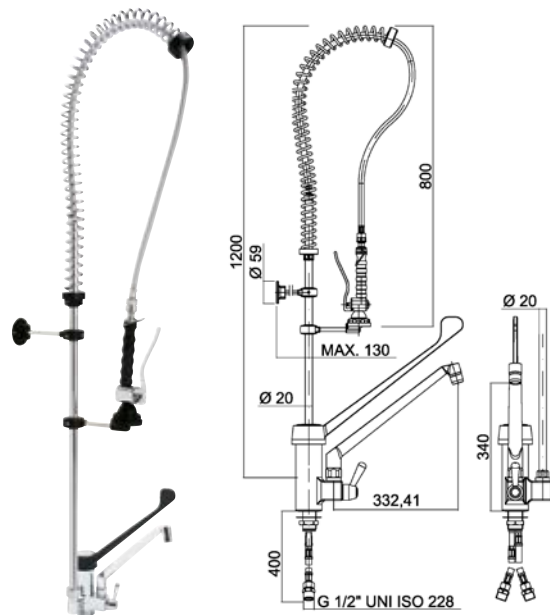

**Model** Easy-open spraying tap with extra tap  
**Code** • R0020216



# SPRAYING TAPS

**High-quality, durable, ergonomic spraying taps designed for intensive use in commercial kitchens.**

- Made of high-density chrome-plated brass with stainless steel springs and a flexible tube that is resistant to high temperature and water pressure.
- Includes flexible water connection tubes.
- Includes all accessories necessary for assembly.

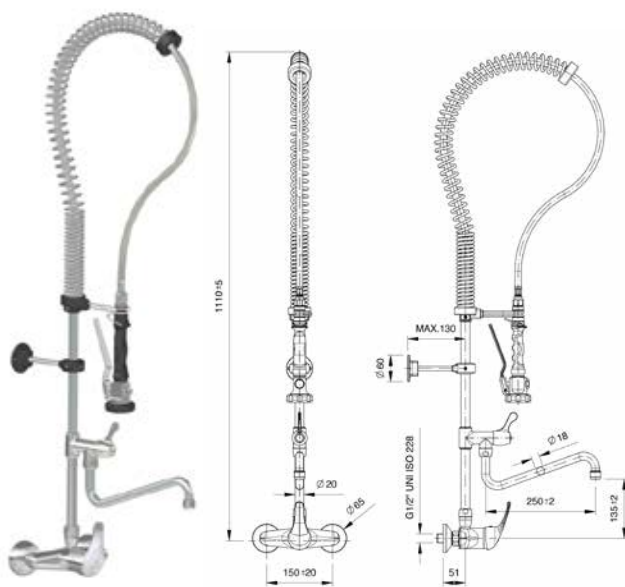

Model	Code
Wall-mounted spraying tap with extra tap	• R0020218

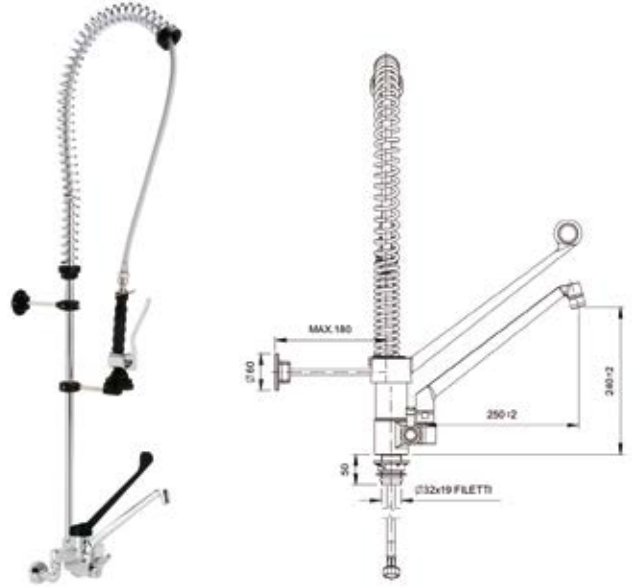

Model	Code
Easy-open wall-mounted spraying tap	• R0020234

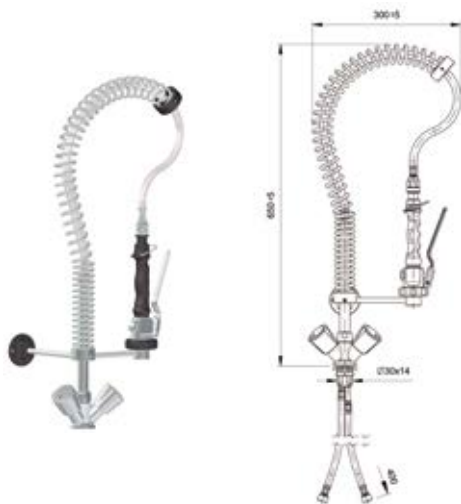

Model	Code
600-mm-high hot/cold spray tap	• R0020303

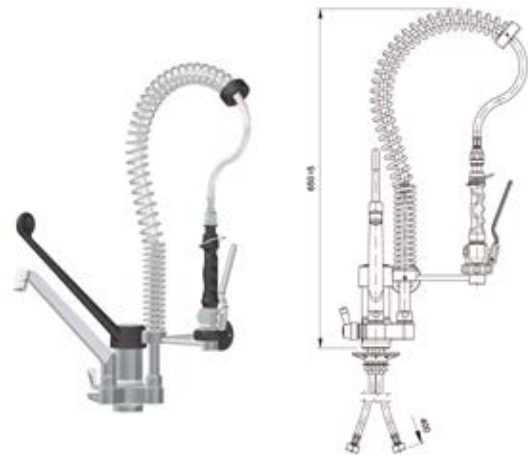

Model	Code
600-mm-high easy-open spraying tap with hot/cold controls	• R0020306



# INDUSTRIAL TAPS

High-quality, durable spraying taps designed for intensive use in commercial kitchens.

- Made of high-density chrome-plated brass.
- Ergonomic handles facilitate opening and closing the tap and regulating water flow.
- Includes flexible water connection tubes.
- Includes all accessories necessary for assembly.

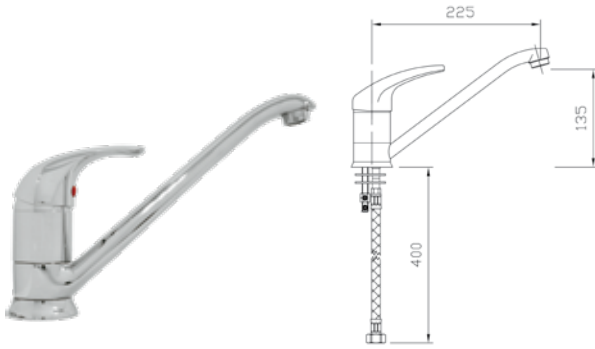

**Model**                      **Code**  
 Low spout tap with short handle                      • R0020221

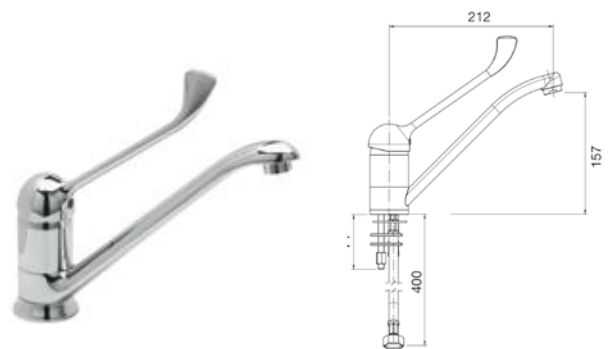

**Model**                      **Code**  
 Low spout tap with long handle                      • R0020304

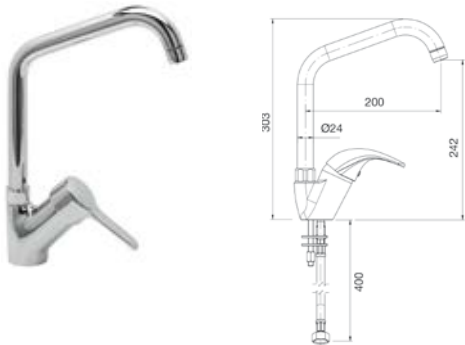

**Model**                      **Code**  
 Single-handle high spout tap                      • R0020202



**Model**                      **Code**  
 Tap with hot/cold controls                      • R0020305

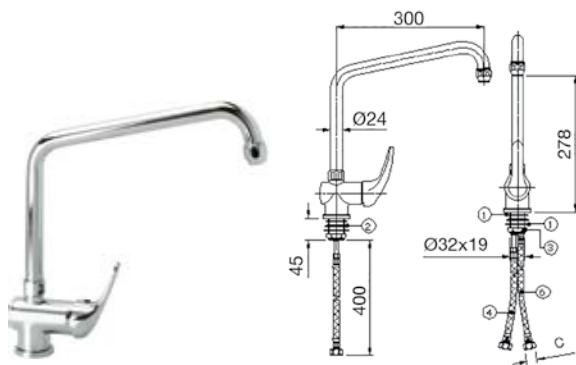

**Model**                      **Code**  
 High spout filled tap                      • R0020238

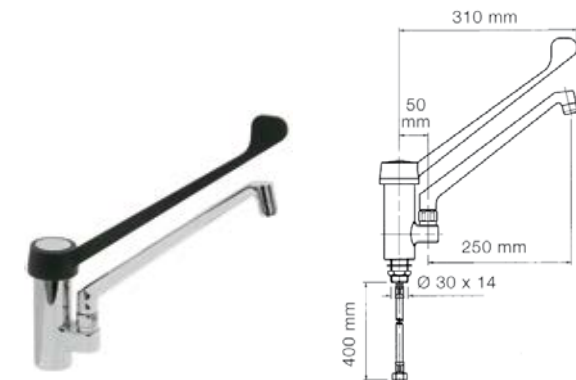

**Model**                      **Code**  
 Easy elbow lever tap                      • R0020215



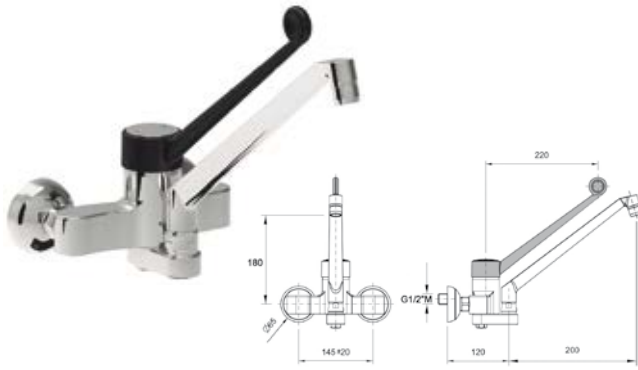

**Model** **Code**

Wall-mounted mixing tap with hot/cold controls • R0020222

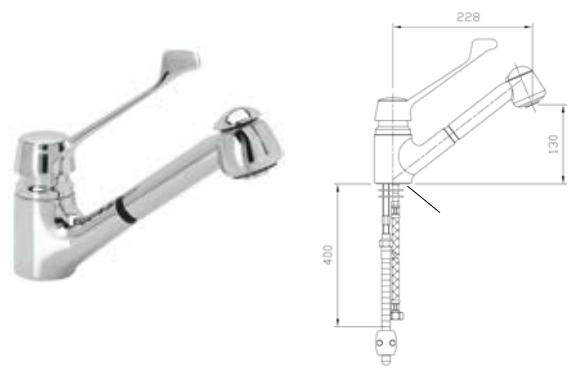

**Model** **Code**

Mixing tap with extendable spout and hot/cold controls • R0020223

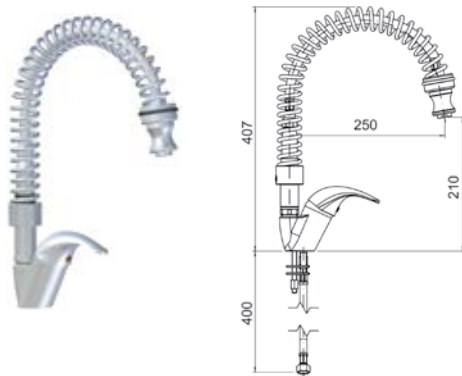

**Model** **Code**

Single-handle spiral mixing tap • R0020239

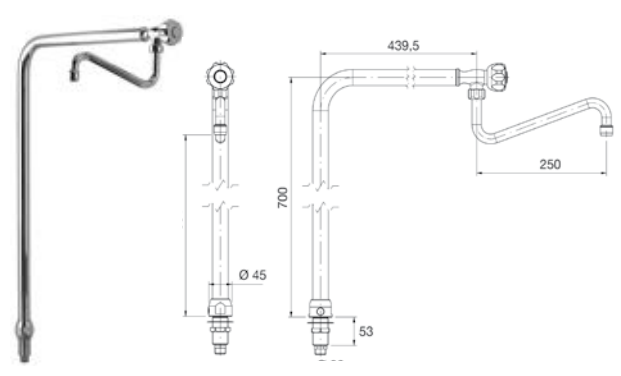

**Model** **Code**

Single knob column tap • R0020219

## TAPS

# ELECTRONIC TAPS

**Taps with an electronic sensor that is activated when approaching or withdrawing hands for the opening and closing of the water flow.**

- Maximum comfort of use and hygiene.
- They incorporate flexible hoses for connection to the water mains.
- Electric mains or battery operated electric models.

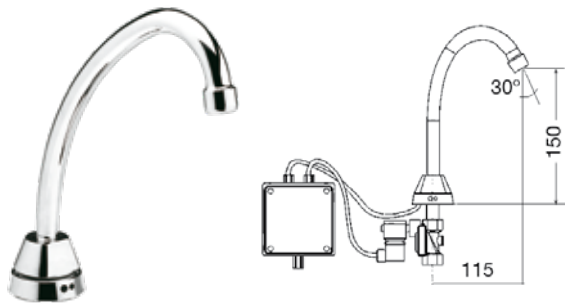

**Model** **Code**

High spout electronic network tap • R0020230

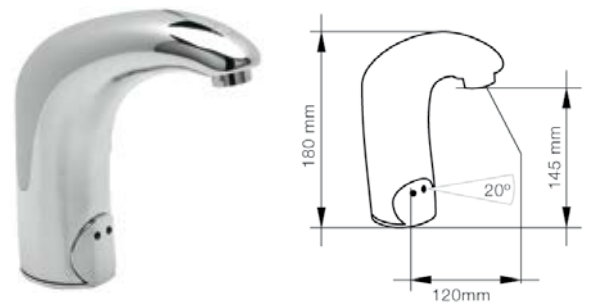

**Model** **Code**

Electronic network tap • R0020214

Battery-operated tap • R0020229





# PUSH TAPS

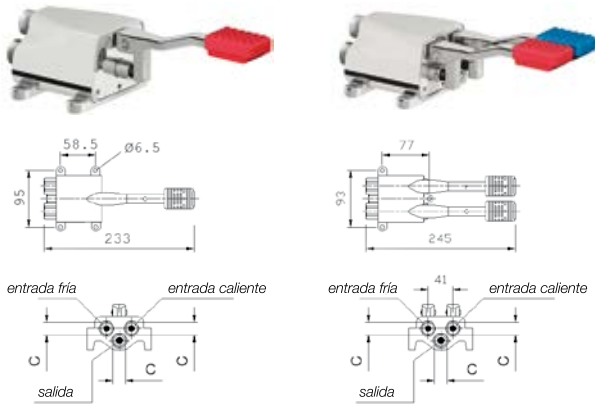

Model	Code
Single hot/cold control pedal	• R0020226
Double hot/cold control pedal	• R0020324

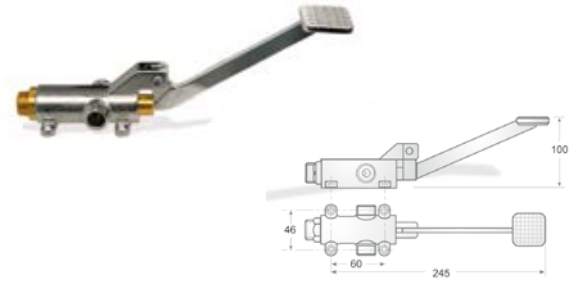

Model	Code
Pedal pushbutton dual water self-mixer	• R0020308



• 21mm diameter tap hole. Please indicate when ordering.

Model	Code
High swivel spout tap	• R0020224

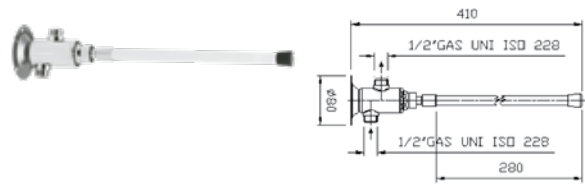

Model	Code
Tap with hot/cold controls, timer and mixing valve	• R0020227
One temperature tap with timer	• R0020225

## HOSE EXTENSION SET WITH TAP

**Extendable taps designed for intensive use in restaurants, the meat industry, fish markets, catering, and more.**

- Made of stainless steel.
- Equipped with temperature-resistant hose for use with foods.
- Retractable handle that can be set to a certain hose length so the user does not need to exert extra strength.
- Wall installation.
- Maximum working pressure: 5 bar.
- Maximum flow at 4 bar: 13 l/min.

Length	Code
10 metres	• R0020232
15 meters	• R0020235
20 meters	• R0020236

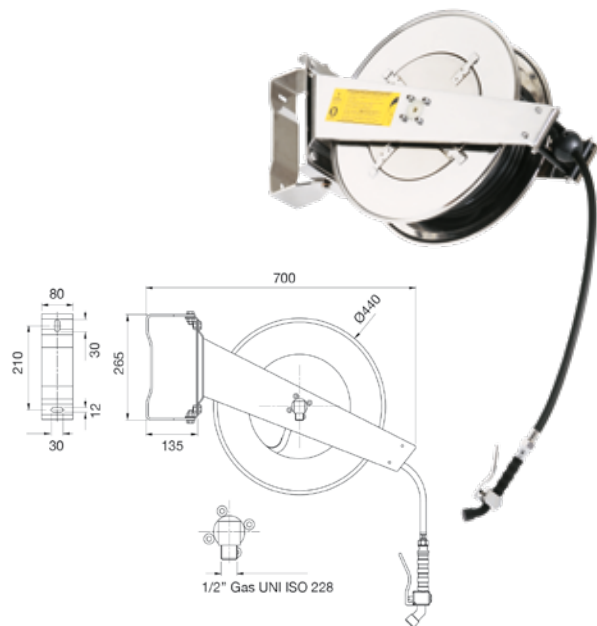



STATIC PREPARATION

# WORK TABLES



**500/550/600/  
700/800/900  
SERIES TABLES**

PAGE 54



**TABLES WITH DRAWERS,  
AND CORNER TABLES**

PAGE 78



**TABLES WITH DOORS AND  
DRAWERS**

PAGE 66



**ACCESSORIES**

PAGE 79



**TABLES  
WITH BASIN**

PAGE 68



**CUSTOMIZATIONS**

PAGE 83



**TABLES WITH NO-DRIP  
EDGE AND BASIN**

PAGE 70



**CUTTING  
BOARD TABLES**

PAGE 84



**TABLES WITH  
BASIN, DOORS,  
AND DRAWERS**

PAGE 72



**SUPPORT TABLES  
FOR COOKING AND WASTE  
TABLES**

PAGE 85



**COUNTERTOPS**

PAGE 74



**RECYCLING TABLES**

PAGE 86



**600-MM-HIGH TABLES**

PAGE 76



**COFFEE SERVICE AND DISPLAY  
CABINET TABLES**

PAGE 87

# WORK TABLE



01  
High quality  
and durable  
work tables

02  
Functional design  
unmatched in the  
market

03  
Wide range of  
compatible accessories  
and additions

FIXING SYSTEM  
**DURBLOCK**  
WORK TABLES

INNOVATIVE, EASY-TO-ASSEMBLE DESIGN



MAXIMUM ROBUSTNESS THANKS TO THE FIXING SYSTEM

SPECIAL ALLOY STRUCTURAL STEEL

SURFACE TREATMENT THAT PROTECTS THE PART FOR YEARS

DURBLOCK IS RUST-FREE AND LASTS FOR AT LEAST 20 YEARS



**COUNTERTOP THICKNESS 1.5 MM**

PAGE 83

Tables with basins, accessories, and supplements that enhance the customization options



Easy installation in 3 minutes with userfriendly assembly.



105 mm high backsplash with rounded safety edges, fully welded, for wall units



# WORK TABLES 500 SERIES



**POSSIBILITY OF CUSTOMISING LENGTH**

Please indicate desired length, price and code of the next higher model (\*)



## CENTER TABLE

- AISI grade 304 brushed stainless steel (18/10) countertops with reinforcing omega brackets.
- 65 mm rounded edge, fully welded front panel.
- In the case of tables with a reinforcement frame, the crossbar can be placed in a central position.
- 40 x 40 mm square stainless steel legs allow you to raise the height of the unit from 850 to 920 mm.
- **Easy assembly in 3 minutes.**
- **Optional:**  
 • **Round legs (page 82).**  
 • **Height adjustable legs from 950 to 1000 mm (page 83).**

FIXING SYSTEM  
**DURBLOCK**  
WORK TABLES



COUNTERTOP THICKNESS 1.5 MM PAGE 83

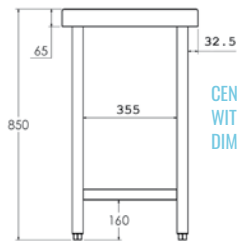

CENTER TABLE WITH SHELF DIMENSIONS

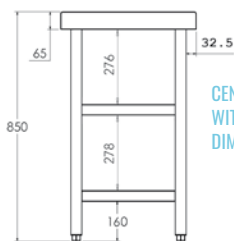

CENTER TABLE WITH 2 SHELVES DIMENSIONS



Total dimensions (mm)	Table with reinforcement frame	Table with shelf	Table with 2 shelves
600 x 500 x 850	• FC050060	• FC150060	• FC250060
800 x 500 x 850	• FC050080	• FC150080	• FC250080
1000 x 500 x 850	• FC050100	• FC150100	• FC250100
1200 x 500 x 850	• FC050120	• FC150120	• FC250120
1400 x 500 x 850	• FC050140	• FC150140	• FC250140
1500 x 500 x 850	• FC050150	• FC150150	• FC250150
1600 x 500 x 850	• FC050160	• FC150160	• FC250160
1800 x 500 x 850	• FC050180	• FC150180	• FC250180
2000 x 500 x 850	• FC050200	• FC150200	• FC250200
2200 x 500 x 850	• FC050220	• FC150220	• FC250220
2400 x 500 x 850	• FC050240	• FC150240	• FC250240





### POSSIBILITY OF CUSTOMISING LENGTH

Please indicate desired length, price and code of the next higher model (\*)



## WALL-FACING TABLE

- AISI grade 304 brushed stainless steel (18/10) countertops with reinforcing omega brackets.
- 105 mm backsplash and 65 mm front panel with rounded safety edges, fully welded.
- In the case of tables with a reinforcement frame, the crossbar can be placed in a central position.
- Tables with doors include: side and rear panels, with a middle shelf made of stainless steel.
- 40 x 40 mm square stainless steel legs allow you to raise the height of the unit from 850 to 920 mm.
- **Easy assembly in 3 minutes.**
- **Models with doors are shipped assembled.**
- **Optional:**  
**Round legs (except for models with doors) (page 80).**  
**Height adjustable legs from 950 to 1000 mm (page 83).**  
**Door latches OPC00001**

FIXING SYSTEM  
**DURBLOCK**  
WORK TABLES



COUNTERTOP THICKNESS 1.5 MM PAGE 83

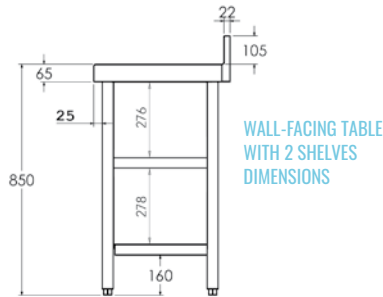
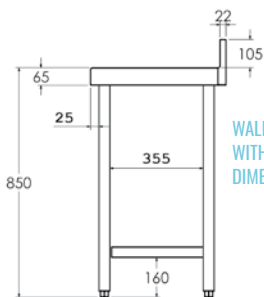

Total dimensions (mm)	Table with reinforcement frame	Table with shelf	Table with 2 shelves	Table with doors
600 x 500 x 850	• FM050060	• FM150060	• FM250060	-
800 x 500 x 850	• FM050080	• FM150080	• FM250080	• FMP50080 SW
1000 x 500 x 850	• FM050100	• FM150100	• FM250100	• FMP50100 SL
1200 x 500 x 850	• FM050120	• FM150120	• FM250120	• FMP50120 SL
1400 x 500 x 850	• FM050140	• FM150140	• FM250140	• FMP50140 SL
1500 x 500 x 850	• FM050150	• FM150150	• FM250150	-
1600 x 500 x 850	• FM050160	• FM150160	• FM250160	• FMP50160 SL
1800 x 500 x 850	• FM050180	• FM150180	• FM250180	• FMP50180 SL
2000 x 500 x 850	• FM050200	• FM150200	• FM250200	• FMP50200 SL
2200 x 500 x 850	• FM050220	• FM150220	• FM250220	-
2400 x 500 x 850	• FM050240	• FM150240	• FM250240	-

• **SW** - Swinging Doors / **SL** - Sliding Doors



• 3-DAY • 24/48-HOUR SHIPPING

# WORK TABLES 550 SERIES



**POSSIBILITY OF CUSTOMISING LENGTH**

Please indicate desired length, price and code of the next higher model (\*)



## CENTER TABLE

- AISI grade 304 brushed stainless steel (18/10) countertops with reinforcing omega brackets.
- 65 mm rounded edge, fully welded front panel.
- In the case of tables with a reinforcement frame, the crossbar can be placed in a central position.
- Tables with doors include: side and rear panels, with a middle shelf made of stainless steel.
- 40 x 40 mm square stainless steel legs allow you to raise the height of the unit from 850 to 920 mm.
- **Easy assembly in 3 minutes.**
- **Models with doors are shipped assembled.**
- **Optional:**  
 Round legs (except for models with doors) (page 80).  
 Height adjustable legs from 950 to 1000 mm (page 83).  
 Door latches OPC00001

FIXING SYSTEM  
**DURBLOCK**  
WORK TABLES

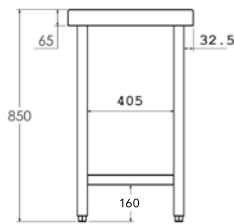

CENTER TABLE WITH SHELF DIMENSIONS

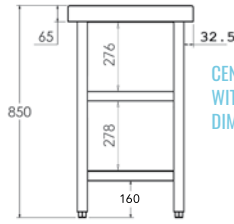

CENTER TABLE WITH 2 SHELVES DIMENSIONS

COUNTERTOP THICKNESS 1.5 MM PAGE 83



Total dimensions (mm)	Table with reinforcement frame	Table with shelf	Table with 2 shelves	Table with doors
600 x 550 x 850	• FC055060	• FC155060	• FC255060	-
800 x 550 x 850	• FC055080	• FC155080	• FC255080	• FCP55080 SW
1000 x 550 x 850	• FC055100	• FC155100	• FC255100	• FCP55100 SL
1200 x 550 x 850	• FC055120	• FC155120	• FC255120	• FCP55120 SL
1400 x 550 x 850	• FC055140	• FC155140	• FC255140	• FCP55140 SL
1500 x 550 x 850	• FC055150	• FC155150	• FC255150	-
1600 x 550 x 850	• FC055160	• FC155160	• FC255160	• FCP55160 SL
1800 x 550 x 850	• FC055180	• FC155180	• FC255180	• FCP55180 SL
2000 x 550 x 850	• FC055200	• FC155200	• FC255200	• FCP55200 SL
2200 x 550 x 850	• FC055220	• FC155220	• FC255220	-
2400 x 550 x 850	• FC055240	• FC155240	• FC255240	-

· **SW** - Swinging Doors / **SL** - Sliding Doors





**POSSIBILITY OF CUSTOMISING LENGTH**

Please indicate desired length, price and code of the next higher model (\*)

**WALL-FACING TABLE**

- AISI grade 304 brushed stainless steel (18/10) countertops with reinforcing omega brackets.
- 105 mm backsplash and 65 mm front panel with rounded safety edges, fully welded.
- In the case of tables with a reinforcement frame, the crossbar can be placed in a central position.
- Tables with doors include: side and rear panels, with a middle shelf made of stainless steel.
- 40 x 40 mm square stainless steel legs allow you to raise the height of the unit from 850 to 920 mm.
- **Easy assembly in 3 minutes.**
- **Models with doors are shipped assembled.**
- **Optional:**  
**Round legs (except for models with doors) (page 80).**  
**Height adjustable legs from 950 to 1000 mm (page 83).**  
**Door latches OPC00001**

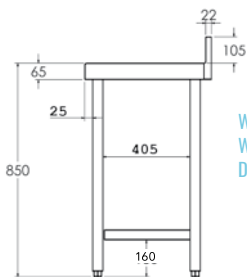
FIXING SYSTEM  
**DURBLOCK**  
WORK TABLES**COUNTERTOP THICKNESS 1.5 MM PAGE 83**

WALL-FACING TABLE WITH SHELF DIMENSIONS

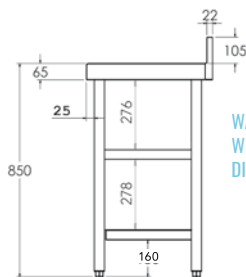

WALL-FACING TABLE WITH 2 SHELVES DIMENSIONS



Total dimensions (mm)	Table with reinforcement frame	Table with shelf	Table with 2 shelves	Table with doors
600 x 550 x 850	• FM055060	• FM155060	• FM255060	-
800 x 550 x 850	• FM055080	• FM155080	• FM255080	• FMP55080 SW
1000 x 550 x 850	• FM055100	• FM155100	• FM255100	• FMP55100 SL
1200 x 550 x 850	• FM055120	• FM155120	• FM255120	• FMP55120 SL
1400 x 550 x 850	• FM055140	• FM155140	• FM255140	• FMP55140 SL
1500 x 550 x 850	• FM055150	• FM155150	• FM255150	-
1600 x 550 x 850	• FM055160	• FM155160	• FM255160	• FMP55160 SL
1800 x 550 x 850	• FM055180	• FM155180	• FM255180	• FMP55180 SL
2000 x 550 x 850	• FM055200	• FM155200	• FM255200	• FMP55200 SL
2200 x 550 x 850	• FM055220	• FM155220	• FM255220	-
2400 x 550 x 850	• FM055240	• FM155240	• FM255240	-

• **SW** - Swinging Doors / **SL** - Sliding Doors• **3-DAY** • **24/48-HOUR SHIPPING**

# WORK TABLES 600 SERIES



**POSSIBILITY OF CUSTOMISING LENGTH**

Please indicate desired length, price and code of the next higher model (\*)



## CENTER TABLE

- AISI grade 304 brushed stainless steel (18/10) countertops with reinforcing omega brackets.
- 65 mm rounded edge, fully welded front panel.
- In the case of tables with a reinforcement frame, the crossbar can be placed in a central position.
- Tables with doors include: side and rear panels, with a middle shelf made of stainless steel.
- 40 x 40 mm square stainless steel legs allow you to raise the height of the unit from 850 to 200 mm.
- **Easy assembly in 3 minutes.**
- **Models with doors are shipped assembled.**
- **Optional:**
  - Round legs (except for models with doors) (page 80).
  - Height adjustable legs from 950 to 1000 mm (page 83).
  - Door latches OPC00001

FIXING SYSTEM  
**DURBLOCK**  
WORK TABLES

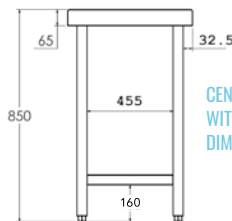

CENTER TABLE WITH SHELF DIMENSIONS

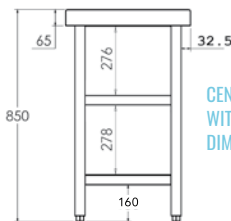

CENTER TABLE WITH 2 SHELVES DIMENSIONS

COUNTERTOP THICKNESS 1.5 MM PAGE 83



Total dimensions (mm)	Table with reinforcement frame	Table with 1 shelf	Table with 2 shelves	Table with doors	Table with pass-through sliding doors
600 x 600 x 850	• FC060060	• FC160060	• FC260060	-	-
700 x 600 x 850	• FC060070	• FC160070	• FC260070	-	-
800 x 600 x 850	• FC060080	• FC160080	• FC260080	• FCP60080 SW	-
900 x 600 x 850	• FC060090	• FC160090	• FC260090	-	-
1000 x 600 x 850	• FC060100	• FC160100	• FC260100	• FCP60100 SL	• FCPP6100
1100 x 600 x 850	• FC060110	• FC160110	• FC260110	-	-
1200 x 600 x 850	• FC060120	• FC160120	• FC260120	• FCP60120 SL	• FCPP6120
1300 x 600 x 850	• FC060130	• FC160130	• FC260130	-	-
1400 x 600 x 850	• FC060140	• FC160140	• FC260140	• FCP60140 SL	• FCPP6140
1500 x 600 x 850	• FC060150	• FC160150	• FC260150	-	-
1600 x 600 x 850	• FC060160	• FC160160	• FC260160	• FCP60160 SL	• FCPP6160
1700 x 600 x 850	• FC060170	• FC160170	• FC260170	-	-
1800 x 600 x 850	• FC060180	• FC160180	• FC260180	• FCP60180 SL	• FCPP6180
1900 x 600 x 850	• FC060190	• FC160190	• FC260190	-	-
2000 x 600 x 850	• FC060200	• FC160200	• FC260200	• FCP60200 SL	• FCPP6200
2200 x 600 x 850	• FC060220	• FC160220	• FC260220	• FCP60220 SL	• FCPP6220
2400 x 600 x 850	• FC060240	• FC160240	• FC260240	• FCP60240 SL	• FCPP6240
2600 x 600 x 850	• FC060260	• FC160260	• FC260260	• FCP60260 SL	• FCPP6260
2800 x 600 x 850	• FC060280	• FC160280	• FC260280	• FCP60280 SL	• FCPP6280

· **SW** - Swinging Doors / **SL** - Sliding Doors





**POSSIBILITY OF CUSTOMISING LENGTH**  
Please indicate desired length, price and code of the next higher model (\*)

## WALL-FACING TABLE

- AISI grade 304 brushed stainless steel (18/10) countertops with reinforcing omega brackets.
- 105 mm backsplash and 65 mm front panel with rounded safety edges, fully welded.
- In the case of tables with a reinforcement frame, the crossbar can be placed in a central position.
- Tables with doors include: side and rear panels, with a middle shelf made of stainless steel.
- 40 x 40 mm square stainless steel legs allow you to raise the height of the unit from 850 to 920 mm.
- **Easy assembly in 3 minutes.**
- **Models with doors are shipped assembled.**
- **Optional:**
  - **Round legs (except for models with doors) (page 80).**
  - **Height adjustable legs from 950 to 1000 mm (page 83).**
  - **Door latches OPC00001**

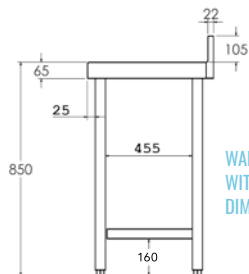

WALL-FACING TABLE WITH SHELF DIMENSIONS

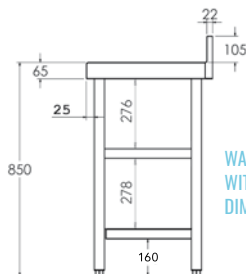

WALL-FACING TABLE WITH 2 SHELVES DIMENSIONS

FIXING SYSTEM  
**DURBLOCK**  
WORK TABLES



**COUNTERTOP THICKNESS 1.5 MM PAGE 83**



Total dimensions (mm)	Table with reinforcement frame	Table with 1 shelf	Table with 2 shelves	Table with doors
600 x 600 x 850	• FM061060	• FM161060	• FM260060	-
700 x 600 x 850	• FM061070	• FM161070	• FM260070	-
800 x 600 x 850	• FM060080	• FM160080	• FM260080	• FMP60080 SW
900 x 600 x 850	• FM060090	• FM160090	• FM260090	-
1000 x 600 x 850	• FM060100	• FM160100	• FM260100	• FMP60100 SL
1100 x 600 x 850	• FM060110	• FM160110	• FM260110	-
1200 x 600 x 850	• FM060120	• FM160120	• FM260120	• FMP60120 SL
1300 x 600 x 850	• FM060130	• FM160130	• FM260130	-
1400 x 600 x 850	• FM060140	• FM160140	• FM260140	• FMP60140 SL
1500 x 600 x 850	• FM060150	• FM160150	• FM260150	-
1600 x 600 x 850	• FM060160	• FM160160	• FM260160	• FMP60160 SL
1700 x 600 x 850	• FM060170	• FM160170	• FM260170	-
1800 x 600 x 850	• FM060180	• FM160180	• FM260180	• FMP60180 SL
1900 x 600 x 850	• FM060190	• FM160190	• FM260190	-
2000 x 600 x 850	• FM060200	• FM160200	• FM260200	• FMP60200 SL
2200 x 600 x 850	• FM060220	• FM160220	• FM260220	• FMP60220 SL
2400 x 600 x 850	• FM060240	• FM160240	• FM260240	• FMP60240 SL
2600 x 600 x 850	• FM060260	• FM160260	• FM260260	• FMP60260 SL
2800 x 600 x 850	• FM060280	• FM160280	• FM260280	• FMP60280 SL

• **SW** - Swinging Doors / **SL** - Sliding Doors



• **3-DAY** • **24/48-HOUR SHIPPING**

WWW.DISTFORM.COM / 59

# WORK TABLES 700 SERIES



**POSSIBILITY OF CUSTOMISING LENGTH**

Please indicate desired length, price and code of the next higher model (\*)



## CENTER TABLE

- AISI grade 304 brushed stainless steel (18/10) countertops with reinforcing omega brackets.
- 65 mm rounded edge, fully welded front panel.
- In the case of tables with a reinforcement frame, the crossbar can be placed in a central position.
- Tables with doors include: side and rear panels, with a middle shelf made of stainless steel.
- 40 x 40 mm square stainless steel legs allow you to raise the height of the unit from 850 to 920 mm.
- **Easy assembly in 3 minutes.**
- **Models with doors are shipped assembled.**
- **Optional:**  
**Round legs (except for models with doors) (page 80).**  
**Height adjustable legs from 950 to 1000 mm (page 83).**  
**Door latches OPC00001**

FIXING SYSTEM  
**DURBLOCK**  
WORK TABLES

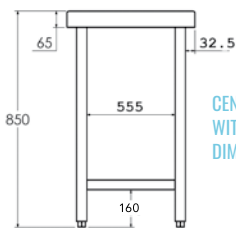

CENTER TABLE WITH SHELF DIMENSIONS

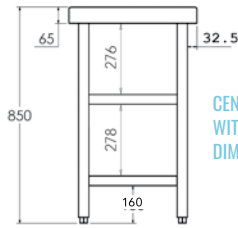

CENTER TABLE WITH 2 SHELVES DIMENSIONS

COUNTERTOP THICKNESS 1.5 MM PAGE 83



Total dimensions (mm)	Table with reinforcement frame	Table with 1 shelf	Table with 2 shelves	Table with doors	Table with pass-through sliding doors
600 x 700 x 850	• FC070060	• FC170060	• FC270060	-	-
700 x 700 x 850	• FC070070	• FC170070	• FC270070	-	-
800 x 700 x 850	• FC070080	• FC170080	• FC270080	• FCP70080 SW	-
900 x 700 x 850	• FC070090	• FC170090	• FC270090	-	-
1000 x 700 x 850	• FC070100	• FC170100	• FC270100	• FCP70100 SL	• FCPP7100
1100 x 700 x 850	• FC070110	• FC170110	• FC270110	-	-
1200 x 700 x 850	• FC070120	• FC170120	• FC270120	• FCP70120 SL	• FCPP7120
1300 x 700 x 850	• FC070130	• FC170130	• FC270130	-	-
1400 x 700 x 850	• FC070140	• FC170140	• FC270140	• FCP70140 SL	• FCPP7140
1500 x 700 x 850	• FC070150	• FC170150	• FC270150	-	-
1600 x 700 x 850	• FC070160	• FC170160	• FC270160	• FCP70160 SL	• FCPP7160
1700 x 700 x 850	• FC070170	• FC170170	• FC270170	-	-
1800 x 700 x 850	• FC070180	• FC170180	• FC270180	• FCP70180 SL	• FCPP7180
1900 x 700 x 850	• FC070190	• FC170190	• FC270190	-	-
2000 x 700 x 850	• FC070200	• FC170200	• FC270200	• FCP70200 SL	• FCPP7200
2200 x 700 x 850	• FC070220	• FC170220	• FC270220	• FCP70220 SL	• FCPP7220
2400 x 700 x 850	• FC070240	• FC170240	• FC270240	• FCP70240 SL	• FCPP7240
2600 x 700 x 850	• FC070260	• FC170260	• FC270260	• FCP70260 SL	• FCPP7260
2800 x 700 x 850	• FC070280	• FC170280	• FC270280	• FCP70280 SL	• FCPP7280

· SW - Swinging Doors / SL - Sliding Doors





**POSSIBILITY OF CUSTOMISING LENGTH**  
Please indicate desired length, price and code of the next higher model (\*)



## WALL-FACING TABLE

- AISI grade 304 brushed stainless steel (18/10) countertops with reinforcing omega brackets.
- 105 mm backsplash and 65 mm front panel with rounded safety edges, fully welded.
- In the case of tables with a reinforcement frame, the crossbar can be placed in a central position.
- Tables with doors include: side and rear panels, with a middle shelf made of stainless steel.
- 40 x 40 mm square stainless steel legs allow you to raise the height of the unit from 850 to 920 mm.
- **Easy assembly in 3 minutes.**
- **Models with doors are shipped assembled.**
- **Optional:**  
Round legs (except for models with doors) (page 80).  
Height adjustable legs from 950 to 1000 mm (page 83).  
Door latches OPC00001

FIXING SYSTEM  
**DURBLOCK**  
WORK TABLES

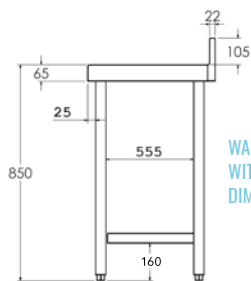

WALL-FACING TABLE  
WITH SHELF  
DIMENSIONS

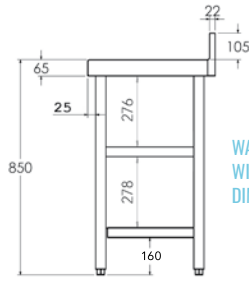

WALL-FACING TABLE  
WITH 2 SHELVES  
DIMENSIONS

COUNTERTOP THICKNESS 1.5 MM PAGE 83



Total dimensions (mm)	Table with reinforcement frame	Table with 1 shelf	Table with 2 shelves	Table with doors
600 x 700 x 850	• FM070060	• FM170060	• FM270060	-
700 x 700 x 850	• FM071070	• FM170070	• FM270070	-
800 x 700 x 850	• FM070080	• FM170080	• FM270080	• FMP70080 SW
900 x 700 x 850	• FM070090	• FM170090	• FM270090	-
1000 x 700 x 850	• FM070100	• FM170100	• FM270100	• FMP70100 SL
1100 x 700 x 850	• FM070110	• FM170110	• FM270110	-
1200 x 700 x 850	• FM070120	• FM170120	• FM270120	• FMP70120 SL
1300 x 700 x 850	• FM070130	• FM170130	• FM270130	-
1400 x 700 x 850	• FM070140	• FM170140	• FM270140	• FMP70140 SL
1500 x 700 x 850	• FM070150	• FM170150	• FM270150	-
1600 x 700 x 850	• FM070160	• FM170160	• FM270160	• FMP70160 SL
1700 x 700 x 850	• FM070170	• FM170170	• FM270170	-
1800 x 700 x 850	• FM070180	• FM170180	• FM270180	• FMP70180 SL
1900 x 700 x 850	• FM070190	• FM170190	• FM270190	-
2000 x 700 x 850	• FM070200	• FM170200	• FM270200	• FMP70200 SL
2200 x 700 x 850	• FM070220	• FM170220	• FM270220	• FMP70220 SL
2400 x 700 x 850	• FM070240	• FM170240	• FM270240	• FMP70240 SL
2600 x 700 x 850	• FM070260	• FM170260	• FM270260	• FMP70260 SL
2800 x 700 x 850	• FM070280	• FM170280	• FM270280	• FMP70280 SL

• **SW** - Swinging Doors / **SL** - Sliding Doors



• 3-DAY • 24/48-HOUR SHIPPING

# WORK TABLES 800 SERIES



**POSSIBILITY OF CUSTOMISING LENGTH**

Please indicate desired length, price and code of the next higher model (\*)



## CENTER TABLE

- AISI grade 304 brushed stainless steel (18/10) countertops with reinforcing omega brackets.
- 65 mm rounded edge, fully welded front panel.
- In the case of tables with a reinforcement frame, the crossbar can be placed in a central position.
- Tables with doors include: side and rear panels, with a middle shelf made of stainless steel.
- 40 x 40 mm square stainless steel legs allow you to raise the height of the unit from 850 to 920 mm.
- **Easy assembly in 3 minutes.**
- **Models with doors are shipped assembled.**
- **Optional:**
  - **Round legs (except for models with doors) (page 80).**
  - **Height adjustable legs from 950 to 1000 mm (page 83).**
  - **Door latches OPC0001**

FIXING SYSTEM  
**DURBLOCK**  
WORK TABLES

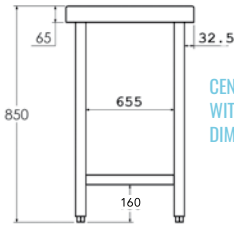

CENTER TABLE WITH SHELF DIMENSIONS

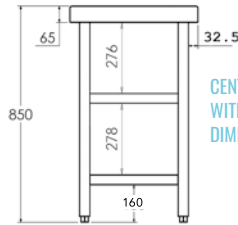

CENTER TABLE WITH 2 SHELVES DIMENSIONS

COUNTERTOP THICKNESS 1.5 MM PAGE 83



Total dimensions (mm)	Table with reinforcement frame	Table with 1 shelf	Table with 2 shelves	Table with doors	Table with pass-through sliding doors
600 x 800 x 850	• FC080060	• FC180060	• FC280060	-	-
700 x 800 x 850	• FC080070	• FC180070	• FC280070	-	-
800 x 800 x 850	• FC080080	• FC180080	• FC280080	• FCP80080 SW	-
900 x 800 x 850	• FC080090	• FC180090	• FC280090	-	-
1000 x 800 x 850	• FC080100	• FC180100	• FC280100	• FCP80100 SL	• FCPP8100
1100 x 800 x 850	• FC080110	• FC180110	• FC280110	-	-
1200 x 800 x 850	• FC080120	• FC180120	• FC280120	• FCP80120 SL	• FCPP8120
1300 x 800 x 850	• FC080130	• FC180130	• FC280130	-	-
1400 x 800 x 850	• FC080140	• FC180140	• FC280140	• FCP80140 SL	• FCPP8140
1500 x 800 x 850	• FC080150	• FC180150	• FC280150	-	-
1600 x 800 x 850	• FC080160	• FC180160	• FC280160	• FCP80160 SL	• FCPP8160
1700 x 800 x 850	• FC080170	• FC180170	• FC280170	-	-
1800 x 800 x 850	• FC080180	• FC180180	• FC280180	• FCP80180 SL	• FCPP8180
1900 x 800 x 850	• FC080190	• FC180190	• FC280190	-	-
2000 x 800 x 850	• FC080200	• FC180200	• FC280200	• FCP80200 SL	• FCPP8200
2200 x 800 x 850	• FC080220	• FC180220	• FC280220	• FCP80220 SL	• FCPP8220
2400 x 800 x 850	• FC080240	• FC180240	• FC280240	• FCP80240 SL	• FCPP8240
2600 x 800 x 850	• FC080260	• FC180260	• FC280260	• FCP80260 SL	• FCPP8260
2800 x 800 x 850	• FC080280	• FC180280	• FC280280	• FCP80280 SL	• FCPP8280

• **SW** - Swinging Doors / **SL** - Sliding Doors





**POSSIBILITY OF CUSTOMISING LENGTH**  
Please indicate desired length, price and code of the next higher model (\*)



## WALL-FACING TABLE

- AISI grade 304 brushed stainless steel (18/10) countertops with reinforcing omega brackets.
- 105 mm backsplash and 65 mm front panel with rounded safety edges, fully welded.
- In the case of tables with a reinforcement frame, the crossbar can be placed in a central position.
- Tables with doors include: side and rear panels, with a middle shelf made of stainless steel.
- 40 x 40 mm square stainless steel legs allow you to raise the height of the unit from 850 to 920 mm.
- **Easy assembly in 3 minutes.**
- **Models with doors are shipped assembled.**
- **Optional:**  
 Round legs (except for models with doors) (page 80).  
 Height adjustable legs from 950 to 1000 mm (page 83).  
 Door latches OPC0001

FIXING SYSTEM  
**DURBLOCK**  
WORK TABLES

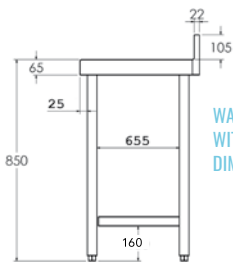

WALL-FACING TABLE  
WITH SHELF  
DIMENSIONS

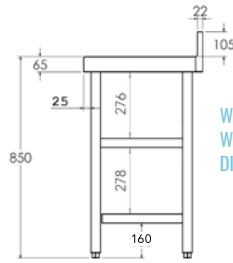

WALL-FACING TABLE  
WITH 2 SHELVES  
DIMENSIONS

COUNTERTOP THICKNESS 1.5 MM PAGE 83



Total dimensions (mm)	Table with reinforcement frame	Table with 1 shelf	Table with 2 shelves	Table with doors
600 x 800 x 850	• FM080060	• FM181060	• FM280060	-
700 x 800 x 850	• FM080070	• FM181070	• FM280070	-
800 x 800 x 850	• FM080080	• FM180080	• FM280080	• FMP80080 SW
900 x 800 x 850	• FM080090	• FM180090	• FM280090	-
1000 x 800 x 850	• FM080100	• FM180100	• FM280100	• FMP80100 SL
1100 x 800 x 850	• FM080110	• FM180110	• FM280110	-
1200 x 800 x 850	• FM080120	• FM180120	• FM280120	• FMP80120 SL
1300 x 800 x 850	• FM080130	• FM180130	• FM280130	-
1400 x 800 x 850	• FM080140	• FM180140	• FM280140	• FMP80140 SL
1500 x 800 x 850	• FM080150	• FM180150	• FM280150	-
1600 x 800 x 850	• FM080160	• FM180160	• FM280160	• FMP80160 SL
1700 x 800 x 850	• FM080170	• FM180170	• FM280170	-
1800 x 800 x 850	• FM080180	• FM180180	• FM280180	• FMP80180 SL
1900 x 800 x 850	• FM080190	• FM180190	• FM280190	-
2000 x 800 x 850	• FM080200	• FM180200	• FM280200	• FMP80200 SL
2200 x 800 x 850	• FM080220	• FM180220	• FM280220	• FMP80220 SL
2400 x 800 x 850	• FM080240	• FM180240	• FM280240	• FMP80240 SL
2600 x 800 x 850	• FM080260	• FM180260	• FM280260	• FMP80260 SL
2800 x 800 x 850	• FM080280	• FM180280	• FM280280	• FMP80280 SL

• **SW** - Swinging Doors / **SL** - Sliding Doors



• 3-DAY • 24/48-HOUR SHIPPING

# WORK TABLES 900 SERIES



**POSSIBILITY OF CUSTOMISING LENGTH**

Please indicate desired length, price and code of the next higher model (\*)



## CENTER TABLE

- AISI grade 304 brushed stainless steel (18/10) countertops with reinforcing omega brackets.
- 65 mm rounded edge, fully welded front panel.
- In the case of tables with a reinforcement frame, the crossbar can be placed in a central position.
- Tables with doors include: side and rear panels, with a middle shelf made of stainless steel.
- 40 x 40 mm square stainless steel legs allow you to raise the height of the unit from 850 to 920 mm.
- **Easy assembly in 3 minutes.**
- **Models with doors are shipped assembled.**
- **Optional:**  
 • **Round legs (except for models with doors) (page 80).**  
 • **Height adjustable legs from 950 to 1000 mm (page 83).**  
 • **Door latches OPC00001**

FIXING SYSTEM  
**DURBLOCK**  
WORK TABLES

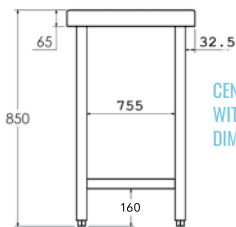

CENTER TABLE WITH SHELF DIMENSIONS

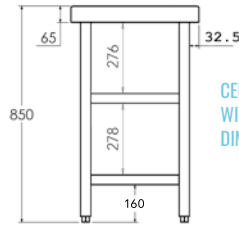

CENTER TABLE WITH 2 SHELVES DIMENSIONS

COUNTERTOP THICKNESS 1.5 MM PAGE 83



Total dimensions (mm)	Table with reinforcement frame	Table with 1 shelf	Table with 2 shelves	Table with doors	Table with pass-through sliding doors
600 x 900 x 850	• FC090060	• FC190060	• FC290060	-	-
700 x 900 x 850	• FC090070	• FC190070	• FC290070	-	-
800 x 900 x 850	• FC090080	• FC190080	• FC290080	• FCP90080 SW	-
900 x 900 x 850	• FC090090	• FC190090	• FC290090	-	-
1000 x 900 x 850	• FC090100	• FC190100	• FC290100	• FCP90100 SL	• FCPP9100
1100 x 900 x 850	• FC090110	• FC190110	• FC290110	-	-
1200 x 900 x 850	• FC090120	• FC190120	• FC290120	• FCP90120 SL	• FCPP9120
1300 x 900 x 850	• FC090130	• FC190130	• FC290130	-	-
1400 x 900 x 850	• FC090140	• FC190140	• FC290140	• FCP90140 SL	• FCPP9140
1500 x 900 x 850	• FC090150	• FC190150	• FC290150	-	-
1600 x 900 x 850	• FC090160	• FC190160	• FC290160	• FCP90160 SL	• FCPP9160
1700 x 900 x 850	• FC090170	• FC190170	• FC290170	-	-
1800 x 900 x 850	• FC090180	• FC190180	• FC290180	• FCP90180 SL	• FCPP9180
1900 x 900 x 850	• FC090190	• FC190190	• FC290190	-	-
2000 x 900 x 850	• FC090200	• FC190200	• FC290200	• FCP90200 SL	• FCPP9200
2200 x 900 x 850	• FC090220	• FC190220	• FC290220	• FCP90220 SL	• FCPP9220
2400 x 900 x 850	• FC090240	• FC190240	• FC290240	• FCP90240 SL	• FCPP9240
2600 x 900 x 850	• FC090260	• FC190260	• FC290260	• FCP90260 SL	• FCPP9260
2800 x 900 x 850	• FC090280	• FC190280	• FC290280	• FCP90280 SL	• FCPP9280

• SW - Swinging Doors / SL - Sliding Doors







**POSSIBILITY OF CUSTOMISING LENGTH**  
Please indicate desired length, price and code of the next higher model (\*)



## WALL-FACING TABLE

- AISI grade 304 brushed stainless steel (18/10) countertops with reinforcing omega brackets.
- 105 mm backsplash and 65 mm front panel with rounded safety edges, fully welded.
- In the case of tables with a reinforcement frame, the crossbar can be placed in a central position.
- Tables with doors include: side and rear panels, with a middle shelf made of stainless steel.
- 40 x 40 mm square stainless steel legs allow you to raise the height of the unit from 850 to 920 mm.
- **Easy assembly in 3 minutes.**
- **Models with doors are shipped assembled.**
- **Optional:**  
Round legs (except for models with doors) (page 80).  
Height adjustable legs from 950 to 1000 mm (page 83).  
Door latches OPC00001

FIXING SYSTEM  
**DURBLOCK**  
WORK TABLES

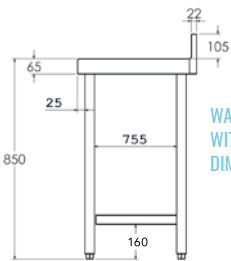

WALL-FACING TABLE  
WITH SHELF  
DIMENSIONS

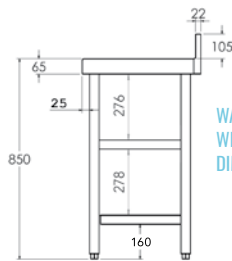

WALL-FACING TABLE  
WITH 2 SHELVES  
DIMENSIONS

COUNTERTOP THICKNESS 1.5 MM PAGE 83



Total dimensions (mm)	Table with reinforcement frame	Table with 1 shelf	Table with 2 shelves	Table with doors
600 x 900 x 850	• FM090060	• FM190060	• FM290060	-
700 x 900 x 850	• FM090070	• FM191070	• FM290070	-
800 x 900 x 850	• FM090080	• FM190080	• FM290080	• FMP90080 SW
900 x 900 x 850	• FM090090	• FM190090	• FM290090	-
1000 x 900 x 850	• FM090100	• FM190100	• FM290100	• FMP90100 SL
1100 x 900 x 850	• FM090110	• FM190110	• FM290110	-
1200 x 900 x 850	• FM090120	• FM190120	• FM290120	• FMP90120 SL
1300 x 900 x 850	• FM090130	• FM190130	• FM290130	-
1400 x 900 x 850	• FM090140	• FM190140	• FM290140	• FMP90140 SL
1500 x 900 x 850	• FM090150	• FM190150	• FM290150	-
1600 x 900 x 850	• FM090160	• FM190160	• FM290160	• FMP90160 SL
1700 x 900 x 850	• FM090170	• FM190170	• FM290170	-
1800 x 900 x 850	• FM090180	• FM190180	• FM290180	• FMP90180 SL
1900 x 900 x 850	• FM090190	• FM190190	• FM290190	-
2000 x 900 x 850	• FM090200	• FM190200	• FM290200	• FMP90200 SL
2200 x 900 x 850	• FM090220	• FM190220	• FM290220	• FMP90220 SL
2400 x 900 x 850	• FM090240	• FM190240	• FM290240	• FMP90240 SL
2600 x 900 x 850	• FM090260	• FM190260	• FM290260	• FMP90260 SL
2800 x 900 x 850	• FM090280	• FM190280	• FM290280	• FMP90280 SL

• **SW** - Swinging Doors / **SL** - Sliding Doors



• **3-DAY** • **24/48-HOUR SHIPPING**

# WORK TABLES WITH DOORS AND DRAWERS 600/700 SERIES



**POSSIBILITY OF CUSTOMISING LENGTH**

Please indicate desired length, price and code of the next higher model (•)



**CENTER TABLE**

- Made of AISI 304 stainless steel (18/10).
- Countertops and shelves have reinforcing omega brackets.
- 65 mm rounded edge, fully welded front panel.
- Shelf with very sturdy supports.
- 40 x 40 mm square stainless steel legs allow you to raise the height of the unit from 850 to 920 mm.
- Suspended sliding doors glide very smoothly. This design does not use bottom runners, facilitating cleaning.
- Module with 3 drawers included.
- Drawers have 290 x 435 x 109 mm of useful space.

**Optional:**

Height adjustable legs from 950 to 1000 mm (page 83).

CENTER TABLE WITH DOORS AND DRAWERS DIMENSIONS

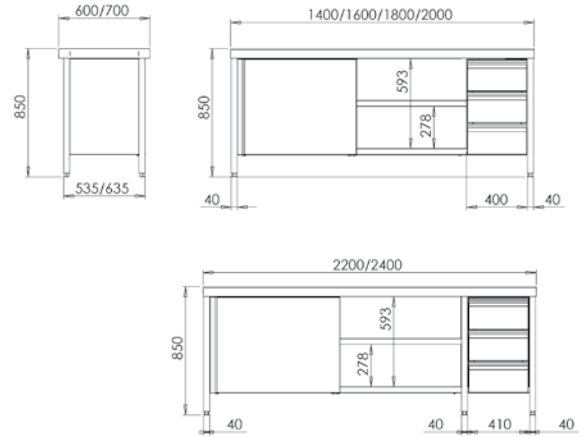

COUNTERTOP THICKNESS 1.5 MM PAGE 83



**600 SERIES**

Total dimensions (mm)	Sliding doors and right-side drawers	Sliding doors and left-side drawers
1400 x 600 x 850	• FCPBD614	• FCPBI614
1600 x 600 x 850	• FCPBD616	• FCPBI616
1800 x 600 x 850	• FCPBD618	• FCPBI618
2000 x 600 x 850	• FCPBD620	• FCPBI620
2200 x 600 x 850	• FCPBD622	• FCPBI622
2400 x 600 x 850	• FCPBD624	• FCPBI624

**700 SERIES**

Total dimensions (mm)	Sliding doors and right-side drawers	Sliding doors and left-side drawers
1400 x 700 x 850	• FCPBD714	• FCPBI714
1600 x 700 x 850	• FCPBD716	• FCPBI716
1800 x 700 x 850	• FCPBD718	• FCPBI718
2000 x 700 x 850	• FCPBD720	• FCPBI720
2200 x 700 x 850	• FCPBD722	• FCPBI722
2400 x 700 x 850	• FCPBD724	• FCPBI724



**POSSIBILITY OF CUSTOMISING LENGTH**

Please indicate desired length, price and code of the next higher model (\*)

**WALL-FACING TABLE**

- Made of AISI 304 stainless steel (18/10).
- Countertops and shelves have reinforcing omega brackets.
- 105 mm backsplash and 65 mm front panel with rounded safety edges, fully welded.
- Shelf with very sturdy supports.
- 40 x 40 mm square stainless steel legs allow you to raise the height of the unit from 850 to 920 mm.
- Suspended sliding doors glide very smoothly. This design does not use bottom runners, facilitating cleaning.
- Module with 3 drawers included.
- Drawers have 290 x 435 x 109 mm of useful space.
- **Optional:**  
Height adjustable legs from 950 to 1000 mm (page 83).

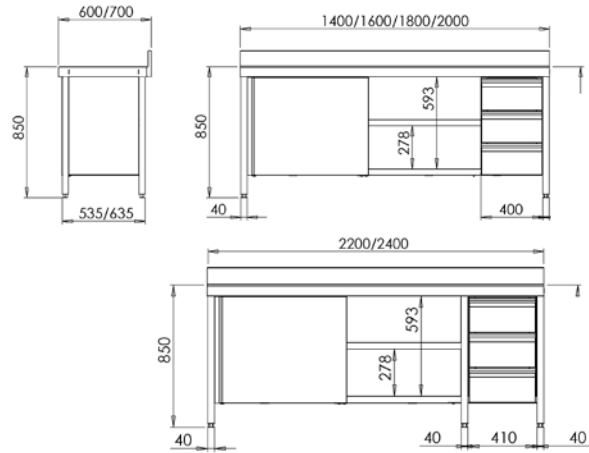
**WALL-FACING TABLE WITH DOORS AND DRAWERS DIMENSIONS****COUNTERTOP THICKNESS 1.5 MM PAGE 83**

FIXING SYSTEM  
**DURBLOCK**  
WORK TABLES

**600 SERIES**

Total dimensions (mm)	Sliding doors and right-side drawers	Sliding doors and left-side drawers
1400 x 600 x 850	• FMPBD614	• FMPBI614
1600 x 600 x 850	• FMPBD616	• FMPBI616
1800 x 600 x 850	• FMPBD618	• FMPBI618
2000 x 600 x 850	• FMPBD620	• FMPBI620
2200 x 600 x 850	• FMPBD622	• FMPBI622
2400 x 600 x 850	• FMPBD624	• FMPBI624

**700 SERIES**

Total dimensions (mm)	Sliding doors and right-side drawers	Sliding doors and left-side drawers
1400 x 700 x 850	• FMPBD714	• FMPBI714
1600 x 700 x 850	• FMPBD716	• FMPBI716
1800 x 700 x 850	• FMPBD718	• FMPBI718
2000 x 700 x 850	• FMPBD720	• FMPBI720
2200 x 700 x 850	• FMPBD722	• FMPBI722
2400 x 700 x 850	• FMPBD724	• FMPBI724



# WORK TABLES WITH BASIN 600/700 SERIES



**POSSIBILITY OF CUSTOMISING LENGTH**

Please indicate desired length, price and code of the next higher model (\*)



## WALL-FACING TABLE WITH BASIN AND REINFORCEMENT FRAME

- Built with AISI grade 304 stainless steel (18/10) countertops.
- Reinforcing omega brackets are provided to offer better support.
- 105mm backsplash and 65mm front panel with rounded safety edges, fully welded.
- 500 x 400 x 250 mm welded basin.
- 40 x 40 mm square stainless steel legs allow you to raise the height of the unit from 850 to 920 mm.
- **Easy assembly in 3 minutes.**
- **Optional:**
  - Round legs (page 82).
  - Height adjustable legs from 950 to 1000 mm (page 83).

FIXING SYSTEM  
**DURBLOCK**  
WORK TABLES



COUNTERTOP THICKNESS 1.5 MM PAGE 83

RELATED PRODUCTS

Taps page 43



**600 SERIES**

Total dimensions (mm)	Right basin	Left basin	Center basin
1000 x 600 x 850	• FCDR6010	• FCIR6010	-
1200 x 600 x 850	• FCDR6012	• FCIR6012	-
1400 x 600 x 850	• FCDR6014	• FCIR6014	-
1500 x 600 x 850	• FCDR6015	• FCIR6015	• FCCR6015
1600 x 600 x 850	• FCDR6016	• FCIR6016	• FCCR6016
1800 x 600 x 850	• FCDR6018	• FCIR6018	• FCCR6018
2000 x 600 x 850	• FCDR6020	• FCIR6020	• FCCR6020
2200 x 600 x 850	• FCDR6022	• FCIR6022	-
2400 x 600 x 850	• FCDR6024	• FCIR6024	-
2600 x 600 x 850	• FCDR6026	• FCIR6026	-
2800 x 600 x 850	• FCDR6028	• FCIR6028	-

**700 SERIES**

Total dimensions (mm)	Right basin	Left basin	Center basin
1000 x 700 x 850	• FCDR7010	• FCIR7010	-
1200 x 700 x 850	• FCDR7012	• FCIR7012	-
1400 x 700 x 850	• FCDR7014	• FCIR7014	-
1500 x 700 x 850	• FCDR7015	• FCIR7015	• FCCR7015
1600 x 700 x 850	• FCDR7016	• FCIR7016	• FCCR7016
1800 x 700 x 850	• FCDR7018	• FCIR7018	• FCCR7018
2000 x 700 x 850	• FCDR7020	• FCIR7020	• FCCR7020
2200 x 700 x 850	• FCDR7022	• FCIR7022	-
2400 x 700 x 850	• FCDR7024	• FCIR7024	-
2600 x 700 x 850	• FCDR7026	• FCIR7026	-
2800 x 700 x 850	• FCDR7028	• FCIR7028	-



# WORK TABLES WITH BASIN AND SHELF 600/700 SERIES



**POSSIBILITY OF CUSTOMISING LENGTH**  
Please indicate desired length, price and code of the next higher model (\*)



## WALL-FACING TABLE WITH BASIN AND SHELF

- Built with AISI grade 304 stainless steel (18/10) countertops.
- Reinforcing omega brackets are provided to offer better support.
- 105 mm backsplash and 65 mm front panel with rounded safety edges, fully welded.
- 500 x 400 x 250 mm welded basin.
- 40 x 40 mm square stainless steel legs allow you to raise the height of the unit from 850 to 920 mm.
- **Easy assembly in 3 minutes.**
- **Optional:**  
Round legs (page 82).  
Height adjustable legs from 950 to 1000 mm (page 83).

FIXING SYSTEM  
**DURBLOCK**  
WORK TABLES



COUNTERTOP THICKNESS 1.5 MM PAGE 83

RELATED PRODUCTS

**Taps** page 43



### 600 SERIES

Total dimensions (mm)	Right basin	Left basin	Center basin
1000 x 600 x 850	• FCDE6010	• FCIE6010	-
1200 x 600 x 850	• FCDE6012	• FCIE6012	-
1400 x 600 x 850	• FCDE6014	• FCIE6014	-
1500 x 600 x 850	• FCDE6015	• FCIE6015	• FCCE6015
1600 x 600 x 850	• FCDE6016	• FCIE6016	• FCCE6016
1800 x 600 x 850	• FCDE6018	• FCIE6018	• FCCE6018
2000 x 600 x 850	• FCDE6020	• FCIE6020	• FCCE6020
2200 x 600 x 850	• FCDE6022	• FCIE6022	-
2400 x 600 x 850	• FCDE6024	• FCIE6024	-
2600 x 600 x 850	• FCDE6026	• FCIE6026	-
2800 x 600 x 850	• FCDE6028	• FCIE6028	-

### 700 SERIES

Total dimensions (mm)	Right basin	Left basin	Center basin
1000 x 700 x 850	• FCDE7010	• FCIE7010	-
1200 x 700 x 850	• FCDE7012	• FCIE7012	-
1400 x 700 x 850	• FCDE7014	• FCIE7014	-
1500 x 700 x 850	• FCDE7015	• FCIE7015	• FCCE7015
1600 x 700 x 850	• FCDE7016	• FCIE7016	• FCCE7016
1800 x 700 x 850	• FCDE7018	• FCIE7018	• FCCE7018
2000 x 700 x 850	• FCDE7020	• FCIE7020	• FCCE7020
2200 x 700 x 850	• FCDE7022	• FCIE7022	-
2400 x 700 x 850	• FCDE7024	• FCIE7024	-
2600 x 700 x 850	• FCDE7026	• FCIE7026	-
2800 x 700 x 850	• FCDE7028	• FCIE7028	-



• 3-DAY • 24/48-HOUR SHIPPING

# WORK TABLES WITH NO-DRIP EDGE AND BASIN 600/700 SERIES

## WALL-FACING TABLE WITH NO-DRIP EDGE, BASIN, AND REINFORCEMENT FRAME

RELATED PRODUCTS

[Taps](#) page 43

- Built with AISI grade 304 brushed stainless steel (18/10) countertops.
- No-drip edge.
- Reinforcing omega brackets are provided to offer better support.
- 105 mm backsplash and 65 mm front panel with rounded safety edges, fully welded.
- 500 x 400 x 250 mm welded basin.
- 40 x 40 mm square stainless steel legs allow you to raise the height of the unit from 850 to 920 mm.
- **Easy assembly in 3 minutes.**
- **Optional:**
  - [Round legs \(page 82\).](#)
  - [Height adjustable legs from 950 to 1000 mm \(page 83\).](#)

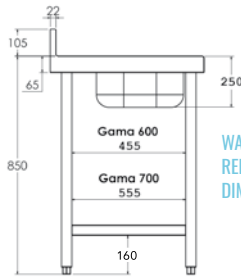

WALL-FACING TABLE WITH REINFORCEMENT FRAME DIMENSIONS



### 600 SERIES

Total dimensions (mm)	Right basin	Left basin	Center basin
1000 x 600 x 850	• FCDRS610	• FCIRS610	-
1200 x 600 x 850	• FCDRS612	• FCIRS612	-
1400 x 600 x 850	• FCDRS614	• FCIRS614	-
1600 x 600 x 850	• FCDRS616	• FCIRS616	• FCCRS616
1800 x 600 x 850	• FCDRS618	• FCIRS618	• FCCRS618
2000 x 600 x 850	• FCDRS620	• FCIRS620	• FCCRS620

### 700 SERIES

Total dimensions (mm)	Right basin	Left basin	Center basin
1000 x 700 x 850	• FCDRS710	• FCIRS710	-
1200 x 700 x 850	• FCDRS712	• FCIRS712	-
1400 x 700 x 850	• FCDRS714	• FCIRS714	-
1600 x 700 x 850	• FCDRS716	• FCIRS716	• FCCRS716
1800 x 700 x 850	• FCDRS718	• FCIRS718	• FCCRS718
2000 x 700 x 850	• FCDRS720	• FCIRS720	• FCCRS720



## WALL-FACING TABLE WITH NO-DRIP EDGE, BASIN, AND SHELF

- Built with AISI grade 304 brushed stainless steel (18/10) countertops.
- No-drip edge.
- Reinforcing omega brackets are provided to offer better support.
- 105 mm backsplash and 65 mm front panel with rounded safety edges, fully welded.
- Stainless steel shelf.
- 500 x 400 x 250 mm welded basin.
- 40 x 40 mm square stainless steel legs allow you to raise the height of the unit from 850 to 920 mm.
- **Easy assembly in 3 minutes.**
- **Optional:**  
[Round legs \(page 82\).](#)  
[Height adjustable legs from 950 to 1000 mm \(page 83\).](#)

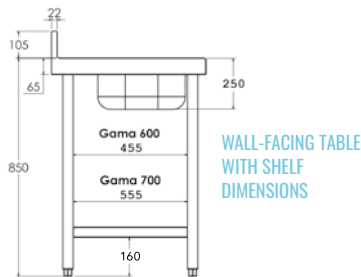

### 600 SERIES

Total dimensions (mm)	Right basin	Left basin	Center basin
1000 x 600 x 850	• FCDES610	• FCIES610	-
1200 x 600 x 850	• FCDES612	• FCIES612	-
1400 x 600 x 850	• FCDES614	• FCIES614	-
1600 x 600 x 850	• FCDES616	• FCIES616	• FCCES616
1800 x 600 x 850	• FCDES618	• FCIES618	• FCCES618
2000 x 600 x 850	• FCDES620	• FCIES620	• FCCES620

### 700 SERIES

Total dimensions (mm)	Right basin	Left basin	Center basin
1000 x 700 x 850	• FCDES710	• FCIES710	-
1200 x 700 x 850	• FCDES712	• FCIES712	-
1400 x 700 x 850	• FCDES714	• FCIES714	-
1600 x 700 x 850	• FCDES716	• FCIES716	• FCCES716
1800 x 700 x 850	• FCDES718	• FCIES718	• FCCES718
2000 x 700 x 850	• FCDES720	• FCIES720	• FCCES720

# WORK TABLES WITH BASIN AND DOORS 600/700 SERIES



**POSSIBILITY OF CUSTOMISING LENGTH**

Please indicate desired length, price and code of the next higher model (\*)



## WALL-FACING TABLE WITH BASIN AND SLIDING DOORS

- Built with AISI grade 304 brushed stainless steel (18/10) countertops.
- Reinforcing omega brackets are provided to offer better support.
- 105 mm backsplash and 65 mm front panel with rounded safety edges, fully welded.
- 500 x 400 x 250 mm welded basin.
- Suspended sliding doors glide very smoothly. This design does not use bottom runners, facilitating cleaning.
- 40 x 40 mm square stainless steel legs allow you to raise the height of the unit from 850 to 920 mm.
- Open rear section to facilitate access to installations.
- **Optional:**  
[Height adjustable legs from 950 to 1000 mm \(page 83\).](#)  
[Door latches OPC00001](#)

FIXING SYSTEM  
**DURBLOCK**  
WORK TABLES



COUNTERTOP THICKNESS 1.5 MM PAGE 83

RELATED PRODUCTS

[Taps page 43](#)



**600 SERIES**

Total dimensions (mm)	Right basin	Left basin	Center basin
1000 x 600 x 850	• FPCD6010	• FPCI6010	-
1200 x 600 x 850	• FPCD6012	• FPCI6012	-
1400 x 600 x 850	• FPCD6014	• FPCI6014	-
1600 x 600 x 850	• FPCD6016	• FPCI6016	• FPCC6016
1800 x 600 x 850	• FPCD6018	• FPCI6018	• FPCC6018
2000 x 600 x 850	• FPCD6020	• FPCI6020	• FPCC6020
2200 x 600 x 850	• FPCD6022	• FPCI6022	-
2400 x 600 x 850	• FPCD6024	• FPCI6024	-
2600 x 600 x 850	• FPCD6026	• FPCI6026	-
2800 x 600 x 850	• FPCD6028	• FPCI6028	-

**700 SERIES**

Total dimensions (mm)	Right basin	Left basin	Center basin
1000 x 700 x 850	• FPCD7010	• FPCI7010	-
1200 x 700 x 850	• FPCD7012	• FPCI7012	-
1400 x 700 x 850	• FPCD7014	• FPCI7014	-
1600 x 700 x 850	• FPCD7016	• FPCI7016	• FPCC7016
1800 x 700 x 850	• FPCD7018	• FPCI7018	• FPCC7018
2000 x 700 x 850	• FPCD7020	• FPCI7020	• FPCC7020
2200 x 700 x 850	• FPCD7022	• FPCI7022	-
2400 x 700 x 850	• FPCD7024	• FPCI7024	-
2600 x 700 x 850	• FPCD7026	• FPCI7026	-
2800 x 700 x 850	• FPCD7028	• FPCI7028	-





# TABLES WITH BASIN, DOORS, AND DRAWERS 600/700 SERIES



**POSSIBILITY OF CUSTOMISING LENGTH**  
Please indicate desired length, price and code of the next higher model (\*)



## WALL-FACING TABLE WITH BASIN, SLIDING DOORS, AND DRAWERS

- Built with AISI grade 304 brushed stainless steel (18/10) countertops.
- Reinforcing omega brackets are provided to offer better support.
- 105 mm backsplash and 65 mm front panel with rounded safety edges, fully welded.
- 500 x 400 x 250 mm welded basin.
- Suspended sliding doors glide very smoothly. This design does not use bottom runners, facilitating cleaning.
- 40 x 40 mm square stainless steel legs allow you to raise the height of the unit from 850 to 920 mm.
- Module with 3 drawers included.
- Drawers have 290 x 435 x 109 mm of useful space.
- Open rear section to facilitate access to installations
- **Optional:**  
Height adjustable legs from 950 to 1000 mm (page 83).  
Door latches OPC00001

FIXING SYSTEM  
**DURBLOCK**  
WORK TABLES



COUNTERTOP THICKNESS 1.5 MM PAGE 83

RELATED PRODUCTS

Taps page 43



600 SERIES

Total dimensions (mm)	Right basin	Left basin
1400 x 600 x 850	• FCDPB614	• FCIPB614
1600 x 600 x 850	• FCDPB616	• FCIPB616
1800 x 600 x 850	• FCDPB618	• FCIPB618
2000 x 600 x 850	• FCDPB620	• FCIPB620
2200 x 600 x 850	• FCDPB622	• FCIPB622
2400 x 600 x 850	• FCDPB624	• FCIPB624

700 SERIES

Total dimensions (mm)	Right basin	Left basin
1400 x 700 x 850	• FCDPB714	• FCIPB714
1600 x 700 x 850	• FCDPB716	• FCIPB716
1800 x 700 x 850	• FCDPB718	• FCIPB718
2000 x 700 x 850	• FCDPB720	• FCIPB720
2200 x 700 x 850	• FCDPB722	• FCIPB722
2400 x 700 x 850	• FCDPB724	• FCIPB724



# CENTER AND WALL-FACING COUNTERTOPS 600/700 SERIES



**POSSIBILITY OF CUSTOMISING LENGTH**

Please indicate desired length, price and code of the next higher model (\*)



## COUNTERTOP

- Built with AISI grade 304 brushed stainless steel (18/10).
- With reinforcing omega brackets.
- 105 mm backsplash and 65 mm front panel with rounded safety edges, fully welded.

COUNTERTOP THICKNESS 1.5 MM PAGE 83

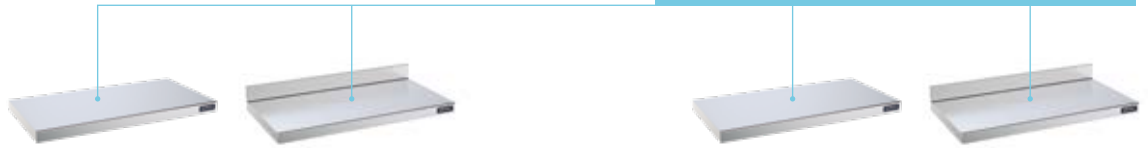

### 600 SERIES

Total dimensions (mm)	Center countertop	Wall-facing countertop
400 x 600	• F0080301	• F0080351
500 x 600	• F0080302	• F0080352
600 x 600	• F0080303	• F0080353
700 x 600	• F0080419	• F0080420
800 x 600	• F0080304	• F0080354
900 x 600	• F0080401	• F0080403
1000 x 600	• F0080305	• F0080355
1100 x 600	• F0080306	• F0080356
1200 x 600	• F0080307	• F0080357
1300 x 600	• F0080308	• F0080358
1400 x 600	• F0080309	• F0080359
1500 x 600	• F0080310	• F0080360
1600 x 600	• F0080311	• F0080361
1700 x 600	• F0080312	• F0080362
1800 x 600	• F0080313	• F0080363
1900 x 600	• F0080314	• F0080364
2000 x 600	• F0080315	• F0080365
2100 x 600	• F0080316	• F0080366
2200 x 600	• F0080317	• F0080367
2300 x 600	• F0080318	• F0080368
2400 x 600	• F0080319	• F0080369
2500 x 600	• F0080320	• F0080370
2600 x 600	• F0080321	• F0080371
2700 x 600	• F0080322	• F0080372
2800 x 600	• F0080323	• F0080373

### 700 SERIES

Total dimensions (mm)	Center countertop	Wall-facing countertop
400 x 700	• F0080326	• F0080376
500 x 700	• F0080327	• F0080377
600 x 700	• F0080328	• F0080378
700 x 700	• F0080421	• F0080422
800 x 700	• F0080329	• F0080379
900 x 700	• F0080402	• F0080404
1000 x 700	• F0080330	• F0080380
1100 x 700	• F0080331	• F0080381
1200 x 700	• F0080332	• F0080382
1300 x 700	• F0080333	• F0080383
1400 x 700	• F0080334	• F0080384
1500 x 700	• F0080335	• F0080385
1600 x 700	• F0080336	• F0080386
1700 x 700	• F0080337	• F0080387
1800 x 700	• F0080338	• F0080388
1900 x 700	• F0080339	• F0080389
2000 x 700	• F0080340	• F0080390
2100 x 700	• F0080341	• F0080391
2200 x 700	• F0080342	• F0080392
2300 x 700	• F0080343	• F0080393
2400 x 700	• F0080344	• F0080394
2500 x 700	• F0080345	• F0080395
2600 x 700	• F0080346	• F0080396
2700 x 700	• F0080347	• F0080397
2800 x 700	• F0080348	• F0080398



# WALL-FACING COUNTERTOP WITH BASIN 600/700 SERIES



**POSSIBILITY OF CUSTOMISING LENGTH**  
Please indicate desired length, price and code of the next higher model (\*)

## COUNTERTOP WITH BASIN

- Built with AISI grade 304 brushed stainless steel (18/10).
- With reinforcing omega brackets.
- 105 mm backsplash and 65 mm front panel with rounded safety edges, fully welded.
- 500 x 400 x 250 mm welded basin.

RELATED PRODUCTS

Taps page 43

COUNTERTOP THICKNESS 1.5 MM PAGE 83



### 600 SERIES

Total dimensions (mm)	Countertop with right basin	Countertop with left basin	Countertop with center basin
1000 x 600	• FEC1006D	• FEC1006I	• FEC1006C
1200 x 600	• FEC1206D	• FEC1206I	• FEC1206C
1400 x 600	• FEC1406D	• FEC1406I	• FEC1406C
1500 x 600	• FEC1506D	• FEC1506I	• FEC1506C
1600 x 600	• FEC1606D	• FEC1606I	• FEC1606C
1800 x 600	• FEC1806D	• FEC1806I	• FEC1806C
2000 x 600	• FEC2006D	• FEC2006I	• FEC2006C
2200 x 600	• FEC2206D	• FEC2206I	• FEC2206C
2400 x 600	• FEC2406D	• FEC2406I	• FEC2406C
2600 x 600	• FEC2606D	• FEC2606I	• FEC2606C
2800 x 600	• FEC2806D	• FEC2806I	• FEC2806C

### 700 SERIES

Total dimensions (mm)	Countertop with right basin	Countertop with left basin	Countertop with center basin
1000 x 700	• FEC1007D	• FEC1007I	• FEC1007C
1200 x 700	• FEC1207D	• FEC1207I	• FEC1207C
1400 x 700	• FEC1407D	• FEC1407I	• FEC1407C
1500 x 700	• FEC1507D	• FEC1507I	• FEC1507C
1600 x 700	• FEC1607D	• FEC1607I	• FEC1607C
1800 x 700	• FEC1807D	• FEC1807I	• FEC1807C
2000 x 700	• FEC2007D	• FEC2007I	• FEC2007C
2200 x 700	• FEC2207D	• FEC2207I	• FEC2207C
2400 x 700	• FEC2407D	• FEC2407I	• FEC2407C
2600 x 700	• FEC2607D	• FEC2607I	• FEC2607C
2800 x 700	• FEC2807D	• FEC2807I	• FEC2807C

## WALL-FACING COUNTERTOP SUPPORTS

- Made of AISI grade 304 stainless steel (18/10).
- For the 600 / 700 Series.
- Price per unit.



Model	Code
Support with leg	• F0020309
Wall mount	• F0020310



• 3-DAY • 24/48-HOUR SHIPPING

WORK TABLES

# 600-MM-HIGH TABLES 600/700 SERIES



**POSSIBILITY OF CUSTOMISING LENGTH**

Please indicate desired length, price and code of the next higher model (\*)

## 600-MM-HIGH TABLES

- **Designed to support cooking appliances at a working height of 850-900 mm.**
- Countertop and shelves made of AISI 304 brushed stainless steel (18/10) with reinforcing omega brackets.
- 105 mm backsplash (wall-facing models) and 65 mm front panel with rounded safety edges, fully welded.
- 40 x 40 mm square stainless steel legs allow you to raise the height of the unit from 600 to 650 mm.
- **Easy assembly in 3 minutes.**
- **Optional:**  
Round legs (page 82).

FIXING SYSTEM  
**DURBLOCK**  
WORK TABLES



COUNTERTOP THICKNESS 1.5 MM PAGE 83

RELATED PRODUCTS

**PACK OF 4 OR 6 CASTORS** page 82



**600 SERIES**

**CENTER TABLE**

**WALL-FACING TABLE**

Total dimensions (mm)	CENTER TABLE		WALL-FACING TABLE	
	With reinforcement frame	With 1 shelf	With reinforcement frame	With 1 shelf
600 x 600 x 600	• FC066060	• FC166060	• FM066060	• FM166060
700 x 600 x 600	• FC066070	• FC166070	• FM066070	• FM166070
800 x 600 x 600	• FC066080	• FC166080	• FM066080	• FM166080
900 x 600 x 600	• FC066090	• FC166090	• FM066090	• FM166090
1000 x 600 x 600	• FC066100	• FC166100	• FM066100	• FM166100
1100 x 600 x 600	• FC066110	• FC166110	• FM066110	• FM166110
1200 x 600 x 600	• FC066120	• FC166120	• FM066120	• FM166120
1300 x 600 x 600	• FC066130	• FC166130	• FM066130	• FM166130
1400 x 600 x 600	• FC066140	• FC166140	• FM066140	• FM166140
1500 x 600 x 600	• FC066150	• FC166150	• FM066150	• FM166150
1600 x 600 x 600	• FC066160	• FC166160	• FM066160	• FM166160
1700 x 600 x 600	• FC066170	• FC166170	• FM066170	• FM166170
1800 x 600 x 600	• FC066180	• FC166180	• FM066180	• FM166180
1900 x 600 x 600	• FC066190	• FC166190	• FM066190	• FM166190
2000 x 600 x 600	• FC066200	• FC166200	• FM066200	• FM166200
2200 x 600 x 600	• FC066220	• FC166220	• FM066220	• FM166220
2400 x 600 x 600	• FC066240	• FC166240	• FM066240	• FM166240
2600 x 600 x 600	• FC066260	• FC166260	• FM066260	• FM166260
2800 x 600 x 600	• FC066280	• FC166280	• FM066280	• FM166280





**POSSIBILITY OF CUSTOMISING LENGTH**

Please indicate desired length, price and code of the next higher model (\*)

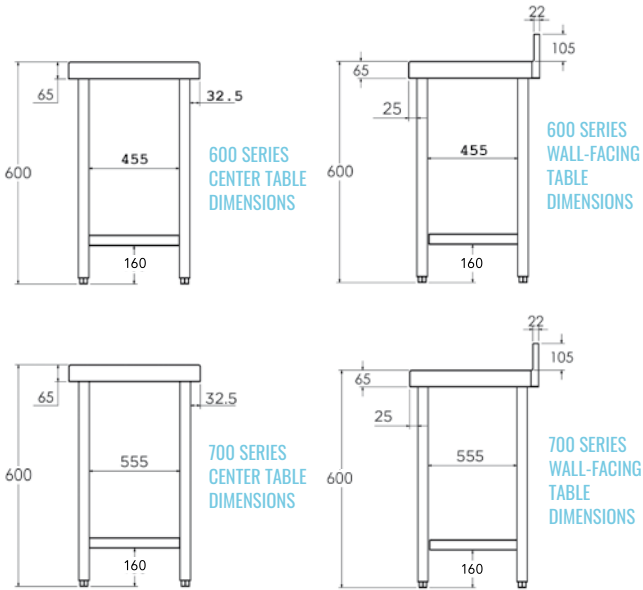

FIXING SYSTEM  
**DURBLOCK**  
WORK TABLES



COUNTERTOP THICKNESS 1.5 MM PAGE 83

RELATED PRODUCTS

PACK OF 4 OR 6 CASTORS page 82



**700 SERIES**

**CENTER TABLE**

**WALL-FACING TABLE**

Total dimensions (mm)	CENTER TABLE		WALL-FACING TABLE	
	With reinforcement frame	With 1 shelf	With reinforcement frame	With 1 shelf
600 x 700 x 600	• FC067060	• FC167060	• FM067060	• FM167060
700 x 700 x 600	• FC067070	• FC167070	• FM067070	• FM167070
800 x 700 x 600	• FC067080	• FC167080	• FM067080	• FM167080
900 x 700 x 600	• FC067090	• FC167090	• FM067090	• FM167090
1000 x 700 x 600	• FC067100	• FC167100	• FM067100	• FM167100
1100 x 700 x 600	• FC067110	• FC167110	• FM067110	• FM167110
1200 x 700 x 600	• FC067120	• FC167120	• FM067120	• FM167120
1300 x 700 x 600	• FC067130	• FC167130	• FM067130	• FM167130
1400 x 700 x 600	• FC067140	• FC167140	• FM067140	• FM167140
1500 x 700 x 600	• FC067150	• FC167150	• FM067150	• FM167150
1600 x 700 x 600	• FC067160	• FC167160	• FM067160	• FM167160
1700 x 700 x 600	• FC067170	• FC167170	• FM067170	• FM167170
1800 x 700 x 600	• FC067180	• FC167180	• FM067180	• FM167180
1900 x 700 x 600	• FC067190	• FC167190	• FM067190	• FM167190
2000 x 700 x 600	• FC067200	• FC167200	• FM067200	• FM167200
2200 x 700 x 600	• FC067220	• FC167220	• FM067220	• FM167220
2400 x 700 x 600	• FC067240	• FC167240	• FM067240	• FM167240
2600 x 700 x 600	• FC067260	• FC167260	• FM067260	• FM167260
2800 x 700 x 600	• FC067280	• FC167280	• FM067280	• FM167280



• 3-DAY • 24/48-HOUR SHIPPING

# TABLES WITH DRAWERS, AND CORNER TABLES

## WALL-FACING TABLE WITH DRAWERS

- Made of AISI 304 stainless steel (18/10).
- 40 x 40 mm square stainless steel legs allow you to raise the height of the unit from 850 to 920 mm.
- Drawers measure 290 x 435 x 110 mm of useful space.
- **Optional:**  
Height adjustable legs from 950 to 1000 mm (page 83).

Total dimensions (mm)	Drawers	Code
500 x 600 x 850	3	• FMB50600
500 x 700 x 850	3	• FMB50700

FIXING SYSTEM  
**DURBLOCK**  
WORK TABLES



## CORNER TABLES

- Countertop and shelf made of AISI 304 stainless steel (18/10).
- Shelves have reinforcing omega brackets.
- 105 mm backsplash and 65 mm front panel with rounded safety edges, fully welded.
- 40 x 40 mm stainless steel square legs allow you to raise the height of the unit from 850 to 920 mm.
- **Easy assembly in 3 minutes.**
- **Optional:**  
Round legs (page 82).

Total dimensions (mm)	Table with 1 shelf	Table with 2 shelves
A B		
600 x 600	• FMA60600	• FMA26060
700 x 700	• FMA70700	• FMA27070
600 x 700	• FMA60700	• FMA26070
700 x 600	• FMA70600	• FMA27060

FIXING SYSTEM  
**DURBLOCK**  
WORK TABLES

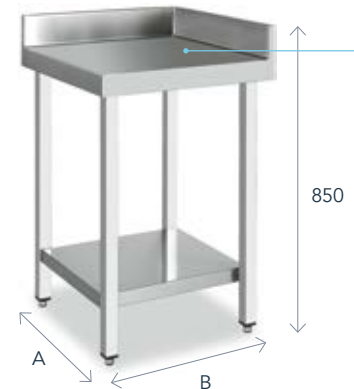

## CORNER TABLE WITH DOOR

- Made of AISI 304 stainless steel (18/10).
- 105 mm backsplash and 65 mm front panel with rounded safety edges, fully welded.
- Fully welded structure.
- 40 x 40 mm square stainless steel legs allow you to raise the height of the unit from 850 to 920 mm.

Model	Total dimensions (mm)	Code
600 Series	1000 x 1000 x 600 x 850	• FA601010
700 Series	1000 x 1000 x 700 x 850	• FA701010

FIXING SYSTEM  
**DURBLOCK**  
WORK TABLES



COUNTERTOP THICKNESS 1.5 MM PAGE 83





**POSSIBILITY OF CUSTOMISING LENGTH**

Please indicate desired length, price and code of the next higher model (\*)



## COUNTERTOP SHELVES

- **Designed to illuminate and maintain the temperature of recently cooked dishes before serving.**
- Shelves made of AISI grade 304 stainless steel (18/10).
- Supports made of round Ø30 mm tubes.
- Single or Double models with 3 options: 1-neutral, 2-halogen light and heat, and 3-infrared heat with ceramic.
- Easy installation by making small holes in the worktop with joining support.
- Lighted switch on the screens.
- **Easy assembly in 3 minutes.**

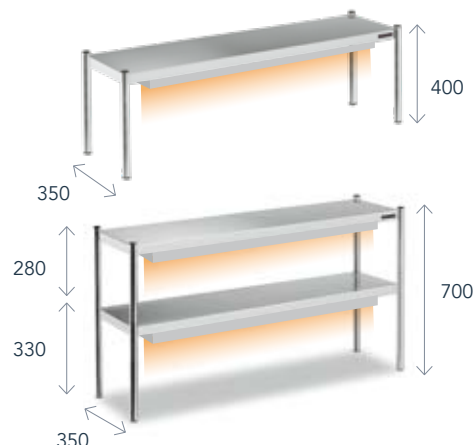

### SINGLE

For work table	Total dimensions (mm)	NEUTRAL		HALOGEN LIGHT AND HEAT		INFRARED HEAT CERAMIC	
		Code	Power (W)	Code	Power (W)	Code	Power (W)
1000 Long	700 x 350 x 400	• F0030001	-	-	-	-	-
1200 Long	900 x 350 x 400	• F0030008	-	• FCH30008	600	• FCC30008	500
1400 Long	1100 x 350 x 400	• F0030002	-	• FCH30002	600	• FCC30002	500
1600 Long	1300 x 350 x 400	• F0030003	-	• FCH30003	900	• FCC30003	750
1800 Long	1500 x 350 x 400	• F0030004	-	• FCH30004	900	• FCC30004	750
2000 Long	1700 x 350 x 400	• F0030005	-	• FCH30005	1200	• FCC30005	1000
2200 Long	1900 x 350 x 400	• F0030009	-	• FCH30009	1200	• FCC30009	1000
2400 Long	2100 x 350 x 400	• F0030010	-	• FCH30010	1500	• FCC30010	1250
2600 Long	2300 x 350 x 400	• F0030011	-	• FCH30011	1800	• FCC30011	1500
2800 Long	2500 x 350 x 400	• F0030012	-	• FCH30012	1800	• FCC30012	1500

### DOUBLE

For work table	Total dimensions (mm)	NEUTRAL		HALOGEN LIGHT AND HEAT		INFRARED HEAT CERAMIC	
		Code	Power (W)	Code	Power (W)	Code	Power (W)
1000 Long	700 x 350 x 700	• F0030101	-	-	-	-	-
1200 Long	900 x 350 x 700	• F0030108	-	• FCH40008	1200	• FCC40008	1000
1400 Long	1100 x 350 x 700	• F0030102	-	• FCH40002	1200	• FCC40002	1000
1600 Long	1300 x 350 x 700	• F0030103	-	• FCH40003	1800	• FCC40003	1500
1800 Long	1500 x 350 x 700	• F0030104	-	• FCH40004	1800	• FCC40004	1500
2000 Long	1700 x 350 x 700	• F0030105	-	• FCH40005	2400	• FCC40005	2000
2200 Long	1900 x 350 x 700	• F0030109	-	• FCH40009	2400	• FCC40009	2000
2400 Long	2100 x 350 x 700	• F0030110	-	• FCH40010	3000	• FCC40010	2500
2600 Long	2300 x 350 x 700	• F0030111	-	• FCH40011	3600	• FCC40011	3000
2800 Long	2500 x 350 x 700	• F0030112	-	• FCH40012	3600	• FCC40012	3000

## HALOGEN STRIP HEATER

- **Designed to fit under countertop shelving (not included).**
- Halogen light and heat unit with R7s-15 bulbs and additional glass protection.
- Unit with infrared heating system featuring long-lasting ceramic components.
- Made of stainless steel.
- It has a light-up switch.
- Easy to mount on the shelf - no tools required.



Total dimensions (mm)	Lamps	Voltage (V/Hz)	HALOGEN LIGHT AND HEAT		INFRARED HEAT CERAMIC	
			Code	Power (W)	Code	Power (W)
800 x 150 x 60	2	230/50	• F1020601	600	• F1040601	500
1200 x 150 x 60	3	230/50	• F1020602	900	• F1040602	750
1600 x 150 x 60	4	230/50	• F1020603	1200	• F1040603	1000
2000 x 150 x 60	5	230/50	• F1020604	1500	• F1040604	1250



# ACCESSORIES

## DRAWER WITH TELESCOPIC RUNNERS

- Made of AISI grade 304 stainless steel (18/10).
- Installed on all work tables except 500 series.

Total dimensions (mm)	Code
460 x 450 x 150	• F0020302



## DRAWER MODULE

- Made of AISI grade 304 stainless steel (18/10).
- Module is easy to install onto a table.
- Modules with 2 drawers: drawers have 290 x 435 x 115 mm of useful space each.
- Modules with 3 drawers: drawers have 290 x 435 x 109 mm of useful space each.
- Modules with 4 drawers: drawers have 290 x 435 x 62 mm of useful space each.
- Drawers with linear ball-bearings.

Model	Total dimensions (mm)	Drawers	Code
600 Series	400 x 510 x 590	2	• FB2C6040
	400 x 510 x 590	3	• FB3C6040
	400 x 510 x 590	4	• FB4C6040
700 Series	400 x 610 x 590	2	• FB2C7040
	400 x 610 x 590	3	• FB3C7040
	400 x 610 x 590	4	• FB4C7040



## HIGH CAPACITY DRAWER MODULE

- **Can be used as a bread chute, for waste bags, etc.**
- Made of AISI grade 304 stainless steel (18/10).
- Includes a clamp for waste bags.
- Module is easy to install onto a table.
- Drawer opens on 4 runners.

Model	Total dimensions (mm)	Code
600 Series	465 x 510 x 590	• F0020340
700 Series	465 x 610 x 590	• F0020341



## RUNNER SET MODULE FOR GN1/1 AND BAKERY TRAYS

- Made of AISI grade 304 stainless steel (18/10).
- Module is easy to install onto a table.

Model	Total dimensions (mm)	Code
GN 1/1	380 x 560 x 590	• F0020332
Bakery	660 x 436 x 596	• F0020337







### POSSIBILITY OF CUSTOMISING LENGTH

Please indicate desired length, price and code of the next higher model (\*)

## SIDE AND BACK PANELS FOR TABLES

- Ideal for protecting walkways and dividing storage areas.
- Made of stainless steel.
- Only for tables with shelf.
- Easy to install on tables.



### SIDE PANEL

For model	Code
500 Series	• FPL00500
550 Series	• FPL00550
600 Series	• FPL00600
700 Series	• FPL00700
800 Series	• FPL00800
900 Series	• FPL00900

### REAR



Table length	Code
600	• FT050600
700	• FT050700
800	• FT050800
900	• FT050900
1000	• FT051000
1100	• FT051100

Table length	Code
1200	• FT051200
1300	• FT051300
1400	• FT051400
1500	• FT051500
1600	• FT051600
1700	• FT051700

Table length	Code
1800	• FT051800
1900	• FT051900
2000	• FT052000
2200	• FT052200
2400	• FT052400
2600	• FT052600
2800	• FT052800



## ADDITIONAL SHELF FOR TABLE

- Made of AISI grade 304 stainless steel (18/10).
- Lower reinforcing omega brackets to increase load capacity.
- Easy to install on tables

Table length	500 Series	550 Series	600 Series	700 Series	800 Series	900 Series
600	• FME50060	• FME55060	• FME60060	• FME70060	• FME80060	• FME90060
700	-	-	• FME60070	• FME70070	• FME80070	• FME90070
800	• FME50080	• FME55080	• FME60080	• FME70080	• FME80080	• FME90080
900	-	-	• FME60090	• FME70090	• FME80090	• FME90090
1000	• FME50100	• FME55100	• FME60100	• FME70100	• FME80100	• FME90100
1100	-	-	• FME60110	• FME70110	• FME80110	• FME90110
1200	• FME50120	• FME55120	• FME60120	• FME70120	• FME80120	• FME90120
1300	-	-	• FME60130	• FME70130	• FME80130	• FME90130
1400	• FME50140	• FME55140	• FME60140	• FME70140	• FME80140	• FME90140
1500	• FME50150	• FME55150	• FME60150	• FME70150	• FME80150	• FME90150
1600	• FME50160	• FME55160	• FME60160	• FME70160	• FME80160	• FME90160
1700	-	-	• FME60170	• FME70170	• FME80170	• FME90170
1800	• FME50180	• FME55180	• FME60180	• FME70180	• FME80180	• FME90180
1900	-	-	• FME60190	• FME70190	• FME80190	• FME90190
2000	• FME50200	• FME55200	• FME60200	• FME70200	• FME80200	• FME90200
2200	• FME50220	• FME55220	• FME60220	• FME70220	• FME80220	• FME90220
2400	• FME50240	• FME55240	• FME60240	• FME70240	• FME80240	• FME90240
2600	-	-	• FME60260	• FME70260	• FME80260	• FME90260
2800	-	-	• FME60280	• FME70280	• FME80280	• FME90280



# ACCESSORIES

## DETACHABLE SIDE SPLASH FOR WORK TABLES AND STANDARD COUNTERTOPS

- Made of AISI grade 304 stainless steel (18/10).
- Easy to install from the side.
- Only for wall-facing tables.



Model	Side	Code
500 Series	Right	• CPE00013
	Left	• CPE00014
550 Series	Right	• CPE00015
	Left	• CPE00016
600 Series	Right	• CPE00005
	Left	• CPE00006

Model	Side	Code
700 Series	Right	• CPE00007
	Left	• CPE00008
800 Series	Right	• CPE00017
	Left	• CPE00018
900 Series	Right	• CPE00019
	Left	• CPE00020

## WASTE CHUTE FOR TABLES AND STANDARD COUNTERTOPS

- Ø200 mm waste hole with a rubber ring for throwing trash directly into a bin beneath the counter.
- High-density food-service grade rubber.
- Removable rubber ring.



Model	Code
Chute + Rubber Ring	• ADE50001
Rubber ring replacement	• CAD00001
Waste chute cover	• RTAPAD01

## PACK OF 4 OR 6 CASTORS

- Comes with the 40 x 40 mm square legs pre-installed.
- Includes 4 or 6 Ø125 mm castors (two with brakes).
- They replace the standard legs of the work table.
- **For tables with doors it is necessary to indicate the assembly.**



### CASTORS FOR 900-MM-HIGH TABLES

- Height of the table with castors = **880 mm**

Model	Table length	Code
4 castors	≤ 2000 mm	• F0020312
6 castors	> 2000 mm	• F0020325

### CASTORS FOR 600-MM-HIGH TABLES

- Height of the table with castors = **600 mm**

Model	Table length	Code
4 castors	≤ 2000 mm	• F0026312
6 castors	> 2000 mm	• F0026325

## ROUND LEGS FOR TABLES

### ROUND LEGS FOR TABLE HEIGHTS OF 850-920 MM

Model	Code
Pack of 4 round legs	• FPMR0001
Pack of 6 round legs	• FPMR0002

### ROUND LEGS FOR TABLE HEIGHTS OF 950-1000 MM



Model	Code
Pack of 4 round legs	• FPMR0003
Pack of 6 round legs	• FPMR0004

### ROUND LEGS FOR TABLE HEIGHTS OF 600-650 MM

Model	Code
Pack of 4 round legs	• FPMR0005
Pack of 6 round legs	• FPMR0006

## TAP HOLE FOR STANDARD TABLES AND COUNTERTOPS

- Hole that is 33 mm in diameter.

Model	Position	Code
Right		• LAVA0001
Left		• LAVA0002
Center		• LAVA0003



# CUSTOMIZATIONS FOR TABLES AND STANDARD COUNTERTOPS

## 1.5 MM THICK STAINLESS STEEL AISI 304 FOR TABLES AND COUNTERTOPS

- Countertops are made of 1.5 mm thick AISI grade 304 stainless steel (18/10).
- Sturdier.
- Additional cost relative to the standard table/countertop price.

Measurement	Code
Up to 1200 mm	• FESP1512
Up to 1600 mm	• FESP1516
Up to 2000 mm	• FESP1520
Up to 2400 mm	• FESP1524
Up to 2800 mm	• FESP1528

## HEIGHT ADJUSTABLE LEGS FROM 950 TO 1000 MM

- Made of AISI 304 18/10 stainless steel.
- They replace the standard legs of the work table.
- **Easy assembly in 3 minutes.**
- **It is necessary to indicate the model of the work table when ordering.**

Model	Code
4 legs	• F4P00950
6 legs	• F6P00950



## FOLDED AND WELDED SIDE BACKSPLASH ON STANDARD TABLES AND COUNTERTOPS

- Made of AISI grade 304 stainless steel (18/10).
- Folded lateral backsplash with sanitary radius, welded at the corners.
- Additional cost relative to the standard table/countertop price.
- **Only compatible with wall-mounted tables and worktops.**

Model	Code
Right	• CPDE0001
Left	• CPIE0002
Right + Left*	• CP2E0003



\*For countertops of up to 2600 mm

## STAINLESS STEEL REINFORCEMENT OMEGAS ON STANDARD TABLES AND COUNTERTOPS

- Substitution of standard omega brackets for stainless steel omega brackets.
- Additional cost relative to the standard table/countertop price.

Dimensions	Countertop only	1 shelf countertop	2 shelves countertop
Up to 1200 mm	• FIX1200E	• FIX1201E	• FIX1202E
Up to 1600 mm	• FIX1600E	• FIX1601E	• FIX1602E
Up to 2000 mm	• FIX2000E	• FIX2001E	• FIX2002E
Up to 2400 mm	• FIX2400E	• FIX2401E	• FIX2402E
Up to 2800 mm	• FIX2800E	• FIX2801E	• FIX2802E

# CUTTING BOARD TABLES

## WALL-FACING CUTTING BOARD TABLE

- Made of AISI grade 304 stainless steel (18/10), welded.
- 40 x 40 mm square stainless steel legs with concealed threaded adjustable feet to raise the height from 850 to 920 mm.
- 30 x 30 mm cross-pieces.
- 25 mm thick polyethylene cutting board included, removable for easy cleaning.
- Stainless steel shelf.
- **No assembly required.**



### 600 SERIES

Total dimensions (mm)	With reinforcement frame	With shelf
1000 x 600 x 850	• F0230311	• F023E311
1500 x 600 x 850	• F0230312	• F023E312

### 700 SERIES

Total dimensions (mm)	With reinforcement frame	With shelf
1000 x 700 x 850	• F0230314	• F023E314
1500 x 700 x 850	• F0230315	• F023E315

## CHOPPING BOARD TABLE

- Made of AISI grade 304 stainless steel (18/10).
- 40 x 40 mm square stainless steel legs with concealed threaded adjustable feet to raise the height from 850 to 920 mm.
- 30 x 30 mm cross-pieces.
- 50 mm thick polyethylene cutting board included.
- Removable countertop for easy cleaning.
- Fully welded structure for greater durability.
- **No assembly required.**

Total dimensions (mm)	Code
500 x 500 x 850	• F0230001



## POLYETHYLENE CUTTING BOARD

Total dimensions (mm)	White Cutting Board	Red Cutting Board
400 x 300 x 20	• RB040320	• RR040320
500 x 300 x 20	• RB050320	• RR050320
600 x 400 x 20	• RB060420	• RR060420



# COOKING SUPPORT TABLES

## OVEN SUPPORT TABLE

- Made of AISI 304 brushed stainless steel (18/10) with reinforcing omega brackets.
- Supports up to 200 kg of weight.
- Containers not included.
- **No assembly required.**

RELATED PRODUCTS

**GASTRONORM CONTAINERS** page 179

Total dimensions (mm)	Capacity	No. of runners	Code
850 x 750 x 700	GN 1/1	12	• F0050201
850 x 850 x 700	GN 1/1	12	• F0050202
1100 x 850 x 700	GN 1/1 and 2/1	6 + 6	• F0050203
1100 x 950 x 700	GN 1/1 and 2/1	6 + 6	• F0050204
850 x 850 x 700	600 x 400	6	• F0050222



# WASTE TABLES

## WALL-FACING TABLE WITH DOOR AND WASTE HOLE

- Made of AISI 304 18/10 stainless steel.
- Waste disposal hole with rubber ring to dispose of waste directly into a rubbish bin under the worktop.
- Square stainless steel legs 40 x 40 mm to raise the height from 850 to 920 mm.
- Bins of up to Ø 500 mm for 50 l bags.
- Bin not included.
- **No assembly required.**

RELATED PRODUCTS

**WASTE CONTAINERS** page 167

Total dimensions (mm)	Code
700 x 600 x 850	• FMPA7060
700 x 700 x 850	• FMPA7070



# RECYCLING TABLES

## OPEN RECYCLING TABLE

- **Designed for sorting waste.**
- Made of AISI 304 18/10 stainless steel.
- 65 mm front piece with rounded finish, fully welded.
- Fully welded 105 mm rear bumper on wall-mounted models.
- Square stainless steel legs 40 x 40 mm to raise the height from 850 to 920 mm.
- Two or three ø 190-280 mm holes for rubber rings.
- Bins not included.
- Coloured rubber rings not included.
- **Easy assembly in 3 minutes.**
- **Optional:**  
  - **Round legs (page 82).**
  - **Height adjustable legs from 950 to 1000 mm (page 83).**



RELATED PRODUCTS

**WASTE CONTAINERS** page 167



### CENTRAL

Total dimensions (mm)	Holes	Code
1200 x 600 x 850	2	• FCR26010
1500 x 600 x 850	3	• FCR36015



### WALL-FACED

Total dimensions (mm)	Holes	Code
1200 x 600 x 850	2	• FMR26010
1500 x 600 x 850	3	• FMR36015

## RUBBER WASTE RING

- **Facilitates the identification of the container.**
- Detachable.
- Easy to clean and disinfect.

Colour	Code
Red — Organic	• ARO000RO
Green — Glass	• ARO000VE
Yellow — Plastic	• ARO000AM
Blue — Paper	• ARO000AZ



# COFFEE SERVICE AND DISPLAY CABINET TABLES



**POSSIBILITY OF CUSTOMISING LENGTH**  
Please indicate desired length, price and code of the next higher model (\*)

## COFFEE SERVICE TABLE

- Exterior made of AISI grade 304 stainless steel (18/10).
- Countertop has stainless steel omega brackets for reinforcement instead of bonded wood.
- Rear backsplash height of 105 mm
- 65 mm front piece with rounded finish
- Drawers made of stainless steel with ball-bearing runners.
- Removable hopper for used coffee, with rubber stopper to dampen the sounds of opening and use.
- Legs with adjustable feet.
- Ø 60 mm hole with cable grommet.
- Stainless steel rear panel is partially open for the installation of the coffee machine.
- **No assembly required.**



Total dimensions (mm)	With countertop	Without countertop
800 x 600 x 1050	• F3020005	• F3E20005
1000 x 600 x 1050	• F3020001	• F3E20001
1500 x 600 x 1050	• F3020002	• F3E20002
2000 x 600 x 1050	• F3020003	• F3E20003
2500 x 600 x 1050	• F3020004	• F3E20004

## DISPLAY TABLE

- Exterior made of AISI grade 304 stainless steel (18/10).
- Countertop has stainless steel omega brackets for reinforcement instead of bonded wood.
- Rear backsplash height of 105 mm.
- 65 mm front piece with rounded finish.
- Legs with adjustable feet.
- **No assembly required.**



### 350 SERIES

#### 1 SHELF

#### 2 SHELVES

Total dimensions (mm)	1 SHELF		2 SHELVES	
	With countertop	Without countertop	With countertop	Without countertop
1000 x 350 x 1050	• F3010002	• F3E10002	• F3010122	• F3E10122
1500 x 350 x 1050	• F3010003	• F3E10003	• F3010123	• F3E10123
2000 x 350 x 1050	• F3010004	• F3E10004	• F3010124	• F3E10124
2500 x 350 x 1050	• F3010008	• F3E10008	• F3010128	• F3E10128

### 600 SERIES

#### 1 SHELF

#### 2 SHELVES

Total dimensions (mm)	1 SHELF		2 SHELVES	
	With countertop	Without countertop	With countertop	Without countertop
1000 x 600 x 1050	• F3010005	• F3E10005	• F3010125	• F3E10125
1500 x 600 x 1050	• F3010006	• F3E10006	• F3010126	• F3E10126
2000 x 600 x 1050	• F3010007	• F3E10007	• F3010127	• F3E10127
2500 x 600 x 1050	• F3010009	• F3E10009	• F3010129	• F3E10129





STATIC PREPARATION

# HOT FOOD AND BAIN-MARIE TABLES



## HOT FOOD TABLES

PAGE 90



## BAIN-MARIE TABLES

PAGE 92



## COUNTERTOP BAIN-MARIE

PAGE 93

# HOT FOOD TABLES

## HOT FOOD TABLE

- **Designed to keep dishes hot prior to serving.**
- Made of AISI 304 stainless steel (18/10).
- Mineral wool thermal insulation.
- 65 mm front panel with rounded edge. 105 mm high backsplash on wall-facing tables.
- Sliding door anchored the top.
- Lateral heat blocks with ventilated heating elements that are easily removable.
- Control panel with lighted switch and 0 to 90°C digital thermostat.
- 150 mm legs allow you to raise the height of the unit from 850 to 900 mm.



HOT FOOD TABLE DIMENSIONS

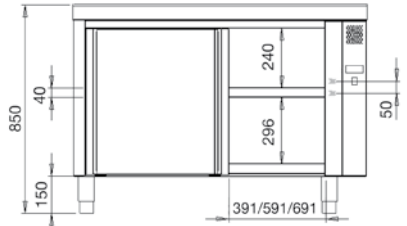

### 600 SERIES CENTER

Total dimensions (mm)	Power (W)	Power supply (V/Hz)	With countertop	Without countertop
1200 x 600 x 850	2000	230/50	• F0440110	• F0080297
1400 x 600 x 850	2000	230/50	• F0440112	• F0080405
1600 x 600 x 850	3000	230/50	• F0440111	• F0080298
1800 x 600 x 850	3000	230/50	• F0440113	• F0080406

### 700 SERIES CENTER

Total dimensions (mm)	Power (W)	Power supply (V/Hz)	With countertop	Without countertop
1200 x 700 x 850	2000	230/50	• F0430110	• F0080197
1400 x 700 x 850	2000	230/50	• F0430113	• F0080407
1600 x 700 x 850	3000	230/50	• F0430111	• F0080198
1800 x 700 x 850	3000	230/50	• F0430112	• F0080199
2000 x 700 x 850	3000	230/50	• F0430114	• F0080408



### 600 SERIES PASS-THROUGH CENTER

Total dimensions (mm)	Power (W)	Power supply (V/Hz)	With countertop	Without countertop
1200 x 600 x 850	3000	230/50	• F0440104	• F0080409
1400 x 600 x 850	3000	230/50	• F0440105	• F0080410
1600 x 600 x 850	3000	230/50	• F0440106	• F0080411
1800 x 600 x 850	3000	230/50	• F0440107	• F0080412

### 700 SERIES PASS-THROUGH CENTER

Total dimensions (mm)	Power (W)	Power supply (V/Hz)	With countertop	Without countertop
1200 x 700 x 850	3000	230/50	• F0430100	• F0080150
1400 x 700 x 850	3000	230/50	• F0430103	• F0080413
1600 x 700 x 850	3000	230/50	• F0430101	• F0080151
1800 x 700 x 850	3000	230/50	• F0430102	• F0080152
2000 x 700 x 850	3000	230/50	• F0430104	• F0080418





### 600 SERIES WALL-FACING

Total dimensions (mm)	Power (W)	Power supply (V/Hz)	With countertop	Without countertop
1200 x 600 x 850	2000	230/50	• F0440000	• F0080297
1400 x 600 x 850	2000	230/50	• F0440002	• F0080405
1600 x 600 x 850	3000	230/50	• F0440001	• F0080298
1800 x 600 x 850	3000	230/50	• F0440003	• F0080406

### 700 SERIES WALL-FACING

Total dimensions (mm)	Power (W)	Power supply (V/Hz)	With countertop	Without countertop
1200 x 700 x 850	2000	230/50	• F0430000	• F0080197
1400 x 700 x 850	2000	230/50	• F0430003	• F0080407
1600 x 700 x 850	3000	230/50	• F0430001	• F0080198
1800 x 700 x 850	3000	230/50	• F0430002	• F0080199
2000 x 700 x 850	3000	230/50	• F0430004	• F0080408

## HOT FOOD TABLES WITH GN 1/1 RUNNERS

RELATED PRODUCTS

- Ideal for storing and conserving hot foods in GN 1/1 containers.
- Made of AISI 304 stainless steel (18/10).
- Mineral wool thermal insulation.
- 65 mm front panel with rounded edge. 105 mm high backsplash on wallfacing tables.
- Control panel with lighted switch and 0 to 90°C digital thermostat.
- 70 mm between runners.
- Swinging doors
- Dry heat reservoir.
- 150 mm legs allow you to raise the height of the unit from 850 to 900 mm.
- 1200 mm table with 2 runners and capacity for 14 GN 1/1 containers.
- 1600 mm table with 3 runners and capacity for 21 GN 1/1 containers.



### 700 SERIES CENTER

Total dimensions (mm)	Power (W)	Power supply (V/Hz)	With countertop	Without countertop
1200 x 700 x 850	2000	230/50	• F0432004	• F0080417
1600 x 700 x 850	3000	230/50	• F0432003	• F0082002



### 700 SERIES WALL-FACING

Total dimensions (mm)	Power (W)	Power supply (V/Hz)	With countertop	Without countertop
1200 x 700 x 850	2000	230/50	• F0432005	• F0080417
1600 x 700 x 850	3000	230/50	• F0432002	• F0082002

# BAIN-MARIE TABLES

## BAIN-MARIE TABLE

- **Designed to keep food at optimal serving temperature.**
- Made of AISI 304 stainless steel (18/10).
- Basin with safety edges for GN containers with a maximum depth of 200 mm.
- Drain with ball valve.
- Hidden silicone heating elements.
- Lighted switch and adjustable 0-90°C digital thermostat.
- Safety thermostat.
- Stainless steel lower shelf.
- **No assembly required.**

### BAIN-MARIE TABLE DIMENSIONS

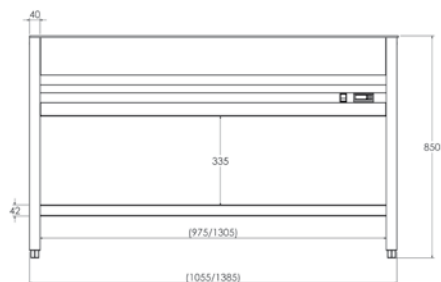

RELATED PRODUCTS

[GASTRONORM CONTAINERS](#) page 179

Total dimensions (mm)	Capacity	Power (W)	Power supply (V/Hz)	Code
1055 x 605 x 850	3 GN 1/1	2400	230/50-60	• F0430203
1385 x 605 x 850	4 GN 1/1	3200	230/50-60	• F0430204

## BAIN-MARIE TABLE WITH RESERVE TANK 700 SERIES

- Made of AISI 304 stainless steel (18/10).
- Countertop with 65 mm fully welded front piece with rounded edges.
- Mineral wool thermal insulation.
- Basin with safety edges on all sides, for GN containers 200 mm deep.
- Hidden resistors with lighted switch and 0 to 90°C digital thermostat.
- Water inlet and drain with ball valve
- Sliding doors anchored at top.
- Dry heat reservoir.
- 150 mm legs allow you to raise the height of the unit from 850 to 900 mm.
- Gastronorm containers are not included.
- **No assembly required.**

RELATED PRODUCTS

[GASTRONORM CONTAINERS](#) page 179

Total dimensions (mm)	Capacity	Power (W)	Power supply (V/Hz)	Code
1200 x 700 x 850	3 GN 1/1	3200	230/50-60	• F0432011
1600 x 700 x 850	4 GN 1/1	6200	230/50-60	• F0432012



# COUNTERTOP BAIN-MARIE

## COUNTERTOP BAIN-MARIE FOR SINGLE GN 1/1

- Compact countertop design helps keep food at optimal serving temperature.
- Made of AISI grade 304 stainless steel (18/10).
- Basin inlaid with safety edges for GN 1/1 containers with a maximum depth of 150 mm.
- Adjustable temperature thermostat with LEDs for operation.
- Tap included.
- Gastronorm containers not included.

RELATED PRODUCTS  
[GASTRONORM CONTAINERS](#) page 179



Total dimensions (mm)	Capacity	Power (W)	Power supply (V/Hz)	Code
325 x 560 x 250	1 GN 1/1	600	230/50-60	• F0420401

## COUNTERTOP BAIN-MARIE FOR DOUBLE GN 1/1

- Compact countertop design helps keep food at optimal serving temperature.
- Made of AISI grade 304 stainless steel (18/10).
- Two basins with safety edges for GN 1/1 tubs with a maximum depth of 150 mm.
- Adjustable temperature thermostat with LEDs for operation.
- Independent temperature control for each basin.
- Tap included.
- Gastronorm containers not included.

RELATED PRODUCTS  
[GASTRONORM CONTAINERS](#) page 179



Total dimensions (mm)	Capacity	Power (W)	Power supply (V/Hz)	Code
650 x 560 x 250	2 GN 1/1	1200	230/50-60	• F0420403

RELATED PRODUCTS  
[BAIN-MARIE TROLLEYS](#) page 199



STATIC PREPARATION

# MODULES AND COUNTERTOPS FOR COMPOSITIONS



**UNITS WITH PASS-THROUGH SHELVES**

PAGE 98



**UNITS WITH SHELVES**

PAGE 99



**UNITS WITH PASS-THROUGH SLIDING DOORS**

PAGE 100



**UNITS WITH SLIDING DOORS**

PAGE 101



**UNITS WITH DRAWERS**

PAGE 102



**UNITS WITH DRAWERS AND SWINGING DOORS**

PAGE 103



**MODULES**

PAGE 104



**600-MM-HIGH UNITS**

PAGE 106



**UNITS WITH DRAWERS AND SLIDING DOORS**

PAGE 108



**SINK CABINETS**

PAGE 110



**CENTRAL AND WALL-FACING COUNTERTOP**

PAGE 112



**WALL-FACING COUNTERTOP WITH BASIN**

PAGE 113



**SUPPORT CABINET FOR TERRACE**

PAGE 114



**RECYCLING CABINET**

PAGE 115



**CUSTOMIZATIONS**

PAGE 116



**CABINETS AND MODULES ACCESSORIES**

PAGE 117

# MODULES AND COUNTERTOPS FOR COMPOSITIONS



01  
Practical solutions to  
optimise space

02  
Wide range of open or closed  
modules, with shelves and drawers  
or with GN runners





Modular design adapts to all kinds of kitchens and facilities



The continuous worktop favors the hygiene maintenance and its adaptability to modular units



**COUNTERTOP THICKNESS 1.5 MM**  
PAGE 116

Wide variety of cabinets with shelves, drawers, sliding and hinged doors with multiple worktop options



The placement of the countertop is simple and agile



Countertops that are customizable in length



# UNITS WITH PASS-THROUGH SHELVES



**POSSIBILITY OF CUSTOMISING LENGTH**

Please indicate desired length, price and code of the next higher model (\*)



## UNIT WITH PASS-THROUGH SHELVES

- Made of AISI grade 304 stainless steel (18/10).
- Countertops and shelves have reinforcing omega brackets.
- 65 mm front panel with rounded edge, fully welded.
- 150 mm legs allow you to raise the height of the unit from 850 to 920 mm.
- Adjustable shelf with very sturdy supports.
- **Optional: height adjustable legs from 900 to 990 mm (page 117).**
- **No assembly required.**

RELATED PRODUCTS

**COUNTERTOPS** page 112

COUNTERTOP THICKNESS 1.5 MM PAGE 116



### 600 SERIES

**Total dimensions (mm)**

- 600 x 600 x 850
- 800 x 600 x 850
- 1000 x 600 x 850
- 1200 x 600 x 850
- 1400 x 600 x 850
- 1600 x 600 x 850
- 1800 x 600 x 850
- 2000 x 600 x 850
- 2200 x 600 x 850
- 2400 x 600 x 850

#### WITH CENTER COUNTERTOP

**Code**

- F0078061
- F0078062
- F0070061
- F0070062
- F0070063
- F0070064
- F0070065
- F0070066
- F0070067
- F0070068

#### WITHOUT COUNTERTOP

**Code**

- F0080061
- F0080062
- F0080063
- F0080064
- F0080065
- F0080066
- F0080067
- F0080068
- F0080069
- F0080070

### 700 SERIES

**Total dimensions (mm)**

- 600 x 700 x 850
- 800 x 700 x 850
- 1000 x 700 x 850
- 1200 x 700 x 850
- 1400 x 700 x 850
- 1600 x 700 x 850
- 1800 x 700 x 850
- 2000 x 700 x 850
- 2200 x 700 x 850
- 2400 x 700 x 850

#### WITH CENTER COUNTERTOP

**Code**

- F0078071
- F0078072
- F0070069
- F0070070
- F0070071
- F0070072
- F0070073
- F0070074
- F0070075
- F0070076

#### WITHOUT COUNTERTOP

**Code**

- F0080071
- F0080072
- F0080073
- F0080074
- F0080075
- F0080076
- F0080077
- F0080078
- F0080079
- F0080080



# UNITS WITH SHELVES



**POSSIBILITY OF CUSTOMISING LENGTH**

Please indicate desired length, price and code of the next higher model (\*)

## UNIT WITH SHELVES

- Made of AISI grade 304 stainless steel (18/10).
- Countertops and shelves have reinforcing omega brackets.
- 105 mm backsplash on wall-facing countertops and 65 mm front panel with rounded safety edges, fully welded.
- 150 mm legs allow you to raise the height of the unit from 850 to 920 mm.
- Adjustable shelf with very sturdy supports.
- **Optional: height adjustable legs from 900 to 990 mm (page 117).**
- **No assembly required.**

RELATED PRODUCTS

**COUNTERTOPS** page 112

COUNTERTOP THICKNESS 1.5 MM PAGE 116



### 600 SERIES

Total dimensions (mm)	WITH WALL-FACING COUNTERTOP	WITH CENTER COUNTERTOP	WITHOUT COUNTERTOP
	Code	Code	Code
600 x 600 x 850	• F0078041	• F0079041	• F0080041
800 x 600 x 850	• F0078042	• F0079042	• F0080042
1000 x 600 x 850	• F0070121	• F0070041	• F0080043
1200 x 600 x 850	• F0070122	• F0070042	• F0080044
1400 x 600 x 850	• F0070123	• F0070043	• F0080045
1600 x 600 x 850	• F0070124	• F0070044	• F0080046
1800 x 600 x 850	• F0070125	• F0070045	• F0080047
2000 x 600 x 850	• F0070126	• F0070046	• F0080048
2200 x 600 x 850	• F0070127	• F0070047	• F0080049
2400 x 600 x 850	• F0070128	• F0070048	• F0080050

### 700 SERIES

Total dimensions (mm)	WITH WALL-FACING COUNTERTOP	WITH CENTER COUNTERTOP	WITHOUT COUNTERTOP
	Code	Code	Code
600 x 700 x 850	• F0078051	• F0079051	• F0080051
800 x 700 x 850	• F0078052	• F0079052	• F0080052
1000 x 700 x 850	• F0070129	• F0070049	• F0080053
1200 x 700 x 850	• F0070130	• F0070050	• F0080054
1400 x 700 x 850	• F0070131	• F0070051	• F0080055
1600 x 700 x 850	• F0070132	• F0070052	• F0080056
1800 x 700 x 850	• F0070133	• F0070053	• F0080057
2000 x 700 x 850	• F0070134	• F0070054	• F0080058
2200 x 700 x 850	• F0070135	• F0070055	• F0080059
2400 x 700 x 850	• F0070136	• F0070056	• F0080060



• 3-DAY SHIPPING

# UNITS WITH PASS-THROUGH SLIDING DOORS



**POSSIBILITY OF CUSTOMISING LENGTH**

Please indicate desired length, price and code of the next higher model (\*)



## UNIT WITH PASS-THROUGH SLIDING DOORS

- Made of AISI grade 304 stainless steel (18/10).
- Countertops and shelves have reinforcing omega brackets.
- 65 mm front panel with rounded edge, fully welded.
- 150 mm legs allow you to raise the height of the unit from 850 to 920 mm.
- Adjustable shelf with very sturdy supports.
- Suspended sliding doors glide very smoothly. This design does not use bottom runners, facilitating cleaning.
- **No assembly required.**
- **Optional: height adjustable legs from 900 to 990 mm (page 117).**

RELATED PRODUCTS

**COUNTERTOPS** page 112

COUNTERTOP THICKNESS 1.5 MM PAGE 116



### 600 SERIES

Total dimensions (mm)
1000 x 600 x 850
1200 x 600 x 850
1400 x 600 x 850
1600 x 600 x 850
1800 x 600 x 850
2000 x 600 x 850

#### WITH CENTER COUNTERTOP

Code
• F0070021
• F0070022
• F0070023
• F0070024
• F0070025
• F0070026

#### WITHOUT COUNTERTOP

Code
• F0080021
• F0080022
• F0080023
• F0080024
• F0080025
• F0080026

### 700 SERIES

Total dimensions (mm)
1000 x 700 x 850
1200 x 700 x 850
1400 x 700 x 850
1600 x 700 x 850
1800 x 700 x 850
2000 x 700 x 850

#### WITH CENTER COUNTERTOP

Code
• F0070027
• F0070028
• F0070029
• F0070030
• F0070031
• F0070032

#### WITHOUT COUNTERTOP

Code
• F0080027
• F0080028
• F0080029
• F0080030
• F0080031
• F0080032



# UNITS WITH SLIDING DOORS



**POSSIBILITY OF CUSTOMISING LENGTH**

Please indicate desired length, price and code of the next higher model (\*)



## UNIT WITH SLIDING DOORS

- Made of AISI grade 304 stainless steel (18/10).
- Countertops and shelves have reinforcing omega brackets.
- 105 mm backsplash on wall-facing countertops and 65 mm front panel with rounded safety edges, fully welded.
- 150 mm legs allow you to raise the height of the unit from 850 to 920 mm.
- Adjustable shelf with very sturdy supports.
- Suspended sliding doors glide very smoothly. This design does not use bottom runners, facilitating cleaning.
- **No assembly required.**
- **Optional: height adjustable legs from 900 to 990 mm (page 117).**

RELATED PRODUCTS

**COUNTERTOPS** page 112

COUNTERTOP THICKNESS 1.5 MM PAGE 116



### 600 SERIES

Total dimensions (mm)	WITH WALL-FACING COUNTERTOP Code	WITH CENTER COUNTERTOP Code	WITHOUT COUNTERTOP Code	FOR COUNTERTOPS WITH BASIN Code
1000 x 600 x 850	• F0070101	• F0070001	• F0080001	• FCU80001
1200 x 600 x 850	• F0070102	• F0070002	• F0080002	• FCU80002
1400 x 600 x 850	• F0070103	• F0070003	• F0080003	• FCU80003
1600 x 600 x 850	• F0070104	• F0070004	• F0080004	• FCU80004
1800 x 600 x 850	• F0070105	• F0070005	• F0080005	• FCU80005
2000 x 600 x 850	• F0070112	• F0070006	• F0080006	• FCU80006

### 700 SERIES

Total dimensions (mm)	WITH WALL-FACING COUNTERTOP Code	WITH CENTER COUNTERTOP Code	WITHOUT COUNTERTOP Code	FOR COUNTERTOPS WITH BASIN Code
1000 x 700 x 850	• F0070106	• F0070007	• F0080007	• FCU80007
1200 x 700 x 850	• F0070107	• F0070008	• F0080008	• FCU80008
1400 x 700 x 850	• F0070108	• F0070009	• F0080009	• FCU80009
1600 x 700 x 850	• F0070109	• F0070010	• F0080010	• FCU80010
1800 x 700 x 850	• F0070110	• F0070011	• F0080011	• FCU80011
2000 x 700 x 850	• F0070111	• F0070012	• F0080012	• FCU80012



• 3-DAY SHIPPING

# UNITS WITH DRAWERS

## UNIT WITH DRAWERS

- Made of AISI grade 304 stainless steel (18/10).
- Countertops with reinforcing omega brackets.
- 105 mm backsplash on wall-facing countertops and 65 mm front panel with rounded safety edges, fully welded.
- 150 mm legs allow you to raise the height of the unit from 850 to 920 mm.
- Fully removable runners
- For 400-mm-wide models, drawers measure 289 x 485 x 125 mm of useful space (3 drawers). 289 x 485 x 78 mm (4 drawers).
- For 500-mm-wide models, drawers measure 389 x 485 x 125 mm of useful space (3 drawers). 389 x 485 x 78 mm (4 drawers).
- **No assembly required.**
- **Optional: height adjustable legs from 900 to 990 mm (page 117).**

RELATED PRODUCTS  
**COUNTERTOPS** page 112

COUNTERTOP THICKNESS 1.5 MM PAGE 116

## 3 DRAWERS



### 600 SERIES

**Total dimensions (mm)**

- 400 x 600 x 850
- 500 x 600 x 850

**WITH WALL-FACING COUNTERTOP**

**Code**

- F0070151
- F0070152

**WITH CENTER COUNTERTOP**

**Code**

- F0070091
- F0070092

**WITHOUT COUNTERTOP**

**Code**

- F0080111
- F0080112

### 700 SERIES

**Total dimensions (mm)**

- 400 x 700 x 850
- 500 x 700 x 850

**Code**

- F0070155
- F0070156

**Code**

- F0070095
- F0070096

**Code**

- F0080113
- F0080114

COUNTERTOP THICKNESS 1.5 MM PAGE 116

## 4 DRAWERS



### 600 SERIES

**Total dimensions (mm)**

- 400 x 600 x 850
- 500 x 600 x 850

**WITH WALL-FACING COUNTERTOP**

**Code**

- F0078121
- F0078122

**WITH CENTER COUNTERTOP**

**Code**

- F0079121
- F0079122

**WITHOUT COUNTERTOP**

**Code**

- F0080121
- F0080122

### 700 SERIES

**Total dimensions (mm)**

- 400 x 700 x 850
- 500 x 700 x 850

**Code**

- F0078123
- F0078124

**Code**

- F0079123
- F0079124

**Code**

- F0080123
- F0080124



# UNITS WITH DRAWERS AND SWINGING DOORS

## DRAWERS AND SWINGING DOORS

RELATED PRODUCTS  
**COUNTERTOPS** page 112

COUNTERTOP THICKNESS 1.5 MM PAGE 116



### 600 SERIES

Total dimensions (mm)	Doors	Drawers	WITH WALL-FACING COUNTERTOP	WITH CENTER COUNTERTOP	WITHOUT COUNTERTOP
			Code	Code	Code
400 x 600 x 850	1	1	• F0078101	• F0079101	• F0080101
500 x 600 x 850	1	1	• F0078102	• F0079102	• F0080102
800 x 600 x 850	2	2	• F0078103	• F0079103	• F0080103
1000 x 600 x 850	2	2	• F0078104	• F0079104	• F0080104

### 700 SERIES

Total dimensions (mm)	Doors	Drawers	WITH WALL-FACING COUNTERTOP	WITH CENTER COUNTERTOP	WITHOUT COUNTERTOP
			Code	Code	Code
400 x 700 x 850	1	1	• F0078106	• F0079106	• F0080106
500 x 700 x 850	1	1	• F0078107	• F0079107	• F0080107
800 x 700 x 850	2	2	• F0078108	• F0079108	• F0080108
1000 x 700 x 850	2	2	• F0078109	• F0079109	• F0080109

COUNTERTOP THICKNESS 1.5 MM PAGE 116

## SWINGING DOORS



### 600 SERIES

Total dimensions (mm)	Doors	WITH WALL-FACING COUNTERTOP	WITH CENTER COUNTERTOP	WITHOUT COUNTERTOP	FOR COUNTERTOPS WITH BASIN
		Code	Code	Code	Code
400 x 600 x 850	1	• F0070141	• F0070081	• F0080091	-
500 x 600 x 850	1	• F0070142	• F0070082	• F0080092	-
600 x 600 x 850	1	• F0078093	• F0079093	• F0080093	• FCU80093
800 x 600 x 850	2	• F0070143	• F0070083	• F0080094	• FCU80094
1000 x 600 x 850	2	• F0070144	• F0070084	• F0080095	• FCU80095

### 700 SERIES

Total dimensions (mm)	Doors	WITH WALL-FACING COUNTERTOP	WITH CENTER COUNTERTOP	WITHOUT COUNTERTOP	FOR COUNTERTOPS WITH BASIN
		Code	Code	Code	Code
400 x 700 x 850	1	• F0070145	• F0070085	• F0080096	-
500 x 700 x 850	1	• F0070146	• F0070086	• F0080097	-
600 x 700 x 850	1	• F0078098	• F0079098	• F0080098	• FCU80098
800 x 700 x 850	2	• F0070147	• F0070087	• F0080099	• FCU80099
1000 x 700 x 850	2	• F0070148	• F0070088	• F0080100	• FCU80100



• 3-DAY SHIPPING

# MODULES

COUNTERTOP THICKNESS 1.5 MM PAGE 116

## HIGH CAPACITY DRAWER



### 600 SERIES

**Total dimensions (mm)**

500 x 600 x 850

**WITH WALL-FACING COUNTERTOP**

**Code**

• F0078132

**WITH CENTER COUNTERTOP**

**Code**

• F0079132

**WITHOUT COUNTERTOP**

**Code**

• F0080132

### 700 SERIES

**Total dimensions (mm)**

500 x 700 x 850

**Code**

• F0078139

**Code**

• F0079139

**Code**

• F0080139

## BASELESS UNIT FOR WASTE CONTAINER

RELATED PRODUCTS

**WASTE CONTAINERS** page 189



### 600 SERIES

**Total dimensions (mm)**

600 x 600 x 850

**WITH WALL-FACING COUNTERTOP**

**Code**

• F0078501

**WITH CENTER COUNTERTOP**

**Code**

• F0079501

**WITHOUT COUNTERTOP**

**Code**

• F0080501

### 700 SERIES

**Total dimensions (mm)**

600 x 700 x 850

**Code**

• F0078502

**Code**

• F0079502

**Code**

• F0080502

**Accessory**

Hole + rubber ring

**Code**

• ADE50001

## 90° CORNER COUNTERTOP

- Made of AISI grade 304 stainless steel (18/10).
- Joins another countertop with the lateral coupling module.
- Straight corners.
- 105 mm backsplash and 65 mm front panel with rounded safety edges, fully welded.
- 150 mm legs allow you to raise the height of the unit from 850 to 920 mm.
- **Optional: height adjustable legs from 900 to 990 mm (page 117).**

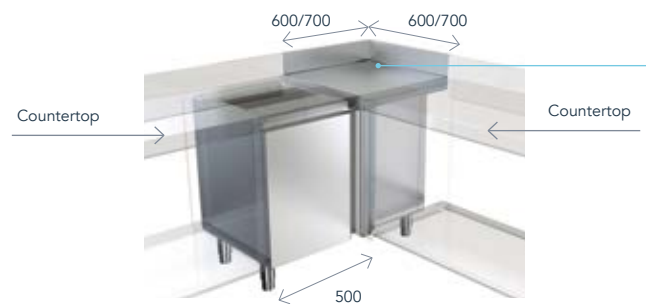

### 600 SERIES

**Total dimensions (mm)**

1100 x 600 x 850

Right

**Code**

• F0080701

1100 x 600 x 850

Left

• F0080702

### 700 SERIES

**Total dimensions (mm)**

1200 x 700 x 850

Right

**Code**

• F0080703

1200 x 700 x 850

Left

• F0080704

## FRAME WITH DOOR

### 600 / 700 SERIES

**Total dimensions (width x height) (mm)**

500 x 670

**Code**

• F0080901

600 x 670

• F0080902

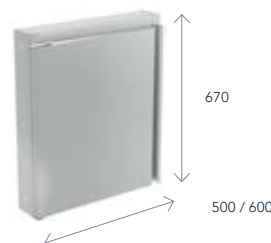





## 90° CHAMFERED CORNER UNIT

### 600 SERIES

Total dimensions (mm)	Code
1000 x 1000 x 600 x 850	• F0070116

### 700 SERIES

Total dimensions (mm)	Code
1000 x 1000 x 700 x 850	• F0070117

## RUNNER SET UNIT



### 600 SERIES

Total dimensions (mm)	Capacity	WITH WALL-FACING COUNTERTOP	WITH CENTER COUNTERTOP	WITHOUT COUNTERTOP
		Code	Code	Code
400 x 600 x 850	1 GN 1/1 Body	• F0780141	• F0790141	• F0080141
800 x 600 x 850	2 GN 1/1 Bodies	• F0780143	• F0790143	• F0080143

### 700 SERIES

Total Dimensions (mm)	Capacity	Code	Code	Code
400 x 700 x 850	1 GN 1/1 Body	• F0780145	• F0790145	• F0080145
500 x 700 x 850	1 600x400 Body	• F0780146	• F0790146	• F0080146
800 x 700 x 850	2 GN 1/1 Bodies	• F0780147	• F0790147	• F0080147
1000 x 700 x 850	2 600x400 Bodies	• F0780148	• F0790148	• F0080148

## HOT FOOD TABLES WITHOUT COUNTERTOP



### 600 SERIES

Total dimensions (mm)	WALL-FACING MODULE	CENTER PASS-THROUGH MODULE	UNIT WITH GN 1/1 GUIDES
		Code	Code
1200 x 600 x 850 *	• F0080297	• F0080409	-
1400 x 600 x 850 *	• F0080405	• F0080410	-
1600 x 600 x 850 **	• F0080298	• F0080411	-
1800 x 600 x 850 **	• F0080406	• F0080412	-

\* Power 2000W - Voltage 230 V / \*\* Power: 3000W - Voltage 230 V

### 700 SERIES

Total dimensions (mm)	Code	Code	Code
1200 x 700 x 850 *	• F0080197	• F0080150	• F0080417
1400 x 700 x 850 *	• F0080407	• F0080413	-
1600 x 700 x 850 **	• F0080198	• F0080151	• F0082002
1800 x 700 x 850 **	• F0080199	• F0080152	-
2000 x 700 x 850 **	• F0080408	• F0080418	-

\* Power 2000W - Voltage 230 V / \*\* Power: 3000W - Voltage 230 V



# 600-MM-HIGH UNITS



**POSSIBILITY OF CUSTOMISING LENGTH**

Please indicate desired length, price and code of the next higher model (\*)



## 600-MM-HIGH UNIT WITH AN OPEN FACE

- Made of AISI grade 304 stainless steel (18/10).
- Countertops and shelves have reinforcing omega brackets.
- 105 mm backsplash on wall-facing countertops and 65 mm front panel with rounded safety edges, fully welded.
- 150 mm legs allow you to raise the height of the unit from 600 to 650 mm.
- **No assembly required.**

RELATED PRODUCTS

**COUNTERTOPS** page 112

COUNTERTOP THICKNESS 1.5 MM PAGE 116



### 600 SERIES

**Total dimensions (mm)**

- 600 x 600 x 600
- 800 x 600 x 600
- 1000 x 600 x 600
- 1200 x 600 x 600
- 1400 x 600 x 600
- 1600 x 600 x 600

**WITH WALL-FACING COUNTERTOP**

**Code**

- F0781001
- F0781002
- F0781003
- F0781004
- F0781005
- F0781006

**WITH CENTER COUNTERTOP**

**Code**

- F0791001
- F0791002
- F0791003
- F0791004
- F0791005
- F0791006

**WITHOUT COUNTERTOP**

**Code**

- F0081001
- F0081002
- F0081003
- F0081004
- F0081005
- F0081006

COUNTERTOP THICKNESS 1.5 MM PAGE 116



### 700 SERIES

**Total dimensions (mm)**

- 600 x 700 x 600
- 800 x 700 x 600
- 1000 x 700 x 600
- 1200 x 700 x 600
- 1400 x 700 x 600
- 1600 x 700 x 600

**WITH WALL-FACING COUNTERTOP**

**Code**

- F0781007
- F0781008
- F0781009
- F0781010
- F0781011
- F0781012

**WITH CENTER COUNTERTOP**

**Code**

- F0791007
- F0791008
- F0791009
- F0791010
- F0791011
- F0791012

**WITHOUT COUNTERTOP**

**Code**

- F0081007
- F0081008
- F0081009
- F0081010
- F0081011
- F0081012



## 600-MM-HIGH UNIT WITH SWINGING DOORS

- Made of AISI grade 304 stainless steel (18/10).
- Countertops and shelves have reinforcing omega brackets.
- 105 mm backsplash on wall-facing countertops and 65 mm front panel with rounded safety edges, fully welded.
- 150 mm legs allow you to raise the height of the unit from 600 to 650 mm.
- **No assembly required.**

RELATED PRODUCTS  
**COUNTERTOPS** page 112

COUNTERTOP THICKNESS 1.5 MM PAGE 116



### 600 SERIES

	WITH WALL-FACING COUNTERTOP	WITH CENTER COUNTERTOP	WITHOUT COUNTERTOP
<b>Total dimensions (mm)</b>	<b>Code</b>	<b>Code</b>	<b>Code</b>
400 x 600 x 600	• F0781020	• F0791020	• F0081020
500 x 600 x 600	• F0781021	• F0791021	• F0081021
600 x 600 x 600	• F0781022	• F0791022	• F0081022
800 x 600 x 600	• F0781023	• F0791023	• F0081023
1000 x 600 x 600	• F0781024	• F0791024	• F0081024

COUNTERTOP THICKNESS 1.5 MM PAGE 116



### 700 SERIES

	WITH WALL-FACING COUNTERTOP	WITH CENTER COUNTERTOP	WITHOUT COUNTERTOP
<b>Total dimensions (mm)</b>	<b>Code</b>	<b>Code</b>	<b>Code</b>
400 x 700 x 600	• F0781025	• F0791025	• F0081025
500 x 700 x 600	• F0781026	• F0791026	• F0081026
600 x 700 x 600	• F0781027	• F0791027	• F0081027
800 x 700 x 600	• F0781028	• F0791028	• F0081028
1000 x 700 x 600	• F0781029	• F0791029	• F0081029



• 3-DAY SHIPPING

# UNIT WITH DRAWERS AND SLIDING DOORS



**POSSIBILITY OF CUSTOMISING LENGTH**

Please indicate desired length, price and code of the next higher model (\*)



## UNIT WITH LEFT-SIDE DRAWERS AND SLIDING DOORS

- Made of AISI 304 stainless steel (18/10).
- Countertops and shelves have reinforcing omega brackets.
- 105 mm backsplash on wall-facing countertops and 65 mm front panel with rounded safety edges, fully welded.
- Adjustable shelf with very sturdy supports.
- 150 mm legs allow you to raise the height of the unit from 850 to 920 mm.
- Suspended sliding doors glide very smoothly. This design does not use bottom runners, facilitating cleaning.
- Useable volume of drawers is 289 x 485 x 125 mm.
- **No assembly required.**
- **Optional: height adjustable legs from 900 to 990 mm (page 117).**

UNIT WITH DRAWERS AND SLIDING DOORS DIMENSIONS

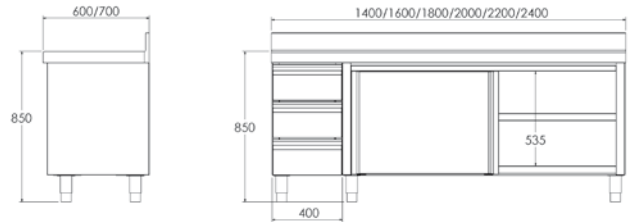

RELATED PRODUCTS

**COUNTERTOPS** page 112

COUNTERTOP THICKNESS 1.5 MM PAGE 116



**600 SERIES**

Total dimensions (mm)	WITH WALL-FACING COUNTERTOP	WITH CENTER COUNTERTOP	WITHOUT COUNTERTOP
	Code	Code	Code
1400 x 600 x 850	• F0071111	• F0071011	• F0083011
1600 x 600 x 850	• F0071112	• F0071012	• F0083012
1800 x 600 x 850	• F0071113	• F0071013	• F0083013
2000 x 600 x 850	• F0071114	• F0071014	• F0083014
2200 x 600 x 850	• F0071115	• F0071015	• F0083015
2400 x 600 x 850	• F0071116	• F0071016	• F0083016

**700 SERIES**

Total dimensions (mm)	WITH WALL-FACING COUNTERTOP	WITH CENTER COUNTERTOP	WITHOUT COUNTERTOP
	Code	Code	Code
1400 x 700 x 850	• F0071131	• F0071031	• F0083031
1600 x 700 x 850	• F0071132	• F0071032	• F0083032
1800 x 700 x 850	• F0071133	• F0071033	• F0083033
2000 x 700 x 850	• F0071134	• F0071034	• F0083034
2200 x 700 x 850	• F0071135	• F0071035	• F0083035
2400 x 700 x 850	• F0071136	• F0071036	• F0083036



**POSSIBILITY OF CUSTOMISING LENGTH**

Please indicate desired length, price and code of the next higher model (•)

**UNIT WITH RIGHT-SIDE DRAWERS AND SLIDING DOORS**

- Made of AISI 304 stainless steel (18/10).
- Countertops and shelves have reinforcing omega brackets.
- 105 mm backsplash on wall-facing countertops and 65 mm front panel with rounded safety edges, fully welded.
- Adjustable shelf with very sturdy supports.
- 150 mm legs allow you to raise the height of the unit from 850 to 920 mm.
- Suspended sliding doors glide very smoothly. This design does not use bottom runners, facilitating cleaning.
- Useable volume of drawers is 289 x 485 x 125 mm.
- **No assembly required.**
- **Optional: height adjustable legs from 900 to 990 mm (page 117).**

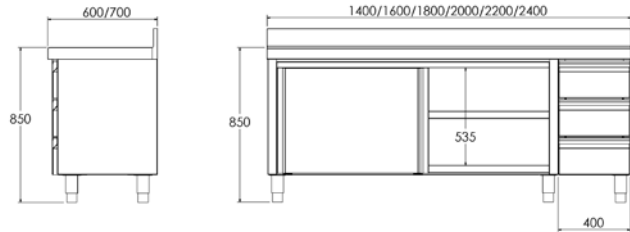
**UNIT WITH SLIDING DOORS DIMENSIONS****RELATED PRODUCTS****COUNTERTOPS** page 112**COUNTERTOP THICKNESS 1.5 MM** PAGE 116**600 SERIES**

Total dimensions (mm)	WITH WALL-FACING COUNTERTOP	WITH CENTER COUNTERTOP	WITHOUT COUNTERTOP
	Código	Código	Código
1400 x 600 x 850	• F0071101	• F0071001	• F0083101
1600 x 600 x 850	• F0071102	• F0071002	• F0083102
1800 x 600 x 850	• F0071103	• F0071003	• F0083103
2000 x 600 x 850	• F0071104	• F0071004	• F0083104
2200 x 600 x 850	• F0071105	• F0071005	• F0083105
2400 x 600 x 850	• F0071106	• F0071006	• F0083106

**700 SERIES**

Total dimensions (mm)	WITH WALL-FACING COUNTERTOP	WITH CENTER COUNTERTOP	WITHOUT COUNTERTOP
	Código	Código	Código
1400 x 700 x 850	• F0071121	• F0071021	• F0083021
1600 x 700 x 850	• F0071122	• F0071022	• F0083022
1800 x 700 x 850	• F0071123	• F0071023	• F0083023
2000 x 700 x 850	• F0071124	• F0071024	• F0083024
2200 x 700 x 850	• F0071125	• F0071025	• F0083025
2400 x 700 x 850	• F0071126	• F0071026	• F0083026

• **3-DAY SHIPPING**

# INDUSTRIAL SINK UNITS

## 600 SERIES

- Made of AISI grade 304 stainless steel (18/10).
- 105 mm backsplash and 65 mm front panel with rounded safety edges, fully welded.
- Basins inlaid with sound-proofing protection.
- Inlaid drain valve and overflow pipe included in each basin.
- 150 mm legs allow you to raise the height of the unit from 850 to 920 mm.
- Rear legs raised 50 mm to allow you to set the industrial sink unit on a floor with a sanitary radius.
- Open rear section to facilitate access to installations.
- Available with hinged or sliding doors depending on the model.
- Taps not included.
- **No assembly required.**
- **Optional: height adjustable legs from 900 to 990 mm (page 117).**

RELATED PRODUCTS

**Taps** page 43

### BASIN DIMENSIONS



## 600 SERIES

Total Dimensions (mm)	Basin dimensions (mm)	Unit with doors	Unit with doors and space for dishwasher
600 x 600	500 x 400 x 250	• FP960600 Swinging	-
1000 x 600	400 x 400 x 250	• FP91060D Sliding	-
	400 x 400 x 250	• FP91060I Sliding	-
	400 x 400 x 250	• FP910600 Sliding	-
1200 x 600	500 x 400 x 250	• FP91260D Sliding	• FP9126LD Swinging
	500 x 400 x 250	• FP91260I Sliding	• FP9126LI Swinging
	500 x 400 x 250	• FP912600 Sliding	-
1400 x 600	400 x 400 x 250	• FP91460D Sliding	-
	400 x 400 x 250	• FP91460I Sliding	-
	500 x 400 x 250	• FP91461D Sliding	• FP9146LD Swinging
	500 x 400 x 250	• FP91461I Sliding	• FP9146LI Swinging
1600 x 600	500 x 400 x 250	• FP91660D Sliding	-
	500 x 400 x 250	• FP91660I Sliding	-
1800 x 600	500 x 400 x 300	• FP91860D Sliding	• FP9186LD Sliding
	500 x 400 x 300	• FP91860I Sliding	• FP9186LI Sliding
2000 x 600	500 x 400 x 250	• FP920600 Sliding	-



## 700 SERIES

- Made of AISI grade 304 stainless steel (18/10).
- 105 mm backsplash and 65 mm front panel with rounded safety edges, fully welded.
- Basins inlaid with sound-proofing protection.
- Inlaid drain valve and overflow pipe included in each basin.
- 150 mm legs allow you to raise the height of the unit from 850 to 920 mm.
- Rear legs raised 50 mm to allow you to set the Industrial sink unit on a floor with a sanitary radius.
- Open rear section to facilitate access to installations.
- Available with hinged or sliding doors depending on the model.
- Taps not included.
- **No assembly required.**
- **Optional: height adjustable legs from 900 to 990 mm (page 117).**

RELATED PRODUCTS

Taps page 43

### BASIN DIMENSIONS

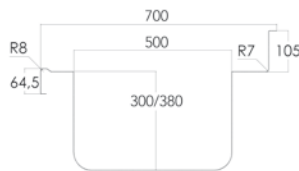

## 700 SERIES

Total dimensions (mm)	Basin dimensions (mm)	Unit with doors	Unit with doors and space for dishwasher
700 x 700	500 x 500 x 300	• FP970700 Swinging	-
	500 x 500 x 300	• FP91070D Sliding	-
1000 x 700	500 x 500 x 300	• FP91070I Sliding	-
	500 x 400 x 250	• FP910700 Sliding	-
1200 x 700	500 x 500 x 300	• FP91270D Sliding	• FP9127LD Swinging
	500 x 500 x 300	• FP91270I Sliding	• FP9127LI Swinging
	500 x 500 x 300	• FP912700 Sliding	-
1400 x 700	600 x 500 x 300	• FP91470D Sliding	• FP9147LD Swinging
	600 x 500 x 300	• FP91470I Sliding	• FP9147LI Swinging
	600 x 500 x 300	• FP914700 Sliding	-
1600 x 700	500 x 500 x 300	• FP91670D Sliding	-
	500 x 500 x 300	• FP91670I Sliding	-
1800 x 700	500 x 500 x 300	• FP91870D Sliding	• FP9187LD Sliding
	500 x 500 x 300	• FP91870I Sliding	• FP9187LI Sliding
	500 x 500 x 300	• FP918700 Sliding	-
2000 x 700	600 x 500 x 300	• FP92070D Sliding	-
	600 x 500 x 300	• FP92070I Sliding	-

# CENTER AND WALL-FACING COUNTERTOP



**POSSIBILITY OF CUSTOMISING LENGTH**

Please indicate desired length, price and code of the next higher model (\*)

## COUNTERTOP

- Built with AISI grade 304 brushed stainless steel (18/10).
- With reinforcing omega brackets.
- 105 mm backsplash and 65 mm front panel with rounded safety edges, fully welded.

COUNTERTOP THICKNESS 1.5 MM PAGE 116

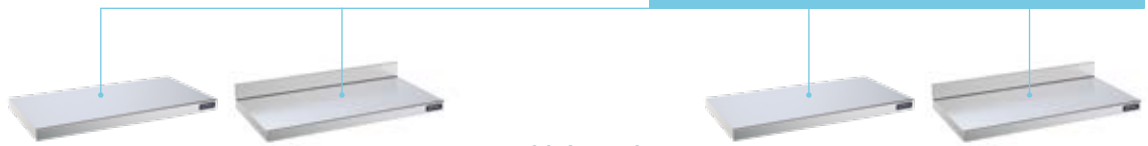

### 600 SERIES

Total dimensions (mm)	Center Countertop	Wall-facing countertop
400 x 600	• F0080301	• F0080351
500 x 600	• F0080302	• F0080352
600 x 600	• F0080303	• F0080353
700 x 600	• F0080419	• F0080420
800 x 600	• F0080304	• F0080354
900 x 600	• F0080401	• F0080403
1000 x 600	• F0080305	• F0080355
1100 x 600	• F0080306	• F0080356
1200 x 600	• F0080307	• F0080357
1300 x 600	• F0080308	• F0080358
1400 x 600	• F0080309	• F0080359
1500 x 600	• F0080310	• F0080360
1600 x 600	• F0080311	• F0080361
1700 x 600	• F0080312	• F0080362
1800 x 600	• F0080313	• F0080363
1900 x 600	• F0080314	• F0080364
2000 x 600	• F0080315	• F0080365
2100 x 600	• F0080316	• F0080366
2200 x 600	• F0080317	• F0080367
2300 x 600	• F0080318	• F0080368
2400 x 600	• F0080319	• F0080369
2500 x 600	• F0080320	• F0080370
2600 x 600	• F0080321	• F0080371
2700 x 600	• F0080322	• F0080372
2800 x 600	• F0080323	• F0080373

### 700 SERIES

Total dimensions (mm)	Center Countertop	Wall-facing countertop
400 x 700	• F0080326	• F0080376
500 x 700	• F0080327	• F0080377
600 x 700	• F0080328	• F0080378
700 x 700	• F0080421	• F0080422
800 x 700	• F0080329	• F0080379
900 x 700	• F0080402	• F0080404
1000 x 700	• F0080330	• F0080380
1100 x 700	• F0080331	• F0080381
1200 x 700	• F0080332	• F0080382
1300 x 700	• F0080333	• F0080383
1400 x 700	• F0080334	• F0080384
1500 x 700	• F0080335	• F0080385
1600 x 700	• F0080336	• F0080386
1700 x 700	• F0080337	• F0080387
1800 x 700	• F0080338	• F0080388
1900 x 700	• F0080339	• F0080389
2000 x 700	• F0080340	• F0080390
2100 x 700	• F0080341	• F0080391
2200 x 700	• F0080342	• F0080392
2300 x 700	• F0080343	• F0080393
2400 x 700	• F0080344	• F0080394
2500 x 700	• F0080345	• F0080395
2600 x 700	• F0080346	• F0080396
2700 x 700	• F0080347	• F0080397
2800 x 700	• F0080348	• F0080398





# WALL-FACING COUNTERTOP WITH BASIN



**POSSIBILITY OF CUSTOMISING LENGTH**

Please indicate desired length, price and code of the next higher model (\*)

## COUNTERTOP WITH BASIN

- Built with AISI grade 304 brushed stainless steel (18/10).
- With reinforcing omega brackets.
- 105 mm backsplash and 65 mm front panel with rounded safety edges, fully welded.
- 500 x 400 x 250 mm welded basin.

RELATED PRODUCTS

**Taps** page 43

COUNTERTOP THICKNESS 1.5 MM PAGE 116



### 600 SERIES

Total dimensions (mm)	Countertop with right basin	Countertop with left basin	Countertop with center basin
1000 x 600	• FEC1006D	• FEC1006I	• FEC1006C
1200 x 600	• FEC1206D	• FEC1206I	• FEC1206C
1400 x 600	• FEC1406D	• FEC1406I	• FEC1406C
1500 x 600	• FEC1506D	• FEC1506I	• FEC1506C
1600 x 600	• FEC1606D	• FEC1606I	• FEC1606C
1800 x 600	• FEC1806D	• FEC1806I	• FEC1806C
2000 x 600	• FEC2006D	• FEC2006I	• FEC2006C
2200 x 600	• FEC2206D	• FEC2206I	• FEC2206C
2400 x 600	• FEC2406D	• FEC2406I	• FEC2406C
2600 x 600	• FEC2606D	• FEC2606I	• FEC2606C
2800 x 600	• FEC2806D	• FEC2806I	• FEC2806C

### 700 SERIES

Total dimensions (mm)	Countertop with right basin	Countertop with left basin	Countertop with center basin
1000 x 700	• FEC1007D	• FEC1007I	• FEC1007C
1200 x 700	• FEC1207D	• FEC1207I	• FEC1207C
1400 x 700	• FEC1407D	• FEC1407I	• FEC1407C
1500 x 700	• FEC1507D	• FEC1507I	• FEC1507C
1600 x 700	• FEC1607D	• FEC1607I	• FEC1607C
1800 x 700	• FEC1807D	• FEC1807I	• FEC1807C
2000 x 700	• FEC2007D	• FEC2007I	• FEC2007C
2200 x 700	• FEC2207D	• FEC2207I	• FEC2207C
2400 x 700	• FEC2407D	• FEC2407I	• FEC2407C
2600 x 700	• FEC2607D	• FEC2607I	• FEC2607C
2800 x 700	• FEC2807D	• FEC2807I	• FEC2807C

# SUPPORT CABINET FOR TERRACE

## SUPPORT CABINET FOR TERRACE

- Made of AISI 304 18/10 stainless steel.
- Worktop with reinforcement omega.
- 105 mm backsplash and 65 mm front panel with rounded safety edges, fully welded.
- Drawers with telescopic runners.
- Large capacity modules with hinged doors.
- Side handle for easy cabinet handling.
- Lateral support to place trays.
- 4 Ø150 mm swivel castors with bumpers, 2 of which feature brakes.
- Models with side panels, fully welded.
- **No assembly required.**



### WITHOUT SIDE PANELS

Total dimensions (mm)	Doors	Drawers	Code
1000 x 600 x 1100	-	2	• F0072001
1000 x 600 x 1100	2	2	• F0072002
1500 x 600 x 1100	3	3	• F0072003

### WITH SIDE PANELS

Total dimensions (mm)	Doors	Drawers	Code
1000 x 600 x 1100	-	2	• F0072004
1000 x 600 x 1100	2	2	• F0072005
1500 x 600 x 1100	3	3	• F0072006



# RECYCLING CABINET

## CLOSED RECYCLING CABINET

- **Ideal for sorting waste.**
- Made of AISI 304 18/10 stainless steel.
- 65 mm front piece with rounded finish, fully welded.
- Fully welded 105 mm backsplash on wall-facing models.
- 150 mm legs allow you to raise the height of the unit from 850 to 920 mm.
- The height of the children's model is from 700 to 750 mm.
- 50 mm advanced rear legs to allow you to set the cabinet on a floor with a sanitary radius.
- Swing doors.
- Two or three Ø 190-280 mm holes for rubber rings.
- Coloured rubber rings not included.
- **No assembly required.**
- **Optional: height adjustable legs from 900 to 990 mm (page 117).**

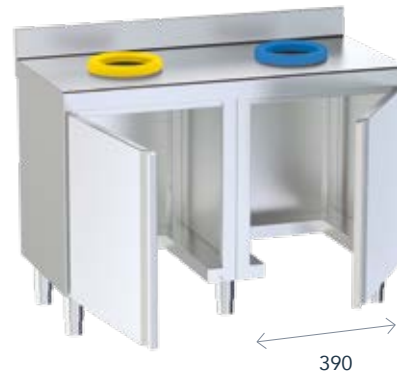

### RELATED PRODUCTS

**CUBES** pg. 167



### CENTRAL

Total dimensions (mm)	Holes	Code
1200 x 600 x 850	2	• F0072013
1800 x 600 x 850	3	• F0072014



### WALL-FACING

Total dimensions (mm)	Holes	Code
1200 x 600 x 850	2	• F0072007
1800 x 600 x 850	3	• F0072008

### CHILDREN'S CENTRAL

Total dimensions (mm)	Holes	Code
1200 x 600 x 700	2	• F0072011
1800 x 600 x 700	3	• F0072012

### CHILDREN'S WALL-FACING

Total dimensions (mm)	Holes	Code
1200 x 600 x 700	2	• F0072009
1800 x 600 x 700	3	• F0072010

## RUBBER WASTE RING

- **Facilitates the identification of the container.**
- Detachable.
- Easy to clean and disinfect.

Colour	Code
Red — Organic	• ARO000RO
Green — Glass	• ARO000VE
Yellow — Plastic	• ARO000AM
Blue — Paper	• ARO000AZ



# CUSTOMIZATIONS FOR COUNTERTOPS

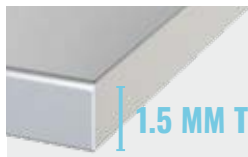

## 1.5 MM THICK COUNTERTOP

- Countertops are made of 1.5 mm thick AISI grade 304 stainless steel (18/10).
- Sturdier.
- Additional cost relative to the standard countertop price.

Measurement	Code
Up to 1200 mm	• FESP1512
Up to 1600 mm	• FESP1516
Up to 2000 mm	• FESP1520
Up to 2400 mm	• FESP1524
Up to 2800 mm	• FESP1528

## COUNTERTOP WASTE CHUTE

- Ø200 mm waste chute with a rubber ring for throwing trash directly into a bin beneath the counter.
- High-density food-service grade rubber.
- Removable rubber ring.



Model	Code
Chute + Rubber Ring	• ADE50001
Rubber ring replacement	• CAD00001
Waste chute cover	• RTAPAD01

## FOLDED AND WELDED SIDE SPLASH ON COUNTERTOPS

- Made of AISI grade 304 stainless steel (18/10).
- Folded lateral backplash with sanitary radius, welded at the corners.
- Additional cost relative to the standard countertop price.
- **Only compatible with wall-mounted worktops**



Model	Code
Right	• CPDE0001
Left	• CPIE0002
Right + Left *	• CP2E0003

\*For countertops of up to 2600 mm

## TAP HOLE IN COUNTERTOP

- 33 mm diameter hole

Model	Position	Code
Right		• LAVA0001
Left		• LAVA0002
Center		• LAVA0003
Between basins		• LAVA0004

## STAINLESS STEEL REINFORCING OMEGA BRACKETS ON COUNTERTOPS

- Substitution of standard omega brackets for stainless steel omega brackets.
- Additional cost relative to the standard countertop price.

Dimensions	Countertop only	1 shelf countertop	2 shelf countertop
Up to 1200 mm	• FIX1200E	• FIX1201E	• FIX1202E
Up to 1600 mm	• FIX1600E	• FIX1601E	• FIX1602E
Up to 2000 mm	• FIX2000E	• FIX2001E	• FIX2002E
Up to 2400 mm	• FIX2400E	• FIX2401E	• FIX2402E
Up to 2800 mm	• FIX2800E	• FIX2801E	• FIX2802E



# CABINETS AND MODULES ACCESSORIES

## PACK OF 4 OR 6 CASTORS

- Includes 4 or 6 Ø150 mm castors (two with brakes).
- They replace the standard legs of the cabinets and modules.
- **It is necessary to indicate the model of the cabinet when ordering.**

Model	For module length	Code
4 castors	≤ 2000 mm	• FRU80001
6 castors	> 2000 mm	• FRU80002

## HEIGHT ADJUSTABLE LEGS FROM 900 TO 990 MM

- Made of AISI 304 18/10 stainless steel.
- They replace the standard legs of the cabinets and modules.
- **It is necessary to indicate the model of the cabinet when ordering.**

Model	Code
4 legs	• FPM00004
6 legs	• FPM00006

## BASEBOARDS

- Made of AISI grade 304 stainless steel (18/10).
- Easy installation.

Measurement	Code
400	• FZ000400
600	• FZ000600
800	• FZ000800
1000	• FZ001000
1200	• FZ001200
1400	• FZ001400
1600	• FZ001600
1800	• FZ001800
2000	• FZ002000
Lateral 600	• FZL00600
Lateral 700	• FZL00700

## EXAMPLE OF POSSIBLE ARRANGEMENT

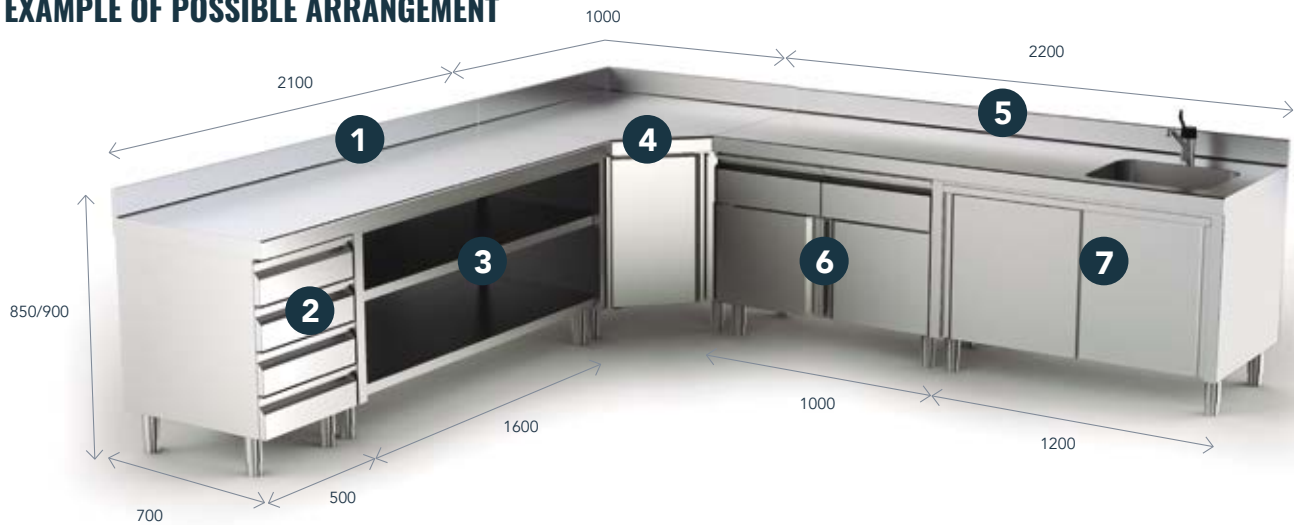

Description	Total dimensions (mm)	Code
1. 700 Series wall-facing countertop	2100 x 700	F0080391
2. 700 Series 4 drawer module without countertop	500 x 700 x 850	F0080124
3. 700 Series module with shelves, no countertop	1600 x 700 x 850	F0080056
4. 700 Series 90° chamfered corner unit	1000 x 1000 x 700 x 850	F0070117
5. 700 Series wall-facing countertop with right-side basin	2200 x 700	FEC2207D
6. 700 Series module with drawers and swinging doors, no countertop	1000 x 700 x 850	F0080109
7. 700 Series sliding door module for countertop with basin	1200 x 700 x 850	FCU80008



STATIC PREPARATION

# CABINETS



## WALL-MOUNTED CABINETS

PAGE 120



## PLATE WARMING CABINETS

PAGE 121



## SUPPORTS

PAGE 121



## FREESTANDING CABINETS

PAGE 122

# WALL-MOUNTED CABINETS

- **For daily use in organizing a commercial kitchen.**
- Made of AISI grade 304 brushed stainless steel (18/10).
- Middle shelf with adjustable height.
- Easy wall mounting.
- Models with swinging doors open on the right side.

- Corner model is designed to connect cabinets in 90° corners.
- Adjustable wall system for inclines greater than 1cm.
- **No assembly required.**



## SWINGING DOORS

Total dimensions (mm)	Doors	Code
400 x 400 x 600	1	• F0240134
500 x 400 x 600	1	• F0240135
800 x 400 x 600	2	• F0240136
1000 x 400 x 600	2	• F0240137

## OPEN

Total dimensions (mm)	Code
1000 x 400 x 600	• F0240130
1200 x 400 x 600	• F0240131
1400 x 400 x 600	• F0240132
1600 x 400 x 600	• F0240133

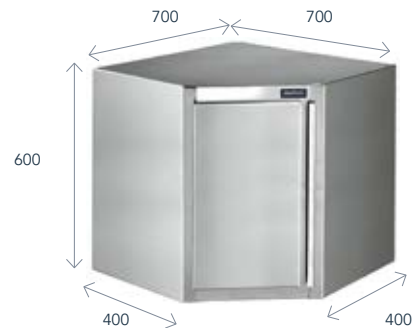

## SLIDING DOORS WITH SHELF

Total dimensions (mm)	With shelf
1000 x 400 x 600	• F0240101
1200 x 400 x 600	• F0240102
1400 x 400 x 600	• F0240104
1600 x 400 x 600	• F0240103
1800 x 400 x 600	• F0240105

## 90° CORNER

Total dimensions (mm)	Code
700 x 400 x 600	• F0240121

## SLIDING DOORS WITH DISH RACK

Total dimensions (mm)	With dish rack
1000 x 400 x 600	• F0240111
1200 x 400 x 600	• F0240112





# PLATE WARMING CABINETS AND SUPPORTS

## PLATE WARMING CABINET

- Keeps plates hot during service.
- Made of AISI grade 304 stainless steel (18/10).
- Lighted switch and adjustable 0-90°C analog thermostat.
- Single unit: 1 adjustable middle shelf.
- Double unit: 2 adjustable middle shelves.
- Modular model: Easy to install on the bottom shelf of a work table.



SINGLE



DOUBLE



MODULAR

Model	Total dimensions (mm)	Power (W)	Power supply (V/Hz)	Plate capacity	Plate diameter	Code
Simple	400 x 460 x 870	400	230/50-60	60	310 mm	• F0420301
Double	800 x 460 x 870	1500	230/50-60	120	310 mm	• F0420302
Modular	400 x 460 x 570	400	230/50-60	30	290 mm	• F0420306

## UTENSIL HANGING RACK

- Made of Ø8 mm AISI 304 18/10 stainless steel tube.
- Welded plates with holes for wall installation (screws and plugs included).



Total dimensions (mm)	Ø	Code
600 x 48	8 mm	• F0210201



# FREESTANDING CABINETS

## FREESTANDING CABINET

- Facilitates storage and organization in the kitchen
- Made of AISI grade 304 brushed stainless steel (18/10).
- All models include 3 stainless steel shelves with reinforcing omega brackets. The center shelf is fixed and the other two are adjustable.
- Maximum load per shelf: 80 kg.
- Lock with key included.
- 150 mm legs allow you to raise the height of the unit.
- **No assembly required.**

FREESTANDING CABINET DIMENSIONS

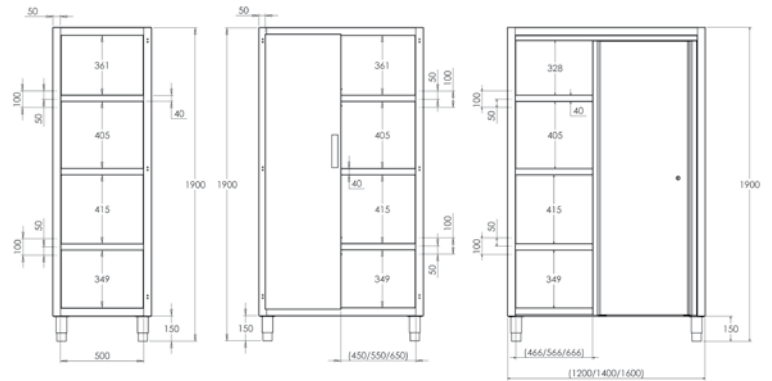

### SWINGING DOORS

Total dimensions (mm)	Code	Doors
600 x 600 x 1900	• F0240000	1
1000 x 600 x 1900	• F0240006	2
1200 x 600 x 1900	• F0240007	2
1400 x 600 x 1900	• F0240008	2
1600 x 600 x 1900	-	-

### SLIDING DOORS

Code	Doors
-	-
• F0240001	2
• F0240002	2
• F0240003	2

## SLOPED PROTECTOR FOR FREESTANDING CABINET

- Useful for preventing the build-up of dust and dirt on top of the cabinet.
- Made of AISI grade 304 brushed stainless steel (18/10).
- Easily installed on freestanding cabinets.

Total dimensions (mm)	Swinging doors	Sliding doors
600 x 600 x 200	• F0240402	-
1000 x 600 x 200	• F0240403	-
1200 x 600 x 200	• F0240404	• F0240406
1400 x 600 x 200	• F0240405	• F0240407
1600 x 600 x 200	-	• F0240408



## CABINET FOR CLEANING PRODUCTS

- Designed to organize and separate cleaning products, keeping them out-of-sight in the work area.
- Made of AISI grade 304 brushed stainless steel (18/10).
- Comes with 3 stainless steel middle shelves and space to organize and separate cleaning products and items.
- Lock with key included.
- 150 mm legs allow you to raise the height of the unit.
- **No assembly required.**

FREESTANDING CABINET DIMENSIONS

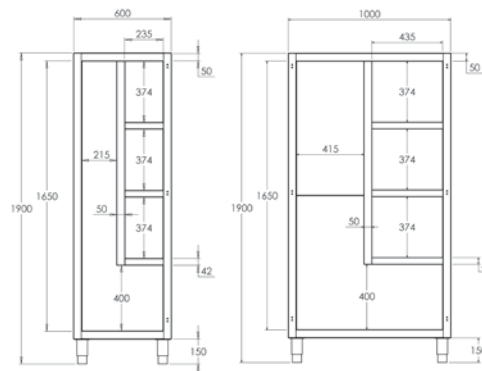

Total dimensions (mm)	Swinging doors	Code
600 x 450 x 1900	1	● F0240201
1000 x 450 x 1900	2	● F0240202

## SLOPED PROTECTOR FOR CLEANING CABINET

- Useful for preventing the build-up of dust and dirt on top of the cabinet.
- Made of AISI grade 304 brushed stainless steel (18/10).
- Easily installed on freestanding cabinets..

Total dimensions (mm)	Code
600 x 450 x 200	● F0240410
1000 x 450 x 200	● F0240409





STATIC PREPARATION

# SHELVING



## WALL-MOUNTED SHELVING

PAGE 126



## SLOTTED PROFILE SHELVING

PAGE 131



## FREESTANDING STAINLESS STEEL SHELVING UNIT

PAGE 138



## FREESTANDING ALUMINIUM SHELVING UNIT

PAGE 148

# WALL-MOUNTED SHELVING



## POSSIBILITY OF CUSTOMISING LENGTH

Please indicate desired length, price and code of the next higher model (\*)



## WELDED WALL-MOUNTED SHELF

- Made of AISI 304 stainless steel (18/10).
- Wall-mountable brackets with Ø8 mm drill holes.
- Screws and plugs for installation are included.
- **Comes fully welded.**



Total dimensions (mm)	Code
600 x 250 x 150	• F0100207
800 x 250 x 150	• F0100208
1000 x 250 x 150	• F0100201
1200 x 250 x 150	• F0100202
1400 x 250 x 150	• F0100203
1500 x 250 x 150	• F0100209
1600 x 250 x 150	• F0100204
1800 x 250 x 150	• F0100205
2000 x 250 x 150	• F0100206

Total dimensions (mm)	Code
600 x 300 x 250	• F0100226
800 x 300 x 250	• F0100227
1000 x 300 x 250	• F0100228
1200 x 300 x 250	• F0100229
1400 x 300 x 250	• F0100230
1500 x 300 x 250	• F0100231
1600 x 300 x 250	• F0100232
1800 x 300 x 250	• F0100233
2000 x 300 x 250	• F0100234

Total dimensions (mm)	Code
600 x 400 x 250	• F0100217
800 x 400 x 250	• F0100218
1000 x 400 x 250	• F0100211
1200 x 400 x 250	• F0100212
1400 x 400 x 250	• F0100213
1500 x 400 x 250	• F0100219
1600 x 400 x 250	• F0100214
1800 x 400 x 250	• F0100215
2000 x 400 x 250	• F0100216



**POSSIBILITY OF CUSTOMISING LENGTH**

Please indicate desired length, price and code of the next higher model (\*)

## WALL-MOUNTED DISH RACK SHELF

- Made of AISI 304 stainless steel (18/10).
- Wall-mountable brackets with Ø8 mm drill holes.
- Screws and plugs for installation are included.
- Removable stainless steel racks.
- For plates with a maximum diameter of 250 mm.
- **Comes fully welded.**



Total dimensions (mm)	Plate capacity	Code
730 x 300 x 180	26	• F0200301
1430 x 300 x 180	52	• F0200302

## WALL-MOUNTED HOOD SHELF

- Made of AISI 304 stainless steel (18/10).
- Wall-mountable brackets with Ø8 mm drill holes.
- Screws and plugs for installation are included.
- Removable stainless steel grill racks for GN 1/1.
- **Comes fully welded.**



Total dimensions (mm)	Plate capacity	Code
590 x 400 x 180	1GN 1/1	• F0200104
1115 x 400 x 180	2GN 1/1	• F0200101
1650 x 400 x 180	3GN 1/1	• F0200102
2180 x 400 x 180	4GN 1/1	• F0200103



## MICROWAVE SHELF

- **Designed to hold microwaves or other appliances, hung from a wall.**
- Made of stainless steel.
- Wall-mountable brackets with Ø8 mm drill holes.
- Screws and plugs for installation are included.
- Ø60 mm hole for wiring.
- **Comes fully welded with disassembled brackets.**



Total dimensions (mm)	Code
600 x 400 x 230	• F0200401
700 x 500 x 280	• F0200403
800 x 400 x 230	• F0200402



## WALL-MOUNTED TUBE SHELF

- Made of AISI 304 stainless steel (18/10).
- Wall-mountable brushed stainless steel brackets with Ø8 mm pre-drilled holes.
- Screws and plugs for installation are included.
- 25 x 25 mm stainless steel tubes.
- **Comes fully welded.**



Total dimensions (mm)	Code
600 x 400 x 248	• F0100007
800 x 400 x 248	• F0100008
1000 x 400 x 248	• F0100001
1200 x 400 x 248	• F0100002
1400 x 400 x 248	• F0100003
1600 x 400 x 248	• F0100004
1800 x 400 x 248	• F0100006 *
2000 x 400 x 248	• F0100005 *

\* Units that have a welded central bracket.



• 24/48-HOUR • 3-DAY SHIPPING

# WALL-MOUNTED SHELVING



## POSSIBILITY OF CUSTOMISING LENGTH

Please indicate desired length, price and code of the next higher model (\*)



## SHELF WITH BRACKETS

- Stainless steel shelving.
- Plugs and screws for installation included.
- Supplied disassembled.
- **Easy assembly in 3 minutes.**



Total dimensions (mm)	Code
600 x 250 x 150	• F0100235
800 x 250 x 150	• F0100236
1000 x 250 x 150	• F0100237
1200 x 250 x 150	• F0100238
1400 x 250 x 150	• F0100239
1500 x 250 x 150	• F0100240
1600 x 250 x 150	• F0100241
1800 x 250 x 150	• F0100242
2000 x 250 x 150	• F0100243

Total dimensions (mm)	Code
600 x 300 x 200	• F0100221
800 x 300 x 200	• F0100222
1000 x 300 x 200	• F0100223
1200 x 300 x 200	• F0100224
1400 x 300 x 200	• F0100225
1500 x 300 x 200	• F0100253
1600 x 300 x 200	• F0100254
1800 x 300 x 200	• F0100255
2000 x 300 x 200	• F0100256

Total dimensions (mm)	Code
600 x 400 x 250	• F0100244
800 x 400 x 250	• F0100245
1000 x 400 x 250	• F0100246
1200 x 400 x 250	• F0100247
1400 x 400 x 250	• F0100248
1500 x 400 x 250	• F0100249
1600 x 400 x 250	• F0100250
1800 x 400 x 250	• F0100251
2000 x 400 x 250	• F0100252





**POSSIBILITY OF CUSTOMISING LENGTH**

Please indicate desired length, price and code of the next higher model (\*)

**SHELF WITH INVERTED BRACKETS**

- Stainless steel shelving.
- Plugs and screws for installation included.
- Supplied disassembled.
- **Easy assembly in 3 minutes.**



Total dimensions (mm)	Code
600 x 250 x 150	• F0100600
800 x 250 x 150	• F0100601
1000 x 250 x 150	• F0100602
1200 x 250 x 150	• F0100603
1400 x 250 x 150	• F0100604
1500 x 250 x 150	• F0100605
1600 x 250 x 150	• F0100606
1800 x 250 x 150	• F0100607
2000 x 250 x 150	• F0100608

Total dimensions (mm)	Code
600 x 300 x 200	• F0100609
800 x 300 x 200	• F0100610
1000 x 300 x 200	• F0100611
1200 x 300 x 200	• F0100612
1400 x 300 x 200	• F0100613
1500 x 300 x 200	• F0100614
1600 x 300 x 200	• F0100615
1800 x 300 x 200	• F0100616
2000 x 300 x 200	• F0100617

Total dimensions (mm)	Code
600 x 400 x 250	• F0100618
800 x 400 x 250	• F0100619
1000 x 400 x 250	• F0100620
1200 x 400 x 250	• F0100621
1400 x 400 x 250	• F0100622
1500 x 400 x 250	• F0100623
1600 x 400 x 250	• F0100624
1800 x 400 x 250	• F0100625
2000 x 400 x 250	• F0100626



• 24/48-HOUR • 3-DAY SHIPPING

# WALL-MOUNTED SHELVING

## ADJUSTABLE WALL-MOUNTED SHELF

- Made entirely of AISI grade 304 brushed stainless steel (18/10).
- Easy to install tracks.
- Screws and plugs for installation are included.



### TRACKS

Height (mm)	Code
600	• F0120001
1000	• F0120002
1500	• F0120003

- Price per unit



### FLAT SHELF

Dimensions (mm)	Code
1000 x 250	• F0100401
1200 x 250	• F0100403
1400 x 250	• F0100402
1600 x 250	• F0100404
1000 x 400	• F0100411
1200 x 400	• F0100413
1400 x 400	• F0100412
1600 x 400	• F0100414



### SLANTED SHELF

Dimensions (mm)	Units	Containers	Code
1000 x 250	4	1/6	• F0100501
1000 x 400	4	1/3	• F0100511

- Containers not included.



### RELATED PRODUCTS

[GASTRONORM CONTAINERS](#) page 179

## WALL-HANGING RACK

- Made of Ø30mm AISI 304 stainless steel (18/10) tube.
- Welded plates with holes for wall installation.
- Screws and plugs for installation are included.
- Comes fully welded.

Total dimensions (mm)	Code
1000 x 150	• F0210001
1500 x 150	• F0210002
2000 x 150	• F0210003



# SLOTTED PROFILE SHELVING



## SLOTTED PROFILE SHELVING

Designs in 4, 5 and 6 levels with the option of adding additional shelves

Two thicknesses: 1 mm or 1.5 mm

Sturdy shelving, capable of supporting up to 350 kg\*

\* Shelf 800 x 300, 1.5 mm thick with reinforcement omegas

### 1 MM OR 1.5 MM THICK SLOTTED PROFILE SHELVES

- Made of AISI 304 18/10 stainless steel.
- Shelf height adjustable every 150 mm.
- Shelf depths available: 300, 400, 500 and 600 mm.
- Trestle heights available: 1700 and 2000 mm.
- Fixing of the shelves to the trestles by means of the screws included.
- **Supplied disassembled.**



# 1MM THICK SLOTTED PROFILE SHELVING



## WITHOUT REINFORCEMENT OMEGAS

Total dimensions (mm)	Total load (Kg)	4 Levels	5 Levels	6 Levels
800 x 300 x 1700	230	• EPI00001	• EPI00033	• EPI00065
1000 x 300 x 1700	180	• EPI00002	• EPI00034	• EPI00066
1200 x 300 x 1700	130	• EPI00003	• EPI00035	• EPI00067
1400 x 300 x 1700	105	• EPI00004	• EPI00036	• EPI00068
800 x 300 x 2000	230	• EPI00005	• EPI00037	• EPI00069
1000 x 300 x 2000	180	• EPI00006	• EPI00038	• EPI00070
1200 x 300 x 2000	130	• EPI00007	• EPI00039	• EPI00071
1400 x 300 x 2000	105	• EPI00008	• EPI00040	• EPI00072
800 x 400 x 1700	205	• EPI00009	• EPI00041	• EPI00073
1000 x 400 x 1700	155	• EPI00010	• EPI00042	• EPI00074
1200 x 400 x 1700	105	• EPI00011	• EPI00043	• EPI00075
1400 x 400 x 1700	80	• EPI00012	• EPI00044	• EPI00076
800 x 400 x 2000	205	• EPI00013	• EPI00045	• EPI00077
1000 x 400 x 2000	155	• EPI00014	• EPI00046	• EPI00078
1200 x 400 x 2000	105	• EPI00015	• EPI00047	• EPI00079
1400 x 400 x 2000	80	• EPI00016	• EPI00048	• EPI00080
800 x 500 x 1700	200	• EPI00017	• EPI00049	• EPI00081
1000 x 500 x 1700	150	• EPI00018	• EPI00050	• EPI00082
1200 x 500 x 1700	100	• EPI00019	• EPI00051	• EPI00083
1400 x 500 x 1700	75	• EPI00020	• EPI00052	• EPI00084
800 x 500 x 2000	200	• EPI00021	• EPI00053	• EPI00085
1000 x 500 x 2000	150	• EPI00022	• EPI00054	• EPI00086
1200 x 500 x 2000	100	• EPI00023	• EPI00055	• EPI00087
1400 x 500 x 2000	75	• EPI00024	• EPI00056	• EPI00088
800 x 600 x 1700	180	• EPI00025	• EPI00057	• EPI00089
1000 x 600 x 1700	130	• EPI00026	• EPI00058	• EPI00090
1200 x 600 x 1700	80	• EPI00027	• EPI00059	• EPI00091
1400 x 600 x 1700	55	• EPI00028	• EPI00060	• EPI00092
800 x 600 x 2000	180	• EPI00029	• EPI00061	• EPI00093
1000 x 600 x 2000	130	• EPI00030	• EPI00062	• EPI00094
1200 x 600 x 2000	80	• EPI00031	• EPI00063	• EPI00095
1400 x 600 x 2000	55	• EPI00032	• EPI00064	• EPI00096





**WITH REINFORCEMENT OMEGAS**

Total dimensions (mm)	Total load (Kg)	4 Levels	5 Levels	6 Levels
800 x 300 x 1700	280	• EPI00097	• EPI00129	• EPI00161
1000 x 300 x 1700	230	• EPI00098	• EPI00130	• EPI00162
1200 x 300 x 1700	180	• EPI00099	• EPI00131	• EPI00163
1400 x 300 x 1700	155	• EPI00100	• EPI00132	• EPI00164
800 x 300 x 2000	280	• EPI00101	• EPI00133	• EPI00165
1000 x 300 x 2000	230	• EPI00102	• EPI00134	• EPI00166
1200 x 300 x 2000	180	• EPI00103	• EPI00135	• EPI00167
1400 x 300 x 2000	155	• EPI00104	• EPI00136	• EPI00168
800 x 400 x 1700	255	• EPI00105	• EPI00137	• EPI00169
1000 x 400 x 1700	205	• EPI00106	• EPI00138	• EPI00170
1200 x 400 x 1700	155	• EPI00107	• EPI00139	• EPI00171
1400 x 400 x 1700	130	• EPI00108	• EPI00140	• EPI00172
800 x 400 x 2000	255	• EPI00109	• EPI00141	• EPI00173
1000 x 400 x 2000	205	• EPI00110	• EPI00142	• EPI00174
1200 x 400 x 2000	155	• EPI00111	• EPI00143	• EPI00175
1400 x 400 x 2000	130	• EPI00112	• EPI00144	• EPI00176
800 x 500 x 1700	250	• EPI00113	• EPI00145	• EPI00177
1000 x 500 x 1700	200	• EPI00114	• EPI00146	• EPI00178
1200 x 500 x 1700	150	• EPI00115	• EPI00147	• EPI00179
1400 x 500 x 1700	125	• EPI00116	• EPI00148	• EPI00180
800 x 500 x 2000	250	• EPI00117	• EPI00149	• EPI00181
1000 x 500 x 2000	200	• EPI00118	• EPI00150	• EPI00182
1200 x 500 x 2000	150	• EPI00119	• EPI00151	• EPI00183
1400 x 500 x 2000	125	• EPI00120	• EPI00152	• EPI00184
800 x 600 x 1700	230	• EPI00121	• EPI00153	• EPI00185
1000 x 600 x 1700	180	• EPI00122	• EPI00154	• EPI00186
1200 x 600 x 1700	130	• EPI00123	• EPI00155	• EPI00187
1400 x 600 x 1700	105	• EPI00124	• EPI00156	• EPI00188
800 x 600 x 2000	230	• EPI00125	• EPI00157	• EPI00189
1000 x 600 x 2000	180	• EPI00126	• EPI00158	• EPI00190
1200 x 600 x 2000	130	• EPI00127	• EPI00159	• EPI00191
1400 x 600 x 2000	105	• EPI00128	• EPI00160	• EPI00192



SHELVING

# 1.5MM THICK SLOTTED PROFILE SHELVING



## WITHOUT REINFORCEMENT OMEGAS

Total dimensions (mm)	Total load (Kg)	4 Levels	5 Levels	6 Levels
800 x 300 x 1700	300	• EPI00193	• EPI00225	• EPI00257
1000 x 300 x 1700	250	• EPI00194	• EPI00226	• EPI00258
1200 x 300 x 1700	150	• EPI00195	• EPI00227	• EPI00259
1400 x 300 x 1700	125	• EPI00196	• EPI00228	• EPI00260
800 x 300 x 2000	300	• EPI00197	• EPI00229	• EPI00261
1000 x 300 x 2000	250	• EPI00198	• EPI00230	• EPI00262
1200 x 300 x 2000	150	• EPI00199	• EPI00231	• EPI00263
1400 x 300 x 2000	125	• EPI00200	• EPI00232	• EPI00264
800 x 400 x 1700	275	• EPI00201	• EPI00233	• EPI00265
1000 x 400 x 1700	225	• EPI00202	• EPI00234	• EPI00266
1200 x 400 x 1700	125	• EPI00203	• EPI00235	• EPI00267
1400 x 400 x 1700	100	• EPI00204	• EPI00236	• EPI00268
800 x 400 x 2000	275	• EPI00205	• EPI00237	• EPI00269
1000 x 400 x 2000	225	• EPI00206	• EPI00238	• EPI00270
1200 x 400 x 2000	125	• EPI00207	• EPI00239	• EPI00271
1400 x 400 x 2000	100	• EPI00208	• EPI00240	• EPI00272
800 x 500 x 1700	275	• EPI00209	• EPI00241	• EPI00273
1000 x 500 x 1700	225	• EPI00210	• EPI00242	• EPI00274
1200 x 500 x 1700	125	• EPI00211	• EPI00243	• EPI00275
1400 x 500 x 1700	100	• EPI00212	• EPI00244	• EPI00276
800 x 500 x 2000	275	• EPI00213	• EPI00245	• EPI00277
1000 x 500 x 2000	225	• EPI00214	• EPI00246	• EPI00278
1200 x 500 x 2000	125	• EPI00215	• EPI00247	• EPI00279
1400 x 500 x 2000	100	• EPI00216	• EPI00248	• EPI00280
800 x 600 x 1700	250	• EPI00217	• EPI00249	• EPI00281
1000 x 600 x 1700	200	• EPI00218	• EPI00250	• EPI00282
1200 x 600 x 1700	100	• EPI00219	• EPI00251	• EPI00283
1400 x 600 x 1700	75	• EPI00220	• EPI00252	• EPI00284
800 x 600 x 2000	250	• EPI00221	• EPI00253	• EPI00285
1000 x 600 x 2000	200	• EPI00222	• EPI00254	• EPI00286
1200 x 600 x 2000	100	• EPI00223	• EPI00255	• EPI00287
1400 x 600 x 2000	75	• EPI00224	• EPI00256	• EPI00288





**WITH REINFORCEMENT OMEGAS**

Total dimensions (mm)	Total load (Kg)	4 Levels	5 Levels	6 Levels
800 x 300 x 1700	350	• EPI00289	• EPI00321	• EPI00353
1000 x 300 x 1700	300	• EPI00290	• EPI00322	• EPI00354
1200 x 300 x 1700	200	• EPI00291	• EPI00323	• EPI00355
1400 x 300 x 1700	175	• EPI00292	• EPI00324	• EPI00356
800 x 300 x 2000	350	• EPI00293	• EPI00325	• EPI00357
1000 x 300 x 2000	300	• EPI00294	• EPI00326	• EPI00358
1200 x 300 x 2000	200	• EPI00295	• EPI00327	• EPI00359
1400 x 300 x 2000	175	• EPI00296	• EPI00328	• EPI00360
800 x 400 x 1700	325	• EPI00297	• EPI00329	• EPI00361
1000 x 400 x 1700	275	• EPI00298	• EPI00330	• EPI00362
1200 x 400 x 1700	175	• EPI00299	• EPI00331	• EPI00363
1400 x 400 x 1700	150	• EPI00300	• EPI00332	• EPI00364
800 x 400 x 2000	325	• EPI00301	• EPI00333	• EPI00365
1000 x 400 x 2000	275	• EPI00302	• EPI00334	• EPI00366
1200 x 400 x 2000	175	• EPI00303	• EPI00335	• EPI00367
1400 x 400 x 2000	150	• EPI00304	• EPI00336	• EPI00368
800 x 500 x 1700	325	• EPI00305	• EPI00337	• EPI00369
1000 x 500 x 1700	275	• EPI00306	• EPI00338	• EPI00370
1200 x 500 x 1700	175	• EPI00307	• EPI00339	• EPI00371
1400 x 500 x 1700	150	• EPI00308	• EPI00340	• EPI00372
800 x 500 x 2000	325	• EPI00309	• EPI00341	• EPI00373
1000 x 500 x 2000	275	• EPI00310	• EPI00342	• EPI00374
1200 x 500 x 2000	175	• EPI00311	• EPI00343	• EPI00375
1400 x 500 x 2000	150	• EPI00312	• EPI00344	• EPI00376
800 x 600 x 1700	300	• EPI00313	• EPI00345	• EPI00377
1000 x 600 x 1700	250	• EPI00314	• EPI00346	• EPI00378
1200 x 600 x 1700	150	• EPI00315	• EPI00347	• EPI00379
1400 x 600 x 1700	125	• EPI00316	• EPI00348	• EPI00380
800 x 600 x 2000	300	• EPI00317	• EPI00349	• EPI00381
1000 x 600 x 2000	250	• EPI00318	• EPI00350	• EPI00382
1200 x 600 x 2000	150	• EPI00319	• EPI00351	• EPI00383
1400 x 600 x 2000	125	• EPI00320	• EPI00352	• EPI00384

# ADDITIONAL 1MM THICK SHELF

- To customise the shelving by adding an additional shelf.
- Made of AISI 304 18/10 stainless steel.
- Models with or without reinforcement omegas.



Total dimensions (mm)	Without reinforcement omegas	With reinforcement omegas
800 x 300 x 1700	• EAI00001	• EAI00033
1000 x 300 x 1700	• EAI00002	• EAI00034
1200 x 300 x 1700	• EAI00003	• EAI00035
1400 x 300 x 1700	• EAI00004	• EAI00036
800 x 300 x 2000	• EAI00005	• EAI00037
1000 x 300 x 2000	• EAI00006	• EAI00038
1200 x 300 x 2000	• EAI00007	• EAI00039
1400 x 300 x 2000	• EAI00008	• EAI00040
800 x 400 x 1700	• EAI00009	• EAI00041
1000 x 400 x 1700	• EAI00010	• EAI00042
1200 x 400 x 1700	• EAI00011	• EAI00043
1400 x 400 x 1700	• EAI00012	• EAI00044
800 x 400 x 2000	• EAI00013	• EAI00045
1000 x 400 x 2000	• EAI00014	• EAI00046
1200 x 400 x 2000	• EAI00015	• EAI00047
1400 x 400 x 2000	• EAI00016	• EAI00048
800 x 500 x 1700	• EAI00017	• EAI00049
1000 x 500 x 1700	• EAI00018	• EAI00050
1200 x 500 x 1700	• EAI00019	• EAI00051
1400 x 500 x 1700	• EAI00020	• EAI00052
800 x 500 x 2000	• EAI00021	• EAI00053
1000 x 500 x 2000	• EAI00022	• EAI00054
1200 x 500 x 2000	• EAI00023	• EAI00055
1400 x 500 x 2000	• EAI00024	• EAI00056
800 x 600 x 1700	• EAI00025	• EAI00057
1000 x 600 x 1700	• EAI00026	• EAI00058
1200 x 600 x 1700	• EAI00027	• EAI00059
1400 x 600 x 1700	• EAI00028	• EAI00060
800 x 600 x 2000	• EAI00029	• EAI00061
1000 x 600 x 2000	• EAI00030	• EAI00062
1200 x 600 x 2000	• EAI00031	• EAI00063
1400 x 600 x 2000	• EAI00032	• EAI00064





# ADDITIONAL 1.5MM THICK SHELF

- To customise the shelving by adding an additional shelf.
- Made of AISI 304 18/10 stainless steel.
- Models with or without reinforcement omegas.



Total dimensions (mm)	Without reinforcement omegas	With reinforcement omegas
800 x 300 x 1700	• EAI00065	• EAI00097
1000 x 300 x 1700	• EAI00066	• EAI00098
1200 x 300 x 1700	• EAI00067	• EAI00099
1400 x 300 x 1700	• EAI00068	• EAI00100
800 x 300 x 2000	• EAI00069	• EAI00101
1000 x 300 x 2000	• EAI00070	• EAI00102
1200 x 300 x 2000	• EAI00071	• EAI00103
1400 x 300 x 2000	• EAI00072	• EAI00104
800 x 400 x 1700	• EAI00073	• EAI00105
1000 x 400 x 1700	• EAI00074	• EAI00106
1200 x 400 x 1700	• EAI00075	• EAI00107
1400 x 400 x 1700	• EAI00076	• EAI00108
800 x 400 x 2000	• EAI00077	• EAI00109
1000 x 400 x 2000	• EAI00078	• EAI00110
1200 x 400 x 2000	• EAI00079	• EAI00111
1400 x 400 x 2000	• EAI00080	• EAI00112
800 x 500 x 1700	• EAI00081	• EAI00113
1000 x 500 x 1700	• EAI00082	• EAI00114
1200 x 500 x 1700	• EAI00083	• EAI00115
1400 x 500 x 1700	• EAI00084	• EAI00116
800 x 500 x 2000	• EAI00085	• EAI00117
1000 x 500 x 2000	• EAI00086	• EAI00118
1200 x 500 x 2000	• EAI00087	• EAI00119
1400 x 500 x 2000	• EAI00088	• EAI00120
800 x 600 x 1700	• EAI00089	• EAI00121
1000 x 600 x 1700	• EAI00090	• EAI00122
1200 x 600 x 1700	• EAI00091	• EAI00123
1400 x 600 x 1700	• EAI00092	• EAI00124
800 x 600 x 2000	• EAI00093	• EAI00125
1000 x 600 x 2000	• EAI00094	• EAI00126
1200 x 600 x 2000	• EAI00095	• EAI00127
1400 x 600 x 2000	• EAI00096	• EAI00128



# FREESTANDING STAINLESS STEEL SHELVING

## FREESTANDING STAINLESS STEEL SHELVING UNIT

- Made of stainless steel.
- Shelf height is adjustable in 160 mm increments, with 11 possible levels.
- 2 shelf depths are available: 400 and 500 mm.
- Shelving unit height available: 1800 mm.
- Trays come in smooth, perforated, or polypropylene options.
- Removable trays for easy cleaning.
- Adjustable legs ensure maximum stability on any surface.
- Designed for easy assembly - no tools required.
- Maximum load per shelf: 170 kg.



· Designed for easy assembly - no tools required.



## SUPPORTS

- Made of 30 x 30 mm stainless steel tube with adjustable feet.

### CENTER SUPPORT

Total dimensions (mm)	Code
1800 x 400	• KCC01840
1800 x 500	• KCC01850

### SIDE SUPPORT

Total dimensions (mm)	Code
1800 x 400	• KCL01840
1800 x 500	• KCL01850



## CORNER PIECE

- Accessory made of AISI 304 stainless steel (18/10) to mount corner shelving.

Total dimensions (mm)	Code
400	• KA000400
500	• KA000500



## SHELF WITH TRAYS



· Polypropylene trays



· Smooth stainless steel trays



· Perforated stainless steel trays

### 400 MM DEPTH

Dimensions (mm)	Polypropylene trays	Smooth stainless steel trays	Perforated stainless steel trays
600 x 400	• K4060003	• K4060002	• K4060001
700 x 400	• K4070003	• K4070002	• K4070001
800 x 400	• K4080003	• K4080002	• K4080001
900 x 400	• K4090003	• K4090002	• K4090001
1000 x 400	• K4100003	• K4100002	• K4100001
1100 x 400	• K4110003	• K4110002	• K4110001
1200 x 400	• K4120003	• K4120002	• K4120001
1300 x 400	• K4130003	• K4130002	• K4130001
1400 x 400	• K4140003	• K4140002	• K4140001
1500 x 400	• K4150003	• K4150002	• K4150001
1600 x 400	• K4160003	• K4160002	• K4160001

### 500 MM DEPTH

Dimensions (mm)	Polypropylene trays	Smooth stainless steel trays	Perforated stainless steel trays
600 x 500	• K5060003	• K5060002	• K5060001
700 x 500	• K5070003	• K5070002	• K5070001
800 x 500	• K5080003	• K5080002	• K5080001
900 x 500	• K5090003	• K5090002	• K5090001
1000 x 500	• K5100003	• K5100002	• K5100001
1100 x 500	• K5110003	• K5110002	• K5110001
1200 x 500	• K5120003	• K5120002	• K5120001
1300 x 500	• K5130003	• K5130002	• K5130001
1500 x 500	• K5140003	• K5140002	• K5140001
1400 x 500	• K5150003	• K5150002	• K5150001
1600 x 500	• K5160003	• K5160002	• K5160001



# FREESTANDING STAINLESS STEEL SHELVING

## TRAYS



Total dimensions (mm)	Polypropylene	Smooth stainless steel	Perforated stainless steel
300 x 400	• KP304003	• KP304002	• KP304001
400 x 400	• KP404003	• KP404002	• KP404001
300 x 500	• KP305003	• KP305002	• KP305001
400 x 500	• KP405003	• KP405002	• KP405001

## BENCH

- For storing boxes in places where sanitation standards prohibit direct contact with the floor.



Total dimensions (mm)	Polypropylene	Smooth stainless steel
1060 x 500 x 180	• KB106003	• KB106002
1260 x 500 x 180	• KB126003	• KB126002
1460 x 500 x 180	• KB146003	• KB146002
1660 x 500 x 180	• KB166003	• KB166002

## HANGING RACK FOR SHELVES

- Made of Ø30 mm AISI 304 stainless steel (18/10) tube.

Dimensions (mm)	Code
800	• KBC00800
900	• KBC00900
1000	• KBC01000
1100	• KBC01100
1200	• KBC01200
1300	• KBC01300
1400	• KBC01400
1500	• KBC01500
1600	• KBC01600



## CASTORS

- Pack includes four Ø125 mm castors (2 with brakes).

Model	Code
Pack of 4 castors	• KRU00001



## BASIC OPTIONS FOR MODULAR SHELVING

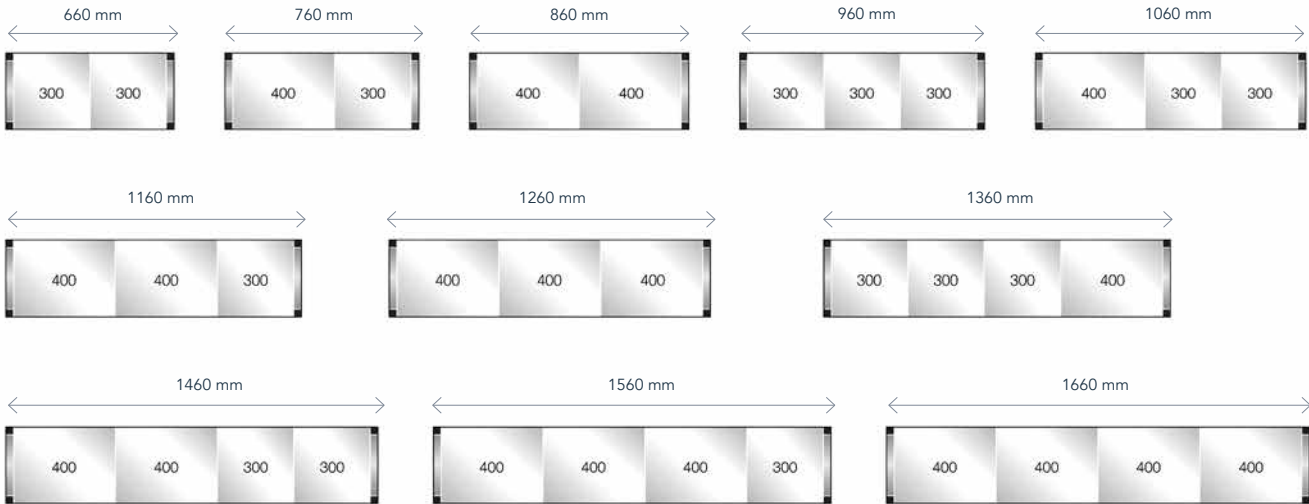

### EXAMPLE OF A SHELVING ORDER:

- To choose your modular shelving units, all you need to know is the dimensions of the room.
- First calculate the linear portion of the shelving unit based on the length of the room (X).
- To determine the length of the corner portion of the shelving unit, subtract the width of the linear shelving unit from the width of the room (Y).
- If the room has a safety radius, subtract it from the length of the room.

Example of how to calculate the estimate for a stainless steel and polypropylene corner shelving unit that is 400-mm-wide with four levels, in a refrigerated chamber.

Refrigerated chamber	X=3000	Y=2400
Shelving 4 levels	linear (3000)	angular (2400-400=2000)
Code	KIT00087	KIT02077
Shelving dimensions	2990 mm	1960 mm

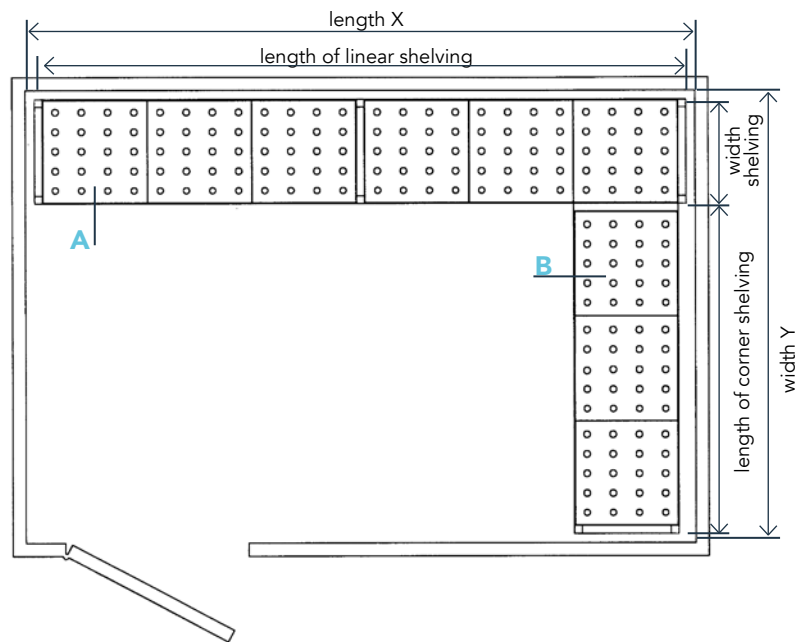

Linear shelving (A)

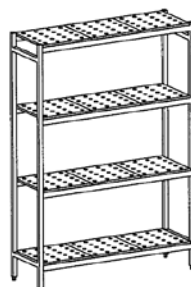

Corner shelving (B)

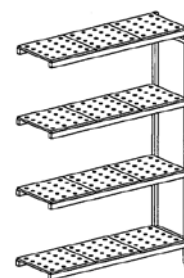

SHELVING

# 1800-MM-HIGH LINEAR STAINLESS STEEL SHELVING

STAINLESS STEEL SHELVING WITH POLYPROPYLENE TRAYS



## 400 MM DEPTH

Length (mm)	3 Levels	4 Levels	5 Levels
660	● KIT00001	● KIT00063	● KIT00125
760	● KIT00002	● KIT00064	● KIT00126
860	● KIT00003	● KIT00065	● KIT00127
960	● KIT00004	● KIT00066	● KIT00128
1060	● KIT00005	● KIT00067	● KIT00129
1160	● KIT00006	● KIT00068	● KIT00130
1260	● KIT00007	● KIT00069	● KIT00131
1360	● KIT00008	● KIT00070	● KIT00132
1460	● KIT00009	● KIT00071	● KIT00133
1560	● KIT00010	● KIT00072	● KIT00134
1660	● KIT00011	● KIT00073	● KIT00135
1690	● KIT00012	● KIT00074	● KIT00136
1790	● KIT00013	● KIT00075	● KIT00137
1890	● KIT00014	● KIT00076	● KIT00138
1990	● KIT00015	● KIT00077	● KIT00139
2090	● KIT00016	● KIT00078	● KIT00140
2190	● KIT00017	● KIT00079	● KIT00141
2290	● KIT00018	● KIT00080	● KIT00142
2390	● KIT00019	● KIT00081	● KIT00143
2490	● KIT00020	● KIT00082	● KIT00144
2590	● KIT00021	● KIT00083	● KIT00145
2690	● KIT00022	● KIT00084	● KIT00146
2790	● KIT00023	● KIT00085	● KIT00147
2890	● KIT00024	● KIT00086	● KIT00148
2990	● KIT00025	● KIT00087	● KIT00149
3090	● KIT00026	● KIT00088	● KIT00150
3190	● KIT00027	● KIT00089	● KIT00151
3290	● KIT00028	● KIT00090	● KIT00152
3320	● KIT00029	● KIT00091	● KIT00153
3420	● KIT00030	● KIT00092	● KIT00154
3520	● KIT00031	● KIT00093	● KIT00155
3620	● KIT00032	● KIT00094	● KIT00156
3720	● KIT00033	● KIT00095	● KIT00157
3820	● KIT00034	● KIT00096	● KIT00158
3920	● KIT00035	● KIT00097	● KIT00159
4020	● KIT00036	● KIT00098	● KIT00160
4120	● KIT00037	● KIT00099	● KIT00161
4220	● KIT00038	● KIT00100	● KIT00162
4320	● KIT00039	● KIT00101	● KIT00163
4420	● KIT00040	● KIT00102	● KIT00164
4520	● KIT00041	● KIT00103	● KIT00165
4620	● KIT00042	● KIT00104	● KIT00166
4720	● KIT00043	● KIT00105	● KIT00167
4820	● KIT00044	● KIT00106	● KIT00168
4920	● KIT00045	● KIT00107	● KIT00169
4950	● KIT00046	● KIT00108	● KIT00170
5050	● KIT00047	● KIT00109	● KIT00171
5150	● KIT00048	● KIT00110	● KIT00172
5250	● KIT00049	● KIT00111	● KIT00173
5350	● KIT00050	● KIT00112	● KIT00174
5450	● KIT00051	● KIT00113	● KIT00175
5550	● KIT00052	● KIT00114	● KIT00176
5650	● KIT00053	● KIT00115	● KIT00177
5750	● KIT00054	● KIT00116	● KIT00178
5850	● KIT00055	● KIT00117	● KIT00179
5950	● KIT00056	● KIT00118	● KIT00180
6050	● KIT00057	● KIT00119	● KIT00181
6150	● KIT00058	● KIT00120	● KIT00182
6250	● KIT00059	● KIT00121	● KIT00183
6350	● KIT00060	● KIT00122	● KIT00184
6450	● KIT00061	● KIT00123	● KIT00185
6550	● KIT00062	● KIT00124	● KIT00186

## 500 MM DEPTH

Length (mm)	3 Levels	4 Levels	5 Levels
660	● KIT00187	● KIT00249	● KIT00311
760	● KIT00188	● KIT00250	● KIT00312
860	● KIT00189	● KIT00251	● KIT00313
960	● KIT00190	● KIT00252	● KIT00314
1060	● KIT00191	● KIT00253	● KIT00315
1160	● KIT00192	● KIT00254	● KIT00316
1260	● KIT00193	● KIT00255	● KIT00317
1360	● KIT00194	● KIT00256	● KIT00318
1460	● KIT00195	● KIT00257	● KIT00319
1560	● KIT00196	● KIT00258	● KIT00320
1660	● KIT00197	● KIT00259	● KIT00321
1690	● KIT00198	● KIT00260	● KIT00322
1790	● KIT00199	● KIT00261	● KIT00323
1890	● KIT00200	● KIT00262	● KIT00324
1990	● KIT00201	● KIT00263	● KIT00325
2090	● KIT00202	● KIT00264	● KIT00326
2190	● KIT00203	● KIT00265	● KIT00327
2290	● KIT00204	● KIT00266	● KIT00328
2390	● KIT00205	● KIT00267	● KIT00329
2490	● KIT00206	● KIT00268	● KIT00330
2590	● KIT00207	● KIT00269	● KIT00331
2690	● KIT00208	● KIT00270	● KIT00332
2790	● KIT00209	● KIT00271	● KIT00333
2890	● KIT00210	● KIT00272	● KIT00334
2990	● KIT00211	● KIT00273	● KIT00335
3090	● KIT00212	● KIT00274	● KIT00336
3190	● KIT00213	● KIT00275	● KIT00337
3290	● KIT00214	● KIT00276	● KIT00338
3320	● KIT00215	● KIT00277	● KIT00339
3420	● KIT00216	● KIT00278	● KIT00340
3520	● KIT00217	● KIT00279	● KIT00341
3620	● KIT00218	● KIT00280	● KIT00342
3720	● KIT00219	● KIT00281	● KIT00343
3820	● KIT00220	● KIT00282	● KIT00344
3920	● KIT00221	● KIT00283	● KIT00345
4020	● KIT00222	● KIT00284	● KIT00346
4120	● KIT00223	● KIT00285	● KIT00347
4220	● KIT00224	● KIT00286	● KIT00348
4320	● KIT00225	● KIT00287	● KIT00349
4420	● KIT00226	● KIT00288	● KIT00350
4520	● KIT00227	● KIT00289	● KIT00351
4620	● KIT00228	● KIT00290	● KIT00352
4720	● KIT00229	● KIT00291	● KIT00353
4820	● KIT00230	● KIT00292	● KIT00354
4920	● KIT00231	● KIT00293	● KIT00355
4950	● KIT00232	● KIT00294	● KIT00356
5050	● KIT00233	● KIT00295	● KIT00357
5150	● KIT00234	● KIT00296	● KIT00358
5250	● KIT00235	● KIT00297	● KIT00359
5350	● KIT00236	● KIT00298	● KIT00360
5450	● KIT00237	● KIT00299	● KIT00361
5550	● KIT00238	● KIT00300	● KIT00362
5650	● KIT00239	● KIT00301	● KIT00363
5750	● KIT00240	● KIT00302	● KIT00364
5850	● KIT00241	● KIT00303	● KIT00365
5950	● KIT00242	● KIT00304	● KIT00366
6050	● KIT00243	● KIT00305	● KIT00367
6150	● KIT00244	● KIT00306	● KIT00368
6250	● KIT00245	● KIT00307	● KIT00369
6350	● KIT00246	● KIT00308	● KIT00370
6450	● KIT00247	● KIT00309	● KIT00371
6550	● KIT00248	● KIT00310	● KIT00372



# 1800-MM-HIGH ANGULAR STAINLESS STEEL SHELVING

## STAINLESS STEEL SHELVING WITH POLYPROPYLENE TRAYS

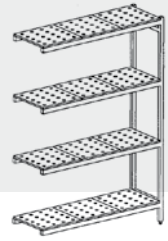

### 400 MM DEPTH

Length (mm)	3 Levels	4 Levels	5 Levels
630	● KIT02001	● KIT02063	● KIT02125
730	● KIT02002	● KIT02064	● KIT02126
830	● KIT02003	● KIT02065	● KIT02127
930	● KIT02004	● KIT02066	● KIT02128
1030	● KIT02005	● KIT02067	● KIT02129
1130	● KIT02006	● KIT02068	● KIT02130
1230	● KIT02007	● KIT02069	● KIT02131
1330	● KIT02008	● KIT02070	● KIT02132
1430	● KIT02009	● KIT02071	● KIT02133
1530	● KIT02010	● KIT02072	● KIT02134
1630	● KIT02011	● KIT02073	● KIT02135
1660	● KIT02012	● KIT02074	● KIT02136
1760	● KIT02013	● KIT02075	● KIT02137
1860	● KIT02014	● KIT02076	● KIT02138
1960	● KIT02015	● KIT02077	● KIT02139
2060	● KIT02016	● KIT02078	● KIT02140
2160	● KIT02017	● KIT02079	● KIT02141
2260	● KIT02018	● KIT02080	● KIT02142
2360	● KIT02019	● KIT02081	● KIT02143
2460	● KIT02020	● KIT02082	● KIT02144
2560	● KIT02021	● KIT02083	● KIT02145
2660	● KIT02022	● KIT02084	● KIT02146
2760	● KIT02023	● KIT02085	● KIT02147
2860	● KIT02024	● KIT02086	● KIT02148
2960	● KIT02025	● KIT02087	● KIT02149
3060	● KIT02026	● KIT02088	● KIT02150
3160	● KIT02027	● KIT02089	● KIT02151
3260	● KIT02028	● KIT02090	● KIT02152
3290	● KIT02029	● KIT02091	● KIT02153
3390	● KIT02030	● KIT02092	● KIT02154
3490	● KIT02031	● KIT02093	● KIT02155
3590	● KIT02032	● KIT02094	● KIT02156
3690	● KIT02033	● KIT02095	● KIT02157
3790	● KIT02034	● KIT02096	● KIT02158
3890	● KIT02035	● KIT02097	● KIT02159
3990	● KIT02036	● KIT02098	● KIT02160
4090	● KIT02037	● KIT02099	● KIT02161
4190	● KIT02038	● KIT02100	● KIT02162
4290	● KIT02039	● KIT02101	● KIT02163
4390	● KIT02040	● KIT02102	● KIT02164
4490	● KIT02041	● KIT02103	● KIT02165
4590	● KIT02042	● KIT02104	● KIT02166
4690	● KIT02043	● KIT02105	● KIT02167
4790	● KIT02044	● KIT02106	● KIT02168
4890	● KIT02045	● KIT02107	● KIT02169
4920	● KIT02046	● KIT02108	● KIT02170
5020	● KIT02047	● KIT02109	● KIT02171
5120	● KIT02048	● KIT02110	● KIT02172
5220	● KIT02049	● KIT02111	● KIT02173
5320	● KIT02050	● KIT02112	● KIT02174
5420	● KIT02051	● KIT02113	● KIT02175
5520	● KIT02052	● KIT02114	● KIT02176
5620	● KIT02053	● KIT02115	● KIT02177
5720	● KIT02054	● KIT02116	● KIT02178
5820	● KIT02055	● KIT02117	● KIT02179
5920	● KIT02056	● KIT02118	● KIT02180
6020	● KIT02057	● KIT02119	● KIT02181
6120	● KIT02058	● KIT02120	● KIT02182
6220	● KIT02059	● KIT02121	● KIT02183
6320	● KIT02060	● KIT02122	● KIT02184
6420	● KIT02061	● KIT02123	● KIT02185
6520	● KIT02062	● KIT02124	● KIT02186

### 500 MM DEPTH

Length (mm)	3 Levels	4 Levels	5 Levels
630	● KIT02187	● KIT02249	● KIT02311
730	● KIT02188	● KIT02250	● KIT02312
830	● KIT02189	● KIT02251	● KIT02313
930	● KIT02190	● KIT02252	● KIT02314
1030	● KIT02191	● KIT02253	● KIT02315
1130	● KIT02192	● KIT02254	● KIT02316
1230	● KIT02193	● KIT02255	● KIT02317
1330	● KIT02194	● KIT02256	● KIT02318
1430	● KIT02195	● KIT02257	● KIT02319
1530	● KIT02196	● KIT02258	● KIT02320
1630	● KIT02197	● KIT02259	● KIT02321
1660	● KIT02198	● KIT02260	● KIT02322
1760	● KIT02199	● KIT02261	● KIT02323
1860	● KIT02200	● KIT02262	● KIT02324
1960	● KIT02201	● KIT02263	● KIT02325
2060	● KIT02202	● KIT02264	● KIT02326
2160	● KIT02203	● KIT02265	● KIT02327
2260	● KIT02204	● KIT02266	● KIT02328
2360	● KIT02205	● KIT02267	● KIT02329
2460	● KIT02206	● KIT02268	● KIT02330
2560	● KIT02207	● KIT02269	● KIT02331
2660	● KIT02208	● KIT02270	● KIT02332
2760	● KIT02209	● KIT02271	● KIT02333
2860	● KIT02210	● KIT02272	● KIT02334
2960	● KIT02211	● KIT02273	● KIT02335
3060	● KIT02212	● KIT02274	● KIT02336
3160	● KIT02213	● KIT02275	● KIT02337
3260	● KIT02214	● KIT02276	● KIT02338
3290	● KIT02215	● KIT02277	● KIT02339
3390	● KIT02216	● KIT02278	● KIT02340
3490	● KIT02217	● KIT02279	● KIT02341
3590	● KIT02218	● KIT02280	● KIT02342
3690	● KIT02219	● KIT02281	● KIT02343
3790	● KIT02220	● KIT02282	● KIT02344
3890	● KIT02221	● KIT02283	● KIT02345
3990	● KIT02222	● KIT02284	● KIT02346
4090	● KIT02223	● KIT02285	● KIT02347
4190	● KIT02224	● KIT02286	● KIT02348
4290	● KIT02225	● KIT02287	● KIT02349
4390	● KIT02226	● KIT02288	● KIT02350
4490	● KIT02227	● KIT02289	● KIT02351
4590	● KIT02228	● KIT02290	● KIT02352
4690	● KIT02229	● KIT02291	● KIT02353
4790	● KIT02230	● KIT02292	● KIT02354
4890	● KIT02231	● KIT02293	● KIT02355
4920	● KIT02232	● KIT02294	● KIT02356
5020	● KIT02233	● KIT02295	● KIT02357
5120	● KIT02234	● KIT02296	● KIT02358
5220	● KIT02235	● KIT02297	● KIT02359
5320	● KIT02236	● KIT02298	● KIT02360
5420	● KIT02237	● KIT02299	● KIT02361
5520	● KIT02238	● KIT02300	● KIT02362
5620	● KIT02239	● KIT02301	● KIT02363
5720	● KIT02240	● KIT02302	● KIT02364
5820	● KIT02241	● KIT02303	● KIT02365
5920	● KIT02242	● KIT02304	● KIT02366
6020	● KIT02243	● KIT02305	● KIT02367
6120	● KIT02244	● KIT02306	● KIT02368
6220	● KIT02245	● KIT02307	● KIT02369
6320	● KIT02246	● KIT02308	● KIT02370
6420	● KIT02247	● KIT02309	● KIT02371
6520	● KIT02248	● KIT02310	● KIT02372



SHELVING

# 1800-MM-HIGH LINEAR STAINLESS STEEL SHELVING

STAINLESS STEEL SHELVING WITH SMOOTH STAINLESS STEEL TRAYS



## 400 MM DEPTH

Length (mm)	3 Levels	4 Levels	5 Levels
660	● KIT00373	● KIT00435	● KIT00497
760	● KIT00374	● KIT00436	● KIT00498
860	● KIT00375	● KIT00437	● KIT00499
960	● KIT00376	● KIT00438	● KIT00500
1060	● KIT00377	● KIT00439	● KIT00501
1160	● KIT00378	● KIT00440	● KIT00502
1260	● KIT00379	● KIT00441	● KIT00503
1360	● KIT00380	● KIT00442	● KIT00504
1460	● KIT00381	● KIT00443	● KIT00505
1560	● KIT00382	● KIT00444	● KIT00506
1660	● KIT00383	● KIT00445	● KIT00507
1690	● KIT00384	● KIT00446	● KIT00508
1790	● KIT00385	● KIT00447	● KIT00509
1890	● KIT00386	● KIT00448	● KIT00510
1990	● KIT00387	● KIT00449	● KIT00511
2090	● KIT00388	● KIT00450	● KIT00512
2190	● KIT00389	● KIT00451	● KIT00513
2290	● KIT00390	● KIT00452	● KIT00514
2390	● KIT00391	● KIT00453	● KIT00515
2490	● KIT00392	● KIT00454	● KIT00516
2590	● KIT00393	● KIT00455	● KIT00517
2690	● KIT00394	● KIT00456	● KIT00518
2790	● KIT00395	● KIT00457	● KIT00519
2890	● KIT00396	● KIT00458	● KIT00520
2990	● KIT00397	● KIT00459	● KIT00521
3090	● KIT00398	● KIT00460	● KIT00522
3190	● KIT00399	● KIT00461	● KIT00523
3290	● KIT00400	● KIT00462	● KIT00524
3320	● KIT00401	● KIT00463	● KIT00525
3420	● KIT00402	● KIT00464	● KIT00526
3520	● KIT00403	● KIT00465	● KIT00527
3620	● KIT00404	● KIT00466	● KIT00528
3720	● KIT00405	● KIT00467	● KIT00529
3820	● KIT00406	● KIT00468	● KIT00530
3920	● KIT00407	● KIT00469	● KIT00531
4020	● KIT00408	● KIT00470	● KIT00532
4120	● KIT00409	● KIT00471	● KIT00533
4220	● KIT00410	● KIT00472	● KIT00534
4320	● KIT00411	● KIT00473	● KIT00535
4420	● KIT00412	● KIT00474	● KIT00536
4520	● KIT00413	● KIT00475	● KIT00537
4620	● KIT00414	● KIT00476	● KIT00538
4720	● KIT00415	● KIT00477	● KIT00539
4820	● KIT00416	● KIT00478	● KIT00540
4920	● KIT00417	● KIT00479	● KIT00541
4950	● KIT00418	● KIT00480	● KIT00542
5050	● KIT00419	● KIT00481	● KIT00543
5150	● KIT00420	● KIT00482	● KIT00544
5250	● KIT00421	● KIT00483	● KIT00545
5350	● KIT00422	● KIT00484	● KIT00546
5450	● KIT00423	● KIT00485	● KIT00547
5550	● KIT00424	● KIT00486	● KIT00548
5650	● KIT00425	● KIT00487	● KIT00549
5750	● KIT00426	● KIT00488	● KIT00550
5850	● KIT00427	● KIT00489	● KIT00551
5950	● KIT00428	● KIT00490	● KIT00552
6050	● KIT00429	● KIT00491	● KIT00553
6150	● KIT00430	● KIT00492	● KIT00554
6250	● KIT00431	● KIT00493	● KIT00555
6350	● KIT00432	● KIT00494	● KIT00556
6450	● KIT00433	● KIT00495	● KIT00557
6550	● KIT00434	● KIT00496	● KIT00558

## 500 MM DEPTH

Length (mm)	3 Levels	4 Levels	5 Levels
660	● KIT00559	● KIT00621	● KIT00683
760	● KIT00560	● KIT00622	● KIT00684
860	● KIT00561	● KIT00623	● KIT00685
960	● KIT00562	● KIT00624	● KIT00686
1060	● KIT00563	● KIT00625	● KIT00687
1160	● KIT00564	● KIT00626	● KIT00688
1260	● KIT00565	● KIT00627	● KIT00689
1360	● KIT00566	● KIT00628	● KIT00690
1460	● KIT00567	● KIT00629	● KIT00691
1560	● KIT00568	● KIT00630	● KIT00692
1660	● KIT00569	● KIT00631	● KIT00693
1690	● KIT00570	● KIT00632	● KIT00694
1790	● KIT00571	● KIT00633	● KIT00695
1890	● KIT00572	● KIT00634	● KIT00696
1990	● KIT00573	● KIT00635	● KIT00697
2090	● KIT00574	● KIT00636	● KIT00698
2190	● KIT00575	● KIT00637	● KIT00699
2290	● KIT00576	● KIT00638	● KIT00700
2390	● KIT00577	● KIT00639	● KIT00701
2490	● KIT00578	● KIT00640	● KIT00702
2590	● KIT00579	● KIT00641	● KIT00703
2690	● KIT00580	● KIT00642	● KIT00704
2790	● KIT00581	● KIT00643	● KIT00705
2890	● KIT00582	● KIT00644	● KIT00706
2990	● KIT00583	● KIT00645	● KIT00707
3090	● KIT00584	● KIT00646	● KIT00708
3190	● KIT00585	● KIT00647	● KIT00709
3290	● KIT00586	● KIT00648	● KIT00710
3320	● KIT00587	● KIT00649	● KIT00711
3420	● KIT00588	● KIT00650	● KIT00712
3520	● KIT00589	● KIT00651	● KIT00713
3620	● KIT00590	● KIT00652	● KIT00714
3720	● KIT00591	● KIT00653	● KIT00715
3820	● KIT00592	● KIT00654	● KIT00716
3920	● KIT00593	● KIT00655	● KIT00717
4020	● KIT00594	● KIT00656	● KIT00718
4120	● KIT00595	● KIT00657	● KIT00719
4220	● KIT00596	● KIT00658	● KIT00720
4320	● KIT00597	● KIT00659	● KIT00721
4420	● KIT00598	● KIT00660	● KIT00722
4520	● KIT00599	● KIT00661	● KIT00723
4620	● KIT00600	● KIT00662	● KIT00724
4720	● KIT00601	● KIT00663	● KIT00725
4820	● KIT00602	● KIT00664	● KIT00726
4920	● KIT00603	● KIT00665	● KIT00727
4950	● KIT00604	● KIT00666	● KIT00728
5050	● KIT00605	● KIT00667	● KIT00729
5150	● KIT00606	● KIT00668	● KIT00730
5250	● KIT00607	● KIT00669	● KIT00731
5350	● KIT00608	● KIT00670	● KIT00732
5450	● KIT00609	● KIT00671	● KIT00733
5550	● KIT00610	● KIT00672	● KIT00734
5650	● KIT00611	● KIT00673	● KIT00735
5750	● KIT00612	● KIT00674	● KIT00736
5850	● KIT00613	● KIT00675	● KIT00737
5950	● KIT00614	● KIT00676	● KIT00738
6050	● KIT00615	● KIT00677	● KIT00739
6150	● KIT00616	● KIT00678	● KIT00740
6250	● KIT00617	● KIT00679	● KIT00741
6350	● KIT00618	● KIT00680	● KIT00742
6450	● KIT00619	● KIT00681	● KIT00743
6550	● KIT00620	● KIT00682	● KIT00744





SHELVING

# 1800-MM-HIGH ANGULAR STAINLESS STEEL SHELVING

STAINLESS STEEL SHELVING WITH SMOOTH STAINLESS STEEL TRAYS

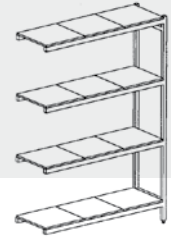

## 400 MM DEPTH

Length (mm)	3 Levels	4 Levels	5 Levels
630	● KIT02373	● KIT02435	● KIT02497
730	● KIT02374	● KIT02436	● KIT02498
830	● KIT02375	● KIT02437	● KIT02499
930	● KIT02376	● KIT02438	● KIT02500
1030	● KIT02377	● KIT02439	● KIT02501
1130	● KIT02378	● KIT02440	● KIT02502
1230	● KIT02379	● KIT02441	● KIT02503
1330	● KIT02380	● KIT02442	● KIT02504
1430	● KIT02381	● KIT02443	● KIT02505
1530	● KIT02382	● KIT02444	● KIT02506
1630	● KIT02383	● KIT02445	● KIT02507
1660	● KIT02384	● KIT02446	● KIT02508
1760	● KIT02385	● KIT02447	● KIT02509
1860	● KIT02386	● KIT02448	● KIT02510
1960	● KIT02387	● KIT02449	● KIT02511
2060	● KIT02388	● KIT02450	● KIT02512
2160	● KIT02389	● KIT02451	● KIT02513
2260	● KIT02390	● KIT02452	● KIT02514
2360	● KIT02391	● KIT02453	● KIT02515
2460	● KIT02392	● KIT02454	● KIT02516
2560	● KIT02393	● KIT02455	● KIT02517
2660	● KIT02394	● KIT02456	● KIT02518
2760	● KIT02395	● KIT02457	● KIT02519
2860	● KIT02396	● KIT02458	● KIT02520
2960	● KIT02397	● KIT02459	● KIT02521
3060	● KIT02398	● KIT02460	● KIT02522
3160	● KIT02399	● KIT02461	● KIT02523
3260	● KIT02400	● KIT02462	● KIT02524
3290	● KIT02401	● KIT02463	● KIT02525
3390	● KIT02402	● KIT02464	● KIT02526
3490	● KIT02403	● KIT02465	● KIT02527
3590	● KIT02404	● KIT02466	● KIT02528
3690	● KIT02405	● KIT02467	● KIT02529
3790	● KIT02406	● KIT02468	● KIT02530
3890	● KIT02407	● KIT02469	● KIT02531
3990	● KIT02408	● KIT02470	● KIT02532
4090	● KIT02409	● KIT02471	● KIT02533
4190	● KIT02410	● KIT02472	● KIT02534
4290	● KIT02411	● KIT02473	● KIT02535
4390	● KIT02412	● KIT02474	● KIT02536
4490	● KIT02413	● KIT02475	● KIT02537
4590	● KIT02414	● KIT02476	● KIT02538
4690	● KIT02415	● KIT02477	● KIT02539
4790	● KIT02416	● KIT02478	● KIT02540
4890	● KIT02417	● KIT02479	● KIT02541
4920	● KIT02418	● KIT02480	● KIT02542
5020	● KIT02419	● KIT02481	● KIT02543
5120	● KIT02420	● KIT02482	● KIT02544
5220	● KIT02421	● KIT02483	● KIT02545
5320	● KIT02422	● KIT02484	● KIT02546
5420	● KIT02423	● KIT02485	● KIT02547
5520	● KIT02424	● KIT02486	● KIT02548
5620	● KIT02425	● KIT02487	● KIT02549
5720	● KIT02426	● KIT02488	● KIT02550
5820	● KIT02427	● KIT02489	● KIT02551
5920	● KIT02428	● KIT02490	● KIT02552
6020	● KIT02429	● KIT02491	● KIT02553
6120	● KIT02430	● KIT02492	● KIT02554
6220	● KIT02431	● KIT02493	● KIT02555
6320	● KIT02432	● KIT02494	● KIT02556
6420	● KIT02433	● KIT02495	● KIT02557
6520	● KIT02434	● KIT02496	● KIT02558

## 500 MM DEPTH

Length (mm)	3 Levels	4 Levels	5 Levels
630	● KIT02559	● KIT02621	● KIT02683
730	● KIT02560	● KIT02622	● KIT02684
830	● KIT02561	● KIT02623	● KIT02685
930	● KIT02562	● KIT02624	● KIT02686
1030	● KIT02563	● KIT02625	● KIT02687
1130	● KIT02564	● KIT02626	● KIT02688
1230	● KIT02565	● KIT02627	● KIT02689
1330	● KIT02566	● KIT02628	● KIT02690
1430	● KIT02567	● KIT02629	● KIT02691
1530	● KIT02568	● KIT02630	● KIT02692
1630	● KIT02569	● KIT02631	● KIT02693
1660	● KIT02570	● KIT02632	● KIT02694
1760	● KIT02571	● KIT02633	● KIT02695
1860	● KIT02572	● KIT02634	● KIT02696
1960	● KIT02573	● KIT02635	● KIT02697
2060	● KIT02574	● KIT02636	● KIT02698
2160	● KIT02575	● KIT02637	● KIT02699
2260	● KIT02576	● KIT02638	● KIT02700
2360	● KIT02577	● KIT02639	● KIT02701
2460	● KIT02578	● KIT02640	● KIT02702
2560	● KIT02579	● KIT02641	● KIT02703
2660	● KIT02580	● KIT02642	● KIT02704
2760	● KIT02581	● KIT02643	● KIT02705
2860	● KIT02582	● KIT02644	● KIT02706
2960	● KIT02583	● KIT02645	● KIT02707
3060	● KIT02584	● KIT02646	● KIT02708
3160	● KIT02585	● KIT02647	● KIT02709
3260	● KIT02586	● KIT02648	● KIT02710
3290	● KIT02587	● KIT02649	● KIT02711
3390	● KIT02588	● KIT02650	● KIT02712
3490	● KIT02589	● KIT02651	● KIT02713
3590	● KIT02590	● KIT02652	● KIT02714
3690	● KIT02591	● KIT02653	● KIT02715
3790	● KIT02592	● KIT02654	● KIT02716
3890	● KIT02593	● KIT02655	● KIT02717
3990	● KIT02594	● KIT02656	● KIT02718
4090	● KIT02595	● KIT02657	● KIT02719
4190	● KIT02596	● KIT02658	● KIT02720
4290	● KIT02597	● KIT02659	● KIT02721
4390	● KIT02598	● KIT02660	● KIT02722
4490	● KIT02599	● KIT02661	● KIT02723
4590	● KIT02600	● KIT02662	● KIT02724
4690	● KIT02601	● KIT02663	● KIT02725
4790	● KIT02602	● KIT02664	● KIT02726
4890	● KIT02603	● KIT02665	● KIT02727
4920	● KIT02604	● KIT02666	● KIT02728
5020	● KIT02605	● KIT02667	● KIT02729
5120	● KIT02606	● KIT02668	● KIT02730
5220	● KIT02607	● KIT02669	● KIT02731
5320	● KIT02608	● KIT02670	● KIT02732
5420	● KIT02609	● KIT02671	● KIT02733
5520	● KIT02610	● KIT02672	● KIT02734
5620	● KIT02611	● KIT02673	● KIT02735
5720	● KIT02612	● KIT02674	● KIT02736
5820	● KIT02613	● KIT02675	● KIT02737
5920	● KIT02614	● KIT02676	● KIT02738
6020	● KIT02615	● KIT02677	● KIT02739
6120	● KIT02616	● KIT02678	● KIT02740
6220	● KIT02617	● KIT02679	● KIT02741
6320	● KIT02618	● KIT02680	● KIT02742
6420	● KIT02619	● KIT02681	● KIT02743
6520	● KIT02620	● KIT02682	● KIT02744



● 24/48-HOUR SHIPPING

SHELVING

# 1800-MM-HIGH LINEAR STAINLESS STEEL SHELVING

STAINLESS STEEL SHELVING WITH PERFORATED STAINLESS STEEL TRAYS



## 400 MM DEPTH

Length (mm)	3 Levels	4 Levels	5 Levels
660	● KIT00745	● KIT00807	● KIT00869
760	● KIT00746	● KIT00808	● KIT00870
860	● KIT00747	● KIT00809	● KIT00871
960	● KIT00748	● KIT00810	● KIT00872
1060	● KIT00749	● KIT00811	● KIT00873
1160	● KIT00750	● KIT00812	● KIT00874
1260	● KIT00751	● KIT00813	● KIT00875
1360	● KIT00752	● KIT00814	● KIT00876
1460	● KIT00753	● KIT00815	● KIT00877
1560	● KIT00754	● KIT00816	● KIT00878
1660	● KIT00755	● KIT00817	● KIT00879
1690	● KIT00756	● KIT00818	● KIT00880
1790	● KIT00757	● KIT00819	● KIT00881
1890	● KIT00758	● KIT00820	● KIT00882
1990	● KIT00759	● KIT00821	● KIT00883
2090	● KIT00760	● KIT00822	● KIT00884
2190	● KIT00761	● KIT00823	● KIT00885
2290	● KIT00762	● KIT00824	● KIT00886
2390	● KIT00763	● KIT00825	● KIT00887
2490	● KIT00764	● KIT00826	● KIT00888
2590	● KIT00765	● KIT00827	● KIT00889
2690	● KIT00766	● KIT00828	● KIT00890
2790	● KIT00767	● KIT00829	● KIT00891
2890	● KIT00768	● KIT00830	● KIT00892
2990	● KIT00769	● KIT00831	● KIT00893
3090	● KIT00770	● KIT00832	● KIT00894
3190	● KIT00771	● KIT00833	● KIT00895
3290	● KIT00772	● KIT00834	● KIT00896
3320	● KIT00773	● KIT00835	● KIT00897
3420	● KIT00774	● KIT00836	● KIT00898
3520	● KIT00775	● KIT00837	● KIT00899
3620	● KIT00776	● KIT00838	● KIT00900
3720	● KIT00777	● KIT00839	● KIT00901
3820	● KIT00778	● KIT00840	● KIT00902
3920	● KIT00779	● KIT00841	● KIT00903
4020	● KIT00780	● KIT00842	● KIT00904
4120	● KIT00781	● KIT00843	● KIT00905
4220	● KIT00782	● KIT00844	● KIT00906
4320	● KIT00783	● KIT00845	● KIT00907
4420	● KIT00784	● KIT00846	● KIT00908
4520	● KIT00785	● KIT00847	● KIT00909
4620	● KIT00786	● KIT00848	● KIT00910
4720	● KIT00787	● KIT00849	● KIT00911
4820	● KIT00788	● KIT00850	● KIT00912
4920	● KIT00789	● KIT00851	● KIT00913
4950	● KIT00790	● KIT00852	● KIT00914
5050	● KIT00791	● KIT00853	● KIT00915
5150	● KIT00792	● KIT00854	● KIT00916
5250	● KIT00793	● KIT00855	● KIT00917
5350	● KIT00794	● KIT00856	● KIT00918
5450	● KIT00795	● KIT00857	● KIT00919
5550	● KIT00796	● KIT00858	● KIT00920
5650	● KIT00797	● KIT00859	● KIT00921
5750	● KIT00798	● KIT00860	● KIT00922
5850	● KIT00799	● KIT00861	● KIT00923
5950	● KIT00800	● KIT00862	● KIT00924
6050	● KIT00801	● KIT00863	● KIT00925
6150	● KIT00802	● KIT00864	● KIT00926
6250	● KIT00803	● KIT00865	● KIT00927
6350	● KIT00804	● KIT00866	● KIT00928
6450	● KIT00805	● KIT00867	● KIT00929
6550	● KIT00806	● KIT00868	● KIT00930

## 500 MM DEPTH

Length (mm)	3 Levels	4 Levels	5 Levels
660	● KIT00931	● KIT00993	● KIT01055
760	● KIT00932	● KIT00994	● KIT01056
860	● KIT00933	● KIT00995	● KIT01057
960	● KIT00934	● KIT00996	● KIT01058
1060	● KIT00935	● KIT00997	● KIT01059
1160	● KIT00936	● KIT00998	● KIT01060
1260	● KIT00937	● KIT00999	● KIT01061
1360	● KIT00938	● KIT01000	● KIT01062
1460	● KIT00939	● KIT01001	● KIT01063
1560	● KIT00940	● KIT01002	● KIT01064
1660	● KIT00941	● KIT01003	● KIT01065
1690	● KIT00942	● KIT01004	● KIT01066
1790	● KIT00943	● KIT01005	● KIT01067
1890	● KIT00944	● KIT01006	● KIT01068
1990	● KIT00945	● KIT01007	● KIT01069
2090	● KIT00946	● KIT01008	● KIT01070
2190	● KIT00947	● KIT01009	● KIT01071
2290	● KIT00948	● KIT01010	● KIT01072
2390	● KIT00949	● KIT01011	● KIT01073
2490	● KIT00950	● KIT01012	● KIT01074
2590	● KIT00951	● KIT01013	● KIT01075
2690	● KIT00952	● KIT01014	● KIT01076
2790	● KIT00953	● KIT01015	● KIT01077
2890	● KIT00954	● KIT01016	● KIT01078
2990	● KIT00955	● KIT01017	● KIT01079
3090	● KIT00956	● KIT01018	● KIT01080
3190	● KIT00957	● KIT01019	● KIT01081
3290	● KIT00958	● KIT01020	● KIT01082
3320	● KIT00959	● KIT01021	● KIT01083
3420	● KIT00960	● KIT01022	● KIT01084
3520	● KIT00961	● KIT01023	● KIT01085
3620	● KIT00962	● KIT01024	● KIT01086
3720	● KIT00963	● KIT01025	● KIT01087
3820	● KIT00964	● KIT01026	● KIT01088
3920	● KIT00965	● KIT01027	● KIT01089
4020	● KIT00966	● KIT01028	● KIT01090
4120	● KIT00967	● KIT01029	● KIT01091
4220	● KIT00968	● KIT01030	● KIT01092
4320	● KIT00969	● KIT01031	● KIT01093
4420	● KIT00970	● KIT01032	● KIT01094
4520	● KIT00971	● KIT01033	● KIT01095
4620	● KIT00972	● KIT01034	● KIT01096
4720	● KIT00973	● KIT01035	● KIT01097
4820	● KIT00974	● KIT01036	● KIT01098
4920	● KIT00975	● KIT01037	● KIT01099
4950	● KIT00976	● KIT01038	● KIT01100
5050	● KIT00977	● KIT01039	● KIT01101
5150	● KIT00978	● KIT01040	● KIT01102
5250	● KIT00979	● KIT01041	● KIT01103
5350	● KIT00980	● KIT01042	● KIT01104
5450	● KIT00981	● KIT01043	● KIT01105
5550	● KIT00982	● KIT01044	● KIT01106
5650	● KIT00983	● KIT01045	● KIT01107
5750	● KIT00984	● KIT01046	● KIT01108
5850	● KIT00985	● KIT01047	● KIT01109
5950	● KIT00986	● KIT01048	● KIT01110
6050	● KIT00987	● KIT01049	● KIT01111
6150	● KIT00988	● KIT01050	● KIT01112
6250	● KIT00989	● KIT01051	● KIT01113
6350	● KIT00990	● KIT01052	● KIT01114
6450	● KIT00991	● KIT01053	● KIT01115
6550	● KIT00992	● KIT01054	● KIT01116



# 1800-MM-HIGH ANGULAR STAINLESS STEEL SHELVING

STAINLESS STEEL SHELVING WITH PERFORATED STAINLESS STEEL TRAYS



## 400 MM DEPTH

Length (mm)	3 Levels	4 Levels	5 Levels
630	● KIT02745	● KIT02807	● KIT02869
730	● KIT02746	● KIT02808	● KIT02870
830	● KIT02747	● KIT02809	● KIT02871
930	● KIT02748	● KIT02810	● KIT02872
1030	● KIT02749	● KIT02811	● KIT02873
1130	● KIT02750	● KIT02812	● KIT02874
1230	● KIT02751	● KIT02813	● KIT02875
1330	● KIT02752	● KIT02814	● KIT02876
1430	● KIT02753	● KIT02815	● KIT02877
1530	● KIT02754	● KIT02816	● KIT02878
1630	● KIT02755	● KIT02817	● KIT02879
1660	● KIT02756	● KIT02818	● KIT02880
1760	● KIT02757	● KIT02819	● KIT02881
1860	● KIT02758	● KIT02820	● KIT02882
1960	● KIT02759	● KIT02821	● KIT02883
2060	● KIT02760	● KIT02822	● KIT02884
2160	● KIT02761	● KIT02823	● KIT02885
2260	● KIT02762	● KIT02824	● KIT02886
2360	● KIT02763	● KIT02825	● KIT02887
2460	● KIT02764	● KIT02826	● KIT02888
2560	● KIT02765	● KIT02827	● KIT02889
2660	● KIT02766	● KIT02828	● KIT02890
2760	● KIT02767	● KIT02829	● KIT02891
2860	● KIT02768	● KIT02830	● KIT02892
2960	● KIT02769	● KIT02831	● KIT02893
3060	● KIT02770	● KIT02832	● KIT02894
3160	● KIT02771	● KIT02833	● KIT02895
3260	● KIT02772	● KIT02834	● KIT02896
3290	● KIT02773	● KIT02835	● KIT02897
3390	● KIT02774	● KIT02836	● KIT02898
3490	● KIT02775	● KIT02837	● KIT02899
3590	● KIT02776	● KIT02838	● KIT02900
3690	● KIT02777	● KIT02839	● KIT02901
3790	● KIT02778	● KIT02840	● KIT02902
3890	● KIT02779	● KIT02841	● KIT02903
3990	● KIT02780	● KIT02842	● KIT02904
4090	● KIT02781	● KIT02843	● KIT02905
4190	● KIT02782	● KIT02844	● KIT02906
4290	● KIT02783	● KIT02845	● KIT02907
4390	● KIT02784	● KIT02846	● KIT02908
4490	● KIT02785	● KIT02847	● KIT02909
4590	● KIT02786	● KIT02848	● KIT02910
4690	● KIT02787	● KIT02849	● KIT02911
4790	● KIT02788	● KIT02850	● KIT02912
4890	● KIT02789	● KIT02851	● KIT02913
4920	● KIT02790	● KIT02852	● KIT02914
5020	● KIT02791	● KIT02853	● KIT02915
5120	● KIT02792	● KIT02854	● KIT02916
5220	● KIT02793	● KIT02855	● KIT02917
5320	● KIT02794	● KIT02856	● KIT02918
5420	● KIT02795	● KIT02857	● KIT02919
5520	● KIT02796	● KIT02858	● KIT02920
5620	● KIT02797	● KIT02859	● KIT02921
5720	● KIT02798	● KIT02860	● KIT02922
5820	● KIT02799	● KIT02861	● KIT02923
5920	● KIT02800	● KIT02862	● KIT02924
6020	● KIT02801	● KIT02863	● KIT02925
6120	● KIT02802	● KIT02864	● KIT02926
6220	● KIT02803	● KIT02865	● KIT02927
6320	● KIT02804	● KIT02866	● KIT02928
6420	● KIT02805	● KIT02867	● KIT02929
6520	● KIT02806	● KIT02868	● KIT02930

## 500 MM DEPTH

Length (mm)	3 Levels	4 Levels	5 Levels
630	● KIT02931	● KIT02993	● KIT03055
730	● KIT02932	● KIT02994	● KIT03056
830	● KIT02933	● KIT02995	● KIT03057
930	● KIT02934	● KIT02996	● KIT03058
1030	● KIT02935	● KIT02997	● KIT03059
1130	● KIT02936	● KIT02998	● KIT03060
1230	● KIT02937	● KIT02999	● KIT03061
1330	● KIT02938	● KIT03000	● KIT03062
1430	● KIT02939	● KIT03001	● KIT03063
1530	● KIT02940	● KIT03002	● KIT03064
1630	● KIT02941	● KIT03003	● KIT03065
1660	● KIT02942	● KIT03004	● KIT03066
1760	● KIT02943	● KIT03005	● KIT03067
1860	● KIT02944	● KIT03006	● KIT03068
1960	● KIT02945	● KIT03007	● KIT03069
2060	● KIT02946	● KIT03008	● KIT03070
2160	● KIT02947	● KIT03009	● KIT03071
2260	● KIT02948	● KIT03010	● KIT03072
2360	● KIT02949	● KIT03011	● KIT03073
2460	● KIT02950	● KIT03012	● KIT03074
2560	● KIT02951	● KIT03013	● KIT03075
2660	● KIT02952	● KIT03014	● KIT03076
2760	● KIT02953	● KIT03015	● KIT03077
2860	● KIT02954	● KIT03016	● KIT03078
2960	● KIT02955	● KIT03017	● KIT03079
3060	● KIT02956	● KIT03018	● KIT03080
3160	● KIT02957	● KIT03019	● KIT03081
3260	● KIT02958	● KIT03020	● KIT03082
3290	● KIT02959	● KIT03021	● KIT03083
3390	● KIT02960	● KIT03022	● KIT03084
3490	● KIT02961	● KIT03023	● KIT03085
3590	● KIT02962	● KIT03024	● KIT03086
3690	● KIT02963	● KIT03025	● KIT03087
3790	● KIT02964	● KIT03026	● KIT03088
3890	● KIT02965	● KIT03027	● KIT03089
3990	● KIT02966	● KIT03028	● KIT03090
4090	● KIT02967	● KIT03029	● KIT03091
4190	● KIT02968	● KIT03030	● KIT03092
4290	● KIT02969	● KIT03031	● KIT03093
4390	● KIT02970	● KIT03032	● KIT03094
4490	● KIT02971	● KIT03033	● KIT03095
4590	● KIT02972	● KIT03034	● KIT03096
4690	● KIT02973	● KIT03035	● KIT03097
4790	● KIT02974	● KIT03036	● KIT03098
4890	● KIT02975	● KIT03037	● KIT03099
4920	● KIT02976	● KIT03038	● KIT03100
5020	● KIT02977	● KIT03039	● KIT03101
5120	● KIT02978	● KIT03040	● KIT03102
5220	● KIT02979	● KIT03041	● KIT03103
5320	● KIT02980	● KIT03042	● KIT03104
5420	● KIT02981	● KIT03043	● KIT03105
5520	● KIT02982	● KIT03044	● KIT03106
5620	● KIT02983	● KIT03045	● KIT03107
5720	● KIT02984	● KIT03046	● KIT03108
5820	● KIT02985	● KIT03047	● KIT03109
5920	● KIT02986	● KIT03048	● KIT03110
6020	● KIT02987	● KIT03049	● KIT03111
6120	● KIT02988	● KIT03050	● KIT03112
6220	● KIT02989	● KIT03051	● KIT03113
6320	● KIT02990	● KIT03052	● KIT03114
6420	● KIT02991	● KIT03053	● KIT03115
6520	● KIT02992	● KIT03054	● KIT03116



● 24/48-HOUR SHIPPING

# FREESTANDING ALUMINIUM SHELVING

## FREESTANDING ALUMINIUM SHELVING UNIT

- **Specially designed to be placed in refrigerated chambers.**
- Easy assembly with fasteners.
- Sturdy 20 micron aluminium structure.
- If weight is spread uniformly, each shelf has a 150 kg capacity.
- Shelf height is adjustable in 150mm increments.
- Self-ventilating, detachable, dishwasher-safe polypropylene grills.
- 2 depths: 370 and 570mm Gastronorm sizes.
- 2 shelving unit heights: 1700 and 2000 mm.
- The screw-free fastener assembly system allows you to save time during installation.



· Detail of the mounting piece



Diagram of the different combinations of shelf width.  
 These shelving units have 10 different shelf lengths for each width.

The kits include: 2 struts, 4 mounting pieces, and an array of grills as per the diagram below

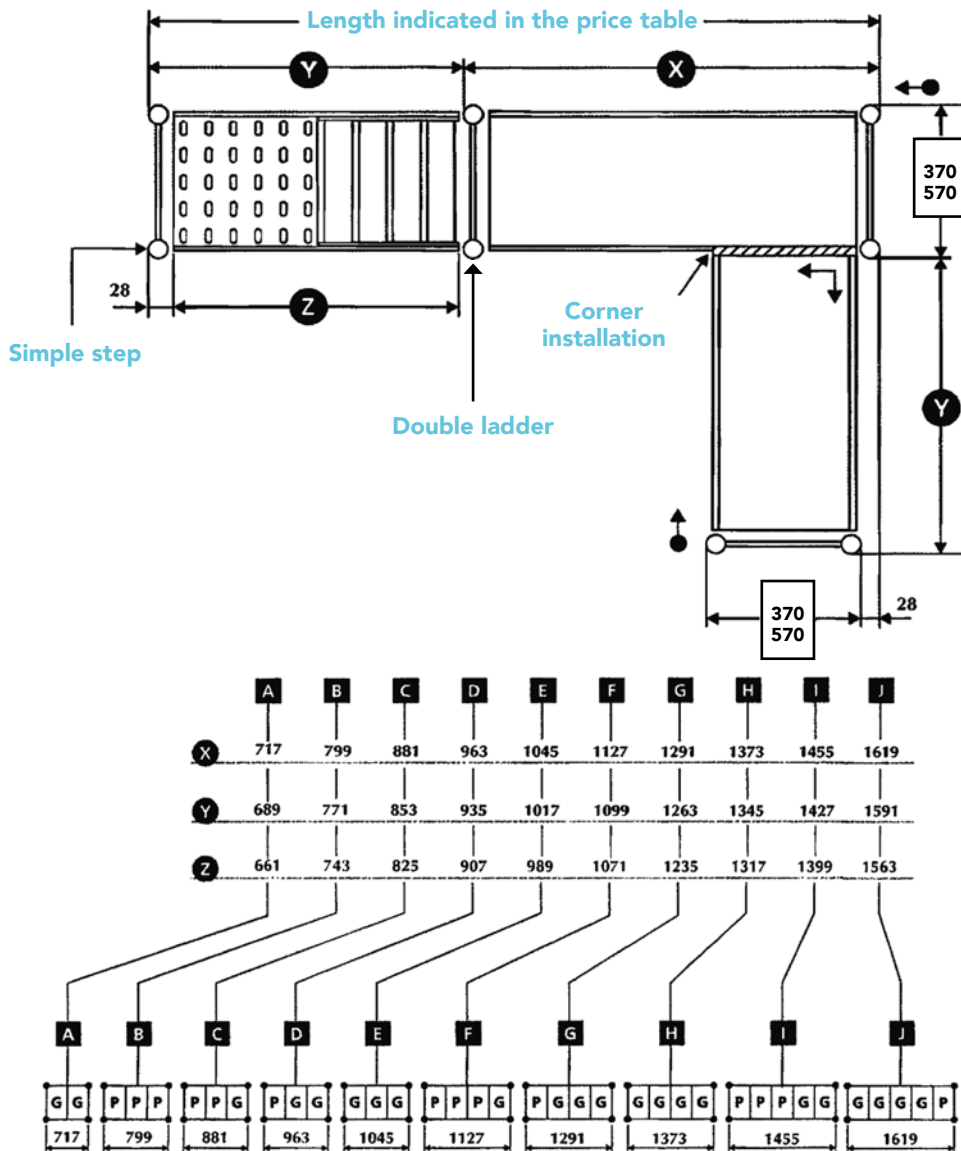

Depth	370	570
Large	325 x 325	525 x 325
Small	325 x 245	525 x 245

# FREESTANDING ALUMINIUM SHELVING

## POLYPROPYLENE TRAYS

- Made entirely out of food grade high density polypropylene.
- 2 struts, 4 mounting pieces, and an array of grills as per the diagram on page 147.
- Easy assembly.
- 370- or 570-mm-wide Grills.



### 370 MM WIDTH

Length (mm)	Grill combination	Code
661	2G	• EAB00001
743	3P	• EAB00002
825	2P + 1G	• EAB00003
907	1P + 2G	• EAB00004
989	3G	• EAB00005
1071	3P + 1G	• EAB00006
1235	1P + 3G	• EAB00007
1317	4G	• EAB00008
1399	3P + 2G	• EAB00009
1563	1P + 4G	• EAB00010

### 570 MM WIDTH

Length (mm)	Grill combination	Code
661	2G	• EAB00011
743	3P	• EAB00012
825	2P + 1G	• EAB00013
907	1P + 2G	• EAB00014
989	3G	• EAB00015
1071	3P + 1G	• EAB00016
1235	1P + 3G	• EAB00017
1317	4G	• EAB00018
1399	3P + 2G	• EAB00019
1563	1P + 4G	• EAB00020

## SUPPORTS

- Made in two heights: 1700 or 2000 mm.
- These feature adjustable legs that can adapt to any kind of floor.
- Machined to allow shelves to be attached every 150 mm.

### 370 MM WIDTH

Support height (mm)	Side support	Center support
1700	• EASL0001	• EASC0001
2000	• EASL0002	• EASC0002

### 570 MM WIDTH

Support height (mm)	Side support	Center support
1700	• EASL0003	• EASC0003
2000	• EASL0004	• EASC0004



## CORNER PIECE

- Accessory for mounting corner shelving.
- Price per unit.

For model	Code	RRP (€)
370 mm Width	• EAPA0001	18
570 mm Width	• EAPA0002	18



## BENCH

- Specially designed to fulfill the hygienic and sanitary standards for refrigerated chambers, which prohibit direct contact between boxes and other products and the ground.



### 370 MM WIDTH

Total dimensions (mm)	Code
717 x 370 x 250	• EABN0001
799 x 370 x 250	• EABN0002
881 x 370 x 250	• EABN0003
963 x 370 x 250	• EABN0004
1045 x 370 x 250	• EABN0005
1127 x 370 x 250	• EABN0006
1291 x 370 x 250	• EABN0007
1373 x 370 x 250	• EABN0008
1455 x 370 x 250	• EABN0009
1619 x 370 x 250	• EABN0010

### 570 MM WIDTH

Total dimensions (mm)	Code
717 x 570 x 250	• EABN0011
799 x 570 x 250	• EABN0012
881 x 570 x 250	• EABN0013
963 x 570 x 250	• EABN0014
1045 x 570 x 250	• EABN0015
1127 x 570 x 250	• EABN0016
1291 x 570 x 250	• EABN0017
1373 x 570 x 250	• EABN0018
1455 x 570 x 250	• EABN0019
1619 x 570 x 250	• EABN0020



SHELVING

# 1700-MM-HIGH LINEAR STAINLESS STEEL SHELVING

ALUMINIUM SHELVING WITH POLYPROPYLENE TRAYS



### 370 MM DEPTH

Length (mm)	Shelves	3 Levels	4 Levels	5 Levels
717	A	●EAL00001	●EAL00055	●EAL00109
799	B	●EAL00002	●EAL00056	●EAL00110
881	C	●EAL00003	●EAL00057	●EAL00111
963	D	●EAL00004	●EAL00058	●EAL00112
1045	E	●EAL00005	●EAL00059	●EAL00113
1127	F	●EAL00006	●EAL00060	●EAL00114
1291	G	●EAL00007	●EAL00061	●EAL00115
1373	H	●EAL00008	●EAL00062	●EAL00116
1455	I	●EAL00009	●EAL00063	●EAL00117
1619	J	●EAL00010	●EAL00064	●EAL00118
1734	2C	●EAL00011	●EAL00065	●EAL00119
1816	C + D	●EAL00012	●EAL00066	●EAL00120
1898	2D	●EAL00013	●EAL00067	●EAL00121
1980	D + E	●EAL00014	●EAL00068	●EAL00122
2062	2E	●EAL00015	●EAL00069	●EAL00123
2144	E + F	●EAL00016	●EAL00070	●EAL00124
2226	2F	●EAL00017	●EAL00071	●EAL00125
2308	E + G	●EAL00018	●EAL00072	●EAL00126
2390	F + G	●EAL00019	●EAL00073	●EAL00127
2472	F + H	●EAL00020	●EAL00074	●EAL00128
2554	2G	●EAL00021	●EAL00075	●EAL00129
2636	G + H	●EAL00022	●EAL00076	●EAL00130
2718	2H	●EAL00023	●EAL00077	●EAL00131
2800	H + I	●EAL00024	●EAL00078	●EAL00132
2882	2I	●EAL00025	●EAL00079	●EAL00133
2964	H + J	●EAL00026	●EAL00080	●EAL00134
3046	I + J	●EAL00027	●EAL00081	●EAL00135
3210	2J	●EAL00028	●EAL00082	●EAL00136
3325	2E + G	●EAL00029	●EAL00083	●EAL00137
3407	E + F + G	●EAL00030	●EAL00084	●EAL00138
3489	2F + G	●EAL00031	●EAL00085	●EAL00139
3571	E + 2G	●EAL00032	●EAL00086	●EAL00140
3653	F + 2G	●EAL00033	●EAL00087	●EAL00141
3735	F + G + H	●EAL00034	●EAL00088	●EAL00142
3817	3G	●EAL00035	●EAL00089	●EAL00143
3899	2G + H	●EAL00036	●EAL00090	●EAL00144
3981	G + 2H	●EAL00037	●EAL00091	●EAL00145
4063	3H	●EAL00038	●EAL00092	●EAL00146
4145	2H + I	●EAL00039	●EAL00093	●EAL00147
4227	H + 2I	●EAL00040	●EAL00094	●EAL00148
4309	3I	●EAL00041	●EAL00095	●EAL00149
4391	H + I + J	●EAL00042	●EAL00096	●EAL00150
4473	2I + J	●EAL00043	●EAL00097	●EAL00151
4555	H + 2J	●EAL00044	●EAL00098	●EAL00152
4637	I + 2J	●EAL00045	●EAL00099	●EAL00153
4801	3J	●EAL00046	●EAL00100	●EAL00154
4916	F + 3G	●EAL00047	●EAL00101	●EAL00155
4998	F + 2G + H	●EAL00048	●EAL00102	●EAL00156
5080	4G	●EAL00049	●EAL00103	●EAL00157
5162	3G + H	●EAL00050	●EAL00104	●EAL00158
5244	2G + 2H	●EAL00051	●EAL00105	●EAL00159
5326	G + 3H	●EAL00052	●EAL00106	●EAL00160
5408	4H	●EAL00053	●EAL00107	●EAL00161
5490	3H + I	●EAL00054	●EAL00108	●EAL00162
5572	2H + 2I	●EAL00649	●EAL00651	●EAL00653
5654	1H + 3I	●EAL00650	●EAL00652	●EAL00654

### 570 MM DEPTH

Length (mm)	Shelves	3 Levels	4 Levels	5 Levels
717	A	●EAL00163	●EAL00217	●EAL00271
799	B	●EAL00164	●EAL00218	●EAL00272
881	C	●EAL00165	●EAL00219	●EAL00273
963	D	●EAL00166	●EAL00220	●EAL00274
1045	E	●EAL00167	●EAL00221	●EAL00275
1127	F	●EAL00168	●EAL00222	●EAL00276
1291	G	●EAL00169	●EAL00223	●EAL00277
1373	H	●EAL00170	●EAL00224	●EAL00278
1455	I	●EAL00171	●EAL00225	●EAL00279
1619	J	●EAL00172	●EAL00226	●EAL00280
1734	2C	●EAL00173	●EAL00227	●EAL00281
1816	C + D	●EAL00174	●EAL00228	●EAL00282
1898	2D	●EAL00175	●EAL00229	●EAL00283
1980	D + E	●EAL00176	●EAL00230	●EAL00284
2062	2E	●EAL00177	●EAL00231	●EAL00285
2144	E + F	●EAL00178	●EAL00232	●EAL00286
2226	2F	●EAL00179	●EAL00233	●EAL00287
2308	E + G	●EAL00180	●EAL00234	●EAL00288
2390	F + G	●EAL00181	●EAL00235	●EAL00289
2472	F + H	●EAL00182	●EAL00236	●EAL00290
2554	2G	●EAL00183	●EAL00237	●EAL00291
2636	G + H	●EAL00184	●EAL00238	●EAL00292
2718	2H	●EAL00185	●EAL00239	●EAL00293
2800	H + I	●EAL00186	●EAL00240	●EAL00294
2882	2I	●EAL00187	●EAL00241	●EAL00295
2964	H + J	●EAL00188	●EAL00242	●EAL00296
3046	I + J	●EAL00189	●EAL00243	●EAL00297
3210	2J	●EAL00190	●EAL00244	●EAL00298
3325	2E + G	●EAL00191	●EAL00245	●EAL00299
3407	E + F + G	●EAL00192	●EAL00246	●EAL00300
3489	2F + G	●EAL00193	●EAL00247	●EAL00301
3571	E + 2G	●EAL00194	●EAL00248	●EAL00302
3653	F + 2G	●EAL00195	●EAL00249	●EAL00303
3735	F + G + H	●EAL00196	●EAL00250	●EAL00304
3817	3G	●EAL00197	●EAL00251	●EAL00305
3899	2G + H	●EAL00198	●EAL00252	●EAL00306
3981	G + 2H	●EAL00199	●EAL00253	●EAL00307
4063	3H	●EAL00200	●EAL00254	●EAL00308
4145	2H + I	●EAL00201	●EAL00255	●EAL00309
4227	H + 2I	●EAL00202	●EAL00256	●EAL00310
4309	3I	●EAL00203	●EAL00257	●EAL00311
4391	H + I + J	●EAL00204	●EAL00258	●EAL00312
4473	2I + J	●EAL00205	●EAL00259	●EAL00313
4555	H + 2J	●EAL00206	●EAL00260	●EAL00314
4637	I + 2J	●EAL00207	●EAL00261	●EAL00315
4801	3J	●EAL00208	●EAL00262	●EAL00316
4916	F + 3G	●EAL00209	●EAL00263	●EAL00317
4998	F + 2G + H	●EAL00210	●EAL00264	●EAL00318
5080	4G	●EAL00211	●EAL00265	●EAL00319
5162	3G + H	●EAL00212	●EAL00266	●EAL00320
5244	2G + 2H	●EAL00213	●EAL00267	●EAL00321
5326	G + 3H	●EAL00214	●EAL00268	●EAL00322
5408	4H	●EAL00215	●EAL00269	●EAL00323
5490	3H + I	●EAL00216	●EAL00270	●EAL00324
5572	2H + 2I	●EAL00655	●EAL00657	●EAL00659
5654	1H + 3I	●EAL00656	●EAL00658	●EAL00660





SHELVING

# 1700-MM-HIGH ANGULAR STAINLESS STEEL SHELVING

ALUMINIUM SHELVING WITH POLYPROPYLENE TRAYS



### 370 MM DEPTH

Length (mm)	Shelves	3 Levels	4 Levels	5 Levels
689	A	•EAA00001	•EAA00055	•EAA00109
771	B	•EAA00002	•EAA00056	•EAA00110
853	C	•EAA00003	•EAA00057	•EAA00111
935	D	•EAA00004	•EAA00058	•EAA00112
1017	E	•EAA00005	•EAA00059	•EAA00113
1099	F	•EAA00006	•EAA00060	•EAA00114
1263	G	•EAA00007	•EAA00061	•EAA00115
1345	H	•EAA00008	•EAA00062	•EAA00116
1427	I	•EAA00009	•EAA00063	•EAA00117
1591	J	•EAA00010	•EAA00064	•EAA00118
1706	2C	•EAA00011	•EAA00065	•EAA00119
1788	C + D	•EAA00012	•EAA00066	•EAA00120
1870	2D	•EAA00013	•EAA00067	•EAA00121
1952	D + E	•EAA00014	•EAA00068	•EAA00122
2034	2E	•EAA00015	•EAA00069	•EAA00123
2116	E + F	•EAA00016	•EAA00070	•EAA00124
2198	2F	•EAA00017	•EAA00071	•EAA00125
2280	E + G	•EAA00018	•EAA00072	•EAA00126
2362	F + G	•EAA00019	•EAA00073	•EAA00127
2444	F + H	•EAA00020	•EAA00074	•EAA00128
2526	2G	•EAA00021	•EAA00075	•EAA00129
2608	G + H	•EAA00022	•EAA00076	•EAA00130
2690	2H	•EAA00023	•EAA00077	•EAA00131
2772	H + I	•EAA00024	•EAA00078	•EAA00132
2854	2I	•EAA00025	•EAA00079	•EAA00133
2936	H + J	•EAA00026	•EAA00080	•EAA00134
3018	I + J	•EAA00027	•EAA00081	•EAA00135
3182	2J	•EAA00028	•EAA00082	•EAA00136
3297	2E + G	•EAA00029	•EAA00083	•EAA00137
3379	E + F + G	•EAA00030	•EAA00084	•EAA00138
3461	2F + G	•EAA00031	•EAA00085	•EAA00139
3543	E + 2G	•EAA00032	•EAA00086	•EAA00140
3625	F + 2G	•EAA00033	•EAA00087	•EAA00141
3707	F + G + H	•EAA00034	•EAA00088	•EAA00142
3789	3G	•EAA00035	•EAA00089	•EAA00143
3871	2G + H	•EAA00036	•EAA00090	•EAA00144
3953	G + 2H	•EAA00037	•EAA00091	•EAA00145
4035	3H	•EAA00038	•EAA00092	•EAA00146
4117	2H + I	•EAA00039	•EAA00093	•EAA00147
4199	H + 2I	•EAA00040	•EAA00094	•EAA00148
4281	3I	•EAA00041	•EAA00095	•EAA00149
4363	H + I + J	•EAA00042	•EAA00096	•EAA00150
4445	2I + J	•EAA00043	•EAA00097	•EAA00151
4527	H + 2J	•EAA00044	•EAA00098	•EAA00152
4609	I + 2J	•EAA00045	•EAA00099	•EAA00153
4773	3J	•EAA00046	•EAA00100	•EAA00154
4888	F + 3G	•EAA00047	•EAA00101	•EAA00155
4970	F + 2G + H	•EAA00048	•EAA00102	•EAA00156
5052	4G	•EAA00049	•EAA00103	•EAA00157
5134	3G + H	•EAA00050	•EAA00104	•EAA00158
5216	2G + 2H	•EAA00051	•EAA00105	•EAA00159
5298	G + 3H	•EAA00052	•EAA00106	•EAA00160
5380	4H	•EAA00053	•EAA00107	•EAA00161
5462	3H + I	•EAA00054	•EAA00108	•EAA00162
5544	2H + 2I	•EAA00649	•EAA00651	•EAA00653
5626	1H + 3I	•EAA00650	•EAA00652	•EAA00654

### 570 MM DEPTH

Length (mm)	Shelves	3 Levels	4 Levels	5 Levels
689	A	•EAA00163	•EAA00217	•EAA00271
771	B	•EAA00164	•EAA00218	•EAA00272
853	C	•EAA00165	•EAA00219	•EAA00273
935	D	•EAA00166	•EAA00220	•EAA00274
1017	E	•EAA00167	•EAA00221	•EAA00275
1099	F	•EAA00168	•EAA00222	•EAA00276
1263	G	•EAA00169	•EAA00223	•EAA00277
1345	H	•EAA00170	•EAA00224	•EAA00278
1427	I	•EAA00171	•EAA00225	•EAA00279
1591	J	•EAA00172	•EAA00226	•EAA00280
1706	2C	•EAA00173	•EAA00227	•EAA00281
1788	C + D	•EAA00174	•EAA00228	•EAA00282
1870	2D	•EAA00175	•EAA00229	•EAA00283
1952	D + E	•EAA00176	•EAA00230	•EAA00284
2034	2E	•EAA00177	•EAA00231	•EAA00285
2116	E + F	•EAA00178	•EAA00232	•EAA00286
2198	2F	•EAA00179	•EAA00233	•EAA00287
2280	E + G	•EAA00180	•EAA00234	•EAA00288
2362	F + G	•EAA00181	•EAA00235	•EAA00289
2444	F + H	•EAA00182	•EAA00236	•EAA00290
2526	2G	•EAA00183	•EAA00237	•EAA00291
2608	G + H	•EAA00184	•EAA00238	•EAA00292
2690	2H	•EAA00185	•EAA00239	•EAA00293
2772	H + I	•EAA00186	•EAA00240	•EAA00294
2854	2I	•EAA00187	•EAA00241	•EAA00295
2936	H + J	•EAA00188	•EAA00242	•EAA00296
3018	I + J	•EAA00189	•EAA00243	•EAA00297
3182	2J	•EAA00190	•EAA00244	•EAA00298
3297	2E + G	•EAA00191	•EAA00245	•EAA00299
3379	E + F + G	•EAA00192	•EAA00246	•EAA00300
3461	2F + G	•EAA00193	•EAA00247	•EAA00301
3543	E + 2G	•EAA00194	•EAA00248	•EAA00302
3625	F + 2G	•EAA00195	•EAA00249	•EAA00303
3707	F + G + H	•EAA00196	•EAA00250	•EAA00304
3789	3G	•EAA00197	•EAA00251	•EAA00305
3871	2G + H	•EAA00198	•EAA00252	•EAA00306
3953	G + 2H	•EAA00199	•EAA00253	•EAA00307
4035	3H	•EAA00200	•EAA00254	•EAA00308
4117	2H + I	•EAA00201	•EAA00255	•EAA00309
4199	H + 2I	•EAA00202	•EAA00256	•EAA00310
4281	3I	•EAA00203	•EAA00257	•EAA00311
4363	H + I + J	•EAA00204	•EAA00258	•EAA00312
4445	2I + J	•EAA00205	•EAA00259	•EAA00313
4527	H + 2J	•EAA00206	•EAA00260	•EAA00314
4609	I + 2J	•EAA00207	•EAA00261	•EAA00315
4773	3J	•EAA00208	•EAA00262	•EAA00316
4888	F + 3G	•EAA00209	•EAA00263	•EAA00317
4970	F + 2G + H	•EAA00210	•EAA00264	•EAA00318
5052	4G	•EAA00211	•EAA00265	•EAA00319
5134	3G + H	•EAA00212	•EAA00266	•EAA00320
5216	2G + 2H	•EAA00213	•EAA00267	•EAA00321
5298	G + 3H	•EAA00214	•EAA00268	•EAA00322
5380	4H	•EAA00215	•EAA00269	•EAA00323
5462	3H + I	•EAA00216	•EAA00270	•EAA00324
5544	2H + 2I	•EAA00655	•EAA00657	•EAA00659
5626	1H + 3I	•EAA00656	•EAA00658	•EAA00660

1 SUPPORT

2 SUPPORTS

3 SUPPORTS

4 SUPPORTS



• 24/48-HOUR SHIPPING

# 2000-MM-HIGH LINEAR STAINLESS STEEL SHELVING

ALUMINIUM SHELVING WITH POLYPROPYLENE TRAYS



## 370 MM DEPTH

Length (mm)	Shelves	3 Levels	4 Levels	5 Levels
717	A	●EAL00325	●EAL00379	●EAL00433
799	B	●EAL00326	●EAL00380	●EAL00434
881	C	●EAL00327	●EAL00381	●EAL00435
963	D	●EAL00328	●EAL00382	●EAL00436
1045	E	●EAL00329	●EAL00383	●EAL00437
1127	F	●EAL00330	●EAL00384	●EAL00438
1291	G	●EAL00331	●EAL00385	●EAL00439
1373	H	●EAL00332	●EAL00386	●EAL00440
1455	I	●EAL00333	●EAL00387	●EAL00441
1619	J	●EAL00334	●EAL00388	●EAL00442
1734	2C	●EAL00335	●EAL00389	●EAL00443
1816	C + D	●EAL00336	●EAL00390	●EAL00444
1898	2D	●EAL00337	●EAL00391	●EAL00445
1980	D + E	●EAL00338	●EAL00392	●EAL00446
2062	2E	●EAL00339	●EAL00393	●EAL00447
2144	E + F	●EAL00340	●EAL00394	●EAL00448
2226	2F	●EAL00341	●EAL00395	●EAL00449
2308	E + G	●EAL00342	●EAL00396	●EAL00450
2390	F + G	●EAL00343	●EAL00397	●EAL00451
2472	F+ H	●EAL00344	●EAL00398	●EAL00452
2554	2G	●EAL00345	●EAL00399	●EAL00453
2636	G + H	●EAL00346	●EAL00400	●EAL00454
2718	2H	●EAL00347	●EAL00401	●EAL00455
2800	H + I	●EAL00348	●EAL00402	●EAL00456
2882	2I	●EAL00349	●EAL00403	●EAL00457
2964	H + J	●EAL00350	●EAL00404	●EAL00458
3046	I + J	●EAL00351	●EAL00405	●EAL00459
3210	2J	●EAL00352	●EAL00406	●EAL00460
3325	2E + G	●EAL00353	●EAL00407	●EAL00461
3407	E + F + G	●EAL00354	●EAL00408	●EAL00462
3489	2F + G	●EAL00355	●EAL00409	●EAL00463
3571	E + 2G	●EAL00356	●EAL00410	●EAL00464
3653	F + 2G	●EAL00357	●EAL00411	●EAL00465
3735	F + G + H	●EAL00358	●EAL00412	●EAL00466
3817	3G	●EAL00359	●EAL00413	●EAL00467
3899	2G + H	●EAL00360	●EAL00414	●EAL00468
3981	G + 2H	●EAL00361	●EAL00415	●EAL00469
4063	3H	●EAL00362	●EAL00416	●EAL00470
4145	2H + I	●EAL00363	●EAL00417	●EAL00471
4227	H + 2I	●EAL00364	●EAL00418	●EAL00472
4309	3I	●EAL00365	●EAL00419	●EAL00473
4391	H + I + J	●EAL00366	●EAL00420	●EAL00474
4473	2I + J	●EAL00367	●EAL00421	●EAL00475
4555	H + 2J	●EAL00368	●EAL00422	●EAL00476
4637	I + 2J	●EAL00369	●EAL00423	●EAL00477
4801	3J	●EAL00370	●EAL00424	●EAL00478
4916	F + 3G	●EAL00371	●EAL00425	●EAL00479
4998	F + 2G + H	●EAL00372	●EAL00426	●EAL00480
5080	4G	●EAL00373	●EAL00427	●EAL00481
5162	3G + H	●EAL00374	●EAL00428	●EAL00482
5244	2G + 2H	●EAL00375	●EAL00429	●EAL00483
5326	G + 3H	●EAL00376	●EAL00430	●EAL00484
5408	4H	●EAL00377	●EAL00431	●EAL00485
5490	3H + I	●EAL00378	●EAL00432	●EAL00486
5572	2H + 2I	●EAL00661	●EAL00663	●EAL00665
5654	1H + 3I	●EAL00662	●EAL00664	●EAL00666

## 570 MM DEPTH

Length (mm)	Shelves	3 Levels	4 Levels	5 Levels
717	A	●EAL00487	●EAL00541	●EAL00595
799	B	●EAL00488	●EAL00542	●EAL00596
881	C	●EAL00489	●EAL00543	●EAL00597
963	D	●EAL00490	●EAL00544	●EAL00598
1045	E	●EAL00491	●EAL00545	●EAL00599
1127	F	●EAL00492	●EAL00546	●EAL00600
1291	G	●EAL00493	●EAL00547	●EAL00601
1373	H	●EAL00494	●EAL00548	●EAL00602
1455	I	●EAL00495	●EAL00549	●EAL00603
1619	J	●EAL00496	●EAL00550	●EAL00604
1734	2C	●EAL00497	●EAL00551	●EAL00605
1816	C + D	●EAL00498	●EAL00552	●EAL00606
1898	2D	●EAL00499	●EAL00553	●EAL00607
1980	D + E	●EAL00500	●EAL00554	●EAL00608
2062	2E	●EAL00501	●EAL00555	●EAL00609
2144	E + F	●EAL00502	●EAL00556	●EAL00610
2226	2F	●EAL00503	●EAL00557	●EAL00611
2308	E + G	●EAL00504	●EAL00558	●EAL00612
2390	F + G	●EAL00505	●EAL00559	●EAL00613
2472	F+ H	●EAL00506	●EAL00560	●EAL00614
2554	2G	●EAL00507	●EAL00561	●EAL00615
2636	G + H	●EAL00508	●EAL00562	●EAL00616
2718	2H	●EAL00509	●EAL00563	●EAL00617
2800	H + I	●EAL00510	●EAL00564	●EAL00618
2882	2I	●EAL00511	●EAL00565	●EAL00619
2964	H + J	●EAL00512	●EAL00566	●EAL00620
3046	I + J	●EAL00513	●EAL00567	●EAL00621
3210	2J	●EAL00514	●EAL00568	●EAL00622
3325	2E + G	●EAL00515	●EAL00569	●EAL00623
3407	E + F + G	●EAL00516	●EAL00570	●EAL00624
3489	2F + G	●EAL00517	●EAL00571	●EAL00625
3571	E + 2G	●EAL00518	●EAL00572	●EAL00626
3653	F + 2G	●EAL00519	●EAL00573	●EAL00627
3735	F + G + H	●EAL00520	●EAL00574	●EAL00628
3817	3G	●EAL00521	●EAL00575	●EAL00629
3899	2G + H	●EAL00522	●EAL00576	●EAL00630
3981	G + 2H	●EAL00523	●EAL00577	●EAL00631
4063	3H	●EAL00524	●EAL00578	●EAL00632
4145	2H + I	●EAL00525	●EAL00579	●EAL00633
4227	H + 2I	●EAL00526	●EAL00580	●EAL00634
4309	3I	●EAL00527	●EAL00581	●EAL00635
4391	H + I + J	●EAL00528	●EAL00582	●EAL00636
4473	2I + J	●EAL00529	●EAL00583	●EAL00637
4555	H + 2J	●EAL00530	●EAL00584	●EAL00638
4637	I + 2J	●EAL00531	●EAL00585	●EAL00639
4801	3J	●EAL00532	●EAL00586	●EAL00640
4916	F + 3G	●EAL00533	●EAL00587	●EAL00641
4998	F + 2G + H	●EAL00534	●EAL00588	●EAL00642
5080	4G	●EAL00535	●EAL00589	●EAL00643
5162	3G + H	●EAL00536	●EAL00590	●EAL00644
5244	2G + 2H	●EAL00537	●EAL00591	●EAL00645
5326	G + 3H	●EAL00538	●EAL00592	●EAL00646
5408	4H	●EAL00539	●EAL00593	●EAL00647
5490	3H + I	●EAL00540	●EAL00594	●EAL00648
5572	2H + 2I	●EAL00667	●EAL00669	●EAL00671
5654	1H + 3I	●EAL00668	●EAL00670	●EAL00672



# 2000-MM-HIGH ANGULAR STAINLESS STEEL SHELVING

ALUMINIUM SHELVING WITH POLYPROPYLENE TRAYS

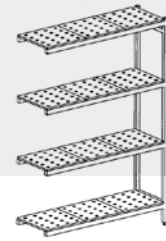

## 370 MM DEPTH

Length (mm)	Shelves	3 Levels	4 Levels	5 Levels
689	A	•EAA00325	•EAA00379	•EAA00433
771	B	•EAA00326	•EAA00380	•EAA00434
853	C	•EAA00327	•EAA00381	•EAA00435
935	D	•EAA00328	•EAA00382	•EAA00436
1017	E	•EAA00329	•EAA00383	•EAA00437
1099	F	•EAA00330	•EAA00384	•EAA00438
1263	G	•EAA00331	•EAA00385	•EAA00439
1345	H	•EAA00332	•EAA00386	•EAA00440
1427	I	•EAA00333	•EAA00387	•EAA00441
1591	J	•EAA00334	•EAA00388	•EAA00442
1706	2C	•EAA00335	•EAA00389	•EAA00443
1788	C + D	•EAA00336	•EAA00390	•EAA00444
1870	2D	•EAA00337	•EAA00391	•EAA00445
1952	D + E	•EAA00338	•EAA00392	•EAA00446
2034	2E	•EAA00339	•EAA00393	•EAA00447
2116	E + F	•EAA00340	•EAA00394	•EAA00448
2198	2F	•EAA00341	•EAA00395	•EAA00449
2280	E + G	•EAA00342	•EAA00396	•EAA00450
2362	F + G	•EAA00343	•EAA00397	•EAA00451
2444	F+ H	•EAA00344	•EAA00398	•EAA00452
2526	2G	•EAA00345	•EAA00399	•EAA00453
2608	G + H	•EAA00346	•EAA00400	•EAA00454
2690	2H	•EAA00347	•EAA00401	•EAA00455
2772	H + I	•EAA00348	•EAA00402	•EAA00456
2854	2I	•EAA00349	•EAA00403	•EAA00457
2936	H + J	•EAA00350	•EAA00404	•EAA00458
3018	I + J	•EAA00351	•EAA00405	•EAA00459
3182	2J	•EAA00352	•EAA00406	•EAA00460
3297	2E + G	•EAA00353	•EAA00407	•EAA00461
3379	E + F + G	•EAA00354	•EAA00408	•EAA00462
3461	2F + G	•EAA00355	•EAA00409	•EAA00463
3543	E + 2G	•EAA00356	•EAA00410	•EAA00464
3625	F + 2G	•EAA00357	•EAA00411	•EAA00465
3707	F + G + H	•EAA00358	•EAA00412	•EAA00466
3789	3G	•EAA00359	•EAA00413	•EAA00467
3871	2G + H	•EAA00360	•EAA00414	•EAA00468
3953	G + 2H	•EAA00361	•EAA00415	•EAA00469
4035	3H	•EAA00362	•EAA00416	•EAA00470
4117	2H + I	•EAA00363	•EAA00417	•EAA00471
4199	H + 2I	•EAA00364	•EAA00418	•EAA00472
4281	3I	•EAA00365	•EAA00419	•EAA00473
4363	H + I + J	•EAA00366	•EAA00420	•EAA00474
4445	2I + J	•EAA00367	•EAA00421	•EAA00475
4527	H + 2J	•EAA00368	•EAA00422	•EAA00476
4609	I + 2J	•EAA00369	•EAA00423	•EAA00477
4773	3J	•EAA00370	•EAA00424	•EAA00478
4888	F + 3G	•EAA00371	•EAA00425	•EAA00479
4970	F + 2G + H	•EAA00372	•EAA00426	•EAA00480
5052	4G	•EAA00373	•EAA00427	•EAA00481
5134	3G + H	•EAA00374	•EAA00428	•EAA00482
5216	2G + 2H	•EAA00375	•EAA00429	•EAA00483
5298	G + 3H	•EAA00376	•EAA00430	•EAA00484
5380	4H	•EAA00377	•EAA00431	•EAA00485
5462	3H + I	•EAA00378	•EAA00432	•EAA00486
5544	2H + 2I	•EAA00661	•EAA00663	•EAA00665
5626	1H + 3I	•EAA00662	•EAA00664	•EAA00666

## 570 MM DEPTH

Length (mm)	Shelves	3 Levels	4 Levels	5 Levels
689	A	•EAA00487	•EAA00541	•EAA00595
771	B	•EAA00488	•EAA00542	•EAA00596
853	C	•EAA00489	•EAA00543	•EAA00597
935	D	•EAA00490	•EAA00544	•EAA00598
1017	E	•EAA00491	•EAA00545	•EAA00599
1099	F	•EAA00492	•EAA00546	•EAA00600
1263	G	•EAA00493	•EAA00547	•EAA00601
1345	H	•EAA00494	•EAA00548	•EAA00602
1427	I	•EAA00495	•EAA00549	•EAA00603
1591	J	•EAA00496	•EAA00550	•EAA00604
1706	2C	•EAA00497	•EAA00551	•EAA00605
1788	C + D	•EAA00498	•EAA00552	•EAA00606
1870	2D	•EAA00499	•EAA00553	•EAA00607
1952	D + E	•EAA00500	•EAA00554	•EAA00608
2034	2E	•EAA00501	•EAA00555	•EAA00609
2116	E + F	•EAA00502	•EAA00556	•EAA00610
2198	2F	•EAA00503	•EAA00557	•EAA00611
2280	E + G	•EAA00504	•EAA00558	•EAA00612
2362	F + G	•EAA00505	•EAA00559	•EAA00613
2444	F+ H	•EAA00506	•EAA00560	•EAA00614
2526	2G	•EAA00507	•EAA00561	•EAA00615
2608	G + H	•EAA00508	•EAA00562	•EAA00616
2690	2H	•EAA00509	•EAA00563	•EAA00617
2772	H + I	•EAA00510	•EAA00564	•EAA00618
2854	2I	•EAA00511	•EAA00565	•EAA00619
2936	H + J	•EAA00512	•EAA00566	•EAA00620
3018	I + J	•EAA00513	•EAA00567	•EAA00621
3182	2J	•EAA00514	•EAA00568	•EAA00622
3297	2E + G	•EAA00515	•EAA00569	•EAA00623
3379	E + F + G	•EAA00516	•EAA00570	•EAA00624
3461	2F + G	•EAA00517	•EAA00571	•EAA00625
3543	E + 2G	•EAA00518	•EAA00572	•EAA00626
3625	F + 2G	•EAA00519	•EAA00573	•EAA00627
3707	F + G + H	•EAA00520	•EAA00574	•EAA00628
3789	3G	•EAA00521	•EAA00575	•EAA00629
3871	2G + H	•EAA00522	•EAA00576	•EAA00630
3953	G + 2H	•EAA00523	•EAA00577	•EAA00631
4035	3H	•EAA00524	•EAA00578	•EAA00632
4117	2H + I	•EAA00525	•EAA00579	•EAA00633
4199	H + 2I	•EAA00526	•EAA00580	•EAA00634
4281	3I	•EAA00527	•EAA00581	•EAA00635
4363	H + I + J	•EAA00528	•EAA00582	•EAA00636
4445	2I + J	•EAA00529	•EAA00583	•EAA00637
4527	H + 2J	•EAA00530	•EAA00584	•EAA00638
4609	I + 2J	•EAA00531	•EAA00585	•EAA00639
4773	3J	•EAA00532	•EAA00586	•EAA00640
4888	F + 3G	•EAA00533	•EAA00587	•EAA00641
4970	F + 2G + H	•EAA00534	•EAA00588	•EAA00642
5052	4G	•EAA00535	•EAA00589	•EAA00643
5134	3G + H	•EAA00536	•EAA00590	•EAA00644
5216	2G + 2H	•EAA00537	•EAA00591	•EAA00645
5298	G + 3H	•EAA00538	•EAA00592	•EAA00646
5380	4H	•EAA00539	•EAA00593	•EAA00647
5462	3H + I	•EAA00540	•EAA00594	•EAA00648
5544	2H + 2I	•EAA00667	•EAA00669	•EAA00671
5626	1H + 3I	•EAA00668	•EAA00670	•EAA00672

1 SUPPORT

2 SUPPORTS

3 SUPPORTS

4 SUPPORTS





# FOOD DISTRIBUTION AND DISPLAY

**TRANSPORT  
TROLLEYS**  
PAGE 159

---

**TEMPERATURE MAINTENANCE AND  
BAIN-MARIE TROLLEYS**  
PAGE 171

---

**GASTRONORM  
CONTAINERS**  
PAGE 179

---

**DROP-IN**  
PAGE 185

---

**SELF-SERVICE**  
PAGE 211

---

**CHILDREN'S SELF-SERVICE**  
PAGE 237



FOOD DISTRIBUTION AND DISPLAY

# TRANSPORT TROLLEYS



## SERVING TROLLEYS

PAGE 160



## TRANSPORT TROLLEYS

PAGE 162



## PLATE TRANSPORTATION TROLLEY

PAGE 165



## TRAY TROLLEYS, FAST FOOD AND SOLID FOOD

PAGE 168



## TROLLEYS FOR DISH RACKS

PAGE 169

# SERVING TROLLEYS

## SERVING TROLLEYS

The sturdiness of the trolleys allows them to transport heavy loads.

- Made of AISI grade 304 stainless steel (18/10) with inlay design and raised outer edges.
- Shelves very sturdy.
- Maximum load distributed across each shelf is 75 kg, with a total maximum load of 200 kg.
- Four Ø125 mm castors with bumpers (2 with brakes).

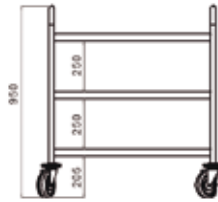
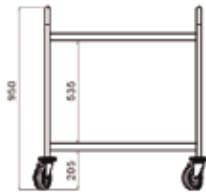

### 2 SHELVES

Total dimensions (mm)	Shelf dimensions (mm)	Assembled trolley	Disassembled trolley
895 x 595 x 950	800 x 500	• F0260401	• FD260401
995 x 595 x 950	900 x 500	• F0260402	• FD260402
1095 x 695 x 950	1000 x 600	• F0260403	• FD260403

### 3 SHELVES

Total dimensions (mm)	Shelf dimensions (mm)	Assembled trolley	Disassembled trolley
895 x 595 x 950	800 x 500	• F0260404	• FD260404
995 x 595 x 950	900 x 500	• F0260405	• FD260405
1095 x 695 x 950	1000 x 600	• F0260406	• FD260406

### 4 SHELVES

Total dimensions (mm)	Shelf dimensions (mm)	Assembled trolley
995 x 595 x 1250	900 x 500	• F0260407
1095 x 695 x 1250	1000 x 600	• F0260408





## ACCESSORIES FOR SERVICE TROLLEYS

- Easy to install on the service trolley without the use of tools.
- Stainless steel utensil basket holder.
- 200 mm Gastronorm 1/3 container holder.
- 200 mm Gastronorm 1/3 pan not included.



### GASTRONORM CONTAINER HOLDER

Model	Code
Support	• F0260207
Basin	• RGN13200



WASTE BAG HOLDER



UTENSIL BASKET HOLDER

For trolley	Total dimensions (mm)	Code
Width 595	527 x 285 x 50	• F0260209
Width 695	627 x 285 x 50	• F0260201

Total dimensions (mm)	Code
525 x 149 x 125	• F0260210
625 x 149 x 125	• F0260202

## ALUMINIUM AND POLYPROPYLENE SERVICE TROLLEY

### Lightweight, heavy-duty service trolley.

- Structure made of aluminium.
- Sturdy shelves and two side handles made of injected polypropylene.
- 4 Ø102 mm swivel castors, 2 of which feature brakes.
- **Supplied assembled.**



Total dimensions (mm)	Shelves	Maximum load per shelf	Code
825 x 410 x 850	3	40 Kg	• F0260410
1000 x 495 x 920	3	50 Kg	• F0260411



# TRANSPORT TROLLEYS

## REINFORCED GN TROLLEY

- Made entirely of AISI grade 304 stainless steel (18/10).
- Sets of runners: 18
- Distance between runners: 75 mm.
- Four Ø125 mm castors with bumpers (2 with brakes).
- Gastronorm containers not included.
- **Quick and easy assembly in just 5 minutes.**

RELATED PRODUCTS

**GASTRONORM CONTAINERS** page 179

Model	Total dimensions (mm)	Code
GN 1/1	460 x 630 x 1700	• F0260601
GN 2/1	660 x 750 x 1700	• F0260901



## PROTECTIVE COVER FOR REINFORCED GN TROLLEY

- 200-micron-thick transparent PVC cover.
- Zip closure.
- Reinforced seams.
- Not machine washable; hand wash only.

Model	Total dimensions (mm)	Code
GN 1/1	460 x 630 x 1700	• F0260602
GN 2/1	660 x 750 x 1700	• F0260902



## SHORT REINFORCED GN TROLLEY

- Made entirely of AISI grade 304 stainless steel (18/10).
- Sets of runners: 7.
- Distance between runners: 75 mm.
- Four Ø125 mm castors with bumpers (2 with brakes).
- Gastronorm containers not included.
- **Quick and easy assembly in just 5 minutes.**

RELATED PRODUCTS

**GASTRONORM CONTAINERS** page 179

Model	Total dimensions (mm)	Code
GN 1/1	460 x 630 x 900	• F0260611
GN 2/1	660 x 750 x 900	• F0260911



## REINFORCED NESTABLE GN 2/1 TROLLEY

Designed to be nestable at 50% of its surface making storage much easier

- Made entirely of AISI grade 304 stainless steel (18/10).
- Sets of runners: 18.
- Distance between runners: 75 mm.
- Four Ø125 mm castors with bumpers (2 with brakes).
- Containers not included.
- **No assembly required.**

### RELATED PRODUCTS

**GASTRONORM CONTAINERS** page 179

Total dimensions (mm)	Code
670 x 750 x 1720	• F0261301



## DEFROSTING TROLLEY

Designed for defrosting food in GN trays.

- The defrosting water from each level is collected in a small 20 mm deep GN tray, located under each 100 mm deep GN tray with a drain.
- Made entirely of AISI 304 18/10 stainless steel.
- Capacity: 9 levels for 9 trays up to 100 mm deep, GN 1/1 or GN 2/1 depending on model.
- 4 Ø125 mm wheels with bumpers, 2 of which feature brakes.
- Includes: 9 100 mm deep perforated trays, GN 1/1 or GN 2/1 according to model
- Includes: 9 20 mm deep trays, GN 1/1 or GN 2/1 according to model.
- Easy cleaning and disinfection system.
- **Supplied disassembled.**

Model	Total dimensions (mm)	Code
GN 1/1	460 x 790 x 1700	• F0260603
GN 2/1	660 x 790 x 1700	• F0260903



## WASHING TROLLEY

Designed for washing vegetables or transporting different foods.

- Made entirely of AISI grade 304 stainless steel (18/10).
- Perforated false bottom.
- Drain with tap.
- Capacity: 90 liters.
- Four Ø105mm castors.
- 600 x 500 x 300 mm Basin.
- **No assembly required.**

Total dimensions (mm)	Code
600 x 500 x 600	• F0260701



# TRANSPORT TROLLEYS

## REINFORCED TROLLEY FOR HEAVY LOADS

**Designed to transport heavy loads.**

- Made entirely of AISI grade 304 stainless steel (18/10).
- Maximum load of 300 kg.
- Ø30mm tubular handles.
- Four Ø150mm castors (2 with brakes).
- **Easy assembly in 3 minutes.**



Total dimensions (mm)	Code
1040 x 640 x 1050	• F0260002

## REINFORCED BAKERY TROLLEY

- Made entirely of AISI grade 304 stainless steel (18/10).
- Sets of runners: 16.
- Distance between runners: 85 mm.
- Four Ø125 mm castors with bumpers (2 with brakes).
- **Quick and easy assembly in just 5 minutes.**



Total dimensions (mm)	Code
537 x 700 x 1720	• F0261001

## REINFORCED LOW PASTRY TROLLEY

- Made entirely of AISI 304 18/10 stainless steel.
- Sets of runners: 8.
- Distance between runners: 85 mm.
- 4 Ø125 mm castors with bumpers, 2 of which feature brakes.
- **Easy and quick assembly in only 5 minutes.**



Total dimensions (mm)	Code
537 x 700 x 990	• F0261002



# PLATE TRANSPORTATION TROLLEY

## STOCK AND PLATE TRANSPORTATION TROLLEY

- Made of AISI 304 18/10 stainless steel.
- Very sturdy, fully-welded structure.
- Shelves lean inwards to prevent plates from falling.
- Four Ø125 mm castors with bumpers (2 with brakes).
- The double model can stack plates measuring up to Ø32 cm on one side and Ø26 cm on the other.
- Bar separator not included.
- **No assembly required.**



SINGLE



DOUBLE

Model	Total dimensions (mm)	Plate capacity	Ø maximum	Code
Single	1165 x 570 x 850	150	32 cm	• F0261501
Double	1165 x 785 x 850	300	32/26 cm	• F0261502



### BAR SEPARATOR

Code	RRP (€)
• F0260208	48

\* Price per unit

## TROLLEY FOR STOCKING AND TRANSPORTING POLYETHYLENE PLATES

- Made of high resistance polyethylene, extremely durable and robust.
- Smooth wheels for easy transport of the fully loaded trolley.
- Easily adjustable polyethylene partition columns for flexible configuration.
- Maximum capacity of 6 columns of plates, adjustable with the removable dividers.
- Includes a vinyl sleeve for safe sanitary storage.
- 2 Ø127 mm wheels with brakes and 2 Ø255 mm wheels without brakes.
- Capacity for 400 plates measuring up to Ø33 cm.
- **No assembly required.**



Total dimensions (mm)	Code
1090 x 720 x 800	• F0261504



# PLATE TRANSPORTATION TROLLEY

## PLATE RACK TROLLEY

**Designed for plating large numbers of dishes before service.**

- Made entirely of AISI grade 304 stainless steel (18/10).
- Capacity for 80 plates with diameters of 200 to 320 mm or 120 plates with diameters of less than 200 mm.
- Comes with a bag of 160 rubber bars for increased safety during movement.
- 540 x 273 mm stainless steel grilles with Ø7 mm bars.
- Ø25 mm stainless steel handle.
- Four Ø125 mm castors with bumpers (2 with brakes).
- Distance between runners: 70 mm.
- Number of levels: 2 x 20.
- **No assembly required.**

Total dimensions (mm)	Code
645 x 665 x 1740	• F0260301



## PROTECTIVE COVER FOR PLATE RACK TROLLEY

- **200-micron-thick transparent PVC cover.**
- Zip closure.
- Reinforced seams.
- Not machine washable; hand wash only.

Total dimensions (mm)	Code
660 x 750 x 1700	• F0260902

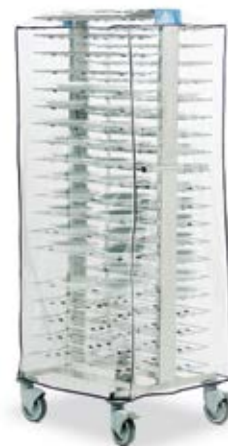

## COUNTERTOP PLATE RACK

**Its small size makes this rack excellent for plating in medium-sized kitchens.**

- Structure made entirely of AISI 304 stainless steel (18/10) with 25mm square tube.
- Capacity for 20 plates between 200 to 320 mm in diameter or 30 plates less than 200mm in diameter.
- Stainless steel grilles with Ø7 mm bars.
- Number of levels: 10.
- Distance between runners: 76 mm.
- **No assembly required.**

Total dimensions (mm)	Code
575 x 320 x 855	• F0260302



## BLACK AND WHITE PLATING TRAY

Suitable for plating large quantities of dishes before serving.

- Made of stainless steel, black coated structure.
- Steel brackets coated in white non-slip plastic.
- Handles for easy mobility of the trolley.
- Capacity for 96 plates measuring from Ø 240 to 310 mm.
- 4 Ø125 mm swivel castors with bumpers, 2 of which feature brakes.
- Separation between levels: 60 mm.
- Number of levels: 4 x 24.
- **No assembly required.**



Total dimensions (mm)	Code
770 x 770 x 1800	• F0260304

## WASTE CONTAINER WITH CASTORS AND LID

- Made entirely of AISI grade 304 stainless steel (18/10).
- Floor inlaid with sanitary radius to facilitate cleaning.
- **No assembly required.**



PEDAL-OPERATED LID



SEPARATE LID

Total dimensions (mm)	Capacity (litres)	Castors	Code	Castors	Code
380 Ø x 605	50	2 of Ø 50 mm	• F0260502	3 of Ø 50 mm	• F0260501
450 Ø x 685	95	2 of Ø 50 mm	• F0260505	3 of Ø 50 mm	• F0260504

## BAG HOLDER WITH PEDAL

- Made entirely of AISI 304 18/10 stainless steel.
- Includes a rubber strap at the top to hold the bag securely.
- 2 Ø60 mm wheels.
- **No assembly required.**

Total dimensions (mm)	Capacity (litres)	Code
380 Ø x 850	Up to 100	• F0260506

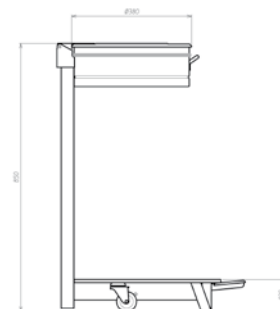

# PLATE TRANSPORTATION TROLLEY

## TRAY TROLLEY

- Made entirely of AISI grade 304 stainless steel (18/10).
- Fully welded sturdy structure.
- Maximum load of 5 kg per level.
- Four Ø125 mm castors with bumpers (2 with brakes).



### SINGLE OR DOUBLE OPENING

Total dimensions (mm)	Runners	Code
565 x 650 x 1720	12	• F0261101
970 x 650 x 1720	12 + 12	• F0261201

- Distance between runners: 100 mm.
- For standard-dimension 450 x 350 mm, 480 x 370 mm, GN 1/1, and 350 x 270 mm (fast food) trays, or other trays (maximum dimensions of 530 x 370 mm).
- Closed models include stainless steel side panels.
- **Only double models are supplied assembled.**



### SINGLE OR DOUBLE CLOSED SIDES

Total dimensions (mm)	Runners	Code
565 x 650 x 1720	12	• F0261102
970 x 650 x 1720	12 + 12	• F0261202

## FAST FOOD WASTE RECEPTACLE

Designed for use in fast-food restaurants, self-service areas, buffets, etc.

- Made of AISI grade 304 stainless steel (18/10).
- Sloped ramp facilitates movement of waste into the bin.
- Capacity for waste bins up to Ø500 mm and 690 mm in height.
- **No assembly required.**

Total dimensions (mm)	Code
668 x 585 x 1300	• F0260512

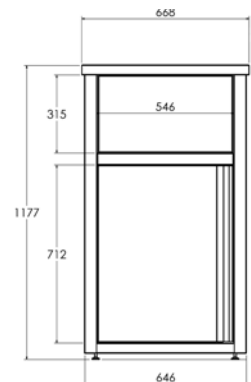

## SOLID FOOD TROLLEY

- Made entirely of AISI grade 304 stainless steel (18/10).
- Four Ø50 mm castors.
- Removable swinging lid.
- Airtight container.
- Floor inlaid with sanitary radius to facilitate cleaning.
- Capacity of 135 L.
- **No assembly required.**

Total dimensions (mm)	Code
395 x 610 x 725	• F0260503





# TROLLEYS FOR DISH RACKS

## TROLLEYS FOR DISH RACKS

### For storing and transporting 500 x 500 mm Dish racks.

- Made entirely of AISI grade 304 stainless steel (18/10).
- Maximum load of 80 kg.
- Four Ø125 mm castors with bumpers (2 with brakes).
- Ø25 mm tube handles on model F0260101.
- Features non-marking rubber protectors on each corner (model F0260001).
- **No assembly required.**



### NO HANDLE

Total dimensions (mm)	Code
520 x 520 x 250	• F0260001



### WITH HANDLE

Total dimensions (mm)	Code
731 x 634 x 1050	• F0260101

## DISH RACK TROLLEY

- Made entirely of AISI grade 304 stainless steel (18/10).
- 25 mm square tube structure.
- Sets of runners: 7.
- Distance between runners: 198 mm.
- Four Ø125 mm castors with bumpers (2 with brakes).
- Dish racks not included.
- **Quick and easy assembly in just 5 minutes.**

Total dimensions (mm)	Code
625 x 637 x 1720	• F0261701





FOOD DISTRIBUTION AND DISPLAY

# TEMPERATURE MAINTENANCE AND BAIN-MARIE TROLLEYS



## ACR HEATED HOLDING TROLLEYS

PAGE 173



## ACGF COLD HOLDING TROLLEYS

PAGE 175



## TEMPERATURE MAINTENANCE TROLLEYS

PAGE 176



## BAIN-MARIE TROLLEYS

PAGE 177

# ACR HEATED HOLDING TROLLEYS

## SPECIALLY DESIGNED FOR BANQUETS AND CATERING

01

### CIRCULATES HOT AIR EVENLY

Its unique positioning system for basins and grill racks prevents contact with walls, allowing the hot air inside to better circulate.



02

### SAVES ENERGY

Thanks to their mineral wool insulation system, trolleys reach the desired temperature faster and maintain it for longer.

03

### OPENING THE DOOR 270°

Upper and lower hinges in stainless steel with a swivel pivot point for full door opening.



04

### EXTREME CLEANLINESS

The heat block and set of monoblock runners (no welding) are easily removable for easy cleaning of the inside of the trolley.

### MOISTURE INSIDE CHAMBER

Humidifier container included. For serving food at the optimal juiciness and temperature.



Locking handles with key included..

05

### IMPROVED ERGONOMIC DESIGN

Rear vertical handles and rubber protectors on each corner make this Trolley easy to move without leaving marks.

### CONTROL PANEL

Lighted power switch, thermostat for regulating temperature between 0°C and 90°C.

### HIGH-RESISTANCE CASTORS

measuring Ø150 mm, 2 with brakes. For any surface.

## ACR HEATED HOLDING TROLLEY

**Designed to facilitate the transport and service of hot meals.**

- Made of AISI 304 18/10 stainless steel.
- Capacity for 6, 11, 17, 22, 34 or 44 GN 2/1 in one or two sets of single-block runners (single piece), depending on model.
- Double wall with rock wool insulation to reduce heat loss and energy consumption.
- Fully removable heating block, ventilated heating element and humidifier system tray included.
- Control panel with illuminated switch, pilot light indicating resistance operation and digital thermostat.
- Silicone weatherstrip around the entire door frame to maintain the temperature inside, removable for easy cleaning.

- 4 heavy duty Ø150 mm wheels, 2 of which feature brakes.
- Vertical rear handles for optimal mobility.
- Non-marking rubber bumpers at each corner of the trolley base.
- Lock with key incorporated in the handle.
- Single-phase spiral connection cable with earth connection.
- Gastronorm grills and containers not included.

### RELATED PRODUCTS

**GASTRONORM CONTAINERS** page 179

**GN GRILL RACKS** page 183



ACR-Mini

ACR-B

ACR-1

ACR-2

### 90°C

Model	Total dimensions (mm)	Capacity	Distance between runners	Power (W)	Power supply (V/N/Hz)	Code
ACR-Mini	700 x 805 x 845	6 GN 2/1 o 12 GN 1/1	55 mm	3000 W	230/1/50-60	• F1400007
ACR-B	700 x 805 x 1150	11 GN 2/1 o 22 GN 1/1	55 mm	3000 W	230/1/50-60	• F1400003
ACR-1	700 x 805 x 1740	17 GN 2/1 o 34 GN 1/1	70 mm	3000 W	230/1/50-60	• F1400011
	700 x 805 x 1740	22 GN 2/1 o 44 GN 1/1	55 mm	3000 W	230/1/50-60	• F1400001
ACR-2	1350 x 805 x 1740	34 GN 2/1 o 68 GN 1/1	70 mm	4000 W	230/1/50-60	• F1400021
	1350 x 805 x 1740	44 GN 2/1 o 88 GN 1/1	55 mm	4000 W	230/1/50-60	• F1400002



# ACGF COLD HOLDING TROLLEYS

## SPECIALLY DESIGNED FOR BANQUETS AND CATERING

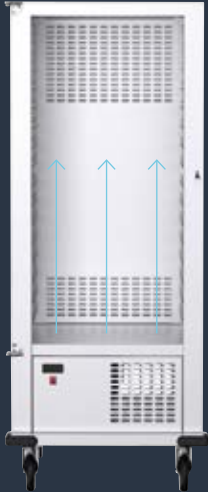

### UNIFORMITY OF COLD AIR CIRCULATION

Unique system for placing trays and grills that prevents them from coming into contact with the interior walls, facilitating air circulation. This cold air is propelled by a fan at the rear which guarantees a perfect homogenisation of the temperature.

### MAXIMUM MOBILITY

The ACGF cooling trolley is completely independent of connections thanks to the evaporator tray included in the lower part. In this way, the trolley is fully mobile in the rooms as it collects the water from the defrosting.



### ENERGY SAVINGS

Thanks to the high quality expanded polystyrene insulation and the use of one-piece silicone weatherseals in the joints, they optimise energy savings and maintain the temperature for a longer period of time.

### MORE ERGONOMICS

Easy mobility thanks to the vertical rear handles and the non-marking rubber pads at each corner.

### CONTROL PANEL

Lighted power switch, thermostat for regulating temperature between -2°C and 8°C.

### HIGH-RESISTANCE CASTORS

measuring Ø150 mm, 2 with brakes. For any surface.

Locking handles with key included..



### OPENING THE DOOR 270°

Upper and lower hinges in stainless steel with a swivel pivot point for full door opening.

NEW

## ACGF COLD HOLDING TROLLEY

**Designed to facilitate transporting cold foods.**

- Made of AISI grade 304 stainless steel (18/10).
- Capacity of 16 GN 2/1.
- Easy-to-use digital control panel.
- Cooling gas R290.
- Optimum performance thanks to expanded polystyrene insulation, density 30kg / 3m CFC-free.
- The interior has no sockets and removable rails for easy cleaning.
- Working temperature -2°C / +8°C.

- Door opens a total of 270 degrees.
- Long vertical handles for optimal mobility.
- Polyethylene bumper to prevent knocks.
- 4 heavy duty Ø150 mm wheels, 2 of which feature brakes.
- Locking handle with key included.
- Spiral single-phase connecting cord with ground connection.
- Slides compatible with GN trays and containers.
- Distance between runners: 70 mm for GN trays of height 65 mm.
- Grill racks and Gastronorm containers not included.

### RELATED PRODUCTS

**GASTRONORM CONTAINERS** page 179  
**GN GRILL RACKS** page 183



COLD HOLDING TROLLEY DIMENSIONS

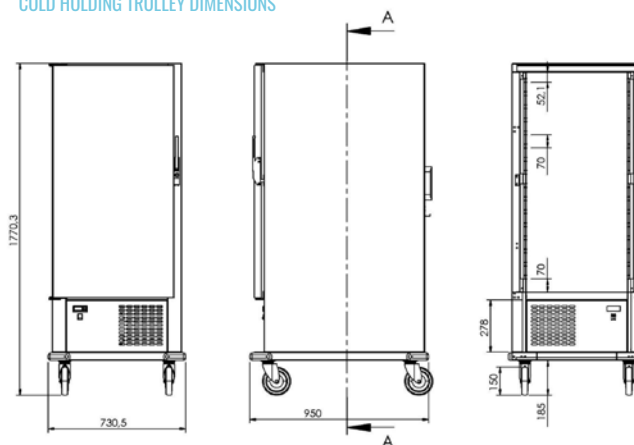

-2° / +8°

Model	Total dimensions (mm)	Capacity	Power (W)	Power supply (V/N/Hz)	Code
ACGF	730 x 950 x 1770	GN 2/1 x 16 o GN 1/1 x 32	400	230/1/50-60	• F2400001



• 24/48-HOUR SHIPPING

# TEMPERATURE MAINTENANCE TROLLEYS

## GN COLD HOLDING TROLLEY

**Designed for transporting cold foods during the service.**

- Made of AISI grade 304 stainless steel (18/10).
- Basin with safety edges on all sides, for GN containers with a maximum depth of 150 mm.
- Drain with ball valve.
- Incorporates lighted switch and digital thermostat.
- Cold trolley designed especially for transporting foods requiring low temperatures for optimal food safety conditions.
- The sanitary radius makes cleaning more convenient.
- Four Ø125 mm swivel castors (2 with brakes, located on the handle side) and bumpers.
- Gastronorm containers not included.
- **No assembly required.**



RELATED PRODUCTS

**GASTRONORM CONTAINERS** page 179

Total dimensions (mm)	Capacity	Power (W)	Power supply (V/Hz)	Code
840 x 676 x 850	2 GN 1/1	380	230/50-60	• F0420501
1060 x 676 x 880	3 GN 1/1	380	230/50-60	• F0420502

## TROLLEY WITH CONSTANT-LEVEL HOT PLATE DISPENSER

**Ideal for heating, transporting and supplying hot plates during service.**

- Made of AISI grade 304 stainless steel (18/10).
- Lighted switch and adjustable 0-9°C thermostat.
- Trolley contains system for adjusting diameter for plates between Ø200 mm and Ø310 mm.
- Spring system helps keep plates at a constant height.
- Handles for easy transport are ergonomically positioned.
- Contains hole for releasing residual liquids inside trolley.
- Four Ø125 mm castors with bumpers (2 with brakes).
- Covers not included.
- **No assembly required.**



F1100711  
Stainless steel cover.

Dimensions (mm)	Power (W)	Power supply (V/Hz)	Plate capacity	Diameter	Code
990 x 540 x 900	1600	230/50-60	130	Ø 200-310	• F0420311
Ø 368 x 140	-	-	-	-	• F1100711





# BAINS-MARIE TROLLEYS

## BAIN-MARIE TROLLEY

Designed for maintaining and transporting food at its optimal serving temperature.

- Made of AISI grade 304 stainless steel (18/10).
- Basin with safety edges for GN containers with a maximum depth of 200 mm.
- Drain with ball valve.
- Hidden silicone heating elements.
- Lighted switch and adjustable 0-90°C digital thermostat.
- Safety thermostat.
- Stainless steel lower shelf.
- Handles for easy transport are ergonomically positioned.
- Four Ø125 mm castors with bumpers (2 with brakes, placed on the side with the handles).
- **No assembly required.**



BAIN-MARIE TROLLEY DIMENSIONS

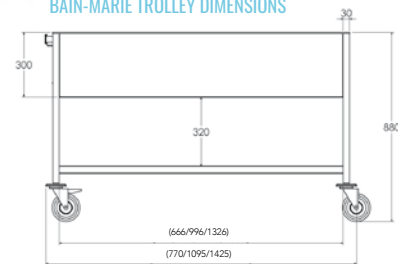

RELATED PRODUCTS

**GASTRONORM CONTAINERS** page 179

Total dimensions (mm)	Capacity	Power (W)	Power supply (V/Hz)	Code
770 x 670 x 880	2 GN 1/1	1600	230/50-60	• F0420201
1095 x 670 x 880	3 GN 1/1	2400	230/50-60	• F0420202
1425 x 670 x 880	4 GN 1/1	3200	230/50-60	• F0420203

## BAIN-MARIE TROLLEY WITH RESERVE TANK

Designed for maintaining and transporting food at its optimal serving temperature.

- Made of AISI grade 304 stainless steel (18/10).
- Basin with safety edges on all sides, for GN containers with a maximum depth of 200 mm.
- Drain with ball valve.
- Hidden silicone heating elements with a lighted switch and thermostat for separately controlling reserve tank and bain-marie temperature.
- Four Ø125 mm swivel castors (2 with brakes, located on the handle side)
- The sanitary radius and concealed heating elements make cleaning more convenient.
- **No assembly required.**



RELATED PRODUCTS

**GASTRONORM CONTAINERS** page 179

Total dimensions (mm)	Capacity	Power (W)	Power supply (V/Hz)	Code
830 x 675 x 850	2 GN 1/1	2350	230/50-60	• F0420211
1160 x 675 x 850	3 GN 1/1	3150	230/50-60	• F0420212



• 3-DAY SHIPPING



FOOD DISTRIBUTION AND DISPLAY

# GASTRONORM CONTAINERS



## SMOOTH GN CONTAINERS

PAGE 180



## GN CONTAINERS WITH HANDLES

PAGE 181



## PERFORATED GN CONTAINERS

PAGE 182





## GN ACCESSORIES

PAGE 183

# SMOOTH GASTRONORM CONTAINERS



· Made of AISI 304 stainless steel (18/10), very sturdy and with reinforced edges.

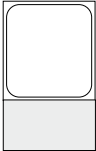
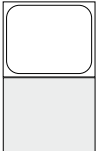
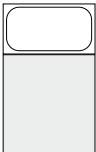
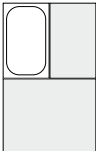
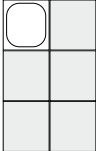
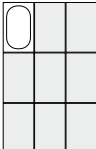



Model	Dimensions	Depth (mm)	Capacity (liters)	Code				
<b>2/1</b>		650 x 530	200	52,00	• RGN21200			
			150	43,10	• RGN21150			
			100	28,90	• RGN21100			
			65	18,80	• RGN21060			
			40	11,50	• RGN21040			
			20	6,20	• RGN21020			
<b>1/1</b>		325x530	200	26,00	• RGN11200			
			150	20,20	• RGN11150			
			100	14,20	• RGN11100			
			65	8,30	• RGN11060			
			40	5,10	• RGN11040			
			20	2,80	• RGN11020			
<b>2/3</b>		325x352	200	18,30	• RGN23200			
			150	13,20	• RGN23150			
			100	8,80	• RGN23100			
			65	5,60	• RGN23065			
			40	3,10	• RGN23040			
			20	1,70	• RGN23020			
<b>1/2</b>		325x265	200	12,00	• RGN12200			
			150	9,10	• RGN12150			
			100	6,10	• RGN12100			
			65	4,10	• RGN12065			
			40	2,20	• RGN12040			
			20	1,20	• RGN12020			
<b>1/3</b>		325x176	200	7,30	• RGN13200			
			150	5,60	• RGN13150			
			100	3,80	• RGN13100			
			65	2,50	• RGN13065			
			40	1,50	• RGN13040			
			20	0,80	• RGN13020			
<b>1/4</b>		265x162	200	5,00	• RGN14200			
			150	4,10	• RGN14150			
			100	2,80	• RGN14100			
			65	1,70	• RGN14065			
			20	0,50	• RGN14020			
			<b>1/6</b>		176x162	200	2,90	• RGN16200
150	2,20	• RGN16150						
100	1,60	• RGN16100						
65	1,00	• RGN16065						
<b>1/9</b>		170x108				100	0,80	• RGN19100
						65	0,60	• RGN19065



# GASTRONORM CONTAINERS WITH MOVEABLE VERTICAL HANDLES

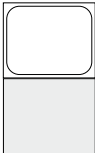
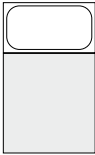

- Made of AISI 304 stainless steel (18/10), very sturdy and with reinforced edges.
- Retractable handles facilitate handling and stacking.

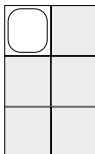
Model	Dimensions	Depth (mm)	Capacity (liters)	Code	
<b>2/1</b>		650 x 530	200	52,00	• RGN2120A
			150	43,10	• RGN2115A
			100	28,90	• RGN2110A
			65	18,80	• RGN2106A
			40	11,50	• RGN2104A
<b>1/1</b>		325x530	200	26,00	• RGN1120A
			150	20,20	• RGN1115A
			100	14,20	• RGN1110A
			65	8,30	• RGN1106A
			40	5,10	• RGN1104A
<b>2/3</b>		325x352	200	18,30	• RGN2320A
			150	13,20	• RGN2315A
			100	8,80	• RGN2310A
			65	5,60	• RGN2306A
			40	3,10	• RGN2304A
<b>1/2</b>		325x265	200	12,00	• RGN1220A
			150	9,10	• RGN1215A
			100	6,10	• RGN1210A
			65	4,10	• RGN1206A
			40	2,20	• RGN1204A
<b>1/3</b>		325x176	200	7,30	• RGN1320A
			150	5,60	• RGN1315A
			100	3,80	• RGN1310A
			65	2,50	• RGN1306A
			40	1,50	• RGN1304A
<b>1/4</b>		265x162	200	5,00	• RGN1420A
			150	4,10	• RGN1415A
			100	2,80	• RGN1410A
			65	1,70	• RGN1406A
			<b>1/6</b>		176x162
150	2,20	• RGN1615A			
100	1,60	• RGN1610A			
65	1,00	• RGN1606A			



# PERFORATED GASTRONORM CONTAINERS

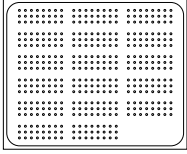
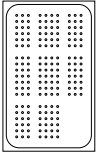
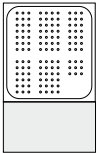
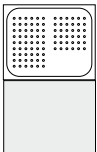

- Made of AISI 304 stainless steel (18/10), very sturdy and with reinforced edges.
- Perforated Gastronorm containers make it easier to drain foods.

Model	Dimensions	Depth (mm)	Capacity (liters)	Code	
<b>2/1</b>		650 x 530	200	52,00	● RGN2120F
			150	43,10	● RGN2115F
			100	28,90	● RGN2110F
			65	18,80	● RGN2106F
			40	11,50	● RGN2104F
			20	6,20	● RGN2102F
<b>1/1</b>		325x530	200	26,00	● RGN1120F
			150	20,20	● RGN1115F
			100	14,20	● RGN1110F
			65	8,30	● RGN1106F
			40	5,10	● RGN1104F
			20	2,80	● RGN1102F
<b>2/3</b>		325x352	200	18,30	● RGN2320F
			150	13,20	● RGN2315F
			100	8,80	● RGN2310F
			65	5,60	● RGN2306F
			40	3,10	● RGN2304F
			20	1,70	● RGN2302F
<b>1/2</b>		325x265	200	12,00	● RGN1220F
			150	9,10	● RGN1215F
			100	6,10	● RGN1210F
			65	4,10	● RGN1206F

## PERFORATED BOTTOM

To separate or drain foods from the bottom of the basin.

For basins	Code
GN 2/1	● RFOND21A
GN 1/1	● RFOND11A
GN 2/3	● RFOND23A
GN 1/2	● RFOND12A
GN 1/3	● RFOND13A
GN 1/4	● RFOND14A



# GN ACCESSORIES

## DIVIDERS

To divide gastronorm containers and maximize their surface area.

Model	Dimensions (mm)	Code
2/1	530	• F1120602
1/1	325	• F1120601

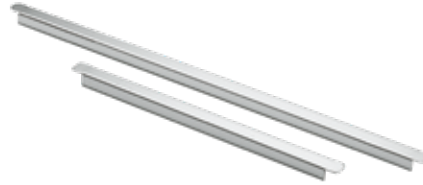

## GASTRONORM LIDS

· Working temperature range: -40°C to +110°C.

### LID

Model	Code
1/1	• RTAPA110
2/3	• RTAPA230
1/2	• RTAPA120
1/3	• RTAPA130
1/4	• RTAPA140
1/6	• RTAPA160
1/9	• RTAPA190



### LID WITH HOLES FOR HANDLES

Model	Code
1/1	• RTAPA11A
2/3	• RTAPA23A
1/2	• RTAPA12A
1/3	• RTAPA13A
1/4	• RTAPA14A
1/6	• RTAPA16A



### AIRTIGHT LID WITH SILICONE

Model	Code
1/1	• RTAPA11S
1/2	• RTAPA12S
1/3	• RTAPA13S
1/4	• RTAPA14S
1/6	• RTAPA16S

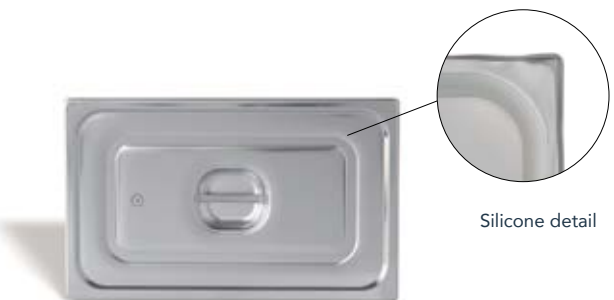

## GASTRONORM GRILL RACKS

· Made of stainless steel

Model	Dimensions (mm)	Code
2/1	645 x 530	• RPARGN21
1/1	530 x 325	• RPARGN11
2/3	352 x 325	• RPARGN23







FOOD DISTRIBUTION AND DISPLAY

# DROP-IN



## COLD ELEMENTS

PÁG. 188



## HOT ELEMENTS

PÁG. 197



## SUPPORTS AND GLASS

PÁG. 200



## ACCESSORIES

PÁG. 208

# DROP-IN

## EVERYTHING YOU NEED FOR ANY PROJECT



### Hygiene and food safety

With an AISI 304 stainless steel (18/10) structure and rounded edges on the inside of the food wells, all drop-in elements are **designed to ensure maximum hygiene and to meet the highest** of food safety standards.

### Energy efficiency

The design and materials used for the drop-in elements allow for **high operational performance**. This efficiency means lower energy consumption, thanks to an optimal distribution of temperature and the use of state-of-the-art insulation, which helps to prevent temperature loss.

### New models

Our drop-in range has expanded to **offer you multiple possibilities based on the food display and maintenance needs** of your business. Our new models of cold, stationary and ventilated food containers, as well as our rectangular glass display cases and straight and sloped supports for placement on the drop-in or buffet unit, come with the highest guarantee of quality and durability.

### Glass display cases

The ventilated refrigeration system of our glass display cases generates and distributes cold air from the lower part of the glass display case to the upper part. This, alongside the diffusing effect between shelves, ensures an **even temperature inside the glass display case**. In addition, the foldable thermo-screens maintain the optimal temperature right up until food is served.

Made of AISI 304 stainless steel (18/10) with safety edges to facilitate cleaning



Easy to attach to the countertop

Control panel integrated into the drop-in; can be removed for exterior assembly. Easy front and rear access



New models and state-of-the-art design of supports and glass. Wide variety to install in the drop-in or the countertop of the buffet unit



DROP-IN



**VENTILATED REFRIGERATION**

Thanks to the ventilated cooling system, the cold air is distributed from the lower part of the cabinet to the upper part, **ensuring a homogeneous temperature inside the cabinet.**



The R290 ECO-POWER refrigerant (propane) used in the cold elements in our drop-in line is the most eco-friendly refrigerant on the market. This natural refrigerant has zero ozone depletion potential and minimal environmental impact. **The excellent thermodynamic properties of R290 will allow you to save on energy consumption and equipment maintenance costs.**

# COLD ELEMENTS

## COLD PLATE

**For maintaining and displaying cold dishes or beverages at the correct temperature during food service.**

- AISI 304 stainless steel (18/10) with safety edges to facilitate cleaning.
- Extruded polystyrene insulation.
- Refrigerated using copper cooling coil in the base.
- Working temperature of 0°C to 4°C.
- Easy to attach to the countertop using the hardware included.
- Drain included.



**Models with control panel group included:**

- Control panel with digital switchboard and lighted switch integrated into the drop-in. Can be removed for exterior assembly.
- R290 refrigerant.



COLD PLATE DIMENSIONS

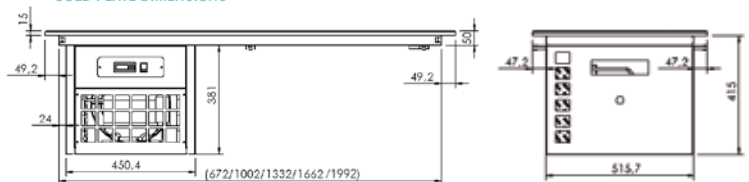

### CONTROL PANEL GROUP NOT INCLUDED

GN Capacity	Total dimensions (mm)	Total built-in dimensions (mm)	Recommended power (hp)	Code
2 GN	770 x 610 x 60	740 x 580 x 45	1/4	• PF000002
3 GN	1100 x 610 x 60	1070 x 580 x 45	1/4	• PF000003
4 GN	1430 x 610 x 60	1400 x 580 x 45	1/3	• PF000004
5 GN	1760 x 610 x 60	1730 x 580 x 45	1/2	• PF000005
6 GN	2080 x 610 x 60	2060 x 580 x 45	1/2	• PF000006

### WITH CONTROL PANEL GROUP INCLUDED

GN Capacity	Total dimensions (mm)	Total built-in dimensions (mm)	hp	Cooling capacity (W)	Power supply (V/Hz)	Code
2 GN	770 x 610 x 440	740 x 580 x 460	1/4	380	230/50	• PFG00002
3 GN	1100 x 610 x 440	1070 x 580 x 460	1/4	380	230/50	• PFG00003
4 GN	1430 x 610 x 440	1400 x 580 x 460	1/3	480	230/50	• PFG00004
5 GN	1760 x 610 x 440	1730 x 580 x 460	1/2	720	230/50	• PFG00005
6 GN	2080 x 610 x 440	2060 x 580 x 460	1/2	720	230/50	• PFG00006



## TWO-LEVEL COLD PLATE

For maintaining and displaying cold dishes or beverages at the correct temperature during food service.

- The 2 levels improve the visibility and display of foods.
- AISI 304 stainless steel (18/10) with safety edges to facilitate cleaning.
- Extruded polystyrene insulation.
- Refrigerated using copper cooling coil in the base.
- Working temperature of 0°C to 4°C.
- Easy to attach to the countertop using the hardware included.



### Models with control panel group included:

- Control panel with digital switchboard and lighted switch integrated into the drop-in. Can be removed for exterior assembly.
- R290 refrigerant.



TWO-LEVEL COLD PLATE DIMENSIONS

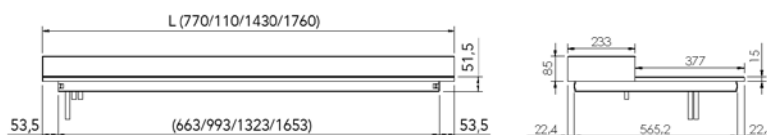

### CONTROL PANEL GROUP NOT INCLUDED

GN Capacity	Total dimensions (mm)	Total built-in dimensions (mm)	Recommended power (hp)	Code
2 GN	770 x 610 x 130	740 x 580 x 45	1/4	• PF020002
3 GN	1100 x 610 x 130	1070 x 580 x 45	1/4	• PF020003
4 GN	1430 x 610 x 130	1400 x 580 x 45	1/3	• PF020004
5 GN	1760 x 610 x 130	1730 x 580 x 45	1/2	• PF020005

### WITH CONTROL PANEL GROUP INCLUDED

GN Capacity	Total dimensions (mm)	Total built-in dimensions (mm)	hp	Cooling capacity (W)	Power supply (V/Hz)	Code
2 GN	770 x 610 x 512	740 x 580 x 460	1/4	380	230/50	• PFG20002
3 GN	1100 x 610 x 512	1070 x 580 x 460	1/4	380	230/50	• PFG20003
4 GN	1430 x 610 x 512	1400 x 580 x 460	1/3	480	230/50	• PFG20004
5 GN	1760 x 610 x 512	1730 x 580 x 460	1/2	720	230/50	• PFG20005

# COLD ELEMENTS

## STATIONARY COLD-FOOD WELL

**For maintaining and displaying cold dishes or beverages at the correct temperature during service.**

- Made from AISI 304 stainless steel (18/10).
- For GN containers with a depth of 65 mm and 150 mm (depending on the model).
- Drain included.
- Polystyrene foam insulation.
- Refrigerated using copper cooling coil in the base.
- Working temperature of 0°C/4°C.
- Easy to attach to the countertop using the fittings included.

**Models with control panel group included:**

- Control panel with digital switchboard and lighted switch integrated into the drop-in. Can be removed for exterior assembly.
- Working temperature of 0°C/4°C.
- R290 refrigerant.

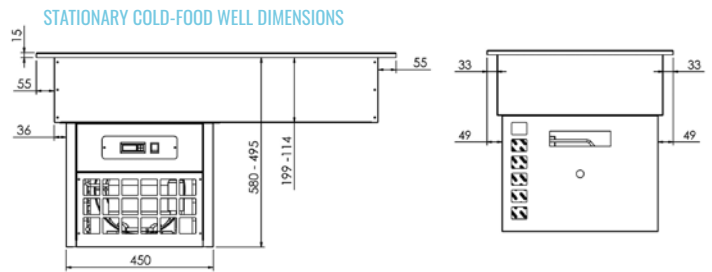

### CONTROL PANEL GROUP NOT INCLUDED

#### GN DEPTH 65 MM

GN Capacity	Total dimensions (mm)	Total built-in dimensions (mm)	Recommended power (hp)	Code
3 GN	1100 x 610 x 130	1070 x 580 x 115	1/5	• CF020003
4 GN	1430 x 610 x 130	1400 x 580 x 115	1/4	• CF020004
5 GN	1760 x 610 x 130	1730 x 580 x 115	3/8	• CF020005
6 GN	2090 x 610 x 130	2060 x 580 x 115	3/8	• CF020006

#### GN DEPTH 150 MM

GN Capacity	Total dimensions (mm)	Total built-in dimensions (mm)	Recommended power (hp)	Code
1 GN	440 x 610 x 215	410 x 580 x 200	1/5	• CF010001
2 GN	770 x 610 x 215	740 x 580 x 200	1/5	• CF010002
3 GN	1100 x 610 x 215	1070 x 580 x 200	1/5	• CF010003
4 GN	1430 x 610 x 215	1400 x 580 x 200	1/4	• CF010004
5 GN	1760 x 610 x 215	1730 x 580 x 200	3/8	• CF010005
6 GN	2090 x 610 x 215	2060 x 580 x 200	3/8	• CF010006



WITH CONTROL PANEL GROUP INCLUDED

GN DEPTH 65 MM

GN Capacity	Total dimensions (mm)	Total built-in dimensions (mm)	hp	Cooling capacity (W)	Power supply (V/Hz)	Code
3 GN	1100 x 610 x 510	1070 x 580 x 495	1/5	380	230/50	• CFG20003
4 GN	1430 x 610 x 510	1400 x 580 x 495	1/4	480	230/50	• CFG20004
5 GN	1760 x 610 x 510	1730 x 580 x 495	3/8	720	230/50	• CFG20005
6 GN	2090 x 610 x 510	2060 x 580 x 495	3/8	720	230/50	• CFG20006

GN DEPTH 150 MM

GN Capacity	Total dimensions (mm)	Total built-in dimensions (mm)	hp	Cooling capacity (W)	Power supply (V/Hz)	Code
1 GN	440 x 610 x 595	410 x 580 x 620	1/5	380	230/50	• CFG10001
2 GN	770 x 610 x 595	740 x 580 x 620	1/5	380	230/50	• CFG10002
3 GN	1100 x 610 x 595	1070 x 580 x 620	1/5	380	230/50	• CFG10003
4 GN	1430 x 610 x 595	1400 x 580 x 620	1/4	480	230/50	• CFG10004
5 GN	1760 x 610 x 595	1730 x 580 x 620	3/8	720	230/50	• CFG10005
6 GN	2090 x 610 x 595	2060 x 580 x 620	3/8	720	230/50	• CFG10006

VENTILATED COLD WELL

For maintaining and displaying cold dishes or beverages at the correct temperature during food service.

- Made from AISI 304 stainless steel (18/10).
- For GN containers with a maximum depth of 200 mm.
- Drain included.
- Extruded polystyrene insulation.
- Refrigeration via a cold-air curtain over wells.
- Working temperature of 0°C/4°C.
- Easy to attach to the countertop using the fittings included.
- With control panel group included.
- Control panel with digital switchboard and illuminated switch integrated into the drop-in. Can be removed for exterior assembly.
- Forced air refrigeration system with R290 refrigerant.



VENTILATED COLD WELL DIMENSIONS

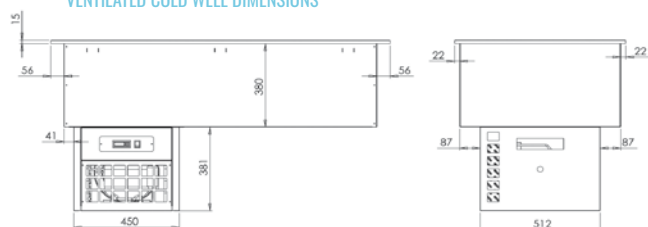

GN Capacity	Total dimensions (mm)	Total built-in dimensions (mm)	hp	Cooling capacity (W)	Power supply (V/Hz)	Code
2 GN	785 x 730 x 780	755 x 700 x 770	1/3	287	230/50	• CFV10002
3 GN	1115 x 730 x 780	1085 x 700 x 770	1/3	430	230/50	• CFV10003
4 GN	1445 x 730 x 780	1415 x 700 x 770	3/4	713	230/50	• CFV10004
5 GN	1775 x 730 x 780	1745 x 700 x 770	3/4	816	230/50	• CFV10005

# COLD ELEMENTS

## FROZEN FOOD WELL

**For maintaining and displaying frozen, packaged, or bulk foods during service.**

- Made from AISI 304 stainless steel (18/10).
- Capacity for 4 ice cream trays (not included) measuring 360 x 165 x 150 mm.
- Transparent protective sliding lids.
- Polystyrene foam insulation.
- Refrigerated using copper cooling coil in the base.
- R290 refrigerant recommended.



- Drain included.
- Working temperature of -15°C / -18°C.
- Easy to attach to the countertop using the fittings included.

**Models with control panel group included:**

- Control panel with digital switchboard and illuminated switch integrated into the drop-in. Can be removed for exterior assembly.

**1-LEVEL MODEL DIMENSIONS**

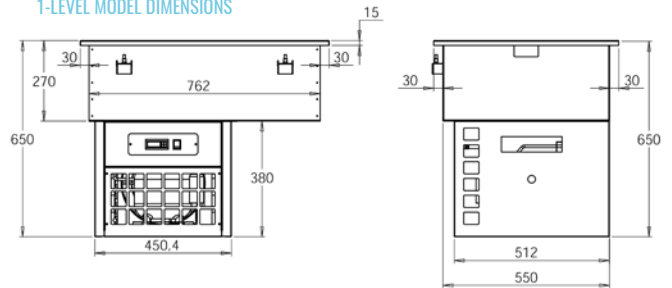

**2-LEVEL MODEL DIMENSIONS**

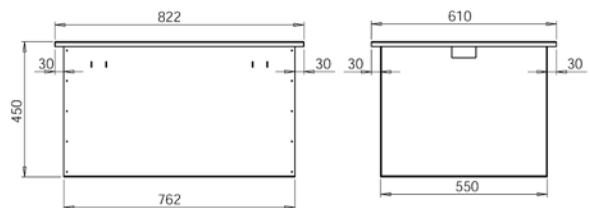

**CONTROL PANEL GROUP NOT INCLUDED**

Model	Total dimensions (mm)	Total built-in measures (mm)	Capacity	Recommended power (hp)	Code
150 mm depth 1 level	822 x 610 x 270	790 x 570 x 270	4 of 5 l. or 4 of 7 l.	1/3	• CH010004
150 mm depth 2 levels	822 x 610 x 450	790 x 570 x 450	4+4 of 5 l. or 4 of 7 l.	1/2	• CH020004

**WITH CONTROL PANEL GROUP INCLUDED**

Model	Total dimensions (mm)	Total built-in measures (mm)	Capacity	hp	Cooling power (W)	Power supply (V/Hz)	Code
150 mm depth 1 level	822 x 610 x 650	790 X 570 X 650	4 of 5 l. or 4 of 7 l.	1/3	350	230/50	• CHG10004

## ICE CREAM CONTAINERS

**Container for storing packaged or bulk ice cream.**

- Made from AISI 304 stainless steel (18/10).



Capacity	Total dimensions (mm)	Code
5 litres	360 x 165 x 120	• RGNH0005
7 litres	360 x 165 x 150	• RGNH0007

## UTENSIL DIPPER TUB

**Basin for washing ice cream scoops.**

- Made from AISI 304 stainless steel (18/10).
- With water input and output.



Total dimensions (mm)	Total built-in dimensions (mm)	Code
110 x 270 x 145	255 x 95 x 145	• RGLH0005





## REFRIGERATED GLASS DISPLAY CASE WITH 3 LEVELS WITH VENTILATED COLD WELL

For maintaining and displaying cold dishes or beverages at the correct temperature during food service.

- Made from AISI 304 stainless steel (18/10).
- Extruded polystyrene insulation.
- For GN containers with a maximum depth of 200 mm.
- Drain included.
- Working temperature of +7°C/10°C in ambient temperature of 25°C.
- Glass display case equipped with tempered side glass.
- Foldable thermo-screen facing customers helps to maintain temperatures when food is not being served.
- Overhead LED lighting.
- Easy to attach to the countertop using the fittings included.

- Power supply: 230 V/1/50 Hz.
- Control panel with digital switchboard and illuminated switch integrated into the drop-in. Can be removed for exterior assembly.
- Forced-air refrigeration system uses R290 refrigerant.

### GLASS DISPLAY CASE DIMENSIONS

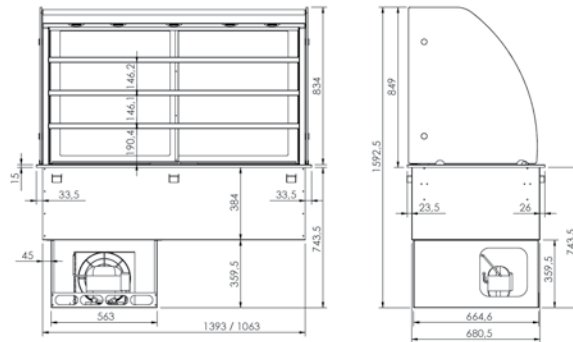

• **Wall-mounted model:** rear section with stainless steel panels and double-layer insulation.

• **Central model:** rear section with glass sliding doors.

Thermo-screen close-up.

### WALL-MOUNTED

Capacity	Total dimensions (mm)	Total built-in dimensions (mm)	hp	Cooling power (W)	Code
3GN 1/1	1130 x 730 x 1600	1100 x 700 x 780	3/4	720	• VMC003GN
4GN 1/1	1460 x 730 x 1600	1430 x 700 x 780	3/4	720	• VMC004GN

### CENTRAL

Capacity	Total dimensions (mm)	Total built-in dimensions (mm)	hp	Cooling power (W)	Code
3GN 1/1	1130 x 730 x 1600	1100 x 700 x 780	3/4	720	• VCC003GN
4GN 1/1	1460 x 730 x 1600	1430 x 700 x 780	3/4	720	• VCC004GN

# COLD ELEMENTS

## STRAIGHT REFRIGERATED GLASS DISPLAY CASE WITH 3 LEVELS AND VENTILATED COLD WELL

For maintaining and displaying cold dishes or beverages at the correct temperature during food service.

- Made from AISI 304 stainless steel (18/10).
- Extruded polystyrene insulation.
- For GN containers with a maximum depth of 200 mm.
- Drain included.
- Working temperature of +7°C/10°C in ambient temperature of 25°C.
- Glass display case equipped with tempered side glass.

- Open front panel with foldable thermo-screen or swinging doors to maintain temperature when food is not being served.
- Overhead LED lighting.
- Easy to attach to the countertop using the fittings included.
- Power supply: 230 V/1/50 Hz.
- Control panel with digital switchboard and illuminated switch integrated into the drop-in. Can be removed for exterior assembly.
- Forced-air refrigeration system uses R290 refrigerant.



- **Wall-mounted model:** rear section with stainless steel panels and double-layer insulation.

- **Central model:** rear section with glass sliding doors.

### GLASS DISPLAY CASE DIMENSIONS

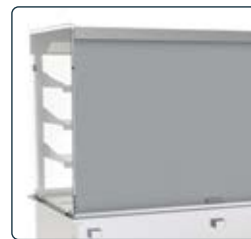
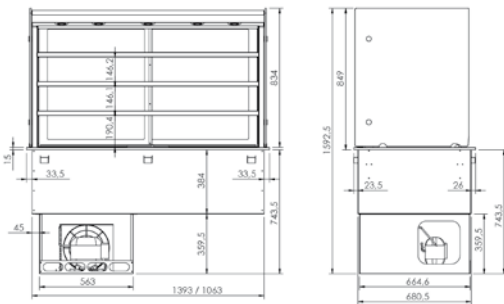

### WALL-MOUNTED

Capacity	Total dimensions (mm)	Total built-in dimensions (mm)	hp	Cooling power (W)
3GN 1/1	1130 x 730 x 1600	1100 x 700 x 780	3/4	720
4GN 1/1	1460 x 730 x 1600	1430 x 700 x 780	3/4	720

### THERMO-SCREEN

Code
• VMRT03GN
• VMRT04GN

### SWINGING DOORS

Code
• VMRA03GN
• VMRA04GN

### CENTRAL

Capacity	Total dimensions (mm)	Total built-in dimensions (mm)	hp	Cooling power (W)
3GN 1/1	1130 x 730 x 1600	1100 x 700 x 780	3/4	720
4GN 1/1	1460 x 730 x 1600	1430 x 700 x 780	3/4	720

### THERMO-SCREEN

Code
• VCRT03GN
• VCRT04GN

### SWINGING DOORS

Code
• VCRA03GN
• VCRA04GN



## REFRIGERATED GLASS DISPLAY CASE WITH 3 LEVELS

For maintaining and displaying cold dishes or beverages at the correct temperature during food service.

- Made from AISI 304 stainless steel (18/10).
- Drain included.
- Open front panel with foldable thermo-screen or swinging doors to maintain temperature when food is not being served.
- Food can be restocked from the rear of the unit using the glass sliding doors.

- Working temperature of +8°C/10°C in ambient temperature of 25°C.
- Glazed glass display case with 3 surfaces and 3 removable shelves.
- Overhead LED lighting.
- Control panel with digital switchboard and illuminated switch.
- Models without base, with insulated base or with insulated well.
- Power supply: 230 V/1/50 Hz.
- Easy to install on any surface.
- Ventilated refrigeration and hermetic compressor with R290 refrigerant.



· Glass display case with insulated well



· Glass display case with insulated base



· Glass display case without base

### GLASS DISPLAY CASE DIMENSIONS

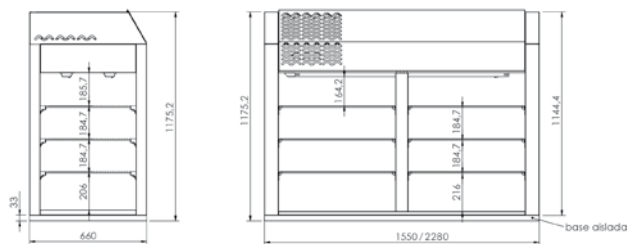

### THERMO-SCREEN

### SWINGING DOORS

Capacity	Model	Total dimensions (mm)	hp	Cooling power (W)	Code	Code
4GN 1/1	Without base	1550 x 660 x 1150	1/3	800	• S1C01001	• S1001001
	With insulated base	1550 x 660 x 1180	1/3	800	• S1C01002	• S1001002
	With insulated well	1550 x 660 x 1430	1/3	800	• S1C01003	• S1001003
6GN 1/1	Without base	2280 x 660 x 1150	3/8	800	-	• S1001011
	With insulated base	2280 x 660 x 1180	3/8	800	-	• S1001012
	With insulated well	2280 x 660 x 1430	3/8	800	-	• S1001013

DROP-IN

# COLD ELEMENTS

## REFRIGERATED GLASS DISPLAY CASE WITH 3 LEVELS AND STATIONARY COLD WELL

For maintaining and displaying cold dishes or beverages at the correct temperature during food service.

- Made from AISI 304 stainless steel (18/10).
- Drain included.
- Open front access for customers with foldable thermo-screen or swinging methacrylate doors.
- Food can be restocked from the rear of the unit using the glass sliding doors.
- Working temperature of +8°C/10°C in ambient temperature of 25°C.
- Glazed glass display case with 3 surfaces and 3 removable shelves.
- Overhead LED lighting.
- Easy to attach to the countertop using the fittings included.
- With control panel group included.
- Two integrated motors, one in the upper part of the display case and the other in the cold well, which generate and distribute cold air from top to bottom with greater power and efficiency.
- Control panel with independent and integrated digital switchboard and illuminated switch; one in the display case and one in the cold well. Can be removed for exterior assembly.
- Power supply: 230 V/1/50 Hz.
- Ventilated refrigeration and hermetic compressor with R290 refrigerant.



### GLASS DISPLAY CASE DIMENSIONS

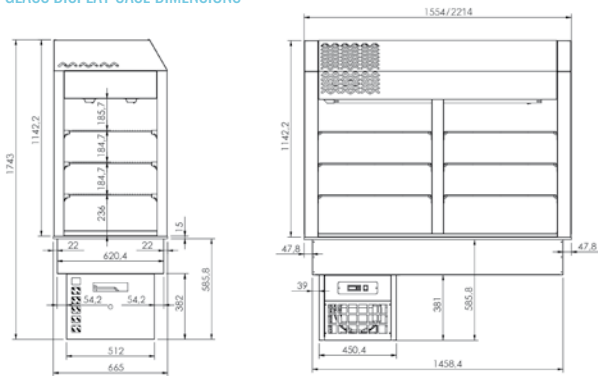

#### THERMO-SCREEN

#### SWINGING DOORS

Capacity	Total dimensions (mm)	Total built-in dimensions (mm)	Cooling Power (W)
4GN 1/1	1554 x 660 x 1750	1340 x 560 x 570	1280
6GN 1/1	2214 x 660 x 1750	2060 x 560 x 570	1520

Code
• F11C1002
-

Code
• F1101002
• F1101003



# HOT ELEMENTS

## BAIN-MARIE WELL

**For maintaining and displaying hot foods at the correct temperature during service.**

- Well made from AISI 304 stainless steel (18/10) with safety edges to facilitate cleaning.
- For GN containers with a maximum depth of 150 mm.
- Drain with ball valve included.
- Hidden silicone heating elements with integrated safety thermostat.
- Temperature is regulated and controlled using digital thermostat (0°C/90°C).
- Easy to attach to the countertop using the fittings included.
- Control panel with digital switchboard and illuminated switch integrated into the drop-in. Can be removed for exterior assembly.



BAIN-MARIE WELL DIMENSIONS

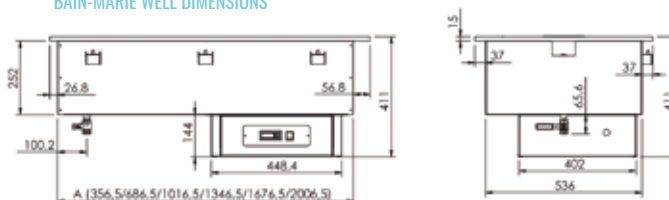

Capacity	Total dimensions (mm)	Total built-in dimensions (mm)	Power (W)	Power supply (V/Hz)	Code
1 GN 1/1	440 x 610 x 415	410 x 580 x 430	800	230/50-60	• BMH10001
2 GN 1/1	770 x 610 x 415	740 x 580 x 430	1600	230/50-60	• BMH10002
3 GN 1/1	1100 x 610 x 415	1070 x 580 x 430	2400	230/50-60	• BMH10003
4 GN 1/1	1430 x 610 x 415	1400 x 580 x 430	3200	230/50-60	• BMH10004
5 GN 1/1	1760 x 610 x 415	1730 x 580 x 430	4000	230/50-60	• BMH10005
6 GN 1/1	2090 x 610 x 415	2060 x 680 x 430	4800	480/50-60	• BMH10006

## STATIONARY DRY-FOOD TUB

**For maintaining and displaying hot food at the correct temperature during food service.**

- For GN trays with a maximum depth of 100 mm.
- Heating elements hidden in removeable perforated false bottom to facilitate cleaning.
- Temperature is regulated and controlled using digital thermostat 0°C/90°C.
- Control panel with digital switchboard and illuminated switch integrated into the drop-in. Can be removed for exterior assembly.
- Integrated safety thermostat.
- Easy to attach to the countertop using the fittings included.



STATIONARY DRY-FOOD TUB DIMENSIONS

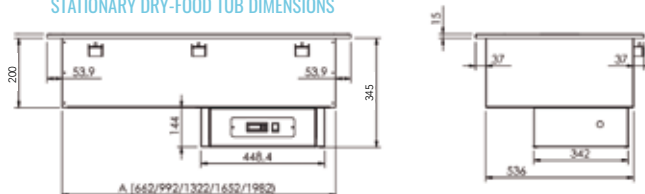

Capacity	Total dimensions (mm)	Total built-in dimensions (mm)	Power (W)	Power supply (V/Hz)	Code
2 GN 1/1	770 x 610 x 360	740 x 580 x 370	1200	230/50-60	• BMS10002
3 GN 1/1	1100 x 610 x 360	1070 x 580 x 370	2000	230/50-60	• BMS10003
4 GN 1/1	1430 x 610 x 360	1400 x 580 x 370	2400	230/50-60	• BMS10004
5 GN 1/1	1760 x 610 x 360	1730 x 580 x 370	2800	230/50-60	• BMS10005
6 GN 1/1	2090 x 610 x 360	2060 x 580 x 370	3200	230/50-60	• BMS10006

# HOT ELEMENTS

## TEMPERED GLASS HOT PLATE

**For maintaining and displaying hot foods at the correct temperature during food service.**

- Made from AISI 304 stainless steel (18/10).
- 6-mm-thick black or white tempered glass.
- Temperature is regulated and controlled using digital thermostat (0°C/90°C).
- Control panel with digital switchboard and illuminated switch integrated into the drop-in. Can be removed for exterior assembly.
- Hidden silicone heating elements.
- Safety thermostat included.
- Easy to attach to the countertop using the fittings included.

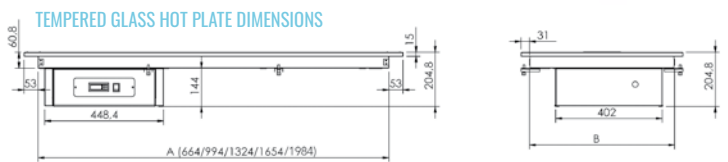

Capacity	Total dimensions (mm)	Total built-in dimensions (mm)	Power (W)	Power supply (V/Hz)	Black colour	White colour
2 GN 1/1	770 x 610 x 200	740 x 580 x 190	900	230/50-60	• PCT00002	• PCTB0002
3 GN 1/1	1100 x 610 x 200	1070 x 580 x 190	1350	230/50-60	• PCT00003	• PCTB0003
4 GN 1/1	1430 x 610 x 200	1400 x 580 x 190	1800	230/50-60	• PCT00004	• PCTB0004
5 GN 1/1	1760 x 610 x 200	1730 x 580 x 190	2250	230/50-60	• PCT00005	• PCTB0005
6 GN 1/1	2090 x 610 x 200	2060 x 580 x 190	2700	230/50-60	• PCT00006	• PCTB0006

## TEMPERED GLASS HOT PLATE WITHOUT FRAME

**For maintaining and displaying hot food at the correct temperature during food service.**

- Made from AISI 304 stainless steel (18/10).
- 6-mm-thick black or white seamless tempered glass.
- Temperature is regulated and controlled using digital thermostat (0°C/90°C).
- Control panel with digital switchboard and illuminated switch integrated into the drop-in. Can be removed for exterior assembly.
- Hidden silicone heating elements.
- Safety thermostat included.
- Easy to attach to the countertop using the fittings included.
- Supports cannot be installed on the plate.

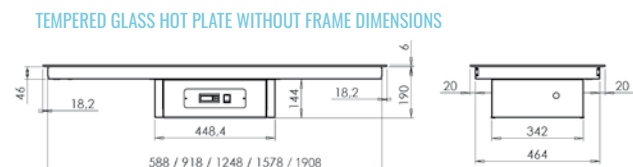

Capacity	Total dimensions (mm)	Total built-in dimensions (mm)	Power (W)	Power supply (V/Hz)	Black colour	White colour
2 GN 1/1	624 x 504 x 185	600 x 480 x 190	900	230/50-60	• PCTM0002	• PCTMB002
3 GN 1/1	954 x 504 x 185	930 x 480 x 190	1350	230/50-60	• PCTM0003	• PCTMB003
4 GN 1/1	1284 x 504 x 185	1260 x 480 x 190	1800	230/50-60	• PCTM0004	• PCTMB004
5 GN 1/1	1614 x 504 x 185	1590 x 480 x 190	2250	230/50-60	• PCTM0005	• PCTMB005
6 GN 1/1	1944 x 504 x 185	1920 x 480 x 190	2700	230/50-60	• PCTM0006	• PCTMB006



## TEMPERED GLASS HOT PLATE FOR DISHES (SHOWCOOKING)

For maintaining and displaying hot dishes at the correct temperature during food service.

- Made from AISI 304 stainless steel (18/10).
- 6-mm-thick black or white seamless tempered glass.
- For plates with a diameter of 26 cm.
- Temperature is regulated and controlled using digital thermostat (0°C/90°C).
- Control panel with digital switchboard and illuminated switch integrated into the drop-in. Can be removed for exterior assembly.
- Hidden silicone heating elements.
- Safety thermostat included.
- Easy to attach to the countertop using the fittings included.
- Supports cannot be installed on the plate.



Ø26 cm Plates capacity	Total dimensions (mm)	Total built-in dimensions (mm)	Power (W)	Power supply (V/Hz)	Black colour	White colour
3 plates	866 x 330 x 135	840 x 300 x 190	700	230/50-60	• PCTP0002	• PCTPB002
5 plates	1366 x 330 x 135	1340 x 300 x 190	1050	230/50-60	• PCTP0003	• PCTPB003
6 plates	1668 x 330 x 135	1645 x 300 x 190	1400	230/50-60	• PCTP0004	• PCTPB004
8 plates	1760 x 330 x 135	1735 x 300 x 190	1750	230/50-60	• PCTP0005	• PCTPB005

## TEMPERED GLASS HOT PLATE COUNTERTOP

Specially designed for hot buffet food delivery areas.

- Can be combined with strip warmer PIMC0002.
- Made from AISI 304 stainless steel (18/10).
- 6-mm-thick tempered glass.
- Analog thermostat ranging from 0°C to 90°C regulates temperature.
- Analog thermostat and lighted switch.
- Hidden silicone heating elements.
- Integrated safety thermostat.
- 1.5 m connecting cord with plug.

TEMPERED GLASS HOT PLATE COUNTERTOP DIMENSIONS



Total dimensions (mm)	Power (W)	Power supply (V/Hz)	Code
500 x 500 x 100	800	230/50-60	• PCTS0002
650 x 550 x 100	800	230/50-60	• PCTS0003
1000 x 500 x 100	1600	230/50-60	• PCTS0004

## STRIP WARMER

Helps keep food warm when heat from above is required.

- Ideal complement to a countertop hot plate.

STRIP WARMER DIMENSIONS

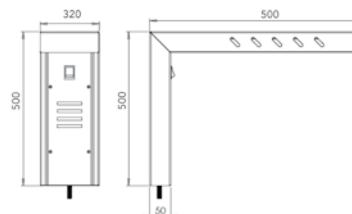

Model	Total dimensions (mm)	Power (W)	Power supply (V/Hz)	Code
With a threaded plug	500 x 320 x 500	300	230/50	• F1100130
With a base	500 x 320 x 500	300	230/50	• PIMC0002

DROP-IN

# SUPPORTS WITH SCREENS FOR DIRECT ASSEMBLY OVER THE DROP-IN

## SUPPORTS WITH SCREENS AND GLASS MUST BE ORDERED SEPARATELY

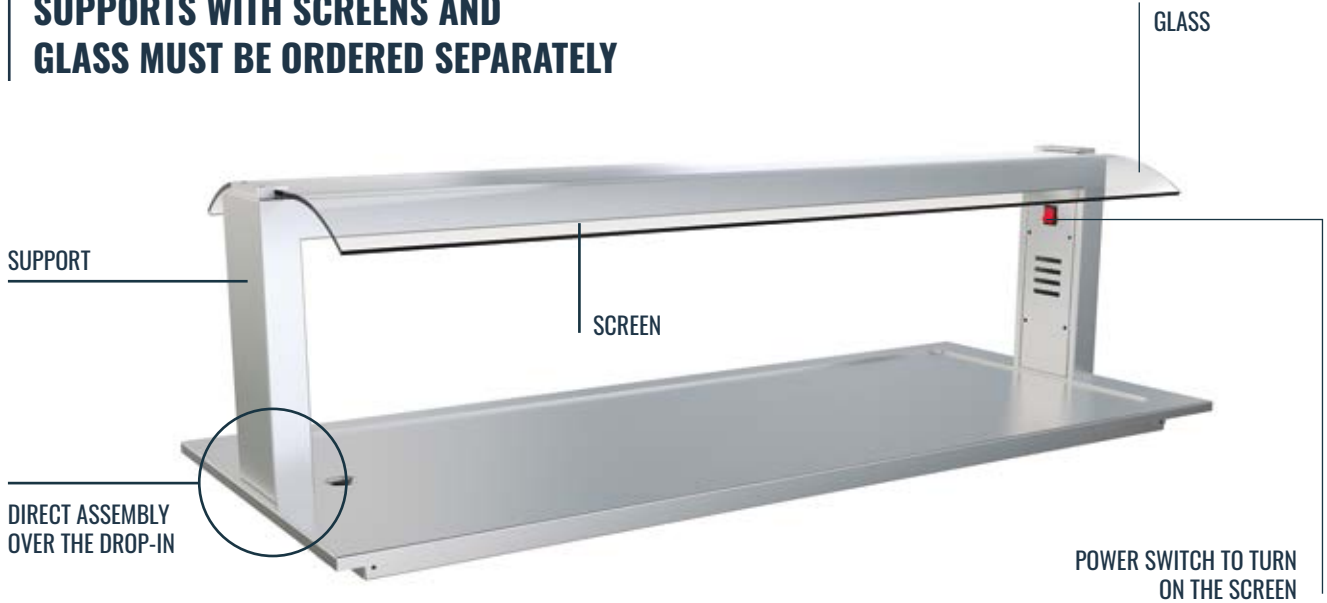

## SUPPORTS WITH SCREEN

- Made from AISI grade 304 stainless steel (18/10).
- Direct assembly over the drop-in.
- Highest-quality finish.
- Exceptionally sturdy single-piece chassis.
- Screens with light: LED lighting.
- Screens with halogen lighting and ceramic heating.
- Power supply (V/Hz) 230/50-60.



## NEUTRAL SUPPORTS

Capacity	Code
2 GN 1/1	• PDN102GN
3 GN 1/1	• PDN103GN
4 GN 1/1	• PDN104GN
5 GN 1/1	• PDN105GN
6 GN 1/1	• PDN106GN

## SUPPORTS WITH LED LIGHTING

Capacity	Power (W)	Code
2 GN 1/1	8	• PDL102GN
3 GN 1/1	12	• PDL103GN
4 GN 1/1	14	• PDL104GN
5 GN 1/1	18	• PDL105GN
6 GN 1/1	24	• PDL106GN

## SUPPORTS WITH HALOGEN LIGHTING AND CERAMIC HEATING

Capacity	Power (W)	Code
2 GN 1/1	480	• PDC102GN
3 GN 1/1	710	• PDC103GN
4 GN 1/1	960	• PDC104GN
5 GN 1/1	960	• PDC105GN
6 GN 1/1	1440	• PDC106GN





DROP-IN

# GLASS FOR DROP-IN SUPPORTS

## GLASS

- Tempered safety glass to hygienically protect food.
- The front glass includes hardware kit for installation.



**TWO-SURFACE CURVED GLASS**

Capacity	Code
2 GN 1/1	• FCRC12GN
3 GN 1/1	• FCRC13GN
4 GN 1/1	• FCRC14GN
5 GN 1/1	• FCRC15GN
6 GN 1/1	• FCRC16GN



**TWO-SURFACE CURVED GLASS FRONT PIECE**

Capacity	Code
2 GN 1/1	• FCRF12GN
3 GN 1/1	• FCRF13GN
4 GN 1/1	• FCRF14GN
5 GN 1/1	• FCRF15GN
6 GN 1/1	• FCRF16GN



**STRAIGHT GLASS**

Capacity	Code
2 GN 1/1	• CDR102GN
3 GN 1/1	• CDR103GN
4 GN 1/1	• CDR104GN
5 GN 1/1	• CDR105GN
6 GN 1/1	• CDR106GN



**FRONT PIECE FOR STRAIGHT GLASS**

Capacity	Code
2 GN 1/1	• CDF102GN
3 GN 1/1	• CDF103GN
4 GN 1/1	• CDF104GN
5 GN 1/1	• CDF105GN
6 GN 1/1	• CDF106GN

DROP-IN

# ACCESSORY

## DIGITAL THERMOMETER

To display the working temperature of the drop-in.

- Ideal for one or two-level ice strips, cold and frozen food tubs, hot food tubs and hot plates.
- Easy to install on any support with screen.



Code
• SLT00001

## SIDE GLASS



Shape	Code
Curved	• CDLC0001
Straight	• CDLR0001

DROP-IN

# SLOPED SUPPORTS WITH SCREENS FOR ASSEMBLY DIRECTLY OVER THE DROP-IN

## SUPPORTS WITH SCREENS AND GLASS MUST BE ORDERED SEPARATELY



## SLOPED SUPPORTS WITH SCREEN

- Made from AISI grade 304 stainless steel (18/10).
- Direct assembly over the drop-in.
- Highest-quality finish.
- Exceptionally sturdy single-piece chassis.
- Screens with light: LED lighting.
- Screens with halogen lighting and ceramic heating.
- Power supply (V/Hz) 230/50-60.



## NEUTRAL SUPPORTS

Capacity	Code
2 GN 1/1	• PDNI12GN
3 GN 1/1	• PDNI13GN
4 GN 1/1	• PDNI14GN
5 GN 1/1	• PDNI15GN
6 GN 1/1	• PDNI16GN

## SUPPORTS WITH LED LIGHTING

Capacity	Power (W)	Code
2 GN 1/1	8	• PDLI12GN
3 GN 1/1	12	• PDLI13GN
4 GN 1/1	14	• PDLI14GN
5 GN 1/1	18	• PDLI15GN
6 GN 1/1	24	• PDLI16GN

## SUPPORTS WITH HALOGEN LIGHTING AND CERAMIC HEATING

Capacity	Power (W)	Code
2 GN 1/1	480	• PDCI12GN
3 GN 1/1	710	• PDCI13GN
4 GN 1/1	960	• PDCI14GN
5 GN 1/1	960	• PDCI15GN
6 GN 1/1	1440	• PDCI16GN



DROP-IN

# GLASS FOR SLOPED DROP-IN SUPPORTS

## GLASS

- Tempered safety glass to hygienically protect food.
- The front glass includes hardware kit for installation.



### STRAIGHT GLASS

Capacity	Code
2 GN 1/1	• CDR102GN
3 GN 1/1	• CDR103GN
4 GN 1/1	• CDR104GN
5 GN 1/1	• CDR105GN
6 GN 1/1	• CDR106GN

### FRONT PIECE FOR STRAIGHT GLASS

Capacity	Code
2 GN 1/1	• FCRF12GN
3 GN 1/1	• FCRF13GN
4 GN 1/1	• FCRF14GN
5 GN 1/1	• FCRF15GN
6 GN 1/1	• FCRF16GN

DROP-IN

# ACCESSORY

## DIGITAL THERMOMETER

To display the working temperature of the drop-in.

- Ideal for one or two-level ice strips, cold and frozen food tubs, hot food tubs and hot plates.
- Easy to install on any support with screen.



Code
• SLT00001

## SIDE GLASS

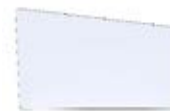

Shape	Code
Sloped	• CDLI0001



• 3-DAY SHIPPING

DROP-IN

# SUPPORTS WITH SCREENS FOR ASSEMBLY DIRECTLY OVER THE BUFFET

**SUPPORTS WITH SCREENS AND  
GLASS MUST BE ORDERED SEPARATELY**



## SUPPORTS WITH SCREEN

- Made from AISI grade 304 stainless steel (18/10).
- Assembly directly over the buffet countertop.
- Highest-quality finish.
- Exceptionally sturdy single-piece chassis.
- Screens with light: LED lighting.
- Screens with halogen lighting and ceramic heating.
- Power supply (V/Hz) 230/50-60.



## NEUTRAL SUPPORTS

Capacity	Code
2 GN 1/1	• PBN102GN
3 GN 1/1	• PBN103GN
4 GN 1/1	• PBN104GN
5 GN 1/1	• PBN105GN
6 GN 1/1	• PBN106GN

## SUPPORTS WITH LED LIGHTING

Capacity	Power (W)	Code
2 GN 1/1	8	• PBL102GN
3 GN 1/1	12	• PBL103GN
4 GN 1/1	14	• PBL104GN
5 GN 1/1	18	• PBL105GN
6 GN 1/1	24	• PBL106GN

## SUPPORTS WITH HALOGEN LIGHTING AND CERAMIC HEATING

Capacity	Power (W)	Code
2 GN 1/1	480	• PBC102GN
3 GN 1/1	710	• PBC103GN
4 GN 1/1	960	• PBC104GN
5 GN 1/1	960	• PBC105GN
6 GN 1/1	1440	• PBC106GN



DROP-IN

# GLASS FOR BUFFET SUPPORTS

## GLASS

- Tempered safety glass to hygienically protect food.
- The front glass includes hardware kit for installation.



**TWO-SURFACE CURVED GLASS**

Capacity	Code
2 GN 1/1	• BCRC02GN
3 GN 1/1	• BCRC03GN
4 GN 1/1	• BCRC04GN
5 GN 1/1	• BCRC05GN
6 GN 1/1	• BCRC06GN



**TWO-SURFACE CURVED GLASS FRONT PIECE**

Capacity	Code
2 GN 1/1	• BCRF02GN
3 GN 1/1	• BCRF03GN
4 GN 1/1	• BCRF04GN
5 GN 1/1	• BCRF05GN
6 GN 1/1	• BCRF06GN



**STRAIGHT GLASS**

Capacity	Code
2 GN 1/1	• BDR002GN
3 GN 1/1	• BDR003GN
4 GN 1/1	• BDR004GN
5 GN 1/1	• BDR005GN
6 GN 1/1	• BDR006GN



**FRONT PIECE FOR STRAIGHT GLASS**

Capacity	Code
2 GN 1/1	• BDF002GN
3 GN 1/1	• BDF003GN
4 GN 1/1	• BDF004GN
5 GN 1/1	• BDF005GN
6 GN 1/1	• BDF006GN

DROP-IN

# ACCESSORY

## DIGITAL THERMOMETER

**To display the working temperature of the drop-in.**

- Ideal for one or two-level ice strips, cold and frozen food tubs, hot food tubs and hot plates.
- Easy to install on any support with screen.

Code
• SLT00001



• 3-DAY SHIPPING

DROP-IN

# SLOPED SUPPORTS WITH SCREENS FOR ASSEMBLY DIRECTLY OVER THE BUFFET

## SUPPORTS WITH SCREENS AND GLASS MUST BE ORDERED SEPARATELY

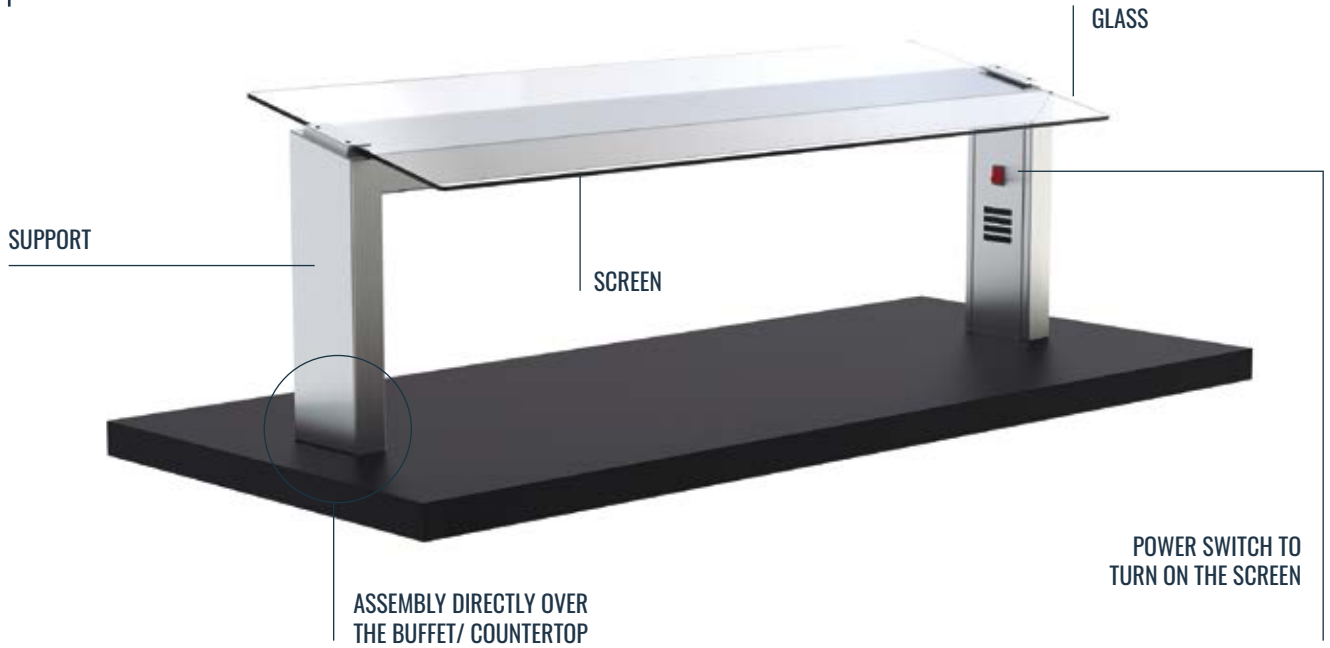

## SLOPED SUPPORTS WITH SCREEN

- Made from AISI grade 304 stainless steel (18/10).
- Assembly directly over the buffet countertop.
- Highest-quality finish.
- Exceptionally sturdy single-piece chassis.
- Screens with light: LED lighting.
- Screens with halogen lighting and ceramic heating.
- Power supply (V/Hz) 230/50-60.



## NEUTRAL SUPPORTS

Capacity	Code
2 GN 1/1	• PBNI12GN
3 GN 1/1	• PBNI13GN
4 GN 1/1	• PBNI14GN
5 GN 1/1	• PBNI15GN
6 GN 1/1	• PBNI16GN

## SUPPORTS WITH LED LIGHTING

Capacity	Power (W)	Code
2 GN 1/1	8	• PBLI12GN
3 GN 1/1	12	• PBLI13GN
4 GN 1/1	14	• PBLI14GN
5 GN 1/1	18	• PBLI15GN
6 GN 1/1	24	• PBLI16GN

## SUPPORTS WITH HALOGEN LIGHTING AND CERAMIC HEATING

Capacity	Power (W)	Code
2 GN 1/1	480	• PBCI12GN
3 GN 1/1	710	• PBCI13GN
4 GN 1/1	960	• PBCI14GN
5 GN 1/1	960	• PBCI15GN
6 GN 1/1	1440	• PBCI16GN



DROP-IN

# GLASS FOR SLOPED BUFFET SUPPORTS

## GLASS

- Tempered safety glass to hygienically protect food.
- The front glass includes hardware kit for installation.

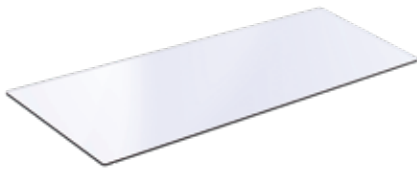

### STRAIGHT GLASS

Capacity	Code
2 GN 1/1	• BDR002GN
3 GN 1/1	• BDR003GN
4 GN 1/1	• BDR004GN
5 GN 1/1	• BDR005GN
6 GN 1/1	• BDR006GN



### FRONT PIECE FOR STRAIGHT GLASS

Capacity	Code
2 GN 1/1	• BCRF02GN
3 GN 1/1	• BCRF03GN
4 GN 1/1	• BCRF04GN
5 GN 1/1	• BCRF05GN
6 GN 1/1	• BCRF06GN

DROP-IN

# ACCESSORY

## DIGITAL THERMOMETER

To display the working temperature of the drop-in.

- Ideal for one or two-level ice strips, cold and frozen food tubs, hot food tubs and hot plates.
- Easy to install on any support with screen.

Code
------

- SLT00001



DROP-IN



• 3-DAY SHIPPING

# ACCESSORIES

## HOT PLATE DISPENSER

Raises dishes to a constant height so they are accessible for removal.

- Springs allow for height adjustment.
- Capacity of 65 or 45 plates.
- Dispenser diameter can be adjusted from 200 mm to 310 mm.
- Analog thermostat ranging from 0°C to 90°C controls temperature.
- 2m connecting cord with plug.
- Mobile control panel with analog thermostat and lighted switch.



Hot dispenser



Neutral dispenser



SST cover

### HOT PLATE DISPENSER DIMENSIONS

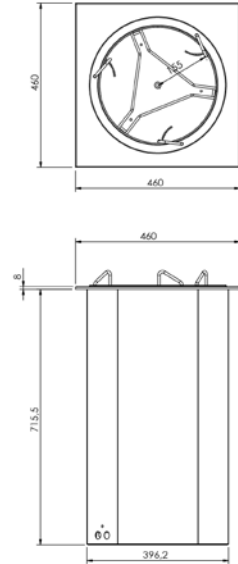

65-plate model

Capacity	Model	Total dimensions (mm)	Total built-in dimensions (mm)	Power (W)	Power supply (V/Hz)	Code
65 plates	Hot	460 x 460 x 800	410 x 410 x 730	800	230/50-60	• F1100701
	Neutral	Ø 425 x 735	Ø 410	-	-	• F1100702
45 plates	Hot	460 x 460 x 575	410 x 410 x 510	800	230/50-60	• F1100704
	Neutral	Ø 425 x 510	Ø 410	-	-	• F1100705
	Cover	Ø 368 x 140	-	-	-	• F1100711

## NEUTRAL DISH RACK DISPENSER

- Made from AISI 304 stainless steel (18/10).
- Tools for attaching to the countertop are included.
- Capacity: Six 110 mm racks or ten 50 mm racks.
- Maximum load of 200 kg.

Total dimensions (mm)	Total built-in dimensions (mm)	Code
590 x 590 x 750	560 x 560 x 750	• F1100703



### NEUTRAL DISH RACK DISPENSER DIMENSIONS

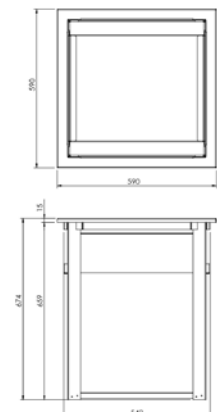







FOOD DISTRIBUTION AND DISPLAY

# SELF-SERVICE



## COLD ELEMENTS

PAGE 214



## HOT ELEMENTS

PAGE 218



## NEUTRAL ELEMENTS

PAGE 222



## ACCESSORIES

PAGE 227



## SUPPORTS AND GLASS

PAGE 232

# SATURNO SELF-SERVICE

GREAT RANGE OF COMBINATIONS FOR HOTELS, HOSPITALS, SERVICE STATIONS, CAMPSITES, CAFÉS AND SCHOOLS



## 01 Modular system

The Saturno self-service product series uses a modular design to provide dining services via the use of **centre islands** or through forming multi-purpose, **versatile food lines**. With many different possibilities for configuration among the various models (cold, neutral or hot) and available functions, the Saturno range will satisfy the needs of any project.

## 02 Easy installation

The hot and cold elements of the Saturno self-service range are **manufactured as independent modules that facilitate access to their interior** thanks to their removable sides, which allows a quick and easy installation of several self-service shelves in a single space. In addition, in cold elements, the front register is removable, which allows a quick and easy installation of several self-service shelves in a single space.

## 03 Functional design

Equipment designed to allow you to present food to your customers in an attractive and ergonomic way, based on the type of food. Each element is carefully designed to **enhance the appearance of the food and products in units and display cases**.

Made from top-quality AISI 304 stainless steel (18/10). Countertop with 65 mm rounded finish front piece, fully welded.



Ease of use to regulate and control the temperature of the self unit thanks to the digital thermostat located on the rear part.



New support and glass designs, more variety and self-service unit customisation.



Refrigerated glass display cases with three levels; capacity for 4 GN or 6 GN, available in two front closing systems, with swinging doors or thermo-screen.



Tubular tray slides and baseboards made of stainless steel (optional).



Optional customisation with decorative panels in solid colours or wood grains.



## Energy efficiency

We at Distform are committed to manufacturing increasingly efficient products. To this end, the **R290 ECO-POWER** refrigerant is used in the cold elements of our self-service range. This eco-friendly gas has a low environmental impact and excellent thermodynamic properties that make it easier to save energy and which benefit the profitability of commercial kitchens.

# COLD ELEMENTS

## SELF-SERVICE COLD PLATE

**For maintaining and displaying cold dishes or beverages at the correct temperature during service.**

- Made from AISI grade 304 stainless steel (18/10).
- Countertop with 65 mm front piece with rounded finish, fully welded.
- Coil refrigeration and hermetic compressor with R290 refrigerant.
- For best refrigeration results, there should be sufficient distance between the front/rear part of the unit and other nearby items that could hinder the performance of the condenser unit.
- Insulated with eco-friendly, HFC-free polystyrene foam.
- Digital thermostat for regulating and controlling temperature.
- 150 mm legs allow you to raise the height of the unit from 850 to 900 mm.
- Removable side panels for easy access to electrical area and compressor.

- Removable front piece for easy access to the compressor.
- Stainless steel front panel, decorative panel optional.

### Models with refrigerated reserve cabinet

- Copper evaporator coil with aluminum fins.
- Reserve temperature of +4°C in room temperature of 25°C.
- Polystyrene foam insulation.
- Reserve cabinet has 4 or 6 runners (removable for easy cleaning) for GN 1/1 pans.
- Tray slides, screen, and glass not included.

### RELATED PRODUCTS

**TRAY SLIDES** page 227

**DECORATIVE PANELS** page 230

**SUPPORTS AND GLASS** page 232



### WITHOUT RESERVE CABINET

Capacity	Total dimensions (mm)	Power (W)	Power supply (V/Hz)	Code
3 GN 1/1	1200 x 700 x 850	480	230/50	• S1001201
4 GN 1/1	1600 x 700 x 850	720	230/50	• S1001202
6 GN 1/1	2300 x 700 x 850	1030	230/50	• S1001205



### WITH REFRIGERATED RESERVE CABINET

Capacity	Total dimensions (mm)	Power (W)	Power supply (V/Hz)	Code
3 GN 1/1	1200 x 700 x 850	480	230/50	• S1001301
4 GN 1/1	1600 x 700 x 850	720	230/50	• S1001302
6 GN 1/1	2300 x 700 x 850	1030	230/50	• S1001305



## SELF-SERVICE COLD-FOOD WELL

For maintaining and displaying cold dishes or beverages at the correct temperature during service.

- Made from AISI grade 304 stainless steel (18/10).
- Countertop with 65 mm front piece with rounded finish, fully welded.
- Basin has safety edges to facilitate cleaning.
- For GN containers with a maximum depth of 150 mm.
- Coil refrigeration and hermetic compressor with R290 refrigerant.
- For best refrigeration results, there should be sufficient distance between the front/rear part of the unit and other nearby items that could hinder the performance of the condenser unit.
- Insulated with eco-friendly, HFC-free polystyrene foam.
- Digital thermostat for regulating and controlling temperature.
- 150 mm legs allow you to raise the height of the unit from 850 to 900 mm.
- Removable side panels for easy access to electrical area and compressor.
- Removable front piece for easy access to the compressor.
- Stainless steel front panel, decorative panel optional.

### Models with refrigerated reserve cabinet

- Copper evaporator coil with aluminum fins.
- Reserve temperature of +4°C in room temperature of 25°C.
- Polystyrene foam insulation.
- Reserve cabinet has 4 or 6 runners (removable for easy cleaning) for GN 1/1 pans.
- Tray slides, screen, and glass not included.

### RELATED PRODUCTS

**TRAY SLIDES** page 227

**DECORATIVE PANELS** page 230

**SUPPORTS AND GLASS** page 232



### WITHOUT RESERVE CABINET

Capacity	Total dimensions (mm)	Power (W)	Power supply (V/Hz)	Code
3 GN 1/1	1200 x 700 x 850	380	230/50	• S1001701
4 GN 1/1	1600 x 700 x 850	480	230/50	• S1001702
6 GN 1/1	2300 x 700 x 850	720	230/50	• S1001705



### WITH REFRIGERATED RESERVE CABINET

Capacity	Total dimensions (mm)	Power (W)	Power supply (V/Hz)	Code
3 GN 1/1	1200 x 700 x 850	380	230/50	• S1001102
4 GN 1/1	1600 x 700 x 850	480	230/50	• S1001101
6 GN 1/1	2300 x 700 x 850	720	230/50	• S1001105



# COLD ELEMENTS

## CENTER ISLAND: COLD PLATE OR COLD FOOD WELL

**For maintaining and displaying cold dishes or beverages at the correct temperature during service.**

- Made from AISI 304 stainless steel (18/10).
- Countertop with 65 mm front piece with rounded finish, fully welded.
- Coil refrigeration and hermetic compressor with R290 refrigerant.
- For best refrigeration results, there should be sufficient distance between the front/rear part of the unit and other nearby items that could hinder the performance of the condenser unit.
- Insulated with eco-friendly, HFC-free polystyrene foam.
- Digital thermostat for regulating and controlling temperature.
- 150 mm legs allow you to raise the height of the unit from 850 to 900 mm.
- Removable side panels for easy access to electrical area and compressor.

- 2 stainless steel front panels, optional decorative panels.
- Tray slides, plate support, screen, and glass not included.

### Center island cold food well:

- Well has safety edges to facilitate cleaning.
- For GN containers with a maximum depth of 150 mm.

#### RELATED PRODUCTS

**TRAY SLIDES** page 227

**DECORATIVE PANELS** page 230

**SUPPORTS AND GLASS** page 232



Model	Capacity	Total dimensions (mm)	Power (W)	Power supply (V/Hz)	Code
Cold plate	4 GN 1/1	1600 x 700 x 850	720	230/50	• S1001203
	6 GN 1/1	2300 x 700 x 850	1030	230/50	• S1001206
Cold-food well	4 GN 1/1	1600 x 700 x 850	480	230/50	• S1001703
	6 GN 1/1	2300 x 700 x 850	720	230/50	• S1001706
Side support for plates	-	520 x 330	-	-	• S1001733





## REFRIGERATED GLASS DISPLAY CASE WITH 3 LEVELS

For maintaining and displaying cold dishes or beverages at the correct temperature during food service.

- Made from AISI 304 stainless steel (18/10).
- Glazed glass display case with three surfaces, sliding doors on rear of unit, interior lighting, three shelves and swinging methacrylate doors or folding thermo-screen doors, depending on the model.
- Master switch and adjustable digital thermostat.
- Working temperature of +10°C in room temperature of +25°C.
- Can be adapted to fit with neutral or cold units.
- Ventilated refrigeration and hermetic compressor with R290 refrigerant.
- For best refrigeration results, there should be sufficient distance between the front/rear part of the unit and other nearby items that could hinder the performance of the condenser unit.
- Space for hermetic compressor, refrigerant in upper portion.
- Side glass with chamber.
- Sliding doors in laminated glass.
- Cold-food well and tray slides not included.



### EXAMPLE OF POSSIBLE CONFIGURATION

Without reserve cabinet	Code
Glass display case without base 4 GN 1/1 with swinging doors	S1001001
Self-service cold well 4 GN 1/1 without reserve cabinet.	S1001702
4 GN Tray slides	S1020003

With refrigerated reserve cabinet	Code
Glass display case without base 4 GN 1/1 with swinging doors	S1001001
Self-service cold well 4 GN 1/1 with reserve cabinet.	S1001101
4 GN Tray slides	S1020003

### RELATED PRODUCTS

**TRAY SLIDES** page 227  
**DECORATIVE PANELS** page 230



Thermo-screen close-up



Swinging doors close-up

### WITHOUT BASE

Capacity	Model	Total dimensions (mm)	Power (W)	Power supply (V/Hz)	Code
4 GN 1/1	Swinging doors	1550 x 660 x 1150	800	230/50	• S1001001
4 GN 1/1	Thermo-screen	1550 x 660 x 1150	800	230/50	• S1C01001
6 GN 1/1	Swinging doors	2280 x 660 x 1150	800	230/50	• S1001011



### WITH INSULATED BASE

Capacity	Model	Total dimensions (mm)	Power (W)	Power supply (V/Hz)	Code
4 GN 1/1	Swinging doors	1550 x 660 x 1150	800	230/50	• S1001002
4 GN 1/1	Thermo-screen	1550 x 660 x 1150	800	230/50	• S1C01002
6 GN 1/1	Swinging doors	2280 x 660 x 1150	800	230/50	• S1001012



• 6-DAY SHIPPING

# HOT ELEMENTS

## BAIN-MARIE SELF-SERVICE UNIT

**For maintaining and displaying hot food at the correct temperature during food service.**

- Made from AISI grade 304 stainless steel (18/10).
- Countertop with 65 mm front piece with rounded finish, fully welded.
- Well has safety edges to facilitate cleaning.
- For GN containers with a maximum depth of 200 mm.
- Indirectly heats water via silicone heating elements located in the bottom of the well.
- Silicone heating elements improve performance and reduce energy usage.
- Digital thermostat ranging from 0°C to 90°C regulates temperature of the bain-marie.

- 1/2" water intake and drainage tubing with ball valve; ergonomically positioned.
- 150mm legs allow you to raise the height of the unit from 850 to 900mm.
- Safety thermostat.
- Removable side panels for easy access to electrical area and plumbing.
- Stainless steel front panel, decorative panel optional.
- Tray slides, screen, and glass not included.

**RELATED PRODUCTS**

- TRAY SLIDES** page 227
- DECORATIVE PANELS** page 230
- SUPPORTS AND GLASS** page 232



### WITHOUT RESERVE CABINET

Capacity	Total dimensions (mm)	Power (W)	Power supply (V/Hz)	Code
3 GN 1/1	1200 x 700 x 850	2400	230/50-60	• S1000601
4 GN 1/1	1600 x 700 x 850	3200	230/50-60	• S1000602
6 GN 1/1	2300 x 700 x 850	4800	380/50-60	• S1000605

### WITH HOT RESERVE CABINET

Capacity	Total dimensions (mm)	Power (W)	Power supply (V/Hz)	Code
3 GN 1/1	1200 x 700 x 850	4400	230/50-60	• S1000701
4 GN 1/1	1600 x 700 x 850	5200	230/50-60	• S1000702
6 GN 1/1	2300 x 700 x 850	7800	380/50-60	• S1000705



## DRY-BAIN-MARIE SELF-SERVICE UNIT

**For maintaining and displaying hot food at the correct temperature during food service.**

- Made from AISI grade 304 stainless steel (18/10).
- Countertop with 65 mm front piece with rounded finish, fully welded.
- For GN containers with a maximum depth of 150 mm.
- Digital thermostat ranging from 0°C to 90°C regulates temperature of the bain-marie.
- 150 mm legs allow you to raise the height of the unit from 850 to 900 mm.
- Safety thermostat.
- Removable side panels for easy access to electrical area.
- Perforated false bottom protects heating elements.
- Stainless steel front panel, decorative panel optional.
- Tray slides, screen, and glass not included.

RELATED PRODUCTS

- TRAY SLIDES** page 227
- DECORATIVE PANELS** page 230
- SUPPORTS AND GLASS** page 232



### WITHOUT RESERVE CABINET

Capacity	Total dimensions (mm)	Power (W)	Power supply (V/Hz)	Code
3 GN 1/1	1200 x 700 x 850	1200	230/50-60	• S1000501
4 GN 1/1	1600 x 700 x 850	1600	230/50-60	• S1000502
6 GN 1/1	2300 x 700 x 850	2400	230/50-60	• S1000505



### WITH HOT RESERVE CABINET

Capacity	Total dimensions (mm)	Power (W)	Power supply (V/Hz)	Code
3 GN 1/1	1200 x 700 x 850	3200	230/50-60	• S1001511
4 GN 1/1	1600 x 700 x 850	3600	230/50-60	• S1001512
6 GN 1/1	2300 x 700 x 850	5400	380/50-60	• S1001515



# HOT ELEMENTS

## SELF-SERVICE TEMPERED GLASS HOT PLATE

For maintaining and displaying hot food at the correct temperature during food service.

- Made from AISI grade 304 stainless steel (18/10).
- 6 mm black seamless tempered glass to facilitate the cleaning process.
- Countertop with 65 mm front piece with rounded finish, fully welded.
- 150 mm legs allow you to raise the height of the unit from 850 to 900 mm.
- Stainless steel front panel, decorative panel optional.
- Digital thermostat included in all models.
- Silicone heating elements improve performance and reduce energy usage.
- Safety thermostat.
- Removable side panels for easy access to electrical area.
- Tray slides not included.



RELATED PRODUCTS  
**TRAY SLIDES** page 227  
**DECORATIVE PANELS** page 230  
**SUPPORTS AND GLASS** page 232

### WITHOUT RESERVE CABINET

Capacity	Total dimensions (mm)	Power (W)	Power supply (V/Hz)	Code
3 GN 1/1	1200 x 700 x 850	2400	230/50-60	• S1001813
4 GN 1/1	1600 x 700 x 850	3200	230/50-60	• S1001814



### WITH HOT RESERVE CABINET

Capacity	Total dimensions (mm)	Power (W)	Power supply (V/Hz)	Code
3 GN 1/1	1200 x 700 x 850	4400	230/50-60	• S1001823
4 GN 1/1	1600 x 700 x 850	5200	230/50-60	• S1001824



## SELF-SERVICE UNIT WITH HOT RESERVE CABINET

Designed to accommodate catering or food units that do not require temperature regulation.

- Hot reserve cabinet inside the unit.
- Made from AISI grade 304 stainless steel (18/10).
- Countertop with 65 mm front piece with rounded finish, fully welded.
- 150 mm legs allow you to raise the height of the unit from 850 to 900 mm.
- Stainless steel front panel, decorative panel optional.
- Perforated middle shelf facilitates even distribution of temperature.
- Digital thermostat included in all models.
- Safety thermostat.
- Removable side panels for easy access to electrical area.
- Tray slides not included.



Capacity	Total dimensions (mm)	Power (W)	Power supply (V/Hz)	Code
3 GN 1/1	1200 x 700 x 850	2000	230/50-60	• S1001801
4 GN 1/1	1600 x 700 x 850	3000	230/50-60	• S1001802



## CENTRE ISLAND: WITH BAIN-MARIE OR DRY HEAT BAIN-MARIE OR TEMPERED GLASS HOT PLATE

For maintaining and displaying hot food at the correct temperature during food service.

- Made from AISI 304 stainless steel (18/10).
- Countertop with 65 mm front piece with rounded finish, fully welded.
- Safety thermostat.
- Removable side panels for easy access to electrical area.
- Digital thermostat ranging from 0°C to 90°C regulates temperature of the bain-marie.
- 150 mm legs allow you to raise the height of the unit from 850 to 900 mm.
- 2 stainless steel front panels, optional decorative panels.
- Tray slides, plate support, screen and glass not included.

### RELATED PRODUCTS

**TRAY SLIDES** page 227

**DECORATIVE PANELS** page 230

**SUPPORTS AND GLASS** page 232

### Centre island with bain-marie

- Well has safety edges to facilitate cleaning.
- For GN pans with a maximum depth of 200 mm.
- Indirectly heats water via silicone heating elements located in the bottom of the well.
- 1/2" water intake and drain pipes with ball valve.

### Center island with dry heat bain-marie

- For GN containers with a maximum depth of 150 mm.
- Perforated false bottom protects heating elements.

### Center island with tempered glass hot plate

- 6 mm black seamless tempered glass to facilitate the cleaning process.
- Silicone heating elements improve performance and reduce energy usage.



### CENTRE ISLAND

Model	Capacity	Total dimensions (mm)	Power (W)	Power supply (V/Hz)	Code
Tempered glass	4 GN 1/1	1600 x 700 x 850	3200	230/50-60	• S1000815
	6 GN 1/1	2300 x 700 x 850	4800	380/50-60	• S1000816
Dry bain-marie	4 GN 1/1	1600 x 700 x 850	1600	230/50-60	• S1000503
	6 GN 1/1	2300 x 700 x 850	2400	230/50-60	• S1000506
Bain-marie	4 GN 1/1	1600 x 700 x 850	3200	230/50-60	• S1000603
	6 GN 1/1	2300 x 700 x 850	4800	380/50-60	• S1000606
Side support for plates	-	520 x 330	-	-	• S1001733



• 6-DAY SHIPPING

# NEUTRAL ELEMENTS

## NEUTRAL SELF-SERVICE UNIT

Designed to accommodate catering or food items on the counter-top which do not require temperature regulation.

- Made from AISI grade 304 stainless steel (18/10).
- Countertop with 65 mm front piece with rounded finish, fully welded.
- 150 mm legs allow you to raise the height of the unit from 850 to 900 mm.
- Stainless steel front panel, decorative panel optional.
- Stainless steel middle shelf.
- Tray slides, screen and glass not included.

RELATED PRODUCTS

**TRAY SLIDES** page 227

**DECORATIVE PANELS** page 230

**SUPPORTS AND GLASS** page 232



NEUTRAL SELF-SERVICE WITH SHELF DIMENSIONS

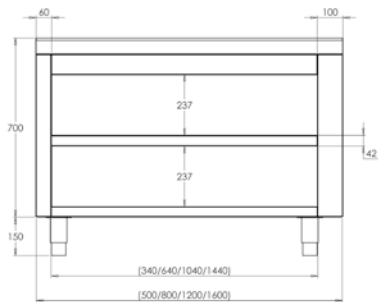

NEUTRAL SELF-SERVICE WITH SWINGING DOORS DIMENSIONS

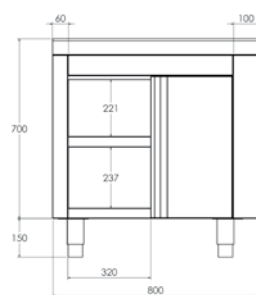

NEUTRAL SELF-SERVICE WITH SLIDING DOORS DIMENSIONS

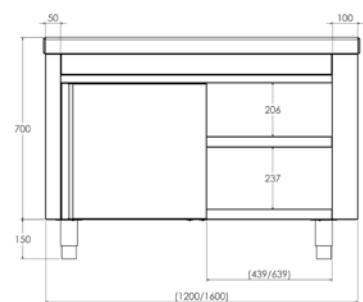

### WITH SHELF

Total dimensions (mm)	Code
500 x 700 x 850	• S1000300
800 x 700 x 850	• S1000301
1200 x 700 x 850	• S1000302
1600 x 700 x 850	• S1000303

### WITH DOORS AND SHELF

Model	Total dimensions (mm)	Code
Swinging doors	800 x 700 x 850	• S1000311
Sliding doors	1200 x 700 x 850	• S1000312
Sliding doors	1600 x 700 x 850	• S1000313



## CORNER UNIT FOR SELF-SERVICE

For joining two self-service units at a corner. Forms interior and exterior angles of 90° and 45°.

- Made from AISI grade 304 stainless steel (18/10).
- Countertop with 65 mm front piece with rounded finish, fully welded.
- 150 mm legs allow you to raise the height of the unit from 850 to 900 mm.
- Stainless steel front panel, decorative panel optional.



### RELATED PRODUCTS

**TRAY SLIDES** page 227

**DECORATIVE PANELS** page 230



MODEL S1000411  
DIMENSIONS

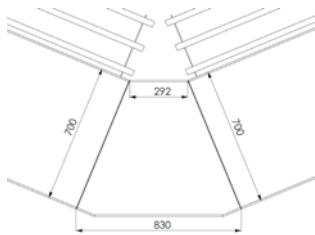

MODEL S1000412  
DIMENSIONS

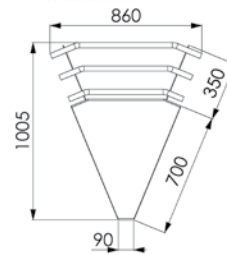

MODEL S1000401  
DIMENSIONS

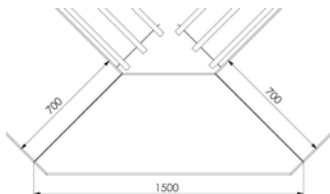

MODEL S1000402  
DIMENSIONS

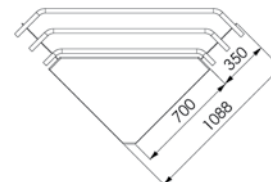

### INTERIOR

Model	Total dimensions (mm)	Code
45°	830 x 680 x 850	• S1000411
90°	1500 x 560 x 850	• S1000401

- Includes middle shelf.
- Tray slides not required.

### EXTERIOR

Model	Total dimensions (mm)	Code
45°	620 x 690 x 850	• S1000412
90°	1060 x 570 x 850	• S1000402

- Tray slides not included.



• 6-DAY SHIPPING

# NEUTRAL ELEMENTS

## SELF-SERVICE CASH REGISTER

Designed for cash register areas.

- Made from AISI grade 304 stainless steel (18/10).
- Countertop with 65 mm front piece with rounded finish, fully welded.
- 150 mm legs allow you to raise the height of the unit from 850 to 900 mm.
- Stainless steel front panel, decorative panel optional.
- Comes with one drawer.
- Tray slides not included.

### RAISED SELF-SERVICE CASH REGISTER DIMENSIONS

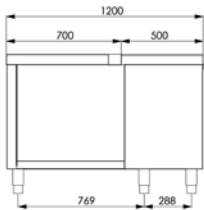

### FREESTANDING SELF-SERVICE CASH REGISTER LEFT

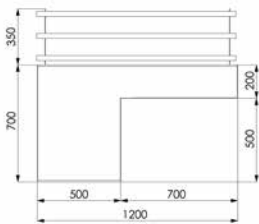

### FREESTANDING SELF-SERVICE CASH REGISTER RIGHT

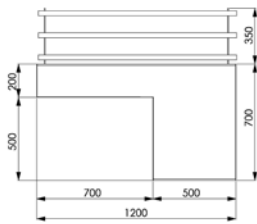

RELATED PRODUCTS

**TRAY SLIDES** page 227  
**DECORATIVE PANELS** page 230



Model	Total dimensions (mm)	Code
Self-service cash register right	1200 x 700 x 850	• S1001401
Self-service cash register left	1200 x 700 x 850	• S1001402

## SELF-SERVICE NEUTRAL DISH RACK DISPENSER

Used for distributing glasses and cups in standard dish racks.

- Made from AISI grade 304 stainless steel (18/10).
- Countertop with 65 mm front piece with rounded finish, fully welded.
- 150 mm legs allow you to raise the height of the unit from 850 to 900 mm.
- Stainless steel front panel, decorative panel optional.
- Approximate capacity: Six 110 mm racks or ten 50 mm racks.
- Tray slides not included.

### SELF-SERVICE NEUTRAL DISH RACK DISPENSER DIMENSIONS

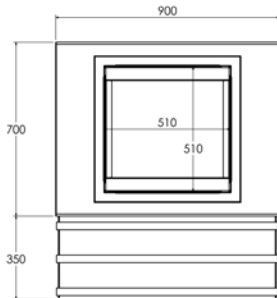

Total dimensions (mm)	Code
900 x 700 x 850	• S1001920





## SELF-SERVICE UNIT FOR PLATE DISPENSER TROLLEY

Designed to position one self-service constant-level plate dispenser.

- Made from AISI grade 304 stainless steel (18/10).
- Countertop with 65 mm front piece with rounded finish, fully welded.
- 150 mm legs allow you to raise the height of the unit from 850 to 900 mm.
- Stainless steel front panel, decorative panel optional.
- Includes an outlet to connect to plate dispenser.
- Tray slides not included.

RELATED PRODUCTS  
**TRAY SLIDES** page 227  
**DECORATIVE PANELS** page 230



S1001930 + F0420311 + F1100711 + F1100711

F0420311 + F1100711 + F1100711

Total dimensions (mm)	Code
1300 x 700 x 850	• S1001930

RELATED PRODUCTS

**HOT-PLATE DISPENSER TROLLEY** page 176

## SELF-SERVICE CONSTANT-LEVEL PLATE DISPENSER

For distributing warm plates at a constant level.

- Made from AISI grade 304 stainless steel (18/10).
- Countertop with 65 mm front piece with rounded finish, fully welded.
- 150 mm legs allow you to raise the height of the unit from 850 to 900 mm.
- Stainless steel front panel, decorative panel optional.
- Adjustable diameter from Ø200 to Ø310 mm.
- Tray slides and stainless steel covers not included.



### SINGLE

Model	Total dimensions (mm)	Capacity	Power (W)	Power supply (V/Hz)	Code
Neutral	500 x 700 x 850	65 plates	-	-	• S1001901
Hot	500 x 700 x 850	65 plates	800	230/50-60	• S1001911
SST cover	Ø 368 x 140	-	-	-	• F1100711



### DOUBLE

Model	Total dimensions (mm)	Capacity	Power (W)	Power supply (V/Hz)	Code
Neutral	1000 x 700 x 850	130 plates	-	-	• S1001902
Hot	1000 x 700 x 850	130 plates	1600	230/50-60	• S1001912
SST cover	Ø 368 x 140	-	-	-	• F1100711



# NEUTRAL ELEMENTS

## CLOSED RECYCLING CABINET

**Ideal for sorting waste.**

- Made of AISI 304 18/10 stainless steel.
- 65 mm front piece with rounded finish, fully welded.
- Fully welded 105 mm rear bumper on wall-mounted models.
- 150 mm legs to raise the height of the unit from 850 to 920 mm.
- 50 mm advanced rear legs that allow the furniture to be placed on floors with a cleaning radius.
- Swing doors.
- Two or three Ø 190-280 mm holes for rubber rings.
- Coloured rubber rings not included.
- **No assembly required.**



RELATED PRODUCTS

**WASTE CONTAINERS** pg. 167



### CENTRAL

Total dimensions (mm)	Holes	Code
1200 x 600 x 850	2	• F0072013
1800 x 600 x 850	3	• F0072014

### MURAL

Total dimensions (mm)	Holes	Code
1200 x 600 x 850	2	• F0072007
1800 x 600 x 850	3	• F0072008

## RUBBER WASTE RING

**Facilitates the identification of the container.**

- Detachable.
- Easy to clean and disinfect.

Colour	Code
Red — Organic	• ARO000RO
Green — Glass	• ARO000VE
Yellow — Plastic	• ARO000AM
Blue — Paper	• ARO000AZ



# ACCESSORIES

## TRAY SLIDES

- Made from AISI grade 304 stainless steel (18/10).
- Can be adjusted to facilitate alignment.
- Decorative chrome end caps.
- Assembly required (sold unattached to buffet units).



For self-service units	Total dimensions (mm)	Code
3 GN, 1200 mm neutral and self-service cash register	1200 x 350	• S1020002
4 GN and 1600 mm neutral	1600 x 350	• S1020003
6 GN	2300 x 350	• S1020005
Single-plate 500 mm neutral self-service constant-level plate dispenser	500 x 350	• S1020006
800 mm neutral	800 x 350	• S1020001
Tableware rack dispenser	900 x 350	• S1020007
Double-plate constant-level plate dispenser	1000 x 350	• S1020011
Plate dispenser	1300 x 350	• S1020008
Exterior 45° corner	804 x 350	• S1020009
Exterior 90° corner	1490 x 350	• S1020010

## BASEBOARDS

For self-service units	Total dimensions (mm)	Code
3 GN, 1200 mm neutral and self-service cash register	1200 x 149	• S1030002
4 GN and 1600 mm neutral	1600 x 149	• S1030003
6 GN	2300 x 149	• S1030005
Single-plate 500 mm neutral self-service constant-level plate dispenser	500 x 149	• S1030006
800 mm neutral	800 x 149	• S1030001
Dish rack dispenser	900 x 149	• S1030007
Double-plate constant-level plate dispenser	1000 x 149	• S1030014
Plate dispenser trolley	1300 x 149	• S1030008
Exterior 90° corner	1018 x 149	• S1030012
Interior 90° corner	570 x 149	• S1030011
Exterior 45° corner	590 x 149	• S1030009
Interior 45° corner	292 x 149	• S1030013
Side baseboard	640 x 149	• S1030015



# ACCESSORIES

## UTENSIL, GLASS AND TRAY DISPENSER

- Made from AISI grade 304 stainless steel (18/10).
- 200-mm-deep GN 2/1 bread pan.
- Capacity for 6 GN 1/3 pans or 2 GN 1/1 pans for utensils.
- Shelves come attached to the structure and can be interchanged.
- Adjustable 150 mm stainless steel legs.

### FREESTANDING

Total dimensions (mm)	Code
800 x 700 x 1500	• S1000003



DISPENSER DIMENSIONS

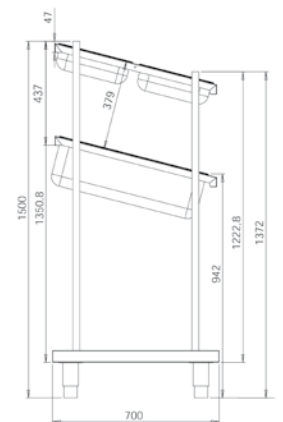

## TRAY, UTENSIL AND BREAD CHUTE DISPENSER

- Made of AISI grade 304 stainless steel (18/10).
- High-capacity bread chute.
- Double shelf for trays and glasses.
- Utensil holder made of food-grade PVC.
- Removable tray to collect bread crumbs.

### FREESTANDING

Total dimensions (mm)	Code
800 x 700 x 1520	• S1000001



DISPENSER DIMENSIONS

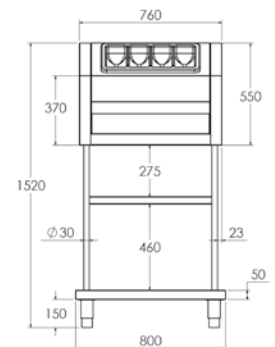

## UTENSIL AND BREAD DISPENSER

- Made from AISI grade 304 stainless steel (18/10).
- High-capacity bread chute.
- Utensil holder made of food-grade PVC.
- Removable tray to collect bread crumbs.

### COUNTERTOP

Total dimensions (mm)	Code
760 x 660 x 550	• S1000201



DISPENSER DIMENSIONS

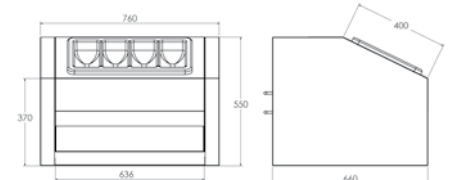

## HAND RAIL

- Made of 40 mm AISI grade 304 stainless steel (18/10).
- Welded plates with holes for floor installation (screws and anchors included).

Total dimensions (mm)	Code
1200 x 900	• S1020801



## TROLLEY FOR GLASS RACKS

- Made from AISI grade 304 stainless steel (18/10).
- Ø125 castors, 2 with brakes.
- 5 sets of runners to fit racks of glasses.
- Racks not included.
- Rack dimensions: 500 x 500 mm.

Total dimensions (mm)	Code
610 x 650 x 1892	• S1000002



TROLLEY DIMENSIONS

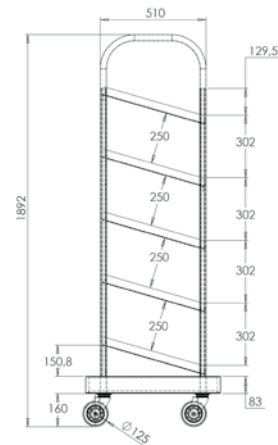

## GLASS DISPENSER

- Made from AISI grade 304 stainless steel (18/10).
- Fully welded.
- 150 mm adjustable legs on the freestanding model.
- 30 mm round tubular legs on the countertop model.

### FREESTANDING (6 SHELVES)

Total dimensions (mm)	Code
610 x 650 x 1892	• S1100706



TROLLEY DIMENSIONS

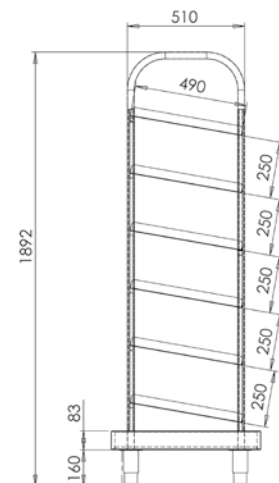

### COUNTERTOP (3 SHELVES)

Total dimensions (mm)	Code
570 x 510 x 990	• S1100707



TROLLEY DIMENSIONS

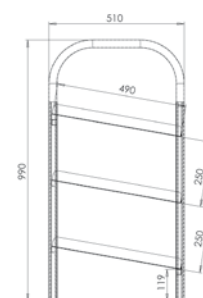

## SELF-SERVICE CASTOR PACK

- 4 Ø150 mm castors (2 with brakes) **for capacities and dimensions lower than 6 GN/2300 mm.**
- 6 Ø150 mm castors (2 with brakes) **for 6 GN capacities.**
- Comes installed in the self-service unit.

Model	Code
4 castors	• F1020301
6 castors	• F1020306





# ACCESSORIES

## DECORATIVE PANELS WITH A WOOD GRAIN FINISH

Stainless steel decoration as standard.  
 Customise your self-service station with decorative panels, available in solid colours or a wood-grain finish.  
 Panels are supplied separately.

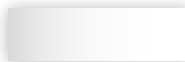

### SOLID FINISH

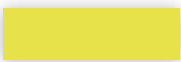
				
For self-service units	White	Orange	Red	Green
500	• S1010901	• S1020901	• S1030901	• S1040901
800	• S1010902	• S1020902	• S1030902	• S1040902
900	• S1010903	• S1020903	• S1030903	• S1040903
1000	• S1010904	• S1020904	• S1030904	• S1040904
1200	• S1010905	• S1020905	• S1030905	• S1040905
1300	• S1010906	• S1020906	• S1030906	• S1040906
1600	• S1010907	• S1020907	• S1030907	• S1040907
2300	• S1010908	• S1020908	• S1030908	• S1040908
Exterior 90° corner	• S1010909	• S1020909	• S1030909	• S1040909
Interior 90° corner	• S1010910	• S1020910	• S1030910	• S1040910
Exterior 45° corner	• S1010911	• S1020911	• S1030911	• S1040911
Interior 45° corner	• S1010912	• S1020912	• S1030912	• S1040912
Centre island kit with food well and plate 4 GN	• S1010913	• S1020913	• S1030913	• S1040913
Centre island kit with bain-marie 4 GN	• S1010914	• S1020914	• S1030914	• S1040914
Centre island kit with food well and plate 6 GN	• S1010915	• S1020915	• S1030915	• S1040915
Centre island kit with bain-marie 6 GN	• S1010916	• S1020916	• S1030916	• S1040916



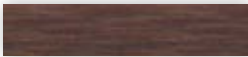
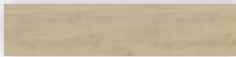
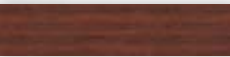

**WOOD-GRAIN FINISH**

			
For self-service units	Wenge	Natural Oak	Tobacco Oak
500	• S1110911	• S1120911	• S1130911
800	• S1110912	• S1120912	• S1130912
900	• S1110913	• S1120913	• S1130913
1000	• S1110914	• S1120914	• S1130914
1200	• S1110915	• S1120915	• S1130915
1300	• S1110916	• S1120916	• S1130916
1600	• S1110917	• S1120917	• S1130917
2300	• S1110918	• S1120918	• S1130918
Exterior 90° corner	• S1110919	• S1120919	• S1130919
Interior 90° corner	• S1110920	• S1120920	• S1130920
Exterior 45° corner	• S1110921	• S1120921	• S1130921
Interior 45° corner	• S1110922	• S1120922	• S1130922
Centre island kit with food well and plate 4 GN	• S1110923	• S1120923	• S1130923
Centre island kit with bain-marie 4 GN	• S1110924	• S1120924	• S1130924
Centre island kit with food well and plate 6 GN	• S1110925	• S1120925	• S1130925
Centre island kit with bain-marie 6 GN	• S1110926	• S1120926	• S1130926

# SUPPORTS WITH SCREENS FOR SELF-SERVICE

## SUPPORTS WITH SCREENS AND GLASS MUST BE ORDERED SEPARATELY

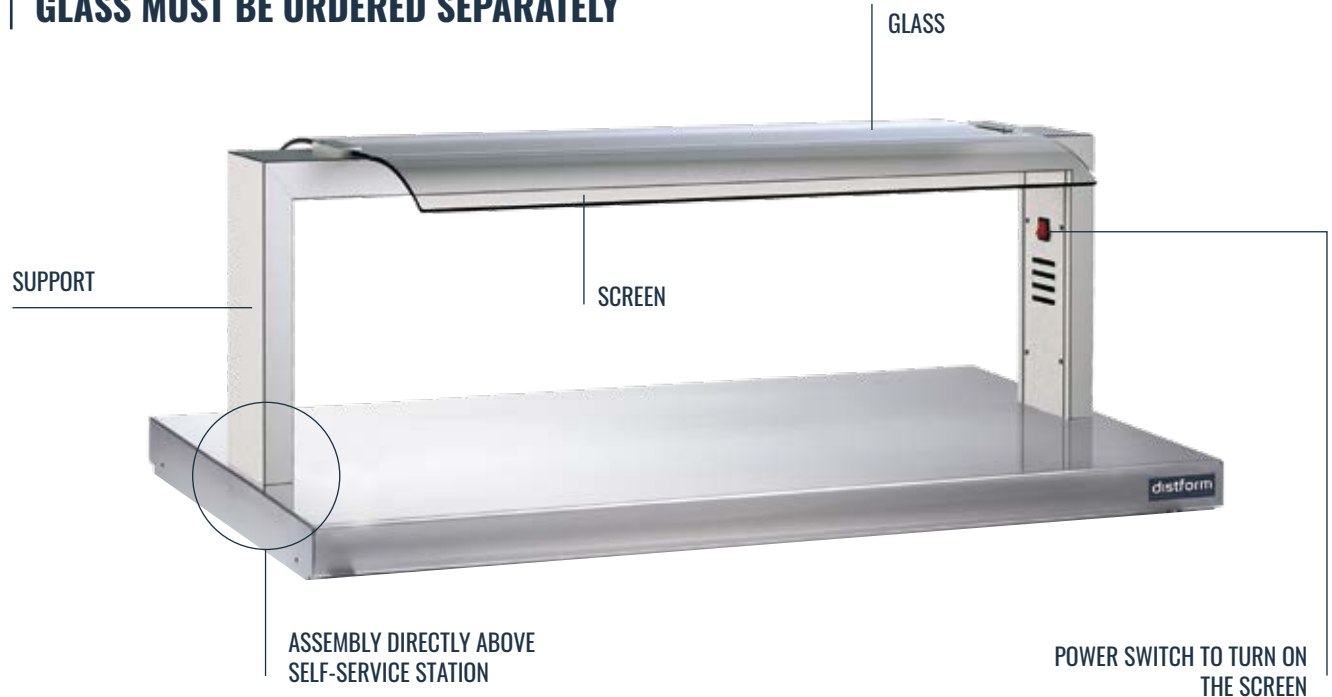

## SUPPORTS WITH SCREEN

- Made from AISI grade 304 stainless steel (18/10).
- Highest-quality finish.
- Exceptionally sturdy single-piece chassis.
- Easy installation on self-service stations.
- Easy access to the installation for maintenance.
- Screens with light: LED lighting.
- Screens with halogen lighting and ceramic heating.
- Power supply (V/Hz) 230/50-60.



## NEUTRAL SUPPORTS

Capacity	Code
3 GN 1/1	• PDN103GN
4 GN 1/1	• PDN104GN
6 GN 1/1	• PDN106GN

## SUPPORTS WITH LED LIGHTING

Capacity	Power (W)	Code
3 GN 1/1	12	• PDL103GN
4 GN 1/1	14	• PDL104GN
6 GN 1/1	18	• PDL106GN

## SUPPORTS WITH HALOGEN LIGHTING AND CERAMIC HEATING

Capacity	Power (W)	Code
3 GN 1/1	710	• PDC103GN
4 GN 1/1	960	• PDC104GN
6 GN 1/1	1440	• PDC106GN





# GLASS FOR SELF-SERVICE SUPPORTS

## GLASS

- Tempered safety glass to hygienically protect food.
- The front glass includes hardware kit for installation.



**TWO-SURFACE CURVED GLASS**

Capacity	Code
3 GN 1/1	• FCRC13GN
4 GN 1/1	• FCRC14GN
6 GN 1/1	• FCRC16GN



**TWO-SURFACE CURVED GLASS FRONT PIECE**

Capacity	Code
3 GN 1/1	• FCRF13GN
4 GN 1/1	• FCRF14GN
6 GN 1/1	• FCRF16GN

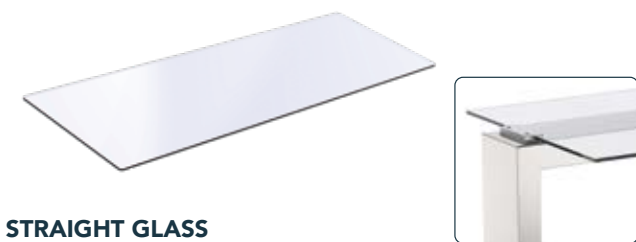

**STRAIGHT GLASS**

Capacity	Code
3 GN 1/1	• CDR103GN
4 GN 1/1	• CDR104GN
6 GN 1/1	• CDR106GN



**FRONT PIECE FOR STRAIGHT GLASS**

Capacity	Code
3 GN 1/1	• CDF103GN
4 GN 1/1	• CDF104GN
6 GN 1/1	• CDF106GN

# ACCESSORIES

## DIGITAL THERMOMETER

To display the working temperature of the drop-in.

- Ideal for ice strips, cold-food wells, hot-food wells and hot plates.
- Easy to install on any support with screen.



Code
• SLT00001

## SIDE GLASS



Shape	Code
Curved	• CDLC0001
Straight	• CDLR0001

# SLOPED SUPPORTS WITH SCREENS FOR SELF-SERVICE

## SUPPORTS WITH SCREENS AND GLASS MUST BE ORDERED SEPARATELY

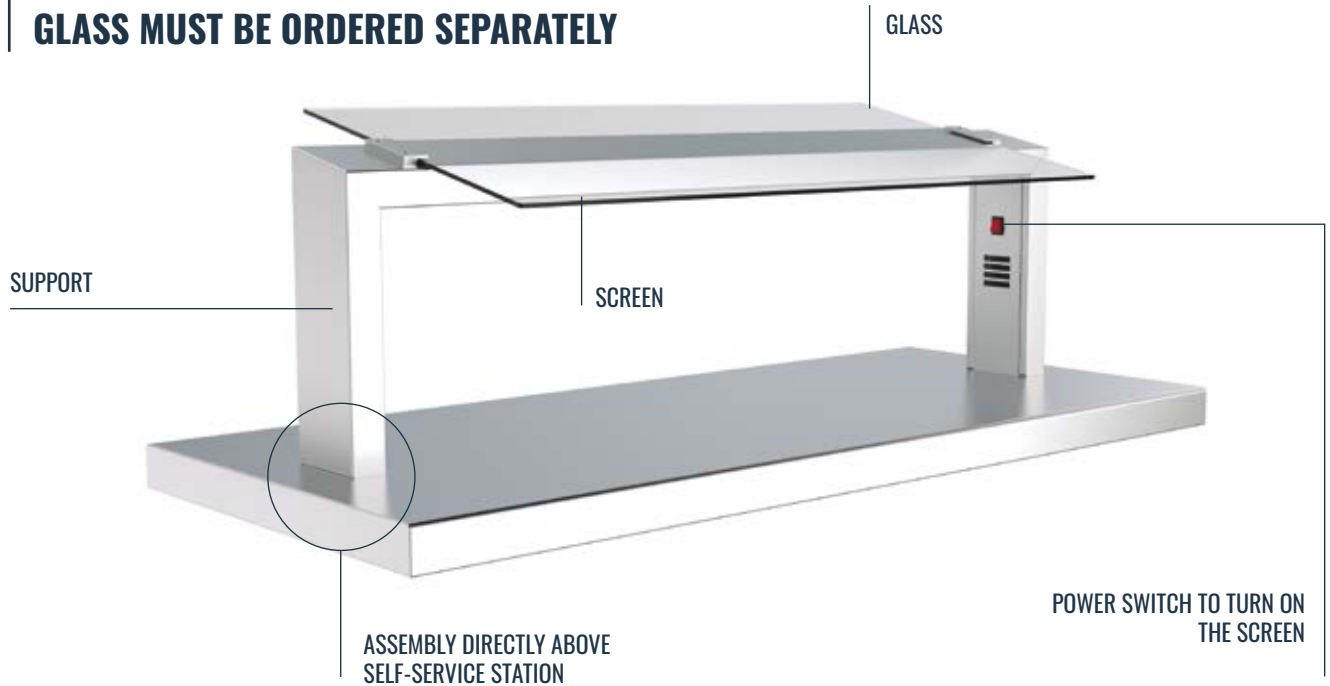

## SLOPED SUPPORTS WITH SCREEN

- Made from AISI grade 304 stainless steel (18/10).
- Highest-quality finish.
- Exceptionally sturdy single-piece chassis.
- Easy installation on self-service stations.
- Easy access to the installation for maintenance.
- Screens with light: LED lighting.
- Screens with halogen lighting and ceramic heating.
- Power supply (V/Hz) 230/50-60.



## NEUTRAL SUPPORTS

Capacity	Code
3 GN 1/1	• PDNI13GN
4 GN 1/1	• PDNI14GN
6 GN 1/1	• PDNI16GN

## SUPPORTS WITH LED LIGHTING

Capacity	Power (W)	Code
3 GN 1/1	12	• PDLI13GN
4 GN 1/1	14	• PDLI14GN
6 GN 1/1	18	• PDLI16GN

## SUPPORTS WITH HALOGEN LIGHTING AND CERAMIC HEATING

Capacity	Power (W)	Code
3 GN 1/1	710	• PDCI13GN
4 GN 1/1	960	• PDCI14GN
6 GN 1/1	1440	• PDCI16GN



# GLASS FOR SLOPED SUPPORTS FOR SELF-SERVICE

## GLASS

- Tempered safety glass to hygienically protect food.
- The front glass includes hardware kit for installation.

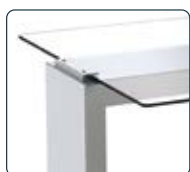

### STRAIGHT GLASS

Capacity	Code
3 GN 1/1	• CDR103GN
4 GN 1/1	• CDR104GN
6 GN 1/1	• CDR106GN

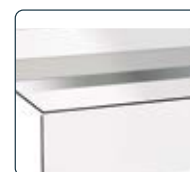

### FRONT PIECE FOR STRAIGHT GLASS

Capacity	Code
3 GN 1/1	• FCRF13GN
4 GN 1/1	• FCRF14GN
6 GN 1/1	• FCRF16GN

# ACCESSORIES

## DIGITAL THERMOMETER

To display the working temperature of the drop-in.

- Ideal for ice strips, cold-food wells, hot-food wells and hot plates.
- Easy to install on any support with screen.



Code
• SLT00001

## SIDE GLASS

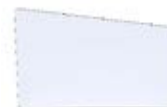

Shape	Code
Sloped	• CDLI0001



DISTRIBUCIÓN Y EXPOSICIÓN DE ALIMENTOS

# CHILDREN'S SELF-SERVICE



## COLD ELEMENTS

PAGE 240



## HOT ELEMENTS

PAGE 243



## NEUTRAL ELEMENTS

PAGE 246



## ACCESSORIES

PAGE 249



## SUPPORTS AND GLASS

PAGE 252

# CHILDREN'S SELF-SERVICE

## MADE-TO-MEASURE UNITS FOR CHILDREN



\* Possibility to decorate using adhesive vinyl.  
(service not included in Distform catalogue)

### 01 Safety

Thanks to an ergonomic shape and reduced height, our line of children's self-service products offers diners a safe user experience. Neutral elements with tray slides prevent children from accessing hot containers, reducing the risk of burns.

### 02 Modular system

The modular design makes it possible to combine multiple independent elements, rendering installation quicker and easier. This helps to optimise the space in which the children's self-service stations are placed, making them more practical.

### 03 Customisation

Multiple customisation options with decorative panels in solid colours or wood grains. In addition to its clean appearance thanks to seamless finishes, this line offers a world of possibilities for commercial kitchens.

## NEW CHILDREN SELF-SERVICE UNITS FOR SCHOOL CAFETERIA, BUFFETS...

Our new line of children's self-service products is especially adapted to the needs of children, making them ideal for installation in school canteens, buffet restaurants, hotels, etc. Low height and ergonomic design facilitate optimal use by the little ones.

The various elements comprising our line of children's self-service products are made with the highest quality AISI 304 18/10 stainless steel, giving them a unique guarantee of hygiene and durability.



### R290 ECO-POWER REFRIGERANT

The R290 ECO-POWER refrigerant used in the cold elements of this self-service line is the most eco-friendly refrigerant on the market. R290 is efficient and has a low contamination risk, ensuring energy saving and profitability.



# COLD ELEMENTS

## CHILDREN'S SELF-SERVICE COLD PLATE UNIT

For maintaining and displaying cold dishes or beverages at the correct temperature during food service.

- Made from AISI grade 304 stainless steel (18/10).
- Countertop with 65 mm front piece with rounded finish, fully welded.
- Coil refrigeration and hermetic compressor with R290 refrigerant.
- For best refrigeration results, there should be sufficient distance between the front/rear part of the unit and other nearby items that could hinder the performance of the condenser unit.
- Insulated with eco-friendly, HFC-free extruded polystyrene foam.
- Digital thermostat for regulating and controlling temperature.
- 150 mm legs to allow you to raise the height of the unit from 700 mm to 750 mm.
- Removable side panels for easy access to electrical area and compressor.
- Removable front piece to facilitate access to the compressor.
- Stainless steel front panel, decorative panel optional.
- Tray slides, screen and glass not included.



RELATED PRODUCTS

TRAY SLIDES page 249

DECORATIVE PANELS page 249

SUPPORTS AND GLASS page 252



### WITHOUT RESERVE CABINET

Capacity	Total dimensions (mm)	Power (W)	Power supply (V/Hz)	Code
3 GN 1/1	1200 x 700 x 700	480	230/50	• S2001201
4 GN 1/1	1600 x 700 x 700	720	230/50	• S2001202





## CHILDREN'S SELF-SERVICE COLD WELL UNIT

For maintaining and displaying cold dishes or beverages at the correct temperature during food service.

- Made from AISI grade 304 stainless steel (18/10).
- Countertop with 65 mm front piece with rounded finish, fully welded.
- Well has safety edges to facilitate cleaning.
- For GN containers with a maximum depth of 150 mm.
- Coil refrigeration and hermetic compressor with R290 refrigerant.
- For best refrigeration results, there should be sufficient distance between the front/rear part of the unit and other nearby items that could hinder the performance of the condenser unit.
- Insulated with eco-friendly, HFC-free extruded polystyrene foam.
- Digital thermostat for regulating and controlling temperature.
- 150 mm legs to allow you to raise the height of the unit from 700 mm to 750 mm.
- Removable side panels for easy access to electrical area and compressor.
- Removable front piece to facilitate access to the compressor.
- Stainless steel front panel, decorative panel optional.
- Tray slides, screen and glass not included.



### RELATED PRODUCTS

**TRAY SLIDES** page 249

**DECORATIVE PANELS** page 249

**SUPPORTS AND GLASS** page 252



### WITHOUT RESERVE CABINET

Capacity	Total dimensions (mm)	Power (W)	Power supply (V/Hz)	Code
3 GN 1/1	1200 x 700 x 700	380	230/50	• S2001701
4 GN 1/1	1600 x 700 x 700	480	230/50	• S2001702



# COLD ELEMENTS

## REFRIGERATED GLASS DISPLAY CASE WITH 3 LEVELS FOR CHILDREN'S SELF-SERVICE

For maintaining and displaying cold dishes or beverages at the correct temperature during food service.

- Made from AISI 304 stainless steel (18/10).
- Glazed glass with three surfaces, laminated glass sliding doors on rear section of unit, interior lighting, three shelves and swinging methacrylate doors or folding thermo-screen doors, depending on the model.
- Master switch and adjustable digital thermostat.
- Working temperature of +10°C in room temperature of +25°C.
- Can be adapted to fit with neutral or cold units.
- Ventilated refrigeration and hermetic compressor with R290 refrigerant.
- For best refrigeration results, there should be sufficient distance between the front/rear part of the unit and other nearby items that could hinder the performance of the condenser unit.
- Space for hermetic compressor, refrigerant in upper section.
- Side glass with chamber.
- Cold-food well unit and tray slides not included.



RELATED PRODUCTS

**TRAY SLIDES** page 249  
**DECORATIVE PANELS** page 249

### EXAMPLE OF POSSIBLE CONFIGURATION

Without reserve cabinet	Code
Glass display case without base 4 GN 1/1 with swinging doors	S1001001
Children's self-service cold well 4 GN 1/1 without reserve cabinet	S2001702
4GN Tray slides	S1020003
Green decorative panel 1600 (4GN)	S2040907



Thermo-screen close-up



Swinging doors close-up

### WITHOUT BASE

Capacity	Model	Total dimensions (mm)	Power (W)	Power supply (V/Hz)	Code
4 GN 1/1	Swinging doors	1550 x 660 x 1150	800	230/50	• S1001001
4 GN 1/1	Thermo-screen	1550 x 660 x 1150	800	230/50	• S1C01001



### WITH INSULATED BASE

Capacity	Model	Total dimensions (mm)	Power (W)	Power supply (V/Hz)	Code
4 GN 1/1	Swinging doors	1550 x 660 x 1150	800	230/50	• S1001002
4 GN 1/1	Thermo-screen	1550 x 660 x 1150	800	230/50	• S1C01002



# HOT ELEMENTS

## CHILDREN'S SELF-SERVICE BAIN-MARIE UNIT

For maintaining and displaying hot food at the correct temperature during food service.

- Made from AISI grade 304 stainless steel (18/10).
- Countertop with 65 mm front piece with rounded finish, fully welded.
- Well has safety edges to facilitate cleaning.
- For GN pans with a maximum depth of 200 mm.
- Indirectly heats water via silicone heating elements located in the bottom of the well.
- Silicone heating elements improve performance and reduce energy usage.
- Digital thermostat ranging from 0°C to 90°C regulates temperature of the bain-marie.
- 1/2" water intake and drain pipes with ball valve are ergonomically positioned.
- 150mm legs allow you to raise the height of the unit from 850 to 900mm.
- Safety thermostat.
- Removable side panels for easy access to electrical area and plumbing.
- Stainless steel front panel, decorative panel optional.
- Containers, tray slides, screen and glass not included.

RELATED PRODUCTS

- TRAY SLIDES page 249
- DECORATIVE PANELS page 249
- SUPPORTS AND GLASS page 252



### WITHOUT RESERVE CABINET

Capacity	Total dimensions (mm)	Power (W)	Power supply (V/Hz)	Code
3 GN 1/1	1200 x 700 x 850	2400	230/50-60	• S2000601
4 GN 1/1	1600 x 700 x 850	3200	230/50-60	• S2000602



### WITH HOT RESERVE CABINET

Capacity	Total dimensions (mm)	Power (W)	Power supply (V/Hz)	Code
3 GN 1/1	1200 x 700 x 850	4400	380/50-60	• S2000701
4 GN 1/1	1600 x 700 x 850	5200	380/50-60	• S2000702



# HOT ELEMENTS

## CHILDREN'S SELF-SERVICE DRY BAIN-MARIE UNIT

**For maintaining and displaying hot food at the correct temperature during food service.**

- Made from AISI grade 304 stainless steel (18/10).
- Countertop with 65 mm front piece with rounded finish, fully welded.
- For GN pans with a maximum depth of 150 mm.
- Digital thermostat ranging from 0°C to 90°C regulates temperature of the bain-marie.
- 150mm legs allow you to raise the height of the unit from 850 to 900mm.
- Safety thermostat.
- Removable side panels for easy access to electrical area.
- Perforated false bottom protects heating elements.
- Stainless steel front panel, decorative panel optional.
- Tray slides, screen, and glass not included.

RELATED PRODUCTS

**TRAY SLIDES** page 249  
**DECORATIVE PANELS** page 249  
**SUPPORTS AND GLASS** page 252



### WITHOUT RESERVE CABINET

Capacity	Total dimensions (mm)	Power (W)	Power supply (V/Hz)	Code
3 GN 1/1	1200 x 700 x 850	1200	230/50-60	• S2000501
4 GN 1/1	1600 x 700 x 850	1600	230/50-60	• S2000502



### WITH HOT RESERVE CABINET

Capacity	Total dimensions (mm)	Power (W)	Power supply (V/Hz)	Code
3 GN 1/1	1200 x 700 x 850	3200	230/50-60	• S2001511
4 GN 1/1	1600 x 700 x 850	3600	230/50-60	• S2001512



## CHILDREN'S SELF-SERVICE TEMPERED GLASS HOT PLATE UNIT

For maintaining and displaying hot food at the correct temperature during food service.

- Made from AISI grade 304 stainless steel (18/10).
- Countertop with 65 mm front piece with rounded finish, fully welded.
- 150 mm legs allow you to raise the height of the unit from 850 to 900 mm.
- Stainless steel front panel, decorative panel optional.
- Digital thermostat included in all models.
- Silicone heating elements improve performance and reduce energy usage.
- Safety thermostat.
- Removable side panels for easy access to electrical area.
- Tray slides not included.

### RELATED PRODUCTS

**TRAY SLIDES** page 249  
**DECORATIVE PANELS** page 249  
**SUPPORTS AND GLASS** page 252



### WITHOUT RESERVE CABINET

Capacity	Total dimensions (mm)	Power (W)	Power supply (V/Hz)	Code
3 GN 1/1	1200 x 700 x 850	2400	230/50-60	• S2001813
4 GN 1/1	1600 x 700 x 850	3200	230/50-60	• S2001814



### WITH HOT RESERVE CABINET

Capacity	Total dimensions (mm)	Power (W)	Power supply (V/Hz)	Code
3 GN 1/1	1200 x 700 x 850	4400	380/50-60	• S2001823
4 GN 1/1	1600 x 700 x 850	5200	380/50-60	• S2001824



# NEUTRAL ELEMENTS

## NEUTRAL CHILDREN'S SELF-SERVICE UNIT

**Designed to accommodate catering or food items on the countertop which do not require temperature regulation.**

- Made from AISI grade 304 stainless steel (18/10).
- Countertop with 65 mm front piece with rounded finish, fully welded.
- 150 mm legs to allow you to raise the height of the unit from 700 mm to 750 mm.
- Stainless steel front panel, decorative panel optional.
- Open rear section for tableware storage.
- Tray slides, screen and glass not included.

RELATED PRODUCTS

**TRAY SLIDES** page 249

**DECORATIVE PANELS** page 249

**SUPPORTS AND GLASS** page 252



Total dimensions (mm)	Code
500 x 700 x 700	• S2000300
800 x 700 x 700	• S2000301
1200 x 700 x 700	• S2000302
1600 x 700 x 700	• S2000303

NEUTRAL CHILDREN'S SELF-SERVICE UNIT DIMENSIONS

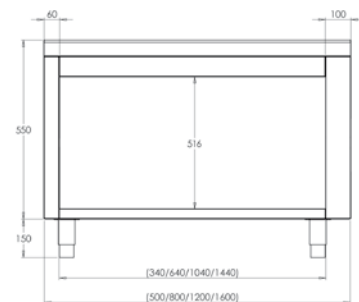

## CHILDREN'S SELF-SERVICE SIDE UNIT FOR HOT SELF-SERVICE

**For serving hot food in a totally safe manner for children. The unit is placed at the side of the hot self-service unit and food is served on the tray slides with no danger to children.**

- Made from AISI grade 304 stainless steel (18/10).
- Countertop with 65 mm front piece with rounded finish, fully welded.
- 150 mm legs to allow you to raise the height of the unit from 700 mm to 750 mm.
- Joining kit included to attach unit to the hot self-service station.
- Must be joined to and flanked by two units.
- Stainless steel front panel, decorative panel optional.
- Tray slides not included.

Total dimensions (mm)	Code
1200 x 240 x 700	• S1000314



## CHILDREN'S SELF-SERVICE CORNER UNIT

For joining two self-service units at a corner. Forms interior and exterior angles of 90° and 45°.

- Made from AISI grade 304 stainless steel (18/10).
- Countertop with 65 mm front piece with rounded finish, fully welded.
- 150 mm legs to allow you to raise the height of the unit from 700 mm to 750 mm.
- Stainless steel front panel, decorative panel optional.



### RELATED PRODUCTS

**TRAY SLIDES** page 249

**DECORATIVE PANELS** page 249



MODEL S1000411  
DIMENSIONS

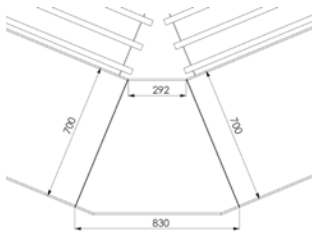

MODEL S1000412  
DIMENSIONS

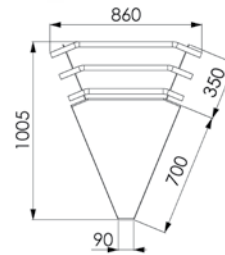

MODEL S1000401  
DIMENSIONS

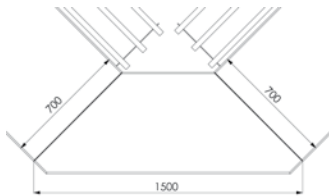

MODEL S1000402  
DIMENSIONS

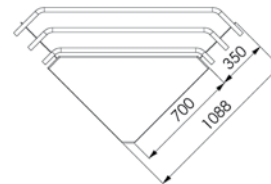

### INTERIOR

Model	Total dimensions (mm)	Code
45°	830 x 680 x 700	• S2000411
90°	1500 x 560 x 700	• S2000401

### EXTERIOR

Model	Total dimensions (mm)	Code
45°	620 x 690 x 700	• S2000412
90°	1060 x 570 x 700	• S2000402

- Includes middle shelf.
- Tray slides not required.

- Tray slides not included.

# NEUTRAL ELEMENTS

## CLOSED RECYCLING CABINET

**Ideal for sorting waste.**

- Made of AISI 304 18/10 stainless steel.
- 65 mm front piece with rounded finish, fully welded.
- Fully welded 105 mm rear bumper on wall-mounted models.
- 150 mm legs to raise the height of the unit from 700 to 750 mm.
- 50 mm advanced rear legs that allow the furniture to be placed on floors with a cleaning radius.
- Swing doors.
- Two or three Ø 190-280 mm holes for rubber rings.
- Coloured rubber rings not included.
- **No assembly required.**

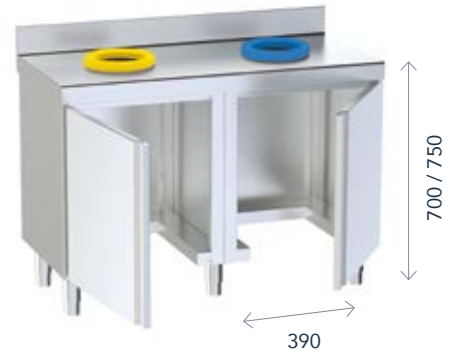

**RELATED PRODUCTS**

**COVER FOR WASTE CHUTE RING** page 80



### CHILDREN'S CENTRE

Total dimensions (mm)	Holes	Code
1200 x 600 x 700	2	• F0072011
1500 x 600 x 700	3	• F0072012

### CHILDREN'S MURAL

Total dimensions (mm)	Holes	Code
1200 x 600 x 700	2	• F0072009
1500 x 600 x 700	3	• F0072010

## RUBBER WASTE RING

**Facilitates the identification of the container.**

- Detachable.
- Easy to clean and disinfect.

Colour	Code
Red — Organic	• ARO000RO
Green — Glass	• ARO000VE
Yellow — Plastic	• ARO000AM
Blue — Paper	• ARO000AZ





# ACCESSORIES

## TRAY SLIDES

- Made from AISI grade 304 stainless steel (18/10).
- Can be adjusted to facilitate alignment.
- Decorative chrome end caps.
- Assembly required (sold unattached to self-service units).



For self-service units	Total dimensions (mm)	Code
3 GN, neutral 1200 mm	1200 x 350	• S1020002
4 GN and 1600 mm neutral	1600 x 350	• S1020003
500 mm neutral	500 x 350	• S1020006
800 mm neutral	800 x 350	• S1020001
Exterior 45° corner	804 x 350	• S1020009
Exterior 90° corner	1490 x 350	• S1020010

## DECORATIVE PANELS WITH A WOOD GRAIN FINISH

- Comes in stainless steel as standard.
- Customise your self-service line with decorative panels, available in solid colour or grain finishes.
- Panels are supplied separately.



## SOLID FINISH

For self-service units	Violet	Orange	Red	Green
500	• S2010901	• S2020901	• S2030901	• S2040901
800	• S2010902	• S2020902	• S2030902	• S2040902
1200	• S2010905	• S2020905	• S2030905	• S2040905
1600	• S2010907	• S2020907	• S2030907	• S2040907
Exterior 90° corner	• S2010909	• S2020909	• S2030909	• S2040909
Interior 90° corner	• S2010910	• S2020910	• S2030910	• S2040910
Exterior 45° corner	• S2010911	• S2020911	• S2030911	• S2040911
Interior 45° corner	• S2010912	• S2020912	• S2030912	• S2040912

## WOOD-GRAIN FINISH

For self-service units	Wenge	Natural Oak	Tobacco Oak
500	• S2110911	• S2120911	• S2130911
800	• S2110912	• S2120912	• S2130912
1200	• S2110915	• S2120915	• S2130915
1600	• S2110917	• S2120917	• S2130917
Exterior 90° corner	• S2110919	• S2120919	• S2130919
Interior 90° corner	• S2110920	• S2120920	• S2130920
Exterior 45° corner	• S2110921	• S2120921	• S2130921
Interior 45° corner	• S2110922	• S2120922	• S2130922

# ACCESSORIES

## TRAY, UTENSIL AND BREAD CHUTE DISPENSER

- Made of AISI grade 304 stainless steel (18/10).
- High-capacity bread chute.
- Double shelf for trays and glasses.
- Utensil holder made of food-grade PVC.
- Removable tray to collect bread crumbs.

### FREESTANDING

Total dimensions (mm)	Code
800 x 700 x 1350	• S2000001

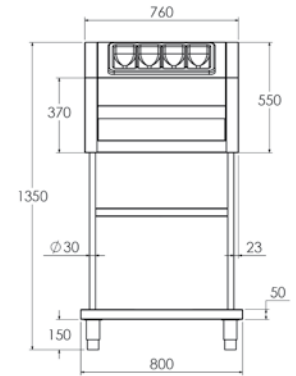

## UTENSIL AND BREAD DISPENSER

- Made from AISI grade 304 stainless steel (18/10).
- High-capacity bread chute.
- Utensil holder made of food-grade PVC.
- Removable tray to collect bread crumbs.

### COUNTERTOP

Total dimensions (mm)	Code
760 x 660 x 550	• S1000201

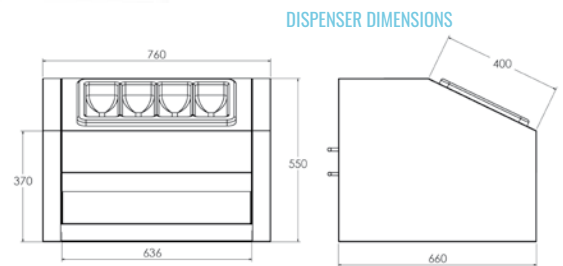

## HAND RAIL

- Made of Ø40 mm AISI grade 304 stainless steel (18/10).
- Welded plates with holes for floor installation (screws and anchors included).

Total dimensions (mm)	Code
1200 x 900	• S1020801



## SELF-SERVICE CASTOR PACK

- 4 Ø150 mm castors (2 with brakes).
- Comes installed in the self-service unit.

Model	Code
4 castors	• F1020301



## GLASS DISPENSER

- Made from AISI grade 304 stainless steel (18/10).
- Fully welded.
- 150 mm adjustable legs on the freestanding model.
- 30 mm round tubular legs on the countertop model.

### FREESTANDING (4 SHELVES)

Total dimensions (mm)	Code
610 x 650 x 1372	• S2100705

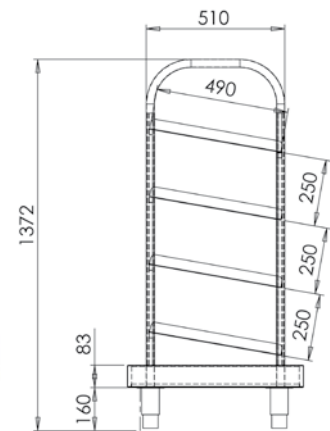

### COUNTERTOP (3 SHELVES)

Total dimensions (mm)	Code
570 x 510 x 990	• S1100707

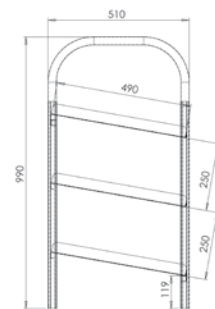

## BASEBOARDS

For self-service units	Total dimensions (mm)	Code
3 GN, neutral 1200 mm	1200 x 149	• S1030002
4 GN and 1600 mm neutral	1600 x 149	• S1030003
500 mm neutral	500 x 149	• S1030006
800 mm neutral	800 x 149	• S1030001
Exterior 90° corner	1018 x 149	• S1030012
Interior 90° corner	570 x 149	• S1030011
Exterior 45° corner	590 x 149	• S1030009
Interior 45° corner	292 x 149	• S1030013
Side baseboard	640 x 149	• S1030015



# SUPPORTS WITH SCREENS FOR SELF-SERVICE

## SUPPORTS WITH SCREENS AND GLASS MUST BE ORDERED SEPARATELY

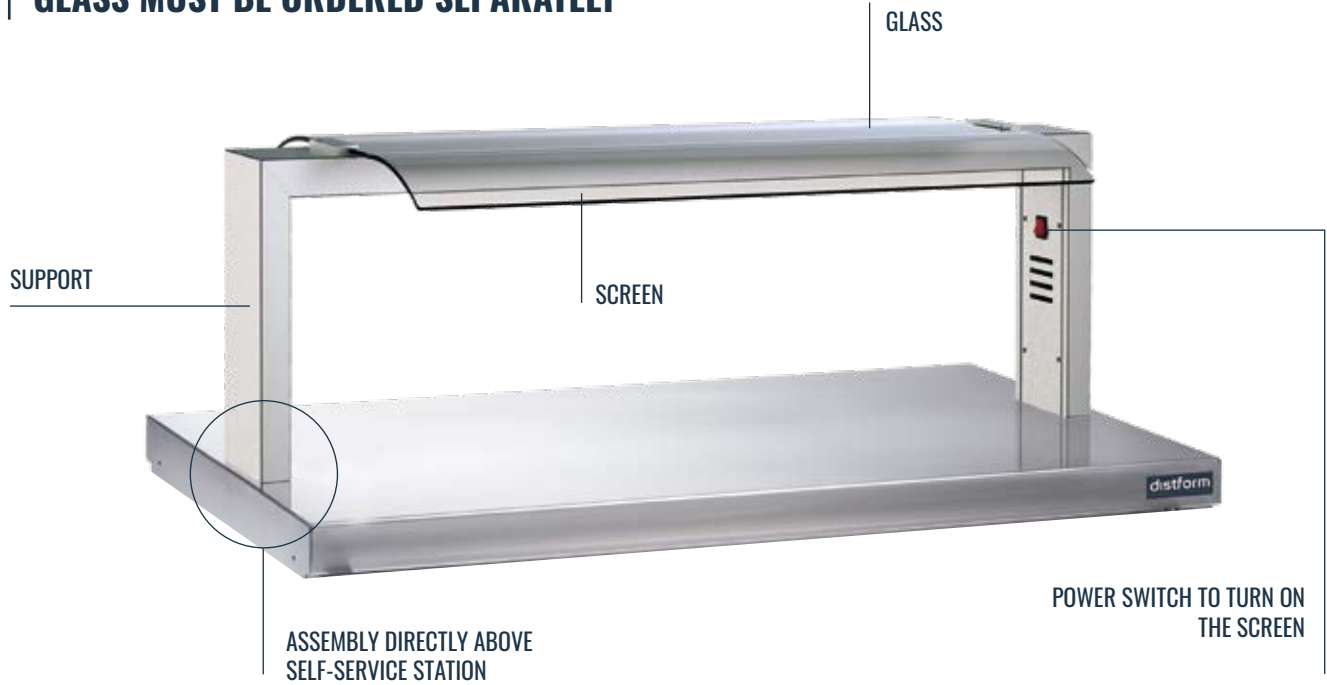

## SUPPORTS WITH SCREEN

- Made from AISI grade 304 stainless steel (18/10).
- Highest-quality finish.
- Exceptionally sturdy single-piece chassis.
- Easy installation on the children's self-service station.
- Easy access to the installation for maintenance.
- Screens with light: LED lighting.
- Screens with halogen lighting and ceramic heating.
- Power supply (V/Hz) 230/50-60.



### NEUTRAL SUPPORTS

Capacity	Code
3 GN 1/1	• PDN103GN
4 GN 1/1	• PDN104GN

### SUPPORTS WITH LED LIGHTING

Capacity	Power (W)	Code
3 GN 1/1	12	• PDL103GN
4 GN 1/1	14	• PDL104GN

### SUPPORTS WITH HALOGEN LIGHTING AND CERAMIC HEATING

Capacity	Power (W)	Code
3 GN 1/1	710	• PDC103GN
4 GN 1/1	960	• PDC104GN



# GLASS FOR SELF-SERVICE SUPPORTS

## GLASS

- Tempered safety glass to hygienically protect food.
- The front glass includes hardware kit for installation.



**TWO-SURFACE CURVED GLASS**

Capacity	Code
3 GN 1/1	• FCRC13GN
4 GN 1/1	• FCRC14GN



**TWO-SURFACE CURVED GLASS FRONT PIECE**

Capacity	Code
3 GN 1/1	• FCRF13GN
4 GN 1/1	• FCRF14GN



**STRAIGHT GLASS**

Capacity	Code
3 GN 1/1	• CDR103GN
4 GN 1/1	• CDR104GN



**FRONT PIECE FOR STRAIGHT GLASS**

Capacity	Code
3 GN 1/1	• CDF103GN
4 GN 1/1	• CDF104GN

# ACCESSORY

## DIGITAL THERMOMETER

To display the working temperature of the drop-in.

- Ideal for ice strips, cold-food wells, hot-food wells and hot plates.
- Easy to install on any support with screen.



Code
• SLT00001

## SIDE GLASS

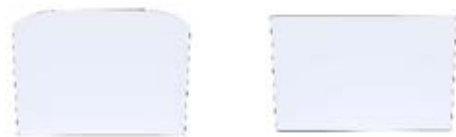

Shape	Code
Curved	• CDLC0001
Straight	• CDLR0001

# SLOPED SUPPORTS WITH SCREENS FOR SELF-SERVICE

**SUPPORTS WITH SCREENS AND GLASS MUST BE ORDERED SEPARATELY**

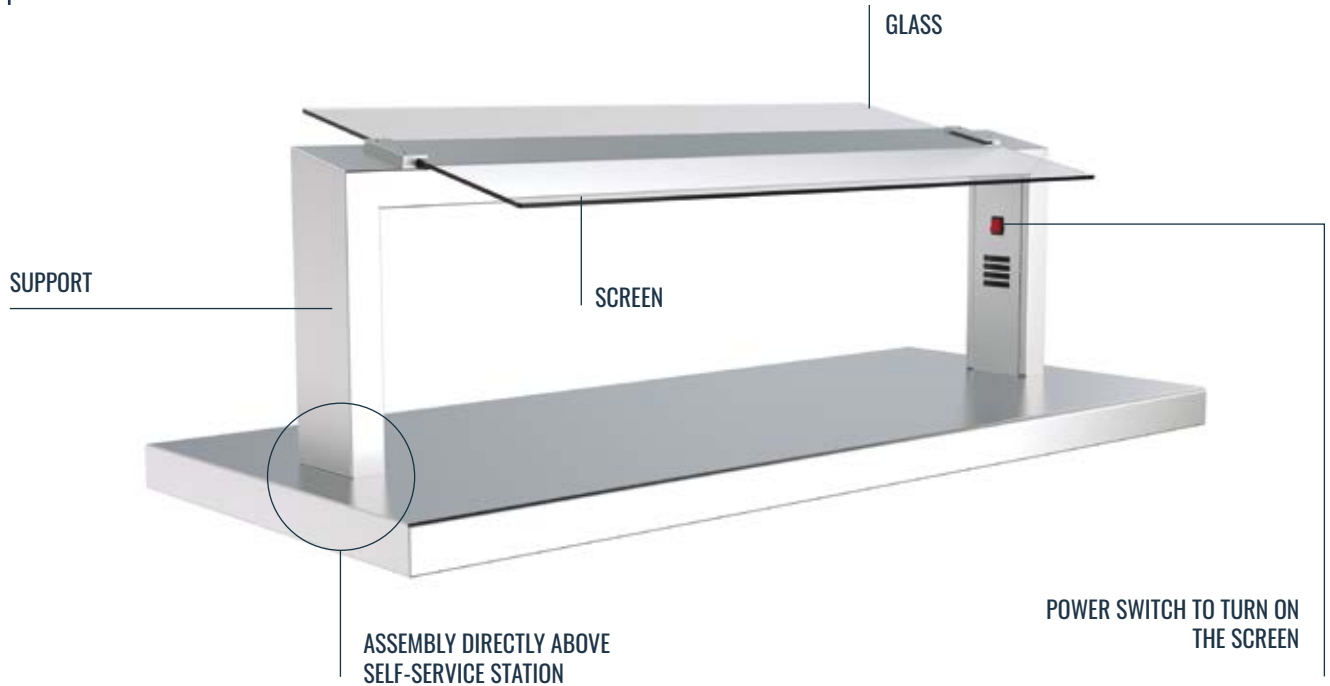

## SLOPED SUPPORTS WITH SCREEN

- Made from AISI grade 304 stainless steel (18/10).
- Highest-quality finish.
- Exceptionally sturdy single-piece chassis.
- Easy installation on the children's self-service station.
- Easy access to the installation for maintenance.
- Screens with light: LED lighting.
- Screens with halogen lighting and ceramic heating.
- Power supply (V/Hz) 230/50-60.



## NEUTRAL SUPPORTS

Capacity	Code
3 GN 1/1	• PDNI13GN
4 GN 1/1	• PDNI14GN

## SUPPORTS WITH LED LIGHTING

Capacity	Power (W)	Code
3 GN 1/1	12	• PDLI13GN
4 GN 1/1	14	• PDLI14GN

## SUPPORTS WITH HALOGEN LIGHTING AND CERAMIC HEATING

Capacity	Power (W)	Code
3 GN 1/1	710	• PDCI13GN
4 GN 1/1	960	• PDCI14GN



# GLASS FOR SLOPED SUPPORTS FOR SELF-SERVICE

## GLASS

- Tempered safety glass to hygienically protect food.
- The front glass includes hardware kit for installation.

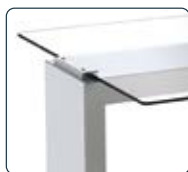
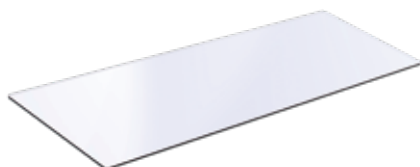

### STRAIGHT GLASS

Capacity	Code
3 GN 1/1	• CDR103GN
4 GN 1/1	• CDR104GN

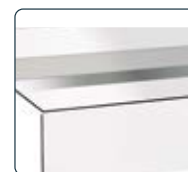

### FRONT PIECE FOR STRAIGHT GLASS

Capacity	Code
3 GN 1/1	• FCRF13GN
4 GN 1/1	• FCRF14GN

# ACCESSORY

## DIGITAL THERMOMETER

To display the working temperature of the drop-in.

- Ideal for ice strips, cold-food wells, hot-food wells and hot plates.
- Easy to install on any support with screen.



Code
• SLT00001

## SIDE GLASS

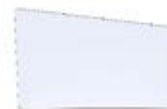

Shape	Code
Sloped	• CDLI0001



# CONDITIONS OF SALE

## 1. PRICES

The prices shown in this price list are in euros and do not include the tax rates established by law. In any case, they do not include installation, commissioning or accessories.

## 2. METHODS OF PAYMENT

The payment conditions for each client are the ones agreed with DISTFORM, S.L.U., being as a general rule the following:- Until the classification and risk of a client is granted, all operations will be paid by means of advance payment.- Payments of less than 1.500€ will not be split.- The products are property of DISTFORM, S.L.U., In the case of non-payment, no order will be dispatched until it is settled, as long as there is no incidence on it.

## 3. ORDERS

- Any modification to the initial quotation is subject to a separate quotation and acceptance of the original order.

- The delivery times indicated in this tariff are indicative and failure to comply with them shall not be grounds for any claim whatsoever.

- The delivery times indicated in this tariff are indicative and failure to comply with them shall not be grounds for any claim whatsoever.

- The total or partial cancellation of the order will not be valid if the products have already left Distform's warehouses or on the same day of dispatch.

- An order containing a product with a particular manufacturing feature may not be cancelled. Specifically, the following items will not be accepted for return:

1. Articles with customisation
2. Articles requiring special manufacture
3. Articles assembled or with accessories that modify their structure such as holes or elements added by mechanical or adhesive bonding.
4. Obsolete spare parts with associated procurement order.

5. Self-service / Drop-in lines

6. Modules and worktops for compositions

- Distform reserves the right to modify prices without prior notice and to replace the materials in the catalogue with others of similar quality and characteristics.

## 4. TRANSPORT

Delivery terms are EXW Distform, 25123 Torrefarrera/Spain. Special packaging or shipping options may be only done at customer's expense. (The mentioned shipping times, marked with the different colours, mean the production times. This is, when the product is ready for pick-up. Does not include transport nor transit times.)

## 5. CONFORMITY OF DELIVERY

In case of any special delivery agreement, and if the customer does not notify Distform immediately of any possible problem or defect at the time of delivery reception, the customer shall have 24 hours to notify us directly by sending a copy of the document to Distform.

If the above mentioned 24 hour time frame is not met, the customer waives any right to file a claim for the merchandise.

The transportation company shall not be responsible for claims filed outside of the established 24 hour time period.

## 6. RETURNS

Returns will not be accepted without prior express written consent from Distform. Our warehouse will automatically reject any unauthorized returns.

Only products with 24-hour shipping periods will be accepted for returns.

Returns may only be accepted if unused, in perfect condition, and in their original packaging. Returns must be made within 30 days of invoicing.

In the event that Distform must reimburse a sum against a previous order's invoice, the amount will be determined based on the condition of the materials returned.



In all such cases, Distform will discount at least 20% of the refund total as an administrative fee. Shipping and handling will always be billed to the Customer.

## 7. RESERVATION OF TITLE

The goods remain the property of Distform until they have been paid for in full by the Client. In the event of non-payment by the Client, Distform may collect the goods affected, reserving the right to claim for any damages that may arise from this. In any case, the costs derived from the withdrawal of the products will be invoiced to the Client.

## 8. WARRANTY

**Legal Guarantee of Conformity:** In accordance with the provisions of Royal Legislative Decree 1/2007, all products sold by Distform S.L.U. benefit from a legal guarantee of conformity which has a duration of 1 year for new products. Deficiencies caused by negligence, knocks, improper use or manipulation, unsuitable voltage, incorrect installation, or materials subject to wear and tear due to normal use are not included.

**Commercial Manufacturer's Warranty:** All products sold by Distform S.L.U. include the official manufacturer's warranty, which in addition to manufacturing defects also covers possible breakdowns that may occur during the warranty period. In the event that Distform S.L.U. arranges the repair of your product with the corresponding authorised workshop of the brand, the shipping costs to our returns centre will be paid by DISTFORM, S.L.U. (as long as it is not a case of non-conformity of origin).

The guarantees do not apply in the following cases:

- Deterioration created by adaptations or adjustments (other than normal operating adjustments) or modifications made to a product without written agreement with the manufacturer.
- All matters relating to periodic maintenance, repair or replacement of parts due to normal wear and tear. The replacement of consumables (batteries, bulbs, fuses, glass, power cables, etc.).

- Deterioration created by improper use of the product or failure to follow the manufacturer's instructions regarding the use and maintenance of the product and incorrect installation. This includes discolouration, rust or corrosion of the appliance or any of its components.

- Damage caused by non-accredited persons or by the users themselves.

- Damage caused by accident, lightning, flood, fire, bad aeration or any other cause of force majeure.

- If the model or serial number on the product has been changed.

- Those products already repaired by technical services not recognised by Distform S.L.U. for possible defects.

The labour service shall be at the Customer's expense. The guarantee will be responsible for materials, not being liable, in any case, for any type of compensation.

Replacement materials shall always travel at the Customer's risk.

## 9. INTELLECTUAL PROPERTY

In accordance with current legislation on intellectual and industrial property, this catalogue and any element, brand, drawing, model, logo, graphic, etc. found in this catalogue are the exclusive property of Distform S.L.U. or its collaborators, who do not grant any licence or right other than the right to consult the catalogue. The reproduction or use of all or part of these elements authorises only to be informed in a personal and private manner. Any reproduction or use of copies made for other purposes is expressly prohibited. Any improper use constitutes fraud and may be prosecuted in accordance with the legislation in force, except in cases of prior written authorisation from Distform S.L.U.

Distform S.L.U. shall not be held responsible in the event of error or omission in any of the photographs, prices, texts or images, information or characteristics of the products, nor in the event of modification of the characteristics of the products by the suppliers.

## 10. LITIGATION AND LIABILITIES

Distform S.L.U. shall not be held responsible for the non-execution of the present conditions in the event of force majeure and in the event of the Client's fault or an unforeseeable event on the part of a person outside the contract.

Distform S.L.U. is not responsible for any consequences that may result from the improper use of the products sold.

Any dispute that may arise will be submitted to the consumer arbitration system (Consumer Arbitration Board / Advertising Jury). In the event that the arbitration decision is not accepted, the dispute will be submitted to the Courts and Tribunals of Lleida.

## 11. CONTACT

Contact us for more information about our range of products.

Website: [www.distform.com](http://www.distform.com)

e-mail: [info@distform.com](mailto:info@distform.com)

Contact phone: +34 800 65 43 42





**distform**

+34 800 65 43 42  
INFO@DISTFORM.COM  
WWW.DISTFORM.COM