

The Connector

Everyday Electricals...& so much more

APR/JUN
2021

Trade Price
Guide

KÄRCHER

MAKE SHORT WORK
OF ANY OUTDOOR
CLEANING JOB!

KÄRCHER
RANGE FROM

£80.00
EX VAT

EACH



FULL RANGE
AVAILABLE
See page 112



Wiring Accessories



Smart Home



Cable & Cable Management



Distribution



Fire & Security



Lighting & Lamps



Heating & Ventilation



Test Equipment



Power Tools,
Fixings & Sundries



Open A Trade Account Today
For £500 instant credit, special
trade pricing & offers



Same Day
Delivery To Site



Order Online
Create joblists, check
invoices & stock

Scan
Me

To download
the digital
catalogue



Denmans
REXEL GROUP

Denmans.co.uk

WE ARE OPEN FOR YOU & operating safely.

Why Denmans?

With over 75 years' experience, Denmans Electrical Wholesalers are open to support you during these challenging times and we are proud to offer our trade customers the choice and value that they rely on, backed by friendly and reliable service at a local level. With 74 branches and an online store, our customers trust our vast knowledge and experience.

Denmans can be counted on to provide trade customers with a range that is second to none, with over 2,500 products available on the same day and a further 9,300 within 24 hours. We even have our own brand range of high quality, competitively priced products.

We are closely following the government guidelines for Covid-19 in order to keep our valued customers and employees safe. Please follow the safety procedures put in place by your local branch, including wearing a face covering when in branch to help us protect each other.

Denmans has a proud history of supporting charities and in partnership with Make a Wish, our branches are selling face masks for only £2.75. All profits go to Make a Wish UK who are dedicated to granting critically ill children's wishes. See page 113

Together, all this creates the Denmans difference – a friendly, knowledgeable electrical wholesaler, who provides the right products at the right price - on time, every time.



Experience the 'Denmans Difference' for yourself:



Trade Account

- Apply now for a Trade account and start saving with exclusive trade prices
- Instant £500 online credit available
- Receive exclusive web promotions.



Flexible Delivery

- Order by **6pm** for **next working day delivery** (Mon-Fri)
- **FREE** delivery on all orders for trade credit customers
- **FREE** delivery on orders over £50
- Delivery to you or on site.



A Great Range

- Over 11,500 products available in our branch network now



Check - Click - Collect

- Check stock nationwide
- Click & Collect



Experts on all things Electrical

- Deal with the experts - we're the specialists who understand our products



Denmans Own Brand

- Tried and tested quality - approved by the trade
- Exclusive to us



Save time online

- Order 24/7, create joblists, check invoices, add users, check local stock



The Denmans App

- Save time on the move by downloading the simple to use App



RECOMMEND A FRIEND

GET £50 CREDIT ON YOUR ACCOUNT

When new account opened & 1st order placed min value £125

Ask in branch or visit Denmans.co.uk

Denmans
REXEL GROUP



Click & Collect
in as little as 1 min



Call
your local branch



Visit
your local branch



NEW Navara CCT LED IP20 Battens

Simple and cost-effective solution for a wide range of commercial and retail applications.

- 5 year warranty*
- IP20 Rated
- High efficiency – up to 125lm/w
- 3000K/4000K/6500K LED
- 140° beam angle
- Instant on
- Range of sizes and wattages
- Emergency options available

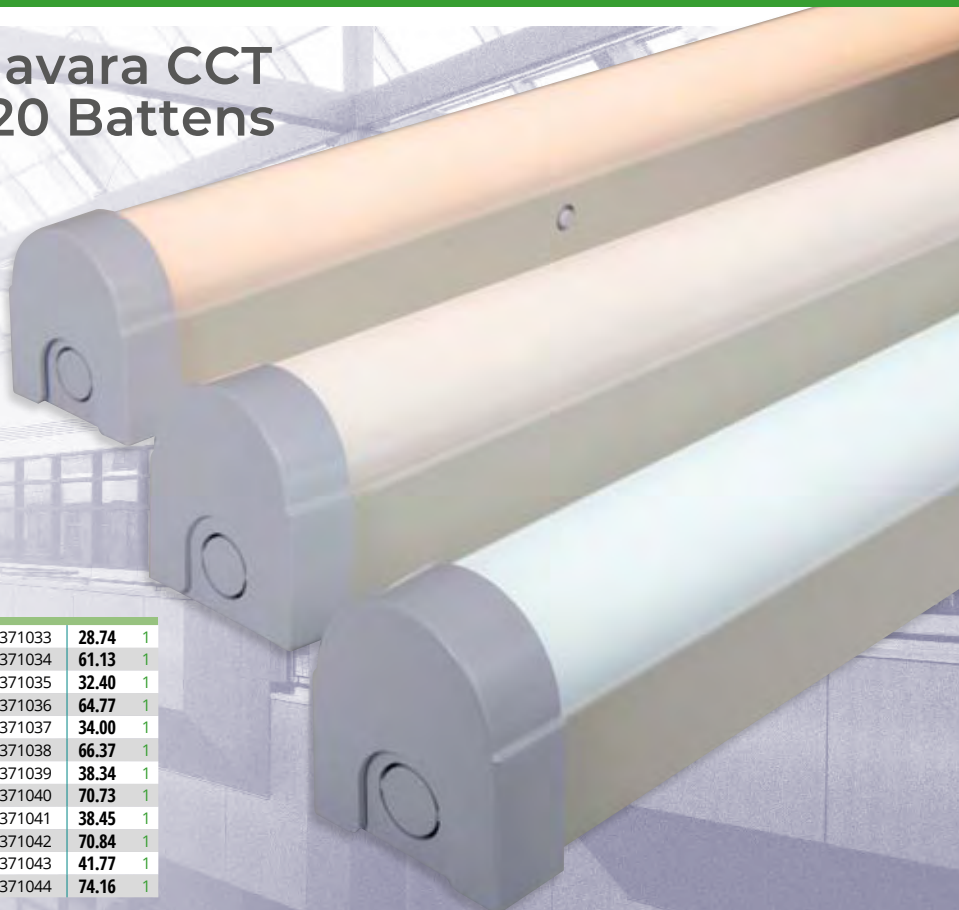

NAVARA X4S-CCT 23W LED IP20 BATTEN	KSR98140	1371033	28.74	1
NAVARA X4S-CCT EM 23W LED IP20 BATTEN	KSR98140/EM	1371034	61.13	1
NAVARA X4T-CCT 40W LED IP20 BATTEN	KSR98141	1371035	32.40	1
NAVARA X4T-CCT EM 40W LED IP20 BATTEN	KSR98141/EM	1371036	64.77	1
NAVARA X5S-CCT 38W LED IP20 BATTEN	KSR98142	1371037	34.00	1
NAVARA X5S-CCT EM 38W LED IP20 BATTEN	KSR98142/EM	1371038	66.37	1
NAVARA X5T-CCT 60W LED IP20 BATTEN	KSR98143	1371039	38.34	1
NAVARA X5T-CCT EM 60W LED IP20 BATTEN	KSR98143/EM	1371040	70.73	1
NAVARA X6S-CCT 48W LED IP20 BATTEN	KSR98144	1371041	38.45	1
NAVARA X6S-CCT EM 48W LED IP20 BATTEN	KSR98144/EM	1371042	70.84	1
NAVARA X6T-CCT 65W LED IP20 BATTEN	KSR98145	1371043	41.77	1
NAVARA X6T-CCT EM 65W LED IP20 BATTEN	KSR98145/EM	1371044	74.16	1

See page 78 for more KSR Light Battens

2.5X FASTER TO INSTALL THAN TRADITIONAL LED BULKHEADS



RADIALED® RAPID LED BULKHEAD

- Detachable terminal, for simple wiring connection
- Multiple cable entry, central and offset rear entry points
- Clip-in tool-less LED gear tray design
- Smooth, even light distribution
- IK10, maximum impact rating
- IP65 protection against dust and moisture
- Emergency, microwave and dimmable options
- Complete with white rim as standard



Rapid LED Bulkhead 8W With RIM	JC070065	1348310	21.48	1
Rapid LED Bulkhead 12W With RIM	JC070075	1348313	26.50	1
Rapid LED Bulkhead 16W With RIM	JC070085	1348316	28.78	1
Rapid LED Bulkhead 20W With RIM	JC070095	1348318	35.65	1

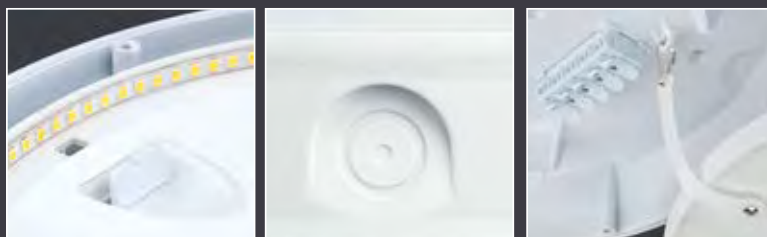

Visit us at Denmans.co.uk for more New Ranges

ENER-J® NEW SMART HOME RANGES ADDED

Smart Home Living

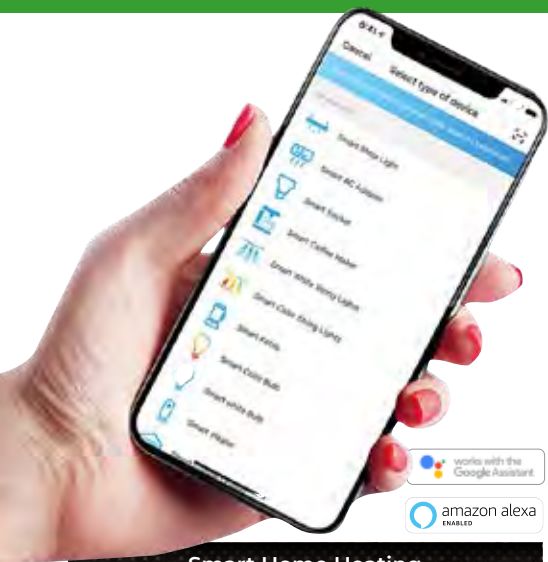

works with the Google Assistant
amazon alexa ENABLED



Smart Indoor & Outdoor Lighting



Smart CCTV



Smart Home Sockets & Switches



Smart Plug/Energy Monitor

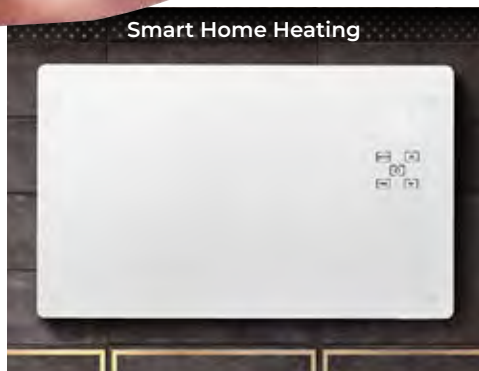

Smart Home Heating



Smart Home Adapters



Smart Home Video Door Bell

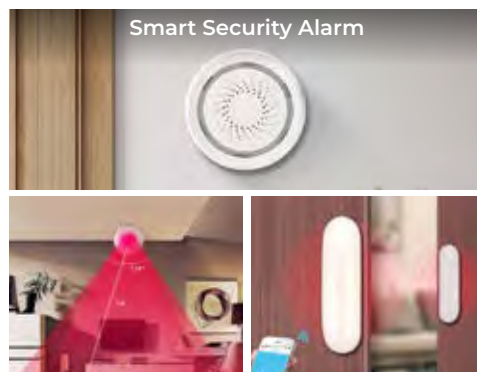

Smart Security Alarm

NO HUB • NO SUBSCRIPTIONS • NO HASSLE

MONTHLY PRIZE DRAW

IT'S SIMPLE! Purchase any Ener-J product in April, May or June to be entered into the monthly prize draw. T&Cs apply:

1st Prize SHA5294 Wi-Fi Outdoor Security Floodlight CW IP Camera Black

2nd Prize 1x SHA5213X Smart Wi-Fi RGB Led Strip Plug and Play Kit 12V 5 Meters IP65

3rd Prize 2x SHA5264 Wi-Fi Smart Plug with Energy Monitor, UK Plug (Max 1600W)

Terms & Conditions: 1st, 2nd & 3rd prize winners will be drawn each month on the 5th working day of the following month. Each transaction will be entered each month. One prize per winner per month.



See page 24 for full ENER-J smart home range & pricing

ORIGINAL FORMULA
OVER
15 YEARS
SUPPORTING THE
BUILDING INDUSTRY

NEW ADHESIVES & SEALANTS RANGES



THE ORIGINAL MULTI-SURFACE CONSTRUCTION SEALANT & ADHESIVE

BONDS ALL METALS EVEN LEAD

PLASTICS INCLUDING PVC & GRP

AND MORE INCLUDING GLASS • MIRROR • POLYSTYRENE FIBREGLASS • WOOD

PLUS OB1

WORKS IN WATER

FEATURES ZERO VOCs

AND IS ACCREDITED BY



ob1original.com

OB1 

JOB DONE

See page 114 for full OB1 range & pricing

EVO-STIK Adhesives & Sealants

NEW



THE UK'S NO.1 ADHESIVE MANUFACTURER, SUPPLYING TO THE DIY AND TRADE MARKETS

FROM £2.20 (ea)

See page 114 for full range information & pricing

DOWSIL 781 Multi-Purpose Silicone

NEW



A ONE PART SILICONE WHICH OFFERS FAST CURE AND EXCELLENT ADHESION TO MOST NON-POROUS SURFACES

FROM £4.50 (ea)

See page 114 for full range information & pricing

GORILLA Adhesives

ADHESIVE SOLUTIONS FOR THE TOUGHEST JOBS ON PLANET EARTH

NEW



FROM £5.95 (ea)

See page 114 for full range information & pricing

Geocel Adhesives & Sealants

NEW



TRADE ADHESIVES & SEALANTS THAT PERFORM IN THE MOST DEMANDING CONDITIONS

FROM £1.99 (ea)

See page 114 for full range information & pricing



NEW POWER TOOLS, BUNDLE DEALS AND ACCESSORIES ADDED TO THE RANGE



M18 Fuel 4pc Kit
M18FPP4G2-502B 2501377742



**M12 Soldering Iron
1x 2.0Ah Battery**
M12SI-201C 2501377743



12V Compact Sds Body Only
M12CH-0 2501377744



**M18 Cordless Rocket Led
Tower Light**
M18SAL-0 2501377745



**Redlithium Usb Cross
Line Laser Kit**
L4CLL-301C 2501377746



Packout Tote Toolbag 25CM
4932464084 2501377747



**18V 115mm Angle Grinder -
Bare Unit**
HD18AG-0 2501377748



**Angle Grinder 115mm
Disc Display**
4932451485 2501377749



Mini Box Spirit Level
4932459100 2501377750

See pages 110 & 111 for full Milwaukee range & pricing





NEW FIXINGS RANGES ADDED

DUOPOWER Universal Wall Plugs

The intelligent universal plug is suitable for fixing in all building materials. This allows a variety of applications with just one plug. The fischer DuoPower adjusts itself automatically to the building material and transfers the highest loads through the three product functions of folding, expanding and knotting.

FROM
£3.48
PER 100

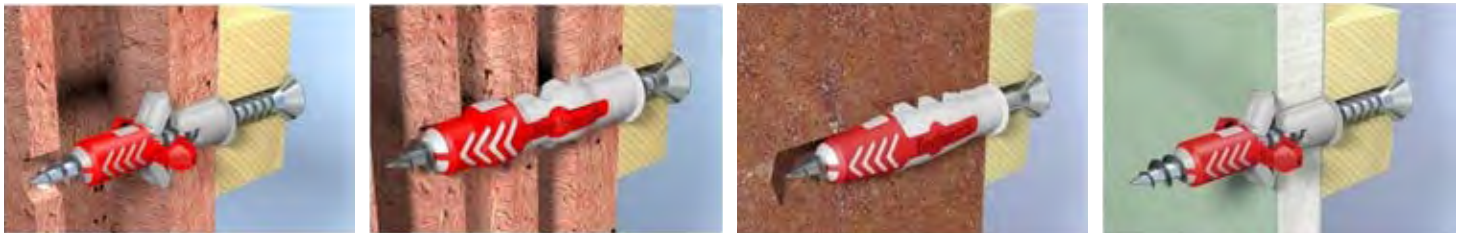

See page 120 for full Fischer range & pricing

OPTIMAXX Wall Bite Screws
OPTIMUM DESIGN. MAXIMUM PERFORMANCE

NO PLUG FIXING SCREW - AN ALL STEEL, EXPANSION FREE ONE PIECE THREADED FASTENER

NEW



FROM
£8.50
PER 100

See page 120 for full range information & pricing

REISSER® R2 Woodscrew - 200pc

LUBRICATED, SHARP, WIDE, DEEP THREAD HELPING THE SCREW DRIVE IN QUICKLY AND EASILY

NEW



FROM
£3.71
PER 200

See page 120 for full range information & pricing



Wiring Accessories

QUICKWIRE - PREWIRED JUNCTION BOXES



Quickwire is an exciting new product that offers a time-saving alternative to a traditional junction box. The Quickwire prewired junction box was designed to help electricians save significant installation time on site – all 4 connections can be wired in 7 seconds!

- Dramatic time savings
- Wire all 4 connections in 7 seconds
- Maintenance free
- Screwless push-fit design
- Fits through 32mm hole



Splitter Junction Box	QSP34	1245617	3.19	1	2.99	10+
Switch And Load Junction Box	QSL34	1245618	3.19	1	2.99	10+
Starter Kit	QKIT	1245619	49.99	1		
Fixing Brackets Box Of 20	QMC-20	1245614	8.97	1		
Wire Strippers	QFKZ-01	1245615	44.99	1		
Removal Tools Box Of 20	QRT-20	1245616	8.97	1		

Ask In Branch for More Details

PROOFVISION TOOTHBRUSH CHARGER

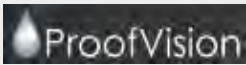

New Dual Toothbrush and Charger/shaver combo available

- White plastic version now available
- Optional clip on plates in Polished Steel or Brushed Steel (purchased separately)
- Compatible with Oral B/Braun Electric Toothbrushes



White Twin Toothbrush Charger

**ONLY
£37.95
EACH**

PV11P 2501371391



White Shaver Socket & Toothbrush Charger Combo

**ONLY
£39.95
EACH**

PV12P 2501371387



Polished Steel Cover For Pv12p Or Pv11p

**ONLY
£5.99
EACH**

PV11-PS-FR 2501371388



Brushed Steel Cover For Pv12p Or Pv11p

**ONLY
£5.99
EACH**

PV11-BS-FR 2501371389



Black Steel Cover For Pv12p Or Pv11p

**ONLY
£5.99
EACH**

PV11-B-FR 2501371390





Verve by Hamilton

 13A SOCKET OUTLETS SWITCHED - Wifi versions available on page 26

PRODUCT NAME																		
1 Gang 13A Single Pole	11SS131SP	0551183	1.32	1	1.24	10+		21SS131SP	0549210	1.60	1	1.51	10+	HM2001N 1292723	1.72	1	1.62	10+
2 Gang 13A Single Pole	11SS132SP	0551185	1.24	1	1.19	10+	1.00 15+	21SS132SP	0549211	1.63	1	1.53	10+	HM2002N 1292724	2.10	1	1.98	10+
1 Gang 13A Double Pole	11SS131DP	0549252	1.57	1	1.42	10+		21SS131DP	0549328	1.87	1	1.76	10+	HM2003N 1292725	1.79	1	1.68	10+
2 Gang 13A Double Pole	11SS132DP	0549253	2.05	1	1.93	10+		21SS132DP	0549330	2.37	1	2.24	10+	HM2004N 1292726	2.43	1	2.28	10+
2G 13A + USB 3.1A Double Pole	11SS132DPU3	1144541	12.27	1	11.93	5+		21SS132DPU3	1144542	12.49	1	12.49	5+	HM2006N* 1292727	13.80	1	12.97	5+
														*4.8A OUTPUT, 2 X OUTLETS RATED AT 2.4A				

 13A SOCKET OUTLETS UNSWITCHED

1 Gang 13A Unswitched	11S131UN	0551182	1.36	1	1.27	10+		21S131UN	0549209	1.58	1	1.49	10+	HM2010 1113810	1.70	1	1.60	10+
2 Gang 13A Unswitched	11S132UN	0549254	2.03	1	1.88	10+		21S132UN	0549329	2.22	1	2.10	10+	HM2011 1113811	2.42	1	2.28	10+
1 Gang 2A Unswitched	11S021UN	0549263	2.84	1	2.73	10+		21S021UN	0549342	2.91	1	2.82	10+	HM2012 1113812	3.14	1	2.96	10+
1 Gang 5A Unswitched	11S051UN	0551196	2.98	1	2.81	10+		21S051UN	0549338	3.58	1	3.38	10+	HM2013 1113813	3.81	1	3.57	10+

 10A PLATE SWITCHES (*6A RATED)

1 Gang 1 Way	11S511 *	0551177	0.63	1										HM2020 1113814	1.00	1	0.94	10+
1 Gang 2 Way	11S512 *	0551178	0.80	1	0.75	10+		21S512	0549205	0.96	1	0.91	10+	HM2021 1113815	1.05	1	0.98	10+
2 Gang 2 Way	11S522 *	0551181	1.38	1	1.31	10+		21S522	0549208	1.52	1	1.43	10+	HM2022 1113816	1.76	1	1.66	10+
3 Gang 2 Way	11S532 *	0551189	2.60	1	2.39	10+		21S532	0549219	2.65	1	2.50	10+	HM2023 1113817	2.82	1	2.66	10+
4 Gang 2 Way	11S542 *	0551207	5.40	1	4.94	10+		21S542	0551287	3.59	1	3.39	10+	HM2024 1113818	6.18	1	5.82	10+
6 Gang 2 Way	11S562 *	0549268	9.60	1				21S562	0551338	10.22	1	9.66	10+	HM2026 1113819	11.12	1	10.46	10+
1 Gang Intermediate	11S513 *	0551192	2.26	1	1.99	10+		21S513	0549220	2.70	1	2.55	10+	HM2027 1113820	2.82	1	2.65	10+
3 Pole Fan Isolator	11S5FS *	0551193	2.56	1	2.35	10+		21S5FS	0549222	2.75	1	2.56	10+	HM2028 1113821	2.96	1	2.79	10+
1 Gang 2 Way Architrave	11A512 *	0549251	1.84	1	1.76	10+		21A512	0549215	2.22	1	2.14	10+	HM2029 1113822	2.31	1	2.17	10+
1 Gang Keyswitch														HM2047 1113856	8.10	1	7.61	10+
1 Gang Keyswitch (Emergency Light)								21S202KELT	0675693	2.35	1	2.22	5+	HM2048 1113832	2.43	1	2.29	10+

 DIMMER PLATES

1 Gang 400W	11DIM4001	0551206	6.81	1	6.48	3+		21DIM4001	0549243	8.02	1	7.57	3+					
2 Gang 250W	11DIM2502	0551211	10.89	1	10.38	3+		21DIM2502	0549247	11.99	1	11.31	3+					
3 Gang 250W	11DIM2503	0549269	16.99	1	16.48	3+		21DIM2503	0551340	18.50	1	17.45	3+					
4 Gang 250W	11DIM2504	0549270	22.44	1	21.58	3+		21DIM2504	0549193	22.72	1	21.88	3+					
1 Gang 5-100W LED/150W Std														HM2031 1113823	12.97	1	12.58	10+
2 Gang 5-100W LED/150W Std														HM2032 1113824	26.08	1	25.30	10+
3 Gang 5-100W LED/150W Std														HM2033 1113825	42.38	1	39.84	10+
4 Gang 5-100W LED/150W Std														HM2034 1113826	55.88	1	52.53	10+

 20A DP SWITCHES

20A DP Switch	11S20	0551194	2.73	1	2.41	10+		21S20	0549221	2.85	1	2.69	10+	HM2040 1113827	3.92	1	3.69	10+
20A DP + Neon	11S20L	0551200	3.52	1	3.30	10+		21S20L	0549349	3.60	1	3.40	10+	HM2041 1113828	4.88	1	4.59	10+
20A DP + Flex Outlet								21S20F	0549336	3.36	1	3.27	10+	HM2042 1113829	3.94	1	3.71	10+
20A DP + Flex Outlet + Neon								21S20LF	0549344	4.39	1	4.19	10+	HM2043 1113830	5.55	1	5.22	10+
20ADP+Neon - marked "Water Heater"	11S20LWH	0549266	4.64	1	3.69	10+		21S20LWH	0549348	3.37	1	3.18	10+	HM2044 1113831	5.84	1	5.49	10+

 45A DP SWITCHES (*50A)

45A 1 Gang DP	11S451	0551203	5.74	1	5.63	10+		21S501 *	0549239	5.72	1	5.40	10+	HM2050 * 1113833	6.16	1	5.80	10+
45A 2 Gang DP Vertical Plate	11S452	0551204	5.74	1	5.57	10+		21S502 *	0549244	6.64	1	6.26	10+	HM2051 * 1113834	7.17	1	6.73	10+
45A 1 Gang + Neon DP	11S451L	0551205	6.41	1	5.97	10+		21S501L *	0551286	6.38	1	6.02	10+	HM2052 * 1113835	7.03	1	6.61	10+
45A 2 Gang Vertical + Neon DP	11S452L	0551208	6.81	1	5.97	10+		21S502L *	0551288	6.93	1	6.53	10+	HM2053 * 1113836	8.11	1	7.62	10+

See page 13 for additional ranges from Eaton, Crabtree and MK. See page 18-19 for our modular grid range.





45A COOKER CONTROL UNITS

PRODUCT NAME

Control Panel	11CC45SS1	0551209	7.50	1	7.23	10+	21CC45SS1	0549246	8.18	1	7.88	10+	HM2060	1113837	8.91	1	8.37	10+
Control Panel + Neon	11CC45SS1L	0551210	7.50	1	7.09	10+	21CC45SS1L	0551304	9.03	1	8.52	10+	HM2061	1113838	9.21	1	8.66	10+
Cable Outlet	11CCOT1	0551201	4.26	1	3.92	10+	21CCOT1	0549229	4.74	1	4.43	10+	HM2062	1113839	5.03	1	4.73	10+
Cable Outlet (2 Way)	PRW217	0224921	6.12	1	5.77	10+												



SPURS/CONNECTION UNITS

13A Unswitched Spur	11SPU13UN	0551190	2.61	1	2.52	10+	21SPU13UN	0549217	2.89	1	2.77	10+	HM2070	1113840	3.00	1	2.83	10+
13A Unswitched Spur + Flex Outlet	11SPU13UNF	0549257	2.73	1	2.63	10+	21SPU13UNF	0549335	3.00	1	2.85	10+	HM2071	1113841	3.09	1	2.90	10+
13A Unswitched Spur Fitted w/ 3A Fuse	11SPU3UN	0551199	2.91	1	2.73	10+												
13A Switched Spur	11SPU13	0551195	2.92	1	2.78	10+	21SPU13	0549223	3.32	1	3.19	10+	HM2073	1113842	3.73	1	3.51	10+
13A Switched Spur + Neon	11SPU13L	0549260	3.35	1	3.24	10+	21SPU13L	0549225	3.68	1	3.54	10+	HM2074	1113843	3.90	1	3.67	10+
13A Switched Spur + Flex Outlet	11SPU13F	0551197	3.48	1	3.17	10+	21SPU13F	0549224	3.44	1	3.30	10+	HM2075	1113844	3.73	1	3.51	10+
13A Switched Spur + Flex outlet + Neon	11SPU13LF	0549261	3.52	1	3.35	10+	21SPU13LF	0549343	3.70	1	3.52	10+	HM2076	1113845	4.23	1	3.97	10+
20A Flex Outlet Plate (*25A Rated)	11FOP25	0551188	2.26	1	2.20	10+	21FOP25 *	0549216	2.51	1	2.41	10+	HM2078	1113846	3.11	1	2.92	10+



BRUSH PLATES

1 Gang Brush Plate	11BRUSH1	0549315	6.57	1	5.23	10+	21BRUSH1	0549316	6.74	1	5.49	10+	HM2113	1113848	7.18	1	6.75	10+
2 Gang Brush Plate	11BRUSH2	0549320	8.35	1	6.81	10+	21BRUSH2	0549321	8.44	1	6.93	10+	HM2114	1113849	9.89	1	9.30	10+



SHAVER SOCKETS

Dual Voltage Shaver Socket	11DVSS	0551212	12.25	1	12.05	10+	21DVSS	0549248	13.85	1	13.25	10+	HM2090	1113847	16.07	1	15.11	10+
----------------------------	--------	---------	-------	---	-------	-----	--------	---------	-------	---	-------	-----	--------	---------	-------	---	-------	-----



TELEPHONE, TV & SATELLITE, NETWORKING

1 Gang TV Point (Non Isolated)	11TV1	0551186	1.76	1	1.65	10+	21TV1	0549214	1.93	1	1.86	10+	HM2081	1113851	1.97	1	1.85	10+
2 Gang TV Point (Non Isolated)	11TV2	0549256	2.61	1	2.52	10+	21TV2	0549334	2.95	1	2.78	10+	HM2082	1113852	3.15	1	2.96	10+
1 Gang Satellite Point	11SAT1	0549255	1.69	1	1.59	10+	21SAT1	0549331	1.82	1	1.73	10+	HM2080	1113850	1.99	1	1.87	10+
Sat/TV Point Combined	BS94/N	0548616	2.55	1	2.41	10+												
Telephone Point - Master	11MASTEL	0551202	4.99	1	4.73	10+	21MASTEL	0551263	5.18	1	4.95	10+	HM2083	1113853	5.55	1	5.22	10+
Telephone Point - Secondary	11SECTEL	0551191	2.78	1	2.61	10+	21SECTEL	0549218	2.94	1	2.78	10+	HM2084	1113854	3.25	1	3.06	10+
1 Gang RJ45 Cat 5e													HM2046	1113855	5.94	1	5.59	10+



BLANK PLATES

1 Gang Blank Plate	11BP1	0549271	0.36	1	0.34	10+	21BP1	0549200	0.51	1	0.48	10+	HM2111	1113872	0.59	1	0.56	10+
2 Gang Blank Plate	11BP2	0549272	0.60	1	0.58	10+	21BP2	0549202	0.80	1	0.75	10+	HM2112	1113873	0.74	1	0.70	10+



PATTRESSES

16mm 1 Gang Pattress	11P116	0551175	0.63	1	0.59	10+	21P116	0549201	0.67	1	0.63	10+	HM2120	1113874	0.71	1	0.66	10+
28mm 1 Gang Pattress	11P128	0551176	0.68	1	0.64	10+	21P128	0549203	0.72	1	0.68	10+	HM2121	1113875	0.80	1	0.76	10+
28mm 2 Gang Pattress	11P228	0551179	1.03	1	1.01	10+	21P228	0549206	1.11	1	1.07	10+	HM2122	1113876	1.24	1	1.17	10+
35mm 1 Gang Pattress							21P135	0675690	1.00	1	0.95	5+	HM2123	1113877	1.07	1	1.00	10+
35mm 2 Gang Pattress							21P235	0675691	1.39	1	1.31	5+	HM2124	1113878	1.47	1	1.38	10+
43mm 1 Gang Pattress	11P143	0551180	1.08	1	1.06	10+												
47mm 1 Gang Pattress							21P147	0549207	1.17	1	1.13	10+	HM2125	1113879	1.30	1	1.22	10+
43mm 2 Gang Pattress	11P243	0551184	1.58	1	1.50	10+												
47mm 2 Gang Pattress							21P247	0549212	1.52	1	1.48	10+	HM2126	1113880	2.11	1	1.98	10+
16mm 1 Gang Architrave Pattress	11A116P	0549250	0.94	1	0.90	10+	21A116P	0549325	1.02	1	0.99	10+	HM2127	1113882	1.08	1	1.01	10+
28mm Dual Box Pattress	11P228D	0551187	2.40	1	2.22	10+												
37mm Dual Box Pattress							21P237D	0549326	1.84	1	1.74	10+	HM2128	1113881	2.54	1	2.39	10+

Check live stock availability



See your trade prices 24/7



Create job lists



Check an order status



DOWNLOAD the DENMANS APP or visit denmans.co.uk



Click & Collect in as little as 1 min



Call your local branch



Visit your local branch



SOCKET OUTLET SWITCHED

PRODUCT NAME

1 Gang 13A Single Pole	DP611	0696024	1.56	1	1.42	10+	S4304	0620871	1.81	1	1.67	10+								
2 Gang 13A Single Pole	DP612	0696025	1.81	1	1.66	5+	S4306	0620872	2.51	1	2.35	5+								
1 Gang 13A Double Pole	DP621	0696026	2.21	1	2.05	10+							K2757WHI	0043792	3.00	1	2.61	10+		
2 Gang 13A Double Pole	DP622	0696027	2.92	1	2.73	5+	4306/D	0045939	3.99	1	3.66	10+	K2747WHI	0043791	3.94	1	3.91	10+	3.75	15+



10A PLATE SWITCHES

1 Gang 1 Way	DP011	0696115	0.66	1	0.59	10+	S4070	0620868	0.98	1	0.90	10+	K4870WHI	0044121	1.63	1	1.42	10+	
1 Gang 2 Way	DP021	0696116	0.85	1	0.82	10+	S4170	0620869	1.14	1	1.03	10+	K4871WHI	0044122	1.92	1	1.67	10+	
2 Gang 2 Way	DP022	0696117	1.72	1	1.55	10+	S4172	0620870	1.85	1	1.68	10+	K4872WHI	0044126	3.31	1	2.88	10+	
3 Gang 2 Way	DP023	0696118	3.66	1	3.30	10+	4173	0022286	5.37	1	4.91	10+	K4873WHI	0044127	7.63	1	6.63	10+	
4 Gang 2 Way	DP024	0696119	7.39	1	6.66	5+	4174	0022287	22.15	1	20.67	10+	K4874WHI	0044163	16.87	1	14.67	5+	
1 Gang Intermediate	DP017	0696109	4.00	1	3.60	10+	4175	0022459	5.56	1	5.09	10+	K4875WHI	0044164	9.00	1	7.82	10+	
3 Pole Fan Isolator	DP048	0696110	4.60	1	4.23	10+	4017/1	0040809	5.77	1	5.52	10+	K4859WHI	0044346	10.32	1	8.97	10+	



DIMMER SWITCHES

1 Gang 400W Dimmer	DP9141	0696036	13.92	1	12.55	3+													
2 Gang 250W Dimmer	DP9132	0696030	21.27	1	19.16	3+													



20A DP SWITCHES

20A DP Switch							4015	0021800	4.26	1	3.90	10+							
20A DP Switch + Flex Outlet	DP401	0696111	3.56	1	3.27	10+							K5403WHI	0044221	5.54	1	4.82	10+	
20A DP Switch + Neon	DP401N	0696112	4.19	1	3.87	10+	S4015/3	0620875	4.00	1	3.62	10+							



45A DP SWITCHES (*50)

1 Gang DP							4016	0161849	15.71	1	14.89	10+							
1 Gang DP + Neon	DP422N	0696103	9.35	1	8.42	10+	4016/3	0161850	10.60	1	9.81	10+							
2 Gang DP Vertical	DP421	0696114	7.34	1	6.82	5+	4500	0001284	16.51	1	15.43	5+							
2 Gang DP Vertical + Neon	DP421N	0696104	9.44	1	8.50	5+	4500/3	0001711	13.12	1	12.31	10+							



45A COOKER CONTROL UNITS

Control Panel	DP425	0696105	10.47	1	9.43	5+	4521/1	0073387	12.93	1	11.74	10+	K5060WHI	0044257	17.08	1			
Cable Outlet	DP345	0696107	4.73	1	4.15	10+	4506	0022575	3.89	1	3.66	10+	K5045WHI	0044248	5.38	1	4.68	10+	



SPURS/CONNECTION UNITS

13A Unswitched Spur							S4828	0620874	3.46	1	3.10	10+							
13A Unswitched Spur + Flex Outlet	DP220	0696108	2.96	1	2.73	10+	S4828	0620874	3.46	1	3.10	10+	K337WHI	0044199	6.50	1	5.65	10+	
13A Switched Spur							S4827	0620873	3.31	1	3.09	10+	K1040WHI	0044211	8.02	1	6.97	10+	
13A Switched Spur + Flex Outlet	DP221	0696097	4.30	1	4.00	10+	S4827/3	0620876	4.56	1	4.29	10+	K330WHI	0044198	6.91	1	6.01	10+	
13A Switched Spur + Neon							S4827/3	0620876	4.56	1	4.29	10+	K1060WHI	0044217	10.81	1	9.40	10+	
Flex Outlet Plate	P212	0500910	1.26	1	1.02	10+	4075	0021894	3.92	1	3.58	10+	K1090WHI	0044219	5.06	1	4.40	10+	

SHAVER UNITS

Dual Voltage Shaver Unit	DP370	0696100	19.56	1	17.62	10+	2400	0022461	27.68	1	25.22	10+	K701WHI	0043755	26.53	1			
--------------------------	-------	---------	-------	---	-------	-----	------	---------	-------	---	-------	-----	---------	---------	-------	---	--	--	--



TELEPHONE, TV & SATELLITE

1 Gang TV Point	DP351	0696101	3.63	1	3.10	10+	7265	0006039	5.29	1	4.87	10+	K3520WHI	0044310	8.96	1	7.79	10+	
1 Gang Secondary BT Point	DP361	0696094	3.33	1	3.00	10+	7284	0022631	3.51	1	3.29	10+	K427WHI	0044301	7.90	1	6.87	10+	



BLANK PLATES

1 Gang Blank Plate	DP391	0696095	0.93	1	0.84	10+	4001	0021843	1.21	1	1.11	20+	K3827WHI	0044342	1.45	1	1.26	10+	
2 Gang Blank Plate	DP392	0696096	1.87	1	1.68	10+	4002	0021844	2.41	1	2.23	10+	K3828WHI	0044343	3.28	1	2.85	10+	



PATTRESSES

Single 16mm/20mm Moulded Box	DF4500	0696085	0.70	1	0.63	10+	9043	0002701	0.90	1	0.83	10+							
Single 28mm/30mm Moulded Box	DF4501	0696086	0.74	1	0.67	10+	S9047	0620877	0.82	1	0.76	10+	K2140WHI	0044370	1.38	1	1.20	10+	
Twin 28mm/30mm Moulded Box	DF4502	0696087	1.28	1	1.15	5+	S9048	0620878	1.44	1	1.35	10+	K2142WHI	0044371	2.63	1	2.28	5+	
Single 44mm/46mm Deep Moulded Box	DF4570	0696088	1.51	1	1.36	10+	9041	0005853	4.54	1	4.28	10+							
Twin 46mm Deep Box w/Cable Clamps	DF4530	0696089	4.08	1	3.67	5+	9054	0082340	6.80	1	6.40	10+							



DESIGNA CURVE DECORATIVE **DESIGNA** Curve

We have a wide range of decorative accessories on offer - with or without inserts, in a range of finishes. If you need help replacing or finding the right product, just ask - we'll do our best to help.



SWITCHES															
	1G 2 Way 10A	4.52	1	4.26	5+	23S512	0549232	23S512B	0549357	22S512	0549231	24S512	0549230		
	2G 2 Way 10A	5.66	1	5.34	5+	23S522	0549238	23S522B	0551268	22S522	0549237	24S522	0549236		
	3G 2 Way 10A	7.41	1	6.99	5+	23S532	0551285	23S532B	0551282	22S532	0551284	24S532	0551283		
	4G 2 Way 10A	12.23	1	11.53	5+	23S542	0551330	23S542B	0551327	22S542	0551329	24S542	0551328		
	6G 2 Way 10A	20.38	1	19.23	5+	23S562	0551346	23S562B	0551347	22S562	0551345	24S562	0551348		
	1G Intermediate	6.99	1	6.59	5+	23S513	0551272	23S513B	0551269	22S513	0551271	24S513	0551270		
	1G 3 Pole Fan Isolator	9.18	1	8.66	5+	23S5FS	0551299	23S5FSB	0551296	22S5FS	0551298	24S5FS	0551297		
	1G 2 Way Dolly Switch	7.83	1	7.39	3+										
	2G 2 Way Dolly Switch	8.19	1	7.73	5+										
DIMMERS - LEADING EDGE															
	1G 2 Way 400W	13.44	1	12.68	5+										
	2G 2 Way 400W	21.13	1	19.93	5+										
	3G 2 Way 400W	28.64	1	27.02	5+										
	4G 2 Way 400W	35.53	1	33.52	5+										
SOCKET OUTLETS - SWITCHED															
	1G Switched	4.76	1	4.49	5+	23SS131DP	0549228	23SS131DPB	0549345	22SS131DP	0549227	24SS131DP	0549226	25SS131DP	0668179
	2G Switched	5.24	1	4.94	5+	23SS132DP	0549235	23SS132DPB	0549358	22SS132DP	0549234	24SS132DP	0549233	25SS132DP	0668180
	2G Switched + 2xUSB Socket 3.1A	16.97	1	16.01	3+	23SS132DPU3	1144543	23SS132DPU3B	1144544	22SS132DPU3	1144545	24SS132DPU3	1144546	25SS132DPU3	1144547
SOCKET OUTLETS - UNSWITCHED															
	1G 2A Unswitched	5.73	1	5.41	5+	23S021UN	0549354	23S021UNB	0549355	22S021UN	0549353	24S021UN	0549356	25S021UN	0668185
	1G 5A Unswitched	6.20	1	5.85	5+	23S051UN	0551265	23S051UNB	0551266	22S051UN	0551264	24S051UN	0551267	25S051UN	0668186
20A DP SWITCHES															
	1G 20A DP														
	1G 20A DP + Neon	9.38	1	8.85	5+	23S20L	0551315	23S20LB	0551312	22S20L	0551314	24S20L	0551313		
45A DP SWITCHES															
	Cooker Switch + Switched Socket + Neon	18.55	1	17.50	5+	23CC45SS1L	0551344	23CC45S1LB	0551341	22CC45SS1L	0551343	24CC45SS1L	0551342	25CC45SS1L	0668160
	1G 45A + Neon	11.12	1	10.49	5+	23S451L	0551323	23S451LB	0551320	22S451L	0551322	24S451L	0551321		
	2G 45A DP Vertical + Neon	12.37	1	11.67	5+										
	1G 45A DP Switch White	10.51	1	9.91	5+	23S451	0551319	23S451B	0551316	22S451	0551318	24S451	0551317		
TELEPHONE & TV OUTLETS															
	1G Master Telephone Socket	8.22	1	7.75	5+	23MASTEL	0551292	23MASTELB	0551289	22MASTEL	0551291	24MASTEL	0551290	25MASTEL	0668184
	1G Slave Telephone Socket	6.56	1	6.19	5+	23SECTEL	0551277	23SECTELB	0551274	22SECTEL	0551276	24SECTEL	0551275	25SECTEL	0668187
	TV Coaxial Socket (non isolating)	6.83	1	6.44	5+	23TV1	0551281	23TV1B	0551278	22TV1	0551280	24TV1	0551279	25TV1	0668181
SPURS/CONNECTION UNITS															
	13A Switched Fuse Spur	6.93	1	6.53	5+	23SPU13	0549242	23SPU13B	0551273	22SPU13	0549241	24SPU13	0549240	25SPU13	0668176
	13A Switched Spur + Neon	9.11	1	8.60	5+	23SPU13L	0551308	23SPU13LB	0551305	22SPU13L	0551307	24SPU13L	0551306	25SPU13L	0668177
	13A Unswitched Spur	8.88	1	8.38	5+	23SPU13UN	0551303	23SPU13UNB	0551300	22SPU13UN	0551302	24SPU13UN	0551301	25SPU13UN	0668178
	13A Switched Spur + Flex Outlet + Neon	9.31	1	8.78	5+	23SPU13LF	0844624	23SPU13LFB	0844625	22SPU13LF	0844626	24SPU13LF	0844627	25SPU13LF	0844628
BRUSH PLATES / FLEX OUTLETS															
	1G Brush Plate	7.22	1	6.81	10+	23BRUSH1	0549318			22BRUSH1	0549317	24BRUSH1	0549319	25BRUSH1	0668158
	2G Brush Plate	12.95	1	12.22	10+	23BRUSH2	0549323			22BRUSH2	0549322	24BRUSH2	0549324	25BRUSH2	0668159
	25A Cord Flex Outlet	8.07	1	7.61	5+	23FOP25	0844629	23FOP25B	0844630	22FOP25	0844631			25FOP25	0844633
BLANK PLATES															
	1G Blank Plate	3.60	1	3.40	5+										
	2G Brush Plate	5.18	1	4.89	5+										
SHAVER SOCKET															
	Shaver Socket	22.28	1	21.02	5+	23DVSS	0549192	23DVSSB	0549189	22DVSS	0549191	24DVSS	0549190	25DVSS	0668183





								Switches											
23S512J	0566234	22S512J	0566214	24S512J	0566221	25S512J	0668174	74R21SS/WH	0550308	7.85	1	7.54	5+	7G24R21SS-W	1190139	8.33	1	8.06	5+
23S522J	0566236	22S522J	0566237	24S522J	0566223	25S522J	0668164	74R22SS/WH	0550310	11.11	1	10.67	5+	7G24R22SS-W	1190143	11.75	1	11.38	5+
23S532J	0566225	22S532J	0566238	24S532J	0566224	25S532J	0668165	74R23SS/WH	0550312	15.00	1	14.40	5+	7G24R23SS-W	1190146	15.89	1	15.39	5+
23S542J	0566226	22S542J	0566239	24S542J	0566216	25S542J	0668166	74R24SS/WH	0550314	26.64	1	25.57	5+	7G24R24SS-W	1190149	28.22	1	27.31	5+
						25S562J	0668167	74R26SS/WH	0550316	36.74	1	35.27	5+						
23S513J	0566235	22S513J	0566215	24S513J	0566222	25S513J	0668175	74R31SS/WH	0550319	14.35	1	13.77	5+	7G24R31SS-W	1190153	15.20	1	14.71	5+
23S5FSJ	0566228	22S5FSJ	0566241	24S5FSJ	0566218	25S5FSJ	0668168	74TPWH	0550341	17.09	1	16.40	5+	7G24TPWH-W	1190167	18.09	1	17.50	5+
23D512	0551294																		
23D522	0551310																		
								Dimmers - Leading Edge											
23DIM4001	0551337	22DIM4001	0551336	24DIM4001	0551335	25DIM4001	0668191	741XLEDITB100	0929739	22.78	1	21.87	5+	7G241XLEDITB100	1190187	24.12	1	23.33	5+
23DIM4002	0549188	22DIM4002	0549187	24DIM4002	0549186	25DIM4002	0668192	742XLEDITB100	0929740	39.18	1	37.62	5+	7G242XLEDITB100	1190191	41.52	1	40.18	5+
23DIM4003	0549196	22DIM4003	0549195	24DIM4003	0549194	25DIM4003	0668193	743XLEDITB100	0929741	61.33	1	58.87	5+	7G243XLEDITB100	1190194	64.97	1	62.86	5+
23DIM4004	0549199	22DIM4004	0549198	24DIM4004	0549197	25DIM4004	0668182	744XLEDITB100	0929742	81.31	1	78.05	5+	7G244XLEDITB100	1190197	86.13	1	83.35	5+
								Socket Outlets - Switched											
								74SS1SS/WH	0550335	10.23	1	9.82	5+	7G24SS1SS-W	1189909	10.84	1	10.49	5+
								74SS2SS/WH	0550166	13.42	1	12.88	5+	7G24SS2SS-W	1189915	14.23	1	13.78	5+
								74SS2USBSS-W	0930510	29.07	1	27.91	5+	7G24SS1USBSS-W	1189912	26.76	1	25.90	5+
								Socket Outlets - Unswitched											
								74US2WH	0550349	12.33	1	11.84	5+						
								74US5WH	0550351	15.47	1	14.86	5+	7G24US5W	1189938	16.39	1	15.86	5+
								20A DP Switches											
								74DPSS/WH	0550291	14.91	1	14.31	5+						
23S20LJ	0566242	22S20LJ	0566210	24S20LJ	0566229	25S20LJ	0668170	74DPNSS/WH	0550289	15.90	1	15.26	5+	7G24DPNSS-W	1190136	16.85	1	16.30	5+
								45A DP Switches											
								7445DPSS1W	0550149	40.79	1	39.16	5+	7G2445SS1SS-W	1190130	43.23	1	41.84	5+
23S451LJ	0566232	22S451LJ	0566212	24S451LJ	0566219	25S451LJ	0668172	7445DPN/WH	0550147	28.68	1	27.53	5+	7G2445NW	1190126	30.41	1	29.41	5+
23S452VLJ	0566233	22S452VLJ	0566213	24S452VLJ	0566220	25S452VLJ	0668173												
				24S451J	0566230	25S451J	0668171	7445VDPNWH	0550152	33.16	1	31.83	5+						
								TELEPHONE & TV OUTLETS											
								74TVSS/WH	0550348	10.05	1	9.65	5+	7G24TCMW	1189924	15.52	1	15.52	5+
								74TCMSS/WH	0550337	14.64	1	14.06	5+	7G24TCSW	1189927	13.29	1	12.85	5+
								74TCSSS/WH	0550339	12.53	1	12.03	5+	7G24TVW	1189935	10.65	1	10.30	5+
								SPURS/CONNECTION UNITS											
								74SPSS/WH	0550333	17.54	1	16.84	5+						
								74SPNSS/WH	0550331	18.54	1	17.80	5+	7G24SPSS-W	1189807	18.59	1	17.99	5+
								74FOSS/WH	0550297	15.47	1	14.86	5+	7G24SPNSS-W	1189951	19.64	1	18.99	5+
								74SPNCOSSW	0550330	20.20	1	19.39	5+						
								BRUSH PLATES / FLEX OUTLETS											
								BLANK PLATES											
23BP1	0549341	22BP1	0549340	24BP1	0549339	25BP1	0668156	74BPDSS	0550282	6.34	1	6.09	5+	7G24BPD	1189768	6.71	1	6.49	5+
23BP2	0549352	22BP2	0549351	24BP2	0549350	25BP2	0668157	74BPSSS	0550283	4.90	1	4.70	5+	7G24BPS	1189769	5.19	1	5.01	5+
								SHAVER SOCKET											
								74SHSSS/WH	0550327	41.68	1	40.02	5+	7G24SHSW	1189786	44.18	1	42.76	5+

See pages 16-17 for additional finishes and designs



Hartland® G2 Range

Hartland G2 Screwless ...at a screw-loose price!

- New Slim, sleek and stylish screwless design
- Manufactured from stainless steel with a new patented easy clip system
- Wide range of products as standard

7G24 R22 SS-QC



7G27 1XLEDITB



7G2MW SS1WH-W



7G29 SS2 AB-B



- Insert Surround Colour Key: (-B) Black, (-W) White, Quartz Grey (QC). - Example 7G24 R22 SS-QC

Complete with High-quality gasket as standard

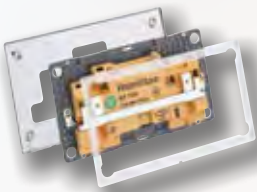

Inserts now available in the new stunning Quartz Grey finish



Screwless front plate, designed with Hamilton's patented easy clip system

Now available in Ten on-trend finishes!



Polished Brass



Satin Brass



Antique Brass



Satin Stainless



Bright Chrome



Black Nickel



Richmond Bronze



Etrium Bronze



Matt White



Matt Black





Hartland® Range

- Slim, Sleek and Stylish
- Standard box-fix electrical accessories
- LED dimming, Grid and Euro Modules also available

78 BPS



71 T22 PB



79 SS1 AB B



77 R23 BC B



74 DTRID W



Finishes available in this range

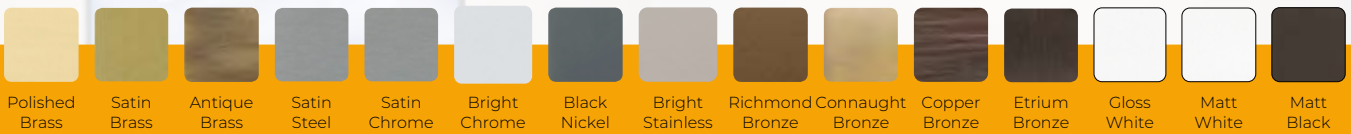

HartlandCFX® Range

- Slim and stylish with soft rounded edges
- Concealed fixing
- 4.8A USB Charging, LED dimming, Grid and Euro Modules also available

78C BPS



71C DPN PB W



79C TV B



77C 2J45 B



74C C11 SS W



Finishes available in this range



Due to manufacturing processes we cannot guarantee an exact colour match and shadings of certain finishes. E&OE



FACEPLATES

Steeple



Steeple Faceplates

1 Gang Plate, White	11FACE1MOD	0549570	0.76	1	0.70	10+
2 Gang Plate, White	11FACE2MOD	0549571	0.75	1	0.68	10+
4 Gang Plate, White	11FACE4MOD	0549574	1.48	1	1.36	10+

DESIGNA Curve



Designa Curve Faceplates

1 Gang Plate, White	21FACE1MOD	0549572	0.80	1	0.74	10+
2 Gang Plate, White	21FACE2MOD	0549573	0.78	1	0.75	10+
4 Gang Plate, White	21FACE4MOD	0549575	1.53	1	1.42	10+
8 Gang Plate, White	21FACE8MOD	0668206	2.10	1	1.91	10+

DESIGNA Curve



Designa Curve Decorative Faceplates

1 G Plate, Polished Chrome	22FACE1MOD	0549598	4.20	1	3.97	10+
2 G Plate, Polished Chrome	22FACE2MOD	0549599	4.20	1	3.97	10+
4 G Plate, Polished Chrome	22FACE4MOD	0549604	6.14	1	5.80	10+
1 G Plate, Satin Steel, White inserts	23FAC1MODB	0568650	4.20	1	3.97	10+
2 G Plate, Satin Steel, White inserts	23FAC2MODB	0568651	4.20	1	3.97	10+
4 G Plate, Satin Steel, White inserts	23FAC4MODB	0568652	6.14	1	5.80	10+
8 G Front Face Plate, White	23FAC8MODB	0668208	11.14	1	10.51	10+
1 G Plate, Satin Steel, Black inserts	23FACE1MOD	0549600	4.20	1	3.97	10+
2 G Plate, Satin Steel, Black inserts	23FACE2MOD	0549601	4.20	1	3.97	10+
4 G Plate, Satin Steel, Black inserts	23FACE4MOD	0549605	6.14	1	5.80	10+
8 G Front Face Plate, Black	23FACE8MOD	0668209	11.14	1	10.51	10+
1 G Plate, Black Nickel	24FACE1MOD	0549602	4.20	1	3.97	10+
2 G Plate, Black Nickel	24FACE2MOD	0549603	4.20	1	3.97	10+
4 G Plate, Black Nickel	24FACE4MOD	0549606	6.14	1	5.80	10+
8 G Front Face Plate, Black Nickel	24FACE8MOD	0668210	11.14	1	10.51	10+
1 G Plate, Graphite	25FACE1MOD	0668169	4.20	1	3.97	10+
2 G Plate, Graphite	25FACE2MOD	0668162	4.20	1	3.97	10+
4 G Plate, Graphite	25FACE4MOD	0668163	6.14	1	5.80	10+
8 G Front Face Plate, Graphite	25FACE8MOD	0668211	11.14	1	10.51	10+

MODULES

DESIGNA Curve



Designa Grid Switches	White Modules	Black Modules				
20AX 1 Way Switch	41S201	0549608	41S201B	0549609	1.65	1
20AX 2 Way Switch	41S202	0549582	41S202B	0549583	1.89	1
10AX Intermediate Switch	41S103	0549596	41S103B	0549597	3.59	1
10AX (20AX) 2 Way Retractive Switch	41S102RET	0549273	41S202RETB	0549274	3.62	1
20AX 2 Way Keyswitch	41S202K	0549312			2.80	1
20AX 2 Way Keyswitch "EMG LTG TEST"	41S202KELT	0549588	41S202KELB	0549587	3.02	1
20A DP Switch	4120DP	0549592	4120DPB	0549593	3.33	1
20A DP Switch + Neon	4120DPL	0549275			3.72	1
20A DP Keyswitch	4120DPK	0549594	4120DPKB	0549595	3.39	1
20A DP Keyswitch "EMG LTG TEST"	4120DPKELT	0549589	4120DPKELB	0568648	3.09	1
20A DP Switch "COOKER"	4120DP-CKR	0549277	4120DPCKRB	0549291	3.72	1
20A DP Switch "DISHWASHER"	4120DP-DSH	0549278	4120DPDSHB	0549292	3.72	1
20A DP Switch "EXTRACTOR FAN"	4120DP-FAN	0549279	4120DPFANB	0549293	3.72	1
20A DP Switch "FRIDGE FREEZER"	4120DP-FFR	0549280	4120DPFFRB	0549294	3.72	1
20A DP Switch "FRIDGE"	4120DP-FRI	0549281	4120DPFRIB	0549295	3.72	1
20A DP Switch "HOB"	4120DP-HOB	0549283	4120DPHOB	0549297	3.72	1
20A DP Switch "COOKER HOOD"	4120DP-HOO	0549284	4120DPHOOB	0549298	3.72	1
20A DP Switch "MICROWAVE"	4120DP-MIC	0549285	4120DPMICB	0549299	3.72	1
20A DP Switch "WASHING MACHINE"	4120DP-WAS	0549286	4120DPWASB	0549300	3.72	1
20A DP Switch "WASHER DRYER"	4120DP-WDY	0549287	4120DPWDYB	0549301	3.72	1
Fused Spur Unit	41FCU13	0549576	41FCU13B	0549581	1.65	1
Telephone Master Socket	41MASTEL	0549613	41MASTELB	0549614	3.13	1
Telephone Slave Socket	41SECTEL	0549585	41SECTELB	0549586	2.83	1
Coaxial Socket	41TV1	0549577	41TV1B	0549578	1.55	1
Satellite Socket	41SAT1	0549579	41SAT1B	0549580	1.58	1
RJ45 Socket	41RJ45	0549590	41RJ45B	0549591	3.07	1
1 Module Blank	41BLANK	0549568	41BLANKB	0549569	0.66	1
1/2 Module Blank	41BLANK1/2	0549566	41BLANK12B	0549567	0.63	1
400W* Trailing Edge Euromod Dimmer	DQDGEU400	0412572			37.84	1
Slave Dimmer for EU Mods	SSGSEU	0205530			10.58	1
1-10V Euromod Dimmer	DSSGDEU10V	0410160			39.21	1

*Can vary depending on lamp characteristics. Some LED lamps may require the use of a load resistor. Multi-switching requires the use of slave units.
PLEASE NOTE: All retractable switches feature 'Bell' symbol

For grid dimmers see page 22.

EATON
Powering Business Worldwide

MODULAR GRID RANGE



Switch Modules

10A 1 Way	DF9000	0696062	2.32	1	2.09	10+
10A 2 Way	DF9001	0696063	2.90	1	2.61	10+
10A 2 Way Push to Make	DF9004	0696065	4.78	1	4.30	10+
20A 2 Way	F9021	0500666	3.36	1	3.05	10+
20A Intermediate	DF9022	0696064	6.53	1	5.88	10+
20A Double Pole	F9023	0500674	4.17	1	3.79	10+
20A DP Keyswitch	F9027	0500764	6.12	1	5.55	10+
20A DP Emerg. Test Key	F9027EL	0500767	7.73	1	7.00	10+
20ADP Keyswitch + Indicator	F9027N	0500768	8.83	1	8.02	10+
20A 2 Way Key Centre Off Bias	F9028	0500771	6.70	1	7.89	10+
20A 2 Way Keyswitch	DF9026	0696055	4.42	1	5.78	10+
20A 2 Way Centre Off	DF9024	0696056	4.66	1	4.20	10+
20A 2 Way Emerg. Test Key	DF9026EL	0696057	8.34	1	7.51	10+

Modules

20A Cable Outlet	DF9073	0696045	5.53	1	4.99	10+
13A Fuse Unit	DF9072	0696046	7.17	1	6.46	10+
250W 2 Way Dimmer	DF9064	0696047	30.30	1	27.30	5+
400W 2 Way Dimmer	DF9065	0696048	33.80	1	30.45	5+
5A 3 Pin Shuttered Socket	F9306	0500834	7.86	1	7.12	10+
Single IEC Co-Ax Female	F3780	0264238	4.77	1	4.32	10+
Single IEC Co-Ax Male	F3781	0264244	4.80	1	4.37	10+
Single Satellite Female	F3782	0264246	4.80	1	4.37	10+
TV/RM/Sat/Return Module	F3783	0264250	14.35	1	13.01	10+
Telephone Secondary	F3784	0291798	3.92	1	3.57	10+
RJ45 CAT6 Module	F3787	0291808	5.46	1	5.07	10+
Blanking Component	DF9060	0696037	1.17	1	1.05	20+
1 Gang Blank Module	F3790	0264248	1.17	1	1.06	10+

20A DP 1 Way Switch Modules, marked with:

"Dishwasher"	DF9023DW	0696058	4.55	1	4.10	10+
"Extractor Fan"	DF9023EF	0696059	3.79	1	3.41	10+
"Fridge Freezer"	DF9023FF	0696060	3.79	1	3.41	10+
"Fridge"	DF9023FG	0696049	3.79	1	3.41	10+
"Freezer"	DF9023FZ	0696050	3.79	1	3.41	10+
"Hob"	DF9023HB	0696051	3.79	1	3.41	10+
"Cooker Hood"	DF9023CH	0696052	3.79	1	3.41	10+
"Microwave"	DF9023MW	0696053	4.55	1	4.10	10+
"Oven"	DF9023OV	0696054	4.55	1	4.10	10+
"Tumble Dryer"	DF9023TD	0696043	3.79	1	3.41	10+
"Washing Machine"	DF9023WM	0696044	3.79	1	3.41	10+
"Washer Dryer"	F9023WDR	0500720	4.49	1	4.06	10+
"Boiler"	F9023BO	0500690	4.17	1	3.76	10+

GRIDS PLATES

Moulded White Plates

1 Gang Plate	DP901	0696090	1.87	1	1.68	10+
2 Gang Plate	DP902	0696079	2.34	1	2.10	10+
3 Gang Plate	DP903	0696080	3.79	1	3.41	5+
4 Gang Plate	DP904	0696081	4.69	1	4.23	5+
6 Gang Plate	DP906	0696082	6.38	1	5.75	10+

Metalclad Plates, Grey

1 Gang Plate	DX901MG	0696083	3.03	1	2.73	10+
2 Gang Plate	DX902MG	0696084	3.03	1	2.73	10+
3 Gang Plate	DX903MG	0696073	4.66	1	4.20	5+
4 Gang Plate	DX904MG	0696074	4.66	1	4.20	5+
6 Gang Plate	DX906MG	0696075	11.65	1	10.50	10+

ACCESSORIES

Spare Key	DF9099	0696040	1.17	1	1.05	10+
1 & 2 Gang Grid Box	DFM8340	0696041	2.10	1	1.89	5+
1 & 2 Gang Grid	FM8349	0080928	2.89	1	2.58	10+
Box KO						
2 & 3 Gang Grid Box	DFM8341	0696042	3.68	1	3.31	5+
3 & 4 Gang Grid Box	FM8350	0080941	5.15	1	4.58	10+
6 & 8 Gang Grid Box	DF8342	0696031	6.81	1	6.14	5+

Denmans
REXEL GROUP



Click & Collect
in as little as 1 min



Call
your local branch



Visit
your local branch



MODULAR GRID RANGE

Verve by Hamilton · Euromod style plates
 · 1-4 Module
 · Designed for Media

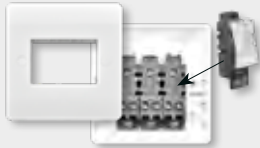

- Matches the Verve range
- Mix and match flexibility
- Modern design



Verve Microgrid Plates

1 Gang 1 Module MG Frontplate	HM2171	1113883	0.85	1	0.80	10+
1 Gang 2 Module MG Frontplate	HM2172	1113884	0.84	1	0.78	10+
1 Gang 3 Module MG Frontplate	HM2173	1113885	2.77	1	2.61	10+
2 Gang 4 Module MG Frontplate	HM2174	1113886	4.95	1	4.65	10+
2 Gang 6 Module (2x3) MG Frontplate	HM2176	1113887	7.23	1	6.80	10+

Verve Microgrid Accessories

10A 2 Way Switch	HM3111	1113888	0.84	1	0.78	10+
10A Intermediate Switch	HM3117	1113889	1.30	1	1.22	10+
10A 3 Pole Fan Isolation	HM3118	1113890	3.82	1	3.59	10+
1 Module Blank	HM3110	1113891	0.80	1	0.75	10+
10A 2 Way Keyswitch	HM3112	1113892	4.17	1	3.92	10+
10A DP Keyswitch "EMG LTG TEST"	HM3113	1113893	4.72	1	4.43	10+
10A 1 Way Retractive Switch	HM3114	1113894	1.07	1	1.00	10+
Fused Spur Unit	HM3115	1113895	2.88	1	2.71	10+
20A DP (double module) Switch	HM3116	1113896	3.63	1	3.41	10+
10A DP Resistive Keyswitch	HM3119	1113897	5.33	1	5.01	10+
20A Flex Outlet	HM3120	1113898	3.29	1	3.09	10+
Dimmer Mounting Kit	HM3121	1115170	6.61	1	6.21	10+

Please Note : All Verve 20A DP Switches are 2 MODULES WIDE

20A DP Switch "DISHWASHER"	HM3116DW	1122861	4.95	1	4.65	10+
20A DP Switch "WASHING MACHINE"	HM3116WM	1122862	4.95	1	4.65	10+
20A DP Switch "FRIDGE FREEZER"	HM3116FF	1122863	4.95	1	4.65	10+
20A DP Switch "COOKER HOOD"	HM3116CH	1122864	4.95	1	4.65	10+
20A DP Switch "OVEN"	HM3116OV	1122865	4.95	1	4.65	10+
20A DP Switch "FRIDGE"	HM3116FG	1122866	4.95	1	4.65	10+
20A DP Switch "FAN"	HM3116FN	1122867	4.95	1	4.65	10+
20A DP Switch "MICROWAVE"	HM3116MW	1122868	4.95	1	4.65	10+

Verve Euromod

1 Gang 1 Module Frontplate	HM2211	1113857	1.07	1	1.00	10+
1 Gang 2 Module Frontplate	HM2212	1113858	1.15	1	1.08	10+
2 Gang 4 Module Frontplate	HM2214	1113859	1.46	1	1.37	10+

Verve Euromod Accessories

13A Socket	HM3210	1113860	2.28	1	2.14	10+
Media Blank	HM3211	1113861	0.64	1	0.60	10+
Satellite Female	HM3212	1113862	1.49	1	1.40	10+
Coax Female	HM3213	1113863	4.38	1	4.12	10+
Coax Male	HM3214	1113864	1.73	1	1.63	10+
Telephone Master	HM3215	1113865	3.68	1	3.46	10+
Telephone Secondary	HM3216	1113866	2.17	1	2.04	10+
CAT5E	HM3217	1113867	2.71	1	2.55	10+
CAT6E	HM3218	1113868	3.96	1	3.72	10+
HDMI	HM3219	1113869	20.66	1	19.42	10+
Speaker Points	HM3220	1113870	10.05	1	9.45	10+
Brush Module	HM3221	1113871	10.78	1	10.13	10+

HOOK-UP POINTS

Circuit Breaker Access Window & Pad lockable IEC60309 switched interlocked socket outlets Flexible enclosure design allows either 16A or 32A switched interlocked socket to be interchanged on the same fixing flange and wire harness



Single versions allow for upgrade of additional switched interlocked socket easily and quickly at later date
 Weatherproof IP66/IP67
 High resistance to UV rays and chemical agents
 Smooth undrilled walls allow custom cable entry position



HOOK-UP 1WAY 16A UNMETERED	665300	1145449	138.52	1	
HOOK-UP 1WAY 16A METERED	665301	1145451	186.97	1	
HOOK-UP 2WAY 16A UNMETERED	665320	1145454	283.09	1	
HOOK-UP 2WAY 16A METERED	665322	1145455	380.03	1	

As of 1st January 2019, all new caravan point installations require a hook-up point with interlocked socket. After this date old versions can no longer be installed.

Available to order

BS4343 INDUSTRIAL PLUGS & SOCKETS

- 110V, 230V or 400V/415V
- 16A, 32A or 63A



16A	110V, YELLOW, 2P&E	230V, Blue, 2P&E	400V, Red, 3P&E	400V, Red, 3PN&E
Plug	16APLUG3YE 0548866 2.44 1	16APLUG3BU 0548865 2.44 1	16APLUG4RE 0548876 4.05 1	16APLUG5RE 0548880 4.82 1
Trailing Socket	16ACOU3YE 0548874 3.52 1	16ACOU3BU 0548873 3.52 1	16ACOU4RE 0548891 6.42 1	16ACOU5RE 0548906 7.97 1
90° Surface Mount Socket	16ASKT3YE 0548902 7.79 1	16ASKT3BU 0548901 7.79 1	16ASKT4RE 0548907 8.38 1	16ASKT5RE 0548908 8.38 1
Vertical Interlocked Switch Socket	16AILOK3YE 0549009 33.33 1	16AILOK3BU 0551798 33.33 1		16AILOK5RE 0551810 46.95 1
32A	110V, Yellow, 2P&E	230V, Blue, 2P&E	400V, Red, 3P&E	400V, Red, 3PN&E
Angled Socket		16AANGS3BU 0551789 19.68 1		
Angled Inlet		16AINLT3BU 0548909 8.45 1		
2W Splitter		16ASPLT3BU 0551802 38.55 1		
Connector	32ACONN3YE 0548919 10.95 1			
Plug	32APLUG3YE 0548896 7.22 1	32APLUG3BU 0548888 6.12 1	32APLUG4RE 0548894 6.84 1	32APLUG5RE 0548897 7.23 1
Trailing Socket		32ACOU3BU 0548912 8.73 1	32ACOU4RE 0548911 8.73 1	32ACOU5RE 0548917 9.81 1
90° Surface Mount Socket		32ASKT3BU 0548920 11.83 1	32ASKT4RE 0548921 11.84 1	32ASKT5RE 0548923 13.05 1
Vertical Interlocked Switch Socket		32AILOK3BU 0551804 41.07 1	32AILOK4RE 0551807 44.44 1	32AILOK5RE 0551813 51.51 1
63A	110V, Yellow, 2P&E	230V, Blue, 2P&E	415V, Red, 3P&E	415V, Red, 3PN&E
Angled Socket		63AANGS3BU 0551814 58.98 1	63AANGS4RE 0551815 58.98 1	63AANGS5RE 0551816 61.64 1
Connector		63ACONN3BU 0551803 39.58 1	63ACONN4RE 0551806 42.06 1	63ACONN5RE 0551808 45.31 1
Plug		63APLUG3BU 0551797 32.87 1	63APLUG4RE 0551799 34.32 1	63APLUG5RE 0551800 36.12 1



BOXES (ARCHITRAVE, DRYLINE & METAL)

Steeple Metal-Adjustable Lugs & Earth Terminals

Metal-Adjustable Lugs & Earth Terminals						
16mm, 1 Gang	S1001N	0551742	0.37	1	0.33	20+
25mm, 1 Gang	S1010N	0551743	0.45	1	0.42	10+
25mm, 2 Gang	S1011N	0551744	0.48	1	0.45	10+
35mm, 1 Gang	S1012N	0551745	0.49	1	0.46	10+
35mm, 2 Gang	S1013N	0551746	0.64	1	0.59	10+
47mm, 1 Gang	S1014N	0551747	0.85	1	0.76	10+
47mm, 2 Gang	S1015N	0551748	1.27	1	1.13	5+
35mm Dual	S1016N	0551749	1.42	1	1.32	5+
25mm Dual	S1018N	0551752	1.39	1	1.21	5+
35mm 2 + 1 Gang	S1019N	0551750	1.89	1	1.75	5+
35mm 6-8 Gang	S1020N	0786426	4.89	1	4.34	5+
35mm 2+1+1 Gang	MB21135	0551757	2.12	1	1.96	5+
35mm 2+2+1 Gang	MB22135	0551758	2.63	1	2.40	5+
35mm 2x2 Gang	MB2X235	0551754	1.81	1	1.67	5+
35mm 3x1 Gang	MB3X135	0551753	1.81	1	1.67	5+
25mm 1G Arch Metal Box	MBARCH	0551751	1.07	1	0.86	10+

SEE PAGE 40 FOR FIRE & ACOUSTIC RATED METAL DRY LINING BOXES

Steeple Dry Lining Boxes

Dry Lining Boxes						
35mm, 1 Gang	BSDLB1	0551607	0.64	1	0.59	20+
35mm, 2 Gang	BSDLB2	0551608	0.74	1	0.70	20+
35mm, Dual Box	BSDLB3	0551635	1.31	1	1.26	20+
47mm, 1 Gang	BSDLB4	0551771	0.72	1	0.66	10+
47mm, 2 Gang	BSDLB5	0551772	0.99	1	0.94	10+
Ceiling Rose Box	CEILINGBOX	0551833	1.31	1	1.21	10+
2 Gang + 1 Gang	FF2+1	0551842	1.78	1	1.68	10+

APPLEBY Dry Lining Boxes

Dry Lining Boxes						
35mm, 1 Gang	SDPB1/N	0003125	0.67	1	0.63	10+
35mm, 2 Gang	SDPB2/N	0003126	0.85	1	0.77	10+
47mm, 1 Gang	SDPB3/N	0041870	0.77	1	0.71	10+
47mm, 2 Gang	SDPB4/N	0033694	1.05	1	0.99	10+

Steeple Grommets (Pack of 100)

Grommets (Pack of 100)						
20mm Open Lip Fastfit	SUPGROM200	0548875	4.14	100	3.98	500+
20mm Open	GRM0200	0550812	2.99	100	2.85	500+
25mm Open	GRM0250	0550824	6.17	100	5.93	500+
20mm Blind	GRMB200	0550817	3.38	100	3.25	500+

Steeple Grommet Strip

Grommet Strip						
25m Grommet Strip	GS2	0964474	19.41	1	18.75	3+

LIGHTING ACCESSORIES

Steeple Pendants

Pendants						
6" Pendant	BSPD6/N	0551609	1.83	1	1.71	10+



Pendants

9" Pendant	669T2	0004018	3.62	1	3.09	10+
------------	-------	---------	------	---	------	-----

Steeple Ceiling Roses

Ceiling Roses						
Clear Base	SCRW3006	0549103	2.35	1	2.14	10+

Steeple Pendants

Pendants						
Short Skirt L/holder	HGL6000	0549099	1.73	1	1.45	10+

LIGHTING ACCESSORIES CONTINUED

Steeple Battenholders

Battenholders						
H/O Skirt Pre-Wired	BS6004	0551766	2.82	1	2.37	10+
Angled B/Holder	BS6007	0551624	2.82	1	2.74	10+

Steeple Plug-in Ceiling Roses

Plug-in Ceiling Roses						
4 Terminal	DCR10	0551142	4.60	1	4.28	10+
4 Terminal 2m Flex	DCR10PW	0551155	7.50	1	6.81	10+

JEANI ACCESSORIES Lampholders

Lampholders						
Brass BC, Switched	A38	0007947	3.55	1		
Brass BC L/holder	A70	0007931	2.62	1		
Porcelain ES	A40	0098823	2.36	1		
1/2" Back Plate	501/100	0007592	1.69	1		
Ashley Batten L/Holder Safety Version	SEL96T	0072110	10.17	1	9.36	10+

JEANI ACCESSORIES Inline Switches

Inline Switches						
2A SP White	701W	0008248	1.92	1		
2A SP Black	701B	0008240	2.17	1		
10A DP White	702W	0008250	6.98	1		
10A DP Black	702B	0008249	7.24	1		

CONNECTOR BLOCKS, CONNECTORS & JUNCTION BOXES

Steeple Junction Boxes

Junction Boxes						
20A 4 -Terminal, Small (2.25")	BS5001	0551780	0.89	1	0.80	10+
30A 3 -Terminal	BS5003	0551606	1.35	1	1.20	10+
20A 4 -Terminal	BS5004	0551605	1.13	1	1.05	10+
20A 6 -Terminal	BS6015	0551765	1.77	1	1.64	10+
60A 3 -Terminal	WA222	0226013	5.07	1	4.28	5+

ashley Junction Boxes

Junction Boxes						
Junction Box	J701	0001580	5.32	1	4.90	5+
Box w/ Terminal Block	J701/TB	0001439	6.50	1	5.99	5+
16A Downlight Junction Box	J501	0254662	2.50	1	2.13	10+
32A 3 Terminal	J803	0276395	6.32	1	5.98	10+
20A 4 Terminal	J804	0276396	7.21	1	6.79	10+

Steeple Connector Blocks

Connector Blocks						
Single Pole 100A	BSCBSP	0551767	4.89	1	4.15	3+
Double Pole 100A	BSCBDP	0551768	7.88	1	6.83	3+

WAGO Push in Connectors (priced per pack, qty as shown)

Push in Connectors (priced per pack, qty as shown)						
2 Port, Yellow, x100	773-102	0590753	6.55	100		
4 Port, Orange, x100	773-104	0590754	11.45	100		
6 Port, Purple, x50	773-106	0590756	7.78	50		
8 Port, Black, x50	773-108	0590757	10.36	50		
3 Port, Red, 41A can take up to 6mm cable, x50	773-173	0590759	11.87	50		
Wagobox Grey	51008319	0590770	1.37	1		
39x44x108mm						
Wagobox Light	51257303	0527570	1.38	1		
39x29x95mm						
Wagobox XL	60339091	1008486	2.52	1		
126x115x55mm						
Wago Capsule Conn Box	51312606	0875687	6.55	1		
Wagobox Conn Lid Plate	51312602	0875690	1.51	1		
Wagobox Conn Side Plate	51312603	0875691	3.03	1		
Wagobox Conn Brkt Grey	51312590	0875692	1.82	1		
Wagobox Mounting Button PK10	51009130	0410157	1.25	1		





CONNECTOR BLOCKS, CONNECTORS & JUNCTION BOXES CONTINUED



24A Mini Push-in Connectors (priced per pack of 100x)

24A Mini Push-in Connectors (priced per pack of 100x)					
2 Port, White, x100	2273-202	0590771	7.73	100	
3 Port, Orange, x100	2273-203	0590772	8.44	100	
4 Port, Red, x100	2273-204	0590773	11.95	100	



32A Compact Connectors (priced per pack)

32A Compact Connectors (priced per pack)					
2 Way, pk of 100	221-412	0806538	20.95	100	19.99 300+
3 Way, pk of 50	221-413	0806539	11.99	50	11.50 150+
5 Way, pk of 25	221-415	0806540	9.85	25	9.35 75+



41A Compact Connectors (priced per pack)

41A Compact Connectors (priced per pack)					
2 Way, pk of 50	221-612	1115646	22.14	50	21.09 150+
3 Way, pk of 30	221-613	1115647	16.29	30	15.51 90+
5 Way, pk of 15	221-615	1115648	13.29	15	12.65 45+



Lighting Connectors (priced per pack of 100x)

Lighting Connectors (priced per pack of 100x)					
Dual 24A	224-112	0590766	16.12	100	



Phone/Data Connectors

Phone/Data Connectors					
Telecommunication Cable Splice Kit, includes Strip & Crimp Tool and Telecommunication Cable Splice Connectors, 25pk	33-719	0453539	25.90	1	
	85-925	0453811	5.50	25	



Steeple Self-Extinguishing Connector Strips - Thermoplastic

Self-Extinguishing Connector Strips - Thermoplastic					
5A, 12 Way	SC1205	0551825	0.50	1	0.40 10+
15A, 12 Way	SC1215	0551830	1.15	1	0.99 10+
30A, 12 Way	SC1230	0551840	1.83	1	1.69 10+
60A, 12 Way	SC1260	0551847	6.21	1	5.98 10+



Steeple

5A Connection Box	BSCONBOX	0551048	1.29	1	1.13 5+
15A Connection Box	DCB15A	0551049	1.22	1	1.15 5+
30A Connection Box	23CHOCBOX	0550810	1.32	1	1.25 5+



Scolmore Push-in Connectors

Push-in Connectors					
20A 3 Pin	CT101C	0336453	2.19	1	1.96 10+
20A 4 Pin	CT202C	0368466	3.09	1	2.87 10+



Steeple

IP68 SWA Joint Box	AJB20	0551792	23.22	1	22.99 3+
--------------------	-------	---------	--------------	---	-----------------



TIMEGUARD Weathersafe IP68 Connectors & Junction Box

Weathersafe IP68 Connectors & Junction Box					
IP68 16A In-Line Connector	WXT68IL16	0800752	6.78	1	6.17 5+
IP68 25A Junction Box	WXT68JB25	0800755	9.89	1	9.16 5+



PowerBreaker Cable Connectors

Cable Connectors					
IP68 10A - 2 Piece	H85Z-C	0552232	12.06	1	11.38 5+



WISKA WAGO WISKA Boxes - IP66 Rated, measurements in mm

WISKA Boxes - IP66 Rated, measurements in mm					
85 x 49 x 51	10109571	1148466	4.09	1	3.86 5+
85 x 49 x 51	10109569	1148467	4.09	1	3.86 5+
85 x 85 x 42, Black	COMBI3085B	0552463	4.25	1	4.25 5+
85 x 85 x 42, Grey	COMBI3085G	0552464	4.50	1	4.25 5+
85 x 85 x 42, White	COMBI3085W	0218012	4.50	1	4.25 5+
95 x 95 x 60, Black	10105602	0801655	5.56	1	5.36 5+
95 x 95 x 60, Grey	10105596	0801654	5.31	1	5.12 5+
95 x 95 x 60, White	COMBI4075W	0801656	5.56	1	5.36 5+
110 x 110 x 66, Black	10061779	0218116	6.71	1	6.45 5+
110 x 110 x 66, Grey	10061778	0218115	6.71	1	6.45 5+
110 x 110 x 66, White	COMBI6075W	0217978	6.71	1	6.45 5+
160 x 140 x 81, Black	COMBI1210B	0552461	14.30	1	13.49 5+
160 x 140 x 81, Grey	COMBI1210G	0552462	14.30	1	13.49 5+



WISKA WAGO Earthing Bars & Mini Junction Boxes

Earthing Bars					
For COMBI3085	EC308	0257015	5.35	1	5.06 5+
For COMBI6075	EC607	0257019	5.35	1	5.06 5+



Mini Junction Boxes					
Mini Junction Box Size 1	MBX01	1171145	1.91	1	
Mini Junction Box Size 2	MBX02	1171146	2.46	1	
Mini Junction Box Size 3	MBX03	1171147	3.14	1	



WISKA WAGO Box Kit (COMBI 407 Box + 3 x WAGO 221 3 pole connectors)

WISKA WAGO Kit	COMBI10109673	1120723	5.99	1	5.78 5+
----------------	---------------	---------	-------------	---	----------------

CONVERTER SOCKETS



Steeple 13A Switched Converter Sockets

13A Switched Converter Sockets					
Convert 1 Gang to 2 Gang	DCONVERT2	1306721	6.04	1	5.71 3+
Convert 1 & 2 gang to 4 gang	DCONVERT4	1005064	12.84	1	12.19 3+

EXCLUSIVE PARTNERSHIP
JOIN BRITAIN'S BUSIEST NETWORK

Join Checktrade FREE for three months*

Don't miss out. Strictly limited offer.

EXCLUSIVE OFFER FOR Denmans trade customers



Visit denmans.co.uk for details

SIGN UP FOR A TRADE ACCOUNT TODAY



- Apply now for a trade account and start saving with exclusive trade prices
- Instant £500 online credit available
- Receive exclusive trade promotions



DIMMER PLATES



Steeple Biscuit Spacers

Biscuit Spacers				
1G 10mm Spacer	BSCUIT1	0549097	0.87	1
2G 10mm Spacer	BSCUIT2	0549100	1.19	1



VARILIGHT LED Dimmers

LED Dimmers				
400W 1 Gang LED	JQP401W	0552425	11.21	1 11.07 3+
250W 2 Gang LED	JQP252W	0552424	22.49	1 22.27 3+
1 Gang 1-10V Dimmer	FQP1M1W	0812117	18.99	1 17.43 3+



1000W Dimmer - Leading Edge

1000W Dimmer - Leading Edge				
1000W Dimmer	D1000-1G	0548615	16.61	1

REFER TO PAGES 12-13 FOR DECORATIVE DIMMERS

DIMMER MODULES



VARILIGHT Module Kit				
120W LED Module Kit	MJP120	1086791	11.58	1 11.43 3+



Hamilton Dimmer Module				
5-100W Dimmer Module	LEDITB100	0932711	13.34	1 12.91 3+



DANLERS Push & Rotary LED Dimmer Module (Max. 250W)				
Push & Rotary LED Dimmer Module (Max. 250W)	LED Dimmer Module	DPDLED	0611563	11.29 1



VARILIGHT 2 Way Switch Only Module (no dimmer function)				
2 Way Switch Only Module (no dimmer function)	2WaySwitch Only Module	MH0	1086789	4.22 1

WIRELESS CONTROLS AND HOME AUTOMATION



'Mercury Air' IP Rated Wireless 4-Channel Switching System
4 Channel IP56 rated remote controlled wireless switch receiver for household and garden electric appliances. 1250W per circuit, max. 4000W total load.

- Enable remote switching to open automatic gates and garage doors
- Suitable for year round outdoor use
- Ideal for garden lighting and water feature pumps
- 2 operating modes: on/off and timed
- Operating range 250m
- Comes with a wireless key fob, 4 channel switch radio transmitter, instructions and fittings



Mercury Air Switching Box	MWM-4CHPSKIT	0930598	16297	1
---------------------------	--------------	---------	-------	---

GRID DIMMERS



DataGrid Dimmers

Suitable for LED. Can be used with Denmans white & decorative grid range (EUROMOD).
Vari Datagrid dim/SW LED 2 way 10-100W Black or White



DataGrid Dimmers				
Black	DKP100B	0934259	16.62	1 16.12 3+
White	DKP100W	0934260	16.62	1 16.12 3+

Steeple

Fits MK, MEM, Wandsworth, Crabtree, GET & DETA Systems



400W LV, 500W T - White (min. operating wattage 40W)	ZGRID500	0548690	24.45	1
--	----------	---------	-------	---

DANLERS Grid Dimmers - Suitable for LED

Grid Dimmers - Suitable for LED				
400W* Trailing Edge Euromod Dimmer	DQDGDEU400	0412572	37.84	1

*Can vary depending on lamp characteristics. Some LED lamps may require the use of a load resistor. Multi-switching requires the use of slave units.



zan LED Grid Dimmers Fits MK, MEM, Wandsworth, Crabtree, GET & DETA Systems



GRID DIMMERS				
5-250W - White	ZGRIDLED+	0933571	56.50	1
5-250W - Black	ZGRIDLED+BLK	0933572	57.50	1

DANLERS RESLOADE Load Resistor



RESLOADE Load Resistor				
Load Resistor	RESLOADE	0568498	21.11	1

*Can be used to try to eliminate lamp instability and flicker when dimming non-resistive loads such as mains directly dimmable LED lamps or dimmable transformers.

NEED SOME MORE?

Re-Order from your online account in seconds denmans.co.uk



IP56 Protected



LED Compatible



Wireless Switching

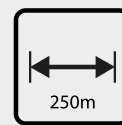

Range Distance 250m



10 YEAR Product Guarantee



Click & Collect
in as little as 1 min



Call
your local branch



Visit
your local branch



DOORBELLS & CHIMES

Steeple



Underdome Bell	DUDB1	0551144	4.57	1
Transformer 4V, 8V, 12V	DBELLTRANS	0550943	12.41	1
Bell Chime c/w Integral Transformer	DTCWH	0550954	11.90	1
White / Black Push	DBPWB	0551121	2.34	1
Illuminated B/W Push	DBPLWB	0551125	2.97	1
Battery/Transformer Operated Chime	DDC1WH	0550923	9.93	1

Honeywell Series 3 150m Wirefree White Door Chime Kits



- Wireless pushbutton and portable doorbell
- Simple, reliable and hassle-free
- Compact size with rich sound
- Easy to install
- Audible range: 60m

Portable Kit	DC311N	0825526	34.54	1
Plug-in Kit	DC311NBS	0825527	38.00	1

METALCLAD ACCESSORIES

Steeple 13A Switched Sockets



13A Switched Sockets				
1 Gang	55SS131SP	0551774	4.40	1 4.24 5+
2 Gang	55SS132SP	0551775	4.72	1 4.53 10+
2-Gang Metalclad SP Switched Socket + 2X USB 3.1A	55SS132DPU3	1190436	14.76	1

10A Switches



10A Switches				
1 Gang, 2 Way	55S512	0551773	3.36	1 3.17 5+
2 Gang, 2 Way	55S522	0551636	4.05	1 3.82 5+
3 Gang, 2 Way	55S532	0551641	6.36	1 5.63 5+

20A DP Switches



20A DP Switches				
Double Pole + Neon	55S201L	0551639	6.51	1 6.11 5+

45A Switches



45A Switches				
1G, DP with Neon	55S451L	0551646	16.52	1 15.59 5+

13A Spur Boxes



13A Spur Boxes				
Unswitched	55SPU13UN	0551640	7.38	1 6.81 5+
Switched	55SPU13	0551777	7.60	1 6.70 5+

RCD PROTECTED ACCESSORIES

niGLON RCD Spur



RCD Spur				
RCD Spur	FS13RCD	0551850	11.99	1 11.25 2+

Steeple 13A RCD Twin Sockets - Unswitched



13A RCD Twin Sockets - Unswitched				
White	RCDSW	0550587	15.67	1 13.08 3+
Metalclad	RCDSM	0550603	18.80	1 16.71 3+

niGLON 13A RCD Plug In Adaptor



13A RCD Plug In Adaptor				
RCD Adaptor	AD13RCD	0548898	7.75	1 7.40 3+
RCD Plug Top	PAD13RCD	0548914	9.09	1

SOCKETS (FLOOR)

Steeple Floor Sockets - Unswitched, Satin Steel

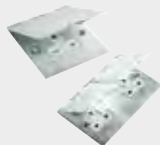

Floor Sockets - Unswitched, Satin Steel				
1 Gang	23FLOOR1	0551339	16.13	1 15.21 3+
2 Gang	23FLOOR2	0549249	24.08	1 22.72 3+

PLUGTOPS, TRAILING LEADS, REELS & ACCESSORIES

DESIGNA Designa Curve Ceiling Pull Switches



Designa Curve Ceiling Pull Switches				
10AX 2 Way	21CS102	0549213	1.98	1 1.86 5+
50A	21CS50	0549245	8.13	1 7.67 5+

Steeple Ceiling Pull Switches



Ceiling Pull Switches				
45A Pull + Neon	11CS45L	0568649	7.75	1 7.25 5+
2 Way Chrome Effect	YPSC	0858569	7.40	1 7.15 5+
Pullswitch				
3 Pole Fan ISO	BS84	0551527	11.52	1 11.09 5+

Crabtree



16A DP + Neon	2163	0022624	14.75	1 13.85 10+
---------------	------	---------	-------	-------------

Steeple Plugtops



Plugtops				
2A ROUND PIN PLUGTOP	TOP2AR	0102910	1.83	1
5A ROUND PIN PLUGTOP	TOP5AR	0102913	3.45	1
White 13A Plugtop	PLUGTOP	0551770	1.15	1 1.02 20+

Steeple Rubber Plugtops



Rubber Plugtops				
Black	7B	0003226	1.98	1 1.83 10+
White	7W	0003281	1.73	1 1.47 10+

Steeple Plugtop Fuses (priced per 10)



Plugtop Fuses (priced per 10)				
3A Fuse	F103	0551837	2.33	10
5A Fuse	F105	0551838	2.33	10
13A Fuse	F113	0551839	2.33	10

Steeple Rubber Sockets



Rubber Sockets				
2G Socket Black	ELS132B	0020285	3.07	1
2G Socket White	ELS132W	0020294	3.07	1
1G Socket Black	ELS13B	0020283	1.61	1
1G Socket White	ELS13W	0020284	1.61	1
4G Socket White	ELS134W	0020295	8.71	1

Cable Reels & Extension Leads



Cable Reels & Extension Leads				
6 Gang Anti-Surge Extension Lead + Thermal Fuse	SRG62N-MP	1158857	13.11	1
4 Gang Socket 2m Flex + Plug	BFG2N	0551526	3.88	1
20m Handheld Cable Reel	HCR42013	1108595	21.98	1
4 Gang, 25m Heavy Duty Cable Reel	NER42513	1108596	31.99	1
4 Gang, 50m Heavy Duty Cable Reel	NER45013	1108597	55.32	1

HiSPEC Pop Up Socket



Pop Up Socket				
'Pull-up' Socket with 2x USB sockets	HSTS3/USB	0552295	34.95	1



SPLASHPROOF ACCESSORIES

Verve by Hamilton



Steeple



IP65 Enclosures - suitable for standard wiring accessories

Single Outdoor	BS165	0551778	8.64	1	8.12	3+
Twin Outdoor	BS265	0551647	14.56	1	13.93	3+
Dual Enclosure Box	DSBE	0550697	25.09	1	23.26	3+

DESIGNA



1G 13A DP Switched Socket	HM5001	1144259	14.24	1	13.38	3+
2G 13A DP Switched Socket	HM5002	1144260	16.06	1	15.10	3+
1G 2W 20A Switch	HM5021	1144261	11.13	1	10.47	3+
2G 2W 20A Switch	HM5022	1144262	12.39	1	11.65	3+
1G 2W 20A (press) Switch	HM5023	1144263	14.20	1	13.35	3+
1G 20A Double Pole Switch	HM5025	1144264	13.61	1	12.79	3+
13A Spur Connection Unit	HM5013	1144265	12.38	1	11.64	3+
1G Enclosure	HM5031	1144266	9.91	1	9.31	3+
2G Enclosure	HM5032	1144267	12.75	1		
2G 13A RCD Socket	HM5005	1144268	49.54	1	46.57	3+

IP66 2G 13A RCD Socket	DEWPRCD2	0550734	52.22	1	50.41	3+
IP66 1G Unswitched Socket	DEWPSS131U	0550732	15.74	1	14.99	3+
IP66 2G 13A Switched Socket	DEWPSS132	0550733	17.50	1	17.11	3+
IP55 1G 2W Switch	DEWPS512	0550729	7.57	1	7.17	3+
IP55 2G 2W Switch	DEWPS522	0550730	8.09	1	7.59	3+
IP55 20A DP Switch	GWP2010	0135977	8.98	1	8.35	5+
13A Fused Connection Unit (for use with DEWPENC)	GRL13FCUPW	0152618	10.29	1		
20A Double Pole Switch (for use with DEWPENC)	SGRL20DPPW	1089534	6.57	1		
IP66 2 Module Enclosure	DEWPENC	0550731	10.65	1		

Introducing the Hamilton Wi-Fi Audio Product range



CONNECT



- Supports Android and iOS
- All in one Solution
- Smart Audio allows playback via wi-fi
- Stream music in one or multiple rooms

STREAM

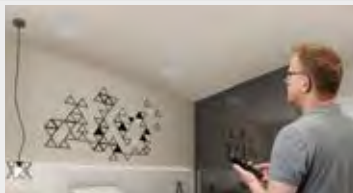

H600-80W8 Ceiling Speakers

Speaker Specification
 Woofers: 6 Inch Kevlar Cone
 Tweeters: 1 Inch Titanium Dome
 Magnetic Front Grill
 Power Handling: 80 Watts
 Frequency Response: 100Hz-20Khz



Appio Wireless Active Speaker

Audio Specification
 Built in amplifier
 20 Watts rms

Functions & Interface
 1 x Aux in
 1 x LAN
 DC In
 On app: EQ, Alarm, Sleep Timer

PLAY



Oyster Wireless Audio Receiver

Bring your existing sound system to life! Connect the Oyster to the Line input on your existing Hi-Fi amplifier to add music streaming features. With the Oyster connected, you can wirelessly connect your Home System to other Hamilton Wireless audio devices and Play music in sync in different rooms around your home

Audio Specification
 Power Amplifier: 2 x 50w 8 ohms
 Frequency Response: 20Hz-20KHz

Audio Interface
 1 x Line in
 1 x Pre-out
 L/R Speaker out
 1 x USB

WIFI
 Bluetooth
 Multi-room
 Multi-source

WSA50BUNDLE (INC. 1xWSA50 + 2xH600-80W8)

ONLY £234.94 BUNDLE



ONLY £182.85 EACH



ONLY £99.90 2 PACK



ONLY £98.99 EACH



ONLY £74.99 EACH

WSA50 1272580 / H600-80W8 1272581 / WMS-1 1272578 / AWR-1 1272579 / WSA50BUNDLE 1272582



Click & Collect in as little as 1 min



Call your local branch



Visit your local branch

RING VIDEO DOORBELL V3

ring

Our most popular doorbell, upgraded with additional security features for your home – including improved motion detection and enhanced Wi-Fi connectivity. Whether you're home or away, you'll always know who's knocking.

- 1080p HD Video & Two-Way Talk
- Advanced motion settings
- Dual-Band 2.4GHz & 5GHz Connectivity
- Rechargeable, Quick-Release Battery Pack
- Night vision
- Works with Alexa, Ring Protect - Enjoy a 30-day free trial of Ring Protect Plan with your purchase. Ring Protect lets you record, save and share all videos from your Ring device.
- Easily set up in minutes



ONLY
£144.99
EACH

8VRS LZ-0EU0 2501307574

See Page 26



Smart
Homes



STAINLESS NEST 3RD GEN LEARNING THERMOSTAT

G Nest

The Nest Learning Thermostat: it programs itself, automatically turns down the heat when you're away and can be controlled remotely. It also shows how much heat you use and why.

The Nest Thermostat E helps save energy. You can change the temperature from the Nest app on your smart device (available on iOS and Android). With its built-in stand, it can go in any room and it's easy to install yourself.



ONLY
£158.30
EACH

T3028GB 1021003

See Page 26

8.5W BC GLS LED DIMMABLE SMART LAMP

Crompton
LAMPS

- Connect wirelessly, no hub required
- Google home & Amazon Alexa enabled
- Compatible with Android and Apple phones
- Dimmable
- White, warm white and RGB available
- High lumen outputs
- 3 year warranty
- 806 lumen

App functionality includes:

- On/Off control
- Colour control
- Dimmable
- Set timers
- Mood settings



ONLY
£15.45
EACH

12325 1145642

See Page 25



SMART CONTROL

Google Nest Wi-Fi



Nest Wifi blankets your whole home in reliable Wi-Fi coverage.

Automatic updates help your network stay safe and sound. One Wifi router with one Wifi point is strong enough to handle up to 200 connected devices, and fast enough to stream multiple 4K videos at a time. Your Nest Wifi point has a speaker with the Google Assistant for extra help around the house. This is Wi-Fi the way it should be.

- Coverage in every corner
- Stream with speed
- Security that's a step ahead
- Hands-free help around the house
- Simple setup in a few steps
- Parental peace of mind
- Manage your connected home



Google Nest Hub Max



Nest Hub Max with the Google Assistant helps your busy family stay in touch and on track. Leave video messages and make video calls. Check in on home when you're away with the built-in Nest Cam. See your own calendar, commute and stay entertained on the 10-inch HD screen and stereo speakers.

- Keep your family connected
- Your home looks out for you. And vice versa
- Make your Smart Home even smarter
- So many ways to stay entertained
- Hands-free help from the Google Assistant



Google Nest WiFi - Router	GA00595-GB	1261230	124.10	1
Google Nest WiFi - Point	GA00667-GB	1261231	107.50	1
Google Nest WiFi Bundle - Router & Point	GA00822-GB	1261232	199.99	1

Google Nest Hub Max - Chalk	GA00426-GB	1264505	183.33	1
Google Nest Hub Max - Charcoal	GA00639-GB	1264506	183.33	1

Google Home

Google Chromecast is designed to make the most of the apps and entertainment already on your phone. Shows, movies, live TV, YouTube, photos and more. It's all just a tap away from all of your family's devices. Just plug Google Chromecast into your TV, power it on, and stream your favourite shows, movies and music right from your phone.

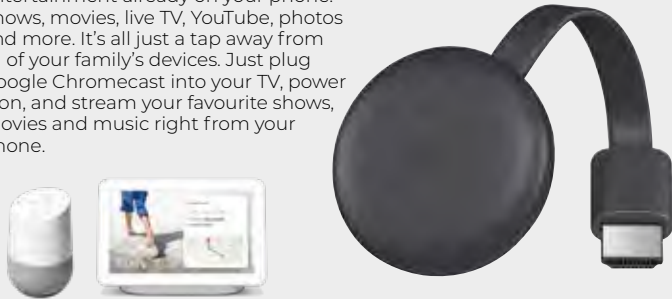

Google Home



Big help is here with Google Home. It has the Google Assistant built in so you can ask it questions and tell it to do things. Just start with "Hey Google" to get answers from Google, play your songs, tackle your day, control your Smart Home and enjoy your entertainment. And through Voice Match, the Assistant provides information personalized for you since it can distinguish your voice from others.

- Get answers from Google
- Enjoy your music
- Tackle your day
- Voice control your smart home
- Enjoy your entertainment
- Designed for any room



Google Nest Chromecast VidEO	GA00439-GB	1261235	24.99	1
------------------------------	------------	---------	-------	---

Nestlabs Home	WNGOGA483UK	1211302	73.95	1
---------------	-------------	---------	-------	---



Get Smart and get connected with the Ener-J range of smart accessories, all controlled with a simple to use App. No hub or subscription

- Security
- Lighting
- CCTV
- Heating
- Wiring Accessories

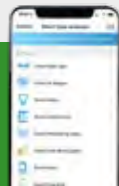

NO HUB NEEDED

Control your smart devices with the ENER-J APP



A	Wi-Fi LED Festoon Lamp Set 7.3M c/w 12 Lamps	SHA5315	1384800	64.99	1
B	WiFi RGB & CCT 5mtr LED Strip Kit - IP65	SHA5213X	1384803	29.90	1
C	WiFi Floodlight RGB/White/Warm White IP65	SHA5321	1384805	22.95	1
D	WiFi Smart Plug With Energy Monitor (Max 1600W)	SHA5264	1384806	12.07	1
E	WiFi 3 Gang Power Strip with 4x USB	SHA5318	1384809	26.03	1
F	WiFi inline Power Switch - Max Load 1600W	SHA5300	1384810	9.29	1
G	WiFi Outdoor Relay Switch	SHA5305	1384811	16.73	1
H	WiFi 13A Twin Socket with 2 USB Ports - Black Finish	SHA5282	1384812	31.59	1
I	WiFi 13A Twin Socket with 2 USB Ports - Silver Finish	SHA5283	1384813	31.59	1
J	WiFi 13A Twin Socket Single USB	SHA5302	1384814	27.88	1
K	WiFi Outside Socket with Twin USB IP55	SHA5275	1384815	37.18	1
L	WiFi Dome Outdoor PTZ IP Camera IP65	SHA5295	1384817	65.06	1
M	WiFi Solar Powered IP Camera IP65	IPC1024	1384818	89.99	1
N	WiFi Slim Video Door Bell	SHA5289	1384819	69.71	1
O	WiFi Security Door Sensor	SHA5265	1384820	14.87	1
P	WiFi Security Eyeball PIR Sensor	SHA5266	1384821	18.59	1
Q	WiFi Security Siren	SHA5267	1384822	18.59	1
R	WiFi Tempered Glass 2kw Smart Panel Heater	SHA5281	1384823	102.25	1
S	1 Gang WiFi Light Switch UK Version - No Neutral Req	SHA5312	1347621	16.71	1





Starter Kits



Lightwave Power Starter Kit Ss	L422	1168797	154.17	1
Lightwave Lighting Starter Kit Ss	L212	1168796	154.17	1
Lightwave Lighting & Power Starter Kit Ss	L21422	1168795	190.83	1
Lightwave Lighting & Power Starter Kit Whi	L21422WH	1168801	199.17	1

Kinetic Switch and Receiver Bundles



No battery, no wiring - self-powered smart switch for house lighting & appliances! Innovative kinetic switches can be installed wherever without running additional wires. No need to channel walls; save material cost & engineer labour fee! Eco-friendly.

- 1 Press switch to produce Kinetic energy
- 2 Kinetic energy is converted into electricity
- 3 Switch transmits signal to receiver
- 4 Receiver controls device/light

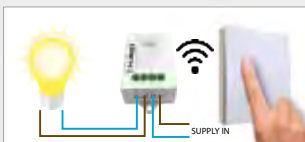

With Wifi receiver

1 Gang Kinetic Switch Receiver Bundle	WS1060	1347624	22.29	1
1 Gang Kinetic Switch and 100W Smart WIFI Receiver - Dimmable	WS1061	1347625	33.43	1
1 Gang Kinetic Switch and 500W Smart WIFI Receiver - Non Dimmable	WS1062	1347626	30.64	1
1 Gang Eco Wireless Kinetic Switch Only	WS1050	1383419	12.07	1
2 Gang Eco Wireless Kinetic Switch Only	WS1051	1383420	13.93	1
3 Gang Eco Wireless Kinetic Switch Only	WS1052	1383421	15.79	1

Smart Sockets



Control and schedule power in the home or outside via touch, voice commands or APP

Improves home wifi with one touch setup.

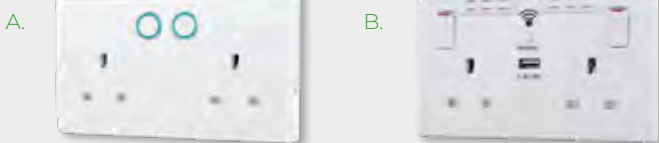

RANGE EXTENDER SOCKETS				
A. BG 822/HC WiFi Double Socket	822/HC	1187442	16.80	1
B. Wi-Fi Range Extender Socket with USB	BG922UWR	1081159	26.99	1
Wi-Fi Range Extender Socket	BG922WR	1081158	25.99	1

SMART LIGHTING

LED Lights



- Connect wirelessly, no hub required
- Google home & Amazon Alexa enabled
- Compatible with Android and Apple phones
- Dimmable
- White, warm white and RGB available
- High lumen outputs
- 3 year warranty

- App functionality includes:
- On/Off control
 - Colour control
 - Dimmable
 - Set timers
 - Mood settings



8.5W BC GLS LED Dimmable Smart Lamp, 806 lumen	12301	1145640	14.29	1
8.5W ES GLS LED Dimmable Smart Lamp, 806 lumen	12318	1145641	14.29	1
8.5W BC GLS LED Dimmable Smart Lamp, 3000K white & RGB, 806 lumen	12325	1145642	15.45	1
8.5W ES GLS LED Dimmable Smart Lamp, 3000K white & RGB, 806 lumen	12332	1145643	15.45	1
5W BC Candle LED Dimmable Smart Lamp, 470 lumen	12349	1145645	14.00	1
5W SES Candle LED Dimmable Smart Lamp, 470 lumen	12356	1145644	14.00	1
5W BC Candle LED Dimmable Smart Lamp, 3000K white & RGB, 470 lumen	12363	1145647	14.29	1
5W SES Candle LED Dimmable Smart Lamp, 3000K white & RGB, 470 lumen	12370	1145646	14.29	1
5W GU10 LED Smart Lamp 2700K-4000K White, 320 lumen	12387	1145648	13.87	1
5W GU10 LED Smart Lamp 3000K White and RGB, 320 lumen	12394	1145649	15.82	1
5W GU10 LED Smart Lamp 4000K White and RGB, 320 lumen	12400	1145650	15.82	1
18W 5m LED Smart Flexi Strip Warm White and Colour Changing, 1500 lumen	12417	1145651	74.90	1



THE DENMANS APP

Save time on the move by downloading the simple to use App





SMART LIGHTING

WIFI Controlled Outdoor Security Floodlight with Built in IP 1080P Security Camera



NO HUB NEEDED
NO MONTHLY FEES
ONE SINGLE APP



WIFI Controlled Outdoor Security Floodlight with Built in IP 1080P Security Camera	SHA5294	1347620	89.99	1
--	---------	---------	-------	---

SMART SECURITY

Ring 5 Piece Wireless Alarm Kit



A smarter way to protect your property from the inside out. Effortless to install and completely customisable to fit any home.

- Includes:
- Base Station
- Keypad
- 1 Contact Sensor
- 1 Motion Detector
- Range Extender



4K11E9-0EU0 RING ALARM 5 PIECE STARTER KIT	4K11E9-0EU0	1286835	207.50	1
4AK1E9-0EU0 RING ALARM KEYPAD	4AK1E9-0EU0	1286831	47.25	1
4AR1E9-0EU0 RING ALARM RANGE EXTENDER	4AR1E9-0EU0	1286832	23.76	1
4SDAE9-0EU0 RING CONTACT SENSOR	4SDAE9-0EU0	1286833	24.17	1
4SPA9-0EU0 RING PIR MOTION SENSOR	4SPA9-0EU0	1286834	32.50	1

SMART HEATING

Nest Learning Thermostat



The Nest Learning Thermostat: it programs itself, automatically turns down the heat when you're away and can be controlled remotely. It also shows how much heat you use and why.

The Nest Thermostat E helps save energy. You can change the temperature from the Nest app on your smart device (available on iOS and Android). With its built-in stand, it can go in any room and it's easy to install yourself.



Stainless Nest 3rd Generation Learning Thermostat	T3028GB	1021003	158.30	1
Copper Nest 3rd Gen Learning Thermostat	T3031EX	1021006	148.33	1
White Nest 3rd Gen Learning Thermostat	T3030EX	1021005	169.00	1
Black Nest 3rd Gen Learning Thermostat	T3029EX	1021004	148.33	1
Nest 'E' Thermostat	HF001235-GB	1143769	147.79	1

Active Heating Multizone Thermostat



Control your heating at home, or from your smartphone, tablet or laptop.

- A Hive Active Heating™ upgrade to control additional heating zones from your smartphone, tablet and laptop
- No need to heat your whole home, just heat the zone you need and you could save energy and money
- Controls zonal heating systems including wet underfloor heating (Hive does not support electric underfloor heating)
- Works with Hive Active Heating™ and the Hive Hub



Note: Use in conjunction with Hive Active Heating Thermostat

Hive Active Heating Multizone Thermostat	UK7004219	1260731	74.99	1
--	-----------	---------	-------	---

SMART SECURITY

Video Doorbell V3



Requires iOS or Android device



Our most popular doorbell, upgraded with additional security features for your home – including improved motion detection and enhanced Wi-Fi connectivity. Whether you're home or away, you'll always know who's knocking.

- 1080p HD Video & Two-Way Talk
- Advanced motion settings
- Dual-Band 2.4GHz & 5GHz Connectivity
- Rechargeable, Quick-Release Battery Pack
- Night vision
- Works with Alexa, Ring Protect - Enjoy a 30-day free trial of Ring Protect Plan with your purchase. Ring Protect lets you record, save and share all videos from your Ring device.
- Easily set up in minutes



Ring Video Doorbell V3	8VRSLZ-0EU0	1307574	144.99	1
------------------------	-------------	---------	--------	---

NEST HELLO Doorbell



Nest Hello lets you know who's there, so you never miss a visitor or a package. And with 24/7 streaming, you can check in anytime.

- Know who's at your door
- HD Talk and listen
- HD video, day or night
- 24/7 streaming
- Quiet time
- Video history
- Familiar face alerts
- Activity zones & clips

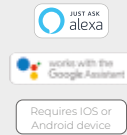

NEST HELLO Doorbell	NC5100GB	1122879	169.99	1
---------------------	----------	---------	--------	---

1080P Video Doorbell C/W Chime

Securefast

Intelligent Wi-Fi video doorbell camera allows you to check who is at your door from anywhere in the world; complete with indoor chime.

- High grade IP53 waterproof and dustproof (AML5C)
- Advanced high speed video processor chip
- Real time monitoring via App
- High definition video and two way audio
- Wi-Fi connection for convenient monitoring
- Low power consumption and energy saving

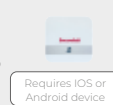

1080P Video Doorbell C/W Chime	AML2C	1219706	83.32	1
--------------------------------	-------	---------	-------	---





SMART SECURITY

Floodlight Cam

Motion-activated HD security camera with built-in floodlights, siren alarm and two-way talk.

- Wi-Fi connection @ 2.4GHz only
- Two-way audio with noise cancellation
- Two 3000K floodlights - 1800 Lumens (Combined)
- Adjustable mount with 140 degree field-of-view
- Temperature range: -20.5°C to 48.5°C (-5°F to 120°F) & Weather Resistant
- Customisable motion detection zones
- Motion-activated camera and floodlights
- App-controlled camera, lights and siren
- Security siren alarm



JUST ASK alexa
Requires IOS or Android device

CAMERAS

Ring Floodlight HD Camera	8SF1P7-BEU0	1219717	174.56	1
Ring Floodlight HD Camera	8SF1P7-WEU0	1219718	174.56	1

NEST CAM Outdoor Camera

- Makes sure that your home is safe by checking in on your phone, even when you are out.
- Instant alerts when unusual motion or sound detected
- 130° wide-angle view
- Built-in microphone & speaker
- Quick & easy set up - put it anywhere



JUST ASK alexa works with the Google Assistant Requires IOS or Android device

CAMERAS

NEST CAM Outdoor Camera	NC2100GB	0955749	132.92	1
-------------------------	----------	---------	--------	---

1080P External Bullet Camera With 2 Way Audio



- 1080P Full Hd
- IP67 Rated
- Up to 30m Vision
- Sharp 18 LED Night Vision



Requires IOS or Android device

CAMERAS

1080P External Bullet Camera With 2 Way Audio	AB72-2	1219708	49.99	1
---	--------	---------	-------	---

Yale Sync Alarm Kits

- No technical knowledge needed for installation
- Preconfigured devices straight out the box
- Compatible with Phillips Hue
- Up to 200m range
- Geolocation compatible
- Full alerts to your phone or smart watch



JUST ASK alexa works with the Google Assistant Requires IOS or Android device



SYNC ALARM KITS

Yale Sync Smart Full Control Kit	IA-340	1231585	350.00	1
Yale Sync Smart Family Kit Plus	IA-330	1231583	299.99	1
Yale Sync Smart Home Family Kit	IA-320	1231582	213.75	1
Yale Sync Smart Home Starter Kit	IA-310	1231581	169.90	1
Additional remote keypad	AC-KP	1231544	39.99	1

SMART SECURITY

Stick Up Cam Wired

Wired indoor/outdoor HD Security camera with two-way talk and versatile mounting options. Power through plug-in or Power over Ethernet. Connectivity via Wi-Fi or Ethernet.

- Wi-Fi connection - 2.4GHz only
- Two-way audio with noise cancellation
- 1080p HD video with live view and night vision
- Adjustable mount - 115° horizontal, 65° vertical
- Retrieving data. Wait a few seconds and try to cut or copy again
- Customisable motion detection zones
- App-controlled camera, lights and siren
- Instant motion-activated notifications
- Security siren alarm



JUST ASK alexa works with the Google Assistant Requires IOS or Android device

CAMERAS

Ring Wired Stick Up Cam	8SW159-WUK0	1286829	74.17	1
-------------------------	-------------	---------	-------	---

WIFI Motion Tracking 1080P CCTV Camera



Monitor any room in your home from your mobile device, day or night.

- 2 way audio
- Capture HD video
- 350° Pan and 110° Tilt
- Motion detection
- Night vision function
- Auto tracking

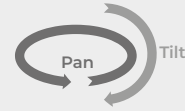

Requires IOS or Android device

CAMERAS

Securefast Auto Tracking WiFi PTZ Camera	APT080-20	1219711	32.50	1
--	-----------	---------	-------	---

Nest Protect: WiFi Smoke and Carbon Monoxide Alarm

Requires IOS or Android device



Know more, worry less. Nest Protect speaks up if there's smoke or carbon monoxide and tells you where the problem is. It will even message your phone.

- Nest Protect sends a message when there's a problem or the batteries run low.
- Silence from the Nest app. Just burnt the toast? Silence the false alarm with your mobile.
- Nest Protect speaks up if there's smoke or carbon monoxide and tells you where it is, so you know what to do



SMOKE AND CARBON MONOXIDE

Nest Protect Smoke + Carbon Monoxide Alarm (2nd Gen) Battery	S3000BWGB	0798876	82.45	1
Nest Protect Smoke + Carbon Monoxide Alarm (2nd Gen) Wired 230V	S3003LWGB	0798877	82.45	1

WIFI Mini 1080p Security Camera

- 1080p HD camera live streaming viewed on your mobile
- Motion sensor phone alerts
- Remote connect and view live stream,
- Supports memory card storage up to 128GB (not included)
- 2 Year warranty



CAMERAS

WIFI Mini 1080p Security Camera	SAPIRW1080P	1219147	32.99	1
---------------------------------	-------------	---------	-------	---



Cable & Cable Management



Due to volatility in copper prices we do not price some of our cable in the Connector.

To ensure we can give you our best prices throughout the month, please ask in branch or check online at

Denmans.co.uk

We monitor the market constantly, to bring you our best possible prices.

TV MOUNTS & BRACKETS



- Suitable for a wide range of screen sizes
- Low profile designs
- Compatible with VESA mounting patterns
- Installation hardware included
- Fixed, tilt and full motion arm options available

**FROM
£9.79
EACH**



For more information & accessories see page 36

GREAT AVAILABILITY AND VALUE ON EVERYDAY ELECTRICALS

IP65 THERMOPLASTIC ENCLOSURES



- Protection class: IP65
- Temperature range: -25 °C - 85 °C
- Glow wire test: 650 °C
- Installation temperature: -5°C - 60°C
- Material: Thermoplastic



STWIB1 STEEPLE 80X80X35 IP65 ENCLOSURE	STWIB1	2501309114	2.00	1
STWIB2 STEEPLE 110X110X60 IP65 ENCLOSURE	STWIB2	2501309115	3.24	1
STWIB3 STEEPLE 160X120X70 IP65 ENCLOSURE	STWIB3	2501309116	5.54	1
STWIB4 STEEPLE 230X180X88 IP65 ENCLOSURE	STWIB4	2501309117	16.36	1
STWIB5 STEEPLE 190X140X75 IP65 ENCLOSURE	STWIB5	2501309118	10.69	1

BRACE CONTRACTOR PACKS



These Contractor Packs offer a complete installation solution, featuring our latest cable management innovation - the BraceFITTING. Whether its LED lighting, garden installations or general protection our BraceCONTRACTOR Packs offers users a high quality, secure, IP67 / IP68 rated solution.

1. Surprisingly easy to use – thanks to the new hinged cover for lightning-fast opening and closing with one simple standard tool.
2. Highest protection as standard – all variants of the non-metallic BraceFITTING with IP68 protection class.
3. Tear-proof – thanks to a new closing system that directly grips in conduit.
4. Twice the security – The directly injected O-ring seal ensures secure installation and perfect sealing properties.
5. Time-saving maintenance – thanks to the external clearly visible O-ring seal.
6. Cost-saving storage – A completely assembled product that keeps everything in one place saving on warehouse space, costs and time.



Wiska Brace Bcab-L-17-20-Bk Cond 10M	10110230	1183072	20.29	1	19.12	3+
Wiska Brace Bcab-L-23-25-Bk Cond 10M	10110316	1183073	32.82	1	29.93	3+
Wiska Brace Bcab-L-17-20-Bk Cond 10M	10110231	1183075	25.66	1	23.81	3+
Wiska Brace Bcab-L-23-25-Bk Cond 10M	10110317	1183076	38.15	1	35.92	3+
Wiska Brace Bcab-L-17-20-Bk Cond 1M	10110226	1183077	8.35	1	7.74	3+
Wiska Brace Fitting Pack of Ten	10110395	1286398	9.45	1	9.00	3+

Denmans
REXEL GROUP



Click & Collect
in as little as 1 min



Call
your local branch



Visit
your local branch



Our booklet cable price list

Our prices range between 71%-98% off manufacturer's published booklet cable trade prices.

Regular customers and volume buyers may negotiate further discounts with our branch managers. Red prices are strictly net.

ALL CABLE WE SELL IS MANUFACTURED TO RELEVANT BRITISH STANDARDS.

Prices correct at time of going to print. Due to the uncertainty over copper prices, prices may be subject to change without notice.

WIRING CABLES

Twin & Earth Cable (6242Y)

1.00mm ² - 50m	6242Y51	0143033		50+	
1.00mm ² - 100m	6242Y1	0142984	GO ONLINE OR IN BRANCH FOR PRICES	100+	
1.50mm ² - 50m	6242Y515	0143052		50+	
1.50mm ² - 100m	6242Y1.5	0143035		100+	
2.50mm ² - 100m	6242Y2.5	0143054		100+	
2.50mm ² - 50m	6242Y525	0143063		50+	
4.00mm ² - 50m	6242Y54	0143070		64.30	50+
4.00mm ² - 100m	6242Y4	0143065		121.99	100+
6.00mm ² - 50m	6242Y56	0143085		77.05	50+
6.00mm ² - 100m	6242Y6	0143072		182.23	100+
10.00mm ² - 50m	6242Y510	0143176		153.50	50+
10.00mm ² - 100m	6242Y10	0143087		304.14	100+
16.00mm ² - 50m	6242Y516	0143184		232.05	50+
16.00mm ² - 100m	6242Y16	0143178		487.59	100+

3 Core & Earth (6243Y)

1.00mm ² - 50m	6243Y51	0143208	27.76	50+		
1.00mm ² - 100m	6243Y1	0143202	52.28	100+	0.00	0
1.50mm ² - 50m	6243Y515	0143216	37.23	50+		
1.50mm ² - 100m	6243Y1.5	0143210	69.99	100+	0.00	0

Low smoke Twin / 3 core and Earth (6242B and 6243B)

1.50mm ² - 100m	H16242B1.5	0142900	64.77	100+
1.50mm ² - 100m	H16243B1.5	0143200	95.56	100+
2.5mm ² - 100m	H16242B2.5	0142914	96.02	100+

Conduit & Trunking Cable H07V-R (6491X)

1.50mm ² - 100m Stranded	I6491G1.5	0003435	20.78	100+
2.50mm ² - 100m Stranded	I6491G2.5	0003436	33.80	100+
4.00mm ² - 100m Stranded	I6491G4	0003437	52.64	100+
6.00mm ² - 100m Stranded	I6491G6	0003528	79.96	100+
10.00mm ² - 50m Stranded	I6491G510	0318126	70.17	50+
10.00mm ² - 100m Stranded	I6491G10	0003529	121.15	100+
16.00mm ² - 50m Stranded	I6491G516	0332362	112.56	50+
16.00mm ² - 100m Stranded	I6491G16	0003530	217.26	100+

Other colours available - ask your branch

Arctic Grade Flexibles

1.50mm ² - 3 Core Blue	I3183BA1.5	0158656	84.23	100+
1.50mm ² - 3 Core Yellow	I3183YA1.5	0158657	84.23	100+
2.50mm ² - 3 Core Blue	I3183BA2.5	0158658	90.34	100+
2.50mm ² - 3 Core Yellow	I3183YA2.5	0158659	90.34	100+

Heat Resistant Flexibles Butyl (3183TQ)

0.75mm ² - 3 Core 50m	I3183TQ575	0446050	42.77	50+
1.00mm ² - 3 Core 50m	I3183TQ51	0446051	53.02	50+
1.50mm ² - 3 Core 50m	I3183TQ515	0446052	65.51	50+

Heat Resistant PVC (309-Y) White

0.75mm ² - 2 Core 50m	I3092Y5.75	0021718	21.64	50+
0.75mm ² - 3 Core 50m	I3093Y5.75	0021720	26.82	50+
1.00mm ² - 3 Core 50m	I3093Y51	0021743	31.44	50+
1.50mm ² - 3 Core 50m	I3093Y51.5	0021744	42.92	50+
2.50mm ² - 3 Core 50m	I3093Y52.5	0021745	70.29	50+
0.75mm ² - 4 Core 50m	I3094Y5.75	0507403	33.06	50+
0.75mm ² - 5 Core 50m	I3095Y5.75	0361466	42.23	50+

Light Flexible (219-Y)

0.50mm ² - 2 Core 100m	I2192Y.5	0021117	21.23	100+
0.50mm ² - 2 Core 50m	I2182Y5.5	0021647	11.59	50+
0.75mm ² - 2 Core 50m	I2182Y5.75	0021648	14.81	50+
0.75mm ² - 3 Core 50m	I3183Y5.75	0022313	22.78	50+
0.75mm ² - 3 Core 50m	I2185Y5.5	0148090	29.89	50+
0.75mm ² - 3 Core (Blk) 50m	I3183Y575B	0313008	22.78	50+
0.75mm ² - 3 Core 100m	I3183Y.75	0094891	43.70	100+
1.00mm ² - 3 Core (Blk) 50m	I3183Y51B	0313150	27.83	50+
1.00mm ² - 3 Core 100m	I3183Y1	0094892	55.17	100+
1.00mm ² - 3 Core 50m	I3183Y51	0022315	27.83	50+
1.0mm ² - 3 Core 50m	I3184Y51	0135797	39.55	50+
1.50mm ² - 3 Core (Blk) 50m	I3183Y515B	0022415	39.79	50+
1.50mm ² - 3 Core 50m	I3183Y51.5	0022417	39.79	50+
1.50mm ² - 3 Core 50m	I3184Y51.5	0148088	51.80	50+
1.50mm ² - 3 Core 100m	I3183Y1.5	0094893	76.06	100+
2.50mm ² - 3 Core 50m	I3183Y52.5	0038279	66.40	50+

Rubber Flex (3183TRS)

0.75mm ² - 3 Core 50m	I3183TRS75	0021872	37.23	50+
1.00mm ² - 3 Core 50m	I3183TRS1	0021924	44.04	50+
1.50mm ² - 3 Core 50m	I3183TRS15	0021925	58.52	50+

Alarm Cables (Multi Stranded)

4 Core - 100m	ALARM4CORE	0548806	15.72	100+
6 Core - 100m	ALARM6CORE	0548807	19.06	100+
8 Core - 100m	ALARM8CORE	0548808	25.12	100+

Bell Wire / Speaker Cable

13 Stranded - 100m	ISPKR	0548802	13.98	100+
79 Stranded - 100m	ISPKR79	0548803	62.74	100+
Parallel Twin PVC White	IBELL	0548801	14.89	100+

Co-Axial Cable Low Loss

RG59+Power Shotgun	RG59SG	0988433	38.24	100+
RG59 Coax - 100m	RG59	0548822	28.94	100+
Satellite TV Cable black	SATELLITEBLK	0548818	17.81	100+
Satellite TV Cable white	SATELLITEWH	0548817	19.15	100+
Coax 100M White	COAXW	0548816	15.01	100+
Digital Coaxial Black	COAX/DIGI	0548819	31.83	100+
Digital Coaxial White	COAX/DIGIWH	0548820	35.00	100+
Twin Digital Co-Ax	TWIN/DIGI	0548821	63.82	100+



Computer Cable



4 Twisted Pair UTP CCA Networking Cable - 305m • Solid UTP cable • Grey PVC insulation • Computer Networking - Allows full speed data transmission between 60-70m maximum	DATA305UTP	0548805	47.48	305
4 Twisted Pair CAT5E Copper Cable Allows full speed data transmission up to the full 305m.	UTP/5E/4CU	0669784	68.39	1
4 Twisted Pair FTP C5 Screened	FTP/5E/4	0599110	126.16	305
CAT6 UTP PVC Cable (305m)	UTP/6E/4P	0341826	107.60	1
CAT6 UTP LSOH Violet (305m)	UTP/6E/4	0338724	101.97	1

Fire Cables



Top British Brand (White also available)				
2 Core 1.5mm² Red	NBUR2C1.5R	0599120	80.65	100+
2 Core 2.5mm² Red	NBUR2C2.5R	0234762	195.75	100+
3 Core 1.5mm² Red	NBUR3C1.5R	0234778	187.84	100+
4 Core 1.5mm² Red	NBUR4C1.5R	0234963	216.22	100+

PIRELLI FP200 also available - please ask your branch for details

Fire Cable Sundries



PVC Clips				
RCHJ32 Red (1.5mm² 2c+3c+E)	NPC2R	0548924	14.80	50
RCHJ32 White (1.5mm² 2c+3c+E)	NPC2W	0548925	14.80	50
RCHJ34 Red (1mm² 4c +1.5mm² 3c+2.5mm² 2c+E)	NPC3R	0548931	16.88	50
RCHJ34 White (1mm² 4c + 1.5mm² 3c + 2.5mm² 2c +E)	NPC3W	0548932	16.88	50
RCHJ37 Red (1.5mm² 4c+E)	NPC4R	0551781	16.88	50
RCHJ37 White (1.5mm² 4c+E)	NPC4W	0551782	16.88	50

Steel Wire Armoured SWA (694)



3 Core per metre				
1.50mm²	H6943X/1.5	0141658	1.17	1 1.06 50+
2.50mm²	H6943X/2.5	0141659	1.70	1 1.55 50+
4.00mm²	H6943X/4	0141660	2.37	1 2.16 50+
6.00mm²	H6943X/6	0141827	3.23	1 2.94 50+
10.00mm²	H6943X/10	0141828	5.27	1 4.79 50+
16.00mm²	H6943X/16	0141829	7.88	1 7.17 50+

4 Core per metre				
1.50mm²	H6944X/1.5	0141860	1.45	1 1.32 50+
2.50mm²	H6944X/2.5	0141861	2.10	1 1.91 50+
4.00mm²	H6944X/4	0141862	2.97	1 2.70 50+
6.00mm²	H6944X/6	0141871	4.33	1 3.94 50+
10.00mm²	H6944X/10	0141872	6.64	1 6.04 50+
16.00mm²	H6944X/16	0141873	9.95	1 9.05 50+

SWA SUNDRIES



Cleats for SWA				
No.4 Cable Cleats	STCC4	1315324	0.04	1
No.5 Cable Cleats	STCC5	1309228	0.05	1
No.6 Cable Cleats	STCC6	1309229	0.10	1
No.7 Cable Cleats	STCC7	1309230	0.11	1
No.8 Cable Cleats	STCC8	1309231	0.12	1
No.9 Cable Cleats	STCC9	1309232	0.25	1
No.10 Cable Cleats	STCC10	1309233	0.14	1
No.11 Cable Cleats	STCC11	1309234	0.19	1
No.12 Cable Cleats	STCC12	1309235	0.20	1
Dangertape 365m	DANGERTAPE	0550803	22.18	1 21.34 3+

*Size 14-20 available to order

Standard Gland Packs for SWA (Pack includes: 2 Glands, 2 Shrouds, 2 Earhtags, 2 Locknuts)



20mm Sml Gland Pack	STBW20SN	0548870	2.86	1	2.24	5+
20mm Gland Pack	STBW20N	0548871	2.99	1	2.70	5+
25mm Gland Pack	STBW25N	0548905	6.50	1	5.75	5+
32mm Gland Pack	STBW32N	0548930	8.00	1	7.70	5+
40mm Gland Pack (1 gland only)	STBW40	0548929	6.95	1	6.50	5+

(Other sizes in stock)

Standard Gland Packs for SWA (Pack includes: 2 Glands, 2 Shrouds, 2 Earhtags, 2 Locknuts)



20mm Sml Gland Pk	STCW20SN	0548879	4.50	1	3.42	5+
20mm Gland Pack	STCW20N	0548884	5.50	1	4.79	5+
25mm Gland Pack	STCW25N	0548928	7.69	1	6.88	5+
32mm Gland Pack	STCW32N	0551791	10.89	1	9.66	5+
20mm Shroud Pack White	MIS20W	0548900	0.79	1	0.65	10+

(Other sizes in stock)

YY & SY CONTROL FLEX

DID YOU KNOW WE STOCK YY&SY CONTROL FLEX?
ASK IN BRANCH

TAILS DOUBLE INSULATED (6181Y)



TAILS DOUBLE INSULATED (6181Y)

Available in Blue or Brown

16.00mm² Blue	6181YBU516	0142559	140.05	50	127.33	50+
16.00mm² Brown	6181YBR516	0142750	140.05	50	127.33	50+
25.00mm² Blue	6181YBU225	0575010	75.82	25	68.93	25+
25.00mm² Brown	6181YBR225	0575009	75.82	25	68.93	25+
25.00mm² Blue	6181YBU525	0373168	146.97	50	133.60	50+
25.00mm² Brown	6181YBR525	0371118	148.49	50	134.99	50+
25mm² x3m x2	6181YPAK3M	0552373	33.14	1		

Tail Pack Contains: 6181Y 25mm² Blue 3m & Brown 3m. 6491X 16mm² Green/Yellow 3m

19 Strand Flexible Tails



50mx25mm Blue	6181Y25FLEXBLU	1143876	219.98	50	200.00	50+
50mx25mm Brown	6181Y25FLEXBRN	1143877	219.98	50	200.00	50+
2x3m 25mm (Brown and Blue)	TAILSPACKFLEXI	1143371	29.49	1		

Tails Pack Contains: Brown/Blue/Earth 3m

TELEPHONE CABLE



Telephone Cable, White, Copper covered aluminium conductors (number of pairs/cores)

Standard, (2/4)	2PAIR	0548809	12.30	100+
Standard, (3/6)	3PAIR	0548811	17.00	100+
Standard, (4/8)	4PAIR	0548813	23.86	100+
Standard, (6/12)	6PAIR	0548814	35.48	100+



External Telephone Cable, 100m Black

External (5 Pair)	5PAIREXT	0550865	92.41	100+
-------------------	----------	---------	--------------	------

COPPER CABLE VERSIONS AVAILABLE TO ORDER

SWA TELE CLEATS



TELCLEAT 10-15MM POLYT	385AA01	0003856	18.00	100
TELCLEAT 12-17MM POLYT	385AA02	0003857	26.80	100
TELCLEAT 15-20MM POLYT	385AA03	0003858	29.00	100
TELCLEAT 18-24MM POLYT	385AA04	0003859	22.00	50
TELCLEAT 22-29MM POLYT	385AA05	0003934	25.00	25
TELCLEAT 26-34MM POLYT	385AA06	0003935	43.25	25
TELCLEAT 32-42MM POLYT	385AA07	0003936	29.00	10





EARTH PRODUCTS



Earth Rods & Accessories					
4' 5/8" Extendable Earth Rod	XCBER458	0548915	9.49	1	
Driving Stud for XCBER458	DS58	0548863	1.92	1	
Clamp for Stud	SDCC58	0548877	4.60	1	
Ext. Coup. for Stud	EC58	0548881	5.03	1	
4ft x 3/8" Copper Rod	SER	0548882	5.25	1	4.75 3+
Rod Clamp Brass	SERC	0548869	3.25	1	2.99 3+
Earthing Nut (Pack Of 2)	SBEUN20-PK2	1243256	3.66	1	3.44 3+



Earth Boxes					
Earth Electrode Box	EEB1BLK	0005699	10.04	1	
Earth Electrode Earth Box Round	E/BOX	0549369	8.54	1	



Steeple

Earth Clamps					
Standard Type	G250/ET	0550862	0.81	1	0.77 20+
Phosphor Bronze	G350/ET	0550863	0.93	1	0.84 20+
32-50mm Blue Clamp	AEC2/2	0548858	1.26	1	1.18 10+



Steeple Earth Blocks

4 Way Earth Block	SETB4	0550862	1.95	1	
8 Way Earth Block	SETB8	0548872	3.50	1	

SLEEVING

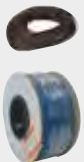

Steeple

Over Sleeving - 100m					
3mm Brown	BR3/DRUM	0548904	4.99	100	
3mm Blue	BLU3/DRUM	0548903	4.99	100	



Earth Sleeving, 100m					
2mm Green/yellow	GY2/DRUM	0548890	4.50	100	
3mm Green/yellow	GY3/DRUM	0548895	4.99	100	
4mm Green/yellow	GY4/DRUM	0548916	7.58	100	

JOINTING KITS



Steeple

Jointing Kits (>indicates kit is suitable for up to the specified cable size)					
> 6mm ² 4 Core SWA	DJK6-4	0551540	11.31	1	11.07 2+
> 25mm ² 2 Core SWA	DJK16-4	0551538	22.47	1	21.57 2+
> 150mm ² 2 Core SWA	DJK35/70-4	0551539	46.63	1	45.19 2+
Branch (Y) Kit < 16mm ² 4 Core SWA	DMB16-4	0551541	51.20	1	49.15 2+



WISKA
make power smile

OneGel					
OneGel Wisk Silicone Gel 300ml	ONEGEL	0667601	17.40	1	16.16 2+
Resil Silicone Resin Blue 1 Litre	RE0100	0981934	26.88	1	

Gel Connector



- IP68
- 24A
- 0.5-1.5mm Cable Size
- Gel insulated
- Perfect for narrow/tight spaces
- Ideal for garden lighting
- 2 or 3 pole



Gel Connector	LEDJOY	1120727	10.50	1
---------------	--------	---------	-------	---

WIRING CLIPS



HellermannTyton

Adjustable P Clips			
Black, Bag of 100	NX14P	0010883	18.21 100



Twin & Earth Clips (plus clips priced per box qty as shown)					
1.0-1.5mm T&E Clips	TE1-1.5GRY	0550843	2.44	100	2.19 1000+
1.0-1.5mm Double Clips	DTE1GREY	0550851	5.62	100	
2.5mm T&E Clips	TE2.5GRY	0550844	2.59	100	2.33 1000+
2.5mm Double Clips	DTE2.5GREY	0550852	5.81	100	
4.0-6.0mm T&E Clips	TE4-6GRY	0550848	4.88	100	
10.0mm T&E Clips	TE10GRY	0550841	2.80	50	
16.0mm T&E Clips	TE16GREY	0550857	7.46	100	
Tub of 800 Mixed 1 & 2.5mm Plus Clips	05TUB05	0550776	19.35	1	18.06 3+



Round Clips			
Bell wire Clip	BELLWCLIP	0550835	3.18 100
3.5mm	RC3.5WHITE	0550842	2.96 100
4.0-5.0mm	RC4-5WHI	0550849	5.22 200
5.0-6.0mm	RC5-6WHI	0550836	2.68 100
6.0-7.0mm	RC6-7WHI	0550837	2.85 100
7.0-8.0mm	RC7-8WHI	0550845	3.13 100
9.0-11.0mm	RC9-11WHI	0550854	5.88 100
12mm	RC12BLACK	0550858	7.37 100
14mm	RC14BLACK	0550855	5.64 50
19-24mm	RC19-24BLK	0550856	7.87 50
7-8mm Red	RC7-8RED	0550850	5.23 100



Other sizes also available, please ask your branch

Black Satellite Clips	SATCLIPBLK	0550840	2.58 100
-----------------------	------------	---------	----------

CABLE STORAGE



Storage Frame	SPOOLER	0442982	31.18 1
---------------	---------	---------	---------



FIRE RATED FIXINGS



A fire rated cable clip fully certified to satisfy legislative requirements to secure all surface cables in escape routes.



Safe-D Fire Cable Clips

Safe-D30, 23mm base	SAFE-D30	0788763	24.49	100
Safe-D40, 31mm base	SAFE-D40	0788764	18.36	50
Safe-D50, 46mm base	SAFE-D50	0788765	21.43	50



Safe-D F Clips

Safe-D F Clip 56x20x8 (100 in a pack)	SAFEDFCLIP30/100	1130387	13.85	1
Safe-D F Clip 110x20x30 (50 in a pack)	SAFEDFCLIP40/50	1130389	11.17	1
Safe-D F Clip 165x20x35 (50 in a pack)	SAFEDFCLIP50/50	1130391	14.48	1
Spring Clip (50 in a pack)	SAFEDSPRING/50	1130392	13.75	1
Fire Rated Screw	DFIX/100	1130395	10.40	1



Twin & Earth Fire Clip

Steel clips fire rated and tested to BS 5839-1: 2017 - for use with twin and earth cables.

- Steel construction
- 2 sizes 1-2.5mm & 4-6mm
- Fire rated



THRS Cable Clip 1-2.5mm	ISM99955	1145633	14.06	100
THRS Cable Clip 4-6mm	ISM99960	1145634	17.38	100



Linian Fire Clips - pack of 100



6-8mm single fire clip Red	1LCR608	1159045	29.89	1	28.92	3+
9-11mm single fire clip Red	1LCR911	1159046	29.89	1	28.92	3+
6-8mm single fire clip White	1LCW608	1159047	29.89	1	28.92	3+
9-11mm single fire clip White	1LCW911	1159048	29.89	1	28.92	3+
6-8mm single fire clip Black	1LCB608	1159043	29.89	1	28.92	3+
9-11mm single fire clip Black	1LCB911	1159044	29.89	1	28.92	3+
6-8mm double fire clip Red	1LCR682	1159051	36.15	1	34.89	3+
9-11mm double fire clip Red	1LCR912	1159052	36.15	1	34.89	3+
6-8mm double fire clip White	1LCW682	1159053	36.15	1	34.89	3+
9-11mm double fire clip White	1LCW912	1159054	36.15	1	34.89	3+
6-8mm double fire clip Black	1LCB682	1159049	36.15	1	34.89	3+
9-11mm double fire clip Black	1LCB912	1159050	36.15	1	34.89	3+

CHANNELLING (METAL & PLASTIC)



Plastic Channelling (priced per m)

12mm x 3m	STCHN12	0549371	0.29	1	0.26	150+
25mm x 3m	STCHN25	0549380	0.36	1	0.33	50+
38mm x 2m	STCHN38	0549374	0.63	1	0.54	100+



Steel Galvanised Channelling (per length)

0.5 inch x 2m	SGC1/M	0549487	0.37	1	0.32	10+
1.0 inch x 2m	SGC2/M	0549488	0.47	1	0.41	10+
1.5 inch x 2m	SGC4/M	0549489	0.65	1	0.56	10+

MINI TRUNKING



Self-Adhesive Mini Trunking (priced per m)

16x16mm x 3m	SA1	0551460	0.92	1	0.85	90+
25x16mm x 3m	SA2	0551461	0.96	1	0.88	45+
38x16mm x 3m	SA3	0551462	2.86	1	2.55	45+
38x25mm x 3m	SA4	0551463	3.01	1	2.61	45+



Plastic Mini Trunking (priced per m)

16x16mm x 3m	STMINI1	0549381	0.61	1	0.54	90+
25x16mm x 3m	STMINI2	0549382	0.72	1	0.65	90+
38x16mm x 3m	STMINI3	0549383	2.31	1	2.03	45+
38x25mm x 3m	STMINI4	0549384	2.25	1	1.95	45+
38x38mm x 3m	STMINI5	0549385	3.44	1	3.05	45+

Trunking Accessories



16x16mm External Angle	SMEA1	0551860	0.90	1	0.78	10+
25x16mm External Angle	SMEA2	0551861	0.90	1	0.80	10+
16x16mm Flat Angle	SMFA1	0551862	0.89	1	0.79	10+
25x16mm Flat Angle	SMFA2	0551863	0.89	1	0.79	10+
25x16mm Flat Tee	SMFT2/2	0551442	1.51	1	1.37	10+
16x16mm Int. Angle	SMIA1	0551864	0.90	1	0.80	10+
25x16mm Int. Angle	SMIA2	0551865	0.90	1	0.80	10+
1G Breakaway Box	SMMB251	0551450	3.05	1	2.69	10+
2G Breakaway Box	SMMB252	0551456	5.32	1	4.63	10+
25x16mm Stop End	SMSE2	0551866	0.89	1	0.79	10+
25x16mm Adaptor	SMTAU2	0551859	0.79	1	0.69	10+
Ceiling Rose box	CRA1/2	0551446	2.70	1	2.34	10+
38x16 Stop End	SMSE3	0551867	0.88	1	0.77	10+
38x16 External Angle	SMEA3	0551438	1.10	1	0.96	10+
38x16 Flat Angle	SMFA3	0551439	1.10	1	0.95	10+
38x16 Internal Angle	SMIA3	0551440	1.10	1	0.96	10+
38x25 Flat Angle	SMEA4	0551443	2.34	1	2.02	10+
38x25 Flat Angle	SMFA4	0551444	2.34	1	2.02	10+
38x25 Internal Angle	SMIA4	0551445	2.34	1	2.02	10+
38x25 Stop End	SMSE4	0551437	1.08	1	0.93	10+

Knockout Boxes - 20mm Conduit



1G 32mm Universal	KBU321	0551448	2.48	1	2.38	10+
2G 32mm Universal	KBU322	0551454	3.92	1	3.78	10+
1G 32mm Rounded	KBR321	0551447	2.48	1	2.38	10+
2G 32mm Rounded	KBR322	0551453	4.08	1	3.92	10+



Knockout Boxes for Mini Trunking

1G 32mm Rounded	STBU321	0551452	2.56	1	2.39	10+
2G 32mm Rounded	STBU322	0551457	3.92	1	3.62	10+





TOP QUALITY CONDUIT



Plastic Oval (priced per m)

12mm x 3m	STOVL12	0549370	0.35	1	0.31	150+
16mm x 3m	STOVL16	0549372	0.37	1	0.33	150+
20mm x 3m	STOVL20	0549373	0.44	1	0.40	150+
25mm x 3m	STOVL25	0549377	0.66	1	0.57	150+

Plastic Round H.I.P. (priced per m)

20mm x 3m Black	ST20PB/3	0549378	0.47	1	0.38	45+
20mm x 3m White	ST20PW/3	0549379	0.47	1	0.38	45+
20mm Bending Spring	20/HSPRING	0551856	4.80	1		
25mm x 3m Black	ST25PB/3	0549375	0.64	1	0.55	10+
25mm x 3m White	ST25PW/3	0549376	0.64	1	0.55	90+
25mm Bending	25/HSPRING	0551468	8.07	1		
Spring Adhesive	PCA250	0798231	8.66	1		

Steel Galvanised Round (Heavy Gauge) (bundle prices, per length), Super quality, British made, exceeds BS requirements. (1 bundle = 10 lengths = 30 metres)

20mm x 3m	20/GN	0552533	8.34	1	7.09	10+
25mm x 3m	25/GN	0552535	11.35	1	9.65	10+
Stock & Die Set	SDG1	0444602	39.94	1		

PLASTIC CONDUIT FITTINGS



Black Plastic, 20mm Conduit Fittings also available in 25mm

1 Way Terminal Box	20PB/1WBX	0551506	1.10	1	1.00	10+
2 Way Through Box	20PB/2WBX	0551508	1.23	1	1.12	10+
3 Way, Tee Box	20PB/3WBX	0551512	1.33	1	1.18	10+
Angle Box	20PB/ABX	0551509	1.24	1	1.12	10+
Inspection Elbow	20PB/INSPE	0551502	0.91	1	0.83	10+
Inspection Bend	20PB/INSPB	0551516	1.53	1	1.41	10+
Inspection Tee	20PB/INSPT	0551517	1.53	1	1.41	10+
Lock Ring	20PB/LOCKR	0551482	0.32	1	0.29	10+
Male Adaptor	20PB/MADA	0551485	0.44	1	0.40	10+
Female Adaptor	20PB/FADA	0551484	0.44	1	0.40	10+
Normal Bend	20PB/NORMB	0551514	1.44	1	1.28	10+
Spacer Bar Saddles	20PB/SBARS	0551486	0.43	1	0.39	10+
Solid Coupler	20PB/COUP	0551477	0.28	1	0.27	10+
Standard Lid	66PB/LID	0551480	0.33	1	0.31	10+
Clip Saddle	20PB/CLSAD	0551476	0.29	1	0.27	10+
PVC 25x20 Conduit Reducer Black	25X20B/RED	0551492	0.66	1	0.63	10+



White Plastic, 20mm Conduit Fittings also available in 25mm

1 Way Terminal Box	20PW/1WBX	0551507	1.10	1	1.00	10+
2 Way Through Box	20PW/2WBX	0551510	1.23	1	1.12	10+
3 Way, Tee Box	20PW/3WBX	0551513	1.33	1	1.18	10+
Angle Box	20PW/ABX	0551511	1.24	1	1.12	10+
Inspection Elbow	20PW/INSPE	0551503	0.91	1	0.83	10+
Inspection Bend	20PW/INSPB	0551518	1.53	1	1.41	10+
Inspection Tee	20PW/INSPT	0551519	1.53	1	1.41	10+
Male Adaptor	20PW/MADA	0551488	0.44	1	0.40	10+
Female Adaptor	20PW/FADA	0551487	0.44	1	0.40	10+
Normal Bend	20PW/NORMB	0551515	1.44	1	1.28	10+
Spacer Bar Saddles	20PW/SBARS	0551489	0.43	1	0.39	10+
Rubber Lid Gasket	RUBBG	0548979	0.10	1	0.09	10+
Standard Lid	66PW/LID	0551481	0.33	1	0.31	10+
Clip Saddle	20PW/CLSAD	0551478	0.29	1	0.27	10+
PVC 25x20 Conduit Reducer White	25X20W/RED	0551493	0.66	1	0.63	10+
Solid Coupler	20PW/COUP	0551479	0.28	1	0.27	10+

Black Plastic, 25mm Conduit Fittings also available in 20mm



1 Way Terminal Box	25PB/1WBX	0551520	2.06	1	1.85	10+
2 Way Through Box	25PB/2WBX	0549361	2.21	1	1.99	10+
2 Way Angle Box	25PB/ABX	0549362	2.21	1	1.99	10+
3 Way Tee Box	25PB/3WBX	0549365	2.47	1	2.22	10+
Spacer Bar Saddle	25PB/SBARS	0551494	0.70	1	0.63	10+
Solid Coupler	25PB/COUP	0551490	0.50	1	0.44	10+
Female Adaptor	25PB/FADA	0551499	0.81	1	0.72	10+
Inspection Bend	25PB/INSPB	0549367	3.25	1	2.88	10+

White Plastic, 25mm Conduit Fittings also available in 20mm



1 Way Terminal Box	25PW/1WBX	0549359	2.06	1	1.85	10+
2 Way Through Box	25PW/2WBX	0549363	2.21	1	1.99	10+
2-Way PVC Angle Box	25PW/ABX	0549364	2.21	1	1.99	10+
25mm White						
3 Way Tee Box	25PW/3WBX	0549366	2.47	1	2.22	10+
Spacer Bar Saddle	25PW/SBARS	0551495	0.70	1	0.63	10+
Solid Coupler	25PW/COUP	0551491	0.50	1	0.44	10+
Female Adaptor	25PW/FADA	0551500	0.81	1	0.72	10+
Inspection Bend	25PW/INSPB	0549368	3.25	1	2.88	10+
Male Adaptor	25PW/MADA	0551501	0.65	1	0.59	10+
Clip Saddle	25PW/CLIKS	0551505	1.02	1	0.92	10+

Metal Saddles (White Powder Coated)

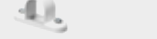

20mm Spacer Bar	SBS20W	0999496	0.32	1	0.29	10+
25mm Spacer Bar	SBS25W	0999497	0.42	1	0.39	10+

METAL CONDUIT FITTINGS

Galvanised Steel 20mm (other galvanised fittings and black enamel available)



1 Way, Terminal Box	20G/1WBX	0549001	1.26	1	1.18	10+
2 Way, Through Box	20G/2WBX	0549002	1.26	1	1.18	10+
3 Way, Tee Box	20G/3WBX	0549003	1.26	1	1.18	10+
Angle Box	20G/ABX	0549004	1.26	1	1.18	10+
'U' box	20G/UBX	0549005	1.63	1	1.56	10+
'Y' box	20G/YBX	0549006	1.63	1	1.53	10+
Galv Loop-In Box 20mm	20G/1WLIBX	0548967	1.39	1	1.31	10+
Inspection Elbow	20G/INSPE	0549008	2.82	1	2.65	10+
Lock Ring	20M/LOCKR	0548974	0.08	1	0.07	10+
Lock Nut	20G/LOCKN	0548973	0.07	1	0.06	10+
Spacer Bar Saddles	20G/SBARS	0548976	0.09	1	0.08	10+
Galv Distance Saddles	20G/DISTS	0548965	0.77	1	0.73	10+
Solid Coupler	20G/COUP	0548983	0.15	1	0.14	10+
Standard Lid	G/LIGHL	0548978	0.09	1	0.08	10+
Dome Cover	20G/DOMEK	0548991	0.50	1	0.47	10+
Male Hooks	20G/MALEH	0548997	1.40	1	1.32	10+
Hook Backplate	G/HOOKB	0548964	0.62	1	0.59	10+

Galvanised Steel (other sizes)



Lock Nut 25mm	25G/LOCKN	0548977	0.10	1	0.09	10+
Solid Coupler 25mm	25G/COUP	0548987	0.22	1	0.21	10+
Lock Nut 32mm	32G/LOCKN	0548986	0.17	1	0.16	10+
Solid Coupler 32mm	32G/COUP	0548992	0.50	1	0.47	10+
Galv Reducer 25-20mm	REDG25X20	0548966	0.73	1	0.69	10+
Galv Hex Stop Plug	HSP20G	0444499	0.71	1		
Lock Nut 38mm	38G/LOCKN	0548990	0.42	1	0.39	10+
Solid Coupler 38mm	38G/COUP	0548996	1.04	1	0.97	10+
Lock Nut 50mm	50G/LOCKN	0548993	0.58	1	0.54	10+
Solid Coupler 50mm	50G/COUP	0549007	1.90	1	1.79	10+
Spacer Bar Saddle 25mm	25G/SBARS	0548962	0.17	1	0.16	10+
Terminal Box 1Way 25mm	25G/1WBX	0548969	3.01	1	2.83	10+

Brass Bushes



20mm Female Bushes	20/FEMAB	0548981	0.15	1	0.14	10+
20mm Male Long Bushes	20/MALEBL	0548963	0.34	1	0.32	10+
20mm Male Bushes	20/MALEBS	0548984	0.17	1	0.16	10+
25mm Male Bushes	25/MALEBS	0548988	0.26	1	0.25	10+
32mm Male Bushes	32/MALEBS	0548989	0.41	1	0.38	10+
38mm Male Bushes	38/MALEBS	0548994	0.68	1	0.64	10+
50mm Male Bushes	50/MALEBS	0548998	1.30	1	1.22	10+

Misc.



20mm Nipples	20/NIPP	0548985	0.55	1	0.44	10+
Draw tape	10M/DTAPE	0551471	10.54	1		



Steeple

FLEXIBLE CONDUIT

Contractor Packs (packs include 10 glands and locknuts)



20mm Plastic Black	CP20/S	0551852	15.52	1	11.63	3+
20mm Plastic White	CP20/W	0551851	15.58	1		
25mm Plastic Black	CP25/S	0551854	20.22	1		
20mm Spiral	CPDSR20	0551855	26.85	1		
20mm spare adaptor for CP20/S	CP20/ADAP	0551832	1.54	1		
25mm spare adaptor for CP20/S	CP25/ADAP	0551834	1.84	1		

MITA

PLASTIC TRUNKING



UPVC Industrial Trunking (priced per m)

50x50mm x 3m Medium Duty	MIDI50	0574155	4.24	1	3.60	18+
50x50mm x 3m Heavy Duty	TRK50/W	0574159	6.05	1	5.12	18+
75x75mm x 3m	TRK75/W	0574160	9.09	1	7.74	12+
100x100mm x 3m	TRK100/W	0574158	19.09	1	16.35	6+

Trunking Accessories



50x50mm Flat Angle	FAU50/W	0018575	9.07	1	7.83	10+
75x75mm Flat Angle	FAU75/W	0018587	11.79	1	10.98	10+
50x50mm Int. Angle	IAU50/W	0018589	11.55	1	10.10	10+
75x75mm Int. Angle	IAU75/W	0018597	16.45	1	15.48	10+
50mm Int. Coupler	ICS50/W	0018645	2.24	1	1.91	10+
Ext. Angle (MIDI50)	MEA50/W	0018978	7.14	1	6.21	10+
Flat Angle (MIDI50)	MFA50/W	0018847	7.18	1	6.23	10+
Int. Angle (MIDI50)	MIA50/W	0018980	7.18	1	6.23	10+
Stop End (MIDI50)	MSE50/W	0574157	2.41	1	2.11	10+
75x75mm Stop End	TSE75/W	0018684	3.92	1	3.36	10+
50x50mm Stop End	STSE50/W	0576531	1.81	1	1.57	5+

marco

Juno Trunking Range (priced per m - min 3m)



100x50mm Trunking(3m)	DMT105	0684013	5.61	1	5.61	12+
External Angle	DMTE105	0683995	5.32	1	4.53	5+
Internal Angle	DMTI105	0683996	5.32	1	4.53	5+
Flat Angle	DMTF105	0683997	5.31	1	4.52	5+
Flat Tee	DMTT105	0683998	10.16	1	8.92	5+
Joint Cover	DMTJ105	0683999	1.64	1	1.36	5+
End Cover	DMTC105	0684007	1.64	1	1.36	5+
Divider*	DMTD105	0684014	1.71	1	1.49	12+

*sold in pairs only (2 x 1.5m)

Juno / Apollo Common Socket Mounting Boxes



35mm 1 Gang Box	DMTSB1	0684008	1.70	1	1.44	10+
35mm 2 Gang Box	DMTSB2	0684009	2.32	1	2.02	10+
25mm 1 Gang Box	DMTSB1-25	0684010	1.55	1	1.35	10+
25mm 2 Gang Box	DMTSB2-25	0684011	2.10	1	1.82	10+

Apollo Trunking Range (per metre - min 3m)



3 Compartment Dado Trunking	DMTD3	0964608	15.14	1	13.52	12+
External Angle	DMTDE3	0964609	5.62	1	5.02	10+
Internal Angle	DMTDI3	0964610	5.62	1	5.02	10+
Flat Angle	DMTDF3	0964611	24.09	1	21.51	10+
Flat Tee	DMTDT3	0964612	40.50	1	36.16	10+
Joint Cover	DMTDJ3	0964613	2.38	1	2.12	10+
End Cover	DMTDC3	0964614	2.38	1	2.12	10+

Elite Compact Trunking Range (per metre - min 3m)



Data Trunking 145x50mm	DMEC3	0925941	15.48	1	13.83	12+
Internal Adjustable Angle	DMEC3I	0925942	6.04	1	5.39	10+
External Adjustable Angle	DMEC3E	0925943	6.04	1	5.39	10+
End Cap	DMEC3C	0925944	2.48	1	2.21	10+
Flat Angle	DMEC3F	0925945	33.70	1	30.09	10+
Flat Tee	DMEC3T	0925946	42.24	1	37.71	10+
Joint Cover	DMEC3J	0925947	2.48	1	2.21	10+

Bench Trunking Units



2 G Unit White Powder Coat	DMTBU2W	0684005	29.78	1		
1+2 G Unit White Powder Coat	DMTBU3W	0684000	37.09	1		

Aluminium Power Poles - 3.6m



Aluminium Pole, uPVC lids	DMTP1	0684012	215.90	1		
White Powder Coated	DMTP1W	0684001	215.90	1		

AVAILABLE TO ORDER

marco

FLOOR BOXES



Cavity Floor Boxes

70mm, 3 Compartment	DMCFB370	0925918	29.93	1		
100mm, 3 Compartment	DMCFB3100	0925919	30.87	1		
130mm, 3 Compartment	DMCFB3130	0925920	39.04	1		



Twin Switch Plates

Dual Earth, 86mm	DMP3-2GS	0925925	8.98	1		
------------------	----------	---------	------	---	--	--



Unswitched Plates

Three Single, 86mm	DMP3-3GS	0925926	18.66	1		
--------------------	----------	---------	-------	---	--	--



Accessory Plates

Moulded 1 x 2 Gang, 86mm	DMP3-1X2GF	0925927	2.75	1		
Moulded 2 x 1 Gang, 86mm	DMP3-2X1GF	0925928	2.37	1		
6 x RJ45, 86mm	DMP3-6D	0925929	2.52	1		
Angled 4 x RJ45, 86mm	DMP3-4DA	0925931	6.40	1		
2 x Euro, 86mm	DMP3-EU	0925932	4.45	1		
Blank, 86mm	DMP3-BP	0925933	2.41	1		

UNITRUNK

CABLE TRAY & ACCESSORIES 3m LENGTHS



Pre-Galvanised Light Duty Cable Tray

50mm x 1.0mm	KLLD50T	0054214	7.10	1	6.53	5+
75mm x 1.0mm	KLLD75T	0054300	9.82	1	8.84	5+
100mm x 1.0mm	KLLD100T	0054395	11.54	1	10.39	5+
150mm x 1.0mm	KLLD150T	0054480	14.49	1	13.03	5+



Pre-Galvanised Medium Duty Cable Tray, Return Flange

50mm	KLMR50T	0112071	10.87	1	9.79	5+
75mm	KLMR75T	0055918	13.32	1	12.23	5+
100mm	KLMR100T	0055968	14.64	1	13.18	5+
150mm	KLMR150T	0056033	18.26	1	16.77	5+

(All gauges readily available)



Cable Tray Couplers

Tray Couplers	KLMR/SC	0420149	4.28	1	4.16	10+
---------------	---------	---------	------	---	------	-----

STEEL WIRE CABLE TRAY SYSTEM

- Quick installation, with easily fabricated bends
- Includes Marco's award winning side coupler - fits into place with 1 turn of a screwdriver
- For internal and external use
- 30, 55 or 106mm depths
- Various finishes including: Electro-Zinc, Electro-Zinc Plus, Pre-Galvanised, Powder Coated, Hot-Dipped Galvanised



Ask in branch for details

UNITRUNK

TRUNKING MIDI & INDUSTRIAL (METAL)



Metal Trunking 3m Lengths

2x2" Steel Trunking	TK22	0038318	25.62	1	23.53	5+
3x3" Steel Trunking	TK33	0038319	36.19	1	32.58	5+
4x4" Steel Trunking	TK44	0038320	48.98	1	44.96	5+

Trunking Accessories Available - Ask Your Branch

UNITRUNK

LIGHTING TRUNKING



Lighting Trunking 2 x 2

2x2 Lighting Trunking 3m Length	LT22X3M	0224236	16.16	1	14.54	5+
Flanged Coupler	FC22	0025377	3.11	1	2.80	5+
Suspension Assembly	FSL22	0162917	2.05	1	1.85	10+
Plastic Lid 3m Lgth	WPL22	0067723	5.19	1	4.66	10+

UNITRUNK

METAL CHANNEL



Metal Channel - 3m

21 x 41mm Slot Channel	UC4121S/3	0053768	13.81	1	12.99	5+
41 x 41mm Plain Channel	UC4141/3	0053439	18.96	1	18.18	5+
41 x 41mm Slot Channel	UC4141S/3	0053777	18.96	1	18.18	5+

Threaded Rod & Accessories Overleaf





Threa Rod & Accessories

Threaded Rod & Accessories					
M6 Threaded Rod 3m	M6/R3	0053787	2.32	1	2.08 10+
M8 Threaded Rod 3m	M8/R3	0053838	3.66	1	3.30 10+
M10 Thr. Rod 3m	M10/R3	0053839	5.24	1	4.72 10+
M6 Hexagonal Nut	M6/HN	0113408	1.28	100	1.15 500+
M8 Hexagonal Nut	M8/HN	0113410	2.75	100	2.52 500+
M10 Hexagonal Nut	M10/HN	0113411	5.06	100	4.64 500+
6 x 10mm Washers	M6/FW	0113355	1.42	100	1.30 500+
6 x 25mm Washers	M6MW	0090695	3.85	100	3.53 500+
8 x 25mm Washers	M8/FW	0113356	2.92	100	2.70 500+
8 x 32mm Washers	M8MW	0090715	4.21	100	3.87 500+
10 x 38mm Washers	M10/FW	0113402	2.53	100	2.32 500+



Adaptable Boxes & Metal Enclosures

Galvanised Steel with Knockouts					
75x75x50	SRG332KO	0551844	4.72	1	
100x100x50	SRG442KO	0551845	5.46	1	
150x150x50	SRG662KO	0551846	5.67	1	
150x150x75	SRG663KO	0551848	8.33	1	



Plastic Enclosures (measurements given in mm)

Plastic Enclosures (measurements given in mm)					
IP65 320x280x175	DJSL242	0550705	40.10	1	
IP54 430x390x175	DJSL244	0550709	58.68	1	
DJSL242 Back Plate	DJSL242BP	0551075	7.10	1	
DJSL244 Back Plate	DJSL244BP	0551083	8.67	1	



IP65 Multiway Outdoor Enclosure Box

IP65 Multiway Outdoor Enclosure Box					
Approx. internal dimensions (mm): 360(L)x 170(W)x 85(D)	BS365	0551779	19.99	1	

Approx. internal dimensions (mm): 360(L) x 170(W) x 85(D)



IP65 Steel Wall Mounting Enclosures

IP65 Steel Wall Mounting Enclosures					
300(H)x 300(W)x 150(D)	WME-33/150	0550430	32.21	1	
400(H)x 300(W)x 150(D)	WME-43/150	0550431	44.74	1	
400(H)x 400(W)x 200(D)	WME-44/200	0550432	57.25	1	
600(H)x 500(W)x 200(D)	WME-65/200	0550434	100.11	1	
Key Lock	WME-KL	0550429	3.63	1	



TAIS GRP Enclosure

TAIS GRP Enclosure					
CWBACK PLATE IP66 258x304x160mm (WHD)		550011	0619322	89.16	1
CWBACK PLATE IP66 340x430x180mm (WHD)		550012	0619323	123.10	1
CWBACK PLATE IP66 449x506x220mm (WHD)		550013	0619324	166.41	1
CWBACK PLATE IP66 450x655x220mm (WHD)		550014	0619325	199.14	1
CWBACK PLATE IP66 558x655x260mm (WHD)		550015	0619326	274.57	1
CWBACK PLATE IP66 631x807x300mm (WHD)		550016	0619327	378.64	1
CWBACK PLATE IP66 848x1058x350mm (WHD)		550017	0619328	690.56	1



Meter Box & Hockey Stick

Surface Mount Electrical Meter Box					
Meter Box	EB0012	0552291	44.99	1	
Hockey Stick	EC1002	0552292	5.25	1	



Cable Glands

20mm IP68 Glands c/w Locknut					
Black	D-DTR2012B	0551820	0.45	1	0.40 10+
Grey	D-DTR2012G	0551821	0.45	1	0.40 10+
Red	D-DTR2012R	0551822	0.45	1	0.40 10+
White	D-DTR2012W	0551823	0.45	1	0.40 10+
25mm, IP68 Compression glands c/w locknut (black)	D-DTR2518B	0551828	1.11	1	0.98 25+
25mm, IP68 Compression glands c/w locknut (white)	D-DTR2518W	0551829	1.11	1	0.98 25+
25 SMALL GROMMETS (40X25) pack of 10*	CUGR40-25	0979602	2.65	1	
50 LARGE GROMMETS (50X50) pack of 10*	CUGR50-50	0979603	6.00	1	



3rd Amendment Compliant Glands

3rd Amendment Compliant Glands					
Plastic Tails Kit for 2x 16mm + 1x 16mm cable (TKE/P32)		10106242	0942001	3.94	1
Plastic Tails Kit for 2x 25mm + 1x 16mm cable (TKE/P40)		10106244	0942003	5.97	1
40-32mm Reducer for TKE/P40		10063574	0219267	2.63	1
TKS32 Gland	TKS32	0973288		1.49	1
Quinox Kit Membrane Grommet		10106226	0941984	7.33	1



Cable Protection

Cable Protector					
Cable Protector					
9.5x19mm Hole Size	MULTI/N	0611774	100.57	9	87.46 9+



Catenary Wire & Accessories

3mm Galvanised Rope Wire					
Rope Kit 30m	CWK	0551805	33.54	1	
3mm Thimble	3224042	0548849	0.52	1	
3mm Rope Grip	3449042	0548850	0.52	1	
Hook Wall Plate	3486002	0548878	4.77	1	
Barrel Strainer	4263162	0548889	6.71	1	



Jack Chain & Suspension Hooks

Luminaire Suspension					
Single galvanised Jack Chain - box of 10m	10JC	0552561	6.53	1	6.16 5+
Monkey puzzle	SC10	0551523	0.43	1	0.41 10+

TV ACCESSORIES

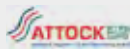

4K/2K/3D Gold Plated HDMI Cables

- Supports 4K x 2K Resolution
- HDMI Ethernet channel
- Gold flashed contacts

HDMI Lead 2m	HDMI2M	1115173	3.38	1	
HDMI Lead 5m	HDMI5M	1115175	6.07	1	
HDMI Lead 10m	HDMI10	1115176	13.20	1	
HDMI Lead 15m	HDMI15	1115177	33.64	1	

Co-axial Plugs and Tools



1. PGF01 F Connector	FCONNECTOR	0045842	0.57	1	
2. Coupler	FSATCONN	0130914	0.59	1	
3. FS204 Splitter 2 Way	AS02	0055338	3.84	1	
4. FS307 Splitter 3 Way	AS03	0081516	4.48	1	
5. TVP2/T Coaxial Plug - Male	COAXMALE	0001968	0.50	1	
6. TVS4/T Coaxial Line Socket - Female	COAXFEMALE	0001969	0.82	1	
7. CS300R Combiner/Splitter	YSPLITTER	0001970	2.83	1	
8. CCX01 Coupler Connector	COAXCONN	0045843	0.90	1	

Bi-Directional Signal Boosters

1. 6" Wall Bracket	WALLBRKT6	0343400	10.50	1	
2. Chimney Bracket Kit	CHIMNEYKIT	0552198	7.13	1	
3. 6ft x 1" Alloy Mast	ALLOYMAST6	0343429	7.65	1	
4. Loft Fixing Kit	LOFTFIXKIT	0001950	8.99	1	
5. 2 Way	A120RD	0552193	21.68	1	
6. 4 Way	A240RD	0552194	30.48	1	
7. 6 Way	A260RD	0552195	42.69	1	
8. 8 Way	A280RD	0552196	48.38	1	
9. 12 Way	A2120D	0295637	63.96	1	



AVSI TV Mounts & Brackets

- Suitable for a wide range of screen sizes
- Low profile designs
- Compatible with VESA mounting patterns
- Installation hardware included
- Fixed, tilt and full motion arm options available



A.	Standard Fixed TV Bracket 400X400	129.541UK	1309240	9.79	1
B.	Standard Fixed TV Bracket 600X400	129.542UK	1309241	11.57	1
C.	Standard Tilt TV Bracket 400X400	129.551UK	1309242	12.13	1
D.	Standard Tilt TV Bracket 600X400	129.552UK	1309243	14.95	1
E.	Curved/Flat Full Motion TV Bracket 32-65"	129.561UK	1309244	50.50	1
F.	Full Motion Wall Mount 13-40"	129.510UK	1309245	15.00	1
G.	Full Motion 13-40" Double Arm	129.512UK	1309246	23.89	1
H.	Full Motion TV Mount 26-55"	129.565UK	1309247	27.95	1

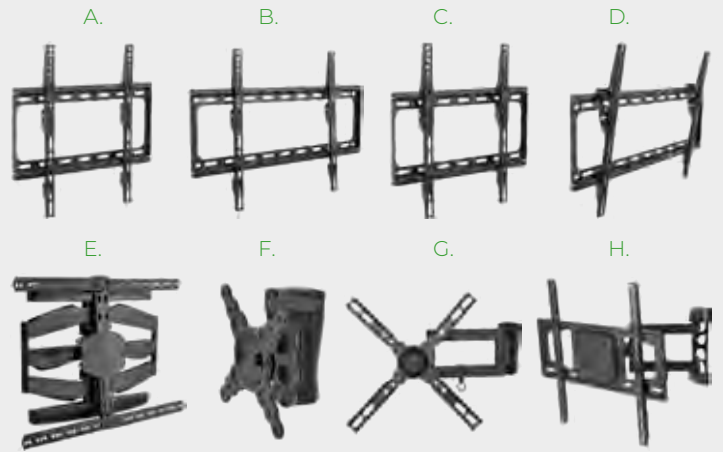

TV AERIALS & ACCESSORIES

TV Aerials Band A, B + C/D



A.	10 Element Wide Band	RX12W	0081479	15.22	1
B.	All in One TV Aerial	XG10T	1219074	32.56	1
C.	Small Aerial	XG5T	0001953	23.24	1
D.	L Bracket for Aerial	E5001	0552199	5.18	1

ALSO AVAILABLE

TV and Networking Module Accessories



See page 18-19

DATA PRODUCTS

ATTOCK Data Cabinet

- Industry standard design 19" wall mount data cabinet
- 1.2mm mild steel construction
- Removable side panels and glass front door - all lockable
- Supplied with depth adjustable heavy-duty steel mounting profiles to take industry standard 19" patch panels, switches and other equipment



6U Data Cabinet	CAB6450	0550889	73.13	1	70.20	3+
-----------------	---------	---------	--------------	---	--------------	----

PATCH APP & GO Patch App And Go

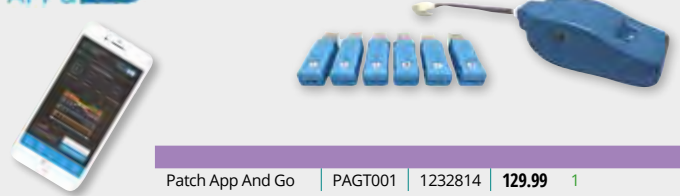

Patch App And Go	PAGT001	1232814	129.99	1
------------------	---------	---------	---------------	---

FEEDTHRU CAT5E CONNECTORS



Open-end connectors where conductor order can be verified prior to crimping.



A.	CAT5 RJ45 FEED THRU PLUG BOX50	85-371	1074259	18.81	1
B.	CAT6 RJ45 FEED THRU PLUG BOX25	85-375	1074261	13.98	1
C.	30-495 IDEA FT-45 FEEDTHRU CRIMP TOOL	30-495	1074256	41.99	1

RATCHET CRIMPER



Ratchet Crimper	RJ45RATCH	0550874	15.31	1
-----------------	-----------	---------	--------------	---

Patch Panels



Patch Panels & Leads							
A.	24 Way Patch Panel	170-12E24	0550887	26.99	1	26.99	3+
	48 Way Patch Panel	170-12E48	0550888	39.42	1	37.05	3+
B.	Cable Management Bar	168-31B1U	0550886	4.09	1	3.85	5+
C.	CAT5e 1m Patch Lead Grey	UTP1LEAD	0550881	0.70	1	0.66	5+
	CAT5e 3m Patch Lead Grey	UTP3LEAD	0550883	1.15	1	1.08	5+
	Cat5 5mtr Patch Lead Grey	PC5E5GY	1305850	2.71	1	2.54	5+
	Cat5 10mtr Patch Lead Grey	PC5E10GY	1305851	3.07	1	2.87	5+
	Cat5 15mtr Patch Lead Grey	PC5E15GY	1305852	4.57	1	4.27	5+
	Cage nuts for Cabinets (Pk 50)	CAGENUTSBK50	1314531	2.89	1		

RJ45 Plugs & Couplers							
D.	Cat5 RJ45 Crimp Plug	171-51F	0550879	0.13	1	0.12	10+
	Cat6 RJ45 Crimp Plug	RJ45PLUGPCAT6	1314532	0.29	1		
	Cat5 RJ45 Coupler	CAT5COUPLER	1314529	1.49	1		

Tools and Accessories							
	Network Continuity Tester Tool	TESTERCAT5E	1306697	7.23	1		
	RJ45 Ratchet Crimper	RJ45RATCH	0550874	15.31	1		
	Cat5 Junction Box	C5JB	1248730	2.05	1		
	ADSL Filter adaptor	ADSLFILTER	1314530	1.43	1		





Distribution

EV CHARGERS



- Compact Design – A4 Paper Size, Attractive Appearance
- Full Protection – Full Electrical Protection, Over/Under Temperature Protection
- Meets European Standards
- Easy to Install – Wall or Pole Mountable
- IP65
- Solar Compatible
- 18th Edition Compliant
- Free Monitoring App
- All OLEV Approved



Wallpods					
A.	PRO EV 7.3KW EV WALL MOUNT 1X32A TYPE 2 SKT WIFI OLEV	EVA-07S	1274097	383.32	1
B.	PRO EV 7.3KW EV WALL MOUNT 1X32A TYPE 2 SKT WIFI OLEV RFID	EVA-07S -SRFID	1274098	433.32	1
	7.2KW 32A EV CHARGER PRO EARTH	EVA-07S-SE	1309120	500.06	1
	7.2KE 32A EV CHARGER PRO EARTH RFID	EVA-07S-SERFID	1309121	541.74	1
Pedestals					
C.	PRO EV 7.3KW EV FLOOR MOUNT 2X32A TYPE 2 SKT WIFI OLEV RFID	EVA-07D-SRFID		1332.51	1
Accessories					
D.	PRO EV POLE FLOOR STAND FOR EVA-S	EV-FLRSTAND	1274061	124.98	1
	PRO EV 5M TYPE 2 11KW EV CHARGING CABLE	EV-11KW	1274062	260.00	1
	PRO EV 5M TYPE 2 7KW EV CHARGING CABLE	EV-7KW	1274063	149.89	1

Ask in Branch for More Details

EV CHARGERS



Rolec EV has a full range to suit every location and budget, from the EV Ready 13a Wallpod to more sophisticated OLEV approved HomeSmart range allowing the user to control charging via the smart app.



Wallpods					
E.	13A (Up To 2Kw) Domestic Socket	EVWP0020	0511305	90.76	1
F.	7.2KW 32A Type 2 Socket	EVWP2020	1148552	359.89	1
G.	7.2KW 32A Type 2 Socket + 5M tethered Lead	EVWP2140	0511353	407.95	1
D.	7.2KW 32A Type 2 Socket Gprs Olev Approved	EVHS2020/OLEV	1187549	449.89	1
	7.2KW 32A Type 2 Socket Gprs Olev Approved + 5M tethered Lead	EVHS2140/OLEV	1187550	524.95	1
Pedestals					
C.	Ev Quantum 2X7.2KW 32A pedestal Type 2 Sockets	EVQR0121	1106122	1089.00	1
	Ev Quantum Ground Mounting Base	GMQR0010	1134306	54.95	1
Accessories					
	Charging Lead 5M 32A Type 1 To Type 2	EVPP0160	0511850	120.87	1
A.	Charging Lead 5M 32A Type 2 To Type 2	EVPP0100	0511844	128.51	1
I.	Parking Sign Aluminium Ev A4 Landscape	EVPS0010	0633262	34.76	1
	Surface Bolted Protection Barrier (48mm)	EVCB0040	0633261	133.31	1
B.	Chargecheck Portable Ev Tester	EVTU0018	0580418	349.89	1

More options available online

For more info ask in branch for details



GARO CHARGERS



GARRO chargers incorporate a stylish design that can be placed both indoors and outdoors at home or work, smart functionality and a simple charging procedure with built-in protection for personal safety.

- Dc monitoring uses a standard type a rcbo
- Dlm installed to ensure protection of the main fuse (needs dlm Meter)
- Motorised interlock to prevent the cable being removed while Charging
- Volt free inputs for additional control
- Type 2 socket or tethered lead
- Olev approved
- European manufactured
- 3 Year comprehensive warranty

For accessories and the full domestic and commercial range please see our website



AVAILABLE TO ORDER

EO Mini				
1.	7.4KW Wall Charger 1 X Type 2 Socket	GLBDC-T274WOPE	1312069	473.33 1
2.	7.4KW Wall Charger Type 2 Tethered Lead	GLBDC-T274FCPE	1312070	499.00 1



EO MINI CHARGERS



AVAILABLE TO ORDER

EO Mini

Looking for a discreet charger for your home? Meet the EO Mini, the smallest fast charger on the market!

EO Mini				
1.	EO Mini White Up To 7.2Kw	EM002-DCL-WH	1266795	382.35 1
2.	EO Mini Black Up To 7.2Kw	EM002-DCL-BK	1266793	382.35 1



EO Mini Pro

OLEV Approved with intelligent software to control your charging from the palm of your hand

EO Mini Pro				
1.	EO Mini Pro Black Up To 7.2Kw	EM002-PRO-DCL-BK	1266789	517.65 1
2.	EO Mini Pro White Up To 7.2Kw	EM002-PRO-DCL-WH	1266791	517.65 1

EO Mini Smart

The smart charger that integrates your solar panels

1.	EO Mini Smart Home White Up To 7.2Kw	EM002-SMART-DCL-WH	1266799	708.82 1
2.	EO Mini Smart Home Black Up To 7.2Kw	EM002-SMA-DCL-BK	1266797	708.82 1

- Compatible with all plug-in electric vehicles
- Universal Type 2 socket as standard
- Power rating configurable at installation up to 7.2kW
- Silver and Blue also available - See website for details
- Size: 175mm(H) x 125mm(W) x 95mm(D)





FUSED SWITCHES



Metal 100A Fused Switch - 2 Pole

- Single phase & switched neutral
- Ideal for the protection & isolation of incoming supplies up to 100A
- Supplied c/w 63A, 80A + 100A fuses
- 35mm max cable capacity



Metal 100A Fused Switch - 2 Pole				
2 Pole	A3FS6380100	0798928	56.97	1



80A Fused Switch

- Supplied with cable duct
- Ideal for the protection & isolation of incoming supplies up to 80A
- Supplied with 80A fuse
- 25mm max cable capacity



80A Fused Switch				
2 Pole	MSF	0550624	22.81	1



Metal 3 Phase Fused Switches - 32A - 125A

- 3 phase + switched neutral
- Door interlock to prevent access to live conductors
- Lockable in OFF position with 3 padlocks (not inc)
- AC21 for switching of resistive loads
- C/w fuses (IEC 60269-2)
- 35mm max. cable capacity



Metal 3 Phase Fused Switches - 32A - 125A				
Steel Fused Switch 32A 4P	FIS324P	1348146	99.96	1
Steel Fused Switch 63-80A 4P	FIS63804P	1348148	172.97	1
Steel Fused Switch 100-125A 4P	FIS1001254P	1348140	190.24	1



45A Main Switch + 6A MCB Red Switchfuse

- For the supply of fire alarm systems in commercial industrial properties
- Conduit knockouts



45A Main Switch + 6A MCB Red Switchfuse				
45A Main Switch	A3FAU456	0798927	34.73	1

CHANGEOVER SWITCHES



Metal 125A Changeover Switch - Single Phase

- Single phase and switched neutral
- 50mm max cable capacity

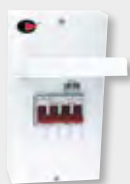

125A, Single Phase	A3M125CS	0798929	100.22	1
--------------------	----------	---------	---------------	---



100A Changeover Switch 4 Pole

- With centre OFF position
- IP65 plastic enclosure
- Max. cable capacity: 35mm



100A, 4 Pole	CS/100/4P	0550421	128.35	1
--------------	-----------	---------	---------------	---

ISOLATORS



Metal Isolator Switch 4 Pole, 32A

- 4 pole 32A for isolating incoming supplies
- 20mm knockouts top, bottom & side
- Padlockable in OFF position (padlock not included)



Metal Isolator Switch				
4 Pole, 32A	M324P	0550578	21.07	1



Metal Rotary Isolators

- Robust steel enclosure
- Door interlock to prevent access to live conductors
- Lockable in OFF position with 3 padlocks (not included)



Metal Rotary Isolators				
Steel Rotary Isolator 32A 4P	IS324P	1348138	81.23	1
Steel Rotary Isolator 125A 4P	IS1254P	1348145	99.51	1
Steel Rotary Isolator 100A 4P	IS1004P	1348144	92.99	1
Steel Rotary Isolator 63A 4P	IS634P	1348142	86.90	1



Rotary Isolators - 4 Pole

- 3 phase & switched neutral
- IP65 enclosure
- Lockable in OFF & ON position
- Max cable capacities;
- 16-25A 6mm
- 32-40A 10mm
- 63A 16mm



Rotary Isolators - 4 Pole				
16A (16A AC22)	IS204	1143862	15.97	1
25A (20A AC22)	IS254	0922659	16.59	1
32A (25A AC22)	IS324	0922660	16.99	1
40A (32A AC22)	IS404	0922661	18.37	1
63A (40A AC22)	IS634	0922662	32.48	1

INTERLOCKED SWITCHED SOCKETS



Rotary Isolators - 4 Pole

- Compliance with standards CEI EN 60309, CEI EN 60529
- Thermoplastic body material
- IP44 Ingress Protection Rating
- Wall Mountable
- Nominal Operational Voltage 230V
- Dimensions (H)395 mm x (W)121.5 mm x (D)146 mm



Rotary Isolators - 4 Pole				
Skt Sw.Int 16A 3P 240V IP44 c/w 25A 2P 3	PMRCD16/301SITT	0395149	178.66	1
Skt Sw.Int 16A 5P 415V IP44 c/w 25A 4P 3	PMRCD16/308SITT	0395219	210.91	1
Skt Sw.Int 32A 3P 240V IP44 c/w 40A 2P 3	PMRCD32/301SITT	0395233	192.31	1
Skt Sw.Int 32A 5P 415V IP44 c/w 40A 4P 3	PMRCD32/308SITT	0395255	214.83	1
Skt Sw.Int 16A 240V 3P IP66 c/w 25A 2P 3	PMRCD16/401SITT	0395221	183.83	1
Skt Sw.Int 16A 5P 415V IP66 c/w 25A 4P 3	PMRCD16/408SITT	0395231	208.50	1
Skt Sw.Int 32A 3P 240V IP66 c/w 40A 2P 3	PMRCD32/401SITT	0395257	213.54	1
Skt Sw.Int 32A 5P 415V IP66 c/w 40A 4P 3	PMRCD32/408SITT	0395283	234.49	1
Skt Sw.Int 63A 5P 415V IP55 c/w 63A 4P 3	PMRCD63/408SIT	0326032	264.29	1



METALCLAD CONSUMER UNITS

Steeple

All plastic components are contained within the metal enclosure in compliance with Amendment 3. Attractively styled, with smooth white powder coated finish and self-closing door.

- Extra height designed for single module RCBOs
- Metal DIN rail assembly
- Earth & Neutral terminals at the top



Metal Consumer Units					
Garage Unit with 2 x MCBs	A3MCGARAGEMS	0791656	29.17	1	27.13 3+
Garage Unit with 2 x MCBs	A3MCGARAGE63	0791655	34.63	1	32.84 3+

Metal 100A Main Switch Consumer Units					
2 Way	A3MX04M	0791657	27.41	1	24.68 3+
6 Way	A3MX08M	0791658	30.34	1	27.28 3+
8 Way	A3MX10M	0798919	31.63	1	30.01 3+
10 Way	A3MX12M	0791659	36.15	1	32.50 3+
14 Way	A3MX16M	0791660	41.26	1	40.01 3+
19 Way	A3MX20M	0798920	54.89	1	49.43 3+

Metal 63A 30MA RCD Consumer Units					
2 Way	A3MX04R	0791661	40.69	1	36.65 3+
6 Way	MX08RA	1380190	46.95	1	41.84 3+
8 Way	A3MX10R	0798921	48.25	1	43.42 3+
10 Way	A3MX12R	0791663	54.96	1	49.47 3+

Metal Dual 63A RCD/High Integrity Consumer Units					
6 Way	A3MX12RRMFLEXI	0791664	63.19	1	58.62 3+
10 Way	A3MX16RRMFLEXI	0791665	57.46	1	
15 Way	A3MX20RRMFLEXI	0791666	81.41	1	75.56 3+

Metal Dual 80A RCD A Type Consumer Units					
6+1 Way Type A 2X80A	A3MX12RRMFLEXIA	1272605	70.56	1	
10+1 Way Type A 2X80A	A3MX16RRMFLEXIA	1272606	68.23	1	
15+1 Way Type A 2X80A	A3MX20RRMFLEXIA	1272607	92.25	1	

Metal Enclosure and Busbar					
4 Way	A3MC04ENC	0791651	26.23	1	24.38 3+

Curve

- Attractive, modern design
- Extra height, designed for single module RCBOs
- Selection of knockouts for mini trunking top and bottom
- Round knockouts on the side 32 & 40mm
- Self-closing top hinged front cover
- Earth and neutral terminal bars at the top
- Metal raised din rail assembly allowing cables to be easily routed from bottom knockout entries



The ONLY true curved design currently available on the market

Metal 100A Main Switch Loaded Consumer Units					
10W 100A M/SW + 6 RCBO (3x32,1x16,2x6)	A3CUR-M10A	1380181	104.84	1	
14W 100A M/SW + 8 RCBO (4x32 1x16 3x6)	A3CUR-M14A	1380182	170.17	1	158.69 3+

Loaded Metal Dual 63A RCD/ High Integrity Consumer Units					
6W DUAL RCCB + 5 MCB'S (2x32,1x16,2x6)	A3CUR-D06A	1380183	88.71	1	83.56 3+
10W DUAL RCCB + 8 MCB'S (4x32 1x16 3x6)	A3CUR-D10A	1380184	76.92	1	
14W DUAL RCCB + 11 MCB'S (1x40,4x32,2x16,4x6)	A3CUR-D14A	1380185	98.86	1	94.98 3+

Metal 100A Main Switch Consumer Units					
2 Way A3 Main Switch Board	A3CUR-SW02	0912031	27.86	1	25.54 3+
6 Way A3 Main Switch Board	A3CUR-SW06	0912032	34.47	1	32.45 3+
10 Way A3 Main Switch Board	A3CUR-SW10	0912033	41.06	1	39.41 3+
14 Way A3 Main Switch Board	A3CUR-SW14	0832902	55.81	1	53.14 3+
18 Way A3 Main Switch Board	A3CUR-SW18	0912034	73.10	1	67.62 3+

Metal Main RCD Incomer Consumer Units					
2W MET CURVE 63A 30MA RCD AMD3	A3CUR-R02	0912035	37.77	1	35.24 3+
6W MET CURVE 63A 30MA RCD AMD3	A3CUR-R06A	1380187	50.92	1	47.13 3+
10W MET CURVE 63A 30MA RCD AMD3	A3CUR-R10A	1380188	57.05	1	52.16 3+

DEVICES & ACCESSORIES

Compatible with Steeple and Curve Consumer Units

DEVICES & ACCESSORIES					
A. Mains Tails Clamp	MTC	1103424	2.33	1	
B. Surge Protector 1 Mod Single Phase	SRGT2CU	1267706	38.76	1	
C. Surge + Cable + MCB Retrofit Kit	SRG1VCU-KIT	1189727	43.87	1	
D. Surge Protection Enclosure Unit	SRG1VCU-RM	1187356	68.73	1	
25 SMALL GROMMETS (40X25) pack of 10*	CUGR40-25	0979602	2.65	1	
E. 50 LARGE GROMMETS (50X50) pack of 10*	CUGR50-50	0979603	6.00	1	

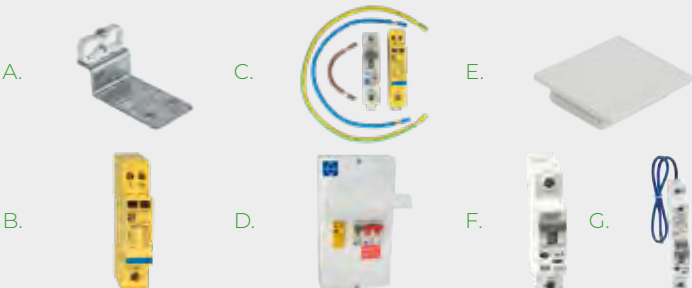

See page 41 for RCD's and additional accessories

Single Pole AC RCBOs - B Types Listed					
G. 6 Amp	RCBO630SP	0549695	12.83	1	11.94 10+
10 Amp	RCBO1030SP	0549689	12.83	1	11.94 10+
16 Amp	RCBO1630SP	0549690	12.83	1	11.94 10+
20 Amp	RCBO2030SP	0549691	12.83	1	11.94 10+
32 Amp	RCBO3230SP	0549692	12.83	1	11.94 10+
40 Amp	RCBO4030SP	0549693	12.83	1	11.94 10+
50 Amp	RCBO5030SP	0549694	12.83	1	11.94 10+

Single Pole RCBOs - A Type					
6 Amp A Type	RCBO-06/30/SPA	1148582	14.53	1	13.33 10+
10 Amp A Type	RCBO-10/30/SPA	1148588	14.53	1	13.33 10+
16 Amp A Type	RCBO-16/30/SPA	1148589	14.53	1	13.33 10+
20 Amp A Type	RCBO-20/30/SPA	1148590	14.53	1	13.33 10+
32 Amp A Type	RCBO-32/30/SPA	1148591	14.53	1	13.33 10+
40 Amp A Type	RCBO-40/30/SPA	1148592	14.53	1	13.33 10+

Single Pole MCBs - B Types Listed (*=also available in C Type)					
F. 6 Amp	G06-1B06	0970539	2.18	1	2.04 10+
10 Amp	G06-1B10	0970540	2.18	1	2.04 10+
16 Amp	G06-1B16	0970541	2.18	1	2.04 10+
20 Amp	G06-1B20	0970542	2.18	1	2.04 10+
32 Amp	G06-1B32	0970543	2.18	1	2.04 10+
40 Amp	G06-1B40	0970544	2.18	1	2.04 10+
50 Amp	G06-1B50	0970545	2.18	1	2.04 10+





18th Edition Hager Consumer Units



- 18th Edition Compliant
- Supplied with Type A RCCDs
- Ample space, even with RCBO's
- Metal din rail ensures devices sit square
- Top mounted terminal for neat & simple connections
- Top, bottom and rear knockouts
- Flush variants available to order



Available in selected branches or next day

Dual RCD A Type Boards				
10 Way 100A	VML910CU	1132307	84.94	1 80.89 3+
16 Way 100A	VML916CU	1132315	88.34	1 84.13 3+
5+5 Way 100A	VML955H	1132321	76.17	1 72.54 3+
6+6 Way 100A	VML966H	1132324	82.74	1 78.80 3+

Dual RCD A Type Boards + Surge Suppressor				
10 Way 100A	VML910CUSPD	1145502	152.28	1 145.04 3+
10 Way 100A	VML910CUSPDRK	1145462	152.28	1 145.04 3+
14 Way 100A	VML914CUSPD	1145503	154.37	1 147.01 3+
14 Way 100A	VML914CUSPDRK	1145528	154.37	1 147.01 3+

Surge Suppressor Kit				
Surge Protection Kit Type2	VM02SPD	1180050	112.30	1

Mains Switch Incomer Board				
6W 100A	VML106	0704041	39.77	1
10W 100A	VML110	0704044	48.68	1
14W 100A	VML114	0704047	52.99	1
20W 100A	VML120	0704053	72.09	1

RCCB Incomer Type A Board				
2W 40A 30MA	VML402AH	1145490	49.59	1
6W 63A 30MA	VML406AH	1145491	55.36	1
6W 100A 30MA	VML306AH	1145493	66.44	1
14W 100A	VML410AH	1145492	63.63	1

Devices				
MCB Type B SP 6A 6KA	MTN106	0159799	2.46	1
MCB Type B SP 10A 6KA	MTN110	0159800	2.46	1
MCB Type B SP 16A 6KA	MTN116	0159808	2.46	1
MCB Type B SP 20A 6KA	MTN120	0159809	2.46	1
MCB Type B SP 25A 6KA	MTN125	0159810	2.46	1
MCB Type B SP 32A 6KA	MTN132	0159811	2.46	1
MCB Type B SP 40A 6KA	MTN140	0159919	2.46	1
MCB Type B SP 50A 6KA	MTN150	0159920	2.46	1
MCB Type B SP 63A 6KA	MTN163	0159921	2.46	1

Devices				
RCBO B Type A 6KA 6A 30MA	ADA306G	1020970	23.13	1 22.03 3+
RCBO B Type A 6KA 10A 30MA	ADA310G	1020971	23.13	1 22.03 3+
RCBO B Type A 6KA 16A 30MA	ADA316G	1020972	23.13	1 22.03 3+
RCBO B Type A 6KA 20A 30MA	ADA320G	1020973	23.13	1 22.03 3+
RCBO B Type A 6KA 25A 30MA	ADA325G	1020974	23.13	1 22.03 3+
RCBO B Type A 6KA 32A 30MA	ADA332G	1020975	23.13	1 22.03 3+
RCBO SP A B 40A 30MA 6KA	ADA140G	1145605	23.13	1 22.03 3+
RCBO SP A B 45A 30MA 6KA	ADA145G	1145616	23.13	1 22.03 3+

Accessories				
Cable Entry Plate (Pack of 10)	VM03CE	1097401	7.02	1
Meter Tail Entry Plt (Pack of 10)	VM04CE	1097403	7.02	1

METALCLAD CONSUMER UNITS



- Ample cable entry knockouts to accommodate cable entry from top, bottom or rear face of the enclosure
- 'Snap-able' busbars enabling easy on-site configuration
- Dual RCCB units come with 3 neutral busbars as standard for high integrity configuration



100A Main Switch Boards				
8 Way Metal Cased	NM806L	1076238	49.50	1
10 Way Metal Cased	NM1106L	1076249	54.99	1

Dual RCD High Integrity Boards				
10 way	NMRS10SSLMHIA	1165370	109.90	1
15 way	NMRS15SSLMHIA	1165371	119.34	1

100A Switchfuse				
100aA Switchfuse	DSF100M	0826796	69.95	1

MCB's				
6A	NHXB06	0351141	2.99	1
16A	NHXB16	0351170	2.99	1
20A	NHXB20	0351172	2.99	1
32A	NHXB32	0351181	2.99	1
40A	NHXB40	0351183	2.99	1
50A	NHXB50	0351184	2.99	1

RCBOs				
6A	NHXSBS1B06	0351591	29.99	1
16A	NHXSBS1B16	0351601	29.99	1
32A	NHXSBS1B32	0351603	29.99	1
40A	NHXSBS1B40	0351654	29.99	1

Metal 100A Main Switch Consumer Units				
2 Way	DEAS2S	0790776	34.96	1 31.50 3+
6 Way	DEAS6S	0790777	37.28	1 33.60 3+
10 Way	DEAS10S	0790778	41.00	1 37.34 3+
14 Way	DEAS14S	0790780	47.75	1 43.86 3+

Metal RCD Consumer Units				
2 Way 63A RCD	DEAS2H63S	0790783	39.48	1 36.29 3+
6 Way 80A RCD	DEAS6H80S	0790786	41.79	1 38.75 3+

Metal Dual RCD/High Integrity Consumer Units				
10 Way inc. 1x 80A + 1x 63A RCD	DEAS10H80H63DS	0790771	55.50	1 50.00 3+
14 Way inc. 1x 80A + 1x 63A RCD	DEAS14H80H63DS	0790774	61.00	1 55.00 3+

Single Pole MCBs - B Types Listed				
6 Amp	EAD06B	0678675	2.18	1 1.98 5+
10 Amp	EAD10B	0678676	2.18	1 1.98 5+
16 Amp	EAD16B	0678677	2.18	1 1.98 5+
20 Amp	EAD20B	0678678	2.18	1 1.98 5+
32 Amp	EAD32B	0678681	2.18	1 1.98 5+
40 Amp	EAD40B	0678679	2.18	1 1.98 5+
50 Amp	EAD50B	0678680	2.18	1 1.98 5+

Single Pole RCBOs - B Types Listed (*=Also Available in C Type)				
6 Amp	DEAD06BH30C	0790754	18.85	1 17.29 3+
10 Amp	DEAD10BH30C	0790755	18.85	1 17.29 3+
16 Amp	DEAD16BH30C	0790756	18.85	1 17.29 3+
20 Amp	DEAD20BH30C	0790757	18.85	1 17.29 3+
25 Amp	DEAD25BH30C	0790758	18.85	1 17.29 3+
32 Amp	DEAD32BH30C	0790759	18.85	1 17.29 3+
40 Amp	DEAD40BH30C	0790760	18.85	1 17.29 3+
45 Amp	DEAD45BH30C	0790761	18.85	1 17.29 3+



INDUSTRIAL CIRCUIT PROTECTION



3 Phase TP&N Boards

- 4, 8, 12 & 16 way TP+N distribution boards
- Finished in epoxy powder coating to AL7035
- Gland plates top and bottom w/knockouts
- Earth & neutral terminals adjacent to MCBs

3 Phase Distribution Boards

4 Way	E-TPN04LW	0976523	108.44	1
8 Way	E-TPN08LW	0976524	138.78	1
12 Way	E-TPN12LW	0976525	164.89	1
16 Way	E-TPN16LW	0976526	241.91	1

Switch 'Incomer' Kit

100 Amp	EMS-1003P	0976623	17.63	1
100 Amp	EMS-1004P	0976625	21.62	1
125 Amp	EMS-1253P	0976624	18.76	1
125 Amp	EMS-1254P	0976626	20.30	1
100 Amp	RCD10-100/30/4A	1103425	88.92	1
100 Amp	RCD10-100/100/4A	1103427	93.36	1
100 Amp	RCD10-100/300/4A	1103426	99.90	1
100 Amp	RCD10-100/100/4S	1103414	150.21	1

Single Pole MCBs (C Types)

6 Amp	E10-1C06	0976536	6.15	1	5.41	10+
10 Amp	E10-1C10	0976537	6.15	1	5.41	10+
16 Amp	E10-1C16	0976538	6.15	1	5.41	10+
20 Amp	E10-1C20	0976539	6.15	1	5.41	10+
25 Amp	E10-1C25	0976540	6.15	1	5.41	10+
32 Amp	E10-1C32	0976541	6.15	1	5.41	10+
40 Amp	E10-1C40	0976542	6.15	1	5.41	10+
50 Amp	E10-1C50	0976543	6.42	1	6.08	10+
63 Amp	E10-1C63	0976544	6.42	1	6.08	10+



Triple Pole MCBs (C Types)

6 Amp	E10-3C06	0976582	18.88	1	17.57	10+
10 Amp	E10-3C10	0976584	18.88	1	17.57	10+
16 Amp	E10-3C16	0976585	18.88	1	17.57	10+
20 Amp	E10-3C20	0976586	18.88	1	17.57	10+
25 Amp	E10-3C25	0976587	18.88	1	17.57	10+
32 Amp	E10-3C32	0976588	18.88	1	17.57	10+
40 Amp	E10-3C40	0976589	24.59	1	23.77	10+
50 Amp	E10-3C50	0976591	24.59	1	23.77	10+
63 Amp	E10-3C63	0976592	24.59	1	23.77	10+

Single Pole RCBO (C Types)

6 Amp	RCBO10-06/30/1M/C	0976613	26.22	1	24.23	10+
10 Amp	RCBO10-10/30/1M/C	0976614	26.22	1	24.23	10+
13 Amp	RCBO10-13/30/1M/C	0976615	26.22	1	24.23	10+
16 Way	RCBO10-16/30/1M/C	0976618	26.22	1	24.23	10+
20 Amp	RCBO10-20/30/1M/C	0976619	26.22	1	24.23	10+
25 Amp	RCBO10-25/30/1M/C	0976620	26.22	1	24.23	10+
32 Amp	RCBO10-32/30/1M/C	0976621	26.22	1	24.23	10+
40 Amp	RCBO10-40/30/1M/C	0976622	26.22	1	24.23	10+

LEWDEN 3 PHASE ACCESSORIES



Accessories



19 Module Extension Box	TPN-EXT19	1103415	53.23	1
Cable Extension Box	TPN-EXTCB	1103416	39.91	1
Joining Box	TPN-JB125	1103417	20.14	1
Metering Panel for Single Boards	TPN-MKSI	1103418	443.38	1
Surge Protector 2 Mod Single Ph	SRG1V1G	1078394	85.82	1
Surge Protector 4 Mod Three Ph	SRG3V1G	1078395	162.27	1

Accessories

Multi Function DIN Rail Blank	MFDRB	1103423	0.86	1
RCCB Fitting Kit for TPN	TPN-RCCBAK	1103419	2.34	1
MCB/RCBO Conversion Kit for E-TPN04LW	E-TPNZB04	1103413	1.45	1
MCB/RCBO Conversion Kit for E-TPN08LW	E-TPNZB08	1103420	2.79	1
MCB/RCBO Conversion Kit for E-TPN12LW	E-TPNZB12	1103421	3.88	1
MCB/RCBO Conversion Kit for E-TPN16LW	E-TPNZB16	1103422	4.70	1

3 PHASE DISTRIBUTION BOARDS



Powering Business Worldwide

- Welded 'case end' design board virtually eliminates distortion during installation
- Unique cable trunking interface kit
- Improved neutral cable clamp design for simple & secure cable connection.
- Removable busbar assembly to assist installation.
- 250A options on 18 and 24 way boards.

3 Phase Distribution Boards

4 Way	EBM41	0329736	124.76	1
6 Way	EBM61	0329737	141.35	1
8 Way	EBM81	0329747	163.77	1
12 Way	EBM121	0329560	193.98	1

Switch 'Incomer' Kit

125 Amp	EBMS1253	0330148	51.18	1
---------	----------	---------	--------------	---

Single Pole RCBOs (C Types)

6 Amp	EMCH106R30C	0504361	57.33	1	53.51	3+
10 Amp	EMCH110R30C	0504362	57.33	1	53.51	3+
16 Amp	EMCH116R30C	0504364	57.33	1	53.51	3+
20 Amp	EMCH120R30C	0504365	57.33	1	53.51	3+
32 Amp	EMCH132R30C	0504368	57.34	1	53.52	3+
40 Amp	EMCH140R30C	0504369	57.33	1	53.51	3+

Blanks

Single Pole	EMBP	0330568	1.28	1	1.20	3+
-------------	------	---------	-------------	---	-------------	----



Single Pole MCBs (C Types)

6 Amp	EMCH106	0330638	10.78	1	10.06	3+
10 Amp	EMCH110	0330669	10.29	1	9.60	3+
16 Amp	EMCH116	0330716	10.29	1	9.60	3+
20 Amp	EMCH120	0330729	10.29	1	9.60	3+
25 Amp	EMCH125	0330770	10.29	1	9.60	3+
32 Amp	EMCH132	0330772	10.29	1	9.60	3+
40 Amp	EMCH140	0330817	11.21	1	10.46	3+
50 Amp	EMCH150	0330827	11.21	1	10.46	3+
63 Amp	EMCH163	0330829	12.15	1	11.34	3+

Triple Pole MCBs (C Types)

6 Amp	EMCH306	0331137	45.61	1	42.57	3+
10 Amp	EMCH310	0331187	43.70	1	40.78	3+
16 Amp	EMCH316	0331189	43.70	1	40.78	3+
20 Amp	EMCH320	0331190	43.70	1	40.78	3+
32 Amp	EMCH332	0331216	43.70	1	40.78	3+
40 Amp	EMCH340	0331217	47.49	1	44.32	3+
50 Amp	EMCH350	0331218	47.49	1	44.32	3+
63 Amp	EMCH363	0331235	52.66	1	49.15	3+





CONSUMER UNIT ACCESSORIES

Din Rail Mounted Accessories



Din Rail 1 metre	DINRAIL	0549643	2.06	1
100A Busbar for Single Phase Boards/Enclosures, 1m	SPB-1P	0550572	16.85	1

Steeple RCDs



40A 30mA 2 Pole RCD	40/30/2	0549676	14.79	1
63A 30mA 2 Pole RCD	63/30/2	0549686	15.51	1
80A 30mA 2 Pole RCD	80/30/2	0550580	20.09	1
80A 100mA 2 Pole RCD	80/100/2	0550579	20.09	1
63A 30mA 2 Pole A Type RCD	63/30/2A	1148586	20.05	1
80A 30mA 2 Pole A Type RCD	80/30/2A	1148587	24.50	1

Time Delayed RCDs

100A 100mA 2 Pole A Type RCD	100/100/2SA	1219153	59.89	1
------------------------------	-------------	---------	--------------	---

Time Clocks

Time Switch 7 Day 1 Chnl 16(4)A	DTC	0550611	33.88	1
Staircase Timer	TCS	0549687	15.27	1

Contactors

20A 2 Pole Contactor	IC20	0549675	12.73	1
24A 4 Pole Contactor	IC24/4	0550591	25.21	1
40A 2 Pole Contactor	IC40/2	0550606	31.57	1
63A 4 Pole Contactor	IC63/4	0549620	45.48	1

Energy Monitoring

100A KWH Meter	KWHM100	0550635	47.61	1
----------------	---------	---------	--------------	---

Transformers

Bell Transformer	BT	0550573	17.94	1
------------------	----	---------	--------------	---

Main Switch

100A Main Switch	GMS1002P	1124459	10.73	1
------------------	----------	---------	--------------	---

Lock Off Devices

MCB Lock, Padlock + 3 Keys	MCBLOCK	0549671	6.47	1
----------------------------	---------	---------	-------------	---

Universal Lock Off



Universal Lock Off	KEWLK	0325268	18.31	1
--------------------	-------	---------	--------------	---

STREET LIGHT CUT OUT

Street Light Cut Out	SLC25A/N	0551786	17.49	1
6A Street Light Fuse	LST6	0548864	2.28	1

For 3 position Roller Shutter Keyswitch see Fire & security. Page 42

ENCLOSURES

Plastic Enclosures



2 Mod + Extra Height	X2MOD	0549644	2.41	1
4 Mod + Extra Height	X4MOD	0549652	3.65	1
4 Mod IP55	4/55	0549673	10.18	1
8 Mod IP55, Extra Height	8/55	0550584	24.33	1

3rd Amendment Compliant Metal Enclosure

5 Mod	A35MODMC	1002841	13.94	1	12.83	3+
-------	----------	---------	--------------	---	--------------	----

DOL STARTERS

Enclosure & Pre-Fitted Contactor



11A 5.5kW 230V Coil	BSHUFB-11I	0573616	35.62	1
11A 5.5kW 400V Coil	BSHUFB-11M	0573617	35.62	1
21A 11kW 230V Coil	BSHUFB-18I	0573618	45.78	1
21A 11kW 400V Coil	BSHUFB-18M	0573619	45.78	1

Thermal Overloads

Overload Relay 0.75-1A	BSRHU10-1A	1002838	13.73	1
Overload Relay 10-7.5A	BSRHU10-7.5A	1002839	16.47	1
Overload Relay 10-10A	BSRHU10-10A	1002840	16.47	1
Overload Relay 1.1-1.6A	BSRHU10-1.6A	0967511	16.47	1
Overload Relay 1.4-2.1A	BSHN10-21A	0573623	16.47	1
Overload Relay 2.3-3.2A	BSRHU10-3.2A	0823509	16.47	1
Overload Relay 4.5-6.3A	BSRHU10-6.3A	0967512	16.47	1
Overload Relay 9-12.5A	BSRHU10-12.5A	0856860	16.47	1
Overload Relay 11.3-16A	BSRHU10-16A	0845381	13.40	1

Replacement Contactors (for BSHUFB-* items above)

11A 5.5kW 240V	BSCU11-10I	0573611	12.76	1
11A 5.5kW 400V	BSCU11-10M	0573612	12.76	1
15A 7.5kW 240V	BSCU16-10I	0573613	15.44	1
21A 11kW 240V	BSCU18-11I	0573614	21.98	1
21A 11kW 400V	BSCU18-11M	0573615	21.98	1

START/STOP BUTTONS

Remote Stop/Start Buttons IP55 Insulated



Autolock Mushroom Stop Pushbutton Station	PB-ESS	0549622	10.97	1
Start/Stop Pushbutton Station	PB-SSS	0549623	14.19	1

HRC FUSES

30A Cartridge Fuse (for 30A Switchfuse only) BS1361	FLC30	0548860	2.08	1
60A Cartridge Fuse BS1361	FLC60	0548886	7.32	1
80A Cartridge Fuse BS1361	FLC80	0548887	7.65	1
100A Cartridge Fuse BS1361	FLC100	0548913	10.94	1

MID APPROVED CREDIT METERS

A.		B.		C.		
A.	WD Dragonfly Steeple MID Single Phase Meter	WD	DRAGONFLY	0968941	38.34	1
B.	MID Approved 3 Phase kWh Meter	WE	263	0968942	112.07	1
C.	MID Approved 100A Dual Coin Meter	WS	LOTMET/N	0603924	147.24	1
	MID Approved Card Meter	WC	CARDMET/N	0677733	147.29	1



Fire & Security

FireAngel®

LEADING THE WAY IN FIRE AND CO SAFETY

GRADE D1 as per BS 5839:6-2019
MAINS + 10 YEAR LITHIUM BATTERY BACKUP



SM-SN-1 Multi-Sensor Smoke Alarm

- Thermoptek Multi-Sensor optical sensing technology - for a faster reaction to all types of fires
- For Use in: Hallway, Landing, Living Room, Bedroom, Dining Room



HM-SN-1 Enhanced Heat Alarm

- Thermistek technology, with a unique patented heat dish
- Mains powered with 10 year Lithium battery backup
- For Use in: Kitchen, Garage, Loft



FS1326-T Carbon Monoxide Alarm

- Advanced electrochemical sensor calibrated and tested in CO gas
- Protects against the silent killer, Carbon Monoxide
- 10 year sealed for life Lithium battery



FS1521W2-T

SMART RF Radio Module

- Enable wireless interlink for up to 50 Smart RF devices
- Fit the Smart RF Module into any Smart RF Ready alarm

GRADE D2 as per BS 5839:6-2019
MAINS + 9V BATTERY BACKUP



SW1-PF-T Optical Smoke Alarm

- High performance optical sensor
- For wireless interlink fit with RF Interlink Base (sold separately)
- For use in: hallway, landing, living room, bedroom, dining room



HW1-PF-T Enhanced Heat Alarm

- Enhanced thermistor sensing technology designed to protect kitchens.
- For wireless interlink fit with RF Interlink Base (sold separately)
- For use in: kitchen, garage, loft



RF-BW-T RF Wireless Interlink Base

- Provides a wireless interlink between SW1-PF-T, HW1-PF-T and CW1-PF-T alarms
- Wireless interlink up to 50 alarms with the RF-BW-T or hardwire interlink up to 12 alarms

Multi-Sensor Smoke Alarm	SM-SN-1	1139145	32.50	1
Mains Powered Heat Alarm	HM-SN-1	1139144	32.50	1
Battery Powered Carbon Monoxide Alarm	FS1326-T	1231601	22.99	1
Smart RF Radio Module	FS1521W2-T	1231604	27.50	1
Smart RF Radio Module	FS1521W2-T	1231604	27.50	1
Mains Heat Alarm + Battery	HW1-PFT	1109177	17.50	1
RF Interlink Base	RF-BW-T	1139137	33.50	1

Denmans
REXEL GROUP



Click & Collect
in as little as 1 min



Call
your local branch



Visit
your local branch



MAINS INTERLINKABLE SMOKE & HEAT DETECTORS

aico® EI140 Series

With smoke alarms providing a critical role in the early detection of a fire in the home and the potential difference between life and death, Denmans are pleased to be distributors for two of the market leaders in fire safety. Kidde, with over 100 years in the fire detection and suppression industry and Aico who are consistently pioneering new technologies in smoke and carbon monoxide alarms.



EI140 Series

Ionisation Smoke Alarm	EI141RC	0591816	13.49	1	12.59	4+
Optical Smoke Alarm	EI146RC	0591818	21.21	1	19.42	4+
Heat Alarm	EI144RC	0591817	27.29	1	25.72	4+
RadioLINK Base for use with EI140 series alarms & EI2110E	EI168RC	0204969	40.72	1	39.29	4+

EI3000 SERIES

aico®

The 3000 Series is Aico's most intelligent series yet, whilst maintaining the simplicity that customers value.

- Real time local data extraction using AudioLINK
- All alarms in the series fit on easi-fit base
- 3rd party BSI accredited



EI3000 SERIES

EI3014 Mains Heat Alarm	EI3014	1108811	43.05	1
EI3016 AICO EI Professional Optical Mains Smoke Alarm	EI3016	1108810	41.48	1
EI3018 Carbon Monoxide Alarm	EI3018	1108813	50.39	1

EI3000 SERIES CONTINUED

EI3024 Aico Ei Professional Multi-Sensor Fire Alarm	EI3024	1108809	53.55	1	51.98	4+
EI3028 Multi-Sensor Fire CO Alarm	EI3028	1108808	66.15	1	64.05	4+
EI3000MRF SmartLINK Module	EI3000MRF	1108812	44.10	1	43.05	4+



SmartLINK capability for wireless interconnection, data extraction and whole system monitoring.



THE DENMANS APP

Save time on the move by downloading the simple to use App



HISPEC SMOKE/HEAT/CO DETECTION RANGE

HISPEC

The new Hispec range offers both mains and battery only radio frequency detectors. Allowing installers to satisfy the specification required for grade D1, D2 fire detection systems

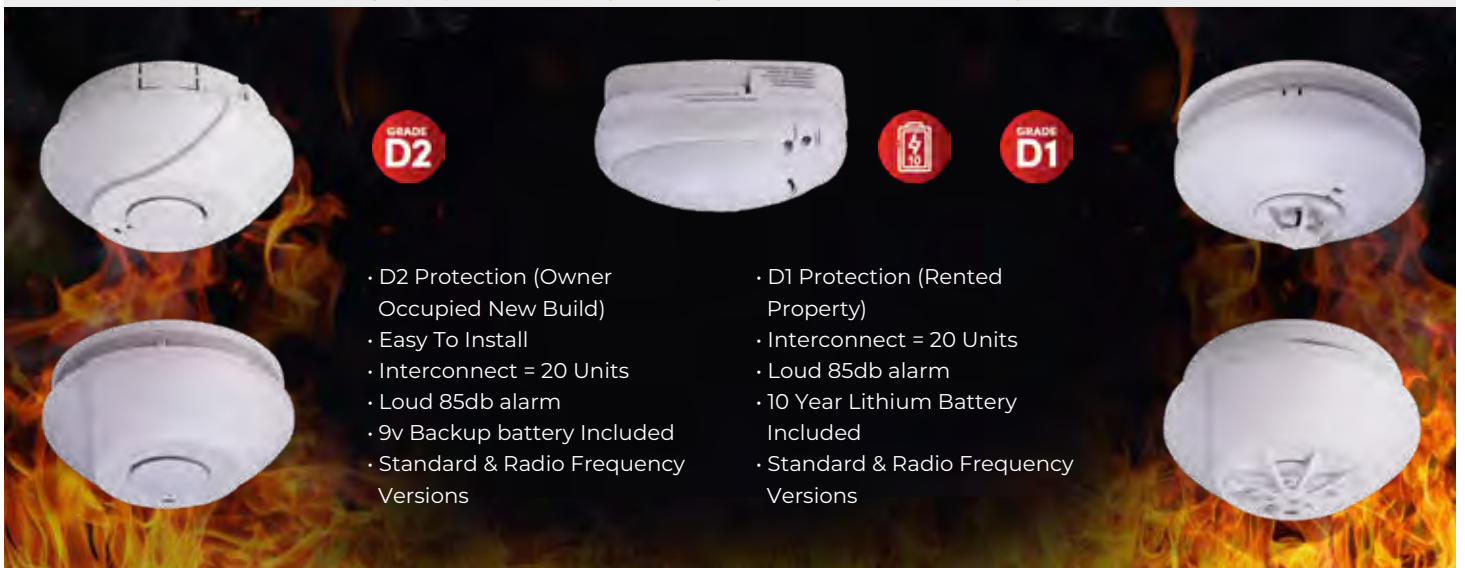

- D2 Protection (Owner Occupied New Build)
- Easy To Install
- Interconnect = 20 Units
- Loud 85db alarm
- 9v Backup battery Included
- Standard & Radio Frequency Versions

- D1 Protection (Rented Property)
- Interconnect = 20 Units
- Loud 85db alarm
- 10 Year Lithium Battery Included
- Standard & Radio Frequency Versions

Mains Interlinkable With 9V Backup Battery

Optical Smoke Detector	HSSA/PE/FF	1126352	12.96	1
Heat Detector	HSSA/HE/FF	1126348	14.95	1
Carbon Monoxide Alarm	HSA/CA	0926068	29.49	1

Mains With 9V Backup Battery and Built in Radio Frequency

Optical Smoke Detector	HSSA/PE/RF	1126353	31.49	1
Heat Detector	HSSA/HE/RF	1126349	33.45	1

Mains Interlinkable With 10 Year Battery

Optical Smoke Detector with 10YR LITHIUM	HSSA/PE/FF10	1276897	21.89	1
Heat Detector with 10YR LITHIUM	HSSA/HE/FF10	1276892	22.89	1

Mains With 10 Year Battery and Built in Radio Frequency

Mains With 10 Year Battery and Built in Radio Frequency	HSSA/PE/RF10	1276901	44.85	1
Heat Detector with 10YR LITHIUM & RF	HSSA/HE/RF10	1276894	44.85	1



DOMESTIC SMOKE & HEAT ALARMS

Miscellaneous



Miscellaneous

9V Battery Powered Ionisation Smoke Alarm	EI100BNX	0047751	5.75	1	5.23	5+
Stand Alone - no wiring required, powered by a 9V Alkaline battery (supplied)						
9V Battery Powered Heat Alarm	EI103C	0047774	21.99	1	21.25	4+
9V Interconnectable battery heat alarm						
Interconnectable Lithium Battery Powered Ionisation Smoke Alarm	EI100TYC	0047773	32.36	1	29.12	4+
9V 10yr Lithium Battery, interconnects with up to 12 other battery powered Aico Alarms						
I-Fire Multi-Sensor Fire Alarm	EI2110E	0826633	54.29	1	49.95	4+
Compatible with RadioLINK+, future proof and fully compatible with existing Aico systems.						
RadioLINK Remote Relay Module	EI428	0164492	58.68	1	55.80	4+
Built-in 5A relay and 10yr+ Rechargeable lithium back-up cells						



RadioLINK Manual Call Point



- Allows remote triggering of alarm system
- 10 year lithium battery
- No wiring required for installation

RadioLINK Manual Call Point

RadioLINK Manual Call Point	EI407	0164491	34.83	1	33.75	4+
With 10yr+ Lithium cells, for use with EI2110E, EI160RC and EI140 series alarms when on EI168RC RadioLINK bases.						



RadioLINK Alarm Controller



- Indicates if source of alarm is a fire or CO alarm
- 4 functions: Test, Locate, Silence, Memory
- Built-in 10yr Lithium Battery
- 10 year lithium battery
- No wiring required for installation

RadioLINK Alarm Controller

RadioLINK Alarm Controller with memory feature. Designed to work with RadioLINK enabled Fire & CO Alarms	EI450	0502192	50.76	1	48.35	4+
--	-------	---------	-------	---	-------	----



Remote Control Switch with Test, Hush & Locate functions for use with EI2110E & EI160RC series alarms.	EI1529RC	0204979	30.05	1	29.37	4+
Mounting Kit & Relay	EI128R	0111247	23.76	1	22.71	4+
Manual Call Point	MCP401RC	0204978	27.88	1	25.62	4+

CARBON MONOXIDE ALARMS



Lithium Battery Powered

- 7yr Lithium battery (sealed in)
- BS EN 50291
- 5 year guarantee



Lithium Battery Powered, Interlinkable

- RadioLINK up-gradeable with optional RadioLINK module



Lithium Battery Powered with Digital Display

- Digital display shows last recorded CO level



Lithium Battery Powered RadioLINK Alarm

- RadioLINK wireless interconnection - if one alarm sounds they all sound



Battery Powered CO Alarms

Lithium Battery Powered	EI208	0502187	21.53	1	18.75	4+
Lithium Battery Powered, Interlinkable	EI208W	0420380	26.32	1	24.48	4+
Lithium Battery Powered with Digital Display	EI208DW	0420379	34.68	1	32.60	4+
Lithium Battery Powered RadioLINK Alarm	EI208WRF	0420385	61.91	1	57.58	4+



EI3018



- Real time local data extraction using AudioLINK
- All alarms in the series fit on easi-fit base
- 3rd party BSI accredited

EI3000 SERIES

EI3018 Carbon Monoxide Alarm	EI3018	1108813	50.39	1		
------------------------------	--------	---------	-------	---	--	--



EI262



- Mains powered with 10 year Rechargeable Lithium Back-up
- RadioLINK wireless interconnection
- Memory feature
- Replaceable sensor module

Mains Powered CO Alarms

Conventional Mains Powered RadioLINK Alarm	EI262	0330614	77.33	1	73.76	4+
EI3018 Carbon Monoxide Alarm	EI3018	1108813	50.39	1		

CALL YOUR LOCAL BRANCH TODAY



EXPERTS ON ALL THINGS ELECTRICAL

Deal with the experts - we're the specialists who understand our products

EATON CONVENTIONAL FIRE SYSTEM

4 wire systems

These use a cable for each detection zone and a cable for each sounder circuit. Usually found in older installations and worked on during upgrades or extensions.



2 wire systems

These can run the detection zone and sounder circuit on a single cable. Used in new installations.





EATON CONVENTIONAL FIRE SYSTEM



- 4 Wire System
- Flexible high specification system
- One-man test facility
- Simple auto-reset user test facility
- Third Party Approved



Conventional Panels

2 Zone Fire Panel **	FX2202CPD-NB	1103410	110.86	1
4 Zone Fire Panel **	FX2204CPD-NB	1103411	121.06	1
8 Zone Fire Panel *	EFCV8Z	0837608	233.14	1
12V 3.2A/hr Alarm Battery	ALARMBAT/3.2	0804449	13.96	1

5-in-1 Detector

5-in-1 Detector	SFXN922	0576487	18.57	1
Common Base	SFXN520	0576493	5.28	1

Call Point

Call Point	SFX201	0576490	6.74	1
5x Replacement Glass for Call Point	SFX5G	0576489	0.00	1

24V 150mm 6" Bell

24V 150mm 6" Bell	SFX006	0642812	18.79	1
-------------------	--------	---------	--------------	---

24V Deep Base Electronic Sounder

24V Deep Base Electronic Sounder	SROLP-R-D	1076690	22.52	1
Sounder Base	SFXN824	0642814	31.01	1
Wall Beacon - Red Flash, Red Body	SFXSOLWRD	0642815	41.89	1
Ceiling Beacon - Red Flash, White Body	SFXSOLCWS	0642816	41.47	1
En54 Sounder Beacon Red Body	SFXROLPWR	0642817	55.03	1

EATON BIWIRE FLEXI 2 WIRE OR CONVENTIONAL SYSTEM



- Combined Technology Panel
- Either 2 wire or Conventional Accessories per zone
- Easy to extend Conventional Systems
- Reduces cabling requirements by around 50%
- Complies with all latest regulations



Bi-Wire Ultra Panels

Bi-Wire Ultra 2 Zone Panel <i>Strictly while stocks last</i>	SEFBW2ZONE	0837593	139.92	1
Bi-Wire Ultra 4 Zone Panel <i>Strictly while stocks last</i>	SEFBW4ZONE	0837594	164.49	1
Bi-Wire Ultra 2 Zone Panel	EFBW2ZFLEXI*	1096454	161.98	1 149.32 2+
Bi-Wire Flexi 4 Zone Panel	EFBW4ZFLEXI*	1096489	183.61	1 168.92 2+
Bi-Wire Flexi 8 Zone Panel	EFBW8ZFLEXI*	1096500	223.75	1 205.83 2+
Battery 12V 5AH (2x required per panel)	MB512	1096572	20.40	1 19.39 2+

Bi-Wire Ultra Accessories

5-in-1 Detector (requires base, extra)	SEFBW5IN1DET	0837599	19.74	1
Common Base	SFXN520	0576493	5.28	1
Cover for Detector Base, pack of 5	SMASC	0837598	15.42	1
Call Point	SEF201BWCP	0837600	16.49	1
5x Replacement Glass for Call Point	SFX5G	0576489	0.00	1

Base Sounder, First Fix

Base Sounder, First Fix	SEF5021BWS	0837596	29.06	1
Base Sounder, VAD Beacon, First Fix	SEF5021BWVBS	0837597	46.95	1
Wall Sounder	SEF009	0837603	43.32	1
Wall Sounder, VAD Beacon	SEF009VBS	0837602	54.98	1

* Requires backup batteries

FIKE TWINFLEX 2 WIRE FIRE SYSTEM



- LCD Display
- Up to 32 devices per zone
- BS5839 & EN54 Part 4 (LPCB) approved



2 Zone 2 Wire Panel*

2 Zone 2 Wire Panel**	SFDWP2-PRO	0624270	187.19	1
4 Zone 2 Wire Panel**	SFDWP4-PRO	0624271	232.24	1
8 Zone 2 Wire Panel**	SFDWP8-PRO	0624272	320.09	1

2 Wire Detector/Sounder & Base

2 Wire Detector/Sounder & Base	SFDW700	0697258	33.24	1
2 Wire Detector & Base	SFDW800	0697259	29.15	1
Manual Call Point	SFDW100	0624276	18.82	1
Remote Fire LED Indicator	SFDW125	0804432	9.37	1
Red Sounder	SFDW400	0624264	18.96	1
Head Removal Tool	SFDW25-0046201	0697260	11.16	1

Flash Point Strobe

Flash Point Strobe	SFDW302	0624265	31.06	1
Detector/Sounder/Strobe	SFDW900	0624274	55.09	1
Deep Base	SFDW901	0624275	3.57	1
5 Keys for SFDW100	SFDW100KEYS	0624268	2.91	1



EASY, CONVENIENT & SAVES THE PLANET

Simply scan the QR code to download the brochures to view anytime, anywhere!





FIRE ALARM PANELS & ACCESSORIES

Tâte Colsón



Mains Voltage Safety Isolator

Fire Alarm Fused Key Switch Red	F400-210R	0800787	28.78	1
Key Switch Connection Unit 13A Red	MCKSPNRD-W	1171186	10.70	1



Wirefree Door Release

Wirefree Door Release - Black	DORGARDBLK	0446192	123.29	1
Wirefree Door Release - Red	DORGARDRED	0446193	123.29	1
Wirefree Door Release - White	DORGARDWHI	0552690	123.29	1



Fire Alarm Log Book	FLB1N	1030022787	7.83	1
Smoke Detector Tester with Sabre	ASCAN	0524892	19.65	1

FIRE BARRIERS & EXTINGUISHER



Also enhances acoustic protection. Other sizes available to order.

Astroflame 2 Hour Rated Intumescent Hoods

150mm Intumescent Hood	AFDLCOV5	1115658	10.99	1
------------------------	----------	---------	--------------	---



Astroflame Intumescent Gaskets & Boxes

Single Socket Gasket	AFSG1G	1115659	1.13	1
Double Socket Gasket	AFSG2G	1115660	1.40	1



Fire and Acoustic Inserts

Single Box Fire & Acoustic Insert	AFFRASOCSIN	1115656	2.56	1	2.23	5+
Double Box Fire & Acoustic Insert	AFFRASOCDIN	1115657	3.86	1	3.36	5+



Fire & Acoustic Rated Metal Dry Lining Boxes

1 Gang 35mm Deep	WA4135	0296169	3.18	1	3.02	10+
2 Gang 35mm Deep	WA4235	0296179	4.96	1	4.72	10+
1 Gang 47mm Deep	WA4147	0296178	4.13	1	3.94	10+
2 Gang 47mm Deep	WA4247	0296180	6.07	1	5.78	10+

CHECK LIVE STOCK AVAILABILITY



Simply Visit:
www.denmans.co.uk

FIRE BARRIERS & EXTINGUISHER

Steeple Fire Extinguisher



- Allows remote triggering of alarm system
- 10 year lithium battery
- No wiring required for installation. Highly effective on all Class A, B & C Fires. Plus safe to use where live electrical equipment is involved
- Dry powder extinguisher
- Size: 1kg
- Squeeze grip control
- Supplied with wall bracket

Fire Extinguisher

Fire Extinguisher	FIREEXT1	1030006185	9.99	1
-------------------	----------	------------	-------------	---

INTRUDER ALARMS - WIRED

Honeywell All-In-One Intruder Alarm Kit

WHILE STOCKS LAST

The complete 1 box solution! Includes:

- 1x 8SP399A Accenta Mini Gen4 Control Panel with LCD Keypad
- 3x 8IR100 Pet Tolerant PIR Sensors
- 1x 8EP420 Live Reson8 Bell Box
- 2x AC035 Door Contacts
- 1x AC030 Panic Attack Button
- 1x UL1213 1.2Ah Battery
- 1x AC066 100m 6 Core Cable
- 1x 6BB002 Fixing Kit



All-In-One Intruder Alarm Kit

All-In-One Intruder Alarm Kit	8EP407N	0548799	146.96	1
-------------------------------	---------	---------	---------------	---

Steeple Compact 8 Zone Alarm Panel

WHILE STOCKS LAST

- Up to 4 Accenta remote keypads per system
- 8 Event memory
- Accepts 1.2 or 2.1Ah battery
- Includes abort and sequential alarm confirmation
- 1A PSU and NVM protection
- 6 programmable outputs for digital communicator



Compact 8 Zone Alarm Panel

Compact 8 Zone Alarm Panel	STAP8Z	0548796	38.99	1
8 Zone Alarm Panel & RKP	STAP8Z/REM	0548797	63.79	1



Backup Batteries

12V 1.2Ah Alarm Battery	ALARMBAT/1.2	0804448	10.58	1
12V 2Ah Alarm Battery	ALARMBAT/2	0548788	12.12	1
12V 3.2Ah Alarm Battery	ALARMBAT/3.2	0804449	13.96	1
12V 7Ah Alarm Battery	ALARMBAT/7	0548791	19.68	1



Intruder Alarm Accessories

Flush Contact	CONTACT/FL	0548780	1.87	1
Surface Contact	CONTACT/SU	0548781	2.45	1
Round Bell Box	STBBROUND	0548794	30.17	1
Round Dummy Box	STDUMROUND	0548785	11.03	1
Dual PIR Detector	STDUALPIR	0548793	23.82	1



Intruder Alarm accessories

LCD Remote Keypad	STKEYPAD	0548792	22.14	1
PIR Pet Detector	STPETPIR	0548786	9.74	1
PIR Detector	STPIR	0548783	7.32	1
Speech Dialler	STSPEECHD	0548798	68.75	1





INTRUDER ALARMS - WIRED



Intruder Alarm accessories

Personal Attack Button	PANICBUT	0548782	5.01	1
6 Way Alarm Junction Box	TB17	0552503	0.85	1
94db Internal Siren	SP20ST	0631474	18.69	1

Texecom 8 Zone Alarm Panels with Keypads
Designed to Perform

Features as VERITAS8 (below), but also includes LCD Keypad with:
 · 8 Zone LED indication
 · Touch tone backlit keys



8 Zone Alarm Panels with Keypads

8 Zone Alarm Panel & Remote Keypad	VERITASREM	0446672	76.64	1
8 Zone Alarm Panel & Keypad	VERITASR8+	0446675	78.07	1

8 Zone Compact Alarm Panel

Features as VERITAS8 (above), plus:
 · Slimline, discrete stand-alone control panel
 · Single button quick set option



8 Zone Compact Alarm Panel

8 Zone Compact Alarm Panel	VERITAS8C	0446669	66.58	1
----------------------------	-----------	---------	--------------	---

Veritas Event Log Alarm Panel

· 8 programmable access codes
 · Zone wiring
 · 8 Zones
 · Single button quick set
 · LCD display keypad
 · Programmable zone keypad w/ text



Veritas Event Log Alarm Panel

Veritas Event Log Alarm Panel	VERITASEXC	0446677	106.48	1
-------------------------------	------------	---------	---------------	---

8 Zone Alarm Panel

· 8 programmable zones plus tamper
 · Latching walk test mode
 · 2 programmable part set suite
 · Accepts up to six backlit LED remote keypads



8 Zone Alarm Panel

8 Zone Alarm Panel	VERITAS8	0446668	66.58	1
--------------------	----------	---------	--------------	---



A. Odyssey 1E Square Bell Box	BB1001	0446654	31.40	1
B. 3E Shield Bell Box	BB3001	0446656	31.40	1
C. Odyssey 4E Slim Bell Box	BB4001	0446659	32.87	1
D. Shock Sensor	IMPE01	0552512	10.95	1
E. 98° PIR	MEDUSAPIR	0552513	8.83	1
F. Bracket for MEDUSAPIR	AFU-0007	0552511	0.54	1



G. Mirage Dual PIR	MIRAGEDUAL	0552514	31.98	1
H. 3D Pet Immune PIR	PETWISEPIR	0591830	12.86	1
I. 104° Adjustable Range PIR	REFLEXPPIR	0446625	15.69	1
J. Bracket for REFLEXPPIR	AFU-0006	0446610	0.54	1
K. Microprocessor Based Ceiling Mount 360° PIR	RF360PIR	0552518	20.87	1
L. Extra Keypad for Veritas Standard Panels	KEYPAD	0446649	39.15	1
M. Extra LCD Keypad for VERITASEXC Panel	RPX01	0446670	63.43	1
N. Speech Dialler	SPEECHDIAL	0446681	104.96	1
O. Extension Speaker Sounder	SOUNDER105	0446611	8.42	1
P. Optical Smoke Detector	OH/4W	0446645	26.24	1



Over 11,500 products available in our branch network now

EATON COMPACT WIRELESS & WIFI ALARM KIT



A security alarm kit that brings next generation cloud capabilities to residential properties. The intruder panel (requires mains supply), with built-in keypad offers up to 20 radio zones and can be programmed, managed and serviced online remotely by installers via Eaton Secure Connect.

- Real time notification to your phone
- Installers can manage panels from anywhere
- Easy access from any internet browser
- Add internal and external cameras to the system

Kit contains :

- 1 x Compact 20 Zone Wireless Panel (requires mains supply)
- 2 x Wireless Pet Tolerant PIR
- 1 x Wireless Door Contact
- 2 x Keyfobs
- 1 x Wireless external sounder/Bell Box

Eaton Compact Wireless & WiFi Alarm Kit

Compact wireless alarm kit	COMPACT-KIT1	1074817	248.66	1
Internal WiFi cube w camera	SCAM-INT-00	1076666	129.59	1
External WiFi bullet camera	SCAM-EXT-00	1076667	175.70	1
Two way key fob	SFOB-2W-4B	1076668	49.31	1
Pack of 5 ID tags	SPROXTAGPK5	1076669	23.40	1
Plug in WiFi adaptor	SI-WIFI01	1076670	39.82	1
GSM module	SI-GSM03	1076671	160.44	1
Slimline door contact (white)	SDET-RDC-W	1076672	32.70	1
Window magnetic/shock detector	SDET-RDCS	1076675	67.69	1
Pet Tolerant PIR	SXCELPRP	1076680	52.11	1
External sounder with blue lens	SSDR-REXT-G2-BL	1076686	74.79	1
External sounder replacement battery	SSDR-R-BAT1	1076689	25.89	1



Wifi Cube Camera available separately



CCTV EQUIPMENT



8 Channel Wireless CCTV

Simple to install CCTV system. Cameras are supplied with a 3m power supply and do not require any cable to the network recorder as the signal is sent via WiFi. The system features strong penetrating wall ability and can go through 2 to 3 walls.

- Up to 1080P full HD image
- Easy installation & operation (no set-up costs)
- Remote viewing on mobile & tablet
- Motion detection
- 20m night vision
- IP65 weatherproof cameras



2MP HD RESOLUTION

8 Channel Wireless CCTV

WiFi 8 Channel Wireless Kit c/w 2x Bullet Cameras	WIFIKIT-8-BL-1TB	1145661	169.99	1
WiFi 8 Channel Wireless Kit c/w 2x Dome Cameras	WIFIKIT-8-DOME-1TB	1145662	169.99	1
Additional WiFi Bullet Camera	WIF2MP-VANDAL	1145663	55.00	1
Additional WiFi Dome Camera	WIF2MP-BULLET	1145664	55.00	1



5MP 4 Camera Colourview CCTV Kit

- Perfect for domestic and commercial applications
- Up to 5MP (2592P)
- 1TB DVR Unit
- Simple Installation
- Motion Detection
- Audio in and Out



Featuring full colour Starlight Cameras that turn night into day!



Colourview camera system

5MP 4 Camera Colourview CCTV Kit	CVPLUS-8-4DOME-1TB	1310583	299.00	1
----------------------------------	--------------------	---------	--------	---

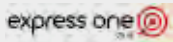

Wireless 7" Touch Screen NVR Kit With 2 X 1080P Cameras

The 7" high-definition touch screen network video recorder is designed with lightweight and easy to place. It can support 4 channels of real-time input at the same time, support motion detection recording, and store video in TF card.

- TCH playback
- Supports dual WIFI
- Supports IOS, Android mobile APP remote access, remote playback and alarm push function.
- Camera can connect recorder through wireless code match.
- NVR can support 4CH of 2MP, H264/H265 pure wireless camera input, battery camera & doorbell.



Wireless Wifi NVR Kit

Wireless 7" NVR 2 Camera Kit	LCD-KIT2MP	1264514	239.98	1
------------------------------	------------	---------	--------	---



5MP IP CCTV KIT

High resolution 5MP CCTV 2 camera kit provides extra detail compared to 1080P versions. Easy installation using Cat5 cable. Power & video via a standard RJ45 connection



Power & video via a standard RJ45 connection

5MP IP CCTV KIT

5MP Power Over Internet 2 Camera CCTV kit	FKIT-5MP4-2E	1167473	326.23	1
---	--------------	---------	--------	---



WiFi Video Doorbell & Chime

- Message alerts
- 2 way audio
- Rechargeable or mains power
- Additional chime available



WiFi Video Doorbell & Chime

Smart WiFi Video Doorbell	RING-WIFI	1138986	69.00	1
WiFi Chime Sounder	WIFI-CHIME	1145660	16.39	1



Nest Hello

- 4:3 Video for head to toe image
- Human detection
- 24/7 Streaming
- IOS & Android Compatible

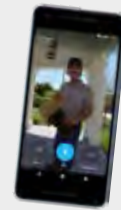

NEST HELLO

NEST HELLO Doorbell	NC2100GB	1122879	169.99	1
---------------------	----------	---------	--------	---



Nest Cam

- Makes sure that your home is safe by checking in on your phone, even when you are out.
- Instant alerts when unusual motion or sound detected
- 130° wide-angle view
- Built-in microphone & speaker
- Quick & easy set up - put it anywhere



Nest CCTV

NEST CAM Outdoor Camera	NC2100GB	0955749	132.92	1
NEST CAM Indoor Camera	NC1102GB	0798878	117.75	1

Check your home anywhere, anytime





DISABILITY ASSISTANCE



- Everything in one box: Ceiling pull cord, power supply, over door indicator, cancel button, disabled sticker
- Compliant to the requirements of: BS8300:2009 Building Regulations Document M



Emergency Assistance Kit	CFEAPULKIT	0552101	70.55	1
--------------------------	------------	---------	--------------	---



* Includes: Single Zone controller, Pull Cord Unit, over door light & sounder, reset button & sticker

Disabled Toilet Alarm*	NC951	0056674	74.15	1
Pull Cord	NC807C	0041773	19.25	1
Over Door Light	NC806CS/SS	0113725	58.22	1
Reset Button	NC809DB	0041775	10.99	1

ACCESS CONTROL

Táte Colsón Door Entry Kits

- 1 - 6 way available from stock
- We can also quote for systems up to 240 ways!



Door Entry Kits				
1 Way Audio Door Entry Kit	F65021N	0552486	40.64	1
2 Way Audio Door Entry Kit	F65022N	0552487	56.74	1
2 Way Intercom Kit	F65232	0552488	46.14	1
12C DC 1A Power Supply	FB42	0552495	24.44	1

12V Rim Strike and Mortice Door Lock

- 1 - 6 way available from stock
 - We can also quote for systems up to 240 ways!
- Ask your local branch



Door Entry Kits				
12V Rim Strike and Mortice Door Lock	ADCN203+S	0552143	11.66	1

Securefaßt



Green Access Control Call Point	AKAMCP3AGF	0639681	9.62	1
Keypad Kit + Electro Magnet + 'Push To Exit' Switch*	AKT4226	0582609	145.21	1

Keypads for internal use only or for external fitting must be mounted in a porched area. Certain doors may require a bracket set to fit the slimline electro magnet - available on request.

ACCESS CONTROL



Door Hold-Open Magnets - Wall Mounted				
Magnet 24V, Plastic	AEM0351	0552473	27.41	1
Magnet 230V, Plastic	AEM0352	0552474	29.69	1
Magnet 24V, Metal	AEM0362	0552475	31.80	1
Magnet 230V, Metal	AEM0363	0552476	34.86	1

Electro Magnets				
Monitored, Standard Single	AEM10020	0552480	44.35	1
Monitored, Slimline Single	AEM10002	0158167	30.92	1
Unmonitored, Standard Single	AEM10010	0158168	42.16	1
Unmonitored, Slimline Single	AEM10001	0552477	28.52	1
Standard Bracket for inward opening door	AEMBR026	0158170	20.67	1
Slimline Bracket for inward opening door	AEMBR089	0552482	14.42	1



Stainless Steel Green Exit Button	AEB6	0569513	21.06	1
Surface Box for AEB6	AEBBOX	108000071	5.70	1
Pushbutton Mechanical Digital Lock	SBL320S	0577434	33.85	1

Roller Shutter Keyswitch - 3 Position

- For use with a 3-position roller shutter.
- For use with roller shutter doors
- 230v
- Key operated
- White



Roller Shutter Keyswitch - 3 Position				
Euro Profile Keyswitch	ZKS-MAN-230	0633353	51.48	1

FOREMATIC

Includes: Motor head, 3 part chain drive rail, installation manual & DVD, 2x keyfobs



Garage Door Opener Kit	F700N	0919979	129.85	1
Canopy Door Adaptor	V201	0919980	80.24	1



FLEXIBLE DELIVERY

- Order by 6pm for next working day delivery (Mon-Fri)
- FREE delivery on all orders for trade credit customers
- FREE delivery on orders over £50
- Delivery to you or on site



Lighting & Lamps



AVAILABLE TO ORDER

A broader outdoor lighting range ready for the darker seasons.
Look out for the basket

FIREGUARD NEXT GENERATION DOWNLIGHT



Fireguard® Next Generation

The next generation of fire-rated LED downlights



FAST & EASY
INSTALLATION



DESIGNED FOR USE
WITH LED LAMPS



INTERCHANGEABLE
ALUMINIUM BEZELS

- Ultra fast press fit loop-in/loop-out terminal
- Harmonized range design ensures continuity throughout all applications
- Tapered can design for easy installation
- Tested for use in solid, I-Joist and steel open web joist ceilings*

Fireguard NG Mains Twist and Lock Can P20/IP65 No Bezel	DE010010/NB	1347600	4.83	1	4.60	10+
Fireguard NG Mains Twist and Lock Bezel IP20 Brushed Nickel	DE010013/BN	1347602	1.29	1	1.23	10+
Fireguard NG Mains Twist and Lock Bezel IP20 Chrome	DE010013/CH	1347603	1.29	1	1.23	10+
Fireguard NG Mains Twist and Lock Bezel P20 White	DE010013/WH	1347604	1.29	1	1.23	10+
Fireguard NG Mains Twist and Lock Bezel IP65 Brushed Nickel	DE010019/BN	1347608	3.75	1	3.58	10+
Fireguard NG Mains Twist and Lock Bezel IP65 Chrome	DE010019/CH	1347609	3.75	1	3.58	10+
Fireguard NG Mains Twist and Lock Bezel IP65 White	DE010019/WH	1347610	3.75	1	3.58	10+
Fireguard NG Mains Twist and Lock Tilt Can IP20 No Bezel	DE010023/NB	1347613	6.09	1	5.80	10+
Fireguard NG Mains Twist and Lock Tilt Bezel Brushed Nickel	DE010026/BN	1347615	2.03	1	1.94	10+
Fireguard NG Mains Twist and Lock Tilt Bezel Chrome	DE010026/CH	1347616	2.03	1	1.94	10+
Fireguard NG Mains Twist and Lock Tilt Bezel White	DE010026/WH	1347617	2.03	1	1.94	10+

JCC Lighting Products Ltd

*See jcc.co.uk for full certification details. It is the responsibility of the installer to ensure compliance with all relevant regulations.

JCC | a LEVITON company

Denmans
REXEL GROUP



Click & Collect
in as little as 1 min



Call
your local branch



Visit
your local branch



5W LED FIRE RATED DOWNLIGHT

Steeple 5W LED Colour Selectable IP65 Fire Rated Downlight

- Output equivalent to a 50W halogen downlight
- Switch on the back of the fitting allows selection between 3000/4000/6000K
- Shallow profile of only 60mm depth
- Push-in connector block allowing loop in loop out
- C/W white trim as standard
- Polished Chrome, Brushed Nickel and Matt Black Trims also available
- Cut out 72mm
- 3000k - 400lm, 4000k - 450lm, 6000 - 420lm

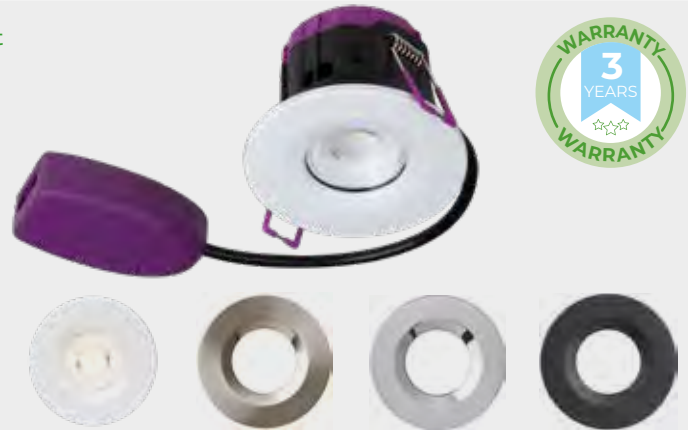

5W LED Colour Selectable IP65 Downlight	STLEDDL5CCT	1313565	10.89	1
Polished Chrome Trim	STTRIM-PC	1134148	1.55	1
Brushed Nickel Trim	STTRIM-BN	1134149	1.55	1
Matt Black Trim	STTRIM-MB	1134150	1.55	1

QR4 4.9W COLOUR SELECTABLE DOWNLIGHT



QR4 4.9W COLOUR SELECTABLE DOWNLIGHT

- 3000K - 400lm, 4000K - 410lm
- Colour selectable 3000K or 4000K
- IP65
- Fully tested for 30,60 and 90 minute fire rated Ceilings
- Supplied with white trim. Trims also available: Chrome, Satin Chrome, Brass, Black
- Cut-out size 72mm



QR4 4.9W COLOUR SELECTABLE DOWNLIGHT					
4.9W Colour Selectable	SKSRFRD375	1144806	11.99	1	11.49 10+

DOWNLIGHT

Steeple 7W WiFi Smart Downlight

- Smart Control via Phone
- Dimmable to 15%
- CCT (K): 3000/4000/6500
- Cut-out (mm): 72.00 mm
- Complete with 3-way double push-in connector block allowing loop in loop out
- Compatible with selected trailing and leading edge dimmers
- 30, 60 and 90min Fire rated

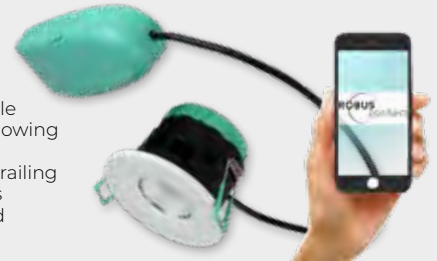

7W WiFi Smart Downlight	STLEDDL7WIFI	1168824	28.03	1
-------------------------	--------------	---------	--------------	---

FIREBREAK QR10 LED COB DIMMABLE DOWNLIGHTS



- 3000K or 4000K versions available
- Beam Angle: 46°
- Lumen Output:
- 756lm Warm White, 807lm Cool White
- 40,000 Hours (average)
- IP65
- Cut-out: 72mm, Minimum Void: 90mm



Available in white - chrome, satin chrome, brass, & black rims available separately



Warm White Dimmable White	SKSRFRD350	0932947	13.99	1	13.49 10+
Cool White Dimmable White	SKSRFRD351	0932948	13.99	1	13.49 10+
Chrome Detachable Rim	SKSRFRD352	0932949	1.85	1	
Satin Detachable Rim	SKSRFRD353	0932950	1.85	1	
Converter Plate White*	KSRFRD356	0931932	4.82	1	
Converter Plate Satin Chrome*	KSRFRD358	0931934	5.89	1	
Converter Plate Chrome*	KSRFRD357	0931933	5.89	1	

*use of Converter Plate invalidates IP and fire rating

* May require reload to balance circuit. For other dimmer compatibility please visit www.ksrlighting.com

All dimmers have been tested in-house.

KSR cannot be held responsible for any change made by dimmer manufacturers.

7W FIRE RATED V50 DOWNLIGHTS



- 7.5W LED
- 600/650 lumens
- Selectable colour temperature from beneath the ceiling, 3000K and 4000K
- Easy pushfit connection
- IP65 rated
- Minimum void requirement 50mm
- Extended range bezels available
- Cut-out size 70mm • Die-cast aluminium bezels
- Tested for use in solid, I-Joist and steel open web joist ceilings*



INCLUDES BEZEL



*See JCC.co.uk for full certification details. It is the responsibility of the installer to ensure compliance with all relevant regulations.

White	DE1001/WH	1093888	14.00	1	13.50 10+
Brushed Nickel	DE1001/BN	1093886	14.00	1	13.50 10+
Chrome	DE1001/CH	1093887	14.00	1	13.50 10+



Visit denmans.co.uk for our Web Weekend special offers.



V50 TILT DOWNLIGHTS



- 20° tiltable and 350° rotatable lens
- Strong, protected spring clips
- Fast, push-fit termination with remote driver
- Two colour selectable from remote driver, 3000K & 4000K
- IP20
- 85mm Cut Out
- 600/650lm
- Die-cast aluminium bezels
- Tested for use in solid, I-Joist and steel open web joist ceilings*



*See JCC.co.uk for full certification details. It is the responsibility of the installer to ensure compliance with all relevant regulations.

V50 TILT F/RATED LED D/LIGHT 7W 650LM BN	DE1002/BN	1093889	32.28	1	
V50 TILT F/RATED LED D/LIGHT 7W 650LM CH	DE1002/CH	1093890	32.27	1	
V50 TILT F/RATED LED D/LIGHT 7W 650LM WH	DE1002/WH	1093891	32.28	1	

QR10 TILT DOWNLIGHT 10 WATT, IP65



- 3000k Warm White - 630 Lumens, 4000k Cool White - 650 Lumens
- Complete with remote plug & play driver
- Beam Angle: 46°
- Interchangeable Rims (white supplied)
- Cut-out: 73mm, Minimum Void: 90mm
- IP65



10W IP65 Warm White	KSRFRD361	0968728	23.99	1	22.99	10+
10W IP65 Cool White	KSRFRD362	0968726	23.99	1	22.99	10+
Detachable Rim Chrome	KSRFRD363	0968730	5.75	1	5.45	3+
Detachable Rim Satin Chrome	KSRFRD364	0968731	5.75	1	5.45	3+

FIREBREAK SWITCHABLE TRIPLE COLOUR DOWNLIGHT FULLY DIMMABLE



7W Firebreak QR10 Triple CCT Downlight

- 3000K - 577 lumens
- 4000K - 652 lumens
- 6000K - 577 lumens
- Life Expectancy: Up to 40,000 hours
- IP65
- Rim - Aluminium
- Cut Out 70-72mm



7W Firebreak QR10 Triple CCT Downlight	KSRFRD374	1117625	15.95	1	14.95	5+
--	-----------	---------	--------------	---	--------------	----

FIREBREAK IP65 10W AUTOSWITCH CCT DOWNLIGHT



Firebreak 10W Autoswitch Triple Colour Downlight

- Changeable output via wall switch or driver
- 655lm 3000k, 736lm 4000k & 648lm 6000k
- Beam Angle: 46°
- IP65
- 40,000 Hours (average)
- Available in white - chrome, satin chrome, brass & black rims available separately
- Cut-out: 73mm
- Minimum Void: 90mm



Colour change from wall switch or dimmer!

Firebreak Autoswitch Downlight	SKSRFRD366	0982124	22.49	1	
--------------------------------	------------	---------	--------------	---	--

COVERTER PLATES

*use of Converter Plate invalidates IP and fire rating



Converter Plate White*	KSRFRD356	0931932	4.82	1	
Converter Plate Chrome*	KSRFRD357	0931933	5.89	1	
Converter Plate Satin Chrome*	KSRFRD358	0931934	5.89	1	



Converter Plate White*	DCR80WH	0550672	13.09	1	11.91	10+
Converter Plate Chrome*	DCR80CR	0550670	12.74	1	11.59	10+
Converter Plate Satin Nickel*	DCR80SN	0550671	12.72	1	11.56	10+

FIRE RATED GU10 TWIST & LOCK DOWNLIGHTS



Mains 240V downlights suitable for use with GU10 standard and LED Lamps

- Fire rated
- IP20
- Push fit terminals
- Lamp not supplied



Fire Rated GU10 Twist & Lock Downlights

Brushed Nickel	DE94113BN	0822998	6.10	1	5.57	10+
Chrome	DE94113CH	0822999	6.10	1	5.57	10+
White	DE94113WH	0823000	6.10	1	5.57	10+

FIRE RATED GU10 DOWNLIGHTS



Fireguard® Next Generation

- Slim profile, die-cast aluminium bezels
- Removable bezel for easy removal when painting the ceiling
- Designed specifically for LED lamps
- Ultra-fast press-fit loop-in/loop-out terminal
- Tested for use in solid, I-Joist and steel open web joist ceilings*
- Available in standard, showerlight and tilt variations
- Complies with 2014 building regulations: Part B, C and E



*See JCC.co.uk for full certification details. It is the responsibility of the installer to ensure compliance with all relevant regulations.

Fireguard® Next Generation

Mains Twist and Lock Can	DE010010/NB	1347600	4.83	1	4.60	10+
Mains Twist and Lock Bezel IP20 Brushed Nickel	DE010013/BN	1347602	1.29	1	1.23	10+
Mains Twist and Lock Bezel IP20 Chrome	DE010013/CH	1347603	1.29	1	1.23	10+
Mains Twist and Lock Bezel P20 White	DE010013/WH	1347604	1.29	1	1.23	10+
Mains Twist and Lock Bezel IP65 Brushed Nickel	DE010019/BN	1347608	3.75	1	3.58	10+
Mains Twist and Lock Bezel IP65 Chrome	DE010019/CH	1347609	3.75	1	3.58	10+
Mains Twist and Lock Bezel IP65 White	DE010019/WH	1347610	3.75	1	3.58	10+
Twist and Lock Tilt Can IP20 No Bezel	DE010023/NB	1347613	6.09	1	5.80	10+
Mains Twist and Lock Tilt Bezel Brushed Nickel	DE010026/BN	1347615	2.03	1	1.94	10+
Mains Twist and Lock Tilt Bezel Chrome	DE010026/CH	1347616	2.03	1	1.94	10+
Mains Twist and Lock Tilt Bezel White	DE010026/WH	1347617	2.03	1	1.94	10+



IP20 GU10 Tilt Downlights



IP20 GU10 TILT DOWNLIGHTS

White	DE94114WH	0967161	8.68	1	7.81	10+
Brushed Nickel	DE94114BN	0967160	8.68	1	7.81	10+
Chrome	DE94114CH	0967162	8.68	1	7.81	10+



IP65 GU10 Shower Downlights



IP65 GU10 Shower Downlights

White	DE94110WH	0822997	10.30	1	9.83	10+
Brushed Nickel	DE94110BN	0822995	10.30	1	9.83	10+
Chrome	DE94110CH	0822996	10.30	1	9.83	10+





IN-BRANCH LED STRIP CUT SERVICE



LED Under Cabinet Light

A full range of 5.8W LED Strip (IP20/65 CW/WW & RGB) available to cut to length in branch. Grab and go for convenience giving time saving and flexibility.

Simply select the type of strip, cut to the required length, pick the appropriate driver, fly lead and accessories in branch and you are ready to go.

- Available in 3000K, 4000K or RGB
- 3000k 673lm, 4000k 715lm per metre
- 12V Constant Voltage
- Class II for Power supply and Class III for LED Strip
- Two dimming options - Dimmable control via remote control using KSR9564 & KSR9566 with an effective range up to 30m or dimmable via WIZ app control (Single Colour)
- 3M Self-adhesive Backing
- Can be cut every 100mm



For runs of 10m+ and higher lumen output KSR's 24v bespoke on order service is still ideal for residential and commercial applications where feature lighting is required.

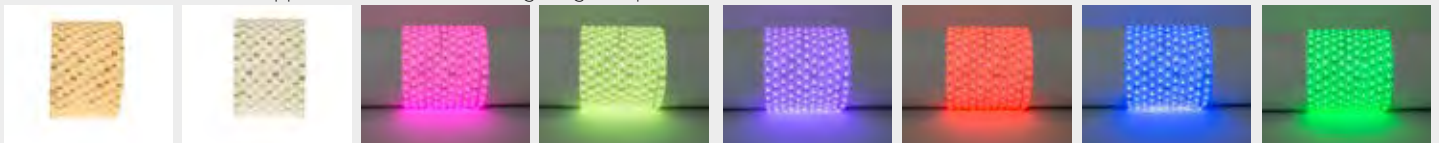

LED Strip				
IP20 5.8WPM 30 LEDs Per Metre 3k 50m Roll	SKSR95100	1272583	2.14	1 1.99 5+
IP20 5.8WPM 30 LEDs Per Metre 4k 50m Roll	SKSR95101	1272584	2.14	1 1.99 5+
IP65 5.8WPM 30 LEDs Per Metre 3k 50m Roll	SKSR95102	1272585	3.48	1 3.24 5+
IP65 5.8WPM 30 LEDs Per Metre 4k 50m Roll	SKSR95103	1272586	3.48	1 3.24 5+
IP20 5.8WPM 12V 30 LEDs Per Metre RGB	SKSR95104	1272587	4.18	1 3.89 5+
IP65 5.8WPM 12V 30 LEDs Per Metre RGB	SKSR95105	1272588	5.26	1 4.89 5+

Accessories				
IP20 Strip To Wire Connector With 3m Lead	SKSR95106	1272589	5.37	1 4.99 2+
IP65 Strip To Wire Conn With 3m Lead CW AD	SKSR95107	1272590	5.37	1 4.99 2+
IP20 RGB Strip To Wire Conn With 3m Lead	SKSR95108	1272591	6.98	1 6.49 2+
IP65 RGB Strip To Wire Conn 3m Lead CW AD	SKSR95109	1272592	6.98	1 6.49 2+
IP20 Strip To Strip Corn Conn CW 10cm Lead	SKSR95110	1272593	2.03	1 1.89 2+
IP65 Strip To Strip Corn Conn CW 10cm Lead	SKSR95111	1272594	2.10	1 1.95 2+
IP20 RGB Strip To Strip Corn Conn	SKSR95112	1272595	2.03	1 1.89 2+
IP65 RGB Strip To Strip Corn Conn	SKSR95113	1272596	2.10	1 1.95 2+
Navara LED Receiver / Controller	KSR9564	1182897	12.39	1
Navara RGBW remote unit	KSR9565	1182507	10.10	1
Navara Single Colour Remote	KSR9566	1182508	10.10	1
Wiz CV3000 Controller for Single Colour LED Strip - Max Loading 30w / 5metres	KSRWIZCV3000	1286359	19.29	1
Wiz CV9000 Controller for Single Colour LED Strip - Max Loading - Max Loading 90w / 10metres	KSRWIZCV9000	1286360	22.50	1

Drivers				
IP20 12W 12V LED DRIVER Max Run 1.5m	SKSRDL297	1272599	8.59	1 7.99 2+
IP20 30W 12V LED DRIVER Max Run 4.5m	SKSRDL298	1272600	13.43	1 12.49 2+
IP20 50W 12V LED DRIVER Max Run 8m	SKSRDL299	1272601	21.39	1 19.89 2+
IP65 12W 12V LED DRIVER Max Run 1.5m	SKSRDL283	1272602	12.35	1 11.49 2+
IP65 35W 12V LED DRIVER Max Run 4.5m	SKSRDL285	1272603	17.19	1 15.99 2+
IP65 60W 12V LED DRIVER Max Run 10m	SKSRDL286	1272604	21.49	1 19.99 2+
IP20 50w 12v Dimmable LED Driver Max Run 8m	KSRDL278	1311922	26.79	1 25.64 10+
IP20 100w 12v Dimmable LED Driver Max Run 16m	KSRDL279	1311923	53.99	1 51.89 10+

LED Strip Accessories				
Navara 2m Slim Surface Profile Bar with Opal Diffuser	KSR9570	1182511	14.21	1
Navara 2m Deep Surface Profile Bar with Opal Diffuse	KSR9571	1182512	17.07	1
Navara 2m Slim Recessed Profile Bar with Opal Diffuser	KSR9572	1182513	14.21	1
Navara 2m Deep Recessed Profile Bar with Opal Diffuser	KSR9573	1182514	17.07	1
Navara 2m Angled Profile Bar with Opal Diffuser	KSR9574	1182515	18.50	1
Navara 2m Plaster Recessed Profile Bar with Opal Diffuser	KSR9575	1182516	35.64	1
Navara End Cap for KSR9570	KSR9580	1182518	0.65	1
Navara End Cap for KSR9571	KSR9581	1182519	0.65	1
Navara Mounting Clip for KSR9570/9571	KSR9582	1182520	0.65	1
Navara End Cap for KSR9574	KSR9583	1182521	0.65	1
Navara Mounting Clip for KSR9574	KSR9584	1182522	0.65	1
Navara End Cap for KSR9575	KSR9585	1182523	0.65	1
Navara Mounting Clip for KSR9575	KSR9586	1182524	0.65	1

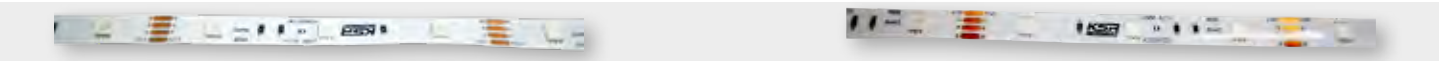
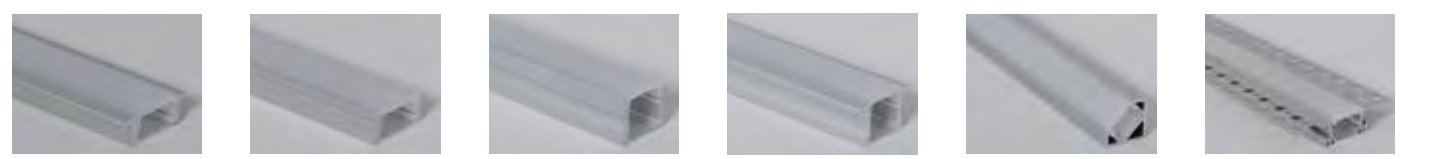

24V BESPOKE LED STRIP



24V made to measure LED strip service
Ideal when runs of 10m+ are required
order the exact length and spec desired

- A choice of 3000K, 4000K or RGBW LED strip, IP20 or IP65
- 3.8W or 7.6W in 3000K or 4000K and 11.5w for RGBW
- Purchase in multiples of 100mm (max 25m or RGBW 15m)
- Custom tail length from 0.5 - 3 metres
- 100% tested before dispatch
- Can be supplied with dimmable or non-dimmable drivers, controls to suit and WiFi enabled
- Suitable for domestic and commercial applications
- 6 different profile bars available



MADE TO MEASURE
...DELIVERED TO YOU IN 48 HOURS



To obtain a personalised quotation for your project contact your local branch.



DOWNLIGHT ACCESSORIES



Downlight Box	7466417	0552211	4.70	1	4.48	5+
GU10 Spare Lampholder	DGU10LH	0551124	2.37	1	2.27	5+
Low Voltage Lampholder	DAWF08	0551120	2.18	1	2.11	5+

TRANSFORMERS & LED DRIVERS

OSRAM Halotronic transformers



70VA Halotronic transformer	HTM70	0050221	14.57	1	13.39	5+
150VA Halotronic transformer	HTM150	0098275	28.81	1	26.56	5+
105VA Halotronic transformer	HTM105	0050222	14.71	1	13.83	5+



LED Driver

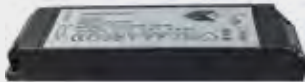

LED Driver						
1 - 10W LED Driver	LEDRVR10W	0549959	10.42	1	9.11	5+

BATHROOM LIGHTING

Steeple Mirror Lights - IP44

- Requires 2 x 15W G13 T8 450mm Flu. Tube 3000K (included)
- Pressed steel base / Glass mirror
- Diffused rectangular light apertures
- Pull cord on/off switch
- Permanent power to integrated dual voltage shaver socket



Mirror Lights - IP44						
Mirror Light + DV Shaver Socket	DML5040	0551041	107.41	1		

BATHROOM LIGHTING



6W LED IP20, 835 Lumens Shaver Light

- 6W 284mm LED retrofit lamp - 3000K
- Dual voltage shaver socket 110v/240v
- Modern design

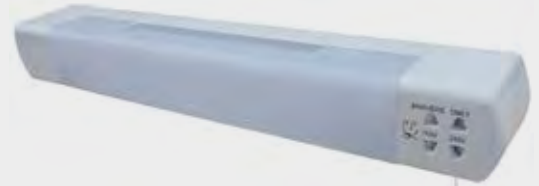

6W LED IP20, 835 Lumens Shaver Light, 2 year warranty	DLEDSDVO	0964440	25.72	1		
---	----------	---------	-------	---	--	--



10W LED 463 Lumens Over Mirror Light

- 10W LED - 3000K
- White/matt silver finish
- Sleek modern design



10W LED 463 Lumens Over Mirror Light, 5 year warranty	DOMLED10	0605485	31.92	1		
---	----------	---------	-------	---	--	--



6W LED IP44, 880 Lumens Shaver Light

- 6W LED - 3000K
- Dual voltage shaver socket 110v/240v
- Optional chrome effect trims included



6W LED IP44, 880 Lumens Shaver Light, 5 year warranty	DLEDSDH44	0642805	37.95	1		
---	-----------	---------	-------	---	--	--

GET READY FOR SUMMER NIGHTS

With our full range of outdoor lighting



Scan Me

TO DISCOVER OUR EXTENSIVE OUTDOOR LIGHTING RANGE





CABINET / STRIP LIGHTING



LED Superflat Light Units



LED Superflat Light Units

LED Superflat Unit 350mm, 160 lumens	DSFLWW9	0550930	10.98	1	10.13	3+
LED Superflat Unit 550mm, 290 lumens	DSFLWW15	0550961	15.09	1	13.91	3+
LED Driver for Superflat Units	DSFLDR36	0550974	17.60	1	16.27	3+

LED Under Cabinet Light



LED Under Cabinet Light



- 3000K warm white colour
- 2W = 100 lumens:
- Not suitable for use with dimmers
- Pre-wired with 2m mains cable and no separate driver required
- Not suitable for recessed installation



LED Under Cabinet Light

LED Under Cabinet Light Circular	DVECOBAPCI	1264515	10.75	1	9.99	3+
LED Under Cabinet Light Triangular	DVECOBAPTR	1264516	10.74	1	9.99	3+



T5 4000K LED Linkable Lights



- T5 size LED linkable fittings
- Supplied with 1.8mtr mains lead & 22cm link lead
- Linkable with up to 5 other fittings
- Built in rocker switch

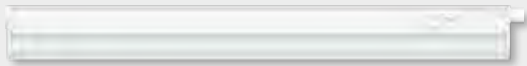

T5 4000K LED Linkable Lights

322mm 4W LED Link Light, 350 lumens	DVECOLT54	1123222	15.12	1	13.86	3+
585mm 8W LED Link Light, 710 lumens	DVECOLT58	1123223	19.02	1	17.23	3+
885mm 10W LED Link Light, 880 lumens	DVECOLT510	1123224	21.68	1	19.71	3+
1185mm 14W LED Link Light, 1240 lm	DVECOLT514	1123225	26.76	1	24.54	3+

CABINET / STRIP LIGHTING



LED Cabinet Lights



- 160 lumens
- 1.7W LED
- 3000K
- Prewired with 2m mains cable and no separate driver required
- Hole cut out 61mm
- Not suitable for use with dimmers
- Round version can be surface or recess mounted



LED Cabinet Lights

1.7W LED Round Cabinet Light, White	DCLED CIRWH	0864887	16.10	1	14.45	3+
1.7W LED Round Cabinet Light	DCLED CIR	0715990	16.10	1	14.45	3+
1.7W LED Triangle Cabinet Light	DCLED TRI	0715991	15.88	1	14.55	3+
1.7W LED Triangle Cabinet Light, White	DCLED TRIWH	0864888	15.88	1	14.55	3+

COLOUR SELECTABLE CABINET LIGHTS



- Interlinkable
- Colour selectable 3000k/4000k
- 30mm deep
- IP20
- c/w 2m mains cable
- c/w 90° and surface mount clips



3W 250MM, 3000k 320LM / 4000k 330lm	SKSRCL194	1309064	8.78	1	8.29	3+
4W 344mm, 3000k 490lm / 4000k 530lm	SKSRCL195	1134276	10.17	1	9.60	3+
7W 571mm, 3000k 490lm / 4000k 530lm	SKSRCL196	1134277	11.90	1	11.22	3+
14W 905mm, 3000k 1450lm / 4000k 1550lm	SKSRCL197	1134278	16.38	1	15.45	3+
18W 1205mm, 3000k 1800lm / 4000k 1950lm	SKSRCL198	1134279	18.53	1	17.48	3+
150mm Link Cable	KSRL144	0543053	0.89	1	0.85	3+
300mm Link Cable	KSRL145	0543054	0.93	1	0.89	3+
500mm Link Cable	KSRL146	0543055	1.10	1	1.05	3+

LED SELF ADHESIVE 5M STRIP KITS



LED Self Adhesive 5m Strip Kits IP65 rated



Flexible LED strip-light, with a self-adhesive 3M backing, can be attached to almost any surface. Suitable for indoor or outdoor applications. LED strip light can be cut at regular intervals for custom DIY applications.

- 30,000 hour life
- RGB, warm white or cool white colour options
- RGB driver kit includes infrared remote control and receiver with dimming, strobe and flash functions
- Kits c/w IP20 AC power adaptor with integrated UK plug, 10cm connecting leads and end clamps
- Larger driver available to support combined LED strips up to 10 m in length
- Accessory kit contains 2 x 15cm flexible connector and 2 x 15cm straight connectors for reconnecting cut off lengths



LED Self Adhesive 5m Strip Kits

5 Mtr Flexible LED Strip WW	12493	1293347	26.50	1	26.16	10+
5 Mtr Flexible LED Strip CW	12509	1293348	26.50	1	26.16	10+
WW/CW Driver 72W 240V	SL5396	0967265	15.16	1		
Flexible Strip Kit 5m 32W 24V - RGB	12516	1286573	33.99	1	31.53	10+
Phoebe LED RGB Driver Kit	12530	1286574	19.59	1	19.35	10+
Phoebe LED Flexible Strip Accessory Kit	12547	1286575	4.13	1	3.91	10+

SIGN UP FOR A TRADE ACCOUNT TODAY



- Apply now for a trade account and start saving with exclusive trade prices
- Instant £500 online credit available
- Receive exclusive trade promotions



PENDANT

ENDON[®]
LIGHTING

A.



B.



C.



D.



E.



F.



A.	Alton 3 Light Pendant Indoor Light Fitting 1805-3AN	55883	0273244	46.19	1
B.	Colman 1 Light Pendant Indoor Light Fitting COLMAN-BL	57044	0567882	42.86	1
C.	Hal 6 Light pendant Indoor Light Fitting	76337	1305874	81.90	1
D.	Hansen Pendant Indoor Light Fitting	76332	1305878	47.61	1
E.	Lambeth 4 Light Pendant Indoor Light Fitting	69455	1305891	69.04	1
F.	Nixon 3 Light pendant Indoor Light Fitting	70560	1306392	93.33	1

WALL

ENDON[®]
LIGHTING

A.



B.



C.



D.



E.



F.



G.



A.	Alton 2 Light Wall Indoor Light Fitting 1805-2AN	55881	0273243	28.57	1
B.	Boyer 2 Light right wall Indoor Light Fitting BOYER-2WBAB-R	58375	0827357	19.53	1
C.	Brio 1 Light Wall Indoor Light Fitting BRIO-1WBAB	57634	0607542	18.10	1
D.	Brio 1 Light Wall Indoor Light Fitting BRIO-1WBCH	57635	0607543	18.10	1
E.	Everett 1 Light Wall Indoor Light Fitting EVERETT-1WBCH	57758	0607634	23.81	1
F.	Fargo 2 Light Wall Indoor Light Fitting FARGO-WBCH	58490	0827398	27.61	1
G.	Hansen 1 Light Wall Indoor Light Fitting	77273	1305881	40.47	1

FLUSH / SEMI FLUSH

ENDON[®]
LIGHTING

A.



B.



C.



D.



E.



F.



A.	Aerith 3 Light Semi flush Indoor Light Fitting 73642	73642	1305854	38.10	1
B.	Boyer 3 Light semi flush Indoor Light Fitting BOYER-3AB	57543	0607538	35.71	1
C.	Brio 3 Light Semi flush Indoor Light Fitting BRIO-3CH	56642	0395841	35.71	1
D.	Gull 3 Light Spot Indoor Light Fitting	59932	0826293	23.81	1
E.	Langella 5 Light semi flush Indoor Light Fitting LANGELLA-5CH	57574	0607724	76.19	1
F.	Welles 3 Light Flush Indoor Light Fitting WELLES-3AB	57574	0607724	76.19	1





BATHROOM

ENDON[®]
LIGHTING



A.	Ashbury 1 Light Wall Bathroom Light Fitting	77088	1305860	50.00	1
B.	Britton 1 Light Wall Bathroom Light Fitting	51885	0826283	17.61	1
C.	Chryla 3 Light Flush Bathroom Light Fitting	60103	0826301	50.00	1
D.	Moda 1 Light Wall Bathroom Light Fitting	76656	1306387	19.06	1

ENDON OUTDOOR AVAILABLE

ENDON[®]
LIGHTING



A.	Louvre 1 Light Floor Outdoor Light Fitting YG-6003-SS	56220	0200480	52.57	1
B.	Burford 1 Light Wall Outdoor Light Fitting	76547	1305863	22.86	1
C.	Chesham PIR 1 Light Wall Outdoor Light Fitting	70331	1305866	39.04	1
D.	Dexter 1 Light Wall Outdoor Light Fitting	74702	1305869	40.47	1
E.	Grant 2 Light Wall Outdoor Light Fitting YG-7501	56232	0217814	47.14	1
F.	Klien 1 Light Wall Outdoor Light Fitting YG-862-SS	56240	0196493	36.19	1

TABLE

ENDON[®]
LIGHTING

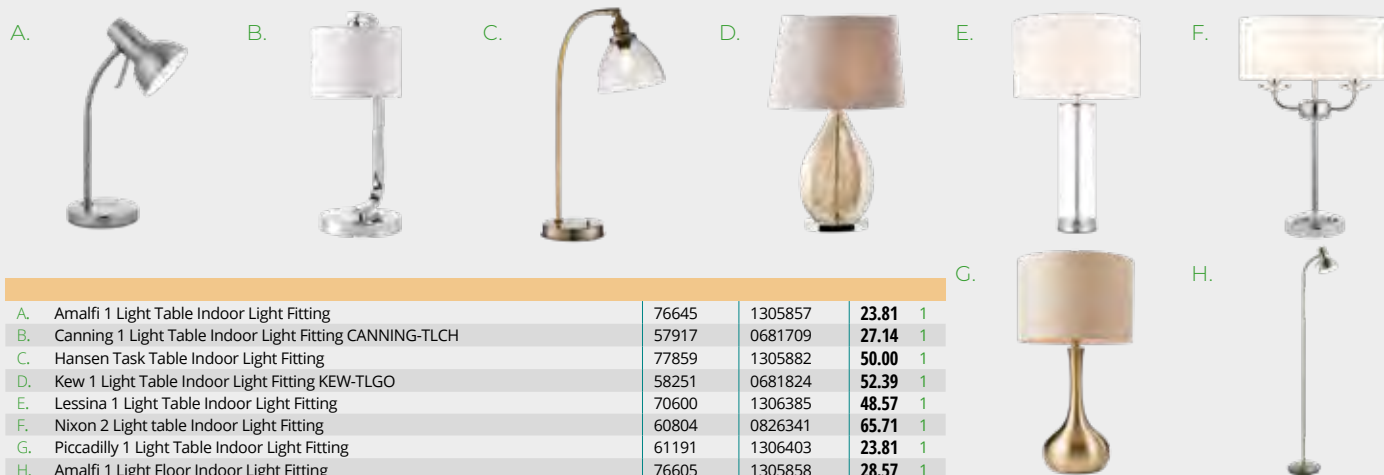

A.	Amalfi 1 Light Table Indoor Light Fitting	76645	1305857	23.81	1
B.	Canning 1 Light Table Indoor Light Fitting CANNING-TLCH	57917	0681709	27.14	1
C.	Hansen Task Table Indoor Light Fitting	77859	1305882	50.00	1
D.	Kew 1 Light Table Indoor Light Fitting KEW-TLGO	58251	0681824	52.39	1
E.	Lessina 1 Light Table Indoor Light Fitting	70600	1306385	48.57	1
F.	Nixon 2 Light table Indoor Light Fitting	60804	0826341	65.71	1
G.	Piccadilly 1 Light Table Indoor Light Fitting	61191	1306403	23.81	1
H.	Amalfi 1 Light Floor Indoor Light Fitting	76605	1305858	28.57	1

Decorative Interior Lighting

Over 150 lines now available to order online





ENER-J®
Smart Home Living

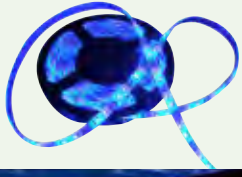

NEW



RGB 16 Million Colors & 8 Scenes



SMART OUTDOOR LIGHTING

Get Smart and get connected with the Ener-J range of smart lighting, all controlled with a simple to use App. No hub or subscription

See page 24 for full ENER-J range & Pricing

TRACK LIGHTING



Track and Spotlights - White finish

- Mains track 240V
- No driver/transformer required
- Can be cut to length
- Supplied with end caps



Track and Spotlights - White finish

4ft Mains Track White	DE14002WH	0549108	14.56	1
8ft Mains Track White	DE14003WH	0549119	27.69	1
Live End White	DE14013WH	0549436	4.37	1
Joiner White	DE14004WH	0549432	2.89	1
T Piece White	DE14006WH	0549106	11.01	1
Centre Feed White	DE14008WH	0549440	8.05	1
50W GU10 Track Fitting White	DE14032WH	0549110	14.68	1

FLEXIBLE DELIVERY



- Order by 6pm for next working day delivery (mon-Fri)
- FREE delivery on all orders for trade credit customers
- FREE delivery on orders over £50
- Delivery to you or on site

BULKHEADS - LED



10W LED Bulkhead with Opal Diffuser

- 1090 lumens
- 40,000 hours life
- A++ Rated
- Polycarbonate construction
- IP65



10W LED Bulkhead with Opal Diffuser	BOPLED10	1357766	15.68	1	15.04	3+
-------------------------------------	----------	---------	--------------	---	--------------	----



7W LED IP44 Bulkhead, 500 lumens

- 500 Lumens
- IP44
- 35,000hr life
- Polycarbonate construction
- PIR version = 120° PIR



7W LED IP44 Bulkhead, 500 lumens						
7W LED IP44 Bulkhead, 500 lumens	DBLEDBK	0804441	21.93	1	20.31	3+
7W LED IP44 Bulkhead + PIR, 500 lumens	DBLEDPIRBK	0804442	31.08	1	28.55	3+

Special promotions every week - Ask in branch or look online

WALL LIGHTS



Bilbao 12W LED Wall Lights

- 12W 4000K LED
- 940 lumens
- IP65
- Ideal for high saline and coastal areas
- Use as plain wall light or with one of three stylish covers

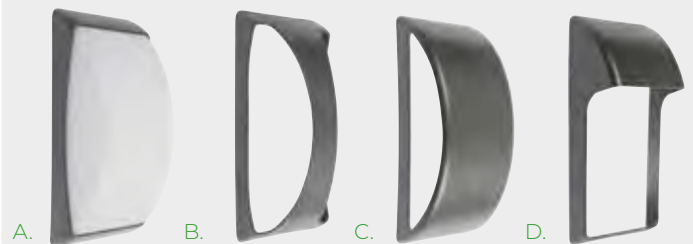

Bilbao 12W LED Wall Light						
A. LED Wall Light Grey	KSR1520	1138752	35.00	1		
B. Louvre Cover Grey	KSR1521	1138753	3.49	1		
C. Up and Down Cover Grey	KSR1522	1138754	3.49	1		
D. Eyelid Cover Grey	KSR1523	1138755	3.49	1		





BULKHEADS - NON-LED



Lamp not included



BULKHEADS - NON-LED

100W BC IP65, Black base	DBH100D	0550922	11.87	1	11.77	3+
100W BC IP65, White base	DBH100DWH	0550924	12.54	1	11.85	3+
100W BC IP65, Glass	SB100G/N	0551522	13.85	1	12.46	3+



Lamp not included

PIR Bulkhead
 · IP44
 · 60W GLS
 · 120° PIR



60 Watt GLS w/ 12m 120° PIR	DPIR80BK	0550505	27.77	1	26.73	3+
-----------------------------	----------	---------	-------	---	-------	----



Calvi Bulkhead Range

- IP44
- E27 40W Max
- Dimmable (lamp dependant)
- Suitable for high saline areas



Calvi Bulkhead Range

A. Round IP44 Bulkhead Black	KSR1505	1138741	8.45	1	7.95	3+
B. Oval IP44 Bulkhead Black	KSR1506	1138742	8.25	1	7.85	3+

UPLIGHTER



Plaster Uplighter

- IP20
- 100W max
- BC Cap Lampholder



Plaster Uplighter

100W Plaster Uplighter	DCW3021	0550972	22.48	1	20.43	3+
------------------------	---------	---------	-------	---	-------	----

CEILING & WALL LIGHTING



'Renzo' IP44 LED Round Bulkheads

- Dual-CCT (3000K/4000K) by integral built-in switch
- Compatible with microwave motion sensor and emergency modules
- Extra long lifetime up to 50,000 hours (average)
- Suitable for wall and ceiling mounting
- IP44



A. 11W Renzo LED IP44 Bulkhead Dual CCT (S)	710264	2501287176	19.37	1		
B. 15W Renzo LED IP44 Bulkhead Dual CCT (M)	710430	2501306239	25.64	1		
C. 22W Renzo LED IP44 Bulkhead Dual CCT (L)	710274	2501287178	32.47	1		
D. Renzo Microwave Sensor	710286	2501287179	17.95	1		
E. Renzo Emergency Module	710267	2501287221	42.43	1		

CEILING & WALL LIGHTING



Eco LED Decorative Ceiling/Wall Light



- 17W
- 4200K, 1350 Lumens
- IP65
- 2D 28W alternative
- Emergency & Microwave versions available
- 3hr emergency versions available



Eco LED Decorative Ceiling/Wall Light

17W LED Decorative Fitting	DCFLEDWHSC	1309095	33.85	1	32.19	3+
17W LED Decorative Fitting Microwave	DMSLEDWHSC	1309096	35.90	1	33.67	3+
17W LED Decorative Fitting Emergency	DCFLWHEM3SC	1309097	43.25	1	37.85	3+
17W LED Decorative Fitting Microwave & Emergency	DMSLWHEM3SC	1309098	52.43	1	47.45	3+



'Carina' Colour Selectable Decorative Ceiling/Wall Fittings



- 17W
- From 1250-1350 lumens
- Warm, Cool White & Daylight
- 35,000hr life (average)
- IP65 ceiling or wall mounted
- 3hr emergency versions available



'Carina' Colour Selectable Decorative Ceiling/Wall Fittings

Decorative Chrome Trim	DCSLEDCH	0972892	42.59	1	38.63	3+
Decorative White Trim	DCSLEDWH	0972893	38.23	1	29.47	3+
Decorative Chrome Trim Emergency	DCSLEDCHM3	0972894	55.32	1	51.25	3+
Decorative White Trim Emergency	DCSLEDWHM3	0972895	53.33	1	50.31	3+
Decorative M/wave, Chrome Trim	DMSCSLEDCH	0972896	50.07	1	46.94	3+
Decorative M/wave, White Trim	DMSCSLEDWH	0972897	46.92	1	43.98	3+
Decorative M/wave, Chrome Trim Emergency	DMSCSLEDCHM3	0972898	63.81	1	60.95	3+
Decorative M/wave, White Trim Emergency	DMSCSLEDWHM3	0972899	62.37	1	58.47	3+



Pacific LED Fitting, Chrome finish



- 12W
- 800 lumens
- Warm White
- 30,000hr life (average)
- IP44 ceiling or wall mounted



Pacific LED Fitting, Chrome finish

Pacific LED Fitting, Chrome finish	DPACIFIC12	0715981	30.90	1		
------------------------------------	------------	---------	-------	---	--	--

Visit Denmans.co.uk for details

Over 150 lines available online



CHAMELEON IP65 BULKHEADS



Chameleon LED Economy Modular Fittings

The Chameleon Bulkheads are a range of LED wall/ceiling fittings with standard, emergency, microwave, microwave emergency and photocell variants. The accessories enable transformation of the fittings from utility to decorative.

Different colour options available to suit the application, as required.

- 12W
- IP65
- Wall or ceiling
- Multiple rim options
- Multiple cable entries
- 4200K, 1200lm
- Prismatic diffuser also available



Chameleon LED Economy Modular Fittings

12W LED Standard Bulkhead White	DCO12SC	1309099	20.81	1	19.95	3+
12W LED Microwave ON/OFF Bulkhead White	DCO12SCMW	1309100	35.84	1	33.79	3+
12W LED Standard Emergency Bulkhead White	DCO12SCEM3	1309101	40.38	1	38.93	3+
12W LED Microwave Emergency Bulkhead White	DCO12SCMW3	1309102	53.76	1	49.15	3+
12W LED Photocell Bulkhead White	DCO12SCPC	1309103	35.75	1	33.91	3+

Trims

Eyelid Trim Black	DEYEBK	1129743	3.61	1		
Eyelid Trim White	DEYEWB	1129744	3.48	1		
Trim Black	DGRILLBK	1129745	3.35	1		
Trim White	DGRILLWH	1129746	3.43	1		
Bezel Trim Black	DCIRCBK	1129747	5.30	1		
Bezel Trim White	DCIRCWH	1129748	5.31	1		
Bezel Trim Polished Chrome	DCIRCCR	1129749	12.29	1		
Bezel Trim Prismatic Diffuser	DCPRIS	1129750	4.80	1		



Navara SF LED CCT Bulkhead



NAVARA SF FITTING

The Navara SF LED surface fittings are a triple CCT surface mounted luminaire. Selectable for 3000, 4000 or 6000K. We have 2 versions in this range. One is 12W the other is the higher output 18W. They are suitable for internal or external mounting, depending on rim choice.

12W
3000K = 950 Lms
4000K = 1398 Lms
6000K = 1060 Lms

18W
3000K = 1458 Lms
4000K = 1512 Lms
6000K = 1641 Lms



Navara SF LED CCT Bulkhead

12W LED Bulkhead White	KSRSF300	1117629	28.33	1	26.98	2+
12W LED Bulkhead White Emergency	KSRSF301	1117630	44.17	1	42.07	3+
12W LED Bulkhead White Microwave	KSRSF302	1117631	40.61	1	38.67	3+
12W LED Bulkhead White Microwave/Emergency	KSRSF303	1117632	56.68	1	53.98	3+
12W LED Bulkhead White Photocell	KSRSF306	1117633	43.48	1	41.40	3+
12W LED Bulkhead White Photocell/Emergency	KSRSF307	1117634	51.96	1	49.48	3+
18W LED Bulkhead White	KSRSF310	1117635	33.05	1	31.47	2+
18W LED Bulkhead White Emergency	KSRSF311	1117636	51.96	1	49.48	3+
18W LED Bulkhead White Microwave	KSRSF312	1117638	62.07	1	59.12	3+
18W LED Bulkhead White Microwave/Emergency	KSRSF313	1117639	82.76	1	78.81	3+
18W LED Bulkhead White Photocell	KSRSF316	1117640	63.87	1	60.82	3+
18W LED Bulkhead White Photocell/Emergency	KSRSF317	1117641	82.76	1	78.81	3+

Navara SF Trims

SF Plain Rim Gloss White	KSRSF320	1117642	3.84	1	3.65	3+
SF Plain Rim Chrome	KSRSF321	1117643	9.96	1	9.49	3+
SF Plain Rim Satin Chrome	KSRSF322	1117644	8.15	1	7.77	3+
SF Plain Rim Matt Black	KSRSF323	1117645	3.84	1	3.65	3+
SF Plain Rim Matt White	KSRSF324	1117646	3.14	1	2.99	3+
SF Eyelid Rim Matt Black	KSRSF325	1117647	3.14	1	2.99	3+
SF Eyelid Rim Matt White	KSRSF326	1117649	3.14	1	2.99	3+
SF Grille Rim Matt Black	KSRSF327	1117650	3.14	1	2.99	3+



ALUMINIUM IP65 LED BULKHEADS



LED Bulkheads

Modern and robust design. Options include full, eyelid and grill case. Black & white finish. Standard, emergency, multi-function microwave and emergency versions.

Full Black 18W 1400 Lumens

Full White 18W 1400 Lumens	DALSTDWHFUL	1133292	63.05	1	57.15	3+
----------------------------	-------------	---------	--------------	---	--------------	----

Eyelid Black 18W 1300 Lumens

Eyelid Black 18W 1300 Lumens	DALSTDBKEYE	1133281	53.37	1	50.42	3+
Eyelid White 18W 1300 Lumens	DALSTDWHEYE	1133293	53.08	1	50.14	3+

Grill Black 18W 1400 Lumens

Grill Black 18W 1400 Lumens	DALSTDBKGRI	1133282	59.93	1	54.33	3+
Grill White 18W 1400 Lumens	DALSTDWHGRI	1133294	60.49	1	54.84	3+

- IP65
- 4200K
- Diecast aluminium base and bezel
- Multiple rim options
- Multiple 20mm cable entries
- Microwave/photocell/emergency available (ask in branch)





UTILITY BULKHEADS - LED

Eterna 18W Utility Bulkheads

- IP65
- 35000 hours
- 4000K
- Microwave sensor versions with on/off & corridor modes
- 3hr emergency versions available



18W Utility Bulkheads					
1400 lumens Opal	DCIROPALSTD	1009572	27.06	1	
1400 lumens Opal Emergency	DCIROPALM3	1009574	48.79	1	47.68 3+
1400 lumens Opal, MW Sensor	DCIROPALMW	1009573	52.42	1	51.59 3+
1400 lumens Opal, MW Sensor Emergency	DCIROPALMW3	1009575	65.50	1	63.20 3+
1600 lumens Prismatic	DCIRPRISSTD	1009576	35.26	1	
1600 lumens Prismatic Emergency	DCIRPRISM3	1009578	49.54	1	48.42 3+
1600 lumens Prismatic, MW Sensor	DCIRPRISMW	1009577	52.42	1	51.59 3+
1600 lumens Prismatic, MW Sensor Emergency	DCIRPRISMW3	1009579	65.19	1	62.90 3+

Eterna 12W LED Bulkheads Full

- Microwave versions: with options to adjust 2-50 lux or disable, detection range 10-100% and time 5sec - 30min
- 800 lumens
- 4200K
- IP66



12W LED Bulkheads Full					
12W LED Standard Bulkhead, Black	DSHFULLBK	0715982	27.77	1	25.79 3+
12W LED Standard Bulkhead, White	DSHFULLWH	0715983	27.82	1	25.85 3+
12W LED Standard Microwave B/head, Blk	DSHFULLMWBK	0715984	38.34	1	35.52 3+
12W LED Standard Microwave B/head, Wht	DSHFULLMWWH	0715985	38.18	1	35.39 3+

Eterna 12W LED Bulkheads - Eyelid Diffuser

- 12W LED Bulkheads
- Microwave versions: with options to adjust 2-50 lux or disable, detection range 10-100% and time 5sec - 30min
- 800 lumens
- 4200K
- IP66



12W LED Bulkheads - Eyelid Diffuser					
12W LED Eyelid Bulkhead, Black	DSHEYEBK	0715986	28.14	1	25.54 3+
12W LED Eyelid Bulkhead, White	DSHEYEWH	0715987	28.27	1	25.66 3+
12W LED Eyelid Microwave B/head, Black	DSHEYEMWBK	0715988	38.61	1	35.11 3+
12W LED Eyelid Microwave B/head, White	DSHEYEMWWH	0715989	38.68	1	35.18 3+

Eterna 6W LED Mini Bulkheads - Standard Diffuser

- Standard versions = 380 lumens
- Eyelid versions = 330 lumens
- 4200K
- IP66
- Full 215mm x 80mm
- Eyelid 200mm x 80mm



6W LED Mini Bulkheads - Standard Diffuser					
6W LED Standard Mini Bulkhead, Black	DMINIFULLBK	0804433	18.38	1	17.30 3+
6W LED Standard Mini Bulkhead, White	DMINIFULLWH	0804434	18.29	1	17.22 3+

6W LED Mini Bulkheads - Eyelid Diffuser					
6W LED Eyelid Mini Bulkhead, Black	DMINIEYEBK	0804435	18.63	1	16.91 3+
6W LED Eyelid Mini Bulkhead, White	DMINIEYEWH	0804436	18.63	1	16.91 3+

TIMEGUARD Diecast Aluminium LED Bulkheads

A theben Group Company

- Round or Oval
- IP65
- Cool White
- Wide light diffusion pattern
- Robust diecast housing

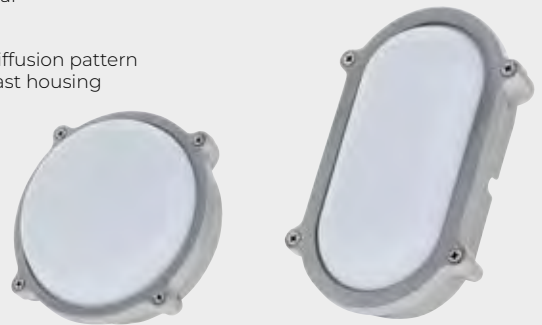

Diecast Aluminium LED Bulkheads					
7W LED Round Bulkhead, 450 lumens	LEDBHR7W	0683197	25.56	1	23.38 3+
15W LED Round Bulkhead, 900 lumens	LEDBHR15W	0683198	39.60	1	36.21 3+
9W LED Oval Bulkhead, 530 lumens	LEDBHO9W	0683200	25.56	1	23.85 3+
15W LED Oval Bulkhead, 900 lumens	LEDBHO15W	0683201	39.60	1	36.21 3+

Eterna 30W LED IP65 Bulkheads

- 2000 lumens
- IP65
- 4200K
- 30,000hr life (average)
- Photocell version for dawn to dusk operation



30W LED Bulkhead, 2000 lm					
30W LED Bulkhead, 2000 lm	DWPACKLED	0857923	59.86	1	56.10 3+
30W LED Bulkhead + Photocell, 2000lm	DWPACKLEDPC	0857924	70.60	1	67.99 3+

11.2W LED Bulkhead, 900lm					
11.2W LED Bulkhead, 900lm	DBULKLED	1000034	55.69	1	50.34 3+
11.2W LED Bulkhead + Photocell, 900lm	DBULKLEDPC	1000035	58.15	1	52.63 3+

NEED SOMETHING OUT OF HOURS?



Simply Visit
www.denmans.co.uk

ALWAYS ON THE GO?



Download the Denmans app today!

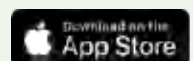



INTERNAL PIRS



Ceiling PIR Sensors

- 6 mtr detection range
- 360° detection
- 10 seconds -15 minutes
- LED 1000W/Halogen 2000W
- IP20

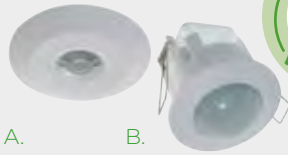

Ceiling PIR Sensors

A. Surface PIR Sensor	KSR8404	1008352	14.29	1	12.99	3+
B. Flush PIR Sensor	KSR8405	1008353	14.29	1	12.99	3+



Ceiling PIR Sensors

A. 8A incandescent load capacity, 4A fluorescent load capacity	SGEFL	0577424	19.99	1		
B. IP54 Push Button Surface Mounted Ceiling PIR Presence Detector	SGESM	0577425	19.99	1		



Ceiling Microwave Sensors

- 2-6 mtr mounting height
- 360° detection
- 1-8 mtr range
- LED 1000W/Halogen 2000W
- IP20



Ceiling Microwave Sensors

Surface Microwave Sensor	KSR8401	1008316	18.69	1	16.99	3+
Flush Microwave Sensor	KSR8402	1008327	18.69	1	16.99	3+



Batten Mount PIR Sensors

- IP65
- Class II
- 360° Detection Angle
- Polycarbonate Construction
- Detection Range at 2-6m mounting height is 10m
- KSR8410 1-10v programmable dimming via remote (supplied with sensor)
- 10sec-30min adjustable
- Hold time 5min-60min standby period programmable (with remote)
- Suitable for 20mm knockouts



KSR Sensors BATTEN Mount PIR Sensor	KSR8409	1245470	24.99	1		
KSR Sensors BATTEN Mount PIR Sensor DIM	KSR8410	1245471	34.98	1		



- Rated Switching: 10A
- 10A - Compact Fluorescent
- No Neutral Required
- Adjustable Timer: 1 - 30 Min



Wall Sensors

PIR Detector - suitable for lighting, heating or ventilation	SPDS-PRM	0635482	39.75	1		
--	----------	---------	-------	---	--	--



- Rated Switching: 10A
- 3A - Compact Fluorescent
- No Neutral Required
- Adjustable Timer: 5 Min - 1 Hr
- Not suitable for LED Lighting



Wall Sensors

Wall PIR Detector	SPDS	0576497	39.99	1		
-------------------	------	---------	-------	---	--	--

PHOTOCELLS



PHOTOCELLS

Electronic Photocell Kit	CPK	0551853	12.99	1		
Photocell Head Only	CPHEAD	0551849	9.10	1		
Remote version of DEMPC	DEMPCR	0550689	16.62	1		
Photocell c/w Timer	DRDT10A	0550693	18.90	1		

EXTERNAL PIRS



110° & 180° Stand Alone PIRs For up to 1300W incandescent load, up 500W Tungsten Halogen load

110° (White) IP44 12m range	DPIR110WH	0550976	16.09	1		
110° (Black) IP44 12m range	DPIR110BK	0550975	16.14	1		
180° (White) IP44 12m range	DPIR180WH	0550485	18.79	1		
180° (Black) IP44 12m range	DPIR180BK	0550484	18.71	1		

360° Stand Alone PIR for up to 2kW incandescent load, 12m range

360° Stand Alone PIR	DEX360PIRW	0550522	29.85	1		
----------------------	------------	---------	-------	---	--	--



A theben Group Company



Stand Alone PIRs

180° 2300W PIR Black	SLB2300	0820011	22.02	1		
180° 2300W PIR White	SLW2300	0820012	22.02	1		



A. 120° White, IP54, 10m range	IS1WHT	0222928	17.97	1		
120° Black, IP54, 10m range	IS1BLK	0222929	17.97	1		
140° Black, 175m2 area	IS140-2BLK	0282860	46.04	1		
140° White, 175m2 area	IS140-2WHT	0390150	46.04	1		
160° Black, 170m2 area, 12m range, 600W resistive loads	IS2160BLK	0216738	26.99	1		
B. 160° White, 170m2 area, 12m range, 600W resistive loads	IS2160WHT	0216743	26.99	1		
240° Black, 230m2 area	IS240BLK	0046068	54.67	1		
240° White, 230m2 area	IS240WHT	0046069	54.67	1		
C. 300° Blk, 300m2 area, 12m range	IS300BLK	1188631	62.67	1		



Can be wired directly into existing fitting (if there is space) or inside DMWCASE



Microwave Sensor & IP65 Enclosure

30-150° 10-12m Microwave Sensor	DMWSENSOR	0716002	16.80	1		
IP65 Enclosure for DMWSENSOR	DMWCASE	0716003	7.12	1		





GARDEN & DECK LIGHTING



LED 'Slice' Bricklights



- Superslim
- Hassle free - no recess required
- White trims available



LED Bricklights

3W Rectangular Bricklight 188 lms	DSLICELONG	0832924	16.36	1	15.39	3+
1.8W Eyelid Bricklight 62 lms	DSLICEEYE	0832926	16.29	1	15.28	3+



IP65 LED Bricklight + Stainless Steel Frame



- Supplied with stainless steel trim
- Integral driver
- 5.4W
- 6000K



IP65 LED Bricklight + Stainless Steel Frame BRICKLIGHTS

DBRICKLED	0935737	25.58	1	24.97	3+
-----------	---------	-------	---	-------	----

NOVELDA SIGN LIGHTS



NOVELDA Sign Lights



The 3 CCT Novelda LED Sign lights are a 3 in one solution for uses in exterior applications where the option to be able to adjust the colour to suit the application is required. These are ideal for Pubs, restaurants and sign lighting applications.



Novelda Sign Lights

Novelda E27 9" Sign Light Black	KSR6100BLK	1245437	37.61	1	34.98	3+
Novelda E27 9" Sign Light Brass	KSR6100BR	1245448	52.57	1	48.89	3+
Novelda 20w 3K/4K/6K LED Sign Light Black	KSR6101BLK	1245459	53.74	1	49.98	3+
Novelda 20w 3K/4K/6K LED Sign Light Brass	KSR6101BR	1245469	69.87	1	64.98	3+

LED PERIMETER LIGHT



LED Perimeter Light



- 1800 lumens
- Wall mounted - can illuminate area 8.5m(W) x 5m(D) (when mounted at 3m)
- Pre-wired with 1m cable & connection box
- Integral photocell (can be bypassed on installation)



20W IP65 LED Perimeter Light

20W IP65 LED Perimeter Light	DPERLED20	0716006	100.05	1		
------------------------------	-----------	---------	--------	---	--	--

GARDEN & DECK LIGHTING



- IP66
- Corrosion free
- GU10 LED
- Fully adjustable



4.5W LED Wall/Spike Mount Spotlight	DETOM1	0796994	29.99	1	29.12	3+
4.5W LED Wall/Spike Twin Mount Spotlight	DETOM2	0922540	55.14	1		



TULUA Spike Light GU10

- GU10 35W or retrofit LED compatible
- Stainless steel or black aluminium
- IP65
- Supplied less lamp



Stainless Steel	KSR1319	1117581	47.54	1	45.65	3+
Black Aluminium	KSR1344	1117720	24.50	1	23.55	3+

Steeple IP68 GU10 Stainless Steel Decklights

- 50W - Requires GU10 LED lamp
- 110mm deep
- Pre wired 1m flex
- IP68



LED Deck Lights Kit	DGDL50SS	0550525	24.95	1	22.69	3+
---------------------	----------	---------	-------	---	-------	----



LED Deck Lights Kit 10x LED Set 6000K

- IP67
- 10 x 0.5W heads
- 3000K or 6000K LED
- Non dimmable
- Driver supplied
- Available in cool white or warm white



10x LED Set 6000K	KSR1333CW	1117654	39.99	1		
10x LED Set 3000K	KSR1333VW	1117665	39.99	1		
Cabello RGB LED 10LGT Decking Kit	KSR1334RGB	1177960	76.11	1		



LED EXTERNAL LIGHTING

Steeple Lanterns



Polycarbonate Lanterns

60W Lantern, Black	DL60B	0550957	17.55	1	16.36	3+
60W Half Lantern, Black	DHL60B	0550991	21.75	1	20.94	3+
60W Half Lantern, White	DHL60WH	0550992	21.67	1	20.86	3+

GLS Lantern

GLS Lantern, black (PIR)	DPIRL60BK	0550530	38.12	1	34.65	3+
GLS Half Lantern, black (PIR)	DPIRHL60BK	0550523	36.10	1	32.81	3+
GLS Half Lantern, white (PIR)	DPIRHL60WH	0550524	36.31	1	33.00	3+

Eterna 7W LED Lanterns

- 420 lumens
- IP44
- 3100K
- 35,000hr life
- Polycarbonate construction
- PIR version = 120° PIR



Ceiling PIR Sensors

7W LED Lantern, Blk, 420 lumens	DVECOFBK	1123218	30.70	1	28.96	2+
7W LED PIR Lantern, Blk, 420 lumens	DVECOPIRBK	1123219	39.80	1	37.55	2+
7W LED Half Lantern, Blk, 420 lumens	DVECOHBK	1123220	25.95	1	24.49	2+
7W LED PIR Half Lantern, Blk, 420 lms	DVECOPIRBK	1123221	34.80	1	28.70	2+

KSR LIGHTING 8W LED Lanterns

- IP44
- 8W 3000K LED
- Suitable for high saline areas
- 400-419 Lumens
- 4 sided or 6 sided options
- PIR versions available
- Non PIR versions can be constructed as either an upward or downward lantern



4 Sided LED Lanterns Black

A. Upward/Downward Lantern	KSR1512	1138746	29.55	1	0.00	3+
B. Upward Lantern with PIR	KSR1513	1138747	35.90	1	34.98	3+

6 Sided LED Lanterns Black

C. Upward/Downward Lantern	KSR1516	1138750	29.55	1	28.99	3+
D. Upward Lantern with PIR	KSR1517	1138751	35.90	1	34.98	3+

Eterna LED Well Glass Fitting

- 9.5W
- 806 lumens
- 2700K
- IP65
- Bracket included for optional corner mounting



LED EXTERNAL LIGHTING

A. LED Well Glass Fitting, Black	DWGLEDBK	0716004	33.09	1	30.14	3+
B. LED Well Fitting, White	DWGLEDDWH	0716005	33.20	1	30.25	3+

KSR LIGHTING Lampara Lantern

- Warranty: 1 Year
- E27
- Manufactured from resin so ideal for high saline areas
- IP44
- Class II
- Lamp Types: E27 20W or 23W Low Energy Not Included
- Body: Resin
- Diffuser: Clear Polycarbonate

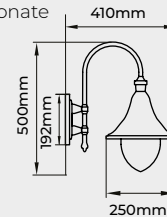
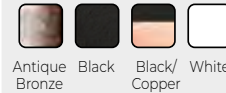

Lampara E27 IP43 Wall Lantern Antique Bronze	KSR3300ANTBRONZE	0350901	62.29	1	
Lampara E27 IP43 Wall Lantern Black	KSR3300BLK	0350902	62.29	1	
Lampara E27 IP43 Wall Lantern Black/Copper	KSR3300BLK/COP	0350903	85.90	1	
Lampara E27 IP43 Wall Lantern White	KSR3300WHT	0350904	62.29	1	

KSR LIGHTING Downward Wall Lantern

- Warranty: 1 Year
- Manufactured from resin so ideal for high saline areas
- E27 lamp (not supplied)
- Body: Resin
- Diffuser: Clear Polycarbonate
- IP44

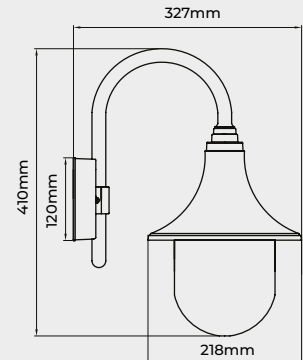

E27 cap IP44 Downward Wall Lantern	KSR1150BLK	0605141	21.71	1	19.79	3+
------------------------------------	------------	---------	-------	---	-------	----





LED EXTERNAL LIGHTING



IP44 GU10 LED Polypropylene Wall Lights

- Polypropylene design
- Requires 1 or 2 LED GU10 lamps (not supplied)
- IP44



IP44 GU10 LED Polypropylene Wall Lights

A. Single LED Poly Wall Light Black	DWLPPSING	0894330	14.64	1	13.45	2+
B. Twin LED Poly Wall Light Black	DWLPTWIN	0894331	17.65	1	16.71	2+



Cody 30W 3000K LED Wall Down Light Anthracite

- IP65
- Class I
- CRI: Ra80
- 36° Reflector
- Loop In/ Out facility
- Integrated non-dimmable driver
- Anodized die cast aluminium for coastal areas
- Life expectancy: up to 30,000 hours
- Body – Cast Aluminium
- Lens – Glass

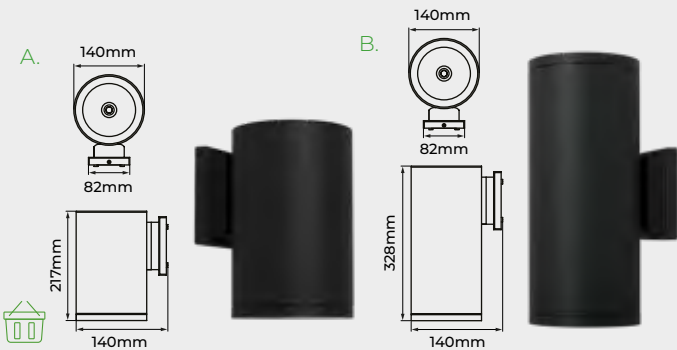

Cody 30W 3000K LED Wall Down Light Anthracite

A. Cody 30W 3000K LED Wall Down Light Anthracite	KSR7197	1182875	114.48	1		
B. Cody 2 X 24W LED Up and Down Wall Light	KSR7198	1182877	152.90	1		
C. Cody 30W 3000K LED Ceiling Light Anthracite	KSR7196	1182874	99.97	1		



Architectural Up/down wall light

- Durable die-cast aluminium construction
- Surface mountable up down wall light
- LED wall light with matching colour temperature and finish to the Architectural Exterior range
- Stylish, ultra modern design



Architectural Up/down wall light IP65 GU10 (Lamp not included)	JC17035	1091831	23.02	1		
--	---------	---------	-------	---	--	--



35W GU10 Up/Down Outside Wall Light

- Class I
- IP44
- Double GU10 35W max
- Suitable for retro fit GU10 LED lamps
- Not suitable for High Saline Areas
- Products supplied less lamp(s)
- 201 Stainless steel grade

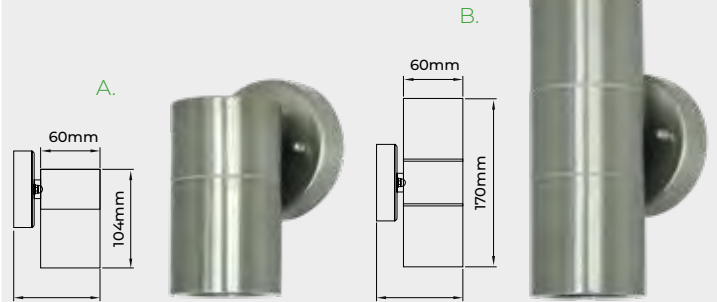

A. 35W GU10 Stainless Steel Single Wall Light	SKSR1356	1246212	12.35	1		
B. 35W GU10 Up/Down Outside Wall Light	SKSR1357	1219587	14.49	1		



IP44 GU10 Stainless Steel Spotlights

- 35W
- Stainless steel construction
- Modern design
- Requires 35W max GU10 lamp (not supplied)
- IP44
- 304 Stainless steel grade

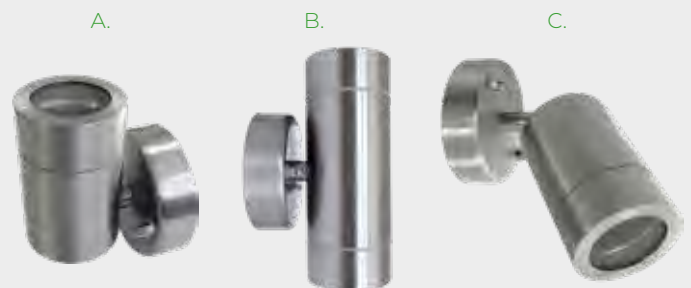

IP44 GU10 Stainless Steel Spotlights

A. Single Spotlight	DSSWLSING	0932907	19.48	1	18.55	3+
B. Dual Spotlight	DSSWLTWIN	0912182	33.13	1	29.28	3+
C. Adjustable Single Spot	DSSWLDIR	0935738	24.91	1	24.27	3+



Tulula GU10 PIR Wall Lights

- GU10 35W or retrofit compatible
- Up to 9m PIR range
- Stainless steel body
- IP44
- Supplied less lamps

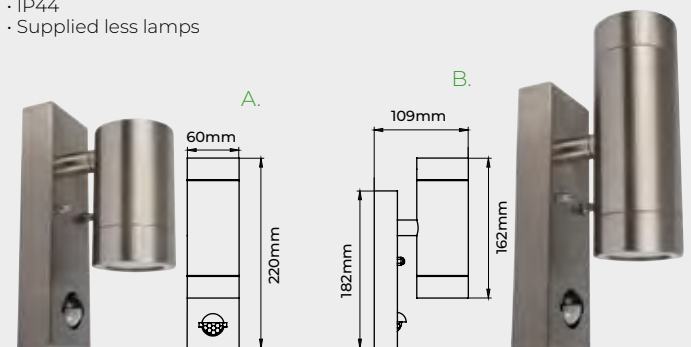

A. Single Wall Light	KSR1340	1117676	28.80	1	27.69	3+
B. Twin Wall Light	KSR1341	1117687	32.80	1	31.54	3+



LED EXTERNAL LIGHTING



Architectural rectangular wall up/down light IP54 14W

- Two directional light output
- Durable die-cast aluminium construction
- IP54 protection against dust and moisture
- Stylish, ultra modern design
- LED wall light with matching colour temperature and finish to the Architectural Exterior range

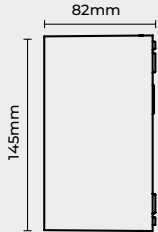

Architectural rectangular wall up/down light IP54 14W	JC17011	1091806	51.30	1
---	---------	---------	--------------	---



Architectural up/down light box IP54 5W 3000K 160Lm

- Wall mountable up down wall light
- IP54 protection against dust and moisture
- Durable die-cast aluminium construction
- LED wall light with matching colour temperature and finish to the Architectural Exterior range

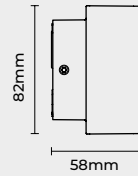

A. Architectural up/down light box IP54 5W 3000K 160Lm (Black)	JC17010BLK	1091804	26.31	1
B. Architectural up/down light box IP54 5W 3000K 160Lm (White)	JC17010WH	1091805	26.31	1



Moby 9W LED Square Wall Downlight

- Warranty: 2 Years
- 9W 3000K LED
- 900 Lumens
- CRI: Ra>80
- 55° Reflector
- Loop In/Out Facility
- Integrated non-dimmable driver
- IP65
- Class I
- Anodized die cast for coastal areas
- Life Expectancy: up to 30,000 hours
- Body – Cast Aluminium
- Lens – Clear Glass

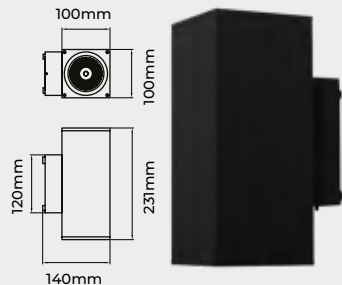
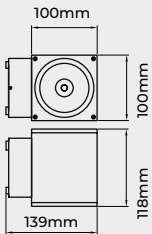

A. Moby 9W LED Square Wall Downlight	KSR7192	1182872	75.91	1
B. Moby 2 X 9W LED Square Up and Down Wall Light	KSR7193	1182873	116.50	1



Orsay 2X 5W LED Up/Down Wall Light Anthracite

- Warranty: 2 Years
- Sharp 2x 5W 3000K LED
- 502 lumens
- CRI: Ra81
- IP55
- Class I
- Body – Cast Aluminium

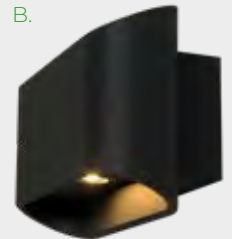
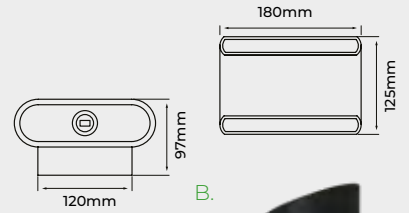

A. Orsay 2X 5W LED Up/Down Wall Light Anthracite	KSR7151	0354519	92.64	1
B. Orsay 9W LED Down Wall Light Anthracite	KSR7150	0354518	85.51	1



Decorative Wall/Post Light 28° Beam Angle

- Durable die-cast aluminium construction
- IP65 protection against water ingress
- Stylish, ultra modern design
- LED wall light with matching colour temperature and finish to the Architectural Exterior range

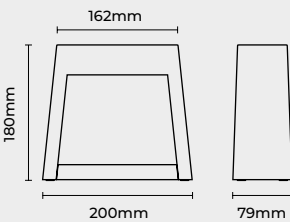

18W Decorative wall/post light 28° beam angle IP65	JC17017	1091812	59.37	1
--	---------	---------	--------------	---





LED EXTERNAL LIGHTING



Flix 8.5W 3000K LED Adjustable Wall Light

- Warranty: 2 Years
- 8.5W 3000K LED
- 330 Lumens
- CRI: Ra85
- IP54
- Class I
- 320° Adjustable head
- Life Expectancy: up to 40,000 hours
- Body – Cast Aluminium
- Lens – Polycarbonate

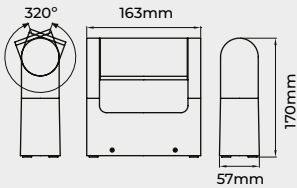

Flix 8.5W 3000K LED Adjustable Wall Light | KSR1908 | 1182506 | **54.55** | 1



Mataro 8.5W 3000K LED Wall Light With Numbers

- Warranty: 2 Years
- 8.5W 3000K LED
- 319 Lumens
- CRI: Ra85
- IP54
- Class I
- Supplied with vinyl number sheet
- Life Expectancy: up to 40,000 hours
- Body – Cast Aluminium
- Cover – Polycarbonate

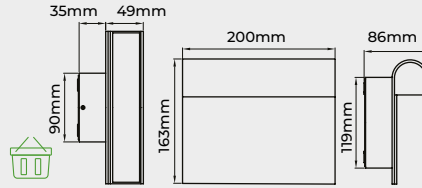

Mataro 8.5W 3000K LED Wall Light With Numbers | KSR1901 | 1182832 | **41.95** | 1



30W Surface Mount up/down Wall Light IP54



- LED wall light with matching colour temperature and finish to the Architectural Exterior range
- Durable die-cast aluminium
- IP54 protection against dust and moisture
- Stylish, ultra modern design
- 3 years extended warranty
- 30W
- 1700 Lumens

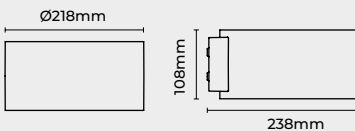

30W Surface Mount up/down Wall Light IP54 | JC17014 | 1091808 | **87.62** | 1



15W Round wall Light 260mm

- Durable die-cast aluminium construction
- IP54 protection against dust and moisture
- LED wall light with matching colour temperature and finish to the Architectural Exterior range
- Stylish, ultra modern design

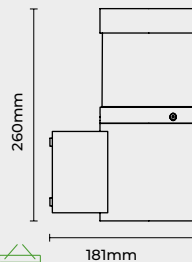

MATCHING BOLLARD ON PAGE 74

15W Round wall Light 260mm | JC17046 | 1091849 | **73.46** | 1



'Acqua' Wall Light

- Polycarbonate lens
- Body: stainless steel
- PIR version = 90° PIR
- 2 year Warranty

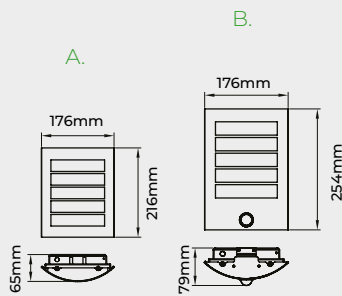
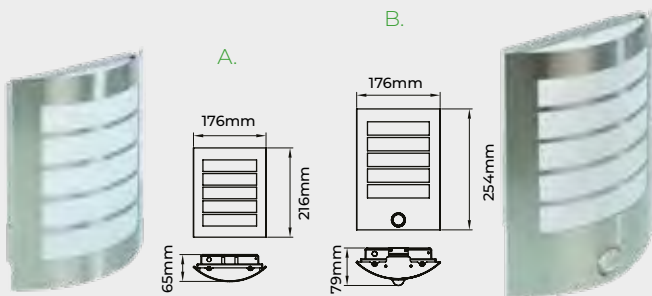

'Acqua' Wall Light
 A. 8W LED IP44, 3000K, 600 lumens | KSR99555S | 0968718 | **25.29** | 1 | **23.46** | 3+
 B. 8W LED IP44, 3000K, 600 lumens PIR | KSR99565S | 0968719 | **33.88** | 1 | **31.21** | 3+



Coro LED Square/Round Up And Down Wall Light

- 2x 3W 3000K LED
- 3000K - 262 lumens
- 316L grade stainless steel
- IP44
- Class I

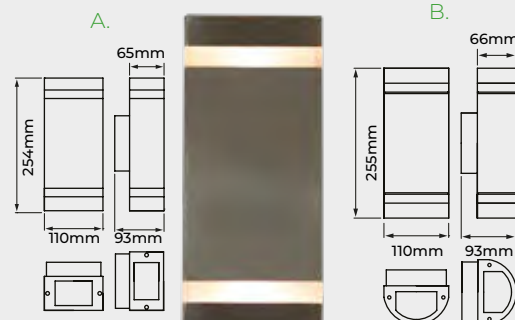
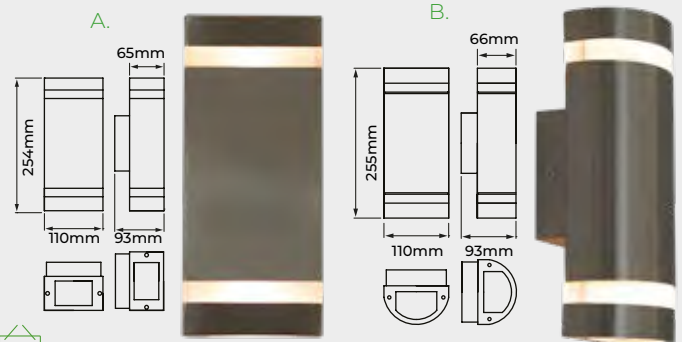

Coro LED Square Up And Down Wall Light
 A. Coro LED Square Up and Down Wall Light | KSR1287 | 0605148 | **52.83** | 1
 B. Coro LED Round Up and Down Wall Light | KSR1286 | 0605147 | **53.14** | 1



LED EXTERNAL LIGHTING



Glazed E27 lantern



- Stylish contemporary design
- Durable die-cast aluminium construction
- Toughened glass lantern with ES E27 lamp holder
- IP54 protection against dust and moisture
- PIR option available
- Suitable for use with LED lamps

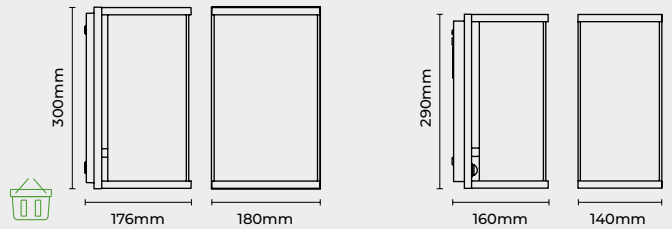

A.	Decorative square wall lantern	JC17037BLK	1091835	50.34	1
B.	Decorative square wall lantern C/W PIR	JC17036BLK	1091833	61.62	1

OUTDOOR & INTERIOR LIGHTING

Available to order in branch and online



LOOK OUT FOR THE BASKET

In our commitment to deliver a broad range of outdoor lighting in time for the darker season, we have expanded our range with many new items now available to order.



Andria E27 Wall Lantern

- Warranty: 1 Year
- E27 40W Max
- Suitable for LED filament lamps
- Product supplied less lamp
- Class I
- IP44
- Body – Aluminium
- Diffuser – Glass

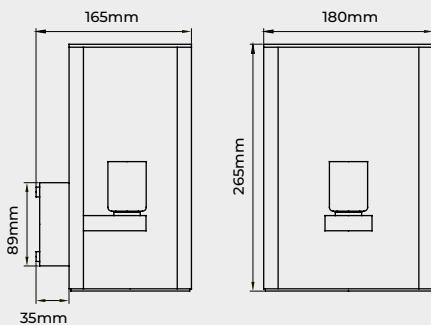

Andria E27 Wall Lantern	KSR7195	1138758	64.94	1
-------------------------	---------	---------	--------------	---



Click & Collect in as little as 1 min



Call your local branch



Visit your local branch



LED EXTERNAL LIGHTING



Boss GU10 Wall Light Anthracite

- Body – Cast aluminium
- Lens – Clear glass
- Warranty: 1 Year
- Requires 1 GU10 lamp (not included)
- IP44

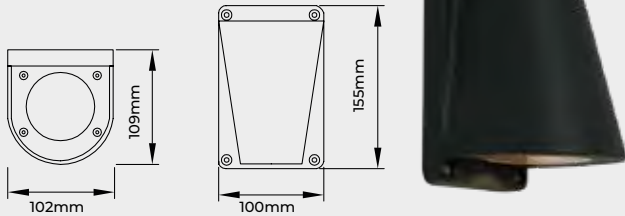

Boss GU10 Wall Light Anthracite | KSR7141ANTH | 0355937 | **51.28** | 1



Sevas GU10 Double Wall Light Anthracite

- Body - Cast aluminium
- Lens - Clear Glass
- Requires 2x GU10 Lamps (not supplied)
- IP55

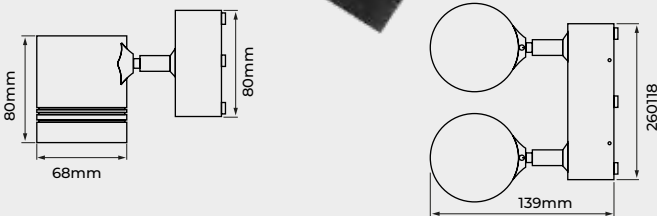

Cane LED Square Up/Down Wall Light Stainless Steel (Set of 2)

- Body – 304 Stainless steel
- Diffuser – Polycarbonate
- Warranty: 2 Years
- 2x 5W Cool White LED - 493 lumens
- Non-dimmable
- Not suitable for high saline areas
- IP44

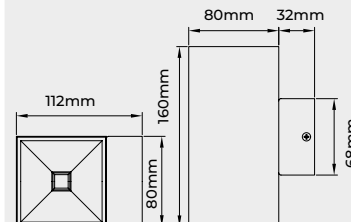

Cane LED Square Up/Down Wall Light Stainless Steel (Set of 2) | KSR1360 | 1117651 | **36.28** | 1



Rocky LED Wall Light Anthracite

- Warranty: 2 Years
- 7.5W Sharp 3000K LED
- 3000K - 200 lumens
- CRI: Ra88
- IP55
- Class I
- Body – Cast Aluminium

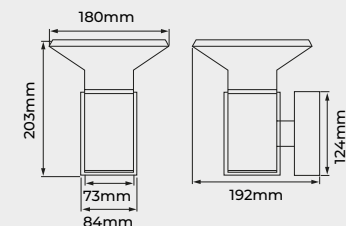

8W LED Lanterns

- Warranty: 2 Years
- 8W 3000K AC LED
- 3000K - 480 lumens
- A concrete mounting kit is available to order separately
- Life Expectancy: Up to 30,000 hours
- Body – Cast Aluminium
- Lens – Polycarbonate
- CRI: Ra82
- IP55
- Class I

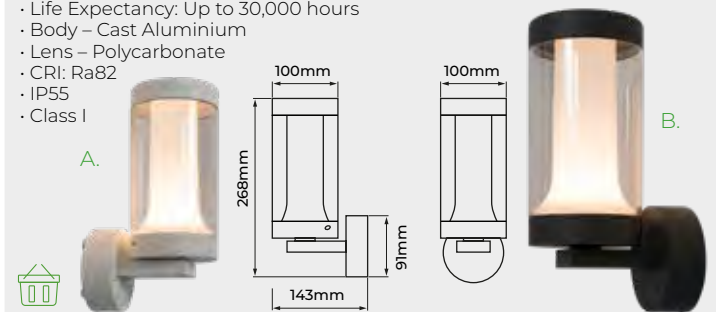

Andria 8W 3000K LED Wall Light White

A.	Andria 8W 3000K LED Wall Light White	KSR7180WHT	0847965	64.89	1
B.	Andria 8W 3000K LED Wall Light Anthracite	KSR7180ANTH	0847964	64.89	1

Rocky 7.5W LED Wall Light Anthracite | KSR7155ANTH | 0800969 | **78.83** | 1



BOLLARDS



Coria Bollard Black

Supplied Fixing Kit

- Concrete kit included
- Root mounting kit available to order separately
- Body – Cast & Extruded aluminium
- Diffuser – Clear PMMA
- Warranty: 1 Year
- E27 46W Max
- IP65



A.	Coria Bollard Black 450mm	KSR9915	1245472	51.23	1
B.	Coria Bollard Black 750mm	KSR9910BLK	0367229	52.69	1
C.	Coria Bollard Black 1000mm	KSR9912BLK	0367254	56.97	1



Coria LED Bollard

Supplied Fixing Kit

- Concrete kit included
- Root mounting kit available to order separately
- 20W CCT Warm White/Cool White/Daylight LED
- Life expectancy up to 30,000 hours
- Body – Die-cast aluminium
- Lens – Polycarbonate
- Warm White - 1528 Lumens
- Cool White - 1724 Lumens
- Daylight - 1535 Lumens
- Warranty: 2 Years
- Beam Angle 180°
- Non-dimmable
- IP65

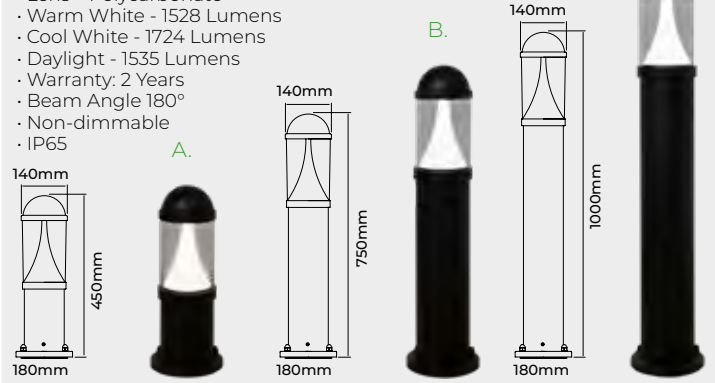

A.	Coria LED Bollard 450mm	KSR9916	1245473	62.31	1
B.	Coria LED Bollard 750mm	KSR9917	1245474	69.23	1
C.	Coria LED Bollard 1000mm	KSR9918	1245475	77.54	1

FIXING KIT

Coria Bollards are supplied with Fixing Kits

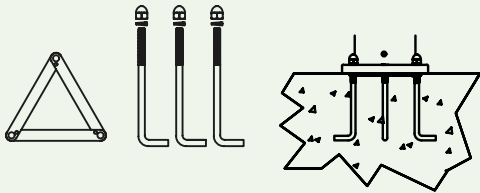

Manta Polycarbonate Bollards

- Body – Polycarbonate
- Lens – Clear Polycarbonate
- Suitable for high saline areas
- Warranty: 1 Year
- E27 46W Max
- Chrome Louvre
- IP65



A.	Manta Polycarbonate Bollards 450	KSR1180BLK	0968594	38.45	1
B.	Manta Polycarbonate Bollards 750	KSR1181BLK	0968595	46.14	1



CHECK-CLICK-COLLECT

- Check stock nationwide
- Click & Collect

RECOMMEND A FRIEND

GET £50 CREDIT ON YOUR ACCOUNT

When new account opened & 1st order placed min value £125

Ask in branch or visit Denmans.co.uk





BOLLARDS



Contemporary Tilted Head Bollard

- Warranty: 2 Years
- 8.5W 3000K LED
- 330 Lumens
- CRI: Ra85
- IP54
- Class I
- 320° Adjustable head
- Life Expectancy: up to 40,000 hours
- Matching wall light available
- Body – Cast Aluminium
- Lens – Polycarbonate



A.	Flix 8.5w 3000K LED Adjustable 300mm Bollard Anthracite	KSR1909	1182517	58.63	1
B.	Flix 8.5w 3000K LED Adjustable 650mm Bollard Anthracite	KSR1910	1182528	69.48	1



Contemporary Block Bollard

- Warranty: 2 Years
- 8.5W 3000K LED
- 75 Lumens
- CRI:Ra68
- IP54
- Class I
- Life expectancy: up to 40,000 hours
- Body – Cast Aluminium

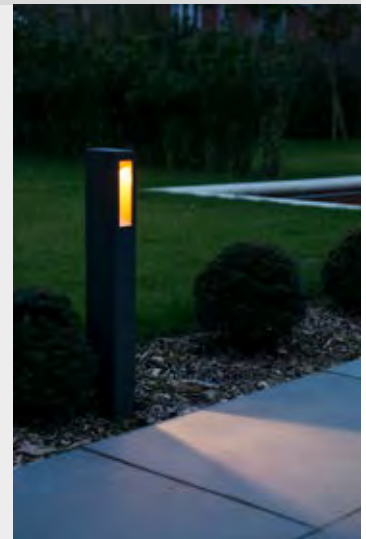
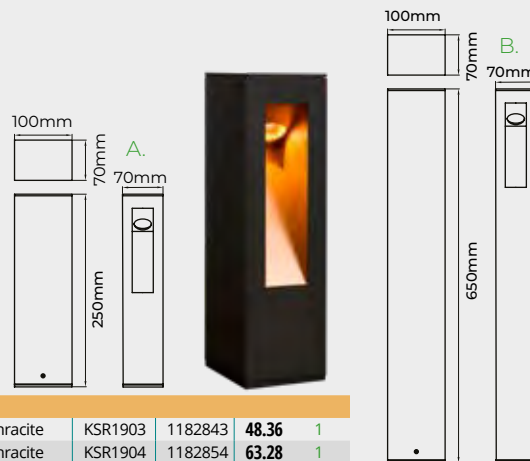

A.	Viella 8.5w 3000K LED 250mm Bollard Anthracite	KSR1903	1182843	48.36	1
B.	Viella 8.5w 3000K LED 650mm Bollard Anthracite	KSR1904	1182854	63.28	1



Cylindrical Bollards

- Warranty: 2 Years
- 8.5W 3000K LED
- 290 Lumens
- CRI:Ra84
- IP54
- Class I
- Life expectancy: up to 40,000 hours
- Body – Cast Aluminium

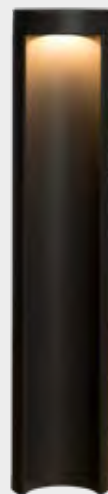
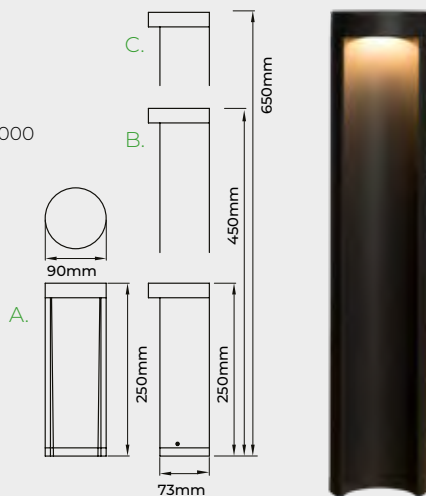

A.	Calanda 8.5w 3000K LED 250mm Bollard Anthracite	KSR1905	1182865	45.79	1
B.	Calanda 8.5w 3000K LED 450mm Bollard Anthracite	KSR1906	1182876	53.64	1
C.	Calanda 8.5w 3000K LED 650mm Bollard Anthracite	KSR1907	1182887	63.28	1



Square Bollards

- Durable die-cast aluminium construction
- Stylish, contemporary design
- IP54 protection against dust and moisture
- ES E27 lamp holder
- Lamp, not included



A.	Decorative square bollard 650mm IP54 Anthracite/ Black	JC17040BLK	1091841	55.39	1
B.	Decorative square bollard 650mm IP54 White	JC17040WH	1091842	55.39	1



BOLLARDS



Squared Framed Bollards

- Warranty: 2 Years
- 13W 3000K LED
- 1075 Lumens
- CRI: Ra83
- IP54
- Class I
- Life expectancy: up to 40,000 hours
- Body – Cast Aluminium
- Lens – Glass



A.	Quinto 13w 3000K LED 230mm Bollard Anthracite	KSR1911	1182539	68.28	1
B.	Quinto 13w 3000K LED 500mm Bollard Anthracite	KSR1906	1182550	79.97	1



Louvred Bollard

- Requires 1 x 20W ES triple turn CFLi (not supplied)
- Fitting is rated at 20W max
- Root or flange fixing: versatile installation options
- Louvred diffuser
- Aluminium
- IP44
- Black

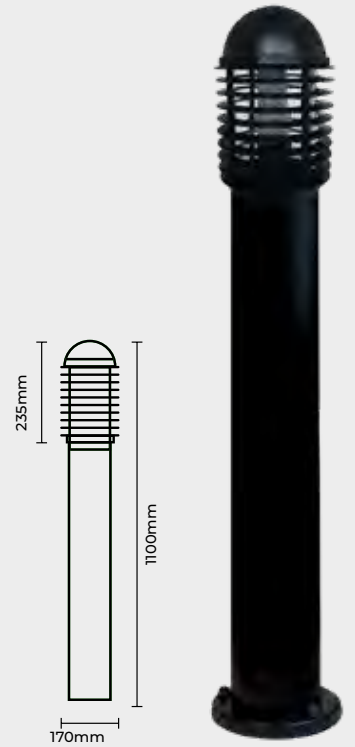

1100mm Tall Louvred Bollard

DB1100BKNL	0551032	73.12	1
------------	---------	--------------	---



Cast Aluminium Bollards

- Warranty: 2 Years
- 8W 3000K AC LED
- 3000K - 480 lumens
- CRI: Ra82
- IP66
- Class I
- Life Expectancy: Up to 30,000 hours
- A concrete mounting kit is available to order separately
- Body – Cast Aluminium
- Lens – Polycarbonate

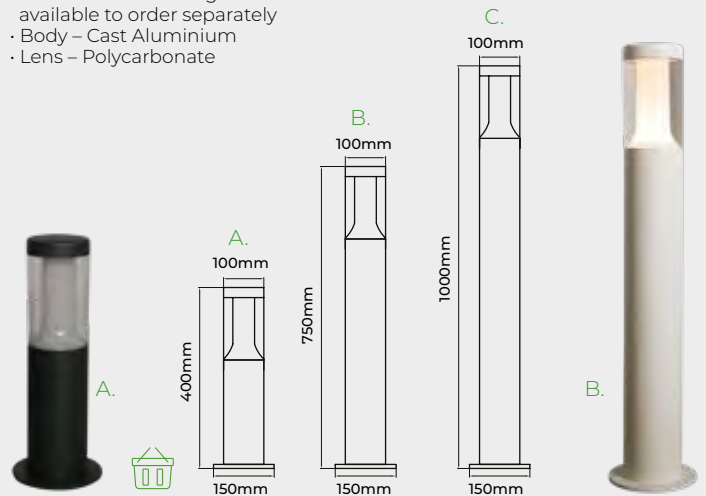

A.	Andria 8w 3000K 480lm LED 400mm IP66 Bollard Anthracite	KSR7184 ANTH	0968645	69.98	1
A.	Andria 8w 3000K 480lm LED 400mm IP66 Bollard White	KSR7184 WHT	0968646	69.98	1
B.	Andria 8w 3000K 480lm LED 750mm IP66 Bollard Anthracite	KSR7181 ANTH	0847966	78.89	1
B.	Andria 8w 3000K 480lm LED 750mm IP66 Bollard White	KSR7181 WHT	0847967	78.89	1
C.	Andria 8w 3000K 480lm LED 1000mm IP66 Bollard Anthracite	KSR7182 ANTH	0847968	88.30	1
C.	Andria 8w 3000K 480lm LED 1000mm IP66 Bollard White	KSR7182 WHT	0847969	88.30	1



Square Bollards

- IP54 protection against water ingress
- Matching colour temperature and finish to the Architectural Exterior range
- Durable die-cast aluminium construction
- Stylish, contemporary design
- Supplied with L-bolts for installation



15W Square post light IP54

JC17032	1091828	60.85	1
---------	---------	--------------	---



Round Post Bollard

- IP54 protection against water ingress
- Matching colour temperature and finish to the Architectural Exterior range
- Durable die-cast aluminium construction
- Supplied with L-bolts for installation



MATCHING WALL LIGHT ON PAGE 69

15W Round post light 265mm 82° beam angle IP54	JC17047	1091850	77.65	1
--	---------	---------	--------------	---





4000K 10-50W LED ALUMINIUM FLOODLIGHTS



4000K 10-50W LED ALUMINIUM FLOODLIGHTS

- Full IP65 protection against dust and moisture
- Angled bracket for easy installation
- Includes 80cm cable
- Manual override function
- 10 - 50W available
- Diecast aluminium body
- Beam angle 110°
- 4000K
- 36,000hr



IP65 LED 4000K Aluminium Floodlight

10W IP65 LED Flood, Black 1000lm	DE45200BLK	1093869	9.30	1	8.39	3+
10W IP65 LED Flood, White 1000lm	DE45200WH	1093870	9.30	1	8.39	3+
20W IP65 LED Flood, Black 2100lm	DE45202BLK	1093873	15.98	1	15.70	3+
20W IP65 LED Flood, White 2100lm	DE45202WH	1093874	15.98	1	15.70	3+
30W IP65 LED Flood, Black 2800lm	DE45204BLK	1093877	24.45	1	22.74	3+
30W IP65 LED Flood, White 2800lm	DE45204WH	1093878	24.45	1	22.74	3+
50W IP65 LED Flood, Black 4500lm	DE45206BLK	1093881	35.55	1	33.08	3+
50W IP65 LED Flood, White 4500lm	DE45206WH	1093882	35.55	1	33.08	3+

IP44 LED 4000K Aluminium Floodlight with PIR

10W IP65 LED Flood, Black + PIR 1000lm	DE090001	1264398	16.79	1	15.70	3+
10W IP44 LED Flood, White + PIR 1000l	DE45201WH	1093872	15.99	1	14.95	3+
20W LED Floodlight White PIR	DE090004	1264401	23.71	1	22.54	3+
20W IP44 LED Flood, White + PIR 2100lm	DE45203WH	1093876	22.58	1	21.47	3+
20W LED Floodlight White PIR	DE090004	1264401	23.71	1	22.54	3+
30W IP44 LED Flood, White + PIR 2800lm	DE45205WH	1093880	31.43	1	29.89	3+
20W LED Floodlight White PIR	DE090004	1264401	23.71	1	22.54	3+
50W IP44 LED Flood, White + PIR 4500lm	DE45207WH	1093884	44.86	1	42.57	3+

SIENA LED FLOODLIGHTS



Siena CCT IP65 LED Floodlights

- Available in four wattages 10W, 20W, 30W and 50W
- Triple CCT switchable, giving the end user the option of 3000K, 4000K or 6000K all in one fitting
- PIR versions available
- IP65 (with or without PIR)
- Cast aluminium body with glass diffuser
- Manual override facility
- Pre-fitted with compression gland for flexibility when wiring
- Push-fit terminals



Siena LED Floodlights

10W, 3000K=735lm, 4000K=895lm, 6000K=815lm	KSR5280BLK	1177954	13.33	1	12.49	3+
10W, 3000K=735lm, 4000K=895lm, 6000K=815lm + PIR	KSR5281BLK	1177961	20.67	1	17.99	3+
20W, 3000K=1580lm, 4000K=1805lm, 6000K=1655lm	KSR5282BLK	1177962	21.20	1	19.89	3+
20W, 3000K=1580lm, 4000K=1805lm, 6000K=1655lm +PIR	KSR5283BLK	1177963	29.79	1	25.95	3+
30W, 3000K=2330lm, 4000K=2795lm, 6000K=2590lm	KSR5284BLK	1177964	34.46	1	31.99	3+
30W, 3000K=2330lm, 4000K=2795lm, 6000K=2590lm +PIR	KSR5285BLK	1177965	37.15	1	34.95	3+
50W, 3000K=3885lm, 4000K=4770lm, 6000K=4120lm	KSR5286BLK	1177966	44.70	1	41.45	3+
50W, 3000K=3885lm, 4000K=4770lm, 6000K=4120lm +PIR	KSR5287BLK	1177967	51.45	1	47.98	3+
Spike Accessory for 10-50W Floods	KSR5294	1245553	2.99	1		

FROM
£12.49
EACH

LUCECO LED SOLAR WALL LIGHTS



2W LED SOLAR PIR WALL LANTERN BLACK

- Easy installation
- 1 Year warranty
- 8 Metre detection range
- 200lm
- 4000k
- IP44



A.

10W LED SOLAR PIR FLOODLIGHT BLACK

- Easy installation
- Same output as a hard wired 10W floodlight
- PIR motion detection and dusk till dawn feature (remains 20% bright)
- 8 Metre detection range
- 2 Year warranty
- 1080lm
- 4000K
- IP65



B.

1.5W LED SOLAR PIR WALL LIGHT BLACK

- 3 brightness settings
- Perfect for entrance areas, balconies, paths and decorative garden lighting
- Adjustable PIR detection range of 2-6M
- Easy installation
- 1 Year warranty
- IP44
- 220lm
- 4000k



C.

2W LED SOLAR PIR WALL LIGHT STAINLESS STEEL

- Easy installation
- 8 Metre detection range
- Dual light distribution
- 100lm
- 4000k
- IP44



D.

A.	2W Solar Wall Lantern Black	LEXSL20B40-01	1138680	20.84	1	
B.	1080 Lumens Black Solar Floodlight	LEXSF11B40-01	1119316	43.95	1	
C.	1.5W Solar Wall Light Black	LEXS22B40-01	1138553	11.98	1	
D.	2W Solar Wall Light Stainless Steel	LEXDSL1S40P-01	1119318	17.73	1	

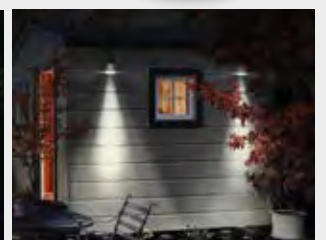
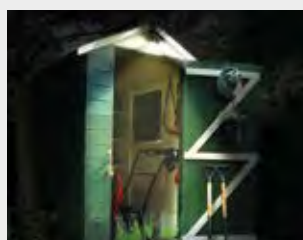



LED FLOODLIGHTS



LED Compact PIR Floodlight Twin Flood – Black

- 2x 10W powerful LED compact floodlight
- 2x 840lm lumens bright white light
- IP55
- 3 Year Warranty



LED Compact PIR Floodlight Twin Flood – Black

Nighteye 2x 10W PIR Flood	LED200PIRBE	1013948	59.57	1	57.25	3+
---------------------------	-------------	---------	-------	---	-------	----

COMMERCIAL LED FLOODLIGHTS



Commercial LED COB Floodlights



- 50W = 3500 lumens, 80W = 6500 lumens, 120W = 8600 lumens, 200W = 17000 lumens
- IP65
- 4000K
- 25,000 hr life (average)



WHILE STOCKS LAST

Commercial LED COB Floodlights

50W IP65 LED COB Floodlight	DFLOOD50	0832909	52.94	1		
80W IP65 LED COB Floodlight	DFLOOD80	0847718	111.02	1	101.79	3+
120W IP65 LED COB Floodlight	DFLOOD120	0864884	139.35	1	134.11	3+
200W IP65 LED COB Floodlight	DFLOOD200	1009824	213.04	1	205.78	3+

FLOODLIGHT BRACKETS

KR PRODUCTS



Floodlight Brackets

A. Swivel Bracket for 10W LED	KRP1	0538459	6.19	1		
B. Swivel Bracket for 30-50W LED	KRP3	0592906	31.85	1		
C. Corner Bracket for 10W LED	KRP5	0543280	6.19	1		



Siena Commercial IP65 LED Floodlights



- High efficiency
- 4000K LED Options
- Cast aluminium body with glass diffuser
- 3000K versions available to order
- Push-fit terminals



FROM £63.55 EACH

Siena LED Floodlights

100W, 4000K=8400lm	KSR5289BLK	1177955	68.00	1	63.55	3+
150W, 4000K=13250lm	KSR5291BLK	1177957	100.34	1	94.00	3+
200W, 4000K=16385lm	KSR5293BLK	1177959	119.10	1	111.50	3+
100W 3000K LED IP65	KSR5288BLK	1177968	68.00	1	63.55	3+
150W 3000K LED IP65	KSR5290BLK	1177956	100.41	1	94.00	3+
200W 3000K LED IP65	KSR5292BLK	1177958	119.08	1	111.50	3+



Over 11,500 products available in our branch network now





LED BATTENS



Economy LED Batten

- IP20
- 30,000 hours
- 4000K



Economy LED Batten

4ft, 18W, 1800lm (single)	SLEDBAT418	1009686	18.75	1	17.99	3+
5ft, 24W, 2400lm (single)	SLEDBAT524	1009687	22.95	1	21.50	3+
5ft, 48W, 4000lm (twin)	SLEDBAT548	1009688	31.00	1	29.50	3+
6ft, 32W, 3400lm (single)	SLEDBAT632	1009689	30.90	1	29.45	3+
6ft, 64W, 5200lm (twin)	SLEDBAT664	1009690	33.95	1	32.50	3+



Navara LED Batten

- Opal Polycarbonate diffuser
- IP20
- 4000K
- Multiple rear entry points - knockouts on both ends
- 5 year warranty from date of purchase
- High output variations available
- A great alternative to a fluorescent fitting
- Emergency versions available



'Navara' LED Battens

X4S 4ft 23W 2760Lm	SKSR9840	0981613	25.53	1	24.49	5+
X4S 4ft 23W 2760Lm Emergency	SKSR9840/EM	0981614	59.32	1	56.62	2+
X4T 4ft 40W 4800Lm	SKSR9841	0981615	27.95	1	26.65	5+
X4T 4ft 40W 4800Lm Emergency	SKSR9841/EM	0981616	62.41	1	59.58	2+
X5S 5ft 38W 4560Lm	SKSR9842	0981617	26.49	1	25.50	5+
X5S 5ft 38W 4560Lm Emergency	SKSR9842/EM	0981618	62.38	1	60.74	2+
X5T 5ft 60W 7200Lm	SKSR9843	0981619	34.99	1	33.99	5+
X5T 5ft 60W 7200Lm Emergency	SKSR9843/EM	0981620	67.60	1	65.82	2+
X6S 6ft 48W 5760Lm	SKSR9844	0981621	34.50	1	33.75	5+
X6S 6ft 48W 5760Lm Emergency	SKSR9844/EM	0981622	66.57	1	64.82	2+
X6T 6ft 65W 7800Lm	SKSR9845	0981623	38.80	1	37.69	5+
X6T 6ft 65W 7800Lm Emergency	SKSR9845/EM	0981624	67.37	1	64.30	2+



Toucan LED Battens

- IP20
- 30,000 hours
- 4000K
- Low profile white powder coated extruded aluminium body
- Only 25mm depth



Toucan LED Battens

0.6m, 18W, 1810Lm	RTC184006-01	0932152	17.15	1		
1.2m, 36W, 3640Lm	RTC364012-01	0932154	28.60	1		
1.5m, 45W, 4340Lm	RTC454015-01	0932155	34.30	1		

FLUORESCENT BATTENS



High Power Factor Fluorescent Battens

- For commercial use
- Switch start or high frequency
- Single or twin fittings



WHILE STOCKS LAST

High Power Factor Fluorescent Battens

5ft Single H/F	S51BATT/HF	0549704	24.25	1	22.88	5+
6ft Single H/F	S61BATT/HF	0549705	26.85	1	25.33	5+
5ft Twin H/F	S52BATT/HF	0549706	27.87	1	26.82	5+
6ft Twin H/F	S62BATT/HF	0549707	30.34	1	28.62	5+



Prismatic Controllers for battens shown above



Prismatic Controllers for battens shown above

For S51BATT HF	S51PRIS	0550457	6.20	1	5.85	5+
For S61BATT HF	S61PRIS	0550458	6.87	1	6.48	5+
For S52BATT HF	S52PRIS	0550463	8.37	1	7.90	5+
For S62BATT HF	S62PRIS	0550464	9.29	1	8.77	5+



High Frequency Weatherproof Fittings



WHILE STOCKS LAST

High Frequency Weatherproof Fittings

5ft 58W Single, H/F	DH158	0578455	9.41	1	9.06	5+
5ft 58W Twin, H/F	DH258	0578458	13.05	1	12.31	5+
6ft 70W Single, H/F	DH170	0578456	12.74	1	12.02	5+
6ft 70W Twin, H/F	DH270	0578459	19.89	1	18.76	5+

LED WEATHERPROOF FITTINGS



5ft 45W IP65 Non-Corrosive Batten

- IP65 5ft Single
- Non-Corrosive Fittings
- 4000 Lumens
- 4000K
- Prewired with 1.5m flex



5ft 45W IP65 Non-Corrosive Batten

5ft Single, IP65 Inc LED Tube	DVECOWP5FT	1166424	24.06	1		
-------------------------------	------------	---------	-------	---	--	--



Lighting & Lamps

LED WEATHERPROOF FITTINGS



Eco LED Weatherproof Batten

- IP65
- 4000K
- 40000 hours
- Push-fit connectors
- Multiple cable entries



WHILE STOCKS LAST



Eco LED Weatherproof Batten

5ft, 30W 2900lm single batten	DVECO5WPSI2	1129751	27.99	1	
5ft, 45W 4300lm twin batten	DVECO5WPTW2	1129752	37.99	1	
6ft, 48W 4500lm single batten	DVECO6WPSI2	1129753	48.49	1	
6ft 65W 6200lm twin batten	DVECO6WPTW2	1129754	55.59	1	

SURFACE MODULAR FITTINGS



Elegance 5' LED Twin Slimline Ceiling Fitting

- 5000 Lumens
- 50W
- Polycarbonate & Aluminium construction
- Push terminal connections
- 40,000hr life (average)
- Emergency version available



Elegance 5' LED Twin Slimline Ceiling Fitting

50W 5' Twin LED 5000 lumens	DELEGANCE5	0979468	72.32	1	70.16	3+
50W 5' Twin LED 5000 lumens EM	DELEGAN5EM3	0979469	100.17	1	96.94	3+



Navara Pro LED Batten



Navara Pro LED Batten

4ft, 22W, 2260lm (single)	KSR9890	1138781	61.94	1	59.99	3+
4ft, 22W, 2260lm (single) Em	KSR9890EM	1138782	95.96	1	92.94	3+
4ft, 38W, 3925lm (twin)	KSR9891	1138783	68.95	1	66.95	3+
4ft, 38W, 3925lm (twin) Em	KSR9891EM	1138784	102.99	1	99.98	3+
5ft, 30W, 3080lm (single)	KSR9892	1138785	75.00	1	72.99	3+
5ft, 30W, 3080lm (single) Em	KSR9892EM	1138786	108.95	1	105.95	3+
5ft, 60W, 6280lm (twin)	KSR9893	1138787	81.95	1	79.95	3+
5ft, 60W, 6280lm Em	KSR9893EM	1138788	115.95	1	112.95	3+



CAT2 Modulares - Non LED

- Low profile surface luminaire with multi chamfered sides and durable plastic end caps
- Lamps extra
- Packed as one unit c/w 'lift and tilt' attachment



WHILE STOCKS LAST

CAT2 Modulares - Non LED

58W Twin, H/F	DSB258HF/N	0780933	49.24	1	45.84	3+
70W Twin, H/F	DSB270HF/N	0780935	57.96	1	51.75	3+

LED WEATHERPROOF FITTINGS



- IP65
- 4000K
- 110° beam angle
- Can be suspended
- IK 10
- Stainless steel clips



Navara X Weatherproof Batten

4ft, 24W X4S single, 3169 lumens	KSR9880	1117607	29.57	1	26.80	3+
4ft, 40W X4T twin, 5149 lumens	KSR9881	1117609	30.16	1	28.19	3+
5ft, 36W X5S single, 4382 lumens	KSR9882	1117611	31.80	1	29.73	3+
5ft, 60W X5T twin, 6786 lumens	KSR9883	1117613	41.31	1	38.61	3+
6ft, 35 X-IP65 X6 single	KSR9886	1277538	40.72	1	38.04	3+
6ft, 65W X-IP65 X6S single	KSR9887	1277540	48.80	1	45.59	3+

Emergency versions available to order :

4ft, 24W X4S single, 3169 lumens	KSR9880EM	1117608	60.16	1	56.39	3+
4ft, 40W X4T twin, 5149 lumens	KSR9881EM	1117610	65.52	1	63.00	3+
5ft, 36W X5S single, 4382 lumens	KSR9882EM	1117612	64.99	1	60.75	3+
5ft, 60W X5T twin, 6786 lumens	KSR9883EM	1117614	75.78	1	70.83	3+
6ft, 35W X-IP65 X6S single	KSR9886EM	1277539	79.84	1	76.77	3+
6ft, 65W X-IP65 X6S	KSR9887EM	1277541	91.92	1	88.38	3+



LED Nano Utility Batten

- Tough polycarbonate construction
- Push fit terminal connections for quick installation
- Cable gland pre-fitted
- Suitable for applications such as garages, lofts, sheds and utilities



2ft LED 18W Batten	SKNANOIP2FT	1348761	11.49	1	10.74	3+
5ft LED 23W Batten	SKNANOIP4FT	1348762	15.57	1	14.48	3+
5ft LED 26W Batten	SKNANOIP5FT	1348763	17.80	1	16.69	3+

COMMERCIAL DOWNLIGHTS



'Starlet' Flat Round Panel Downlights

- 3W : 160lm or 6w : 360lm
- 4000K
- IP20
- 120° beam angle
- Plug & play driver to head unit - easy installation



'Starlet' Flat Round Panel Downlights

6W, 120mm, 360 lumens	SKSR9791	1021031	9.70	1	8.86	3+
12W, 170mm, 820 lumens	KSR9791	1021032	11.23	1	10.59	3+
18W, 225mm, 1350 lumens	SKSR9793	1021033	20.70	1	18.95	3+
24W, 300mm, 1650 lumens	SKSR9794	1021034	23.40	1	22.69	3+



Atlanta Universal Downlight



Integrated LED recessed downlight with 14mm slim profile. Features a unique universal fixing that can be adjusted to fit any existing recess from 2.5" to 8" (63.5-203mm) diameter. Includes a high quality on-board driver for flicker-free light output. Fitting is suitable for surface mounting or recessed installations. Includes 25cm pre-wired cable.

- Fitting 230mm diameter
- 120° beam angle
- 30,000hr life



Atlanta Universal Downlight

3000K 1550lm, 18.5W	10536	1121341	24.95	1	22.46	3+
4000K 1600lm, 18.5W	10543	1121352	24.95	1	22.46	3+





RECESSED MODULAR FITTINGS



36W Square 600x600 LED Panel



- An exceptional LED lay-in fitting for use in high footfall applications where access is limited and maintenance difficult. Non dimming driver included.
- Tp(b) fire rated
- 50,000 hr avg rated life
- 4000K
- 3400lm
- Backlit
- IP20
- UGR22



36W LED 600x600 Panel 3400lm	STLEDPAN4KV2	1385079	24.71	1	22.98	5+
3Hr Emergency Pack	SEMG130201	1293278	60.45	1		
Surface mounting frame for STLEDPAN4K	S130332	1293280	32.95	1		
Suspension kit for STLEDPAN4K	S130212	1293281	9.95	1		



Next Generation Skytile Base 600X600 Panel



- 30W 3000 lumen LED backlit panel
- 4000K and 5000K colour temperature options
- 100 lumens per circuit watt
- IP20 and TP(b) protection
- Available in EM, self-test, dali and 1-10 volt dimming



*Dali/1-10V versions available to order.

Skytile Base LED 600x600 Panels

30W Skytile Base 3140LM 4000K	DE080046	1232703	25.95	1	24.95	5+
30W SKYTILE BASE 3000LM 5000K	DE080051	1309060	25.95	1	24.95	5+
Emergency Remote Pack	JCEM001	1091764	50.43	1		



LED 600x600 Panels



- Dimmable and Non-Dimmable
- IP20
- 30,000hr average rated life
- Ultra slim profile
- Emergency compatible using DEBPM3
- Only available to order



*Only suitable for use with either 1-10V dimmer or push to make retractive switch

36W 600x600 LED Panel, 3600 lumens Dimmable

36W 600x600 LED Panel, 3600 lumens	600P4K	1143970	29.55	1		
36W 600x600 LED Panel, 3600 lumens Dimmable*	600DIMP4K	1144053	98.91	1		

MARSHALLING BOXES



Marshalling Boxes



4 Way Box	KLDS4	0099037	74.17	1		
6 Way Box	KLDS6	0065556	87.18	1		
8 Way Box	KLDS8	0065557	91.91	1		
10 Way Box	KLDS10	0065558	110.12	1		

CONNECTORS



Connectors



4 Pin, c/w Flex	CR64AX/3.0	0065535	20.55	1		
3 Pin, Plug-In	P22	0065564	2.60	1		
3 Pin Plug-In c/w Flex	P22/3.0	0065607	7.42	1		
AX, 4 Pin, White	P64/AX	0066081	4.82	1		

LED LOWBAYS



- Suspension pack included
- IP40
- 35000 hrs
- 4000K



LED Linear Lowbays - IP40, 4000K

30W Lowbay 3050 lumens 371mm	DLEDLBY30	0987238	57.09	1	53.86	2+
50W Lowbay 5100 lumens 522mm	DLEDLBY50	0987239	75.38	1	71.10	2+
80W Lowbay 8150 lumens 820mm	DLEDLBY80	0987240	101.83	1	96.06	2+
120W Lowbay 12,200 lumens 1220mm	DLEDLBY120	0987241	152.63	1	146.87	2+

Wall/Ceiling Rod mount brkt for DLEDLBY120

Wall/Ceiling Rod mount brkt for DLEDLBY120	DLBB120	0922537	8.02	1		
Wall/Ceiling Rod mount brkt for DLEDLBY30/50	DLBB3050	0922535	5.85	1		
Wall/Ceiling Rod mount brkt for DLEDLBY80	DLBB80	0922536	7.97	1		

LED HIGHBAYS



- Circular Highbay Only:
- 1-10 Volt dimming capability as standard
- 80cm safety cable attached
- 120° beam angle



LED Circular Highbay - IP65, 4000K

100W LED 14850LM 4000K CIRC H/BAY IP65	DHBCIR100	1231655	90.04	1		
150W LED 21000LM 4000K CIRC H/BAY IP65	DHBCIR150	1231656	100.14	1		
90° Aluminium Reflector	DHBCIRDIF90	1231657	18.42	1		



Toughbay LED Highbays

- Ultra efficient, 120 Lumens per circuit Watt
- High CRI of 80
- Emergency versions available
- 5 year extended warranty
- Non dimmable



100W 12000lm LED Toughbay	DE040041	1293672	83.03	1		
100W 12000lm LED Toughbay Emergency Light	DE040042	1293673	152.50	1		
150W 18000lm LED Toughbay	DE040043	1293674	99.20	1		
150W 18000lm LED Toughbay Emergency Light	DE040044	1293675	169.67	1		
200W 24000lm LED Toughbay	DE040045	1293676	131.51	1		
200W 24000lm LED Toughbay Emergency Light	DE040046	1293677	195.70	1		



Toughbay Retrofit Highbay

- 100W, 150W and 200W options up to 24,500lm
- IP65 and dimmable standard
- Available in 60° and 90° beam options



Toughbay Retrofit Highbay						
100W 12300Lm 60°	DE040001	1243286	96.88	1		
100W 12300Lm 90°	DE040005	1243287	96.88	1		
150W 18400Lm 60°	DE040009	1243288	111.16	1		
150W 18400Lm 90°	DE040013	1243289	111.16	1		
200W 24500Lm 60°	DE040017	1243290	142.04	1		
200W 24500Lm 90°	DE040021	1243291	142.04	1		



EMERGENCY LIGHTING (BULKHEADS)



5W Emergency Bulkhead



- Maintained or non-maintained
- Minimum 3 hour emergency functionality
- IP65
- Hinged gear tray
- 220lm mains / 130lm battery
- Supplied with legend



5W Emergency Bulkhead					
5W Emergency Bulkhead	DVECOEM3ML	1123230	16.44	1	15.20 5+



7W LED Emergency Bulkhead



- 235lm (Mains) 150lm (Battery)
- High Output LEDs
- Facility for remote switching, maintained and non-maintained mode
- Supplied with multiple legend options
- L x 355mm H x 110mm D x 70mm
- Minimum 3 hour emergency functionality



7W Emergency Bulkhead					
7W Emergency Bulkhead	DEMLED3M	1161690	19.78	1	17.35 3+

EMERGENCY TWINSPOTS



Compact Emergency LED Twin Spot



- 2W, 6300k, IP20
- Polycarbonate construction
- Individual indicator to show 'Lamps Healthy' and 'Charge'
- Horizontally and vertically adjustable heads, 180° rotation across the horizontal plane
- Minimum 3 hour functionality in emergency mode
- Dimensions 285mmx250mmx50mm



Compact Emergency Twinspot					
Compact Emergency Twinspot	DVECOTWINSP	1161721	37.31	1	34.31 3+

EMERGENCY LIGHTING (EXIT BOXES)



4W Compact Emergency LED Exit Box



- 4W, 30,000hrs, IP20
- 3 hour maintained mode as standard which can also be configured for non maintained operation
- Facility for remote switching
- ISO 7010 up arrow legend included
- Viewing distance 29m
- LED charge light and battery test button
- Dimensions 300mmx180mmx40mm



4W Compact Emergency LED Exit Box					
Compact Emergency LED Exit Box	DVECOEXIT3M	1161698	25.86	1	25.56 3+



4W LED Exit Box



- Low energy alternative to standard emergency exit signs
- 4W, 30,000hrs, IP20
- Fitting with proven long term reliability and performance.
- 3 hour maintained mode as standard which can also be configured for non maintained operation
- Facility for remote switching
- Interchangeable Signs Directive polycarbonate down arrow exit legend included
- LED charge light and battery test button
- Viewing distance 32m
- 55 lumens in mains mode
- Dimensions 390mmx192mmx60mm



4W LED Exit Box					
4W LED M3 Exitbox	DEXIT3MLED	0550565	31.88	1	29.75 3+

EMERGENCY TWINSPOTS



2x 3W LED Twin Spot



- Provides superior light output to traditional Twinspot fittings
- 7W, 3500k, 441lm, IP65
- Twin 3W LED projectors: provide superior light output to traditional twinspot fittings
- Horizontally and vertically adjustable heads, 180° rotation across the horizontal plane
- IP65 rating utilising high quality polycarbonate enclosure: for installation in wet or dusty environments
- Individual indicator to show 'Lamps Healthy' and 'Charge'
- Minimum 3 hour non-maintained functionality in emergency mode
- Dimensions 295mmx300mmx70mm



2x 3W LED Twin Spot					
LED IP65 Twinspot	DLEDTWINSPOT	0671857	47.84	1	





EMERGENCY LIGHTING (DOWNLIGHTS)



1.4W LED 3hr Non-Maintained Downlight



This LED compact recessed emergency light is ideal for use in corridors, stairwells and other places that require a smart, discreet emergency unit.

- 118 lumens
- IP20
- 32mm diameter hole cut-out, actual fitting size 45mm
- Matt silver and white trims included
- Aluminium construction



1.4W LED 3hr Non-Maintained Downlight

LED 3hr Non-maintained Downlight (ø32), 118 lumens	DLDLEM3	0635765	21.68	1	
--	---------	---------	-------	---	--



Self-test Surface Mount Emergency Downlight



- 3W / 6000K
- Automatic testing in accordance with EN62034
- Polycarbonate construction
- Supplied with open area lens

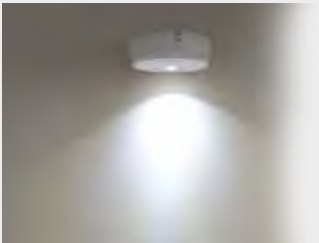

Self-test Surface Mount Emergency Downlight

Self test surface mount emergency downlight	DSESMDEM3	1161702	46.12	1	39.71 3+
---	-----------	---------	-------	---	----------



LED Fitting and Reeded Diffuser White 162 Lumens



- 162 lm/6500K
- 5.2W / 18,000 hrs
- Hinged gear tray: easy installation and maintenance
- Hole cut out size: 115mm x 320mm
- Facility for non-maintained mode & remote switching



LED Maintained Recessed Emergency Fitting

LED Fitting and Reeded Diffuser White 162 Lumens	DLEDREM3	0855881	37.07	1	35.11 3+
--	----------	---------	-------	---	----------

EMERGENCY LIGHTING (HANGING SIGNS)



2.4W LED Double Sided Maintained Hanging Sign Light



- 171 lumens
- IP20
- 3hr maintained mode, can be configured for non-maintained
- Aluminium housing



1.4W LED 3hr Non-Maintained Downlight

Hanging Sign White + Down Legend	DSIGNLEDEM3	0855058	59.78	1	55.28 3+
Left/Right Arrow Legend	DSIGNLGD	0934607	6.99	1	6.05 3+



2.8W LED Multi Fixing Exit Sign



Comes with 4 fixing options: Ceiling mounted, Suspended End mounted and Wall mounted

- 2.8W / 6000K
- Double sided ISO 7010
- Up arrow legend included (other legends available)
- Viewing distance 30m
- Polycarbonate construction



2.8W LED Multi Fixing Exit Sign

2.8W LED Multi Fixing Exit Sign	DEXITMMO	1161705	60.65	1	55.99 3+
---------------------------------	----------	---------	-------	---	----------

BATTERY REPLACEMENT

Helping your emergency lighting perform longer...



If after routine operation check, the lamp does not remain lit for the three hour period, a new battery pack may be required.

01 Switch off the electricity at the mains, both switched and permanent supply.

02 Allow batteries to fully discharge, then reconnect to supply and allow to charge for 24 hours

03 Test again for 3 hours, if light does not remain lit, change the battery pack.

04 Check install guides for procedure on changing the battery.



WE ONLY RECOMMEND ETERNA REPLACEMENT BATTERIES WITH ETERNA EMERGENCY PRODUCTS

Ask in Branch for a full list of batteries available and pricing, or visit: www.eterna-lighting.co.uk/battery-replacement-service for more information

*ISO7010 & Signs Directive legend formats are legal & acceptable on all Emergency products for new & existing installations. Extensions to existing installations should be made in the same format as originally installed & should not be mixed.



SELF TEST EMERGENCY PRODUCT AVAILABLE TO ORDER



EternaPro
LED
5 YEAR
Warranty*

THE BENEFITS OF ETERNA'S SELF-TEST EMERGENCY LIGHTING

- ✓ More effective and reliable than manual testing
- ✓ Easy to install
- ✓ Saves time and money
- ✓ Testing causes no disruption to the normal operation of the building
- ✓ Staggered tests mean all areas are protected in the event of a power failure

Ask in branch for details.

EMERGENCY ACCESSORIES



Directive Legends*

- ISO7010
- For use with DEXIT3MLED



Directive Legends*

Legend Left Arrow	DISOEBLGDL	1002812	6.94	1
Legend Right Arrow	DISOEBLGDR	1002813	6.78	1
Legend Up Arrow	DISOEBLGDU	1002814	7.06	1
Legend Left Arrow	DISOEBLDGG	1002815	6.94	1

D Cell Batteries for Emergency Lights



D Cell Batteries for Emergency Lights

2x D Cell Stick	2DH4-0L4	0326875	9.28	1
3x D Cell Stick	3DH4-0L4	0326877	12.85	1
2x D Cell Side by Side	2DH4-0L3	0005354	9.28	1
3x D Cell Side by Side	3DH4-0L3	0326876	12.85	1



Adhesive Legend Set*

- ISO7010
- For use with DB3MLED



Adhesive Legend Set*

Adhesive Legend Set	DISOLGDSET	1002811	1.10	1
Adhesive Legend Set (EU Directive)	DLGDSET	0625855	1.53	1

CONTACTUM Key Switch

- Rated Switching: 16A (8A)
- Manual Override
- Voltage Free Contacts
- Not suitable for discharge lighting



Key Switch

20A DP Keyswitch	X2814/KS	0196775	6.94	1	6.64	3+
------------------	----------	---------	-------------	---	-------------	----



Emergency Lighting Logbook & Certificate Book



Emergency Lighting Logbook & Certificate Book

Logbook	EM1LOG	0236257	12.72	1
Certificate Book	EMCERT	0326855	12.72	1



Click & Collect
in as little as 1 min



Call
your local branch



Visit
your local branch

Key:
(all LED unless
stated otherwise)

FLU
Fluorescent

HAL
Halogen

INC
Incandescent



GU10 LED LAMPS

Steeple 4W GU10s - 10 PACK

- WW: 3000K, 355 lumens
- CW: 4000K, 345 lumens
- Beam angle 35°
- 15,000hrs



x10



Warm White Lamp 10 PACK	STGU10WW10PK	1186939	17.50	1	
Cool White Lamp 10 PACK	STGU10CW10PK	1186940	17.50	1	

Steeple Wide Angled Flood LED GU10 Lamps

Ideal solution for an overall ambient lighting effect, perfect for general illumination rather than directional, focused light.

4W = similar lighting effect to 50W halogen
6W = visually superior lighting effect to 50W halogen



4W 320 WW 105°	VLWAF320WW	0934234	1.35	1	1.25	10+
4W 340 CW 105°	VLWAF340CW	0912184	4.22	1	3.90	10+
6W 500 WW 105°	V500LWAFWW	1009835	5.12	1	4.95	3+
6W 520 CW 105°	V520LWAFCW	1009836	5.12	1	4.95	3+

Crompton LED GU10

- 4000k CW (360 lumens) or 2700k WW (340 lumens)
- 35° beam angle
- Glass construction
- 15,000 hr (average)
- Non-dimmable



4.5W 360 CW 35°	4WGU10CW	0889878	1.99	1	
4.5W 340 WW 35°	4WGU10WW	0889877	1.99	1	

MEGAMAN Energy Saving Lamps 5.5W DIMMABLE GU10 GLASS LAMP

Glass 5.5W Dimmable GU10 lamp, compatible with many leading brands of dimmer including Varilight, Hamilton Verve.

- Dimmable
- 5.5W
- 390 Lumens
- 36° beam angle
- 15,000 average hours



5.5W 2800K Dimmable Gu10 Glass Lamp	S142220	1171166	3.94	1	3.75	10+
5.5W 4000K Dimmable Gu10 Glass Lamp	S142222	1171167	3.94	1	3.75	10+

LOW VOLTAGE LAMPS

Crompton LOW VOLTAGE LAMPS

Low Voltage MR16 - Glass Front, 50mm



5W 350 38°	5WMR16WW	0889879	5.95	1	5.39	10+
5W 350 38°	5WMR16CW	0889880	5.95	1	5.39	10+

Crompton LED 12V G4 Capsule Lamps

- Silicon design
- 6000hr life
- Ideal for direct retrofit in existing fittings

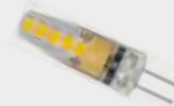

2W 190 G4, WW	2W/G4WW	0979599	4.12	1	3.43	10+
2W 200 G4, CW	2W/G4CW	0979600	4.12	1	3.43	10+

Crompton Low Voltage G4 Capsule Lamps



10W 130 G4 Capsule	M91	0549831	0.98	1	0.87	10+
20W 350 G4 Capsule	M47	0549830	0.98	1	0.87	10+

MAINS DISPLAY LAMPS

Crompton G9 240V LED Lamp

6,000 hr life, 2700K



2.5W 210 WW	2.5/G9WW	0834064	4.12	1	3.28	10+
2.5W 210 CW	2.5/G9CW	0834065	4.12	1	3.28	10+

Crompton Linear Tungsten Halogen Tubes



120W 2250 78mm, 240V	120/TH	0550023	1.77	1	1.59	10+
160W 3100 118mm, 240V	160/TH	0550020	1.77	1	1.59	10+
230W 4650 118mm, 240V	230/TH	0550021	1.77	1	1.59	10+
400W 8550 118mm, 240V	400/TH	0550022	1.77	1	1.59	10+

Smart Lamps



EXCLUSIVE TO Denmans

Works with the Google Assistant

amazon alexa ENABLED

See page 25



Lighting & Lamps

GLS LAMPS

Steeple

8.5W GLS BC - 3 PACK
Non-Dimmable

- WW: 3000K, 806 lumens
- 15,000hrs

x3



BC LED GLS 3 PACK	STGLSWWBC3PK	1186941	6.96	1
-------------------	--------------	---------	-------------	---

Steeple

LED Filament Lamp GLS

- Warm White 3000k
- 15,000hr ave. life

x3



3pk BC GLS Filament 806lm 7.5W 806lm 60mm BC	STFILGLSWWBC3	1306693	11.99	1
3pk ES GLS Filament 806lm 7.5W 806lm 60mm ES	STFILGLSWWES3	1306694	11.99	1

Compton
LAMPS

LED GLS Lamps

- 6W, 9.5W & 12W
- 2700K WW, 6500K DL
- 20,000hr (average)
- 4,000K and 6000k available to order



Non-Dimmable

6W 470 BC, Opal, WW	6W/BCGLSWWN	1005053	3.61	1	3.20	10+
6W 470 ES, Opal, WW	6W/ESGLSWWN	1005054	3.61	1	3.20	10+
9.5W 806 BC, Opal, WW	9.5W/BCGLSWW	1005055	4.36	1		
9.5W 806 ES, Opal, WW	9.5W/ESGLSWW	1005056	4.36	1	3.96	10+
12W 1055 BC, Opal, WW	12W/BCGLSWW	1005057	5.58	1	5.10	10+
12W 1055 ES, Opal, WW	12W/ESGLSWW	1005058	5.58	1	5.10	10+

Dimmable

12W 1055 BC, Opal, WW	12W/BCGLSWWD	1005061	7.87	1	7.01	10+
12W 1055 ES, Opal, WW	12W/ESGLSWWD	1005062	8.38	1	7.44	10+

Compton
LAMPS

CRLA LED Filament Lamp
GLS Dimmable - Warm White



5W 470lm 60mm BC	4184	0875278	4.81	1	4.55	10+
WW 5W 470lm 60mm BC	4191	0865624	4.81	1	4.55	10+
Clear WW 7.5W 806lm 60mm BC	4207	0875279	5.54	1	5.24	10+

Compton
LAMPS

LED GLS Dusk to Dawn Lamps
Non-Dimmable

- Quickly replace fluorescent DD lamps with little or no rewiring
- Long life of 30,000h
- Optional 10% dimming corridor function
- Emergency Module
- Compatible with Kosnic LED DD lamps
- 3 hours rated duration
- Supplied with internal battery and all necessary leads and connectors



9.5W 806 BC	9.5W/BC/WW/PC	1085970	9.98	1
9.5W 806 ES	9.5W/ES/WW/PC	1085971	9.98	1

GLS LAMPS

Compton
LAMPS

LED GLS Coloured Lamps



1.5W BC, Amber	1.5/BCGLSA	0834068	4.99	1	4.66	5+
1.5W ES, Amber	1.5/ESGLSA	0834069	4.99	1	4.66	5+
1.5W BC, Blue	1.5/BCGLSB	0834070	4.99	1	4.66	5+
1.5W ES, Blue	1.5/ESGLSB	0834071	4.99	1	4.66	5+
1.5W BC, Green	1.5/BCGLSG	0834072	4.99	1	4.66	5+
1.5W ES, Green	1.5/ESGLSG	0834073	4.99	1	4.66	5+
1.5W BC, Red	1.5/BCGLSR	0834074	4.99	1	4.66	5+
1.5W ES, Red	1.5/ESGLSR	0834075	4.99	1	4.66	5+
1.5W BC, Yellow	1.5/BCGLSY	0834076	4.99	1	4.66	5+
1.5W ES, Yellow	1.5/ESGLSY	0834077	4.99	1	4.66	5+

Steeple

CFL Spiral GLS Replacement Lamps



FLU

11W 650 BC	11W/BCSPRLT2	0837068	2.93	1	2.77	10+
20W 1200 BC	20W/BCSPRLT2	0837072	3.24	1	2.98	10+

Compton
LAMPS

GLS Lamps



HAL

42W 630 BC, Clear	42/BCCH	0550035	1.57	1	1.36	10+
42W 630 ES, Clear	42/ESCH	0550036	1.57	1	1.36	10+

CANDLE LAMPS

Steeple

8.5W Candle SES - 3 PACK

- WW: 3000K, 470 lumens
- 15,000hrs



x3



SES LED Candle 3 PACK	STCANWSES3PK	1186942	7.95	1
-----------------------	--------------	---------	-------------	---

Steeple

LED Filament Lamp Candle



x3



3pk SES Candle Filament 470lm 5W 470lm 35mm SES	STFILCANWSES3	1306695	9.99	1
--	---------------	---------	-------------	---





CANDLE LAMPS



CLRA LED Filament Lamp Candle

Dimmable - Warm White



CLEAR WW 5W 470lm 35mm BC	7130	0987585	4.33	1	3.97	10+
CLEAR WW 5W 470lm 35mm SES	7161	0987587	4.33	1	3.97	10+



LED Candle Lamps

- 15,000 hr life
- 2700K Warm White



5.5W 470 BC WW	5.5W/BCCANWW	0905255	4.00	1	3.47	10+
5.5W 470 ES WW	5.5W/ESCANWW	0905257	4.00	1	3.47	10+
5.5W 470 SBC WW	5.5W/SBCCANWW	0905256	4.00	1	3.47	10+
5.5W 470 SES WW	5.5W/SESCANWW	0905258	4.00	1		

Halogen Candle Lamps



- 15,000 hr life
- 2700K Warm White



28W 375 BC Clear	28/BPCCH	0550040	1.57	1	1.36	10+
28W 375 SES Clear	28/SEPCC	0550042	1.57	1	1.36	10+
42W 630 SES Clear	42/SEPCC	0550044	1.57	1	1.36	10+

GOLFBALL LAMPS



LED Golfball Lamps

- 15,000 hr life
- WW = 2700K
- 4,000K available to order



5.5W 470 BC WW	5.5W/BCRNDWW	0905264	4.00	1	3.47	10+
5.5W 470 ES WW	5.5W/ESRNDWW	0905266	4.00	1	3.47	10+
5.5W 470 SBC WW	5.5W/SBCRNDWW	0905265	4.00	1	3.47	10+
5.5W 470 SES WW	5.5W/SESRNDWW	0905267	4.00	1	3.47	10+



CRLA LED Filament Lamp

Round Dimmable - Warm White



WW 5W 470lm 45mm BC	7215	0987589	4.33	1	3.97	10+
WW 5W 470lm 45mm ES	7239	0987590	4.33	1	3.97	10+
WW 5W 470lm 45mm SES	7246	0987591	4.33	1	3.97	10+

GOLFBALL LAMPS



Halogen Golfball Lamps



42W 630 BC Clear	42/BRLCH	0549884	1.57	1	1.36	10+
42W 630 ES Clear	42/ERLCH	0549886	1.57	1	1.36	10+
28W 375 SES Clear	28/SERLCH	0549883	1.57	1	1.36	10+

LED REFLECTOR LAMPS (R39 TO R80)



LED PAR38 Reflector Lamps

LED PAR (Pressed Aluminium reflector) lamps feature a glass enclosure and highly reflective aluminium coating applied internally.



- 15,000 hour life
- Prismatic Lens
- IP65 Rated – suitable for outside use
- Various Colours also available

LED reflector replacement lamps shaped and sized similar to R39, R50, R63 or R80 reflector lamps. True retrofit replacements for incandescent lamps.

13W / 830 Lumens / WW	13/PAR38CLEAR	0868755	14.30	1	13.86	10+
-----------------------	---------------	---------	--------------	---	--------------	-----



LED Reflector Lamps

- 20,000 hour life
- 2700K Warm White
- Opal Finish



3.5 240 R39 Reflector	3.5/SER39W	1020713	4.36	1		
4.5 260 R50 Reflector	4.5/SER50W	1020716	5.18	1		
6 470 R63 Reflector	6/ESR63W	1020714	6.51	1		
9.5 780 R80 Reflector	9.5/ESR80W	1020715	9.25	1		



Incandescent Reflectors



- 2000 hour life
- Heat resistant glass
- Internally fused for safety



80W n/a PAR38 Flood	80/EP38F	0549974	5.77	1	5.00	10+
---------------------	----------	---------	-------------	---	-------------	-----

APPLIANCE & PYGMY LAMPS



1.3W SES (E14) LED Pygmy Lamp

- 25,000 hr life
- 2700K Warm White
- 90 Lumens
- Equivalent to 15W incandescent



1.3W SES (E14) LED Pygmy Lamp						
1.3W SES (E14) LED Pygmy (Suitable for fridges)	1.3W/SES/PYGYMY	1108814	6.82	1	4.77	10+



APPLIANCE & PYGMY LAMPS



Appliance/PYGMY Lamps (Clear Glass)



15W 105 SES Oven	AO15CSES	0549835	1.46	1	1.28	10+
25W 125 SES Oven	AO25CSES	0549836	1.46	1	1.28	10+
40W 340 SES Cooker Hood	AC40CSES	0549834	1.46	1	1.28	10+
15W 90 BC Pygmy	15/BPC	0549820	0.73	1	0.63	10+
15W 105 SES Pygmy	15/SEPC	0549821	0.73	1	0.63	10+

DECORATIVE LAMPS



Squirrel Cage, Dimmable, Antique Bronze

Resembles the look and feel of a traditional incandescent lamp

- 15,000 hour lifespan
- 7,500 switching cycles
- Antique bronze finish
- DuoDim™ technology
- LED filament technology
- Suitable for indoor use only



5W 470 64mm, BC	5/BCSQWW	0834082	8.63	1	7.38	10+
5W 470 64mm, ES	5/ESSQWW	0834083	8.63	1	7.38	10+
7.5W 806 64mm, BC	7.5/BCSQWW	0834084	8.63	1	7.38	10+
7.5W 806 64mm, ES	7.5/ESSQWW	0834085	8.63	1	7.38	10+



Globe Shape, Dimmable, Antique Bronze

- Exact equivalent brightness for regular 35W incandescent lamps
- 15,000 hour lifespan
- 7,500 switching cycles
- Colour rendering index: Ra≥80
- Antique bronze finish
- DuoDim™ technology
- For indoor use only



5W 470 80mm, BC	5/BCG80WW	0834086	8.63	1	7.38	10+
5W 470 80mm, ES	5/ESG80WW	0834087	8.63	1	7.38	10+
5W 470 95mm, BC	5/BCG95WW	0834088	8.63	1	7.38	10+
5W 470 95mm, ES	5/ESG95WW	0834089	8.63	1	7.38	10+
7.5W 806 125mm, BC	7.5/BCG125WW	0834090	10.37	1	8.86	10+
7.5W 806 125mm, ES	7.5/ESG125WW	0834091	10.37	1	8.86	10+

TUBES & STARTERS



LED T8 Full Glass Tubes



9W 810 2ft, CW, T8	9/2LEDWCW	0698046	6.10	1	5.50	5+
22W 2050 4ft, CW, T8	22/4LEDWCW	0698048	10.75	1	9.95	5+
24W 2500 5ft, CW, T8	24/5LEDWCW	0698049	13.50	1	12.99	5+
28W 3000 6ft, CW, T8	28/6LEDWCW	1085972	20.75	1	19.99	5+

All sizes also available in Warm White & Daylight (except 6ft, CW/Daylight only).
6ft Shatterproof & 8ft LED Tube also available - ask your branch for details.
Need to check foodsafe compatibility if using emergency fitting.

TUBES & STARTERS



T8 Triphosphor Tubes



15W 960 18", White	15/18TPW	0549877	4.46	1	3.87	25+
18W 1350 2ft, White	18/2TPW	0549934	1.96	1	1.79	25+
18W 1350 2ft, Cool White	18/2TPCW	0549935	1.96	1	1.79	25+
18W 1350 2ft, Daylight	18/2TPDL	0549936	1.96	1	1.79	25+
30W 2400 3ft, White	30/3TPW	0549933	3.43	1	3.10	25+
36W 3350 4ft, White	36/4TPW	0549937	2.68	1	2.43	25+
36W 3350 4ft, Cool White	36/4TPCW	0549938	2.68	1	2.43	25+
36W 3350 4ft, Daylight	36/4TPDL	0549939	2.68	1	2.43	25+
58W 5200 5ft, White	58/5TPW	0549940	3.29	1	2.97	25+
58W 5200 5ft, Cool White	58/5TPCW	0549941	3.29	1	2.97	25+
58W 5200 5ft, Daylight	58/5TPDL	0549942	3.29	1	2.97	25+
70W 6300 6ft, White	70/6TPW	0549943	5.78	1	5.31	25+
70W 6300 6ft, Cool White	70/6TPCW	0549944	5.78	1	5.31	25+
70W 5800 6ft, Daylight	70/6TPDL	0549945	5.78	1	5.31	25+



T9 Circular Tubes



40W 3450 Circular, White	40/CIRTPWW	0549931	13.45	1		
60W 4050 Circular, White	60/CIRTPWW	0549932	13.56	1		



T5 Halophosphate Tubes



6W 260 9", White	6/9W	0549838	1.27	1	1.10	25+
8W 380 12", White	8/12W	0549837	1.27	1	1.10	25+
13W 800 21", White	13/21W	0549840	1.63	1	1.42	25+



LED Double Ended Strip Lamps



3.5W 300 221mm, Opal	3.5W/DET21	0935431	8.10	1		
6W 500 284mm, Opal	6W/DET284	0935432	8.88	1		

Steeple Starters



Starters

4 - 65W Starter	FSU	0549092	0.69	1	0.44	10+
4 - 22W Starter	FS2	0549095	0.94	1	0.75	10+
70 - 125W Starter	FS125	0549101	1.97	1	1.52	10+
4 - 125W Electronic Starter	NEFS600	0552357	3.61	1	3.22	10+





2D LAMPS



LED 2D Retrofit Lamp

- Quickly replace fluorescent DD lamps with little or no rewiring
- Long life of 30,000h
- Optional 10% dimming corridor function Emergency Module
- Compatible with Kosnic LED DD lamps
- 3 hours rated duration
- Supplied with internal battery and all necessary leads and connectors



12W 1320 4 Pin	SKLED12STD/4P-W40	0893943	20.43	1	18.25	10+
12W 1200 4 Pin	SKLED12CRD/4P-W40	0893944	40.57	1	36.22	10+
LED Emergency Module	SKTC27EME-DD	0893945	36.88	1	33.54	10+



2D Retrofit Lamps

- Energy saving LED 2D Retrofit for direct replacement into most 2D fittings with little or no rewiring
- 40,000hr life
 - 50,000 switching cycles
 - 835 - 3500K white colour



2D Retrofit Lamps

8W 16W equivalent	8W/2D2PIN	1072467	7.74	1		
8W 16W equivalent	8W/2D4PIN	1072468	7.74	1		
16W 26W equivalent	16W/2D4PIN	1072469	9.99	1		



2D Lamps

- 10,000 hour life
- 5,000 switching cycles
- GR8 2-Pin cap
- 3500K white colour temperature
- Colour rendering index ≥82
- Not suitable for dimming
- 2 year warranty



16W 1050 2 Pin	CLC16W2PIN	0549903	2.85	1	2.73	10+
16W 1050 4 Pin	CLC16W4PIN	0549904	2.85	1	2.73	10+
28W 2050 2 Pin	CLC28W2PIN	0549923	3.30	1	3.01	10+
28W 2050 4 Pin	CLC28W4PIN	0549924	3.30	1	3.01	10+
38W 2700 4 Pin	CLC38W4PIN	0549926	3.34	1	3.09	10+

PL LAMPS



- 10,000 hour life
- 8,000 switching cycles
- G24d-2 2-Pin cap
- 4000K cool white colour temperature
- Colour rendering index ≥85
- Not suitable for dimming
- Recommended for indoor use only
- 2 year warranty



25W 2700 PLL Retrofit CW	25W/PLCCW	0935437	19.13	1	17.07	10+
8W 650 PLC Retrofit CW	8W/PLCCW	0967163	10.69	1	9.54	10+
12W 1020 PLC Retrofit CW	12W/PLCCW	0967164	12.10	1	10.79	10+

PL LAMPS



9W 600 PLS 2 Pin White	CLS9SW	0549848	1.81	1	1.57	10+
9W 600 PLS 2 Pin CW	CLS9SCW	0549846	1.81	1	1.57	10+
11W 830 PLS 2 Pin CW	CLS11SCW	0549847	1.81	1	1.57	10+
13W 900 D Type 2 Pin CW	CLD13SCW	0549865	3.78	1	3.28	10+
18W 1200 D Type 2 Pin W	CLD18SW	0549871	3.78	1	3.28	10+
18W 1200 D Type 2 Pin CW	CLD18SCW	0549864	3.78	1	3.28	10+
26W 1710 D Type 2 Pin W	CLD26SW	0549869	3.78	1	3.28	10+
26W 1710 D Type 2 Pin CW	CLD26SCW	0549870	3.78	1	3.28	10+
13W 900 DE Type 4 Pin W	CLDE13SW	0549868	3.78	1	3.28	10+
18W 1200 DE Type 4 Pin W	CLDE18SW	0549867	3.78	1	3.28	10+
26W 1710 DE Type 4 Pin W	CLDE26SW	0549866	3.78	1	3.28	10+
40W 3320 PLL 4 Pin CW	CLL40SCW	0549968	4.95	1	4.29	10+
55W 4510 PLL 4 Pin CW	CLL55SCW	0549970	5.09	1	4.32	10+

COMMERCIAL & DISCHARGE LAMPS



Commercial LED COB Lamps

- 50,000hr life
- Beam angle: 360°
- IP20
- Ambient temperature: -20°C to 50°C
- CRI: 80Ra
- Lamp efficacy: 110lm/W



20W ES LED 6000k 2200lm	SPLRTF074	0009235	23.25	1		
30W ES LED 6000k 3300lm	SPLRTF075	0009236	38.33	1		
40W ES LED 6000k 4400lm	SPLRTF076	0009237	41.45	1		
60W ES LED 6000k 6600lm	SPLRTF077	0009238	50.73	1		
80W GES LED 6000k 8800lm	SPLRTF078	0009239	78.55	1		
100W GES LED 6000k 11000lm	SPLRTF079	0009240	81.47	1		



SonEI Elliptical High Pressure Sodium



70W 6270 With Ignitor	70/SONEIHO	0623920	8.99	1		
-----------------------	------------	---------	-------------	---	--	--



Metal Halide Double Ended



70W 5200 HQI, White	HQITS70/W	0549980	10.25	1		
150W 11250 HQI, White	HQITS150/W	0549981	10.25	1		
150W 11250 HQI, Neutral	HQITS150/N	0549979	10.25	1		

Tubular GES Metal Halide



250W 21500 HQI/Son-in-1	HQI250DUAL	0549987	20.32	1		
400W 41000 HQI/Son-in-1	HQI400DUAL	0549986	20.32	1		

CAN'T FIND WHAT YOU ARE LOOKING FOR? CALL US, ASK IN BRANCH OR VISIT DENMANS.CO.UK



Heating & Ventilation

4 IN QUIET FAN + TIMER

Steeple

- Decibel Level of ONLY 16dB(A) at 3m
- An impressive extraction rate of 75m³/hr
- Low energy motor with a maximum consumption of 7 Watts
- Complete with integral backdraught shutters
- High quality, long life motors continuously rated and warranted for a minimum of 30,000 hours or 3 years



**ONLY
£43.34
EACH**

SSF4T 1219762

See page 90

DESIGNA 1KW LOT20 ALUMINIUM RADIATOR

DESIGNA



- 7 day integrated timer
- Colour changing LCD display
- Touch sensitive controls
- 100% Efficiency
- Energy-saving technologies such as Adaptive Start and Open Window Detection



**ONLY
£281.87
EACH**

DESAR100 1169530

See page 97

GREAT AVAILABILITY AND VALUE ON EVERYDAY ELECTRICALS

REDRING SHOWERS



8.5kw Pure Shower

Available in 8.5, 9.5 & 10.5kW

- ✓ 3 year Warranty
- ✓ Push Button Start/Stop
- ✗ Phased Shutdown
- ✗ Audible Alerts
- ✓ Multi 4 Water Connectivity
- ✓ Multi 3 Electrical Connectivity
- ✗ Digital Temperature Display
- ✓ 1 Bar Min Water Pressure

1 Showerhead Spray Pattern

8.5kw Glow Shower

Available in 8.5, 9.5 & 10.5kW

- ✓ 3 year Warranty
- ✓ Push Button Start/Stop
- ✓ Phased Shutdown
- ✗ Audible Alerts
- ✓ Multi 4 Water Connectivity
- ✓ Multi 3 Electrical Connectivity
- ✓ Digital Temperature Display
- ✓ 1 Bar Min Water Pressure

5 Showerhead Spray Pattern

Glow Thermostatic Shower

Available in 8.5, 9.5kW

- ✓ 3 year Warranty
- ✓ Push Button Start/Stop
- ✓ Phased Shutdown
- ✓ Audible Alerts
- ✓ Multi 4 Water Connectivity
- ✓ Multi 3 Electrical Connectivity
- ✓ Digital Temperature Display
- ✓ 1 Bar Min Water Pressure

5 Showerhead Spray Pattern

All Redring Showers are supplied with an onsite warranty!



**ONLY
£49.99
EACH**

PURE8.5 2501008376



**ONLY
£129.99
EACH**

GLOW8.5 2501008383



**ONLY
£214.61
EACH**

RGS8T 2501142135





Use this simple formula to convert from m³/hr to ltr/sec: Divide the m³/hr measurement by 3.6

cm/hr	70	80	90	100	110	120	130	140	150	200	250	300	350
ltr/sec	19.44	22.22	25.00	27.78	30.56	33.33	36.11	38.89	41.67	55.56	69.44	83.33	97.22

What the regulations say:

	Toilet/sanitary accommodation	6 l/sec (22m³/hr)
	Bathroom/shower room	15 l/sec (54m³/hr)
	Kitchen adjacent to hob	30 l/sec (108m³/hr)
	Kitchen without cooker hood	60 l/sec (216m³/hr)
	Utility room	30 l/sec (108m³/hr)

Building Regulations Approved Document F:

Ventilation (2010 Edition), stipulates the provision of adequate mechanical ventilation rates in non-habitable rooms such as toilets, bathrooms, shower rooms, kitchens and utility rooms in domestic dwellings.

Once you have chosen the correct size fan as far as the performance requirements are concerned, it's then important to pick the correct fan for the correct application.



Axial Fans:

These fans are perfect where you are ducting the fan straight through the wall or on a small length of ducting up to 1 metre.



Centrifugal Fans:

A centrifugal fan is ideal where you need ducting in excess of 1 metre up to 3 metres in length.



Inline Axial Fans:

Our standard Inline fans are ideal where you can fit the fans remotely and will perform up to a maximum 1.5 metres in ducting.



Inline Mixflo/Centrifugal Fans:

When you need to extract over a distance greater than 3m these fans should be used to ensure adequate performance is achieved.

4" FANS

Steeple 4" Axial Fans

- 85m³/hr
- Noise level: 41dB(A)
- IP44 (pullcord model IP24)
- Timer adjustable from 1-45 mins
- Complies with building regs



4" Axial Fans

4" IP24 Fan + Pullcord (85m ³ /hr)	SF4N	0549525	12.21	1	
4" IP44 Fan + Timer (85m ³ /hr)	SF4TN	0549526	12.94	1	11.22 3+
4" IP44 Fan + Humidistat (85m ³ /hr)	SF4HSN	0551394	44.68	1	39.63 3+
4" IP44 Fan + Shutter + Timer (85m ³ /hr)	SF4ESTN	0551392	44.02	1	38.67 3+
4" Window Fan + Pullcord + Internal Shutters	SF4ESPWN	0551392	44.02	1	38.67 3+

Steeple 4" Extra Low Voltage Fans + Transformer

- 85m³/hr
- Noise level: 41dB(A)
- IP44
- Totally safe ventilation for Zone 1 areas



4" Extra Low Voltage Fans + Transformer

4" SELV Fan (85m ³ /hr)	LVSF4N	0551389	42.10	1	36.77 3+
4" SELV Fan + Timer (85m ³ /hr)	LVSF4TN	0551398	52.25	1	46.29 3+
4" SELV Humidistat Fan (85m ³ /hr)	LVSF4HSN	0551403	77.85	1	



Punto 4" Fans

- Airflow 90m³/h
- Noise level 37.5db
- IPX4
- Timer 3-20min Adjustable
- Complies to Part F



Punto 4" Fans

M100/4 4" Fan with pull cord	D11641	1219904	19.54	1	
M100/4 4" Fan & Timer	D11211	1219905	13.77	1	
M100/4 4" Fan humidistat and timer	D11603	1219906	46.70	1	
M100/4 4" Fan with Auto Shutters & Timer	D11231	1219907	38.50	1	



Punto 4" Low Voltage Fans

- Airflow 90m³/h
- Noise level 37.5db
- IPX4
- Timer 3-20min Adjustable
- Complies to Part F



Punto 4" Low Voltage Fans

4" Low Voltage Fan (requires transformer)	D11203	1219910	18.36	1	
Transformer for 11203 with Pull Cord	D22152	1219911	24.79	1	
Transformer for 11203 with timer	D22151	1219912	33.59	1	
Transformer for 11203 with timer & humidistat	D22157	1219913	57.27	1	

AIRFLOW 4" ICON Fans

- 76m³/hr (ICONECO15)
- 118m³/hr (ICON30)
- Noise level: 35dB(A)
- IPX4



4" ICON Fans

4" IPX4 Eco Fan (67m ³ /hr)	ICONECO15	0393034	54.11	1	51.05 2+
4" Utility Fan (118m ³ /hr)	ICON30	0151802	107.36	1	101.28 2+
iCON Pull Cord Module	PCM	0151812	14.07	1	13.28 2+
iCON Timer Module	TM	0151813	15.01	1	14.16 2+
iCON Timer/Humidistat Pull Cord Module	HTM	0592478	38.92	1	36.72 2+

Xpelair 4" Axial Fans

- 76m³/hr
- Noise level: 35dB(A)
- IPX5 (except DX100IPR IPX4)
- BEAB approved



4" Axial Fans

4" Window Fan + Pullcord + Internal Shutters	DX100	0079981	27.51	1	
4" Wall Fan + Timer + Mount Kit (76m ³ /hr)	DX100T	0079990	35.84	1	



TRUSTED BRANDS AVAILABLE



4" FANS



4" Quiet Fans

- 75m³/hr
- Noise level: 27dB(A)
- IP44 (pullcord model IP24)
- Complies with both Part F & L
- 60% quieter and 75% more efficient than Steeple equivalent



4" Quiet Fans

4" IP44 Quiet Fan - Standard (75m ³ /hr)	QF100S	0549527	30.09	1	27.38	3+
4" IP24 Quiet Fan + Pullcord (75m ³ /hr)	QF100P	0551349	32.84	1	29.29	3+
4" IP24 Quiet Fan + Timer (75m ³ /hr)	QF100T	0551350	35.02	1	32.09	3+
4" IP44 Quiet Fan + Humidistat (75m ³ /hr)	QF100H	0551351	47.94	1	42.76	3+

Steeple 4" Silent Fan

- Decibel Level of ONLY 16dB(A) at 3m
- An impressive extraction rate of 75m³/hr
- Low energy motor with a maximum consumption of 7 Watts
- Complete with integral backdraught shutters
- High quality, long life motors continuously rated and warranted for a minimum of 30,000 hours or 3 years



4" Silent Fan

4" Silent Conceal Fan	SSF4	1219761	39.59	1	
4" Silent Conceal Fan with Timer	SSF4T	1219762	43.34	1	

MANROSE 4" Continuum Fans

- Continuous running axial fan
- Trickle = 8 l/s, Boost = 15l/s
- Noise level: 15dB(A)
- IPX4
- Only 3.5W on trickle
- Modern design, flat, tile-like front cover
- Complies with both Part F & L
- 60% quieter and 75% more efficient than Steeple equivalent



4" Continuum Fans

4" IPX4 Continuum Fan + Timer (54m ³ /hr)	CRA100T	0805965	96.51	1	
--	---------	---------	-------	---	--

Vent-Axia 4" Silent Fans

- 75m³/hr (54m³/hr low speed)
- Noise level: 16dB(A)
- IP44
- Complies with both Part F & L



4" Silent Fans

4" Silent Fan - Standard (75m ³ /hr)	VASF100B	0423137	57.50	1	54.22	3+
4" Silent Fan + Timer (75m ³ /hr)	VASF100T	0423155	69.90	1	66.01	3+



4" Quiet Fan IPX5 range

IPX5 compliant. IEE Regulations (UK) allow for IX5 240V fans to be installed into zone 1 without the need for low voltage transformer, making this comprehensive range ideal for bathrooms and toilets



4" Quiet Fans

4" Standard IPX5 Extractor Fan	SQF100SX5	1093149	36.77	1	32.08	3+
4" Timer IPX5 Extractor Fan	SQF100TX5	1093151	36.77	1	32.08	3+
4" Humidistat IPX5 Extractor Fan	SQF100HX5	1093152	49.69	1	45.56	3+



Punto 4" Quiet Fans

- Airflow 90m³/h
- Noise level 26.9db
- IP45
- Timer 3-20min Adjustable
- Complies to Part F



Punto 4" Quiet Fans

4" Quiet Fan + Timer	D11314	1219908	35.15	1	
4" Quiet Fan with Timer & Humidistat	D11262	1219909	88.12	1	



4" Mayfair Fan

- 79m³/hr
- Noise level: 38.8dB(A)
- IP21



4" Mayfair Fan

4" Single Speed Fan + Timer (79m ³ /hr)	MAY202B	0022692	214.78	1	
--	---------	---------	--------	---	--

HOW MANY DECIBELS? HERE'S A SIMPLE GUIDE

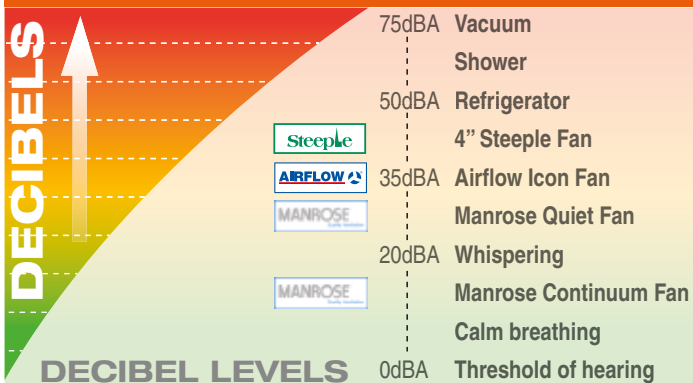

THE DENMANS APP

Save time on the move by downloading the simple to use App



Click & Collect in as little as 1 min



Call your local branch



Visit your local branch



5" FANS

Steeple 5" Axial Fans

- 131m³/hr
- Noise level: 41dB(A)
- IPX4
- Suitable for utility rooms



5" Axial Fans

5" IPX4 Axial Fan (131m ³ /hr)	SF5N	0551386	23.57	1	20.80	3+
5" IPX4 Axial Fan + Timer (131m ³ /hr)	SF5TN	0551388	30.10	1	26.56	3+

6" FANS

Steeple 6" Axial Fans

- 230m³/hr
- Noise level: 40dB(A)
- IP44
- Suitable for kitchens



6" Axial Fans

6" IP44 Fan (230m ³ /hr)	SF6N	0551390	34.79	1	32.09	3+
6" IP44 Fan + Pullcord (230m ³ /hr)	SF6PN	0551391	39.48	1	35.85	3+
6" IP44 Fan + Timer (230m ³ /hr)	SF6TN	0551355	40.17	1		
6" IP44 Fan + Shutter + Timer (230m ³ /hr)	SF6ESTN	0551395	48.70	1	43.74	3+
6" IP44 Fan + Humidistat (230m ³ /hr)	SF6HSN	0551402	48.09	1	43.87	3+
6" IP44 Window/Wall Fan + Pullcord (230m ³ /hr)	SF6ASWN	0551400	55.43	1	50.56	3+

AIRFLOW 6" Icon Kitchen Fan

- 260m³/hr max
- Noise level: 44.6dB(A)
- IPX4



6" Axial Fans

6" IPX4 Icon Kitchen Fan (260m ³ /hr)	ICON60	0151803	113.37	1		
--	--------	---------	---------------	---	--	--



Punto M150/6" Kitchen Fans

- Airflow 335m³/h
- Noise level 46db
- IPX4
- Timer 3-20min
- Complies to Part F



Punto M150/6" Kitchen Fans

M150/6" Kitchen Fan	D11401	1219914	38.57	1		
M150/6" Kitchen Fan with pull cord	D11851	1219915	39.67	1		
M150/6" Kitchen Fan with Timer	D11411	1219916	42.63	1		
6" Kitchen Fan with Timer and Humidistat	D11693	1219917	66.09	1		
M150/6" Kitchen Fan with Auto Shutters	D11431	1219918	57.00	1		

9" AND 12" FANS

Steeple 9" Axial Fan

- 668m³/hr
- Noise level: 50dB(A)
- IP44



12" Axial Fan

- 1100m³/hr
- Noise level: 60dB(A)
- IP44



9" AND 12" FANS

9" IP44 Axial Commercial Fan* (668m ³ /hr)	SF9N	0551406	152.57	1		
12" IP44 Axial Commercial Fan* (1100m ³ /hr)*	SF12N	0551354	238.63	1		
Wall Mounting Kit for SF9N	1291	0552203	22.27	1		
Wall Mounting Kit for SF12N	1292	0552204	27.91	1		
Controller for SF9N & SF12N	SFC	0551356	51.24	1		

* Wall mounting kit required, see below

4" CENTRIFUGAL FANS

Steeple 4" Centrifugal Fan

- 90m³/hr
- Noise level: 42dB(A)
- IP44
- Designed to move air over longer distances



4" Centrifugal Fan

4" IP44 Fan + Humidistat (85m ³ /hr)	CENTRFANTN	0551397	39.84	1	35.54	3+
---	------------	---------	--------------	---	--------------	----

AIRFLOW 4" Centrifugal Fan

- 111m³/hr
- Noise level: 58dB(A)
- IPX4



4" Centrifugal Fan

4" New Style Centrifugal Fan (111m ³ /hr)	71766401	0000618	105.15	1	99.20	3+
--	----------	---------	---------------	---	--------------	----



4" Centrifugal Fan

- Airflow 70m²/h
- Noise level 40db
- IPX4
- Timer 3-20min
- Complies to Part F



4" Centrifugal Fan

Ariett 4" Centrifugal Fan + Timer	D11976	1219919	34.20	1		
-----------------------------------	--------	---------	--------------	---	--	--

COOKER HOODS



WE HAVE A WIDE RANGE OF COOKER HOOD DESIGNS AVAILABLE TO ORDER. Ask your branch FOR FURTHER DETAILS!



Denmans Own Brand

- Tried and tested quality – approved by the trade
- Exclusive to us



Check live stock availability

Simply Visit:

www.denmans.co.uk

INLINE FANS

Steeple 4" Axial Fans 4" IP44 Shower Fans

- 85m³/hr
- Noise level: 41dB(A)
- IP44
- Inline installation for remote locations



4" Axial Fans 4" IP44 Shower Fans

4" IP44 Shower Fan (85m ³ /hr)	SDUCTFN	0551384	30.49	1	26.74	3+
4" IP44 Shower Fan + Timer (85m ³ /hr)	SDUCTFTN	0551387	29.08	1	24.99	2+

Steeple 4" IP44 LED Shower Fan Light Kit

- 85m³/hr
- Noise level: 40dB(A)
- IP44
- Complies with both Part F & L
- Inline axial fan
- Low 3W LED MR16 lamp



4" IP44 LED Shower Fan Light Kit

4" IP44 LED Shower Fan Light Kit (85m ³ /hr) - includes: LED Driver, 1x length ducting, External Wall Grille, Fixing Screws, plugs & straps, 2x bezels	TFANLITLED	0606750	67.44	1	58.28	2+
---	------------	---------	-------	---	-------	----

Steeple 4" Centrifugal Inline LED Shower Fan

- 110m³/hr
- Noise level: 45dB(A)
- IP44
- Low 3W LED MR16 lamp



4" Centrifugal Inline LED Shower Fan

4" Inline LED Showerlite Kit (110m ³ /hr)	TCFLITLED	0852037	86.20	1		
--	-----------	---------	-------	---	--	--



4" Lineo Duct Fans

- 255m³/hr
- Noise level: 39.4dB(A)
- IP44



4" Lineo Duct Fans

4" Duct Fan (255m ³ /hr)	DLIN100	0576532	61.45	1	54.99	2+
4" Duct Fan+ Timer (255m ³ /hr)	DLIN100T	0576533	68.85	1	58.65	2+

Steeple 4" Inline Centrifugal Duct Fans

- 110m³/hr
- Noise level: 45dB(A)
- IP44
- High pressure over longer lengths of ducting



4" Inline Centrifugal Duct Fans

4" Inline Centrifugal Duct Fan (110m ³ /hr)	SM50S	0636999	35.43	1	29.50	3+
4" Inline Centrifugal Duct Fan + Timer (110m ³ /hr)	SM50T	0637000	36.91	1	32.50	3+



6" Inline Duct Fans

- 550m³/hr max
- Noise level: 50.5dB(A)
- IP44



6" Inline Duct Fans

6" Lineo Duct Fan (550m ³ /hr - max.)	DLIN150	0853507	75.06	1	67.45	2+
6" Lineo Duct Fan + Timer (550m ³ /hr - max.)	DLIN150T	0853508	81.18	1	74.15	2+

Steeple 4" Mixflo Fans

- 244.8m³/hr (high speed)
- Noise level: 24dB(A)
- IPX4
- BEAB approved
- Complies with part F&L
- 3 speed options
- ERP compliant



4" Mixflo Fans

4" Mixflo Fan (244.8m ³ /hr)	SMF100S	0549517	55.43	1	51.35	3+
4" Mixflo Fan + Timer (244.8m ³ /hr)	SMF100T	0549520	57.70	1	52.42	3+

EASY, CONVENIENT & SAVES THE PLANET



Simply scan the QR code to download the brochures to view anytime, anywhere!



VENTILATION ACCESSORIES

Steeple Doorswitch

- cabinet, push to break, autoswitch
- Momentary push switch: push to break contacts
- Switching 1 Amp Max (250V)



Doorswitch

Doorswitch	DXS63W	0551163	6.21	1		
------------	--------	---------	------	---	--	--

Steeple Light Grilles

- Suitable for use with the fans and ventilation
- Includes LED driver, fitted LED lamp and grille + 2x bezels
- With white/chrome finish
- IP44



Light Grilles

4" IP44 LED Light Diffuser (includes: LED Driver, fitted LED lamp, grille + 2x bezels: white/chrome)	LEDLITEGRILL	0874282	33.93	1	29.93	3+
--	--------------	---------	-------	---	-------	----





VENTILATION ACCESSORIES

Steeple 4" Ducting



4" Ducting				
A.	4" x 3m PVC Ducting	SD4/3N	0549493	5.70 1
B.	4" x 10m PVC Ducting	SD4/10N	0549496	15.85 1
C.	4" x 45m PVC Ducting	SD4/45N	0549509	37.01 1
D.	4" x 10m Insulated Ducting	SD10M/INS	0549507	31.71 1
E.	4" x 3m Aluminium Ducting	1010	0081341	17.67 1

5" Ducting				
	5" x 3m PVC Ducting	SD5/3N	0549494	9.00 1

6" Ducting				
	6" x 3m PVC Ducting	SD6/3N	0549495	9.78 1

Steeple 4" Fan Duct Accessories



4" Fan Duct Accessories				
A.	100mm PVC Duct x 350mm	41350	0036551	2.72 1
B.	100mm PVC Duct x 1m	41900	0036564	7.49 1
C.	100mm PVC Duct x 2m	42000	0183670	14.78 1
D.	100mm 90° Bend	44900	0168924	3.37 1
E.	100mm T Piece for Rigid Ducting	44920	0168922	5.18 1
F.	Round to Rectangular 90° Bend	SFD300	0792493	3.55 1
G.	100mm Condensation Trap	1440	0039766	16.47 1
H.	5" to 4" Reducer	54119	0168933	2.96 1
I.	6" to 5" Reducer	65118	0168944	3.01 1
J.	Delux Quick Fit Wall Kit - White Grille	DHRIWKW	0964441	23.76 1
K.	Delux Quick Fit Wall Kit - Black Grille	DHRIWKB	0964442	23.76 1
L.	Delux Quick Fit Wall Kit c/w Back Draught Shutter White	DHRIWKWBS	0964443	28.47 1
M.	Delux Quick Fit Wall Kit c/w Back Draught Shutter Brown	DHRIWKBBS	0964444	28.47 1

Steeple FLAT DUCTING AND ACCESSORIES AVAILABLE - ASK YOUR BRANCH!

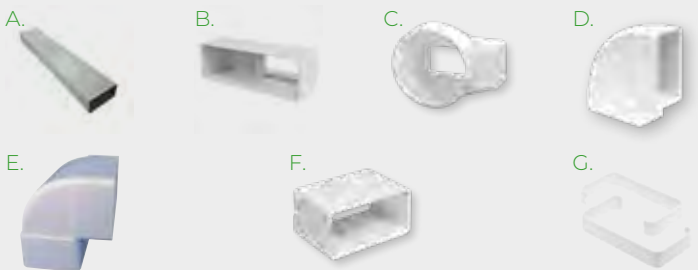

Flat Ducting				
A.	110 x 54mm 1.5m length Flat Ducting	SFD150	0792491	6.81 1
B.	Female Airbrick Adaptor	SFD770	0792497	3.38 1
C.	Female to 100mm Round Connector	SFD701	0792496	3.55 1
D.	90° Female Horizontal Bend	SFD500	0792494	3.18 1
E.	90° Female Vertical Bend	SFD600	0792495	2.81 1
F.	Flat Duct Female Connector	SFD200	0792492	1.37 1
G.	Flat Duct Fixing Bracket	SFD220	0792498	0.72 1

Steeple 4" Fan Accessories



4" Fan Accessories				
A.	4" Backdraught Shutter White	SBDRAUGH4N	0551368	6.72 1
B.	4" Gravity Shutter Terracotta	SG4/TERN	0551361	3.44 1
C.	4" Gravity Shutter White	SG4N	0551365	3.44 1
D.	4" Gravity Shutter Brown	SG4/BROWNN	0551366	3.44 1
E.	4" Gravity Shutter Black	SG4/BLN	0591201	3.98 1
F.	4" Grille White	SGRIL4/WHN	0551364	3.44 1
G.	4" Fixed Grille Terracotta	SGRIL4/TEN	0551363	3.44 1
H.	4" Fixed Grille Brown	SGRIL4/BRN	0551362	3.44 1
I.	4" Fixed Grille Black	SGRIL4/BLN	0563873	3.44 1
J.	4" Wall Cowl White	SCOVER4WHN	0551367	4.80 1
K.	4" Circular Grille White	SCIRVENT4N	0551379	5.60 1
L.	4" Grille White	SGRILCIR/C	0551381	11.51 1
M.	4" Grille Chrome	FANCOVERCN	0551378	9.21 1
N.	4" Duct Connector	SDUCTCON4N	0551360	3.44 1
O.	4" Plastic Y" Duct Piece	SYPIECEN	0551382	2.96 1

Steeple 5" Fan Accessories



5" Fan Accessories				
A.	5" Gravity Shutter White	SG5/WHN	0551371	9.54 1
B.	5" Grille White	SGRIL5/WHN	0551374	9.54 1
C.	5" Gravity Shutter Brown	SG5/BRN	0551369	9.54 1
D.	5" Grille Brown	SGRIL5/BRN	0551372	9.54 1

Steeple 6" Fan Accessories



6" Fan Accessories				
A.	6" Gravity Shutter White	SG6N	0551375	8.27 1
B.	6" Gravity Shutter Brown	SG6/BRN	0582345	8.27 1
C.	6" Fixed Grille Brown	SGRIL6/BRN	0582344	8.27 1
D.	6" Gravity Shutter Terracotta	SG6/TERN	0551380	8.27 1
E.	6" Fixed Grille Terracotta	SGRIL6/TEN	0551376	8.27 1
F.	VENTILATION ACCESSORIES	SGRIL6/WHN	0551377	8.27 1



WHOLE HOUSE VENTILATION



3 Speed AC Whole House Ventilation Unit

- Up to 500m³/hr
- Noise level: 48dB(A)
- Can extract from up to 5 wet rooms simultaneously



3 Speed AC Whole House Ventilation Unit

ManiVent Whole House Ventilation System (240m ³ /hr low, 362m ³ /hr med, 500m ³ /hr high)	MANI3000	0292904	152.95	1
--	----------	---------	---------------	---



Centralised Continuous Ventilation Unit

- 385m³/hr
- Noise level: 32dB(A)
- Universal unit - between 2 & 5 bath/shower/utility rooms
- Unit c/w 2x 80mm spigots
- Now includes controller



PENTA House Ventilation System

Centralised Continuous Ventilation Unit (PENTA accessories and ducting sold separately)	12103	1180273	138.42	1
Spare PENTA 30m ³ Spigot	22325	0205694	11.50	1
10m 80mm Aluminium Ducting	46531	0065371	25.90	1

POSITIVE PRESSURE UNITS



Positive Pressure Units

- Flat Unit 129.6m³/hr
- Loft Unit 226.8m³/hr
- Noise level: 32dB(A)
- Brings fresh filtered air continuously into property, reducing condensation



Positive Pressure Units

Flat Unit (129.6m ³ /hr)	SMPPS/F	0631690	343.64	1
Loft Unit (226.8m ³ /hr)	SMPPS/L/H	0631691	343.64	1

HEAT RECOVERY



Whole House Heat Recovery Unit

- Weights only 24kg
- Tool free filter access
- Accessible condensate connection
- External controllers and sensors available
- Vertical or horizontal duct connections
- Up to 94% heat recovery



Whole House Heat Recovery Unit

Low Watt Whole House Heat Recovery Unit (Left Handed)	HR6000PL	1095378	1484.29	1
Low Watt Whole House Heat Recovery Unit (Right Handed)	HR6000PR	1095379	1484.29	1



Whole House Heat Recovery System

- 280m³/hr
- Noise level: 31dB(A)
- Provides powerful extraction while still maintaining 91% heat recovery



Whole House Heat Recovery System

Low Watt Whole House Heat Recovery System	MANHR4500DC	0337023	1167.00	1
---	-------------	---------	----------------	---

UNDERFLOOR HEATING



Classic Heating Mats
Ideal for refurbishment projects in existing dwellings or in new-build extension projects, either as direct floor heating or as floor storage heating.
0.5m wide.



150W/m² for Concrete Floors

1.0m ² Area, 150W Heating Load	150MH1.0	0643173	40.59	1
1.5m ² Area, 225W Heating Load	150MH1.5	0643175	46.35	1
2.0m ² Area, 300W Heating Load	150MH2.0	0643176	54.58	1
3.0m ² Area, 450W Heating Load	150MH3.0	0643177	72.11	1
4.0m ² Area, 600W Heating Load	150MH4.0	0779075	101.97	1
5.0m ² Area, 750W Heating Load	150MH5.0	0779076	123.59	1
10.0m ² Area, 1500W Heating Load	150MH10.0	0779077	216.28	1

200W/m² for Concrete Floors & High Heat Loss Areas

1.0m ² Area, 200W Heating Load	200MH1.0	0643178	39.35	1
2.0m ² Area, 400W Heating Load	200MH2.0	0643179	68.17	1
3.0m ² Area, 600W Heating Load	200MH3.0	0643180	93.44	1
5.0m ² Area, 1000W Heating Load	200MH5.0	0643174	141.41	1
10.0m ² Area, 2000W Heating Load	200MH10.0	1009834	306.53	1

THERMOSTATS



Easy to use floor sensing thermostat packed with innovative features to optimise comfort and minimise running costs. 'MyHeat Touch' is compatible with various sensors, not only MyHeat.



Thermostats

'MyHeat Touch' Thermostat *White (W), Black (B), Silver (S)	MH3500W	0643168	70.04	1
15A Analogue Thermostat	MH3131	0643169	45.33	1
16A Fully Programmable Thermostat & Programmer	MH3232	0643170	55.62	1

THERMAL INSULATION

Thermal insulation must be laid before installing radiant underfloor heating system.



Thermal Insulation

6mm thick Backer Board, 1250 x 600mm (Area 0.75m ²)	MHTBB06	0643171	11.84	1
10mm thick Backer Board, 1250 x 600mm (Area 0.75m ²)	MHTBB10	0643172	11.84	1

MIRROR DE-MISTERS

The simple solution to a misted up mirror! Installed behind your mirror and connected to the bathroom lighting circuit you can view a clear mirror even if the bathroom is full of steam. Will fit on most types of mirror.



Mirror De-Misters

252 x 274mm 12.5W De-mister	MH1306	0550869	19.84	1
574 x 274mm 25W De-mister	MH1307	0550870	24.41	1
519 x 524mm 50W De-mister	MH1308	0550871	29.00	1
1004 x 524mm 100W De-mister	MH1309	0550872	38.14	1





TRUSTED BRANDS AVAILABLE



Also Available:

Cable Kits: Offers the versatility of a choice of cable spacing to provide the appropriate power rating and suits rooms with irregular floor areas where a heating mat might be awkward to lay. Don't forget to choose your stat!

Radiant Heating Film: The modern and easy way to install comfortable floor heating systems that last for decades, requires no maintenance and provides significantly lower running costs than alternative heating systems.

ASK YOUR BRANCH FOR MORE INFORMATION

We have various options available, so whatever your underfloor heating needs, we have the solution that's right for you!

CONVECTOR HEATERS



2kW Convector Heaters



WHILE STOCKS LAST

2kW Convector Heaters

Standard	DCONVECTSTD	1009818	24.02	1	23.18	3+
Standard with Timer	DCONVECTTIM	1009819	28.40	1	27.36	3+
Turbo	DCONVECTFAN	1009820	30.59	1	29.52	3+
Standard	HCONH	0823558	20.14	1		

OIL FILLED RADIATORS



- Integral cable and plug storage facility
- Fitted with 1.5m flex and plug top
- Power indicator light
- Multi-directional castors



OIL FILLED RADIATORS

1.5kW	DOILH157	1009821	41.40	1	37.69	3+
2kW	DOILH211	1009822	38.90	1		
2kW with Timer	DOILH211TIM	1009823	51.75	1	48.50	3+

FAN HEATERS



2kW Downflow Heaters



2kW Downflow Heaters

1-2kW	DFH2KW	1123231	35.03	1	31.64	3+
-------	--------	---------	-------	---	-------	----



Downflow Heater



Downflow Heater

Heater with 30min run-back timer	SFX20VE	1145665	39.99	1		
----------------------------------	---------	---------	-------	---	--	--



Fan Heater



Fan Heater

2kW Fan Heater	FH201	0667679	13.52	1	11.90	3+
----------------	-------	---------	-------	---	-------	----

TOWEL RAILS



Curved Ladder Style Towel Rail

Dimensions in mm: 860 (H) x 530 (W) x 140 (WD)
Weight: 2.9kg



Curved Ladder Style Towel Rail

100W Ladder Towel Rail 860x530	AQ100LC	0967230	81.50	1		
--------------------------------	---------	---------	-------	---	--	--



TR range towel rails are permanently liquid filled for maintenance free operation. No plumbing, no problems.



60W, Chrome 615(h)x530(w)x93(d)	TTRC90	0662206	93.85	1		
100W, White 616(h)x533(w)x93(d)	TTRS120	0662209	71.09	1		
90W Chrome 530(h) x 615(w) x 93mm(d)	TTRC130	0662207	114.97	1		



S' Shape Wall Mounting Towel Rail

Dimensions in mm: 645 (H) x 500 (W) x 110 (WD)
Weight: 1.6kg

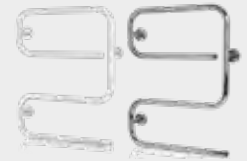

S' Shape Wall Mounting Towel Rail

Chrome finish 50W, IP21	AL50SC	0804445	36.59	1		
White finish 80W, IP21	AL80SW	0804444	26.86	1		

10.28 PORTABLE AIR CONDITIONER UNITS



- Floor Mounting
- Remote Control
- Domestic and commercial applications



Portable Air Conditioner 9000 BTU	AC12P	1310688	245.00	1		
Portable Air Conditioner 12000 BTU	AC9P	1310689	220.00	1		

PLUG-IN TIMER



- Rated 13A
- 36 On / 36 Off
- 24 Hr Timer
- Manual Override



24 Hour Plug-In Timer	SPIT24M	0979604	5.69	1		
-----------------------	---------	---------	------	---	--	--



- Rated Switching: 13A (4A)
- 48 On / 48 Off
- 15 Min Increment
- Manual Override Switch



24hr Timed Socket	TS70A-C	0337968	28.43	1		
-------------------	---------	---------	-------	---	--	--



Ecodesign products are compliant with Lot20 regulations.
For more information ask in branch or see www.lot20.co.uk

TUBULAR HEATERS & WIRE GUARDS

Dimplex Tubular Heaters with Integral Thermostat, IPX4



Ideal for applications which require safe, low-wattage background heating for localised frost protection or as window de-misters.

Tubular Heaters with Integral Thermostat, IPX4

1ft 40W Tubular Heater	DTH1FT	0807220	14.20	1
2ft 80W Tubular Heater	DTH2FT	0807221	23.77	1
3ft 120W Tubular Heater	DTH3FT	0807222	27.90	1
4ft 160W Tubular Heater	DTH4FT	0807223	32.26	1

C. AIANO & SONS

Guards for Tubular Heaters



Guards for Tubular Heaters

1ft Tubular Heater Guard	STG11	0795882	19.50	1
2ft Tubular Heater Guard	STG21	0795885	24.95	1
3ft Tubular Heater Guard	STG31	0795889	34.00	1
4ft Tubular Heater Guard	STG41	0795893	28.23	1

SCREEN HEATERS (OVERDOOR)

Steeple



3kW Screen Heater, pre-wired with 1.25m mains cable, 1.5kw/3kw output, illuminated switch & cold air flow option. Easy installation.	DSH3WH	0551042	90.22	1
--	--------	---------	-------	---

Dimplex Tubular Heaters with Integral Thermostat, IPX4



Overdoor Heater	AC3N	0144836	157.93	1
-----------------	------	---------	--------	---

LARGER HEATERS AVAILABLE TO ORDER
ASK YOUR BRANCH FOR DETAILS

FROST PROTECTION HEATER



500W Frost Protector

- Wall mounting (bracket included)
- Adjustable stat
- Pre-wired with 1.5m flex and BS plug
- Safety Overheat temperature protection.
- For heating smaller spaces or frost protection in larger areas.
- IPX0 rated
- Metal body with plastic end caps



500W Frost Protector	500W Frost Protector	SFW500Z	1139196	24.98	1
----------------------	----------------------	---------	---------	-------	---

Steeple

Plinth Heater (Brown/White & Stainless Steel Fascias)

- Quiet running
- 2400W (2.4KW)
- Pressed steel construction
- Airflow 0.85m³/min
- Pre-wired with 1.5 metre of mains lead
- 800W fan only, 1600W half heat and fan, 2400W full heat and fan
- Three fascias included: brown, white & stainless steel
- IP20 Rated



Plinth Heater (Brown/White & Stainless Steel Fascias)	2.4kW	DPFH2400	0551044	107.09	1	102.00	3+
---	-------	----------	---------	--------	---	--------	----

PATIO HEATERS



- Gold lamp
- Weatherproof for outdoor use
- Silent operation
- Stylish, lightweight aluminium construction
- Lasts an average of 7000 hours
- Wall mounted – secure bracket included
- Side reflectors for added heat output and efficiency
- Instantaneous cost effective heating



1.5kW IP24 Quartz Heater	SK1500	0874283	78.65	1
--------------------------	--------	---------	-------	---

Dimplex

- Energy saving
- Low running costs
- For permanent external installations with IPX4
- High quality aluminium construction
- Rugged design for commercial or domestic settings
- Single element 2kW halogen model with Philips element
- Adjustable wall bracket fitted as standard
- Optional fixing kit for parasol or hung mounting arrangements

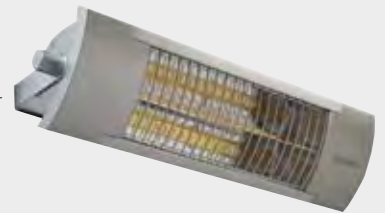

1.3kW IP24 Infra-red	OPH13	0222697	106.94	1
2kW IP24 Halogen	OPH20	0222718	177.39	1

INFRARED HEATERS

Dimplex

- Choice of heat outputs (0.60 / 1.20kW)
- Designed to provide rapid beamed warmth
- Adjustable beam angle to direct heat where it's needed
- IP24 rated
- Pull cord operation

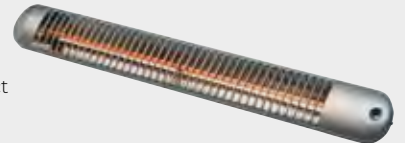

INFRARED HEATERS	1.2/0.6kW WALL HEATER	IRX60/120E	1143486	49.34	1
------------------	-----------------------	------------	---------	-------	---

PIPE FREEZE PROTECTION

MYHEAT® Pipe Freeze Protection, c/w 13A plug

- Protects hot and cold water pipework that may be subject to freezing conditions
- A simple low cost solution for the prevention of burst pipes
- Suitable for both metal and plastic pipe up to 50mm in diameter
- Ready made unit fitted with a 1.5m cold lead and a 3-pin plug
- Integrated thermostat energises system when temperature falls below +3°C
- Frost protection for pipes
- IP66 rating
- Maintenance free



Pipe Freeze Protection, c/w 13A plug	2m 20W	PFP2	0933582	51.22	1
	3m 30W	PFP3	0933583	53.73	1
	4m 40W	PFP4	0933584	55.38	1
	6m 72W	PFP6	0933585	60.66	1
	10m 136W	PFP10	0933586	71.63	1





PANEL HEATERS



Panel Heaters - LOT20

- Lot 20 compliant
- Slim, compact and light design in corrosion resistant powder coated body.
- Highly efficient sheathed heating element with aluminium diffuser
- Easy to install using wall mounting bracket (pre-fitted)
- LCD digital control with adjustable thermostat & 24Hr/7Day programmable timer - moulded at rear on side
- Silent operation with instant, even flow of heat and overheat thermal safety protection cutout



Panel Heaters - LOT20

1Kw H400 x W500 x D85mm	PH1TIM/LCDN	1267132	79.95	1	
1.5Kw H400 x W640 x D85mm	PH1.5TIM/LCDN	1267133	89.92	1	
2Kw H400 x W940 x D85mm	PH2TIM/LCDN	1267134	104.95	1	



Panel Heaters - LOT20

- Quiet, convection heating. Moves warm air quickly and evenly without a fan. High performance in a compact design.
- Digitally controlled
- 7 day programmable
- Open window detection
- Slimline design
- Frost protection



Panel Heaters - LOT20

0.75kW H430 x W620 x D108	DESPH075E	1096449	114.47	1	107.95	3+
1.25kW H430 x W690 x D108	DESPH125E	1096450	124.21	1	118.25	3+
1.5kW H430 x W690 x D108	DESPH150E	1096451	132.98	1	121.53	3+
2kW H430 x W860 x D108	DESPH200E	1096452	139.16	1	129.89	3+
3kW H430 x W860 x D115	DESPH300E	1096453	156.72	1	149.20	3+

ELECTRIC RADIATORS



Electric Aluminium Radiators

- 7 day integrated timer
- Colour changing LCD display
- Touch sensitive controls
- 100% Efficiency
- Energy-saving technologies such as Adaptive Start and Open Window Detection



Electric Aluminium Radiators

0.33KW Aluminium Radiator	DESAR033	1169527	194.62	1	175.16	2+
0.5KW Aluminium Radiator	DESAR050	1169528	205.49	1	184.93	2+
0.75KW Aluminium Radiator	DESAR075	1169529	246.83	1	222.13	2+
1KW Aluminium Radiator	DESAR100	1169530	281.87	1	253.68	2+
1.5KW Aluminium Radiator	DESAR150	1169531	363.38	1	327.04	2+
2KW Aluminium Radiator	DESAR200	1169532	402.32	1	362.10	2+

ELECTRIC RADIATORS



Oil Filled Designer Electric Radiators

Simple to install and easy to use these quality radiators provide the comfort of radiant and convected heat. 24hr Digital Control, White (Dimensions in mm).



Dry Technology Designer Electric Radiators

0.5kW, H580 x W415 x D100	RF4EPLUS	1123216	235.16	1	216.29	3+
0.75kW, H580 x W575 x D100	RF6EPLUS	1123188	286.06	1	264.68	3+
1kW, H580 x W735 x D100	RF8EPLUS	1123189	333.76	1	308.84	3+
1.25kW, H580 x W895 x D100	RF10EPLUS	1123190	384.14	1	356.24	3+
1.5kW, H580 x W1055 x D100	RF12EPLUS	1123191	437.96	1	404.71	3+
2kW, H580 x W1215 x D100	RF14EPLUS	1123192	489.47	1	452.18	3+



Dry Technology Designer Electric Radiators

Simple to install and easy to use these quality radiators provide the comfort of radiant and convected heat. 24hr Digital Control, White (Dimensions in mm).



Dry Technology Designer Electric Radiators

0.5kW, H580 x W415 x D125	RX4EPLUS	1123199	261.92	1	237.59	3+
0.75kW, H580 x W575 x D125	RX6EPLUS	1123200	285.15	1	258.66	3+
1kW, H580 x W735 x D125	RX8EPLUS	1123201	329.42	1	298.82	3+
1.25kW, H580 x W895 x D125	RX10EPLUS	1123202	363.92	1	330.12	3+
1.5kW, H580 x W1055 x D125	RX12EPLUS	1123203	397.49	1	360.57	3+
2kW, H580 x W1215 x D125	RX14EPLUS	1123204	438.95	1	398.18	3+

STORAGE HEATERS



Oil Filled Designer Electric Radiators

- Digitally controlled
- 7 day programmable
- Fan assisted
- Open window detection
- New slimmer profile
- 2 year Warranty



Storage heaters use inexpensive off-peak electricity to store heat in a core of high density bricks. They release heat slowly and are designed to keep you warm for the whole day. Storage heaters use inexpensive off-peak electricity to store heat in a core of high density bricks. They release heat slowly and are designed to keep you warm for the whole day. NOTE: New storage heaters require a dual supply.

Auto Night Storage Heaters

0.5kW	DESE050	1096444	362.47	1	338.38	3+
0.7kW	DESE070	1096445	389.52	1	363.55	3+
1KW	DESE100	1096446	435.31	1	414.41	3+
1.25kW	DESE125	1096447	484.68	1	452.37	3+
1.5kW	DESE150	1096448	524.03	1	489.10	3+



Quantum Storage Heaters

- Stylish, compact design for unobtrusive heating
- Adapts to the your requirements to save energy
- Up to 27% cheaper to run than a standard storage heater system*
- Easy-to-use controls
- Boost element to ensure heat is always available



500W Quantum	QM050RF	1219113	POA	1	
700W Quantum	QM070RF	1219114	POA	1	
1000W Quantum	QM100RF	1219115	POA	1	
1250W Quantum	QM125RF	1219116	POA	1	
1500W Quantum	QM150RF	1219117	POA	1	



24 HR GENERAL PURPOSE & IMMERSION HEATER TIMERS



- Rated Switching: 16A (8A)
- 48 On / 48 Off
- Manual Override
- Voltage Free Contacts
- Not suitable for discharge lighting



General Purpose and Immersion Heater Timer	IHTGPT01	0549406	21.50	1
General Purpose Box Mounted 24hr Timer	SBSTUZHO	0549407	22.67	1
7 Day Socket Box Timeswitch	OP-SBSDIGI	1080845	32.50	1
7 Day Socket Box Timeswitch	OP-SBSW	1080848	27.45	1



A theben Group Company

- Rated Switching: 16A (4A)
- Manual Override
- Voltage Free Contacts



24hr Electronic Immersion Heater Timeswitch	NTT06	0534329	40.97	1
---	-------	---------	--------------	---

7 DAY GENERAL PURPOSE & IMMERSION HEATER TIMERS



- Rated Switching: 16A (8A)
- Manual Override
- Voltage Free Contacts
- Not suitable for discharge lighting



7 Day General Purpose Timer	IHTGPTW01	0549408	28.04	1
-----------------------------	-----------	---------	--------------	---



A theben Group Company

- Rated Switching: 16A (4A)
- Manual Override
- Voltage Free Contacts



7 Day Electronic Immersion Heater Timeswitch	NTT07	0534330	44.20	1
--	-------	---------	--------------	---

ECONOMY 7 HOT WATER CONTROLLERS



- Rated Switching: 13A
- 1 On / 1 Off
- Industry Standard Plate
- Neutral Required
- 4.5-7 Hrs
- Suitable for single and twin immersion heaters



Economy7 Immersion Heater Controller with Boost	E7/QUARTZ	0011739	65.79	1
Electronic version of E7/QUARTZ	ELECTRONI7	0011742	62.79	1

ECONOMY 7 HOT WATER CONTROLLERS



A theben Group Company

- Rated: 13A (5A)
- Neutral Required
- Up to 2 Hrs
- 15, 30, 60, 120 Min Boost Options



2hr Electronic Boost Timer	TGBT4	0284296	25.12	1
----------------------------	-------	---------	--------------	---

TIME FUSED SPURS



- Rated Switching: 13A (6A)
- 28 On / 28 OFF
- Fits 25mm Back Box



Time Fused Spur 7 Day	T205-C	0671091	30.50	1
-----------------------	--------	---------	--------------	---



A theben Group Company

- Rated Switching: 13A 3kW
- 4 On / 4 Off
- 500W Fluorescent Boost Facility



Supply Master 24hr	FST24	0683194	50.21	1
Supply Master 7 Day	FST77	0683195	52.26	1

CENTRAL HEATING CONTROLLERS



- Rated Switching: 3A (1A)
- 3 On / 3 Off
- Industry Standard Plate
- Boost / Advance Options



Centaur Plus 1 channel, 24hr	C11	0043951	29.99	1
Centaur Plus 1 channel, 7 Day	C17	0043941	49.20	1
Centaur Plus 2 channel, 24hr	C21	0043942	32.45	1
Centaur Plus 2 channel, 7 day	C27	0043940	40.38	1



- Rated Switching: 3A (1A)
- 3 On / 3 Off Per Channel
- Boost / Advance Options
- 5Yr Warranty



Channel Plus 2 channel, 24hrs	H21XL	0033497	59.06	1
Channel Plus 2 channel, 7 day	H27XL	0033496	61.95	1
Channel Plus 3 channel, 7 day	H37XL	0033495	110.31	1
Channel Plus 4 channel, 7 day	H47XL	0202073	149.30	1



- Rated: 5A
- 10 Terminals
- Multiple Breakouts
- Warning Label on cover



Central Heating Connection Unit	BG906	0003587	7.33	1
Wago Wiring Centre	60362958	1147673	12.20	1

CONVENTIONAL THERMOSTATS



- Rated Switching: 16A (4A)
- Temperature Range: 10 to 30°C
- No Neutral Required



Room Thermostat	ROOMSTAT	0549404	9.05	1
-----------------	----------	---------	-------------	---





FROST THERMOSTAT



- Rated Switching: 16A (4A)
- Temperature Range: -5 to 10°C
- No Neutral Required



Frost Thermostat	FROSTSTATN	0549405	12.79	1
------------------	------------	---------	-------	---

CYLINDER THERMOSTAT



- Rated Switching: 16A
- Temperature Range: 20 to 90°C
- No Neutral Required
- Changeover Contacts
- Supplied w/ Strap & Buckle



Cylinder Thermostat	HCT2	0087334	14.15	1
---------------------	------	---------	-------	---

PROGRAMMABLE THERMOSTAT



- Radio frequency programmable thermostat
- Equipped for wall mounting or table-top use
- Wall-mounted receiver
- Volt-free switching suitable for combination boilers
- Class IV control, 2% system efficiency contribution



Optimum Vibe Wireless RF Thermostat	OP-TP1STAT	1261237	51.97	1
-------------------------------------	------------	---------	-------	---

TIME DELAY SWITCH



- Rated Switching: 10A
- No Neutral Required
- Adjustable timer: 10sec - 20min



Time Lag Switch	SELLIPSE	0576494	19.70	1
-----------------	----------	---------	-------	---



- 2 wire (no neutral)
- Stylish green LED ring
- Switches any type of load
- Works with any type of lamp
- 5 year warranty



Time Delay Switch for LED Loads	GI-TLC	0282580	29.01	1
---------------------------------	--------	---------	-------	---



- IP66
- Rated Switching: 16A
- 3A - Compact Fluorescent
- Adjustable Timer: 1 Sec - 2 Hrs



Multi Range Weatherproof Timer	SMRT-16/WP	0609478	42.17	1
--------------------------------	------------	---------	-------	---

REMOTE ACCESS / WI-FI ENABLED CONTROLS



A theben Group Company

WiFi enabled control for all manner of electrical applications connected to Timeguard's FSTWiFi 13A Fused Spur Timeswitch.

- Wifi smartphone control
- 13A fused
- Fits 25mm box
- Boost feature
- 3yr guarantee



WiFi 13A Switched Spur	FSTWIFI	0979558	61.84	1
------------------------	---------	---------	-------	---



The new Optimum range provides the ability to control devices via WiFi or 4G using the various types of timer listed below



- 24hr/7 day Timer
- up to 16A
- WiFi/Smartphone control
- Manual override



A. WiFi Socket Box Timer	OP-SBWF01	1093687	41.55	1
B. WiFi Plug-in Timer	OP-TIPWF01	1093688	24.10	1
C. WiFi Din Rail Timer	OP-DRWF01	1093689	39.20	1
D. WiFi Boiler/Immersion/ General Purpose Timer	OP-BMH-TWF01	1093690	41.54	1

NEST LEARNING THERMOSTAT



The Nest Learning Thermostat: it programs itself, automatically turns down the heat when you're away and can be controlled remotely. It also shows how much heat you use and why.

The Nest Thermostat E helps save energy. You can change the temperature from the Nest app on your smart device (available on iOS and Android). With its built-in stand, it can go in any room and it's easy to install yourself.

Nest 3rd Generation Learning Thermostat	T3028GB	1021003	158.30	1
Nest Stand for new 3rd Generation Learning Thermostat	AT3000GB	1021007	29.17	1
Nest 'E' Thermostat	HF001235-GB	1143769	147.79	1





HAND DRYERS

	BRAND	DESCRIPTION	CODES	WATTAGE	DRYING TIME (approx)	RMP	TRAFFIC	FINISH	COLD/WARM	PRICE	
		1800W Hand Dryer	SM48	0272023	1800W	30-35 sec	2830	Low	White	Warm	72.15
		1.4kW Eco Hand Dryer (with Eco 0.5kW setting)	C21HD08	0611776	1800W	8-12 sec	25000	Med-High	Chrome	Warm	113.31
		1.4kW Eco Hand Dryer (with Eco 0.5kW setting)	C21HD09	0611777	1800W	8-12 sec	25000	Med-High	White	Warm	113.31
		Vandal Resistant Autodryer	DSSHDA2500	0551046	2500W	30-45 sec	8200	High	Steel	Warm	114.30
		Airforce High Speed Low	AIRFORCE	0374466	1100W	12-15 sec	37000	High	White	Cold	352.62
		Jet Hand Dryer	C21HD04	0687708	1900W	5-7 sec	20000	Med-High	Silver	Warm	378.75

HANDWASH UNITS



Economical and instant, the i3VS handwash unit is compact and simple to operate with a single on/off and temperature control lever.

Perfect Compact Water Heaters

3kW		SI3VS	0867185	50.00	1
-----	--	-------	---------	--------------	---

AUTOSENSOR HANDWASH UNIT

3kW		AV3S	0704795	83.45	1
-----	--	------	---------	--------------	---

Instant Electric Hot Tap Water*

2.5kW		TAP1	0704292	58.25	1
-------	--	------	---------	--------------	---

*Suitable to replace most existing mixer taps. 2.5kW.
Max temp 50°C



STORAGE VENTED



3kW Oversink Heaters

3kW 7L Oversink Heater	OSINK7	0599095	75.72	1
------------------------	--------	---------	--------------	---



STORAGE UNVENTED



Ideal for use in kitchens & offices where there is no central hot water system nearby

- 2kW element
- External temperature control
- Supplies hot water for up to 3 basins



Undersink Unvented Water Heaters & Accessories

5 litres (1 basin)		BSSF05K	0551415	88.35	1
10 litres (2 basins)		BSSF10K	0551416	92.12	1
15 litres (3 basins)		BSSF15K	0551418	99.60	1
Expansion Vessel & Check Valve Kit*		BSSF3	0551410	31.71	1
Pressure-Reducing Valve**		BSSF5	0551409	27.88	1

* required if cold water drawn-off is nearby
** required for pressures above 4.2 bar



- 1.5kW - 2kW element
- External temperature control
- Supplies hot water for up to 4 basins

Mini 6 litres	MS6	0951834	66.66	1
10 litres under sink	TS10	0844826	107.24	1
15 litres under sink	TS15	0844827	116.18	1



INSTANTANEOUS



'Perfect' Compact Water Heaters one of the smallest available in the UK at just 150(H) x 135(W) x 70(D)mm

Perfect Compact Water Heaters

3.5kW Water Heater		PERFECT35	0551650	85.90	1
5.5kW Water Heater		PERFECT55	0662932	95.81	1



Multi-Point Instantaneous Water Heater Water supplied to 1 or 2 outlets, 1 shower + 1 hand basin or 2 hand basins)

Multi-Point Instantaneous Water Heater

9.5kW		SRP1	0979470	120.58	1
-------	--	------	---------	---------------	---



STORAGE VENTED



Ideal for occasional use light dish washing at a single kitchen sink in the workplace. For example, portable buildings, offices, shops, workshops, garages and other small commercial premises.

2kW 5 Litre Water Heaters

2kW Undersink Heater		HF05VC	0551414	88.30	1
2kW Oversink Heater		BSHF05	0551412	67.30	1



Large heavy duty non-drip taps. Designed for direct connection to a potable cold water supply using fittings supplied. This wall mounted boiler has a rear connection and overflow and requires two bar incoming water pressure.

5L Wall Mounted	WMS5	0552158	539.79	1
3L Wall Kettle Water Heater	WMSP3W	0552159	566.99	1
7L Wall Kettle Water Heater	WMSP7W	0552160	674.17	1
5L Desktop Kettle Hot Water Dispenser	CTS5	0552157	415.78	1

Huge range of Water Kettles available - Ask for more details





REDRING PURE SHOWER

ERP RATINGS



A

In the same way that fridges, freezers and other white goods now have energy labels, from September 2015 energy labelling has come into force for water heaters of a certain capacity, including those with an instantaneous heating design, such as electric showers. This will mean these types of products will need to meet minimum energy performance criteria and require an energy label showing their energy efficiency class and level of energy consumption.

GUIDE TO SHOWERS KEY

INPUT	Bottom Left / Right	Top Left / Right	Left	Right	Universal	Multi-Fit	Rear Fed
Electric							
Water							



Pure Shower (7.5kW, 8.5kW and 9.5kW)

- Three power settings for energy efficiency
- Ergonomic rotary controls
- Push button Start/Stop control
- 1m anti-kink hose
- 2 year Warranty (on site repair)

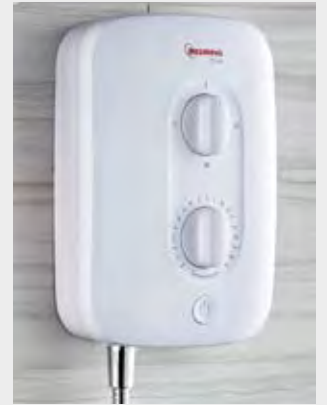

Pure Shower (7.5kW, 8.5kW and 9.5kW)

7.5kW Shower		PURE7.5	1008372	49.99	1
8.5kW Shower		PURE8.5	1008376	49.99	1
9.5kW Shower		PURE9.5	1008377	55.63	1

TRITON AVENA ELECTRIC SHOWERS



- Power selector for Cold/Economy/ High options
- Temperature control with numbered dial
- Single stop/start control
- Power on indicator
- 2 Year guarantee



8.5kW		SPAVENA8	0864881	59.15	1
9.5kW		SPAVENA9	0864882	62.40	1

MIRA VIE ELECTRIC SHOWERS



- Separate power and temperature controls to fine tune your perfect shower
- Push button on/off
- Eco setting designed to save water and energy
- Clearscale™ technology cuts limescale by half for a better performing, longer lasting shower
- Single spray showerhead
- 2 Year guarantee



8.5kW - White/Chrome		NVIE8.5WC	0667793	115.03	1
9.5kW - White/Chrome		NVIE9.5WC	0667794	123.94	1

MIRA JUMP ELECTRIC SHOWERS



- Now multi-fit* - water and cable. (*Additional kit required to enable entry into the right hand side.)
- Clearscale™ technology cuts lime scale by half
- Separate power and temperature/ flow controls.
- 4 Mode showerhead
- Flexible fittings kit
- 2 Year guarantee



8.5kW - White/Chrome		NJUMP8.5	0667796	132.86	1
9.5kW - White/Chrome		NJUMP9.5	0667797	141.78	1
10.8kW - White/Chrome		NJUMP10.8	0667795	150.69	1

TRITON T80Z FAST-FIT



- The T80Z Fast-Fit is the ultimate replacement shower. The high quality design is packed with features to simplify installation including cable and water entry options from all possible directions
- 2 Year guarantee



7.5kW - White		SP8007ZFF	0476402	138.13	1
8.5kW - White		SP8008ZFF	0476403	139.98	1
9.5kW - White		SP8009ZFF	0476404	145.88	1
10.5kW - White		SP8001ZFF	0476405	153.11	1

MIRA SPORT ELECTRIC SHOWERS



- Advanced pressure stabilised temperature control
- Separate power and temperature controls
- Push button on/off
- Phased shutdown
- Large 110mm 4 spray showerhead
- Adjustable slide bar
- 2 Year guarantee



7.5kW - White/Chrome		NSPORT75	0482835	232.50	1
9kW - White/Chrome		SNSPORT9	0585465	245.86	1
10.8kW - White/Chrome		NSPORT108	0482838	258.38	1

MIRA ADVANCE ATL FLEX THERMOSTATIC ELECTRIC SHOWERS



- Inclusive design for easy use by everyone. BEAB CARE mark and endorsed by the Royal Institute for the Blind.
- Thermostatic temperature stability
- Separate temperature and flow controls
- Adjustable Temperature Limit with 8 different settings
- Phased shutdown
- 4 spray showerhead
- 2 Year guarantee



8.7kW - White/Chrome		ADVANCE8.7FLEX	1082447	306.18	1
----------------------	--	----------------	---------	--------	---



Test Equipment

ALL KEWTECH MFTs HAVE THESE 5 BASIC ATTRIBUTES:

1. EASE OF USE

As with all Kewtech products the user interface is straightforward

2. BEST LOOP PERFORMANCE

Benchmarked against others - the best loop performance with low susceptibility to noise and RCD uplift

3. NO BANGS

Continuous live circuit monitoring so no bangs when you inadvertently touch live circuits during dead testing - even with the test button locked down

4. G7 TEST LEADS

High integrity test leads - tested for flexibility, impact, strain relief and for consistent crocodile clip performance

5. AUTO RCD TEST

After testing the instrument displays all six results

GREAT AVAILABILITY AND VALUE ON EVERYDAY ELECTRICALS

18TH EDITION MULTI-FUNCTION TESTERS

KEWTECH Multifunction Tester 5in1

- Easy to use
- New Anti Trip Technology loop test - for full no trip Loop testing on RCDs of all types. Low susceptibility of RCD uplift and noise interference
- Displays PFC/PSC at same time as Loop reading
- 250 / 500 / 1000V insulation test with auto discharge
- Test leads auto-null for continuity mode
- RCD auto test mode for 30mA RCDs
- RCD ramp test function
- End of line calibration certificate included
- Hand-free mode controlled by separate button
- Single rotary dial for function selection
- Mains polarity test



Multifunction Tester 5in1 | KT63DL | 1285679 | 438.61 | 1

KEWTECH Multifunction Tester 6in1

- Easy to use - single rotary dial with four secondary function keys
- Large colour display
- New anti-trip technology loop test - for full no trip loop testing with RCDs (>30mA) of all types in the circuit.
- Very low susceptibility of RCD uplift and noise interference
- Displays PFC/PSC at the same time as Loop reading
- 250 / 500 / 1000V insulation test with auto discharge
- Test lead auto null for continuity
- RCD tests AC/A & ACS/AS
- RCD ratings 10, 30, 100, 300, 500, 1000mA
- RCD auto-test for 30mA RCDs
- Phase rotation
- Three ways to start a test - single press of the test button, handsfree use of the test button (continuous testing) or by test button in test probe.
- Special DNO mains polarity test
- IP54



Multifunction Tester 6in1 | KT63PLUS | 1276908 | 699.00 | 1

KEWTECH 6-in-1 Multi-Function Tester

- Continuity, Insulation, Loop, PSC, RCD & Volts
- Auto nulls- test lead resistance, 250/500/1000V insulation and non trip loop test
- Extra test probe with integral test button
- Comprehensive RCD test - type A, AC, AS & ACS
- RCD auto-test with results all on one screen



KT64DL & KT65DL All auto RCD tests on one screen
 KT65DL PAT Testing
 KT65DL 0.001 Ohm loop resolution



6-in-1 Multi-Function Tester | KT64DL | 0622429 | 629.59 | 1

KEWTECH 8-in-1 Multi-Function Tester

- Easy to use - straight forward interface
- Max Zs tables - shows you the maximum loop value for almost all fuses/MCBs
- 0.001Ω resolution high current loop test
- PAT tests in conjunction with the Pat Adaptor
- Free basic software, includes PAT download
- NEW Anti-trip technology for full no trip LOOP testing on all RCD types



8-in-1 Multi-Function Tester | KT65DL | 0622430 | 769.50 | 1



UNIVERSAL TEST LEADS

KEWTECH Electrical Test Leads Kit

- Stress tested for pull out and bending
- GS38 probe tips and finger guards
- Fuse option available for non BSEN61557 instruments

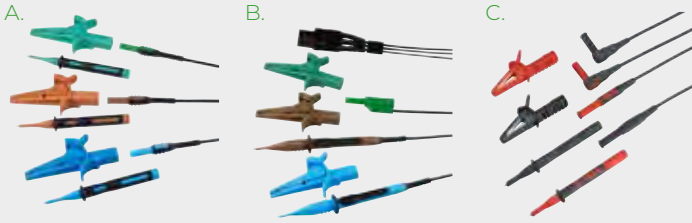

A.	For testers using universal 4mm connectors including KT64DL & KT65DL	ACC065	0305440	56.75	1w
B.	3 Wire fused distribution board test leads with IEC connector. Piggy back facility for 2 wire testing	ACC016E	0147369	51.16	1
C.	2 Wire test lead set for testers using universal 4mm test leads including DMMs & Clamps	ACC020	0147367	34.92	1

TESTING ACCESSORIES

'Lightmate' Lighting Circuit Testers Kit

- 5 testing adaptors for lighting points: BC, ES, SBC, SES & GU10.
- As per NICEIC guidance for Loop testing on lighting circuits



'Lightmate' Lighting Circuit Testers Kit		LITMATEKIT	0351351	57.40	1
--	--	------------	---------	-------	---

KEWTECH 50m Test Lead Extension

- 50m high quality test lead extension lead on purpose design reel.
- As per NICEIC guidance for R2 testing



50m Test Lead Extension		ACC50MTL	0206852	88.16	1
-------------------------	--	----------	---------	-------	---

KEWTECH 18th Edition Testing Accessories

- An essential part of a safe isolation kit
- Works with any two pole tester



18TH EDITION TESTING ACCESSORIES		KEWPROVE3	0262314	59.73	1
----------------------------------	--	-----------	---------	-------	---

TESTING ACCESSORIES

KEWTECH R2 Socket Adaptor

- R2 break out adaptors makes testing faster, easier, more accurate and safer.
- For R1+R2, R2 & loop testing



R2 Socket Adaptor		R2-CHECK	0183474	14.99	1
-------------------	--	----------	---------	-------	---

KEWTECH PAT Adaptor

- Unique - converts your MFT into a PAT tester!
- Great for when you have a small number of appliances to test.
- Covers the mandatory earth bond and insulation tests as required by the Code of Practice



PAT Adaptor		PATADAPT1	0305467	48.25	1
-------------	--	-----------	---------	-------	---

CERTIFICATION & LOG BOOKS

KEWTECH



All log books come with duplicate NCR pages For New Installations (Electrical Installation Certificate)

Base document	TC1/LOG	0161407	12.44	1
Results pages for up to 12 way (or use TC6)	TC5/LOG	0161418	12.44	1
Results pages up to 36 and more ways (or use TC5)	TC6/LOG	0161419	12.44	1

KEWTECH



For Existing Installations (Electrical Installation Condition Report)

Base document	TC3/LOG	0161417	12.44	1
Schedule of inspections up to 100A supply (or use TC8)	TC4/LOG	0485824	12.44	1
Observations - for extra observations (Optional)	TC7/LOG	0164495	12.44	1
Schedule of inspections over 100A supply (or use TC4)	TC8/LOG	0477488	12.44	1



CERTIFICATION & LOG BOOKS

KEWTECH



Minor Works

Minor works – standalone certification	TC2/LOG	0161408	12.44	1
--	---------	---------	-------	---

Multiple Pat testing results per page PAT testing log book

PAT testing log book	PATLOG1	0161406	12.44	1
----------------------	---------	---------	-------	---

IET



18th Edition Wiring Regulations Amendments

18th IET Regs Book	PIETREG18	1117776	83.50	1
18th IET On Site Guide	PIETOSG18	1117778	29.95	1
18th IET Inspection Testing Certification	PNICITC18	1117779	23.25	1
18th NICEIC Site Guide - up to 100A	PNICSG18	1117777	23.25	1
18TH EDITION WIRING REGULATION AMENDMENTS	PIETGN118	1117862	35.47	1
IET Guidance Note 3: Inspection and Testing	PIETGN318	1117863	32.67	1
IET Guidance Note 2: Isolation & Switching	PIETGN218	1127660	29.87	1
IET Guidance Note 4: Protection Against Fire	PIETGN418	1127661	29.87	1
IET Guidance Note 5: Protection Against Electric Shock	PIETGN518	1127662	29.87	1
IET Guidance Note 6: Protection Against Overcurrent	PIETGN618	1127663	29.87	1
18TH EDITION WIRING REGULATION AMENDMENTS	PIETGN718	1127664	29.87	1
IET Guidance Note 8: Earthing and Bonding	PIETGN818	1127665	29.87	1

INFRA-RED FOREHEAD THERMOMETER

- Non-contact infra-red forehead thermometer
- Measures body temperature from 32 to 42.5 °C
- High accuracy of 0.3 °C
- Fast response time 0.5 seconds
- User adjustable alarm with visual and audible alert
- Recall 32 most recent measurements
- Easily switch between body and surface modes
- Non-contact measurement method for safer testing



Infra-Red Forehead Thermometer	C-FIT	1309113	63.99	1
--------------------------------	-------	---------	-------	---

PORTABLE APPLIANCE TESTERS

KEWTECH

Next Generation Battery Powered

- Manual PAT Tester, battery powered, with automatic test sequences, which makes testing easy and fast.
- Comes with all test leads for 230V appliance and extension lead testing

EZYPAT PRO Kit – the entry level PAT tester from Kewtech with auto test sequencing and simple set-up for ease of use and efficient testing. Ideal for low risk environments.

EZYPAT PLUS PRO Kit – the advanced manual tester with auto test sequencing and run leakage tests at 230V and 110V. Tests any appliance.

- IF Safe – 250V & 500V insulation tests
- Auto test sequences
- Works manually with the free KEW PAT App
- (includes EZYPAT tester, all test leads for 230V appliances and ex tension lead testing, large soft carry case, 500 PASS labels and 250 FAIL labels).

- IT Safe – 250V & 500V insulation tests
- Auto test sequences
- 110V & 230V run tests
- Works manually with the free KEW PAT App
- (includes EZYPAT tester, all test leads for 230V/110V appliances and extension lead testing, large soft carry case, 500 PASS labels and 250 FAIL labels)



SMARTPAT PRO Kit – The next generation tester from Kewtech. The UK's first Wi-Fi enabled PAT tester remotely controlled from your phone or tablet. The ultimate downloading PAT tester when used with the KEWPAT App.



- IT Safe – 250V & 500V insulation tests
- 100V & 230V run tests
- 10mA & 30mA RCD test without tripping the building's RCD
- Remotely controlled by the free KEW PAT App or use in manual mode.

Next Generation Battery Powered

A. EZYPATPRO PAT Kit	EZYPATPRO	1136922	374.06	1
B. EZYPATPRO Plus PAT Kit	EZYPAT+PRO	1136923	490.25	1
C. SMARTPAT PAT Kit	SMARTPATPRO	1136924	867.18	1

SAFE ISOLATION KIT

KEWTECH Safe Isolation Kit

- Everything in one box: Ceiling pull cord, power supply, over door indicator, cancel button, disabled sticker
- Compliant to the requirements of: BS8300:2009 Building Regulations

Kit Includes:

- KI1780 - 2 Pole Voltage Detector
- Two Pole Tester with continuity, audible tone, phase rotation and torch.
- Kewprove 3 - Compact Proving Unit
- Know voltage source to prove voltage testers
- Kewlok - Universal Lockout
- The universal lockout that fits all toggle type main switches, MCBS, RCDs & RCBOs. Comes with two rewritable labels and selectable combination.
- Isolation Kit Bag

All in a rugged case that retains the proving unit in an accessible, ready to use, position at all

Manual Mains Tested PAT Tester	KEWIS02	0668245	215.97	1
--------------------------------	---------	---------	--------	---





VOLTAGE DETECTION & SOCKET TESTER

KEWTECH Non Contact Voltage Tester

- Detects voltage between 90-600V AC, without metallic contact
- Tip glows red when voltage is detected
- Pocket sized pen shape with clip
- Comes with 2 year guarantee



Non Contact Voltage Tester			
Kewtech Uno	KEWSTICKUNO	0514907	12.44 1

KEWTECH Dual Sensitivity Voltage Detector

- First level of detection indicates the presence of a hazardous voltage.
- Second level determines between live and dead cables only 6mm apart.



Dual Sensitivity Voltage Detector			
Kewtech Duo	KTDUO	0514908	22.44 1

KEWTECH Voltage & Continuity Detector

- Oversized LEDs give clear indication
- LED tree lights up even with flat batteries
- Special GS38 probe tips with no removable covers which fits long reach terminals such as RCBOs



Voltage & Continuity Detector			
Single Pole Voltage Detector	KT1710	1086062	28.67 1
2 Pole Voltage Detector	KT1780	0586143	41.75 1

KEWTECH Loop Socket Tester

- Checks correct socket outlet wiring
- Checks for safe earth loop impedance
- Checks 30mA RCDs
- Checks for correct mains supply polarity



Loop Socket Tester			
Loop Socket Tester	LOOPCHECK7	0379781	40.12 1

KEWTECH Mains Wiring Plug-in Tester

- Error-free indication of socket status
- Tests BS1363 sockets



Mains Wiring Plug-in Tester			
Mains Wiring Plug-in Tester	KEWCHECK103	0160856	14.93 1 13.99 3+

DIGITAL MULTIMETERS & CLAMPS

KEWTECH Digital Multimeter

- Auto and manual ranging
- Measures AC/DC current up to 10A
- Measures AC/DC voltage up to 600V



Digital Multimeter			
Digital Multimeter	KT115	0147332	39.29

KEWTECH Digital AC Clamp Meter

- Measures current up to 400A AC
- Measures up to 600V AC
- Category 3



Digital AC Clamp Meter			
Digital AC Clamp Meter	KT200	0161068	37.16 1

THERMAL IMAGING CAMERA

FLIR Flir One PRO Thermal Imaging Camera for Smartphone

Simply attach the FLIR ONE Pro to your Android phone or tablet and turn it into a powerful thermal imager. Ideal if you're inspecting homes, cars, electrical panels or finding water damage.

- Find hidden electrical problems, energy loss, water damage
- FLIR ONE allows you to see and measure temperature differences accurately and from a safe distance
- Gives you the sharpest mobile thermal imaging performance - Ever
- One Fit adjustable connector

*Phone not included



Flir ONE - Micro USB	435-001103	1143887	299.00 1
Flir ONE Pro - USB-C	435-0007-03	1143888	299.00 1
Flir ONE Pro - IOS	435-006-03	1143889	299.00 1



Power Tools,
Fixings & Sundries



armeg



DEWALT

18V XR LI-ION GRINDER (BARE)

DCG412N-XJ
2501312106

£87.95

Includes low
profile gear case

Powerful grinder with
7000rpm motor and high
torque for heavy duty cutting
and grinding applications

DEWALT

DeWalt COMBI 18V CORDLESS KIT 2x5ah Batteries

DCD796P2-GB
2501312103

£189.95



Denmans
REXEL GROUP



Click & Collect
in as little as 1 min



Call
your local branch



Visit
your local branch



DEWALT DRILLS



F.

Drills					
A.	IMPACT DRIVER CORDLESS	DCF887P2-GB	1312104	200.00	1
B.	DeWalt COMBI 18V CORDLESS KIT 2x5Ah Batteries	DCD796P2-GB	1312103	189.95	1
C.	Twin Pack - Combi & Impact Cordless	DCK206M2T-GB	1312101	244.95	1
D.	SDS 18V CORDLESS	DCH253M2-GB	1312105	269.95	1
E.	18V 6PC KIT 3x 5.0AH	DCK694P3-GB	1357765	850.00	1
F.	Twin Pack - SDS & Combi	DCK206M2T-GB	1312102	316.95	1

DEWALT GRINDING/CHASING



ANGLE GRIDER CODLESS BODY	DCG412N-XJ	1312106	87.95	1
54V XR FLEXVOLT Wall Chaser - 2 x 6Ah	DCG200T2-GB	1312117	614.95	1

DEWALT GRINDING/CHASING



Dust Extraction				
HOOVER/DUST EXTRACTOR CORDLESS	DCV584L-GB	1312116	159.95	1
Flexvolt Dust Extractor Kitted	DCV586MT2-GB	1312118	499.95	1

DEWALT SAWING



Sawing				
MULTI TOOL CORDLESS BODY	DCS355N-XJ	1312107	99.95	1
RECIPROCATING SAW BODY	DCS380N-XJ	1312115	107.95	1

DEWALT LASER LEVEL



Laser Level				
Cross Line Laser RED	DW088K-XJ	1312112	94.95	1



DEWALT HEAT GUN

Heat gun

- 530°C on a high setting and 290°C on a low setting
- Self-Levelling up to 4 degrees surface
- Switched on using the lock-on button to improve comfort
- Built-in LED light
- Supplied with two types of applicator nozzles (reflector and surface)



Heat Gun Body	DCE530N-XJ	1312111	82.95	1
---------------	------------	---------	-------	---

CABLE TACKER GUN

Dewalt 18V Cable Tacker Gun

The DCN701 18V MAX Cordless Cable Stapler is a light and compact solution to replace the usual manual cable fastening methods. It will allow you to be efficient in tight spaces while ensuring you that you get the job done right the first time.

- Nail Length: 25.4 mm
- Magazine capacity: 35 Nails
- Integrated cable guide for easy alignment of cables
- Automatic Depth of drive to ensure consistent drive without user intervention



18V Cable Tacker Gun (Body Only)	DCN701-N	1187357	195.00	1
18V Cable Tacker Gun CW 2 X 2.0AH Batteries	DCN701-D2	1187358	249.95	1
540 24X17 Staples For DCN701 Tacker Gun	DRS18100	1187359	12.99	1

DEWALT RADIO



DAB Radio	DCR020	1312165	99.95	1
TSTAK AUDIO AND CHARGER GB	DWST1-81079-GB	1312110	174.95	1

DEWALT BATTERIES



A. Battery 18V 4.0Ah	DCB182-XJ	1312108	68.00	1
B. Battery 18V 5.0Ah	DCB184-XJ	1312109	64.95	1
C. XR MultiVolt Charger	DCB115-GB	1357762	35.00	1
D. Charge XR Batt. Adapter	DCB090-XJ	1357763	25.00	1

DEWALT POWER TOOL ACCESSORIES

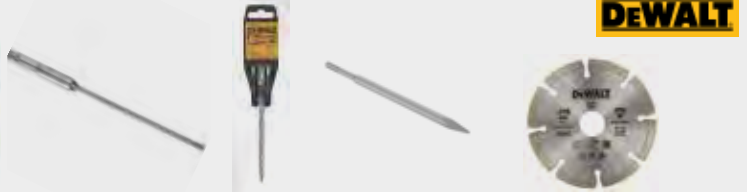

CASSETTE, 5 BRAD POINT DRILLS	DT4535-QZ	1312356	5.99	1
10 PCE JIGSAW SET - WOOD/METAL CUTTING	DT2294-QZ	1312357	11.99	1
9pc Extreme Flatwood Set	DT70751-QZ	1312358	19.99	1
6 pc Recip blade tough set	DT2444-QZ	1312359	12.99	1
14 Piece Screwdriver Set	DT70512T-QZ	1312360	9.99	1
PZ2 25mm Standard Tic Tac x21 Display - MOQ 21 pieces	DT71521-QZ	1312361	4.99	1
Ph2 25mm Standard Tic Tac x21 Display - MOQ 21 pieces	DT71522-QZ	1312362	4.99	1
4 PIECE SDS EXTREME SET	DT9702-QZ	1312363	9.99	1
HSS-G CASS 13 PCE	DT5922-QZ	1312364	9.99	1
Abrasive Disc 115x1.2mm Thin Cut INOX 10pcs TIN: MOQ 10 Tins	DT42335TZ-QZ	1312365	7.49	1
Ph2 25mm Torsion Tic Tac x21 Display (multiples of 21)	DT70555T-QZ	1312366	7.99	1
Pz2 25mm Torsion Tic Tac x21 Display (multiples of 21)	DT70556T-QZ	1312367	7.99	1
SPADE BIT TRI FLUTE EXT 3PC SET 152MM	DT90237-QZ	1312368	10.99	1
SPADE BIT TRI FLUTE EXT 6PC SET 152MM	DT90238-QZ	1312369	24.99	1
SPADE BIT TRI FLUTE EXTREME 16 x 152MM	DT90240-QZ	1312370	4.59	1
SPADE BIT TRI FLUTE EXTREME 20 x 152MM	DT90241-QZ	1312371	4.79	1
SPADE BIT TRI FLUTE EXTREME 22 x 152MM	DT90242-QZ	1312372	4.99	1
SPADE BIT TRI FLUTE EXTREME 25 x 152MM	DT90243-QZ	1312373	5.49	1
SPADE BIT TRI FLUTE EXTREME 28 x 152MM	DT90244-QZ	1312374	6.99	1
SPADE BIT TRI FLUTE EXTREME 32 x 152MM	DT90245-QZ	1312375	7.49	1
SPADE BIT TRI FLUTE EXTREME 18 x 152MM	DT90293-QZ	1312376	4.69	1
IR BIM HOLE SAW KIT INT600L (16, 20, 25, 32, 38, 51, 2 x arbor, pilot bit + case)	10506441	1312399	39.99	1

SDS+ Extreme 5 X 160 x 100	DT9505-QZ	1312377	2.49	1
SDS+ EXTREME 5.5 X 160	DT9509-QZ	1312378	2.59	1
SDS+ EXTREME 5.5 X 210	DT9510-QZ	1312379	3.49	1
SDS+ EXTREME 6x160	DT9515-QZ	1312380	2.79	1
SDS+ EXTREME 6 x 210	DT9516-QZ	1312381	3.79	1
SDS+ EXTREME 6.5 x 160	DT9520-QZ	1312382	2.89	1
SDS+ EXTREME 7 x 160	DT9525-QZ	1312383	2.99	1
SDS+ EXTREME 7 X 210	DT9526-QZ	1312384	3.99	1
SDS+ Extreme 8 X 160	DT9529-QZ	1312385	3.09	1
SDS+ EXTREME 8 x 210	DT9530-QZ	1312386	3.29	1
SDS+ EXTREME 8 X 260	DT9531-QZ	1312387	5.49	1
SDS+ EXTREME 10 x 210	DT9541-QZ	1312388	3.99	1
BIT, SDS+ EXTREME 10 X 1000	DT9547-QZ	1312389	24.99	1
SDS+ EXTREME 12 x 200	DT9553-QZ	1312390	4.49	1
SDS+ EXTREME 14 X 200 x 150	DT9567-QZ	1312391	4.99	1
CHISEL POINTED SDS+	DT6801-QZ	1312392	4.99	1
CHISEL FLAT SDS+	DT6802-QZ	1312393	4.99	1
CHISEL SPADE SDS+	DT6803-QZ	1312394	4.99	1
100pc DT7500-QZ Bit Holder Sweetie Jar (100pcs)	DT90392-QZ	1312395	2.49	1
WHEEL DIAMOND 115x22.2	DT3701-QZ	1312396	3.99	1
21pc Black Oxide Metal Drilling Set (multiples of 5)	DT17101-QZ	1312397	19.99	1
SPADE BIT TRI FLUTE EXT 3PC SET 152MM	DT90237-QZ	1312398	10.99	1





MAKITA POWER TOOLS



Drills					
A.	18V LXT Li-Ion Combi, BODY ONLY	DHP453Z	0772845	56.50	1
B.	18V LXT Brushless Impact Driver BODY ONLY	DTD153Z	0971374	85.80	1
C.	12V Twin Pack c/w 2 x 2.0Ah Batteries	CLX228AJ	1248620	130.00	1
D.	18V LXT Li-Ion Brushless Combi c/w 2x5.0Ah Batteries & 101pc Accessory Set	DHP485STX5	1315356	201.95	1
E.	18V HAMMER DRILL	DHR202Z	0772865	109.00	1
F.	18V LXT Li-Ion Twin Pack, c/w 2 x 5.0Ah Batteries	DLX2131TJ	1297399	232.25	1
G.	18V 2x5.0Ah COMBI DRILL MAKPAC KIT	DHP482RTWJ	1313499	158.00	1

MAKITA SAWING



A.	18V LXT Reciprocating Saw BODY ONLY	DJR186Z	0971337	80.75	1
B.	18V LXT Multi Tool BODY ONLY	DTM51Z	0830029	100.95	1
C.	18V LXT Jigsaw BODY ONLY	DJV180Z	0772891	106.00	1
D.	18V LXT Brushless 165mm Jigsaw BODY ONLY	DJV182Z	0772895	126.20	1
E.	18V LXT 165mm Circ Saw BODY ONLY	DSS610Z	0772940	108.00	1
F.	18V LXT Brushless 165mm Circ Saw BODY ONLY	DHS680Z	0825130	135.00	1

MAKITA GRINDING/CHASING



A.	18V LXT Angle Grinder, 115mm, BODY ONLY	DGA452Z	0772834	80.75	1
B.	18V LXT Brushless Angle Grinder, 115mm, BODY ONLY	DGA463Z	1112497	126.20	1
C.	18V LXT SDS+ Rotary Hammer Drill, BODY ONLY	DHR202Z	0772865	109.00	1

MAKITA RADIO



Radio				
DAB/DAB+ Site Radio with Bluetooth	DMR115	1297296	160.50	1

MAKITA ACCESSORIES



A.	18V LED Torch	DML801	1315354	30.10	1
B.	5.0Ah Lithium-Ion Battery Pack	632F07-0	1315355	67.00	1
C.	227pc General Maintenance Set	P-90532	1357769	90.90	1



MILWAUKEE DRILLS



Drills					
A.	M18BLPD2-502X M18 BLESS PERC DRILL 2 X 6AH BATT	4933464518	1313454	219.95	1
B.	M18FPD2-502X 18V COMBI DRILL KIT	4933464265	1312119	269.95	1
C.	M18BLPP2A2-502X M18 BLESS TWIN PACK	4933464523	1313455	249.95	1
D.	M18FPP2A2-502X 18V TWIN PACK KIT	4933464269	1312129	329.95	1
E.	M18CHX-502X 18V SDS+ DRILL KIT	4933451383	1312121	374.95	1
F.	M18BLID2-0X 18V IMPACT DRIVER	4933464519	1312120	84.95	1
G.	M18CHX-0 M18 FUEL SDS+ HAMMER DRILL BODY ONLY	4933447420	1313459	199.95	1
H.	M18 Fuel 6 Piece Kit	4933464918	1357114	750.00	1
I.	M18 FUEL 4PC KIT	M18FPP4G2-502B	1377742	609.95	1

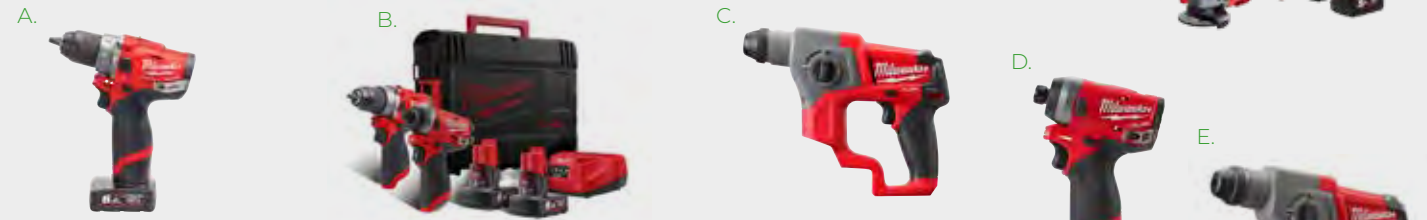

Drills 12V					
A.	M12FID-0 M12 IMPACT DRIVER BODY ONLY	4933459822	1313460	99.95	1
B.	M12FPP2A-602X M12 FUEL TWIN PACK 2 X 6AH BATTERY	4933459811	1313453	269.95	1
C.	M12CH-0 M12 FUEL SDS PLUS HAMMER BODY ONLY	4933441947	1313458	124.95	1
D.	M12FID-0 M12 IMPACT DRIVER BODY ONLY	4933459822	1313460	99.95	1
E.	12V COMPACT SDS BODY ONLY	M12CH-0	1377744	135.00	1

MILWAUKEE SAWING



Sawing					
A.	M18™ Brushless 66MM Circular Saw (Naked - no batteries or charger)	M18BLC566-0	1312123	174.95	1
B.	M18™ Multi Tool (Naked - no batteries or charger)	M18BMT-0	1312124	99.95	1
C.	M18 Hackzall Recip Saw (Naked - no batteries or charger)	C18HZ-0	1312125	132.95	1
D.	M18 Jigsaw (Naked - no batteries or charger)	M18BJS-0	1312126	119.95	1



Sawing 12V					
E.	C12MT-0 M12 COMPACT MULTITOOL BODY ONLY	4933427180	1313457	129.95	1

MILWAUKEE GRINDING/CHASING



Grinding / Chasing					
A.	M18 FUEL™ Braking Grinder with Paddle Switch (Naked - no batteries or charger)	4933451007	1312122	125.00	1
B.	18V 115MM ANGLE GRINDER - BARE UNIT	HD18AG-0	1377748	115.00	1

MILWAUKEE SOLDERING



Soldering					
	M12 SOLDERING IRON - 1 X 2.0AH BATTERY	M12SI-201C	1377743	125.00	1





MILWAUKEE CROSS LINE LASER KIT



REDLITHIUM USB CROSS LINE LASER KIT	L4CLL-301C	1377746	220.00	1
-------------------------------------	------------	---------	--------	---

MILWAUKEE TOWER LIGHT



M18 CORDLESS ROCKET LED TOWER LIGHT - BARE	M18SAL-0	1377745	170.00	1
--	----------	---------	--------	---

MILWAUKEE DUST EXTRACTION



M18™ Vacuum (Naked - no batteries or charger)	M18VC2-0	1312128	99.95	1
---	----------	---------	-------	---

MILWAUKEE RADIO



M18SRDAB+0 DAB 18V RADIO BODY ONLY	4933451252	1312127	112.95	1
------------------------------------	------------	---------	--------	---

MILWAUKEE BATTERIES & CHARGERS



A. M18B4 M18 4AH BATTERY REDLITHIUM ION	4932430063	1313461	49.50	1
B. M18B5 18V BATTERY 5.0AH	4932430483	1312130	58.95	1
C. M12B4 4AH REDLITHIUM ION BATTERY	4932430065	1313463	39.95	1
D. M12B6 6AH REDLITHIUM ION BATTERY	4932451395	1313464	49.95	1
E. M12-18FC M18/M12 RAPID CHARGER	4932451080	1313462	42.00	1
F. C12C M12 BATTERY	4932352069	1313465	28.99	1

G. M18 Dual Rapid Charger	4932472074	1357120	89.00	1
H. M18 Multi-Bay Charger	4932430310	1357119	78.00	1

MILWAUKEE ACCESSORIES



A. 49pc Shockwave Set	4932472057	1313538	27.95	1
B. 70pc Shockwave Set	4932471587	1313539	33.95	1
C. 25pcs Shockwave P22 Tic Tax Box - MOQ 30	4932430864	1313540	4.95	1
D. 19pcs HSS Metal Drill Bit Set - MOQ 6	4932352374	1313541	24.95	1
E. 5pcs SDS+ Drill Bit Set	4932352834	1313542	11.95	1
F. 7pcs VDE Screwdriver Set	4932464067	1313543	28.95	1
G. Fastback Flip Knife	4932471356	1313544	8.95	1
H. ANGLE GRINDER 115MM DISC DISPLAY	4932451485	1377749	0.83	1
I. Mag Tape 5-16/27 - 1pc	4932464602	1313546	12.95	1
J. Mag Tape 8-26/27 - 1pc	4932464603	1313547	15.95	1
K. MINI BOX SPIRIT LEVEL	4932459100	1377750	5.83	1
L. Electricians Pouch -1pc	48228112	1313545	44.95	1
M. PACKOUT™ 40cm Tote Toolbag -1pc	4932464085	1313550	87.95	1
N. PACKOUT TOTE TOOLBAG 25CM	4932464084	1377747	65.00	1
O. PACKOUT™ Crate	4932471724	1313549	45.95	1
P. PACKOUT™ Organiser Case - 1pc	4932464082	1313551	49.95	1
Q. PACKOUT™ 3pcs Set -1pc	4932464244	1313548	219.95	1





BOSCH POWER TOOLS



Power Tools

A.	ELECTRIC SCREWDRIVER + CHARGER,USB+25PC ACCY SET 3.6V	GO2KIT	1347427	50.00	1
B.	18V MULTI TOOL BARE / L-BOXX	06018B6001	1314541	132.95	1
C.	18V ANGLE GRINDER BARE / L-BOXX	060193A304	1314539	124.95	1
D.	BOSP ANGLE GRINDER 18V	GWX18V8L	1304765	129.95	1
E.	18V CIRC SAW BARE / L-BOXX	060166H006	1314540	139.95	1
F.	18V JIGSAW BARE / L-BOXX	06015A6101	1314543	132.95	1
G.	18V RECIPI SAW BARE / L-BOXX	060164J007	1314542	149.95	1
H.	BRUSHLESS CORDLESS LI-ION COMBI-DRILL 18V	GSB18V60C5C	0972325	232.95	1
I.	18V IMPACT DRIVER BARE / L-BOXX	06019G4102	1314537	134.95	1
J.	SDS HAMMER DRILL 18V	GBH18V21C	1304745	259.95	1
K.	TWIN PK 18V COMBI/IMPACT + 2x 5.0Ah BATTERIES + CHARGER	06019G4172	1314545	305.00	1
L.	BOSCH GAS 18V-10L DUST EXTRACTION/ VAC BARE	06019C6300	1314544	99.95	1



BOSCH ACCESSORIES



Accessories

A.	DRILL BIT SET CYL-9 MULTIPURPOSE 5.5-6-7-8MM TCT	2608595362	0178161	8.45	1
B.	S/DRV BIT SET 32 PIECE	2607017063	0841820	8.95	1
C.	DRILL BIT SET 7 PIECE	2608577347	1108449	8.95	1
D.	MS BIT SET 5 PIECE	2608837138	1108270	12.95	1
E.	JIGSAW BLADE SET 15PCE	2607011437	1236651	15.95	1
F.	BLADE JIGSAW T144D 5 PIECE 100MM HCS	2608630040	0040237	3.95	1
G.	BLADE JIGSAW T118A 5 PIECE 92MM HSS	2608631013	0040450	4.70	1
H.	JIGSAW BLADE SET (5)	2608630014	0040183	5.25	1
I.	SABRE BLD SET 5PCE	2608656015	0104211	8.95	1
J.	SABRE SAW BLADES (2)	2608650673	0040653	7.65	1
K.	SABRE BLD SET 5PCE	2608656016	0104219	9.95	1
L.	SABRE SAW BLD	2608653182	1128916	13.89	1
M.	X-LOCK MULTI WHEEL 115X1MM	2608619283	1177377	9.95	1
N.	SABRE SAW BLADES (5)	2608650676	0040658	10.95	1
O.	C/S/BLD 165.1X20MM40TPI	F03FS02411	1156122	18.98	1
P.	C/S/BLD 165.1X20MM24TPI	F03FS02409	1156120	14.49	1
Q.	BATTERY CHARGER 18V	GAL18V40	1304778	37.95	1
R.	18V 5.0AH LITH-ION COOLPACK BATTERY	1600A002U5	1314546	73.00	1



KARCHER POWER TOOLS & ACCESSORIES



Power Tools

A.	K2 UNIVERSAL HOME	16730070	1371558	80.00	1
B.	K3 PREMIUM POWER CONTROL HOME	16027550	1371559	135.00	1
C.	K4 PREMIUM POWER CONTROL HOME	13240340	1371560	210.00	1
D.	EXPERT ONE	15141570	1371561	420.00	1
E.	KARK2850 KARCHER K2.85 PREMIUM PRESSURE WASHER	KARK2850	1293783	84.99	1
F.	HAND HELD BATTERY MULTIJET WASHER	KHB5	1315486	84.99	1

Accessories

G.	FJ 6 FOAM NOZZLE	26431470	1371562	14.95	1
H.	CAR SHAMPOO 3IN1 1L	62957500	1371563	6.95	1
I.	UNIVERSAL PURIFIER 1L	62957530	1371564	19.95	1
J.	WW1-1-633-011.0 WW1 KARCHER WINDOW VAC	WW1-1-633-011.0	1311890	33.33	1
K.	24450340 KARCHER BATTERY POWER 18/25	24450340	1313251	58.33	1





MULTI TOOL ACCESSORIES



A.	SMART Trade 4 Piece Electrician's Kit	H4EMK	1312402	16.75	1
B.	SMART Trade 32mm Bi-Metal Sawblade	H32BM1	1312403	4.58	1
C.	SMART Trade 44mm Bi-Metal Sawblade	H44BM1	1312404	5.27	1
D.	SMART Trade 32mm Japanese Tooth Sawblade	H32CJ1	1312405	4.57	1
E.	SMART Trade 63mm Japanese Tooth Sawblade	H63CJ1	1312406	4.57	1
F.	SMART Trade 8 Piece Blade Set	H8MAK	1312410	19.64	1
G.	SMART Trade 32mm Mortar Buster Brazed Diamond Blade	H32DB1	1312407	18.53	1
H.	SMART Trade 75mm Single Box Cutter	HBC75	1312408	16.61	1
I.	SMART Trade 76mm Hole Saw	HHS76	1312409	19.94	1

SUM UP CARD READER



The perfect partner for your business. Accept payments on the go, wherever your business takes you.

Air Bluetooth Reader - Links to a mobile phone via Bluetooth supporting Credit & Debit cards, Apple and Google pay and contactless payment.

3G Reader - Standalone Device - You don't need a smartphone or tablet. Connect using the free built-in SIM card with unlimited 3G data, or use Wi-Fi. Make up to 50 transactions on a single charge

Charging Cradle - Practical - Stay fully charged all the time. Fast transactions and the perfect accessory for any countertop.



A.	SumUp-AIR Bluetooth Card Reader Air	SUMUP-AIR	1310582	24.99	1
B.	SumUp-3G Card Reader	SUMUP-3G	1313232	89.00	1
C.	SumUp-Cradle For Card Reader	SUMUP-CRADLE	1314686	17.98	1

TRACER MARKER PENS & PENCILS



A.	TRACER Deep Pencil Marker & Site Holster	ADP2	1312411	6.95	1
B.	TRACER Double tipped Marker Pen & Site Holster	AMP2	1312412	6.95	1
C.	TRACER Lead Holster - 6x Replacement leads in TRACER Holster (4x 2B & 2x Yellow)	ALH1	1312413	5.21	1
D.	TRACER Deep Pencil Marker with ALH1 Lead set (blister pack)	AMK1	1312414	10.49	1
E.	TRACER Clog Free Marker Kit - 3pc pack (1x Black / 1x Blue / 1x Red) c/w Site Holders.	ACF-MK3	1312415	12.16	1

Denmans
REXEL GROUP

PROUDLY SUPPORTING

Make-A-Wish
UNITED KINGDOM

All profits go to
Make A Wish.

While Stocks Last!

ONLY
£2.75

Available Online
& In Branch





CARL KAMMERLING INTERNATIONAL
DESIGNED FOR PROFESSIONALS

NOW AVAILABLE
AT ALL DENMANS' BRANCHES

PLIERS & SIDECUTTERS



Redline VDE Combicutter 1 160mm	431004	0175847	27.40	1
Redline VDE Combicutter 1 180mm	T39071-1180	0236118	29.83	1
Redline VDE Combicutter 3 Max	T39071-3180	0236223	30.94	1
Redline VDE Combi Plier 185mm	431002	0175834	26.38	1
Redline VDE Combi Plier 205mm	431003	0175835	29.18	1
Redline VDE Side Cutter 160mm	431017	0258961	32.46	1
Redline VDE Heavy Duty Cable Cutters 165mm	431030	0258949	34.52	1
Redline VDE High Leverage Side Cutters 200mm	T37021200	0893307	38.80	1
Redline VDE Electrician's Plier 180mm	T39077-180	0281608	31.60	1
Redline VDE Snipe Nose Plier 200mm	431014	0175857	25.88	1

CUTTERS & SLICES



PVC Conduit Pipe Cutter	430001	0174689	23.56	1
Electrician's Scissors	492001	0175870	15.45	1
Armour Slice SWA Cable Stripper	T2250	0642728	30.63	1
Armour Slice Spare Blades	T2255	0642729	5.89	1

VDE SCREWDRIVERS



Dextro VDE Screwdriver SLP2.5 x 75	T49144-025	0292640	4.58	1
Dextro VDE Screwdriver SLP3.0 x 100	T49144-030	0292693	5.26	1
Dextro VDE Screwdriver SLP3.5 x 100	T49144-035	0292694	5.44	1
Dextro VDE Screwdriver SLP4.0 x 100	T49144-40	0292695	6.06	1
Dextro VDE Screwdriver SLP2.5 x 125	T49144-055	0292696	6.74	1
Dextro VDE Screwdriver PZD/SDV0 x 60	T49143-0	0292238	5.44	1
Dextro VDE Screwdriver PZD/SDV1 x 80	T49143-1	0292239	6.24	1
Dextro VDE Screwdriver PZD/SDV2 x 100	T49143-2	0292528	7.45	1
Dextro VDE Screwdriver PH1 x 80	T49142-1	0292112	6.06	1
Dextro VDE Screwdriver PH2 x 100	T49142-2	0292236	6.52	1
Dextro VDE Screwdriver MOD 1 x 75	T49145-1	0292740	6.92	1
Dextro VDE Screwdriver MOD 2 x 100	T49145-2	0293032	8.72	1
PZ2 x 46mm Stubby Screwdriver	T48343-2	0988428	7.73	1
SL4.0 x 46mm Stubby Screwdriver	T48344-040	0988429	7.73	1
Precision Screwdriver Set	T4897	1076664	19.45	1
Rethreading Tool	495028	0238139	5.69	1

VDE SLIM SCREWDRIVERS



SL3.5 x 100mm	T49244-035	0966607	7.17	1
SL4.0 x 100mm	T49244-040	0966608	8.37	1
SL5.5 x 125mm	T49244-055	0966609	9.98	1
PH1 x 100mm	T49242-1	0966612	9.18	1
PH2 x 125mm	T49242-2	0966613	11.03	1
MOD2 x 125mm	T49245-2	0966614	13.19	1

CABLE STRIPPER



CK Cable stripper

- Designed for Twin & Earth up to 12mm
- No adjustments necessary
- Removes both the external sheathing and internal conductor insulation

CK Cable stripper

CK Cable stripper	T1260	1187243	54.20	1
-------------------	-------	---------	-------	---

SEALANTS & ADHESIVES

Adhesive Gun



Easiflow HD 10" Skeleton Gun	3282368/Z02	1379363	4.20	1
------------------------------	-------------	---------	------	---

Sealant/Adhesive



Sealant/Adhesive white 290ml	OB1 M-S S&A wht	1379292	8.20	1
Sealant/Adhesive clear 290ml	OB1 M-S S&A dr	1379293	8.20	1
Sealant/Adhesive grey 290ml	OB1 MS S&A GRY	1381872	8.20	1
Sealant/Adhesive black 290ml	OB1 M-S S&A BLK	1381873	8.20	1

Trade Adhesive



Trade Multipurpose Sealant White 280ml	483439	1379294	3.69	1
Trade Multipurpose Sealant Clear 280ml	483422	1379295	3.69	1

Contractor Adhesive



Contractor GP Silicone C3 White	5002101/C04	1379357	2.10	1
Contractor GP Silicone C3 Clear	5002102/C04	1379358	2.10	1

Trade Adhesive



781 Multi-Purpose Silicone 310ml White	3295231/C05	1379364	4.50	1
781 Multi-Purpose Silicone 310ml Clear	3295036/C05	1379365	4.50	1

SEALANTS & ADHESIVES

EVO-STIK Adhesive



GRIPFILL ADHESIVE 350ML	18601	1379288	2.20	1
GRIPFILL Solvent-free White 350ml	18631	1379289	2.60	1
*Sticks Like Sh*t* Adhesive 290ml white	663688	1379290	5.20	1
*Sticks Like Sh*t* Adhesive 290ml clear	663824	1379291	5.70	1

Geocel Adhesive



theWORKS Pro Silicone/Adhesive 290ml Clear	6001241/C03	1379359	8.00	1
theWORKS Pro Silicone/Adhesive 290ml White	6001240/C03	1379360	8.00	1
Contractors Caulk 380ml White	2939801/C06	1379361	1.99	1
Contractor Straw Foam 750ml	5002201/Z02	1379362	4.50	1

Adhesive



GLUE 60ML	1044203	1376440	5.95	1
SUPER GLUE 15G	GOR4049202	1376441	6.95	1
EPOXY 25ML	6044001	1376442	5.50	1
TAPE 11M BLACK	3044000	1376443	6.50	1

CLEANING



Cleaning				
Tub of 80 Heavy Duty Wipes	2020/2420	0446187	10.50	1
Tub of 80 Multi-Purpose Wipes	SYCWIPES	0446189	6.49	1





PERSONAL PROTECTIVE EQUIPMENT



A.	Safety Helmet (Blue)	HELMET/BLU	1030056758	4.98	1
B.	Helmet Clips (Pack of 4)	HELMCLIP	1030055009	3.91	1
C.	High Vis. Vest, Yellow, L/XL	HWW03XL	1031004561	3.07	1
D.	Uvex Ultrasonic Goggles	9302645	1030017081	10.50	1
E.	Ear Plugs - Yellow Neon	ES-01-001	1030021408	0.25	1
F.	Classic Ear Defenders	EARDEF	1072244	3.25	1
G.	Fingerless Cut Proof Gloves	F/LESSGLV	1030045112	2.29	1
H.	Disposable Dust Mask (20 pk)	DUSTMASK	1030005334	9.95	1
I.	Latex Gloves (Box of 100)	LATEXGLOVE	1072263	5.45	1
G.	Disposable Overshoe (50 pk)	OVERSHOE	1030008856	4.19	50

BATTERIES

DURACELL

Duracell Industrial Batteries

WHILE STOCKS LAST



Duracell Industrial Batteries

AA Industrial	MN1500	1050071270	0.44	1	0.41	20+
AAA Industrial	MN2400	1050071272	0.50	1	0.45	20+
9V PP3 Industrial	MN1604	1050071271	1.79	1	1.64	5+
C Industrial	MN1400	1050071274	0.96	1	0.88	10+
D Industrial	MN1300	1050071273	1.28	1	1.15	10+

Energizer

Energizer Industrial Batteries



Energizer Industrial Batteries

AA Industrial Energizer	ENER-AA	1274696	0.50	1	0.45	10+
AAA Industrial Energizer	ENER-AAA	1274697	0.50	1	0.45	10+
9V PP3 Industrial Energizer	ENER-9V	1274700	1.79	1	1.64	12+
C Industrial Energizer	ENER-C	1274698	0.96	1	0.88	12+
D Industrial Energizer	ENER-D	1274699	1.28	1	1.15	12+
2032 Button Cell Battery 4 pack	ENER-2032	1274672	2.99	1		
2025 Button Cell Battery 4 pack	ENER-2025	1274673	2.99	1		
2016 Button Cell Battery 4 pack	ENER-2016	1274674	2.90	1		



6V Lantern Battery

6V Lantern Battery	PJ996/N	1030007344	2.47	1	2.33	5+
--------------------	---------	------------	------	---	------	----

EASY, CONVENIENT & SAVES THE PLANET



Simply scan the QR code to download the brochures to view anytime, anywhere!



DRILL BITS & HOLE CUTTERS

ARMEG Drill Bits (More sizes available - Ask your branch)

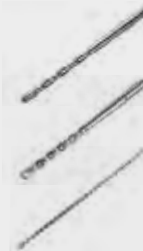

5.5 x 150 Masonry Bit	P05.5X150	0300385	2.10	1
6.0 x 150 Masonry Bit	P06.0X150	0300386	2.32	1
5.5 x 160 SDS Plus Hammer Bit	S05.5X160	0299603	1.93	1
6.0 x 160 SDS Plus Hammer Bit	S06.0X160	0299624	4.18	1
10 x 450 SDS Plus Hammer Bit	S10.0X450	0299824	9.27	1
12 x 450 SDS Plus Hammer Bit	S12.0X450	0300010	9.44	1
16 x 450 SDS Plus Hammer Bit	S16.0X450	0300392	9.40	1

Steeple Drill Bit Set



SDS Plus Masonry 3 Piece Drill Bit Set - includes: 12x1000mm, 16x1000mm, 24x1000mm	125628	0837592	20.86	1
--	--------	---------	-------	---

ARMEG Drill Bits - Metal



3mm Drill Bit	YM300W	0302744	1.11	1
4mm Drill Bit	YM400W	0552053	1.24	1
5mm Drill Bit	YM500W	0552054	0.87	1

ARMEG Re-Threader



3.5mm Re-Threader	EMWRT03.5	0384361	9.41	1
-------------------	-----------	---------	------	---

Wood Beaver Drill Bits



20mm Wood Beaver	WWB20.0T	0302339	6.36	1
25mm Wood Beaver	WWB25.0T	0302373	6.75	1
32mm Wood Beaver	WWB32.0T	0302375	16.22	1
Wood Beaver - 4 Piece Set (16, 20, 25 & 32mm)	WWB4PCSET	0302208	27.52	1
20mm Nail Proof Beaver	WWBNP20	0528446	15.59	1
25mm Nail Proof Beaver	WWBNP25	0528443	20.49	1

Stubby Beaver



20 x 120mm Stubby Wood Beaver	WWBST20	0528441	8.03	1
22 x 120mm Stubby Wood Beaver	WWBST22	0528442	8.09	1

Flat Bits



6 Piece Flat Bit Set (13, 16, 20, 22, 25 & 32mm)	WF6SET	0301668	12.18	1
Flat Wood Bit - 16mm	WF16.0X160	0301685	2.31	1
Flat Wood Bit - 20mm	WF20.0X160	0301688	2.08	1
Flat Wood Bit - 22mm	WF22.0X160	0301689	2.14	1
Flat Wood Bit - 25mm	WF25.0X160	0301690	2.16	1



DRILL BITS & HOLE CUTTERS



ARMEG Holesaws (other sizes available)

20mm Holesaw	PCH020	0473607	4.37	1
25mm Holesaw	PCH025	0473609	5.41	1
32mm Holesaw	PCH032	0473610	6.41	1
64mm Holesaw	PCH064	0473619	8.97	1
73mm Holesaw	PCH073	0473623	9.86	1
86mm Holesaw	PCH086	0473627	14.92	1



Holesaw Kit

Elec Holesaw Kit	CH6SETELHEX	0299321	26.49	1
Adjustable Hole Cutter	AHC40-200	0327604	54.48	1



D-A-D-E Dust/Debris Extractor

Dust/Debris Extractor	DADE	0619990	12.99	1
-----------------------	------	---------	-------	---



ARMEG Arbors

9.5mm Hex Arbor	CHD1629HEX	0299489	5.65	1
32mm Hex Arbor	CHD3264HEX	0299491	16.60	1
Pilot Drill for Arbor	CHPD	0299493	3.86	1



ARMEG Acceler8% Sheet Steel Holesaw

20mm	SSH020	0563656	15.94	1
25mm	SSH025	0563658	16.56	1
32mm	SSH032	0563660	21.04	1
3 Piece Holesaw Set	SSH3PCSET	0563663	43.75	1



ARMEG Hole Cutters & Box Sinkers

EBS Starter Kit	EBS.RS.SET	0552043	52.23	1
Complete Box Sinking Set	EBSTCINSTS	0387484	250.47	1
127mm Board Cutter Set	SBC127PGST	0300977	52.94	1
127mm Replacement Plug	RPSBC127P	0299579	2.82	1
SBC Plug Cap 111mm	RPSBC111P	0299578	2.27	1
5 Piece Diamond Core Drill Kit	CDD5PCSET	0299026	115.45	1



Quick Cone Drill Bits

6-20mm	ECD06-20	0407728	24.79	1
16-30.5mm	ECD16-30.5	0407740	39.27	1



Step Drills

4mm to 22mm	EMW04-22	0407390	34.18	1
5mm to 35mm	EMW05-35	0342938	62.55	1



Steeple Quick Change Magnetic Bit Holder

Magnetic Bit Holder	SDMBH1/4	1021035	7.88	1
---------------------	----------	---------	------	---

HAND TOOLS



FAITHFUL Claw Hammer

Steel Shaft 16oz Claw Hammer	FAICAS16	1278224	9.43	1
------------------------------	----------	---------	------	---



CK Saws and Blades

Plasterboard Saw	T0831	0068326	4.27	1
------------------	-------	---------	------	---

HAND TOOLS

Hacksaws



12" Hacksaw	HS001	0552046	17.78	1
12" Bi-Metal Hacksaw Blades (x2)	HS002	0552047	7.77	1
Junior Hacksaw 150Mm (6In)	FAJH	1267310	3.89	1
Junior Hacksaw Blades (Pack of 10)	FAJHBS	1267311	4.19	1



4 Way Utility Key

4 Way Utility Key	MS134	0552128	2.10	1
-------------------	-------	---------	------	---



Tape Measure

Tape Measure	DTMSM	0805320	4.89	1
--------------	-------	---------	------	---

CABLE ROD KITS



SUPER ROD Cable Rod Kit

Cable Rod Kit	CABLEROD	0376461	36.80	1
---------------	----------	---------	-------	---



Cable Rod Mega Set

Cable Rod Mega Set	CRMX	0415401	115.95	1
--------------------	------	---------	--------	---



Gekko Gripper

Gekko Gripper	SRGG6-1	0631465	21.95	1
---------------	---------	---------	-------	---

CABLE TIES



Plastic Cable Ties - Packs of 100 (unless stated)

100 x 2.5mm Black	CT100	0551554	0.92	100	0.78	500+
100 x 2.5mm Neutral	CT100N	0551555	0.92	100	0.78	500+
140 x 3.6mm Black	CT140	0551556	2.17	100	1.86	500+
140 x 3.6mm Neutral	CT140N	0551557	2.17	100	1.86	500+
200 x 4.8mm Black	CT200	0551559	3.72	100	3.18	500+
200 x 4.8mm Neutral	CT200N	0551560	3.72	100	3.18	500+
295 x 4.8mm Black	CT300	0551566	5.56	100	4.75	500+
370 x 4.8mm Black	CT370	0551573	7.10	100	6.05	500+
370 x 4.8mm Neutral	CT370N	0551574	7.10	100	6.05	500+
370 x 7.6mm Black	CT370WIDE	0551576	14.35	100	12.22	500+
Small Tie Bases	STB	0551567	6.67	100	5.68	500+
Large Tie Bases	LTB	0551569	12.13	100	10.37	500+



Metal Cable Ties

200mm (x100)	SRBT50S	0551580	14.14	100	12.71	200+
300mm (x100)	SRBT75S	0551585	16.77	100	15.85	200+
Tensioner Tool for Metal Cable Ties	DRST1	0551553	38.78	1		

METAL CABLE TIES AVAILABLE IN OTHER SIZES - ASK YOUR BRANCH

FLY KILLERS



MANROSE Fly Killers

2x8W 50 M² Fly Killer	MANFK50	0427308	45.88	1
2x10W 80 M² Fly Killer	MANFK80	0427317	52.49	1
2x20W 150 M² Fly Killer	MANFK150	0427318	64.12	1



Replacement Lamps for MANFK models

8W Tube for MANFK50	MANLMP8W	0568641	6.95	1
10W Tube for MANFK80	MANLMP10W	0568642	7.71	1
20W Tube for MANFK150	MANLMP20W	0568643	8.74	1



CABLE CRIMP LUGS & KITS



Piggy Backs

Blue, 2.5mm	PB2.5	0551570	5.28	100
-------------	-------	---------	------	-----



Slide Terminals

Red, 1.5mm	SO1.5-6.3	0551563	4.10	100
Blue, 2.5mm	SO2.5-6.3	0551571	5.34	100



Core End/Bootlace Ferrules

1.5mm	SCE1.5B	0838898	1.24	100
2.5mm	SCE2.5B	0838899	1.50	100



Male Tab Connectors

Red, 1.5mm	SRTAB63	0838900	3.51	100
Blue, 2.5mm	SBTAB63	0838901	3.87	100



Crimp Lugs

10mm ² M6 (x100)	CL10-6	0551577	17.52	100
10mm ² M8 (x100)	CL10-8	0551578	17.52	100
16mm ² M10 (x100)	CL16-10	0551579	22.94	100
16mm ² M6 (x100)	CL16-6	0551581	26.70	100
16mm ² M8 (x100)	CL16-8	0551582	26.83	100
25mm ² M10 (x100)	CL25-10	0551583	29.99	100
25mm ² M8 (x100)	CL25-8	0551584	28.76	100
35mm ² M10 (x100)	CL35-10	0551586	48.21	100
50mm ² M10 (x100)	CL50-10	0551589	79.03	100



Splice Connectors

10mm (x100)	CS10	0551535	23.14	100
16mm (x100)	CS16	0551536	33.09	100



Butt Connectors - Packs of 100 (unless stated)

Red, 1.5mm	B1.5	0551562	3.37	100
Blue, 2.5mm	B2.5	0551564	4.11	100
Yellow, 6mm	B6	0551572	5.53	100



Ring Terminals

Red, 1.5mm	R1.5-5	0551558	2.45	100
Blue, 2.5mm	R2.5-5	0551561	2.85	100
Yellow, 6mm	R6.0-6	0551575	5.82	100

CABLE & CRIMPING TOOLS



Crimping Tools

Insulated Crimp Kit	O8CRIMPKIT	0550864	35.03	1
Ratchet Crimper	RATCH	0551543	12.50	1
Bare Crimp Lug Kit	DK3/DEN	0551552	33.50	1
1.5-14mm Copper Tube Crimping Tool	CMP7	0867187	19.99	1



Steeple Cable Strippers

Ratchet Cable Stripper	UNISTRIP	0551550	10.95	1
T-5 Wire Stripper 0.75 - 6mm ²	T/STRIPPER	0221355	11.28	1



Cable Tacker

3-in-1 Staple & Cable Tacker Gun	101332	0918208	13.09	1
Cable Tacker Clip - White (x5000)	S24TCT4510W	1170497	9.27	5000

LABEL PRINTERS & ACCESSORIES



brother at your side Label Printers

Labelling Machine	SPT100VP	0669555	56.31	1
-------------------	----------	---------	-------	---



Electricians Handheld Label Printer

Automatic cutter	SPT100VP	0669555	56.31	1
------------------	----------	---------	-------	---

PT-E550WVP handheld label printer with case, charger and battery. 2 tapes: 24mm & 12mm

Gloss Label Cartridges (Other colours and sizes available)



9mm Black/White	TZ221	0552154	16.49	1
12mm Black/White	TZ231	0442743	18.01	1
6mm Black / White Gloss	TZ211	0552153	14.63	1
9mm Black / Clear Gloss	TZ121	0552151	14.51	1
9mm Black / Yellow	TZ621	0683751	16.49	1
12mm Black / Yellow Gloss	TZ631	0442746	18.01	1
12mm Black / Clear Gloss	TZ131	0552152	16.40	1
12mm Black / Red Gloss	TZ431	0552155	18.01	1
18mm Black / White Gloss	TZ241	0442745	21.89	1
18mm Black / Yellow Gloss	TZ641	0442749	21.89	1
24mm Black / White	TZ251	0442750	24.12	1
24mm Black / Red Gloss	TZ451	0552156	24.12	1
24mm Black / Yellow	TZ651	0442752	24.12	1
24mm Black / Green	TZ751	0683750	24.12	1

EXCLUSIVE PARTNERSHIP
JOIN BRITAIN'S BUSIEST NETWORK

Join Checktrade
FREE for three
months*

Don't miss out.
Strictly limited offer.

EXCLUSIVE OFFER FOR
Denmans trade customers

Visit denmans.co.uk for details

Electrical Warning Labels (More labels available - ask your branch)



Danger 230V: 50x20mm	VHC2YB	0553764	0.07	100+
Danger 230V: 80x35mm	VTLF2YB	0553757	0.08	100+
Danger 400V: 50x20mm	VHC6YB	0553753	0.07	100+
Danger 400V: 80x35mm	VTLF6YB	0553758	0.08	100+
Safety Electrical Connection	VPF50YBG	0553754	0.09	100+
Periodic Inspect: 130x55mm	VPJ24YBG	0553755	0.18	100+
Isolate Supply	VTLF22YB	0553756	0.08	100+
Small PAT Test Label	WLTESTEDP	0553748	0.05	50+
PAT Test Label Roll	WLTESTES/R	0598354	0.02	500+
Col Harmon Label Pack	WLWR	0553750	5.10	5+

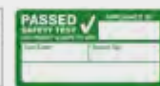
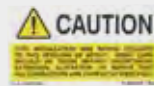



WORKWEAR

Workwear available - all sizes
Ask in branch for details



Trousers

The Apache Holster Trousers are a good, all-round, functional work trouser. They have been triple stitched in key areas and have a low rise comfort waist design. With Cordura® holster and knee pad pockets, they also have a Cordura® reinforced hem and reflective piping. Other features include: a side cargo pocket, large phone pocket, tunnel belt loop and YKK zip.

Material Weight: 280g
Material Composition: 65% Polyester, 35% Cotton



APACHE GREY / BLACK				
W30 L29	APAHTG2930	1284826	29.98	1
W30 L31	APAHTG3130	1284827	29.98	1
W30 L33	APAHTG3330	1284828	29.98	1
W32 L29	APAHTG2932	1284829	29.98	1
W32 L31	APAHTG3132	1284830	29.98	1
W32 L33	APAHTG3332	1284831	29.98	1
W34 L29	APAHTG2934	1284832	29.98	1
W34 L31	APAHTG3134	1284833	29.98	1
W34 L33	APAHTG3334	1284834	29.98	1
W36 L29	APAHTG2936	1284562	29.98	1
W36 L31	APAHTG3136	1284563	29.98	1
W36 L33	APAHTG3336	1284564	29.98	1
W38 L29	APAHTG2938	1284565	29.98	1
W38 L31	APAHTG3138	1284566	29.98	1
W38 L33	APAHTG3338	1284567	29.98	1
W40 L31	APAHTG3140	1284568	29.98	1
W40 L33	APAHTG3340	1284569	29.98	1
W42 L31	APAHTG3142	1284570	29.98	1
W42 L33	APAHTG3342	1284571	29.98	1

EN Test:
CE EN ISO
20345-2011
Safety Rating: S1P
Slip Rating: SRC



Scan 4D Ring Chukka Boots



Scan 4D Ring Chukka Boots				
UK6	SCAFWCHUK6	1281993	20.98	1
UK7	SCAFWCHUK7	1281994	20.98	1
UK8	SCAFWCHUK8	1281995	20.98	1
UK9	SCAFWCHUK9	1281996	20.98	1
UK10	SCAFWCHUK10	1281997	20.98	1
UK11	SCAFWCHUK11	1281998	20.98	1
UK12	SCAFWCHUK12	1281999	20.98	1

EN Test:
CE EN ISO
20345-2011
Safety Rating: S1P
Slip Rating: SRC



Scan Texas Lined Rigger Boots



Scan Texas Lined Rigger Boots				
UK6	SCAFWTexas6	1282007	28.30	1
UK7	SCAFWTexas7	1282008	28.30	1
UK8	SCAFWTexas8	1282009	28.30	1
UK9	SCAFWTexas9	1282010	28.30	1
UK10	SCAFWTexas10	1282011	28.30	1
UK11	SCAFWTexas11	1282012	28.30	1
UK12	SCAFWTexas12	1282013	28.30	1

EN Test:
CE EN ISO
20345-2011
Safety Rating: SB
Slip Rating: SRA



Cutter Safety Trainers



DeWalt Cutter Safety Trainers				
UK6	DEWCUTTER6	1282000	53.63	1
UK7	DEWCUTTER7	1282001	53.63	1
UK8	DEWCUTTER8	1282002	53.63	1
UK9	DEWCUTTER9	1282003	53.63	1
UK10	DEWCUTTER10	1282004	53.63	1
UK11	DEWCUTTER11	1282005	53.63	1
UK12	DEWCUTTER12	1282006	53.63	1

LADDERS

Heavy Duty Ladders

- Fibreglass Rails - Safer for working around electricity
- Lightweight, Strong, Heat and Weather resistant
- Non slip steps and rubber non-slip feet for greater safety
- Conforms to BS EN-131-1-2-3 for professional use



4 Tread Ladder	4TREAD	0548728	65.71	1
6 Tread Ladder	6TREAD	0548729	77.27	1
8 Tread Ladder	8TREAD	0548730	98.27	1
Work Platform (390(W) x 965(L) x 480(H)mm)	WP1	0548727	44.29	1

LADDER CLAMPS & VAN STORAGE



Ladder Safe Clamps (pk of 2)

Ladder Safe Clamps (pk of 2)	RAS21P	0552094	49.11	1
------------------------------	--------	---------	-------	---



Pipe Carrier (Available to order)

Aluminium 3m Pipe Carrier	RP12	0552095	126.51	1
Tie Down Set	285155	0933616	10.85	1



Van Boxes Available

ASK IN BRANCH

TORCHES / TASKLIGHT / HEADTORCH

LED Lantern (4x D Cell / 1x 4R25)	HANDLAMP/N	0552341	4.77	1
CT-2 Torch/Worklight	CT-2	1187236	14.49	1
PS-H1 75lm Headtorch	PS-H1	0933574	9.49	1
200lm Extendable Hand Torch	LHEXTEND200	1248733	13.99	1
PL-3 Penlight	PL-3	1192362	8.99	1

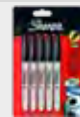

Permanent Markers

Sharpie Fine Marker Pen - 5 Pack	SHARPIE5	1267309	4.75	1
----------------------------------	----------	---------	------	---

TAPE



Steeple PVC Tape, to BS3924, 33m x 19mm:

Green/Yellow	GNV19	0550786	Grey	GREY19	0550787
Blue	BU19	0550785	Yellow	YE19	0550790
White	WH19	0550789	Black	BL19	0550783
Brown	BRN19	0550784	Red	RE19	0550788
All colours					1.13 1 0.92 10+



Gaffer Tape

Gaffer Tape, 50m roll, Black	GAFFER/BLK	0550796	5.43	1
Gaffer Tape, 50m roll, Silver	GAFFER/SLV	0550800	5.43	1





TAPE



Self Amalgamating Tape

19mm x 10m	2423000	0838331	5.37	1
------------	---------	---------	------	---



Heat Shrink Tape

Mixed Pack	DHSMULTI	0551537	7.80	1
------------	----------	---------	------	---

FIXINGS

Steeple Woodscrews



Twin-thread hardened BZP countersunk pozidrive. 8mm head. Boxed in 200s

0.5" length	4X0.50CROSS	0836829	1.99	200	1.63	1000+
0.75" length	8X.75CROSS	0550814	3.71	200	3.14	1000+
1" length	8X1CROSS	0550811	3.38	200	2.89	1000+
1.25" length	8X1.25CROSS	0550815	4.63	200	3.87	1000+
1.5" length	8X1.5CROSS	0550816	4.69	200	4.30	1000+
2" length	8X2CROSS	0550822	5.80	200	5.41	1000+
3" length	8X3CROSS	0836830	6.35	200	5.99	1000+
1.5" length	10X1.5CROSS	0836831	7.71	200	6.64	1000+
2" length	10X2CROSS	0836832	10.28	200	8.74	1000+
Twin-thread hardened BZP countersunk pozidrive. 8mm head. Boxed in 100s						
3" length	10X3CROSS	0836833	6.46	100	4.41	1000+

DEWALT Walldog



Walldog - 32mm CSK - Chrome (pack contains 100 pieces)	DFM424015P	1312400	8.99	1
Walldog - 32mm PAN - Chrome (pack contains 100 pieces)	DFM425005P	1312401	8.99	1



Tub of 500x mixed Woodscrews & Wall Plugs

Tub of 500x mixed Woodscrews & Wall Plugs	05TUB02	0550831	17.82	1	15.95	3+
---	---------	---------	-------	---	-------	----

Wall Plugs



Yellow (x100)	WPYELLOW	0550860	1.03	100	0.98	500+
Red (x100)	WPRED/N	0549415	1.49	100	1.27	500+
Brown (x100)	WPBROWN	0550861	2.05	100	1.80	500+



walraven Sharp point for accurate positioning. Serrated point for easier hammering-in. Collar prevents falling through. Hammer-in plug expands and does not rotate on screwing. Removable with minimal damage to the wall.

Hammer In Plug for Plasterboard (x200)	GOLDPL200	0563875	22.01	1	19.81	5+
--	-----------	---------	-------	---	-------	----

FOR CABLE CLIPS - SEE LISTING ON PAGE 32



Cavity Wall Fixings Plasterboard Fixing Metal (x100)

Plasterboard Fixing Metal (x100)	SD100	0550827	11.96	100	10.47	500+
----------------------------------	-------	---------	-------	-----	-------	------



Drivas Tub Tub of 200 Metal Drivas

Tub of 200 Metal Drivas	1776111	0142648	16.30	1
-------------------------	---------	---------	-------	---



Steeple Nails

25mm Capping Nails (x100)	CAP25	0550834	6.33	100	5.81	1000+
---------------------------	-------	---------	------	-----	------	-------

FIXINGS

orbix Self Drilling/Tapping Screw Kit



Selection pack containing low profile head metal and multi woodscrews. Also includes countersunk, panhead self drilling screws and point caps. Complete with robust plastic case.

Orbix Screw Kit	OBX-SCT-PK	0387494	20.74	1
-----------------	------------	---------	-------	---



Deligo Clout Nails

30mm Clout Nails (x100)	ZC30	0552668	3.19	1	2.87	5+
-------------------------	------	---------	------	---	------	----



Steeple Extension Stud

M3.5 Extension Stud	M35EX	0551826	0.69	1
---------------------	-------	---------	------	---



Socket Screws

35mm (x100)	SM3.5X35	0550813	3.95	100
50mm (x100)	SM3.5X50	0550818	4.94	100
75mm (x50)	SM3.5X75	0550823	7.30	100



M4 Brass Pan Head Screws

10mm length (x100)	SM4X10	0550825	6.94	100
12mm length (x100)	SM4X12	0550828	7.12	100
16mm length (x100)	SM4X16	0550829	7.59	100
20mm length (x100)	SM4X20	0550830	8.64	100
25mm length (x100)	SM4X25	0550832	9.42	100
Brass Nut (x100)	SM4N	0550820	5.94	100
Brass Washer (x100)	SM4W	0550821	6.97	100



Fixing Bands

Suitable for suspended installations and anchoring in electrical, building, heating and ventilation installations.

12mm Black, 10m pack	FS12B	0549014	12.54	1
Steeple Fixing Band	GB12	1266756	3.90	1



UNITRUNK Threaded Rod & Accessories

M6 Threaded Rod 3m	M6/R3	0053787	2.32	1	2.08	10+
M8 Threaded Rod 3m	M8/R3	0053838	3.66	1	3.30	10+
M10 Thr. Rod 3m	M10/R3	0053839	5.24	1	4.72	10+
M6 Hexagonal Nut	M6/HN	0113408	1.28	100	1.15	500+
M8 Hexagonal Nut	M8/HN	0113410	2.75	100	2.52	500+
M10 Hexagonal Nut	M10/HN	0113411	5.06	100	4.64	500+
6 x 10mm Washers	M6/FW	0113355	1.42	100	1.30	500+
6 x 25mm Washers	M6MW	0090695	3.85	100	3.53	500+
8 x 25mm Washers	M8/FW	0113356	2.92	100	2.70	500+
8 x 32mm Washers	M8MW	0090715	4.21	100	3.87	500+
10 x 38mm Washers	M10/FW	0113402	2.53	100	2.32	500+



walraven Beam Clips

For a solid fixing to steel construction without the need for welding or drilling

5-9mm Grip	BC250	0413241	0.51	1	0.46	25+
10-16mm Grip	BC500	0413242	0.52	1	0.47	25+



Girdler Clips

For quick fixing of cables.

12-14mm 4-7mm Grip	CR412	0413446	0.26	1	0.23	25+
12-14mm 8-12mm Grip	CR812	0413447	0.28	1	0.25	25+

We stock, or can source, a huge range of clip fixings for the management of service and cables - please ask your branch!



FISCHER SCREWS & FIXINGS



fischer DUOPOWER Universal Wall Plugs

DUOPOWER Universal Wall Plugs 6 x 30mm Pack of 100	555006	1263913	3.48	100
DUOPOWER Universal Wall Plugs 8 x 40mm Pack of 100	555008	1263914	5.93	100



fischer Concrete Screw With Female Connector

FBS 6x35 M8/10 I	546400	1264078	52.89	100
FBS 6x55 M8/10 I	546401	1264080	58.21	100



fischer Hollow Wall Fixings

HM Hollow Wall Fixings 5x65	519775	1263727	9.99	50
-----------------------------	--------	---------	------	----



fischer Metal Expansion Plugs

FMD 6 x 32 Metal Expansion Plug Pack of 100	61224	1264133	8.70	100
FMD 8 x 38 Metal Expansion Plug Pack of 100	61225	1264138	10.33	100



fischer Toggles

KD 5 TOGGLES	80187	1263330	13.77	25
--------------	-------	---------	-------	----



fischer Plasterboard Fixing With Screw

PDM 35mm Metal Self Drill - 100	42793	1263871	9.04	100
---------------------------------	-------	---------	------	-----



fischer Intumescent Putty Pad

FIPP/I-S 170mm x 170mm	53578	1263667	4.38	1
FIPP/I-D 230mm x 170mm	54757	1263666	5.03	1



fischer Drop In Anchor

EA II Drop In Anchor M8 x 30mm ETA Approved Box of 100	48284	1263563	16.23	100
EA II Drop In Anchor M10 x 25mm ETA Approved Box of 50	532232	1263910	10.54	50
M8 Drop In Anchor	535963	1263559	9.17	100
M10 Drop In Anchor	535964	1263422	5.00	50



fischer FIS Resin

FIS P Plus 300ml	523226	1263426	8.33	1
FIS VL 300ml (ETA Approved)	539461	1263917	9.16	1



fischer Pre-cut Resin Studs

10 x 130mm Pack of 4	503072	1263241	3.33	4
12 x 160mm Pack of 4	503073	1263242	4.17	4

OPTIMAXX SCREWS

Wall Bite Screws

- No plug fixing screw - An all steel, expansion free one piece threaded fastener
- Suitable for most common building materials including concrete, brick, timber and plasterboard.
- No pre drilling required in timber and plasterboard
- Torx Drive (Bit included) reducing 'cam out'

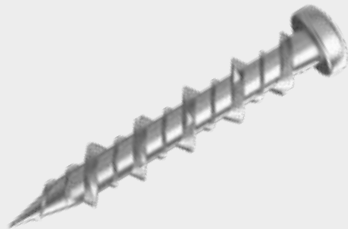

6.5x32 OPTIMAXX Wall Bite Screw Silver	C650-320	1382243	8.50	100
6.5x38 OPTIMAXX Wall Bite Screw Silver	C650-380	1382244	8.50	75
6.5x32 OPTIMAXX Wall Bite Screw White	C650-320W	1382245	8.50	100
6.5x38 OPTIMAXX Wall Bite Screw White	C650-380W	1382246	8.50	75

Woodscrews

- Unique 24 grooves self countersink into all materials without the need to counter bore
- Double reinforced collar strengthens underside of the head
- Sharp, wide, deep thread formation coated with a unique lubricant facilitates fast continuous insertion.



5.0X70 OPTIMAXX WOODSCREW 200PC	C288-535	1376256	11.87	200
5.0X100 OPTIMAXX WOODSCREW 200PC	C288-550	1376257	21.00	200
4.0X30 OPTIMAXX WOODSCREW 200PC	C288-415	1376251	4.54	200
4.0X40 OPTIMAXX WOODSCREW 200PC	C288-420	1376252	5.36	200
4.0X50 OPTIMAXX WOODSCREW 200PC	C288-425	1376253	5.99	200
5.0X40 OPTIMAXX WOODSCREW 200PC	C288-520	1376254	6.95	200
5.0X50 OPTIMAXX WOODSCREW 200PC	C288-525	1376255	8.06	200

REISSER WOODSCREWS

R2 Wood Screws

- Single Threaded Woodscrew giving a higher pullout value
- Lubricated, Sharp, Wide, deep thread helping the screw drive in quickly and easily
- High Strength, specially hardened steel gives the R2 maximum tensile and torsional strength.
- Re-inforced collar under the head gives additional support to prevent snapping and reduces the risk of the bit jumping out and rounding off the edges.



R2 SCREWS CSK PZD FT YELLOW 04.0 x 025 CP	9200S220400254	1376311	3.71	200
R2 SCREWS CSK PZD FT YELLOW 04.0 x 030 CP	9200S220400304	1376312	4.04	200
R2 SCREWS CSK PZD FT YELLOW 04.0 x 040 CP	9200S220400404	1376313	5.18	200
R2 SCREWS CSK PZD FT YELLOW 04.0 x 050 CP	9200S220400504	1376314	6.83	200
R2 SCREWS CSK PZD PT YELLOW 04.0 x 060 CP	9221S220400604	1376315	9.28	200
R2 SCREWS CSK PZD PT YELLOW 04.0 x 070 CP	9221S220400704	1376316	10.92	200
R2 SCREWS CSK PZD PT YELLOW 04.0 x 080 CP	9221S220400804	1376317	13.64	200
R2 SCREWS CSK PZD FT YELLOW 05.0 x 040 CP	9200S220500404	1376318	7.53	200
R2 SCREWS CSK PZD FT YELLOW 05.0 x 050 CP	9200S220500504	1376319	9.05	200
R2 SCREWS CSK PZD PT YELLOW 05.0 x 060 CP	9221S220500604	1376320	11.11	200
R2 SCREWS CSK PZD PT YELLOW 05.0 x 070 CP	9221S220500704	1376321	13.32	200
R2 SCREWS CSK PZD PT YELLOW 05.0 x 080 CP	9221S220500804	1376322	14.82	200
R2 SCREWS CSK PZD PT YELLOW 05.0 x 100 CP	9221S220501004	1376323	23.59	200



IP RATINGS EXPLAINED

IP ratings refer to the protection against contact and foreign bodies and protection against water.

(IP = Ingress Protection)

The first digit of an IP rating refers to the protection against contact and foreign bodies, 0.x meaning no protection through to 6.x meaning full protection against ingress of dust.

The second digit of an IP rating refers to water protection, x.0 meaning no protection through to x.8 meaning full protection against continuous submersion.

FIRST DIGIT:

Level	Object Size Protected Against	Effective Against
0	-	No protection against contact and ingress of objects
1	> 50 mm	Any large surface of the body, such as the back of a hand, but no protection against deliberate contact with a body part
2	> 12.5 mm	Fingers or similar objects
3	> 2.5 mm	Tools, thick wires, etc.
4	> 1 mm	Most wires, screws, etc.
5	Dust Protected	Ingress of dust is not entirely prevented, but it must not enter in sufficient quantity to interfere with the satisfactory operation of the equipment; complete protection against contact
6	Dust Tight	No ingress of dust; complete protection against contact

SECOND DIGIT:

Level	Protected Against	Details
0	Not Protected	-
1	Dripping Water	Dripping water (vertically falling drops) shall have no harmful effect.
2	Dripping Water when tilted up to 15°	Vertically dripping water shall have no harmful effect when the enclosure is tilted at an angle up to 15° from its normal position.
3	Spraying Water	Water falling as a spray at any angle up to 60° from the vertical shall have no harmful effect.
4	Splashing Water	Water splashing against the enclosure from any direction shall have no harmful effect.
5	Water Jets	Water projected by a nozzle against enclosure from any direction shall have no harmful effects.
6	Powerful Water Jets	Water projected in powerful jets against the enclosure from any direction shall have no harmful effects.
7	Immersion up to 1 metre	Ingress of water in harmful quantity shall not be possible when the enclosure is immersed in water under defined conditions of pressure and time (up to 1 metre of submersion).
8	Immersion Beyond 1 metre	The equipment is suitable for continuous immersion in water under conditions which shall be specified by the manufacturer. NOTE: Normally, this will mean that the equipment is hermetically sealed. However, with certain types of equipment, it can mean that water can enter but only in such a manner that produces no harmful effects.

BATHROOM ZONES EXPLAINED



Using electrical equipment in bath or shower rooms has always needed care to ensure safety. Now the IEE Wiring Regulations (17th Edition) have identified particular zones within the bathroom to indicate what type of electrical equipment can be installed.

<p>ZONE 0 Inside the bath or shower. Any fitting used here must be SELV (max. 12V) and a minimum of IPX7 (protected against immersion in water).</p>	<p>ZONE 1 Above the bath or shower to a height of 2.25m. A minimum rating of IPX4 is required* (see Note 1).</p>
<p>ZONE 2 The area stretching to 0.6m outside the bath or shower and above the bath or shower. An IP rating of at least IPX4 is required (see Note 1).</p>	<p>OUTSIDE ZONES Anywhere outside Zones 0, 1 & 2. Where water jets are not to be used for cleaning purposes, the general rules BS7671 apply* (see Note 1).</p>

- Notes:
- In Zones 1 & 2, if there is a likelihood of water jets being used for cleaning purposes, a minimum of IPX5 is required.
 - Basins are not covered, however they are usually considered to be Zone 2.
 - Providing that the space under the bath cannot be accessed without using tools, that space is considered to be out of Zone. However - if in any doubt, please check.
 - The information contained on this page is for guidance only. Always refer to the current IEE regulations or a qualified electrician to ensure that you are guided by the latest regulations and code of practice.

GLAND SELECTION CHART

The gland sizes recommended in this chart are for guidance only and are based on cables manufactured to BS5467. In accordance with BS6121 actual cable dimensions must be used for gland selection.

Cable Size	Number of Cores											
	1	2	3	4	5	7	10	12	19	27	37	48
1.5mm	-	-	20S	20S	20S	20S	20	20	25	25	32	32
2.5mm	-	20S	20S	20S	20S	20	25	25	25	32	32	40
4mm	-	20S	20S	20	20	25	25	25	32	40	-	-
6mm	-	20	20	20	-	-	-	-	-	-	-	-
10mm	-	20	20/25	25	-	-	-	-	-	-	-	-
16mm	-	25	25	25	-	-	-	-	-	-	-	-
25mm	-	20/25	25/32	32	-	-	-	-	-	-	-	-
35mm	-	25/32	25/32	32/40	-	-	-	-	-	-	-	-
50mm	20	32	32	40	-	-	-	-	-	-	-	-

SWA CLEAT CHART

Chart covers booklet cables up to 25mm² 4 core PVC/SWA/PVC.

Cable Size	Number of Cores			
	1	2	3	4
1.5mm	-	-	5	5
2.5mm	-	5	5	6
4mm	-	5	6	6
6mm	-	6	7	7
10mm	-	7	7	8
16mm	-	8	9	10
25mm	-	10	11	12
35mm	-	-	-	-
50mm	-	-	-	-

A-Z Product Listing

A		Deck Lights	65	Highbay Lighting	79	P		Towel Rails	95
Access Control	51	Decorative Accessories	12-15	Hole Cutters	115-116	P Clips	31	Track Lighting	60
Adaptable Boxes	19, 35	Decorative Lamps	86	HRC Fuses	43	Panel Radiators	97	Trailing Leads	21
Aerials	35-36	Dimming Plates/Modules	16-20	I		PAT Testers	102-104	Transformers/Lighting	56
Alarm Cables	29	Disability/Emergency Assist	51	Immersion Heaters	98	Patch Panels	36	Trunking (all types)	32-34
Appliance Lamps	85	Discharge Lamps	87	Industrial Plugs & Sockets	17	Patio Heaters	96	Tubular Heaters	96
B		Distribution	37-43	(BS4343)	19	Pattresses	11	Tungsten Halogen Lamps	83-85
Bathroom Fans	89-94	Door Entry Kits	51	Infra Red Heaters	94	Pendants	18	TV Aerials & Accessories	35-36
Bathroom Lighting	54	Doorbells	21, 23	Inline Switches	18	Photocells	64	TV/Telephone/Satellite	29, 31,
Battenholders	18	Double Pole Switches	11-17, 21	Intruder Alarms	48-49	PIRs (Intruder Alarms)	48-49		35-36
Battens	77	Downflow Heaters	95	Intruder Alarms	48-49	PIRs (Lighting)	64	Outlets	11-17
Batteries	115	Downlights & Accessories	53-54	Isolation Kit	103, 105	PL Lamps	87	Twin & Earth Cable	29
Bell Pushes	21	Downlights (Commercial)	78	J		Plastic Conduit Fittings	33	U	
Bell Wire / Speaker Cable	29	Drill Bits	108, 111,	Jack Chain	35	Plug Tops	21	Underfloor Heating	94
Bi-Wire Fire Alarm Panels	47		115	Jointing Kits	31	Positive Pressure Units	94	V	
Blank Plates	10-13	Dry Lining Boxes	18	Junction Boxes	8, 18 - 19	PPE	113, 115	Ventilation Accessories	92-93
Bricklights	65	E		K		Pull Switches	21	Verve by Hamilton	9-10-17
Brush Plates	10-13	Earth Products	31	Kitchen Fans	91	R		Voltage Detection	104-105
Bulkheads	60-63	Electrical Test Leads	103	Knockout Boxes	32	RCD Enclosures	43	W	
C		Emergency Lighting	80-82	L		RCD Protected Accessories	21	Wall Kettles	100
Cabinet Lighting	57	Enclosures	35, 43	2D Lamps	87	RCDs	40-43	Wall Lighting	61-63,
Cable	29-31	EV Charging	37	Labels & Label Printer	117	S			66-68
Cable Clips	31-32	Extension/Cable Reels	21	Ladders	118	Screen Heaters	96	Water Heaters	100
Cable Crimps & Lugs	117	F		Lampolders	18	Shaver Sockets	11-12	Weatherproof Battens	77-78
Cable Glands	35	Faceplates	16	Lamps & Tubes	81	Shower Fans	89-90,	Whole House Ventilation	94
Cable Management	31-35	Fan Heaters	95	Lanterns	64, 66	Showers	101	WiFi Alarms	27, 49
Cable Protector	35	Fans & Ventilation	88-101	LED Battens	77	Signlights	65	WiFi Heating	26, 99
Cable Storage	31	Fire & Security	44-51	LED Floodlights	75-76	Sleeving	31	WiFi Extender Socket	25
Cable Ties	116	Fire Alarm Accessories	46-48	LED Lamps	81-85	Smart Home	23-27	Wire/Wiring Cable	29-30
Cable Tray	34	Fire Alarms / Panels	47	LED Panels	79	Smoke Alarms	45-46	Wiring Accessories	9-22
Caravan Hook Up Points	17	Fire Barriers	48	Lighting & Lamps	52-85	Sockets	9-14	Wiring Clips	31
Carbon Monoxide Alarms	45-46	Fire Cable & Sundries	30	Lighting Accessories	20	Speciality/Effect Lighting	55	WISKA Boxes	19
Catenary Wire	35	Fire Extinguisher	48	Lighting Controls (Wireless)	26-27	Splashproof Accessories	22	Workwear	115, 118
CCTV Systems	26-27, 50	Fire Rated Downlights	53-54	Lighting Trunking	34	Spotlights	60		
Ceiling Lighting	58, 61-64	Fixings	119	LOT 20	97	Spurs/Connection Units	10, 12-14		
Ceiling Roses	18	Flex	29	Lowbay Lighting	79	Start/Stop Buttons	43		
Ceiling Sensor	64	Flexible Conduit	34	M		Steel Trunking	34		
Ceiling Switches	21	Floodlighting	75-76,	Marshalling Boxes	79	Storage Heaters	97		
Central Heating Controls	98-99	Floor Boxes	34	Metal Channel	34	Strip Connectors	19		
Centrifugal Fans	89, 91	Floor Sockets	21	Metal Conduit Fittings	33	Strip Lighting	55, 57		
Certification Books	103-104	Fluorescent Lighting	77	Metal Enclosures	35	Sundries	106-119		
Channelling	32	Fluorescent Starters	86	Metalclad Accessories	21	Suspension Hooks	35		
Chimes	21	Fluorescent Tubes	87	Meter Box	35	SWA Cable & Sundries	30		
Co-Axial Cable	29	Fly Killers	116	Meters	43	Switches	9-17		
Commercial Fans	91	Frost/Pipe Freeze Protection	96	Mini Trunking	32	T			
Computer Cable	30	Fuses	21, 43	Mirror De-Misters	94	Tails	30		
Conduit	32-34	G		Modular Fittings	62	Telephone Cable	30		
Connected Home	23-27	Garden Lights	59-76	Multi-Function Testers	102	Telephone Outlets	10-13		
Connector Blocks	18	Garden Spike Spotlights	65	N		Test			
Connectors	19	Grid Dimmers	20	New Products	3-7	Instruments/Equipment	100-103		
Consumer Unit Accessories	43	Grid Switches	16-17	O		Testing Accessories	102-105		
Consumer Units	40-43	Grommets/Grommet Strip	18, 35, 40	Oil Filled Radiators	95	Thermal Insulation	94		
Contactors	43	H		Outdoor Lighting	60-76	Thermostats	98-99		
Converter Sockets	19	Hand Dryers	100	Outdoor Battens	77-78	Threaded Rod	119		
Cooker Control Units	11	Hand Tools	106-112	Oval Conduit	33	Toilet Fans	89-91		
Cooker Hoods	91	Heat Alarms	44-46	Heating	94-97	Tools, Fixings & Sundries	106-120		
D		Heating Controls	98-99	Torches					
Data Cabinet	36								
Data Products	35-36								



PROUDLY SUPPORTING



OUR CHOSEN CHARITY FOR
2020 - 2021

MAILING LIST:

For amendments or to be removed please contact your account holding branch.

BRANCHES:

24 Hour answerphone service available in selected branches. Standard opening hours: 7.30am to 5pm, Monday to Friday. Some branches open earlier and on Saturdays, so please check with your local branch for their extended hours.

STOCK:

The Connector lists only the most popular lines, a much wider range is available ex-stock, please ask your branch for more information.

SPECIALS:

Our expert staff can quote for absolutely anything electrical.

PRICES:

Low Trade prices, most well below manufacturers trade lists. No surprise policy - we regularly publish our prices.

FREE DELIVERY*:

Our vans make daily deliveries. No delivery charge if within branch locality. (*Within their local trade areas.)

PRICING & OFFERS:

All subject to Denmans Terms & Conditions. Available on request. Unless otherwise stated, free gifts are one per account customer, and subject to availability.

OUR PRICING POLICY:

All prices exclude VAT. Our prices have been price checked to offer you the best day-to-day prices in the industry and are not normally subject to a further discount, however if you have substantial business on a particular product there are further volume discounts

that could be negotiable, please ask your local branch for a quote.

Prices apply to carton quantities, higher prices apply to broken carton quantities. We make every effort to ensure printed prices remain correct throughout the life of each edition of The Connector but where absolutely necessary, we reserve the right to change prices.

Therefore invoiced prices will be those ruling at the date of despatch. The Connector prices may not apply to cash sale customers. Whilst every care is taken to ensure the accuracy of illustrations, we reserve the right to supply alternative products where necessary.

Terms and Conditions apply to all warranties mentioned in The Connector - please ask for further details. All offers subject to availability and Denmans Terms and Conditions.





EASY TO DO BUSINESS WITH...



denmans.co.uk
Online or via
the app



CALL your local branch



VISIT your local branch

...SHOP YOUR WAY



All information shown correct at time of going to print. Check www.denmans.co.uk for current information.

SOUTH WEST ENGLAND

Branch	Postcode	Telephone	Email (@denmans.co.uk)
1. Barnstaple	EX31 1QN	01271 374771	barnstaple@
2. Bath	BA1 3EU	01225 444644	bath@
3. Bristol - Bradley Stoke	BS32 4EU	01454 201320	bradleystoke@
4. Bristol - Central	B55 OSP	0117 954 8130	bristolcentral@
5. Bristol - Redland	BS6 6EZ	0117 973 7639	redland@
6. Cheltenham	GL51 8LZ	01242 226369	cheltenham@
7. Exeter	EX2 5GL	01392 447744	exeter@
8. Falmouth	TR10 9DQ	01326 373900	falmouth@
9. Gloucester	GL1 3QA	01452 529546	gloucester@
10. Melksham	SN12 6SS	01225 703102	melksham@
11. Newton Abbot	TQ12 4PB	01626 367733	newtonabbot@
12. Paignton	TQ4 7QN	01803 663380	paignton@
13. Penzance	TR20 8HT	01736 350221	penzance@
14. Plymouth	PL4 0LE	01752 220871	plymouth@
15. Saltash	PL12 6LE	01752 844023	saltash@
16. St Austell	PL25 5NE	01726 66171	staustell@
17. Stroud	GL5 3JX	01453 764542	stroud@
18. Taunton	TA2 8RX	01823 337451	taunton@
19. Tiverton	EX16 6SR	01884 242023	tiverton@
20. Torquay	TQ1 4UE	01803 313983	torquay@
21. Weston-super-Mare	BS24 9DJ	01934 412067	westonsupermare@

SOUTH & SOUTH EAST ENGLAND

22. Bournemouth	BH9 3AQ	01202 547396	bournemouth@
23. Dorchester	DT1 2PG	01305 265522	dorchester1@
24. Hastings	TN37 7PJ	01424 755833	hastings@
25. Oxford	OX2 0LX	01865 725500	oxford@
26. Poole	BH17 7BP	01202 692868	poole@
27. Southampton	SO15 0LA	02380 773831	southampton@
28. Swindon	SN3 4NS	01793 836900	swindon@

EAST ANGLIA & ESSEX

29. Basildon	SS15 6ED	01268 418181	basildon@
30. Beccles	NR34 7TQ	01502 715621	beccles@
31. Braintree	CM7 2GB	01376 323816	braintree@
32. Bury St Edmunds	IP32 7BX	01284 752481	burystedmunds@
33. Colchester	CO1 1BX	01206 904470	colchester@
34. Ipswich	IP5 3RG	01473 622100	ipswich@
35. King's Lynn	PE30 4HY	01553 768287	kingslynn@
36. Norwich	NR3 2BX	01603 412300	norwich@
37. Thetford	IP24 1HS	01842 755927	thetford@

MIDLANDS & CENTRAL ENGLAND

Branch	Postcode	Telephone	Email (@denmans.co.uk)
38. Banbury	OX16 2RB	01295 259993	banbury@
39. Birmingham - Bordesley Green	B9 4TA	0121 766 6788	bordesleygreen@
40. Birmingham - Erdington	B23 6UJ	0121 382 5050	erdington@
41. Birmingham - Kings Norton	B30 3HD	0121 415 3870	kingsnorton@
42. Birmingham - Perry Barr	B42 1BX	0121 356 5266	perrybarr@
43. Brackley	NN13 7LE	01280 705070	brackley@
44. Burton on Trent	DE13 0FW	01283 531230	burtonontrent@
45. Coventry	CV1 4DW	02476 634700	coventry@
46. Dudley	DY5 1LL	01384 455244	dudley@
47. Hereford	HR4 9NS	01432 357251	hereford@
48. Kettering	NN16 0QZ	01536 513152	kettering@
49. Kidderminster	DY11 7QP	01562 740707	kidderminster@
50. Leamington Spa	CV31 1XB	01926 831484	leamingtonspa@
51. Leicester	LE1 1QR	0116 2622588	leicester@
52. Leighton Buzzard	LU7 4TZ	01525 374666	leightonbuzzard@
53. Long Eaton	NG10 1PX	0115 946 4838	longeaton@
54. Loughborough	LE11 5GU	01509 240875	loughborough@
55. Northampton	NN1 2TN	01604 621711	northampton@
56. Nottingham	NG5 6LJ	0115 926 6341	nottingham@
57. Telford	TF3 3DG	01952 290047	telford@
58. Walsall	WS2 9NW	01922 646353	walsall@
59. Wellingborough	NN8 2QE	01933 226062	wellingborough@

NORTHERN ENGLAND

60. Accrington	BB5 1EF	01254 383421	accrington@
61. Chesterfield	S40 3DL	01246 556831	chesterfield@
62. Huddersfield	HD2 1YR	01484 511340	huddersfield@
63. Macclesfield	SK10 2BN	01625 612378	macclesfield@
64. Manchester	M17 1RW	0161 872 4994	manchester@
65. Mansfield	NG18 5ES	01623 655990	mansfield@
66. Merseyside	L6 9DF	0151 264 7171	merseyside@
67. Preston	PR1 1QE	01772 822052	preston@
68. Southport	PR9 0SF	01704 532261	southport@
69. Stockport	SK1 3JN	0161 480 6111	stockport@
70. Wirral	CH62 3QL	0151 3344372	wirral@
71. York	YO30 4WU	01904 693241	york@
72. Leeds	LS7 1QB	01133 314200	leeds@

WALES

73. Cwmbran	NP44 3AS	01633 483666	cwmbran@
74. Wrexham	LL11 2UB	01978 291186	wrexham@



RETHINK WHAT'S POSSIBLE

Nanoleaf offer statement LED lighting to bring life into any space and set the perfect mood for every occasion. With an innovative range of light panels, smart bulbs and light strips to choose from, you can create completely unique installations in any home. Nanoleaf is ushering in a new era of lighting that centres around complete personalisation.

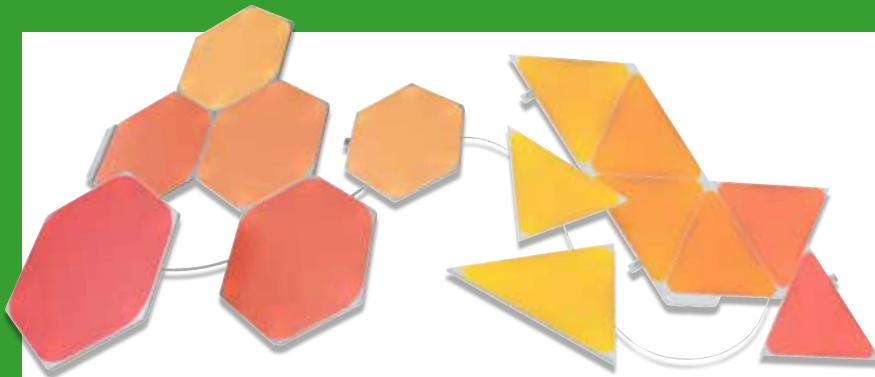

Multicolour Shapes Hexagons Starter Kit - 5 Panels	NL42-5002HX-5PK	1377761	99.99	1
Multicolour Shapes Hexagons Starter Kit - 9 Panels	NL42-0002HX-9PK	1377762	149.99	1
Multicolour Shapes Hexagons Starter Kit - 15 Panels	NL42-6002HX-15PK	1377763	224.99	1
Multicolour Shapes Hexagons Expansion Pack 3 Panels	NL42-0001HX-3PK	1377764	41.66	1
Shapes Flexible Linkers	NC04-0070	1377765	8.33	1
Shapes 42w Additional Power Supply	NC04-0051	1377766	16.66	1
Multicolour Shapes Triangles Starter Kit - 4pk	NL47-2002TW-4PK	1377767	74.99	1
Multicolour Shapes Triangles Starter Kit - 9pk	NL47-0002TW-9PK	1377768	149.99	1
Multicolour Shapes Triangles Starter Kit - 15pk	NL47-6002TW-15PK	1377769	224.99	1
Multicolour Shapes Triangles Expansion Pack 3 Panels	NL47-0001TW-3PK	1377770	41.66	1
Multicolour Shapes Triangles Mini Starter Kit - 5pk	NL48-5002TW-5PK	1377771	74.99	1
Shapes Triangles Mini Expansion Pack - 10 Panels	NL48-1001TW-10PK	1377772	74.99	1
Nanoleaf Essentials Smart Light Strip - 2M Starter kit	NL55-0002LS-2M	1381870	37.49	1
Nanoleaf Essentials Smart Light Strip - 1M Expansion kit	NL55-0001LS-1M	1381871	14.99	1
Nanoleaf Essentials Smart E27 light bulb	NL45-0800WT240E27	1381868	14.99	1
Nanoleaf Essentials Smart B22 light bulb	NL45-0800WT240B22	1381869	14.99	1



To see the full range go to [Denmans.co.uk](https://www.denmans.co.uk)