

CONTROLLERS, DRIVES, MOTORS, INTERFACES
RODLESS ACTUATORS, ROD SCREW ACTUATORS,
GUIDED SCREW ACTUATORS



Visit
www.tolomatic.com to get
the most up-to-date technical
information.

ALL CATALOG PRODUCTS ARE
MANUFACTURED TO FIT YOUR
APPLICATION REQUIREMENTS AND ARE
SHIPPED IN 5-DAYS OR LESS FROM OUR
IN-HOUSE MANUFACTURING FACILITY

3600-4609_0212

TOL-O-MATIC HAS THE RESOURCES TO HELP YOU GET WHAT YOU NEED.

PRODUCTS AND PEOPLE YOU NEED TO GET THE JOB DONE RIGHT.

At Tol-O-Matic we have the resources and the experience to give you what you need when you need it. Working together we can find solutions whether it is a new feature, better performance or a whole new product line. Our sales department will make sure all your questions are answered. Our engineers will assist you with your application design. Our model shop will make all the tooling and specials you need for a new product—not in 6 months or a year—but when you need them.

QUALITY PRODUCTS, COMPETITIVELY PRICED WHEN YOU WANT THEM.

Our engineering laboratory pushes our products to the breaking point running them 24 hours a day, 7 days a week for millions of cycles looking for ways to improve them. They work with R&D to develop new manufacturing techniques and to perfect new products. For each new product, detailed engineered drawings are converted into hand-crafted sample products for testing, then precision tooling is built on site by Tol-O-Matic's own skilled craftsmen with the highest standards of quality, care and dedication to details. The products are tested again by engineering and by selected field representatives. Tol-O-Matic has heavily invested in research to guarantee you delivery of the highest quality products not in months or weeks, but within days of your order, and with a warranty rate less than 1/2 of 1%.

UNCONDITIONAL 100% SATISFACTION GUARANTEE.

Tol-O-Matic has built its reputation on customer satisfaction. For almost 50 years it has been our policy that, if for any reason you have a problem with any Tol-O-Matic product ordered, we will do whatever it takes to make sure you are 100% satisfied. Working together we will arrive at a solution that works best for you.

TOL-O-MATIC TRAINING CENTER

There is a Tol-O-Matic product for just about every application that may come your way and it is our goal to remove every obstacle, give you every tool, device and piece of knowledge necessary to learn how to size and apply Tol-O-Matic products. That is why we supply the most advanced in-depth training in the industry—free of charge to all our distributors and their customers.



Located in west suburban Minneapolis, Minnesota, Tol-O-Matic headquarters is designed for improved communication and manufacturing techniques to meet customer needs today and well into the future.

© Copyright 2003, Tol-O-Matic, Inc. All rights reserved. No part of this publication may be reproduced, transmitted, transcribed, stored in a retrieval system, or translated into any language in any form by any means without the written permission of Tol-O-Matic, Inc.

Tol-O-Matic, Axidyne, and Excellence in Motion are registered trademarks, Tol-O-Matic, Inc. Other product and corporate names may be trademarks of other companies, and are used only for explanation and to the owner's benefit, without intent to infringe.

Information furnished in this catalog is believed to be accurate and reliable. However, Tol-O-Matic assumes no responsibility for its use or for any errors that may appear in this document. Tol-O-Matic reserves the right to change the design or operation of the equipment described herein and any associated motion products without notice. Information in this document is subject to change without notice.

09/2003 • 15M • CG

CONTENTS



ABOUT TOL-O-MATIC

DEDICATED TO YOUR SATISFACTION.....A-2	WORLD CLASS MOTION PRODUCTS.....A-3	APPLICATION EXAMPLES.....A-4
--	-------------------------------------	------------------------------

PRODUCT OVERVIEW

AXIDYNE SYSTEM COMPONENTS.....B-2	MOTOR COMPARISON.....B-10	RSA/RSM SERIES.....B-14
SYSTEM SELECTION ADVICE.....B-3	TK SERIES.....B-11	GSA/GSM SERIES.....B-15
SIZING & SELECTION SOFTWARE.....B-4	B3/M3 SERIES.....B-12	MOTORS/CONTROLS/DRIVES.....B-16
ACTUATOR COMPARISON.....B-8	SLS/MLS SERIES, BCS SERIES.....B-13	

RODLESS ACTUATORS

B3S/M3S SERIES SCREW DRIVES		TKS TRUTRACK SERIES SCREW DRIVES		TKB75	
OVERVIEW AND OPTIONS.....C-3		OVERVIEW AND OPTIONS.....C-49		ORDERING.....C-102	
OVERALL SERIES SPECIFICATIONS.....C-3		OVERALL SERIES SPECIFICATIONS.....C-50		BCS/MCS SERIES SCREW DRIVES	
B3S/M3S10.....C-11		TKS10.....C-57		OVERVIEW AND OPTIONS.....C-103	
B3S/M3S15.....C-16		TKS25.....C-62		OVERALL SERIES SPECIFICATIONS.....C-104	
B3S/M3S20.....C-22		TKS50.....C-68		B3S/MCS10.....C-110	
ORDERING.....C-27		TKS75.....C-74		B3S/MCS15.....C-114	
B3W/M3W SERIES BELT DRIVES		TKB TRUTRACK SERIES BELT DRIVES		B3S/MCS20	
OVERVIEW AND OPTIONS.....C-29		OVERVIEW AND OPTIONS.....C-81		ORDERING.....C-119	
OVERALL SERIES SPECIFICATIONS.....C-30		OVERALL SERIES SPECIFICATIONS.....C-82		SLS/MLS SERIES SCREW DRIVES	
B3W/M3W10.....C-35		TKB10.....C-88		OVERVIEW AND OPTIONS.....C-125	
B3W/M3W15.....C-39		TKB25.....C-91		SLS10.....C-126	
B3W/M3W20.....C-43		TKB50.....C-95		ORDERING.....C-134	
ORDERING.....C-47					

ROD SCREW ACTUATORS

OVERVIEW AND OPTIONS.....D-2	RSA/RSM16.....D-17	RSA/RSM50.....D-38
OVERALL SPECIFICATIONS.....D-4	RSA/RSM24.....D-24	RSA/RSM64.....D-45
RSA/RSM12.....D-10	RSA/RSM32.....D-31	ORDERING.....D-52

GUIDED SCREW ACTUATORS

OVERVIEW AND OPTIONS.....E-2	GSA/GSM16.....E-18	ORDERING.....E-36
OVERALL SPECIFICATIONS.....E-4	GSA/GSM24.....E-24	
GSA/GSM12.....E-11	GSA/GSM32.....E-30	

BRUSHLESS SERVO MOTORS/CONTROLS/INTERFACES

MRV MOTORS.....F-3	AXIOM DV DRIVE.....F-11	CABLES.....F-25
GEARHEAD REDUCTION.....F-10	AXIOM PV DRIVE/CONTROLLER.....F-18	ORDERING.....F-26

SWITCHES

SPECIFICATIONS.....I-3	COUPLERS AND KITS.....I-4	ORDERING.....I-6
------------------------	---------------------------	------------------

ENGINEERING RESOURCES

GLOSSARY.....J-2	RODLESS SELECTION FACTORS.....J-10	ROTARY MOTOR SELECTION.....J-19
CONVERSION TABLES.....J-5	ROD SCREW SELECTION FACTORS.....J-13	
MOTION PROFILES.....J-6	GUIDED SCREW SELECTION FACTORS.....J-16	

ABOUT TOL-O-MATIC



A

PRODUCT OVERVIEW



B

RODLESS



C

ROD SCREW



D

GUIDED SCREW



E

BRUSHLESS



F

SWITCHES



I

RESOURCES



J

About Tol-O-Matic

ABOUT TOL-O-MATIC

Dedicated to your satisfaction

- Proven products
- Fastest delivery
- High quality
- Applied knowledge
- Multiple technologies
- Flexibility
- Satisfaction guaranteed

WE ARE DEDICATED TO YOUR SATISFACTION

Tol-O-Matic employees are proud of the quality, performance and reliability of the products we make. We are committed to give you the best speed, price, service, and delivery possible.

We Build Proven Products

- 50 years of building motion products.



Choose from Multiple Technologies

- Use fluid power systems, Axidyne electric systems and power transmission technology for the accurate motion that meets your price needs.



Our Delivery is the Industry's Fastest

- Actuators built your way in just 5 days.



We offer Flexibility

- We frequently modify standard catalog products and create totally unique designs to meet special motion, space, load and accuracy requirements.



Our High Quality Commitment

- ISO 9001:2000 certified quality system provides assurance that our products are built to specific quality guidelines.



Your Satisfaction is Guaranteed

- At Tol-O-Matic we will do whatever it takes to make sure you are 100% satisfied.



Apply Our Knowledge

- Everyone at Tol-O-Matic thinks of themselves as part of the sales staff. Call us for answers 1-800-378-2174.



CALL US TODAY, WE WILL DELIVER OUR BEST.

About Tol-O-Matic

ABOUT TOL-O-MATIC

World class motion products

- Standard catalog products
- Modified standard products
- Custom products

WORLD CLASS MOTION CONTROL PRODUCTS

STANDARD CATALOG PRODUCTS



High accuracy motion systems complete with motors, drives, controllers and software.

Our standard catalog product line contains over 1,450 choices and more than 1/3 of these are built to your specified stroke length. We make it easy for you to select any of our motion control products:

- Use our Tol-O-Motion™ sizing and selection software
- Call our network of distributors and representatives
- Call our customer service representatives and technical sales coordinators at the factory.

Standard catalog products are just a portion of what Tol-O-Matic has to offer.

MODIFIED STANDARD PRODUCTS



This standard B3S has a nickel plated extrusion, other parts are made of stainless-steel. A special mounting bracket supports a nonstandard motor

Modified standard products are catalog products modified to your unique needs. Different tapped holes, material, coatings, and mounting brackets are commonly requested. Modifications can accommodate anything from harsh operating environments, unusual mounting needs to the use of nonstandard motors. Call Tol-O-Matic for price and delivery time required.

CUSTOM PRODUCTS

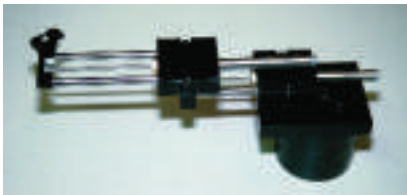

This multi-axis actuator doesn't resemble any of our standard catalog products. It was built to fit a manufacturer's motion space load and accuracy requirements.

Custom products are a blank page. They can be revisions of existing products or completely new actuators. Our engineering team enjoys the challenge of creating unique products that will meet your design constraints.

Axidyne Application Solutions

ABOUT TOL-O-MATIC

Axidyne Application Solutions

- Surgical tubing winder
- Positioning tables

SURGICAL TUBING WINDER

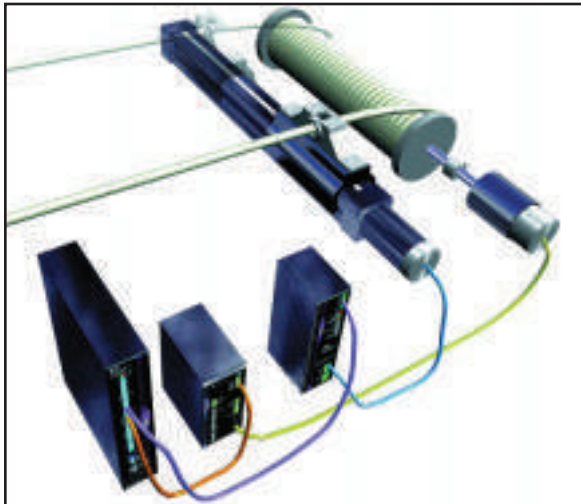

Application description:

A manufacturer of surgical tubing winds the tubing on a spool with a constant tension, which is critical so as not to deform the tubing shape or size.

Application requirements:

- Constant tension provided by winding spool
- Reciprocating tube position guide
- Tube guide and tensioning must compensate for process speed variations

Tol-O-Matic solution:

For precise tension control, the AXIOM DV10 drive operates in torque mode, with a MRV brushless servo motor and provides an optimal solution. The controller must be able to provide torque adjustment that is inversely proportional to the spool diameter. This adjustment will be made each time the tube position guide changes direction. The controller must also be able to provide linear interpolation between the spool motor position and the reciprocating tube guide position. A low-cost solution for the reciprocating guide is a BCS Series screw-drive actuator driven by a customer supplied microstepping drive and stepper motor. Therefore, the controller must be able to provide an analog torque signal for the servo drive as well as a step-and-direction signal for the microstepping drive. Also, the controller must be able to supply a correction algorithm for tension control with linear interpolation between the two axes.

Tol-O-Matic System Components:

- AXIOM® DV10 digital brushless servo drive/MRV brushless servo motor
- BCS screw drive rod bearing actuator
- Motor couplings, motor adapters and cabling automatically selected using the Tol-O-Motion™ sizing software configuration generator

POSITIONING TABLES

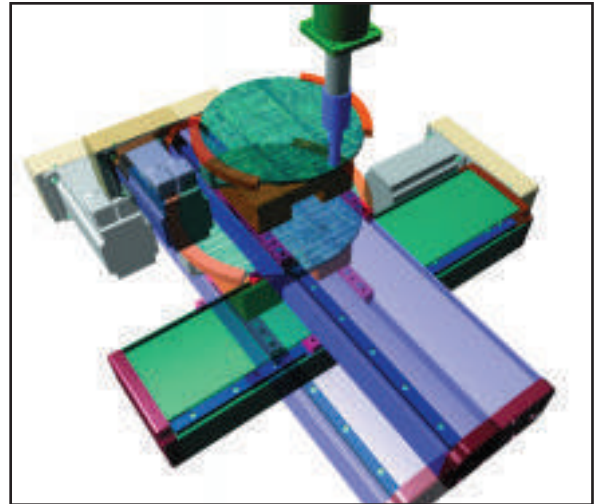

Application description:

A manufacturer is making positioning tables which move under a sensor used to measure the solder levels on a printed circuit board. A two-axis motion controller with a PLC is part of their existing set-up.

Application requirements:

- Two actuators mounted carrier-to-base
- Minimized vibration
- Attractive Package
- Motor and Drive for each axis
- Speed requirement of 4 inches per second for each axis
- Space is limited
- Cost-effective drive/motor/actuator package
- Maximum load deflection: .0001"

Tol-O-Matic solution:

Space is a concern in this application, so the TKS10 screw-drive actuator with a reverse parallel option was selected to reduce length. Two 23-frame brushless servo motors were selected for the most repeatable solution. An Axiom PV controller/drive was chosen for this application.

Tol-O-Matic System Components:

- Two TruTrack TKS10 screw-drive actuators with reverse parallel mounting configuration
- Two Axiom PV30 controller/drives
- Two MRV231 brushless servo motors
- All motor couplings, motor adapters and cabling automatically selected using the Tol-O-Motion™ sizing software configuration generator

Axidyne Application Solutions

ABOUT TOL-O-MATIC

SCANNING DEVICE

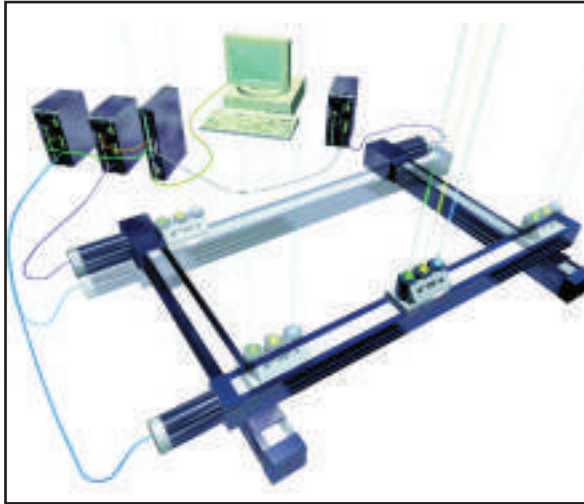

Application description:

The developer of a new scanning device requires a method of traversing 48 inches on the X-axis in less than 1 second and then indexing along the Y-axis over a distance of 72 inches following each X-axis scan.

Application requirements:

- X-Y positioning of a 50 lb. scanning head
- 48-inch X-axis move in less than 1 second
- 72-inch Y-axis travel distance
- Better than 0.010-inch repeatability

Tol-O-Matic solution:

Speed and stroke requirements in the X-axis do not allow the use of a screw actuator. The moment load generated by the scanning head and 72-inch Y-axis does not allow a single actuator to be used for the X-axis. Therefore, two B3W15 belt-drive actuators were used in the gantry configuration shown. The speed requirements also do not allow the use of stepper or brushed dc systems. MRV brushless servo motors, driven and controlled by the Axiom PVs. The two X-axis motors/drives were electronically geared together while operating the third axis independently. Programming was done over RS232 from a PC using the user friendly Tol-O-Motion™ programming software.

Tol-O-Matic system components:

- SSC3 three-axis multifunction controller
- Two Axiom® PV20 controller/drives
- Two MRV31 brushless servo motors
- Axiom® PV10 controller/drive
- Two B3W15 belt-drive actuators
- B3S10 screw-drive actuator
- Motor couplings, motor adapters and cabling automatically selected using the Tol-O-Motion™ sizing and selection software configuration generator

PARTS GRINDER

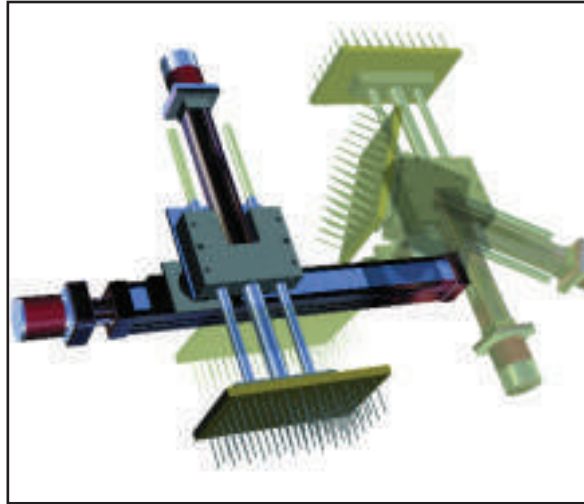

Application description:

A manufacturer wants to design a machine that will grind 500 small parts at a time to the the same length within 0.0005" repeatability.

Application requirements:

- Three axes: Main axis to move the parts back and forth, rotating axis to rotate the parts 180° before grinding, and a screw actuator with guidance to compensate for wear on the grinder.
- User interface to allow operator to select part numbers, batch sizes and move distances for grinding compensation.
- 18" stroke on main actuator, and 4" stroke on the grinder indexer.

Tol-O-Matic solution:

Selected for the main axis is a B3S15 with 2TPI low backlash ball nut, driven by a MRV233 brushless servo motor. Rotation is supplied by a 23-frame brushless servo motor and gearhead reduction. A GSA24 guided screw actuator indexes the parts to the grinder forward and backward. The operator can input a "Delta" value based on periodic quality checks during the process.

Tol-O-Matic System Components:

- Three Axiom PV30 controller/drives
- Three MRV brushless servo motors
- B3S15 screw-drive actuator
- GSA24 guided screw actuator
- Motor couplings, motor adapters and cabling automatically selected using the Tol-O-Motion™ sizing and selection software configuration generator

Axidyne Application Solutions

- Scanning device
- Parts grinder

Axidyne Application Solutions

ABOUT TOL-O-MATIC

Axidyne Application Solutions

- Volumetric Filling
- Lens Gluer

VOLUMETRIC FILLING

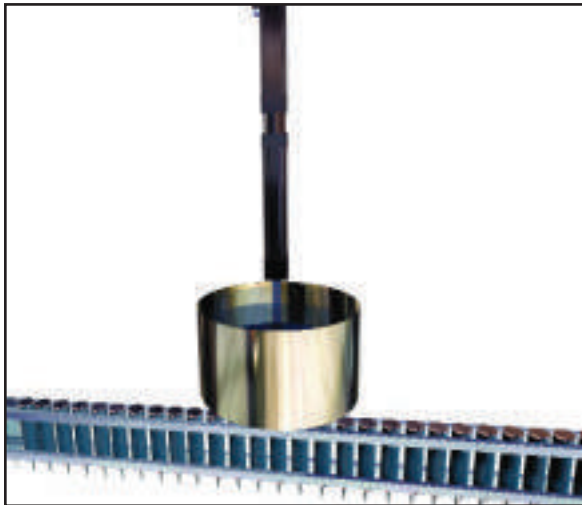

Application description:

A volumetric filler machine currently uses a pneumatic cylinder to operate a piston pump. Product is being wasted as a result, due to lack of precision.

Application requirements:

- Precise volume control, accurate fill rate
- Quick change between products
- Stroke: 8 inches
- Force: approximately 200 lbs.
- Easy to set up and program

Tol-O-Matic solution:

Due to the torque demand of this application, a brushless servo system was the best choice. For this basic single-axis application, the Axiom®Plus PV10 controller/drive was selected along with an MRV23 servo motor. The RSA50 actuator with the 1" diameter acme screw, was the best selection for the given thrust requirement.

Tol-O-Matic System Components:

- Axiom®Plus PV10 controller/drive
- MRV23 brushless servo motor
- RSA50 rod screw actuator
- Motor couplings, motor adapters and cabling automatically selected using the Tol-O-Motion™ sizing and selection configuration generator.

LENS GLUER

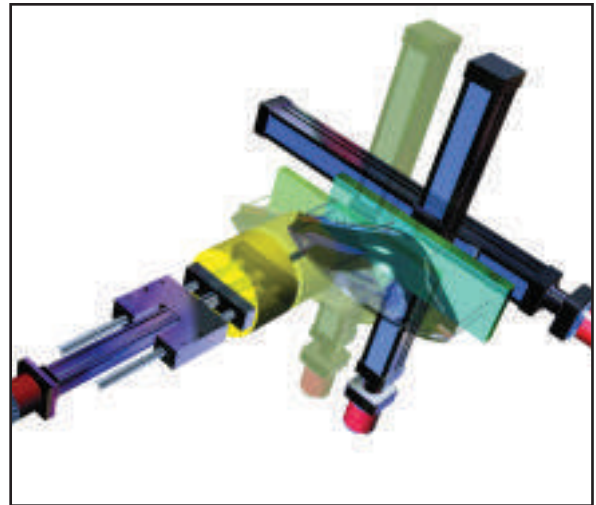

Application description:

A snowmobile lens manufacturer wants to put a bead of adhesive in the groove on the edge of a lens. Cycle time per lens is 20 seconds. The weight of the lens and nest is no more than 10 pounds. The weight of the glue gun is 4 pounds maximum.

Application requirements:

- Velocity control
- Interface to joystick
- Stroke requirements: x axis- 12", Y-axis-24", Z-axis-40"
- Less than 10 pound load for lens and nest
- Less than 4 pound load for glue gun
- 3" per second maximum speed for movement of lens and nest (B3S axes). Glue gun (GSA axis) to follow the curvature of the lens

Tol-O-Matic solution:

Two B3S15s are used to supply motion to the lens and nest. A B3S15 with 40" stroke and a 2TPI ball screw is selected for the Z-axis. The Y-axis uses a B3S15 with 24" stroke and a 5TPI ball screw. A GSA16 with a stroke of 12" moves the glue gun on the X-axis. It uses a 1TPI acme screw. All three actuators use a MRV21 brushless servo motor. The Axiom PV20 controller/drives complete the system.

Tol-O-Matic System Components:

- Three Axiom PV controller/drives
- MRV21 brushless servo motors
- GSA16 guided screw actuator
- 2-B3S15 screw-drive actuators
- Motor couplings, motor adapters and cabling automatically selected using the Tol-O-Motion™ sizing and selection software configuration generator



SYSTEM COMPONENTS AND SELECTION

- Axidyne motion system components
- System selection
- Using the Tol-O-Motion sizing software
- Actuator basics
- Motor system basics



ACTUATOR SERIES AND FEATURES

- Rodless actuator families and features
- Rod style actuator features
- Guided rod screw actuator features



DRIVE SYSTEMS

- Brushless servo system basic components and features

Axidyne® System Components and Selection

AXIDYNE ELECTRIC LINEAR MOTION SYSTEM COMPONENTS

PRODUCT OVERVIEW

Axidyne System Components

- Axidyne Electric Linear Motion Systems

- A mechanical actuator to convert motor rotary motion to linear motion.
- A motor to convert electrical energy to mechanical energy in the form of rotary motion.
- A drive to interpret the incoming command and motor position signal, and provide a corresponding conversion of line voltage to appropriately phased voltage for the motor.
- A controller to store and/or interpret high level commands received from a computer or operator interface, and to generate the necessary signals to control motor velocity, acceleration, position, and direction based on program and discrete inputs.
- An operator interface to allow system operators to program or signal the controller remotely.

This modular approach provides flexibility in control system design and helps provide the most cost-effective solution to a range of linear motion control requirements.

MOTOR: MRV - BRUSHLESS SERVO (SHOWN)

**ACTUATOR: B3S/M3S - B3 SCREW-DRIVE ACTUATOR
B3B/M3B - B3 BELT-DRIVE ACTUATOR
TKS - TRU-TRACK SCREW-DRIVE ACTUATOR
TKB - TRU-TRACK BELT-DRIVE ACTUATOR (SHOWN)**

**BCS - BC SCREW-DRIVE ACTUATOR
SLS/MLS - LS SCREW-DRIVE ACTUATOR
RSA/RSM - ROD SCREW ACTUATOR
GSA/GSM - GUIDED SCREW ACTUATOR (SHOWN)**

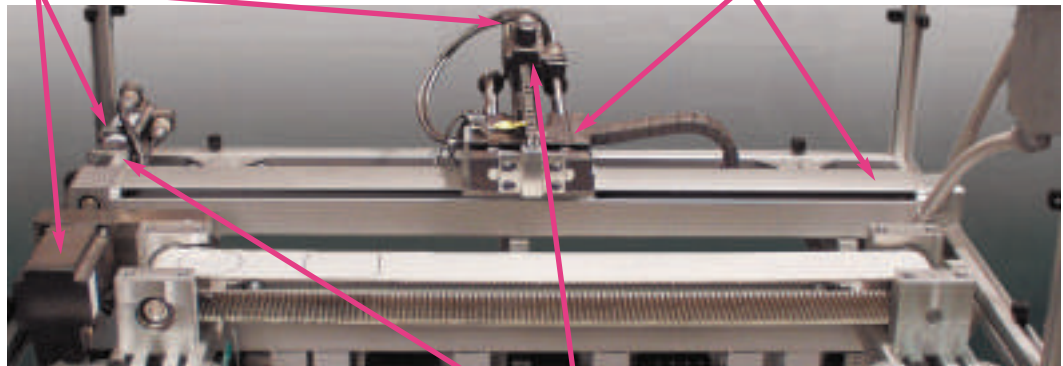

**MOTOR MOUNT, SCREW-DRIVE:
RP - REVERSE PARALLEL
LMI - INLINE (SHOWN)**

**MOTOR MOUNT, BELT-DRIVE:
DIRECT DRIVE (SHOWN)
REDUCTION DRIVE**

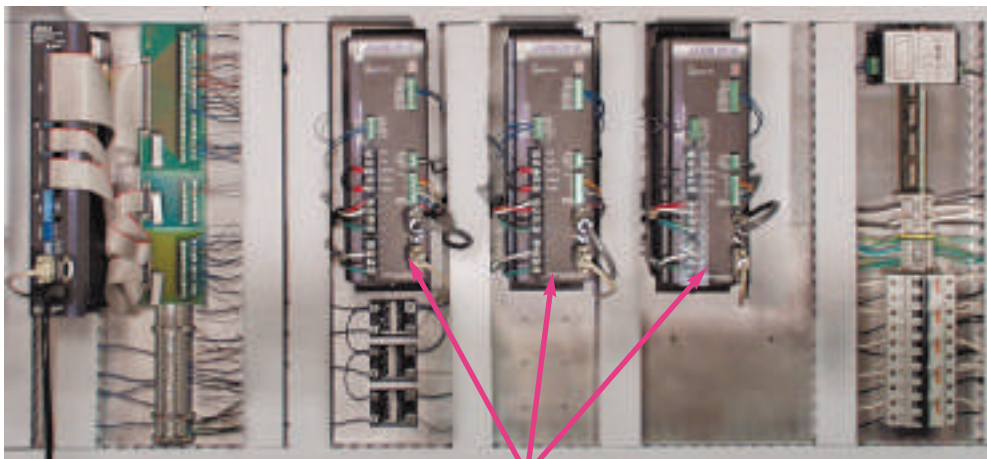

**CONTROLLER/DRIVE COMBINATIONS:
AXIOM® PV - BRUSHLESS CONTROLLER/DRIVE**

DRIVE: AXIOM® DV - BRUSHLESS DRIVE (SHOWN)

Axi^{dyne}® System Components and Selection

A SIMPLE 2-STEP PROCESS

1) DETERMINE THE REQUIREMENTS OF YOUR APPLICATION:

Be sure to include:

_____ Stroke Length _____ Load Weight _____ Thrust Force
_____ Moment Loads _____ Resolution/Repeatability _____ Actuator Orientation
_____ Duty Cycle _____ Motion Profile



PRODUCT OVERVIEW

Axidyne System Selection

• 2-step selection

2) USE TOL-O-MOTION™ SIZING & SELECTION SOFTWARE.

Our easy to use software leads you through the selection process step-by-step, making it easy to choose the right combination of products in a user-friendly Windows® format. The next few pages give you an overview of the software. You can be sure that the components selected are 100% compatible and backed by Tol-O-Matic's satisfaction guarantee. The software is available free on CD or on our web site: www.tolomatic.com

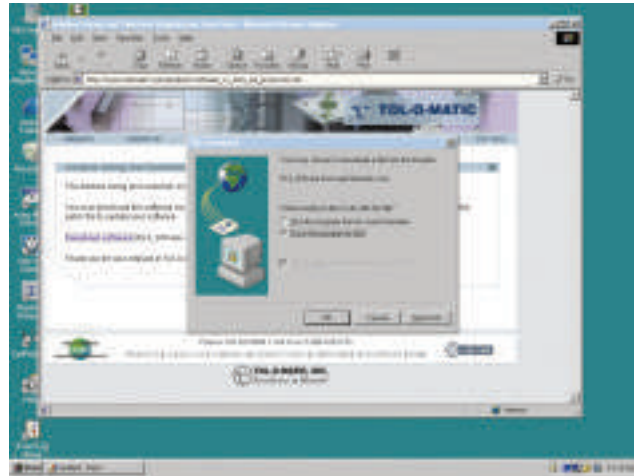

OR

2) CALL TOL-O-MATIC 1-800-328-2174

Tol-O-Matic, your local distributor or representative can take your information and determine the most cost-effective Axidyne system for your application. (Find your local distributor at www.tolomatic.com)



Axi-dyne® System Components and Selection

USING THE SIZING & SELECTION SOFTWARE

TOL-O-MOTION SIZING & SELECTION SOFTWARE

PRODUCT OVERVIEW

Using Tol-O-Motion Sizing & Selection Software

- Menu bar
- Actuator choice
- Stroke length and orientation
- Motion profile

This easy, step-by-step process for selecting your electric motion system, eliminates the time and hassle of mixing, matching and integrating components.

Once all required application parameters are entered, the software will calculate performance required and display a list of compatible systems. By default the list is sorted by price but it can also be sorted by motor performance.

PRESSING THE F1 (HELP) BUTTON, AT ANY TIME, DISPLAYS SOFTWARE HELP AS WELL AS AN EXTENSIVE INDEX OF TOL-O-MATIC PRODUCT INFORMATION

Menu Bar



THE SOFTWARE WILL DIRECT YOU STEP-BY-STEP THROUGH THE INFORMATION NEEDED TO SELECT THE CORRECT AXIDYNE SYSTEM. USE THE GRAPHICAL USER INTERFACE TO POINT-AND-CLICK AND FILL IN THE BLANKS. AT ANY TIME YOU MAY JUMP BETWEEN WINDOWS TO MODIFY THE SYSTEM PARAMETERS AND/OR COMPONENTS.

1. Select actuator style

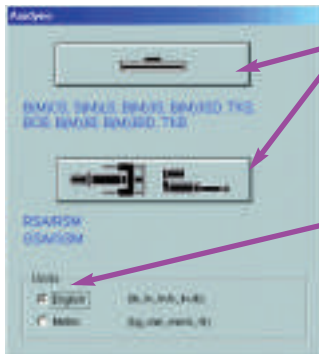

CHOOSE EITHER A ROD OR RODLESS STYLE ACTUATOR

SELECT EITHER ENGLISH OR METRIC MEASUREMENT DISPLAY

2. Select stroke length and orientation

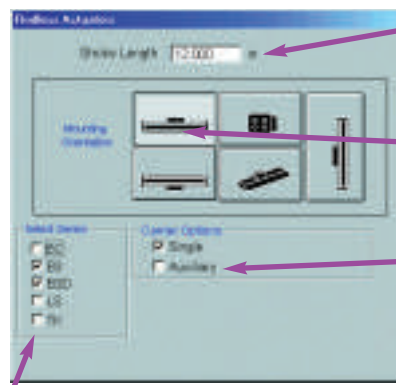

ENTER THE DESIRED ACTUATOR STROKE LENGTH

CHOOSE THE MOUNTING ORIENTATION OF THE ACTUATOR

SELECT EITHER THE STANDARD SINGLE CARRIER OR THE AUXILIARY (2ND CARRIER) OPTION

SELECT THE ACTUATOR SERIES FOR THE SOFTWARE TO EXAMINE (MORE THAN ONE MAY BE SELECTED)

3. Create a motion profile

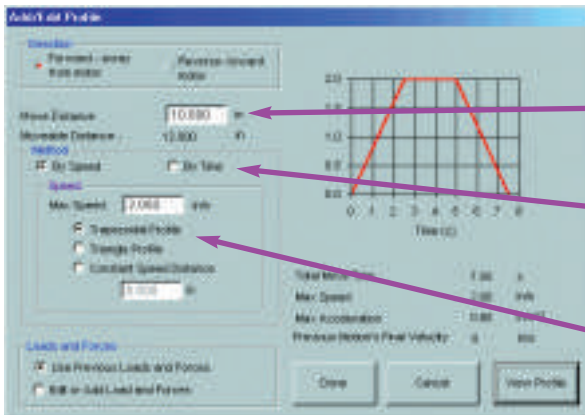

ENTER THE DESIRED MOVE DISTANCE

SELECT THE MOTION METHOD
• BY TIME, OR
• BY SPEED

MOTION PROFILE CAN BE SELECTED AS TRAPEZOIDAL OR TRIANGULAR

ACCELERATION AND DECELERATION RATES ARE ADJUSTABLE.

Axi-dyne® System Components and Selection

USING THE SIZING & SELECTION SOFTWARE

4. Define load weights and moments

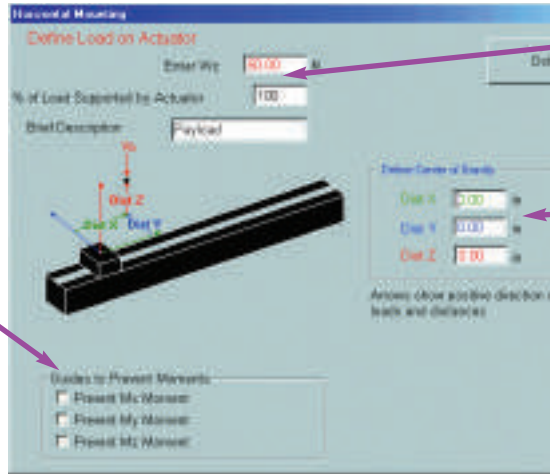

ENTER THE LOAD AND MOMENT FOR YOUR APPLICATION

DEFINE THE CENTER OF GRAVITY

CHECK THE APPROPRIATE BOXES IF YOUR APPLICATION IS EXTERNALLY GUIDED AND SUPPORTED

PRODUCT OVERVIEW

Using Tol-O-Motion Sizing & Selection Software

- Load weights and moments
- Thrust force
- Motor system

5. Define the thrust force

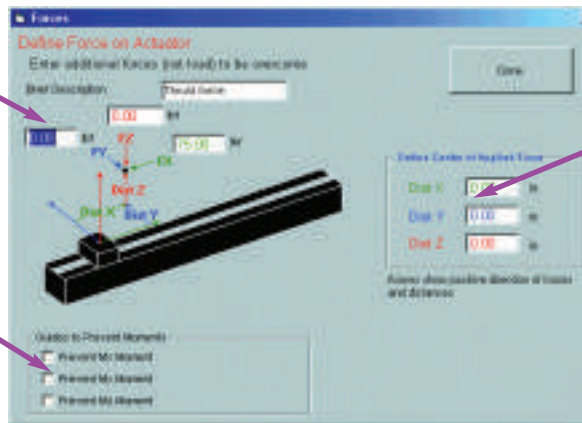

ENTER THE THRUST FORCE REQUIRED FOR YOUR APPLICATION

CHECK THE APPROPRIATE BOXES IF YOUR APPLICATION IS EXTERNALLY GUIDED AND SUPPORTED

DEFINE THE CENTER OF APPLIED FORCE REQUIRED FOR YOUR APPLICATION

6. Select a motor system

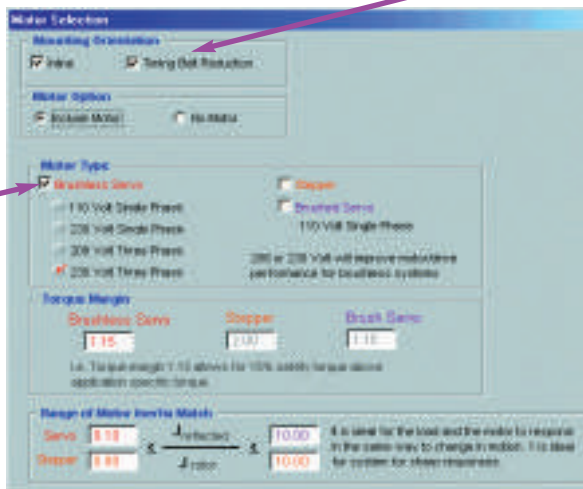

CHOOSE THE MOTOR TYPE:
• BRUSHLESS SERVO

CHOOSE THE MOTOR ORIENTATION:

- IN-LINE
- REVERSE PARALLEL

Axi-dyne® System Components and Selection

USING THE SIZING & SELECTION SOFTWARE

PRODUCT OVERVIEW

Using Tol-O-Motion Sizing & Selection Software

- Controller and options
- Combination selection

7. Select controller and options

SELECT THE APPROPRIATE CONTROLLER DEPENDING UPON YOU MOTOR SYSTEM

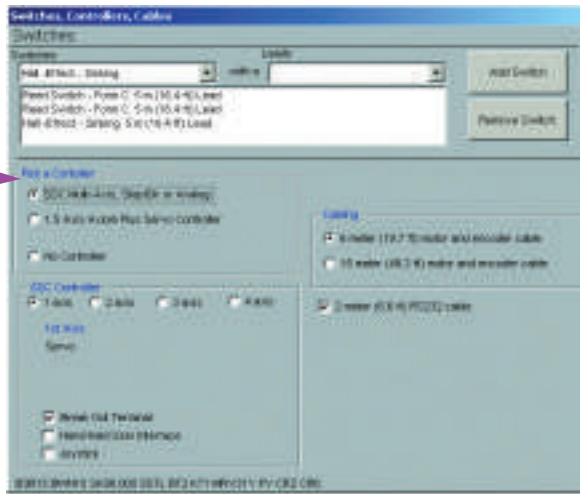

8. Review the possible combinations and make a selection

SORTING OPTIONS INCLUDE BY PRICE (LOWEST IS LISTED FIRST) OR BY MOTOR PERFORMANCE

Axidyne Sizing Results

Sort by Price Sort by Motor Performance

Matched Actuators (Sorted by List Price, Lowest First)

Actuator	Screw or Belt	Reduction	Ratio	Motor/Drive	Inertia Ratio	Torque Margin	%Difference
B3S10	SN02	LMI	1	MRV21Y	8.16	2.14	0.00
B3S10	SN02	LMI	1	MRV22Y	4.40	4.16	1.39
B3S10	SN02	RP2	2	MRV21Y	2.96	3.43	3.00
B3S10	SN02	RP1	1	MRV21Y	8.49	2.02	3.00
B3S10	SN02	LMI	1	MRV23Y	3.05	5.88	3.50
B3S10	SN01	RP2	2	MRV21Y	8.38	2.48	4.31
B3S10	SN02	RP2	2	MRV22Y	1.59	6.57	4.38
B3S10	SN02	RP1	1	MRV22Y	4.58	3.93	4.38
B3S10	SN02	LMI	1	MRV24Y	2.26	8.09	5.28
B3S10	SN01	RP2	2	MRV22Y	4.52	4.85	5.69
B3S10	SN02	RP2	2	MRV23Y	1.10	8.94	6.50

Note: An actuator must be selected

%Difference is the difference in price of currently selected actuator and lowest priced actuator sized.

Drive Options

Brushless
 Axiom Drive

Last Actuator Chosen: B3S15 BN02 SK23.000 LMI BM2 TM1 MRV31Y PV CRZ CR6

Axi-dyne® System Components and Selection

USING THE SIZING & SELECTION SOFTWARE

8. Generate application reports (save or print for reference)

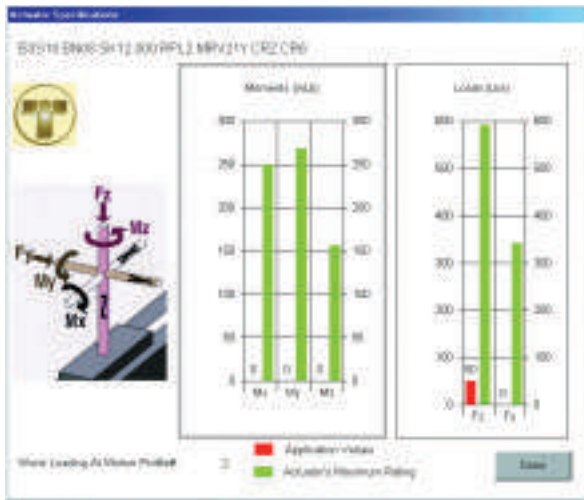

ACTUATOR SPECIFICATION WINDOW ALLOWS YOU TO VIEW MOMENTS AND FORCES OF THE APPLICATION'S VALUES VS ACTUATOR'S MAXIMUM RATING

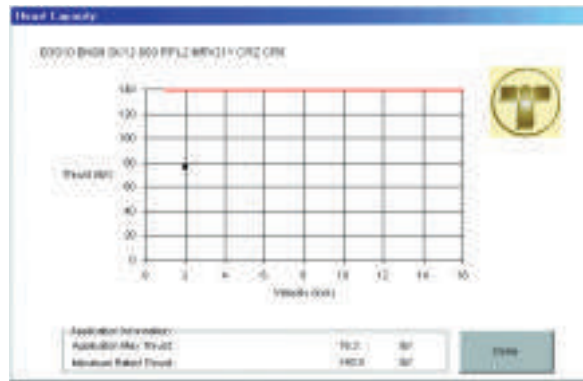

THRUST CAPACITY WINDOW SHOWS THE APPLICATION'S RATED THRUST VS MAXIMUM RATED THRUST OF A SYSTEM.

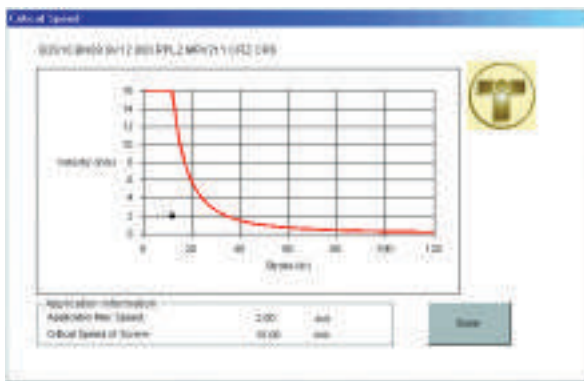

THE CRITICAL SPEED WINDOW SHOWS THE APPLICATION'S MAXIMUM SPEED, RELATIVE TO CRITICAL SPEED OF THE SCREW.

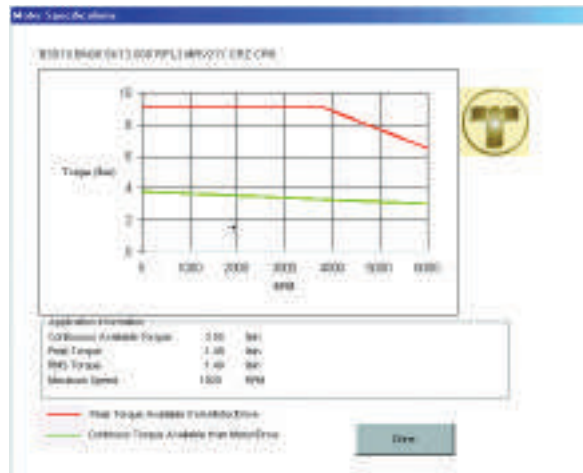

THE MOTOR SPECIFICATION WINDOW SHOWS HOW YOUR APPLICATION'S TORQUE COMPARES TO CONTINUOUS AND PEAK TORQUE.

8. Generate a sizing report to request a quote (save or print for reference)

EMAIL, FAX OR SEND TO TOL-O-MATIC OR YOUR AUTHORIZED TOL-O-MATIC REPRESENTATIVE

REPORT GENERATES THE COMPLETE CONFIGURATION STRING OF PRODUCT SELECTED

DESCRIPTION OF ALL CONFIGURED OPTIONS

PRODUCT OVERVIEW

Using Tol-O-Motion Sizing & Selection Software

- Application reports
- Sizing report

Axidyne® System Components and Selection

ACTUATOR CHOICE FLOW CHART

ACTUATOR BASICS

The flow chart at right is intended to provide some general comparisons to determine which actuator will work best for your application. Use the Tol-O-Motion™ sizing & selection software (available at www.tolomatic.com) to choose the exact Axidyne system for your needs. **Complete product features and performance information are included at the beginning of each product section.** The red bar graphs compare performance criteria of Tol-O-Matic actuators. *Longer red bars indicate higher numbers.*

AXIDYNE ACTUATORS ARE AVAILABLE IN TWO TYPES:

- 1) rod actuators (including GSA): featuring a rod that extends out of the actuator body, or
- 2) rodless actuators: featuring a carrier that moves along the length of the actuator body.

THRUST IS TRANSFERRED BY:

- 1) screw drive: featuring a rotating screw and an anchored nut (rod actuators are only available with screw drive), or
- 2) belt drive: featuring a belt anchored to the carrier that moves between pulleys at each end of the actuator.

SCREW AND NUT CHOICES:

- 1) Acme: featuring a solid nut of Delrin® or Bronze, or
- 2) Ball: featuring a recirculating ball bearing nut

PRODUCT OVERVIEW

Actuator Choice Flow Chart

- Rod actuators
 - RSA/RSM
 - GSA/GSM
- Rodless actuators
 - TKS
 - B3S/M3S
 - BCS/MCS
 - SLS/MLS
 - B3B/M3B
 - TKB

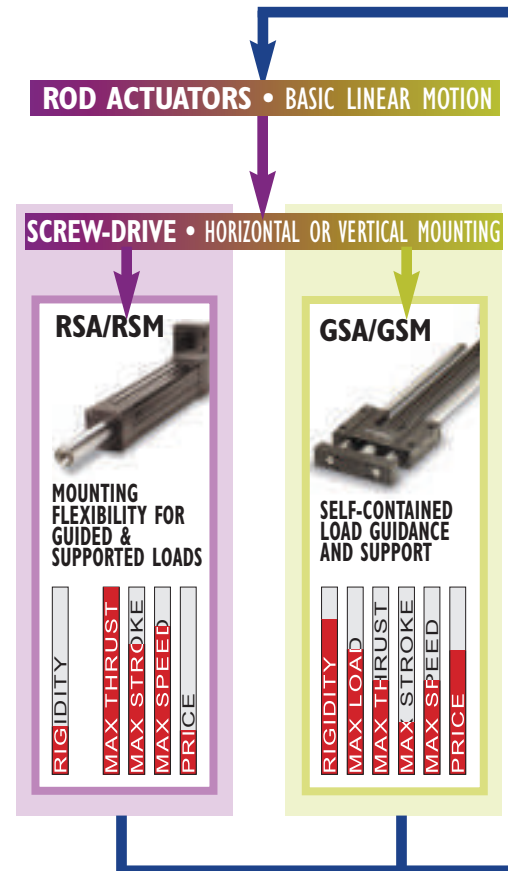

Axi-dyne® System Components and Selection

ACTUATOR TYPE CHOICE • LINEAR ACTUATORS

RODLESS ACTUATORS • COMPACT SIZE, MOVEMENT WITHIN LENGTH OF ACTUATOR

SCREW-DRIVE • HORIZONTAL OR VERTICAL MOUNTING

BELT-DRIVE • HORIZONTAL MOUNTING

TKS



SUPERIOR STRAIGHTNESS & FLATNESS

RIGIDITY	██████████
MAX LOAD	██████████
MAX THRUST	██████████
MAX STROKE	██████████
MAX SPEED	██████████
PRICE	██████████

B3S/M3S



HEAVY DUTY RECIRCULATING BEARING SYSTEM

RIGIDITY	██████████
MAX LOAD	██████████
MAX THRUST	██████████
MAX STROKE	██████████
MAX SPEED	██████████
PRICE	██████████

BCS/MCS



ADJUSTABLE CARRIER BRACKET, SELF LUBRICATING BEARING RODS

RIGIDITY	██████████
MAX LOAD	██████████
MAX THRUST	██████████
MAX STROKE	██████████
MAX SPEED	██████████
PRICE	██████████

SLS/MLS



RIGID, TORQUE RESISTANT, LOW PROFILE DESIGN

RIGIDITY	██████████
MAX LOAD	██████████
MAX THRUST	██████████
MAX STROKE	██████████
MAX SPEED	██████████
PRICE	██████████

B3W/M3W



HEAVY DUTY RECIRCULATING BEARING SYSTEM

RIGIDITY	██████████
MAX LOAD	██████████
MAX THRUST	██████████
MAX STROKE	██████████
MAX SPEED	██████████
PRICE	██████████

TKB



SUPERIOR STRAIGHTNESS & FLATNESS

RIGIDITY	██████████
MAX LOAD	██████████
MAX THRUST	██████████
MAX STROKE	██████████
MAX SPEED	██████████
PRICE	██████████

SCREW & NUT CHOICE

ACME SCREW & NUT



QUIET OPERATION

CYCLE RATE	██████████
MAX THRUST	██████████
PRICE	██████████

BALL SCREW & NUT



LONG LIFE

CYCLE RATE	██████████
MAX THRUST	██████████
PRICE	██████████

MOTOR SYSTEM CHOICE (SEE NEXT PAGE)

PRODUCT OVERVIEW

Actuator Choice Flow Chart

- Rod actuators
 - RSA/RSM
 - GSA/GSM
- Rodless actuators
 - TKS
 - B3S/M3S
 - BCS/MCS
 - SLS/MLS
 - B3W/M3W
 - TKB

Axi dyne[®] System Components and Selection

MOTOR SYSTEM CHOICE FLOW CHART

PRODUCT OVERVIEW

- Motor System Choice Flow Chart**
- Microstepping system

Application requirements of precision, repeatability and price will determine the type of motor system to choose. The flow chart at right is intended to provide some general comparisons to determine which Axidyne motor system will work best for your application. Use Tol-O-Motion sizing & selection software (available at www.tolomatic.com) to choose the exact Axidyne system for your needs. **Complete product features and performance information are included at the beginning of each product section.** The red bar graphs compare performance criteria of Tol-O-Matic motor systems. *Longer red bars indicate higher numbers.*

CLOSED LOOP

Closed loop systems monitor encoder feedback and compare them to program commands, making corrections to eliminate error.

DRIVES AND CONTROLLERS

1) Axiom[®] Plus PV controller/drive for single-axis control, see features on page F-18.

Tol-O-Motion programming software

is provided free of charge with any controller purchase. Check www.tolomatic.com for the latest upgrades.

CLOSED LOOP • POSITION FEEDBACK

BRUSHLESS SERVO SYSTEMS



- EXTREMELY SMOOTH AND QUIET OPERATION
- GOOD FOR HIGH TORQUES (UP TO 45 IN-LBS. (5.08 N-M) CONTINUOUS, 140 IN-LBS. (15.82 N-M) PEAK)
- GOOD FOR HIGH SPEEDS, UP TO 6,000 RPM
- HIGH RESOLUTION, 4,000 COUNTS PER REVOLUTION
- PROVIDE TORQUE CONTROL
- GOOD FOR SHORT, REPETITIVE MOVES
- MAINTENANCE FREE

MRV



MOTOR

DRIVE ONLY

AXIOM DV



BRUSHLESS SERVO DRIVE

DRIVE / CONTROLLER

AXIOM PV



BRUSHLESS CONTROLLER / MOTOR DRIVE

AxiAxi[®] *dyne* Actuator Series and Features

RODLESS ACTUATORS

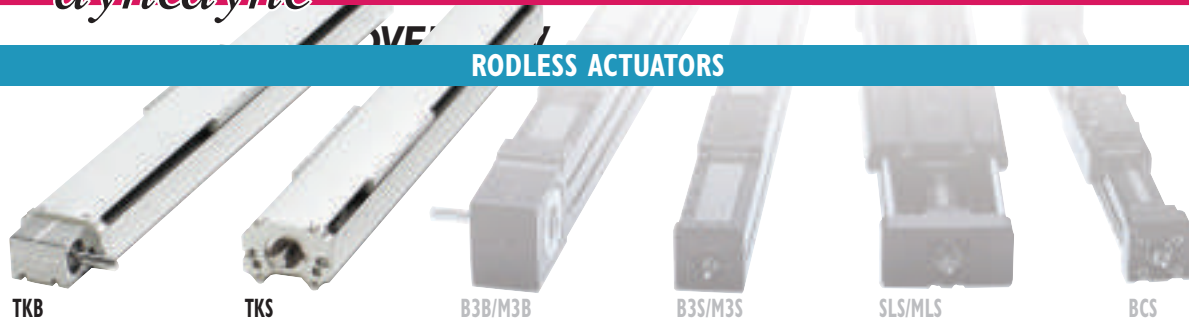

PRODUCT OVERVIEW

Rodless Actuators

- TKS screw-drive actuators
- TKB belt-drive actuators

TRUTrack™ TKS SCREW-DRIVE AND TKB BELT-DRIVE ACTUATORS

The TruTrack line of Axidyne actuators provides straighter, truer, linear motion (within 0.0002 inches per inch) than any other Tol-O-Matic actuator. The TruTrack guidance system uses ground linear rails and ball bearing blocks to decrease deflection and guide the carrier and its load. Choice of either lead screw or timing belt drive systems makes these actuators versatile enough to accommodate low/high thrust and speed applications where repeatability and low deflection are important.

- 4 compact overall envelope sizes ranging from 1.74 x 3 inches (44.2 x 76.2 mm) to 3.42 x 6.13 inches (86.9 x 155.6 mm)
- Screw-drive models available in 4 different screw sizes with acme or ball nut configurations
- Linear rails guide carrier for lowest deflection
- Ball screw or timing belt drive options for maximum flexibility
- Heavy-duty drive belts provide for greater thrusts and velocities
- System payloads ranging from 100 lbs (445 N) for the TK10 Series to 750 lbs (3338 N) for the TK75 Series.
- Multiple gearhead selections in gear ratios of 5.5:1 and 10:1
- Stroke lengths available in any incremental length ranging from 0 to 96 inches (2438 mm) depending on actuator type and body size
- Removable cover for rapid access to internal components and easy maintenance
- Internal sensing capability keeps wiring contained for clean, easy management
- Easy, secure mounting allows two axis configuration with adapter plates
- Internal motor coupling keeps package size compact
- Optional bellows cover helps keep contaminants out
- Matched with 8 different brushless servo motor selections in 17, 23, and 34 frame sizes.

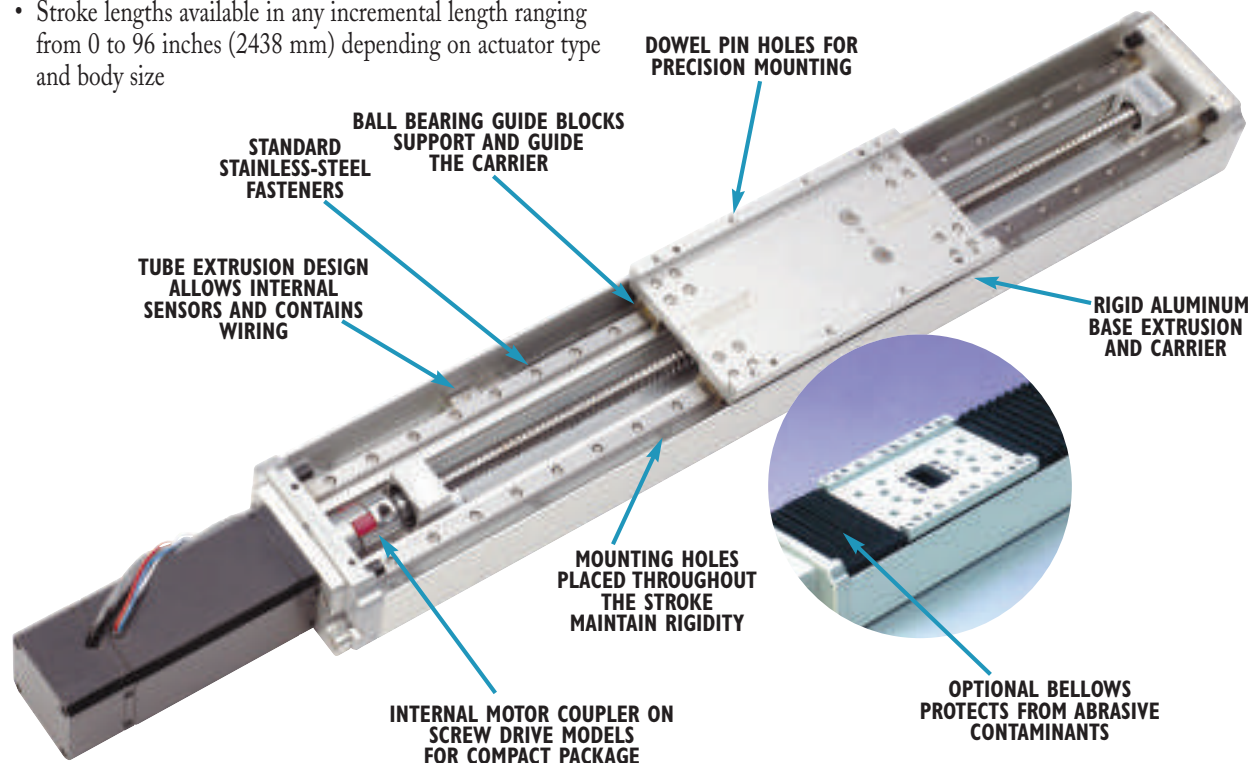

Axi-dyne® Actuator Series and Features

RODLESS ACTUATORS



PRODUCT OVERVIEW

Rodless Actuators

- B3S/M3S screw-drive actuators
- B3B/M3B belt-drive actuators

B3S/M3S SCREW-DRIVE AND B3W/M3W BELT-DRIVE ACTUATORS

For high load and moment load capacity with consistent tracking, this series of actuators features a patented heavy duty recirculating bearing system in gothic arch rail guides. This system offers wear resistance with repeatable accuracy. Bearings are sealed for long wear and extended performance.

The B3S and B3B Series provide high load (over 2000 lbs) and moment capacity with consistent tracking for full actuator life.

B3S SCREW-DRIVE

- 3 body sizes
- Same envelope size as BCS actuators with higher load capacities
- Three english body sizes and 20 different screw/nut combinations.
- Three metric body sizes and 12 screw/nut combinations.
- Custom order strokes in any incremental length, up to 120 inches depending on screw selection.

B3W BELT-DRIVE

- 3 body sizes
- Polyurethane with steel tension members belt material for greater thrust capacity.
- Available 3:1 Reduction drive for matching motor speed and inertia.
- Custom-order stroke lengths, up to 292 inches in any incremental length. (For longer strokes, consult the factory.)

PATENTED* SEALED RECIRCULATING BEARING SYSTEM PROVIDES WEAR RESISTANCE WITH REPEATED ACCURACY

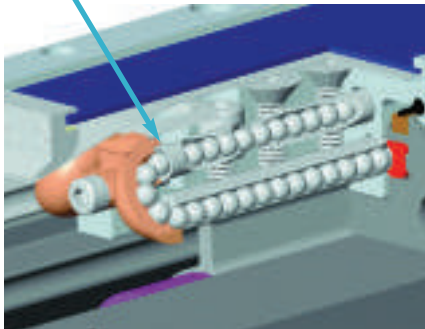

*U.S. PATENT NO. 5,555,789 **U.S. PATENT NO. 4,545,290



UNIQUE LOAD BEARING CARRIER DESIGN RIDES ON THE BEARING RAILS FOR SMOOTH LOAD MOVEMENT WITH MINIMAL PLAY, RESULTING IN THE HIGHEST MOMENT RATINGS POSSIBLE

PATENTED BAND RETENTION SYSTEM**

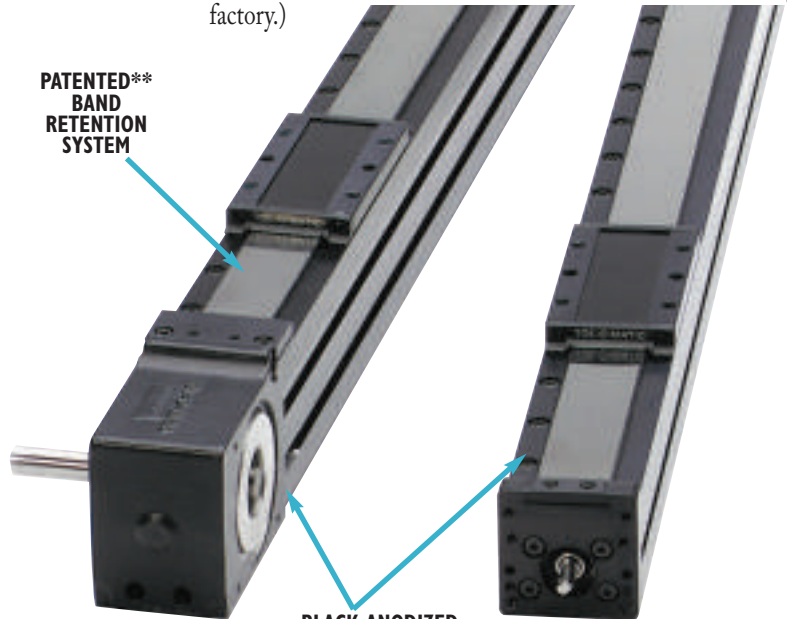

BLACK ANODIZED EXTRUDED ALUMINUM FOR CORROSION RESISTANT LONG WEAR

PATENTED* WEDGE DESIGN GUARANTEES THAT THE RACEWAYS ARE PARALLEL, WHICH INSURES CONSISTENT PRELOAD THROUGHOUT THE LENGTH OF THE CYLINDER**

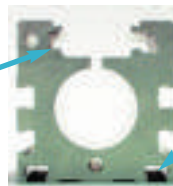

T-SLOT NUTS ARE PROVIDED FOR FLEXIBLE MOUNTING, ANYWHERE ALONG THE LENGTH OF THE ACTUATOR IN THE BOTTOM 2 RAILS. (4 NUTS ARE PROVIDED FOR THE FIRST 24 INCHES OF STROKE. 2 MORE FOR EACH ADDITIONAL 20 INCHES OF STROKE.)

***U.S. PATENT NO. 6,584,887

Axi-dyne® Actuator Series and Features

RODLESS ACTUATORS

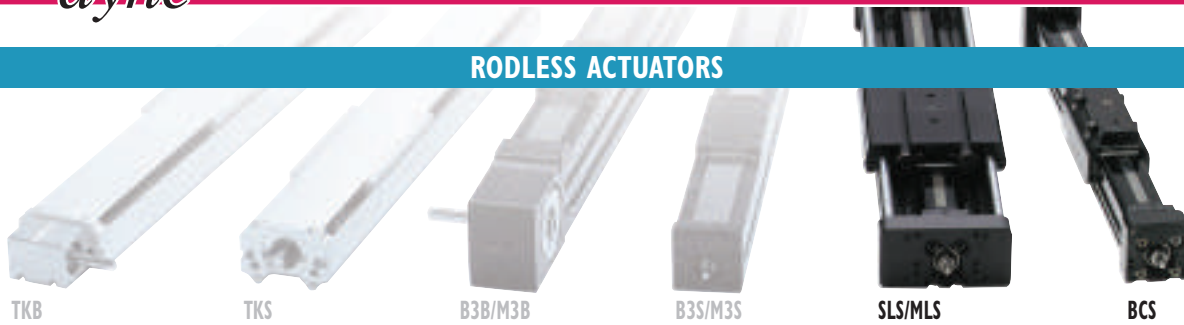

PRODUCT OVERVIEW

Rodless Actuators

- SLS/MLS screw-drive actuators
- BCS screw-drive actuators

SLS/MLS & BCS/MCS SCREW-DRIVE ACTUATORS

SLS/MLS SCREW-DRIVE ACTUATOR

These pre-engineered, load-supporting and fully enclosed slide-style actuators use a guidance system of recirculating bearings on ground steel shafts providing consistent carrier tracking and long actuator life. Using the same patented band retention system as the BCS style actuators, SLS actuators are available in one body size and offer a rigid, low-profile design, ideal for space-sensitive applications.

- Extruded work table, fully extruded anodized-aluminum work table has two parallel 'T' slots for mounting flexibility and stability.
- Single-piece housing, fully extruded anodized aluminum housing increases stability and provides continuous bearing rod support along full stroke.
- One english body size and four screw/nut combinations with anti-backlash option.
- One metric body size and three screw/nut combinations
- Custom-order strokes in any incremental length, up to 72 inches.

BCS/MCS SCREW-DRIVE ACTUATOR

This group of actuators utilizes a guidance system consisting of a patented adjustable carrier bracket designed to transmit the load to the cylinder body instead of the screw or belt for true tracking, superior load support and controlled minimum friction load. The load-bearing carrier system uses two self-lubricating Delrin bearing rods to pass force directly to the cylinder tube. A patented band retention system uses a T-shaped elastomer strip bonded to a stainless steel band inserted directly into the body housing forming a tight metal-to-metal seal.

BCS Screw-Drive

- Three english body sizes and 12 screw/nut combinations.
- Three metric body sizes and 12 screw/nut combinations.
- Custom-order strokes in any incremental length, up to 120 inches.

* U.S. PATENT NO. 4,724,744
 ** U.S. PATENT NO. 4,545,290
 *** U.S. PATENT NO. 4,852,465

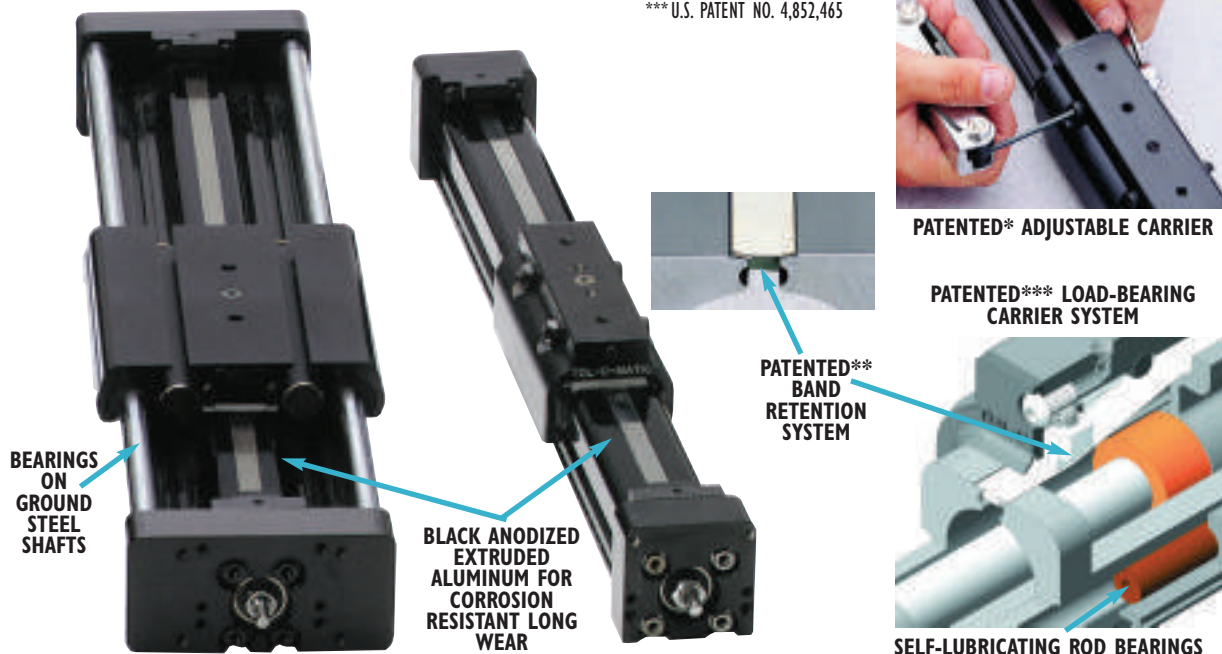

Axi dyne[®] Actuator Series and Features

ROD STYLE ACTUATORS

PRODUCT OVERVIEW

Rod Actuator

- RSA/RSM rod screw actuator

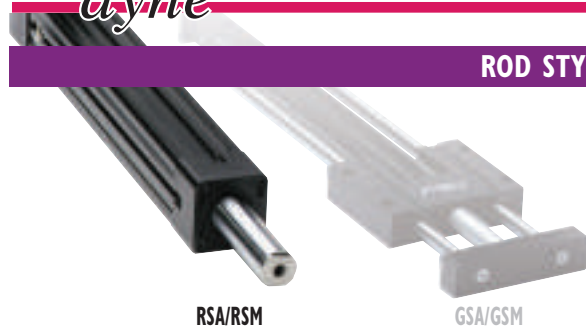

RSA/RSM ROD SCREW ACTUATOR

The Axidyne family of rod screw actuators offers the most complete selection of sizes, options and system components. Designed with high performance, high thrust, dependability and mounting flexibility in mind, these actuators easily combine with our other motion control components in brushless servo, microstepping or brushed dc system configurations. Together, they offer a cost-competitive solution for a multitude of motion control applications.

- 6 different body sizes ranging from .75-inch (19mm) to 4-inch (100mm) body sizes.
- 5 different screw sizes ranging from .375-inch to 1.5-inches with either solid or ball nut configuration.
- System thrust capabilities ranging from 70 lbs (311.4N) for the RSA/RSM12 Series to 7000 lbs (31,138N) for the RSA/RSM64 Series.
- 8 different brushless servo motor selections in 17, 23 and 34 frame sizes.
- 7 different gearhead selections in gear ratios of 5.5:1 or 10:1.
- Stroke lengths available in any incremental length ranging from 0 to 60 inches depending on actuator body size.
- Magnets (for use with either dc reed, Hall-effect or ac Triac switches) come standard on all four sides of the actuator for greater mounting flexibility.
- Conforms to both NFPA and ISO industry mounting standards.

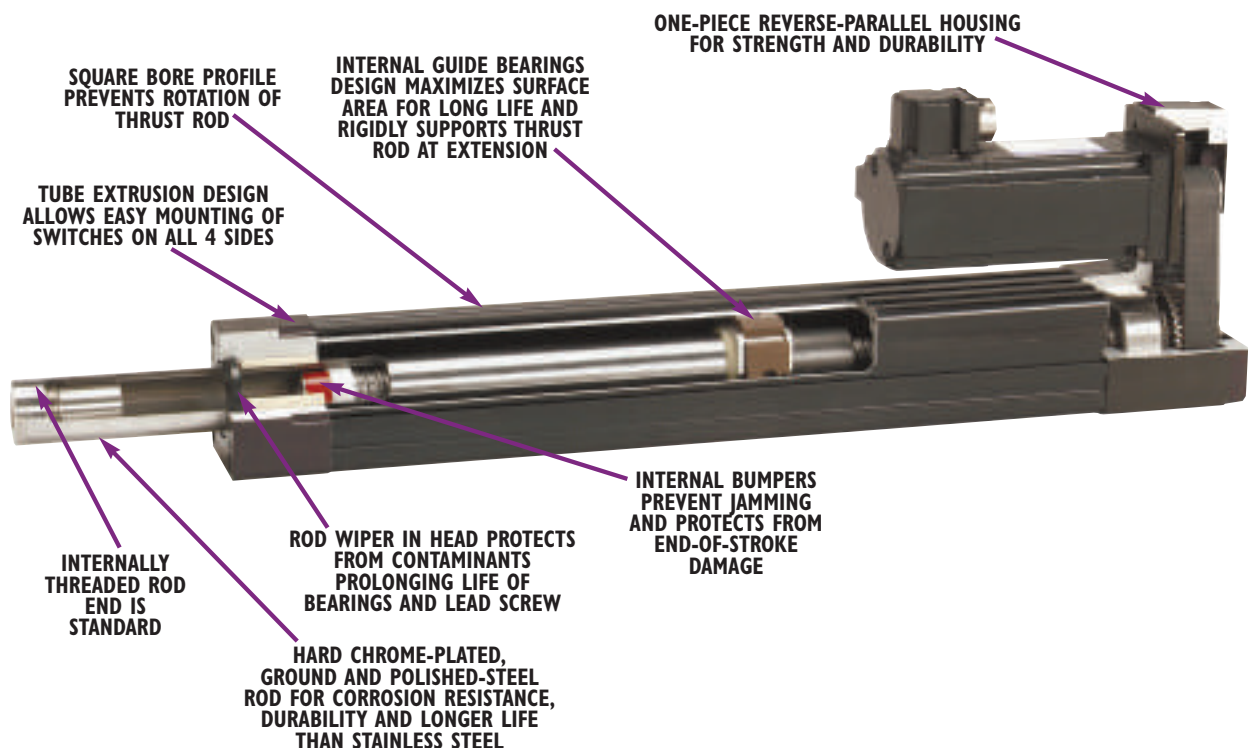

Axidyne[®] Actuator Series and Features

GUIDED ROD STYLE ACTUATORS

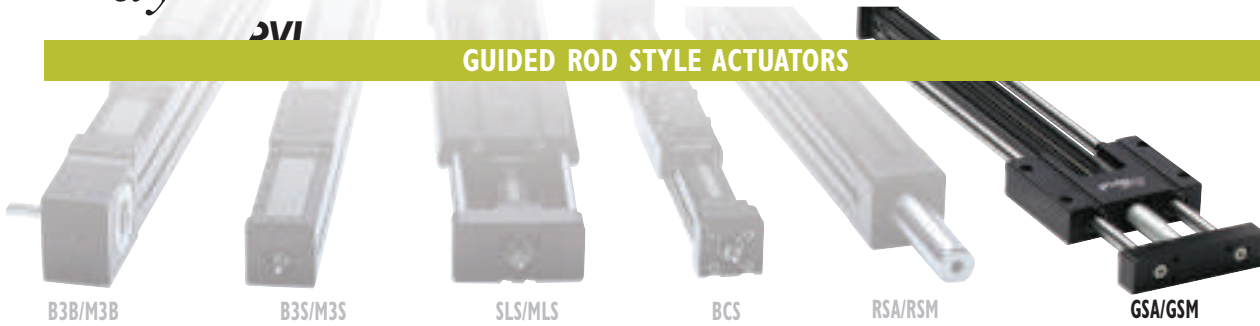

PRODUCT OVERVIEW

Rod Actuator
 • GSA/GSM guided rod screw actuator

GSA/GSM GUIDED ROD SCREW ACTUATOR

The Axidyne family of guided screw actuators combines rod screw actuators with mounting block, guide rods and bearings based on Tol-O-Matic's extensive experience with pneumatically guided actuators. The GSA/GSM offers a complete selection of sizes, options and system components. Designed with high performance, dependability and mounting flexibility in mind, these actuators easily combine with any of our motion control system components in brushless servo configurations. Together, they offer a cost-competitive solution for a multitude of motion control applications.

- Four english and metric body sizes ranging from .75-inch (19mm) to 2-inch (50mm) with in line or reverse parallel motor configuration.
- Fifteen english screw/nut combinations and screw sizes ranging from .375-inch to .750 -inches with either solid Acme (plastic or bronze) or ball nut configuration.
- System thrust capabilities ranging from 70 lbs (311.4N) for the GSA/GSM12 Series to 2700 lbs (12,010N) for the GSA/GSM32 Series.
- Choice of linear ball or composite bearings with internal lubrication of guide rods for increased life of bearings.
- Standard or oversize guide rod diameter for increased rigidity and lower deflection
- 8 different brushless servo motor selections in 17, 23 and 34 frame sizes.
- 6 different gearhead selections in gear ratios of 5.5:1 or 10:1.
- Stroke lengths available in any incremental length ranging from 0 to 36" (914mm) depending on actuator body size.
- Available with the widest range of options including stop collars, stainless-steel guide rods, adapter plates and switches: dc Reed, Hall-effect or ac Triac.

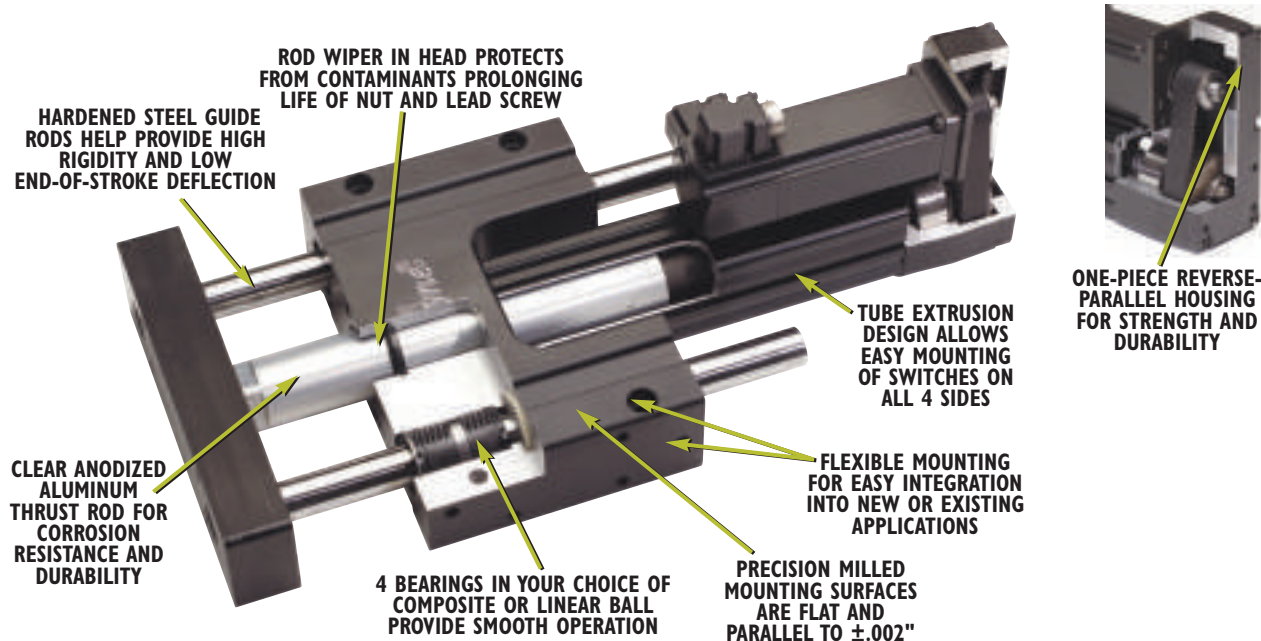

BRUSHLESS SERVO SYSTEM - MOTORS, DRIVES AND CONTROLS

MRV, AXIOM® DV, AXIOM® PV

MRV - BRUSHLESS SERVO MOTORS

- Rugged, with large shafts and bearings, IP65
- Convenient MS connectors
- Common flanges (NEMA 17, 23, 34 and 56)
- Integral temperature switch and 1000 line encoder

AXIOM® DV - BRUSHLESS SERVO DRIVE

- Designed to drive MRV motors
- Peak current ratings of 10A, 20A and 30A
- State-of-the-art vector commutation and current control for efficient high-bandwidth servo performance
- Simple Windows®-based software for set-up and installation

AXIOM® PLUS PV CONTROLLER/DRIVE:

- Combines into one unit:
 - PLC: with real-time scan, 175 rung ladder logic
 - Motion Controller: with 1 to 1.5 axis, event triggering, motion pause and resume, point & click editor
 - AXIOM drive: with all features listed above
- Includes Tol-O-Motion™ Axiom Motion Control Software and intuitive point and click sequential program and PLC ladder logic editors

PRODUCT OVERVIEW

Brushless Servo System

- Motors
- Drives
- Controls

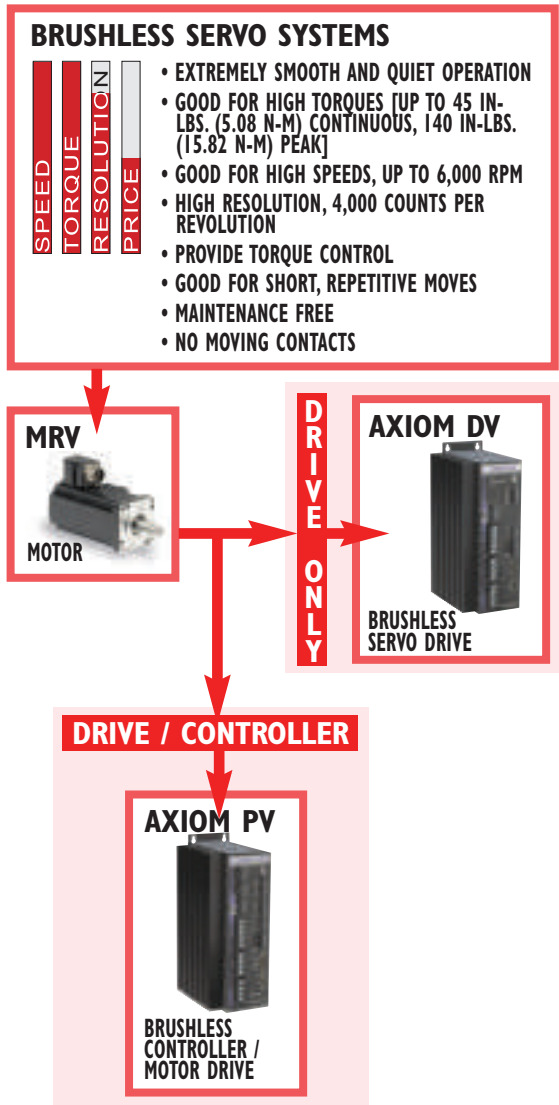

This page is intentionally left blank

Rodless Actuator Technical Data



***B3S/M3S SCREW DRIVE ACTUATORS
B3W/M3W BELT DRIVE ACTUATORS***



***TruTrack TKS SCREW DRIVE ACTUATORS
TruTrack TKB BELT DRIVE ACTUATORS***



BCS/MCS SCREW DRIVE ACTUATORS



SLS/MLS SCREW DRIVE ACTUATORS

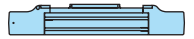

RODLESS

The following pages contain detailed information about Tolomatic rodless actuators. Visit www.tolomatic.com for the latest updates, CAD files and software support downloads.

B3S SCREW DRIVEN ACTUATORS

ENDURANCE TECHNOLOGYSM

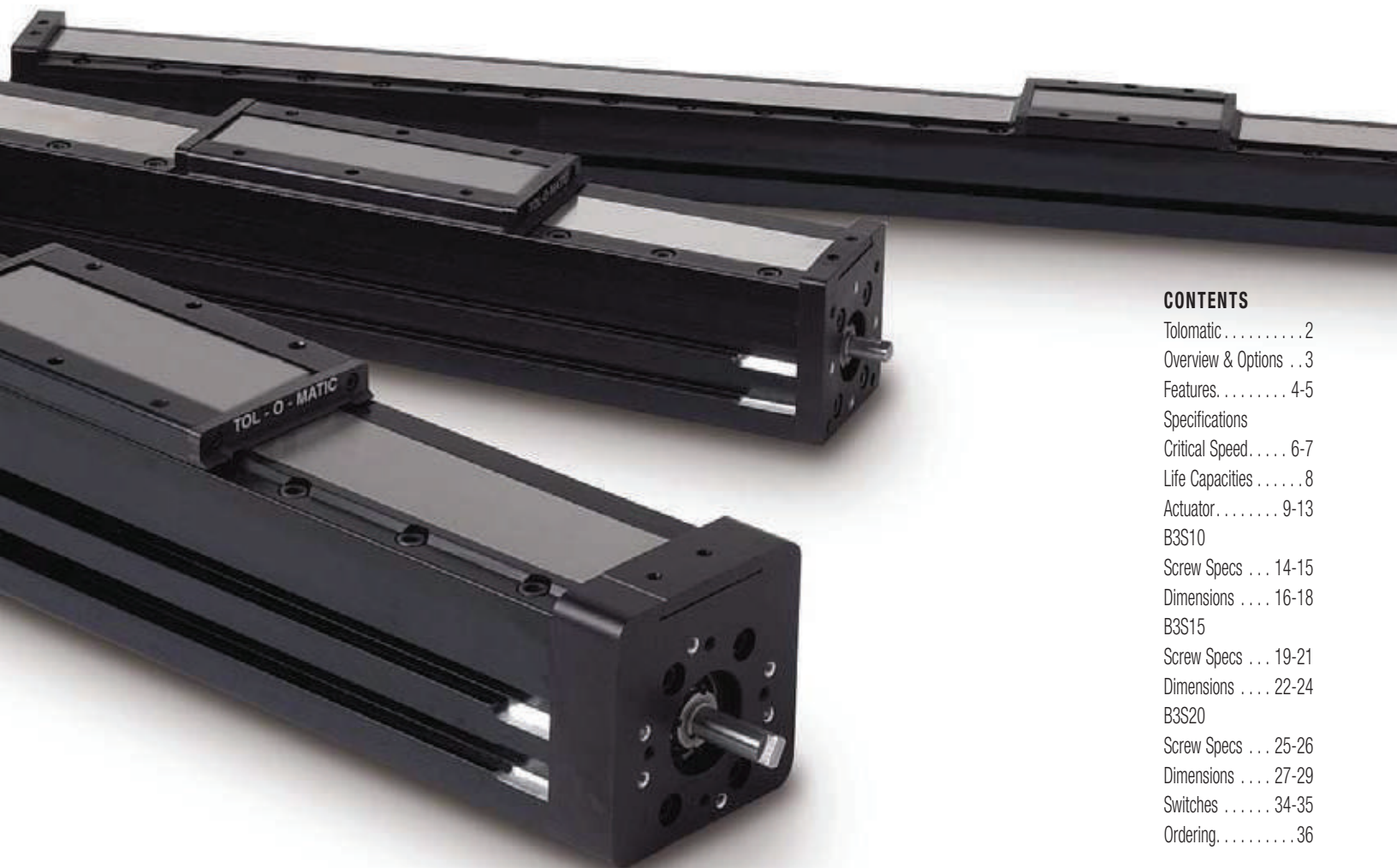

CONTENTS

Tolomatic	2
Overview & Options . . .	3
Features	4-5
Specifications	
Critical Speed	6-7
Life Capacities	8
Actuator	9-13
B3S10	
Screw Specs	14-15
Dimensions	16-18
B3S15	
Screw Specs	19-21
Dimensions	22-24
B3S20	
Screw Specs	25-26
Dimensions	27-29
Switches	34-35
Ordering	36

MAXIMUM DURABILITY

THE TOLOMATIC DIFFERENCE What you expect from the industry leader:



EXCELLENT CUSTOMER SERVICE & TECHNICAL SUPPORT

Our people make the difference! Expect prompt, courteous replies to all of your application and product questions.



INDUSTRY LEADING DELIVERIES

Standard catalog products are built to order and ready-to-ship in 5 days or less. Modified and custom products ship weeks ahead of the competition.

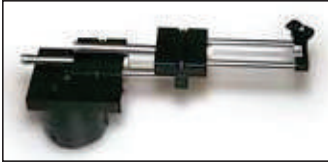

INNOVATIVE PRODUCTS

From standard catalog products... to modified products... to completely unique custom products, Tolomatic designs and builds the best solutions for your challenging applications.

B3S



SIZING & SELECTION SOFTWARE

Windows® compatible, downloadable from our website – FREE – the best tool of its kind on the market! Product selection has never been easier.



3D MODELS & 2D DRAWINGS AVAILABLE ON THE WEB

Easy to access CAD files are available in many popular formats.

ALSO CONSIDER THESE OTHER TOLOMATIC PRODUCTS:

PNEUMATIC PRODUCTS



RODLESS CYLINDERS: Band Cylinders, Cable Cylinders, MAGNETICALLY COUPLED CYLINDERS/SLIDES; GUIDED ROD CYLINDER SLIDES

"FOLDOut" Br OChure #9900-9075 BAnD CyLinDer Br OChure #9900-4015 CATALog #9900-4000 www.tolomatic.com/pneumatic

ELECTRIC PRODUCTS



ROD & GUIDED ROD STYLE ACTUATORS, HIGH THRUST ACTUATORS, SCREW & BELT DRIVE RODLESS ACTUATORS, MOTORS, AXIOM DRIVES/CONTROLLERS

"FOLDOut" Br OChure #9900-9074 eLeCTriC Pr ODuCTS Br OChure #9900-4016 MXe Br OChure #8300-4000 STePPer Br OChure #3600-4160 www.tolomatic.com/electric

POWER TRANSMISSION PRODUCTS

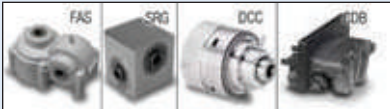

GEARBOXES: Float-A-Shaft™, Slide-Rite™; DISC CONE CLUTCH; CALIPER DISC BRAKE

"FOLDOut" Br OChure #9900-9076 CATALog #9900-4009 www.tolomatic.com/pt



3800 County Road 116 • Hamel, MN 55340 U.S.A.
Phone: (763) 478-8000 • Fax: (763) 478-8080

Toll-Free: **1-800-328-2174**

Email: help@tolomatic.com • <http://www.tolomatic.com>

All brand and product names are trademarks or registered trademarks of their respective owners. Information in this document is believed accurate at time of printing. However, Tolomatic assumes no responsibility for its use or for any errors that may appear in this document. Tolomatic reserves the right to change the design or operation of the equipment described herein and any associated motion products without notice. Information in this document is subject to change without notice.

Visit www.tolomatic.com for the most up-to-date technical information



B3S Rodless Screw Driven Actuator

OVERVIEW & OPTIONS

APPLICATION BENEFITS

- Accommodate heavy loads
- Handle high moment loads with consistent, smooth operation
- Cost-effective alternative to auxiliary rail systems
- Consistent work point deflection through life of product
- 100% duty cycle

BEARING SYSTEM

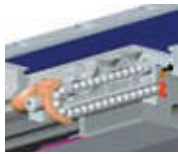

- Heavy duty recirculating bearings in gothic arch rail guide.
- Wear resistance with repeatable accuracy
- Patented* sealed bearing system — for long life
- High load and moment capacities
- Consistent tracking for full actuator life

STANDARD MOUNTING



- B3S actuators have T-nut mounting in the body base with four T-nuts for the first 24 inches of stroke. Two nuts are provided for each additional 20 inches.

ACTUATOR/MOTOR FACTORS

- Actuator's operating temperature range (40-130° F, 4-54° C) should take into consideration heat generated by the motor and drive, linear velocity and work cycle time.
- For large frame motors or small actuators, cantilevered motors need to be supported, if subjected to continuous rapid reversing duty and/or under dynamic conditions.

AVAILABLE OPTIONS



Tube Supports: Provide intermediate support of actuator body at the recommended intervals.



Auxiliary Carrier: Increases rigidity, load-carrying capacity and bending moments.

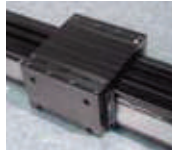

Dual 180° Carrier: Allows load to be rotated 90° from the cylinder's carrier, providing an additional load bearing surface. Requires its own proprietary tube supports and foot mounts.



Auxiliary Dual 180° Carrier: Substantially increases loads and moments.

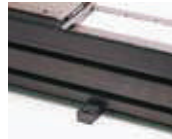

Mounting Plates: Provide clearance height for motors and motor mounts when mounting an actuator on a flush surface and provide the means for top mounting access. Kits include plates and mounting screws.



Absolute Position Feedback: A linear transducer embedded within the cylinder extrusion in conjunction with the carrier magnet precisely measure and report carrier position.



Motor Mounting and Gearbox Reduction:

In-line Motor Mounting — This motor mounting option uses a spacer and coupler to join the motor to the actuator shaft.



Reverse-parallel Motor Mounting — These factory assembled configurations allow offset mounting of the motor to either side of, or below the actuator. Available in 1:1 or 2:1 drive ratios, they offer quiet, zero-backlash coupling of the motor to the actuator screw shaft.



Planetary Gearboxes — Designed for applications requiring reduction for higher torque at lower speeds. Tolomatic, in partnership with Apex Dynamics, offers high precision, high speed, single stage, true planetary gearboxes. gear ratios of 5:1 and 10:1 are available and compatible with our 23 and 34 frame Mr V brushless servo and Mr S stepper motors.



Switches: Reed, dc Hall-effect and ac Tri AC.

* U.S. Patent No. 5,555,789

A

B

MXE-S

MXE-P

MXB-U

MXB-P

B3S

B3W

TKS

TKB

BCS

SLS

RSA

GSWA

GSA

MRV

MRS

GEARBOX

SWITCH

C

A

B3S Rodless Screw Driven Actuator

B

ENDURANCE TECHNOLOGYSM

Look for this endurance technology symbol indicating our durability design features

The B3S rodless style actuator is designed for carrying moderate to heavy loads and accommodating the associated bending and dynamic moments. Based upon our BC3 pneumatic band cylinder, it utilizes a patented integral recirculating ball bearing guidance system that provides consistent and durable performance. Customized stroke lengths up to 120 inches and multiple screw options are available. Contact your local distributor for more information.

MXE-S

MXE-P

MXB-U

MXB-P

B3S

B3W

TKS

TKB

BCS

SLS

RSA

GSA

GSA

MRV

MRS

GEARBOX

SWITCH

r ODLess ACTuator S

r ODL Style ACTuator S

COntrol SyStemS +

C

LOAD-BEARING CARRIER DESIGN

- Recirculating ball bearing system provides guidance, high efficiency and durability
- Load and moments are transmitted directly to the actuator body

FORMED END CAP WIPERS

- Prevent contaminants from entering the sealing band area to protect internal components

INTERNAL BUMPERS

- Bumpers protect the screw and nut assembly from damage at end of stroke

STAINLESS STEEL SEALING BAND

- Prevents contaminants from entering the screw and nut area for extended performance
- Fatigue resistant stainless steel bands are specifically made to offer long life and will not elongate
- Provides IP44 protection for bearings and screw nut

MULTIPLE SCREW TECHNOLOGIES •

YOU CAN CHOOSE:

- Solid nuts of bronze or engineered resins offer quiet performance at the lowest cost; anti-backlash available
- Ball nuts offer positioning accuracy and repeatability with longer life; low-backlash available



5 DAYS
BUILT-TO-ORDER

TOLOMATIC... MAXIMUM DURABILITY

A

B

MXE-S

MXE-P

MXB-U

MXB-P

B3S

B3W

TKS

TKB

BCS

SLS

RSA

GSWA

GSA

MRV

MRS

GEARBOX

SWITCH

C

SCREW SUPPORT BEARINGS

- Unique high thrust bearing assembly design eliminates runout and isolates the linear forces from the drive shaft

LIGHTWEIGHT ALUMINUM DESIGN

- Black anodized extrusion design is optimized for rigidity and strength
- External switch channels on both sides allow easy placement and adjustment of position indicating switches

PATENTED WEDGE BEARING SYSTEM

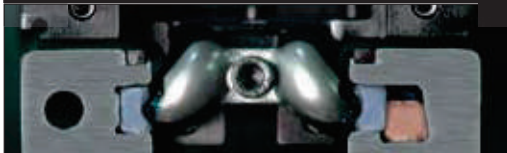

- Unique design incorporates hardened steel raceways integral to the aluminum extrusion
- Bearing surfaces are adjusted at the factory for optimum preload and smooth performance



MOTOR ORIENTATION YOU CAN CHOOSE:

- Inline option directly couples the driving shafts and is a one-piece housing construction for optimum alignment and support of the motor
- Reverse-parallel option minimizes the overall length and offers a 1:1 or 2:1 belt ratio

YOUR MOTOR HERE YOU CAN CHOOSE:

- Motor or gearbox supplied and installed by TOLOMATIC
- Specify the device to be installed and actuator ships with proper mounting hardware
- Specify and ship your device to TOLOMATIC for factory installation

OPTIONS



CARRIER OPTIONS

- Auxiliary Carrier** **[D][C]**
- Dual 180° Carrier** **[D]**
- 2X higher load capacity
- High bending moment capacity



MOUNTING OPTIONS

- T-Nuts** **[T][N]**
- For direct mounting
- Tube Supports** **[T][S]**
- Mounting Plates** **[M][P]**
- Clearance for motor and mount
- Metric Option** **[M]**
- Metric mounting

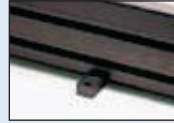

SENSING OPTIONS

- Absolute Position Feedback** **[A][P][F]**
- Realtime load position feedback
- Available in any stroke length
- Switches**
- Styles include: reed, hall-effect or triac



B3S Rodless Screw Driven Actuator

ACME SCREW/NUT COMBINATIONS



ACME SCREW CRITICAL SPEED CAPACITIES

CRITICAL SPEED WITH INCH (US standard) ACME SCREW

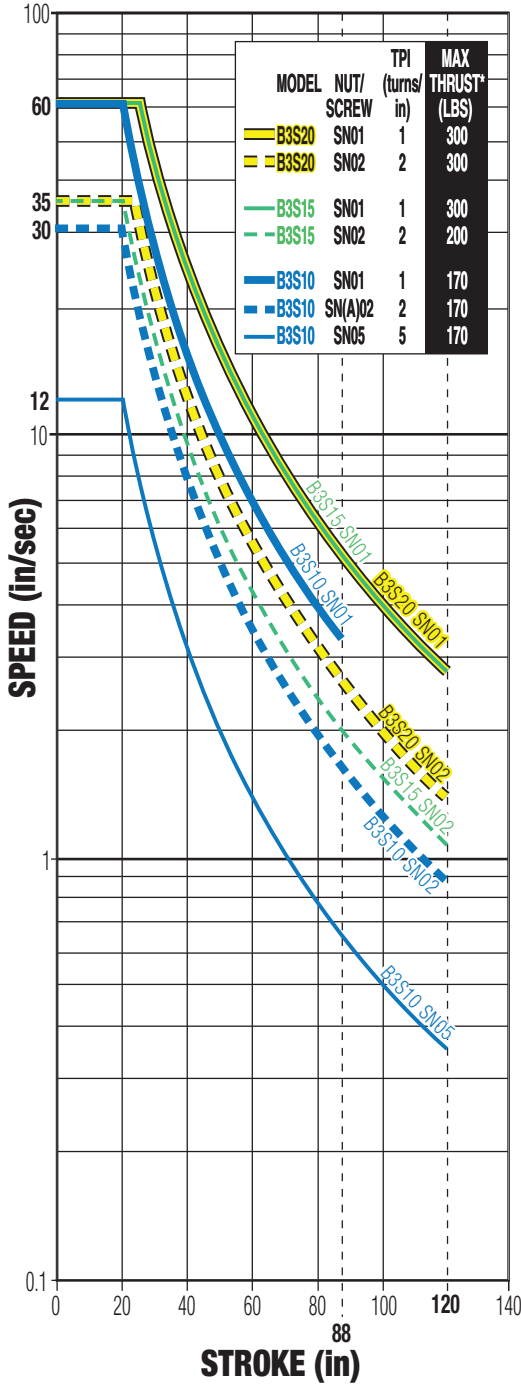

CRITICAL SPEED WITH METRIC ACME SCREW

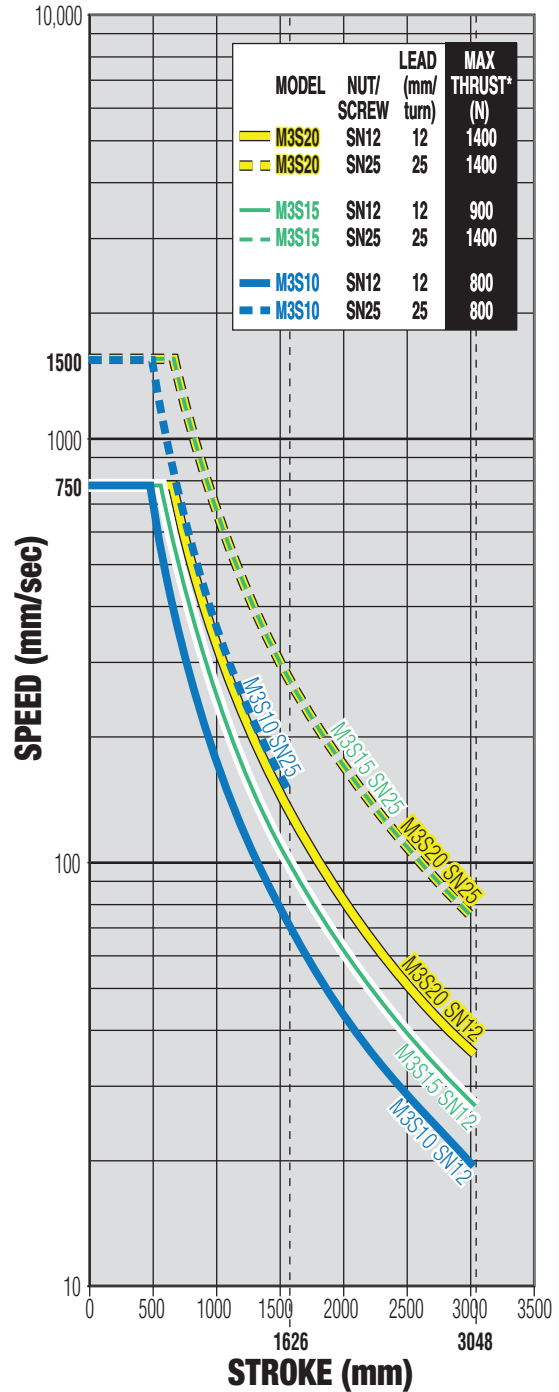

* Maximum thrust is the maximum continuous dynamic thrust subject to Thrust x Velocity limitation.

Dotted lines represent maximum stroke for screw selections.

For Screw PV limits, refer to the individual charts located in the technical section for each actuator body size.

SCREW CODE	DESCRIPTION
SN	Solid Nut
SNA	Anti-backlash Solid Nut

B3S Rodless Screw Driven Actuator

BALL SCREW/NUT COMBINATIONS



A

B

BALL SCREW CRITICAL SPEED CAPACITIES

CRITICAL SPEED WITH INCH (US standard) BALL SCREW

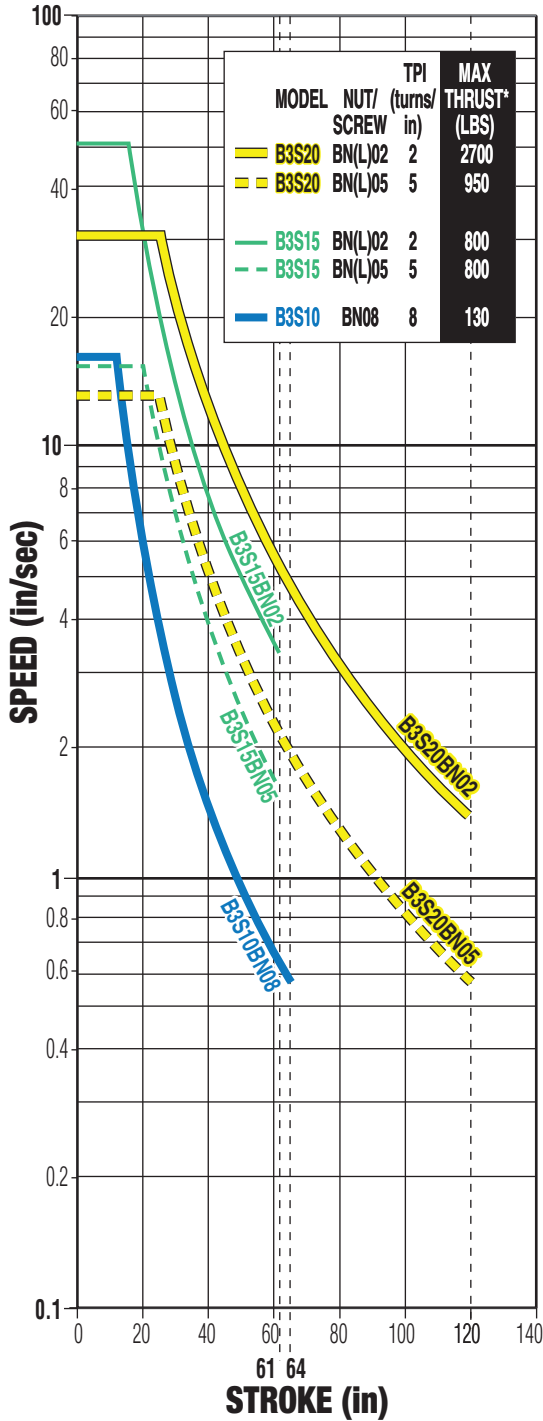

CRITICAL SPEED WITH METRIC BALL SCREW

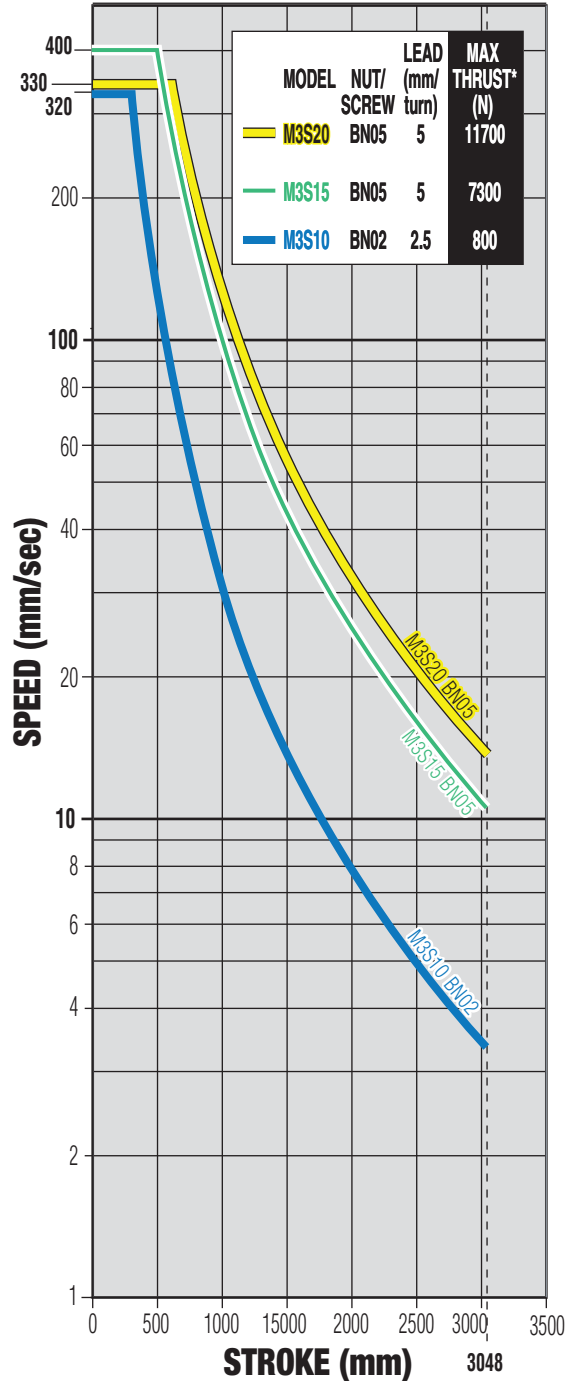

! * Maximum thrust reflects 90% reliability for 1 million linear inches of travel.
Dotted lines represent maximum stroke for screw selections.

SCREW CODE DESCRIPTION
 BN Ball Nut
 BNL Low-Backlash Ball Nut

- MXE-S
- MXE-P
- MXB-U
- MXB-P
- B3S**
- B3W
- TKS
- TKB
- BCS
- SLS
- RSA
- GSWA
- GSA
- MRV
- MRS
- GEARBOX
- SWITCH

C

B3S Rodless Screw Driven Actuator

BALL SCREW/NUT COMBINATIONS



LIFE CAPACITIES WITH INCH (US standard) BALL SCREW

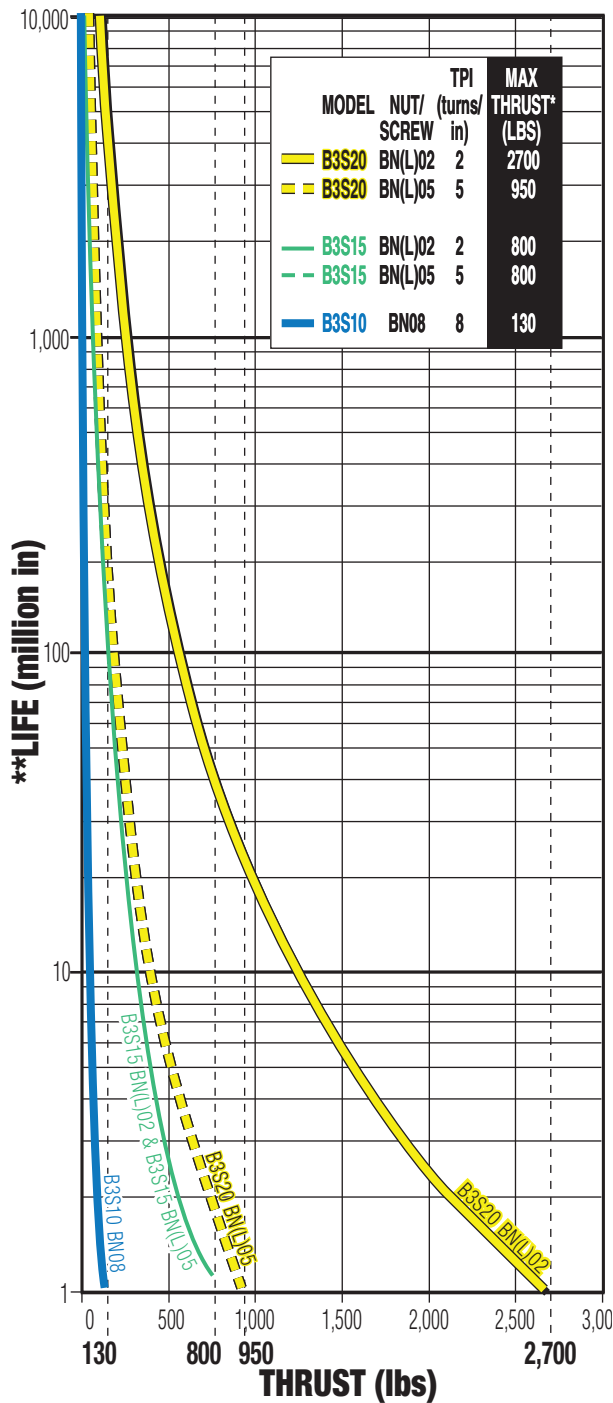

LIFE CAPACITIES WITH METRIC BALL SCREW

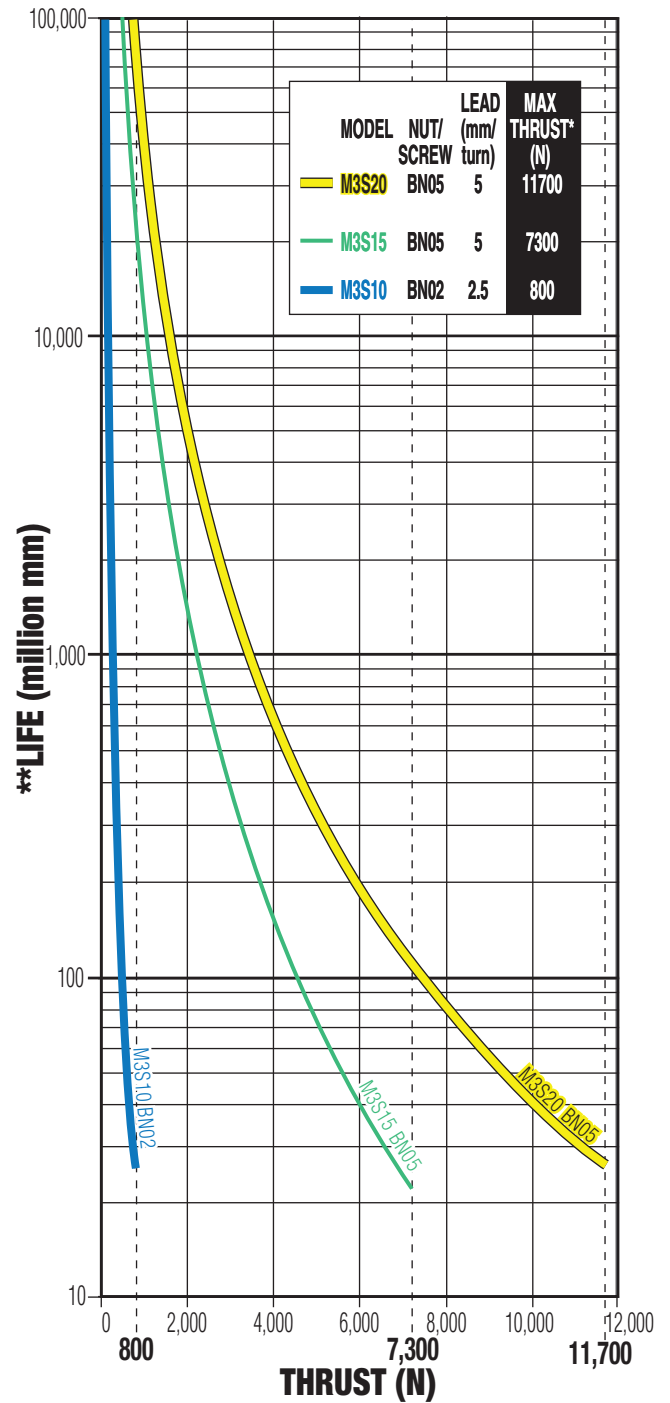

* Maximum thrust reflects 90% reliability for 1 million linear inches of travel.

Dotted lines represent maximum thrust for screw selections.

**Life indicates theoretical maximum life of screw only, under ideal conditions and does not indicate expected life of actuator.

B3S Rodless Screw Driven Actuator

OVERALL SERIES SPECIFICATIONS



SPECIFICATIONS RELATED TO ACTUATOR SIZE AND SCREW SELECTION

INCH (US standard) LEAD SCREWS											
ACTUATOR SERIES	SCREW DIA. (in)	SCREW TYPE	TPI (turns/in)	LEAD ACCURACY (in/ft)	BACKLASH (in)	MAXIMUM THRUST* (lb)	MAXIMUM STROKE (in)	INERTIA (lb-in ²)			BREAKAWAY TORQUE (lb-in)
								BASE ACTUATOR		PER/in OF STROKE	
								In Line	Rev. Parallel		
B3S10	0.375	BN	08	0.004	0.015	130	64	0.0034	0.0042	0.0005	1.125
	0.375	BNL	08	0.004	0.002	130	64	0.0034	0.0042	0.0005	1.125
	0.500	SN	05	0.006	0.007	170	120	0.0114	0.0142	0.0017	1.250
	0.500	SN	02	0.005	0.007	170	120	0.0159	0.0187	0.0017	1.750
	0.500	SNA	02	0.005	0.003	170	120	0.0193	0.0221	0.0017	1.750
	0.500	SN	01	0.006	0.007	170	88	0.0320	0.0348	0.0017	2.500
B3S15	0.500	BN	02	0.003	0.015	800	61	0.0253	0.0282	0.0017	1.563
	0.500	BNL	02	0.003	0.002	800	61	0.0253	0.0282	0.0017	1.563
	0.625	SN	02	0.005	0.007	200	120	0.0480	0.0550	0.0042	1.875
	0.625	BN	05	0.003	0.015	800	61	0.0397	0.0467	0.0042	1.250
	0.625	BNL	05	0.003	0.002	800	61	0.0397	0.0467	0.0042	1.250
	0.750	SN	01	0.005	0.007	300	120	0.1185	0.1329	0.0087	2.813
B3S20	0.750	SN	02	0.005	0.007	300	120	0.1159	0.1224	0.0087	3.438
	0.750	SN	01	0.005	0.007	300	120	0.1565	0.1630	0.0087	5.000
	0.750	BN	02	0.004	0.015	2700	120	0.1159	0.1224	0.0087	3.125
	0.750	BNL	02	0.004	0.002	2700	120	0.1159	0.1224	0.0087	3.125
	0.750	BN	05	0.003	0.015	950	120	0.1045	0.1110	0.0087	2.188
	0.750	BNL	05	0.003	0.002	950	120	0.1045	0.1110	0.0087	2.188

METRIC LEAD SCREWS											
ACTUATOR SERIES	SCREW DIA. (mm)	SCREW TYPE	LEAD (mm/turn)	LEAD ACCURACY (mm/300)	BACKLASH (mm)	MAXIMUM THRUST* (N)	MAXIMUM STROKE (mm)	INERTIA (kg-m ² x 10 ⁻⁶)			BREAKAWAY TORQUE (N-m)
								BASE ACTUATOR		PER/mm OF STROKE	
								In Line	Rev. Parallel		
M3S10	10	BN	2.5	0.13	0.38	800	1626	1.14	1.43	0.176	0.13
	10	BNL	2.5	0.13	0.05	800	1626	1.14	1.43	0.176	0.13
	12	SN	12	0.13	0.18	800	3048	3.03	4.50	0.410	0.20
	12	SN	25	0.13	0.18	800	3048	8.54	9.21	0.410	0.28
M3S15	15	SN	12	0.13	0.18	900	3048	11.35	12.96	0.966	0.27
	16	BN	5	0.13	0.38	7300	1549	11.93	14.04	1.258	0.16
	16	BNL	5	0.13	0.05	7300	1549	11.93	14.04	1.258	0.16
M3S20	19	SN	25	0.13	0.18	1400	3048	34.05	38.26	2.517	0.32
	19	SN	12	0.13	0.18	1400	3048	44.96	35.04	2.517	0.39
	19	SN	25	0.13	0.18	1400	3048	33.14	46.86	2.517	0.57
M3S20	20	BN	5	0.13	0.38	11700	3048	36.97	39.28	3.102	0.25
	20	BNL	5	0.13	0.05	11700	3048	36.97	39.28	3.102	0.25

SCREW CODE	DESCRIPTION
SN	Solid Nut
SNA	Anti-backlash Solid Nut
BN	Ball Nut
BNL	Low-Backlash Ball Nut



* For Acme screws, maximum thrust is the maximum continuous dynamic thrust subject to Thrust x Velocity limitation.

For ball screws, maximum thrust reflects 90% reliability for 1 million linear inches of travel.

- MXE-S
- MXE-P
- MXB-U
- MXB-P
- B3S**
- B3W
- TKS
- TKB
- BCS
- SLS
- RSA
- GSWA
- GSA
- MRV
- MRS
- GEARBOX
- SWITCH

B3S Rodless Screw Driven Actuator

OVERALL SERIES SPECIFICATIONS



GENERAL ACTUATOR SPECIFICATIONS

B3S INCH (US standard) ACTUATORS						
ACTUATOR SERIES	CARRIER WEIGHT (lb)	BASE WEIGHT (lb)	WEIGHT PER/IN OF STROKE (lb)	STRAIGHTNESS & FLATNESS (in) ¹ (Supported)	TEMPERATURE RANGE ² (F°)	IP RATING ³
B3S10	0.85	2.15	0.300	0.00067 x L*	40 - 130	44
B3S15	1.56	8.75	0.570	0.00067 x L*	40 - 130	44
B3S20	2.15	14.38	0.880	0.00067 x L*	40 - 130	44

M3S METRIC ACTUATORS						
ACTUATOR SERIES	CARRIER WEIGHT (kg)	BASE WEIGHT (kg)	WEIGHT PER/mm OF STROKE (g)	STRAIGHTNESS & FLATNESS (mm) ¹ (Supported)	TEMP. RANGE ² (C°)	IP RATING ³
M3S10	0.40	1.00	5.40	0.00067 x L*	4 - 54	44
M3S15	0.70	3.96	10.18	0.00067 x L*	4 - 54	44
M3S20	0.97	6.52	15.73	0.00067 x L*	4 - 54	44



¹ The listed values relating to straightness/flatness are intended for reference purposes only, and not as an engineering standard of absolute tolerance for a given actuator. Appropriate installation is the single most important factor in reducing such deviation, so good engineering practices such as measurement, mapping, etc. must be employed in applications with stringent straightness/flatness requirements.

² Heat generated by the motor and drive should be taken into consideration as well as linear velocity and work cycle time. For applications that require operation outside of the recommended temperature range, contact the factory.

³ Protected against ingress of solid particles greater than .039 in (1mm) and splashing water.

* "L" is maximum distance between supports— See the support recommendation graph on page 12.

LARGE FRAME MOTORS AND SMALLER SIZE ACTUATORS: Cantilevered motors need to be supported, if subjected to continuous rapid reversing duty and/or under dynamic conditions.

FRICITION FORCE

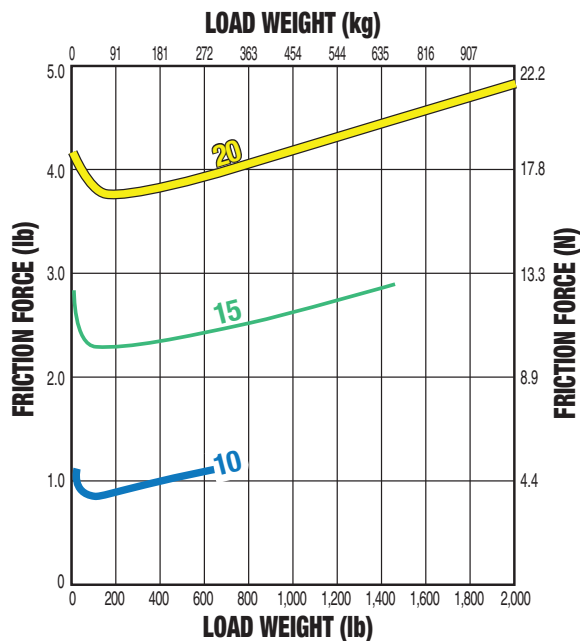

B3S Rodless Screw Driven Actuator

OVERALL SERIES SPECIFICATIONS



DYNAMIC BENDING MOMENTS AND LOADS

MAXIMUM BENDING MOMENTS AND LOADS			INCH (US standard)			METRIC		
STANDARD CARRIER			B3S10	B3S15	B3S20	M3S10	M3S15	M3S20
	Mx Moment (Roll)	(lb-in : n-m)	250	859	1,662	28.2	97.1	187.8
	My Moment (Pitch)	(lb-in : n-m)	269	1,033	1,472	30.4	116.7	166.3
	Mz Moment (Yaw)	(lb-in : n-m)	156	596	850	17.6	67.3	96.0
	Fy Load (Radial)	(lb : n)	341	840	1,159	1,517	3,737	5,155
	Fz Load (Lateral)	(lb : n)	591	1454	2008	2,629	6,468	8,932
	AUXILIARY CARRIER: Increases rigidity, load-carrying capacity and moments			B3S10	B3S15	B3S20	M3S10	M3S15
	Mx Moment (Roll)	*(lb-in : n-m)	500	1,718	3,324	56.5	194.1	375.6
	My Moment (Pitch)	*(lb-in : n-m)	2,825	11,734	16,265	319.2	1,325.8	1,837.7
	Mz Moment (Yaw)	*(lb-in : n-m)	1,630	6,779	9,388	184.2	765.9	1,060.7
	Fy Load (Radial)	(lb : n)	682	1,680	2,318	3,034	7,473	10,311
	Fz Load (Lateral)	(lb : n)	1,182	2,908	4,016	5,258	12,935	17,864
	Minimum Dimension 'D'	(in : mm)	4.88	8.07	8.10	124.0	205.2	205.7
DUAL 180° CARRIER: Allows 90° rotation of load, adds load bearing surface			B3SD10	B3SD15	B3SD20	M3SD10	M3SD15	M3SD20
	Mx Moment (Roll)	(lb-in : n-m)	657	2,468	4,527	74.2	278.8	511.5
	My Moment (Pitch)	(lb-in : n-m)	312	1,192	1,700	35.3	134.7	192.1
	Mz Moment (Yaw)	(lb-in : n-m)	538	2,066	2,944	60.8	233.4	332.6
	Fy Load (Radial)	(lb : n)	1,182	2,908	4,016	5,258	12,935	17,864
	Fz Load (Lateral)	(lb : n)	682	1,680	2,318	3,034	7,473	10,311
	AUXILIARY DUAL 180° CARRIER: Substantially increases moment and loads			B3SD10	B3SD15	B3SD20	M3SD10	M3SD15
	Mx Moment (Roll)	*(lb-in : n-m)	1,314	4,936	9,054	148.5	557.7	1,023.0
	My Moment (Pitch)	*(lb-in : n-m)	3,328	13,558	18,776	376.0	1,531.9	2,121.4
	Mz Moment (Yaw)	*(lb-in : n-m)	5,768	23,468	32,530	651.7	2,651.5	3,675.4
	Fy Load (Radial)	(lb : n)	2,364	5,816	8,032	10,516	25,871	35,728
	Fz Load (Lateral)	(lb : n)	1,364	3,360	4,636	6,067	14,946	20,622
	Minimum Dimension 'D'	(in : mm)	4.88	8.07	8.10	124.0	205.0	205.7

! The Dual 180° carrier requires its own proprietary tube supports and foot mounts. See dimensional information. Breakaway torque will also increase when using the Auxiliary carrier or the Dual 180° carrier options. When ordering, determine your working stroke and enter this value into the configuration string. Overall actuator length will automatically be calculated.

Deflection Considerations: In applications where substantial Mx or My moments come into play, deflection of the cylinder tube, carrier and supports must be considered. The deflection factors shown in the Load Deflection charts on the following page, are based on cylinder mounted with tube supports at minimum recommended spacing. If more rigidity is desired, refer to the Auxiliary or Dual Carrier options.

*Loads shown in table are at minimum "D" dimension, for ratings with longer "D" dimension see graphs on page 13.

! The above ratings are the maximum values for shock-free, vibration-free operation in a typical industrial environment, which must not be exceeded even in dynamic operation. Contact Tolomatic for assistance in selecting the most appropriate actuator for your application.

Life of the actuator will vary for each application depending on the combined loads, motion parameters and operating conditions. The load factor (L_f) ratios for each application must not exceed a value of 1 (see formula at right). Exceeding a load factor of 1 will diminish the actuator's rated life.

$$L_f = \frac{M_x}{M_{x_{max}}} + \frac{M_y}{M_{y_{max}}} + \frac{M_z}{M_{z_{max}}} + \frac{F_y}{F_{y_{max}}} + \frac{F_z}{F_{z_{max}}} \leq 1$$

With combined loads, L_f must not exceed the value 1.

- MXE-S
- MXE-P
- MXB-U
- MXB-P
- B3S**
- B3W
- TKS
- TKB
- BCS
- SLS
- RSa
- GswA
- GSA
- MRV
- MRS
- GEARBOX
- SWITCH

B3S Rodless Screw Driven Actuator

OVERALL SERIES SPECIFICATIONS



LOAD DEFLECTION

DEFLECTION ABOUT X AXIS

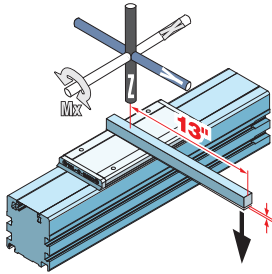

DEFLECTION TESTING WAS DONE UNDER THESE CRITERIA:

- 1.) Actuator was properly mounted with distance between supports within recommendations (see Support Recommendations below)
- 2.) Deflection was measured from center of carrier as shown ($M_x = 13"$, $M_y = 8"$)

DEFLECTION ABOUT Y AXIS

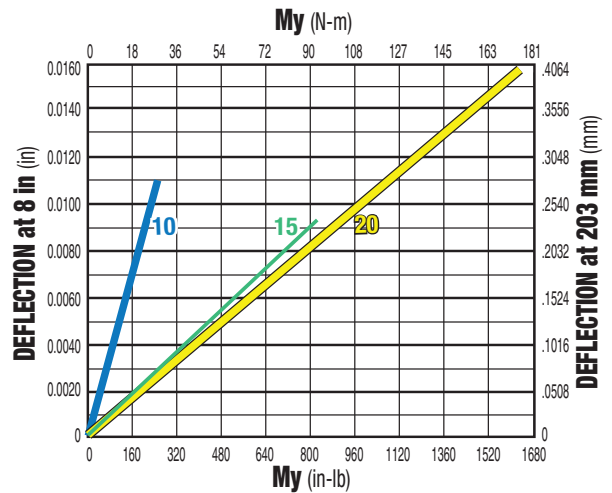
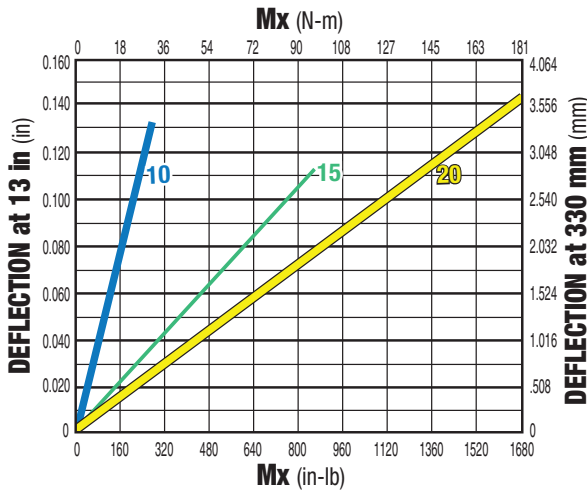
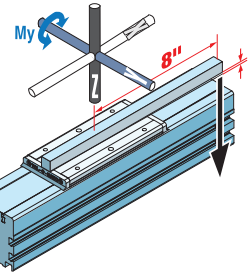

SUPPORT RECOMMENDATIONS

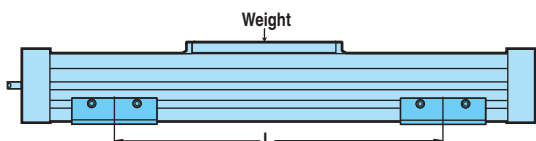
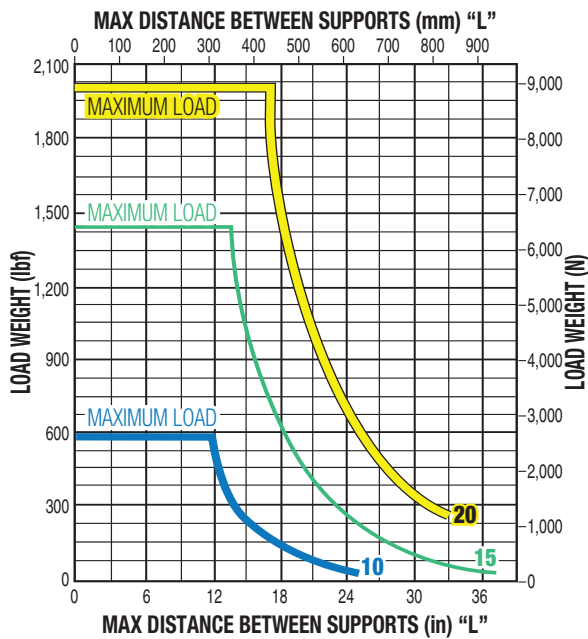

B3S Rodless Screw Driven Actuator

OVERALL SERIES SPECIFICATIONS



A

B

AUXILIARY CARRIER: BENDING MOMENT AT 'D' DISTANCE

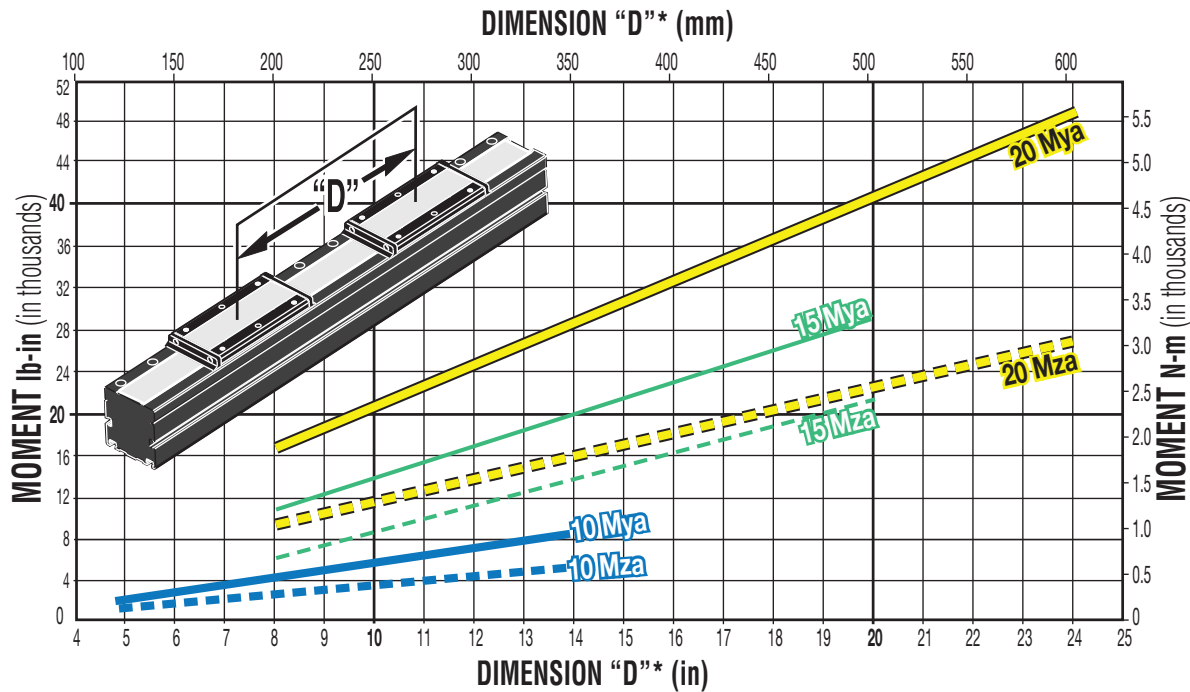

MXE-S

MXE-P

MXB-U

MXB-P

r ODL eSS ACTuATOr S

B3S

B3W

TKS

TKB

BCS

SLS

AUXILIARY DUAL 180° CARRIER: BENDING MOMENT AT 'D' DISTANCE

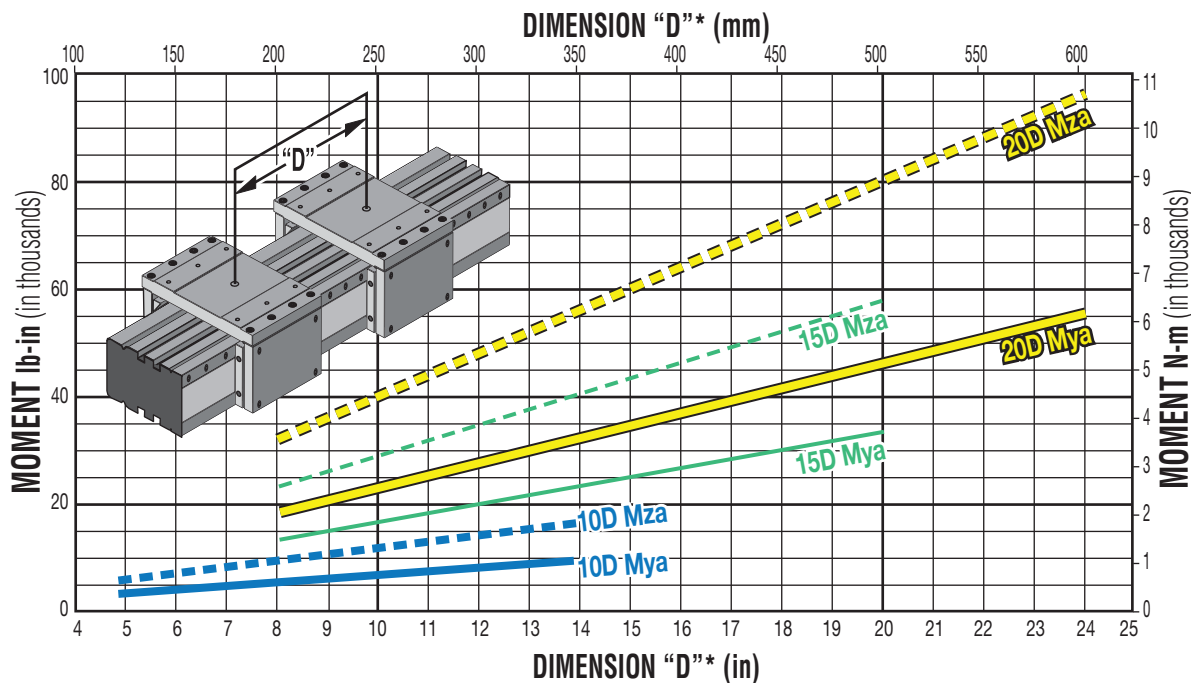

r OD STyLe ACTuATOr S

RSA

GSWA

GSA

MRV

MRS

GEARBOX

SWITCH

C

- Rates shown on both graphs were calculated with these assumptions:
- 1.) Coupling between carriers is rigid.
 - 2.) Load is equally distributed between carriers.
 - 3.) Coupling device applies no misalignment loads to carriers.

* Customer must specify Dimension "D" (Distance between carrier center lines) when ordering.

Life of the actuator will vary for each application depending on the combined loads, motion parameters and operating conditions. The load factor (L_F) ratios for each application must not exceed a value of 1 (see formula at right). Exceeding a load factor of 1 will diminish the actuator's rated life.

$$L_F = \frac{M_x}{M_{x_{max}}} + \frac{M_y}{M_{y_{max}}} + \frac{M_z}{M_{z_{max}}} + \frac{F_y}{F_{y_{max}}} + \frac{F_z}{F_{z_{max}}} \leq 1$$

With combined loads, L_F must not exceed the value 1.

A

B3S10 Rodless Screw Driven Actuator

ACME SCREW SPECIFICATIONS

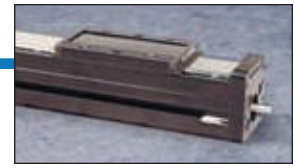

B

B3S10/M3S10 ACME SCREW CRITICAL SPEED AND PV LIMITS

CRITICAL SPEED WITH 1/2" INCH (US standard) ACME SCREW

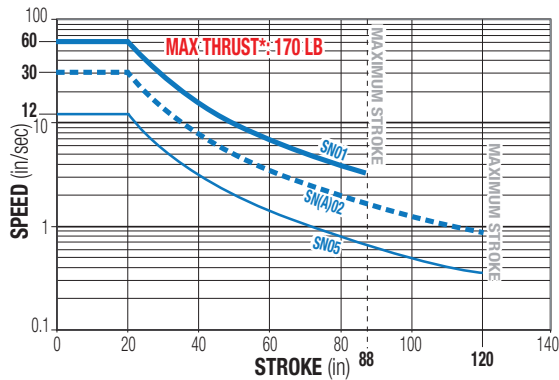

CRITICAL SPEED WITH 12mm METRIC ACME SCREW

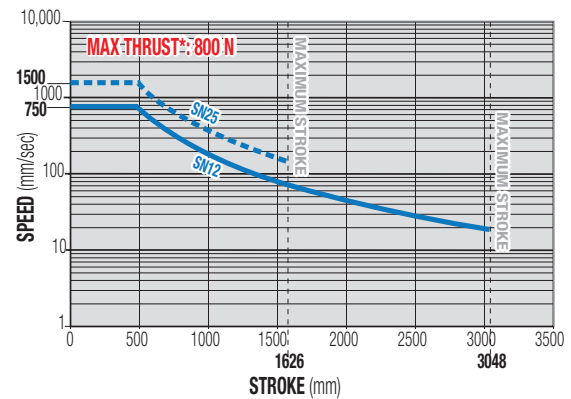

PV LIMITS: 1/2" 1 TPI INCH (US standard) ACME SCREW

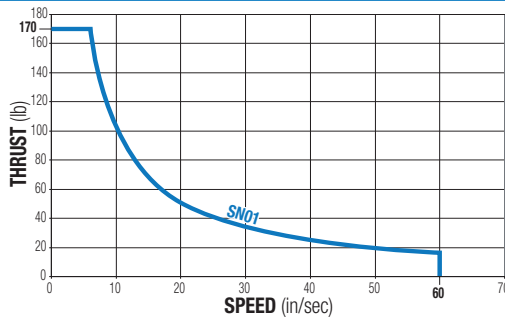

PV LIMITS: 12mm ACME METRIC SCREW w/25mm LEAD

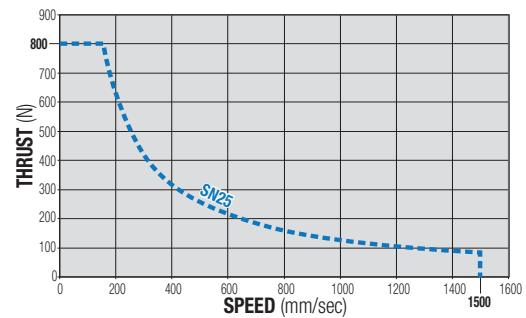

PV LIMITS: 1/2" 2 TPI INCH (US standard) ACME SCREW

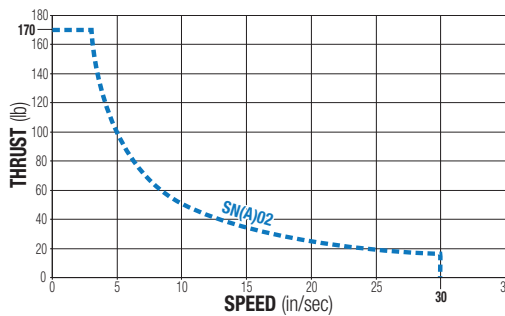

PV LIMITS: 12mm ACME METRIC SCREW w/12mm LEAD

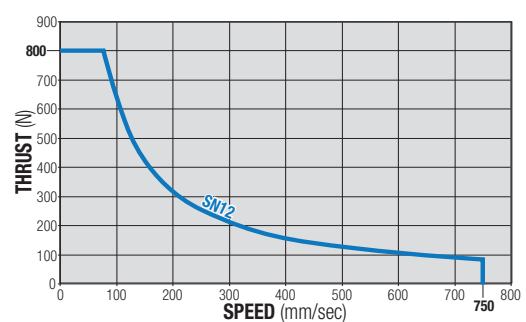

SN = Solid Nut

SNA = Solid Anti-backlash Nut

! * Maximum thrust is the maximum continuous dynamic thrust subject to Thrust x Velocity limitation.

PV LIMITS: Any material which carries a sliding load is limited by heat buildup. The factors that affect heat generation rate in an application are the pressure on the nut in pounds per square inch and the surface velocity in feet per minute. The product of these factors provides a measure of the severity of an application.

$$\frac{P}{(\text{Max. Thrust Rating})} \times \frac{V}{(\text{Max. Speed Rating})} \leq 0.1$$

MXE-S

MXE-P

MXB-U

MXB-P

B3S

B3W

TKS

TKB

BCS

SLS

RSA

GSA

GSA

MRV

MRS

GEARBOX

SWITCH

C

RODLESS ACTUATOR S
r OD StylE ACTUATOR S
COntROL SyStEMS +

B3S10 Rodless Screw Driven Actuator

BALL SCREW SPECIFICATIONS



A
B

B3S10/M3S10 BALL SCREW SPECIFICATIONS

CRITICAL SPEED WITH 3/8" INCH (US standard) BALL SCREW

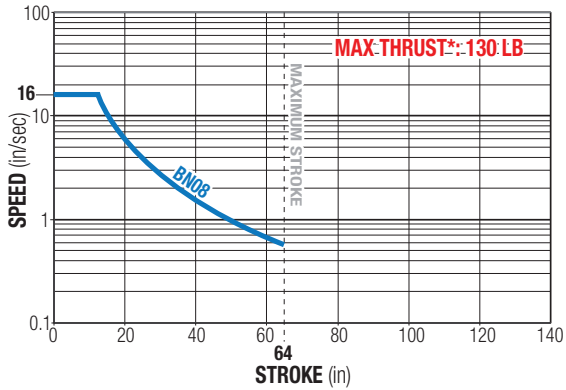

CRITICAL SPEED WITH 10mm METRIC BALL SCREW

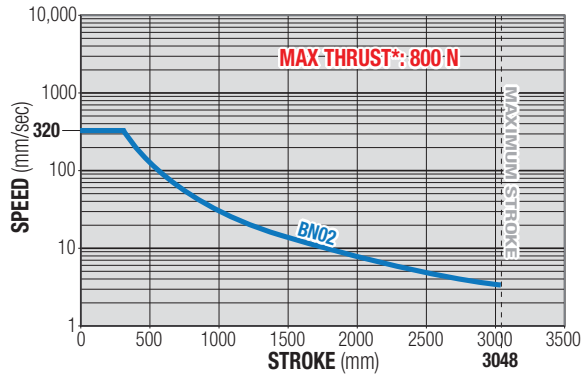

LIFE CALCULATION: 3/8" 8TPI INCH (US standard) BALL SCREW

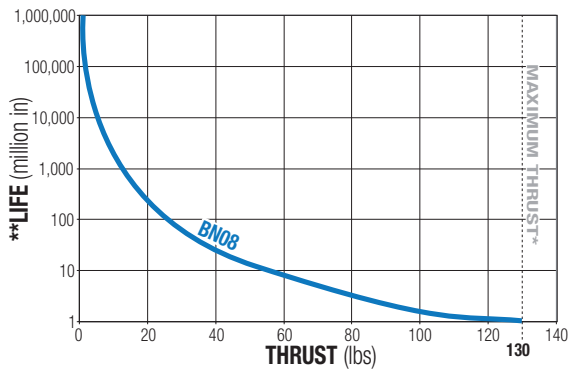

LIFE CALCULATION: 10mm METRIC BALL SCREW w/2.5mm LEAD

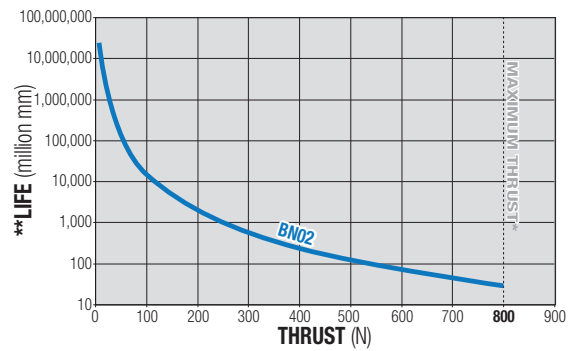

BN = Ball Nut



* Maximum thrust reflects 90% reliability for 1 million linear inches of travel.

**Life indicates theoretical maximum life of screw only, under ideal conditions and does not indicate expected life of actuator.

- MXE-S
- MXE-P
- MXB-U
- MXB-P
- B3S**
- B3W
- TKS
- TKB
- BCS
- SLS

- RSA
- GSWA
- GSA

- MRV
- MRS
- GEARBOX
- SWITCH

C

B3S10 Rodless Screw Driven Actuator



DIMENSIONS

B3S10/M3S10 ACTUATOR AND OPTIONS

MXE-S

MXE-P

MXB-U

MXB-P

B3S

B3W

TKS

TKB

BCS

SLS

RSA

GSA

GSA

MRV

MRS

GEARBOX

SWITCH

RODLESS ACTUATOR S

ROD STYLE ACTUATOR S

CONTR OL SYSTEMS +

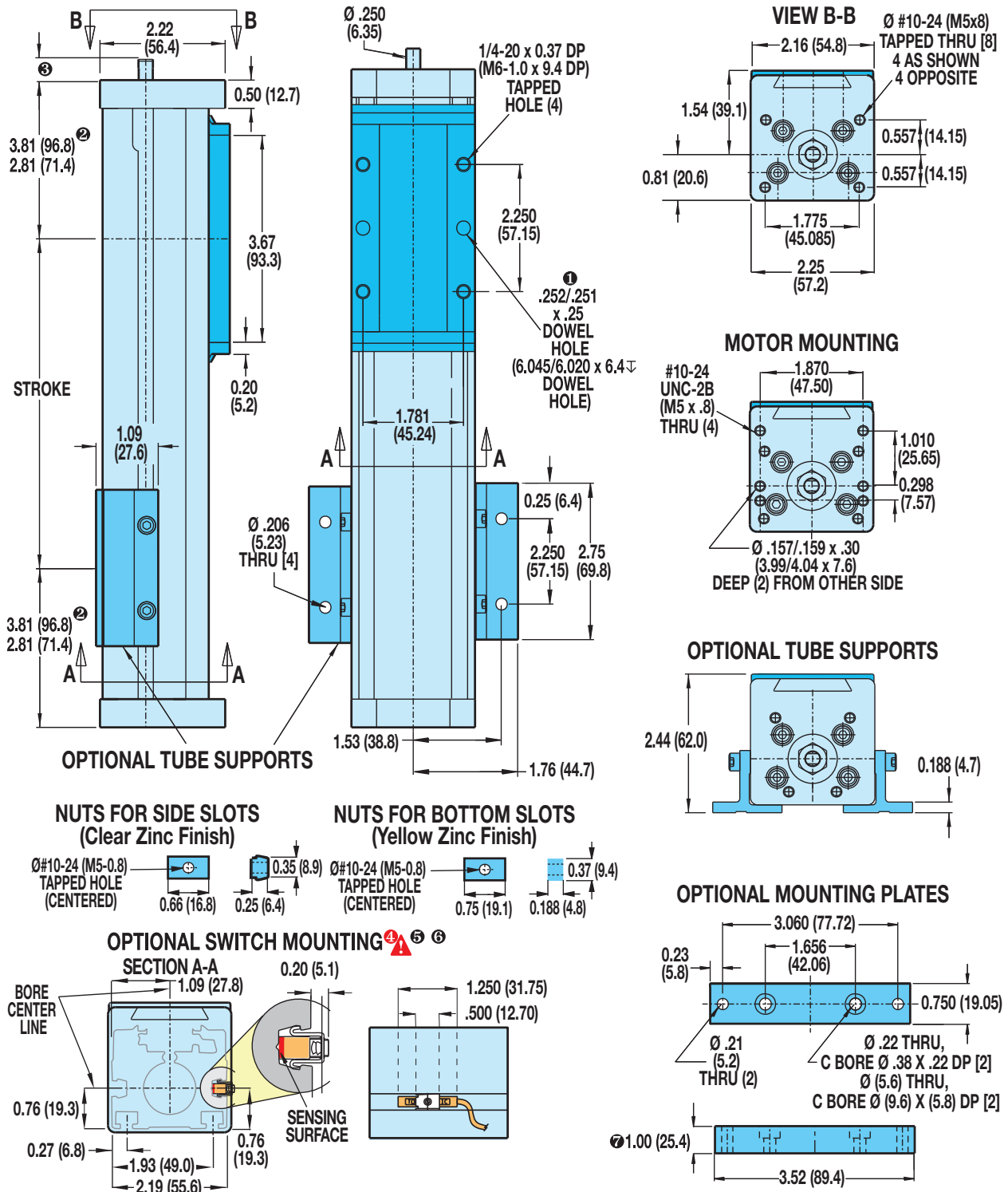

① DOWEL PINS $\text{Ø } .003 \text{ (0.08mm)}$ (M)

② FOR SNAO2 STYLE ONLY

③ SHAFT LENGTH

In-line mounting	0.55 (13.8)
Extended shaft for RP & 23-frame motor	1.99 (50.5)
Extended shaft for RP & 34-frame motor	2.20 (55.9)
Extended shaft for purchases prior to 6/24/02	1.63 (41.4)

⚠ **CAUTION: DO NOT OVERTIGHTEN SWITCH HARDWARE WHEN INSTALLING**

⚡ **NOTE:** The scored face of the switch indicates the sensing surface and must face toward the magnet

⑥ **NOTE:** Some actuators require switch mounting on a specific side of the actuator. Call Tolomatic 1-800-328-2174 for details

⑦ **WHEN USED WITH 34-FRAME MOTORS OR ALL MRV MOTORS.**

Unless otherwise noted, all dimensions shown are in inches (Dimensions in parenthesis are in millimeters)

B3S10 Rodless Screw Driven Actuator

DIMENSIONS

B3SD10/M3SD10 DUAL 180° OPTION

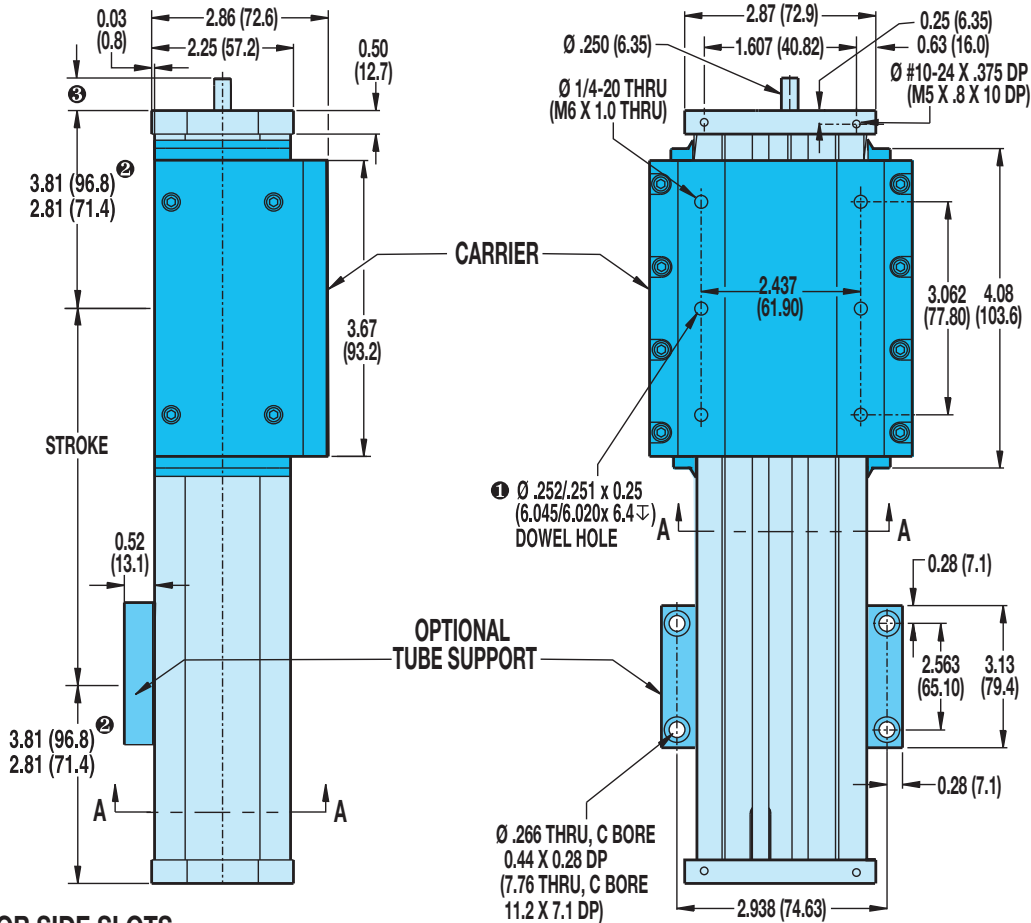

NUTS FOR SIDE SLOTS (Clear Zinc Finish)

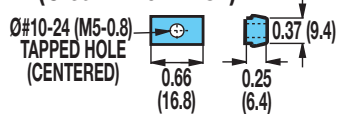

OPTIONAL SWITCH MOUNTING

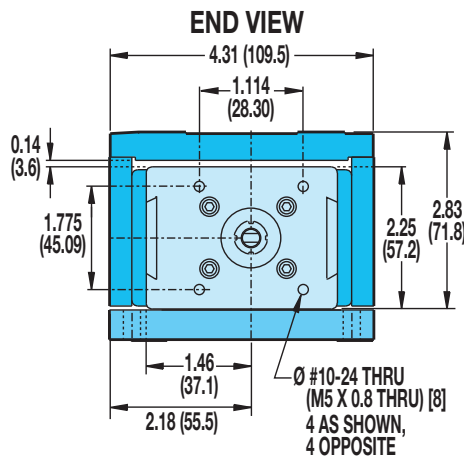
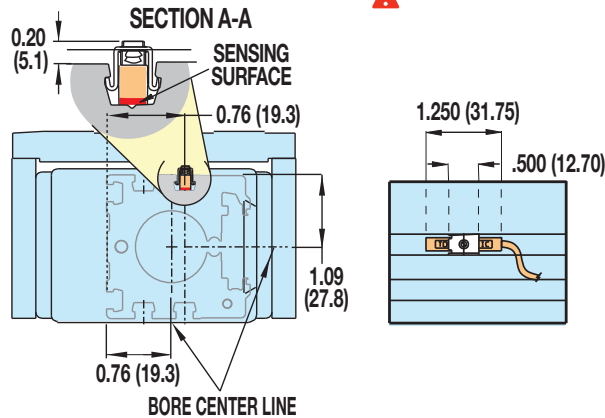

① DOWEL PINS \oplus .003 (08mm) (M)

② FOR SNA02 STYLE ONLY

③ SHAFT LENGTH

In-line mounting	0.55 (13.8)
Extended shaft for RP & 23-frame motor	1.99 (50.5)
Extended shaft for RP & 34-frame motor	2.20 (55.9)
Extended shaft for purchases prior to 6/24/02	1.63 (41.4)

⚠ **CAUTION: DO NOT OVERTIGHTEN SWITCH HARDWARE WHEN INSTALLING**

⑤ NOTE: The scored face of the switch indicates the sensing surface and must face toward the magnet

⑥ NOTE: Some actuators require switch mounting on a specific side of the actuator. Call Tolomatic 1-800-328-2174 for details

- MXE-S
- MXE-P
- MXB-U
- MXB-P
- B3S**
- B3W
- TKS
- TKB
- BCS
- SLS

- RSA
- GSWA
- GSA

- MRV
- MRS
- GEARBOX
- SWITCH

C

DIMENSIONS

B3S10/M3S10: IN-LINE MOUNT FOR MOTORS OR GEARBOXES

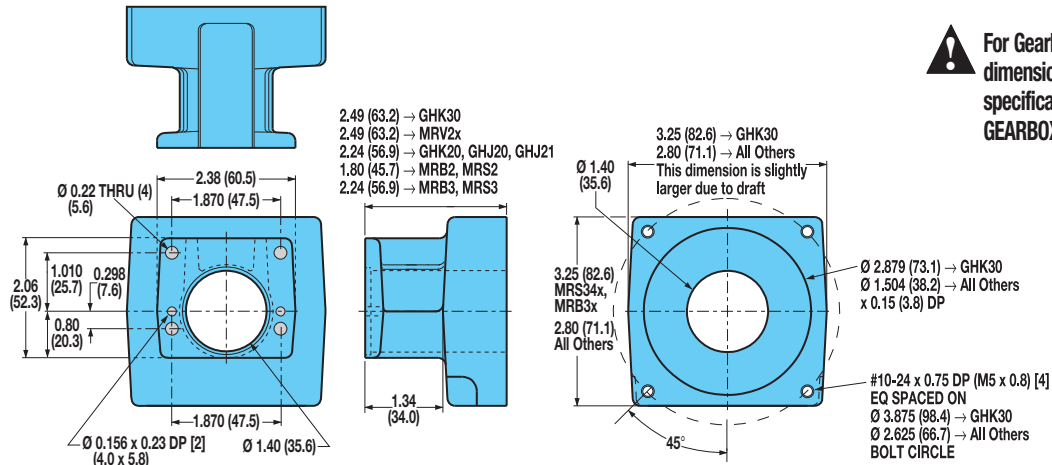

B3S10/M3S10: REVERSE PARALLEL MOUNTING

STANDARD CARRIER

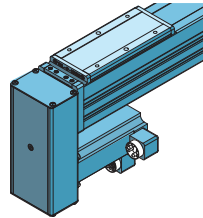

REVERSE-PARALLEL BOTTOM (RPB)
mounting surface shown up

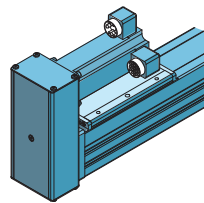

REVERSE-PARALLEL TOP (RPT)
mounting surface shown up

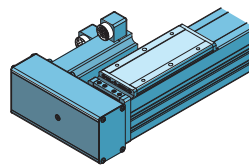

REVERSE-PARALLEL LEFT (RPL)
mounting surface shown up

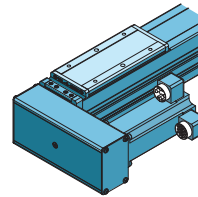

REVERSE-PARALLEL RIGHT (RPR)
mounting surface shown up

SPECIFICATIONS:

Motor	MRV21,22,23,24	
reduction Drive Weight	1:1 & 2:1 Ratio	2.06 lb. 0.9344 kg.
reduction inertia at Motor Shaft	1:1 ratio	0.0875 0.2559
	2:1 ratio	0.1125 0.3291
		lb-in ² kg-cm ²
reduction efficiency:	0.95	

BOTTOM MOUNT

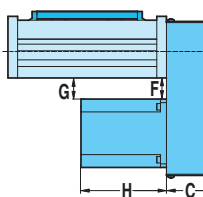

TOP MOUNT

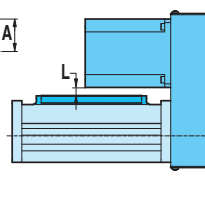

SIDE MOUNT (Right Shown)

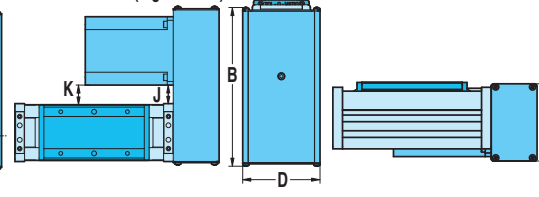

DIMENSIONS

	MOTOR		A		B		C		D		F		G		H		J		K		L	
	in.	mm	in.	mm	in.	mm	in.	mm	in.	mm	in.	mm	in.	mm	in.	mm	in.	mm	in.	mm	in.	mm
BRUSHLESS	MRV21	1.44	36.6	6.96	176.7	2.13	54.0	3.25	82.6	1.80	45.6	1.84	46.8	4.75	120.7	1.48	37.6	1.51	38.4	1.06	26.9	
	MRV22	1.44	36.6	6.96	176.7	2.13	54.0	3.25	82.6	1.80	45.6	1.84	46.8	5.75	146.1	1.48	37.6	1.51	38.4	1.06	26.9	
	MRV23	1.44	36.6	6.96	176.7	2.13	54.0	3.25	82.6	1.80	45.6	1.84	46.8	6.75	171.5	1.48	37.6	1.51	38.4	1.06	26.9	
	MRV24	1.44	36.6	6.96	176.7	2.13	54.0	3.25	82.6	1.80	45.6	1.84	46.8	7.75	196.9	1.48	37.6	1.51	38.4	1.06	26.9	

DUAL 180° CARRIER

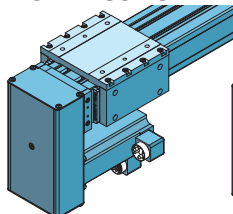

REVERSE-PARALLEL BOTTOM (RPB)
mounting surface shown up

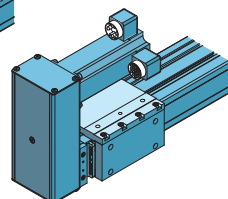

REVERSE-PARALLEL TOP (RPT)
mounting surface shown up

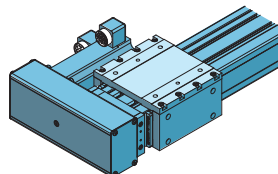

REVERSE-PARALLEL LEFT (RPL)
mounting surface shown up

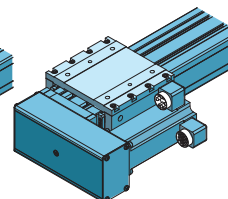

REVERSE-PARALLEL RIGHT (RPR)
mounting surface shown up

B3S15 Rodless Screw Driven Actuator

ACME SCREW SPECIFICATIONS



A

B

B3S15 INCH (US standard) ACME SCREW SPECIFICATIONS

CRITICAL SPEED WITH 5/8" INCH (US standard) ACME SCREW

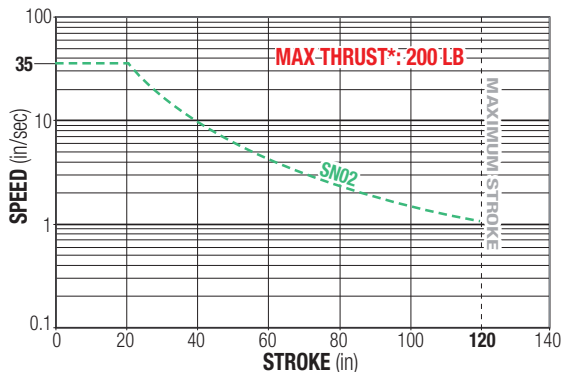

CRITICAL SPEED WITH 3/4" INCH (US standard) ACME SCREW

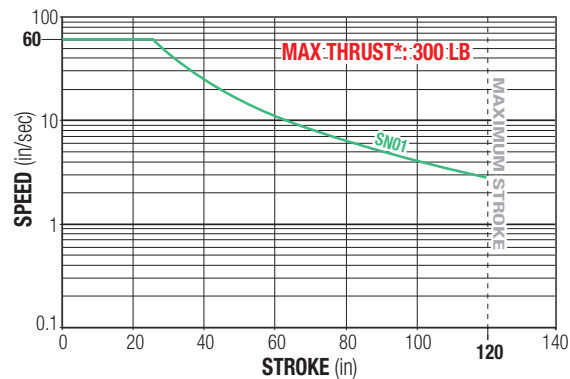

PV LIMITS: 5/8" 2TPI INCH (US standard) ACME SCREW

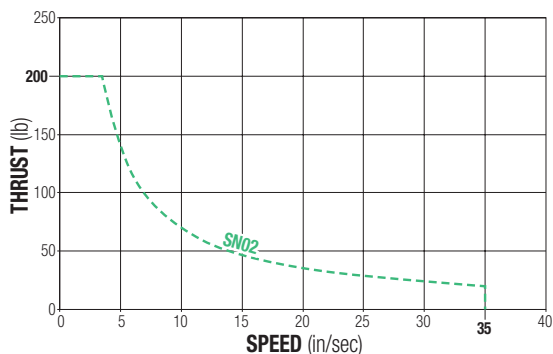

PV LIMITS: 3/4" 1TPI INCH (US standard) ACME SCREW

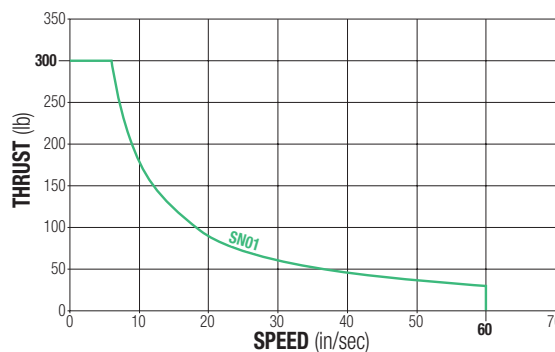

SN = Solid Nut

SNA = Solid Anti-backlash Nut



* Maximum thrust is the maximum continuous dynamic thrust subject to Thrust x Velocity limitation.

PV LIMITS: Any material which carries a sliding load is limited by heat buildup. The factors that affect heat generation rate in an application are the pressure on the nut in pounds per square inch and the surface velocity in feet per minute. The product of these factors provides a measure of the severity of an application.

$$\frac{P}{(\text{Max. Thrust Rating})} \times \frac{V}{(\text{Max. Speed Rating})} \leq 0.1$$



MXE-S

MXE-P

MXB-U

MXB-P

B3S

B3W

TKS

TKB

BCS

SLS

RSA

GSWA

GSA

MRV

MRS

GEARBOX

SWITCH

C

B3S15 Rodless Screw Driven Actuator

BALL SCREW SPECIFICATIONS



B3S15/M3S15 BALL SCREW SPECIFICATIONS

CRITICAL SPEED WITH 1/2" INCH (US standard) BALL SCREW

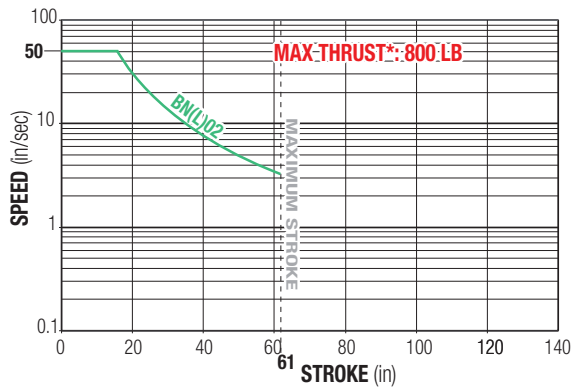

CRITICAL SPEED WITH 16mm METRIC BALL SCREW

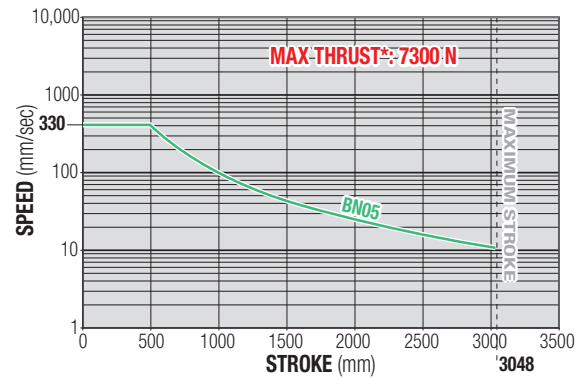

CRITICAL SPEED WITH 5/8" INCH (US standard) BALL SCREW

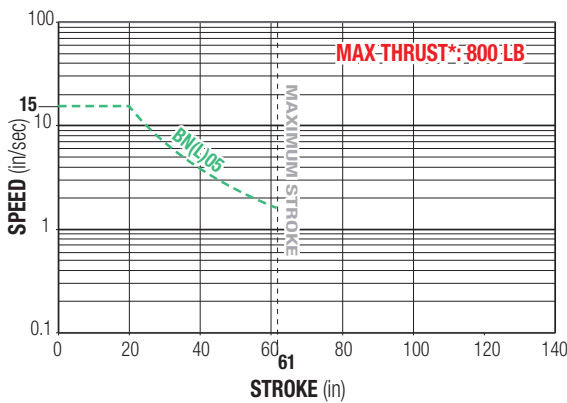

LIFE CALCULATION: 16mm METRIC BALL SCREW w/5mm LEAD

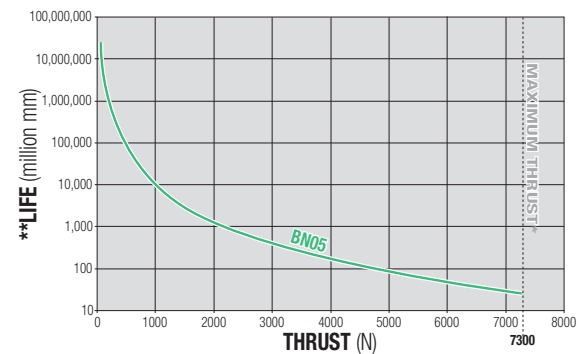

LIFE CALCULATION: 1/2" w/2TPI & 5/8" w/5TPI INCH (US standard) BALL SCREW

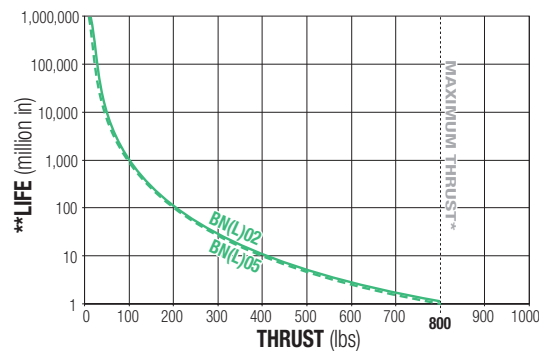

BN = Ball Nut

BNL = Ball Nut with Low-Backlash



*** Maximum thrust reflects 90% reliability for 1 million linear inches of travel.**

**Life indicates theoretical maximum life of screw only, under ideal conditions and does not indicate expected life of actuator.

MXE-S

MXE-P

MXB-U

MXB-P

B3S

B3W

TKS

TKB

BCS

SLS

RSA

GSA

GSA

MRV

MRS

GEARBOX

SWITCH

M3S15 Rodless Screw Driven Actuator

ACME SCREW SPECIFICATIONS



A

B

M3S15 METRIC ACME SCREW SPECIFICATIONS

CRITICAL SPEED WITH 15mm METRIC ACME SCREW

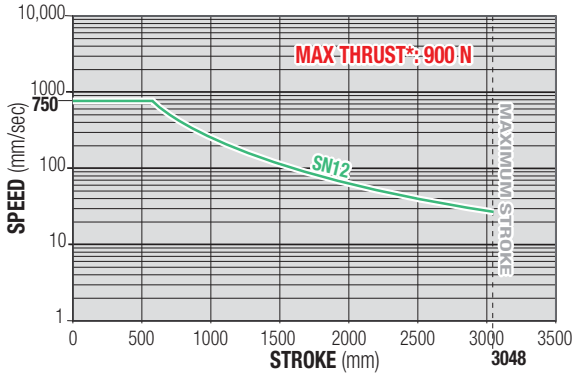

CRITICAL SPEED WITH 19mm METRIC ACME SCREW

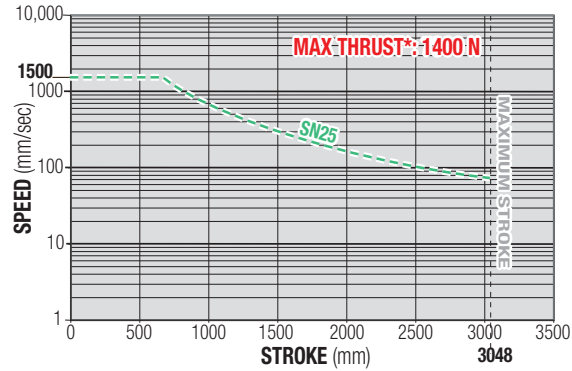

PV LIMITS: 15mm METRIC ACME SCREW w/12mm LEAD

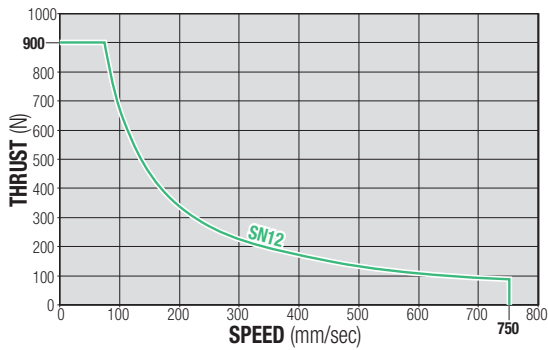

PV LIMITS: 19mm METRIC ACME SCREW w/25mm LEAD

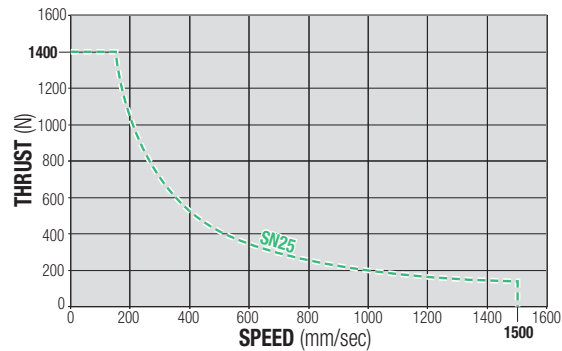

SN = Solid Nut



*** Maximum thrust is the maximum continuous dynamic thrust subject to Thrust x Velocity limitation.**

PV LIMITS: Any material which carries a sliding load is limited by heat buildup. The factors that affect heat generation rate in an application are the pressure on the nut in pounds per square inch and the surface velocity in feet per minute. The product of these factors provides a measure of the severity of an application.

$$\left(\frac{P}{(\text{Max. Thrust Rating})} \right) \times \left(\frac{V}{(\text{Max. Speed Rating})} \right) \leq 0.1$$

MXE-S

MXE-P

MXB-U

MXB-P

B3S

B3W

TKS

TKB

BCS

SLS

RSA

GSWA

GSA

MRV

MRS

GEARBOX

SWITCH

C

DIMENSIONS

B3S15/M3S15 ACTUATOR AND OPTIONS

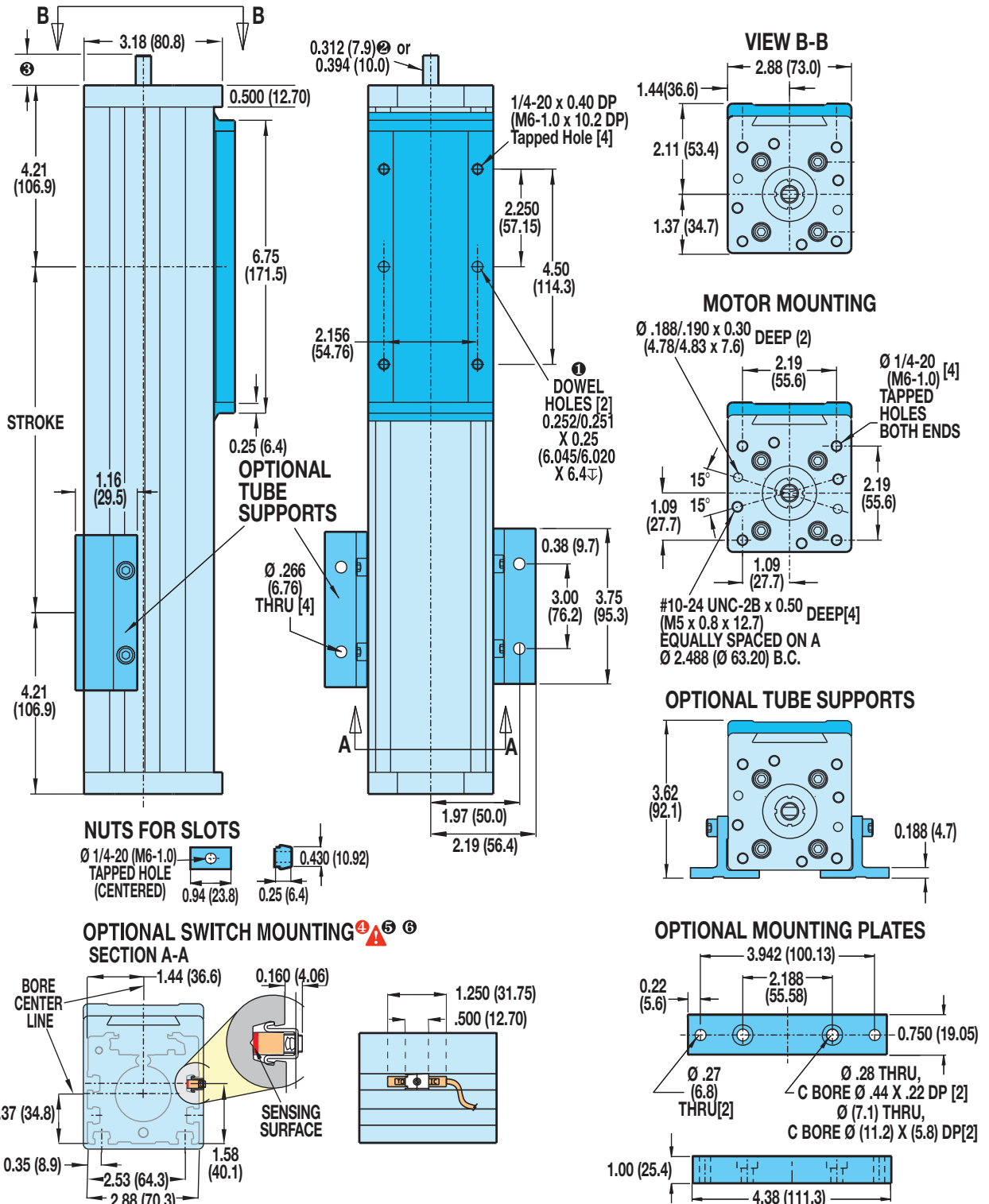

① DOWEL PINS $\pm .003$ (08mm) M

② FOR B3S15BN02 & B3S15BNL02

③ SHAFT LENGTH

In-line mounting	0.69 (17.5)
Extended shaft for RP & 23-frame motor	1.99 (50.5)
Extended shaft for RP & 34-frame motor	2.20 (55.9)
Extended shaft for purchases prior to 6/24/02	1.95 (49.5)

⚠️ **CAUTION: DO NOT OVERTIGHTEN SWITCH HARDWARE WHEN INSTALLING**

⑤ NOTE: The scored face of the switch indicates the sensing surface and must face toward the magnet

⑥ NOTE: Some actuators require switch mounting on a specific side of the actuator. Call Tolomatic 1-800-328-2174 for details

Unless otherwise noted, all dimensions shown are in inches (Dimensions in parenthesis are in millimeters)

B3S15 Rodless Screw Driven Actuator



DIMENSIONS

B3SD15/M3SD15 DUAL 180° OPTION

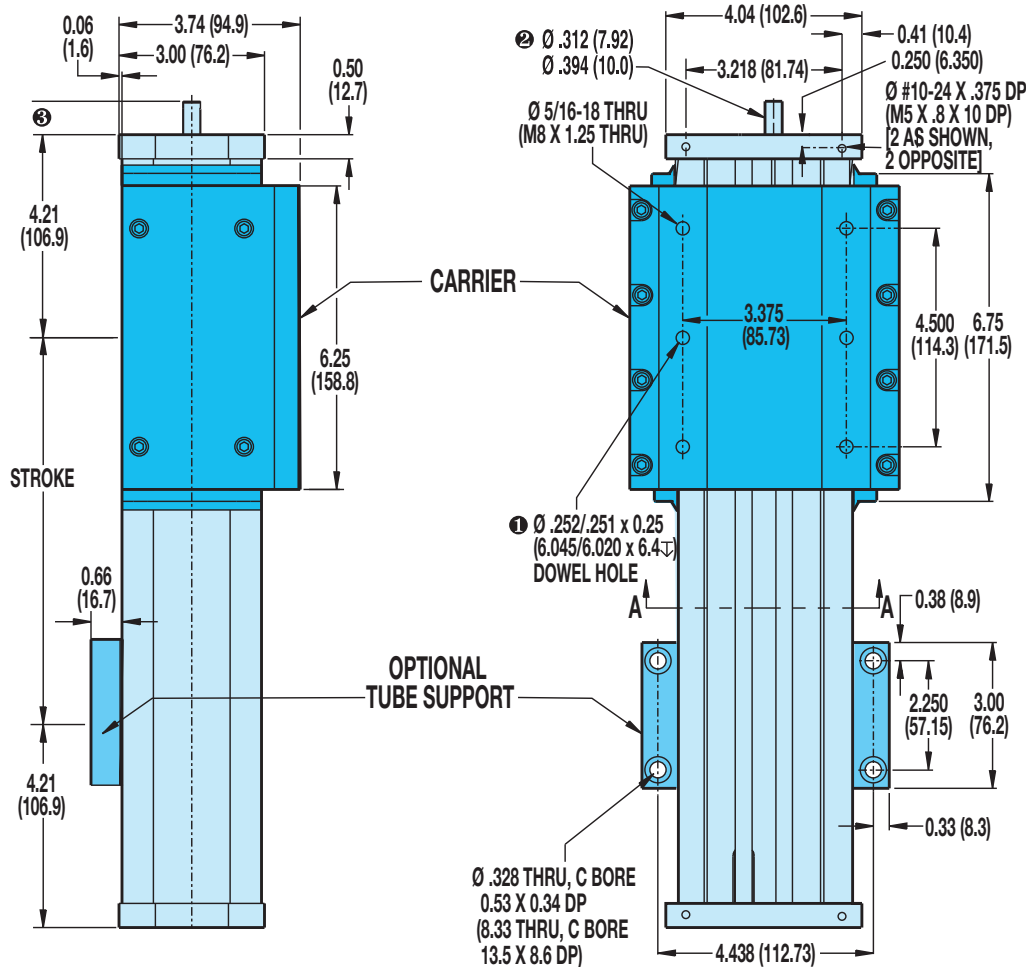

NUTS FOR SLOTS

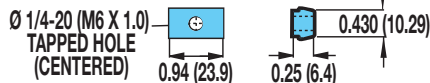

OPTIONAL SWITCH MOUNTING

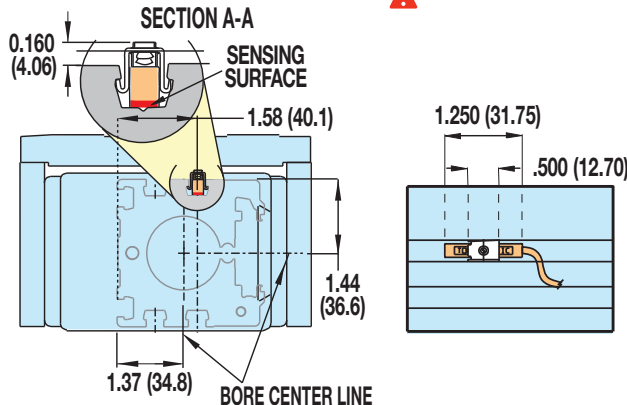

END VIEW

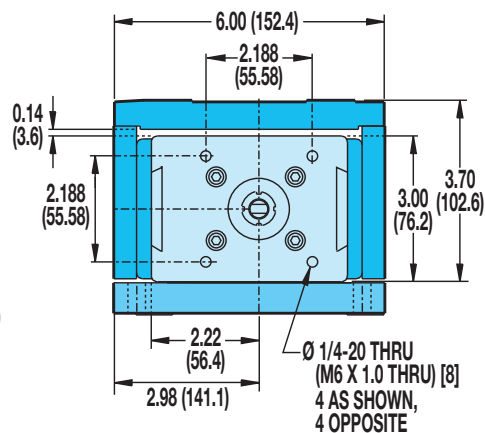

1 DOWEL PINS

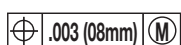

2 FOR B3S15BN02 & B3S15BNL02

3 SHAFT LENGTH

In-line mounting	0.69 (17.5)
Extended shaft for RP & 23-frame motor	1.99 (50.5)
Extended shaft for RP & 34-frame motor	2.20 (55.9)
Extended shaft for purchases prior to 6/24/02	1.95 (49.5)

4 CAUTION: DO NOT OVERTIGHTEN SWITCH HARDWARE WHEN INSTALLING

5 NOTE: The scored face of the switch indicates the sensing surface and must face toward the magnet

6 NOTE: Some actuators require switch mounting on a specific side of the actuator. Call Tolomatic 1-800-328-2174 for details

MXE-S
MXE-P
MXB-U
MXB-P
B3S
B3W
TKS
TKB
BCS
SLS
RSA
GSWA
GSA
MRV
MRS
GEARBOX
SWITCH

A
B
r O D L e S S A C T U A T O R S
r O D S T Y L e A C T U A T O R S
C O N T R O L S y S T e M S +

B3S15/M3S15: IN-LINE MOUNT FOR MOTORS OR GEARBOXES

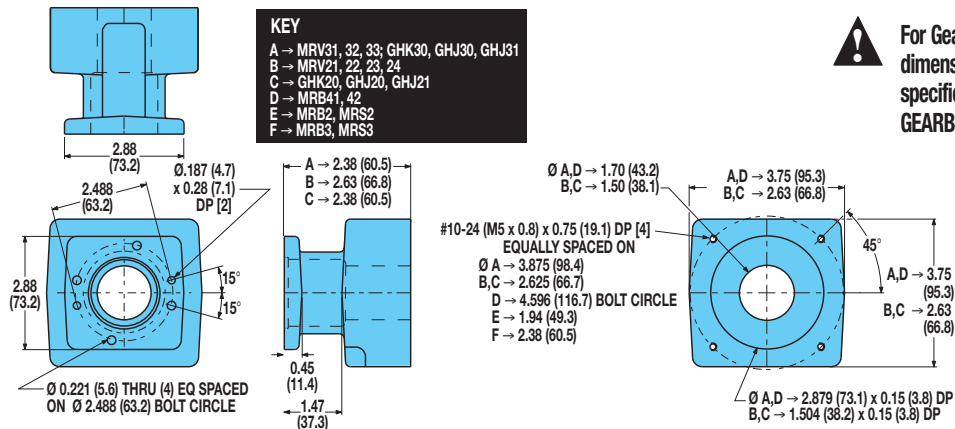

B3S15/M3S15: REVERSE PARALLEL MOUNTING

STANDARD CARRIER

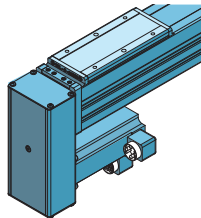

REVERSE-PARALLEL BOTTOM (RPB)
mounting surface shown up

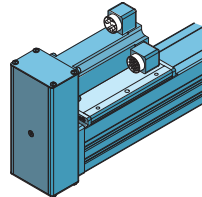

REVERSE-PARALLEL TOP (RPT)
mounting surface shown up

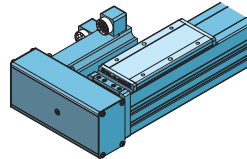

REVERSE-PARALLEL LEFT (RPL)
mounting surface shown up

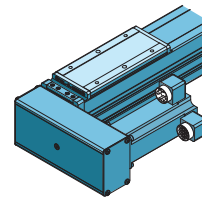

REVERSE-PARALLEL RIGHT (RPR)
mounting surface shown up

SPECIFICATIONS:

Motor	MRV21, 22, 23, 24, 31, 32, 33
reduction Drive Weight	
1:1 Ratio	2.17 lb. 0.98 kg.
2:1 Ratio	2.40 lb. 1.09 kg.
reduction inertia at Motor Shaft	
1:1 r atio	0.070 0.2043
2:1 r atio	0.095 0.2767
	lb-in ² kg-cm ²
reduction efficiency:	0.95

BOTTOM MOUNT

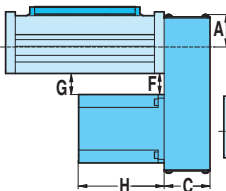

TOP MOUNT

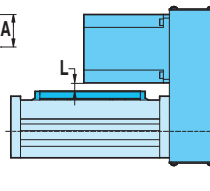

SIDE MOUNT (Right Shown)

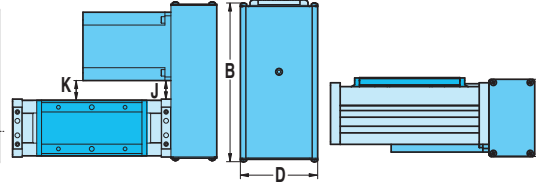

DIMENSIONS

	MOTOR	A		B		C		D		F		G		H		J		K		L	
		in.	mm	in.	mm	in.	mm	in.	mm	in.	mm	in.	mm	in.	mm	in.	mm	in.	mm	in.	mm
BRUSHLESS	MRV21	1.44	36.6	7.46	189.4	2.13	54.0	3.25	82.6	1.74	44.1	1.74	44.1	4.75	120.7	1.61	40.8	1.67	42.3	1.00	25.3
	MRV22	1.44	36.6	7.46	189.4	2.13	54.0	3.25	82.6	1.74	44.1	1.74	44.1	5.75	146.1	1.61	40.8	1.67	42.3	1.00	25.3
	MRV23	1.44	36.6	7.46	189.4	2.13	54.0	3.25	82.6	1.74	44.1	1.74	44.1	6.75	171.5	1.61	40.8	1.67	42.3	1.00	25.3
	MRV24	1.44	36.6	7.46	189.4	2.13	54.0	3.25	82.6	1.74	44.1	1.74	44.1	7.75	196.9	1.61	40.8	1.67	42.3	1.00	25.3
	MRV31	2.12	53.8	8.14	206.6	2.38	60.3	4.00	101.6	1.09	27.7	1.09	27.7	6.11	155.2	0.96	24.4	1.02	25.9	0.35	8.9
	MRV32	2.12	53.8	8.14	206.6	2.38	60.3	4.00	101.6	1.09	27.7	1.09	27.7	7.36	186.9	0.96	24.4	1.02	25.9	0.35	8.9
	MRV33	2.12	53.8	8.14	206.6	2.38	60.3	4.00	101.6	1.09	27.7	1.09	27.7	8.61	218.7	0.96	24.4	1.02	25.9	0.35	8.9

DUAL 180° CARRIER

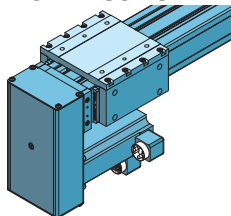

REVERSE-PARALLEL BOTTOM (RPB)
mounting surface shown up

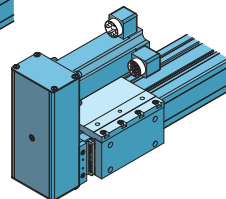

REVERSE-PARALLEL TOP (RPT)
mounting surface shown up

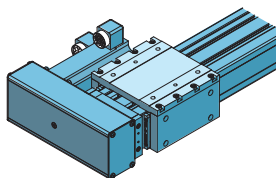

REVERSE-PARALLEL LEFT (RPL)
mounting surface shown up

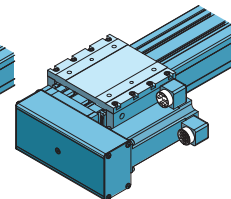

REVERSE-PARALLEL RIGHT (RPR)
mounting surface shown up

B3S20 Rodless Screw Driven Actuator

ACME SCREW SPECIFICATIONS



A

B

B3S20/M3S20 ACME SCREW SPECIFICATIONS

CRITICAL SPEED WITH 3/4" INCH (US standard) ACME SCREW

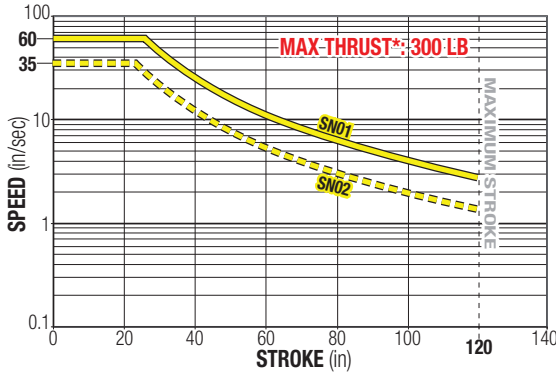

CRITICAL SPEED WITH 19mm METRIC ACME SCREW

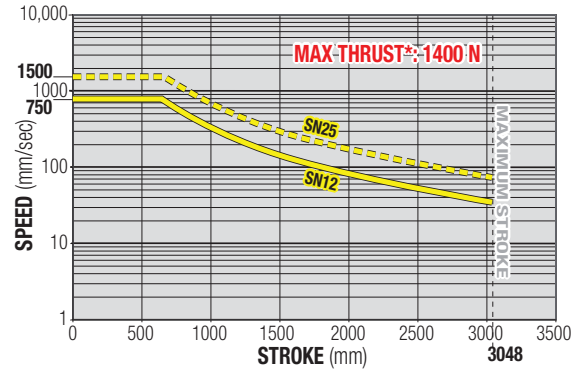

PV LIMITS: 3/4" 1TPI INCH (US standard) ACME SCREW

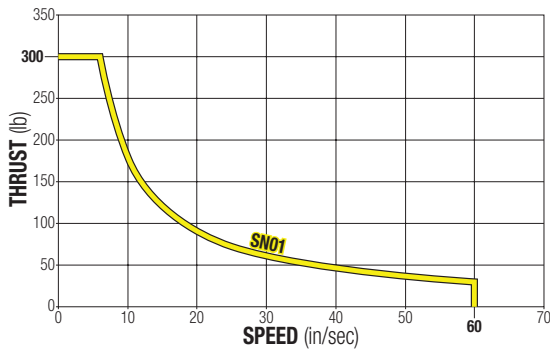

PV LIMITS: 19mm METRIC ACME SCREW w/25mm LEAD

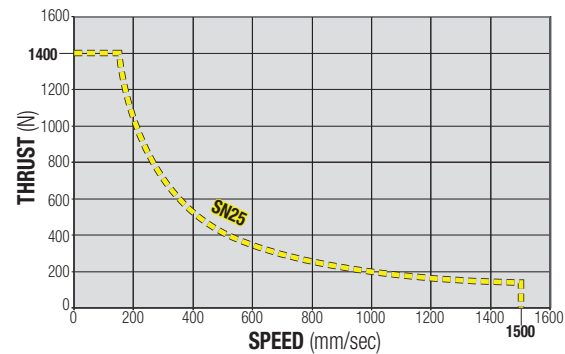

PV LIMITS: 3/4" 2TPI INCH (US standard) ACME SCREW

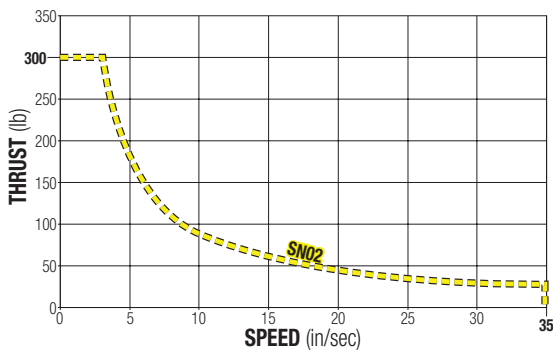

PV LIMITS: 19mm METRIC ACME SCREW w/12mm LEAD

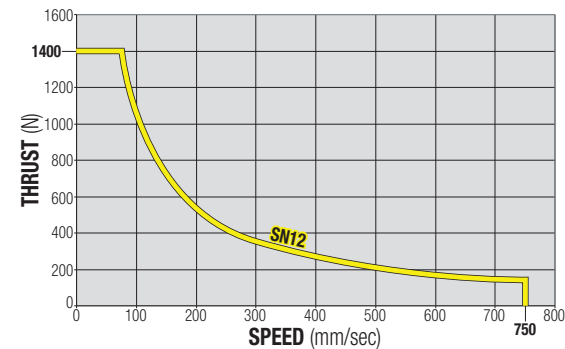

SN = Solid Nut

SNA = Solid Anti-backlash Nut



*** Maximum thrust is the maximum continuous dynamic thrust subject to Thrust x Velocity limitation.**

PV LIMITS: Any material which carries a sliding load is limited by heat buildup. The factors that affect heat generation rate in an application are the pressure on the nut in pounds per square inch and the surface velocity in feet per minute. The product of these factors provides a measure of the severity of an application.

$$\frac{P}{(\text{Max. Thrust Rating})} \times \frac{V}{(\text{Max. Speed Rating})} \leq 0.1$$

MXE-S

MXE-P

MXB-U

MXB-P

B3S

B3W

TKS

TKB

BCS

SLS

RSA

GWSA

GSA

MRV

MRS

GEARBOX

SWITCH

C

A

B3S20 Rodless Screw Driven Actuator

BALL SCREW SPECIFICATIONS



B

B3S20/M3S20 BALL SCREW SPECIFICATIONS

CRITICAL SPEED WITH 3/4" INCH (US standard) BALL SCREW

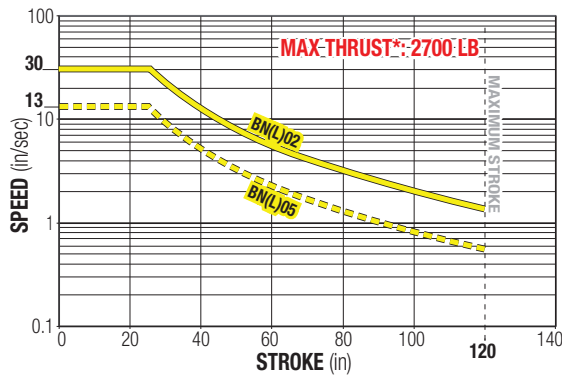

CRITICAL SPEED WITH 20mm METRIC BALL SCREW

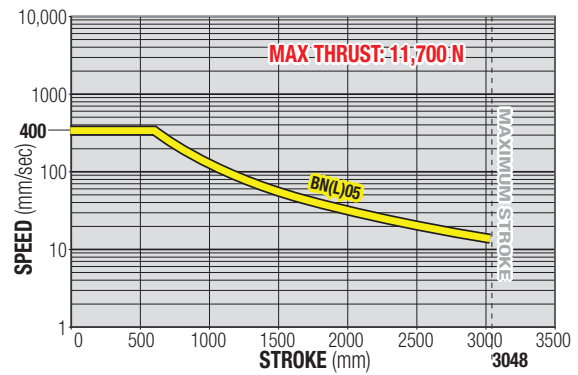

LIFE CALCULATION: 3/4" INCH (US standard) BALL SCREW, 2TPI

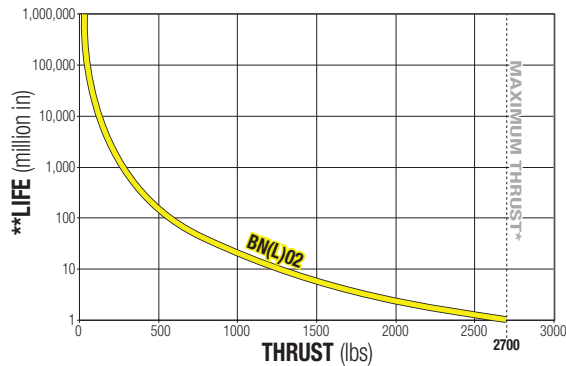

LIFE CALCULATION: 20mm METRIC BALL SCREW w/5mm LEAD

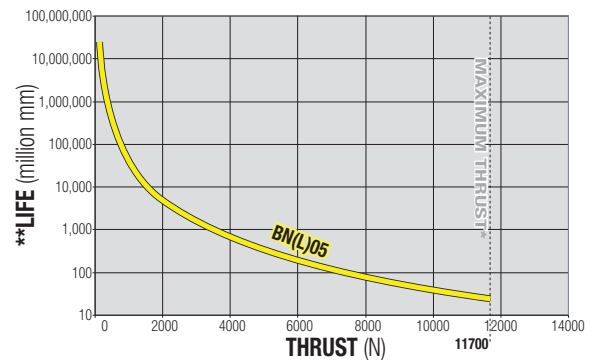

LIFE CALCULATION: 3/4" INCH (US standard) BALL SCREW, 5TPI

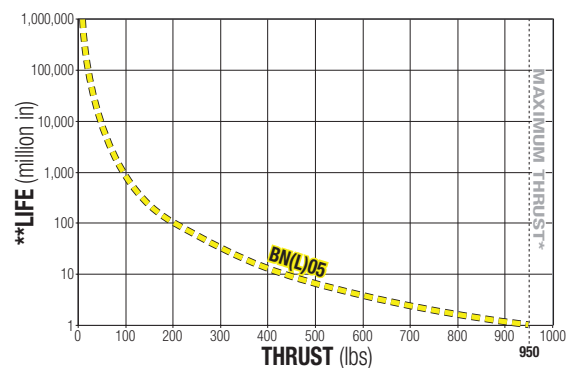

BN = Ball Nut

BNL = Ball Nut with Low-Backlash



* Maximum thrust reflects 90% reliability for 1 million linear inches of travel.

**Life indicates theoretical maximum life of screw only, under ideal conditions and does not indicate expected life of actuator.

MXE-S

MXE-P

MXB-U

MXB-P

B3S

B3W

TKS

TKB

BCS

SLS

RSA

GSA

GSA

MRV

MRS

GEARBOX

SWITCH

C

B3S20 Rodless Screw Driven Actuator

DIMENSIONS



B3S20/M3S20 ACTUATOR AND OPTIONS

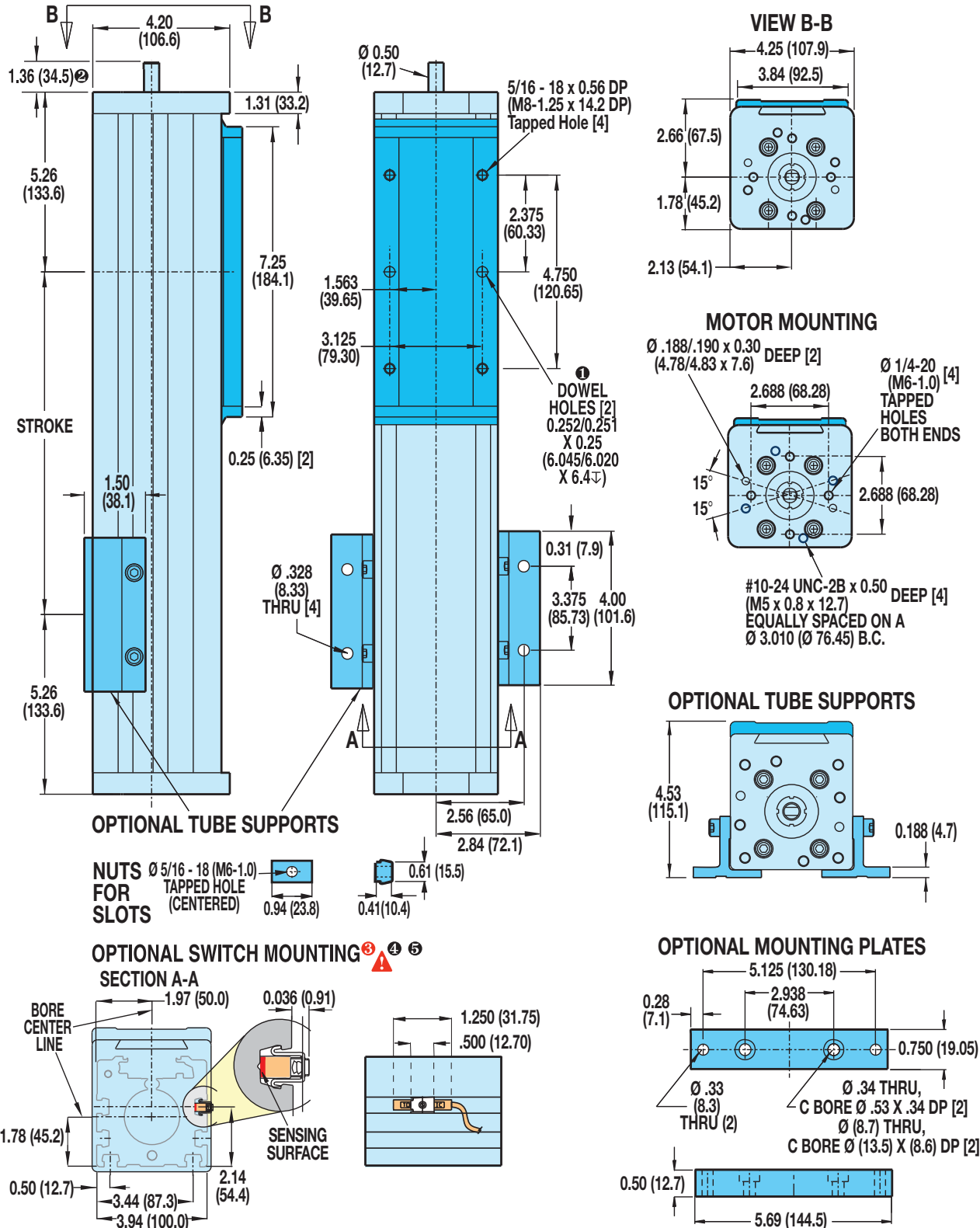

- ① DOWEL PINS \oplus .003 (08mm) M
- ② FOR EXTENDED SHAFT 2.11 (53.6)
- ③ **CAUTION: DO NOT OVERTIGHTEN SWITCH HARDWARE WHEN INSTALLING**
- ④ NOTE: The scored face of the switch indicates the sensing surface and must face toward the magnet
- ⑤ NOTE: Some actuators require switch mounting on a specific side of the actuator. Call Tolomatic 1-800-328-2174 for details

r ODLeSS ACTuATOr S

r OD STyLe ACTuATOr S

COnTr OL SyStemS +

MXE-S
MXE-P
MXB-U
MXB-P
B3S
B3W
TKS
TKB
BCS
SLS
RSA
GSWA
GSA
MRV
MRS
GEARBOX
SWITCH

A

B

C

B3SD20/M3SD20 DUAL 180° OPTION

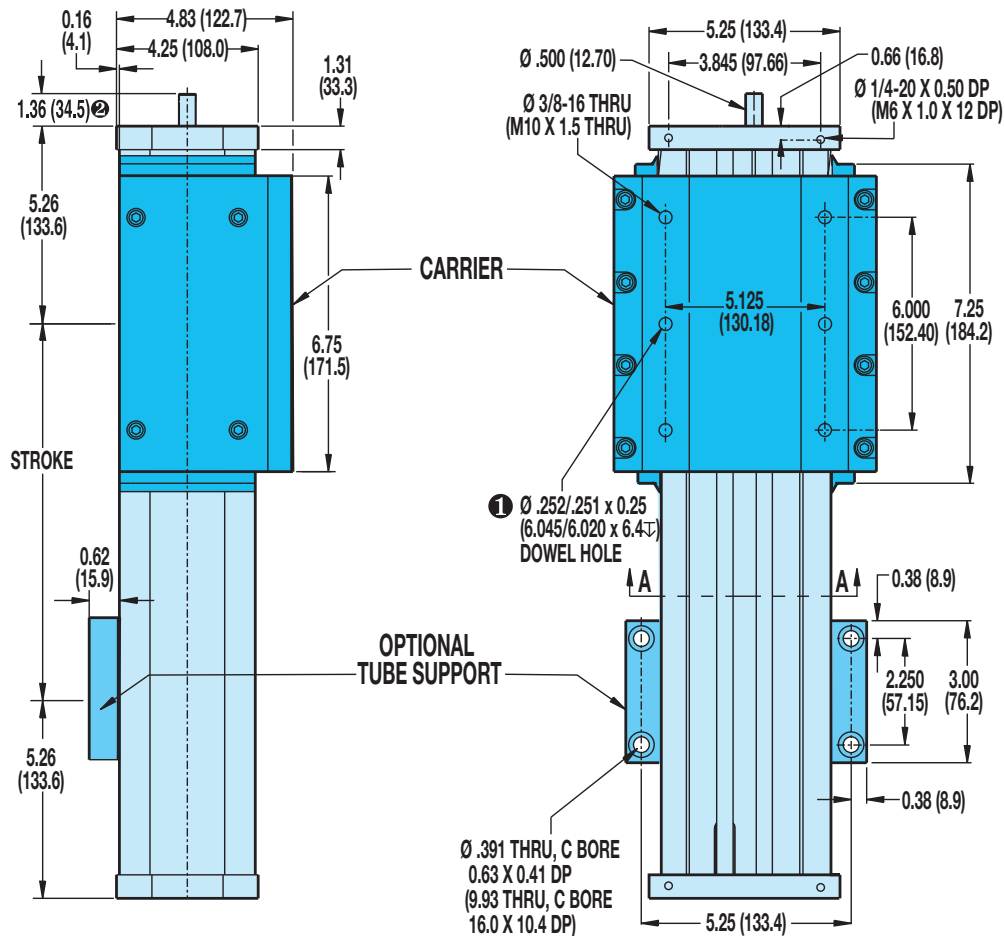

NUTS FOR SLOTS

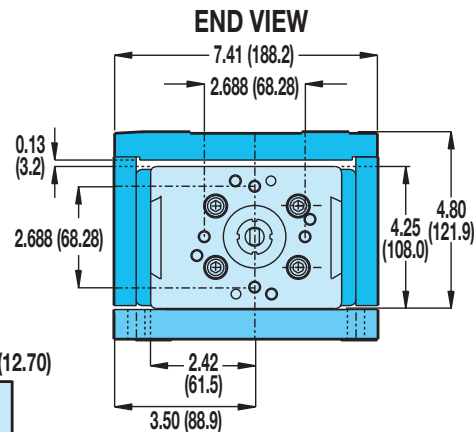
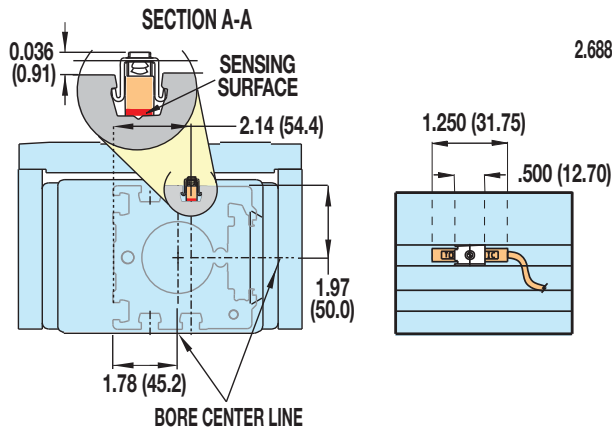
OPTIONAL SWITCH MOUNTING 

① DOWEL PINS  .003 (08mm) 

② FOR EXTENDED SHAFT 2.11 (53.6)

 **CAUTION: DO NOT OVERTIGHTEN SWITCH HARDWARE WHEN INSTALLING**

④ NOTE: The scored face of the switch indicates the sensing surface and must face toward the magnet

⑤ NOTE: Some actuators require switch mounting on a specific side of the actuator. Call Tolomatic 1-800-328-2174 for details

B3S20 Rodless Screw Driven Actuator

DIMENSIONS



B3S20/M3S20: IN-LINE MOUNT FOR MOTORS OR GEARBOXES

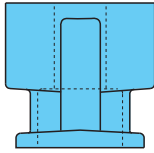

KEY
 A → MRV31, 32, 33; GHK30, GHJ30, GHJ31
 B → MRV21, 22, 23, 24
 C → GHK20, GHJ20, GHJ21
 D → MRB 41, MRB42
 E → MRB2, MRS2
 F → MRB3, MRS3



For Gearbox dimensions and specifications, refer to GEARBOX section

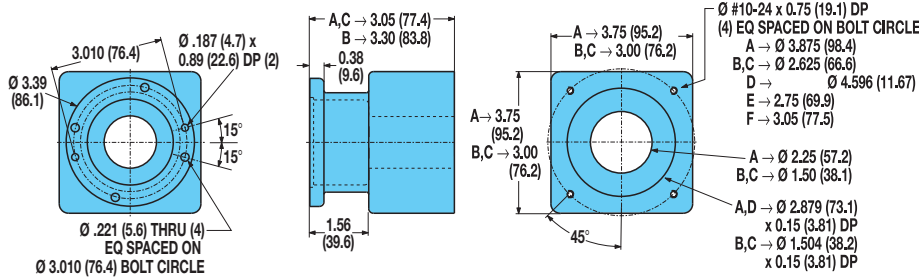

B3S20/M3S20: REVERSE PARALLEL MOUNTING

STANDARD CARRIER

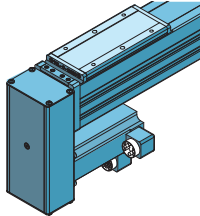

REVERSE-PARALLEL BOTTOM (RPB)
mounting surface shown up

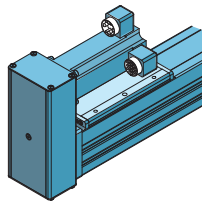

REVERSE-PARALLEL TOP (RPT)
mounting surface shown up

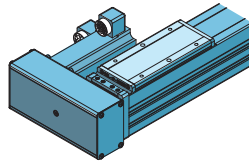

REVERSE-PARALLEL LEFT (RPL)
mounting surface shown up

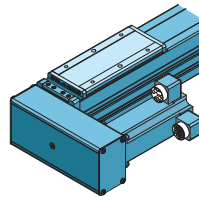

REVERSE-PARALLEL RIGHT (RPR)
mounting surface shown up

BOTTOM MOUNT

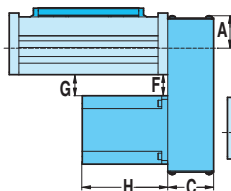

TOP MOUNT

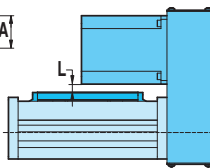

SIDE MOUNT (Right Shown)

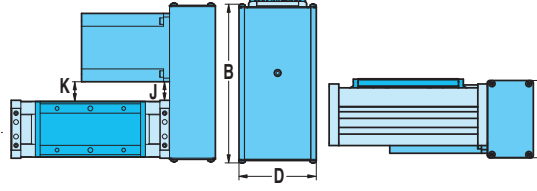

SPECIFICATIONS:

Motor	MRV21, 22, 23, 24	
reduction Drive Weight		
1:1 Ratio	3.07 lb.	1.39 kg.
2:1 Ratio	3.23 lb.	1.47 kg.
Motor	MRV31, 32, 33,	
reduction Drive Weight		
1:1 Ratio	3.13 lb.	1.42 kg.
2:1 Ratio	3.29 lb.	1.49 kg.
reduction inertia at Motor Shaft		
1:1 ratio	0.118	0.3447
2:1 ratio	0.100	0.2928
	lb-in ²	kg-cm ²
reduction efficiency:	0.95	

DIMENSIONS

	MOTOR		A		B		C		D		F		G		H		J		K		L	
	in.	mm	in.	mm	in.	mm	in.	mm	in.	mm	in.	mm	in.	mm	in.	mm	in.	mm	in.	mm	in.	mm
BRUSHLESS	MRV21	1.44	36.6	9.31	236.5	2.38	60.3	4.00	101.6	2.34	59.5	2.35	59.6	4.75	120.7	2.00	50.8	2.16	54.7	1.47	37.2	
	MRV22	1.44	36.6	9.31	236.5	2.38	60.3	4.00	101.6	2.34	59.5	2.35	59.6	5.75	146.1	2.00	50.8	2.16	54.7	1.47	37.2	
	MRV23	1.44	36.6	9.31	236.5	2.38	60.3	4.00	101.6	2.34	59.5	2.35	59.6	6.75	171.5	2.00	50.8	2.16	54.7	1.47	37.2	
	MRV24	1.44	36.6	9.31	236.5	2.38	60.3	4.00	101.6	2.34	59.5	2.35	59.6	7.75	196.9	2.00	50.8	2.16	54.7	1.47	37.2	
	MRV31	1.96	49.7	9.83	249.6	2.38	60.3	4.00	101.6	1.70	43.2	1.70	43.2	6.11	155.2	1.36	34.4	1.51	38.4	0.82	20.9	
	MRV32	1.96	49.7	9.83	249.6	2.38	60.3	4.00	101.6	1.70	43.2	1.70	43.2	7.36	186.9	1.36	34.4	1.51	38.4	0.82	20.9	
	MRV33	1.96	49.7	9.83	249.6	2.38	60.3	4.00	101.6	1.70	43.2	1.70	43.2	8.61	218.7	1.36	34.4	1.51	38.4	0.82	20.9	

DUAL 180° CARRIER

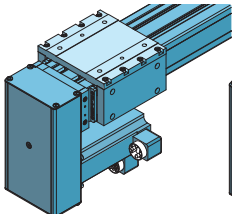

REVERSE-PARALLEL BOTTOM (RPB)
mounting surface shown up

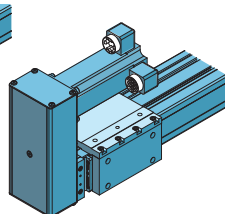

REVERSE-PARALLEL TOP (RPT)
mounting surface shown up

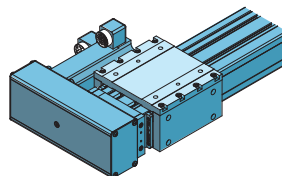

REVERSE-PARALLEL LEFT (RPL)
mounting surface shown up

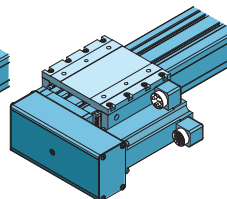

REVERSE-PARALLEL RIGHT (RPR)
mounting surface shown up

MXE-S
 MXE-P
 MXB-U
 MXB-P
 B3S
 B3W
 TKS
 TKB
 BCS
 SLS
 RSA
 GSWA
 GSA
 MRV
 MRS
 GEARBOX
 SWITCH

A
B
C

B3S Rodless Screw Driven Actuator

SWITCHES



There are 10 sensing choices for this actuator: DC reed, form A (open) or form C (open or closed); AC reed (Triac, open); Hall-effect, sourcing, PNP (open); Hall-effect, sinking, NPN (open); each with either flying leads or QD (quick disconnect). Commonly used to send analog signals to PLC (programmable logic controllers), TLL, CMOS circuit or other controller device. These switches are activated by the actuator's internal magnet.

Switches contain reverse polarity protection. QD cables are shielded; shield should be terminated at flying lead end.

If necessary to remove factory installed switches, be sure to reinstall on the same of side of actuator with scored face of switch toward internal magnet.

SPECIFICATIONS

	Order Code	Part Number	Lead	Switching Logic	Cable Shielding	Cable Minimum Bend Radius		Power LED	Signal LED	Operating Voltage	**Power Rating (Watts)	Voltage Drop	Current Consumption	Temp. Range
						Static	Dynamic							
REED DC	R T	3600-9082	5m	"A" normally Open	unshielded	0.630" [16mm]	not recommended	none	red	200 Vdc max.	10.0§	2.6 V typical at 100 mA	-	-40° to 158° F
	R M	3600-9083	QD*	Open	Shielded†	0.630" [16mm]	1.260" [32mm]							
	B T	3600-9084	5m	"C" Normally Open or Closed	unshielded	0.630" [16mm]	not recommended	none	none	120 Vdc max.	3.0§§	nA		
	B M	3600-9085	QD*	Closed	Shielded†	0.630" [16mm]	1.260" [32mm]							
REED AC	C T	3600-9086	5m	Triac normally Open	unshielded	0.630" [16mm]	not recommended	none	none	120 Vac max.	10.0	1 Amp at 86° F [30°C]	-40° to 158° F	
	C M	3600-9087	QD*	Open	Shielded†	0.630" [16mm]	1.260" [32mm]					0.5 Amp at 140° F [60°C]		-40° to 70° C]
HALL-EFFECT DC	T T	3600-9088	5m	PnP (Sourcing) normally Open	unshielded	0.630" [16mm]	not recommended	none	red	5 - 25 Vdc	5.0	200mA @25Vdc	-	-
	T M	3600-9089	QD*	Open	Shielded†	0.630" [16mm]	1.260" [32mm]							
	K T	3600-9090	5m	nPn (Sinking) normally Open	unshielded	0.630" [16mm]	not recommended	none	red					
	K M	3600-9091	QD*	Open	Shielded†	0.630" [16mm]	1.260" [32mm]							

⚠ CAUTION: DO NOT OVER TIGHTEN SWITCH HARDWARE WHEN INSTALLING!

⚠ ** WARNING: Do not exceed power rating (Watt = Voltage X Amperage). Permanent damage to sensor will occur.

*QD = Quick Disconnect; Male coupler is located 6" [152mm] from sensor, Female coupler to flying lead (part #2503-1025) distance is 197" [5m] also see Cable Shielding specification above

⚠ REPLACEMENT OF QD SWITCHES MANUFACTURED BEFORE JULY 1, 1997: it will be necessary to replace or rewire the female end coupler.



†Shielded from the female quick disconnect coupler to the flying leads. Shield should be terminated at flying lead end.

§ Maximum current 500mA (not to exceed 10VA) Refer to Temperature vs. Current graph and Voltage Derating graph

§§ Maximum current 250mA (not to exceed 3VA) Refer to Temperature vs. Current graph and Voltage Derating graph

Reed Switch Life Expectancy: Up to 200,000,000 cycles (depending on load current, duty cycle and environmental conditions)

B3S Rodless Screw Driven Actuator

SWITCHES

TEMP. vs CURRENT, DC REED

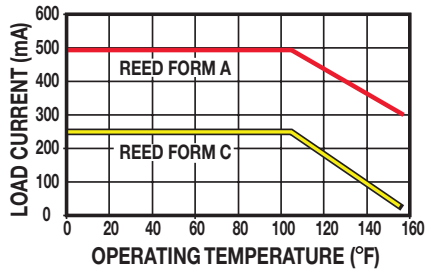

TEMP. vs CURRENT, AC REED

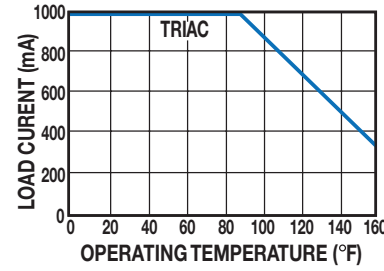

VOLTAGE DERATING, DC REED

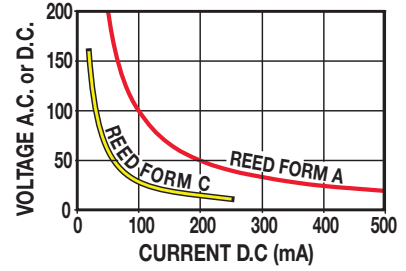

WIRING DIAGRAMS

DC REED, FORM A

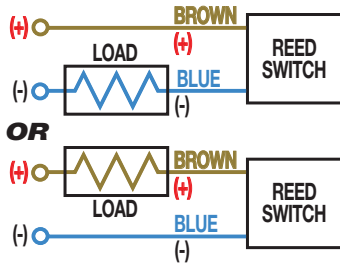

AC REED, TRIAC

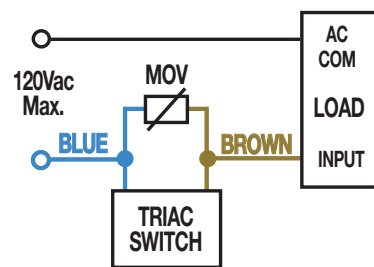

HALL-EFFECT, SOURCING, PNP

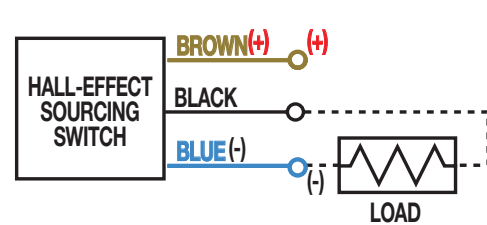

DC REED, FORM C

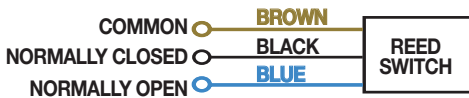

HALL-EFFECT, SINKING, NPN

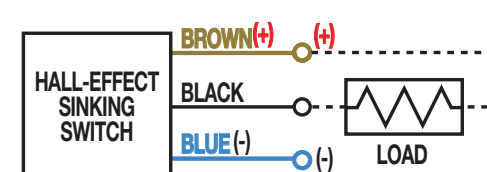

⚠ THE NOTCHED FACE OF THE SWITCH INDICATES THE SENSING SURFACE AND MUST FACE TOWARD THE MAGNET.



⚠ THE NOTCHED GROOVE IN THE ACTUATOR INDICATES THE GROOVE TO INSTALL THE SWITCH. CONTACT TOLOMATIC IF SWITCHES ARE REQUIRED ON ANOTHER SIDE OF ACTUATOR.

- MXE-S
- MXE-P
- MXB-U
- MXB-P
- B3S
- B3W
- TKS
- TKB
- BCS
- SLS
- RSA
- GSWA
- GSA
- MRV
- MRS
- GEARBOX
- SWITCH

A

B

MXE-S

MXE-P

MXB-U

MXB-P

B3S

B3W

TKS

TKB

BCS

SLS

RSA

GSA

GSA

MRV

MRS

GEARBOX

SWITCH

C

B3S Rodless Screw Driven Actuator

5 DAYS
BUILT-TO-ORDER

ORDERING

BASE MODEL

B3SD 20 BNL02 SK36 LMI

OPTIONS

DC18 TS2 BM2 TN8

MODEL TYPE

B3S B3S Series inch (US standard) Screw Drive
B3SD B3S Series Inch (US standard) Screw Drive with Dual 180° Carrier
M3S B3S Series Metric Screw Drive
M3SD B3S Series Metric Screw Drive with Dual 180° Carrier

TUBE BORE DIAMETER

10 1-inch (25 mm) bore
15 1½-inch (40 mm) bore
20 2-inch (50 mm) bore

NUT/SCREW CONFIGURATION

Inch (US standard) MODELS

SOLID NUT / PITCH (turn/in)	SERIES
SN01	B3S(D)10, 15, 20
SN02	B3S(D)10, 15, 20
SNA02	B3S(D)10, 15
SN05	B3S(D)10

BALL NUT / PITCH (turn/in)	SERIES
BN02	B3S(D)15, 20
BNL02	B3S(D)15, 20
BN05	B3S(D)15, 20
BNL05	B3S(D)15, 20
BN08	B3S(D)10
BNL08	B3S(D)10

METRIC MODELS

SOLID NUT / LEAD (mm/turn)	SERIES
SN12	M3S(D)10, 15, 20
SN25	M3S(D)10, 15, 20

BALL NUT / LEAD (mm/turn)	SERIES
BN02	M3S(D)10
BNL02	M3S(D)10
BN05	M3S(D)15, 20
BNL05	M3S(D)15, 20

STROKE LENGTH

SK Stroke, then enter desired stroke length in decimal inches

MOTOR MOUNTING / REDUCTIONS

(must choose one)

LMI in-Line mounting
LME23 ext. shaft for r P & 23 frame motor
LME34 ext. shaft for r P & 34 frame motor
LME40 ext. shaft for r P & 40 frame motor
***LMX** Extended shaft - old style (see note)
**For replacement actuators with extended motor shafts purchased prior to 6/24/02, use the LMX configuration code.*

▲ A motor size and code must be selected when specifying a reverse-parallel mounting configuration. Reference the MRV or MRS section for the motor types and selections.

RPL1 1:1 r everse-Parallel mount left
RPR1 1:1 r everse-Parallel mount right
RPB1 1:1 r everse-Parallel mount bottom
RPT1 1:1 r everse-Parallel mount top
RPL2 2:1 r everse-Parallel mount left
RPR2 2:1 r everse-Parallel mount right
RPB2 2:1 r everse-Parallel mount bottom
RPT2 2:1 r everse-Parallel mount top

TO ORDER MOTORS/CONTROLS/INTERFACES

BRUSHLESS SERVO (see MRV section)

STEPPER (see MRS section)

▲ Not all codes listed are compatible with all options.

Use Sizing & Selection Software to determine available options and accessories based on your application requirements.

AUXILIARY CARRIER

DC Auxiliary Carrier, then center-to-center spacing desired in decimal inches. (Center-to-Center spacing will add to overall dead length and will not subtract from the stroke length)

SUPPORTS AND MOUNTING PLATES

(both may be selected)

TS Tube Supports plus quantity desired
****MP** Mounting Plates plus quantity desired

***Mounting plates are not available on B3SD Dual 180° models.*

SWITCHES[§]

(Quantity desired follows product code)

RM Reed Switch (Form A) with 5-meter lead/QD (Quick-disconnect)
RT Reed Switch (Form A) with 5-m lead
BM Reed Switch (Form C) with 5-meter lead/QD
BT Reed Switch (Form C) with 5-m lead
KM Hall-effect Sinking Switch with 5-meter lead/QD
KT Hall-effect Sinking Switch w/ 5-m lead
TM hall-effect Sourcing Switch with 5-meter lead/QD
TT hall-effect Sourcing Switch with 5-meter lead
CM TRIAC Switch with 5-meter lead/QD
CT Tri AC Switch with 5-meter lead

T-NUTS

TN Additional T-nuts and quantity

FIELD RETROFIT KITS

ITEM	B3S10	B3S15	B3S20	M3S10	M3S15	M3S20
Tube Supports	3410-9006	3415-9006	3420-9006	4410-9006	4415-9006	4420-9006
Tube Supports (with APF option)	3410-9361	3415-9006	3420-9006	4410-9361	4415-9006	4420-9006
Cable for APF option	3604-1573	3604-1573	3604-1573	3604-1573	3604-1573	3604-1573
Tube Supports (B3SD Dual 180° models)	3410-9026	3415-9026	3420-9026	4410-9026	4415-9026	4420-9026
1/2" Mounting Plates	—	3415-9056	—	—	4415-9030	—
1/2" Mounting Plates (MRB/MRS/MRV all frame motors)	—	—	3420-9056	—	—	4420-9030
1" Mounting Plates (MRB/MRS 23-frame; MRV all frame motors)	3410-9057	—	—	4410-9031	—	—
1" Mounting Plates (MRB/MRS/MRV 34-frame motors)	—	3415-9057	—	—	4415-9031	—
Optional MP Plate (1/2" B3S10/M3S10 Mounting Plate)	3410-9056	—	—	4410-9030	—	—

B3W RODLESS BELT DRIVEN ACTUATOR

 **ENDURANCE TECHNOLOGY** SM



MAXIMUM DURABILITY

B3W Rodless Belt Driven Actuator



The B3W rodless style actuator is designed for carrying moderate to heavy loads at moderate to high speeds with large bending moment capacities. Based upon the BC3 pneumatic band cylinder, with our exclusive **ENDURANCE TECHNOLOGY™** features, it utilizes a patented integral recirculating ball bearing guidance system that provides consistent and durable performance. Each

B3W is built-to-order in stroke lengths up to 292 inches. Nobody knows rodless like Tolomatic, and the B3W proves it.





- Low profile to fit your application
- High precision bearings feature smooth, low breakaway motion
- Highest load and bending moment capacities

A COMPARISON OF BELT DRIVE ACTUATORS

All Tolomatic belt drive actuators feature:

- High linear velocity
- High acceleration rate
- Long stroke lengths
- Excellent repeatability
- High duty cycles
- Low profile

Unique features include:

<i>MXB-U Electric Belt Drive</i>	<i>MXB-P Electric Belt Drive</i>	<i>B3W Electric Belt Drive</i>	<i>TKB Electric Belt Drive</i>
			
<ul style="list-style-type: none"> • Requires external guidance and support 	<ul style="list-style-type: none"> • High load and bending moment capacities • High precision bearings feature smooth, low breakaway motion • Durable profiled rail design uses THK® Caged Ball® technology to reduce friction and extend actuator life 		<ul style="list-style-type: none"> • Superior rigidity, high moment loads • Straightness and flatness within 0.0002 inches per inch of stroke • Wide stable platform for XY applications • Lowest carrier deflection of any Tolomatic actuator
<i>www.tolomatic.com for complete information, search by literature number:</i>			
#8500-4000	#8500-4000	#3600-4148	#3600-4609

A Comparison of Tolomatic Belt Drive Actuators

APPLICATIONS

A rodless belt actuator integrates the advantages of a linear belt solution with a load support and guidance system. This combination allows you to install a pre-assembled and compact solution, often without the need of external guide rails or load support systems. Available in multiple frame sizes with options such as dual carriers and dual support systems, you can choose

the proper level of load and moment support required for your application. The result of this combination is a belt actuator that is:

- Easy to size, design and order
- Quick to install and maintain
- Simple to integrate and control
- Provides a lower installed cost

APPLICATION: High Speed Flying Cut Off



- +Test stations
- +Product handling
- +Camera positioning

APPLICATION: X-Y Multi Axis

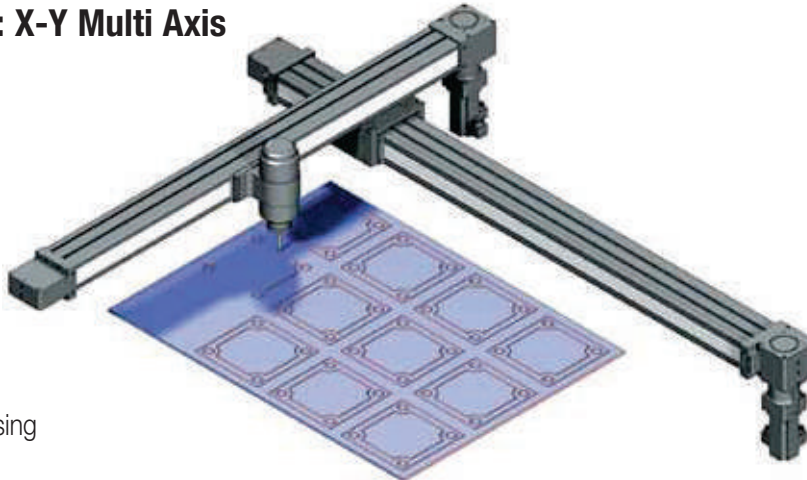

- +Laser marking
- +Material cutting
- +Adhesive dispensing

CONTENTS

B3W Belt Drive Actuator..	2
Belt Drive Comparison.....	2
Applications	3
Belt Construction.....	4
Belt Drive Advantages	4
B3W Performance.....	5
B3W Features	6
Specifications	8
Bending Moments	9
Load Deflection	10
Auxiliary Carrier.....	11
Dimensions.....	12-17
B3W10.....	12
Dual 180	13
B3W15.....	14
Dual 180	15
B3W20.....	16
Dual 180	17
Motor Orientation	18
Application Data	
Worksheet	19
Selection Guidelines	20
Switches	21
Ordering	23
Other Tolomatic	
Products.....	24

FREE downloads at www.tolomatic.com:



• **Sizing & Selection Software**

• **3D Solid Models**



B3W Rodless Belt Driven Actuator

FEATURES

ADVANTAGES OF BELT SOLUTIONS

The use of synchronous belts, often referred to as timing belts, have become a standard in the automated motion industry as an alternate to screw drive mechanisms for producing linear motion.

This design for linear motion provides an excellent solution for applications that require:

- High-speed linear velocities
- High acceleration rates

- Long length strokes
- High repeatability
- High duty cycles

A belt solution is ideal for linear positioning and gantry applications. Linear velocities can now reach up to 200 in/sec with acceleration rates at 1200 in/sec². Belting material is available in lengths that allow stroke lengths over 24 feet, two to three times longer than screw actuators.

BELT CONSTRUCTION

Tolomatic installs an HTD synchronous belt in the B3W product line that features a curvilinear tooth profile. This type of tooth profile distributes tooth load more evenly and provides greater tooth shear strength, allowing for higher thrust loading. The deep teeth of the HTD profile are more cogging-resistant at a given tension, preventing potentially damaging positioning errors.

Tolomatic's standard belt is a polyurethane material reinforced with steel tension members

to produce high carrier thrusts without belt stretch. A Kevlar[®] reinforced belt featuring equal thrust capability is also available for applications that may experience high shock loading.

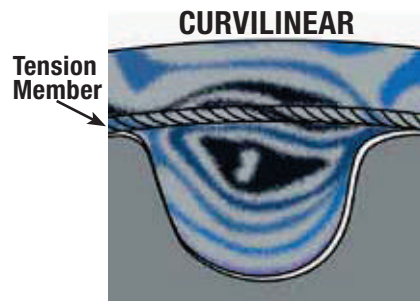

Tolomatic's tooth belt profile distributes load evenly.



World class performance,
five days built-to-order and
legendary customer service ...

*what you expect from the
rodless leader ...*



B3W Rodless Belt Driven Actuator

PERFORMANCE



CARRIER SPEED CAPABILITIES

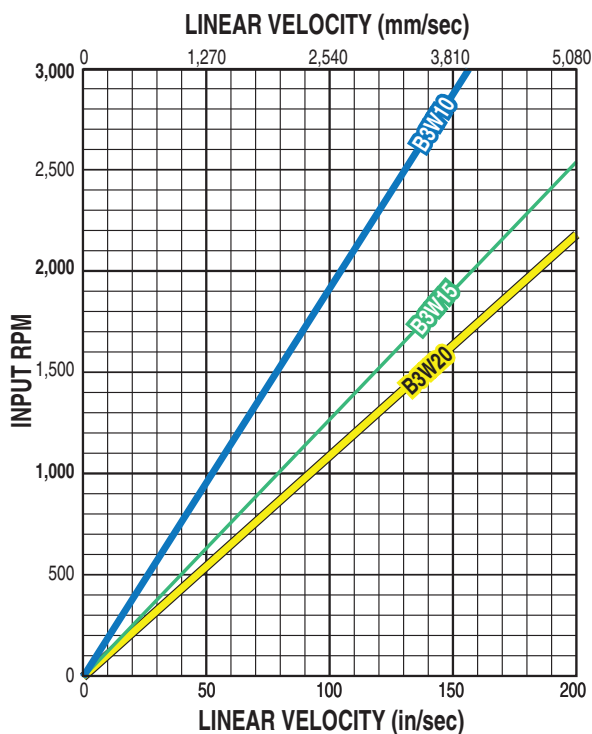

MAXIMUM BELT THRUST

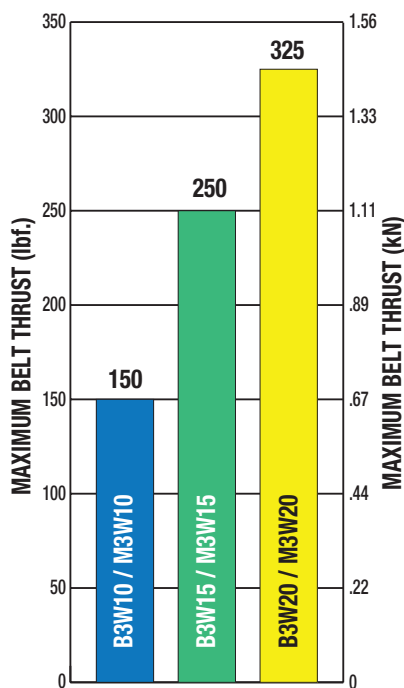

MAXIMUM ACCELERATION AS A FUNCTION OF LOAD WEIGHT

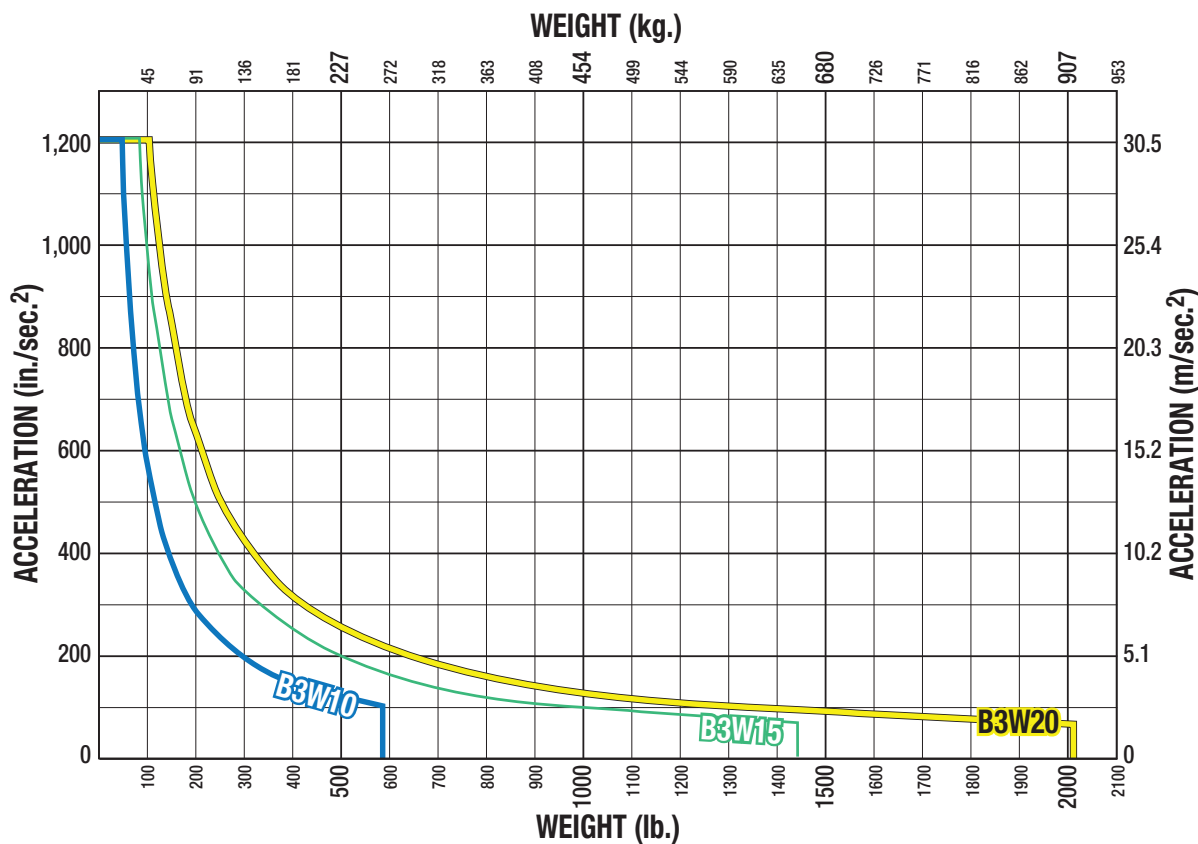

B3W Rodless Belt Driven Actuator

ENDURANCE TECHNOLOGYSM

Look for this endurance technology symbol indicating our durability design features

**5 DAYS
BUILT-TO-ORDER**

• YOUR MOTOR HERE •

YOU CAN CHOOSE:

- Motor or gearbox supplied and installed by Tolomatic
- Specify the device to be installed and actuator ships with proper mounting hardware
- Specify and ship your device to Tolomatic for factory installation

• MOTOR ORIENTATION •

YOU CAN CHOOSE:

- Direct drive option directly couples the driving shafts and is a one-piece housing construction for optimum alignment and support of the motor
- Reduction drive option offers the ability to reduce the reflected inertia and lower the motor torque requirements

• LIGHTWEIGHT ALUMINUM DESIGN •

- Black anodized extrusion design is optimized for rigidity and strength
- External switch channels on both sides allow easy placement and adjustment of position indicating switches

• OVERSIZED PULLEY BEARINGS •

- Drive shaft assembly incorporates sealed ball bearings for complete support of the increased belt tension at high speeds

• MULTIPLE BELT TECHNOLOGIES •

YOU CAN CHOOSE:

- Polyurethane steel-cord reinforced HTD style belt (standard)
- Polyurethane Kevlar[®] reinforced HTD style belt

• INTERNAL BUMPERS •

- Bumpers protect the belt and clamp assembly from damage at end of stroke

TOLOMATIC... MAXIMUM DURABILITY

PATENTED WEDGE BEARING SYSTEM



- Unique design incorporates hardened steel raceways integral to the aluminum extrusion
- Bearing surfaces are adjusted at the factory for optimum preload and smooth performance



FORMED END CAP WIPERS

- Prevents contaminants from entering the sealing band area to protect internal components

BELT TENSIONING SYSTEM

- Full access to the idle pulley allows ease of adjustment for alignment and tensioning
- Dual adjustment screws and field tensioning kit provide simple maintenance



LOAD-BEARING CARRIER DESIGN

- Recirculating ball bearing system provides guidance, high efficiency and long life
- Load and moments are transmitted directly to the actuator body

STAINLESS STEEL SEALING BAND

- Prevents contaminants from entering the bearing area for extended performance
- Fatigue resistant stainless steel bands are specifically made to offer long life and will not elongate
- Provides IP44 protection for bearings and belt

OPTIONS



CARRIER OPTIONS

AUXILIARY CARRIER doubles the load capacity and increases pitch and yaw bending moment capacities



DUAL 180° CARRIER increases the load capacity, increases roll and yaw bending moment capacities and offers a wide mounting platform



MOUNTING OPTIONS

SURFACE MOUNT two t-slots are integral on the entire underside of the actuator body for direct mounting



TUBE SUPPORTS provide intermediate support of the actuator body throughout long stroke lengths



METRIC OPTION

Metric tapped holes for mounting of load to carrier and of actuator to mating surfaces

SWITCHES

Styles include: reed, Hall-effect or triac

B3W Rodless Belt Driven Actuator

SPECIFICATIONS



B3W SPECIFICATIONS

		STANDARD				METRIC		
		B3W10	B3W15	B3W20		M3W10	M3W15	M3W20
Max. Stroke	in	204	204	156	mm	5,182	5,182	3,962
Max. Velocity	in/sec	200	200	200	m/sec	5.08	5.08	5.08
Max. Acceleration	in/sec ²	1,200	1,200	1,200	m/sec ²	30.48	30.48	30.48
Max. Input Torque	lb-in	75.23	112.80	244.40	N-m	8.50	12.75	27.61
Breakaway Torque	lb-in	9.38	12.50	28.13	N-m	1.06	1.41	3.18
Dual 180 or Aux Carrier	lb-in	11.88	15.00	31.25	N-m	1.34	1.69	3.53
Dual 180 & Aux Carrier	lb-in	16.88	25.00	47.50	N-m	1.91	2.82	5.37
Pulley Pitch Dia.	in	1.003	1.504	1.754	mm	25.48	38.20	44.55
Stoke per Rev.	in/rev	3.151	4.725	5.510	mm/rev	80.04	120.02	139.95
Repeatability	in	+/- 0.002	+/- 0.002	+/- 0.002	mm	+/- 0.05	+/- 0.05	+/- 0.05
Straightness & Flatness ¹	in	0.00067 x L*	0.00067 x L*	0.00067 x L*	mm	0.017 x L*	0.017 x L*	0.017 x L*
Temp. Range ²	°F	40 - 130	40 - 130	40 - 130	°C	4 - 54	4 - 54	4 - 54
IP Rating ³	IP	44	44	44	IP	44	44	44
Weight (zero stroke)	lb	7.54	25.12	35.40	kg	3.42	11.39	16.06
Weight (per unit of stroke)	lb/in	0.389	0.395	0.716	kg/mm	0.0069	0.0071	0.0128
Weight of pulley	lb	0.015	0.054	0.1036	kg	0.0068	0.0244	0.0470
Weight of carrier	lb	0.85	1.56	2.14	kg	0.39	0.71	0.97
Inertia (zero stroke)	lb-in ²	0.2846	1.3917	2.6607	kg-cm ²	0.833	4.073	7.786
Inertia (per unit of stroke)	lb-in ² /in	0.0016	0.0017	0.0114	kg-cm ² /mm	0.00018	0.00020	0.00131
Inertia of pulley	lb-in ²	0.0093	0.0748	0.1441	kg-cm ²	0.027	0.219	0.422
Inertia of carrier	lb-in ²	0.1041	0.5089	0.9728	kg-cm ²	0.305	1.489	2.847



¹ The listed values relating to straightness/flatness are intended for reference purposes only, and not as an engineering standard of absolute tolerance for a given actuator. Appropriate installation is the single most important factor in reducing such deviation, so good engineering practices such as measurement, mapping, etc. must be employed in applications with stringent straightness/flatness requirements.

² Heat generated by the motor and drive should be taken into consideration as well as linear velocity and work cycle time. For applications that require operation outside of the recommended temperature range, contact the factory.

³ Protected against ingress of solid particles greater than .039 in (1mm) and splashing water.

*"L" is maximum distance between supports - See Support Recommendations graph pg 10.

LARGE FRAME MOTORS AND SMALLER SIZE ACTUATORS: Cantilevered motors need to be supported if subjected to continuous rapid reversing duty and/or under dynamic conditions.

NOTE: Zero stroke inertia and weight are for an assembled actuator (including carrier, pulley and belt material) that has zero stroke length. To calculate system inertia use the formula below:

$$\text{System Inertia} = \text{Inertia (zero stroke)} + [\text{Inertia (per unit of stroke)} \times \text{number of units}]$$

(For weight calculation substitute inertia with weight in the above formula)

B3W Rodless Belt Driven Actuator

SPECIFICATIONS



DYNAMIC BENDING MOMENTS AND LOADS

		STANDARD			METRIC		
STANDARD CARRIER		B3W10	B3W15	B3W20	M3W10	M3W15	M3W20
	Mx Moment (Roll) (lb-in : N-m)	250	859	1,662	28.2	97.1	187.8
	My Moment (Pitch) (lb-in : N-m)	269	1,033	1,472	30.4	116.7	166.3
	Mz Moment (Yaw) (lb-in : N-m)	156	596	850	17.6	67.3	96.0
	Fy Load (Radial) (lb : N)	341	840	1,159	1,517	3,737	5,155
	Fz Load (Lateral) (lb : N)	591	1,454	2,008	2,629	6,468	8,932
AUXILIARY CARRIER: Increases rigidity, load-carrying capacity and moments		B3W10	B3W15	B3W20	M3W10	M3W15	M3W20
	Mx Moment (Roll) *(lb-in : N-m)	500	1,718	3,324	56.5	194.1	375.6
	My Moment (Pitch) *(lb-in : N-m)	2,825	11,734	16,265	319.2	1,325.8	1,837.7
	Mz Moment (Yaw) *(lb-in : N-m)	1,630	6,779	9,388	184.2	765.9	1,060.7
	Fy Load (Radial) (lb : N)	682	1,680	2,318	3,034	7,473	10,311
	Fz Load (Lateral) (lb : N)	1,182	2,908	4,016	5,258	12,935	17,864
	Minimum Dimension 'D' (in : mm)	4.88	8.07	8.10	124.0	205.2	205.7
DUAL 180° CARRIER: Allows 90° rotation of load, adds load bearing surface		B3WD10	B3WD15	B3WD20	M3WD10	M3WD15	M3WD20
	Mx Moment (Roll) (lb-in : N-m)	657	2,468	4,527	74.2	278.8	511.5
	My Moment (Pitch) (lb-in : N-m)	312	1,192	1,700	35.3	134.7	192.1
	Mz Moment (Yaw) (lb-in : N-m)	538	2,066	2,944	60.8	233.4	332.6
	Fy Load (Radial) (lb : N)	1,182	2,908	4,016	5,258	12,935	17,864
	Fz Load (Lateral) (lb : N)	682	1,680	2,318	3,034	7,473	10,311
AUXILIARY DUAL 180° CARRIER: Substantially increases moment and loads		B3WD10	B3WD15	B3WD20	M3WD10	M3WD15	M3WD20
	Mx Moment (Roll) *(lb-in : N-m)	1,314	4,936	9,054	148.5	557.7	1,023.0
	My Moment (Pitch) *(lb-in : N-m)	3,328	13,558	18,776	376.0	1,531.9	2,121.4
	Mz Moment (Yaw) *(lb-in : N-m)	5,768	23,468	32,530	651.7	2,651.5	3,675.4
	Fy Load (Radial) (lb : N)	2,364	5,816	8,032	10,516	25,871	35,728
	Fz Load (Lateral) (lb : N)	1,364	3,360	4,636	6,067	14,946	20,622
	Minimum Dimension 'D' (in : mm)	4.88	8.07	8.10	124.0	205.0	205.7

! The Dual 180° carrier requires its own proprietary tube supports and foot mounts. See dimensional information. Breakaway torque will also increase when using the Auxiliary carrier or the Dual 180° carrier options. When ordering, determine working stroke and enter this value into the configuration string. Overall actuator length will automatically be calculated.

Deflection Considerations: In applications where substantial Mx or My moments come into play, deflection of the cylinder tube, carrier and supports must be considered. The deflection factors shown in the Load Deflection charts on the following page are based on cylinder mounted with tube supports at minimum recommended spacing. If more rigidity is desired, refer to the Auxiliary or Dual Carrier options.

*Loads shown in table are at minimum "D" dimension, for ratings with longer "D" dimension see graphs on page 11.

Life of the actuator will vary for each application depending on the combined loads, motion parameters and operating conditions. The load factor (L_f) ratios for each application must not exceed a value of 1 (see formula at right). Exceeding a load factor of 1 will diminish the actuator's rated life.

$$L_f = \frac{M_x}{M_{x_{max}}} + \frac{M_y}{M_{y_{max}}} + \frac{M_z}{M_{z_{max}}} + \frac{F_y}{F_{y_{max}}} + \frac{F_z}{F_{z_{max}}} \leq 1$$

With combined loads, L_f must not exceed the value 1.

B3W Rodless Belt Driven Actuator

SPECIFICATIONS



LOAD DEFLECTION

DEFLECTION ABOUT X AXIS

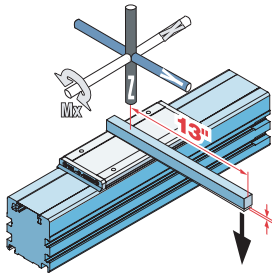

DEFLECTION TESTING WAS DONE UNDER THESE CRITERIA:

- 1.) Actuator was properly mounted with distance between supports within recommendations (see Support Recommendations below)
- 2.) Deflection was measured from center of carrier as shown ($M_x = 13"$, $M_y = 8"$)

DEFLECTION ABOUT Y AXIS

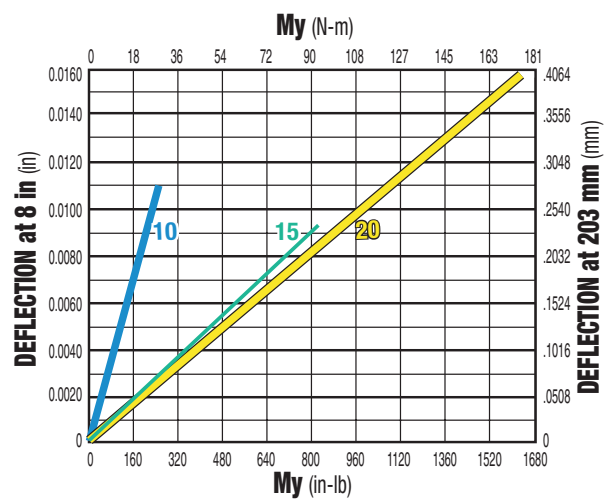
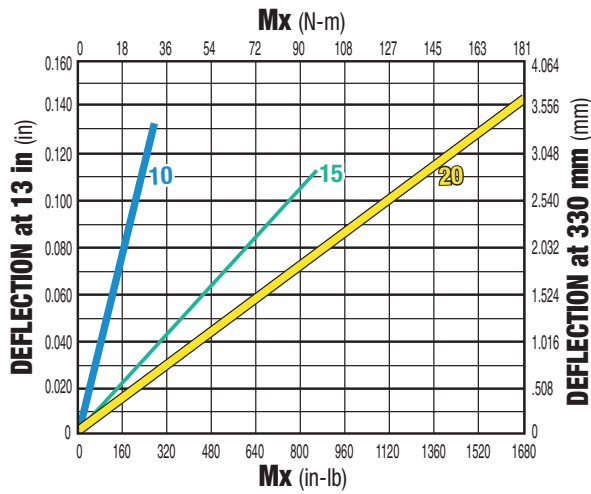
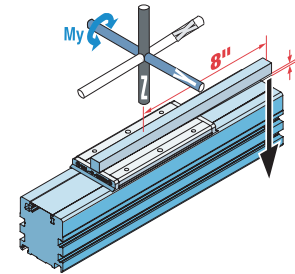

SUPPORT RECOMMENDATIONS

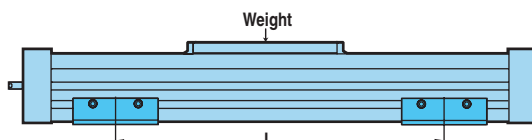
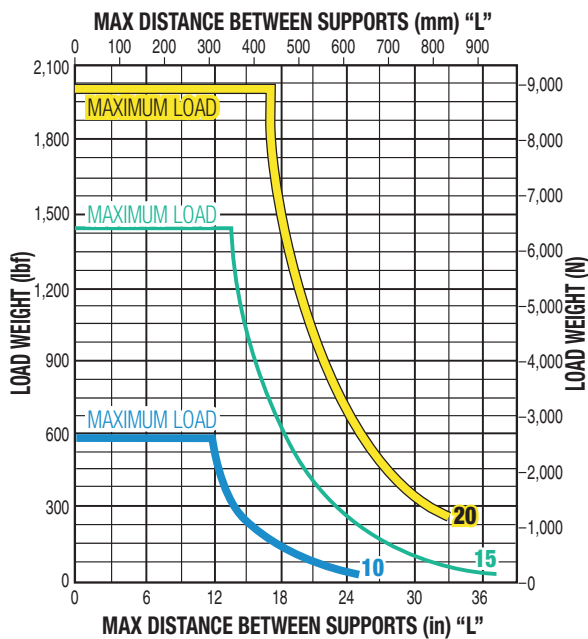

FRICTION FORCE

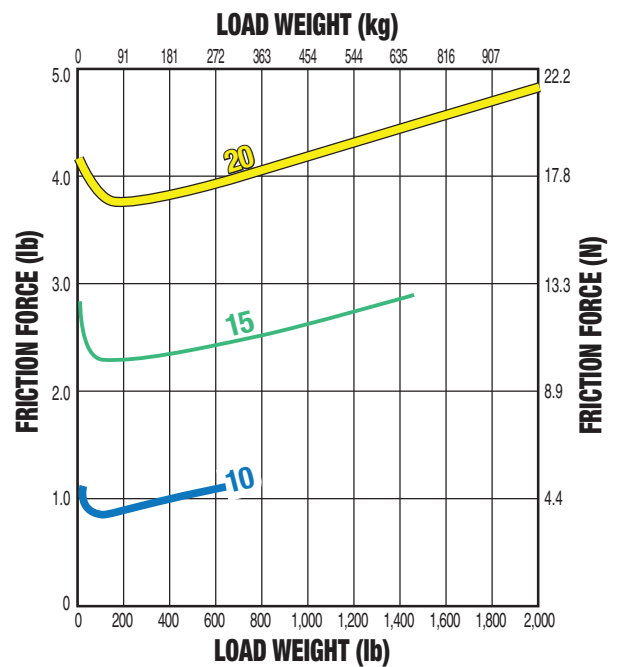

B3W Rodless Belt Driven Actuator

SPECIFICATIONS



AUXILIARY CARRIER: BENDING MOMENT AT 'D' DISTANCE

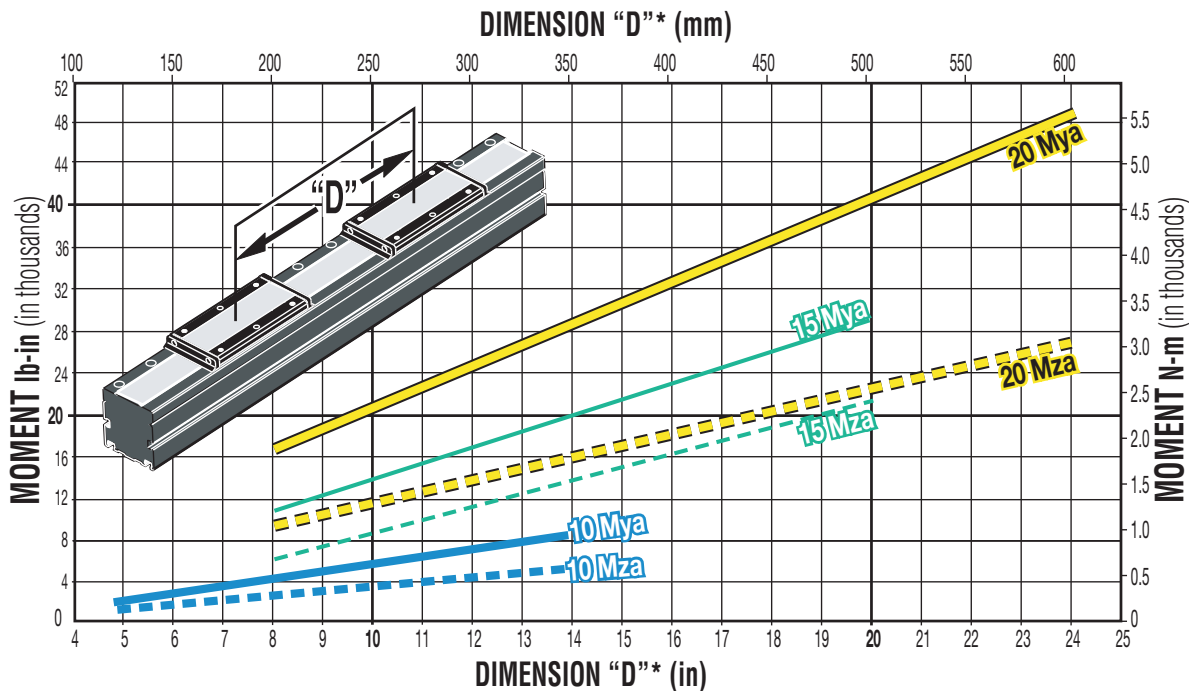

AUXILIARY DUAL 180° CARRIER: BENDING MOMENT AT 'D' DISTANCE

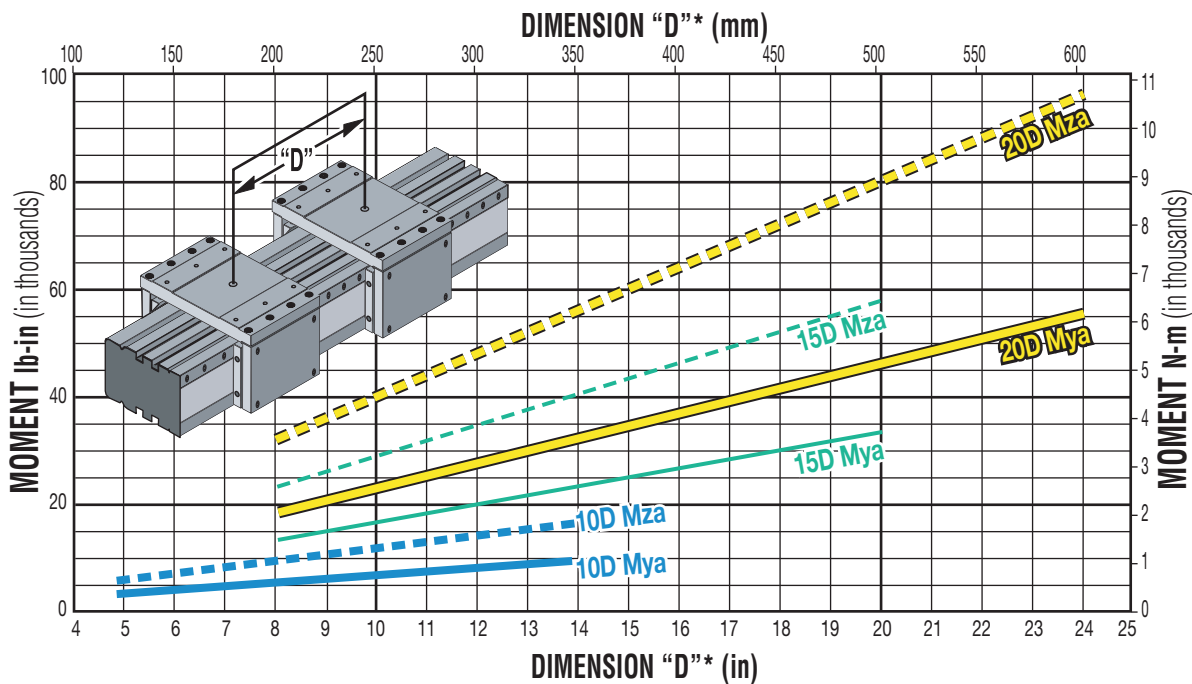

- Rates shown on both graphs were calculated with these assumptions:
- 1.) Coupling between carriers is rigid.
 - 2.) Load is equally distributed between carriers.
 - 3.) Coupling device applies no misalignment loads to carriers.

* Customer must specify Dimension "D" (Distance between carrier center lines) when ordering.

Life of the actuator will vary for each application depending on the combined loads, motion parameters and operating conditions. The load factor (L_F) ratios for each application must not exceed a value of 1 (see formula at right). Exceeding a load factor of 1 will diminish the actuator's rated life.

$$L_F = \frac{M_x}{M_{x_{max}}} + \frac{M_y}{M_{y_{max}}} + \frac{M_z}{M_{z_{max}}} + \frac{F_y}{F_{y_{max}}} + \frac{F_z}{F_{z_{max}}} \leq 1$$

With combined loads, L_F must not exceed the value 1.

B3W10 Rodless Belt Driven Actuator

DIMENSIONS



B3W10 ACTUATOR AND OPTIONS

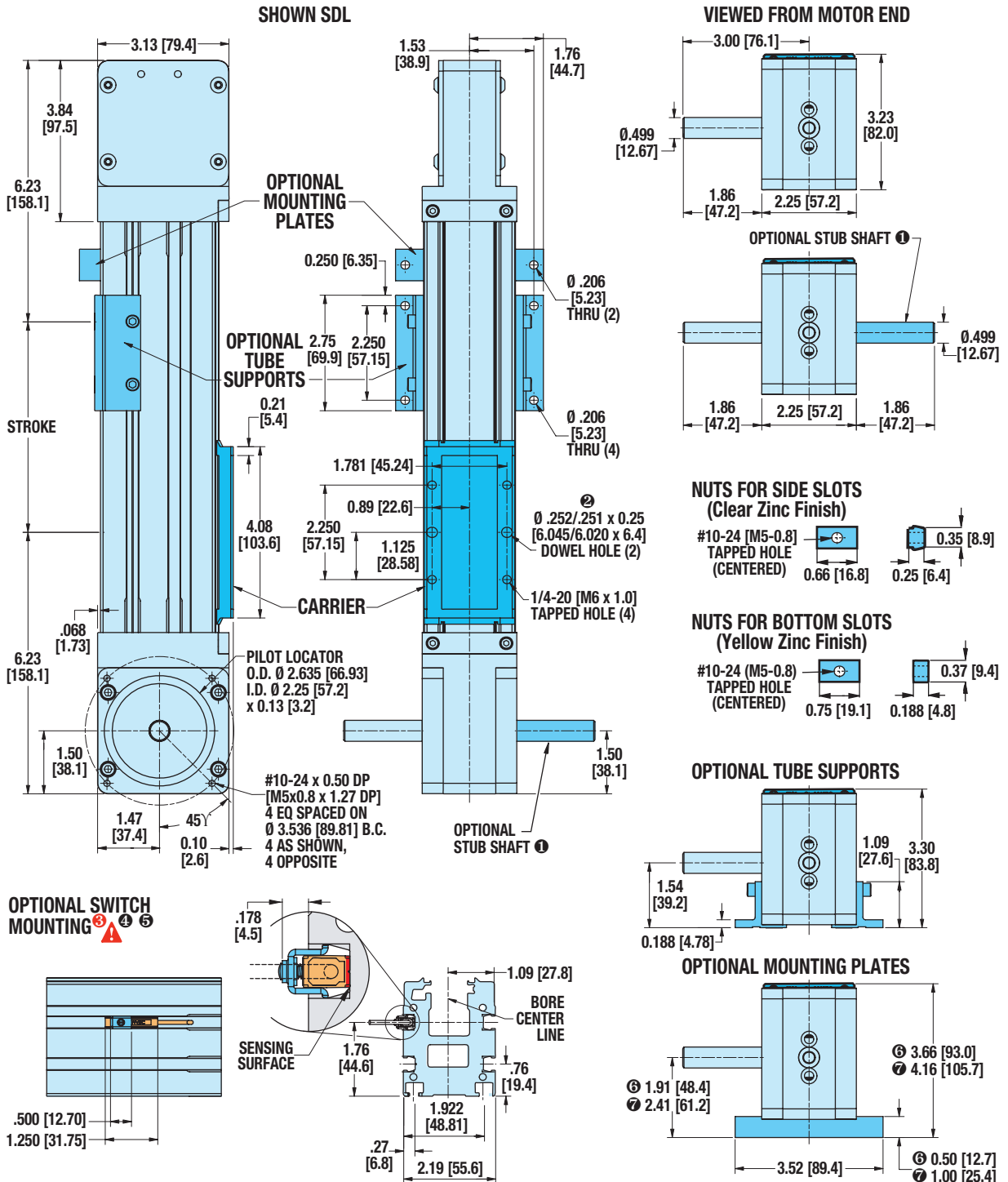

① ONE STUB SHAFT IS STANDARD ON ALL B3W ACTUATORS

② DOWEL PINS $\pm .003 (.08\text{mm})$ M

③ **CAUTION: DO NOT OVERTIGHTEN SWITCH HARDWARE WHEN INSTALLING**

④ NOTE: The scored face of the switch indicates the sensing surface and must face toward the magnet

⑤ NOTE: Some actuators require switch mounting on a specific side of the actuator. Call Tolomatic 1-800-328-2174 for details

⑥ WHEN USED WITH 23-FRAME MOTORS

⑦ WHEN USED WITH 34-FRAME MOTORS

Unless otherwise noted, all dimensions shown are in inches [Dimensions in brackets are in millimeters]

B3W10 Rodless Belt Driven Actuator

DIMENSIONS

3D CAD AVAILABLE AT
WWW.TOLOMATIC.COM



WWW.3DCONTENTCENTRAL.COM

B3WD10 DUAL 180° OPTION

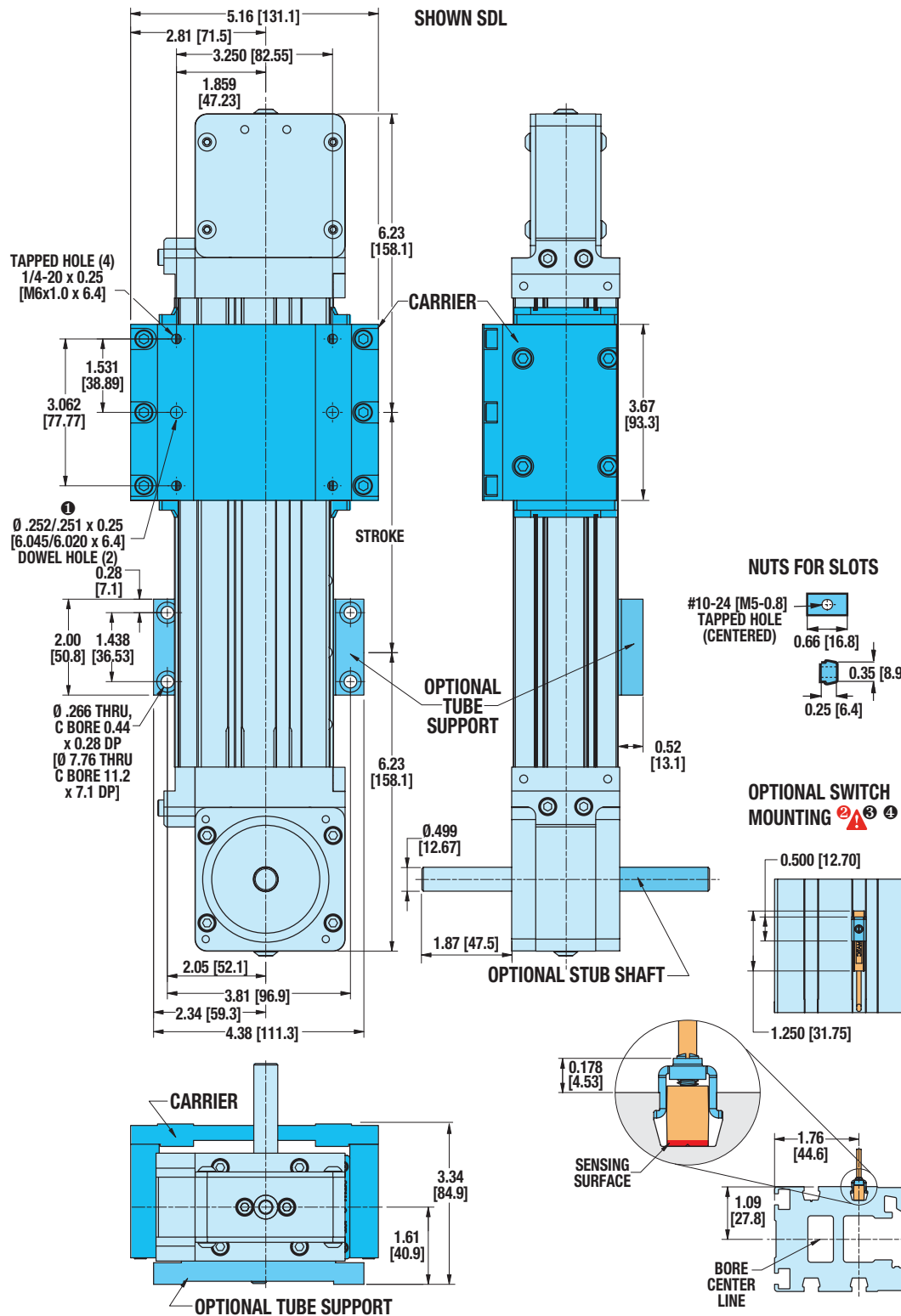

① DOWEL PINS $\pm .003 (.08\text{mm})$ (M)

⚠️ CAUTION: DO NOT OVERTIGHTEN SWITCH HARDWARE WHEN INSTALLING

Ⓝ NOTE: The scored face of the switch indicates the sensing surface and must face toward the magnet

Ⓞ NOTE: Some actuators require switch mounting on a specific side of the actuator. Call Tolomatic 1-800-328-2174 for details

B3W15 Rodless Belt Driven Actuator

DIMENSIONS



B3W15 ACTUATOR AND OPTIONS

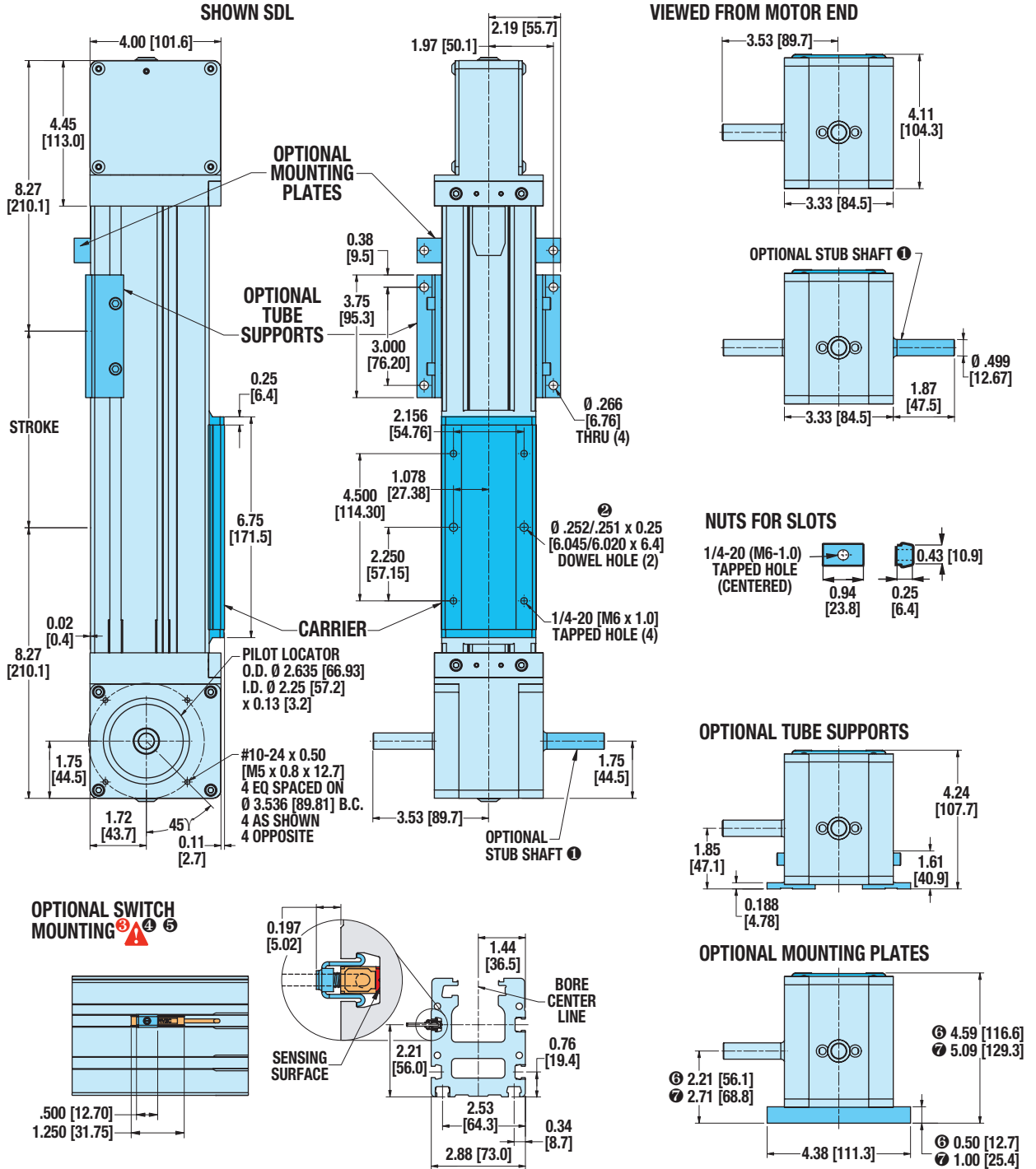

① ONE STUB SHAFT IS STANDARD ON ALL B3W ACTUATORS

② DOWEL PINS \varnothing .003 (.08mm) (M)

③ **CAUTION: DO NOT OVERTIGHTEN SWITCH HARDWARE WHEN INSTALLING**

④ NOTE: The scored face of the switch indicates the sensing surface and must face toward the magnet

⑤ NOTE: Some actuators require switch mounting on a specific side of the actuator. Call Tolomatic 1-800-328-2174 for details

⑥ WHEN USED WITH 23-FRAME MOTORS

⑦ WHEN USED WITH 34-FRAME MOTORS

Unless otherwise noted, all dimensions shown are in inches [Dimensions in brackets are in millimeters]

B3W15 Rodless Belt Driven Actuator

DIMENSIONS

B3WD15 DUAL 180° OPTION

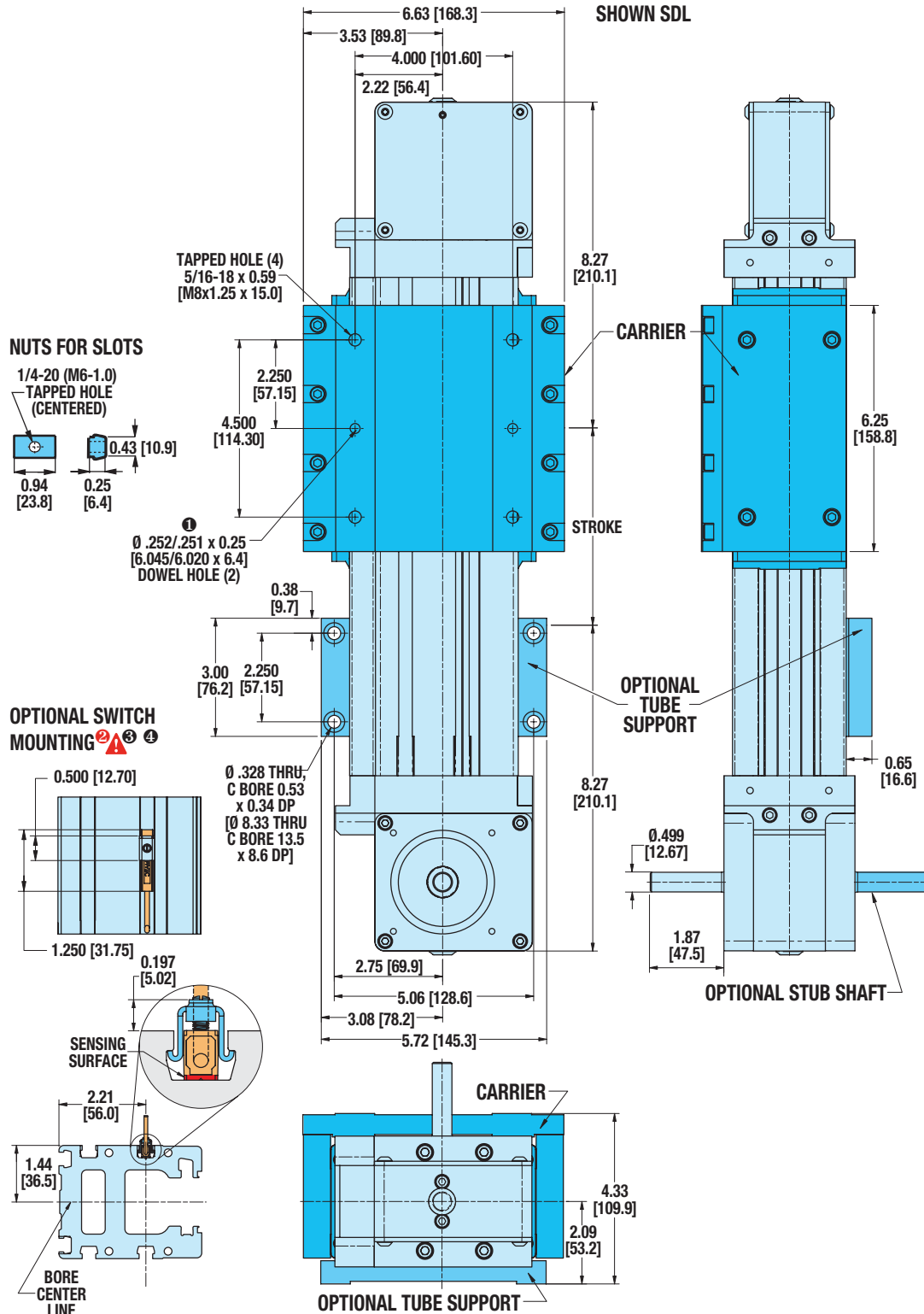

- ① DOWEL PINS $\text{⌀} .003 (.08\text{mm}) \text{Ⓜ}$
- Ⓜ **CAUTION: DO NOT OVERTIGHTEN SWITCH HARDWARE WHEN INSTALLING**
- Ⓝ NOTE: The scored face of the switch indicates the sensing surface and must face toward the magnet
- Ⓞ NOTE: Some actuators require switch mounting on a specific side of the actuator. Call Tolomatic 1-800-328-2174 for details

B3W20 Rodless Belt Driven Actuator

DIMENSIONS

B3W20 ACTUATOR AND OPTIONS

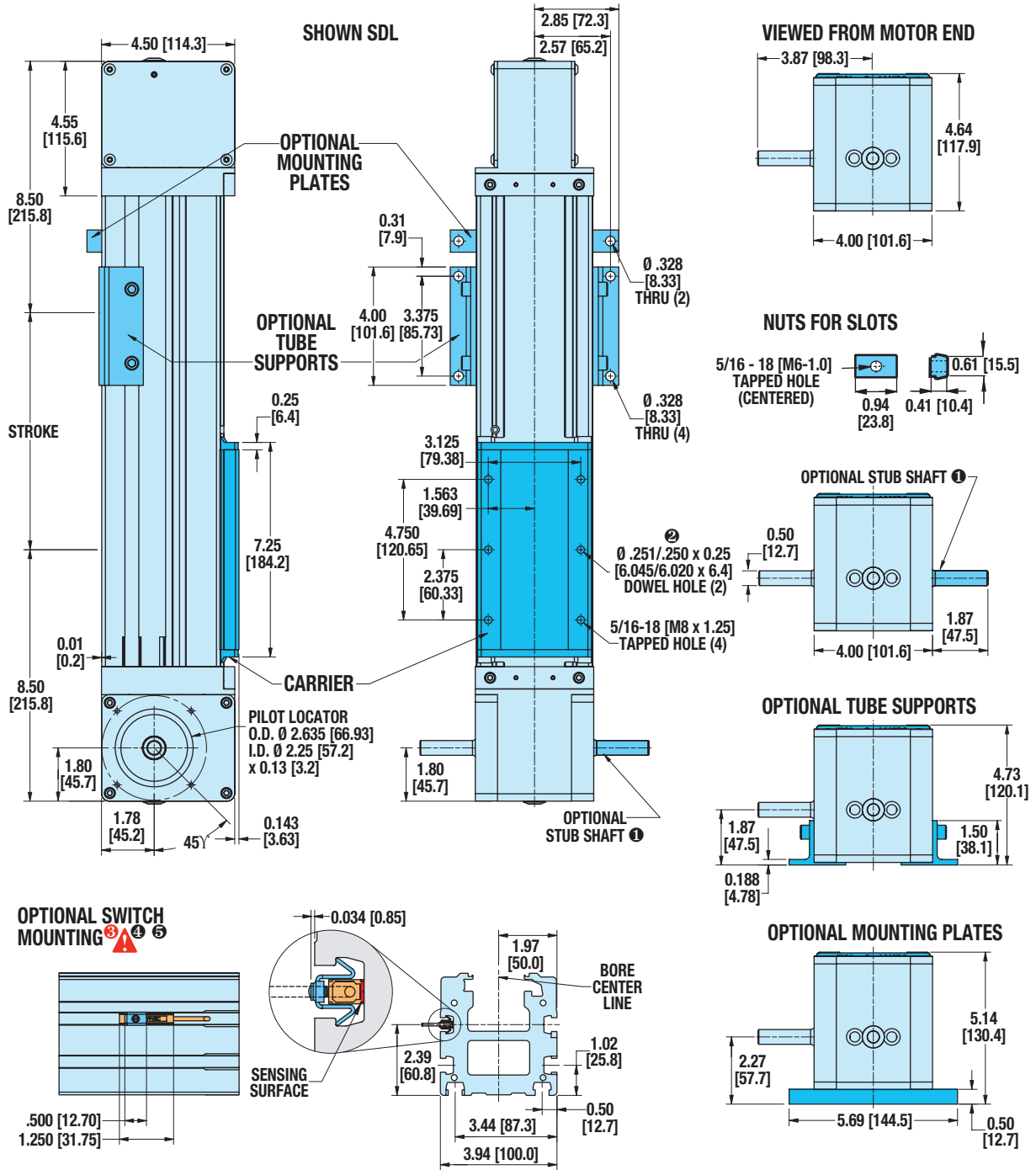

① ONE STUB SHAFT IS STANDARD ON ALL B3W ACTUATORS

⚠ **CAUTION: DO NOT OVERTIGHTEN SWITCH HARDWARE WHEN INSTALLING**

⑤ NOTE: Some actuators require switch mounting on a specific side of the actuator. Call Tolomatic 1-800-328-2174 for details

② DOWEL PINS $\pm .003 (.08\text{mm})$ M

④ NOTE: The scored face of the switch indicates the sensing surface and must face toward the magnet

Unless otherwise noted, all dimensions shown are in inches [Dimensions in brackets are in millimeters]

B3W20 Rodless Belt Driven Actuator

DIMENSIONS

B3WD20 DUAL 180° OPTION

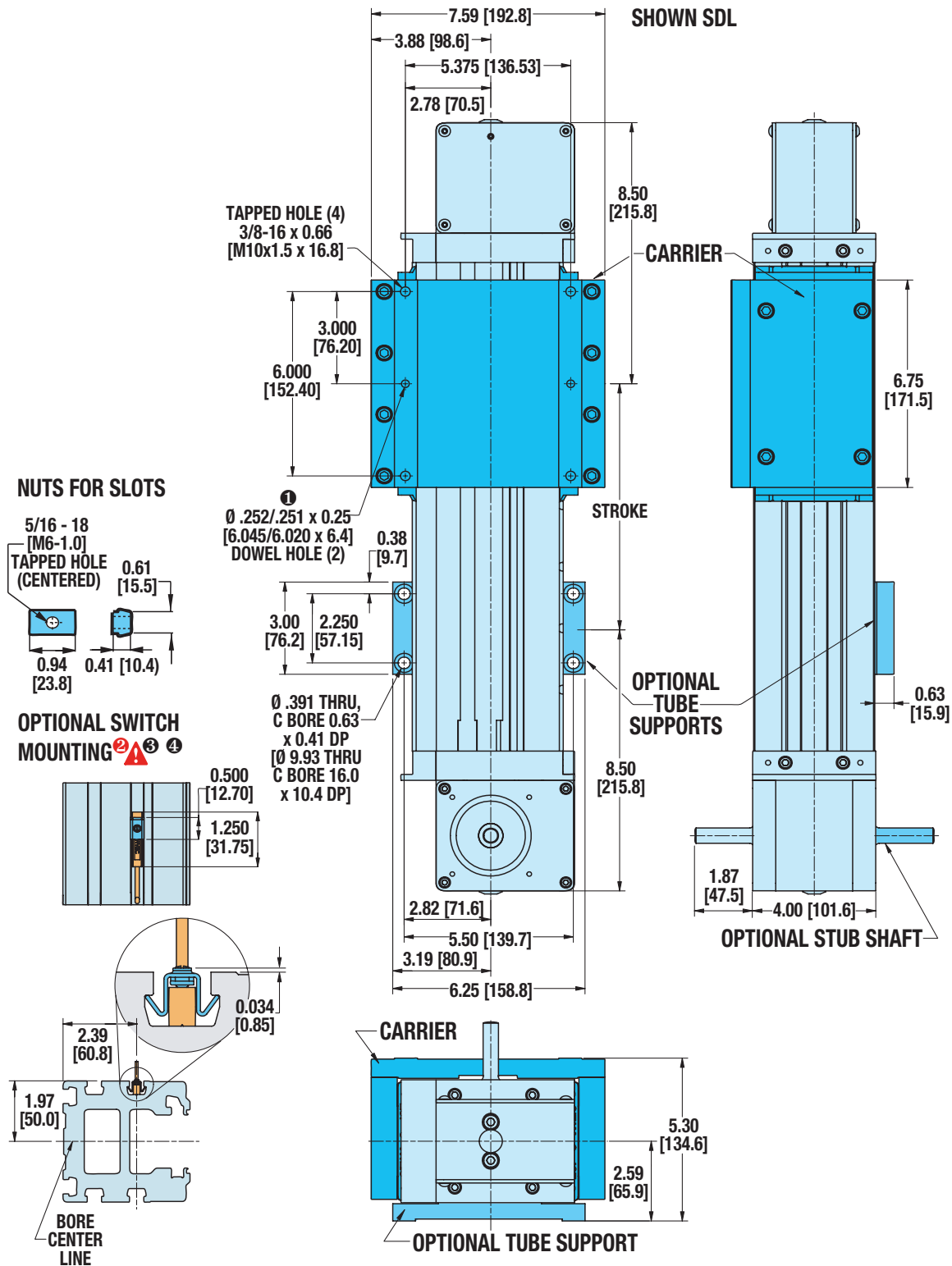

① DOWEL PINS $\pm .003$ (.08mm) M

Ⓝ **CAUTION: DO NOT OVERTIGHTEN SWITCH HARDWARE WHEN INSTALLING**

③ NOTE: The scored face of the switch indicates the sensing surface and must face toward the magnet

④ NOTE: Some actuators require switch mounting on a specific side of the actuator. Call Tolomatic 1-800-328-2174 for details

B3W Rodless Belt Driven Actuator

MOTOR ORIENTATION



B3W DIRECT DRIVE MOTOR MOUNTING

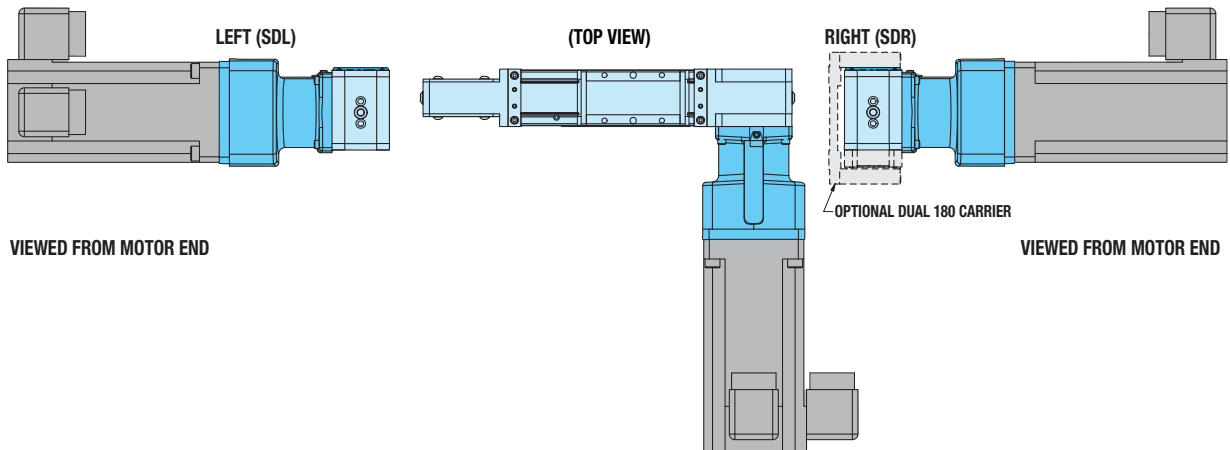

B3W(D)10 REDUCTION DRIVE MOTOR MOUNTING

STANDARD CARRIER

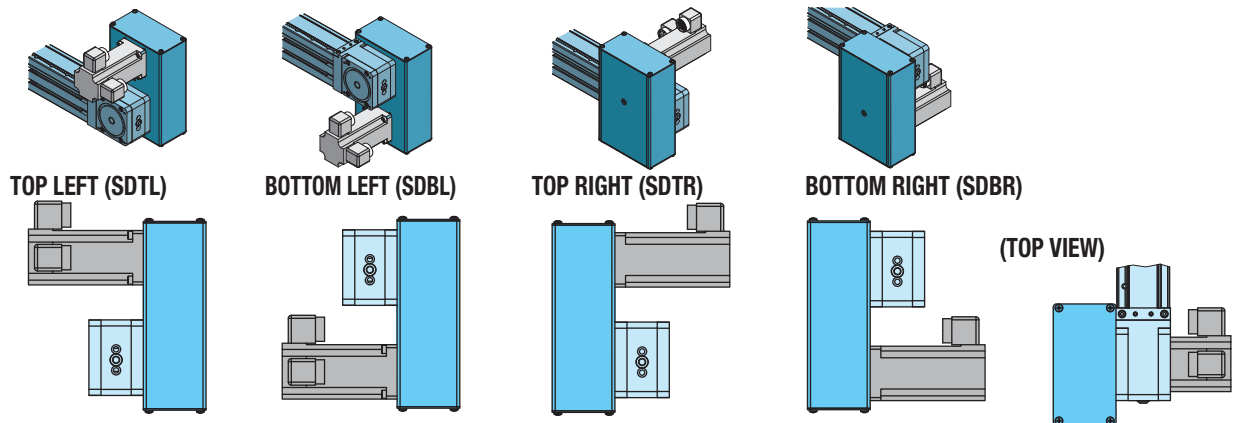

DUAL 180° CARRIER

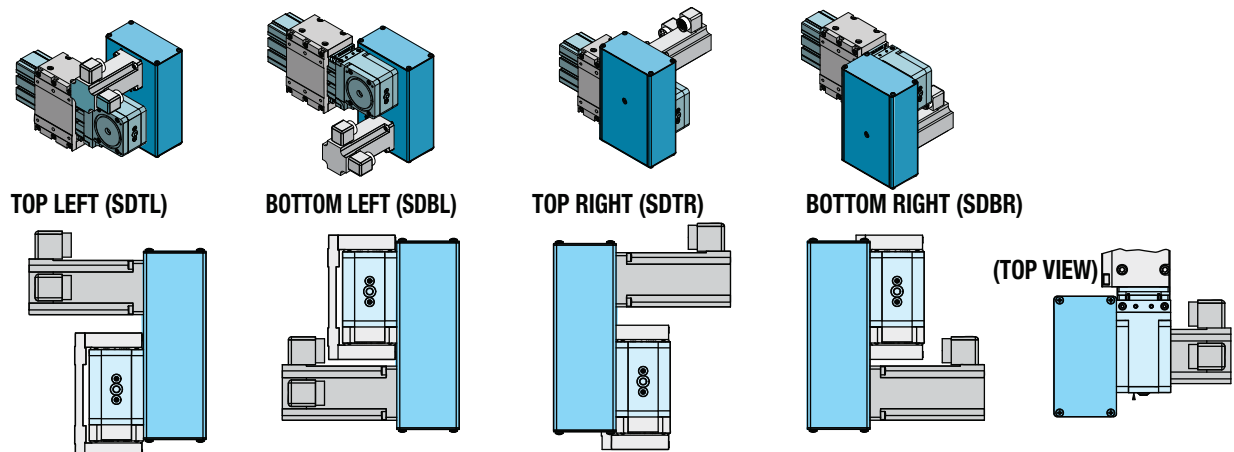

APPLICATION DATA WORKSHEET Fill in known data. Not all information is required for all applications

ORIENTATION

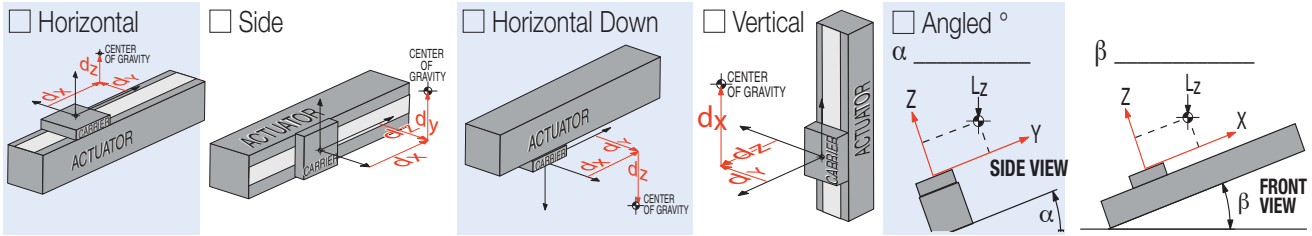

Load attached to carrier OR Load supported by other mechanism

DISTANCE FROM CENTER OF CARRIER TO LOAD CENTER OF GRAVITY

d_x _____
 d_y _____
 d_z _____

inch (U.S. Standard) millimeters (Metric)

STROKE LENGTH _____

inch (S I) (U.S. Standard)

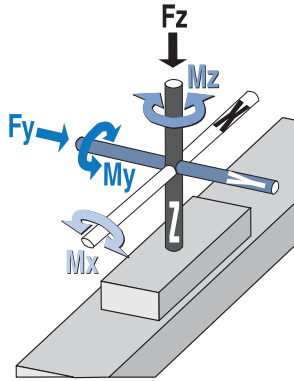

BENDING MOMENTS APPLIED TO CARRIER

in.-lbs. (U.S. Standard) N-m (Metric)
 M_x _____
 M_y _____
 M_z _____

PRECISION

Repeatability _____
 inch millimeters

NOTE: If load or force on carrier changes during cycle use the highest numbers for calculations

LOAD _____

lb. (U.S. Standard) kg. (Metric)

FORCES APPLIED TO CARRIER

lbf. (U.S. Standard) N (Metric)

F_z _____
 F_y _____

OPERATING ENVIRONMENT

Temperature, Contamination, etc.

MOVE PROFILE

Move Distance _____

inch millimeters

Dwell Time After Move _____

Max. Speed _____

in/sec mm/sec

MOVE TIME _____

sec

NO. OF CYCLES _____

per minute per hour

MOTION PROFILE

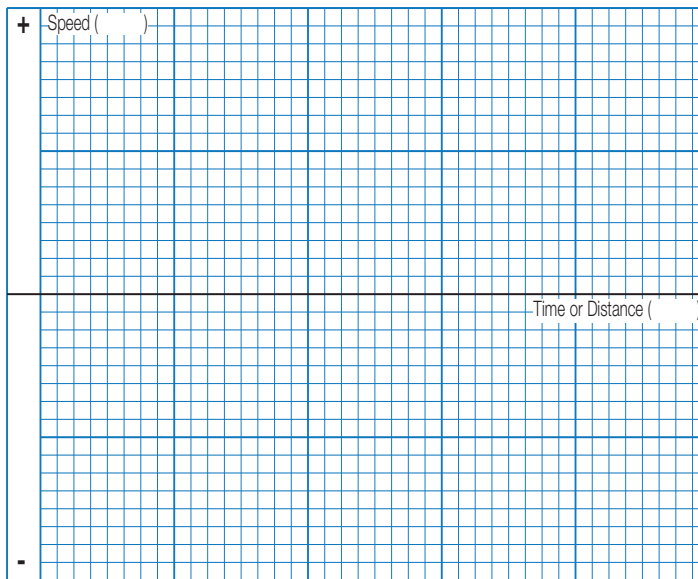

Graph your most demanding cycle, including accel/decel, velocity and dwell times. You may also want to indicate load variations and I/O changes during the cycle. Label axes with proper scale and units.

CONTACT INFORMATION

Name, Phone, Email
 Co. Name, Etc.

STOP USE THE TOLOMATIC SIZING AND SELECTION SOFTWARE AVAILABLE ON-LINE AT www.tolomatic.com OR... CALL TOLOMATIC AT 1-800-328-2174. We will provide any assistance needed to determine the proper actuator for the job.

FAX 1-763-478-8080

EMAIL help@tolomatic.com

Rodless Belt Driven Actuators

SELECTION GUIDELINES

The process of selecting a belt driven actuator for a given application can be complex. **It is highly recommended that you contact Tolomatic or a Tolomatic distributor for assistance in selecting the best actuator for your application.** The following overview of the selection guidelines are for educational purposes only.

1 CHOOSE ACTUATOR SIZE

Choose an actuator that has the thrust, speed and moment load capacity to move the load.

- A) For maximum thrust use the table below.
- B) Maximum speed of B3W 200 in/sec (5 m/sec).
- C) For B3W moment and load capacities see tables on page 9.

SIZE	MAXIMUM THRUST	
	lbf	N
10	150	667
15	250	1112
20	325	1445

2 COMPARE LOAD TO MAXIMUM LOAD CAPACITIES

Calculate the application load (combination of load mass and forces applied to the carrier) and application bending moments (sum of all moments M_x , M_y , and M_z applied to the carrier). Be sure to evaluate the magnitude of dynamic inertia moments. When a rigidly attached load mass is accelerated or decelerated, its inertia induces bending moments on the carrier. Careful attention to how the load is decelerated at the end of the stroke is required for improved actuator performance and application safety. If either load or any of the moments exceed figures indicated in the Moment and Load Capacity tables (page 9) for the actuator consider:

- 1) A larger actuator size
- 2) Auxiliary carrier
- 3) Dual 180° carrier

3 CALCULATE LOAD FACTOR (LF)

For loads with a center of gravity offset from the carrier account for both applied (static) and dynamic loads. The load factor (LF) must not exceed the value of 1.

$$L_f = \frac{M_x}{M_{x_{max}}} + \frac{M_y}{M_{y_{max}}} + \frac{M_z}{M_{z_{max}}} + \frac{F_y}{F_{y_{max}}} + \frac{F_z}{F_{z_{max}}} \leq 1$$

If L_f does exceed the value of 1, consider the three choices listed in step #2.

4 ESTABLISH YOUR MOTION PROFILE AND CALCULATE ACCELERATION RATE

Using the application stroke length and maximum carrier velocity (or time to complete the linear motion), establish the motion profile. Select either triangular (accel-decel) or trapezoidal (accel-constant speed-decel) profile. Now calculate the maximum acceleration and deceleration rates of the move. Acceleration/deceleration should not exceed 1200 in/sec² (30.48 m/sec²). Also, do not exceed safe rates of dynamic inertia moments determined in step #3.

5 SELECT MOTOR (GEARHEAD IF NECESSARY) AND DRIVE

To help select a motor and drive, use the sizing equations located in the Engineering Resources section of the Tolomatic Electric Products Catalog (#3600-4609) to calculate the application thrust and torque requirements. Refer to Motor sections to determine the motor and drive.

6 DETERMINE MOUNTING PLATE REQUIREMENTS

- Consult the Mounting Plate Requirements graph for the model selected (page 10)
- Cross reference the application load and maximum distance between supports
- Select the appropriate number of mounting plates

7 CONSIDER OPTIONS

- Choose metric or inch (U.S. standard) mounting. When ordering use  and indicate stroke length in inches.
- Switches - Reed, Hall-effect PNP or NPN and Triac



USE THE TOLOMATIC SIZING AND SELECTION SOFTWARE AVAILABLE ON-LINE AT www.tolomatic.com OR... CALL TOLOMATIC AT 1-800-328-2174. We will provide any assistance needed to determine the proper MX actuator for the job.

B3W Rodless Belt Driven Actuator

SWITCHES

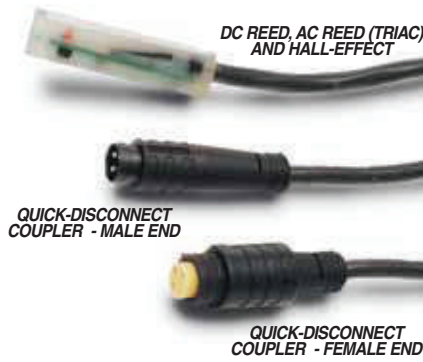

There are 10 sensing choices for this actuator: DC reed, form A (open) or form C (open or closed); AC reed (Triac, open); Hall-effect, sourcing, PNP (open); Hall-effect, sinking, NPN (open); each with either flying leads or QD (quick disconnect). Commonly used to send analog signals to PLC (programmable logic controllers), TLL, CMOS circuit or other controller device. These switches are activated by the actuator's internal magnet.

Switches contain reverse polarity protection. QD cables are shielded; shield should be terminated at flying lead end.

If necessary to remove factory installed switches, be sure to reinstall on the same side of actuator with scored face of switch toward internal magnet.

SPECIFICATIONS

	Order Code	Part Number	Lead	Switching Logic	Cable Shielding	Cable Minimum Bend Radius		Power LED	Signal LED	Operating Voltage	**Power Rating (Watts)	Voltage Drop	Current Consumption	Temp. Range
						Static	Dynamic							
REED DC	R T	3600-9082	5m	"A" Normally Open	Unshielded	0.630" [16mm]	not recommended	None	Red	200 Vdc max.	10.0 [§]	2.6 V typical at 100 mA	—	-40° to 158° F [-40° to 70° C]
	R M	3600-9083	QD*		Shielded†	0.630" [16mm]	1.260" [32mm]							
	B T	3600-9084	5m	"C" Normally Open or Closed	Unshielded	0.630" [16mm]	not recommended	None	None	120 Vdc max.	3.0 ^{§§}	NA		
	B M	3600-9085	QD*		Shielded†	0.630" [16mm]	1.260" [32mm]							
REED AC	C T	3600-9086	5m	Triac Normally Open	Unshielded	0.630" [16mm]	not recommended	None	None	120 Vac max.	10.0	—	1 Amp at 86° F [30°C]	
	C M	3600-9087	QD*		Shielded†	0.630" [16mm]	1.260" [32mm]							0.5 Amp at 140° F [60°C]
HALL-EFFECT DC	T T	3600-9088	5m	PNP (Sourcing) Normally Open	Unshielded	0.630" [16mm]	not recommended	None	Red	5 - 25 Vdc	5.0	—	200mA @25Vdc	
	T M	3600-9089	QD*		Shielded†	0.630" [16mm]	1.260" [32mm]							
	K T	3600-9090	5m	NPN (Sinking) Normally Open	Unshielded	0.630" [16mm]	not recommended	None	Red					
	K M	3600-9091	QD*		Shielded†	0.630" [16mm]	1.260" [32mm]							

CAUTION: DO NOT OVER TIGHTEN SWITCH HARDWARE WHEN INSTALLING!

WARNING: Do not exceed power rating (Watt = Voltage X Amperage). Permanent damage to sensor will occur.

*QD = Quick Disconnect; Male coupler is located 6" [152mm] from sensor, Female coupler to flying lead (part #2503-1025) distance is 197" [5m] also see Cable Shielding specification above

REPLACEMENT OF QD SWITCHES MANUFACTURED BEFORE JULY 1, 1997: It will be necessary to replace or rewire the female end coupler.



†Shielded from the female quick disconnect coupler to the flying leads. Shield should be terminated at flying lead end.

§ Maximum current 500mA (not to exceed 10VA) Refer to Temperature vs. Current graph and Voltage Derating graph

§§ Maximum current 250mA (not to exceed 3VA) Refer to Temperature vs. Current graph and Voltage Derating graph

Reed Switch Life Expectancy: Up to 200,000,000 cycles (depending on load current, duty cycle and environmental conditions)

B3W Rodless Belt Driven Actuator

SWITCHES

TEMP. vs CURRENT, DC REED

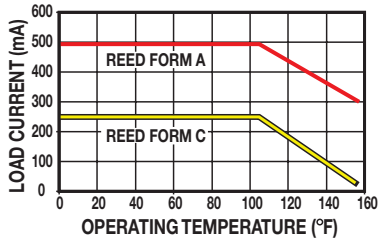

TEMP. vs CURRENT, AC REED

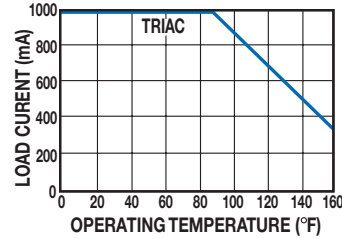

VOLTAGE DERATING, DC REED

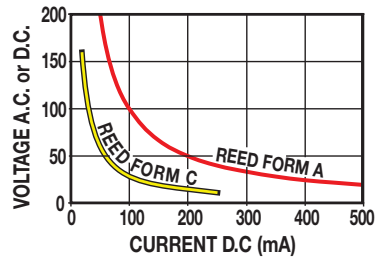

WIRING DIAGRAMS

DC REED, FORM A

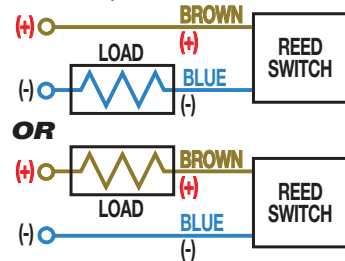

DC REED, FORM C

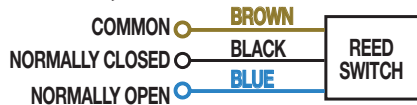

AC REED, TRIAC

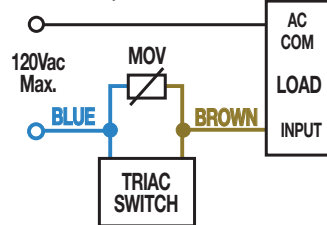

HALL-EFFECT, SOURCING, PNP

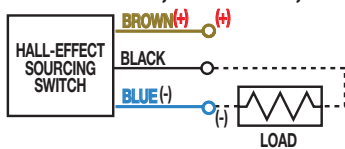

HALL-EFFECT, SINKING, NPN

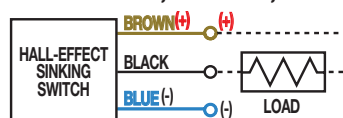

⚠ THE NOTCHED FACE OF THE SWITCH INDICATES THE SENSING SURFACE AND MUST FACE TOWARD THE MAGNET.



⚠ THE NOTCHED GROOVE IN THE ACTUATOR INDICATES THE GROOVE TO INSTALL THE SWITCH. CONTACT TOLOMATIC IF SWITCHES ARE REQUIRED ON ANOTHER SIDE OF ACTUATOR.

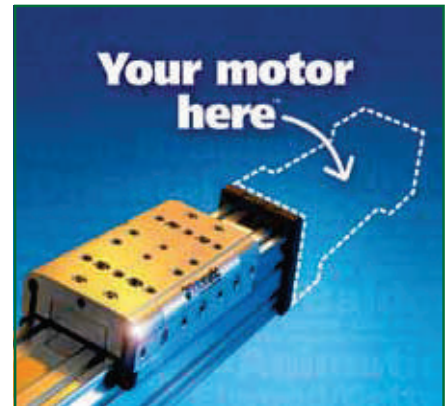

CUSTOM MOTOR MOUNTS. FIVE DAYS.

- Select a high-performance Tolomatic electric actuator and we'll provide a motor-specific interface for YOUR motor. With our online database, you can select from over 60 motor manufacturers and hundreds of models.

Visit www.tolomatic.com/ymh today to find your motor/actuator match!

or

Select a complete system from tolomatic



- Motors • Drives • Controllers • Gearboxes

Tolomatic offers digital servo or stepper drives with motors matched to provide optimal performance with Tolomatic actuators.

CONFIGURE AN ACTUATOR AND A COMPLETE MOTION CONTROL SYSTEM TODAY USING TOLOMATIC'S EASY-TO-USE SIZING & SELECTION SOFTWARE



Available FREE at www.tolomatic.com

B3W Rodless Belt Driven Actuator

ORDERING



BASE MODEL SPECIFICATIONS

B3WD 20 BWS40 SK56 SDTR

OPTIONS SPECIFICATIONS

DC18 TS2 BM2 TN16

MODEL TYPE

B3W B3W Series Belt Drive
B3WD B3W Series Belt Drive with Dual 180° Carrier
M3W* B3W Series Metric Belt Drive
M3WD* B3W Series Metric Belt Drive with Dual 180° Carrier

** The M3W metric version provides metric tapped holes for mounting of the load to the carrier and of the actuator to mounting surfaces*

TUBE BORE DIAMETER

10 1-inch (25 mm) bore
15 1 1/2-inch (40 mm) bore
20 2-inch (50 mm) bore

BELT MATERIAL AND WIDTH

BWS18 18mm Polyurethane Steel belt (B3W10)
BWS30 30mm Polyurethane Steel belt (B3W15)
BWS40 40mm Polyurethane Steel belt (B3W20)

STROKE LENGTH

SK _ _ _ _ Stroke, enter desired stroke length in decimal inches

MOTOR MOUNTING / REDUCTIONS

(must choose one)

SDL, SDLB* Direct Drive on left
SDR, SDRB* Direct Drive on right

▲ A motor size and code must be selected when specifying a 3:1 reduction. Reference the ordering pages* in sections F, G and H for the motor types and selections.

SDTL, SDTLB* 3:1 Reduction on top left
SDTR, SDTRB* 3:1 Reduction on top right
SDBL, SDBLB* 3:1 Reduction on bottom left
SDBR, SDBRB* 3:1 Reduction on bottom right
** For Dual Stub Shaft option*

AUXILIARY CARRIER

DC _ _ _ _ Auxiliary Carrier, enter center-to-center spacing desired in decimal inches.

▲ Center-to-Center spacing will add to overall dead length and will not subtract from the stroke length

GEARBOX, CONTROLS, MOTORS

Brushless Motors & Controls:
Servo 3600-4609, see F Section
Stepper Motors & Controls: see Literature #3600-4160
Gearbox See Literature #3600-4161

SUPPORTS AND MOUNTING PLATES

(both may be selected)

TS _ Tube Supports, enter quantity desired
MP _ Mounting Plates, enter quantity desired

SWITCHES

CODE	TYPE	QUICK-DISCONNECT	LEAD LENGTH	QUANTITY
RM	Form A	QD	5 meters	After code enter quantity desired
RT		no		
BM		QD		
BT	Form C	no		
KM		QD		
KT	Sinking	no		
TM	Sourcing	QD		
TT		no		
CM	TRIAC	QD		
CT		no		

T-NUTS

TN _ Additional T-Nuts, enter quantity

▲ Not all codes listed are compatible with all options.
Use Tolomatic Sizing Software to determine available options and accessories based on your application requirements.

FIELD RETROFIT KITS						
ITEM	B3W10	B3W15	B3W20	M3W10	M3W15	M3W20
Tube Supports	3410-9006	3415-9006	3420-9006	4410-9006	4415-9006	4420-9006
Tube Supports (B3WD Dual 180° models)	3410-9170	3415-9170	3420-9170	4410-9170	4415-9170	4420-9170
1/2" Mounting Plates (MRV 23-frame motors)	3410-9056	3415-9056	—	4410-9030	4415-9030	—
1/2" Mounting Plates (MRV all frame motors)	—	—	3420-9056	—	—	4420-9030
1" Mounting Plates (MRV all frame motors)	3410-9057	—	—	4410-9031	—	—
1" Mounting Plates (MRV 34-frame motors)	—	3415-9057	—	—	4415-9031	—

THE TOLOMATIC DIFFERENCE

What you expect from the industry leader:



EXCELLENT CUSTOMER SERVICE & TECHNICAL SUPPORT

Our people make the difference! Expect prompt, courteous replies to all of your application and product questions.



INDUSTRY LEADING DELIVERIES

Standard catalog products are built to order and ready-to-ship in 5 days or less. Modified and custom products ship weeks ahead of the competition.

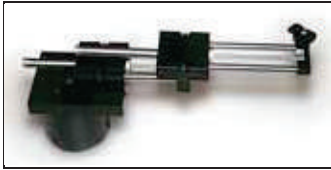

INNOVATIVE PRODUCTS

From standard catalog products... to modified products... to completely unique custom products, Tolomatic designs and builds the best solutions for your challenging applications.



SIZING & SELECTION SOFTWARE

Windows® compatible, downloadable from our website – FREE – the best tool of its kind on the market! Product selection has never been easier.



3D MODELS & 2D DRAWINGS AVAILABLE ON THE WEB

Easy to access CAD files are available in many popular formats.

ALSO CONSIDER THESE OTHER TOLOMATIC PRODUCTS:

PNEUMATIC PRODUCTS



RODLESS CYLINDERS: Band Cylinders, Cable Cylinders, MAGNETICALLY COUPLED CYLINDERS/SLIDES; GUIDED ROD CYLINDER SLIDES; ROTARY ACTUATORS
"FOLDOUT" BROCHURE #9900-9075 PRODUCTS BROCHURE #9900-4028 www.tolomatic.com/pneumatic

ELECTRIC PRODUCTS



ROD & GUIDED ROD STYLE ACTUATORS, HIGH THRUST ACTUATORS, SCREW & BELT DRIVE RODLESS ACTUATORS, MOTORS, AXIOM DRIVES/CONTROLLERS
"FOLDOUT" BROCHURE #9900-9074 PRODUCTS BROCHURE #9900-4016 www.tolomatic.com/electric

POWER TRANSMISSION PRODUCTS



GEARBOXES: Float-A-Shaft®, Slide-Rite®; DISC CONE CLUTCH; CALIPER DISC BRAKE
"FOLDOUT" BROCHURE #9900-9076 PRODUCTS BROCHURE #9900-4029 www.tolomatic.com/pt



3800 County Road 116 • Hamel, MN 55340 U.S.A.
Phone: (763) 478-8000 • Fax: (763) 478-8080

Toll-Free: **1-800-328-2174**

Email: help@tolomatic.com • <http://www.tolomatic.com>

All brand and product names are trademarks or registered trademarks of their respective owners. Information in this document is believed accurate at time of printing. However, Tolomatic assumes no responsibility for its use or for any errors that may appear in this document. Tolomatic reserves the right to change the design or operation of the equipment described herein and any associated motion products without notice. Information in this document is subject to change without notice.

Visit www.tolomatic.com for the most up-to-date technical information



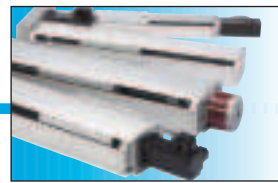

APPLICATION BENEFITS

- High precision with straightness and flatness within 0.0002 inches per inch
- Superior rigidity with high moment loads
- Lowest deflection rate of any Tol-O-Matic actuator
- Excellent repeatability
- Wide stable platform for XY applications

GUIDANCE SYSTEM



- Ground linear profiled rails and ball bearing blocks decrease deflection and provide smooth carrier/load movement

STANDARD MOUNTING



- Mounting holes are spaced the length of the actuator for ease in mounting directly to a flat surface.

ACTUATOR/MOTOR FACTORS

- Actuator's operating temperature range (40-130° F, 4-54° C) should take into consideration heat generated by the motor and drive, linear velocity and work cycle time.
- For large frame motors or small actuators, cantilevered motors need to be supported, if subjected to continuous rapid reversing duty and/or under dynamic conditions.

AVAILABLE OPTIONS



Mounting Plates: provide clearance height for motors and motor mounts when mounting on a flush surface. Recommended on all TruTrack actuators, they prevent actuator body deflections over 0.015 in (3.8mm).



Auxiliary Carrier: Increases rigidity, load-carrying capacity and bending moments



Double C-face Brake: a power-off holding brake with an output shaft.

Double C-Face brakes are used for static holding (back driving prevention) and are not designed for dynamic stopping. If your application requires stopping, please contact Tol-O-Matic.



Bellows: protects from dust and dirt environments.



Motor Mounting and Gearhead Reduction:

In-line Motor Mounting— motor is internally coupled to the actuator shaft.



Reverse-parallel Motor Mounting—These factory assembled configurations allow offset mounting of the motor to either side of, or below the actuator. Available in 1:1 or 2:1 drive ratios, they offer quiet, zero-backlash coupling of the motor to the actuator screw shaft.



Gearhead Reduction—Gearheads are available for applications requiring reduction for inertia matching or higher torque at lower speeds. High efficiency, single stage, true planetary gearheads are available in 5.5:1 and 10:1 ratios for reduction solutions with most Tol-O-Matic NEMA 23- and 34-frame motors. For gearhead specifications and dimensions, see page F-10.



Switches: Available in ac reed or dc Hall-effect. (Triac switches are not available on TruTrack actuators) See section I.



RODLESS

TKS Series

- Application benefits
- Bearing system
- Standard mounting
- Actuator/motor factors
- Available options

TRUtrack™ TKS Screw Drives

ACME AND BALL SCREW/NUT COMBINATIONS

TKS ENGLISH ACME AND BALL SCREW CRITICAL SPEED CAPACITIES

CRITICAL SPEED WITH ENGLISH ACME SCREW

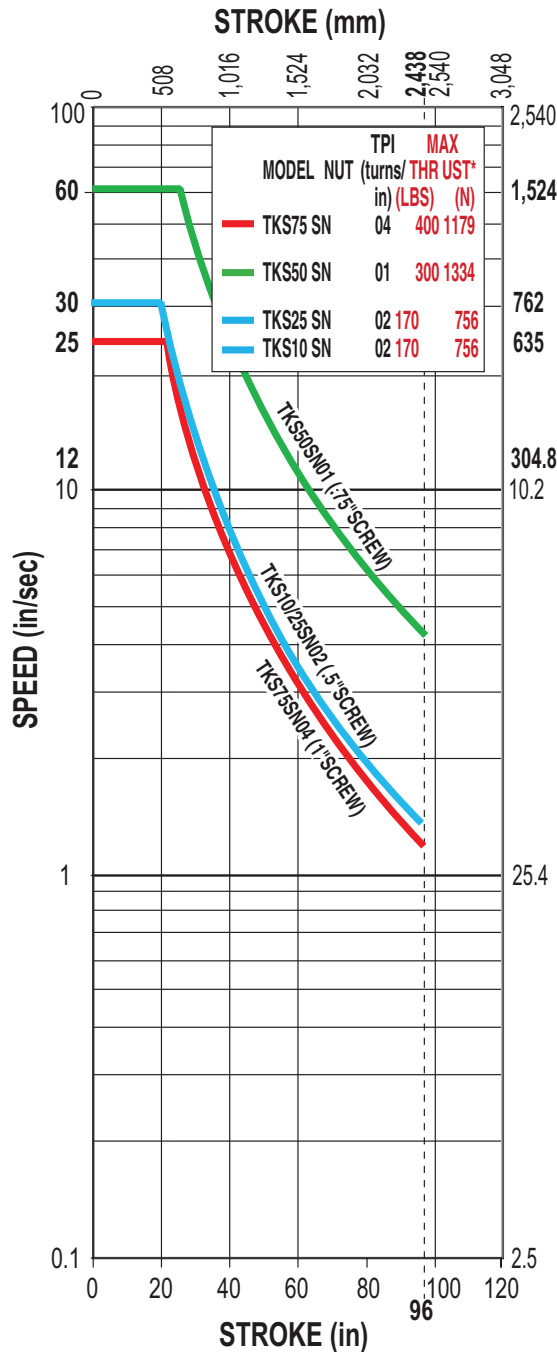

CRITICAL SPEED WITH ENGLISH BALL SCREW

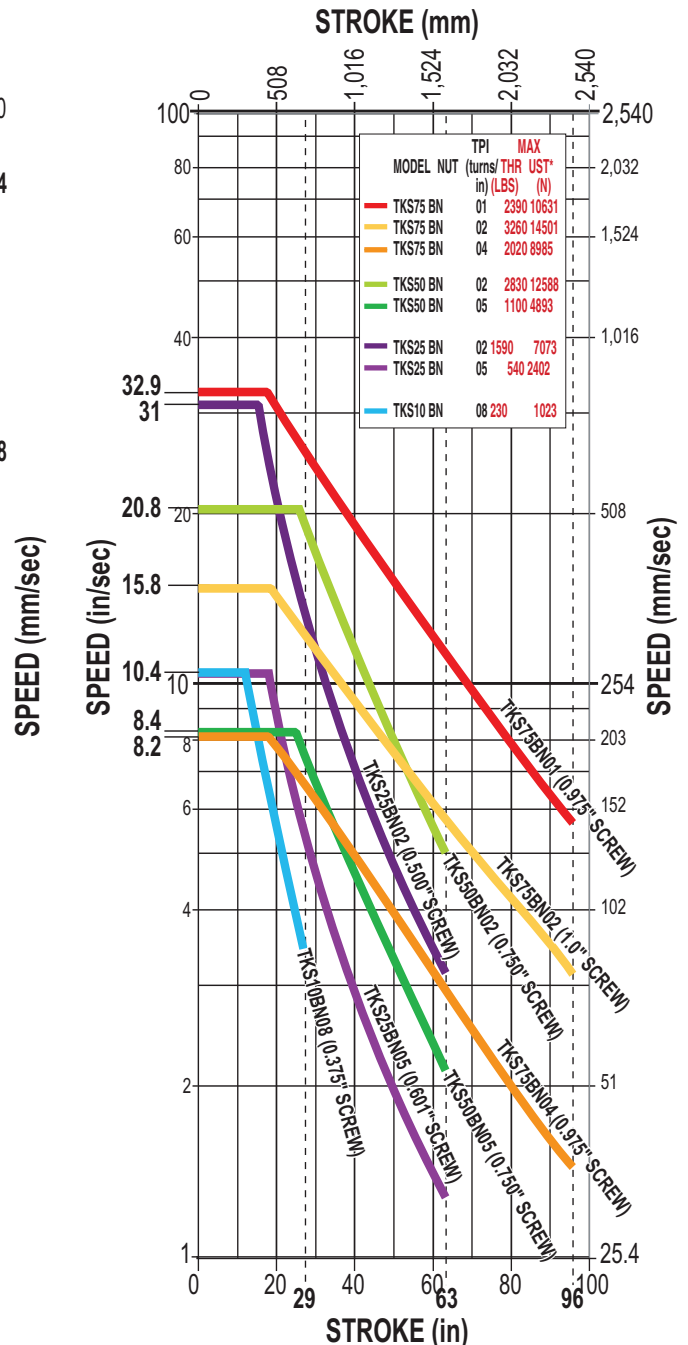

RODLESS

TKS Series

- Acme screw/nut combinations
- Acme screw critical speed
- Ball screw/nut combinations
- Ball screw critical speed



* For Acme screws, maximum thrust is the maximum continuous dynamic thrust subject to Thrust x Velocity limitation. For ball screws, maximum thrust reflects 90% reliability for 1 million linear inches of travel.

Dotted lines represent maximum stroke for screw selections.

For Acme Screw PV limits, refer to the individual charts located in the technical section for each actuator body size.

SCREW TYPE	DESCRIPTION
SN	Solid Nut
BN	Ball Nut

Axi *dyne*™ TRUTrack™ TKS Screw Drives

BALL SCREW SPECIFICATIONS

TKS ENGLISH BALL SCREW LIFE CALCULATION

LIFE CAPACITIES WITH ENGLISH BALL SCREW

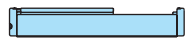
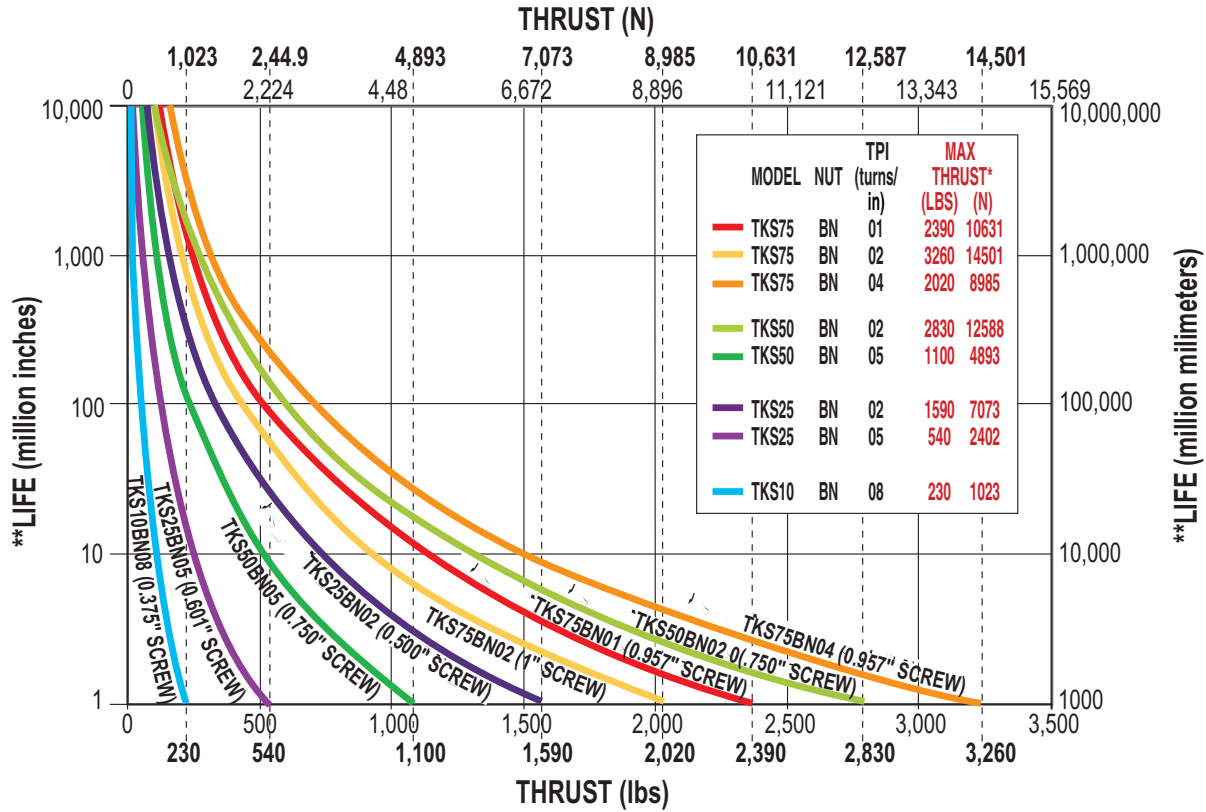

RODLESS

- TKS Series**
- Ball screw life capacities

SCREW TYPE	DESCRIPTION
BN	Ball Nut



* Maximum thrust reflects 90% reliability for 1 million linear inches of travel.

Dotted lines represent maximum thrust for screw selections.

**Life indicates theoretical maximum life of screw only, under ideal conditions and does not indicate expected life of actuator.

Axi *dyne*® TRUTrack™ TKS Screw Drives

OVERALL SERIES SPECIFICATIONS

SPECIFICATIONS RELATED TO ACTUATOR SIZE AND SCREW SELECTION

TKS ENGLISH LEAD SCREWS											
ACTUATOR SERIES	SCREW DIA. (in)	SCREW TYPE	TPI (turns/in)	LEAD ACCURACY (in/ft)	BACKLASH (in)	MAXIMUM THRUST* (lb)	MAXIMUM STROKE (in)	INERTIA (lb-in ²)			BREAKAWAY TORQUE (lb-in)
								BASE ACTUATOR		PER/in OF STROKE	
								In Line	Rev. Parallel		
TKS10	0.500	SN	02	0.003	0.007	170	96	0.0126	0.0159	0.0017	0.938
	0.375	BN	08	0.004	0.002	230	29	0.0029	0.0038	0.0005	0.813
TKS25	0.500	SN	02	0.003	0.007	170	96	0.0263	0.0291	0.0017	1.750
	0.500	BN	02	0.004	0.002	1590	63	0.0263	0.0291	0.0017	1.438
TKS50	0.625	BN	05	0.004	0.002	540	63	0.0311	0.0380	0.0042	1.063
	0.750	SN	01	0.003	0.007	300	96	0.1472	0.1577	0.0087	3.750
TKS75	0.750	BN	02	0.004	0.002	2830	63	0.0867	0.0972	0.0087	1.875
	0.750	BN	05	0.004	0.002	1100	63	0.0698	0.0803	0.0087	1.500
TKS100	1.00	SN	04	0.003	0.007	400	96	0.2196	0.2737	0.0275	2.813
	1.00	BN	01	0.004	0.002	2390	96	0.3037	0.3578	0.0275	3.438
	1.00	BN	02	0.004	0.002	3260	96	0.2364	0.2905	0.0275	2.813
	1.00	BN	04	0.004	0.002	2020	96	0.2196	0.2737	0.0275	2.500

METRIC CONVERSIONS											
ACTUATOR SERIES	SCREW Ø (in)	SCREW TYPE	TPI (turns/in)	LEAD ACCURACY (mm/300)	BACKLASH (mm)	MAXIMUM THRUST* (N)	MAXIMUM STROKE (mm)	INERTIA (kg-m ² x 10 ⁻⁴)			BREAKAWAY TORQUE (N-m)
								BASE ACTUATOR		PER/mm OF STROKE	
								In Line	Rev. Parallel		
TKS10	0.50	SN	02	0.0762	0.1778	756	2438	3.69	4.65	0.50	0.11
	0.375	BN	08	0.1016	0.0508	1023	737	0.85	1.11	0.15	0.09
TKS25	0.50	SN	02	0.0762	0.1778	756	2438	7.69	8.51	0.49	0.20
	0.50	BN	02	0.1016	0.0508	7073	1600	7.69	8.51	0.49	0.16
TKS50	0.625	BN	05	0.1016	0.0508	2402	1600	9.10	11.12	2.17	0.12
	0.75	SN	01	0.0762	0.1778	1334	2438	43.06	46.13	2.54	0.42
TKS75	0.75	BN	02	0.1016	0.0508	12588	1600	25.36	28.43	2.54	0.21
	0.75	BN	05	0.1016	0.0508	4893	1600	20.42	23.49	2.54	0.17
TKS100	1.00	SN	04	0.0762	0.1778	1779	2438	64.23	80.06	8.04	0.31
	1.00	BN	01	0.1016	0.0508	10631	2438	88.83	104.66	8.04	0.39
	1.00	BN	02	0.1016	0.0508	14234	2438	69.15	84.97	8.04	0.31
	1.00	BN	04	0.1016	0.0508	8985	2438	64.23	80.06	8.04	0.28

 **Contact the factory for higher accuracy and lower backlash options.**

* For Acme screws, maximum thrust is the maximum continuous dynamic thrust subject to Thrust x Velocity limitation. For ball screws, maximum thrust reflects 90% reliability for 1 million linear inches of travel.

SCREW TYPE	DESCRIPTION
SN	Solid Nut
BN	Ball Nut

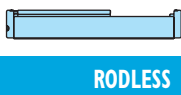

RODLESS

TKS Series
• Actuator/Nut specifications

OVERALL SERIES SPECIFICATIONS

GENERAL ACTUATOR SPECIFICATIONS

SPECIFICATIONS	TKS ENGLISH ACTUATORS				METRIC CONVERSIONS			
	TKS10	TKS25	TKS50	TKS75	TKS10	TKS25	TKS50	TKS75
Carrier weight (lbs : kg)	0.56	2.31	3.18	3.54	0.25	1.05	1.44	1.61
Base weight in-line model (including carrier without motor) (lbs : kg)	3.22	9.46	14.56	17.95	1.46	4.29	6.60	8.14
Weight per/in (mm) of stroke (lbs : kg)	0.229	0.527	0.728	0.932	0.10	0.24	0.33	0.42
Straightness (YX Plane) (unconstrained ¹) (in/in : mm/mm)	0.0004	0.0004	0.0004	0.0004	0.0004	0.0004	0.0004	0.0004
Straightness (YX Plane) (constrained ²) (in/in : mm/mm)	0.0002	0.0002	0.0002	0.0002	0.0002	0.0002	0.0002	0.0002
Flatness (ZX Plane) (unconstrained ¹) (in/in : mm/mm)	0.0008	0.0008	0.0008	0.0008	0.0008	0.0008	0.0008	0.0008
Flatness (ZX Plane) (constrained ²) (in/in : mm/mm)	0.0002	0.0002	0.0002	0.0002	0.0002	0.0002	0.0002	0.0002
Screw uni-directional repeatability ³ (in : mm)	±0.0004	±0.0004	±0.0004	±0.0004	±0.010	±0.010	±0.010	±0.010
Temperature Range ⁴ (F° : C°)	40-130	40-130	40-130	40-130	4-54	4-54	4-54	4-54



RODLESS

TKS Series

- General actuator specifications
- Friction force
- Lubrication
- Mounting recommendations



¹ Listed values are intended for reference purposes only, and not as an engineering standard of absolute tolerance for a given actuator. Values were derived from testing of characteristic samples of appropriate products, and indicate an expected range of deviation from a theoretical straight line in the indicated plane of carrier motion. Appropriate installation is the single most important factor in reducing such deviation, so good engineering practices such as measurement, mapping, etc. must be employed in applications with stringent straightness/flatness requirements. For more information on how these values were obtained, please read the white paper on this subject available at www.tolomatic.com.

² Actuator mounted on a flat surface and fully restrained. (See dimensional drawings on pages C-58, C-64, C-70 and C-76)

³ Ball screw; not including backlash

⁴ Heat generated by the motor and drive should be taken into consideration as well as linear velocity and work cycle time. For applications that require operation outside of the recommended temperature range, contact the factory.

LARGE FRAME MOTORS AND SMALLER SIZE ACTUATORS: Cantilevered motors need to be supported, if subjected to continuous rapid reversing duty and/or under dynamic conditions.

FRICITION FORCE

$$lbf = 0.0003 \times \text{LOAD (lb)} + 3.96$$

$$N = 0.003 \times \text{LOAD (kg)} + 17.6$$

LUBRICATION

Proper and adequate lubrication is essential for normal operation of TruTrack actuators. Poor lubrication will cause quicker wear and decrease service life of the actuator. For general use, lubrication should be performed at intervals of 4,000,000 linear inches of travel (100 km) or once every year, whichever occurs first. However, the operating conditions of certain applications may require more frequent lubrication. Please consult Tol-O-Matic for recommendations.

Recommended greases:

- Multi-purpose grease based on refined mineral oil containing lithium thickening agent (excellent at high pressures, excellent viscosity stability).
- Grease based on a high-grade synthetic oil containing a urea thickening agent (long life, wide temperature range).

MOUNTING RECOMMENDATIONS

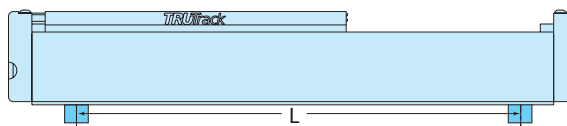
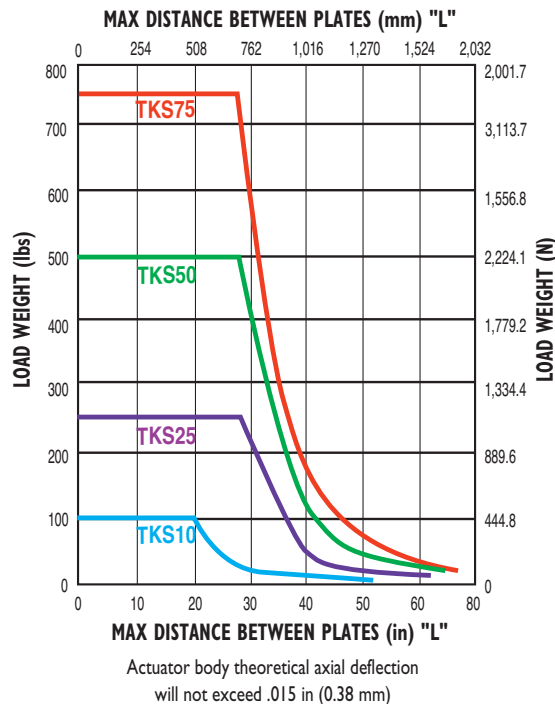

Axi-dyne[®] TRUTrack™ TKS Screw Drives

OVERALL SERIES SPECIFICATIONS

BENDING MOMENTS AND LOADS

STANDARD CARRIER		MAXIMUM BENDING MOMENTS AND LOADS*				ENGLISH		METRIC CONVERSIONS		
		TKS10	TKS25	TKS50	TKS75	TKS10	TKS25	TKS50	TKS75	
	Maximum Dynamic Bending Moments									
	Mx (Roll)	(lb-in : N-m)	85	721	971	1151	9.6	81.5	109.7	130.0
	My (Pitch)	(lb-in : N-m)	234	1014	1442	1477	26.4	114.6	162.9	166.9
	Mz (Yaw)	(lb-in : N-m)	234	915	1301	1332	26.4	103.4	147.0	150.5
	Maximum Dynamic Loads									
	Fy (Radial Load)	(lb : N)	100	250	500	750	445	1113	2225	3338
	Fz (Lateral Load)	(lb : N)	100	250	500	750	445	1113	2225	2225
	Fzr (Reverse Lateral Load)	(lb : N)	100	250	500	750	445	1113	2225	2225
	Maximum Static Bending Moments									
	Mx (Roll)	(lb-in : N-m)	170	1251	1685	1997	19.2	141.3	190.3	225.6
My (Pitch)	(lb-in : N-m)	468	1759	2502	2563	52.9	198.8	282.7	289.5	
Mz (Yaw)	(lb-in : N-m)	468	1588	2257	2311	52.9	179.4	255.0	261.1	
Maximum Static Loads										
Fy (Radial Load)	(lb : N)	200	434	868	1301	890	1931	3863	5789	
Fz (Lateral Load)	(lb : N)	200	434	868	868	890	1931	3863	3863	
Fzr (Reverse Lateral Load)	(lb : N)	200	434	868	868	890	1931	3863	3863	
AUXILIARY CARRIER: Increases rigidity, load-carrying capacity and moments		TKS10	TKS25	TKS50	TKS75	TKS10	TKS25	TKS50	TKS75	
	Maximum Dynamic Bending Moments									
	Mx (Roll)	** (lb-in : N-m)	170	1442	1942	2302	19.2	162.9	219.4	260.1
	My (Pitch)	** (lb-in : N-m)	563	1733	3810	3875	63.6	195.7	430.5	437.8
	Mz (Yaw)	** (lb-in : N-m)	563	1733	3810	3875	63.6	195.7	430.5	437.8
	Maximum Dynamic Loads									
	Fy (Radial Load)	(lb : N)	200	500	1000	1500	890	2225	4450	6675
	Fz (Lateral Load)	(lb : N)	200	500	1000	1500	890	2225	4450	4450
	Fzr (Reverse Lateral Load)	(lb : N)	200	500	1000	1500	890	2225	4450	4450
	Maximum Static Bending Moments									
	Mx (Roll)	** (lb-in : N-m)	340	2502	3369	3994	38	283	381	451
My (Pitch)	** (lb-in : N-m)	1126	3006	6610	6723	127	340	747	760	
Mz (Yaw)	** (lb-in : N-m)	1126	3006	6610	6723	127	340	747	760	
Maximum Static Loads										
Fy (Radial Load)	(lb : N)	400	868	1735	2603	1780	3863	7721	11583	
Fz (Lateral Load)	(lb : N)	400	868	1735	1735	1780	3863	7721	7721	
Fzr (Reverse Lateral Load)	(lb : N)	400	868	1735	1735	1780	3863	7721	7721	
Minimum Dimension 'D'	(in : mm)	5.63	6.93	7.63	7.75	142.9	176.0	193.8	196.9	



* Bending moments are based on 200,000 (5,000 KM) linear inches of carrier travel.

Breakaway torque will increase when using the Auxiliary carrier option. When ordering, determine your working stroke and enter this value into the configuration string. Overall actuator length will automatically be calculated.

Deflection Considerations: In applications where substantial Mx or My moments come into play, deflection of the cylinder tube, carrier and supports must be considered. The deflection factors shown in the Load Deflection charts, are based on cylinder mounted with tube supports at minimum recommended spacing. If more rigidity is desired, refer to the Auxiliary or Dual Carrier options.

** Loads shown in table are at minimum "D" dimension, for ratings with longer "D" dimension see graph on page C-57.

Axi-dyne® TRUtrack™ TKS Screw Drives

OVERALL SERIES SPECIFICATIONS

LOAD DEFLECTION

X-AXIS DEFLECTION

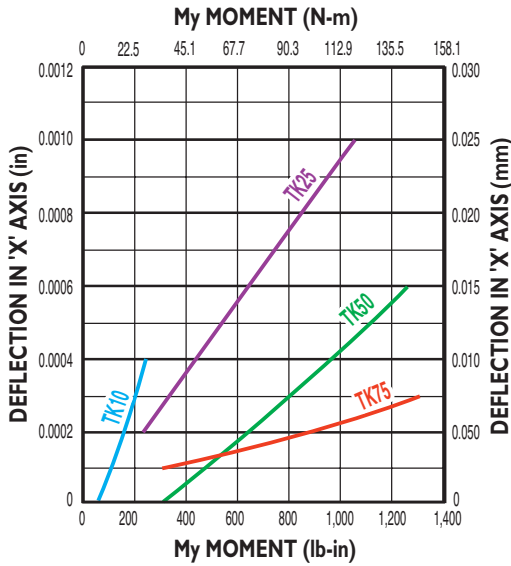
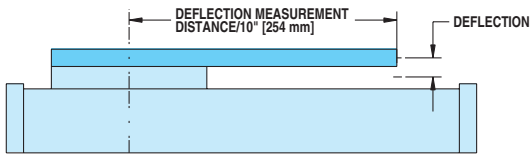

Y-AXIS DEFLECTION

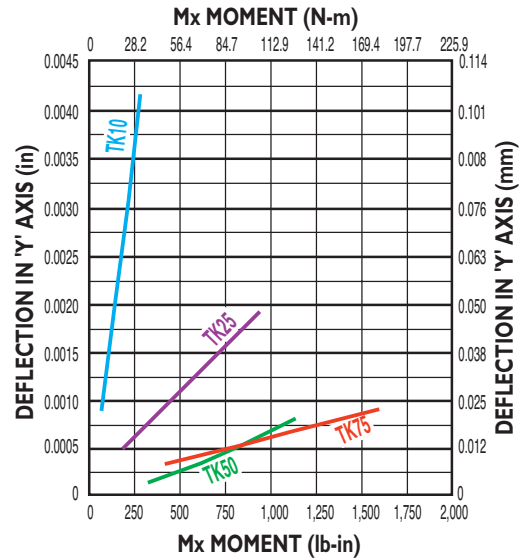
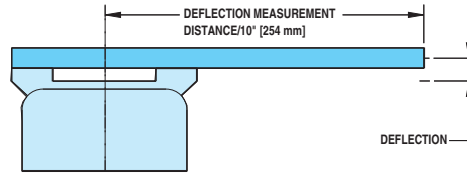

RODLESS

- TKS Series
- Load deflection
- Auxiliary Carrier

AUXILIARY CARRIER: BENDING MOMENT AT 'D' DISTANCE

DYNAMIC BENDING MOMENT

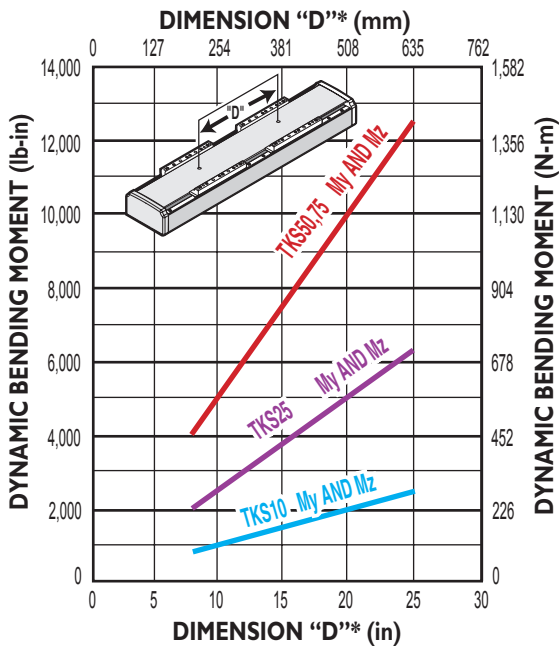

STATIC BENDING MOMENT

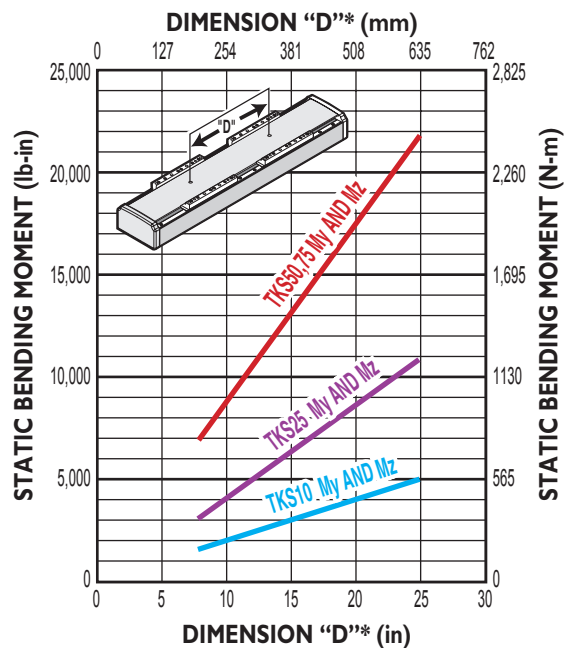

- Rates shown on charts were calculated with these assumptions:
- 1.) Coupling between carriers is rigid.
 - 2.) Load is equally distributed between carriers.
 - 3.) Coupling device applies no misalignment loads to carriers.

* Customer must specify Dimension "D" (Distance between carrier center lines) in configuration string.

Axi *dyne*® TRUTrack™ TKS Screw Drives

OVERALL SERIES SPECIFICATIONS

BELLOWS STROKE REQUIREMENTS

STANDARD ACTUATOR

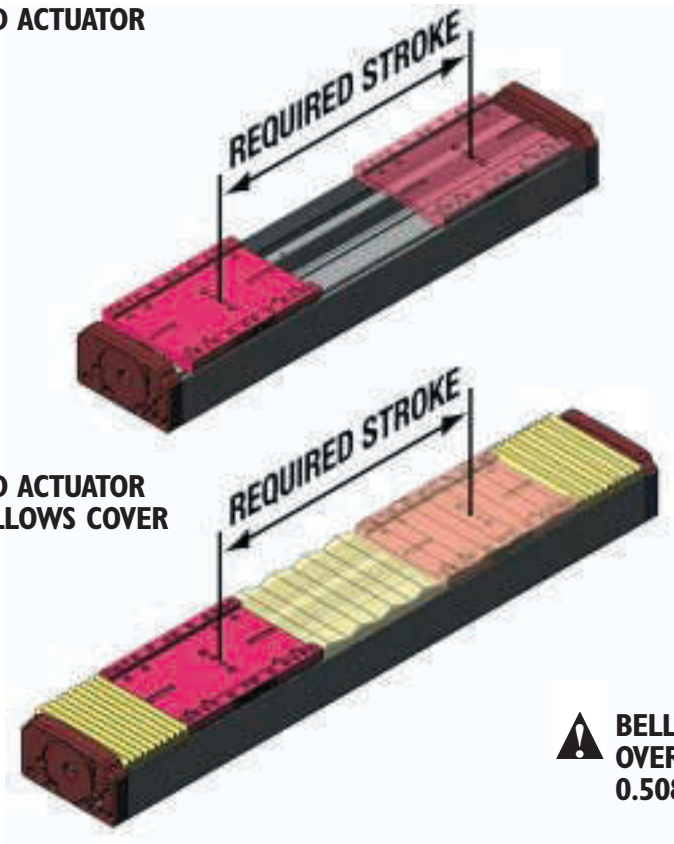

STANDARD ACTUATOR WITH BELLOWS COVER

⚠ BELLOWS COVER OPTION INCREASES OVERALL ACTUATOR LENGTH BY 0.508 x STROKE

MAXIMUM AVAILABLE STROKE FOR BELLOWS OPTION	WITH BALL NUT	WITH SOLID NUT
TKS10	24 inches (610 mm)	64 inches (1626 mm)
TKS25	44 inches (1118 mm)	64 inches (1626 mm)
TKS50	56 inches (1422 mm)	64 inches (1626 mm)
TKS75	64 inches (1626 mm)	64 inches (1626 mm)

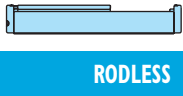

TKS Series
• Bellows stroke requirements

TRUTrack™ TKS10 Series

SCREW SPECIFICATIONS



TKS10 ACME SCREW CRITICAL SPEED AND PV LIMITS

CRITICAL SPEED WITH 0.500" 2TPI ENGLISH ACME SCREW

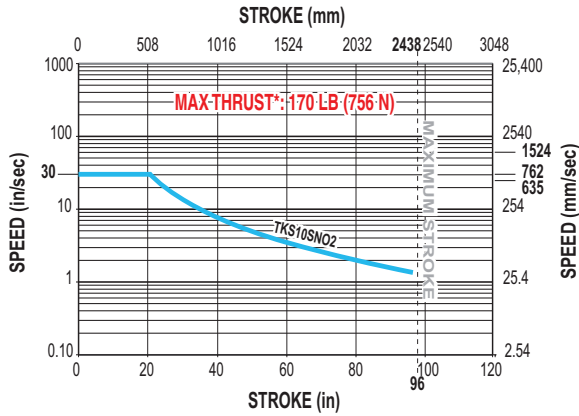

PV LIMITS: 0.500" 2 TPI ENGLISH ACME SCREW

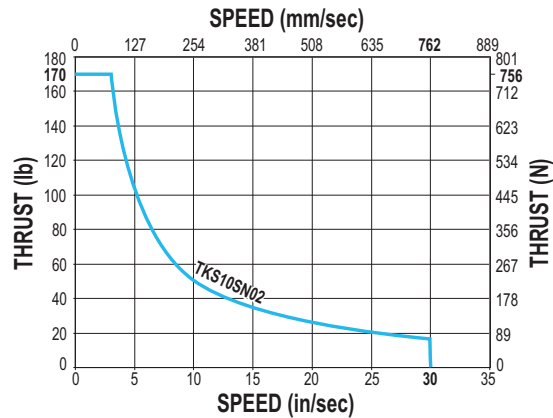

RODLESS

TKS10 Series

- Acme screw critical speed capacities and PV limits
- Ball screw critical speed capacities and life calculations

SN = Solid Nut



* Maximum thrust is the maximum continuous dynamic thrust subject to Thrust x Velocity limitation.

PV LIMITS: Any material which carries a sliding load is limited by heat buildup. The factors that affect heat generation rate in an application are the pressure on the nut in pounds per square inch and the surface velocity in feet per minute. The product of these factors provides a measure of the severity of an application.

$$P = \frac{\text{Thrust}}{\text{Max. Thrust Rating}} \times V = \frac{\text{Speed}}{\text{Max. Speed Rating}} \leq 0.1$$

TKS10 BALL SCREW CRITICAL SPEED AND LIFE CALCULATIONS

CRITICAL SPEED WITH 0.375" 8TPI ENGLISH BALL SCREW

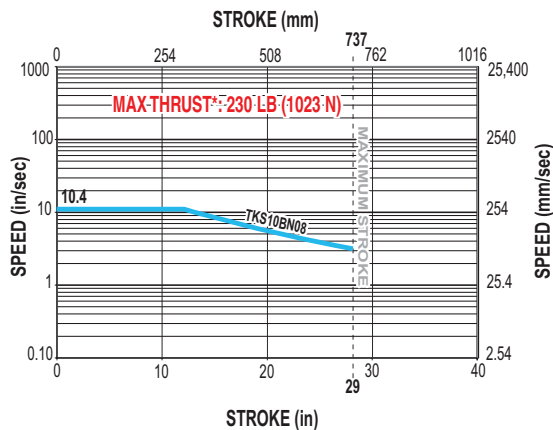

LIFE CALCULATION: 0.375" 8TPI ENGLISH BALL SCREW

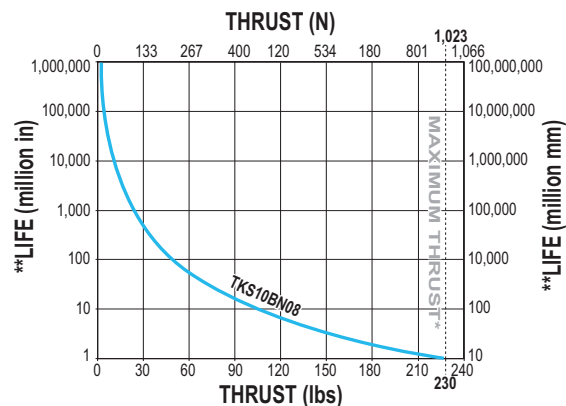

BN = Ball Nut



* Maximum thrust reflects 90% reliability for 1 million linear inches of travel.

**Life indicates theoretical maximum life of screw only, under ideal conditions and does not indicate expected life of actuator.

Axi-dyne® TRUTrack™ TKS10 Series

DIMENSIONS

TKS10 ACTUATOR AND OPTIONS



RODLESS

TKS10 Series

- Actuator and options dimensions

OPTIONAL MOUNTING PLATE

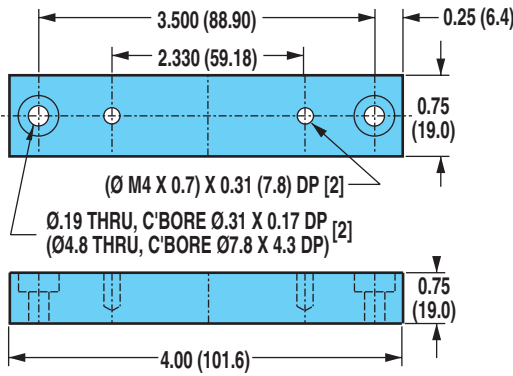

MOTOR END (END VIEW)

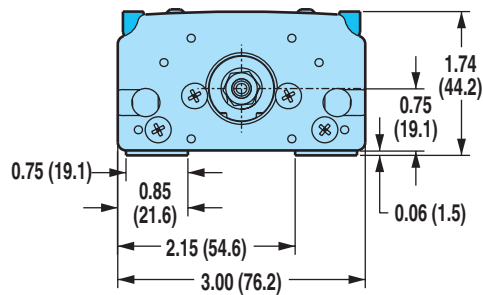

MOTOR END (IDLE END REVERSE PARALLEL (RP) UNITS)

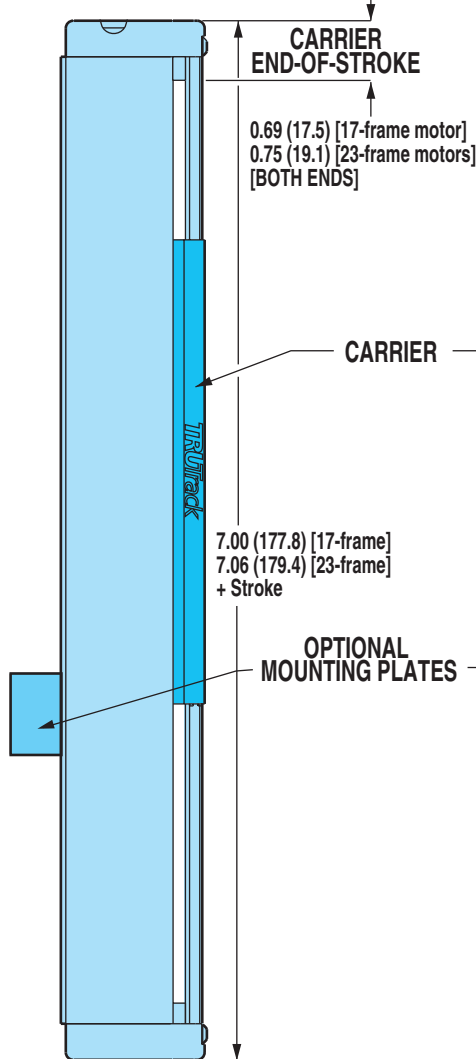

IDLE END (MOTOR END REVERSE PARALLEL (RP) UNITS)

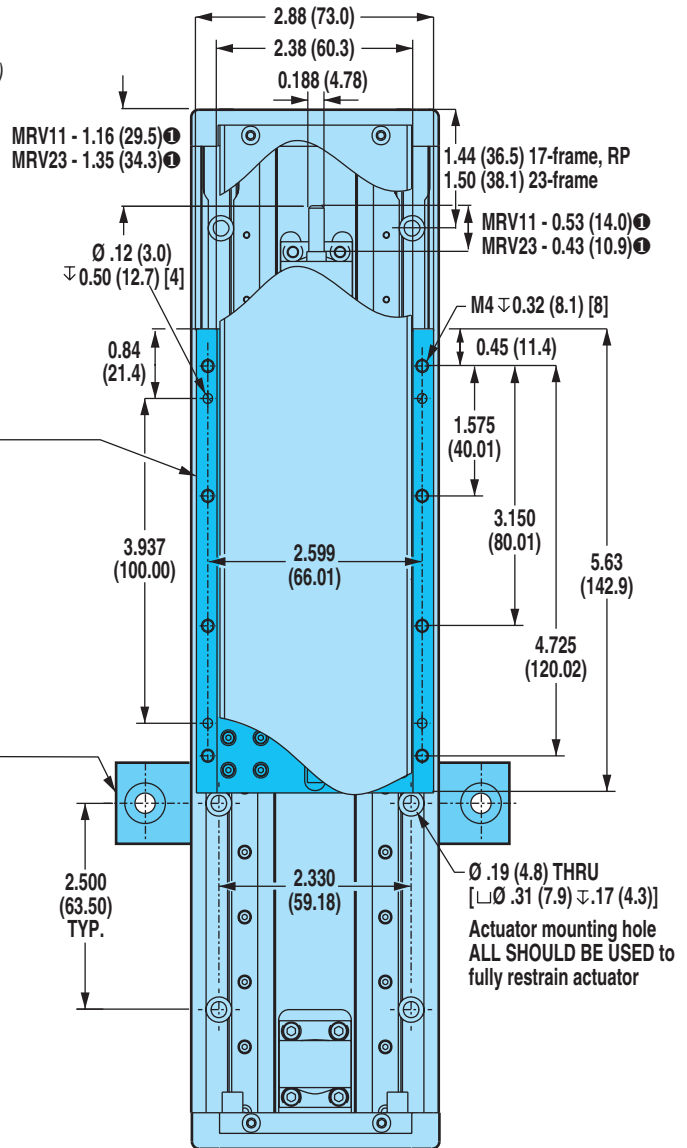

IDLE END (MOTOR END REVERSE PARALLEL (RP) UNITS)

① WHEN SPECIFYING THE XY/XJ SHAFT OPTION: IF A TOL-O-MATIC MOTOR IS NOT SPECIFIED IN THE CONFIGURATION STRING, CUSTOMER'S MOTOR MUST CONFORM TO THE SHAFT DIMENSIONS SHOWN FOR MOUNTING COMPATIBILITY. PLEASE SPECIFY YOUR MOTOR TYPE AND FRAME SIZE WHEN ORDERING.

Unless otherwise noted, all dimensions shown are in inches (Dimensions in parenthesis are in millimeters)

DIMENSIONS

TKS10: DOUBLE C-FACE BRAKE OPTION

BRAKE FOR 23-FRAME MOTOR

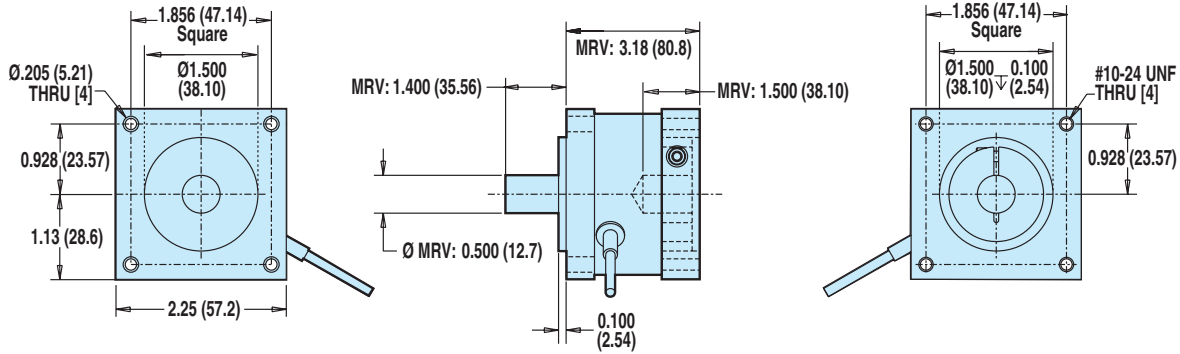

RODLESS

TKS10 Series
• Double C-face Brake dimensions

MOTOR TYPE	MOTOR/ FRAME	BRAKE PART NO.	STATIC TORQUE		REFLECTED INERTIA		WEIGHT		VOLTAGE	CURRENT	RESISTANCE	CABLE LENGTH	
			lb-in	N-m	lb-in ²	kg-m ² x 10 ⁻⁴	lb	kg				in	mm
BRUSHLESS	MRV 23	3600-6286	10	1.130	0.0125	3.66	10.6	0.48	24	0.182	132.0	16.75	425

MAXIMUM BRAKE HOLDING LOADS						
LEADSCREW/NUT REDUCTION	23-FRAME BRAKE					
	INLINE		5.5:1 GEARHEAD		10:1 GEARHEAD	
	lb	kg	lb	kg	lb	kg
TKS10 with SN02	180	81.6	180	81.6	180	81.6
TKS10 with BN08	559	253.5	1874	850.0	1874	850.0



Double C-face brakes are used for static holding (back driving prevention) and are not designed for dynamic stopping. Please contact Tol-O-Matic if your application requires dynamic stopping. This brake can be used with other Tol-O-Matic systems. Consult the factory for availability.

DIMENSIONS

TKS10: IN-LINE MOUNT FOR 17-FRAME BRUSHLESS (MRV) MOTORS

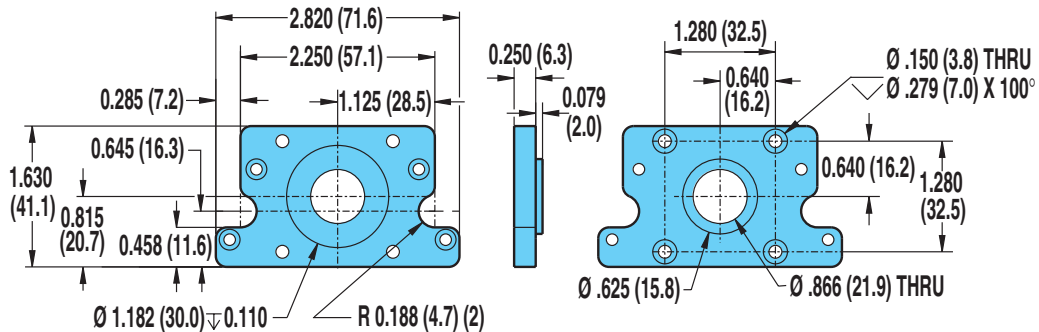

! 17-frame MRV motors cannot be mounted directly to the actuator head and require the use of the motor adapter plate shown. Gearhead option is not available with 17-frame motors.

TKS10: IN-LINE MOUNT FOR 23-FRAME BRUSHLESS (MRV) MOTORS OR GEARHEAD

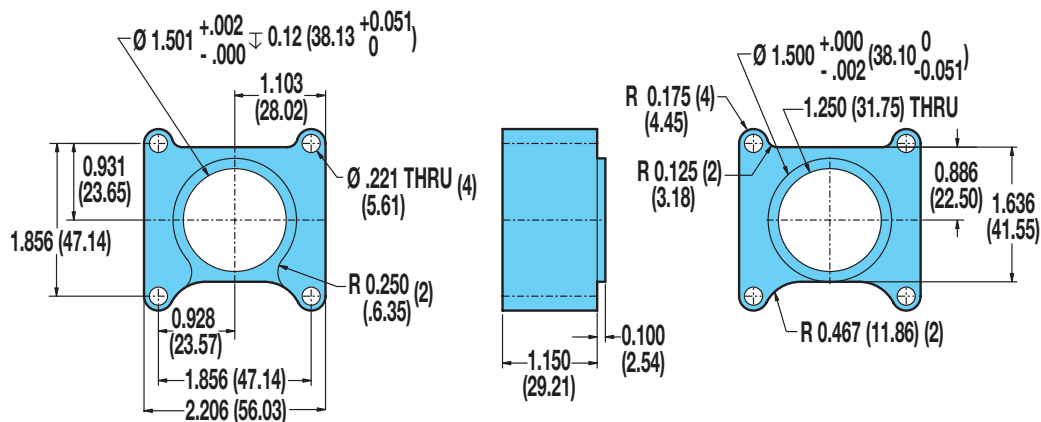

! 23-frame brushless MRV motors cannot be mounted directly to the actuator head and requires the use of the motor adapter plate shown.



INTERCHANGING MOTORS: Leadscrews on TruTrack actuators are specific to the motor type specified. Motor mounting plates do not provide for interchanging servo or stepper motors.

For gearhead dimensions and specifications, refer to page F-10.

Axi dyne® TRUTrack™ TKS10 Series

DIMENSIONS

TKS10: REVERSE PARALLEL MOUNTING

BOTTOM MOUNT

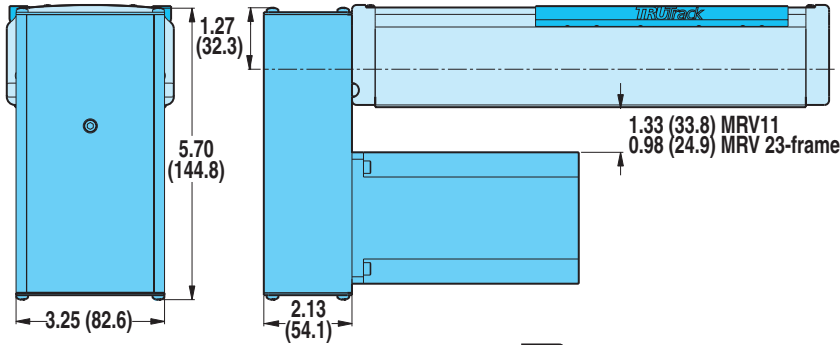

TOP MOUNT

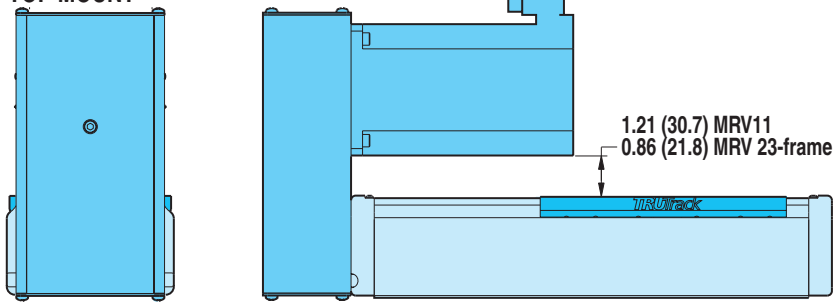

SIDE MOUNT

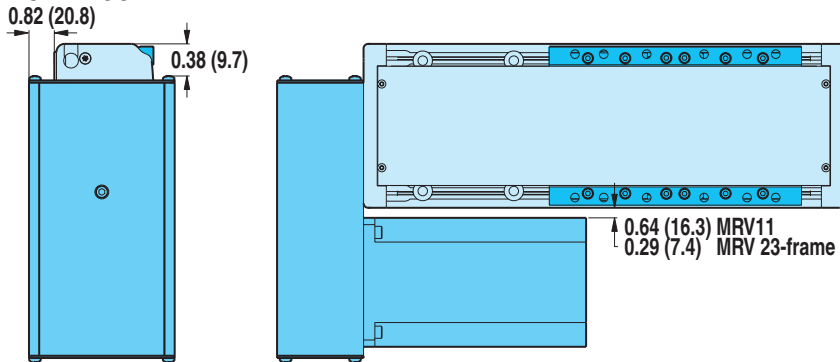

RODLESS

- TKS10 Series**
- Reverse parallel mounting

SPECIFICATIONS

MOTOR	WEIGHT OF REDUCTION DRIVE				REDUCTION INERTIA AT MOTOR SHAFT			
	1:1		2:1		1:1 RATIO		2:1 RATIO	
	lbs	kg	lbs	kg	lb-in ²	kg-cm ²	lb-in ²	kg-cm ²
BRUSHLESS MRV 11, 21, 22 23, 24	1.80	0.82	1.80	0.82	.039	.1141	.047	.1368

REDUCTION EFFICIENCY: 0.95



Axi dylene[®] TRUTrack™ TKS25 Series ACME SCREW SPECIFICATIONS

TKS25 ACME SCREW CRITICAL SPEED AND PV LIMITS

CRITICAL SPEED WITH 0.500" ENGLISH ACME SCREW

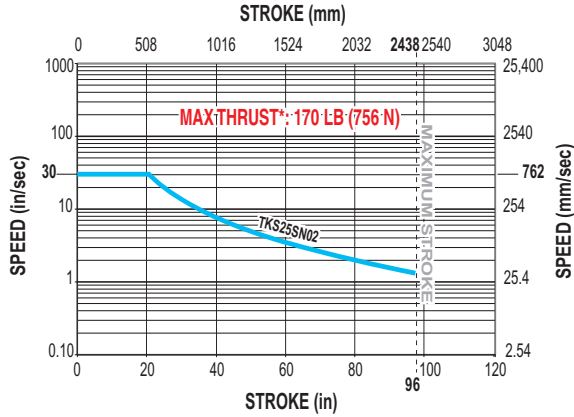

PV LIMITS: 1/2" 2 TPI ENGLISH ACME SCREW

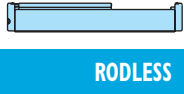
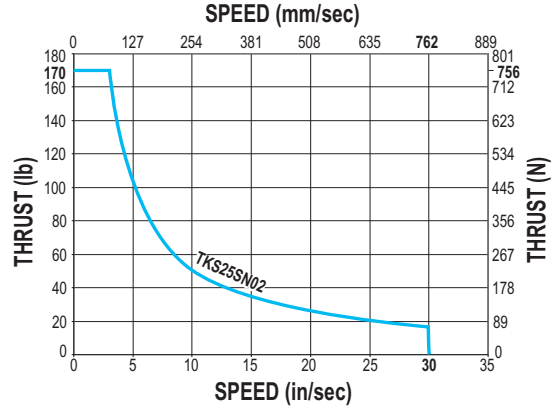

TKS25 Series
• Acme screw critical speed capacities and PV limits

SN = Solid Nut



* *Maximum thrust is the maximum continuous dynamic thrust subject to Thrust x Velocity limitation.*

PV LIMITS: Any material which carries a sliding load is limited by heat buildup. The factors that affect heat generation rate in an application are the pressure on the nut in pounds per square inch and the surface velocity in feet per minute. The product of these factors provides a measure of the severity of an application.

$$P = \frac{\text{Thrust}}{\text{Max. Thrust Rating}} \times V = \frac{\text{Speed}}{\text{Max. Speed Rating}} \leq 0.1$$

TRUtrack™ TKS25 Series

BALL SCREW SPECIFICATIONS

TKS25 BALL SCREW CRITICAL SPEED AND LIFE CALCULATIONS

CRITICAL SPEED WITH 0.500" 2TPI ENGLISH BALL SCREW

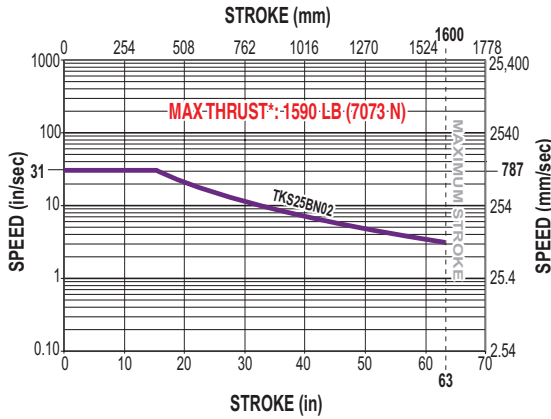

LIFE CALCULATION: 0.500" 2TPI ENGLISH BALL SCREW

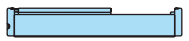
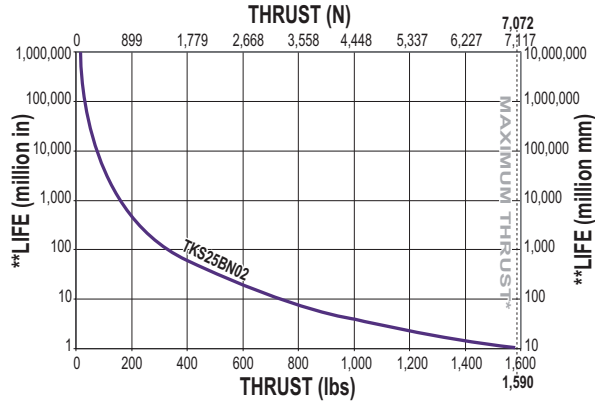

RODLESS

TKS25 Series

- Ball screw critical speed capacities and life calculations

CRITICAL SPEED WITH 0.601" 5TPI ENGLISH BALL SCREW

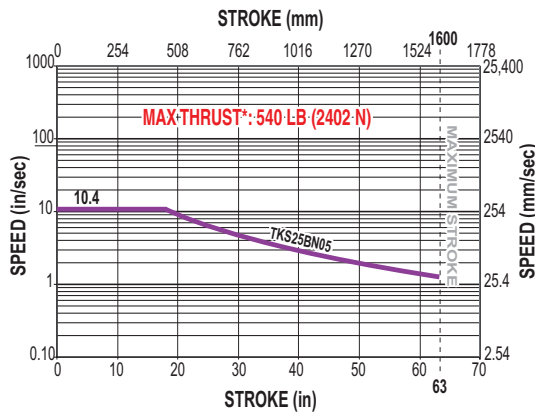

LIFE CALCULATION: 0.601" 5TPI ENGLISH BALL SCREW

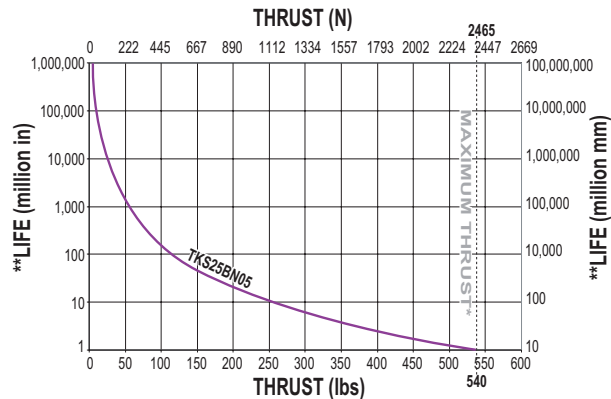

BN = Ball Nut



* Maximum thrust reflects 90% reliability for 1 million linear inches of travel.

**Life indicates theoretical maximum life of screw only, under ideal conditions and does not indicate expected life of actuator.

Axi-dyne[®] TRUTrack™ TKS25 Series

DIMENSIONS

TKS25 ACTUATOR AND OPTIONS



RODLESS

TKS25 Series

- Actuator and options dimensions

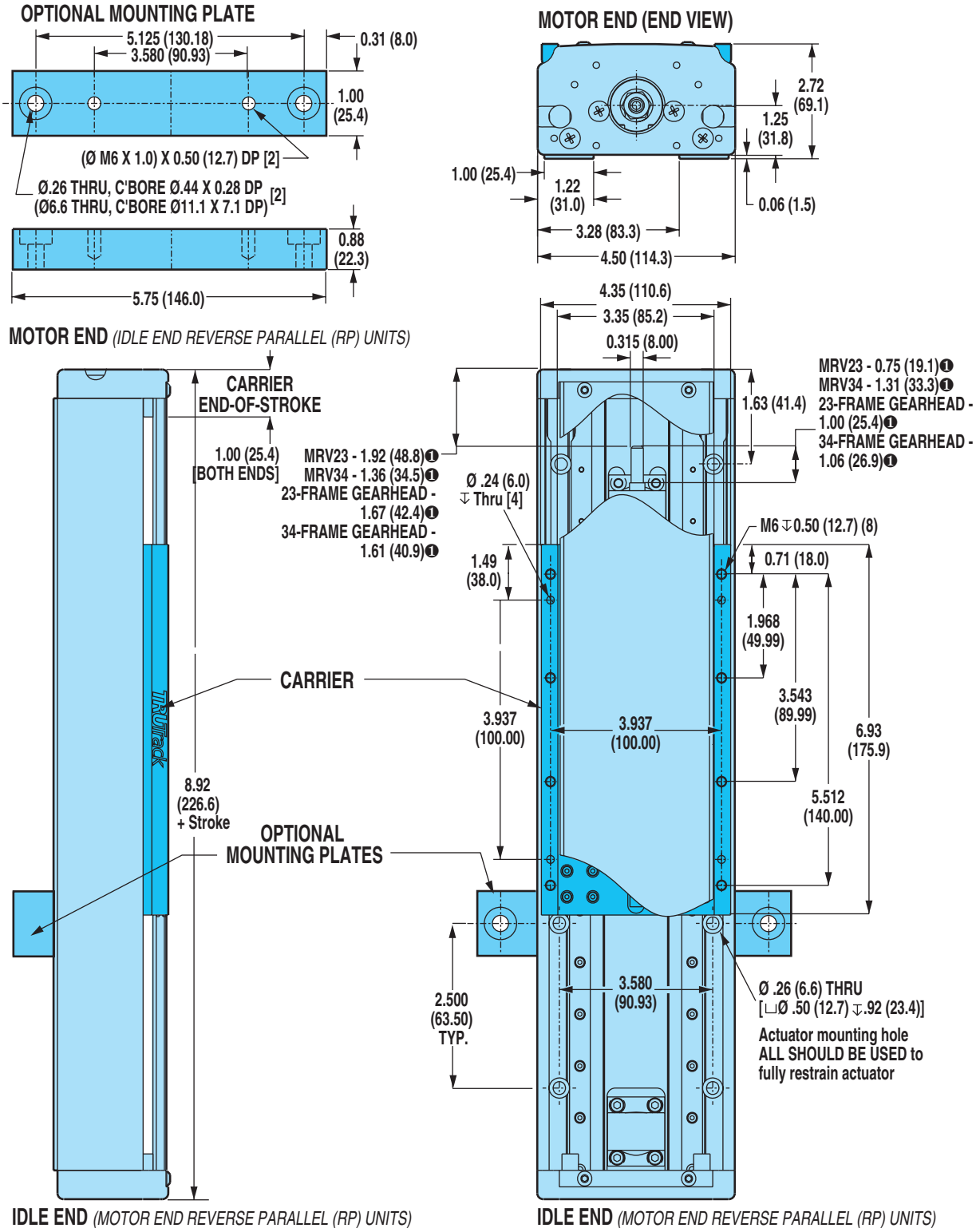

Ⓢ WHEN SPECIFYING THE XY/XJ SHAFT OPTION: IF A TOL-O-MATIC MOTOR IS NOT SPECIFIED IN THE CONFIGURATION STRING, CUSTOMER'S MOTOR MUST CONFORM TO THE SHAFT DIMENSIONS SHOWN FOR MOUNTING COMPATIBILITY. PLEASE SPECIFY YOUR MOTOR TYPE AND FRAME SIZE WHEN ORDERING.

Unless otherwise noted, all dimensions shown are in inches (Dimensions in parenthesis are in millimeters)

Axi-dyne[®] TRUTrack™ TKS25 Series

DIMENSIONS

TKS25: DOUBLE C-FACE BRAKE OPTION

BRAKE FOR 23-FRAME MOTOR

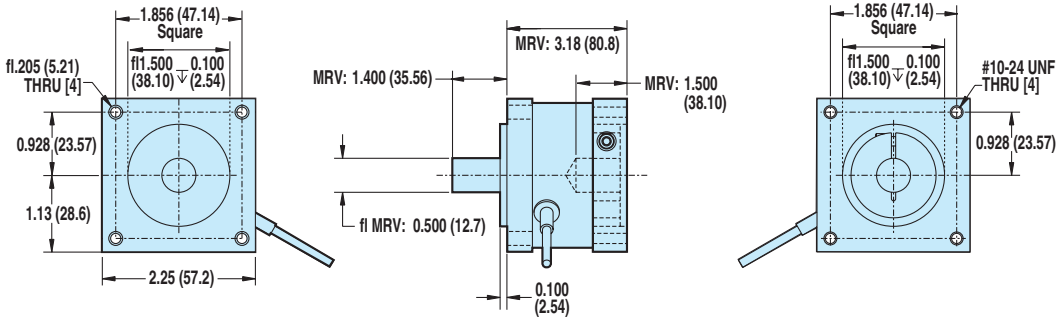

BRAKE FOR 34-FRAME MOTOR

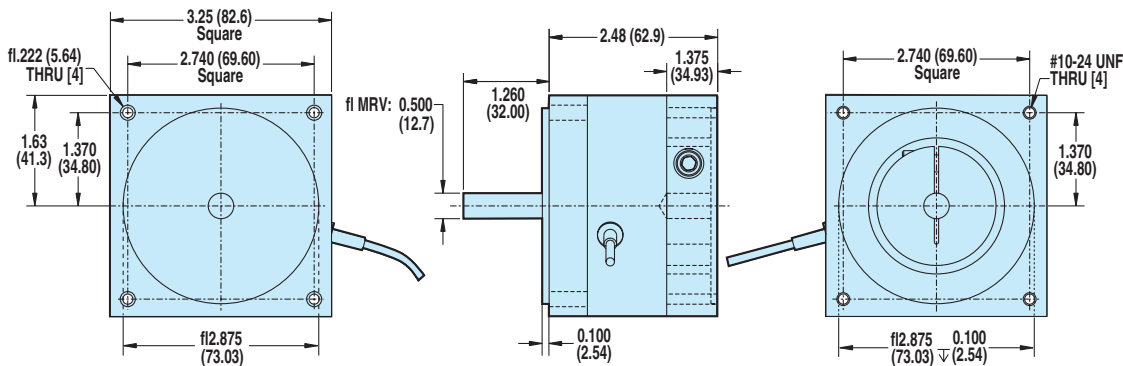

RODLESS

TKS25 Series

- Double C-face brake option dimensions

MOTOR TYPE	MOTOR/ FRAME	BRAKE PART NO.	STATIC TORQUE		REFLECTED INERTIA		WEIGHT		VOLTAGE	CURRENT	RESISTANCE	CABLE LENGTH	
			lb-in	N-m	lb-in ²	kg-M ² x10 ⁻⁴	lb	kg				in	mm
BRUSHLESS	MRV 23	3600-6286	10	1.130	0.0125	3.66	1.49	0.68	24	0.286	83.6	16.75	425
	MRV 34	3600-6288	25	2.825	0.1087	31.79	2.88	1.31	24	0.369	65.1	18.0	457

MAXIMUM BRAKE HOLDING LOADS												
LEADSCREW/NUT REDUCTION	23-FRAME BRAKE						34-FRAME BRAKE					
	INLINE		5.5:1 GEARHEAD		10:1 GEARHEAD		INLINE		5.5:1 GEARHEAD		10:1 GEARHEAD	
	lb	kg	lb	kg	lb	kg	lb	kg	lb	kg	lb	kg
TKS25 with SN02	180	81.6	180	81.6	180	81.6	180	81.6	180	81.6	180	81.6
TKS25 with BN02	140	63.5	903	409.5	1643	745.2	349	158.3	2259	1024.6	4107	1862.8
TKS25 with BN05	349	158.3	2259	1024.6	4008	1817.9	873	395.9	4008	1817.9	4008	1817.9

⚠ Double C-face brakes are used for static holding (back driving prevention) and are not designed for dynamic stopping. Please contact Tol-O-Matic if your application requires dynamic stopping. This brake can be used with other Tol-O-Matic systems. Consult the factory for availability.

Axi-dyne® TRUTrack™ TKS25 Series

DIMENSIONS

**TKS25: IN-LINE MOUNT FOR 34-FRAME BRUSHLESS (MRV) MOTORS,
OR 34-FRAME GEARHEAD**

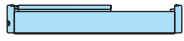

RODLESS

TKS Series
• In-line motor mounting

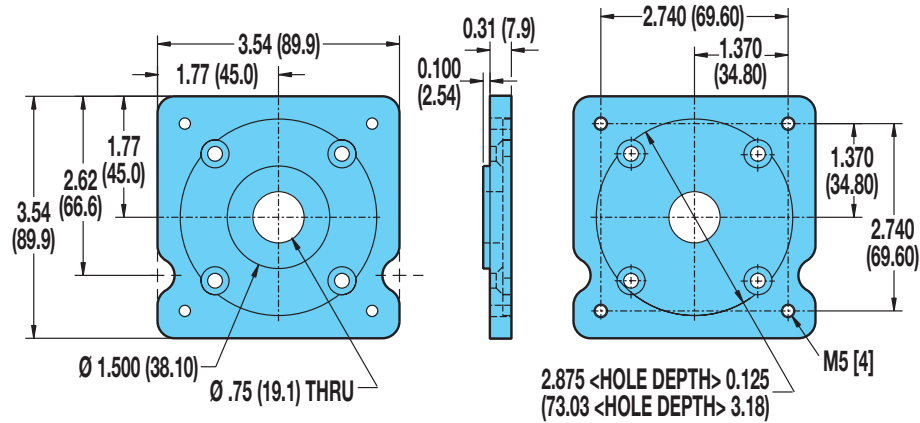

! *23-frame brushless MRV motors are mounted directly to the actuator head and require no motor adapter plates.
34-frame brushless MRV motors cannot be mounted directly to the actuator head and require the use of the motor adapter plate shown.*



INTERCHANGING MOTORS: Leadscrews on TruTrack actuators are specific to the motor type specified. Motor mounting plates do not provide for interchanging servo or stepper motors.

For gearhead dimensions and specifications, refer to page F-10

Axi-dyne® TRUTrack™ TKS25 Series

DIMENSIONS

TKS25: REVERSE PARALLEL MOUNTING

BOTTOM MOUNT

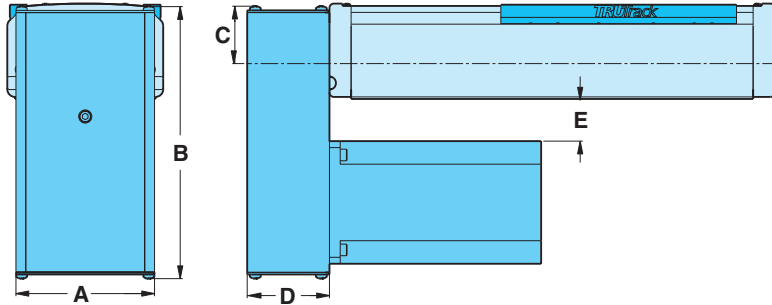

TOP MOUNT

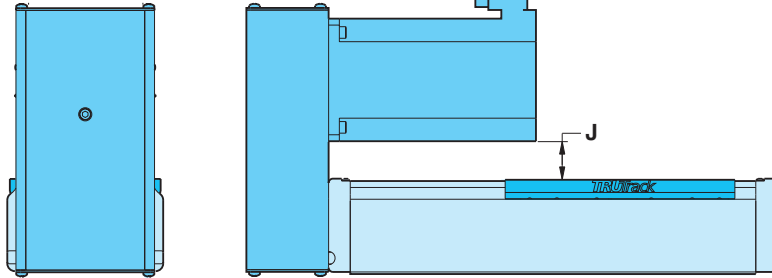

SIDE MOUNT

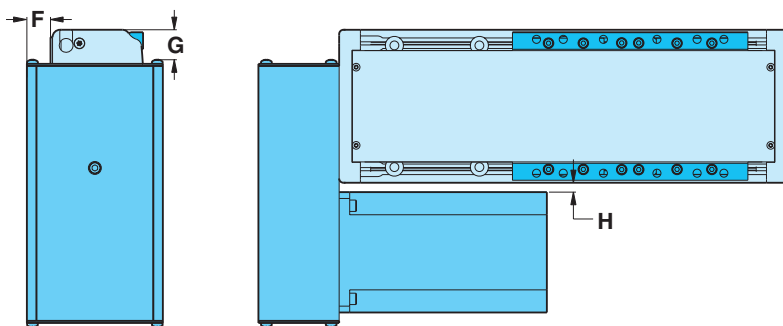

SPECIFICATIONS

BRUSHLESS	MOTOR	WEIGHT OF REDUCTION DRIVE			
		1:1		2:1	
		lbs	kg	lbs	kg
	MRV21, 22, 23, 24	2.51	1.14	2.74	1.24
	MRV31, 32, 33	2.75	1.25	2.98	1.35

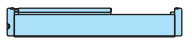

RODLESS

TKS25 Series
• Reverse parallel mounting

BRUSHLESS	MOTOR	REDUCTION INERTIA AT MOTOR SHAFT			
		1:1		2:1	
		in-lb ²	kg-cm ²	in-lb ²	kg-cm ²
	MRV21, 22, 23, 24	.038	.1112	.103	.3014
	MRV31, 32, 33	.038	.1112	.103	.3014

REDUCTION EFFICIENCY: 0.95

DIMENSIONS

	MOTORS	A		B		C		D		E		F		G		H		J	
		in.	mm	in.	mm	in.	mm	in.	mm	in.	mm	in.	mm	in.	mm	in.	mm	in.	mm
BRUSHLESS	MRV21, 22, 23, 24	3.25	82.6	7.02	178.4	1.33	33.8	2.13	54.1	1.74	44.2	0.32	8.1	1.07	27.2	0.80	20.3	1.78	45.2
	MRV31, 32, 33	4.00	101.6	7.79	197.9	1.33	33.8	2.38	60.5	0.97	24.6	0.69	17.5	1.07	27.2	0.15	3.8	1.01	25.7



Axi dyne® TRUTrack™ TKS50 Series ACME SCREW SPECIFICATIONS

TKS50 ACME SCREW CRITICAL SPEED AND PV LIMITS

CRITICAL SPEED WITH 0.750" ITPI ENGLISH ACME SCREW

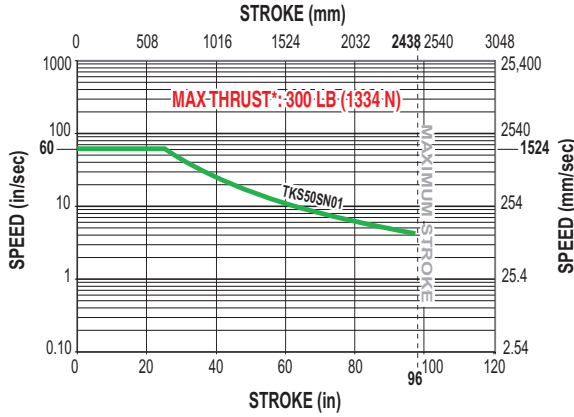

PV LIMITS: 0.750" ITPI ENGLISH ACME SCREW

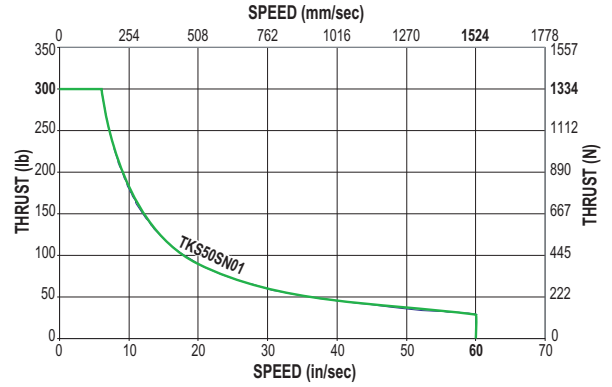

RODLESS

TKS50 Series

- Acme screw critical speed capacities and PV limits

SN = Solid Nut



* *Maximum thrust is the maximum continuous dynamic thrust subject to Thrust x Velocity limitation.*

PV LIMITS: Any material which carries a sliding load is limited by heat buildup. The factors that affect heat generation rate in an application are the pressure on the nut in pounds per square inch and the surface velocity in feet per minute. The product of these factors provides a measure of the severity of an application.

$$P = \frac{\text{Thrust}}{\text{Max. Thrust Rating}} \times V = \frac{\text{Speed}}{\text{Max. Speed Rating}} \leq 0.1$$

TRUtrack™ TKS50 Series

BALL SCREW SPECIFICATIONS

TKS50 BALL SCREW CRITICAL SPEED AND LIFE CALCULATIONS

CRITICAL SPEED WITH 0.750" 2TPI ENGLISH BALL SCREW

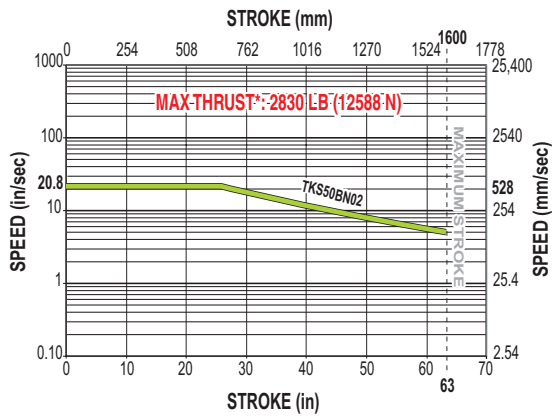

LIFE CALCULATION: 0.750" 2TPI ENGLISH BALL SCREW

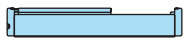
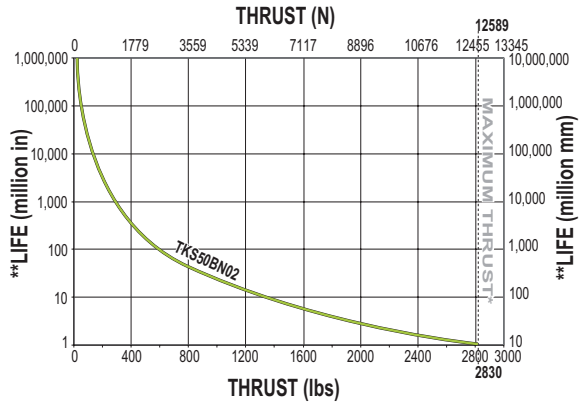

RODLESS

TKS50 Series

- Ball screw critical speed capacities and life calculations

CRITICAL SPEED WITH 0.750" 5TPI ENGLISH BALL SCREW

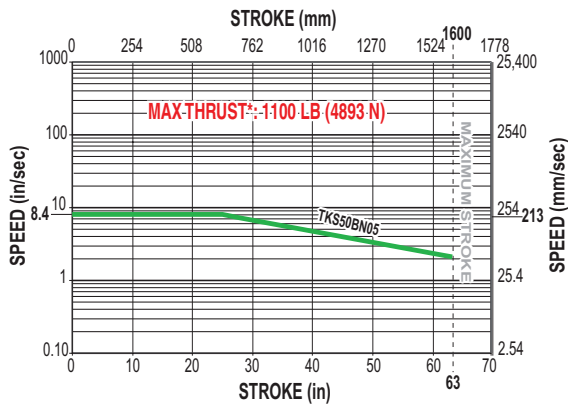

LIFE CALCULATION: 0.750" 5TPI ENGLISH BALL SCREW

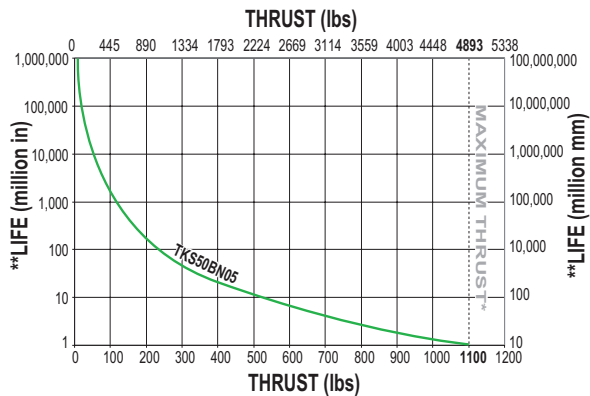

BN = Ball Nut



* Maximum thrust reflects 90% reliability for 1 million linear inches of travel.

**Life indicates theoretical maximum life of screw only, under ideal conditions and does not indicate expected life of actuator.

Axi-dyne[®] TRUTrack™ TKS50 Series

DIMENSIONS

TKS50 ACTUATOR AND OPTIONS DIMENSIONS



RODLESS

TKS50 Series
• Actuator and option dimensions

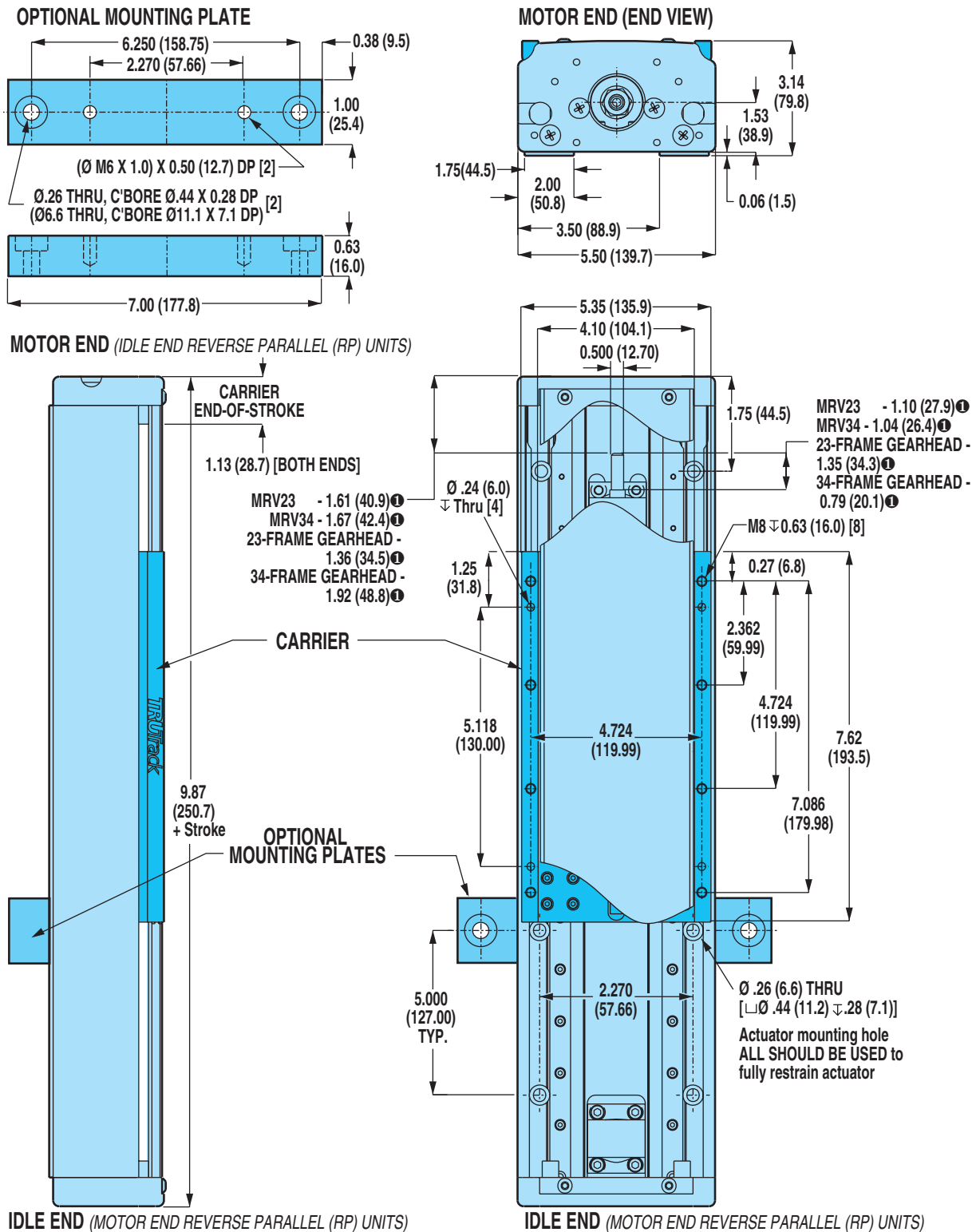

① WHEN SPECIFYING THE XY/XJ SHAFT OPTION: IF A TOL-O-MATIC MOTOR IS NOT SPECIFIED IN THE CONFIGURATION STRING, CUSTOMER'S MOTOR MUST CONFORM TO THE SHAFT DIMENSIONS SHOWN FOR MOUNTING COMPATIBILITY. PLEASE SPECIFY YOUR MOTOR TYPE AND FRAME SIZE WHEN ORDERING.

Unless otherwise noted, all dimensions shown are in inches (Dimensions in parenthesis are in millimeters)

Axi dyne[®] TRUTrack™ TKS50 Series

DIMENSIONS

TKS50: DOUBLE C-FACE BRAKE OPTION

BRAKE FOR 23-FRAME MOTOR

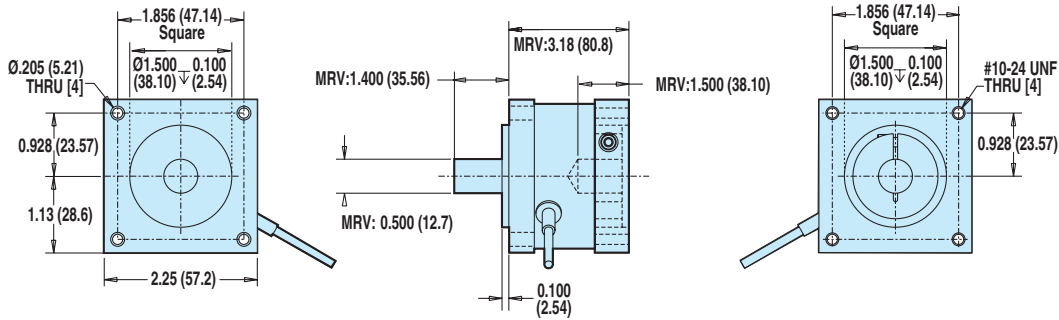

BRAKE FOR 34-FRAME MOTOR

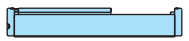
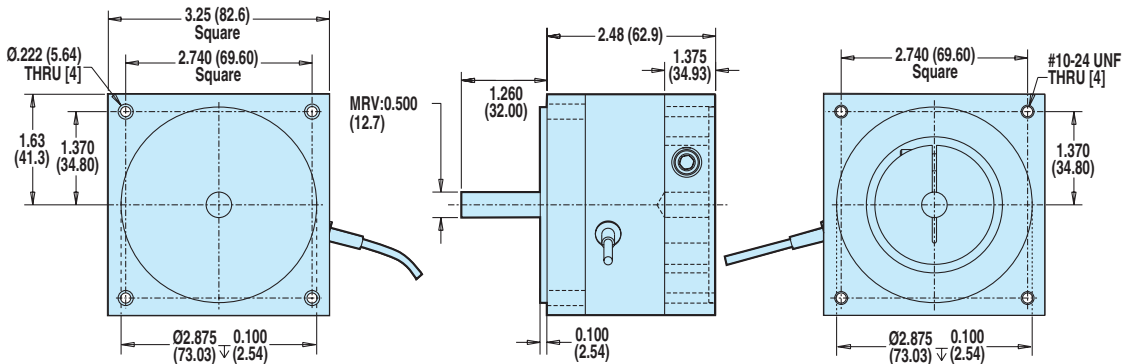

RODLESS

TKS50 Series

- Double C-face brake option dimensions

MOTOR TYPE	MOTOR/ FRAME	BRAKE PART NO.	STATIC TORQUE		REFLECTED INERTIA		WEIGHT		VOLTAGE	CURRENT	RESISTANCE	CABLE LENGTH	
			lb-in	N-m	lb-in ²	kg-m ² x 10 ⁻⁴	lb	kg	Vdc	Amps	Ohms	in	mm
BRUSHLESS	MRV 23	3600-6286	10	1.130	0.0125	3.66	1.49	0.68	24	0.286	83.6	16.75	425
	MRV 34	3600-6288	25	2.825	0.1087	31.79	2.88	1.31	24	0.369	65.1	18.00	457

MAXIMUM BRAKE HOLDING LOADS

LEADSCREW/NUT REDUCTION	23-FRAME BRAKE						34-FRAME BRAKE					
	INLINE		5.5:1 GEARHEAD		10:1 GEARHEAD		INLINE		5.5:1 GEARHEAD		10:1 GEARHEAD	
	lb	kg	lb	kg	lb	kg	lb	kg	lb	kg	lb	kg
TKS50 with SN01	105	47.6	300	136.0	300	136.0	262	118.8	300	136.0	300	136.0
TKS50 with BN02	140	63.5	903	409.5	1643	745.2	349	158.3	2259	1024.6	4107	1862.8
TKS50 with BN05	349	158.3	2259	1024.6	4107	1862.8	873	395.9	5647	2561.4	10055	4560.8

⚠ Double C-face brakes are used for static holding (back driving prevention) and are not designed for dynamic stopping. Please contact Tol-O-Matic if your application requires dynamic stopping. This brake can be used with other Tol-O-Matic systems. Consult the factory for availability.

Axi-dyne® TRUTrack™ TKS50 Series

DIMENSIONS

TKS50: IN-LINE MOUNT FOR 23-FRAME BRUSHLESS (MRV) MOTORS OR 23-FRAME GEARHEAD



RODLESS

TKS50 Series

- In-line motor mounting dimensions

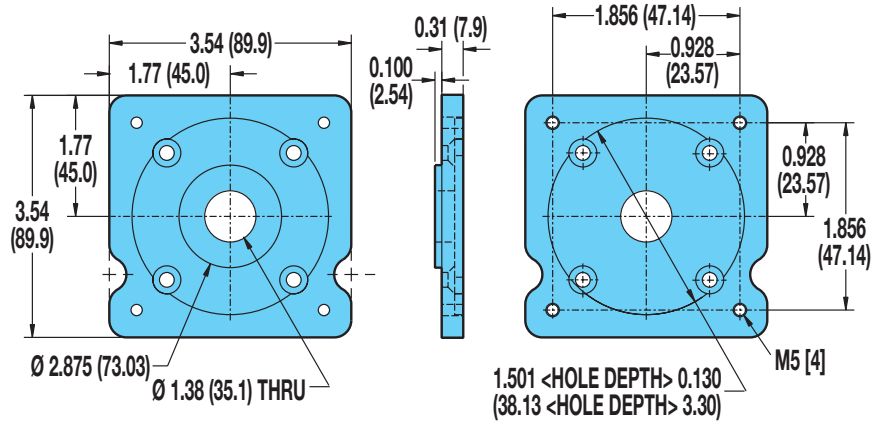

- ⚠ **34-frame brushless MRV motors are mounted directly to the actuator head and require no motor adapter plates.**
- ⚠ **23-frame brushless MRV motors cannot be mounted directly to the actuator head and require the use of the adapter plate shown.**



INTERCHANGING MOTORS: Leadscrews on TruTrack actuators are specific to the motor type specified. Motor mounting plates do not provide for interchanging servo or stepper motors.

For gearhead dimensions and specifications, refer to page F-10.

Axi-dyne® TRUtrack™ TKS50 Series

DIMENSIONS

TKS50: REVERSE PARALLEL MOUNTING

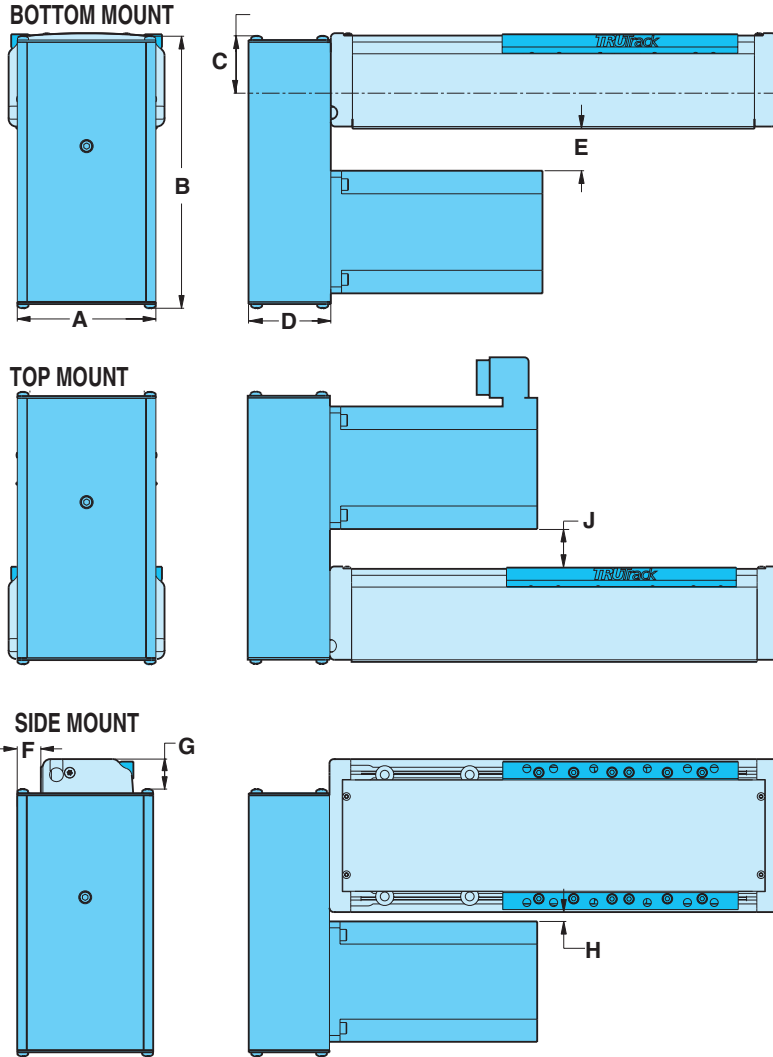

SPECIFICATIONS

MOTOR	WEIGHT OF REDUCTION DRIVE			
	1:1		2:1	
	lbs	kg	lbs	kg
BRUSHLESS MRV21, 22, 23, 24	2.85	1.29	3.08	1.40
MRV31, 32, 33	3.40	1.54	3.56	1.62

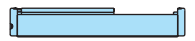

RODLESS

TKS50 Series
• Reverse parallel mounting

MOTOR	REDUCTION INERTIA AT MOTOR SHAFT			
	1:1		2:1	
	lb-in ²	kg-cm ²	lb-in ²	kg-cm ²
BRUSHLESS MRV21, 22, 23, 24	.036	.1054	.227	.6628
MRV31, 32, 33	.036	.1054	.227	.6628

REDUCTION EFFICIENCY: 0.95

DIMENSIONS

MOTORS	A		B		C		D		E		F		G		H		J	
	in.	mm	in.	mm	in.	mm	in.	mm	in.	mm	in.	mm	in.	mm	in.	mm	in.	mm
BRUSHLESS MRV21, 22, 23, 24	3.25	82.6	7.02	178.4	1.33	33.8	2.13	54.1	1.74	44.2	0.32	8.1	1.07	27.2	0.80	20.3	1.78	45.2
MRV31, 32, 33	4.00	101.6	7.79	197.9	1.33	33.8	2.38	60.5	0.97	24.6	0.69	17.5	1.07	27.2	0.15	3.8	1.01	25.7



Axi
dyne®

TRUTrack™ TKS75 Series ACME SCREW SPECIFICATIONS

TKS75 ACME SCREW CRITICAL SPEED AND PV LIMITS

CRITICAL SPEED WITH 1" 4TPI ENGLISH ACME SCREW

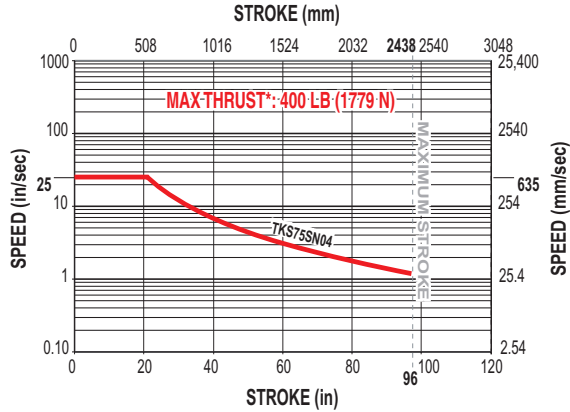

PV LIMITS: 1" 4TPI ENGLISH ACME SCREW

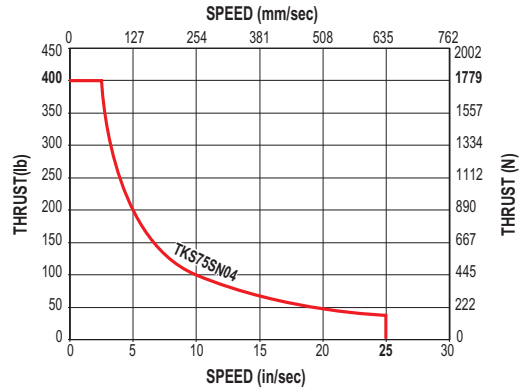

RODLESS

TKS75 Series

- Acme screw critical speed capacities and PV limits

SN = Solid Nut



* *Maximum thrust is the maximum continuous dynamic thrust subject to Thrust x Velocity limitation.*

PV LIMITS: Any material which carries a sliding load is limited by heat buildup. The factors that affect heat generation rate in an application are the pressure on the nut in pounds per square inch and the surface velocity in feet per minute. The product of these factors provides a measure of the severity of an application.

$$P = \frac{\text{Thrust}}{\text{Max. Thrust Rating}} \times V = \frac{\text{Speed}}{\text{Max. Speed Rating}} \leq 0.1$$

TRUTrack™ TKS75 Series

BALL SCREW SPECIFICATIONS

TKS75 BALL SCREW CRITICAL SPEED AND LIFE CALCULATIONS

CRITICAL SPEED WITH 0.927" ITPI ENGLISH BALL SCREW

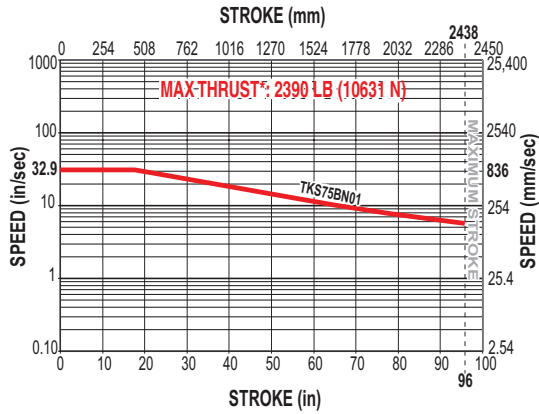

LIFE CALCULATION: 0.927" ITPI ENGLISH BALL SCREW

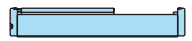
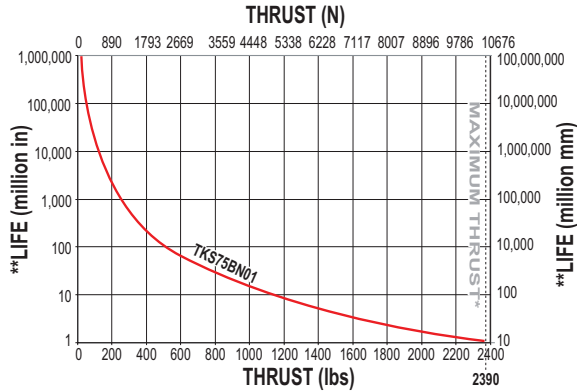

RODLESS

TKS75 Series

- Ball screw critical speed capacities and life calculations

CRITICAL SPEED WITH 0.957" 4TPI ENGLISH BALL SCREW

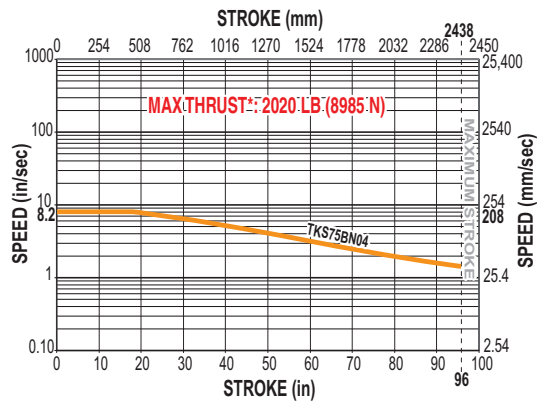

LIFE CALCULATION: 0.957" 4TPI ENGLISH BALL SCREW

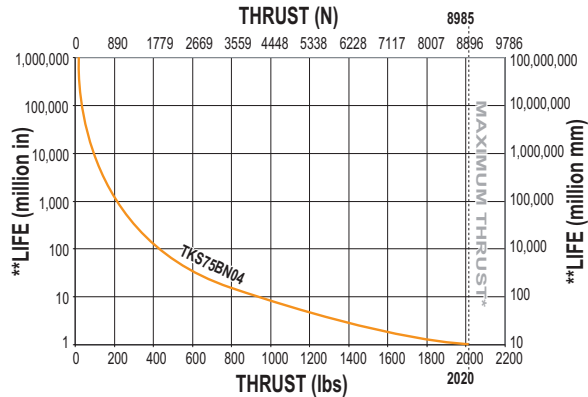

CRITICAL SPEED WITH 1" 2TPI ENGLISH BALL SCREW

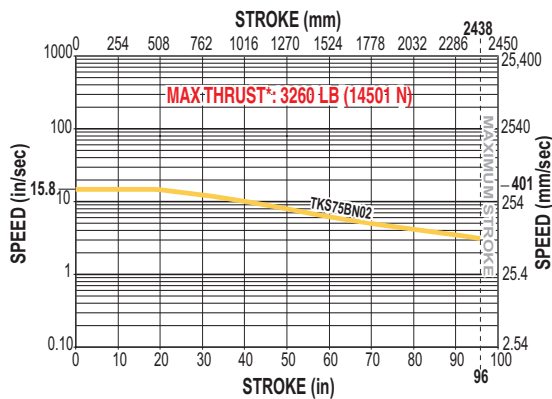

LIFE CALCULATION: 1" 2TPI ENGLISH BALL SCREW

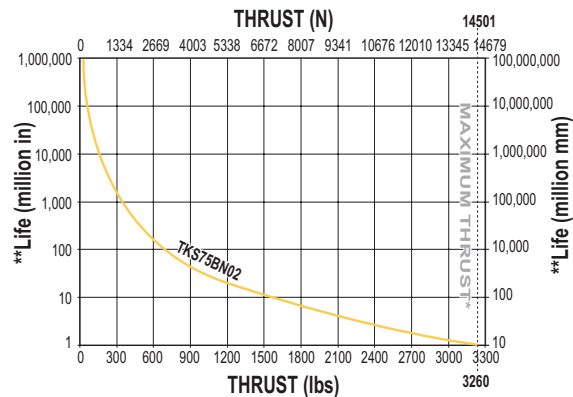

BN = Ball Nut



* Maximum thrust reflects 90% reliability for 1 million linear inches of travel.

**Life indicates theoretical maximum life of screw only, under ideal conditions and does not indicate expected life of actuator.

Axi-dyne® TRUTrack™ TKS75 Series

DIMENSIONS

TKS75 ACTUATOR AND OPTIONS

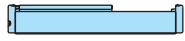

RODLESS

TKS75 Series
• Actuator and options dimensions

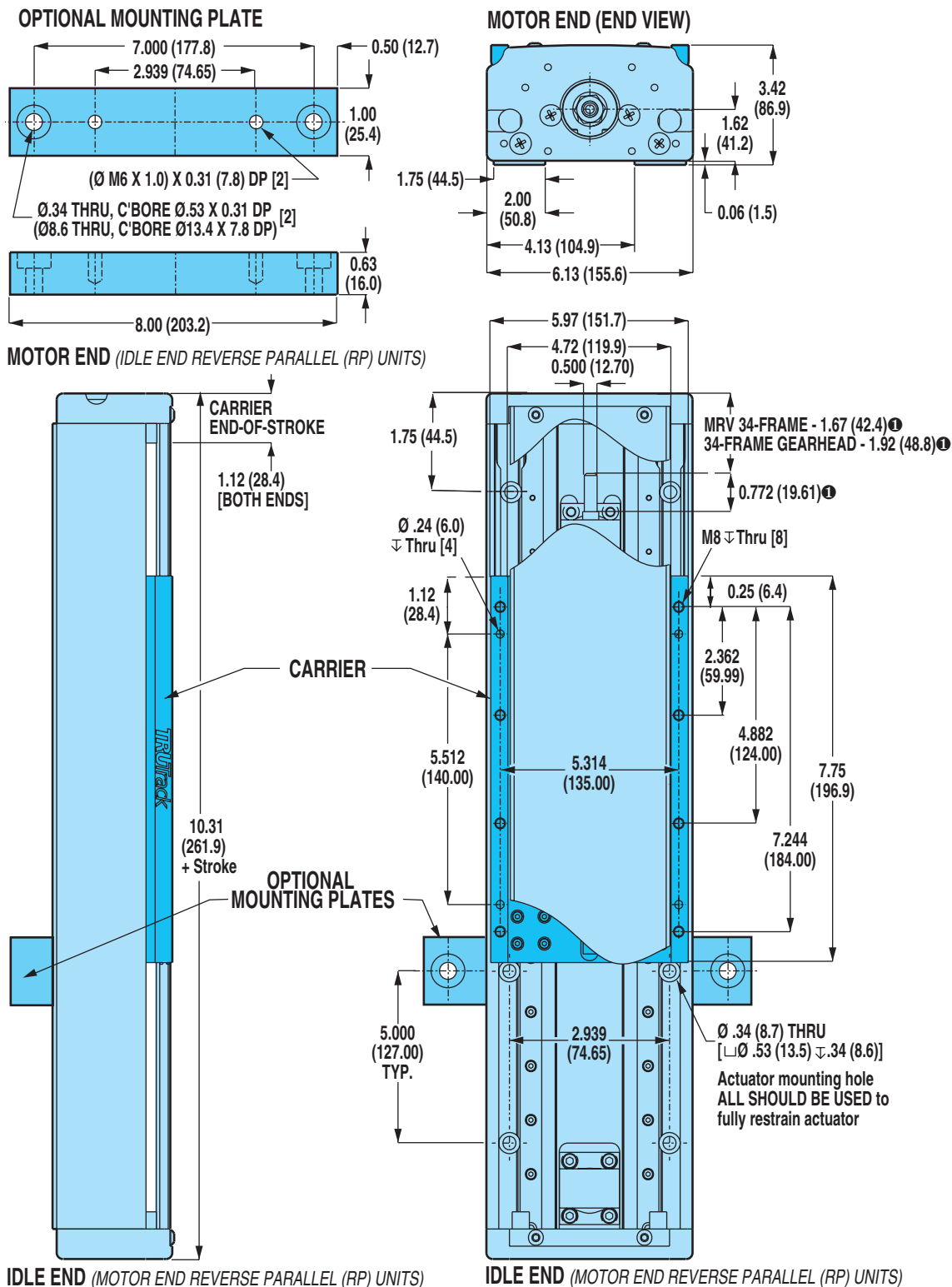

① WHEN SPECIFYING THE XY/XJ SHAFT OPTION: IF A TOL-O-MATIC MOTOR IS NOT SPECIFIED IN THE CONFIGURATION STRING, CUSTOMER'S MOTOR MUST CONFORM TO THE SHAFT DIMENSIONS SHOWN FOR MOUNTING COMPATIBILITY. PLEASE SPECIFY YOUR MOTOR TYPE AND FRAME SIZE WHEN ORDERING.

Unless otherwise noted, all dimensions shown are in inches (Dimensions in parenthesis are in millimeters)

Axi-dyne® TRUTrack™ TKS75 Series

DIMENSIONS

TKS75: DOUBLE C-FACE BRAKE OPTION

BRAKE FOR 34-FRAME MOTOR

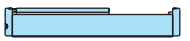
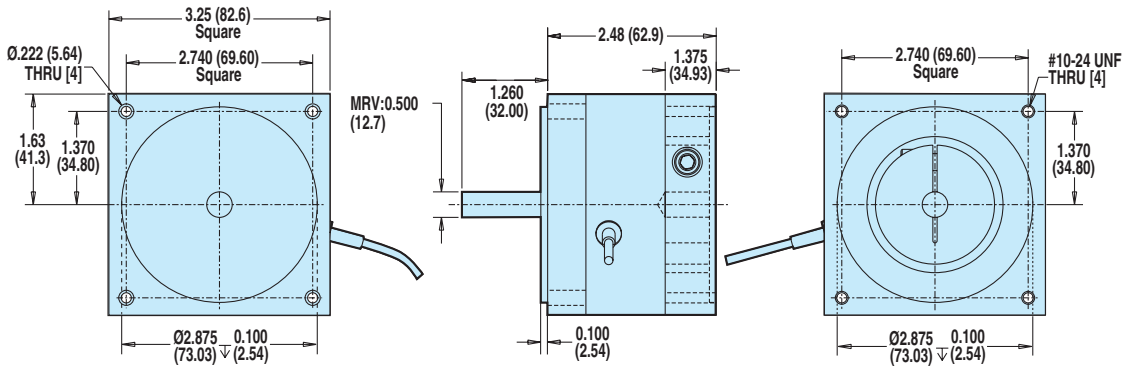

RODLESS

TKS75 Series

- Double C-face brake option
- In-line motor mounting

MOTOR TYPE	MOTOR/ FRAME	BRAKE PART NO.	STATIC TORQUE		REFLECTED INERTIA		WEIGHT		Vdc	CURRENT Amps	RESISTANCE Ohms	CABLE LENGTH	
			lb-in	N-m	lb-in ²	kg-m ² x 10 ⁻⁴	lb	kg				in	mm
BRUSHLESS	MRV 34	3600-6288	25	2.825	0.1087	5.47	2.88	1.31	24	0.369	65.1	18.0	457

MAXIMUM BRAKE HOLDING LOADS

LEADSCREW/NUT REDUCTION	34-FRAME BRAKE					
	INLINE		5.5:1 GEARHEAD		10:1 GEARHEAD	
	lb	kg	lb	kg	lb	kg
TKS75 with SN04	419	190.0	419	190.0	419	190.0
TKS75 with BN01	175	79.3	1129	512.1	2053	931.2
TKS75 with BN02	349	158.3	2259	1024.6	4107	1862.8
TKS75 with BN04	698	316.6	4517	2048.8	8213	3725.3

! Double C-face brakes are used for static holding (back driving prevention) and are not designed for dynamic stopping. Please contact Tol-O-Matic if your application requires dynamic stopping. This brake can be used with other Tol-O-Matic systems. Consult the factory for availability.

TKS75: IN-LINE MOTOR AND GEARHEAD MOUNTING

All brushless servo (MRV) and gearheads may be mounted directly to the actuator head and do not require the use of motor adapter plates.

Reference the MOTOR END (END VIEW) in the dimensional drawing on page C-78



INTERCHANGING MOTORS: Leadscrews on TruTrack actuators are specific to the motor type specified. Motor mounting plates do not provide for interchanging servo or stepper motors.

For gearhead dimensions and specifications, refer to page F-10.

Axi-dyne® TRUTrack™ TKS75 Series

DIMENSIONS

TKS75: REVERSE PARALLEL MOUNTING



RODLESS

TKS75 Series
• Reverse parallel mounting

BOTTOM MOUNT

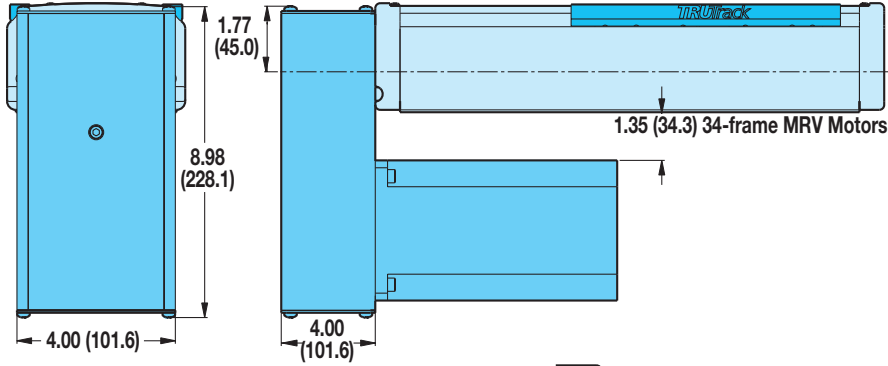

TOP MOUNT

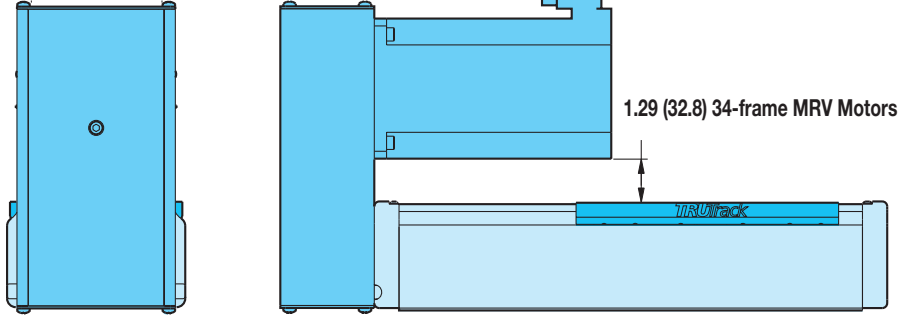

SIDE MOUNT

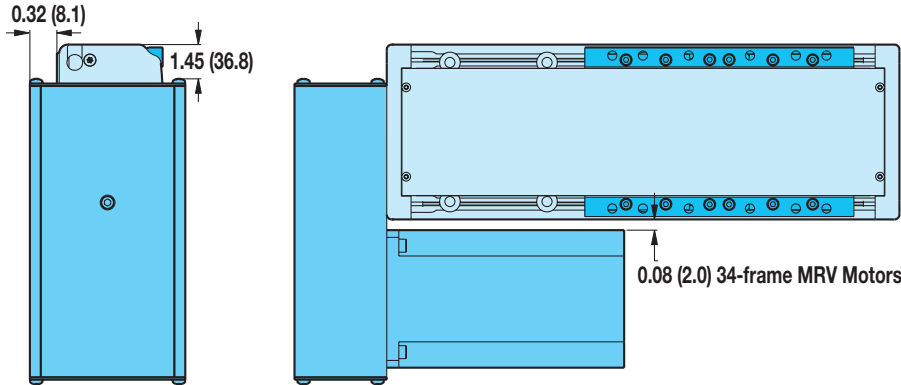

SPECIFICATIONS

MOTOR	WEIGHT OF REDUCTION DRIVE				REDUCTION INERTIA AT MOTOR SHAFT			
	1:1		2:1		1:1		2:1	
	lbs	kg	lbs	kg	lb-in ²	kg-cm ²	lb-in ²	kg-cm ²
BRUSHLESS MRV31, 32, 33	3.40	1.54	3.56	1.62	.036	.1054	.227	.6628

REDUCTION EFFICIENCY: 0.95

Axi-dyne[®] TRUtrack™ TKS Screw Drive

ORDERING

BASE MODEL SPECIFICATIONS

TKS 50 BN02 SK55 LMB

OPTIONS SPECIFICATIONS

DC18 KT2 BE2 BRK LU MP4

MODEL TYPE

TKS TKS Series TruTrack English Screw Drive

PAYLOAD LIMITS

10	100 lbs	50	500 lbs
25	250 lbs	75	750 lbs

NUT/SCREW CONFIGURATION

ENGLISH MODELS

SOLID NUT / PITCH (turn/in)	SERIES
SN01	TKS50
SN02	TKS10, 25
SN04	TKS75

BALL NUT / PITCH (turn/in)	SERIES
BN01	TKS75
BN02	TKS25, 50, 75
BN04	TKS75
BN05	TKS25, 50
BN08	TKS10

STROKE LENGTH

SK Stroke, then enter desired stroke length in decimal inches

MODEL		MAX STROKE* (in)
TKS10	Ball Nut	29
	Solid Nut	96
TKS25	Ball Nut	63
	Solid Nut	96
TKS50	Ball Nut	63
	Solid Nut	96
TKS75	Ball/Solid Nut	96

*Actuator cover has maximum stroke of 48 inches

MOTOR MOUNTING / REDUCTIONS

▲ *The length on the leadscrew and coupling device is determined by motor selection. Motor type and frame size must be specified when ordering. Reference the ordering pages in sections F, G and H for the motor types and selections.*

(must choose one)

LMI In-Line mount
 LMB In-Line mount with brake
 LMG In-Line mount with gearhead
 RPL1 1:1 Reverse-Parallel mount left
 RPR1 1:1 Reverse-Parallel mount right
 RPB1 1:1 Reverse-Parallel mount bottom
 RPT1 1:1 Reverse-Parallel mount top
 RPL2 2:1 Reverse-Parallel mount left
 RPR2 2:1 Reverse-Parallel mount right
 RPB2 2:1 Reverse-Parallel mount bottom
 RPT2 2:1 Reverse-Parallel mount top

▲ *When the LMB option is selected, the configurator picks the appropriate screw and hardware to accommodate the mounting of the brake based on motor selection. The brake option "BRK" must also be indicated in the configuration string.*

When the LMG option is selected, the configurator picks the appropriate screw and hardware to accommodate the mounting of the gearhead based on motor selection. A gearhead reduction must also be indicated in the configuration string. Please reference the motor ordering pages for available options.

AUXILIARY CARRIER

DC_ Auxiliary Carrier, then center-to-center spacing desired in decimal inches. (Center-to-Center spacing will add to overall dead length and will not subtract from the stroke length)

SWITCHES

RT_ Reed Switch (Form A) with 5-meter lead, and quantity desired
 BT_ Reed Switch (Form C) with 5-meter lead, and quantity desired
 KT_ Hall-effect Sinking Switch with 5-meter lead, and quantity desired
 TT_ Hall-effect Sourcing Switch with 5-meter lead, and quantity desired
 SP*_ Sensor Package

*Includes: Two Form C reed switches w/5-meter leads, mounted 1" from end-of-stroke and one Hall-effect sinking switch w/5-meter lead, mounted 2" from end-of-stroke on motor end.

BELLOWS

BE2 Bellows option (increases the dead length of the actuator, see page C-58)

BRAKE OPTION

BRK In-line mounted brake***
 *** Used with the LMB in-line mounting option.

SPECIAL LUBRICATION

LU Low dust generating grease

MOUNTING PLATES

MP_ Mounting Plates plus quantity desired

▲ *Not all codes listed are compatible with all options.*

Use the Tol-O-Motion™ Sizing Software to determine available options and accessories based on your application requirements.

TO ORDER MOTORS/CONTROLS/INTERFACES

 BRUSHLESS SERVO (SEE PAGE F-33)

FIELD RETROFIT KITS

ITEM	TKS10	TKS25	TKS50	TKS75
Mounting Plates	0601-9803	0602-9803	0603-9803	0604-9803

RODLESS

TKS75 Series

• Ordering

Customization, Tol-O-Matic does it every day

Tol-O-Matic's ability to provide creative and imaginative solutions for our customers has made us a world leader in the manufacture of automation components. Every Tol-O-Matic product is custom made specifically to your order. Our product line contains over 30,000 base models, most of these manufactured in customer specified strokes. Add on our wide variety of available options and Tol-O-Matic offers literally millions of choices to fit your application. Even with so many choices we encourage you to contact us with your "specials" requirements. We have the resources to create whatever it is you may need.

Exacting precision for a 5-axis milling machine.

Tol-O-Matic worked with this manufacturer to create a prototype specific to their application. Standard RSA rod screw actuators were completely modified with special bearings and precision-matched lead screws to provide the highest possible accuracy, rigidity and ultra low-backlash. A series of six Axidyne DV drives worked with their existing controls and proprietary software system to cue the six legs of actuator motion.

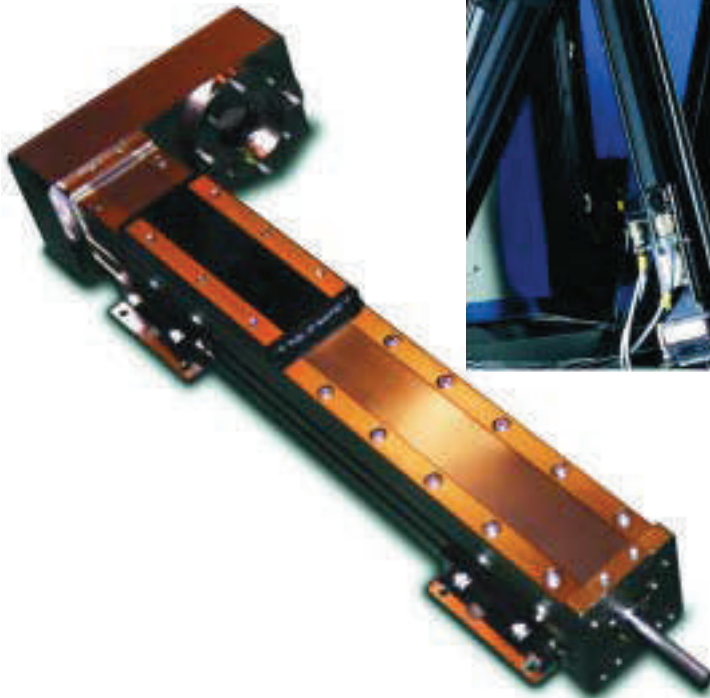
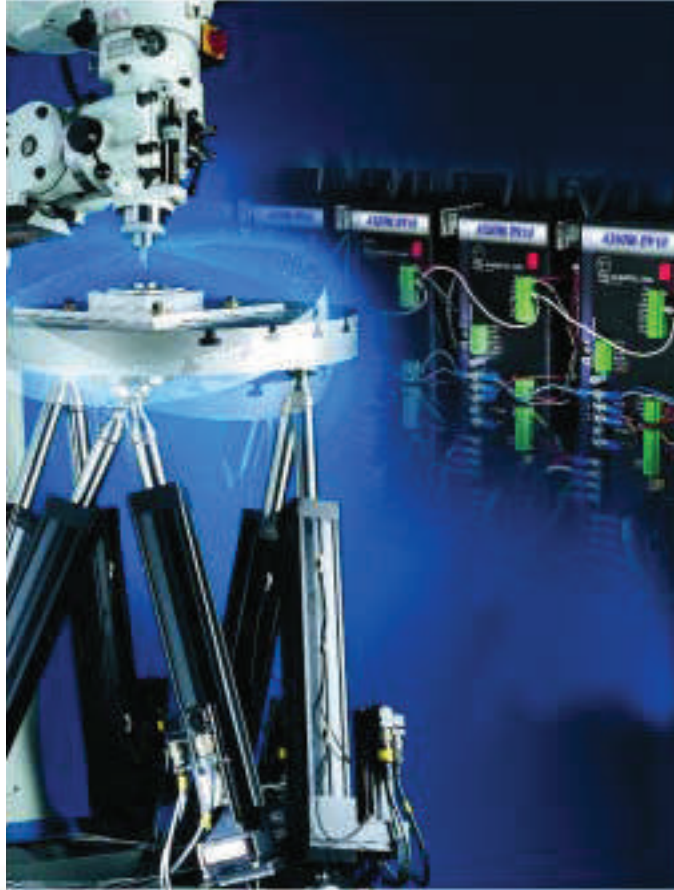

An actuator for an extremely corrosive environment

This standard B3S actuator has a nickel-plated extrusion, other components were made of stainless-steel. A special mounting bracket was created to use with a nonstandard motor.

YES, we can create it.

Tol-O-Matic has created hundreds of special proprietary products for a wide variety of different industries. From simple refinements like creating new mounting brackets or tapped holes to redesigning an existing product, or creating a completely new product, Tol-O-Matic has the resources available to design, test and manufacture whatever you need. Our engineers are available to visit your facility and discuss your special requirements.

Axi-dyne® TRUTrack™ TKB Belt Drives

OVERVIEW



APPLICATION BENEFITS

- Straightness and flatness within 0.0002 inches per inch
- Superior rigidity, high moment loads, faster speeds
- Lowest carrier deflection of any Tol-O-Matic actuator
- Excellent repeatability
- Wide stable platform for XY applications

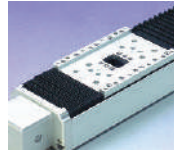

Bellows: protects from dust and dirt environments.

GUIDANCE SYSTEM



- Ground linear profiled rails and ball bearing blocks decreases deflection and provide smooth carrier/load movement

STANDARD MOUNTING



- Mounting holes are spaced the length of the actuator for ease in mounting directly to a flat surface.

ACTUATOR/MOTOR FACTORS

- Actuator's operating temperature range (40-130° F, 4-54° C) should take into consideration heat generated by the motor and drive, linear velocity and work cycle time.
- For large frame motors or small actuators, cantilevered motors need to be supported, if subjected to continuous rapid reversing duty and/or under dynamic conditions.

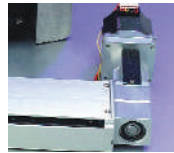

Motor Mounting and Gearhead Reduction:

Direct Drive Mounting— motor is mounted directly to the drive end assembly. Motor may be mounted directly on the left or right side.

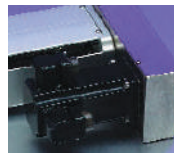

Reduction Drive Mounting—motor is mounted to the reduction assembly, providing a speed reduction from the motor to the belt drive wheel. TKB actuators are available with a 1:1 or 2:1 reduction.



Gearhead Reduction—Gearheads are available for applications requiring reduction for inertia matching or higher torque at lower speeds. High efficiency, single stage, true planetary gearheads are available in 5.5:1 and 10:1 ratios for reduction solutions with most Tol-O-Matic NEMA 23- and 34-frame motors. For gearhead specifications and dimensions see page F-10.



Switches: Available in ac reed or dc Hall-effect. (TRIAC switches are not available on TruTrack actuators) See section I.

AVAILABLE OPTIONS



Mounting Plates: provide clearance height for motors and motor mounts when mounting on a flush surface. Recommended on all TruTrack actuators, they prevent actuator body deflections over .015 in (3.8mm).

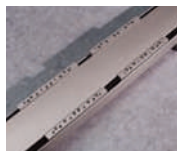

Auxiliary Carrier: Increases rigidity, load-carrying capacity and bending moments



RODLESS

TKB Series

- Application benefits
- Guidance system
- Standard mounting
- Actuator/motor factors
- Available options

Axi-dyne[®] TRUTrack™ TKB Belt Drives

BELT PERFORMANCE

BELT FORCE AND SPEED CAPACITIES

BELT FORCE FOR TKB ACTUATORS

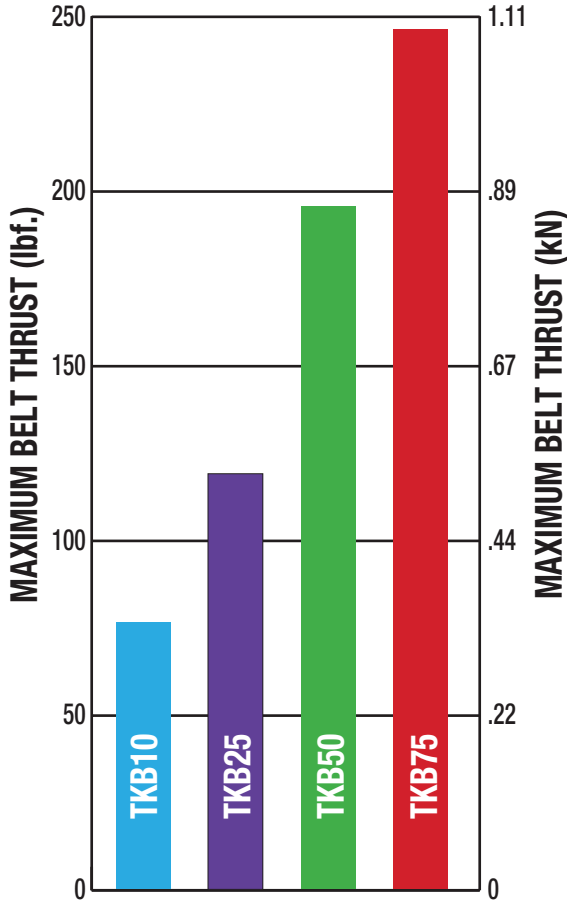

BELT SPEED FOR TKB ACTUATORS

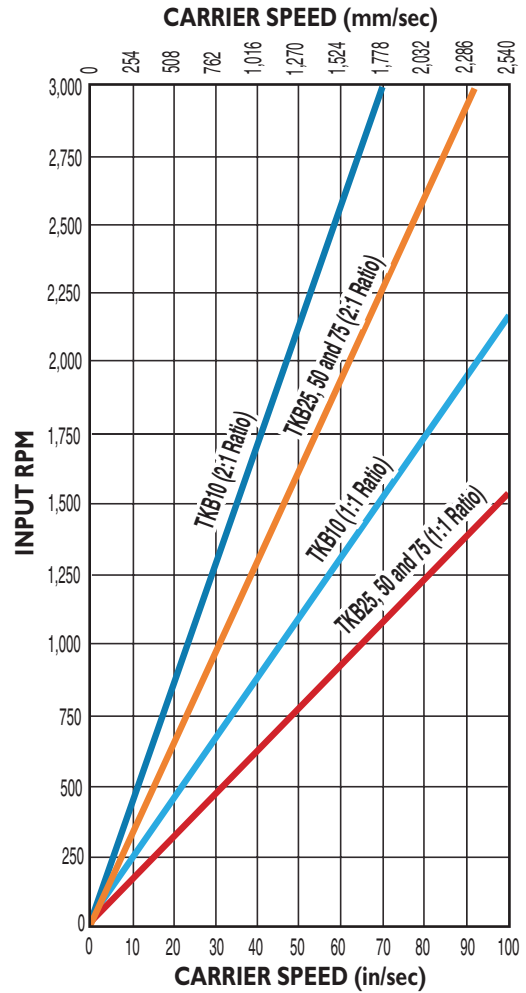

BELT SPECIFICATIONS

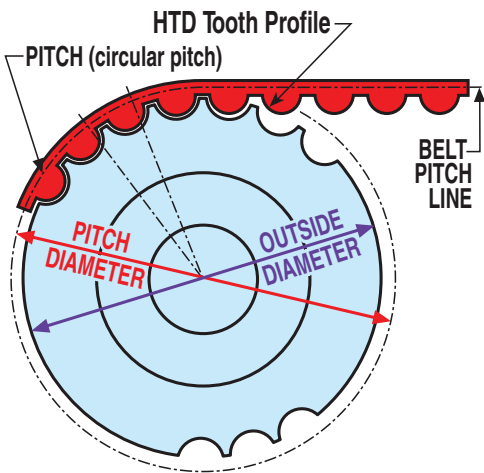

STYLE:	HTD Tooth
TOOTH PITCH:	5mm
BELT MATERIAL:	Polyurethane body with steel tension members
CHARACTERISTICS:	<ul style="list-style-type: none"> • For higher speed, higher load applications • Heavy duty drive and idler pulley bearings

Axi *dyne*® TRUTrack™ TKB Belt Drives

OVERALL SERIES SPECIFICATIONS

TKB BELT, INERTIA AND BREAKAWAY TORQUE SPECIFICATIONS

TKB ENGLISH ACTUATORS								
ACTUATOR SERIES	MAXIMUM STROKE (in)	BELT WIDTH (in)	BELT DEAD LENGTH (in)	WHEEL PITCH DIA. (in)	MOTION RATIO (in/rev)	STRAIGHTNESS & FLATNESS (in) ¹ (Constrained)	TEMP. RANGE ² (F)	BREAKAWAY TORQUE (lb-in)
TKB10	96	0.59	15.88	0.89	2.787	0.0002	40 - 130	3.5
TKB25	96	1.00	23.12	1.19	3.742	0.0002	40 - 130	10.0
TKB50	96	1.57	26.23	1.19	3.742	0.0002	40 - 130	10.0
TKB75	196	1.97	25.68	1.19	3.742	0.0002	40 - 130	10.0



RODLESS

TKB METRIC ACTUATORS								
ACTUATOR SERIES	MAXIMUM STROKE (mm)	BELT WIDTH (mm)	BELT DEAD LENGTH (mm)	WHEEL PITCH DIA. (mm)	MOTION RATIO (mm/rev)	STRAIGHTNESS & FLATNESS (mm) ¹ (Constrained)	TEMP. RANGE ² (C)	BREAKAWAY TORQUE (N-m)
TKB10	2438	15.0	333.6	22.5	70.78	0.005	4 - 54	0.35
TKB25	2438	25.4	533.8	30.3	95.05	0.005	4 - 54	1.06
TKB50	2438	40.0	867.4	30.3	95.05	0.005	4 - 54	1.06
TKB75	2438	50.0	1089.8	30.3	95.05	0.005	4 - 54	1.06

GENERAL ACTUATOR SPECIFICATIONS

TKB ENGLISH ACTUATORS						
ACTUATOR SERIES	CARRIER WEIGHT (lb.)	BASE WEIGHT (inc. carrier) (lb.)	WEIGHT PER (in) OF STROKE (lb.)	INERTIA (lb-in ²) BASE ACTUATOR (inc. carrier assy.)	INERTIA (lb-in ²) PER (in) OF STROKE	REPEATABILITY (in.)
TKB10	0.64	3.23	0.20	0.165	0.0012	±0.002
TKB25	2.41	10.69	0.46	1.100	0.0046	±0.002
TKB50	3.38	14.99	0.61	1.576	0.0072	±0.002
TKB75	4.42	18.34	0.72	2.039	0.0090	±0.002

TKB METRIC ACTUATORS						
ACTUATOR SERIES	CARRIER MASS (kg)	BASE MASS (inc. carrier) (kg)	MASS PER (mm) OF STROKE (kg)	INERTIA (kg-cm ²) BASE ACTUATOR (inc. carrier assy.)	INERTIA (kg-cm ²) PER (mm) OF STROKE	REPEATABILITY (mm)
TKB10	0.3	1.5	0.09	0.48	0.41	±0.05
TKB25	1.1	4.8	0.21	3.22	1.29	±0.05
TKB50	1.5	6.8	0.28	4.61	2.05	±0.05
TKB75	1.5	8.3	0.32	5.97	2.54	±0.05



¹ The listed values relating to straightness/flatness are intended for reference purposes only, and not as an engineering standard of absolute tolerance for a given actuator. Appropriate installation is the single most important factor in reducing such deviation, so good engineering practices such as measurement, mapping, etc. must be employed in applications with stringent straightness/flatness requirements.

² Heat generated by the motor and drive should be taken into consideration as well as linear velocity and work cycle time. For applications that require operation outside of the recommended temperature range, contact the factory.

LARGE FRAME MOTORS AND SMALLER SIZE ACTUATORS: Cantilevered motors need to be supported, if subjected to continuous rapid reversing duty and/or under dynamic conditions.

Axi-dyne[®] TRUTrack™ TKB Belt Drives

OVERALL SERIES SPECIFICATIONS

MOUNTING RECOMMENDATIONS

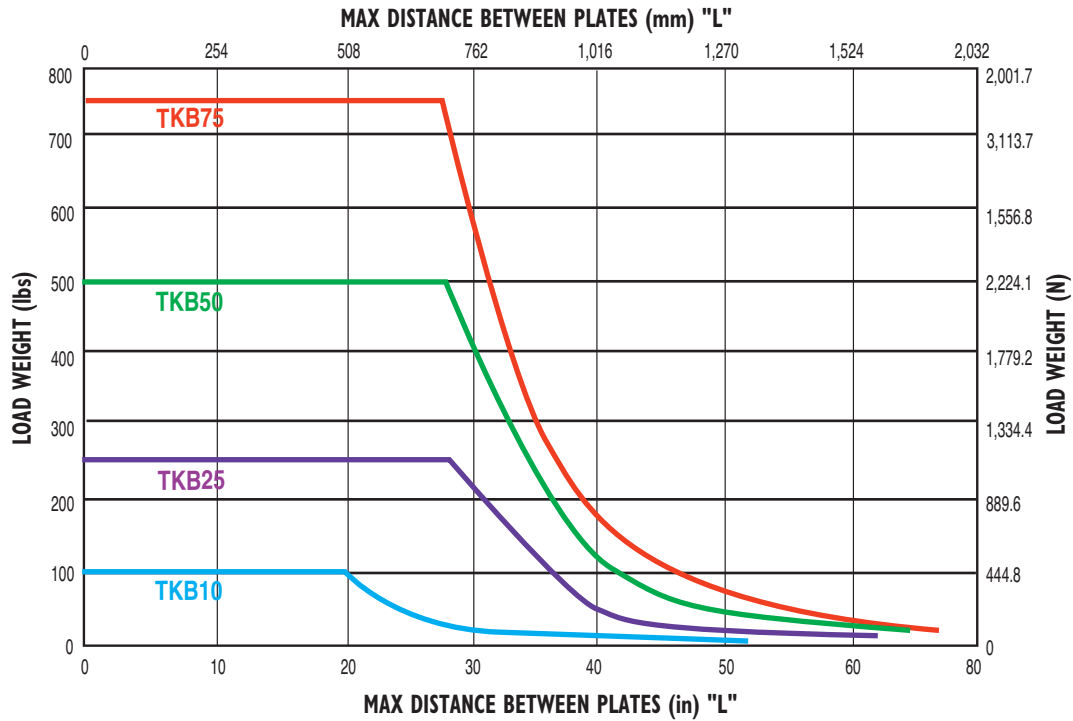

Actuator body theoretical axial deflection will not exceed .015 in (0.38 mm)

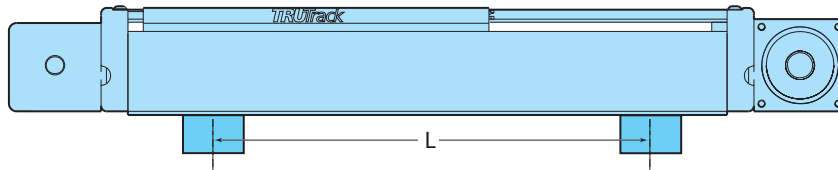

FRICITION FORCE

$$lbf = 0.0003 \times \text{LOAD (lb)} + 3.96$$

$$N = 0.003 \times \text{LOAD (kg)} + 17.6$$

Axi-dyne® TRUTrack™ TKB Belt Drives

OVERALL SERIES SPECIFICATIONS

BELLOWS OPTION STROKE REQUIREMENTS

STANDARD ACTUATOR

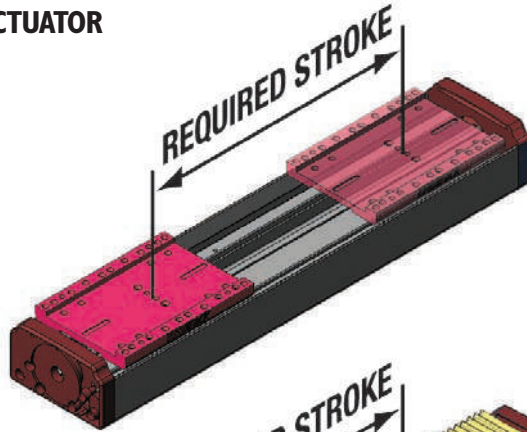

STANDARD ACTUATOR WITH BELLOWS COVER

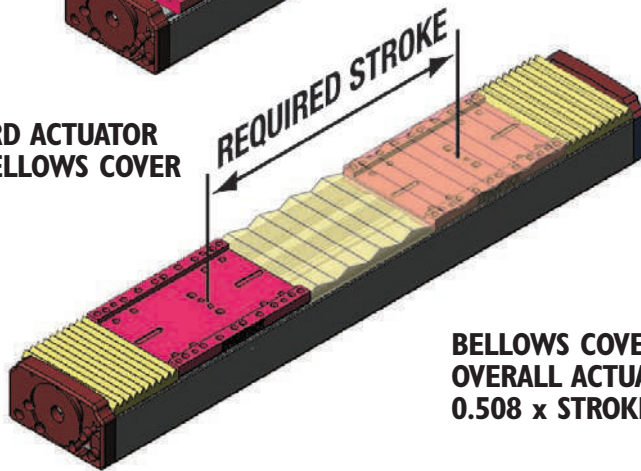

**BELLOWS COVER OPTION INCREASES
OVERALL ACTUATOR LENGTH BY
0.508 x STROKE**



RODLESS

TKB Series
• Bellows option

MAXIMUM AVAILABLE STROKE FOR BELLOWS OPTION

TKB10	64 inches (1626 mm)
TKB25	64 inches (1626 mm)
TKB50	64 inches (1626 mm)
TKB75	64 inches (1626 mm)

Axi-dyne® TRUTrack™ TKB Belt Drives

OVERALL SERIES SPECIFICATIONS

BENDING MOMENTS AND LOADS



RODLESS

TKB Series

- Bending moments and loads

STANDARD CARRIER		MAXIMUM BENDING MOMENTS AND LOADS*				ENGLISH				METRIC CONVERSIONS			
		TKB10	TKB25	TKB50	TKB75	TKB10	TKB25	TKB50	TKB75	TKB10	TKB25	TKB50	TKB75
	Maximum Dynamic Bending Moments												
	Mx (Roll) (lb-in : N-m)	85	721	971	1151	9.6	81.5	109.7	130.0				
	My (Pitch) (lb-in : N-m)	234	1014	1442	1477	26.4	114.6	162.9	166.9				
	Mz (Yaw) (lb-in : N-m)	234	915	1301	1332	26.4	103.4	147.0	150.5				
	Maximum Dynamic Loads												
	Fy (Radial Load) (lb : N)	100	250	500	750	445	1113	2225	3338				
	Fz (Lateral Load) (lb : N)	100	250	500	750	445	1113	2225	2225				
	Fzr (Reverse Lateral Load) (lb : N)	100	250	500	750	445	1113	2225	2225				
	Maximum Static Bending Moments												
	Mx (Roll) (lb-in : N-m)	170	1251	1685	1997	19.2	141.3	190.3	225.6				
	My (Pitch) (lb-in : N-m)	468	1759	2502	2563	52.9	198.8	282.7	289.5				
	Mz (Yaw) (lb-in : N-m)	468	1588	2257	2311	52.9	179.4	255.0	261.1				
Maximum Static Loads													
Fy (Radial Load) (lb : N)	200	434	868	1301	890	1931	3863	5789					
Fz (Lateral Load) (lb : N)	200	434	868	868	890	1931	3863	3863					
Fzr (Reverse Lateral Load) (lb : N)	200	434	868	868	890	1931	3863	3863					
AUXILIARY CARRIER: Increases rigidity, load-carrying capacity and moments		TKB10	TKB25	TKB50	TKB75	TKB10	TKB25	TKB50	TKB75				
	Maximum Dynamic Bending Moments												
	Mx (Roll) ^{**} (lb-in : N-m)	170	1442	1942	2302	19.2	162.9	219.4	260.1				
	My (Pitch) ^{**} (lb-in : N-m)	563	1733	3810	3875	63.6	195.7	430.5	437.8				
	Mz (Yaw) ^{**} (lb-in : N-m)	563	1733	3810	3875	63.6	195.7	430.5	437.8				
	Maximum Dynamic Loads												
	Fy (Radial Load) (lb : N)	200	500	1000	1500	890	2225	4450	6675				
	Fz (Lateral Load) (lb : N)	200	500	1000	1500	890	2225	4450	4450				
	Fzr (Reverse Lateral Load) (lb : N)	200	500	1000	1500	890	2225	4450	4450				
	Maximum Static Bending Moments												
	Mx (Roll) ^{**} (lb-in : N-m)	340	2502	3369	3994	38	283	381	451				
	My (Pitch) ^{**} (lb-in : N-m)	1126	3006	6610	6723	127	340	747	760				
	Mz (Yaw) ^{**} (lb-in : N-m)	1126	3006	6610	6723	127	340	747	760				
Maximum Static Loads													
Fy (Radial Load) (lb : N)	400	868	1735	2603	1780	3863	7721	11583					
Fz (Lateral Load) (lb : N)	400	868	1735	1735	1780	3863	7721	7721					
Fzr (Reverse Lateral Load) (lb : N)	400	868	1735	1735	1780	3863	7721	7721					
Minimum Dimension 'D' (in : mm)	5.63	6.93	7.63	7.75	142.9	176.0	193.8	196.9					



* Bending moments are based on 200,000,000 (5,000 KM) linear inches of carrier travel.

Breakaway torque will increase when using the Auxiliary carrier option. When ordering, determine your working stroke and enter this value into the configuration string. Overall actuator length will automatically be calculated.

Deflection Considerations: In applications where substantial Mx or My moments come into play, deflection of the cylinder tube, carrier and supports must be considered. The deflection factors shown in the Load Deflection charts, are based on cylinder mounted with tube supports at minimum recommended spacing. If more rigidity is desired, refer to the Auxiliary or Dual Carrier options.

** Loads shown in table are at minimum "D" dimension, for ratings with longer "D" dimension see graph on page C-87.

Axi-dyne® TRUTrack™ TKB Belt Drives

OVERALL SERIES SPECIFICATIONS

LOAD DEFLECTION

X-AXIS DEFLECTION

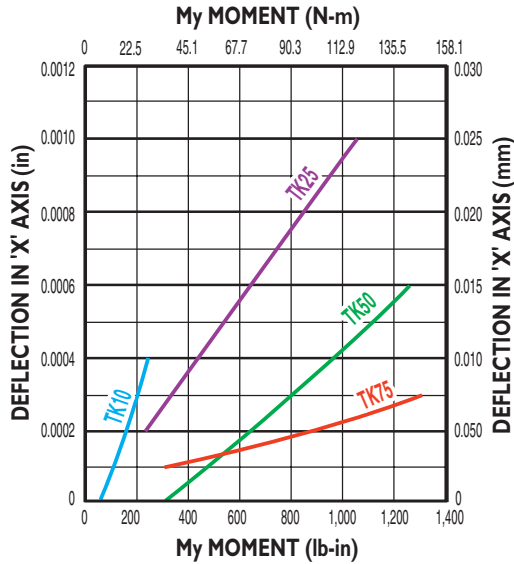
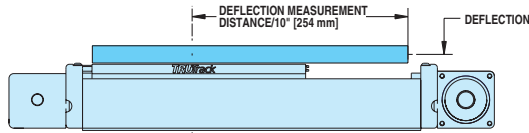

Y-AXIS DEFLECTION

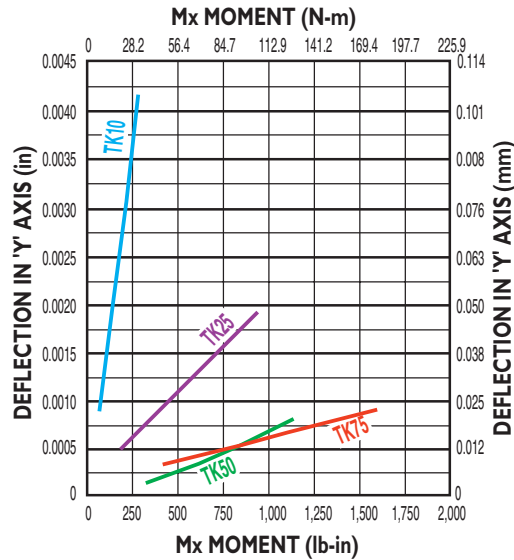
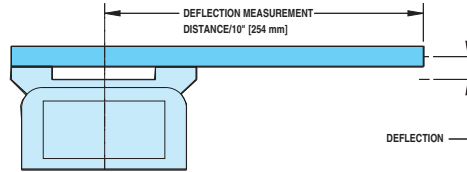

RODLESS

- TKB Series**
- Load deflection
 - Auxiliary carrier

AUXILIARY CARRIER: BENDING MOMENT AT 'D' DISTANCE

DYNAMIC BENDING MOMENT

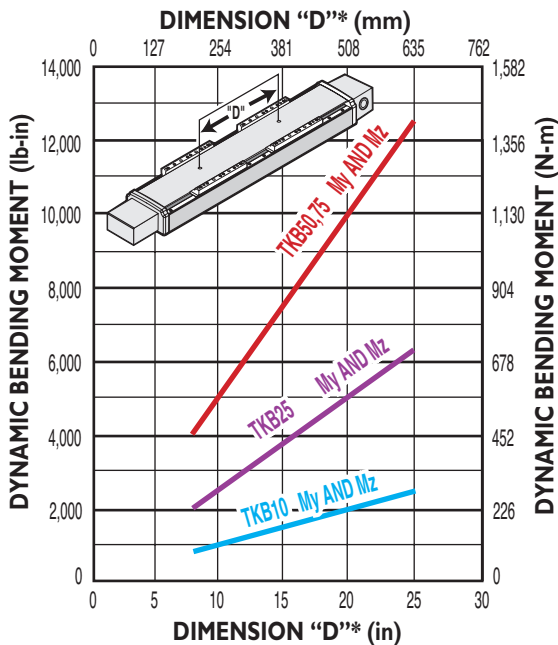

STATIC BENDING MOMENT

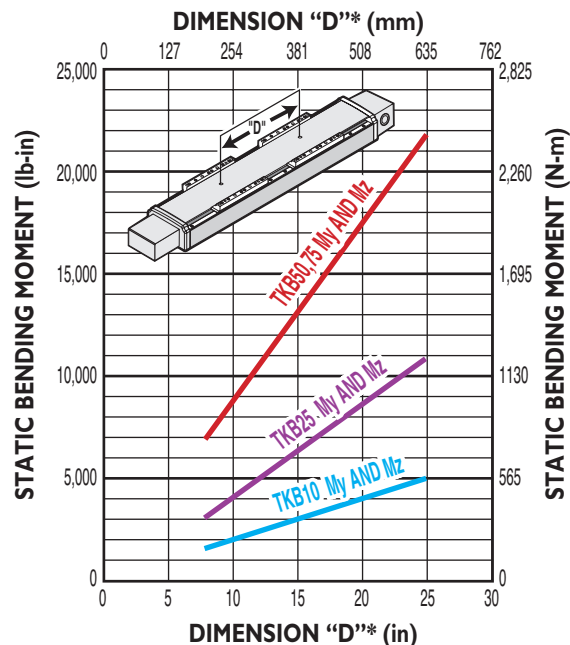

- Rates shown on charts were calculated with these assumptions:
- 1.) Coupling between carriers is rigid.
 - 2.) Load is equally distributed between carriers.
 - 3.) Coupling device applies no misalignment loads to carriers.

* Customer must specify Dimension "D" (Distance between carrier center lines) in configuration string.

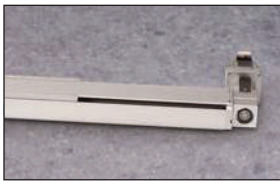

Axi-dyne® TRUTrack™ TKB10 Series BELT SPECIFICATIONS

TKB10 MAXIMUM ACCELERATION AS A FUNCTION OF CARRIER LOAD WEIGHT

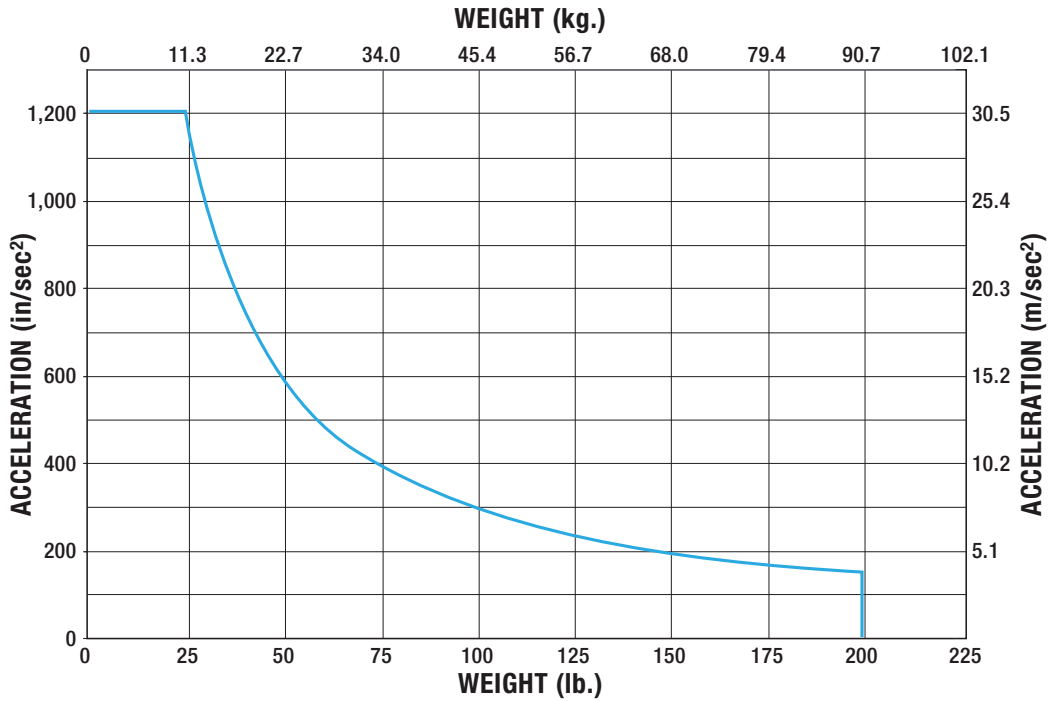

Total load on belt not to exceed 75 lbf. (334 N).

TKB10 MAXIMUM BELT SPEED

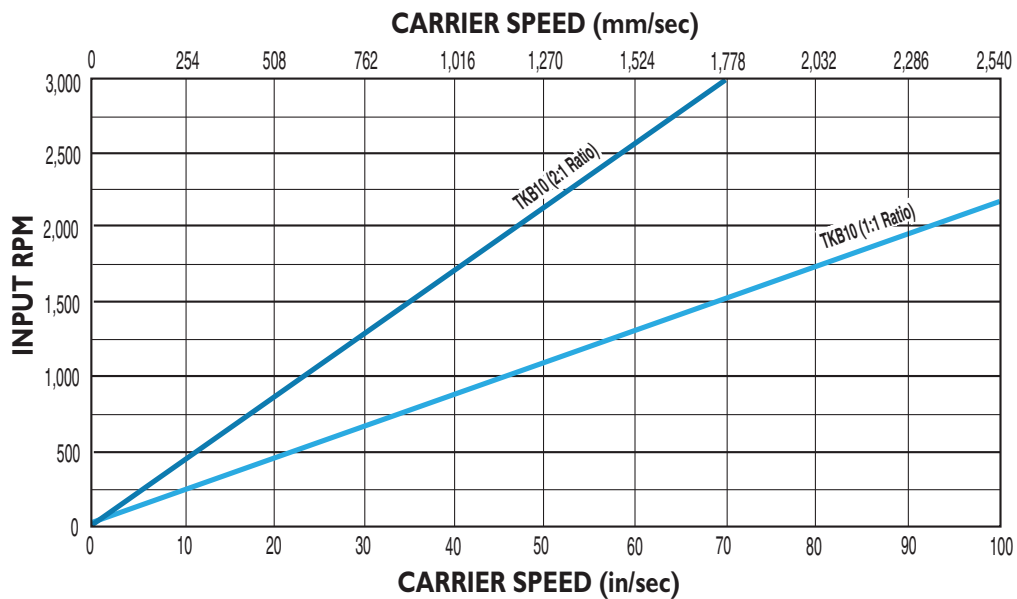

Axi-dyne® TRUTrack™ TKB10 Series

DIMENSIONS

TKB10 ACTUATOR AND OPTIONS

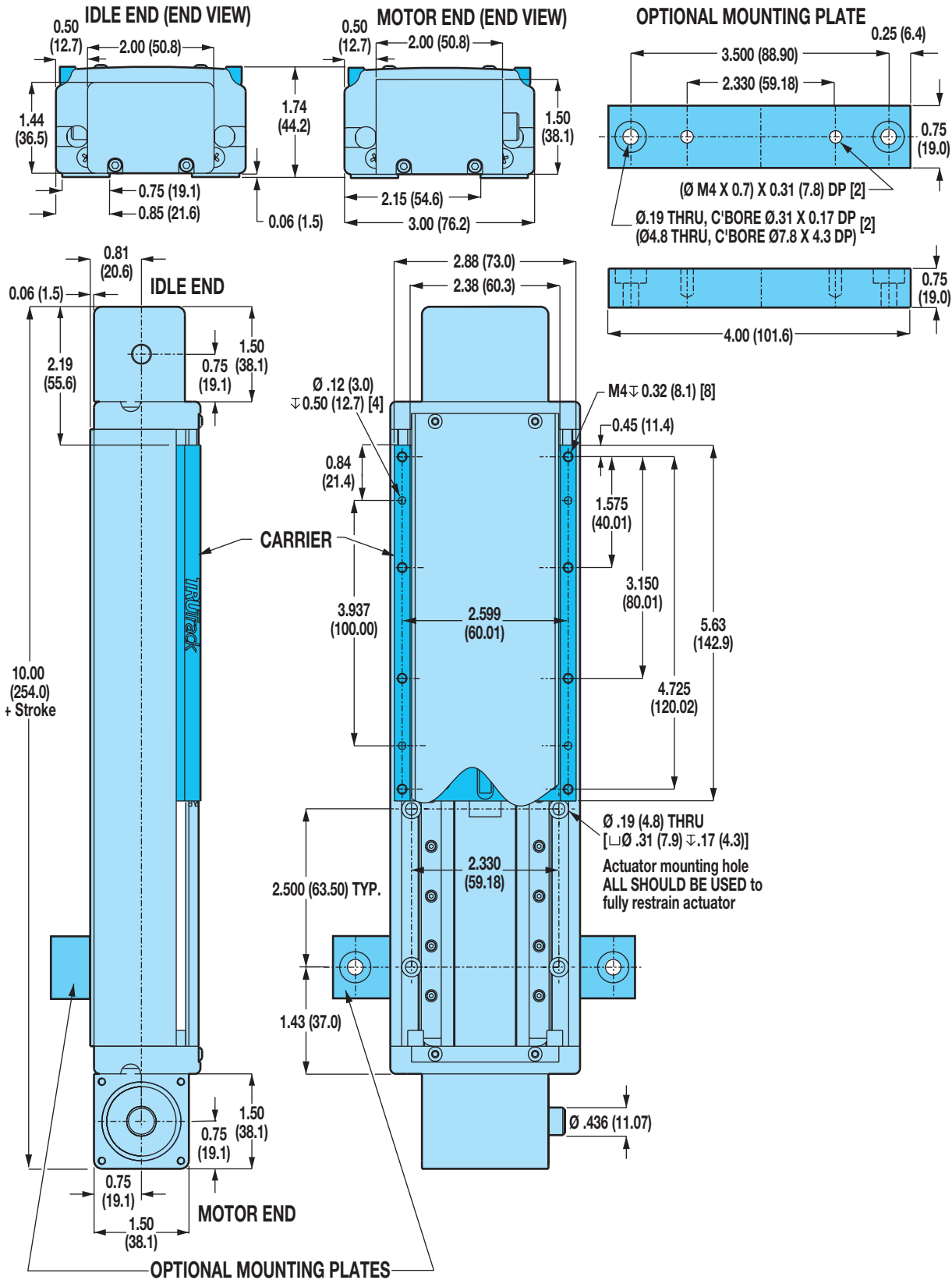

RODLESS

TKB10 Series

• Actuator and options dimensions

Unless otherwise noted, all dimensions shown are in inches (Dimensions in parenthesis are in millimeters)

Axi-dyne® TRUTrack™ TKB10 Series

DIMENSIONS

TKB10 DIRECT DRIVE MOTOR MOUNTING

For 23-frame MRV brushless and 23-frame gearheads



RODLESS

- TKB10 Series**
- Direct drive mounting
 - Xy/Xj shaft option
 - Reduction drive mounting

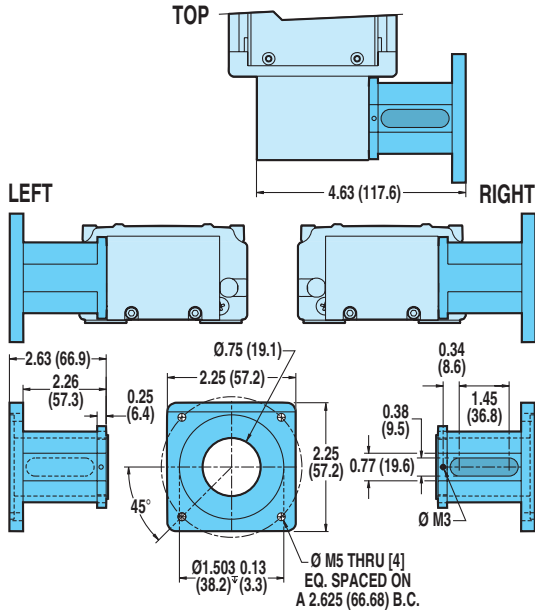

XY/XJ SHAFT OPTION

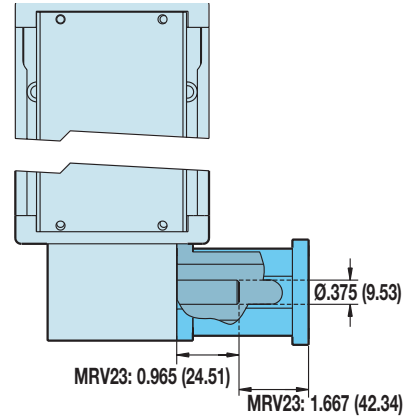

If a Tol-O-Matic motor is not specified in the configuration string, customer's motor must conform to the shaft dimensions shown for mounting compatibility. Please specify your motor type and frame size when ordering. See ordering page F-26 and refer to Customer Supplied Motor Mounting Specifications document 3600-4632.

TKB10 REDUCTION DRIVE MOTOR MOUNTING

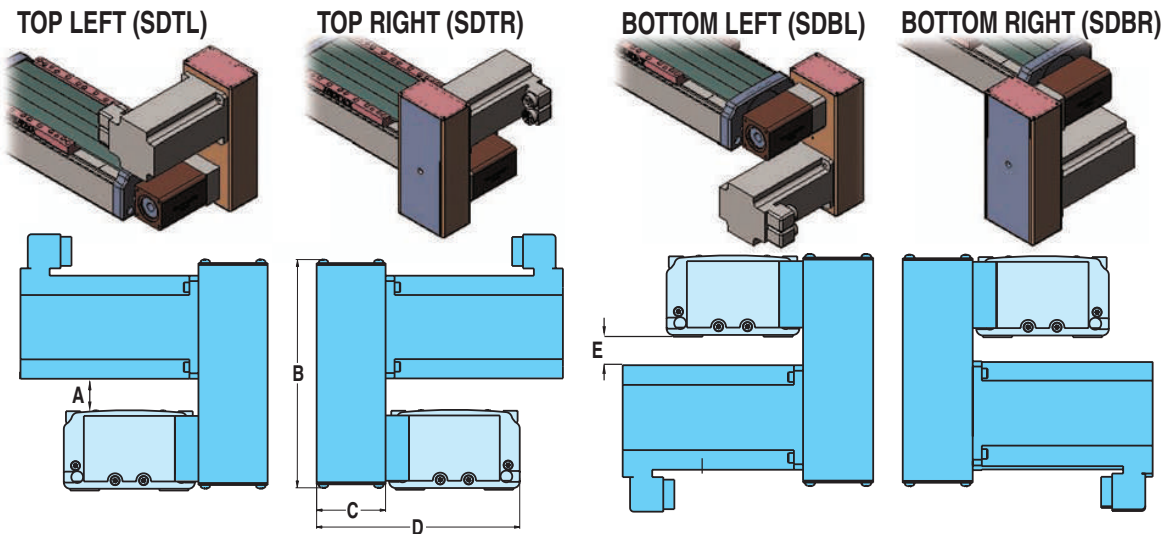

DIMENSIONS

MOTORS	A		B		C		D		E		
	in.	mm	in.	mm	in.	mm	in.	mm	in.	mm	
BRUSHLESS	MRV11	1.21	30.7	5.70	144.8	2.13	54.1	4.50	114.3	1.33	33.7
	MRV21, 22, 23, 24	0.86	21.9	5.70	144.8	2.13	54.1	4.50	114.3	0.98	24.9

SPECIFICATIONS

MOTORS	REDUCTION DRIVE WEIGHT				REDUCTION INERTIA AT MOTOR SHAFT			
	1:1 RATIO		2:1 RATIO		1:1 RATIO		2:1 RATIO	
	lb	kg	lb	kg	lb-in ²	kg-cm ²	lb-in ²	kg-cm ²
MRV11	1.80	0.82	1.80	0.82	.056	.1639	.088	.2568
MRV21, 22, 23, 24	1.80	0.82	1.80	0.82	.056	.1639	.088	.2568

REDUCTION EFFICIENCY: 0.95

Axi-dyne® TRUTrack™ TKB25 Series

BELT SPECIFICATIONS



TKB25 MAXIMUM ACCELERATION AS A FUNCTION OF CARRIER LOAD WEIGHT

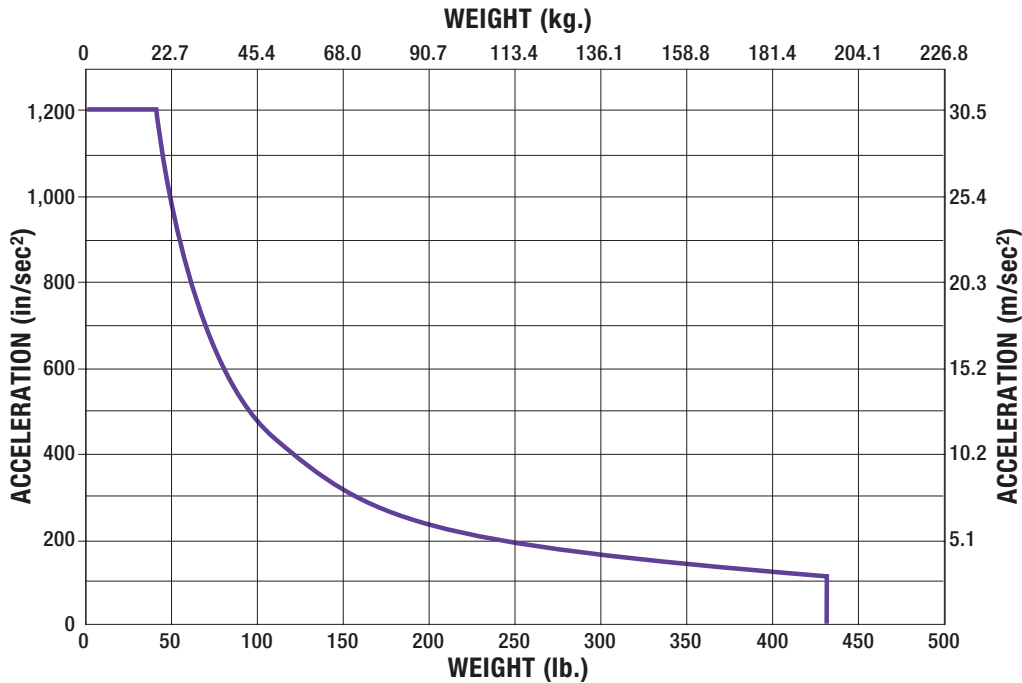

RODLESS

- TKB25 Series**
- Belt load
 - Maximum belt speed

⚠ Total load on belt not to exceed 120 lbf. (534 N).

TKB25 MAXIMUM BELT SPEED

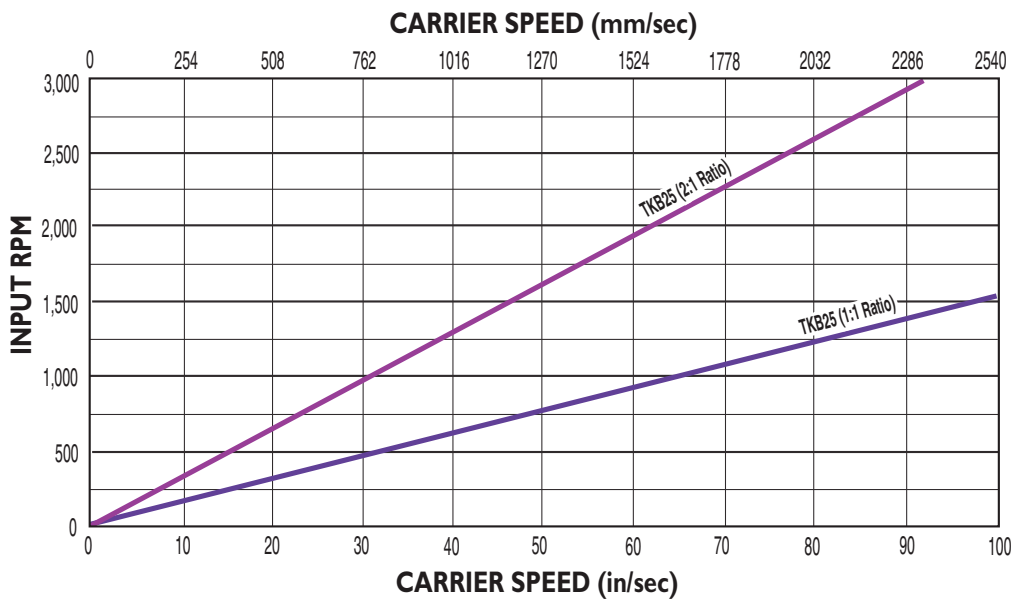

Axi-dyne® TRUTrack™ TKB25 Series

DIMENSIONS

TKB25 ACTUATOR AND OPTIONS



RODLESS

TKB10 Series
• Actuator and option dimensions

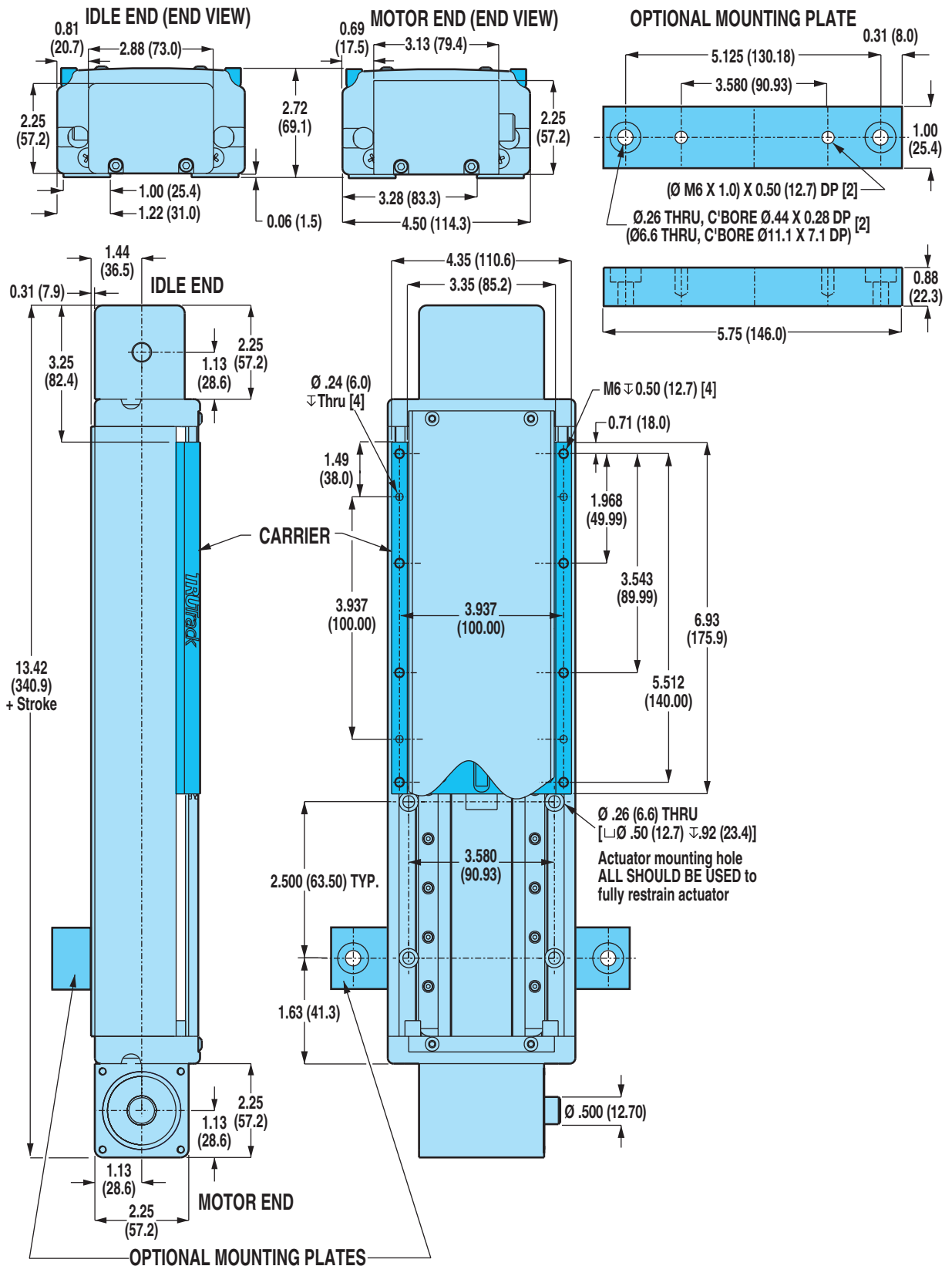

Unless otherwise noted, all dimensions shown are in inches (Dimensions in parenthesis are in millimeters)

Axi-dyne® TRUTrack™ TKB25 Series

DIMENSIONS

TKB25 DIRECT DRIVE MOUNTING MOTOR ADAPTER

For 23-frame MRV brushless motors and gearheads

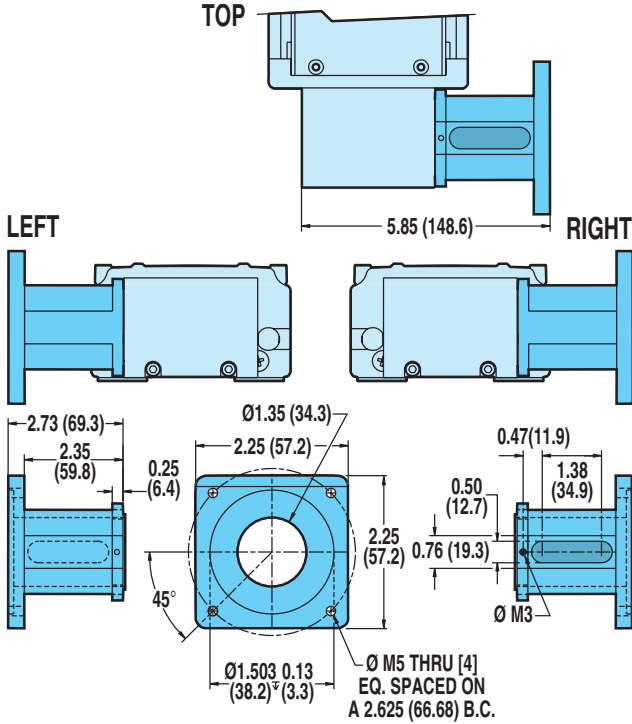

XY/XJ SHAFT OPTION

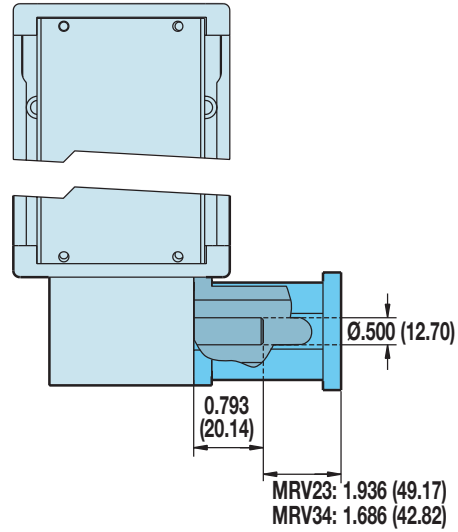

RODLESS

TKB25 Series
• Direct drive motor and gearhead mounting

! If a Tol-O-Matic motor is not specified in the configuration string, customer's motor must conform to the shaft dimensions shown for mounting compatibility. Please specify your motor type and frame size when ordering. See ordering pages F-26 and refer to Customer Supplied Motor Mounting Specifications document 3600-4632.

For 34-frame MRV brushless and 34-frame gearheads.

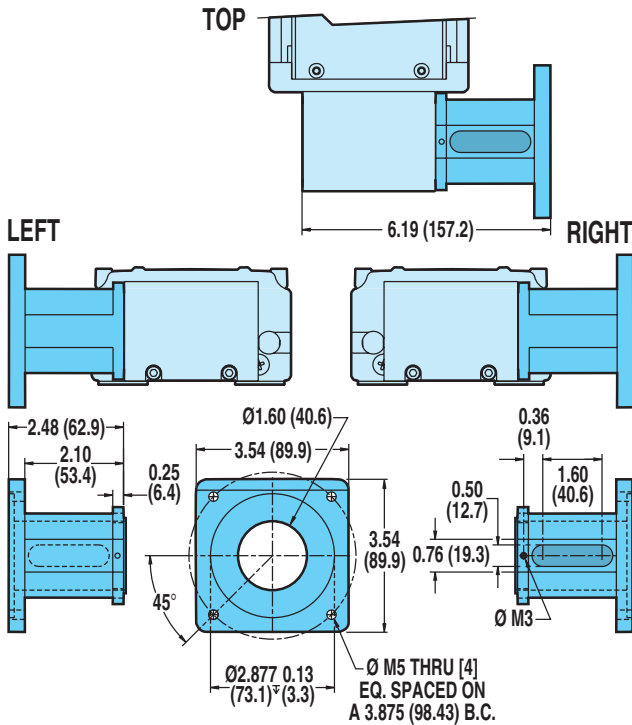

Axi dyne® TRUTrack™ TKB25 Series

DIMENSIONS

TKB25 REDUCTION DRIVE MOTOR MOUNTING

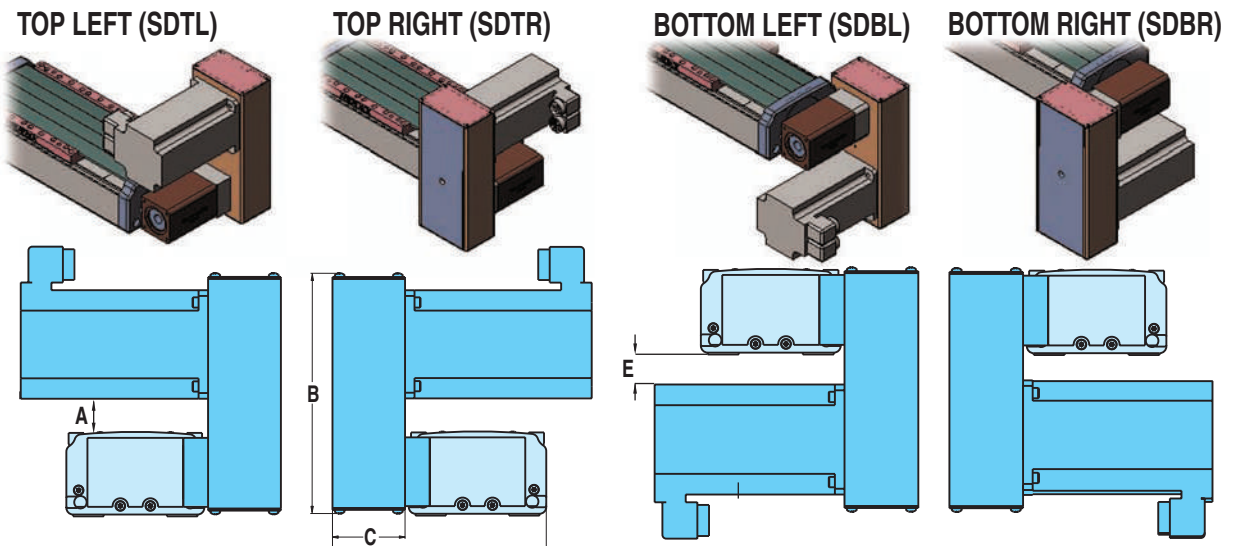

TKB25 Series
• Reduction drive motor mounting

DIMENSIONS

MOTORS	A		B		C		D		E	
	in.	mm	in.	mm	in.	mm	in.	mm	in.	mm
BRUSHLESS MRV21, 22, 23, 24	1.77	44.9	7.02	178.3	2.13	54.1	5.67	144.1	1.61	40.8
MRV31, 32, 33	1.12	28.5	7.79	197.9	2.38	60.5	5.92	150.4	0.96	24.4

SPECIFICATIONS

MOTORS	REDUCTION DRIVE WEIGHT				REDUCTION INERTIA AT MOTOR SHAFT			
	1:1 RATIO		2:1 RATIO		1:1 RATIO		2:1 RATIO	
	lb	kg	lb	kg	lb-in ²	kg-cm ²	lb-in ²	kg-cm ²
MRV21, 22, 23, 24	2.55	1.16	2.78	1.26	.036	.1054	.227	.6628
MRV31, 32, 33	2.80	1.27	3.03	1.37	.036	.1054	.227	.6628

REDUCTION EFFICIENCY: 0.95

Axi-dyne® TRUTrack™ TKB50 Series

BELT SPECIFICATIONS



TKB50 MAXIMUM ACCELERATION AS A FUNCTION OF CARRIER LOAD WEIGHT

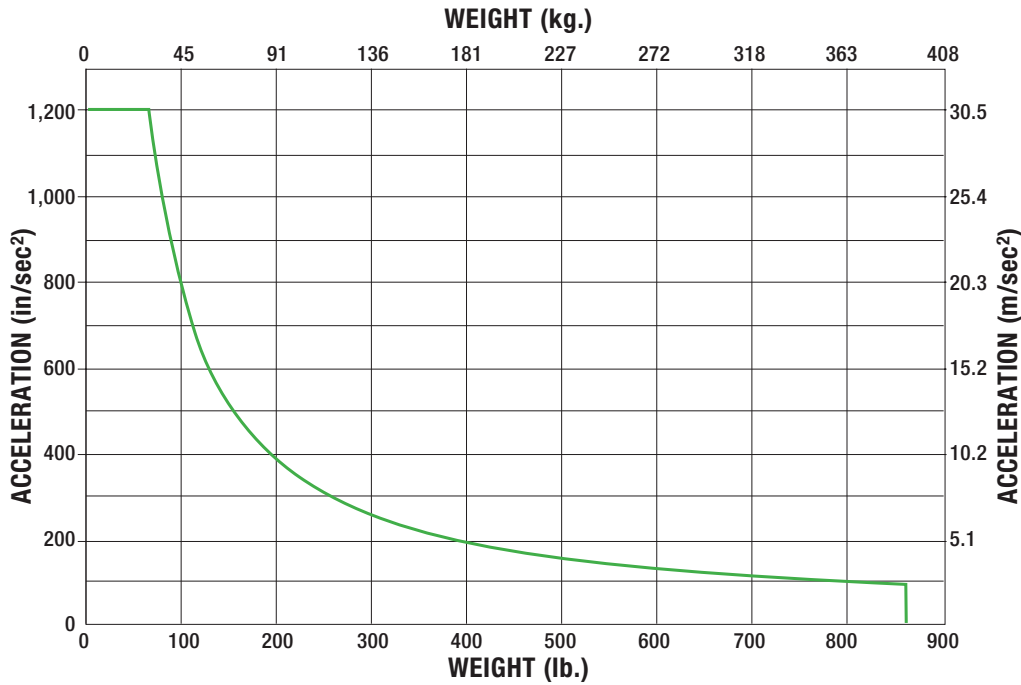

RODLESS

TKB50 Series

- Belt load
- Maximum belt speed



Total load on belt not to exceed 195 lbf. (867 N).

TKB50 MAXIMUM BELT SPEED

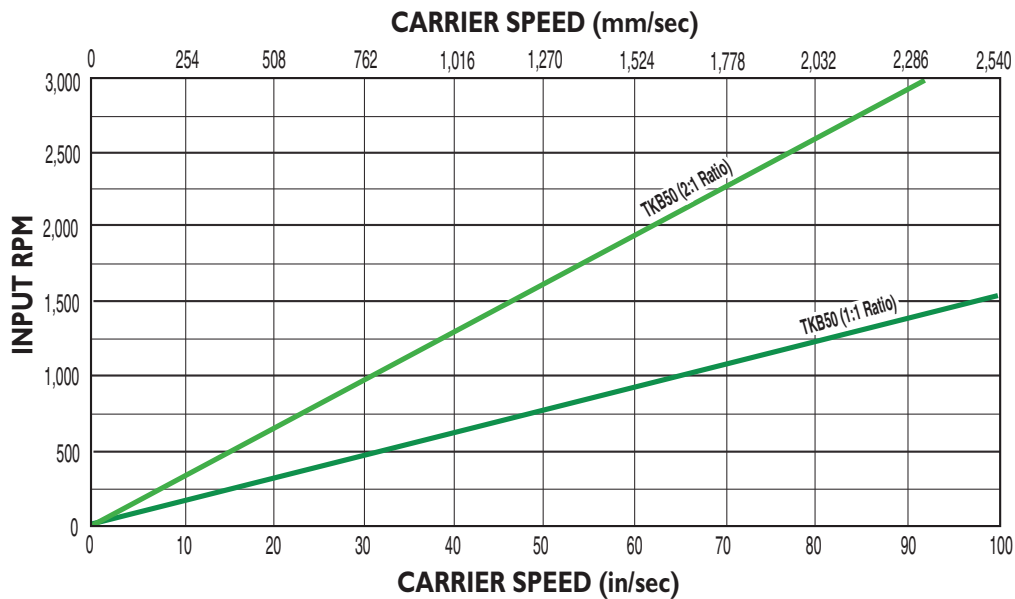

Axi-dyne® TRUTrack™ TKB50 Series

DIMENSIONS

TKB50 ACTUATOR AND OPTIONS



RODLESS

TKB50 Series

- Actuator and options dimensions

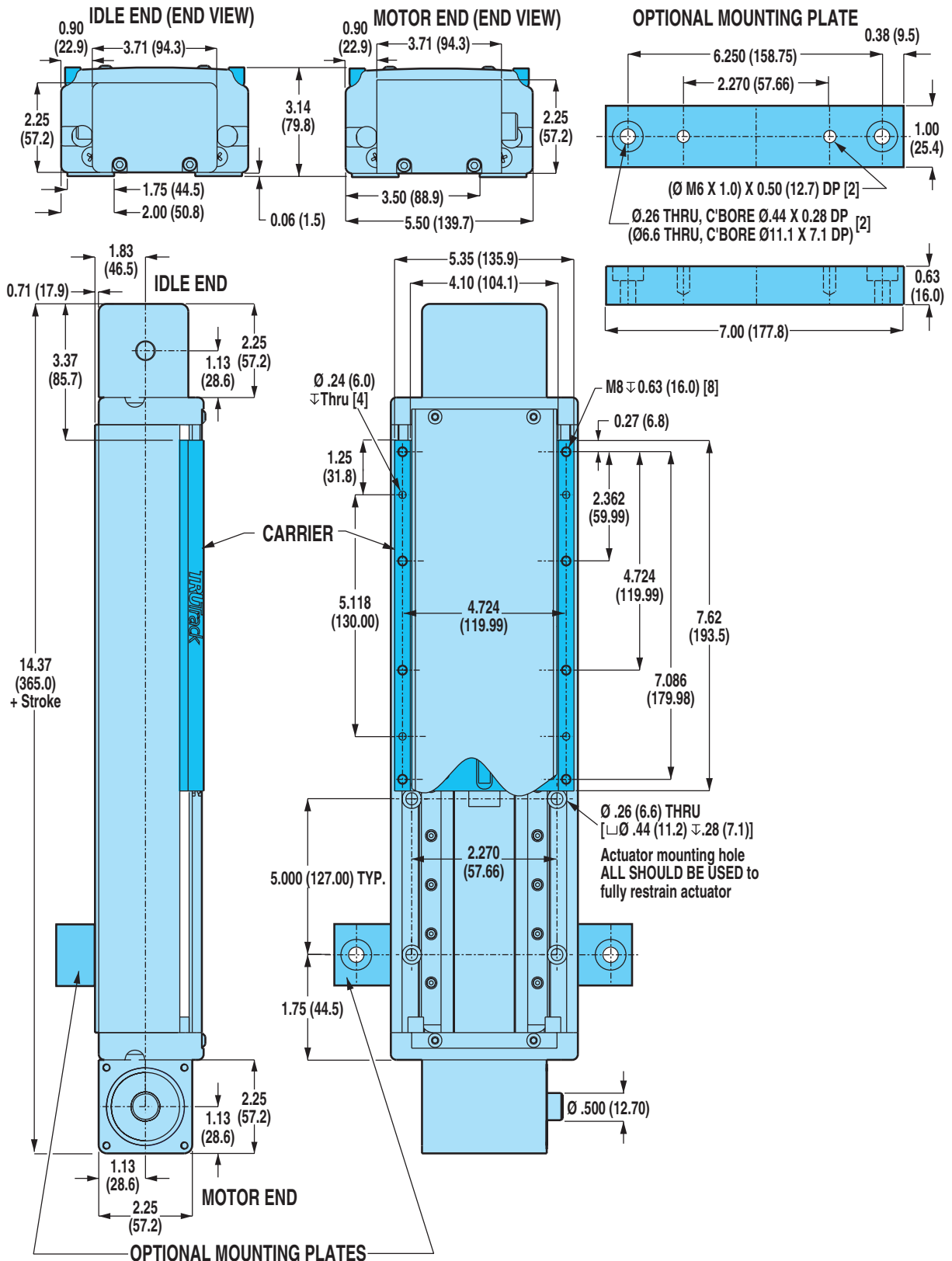

Unless otherwise noted, all dimensions shown are in inches (Dimensions in parenthesis are in millimeters)

Axi-dyne® TRUTrack™ TKB50 Series

DIMENSIONS

TKB50 DIRECT DRIVE MOUNTING MOTOR ADAPTER

For 23-frame MRV brushless motors and gearheads

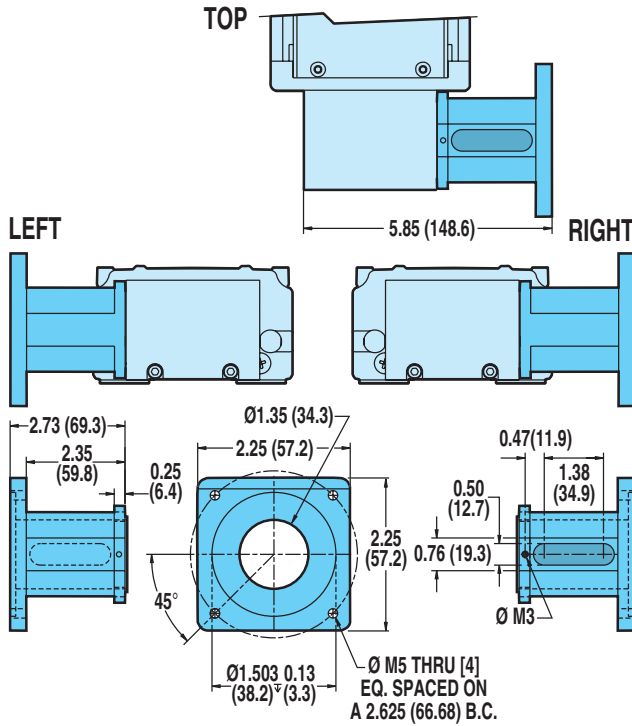

For 34-frame MRV brushless and 34-frame gearheads.

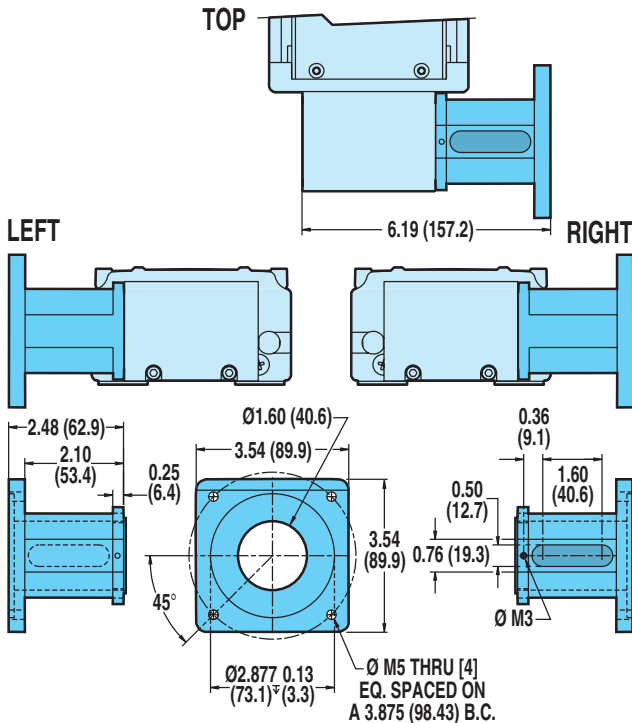

XY/XJ SHAFT OPTION

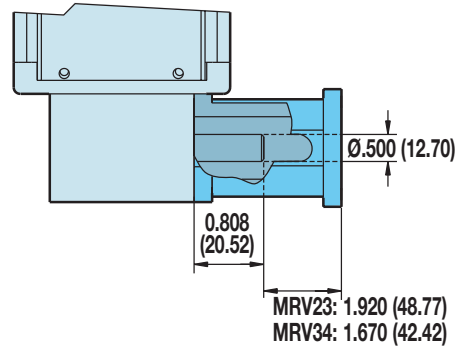

RODLESS

- TKB50 Series**
- Direct drive motor mounting
 - Xy/Xj shaft option

! If a Tol-O-Matic motor is not specified in the configuration string, customer's motor must conform to the shaft dimensions shown for mounting compatibility. Please specify your motor type and frame size when ordering. See ordering page F-26 and refer to Customer Supplied Motor Mounting Specifications document 3600-4632.

Axi-dyne® TRUTrack™ TKB50 Series

DIMENSIONS

TKB50 REDUCTION DRIVE MOTOR MOUNTING

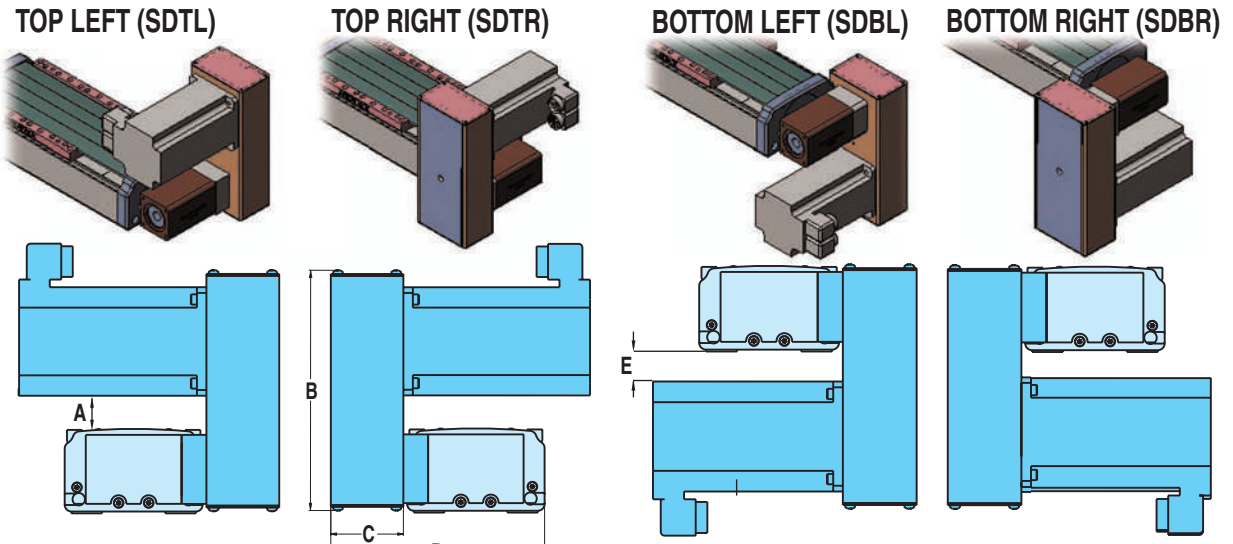

RODLESS

TKB50 Series
• Reduction drive motor mounting

DIMENSIONS

	MOTORS	A		B		C		D		E	
		in.	mm	in.	mm	in.	mm	in.	mm	in.	mm
		BRUSHLESS	MRV21, 22, 23, 24	2.50	63.4	8.34	211.8	2.13	54.1	6.48	164.6
	MRV31, 32, 33	1.85	47.0	8.98	228.1	2.38	60.5	6.73	170.9	1.31	33.3

SPECIFICATIONS

MOTORS	REDUCTION DRIVE WEIGHT				REDUCTION INERTIA AT MOTOR SHAFT			
	1:1 RATIO		2:1 RATIO		1:1 RATIO		2:1 RATIO	
	lb	kg	lb	kg	lb-in ²	kg-cm ²	lb-in ²	kg-cm ²
MRV21, 22, 23, 24	2.87	1.30	3.10	1.40	.036	.1054	.227	.6628
MRV31, 32, 33	3.44	1.56	3.60	1.63	.036	.1054	.227	.6628

REDUCTION EFFICIENCY: 0.95

Axi-dyne® TRUTrack™ TKB75 Series

BELT SPECIFICATIONS

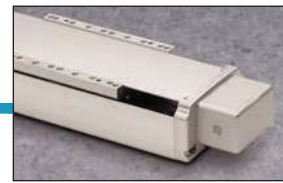

TKB75 MAXIMUM ACCELERATION AS A FUNCTION OF CARRIER LOAD WEIGHT

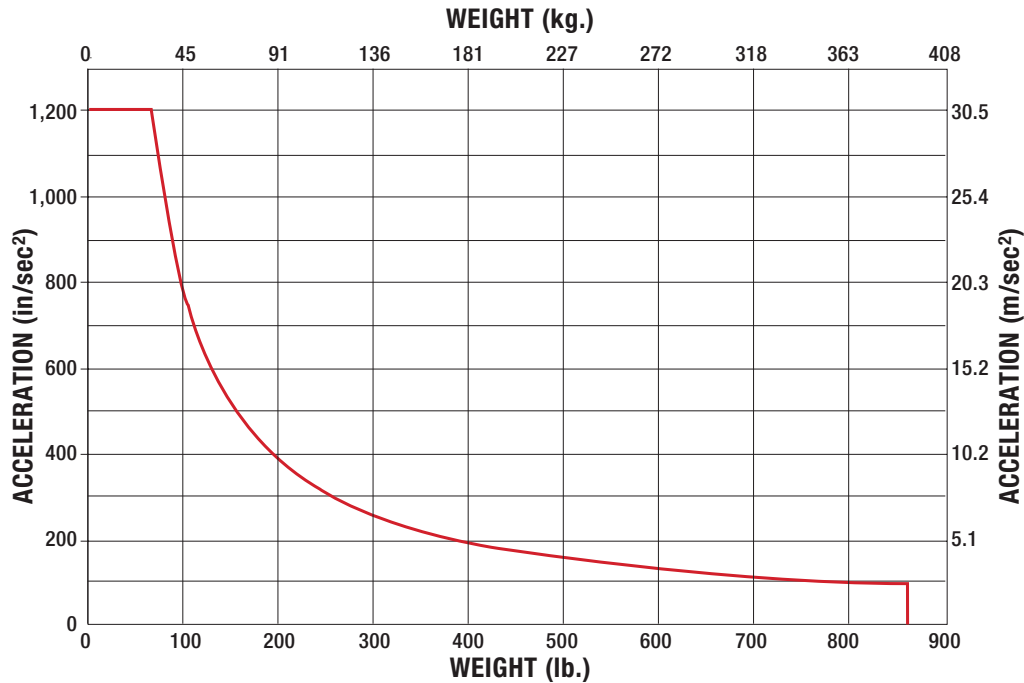

RODLESS

TKB75 Series

- Belt load
- Maximum belt speed



Total load on belt not to exceed 245 lbf. (1090 N).

TKB75 MAXIMUM BELT SPEED

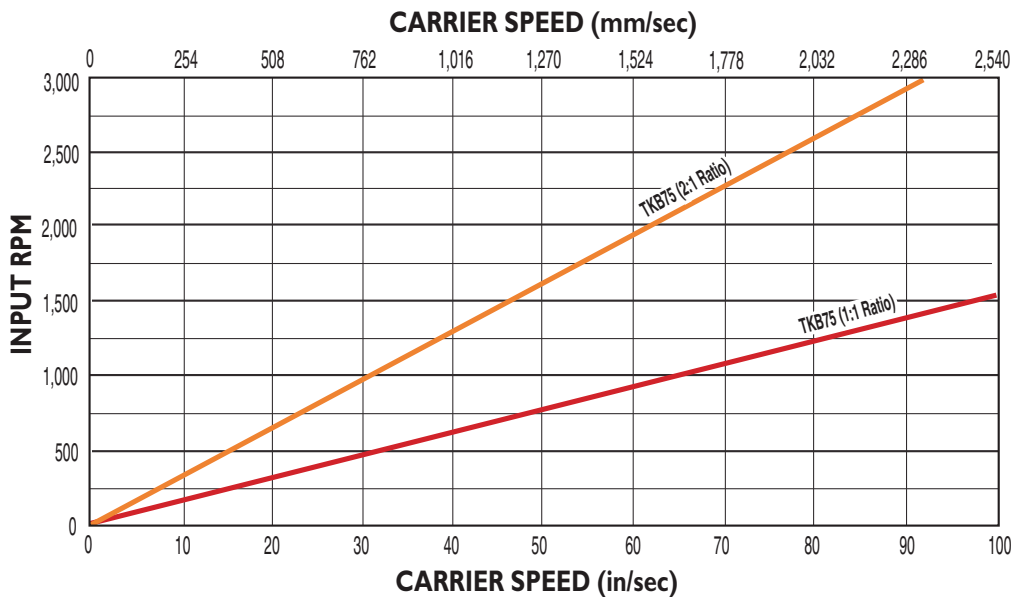

Axi dyne® TRUTrack™ TKB75 Series

DIMENSIONS

TKB75 ACTUATOR AND OPTIONS



RODLESS

TKB75 Series

- Actuator and options dimensions

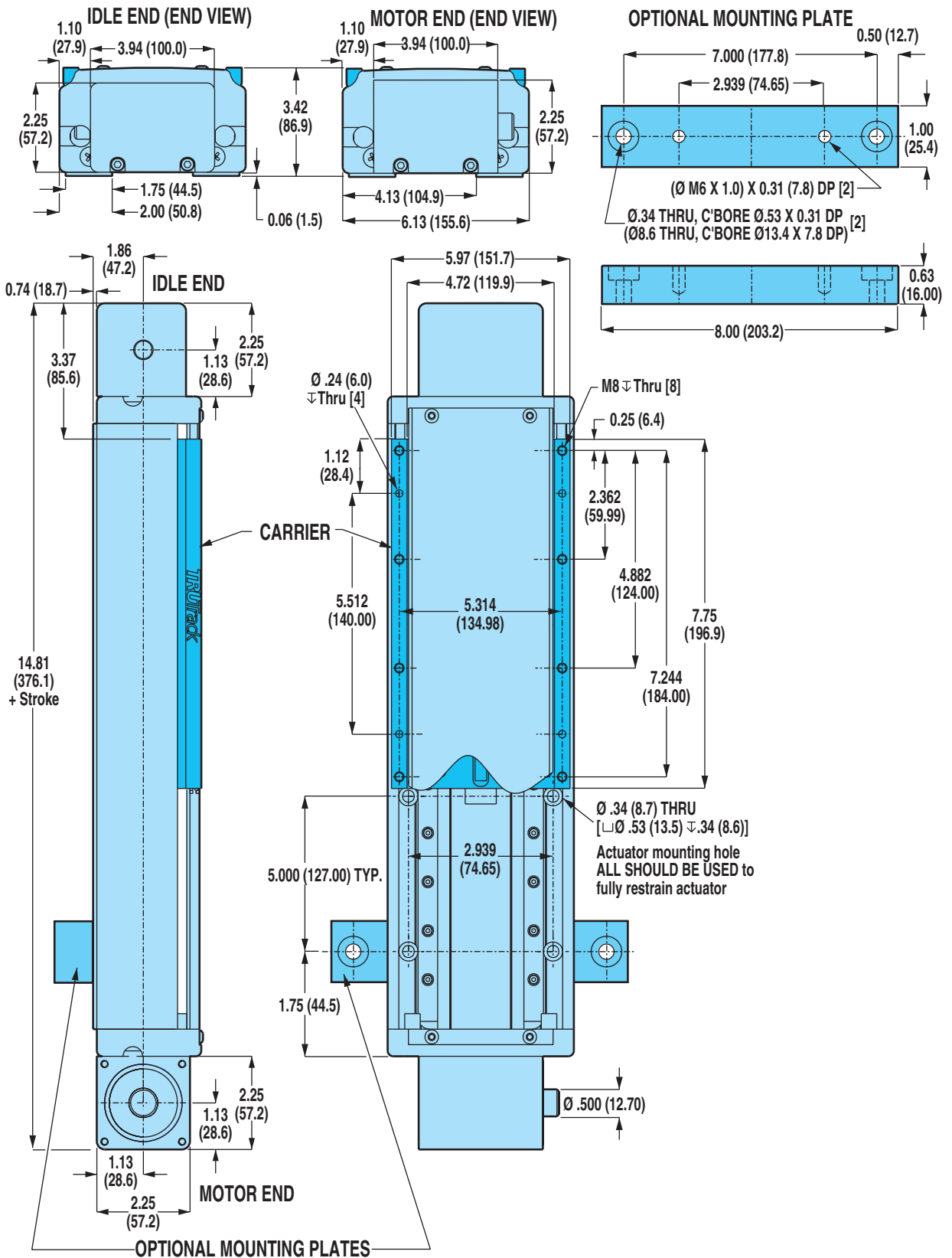

Unless otherwise noted, all dimensions shown are in inches (Dimensions in parenthesis are in millimeters)

Axi-dyne[®] TRUTrack™ TKB75 Series

DIMENSIONS

TKB75 DIRECT DRIVE MOTOR MOUNTING

For 34-frame MRV brushless and 34-frame gearheads

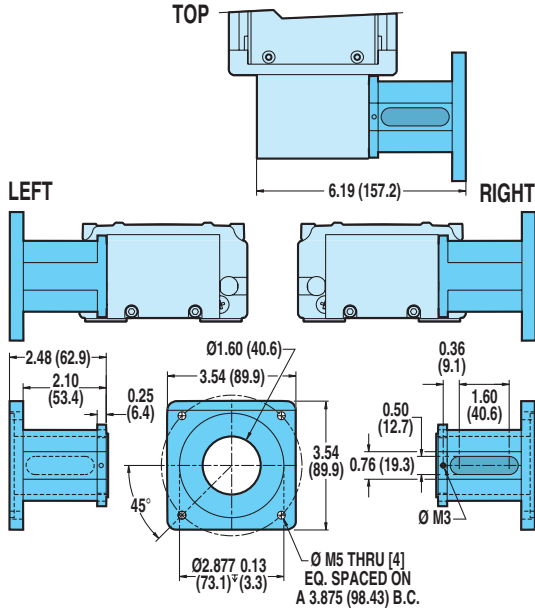

XY/XJ SHAFT OPTION

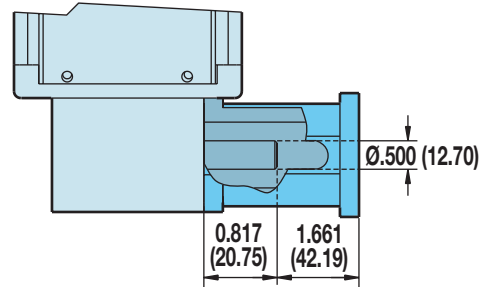

RODLESS

TKB75 Series

- Direct drive motor mounting dimensions
- Reduction drive motor mounting dimensions
- Xy/Xj motor mounting option



If a Tol-O-Matic motor is not specified in the configuration string, customer's motor must conform to the shaft dimensions shown for mounting compatibility. Please specify your motor type and frame size when ordering. See ordering pages F-26 and refer to Customer Supplied Motor Mounting Specifications document 3600-4632.

TKB75 REDUCTION DRIVE MOTOR MOUNTING

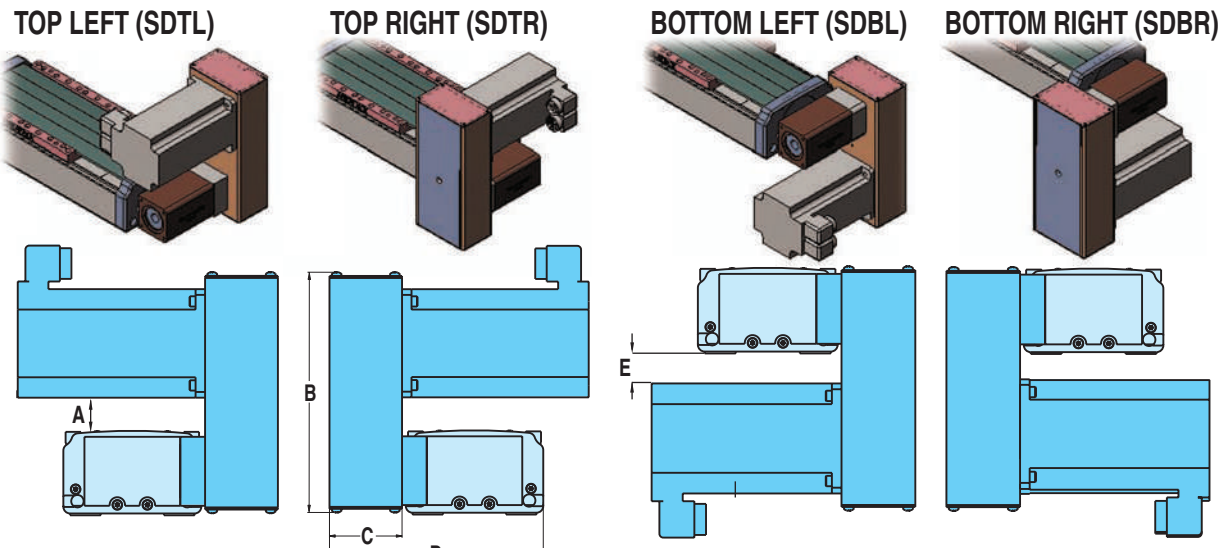

DIMENSIONS

MOTORS	A		B		C		D		E	
	in.	mm	in.	mm	in.	mm	in.	mm	in.	mm
MRV31, 32, 33	1.60	40.7	8.98	228.1	2.38	60.5	7.00	177.9	1.28	32.5

SPECIFICATIONS

MOTORS	REDUCTION DRIVE WEIGHT				REDUCTION INERTIA AT MOTOR SHAFT			
	1:1 RATIO		2:1 RATIO		1:1 RATIO		2:1 RATIO	
	lb	kg	lb	kg	lb-in ²	kg-cm ²	lb-in ²	kg-cm ²
MRV31, 32, 33	3.44	1.56	3.60	1.63	.036	.1054	.227	.6628

REDUCTION EFFICIENCY: 0.95

Axi *dyne*® TRUTrack™ TKB Belt Drives

ORDERING

BASE MODEL SPECIFICATIONS

TKB 50 SK48 SDBR2

MODEL TYPE
TKB TKB Series TruTrack Belt Drive

PAYLOAD LIMITS

10	100 lbs
25	250 lbs
50	500 lbs
75	750 lbs

STROKE LENGTH

SK Stroke, then enter desired stroke length in decimal inches

MODEL	MAX STROKE* (in)
TKB ALL SIZES	96

*Actuator cover has maximum stroke of 48 inches

MOTOR MOUNTING / REDUCTIONS

(must choose one)

SDL Direct Drive / left
SDR Direct Drive / right

⚠ A motor size and code must be selected when specifying a 1:1 or 2:1 reduction. Reference the ordering pages in sections F, G and H for the motor types and selections.

SDTL1 1:1 Reduction Drive / top left
SDTR1 1:1 Reduction Drive / top right
SDBL1 1:1 Reduction Drive / bottom left
SDBR1 1:1 Reduction Drive / bottom right
SDTL2 2:1 Reduction Drive / top left
SDTR2 2:1 Reduction Drive / top right
SDBL2 2:1 Reduction Drive / bottom left
SDBR2 2:1 Reduction Drive / bottom right

OPTIONS SPECIFICATIONS

DC18 KT2 BE2 LU MP4

AUXILIARY CARRIER

DC_ Auxiliary Carrier, then center-to-center spacing desired in decimal inches. (Center-to-Center spacing will add to overall dead length and will not subtract from the stroke length)

SWITCHES

RT_ Reed Switch (Form A) with 5-meter lead, and quantity desired
BT_ Reed Switch (Form C) with 5-meter lead, and quantity desired
KT_ Hall-effect Sinking Switch with 5-meter lead, and quantity desired
TT_ Hall-effect Sourcing Switch with 5-meter lead, and quantity desired
SP* Sensor Package

*Includes: Two Form C reed switches w/5-meter leads, mounted 1" from end-of-stroke and one Hall-effect sinking switch w/5-meter lead, mounted 2" from end-of-stroke on motor end.

BELLOWS

BE2 Bellows option (increases the dead length of the actuator, see page C-87)

SPECIAL LUBRICATION

LU Low dust generating grease

MOUNTING PLATES

MP_ Mounting Plates plus quantity desired



RODLESS

TKB Series
• Ordering

TO ORDER MOTORS/CONTROLS/INTERFACES

 **BRUSHLESS SERVO (SEE PAGE F-33)**



Not all codes listed are compatible with all options.

Use the Tol-O-Motion™ Sizing Software to determine available options and accessories based on your application requirements.

FIELD RETROFIT KITS				
ITEM	TKB10	TKB25	TKB50	TKB75
Mounting Plates	0601-9803	0602-9803	0603-9803	0604-9803

BCS/MCS Screw Drives

OVERVIEW



APPLICATION BENEFITS

- Moderate load carrying capabilities at an economical price
- Easily retrofittable and interchangeable
- Adjustable carrier and self-lubricating bearings for easy maintenance

GUIDANCE SYSTEM

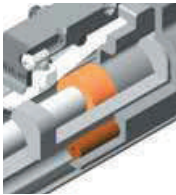

A patented* adjustable carrier bracket transmits the load to the cylinder body, instead of the screw for true tracking, superior load support and controlled minimum friction load. Two self-lubricating Delrin bearing rods, pass force directly to the cylinder tube. Patented** Band Retention system uses a T-shaped elastomer strip bonded to a stainless steel band, inserted directly into the body housing forming a tight metal-to-metal seal for clean operation.

* U.S. Patent No. 4724744

** U.S. Patent No. 4545290

STANDARD MOUNTING



Mounting holes are provided on the underside of the cylinder heads. To mount, transfer the location of holes to the receiving surface. Drill mounting holes 1/32" larger than diameter of the mounting screws and attach securely with appropriate screws.

ACTUATOR/MOTOR FACTORS

- Actuator's operating temperature range (40-130° F, 4-54° C) should take into consideration heat generated by the motor and drive, linear velocity and work cycle time.
- For large frame motors or small actuators, cantilevered motors need to be supported, if subjected to continuous rapid reversing duty and/or under dynamic conditions.

AVAILABLE OPTIONS



Tube Supports: Provide intermediate support of actuator body at the recommended intervals. They are designed to fit into the dove-tailed grooves running the entire length of the cylinder tube.



Mounting Plates: Provide clearance height for motors and motor mounts when mounting an actuator on a flush surface. Mounted to the tapped holes in cylinder heads, they provide the means for top mounting access. Kits include plates and mounting screws.



Floating Mount Bracket: Compensates for non-parallelism between the actuator and an external support/guidance system. These mounts should be used on independently-guided loads to eliminate actuator binding. Use of the Float Mount, adds 0.014" (0.36 mm) to the backlash.



Auxiliary Carrier: Increases rigidity, load-carrying capacity and bending moments



Motor Mounting and Gearhead Reduction:

In-line Motor Mounting— This motor mounting option uses a spacer and coupler to join the motor to the actuator shaft.

Reverse-parallel Motor Mounting—These factory assembled configurations allow off-set mounting of the motor to either side of, or below the actuator. Available in 1:1 or 2:1 drive ratios, they offer quiet, zero-backlash coupling of the motor to the actuator screw shaft.

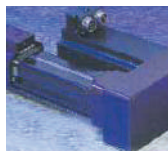

Gearhead Reduction—Gearheads are available for applications requiring reduction for inertia matching or higher torque at lower speeds. High efficiency, single stage, true planetary gearheads are available in 5.5:1 and 10:1 ratios for reduction solutions with most Tolomatic NEMA 23 and 34 face motors. See page F-10.



Switches: Reed, dc Hall-effect and ac TRIAC. See section I.

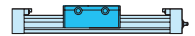

RODLESS

BCS/MCS Series

- Application benefits
- Guidance system
- Standard mounting
- Actuator/motor factors
- Available options

BCS/MCS Screw Drives

ACME SCREW/NUT COMBINATIONS

ACME SCREW CRITICAL SPEED CAPACITIES

CRITICAL SPEED WITH ENGLISH ACME SCREW

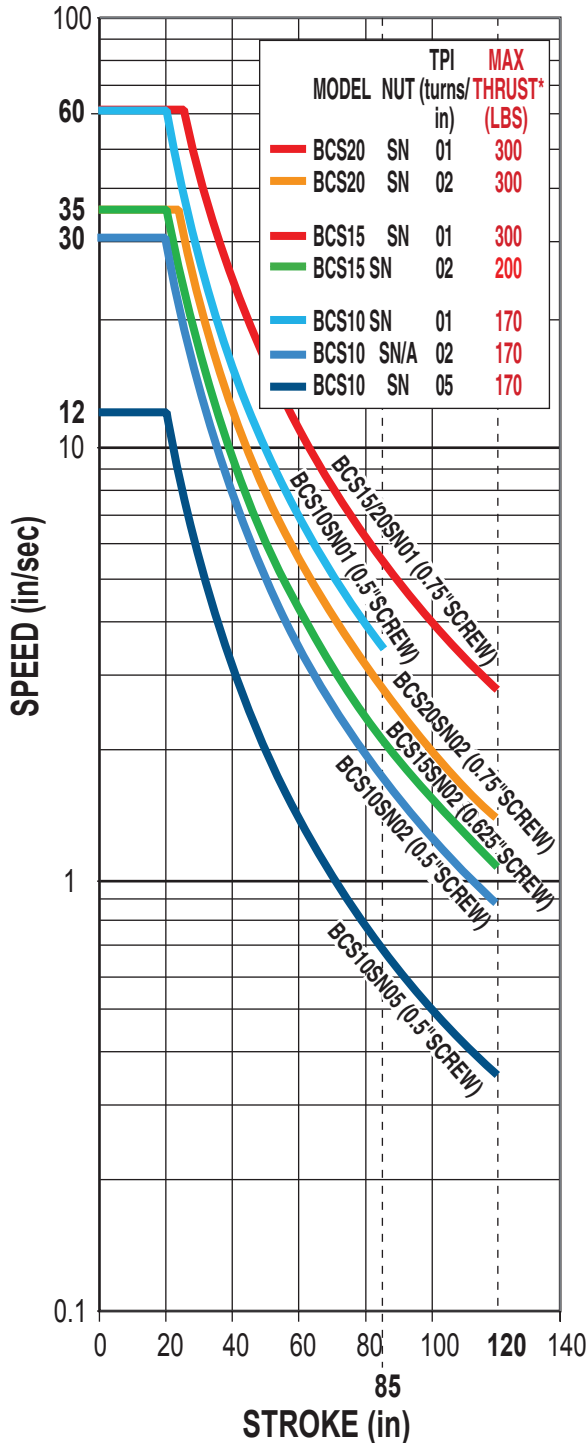

CRITICAL SPEED WITH METRIC ACME SCREW

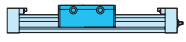
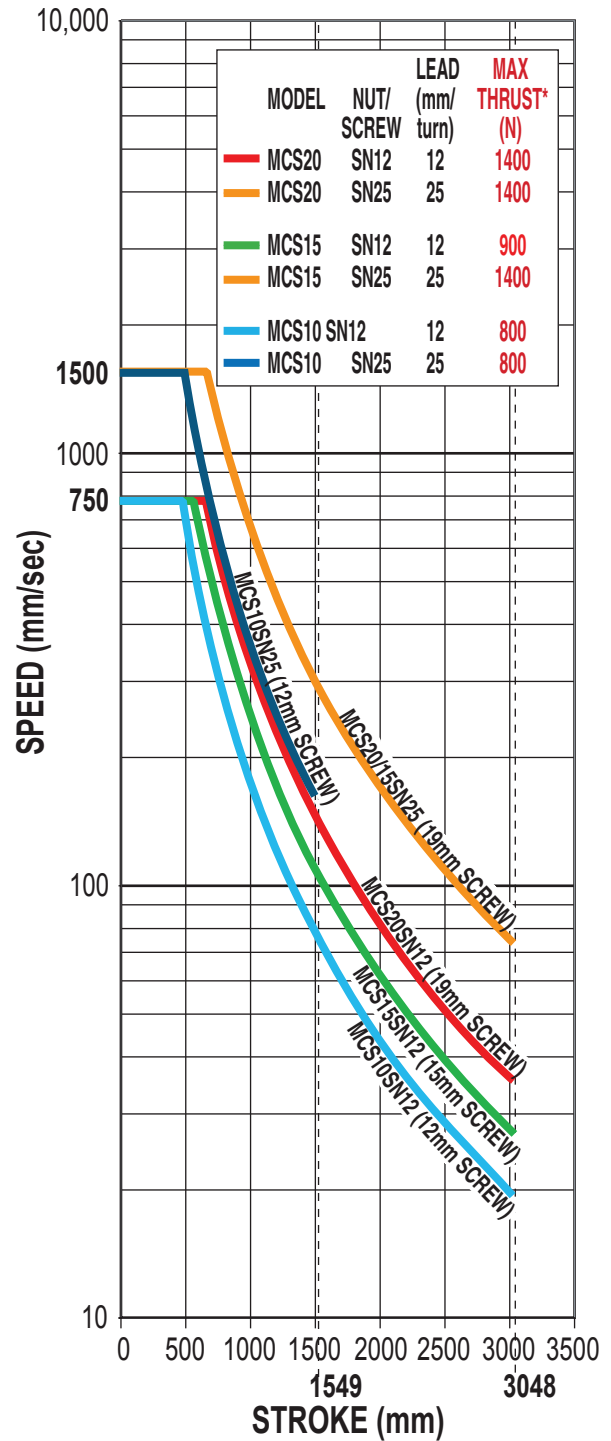

RODLESS

BCS/MCS Series

- Acme critical speed capacities



* Maximum thrust is the maximum continuous dynamic thrust subject to Thrust x Velocity limitation.

Dotted lines represent maximum stroke for screw selections.

For Screw PV limits, refer to the individual charts located in the technical section for each actuator body size.

BCS/MCS Screw Drives

BALL SCREW/NUT COMBINATIONS

BALL SCREW CRITICAL SPEED CAPACITIES

CRITICAL SPEED WITH ENGLISH BALL SCREW

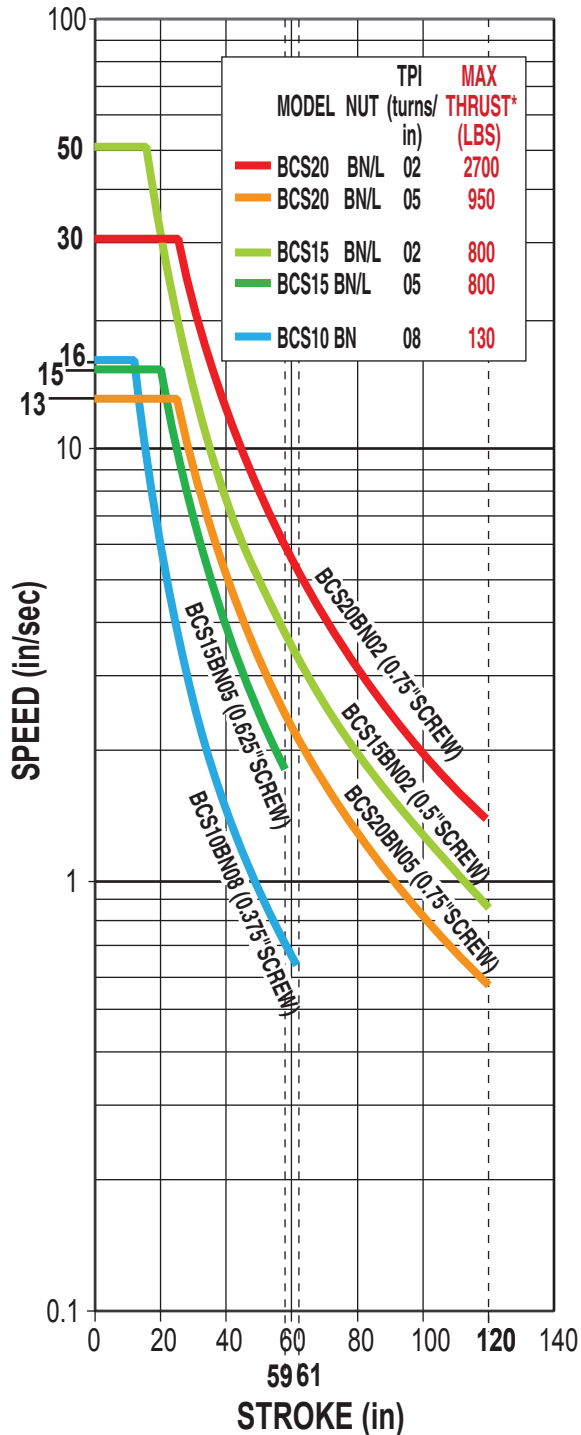

CRITICAL SPEED WITH METRIC BALL SCREW

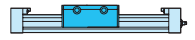
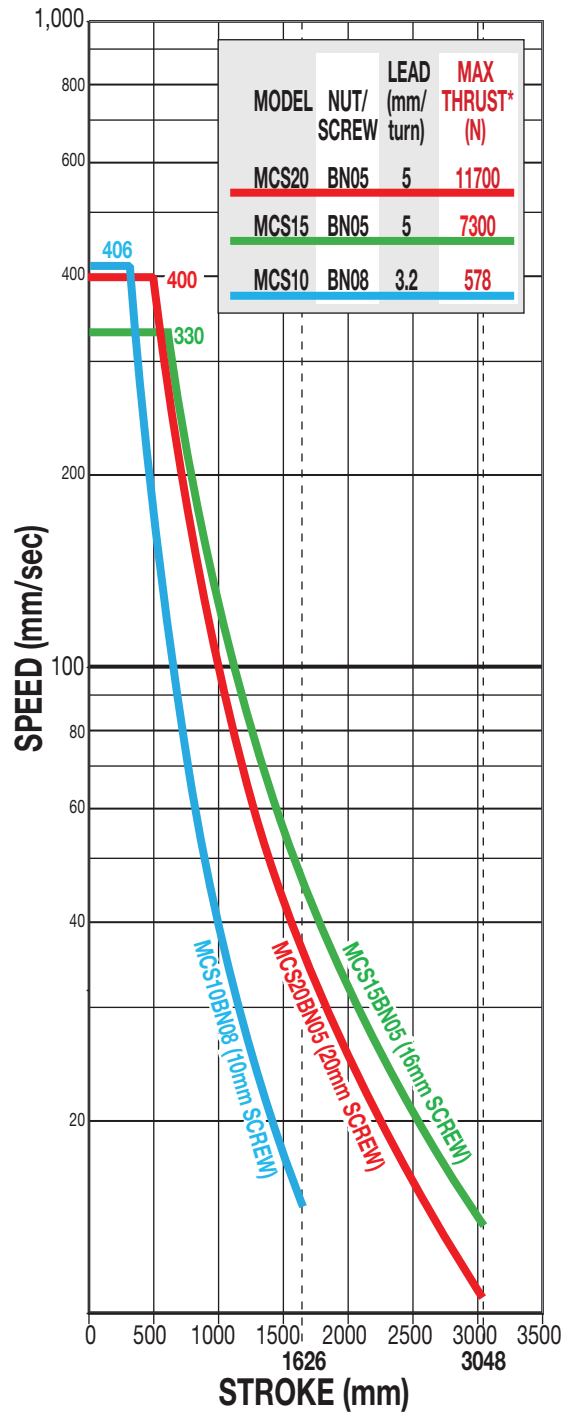

RODLESS

BCS/MCS Series

- Ball screw critical speed capacities



* Maximum thrust reflects 90% reliability for 1 million linear inches of travel.

Dotted lines represent maximum stroke for screw selections.

Refer to the technical section for each actuator body size for details on life calculations for individual screws.

BCS/MCS Screw Drives

BALL SCREW SPECIFICATIONS

BALL SCREW LIFE CALCULATION

LIFE CAPACITIES WITH ENGLISH BALL SCREW

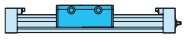
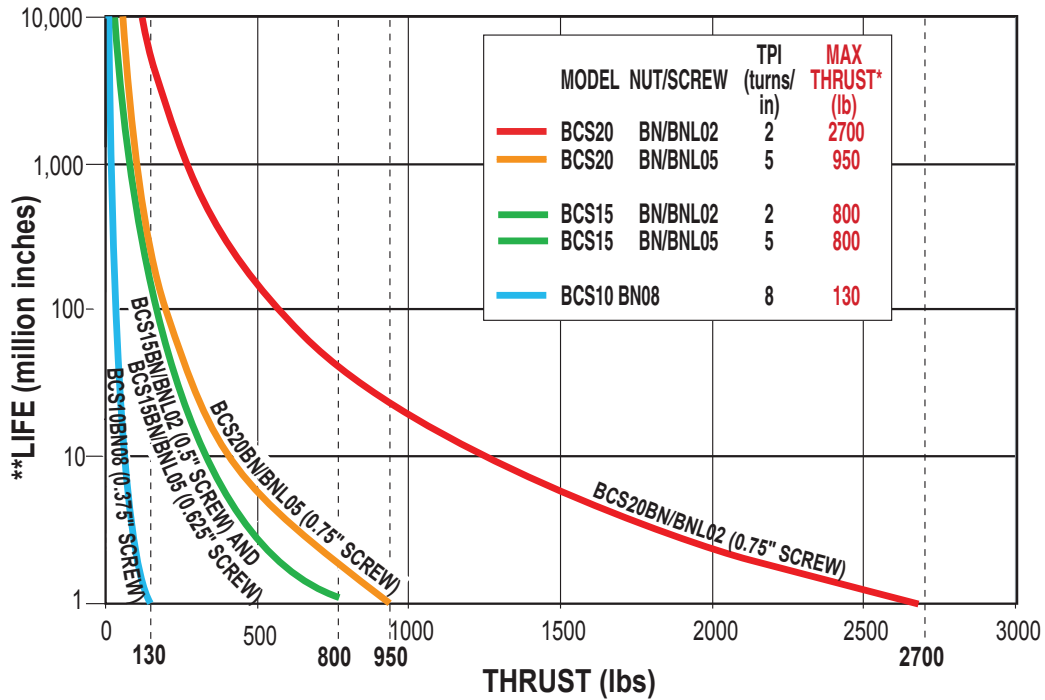

RODLESS

BCS/MCS Series

- Ball screw life calculations

LIFE CAPACITIES WITH METRIC BALL SCREW

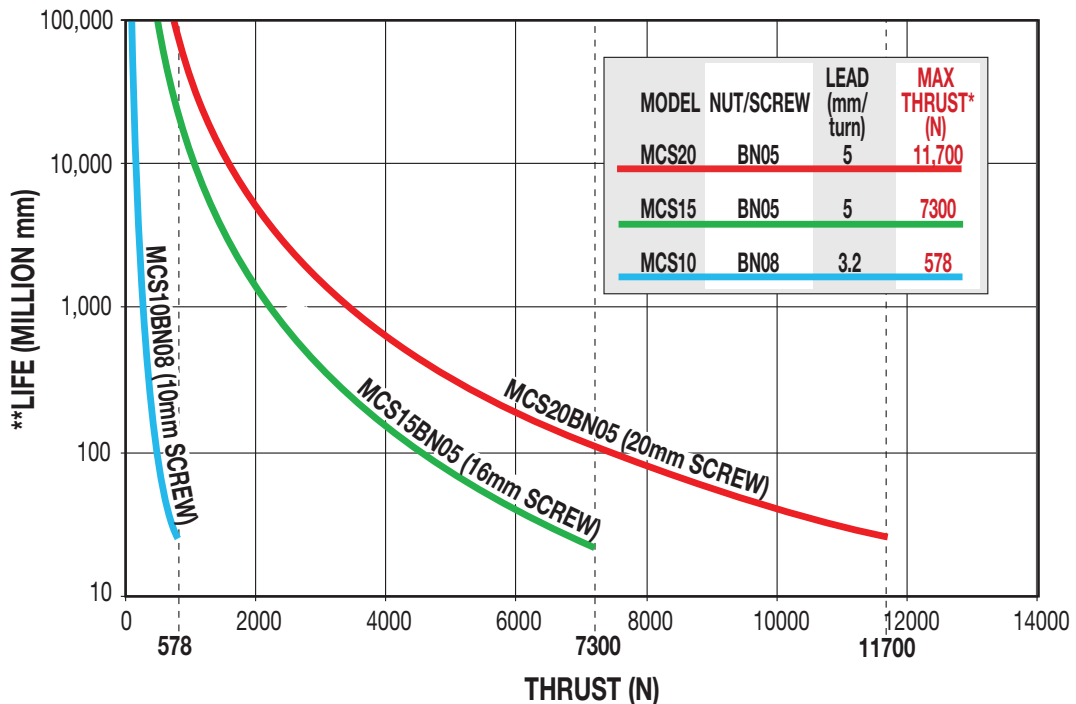

* Maximum thrust reflects 90% reliability for 1 million linear inches of travel.

Dotted lines represent maximum thrust for screw selections.

**Life indicates theoretical maximum life of screw only, under ideal conditions and does not indicate expected life of actuator.

BCS/MCS Screw Drives

OVERALL SERIES SPECIFICATIONS

SPECIFICATIONS RELATED TO ACTUATOR SIZE AND SCREW SELECTION

ENGLISH LEAD SCREWS											
ACTUATOR SERIES	SCREW DIA. (in)	SCREW TYPE	TPI (turns/in)	LEAD ACCURACY (in/ft)	BACKLASH (in)	MAXIMUM THRUST* (lb)	MAXIMUM STROKE (in)	INERTIA (lb-in ²)			BREAKAWAY TORQUE (lb-in)
								BASE ACTUATOR		PER/in OF STROKE	
								In Line	Rev. Parallel		
BCS10	0.375	BN	08	0.004	0.015	130	61	0.0046	0.0054	0.0005	1.000
	0.375	BNL	08	0.004	0.002	130	61	0.0046	0.0054	0.0005	1.000
	0.500	SN	01	0.006	0.007	170	85	0.0321	0.0348	0.0017	1.857
	0.500	SN	02	0.005	0.007	170	120	0.0190	0.0217	0.0017	1.563
	0.500	SNA	02	0.005	0.003	170	120	0.0190	0.0217	0.0017	1.563
	0.500	SN	05	0.006	0.007	170	120	0.0153	0.0180	0.0017	1.125
BCS15	0.500	BN	02	0.003	0.015	800	59	0.0299	0.0327	0.0017	1.375
	0.500	BNL	02	0.003	0.002	800	59	0.0299	0.0327	0.0017	1.375
	0.625	BN	05	0.003	0.015	800	59	0.0455	0.0524	0.0042	1.188
	0.625	BNL	05	0.003	0.002	800	59	0.0455	0.0524	0.0042	1.188
	0.625	SN	02	0.005	0.007	200	120	0.0558	0.0627	0.0042	1.563
	0.750	SN	01	0.005	0.007	300	120	0.1391	0.1536	0.0087	2.188
BCS20	0.750	BN	02	0.004	0.015	2700	120	0.1241	0.1374	0.0087	1.750
	0.750	BNL	02	0.004	0.002	2700	120	0.1241	0.1374	0.0087	1.750
	0.750	BN	05	0.003	0.015	950	120	0.1091	0.1224	0.0087	1.563
	0.750	BNL	05	0.003	0.002	950	120	0.1091	0.1224	0.0087	1.563
	0.750	SN	01	0.005	0.007	300	120	0.1775	0.1908	0.0087	3.125
	0.750	SN	02	0.005	0.007	300	120	0.1241	0.1374	0.0087	2.188

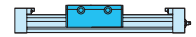

RODLESS

BCS/MCS Series

- Actuator size/screw specifications

METRIC LEAD SCREWS											
ACTUATOR SERIES	SCREW DIA. (mm)	SCREW TYPE	LEAD (mm/turn)	LEAD ACCURACY (mm/300)	BACKLASH (mm)	MAXIMUM THRUST* (N)	MAXIMUM STROKE (mm)	INERTIA (kg-m ² x 10 ⁻⁶)			BREAKAWAY TORQUE (N-m)
								BASE ACTUATOR		PER/mm OF STROKE	
								In Line	Rev. Parallel		
MCS10	10	BN	3.2	0.13	0.38	578	1549	31.94	37.50	3.472	0.11
	10	BNL	3.2	0.13	0.05	578	1549	31.94	67.50	3.472	0.11
	12	SN	12	0.13	0.18	800	3048	4.53	5.18	0.410	0.20
	12	SN	25	0.13	0.18	800	1626	8.34	8.98	0.410	0.28
MCS15	15	SN	12	0.13	0.18	900	3048	13.22	14.83	0.966	0.27
	16	BN	5	0.13	0.38	7300	1499	13.69	15.77	1.258	0.16
	16	BNL	5	0.13	0.05	7300	1499	13.69	15.77	1.258	0.16
MCS20	19	SN	25	0.13	0.18	1400	3048	39.98	44.17	2.517	0.32
	19	SN	12	0.13	0.18	1400	3048	35.42	39.28	2.517	0.39
	19	SN	25	0.13	0.18	1400	3048	50.95	54.81	2.517	0.57
	20	BN	5	0.13	0.38	11700	3048	38.61	43.32	3.102	0.25
	20	BNL	5	0.13	0.05	11700	3048	38.61	43.32	3.102	0.25

SCREW CODE DESCRIPTION

SN	Solid Nut
SNA	Anti-backlash Solid Nut
BN	Ball Nut
BNL	Low-Backlash Ball Nut



Contact the factory for higher accuracy and lower backlash options.

* For Acme screws, maximum thrust is the maximum continuous dynamic thrust subject to Thrust x Velocity limitation.

For ball screws, maximum thrust reflects 90% reliability for 1 million linear inches of travel.

BCS/MCS Screw Drives

OVERALL SERIES SPECIFICATIONS

GENERAL ACTUATOR SPECIFICATIONS

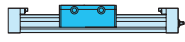

RODLESS

BCS/MCS Series

- General actuator specifications
- Friction force
- Support recommendations

BCS ENGLISH ACTUATORS					
ACTUATOR SERIES	CARRIER WEIGHT (lb)	BASE WEIGHT (lb) (Including Carrier)	WEIGHT PER/IN OF STROKE (lb)	TEMPERATURE RANGE* (F)	IP RATING**
BCS10	0.69	2.91	0.176	40 - 130	44
BCS15	1.94	6.61	0.392	40 - 130	44
BCS20	2.81	14.59	0.666	40 - 130	44

MCS METRIC ACTUATORS					
ACTUATOR SERIES	CARRIER WEIGHT (kg)	BASE WEIGHT (kg) (Including Carrier)	WEIGHT PER/mm OF STROKE (g)	TEMPERATURE RANGE* (C)	IP RATING**
MCS10	0.31	1.32	3.1	4 - 54	44
MCS15	0.88	2.90	7.0	4 - 54	44
MCS20	1.27	6.62	11.9	4 - 54	44



* Heat generated by the motor and drive should be taken into consideration as well as linear velocity and work cycle time. For applications that require operation outside of the recommended temperature range, contact the factory.

** Protected against ingress of solid particles greater than .039 in (1mm) and splashing water

LARGE FRAME MOTORS AND SMALLER SIZE ACTUATORS: Cantilevered motors need to be supported, if subjected to continuous rapid reversing duty and/or under dynamic conditions.

BCS CARRIER BRACKET BOLT ADJUSTMENT (ALL SIZES)



BCS carrier bracket adjustment bolts should be adjusted to suit each individual application, depending on the degree of rigidity required. A good starting point is to tighten the nut on the bolt until there is no lateral movement of the bolt. Then,

equally tighten each nut on the carrier bolt while moving the carrier by hand along the length of the stroke. When all lateral play in the carrier is eliminated and free movement along the length of the stroke is maintained, your carrier bracket is adjusted properly. Some applications may require fine tuning of this adjustment to gain more lateral play or a higher degree of rigidity. In demanding applications, carrier adjustments should be done periodically.



* CAUTION:

Over-tightening increases drive torque of motor and drive.

FRICITION FORCE

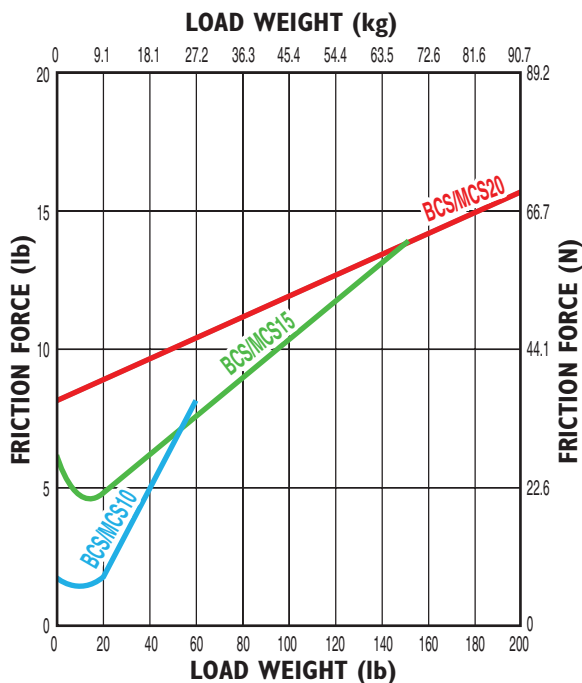

SUPPORT RECOMMENDATIONS

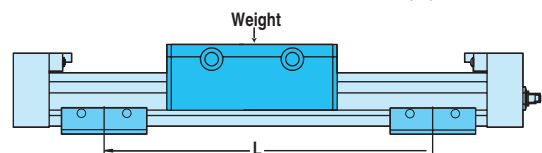
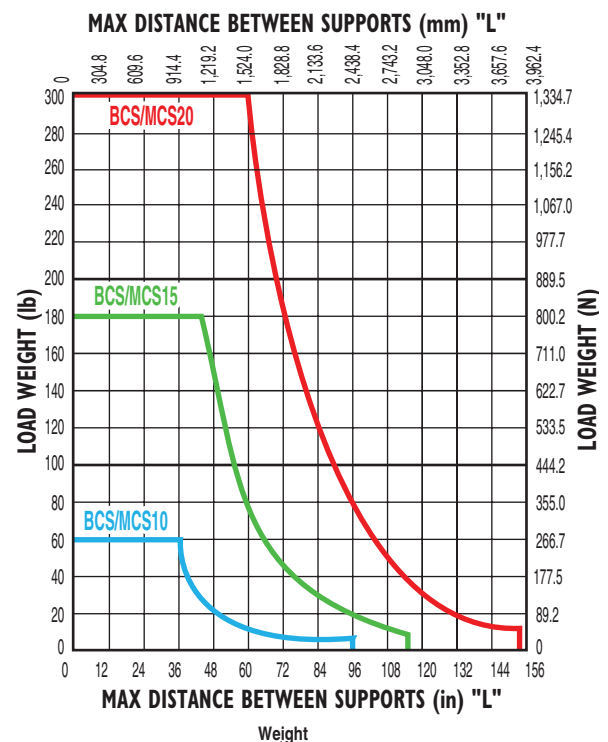

BCS/MCS Screw Drives

OVERALL SERIES SPECIFICATIONS

DYNAMIC BENDING MOMENTS AND LOADS

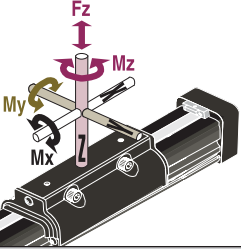
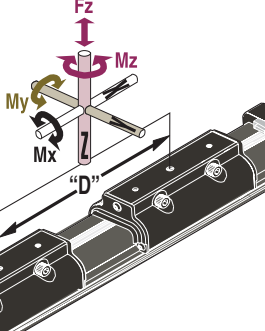
STANDARD CARRIER		MAXIMUM BENDING MOMENTS AND LOADS			METRIC		
		BCS10	BCS15	BCS20	MCS10	MCS15	MCS20
	Mx Moment (Roll) (lb-in) : N-m	55	275	300	6.2	31.1	33.9
	My Moment (Pitch) (lb-in) : N-m	100	500	1100	11.3	56.5	124.3
	Mz Moment (Yaw) (lb-in) : N-m	30	200	325	3.4	22.6	36.7
	Fz Load (Lateral) (lb) : N	60	180	300	267	801	1335
AUXILIARY CARRIER: Increases rigidity, load-carrying capacity and moments		BCS10	BCS15	BCS20	MCS10	MCS15	MCS20
	Mx Moment (Roll) *(lb-in) : N-m	110	550	600	12.4	62.1	67.8
	My Moment (Pitch) *(lb-in) : N-m	287	1453	2430	32.4	164.1	274.6
	Mz Moment (Yaw) *(lb-in) : N-m	287	1453	2430	32.4	164.1	274.6
	Fz Load (Lateral) (lb : N)	120	360	600	534	1602	2670
	Minimum Dimension 'D' (in : mm)	5.10	6.50	8.10	129.5	165.0	206.0

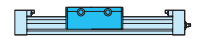

RODLESS

BCS/MCS Series

- Bending moments and loads
- Auxiliary carrier

! Please see *BCS Carrier Bracket Bolt Adjustment* on page C-108

! Breakaway torque will increase when using the Auxiliary carrier option. When ordering, determine your working stroke and enter this value into the configuration string. Overall actuator length will automatically be calculated.

*Loads shown in table are at minimum "D" dimension, for ratings with longer "D" dimension see graph below.

AUXILIARY CARRIER: BENDING MOMENT AT 'D' DISTANCE

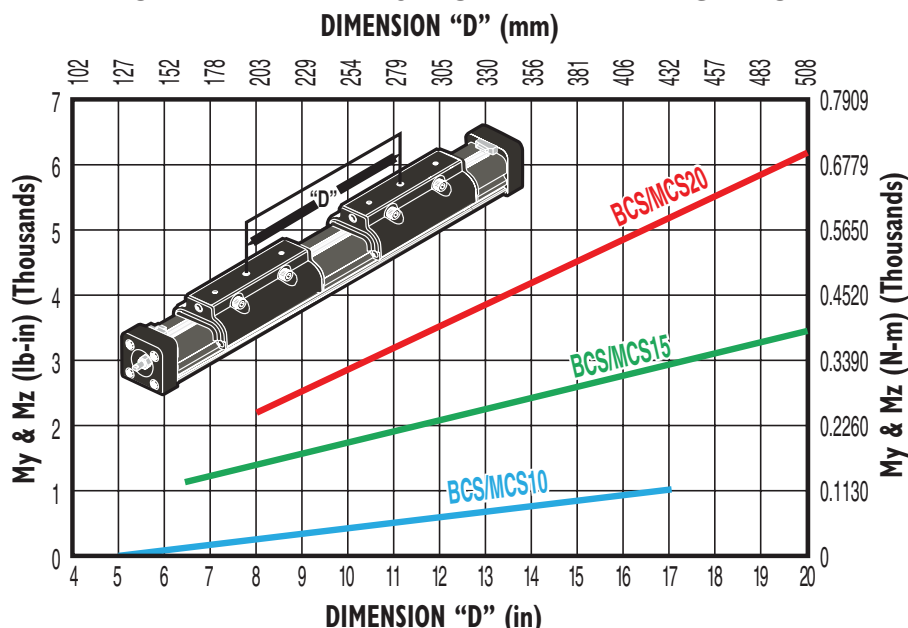

Rates shown on charts were calculated with these assumptions:

- 1.) Coupling between carriers is rigid.
- 2.) Load is equally distributed between carriers.

3.) Coupling device applies no misalignment loads to carriers.

* Customer must specify Dimension "D" (Distance between carrier center lines) in configuration string.

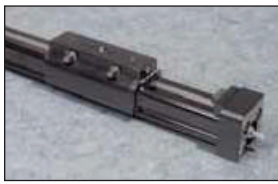

BCS/MCS10 Series

ACME SCREW SPECIFICATIONS

BCS10/MCS10 ACME SCREW CRITICAL SPEED AND PV LIMITS

CRITICAL SPEED WITH 1/2" ENGLISH ACME SCREW

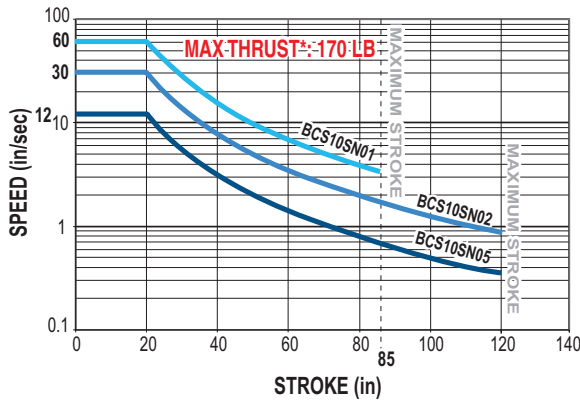

CRITICAL SPEED WITH 12mm METRIC ACME SCREW

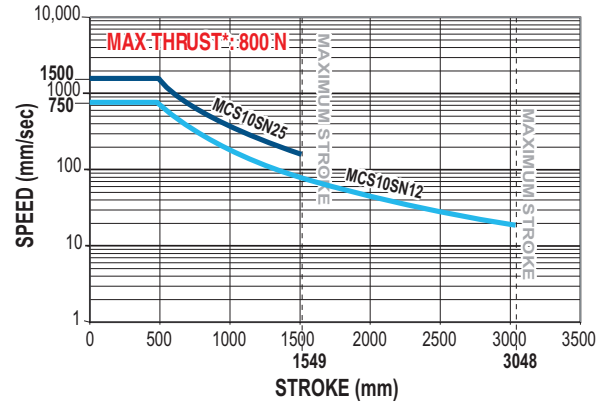

PV LIMITS: 1/2" 1 TPI ENGLISH ACME SCREW

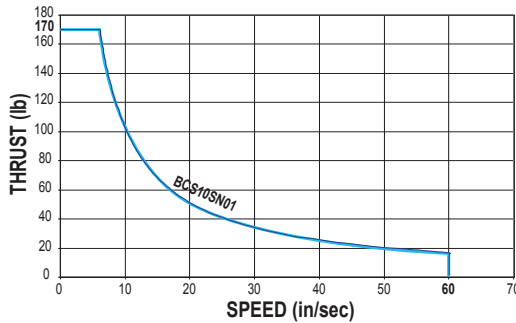

PV LIMITS: 12mm ACME METRIC SCREW w/25mm LEAD

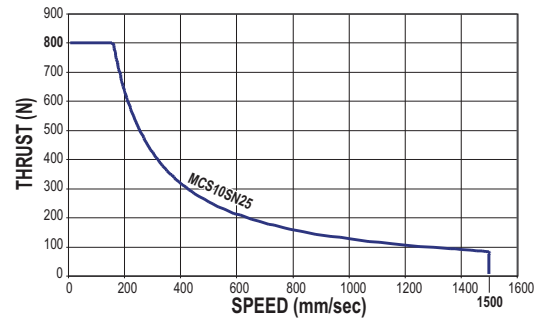

PV LIMITS: 1/2" 2 TPI ENGLISH ACME SCREW

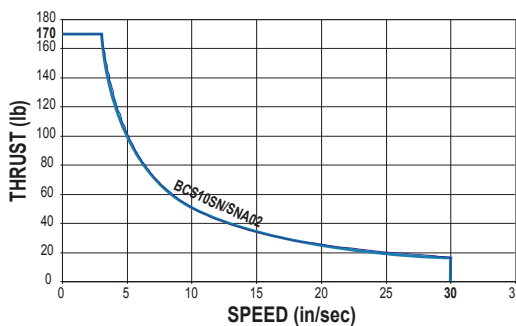

PV LIMITS: 12mm ACME METRIC SCREW w/12mm LEAD

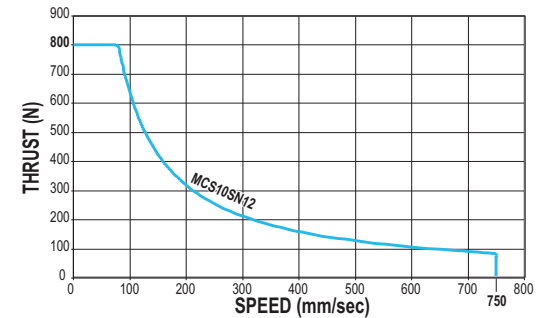

PV LIMITS: 1/2" 5 TPI ENGLISH ACME SCREW

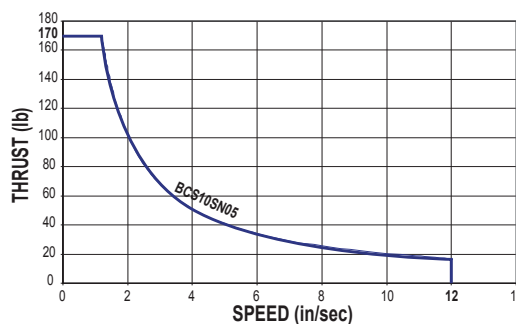

SN = Solid Nut

SNA = Solid Anti-backlash Nut

! * Maximum thrust is the maximum continuous dynamic thrust subject to Thrust x Velocity limitation.

PV LIMITS: Any material which carries a sliding load is limited by heat buildup. The factors that affect heat generation rate in an application are the pressure on the nut in pounds per square inch and the surface velocity in feet per minute. The product of these factors provides a measure of the severity of an application.

$$\frac{P}{(\text{Max. Thrust Rating})} \times \frac{V}{(\text{Max. Speed Rating})} \leq 0.1$$

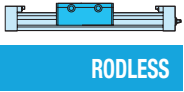

RODLESS

BCS/MCS10 Series

- Acme screw critical speed capacities and PV limits

BCS/MCS10 Series

BALL SCREW SPECIFICATIONS

BCS/MCS10 BALL SCREW SPECIFICATIONS

CRITICAL SPEED WITH 3/8" ENGLISH BALL SCREW

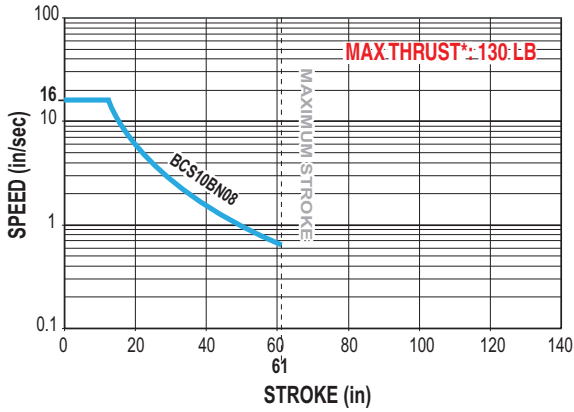

CRITICAL SPEED WITH 10mm METRIC BALL SCREW

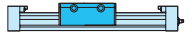
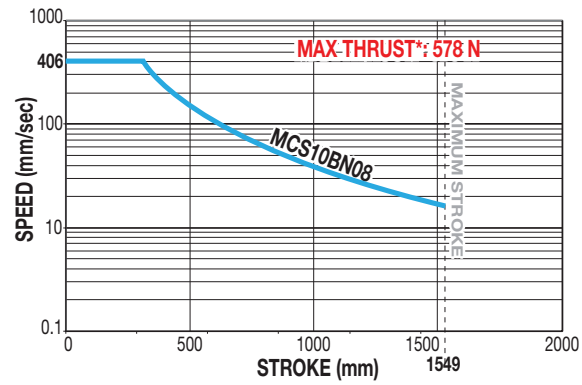

RODLESS

BCS/MCS10 Series

- Ball screw critical speed capacities and life calculations

LIFE CALCULATION: 3/8" 8TPI ENGLISH BALL SCREW

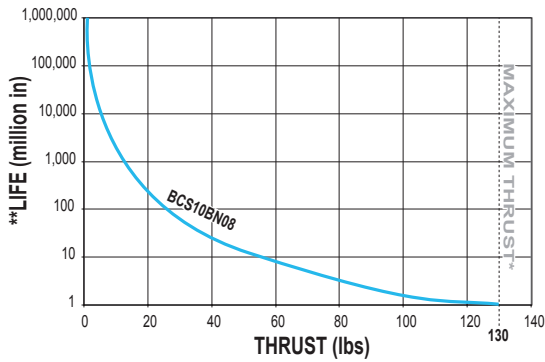

LIFE CALCULATION: 10mm METRIC BALL SCREW w/3.2mm LEAD

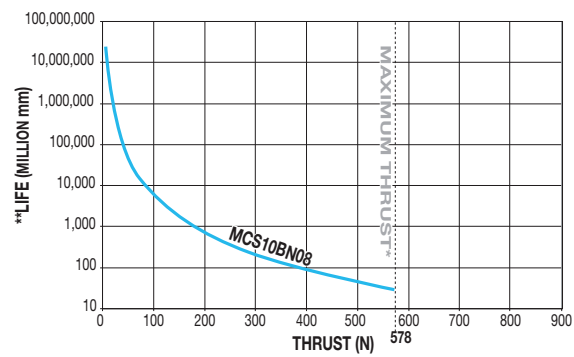

BN = Ball Nut



* Maximum thrust reflects 90% reliability for 1 million linear inches of travel.

**Life indicates theoretical maximum life of screw only, under ideal conditions and does not indicate expected life of actuator.

BCS/MCS10 Series

DIMENSIONS

BCS10/MCS10 ACTUATOR AND OPTIONS

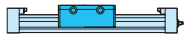

RODLESS

BCS/MCS10 Series

- Actuator and options dimensions

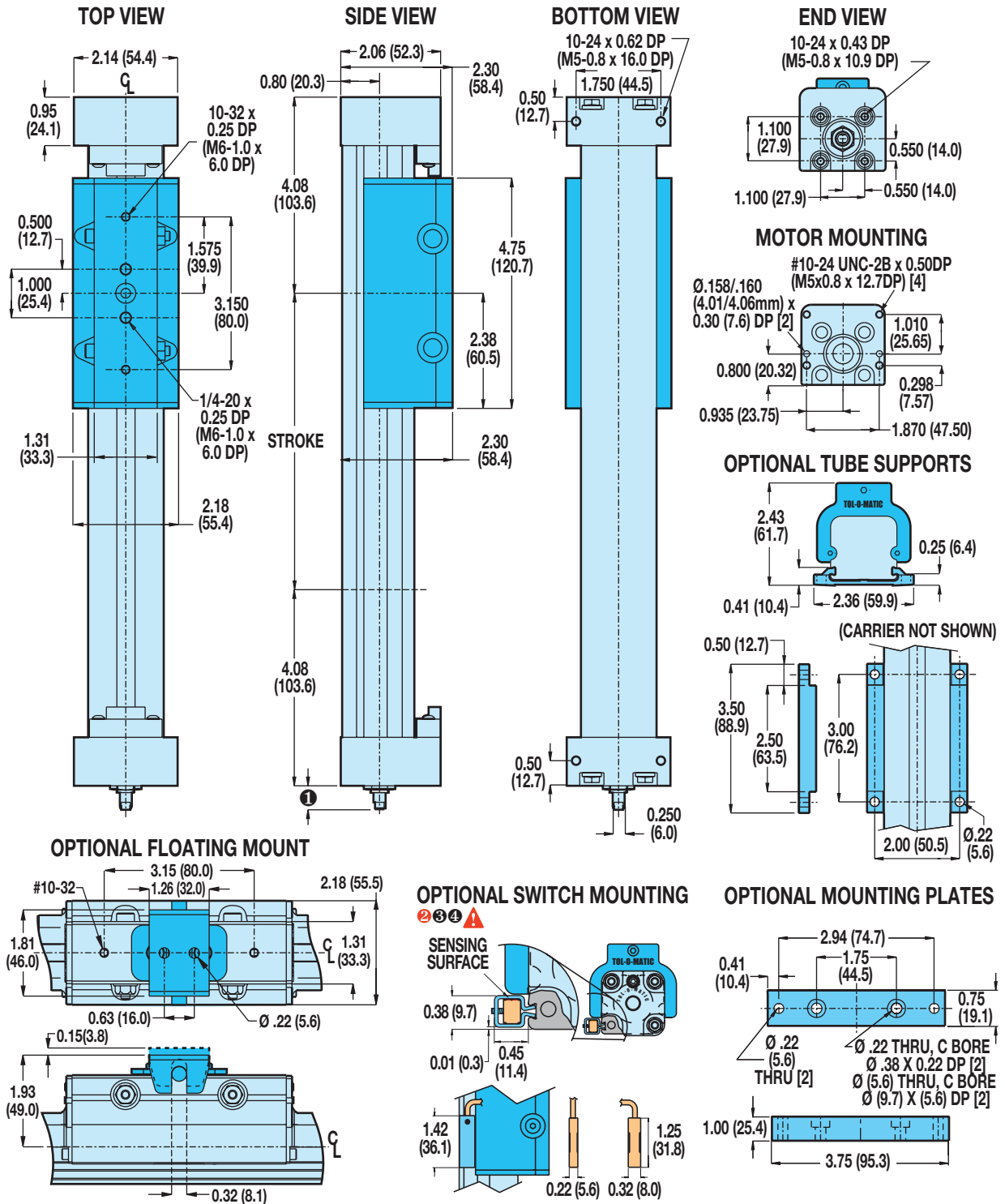

① SHAFT LENGTH

In-line mounting	0.53 (13.5)
Extended shaft for RP & 23-frame motor	1.89 (48.0)
Extended shaft for RP & 34-frame motor	2.10 (53.3)
Extended shaft for purchases prior to 6/24/02	1.53 (38.9)

⚠ CAUTION: DO NOT OVERTIGHTEN SWITCH HARDWARE WHEN INSTALLING

② NOTE: The scored face of the switch indicates the sensing surface and must face toward the magnet

④ NOTE: Some actuators require switch mounting on a specific side of the actuator. Call Tol-O-Matic 1-800-328-2174 for details

Unless otherwise noted, all dimensions shown are in inches (Dimensions in parenthesis are in millimeters)

BCS/MCS10 Series

DIMENSIONS

BCS/MCS10: IN-LINE MOUNT FOR MOTORS OR GEARHEADS

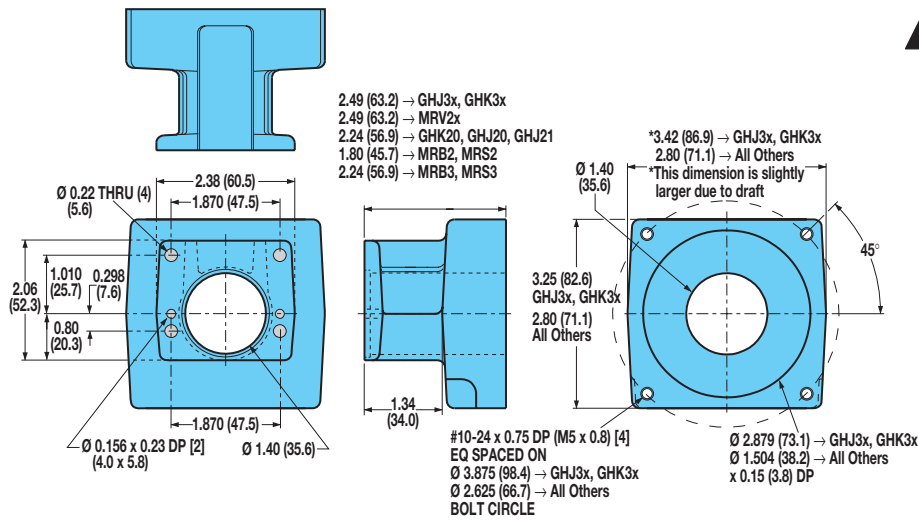

! For gearhead dimensions and specifications, refer to page F-10.

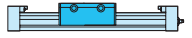

RODLESS

BCS/MCS10 Series

- In-line motor mounting
- Reverse parallel mounting

BCS/MCS10: REVERSE PARALLEL MOUNTING

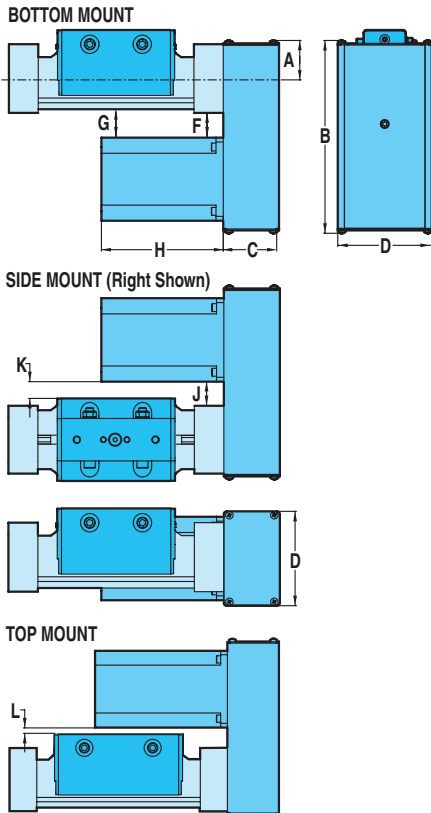

SPECIFICATIONS

MOTOR	WEIGHT OF REDUCTION DRIVE				REDUCTION INERTIA AT MOTOR SHAFT			
	1:1		2:1		1:1		2:1	
	lbs	kg	lbs	kg	lb-in ²	kg-cm ²	lb-in ²	kg-cm ²
BRUSHLESS MRV21, 22, 23, 24	2.06	0.9344	2.06	.9344	.070	.2043	.095	.2767

REDUCTION EFFICIENCY: 0.95

DIMENSIONS

MOTOR	A		B		C		D		F		G		H		J		K		L	
	in.	mm	in.	mm	in.	mm	in.	mm	in.	mm	in.	mm	in.	mm	in.	mm	in.	mm	in.	mm
BRUSHLESS MRV21	1.44	36.6	6.96	176.7	2.13	54.0	3.25	82.6	1.81	45.9	1.83	46.5	4.75	120.7	1.54	39.1	1.83	46.5	1.11	28.2
MRV22	1.44	36.6	6.96	176.7	2.13	54.0	3.25	82.6	1.81	45.9	1.83	46.5	5.75	146.1	1.54	39.1	1.83	46.5	1.11	28.2
MRV23	1.44	36.6	6.96	176.7	2.13	54.0	3.25	82.6	1.81	45.9	1.83	46.5	6.75	171.5	1.54	39.1	1.83	46.5	1.11	28.2
MRV24	1.44	36.6	6.96	176.7	2.13	54.0	3.25	82.6	1.81	45.9	1.83	46.5	7.75	196.9	1.54	39.1	1.83	46.5	1.11	28.2



BCS/MCS15 Series

ACME SCREW SPECIFICATIONS

BCS15 ENGLISH ACME SCREW SPECIFICATIONS

CRITICAL SPEED WITH 5/8" ENGLISH ACME SCREW

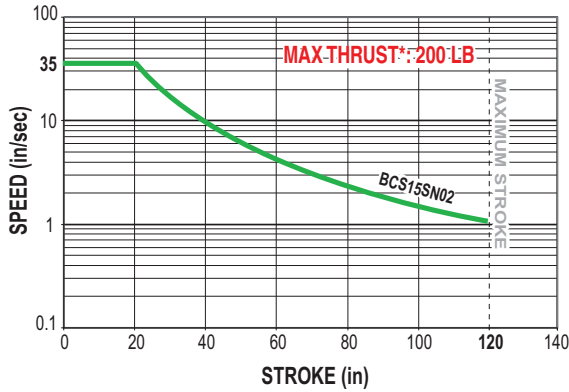

CRITICAL SPEED WITH 3/4" ENGLISH ACME SCREW

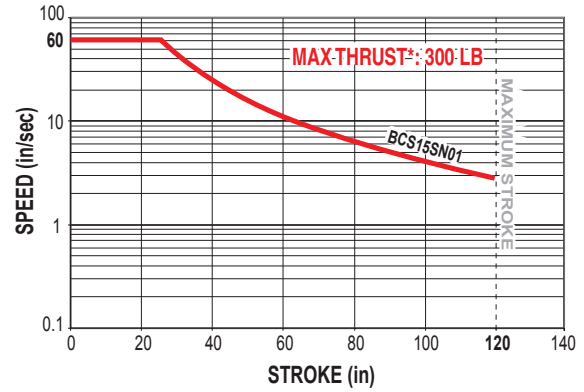

PV LIMITS: 5/8" 2TPI ENGLISH ACME SCREW

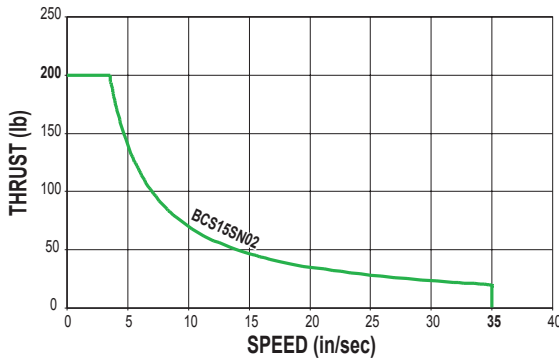

PV LIMITS: 3/4" 1TPI ENGLISH ACME SCREW

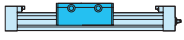
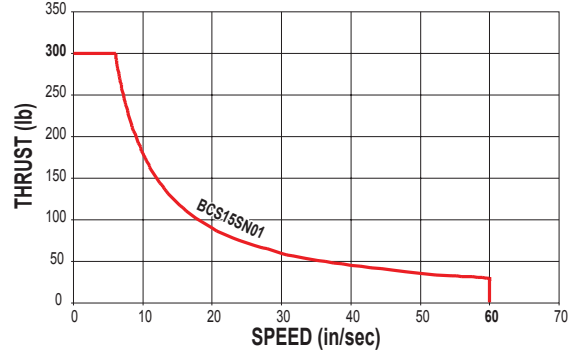

RODLESS

BCS/MC15S Series

- English acme screw critical speed capacities and PV limits

SN = Solid Nut

SNA = Solid Anti-backlash Nut



*** Maximum thrust is the maximum continuous dynamic thrust subject to Thrust x Velocity limitation.**

PV LIMITS: Any material which carries a sliding load is limited by heat buildup. The factors that affect heat generation rate in an application are the pressure on the nut in pounds per square inch and the surface velocity in feet per minute. The product of these factors provides a measure of the severity of an application.

$$\frac{P}{(\text{Max. Thrust Rating})} \times \frac{V}{(\text{Max. Speed Rating})} \leq 0.1$$

BCS/MCS15 Series

ACME SCREW SPECIFICATIONS

MCS15 METRIC ACME SCREW SPECIFICATIONS

CRITICAL SPEED WITH 15mm METRIC ACME SCREW

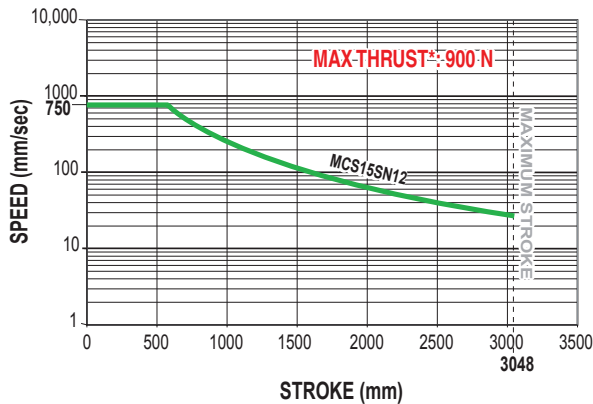

CRITICAL SPEED WITH 19mm METRIC ACME SCREW

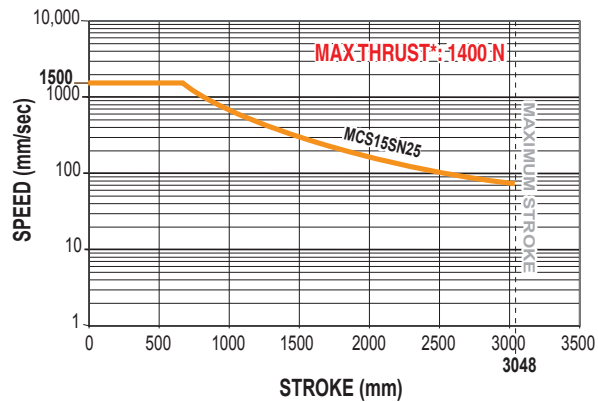

PV LIMITS: 15mm METRIC ACME SCREW w/12mm LEAD

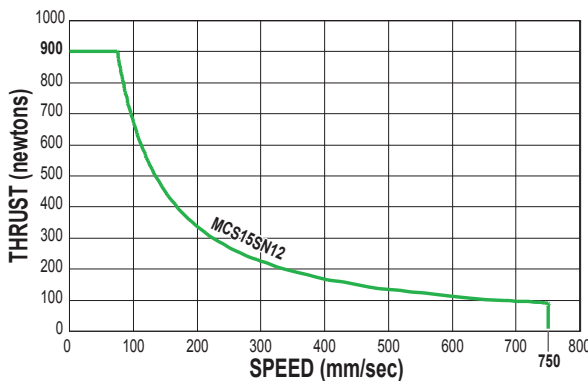

PV LIMITS: 19mm METRIC ACME SCREW w/25mm LEAD

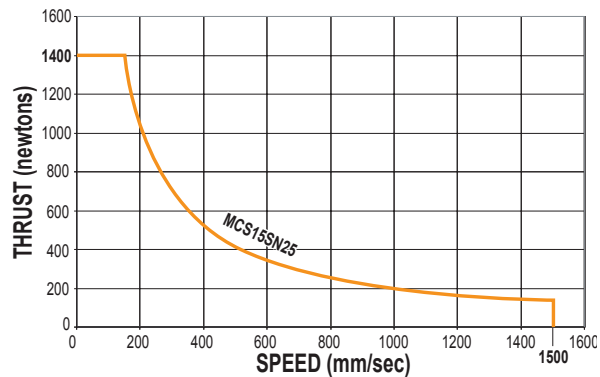

RODLESS

BCS/MCS15 Series

- Metric acme screw critical speed capacities and PV limits

SN = Solid Nut



*** Maximum thrust is the maximum continuous dynamic thrust subject to Thrust x Velocity limitation.**

PV LIMITS: Any material which carries a sliding load is limited by heat buildup. The factors that affect heat generation rate in an application are the pressure on the nut in pounds per square inch and the surface velocity in feet per minute. The product of these factors provides a measure of the severity of an application.

$$\left(\frac{P}{(\text{Max. Thrust Rating})} \right) \times \left(\frac{V}{(\text{Max. Speed Rating})} \right) \leq 0.1$$

BCS/MCS15 Series

BALL SCREW SPECIFICATIONS

BCS/MCS15 BALL SCREW SPECIFICATIONS

CRITICAL SPEED WITH 1/2" ENGLISH BALL SCREW

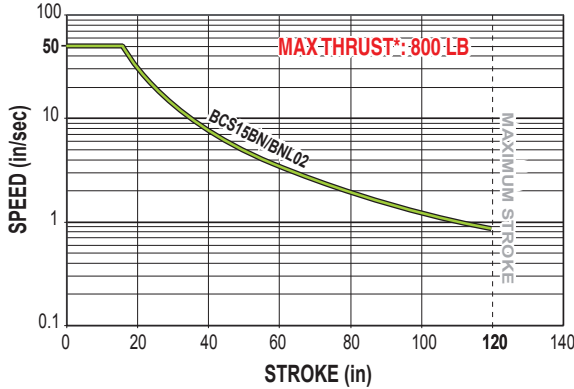

CRITICAL SPEED WITH 16mm METRIC BALL SCREW

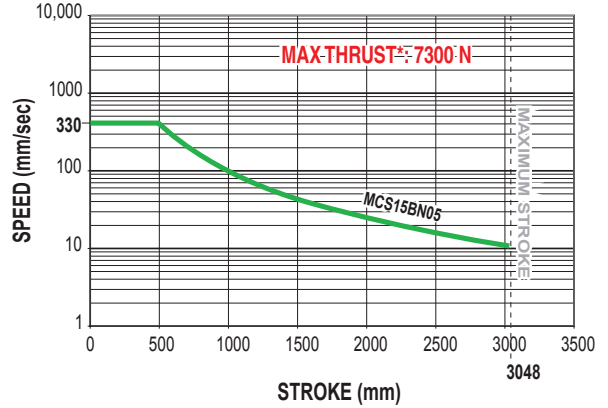

CRITICAL SPEED WITH 5/8" ENGLISH BALL SCREW

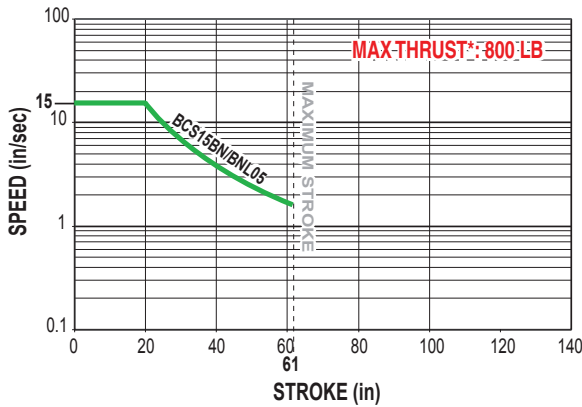

LIFE CALCULATION: 16mm METRIC BALL SCREW w/5mm LEAD

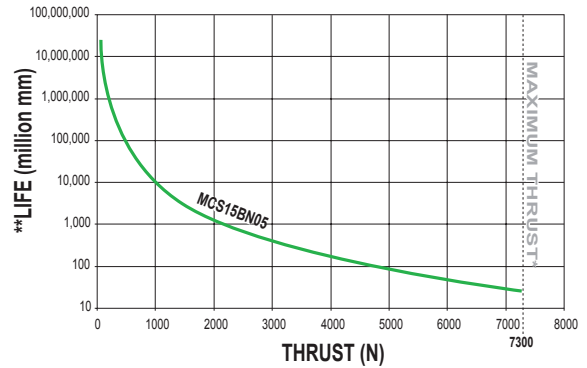

LIFE CALCULATION: 1/2" w/2TPI & 5/8" w/5TPI ENGLISH BALL SCREW

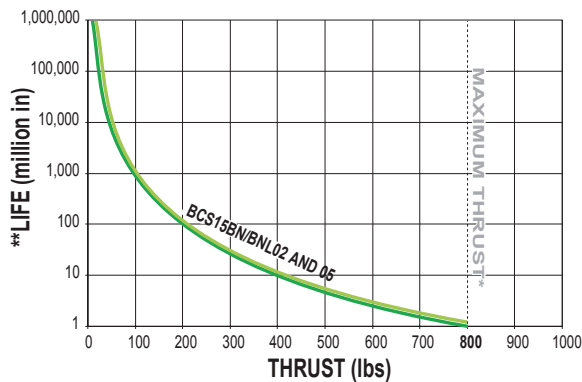

BN = Ball Nut

BNL = Ball Nut with Low-Backlash



* Maximum thrust reflects 90% reliability for 1 million linear inches of travel.

**Life indicates theoretical maximum life of screw only, under ideal conditions and does not indicate expected life of actuator.

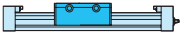

RODLESS

BCS/MCS15 Series

- Ball screw critical speed capacities and life calculations

BCS/MCS15 Series

DIMENSIONS

BCS15/MCS15 ACTUATOR AND OPTIONS

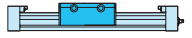
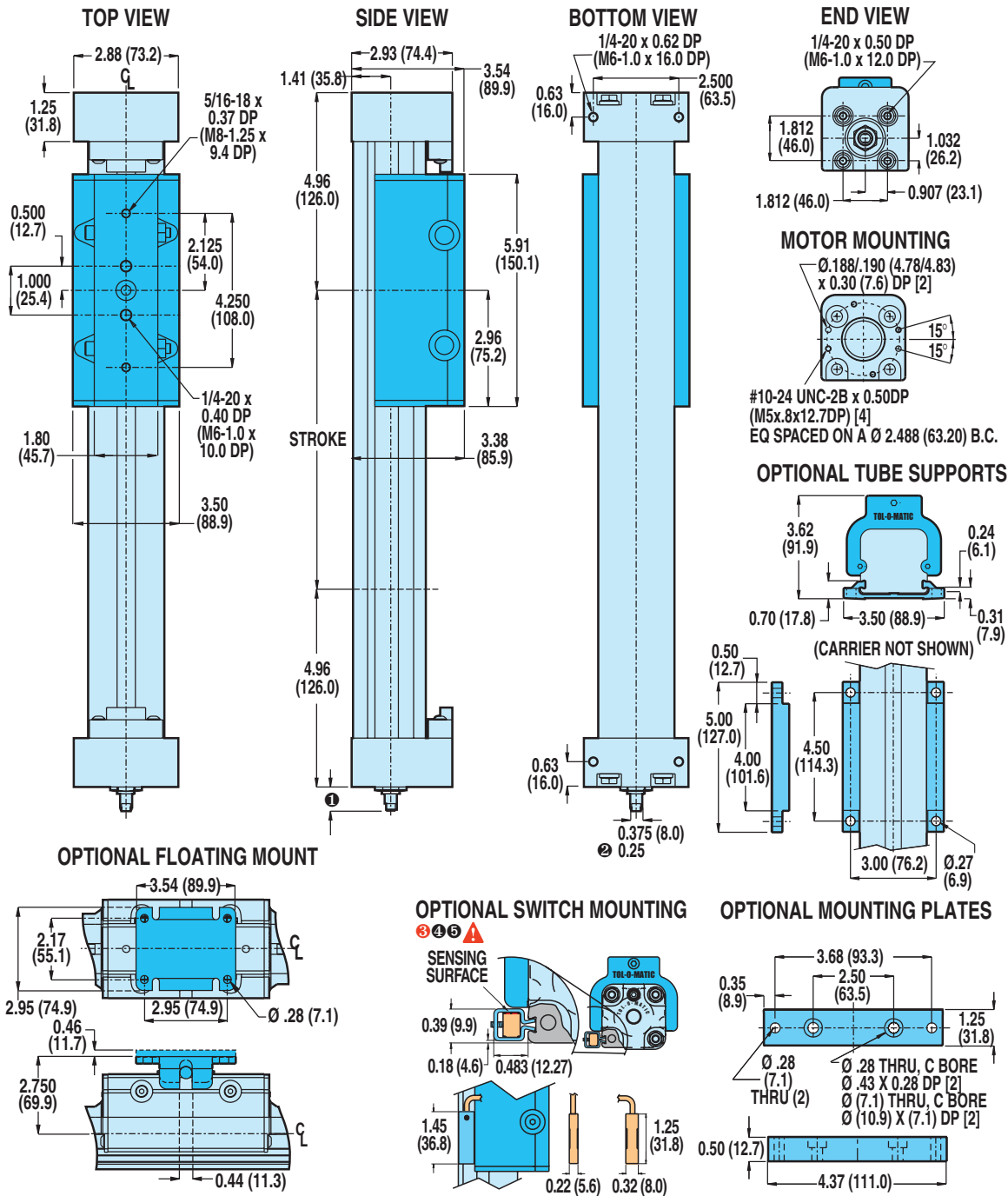

RODLESS

BCS/MCS15 Series

- Actuator and options dimensions

① SHAFT LENGTH

In-line mounting	0.65 (16.5)
Extended shaft for RP & 23-frame motor	1.94 (49.3)
Extended shaft for RP & 34-frame motor	2.15 (54.6)
Extended shaft for RP & 40-frame motor	2.31 (58.7)
Extended shaft for purchases prior to 6/24/02	1.90 (48.2)

② FOR 1/2" 2TPI BALL-SCREW STYLE ONLY

⚠ CAUTION: DO NOT OVERTIGHTEN SWITCH HARDWARE WHEN INSTALLING

④ NOTE: The scored face of the switch indicates the sensing surface and must face toward the magnet

⑤ NOTE: Some actuators require switch mounting on a specific side of the actuator. Call Tol-O-Matic 1-800-328-2174 for details

Unless otherwise noted, all dimensions shown are in inches (Dimensions in parenthesis are in millimeters)

BCS/MCS15 Series

DIMENSIONS

BCS/MCS15: IN-LINE MOUNT FOR MOTORS AND GEARHEADS

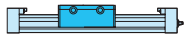

RODLESS

BCS/MCS15 Series

- In-line motor mounting
- Reverse parallel mounting dimensions

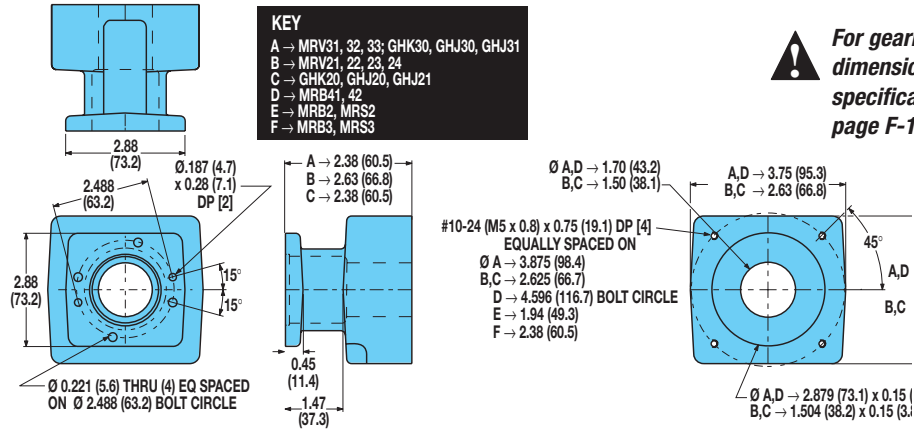

BCS/MCS15: REVERSE PARALLEL MOUNTING

SPECIFICATIONS

MOTOR	WEIGHT OF REDUCTION DRIVE				REDUCTION INERTIA AT MOTOR SHAFT			
	1:1		2:1		1:1		2:1	
	lbs	kg	lbs	kg	lb-in ²	kg-cm ²	lb-in ²	kg-cm ²
BRUSHLESS MRV21, 22, 23, 24	2.17	0.9843	2.40	1.0886	.070	.2043	.095	.2767
MRV31, 32, 33	2.61	1.1839	2.84	1.2882	.070	.2043	.095	.2767

REDUCTION EFFICIENCY: 0.95

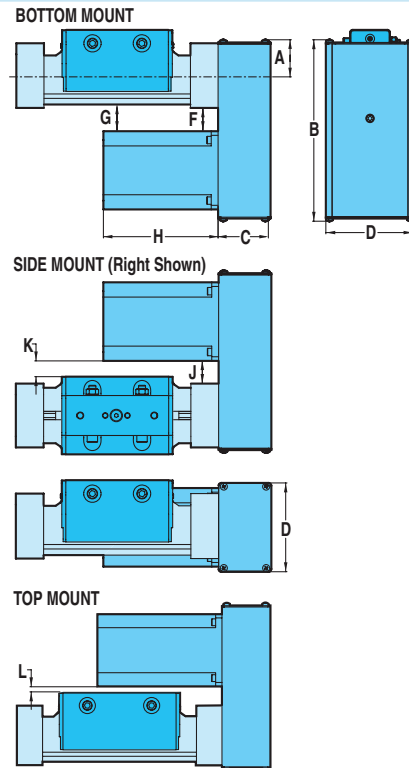

DIMENSIONS

MOTOR	A		B		C		D		F		G		H		J		K		L	
	in.	mm	in.	mm	in.	mm	in.	mm	in.	mm	in.	mm	in.	mm	in.	mm	in.	mm	in.	mm
BRUSHLESS MRV21	1.44	36.6	7.46	189.4	2.13	54.0	3.25	82.6	1.70	43.2	1.85	47.0	4.75	120.7	1.67	42.4	1.86	47.2	0.98	25.3
MRV22	1.44	36.6	7.46	189.4	2.13	54.0	3.25	82.6	1.70	43.2	1.85	47.0	5.75	146.1	1.67	42.4	1.86	47.2	0.98	25.3
MRV23	1.44	36.6	7.46	189.4	2.13	54.0	3.25	82.6	1.70	43.2	1.85	47.0	6.75	171.5	1.67	42.4	1.86	47.2	0.98	25.3
MRV24	1.44	36.6	7.46	189.4	2.13	54.0	3.25	82.6	1.70	43.2	1.85	47.0	7.75	196.9	1.67	42.4	1.86	47.2	0.98	25.3
MRV31	2.12	53.8	8.14	206.6	2.38	60.3	4.00	101.6	1.05	26.7	1.21	30.7	6.11	155.2	1.02	25.9	1.21	30.7	0.33	8.9
MRV32	2.12	53.8	8.14	206.6	2.38	60.3	4.00	101.6	1.05	26.7	1.21	30.7	7.36	186.9	1.02	25.9	1.21	30.7	0.33	8.9
MRV33	2.12	53.8	8.14	206.6	2.38	60.3	4.00	101.6	1.05	26.7	1.21	30.7	8.61	218.7	1.02	25.9	1.21	30.7	0.33	8.9

BCS/MCS20 Series

ACME SCREW SPECIFICATIONS



BCS/MCS20 ACME SCREW SPECIFICATIONS

CRITICAL SPEED WITH 3/4" ENGLISH ACME SCREW

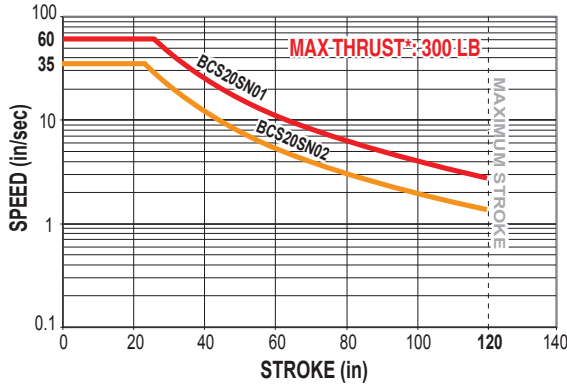

CRITICAL SPEED WITH 19mm METRIC ACME SCREW

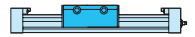
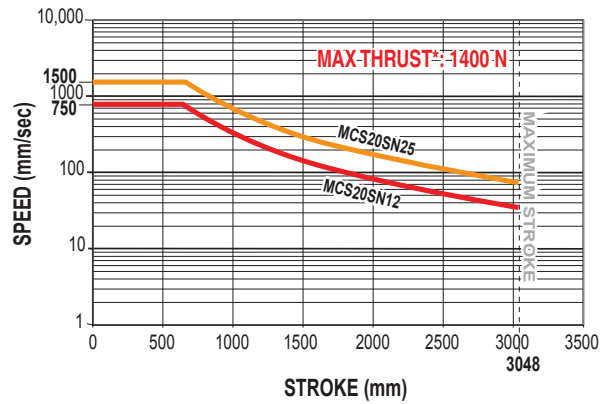

RODLESS

BCS/MCS20 Series

- Acme screw critical speed capacities and PV limits

PV LIMITS: 3/4" 1TPI ENGLISH ACME SCREW

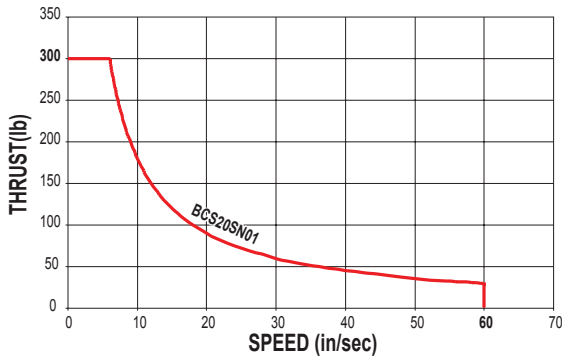

PV LIMITS: 19mm METRIC ACME SCREW w/25mm LEAD

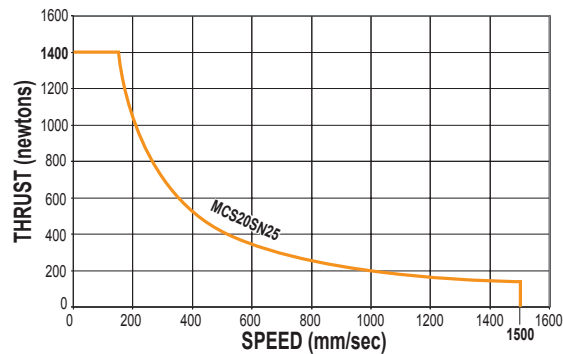

PV LIMITS: 3/4" 2TPI ENGLISH ACME SCREW

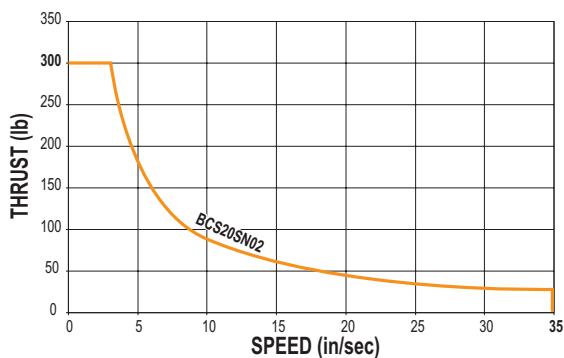

PV LIMITS: 19mm METRIC ACME SCREW w/12mm LEAD

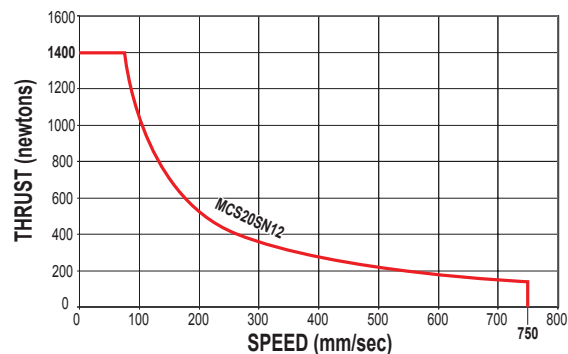

SN = Solid Nut
SNA = Solid Anti-backlash Nut



* Maximum thrust is the maximum continuous dynamic thrust subject to Thrust x Velocity limitation.

PV LIMITS: Any material which carries a sliding load is limited by heat buildup. The factors that affect heat generation rate in an application are the pressure on the nut in pounds per square inch and the surface velocity in feet per minute. The product of these factors provides a measure of the severity of an application.

$$\left(\frac{P}{(\text{Max. Thrust Rating})} \right) \times \left(\frac{V}{(\text{Max. Speed Rating})} \right) \leq 0.1$$

BCS/MCS20 Series

BALL SCREW SPECIFICATIONS

BCS20/MCS20 BALL SCREW SPECIFICATIONS

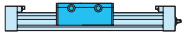

RODLESS

BCS/MCS20 Series

- Ball screw critical speed capacities and life calculations

CRITICAL SPEED WITH 3/4" ENGLISH BALL SCREW, 2TPI

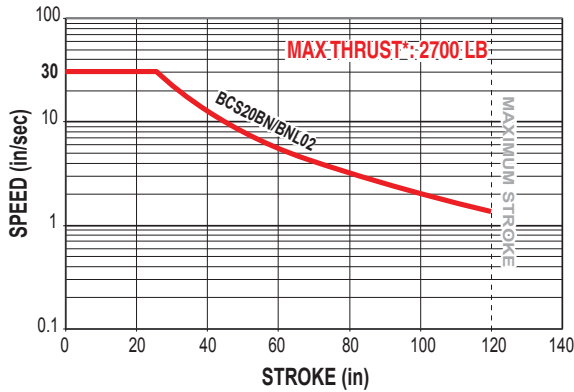

LIFE CALCULATION: 3/4" ENGLISH BALL SCREW, 5TPI

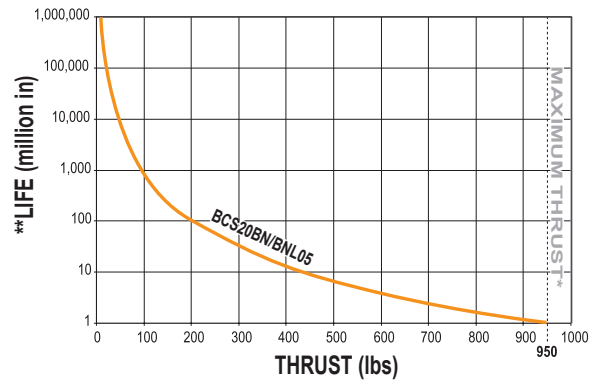

LIFE CALCULATION: 3/4" ENGLISH BALL SCREW, 2TPI

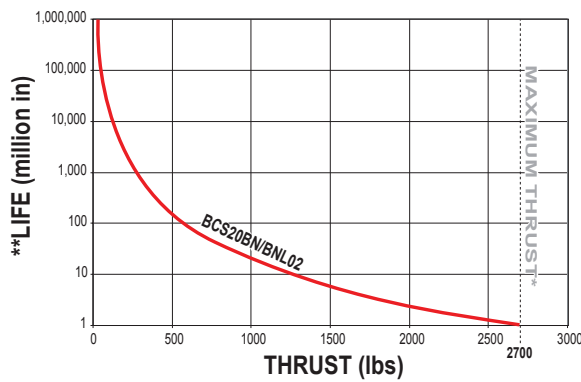

CRITICAL SPEED WITH 20mm METRIC BALL SCREW

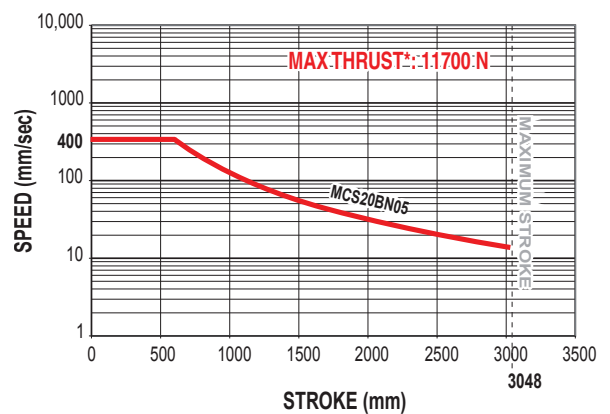

CRITICAL SPEED WITH 3/4" ENGLISH BALL SCREW, 5TPI

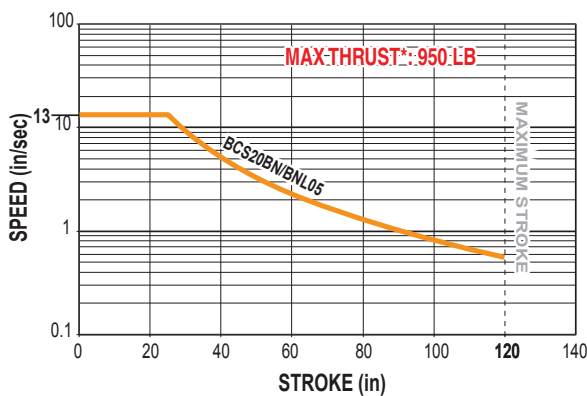

LIFE CALCULATION: 20mm METRIC BALL SCREW w/5mm LEAD

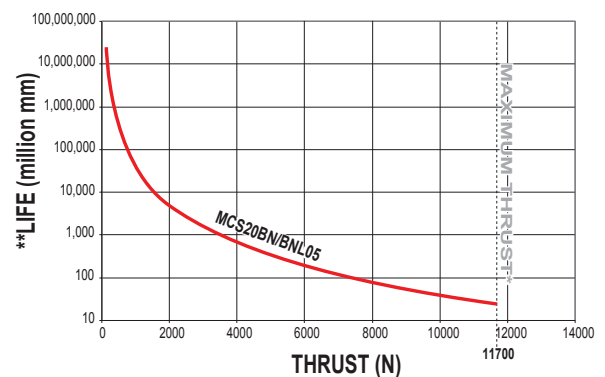

BN = Ball Nut

BNL = Ball Nut with Low-Backlash



* Maximum thrust reflects 90% reliability for 1 million linear inches of travel.

**Life indicates theoretical maximum life of screw only, under ideal conditions and does not indicate expected life of actuator.

BCS/MCS20 Series

DIMENSIONS

BCS20 ACTUATOR AND OPTIONS

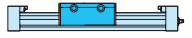
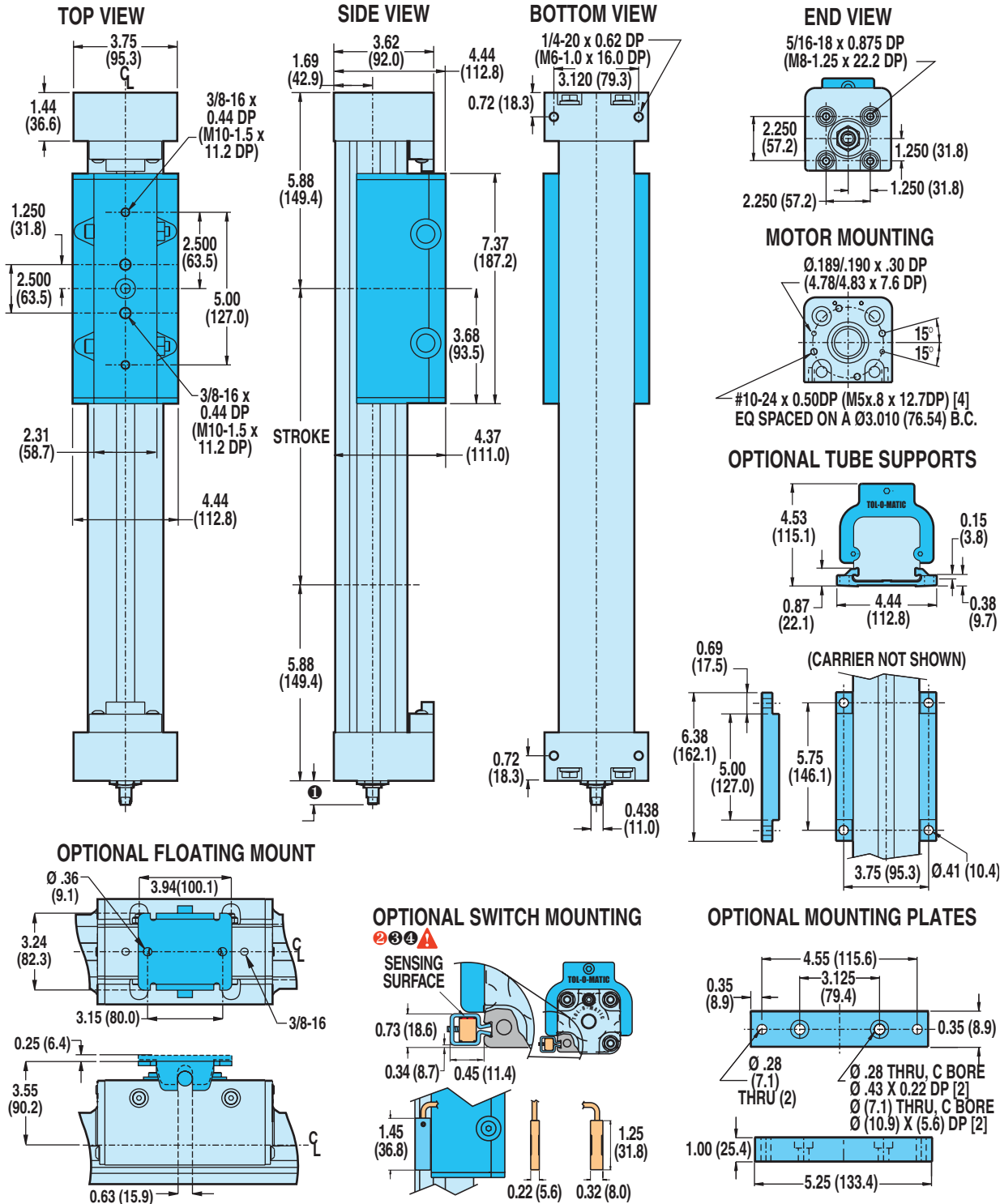

RODLESS

BCS/MCS20 Series

- Actuator and option dimensions

① SHAFT LENGTH

In-line mounting	0.78 (19.8)
Extended shaft for RP & 23-frame motor	2.16 (54.9)
Extended shaft for RP & 34-frame motor	2.16 (54.9)
Extended shaft for RP & 40-frame motor	2.31 (58.7)
Extended shaft for purchases prior to 6/24/02	2.28 (57.9)

⚠ CAUTION: DO NOT OVERTIGHTEN SWITCH HARDWARE WHEN INSTALLING

② NOTE: The scored face of the switch indicates the sensing surface and must face toward the magnet

③ NOTE: Some actuators require switch mounting on a specific side of the actuator. Call Tol-O-Matic 1-800-328-2174 for details

Unless otherwise noted, all dimensions shown are in inches (Dimensions in parenthesis are in millimeters)

BCS/MCS20 Series

DIMENSIONS

BCS/MCS20: IN-LINE MOUNT FOR MOTORS AND GEARHEADS

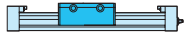

RODLESS

BCS/MCS20 Series

- In-line motor mounting

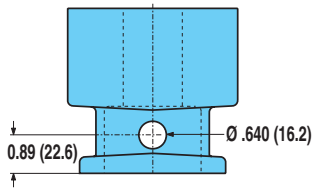

MOTORS KEY

A → MRV3x, MRB3x
 B → MRV2x
 C → GHK20x, GHJ20x, GHJ21x, GHJ30x, GHJ31x, GHK30
 D → MRB4x
 E → MRB2, MRS2
 F → MRB3, MRS3



For gearhead dimensions and specifications, refer to page F-10.

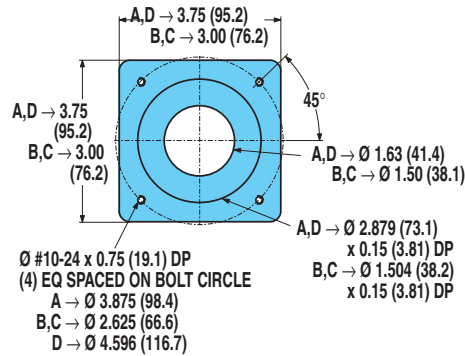
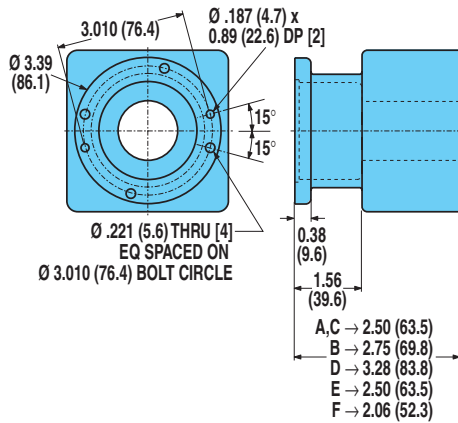

BCS/MCS20 Series

DIMENSIONS

BCS/MCS20: REVERSE PARALLEL MOUNTING

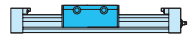
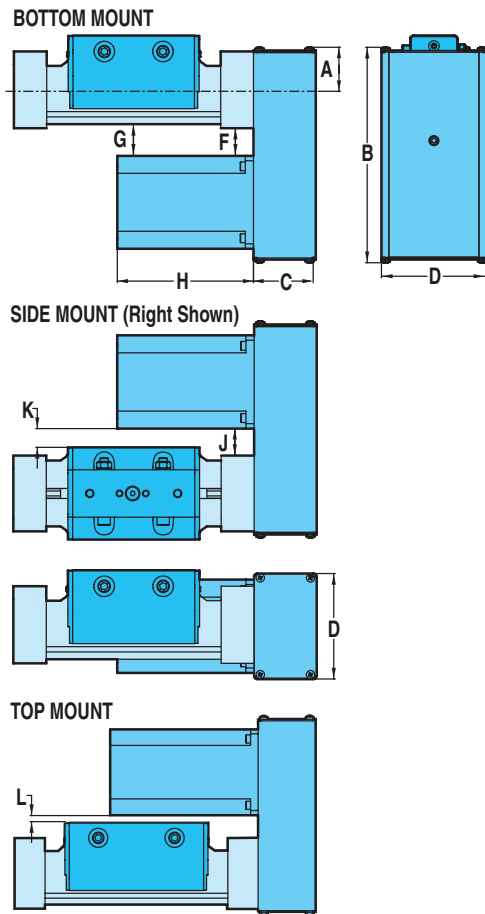

RODLESS

BCS/MCS20 Series

- Reverse parallel mounting

SPECIFICATIONS

MOTOR	WEIGHT OF REDUCTION DRIVE				REDUCTION INERTIA AT MOTOR SHAFT			
	1:1		2:1		1:1		2:1	
	lbs	kg	lbs	kg	lb-in ²	kg-cm ²	lb-in ²	kg-cm ²
BRUSHLESS MRV21, 22, 23, 24	3.11	1.41	3.27	1.48	.118	.3447	.100	.2928
MRV31, 32, 33	3.18	1.44	3.34	1.51	.118	.3447	.100	.2928

REDUCTION EFFICIENCY: 0.95

DIMENSIONS

MOTOR	A		B		C		D		F		G		H		J		K		L	
	in.	mm	in.	mm	in.	mm	in.	mm	in.	mm	in.	mm	in.	mm	in.	mm	in.	mm	in.	mm
BRUSHLESS MRV21	1.44	36.6	9.31	236.5	2.38	60.3	4.00	101.6	2.44	61.8	2.50	63.5	4.75	120.7	2.25	57.2	2.56	65.0	1.38	34.9
MRV22	1.44	36.6	9.31	236.5	2.38	60.3	4.00	101.6	2.44	61.8	2.50	63.5	5.75	146.1	2.25	57.2	2.56	65.0	1.38	34.9
MRV23	1.44	36.6	9.31	236.5	2.38	60.3	4.00	101.6	2.44	61.8	2.50	63.5	6.75	171.5	2.25	57.2	2.56	65.0	1.38	34.9
MRV24	1.44	36.6	9.31	236.5	2.38	60.3	4.00	101.6	2.44	61.8	2.50	63.5	7.75	196.9	2.25	57.2	2.56	65.0	1.38	34.9
MRV31	1.96	49.7	9.83	249.6	2.38	60.3	4.00	101.6	1.79	45.5	1.86	47.2	6.11	155.2	1.61	40.9	1.92	48.8	0.73	18.5
MRV32	1.96	49.7	9.83	249.6	2.38	60.3	4.00	101.6	1.79	45.5	1.86	47.2	7.36	186.9	1.61	40.9	1.92	48.8	0.73	18.5
MRV33	1.96	49.7	9.83	249.6	2.38	60.3	4.00	101.6	1.79	45.5	1.86	47.2	8.61	218.7	1.61	40.9	1.92	48.8	0.73	18.5

BCS/MCS Screw Drives

ORDERING

BASE MODEL SPECIFICATIONS

BCS **20** **BN02** **SK45** **RPL1**

OPTIONS SPECIFICATIONS

DC18 **KT2** **MP4**

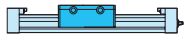

RODLESS

BCS/MCS Series

- Ordering

MODEL TYPE

BCS BCS Series English Screw Drive
MCS MCS Series Metric Screw Drive

STROKE LENGTH

SK Stroke, then enter desired stroke length in decimal inches

AUXILIARY CARRIER

DC_ Auxiliary Carrier, then center-to-center spacing desired in decimal inches. (Center-to-Center spacing will add to overall dead length and will not subtract from the stroke length)

TUBE BORE DIAMETER

10 1-inch (25 mm) bore
15 1-1/2-inch (40 mm) bore
20 2-inch (50 mm) bore

MOTOR MOUNTING / REDUCTIONS

(must choose one)

LMI In-Line mounting
LME23 Ext. shaft for RP & 23 frame motor
LME34 Ext. shaft for RP & 34 frame motor
LME40 Ext. shaft for RP & 40 frame motor
****LMX** Extended shaft - old style (see note)
****For replacement actuators with extended motor shafts purchased prior to 6/24/02 use LMX**

⚠ A motor size and code must be selected when specifying a reverse-parallel mounting configuration. Reference the ordering pages in sections F, G and H for the motor types and selections.

RPL1 1:1 Reverse-Parallel mount left
RPR1 1:1 Reverse-Parallel mount right
RPB1 1:1 Reverse-Parallel mount bottom
RPT1 1:1 Reverse-Parallel mount top
RPL2 2:1 Reverse-Parallel mount left
RPR2 2:1 Reverse-Parallel mount right
RPB2 2:1 Reverse-Parallel mount bottom
RPT2 2:1 Reverse-Parallel mount top

SWITCHES

RM_ Reed Switch (Form A) with 5-meter lead/QD (*quick-disconnect*), & quantity
RT_ Reed Switch (Form A) with 5-meter lead, and quantity desired
BM_ Reed Switch (Form C) with 5-meter lead/QD, and quantity desired
BT_ Reed Switch (Form C) with 5-meter lead, and quantity desired
KM_ Hall-effect Sinking Switch with 5-meter lead/QD, and quantity desired
KT_ Hall-effect Sinking Switch with 5-meter lead, and quantity desired
TM_ Hall-effect Sourcing Switch with 5-meter lead/QD, and quantity desired
TT_ Hall-effect Sourcing Switch with 5-meter lead, and quantity desired
CM_ TRIAC Switch with 5-meter lead/QD, and quantity desired
CT_ TRIAC Switch with 5-meter lead, and quantity desired

NUT/SCREW CONFIGURATION

ENGLISH MODELS

SOLID NUT / PITCH (turn/in)	SERIES
SN01	BCS10, 15, 20
SN02	BCS10, 15, 20
SNA02	BCS10, 15
SN05	BCS10, 15

BALL NUT / PITCH (turn/in)	SERIES
BN02	BCS15, 20
BNL02	BCS15, 20
BN05	BCS15, 20
BNL05	BCS15, 20
BN08	BCS10
BNL08	BCS10

METRIC MODELS

SOLID NUT / LEAD (mm/turn)	SERIES
SN12	MCS10, 15, 20
SN25	MCS10, 15, 20

BALL NUT / LEAD (mm/turn)	SERIES
BN08	MCS10
BNL08	MCS10
BN05	MCS15, 20
BNL05	MCS15, 20

TO ORDER MOTORS/CONTROLS/INTERFACES

BRUSHLESS SERVO (SEE PAGE F-33)

SUPPORTS AND MOUNTING PLATES

(both may be selected)
TS_ Tube Supports plus quantity desired
MP_ Mounting Plates plus quantity desired

⚠ **Not all codes listed are compatible with all options.**

Use the Sizing Software to determine available options and accessories based on your application requirements.

FIELD RETROFIT KITS

ITEM	B3S10	B3S15	B3S20	M3S10	M3S15	M3S20
Tube Supports	4510-1010	4515-1010	4520-1010	4510-1010	4515-1010	4520-1010
Mounting Plates	0910-9133	0915-9135	0920-9038	0510-9105	0515-9138	0520-9105

SLS/MLS Screw Drives

OVERVIEW



APPLICATION BENEFITS

- Rigid, low-profile design is ideal for space-sensitive applications
- Consistent carrier tracking and long actuator life
- Wide base for ease of mounting.

GUIDANCE SYSTEM



Pre-engineered and fully enclosed the SLS slide guidance system consists of recirculating bearings on ground steel shafts, offering stability and endurance.



Uses the same patented Band Retention system as the BCS—a T-shaped elastomer strip bonded to a stainless steel band, inserted directly into the body housing forming a tight metal-to-metal seal for clean operation.

STANDARD MOUNTING



Actuators are provided with T-nuts in the base of the cylinder body. Four T-nuts for the first 24 inches of stroke are standard. Two nuts are provided for each additional 20 inches of stroke. The SLS tube and work table accept 1/4" threaded square nuts (MLS, M6 threaded square nuts).

ACTUATOR/MOTOR FACTORS

- Actuator's operating temperature range (40-130° F, 4-54° C) should take into consideration heat generated by the motor and drive, linear velocity and work cycle time.
- For large frame motors or small actuators, cantilevered motors need to be supported, if subjected to continuous rapid reversing duty and/or under dynamic conditions.

AVAILABLE OPTIONS

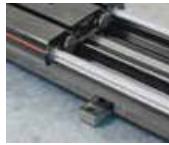

Mounting Plates: Provide clearance height for motors and motor mounts when mounting an actuator on a flush surface. Mount to either tapped holes in cylinder heads or to T-nuts, they provide the means for top mounting access. Kits include plates and mounting screws.



Auxiliary Carrier: Increases rigidity, load-carrying capacity and bending moments



Motor Mounting and Gearhead Reduction:

In-line Motor Mounting— This motor mounting option uses a spacer and coupler to join the motor to the actuator shaft.



Gearhead Reduction—Gearheads are available for applications requiring reduction for inertia matching or higher torque at lower speeds. High efficiency, single stage, true planetary gearheads are available in 5.5:1 and 10:1 ratios for reduction solutions with most Tolomatic NEMA 23 and 34 face motors. For gearhead specifications and dimensions, see page F-10.



Switches: Reed, dc Hall-effect and ac TRIAC.

See section I.

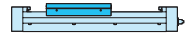

RODLESS

SLS/MLS Series

- Application benefits
- Guidance system
- Standard mounting
- Actuator/motor factors
- Available options

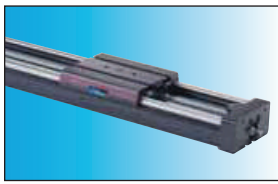

SLS/MLS10 Series

ACME SCREW SPECIFICATIONS

SLS/MLS10 ACME SCREW CRITICAL SPEED AND PV LIMITS

CRITICAL SPEED WITH 1/2" ENGLISH ACME SCREW

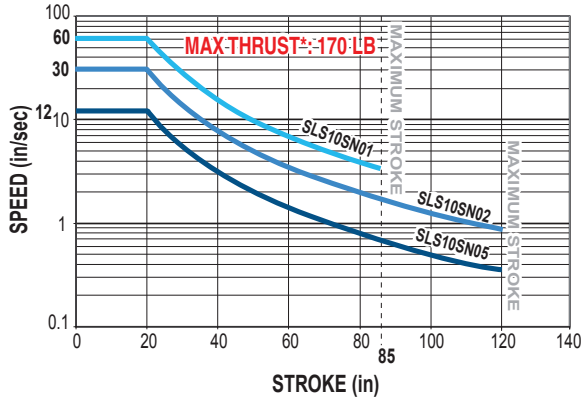

CRITICAL SPEED WITH 12mm METRIC ACME SCREW

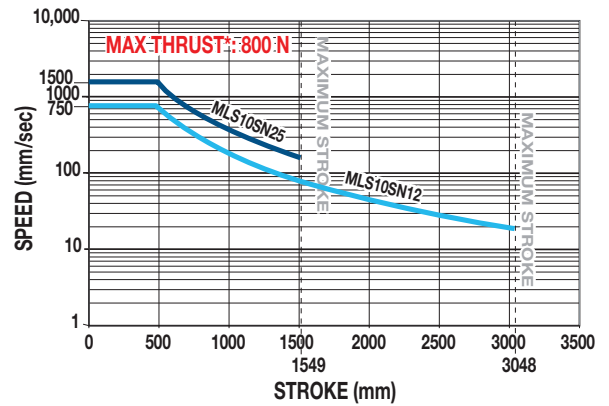

PV LIMITS: 1/2" 1 TPI ENGLISH ACME SCREW

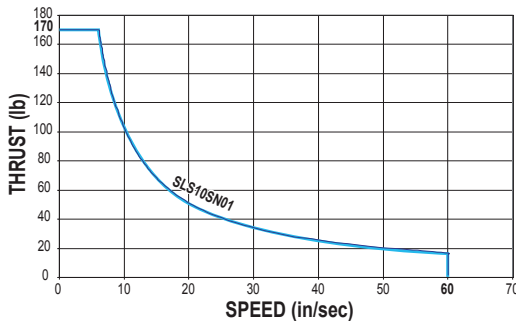

PV LIMITS: 12mm ACME METRIC SCREW w/25mm LEAD

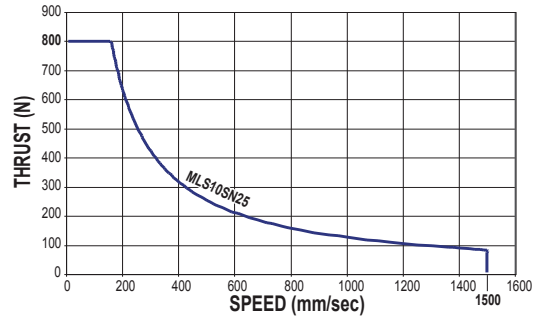

PV LIMITS: 1/2" 2 TPI ENGLISH ACME SCREW

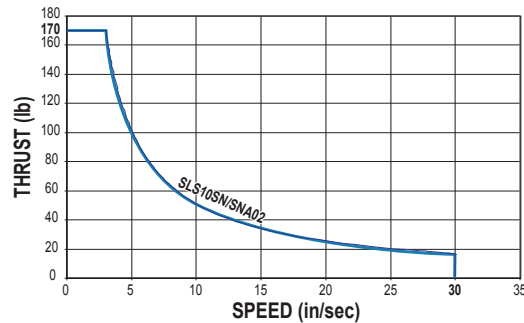

PV LIMITS: 12mm ACME METRIC SCREW w/12mm LEAD

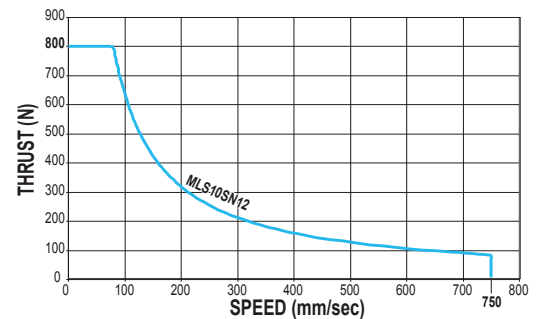

PV LIMITS: 1/2" 5 TPI ENGLISH ACME SCREW

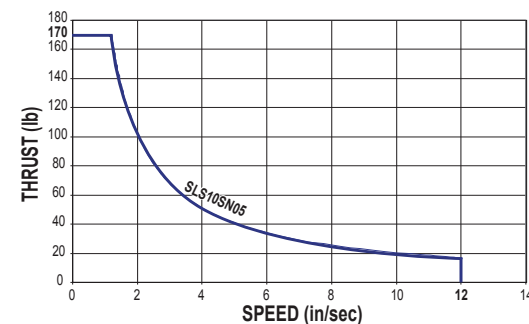

SN = Solid Nut
SNA = Solid Anti-backlash Nut

⚠️ * Maximum thrust is the maximum continuous dynamic thrust subject to Thrust x Velocity limitation.

PV LIMITS: Any material which carries a sliding load is limited by heat buildup. The factors that affect heat generation rate in an application are the pressure on the nut in pounds per square inch and the surface velocity in feet per minute. The product of these factors provides a measure of the severity of an application.

$$\left(\frac{P}{(\text{Max. Thrust Rating})} \right) \times \left(\frac{V}{(\text{Max. Speed Rating})} \right) \leq 0.1$$

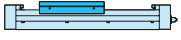

RODLESS

SLS/MLS10 Series

- Acme screw critical speed capacities and PV limits

SLS/MLS10 Series

BALL SCREW SPECIFICATIONS

SLS/MLS10 BALL SCREW SPECIFICATIONS

CRITICAL SPEED WITH 3/8" ENGLISH BALL SCREW

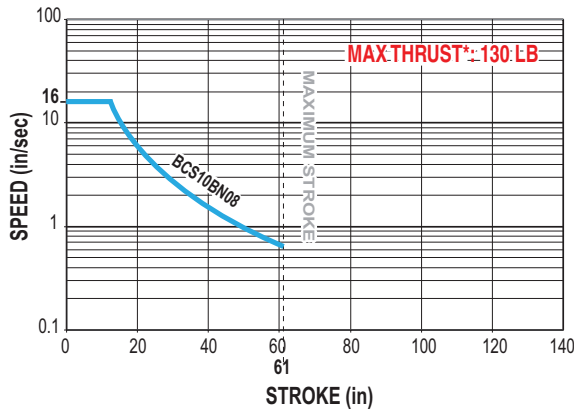

CRITICAL SPEED WITH 10mm METRIC BALL SCREW

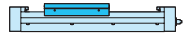
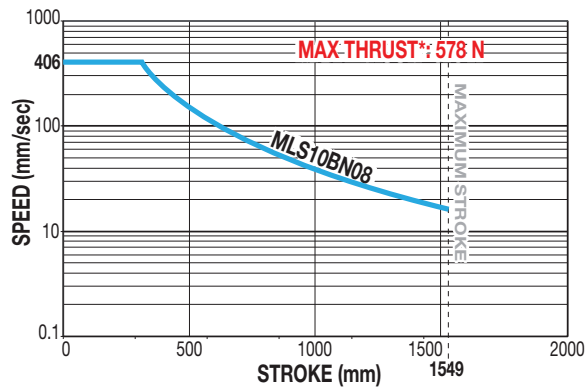

RODLESS

SLS/MLS10 Series

- Ball screw critical speed capacities and life calculations

LIFE CALCULATION: 3/8" 8TPI ENGLISH BALL SCREW

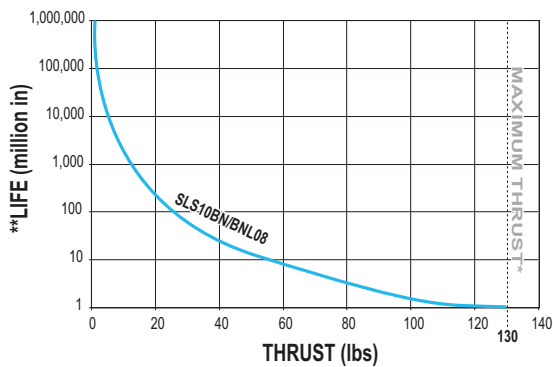

LIFE CALCULATION: 10mm METRIC BALL SCREW w/3.2mm LEAD

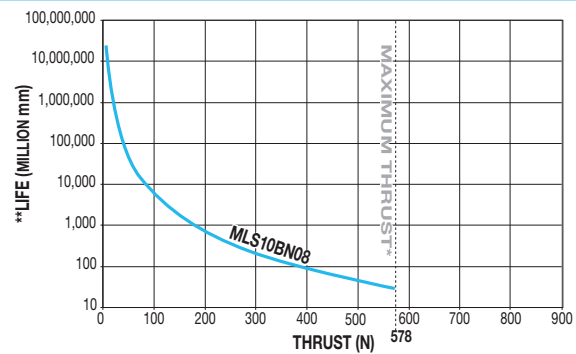

BN = Ball Nut



*** Maximum thrust reflects 90% reliability for 1 million linear inches of travel.**

****Life indicates theoretical maximum life of screw only, under ideal conditions and does not indicate expected life of actuator.**

SLS/MLS10 Series

SPECIFICATIONS

SPECIFICATIONS RELATED TO ACTUATOR SIZE AND SCREW SELECTION

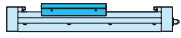

RODLESS

SLS/MLS10 Series

- Actuator and screw specifications

ENGLISH LEAD SCREWS										
ACTUATOR SERIES	SCREW DIA. (in)	SCREW TYPE	TPI (turns/in)	LEAD ACCURACY (in/ft)	BACKLASH (in)	MAXIMUM THRUST* (lb)	MAXIMUM STROKE (in)	INERTIA (lb-in ²)		BREAKAWAY TORQUE (lb-in)
								BASE ACTUATOR	PER/in	
								In Line	OF STROKE	
SLS10	0.375	BN	08	0.004	0.015	130	61	0.0054	0.0005	1.063
	0.375	BNL	08	0.004	0.002	130	61	0.0054	0.0005	1.063
	0.500	SN	01	0.006	0.007	170	85	0.0554	0.0017	1.875
	0.500	SN	02	0.005	0.007	170	120	0.0262	0.0017	1.438
	0.500	SNA	02	0.005	0.003	170	120	0.0262	0.0017	1.438
	0.500	SN	05	0.006	0.007	170	120	0.0180	0.0017	1.250

METRIC LEAD SCREWS										
ACTUATOR SERIES	SCREW DIA. (mm)	SCREW TYPE	LEAD (mm/turn)	LEAD ACCURACY (mm/300)	BACKLASH (mm)	MAXIMUM THRUST (N)	MAXIMUM STROKE (mm)	INERTIA (kg-m ² x 10 ⁻⁶)		BREAKAWAY TORQUE (N-m)
								BASE ACTUATOR	PER/mm	
								In Line	OF STROKE	
MCS10	10	BN	3.2	0.13	0.38	578	1549	37.50	3.47	0.12
	10	BNL	3.2	0.13	0.05	578	1549	37.50	3.47	0.12
	12	SN	12	0.13	0.18	800	3048	6.49	0.41	0.17
	12	SN	25	0.13	0.18	800	1626	15.01	0.41	0.17

SCREW CODE DESCRIPTION

SN	Solid Nut
SNA	Anti-backlash Solid Nut
BN	Ball Nut
BNL	Low-Backlash Ball Nut



Contact the factory for higher accuracy and lower backlash options.
 * For Acme screws, maximum thrust is the maximum continuous dynamic thrust subject to Thrust x Velocity limitation. For ball screws, maximum thrust reflects 90% reliability for 1 million linear inches of travel.

GENERAL ACTUATOR SPECIFICATIONS

SLS ENGLISH ACTUATORS					
ACTUATOR SERIES	CARRIER WEIGHT (lb)	BASE WEIGHT (lb) (Including Carrier)	WEIGHT PER/IN OF STROKE (lb)	TEMPERATURE RANGE* (F)	IP RATING**
SLS10	1.54	6.05	0.404	40 - 130	44

MLS METRIC ACTUATORS					
ACTUATOR SERIES	CARRIER WEIGHT (kg)	BASE WEIGHT (kg) (Including Carrier)	WEIGHT PER/mm OF STROKE (g)	TEMPERATURE RANGE* (C)	IP RATING**
MLS10	0.69	2.74	7.23	4 - 54	44



- * Heat generated by the motor and drive should be taken into consideration as well as linear velocity and work cycle time. For applications that require operation outside of the recommended temperature range, contact the factory.
- ** Protected against ingress of solid particles greater than .039 in (1mm) and splashing water.

LARGE FRAME MOTORS AND SMALLER SIZE ACTUATORS: Cantilevered motors need to be supported, if subjected to continuous rapid reversing duty and/or under dynamic conditions.

SLS/MLS10 Series

SPECIFICATIONS

FRICITION FORCE

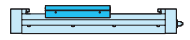
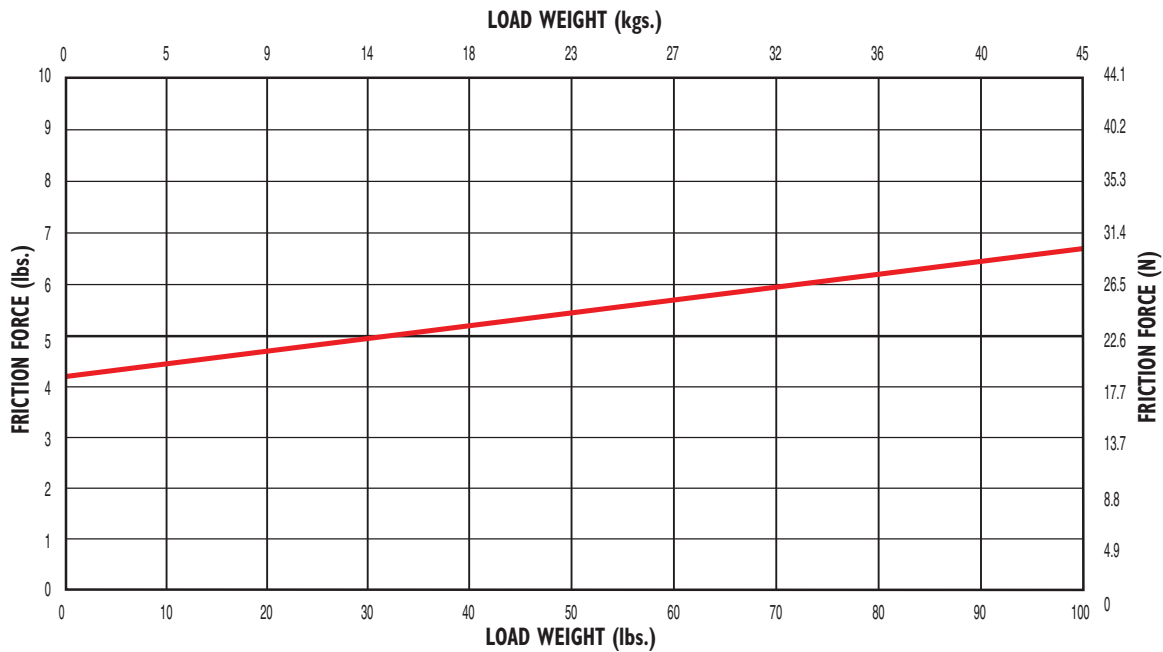

RODLESS

SLS/MLS10 Series

- Friction Force
- Support recommendations
- Bending moments and loads

SUPPORT RECOMMENDATIONS

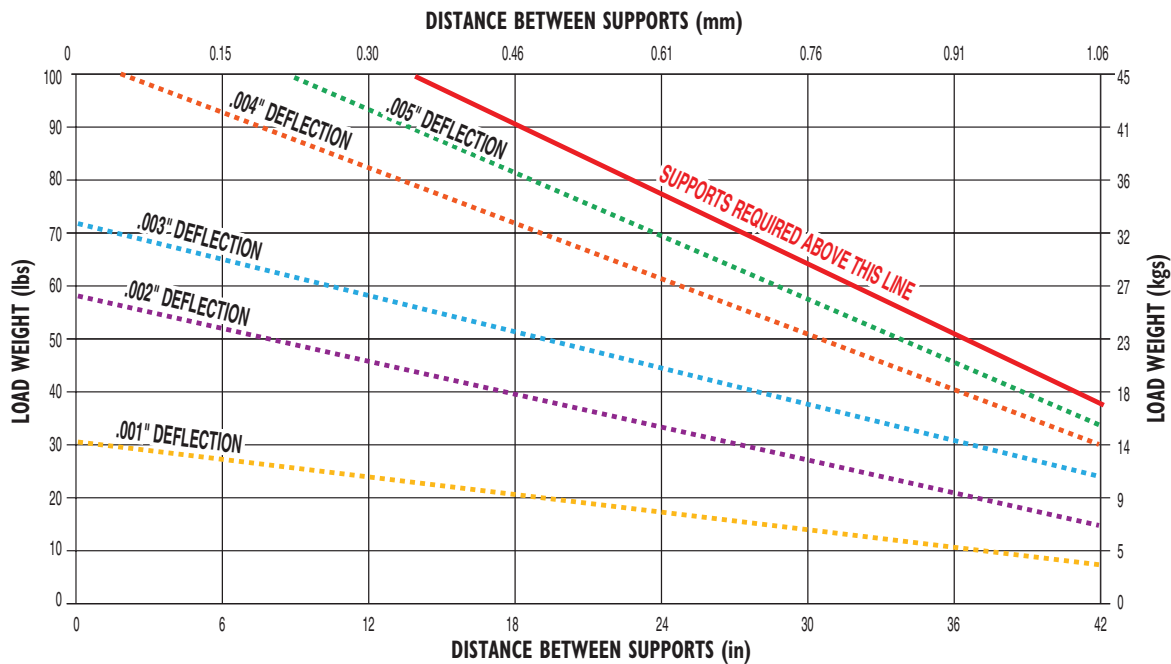

SLS/MLS10 Series

SPECIFICATIONS

DYNAMIC BENDING MOMENTS AND LOADS

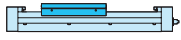

RODLESS

SLS/MLS10 Series

- Bending moments and loads

		MAXIMUM BENDING MOMENTS AND LOADS	ENGLISH	METRIC
STANDARD CARRIER			SLS10	MLS10
	Mx Moment (Roll) (lb-in) : N-m	80	9.0	
	My Moment (Pitch) (lb-in) : N-m	80	9.0	
	Mz Moment (Yaw) (lb-in) : N-m	125	14.1	
	Fz Load (Lateral) (lb) : N	100	445	
AUXILIARY CARRIER: Increases rigidity, load-carrying capacity and moments			SLS10	MLS10
	Mx Moment (Roll) *(lb-in) : N-m	160	18.1	
	My Moment (Pitch) *(lb-in) : N-m	178	20.1	
	Mz Moment (Yaw) *(lb-in) : N-m	278	31.3	
	Fz Load (Lateral) (lb) : N	200	890	
	Minimum Dimension 'D' (in : mm)	5.5	169.7	

! Breakaway torque will increase when using the Auxiliary carrier option. When ordering, determine your working stroke and enter this value into the configuration string. Overall actuator length will automatically be calculated.

*Loads shown in table are at minimum "D" dimension, for ratings with longer "D" dimension see graph on page C-131.

SLS/MLS10 Series

SPECIFICATIONS

LOAD DEFLECTION

Y-AXIS DEFLECTION

Figures calculated with the following considerations:

- 1.) Tube supports spaced at minimum distances for each bore size

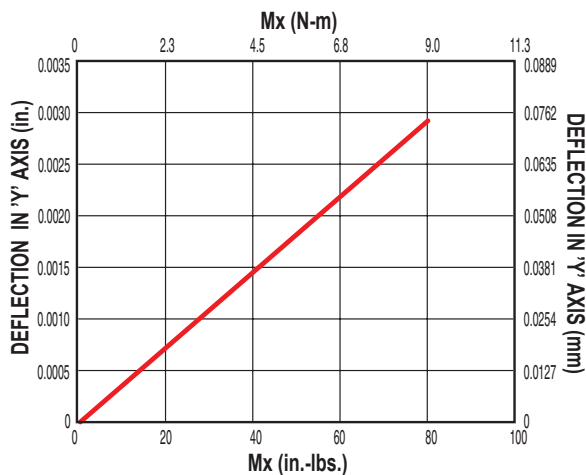
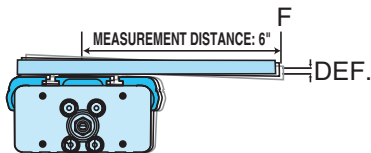

X-AXIS DEFLECTION

Figures calculated with the following considerations:

- 1.) Tube supports spaced at minimum distances for each bore size
- 2.) Measurement distance from F to center of carrier is 8 inches

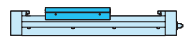
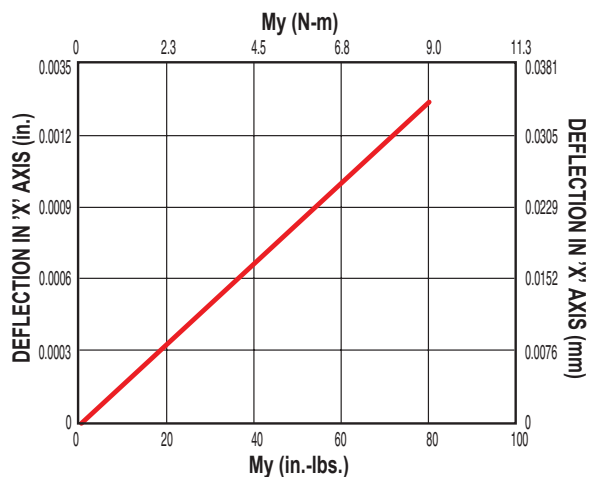
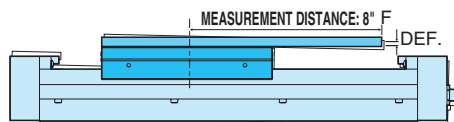

RODLESS

SLS/MLS10 Series

- Load deflection
- Auxiliary carrier

AUXILIARY CARRIER: BENDING MOMENT AT 'D' DISTANCE

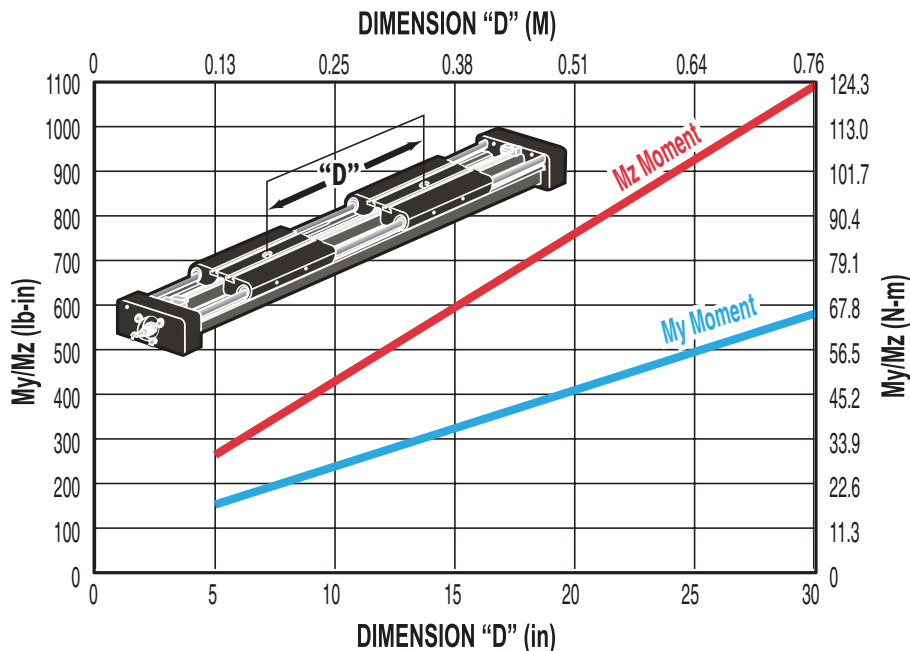

Rates shown on charts were calculated with these assumptions:

- 1.) Coupling between carriers is rigid.
- 2.) Load is equally distributed between carriers.
- 3.) Coupling device applies no misalignment loads to carriers.

* Customer must specify Dimension "D" (Distance between carrier center lines) in configuration string.

SLS/MLS10 Series

DIMENSIONS

SLS10/MLS10 ACTUATOR AND OPTIONS DIMENSIONS

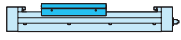

RODLESS

SLS/MLS10 Series

- Actuator and options dimensions

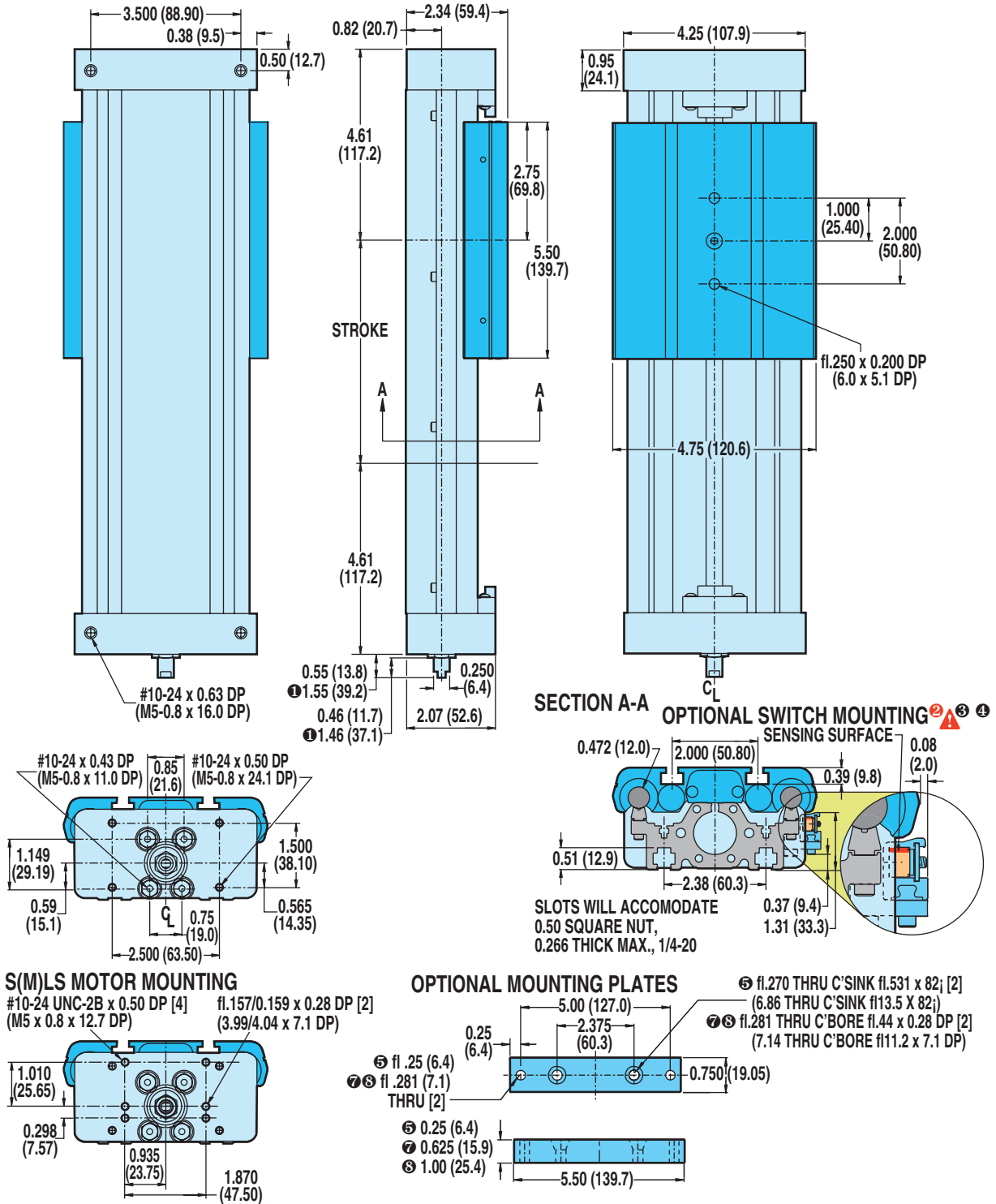

Unless otherwise noted, all dimensions shown are in inches (Dimensions in parenthesis are in millimeters)

SLS/MLS10 Series

DIMENSIONS

SLS/MLS10: IN-LINE MOUNT FOR BRUSHLESS MOTORS (MRV) AND GEARHEADS

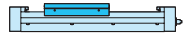
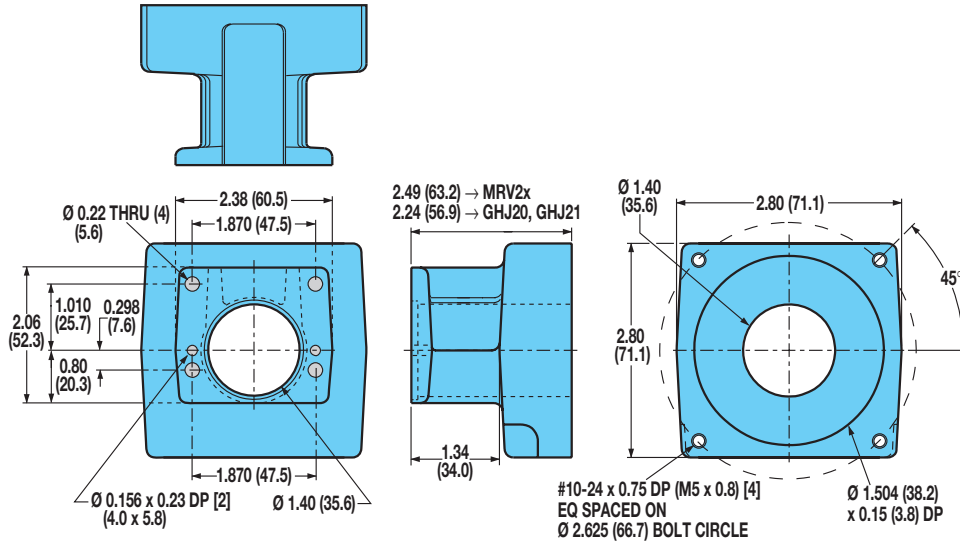

RODLESS

SLS/MLS10 Series

- In-line mounting dimensions



For gearhead dimensions and specifications, refer to page F-10.

SLS/MLS10 Series

ORDERING

BASE MODEL SPECIFICATIONS

SLS 10 SN02 SK25 LMI

OPTIONS SPECIFICATIONS

DC18 KT2 TN4 MP2

MODEL TYPE

SLS SLS Series English Screw Drive
MLS MLS Series Metric Screw Drive

TUBE BORE DIAMETER

10 1-inch (25 mm) bore

NUT/SCREW CONFIGURATION

ENGLISH MODELS

SOLID NUT / PITCH (turn/in)	SERIES
SN01	SLS10
SN02	SLS10
SNA02	SLS10
SN05	SLS10

BALL NUT / PITCH (turn/in)	SERIES
BN08	SLS10
BNL08	SLS10

METRIC MODELS

SOLID NUT / LEAD (mm/turn)	SERIES
SN12	MLS10
SN25	MLS10

BALL NUT / LEAD (mm/turn)	SERIES
BN08	MLS10
BNL08	MLS10

STROKE LENGTH

SK Stroke, then enter desired stroke length in decimal inches

MOTOR MOUNTING / REDUCTIONS

(must choose one)

LMI In-Line mounting
****LMX** Extended shaft - old style (see note)

****For replacement actuators with extended motor shafts purchased prior to 6/24/02 use LMX**

AUXILIARY CARRIER

DC_ Auxiliary Carrier, then center-to-center spacing desired in decimal inches. (Center-to-Center spacing will add to overall dead length and will not subtract from the stroke length)

SWITCHES

RM_ Reed Switch (Form A) with 5-meter lead/QD (*quick-disconnect*), & quantity
RT_ Reed Switch (Form A) with 5-meter lead, and quantity desired
BM_ Reed Switch (Form C) with 5-meter lead/QD, and quantity desired
BT_ Reed Switch (Form C) with 5-meter lead, and quantity desired
KM_ Hall-effect Sinking Switch with 5-meter lead/QD, and quantity desired
KT_ Hall-effect Sinking Switch with 5-meter lead, and quantity desired
TM_ Hall-effect Sourcing Switch with 5-meter lead/QD, and quantity desired
TT_ Hall-effect Sourcing Switch with 5-meter lead, and quantity desired
CM_ TRIAC Switch with 5-meter lead/QD, and quantity desired
CT_ TRIAC Switch with 5-meter lead, and quantity desired

T-NUT OPTION

TN_ Additional T-nuts and quantity

MOUNTING PLATES

MP_ Mounting Plates plus quantity desired

! *Not all codes listed are compatible with all options.*

Use the Sizing Software to determine available options and accessories based on your application requirements.

TO ORDER MOTORS/CONTROLS/INTERFACES

 **BRUSHLESS SERVO (SEE PAGE F-33)**

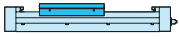

RODLESS

SLS/MLS10 Series

- Ordering

FIELD RETROFIT KITS

ITEM	SLS10	MLS10
1/4" Mounting Plates	0610-9010	0610-9010
1/2" Mounting Plates	0610-9045	0610-9045

Axi*dyne*[®] Brushless Servo System

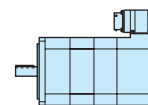

BRUSHLESS

- **MRV BRUSHLESS SERVO MOTORS**
- **AXIOM[®] DV SERVO DRIVE**
- **AXIOM[®] PV SERVO CONTROLLER/DRIVE**
- **SSC CONTROLLER**
- **JS JOYSTICK INTERFACE**
- **SIT HAND-HELD INTERFACE**

Axi dyne® Brushless Servo System

OVERVIEW

APPLICATION BENEFITS

- Extremely smooth and quiet operation
- Good for high torques [up to 45 in-lbs. (5.08 N-m) continuous, 140 in-lbs. (15.82 N-m) peak]
- Good for high speeds, up to 6,000 RPM
- High resolution, 4,000 counts per revolution
- Provide torque control
- Good for short, repetitive moves
- Maintenance free with no moving contacts

MOTOR



MRV - Brushless Servo Motors

- Rugged, with large shafts and bearings, IP65
- Convenient MS connectors
- Common flanges (NEMA 17, 23, 34 and 56)
- Integral temperature sensor and 1000 line encoder
- Gearhead reduction available in gear ratios of 5.5:1 and 10:1 when selected with Tol-O-Matic screw-drive actuators

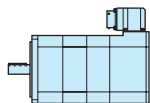

BRUSHLESS

Overview

DRIVE



Axiom DV - Servo Drive

- Designed to drive MRV motors
- Peak current ratings of 10A, 20A and 30A
- State-of-the-art vector commutation and current control for efficient high-bandwidth servo performance
- Simple Windows®-based software for set-up and installation

DRIVE - CONTROLLER



Axiom® PV Controller/Drive:

- Combines into one unit:
 - PLC: with real-time scan, 175 rung ladder logic
 - Motion Controller: with 1.5 axis, event triggering, motion pause and resume, point & click editor
 - Axiom drive: with all features listed above

- Includes Tol-O-Motion™ Axiom Motion Control Software and intuitive point and click sequential program and PLC ladder logic editors

CONTROLLER



SSC Controller:

- Performs any motion task including jogging, point-to-point positioning, linear and circular interpolation, electronic gearing, camming and contouring
- Multitasking feature permits simultaneous execution of four independent applications programs
- Tol-O-Motion SSC Motion Control Software allows setup & programming with easy-to-use Windows® interface
- Up to 4 axes per unit - up to 4 units can be daisy-chained
- 4M non-volatile EEPROM memory for executing custom application programs - permits stand-alone operation
- Relative and absolute positioning with more than ± 2,000,000,000 counts per move
- Inputs: opto-isolated dedicated for home, abort, forward and reverse limits, 8 uncommitted; 7 analog inputs
- Outputs: 8 programmable

INTERFACES



JS - Joystick

- Use with SSC joystick teach mode



SIT - Hand-held interface

- 45 key - keypad, LCD display
- for use with SSC

Host compatible PC

Axi dyne® MRV Brushless Servo Motors

FEATURES AND SPECIFICATIONS



COMPATIBILITY:
SYSTEM: BRUSHLESS
MOTORS: MRV
DRIVE: AXIOM DV
AXIOM PV
CONTROLLER: SSC
AXIOM PV
INTERFACE: JS
SIT

MRV Brushless Servo Motors

Tol-O-Matic's MRV series brushless servo motors provide a wide range of rated torques and speeds for applications requiring long life under continuous, difficult environment operation. These motors are designed for maximum power density. The MRV series motor come with an internally mounted 1000 line encoder.

FEATURES

- Rugged industrial enclosures
- Large shafts and bearings for longer life with high radial and axial loads
- Dual convenient MS connectors to simplify motor termination and provide excellent noise immunity
- Common industrial mechanical flanges (NEMA 17, 23, 34, 56)
- Integral 1000 line TTL encoder with differential line driver outputs
- Ideally suited for use with Axiom DV drives (motor parameters are stored with drive) – torque/speed curves shown on the following pages reflect MRV motors with Axiom drive performance.
- Internal thermal protection
- IP65* rated (except MRV11)
**Totally protected against dust and low pressure jets of water.*

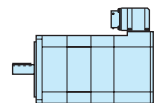

BRUSHLESS

MRV Motors

- Features
- Specifications

SPECIFICATIONS

Model	KE (1)	KT (2)	Resistance (3)		Rotor Inertia		Thermal Resistance	Cont. Stall P Torque		Peak Stall Torque		Max. Speed	Inductance (4)	Weight	
	Volts/1000RPM	lb-in/amp	N-m/amp	Ohms	lb-in ²	kg-m ² x 10 ⁶	°C/W	lb-in	N-m	lb-in	N-m	RPM	mH	lbs	kgs
MRV11	6.06	0.893	0.100	2.24	0.020	5.72	—	2.50	0.28	12.50	1.41	5,000	1.63	1.16	0.53
MRV21	8.80	1.290	0.144	2.22	0.053	15.58	1.80	3.75	0.42	11.31	1.28	6,000	1.81	2.20	1.00
MRV22	14.50	2.120	0.237	2.04	0.099	28.90	1.30	7.50	0.85	22.50	2.54	6,000	2.10	3.10	1.40
MRV23	21.80	3.190	0.357	2.73	0.143	41.70	1.23	11.25	1.27	33.81	3.82	6,000	2.95	4.00	1.80
MRV24	29.00	4.250	0.476	3.36	0.193	56.33	1.16	15.63	1.77	46.88	5.30	6,000	3.81	5.00	2.30
MRV31	14.80	2.170	0.243	1.10	0.386	112.85	0.72	17.00	1.92	85.00	9.60	6,000	2.60	8.00	3.60
MRV32	22.20	3.250	0.364	0.80	0.694	203.02	0.58	30.00	3.39	150.00	16.90	6,000	2.50	11.50	5.20
MRV33	25.90	3.790	0.424	0.60	1.006	294.47	0.56	44.00	4.97	220.00	24.90	6,000	2.10	14.00	6.35
MRV51	48.90	7.150	0.801	0.54	2.531	740.75	0.72	80.00	9.04	240.00	27.10	3,000	3.06	26.00	11.80

ALL RATINGS TYPICAL AND AT 77°F (25°C) UNLESS OTHERWISE NOTED. WINDING TEMPERATURE AT 257°F (125°C).

(1) L-L, RMS (±10%) (2) PER PHASE, RMS (±10%) (3) L-L DC RESISTANCE (±10%) (4) L-L (±15%)

Axi-dyne[®] MRV Brushless Servo Motors

PERFORMANCE DATA WITH AXIOM[®] DV/PV DRIVES

MRV11Y • DV/PV10 DRIVE • THREE-PHASE

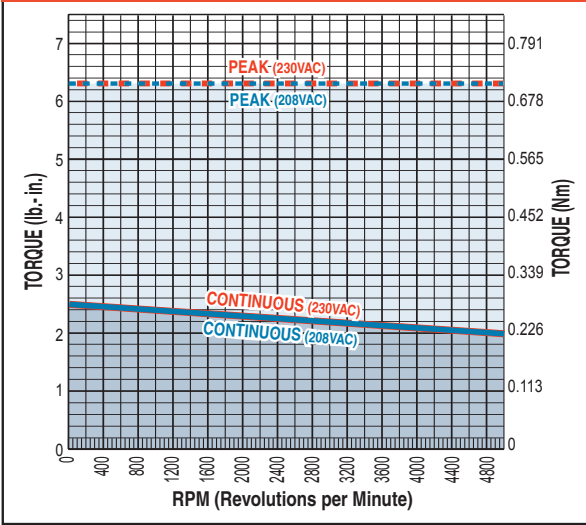

MRV11Y • DV/PV10 DRIVE • SINGLE-PHASE

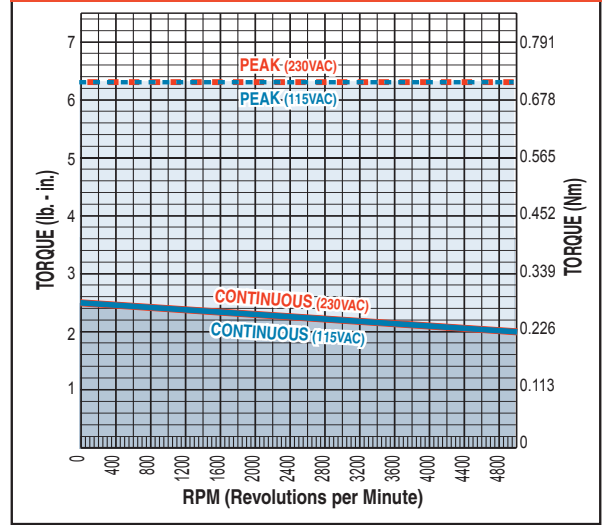

MRV21Y • DV/PV10 DRIVE • THREE-PHASE

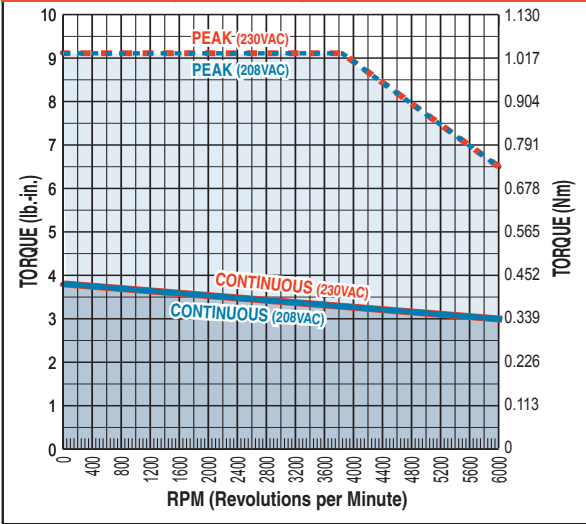

MRV21Y • DV/PV10 DRIVE • SINGLE-PHASE

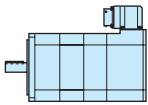
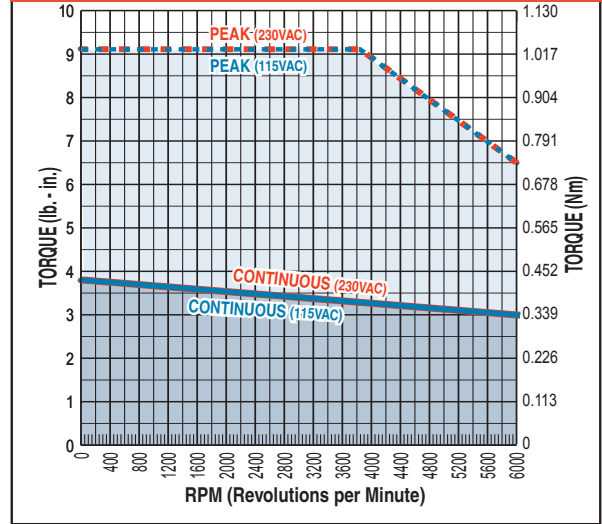

BRUSHLESS

MRV Motors
• Performance data

MRV22Y • DV/PV10 DRIVE • THREE-PHASE

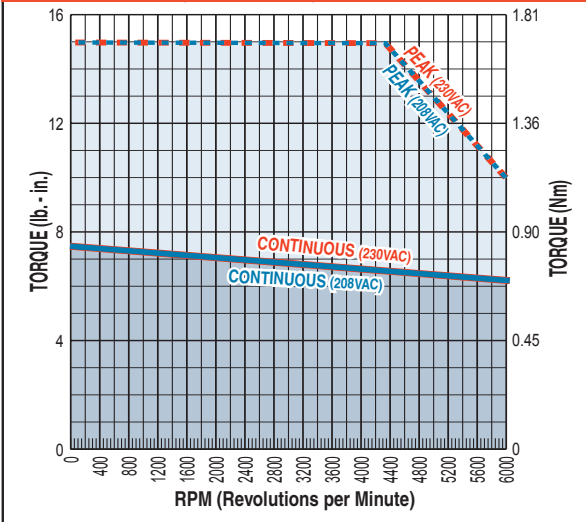

MRV22Y • DV/PV10 DRIVE • SINGLE-PHASE

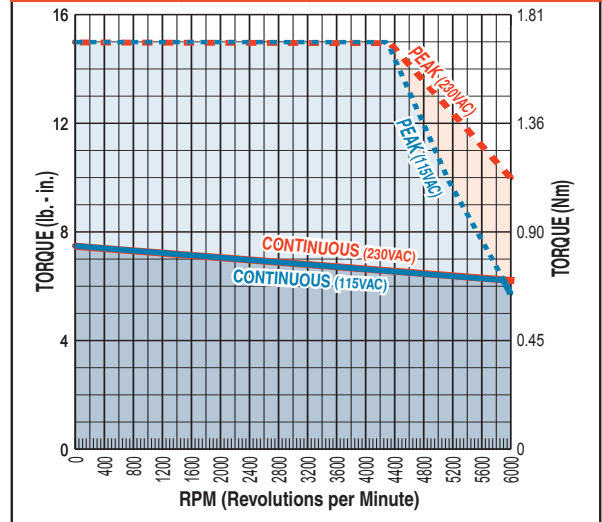

Axi-dyne[®] MRV Brushless Servo Motors

PERFORMANCE DATA WITH AXIOM[®] DVIPV DRIVES

MRV23Y • DV/PV10 DRIVE • THREE-PHASE

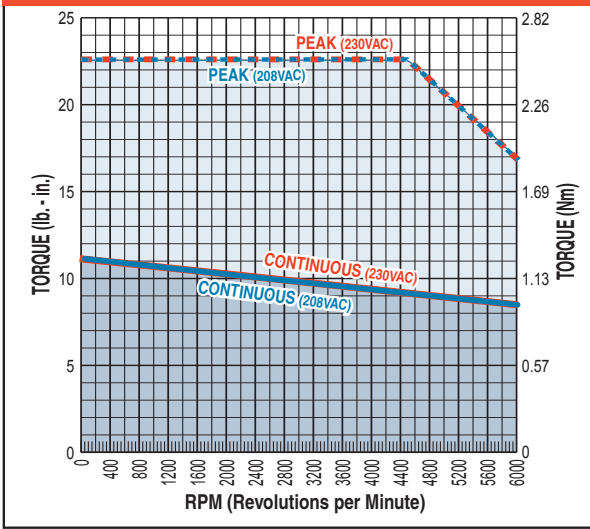

MRV23Y • DV/PV10 DRIVE • SINGLE-PHASE

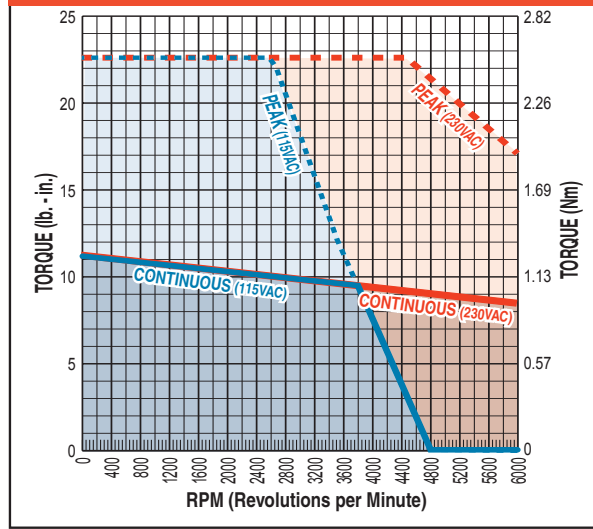

MRV24Y • DV/PV10 DRIVE • THREE-PHASE

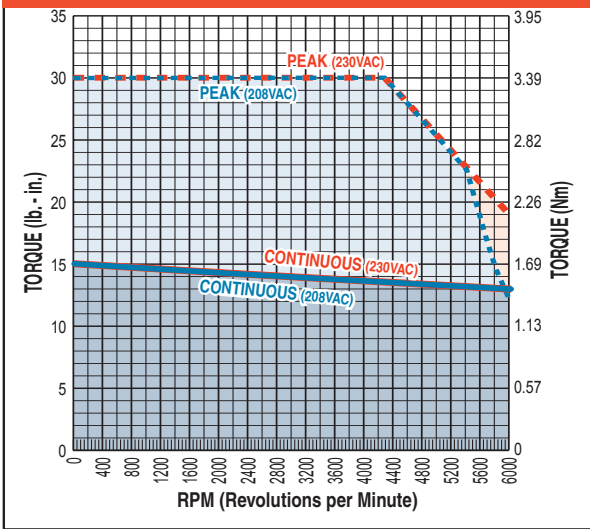

MRV24Y • DV/PV10 DRIVE • SINGLE-PHASE

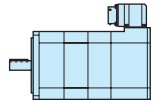
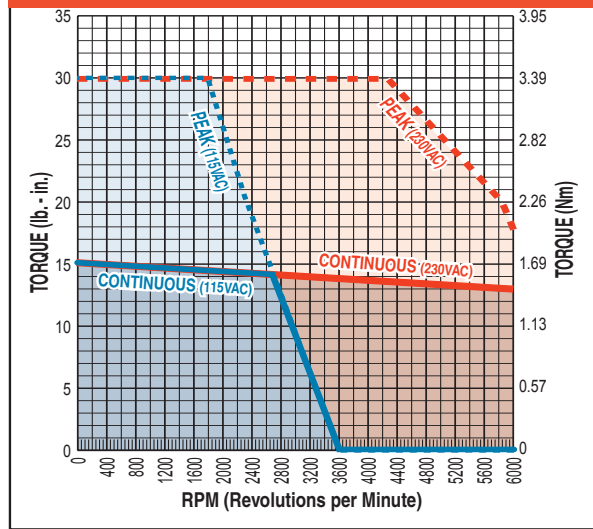

BRUSHLESS

MRV Motors
• Performance data

MRV31Y • DV/PV10 DRIVE • THREE-PHASE

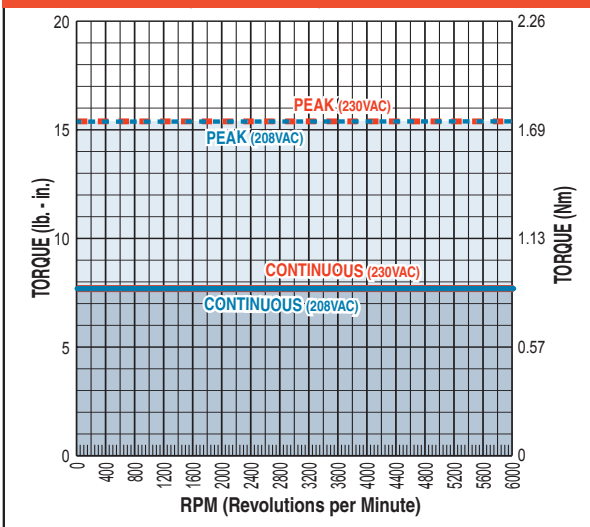

MRV31Y • DV/PV10 DRIVE • SINGLE-PHASE

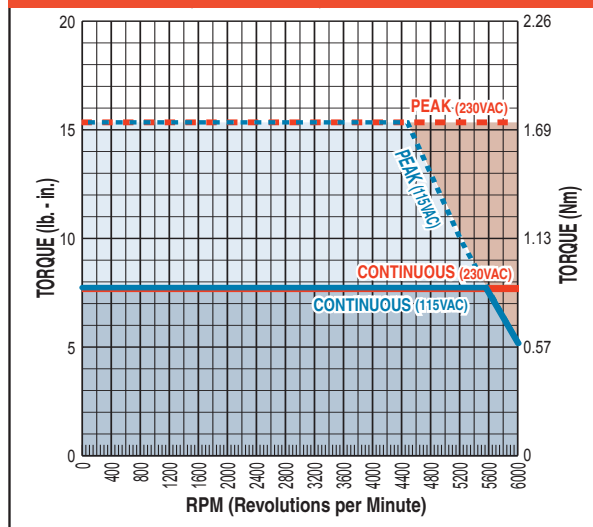

Axi dyne[®] MRV Brushless Servo Motors

PERFORMANCE DATA WITH AXIOM[®] DV/VPV DRIVES

MRV31Z • DV/VPV20 DRIVE • THREE-PHASE

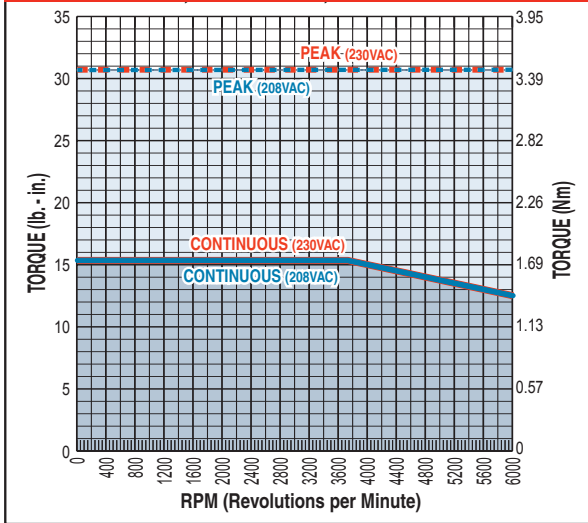

MRV31Z • DV/VPV20 DRIVE • SINGLE-PHASE

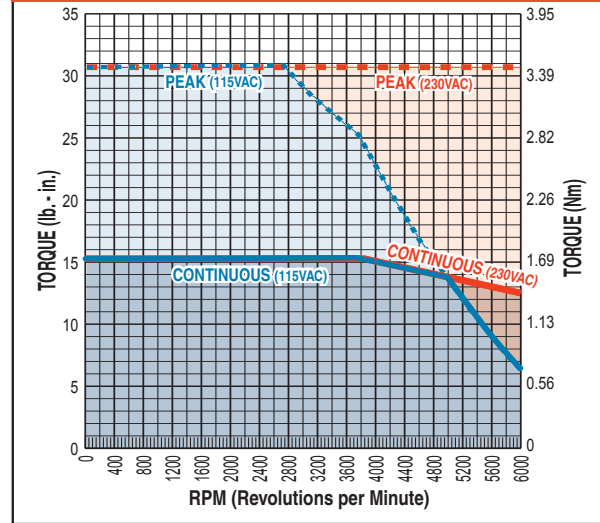

MRV32Y • DV/VPV20 DRIVE • THREE-PHASE

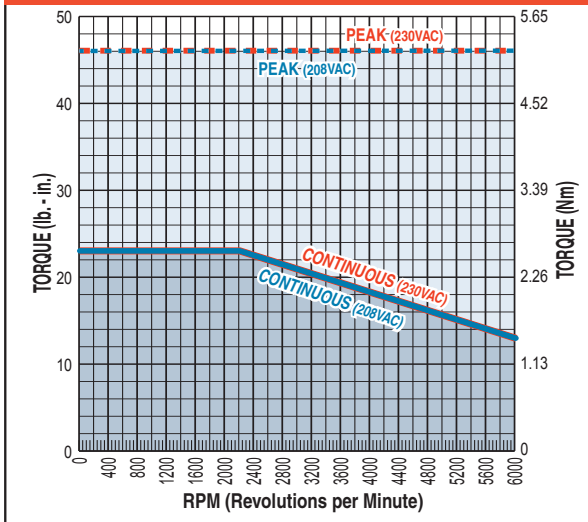

MRV32Y • DV/VPV20 DRIVE • SINGLE-PHASE

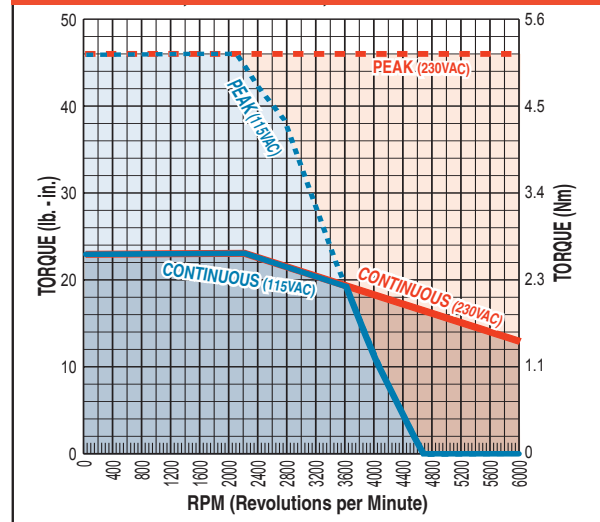

MRV32Z • DV/VPV30 DRIVE • THREE-PHASE

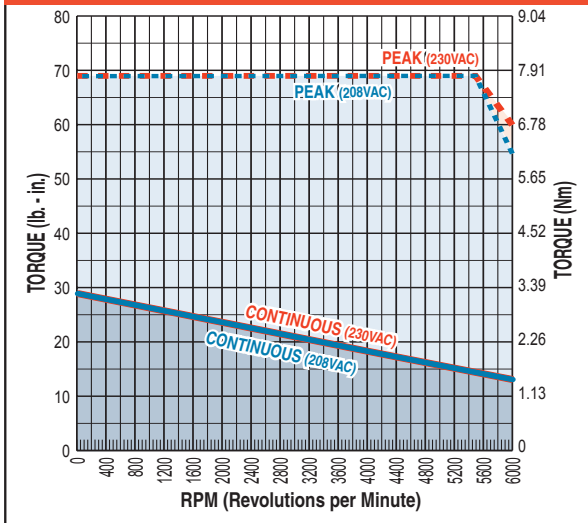

MRV32Z • DV/VPV30 DRIVE • SINGLE-PHASE

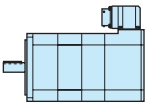
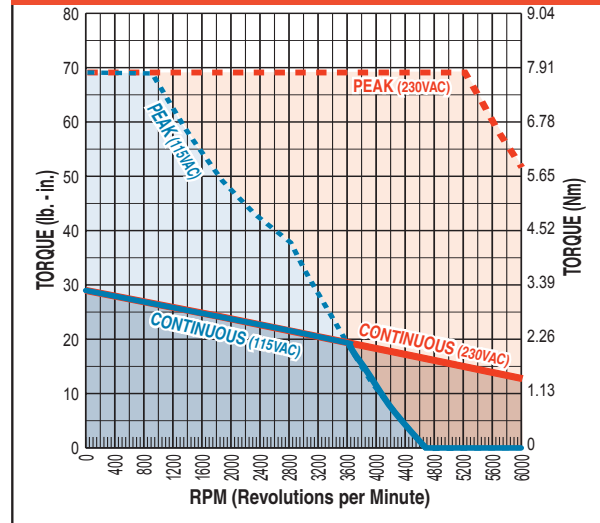

BRUSHLESS

MRV Motors
• Performance data



MRV Brushless Servo Motors

PERFORMANCE DATA WITH AXIOM® DVIPV DRIVES

MRV33Y • DV/PV20 DRIVE • THREE-PHASE

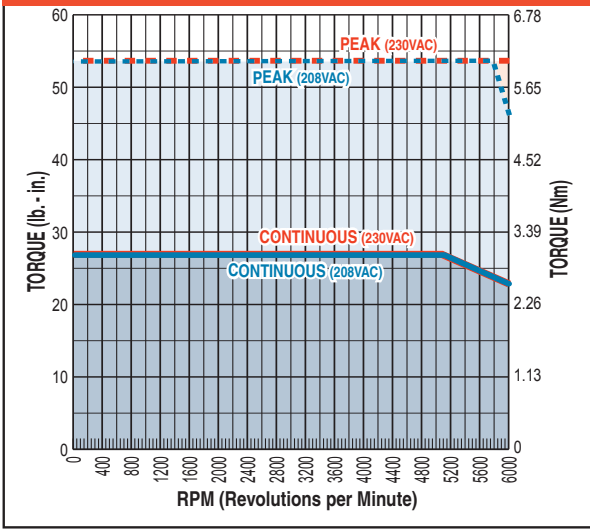

MRV33Y • DV/PV20 DRIVE • SINGLE-PHASE

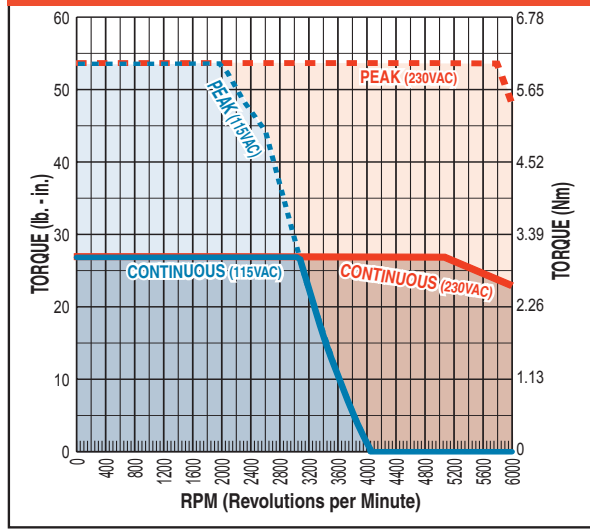

MRV33Z • DV/PV30 DRIVE • THREE-PHASE

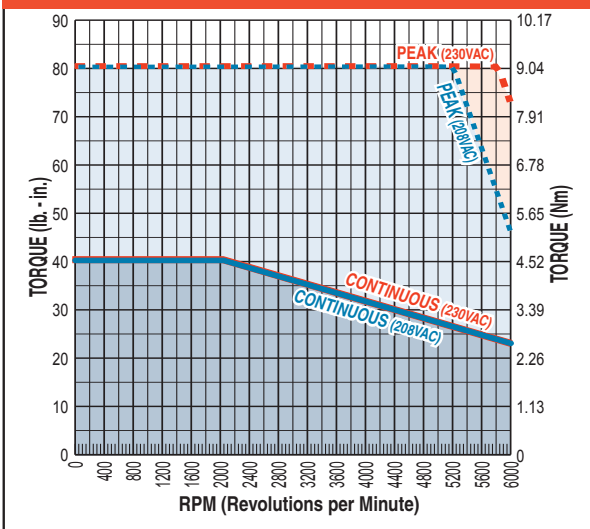

MRV33Z • DV/PV30 DRIVE • SINGLE-PHASE

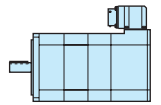
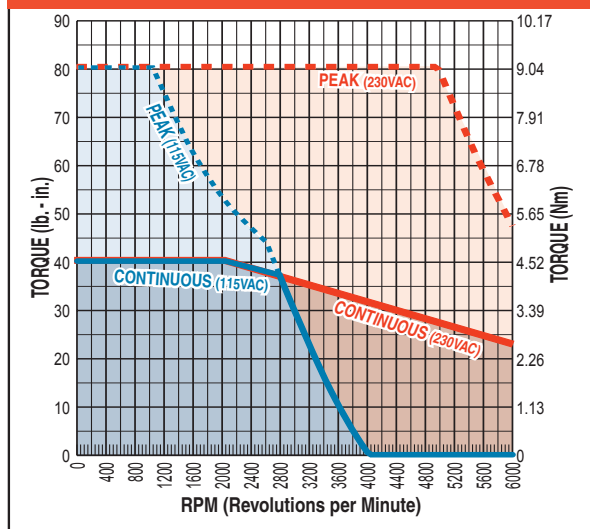

BRUSHLESS

MRV Motors

- Performance data

MRV51Y • DV/PV30 DRIVE • THREE-PHASE

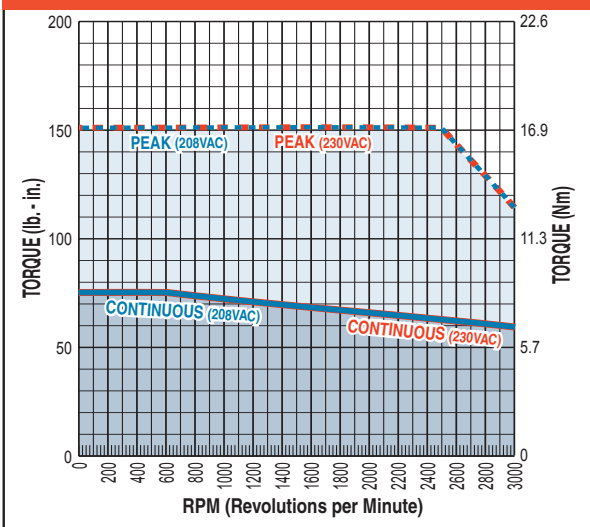

MRV51Y • DV/PV30 DRIVE • SINGLE-PHASE

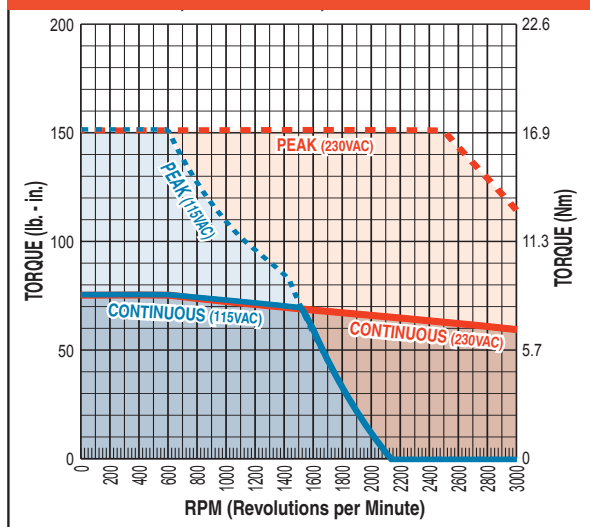

Axi-dyne[®] MRV Brushless Servo Motors

DIMENSIONS

MRV I

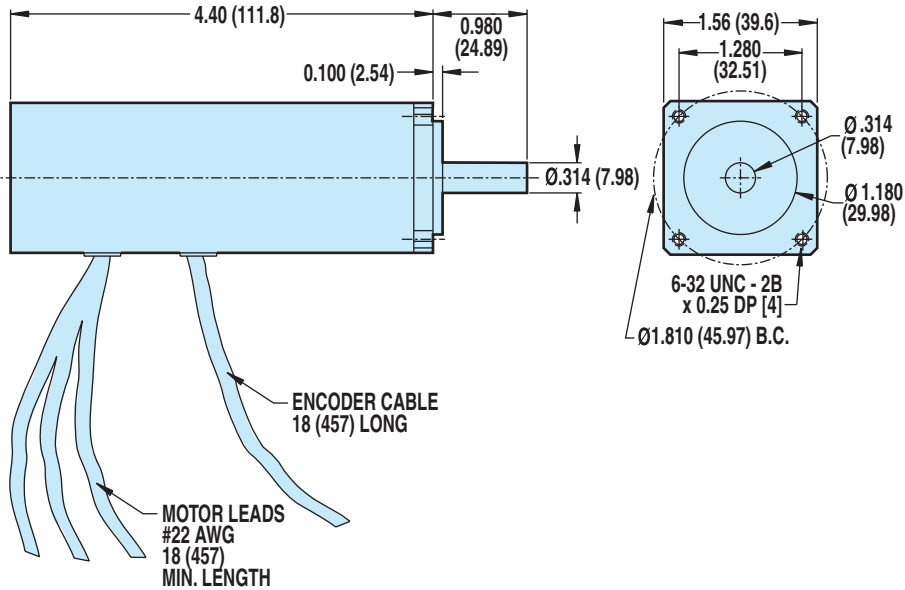

MRV21, 22, 23, 24

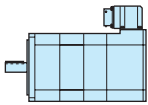

BRUSHLESS

MRV Motors
• Dimensions

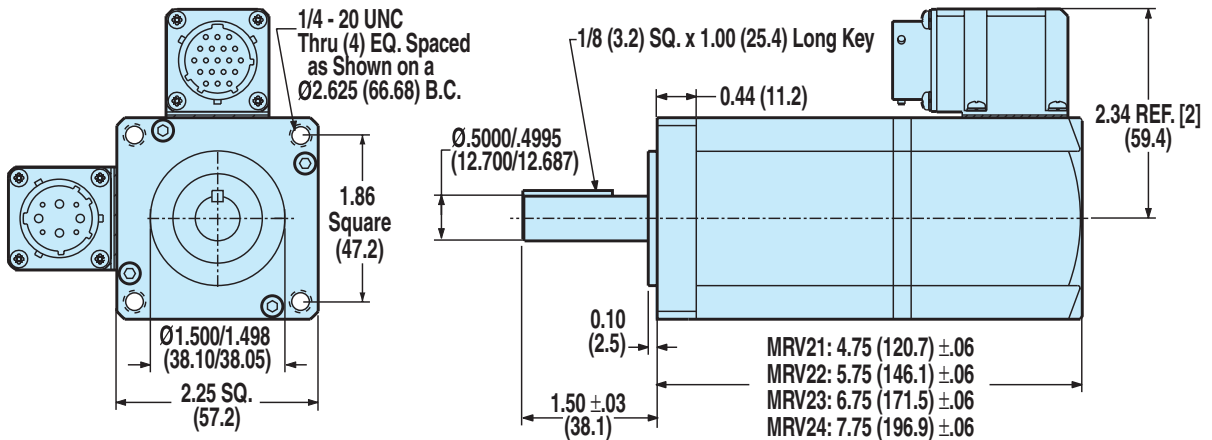

Unless otherwise noted, all dimensions shown are in inches (Dimensions in parenthesis are in millimeters)

Axi dyne® MRV Brushless Servo Motors

DIMENSIONS

MRV31, 32, 33

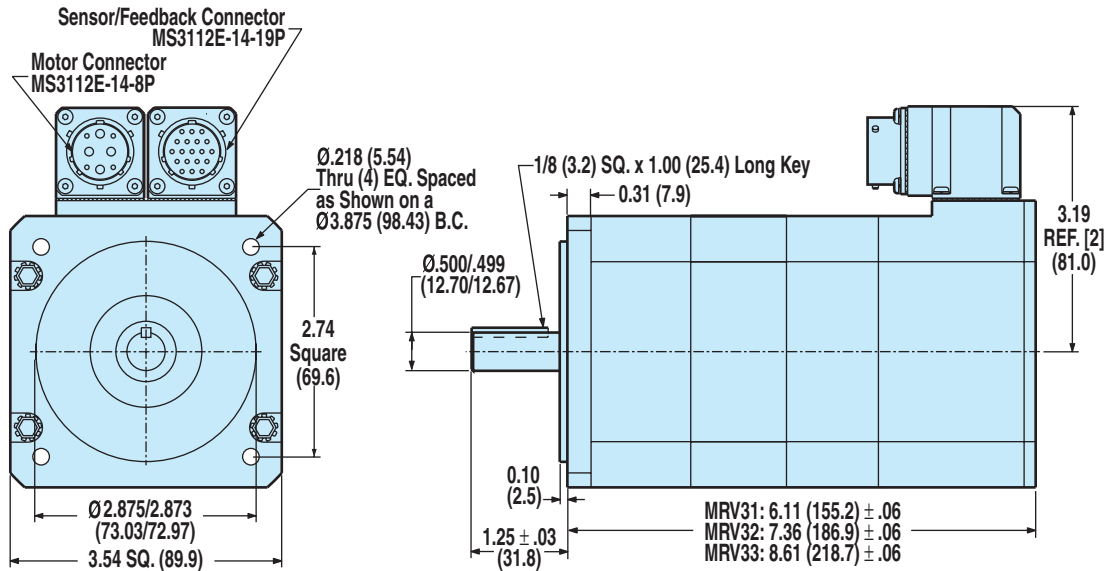

MRV51

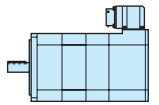
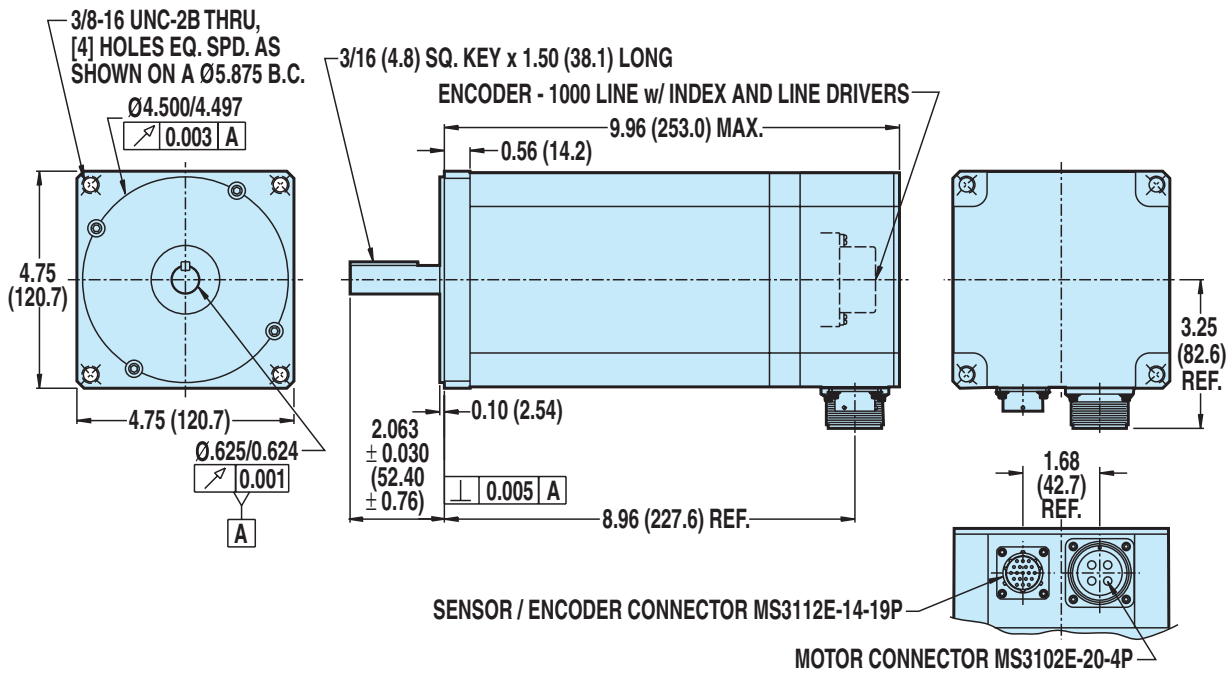

BRUSHLESS

MRV Motors
• Dimensions

Axi-dyne® Gearhead Reduction

SPECIFICATIONS AND DIMENSIONS

- COMPATIBILITY:**
 SYSTEM: BRUSHLESS
 MOTORS: MRV
 ACTUATORS: ALL TOL-O-MATIC SCREW DRIVES
- COMPATIBILITY:**
 SYSTEM: STEPPER
 MOTORS: MRS
 ACTUATORS: ALL TOL-O-MATIC SCREW DRIVES
- COMPATIBILITY:**
 SYSTEM: BRUSHED DC
 MOTORS: MRB
 ACTUATORS: ALL TOL-O-MATIC SCREW DRIVES



For those applications requiring reduction for inertia matching or higher torque at lower speeds, Tol-O-Matic offers high efficiency, single stage, true planetary gearheads. Gear ratios of 5.5:1 and 10:1 are available and are compatible with 23- and 34-frame MRV Brushless Servo, MRS Microstepping and Brushed DC motors.

SPECIFICATIONS

Efficiency:	85%
Backlash:	less than 10 arc minutes
Max. Input Speed:	5000 RPM

⚠ * Reflected inertia is inertia at motor side of gearhead.
 § Only available on RSA64 LMI

For a complete part listing of screw-drive motor and gearhead mounting kits referencing actuator/motor/coupler compatibilities, refer to document 3600-4631 available on the Literature/Axidyne/Part Sheet section of our web site at: www.tolomatic.com.

CONFIG NO.	PART NO.	FRAME SIZE	GEAR RATIO	REFLECTED INERTIA*		INPUT SHAFT DIA. (in)	WEIGHT	
				lb-in ²	kg-m ²		lbs	kgs
GHJ20	3600-6151	23	5.5:1	0.0213	6.22	0.500	2.00	0.91
GHJ21	3600-6152	23	10:1	0.0181	5.30	0.500	1.98	0.90
GHJ30	3600-6154	34	5.5:1	0.1131	33.09	0.500	4.60	2.09
GHJ31	3600-6155	34	10:1	0.0888	25.96	0.500	4.78	2.17
GHJ32§	3600-6156	34	10:1	0.0888	25.96	0.500	4.81	2.18

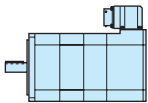

BRUSHLESS

23- AND 34-FRAME GEARHEADS

Gearhead Reduction

- Specifications
- Dimensions

23 FRAME GEARHEAD

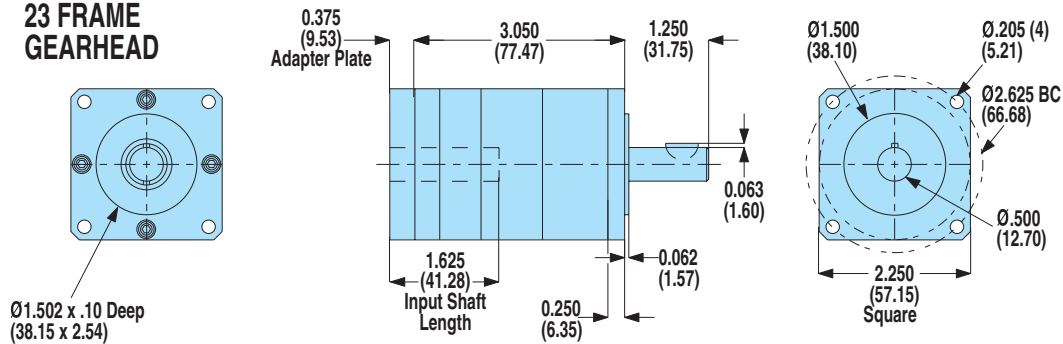

34 FRAME GEARHEAD

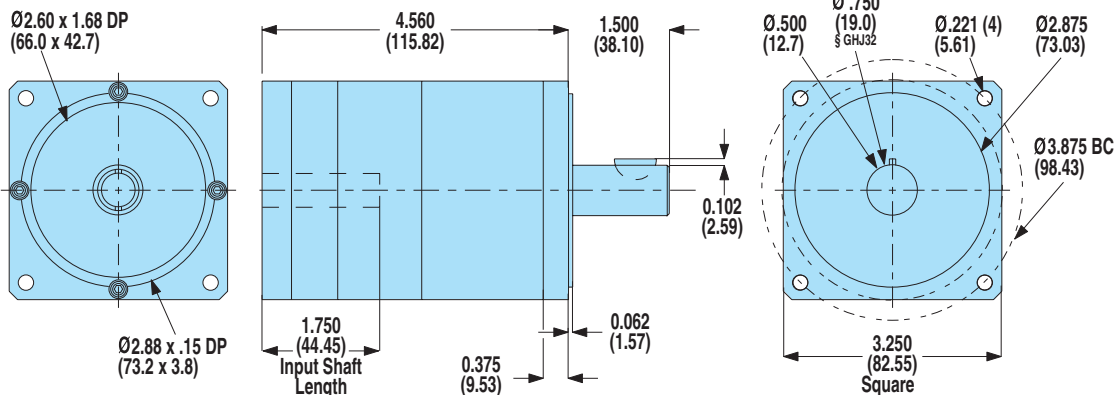

Unless otherwise noted, all dimensions shown are in inches (Dimensions in parenthesis are in millimeters)

Axi dyne® AXIOM® DV Brushless Servo Drive

FEATURES

COMPATIBILITY:
SYSTEM: BRUSHLESS
MOTORS: MRV
DRIVE: AXIOM DV

CONTROLLER: SSC
INTERFACE: JS
SIT



• **CONSIDER THE AXIOM PV FOR ALL OF THE FEATURES OF THE AXIOM DV, PLUS AN INTEGRAL CONTROLLER, & PLC ELIMINATING THE NEED FOR THE SSC CONTROLLER**

The Axiom series of brushless and brushed servo drives combine high-speed accuracy with user friendly set-up and diagnostics. The Axiom DV series is a state-of-the-art DSP controlled digital vector commutated drive for a full range of brushless servo motors. DV series drives are available in 10, 20 and 30 Amp peak ratings (3 sec). All come with convenient pluggable screw terminal connectors and offer fast, easy set-up and installation for use in a wide variety of applications.

AXIOM® DV DRIVE FEATURES

- Space vector commutation provides better bus voltage utilization than traditional sine drives for improved speed/torque curves
- Flux vector current control provides more accurate high bandwidth control of torque producing current for better efficiency and more torque over the full speed range than with traditional sine drives
- Drives MRV series brushless servo motors
- Autophasing eliminates the need for Hall sensors in motors
- Pluggable screw terminal connectors eliminate the need for special connectors and secondary breakout terminal strips
- 115/208-230Vac input, single or 3-phase
- Short circuit, over current and over voltage protection prevents drive damage
- 25W or 50W internal regeneration
- External regeneration connections
- Analog torque and velocity command (\pm) 10V or step and direction (CW/CCW) position control
- Feedback from differential A+B and index channel optical encoder (5V)
- Maximum line count of 500,000/motor commutation cycle
- CW/CCW travel limit inputs
- Drive enable input
- Fault, enabled, and in-position outputs
- 3A brake relay
- 3 second peak ratings

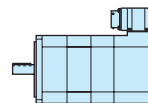

BRUSHLESS

Axiom DV Drive

• Features

Axi dyne® AXIOM® DV Brushless Servo Drive

SPECIFICATIONS

AXIOM® DV SPECIFICATIONS

SPECIFICATIONS	Axiom™ DV and DB Series Drives		
	DV10	DV20	DV30
Power			
Continuous Current Rating:	5 Amps	10 Amps	15 Amps
Peak Current Rating (3 sec):	10 Amps	20 Amps	30 Amps
Max Input Current (single phase):	12.5 Amps	25 Amps	37.5 Amps
Input Voltage (single/3-phase):	95Vac -130Vac / 190Vac - 250Vac (voltage range is switch selectable)		
Input Frequency:	47Hz - 63Hz		
Command Sources			
Analog Torque/Velocity Input:	± 10V, 16.4K ohm impedance		
Step and Direction or Step CW/Step CCW:	1 MHz maximum, 5V differential or single ended drivers		
Serial Communication Port			
Type:	RS232		
Baud Rate:	19,200 baud		
Control Loops			
Type:	All digital		
Loop Modes:	Torque, Velocity and Position Control		
Torque Update Rate:	10KHz		
Velocity Update Rate:	5KHz		
Position Update Rate:	2.5KHz		
Inputs and Outputs			
Dedicated Optically Isolated Inputs:	5Vdc - 25Vdc, 2.7ma - 15ma ENABLE, CW LIMIT and CCW LIMIT. Can be configured to source or sink current.		
Dedicated Optically Isolated Outputs:	3 optically isolated, 25Vdc max., 50ma max. IN POSITION, ENABLED and FAULT. Can be configured to source or sink current.		
1 Dedicated Brake Relay Output:	N.O. contact, 24Vdc, 115/230Vac, 3A max.		
Motor Feedback:	Incremental encoder, 5Vdc, differential 4Mhz max., A/B/I channels 250 line min. with a 4 pole motor 125 line min. with a 2 pole motor		
Encoder Output:	Differential, 5Vdc, A/B/I channels		
Connectors			
Serial:	9 pin D-Sub.		
Control and Feedback:	15 pin D-Sub.		
Power, Motor, Brake Relay, Regen:	Screw terminal block		
All Others:	Pluggable screw terminal blocks		
Approvals	UL, CUL, CE		
Environmental			
Storage Temperature:	-40°C to 70°C		
Operating Temperature:	0°C to 50°C		
Humidity:	5% to 95%, non-condensing		
Weight:	DV10	DV20	DV30
	8 lbs	12 lbs	12 lbs
	(3.7 Kg)	(5.5 Kg)	(5.5 Kg)

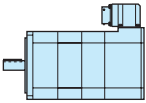

BRUSHLESS

Axiom DV Drive

- Specifications

Axi dyne® Axiom® DV Brushless Servo Drive

CONNECTORS

AXIOM® DV CONNECTORS

TB1 - BRAKE/REGEN

1 - Brake	4 - External Regen
2 - Brake	5 - Internal Regen
3 - Regen Common	

TB2 - MOTOR

1 - Motor R	3 - Motor T
2 - Motor S	4 - Motor Ground

TB3 - AC POWER

1 - L3	3 - L1
2 - L2	4 - Ground

J3 - OUTPUTS

1 - In Position +	4 - Enabled Out -
2 - In Position -	5 - Fault Out +
3 - Enabled Out +	6 - Fault Out -

J4 - INPUTS

1 - CW Limit	6 - Step/Step CW +
2 - CCW Limit	7 - Step/Step CW -
3 - Limit Common	8 - Direction/Step CCW +
4 - Enable +	9 - Direction/Step CCW -
5 - Enable -	

J6 - ANALOG INPUT COMMAND

1 - Analog Common	3 - Analog -
2 - Analog +	4 - Shield

J7 - MOTOR ENCODER

1 - Encoder +5V	6 - I+
2 - A+	7 - I-
3 - A-	8 - Common/Shield
4 - B+	9 - Motor Temp
5 - B-	

PI - BUFFERED ENCODER OUTPUT

1 - Reserved	8 - Common
2 - Reserved	9 - Encoder Out A+
3 - Reserved	10 - Encoder Out A-
4 - Reserved	11 - Encoder Out B+
5 - Reserved	12 - Encoder Out B-
6 - Reserved	13 - Encoder Out I+
7 - Reserved	14 - Encoder Out I-

P2 - COMMUNICATIONS

1 - Reserved	6 - Reserved
2 - RS-232 TX	7 - Reserved
3 - RS-232 RX	8 - Reserved
4 - Reserved	9 - +5Vdc (30ma MAX.)
5 - Common	

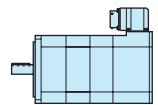

BRUSHLESS

Axiom DV Drive
• Connectors

Axi dyne® Axiom® DV Brushless Servo Drive

SET-UP / CONFIGURATION

Axiom® Windows®-based PC setup software with a “control-panel” approach, makes it easy to get up and running fast. All set-up and configuration functions are performed using two main control-panel screens. Simple mouse-click commands automatically configure the control functions, eliminating layers of screens and menus. This approach also allows more relevant diagnostic information to be displayed simultaneously. All control screens include a command menu at the upper left to permit convenient selection of high-level functions and options.

A main menu is provided which allows selection of the main control panel functions, active comm port, etc. Tutorial selections are provided which emulate the main control-panel functions in an off-line manner and provide “help” text and function definitions/ descriptions so that users can actively familiarize themselves with the software without actually connecting a drive.

The software communicates with the drive using a standard RS-232 connection operating at 19,200 baud, using either comm port 1 or 2 of the PC. It can be installed and executed from any PC running Windows 95, 98, NT, 2000 or XP.

SET-UP CONFIGURATION

Drive operating mode and other options can all be selected/enabled from this screen. All set-up parameters can be uploaded and downloaded with a single click of the mouse. The parameter set can be saved to or retrieved from a disk file. Once downloaded to the drive, all parameters are stored in non-volatile EEPROM memory.

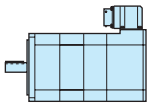

BRUSHLESS

Axiom DV Drive
• Set-up / configuration

The screenshot shows the 'Setup and Configuration' window with the following sections and annotations:

- Commands, Set-up and Configuration Mode:** A list of actions including 'Select Drive', 'Select Standard Motor', 'Retrieve Parm's from Disk File', 'Upload Parm's from Drive', 'Download Parm's to Drive', 'Save Parm's to Disk File', and 'Exit Drive Set-Up Mode'.
- Drive Model Selection / Setup:**
 - Drive Model #: DV10 (Annotated: DRIVE MODEL # DISPLAY AND PARAMETER CONFIGURATION.)
 - Drive Continuous Current: 5
 - Drive Peak Current: 10.0 amps
 - Clockwise Travel Limit: N-Open
 - Counter-CW Travel Limit: N-Open
 - Drive Enabled Output: N-Open
 - Drive Faulted Output: N-Open
 - In-Position Output: N-Open
- Motor Model Selection / Setup:**
 - Motor Model #: MRV21
 - Motor Cont. Stall Torque: 3.75 in-lb
 - Motor Peak Torque: 11.3 in-lb
 - Ke, Volts L-L rms/krpm: 8.9
 - Kt, in-lb/Amp-ph rms: 1.29
 - # of Magnetic Poles: 4
 - Encoder pulses/rev (x4): 4030
 - Maximum Speed, rpm: 6000
- Drive Operating Mode Selection:**
 - Torque Mode, Analog Input
 - Velocity Mode, Analog Input** (Annotated: DRIVE MODE SELECTION.)
 - Step/Dir Input Position Mode
 - CW/CCW Input Position Mode
- Gains and Offsets:**
 - Anl Offset = 0 mV, VDgain = 0
 - Anl In SF = 1.00, VIgain = 0
 - VPgain = 18, Allgain = 3
 - Vlgain = 55
- Phasing Configuration:**
 - Phasing Position Increment (degrees): 0
 - Phasing Torque (% of drive peak): 60%

(Annotated: DISPLAY OF TUNING AND OFFSET PARAMETERS FOR REFERENCE PURPOSES (SET IN TUNING CONTROL SCREEN).)

(Annotated: MOTOR SELECTION AND CONFIGURATION.)

(Annotated: CONFIGURATION/SET-UP FOR AUTO-PHASING FUNCTION INCLUDING INDEX PULSE MONITORING FOR COMMUTATION ACCURACY AND FASTER DETECTION OF FEEDBACK ERRORS.)

Axi-dyne® Axiom® DV Brushless Servo Drive

SET-UP / CONFIGURATION

TUNING AND DIAGNOSTICS

Use the 4-channel oscilloscope display for analysis of motion response when tuning and diagnosing. Scaling and format of the displayed traces can be easily modified. Values can be read directly off the traces at any point. Continuously updated bar graph displays allow important data to be viewed while motion is occurring. These displays are configured automatically based on drive operating mode they include peak detection functions and numeric displays. A status section of this control screen displays the current state of I/O and fault information.

Selecting "Drive-Tuning" from the command menu activates and displays the control functions for manual and automatic drive tuning. Use these controls to set-up and start actuation of an appropriate unit-step motion command and then enable automatic tuning parameter adjustment. Manual adjustments to tuning parameters can be easily accomplished.

The oscilloscope functions are used in conjunction with tuning, ensuring desired response goals are achieved. All tuning parameters are updated and activated immediately in the drive when modified (and also stored in EEPROM memory).

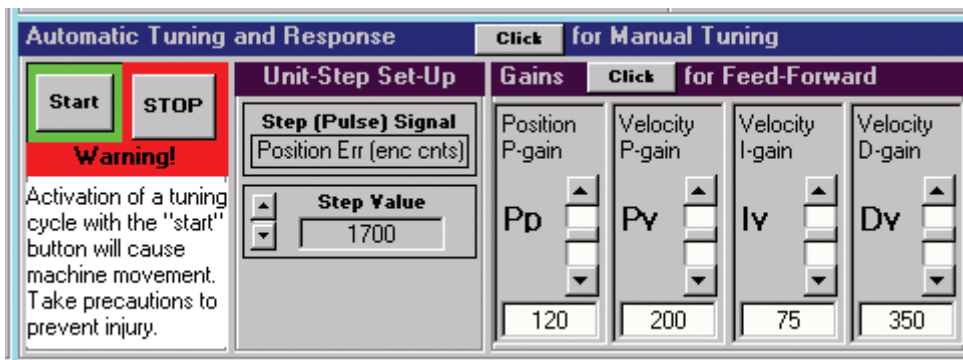

TUNING CONTROLS ALLOW USER CONFIGURABLE UNIT-STEP ACTUATION. AUTOMATIC AND MANUAL TUNING FUNCTIONS ARE PROVIDED. OPTIONAL VALUES FOR FEED FORWARD GAINS AND ANALOG OFFSETS CAN ALSO BE ENTERED.

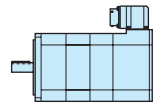

4-CHANNEL OSCILLOSCOPE DISPLAY FOR SET-UP/TUNING AND SUBSEQUENT DIAGNOSIS. FLEXIBLE DISPLAY CONFIGURATION AND SLIDING VALUE INDICATOR, MAKE ANALYSIS QUICK AND EASY. INCLUDES USER CONTROLLED TRIGGER FUNCTIONS.

BRUSHLESS

Axiom DV Drive
• Set-up / configuration

ALL SOFTWARE SCREENS INCLUDE SEPARATE MENUS OF HIGH-LEVEL FUNCTIONS IN THE UPPER LEFT CORNER TO FACILITATE QUICK TRANSITIONS BETWEEN SCREENS AND FUNCTIONS.

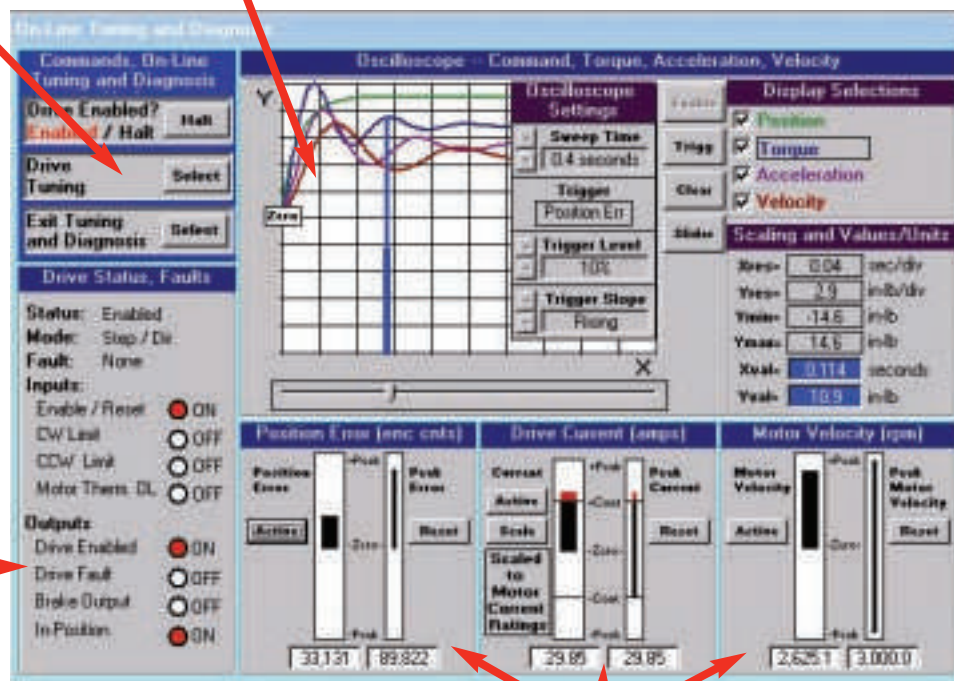

CONTINUOUS DISPLAY OF CRITICAL DRIVE STATUS INFORMATION AS WELL AS PHYSICAL STATE OF I/O.

DIAGNOSTIC BAR GRAPH DISPLAYS OF CRITICAL SYSTEM VALUES, UPDATED CONTINUOUSLY. INCLUDES PEAK DETECTION AND NUMERIC DISPLAY.

Axi dyne[®] Axiom[®] DV Brushless Servo Drive

DIMENSIONS

AXIOM DV10

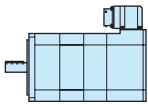
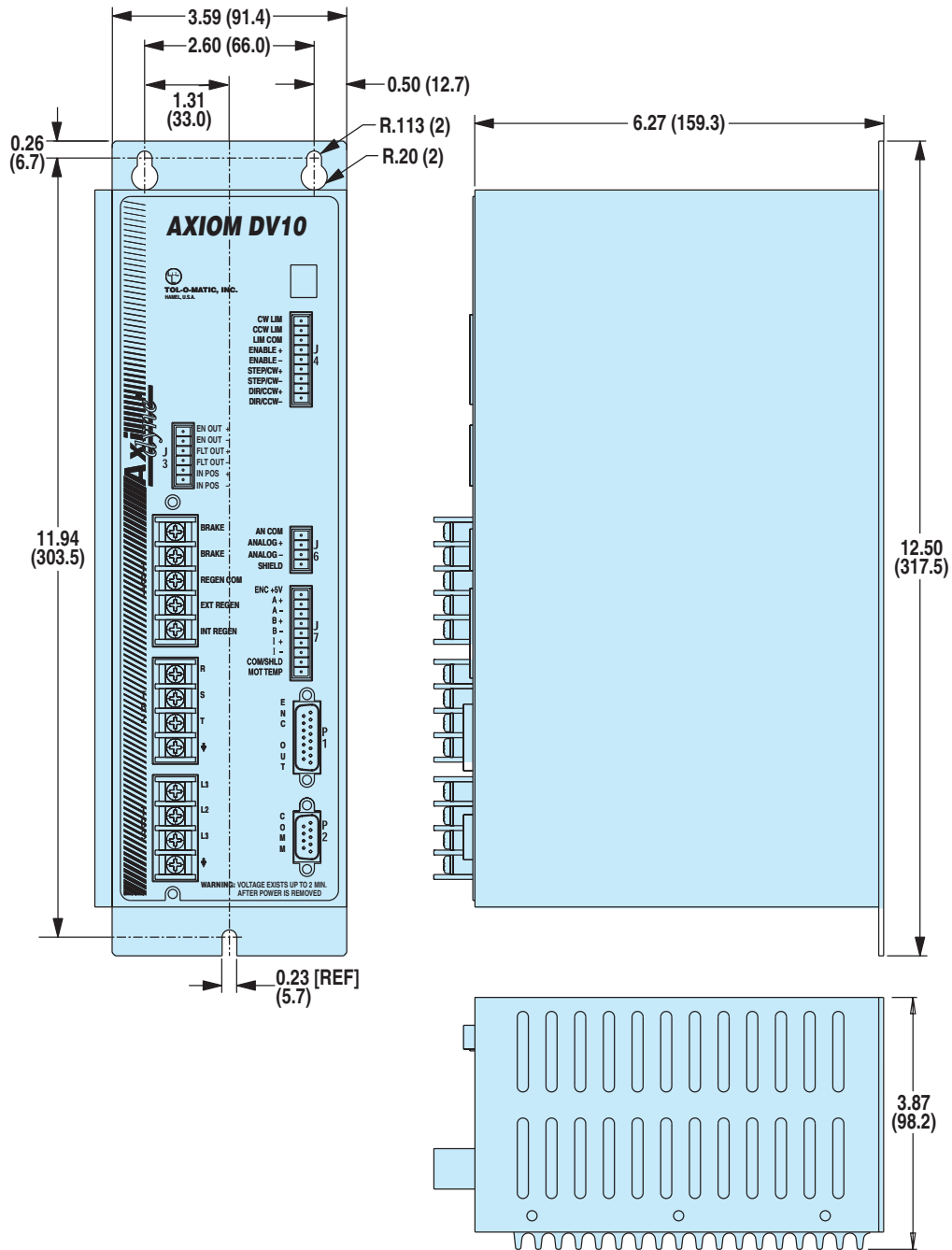

BRUSHLESS

Axiom DV Drive
• Dimensions

Unless otherwise noted, all dimensions shown are in inches (Dimensions in parenthesis are in millimeters)

Axi dyne® Axiom® DV Brushless Servo Drive

DIMENSIONS

AXIOM DV20, DV30

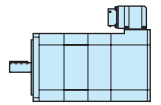
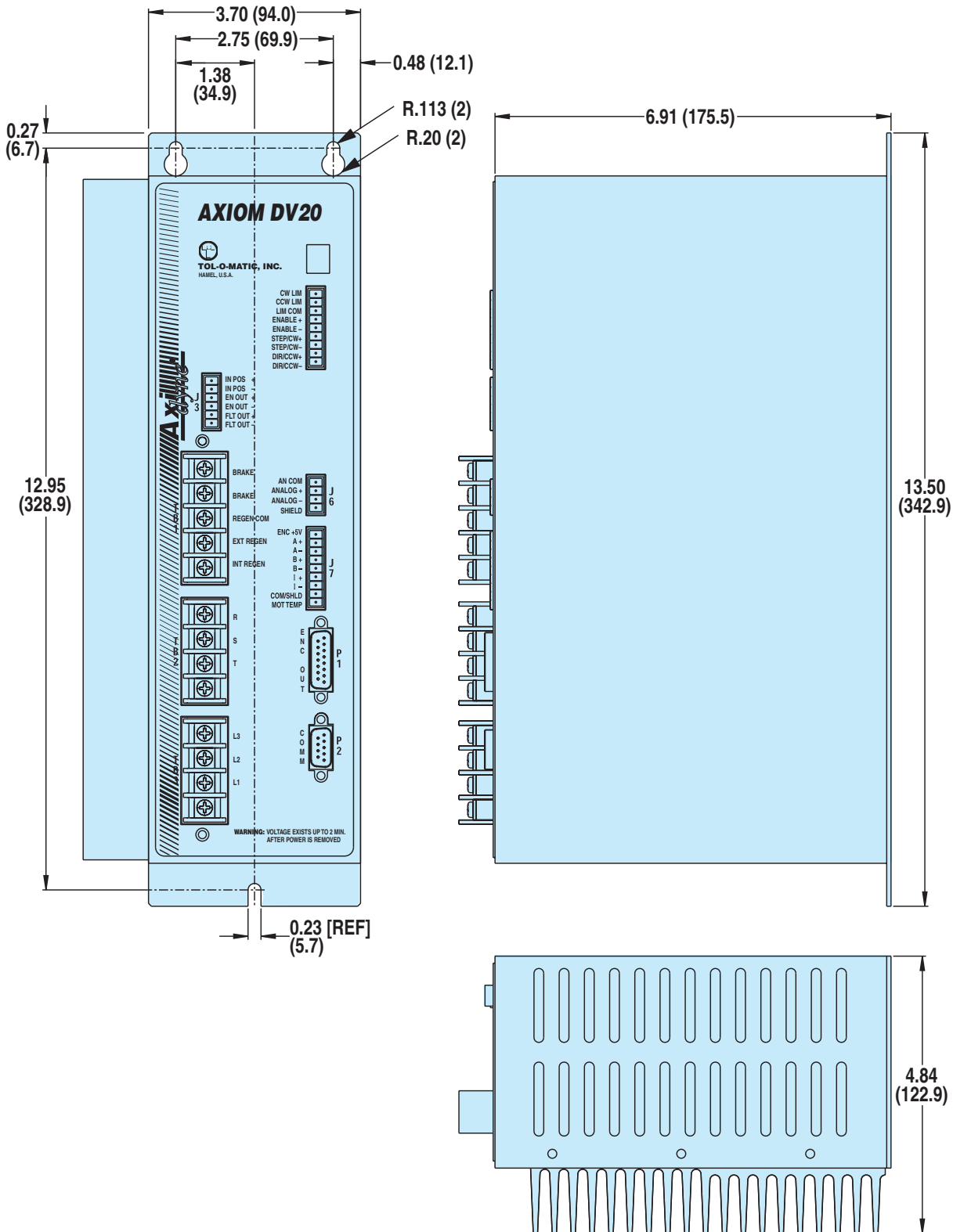

BRUSHLESS

Axiom DV Drive
• Dimensions

Axi dyne[®] Axiom[®] PV Servo Drive/Controller

FEATURES



The Axiom PV sequential motion controller offers intuitive yet sophisticated functionality. The integrated PLC performs real-time scans on a separate thread and communicates through software rather than physical wiring. Windows[®]-based software utilizes a point and click sequential program and PLC ladder logic editor, allowing programming without learning code. The Axiom PV incorporates the same vector drive technology used in our Axiom DV drive. It is price competitive with integrated motion controllers/drives that do not offer PLC capability.

COMPATIBILITY:
 SYSTEM: BRUSHLESS
 MOTORS: MRV
 DRIVE: AXIOM PV
 CONTROLLER: AXIOM PV
 INTERFACE: JS
 SIT

AXIOM[®] PV FEATURES

PLC:

- Real-time scan supervisory function continuous from power-up
- Typical scan time of 2-4 milliseconds
- Ladder logic allows 175 rungs, 4 lines deep, 5 input operations, and an output coil
- Operations include: normally-open, normally-closed, logical invert, one-shot, output coil, latch, unlatch, timers and counters
- 64 character rung descriptor downloaded and uploaded with program
- Internal bit-flags for information transfer between controller and PLC

DRIVE:

- PV series drives use space vector commutation providing better bus voltage utilization than traditional sine drives for improved speed/torque curves
- Flux vector current control provides accurate high bandwidth control of torque producing current for better efficiency and more torque over the full speed range than with traditional sine drives
- Drives MRV series brushless servo motors or can be configured for customer specified linear or rotary 3-phase brushless servo motors
- Autophasing eliminates the need for Hall sensors in motors
- Drive enable input

MOTION CONTROLLER:

- 1.5 axis (gearing to auxiliary axis)
- Commands include: absolute, incremental and velocity moves, branch to labels, subroutine calls, repeat loops, time delays, wait on conditions/inputs, output/flag control and parameter value changes including torque limit, following error, position band, follower gear ratio, and maximum velocity
- Event triggering based on intermediate positions
- Motion pause and resume
- Comment lines and labels down-loaded and uploaded with program

GENERAL:

- Modbus RTU and ASCII interface
- Pluggable screw terminal connectors eliminate the need for special connectors and secondary breakout terminal strips
- Short circuit, over current and over voltage protection prevents drive damage
- 25W or 50W internal regeneration
- External regeneration connections
- CW/CCW travel limit inputs
- Fault, enabled, and in-position outputs
- 3A brake relay
- 3 second peak ratings

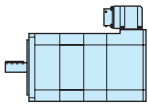

BRUSHLESS

**Axiom PV
Drive/Controller**

• Features

Axi dyne® Axiom® PV Servo Drive/Controller

SPECIFICATIONS

AXIOM® PV SPECIFICATIONS

SPECIFICATIONS	Axiom® PV Series Drives		
Power	PV10	PV20	PV30
Peak Output Current:	10 Amps	20 Amps	30 Amps
Continuous Output Current:	5 Amps	10 Amps	15 Amps
Continuous Output Power:	1.4 kW	2.8 kW	4.2 kW
Input Voltage:	95 Vac - 250 Vac 1Ø; 95 Vac - 250 Vac 3Ø (voltage range is switch selectable)		
Input Frequency:	47Hz - 63Hz		
User Programming			
Language/Programming Environment:	Tol-O-Motion™ windows-based software with point and click sequential program and PLC ladder logic editors		
Firmware Field Upgradeable:	YES		
User Program Storage Capacity:	500 lines of graphic-based, high-level sequential motion and control instructions with unlimited subroutine calls.		
PLC			
Connection/Capabilities:	Internal PLC with typical real-time scan of 2-4 msec, 10-12 msec for programs of maximum capacity; 15 inputs		
Interface			
Interfaces supported:	Modbus RTU ASCII		
Inputs/Outputs			
General-Purpose Digital Inputs:	15 optically isolated 5-25 Vdc		
Inputs/Outputs:	Sinking/sourcing selectable		
General-Purpose Digital Outputs:	8 optically isolated, 5-25 Vdc, 20 mA maximum		
Communications:	Serial: RS-232, 19,200 baud rate		
Motor Feedback			
Input Modes:	Incremental with index		
Maximum Input Frequency:	4 MHz (post-quadrature)		
Commutation Startup:	Auto-phase - no Hall sensors required		
Connectors			
Auxiliary Feedback, I/O, Analog I/O:	Wire trap screw terminals		
Motor Feedback:	Wire trap screw terminals		
Serial Port:	9-pin D-sub		
Main AC, Motor Power and DC Bus:	Screw terminal block		
Approvals:	UL, CUL, CE		
Environmental			
Storage Temperature:	-40°C to 70°C (-40°F to 158°F)		
Operating Temperature:	0°C to 50°C (32°F to 126°F)		
Humidity:	5% to 95% noncondensing		
Weight	PV10	PV20	PV30
	8.5 lbs (3.85 kg)	12.5 lbs (5.66 kg)	12.5 lbs (5.66 kg)

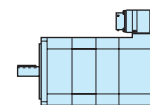

BRUSHLESS

**Axiom PV
Drive/Controller**

• Specifications

Axi dyne[®] Axiom[®] PV Servo Drive/Controller

CONNECTORS

AXIOM[®] PV CONNECTORS

TB1 - BRAKE/REGEN

1 - Brake	2 - Brake
3 - Regen Com	4 - External Regen
5 - Internal Regen	

TB2 - MOTOR

1 - Motor R	2 - Motor S
3 - Motor T	4 - Motor Ground

TB3 - AC POWER

1 - L3	2 - L2
3 - L1	4 - Ground

J1 - Outputs

1 - Output 1 +	2 - Output 1 -
3 - Output 2 +	4 - Output 2 -
5 - Output 3 +	6 - Output 3 -

J2 - OUTPUTS

1 - +24Vdc	2 - 24Vdc Return
3 - Output 4 +	4 - Output 4 -
5 - Output 5 +	6 - Output 5 -

J3 - OUTPUTS

1 - Output 6 +	2 - Output 6 -
3 - Output 7 +	4 - Output 7 -
5 - Output 8 +	6 - Output 8 -

J4 - INPUTS

1 - +24Vdc	2 - 24Vdc Return
3 - Com 1 - 6	4 - Input 1
5 - Input 2	6 - Input 3
7 - Input 4	8 - Input 5
9 - Input 6	

J5 - INPUTS

1 - +24Vdc	2 - 24Vdc Return
3 - Com 7 - 12	4 - Input 7
5 - Input 8	6 - Input 9
7 - Input 10	8 - Input 11
9 - Input 12	

J6 - INPUTS

1 - Com 13 - 15	2 - Input 13
3 - Input 14	4 - Input 15

J7 - MOTOR ENCODER

1 - Encoder +5V	2 - A +
3 - A -	4 - B +
5 - B -	6 - I +
7 - I -	8 - Com/Shld
9 - Motor Temp	

P1 - Buffered encoder out/auxiliary encoder

1 - +5V Encoder	2 - Aux Encoder A +
3 - Aux Encoder A -	4 - Aux Encoder B +
5 - Aux Encoder B -	6 - Aux Encoder I +
7 - Aux Encoder I -	8 - Encoder Common
9 - Motor Encoder Out A +	
10 - Motor Encoder Out A -	
11 - Motor Encoder Out B +	
12 - Motor Encoder Out B -	
13 - Motor Encoder Out I +	
14 - Motor Encoder Out I -	
15 - Reserved	

P2 - COMMUNICATIONS

1 - Reserved	2 - RS-232 TX
3 - RS-232 RX	4 - Reserved
5 - Common	6 - Reserved
7 - Reserved	8 - Reserved
9 - +5Vdc (30mA Max.)	

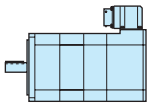

BRUSHLESS

Axiom PV
Drive/Controller

• Connectors

Axi-dyne® Axiom® PV Servo Drive/Controller

PLC / Sequential program editors

Axiom® PV set-up and configuration software has a similar look and feel to the Axiom DV software. A configuration option for motor selection and related parameters is included, along with a tuning and diagnostic mode. Help menus and control loop description information can be accessed from the main menu.

The Axiom PV also includes a point and click sequential program and PLC ladder logic editor. Instructions include incremental and absolute motion commands, branching (conditional and unconditional), subroutine calls, repeat loops, I/O control, time delays, etc. Use the PLC editor to enter and edit PLC programs, which run using an independent scan. The PLC program accesses all 15 inputs and 8 outputs of the Axiom PV, including general purpose and dedicated internal flags.

Both of these editors utilize easy icon/text driven selections, making the creation of motion profiles a snap (no code memorization required).

AXIOM® PV PLC EDITOR

The PLC Editor main menu allows user access to all editing functions along with a 175 rung ladder display. Rungs can be inserted at any point in the program and are easily edited by simply double-clicking with the mouse and selecting the desired functions from subsequent menus. The PLC program's real-time scan is continuous upon power-up and ranges from 2-4 milliseconds for a typical application, with 10-12 milliseconds for a maximum-length program.

ALL USER COMMENTS ARE STORED WITH THE PLC PROGRAM WHEN DOWNLOADED TO THE AXIOM PV.

COMPLETE LADDER LISTING ALONG WITH I/O FLAGS CAN BE PRINTED OUT FOR REFERENCE.

REAL-TIME SCAN FUNCTION CONNECTS TO AXIOM PV AND MONITORS LOGICAL STATE OF ALL I/O AND FLAGS IN PLC PROGRAM.

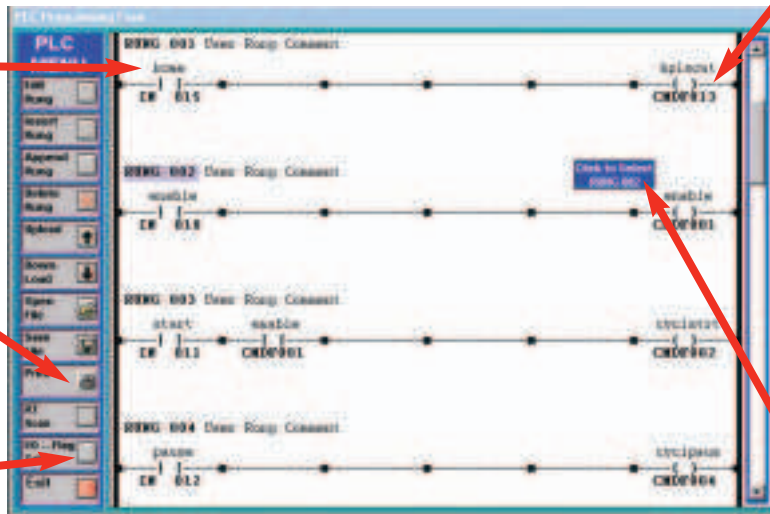

UP TO 500 LINES OF GRAPHIC-BASED, HIGH-LEVEL SEQUENTIAL MOTION AND CONTROL INSTRUCTIONS, WITH UNLIMITED SUBROUTINE CALLS. EACH RUNG CAN BE 4 LINES DEEP AND 5 INPUT OPERATIONS IN WIDTH, PLUS THE OUTPUT COIL.

UP TO 64 CHARACTERS DESCRIPTION FOR EACH RUNG FUNCTION AND 8 CHARACTERS FOR OPERAND COMMENTS.

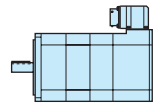

BRUSHLESS

Axiom PV Drive/Controller
 • PLC / sequential program editors

OPERANDS ARE EASILY SELECTED WITH USER COMMENTS AND "IN-USE" DESIGNATION DISPLAYS.

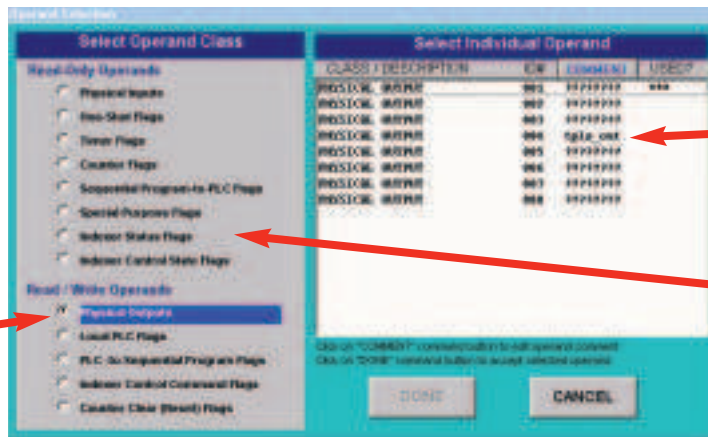

OPERANDS ARE EASILY SELECTED WITH USER COMMENTS AND "IN-USE" DESIGNATION DISPLAYS.

OPERATIONS SUPPORTED INCLUDE: NORMALLY-OPEN, NORMALLY-CLOSED, LOGICAL INVERT, ONE-SHOT, OUTPUT COIL, LATCH, UNLATCH, TIMERS, AND COUNTERS.

Axi-dyne® Axiom® PV Servo Drive/Controller

PLC / Sequential program editors

AXIOM® PV SEQUENTIAL PROGRAM EDITOR

The Sequential Editor main menu provides easy access to all essential program and display functions. Using a series of menus, the program guides the user through instruction selection. The Incremental Position Move window allows two separate trigger moves to be defined based on incremental position reached, physical input transition or flag from the PLC. Two actions can be commanded for each trigger event including torque limit or velocity change, output control or flag passing to PLC. This functionality allows an almost limitless combination of functions associated with a single move, while the PLC facilitates real-time control.

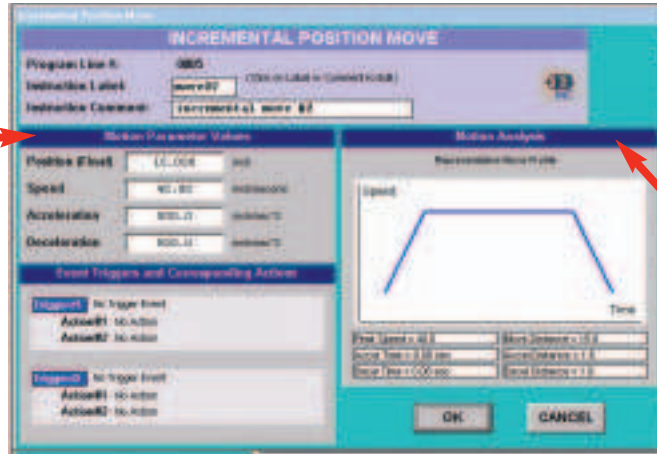

ENTERED MOTION PARAMETERS INSTANTLY UPDATE MOTION PROFILE TO SHOW MOVE TRAJECTORY

ENTERED MOTION PARAMETERS INSTANTLY UPDATE MOTION PROFILE TO SHOW MOVE TRAJECTORY

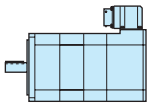

BRUSHLESS

Axiom PV Drive/Controller
 • PLC / sequential program editors

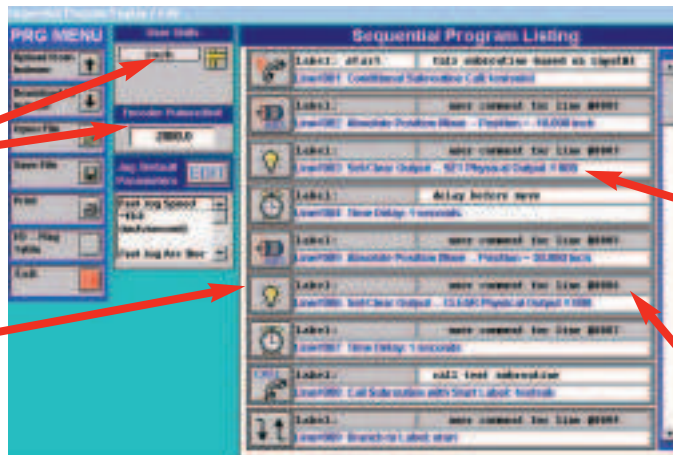

DECIMAL PRECISION USER UNITS AND TWO JOG SPEEDS.

CLICK DESIRED AREA OF DISPLAY TO EDIT

ALL USER COMMENTS AND LABELS ARE STORED WITH THE PROGRAM WHEN DOWNLOADED TO THE AXIOM PV.

EACH INSTRUCTION INCLUDES AN 8 CHARACTER LABEL USED FOR BRANCHING, SUBROUTINE CALL DESTINATIONS AND A 32 CHARACTER USER COMMENT.

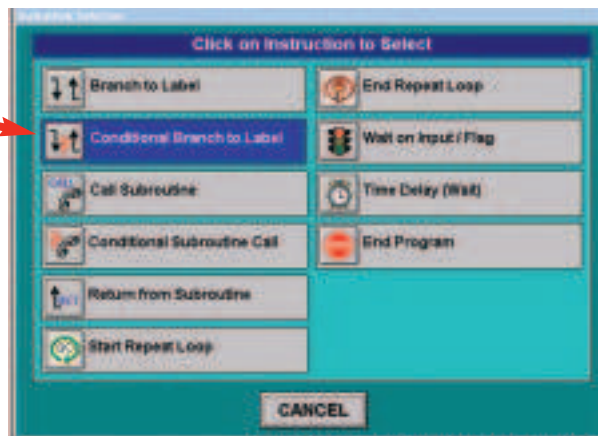

SERIES OF INSTRUCTION MENUS MAKE EASY SELECTION OF PROGRAM CONTROL, MOTION COMMANDS, ETC.

Axi dyne® Axiom® PV Servo Drive/Controller

DIMENSIONS

AXIOM PV10

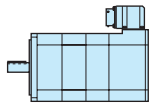
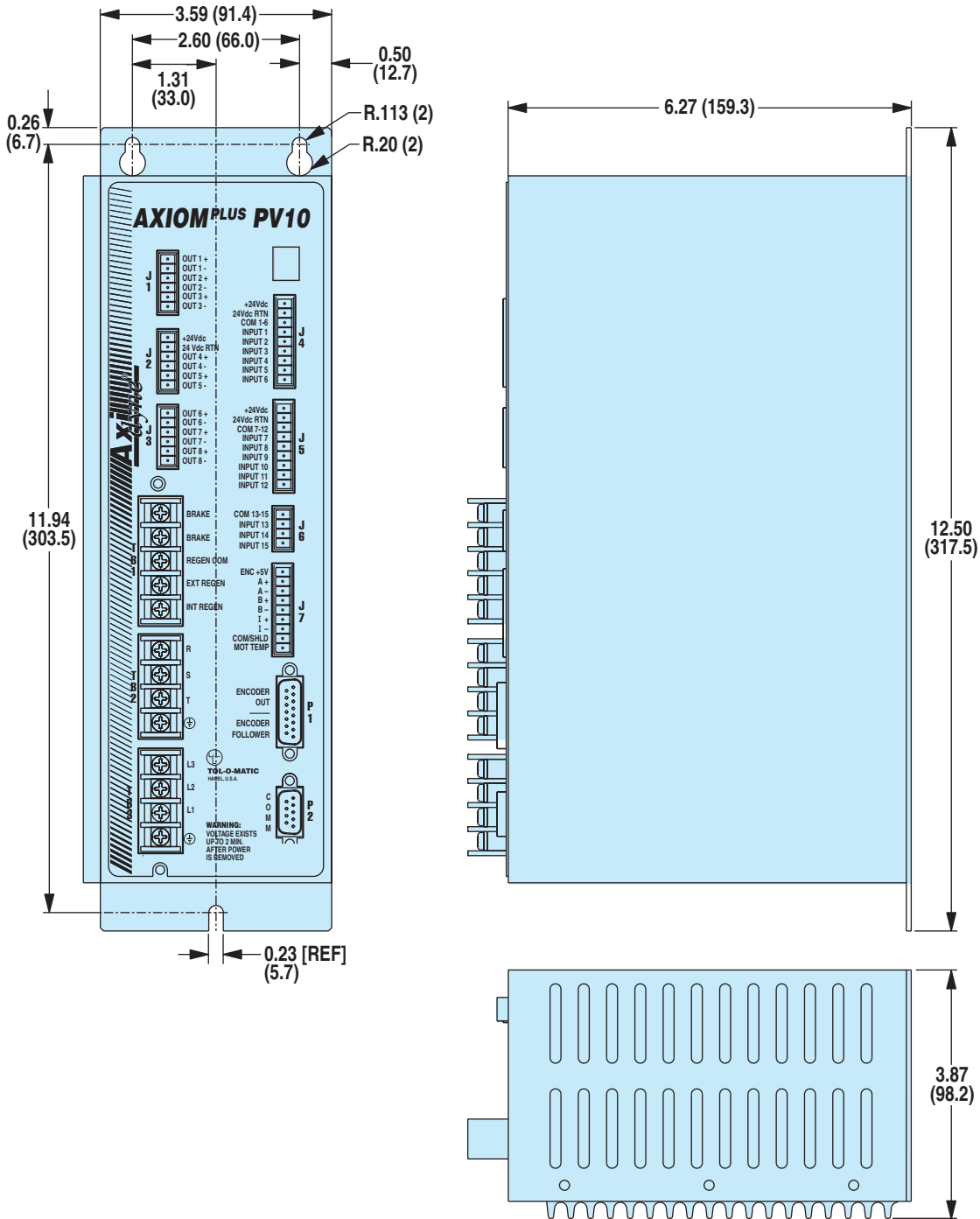

BRUSHLESS

**Axiom PV
Drive/Controller**

- Dimensions

Unless otherwise noted, all dimensions shown are in inches (Dimensions in parenthesis are in millimeters)

Axi^{dyne}® Axiom[®] PV Servo Drive/Controller

DIMENSIONS

AXIOM PV20, PV30

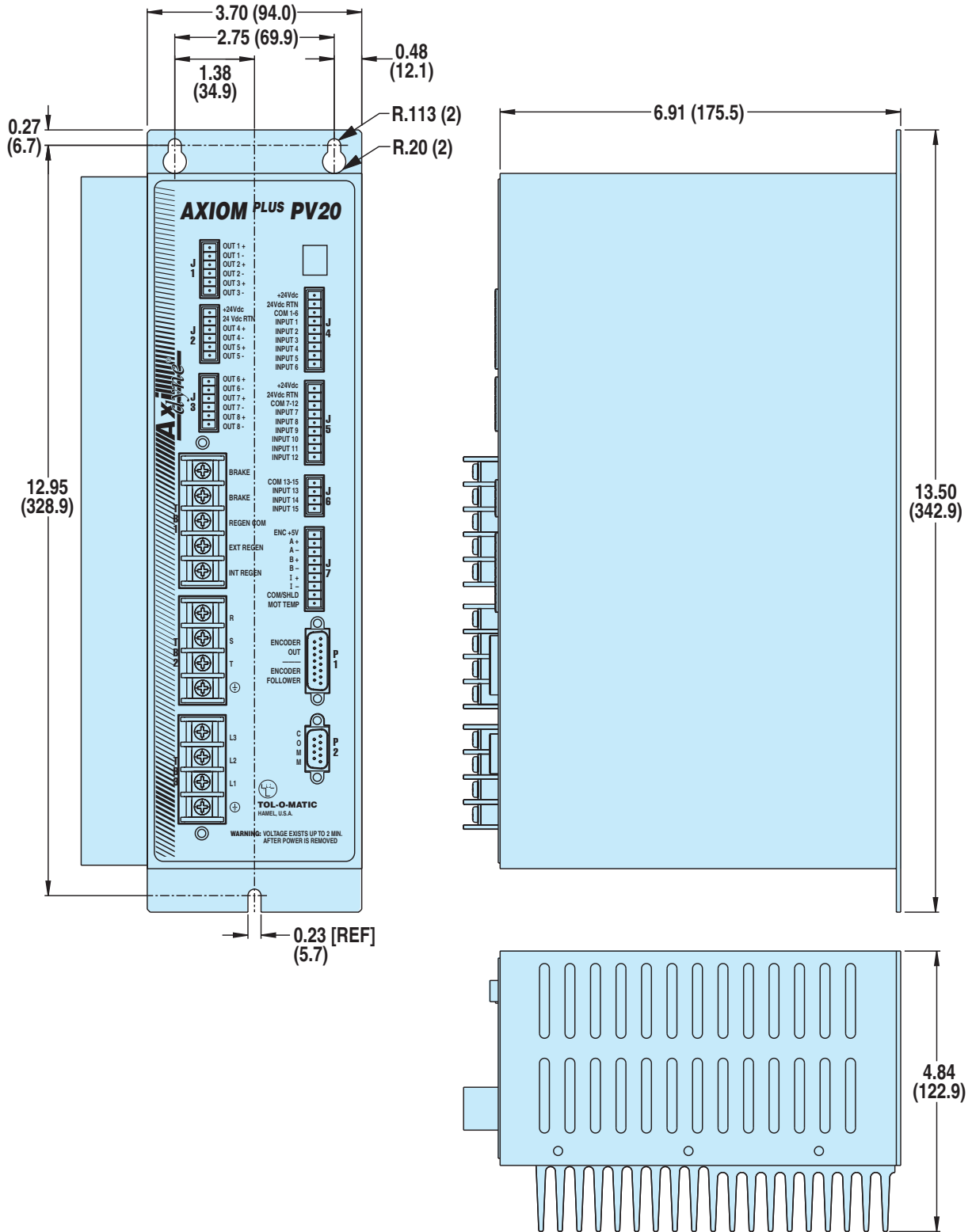

Axi-dyne® Brushless Servo System

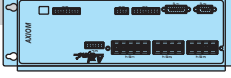

CABLES

MRV MOTORS TO AXIOM DV DRIVE & AXIOM PV DRIVE/CONTROLLER

MRV11  TO: AXIOM DV10, AXIOM PV10 

Config Code	Replacement Part Number	Included with Drive	Type	Cable Length	Motor Size	CONNECTORS AT		Axiom DV/PV Size
						Motor	Axiom DV/PV 10	
-	-	YES	Power	18 in	All	Flying leads	Screw terminal	10
-	-	YES	Encoder	18 in	All	Flying leads	Screw terminal	10

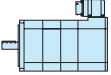
MRV21, MRV22, MRV23, MRV24
MRV31, MRV32, MRV33, MRV51 TO: AXIOM DV10, AXIOM DV20, AXIOM DV30
AXIOM PV10, AXIOM PV20, AXIOM PV30

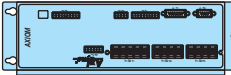

  CR6 OR CR15 

Config Code	Replacement Part Number	Included with Drive	Type	Cable Length	Motor Size	CONNECTORS AT		Axiom DV/PV Size
						Motor	Axiom DV/PV 10	
CR6	3604-1190	Optional	Power	6m	21 to 24	MS	Screw terminal	10
CR15	3604-1191	Optional	Power	15m	21 to 24	MS	Screw terminal	10
CR6	3604-1192	Optional	Power	6m	31 to 33	MS	Screw terminal	20
CR15	3604-1193	Optional	Power	15m	31 to 33	MS	Screw terminal	20
CR6	3604-1194	Optional	Power	6m	31 to 33	MS	Screw terminal	30
CR15	3604-1195	Optional	Power	15m	31 to 33	MS	Screw terminal	30
CR6	3604-1196	Optional	Encoder	6m	All	MS	Screw terminal	All
CR15	3604-1197	Optional	Encoder	15m	All	MS	Screw terminal	All

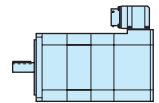
MS = Military Style, IP65

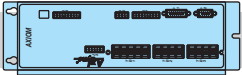
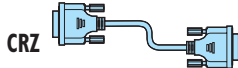

CONTROLLER TO IBM COMPATIBLE PC

AXIOM PV10, AXIOM PV20 or AXIOM PV30  TO:  PC 

Config Code	Replacement Part Number	Type	Cable Length	Drive	CONNECTORS AT PC	PC Size
CRZ	3600-1172	Comm	2m	AxiomPV	DB9	All

BRUSHLESS

Cables

Axi dyne® Brushless Servo System

ORDERING

MOTOR STYLE, SIZE AND GEARHEAD REDUCTION

MRV 31Y GHJ30

MOTOR TYPE

MRV Brushless Servo Motor

MOTOR SIZE / DRIVE SIZE

MODEL	FRAME SIZE	STACK SIZE	DRIVE SIZE
11Y	17	1	Axiom DV10
21Y	23	1	Axiom DV10
22Y	23	2	Axiom DV10
23Y	23	3	Axiom DV10
24Y	23	4	Axiom DV10
31Y	34	1	Axiom DV10
31Z	34	1	Axiom DV20
32Y	34	2	Axiom DV20
32Z	34	2	Axiom DV30
33Y	34	3	Axiom DV20
33Z	34	3	Axiom DV30
51Y	56	1	Axiom DV30

Once motor type and frame size is selected, the appropriate adapter and couplers required are automatically chosen.

NO DRIVE OPTION

X Replace Y or Z with X if motor drive is NOT required (do not put 'Y' or 'Z' in string)

NO MOTOR OPTION

XY* Motor(s) supplied by customer, Tol-O-Matic to mount using standard hardware and couplers

XJ* Motor(s) supplied and mounted by customer, Tol-O-Matic to furnish standard hardware and couplers

* NOTE: For XY and XJ options, a full end-face and shaft dimensional drawing must accompany the order for the actuator. Customer motors must be directly interchangeable with Tol-O-Matic motors.

CONTROLLER CABLES & CONNECTIONS

PV CR15 CRZ

CONTROLLER OR DRIVE COMBINATION

SINGLE AXIS APPLICATIONS

PV Axiom®Plus Controller/Drive
(Drive size is determined by "Y" or "Z" in motor code)

GEARHEAD REDUCTIONS

(In-line or Direct-Drive mounting configurations only)

MODEL	INPUT DIA.	MOTOR SIZE	REDUCTION RATIO
GHJ20	1/2-inch	23	5.5
GHJ21	1/2-inch	23	10
GHJ30	1/2-inch	34	5.5
GHJ31	1/2-inch	34	10

TO ORDER ACTUATORS

 B3S/M3S SERIES (SEE PAGE C-27)

 B3B/M3B SERIES (SEE PAGE C-47)

 TKS SERIES (SEE PAGE C-79)

 TKB SERIES (SEE PAGE C-102)

 BCS/MCS SERIES (SEE PAGE C-124)

 SLS/MLS SERIES (SEE PAGE C-134)

 RSA/RSM SERIES (SEE PAGE D-52)

 GSA/GSM SERIES (SEE PAGE E-36)

CABLES

FOR AXIOM DV OR AXIOM PV MUST SPECIFY ENCODER, POWER CABLE LENGTH

CR6 6-meter encoder cable, power cable

CR15 15-meter encoder cable, power cable

▲ MRV11 motor has flying leads, special cables are not required.

▲ If ordering with AXIOM drive, controller encoder cables are included for each axis.

Indicate if breakout terminal and ribbon cables are needed.

BON No breakout terminals
BOY*** With breakout terminals

***BOY option includes:

- 60 pin/18" (457mm) ribbon cable & 60 pin breakout
- 26 pin/18" (457mm) ribbon cable & 26 pin breakout
- If any axis configured w/ step & direction output — 20 pin/18" (457mm) ribbon cable & 20 pin breakout

▲ Not all codes listed are compatible with all options.

Use the Tol-O-Motion™ Sizing Software to determine available options and accessories based on your application requirements.

User manuals and software CD-ROM is included with any controller or drive ordered. Manuals and software are also available for download at www.tolomatic.com

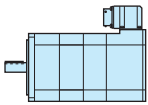

BRUSHLESS

System Ordering

Axi dyne® Brushless Servo System

FIELD RETROFIT ORDERING

*AXIOM PV CONTROLLER / DRIVE

Config. Code	Includes	Part #
PV10	Controller/Drive (order cables below)	3604-0008
PV20	Controller/Drive (order cables below)	3604-0009
PV30	Controller/Drive (order cables below)	3604-0010

*Includes user manual and software CD-ROM

*AXIOM DV DRIVE

Config. Code	Includes	Part #
DV10	Drive only (order cables below)	3604-0009
DV20	Drive only (order cables below)	3604-0010
DV30	Drive only (order cables below)	3604-0011
DB20	cables are included as motor flying leads	3604-0012

*Includes user manual and software CD-ROM

MRV BRUSHLESS SERVO MOTORS

Config. Code	Part #
MRV11**	3600-6239
MRV21	3600-6240
MRV22	3600-6241
MRV23	3600-6242
MRV24	3600-6243
MRV31	3600-6244
MRV32	3600-6245
MRV33	3600-6246
MRV51	3600-6247

** For RSA Rod Screw Actuators only

CABLES

Config Code	Item	Part #
CRZ	RS232 Cable	3600-1172
CR6 (DV10)	6m Motor Cable	3604-1190
CR6 (DV10)	6m Encoder Cable	3604-1196
CR15 (DV10)	15m Motor Cable	3604-1191
CR15 (DV10)	15m Encoder Cable	3604-1197
CR6 (DV20)	6m Motor Cable	3604-1192
CR6 (DV20)	6m Encoder Cable	3604-1196
CR15 (DV20)	15m Motor Cable	3604-1193
CR15 (DV20)	15m Encoder Cable	3604-1197
CR6 (DV30)	6m Motor Cable	3604-1194
CR6 (DV30 & MRV51)	6m Motor Cable	3604-1202
CR6 (DV30)	6m Encoder Cable	3604-1196
CR15 (DV30)	15m Motor Cable	3604-1195
CR15 (DV30 & MRV51)	15m Motor Cable	3604-1203
CR15 (DV30)	15m Encoder Cable	3604-1197

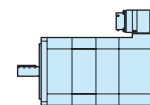

BRUSHLESS

Field Retrofit
Ordering

This page is intentionally left blank



- **DC REED**
- **DC HALL-EFFECT**
- **ACTRIAC**
- **QUICK-DISCONNECT COUPLERS**
- **SWITCH KITS**

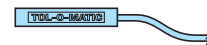

SWITCHES



Axi-dyne® Switches OVERVIEW

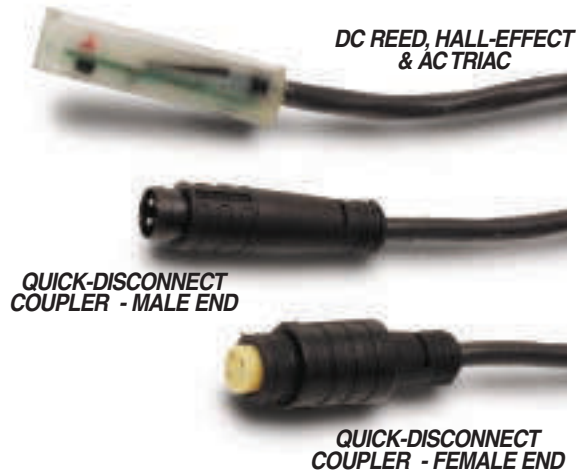

UNIVERSAL SWITCH

Commonly used for end-of-stroke signalling to programmable controllers and homing sensors, these switches are activated by the actuator's internal magnet.

If necessary to remove factory installed switches, be sure to reinstall on the same of side of actuator with scored face of switch toward internal magnet.

Switches contain reverse polarity protection. Switch cable is UNSHIELDED for switches that DO NOT incorporate the quick-disconnect feature. *Switches with quick-disconnect coupler feature have SHIELDED cable from the female quick-disconnect coupler to the flying leads.* Shield should be terminated at flying lead end.

DC REED AND AC TRIAC SWITCHES

These are mechanical switches designed for signalling position to devices such as programmable logic controllers.

DC HALL-EFFECT SWITCHES

Available in either sinking type (NPN), or sourcing type (PNP). These solid-state switches are designed to signal devices such as programmable controllers, dc loads, and TTL or CMOS circuits.



* 197" (5M) LENGTH, QUICK-DISCONNECT COUPLER IS POSITIONED 6" FROM THE SENSOR

THE SCORED FACE OF THE SWITCH INDICATES THE SENSING SURFACE AND MUST FACE TOWARD THE MAGNET.

THE NOTCHED GROOVE IN THE ACTUATOR INDICATES THE SIDE WITH THE MAGNET. CONTACT TOL-O-MATIC IF SWITCHES ARE REQUIRED ON BOTH SIDES OF ACTUATOR.

CAUTION: DO NOT OVER TIGHTEN SWITCH HARDWARE WHEN INSTALLING!

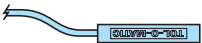

SWITCHES

Overview



DC REED SWITCH FORM A AND FORM C SPECIFICATIONS

RESISTANCE	0.1 Ω Initial (Maximum)	
RELEASE TIME	1.0 msec. maximum	
OPERATING TEMP.	-40° F (-40 C) to 158° F (70° C)	
CABLE MINIMUM	5m CABLE with PVC jacket: 0.630" static, dynamic not recommended	
BEND RADIUS	5m Quick-Disconnect style CABLE with PVC jacket: 0.630" static, 1.260" dynamic	
LIFE EXPECTANCY	Up to 200,000,000 cycles (depending on load current, duty cycle and environmental conditions)	
	FORM A	FORM C
CONTACTS	Single-pole, single-throw, normally-open	Single-pole, double-throw, normally-open / normally-closed
CONTACT RATING	10 Watts, maximum current 500mA (not to exceed 10VA) (Refer to Temperature vs. Current and Voltage Derating charts.)	3 Watts, maximum current 250mA (not to exceed 3VA) (Refer to Temperature vs. Current and Voltage Derating charts.)
VOLTAGE DROP	2.6V typical @ 100mA	NA
INPUT VOLTAGE	200Vdc maximum	120Vdc maximum
OPERATING TIME	0.6 msec. maximum (including bounce)	0.7 msec. maximum (including bounce)
INDICATOR	Red LED lit when 4mA min. (at 24V) flows through contacts	None

FORM A REED SWITCH: WIRING

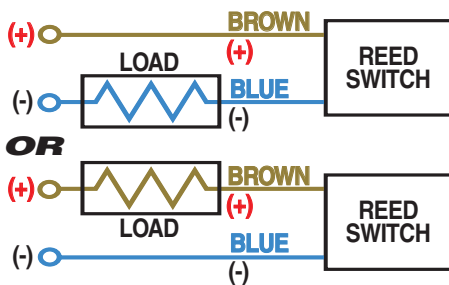

FORM C REED SWITCH: WIRING

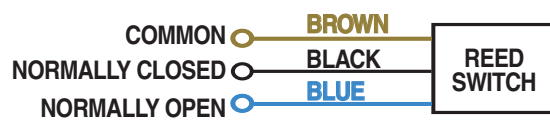

FORM A REED SWITCH: TEMPERATURE VS CURRENT

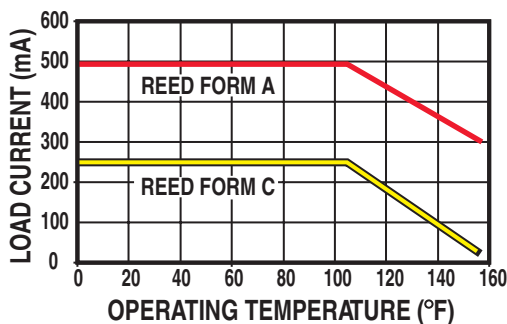

FORM C REED SWITCH: TEMPERATURE VS CURRENT

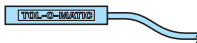
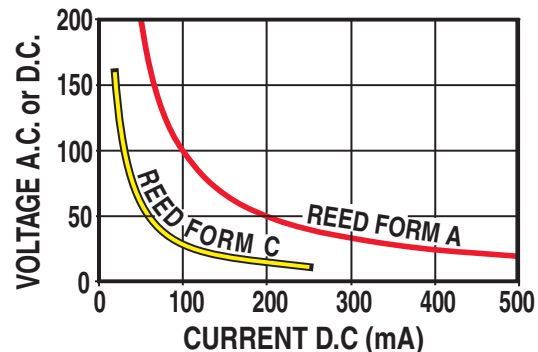

SWITCHES

Specifications

- Dc reed

HALL-EFFECT SWITCH SPECIFICATIONS

INPUT VOLTAGE	5 to 25Vdc
OUTPUT	Open collector transistor switch
OUTPUT RATING	25Vdc, 200mA dc
ON TRIP POINT	150 Gauss maximum
OFF TRIP POINT	40 Gauss minimum
OPERATING TEMP.	0° F (-18 C) to 150° F (66° C)
OPERATING SPEED	<10 micro sec..
INDICATOR	Red LED lit when sensor is activated
CABLE MINIMUM	5m CABLE with PVC jacket: 0.630" static, dynamic not recommended
BEND RADIUS	5m Quick-Disconnect style CABLE with PVC jacket: 0.630" static, 1.260" dynamic

HALL-EFFECT SOURCING SWITCH: WIRING

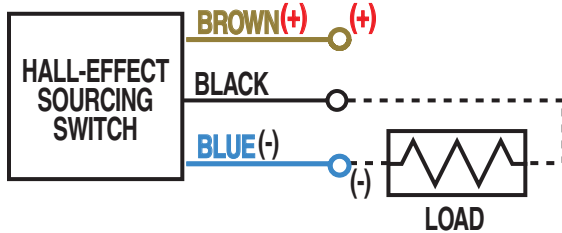

HALL-EFFECT SINKING SWITCH: WIRING

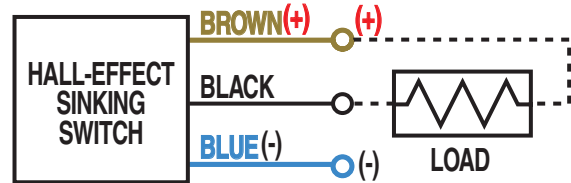

AC TRIAC SWITCH SPECIFICATIONS

CONTACTS	Single-pole, single-throw, normally-open
INPUT VOLTAGE	120Vac maximum
FREQUENCY	47 - 63 Hz
CONTINUOUS CURRENT	1 Amp at 86° F (30° C)
CURRENT	0,5 Amp at 140° F (60° C)
PEAK SURGE CURRENT	10 Amp
OPERATING TEMP.	-40° F (-40 C) to 158° F (70° C)
INDICATOR	None
CABLE MINIMUM	5m CABLE with PVC jacket: 0.630" (16mm) static, dynamic not recommended
BEND RADIUS	5m Quick-Disconnect style CABLE with PVC jacket: 0.630" (16mm) static, 1.260 (32mm) dynamic
LIFE EXPECTANCY	Up to 200,000,000 cycles (depending on load current, duty cycle and environmental conditions)

AC TRIAC SWITCH: WIRING

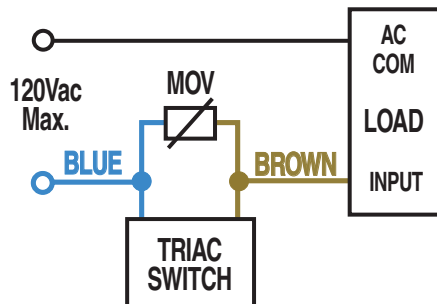

AC TRIAC SWITCH: TEMPERATURE VS CURRENT

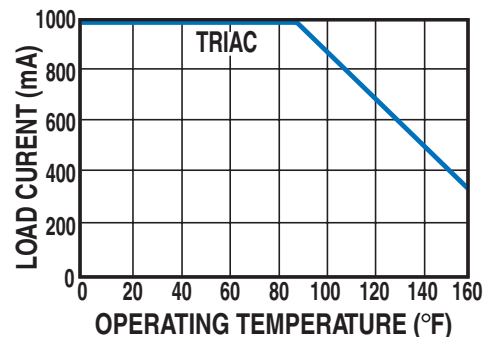

SWITCHES

Specifications

- Hall-effect
- Ac triac

QUICK-DISCONNECT COUPLERS



Quick-disconnect couplers are available for all switches in 197" (5m) length. These couplers allow switches to be removed quickly and easily. Switch includes one male-end coupler (hard wired to switch) and one female-end coupler with additional cable for in-line splice. Replacement switch with hard-wired male-end connector is available as a service part.

Note: Quick-disconnect coupler is positioned 6" (152mm) from the sensor.

Not compatible with TruTrack actuators

IMPORTANT NOTE:

An important note regarding field retrofit of quick-disconnect couplers: If replacing a quick-disconnect switch manufactured before 7-1-97 it will also be necessary to replace or rewire the female-end coupler with the in-line splice.

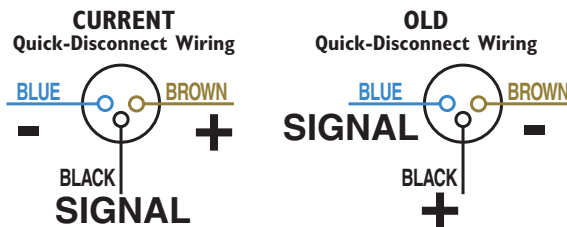

SP (SENSOR PACKAGE) TRUTRACK SWITCH KITS



These kits contain 2 form C Reed and 1 Hall-effect sinking switch with 5m leads and necessary mounting hardware. Switches on TruTrack actuators are mounted internally on the tube extension, encasing both switch and wire for a neat compact package.

NOTE:

When configured with initial order, the 2 form C Reed switches (limit sensors) will be set at factory 1" (25mm) from the end of stroke. The 1 sinking Hall-effect switch (home sensor) will be set 2" (51mm) from the end of stroke on the motor end. Switches are easily adjusted for specific applications.

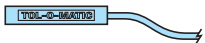

SWITCHES

Couplers and Kits

- Quick-disconnect couplers
- TruTrack sensor package

SWITCH KIT AVAILABILITY

ACTUATOR MODEL								Switch Config. Code	Switch Description
B3S M3S	B3W M3W	BCS MCS	SLS MLS	RSA RSM	GSA GSM	TKS	TKB		
•	•	•	•	•	•	•	•	BT	Reed, Form C, 5m lead
•	•	•	•	•	•	—	—	BM	Reed, Form C, 5m quick-disconnect lead
•	•	•	•	•	•	•	•	RT	Reed, Form A, 5m lead
•	•	•	•	•	•	—	—	RM	Reed, Form A, 5m quick-disconnect lead
•	•	•	•	•	•	•	•	KT	Hall-effect, Sinking, 5m lead
•	•	•	•	•	•	—	—	KM	Hall-effect, Sinking, 5m quick-disconnect lead
•	•	•	•	•	•	•	•	TT	Hall-effect, Sourcing, 5m lead
•	•	•	•	•	•	—	—	TM	Hall-effect, Sourcing, 5m quick-disconnect lead
•	•	•	•	•	•	—	—	CT	ac Triac, 5m lead
•	•	•	•	•	•	—	—	CM	ac Triac, 5m quick-disconnect lead
—	—	—	—	—	—	•	•	SP	(2 BT & 1 KT) 2 Reed, Form C, 5m lead & 1 Hall-effect, Sinking, 5m lead

• = Available — = Not Available

ORDERING

KIT (Hardware & Switch)	DESCRIPTION	SWITCH ONLY (No Hardware)
DC REED SWITCHES		
BT	Form C Reed Switch with 5 meter lead	3600-9084
BM	Form C Reed Switch with Quick-disconnect Coupler (Male)*	3600-9085
RT	Form A Reed Switch with 5 meter lead	3600-9082
RM	Form A Reed Switch with Quick-disconnect Coupler (Male)*	3600-9083
AC TRIAC SWITCHES		
CT	ac Triac Reed Switch with 5 meter lead	3600-9086
CM	ac Triac Reed Switch with Quick-disconnect Coupler (Male)*	3600-9087
HALL-EFFECT SWITCHES		
KT	Hall-effect (Sinking) Switch with 5 meter lead	3600-9090
KM	Hall-effect (Sinking) Switch with Quick-disconnect Coupler (Male)*	3600-9091
TT	Hall-effect (Sourcing) Switch with 5 meter lead	3600-9088
TM	Hall-effect (Sourcing) Switch with Q-D Coupler (Male)*	3600-9089
	Connector (Female) 5 meter lead	2503-1025



Contact Tol-O-Matic regarding magnet requirements for actuators that did not previously have a switch or if replacing a reed or triac switch with a Hall-effect.

* Sensor is 6 inches from male coupler on quick-disconnect units

To order field retrofit switch and hardware kits for all Tol-O-Matic actuators, specify 'SW' then the actuator model, bore size and code for switch needed.

EXAMPLE:
Option Model Switch
SW RSA24 RT

Hardware and form A reed switch with 5-meter lead for an RSA24

SWITCHES

Kit Availability and Ordering



- **GLOSSARY**
- **CONVERSION TABLES**
- **BASIC SIZING EQUATIONS**
- **ROTARY SIZING EQUATIONS**

Call 1-800-328-2174 for answers to any questions about Axidyne systems and visit tolomatic.com for Tol-O-Motion Sizing & Selection software.

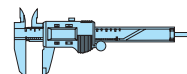

A - D

A

ABSOLUTE MOVE: A move with reference to a fixed absolute zero location.

AC SERVO: Motor/Drive that generates sinusoidal motor currents and sinusoidal back EMF in a brushless motor.

ACCURACY: The degree to which an actuator is able to move to a specific commanded point. On the bullseye below, notice that all the holes are centered around the middle of the target, but the grouping is not very close together. Good accuracy does not require good repeatability. (*see repeatability & accuracy*)

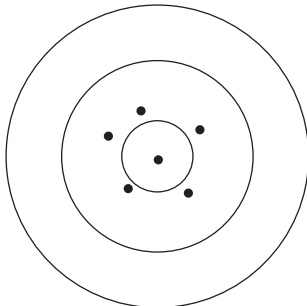

ACME SCREW/NUT: Threaded screw and nut design which utilizes sliding surfaces between the two. Typical efficiencies are between 60-70%.

AUTO-PHASING: The drive function that determines the motor's angular rotor position for commutation without the need for Hall Effect switches.

AXIAL LOADING: Load where the force is acting along the axis of actuator (bearing) in any direction.

B

BACK EMF: Voltage produced across a motor winding due to the winding turns being cut by a magnetic field. This voltage is directly proportional to rotor velocity and is opposite in polarity to the applied voltage.

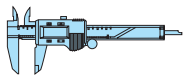

RESOURCES

Glossary

J-2

BACKLASH: Linear distance which is lost in positioning the nut or carrier when the screw direction of rotation changes.

BALL SCREW/NUT: Screw and nut design utilizing a nut that contains one or more circuits of recirculating steel balls which roll between the screw and nut.

BAUD RATE: Number of binary bits transmitted per second in a serial communication system.

BENDING MOMENT: Equivalent torque produced by a force displaced by a known distance from the carriage. Ex. M_x , M_y , M_z , F_z

(*See illustration below*).

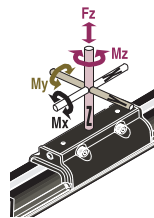

BREAKAWAY TORQUE: Torque required to start an actuator in motion. In an electric actuator, this consists primarily of the torque to overcome the preload of the lead screw nut assembly and the static friction of the carrier bearings.

BRUSHLESS DC SERVO: Motor/drive that generates trapezoidal motor currents and trapezoidal back EMF in a brushless motor.

C

CARRIER: Moving part of a rodless actuator providing a mounting surface for a load.

CLOSED LOOP (FEED BACK): System where the output is measured and compared to the input. If this system is capable of making corrections to minimize the difference it is classified as a servo.

COMMUTATION: Switching of drive voltage to the motor windings necessary to provide continuous rotation. A brush motor uses mechanical switching through a brush-bar contact. Brushless motors use separate devices such as Hall Sensors to sense the rotor position. This information is then processed by the drive to determine the switching sequence.

CONTINUOUS TORQUE: Another term for RMS torque. See RMS torque

CRITICAL SPEED: Rotational speed of a lead screw at which the screw begins to oscillate or whip. This speed is dependent on the screw length and diameter.

CYCLE: A complete motion of actuator's carrier or tooling plate from start to finish and back.

CYCLE RATE: Total number of complete cycles in a specific period of time.

CENTER OF GRAVITY (CENTER OF MASS): The point at which the entire weight of a body may be considered as concentrated so that if supported at this point the body would remain in equilibrium in any position.

D

DEAD LENGTH: Result of subtraction of stroke length from overall length of an actuator.

DEFLECTION: Amount of displacement of a point on rodless actuator carrier or rod actuator tooling plate, under load by forces or bending moments, measured in the direction perpendicular to actuator axis.

D - R

DUTY CYCLE: Ratio of on time to total cycle time.

$$\text{Duty Cycle} = \frac{\text{On Time}}{(\text{On Time} + \text{Off Time})}$$

DWELL TIME: A pause of motion within a move cycle.

E

EFFICIENCY: Ratio of power output to power input.

ENCODER: Device used to provide relative position and velocity information to a drive or controller by sensing mechanical motion and providing a corresponding pulse rate as output.

F

FLATNESS: When traveling in a straight horizontal line, the vertical deviation above or below the horizontal plane of travel of the carrier.

G

GANTRY: A method of connecting two actuators together by a drive shaft so one motor can operate both actuators.

H

HOLDING TORQUE: Maximum external torque that can be applied to a stopped, energized motor without causing the rotor to rotate.

INCREMENTAL MOVE: A positional move referenced from the current position.

INERTIA: Measure of an object's resistance to change in motion that is a function of the object's mass and shape.

INERTIA MATCH: If the reflected inertia of the load is equal to the rotor inertia of the motor, the system will operate optimally for efficiency and dynamic performance.

L

LEAD: Linear travel of a lead screw nut or carriage for every one full rotation of the lead screw expressed in inches per rev.

LOAD: A mass or weight supported by the carrier (rodless cylinders) or tooling plate (rod type cylinders). Ex. Fz (See illustration below).

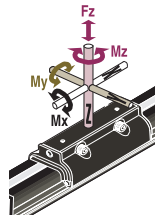

M

MAXIMUM DYNAMIC LOAD:

Load of constant magnitude acting in one direction that results in a nominal life (travel) of a linear motion actuator (component).

MAXIMUM STATIC LOAD:

Maximum load of constant magnitude acting in one direction that a static actuator (component) can withstand without permanent deformation.

MICROSTEPPING: Type of drive that proportions the current in a step motor's windings to provide intermediate positions between full steps. Advantages over full and half stepping include smoothness of rotation and higher position resolution.

MOMENT LOAD: Rotational forces applied to the carrier equal to the linear force applied (weight) multiplied by the distance between the location of the force (center of gravity) and the surface center of the carrier. Typically expressed as yaw (Mz), pitch (Mx) and Roll (My). (See illustration with "LOAD").

MOTION PROFILE: Definition of an object's position and velocity relationships in time during a move.

O

OPEN LOOP: Motion control system where no position or velocity signals are provided for correction. Typically, stepper systems run as open loop systems.

OPTICALLY ISOLATED:

Transmission of a signal from one device to another with a light source (emitted) and sensor (received), in order to avoid direct electrical contact.

P

PITCH: Number of revolutions required by a leadscrew to move the nut or carrier one inch, expressed in revs/per inch

PLC: (Programmable logic controller) A digital electronic device that uses to store instructions and to implement functions such as logic sequencing, timing and counting in order to control machines and processes.

PWM: Pulse Width Modulation is a method of controlling current in the windings of a motor by on-off switching of transistors to vary the duty cycle.

R

RADIAL LOAD: Load where the force is acting perpendicular to the axis of actuator (bearing) in the direction of actuator (bearing).

REGENERATION: Characteristic of a motor to act as a generator when the CEMF (counter electromotive force) is larger than the drive's applied voltage.

REGENERATION BRAKING: The technique of slowing or stopping a drive by regeneration.

REPEATABILITY: The degree to which an actuator can return to a reference location. Notice on the bullseye on the next page that the holes are close together, however the

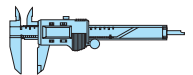

RESOURCES

Glossary

R - Z

grouping is far from the bullseye. Repeatability can be thought of as how tight of a grouping can be made. Unidirectional repeatability, measured by approaching a position from a single direction, hides errors caused by backlash and hysteresis effects. Bidirectional repeatability, measured by approaching a position from opposing directions, includes these effects, and provides a more meaningful specification.

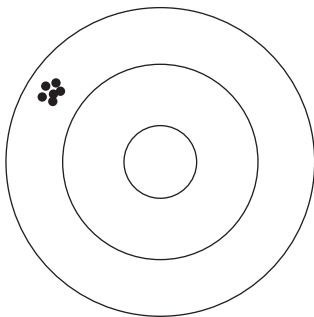

REPEATABILITY & ACCURACY:

The measure of how close to a programmed point the actuator can come, and how close it gets to that same point again. The repeatability of industrial actuators is usually much better than the accuracy. Notice on the bullseye below that the points are centered around the middle of the target and are grouped close together. This is good accuracy and repeatability.

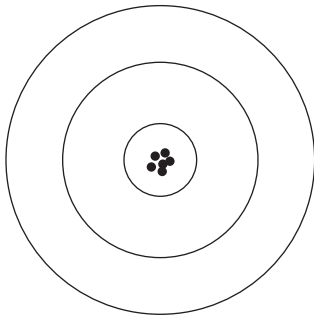

RESOLUTION: The smallest position increment that can be achieved.

RESOLVER: A feedback device consisting of a stator and rotor that provides position and velocity information to the drive for

commutation.

REVERSE RADIAL LOAD: Load where the force is acting perpendicular to the axis of actuator (bearing) in the direction opposite from actuator (bearing).

RMS TORQUE: In an intermittent application, this is the torque provided to generate equivalent motor heating to one operating in a steady state.

$$T_{rms} = \sqrt{\frac{\sum(T_i^2 \cdot t_i)}{\sum t_i}}$$

where: T_i = Torque during interval i
 t_i = Time of interval i

RS232: A standard for data communication that defines voltages and time requirements for information to be transferred on a single line in sequential format.

S

SERVO: System that compares the output of a device (by monitoring position, velocity, and/or torque) with the desired outcome and makes corrections to minimize the difference.

SERVO MOTOR: Motor used in closed loop systems where feedback is used to control motor position, velocity, and/or torque, usually expected to have high torque/inertia ratio.

SLEW: Constant non-zero velocity portion of a motion profile.

STALL TORQUE: Maximum torque available at zero speed.

STEPPER MOTOR: Motor which translates electrical pulses into motion, where the pulse rate controls velocity and position.

STIFFNESS: System ability to maintain accuracy when subject to disturbance.

STRAIGHTNESS: When traveling in a straight horizontal line, the side to

side deviation within the horizontal plane of travel of the carrier.

STROKE LENGTH: The distance that the carrier and its load will move on the actuator.

T

THRUST: Measurement of linear force.

TORQUE: Measurement of force producing rotation.

TORQUE CONSTANT: Torque generated in a DC motor per ampere applied to the windings.

$$K_t = \frac{T \text{ (oz.-in.)}}{A \text{ (amp)}}$$

VOLTAGE CONSTANT: Back EMF generated by a DC motor usually in units of volts per 1000 rpm.

$$K_e = \frac{\text{volts}}{1000 \text{ rpm}}$$

TRAPEZOIDAL PROFILE: a velocity vs time profile that is characterized by total move time split evenly for acceleration, deceleration and velocity.

TRIANGULAR PROFILE: a velocity vs time profile that is characterized by equal time for acceleration and deceleration.

VECTOR DRIVE: A class of drives that sense motor current in each individual motor phase and resolves these readings into two current vectors. One vector is the torque producing current and other is the waste current. The current control algorithm then works to drive the non-torque-producing component to zero. This result in a high bandwidth torque response over the full speed range without the phase lag and tolerance issues that place older drive technologies.

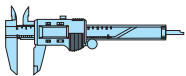

RESOURCES

Glossary

Axi-dyne® Conversion Tables

To convert from A to B, multiply by the entry in table

LENGTH

A \ B	in	ft	yd	mm	cm	m
in	1.0	0.0833	0.028	25.4	2.54	0.0254
ft	12.0	1.0	0.333	304.8	30.48	0.3048
yd	36.0	3.0	1.0	914.4	91.44	0.914
mm	0.03937	0.00328	1.09×10^{-3}	1.0	0.1	0.001
cm	0.3937	0.03281	1.09×10^{-2}	10.0	1.0	0.01
m	39.37	3.281	1.09	1000.0	100.0	1.0

MASS

A \ B	gm	kg	slug	lb(m)	oz(m)
gm	1.0	0.001	6.852×10^{-5}	2.205×10^{-3}	0.03527
kg	1000.0	1.0	6.852×10^{-2}	2.205	35.274
slug	14590.0	14.59	1.0	32.2	514.72
lb(m)	453.6	0.45359	0.0311	1.0	16.0
oz(m)	28.35	0.02835	1.94×10^{-3}	0.0625	1.0

FORCE

A \ B	lb(f)	N	dyne	oz(f)	kg(f)	gm(f)
lb(f)	1.0	4.4482	4.448×10^5	16.0	0.45359	453.6
N	0.22481	1.0	100.000	3.5967	0.10197	---
dyne	2.248×10^{-6}	0.00001	1.0	3.59×10^{-5}	---	980.6
oz(f)	0.0625	0.27801	2.78×10^4	1.0	0.02835	28.35
kg(f)	2.205	9.80665	---	35.274	1.0	1000.0
gm(f)	2.205×10^{-3}	---	1.02×10^{-3}	0.03527	0.001	1.0

NOTE: lb(f) = 1 slug x 1 ft/s² N = 1 kg x 1 m/s² dyne = 1gm x 1 cm/s²

POWER

A \ B	Watts	KW	HP (English)	HP(Metric)	ft-lb/s	in-lb/s
Watts	1.0	1×10^{-3}	1.34×10^{-3}	1.36×10^{-3}	0.74	8.88
kw	1000.0	1.0	1.34	1.36	738.0	8880.0
hp(English)	746.0	0.746	1.0	1.01	550.0	6600.0
hp(Metric)	736.0	.0736	0.986	1.0	543.0	6516.0
ft-lb/s	1.35	1.36×10^{-3}	1.82×10^{-3}	1.84×10^{-3}	1.0	12.0
in-lb/s	0.113	1.13×10^{-4}	1.52×10^{-4}	1.53×10^{-4}	8.3×10^{-2}	1.0

INERTIA (ROTARY)

NOTE: Mass inertia = $\frac{wt. \cdot inertia}{g}$

A \ B	gm-cm ²	oz-in ²	gm-cm-s ²	kg-cm ²	lb-in ²	oz-in-s ²	lb-ft ²	kg-cm-s ²	lb-in-s ²	lb-ft-s ² or slug-ft-s ²
gm-cm ²	1.0	5.46×10^{-2}	1.01×10^{-3}	10^{-3}	3.417×10^{-4}	1.41×10^{-5}	2.37×10^{-6}	1.01×10^{-4}	8.85×10^{-7}	7.37×10^{-4}
oz-in ²	182.9	1.0	.186	0.182	0.0625	2.59×10^{-3}	4.34×10^{-4}	1.86×10^{-4}	1.61×10^{-4}	1.34×10^{-5}
gm-cm-s ²	980.6	5.36	1.0	0.9806	0.335	1.38×10^{-2}	2.32×10^{-3}	10^{-3}	8.67×10^{-4}	7.23×10^{-5}
kg-cm ²	1000.0	5.46	1.019	1.0	0.3417	1.41×10^{-2}	2.37×10^{-3}	1.019×10^{-3}	8.85×10^{-4}	7.37×10^{-5}
lb-in ²	2.92×10^3	16.0	2.984	2.925	1.0	4.14×10^{-2}	6.94×10^{-3}	2.96×10^{-3}	2.59×10^{-3}	2.15×10^{-4}
oz-in-s ²	7.06×10^4	386.0	72.0	70.615	24.13	1.0	0.1675	7.20×10^{-2}	6.25×10^{-2}	5.20×10^{-3}
lb-ft ²	4.21×10^5	2304.0	429.71	421.40	144.0	5.967	1.0	0.4297	0.3729	3.10×10^{-2}
kg-cm-s ²	9.8×10^5	5.36×10^3	1000.0	980.66	335.1	13.887	2.327	1.0	0.8679	7.23×10^{-2}
lb-in-s ²	1.129×10^4	6.177×10^3	1.152×10^3	1.129×10^3	386.08	16.0	2.681	1.152	1.0	8.33×10^{-2}
lb-ft-s ²	1.355×10^7	7.41×10^4	1.38×10^4	1.35×10^4	4.63×10^3	192.0	32.17	13.825	12.0	1.0

TEMPERATURE

$^{\circ}F = (1.8 \times ^{\circ}C) + 32$
$^{\circ}C = .555 (^{\circ}F - 32)$

GRAVITY

(Acceleration Constant)
$g = 386 \text{ in/s}^2 = 32.2 \text{ ft/s}^2 = 9.8 \text{ m/s}^2$

TORQUE

A \ B	dyne-cm	gm-cm	oz-in	kg-cm	lb-in	N-m	lb/ft	kg/m
dyne-cm	1.0	1.019×10^{-3}	1.416×10^{-5}	1.0197×10^{-6}	8.850×10^{-7}	10^{-7}	7.375×10^{-6}	1.019×10^{-6}
gm-cm	980.665	1.0	1.388×10^{-2}	10^{-3}	8.679×10^{-4}	9.806×10^{-3}	7.233×10^{-5}	10^{-5}
oz-in	7.061×10^4	72.007	1.0	7.200×10^{-2}	6.25×10^{-2}	7.061×10^{-3}	5.208×10^{-3}	7.200×10^{-4}
kg-cm	9.806×10^5	1000.0	13.877	1.0	0.8679	9.806×10^{-2}	7.233×10^{-2}	10^{-2}
lb-in	1.129×10^6	1.152×10^3	16.0	1.152	1.0	0.112	8.333×10^{-2}	1.152×10^{-2}
N-m	10^7	1.019×10^4	141.612	10.197	8.850	1.0	0.737	0.102
lb-ft	1.355×10^7	1.382×10^4	192.0	13.825	12.0	1.355	1.0	0.138
kg-m	9.806×10^7	10^5	1.388×10^3	100.0	86.796	9.806	7.233	1.0

LINEAR VELOCITY

A \ B	in/min	ft/min	in/sec	ft/sec	mm/sec	m/sec
in/min	1.0	0.0833	0.0167	1.39×10^{-3}	0.42	4.2×10^{-4}
ft/min	12.0	1.0	0.2	0.0167	5.08	5.08×10^{-3}
in/sec	60.0	5.0	1.0	0.083	25.4	0.0254
ft/sec	720.0	60.0	12.0	1.0	304.8	0.3048
cm/sec	2362.2	196.9	39.37	3.281	1000	1.0
m	2362.2	196.9	39.37	3.281	1000	1.0

ANGULAR VELOCITY

A \ B	deg/s	rad/s	rpm	rps
deg/s	1.0	1.75×10^{-2}	0.167	2.78×10^{-3}
rad/s	57.3	1.0	9.55	0.159
rpm	6.0	0.105	1.0	1.67×10^{-2}
rps	360.0	6.28	60.0	1.0

ABBREVIATED TERMS

C = Celsius	gm(f) = gram force	lb(f) = pound force	oz(f) = ounce force
cm = centimeter	hp = horse power	lb(m) = pound mass	oz(m) = ounce mass
F = Fahrenheit	in = inch	min = minute	rad = radians
ft = foot	kg = kilogram	mm = millimeter	rpm = revs per minute
g = gravity	kg(f) = kilogram force	m = meter	rps = revs per second
gm = gram	kw = Kilowatt	N = Newton	s = seconds

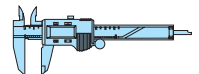

RESOURCES

Conversion Tables

Axi dyne® Basic Sizing Equations

MOTION PROFILES

MOTION PROFILE INTRODUCTION

Move Profile

Actuator selection begins with the calculation of speed requirements. A move profile is a plot of velocity vs. time for a machine cycle.

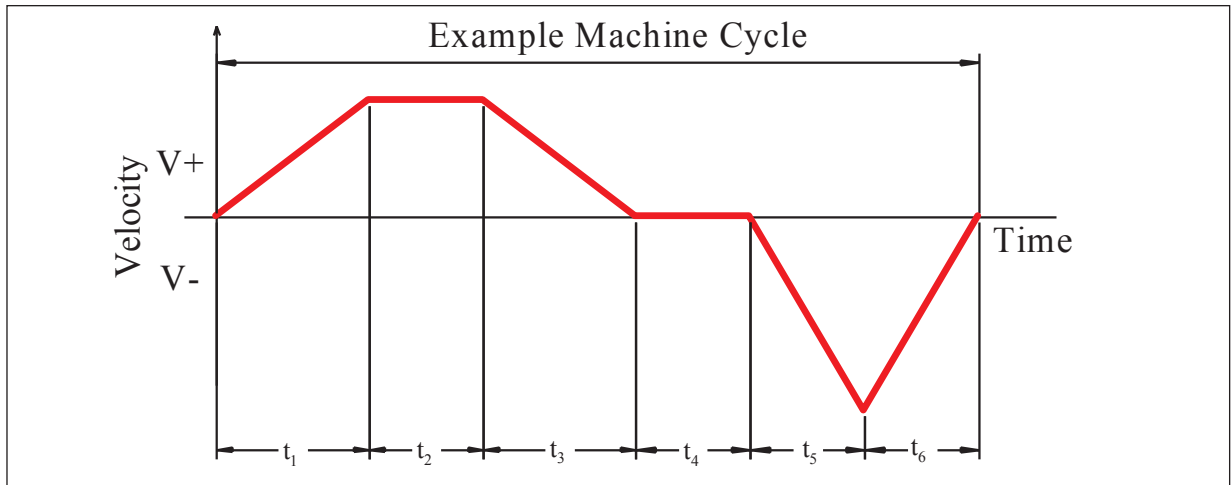

The Figure above shows a typical machine cycle. The first move is a trapezoidal move profile and the second is a triangular profile. During the trapezoidal move the load accelerates for a time (t_1), has a constant speed for time (t_2) and decelerates to a stop in time (t_3). After a dwell time (t_4) the load reverses direction and accelerates for time (t_5) and then decelerates back to a stop in time (t_6).

Trapezoidal and Triangular Profiles

Each actuator will have a maximum speed that it can achieve for each specific load capacity. This maximum speed will determine which type of motion profile can be used to complete the move. Two common types move profiles are trapezoidal and triangular.

If the average velocity of the profile, is less than half the maximum velocity of the actuator, then triangular profiles can be used. Triangular profiles result in the lowest possible acceleration and deceleration. Otherwise a trapezoidal profile with 3 equal divisions will result in 25% lower maximum speed and 12.5% higher acceleration and deceleration. This is commonly called a 1/3 trapezoidal profile. The trapezoidal move profile provides a good compromise between acceleration rate and max speed and is the recommended move profile.

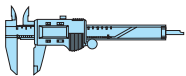
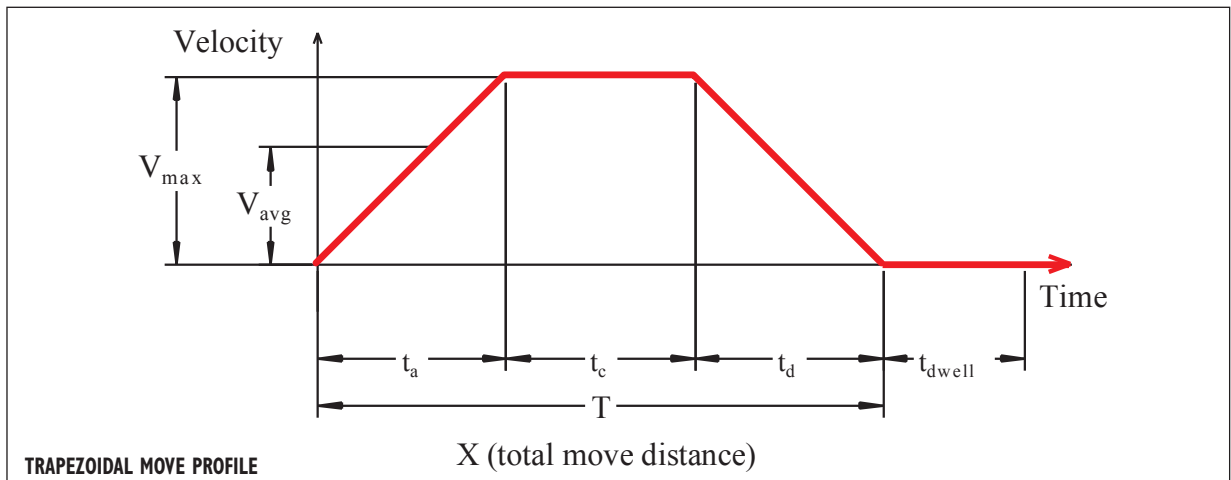

RESOURCES

Sizing Equations
• Motion profiles

Axi-dyne® Basic Sizing Equations

MOTION PROFILES



TRIANGULAR PROFILE

$$\text{Assume : } t_a = t_c = t_d = \frac{T}{3}$$

$$\text{Then : } V_{\max} = \frac{1.5 \cdot X}{T}$$

$$a = d = \frac{4.5 \cdot X}{T^2}$$

$$V_{\text{avg}} = \frac{X}{T}$$

X = total move distance
 T = total move time
 a = acceleration rate
 d = deceleration rate
 t_a = acceleration time
 t_c = constant speed time
 t_d = deceleration time
 t_{dwell} = dwell time
 V_{\max} = maximum velocity
 V_{avg} = average velocity

TRAPEZOIDAL EQUATIONS

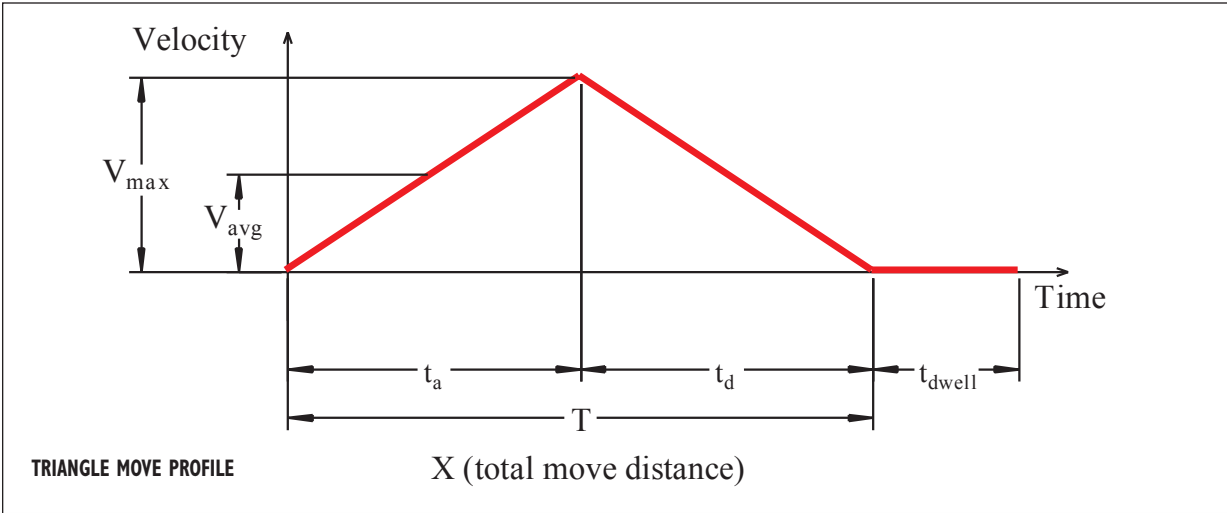

$$V_{\max} = 2 \cdot V_{\text{avg}} = 2 \frac{X}{T}$$

$$t_a = t_d = \frac{T}{2}$$

$$a = d = \frac{2 \cdot V_{\max}}{T} = \frac{4 \cdot X}{T^2}$$

TRIANGULAR EQUATIONS

X = total move distance
 T = total move time
 a = acceleration rate
 d = deceleration rate
 t_a = acceleration time
 t_d = deceleration time
 t_{dwell} = dwell time
 V_{\max} = maximum velocity
 V_{avg} = average velocity

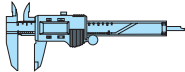

RESOURCES

Sizing Equations
 • Motion profiles

Axi dyne® Basic Sizing Equations

MOTION PROFILES

TRAPEZOIDAL MOTION PROFILE

Motion parameter calculations for a Trapezoidal motion profile

X = Total move distance..... = _____ (in.)

T = Total move time..... = _____ (sec.)

t_{dwell} = Dwell time after the motion..... = _____ (sec.)

Trapezoidal move profile *(Enter your application values designated in light blue.)*

Calculate the maximum velocity of the move

$$V_{\max} = 1.5 \cdot \frac{X}{T} = 1.5 \cdot \left[\frac{X}{T} \right] \dots\dots\dots = \text{_____ (in./sec.)}$$

Calculate the maximum acceleration rate of the move

$$a = \frac{4.5 \cdot X}{T^2} = \frac{4.5 \cdot \left[\frac{X}{T^2} \right]}{\dots\dots\dots} = \text{_____ (in./sec.^2)}$$

Calculate the acceleration time for the move

$$t_a = \frac{T}{3} = \left[\frac{T}{3} \right] \dots\dots\dots = \text{_____ (sec.)}$$

Calculate the constant speed time for the move

$$t_d = \frac{T}{3} = \left[\frac{T}{3} \right] \dots\dots\dots = \text{_____ (sec.)}$$

Calculate the deceleration time for the move

$$t_d = \frac{T}{3} = \left[\frac{T}{3} \right] \dots\dots\dots = \text{_____ (sec.)}$$

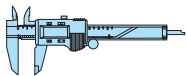

RESOURCES

Sizing Equations
• Motion profiles

Axi-dyne® Basic Sizing Equations

MOTION PROFILES

FOR GREATER SPEED AND ACCURACY USE TOL-O-MOTION SIZING & SELECTION SOFTWARE AVAILABLE AT WWW.TOLOMATIC.COM

EXAMPLE

An actuator needs to move 12 inches in 2 seconds, then wait for 1 sec. Using a trapezoidal profile, calculate the acceleration/deceleration rate, move time for each segment and maximum velocity.

X = Total move distance..... = 12 inches
 T = Total move time..... = 2 sec
 t_{dwell} = Dwell time after the motion..... = 1 sec

Trapezoidal move profile

Calculate the maximum velocity of the move

$$V_{max} = 1.5 \cdot \frac{X}{T} = 1.5 \cdot \frac{[12]}{[2]} = 9 \frac{in}{sec}$$

Calculate the maximum acceleration rate of the move

$$a = \frac{4.5 \cdot X}{T^2} = \frac{4.5 \cdot [12]}{[2^2]} = 13.5 \frac{in}{sec^2}$$

Calculate the acceleration time for the move

$$t_a = \frac{T}{3} = \frac{[2]}{3} = 0.667 sec$$

Calculate the constant speed time for the move

$$t_d = \frac{T}{3} = \frac{[2]}{3} = 0.667 sec$$

Calculate the deceleration time for the move

$$t_d = \frac{T}{3} = \frac{[2]}{3} = 0.667 sec$$

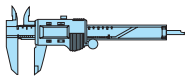

RESOURCES

Sizing Equations
 • Motion profiles

Axi dyne® Basic Sizing Equations

RODLESS ACTUATOR SIZING

INTRODUCTION

Rodless actuators have bearings that are designed to support loads, however actuator loading is limited, and moment, normal, and side loads on the rodless actuator need to be evaluated. Moment loads are rotational forces (or torque) which are applied to the carriage assembly. They are defined by the axis they are acting upon.

Note: *This manual sizing example only applies to horizontal applications with a single carrier supporting 100% of the load weight. For other orientations or dual carrier systems it is recommended that the sizing and selection software be used.*

To evaluate the actuator forces use the diagram below. The three forces (F_x , F_y , F_z) and the load weight (W) are a general loading condition and applies to the load a distance (x,y,z) from the center point of the carrier. These forces may be due to gravity, friction, applied loads and the actuator thrust. Each of these forces may act at different points of application. For example, gravity will act at the center of gravity of the load, while friction and applied loads will act at the edge of the load.

The equations for moment loads assume that the directions of the arrows in the figure are positive. If the forces or torques in your application work in the opposite direction, they are negative and they should be entered as negative numbers.

The thrust required to move a load a given distance in a given time may be calculated by summing all of the forces that act on the load. These forces fall within the following four types:

GRAVITY is an important factor when the load is being raised or lowered. When the application is moving horizontal the gravity force is zero.

FRICTION FORCE is present from the friction in the guide rod bearings. This force will very depending on the type of bearing used.

EXTERNAL FORCE can come from springs, other actuators, magnets, and are the forces that act in the direction of travel other than bearing friction.

ACCELERATION/DECELERATION FORCE is the force that the actuator needs to produce to get the load to the required speed and slow it back down.

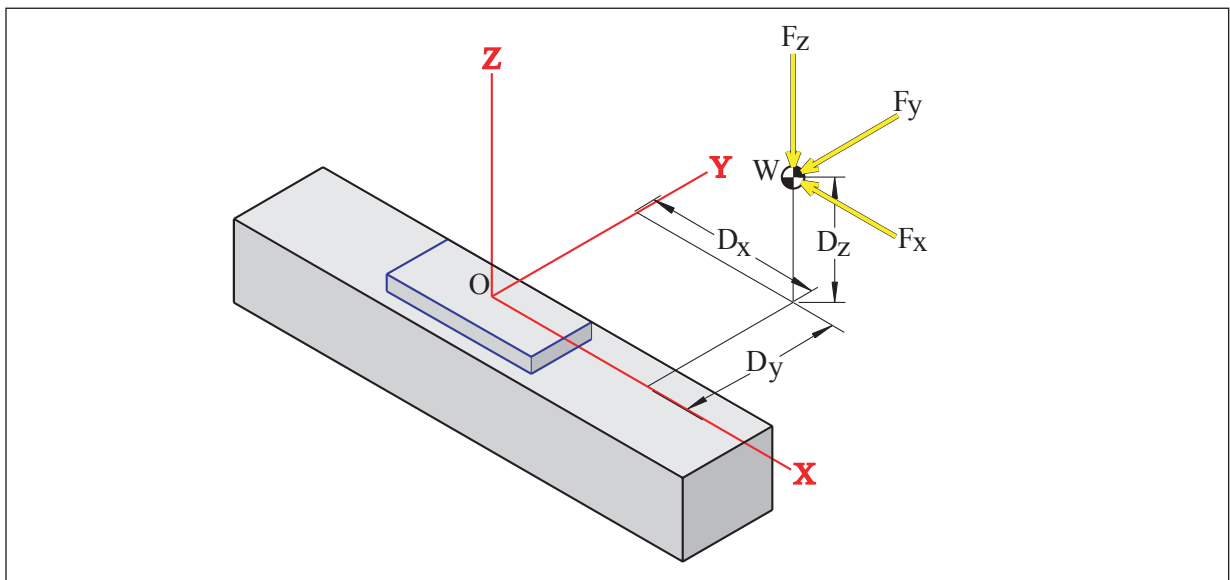

The figure above shows a top view general case where the force required by the actuator must be determined. All the forces are included, and it is important to note that all of these forces can change over time, so the actuator force must be calculated for each section of the move profile. The worst case thrust, speed and tooling plate deflection required should be used to pick the appropriate actuator.

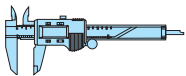

RESOURCES

Sizing Equations
• Rodless actuators

J-10

Axi dyne® Basic Sizing Equations

RODLESS ACTUATOR SIZING

REQUIRED INFORMATION, CALCULATIONS

Required information

- W = Weight of object being moved..... = _____ (lbs.)
 a = Maximum acceleration rate from motion profile..... = _____ (in./sec.²)
 g = Gravity constant..... = $386 \frac{\text{in}}{\text{sec}^2}$
 D_x = Distance from center of carrier to center of gravity of load along X axis = _____ (in.)
 D_y = Distance from center of carrier to center of gravity of load along Y axis = _____ (in.)
 D_z = Distance from center of carrier to center of gravity of load along Z axis = _____ (in.)
 F_{ext_x} = External force on load along the X axis..... = _____ (lbs.)
 F_{ext_y} = External force on load along the Y axis..... = _____ (lbs.)
 F_{ext_z} = External force on load along the Z axis..... = _____ (lbs.)

Calculations (Enter your application values designated in light blue.)

Force in the X axis

$$F_x = F_{\text{ext}_x} + \frac{W}{g} \cdot a = [F_{\text{ext}_x}] + \left[\frac{W}{g} \right] \cdot [a] \dots\dots\dots = \text{_____ (lbs.)}$$

Force in the Y axis

$$F_y = F_{\text{ext}_y} = \dots\dots\dots = \text{_____ (lbs.)}$$

Force in the Z axis

$$F_z = F_{\text{ext}_z} + W = [F_{\text{ext}_z}] + [W] \dots\dots\dots = \text{_____ (lbs.)}$$

Moment load about the X axis

$$M_x = F_z \cdot D_y - F_y \cdot D_z = [F_z] \cdot [D_y] - [F_y] \cdot [D_z] \dots\dots\dots = \text{_____ (lbs.-in.)}$$

Moment load about the Y axis

$$M_y = F_z \cdot D_x - F_x \cdot D_z = [F_z] \cdot [D_x] - [F_x] \cdot [D_z] \dots\dots\dots = \text{_____ (lbs.-in.)}$$

Moment load about the Z axis

$$M_z = F_y \cdot D_x - F_x \cdot D_y = [F_y] \cdot [D_x] - [F_x] \cdot [D_y] \dots\dots\dots = \text{_____ (lbs.-in.)}$$

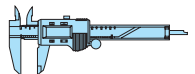

RESOURCES

Sizing Equations
• Rodless actuators

Axi *dyne*® Basic Sizing Equations

RODLESS ACTUATOR SIZING

SELECTING THE CORRECT ACTUATOR

Pick an actuator that has the thrust, speed, and moment load capability to move the load. Use the speed/stroke graph for the screw, and the specification tables for the actuator families shown in Section C. Keep in mind the following information during the selection process:

Screw Critical Speed and Thrust limit

When using the critical speed charts, the intersection on the graph of the application speed and the actuator stroke length must lie below the curve for the screw being considered. Each screw also has a thrust limit and the Fx force must be below this limit.

Moment Loads

Application moment loads calculated for the X, Y and Z axis must be less than the values shown in the Section C tables for the actuator being considered.

Forces

Application forces calculated for the Y and Z axis must be less than the values shown in the Section C tables for the actuator being considered.

Loading Combination Factor

The actuator is not designed to have the full rated load on all axis at the same time. The loading combination factor (see below) is used to determine if the combination of all the forces is excessive for the actuator chosen.

Required information *(Enter your application values designated in light blue.)*

F_x = Force in the X axis.....	=	_____ (lbs.)
F_y = Force in the Y axis.....	=	_____ (lbs.)
F_z = Force in the Z axis.....	=	_____ (lbs.)
M_x = Moment load about the X axis.....	=	_____ (lbs.-in.)
M_y = Moment load about the Y axis.....	=	_____ (lbs.-in.)
M_z = Moment load about the Z axis.....	=	_____ (lbs.-in.)

$$C_f = \frac{M_x}{M_{x_max}} + \frac{M_y}{M_{y_max}} + \frac{M_z}{M_{z_max}} + \frac{F_y}{F_{y_max}} + \frac{F_z}{F_{z_max}}$$

$$C_f = \left[\frac{M_x}{M_{x_max}} \right] + \left[\frac{M_y}{M_{y_max}} \right] + \left[\frac{M_z}{M_{z_max}} \right] + \left[\frac{F_y}{F_{y_max}} \right] + \left[\frac{F_z}{F_{z_max}} \right] \dots = \underline{\hspace{2cm}}$$

The moment combination factor must be less than or equal to 1.5
 If it is greater than 1.5 a larger actuator should be chosen.

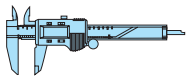
$$C_f \leq 1.5$$

RESOURCES

Sizing Equations
 • Rodless actuators

Axi dyne® Basic Sizing Equations

ROD SCREW ACTUATOR SIZING

INTRODUCTION

Rod style actuators are used when the load being moved is guided by an external device. In the following example the load is being pushed up an incline. The actuator does not need to support the weight of the load just provide thrust to push it up the incline.

The thrust required to move a load a given distance in a given time may be calculated by summing all of the forces that act on the load. These forces fall within the following four types:

GRAVITY is an important factor when the load is being raised or lowered. When the application is moving horizontal the gravity force is zero.

FRICTION FORCE is present when moving the load using external supports. An example would be pushing a box across a conveyor belt or when using an external bearing support.

EXTERNAL FORCE can come from springs, other actuators, magnets, and are the forces that act in the direction of travel on the load other than friction and gravity.

ACCELERATION/DECELERATION FORCE is the force that the actuator needs to produce to get the load to the required speed and slow it back down. By convention when accelerating the force is positive and when decelerating the force is negative.

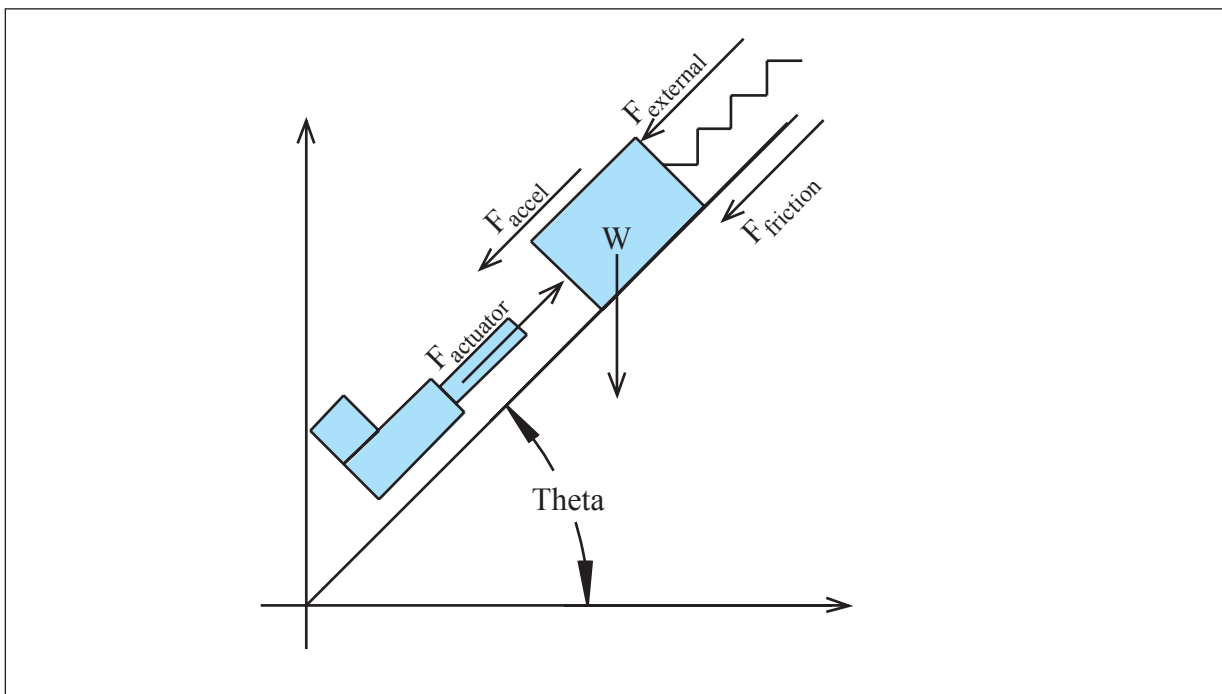

The figure above shows a general case where the force required by the actuator must be determined. All the forces are included, and it is important to note that all of these forces can change over time, so the actuator force must be calculated for each section of the move profile. The worst case thrust and speed required should be used to pick the appropriate actuator.

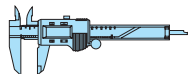

RESOURCES

Sizing Equations
• Rod screw actuators

Axi dyne® Basic Sizing Equations

ROD SCREW ACTUATOR SIZING

REQUIRED INFORMATION, CALCULATIONS

Required information

W_{load} = Weight of object being moved = _____ (lbs.)
 W_b = Base weight of moving parts = _____ (lbs.)
 W_{stroke} = Weight of moving parts per inch of stroke..... = _____ (lbs./in.)
 W = Total weight = $W_{load} + W_b + W_{stroke} \cdot stroke$ = _____ (lbs.)
 a = Acceleration rate from the motion profile..... = _____ (in./sec.²)
 g = Gravity constant..... = $386 \frac{\text{in}}{\text{sec}^2}$
 μ = Coefficient of friction for selected bearing type..... = _____
 θ = Angle of the actuator from horizontal..... = _____ °
 $F_{external}$ = External force acting in the direction of travel..... = _____ (lbs.)

Calculations (Enter your application values designated in light blue.)

Force to accelerate load

$$F_{accel} = \frac{W}{g} \cdot a = \left[\frac{W}{g} \right] \cdot \left[a \right] \dots\dots\dots = \text{_____ (lbs.)}$$

Force from friction

$$F_{friction} = \mu \cdot W \cdot \cos(\theta) = \left[\mu \right] \cdot \left[W \right] \cdot \cos \left[\theta \right] \dots\dots\dots = \text{_____ (lbs.)}$$

Force due to gravity

$$F_{gravity} = W \cdot \sin(\theta) = \left[W \right] \cdot \left[\theta \right] \dots\dots\dots = \text{_____ (lbs.)}$$

Force during acceleration segment

$$F_a = F_{gravity} + F_{friction} + F_{external} + F_{accel} = \left[F_{gravity} \right] + \left[F_{friction} \right] + \left[F_{external} \right] + \left[F_{accel} \right] = \text{_____ (lbs.)}$$

Force during constant speed segment

$$F_c = F_{gravity} + F_{friction} + F_{external} = \left[F_{gravity} \right] + \left[F_{friction} \right] + \left[F_{external} \right] \dots\dots\dots = \text{_____ (lbs.)}$$

Force during deceleration segment

$$F_d = F_{gravity} + F_{friction} + F_{external} - F_{accel} = \left[F_{gravity} \right] + \left[F_{friction} \right] + \left[F_{external} \right] - \left[F_{accel} \right] = \text{_____ (lbs.)}$$

Force during the dwell segment (zero is value is negative)

$$F_{dwell} = F_{gravity} - F_{friction} + F_{external} = \left[F_{gravity} \right] - \left[F_{friction} \right] + \left[F_{external} \right] \dots\dots\dots = \text{_____ (lbs.)}$$

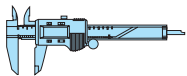

RESOURCES

Sizing Equations
• Rod screw actuators

Axi dyne® Basic Sizing Equations

ROD SCREW ACTUATOR SIZING

SELECTING THE CORRECT ACTUATOR

Pick an actuator that has the thrust, speed and stroke capability to move the load. Use the graphs in this catalog to determine the speed/stroke length and the maximum screw thrust for the actuators shown in Section D. Keep in mind the following information during the selection process:

Screw Critical Speed and Thrust limit

When using the critical speed charts, the intersection on the graph of the application speed and the actuator stroke length must lie below the curve for the screw being considered. Each screw also has a thrust limit and the maximum thrust from the motion segments must be below this limit.

The options when selecting an actuator are:

1. Body size – 6 body sizes available.
2. Inline or reverse parallel motor mounting
Effects the mounting options and motor sizes possible (see actuator options in Section D).

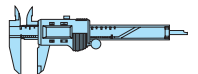

RESOURCES

Sizing Equations
• Rod screw actuators

Axi dyne® Basic Sizing Equations

GUIDED SCREW ACTUATOR SIZING

INTRODUCTION

Guided Screw Actuators (GSA) are used when the load being moved needs to be supported and guided. The actuator will support the weight of the load as it is moved along the actuator stroke.

Note: *This manual sizing example only applies to horizontal applications with the tooling plate in the horizontal orientation. For other orientations it is recommended that the sizing and selection be used.*

The thrust required to move a load a given distance in a given time may be calculated by summing all of the forces that act on the load. These forces fall within the following four types:

GRAVITY is an important factor when the load is being raised or lowered. When the application is moving horizontal the gravity force is zero.

FRICTION FORCE is present from the friction in the guide rod bearings. This force will vary depending on the type of bearing used.

EXTERNAL FORCE can come from springs, other actuators, magnets, and are the forces that act in the direction of travel other than bearing friction.

ACCELERATION/DECELERATION FORCE is the force that the actuator needs to produce to get the load to the required speed and slow it back down.

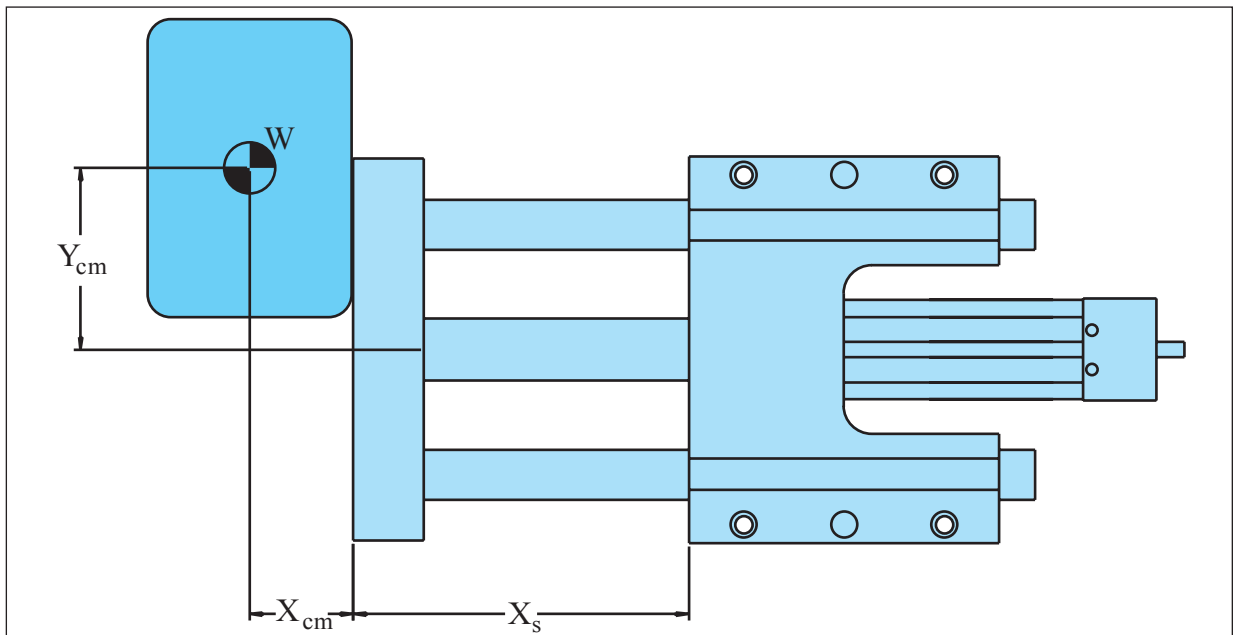

The figure above shows a top view general case where the force required by the actuator must be determined. All the forces are included, and it is important to note that all of these forces can change over time, so the actuator force must be calculated for each section of the move profile. The worst case thrust, speed and tooling plate deflection required should be used to pick the appropriate actuator.

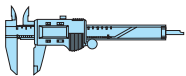

RESOURCES

Sizing Equations
• Guided screw actuators

REQUIRED INFORMATION, CALCULATIONS

Required information

- W_{load} = Weight of object being moved = _____ (lbs.)
 W_b = Base weight of moving parts = _____ (lbs.)
 W_{stroke} = Weight of moving parts per inch of stroke..... = _____ (lbs./in.)
 W = Total weight = $W_{load} + W_b + W_{stroke} \cdot stroke$ = _____ (lbs.)
 a = Acceleration rate from motion profile..... = _____ (in./sec.²)
 g = Gravity constant..... = $386 \frac{\text{in}}{\text{sec}^2}$
 μ = Coefficient of friction for selected bearing type..... = _____
 X_s = Stroke length of the actuator..... = _____ (in.)
 X_{CM} = Distance from the tooling plate to the load's center of mass..... = _____ (in.)
 Y_{CM} = Distance from the center of tooling plate the the load's center of mass... = _____ (in.)
 $F_{external}$ = External force on load..... = _____ (lbs.)

Calculations (Enter your application values designated in light blue.)

Force to accelerate load

$$F_{accel} = \frac{W}{g} \cdot a = \left[\frac{W}{g} \right] \cdot \left[a \right] \dots\dots\dots = \text{_____ (lbs.)}$$

Force from guide bearing friction

$$F_{friction} = \mu \cdot W = \left[\mu \right] \cdot \left[W \right] \dots\dots\dots = \text{_____ (lbs.)}$$

Force during acceleration segment

$$F_a = F_{friction} + F_{external} + F_{accel} = \left[F_{friction} \right] + \left[F_{external} \right] + \left[F_{accel} \right] \dots\dots\dots = \text{_____ (lbs.)}$$

Force during constant speed segment

$$F_c = F_{friction} + F_{external} = \left[F_{friction} \right] + \left[F_{external} \right] \dots\dots\dots = \text{_____ (lbs.)}$$

Force during deceleration segment

$$F_d = F_{friction} + F_{external} - F_{accel} = \left[F_{friction} \right] + \left[F_{external} \right] - \left[F_{accel} \right] \dots\dots\dots = \text{_____ (lbs.)}$$

Adjusted stroke length

$$X_{adj} = X_s + X_{CM} = \left[X_s \right] + \left[X_{CM} \right] \dots\dots\dots = \text{_____ (lbs.)}$$

Weight adjusted for an off center load

$$W_{adj} = W \cdot (1 + 0.48 \cdot Y_{CM}) = \left[W \right] \cdot (1 + 0.48 \cdot \left[Y_{CM} \right]) \dots\dots\dots = \text{_____ (lbs.)}$$

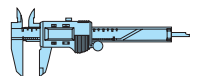

RESOURCES

- Sizing Equations**
 • Guided screw actuators

Axi dyne® Basic Sizing Equations

GUIDED SCREW ACTUATOR SIZING

SELECTING THE CORRECT ACTUATOR

Pick an actuator that has the thrust, speed, and guide rod deflection capability to move the load. There are three graphs in Section E of this catalog, thrust/speed for the screw, load weight/stroke for bearing and guide rod deflection/stroke length. All three graphs must be used to select an actuator. Keep in mind the following information during the selection process:

Screw Critical Speed and Thrust limit

When using the critical speed charts, the intersection on the graph of the application speed and the actuator stroke length must lie below the curve for the screw being considered. Each screw also has a thrust limit and the maximum thrust from the motion segments must be below this limit.

Guide Bearing Capacity

When using the load weight/stroke charts, the intersection point of adjusted stroke length and load weight values should always lie under the curve in order to obtain a nominal bearing life. If composite bearings are selected, linear speed must be taken into consideration.

Guide Rod Deflection

When using the deflection charts, the intersection point of adjusted stroke length and load weight values should always lie under the curve for the desired amount of guide rod deflection when actuator is fully extended. The recommended maximum for guide rod deflection is 0.064 inches.

The options when selecting an actuator are:

1. Body size – 4 body sizes available.
2. Guide Rod
 - Standard
 - Oversize – Reduces the deflection of tooling plate (only available with composite bearings).
 - Stainless Steel Standard Sized – Used when environments require.
 - Stainless Steel Oversized - Used when environments require reducing the deflection of tooling plate.
3. Bearing type
 - Linear ball – Used for long life in clean environments, only available with standard guide rods
 - Composite – Used in dirty environments and where stainless steel guide rods are required.

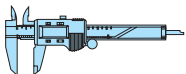

RESOURCES

Sizing Equations
• Guided screw actuators

Axi-dyne® Basic Sizing Equations

MOTOR SELECTION

INTRODUCTION

To determine the correct motor selection, it is first necessary to calculate the motor torque required for a direct drive system. This is done by setting the reduction ratio and efficiency to one and the reduction and motor inertia to zero. This will result in a torque required directly at the input to the actuator. By using the motor/drive, speed/torque curves found in Section F for Brushless motors, Section G for Microstepping motors and Section H for brushed dc motors, a suitable motor and drive combination can be selected. If a motor is not available that produces the required torque or the inertia ratio is not in a valid range, a reduction will be required. Both belt and planetary gearhead reductions are available (see relevant actuator section in this catalog for ratio's available for each actuator family). Recalculate the motor torque using the new reduction ratio and its efficiency. Once a motor and reduction have been determined, calculate the selected motor's inertia (motor uses some of its available torque to accelerate the rotor, reducing torque available to accelerate the actuator).

SERVO MOTOR SYSTEM

Servo motor systems have two speed/torque curves: one for continuous duty operation and another for intermittent duty. A servo system can be selected according to the total torque and maximum velocity indicated by the continuous duty curve. However, by calculating the root mean square (RMS) torque based on the application duty cycle, you may be able to take advantage of the higher peak torque available in the intermittent duty range. The RMS torque must fall within the continuous duty region of the motor/drive and the application maximum must fall under the peak torque of the motor. Use the following formula when calculating the RMS torque. When selecting a servo motor, it is necessary to add a margin of safety to the torque required to move the load. The recommended margin for servo motors is 15%.

$$T_{RMS} = \sqrt{\frac{T_a^2 t_a + T_c^2 t_c + T_d^2 t_d + T_{dwell}^2 t_{dwell}}{T}} \quad \text{RMS Torque}$$

T_a = Torque during the acceleration motion segment.
 t_a = acceleration time
 T_c = Torque during the constant speed motion segment
 t_c = constant speed time
 T_d = Torque during the deceleration motion segment.
 t_d = deceleration time
 T_{dwell} = Torque used during the dwell motion segment.
 t_{dwell} = dwell time
 T = Total time for the move

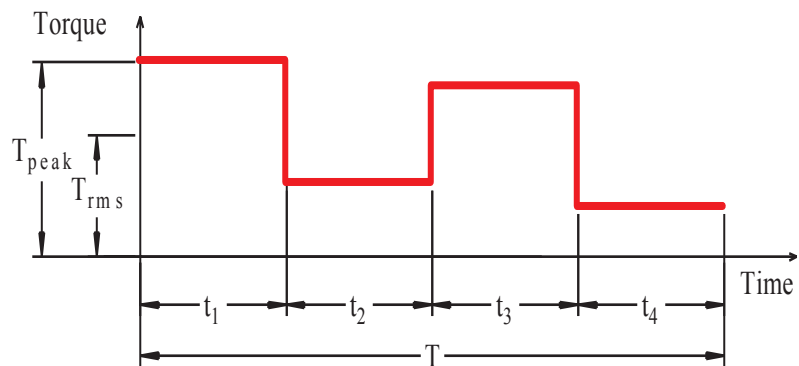

STEPPER MOTOR SYSTEM

Microstepping motor systems have speed/torque curves based on continuous duty operation. To choose a stepper motor, take the peak torque from the application and add a 50% torque margin. When using the published torque curves, the intersection of the torque and the application speed must be below the curve for the selected motor.

Inertia Ratio

The inertia ratio is the ratio of load inertia over the motor inertia. If high load to motor inertia mismatch exists, it can result in load instabilities for compliant systems. The closer the inertia ratio is to one, the better the dynamic response of the motor. The following table shows the recommended inertia ratio's for the different motor types.

MOTOR TYPE	INERTIA RATIO
Brushless Servo	0.1 < Inertia ratio < 10
Brush Servo	0.1 < Inertia ratio < 10
Stepper	0.1 < Inertia ratio < 10

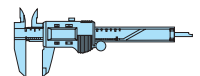

RESOURCES

Sizing Equations
 • Motor selection

Axi dyne® Basic Sizing Equations

MOTOR SELECTION

REQUIRED INFORMATION, CALCULATIONS

Required information

J_{base} = Inertia of the base actuator.....	= _____	(lbs.-in. ²)
J_{stroke} = Inertia of the actuator per inch of stroke	= _____	($\frac{\text{lbs.-in.}^2}{\text{in.}}$)
$stroke$ = Stroke length of the actuator	= _____	(in.)
$T_{preload}$ = Preload torque of the actuator.....	= _____	(lbs.-in.)
π =	= 3.142	
p = Pitch of the screw in Turns Per Inch (TPI).....	= _____	
e = Efficiency of the screw or belt	= _____	
n = Reduction ratio between the motor and the actuator	= _____	
e_n = Efficiency of the reduction	= _____	
J_n = Inertia of the reduction device	= _____	(lbs.-in. ²)
J_{motor} = Inertia of the motor	= _____	(lbs.-in. ²)
r = Radius of the drive belt pulley	= _____	(in.)
J_{pulley} = Inertia of the drive belt pulleys	= _____	(lbs.-in. ²)
T = Total thrust	= _____	(lbs.)

Calculations (Enter your application values designated in light blue.)

Inertia of the load being moved:

SCREW-DRIVE

$$J_{load} = \frac{\frac{W_{load}}{g}}{(2 \cdot \pi \cdot p)^2 \cdot n^2} = \frac{[\frac{W_{load}}{386.098}]}{(2 \cdot [3.142] \cdot [p])^2 \cdot [n]^2} = \text{_____} \text{ (lbs.-in.}^2\text{)}$$

BELT-DRIVE

$$J_{load} = \frac{W_{load}}{g} \cdot \frac{r^2}{n^2} = \frac{[\frac{W_{load}}{386.098}]}{[\frac{r^2}{n^2}]} = \text{_____} \text{ (lbs.-in.}^2\text{)}$$

Torque to accelerate load:

SCREW-DRIVE

$$T_{accel} = 2 \cdot \pi \cdot p \cdot a \left(\frac{J_{load}}{e} \cdot \frac{n}{e_n} + (J_{base} + J_{stroke} \cdot stroke) \cdot \frac{n}{e_n} + J_n + J_{motor} \right)$$

$$2 \cdot [3.142] \cdot [p] \cdot [a] \left(\left[\frac{J_{load}}{e} \right] \cdot \left[\frac{n}{e_n} \right] + ([J_{base}] + [J_{stroke}] \cdot [stroke]) \cdot \left[\frac{n}{e_n} \right] + [J_n] + [J_{motor}] \right) = \text{_____} \text{ (lbs.-in.}^2\text{)}$$

BELT-DRIVE

$$T_{accel} = \frac{a}{r} \left(\frac{J_{load}}{e} \cdot \frac{n}{e_n} + (J_{base} + J_{stroke} \cdot stroke) \cdot \frac{n}{e_n} + J_n + J_{pulleys} + J_{motor} \right)$$

$$\left[\frac{a}{r} \right] \left(\left[\frac{J_{load}}{e} \right] \cdot \left[\frac{n}{e_n} \right] + ([J_{base}] + [J_{stroke}] \cdot [stroke]) \cdot \left[\frac{n}{e_n} \right] + [J_n] + [J_{pulleys}] + [J_{motor}] \right) = \text{_____} \text{ (lbs.-in.}^2\text{)}$$

Torque to overcome gravity:

SCREW-DRIVE

$$T_{gravity} = \frac{F_{gravity}}{2 \cdot \pi \cdot p \cdot e_{screw} \cdot n \cdot e_n} = \frac{[\frac{F_{gravity}}{2 \cdot [3.142] \cdot [p] \cdot [e_{screw}] \cdot [n] \cdot [e_n]}]}{[2] \cdot [3.142] \cdot [p] \cdot [e_{screw}] \cdot [n] \cdot [e_n]} = \text{_____} \text{ (lbs.-in.)}$$

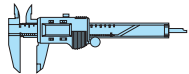

RESOURCES

Sizing Equations
• Motor selection

Axi *dyne*® Basic Sizing Equations

MOTOR SELECTION

CALCULATIONS (continued)

Torque to overcome gravity:

BELT-DRIVE

$$T_{gravity} = \frac{F_{gravity} \cdot r}{e \cdot n \cdot e_n} = \frac{[F_{gravity}] \cdot [r]}{[e] \cdot [n] \cdot [e_n]} \dots\dots\dots = \text{_____} \text{ (lbs.-in.)}$$

Torque to overcome external friction:

SCREW-DRIVE

$$T_{friction} = \frac{F_{friction}}{2 \cdot \pi \cdot p \cdot e_{screw} \cdot n \cdot e_n} = \frac{[F_{friction}]}{[2] \cdot [3.142] \cdot [p] \cdot [e_{screw}] \cdot [n] \cdot [e_n]} = \text{_____} \text{ (lbs.-in.)}$$

BELT-DRIVE

$$T_{friction} = \frac{F_{friction} \cdot r}{e \cdot n \cdot e_n} = \frac{[F_{friction}] \cdot [r]}{[e] \cdot [n] \cdot [e_n]} \dots\dots\dots = \text{_____} \text{ (lbs.-in.)}$$

Torque to overcome external force:

SCREW-DRIVE

$$T_{ext} = \frac{F_{ext}}{2 \cdot \pi \cdot p \cdot e_{screw} \cdot n \cdot e_n} = \frac{[F_{ext}]}{[2] \cdot [3.142] \cdot [p] \cdot [e_{screw}] \cdot [n] \cdot [e_n]} \dots\dots\dots = \text{_____} \text{ (lbs.-in.)}$$

BELT-DRIVE

$$T_{ext} = \frac{F_{ext} \cdot r}{e \cdot n \cdot e_n} = \frac{[F_{ext}] \cdot [r]}{[e] \cdot [n] \cdot [e_n]} \dots\dots\dots = \text{_____} \text{ (lbs.-in.)}$$

Maximum RPM of the motor:

SCREW-DRIVE

$$RPM = V_{max} \cdot p \cdot n = [V_{max}] \cdot [p] \cdot [n] \dots\dots\dots = \text{_____} \text{ (lbs.-in.)}$$

BELT-DRIVE

$$RPM = \frac{30 \cdot V_{max} \cdot n}{\pi \cdot r} = \frac{[30] \cdot [V_{max}] \cdot [n]}{[3.142] \cdot [r]} \dots\dots\dots = \text{_____} \text{ (lbs.-in.)}$$

Torque during the acceleration motion segment: SCREW-DRIVE & BELT-DRIVE

$$T_a = T_{gravity} + T_{friction} + T_{acc} + T_{breakaway} + T_{ext}$$

$$T_a = [T_{gravity}] + [T_{friction}] + [T_{acc}] + [T_{breakaway}] + [T_{ext}] \dots\dots\dots = \text{_____} \text{ (lbs.-in.)}$$

Torque during the constant speed motion segment: SCREW-DRIVE & BELT-DRIVE

$$T_c = T_{gravity} + T_{friction} + T_{breakaway} + T_{ext}$$

$$T_c = [T_{gravity}] + [T_{friction}] + [T_{breakaway}] + [T_{ext}] \dots\dots\dots = \text{_____} \text{ (lbs.-in.)}$$

Torque during the deceleration motion segment: SCREW-DRIVE & BELT-DRIVE

$$T_d = T_{gravity} + T_{friction} + T_{acc} - T_{breakaway} + T_{ext}$$

$$T_d = [T_{gravity}] + [T_{friction}] + [T_{acc}] - [T_{breakaway}] + [T_{ext}] \dots\dots\dots = \text{_____} \text{ (lbs.-in.)}$$

Torque during the dwell motion segment: SCREW-DRIVE & BELT-DRIVE

$$T_{dwell} = T_{gravity} - T_{friction} - T_{breakaway} + T_{ext}$$

$$T_{dwell} = [T_{gravity}] - [T_{friction}] - [T_{breakaway}] + [T_{ext}] \dots\dots\dots = \text{_____} \text{ (lbs.-in.)}$$

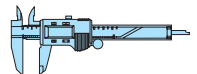

RESOURCES

- Sizing Equations
- Motor selection

Axi dyne® Basic Sizing Equations

MOTOR SELECTION

CALCULATIONS (continued)

Root Mean Square (RMS) torque (required for servo motor sizing)

$$T_{RMS} = \sqrt{\frac{T_a^2 t_a + T_c^2 t_c + T_d^2 t_d + T_{dwell}^2 t_{dwell}}{T}}$$

$$T_{RMS} = \sqrt{\frac{[T_a]^2 [t_a] + [T_c]^2 [t_c] + [T_d]^2 [t_d] + [T_{dwell}]^2 [t_{dwell}]}{[T]}} = \text{_____ (lbs.-in.)}$$

Peak torque during the motion segments

$$T_{max} = \text{_____} = \text{_____ (lbs.-in.)}$$

Torque margin for the motor type selected

$$M = (1.15 \text{ for servo motors}), (2.0 \text{ for stepper motors}) \text{_____} = \text{_____ (lbs.-in.)}$$

Continuous torque required at the motor

$$T_{cont} = T_{RMS} \cdot M = [T_{RMS}] \cdot [M] \text{_____} = \text{_____ (lbs.-in.)}$$

Peak torque required at the motor

$$T_{peak} = T_{max} \cdot M = [T_{max}] \cdot [M] \text{_____} = \text{_____ (lbs.-in.)}$$

Inertia of the actuator and load at the input.

SCREW-DRIVE

$$J_{total} = J_{load} + J_{base} + J_{stroke} \cdot stroke + J_n = [J_{load}] + [J_{base}] + [J_{stroke}] \cdot [stroke] + [J_n] = \text{_____ (lbs.-in.}^2\text{)}$$

BELT-DRIVE

$$J_{total} = J_{load} + J_{base} + J_{stroke} \cdot stroke + J_{pulleys} + J_n$$

$$J_{total} = [J_{load}] + [J_{base}] + [J_{stroke}] \cdot [stroke] + [J_{pulleys}] + [J_n] \text{_____} = \text{_____ (lbs.-in.}^2\text{)}$$

Inertia of the motor

$$J_{motor} = \text{_____} = \text{_____ (lbs.-in.}^2\text{)}$$

Inertia ratio of the load vs the motor

$$I_{ratio} = \frac{J_{total}}{J_{motor}} = \frac{[J_{total}]}{[J_{motor}]} \text{_____} = \text{_____ (lbs.-in.}^2\text{)}$$

Total thrust: SCREW-DRIVE

$$T = 2 \cdot \pi \cdot p \cdot e \cdot e_n \cdot n \left[T_a - \left((J_{base} + J_{stroke} \cdot stroke) \frac{n}{e_n} + J_n + J_{motor} \right) \cdot \frac{2 \cdot \pi \cdot p \cdot a}{g} - T_{breakaway} - T_{friction} \right]$$

$$T = 2 \cdot [3.142] \cdot [e] \cdot [e_n] \cdot [n] \left[[T_a] - \left(([J_{base}] + [J_{stroke}] \cdot [stroke]) \left[\frac{n}{e_n} \right] + [J_n] + [J_{motor}] \right) \cdot \frac{[2] \cdot [3.142] \cdot [p] \cdot [a]}{[g]} - [T_{breakaway}] - [T_{friction}] \right] \text{_____} = \text{_____ (lbs.)}$$

Total thrust: BELT-DRIVE

$$T = \frac{e \cdot e_n \cdot n}{r} \left[T_a - \left((J_{base} + J_{stroke} \cdot stroke + J_{pulleys}) \frac{n}{e_n} + J_n + J_{motor} \right) \cdot \frac{a}{g \cdot r} - T_{breakaway} - T_{friction} \right]$$

$$T = \frac{[e] \cdot [e_n] \cdot [n]}{[r]} \left[[T_a] - \left(([J_{base}] + [J_{stroke}] \cdot [stroke] + [J_{pulleys}]) \left[\frac{n}{e_n} \right] + [J_n] + [J_{motor}] \right) \cdot \frac{[a]}{[g] \cdot [r]} - [T_{breakaway}] - [T_{friction}] \right] \text{_____} = \text{_____ (lbs.)}$$

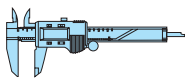

RESOURCES

Sizing Equations
• Motor selection

Axi dyne[®] Terms and Conditions of Sale

1. **ORDER ACCEPTANCE.** All orders or services are subject to acceptance in Minnesota by the written approval of an authorized official of Tol-O-Matic, Inc. Any such order shall be subject to these Terms and Conditions of Sale, and acceptance shall be conditioned on Purchaser's assent to such conditions. Purchaser's assent shall be deemed given unless Purchaser shall expressly notify Tol-O-Matic, Inc. in writing to the contrary within five (5) days after receipt of acknowledgment to confirmation of an order.

2. **CANCELLATION AND CHANGES.** No order accepted by Tol-O-Matic, Inc. may be modified in any manner by Purchaser unless agreed to in writing, by an authorized official of Tol-O-Matic, Inc.. Order cancellations, including reductions to order quantities, and changes shall be governed by the following:

- a. Any standard product order scheduled for shipment within five (5) working days of purchaser's request to cancel or modify will be shipped as previously acknowledged and purchaser agrees to accept shipment and payment responsibility, in full, at the price agreed upon.
- b. "Customer Special" orders scheduled for shipment within twenty (20) working days of purchaser's request to cancel or modify will be shipped as previously acknowledged and purchaser agrees to accept shipment and payment responsibility, in full, at the price agreed upon.
- c. All work in connection with "Customer Special" orders, not covered under Paragraph b, will be stopped immediately upon notification, and purchaser agrees to reimburse Tol-O-Matic, Inc. for all work-in-process and any materials or supplies used, or for which commitments have been made by Tol-O-Matic, Inc. in connection therewith.

3. **QUOTATIONS AND PRICES.** Written quotations automatically expire 30 calendar days from the date issued unless terminated sooner by written notice. (Verbal quotations expire, unless accepted in writing, the same day.)

All published prices and discounts are subject to change without notice. In the event of a net price change, the price of product(s) on order will be the price in effect on the date of order acknowledgment. Any addition to an outstanding order will be accepted at prices in effect when the addition is made.

4. **MINIMUM BILLING.** Orders amounting to less than \$35.00 net will be billed at \$35.00
5. **TAXES.** Any Manufacturer's Tax, Retailers Occupation Tax, Use Tax, Sales Tax, Excise Tax, Duty, Customer, Inspection or Testing Fee, or any other tax, fee or charge of any nature whatsoever, imposed by any government authority, on or measured by any transactions between Tol-O-Matic, Inc. and Purchaser shall be paid by the Purchaser in addition to the prices quoted or involved. In the event Tol-O-Matic, Inc. shall be required to pay any such tax, fee or charge, Purchaser shall reimburse therefore.
6. **TERMS OF PAYMENT.** Net invoice amount is due within 30 days from date of invoice subject to credit approval. A 2% per month service charge

shall apply to all invoices not paid within 30 days. All clerical errors are subject to correction. Any invoice in not paid within 60 days will subject that account to an immediate shipping hold.

7. **F.O.B. POINT.** All sales are F.O.B. Tol-O-Matic, Inc.'s facility in Hamel, Minnesota, unless quoted otherwise.
8. **DELIVERY.** Delivery of product(s) by Tol-O-Matic, Inc. to a carrier shall constitute delivery to Purchaser, and regardless of freight payment, title and all risk or loss or damage in transit shall pass to Purchaser at that time.

Should shipment be held beyond scheduled date, upon request of Purchaser, product will be billed and Purchaser agrees to accept any charges for warehousing, trucking and other expenses as may be incident to such delay.

Great care is taken by Tol-O-Matic, Inc. in crating its product. Tol-O-Matic, Inc. cannot be held responsible for breakage after having received "In Good Order" receipts from the transporting carrier. All claims for loss and damage must be made by Purchaser to the carrier within 14 days from receipt of goods. Tol-O-Matic, Inc. will assist insofar as practical in securing satisfactory adjustment of such claims wherever possible.

Claims for shortages or other errors must be made, in writing, within ten (10) days to Tol-O-Matic, Inc. and any additional expense of the method or route of shipment specified by Purchaser shall be borne by the Purchaser.

9. **SHIPPING SCHEDULES.** All quoted shipping schedules are approximate and will depend upon prompt receipt from Purchaser of confirming copy of Purchase Order. Dimensional drawings and specifications submitted by Tol-O-Matic, Inc. to Purchaser for approval must be returned to Tol-O-Matic, Inc. within 10 working days, with approval granted, and any exceptions noted, in order to avoid delay in manufacturing schedules.

Orders which include penalty clauses for failure to meet shipping schedules will not be acceptable, except in those cases specifically approved in writing by the General Manager of Tol-O-Matic, Inc..

Tol-O-Matic, Inc. shall not be liable for damage as a result of any delay due to any cause beyond Tol-O-Matic, Inc.'s reasonable control, including, without limitation, an Act of Nature; act of Purchaser; embargo, or other government act, regulation or request; fire; accident; strike; slow down; war; riot; flood; delay in transportation; and inability to obtain necessary labor, materials or manufacturing facilities. In the event of any such delay, the date of delivery shall be extended for a period equal to the time loss by reason of the delay. The acceptance of the product when delivered shall constitute a waiver of all claims for damages caused by any such delays.

10. **RETURN OF PRODUCT.** No product may be returned without first obtaining a Return Goods Authorization form and confirming memorandum from Tol-O-Matic, Inc.. Product, if accepted for credit, shall be subject to a minimum service charge of 35% of the invoice price and all

transportation charges shall be prepaid by the Purchaser; however, assembled products classified as "special," such as Cable Cylinders and other products which have been modified or built as "Customer Specials," are not returnable to Tol-O-Matic, Inc..

11. **WARRANTY.** Tol-O-Matic, Inc., WARRANTS PRODUCT MANUFACTURED BY IT TO BE FREE FROM DEFECTS IN MATERIAL AND WORKMANSHIP FOR A PERIOD OF ONE YEAR FROM DATE OF SHIPMENT BY Tol-O-Matic, Inc.. IF WITHIN SUCH PERIOD ANY SUCH PRODUCT SHALL BE PROVED TO Tol-O-Matic, Inc.'s SATISFACTION TO BE SO DEFECTIVE, SUCH PRODUCT SHALL EITHER BE REPAIRED OR REPLACED AT Tol-O-Matic, Inc.'s OPTION.

THIS WARRANTY SHALL NOT APPLY:

- a. TO PRODUCT NOT MANUFACTURED BY Tol-O-Matic, Inc. WITH RESPECT TO PRODUCT NOT MANUFACTURED BY Tol-O-Matic, Inc.. THE WARRANTY OBLIGATIONS OF Tol-O-Matic, Inc. SHALL IN ALL RESPECTS CONFORM AND BE LIMITED TO THE WARRANTY ACTUALLY EXTENDED TO Tol-O-Matic, Inc. BY ITS SUPPLIER.
- b. TO PRODUCT WHICH SHALL HAVE BEEN REPAIRED OR ALTERED BY PARTIES OTHER THAN Tol-O-Matic, Inc. SO AS, IN Tol-O-Matic, Inc.'s JUDGMENT, TO AFFECT THE SAME ADVERSELY, OR
- c. TO PRODUCT WHICH SHALL HAVE BEEN SUBJECT TO NEGLIGENCE, ACCIDENT, OR DAMAGE BY CIRCUMSTANCES BEYOND THE CONTROL OF Tol-O-Matic, Inc. OR TO IMPROPER OPERATION MAINTENANCE OR STORAGE, OR TO OTHER THAN NORMAL USE AND SERVICE.

THE FOREGOING WARRANTIES ARE EXCLUSIVE AND IN LIEU OF ALL OTHER EXPRESS AND IMPLIED WARRANTIES WHATSOEVER, INCLUDING BUT NOT LIMITED TO IMPLIED WARRANTIES OF MERCHANTABILITY AND FITNESS FOR A PARTICULAR PURPOSE, Tol-O-Matic, Inc. SHALL NOT BE SUBJECT TO ANY OTHER OBLIGATIONS OR LIABILITIES WHATSOEVER WITH RESPECT TO PRODUCT MANUFACTURED OR SUPPLIED BY Tol-O-Matic, Inc. OR SERVICE RENDERED BY IT.

12. **CONSEQUENTIAL DAMAGE.** Tol-O-Matic, Inc., shall not, under any circumstances be liable for consequential damages.
13. **SERVICE CHARGES.** Should the Purchaser request the service of any erector, demonstrator or service man (except as specifically provided for and included in the price of the product) such service will be rendered at the rate outlined in the schedule of field service charges in effect at the date of request.

TOL-O-MATIC MAKES PRODUCTS FOR ANYTHING THAT MOVES!

AXIDYNE® ELECTRIC



SW44 High Thrust Actuator
BROCHURE 3604-4155 & 3604-4156

AXIDYNE® ELECTRIC



BCS Screw-Drive Linear Actuator
CATALOG NUMBER 3600-4609

AXIDYNE® ELECTRIC



B3S Screw-Drive Linear Actuator
CATALOG NUMBER 3600-4609

AXIDYNE® ELECTRIC



B3W Belt-Drive Linear Actuator
CATALOG NUMBER 3600-4609

AXIDYNE® ELECTRIC



RSA Rod Screw Actuator
CATALOG NUMBER 3600-4609

AXIDYNE® ELECTRIC



TKB TruTrack Linear Actuator
CATALOG NUMBER 3600-4609

AXIDYNE® ELECTRIC



TKS TruTrack Linear Actuator
CATALOG NUMBER 3600-4609

AXIDYNE® ELECTRIC



SLS Screw-Drive Linear Actuator
CATALOG NUMBER 3600-4609

AXIDYNE® ELECTRIC



GSA Guided Screw Actuator
CATALOG NUMBER 3600-4609

AXIDYNE® ELECTRIC



MRV Motors
CATALOG NUMBER 3600-4609

AXIDYNE® ELECTRIC



Axiom DV & Axiom PV
CATALOG NUMBER 3600-4609

PNEUMATIC



LS Linear Slide
CATALOG NUMBER 9900-4000

PNEUMATIC



BC2 Band Cylinder
CATALOG NUMBER 9900-4000

PNEUMATIC



BC3 Band Cylinder
CATALOG NUMBER 9900-4000

PNEUMATIC



BC4 Band Cylinder
CATALOG NUMBER 9900-4000

PNEUMATIC / HYDRAULIC



CC Cable Cylinder
CATALOG NUMBER 9900-4000

PNEUMATIC



MG Mag. Coupled Cylinder
CATALOG NUMBER 9900-4000

PNEUMATIC



MGS Mag. Coupled Slide
CATALOG NUMBER 9900-4000

PNEUMATIC



PB2 Power-Block2 Rod Cylinder Slide
CATALOG NUMBER 9900-4000

PNEUMATIC



RCS Rod Cylinder Slide
CATALOG NUMBER 9900-4000

POWER TRANSMISSION



Float-A-Shaft Gear Drives
CATALOG NUMBER 9900-4009

POWER TRANSMISSION



Slide Rite™ Gearbox
CATALOG NUMBER 9900-4009

POWER TRANSMISSION



Disc Cone Clutches
CATALOG NUMBER 9900-4009

POWER TRANSMISSION



Caliper Disc Brakes
CATALOG NUMBER 9900-4009



TOL-O-MATIC

3800 County Road 116 • Hamel, MN 55340, U.S.A.

Phone: (763) 478-8000 • Fax: (763) 478-8080 • Toll-Free: 1-800-328-2174
U.S. and Canada

URL: <http://www.Tolomatic.com>

Email: help@Tolomatic.com